

2017-12-01

Tribopairs in Wellbore Drilling: A Study of PCD Tilting Pad Bearings in an Electric Submersible Pump

Cameron B. Ellis
Brigham Young University

Follow this and additional works at: <https://scholarsarchive.byu.edu/etd>

BYU ScholarsArchive Citation

Ellis, Cameron B., "Tribopairs in Wellbore Drilling: A Study of PCD Tilting Pad Bearings in an Electric Submersible Pump" (2017).
All Theses and Dissertations. 7284.
<https://scholarsarchive.byu.edu/etd/7284>

This Thesis is brought to you for free and open access by BYU ScholarsArchive. It has been accepted for inclusion in All Theses and Dissertations by an authorized administrator of BYU ScholarsArchive. For more information, please contact scholarsarchive@byu.edu, ellen_amatangelo@byu.edu.

Tribopairs in Wellbore Drilling: A Study of PCD Tilting Pad Bearings
In an Electric Submersible Pump

Cameron B. Ellis

A thesis submitted to the faculty of
Brigham Young University
in partial fulfillment of the requirements for the degree of
Master of Science

Jason A. Weaver, Chair
Michael P. Miles
Andrew R. George

School of Technology
Brigham Young University

Copyright © 2017 Cameron B. Ellis

All Rights Reserved

ABSTRACT

Tribopairs in Wellbore Drilling: A Study of PCD Tilting Pad Bearings In an Electric Submersible Pump

Cameron B. Ellis
School of Technology, BYU
Master of Science

A polycrystalline diamond was tested as a bearing material for a tilting pad thrust bearing to be used in an electric submersible pump, which elevates process fluids from the bottom of well bores. The goal of this study was to compare the PCD to a current best of technology, which is stainless steel with an engineering polymer.

This study found that PCD can handle larger loads than current technology but is limited in size due to diamond sintering and manufacturing constraints; the maximum size is Ø75mm.

Keywords: Cameron Ellis, tilting pad bearing, PCD, electric submersible pump, ESP, polycrystalline diamond, PCD/PCD tribopair, PCD/SiC tribopair

ACKNOWLEDGEMENTS

I am beyond grateful for the endless support throughout this endeavor from my lovely wife, Ann Dee. Our children, Van, Asher, Milo, Sammy and Penny, are a shining example of support in every morning conversation as well as nightly prayers; you all really make this worth it.

Thanks to my committee who helped guide me through this process, and the faculty at Brigham Young University who showed support throughout.

I would like to thank USSynthetic for allowing the publication of this case study.

TABLE OF CONTENTS

TABLE OF CONTENTS.....	iv
LIST OF TABLES.....	vii
LIST OF FIGURES	viii
1 INTRODUCTION.....	1
1.1 Wellbores	1
1.2 Artificial Lift	2
1.3 Wear Rates of Bearing Surface Materials.....	7
1.4 Polycrystalline Diamond as an Engineering Material.....	7
1.5 Research Hypothesis	9
1.6 Delimitations	10
1.7 Definition of Terms.....	10
2 LITERATURE REVIEW	12
2.1 Bearing Surfaces Consisting of Babbitt	12
2.2 Tribopairs Consisting of Polymers.....	13
2.3 Tribopairs Consisting of Polycrystalline Diamond Compacts.....	14
2.4 Wear Mechanisms	15
2.5 Application of PCD in Fluid Environment Bearings	16
2.6 Current State of the Art for Tilting Pad Bearings	17
2.7 Friction Coefficients in Materials	18
3 METHODOLOGY	20
3.1 Overview of Case Study.....	20

3.2	Manufacturing Restrictions Effect on Case Study	20
3.3	Summary of SVTR.....	22
3.4	Scope of Test.....	22
3.4.1	SVRT Test Hardware.....	22
3.4.2	Test Materials.....	24
3.4.3	Test Parameters	24
3.4.3.1	General Description of Ultimate Load Test Procedure.....	24
3.4.3.2	General Description of No Flow Test Procedure.....	26
3.4.3.3	General Description of Duration Test Procedure.....	26
4	DISCUSSION OF RESULTS	27
4.1	Case Study PCD performance.....	27
4.1.1	Ø107mm Collar Ultimate Load Test	28
4.1.1.1	Ø107mm Segmented PCD Collar.....	29
4.1.1.2	Ø107mm Continuous SiC Collar	29
4.1.2	Ø75mm Continuous PCD Collar	30
4.1.2.1	Ultimate Load Test	30
4.1.2.2	No Flow Test.....	30
4.1.2.3	Duration Test	31
4.2	Case Study Evaluation of Results	31
4.3	Tribopair Comparisons.....	34
5	CONCLUSIONS	35

REFERENCES	37
APPENDICES	40
APPENDIX A. IMAGES OF PCD PADS FROM TEST #5	41
APPENDIX B. IMAGES OF PCD COLLAR FROM TEST #5	42
APPENDIX C. DETAILED RESULTS OF ULT. LOAD TEST #5 Ø75mm	43
APPENDIX D. ADDITIONAL SVTR DETAILS	44

LIST OF TABLES

Table 1 Physical and Mechanical Properties of Bearing Materials	8
Table 2 Small Vertical Test Rig Results.....	28

LIST OF FIGURES

Figure 1 The ESP Motor Is a Three-Phase Induction Design.....	4
Figure 2 Exploded View of PCD Collar (left) and PCD Pad (right)	6
Figure 3 ESP Stages, Housing	6
Figure 4 Experimental Results of CoF Against vs. Rotational Speed	16
Figure 5 Sliding Friction Results	19
Figure 6 Segmented Collar (left), PCD Pad (center), Section View of PCD Pad (right)	21
Figure 7 SVTR Test Head and Low Flow Hydraulic Pump.....	23
Figure 8 Ø107mm Segmented PCD Collar	27

1 INTRODUCTION

1.1 Wellbores

Oil wellbores are drilled miles into the earth. The tooling required is substantial in its cost and size. The operating conditions near the drill head produce heat and contaminants from the earth which cause rapid deterioration of the tooling.

The interface of the bearing surfaces, typically one rotating and the other stationary, are the most sensitive to these harmful operating conditions. If drilling components break down, the operators must stop the drill and remove of the entire length of the drill string.

An additional problem is heat. Since the drill bit uses friction to cut away the rock, it produces heat, which must be reduced with processing fluids which carry away the rock debris at a high rate. This debris causes the bearing seals to wear away which introduces the processing fluids into the bearing's internal components.

Bearings are rated for a certain service time, obtained through controlled experiments and field tests. This service time is shortened by process fluids entering the bearing housings. With thousands of pounds of pressure per square inch between bearing surfaces, each particle introduced via the processing fluid will contribute to a breakdown and removal of bearing surface material. Over a shorter amount of service time the friction between the tribopairs is too high and causes failure to the rotating system.

Drilling companies benefit from systems that allow the drill string to remain active for longer periods of time. Materials best suited to provide longer run times have changed over the last few decades. This paper hopes to solve the relatively short operating life of tools used to recover the oil produced in a wellbore.

1.2 Artificial Lift

Artificial lift is a process used on wellbores to increase pressure within the reservoir to bring oil to the surface. When the natural pressure of the reservoir is not enough to push the oil to the surface, artificial lift is used to recover more oil production.

In the history of artificial lift, there has been a continual effort to improve the life of the electrical submersible pumps (ESP) which raises the process fluids out of the well bore (Camargo, 2008) (Camacho, 2016) (Hackworth, 2016). The fluid used in the tilting pad thrust bearing assembly flows in a hydrodynamic state (Elwell, 1974) when the motor is turning at operational speeds (Liming, 2017).

The main component that allows the lift of fluids during a hydrodynamic state is the tilting pad bearing (Elwell, 1974) which requires lubrication to function properly (Liming, 2017). In order to improve pumping conditions, experiments have studied increasing load-bearing capacity (Liming, 2017) and tested different tribopairs (Sha, 2016) to lengthen the life of the components.

In order to avoid or reduce excessive pad deformations and uneven load sharing, Liming, Z., et al. (Liming, 2017) focused on special designs which would improve lubrication performance. Often the processing fluids contain metals and other hard materials which cause the

breakdown of hydrodynamic fluid, causing the bearing to fail due to wear as the tribopair comes in to contact.

In an effort to avoid this kind of failure while lifting the fluid, the oil-field industry has relied on experience and estimations for how long the ESP can operate. A replacement of the tilting pad bearings once the wellbore has finished producing is favored over pushing the string for one more wellbore and having the ESP fail. ESP are used to artificially lift process fluids such as liquid petroleum, oil, disposal or injection fluids, and brine to the surface (Elwell, 1974). An ESP consists of a multistage centrifugal pump powered by a motor (Figure 1) that induces lift to the fluid. This lift produces pressure on a sealed tilting-pad bearing (or thrust bearing assembly).

The fluid flowing in the thrust bearing assembly becomes hydrodynamic when the motor is turning at operational speeds (approximately 3,500 rpm) (Garner, 1977). During continuous operation, the bearing fluid gradually increases in temperature. If fluid temperature exceeds its viscosity rating (usually around 80°C) (Daniel, 2013), the fluid can break down, reducing the viscosity of the fluid, allowing the tilting pad bearing's pad and collar (Figure 1/ Figure 2) to contact. The resulting contact friction under the high load and high speed can cause catastrophic failure of the bearing.

To illustrate the importance of long operating life, a new well using an ESP can produce 500 to 1400 barrels of oil equivalent per day (Diamondback 2014 Q1 Financials). When downhole failures occur because of bearing failures, the resulting pulling of operations and lost production time is costly, especially in offshore endeavors. The ESP has to be removed from the

wellbore (or “tripping”) to service the damaged components, causing downtime and lost revenue in the millions of USD. Long life of the ESP is needed to maintain economical production.

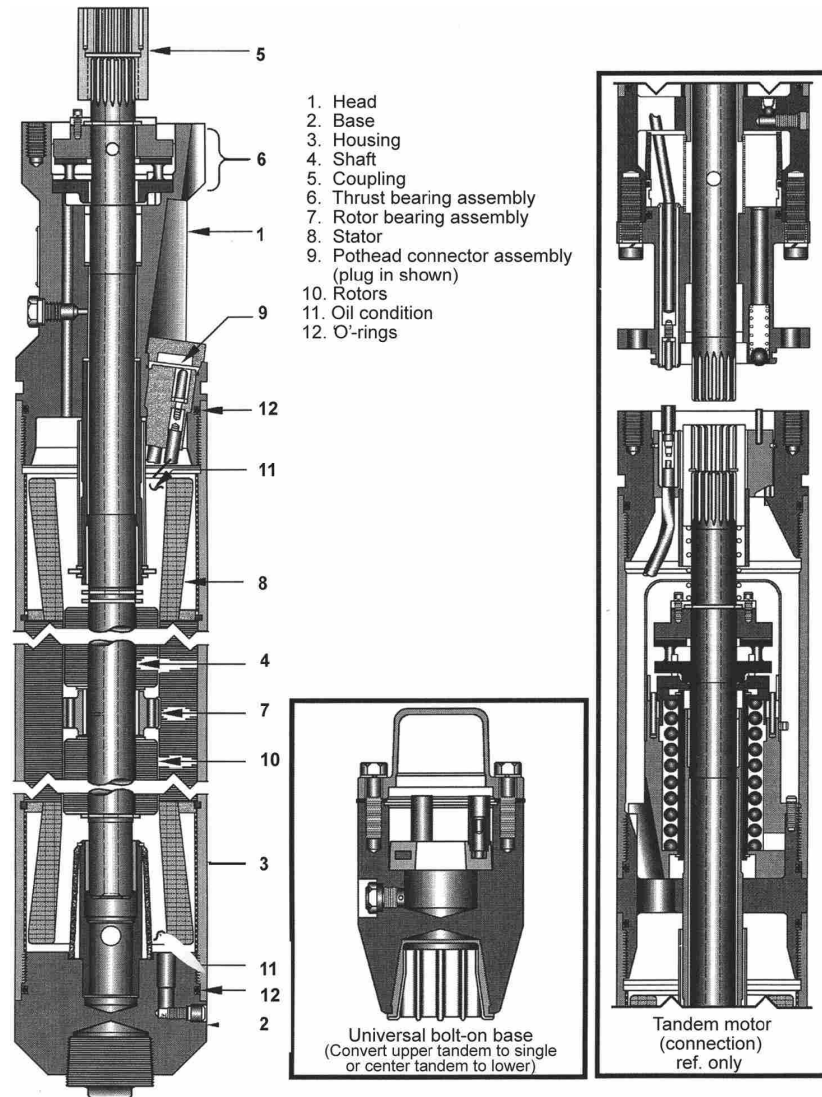

Figure 1 The ESP Motor Is a Three-Phase Induction Design

Current ESP technology uses sets of tilting pad bearings, thrust in the mixed stage (Figure 3), with pad/collar combinations of stainless steel, a ceramic material (SiC) or

engineering polymer (PEEK). These material combinations are prone to catastrophic failure at high fluid temperature, as described above.

One type of catastrophic failure of the bearing occurs when the viscosity of the bearing fluid is lowered beyond the requirements for a hydrodynamic fluid. The fluid-film break down allows the opposing bearing faces to contact while one is rotating at several thousand revolutions per minute. A high axial load causes the friction and drag to deform both the pads and the collar by galling, welding or scarring. Even if the fluid is allowed to cool to a safe operating temperature, the damage to the bearing faces prevents the ESP from functioning.

Another condition that leads to catastrophic failure is when, through vibration or variation in manufacture of the pad interface, the face of the collar touches one of the pads. This causes scarring on the faces which creates a less stable local environment for a hydrodynamic condition. The motor can still run, but usually more touches occur shortly after the bearing surfaces begin to degrade and catastrophic failure occurs.

There are very few non-catastrophic failures. A non-catastrophic failure would occur when the faces touch while rotating at a lower speeds and axial forces. In this case there would be less scarring or deformation of the faces, but would typically lead to a catastrophic failure due to the surface conditions of the bearing.

The surfaces also experience considerable wear during normal starting and stopping operations, which leads to eventual bearing failure as well. Due to the millions of dollars lost during a repair and replacement, a tilting pad bearing with a more durable surface would save hours of repairs and millions in oil production.

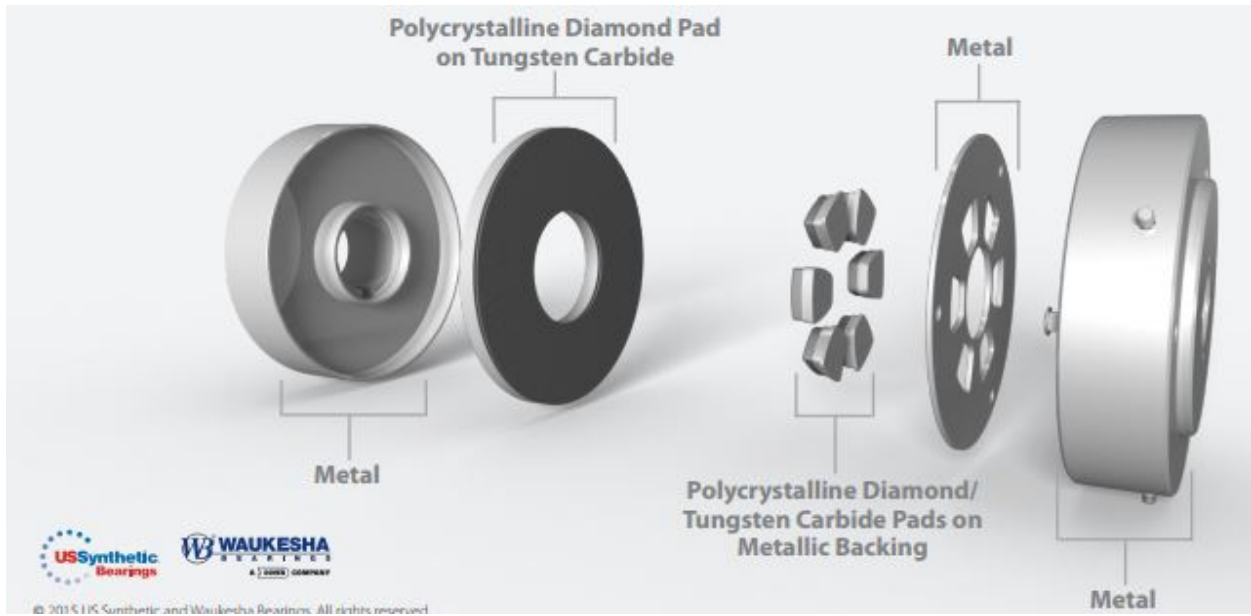

Figure 2 Exploded View of PCD Collar (left) and PCD Pad (right)

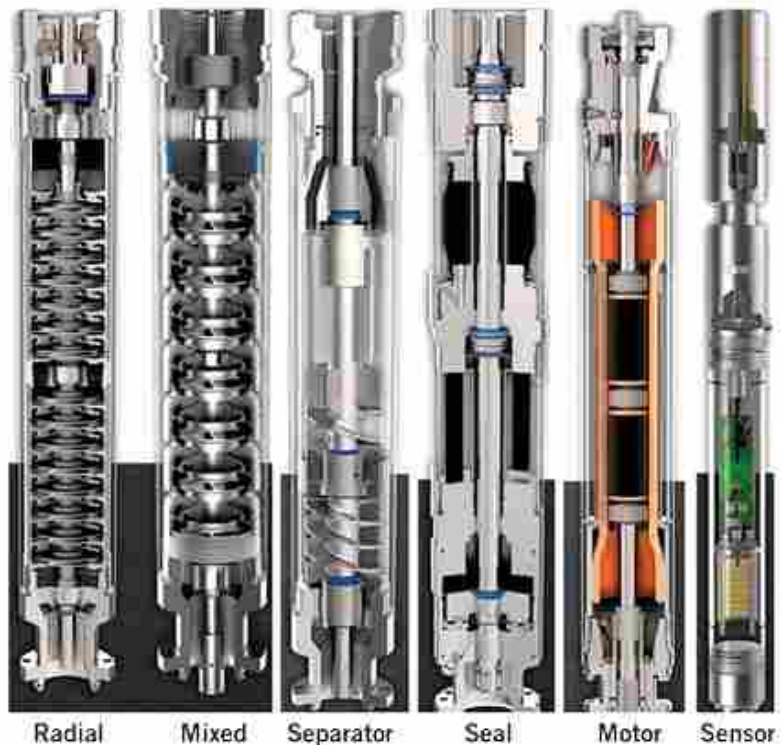

Figure 3 ESP Stages, Housing

1.3 Wear Rates of Bearing Surface Materials

The tilting pad bearing consists of a stationary collar and a rotating set of pads (Cooley, 2014). These perform best when in a hydrodynamic state, but are in contact during start-ups and stops. This sliding contact serves to wear down the surfaces, which impedes achieving a hydrodynamic condition. The study of wear rates and performance, therefore, has been experimented broadly to understand which tribopairs are best suited for artificial lift application.

Tribologists pair together materials and measure the wear rates, friction, cavitation (Biswas, 1984) and other interactions that would contribute to increased wear such as temperature, composition and speed of the fluid. Materials are paired together for best performance, having lower wear rates, with lower coefficients of friction and higher hardness (Daniel, 2013).

1.4 Polycrystalline Diamond as an Engineering Material

Polycrystalline diamond is an engineering material well suited for this application because of its high thermal conductivity, high toughness and low coefficient of friction (Table 1). A bearing surface with high thermal conductivity would reduce localized temperature extremes that lead to fluid and bearing degradation. During brief surface contact a high thermal conductivity would reduce the likelihood of causing localized welding of the surfaces, which would have led to scoring and galling of the bearing surface. In sliding bearings, low coefficients of friction are desired in order to decrease heat generation and reduce power losses.

Because of its extreme hardness, polycrystalline diamond is very resistant to wear from abrasive particles in lubricants or process fluids. The use of PCD/PCD would allow for operation in harsher environments.

Table 1 Physical and Mechanical Properties of Bearing Materials

Properties	Polycrystalline Diamond (PCD)	Tungsten Carbide	Steel (4140)	Silicon Nitride	Silicon Carbide
Coefficient of Friction	0.05-0.08**	0.2-0.25†	0.42‡	--	--
Thermal Conductivity (W/m*K)	543	70	42.6	30	85
Fracture Toughness (MPa√m)	13-15	10-25	50	4	3.5-4
Hardness (GPa, Knoop)	49.8	1.8	0.2	1.8	2.4
Compressive Strength (GPa)	6.9-7.6	2.68	--	--	2.5
Young's Modulus (GPa)	841	669-696	205	296	434
Tensile Strength (MPa)	1,300-1,600	334	415	520	500
<p>*ASI 4140 Steel, annealed at 815°C (1500°F) furnace cooled 11°C (20°F)/hour to 665°C (1230°F), air cooled, 25 mm (1 in.) round(1107°F) temper)</p> <p>** PCD on PCD in H2O, dynamic, dynamic</p> <p>†Tungsten Carbide on Tungsten Carbide, static</p> <p>‡Steel (Hard) on Steel (Hard), dynamic</p> <p>Sources: Bertagnolli, US Synthetic; Roberts et al., De Beers; Cooley, US Synthetic; Jiang Qian, US Synthetic; Glowka, SNL; Sexton, US Synthetic; Lin, UC Berkeley, MatWeb.com, Cerco</p>					

1.5 Research Hypothesis

While the state-of-the-art for bearings has recently changed to include PCD, few papers have been published which compare PCD as a bearing surface in a tilting pad bearing. Some recent articles predict the wear and performance of PCD as a thrust bearing, as Sexton et al show through laboratory testing (Sexton, 2009), and Knuteson et al show that some PCD thrust bearings can operate in a hydrodynamic state (Knuteson, 2011) if the right conditions occur after a wear-in period.

These studies are promising because tilting pad bearings operate in hydrodynamic conditions. However, no study so far has experimented with using PCD as a bearing surface in a tilting pad bearing, although Knuteson et al proposed the use of PCD in tilting pad bearings.

It is hypothesized that if PCD is used in a tilting pad bearing, as both the pad and the collar, then the operating life of the ESP will increase many times over.

This paper proposes that an ESP tilting pad bearing with polycrystalline diamond (PCD) for both pad and collar will perform longer than the current SS/PEEK tribopair under identical conditions. This claim relies on the mechanical properties listed in Table 1. To test this hypothesis, this PCD/PCD tribopair will be set up on a test rig that is designed to control the inputs of rotational speed, axial load, and fluid flow and outputting the actual values of the desired parameters. The tilting pad bearings will be subjected to axial loads to determine the ultimate load for the design tested.

This paper also proposes that the use of PCD would decrease the likelihood of catastrophic failure when the pads and collar touch while in operation. This is attributed to its high thermal conductivity removing heat from the fluid and allowing it to remain in the hydrodynamic state.

This hypothesis was tested on the same test rig with the fluid flow being restricted completely. Currently, the SS/PEEK tribopair last for approximately five minutes.

Initially a medium-to-small sized ESP motor of Ø107mm was considered. A typical requirement for a tilting pad bearing this size is to function when the motor is providing a load in a range from 16 MPa to 40 MPa. This pressure is similar to a field ESP running several miles below the surface.

1.6 Delimitations

As PCD is a new material in the tilting pad bearing design, the collar diameter is limited to Ø75mm for a continuous surface. Designs with larger diameters will use segmented, or discontinuous, collars which are known to reduce the performance of the tribopair in use. The initial testing will be with a Ø107mm design of PCD pads with a PCD collar which is segmented. If results warrant a continuous collar then a SiC is available to use.

This test will be conducted jointly between sister companies US Synthetic Bearings, who manufacture PCD sliding thrust and radial bearings, and Waukesha Bearings, who manufacture tilting-pad bearings.

1.7 Definition of Terms

CoF – Coefficient of Friction

Collar – The continuous-surface of the pair; it has no tilting features; Ø107 mm PCD is a segmented collar, whereas the Ø75mm PCD is a continuous surface.

ESP – Electric Submersible Pump

Pad – The tilting mechanism; there are three pads for the Ø75mm and Ø107mm bearings. Larger diameter bearings can have more pads, depending on pad size and bearing diameter.

PCD – Polycrystalline Diamond

PCD compact – sintered PCD bonded to a tungsten carbide substrate

PEEK – Polyether ether ketone, a thermoplastic polymer used in engineering applications

SiC – Silicon Carbide

SS – Stainless Steel

Tribopair – Two bearing surfaces in contact while moving or rotating in opposite directions or at different speeds

2 LITERATURE REVIEW

Previous research related to this work can be grouped into the following topics: bearing surfaces consisting of Babbitt, tribopairs consisting of polymers, and tribopairs consisting of polycrystalline diamond compacts.

Progress in bearing technology and advances in research are driven by the oil industry's desire to increase oil production and reduce their operating costs. With a bearing material selection comes pros and cons; the material's low friction coefficient can deliver good performance until the constantly rising temperature causes surface failures, the material has a known wear rate and lifetime until foreign particles enter the processing fluid and reduce the life by 50% or more. The industry looks to adopt the best technology that the market can bear, which depend on the state-of-the-art in tribology as well as world and national oil prices.

2.1 Bearing Surfaces Consisting of Babbitt

Babbitt is a tin-based alloy which has been used as a bearing surface since its 1893 discovery. Biswas et al observed that failures with Babbitt pads in a tilting pad bearing occurred in several ways: pitting, abrasive damage, thermal fatigue, and cavitation. Pitting is caused by electrical discharge when coupled to a generator or by the water droplets in the steam turbine vapor building up electrostatic charges. (Biswas, 1984)

Foreign particles rolled between the surfaces, abrading the soft Babbitt metal. Thermal fatigue resulted in the Babbitt debonding. Cavitation was observed, although it was established afterwards that the setting of the pads was incorrect due to a mix-up in the active and non-active side pads, which led to inadequate film pressure in the active side pads. (Biswas, 1984)

Ronen et al tested hydrodynamic radial bearings, focusing on different shaft (carbon and alloy steels) and liner (Phosphor bronze, Cu-Pb alloy and Al-Sn alloy) materials and found “that both the shaft wear and the liner wear depend mainly on the relative hardnesses of the shaft and liner materials rather than on the actual hardnesses of either.” It is noted that wear was primarily due to abrasive particles becoming embedded, and the hardness ratio of the two materials would predict if the wear were predominantly on either the shaft or the liner. (Ronen, 1981)

Although Babbitt is widely used, it has a low melting point which reduces its life. Many industries use these bearings and have need of higher power densities. The next generation of interface materials must continue to work under aggressive conditions which Babbitt cannot.

2.2 Tribopairs Consisting of Polymers

Lan et al propose three advanced coatings as the next generation of interface materials: polytetrafluoroethylene (PTFE) based, polyetheretherketone (PEEK) based, and aromatic thermosetting polyester (ATSP) based coatings.

Their experiments showed improved performance over the bare interface materials. Experiments showed low coefficient of friction and low wear rates for the polymer coatings. Of the three coatings tested, ATSP had the lowest CoF of 0.108 and the lowest wear rate of the coatings (the bare substrate had the best wear rate.) (Lan, 2016)

Chatterton 2015 also noticed the trend of industrial thrust bearings transitioning from white metal to polymeric materials, such as PTFE or PEEK. By creating a thermoelastohydrodynamic (TEHD) model for a tilting pad thrust bearing, the industry could benefit from reduced overall size for a required capacity, very low coefficient of friction and chemical resilience in seawater.

While PTFE was found to have a CoF of 0.04, its lower thermal conductivity caused the polymeric material to experience greater deformities, increasing the temperature of the lubricant. This environment also made it possible for the coating layer moving from the higher-pressure zones on the pad to lower pressure. This creep causes variation on the pressure and results in a pad crowning problem, which is in agreement with the TEHD model. (Chatterton, 2015)

Polymer bearings have proved to have a long life when the processing fluids remained free of debris or other hard contaminants. Although providing a lower friction coefficient than Babbitt they require a lower operating temperature. One material that has both low friction coefficients and high thermal stability is polycrystalline diamond (PCD).

2.3 Tribopairs Consisting of Polycrystalline Diamond Compacts

The previous use of diamond as an engineering material was as a single-crystal diamond, and the isotropic wear of the (PCD) overcame the soft and hard directional problems which plagued the single-crystal diamond. (Crompton, 1973)

Mehan et al used this isotropic wear understanding to evaluate the performance of PCD and other materials sliding against steel. (Mehan, 1981) Their tests found that PCD compacts provided the best combination of low metallic wear rates and low friction, under both dry and lubricated conditions.

Mehan et al next focused on the dry sliding wear of diamond against steel and found that simple wear rules apply, i.e. proportional to load and sliding distance. (Mehan, 1982) They found that the surface roughness has a significant effect on wear and ceramics against steel had wear whereas PCD compact has no measurable metal wear.

Sha 2016 et al showed that PCD tribological behaviors were significantly affected by mating materials. They used Raman spectroscopy to show that combinations of PCD/SiC and PCD/Si₃N₄ had coefficients of friction about ten times as high as PCD/GCr15 and PCD/Al₂O₃. Under vacuum conditions, the PCD performs low stable COFs around 0.05 and 0.08 sliding against Al₂O₃ or GCr15, respectively, whereas those of the PCD sliding against Si₃N₄ or SiC are about 0.85 and 1.15, respectively. (Sha, 2016)

2.4 Wear Mechanisms

PCD is also used both as an abrasive compound and a cutting insert to machine other materials. Studies in this capacity have given insight into the wear mechanisms of PCD.

Davim et al used both PCD and cemented carbide (K20) to machine PEEK. Both PCD and K20 performed well, with PCD provided a better surface quality of the PEEK. The PCD tool delivered surface qualities that meet international dimensional precision requirements. (Davim, 2004)

Moseley 2009 et al studied the wear and fracture mechanisms of PCD while cutting reinforced concrete cores. The chipping and fracture occur in the PCD as cutting through the rebar and concrete were driven by a cyclic impact. PCD compacts offer a lifetime 10 times longer than the previous technology of diamond impregnated inserts. (Moseley, 2009)

2.5 Application of PCD in Fluid Environment Bearings

Khonsari et al. (Khonsari, 2012) applied PCD to marine hydrokinetic power generators and determined the life and performance of the PCD thrust bearing with the benefit of cooling from the surrounding water. They observed decreased wear rates at the PCD-to-PCD interface, which would lead to extended life of the bearings. This paper notes that the use process fluids, including water, to cool the surface of the PCD can be further extended to the tilting pad bearing used a PCD/PCD tribopair.

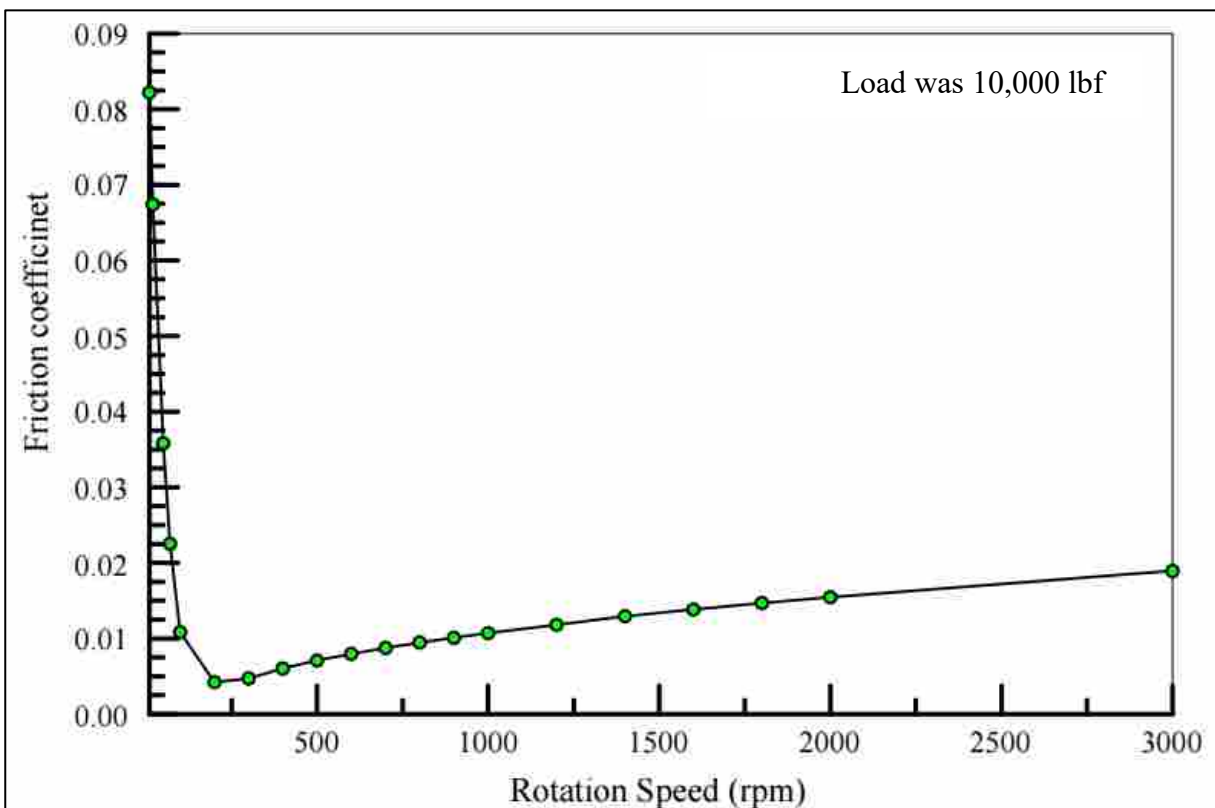

Figure 4 Experimental Results of CoF Against vs. Rotational Speed

Khonsari et al. (Khonsari, 2012) noted that hydrodynamic lift occurred when the rotational speed was about 250 rpm (Figure 4). This is used as the baseline for hydrodynamic lift in a PCD/PCD tribopair.

Sexton et al (Sexton, 2009) operated PCD thrust bearings in down-hole applications for several years. These PCD thrust and radial bearings were run and cooled with the abrasive process fluid, which would quickly fail a traditional roller bearing.

Sexton et al. saw some wear failures from field runs and wanted to replicate the failure mode to establish maximum operating limits. They found that high temperatures (greater than 800° C) were breaking down the diamond-to-diamond bonds and causing it to convert to graphite. The load limit and wear rate both depended on the size and speed of the rotating bearing.

2.6 Current State of the Art for Tilting Pad Bearings

Tilting pad bearings are used in electric submersible pumps to capture the oil from deep oil wells and bring it to the surface. The use of PCD in tilting pad bearings is a recent innovation. An initial literature search for PCD in tilting pad applications returned no results, so a literature review was conducted to discover the established physical limits of the Babbitt and SiC, the current technology that hasn't changed since 1980. The literature below describes analytical models and experimental tests that have been used to characterize polymeric and white metal interfaces. Similar testing will be used in this paper to characterize the new PCD interface.

To establish a baseline, a search was performed for a recent experiment of polymeric and white metal interfaces. A paper by Chatterton, et al. (Chatterton, 2015) puts forth equations for

mechanical and thermal pad deformation and thermal behavior, which will be used in this paper to measure the performance of PCD for comparison.

Ettles, et al. (Ettles, 2006) developed methods and tests to calculate the safety margin for thrust bearings, focusing on fracture toughness, tensile strength, Young's modulus and the coefficient of friction. The PCD bearing surface will be tested in a controlled rig to evaluate these same properties.

Zhang et al. (Zhang, 2015) discussed the load limits of white metal due to high temperature. As the temperature increases, the toughness reduces, causing wear scarring and reduced performance. PCD operating temperatures will be evaluated against the parameters set forth by Zhang, et al.

In a paper widely regarded as the standard, Biswas, et al. (Biswas, 1984) gave a thorough treatment to failed white metal pads, providing analysis of the grain structure.

2.7 Friction Coefficients in Materials

Faverjon et al conducted a battery of tests to establish friction coefficients of materials to discover which would perform best without lubricant. Carbide and HSS averaged friction coefficients of 0.8-1 whereas the PCD had the lowest friction coefficient on average of 0.4-0.5 without lubrication and with a minimum quantity of lubricant it decreased to 0.1-0.2 (Faverjon, 2013).

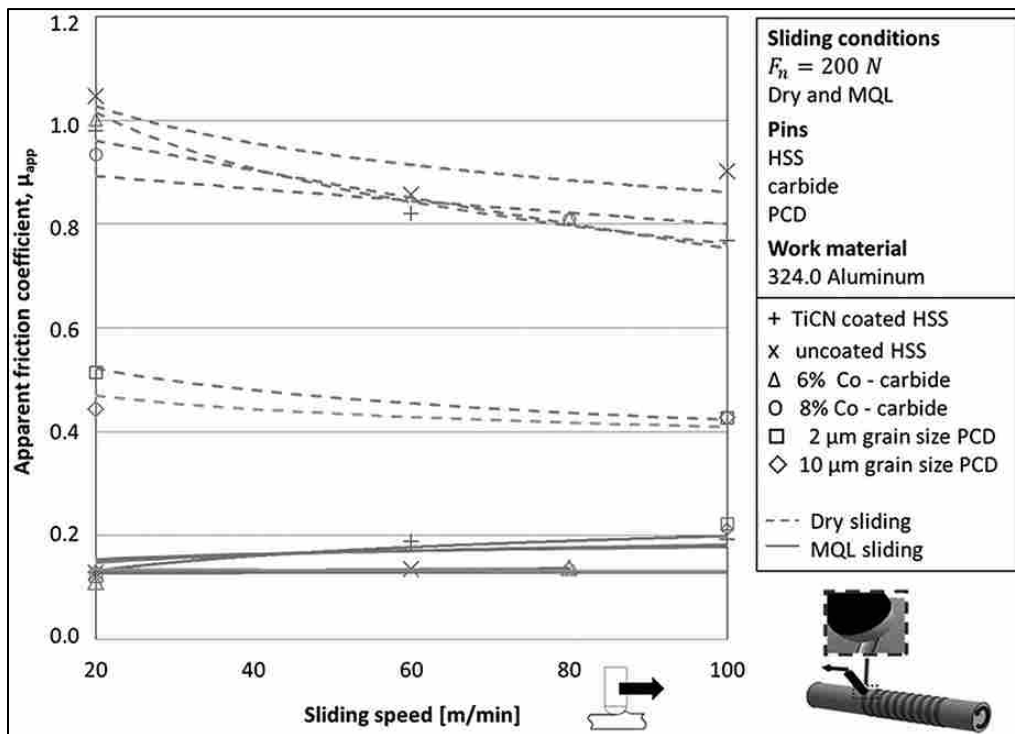

Figure 5 Sliding Friction Results

3 METHODOLOGY

3.1 Overview of Case Study

Leopard 1970 showed improvement in power of a tilting pad bearing by directed lubricant at the leading edge of the pad rather than the traditional lubricant flooding. This provided a reduction of the power loss via drag by half. (Leopard, 1970) This case study also uses the directed lubricant as it is the current generally accepted best practice.

The proposed observational experiment will expose the bearing to forces that are typical to an ESP while it is running to lift the process fluids from the wellbore. The results of each test will direct the design and parameters of the following test.

As we have a limited number of bearings and budgetary constraints, the results will often be one data point – that of success or failure. When a failure occurs (see General Description of Ultimate Load Test Procedure) the reason will be noted, but not the values of the instrument readings per Waukesha non-disclosure agreement. A representative instrument reading is given in Figure 5.

3.2 Manufacturing Restrictions Effect on Case Study

The specimen to be used in the first trial run is a PCD/PCD tribopair. In order to manufacture the PCD collar with a diameter of 107mm it was necessary to EDM cut a PCD wafer into a quarter of the ring surface (Figure 6). The resulting collar has four segments

approximately .015 wide, due to manufacturing variability. For segmented collars the smaller the gap, the less turbulence that will be caused. This turbulence disrupts the hydrodynamic condition of the fluid and can lead to the surfaces touching which would lead to catastrophic failures with SS/PEEK, while PCD/PCD could cause spikes to the current in the motor.

Also of note is that each test was not replicated, so the results expressed here are taken as a single response and weighed against the design criteria. A more robust test would include randomized combinations and multiple replications, depending on the design of experiment. It is the author's opinion that this could be done once this initial design is successful as a proof of concept. Further tests would occur once funding is allocated, which is dependent upon these test results.

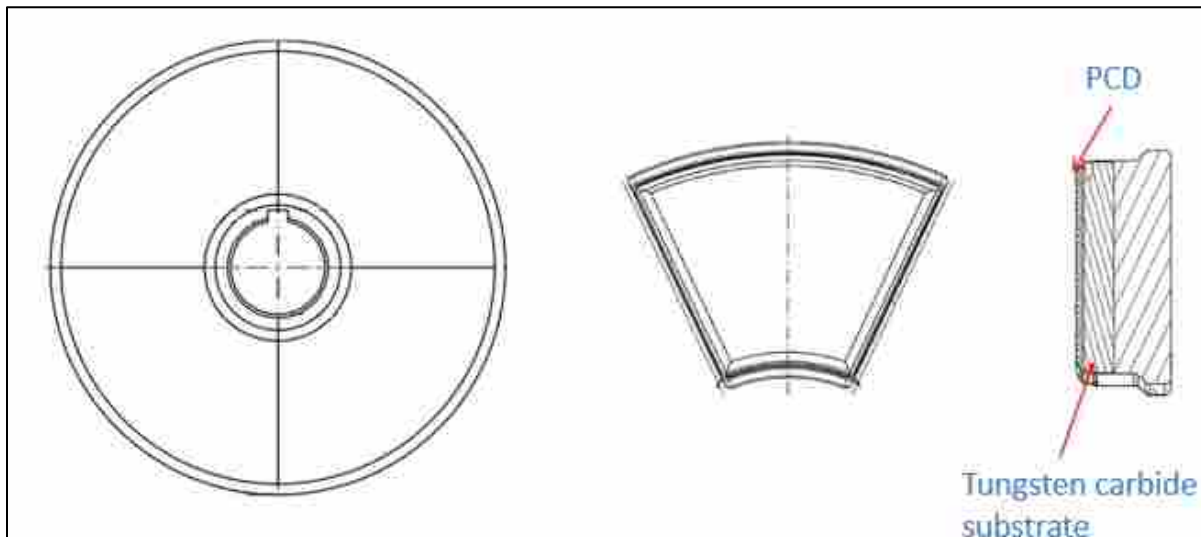

Figure 6 Segmented Collar (left), PCD Pad (center), Section View of PCD Pad (right)

3.3 Summary of SVTR

Waukesha Bearings has teamed up with USSynthetic Bearings and will conduct an ultimate load test. This will be led by Sriram Venkatesan, Development Engineer. Internal documentation is used to control the inputs in the following tests. The results will remain internal save for the overall results of the bearing tested.

An ultimate load test will be performed on the Small Vertical Test Rig (SVTR). The bearing assembly uses three PCD pads, retained with a non-leveling carrier plate and running against a thrust collar with a PCD insert (Figure 6). The SVTR uses city water for bearing lubrication, and is instrumented with thermocouples, a flowmeter, and a current transducer.

3.4 Scope of Test

This test is an experiment with fixed and monitored parameters with no randomization. No causation is inferred from successful results, only that the material combination has met the criteria. The results are dependent on the type of substrate due to its physical properties. The scope of the test is limited to the substrates evaluated in the combinations as shown below in Test Materials.

3.4.1 SVTR Test Hardware

Testing was performed on the WB SVTR shown in Figure 1. The SVTR is a vertical test rig that has a submerged 10 hp AC motor that operates at a synchronous speed of 3600 rpm. Data were collected, and test rig components were controlled through a National Instruments (NI) Compact FieldPOINT (cFP) distributed input and control module system, which is controlled and monitored by NI LabView software. Load is applied to the test bearing with a hydraulic

piston assembly and deadweight tester. Water is supplied by a 1 hp pump with flow controlled by manual needle valves.



Figure 7 SVTR Test Head and Low Flow Hydraulic Pump

The SVTR is controlled and all data is collected by NI cFP modules and LabView software. Water flow is measured by an Omega flow meter, an FTB-9510 S/N 277060. Motor current is measured with an Acuamp ACT050-10-5 current sensing transducer. Water inlet temperature, water reservoir temperature, motor reservoir temperature, and outlet temperatures are measured using type K thermocouples.

3.4.2 Test Materials

The control group of collars are stainless steel, SiC sintered and SiC reaction bonded, which are all continuous. The PCD collars less than $\text{Ø}75\text{mm}$ are a continuous surface, while the larger $\text{Ø}107\text{mm}$ is segmented.

The control for pads will be a typical tribopair of PEEK in combination with a stainless steel collar. The PCD pads tested are proportionately sized for the collar it will be tested with. Figure 6 shows the $\text{Ø}107\text{mm}$ tribopair of PCD/PCD and the relation in size between the collar and the pads.

If the segmented features on the larger PCD collars give test results that are below the design criteria we will test a continuous SiC collar. This will provide a case to account for breakdown of hydrodynamic fluid conditions due to the segmented surface of the PCD collar.

3.4.3 Test Parameters

The test ran PCD pads on a non-leveling center pivot retainer. The pads were retained with a cover plate and ran against a thrust collar with a PCD insert.

The required Ultimate Load is 16 MPa. The load applied will change depending on the surface area of the tribopair.

3.4.3.1 General Description of Ultimate Load Test Procedure

Testing is conducted using the SVTR as follows:

1. Initiate Data Acquisition system and turn on the lubricant circuit
2. Start motor with no external load on thrust bearing

3. Allow system to achieve steady state condition (temperature, motor current etc.)
4. Apply a 2,000 N (449.6 lbf) load on bearing by adjusting the hydraulic line pressure
 - The load increases gradually
5. Allow system to achieve steady state and hold for 10 minutes
6. Acquire raw data (internal to Waukesha)
7. Increase load in 2,000 N (449.6 lbf) increments and repeat steps 5 & 6
8. Repeat step 7 until one of the following conditions occurs,
 - Seizure of drive motor (motor torque limit/motor current preset limit of 14 Amps reached)
 - Reached maximum rated rig load limit of 40,000 N (8,992 lb.)
 - Lubricant temperature begins to approach boiling point – 80° C (176° F) is specified limit
 - Breakage of Test bearing or Collar – Failure
 - Breakage of Motor bearing – Failure (Based on experience, this does not happen below 40,000N)

The test may also be halted earlier for inspection based on unusual readings from measured instrumentation at operator discretion. Test flow was held constant at 2 lpm of water.

9. The bearing Ultimate Load is the applied load during Step 8.

- Note when test is stopped due to reaching rig limit, the true ultimate load of the test bearing is not known

3.4.3.2 General Description of No Flow Test Procedure

To test the influence of the PCD's thermal conductivity on the process fluid, a no flow test is recommended. This test will compare the SS/PEEK tribopair, which is a typical candidate and a good selection for a benchmark test.

The no flow test is a pass/fail test, which is run under an 8 MPa load. This study will compare the SS/PEEK average time of five minutes and an average rise in temperature of 25°C. For the PCD/PCD test, we will observe a rise in 25°C in either more or less than five minutes.

3.4.3.3 General Description of Duration Test Procedure

A longer test under a smaller load will be performed on the PCD/PCD. This test is typically run for 120 hours, and as a pass/fail test the expectation is that a pass would run without any issues as listed in 3.4.3.1 General Description of Ultimate Load Test Procedure. For reference, the SS/PEEK tribopair passes the 120-hour test.

4 DISCUSSION OF RESULTS

4.1 Case Study PCD performance

The ultimate load is the primary test for acceptance of PCD in a tilting pad bearing. The expectation was that the PCD would out-perform the SiC. When that wasn't the case (see Table 2, Tests #1 & #2) time and resources were used to evaluate why actual result was different from the expected result. Our findings were used to determine the next material combination, test rig parameter change, design size or material condition to gain an understanding of PCD as an ESP bearing.

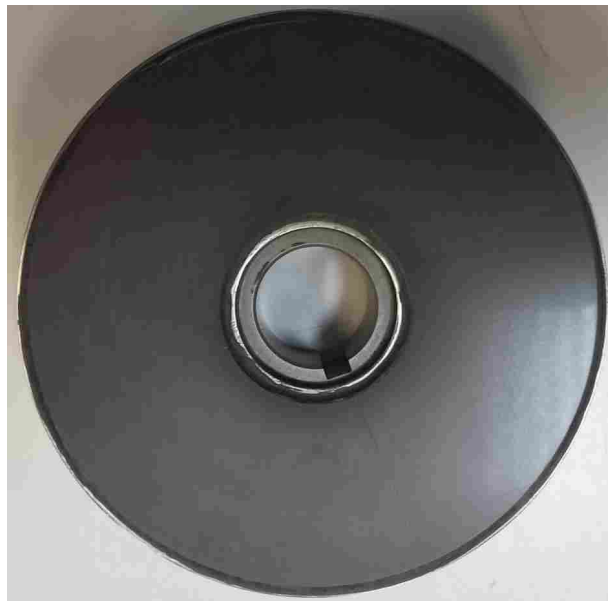

Figure 8 Ø107mm Segmented PCD Collar

Table 2 Small Vertical Test Rig Results

Test #	Type	Collar OD (mm)	Collar Material	Pad Material	Bearing Area (mm ²)	Applied Load, kN (klbf)	Bearing Unit Load (MPa)	Comments
1	Ultimate Load	107	PCD (segmented)	PCD	2500 (3 pads)	27 (6.1)	8	Stopped test due to motor current spike
2	Ultimate Load	107	PCD (segmented)	PCD	2500 (3 pads)	27 (6.1)	11	Stopped test due to motor current spike
3	Ultimate Load	107	SiC (sintered)	PCD	2500 (3 pads)	40 (9.0)	16	Test Rig limit reached. Not the Ultimate Load limit for this tribopair
4	Ultimate Load (Benchmark)	75	Stainless Steel	PEEK	900 (3 pads)	16.7 (3.75)	23	Test was stopped due to severe indentation on the pad-pivot interface
5	Ultimate Load	75	PCD (continuous)	PCD	710 (3 pads)	40 (9.0)	44	The faces appeared as new after the test. Power loss steps up at 16 MPa.
6	No Flow	75	PCD (continuous)	PCD	710 (3 pads)	5.5 (1.24)	8	Test chamber temperature rise of 25°C (45°F) over a period of 30 minutes
7	Duration	75	PCD (continuous)	PCD	710 (3 pads)	11.3 (2.54)	16	Duration test for 120 hours

4.1.1 Ø107mm Collar Ultimate Load Test

This design has a segmented collar which is known to be a potential issue for allowing a hydrodynamic state. The discontinuous surface causes the fluid to undergo changes in pressure and direction, resulting in turbulence which causes power loss. (Bouard, 1996) If there was a failure on the continuous SiC collar, we would assign that to whichever machine output that was

approaching its limit, such as ΔT of the process fluid. In order to know if these assumptions were valid in this design, the first test was run.

4.1.1.1 Ø107mm Segmented PCD Collar

In this ultimate load test (Table 2, Test #1), the PCD/PCD tribopair caused the motor current to spike at a load lower than the design requirement of 8 MPa. The cause of this failure was determined to be the poor surface finish of the PCD collar. When the segmented collar was manufactured, the surface flatness was not below the required 0.0008", so the collar was lapped to the surface flatness tolerance, and then polished to a surface finish of 20 μ inch.

Because the SiC has surface finish of 2 μ inch, the decision was made to polish the Ø107mm PCD collar to a better surface finish and run another ultimate load test.

After polishing the segmented PCD collar to 8 μ inch, the PCD/PCD tribopair was once again put through the ultimate load test (Table 2, Test #2). The test was stopped due to a spike in the motor current. Because the surface finish was at an acceptable level, the cause for this failure was hypothesized to be the segmented surface of the collar.

With the PCD collar in the Ø107mm design suffering from gaps between the segments disturbing the hydrodynamic fluid, the next iteration was designed to isolate the PCD pads and test them against a continuous collar.

4.1.1.2 Ø107mm Continuous SiC Collar

The SiC collar has a continuous surface and will provide a standard, or baseline, to test the PCD pads. This will also serve to test the cause for the previous two failures. Because this

test (Table 2, Test #3) reached the limit of the rig, the SiC/PCD tribopair has an ultimate load above 44 MPa, which meets the design criteria.

4.1.2 Ø75mm Continuous PCD Collar

With a positive result from PCD pads on a SiC collar, it was now necessary to reconcile the failures in the PCD collar. We attributed the failure to the segmented face of the collar, so we concluded that the next step in evaluating PCD would be to test a continuous PCD collar with PCD pads. The largest available continuous PCD is Ø75mm.

4.1.2.1 Ultimate Load Test

A Ø75mm SS/PEEK bearing was used for a benchmark test (Table 2, Test #4). This test reached an ultimate load of 23 MPa and was stopped due to severe indentations on the pivot pad interface.

The PCD/PCD tribopair was run up to the rig limit (Table 2, Test #5) of 44 MPa (see Appendix A. for Images of PCD Pads and Appendix B. for Images of PCD Collar). Meeting the design requirements and surpassing the SS/PEEK benchmark test is a significant success to this concept bearing. The next two tests will put the PCD/PCD tribopair through a final evaluation against typical SiC/PEEK test results.

4.1.2.2 No Flow Test

The PCD/PCD tribopair was subjected to a test where the fluid does not cycle through the rig. This is done so that the temperature increases due to the movement of the tilting pad bearing through the static fluid. Temperature increase causes the fluid to breakdown which in turn prevents the hydrodynamic fluid condition from continuing.

In this test, the SiC/PEEK will typically last 5 minutes. The PCD/PCD was subjected to the same parameters and requirement of 8MPa (Table 2, Test #6) and successfully lasted for 30 minutes. The hypothesis here is that the high thermal conductivity of the PCD dissipated heat from the fluid into the bearing body, allowing the hydrodynamic conditions to last longer, thus extending the typical SiC/PEEK time by a factor of six. This result exceeded the design requirement.

4.1.2.3 Duration Test

The PCD/PCD tribopair was then tested for duration, which ran the test for 120 hours at 16 MPa. This test included fluid cycling as in ultimate load tests. The test was run to completion and met the requirements for the design.

4.2 Case Study Evaluation of Results

In the Ø75mm group (Table 2, Test #4), SS/PEEK tribopair performed similarly to the PCD/SiC tribopair as the rig limit was reached. PCD/PCD tribopair test was stopped due to high motor torque. This tribopair had a segmented PCD collar, whereas the SS and SiC had continuous collars.

In the Ø75mm group, the SS/PEEK tribopair test was stopped due to pad pivot interface breakdown. The PCD/PCD tribopair reached the rig limit. This is attributed to the low coefficient of friction of PCD preventing any scarring that would degrade the bearing surfaces.

It is costly to bring the PCD surface finish to 2µinch, which is why in Test #2, the surface finish was improved from 20µinch to only 8µinch via additional polishing. The next design's

criteria for surface finish can be tightened to $8\mu\text{inch}$, addressing the issue with the size of the segment gaps, or another test can be run with a surface finish of $2\mu\text{inch}$.

The second $\text{Ø}107\text{mm}$ bearing also failed via the gaps between the PCD collar segments. The gaps in the segmented collar are a result of the manufacturing process. With EDM cut surfaces that are perpendicular to the PCD surface, a sharp edge remains that can be chipped anytime throughout its life prior to running in an ESP, especially during assembly of the collar. Typically, a small 45° chamfer of about $0.010''$ is ground into the edge to prevent this chipping from occurring. When the PCD is assembled into the collar, the $0.020''$ gap would be a site that would cause cavitation which could prevent a hydrodynamic condition. For the collar, smaller chamfers would decrease the gaps, so the assembly process needs to be improved to produce PCD collars with smaller gaps between each segment.

The ESP motors also use radial bearings that would also suffer from the same segment gap issue. Once the gaps are resolved in the collar design, the concept of radial tilting pad bearings can be tested and proved.

The claim was shown to be true for the $\text{Ø}75\text{mm}$ design, successfully passing the ultimate load, no flow and duration tests. This is a positive proof of concept for a PCD/PCD tribopair tilting pad thrust bearing. For this size, the continuous PCD compacts are made on a belt press, which, due to the belt press's own size constraints, limits the maximum diameter of the PCD. Until the manufacture of PCD on a belt press can produce a larger diameter than 75mm , this is the maximum design size for a continuous PCD collar from a single PCD compact.

As shown in Section 2.5, an additional advantage that a PCD/PCD interface has is that it can be exposed to the processing fluids and any solids that the ESP is elevating to the surface. The SS/PEEK and all other conventional combinations require a seal to keep out sands and other

debris typically found down hole. The PCD/PCD can be run on a thrust test rig, exposed to sands and other fine materials. This would further reduce the temperature of the bearing surfaces and the fluid in contact with it, making it an excellent candidate for the next stage of testing.

Due to the higher cost of manufacturing, Sexton et al. (Sexton, 2009) estimate that for a PCD thrust bearing to be feasible the life of the bearing must be five to ten times longer than a traditional bearing. This could be broadly applied to a traditional tilting pad bearing life where, analogous to a PCD/PCD thrust bearing having more than ten times the life of a traditional thrust bearing, a PCD tilting pad bearing life must be ten times longer. However, with a PCD/SiC bearing, the cost will substantially rise without the full benefits of PCD/PCD. Further study must be done to test the relative cost/benefit of the PCD/SiC as well as the PCD/PCD, where Sexton's estimate of ten times the life can be compared to the performance gains of the first and second tribopair against the current designs.

The bearing diameter used for each test was limited in size due to several factors such as manufacturing process, testing rig size, tribopair combinations on hand for a proof-of-concept test and cost. For future work, the first step is to test the hypothesis that the gaps in the segmented PCD collar are the cause of the test failure. Ideally the test would include PCD pads paired with PCD collar specimens with no gaps, 0.010" gaps and 0.020" gaps, with iterative data which can be analyzed. These data will help in moving into testing different collar materials with PCD pads.

Because the Ø107mm PCD/SiC succeeded and the PCD/PCD failed, there is valid proof that a difference between the two models is the cause of these results. For future work, the Friction Coefficient for the PCD/SiC as well as PCD/PCD can be obtained through testing on a tribometer or other testing rig designed or adapted to measure force and speed. This will help to

identify the low CoF for the PCD/PCD tribopair (in comparison to the PCD/SiC) merits further study, experimentation and research to produce a viable PCD/PCD tilting pad bearing for diameters larger than 107mm.

4.3 Tribopair Comparisons

Bringing in the empirically observed data on the materials in question shows where the best performing material should be. Looking at the progress of the industry to continually improve their material, one can see that the best-working material is sunsetted only after the next shift in material technology has taken place.

PCD is ready to take the technology to the next step. Manufacturing processes, costs and availability have limited the speed to market as well as experimenting in the lab and testing in the field.

By identifying the best tribopair combination, be it PCD/PEEK, PCD/ceramic or PCD/PCD, the industry can move forward the science behind PCD as a bearing surface in a tilting pad bearing. This can be leveraged to a great benefit in ESP for lifting the oil to the surface. The PCD operating limits are high, but the cost of manufacture is also high possibly due to low adoption of this material. With a new step forward in technology and as the new material is used by more companies and studied by more scientists and universities, performance can continually improve. Also, as traditional tilting pad bearings are displaced by PCD, its cost of manufacture will decrease via competition or vendor-customer agreements.

5 CONCLUSIONS

The current study tested the hypothesis that PCD used as both pad and collar in a tilting pad bearing would increase the life of the artificial lift tool. This claim was not successfully made with the first set of tests, in which the Ø107mm bearing failed via high friction from either the roughness of the surface finish of the PCD pads or the gaps in the segmented PCD collar.

Tests with the Ø75mm bearing successfully ran to the load limit of the test rig, met the design requirements for no flow and exceeded the design requirements for duration.

This test confirmed that the oilfield industry should incorporate PCD in the tilting pad bearing portion of an ESP for artificial lift. In addition to the data produced in controlled laboratory tests, field tests carried out by drilling companies would show the correlation between expected and actual operational performance.

Additional research should be carried out to define the coefficient of friction for a PCD/PCD tilting pad bearing, as well as PCD/SiC. This will benefit future work that uses polycrystalline diamond as a bearing surface.

Because of the limitations of this study, additional research should focus on manufacturing a larger continuous PCD collar. A complimentary change would be to increase the number pads, each with a larger surface area than those tested in this paper. Moreover, iterative testing will allow for statistical analysis of these data.

Over the general field of bearings, PCD has yet to be fully adopted as a replacement for traditional bearings, such as cone, roller and journal bearings. Because of the need to keep temperatures under 800° C, PCD currently is limited to designs where a fluid can run across the PCD surface, dissipating the heat. Hydroelectric generation (Khonsari, 2012) is a growing industry with government backing that could use PCD bearing surfaces in many different applications. Industrial mixers can benefit from the long life of the bearing with longer mean times between breakdowns, requiring less frequent draining and cleaning of the mixer to prepare for a bearing replacement. Chemical inert PCD would be ideal in chemical mixers as well. Future tests could be run in conjunction within any of these developing applications.

REFERENCES

- Biswas, S., T Chander, and DS Gole. "Some Observations on the Surface and Subsurface Features of Failed Babbitt Pads." *Tribology International* 17, no. 2 (1984): 99-105.
- Bouard, L., M. Fillon, and J. Frêne. "Comparison between Three Turbulent Models — Application to Thermohydrodynamic Performances of Tilting-Pad Journal Bearings." *Tribology International* 29, no. 1 (1996/02/01/ 1996): 11-18.
- Camacho, A., LF Pastre, S Boyce, and J Macdonald. *High-Reliability Esp Application in the North Sea*. SPE Middle East Artificial Lift Conference and Exhibition: Society of Petroleum Engineers, 2016.
- Camargo, E., José Aguilar, Addison Ríos, Francklin Rivas, and Joseph Aguilar-Martin. "Nodal Analysis-Based Design for Improving Gas Lift Wells Production." *WSEAS Transactions on Informations Science & Applications* 5, no. 5 (2008): 706-15.
- Chatterton, S., Paolo Pennacchi, and Andrea Vania. *Multiphysics Tehd Model of a Tilting-Pad Thrust Bearing with Polymeric Layer*. Proceedings of the 9th IFToMM International Conference on Rotor Dynamics: Springer, 2015.
- Cooley, C.H. and T.N. Sexton. *Methods of Operating a Bearing Apparatus Including Tilting Pads*. Google Patents, 2014.
- Crompton, D., W Hirst, and MGW Howse. *The Wear of Diamond*. Vol. 333. Proceedings of the Royal Society of London A: Mathematical, Physical and Engineering Sciences: The Royal Society, 1973.
- Daniel, G. B. and K. L. Cavalca. "Evaluation of the Thermal Effects in Tilting Pad Bearing." *International Journal of Rotating Machinery* 2013 (2013): 17.
- Davim, J.P. and Pedro Reis. "Machinability Study on Composite (Polyetheretherketone Reinforced with 30% Glass Fibre–Peek Gf 30) Using Polycrystalline Diamond (Pcd) and Cemented Carbide (K20) Tools." *The International Journal of Advanced Manufacturing Technology* 23, no. 5-6 (2004): 412-18.
- Elwell, R. *Compact Tilting Pad Thrust Bearing*. Google Patents, 1974.
- Ettles, C.M., Jan Seyler, and Michael Bottenschein. "Calculation of a Safety Margin for Hydro Generator Thrust Bearings©." *Tribology & lubrication technology* 62, no. 6 (2006): 46.

- Faverjon, P., Joël Rech, and René Leroy. "Influence of Minimum Quantity Lubrication on Friction Coefficient and Work-Material Adhesion During Machining of Cast Aluminum with Various Cutting Tool Substrates Made of Polycrystalline Diamond, High Speed Steel, and Carbides." *Journal of Tribology* 135, no. 4 (2013): 041602-02-8.
- Garner, D.R., GJ Jones, and FA Martin. "Turbulent Journal Bearings: Design Charts for Performance Prediction." *ASLE TRANSACTIONS* 20, no. 3 (1977): 221-32.
- Hackworth, M. and Sandy Williams. *Real-Time Decision Making for Esp Management and Optimization*. SPE North America Artificial Lift Conference and Exhibition: Society of Petroleum Engineers, 2016.
- Khonsari, M.M. and Brent Lingwall. "The Development of Open Water-Lubricated Polycrystalline Diamond (Pcd) Thrust Bearings for Use in Marine Hydrokinetic (Mhk) Energy Machines." (2012).
- Knuteson, C. W., T. N. Sexton, and C. H. Cooley. "Wear-in Behaviour of Polycrystalline Diamond Thrust Bearings." *Wear* 271, no. 9 (2011/07/29/ 2011): 2106-10.
- Lan, P., Jacob L Meyer, Bitva Vaezian, and Andreas A Polycarpou. "Advanced Polymeric Coatings for Tilting Pad Bearings with Application in the Oil and Gas Industry." *Wear* 354 (2016): 10-20.
- Leopard, A. J. "Directed Lubrication for Tilting-Pad Thrust Bearings." *Tribology* 3, no. 4 (1970/11/01 1970): 206-10.
- Liming, Z., Luo Yongyao, Wang Zhengwei, Liu Xin, and Xiao Yexiang. "A Review on the Large Tilting Pad Thrust Bearings in the Hydropower Units." *Renewable and Sustainable Energy Reviews* 69 (3// 2017): 1182-98.
- Mehan, R.L. "Dry Sliding Wear of Diamond Materials." *Wear* 78, no. 3 (6/1/ 1982): 365-83.
- Mehan, R.L. and S. C. Hayden. "Friction and Wear of Diamond Materials and Other Ceramics against Metal." *Wear* 74, no. 2 (12/22/ 1981): 195-212.
- Moseley, S.G., K. P. Bohn, and M. Goedicke-meier. "Core Drilling in Reinforced Concrete Using Polycrystalline Diamond (Pcd) Cutters: Wear and Fracture Mechanisms." *International Journal of Refractory Metals and Hard Materials* 27, no. 2 (3// 2009): 394-402.
- Ronen, A. and S. Malkin. "Wear Mechanisms of Statically Loaded Hydrodynamic Bearings by Contaminant Abrasive Particles." *Wear* 68, no. 3 (1981/05/15 1981): 371-89.
- Sexton, TN and CH Cooley. "Polycrystalline Diamond Thrust Bearings for Down-Hole Oil and Gas Drilling Tools." *Wear* 267, no. 5 (2009): 1041-45.

Sha, X., Wen Yue, Yihui Zhao, Fang Lin, and Chengbiao Wang. "Effect of Sliding Mating Materials on Vacuum Tribological Behaviors of Sintered Polycrystalline Diamond." *International Journal of Refractory Metals and Hard Materials* 54 (2016): 116-26.

Zhang, F., Wu Ouyang, Honglun Hong, Yongsheng Guan, Xiaoyang Yuan, and Guangneng Dong. "Experimental Study on Pad Temperature and Film Thickness of Tilting-Pad Journal Bearings with an Elastic-Pivot Pad." *Tribology International* 88 (8// 2015): 228-35.

APPENDICES

APPENDIX A. IMAGES OF PCD PADS FROM TEST #5

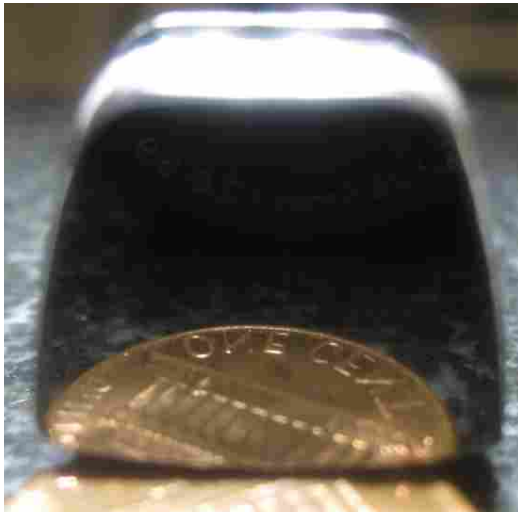

APPENDIX B. IMAGES OF PCD COLLAR FROM TEST #5



APPENDIX C. DETAILED RESULTS OF ULT. LOAD TEST #5 Ø75MM

In the Ultimate Load test the PCD/PCD tribopair caused elevated motor current, and the test was stopped in accordance with Step 8 of 3.4.3.1 General Description of Ultimate Load Test Procedure. The PCD collar, which was segmented, had a surface finish of $20\mu\text{inch}$. The SiC collar, which was continuous, had a better surface finish of $2\mu\text{inch}$.

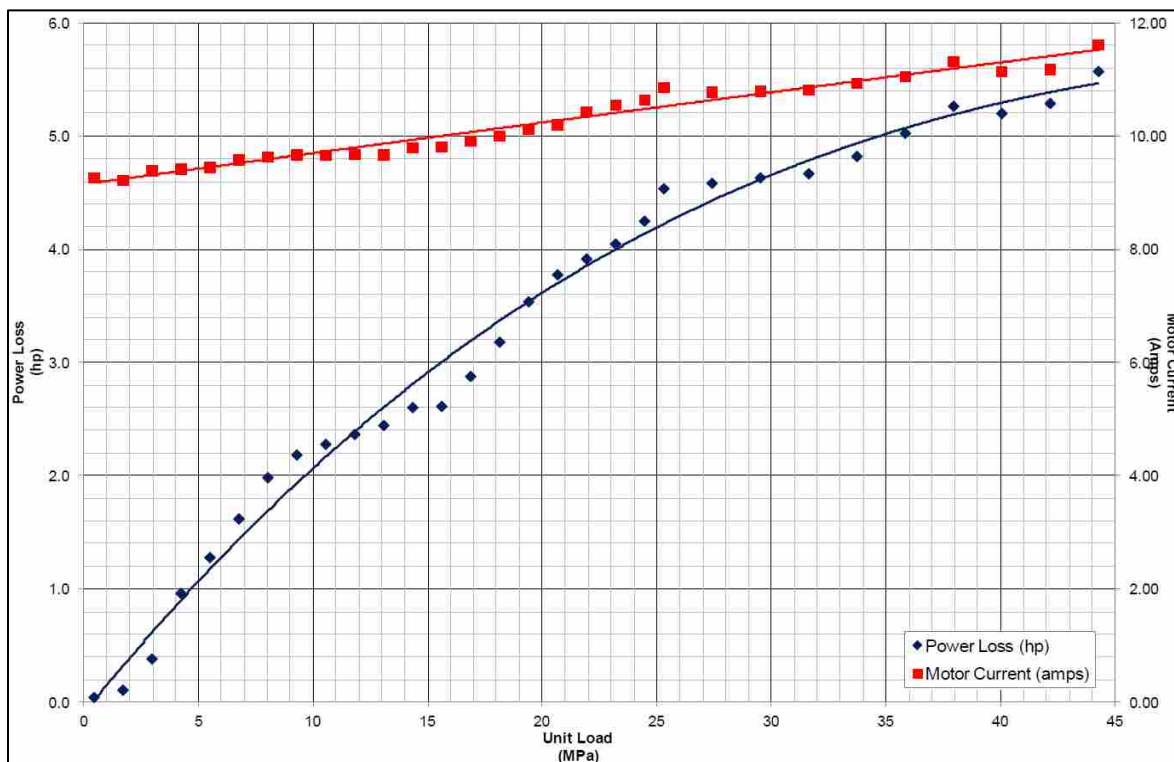

A load of 7107 lbs (44.2 MPa) was reached during testing, with a power loss of 5.6 horsepower and a motor current of 11.62 amps. Testing was stopped at the 7107 lb load step due to a ΔT (water outlet – water inlet) of over $50\text{ }^\circ\text{F}$

APPENDIX D. ADDITIONAL SVTR DETAILS

Maximum (Rated) Rig Load Limit: 40,000 N

Bearing Design: Non-Equalized TPT bearing

Bearing Support: Carrier ring with machined pivots

Bearing Lubrication: Flooded

Number of tilting pads: 3

Size pad (OD: 99 mm Pad ID: 43 mm)

Total Bearing Load Surface Area: 2,500 mm²

Thrust Collar OD: 107 mm (segmented); 75 mm continuous

Collar ID/Shaft Diameter: 25mm

Drive Motor Power: 7.5 KW

Speed: 3,600 RPM (fixed)

Line Speed at Bearing Mean Diameter: 13 m/s

Line Speed at Collar OD: 20 m/s

Lubricant: Tap Water

Lubricant Flow rate: 2 LPM (fixed)

Lubricant Inlet Temperature: Ambient (20 – 25°C)