

Wilfrid Laurier University

Scholars Commons @ Laurier

Theses and Dissertations (Comprehensive)

2009

Mechanism(s) of 3-Trifluoromethyl-4-Nitrophenol (TFM) Toxicity in Sea Lamprey (*Petromyzon marinus*) & Rainbow Trout (*Oncorhynchus mykiss*)

Oana Birceanu
Wilfrid Laurier University

Follow this and additional works at: <https://scholars.wlu.ca/etd>



Part of the [Aquaculture and Fisheries Commons](#)

Recommended Citation

Birceanu, Oana, "Mechanism(s) of 3-Trifluoromethyl-4-Nitrophenol (TFM) Toxicity in Sea Lamprey (*Petromyzon marinus*) & Rainbow Trout (*Oncorhynchus mykiss*)" (2009). *Theses and Dissertations (Comprehensive)*. 927.

<https://scholars.wlu.ca/etd/927>

This Thesis is brought to you for free and open access by Scholars Commons @ Laurier. It has been accepted for inclusion in Theses and Dissertations (Comprehensive) by an authorized administrator of Scholars Commons @ Laurier. For more information, please contact scholarscommons@wlu.ca.



Library and Archives
Canada

Published Heritage
Branch

395 Wellington Street
Ottawa ON K1A 0N4
Canada

Bibliothèque et
Archives Canada

Direction du
Patrimoine de l'édition

395, rue Wellington
Ottawa ON K1A 0N4
Canada

Your file *Votre référence*
ISBN: 978-0-494-54222-4
Our file *Notre référence*
ISBN: 978-0-494-54222-4

NOTICE:

The author has granted a non-exclusive license allowing Library and Archives Canada to reproduce, publish, archive, preserve, conserve, communicate to the public by telecommunication or on the Internet, loan, distribute and sell theses worldwide, for commercial or non-commercial purposes, in microform, paper, electronic and/or any other formats.

The author retains copyright ownership and moral rights in this thesis. Neither the thesis nor substantial extracts from it may be printed or otherwise reproduced without the author's permission.

In compliance with the Canadian Privacy Act some supporting forms may have been removed from this thesis.

While these forms may be included in the document page count, their removal does not represent any loss of content from the thesis.

AVIS:

L'auteur a accordé une licence non exclusive permettant à la Bibliothèque et Archives Canada de reproduire, publier, archiver, sauvegarder, conserver, transmettre au public par télécommunication ou par l'Internet, prêter, distribuer et vendre des thèses partout dans le monde, à des fins commerciales ou autres, sur support microforme, papier, électronique et/ou autres formats.

L'auteur conserve la propriété du droit d'auteur et des droits moraux qui protègent cette thèse. Ni la thèse ni des extraits substantiels de celle-ci ne doivent être imprimés ou autrement reproduits sans son autorisation.

Conformément à la loi canadienne sur la protection de la vie privée, quelques formulaires secondaires ont été enlevés de cette thèse.

Bien que ces formulaires aient inclus dans la pagination, il n'y aura aucun contenu manquant.

Canada

**Mechanism(s) of 3-Trifluoromethyl-4-Nitrophenol
(TFM) Toxicity in Sea Lamprey (*Petromyzon
marinus*) & Rainbow Trout (*Oncorhynchus mykiss*)**

by

Oana Birceanu

Bachelor of Science Honours, Wilfrid Laurier University, 2007

THESIS

Submitted to the Department of Biology

Faculty of Science

in partial fulfillment of the requirements for

Master of Science in Integrative Biology

Wilfrid Laurier University

2009

Oana Birceanu 2009©

ABSTRACT

The pesticide, 3-trifluoromethyl-4-nitrophenol (TFM), has been extensively used over the last 50 years to control invasive sea lamprey (*P. marinus*) populations in the Great Lakes, but its mechanism of toxicity is unresolved. Due to its structural similarity to phenolic compounds known to inhibit mitochondrial ATP production, one hypothesis on the mode of action of TFM is that it impairs mitochondrial oxidative phosphorylation. A second hypothesis is that TFM targets the gill, interfering with gill ion uptake. Exposure of larval sea lamprey and rainbow trout (*O. mykiss*), to each animal's respective 12-h TFM LC50, resulted in marked disturbances to internal fuel stores, but not ion balance. In the brain and liver, glycogen levels decreased by more than 50% in both species in response to TFM exposure, suggesting that a mismatch between ATP supply and ATP demand occurred. These findings support the hypothesis that death in lamprey and trout exposed to TFM is due to a depletion of ATP and ATP-generating fuels (glycogen). Experiments with isolated mitochondria demonstrated that TFM uncouples mitochondrial oxidative phosphorylation. Impairment of mitochondrial oxidative ATP production was most likely the result of TFM-induced reductions in the proton-motive force, which is needed to drive H^+ flow through the ATP-synthase. In lamprey, TFM caused no disturbances in Na^+ uptake, suggesting that it does not compromise lamprey gill function. In trout, TFM exposure resulted in a 60% reduction in Na^+ uptake, which may have been caused by a shortfall in ATP supply for gill Na^+/K^+ ATPases. The knowledge that TFM uncouples mitochondrial oxidative phosphorylation and the effects that it has on energy stores in lamprey and trout could help better predict target and non-target sensitivity to TFM.

Acknowledgements

I would like to thank my supervisor, Dr. Michael P. Wilkie, for his valuable advice and input into my thesis. I would also like to thank my committee members, Drs. Deborah MacLatchy, James McGeer and Grant McClelland, for their help and guidance. I am grateful to Yvonne Kara and Matthew Henry for all their help with the assays and experiments, as well as to the Wilkie, McGeer and McClelland labs for their support. I would like to especially thank Drs. McGeer, McClelland and Diano Marone for allowing me to use the atomic mass absorption spectrophotometer, the Clarke Type II oxygen electrode and the confocal microscope, respectively, and I am also grateful to Gena Braun for training me on some of these instruments. I also thank Jason Brown and Richelle Mader-Monaghan for putting me on the right path to finishing Chapter 4, and Brian Stephenson and the Sea Lamprey Control Center for providing the certified TFM standards and for allowing me to witness and assist with a TFM stream treatment. Lastly, I would like to thank my family and my fiancée, Ovidiu Bistrrian, for all their help and patience as I was completing my thesis.

TABLE OF CONTENTS

Abstract	ii
Acknowledgements	iii
Table of Contents	iv
List of Tables	ix
List of Figures	xi
Chapter 1: History of TFM Application, Hypotheses on its mode of action and a Need to Determine the Mechanism of Toxicity	1
The Biology and Life History of the Sea Lamprey (<i>P. marinus</i>)	2
The Invasion of the Great Lakes by Sea Lamprey	3
Initial Efforts to Control the Sea Lamprey Population	4
The Discovery of Lampricides	5
Characteristics of a Lampricide Treatment	6
TFM Toxicity and the Need to Improve TFM Treatment Effectiveness	7
Determining the Mechanism of TFM Toxicity	9
Thesis Objectives	14
Figures	17
Chapter 2: Failure of ATP Supply to Match ATP Demand: The Mechanism of Toxicity of the Lampricide, 3-trifluoromethyl-4-nitrophenol (TFM) Used to Control Sea Lamprey (<i>Petromyzon marinus</i>) Populations in the Great Lakes	25

Abstract	26
Introduction	27
Material and Methods	30
Experimental Animals and Holding	30
Experimental Protocol	30
<i>Determination of the Acute Toxicity of TFM</i>	30
<i>Effects of TFM on Lamprey Metabolism and</i>	
<i>Plasma Ion Balance</i>	31
<i>Effects of TFM on Gill Ion Uptake and Whole Body Ion</i>	
<i>Balance</i>	33
Analytical Techniques	35
<i>Blood and Tissue Processing and Analysis</i>	35
<i>Gill Na⁺/K⁺ ATPase Activity Determination</i>	37
<i>Determination of Na⁺ Uptake</i>	38
Calculations and Statistical Analysis	38
Results	39
Determination of the Acute Toxicity of TFM	39
Effects of TFM on Larval Lamprey Metabolism	39
Effects of TFM on Lamprey Ion Balance and Haematology	41
Discussion	43
Effects of TFM on Energy Stores	43
Effects of TFM on Ion Balance and Haematology	48

Mechanism of TFM Toxicity – Relevance for Field Applications and Risk Assessment	49
Tables	52
Figures	55
Chapter 3: The Mechanism of Toxicity of the Lampricide, 3-trifluoromethyl-4-nitrophenol (TFM), in a Non-Target Fish, the Rainbow Trout (<i>Oncorhynchus mykiss</i>)	67
Abstract	68
Introduction	69
Material and Methods	72
Experimental Animals and Holding	72
Experimental Protocol	72
<i>Determination of the Acute Toxicity of TFM</i>	72
<i>Effects of TFM on Rainbow Trout Metabolism</i>	73
<i>Effects of TFM on Trout Ion Balance and Haematology</i>	74
Analytical Techniques	76
<i>Blood and Tissue Processing and Analysis</i>	76
<i>Gill Na⁺/K⁺ ATPase Activity Determination</i>	78
<i>Determination of Na⁺ Uptake</i>	79
Calculations and Statistical Analysis	79
Results	80
Determination of the Acute Toxicity of TFM in Trout	80

Effects of TFM on Rainbow Trout Metabolism	80
Effects of TFM on Trout Ion Balance and Haematology	82
Discussion	84
Effects of TFM on Energy Stores in Rainbow Trout	84
Effects of TFM on Ion Balance and Haematology in Rainbow Trout	90
Mechanism of TFM of TFM Toxicity in Rainbow Trout – Relevance for Field Applications and Risk Assessment	91
Tables	93
Figures	96
Chapter 4: TFM-Induced Mismatches Between ATP Supply and ATP Demand in Sea Lamprey (<i>Petromyzon marinus</i>) and Rainbow Trout (<i>Oncorhynchus mykiss</i>) Are Due to Inhibited Mitochondrial ATP Production	114
Abstract	115
Introduction	116
Material and Methods	119
Experimental Animals and Holding	119
Isolation of Mitochondria	119
Measurement of Mitochondrial Oxygen Consumption Rates	121
Measurement of Mitochondrial Membrane Potential	123
Qualitative Assessment of Mitochondrial Fluorescence	125

Statistical Analysis	125
Results	126
Discussion	129
Figures	137
Chapter 5: An Integrated Model of TFM Toxicity in Sea Lamprey (<i>Petromyzon marinus</i>) and Non-Target Rainbow Trout (<i>Oncorhynchus mykiss</i>)	147
An Overview of the Integrated Responses of Sea Lamprey and Trout to TFM	148
Model of the Mechanism of Toxicity of 3-trifluoromethyl- 4-nitrophenol (TFM)	148
Implications for TFM Field Treatments	152
Future Directions	153
Conclusions	155
Figures	156
References	160
Appendix A – List of Abbreviations	179

LIST OF TABLES

Chapter 2

- Table 2-1. Blood hemoglobin (Hb), hematocrit (Hct), mean cell hemoglobin concentration (MCHC), plasma Na^+ , plasma Cl^- , and tissue water in larval lamprey exposed to toxic concentrations of TFM (12-h $\text{LC}_{50} \sim 4.6 \text{ mg l}^{-1}$). 52
- Table 2-2. The effects of toxic doses of TFM (12-h $\text{LC}_{50} \sim 2.0 \text{ mg l}^{-1}$ TFM) upon whole body ion concentrations in larval lamprey. 53
- Table 2-3. Na^+ uptake, gill Na^+/K^+ ATPase activity (specific and wet weight activity) and gill protein concentration in larval sea lamprey exposed to their respective 12-h TFM LC_{50} in City of Hamilton dechlorinated tap water (2.0 mg l^{-1} , Na^+ uptake experiments) and Wilfrid Laurier University well water (4.6 mg l^{-1} , gill Na^+/K^+ ATPase activity and protein concentration). 54

Chapter 3

- Table 3-1. The haematology, blood glucose and lactate concentrations, and muscle water content in rainbow trout exposed to toxic concentrations of TFM (12-h $\text{LC}_{50} \sim 12.8 \text{ mg l}^{-1}$). 93
- Table 3-2. The effects of toxic concentrations of TFM (12-h $\text{LC}_{50} \sim 11.0 \text{ mg l}^{-1}$ TFM) upon whole body ion concentrations in rainbow trout. 94

Table 3-3. Gill Na⁺/K⁺ ATPase activity (specific and wet weight activity) and protein concentration in rainbow trout exposed to their respective 12-h TFM LC50 (4.6 mg l⁻¹) in Wilfrid Laurier University well water. 95

LIST OF FIGURES

Chapter 1

Figure 1-1. Molecular Structure of TFM and 2,4-DNP.	17
Figure 1-2. Application of TFM to Streams.	19
Figure 1-3. Ion Uptake Model at the Level of the Gill in Freshwater Fishes.	21
Figure 1.4. Mitochondrial Oxidative Phosphorylation.	23

Chapter 2

Figure 2-1. Effects of TFM on Brain Glycogen and Lactate in Lamprey.	55
Figure 2-2. Effects of TFM on Brain ATP and PCr in Lamprey.	57
Figure 2-3. Effects of TFM on Liver Glycogen and Lactate in Lamprey.	59
Figure 2-4. Effects of TFM on Liver ATP and PCr in Lamprey.	61
Figure 2-5. Effects of TFM on Muscle Glycogen and Lactate in Lamprey.	63
Figure 2-6. Effects of TFM on Muscle ATP and PCr in Lamprey.	65

Chapter 3

Figure 3-1. Effects of TFM on Brain Glycogen and Lactate in Trout.	96
Figure 3-2. Effects of TFM on Brain ATP and PCr in Trout.	98
Figure 3-3. Effects of TFM on Liver Glycogen and Lactate in Trout.	100
Figure 3-4. Effects of TFM on Liver ATP and PCr in Trout.	102
Figure 3-5. Effects of TFM on Kidney Glycogen and Lactate in Trout.	104
Figure 3-6. Effects of TFM on Kidney ATP and PCr in Trout.	106
Figure 3-7. Effects of TFM on Muscle Glycogen and Lactate in Trout.	108
Figure 3-8. Effects of TFM on Muscle ATP and PCr in Trout.	110

Figure 3-9. Effects of TFM on Na ⁺ Influx Rate in Rainbow Trout.	112
Chapter 4	
Figure 4-1. Effects of TFM and kCh on Lamprey and Rainbow Trout Mitochondria.	137
Figure 4-2. Effects of TFM and 2,4-DNP on Sea Lamprey Mitochondrial Respiration.	139
Figure 4-3. Effects of TFM and 2,4-DNP on Rainbow Trout Mitochondrial Respiration.	141
Figure 4-4. Effects of TFM and 2,4-DNP on Mitochondrial Membrane Potential.	143
Figure 4-5. Qualitative effects of TFM and 2,4-DNP on Sea Lamprey and Rainbow Trout Mitochondrial RH123 Uptake.	145
Chapter 5	
Figure 5-1. Model for the Mechanism of Toxicity of TFM.	156
Figure 5-2. Integrating <i>In vivo</i> and <i>In vitro</i> Studies on the Mode of Action of TFM in Sea Lamprey and Rainbow Trout.	158

Chapter 1

History of TFM Application, Hypotheses on its Mode of Action and a Need to Determine the Mechanism of Toxicity

The Biology and Life History of the Sea Lamprey (*Petromyzon marinus*)

Sea lamprey (*Petromyzon marinus*) spend most of their life (generally 3 – 7 years) burrowed in the sediment of rivers and streams as filter-feeding larvae called ammocoetes (Beamish and Potter 1975; Youson 1980). This prolonged life history stage is characterized by a low metabolic rate (Lewis and Potter 1975; Lewis 1980), and the consumption of detritus and diatoms of low digestibility (Youson 1980; Sutton and Bowen 1994). As the larval lamprey develop, they gradually increase their lipid stores, which become a critical fuel reserve used during metamorphosis, a non-trophic (non-feeding) life stage of both anadromous and landlocked sea lamprey populations (Lowe et al. 1973; Beamish and Potter 1975; O'Boyle and Beamish 1977; Youson 1980; Youson et al. 1993).

After sufficient lipid stores have accumulated, larval sea lamprey undergo a prolonged (several months) metamorphosis characterized by complex structural and physiological changes (Youson 1980, 2003). These changes include the development of eyes, changes in body coloration, and a reorganization of the internal organs including the liver and kidneys (Youson and Potter 1979; Youson 1980). Pronounced changes also take place in the organization of the feeding and breathing organs, and include the development of an oral disc (buccal funnel), which lamprey use to attach to fishes, and a rasping tongue, which penetrates the hide of fishes, giving them access to the fish's blood during the subsequent parasitic stage of their life cycle. The gills are also re-organized, switching from a unidirectionally ventilated respiratory organ to a tidally ventilated gill, in which water is pumped in and out of the gill pouches, allowing the fish to breathe while attached to its host (Youson 1980; Rovainen 1969; Bence et al. 2003).

Following metamorphosis, parasitic sea lamprey migrate downstream, to waters of the northwest Atlantic (anadromous populations) or to the fresh waters of the Great Lakes and other adjacent waters (landlocked populations; Beamish and Potter 1975; Youson 1980). A parasitic lamprey can stay attached to its host for variable amounts of time (days to weeks), and the consumption of blood by the lamprey frequently leads to the death of the host due to blood loss or secondary infections (Lawrie 1970; Farmer et al. 1975).

At the conclusion of the 1.5-2 year parasitic stage, sea lamprey cease feeding and migrate up freshwater streams, spawn and then die (Beamish and Potter 1975; Youson 2003). Factors such as water temperature, photoperiod, size of the lamprey, lipid store levels and river discharge are thought to play a role in initiating migratory behaviour (Applegate 1950; Beamish and Potter 1975; Youson 1980; Beamish 1980). The detection of bile-acids secreted by resident larval sea lamprey are also thought to act as pheromones that help the up-stream migrant lamprey locate streams with suitable spawning habitat (Applegate 1950; Li et al. 1995; Li and Sorensen 1997; Bjerselius et al. 2000). The up-stream migrant males also secrete another bile-based pheromone to attract the females to their nests (Li et al. 2002).

The Invasion of the Great Lakes by Sea Lamprey

Historical records of sea lamprey spawning in Lake Ontario in the early 1800s (Lark 1973), and more recent genetic studies suggest that the sea lamprey are native to Lake Ontario and that they naturally migrated into the lake via the St. Lawrence River following the last ice age (Waldman et al. 2004; Bryan et al. 2005). However, their presence in the Great Lakes was confined to Lake Ontario by Niagara Falls, which

prevented migration into Lake Erie and the other Great Lakes. The construction of the Welland Canal, however, allowed sea lamprey to circumvent Niagara Falls and subsequently invade Lake Erie and the Upper Great Lakes in the late 19th and early 20th century. The lamprey invasion resulted in significant declines in economically important fish populations such as lake trout (*Salvelinus nemaychus*), whitefish (*Coregonus linnaeus*) and lake herring (*Coregonus artedii*; Lawrie 1970; Smith and Tibbles 1980). The sea lamprey invasion (1930-1967), combined with the effects of overfishing, caused the collapse of many fisheries, including the lake trout fishery (Lawrie 1970). In 1946, the Great Lakes Sea Lamprey Committee was established to coordinate initial efforts to control the sea lamprey population (Lawrie 1970; McDonald and Kolar 2007). Nine years later, the Great Lakes Fisheries Commission (GLFC) was established as a bi-national partnership between Canada and the U.S., with the mandate to “eradicate and minimize the sea lamprey population” (GLFC 1955).

Initial Efforts to Control the Sea Lamprey Population

The first objective of the GLFC was to determine the extent of the lamprey invasion by monitoring commercial catches of affected fish species and surveying streams and rivers to locate spawning grounds (Lawrie 1970). The first measures taken to control sea lamprey populations were electrical barriers constructed on spawning streams in the 1940s. However, these were eventually abandoned because they did not reduce the adult population as expected, and they also negatively impacted the non-target fish populations (Lawrie 1970; Smith and Tibbles 1980).

The current integrated pest management sea lamprey control program involves: the trapping of migrating adults to reduce the number of spawners (Mullett et al. 2003; Li et al. 2007); the operation of low-head barrier dams to prevent up-stream migration (Lavis et al. 2003); the release of sterile males to compete for females (Twohey et al. 2003); and the application of lamprey specific lampricides [3-trifluoromethyl-4-nitrophenol (TFM) and niclosamide (Bayluscide®)] to control sea lamprey populations. The most effective method of control has proven to be the lampricides, which are applied in concentrations that eradicate larval sea lamprey, but usually have only minimal effects on non-target fish populations (McDonald and Kolar 2007).

The Discovery of Lampricides

Due to the lack of effectiveness of the electrical barriers and traps used in the 1940s, extensive research began in early 1950s to discover a water soluble compound that was selectively toxic to larval sea lamprey, but harmless to the non-target fish and invertebrate populations. Out of the 6000 chemicals tested, 3-trifluoromethyl-4-nitrophenol (TFM; Fig. 1-1a) was determined to be the most effective (Applegate et al. 1961). As a consequence, a chemical control program was implemented in 1958 in Lake Superior tributaries (Applegate et al. 1961), and then extended to the other Great Lakes over the next decade (McDonald and Kolar 2007). In 1963, the molluscicide niclosamide (Bayluscide®) was also found to be toxic to larval lamprey populations, alone and in combination with TFM (Howell et al. 1964), which reduced the amounts of TFM required to treat larger streams and rivers. However, niclosamide is more toxic than TFM to non-target organisms and it is rarely used alone (Dawson 2003). Although the application of

TFM in combination with niclosamide has proven to be effective in areas of streams that are characterized by rapidly flowing water, the application of TFM alone is the most widely used method of reducing the larval sea lamprey populations (Dawson 2003; McDonald and Kolar 2007).

Characteristics of a Lampricide Treatment

The treatment of a stream with lampricide consists of four steps: assessment of the larval population, collection of water chemistry and flow data, determination of the mean lethal concentration (MLC) required to kill 99.9% of the larvae, and the application of the lampricide (McDonald and Kolar 2007). The pre-treatment assessment determines the degree of larval lamprey infestation in a particular stream by looking at populations in the main branch and tributaries, as well as the size, age and structure of the larval lamprey population. This information is used to determine the condition factor for the larvae, which is calculated from the measured body length and mass of the larvae ($CF = [(body\ mass\ (g)/length\ (mm)]^3 \times 10^6$; Holmes and Youson 1994). The CF is an important indicator of the likelihood that ammocoetes will complete metamorphosis in the upcoming year, and is therefore an important criterion for determining whether or not a stream will be treated with TFM the following year (McDonald and Kolar 2007; B. Stephenson, Manager, Sea Lamprey Control Center, personal communication).

The MLC is determined by either conducting on-site toxicity tests using larvae and water from the stream of interest, or by using the pH-alkalinity model described in Bills et al. (2003). The latter is the preferred method, particularly for streams where there is an abundance of data collected from previous years (B. Stephenson, Manager, Sea

Lamprey Control Center, personal communication). Once the MLC is calculated, the treatment crew managers then determine the target concentration and application rates of TFM, and the location of booster sites to counter the lampricide loss due to dilution as the chemical moves downstream (McDonald and Kolar 2007).

There are two lampricide application methods. The first is the “sprinkler” method (Fig. 1-2a), where TFM is released directly into the water column at a pre-determined rate through a perforated hose to ensure optimal mixing at the initial application site on the main branch and tributaries. The second is the “drop-jug” method (Fig. 1-2b), where perforated jugs of TFM are set downstream from the main application site to boost the concentration of lampricide (B. Stephenson personal communication). TFM is applied to the mainstream at the initial application point for 12-13 hours to achieve a 9-h duration where the concentration of TFM is $1.5 \times \text{MLC}$. Water samples are collected periodically, analyzed for TFM, and the TFM application rates are adjusted accordingly, to maintain the desired concentration in the water. When sensitive non-target species (such as the larval lake sturgeon (*Acipenser fulvescens*)) are present in the stream, the concentration of TFM may be adjusted to $1.2 \times \text{MLC}$ to minimize the non-target effects (McDonald and Kolar 2007; B. Stephenson, Manager, Sea Lamprey Control Center, personal communication).

TFM Toxicity and the Need to Improve Treatment Effectiveness

The greater sensitivity of sea lamprey to TFM is thought to mainly be due to their low capacity to detoxify TFM compared to non-target fishes (Lech and Statham 1975; Kane et al. 1993). In fish, the detoxification of TFM, and many other xenobiotics, occurs

through the process of glucuronidation, which is catalyzed by the enzyme uridine diphosphate glucuronosyltransferase (UDPGT; Lech and Statham 1975; Clarke et al. 1991). Glucuronidation involves the addition of glucuronic acid to a lipophilic chemical (e.g. TFM), making the molecule more hydrophilic, which usually decreases its toxicity and makes it easier to excrete (Meech and Mackenzie 1997). Sea lamprey have low amounts of UDPGT, a membrane-bound enzyme primarily found in the hepatic endoplasmic reticulum, which catalyzes the glucuronidation of TFM (Lech and Constrini 1972; Lech and Statham 1975; Clarke et al. 1991; Kane et al. 1994; Vue et al. 2002). The sensitivity of the larval lamprey to TFM is related to their limited ability to use the glucuronidation pathway to metabolize this compound to the same degree as most non-target fish populations (Lech and Statham 1975; Kane et al. 1993).

Although TFM has proven to be effective at controlling the larval sea lamprey populations in the Great Lakes, parasitic sea lamprey numbers are still above desired levels (McDonald and Kolar 2007). In their Vision for the New Millennium (GLFC 2001), the GLFC identified the need to improve lampricide treatment effectiveness in order to reduce TFM use to address the ongoing public concern about the release of pesticides in the environment and to lower the overall costs of TFM treatments, while maximizing treatment effectiveness and minimizing non-target effects.

McDonald and Kolar (2007) summarized a number of key priorities identified by the Lampricide Control Task Force that should be considered to improve the effectiveness of lampricide treatments. These priorities included better knowledge of non-target effects, new lampricide development, better understanding of the biological basis for the selectivity of lampricides, and a more thorough understanding of the mechanisms

of TFM toxicity. The goal of my M.Sc. thesis is to use *in vivo* and *in vitro* techniques to determine the mode of TFM toxicity in larval sea lamprey, and in a representative non-target fish, the rainbow trout (*Oncorhynchus mykiss*).

Determining the Mechanism of TFM Toxicity

TFM causes death by impairing ion uptake by larval sea lamprey, but not by non-target fishes. TFM has been reported to cause morphological changes in larval sea lamprey

gills, suggesting that it might impair gill ion uptake, leading to disruptions in ion homeostasis (Christie and Battle 1963; Mallatt et al. 1984; Mallatt et al. 1994).

Freshwater fishes are faced with a continual influx of water and loss of ions across their gills due to the presence of large inwardly directed osmotic gradients and outwardly directed electrochemical gradients for ions (Marshall 2002; Evans et al. 2005). In response to these unfavorable conditions, freshwater fishes excrete copious amounts of dilute urine and they also take up ions (Na^+ , Cl^- , Ca^{2+}) from the water using active transport processes in the gills (Marshall 2002; Fig. 1-3). For instance, Na^+ uptake is thought to take place via Na^+ channels found in the apical membrane of the fish gill down electrochemical gradients that are maintained by apical H^+ -ATPase pumps and Na^+/K^+ -ATPase pumps found on the basolateral membrane (Avella and Bornancin 1989; Lin and Randall 1993; Sullivan et al. 1995). This Na^+/K^+ -ATPase pump moves the Na^+ from the gill cytosol into the blood against the large outwardly directed gradient that is present between the blood and water. Calcium is taken up in an analogous manner, while Cl^- is taken up via apical $\text{Cl}^-/\text{HCO}_3^-$ transporters found in the same mitochondria rich cells. Many studies have shown that these transport processes can be inhibited by toxins (e.g.

metals such as lead, cadmium), changes in water pH, or hardness, which lead to disruption of ion homeostasis, and eventually cause death of the fish (e.g. Rogers et al. 2003; Taylor et al. 2003; Birceanu et al. 2008).

The possibility that TFM interferes with ionoregulation was also raised by Mallatt and colleagues (1984, 1993). Mallatt and colleagues (1984) observed the formation of spaces between cells, vacuolization within cells, and mitochondrial swelling in the ion-uptake cells of TFM exposed lamprey. The authors also reported extensive mitochondrial damage to mitochondria rich (MR) cells, which could impair the ion-uptake capabilities of these cells. The damage observed in lamprey gills was not observed, however, in chloride cells of the trout exposed to their respective TFM LC99.9. These findings suggested that the mechanism of TFM toxicity in lamprey could be related to reductions in plasma ions such as Na^+ and Cl^- , and Ca^{2+} and/or related osmotic disturbances. Moreover, this work also raised the possibility that the specificity of TFM to lamprey could be related to a greater sensitivity of lamprey gills to TFM. Recently, Wilkie et al. (2007a) reported that there were no significant changes in the plasma Cl^- concentration of larval lamprey exposed to TFM (12-h LC50) suggesting that if there was gill damage (c.f. Mallatt et al. 1984, 1994), it did not significantly impair internal ion balance. Wilkie et al. (2007a) did propose that the potential ionic disturbances could be a secondary effect of TFM exposure, rather than a direct mode of toxicity. However, it should be noted that the exposure concentrations in the Mallatt et al. (1984, 1994) study were much higher, leaving the possibility that TFM could still result in ionic disturbances when fish were exposed to concentrations of TFM normally used in the field (1-1.5 \times the LC99.9). Accordingly, one goal of my thesis was to examine the effects of TFM upon gill

mediated ion exchange and internal ion balance in greater detail, in both larval sea lamprey and rainbow trout.

TFM causes death by uncoupling mitochondrial oxidative phosphorylation, thus depleting the nervous system of glycogen and ATP. Oxidative phosphorylation is the process by which the energy obtained from oxidation of nutrients is utilized to generate ATP from ADP + P_i (Voet et al. 2006; Fig. 1-4). In eukaryotes, oxidative phosphorylation occurs in the mitochondria as electrons are passed down the electron transport chain (ETC) in a series of redox reactions. The ETC is comprised of four protein complexes (I, II, III, and IV) found in the inner membrane of the mitochondria. As the electrons are passed from one complex to another, complexes I, III and IV pump protons (H⁺) from the mitochondrial matrix into the inner membrane space, which generates a proton gradient (or proton-motive force; Fig. 1-4). Because the inner membrane is usually not permeable to H⁺ ions, the H⁺ flow back into the matrix down their electrochemical gradients via ATP synthase. The ATP synthase harnesses the energy released by this inward H⁺ flow, leading to the formation of ATP from ADP (phosphorylation). In this manner, the formation of ATP and the movement of electrons across the ETC are said to be coupled, and the whole process is referred to as oxidative phosphorylation (McLaughlin and Dilger 1980; Wallace and Starkov 2000; Voet et al. 2006).

Several xenobiotics, mostly pesticides, are known to cause death by disrupting the process of oxidative phosphorylation. These compounds are able to disrupt either the movement of electrons across the ETC, or increase the permeability of the inner membrane to protons, thus reducing the electromotive force for inward H⁺ movement

(McLaughlin and Dilger 1980; Wallace and Starkov 2000). The net effect of either process is a reduced H^+ gradient, and a reduction or prevention of ATP formation (phosphorylation), which is referred to as an “uncoupling of oxidative phosphorylation” (Wallace and Starkov 2000). As a result, ATP supply may no longer be sufficient to meet ATP demands in the body. If the disturbance is severe, the depletion of ATP supply to the organs, such as the brain, could eventually lead to death of the organism.

When oxidative phosphorylation becomes uncoupled, the passage of electrons along the ETC is accelerated, in an attempt to restore the H^+ gradient. Therefore, there is an increase in oxygen consumption and the inner mitochondrial membrane becomes depolarized. Due to TFM's similar molecular structure to known uncouplers of oxidative phosphorylation, such as 2,4-dinitrophenol (2,4-DNP; Fig. 1-4), it has been hypothesized that the lampricide causes death in larval lamprey and non-target fishes by uncoupling mitochondrial oxidative phosphorylation (Applegate 1950; Kawatski and McDonald 1974; Niblett and Ballantyne 1976), leading to increased oxygen consumption by mitochondria (Wallace and Starkov 2000; Voet et al. 2006). Indeed, Niblett and Ballantyne (1976) noted an increase in oxygen consumption in mitochondria isolated from rats exposed to TFM, without corresponding increases in ADP utilization by the mitochondria. Moreover, these uncoupling effects of TFM on mitochondrial respiration were more pronounced than those of 2,4-DNP. However, these findings were never validated by comparable work in sea lamprey or non-target fishes, in which the evidence favoring TFM-induced uncoupling of oxidative phosphorylation is limited. Smith and King (1960) reported that the oxygen consumption rate of intact lamprey increased in the presence of TFM, indirectly supporting the hypothesis that TFM uncouples oxidative

phosphorylation in fish. Further evidence was provided by Kawatski and McDonald (1974), who reported an increase in oxygen consumption in the brain of trout, and in the liver of the blue gill (*Lepomis macrochirus*), when fishes were exposed to TFM.

Wilkie et al. (2007a) observed that while there were no changes in whole body ATP, pyruvate and glycogen concentrations in TFM-exposed lamprey, the concentration of glucose in the plasma significantly decreased after a 12 h exposure. They suggested that this glucose depletion may have been due to increased reliance on glycolysis to produce ATP due to TFM-induced reductions in oxidative phosphorylation. The authors did not observe any change in whole body ATP levels. However, any disturbance to ATP concentrations would have been offset by the hydrolysis of phosphocreatine (PCr) via creatine phosphokinase (CK). This would cause a decrease in PCr before any change would be seen in ATP, which is what the authors demonstrated in their study. Similar findings were reported in mollusks by Viant et al. (2001), where the authors concluded that after exposure to TFM, mitochondrial ATP formation was impeded. While the findings of Wilkie et al. (2007a) and Viant et al. (2001) support the prediction that TFM exposure results in a mismatch between ATP supply and ATP demand, neither study directly demonstrated that TFM uncoupled oxidative phosphorylation. Moreover, Wilkie et al. (2007a) suggested that death could arise from neural arrest due to a lack of glucose/glycogen to energize nervous system activity. It remains unclear from their work whether or not TFM caused the mismatch in ATP balance by increasing ATP demands, restricting ATP supply, or both. Moreover, the hypothesis that TFM caused death by starving the nervous system of glucose has not been verified by measuring glycogen and its metabolites (e.g. lactate) in critical tissues such as the brain and the liver. Accordingly,

another goal of my thesis was to determine how TFM exposure influenced energy reserves, such as glycogen, ATP and PCr, in the brain, liver and muscle of lamprey and trout exposed to sub-lethal concentrations of TFM. I predicted that TFM exposure would result in a depletion of these energy reserves in lamprey and trout, and that death would result when ATP was no longer available to satisfy the requirements of the body.

While such measurements of tissue energy reserves could potentially demonstrate that TFM causes death by causing a mismatch in ATP supply and ATP demand, such experiments would not directly indicate if TFM interfered with ATP supply by uncoupling oxidative phosphorylation. The final goal of my thesis was to use mitochondria isolated from rainbow trout and lamprey to test the hypothesis that TFM does in fact interfere with oxidative phosphorylation in the mitochondria.

Thesis Objectives

The toxic effects of TFM on larval lamprey and on non-target fish populations have been extensively studied (e.g. Applegate and King 1961; Bills et al. 2003; Boogaard et al. 2003), but the actual mechanism of TFM toxicity remains unknown. Therefore, the major objective of my M.Sc. thesis was to determine the mechanisms of TFM toxicity to larval sea lamprey and a representative non-target fish species, the rainbow trout. To achieve this goal, I tested the following three hypotheses addressing the mode of TFM toxicity in sea lamprey and rainbow trout:

Hypothesis I. TFM causes reductions in glycogen in the liver and brain due to a mismatch between ATP supply and ATP demand, and are the actual cause of mortality in sea lamprey and non-target fishes (Chapters 2, 3).

Hypothesis II. The death of lamprey exposed to toxic concentrations of TFM results from internal ion imbalances arising from TFM-induced interference with gill mediated ion uptake (Chapters 2, 3).

Hypothesis III. TFM interferes with ATP supply by inhibiting oxidative phosphorylation in the mitochondria (Chapter 4).

Hypotheses I and II were tested in larval lamprey and rainbow trout, respectively, by exposing the fish to TFM (12-h LC50), and collecting tissues (brain, liver, muscle, blood) at different time intervals. I then quantified energy stores and metabolites in these tissues to determine if TFM caused an imbalance in ATP supply and ATP demand. I also measured Na^+ uptake, gill Na^+/K^+ ATPase activity, and plasma and whole body ion (Na^+ , Cl^- , Ca^{2+} and K^+) concentrations to determine if TFM exposure interfered with gill mediated ion uptake leading to potentially toxic internal ion imbalances.

Hypothesis III was investigated using mitochondria isolated from the livers of upstream migrant sea lamprey and rainbow trout. I then exposed the isolated mitochondria to a range of TFM concentrations that these fish would likely experience if exposed to TFM in the field. To determine if TFM uncoupled oxidative phosphorylation, I then monitored its effects on mitochondrial respiration (Chapter 4).

Ultimately, my thesis will provide insight into the mechanism of TFM toxicity, and provide data on the sub-lethal effects of the lampricide in both lamprey and non-target species. Identifying the mode of action of TFM will also help fisheries managers better predict non-target species sensitivity, and determine the time of year when larval lamprey and non-target fishes are most sensitive to the lampricide. By allowing sea

lamprey control personnel to schedule TFM treatments when larval lamprey are most sensitive, it could further reduce the amount of pesticide that is released in the environment and lower treatment costs. Moreover, understanding the mode of action of the lampricide will help explain the seasonal variation in TFM sensitivity that has been recently noted by Scholefield et al. (2008) in sea lamprey.

Figure 1-1. Molecular Structure of TFM and 2,4-DNP. The lampricide TFM (a) is believed to exert its toxicity by uncoupling mitochondria oxidative phosphorylation because of its structural similarity to a known uncoupler, 2,4-dinitrophenol (2,4-DNP; b).

(a)

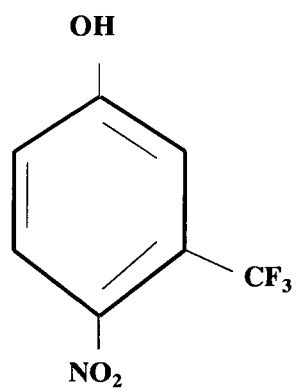

TFM

(b)

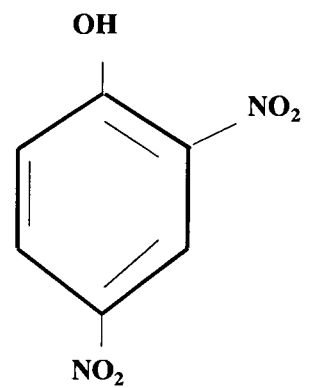

2,4-DNP

Figure 1-2. Application of TFM to Streams. There are two different methods that are currently used to apply TFM to the streams: the “sprinkler” method (a) and the “drop-jug” method (b). The “sprinkler” method is used to release TFM directly into the water column at a pre-determined rate through a perforated hose to ensure optimal mixing at the initial application site on the main branch and tributaries. The “drop-jug” method uses perforated jugs of TFM that are set downstream from the main application site to boost the concentration of lampricide (B. Stephenson personal communication). Pictures by O. Birceanu.

(a)



(b)

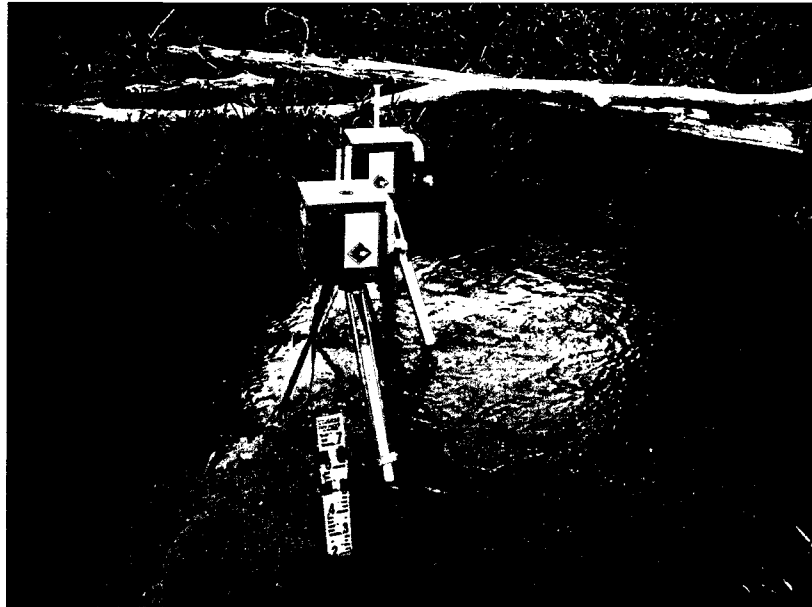

Figure 1-3. Ion Uptake Model at the Level of the Gill in Freshwater Fishes.

The model describes the uptake of various ions (Na^+ , Cl^- and Ca^{2+}) from fresh water, at the apical side of the chloride cell (CC), and the eventual transfer of these ions into the body of the fish via ATP-driven enzymes (solid circles) and exchangers (open circles) at the basolateral membrane. Ion channels are denoted by the horizontal lines, while the arrows indicate ion movement in and out of the CC. CA = carbonic anhydrase; PVC = pavement cell. Model adapted from Marshall (2002).

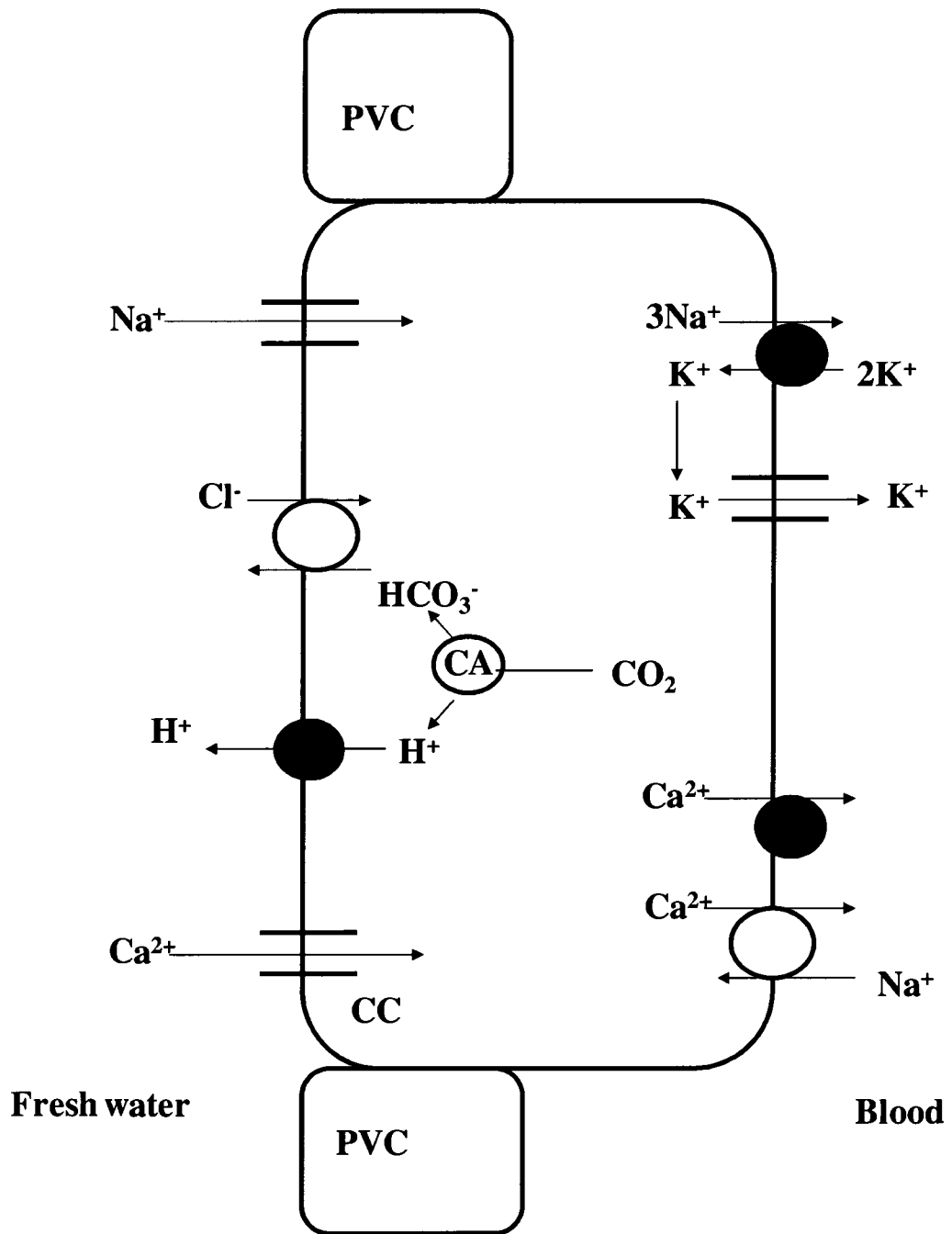
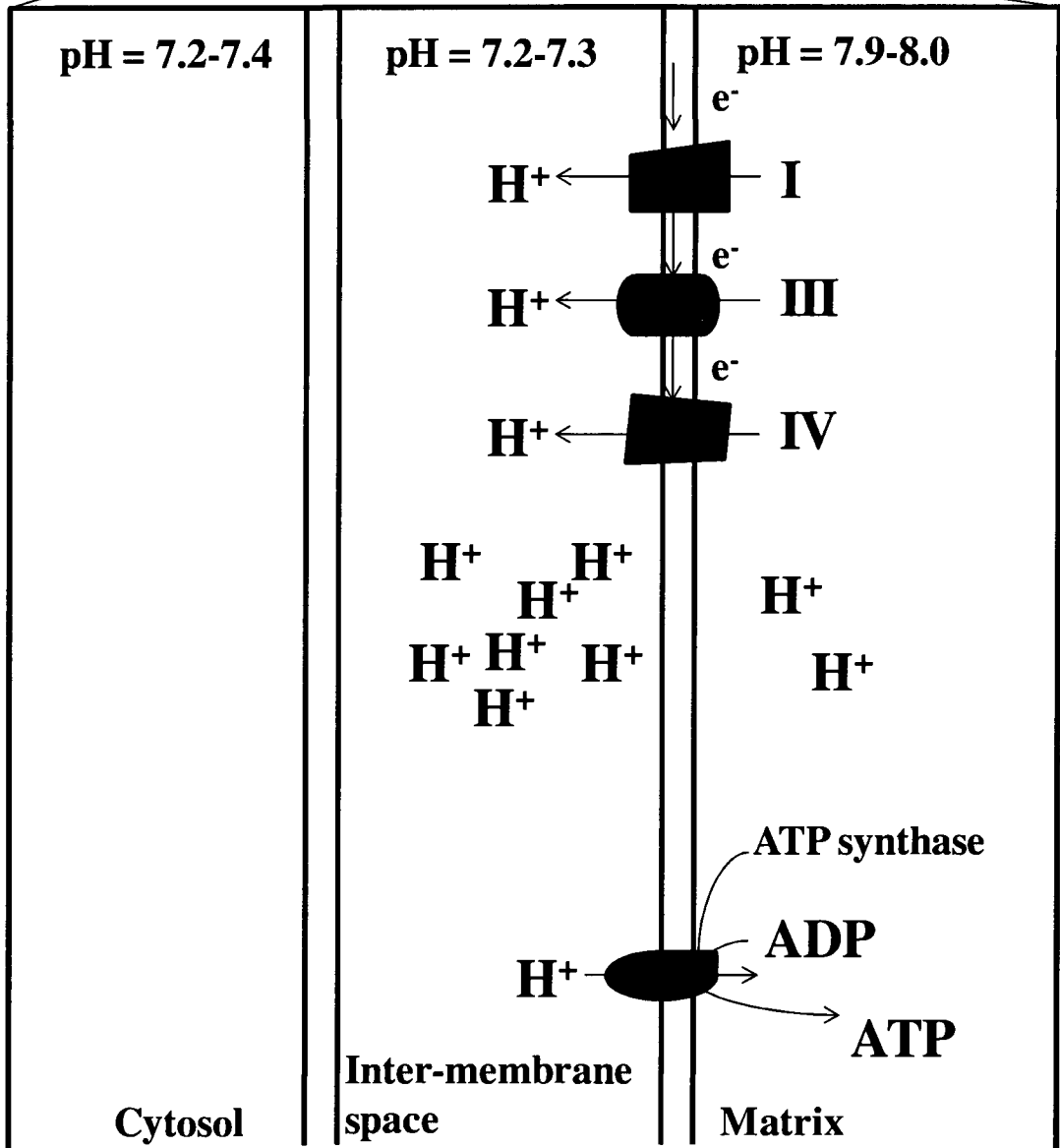

Figure 1-4. Mitochondrial Oxidative Phosphorylation. Simplified schematic of the oxidative phosphorylation process at the level of the mitochondria. As protein complexes I, III and IV of the electron transport chain located in the inner mitochondrial membrane pass electrons down, they release a proton (H^+) in the inner-mitochondrial membrane. This creates a proton gradient or proton motive force that drives ATP formation. The mitochondrial inner membrane is impermeable to these protons. Therefore, the protons move back into the matrix, down their concentration gradient, through ATP-synthase. This process drives the phosphorylation of ADP to ATP, thus producing the high energy molecule that drives all the energy consuming processes in the cell. Figure adapted from Hill et al. (2004).



Mitochondrion



Chapter 2

Failure of ATP Supply to Match ATP Demand: The Mechanism of Toxicity of the Lampricide, 3-trifluoromethyl-4-nitrophenol (TFM), Used to Control Sea Lamprey (*Petromyzon marinus*) Populations in the Great Lakes

Manuscript accepted for publication in Aquatic Toxicology (Accepted July 14, 2009).

(Birceanu, O. et al. In Press. doi: 10.1016/j.aquatox.2009.07.012).

ABSTRACT

The pesticide, 3-trifluoromethyl-4-nitrophenol (TFM), has been extensively used to control invasive sea lamprey (*Petromyzon marinus*) populations in the Great Lakes, but its mechanism(s) of toxicity is unresolved. A better knowledge of the mode of toxicity of this pesticide is needed for predicting and improving the effectiveness of TFM treatments on lamprey, and for risk assessments regarding potential adverse effects on invertebrate and vertebrate non-target organisms. We investigated two hypotheses of TFM toxicity in larval sea lamprey. The first was that TFM interferes with oxidative ATP production by mitochondria, causing rapid depletion of energy stores in vital, metabolically active tissues such as the liver and brain. The second was that TFM toxicity resulted from disruption of gill-ion uptake, adversely affecting ion homeostasis. Exposure of larval sea lamprey to 4.6 mg l⁻¹ TFM (12-h LC50) caused glycogen concentrations in the brain to decrease by 80% after 12 h, suggesting that the animals increased their reliance on glycolysis to generate ATP due to a shortfall in ATP supply. This conclusion was reinforced by a 9-fold increase in brain lactate concentration, a 30% decrease in brain ATP concentration, and an 80% decrease in phosphocreatine (PCr) concentration after 9 h and 12 h. A more pronounced trend was noted in the liver, where glycogen decreased by 85% and ATP was no longer detected after 9 and 12 h. TFM led to marginal changes in whole body Na⁺, Cl⁻, Ca²⁺ and K⁺, as well as in plasma Na⁺ and Cl⁻, which were unlikely to have contributed to toxicity. TFM had no adverse effect on Na⁺ uptake rates or gill Na⁺/K⁺ ATPase activity. We conclude that TFM toxicity in the sea lamprey is due to a mismatch between ATP consumption and ATP production rates, leading to a depletion of glycogen in the liver and brain, which ultimately leads to neural arrest and death.

INTRODUCTION

Sea lamprey (*Petromyzon marinus*) typically spend 3 – 7 years as filter-feeding larvae, burrowed in the sediment of rivers and streams, before undergoing metamorphosis into parasitic lamprey which feed on the blood on teleost fishes (Beamish and Potter 1975; Youson 1980). Following the sea lamprey invasion of the upper Great Lakes in the early 1900s, sea lamprey decimated commercial and recreational fisheries contributing to the near collapse of the lake trout fishery in the mid-part of the century (Lawrie 1970; Smith and Tibbles 1980). Since the late 1950's, the halogenated phenol, 3-trifluoromethyl-4-nitrophenol (TFM) has been used as a selective lampricide which targets larval lamprey in Great Lakes rivers and streams as part of an integrated pest management program to control parasitic sea lamprey populations (Lawrie 1970; Olson and Marking 1973; Smith and Tibbles 1980; Hubert 2003; McDonald and Kolar 2007). However, lampricide treatments are expensive, labor intensive and there is increasing public concern regarding the use of pesticides in general (GLFC 2001). There is therefore a need to better understand the mechanism(s) of TFM toxicity so that more effective TFM treatment protocols can be developed to control sea lamprey populations, and to better assess and manage the risk of potential sub-lethal and lethal adverse effects to non-target vertebrate and invertebrate organisms.

The sensitivity of larval lamprey and non-target fish populations to TFM have been described in many acute toxicity studies (e.g. Applegate and King 1962; Bills et al. 2003; Boogaard et al. 2003). It is known that the maximal concentration of TFM tolerated for juvenile and mature fishes is 3-5 times higher than the concentration required to kill larval lamprey, due the greater ability of most teleosts to detoxify the pesticide by

glucuronidation (Olson and Marking 1973; Lech and Statham 1975; Kane et al. 1994). The actual mechanism of TFM toxicity and its associated physiological disturbances to fishes have been described in only a few studies, however (e.g. Viant et al. 2001; Wilkie et al. 2007a). Applegate et al. (1966) proposed that TFM caused death by impairing ATP production due to TFM's structural similarity to known uncouplers of mitochondrial oxidative phosphorylation, such as 2,4-dinitrophenol (2,4- DNP; Fig. 1-1b). To date, the only direct evidence of mitochondrial uncoupling is in rat liver, where the stimulatory effects of TFM on mitochondrial respiration were more pronounced than those of 2,4-DNP (Niblett and Ballantyne 1976).

Wilkie et al. (2007a) reported that the concentration of glucose in the plasma and the concentration of phosphocreatine (PCr) in whole bodies of larval lamprey significantly decreased as a result of TFM exposure. These data suggested that there was a greater reliance on limited glycogen and glucose reserves for anaerobic ATP production during TFM exposure, supporting the hypothesis that TFM targets ATP supply pathways and/or increases ATP demand. To our knowledge, no research has shown evidence of TFM-induced ATP depletion or anaerobic substrate depletion in essential fuel storage areas such as the liver, or in the brain of lamprey which contain relatively large glycogen reserves compared to other vertebrates (Rovainen 1970; Rovainen et al. 1971). To test the hypothesis that TFM exposure resulted in a mismatch between ATP supply and ATP demand, we exposed larval lamprey to TFM (the 12-h LC50) and measured changes in tissue glycogen, ATP, PCr, and lactate at different intervals. The 12 h exposure period matches the duration of actual TFM treatments in the field (Hubert 2003).

TFM has also been shown to target the gills (Christie and Battle 1963) and cause ultrastructural changes in the mitochondria rich cells (MR cells, ionocytes or ion uptake cells), which are involved in gill-mediated ion uptake (Mallatt et al. 1985, 1994). These findings suggest that TFM might also compromise internal ion homeostasis. Accordingly, the additional hypothesis that TFM interferes with gill-mediated ion uptake was tested by measuring Na^+ uptake, gill Na^+/K^+ ATPase activity, and blood and whole body ion concentrations in lamprey.

MATERIAL AND METHODS

Experimental Animals and Holding

Larval sea lamprey (*P. marinus*, 1-2 g, 9-12 cm in length) were provided courtesy of the US Geological Survey (USGS) out of the Hammond Bay Biological Station (Millersburg, MI, USA), and held in 500 l tanks receiving Wilfrid Laurier University well water on a flow-through basis (pH ~ 8.0; titratable alkalinity ~ 200 mg CaCO₃ l⁻¹; hardness ~ 450 mg CaCO₃ l⁻¹; temperature ~ 10-13 °C). The tanks were lined with fine silica sand (4-5 cm deep) to provide substrate for the burrow-dwelling larvae, which were held under a 12 h light:12 h dark photoperiod, and fed weekly with baker's yeast (2 g yeast per larva; Holmes and Youson 1994; Wilkie et al. 1999). The animals were held in the lab for approximately 4 months before experiments commenced. Prior to experiments, larvae were starved for 72 h. Experiments and fish husbandry were approved by the Wilfrid Laurier University Animal Care Committee and followed Canadian Council of Animal Care guidelines.

Experimental Protocol

Determination of the Acute Toxicity of TFM

To establish TFM exposure concentrations in Wilfrid Laurier well-water, two separate toxicity range finder experiments were conducted by exposing the larvae to nominal TFM concentrations of 0.0, 0.5, 1.0, 2.5, 5.0, 10.0, 25.0 mg l⁻¹ TFM for 12 h. In the first experiment, larvae were provided with 2 g of aquarium cotton that was diffusely distributed in the 5 l exposure containers to mimic the burrow-dwelling habitat of the larvae and to minimize stress (thigmokinesis: Rovainen and Schieber 1975). The toxicity

data (12-h LC50) was then compared to the 12-h LC50 measured in the absence of cotton. Because the 12-h LC50 values were identical (4.6 mg/L; see Results), all subsequent TFM exposure experiments were done in the presence of cotton to ensure that changes in metabolic, ionic or haematological status were due to TFM and not excessive activity due to a lack of burrowing substrate. For each toxicity range finder experiment (cotton or no-cotton), a total of 8 fish were exposed to each TFM concentration. The experiments were done in the dark, since larval lamprey are negatively phototactic (Rovainen and Schieber 1975) and TFM is sensitive to photodegradation (Carey and Fox 1981). Field formulation TFM (Clariant SFC GMBH WERK, Griesheim, Germany) was used for all experiments [35% active ingredient dissolved in isopropanol; provided courtesy of Fisheries and Oceans Canada (DFO)], and TFM exposure concentrations verified using precision TFM standards provided by DFO. Water TFM was measured using a 96-well plate spectrophotometer (SpectraMax 190, Molecular Devices, CA), at a wavelength of 395 nm, according to the Standard Operating Procedures of the Department of Fisheries and Oceans, Sea Lamprey Control Centre (IOP: 012.4).

Effects of TFM on Lamprey Metabolism and Plasma Ion Balance

To test the hypothesis that TFM toxicity was associated with an energy imbalance, the effects of TFM on fuel stores (high energy phosphagens, glycogen and glucose) and metabolites (lactate, pyruvate and creatine) were measured in different lamprey tissues (liver, brain, muscle) and blood at pre-determined intervals (1, 3, 6, 9, 12 h) during exposure to the TFM 12-h LC50 (4.6 mg l⁻¹; see Results). Potential haematological and ionic disturbances were also evaluated by measuring blood haemoglobin (Hb)

concentration and haematocrit (Hct), ion concentration in the plasma (Na^+ , Cl^-) and whole body (Na^+ , Cl^- , Ca^{2+} and K^+), muscle water content, and gill Na^+/K^+ -ATPase activity.

Animals were starved for 72 h prior to the beginning of experiments, after which individual larvae were placed in well aerated, darkened chambers containing aquarium cotton (0.2 g per chamber) and 0.5 l of well water approximately 12-24 h prior to TFM exposure. Because the larvae were held under static conditions, approximately 50% of the water was changed before the start of the experiments to minimize the amount of ammonia build-up. Since larval lamprey have very low ammonia excretion rates of between 20-50 $\text{nmol N g}^{-1} \text{h}^{-1}$ (Wilkie et al. 2006, 2007a), ammonia concentrations no greater than 20 $\mu\text{mol l}^{-1}$ would have accumulated in each container, below concentrations known to be toxic to larval sea lamprey (96-h $\text{LC}_{50} = 3 \text{ mmol l}^{-1}$; Wilkie et al. 1999). Water samples were collected at 0, 1, 3, 6, 9 and 12 h of exposure for TFM determination.

The larval lamprey were terminally sampled at 1, 3, 6, 9 and 12 h of TFM exposure or under control conditions (no TFM exposure) with an overdose of tricaine methanesulfonate (MS222) anaesthesia [1.5 g l^{-1} MS222 (Syndel Labs, Vancouver, British Columbia) buffered with 3.0 g l^{-1} NaHCO_3]. Initially, there were 8 fish per TFM exposure time, but the numbers decreased because of mortality prior to the designated sampling time. For this experiment, only surviving fish were sampled, and 50% mortality was achieved after 12 h of exposure. To rule out possible diurnal fluctuations in tissue metabolites, haematology, plasma ions, or whole body ions and water content, control larvae were sampled at time zero, or after 6 h or 12 h of the experiment.

After anesthetization, fish were blotted dry with a paper towel, and their mass and length were measured. An incision was then made through the heart and blood was collected into non-heparinized capillary tubes. A sub-sample of this blood (10 μ l) was immediately mixed with 20 μ l PCA for later determination of lactate and glucose concentrations. A sub-sample of blood (10 μ l) was also mixed with 2.5 ml Drabkin's reagent for haemoglobin determination. Capillary tubes were then centrifuged for 5 minutes at 10,000 $\times g$ for haematocrit determination, and aliquots of the plasma drawn off and frozen at -80 $^{\circ}$ C for later determination of plasma ions (Na^+ , Cl^-). Immediately following blood collection (within 1 minute), the liver, gills, brain and the trunk (minus the remaining viscera except kidney) were removed from each larval lamprey, snap frozen in liquid nitrogen (Wang et al. 1994a), and stored at -80 $^{\circ}$ C until processed for analysis.

Effects of TFM on Gill Ion Uptake and Whole Body Ion Balance

In addition to the plasma ion concentrations and Na^+/K^+ -ATPase activity determination, an additional series of experiments was conducted at McMaster University in dechlorinated, City of Hamilton tap water (pH \sim 8.0; $[\text{Ca}] \sim 930 \mu\text{mol l}^{-1}$; $[\text{Mg}] \sim 400 \mu\text{mol l}^{-1}$; $[\text{Na}] \sim 950 \mu\text{mol l}^{-1}$; temperature \sim 10-13 $^{\circ}$ C; pH \sim 7.4), to determine if TFM directly interferes with gill-mediated Na^+ uptake and whole body ion balance. As described above, a range finder experiment was first conducted to determine the 12-h TFM LC50 (2.0 mg l^{-1} TFM), and to determine the TFM concentration for subsequent exposures (12 -h LC50 = 2.0 mg l^{-1}). Unlike the experiments designed to examine intermediary metabolism, the fish in these experiments were held in 0.5 l of water in

groups of three per container. The Na⁺ influx rate was measured over different 3 h intervals (0-3, 3-6, 6-9, 9-12 h) during TFM exposure. Simultaneous control larvae (no TFM present) were also sampled at time 0, 6 h and 12 h of the experiment to rule out diurnal fluctuations in Na⁺ influx.

To ensure that isotope was adequately mixed in the flux chambers, each 3 h flux determination period was initiated following the addition of ²⁴Na (5 μCi as Na₂CO₃, specific activity 20.0 μCi mg⁻¹) to each container 10 minutes prior to collecting the initial water sample (sample volume = 10 mL). Additional water samples were collected 1 h and 3 h after the flux was initiated. The water samples were then analyzed for cold (non-radioactive) Na⁺ concentration, and total radioactivity. At the end of the flux, the fish were killed by a blow to the head, and then washed in deionized (DI) water for three minutes, followed by a second 3 minute wash in 20 mmol l⁻¹ NaCl, to wash off any externally bound isotope. The gamma counts of ²⁴Na in whole fish and water were then immediately determined using a 1480 Automatic Wallac182 Wizard Gamma Counter (PerkinElmer Life Sciences, Woodbridge, ON).

After ²⁴Na⁺ counts were exhausted (approximately 2 weeks), 5 volumes of 1N HNO₃ was added to a 50 ml centrifuge tube containing a single fish, and the whole bodies digested for 48 h at 60°C. The homogenates were then vortexed, and a sub-sample (1.5 ml) was then withdrawn and centrifuged at 10,000 × g for two minutes. The supernatant was then diluted using deionized water and analyzed using atomic absorption spectroscopy for Na⁺, K⁺, Mg²⁺, and Ca²⁺ concentration using well established protocols.

Analytical Techniques

Blood and Tissue Processing and Analysis

Unless noted, all enzymes and reagents were purchased from the Sigma-Aldrich Chemical Company (St. Louis, MO, USA). Blood haemoglobin concentration was determined using the cyanomethaemoglobin method and sample absorbance read on a plate spectrophotometer (SpectraMax 190, Molecular Devices, CA) at a wavelength of 540 nm. Respective blood lactate and glucose concentrations were determined enzymatically on blood:perchloric acid (1:2 ratio) supernatants using lactate dehydrogenase or hexokinase, and read at 340 nm on the plate spectrophotometer, as described by Bergmeyer (1983).

Whole body Na^+ , K^+ , and Ca^{2+} , and plasma Na^+ , were quantified using atomic absorption spectrophotometry (SpectrAA 880, N_2 gas; Varian, 171 Mississauga, ON); water Na^+ concentrations were determined in a similar manner. Whole body and plasma Cl^- concentrations were determined colorimetrically using the mercuric thiocyanate assay (Zall et al. 1956).

Tissue processing for ATP, PCr, glycogen and metabolite determination is outlined in Wilkie et al. (1997, 2001). Briefly, the frozen trunk was initially pulverized to smaller chunks using a hammer and then muscle chunks were quickly transferred to a liquid N_2 -cooled mortar and pestle. For tissue water analysis, 50 mg frozen tissue was dried at 60°C for 48 h. The remaining frozen pieces of tissue were then ground to a fine powder under liquid N_2 , followed by deproteination in 4 volumes of 8% perchloric acid (PCA) containing 1 mmol l^{-1} ethylenediaminetetraacetic acid (EDTA), left on ice for 10 min, and then split into two sub-samples. Sub-sample one was processed for metabolite

(lactate, pyruvate and creatine) and fuel store (ATP, PCr) determination. Sub-sample two was neutralized with $3 \text{ mol l}^{-1} \text{ K}_2\text{CO}_3$, frozen in liquid N_2 , and saved at $-80 \text{ }^\circ\text{C}$ until processed for glycogen. Sub-sample one (fuels and metabolites) was centrifuged at $10,000 \times g$ for 2 minutes, the supernatant drawn off, weighed and neutralized with 0.5 volumes of $2 \text{ mol l}^{-1} \text{ KOH}$ cocktail (composed of 0.4 mol l^{-1} imidazole and $0.4 \text{ mol l}^{-1} \text{ KCl}$). This solution was then vortexed, centrifuged again, and the supernatant removed and stored at $-80 \text{ }^\circ\text{C}$. The same procedure was used for the brain and the liver samples, except that, due to the small size of these tissues, the PCA solution was added directly to the microcentrifuge tube and the samples were homogenized on ice using a hand held motorized plastic pestle homogenizer (Gerresheimer Kimble Kontes LLC, Düsseldorf, Germany).

The extract arising from sub-sample one was analyzed using enzymatic assays (Bergmeyer 1983) for ATP (hexokinase, using glucose-6-phosphatase as coupling enzyme), PCr (creatine kinase), pyruvate (lactate dehydrogenase; muscle only) and lactate (lactate dehydrogenase). ATP, PCr, creatine, and lactate are each expressed as $\mu\text{mol g}^{-1}$ wet tissue. Tissue glycogen was determined in the second, neutralized extract obtained from sub-sample two, to which one part 2 mol l^{-1} acetate buffer to one part tissue was added, followed by 40 units (U) amyloglucosidase to convert the glycogen to glucose and incubated at $37 \text{ }^\circ\text{C}$ for 2 h. The incubation was terminated by adding 70% PCA to the digest, and then neutralized with $3 \text{ mol l}^{-1} \text{ K}_2\text{CO}_3$. Samples were stored at $-80 \text{ }^\circ\text{C}$ for later analysis of glucose. A second sub-sample of homogenate was saved and later used to determine the free glucose in the tissues, which was subsequently subtracted from the

total glucose in the tissue to yield the glycogen concentration in μmol glucosyl units g^{-1} wet tissue.

Gill Na^+/K^+ -ATPase Activity Determination

Gill processing to determine the effects of TFM exposure on Na^+/K^+ -ATPase activity followed the protocol outlined by McCormick (1993). Briefly, the activity of the Na^+/K^+ -ATPase was calculated as the difference between the uninhibited total activity and ouabain inhibited ATPase activity. The reaction media contained 2.8 mmol l^{-1} phosphoenolpyruvate (PEP), 3.5 mmol l^{-1} ATP, 0.33 mmol l^{-1} NADH, LDH (4 U ml^{-1}) and pyruvate kinase (PK; 5 U ml^{-1}) in imidazole buffer (50 mmol l^{-1}) at pH 7.5. A salt solution containing 50 mmol l^{-1} imidazole buffer, 190 mmol l^{-1} NaCl, 10.5 mmol l^{-1} $\text{MgCl}_2 \cdot 6\text{H}_2\text{O}$ and 42 mmol l^{-1} KCl in deionized water at pH 7.5 was added to the reaction media the day of the assay in a 3:1 ratio, and kept on ice before use.

The gills were processed for Na^+/K^+ -ATPase activity quantification by adding approximately 25 mg gill tissue to 500 μl of salt solution, and homogenized using a hand-held motorized plastic pestle on ice to homogenize the tissue. For each gill, 12.5 μl of homogenate were then added to individual wells on the microplate in triplicate, followed by 200 μl of reaction media-salt solution mixture. The Na^+/K^+ -ATPase activity was then determined on the homogenates by monitoring the decrease in the absorbance (at 340 nm) of the mixture over 10 minutes in the presence or absence of ouabain in the reaction media-salt solution mixture. The protein concentration in the gill homogenate was determined by Bradford assay (Bradford 1976).

Determination of Na⁺ Uptake

Determination of Na⁺ influx rate was based on the increase in whole body gamma radioactivity during exposure to TFM. Following gamma count determination, samples were allowed to decay for 2 weeks at 4°C (²⁴Na⁺ has a half life of ~ 15 h), after which the carcasses were processed for whole body ion (Na⁺, Cl⁻, K⁺ and Ca²⁺) analysis, as previously described. Whole body Na⁺ influx rates in larval lamprey were determined based on the accumulation of gamma radioactivity in the fish during the 3-h flux period as described by Hogstrand et al. (1994):

$$\text{Na}^+ \text{ influx Rate} = \frac{\text{CPM}_{\text{lamprey}}}{(\text{MSA} \cdot T)} \quad (1)$$

where CPM is the gamma counts per minute per gram fish, MSA is the mean specific activity of ²⁴Na⁺ in the water (cpm ²⁴Na⁺ nmol⁻¹), and T is the duration of the flux period (3 h).

Calculations and Statistical Analysis

Determination of the 12-h LC50 for larval lamprey exposed to TFM was done by probit analysis (Sprague, 1969) using software available from the US Environmental Protection Agency (USEPA Probit Analysis Program, version 5.1).

Data are presented as mean ± 1 SEM. All comparisons were unpaired and analyzed using one-way analysis of variance (ANOVA). When significant variability was observed, statistical significance between the means was assessed using the Tukey-Kramer post-test at the $p < 0.05$ level. When the requirement for homogeneity of variance was not satisfied, a nonparametric ANOVA was used, followed by Dunn's test where appropriate.

RESULTS

Determination of the Acute Toxicity of TFM

The nominal TFM concentrations of 0.5, 1.0, 2.5, 5.0, 10.0, 25.0 mg l⁻¹ were reflected by measured TFM concentrations of 0.16 ± 0.05, 1.07 ± 0.1, 2.31 ± 0.1, 5.47 ± 0.3, 12.49 ± 0.6, 24.99 ± 0.7 mg l⁻¹, respectively. The larval sea lamprey exposed to TFM in the cotton versus the non-cotton group had identical 12-h LC50s for TFM of 4.6 mg l⁻¹ (p>0.05, data not shown). Subsequently, larval sea lamprey were exposed to a nominal TFM concentration of 4.6 mg l⁻¹ (measured 4.60 ± 0.04 mg l⁻¹) in the subsequent experiments that investigated how TFM influenced energy use and ion balance in these fish. The 12-h LC50 in City of Hamilton dechlorinated tap water at McMaster was about 50 % lower, with a value of 2.0 mg l⁻¹ (data not shown). Subsequently, larval sea lamprey were exposed to a nominal TFM concentration of 2.0 mg l⁻¹ (measured 1.80 ± 0.04 mg l⁻¹) to assess the effects of TFM on branchial Na⁺ uptake.

Effects of TFM on Larval Lamprey Metabolism

Exposure of larval sea lamprey to 4.6 mg l⁻¹ TFM significantly altered energy stores in the brain, liver, blood and muscle of the fish. In the brain, the glycogen concentration was approximately 7.4 ± 0.8 µmol g⁻¹ wet tissue under control conditions, and steadily declined with TFM exposure. After 9 and 12 h, the levels had significantly decreased by approximately 72% compared to controls (Fig. 2-1a). This drop in brain glycogen concentration was accompanied by corresponding increases in brain lactate concentration, which had increased by 9-fold after 9 h and 12 h (Fig. 2-1b). Brain ATP reserves were also adversely affected by TFM, declining by approximately 40% (Fig. 2-

2a) over 9 and 12 h, compared to control values of $1.6 \pm 0.1 \mu\text{mol g}^{-1}$ wet tissue. The impact of TFM was greatest on PCr, however, which decreased by approximately 50 % after 3 h, from control values of $7.5 \pm 0.5 \mu\text{mol g}^{-1}$ wet tissue (Fig. 2-2b). By 9-12 h, PCr had declined by more than 80% compared to controls (Fig. 2-2b).

Along with the changes in the brain during TFM exposure, there was also a marked depletion of fuel reserves in the liver. In control animals, the liver glycogen concentration was $18.3 \pm 2.2 \mu\text{mol g}^{-1}$ wet tissue, and decreased by approximately 60% after 3 h of TFM exposure (Fig. 2-3a). By the 9 and 12 h sampling periods, there was an 85% decrease in liver glycogen levels (Fig. 2-3a). Predictably, the drop in glycogen was accompanied by simultaneous increases in liver lactate, which had increased by 4-fold after 9 and 12 h of TFM exposure compared to controls (Fig. 2-3b). The depletion of glycogen was accompanied by reductions in ATP, which decreased by more than 60% from control values of $0.6 \pm 0.1 \mu\text{mol g}^{-1}$ wet tissue after only 1 hour of TFM exposure (Fig. 2-4a). By 3 h, liver ATP levels had decreased by 90%, and after 6 h of exposure, ATP was no longer detected in the liver (Fig. 2-4a). Liver PCr followed a different trend, however. Initially, there was a 90% decrease in liver PCr after 1 h of exposure (Fig. 2-4b), compared to control values of $1.3 \pm 0.4 \mu\text{mol g}^{-1}$ wet tissue. However, PCr concentrations rebounded towards control levels after 3 h of exposure and then stabilized (Fig. 2-4b).

Disturbances in metabolite and fuel stores were less pronounced in the muscle, where glycogen reserves were unaffected over the first 6 h of TFM exposure compared to the control values of $20.2 \pm 2.1 \mu\text{mol g}^{-1}$ wet tissue. However, a marked 75 % reduction in muscle glycogen reserves was observed after 9 and 12 h of exposure to TFM (Fig. 2-5a).

The decrease in glycogen was accompanied by a simultaneous increase in lactate, which had increased by 3-fold after 12 h of exposure (Fig. 2-5b). Despite the change in glycogen and lactate, there were no changes in muscle pyruvate concentration, which fluctuated around $0.1 \mu\text{mol g}^{-1}$ wet tissue (data not shown).

Muscle ATP concentrations were unaffected by TFM exposure, at approximately $2.7 \pm 0.1 \mu\text{mol g}^{-1}$ wet tissue (Fig. 2-6a). Although muscle PCr exhibited a steady downward trend, values were not significantly different from the control value of $24.3 \pm 2.8 \mu\text{mol g}^{-1}$ wet tissue (Fig. 2-6b).

The metabolic disturbances seen in the brain and in the liver were reflected by changes in the blood lactate concentration. Although blood lactate was highly variable, it significantly increased compared to control values only after 12 h of TFM exposure (Table 2-1). While blood glucose levels were also variable, they remained unaffected by exposure to TFM (Table 2-1).

Effects of TFM on Lamprey Ion Balance and Haematology

TFM had little effect on haematology, tissue water or plasma ion balance (Table 2-1). Blood haemoglobin (Hb) remained unaltered by the TFM exposure, with values ranging from 6.7 to 9.9 g dl⁻¹, and control values of $7.4 \pm 1.0 \text{ g dl}^{-1}$ (Table 2-1). Haematocrit (Hct) and mean cellular haemoglobin concentration (MCHC) were also unaffected by TFM, with values averaging $30.7 \pm 0.6\%$ and $28.7 \pm 2.1 \text{ g dl}^{-1}$, respectively (Table 2-1). Plasma Na⁺ concentrations ranged from 81-105 mmol l⁻¹ in TFM-treated fish, but were not significantly different from control animals, in which the average Na⁺ concentration was $96.5 \pm 2.0 \text{ mmol l}^{-1}$ (Table 2-1). Plasma Cl⁻ was similarly unaffected,

and did not deviate from the control value of 92 mmol l^{-1} observed in lamprey not exposed to TFM (Table 2-1).

The Na^+ influx rates of control larval lamprey were approximately $70.0 \pm 6.4 \text{ nmol g}^{-1} \text{ h}^{-1}$ and were maintained throughout the entire 12 h period of TFM exposure (Table 2-3; note that at 9 h only one fish survived and it was not represented on the graph). This lack of TFM interference with Na^+ uptake was reflected by an absence of disturbance to the whole body concentrations of Na^+ , Cl^- , and K^+ which remained stable at 39.3 ± 1.5 , 35.8 ± 1.8 , and $63.9 \pm 1.0 \text{ mmol g}^{-1}$, respectively (Table 2-2). Whole body Ca^{2+} concentrations significantly increased at 6 h of exposure, returning to control levels of $21.1 \pm 1.1 \text{ mmol g}^{-1}$ thereafter (Table 2-2).

Gill Na^+/K^+ -ATPase specific activity was maintained near $0.5\text{-}0.6 \text{ nmol ADP } \mu\text{g protein}^{-1} \text{ h}^{-1}$ in the presence of TFM, and had significantly increased by approximately 7.5-fold after 9 h exposure, before returning to control levels after 12 h (Table 2-3). This rate was accompanied by a similar trend in the gill Na^+/K^+ -ATPase wet weight activity, where the activity increased 2.5-3.5 times after 9 h exposure to TFM, but this trend was not significant (Table 2-3). The total protein content in the gill remained unchanged over the 12 h exposure, averaging $44\text{-}60 \mu\text{g protein mg}^{-1}$ wet tissue (Table 2-3).

DISCUSSION

Effects of TFM on Energy Stores

Our findings support the hypothesis that TFM toxicity is due to a failure of ATP supply to match ATP demand, which is characterized by substantial reductions of on-board energy reserves in the brain, liver and to a lesser extent the muscle, of larval sea lamprey. Because our preliminary range-finder experiments indicated that the 12-h LC50 in larval lamprey burrowed in cotton was identical to that determined in the absence of cotton, we chose to conduct our TFM exposures using the cotton substrate. The presence of burrowing substrate is known to calm larval sea lamprey (thigmokinesis; Rovainen and Schieber 1975), and would have minimized any spontaneous activity that could have altered energy store and metabolite concentrations in the animals. Although larval lamprey are often considered “sedentary”, short periods of vigorous swimming do result in marked disturbances to muscle glycogen, lactate and PCr concentrations (Wilkie et al. 2001), which could have masked the effects of TFM on these fuel stores and metabolites.

Exposure to TFM reduced ATP, PCr and glycogen concentrations in the brain and liver, and resulted in the concordant accumulation of lactate. This observation strongly supports the hypothesis that larval lamprey are forced to rely on glycolysis when the aerobically generated ATP supply does not keep pace with resting ATP demands. Disturbances were less pronounced in the muscle, possibly because muscle was relatively inactive during TFM exposure compared to the more metabolically active liver and nervous system. Another important consideration is that unlike the liver and meninges of the brain, the glycogen in muscle is not involved in maintaining glucose homeostasis in the circulatory or nervous systems (Panserat et al. 2000). In lamprey, as in other

vertebrates, muscle glycogen is used to rapidly generate ATP by glycolysis during high intensity exercise (see Wang et al. 1994b; Kieffer 2000 for reviews), such as would occur with burrowing or vigorous swimming by larval sea lamprey (Wilkie et al. 2001). It is also unlikely that TFM impaired oxygen uptake or delivery because TFM toxicity is unaltered in hypoxic waters (dissolved O₂ down to 30 % saturation; Seelye and Scholefield 1990), and it stimulates oxygen consumption in both the whole animal (Schnick 1972) and in isolated liver mitochondria of lamprey (discussed in Chapter 4).

The pronounced reductions in glycogen in the brain suggest that hypoglycemia contributed to death in the larval lamprey by depriving the nervous system of its primary energy supply (“neural arrest”), as suggested previously (Wilkie et al. 2007a). Because glucose is a critical substrate for brain function in vertebrates it is very susceptible to reductions, or even depletion, of this critical fuel reserve as a result of food deprivation, ischemia, or hypoxia/anoxia (McIlwain and Bachelar 1985; Rovainen et al. 1969; Rovainen 1970; Soengas et al. 1998; Polakof et al. 2007). For instance, Soengas et al. (1998) observed a marked decrease in brain glycogen levels in trout that had been starved for 14 days. Lowry et al. (1964) noted that during brain ischaemia in mice, brain glucose was the most rapidly consumed energy store. Similarly, exposure of isolated larval lamprey brain and meninges to anoxic conditions resulted in rapid, marked reductions in brain glycogen and glucose (Rovainen et al. 1969; Rovainen et al. 1971).

In vertebrates, liver glycogen reserves are usually the most important factor controlling blood glucose homeostasis (Niswender et al. 1997; Moon 2001). Sea lamprey have relatively low liver glycogen reserves (O’Boyle and Beamish 1977), but high concentrations of glycogen in the meninges of the brain compared to other vertebrates

(Rovainen et al. 1969; Rovainen 1970; Foster et al. 1993), which could partially explain their high tolerance to hypoxic conditions (Lewis 1980). High brain glycogen stores have been shown to provide tolerance to long term hypoxia and anoxia in several other species, such as the crucian carp, freshwater turtles and goldfish (McDougal et al. 1968), which have brain glycogen reserves between 12.8 and 19.5 $\mu\text{mol g}^{-1}$ (Lutz et al. 2003). The decrease in brain glycogen seen in the larval sea lamprey in response to TFM is similar to that noted in crucian carp by Schmidt and Wegener (1988), who found that brain glycogen decreased by 95 % after 7 h of anoxia, which is comparable to the 70% decrease in larval sea lamprey brain glycogen reserves observed in this study. Moreover, the importance of brain glycogen stores in anoxia tolerance is further emphasized by the fact that in turtles and goldfish ATP levels remain unchanged for 1 h and 4 h, respectively, after decapitation (McDougal et al. 1968), suggesting that glycolysis plays an important role in maintaining ATP reserves. In lamprey, Rovainen (1970) also suggested that brain glycogen might also be important for maintaining homeostasis of the nervous system between feeding bouts during the parasitic phase of the sea lamprey life cycle. Although glycogen stores in the meninges of the lamprey brain are higher than in other fishes, the relatively small mass of this tissue in lamprey (approximately 1 % of the larval lamprey's body mass; data not shown) would likely provide only short-term relief from oxygen starvation or TFM exposure.

The resting brain glycogen concentrations we measured were lower than previously reported in larval and upstream migrant sea lamprey (Rovainen et al. 1969; Rovainen 1970; Foster et al. 1993). This observation could be because the larval lamprey used in this study had been in the laboratory for 4 months prior to the start of the

experiments, compared to a few weeks or less in previous studies (Rovainen et al. 1969; Rovainen 1970; Foster et al. 1993). Moreover, the fish used in this study were fed a weekly maintenance ration of yeast (Holmes and Youson 1994; Wilkie et al. 2001; Wilkie et al. 2007a), rather than their natural diet of detritus (Sutton and Bowen 1994), which could have led to a gradual reduction of internal glycogen reserves (see above). Because TFM results in marked depletion of glycogen stores, this raises the possibility that other factors influencing on-board glycogen stores such as starvation, season or life stage could influence the TFM sensitivity of larval lamprey. Indeed, larval lamprey are reported to be more sensitive to TFM in the spring compared to late summer (Scholefield et al. 2008), when brain and liver glycogen concentrations could be lower due to a lack of high quality food during the preceding winter months.

Further support for the hypothesis that TFM interferes with oxidative ATP production was observed in the liver, where more pronounced decreases (approximately 90 %) in glycogen were detected after 9 and 12 h of exposure to TFM (Fig. 3a). The liver glycogen concentration of $18 \mu\text{mol g}^{-1}$ obtained for controls in the present study is in agreement with previous measurements in larval lamprey ($\sim 22 \mu\text{mol g}^{-1}$; O'Boyle and Beamish 1977), but lower than measured in other fish of comparable body size (Begg and Pankhurst 2004; Soengas et al. 1998). As a result, the amount of glycogen available for glucose homeostasis in the larval lamprey is proportionately less than in other vertebrates. Thus, in addition to the sea lamprey's limited ability to detoxify TFM by glucuronidation (Kane et al. 1994; Hubert et al. 2005), we suggest that these lower hepatic glycogen reserves might also contribute to the greater sensitivity of this animal to TFM than more resistant non-target fishes.

Although muscle glycogen is not thought to be involved in blood glucose-homeostasis, a similar TFM-induced reduction in glycogen was noted in this tissue. The numbers were in accord with the literature (O'Boyle and Beamish 1974), and the decrease observed in glycogen after 9 and 12 h of TFM exposure was significant (Fig.5a). Unlike the brain and the liver (Rovainen et al. 1971), the muscle of lamprey lacks glucose-6-phosphatase (Panserat et al. 2000) and is unable to export glucose to the circulation. At first glance, the reduction noted in muscle glycogen might be considered surprising, but the muscle does represent the largest glycogen reserve in larval lamprey (O'Boyle and Beamish 1977), and glycogen is retained in this compartment to fuel burst exercise (Kieffer 2000; Wilkie et al. 2001). In contrast to many teleosts, the muscle of the lamprey is a mixture of red fibres (oxidative fibres) and white fibres (glycolytic fibres) (Peters and MacKay 1961; Meyer 1979). If TFM uncouples oxidative phosphorylation, then the muscle would rely to a greater extent on glycolysis to satisfy even its resting ATP demands during exposure to TFM. Muscle activity could be a factor in glycogen depletion in the wild as larvae come out of the sand during stream treatments with TFM. These fish did not come out of the cotton as the TFM exposure time increased, underscoring our thesis that exercise was not a factor that contributed to the decrease in muscle glycogen after 12 h of exposure.

Further support for the hypothesis that TFM causes a mismatch between ATP supply and demand was the significant decrease in ATP concentration observed in the brain and liver after 6 h of TFM exposure. As ATP was consumed in the brain, it was likely initially replenished by the dephosphorylation of PCr via creatine kinase (CK; Hochachka 1991). Because PCr buffers ATP concentrations in response to decreases in

the ATP/ADP ratio, steady-state ATP concentrations are usually maintained in tissues except during high intensity exercise or oxygen starvation (Moyes and West 1995; McLeish and Kenyon 2005). Because the CK reaction is reversible, the replenishment of PCr following such challenges requires ATP (Hochachka 1991; Ellington 2001). The persistent reduction of PCr in brain, and muscle indicates that the supply of ATP continued to be limited during TFM exposure.

After an initial reduction in PCr in the liver, it was notable that PCr concentrations were restored in parallel to the simultaneous depletion of ATP as TFM exposure continued. While we have no explanation for this observation (the PCr assay was run in the same manner as for the other tissues, with no methodological changes), it is important to note that there are different isozymes of CK found in different tissues (e.g. brain vs muscle), and in the cytosolic versus mitochondrial compartments of vertebrate cells (McLeish and Kenyon 2005). Since the kinetic properties of these isozymes differ, it is possible that the unexpected effect of TFM on PCr in the liver compared to the brain and muscle was a reflection of variation in the type of CK present in these tissues. This possibility requires further investigation, however.

Effects of TFM on Ion Balance and Haematology

The current findings suggest that acute (12 h) TFM exposure has no negative impact on gill Na⁺ influx, or plasma and whole body ions, haematology, or tissue water. The transient increase of the Na⁺/K⁺-ATPase activity after 9 h of TFM exposure suggests that the lamprey may have compensated for a decrease in their ability to take-up Na⁺ from the water due to limited ATP supply to power Na⁺/K⁺-ATPase. However, because the wet

weight and protein specific activity more or less increased in tandem, our findings suggest that the increase in Na^+/K^+ -ATPase activity was not due to an increase in the protein content, but rather due to an increase in the number of active units of the enzyme.

More research is needed, however, to establish if TFM exerts its toxicity by disrupting ion balance in the body of the sea lamprey. Several studies have reported histological damage or alterations to the gills of larval lamprey exposed to TFM (Christie and Battle 1963; Mallatt et al. 1985, 1994). Most damage was noted in the mitochondrial rich cells [MRCs; and also referred to as ion uptake cells (Mallatt et al. 1994) and MR platelet cells (Bartels and Potter 2004)], with cell and mitochondrial swelling, the appearance of vacuoles, and the development of spaces between gill epithelial cells reported. Based on these observations, Mallatt et al. (1994) suggested that TFM could impair ion uptake and ion regulation in larval lamprey. While we cannot discount the possibility that such damage occurs with TFM exposure, especially at the higher TFM concentrations likely to be encountered during actual field treatments, our findings suggest that such damage would be unlikely to be the proximate cause of TFM toxicity in lamprey. In support of our conclusion, Wilkie et al. (2007a) also reported no change in plasma Cl^- concentration, haemoglobin, haematocrit, MCHC and tissue water in larval lamprey exposed to TFM in similar pH hard waters.

Mechanism of TFM Toxicity – Relevance for Field Applications and Risk

Assessment

The current study provides evidence that TFM interferes with hepatic ATP production in larval lamprey, forcing them to rely on PCr and glycolysis to meet their

basal ATP demands. Eventually, the greater reliance on glycolysis likely starves the nervous system of glucose, leading to death. Our evidence suggests that TFM sensitivity may be related to the size of the glycogen pools in the brain and liver. This observation may help explain some of the seasonal variation in larval lamprey TFM sensitivity recently reported by Scholefield et al. (2008), in which sensitivity to TFM was greater in spring compared to late summer in lamprey collected from the same streams. We suggest that the greater TFM sensitivity of larval lamprey in the spring might occur because glycogen stores are reduced (O'Boyle and Beamish 1977) as the animals emerge from an over-wintering period when food supply is limited compared to the summer. As a result, TFM sensitivity would be less in the summer, when these filter-feeding animals would have consumed higher quality and greater amounts of food (Sutton and Bowen 1994). This knowledge may provide a mechanistic explanation for the seasonal variation in TFM sensitivity (Scholefield et al. 2008), and support strategies aimed at modifying TFM dosages based on season. This could be particularly important in streams known to contain sensitive non-target organisms, as their sensitivity could be enhanced when the animals emerge from the over-wintering period and have low glycogen reserves. These streams containing the sensitive organisms could be designated for treatments when lower doses of TFM are needed for lampricide treatment.

In the absence of sudden changes in water chemistry, non-target organisms would rarely be exposed to lethal concentrations of TFM (McDonald and Kolar 2007). However, non-target fishes could be vulnerable to similar metabolic disturbances to those described in larval lamprey during exposure to sub-lethal concentrations of TFM transiently encountered during lampricide treatments. Viant et al. (2001) reported marked

reductions in PCr in molluscs exposed to TFM. It therefore seems reasonable to suggest that TFM likely has similar effects on energy stores in both non-target invertebrates and vertebrates. TFM is also one of many toxicants thought to interfere with oxidative ATP production in the mitochondria. Our findings suggest that as long as mobilizeable glycogen is present (e.g. brain, liver), an animal would be able to temporarily make up for a shortfall in ATP by using glycolysis in the presence of such toxicants. An inability to clear the TFM or other uncoupling toxicants would culminate in death, however, once the glycogen stores were depleted. Thus, the size of the mobilizeable glycogen pool and the factors that influence glycogen stores (season, life stage, presence of environmental stressors) could therefore be a critical determinant of the sensitivity of aquatic organisms to TFM or other chemicals that target oxidative ATP production by the mitochondria.

Table 2-1. Blood hemoglobin (Hb), hematocrit (Hct), mean cell hemoglobin concentration (MCHC), plasma Na⁺, plasma Cl⁻, and tissue water in larval lamprey exposed to toxic concentrations of TFM (12-h LC50 ~ 4.6 mg ml⁻¹). Data

presented as the mean ± 1 SEM (N). Data sharing the same letter are not significantly different.

TFM exposure time (h)	Hb (g dl ⁻¹)	Hct (%)	MCHC (g dl ⁻¹)	Plasma Na⁺ (mmol l ⁻¹)	Plasma Cl⁻ (mmol l ⁻¹)	Blood glucose (μmol g ⁻¹)	Blood lactate (μmol g ⁻¹)	Tissue H₂O (ml g ⁻¹ dry tissue)
Control	7.4 ± 1.0 (11) ^a	30.6 ± 3.6 (8) ^a	25.0 ± 3.3 (8) ^a	96.5 ± 2.0 (16) ^{a,b}	92.1 ± 3.3 (10) ^a	2.2 ± 0.2 (28) ^a	0.4 ± 0.2 (28) ^a	5.2 ± 0.2 (29) ^a
1	9.8 ± 0.9 (8) ^a	32.2 ± 3.3 (8) ^a	33.6 ± 5.8 (8) ^a	81.3 ± 6.4 (7) ^a	86.7 ± 7.1 (7) ^a	1.0 ± 0.4 (8) ^a	1.3 ± 0.4 (7) ^{a,b}	4.2 ± 0.3 (8) ^a
3	7.8 ± 1.0 (8) ^a	28.5 ± 2.8 (7) ^a	28.8 ± 5.3 (7) ^a	81.3 ± 6.4 (5) ^{a,b}	89.6 ± 5.4 (5) ^a	1.6 ± 0.4 (7) ^a	0.6 ± 0.3 (7) ^{a,b}	5.0 ± 0.6 (8) ^a
6	9.9 ± 2.4 (6) ^a	29.9 ± 4.1 (5) ^a	36.3 ± 4.0 (5) ^a	105 ± 9.4 (4) ^b	100.6 ± 6.7 (4) ^a	1.1 ± 0.6 (6) ^a	0.6 ± 0.3 (6) ^{a,b}	5.5 ± 0.5 (6) ^a
9	6.9 ± 1.2 (7) ^a	32.6 ± 3.3 (6) ^a	27.4 ± 5.4 (6) ^a	88.4 ± 7.6 (6) ^{a,b}	78.5 ± 4.6 (6) ^a	1.6 ± 0.5 (7) ^a	1.6 ± 0.8 (7) ^{a,b}	5.2 ± 0.3 (7) ^a
12	6.7 ± 1.0 (7) ^a	30.6 ± 3.8 (6) ^a	20.9 ± 5.6 (6) ^a	91.3 ± 14.8 (6) ^{a,b}	87.2 ± 5.0 (6) ^a	1.2 ± 0.4 (7) ^a	2.1 ± 0.7 (7) ^b	4.6 ± 0.4 (7) ^a

Table 2-2. The effects of toxic doses of TFM (12-h LC50 ~ 2.0 mg l⁻¹ TFM) upon whole body ion concentrations in larval lamprey. Data presented as the mean ± 1 SEM (N). Data sharing the same letter are not significantly different.

TFM exposure time (h)	Na ⁺ (μmol g ⁻¹ wet tissue)	Cl ⁻ (μmol g ⁻¹ wet tissue)	Ca ²⁺ (μmol g ⁻¹ wet tissue)	K ⁺ (μmol g ⁻¹ wet tissue)
Controls	39.3 ± 1.5 (9) ^a	35.8 ± 1.8 (9) ^a	21.1 ± 1.1 (9) ^a	63.9 ± 1.0 (9) ^{a,b}
3	37.5 ± 1.5 (7) ^a	32.8 ± 1.0 (7) ^a	23.8 ± 1.1 (8) ^{a,b}	59.8 ± 1.5 (7) ^a
6	41.2 ± 1.9 (7) ^a	38.2 ± 1.1 (7) ^a	25.8 ± 0.9 (7) ^b	62.9 ± 1.5 (7) ^{a,b}
9	35.5 (1) ^a	33.6 (1) ^a	25.1 (1) ^{a,b}	66.5 (1) ^{a,b}
12	37.7 ± 0.6 (9) ^a	33.5 ± 1.3 (9) ^a	21.3 ± 0.8 (9) ^a	66.4 ± 0.9 (9) ^b

Table 2-3. Na⁺ uptake, gill Na⁺/K⁺ ATPase activity (specific and wet weight activity) and gill protein concentration in larval sea lamprey exposed to their respective 12-h TFM LC50 in City of Hamilton dechlorinated tap water (2.0 mg l⁻¹, Na⁺ uptake experiments) and Wilfrid Laurier University well water (4.6 mg l⁻¹, gill Na⁺/K⁺ ATPase activity and protein concentration). Data presented as the mean ± 1 SEM (N). Data sharing the same letter are not significantly different. For the Na⁺ uptake data there were no fish at the 1 h sampling time.

TFM exposure time (h)	Na⁺ uptake (nmol g⁻¹ h⁻¹)	Na⁺/K⁺ ATPase specific activity (nmol ADP μg⁻¹ prot. h⁻¹)	Na⁺/K⁺ ATPase wet weight activity (nmol ADP mg⁻¹ wet tissue h⁻¹)	Gill protein concentration (μg prot. mg tissue⁻¹)
Controls	70.1 ± 6.4 (9) ^a	0.13 ± 0.12 (29) ^a	192.5 ± 116.2 (29) ^a	49.1 ± 3.1 (29) ^a
1	-	0.45 ± 0.27 (8) ^{a,b}	483.6 ± 292.3 (8) ^a	54.4 ± 3.6 (8) ^a
3	84.7 ± 10.1 (7) ^a	0.51 ± 0.25 (8) ^{a,b}	646.6 ± 313.1 (8) ^a	59.5 ± 9.0 (7) ^a
6	91.4 ± 16.2 (7) ^a	0.58 ± 0.34 (6) ^{a,b}	529.8 ± 278.3 (6) ^a	44.1 ± 3.5 (6) ^a
9	47.6 ± 11.9 (7) ^a	0.97 ± 0.49 (7) ^b	564.0 ± 349.4 (7) ^a	50.4 ± 6.1 (7) ^a
12	82.3 ± 20.1 (9) ^a	0.18 ± 0.26 (7) ^{a,b}	266.7 ± 303.6 (7) ^a	57.0 ± 5.1 (7) ^a

Figure 2-1. Effects of TFM on Brain Glycogen and Lactate in Lamprey.

Changes in brain concentrations of (a) glycogen and (b) lactate in resting larval sea lamprey (*Petromyzon marinus*) following exposure to 3-trifluoromethyl-4-nitrophenol (TFM; solid bars) at a nominal concentration of 4.6 mg l⁻¹ for 1, 3, 6, 9 and 12 h or held under control conditions (no TFM; open bars). Data are expressed as the mean + 1 SEM (N). Bars sharing the same letter are not significantly different.

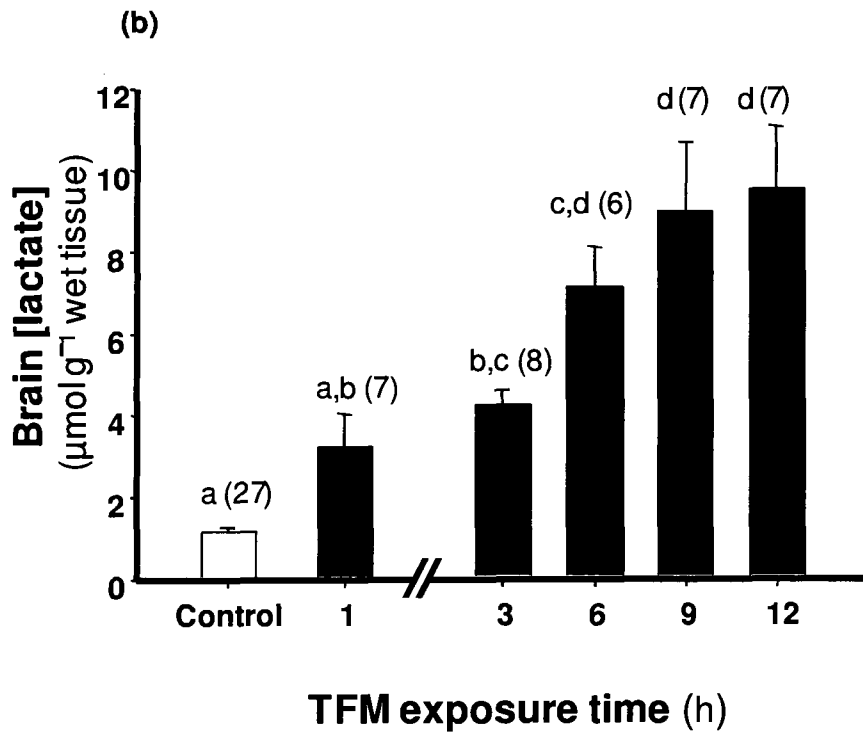
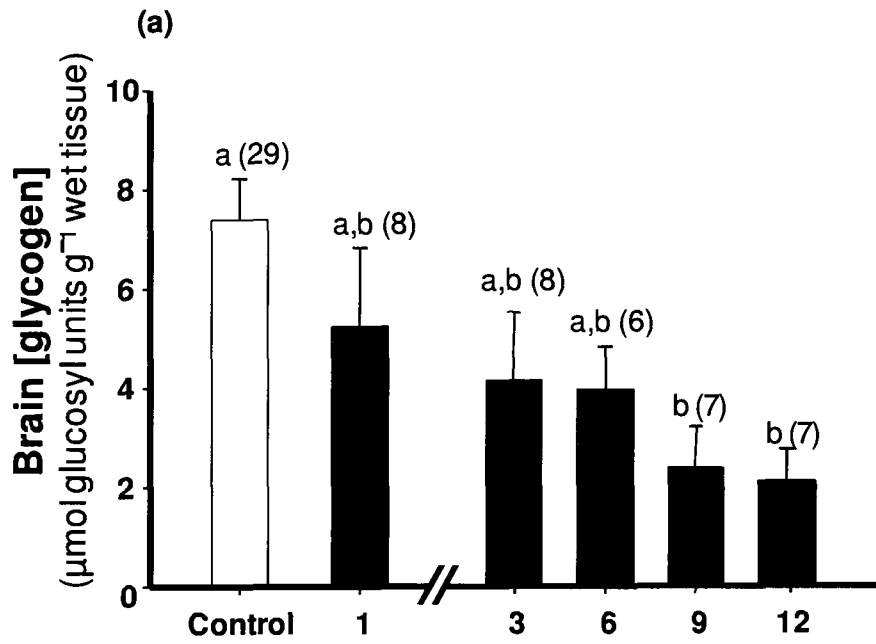

Figure 2-2. Effects of TFM on Brain ATP and PCr in Lamprey. Changes in brain concentrations of (a) adenosine triphosphate (ATP) and (b) phosphocreatine (PCr) in resting larval sea lamprey (*Petromyzon marinus*) following exposure to 3-trifluoromethyl-4-nitrophenol (TFM; solid bars) at a nominal concentration of 4.6 mg l⁻¹ for 1, 3, 6, 9 and 12 h or held under control conditions (no TFM; open bars). Data are expressed as the mean + 1 SEM (N). Bars sharing the same letter are not significantly different.

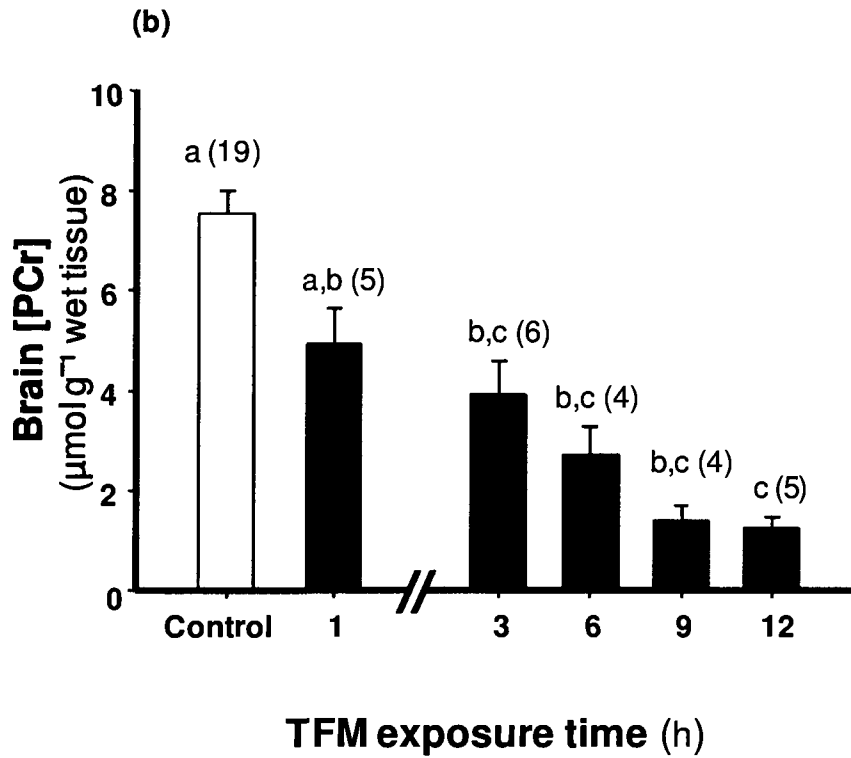
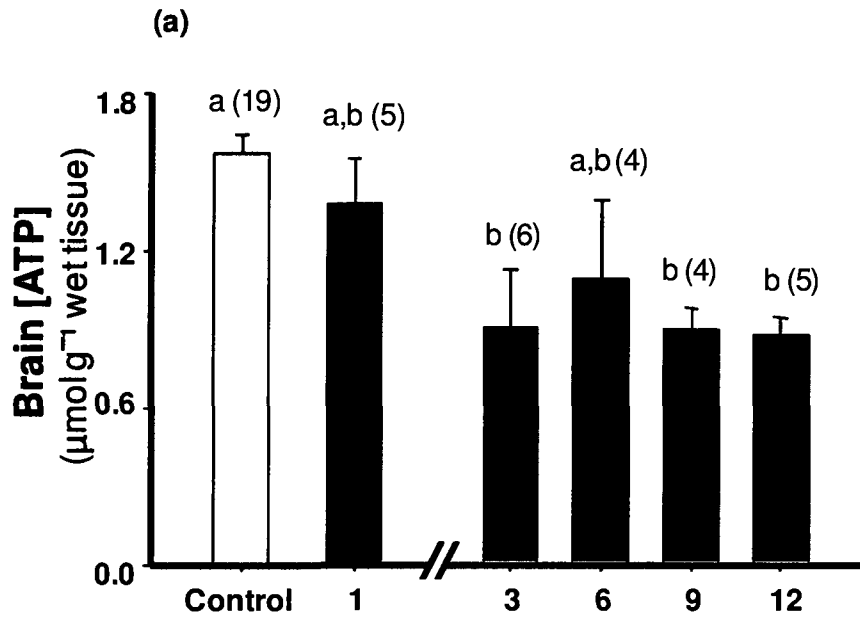

Figure 2-3. Effects of TFM on Liver Glycogen and Lactate in Lamprey.

Changes in liver concentrations of (a) glycogen and (b) lactate in resting larval sea lamprey (*Petromyzon marinus*) following exposure to 3-trifluoromethyl-4-nitrophenol (TFM; solid bars) at a nominal concentration of 4.6 mg l⁻¹ for 1, 3, 6, 9 and 12 h or held under control conditions (no TFM; open bars). Data are expressed as the mean + 1 SEM (N). Bars sharing the same letter are not significantly different.

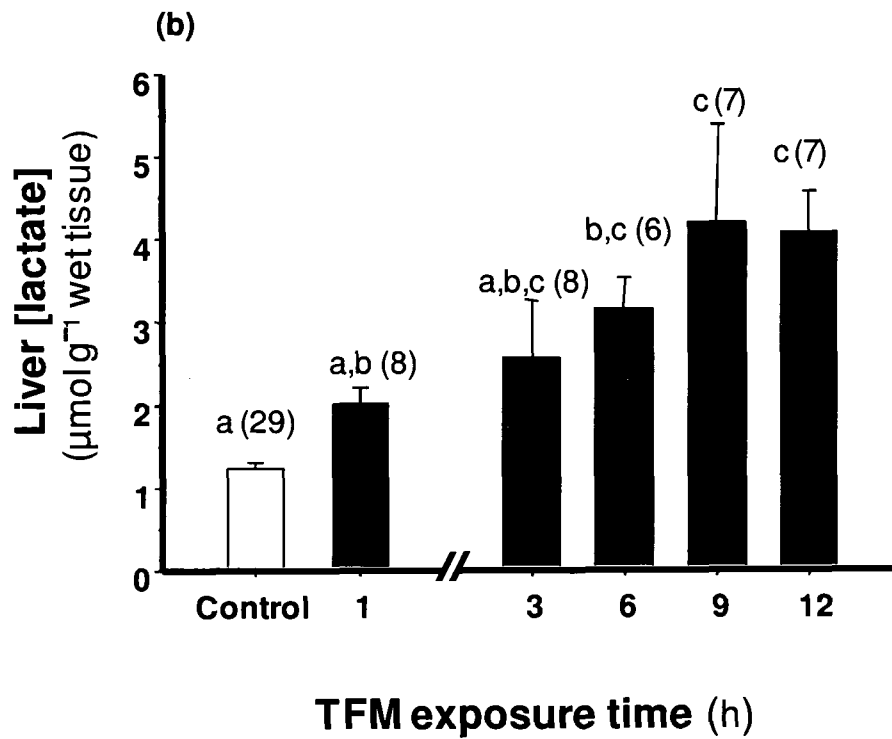
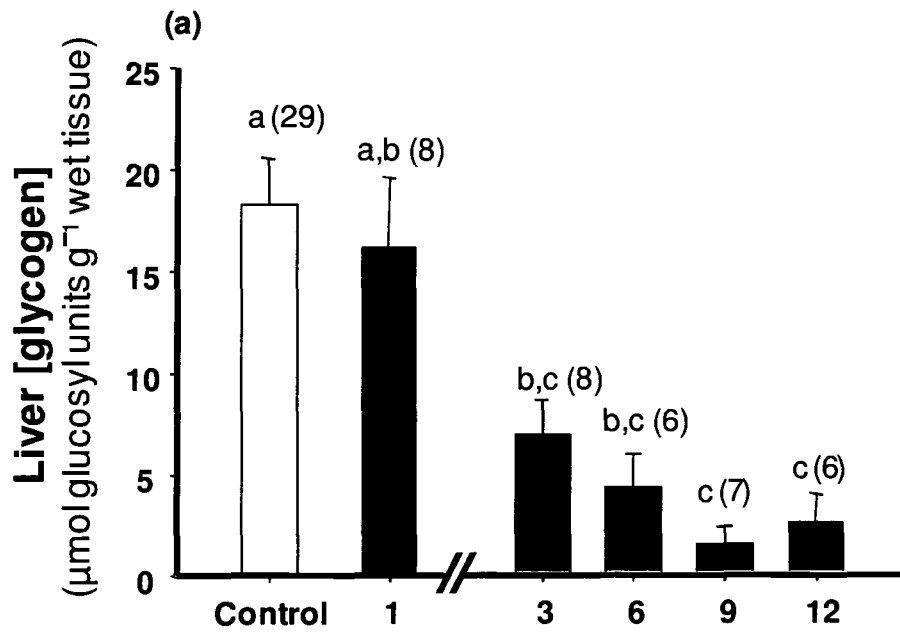

Figure 2-4. Effects of TFM on Liver ATP and PCr in Lamprey. Changes in liver concentrations of (a) adenosine triphosphate (ATP) and (b) phosphocreatine (PCr) in resting larval sea lamprey (*Petromyzon marinus*) following exposure to 3-trifluoromethyl-4-nitrophenol (TFM; solid bars) at a nominal concentration of 4.6 mg l⁻¹ for 1, 3, 6, 9 and 12 h or held under control conditions (no TFM; open bars). Data are expressed as the mean + 1 SEM (N). Bars sharing the same letter are not significantly different.

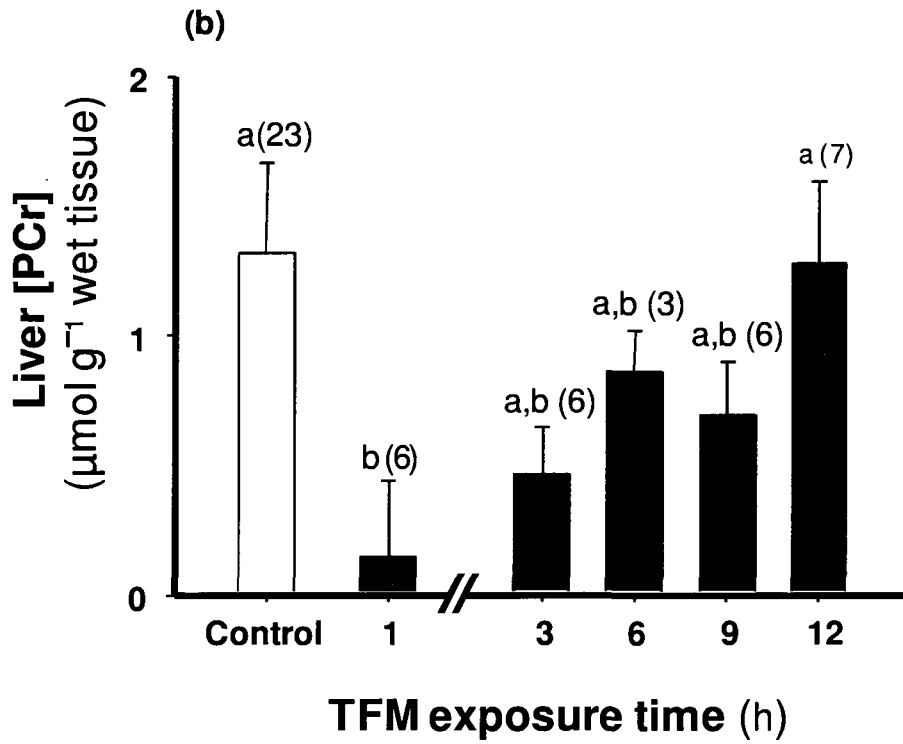
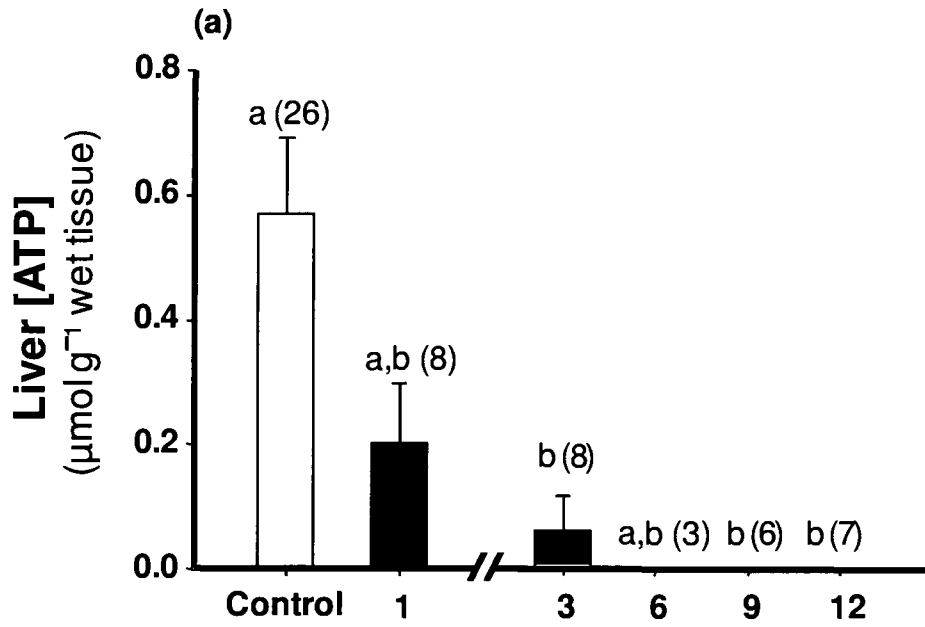
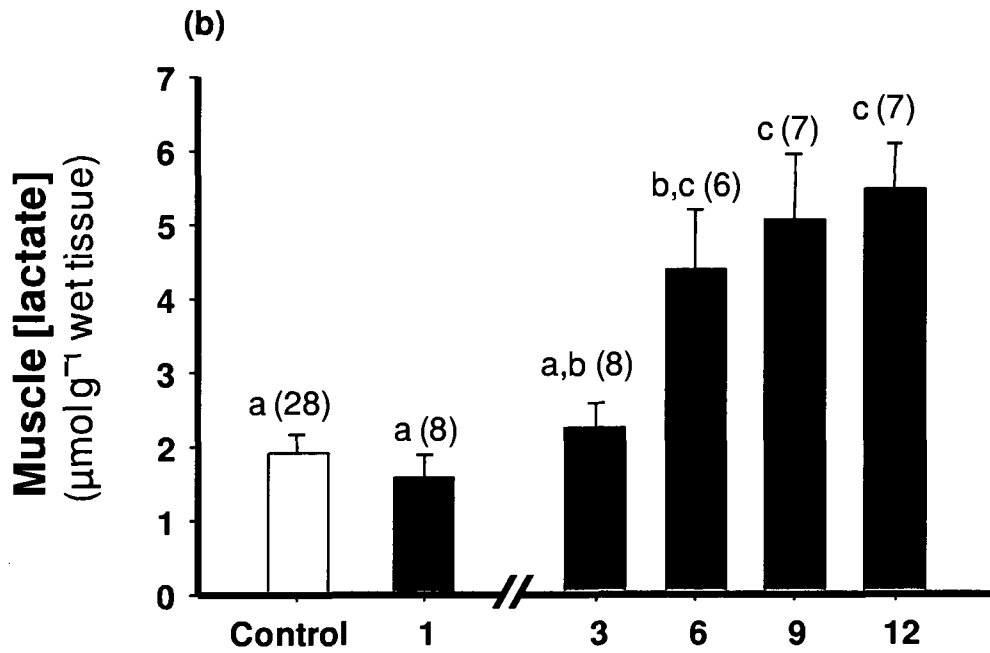
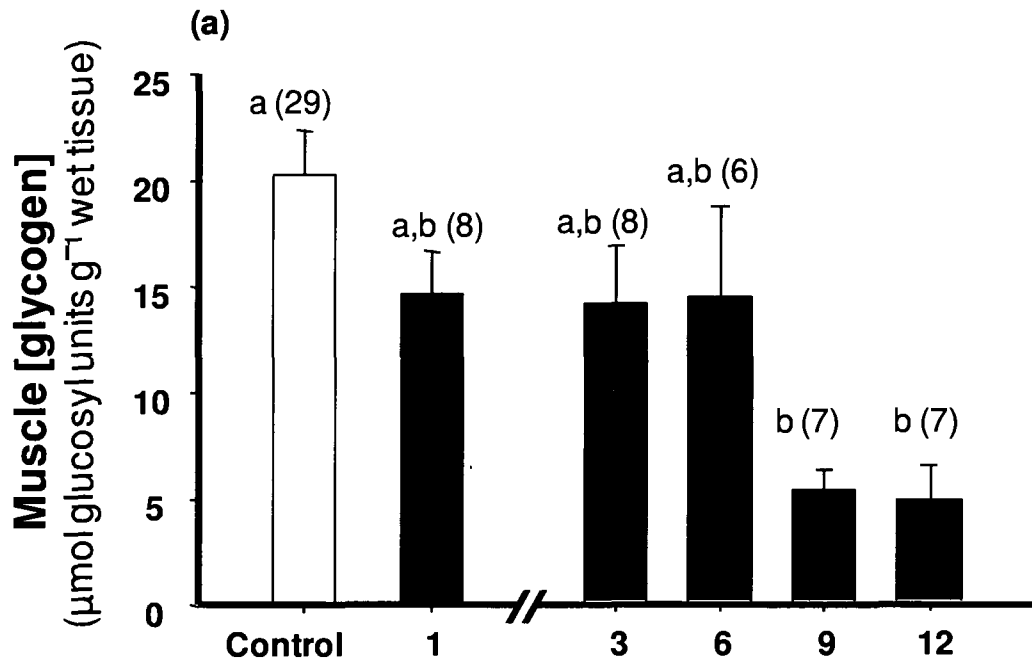

Figure 2-5. Effects of TFM on Muscle Glycogen and Lactate in Lamprey.

Changes in muscle concentrations of (a) glycogen and (b) lactate in resting larval sea lamprey (*Petromyzon marinus*) following exposure to 3-trifluoromethyl-4-nitrophenol (TFM; solid bars) at a nominal concentration of 4.6 mg l⁻¹ for 1, 3, 6, 9 and 12 h or held under control conditions (no TFM; open bars). Data are expressed as the mean + 1 SEM (N). Bars sharing the same letter are not significantly different.



TFM exposure time (h)

Figure 2-6. Effects of TFM on Muscle ATP and PCr in Lamprey. Changes in muscle concentrations of (a) adenosine triphosphate (ATP) and (b) phosphocreatine (PCr) in resting larval sea lamprey (*Petromyzon marinus*) following exposure to 3-trifluoromethyl-4-nitrophenol (TFM; solid bars) at a nominal concentration of 4.6 mg l⁻¹ for 1, 3, 6, 9 and 12 h or held under control conditions (no TFM; open bars). Data are expressed as the mean + 1 SEM (N). Bars sharing the same letter are not significantly different.

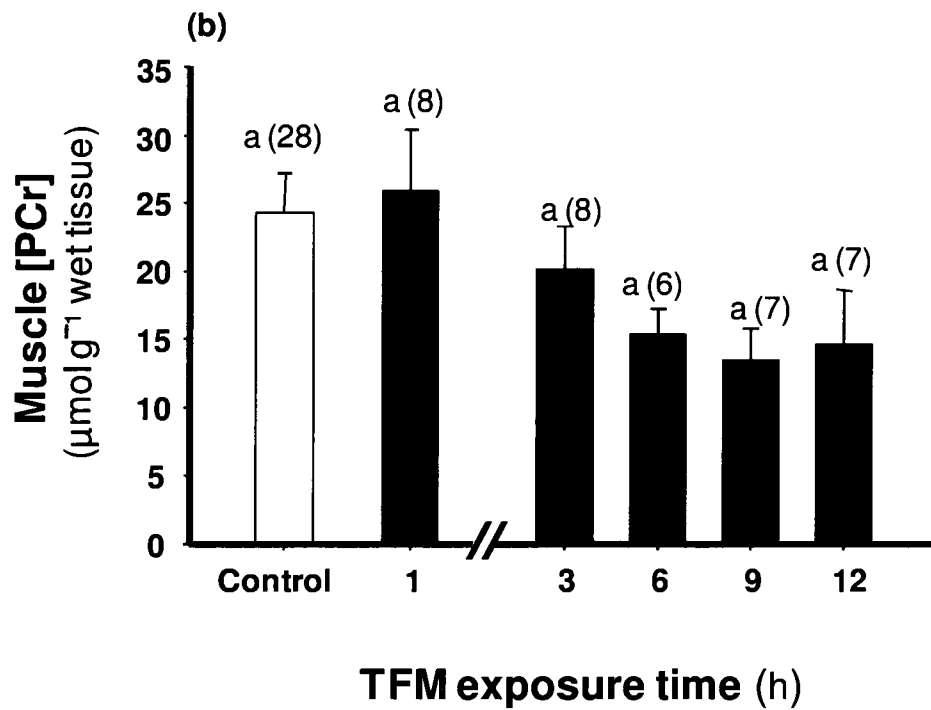
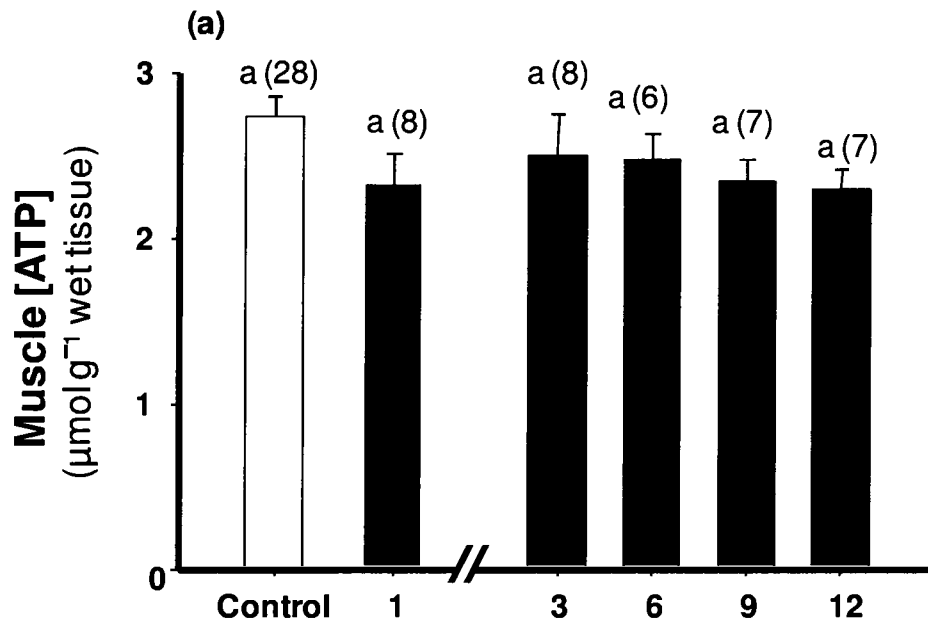

Chapter 3

The Mechanism of Toxicity of the Lampricide, 3-Trifluoromethyl-4-Nitrophenol (TFM) in a Non-Target Fish, the Rainbow Trout (*Oncorhynchus mykiss*)

ABSTRACT

The lampricide, 3-trifluoromethyl-4-nitrophenol (TFM), has been extensively used to control sea lamprey (*Petromyzon marinus*) populations in the Great Lakes, but its mode of toxicity in target and non-target species is not entirely understood. Knowledge on the mode of toxicity of TFM is needed for improving the effectiveness of TFM treatments, and predicting potential adverse effects on non-target fishes. We investigated two hypotheses of TFM toxicity in a non-target species, the rainbow trout (*O. mykiss*). The first was that TFM interferes with mitochondrial oxidative ATP production, causing depletion of energy stores in metabolically active tissues such as the liver and brain. The second was that TFM toxicity results from disruption of gill-ion uptake, affecting ion homeostasis. Exposure of rainbow trout to 11.0 mg l⁻¹ TFM (12-h LC50) caused brain glycogen concentrations to decrease by 50% at 12 h, suggesting that the animals increased their reliance on glycolysis to generate ATP due to a shortfall in ATP supply. This was reinforced by an initial 75% decrease in brain ATP at 1 h of exposure, with no changes in PCr after 9 h and 12 h. The liver remained unaffected by TFM exposure. In kidney there was a 40% increase in lactate at 1, 3, and 6 h, while ATP and PCr decreased by ~40-50% and 70%, respectively, by 3 h for ATP and 6 h for PCr. Muscle glycogen decreased by 60% after 12 h of exposure. TFM exposure led to minimal changes in whole body Na⁺, Cl⁻, Ca²⁺ and K⁺, as well as in plasma Na⁺ and Cl⁻. There was a 60% decrease in Na⁺ uptake rate, suggesting that an ionic disturbance might have enhanced TFM toxicity, but TFM had no adverse effect on gill Na⁺/K⁺ ATPase activity. We conclude that TFM toxicity in trout is due to a mismatch between ATP supply and demand, leading to a depletion of glycogen in the brain, leading to neural arrest and death.

INTRODUCTION

The lampricide 3-trifluoromethyl-4-nitrophenol (TFM), used to control the sea lamprey (*Petromyzon marinus*) populations in the Great Lakes, is applied to larval sea lamprey nursery streams that are found within the Great Lakes basin (Smith and Tibbles 1980; Boogaard et al. 2003; Bills et al. 2003; McDonald and Kolar 2007). TFM is the major element in the integrated pest management program to control sea lamprey populations in this region and its application has contributed to the restoration of fisheries that were decimated in the mid-20th century due to the combined effects of overfishing and lamprey predation (Lawrie 1970; Christie et al. 2003; McDonald and Kolar 2007). Treatments with TFM have proven effective mainly because of the specificity of TFM for the larval lamprey (Applegate and King 1962; Lech and Costrini 1972; Lech and Statham 1975), and their relatively sedentary life style which restricts them to the streams that empty into the Great Lakes. Despite its success in sea lamprey control, little is known about the mode of toxic action of TFM to larval lamprey or non-target fishes (McDonald and Kolar 2007; Wilkie et al. 2007a).

It is known that the concentration of TFM tolerated by most fishes is 3-5 times higher than that required to kill larval sea lamprey (Applegate and King 1962; Bills et al. 2003; Boogaard et al. 2003). This ability to withstand TFM is related to the greater capacity of most non-target fishes to biotransform TFM to TFM-glucuronide via the process of glucuronidation (Olson and Marking 1973; Lech 1974; Lech and Statham 1975; Kane et al. 1993, 1994). A few studies, however, have examined the actual mechanism of toxicity of TFM and/or its physiological effects on lamprey (Wilkie et al.

2007a; Birceanu et al. 2009-Chapter 2) or other species (Christie and Battle 1961; Mallatt et al. 1985, 1994; Kane et al. 1993; Viant et al. 2001).

Damage to the gills by TFM was reported in trout (*Oncorhynchus mykiss*) and larval lamprey by Christie and Battle (1961), but Mallatt et al. (1994) detected no changes in gill ultrastructure in trout exposed to their 9-h TFM LC100. Kane et al. (1993) reported that bullfrog (*Rana catesbiana*) tadpoles were approximately 13 times more sensitive to TFM than adults due to a lower glucuronidation capacity in the tadpole phase (larval LC50 = 0.95 mg l⁻¹) vs adult frogs (LC50 = 12.99 mg l⁻¹). Building upon evidence that TFM might uncouple oxidative phosphorylation in the mitochondria, Viant et al. (2001) demonstrated that TFM exposure resulted in reduced phosphagen reserves in limpets (*Lottia gigantea*) and abalone (*Haliotis rufescens*) exposed to sub-lethal concentrations of the lampricide, suggesting there was indeed disrupted ATP supply in these molluscs.

Further evidence that TFM exerts its toxic effects by creating a shortfall in ATP supply in lamprey was provided by Wilkie et al. (2007a) who observed significant decreases in plasma glucose and whole body PCr in larval lamprey exposed to TFM (12-h LC50 = 2.0 mg l⁻¹). Moreover, Birceanu et al. (2009-Chapter 2) found that as the exposure time increased, ATP and glycogen levels in the brains and in livers of the experimental fish were reduced in a step-wise fashion, and eventually were depleted, during a 12-h exposure to TFM (12-h LC50). Although Viant et al. (2001) suggested that TFM tolerance could be related to the ability of organisms, such as limpets (which are not typically exposed to TFM) to sustain anaerobic glycolysis for long periods, little work has been done to address this question. The objective of this study was to therefore determine if a non-target species likely to encounter TFM during typical field treatments, the

rainbow trout, also experienced a mismatch between ATP supply and ATP demand as recently demonstrated in larval lamprey (Birceanu et al. 2009-Chapter 2). Accordingly, to test the hypothesis that TFM toxicity results in a mismatch between ATP supply and ATP demand in the trout, we exposed the fish to their respective 12-h TFM LC50, and measured changes in tissue (brain, liver, muscle, kidney) glycogen, ATP, PCr and lactate over the 12 h exposure period.

A second objective was to determine if TFM interfered with gill-mediated ion and osmotic regulation in the trout. Christie and Battle (1963) reported significant vasodilation and intra-epithelial edema in the gills of rainbow trout exposed to sub-lethal concentrations of TFM (3 mg l^{-1}), suggesting that TFM could cause death by inducing ion loss by increasing the ion permeability of the branchial epithelial cells. Mallatt et al. (1994) observed ultrastructural changes in gill ion uptake cells of lamprey (ionocytes/mitochondria rich cells) including vacuolization and damage to mitochondria, but they did not observe similar changes in the gills of trout. To help resolve these apparent discrepancies, we therefore tested the additional hypothesis that TFM interferes with gill-mediated ion uptake and osmoregulation in trout by measuring rates of Na^+ uptake, gill Na^+/K^+ ATPase activity, and whole body ion (Na^+ , Cl^- , Ca^{2+} and K^+) concentrations, and muscle tissue water in trout exposed to TFM.

MATERIAL AND METHODS

Experimental Animals and Holding

Rainbow trout (*O. mykiss*, 3-5 g, 7.3 ± 2.3 cm) were purchased from Rainbow Springs Trout Hatchery (Thamesford, ON) and held in 120 l tanks receiving Wilfrid Laurier University well water on a flow-through basis (pH ~ 8.0; titratable alkalinity ~ 200 mg CaCO₃ l⁻¹; hardness ~ 450 mg CaCO₃ l⁻¹; temperature ~ 10-13 °C). The fish were held under a 12 h light:12 h dark photoperiod, and fed 3 times per week with ground 3.0 floating pellets (Corey Feed Mills, Fredericton, NB). The animals were held in the lab for at least 2 weeks before experiments commenced, and were starved for 72 h prior to the experiments. All experiments and fish husbandry were approved by the Wilfrid Laurier University Animal Care Committee and followed Canadian Council of Animal Care guidelines.

Experimental Protocol

Determination of the Acute Toxicity of TFM

To establish suitable TFM exposure concentrations in Wilfrid Laurier well-water, a range finder experiment was conducted by exposing trout to nominal TFM concentrations between 8 and 25 mg l⁻¹. A total of 5 fish were exposed to each concentration, and pH averaged 8.14 ± 0.03 . The experiments were conducted in the dark, since TFM is sensitive to photodegradation (Carey and Fox 1981). To determine the TFM exposure concentration (12-h LC50) in City of Hamilton dechlorinated tap water, trout were exposed to nominal TFM concentrations ranging from 2.0 to 20.0 mg l⁻¹. Field formulation TFM (Clariant SFC GMBH WERK, Griesheim, Germany) was used for all

range-finder and TFM exposure experiments [35% active ingredient dissolved in isopropanol; provided courtesy of the Sea Lamprey Control Center, Fisheries and Oceans Canada (DFO), Sault Ste. Marie, ON], and TFM exposure concentrations were verified using precision TFM standards provided by the Sea Lamprey Control Center. Water TFM was measured using a 96-well plate spectrophotometer (SpectraMax 190, Molecular Devices, CA), at a wavelength of 395 nm, according to the Standard Operating Procedures of the Department of Fisheries and Oceans, Sea Lamprey Control Centre (IOP: 012.4).

Effects of TFM on Rainbow Trout Metabolism

To test the hypothesis that TFM toxicity was associated with an energy imbalance in trout, the effects of TFM on fuel stores (high energy phosphagens, glycogen and glucose) and metabolites (lactate, pyruvate and creatine) were measured in the liver, brain, muscle and blood at different intervals (1, 3, 6, 9, 12 h) during exposure to the pre-determined 12-h LC50 of TFM (11.0 mg l⁻¹; see Results). The protocol was identical to that used by Birceanu et al. (2009-Chapter 2) for larval sea lamprey, but slightly modified. Briefly, fish were contained in static containers filled with 1.0 l of Wilfrid Laurier aerated well water and were allowed to acclimate for 12-24 h prior to the beginning of the experiment. Immediately prior to the addition of TFM, approximately 75% of the water was removed by siphoning, to minimize stress on the fish, and then replaced. As with the previous experiments on larval lamprey, the containers were darkened to prevent the photodegradation of TFM (Carey and Fox 1981), but cotton substrate was not added to the water.

At each sample interval (0, 1, 3, 6, 9, 12 h), sub-sets of fish were anaesthetized with 1.5 g l^{-1} tricainemethanesulfonate (MS222) buffered with 3.0 g NaHCO_3 , blotted dry with a paper towel, and their mass and lengths were measured. Blood was then collected by cardiac puncture using a 1 ml insulin syringe that was previously rinsed with 50 IU heparin solution to prevent blood from clotting. Blood for subsequent lactate, haemoglobin, and haematocrit determination, and tissues (brain, muscle, kidney, liver) for metabolite and fuel store analysis were processed as described by Birceanu et al. (2009-Chapter 2). Whole blood was processed by adding $10 \mu\text{l}$ to 2 parts perchloric acid ($20 \mu\text{l}$) for later determination of lactate concentration, and another $10 \mu\text{l}$ sub-sample was added to 2.5 ml of Drabkin's reagent for blood haemoglobin determination. The remaining whole was transferred to capillary tubes, and centrifuged for 5 min at $10,000 \times g$ for haematocrit determination. The remaining blood sample was centrifuged at $10,000 \times g$ for 3 min, and the plasma was collected and frozen in liquid nitrogen for later determination of plasma glucose concentration. Immediately following blood sampling (within 1 minute), the brain, liver, gills, kidney and muscle fillets were collected from each fish, and snap frozen in liquid nitrogen (Wang et al. 1994a). All tissues were kept at $-80 \text{ }^\circ\text{C}$ until processed for analysis.

Effects of TFM on Rainbow Trout Ion Balance and Haematology

A series of experiments was also conducted at McMaster University in dechlorinated, City of Hamilton tap water (pH ~ 8.0 ; $[\text{Ca}] \sim 930 \mu\text{mol l}^{-1}$; $[\text{Mg}] \sim 400 \mu\text{mol l}^{-1}$; $[\text{Na}] \sim 950 \mu\text{mol l}^{-1}$; temperature $\sim 10\text{-}13 \text{ }^\circ\text{C}$; pH ~ 7.4), to determine if TFM directly interfered with gill-mediated Na^+ uptake and whole body ion balance in rainbow

trout. Similar to the experiments described above, these studies were preceded by a range finder experiment to determine the 12-h TFM LC50 (11.0 mg l⁻¹ TFM) to which the trout would be exposed when examining the effects of the lampricide on Na⁺ uptake rates. Exposure to TFM was conducted in the same manner as described above, except that the trout were held in 2.0 l of water in groups of 4 per container (in triplicate). The fish were also acclimated to these conditions for 12 h, with approximately 75% of the water replaced prior to the start of the radio-tracer experiments designed to measure Na⁺-uptake rates.

The protocol followed that described by Birceanu et al. (2009-Chapter 2). Briefly, each 3 h flux determination period was initiated following the addition of ²⁴Na (5 µCi as Na₂CO₃, specific activity 20.0 µCi mg⁻¹) to each container 10 minutes prior to collecting the initial water sample (sample volume = 10 mL). Additional water samples were collected 1 h and 3 h after the flux was initiated. The water samples were then analyzed for cold (non-radioactive) Na⁺ concentration, and total radioactivity. At the end of the flux, the fish were killed by a blow to the head, and then washed in deionized (DI) water for three minutes, followed by a second 3 minute wash in 20 mmol l⁻¹ NaCl, to wash off any externally bound isotope. The gamma counts of ²⁴Na in whole fish and water were then immediately determined using a 1480 Automatic Wallac182 Wizard Gamma Counter (PerkinElmer Life Sciences, Woodbridge, ON).

After ²⁴Na counts were exhausted (approximately 2 weeks), 5 volumes of 1N HNO₃ was added to a 50 ml centrifuge tube containing a single fish, and the whole bodies digested for 48 h at 60°C. The homogenates were then vortexed, and a sub-sample (1.5 ml) was then withdrawn and centrifuged at 10,000 × g for two minutes. The supernatant

was then diluted using deionized water and analyzed using atomic spectroscopy for Na⁺, K⁺, Mg²⁺, and Ca²⁺ concentration using well established protocols.

Analytical techniques

Blood and Tissue Processing and Analysis

Unless noted, all enzymes and reagents were purchased from the Sigma-Aldrich Chemical Company (St. Louis, MO, USA). Blood haemoglobin concentration was determined using the cyanomethaemoglobin method and sample absorbance read on a plate spectrophotometer (SpectraMax 190, Molecular Devices, CA) at a wavelength of 540 nm. Blood lactate and glucose were determined enzymatically (lactate dehydrogenase and hexokinase, respectively) using micro-modifications of procedures described in Bergmeyer (1983). Whole body Na⁺, K⁺, and Ca²⁺, and water Na⁺ were quantified using atomic absorption mass spectrophotometry (SpectrAA 880, N2 gas; Varian, 171 Mississauga, ON). Whole body and water Cl⁻ concentrations were determined colorimetrically using the mercuric thiocyanate assay (Zall et al., 1956).

Tissue processing for ATP, PCr, glycogen and metabolite determination is outlined in Wilkie et al. (1997, 2001) and was conducted as described in Chapter 2 (Birceanu et al. 2009). Briefly, frozen muscle tissue was initially pulverized using a hammer and the still frozen-pieces were quickly transferred to a liquid N₂-cooled mortar and pestle. Approximately 50 mg of the frozen muscle was dried to constant weight at 60°C for 48 h, and the difference used to calculate the percentage muscle water, which was then expressed as ml water per g dry tissue (e.g. Wilkie et al. 2007b). The remaining frozen tissue pieces were then ground to a fine powder under liquid N₂, followed by

deproteination in 4 volumes of 8% perchloric acid (PCA) containing 1 mmol l^{-1} ethylenediaminetetraacetic acid (EDTA), left on ice for 10 min, and then split into two sub-samples. Sub-sample one was processed for metabolite (lactate, pyruvate and creatine) and fuel store (ATP, PCr) determination. Sub-sample two was neutralized with $3 \text{ mol l}^{-1} \text{ K}_2\text{CO}_3$, frozen in liquid N_2 , and saved at $-80 \text{ }^\circ\text{C}$ until processed for glycogen. Sub-sample one (fuels and metabolites) was then centrifuged at $10,000 \times g$ for 2 minutes, the supernatant drawn off, weighed and neutralized with 0.5 volumes of $2 \text{ mol l}^{-1} \text{ KOH}$ cocktail (composed of 0.4 mol l^{-1} imidazole and $0.4 \text{ mol l}^{-1} \text{ KCl}$). This solution was then vortexed, centrifuged again, and the supernatant removed and stored at $-80 \text{ }^\circ\text{C}$. The same procedure was used for the brain and the liver samples, except that, due to the small size of these tissues, the PCA solution was added directly to the microcentrifuge tube and the samples homogenized on ice using a hand-held motorized pestle (Gerresheimer Kimble Kontes LLC, Düsseldorf, Germany). The extract arising from sub-sample one was analyzed enzymatically for determination of ATP (hexokinase, using glucose-6-phosphatase as coupling enzyme), PCr (creatine kinase), pyruvate (lactate dehydrogenase; muscle only) and lactate (lactate dehydrogenase) based on methods in Bergmeyer (1983). ATP, PCr, creatine, and lactate were each expressed as $\mu\text{mol g}^{-1}$ wet tissue. Tissue glycogen was determined in the second, neutralized extract obtained from sub-sample two, to which one part 2 mol l^{-1} acetate buffer to one part tissue was added, followed by 40 units (U) amyloglucosidase to convert the glycogen to glucose, and incubated at $37 \text{ }^\circ\text{C}$ for 2 h. The incubation was terminated by adding 70% PCA to the digest, and then neutralizing the solution with $3 \text{ mol l}^{-1} \text{ K}_2\text{CO}_3$. Samples were stored at $-80 \text{ }^\circ\text{C}$ for later analysis of glucose. A second sub-sample of homogenate was saved and later used to

determine the free glucose concentration in the tissues. This glucose concentration was subsequently subtracted from the total glucose in the tissue to yield the glycogen concentration in μmol glucosyl units g^{-1} wet tissue.

Gill Na^+/K^+ -ATPase Activity Determination

Gill Na^+/K^+ -ATPase activity followed the protocol outlined by McCormick (1993), in which the activity of the Na^+/K^+ -ATPase was calculated from the difference between the uninhibited total ATPase activity and ouabain inhibited ATPase activity. The reaction media for the experiment contained 2.8 mmol l^{-1} phosphoenolpyruvate (PEP), 3.5 mmol l^{-1} ATP, 0.33 mmol l^{-1} NADH, LDH (4 U ml^{-1}) and pyruvate kinase (PK; 5 U ml^{-1}) in imidazole buffer (50 mmol l^{-1}) at pH 7.5. A salt solution containing 50 mmol l^{-1} imidazole buffer, 190 mmol l^{-1} NaCl, 10.5 mmol l^{-1} $\text{MgCl}_2 \cdot 6\text{H}_2\text{O}$ and 42 mmol l^{-1} KCl in deionized water at pH 7.5 was added to the reaction media the day of the assay in a 3:1 ratio, and kept on ice before use.

Quantification of Na^+/K^+ -ATPase activity was done on approximately 25 mg gill tissue added to 500 μl of the salt solution, and then homogenized on ice using a hand-held motorized pestle. For each gill, 12.5 μl of homogenate were then added to individual microplate wells in triplicate, followed by 200 μl of reaction media-salt solution mixture, and the decrease in absorbance (at 340 nm) of each mixture followed over 10 minutes in the presence or absence of ouabain. The protein concentration in each gill homogenate was determined by Bradford assay (Bradford, 1976), so that specific Na^+/K^+ -ATPase activity could be calculated, as well as wet weight activity.

Determination of Na⁺ Uptake

Determination of Na⁺ influx rate was based on the increase in whole body gamma radioactivity during exposure to TFM. Following gamma count determination, samples were allowed to decay 2 weeks at 4°C (²⁴Na has a half life of ~ 15 h), after which the carcasses were processed for whole body ion (Na⁺, Cl⁻, K⁺ and Ca²⁺) analysis (described above). Whole body Na⁺ influx rates in rainbow trout were determined based on the accumulation of gamma radioactivity in the fish during the 3-h flux period as described by Hogstrand et al. (1994) and in Chapter 2 (Birceanu et al. 2009):

$$\text{Na}^+ \text{ influx Rate} = \text{CPM}_{\text{lamprey}} / (\text{MSA} \cdot \text{T}) \quad (1)$$

where CPM is the gamma counts per minute per gram fish, MSA is the mean specific activity of the water, and T is the duration of the flux period (3 h).

Calculations and Statistical Analysis

Determination of the 12-h LC50 for rainbow trout exposed to TFM was done by probit analysis (Sprague 1969) using software provided by the US Environmental Protection Agency (USEPA Probit Analysis Program, version 5.1). All data are presented as the mean ± 1 SEM. All comparisons were unpaired and analyzed using one-way analysis of variance (ANOVA). When significant variability was observed, statistical significance between the means was assessed using the Tukey-Kramer post-test at the $p < 0.05$ level. When the requirement for homogeneity of variance was not satisfied, a nonparametric ANOVA was used, followed by Dunn's test where appropriate.

RESULTS

Determination of the Acute Toxicity of TFM in Rainbow Trout

To determine the TFM exposure concentration in Wilfrid Laurier well-water (12-h TFM LC50), a range finder experiment was conducted by exposing the trout to measured TFM concentrations of 0.0, 9.5, 14, 20, 25 and 29 mg l⁻¹). This experiment yielded a 12-h TFM LC50 of 11.3 mg l⁻¹ (CI = 0.9 to 16.0), which became the nominal TFM concentration to which the trout were subsequently exposed in the experiments designed to determine how TFM affected energy balance and ion homeostasis. A range-finder experiment was conducted in City of Hamilton dechlorinated tap water, to determine if an exposure concentration of 11.3 mg l⁻¹ TFM was appropriate. Subsequently, trout were exposed to a nominal concentration of 11.3 mg l⁻¹ (12-h TFM LC50 in City of Hamilton dechlorinated tap water), which was used to assess the effects of TFM on whole body ions (Na⁺, Cl⁻, Ca²⁺ and K⁺) and Na⁺ uptake.

Effects of TFM on Rainbow Trout Metabolism

Exposure of rainbow trout to the 12-h LC50 (measured concentration = 12.8 ± 0.1 mg l⁻¹) of TFM markedly lowered energy stores in the brain, kidney and muscle, but not in the liver. Brain glycogen levels were approximately 4.6 ± 0.9 $\mu\text{mol glucosyl units g}^{-1}$ wet tissue, and decreased by approximately 50% after 12 h of exposure (Fig. 3-1a). The decrease in brain glycogen was reflected by a significant increase in brain lactate at 1 h and 6 h, after which lactate levels returned to control values of 10.6 ± 0.8 $\mu\text{mol g}^{-1}$ wet tissue (Fig. 3-1b). Brain ATP levels were also adversely affected by TFM, decreasing by approximately 64% after 1 h of exposure, from control values of 0.6 ± 0.1 $\mu\text{mol g}^{-1}$ wet

tissue (Fig. 3-2a). PCr values were not significantly different from control levels of $3.0 \pm 1.2 \mu\text{mol g}^{-1}$ wet tissue (Fig. 3-2b).

The changes noted in brain fuel store and metabolite levels were not reflected in the liver. Liver glycogen appeared to decrease by 3 h of exposure to TFM, but the decrease was not significantly different from controls. After 3 h, liver glycogen concentrations increased back to control values of $47.9 \pm 9.5 \mu\text{mol glucosyl units g}^{-1}$ wet tissue (Fig. 3-3a). Liver lactate values were not significantly different from control levels of $4.2 \pm 0.6 \mu\text{mol g}^{-1}$ wet tissue, fluctuating between 4.5 and $7.0 \mu\text{mol g}^{-1}$ wet tissue (Fig. 3-3b). Liver ATP and PCr levels were unaltered by exposure to TFM, at approximately $1.1 \pm 0.1 \mu\text{mol g}^{-1}$ and $8.4 \pm 0.1 \mu\text{mol g}^{-1}$ wet tissue, respectively (Fig. 3-4).

Kidney glycogen levels were unaffected by TFM, with controls averaging $8.5 \pm 1.2 \mu\text{mol glucosyl units g}^{-1}$ wet tissue (Fig. 3-5a), but kidney lactate was 40% higher after 1, 3, and 6 h of exposure compared to control lactate concentrations of $6.4 \pm 0.5 \mu\text{mol g}^{-1}$ wet tissue (Fig. 3-5b). Kidney ATP had decreased by almost 50% over the first 6 h of TFM. By 9 h, however, ATP concentrations in the surviving animals were similar to the control values of $0.4 \pm 0.03 \mu\text{mol g}^{-1}$ wet tissue (Fig. 3-6a). These changes were accompanied by 70% lower concentrations of PCr after 3 h of TFM. However, PCr concentrations were comparable to the control values of $1.2 \pm 0.3 \mu\text{mol g}^{-1}$ wet tissue from 6-12 h in those fish that survived TFM exposure (Fig. 3-6b).

Disturbances were also observed in the muscle where glycogen fluctuated between 2-5 $\mu\text{mol glucosyl units g}^{-1}$ wet tissue over the first 9 h of TFM exposure compared to control values of $5.4 \pm 0.9 \mu\text{mol glucosyl units g}^{-1}$ wet tissue (Fig. 3-7a). At 12 h, however, muscle glycogen had significantly decreased by more than 60% compared to the non-

TFM exposed controls (Fig. 3-7a). The adverse effect of TFM exposure on muscle glycogen was accompanied by a 40% increase in muscle lactate after 1 h, which was sustained for 6 h (Fig. 3-7b). However, lactate declined slightly between 9 and 12 h in surviving fish, to levels that were not significantly different from the control values of $0.8 \mu\text{mol g}^{-1}$ wet tissue. Muscle ATP, although variable, remained unaltered from control values of $0.7 \pm 0.3 \mu\text{mol g}^{-1}$ wet tissue (Fig. 3-8a), and muscle PCr was unaffected by TFM fluctuating around $31.7 \pm 2.0 \mu\text{mol g}^{-1}$ wet tissue (Fig. 3-8b).

The metabolic disturbances noted in the brain, muscle and kidney were reflected by minimal changes in blood lactate concentrations, which increased by 50% at 3 h and 6 h of TFM exposure. However, this increase was not quite significant ($p = 0.08$) from control values of $1.6 \pm 0.3 \text{ mmol l}^{-1}$. Blood glucose levels remained unaltered throughout the exposure, averaging $9.2 \pm 1.2 \text{ mmol l}^{-1}$ (Table 3-1).

Effects of TFM on Trout Ion Balance and Haematology

TFM significantly altered Na^+ uptake in trout. After 3 h of exposure, Na^+ uptake decreased by approximately 60% from control values of $1091.0 \pm 85.9 \mu\text{mol g}^{-1} \text{ h}^{-1}$ (Fig. 3-9), and this decrease was maintained throughout the 12 h exposure. Despite this inhibition, gill Na^+/K^+ ATPase activity was maintained at $3.3 \pm 0.5 \text{ nmol ADP } \mu\text{g protein}^{-1} \text{ h}^{-1}$ and was not affected by TFM (Table 3-3). Similarly, wet weight activity and total gill protein concentration remained unchanged over the 12 h exposure (Table 3-3).

TFM had some transient effects on haematology (Table 3-1). Blood haemoglobin (Hb) concentration increased by 35% after 3 h of exposure to TFM. However, Hb values returned to control levels of $6.8 \pm 0.7 \text{ g dL}^{-1}$ by 6 h (Table 1). Haematocrit (Hct) and

mean cellular haemoglobin concentration (MCHC) were unaffected by TFM, averaging $22.2 \pm 2.2\%$ and $33.3 \pm 3.2 \text{ g dL}^{-1}$, respectively (Table 3-1).

Whole body Na^+ levels varied slightly with TFM exposure, increasing by 13% compared to control values of $47.8 \pm 1.5 \text{ mmol l}^{-1}$ after 12 h. However, whole body Cl^- and Ca^{2+} remained unaltered from control concentrations of $35.6 \pm 2.0 \text{ mmol l}^{-1}$ and $111.2 \pm 0.9 \text{ mmol l}^{-1}$, respectively. Whole body K^+ however, decreased by 18% after 3 h of exposure, and then increased by 23% after 6 h, when compared to the control value of $79.1 \pm 1.4 \text{ mmol l}^{-1}$ (Table 2).

DISCUSSION

Effects of TFM on Energy Stores in Rainbow Trout

To determine the effects of TFM on a representative non-target fish species, rainbow trout were exposed to a concentration of TFM (12-h LC50) that was low enough to cause partial mortality, but high enough to elicit a metabolic response. Subsequently, trout were exposed to a nominal TFM concentration of 11.3 mg l^{-1} for various intervals of time in Wilfrid Laurier University well water, to determine the effects of the lampricide on metabolites and fuel stores in vital tissues. A similar 12-h TFM LC50 value (11.0 mg l^{-1}) was calculated for trout in City of Hamilton dechlorinated tap water, after fish were exposed to a range of TFM concentrations. This TFM exposure was used to assess the effects of the lampricide on Na^+ uptake and whole body ions in City of Hamilton dechlorinated tap water. The 12-h TFM LC50 value was well within the range predicted by the alkalinity model developed by Bills et al. (2003) for brown trout. According to the criteria outlined by Bills et al. (2003), water with a pH and alkalinity similar to City of Hamilton dechlorinated tap water (alkalinity $\sim 120 \text{ mg CaCO}_3 \text{ l}^{-1}$; pH ~ 8.0 ; Morgan et al. 2005), should result in a 12-h TFM LC50 of approximately $9.8 \pm 1.0 \text{ mg l}^{-1}$, while the 12-h LC50 in water similar to Wilfrid Laurier University well water (alkalinity $\sim 200 \text{ mg CaCO}_3 \text{ l}^{-1}$; pH ~ 8.0) should be approximately $11.2 \pm 1.3 \text{ mg l}^{-1}$.

The current study provides evidence that TFM causes a metabolic disturbance in non-target fishes exposed to TFM (12-h LC50). Exposure of rainbow trout to TFM caused marked decreases in brain and muscle glycogen levels by 12 h of exposure. The concordant accumulation in lactate in both tissues also supports the hypothesis that trout increased their reliance on glycolysis to meet their ATP demands. Liver glycogen was not

affected by TFM, although it is known to be involved in maintaining glucose homeostasis in the circulatory and nervous systems of vertebrates (Pagliasotti et al. 1994; Panserat et al. 2000). However, trout have much larger reserve of glycogen in their livers compared to other tissues (Vijayan and Moon 1992; Bleau et al. 1996; Soengas et al. 1998; Shanghavi and Weber 1999; Begg and Pankhurst 2004). The trout rely on this large glycogen pool is for immediate energy requirements, such as maintaining blood glucose levels during starvation or during chronic exposure to stressors (Vijayan and Moon 1992; Bleau et al. 1996). Vijayan and Moon (1992) determined that handling had no effect on liver glycogen in fed trout, but liver glycogen reserves were approximately 50% lower in fish that had been starved for 30 days and then further decreased 8 h post-handling. This suggests that liver glycogen is a robust energy store, but that it appears to be negatively impacted by prolonged exposure to a stressor. Therefore, it is possible that the 12 h exposure to TFM was not long enough to elicit as much of a disturbance in trout liver glycogen as it did in the brain or in the muscle of these fishes.

The pronounced decrease in brain glycogen (Fig. 3-1a) suggests that hypoglycaemia contributed to death in rainbow trout by depleting the nervous system of its main fuel source, glucose, thus causing neural arrest, as previously suggested by Wilkie et al. (2007a) and reported by Birceanu et al. (2009-Chapter 2) in larval sea lamprey. Glucose is the main energy source in the brain of vertebrates, which is highly susceptible to glucose reductions caused by food deprivation, hypoxia/anoxia, ischemia and toxicant exposures (Lowry et al. 1964; Soengas et al. 1998, 2006; Polakof et al. 2007; Birceanu et al. 2009). Soengas et al. (1998) reported that brain glycogen significantly decreased in trout that had been starved for 14 days, while Lowry et al. (1964) determined

that glycogen was the most rapidly consumed energy store in the brain of ischaemic mice. Birceanu et al. (2009) showed that TFM decreased brain glycogen reserves in larval sea lamprey by 70% after 9-12 h of exposure. The current study shows that TFM does cause a decrease in glycogen in trout, but not to the same degree as it does in larval lamprey exposed to doses of TFM with equivalent toxicity (i.e. the respective 12-h LC50 for each species).

Liver glycogen did appear to follow a downward trend after 3 h of TFM exposure (Fig. 3-3a), which is consistent with the response observed in the livers of fishes during the early stages of recovery from severe hypoxia (Mandic et al. 2008). Mandic et al. (2008) suggested that decreases in liver glycogen stores (e.g. as a result of hypoxia) could be related to the replenishment of glycogen in other organs that are more sensitive to hypoxia and anoxia, such as the brain (Lowry et al. 1964; Lutz et al. 2003), thus increasing and/or replenishing the brain glycogen levels to provide temporary relief from the stress. Indeed, high brain glycogen levels have been linked to hypoxia/anoxia tolerance in several species, such as the Crucian carp (*Carassius carassius*) and goldfish (*Carassius auratus*). High glycogen is thought to act as a line of defence against ATP depletion during hypoxia and recovery from hypoxia, when the only source of ATP production is via the anaerobic process of glycolysis (Soengas and Aldegunde 2002; Lutz et al. 2003).

Similar to liver glycogen, kidney glycogen levels were unaffected by TFM exposure. Lactate, however, increased slightly by approximately 40% after 1 h of exposure, and this increase was maintained up to 6 h (Fig. 3-5a). The kidney and the liver are the two most important organs that maintain glucose levels in the body (Shanghavi

and Weber 1999; Moyes and Schulte 2006). The finding that kidney glycogen decreased with exposure to TFM therefore suggests that trout were relying more on glycolysis in this and other tissues, to meet the body's glucose requirements. Although the liver and the kidney are the sites of toxicant detoxification in fish, the fact that TFM had little impact on kidney glycogen was not surprising, as previous studies found that kidney glycogen did not appear to be affected by exercise or starvation. Shanghavi and Weber (1999) demonstrated that steady exercise had little impact on kidney glycogen in rainbow trout, and that fish were able to maintain a steady glucose level in the body by matching the rate of hepatic glucose production with the rate of peripheral glucose utilization. Soengas et al. (2006) determined that trout use glucose poorly, as fasting did not significantly impact kidney glycogen, but re-feeding significantly increased glycogen in all the tissues studied.

Further support for the hypothesis that TFM interferes with oxidative ATP production was observed in the muscle, where glycogen levels decreased by more than 50% after 12 h of exposure to TFM. The decrease in muscle glycogen might appear surprising at first, since the trout muscle glycogen is not involved in maintaining glucose homeostasis in the nervous and circulatory systems (Panserat et al. 2000). Instead, muscle glycogen is used to generate ATP by glycolysis during vigorous exercise, such as during burst swimming (Wang et al. 1994b; Kieffer 2000). However, Mandic et al. (2008) reported a 60% decrease in white muscle glycogen levels immediately following hypoxia in goldfish, and provided evidence that muscle glycogen stores were preferentially used over liver glycogen stores to support glycolysis. This provides an explanation as to why muscle glycogen decreased, but liver glycogen reserves remained unaffected in the presence of TFM in the current study. Moreover, the trout used in this study had low

muscle glycogen reserves due to their small size, as reported by Ferguson et al. (1993) for similar size trout. These lower glycogen reserves might have made the muscle more susceptible to TFM-induced perturbations, thus leading to the decrease in glycogen noted in this study after a prolonged (12 h) TFM exposure. It seems unlikely, however, that TFM impaired oxygen uptake or delivery to the tissues, as TFM toxicity is unaltered in hypoxic waters (Seelye and Scholefield 1990). Moreover, Kawatski and McDonald (1974) reported an increase in *in vitro* oxygen utilization in isolated trout brain and bluegill liver preparations in the presence of low concentrations of TFM of 1.0 – 1.5 mg l⁻¹ and 10.0 mg l⁻¹, respectively.

Additional evidence that TFM causes a mismatch between ATP supply and ATP demand was provided by the initial decreases in brain and kidney ATP after 1 h exposure to lampricide (Fig. 3-2a). The decreased ATP in these tissues was likely replenished by dephosphorylation of PCr (Hochachka 1991). PCr buffers ATP in response to low ATP concentrations, thus temporarily maintaining ATP levels in the body (Moyes and West 1995; McLeish and Kenyon 2005). The decrease in PCr also coincides with that of ATP in the kidney (Fig. 3-6b), with levels recovering 6-9 h of TFM exposure.

The ability of surviving rainbow trout to maintain or restore fuel store reserves as TFM exposure continued might be related to an ability to enhance their glucuronidation capacity during the exposure period. Glucuronidation is a major pathway of detoxification of endogenous and xenobiotic compounds, and it is catalyzed by the enzyme UDP-glucuronosyltransferase (UDPGT; Clarke et al. 1991). In fishes, it is the major route by which phenolic compounds such as TFM are detoxified (as opposed to the mixed function oxidases). Because the liver and kidney are major sites of glucuronidation

in fishes (Lech and Costrini 1972; Kawatski and McDonald 1974), a rapid increase in their capacity to detoxify TFM might therefore explain why only lesser changes in glycogen concentrations occurred in these organs compared to larval lamprey (Birceanu et al. 2009-Chapter 2), which have a very low glucuronidation capacity and experience pronounced reductions in glycogen, ATP and PCr in the brain, liver and, to a lesser extent, muscle.

Unlike mammals, which use the process of glucuronidation in phase II detoxification, fish such as trout rely on this pathway to inactivate a variety of xenobiotics including TFM. Several studies have shown that the selective toxicity of TFM could be related to the higher glucuronidation capacity of non-target species to detoxify this lampricide (Lech 1973; Lech and Statham 1975). Lech and Statham (1975) determined that larval sea lamprey not only accumulated more TFM per unit time in various tissues than trout, but also had a limited capacity for glucuronidation compared to trout. Lech et al. (1973) reported that the concentration of TFM-glucuronide excreted in trout bile increased by more than 50% after 4 h of exposure, while Lech and Statham (1975) could not detect any TFM-glucuronide formation in larval lamprey exposed to lethal concentrations of TFM. Our study showed that trout start to recover from the initial metabolic disturbances noted after 1 h of exposure. After 6 h, the fish recovered their fuel stores in the tissues that were affected (kidney and muscle) by TFM, except for the more sensitive brain glycogen stores. Although this aspect of TFM toxicity needs further investigation, it is possible that trout increase their glucuronidation detoxification capacity during exposure to TFM, either by increasing the UDPGT transcription rate or the specific activity of this enzyme. Further studies investigating the detoxification

activity of the enzymes involved in the glucuronidation pathway, as well as how the gene and protein expression of UDPGT changes in the presence of various concentrations of TFM, or after longer TFM exposure, need to be conducted to elucidate how this pathway is influenced by exposure to the lampricide.

Effects of TFM on Ion Balance and Haematology in Rainbow Trout

The 60% decrease in Na^+ uptake suggests another manner in which TFM exerts its toxicity is by impairing ionoregulation in rainbow trout (Fig. 3-9). This hypothesis was also supported by the increase in haemoglobin concentration at 6 h of exposure. There were, however, no changes in haematocrit or mean cellular haemoglobin concentration. The absence of substantive changes in muscle water and ions (Na^+ , K^+ , Cl^- , Ca^{2+}) and gill Na^+/K^+ ATPase activity suggests that, although the impact on Na^+ uptake was significant, any internal homeostatic disturbances that resulted were minimal (Tables 3-1 to 3-3).

One possible explanation for the TFM-induced reductions in Na^+ -uptake was that TFM impaired ATP substrate supply to the gill Na^+/K^+ ATPase, resulting in a direct reduction in Na^+/K^+ -ATPase turnover. Such an effect would be impossible to detect, using the current Na^+/K^+ ATPase assay, which uses crudely homogenized gill filaments exposed to saturating concentrations of ATP (excess ATP) in order to assess the maximal activity of the enzyme. Further studies could be conducted to determine ATP levels in the gills prior to processing them for Na^+/K^+ ATPase activity, which could provide information as to whether a potential decrease in ATP in the gills due to TFM exposure also decreases the activity of the enzyme. The absence of an effect of TFM on the Na^+/K^+ -ATPase activity also suggests that TFM did not damage this critical transporter

either directly or indirectly. Thus, it seems unlikely that any effects of TFM on ion uptake would only be temporary if these fish were transiently exposed to TFM during an actual TFM treatment in the field. This conclusion is supported by the findings of Mallatt and colleagues, who reported significant changes in the gill ultrastructure of lamprey exposed to lethal concentrations of TFM, but did not find similar damage in trout (Mallatt et al. 1985, 1994).

Mechanism of TFM Toxicity in Rainbow Trout – Relevance for Field Applications and Risk Assessment

The current study provides evidence that TFM interferes with ATP production in rainbow trout, a representative non-target species that resides in many streams treated with this lampricide. The effects of TFM in trout, although less pronounced, appear to be similar to those described by Wilkie et al. (2007a) and Birceanu et al. (2009) in larval sea lamprey in that it results in a mismatch between ATP supply and ATP demand, forcing the fish to rely more on glycolysis to generate ATP. Eventually, due to the greater reliance on glycolysis, glycogen and glucose stores are reduced. When this occurs in the brain, and significant TFM exposure persists, the nervous system is eventually starved of glucose, leading to the death of the fish.

Although non-target fish will not encounter lethal concentrations of TFM during a regular stream treatment (McDonald and Kolar 2007), they may be inadvertently exposed to toxic/lethal concentrations of TFM due to sudden drops in stream pH which could occur due to changes in plant/algal respiration which generates acidifying CO₂. As a result, death could result from marked deficits in ATP, leading to increased reliance on

anaerobic glycolysis, and eventually death should neural stores of glycogen be depleted. However, this study demonstrates that even fish that survive the lampricide exposure experience metabolic disturbance characterized by marked decreases in the fuel stores in not only the brain, but also the muscle. Such decreases in muscle glycogen could adversely impact burst and/or endurance swimming, which are essential processes for foraging, migration, reproduction and predator evasion.

The sensitivity of fishes to TFM could also be greater as they emerge from the over-wintering periods, when food supply, and their glycogen reserves are limited. As previously shown (Soengas et al. 1998; Soengas and Aldegunde 2002; Soengas et al. 2006; Polakof et al. 2007), trout glycogen reserves, especially brain glycogen, are quite labile when the fish are starved. Therefore, starvation could increase sensitivity to TFM in non-targets. Moreover, glycogen reserves vary with life stage and size in non-target fishes (Ferguson et al. 1993), which implies that sensitivity of non-target fishes could also be life stage dependant. Further studies analyzing the TFM sensitivity of fishes at different life-stages and seasons are therefore needed to better evaluate the sub-lethal effects that transient TFM exposure has on non-target fishes. Perhaps pre-treatment surveys could eventually use a “life stage and glycogen index” to estimate the TFM sensitivity of non-target fishes, so that the timing and amounts of TFM used for treatments can be adjusted by sea lamprey control personnel to minimize the amounts of larvicide used in the presence of sensitive non-target species.

Table 3-1. The haematology, blood glucose and lactate concentrations, and muscle water content in rainbow trout exposed to toxic concentrations of TFM (12-h LC 50 ~ 12.8 mg l⁻¹). Data presented as the mean ± SEM (N). Data points sharing the same letter are not significantly different.

TFM exposure time (h)	Haemoglobin (g dl ⁻¹)	Haematocrit (%)	Mean Cell Haemoglobin (g dl ⁻¹)	Blood glucose (μmol g ⁻¹)	Blood lactate (μmol g ⁻¹)	Muscle H ₂ O (ml g ⁻¹ dry tissue)
Control	6.8 ± 0.7 (10) ^{a,b}	23.5 ± 4.7 (9) ^a	29.1 ± 6.0 (8) ^a	9.2 ± 1.2 (12) ^a	1.6 ± 0.3 (11) ^a	3.8 ± 0.1 (11) ^a
1	7.5 ± 0.9 (7) ^{a,b}	20.3 ± 2.0 (7) ^a	38.0 ± 6.1 (7) ^a	10.1 ± 1.8 (8) ^a	2.4 ± 0.3 (8) ^a	3.6 ± 0.2 (8) ^a
3	10.5 ± 1.1 (6) ^b	23.3 ± 2.8 (5) ^a	43.5 ± 2.7 (5) ^a	7.5 ± 2.2 (6) ^a	3.2 ± 0.6 (6) ^a	3.7 ± 0.1 (6) ^a
6	6.1 ± 0.7 (5) ^a	29.1 ± 5.8 (5) ^a	24.6 ± 6.7 (5) ^a	9.4 ± 1.8 (6) ^a	3.0 ± 0.6 (6) ^a	4.0 ± 0.3 (6) ^a
9	5.7 ± 0.8 (6) ^a	24.3 ± 3.5 (6) ^a	25.5 ± 5.3 (6) ^a	8.3 ± 1.5 (6) ^a	2.2 ± 0.3 (6) ^a	3.8 ± 0.1 (6) ^a
12	6.8 ± 1.3 (7) ^{a,b}	12.6 ± 4.6 (6) ^a	38.2 ± 11.2 (4) ^a	5.7 ± 1.6 (7) ^a	1.7 ± 0.5 (6) ^a	4.0 ± 0.1 (7) ^a

*Means are considered not quite significant ($p = 0.08$)

Table 3-2. The effects of toxic concentrations of TFM (12-h LC50 ~ 11.0 mg l⁻¹ TFM) upon whole body ion

concentrations in rainbow trout. Data presented as the mean ± SEM (N). Data points sharing the same letter are not significantly different.

TFM exposure time (h)	Na⁺ (mmol l ⁻¹)	Cl⁻ (mmol l ⁻¹)	Ca²⁺ (mmol l ⁻¹)	K⁺ (mmol l ⁻¹)
Controls	47.8 ± 1.5 (10) ^a	35.6 ± 2.0 (12) ^a	111.2 ± 0.9 (9) ^a	79.1 ± 1.4 (12) ^a
3	52.1 ± 1.8 (8) ^{a,b}	36.5 ± 2.0 (8) ^a	110.2 ± 1.3 (8) ^a	64.8 ± 1.7 (8) ^b
6	52.7 ± 1.1 (4) ^{a,b}	35.4 ± 1.4 (4) ^a	115.1 ± 2.0 (4) ^a	103.3 ± 1.5 (4) ^c
9	53.0 ± 1.3 (6) ^{a,b}	39.4 ± 1.5 (6) ^a	112.8 ± 1.9 (6) ^a	83.8 ± 1.1 (6) ^a
12	54.8 ± 1.5 (9) ^b	42.2 ± 1.7 (9) ^a	114.35 ± 1.0 (9) ^a	76.2 ± 1.5 (9) ^a

Table 3-3. Gill Na⁺/K⁺ ATPase activity (specific and wet weight activity) and protein concentration in rainbow trout exposed to their respective 12-h TFM LC50 (4.6 mg l⁻¹) in Wilfrid Laurier University well water. Data presented as the mean ± 1 SEM (N). Data sharing the same letter are not significantly different. For the Na⁺ uptake data there were no fish at the 1 h sampling time.

TFM exposure time (h)	Na⁺/K⁺ ATPase specific activity (nmol ADP μg ⁻¹ prot. h ⁻¹)	Na⁺/K⁺ ATPase wet weight activity (nmol ADP mg ⁻¹ wet tissue h ⁻¹)	Gill protein concentration (μg prot. mg tissue ⁻¹)
Controls	3.29 ± 0.48 (11) ^a	2871.6 ± 510.7 (11) ^a	51.2 ± 4.6 (11) ^a
1	3.18 ± 0.49 (8) ^a	3094.9 ± 420.2 (8) ^a	51.6 ± 5.9 (8) ^a
3	2.80 ± 0.41 (6) ^a	2112.3 ± 383.7 (6) ^a	52.4 ± 6.6 (6) ^a
6	2.78 ± 0.34 (6) ^a	2693.5 ± 455.5 (6) ^a	49.8 ± 3.1 (6) ^a
9	3.75 ± 0.59 (6) ^a	3486.3 ± 477.4 (6) ^a	55.5 ± 6.5 (6) ^a
12	3.67 ± 0.36 (7) ^a	2924.6 ± 338.5 (7) ^a	46.5 ± 3.1 (7) ^a

Figure 3-1. Effects of TFM on Brain Glycogen and Lactate in Trout. Changes in brain concentrations of (a) glycogen and (b) lactate in resting rainbow trout (*Oncorhynchus mykiss*) following exposure to 3-trifluoromethyl-4-nitrophenol (TFM; solid bars) at a nominal concentration of 11.3 mg l⁻¹ for 1, 3, 6, 9 and 12 h, or held under control conditions (no TFM; open bars). Data are expressed as the mean + 1 SEM (N). Bars sharing the same letter are not significantly different.

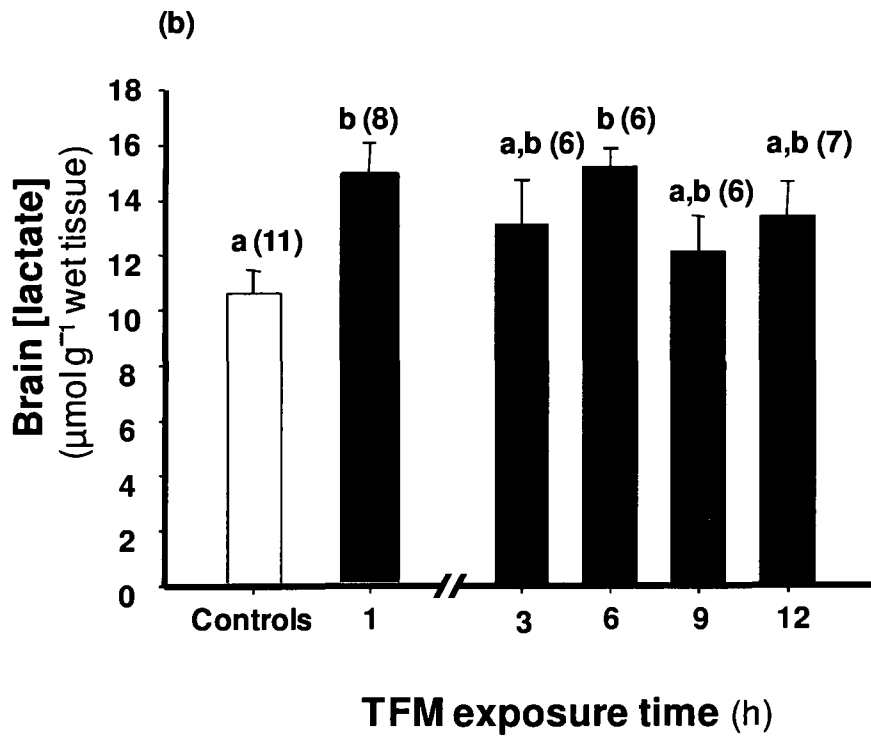
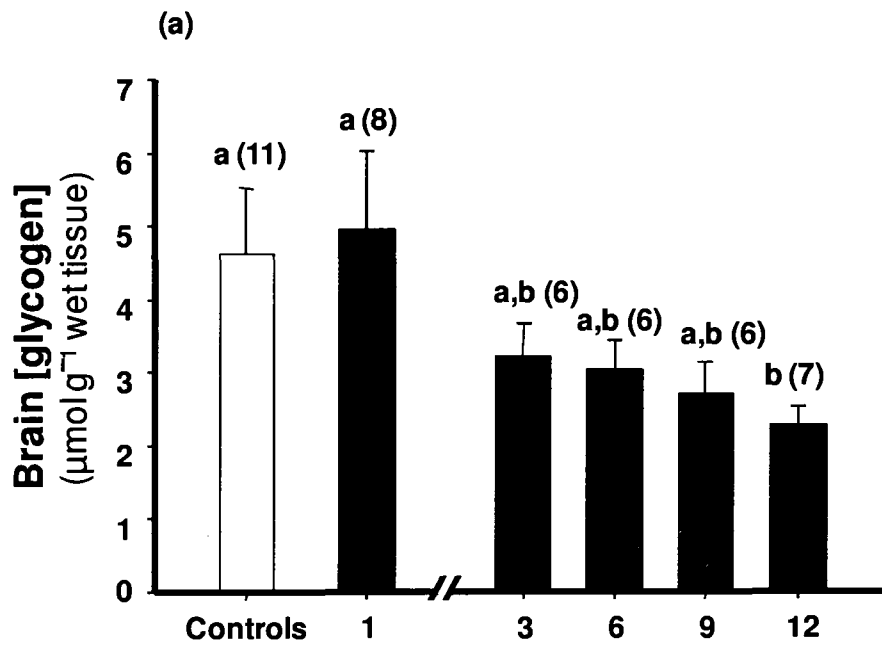

Figure 3-2. Effects of TFM on Brain ATP and PCr in Trout. Changes in brain concentrations of (a) adenosine triphosphate (ATP) and (b) phosphocreatine (PCr) in resting rainbow trout (*Oncorhynchus mykiss*) following exposure to 3-trifluoromethyl-4-nitrophenol (TFM; solid bars) at a nominal concentration of 11.3 mg l⁻¹ for 1, 3, 6, 9 and 12 h, or held under control conditions (no TFM; open bars). Data are expressed as the mean + 1 SEM (N). Bars sharing the same letter are not significantly different.

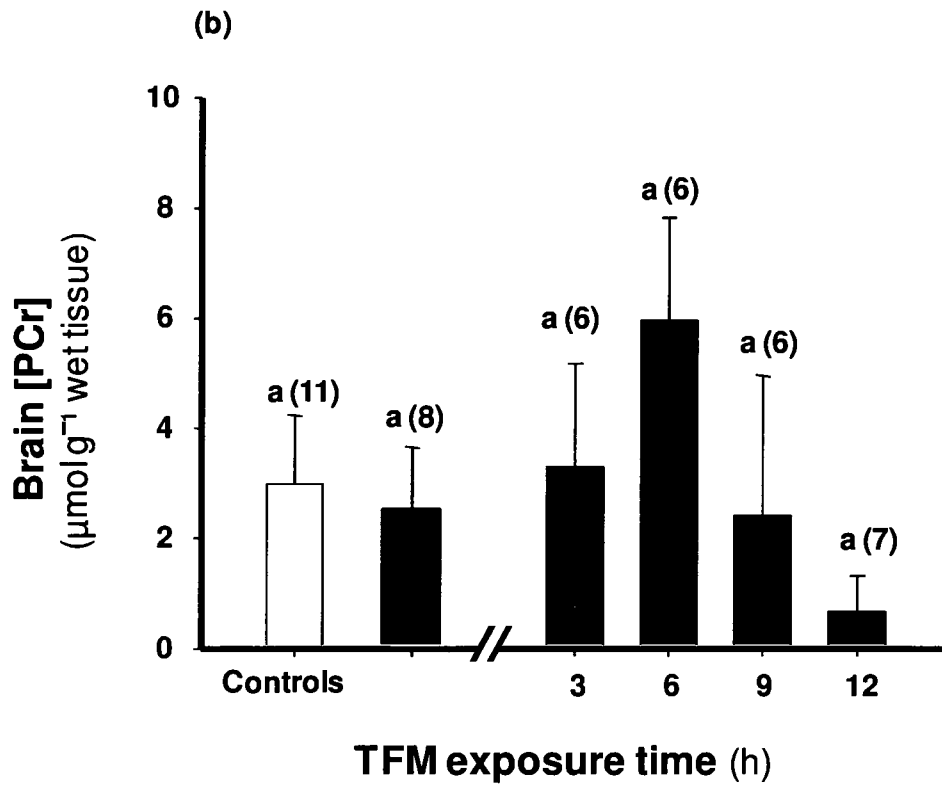
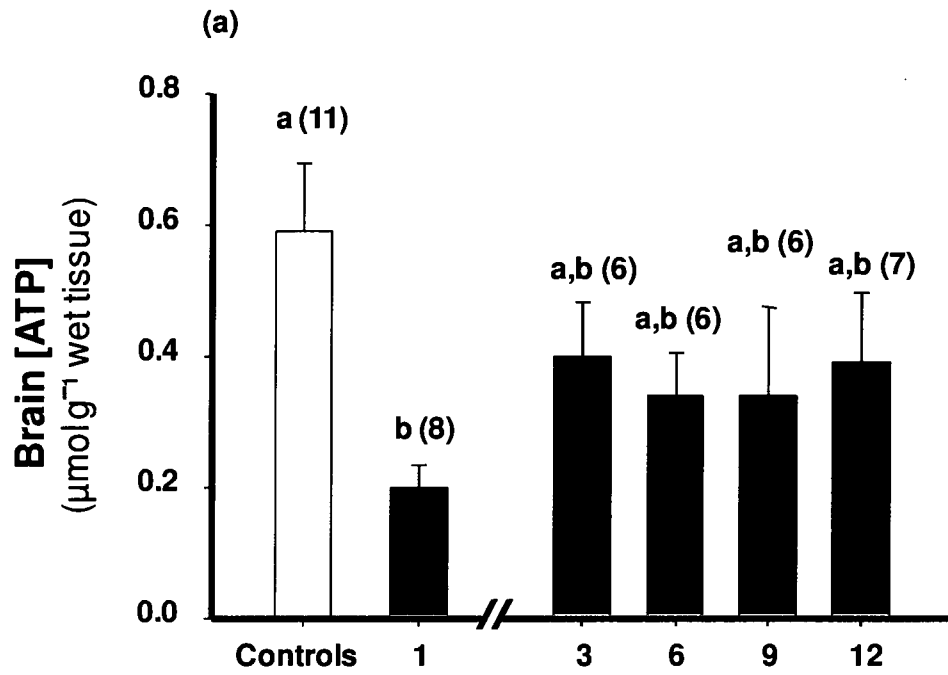
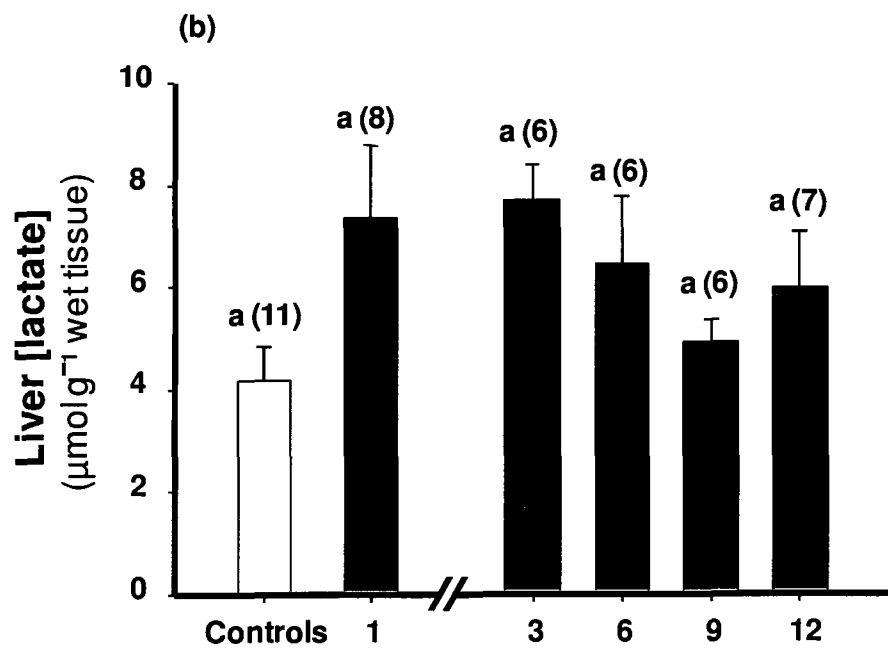
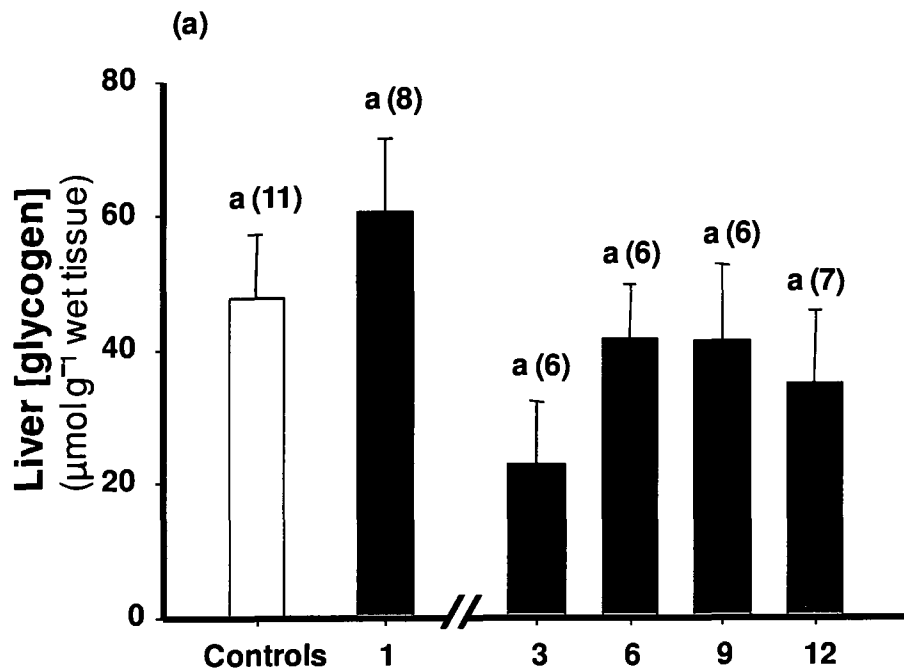

Figure 3-3. Effects of TFM on Liver Glycogen and Lactate in Trout. Changes in liver concentrations of (a) glycogen and (b) lactate in resting rainbow trout (*Oncorhynchus mykiss*) following exposure to 3-trifluoromethyl-4-nitrophenol (TFM; solid bars) at a nominal concentration of 11.3 mg l⁻¹ for 1, 3, 6, 9 and 12 h, or held under control conditions (no TFM; open bars). Data are expressed as the mean + 1 SEM (N). Bars sharing the same letter are not significantly different.



TFM exposure time (h)

Figure 3-4. Effects of TFM on Liver ATP and PCr in Trout. Changes in liver concentrations of (a) adenosine triphosphate (ATP) and (b) phosphocreatine (PCr) in resting rainbow trout (*Oncorhynchus mykiss*) following exposure to 3-trifluoromethyl-4-nitrophenol (TFM; solid bars) at a nominal concentration of 11.3 mg l⁻¹ for 1, 3, 6, 9 and 12 h, or held under control conditions (no TFM; open bars). Data are expressed as the mean + 1 SEM (N). Bars sharing the same letter are not significantly different.

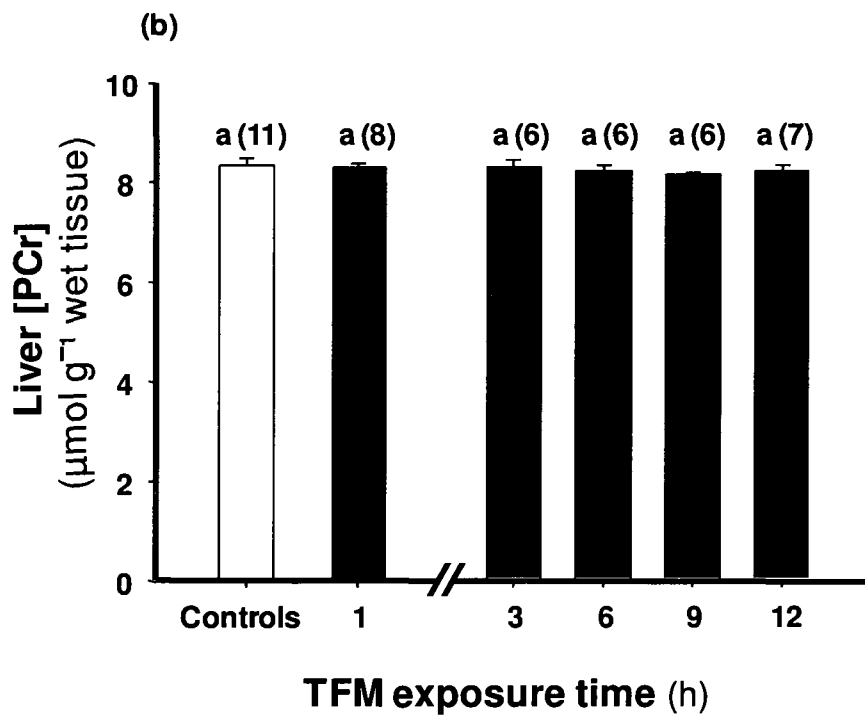
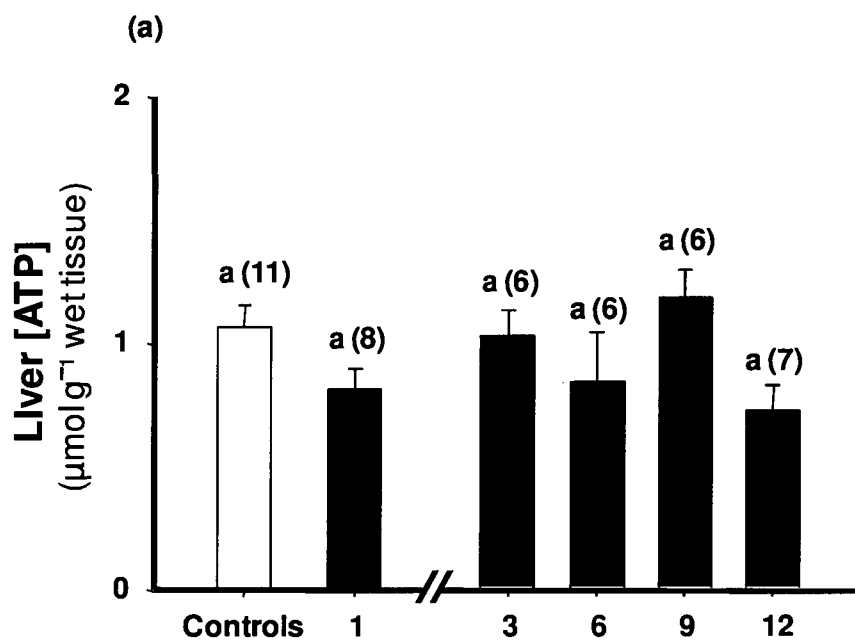

Figure 3-5. Effects of TFM on Kidney Glycogen and Lactate in Trout.

Changes in kidney concentrations of (a) glycogen and (b) lactate in resting rainbow trout (*Oncorhynchus mykiss*) following exposure to 3-trifluoromethyl-4-nitrophenol (TFM; solid bars) at a nominal concentration of 11.3 mg l⁻¹ for 1, 3, 6, 9 and 12 h, or held under control conditions (no TFM; open bars). Data are expressed as the mean + 1 SEM (N). Bars sharing the same letter are not significantly different.

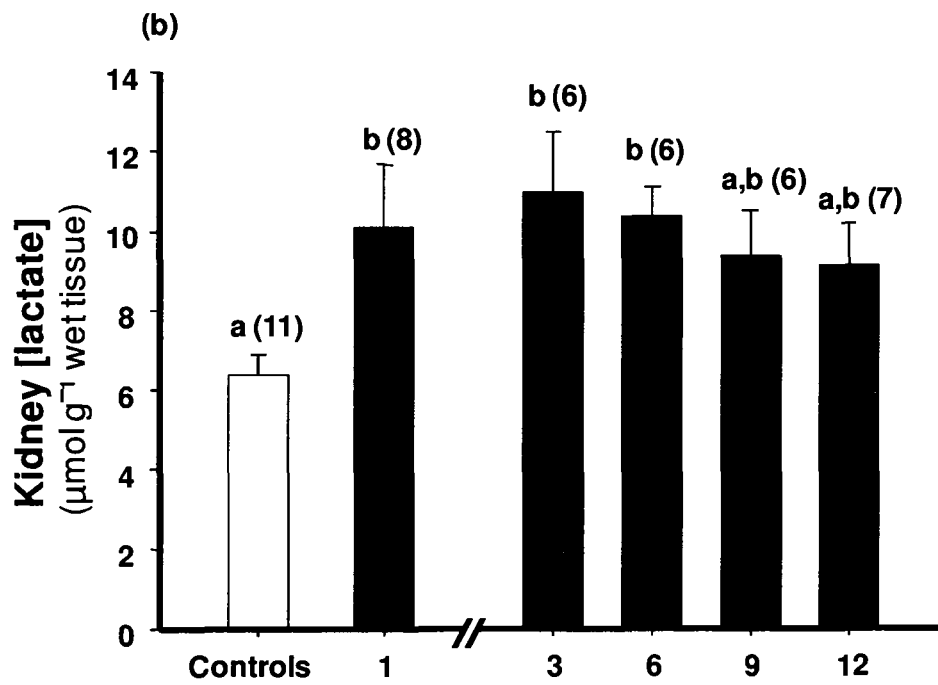
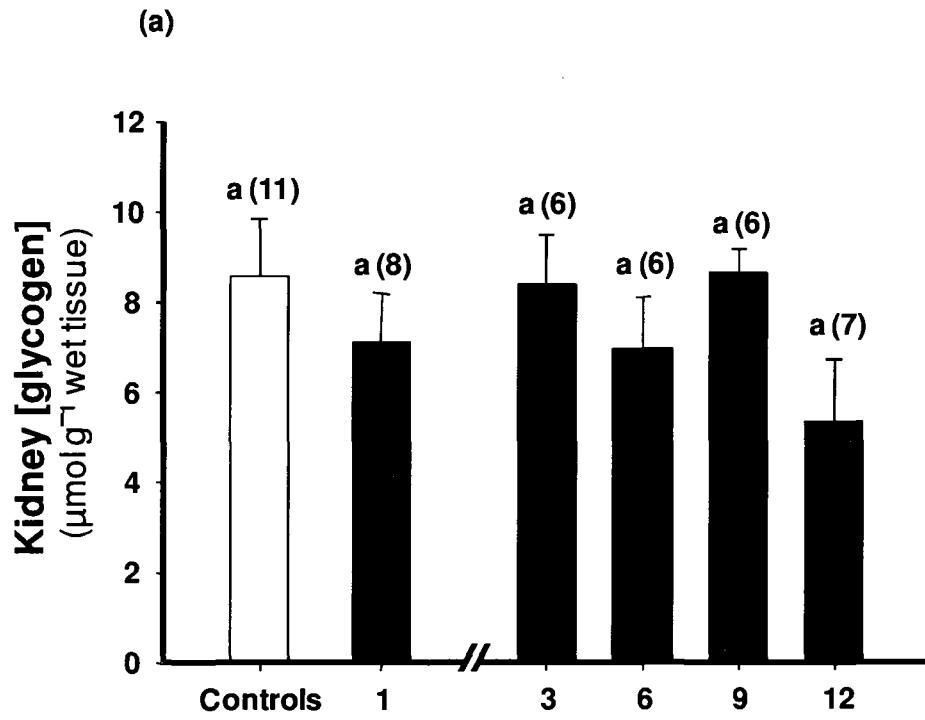

Figure 3-6. Effects of TFM on Kidney ATP and PCr in Trout. Changes in kidney concentrations of (a) adenosine triphosphate (ATP) and (b) phosphocreatine (PCr) in resting rainbow trout (*Oncorhynchus mykiss*) following exposure to 3-trifluoromethyl-4-nitrophenol (TFM; solid bars) at a nominal concentration of 11.3 mg l⁻¹ for 1, 3, 6, 9 and 12 h, or held under control conditions (no TFM; open bars). Data are expressed as the mean + 1 SEM (N). Bars sharing the same letter are not significantly different.

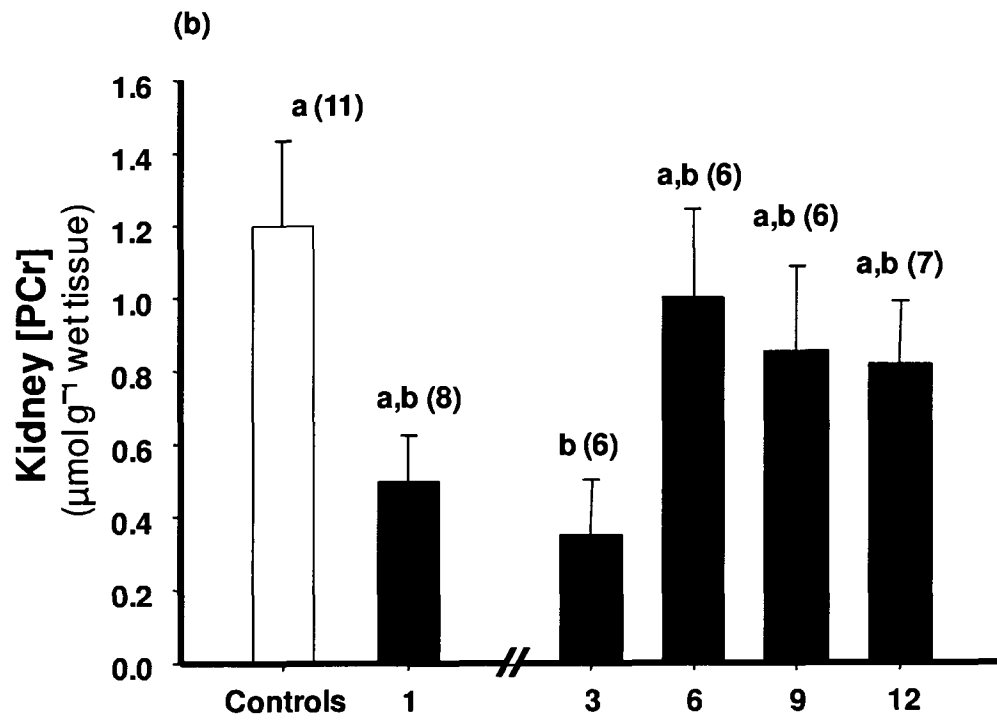
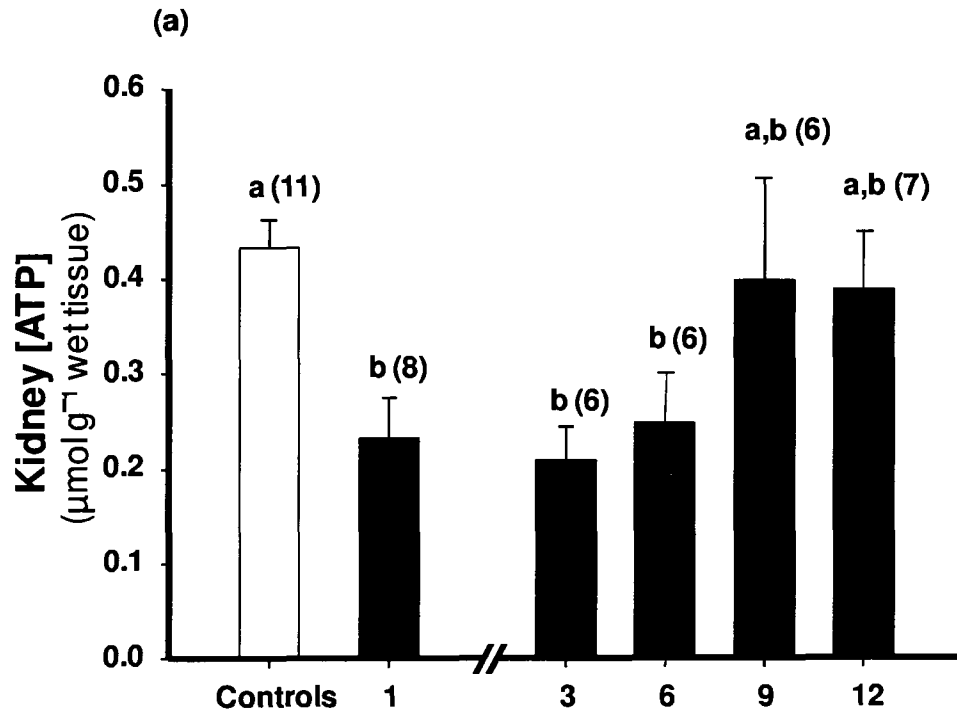
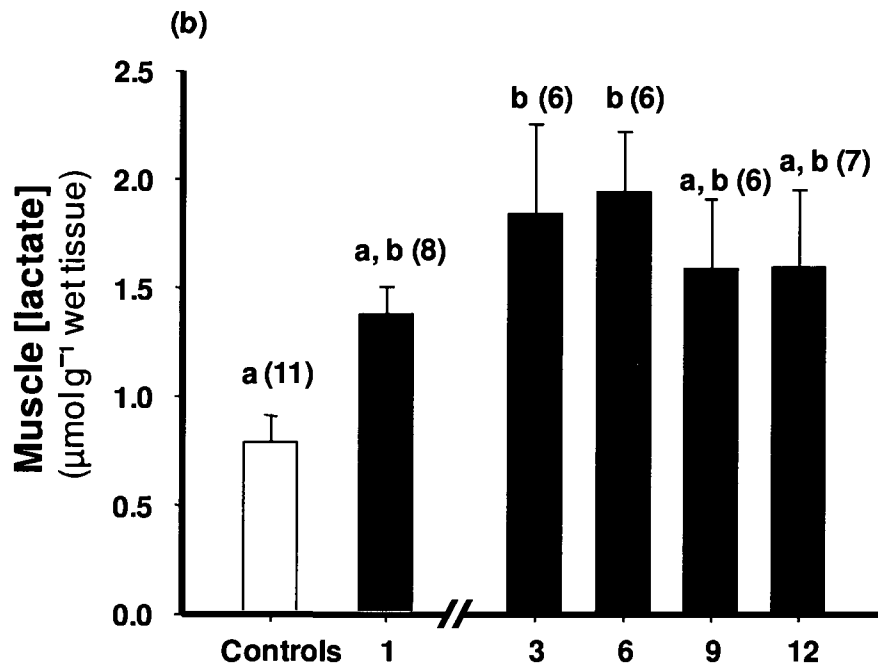
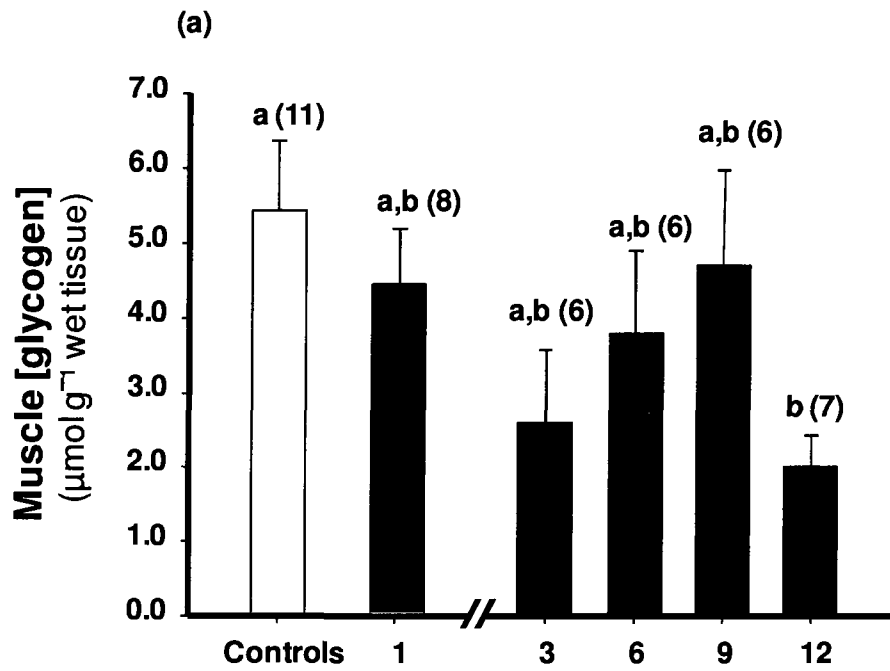

Figure 3-7. Effects of TFM on Muscle Glycogen and Lactate in Trout.

Changes in muscle concentrations of (a) glycogen and (b) lactate in resting rainbow trout (*Oncorhynchus mykiss*) following exposure to 3-trifluoromethyl-4-nitrophenol (TFM; solid bars) at a nominal concentration of 11.3 mg l⁻¹ for 1, 3, 6, 9 and 12 h, or held under control conditions (no TFM; open bars). Data are expressed as the mean + 1 SEM (N). Bars sharing the same letter are not significantly different.



TFM exposure time (h)

Figure 3-8. Effects of TFM on Muscle ATP and PCr in Trout. Changes in muscle concentrations of (a) adenosine triphosphate (ATP) and (b) phosphocreatine (PCr) in resting rainbow trout (*Oncorhynchus mykiss*) following exposure to 3-trifluoromethyl-4-nitrophenol (TFM; solid bars) at a nominal concentration of 11.3 mg l⁻¹ for 1, 3, 6, 9 and 12 h, or held under control conditions (no TFM; open bars). Data are expressed as the mean + 1 SEM (N). Bars sharing the same letter are not significantly different.

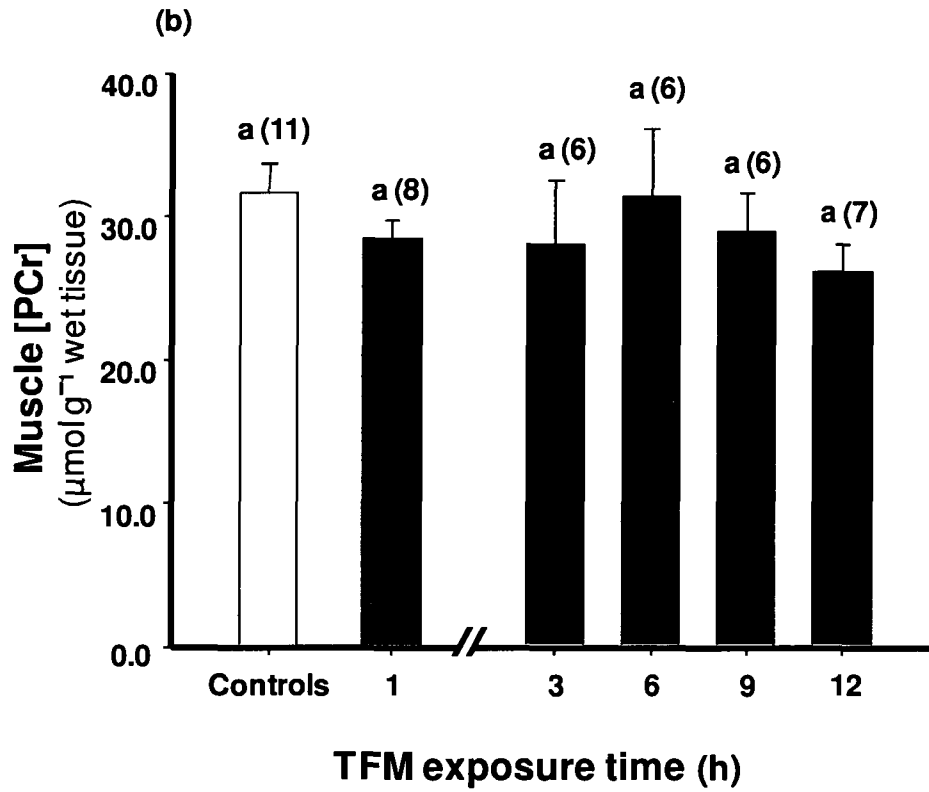
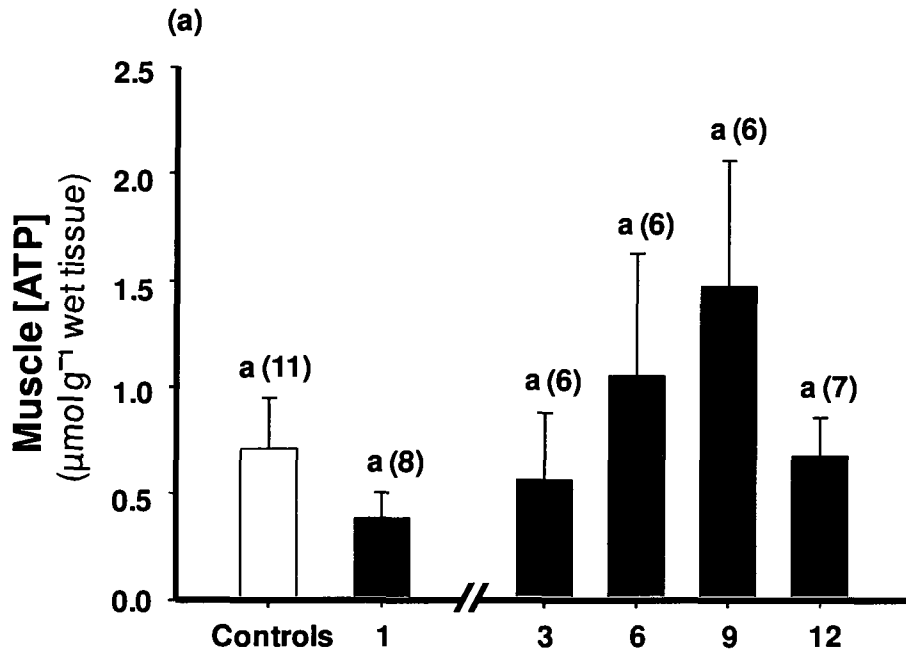
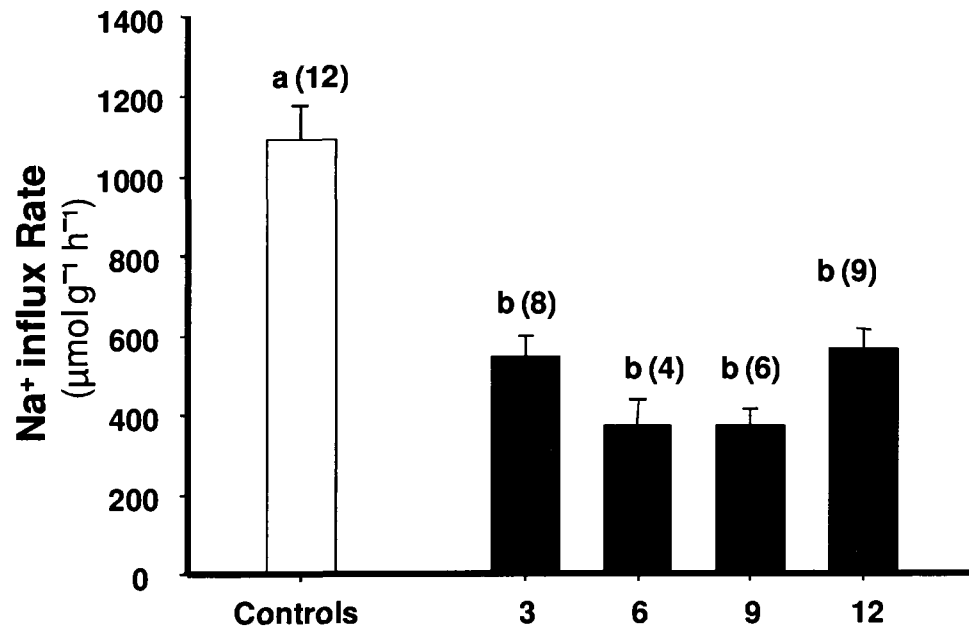

Figure 3-9. Effects of TFM on Na⁺ Influx Rate in Trout. Changes in Na⁺ influx rates in resting rainbow trout (*Oncorhynchus mykiss*) following exposure to 3-trifluormethyl-4-nitrophenol (TFM; solid bars) at a nominal concentration of 11.0 mg l⁻¹ for 3, 6, 9 and 12 h. Data are expressed as the mean + 1 SEM (N). Bars sharing the same letter are not significantly different.



Chapter 4

TFM-Induced Mismatches Between ATP Supply and ATP Demand in Sea Lamprey (*Petromyzon marinus*) and Rainbow Trout (*Oncorhynchus mykiss*) Are Due to Inhibited Mitochondrial ATP Production

ABSTRACT

Toxicity of 3-trifluoromethyl-4-nitrophenol (TFM), is due to a mismatch between ATP supply and ATP demand in lamprey and trout, leading to glycogen depletion that starves the nervous system of ATP (Chapters 2,3). The cause of this TFM-induced ATP deficit is unknown. One possibility is that TFM uncouples mitochondrial oxidative phosphorylation, thus impairing ATP production. To test this hypothesis, mitochondria were isolated from the livers of sea lamprey and rainbow trout. Mitochondrial O₂ consumption rates were measured in the presence of TFM or 2,4-DNP, a known uncoupler of oxidative phosphorylation. TFM and 2,4-DNP markedly increased basal mitochondrial (State IV-absence of ADP in the reaction media) O₂ consumption in a dose-dependent fashion. The presence of the uncouplers decreased the respiratory control ratios [RCR = State III O₂ consumption rate (in presence of ADP) divided by the State IV O₂ consumption rate] by 50% in lamprey and 70% in trout. Thus, TFM uncouples oxidative phosphorylation in mitochondria. To determine how TFM exerted its uncoupling effect, the mitochondrial transmembrane potential (TMP) was recorded using the mitochondria-specific dye rhodamine 123 (RH123). TMP decreased by 17% in sea lamprey, and by 28% in trout. These findings suggest that TFM acted as a protonophore, shuttling H⁺ into the mitochondrial matrix, thus reducing the H⁺ gradient (proton motive force) between the inter-membrane space and the matrix which drives ATP synthesis. Fluorescent images revealed a breakdown in electrical properties of the mitochondria, which likely contributed to the uncoupling effects of TFM. It is concluded that the mode of action of TFM in both sea lamprey and rainbow trout is uncoupling of oxidative phosphorylation, leading to a depletion of ATP in the body, eventually causing death.

INTRODUCTION

The lampricide, 3-trifluoromethyl-4-nitrophenol (TFM) is a halogenated phenol compound, with similar structural and chemical properties to compounds such as 2,4-dinitrophenol (2,4-DNP; Fig. 1-4; see Hubert 2003 for review), which are known to impair ATP production in the mitochondria by uncoupling oxidative phosphorylation (Wallace and Starkov 2000). Applegate et al. (1966) originally suggested that TFM could cause death by impairing mitochondrial ATP production. Compounds such as 2,4-DNP are thought to increase the permeability of the inner mitochondrial membrane to H⁺ ions (protons; see Wallace and Starkov 2000 for review), resulting in a dissipation of the proton gradient (proton motive force) which drives ATP formation, leading to the reduction or elimination of ATP production. This uncoupling is manifested by an increase in oxygen consumption by the mitochondria, as flow through the electron transport chain (ETC) increases in order to compensate for the reduced proton gradient (Emel'yanova et al. 2004; Wallace and Starkov 2000).

Indirect evidence of possible uncoupling by TFM were noted by Smith and King (1960), who reported that the O₂ consumption rates of larval sea lamprey (*Petromyzon marinus*) increased with exposure to TFM. Similarly, Kawatski et al. (1974) reported increased *in vivo* O₂ consumption rates of aquatic midges (*Chironomus tentans*) in the presence of the lampricide. Birceanu et al. (2009-Chapter 2) reported that there were marked decreases in the glycogen and ATP reserves in different tissues of TFM-exposed larval sea lamprey and non-target rainbow trout (*Oncorhynchus mykiss*), further supporting the hypothesis that the mode of action of the lampricide is due to a TFM-induced mismatch between ATP supply and ATP demand. Wilkie et al. (2007a),

proposed that when all these anaerobic glycogen and glucose reserves were depleted as a result of TFM exposure, ATP production would cease and neural arrest and death would soon follow.

Despite evidence that TFM exposure results in a mismatch between ATP supply and ATP demand in larval lamprey (Chapter 2) and trout (Chapter 3), there is no evidence to suggest how this ATP deficit arises in the first place. The only direct evidence that TFM uncouples oxidative phosphorylation is from experiments on mitochondria isolated from rat liver, where a marked increase in oxygen consumption in the presence of TFM was noted by Niblett and Ballantyne (1976). The purpose of this study was to test the hypothesis that TFM inhibits ATP production by uncoupling oxidative phosphorylation in mitochondria isolated from the sea lamprey, and from a representative non-target fish, the rainbow trout. In order to determine the mechanism of toxicity of the lampricide, the effects of TFM on mitochondrial respiration were measured *in vitro* in both species, and compared to those of the known uncoupler 2,4-DNP. To shed more light on how TFM exerts its toxic effects on mitochondria, the hypothesis that TFM increased the proton permeability of the inner mitochondrial membrane was also tested by measuring the electrical potential between the outside of the mitochondria and the mitochondrial matrix using rhodamine 123 (RH123). RH123 is a fluorescent, cationic dye that is localized inside the mitochondrial matrix in proportion to the electrical potential difference between the inter-membrane space and the mitochondrial matrix (Yamamoto et al. 1995; Dykens and Stout 2001; Škárka and Ošťádal 2002; Baracca et al. 2003). If the electrical potential of the matrix becomes more positive due to an influx of protons,

which would occur in the presence of uncouplers such as 2,4-DNP, less $\text{RH}_{1,2,3}$ accumulates in the matrix (Rottenberg 1984).

MATERIAL AND METHODS

Experimental Animals and Holding

Adult up-stream migrant sea lamprey (*P. marinus*, 156.6 ± 7.1 g) were provided courtesy of US Geological Survey (USGS) Hammond Bay Biological Station (Millersburg, MI), and held in 500 L tanks receiving Wilfrid Laurier University well water on a flow-through basis (pH ~ 8.0; titratable alkalinity ~ 200 mg CaCO₃ l⁻¹; hardness ~ 450 mg CaCO₃ l⁻¹). The holding water was chilled to 6 °C to depress the metabolic rate of the lamprey and to allow the animals to survive longer in the laboratory. Rainbow trout (*O. mykiss*, 273.0 ± 56.1 g) were purchased from Rainbow Springs Trout Hatchery (Thamesford, ON) and held in 120 l tanks also receiving Wilfrid Laurier University well water on a flow-through basis (identical water quality to that used for lamprey, but at 11-12 °C). Fish were held under a 12 h light:12 h dark photoperiod. Because sea lamprey do not feed during the up-stream migration period, they were not fed for the time they were in the laboratory (at least 2 weeks). Rainbow trout were fed to satiation 3 times per week with 3.0 point floating pellets (Corey Feed Mills Ltd., Fredericton, NB). The animals were held in the laboratory a minimum of 2 weeks, and the trout were starved 72 h, before experiments commenced. All experiments and fish husbandry were approved by the Wilfrid Laurier University Animal Care Committee, and followed Canadian Council of Animal Care guidelines.

Isolation of Mitochondria

Unless otherwise specified, all the chemicals used in this study were purchased from Sigma-Aldrich Chemical Company (St. Louis, MI). Field formulation TFM

(Clariant SFC GMBH WERK, Griesheim, Germany) was used for all experiments [35% active ingredient dissolved in isopropanol; provided courtesy of Fisheries and Oceans Canada (DFO)].

The isolation of mitochondria from sea lamprey liver was conducted as described by Ballantyne et al. (1989) and LeBlanc et al. (1995). Immediately prior to extracting the liver from lamprey, the animals were killed by a blow to head. The liver was then rapidly removed and placed in ice-cold isolation buffer (approximately 10 volumes), consisting of sucrose (250 mmol l⁻¹), HEPES (30 mmol l⁻¹), ethylene glycolaminoethylethertetraacetic acid (EGTA; 1 mmol l⁻¹), 1% fatty acid-free BSA (Roche Diagnostics GmbH, Mannheim, Germany), at pH 7.4. The liver was then homogenized using a Potter-Elvehjem homogenizer with a loose-fitting Teflon pestle, which was passed over the tissue three times, to break the cells and expose the mitochondria. The homogenates were then centrifuged two successive times at 500 × g for 10 min at 4°C, and the resulting supernatant was passed through cheese cloth between the centrifugations. The supernatant was then centrifuged at 9700 × g for 10 min at 4°C, and the resulting mitochondrial pellet was re-suspended in the ice-cold isolation buffer and centrifuged again at 9700 × g for 10 min at 4°C. The final mitochondrial pellet was then re-suspended in 500 µl of ice cold isolation buffer to yield a final protein concentration of 10-20 mg ml⁻¹, and kept on ice until used in mitochondrial O₂ consumption experiments. The protein concentration for both sea lamprey and rainbow trout mitochondria isolates was determined by the Bradford method (Bradford 1976), using bovine serum albumin (BSA) as a standard.

The rainbow trout liver was removed as previously described for the lamprey, using isolation buffer that was identical to that used to isolate mitochondria from sea lamprey, except that the concentration of HEPES was 10 mmol l^{-1} . Other methods followed those of Suarez and Hochachka (1981), with the following changes. Briefly, as for lamprey, the liver was processed using a Potter-Elvehjem homogenizer with a loose-fitting Teflon pestle, which was passed over the tissue three times, to break the cells and expose the mitochondria. The homogenates were then centrifuged two successive times at $1000 \times g$ for 10 min at 4°C , and the resulting supernatant was passed through cheese cloth between the centrifugations. The resulting supernatant was then centrifuged at $8700 \times g$ for 10 min, and the pellet re-suspended in the isolation buffer, and centrifuged again at $8700 \times g$ for 10 min. The resulting mitochondrial pellet was re-suspended in $500 \mu\text{l}$ isolation buffer, to yield a final protein concentration of $15\text{-}20 \text{ mg ml}^{-1}$.

Measurement of Mitochondrial Oxygen Consumption Rates

Mitochondria O_2 consumption rates were measured with a Rank Brothers Oxygen Monitoring System (Model 20, Bottisham, Cambridge, England). All assays were conducted in a final volume of 1 ml, in a water-jacketed cell, at 22°C , in which the mitochondrial suspensions were mixed with a magnetic stirrer and a Teflon-covered stir bar. Measurements of oxygen consumption were made using Clarke-type O_2 electrodes (Series 1392, Rank Brothers Ltd., Cambridge, England), with the Vernier LabPro four-channel unit. The sea lamprey mitochondria reaction medium (MRM) consisted of KCl (150 mmol l^{-1}), HEPES (30 mmol l^{-1}), KH_2PO_4 (10 mmol l^{-1}), 1% fatty acid-free BSA, at pH 7.4 (Ballantyne et al. 1989; LeBlanc et al. 1995). The rainbow trout MRM consisted

of sucrose (225 mmol l⁻¹), HEPES (20 mmol l⁻¹), KH₂PO₄ (10 mmol l⁻¹), EGTA (0.5 mmol l⁻¹), 1% fatty acid-free BSA, at pH 7.4 (Suarez and Hochochka, 1981). In each case, mitochondria were added to the MRM to get a target protein concentration of 0.3-1.0 mg ml⁻¹ in the chamber. Mitochondrial respiration was initiated by adding succinate (6 mmol l⁻¹), in the presence of rotenone (5 μmol l⁻¹, dissolved in ethanol), to the reaction media to induce State II oxygen consumption (also known as “sparking”). State III oxygen consumption (Chance and Williams 1955) was measured after adding ADP (0.1 mmol l⁻¹) to induce ATP production (phosphorylation), in the presence of the succinate sparker and rotenone. 6-ketocholestanol (kCh; 20 μmol l⁻¹) was added to the mitochondria suspension after addition of the treatments, in an attempt to recover the mitochondria from the effects of TFM or 2,4-DNP. Substrates were dissolved in MRM and injected into the cell through a removable stopper using a Hamilton syringe. Oxygen consumption was then monitored in the presence of 12.5, 25, 50 and 100 μmol l⁻¹ 2,4-DNP or TFM to determine their effects on State III and State IV O₂ consumption, which were used to calculate mitochondria respiratory control ratios (RCR). Rates of O₂ consumption were based on the rate of O₂ disappearance in the each chamber, while RCRs were calculated according to Estabrook (1967) where:

$$\text{RCR} = \frac{\text{State III O}_2 \text{ consumption rate}}{\text{State IV O}_2 \text{ consumption rate}} \quad (1)$$

where State III and State IV O₂ consumption is expressed in nmol O₂ mg prot.⁻¹ min⁻¹, and RCR is unitless.

Measurement of Mitochondrial Membrane Potential

For the measurement of the mitochondrial potential, mitochondria were isolated from the livers of sea lamprey and rainbow trout as previously described. Changes in the relative electrical potential of the mitochondria relative to the suspension medium were measured in State IV mitochondria as previously described by Yamamoto et al. (1995), with minor changes. Mitochondria were isolated as sea lamprey and rainbow trout (described above), and the mitochondria suspension was diluted in MRM to 1 mg ml⁻¹ mitochondrial protein, after which succinate and rotenone were added. After mixing for 5 min, different concentrations of 2,4-DNP or TFM (0, 12.5, 25, 50 and 100 µmol l⁻¹) were added in appropriately labeled centrifuge tubes. Samples were gently mixed by inversion for 5 min, after which they were diluted to 0.5 mg ml⁻¹ mitochondrial protein. The homogenate was then stained with 0.5 µg ml⁻¹ RH123, and gently mixed for another 5 min. RH123 distributes electrophoretically into the mitochondrial matrix in response to an electrical potential across the mitochondrial membrane (Dykens and Stout 2001; Baracca et al. 2003). The stained mitochondria pellet was obtained by centrifugation at 13,200 × g for 15 min. The supernatant (SN) was removed and the pellet (P) was resuspended in the respective mitochondria reaction medium for each species. Absorbance of the supernatant and the resuspended pellet was then measured on 100 µl of sample at 500 nm, using a 96-well plate spectrophotometer (SpectraMax 190, Molecular Devices, CA). The uncoupler p-trifluoromethoxy carbonyl cyanide phenyl hydrazone (FCCP; 8 µmol l⁻¹) was used as a positive control for both the sea lamprey and the rainbow trout mitochondria experiments.

The absorbance coefficient (ϵ) of RH123 under the experimental conditions was calculated to be $0.2808 \text{ nm } (\mu\text{g ml}^{-1})^{-1} \text{ cm}^{-1}$, using the Beer-Lambert equation. The protein concentration in the reaction medium was determined by the Bradford method (Bradford 1976), with BSA as a standard. For the assay, 0.5 mg ml^{-1} mitochondrial protein was used.

RH123 accumulates in the matrix due to its charge and solubility in the inner membrane and in the matrix. Therefore, rhodamine uptake, the in-to-out RH123 gradient and membrane potential of the mitochondria were calculated as described by Yamamoto et al. (1995) in which:

$$\text{RH123 uptake} = \frac{(\text{SN}_{\text{abs}} - \text{P}_{\text{abs}}) / 0.2808}{[\text{protein}]} \quad (2)$$

where RH123 is measured in $\mu\text{g mg protein}^{-1}$, SN_{abs} and P_{abs} are the respective supernatant and pellet absorbances at 500 nm, and 0.2808 is the absorbance co-efficient of RH123.

The in-to-out concentration gradient of RH123 (ΔG) was needed to calculate the membrane potential, and was calculated using the following equation:

$$\Delta G = \frac{\text{RH 123 uptake} \times 1000}{\text{SN}_{\text{abs}} / 0.2808} \quad (3)$$

where ΔG is based on 1 mg mitochondria in 1 μl of media (Yamamoto et al. 1995).

Mitochondrial membrane potential (TMP in mV) was calculated according to the Nernst equation as:

$$\text{TMP} = 58.4 \times \log (\Delta G) \quad (4)$$

Qualitative Assessment of Mitochondria Fluorescence

Mitochondria fluorescence was evaluated using confocal microscopy (Olympus FV1000 Confocal Laser Scanning Microscope), at 600X magnification with oil immersion. Mitochondria were isolated as previously described. Exactly 50 μ L from each sample were then added to the slides, and viewed using the Rhodamine green dye protocol from the Fluoview FV1000 (FV10-ASW, Ver. 1.7) software, using an argon laser. Epifluorescence was conducted using the mercury lamp, with a fluorescein isothiocyanate (FITC) filter cube, with an excitation wavelength of 488 nm, which is closest to the excitation wavelength of RH123 (500 nm). Pictures were collected at a high voltage (HV) of 488 mV and a confocal aperture (CA) of 96 mV.

Statistical Analysis

All the data are presented as the mean \pm standard error of the mean (S.E.M.), with the number of animals at each exposure concentration indicated in brackets. Rates of O₂ consumption, respiratory control ratios and membrane potential between the various exposure concentrations were analyzed using Friedman parametric repeated measures analysis of variance (ANOVA) with Dunn's post-test, at the 95% confidence interval. Measurements of O₂ consumption rates and RCR were conducted simultaneously with control measurements (non-TFM or -DNP exposed mitochondria) for each fish. Statistical significance was set to the $P < 0.05$ level.

RESULTS

The isolation procedure yielded mitochondria in which State II, III and IV respiration were clearly distinguishable from one another. Representative tracings for both lamprey and trout are presented in Figure 4-1. State II respiration was initiated (sparked) by the addition of succinate (6 mmol l^{-1}), after inhibiting Complex I of the electron transport chain with rotenone ($5 \text{ } \mu\text{mol l}^{-1}$). The addition of ADP, as a substrate for mitochondrial ATP-synthase, resulted in a period of increased O_2 consumption (State III), which typically lasted 10-15 min, before O_2 consumption rates decreased as the mitochondria entered State IV respiration, due to the depletion of the ADP. As Fig 4-1 demonstrates, the addition of TFM ($100 \text{ } \mu\text{mol l}^{-1}$) increased rates of State IV oxygen consumption, and the effect was only slightly reversed by the addition of the kCh ($20 \text{ } \mu\text{mol l}^{-1}$) in lamprey mitochondria (Fig. 4-1a), and not at all in trout mitochondria (Fig. 4-1b).

Predictably, when the TFM concentration was sequentially increased in the reaction medium, State III oxygen consumption was unaffected in both lamprey and trout, averaging $14.5 \pm 2.0 \text{ nmol O}_2 \text{ mg protein}^{-1} \text{ min}^{-1}$ in lamprey (Fig. 4-2a) and $9.0 \pm 1.0 \text{ nmol O}_2 \text{ mg protein}^{-1} \text{ min}^{-1}$ in trout (Fig. 4-3a). Similar findings were observed for 2,4-DNP, which served as a positive control. However, successive increases in TFM concentration, or 2,4-DNP concentration, each resulted in a dose dependent increase in State IV O_2 consumption in lamprey and trout mitochondria, from control values of $6.8 \pm 0.3 \text{ nmol O}_2 \text{ mg protein}^{-1} \text{ min}^{-1}$ in lamprey (Fig. 4-2b) and $3.5 \pm 0.8 \text{ nmol O}_2 \text{ mg protein}^{-1} \text{ min}^{-1}$ in trout (Fig. 4-3b). As a result of the TFM and 2,4-DNP mediated increases in State IV respiration, there was a pronounced 50 % reduction in the RCR in lamprey

mitochondria, which decreased from a control average of approximately 2.3 ± 0.2 to ~ 1.0 in the presence of both TFM, and the positive control, 2,4-DNP (Fig. 4-2c). Similar, but more pronounced reductions in the RCR were observed in trout mitochondria, which decreased by almost 70 % from a value of approximately 3.3 ± 0.4 in the absence of TFM to ~ 1.0 when exposed to the highest concentration of TFM or 2,4-DNP ($100 \mu\text{mol l}^{-1}$; Fig. 4-3c).

TFM and FCCP induced marked changes in membrane potential in both sea lamprey and rainbow trout (TFM only; Fig. 4-4), but only the higher concentration of 2,4-DNP had an effect on membrane potential only in lamprey. In sea lamprey (Fig. 4-4a), 50 and $100 \mu\text{mol l}^{-1}$ TFM caused an approximately 25% decrease in membrane potential, from control values of -192.5 ± 4.8 mV. These values were also significantly lower than the membrane potential measured in the presence of the same concentrations of 2,4-DNP. Membrane potential was less affected by exposure to 2,4-DNP. There was a 17% decrease in membrane potential only at $100 \mu\text{mol l}^{-1}$ DNP, compared to controls. The positive control (FCCP exposure) also induced a marked decrease in membrane potential, which was significantly lower than the disturbances induced by 2,4-DNP and the lower concentrations of TFM (Fig. 4-4a). In rainbow trout (Fig. 4-4b), 2,4-DNP did not appear to affect membrane potential. TFM, however, caused a marked, 28% decrease in membrane potential at the $50 \mu\text{mol l}^{-1}$ TFM, but this was not maintained at $100 \mu\text{mol l}^{-1}$ TFM. This marked decrease was also lower than the positive control, which induced a membrane potential that was not significantly different from control values of -188.5 ± 8.1 mV (Fig. 4-6b).

Measured decreases in RH123 uptake, and, hence, in membrane potential were validated using confocal microscopy. This analysis clearly demonstrated that TFM and FCCP, but not 2,4-DNP, caused a reduction in the fluorescence of mitochondria. In sea lamprey (Fig. 4-5a), less RH123 dye was absorbed as the concentration of TFM was increased. A similar trend was noted in the FCCP exposure when compared to the negative control. In the 2,4-DNP exposure it appeared that there was a decreased RH123 uptake only at the 100 $\mu\text{mol l}^{-1}$ DNP. Similarly, in rainbow trout (Fig. 4-5b), there was qualitatively less fluorescence at the 25 and 50 $\mu\text{mol l}^{-1}$ TFM, after which fluorescence appeared to increase at 100 $\mu\text{mol l}^{-1}$ TFM. There appeared to be no qualitative difference in the fluorescence of the mitochondria exposed to 2,4-DNP or FCCP in trout.

DISCUSSION

The increases in State IV respiration and corresponding reductions in RCR, along with decreases in mitochondrial membrane potential that were observed in lamprey and trout mitochondria, support the hypothesis that TFM uncouples oxidative phosphorylation, most likely by increasing the H⁺ permeability of the inner mitochondrial membrane. Moreover, there appear to be few differences in the responses of mitochondria isolated from lamprey and trout to TFM, or to the positive control, 2,4-DNP.

To determine the effects of TFM on isolated liver mitochondria, and compare them to those of 2,4-DNP, a range of concentrations were used to identify dose-responsiveness of lamprey and trout to each compound. The exposure concentrations of TFM and 2,4-DNP used, bracket the TFM concentrations measured by Lech and Statham (1975) in the livers of rainbow trout and larval sea lamprey exposed to the LC99.9 of the sea lamprey (1.0 mg ml⁻¹). It was notable that oxidative phosphorylation was impaired even at the lowest concentrations of TFM used (10 μmol l⁻¹) suggesting that even fish transiently exposed to sub-lethal concentrations might experience some metabolic disturbance. During a TFM stream treatment, non-target species such as the rainbow trout, would typically encounter sub-lethal concentrations of TFM, as their LC50 is approximately 3-4 times higher than that of larval sea lamprey (Chapter 3; Olson and Marking 1973; Bills et al. 2003; McDonald and Kolar 2007). Although the concentration of TFM used for stream treatments are not lethal to non-target species, they still appear to accumulate mostly in the liver or in the muscle (Lech 1974; Lech and Statham 1975; Schultz et al. 1979; Hubert et al. 2005). The dose-dependent nature of uncoupling caused by TFM, therefore suggest that there could be mild metabolic disturbances if the amount

of TFM entering the body were low, or very pronounced if concentrations approached more toxic levels (e.g. the 120-h LC50) as reported by Birceanu et al. (2009-Chapter 2) in larval sea lamprey exposed to their 12-h TFM LC50.

The finding that TFM is an uncoupler of oxidative phosphorylation, and that its mechanism of toxicity could be similar to that of 2,4-DNP, confirms that it interferes with ATP production in both the sea lamprey and non-target species, such as the rainbow trout. The addition of $100 \mu\text{mol l}^{-1}$ TFM to mitochondria in State IV respiration markedly increased O_2 consumption during State IV respiration (Fig. 4-1). State IV respiration is normally marked by lower oxygen consumption compared to State III respiration. O_2 consumption increases during State III respiration due to greater ETC activity due to increased H^+ flow through the ATP- synthase when ATP is being generated from ADP (phosphorylation). In other words, O_2 consumption increases in the presence of ADP (State III) in order to maintain the proton gradient between the inter-membrane space and the mitochondrial matrix. After ADP is depleted, oxygen consumption typically decreases and remains low (State IV). The increase in State IV oxygen consumption in the presence of TFM suggests that the lampricide disrupted the proton gradient causing these protons to move back into the matrix non-specifically. As a consequence, the activity of the ETC increased in an attempt to restore the proton gradient (McLaughlin and Dilger 1980; Starkov et al. 1997; Wallace and Starkov 2000; Boelsterli 2009). Since oxygen is the final electron acceptor of the ETC, mitochondrial O_2 consumption rate increased.

TFM and 2,4-DNP appear to act in a similar manner on mitochondria. State IV respiration rates were markedly increased by the presence of the two chemicals, which resulted in corresponding decreases in RCR. In sea lamprey mitochondria, TFM appeared

to be a more effective uncoupler than 2,4-DNP at lower concentrations ($25 \mu\text{mol l}^{-1}$; Fig. 4-2), which is in agreement with the findings of Niblett and Ballantyne (1976). These authors noted that 4.3 nmol l^{-1} TFM caused a 50% reduction in ADP/O ratios (the amount of ADP consumed per oxygen molecule), while 11.2 nmol l^{-1} DNP were necessary to cause the same effect. The decrease in ADP/O ratios suggests that more oxygen is consumed per ADP molecule, which leads to an increase in mitochondrial respiration with less ATP production (i.e. the mitochondria become uncoupled). Neither TFM nor 2,4-DNP caused marked changes in oxygen consumption in mitochondria in State III respiration, compared to control values, which was expected because mitochondria in this state have high oxygen consumption rates to begin with, due to the aforementioned increased rates of proton movement through the ATP synthase. Since State III respiration was unaffected by TFM and 2,4-DNP, it suggests that neither uncoupler negatively interacts with the ATP-synthase.

Additional evidence that TFM uncouples mitochondria by disrupting the proton gradient or the proton motive force comes from the mitochondrial transmembrane potential data. The significant decreases in TMP suggest that TFM caused protons to move from the inter-membrane space, back into the matrix, without going through the ATP-synthase. In both trout and lamprey, TFM had more potent effects than 2,4-DNP, which resulted in no or little change in TMP. In lamprey, only the $100 \mu\text{mol l}^{-1}$ 2,4-DNP caused a significant decrease in membrane potential, while in trout liver mitochondria 2,4-DNP had no effect. These findings further support the hypothesis that TFM is a more potent uncoupler than 2,4-DNP, as suggested by Niblett and Ballantyne (1976). One possible explanation is that TFM may be more efficient at moving protons back into the

matrix, either by shuttling them through the inner membrane, or by causing the inner membrane to become leakier and more permeable to protons. Indeed, it has been speculated that this is the mode of action of FCCP and 2,4-DNP, which are called protonophores, due to their propensity to increase the net proton permeability of the inner mitochondrial membrane (Rottenberg 1970; Mitchell 1979; McLaughlin and Dilger 1980; Wallace and Starkov 2000; Boelsterli 2009). It should be noted, however, that $8 \mu\text{mol l}^{-1}$ FCCP did not cause a significant decrease in transmembrane potential in trout in the current study. This could be attributed to the mechanism by which FCCP interacts with the trout mitochondrial inner membrane, which could be different from the 2,4-DNP or TFM interactions. However, this aspect needs further investigating.

Protonophores such as 2,4-DNP and FCCP are weak acids (Wallace and Starkov 2000), and are thought to bind to specific protein-binding sites on the inner mitochondrial membrane, which facilitates their movement across inner mitochondrial membrane (McLaughlin and Dilger 1980; Wallace and Starkov 2000). Andreyev et al. (1989) postulated the possibility that for 2,4-DNP, such a protein channel might be the ATP/ADP antiporter, which transports a molecule of ATP from the matrix to the inter-membrane space, in exchange for a molecule of ADP from the inter-membrane space. Schönfeld et al. (1996) demonstrated that the translocation of fatty acids by the ATP/ADP antiporter in the inner mitochondrial membrane was necessary for these compounds to exert their uncoupling effects. Indeed, fatty acids are weak acids, and are also known to uncouple oxidative phosphorylation using a similar inter-membrane space to matrix proton shuttle arrangement (McLaughlin and Dilger 1980), although this depends on the chain length and unsaturation level of the fatty acids (Rottenberg and Hashimoto 1985). It

remains to be determined if the mechanisms behind the protonophore-like effects of TFM are similar to those described for 2,4-DNP or fatty acids (Rolo et al. 2000).

Both TFM and 2,4-DNP uncoupled the mitochondria, bringing the RCR (State III/State IV ratio) near 1. It should be noted that sea lamprey mitochondria had lower RCR values than the rainbow trout, to begin with (Fig. 4-2). However, the lamprey mitochondria RCRs are in agreement with values previously reported in river lamprey (*Lampetra fluviatilis*) and the sea lamprey (LeBlanc et al. 1995; Emel'yanova et al. 2004; Savina et al. 2006). The lower RCRs of lamprey appear to be influenced by ambient temperature and life stage of the lamprey. Savina et al. (2006) reported that the respiration rates of isolated liver mitochondria from river lamprey were 5-6 times lower in February compared to April. The low metabolic rates of lamprey compared to terrestrial vertebrates might also explain the low basal RCR. Emel'yanova et al. (2004) reported that uncouplers such as 2,4-DNP, FCCP and laurate, caused more pronounced reductions on basal (non-phosphorylating or State IV O₂ consumption) in rats and frogs, compared to river lamprey mitochondria. They therefore suggested that organisms with lower metabolic rates may not only have lower mitochondrial respiration rates, but that the mitochondria may not be as tightly coupled (lower RCR values). Moreover, the livers of sea lamprey accumulate bile acids as they mature following metamorphosis due to a loss of their bile ducts (Youson 1980; Youson 2003). Rolo et al. (2000) showed that bile acids decreased State III respiration rate and RCR, and increased State IV in isolated rat liver mitochondria. Similar bile acid accumulation might also contribute to the lower RCR's seen in lamprey mitochondria.

The build-up of bile salts in the sea lamprey only occurs following metamorphosis, which initially gives the liver an orange, followed by emerald-green coloration, as the animals proceed through the parasitic and upstream migrant phases of their life cycle, and the plasma becomes progressively greener due to the increasing presence of bile pigments as the animals approach reproductive maturity. Thus, all tissues in the body, with the possible exception of the cerebrospinal fluid, would be exposed to increasing concentrations bile salts, as sea lamprey enters the terminal phase of its life cycle, compromising mitochondrial function (Jaeschke et al. 2002). Thus, it is possible that the mitochondria isolated from the livers of upstream migrant sea lamprey could be more sensitive to TFM than those of larval sea lamprey with intact bile ducts. Indeed, the 12-h LC50 for TFM is about 50 % lower for upstream migrant lamprey compared to larval sea lamprey (M. Henry, O. Birceanu, and M.P. Wilkie, unpublished findings). It would therefore be very informative to develop techniques to isolate the mitochondria from the much smaller ammocoetes to further understand how bile affects not only the TFM sensitivity of lamprey at different life stages, but also metabolic processes in general.

The effect of the TFM on State IV respiration in rainbow trout did not appear to be affected by addition of 6-ketocholestanol (kCh; Fig. 4-1b). In sea lamprey, however, kCh slightly reversed the inhibition of oxidative phosphorylation during exposure to high concentrations of TFM (Fig. 4-1a). By increasing the membrane dipole potential, kCh completely prevents or reverses the uncoupling activity of low concentrations of potent protonophores, such as SF6847 or 2,4-DNP (Starkov et al. 1997). However, the mode of action of kCh is not by binding with the uncoupler, thus preventing it from reaching the

membrane (Starkov et al. 1997). Rather, inner-mitochondrial proteins appear to be involved in recovery by kCh, which could suggest that similar proteins may be involved in the initial uncoupling of the mitochondria with TFM noted in this study. Starkov et al. (1997) demonstrated that uncoupling with low concentrations of 2,4-DNP was partially mediated by the ATP/ADP antiporter. Skulachev (1988, 1991) demonstrated that thermogenin, a brown fat protein, and the ATP/ADP antiporter, were involved in uncoupling by fatty acids. Thus it is possible that such proteins are involved in uncoupling by 2,4-DNP or TFM but further investigation is required.

The rainbow trout mitochondria in the current study appeared to be at least as sensitive to uncoupling by TFM as were the sea lamprey mitochondria. This suggests that the ability of the trout to tolerate higher concentrations of TFM is not directly related to differences in the sensitivity of mitochondria to TFM, but it is more likely dependent upon the fish's ability to detoxify the lampricide before it reaches the mitochondria. The major pathway of detoxification of xenobiotics in teleosts is glucuronidation, which uses a pathway catalyzed by the enzyme UDP-glucuronosyltransferase (UDPGT; Clarke et al. 1991). In fishes, glucuronidation is the major route by which phenolic compounds such as TFM are detoxified (as opposed to the mixed function oxidases), with the liver and kidney as the major sites for this process (Lech and Costrini 1972; Kawatski and McDonald 1974). Because the UDPGTs are found in the cytosol or in the endoplasmic reticulum (Lech and Constrinin 1972; Lech and Statham 1975; Kane et al. 1994; Vue et al. 2002), not in mitochondria, no TFM detoxification would have taken place in the trout mitochondria isolates used in the present study. As a result, the trout isolated mitochondria used in this study were just as sensitive to TFM exposure as the sea lamprey

mitochondria. In actual field TFM treatments, however, trout mitochondria would not normally encounter such high internal TFM concentrations due to trout's greater ability to use glucuronidation to detoxify the little TFM that does accumulate.

The current study provides evidence that the mechanism of toxicity of the lampricide TFM is by uncoupling of oxidative phosphorylation in the mitochondria of sea lamprey and rainbow trout. Birceanu et al. (2009-Chapter 2) noted marked decreases in glycogen, phosphocreatine and ATP stores in critical tissues of larval sea lamprey and rainbow trout exposed to their respective 12-h TFM LC50s, including the brain and liver. It is now clear that this mismatch in ATP supply versus ATP demand was initiated at the level of the mitochondria by TFM. The evidence presented here strongly suggests that TFM increased the proton permeability of the inner mitochondrial membrane, leading to a break-down in the proton-motive force, which consequently reduced proton flow through the ATP synthase, lowering the rates of ATP production. Thus, previously reported deficits in ATP likely resulted from declines in mitochondrial ATP production, necessitating greater reliance on anaerobic metabolism, and therefore reducing phosphocreatine and glycogen reserves. When glucose/glycogen reserves are depleted, death of the fish rapidly follows.

Figure 4-1. Effects of TFM and kCh on Lamprey and Rainbow Trout

Mitochondria. Representative tracings of O₂ consumption rates in mitochondria isolated from the liver of (a) sea lamprey or (b) rainbow trout in the absence and presence of TFM. O₂ consumption (nmol O₂ ml⁻¹ min⁻¹) rates are indicated by the numbers included on each trace. State II O₂ consumption was initiated by “sparking” the mitochondria with succinate (6 mmol l⁻¹) in the presence of rotenone (5 μmol l⁻¹). State III O₂ consumption was then induced by the addition ADP (100 μmol l⁻¹) to initiate ATP synthesis. State IV O₂ consumption followed after all ADP substrate was consumed, at which time TFM was added to determine its effects on basal (State IV) mitochondrial O₂ consumption. 6-ketocholestanol (kCh) was added to the mitochondria reaction medium (MRM) to determine if it was protective against TFM-induced increases in State IV O₂ consumption. All measurements were conducted at 22°C, in 1 ml MRM. Arrows indicate the points at which each chemical was added to the MRM, and Roman numerals represent the State II, III or IV O₂ consumption.

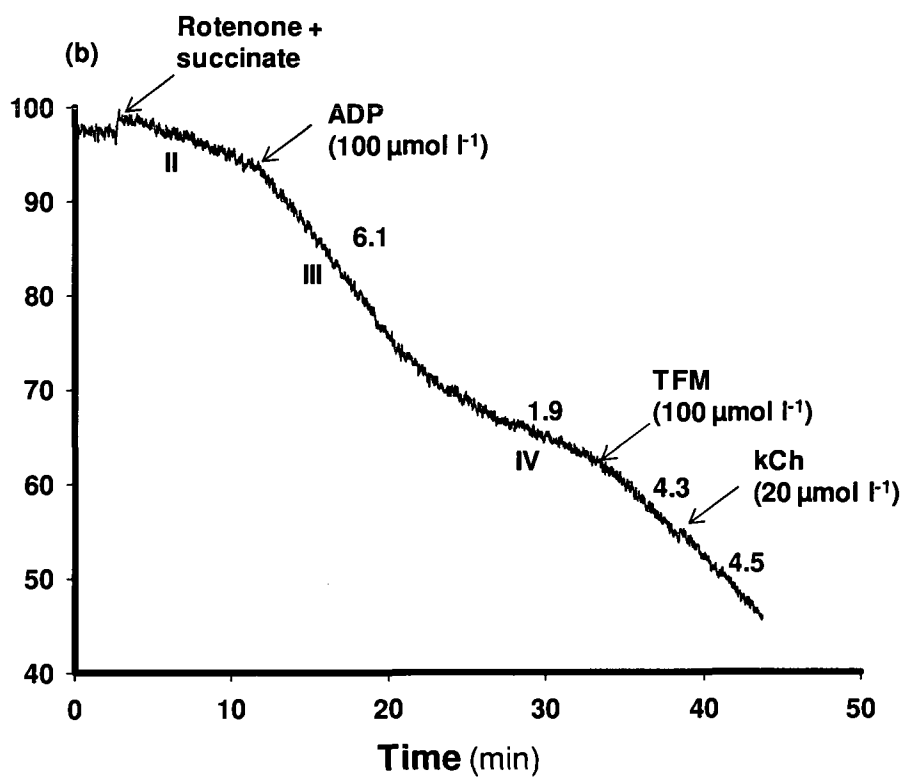
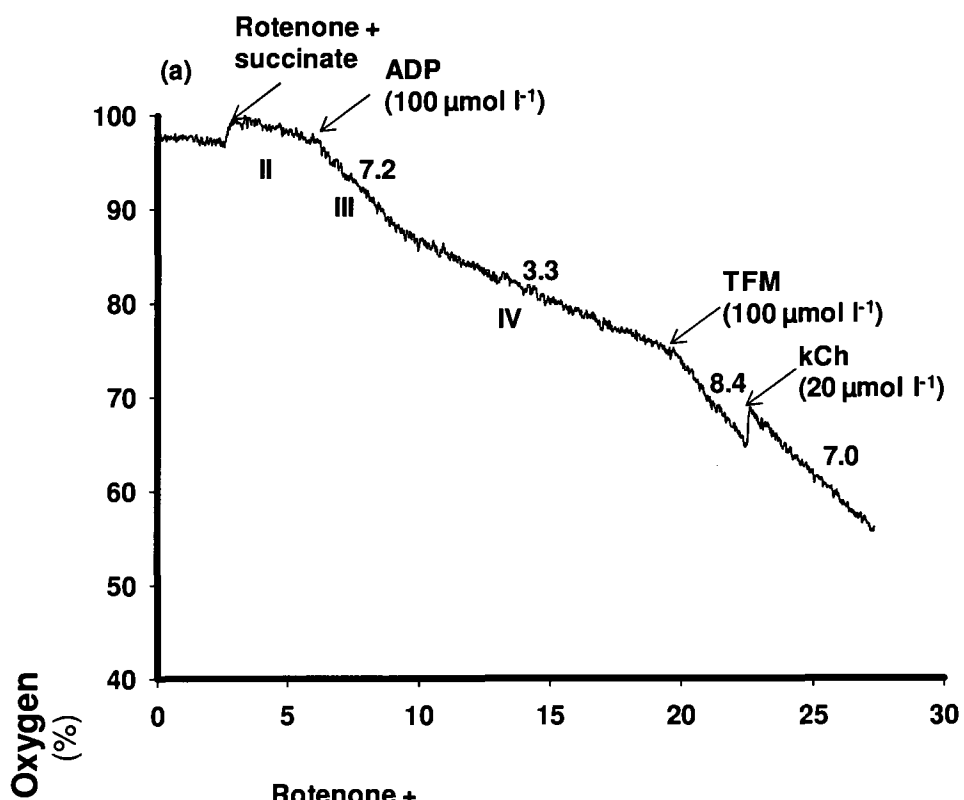

Figure 4-2. Effects of TFM and 2,4-DNP on Sea Lamprey Mitochondrial Respiration. Rates of O₂ consumption in mitochondria isolated from upstream migrant sea lamprey in the presence of TFM (solid circles) or 2,4-DNP (open circles) during (a) State III respiration (presence of ADP), or (b) State IV respiration (ADP depleted). The ratio of State III (no treatment)/State IV (controls and treatments) O₂ consumption rates were used to calculate the (c) respiratory control ratios. Letters represent significant differences between the treatments and their respective controls. Asterisks (*) represent significant differences between the same exposure concentrations of TFM and 2,4-DNP. Data points sharing the same letter are not significantly different. Refer to method and materials and legend of Fig. 4-1 for further details of experimental conditions.

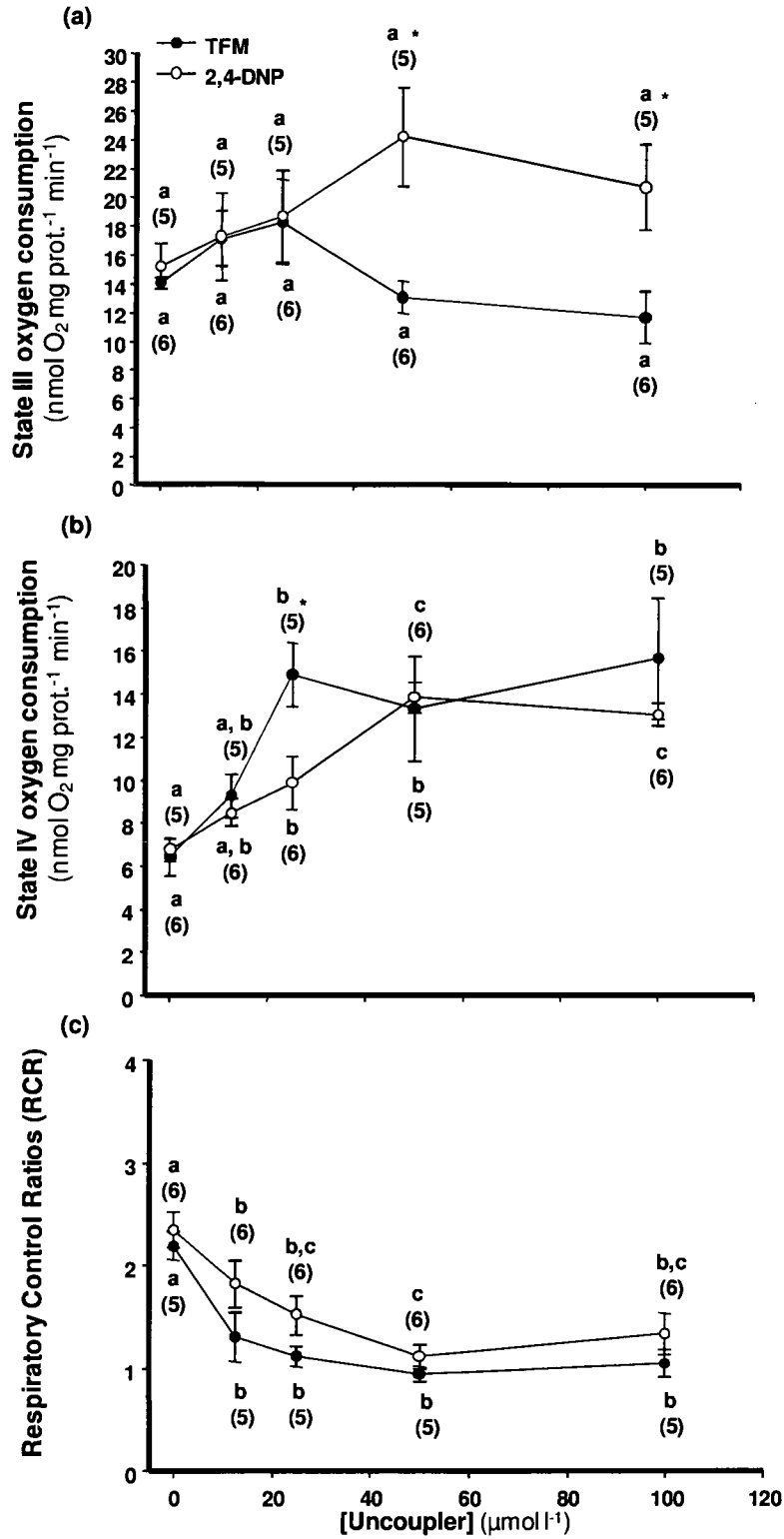

Figure 4-3. Effects of TFM and 2,4-DNP on Rainbow Trout Mitochondrial

Respiration. Rates of O₂ consumption in mitochondria isolated from rainbow trout in the presence of TFM (solid circles) or 2,4-DNP (open circles) during (a) State III respiration (presence of ADP), or (b) State IV respiration (ADP depleted). The ratio of State III(no treatment)/State IV (controls and treatments) O₂ consumption rates were used to calculate the (c) respiratory control ratios. Letters represent significant differences between the treatments and their respective controls. Asterisks (*) represent significant differences between the same exposure concentrations of TFM and 2,4-DNP. Data points sharing the same letter are not significantly different. Refer to method and materials and legend of Fig. 4-1 for further details of experimental conditions.

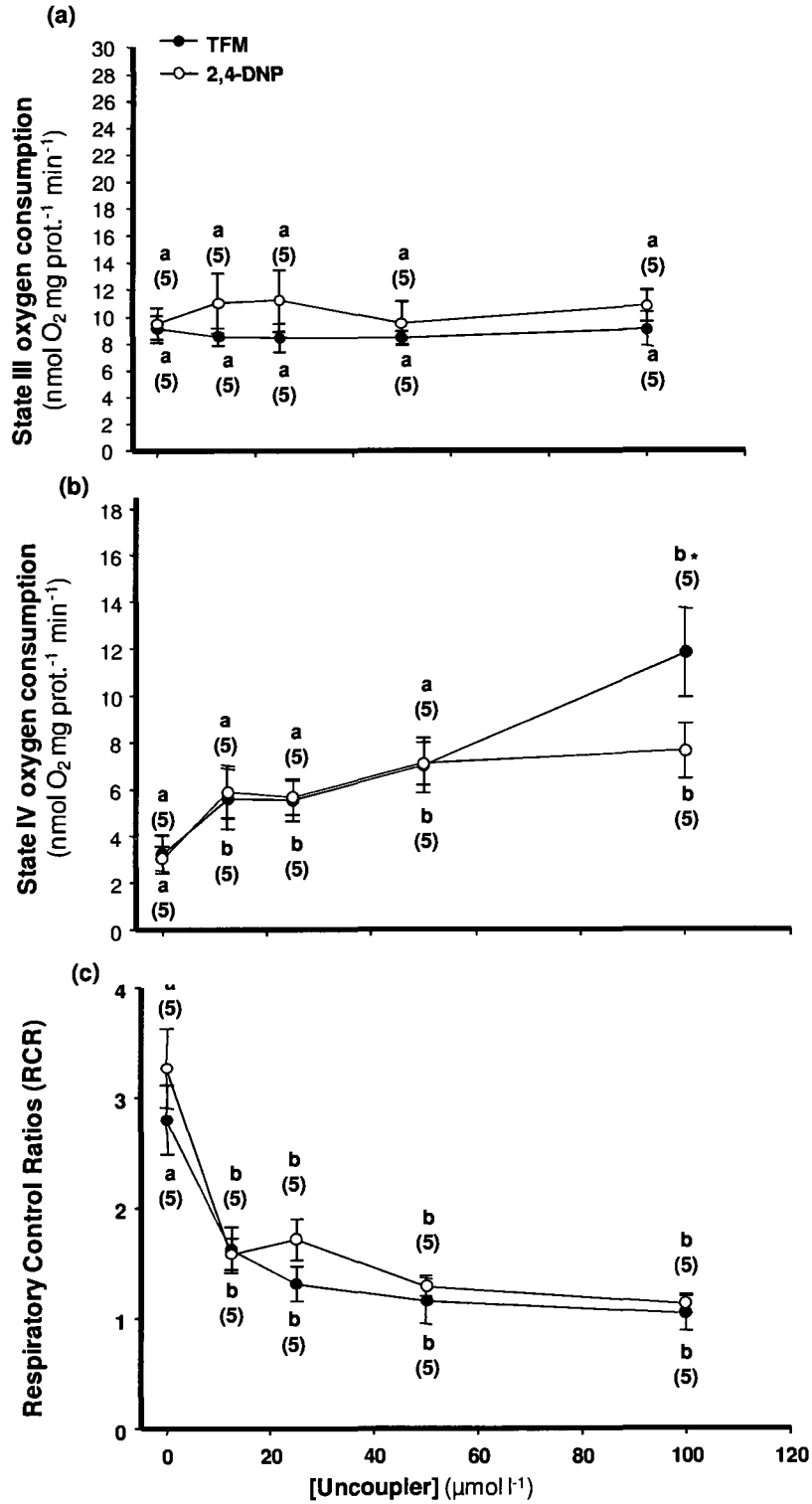

Figure 4-4. Effects of TFM and 2,4-DNP on Mitochondrial Membrane

Potential. Mitochondrial membrane potential measured in (a) sea lamprey and (b) rainbow trout in the presence of TFM (solid circles) or 2,4-DNP (open circles). FCCP (open diamonds) was used as a positive control. Letters represent significant differences between the treatments and their respective controls. Asterisks (*) denote significant differences between State IV respiration in the presence of the two uncouplers at the same concentrations; daggers (†) denotes significant differences between TFM or 2,4-DNP treatments and the positive control (FCCP). Data points sharing the same letter are not significantly different.

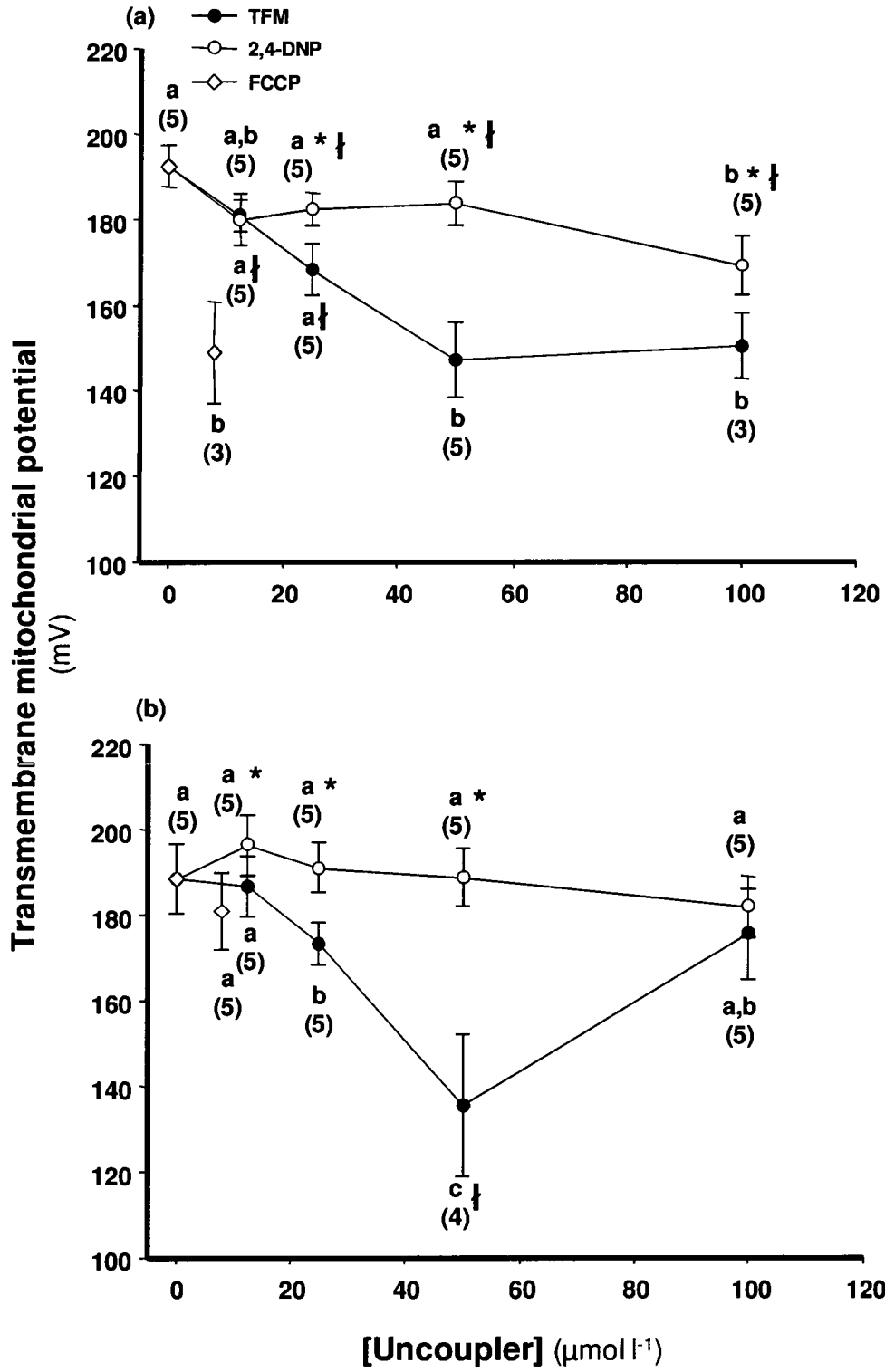
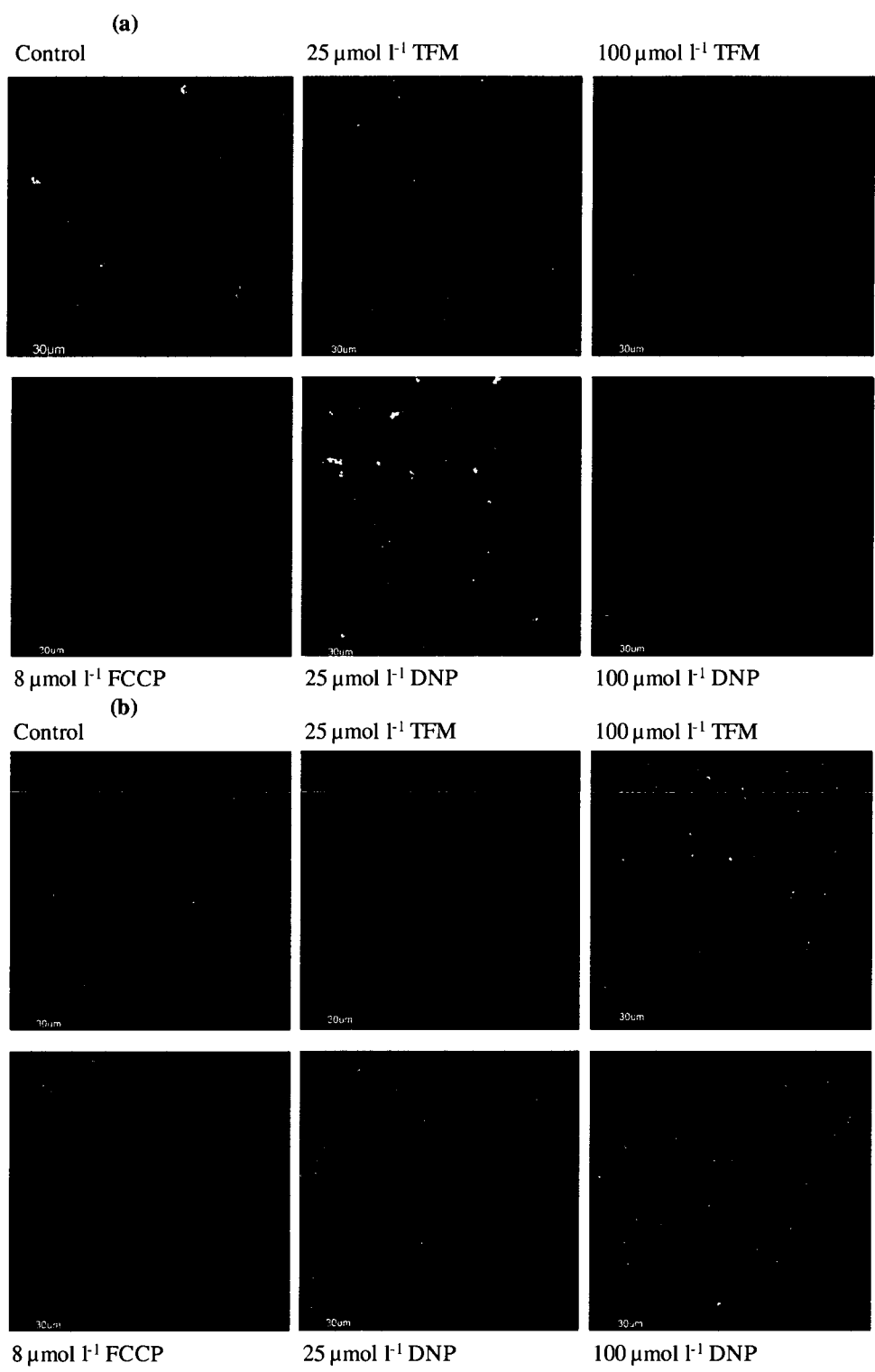

Figure 4-5. Qualitative Effects of TFM and 2,4-DNP on Sea Lamprey and Rainbow Trout Mitochondrial RH123 Uptake. Photomicrographs of RH123 fluorescence in mitochondria (0.5 mg ml^{-1}) isolated from (a) sea lamprey and (b) rainbow trout livers in the presence of TFM, 2-4 DNP or FCCP ($8 \text{ } \mu\text{mol l}^{-1}$; positive control) for both species. Control micrographs (the negative control) represent RH123 stained mitochondria, with no treatment.



Chapter 5

An Integrated Model of TFM Toxicity in Sea Lamprey (*Petromyzon marinus*) and Rainbow Trout (*Oncorhynchus mykiss*)

An Overview of the Integrated Responses of Sea Lamprey and Trout to TFM

The lampricide 3-trifluoromethyl-4-nitrophenol (TFM), was initially thought to exert its toxic effects by interfering with mitochondrial ATP production (Applegate et al. 1966) because of its structural similarity to phenolic compounds such as 2,4-dinitrophenol (2,4-DNP; Fig. 1-4). Such compounds are known to inhibit the process of oxidative phosphorylation, which drives ATP production in mitochondria. Niblett and Ballantyne (1976) used isolated rat mitochondria to show that TFM is indeed an uncoupler of oxidative phosphorylation, and that its effects on mitochondria were more pronounced than those of 2,4-DNP. However, similar isolated-mitochondria studies were never conducted in the sea lamprey (the target organism) or non-target species. My thesis demonstrates that TFM exerts its toxicity in both sea lamprey and rainbow trout by uncoupling mitochondrial oxidative ATP production, resulting in increased reliance on anaerobic fuels (glycogen) and phosphagens (PCr). This increased reliance on glycolysis and PCr hydrolysis eventually results in death when the glycogen and phosphagen reserves are depleted and the ATP supply becomes insufficient for critical organs such as the brain. Below I provide a model which depicts these events, and propose how such disturbances occur when fish are exposed to TFM.

Model of the Mechanism of Toxicity of 3-Trifluoromethyl-4-Nitrophenol (TFM)

Using isolated mitochondria from liver in sea lamprey and trout, I demonstrated that as the concentration of TFM increased, basal rates of

mitochondrial oxygen consumption (State IV) increased, lowering the respiratory control ratio (RCR) of the liver mitochondria of these fish. These findings are strong evidence that processes mediated by the electron-transport chain (establishment of the proton motive force) and ATP production (phosphorylation) processes are not as tightly linked (or coupled) in the presence of TFM. The similar response of the mitochondria to TFM as to 2,4-DNP is also evidence that TFM has a similar mechanism of action to this well-known uncoupler of oxidative phosphorylation (Figs. 4-2c, 4-3c).

In normally functioning mitochondria, complexes I, III and IV of the electron transport chain (ETC) pump protons (H^+) across the inner-mitochondrial membrane, from the matrix into the inter-membrane space. These events are driven by the movement of electrons down the ETC. Oxygen is consumed in the process because it is the final electron acceptor of the ETC (Moyes and Schulte 2006). The movement of H^+ from the matrix into the inter-membrane space generates the proton-motive force (proton gradient). The proton motive force drives ATP formation via ATP-synthase (Fig. 5-1a); as the H^+ move down their electrochemical gradient from the inter-membrane space back into the matrix via the ATP-synthase, energy is released that is harnessed by the ATP-synthase to convert ADP to ATP (phosphorylation).

Protonophores, such as 2,4-DNP, FCCP and likely TFM, shuttle protons back into the matrix and dissipate the proton gradient that drives the formation of ATP in the mitochondria (Fig.5-1b). This shuttling process occurs either by direct binding of H^+ to the uncoupler (Wallace and Starkov 2000), or by formation of

protein channels (pores) in the inner mitochondrial membrane (Cunnaro and Weiner 1975; McLaughlin and Dilger 1980; Wallace and Starkov 2000). It is unclear which mechanism is used by TFM from the work conducted in my thesis, but this certainly deserves future investigation.

The phenolic compound 2,4-DNP is a classic protonophore, which shuttles the H^+ across the inner mitochondrial membrane (McLaughlin and Dilger 1980; Skulachev 1998; Wallace and Starkov 2000). In other words, protonophores increase the net H^+ permeability of the inner mitochondrial membrane (Fig. 5-1). The net effect of such protonophores is that the H^+ electrochemical gradient is reduced between the intermembrane space and matrix (proton motive force decreases). Due to the reduction in the proton-motive force, this process reduces H^+ movement through ATP-synthase, resulting in a corresponding reduction in ATP production by the mitochondria (Fig. 5-1).

Regardless of how TFM increases the H^+ -permeability of the inner membrane, the net effect of TFM exposure is a decrease in the proton motive force which drives ATP production by oxidative phosphorylation. As a consequence, the ETC will increase its activity in an attempt to maintain or restore that proton gradient, thus stimulating non-phosphorylating (State IV) mitochondrial oxygen consumption (Fig. 5-1b) as previously described for many other types of protonophores including 2,4-DNP and p-trifluoromethoxyphenylhydrazone (FCCP; Skulachev 1971; Liberman et al. 1969).

In vivo experiments on lamprey and trout (Chapters 2 and 3) demonstrated that a consequence of TFM-induced reductions of ATP production in trout and larval lamprey was increased reliance on PCr hydrolysis and glycolysis to meet their ATP demands as TFM exposure time increased. Compared to glycogen, PCr provides only short-term relief from decreases in ATP, as the levels of PCr in various tissues are quite small compared to the glycogen. As mitochondrial ATP production remained suppressed in the presence of TFM, the fish relied more on their glycogen reserves to sustain glycolysis, in an attempt to meet ATP demands. As a result, the glycogen reserves in different tissues, particularly the liver and the brain, markedly decreased in both sea lamprey and rainbow trout (Fig. 5-2). The reduction in glycogen was more pronounced in larval sea lamprey, despite the fact that each was exposed to its respective 12-h TFM LC50. One explanation for less pronounced reductions in glycogen and PCr in trout compared to lamprey could be that the trout were able to detoxify the TFM more efficiently and at a faster rate than the lamprey (Lech and Statham 1975). Another implication of this observation is that it suggests that there may be other mechanism(s) of TFM toxicity in trout that are not as prevalent in lamprey, such as disturbances in ion homeostasis. Indeed, the decrease in Na⁺ uptake by rainbow trout exposed to TFM supports the hypothesis that TFM could interfere with ion homeostasis in these fish. Due to TFM-induced ATP deficits, it is possible that the gill, and possibly kidney, Na⁺/K⁺ ATPases did not have enough ATP to maintain their function of shuttling Na⁺ ions into the body, leading to decreased Na⁺ uptake (Fig. 5-2).

Implications for TFM Field Treatments

Three goals of the Great Lakes Fisheries Commission (GLFC), which oversees sea lamprey control in the Great Lakes, are to decrease the amount of TFM that is released in the environment, reduce the non-target effects of TFM, and reduce treatment costs (GLFC 2001; McDonald and Kolar 2007). A better understanding of the mechanism of toxicity of TFM could therefore have important implications for achieving these goals. For instance, differences in glycogen reserves could explain the seasonal sensitivity of larval sea lamprey to TFM (Scholefield et al. 2008). One explanation for this finding could be that the larvae could have lower glycogen reserves when they come out of the overwintering period, when food is limited, compared to late summer/early fall, when food is readily available. Indeed, O'Boyle and Beamish (1977) demonstrated that liver glycogen reserves were 28% lower in winter than late summer in pre-metamorphic lamprey, the targets of most lampricide treatments (McDonald and Kolar 2007). If the TFM sensitivity of lamprey is greater when they have lower glycogen reserves, it may then allow sea-lamprey control personnel to use lower amounts of lampricide in the spring compared to the later summer treatments. The use of less TFM in the spring would result in cost savings, and minimize the environmental impact of the TFM treatment by reducing possible non-target effects on other fishes and invertebrates. Alternatively, TFM-sensitive non-target fishes, such as sturgeon (*Acipenser fulvescens*) and other organisms, such as mudpuppy (*Necturus maculosus*), could be more TFM-sensitive, and have lower glycogen levels and higher TFM sensitivity in the spring compared to late

summer. In such situations, it may be possible to restrict treatments to later in the year when the sensitive non-target species may be less vulnerable to TFM.

Future Directions

While it is clear that TFM causes ATP deficits in the body by uncoupling mitochondrial oxidative phosphorylation, further experiments are needed to identify the exact pathway(s) that TFM interferes with in the oxidation/ phosphorylation chain of reactions. Experiments analyzing the effects of this uncoupler on artificial membranes of various porosities and lipid contents (McLaughlin and Dilger 1980) could elucidate the mode in which TFM interacts with the mitochondrial inner membrane. In addition, to determine if TFM might cause depolarization across the inner mitochondrial membrane through the generation of inner membrane pores, thus increasing permeability H^+ permeability, experiments using drugs that block such inner membrane pore formation, such as cyclosporine A (Jaeschke et al. 2002), could be used. If the presence of cyclosporine A causes a decrease in the effects of TFM, one can conclude that the lampricide increases mitochondrial membrane permeability by causing the formation of pores, which allow the H^+ to move back into the matrix without going through the ATP-synthase.

The ATP/ADP antiporter, which shuttles ADP from the inner-membrane space into the matrix, and ATP from the matrix into the inner-membrane space to drive the ATP formation reactions, could play a role in TFM toxicity, but this needs further investigating. The ATP/ADP antiporter appears to be involved in

the toxicity of 2,4-DNP and fatty acids (Andreyev et al. 1989; Schönfeld et al. 1996). This protein could promote the translocation of TFM from the inter-membrane space, across the inner-mitochondrial membrane and into matrix, along with H^+ . Thus, this process could be an additional/alternate mechanism by which TFM reduces the proton-motive force across the inner-mitochondrial membrane (Fig. 4-4; McLaughlin and Dilger 1980; Wallace and Starkov 2000).

While determining the mechanism of toxicity of TFM is important, it would also be helpful to understand more about the glucuronidation process in non-target species. Experiments investigating the circumstances under which the activation of UDP-glucuronyltransferases, the group of enzymes that catalyze glucuronidation, is stimulated and how their absence would affect TFM sensitivity in non-targets would provide more information on the detoxification process. Western Blots analyzing the expression level of UDPGTs could determine which UDPGT isoforms are involved in TFM detoxification, and how altering their levels of expression would affect TFM sensitivity in fish. This could provide further information on the various strategies used by fishes to detoxify xenobiotics. Linking the ability of non-target organisms to detoxify the lampricide with their ability to recover from exposure to sub-lethal doses of TFM would provide more information on the mechanism of toxicity of TFM as well as on the detoxification process.

Knowing the mechanism of toxicity of TFM could be advantageous to the GLFC, because such knowledge could improve their ability to predict when non-target organisms are most vulnerable to TFM or when larval lamprey are most

sensitive. Targeting the larvae when they are most sensitive could potentially reduce the amount of TFM used, or the duration of TFM treatments, thus saving human and financial resources. The finding that trout muscle glycogen is affected by exposure to sub-lethal concentrations of TFM suggests that the lampricide could have indirect effects on non-target fishes. Such reductions in glycogen could compromise the burst and prolonged swimming abilities of non-target fishes, thus affecting foraging, predator evasion, migration and mating behavior (Kiefer 2000; Wilkie et al. 2001).

Conclusions

This thesis used an integrative approach to demonstrate that the lampricide TFM uncouples mitochondrial oxidative phosphorylation, leading to a mismatch between ATP supply and demand in the bodies of lamprey and trout. Therefore, fish rely more on glycolysis, in an attempt to increase ATP supply. Although glycogen reserves offer a limited relief from such a challenge, once these reserves are depleted, death ensues. This improved understanding of the mode of TFM toxicity may therefore aid the GLFC in predicting which non-target species are more sensitive to the lampricide and why, and allow the GLFC to adjust treatment concentrations accordingly. Finally, this improved knowledge on the mechanism of TFM toxicity should assist the GLFC in their efforts to re-register this pesticide with the USEPA and Health Canada in the future, so that TFM can continue to be used in the integrated management of the sea lamprey in the Great Lakes, where this invasive species continues have a detrimental effect on sport fisheries.

Figure 5-1. Model for the Mechanism of Toxicity of TFM. In (a) control mitochondria complexes I, III and IV of ETC (filled circles labeled with roman numerals) move protons (H^+) from the matrix (M) into the inter-membrane space (IMS; step 1). The resultant generation of a proton gradient (proton-motive force (step 2), is used to drive proton movement through the ATP synthase (step 3). As the protons move from the IMS into M via the ATP-synthase, the energy released is harnessed to drive the phosphorylation of ADP to ATP (step 4). In the presence of (b) TFM, however, the proton gradient is dissipated (step 5) as TFM shuttles H^+ into the matrix, but bypassing the ATP synthase (step 6). By reducing H^+ flow through the ATP-synthase, the activity of the ETC is increased in an attempt to restore the H^+ gradient, which results in an increase in basal (State IV) mitochondrial O_2 consumption. More O_2 is consumed in this process because it is the final acceptor of electrons from the ETC. The net effect of TFM is therefore lowered ATP production by the mitochondria, which results in a mismatch between ATP supply and ATP demands. Therefore, the fish primarily rely on glycolysis to compensate for the short-fall in ATP supply. When the glycogen/glucose stores that drive glycolysis are depleted, the organism can no longer survive.

(a)

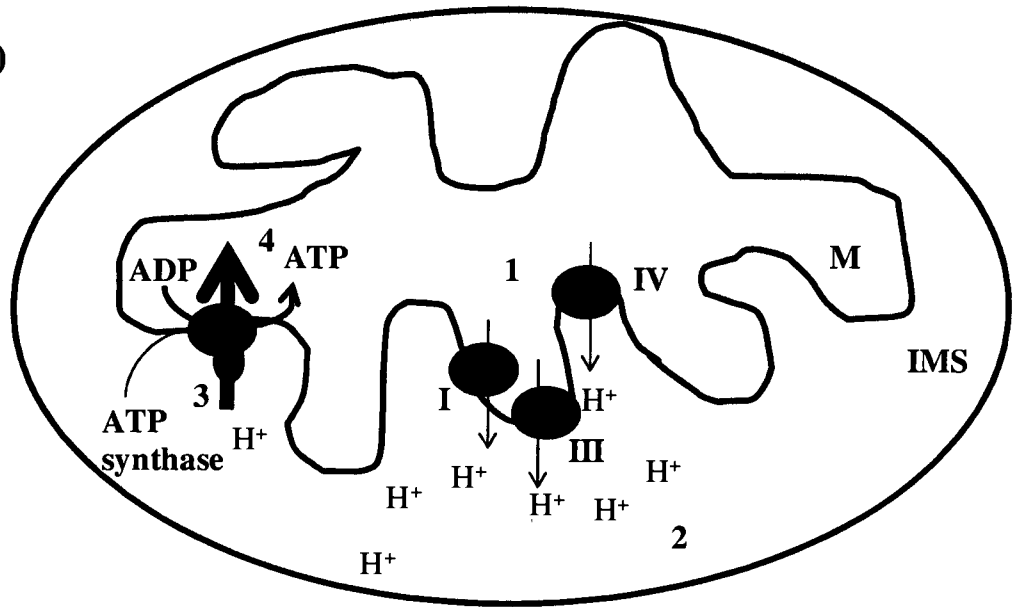

(b)

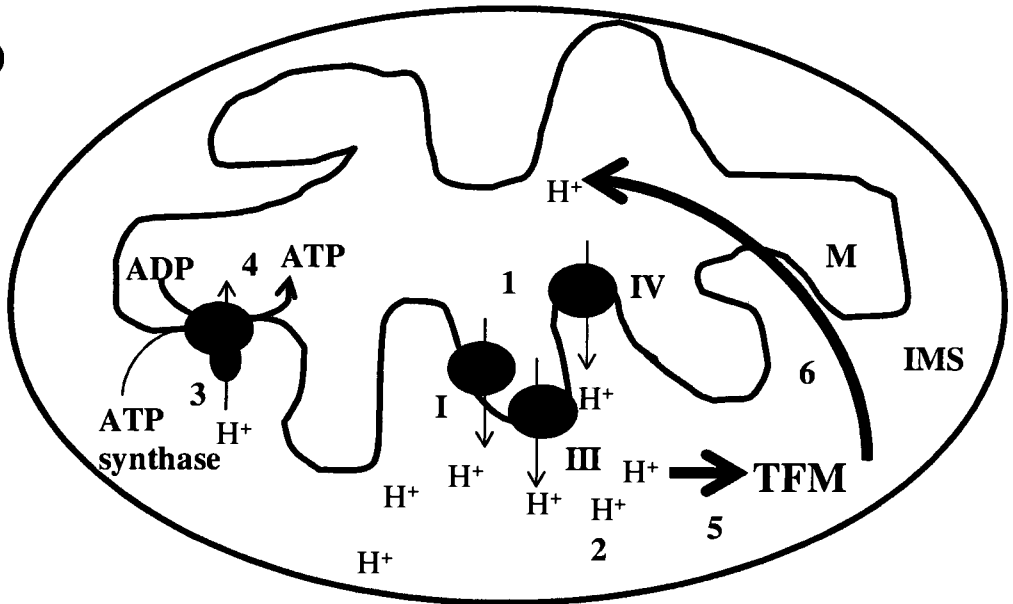
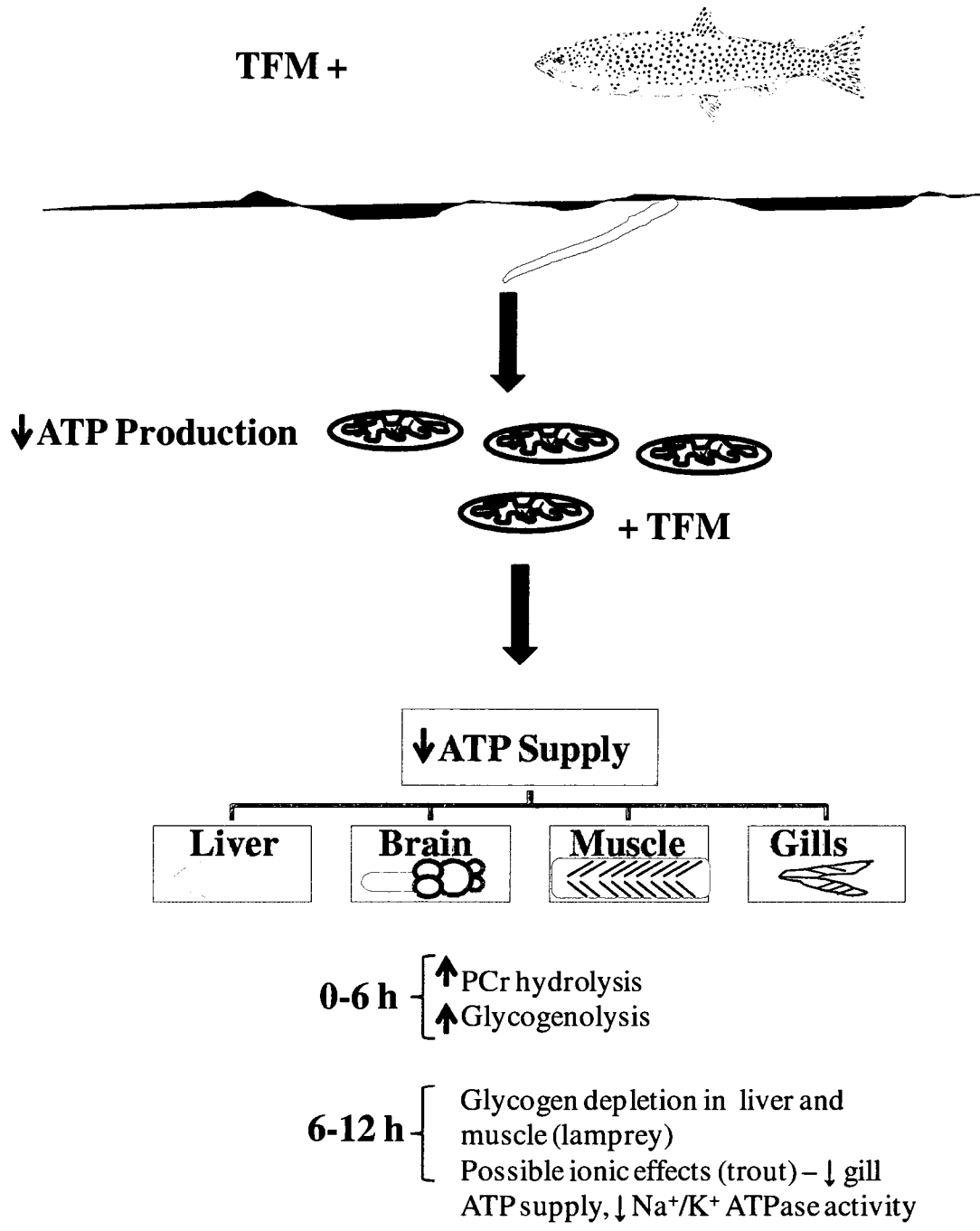

Figure 5-2. Integrating *In vivo* and *In vitro* Studies on the Mode of Action of TFM in Sea Lamprey and Rainbow Trout. As fish are exposed to lethal concentrations of TFM, the unconjugated form of the lampricide accumulates in vital tissues, such as the liver, brain and muscle. As TFM dissipates the mitochondrial proton gradient, ATP production decreases. As a consequence, fish rely more on glycolysis, in an attempt to match the ATP supply with the ATP demand. Therefore, glycogen levels in the tissues decrease, along with PCr, which is dephosphorylated to produce ATP. Once glycogen levels are depleted, death eventually results. The effects of TFM on metabolites and fuel stores were more pronounced in the lamprey, which are more sensitive to the lampricide than the trout, due to their limited ability to detoxify TFM. However, in trout, there could be ionic disturbances that could enhance the effects of TFM possibly due to gill damage or a decrease in Na^+/K^+ ATPase activity due to a mismatch between ATP supply and demand. Trout picture obtained from http://palaeo-electronica.org/2001_2/fish/images/17/17_11.jpg



REFERENCES

- Andreyev, A.Y., Bondareva, T.O., Dedukhova, V.I., Mokhova, E.N., Skulachev, V.P., Tsofina, L.M., Volkov, N. I., Vygodina, T.V., 1989. The ATP/ADP antiporter is involved in the uncoupling effect of fatty acids on mitochondria. *Eur. J. Biochem.* 182, 585-592.
- Applegate, V.C., 1950. Natural history of the sea lamprey (*Petromyzon marinus*) in Michigan. U.S. Fish Wildl. Spec. Sci. Rep. Fish. Serv. 55.
- Applegate, V.C., Howell, J.H., Moffett, J.W. Johnson, B.G.H., Smith, M.A., 1961. Use of 3-trifluoromethyl-4-nitrophenol as a selective sea lamprey larvicide. Great Lakes Fishery Commission Tech. Rep. 1, 35 pp.
- Applegate, V.C., Johnson, B.G.H., Smith, M.A., 1966. The relation between molecular structure and biological activity among mono-nitrophenols containing halogens. *Gt. Lakes Fish. Comm. Tech. Rep.* 11, 1-19.
- Applegate, V.C., King, E.L., 1962. Comparative toxicity of 3-trifluoromethyl-4-nitrophenol (TFM) to larval lamprey and eleven species of fishes. *Trans. Am. Fish. Soc.* 91, 342-345.
- Avella, M., Bornancin, M., 1989. A new analysis of ammonia and sodium transport through the gills of the freshwater rainbow trout (*Salmo gairdneri*). *J. Exp. Biol.* 142, 155-175.
- Ballantyne, J.S., Flannigan, D., White, T.B., 1989. Effects of temperature on the oxidation of fatty acids, acyl carnitines, and ketone bodies by mitochondria isolated from the liver of the lake charr, *Salvelinus namaycush*. *Can. J. Fish. Aquat. Sci.* 46, 950-954.

- Baracca, A., Sgarbi G., Solaini, G., Lenaz, G., 2003. Rhodamine 123 as a probe of mitochondrial membrane potential: evaluation of proton flux through F_0 during ATP synthesis. *Biochemica et Biophysica Acta*. 1606, 137-146.
- Bartels, H., Potter, I.C., 2004. Cellular composition and ultrastructure of the gill epithelium. *J. Exp. Biol.* 207, 3447-3462.
- Beamish, F.W.H, Potter, I.C., 1975. The biology of the anadromous sea lamprey (*Petromyzon marinus*) in New Brunswick. *J. Zool.* 177, 57-72.
- Begg, K., Pankhurst, N.W., 2004. Endocrine and metabolic responses to stress in a laboratory population of the tropical damselfish *Acanthochromis polyacanthus*. *J. Fish. Bio.* 64, 133-145.
- Bence, J.R., Bergstedt, R.A., Christie, G.C., Cochran, P.A., Ebener, M.P., Koonce, J.F., Rutter, M.A., Swink, W.D., 2003. Sea lamprey (*Petromyzon marinus*) parasite-host interactions in the Great Lakes. *J. Great Lakes Res.* 29 (Suppl. 1), 253-282.
- Bergmeyer, H.L., 1983. *Methods for enzymatic analysis*. Academic Press, New York.
- Bills, T.D., Boogaard, M.A., Johnson, D.A., Brege, D.C., Scholefield, R.J., Westman, R.W., Stephens, B.E., 2003. Development of a pH/alkalinity treatment model for applications of the lampricide TFM to streams tributary to the Great Lakes. *J. Gt. Lakes Res.* 29(Suppl. 1), 510-520.
- Birceanu, O., Chowdhury, M.J., Gillis, P.L., McGeer, J.C., Wood, C.M., Wilkie, M.P., 2008. Modes of metal toxicity and impaired branchial ionoregulation in rainbow trout exposed to mixtures of Pb and Cd in soft water. *Aqua. Tox.* 89, 222-231.
- Birceanu, O., McClelland, G.B., Wang, Y.S., Wilkie, M.P., 2009. Failure of ATP supply

to match ATP demand: The mechanism of toxicity of the lampricide, 3-trifluoromethyl-4-nitrophenol (TFM), used to control sea lamprey (*Petromyzon marinus*) populations in the Great Lakes. *Aqua. Tox.* In press.

Bjerselius, R., Li, W., Teeter, J.H., Seelye, J.G., Johnsen, P.B., Maniak, P.J., Grant, G.C., Polkinghorne, C.N., Sorensen, P.W., 2000. Direct behavioural evidence that unique bile acids released by larval sea lamprey (*Petromyzon marinus*) function as a migratory pheromone. *Can. J. Fish. Aquat. Sci.* 57, 557-569.

Bleau, H., Daniel, C., Chevalier, G., van Tra, H., Hontela, A., 1996. Effects of acute exposure to mercury chloride and methyl mercury on plasma cortisol, T3, T4, glucose and liver glycogen in rainbow trout (*Oncorhynchus mykiss*). *Aqua. Tox.* 34, 221-235.

Boelsterli, U.A. Mechanistic toxicology., 2009. The molecular basis of how chemicals disrupt biological targets. Informa Healthcare. New York.

Boogaard, M.A., Kolar, C.S., Waller, D.L., 2004. Acute toxicity of 3-trifluoromethyl-4-nitrophenol (TFM) and a TFM-1% niclosamide mixture to the giant floater (*Pyganodon grandis*), fragile papershell (*Leptodea fragilis*), and pink heelsplitter (*Potamilus alatus*) unionid mussels and sea lamprey (*Petromyzon marinus*) larvae. Report submitted to the Lake Champlain Fish and Wildlife Management Cooperative, Essex Junction, Vermont, June 2004. 21 pp.

Boogaard, M.A., Bills, T.D., Johnson, D.A., 2003. Acute toxicity of TFM and TFM/niclosamide mixture to selected species of fish, including the lake sturgeon (*Acipenser fulvescens*) and mudpuppies (*Necturus maculosus*), in laboratory and field studies. *J. Gt. Lakes. Res.* 29 (Suppl. 1), 519-541.

- Bradford M., 1976. A rapid and sensitive method for the quantitation of microgram quantities of protein utilizing the principle of dye-binding. *Anal. Biochem.* 72, 248-254.
- Bryan, M.B., Zalinski, D., Filcek, K.B., Libants, S., Li, W., Scribner, K.T., 2005. Patterns of invasion and colonization of the sea lamprey (*Petromyzon marinus*) in North America as revealed by microsatellite genotypes. *Molec. Ecol.* 14, 3757-3773.
- Bury, N.R., Wood, C.M., 1999. Mechanism of branchial apical silver uptake by rainbow trout is via the proton-coupled Na⁺ channel. *Am. J. Physiol. Regulatory Integrative Comp. Physiol.* 277, 1385-1391.
- Carey, J.H., Fox, M.E., 1981. Photodegradation of the lampricide 3-trifluoromethyl-4-nitrophenol (TFM). 1 Pathway of the direct photolysis in solution. *J. Great Lakes Res.* 7, 234-241.
- Chance, B., Williams, G.R., 1955. Respiratory enzymes in oxidative phosphorylation. III. The steady state. *J. Biol. Chem.* 217, 409-427.
- Christie, G.C., Adams, J.V., Steeves, T.B., Slade, J.W., Cuddy, D.W., Fodale, M.F., Young, R.J., Kuc, M., Jones, M.L., 2003. Selecting Great Lakes streams for lampricide treatment based on larval sea lamprey survey. *J. Great Lakes Res.* 29: 152-160.
- Christie, R.M., Battle, H.I., 1963. Histological effects of 3-trifluoromethyl-4-nitrophenol (TFM) on larval lamprey and trout. *Can. J. Zool.* 41, 51-61.
- Clarke, D.J., George, S.G., Burchell, B., 1991. Glucuronidation in fish. *Aqua. Tox.* 20, 35-56.
- Cunnaro, J., Weiner, M.W., 1975. Mechanism of action of agents which uncouple o

- oxidative phosphorylation: direct correlation between proton-carrying and respiratory releasing properties using rat liver mitochondria. *Biochim. Biophys. Acta.* 387, 234-240.
- Dawson, V.K., 2003. Environmental fate and effects of the lampricide bayluscide: a review. *J. Great Lakes Res.* 29, 475-492.
- Drysdale, G.R., Cohn, M., 1958. On the mode of action of 2,4-dinitrophenol in uncoupling oxidative phosphorylation. *J. Biolog. Chem.* 1574-1577.
- Dykens, J.A., Stout, A.K., 2001. Assessment of mitochondrial membrane potential in situ using single potentiometric dyes and a novel fluorescence resonance energy transfer technique. *Methods Cell Biol.* 65, 285-309.
- Ellington, R.W., 2001. Evolution and physiological roles of phosphagen systems. *Annual review of physiology* 63, 289-325.
- Emel'yanova, L.V., Samartsev, V.N., Savina, M.V., 2004. Effect of uncouplers on non-phosphorylating respiration of liver mitochondria in river lamprey and common frog at the autumn-winter period of metabolic depression. *J. Evol. Biochem. Physiol.* 40, 102-105.
- Estabrook, R.W., 1967. Mitochondrial respiratory control and polarographic measurement ADP:O ratios. *Methods Enzymol.* 10, 41-47.
- Evans, D.H., Piermarini, P.M., Choe, K.P., 2005. The multifunctional fish gill: dominant site of gas exchange, osmoregulation, acid-base regulation, and excretion of nitrogenous waste. *Physiol. Rev.* 85, 97-177.
- Evdokimova, E., Taper, H., Calderon, P.B., 2001. Role of ATP and glycogen reserves in both paracetamol sulfonation and glucuronidation by cultured precision-cut rat

- liver slices. *Toxicol. In Vitro.* 15, 683-690.
- Farmer, G.J., Beamish, F.W.H., Robinson, G.A., 1975. Food consumption of the adult landlocked sea lamprey, *Petromyzon marinus* L. *Comp. Physiol. Biochem.* 50A, 753-757.
- Ferguson, R.A., Kieffer, J.D., Tufts, B.L., 1993. The effects of body size on the acid-base and metabolite status in the white muscle of rainbow trout before and after exhaustive exercise. *J. Exp. Biol.* 180, 195-207.
- Foster, G.D., Youson, J.H., Moon, T.W., 1993. Carbohydrate metabolism in the brain of adult lamprey. *J. Exp. Zool.* 267, 27-32.
- GLFC, 1955. Convention on Great Lakes Fisheries. GLFC, Ann Arbor, MI.
- GLFC, 2001. Strategic vision of the Great Lakes Fishery Commission for the First Decade of the New Millennium. Great Lakes Fishery Commission. Ann Arbor. Mich. Available from www.glfc.org/pubs/viscon/html [accessed 1 June 2006].
- Grosell, M., Wood, C.M., 2002. Copper uptake across rainbow trout gills: mechanisms of apical entry. *J. Exp. Biol.* 205, 1179-1188.
- Henry, M., Birceanu, O., Wilkie, M.P., Unpublished findings.
- Hochachka, P.W., 1991. Design of energy metabolism. *In* Comparative animal physiology. Environmental and metabolic animal physiology. Fourth ed. C. Ladd Posser. Wiley-Liss. New York. pp. 325-351.
- Hogstrand, C., Wilson, R.W., Polgar, D., Wood, C.M., 1994. Effects of zinc on the kinetics of branchial calcium uptake in freshwater rainbow trout during adaptation to waterborne zinc. *J. exp. Biol.* 186, 55-73.
- Holmes, J.A., Youson, J.H., 1994. Fall condition factor and temperature influence the

- incidence of metamorphosis in sea lamprey, *Petromyzon marinus*. Can. J. Zool. 72, 1134-1140.
- Howell, J.H., King, E.L. Jr., Smith, A.J., Hanson, L.H., 1964. Synergism of 5,2'-dichloro-nitrosalicylanilide and 3-trifluoromethyl-4-nitrophenol in a selective lamprey larvicide. Great Lakes Fishery Commission Technical Report 8.
- Hubert, T.D., 2003. Environmental fate and effects of the lampricide TFM: a review. J. Great Lakes Res. 29, 456-474.
- Hubert, T.D., Bernardy, J.A., Vue, C., Dawson, V.K., Boogaard, M.A., Schreier, T.M., Gingerich, W.H., 2005. Residues of the lampricide 3-trifluoromethyl-4-nitrophenol and niclosamide in muscle tissue of rainbow trout. J. Agric. Food. Chem. 53, 5342-5346.
- Jaeschke, H., Gores, G.J., Cederbaum, A.I., Hinson, J.A., Pessayre, D., Lemasters, J.J., 2002. Mechanisms of hepatotoxicity. Toxicological Sciences. 65, 166-176.
- Kane, A.S., Day, W.W., Reimschuessel, R., Lipsky, M.M., 1993. 3-trifluoromethyl-4-nitrophenol (TFM) toxicity and hepatic microsomal UDP-glucuronyltransferase activity in larval and adult bullfrogs. Aqua. Tox. 27, 51-60.
- Kane, A.S., Kahng, M.W., Reimschuessel, R., 1994. UDP-glucuronyltransferase kinetics for 3-trifluoromethyl-4-nitrophenol (TFM) in fish. Trans. Am. Fish. Soc. 123, 217-222.
- Kawatski, J.A., Dawson, V.K., Reuvers, M.L., 1974. Effect of TFM and Bayer 73 on *in vivo* oxygen consumption of the aquatic midge *Chironomus tetans*. Trans. Am. Fish. Soc. 3, 551-556.
- Kawatski, J.A., McDonald, M. J., 1974. Effects of 3-trifluoromethyl-4-nitrophenol on *in*

- vitro* tissue respiration of four species of fish with preliminary notes on its *in vitro* biotransformation. *Comp. Gen. Pharmac.* 5, 67-76.
- Kieffer, J.D., 2000. Limits to exhaustive exercise in fish. *Comp. Biochem. Physiol. A.* 126, 161-179.
- Lark, J.G.I., 1973. An early record of the sea lamprey (*Petromyzon marinus*) from Lake Ontario. *J. Fish. Res. Board Can.* 30, 131-133.
- Lavis, D.S., Hallett, A., Koon, E.M., McAuley, T.C., 2003. History and advances in barriers as an alternative method to suppress sea lamprey in the Great Lakes. *J. Gt. Lakes. Res.* 29, 362-372.
- Lawrie, A.H., 1970. The sea lamprey in the Great Lakes. *Trans. Am. Fish. Soc.* 99, 766-775.
- LeBlanc, P.J., Gillis, T.E., Gerrits, M.F., Ballantyne, J.S., 1995. Metabolic organization of liver and somatic muscle of landlocked sea lamprey, *Petromyzon marinus*, during the spawning migration. *Can. J. Zool.* 73, 916-923.
- Lech, J.J., 1974. Glucuronide formation in rainbow trout – effect of salicylamide on the acute toxicity, conjugation and excretion of 3-trifluoromethyl-4-nitrophenol. *Biochem. Pharmacol.* 23, 2403-2410.
- Lech, J.J., Constrini, N.V., 1972. *In vitro* and *in vivo* metabolism of 3-trifluoromethyl-4-nitrophenol (TFM) in rainbow trout. *Comp. gen. Pharmac.* 3, 160-166.
- Lech, J.J., Pepple, S., Anderson, M., 1973. Effects of novobiocin on the acute toxicity, metabolism and biliary excretion of 3-trifluoromethyl-4-nitrophenol in rainbow trout. *Tox. Applied Pharmacol.* 25, 542-552.
- Lech, J.J., Statham, C., 1975. Role of glucuronide formation in the selective toxicity of 3-

- trifluoromethyl-4-nitrophenol (TFM) for the sea lamprey: comparative aspects of TFM uptake and conjugation in sea lamprey and rainbow trout. *Toxicol. Appl. Pharmacol.* 31, 150-158.
- Lewis, S.V., 1980. Respiration of lamprey. *Can. J. Fish. Aquat. Sci.* 37, 1711-1722.
- Li, W., Scott, A.P., Siefkes, M.J., Yan, H., Liu, Q., Yun, S.S., Gage, D.A., 2002. Bile acid secreted by male sea lamprey that acts as a sex pheromone. *Science*. 296, 138-141.
- Li, W., Sorensen, P.W., 1997. Highly independent olfactory receptor sites for naturally occurring bile acids in the sea lamprey, *Petromyzon marinus*. *J. Comp. Physiol.* 180, 429-438.
- Li, W., Sorensen, P.W., Gallaher, D., 1995. The olfactory system of migratory adult sea lamprey (*Petromyzon marinus*) is specifically and acutely sensitive to unique bile acids released by conspecific larvae. *J. Gen. Physiol.* 105, 569-589.
- Li, W., Twohey, M., Jones, M., Wagner, M., 2007. Research to guide use of pheromones to control sea lamprey. *J. Gt. Lakes Res.* 33, 70-86.
- Liberman, E.A., Topaly, V.P., Tsofina, L.M., Jasaitis, A.A., Skulachev, V.P., 1969. Mechanism of coupling of oxidative phosphorylation and the membrane potential of mitochondria. *Nature London*. 222, 1076-1078.
- Lin, H., Randall, D.J., 1993. H⁺-ATPase activity in crude homogenates of fish gill tissue: inhibitor sensitivity and environmental and hormonal regulation. *J. Exp. Biol.* 180, 163-174.
- Lowe, D.R., Beamish, F.W.H., Potter, I.C., 1973. Changes in proximate body composition of the landlocked sea lamprey *Petromyzon marinus* (L.) during larval

- life and metamorphosis. *J. Fish Biol.* 5, 673-682.
- Lowry, O.H., Passonneau, J.V., Hasselberger, F.X., Schulz, D.W., 1964. The effect of ischemia on known substrates and cofactors of the glycolytic pathway in the brain. *J. Biol. Chem.* 239, 18-30.
- Lutz, P.L., Nilsson, G.E., Prentice H.M., 2003. The brain without oxygen. Causes of failure-physiological and molecular causes for survival. 3rd Edition. Kluwer Academic Publishers.
- Mallatt, J., McCall, R.D., Bailey, J.F., Seelye, J., 1994. Effects of lampricides on the gill ultrastructure of larval sea lamprey and rainbow trout fry. *Can. J. Zool.* 72, 1653-1664.
- Mallatt, J., Ridgeway, R.L., Paulsen, C., 1985. Ultrastructural effects of 3-trifluoromethyl-4-nitrophenol on gills of the larval lamprey (*Petromyzon marinus*). *Can. J. Zool.* 63, 155-164.
- Mandic, M., Lau, G.Y., Nijjar, M.M., Richards, J.G., 2008. Metabolic recovery in goldfish: A comparison of recovery from severe hypoxia exposure and exhaustive exercise. *Comp. Biochem. Physiol. C. Toxicol. Pharmacol.* 148, 332-338.
- Marshall, W.S., 2002. Na⁺, Cl⁻, Ca²⁺ and Zn²⁺ transport by fish gills: retrospective review and prospective synthesis. *J. Exp. Zool.* 293, 264-283.
- McCormick, S.D., 1993. Methods for nonlethal gill biopsy and measurement of Na⁺/K⁺-ATPase activity. *Can. J. Fish. Aquat. Sci.* 50, 656-658.
- McDonald, D.G., Kolar, C.S., 2007. Research to guide the use of lampricides for controlling sea lamprey. *J. Great Lakes Res.* 33 (Special Issue 2), 20-34.

- McDougal, D.B., Holowach, Jr.J., Howe, M.C., Jones, E.M., and Thomas, C.A., 1968.
The effects of anoxia upon energy sources and selected metabolic intermediates in the brains of fish, frog and turtle. *J. Neurochem.* 15, 577-588.
- McIlwain, H., Bachelard, H.S., 1985. *Biochemistry and the central nervous system.*
Churchill Livingstone, London.
- McLaughlin, S.G., Dilger, J.P., 1980. Transport of protons across membranes by weak acids. *Physiological reviews.* 60, 825-863.
- McLeish, M.J., Kenyon, G.L., 2005. Relating structure to mechanism in creatine kinase. *Critical Reviews in Biochemistry and Molecular Biology.* 40, 1-20.
- Meech, R., Mackenzie, P.I., 1997. Structure and function of uridine diphosphateglucuronosyltransferases. *Clinic. Exp. Pharmacol. Physiol.* 24, 907-915.
- Meyer, W., 1979. Oxidative enzymes and myosin-ATPase in the trunk musculature of the river lamprey (*Lampetra fluviatilis*). *Histochem. J.* 11, 187-195.
- Mitchell, P., 1979. Compartmentation and communication in living systems. Ligand conduction: a general catalytic principle in chemical, osmotic, and chemiosmotic reaction systems. *Eur. J. Biochem.* 95, 1-20.
- Moon, T., 2001. Glucose intolerance in teleost fish: fact or fiction?. *Comp. Biochem. Physiol. (Part B)* 129, 243-249.
- Morgan, T.P., Guadagnolo, C.M., Grosell, M., Wood, C.M., 2005. Effects of water hardness on physiological responses to chronic waterborne to silver exposure in early life stages of rainbow trout (*Oncorhynchus mykiss*). *Aqua. Tox.* 74, 333-350.
- Moyes, C.D., Schulte, P.M., 2006. *Principles of animal physiology.* Pearson Benjamin

Cummings. San Francisco.

Moyes, C.D., West, T.G., 1995. Exercise metabolism in fish. *In* Biochemistry and molecular biology of fishes. Vol 4. *Edited by* P.W. Hochachka and T.P.

Mommsen. Elsevier, New York. pp. 367-392.

Mullett, K.M., Heinrich, J.W., Adams, J.V., Young, R.J., Henson, M.P., McDonald, R.B.,

Fodale, M.F., 2003. Estimating lake-wide abundance of spawning phase sea lamprey (*Petromyzon marinus*) in the Great Lakes: extrapolating from sampled streams using regression models. *J. Great Lakes Res.* 29 (Supplement 1), 240–252.

Niblett, P.D., Ballantyne, J.S., 1976. Uncoupling of oxidative phosphorylation in rat liver mitochondria by the lamprey larvicide TFM (3-trifluoromethyl-4-nitrophenol).

Pest. Biochem. Physiol. 2, 103-120.

Niswender, K.D., Shiota, M., Postic, C., Cherrington, A.D., Magnuson, M.A., 1997.

Effects of increased glucokinase gene copy number on glucose homeostasis and hepatic glucose metabolism. *J. Biol. Chem.* 272, 22570-22575.

O'Boyle, R.N., Beamish, F.W.H., 1977. Growth and intermediary metabolism of larval and metamorphosing stages of the landlocked sea lamprey, *Petromyzon marinus*

L. Environ. Biol. Fishes. 2, 103-120.

Olson, L.E., Marking, L.L., 1973. Toxicity of TFM (lampricide) to six early life stages of rainbow trout (*Salmo gairdneri*). *J. Fish. Res. Board Can.* 30, 1047-1052.

Panserat, S., Médale, F., Bréque, J., Plagnes-Juan, E., Kaushik, S., 2000. Lack of

- significant long-term effect of dietary carbohydrates on hepatic glucose-6-phosphate expression in rainbow trout (*Oncorhynchus mykiss*). *J. Nutr. Biochem.* 11, 22-29.
- Peters, A., Mackay, B., 1961. The structure and innervation of the myotomes of the lamprey. *J. Anat.* 95, 575-585.
- Polakof, S., Ceinos, R.M., Fernandez-Duran, B., Miguez, J.M., Soengas, J.L., 2007. Daily changes in parameters of energy metabolism in brain of rainbow trout: dependence on feeding. *Comp. Biochem. Physiol.* 146, 265-273.
- Rolo, A.P., Oliveira, P.J., Moreno, A.J.M., Palmeira, C.M., 2000. Bile acids affect liver mitochondrial bioenergetics: possible relevance for cholestasis therapy. *Toxicological Sciences.* 57, 177-185.
- Rogers, J.T., Richards, J.G., Wood, C.M., 2003. Ionoregulatory disruption as the acute toxic mechanism of lead in the rainbow trout (*Oncorhynchus mykiss*). *Am. J. Physiol.* 289, R463-R472.
- Rottenberg, H., 1970. ATP synthesis and electrical membrane potential in mitochondria. *Eur. J. Biochem.* 15, 22-28.
- Rottenberg, H., 1984. Membrane potential and surface potential in mitochondria: Uptake and binding of lipophilic cations. *J. Membr. Biol.* 81, 127-128.
- Rottenber, H., Hashimoto, K., 1985. Fatty acid uncoupling of oxidative phosphorylation in rat liver mitochondria. *Biochem.* 25, 1747-1755.
- Rovainen, C.M., 1970. Glucose production by lamprey meninges. *Science.* 167, 889-890.
- Rovainen, C.M., Lemcoe, G.E., Peterson, A., 1971. Structure and chemistry of glucose-producing cells in meningeal tissue of the lamprey. *Brain research.* 30, 99-118.

- Rovainen, C.M., Lowry, O.H., Passonneau, J.V., 1969. Levels of metabolites and glucose production in the lamprey brain. *J. Neurochem.* 16, 1451-1458.
- Rovainen, C.M., Schieber, M.H., 1975. Ventilation of larval lamprey. *J. Comp. Physiol.* 104, 185-203.
- Savina, M.V., Emelyanova, L.V., Belyaeva, E.A., 2006. Bioenergetic parameters of lamprey and frog liver mitochondria during metabolic depression and activity. *Comp. Biochem. Physiol. (Part B)* 145, 296-305.
- Schmidt, H., Wegener, G., 1988. Glycogen phosphorylase in fish brain (*Carassius carassius*) during hypoxia. *Biochem. Soc. Transactions* 16, 621-622.
- Schnick, R.A., 1972. A review of the literature on TFM (3-trifluoromethyl-4-nitrophenol) as a lamprey larvicide. *Investigations in Fish Control* 44. United States Department of the Interior. Fish and Wildlife Service. Washington, D.C.
- Scholefield, R.J., Slaght, K.S., Stephens, B.E., 2008. Seasonal variation in sensitivity of larval sea lamprey to the lampricide 3-trifluoromethyl-4-nitrophenol. *North Am. J. Fish. Manag.* 28, 1609-1617.
- Schönfeld, P., Ježek, P., Belyaeva, E.A., Borecky, J., Slyshenkov, V.S., Wieckowieski, M.R., Wojtczak, L., 1996. Photomodification of mitochondrial proteins by azido fatty acids and its effect of mitochondrial energetic. Further evidence for the role of the ADP/ATP carrier in fatty-acid-mediated uncoupling. *Eur. J. Biochem.* 240, 387-393.
- Schreier, T.M., Dawson, V.K., Choi, Y., Spanjers, N.J., Boogaard, M.A., 2000.

- Determination of niclosamide residues in rainbow trout (*Oncorhynchus mykiss*) and channel catfish (*Ictalurus punctatus*) fillet tissue by high-performance liquid chromatography. *J. Agric. Food. Chem.* 48, 2212-2215.
- Schultz, D.P., Harman, P.D., Luhning, C.W., 1979. Uptake, metabolism and elimination of the lampricide 3-trifluoromethyl-4-nitrophenol by largemouth bass (*Micropterus salmoides*). *J. Agric. Food. Chem.* 27, 328-331.
- Seelye, J.G., Scholefield, R.J., 1990. Effects of changes in dissolved oxygen on the toxicity of 3-trifluoromethyl-4-nitrophenol (TFM) to sea lamprey and rainbow trout. Great Lakes Fishery Commission. Technical Report No. 56.
- Shanghavi, D.S., Weber, J.M., 1999. Effects of sustained swimming on hepatic glucose production of rainbow trout. *J. Exp. Biol.* 202, 2161-2166.
- Sills, J.B., Allen, J.L., 1975. Accumulation and loss of residues of 3-trifluoromethyl-4-nitrophenol (TFM) in fish muscle tissue: laboratory studies. *Investigations in Fish Control.* 65, 1-10.
- Skulachev, V.P., 1971. Energy transformation in the respiratory chain. *Curr. Top. Bioenerg.* 4, 127-190.
- Skulachev, V.P., 1988. Membrane bioenergetics. Springer-Verlag. Berlin.
- Skulachev, V.P., 1991. *FEBBS Lett.* 294, 158-162.
- Škárka, L., Ošťádal, B., 2002. Mitochondrial membrane potential in cardiac myocytes. *Physiol. Res.* 51, 425-434.
- Smith, B. R., King, E.L. Jr., 1960. Lamprey control in the United States. *Great Lakes Fish. Comm. Annu. Appendix C*, 34-49.
- Smith, B.R., Tibbles, J.J., 1980. Sea lamprey (*Petromyzon marinus*) in Lakes Huron,

- Michigan, and Superior: history of invasion and control. 1936-1978. *Can. J. Fish. Aquat. Sci.* 37, 1780-1801.
- Soengas, J.L., Aldegunde, M., 2002. Energy metabolism of fish brain. *Comp. Biochem. Physiol. (Part B)* 131, 271-296.
- Soengas, J.L., Polakof, S., Chen, X., Sangiao-Alvarellos, S., Moon, T.W., 2006. Glucokinase and hexokinase expression and activities in rainbow trout tissues: changes during food deprivation and refeeding. *Am. J. Physiol.* 291, R810-R821.
- Soengas, J.L., Strong, E.F., Andres, M.D., 1998. Glucose, lactate and β -hydroxybutyrate utilization by rainbow trout brain: changes during food deprivation. *Physiol. Zool.* 71, 285-293.
- Sprague, J.B., 1969. Measurement of pollutant toxicity to fish I. Bioassay methods for acute toxicity. *Water. Res.* 3, 793-821.
- Starkov, A.A., Bloch, D.A., Chernyak, B.V., Dedukhova, V.I., Mansurova, S.E., Severina, I.I., Simonyan, R.A., Vygodina, T.V., Skulachev, V.P., 1997. 6-Ketocholestanol is a recoupler for mitochondria, chromatophores and cytochrome oxidase proteoliposomes. *Biochemica et Biophysica Acta.* 1318, 159-172.
- Suarez, R.K., Hochachka, P.W., 1981. Preparation and properties of rainbow trout liver mitochondria. *J. Comp. Physiol.* 143, 269-273.
- Sullivan, G.V., Fryer, J.N., Perry, S.F., 1995. Immunolocalization of proton pumps (H^+ -ATPase) in pavement cells of rainbow trout gill. *J. Exp. Biol.* 198, 2619-2629.
- Sutton, T.M., Bowen, S.H., 1994. Significance of organic detritus in the diet of larval lamprey in the Great Lakes basin. *Can. J. Fish. Aquat. Sci.* 51, 2380-2387.
- Taylor, L.N., Wood, C.M., McDonald, D.G., 2003. An evaluation of sodium loss and gill

- metal binding properties in rainbow trout and yellow perch to explain species differences in copper tolerance. *Environ. Toxicol. Chem.* 22, 2159-2166.
- Twohey, M.B., Sorensen, P.W., Li, W., 2003. Possible applications of pheromones in an integrated sea lamprey management program. *J. Gt. Lakes. Res.* 29, 794-800.
- Viant, M.R., Walton, J.H., Tjeerdema, R.S., 2001. Comparative sub-lethal actions of 3-trifluoromethyl-4-nitrophenol in marine molluscs as measured by *in vivo* ^{31}P NMR. *Pest. Biochem. Physiol.* 71, 40-47.
- Vijayan, M.M., Moon, T.W., 1992. Acute handling stress alters hepatic glycogen metabolism in food-deprived rainbow trout (*Oncorhynchus mykiss*). *Can. J. Fish. Aquat. Sci.* 49, 2260-2266.
- Voet, D., Voet, J.G., Pratt, C.W., 2006. *Fundamentals of Biochemistry. Life at the Molecular Level 2nd Edition.* John Wiley and Sons, Inc.
- Vue, C., Bernardy, J.A., Hubert, T.D., Gingerich, W.H., Stehly, G.R., 2002. Relatively rapid loss of lampricide residues from fillet tissue of fish after routine treatment. *J. Agric. Food. Chem.* 50, 6786-6789.
- Waldman, J.R., Grunwald, C., Roy, N.K., Wirgin, I.I. 2004. Mitochondrial DNA analysis indicates sea lamprey are indigenous to Lake Ontario. *Trans. Am. Fish. Soc.* 133, 950-960.
- Wallace, K.B., Starkov, A.A., 2000. Mitochondrial targets of drug toxicity. *Annu. Rev. Pharmacol. Toxicol.* 40, 353-388.
- Wang, Y.S., Wilkie, M.P., Heigenhauser, G.J.F., Wood, C.M., 1994a. The analysis of metabolites in rainbow trout white muscle: a comparison of different sampling and processing methods. *J. Fish. Biol.* 45, 855-873.

- Wang, Y.S., Heigenhauser, G.J.F., Wood, C.M., 1994b. Integrated responses to exhaustive exercise and recovery in rainbow trout white muscle: acid-base, phosphagen, carbohydrate, lipid, ammonia, fluid volume and electrolyte metabolism. *J. Exp. Biol.* 195, 227-258.
- Wilkie, M.P., Bradshaw, P.G., Joanis, V., Claude, J.F., Swindell, S.L., 2001. Rapid metabolic recovery following vigorous exercise in burrow-dwelling larval sea lamprey (*Petromyzon marinus*). *Physiol. Biochem. Zool.* 74, 261:272.
- Wilkie, M.P., Brobbel, C.M., Forsyth, L., Davidson, K., Tufts, B.L., 1997. The influence of temperature on postexercise physiology and survival of Atlantic salmon (*Salmo salar*). *Can. J. Fish. Aquat. Sci.* 54, 503-511.
- Wilkie, M.P., Claude, J.F., Cockshutt, A., Holmes, J.A., Wang, Y.S., Youson, J.H., Walsh, P.J., 2006. Shifting patterns of nitrogenous excretion and amino acid catabolism capacity during the life cycle of the sea lamprey (*Petromyzon marinus*). *Physiol. Biochem. Zool.* 79, 885-898.
- Wilkie, M.P., Holmes, J.A., Youson, J.H., 2007a. The lampricide 3-trifluoromethyl-4-nitrophenol (TFM) interferes with intermediary metabolism and glucose homeostasis, but not ion balance, in larval sea lamprey (*Petromyzon marinus*). *Can. J. Fish. Aquat. Sci.* 64, 1-9.
- Wilkie, M.P., Laurent, P., Wood, C.M., 1999. The physiological basis for altered Na⁺ and Cl⁻ movements across the gills of rainbow trout in highly alkaline (pH 9.5) water. *Physiol. Biochem. Zoology.* 72, 360-368.
- Wilkie, M.P., Morgan, T.P., Galvez, F., Smith, R.W., Kajimura, M., Ip, Y.K., Wood,

- C.M., 2007b. The African lungfish (*Protopterus dolloi*): ionoregulation and osmoregulation in a fish out of water. *Physiol. Biochem. Zool.* 80, 99-112.
- Yamamoto, Y., Obara, M., Isselhard, W., Sturz, J., Morimoto, T., Minor T., Saad, S., Ozawa, K., 1995. Rapid determination of the membrane potential of mitochondria in small biopsy specimens of the liver. *Eur. Surg. Res.* 27, 145-150.
- Youson, J.H., 1980. Morphology and physiology of lamprey metamorphosis. *Can. J. Fish. Aquat. Sci.* 37, 1687-1710.
- Youson, J.H., 2003. The biology of metamorphosis in sea lamprey: endocrine, environmental, and physiological cues and events, and their potential application to lamprey control. *J. Great Lakes Res.* 29, 26-49.
- Youson, J.H., Holmes, J.A., Guchardi, J.A., Seelye, J.G., Beaver, R.E., Gersmehl, J.E., Sower, S.A., Beamish, F.W.H., 1993. Importance of condition factor and the influence of water temperature and photoperiod on metamorphosis of sea lamprey, *Petromyzon marinus*. *Can. J. Fish. Aquat. Sci.* 50, 2448-2456.
- Youson, J.H., Potter, I.C., 1979. A description of the stages in the metamorphosis of the anadromous sea lamprey, *Petromyzon marinus* L. *Can. J. Zool.* 57, 1808-1817.
- Zall, D.M., Fisher, M.D., Garner, Q.M., 1956. Photometric determination of chloride in water. *Analyt. Chem.* 28, 1665-1678.

APPENDIX A

List of Abbreviations

2,4-DNP	2,4-dinitrophenol
ADP	adenosine diphosphate
ATP	adenosine triphosphate
CA	carbonic anhydrase
CC	chloride cell
CK	creatine kinase
ETC	electron transport chain
FCCP	p-trifluoromethoxy carbonyl cyanide phenyl hydrazone
M	mitochondrial matrix
TMP	(mitochondrial) transmembrane potential
IMS	(mitochondrial) inter-membrane space
PCr	phosphocreatine
PVC	pavement cell
TFM	3-trifluoromethyl-4-nitrophenol