

2012

Fabricating a Future Architecture

Kris L. Weeks

University of Massachusetts Amherst, krisweeks@yahoo.com

Follow this and additional works at: <http://scholarworks.umass.edu/theses>



Part of the [Architecture Commons](#)

Weeks, Kris L., "Fabricating a Future Architecture" (2012). *Masters Theses 1911 - February 2014*. 866.
<http://scholarworks.umass.edu/theses/866>

This thesis is brought to you for free and open access by the Dissertations and Theses at ScholarWorks@UMass Amherst. It has been accepted for inclusion in Masters Theses 1911 - February 2014 by an authorized administrator of ScholarWorks@UMass Amherst. For more information, please contact scholarworks@library.umass.edu.

FABRICATING A FUTURE ARCHITECTURE

A Thesis Presented

by

KRIS L. WEEKS

Submitted to the Graduate School of the
University of Massachusetts Amherst in partial fulfillment
of the requirements for the degree of

MASTER OF ARCHITECTURE

May 2012

Department of Art, Architecture, and Art History

© Copyright by Kris L. Weeks 2012

All Rights Reserved

FABRICATING A FUTURE ARCHITECTURE

A Thesis Presented

By

KRIS L. WEEKS

Approved as to style and content by:

Kathleen Lugosch, Chair

Skender Luarasi, Member

William T. Oedel, Chair
Department of Art, Architecture, and Art
History

DEDICATION

To my loving wife Karyn and my children Catherine, Jonathan, and Amelia.

Thank you for all your love, support and smiles.

ACKNOWLEDGMENTS

I would like to thank faculty members Ray K. Mann, Kathleen Lugosch, and Skender Luarasi for their help and support with this project. Skender, you have opened my eyes to new ways of doing things that will serve me well throughout my career. I offer thanks also to Steven Schreiber for giving me the chance to work on the architecture department's first piece of digital fabrication equipment. I hope it is the beginning of a much larger collection.

I would also like to thank everyone who took the time to discuss digital fabrication with me, in no particular order and including but not limited to Eric Jensen, Thom Long, Mark Leonard, Andrew Thurlow, Carl Ingram, Reg Prentice, Stephen Van Dyck, Jeffrey McGrew, Ken Murphy, Erleen Hatfield, Bruce Bradshaw, Tom Hancock, and Chris Carbone. Thanks also to my former Autodesk colleagues, including but not limited to Phil Bernstein, Jeff Agla, and Wai-Ming Chu, for connecting me with people in the field who are pioneering ways to use this exciting new technology.

Finally, I would like to thank all of my classmates, especially those of us who went through the three-year Master of Architecture program together, for your help, friendship, knowledge, and support. It was an amazing experience to be part of such a talented group. I wish each of you unparalleled success in your lives and careers.

ABSTRACT

FABRICATING A FUTURE ARCHITECTURE

MAY 2012

KRIS L. WEEKS, B.S., WORCESTER POLYTECHNIC INSTITUTE

M. ARCH., UNIVERSITY OF MASSACHUSETTS AMHERST

Directed by: Professor Kathleen Lugosch

During the Renaissance era, the builder was the master of both design and fabrication. The Industrial Revolution split these two activities in the pursuit of higher efficiency. Now, the ascendance of digital fabrication could bring the two back together. This study explores the current and future use of digital fabrication in architecture. Digital fabrication is increasingly used to manufacture components for other industries, but it is experiencing slower adoption in the building industry due to size and material limitations and a contract process that makes fabricators less willing to take risks on newer digital technology. A design project was undertaken to establish a digital design-to-fabrication workflow that could work on actual building components for a large-scale built environment. The resulting workflow did offer the advantages of design freedom and the elimination of shop drawings, but the absence of large-scale 3D printing still makes it difficult to quickly fabricate and assemble mass-customized, non-uniform 3D designs.

TABLE OF CONTENTS

	Page
LIST OF TABLES.....	ix
LIST OF FIGURES.....	x
CHAPTER	
1. THE MASTER BUILDER REBORN	1
1.1 Introduction	1
1.2 The Coming Revolution of Digital Fabrication.....	2
2. DIGITAL FABRICATION EXPLAINED	5
2.1 What Is Digital Fabrication?.....	5
2.2 Computers and Computer-Aided Design (CAD) Software	6
2.3 Digital Fabrication Methods.....	7
2.3.1 Additive Methods	8
2.3.2 Open-Source Equipment	10
2.3.3 Subtractive	10
2.3.4 Miscellaneous	11
2.4 Advantages of Digital Fabrication.....	14
2.5 Disadvantages of Digital Fabrication.....	14
3. DIGITAL FABRICATION IMPLEMENTATION	16
3.1 Educational Use	16
3.2 Professional Use.....	16
3.4 Implications of Digital Fabrication.....	17
4. FABRICATION PROJECT PRECEDENTS.....	19

4.1 Whole Building Printing from Contour Crafting	19
4.2 Radiolaria Installation	20
4.3 Beijing National Stadium	21
4.4. Office Renovation by Because We Can	22
4.5 Cleveland Medical Mart	23
5. DESIGN PROJECT EXPLORATION: SITE	28
5.1 Design Project Introduction	28
5.2 Previous Design Project Precedent	29
5.3 Site Introduction	35
6. DESIGN PROJECT EXPLORATION: PROCESS	42
6.1 Design Considerations	42
6.2 Digital Design Process	45
6.2.1 Form making	45
6.2.2 Scripting to Create Components	48
6.2.3 Scripting to Automate Fabrication Output	51
6.2.4 Lower level site design	53
6.3 Final Design with Digitally-Fabricated Components	54
6.4 Structural Joint Details	60
7. CONCLUSION	62
BIBLIOGRAPHY	65

LIST OF TABLES

Table	Page
Table 1: Common CAD programs for direct digital model to fabrication	6
Table 2: Inventory of digital fabrication methods	12

LIST OF FIGURES

Figure	Page
Figure 1: Prototype of Contour Crafting machine	20
Figure 2: 3-meter high prototype of Radiolaria pavilion by Shiro Studio	21
Figure 3: The "Bird's Nest": Beijing National Olympic Stadium.....	22
Figure 4: Rendering of Cleveland Medical Mart and Convention Center by LMN Architects in Seattle, WA.....	24
Figure 5: Process of using a 3D printed part to create a rubber mold.....	25
Figure 6: Small-scale physical model with plaster panels	26
Figure 7: Full-size panels cast in a rubber mold made from a master panel	27
Figure 8: Schooling fish and flocking birds inspired the ideas and patterns of the urban hiking park.....	30
Figure 9: Aerial view of an earlier incarnation of urban hiking park.....	31
Figure 10: Lower level of urban hiking park	31
Figure 11: Walking along the lower level	32
Figure 12: Ascending an incline	33
Figure 13: Structure and grated decking serves as a walking surface on the exterior above while providing shading and screening below.	33
Figure 14: The grating ensures a degree of lightness while providing elemental filtration for a large structure that could otherwise be quite oppressive.....	34
Figure 15: Aerial view of site location.....	35
Figure 16: Wider view of site location and diagram of adjacent buildings and circulation.....	36
Figure 17: Close-up view of site location and diagram	37
Figure 18: View of the site from the south, looking north.....	38

Figure 19: Looking east from the intersection of Massachusetts Avenue and Boylston Street ...	39
Figure 20: Stair access into the site from Boylston	39
Figure 21: Looking west down into the site from the public alley located off Hereford Street ...	40
Figure 22: Looking east from the west end of the site; public alley is in the middle.....	41
Figure 23: Rhinoceros model of the two main forms used to create the hiking/shading structure	46
Figure 24: Perspective view of forms	47
Figure 25: A portion of the Grasshopper script used to create the components from the forms.....	49
Figure 26: The resulting building components after running the script.....	50
Figure 27: The ‘baked’ building components (adjacent buildings not shown for clarity)	51
Figure 28: Results of a script used to create fabrication profiles of the building components	53
Figure 29: Rendering of CityHike superimposed on aerial photo of the site	54
Figure 30: Top level plan of CityHike	55
Figure 31: Lower level plan of CityHike	55
Figure 32: Aerial view of CityHike rendering	56
Figure 33: View from the west hilltop looking east.....	56
Figure 34: Underneath the structure, looking east to west.....	57
Figure 35: View of amphitheater and stage.....	57
Figure 36: Approaching CityHike from Boylston Street near Massachusetts Avenue intersection	58
Figure 37: View looking east from the handball court.....	58
Figure 38: View from the Massachusetts Turnpike, west to east	59
Figure 39: View from eastern hilltop, looking west.....	60

Figure 40: Joint detail proposal61

CHAPTER 1

THE MASTER BUILDER REBORN

1.1 Introduction

As the twenty-first century progresses, we find ourselves once again in a state of flux, just as our forebears did at the beginning of the centuries preceding this one. At local and international levels, we witness a discord, or at least a disorientation, that hampers many of our socioeconomic and geopolitical institutions; their inability to adapt to contemporary conditions not only hampers their ability to make progress, but it threatens their continued existence as well. Despite a level of affluence and technological capability hitherto unseen in the world, we grope for a way forward.

A prominent trend afflicting many aspects of society is one of reduction. As technology expands, natural barriers of time and distance recede, and there are ever greater pressures to make things faster, cheaper, and seemingly less complex while simultaneously making them capable of doing much, much more.

The current architectural industry has not been spared. Increased desire by building owners to build bigger and faster has concentrated much of professional architectural practice and expertise among a few score of large, global firms. A poor global economy has led to an overall reduction in building construction, which in turn has led to a reduction in the size of the architectural workforce. More troubling still is the long-term prospect of reduced architectural involvement in building projects. The increasing size and technical aspects of buildings have spawned design teams that are swollen with an expanding pool of participants. Not only are

architects, civil and structural engineers, and building systems engineers considered *de rigueur* for most medium to large-scale building projects, it is now possible for the extended team to consist of urban planners, landscape and environmental designers, construction managers, cost estimators, fire protection engineers, interior designers, code-compliance consultants, accessibility experts, lighting consultants, energy efficiency consultants, programming and wayfinding experts, graphic designers, and building scientists. As the role of the architect shrinks, architectural practitioners risk being reduced to exterior stylists¹, meeting organizers, or owners' paymasters.

1.2 The Coming Revolution of Digital Fabrication

In light of the advancements in building technology, Kieran and Timberlake posit, "Why is it that the master builders of today arise from the ranks of the process engineer, not the architect?"²

Digital fabrication may offer an opportunity for architects to inject themselves back into the heart of design, and ultimately lead a renaissance in what is currently a highly-fractured field. Creating designs that can be directly output from computer to fabrication systems offers many promises. On a practical scale, architects can make the trend of reduction work for them by using digital design and fabrication to reduce time and costs when constructing a building. On a philosophical scale, architects can simultaneously achieve a new level of design freedom while implementing a truly holistic approach to structural and system integration. In the process, the

¹ (Chodikoff 2007) p. 26.

² (Kieran 2003) p. xi.

architect could revive the practice of Renaissance-era master builders, craftsmen, and artisans who were learned both in the ways of design and fabrication³, whom often performed both tasks, and as a result often achieved a highly-desirable, enduring balance between the form and function of many medieval buildings.

This thesis will explore the current and potential impact of digital fabrication on the world of architecture. Digital fabrication is a process where a component is manufactured directly from a digital model generated on a computer. It typically requires specialized equipment that is capable of reading the digital models, and in turn that equipment uses those models to directly fabricate the physical output.

The prospect of digital fabrication has already had a profound impact on the manufacturing industry. What started out as a way to quickly create prototype parts, a process known as rapid prototyping (RP), has now progressed to the point where similar machines are being used to fabricate mass quantities of parts to be used directly in products.⁴ It may one day become the dominant method of manufacturing components, rather than the current method of mass production that requires several different stages of activity performed by different, specialized groups of operators and technicians.⁵

Early rapid prototyping tools were used to create small-scale versions of architectural models. As the digital fabrication machines have become more capable of making larger parts out of a wider range of materials, it is now possible to make many sizes of building components

³ (Gershenfeld 2005) p. 42.

⁴ (The Economist 2011)

⁵ (The Economist 2011)

directly from digital models. It may be possible in the near future to fabricate whole buildings, on site, using large-scale digital fabrication machines.

In this thesis, I will focus more on the capability to fabricate full-scale buildings and components while reporting less on the capability to fabricate small-scale architectural models used for client relations, or as part of an architectural academic curriculum. The research portion will explore the current state of digital fabrication, and measure its promise versus actual capabilities and adoption among professional practice. Where appropriate I will discuss the wider impacts of digital fabrication on intended and unintended outcomes, such as the potential uncoupling from traditional building forms and recognizable craft, the potential for a building's performance in terms of sustainability, and the prospect of mass customization and its effect on building patterns and resulting urban fabric. I will detail precedents where architects used varying degrees of digital fabrication to create actual building components.

The design component will explore the capability of using full-scale, digitally-fabricated components in an urban built-environment project.

CHAPTER 2

DIGITAL FABRICATION EXPLAINED

2.1 What Is Digital Fabrication?

Digital fabrication is the creation of a physical part from a digital model. The process typically involves the creation of a digital model which is then fabricated into an actual, physical part using a machine capable of creating output directly from the digital model. The digital model is created using a computer-aided design (CAD) program. The model is processed using a computer-aided manufacturing (CAM) program. For example, if the part is to be milled from a block of raw material, the CAM program is used to create the cutting paths that the tool must follow in order to create the desired part. The CAM portion may be simple, as in the case of laser and water jet cutters, or it can be more complex, as in the case of the computer-numeric controlled (CNC) milling machine.

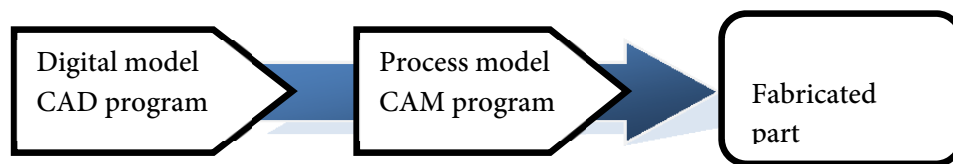

This differs from the traditional fabrication process. In the traditional process, a part is usually designed and documented using CAD, but it is delivered to the fabrication team in the form of hardcopy drawings. The manufacturing team manually creates the CAM programs and all of the equipment, such as custom fixtures or jigs, needed to create the parts. The fabrication team then creates the parts.

As it is a nascent technology, digital fabrication can be interpreted in different ways. The term is used to describe parts that are made wholly and in a fully-automated fashion by a

machine from a computer-generated model. It can also describe parts and assemblies that are partially made by digital fabrication machines, and it even applies to finished parts made manually with the help of digitally-fabricated parts. An example of that would be digitally-fabricating an irregular-shaped mold form that could then be used to cast an irregular concrete shape.

It can also imply that the digital model is analyzed through simulation, such as for structural integrity, and then physically modeled to some scale or degree to prove the design and/or process.

2.2 Computers and Computer-Aided Design (CAD) Software

The computational and modeling capabilities of computers and CAD software make digital fabrication possible. Three-dimensional (3D) modeling software is now very common for design, yet two-dimensional (2D) drawing programs can also be used to generate digital profiles for processes such as laser, plasma, or water-jet cutting.

Table 1: Common CAD programs for direct digital model to fabrication

CAD program	2D or 3D
AutoCAD	Both
Rhinoceros	Both
SolidWorks	Both
CATIA	Both
Inventor	Both
cadwork	Both
Revit	Both

For simpler fabrication processes, such as the aforementioned 2D profile-cutting methods, the CAM conversion is quite simple. The cutting machine usually comes with proprietary software that can easily convert CAD vector lines into cutting paths. More complex fabrication equipment like 3D printers also come with proprietary CAM software, but it usually requires more work to process your digital model in preparation for printing. For example, you may have to modify your digital model if any cross-sectional areas are below a certain size, thus making that area too weak in the printed part. Depending on the type of 3D printer used, you may have to experiment with the orientation of your part in the printer to minimize the amount of support structures needed to complete printing the object, and which are then cut off or broken off the finished part.

The most complex processes involve the generation of 3D cutting tool paths, such as what is required for CNC milling machines and routers. These methods require a high level of machining knowledge. The tool paths can typically be automatically generated using CAM software, but it requires first-hand experience to properly configure the mill-turning speed, cutting tool feed rate, and depth of cut based on the raw material, finished part geometry, and cutting tool size, shape, and material.

2.3 Digital Fabrication Methods

Fabrication methods typically fall into two categories: additive and subtractive. With additive methods, parts are built up from a raw material, typically a powder or liquid that is fused together. Additive parts produce little to no waste. With subtractive methods, material is removed from raw stock to machine or shape the finished part.

There are also computers and CAD software, which are integral to the entire process, and there are other tools that can be part of a digital fabrication process. All of the tools that can be used in digital fabrication will be identified and described in the following sections.

2.3.1 Additive Methods

3D printers are increasingly being used to create a wide variety of parts in an expanding range of materials. Previously used only for prototyping, they are now achieving speeds and accuracies that are making them a more viable option for production parts.

Many 3D printers use inkjet printer technology; a print head travels along a gantry, depositing material on the printer table. The 3D printing process starts by taking a digital 3D model of a part, and using its own proprietary CAM software, automatically slices the digital model into very thin cross-sectional layers (approximately 0.5 to 0.1 mm thick; although this varies by machine and material).

Each cross-sectional slice is basically a 2D profile. The printer will either deposit liquid material in the shape of that profile, or it will use a binder or heat to fuse the powder into the shape of that profile. The thickness of that layer is the same as the slice of the digital model. After that layer is formed, the table moves down the appropriate distance, such as 0.1 mm for the Z Corporation printer, and a new cross-sectional layer is added over the top of the previous layer. This is repeated until the part is complete.

There are quite a few different 3D printing methods available on the market today.⁶

Each one has different advantages, such as accuracy, materials, or speed:

- Z Corporation⁷: Creates plastic parts by fusing layers of powder with a liquid resin. The entire table is covered with powder. The powder that is not fused can be reused in subsequent printing. This method does not require any structural support the way that some other methods do.⁷
- Objet⁸: Creates plastic parts from a liquid resin that is cured by a UV light.⁸
- Fused Deposition Modeling (FDM): FDM is usually less costly for both the machine and the material than the Z Corporation or Objet printers, although it is not usually as precise as those printers. FDM works by feeding a plastic, flexible wire into the print head where it is heated into a semi-solid state. The material is then printed in thin layers. FDM parts may require structural support by printing additional material that holds up the part while it's being printed.⁹
- Stereolithography (SLT or SLA): Stereolithography is one of the older 3D printing technologies. It uses a UV-curable photopolymer liquid that is fused solid by a UV laser to create the model. Like FDM, it may also require support structures.
- Selective Laser Sintering (SLS) or Direct Metal Laser Sintering (DMSL): These processes can create finished parts out of metal. These processes use a laser to fuse plastic, ceramic, or metallic powder into finished parts.

⁶ (GPI Prototype & Manufacturing Services 2011)

⁷ (Leonard 2011)

⁸ (Bradshaw 2011)

⁹ (Ingram 2011)

- D-Shape: This process uses sand plus an inorganic binder to create solid sandstone shapes. This process can produce larger shapes, up to several feet high.¹⁰

2.3.2 Open-Source Equipment

An exciting development in 3D printing is the emergence of open-source machines. These are machines whose plans and parts are publically available for anyone to make and use. Some of the more widely-known ones are Makerbot, Fab@Home, and RepRap.

2.3.3 Subtractive

Subtractive methods work by cutting finished shapes from a larger source material. There are cutters that cut 2D profiles of parts, and there are other machines that can mill shapes in 3D.¹¹

There are three major types of computer numeric control (CNC) cutters: laser, plasma, and water jet. These cutters cut 2D profiles of parts, and have limited capabilities for making 3D shapes. The laser cutter uses a laser to cut or etch material such as wood, plastic and metal. The plasma cutter uses plasma torch to melt and cut steel and other metal shapes. The water jet cutter uses a high-speed jet of water, mixed with hard, abrasive particles such as diamonds, to cut wood, plastic, metal, and masonry.¹²

For 3D cutting, there are two common types of machines: milling machines and routers. Routers are typically used for wood, while milling machines can work on wood, metal or plastic.

¹⁰ (Abrahams 2010)

¹¹ (Jensen 2011)

¹² (GPI Prototype & Manufacturing Services 2011)

2.3.4 Miscellaneous

There are some other machines and tools that are useful for digital fabrication:

- Die cutters: Cuts and scores sheets like cardstock or vinyl. Scored parts can be manually folded into 3D shapes.
- Three-dimensional (3D) scanners: Used to quickly digitize an existing physical object and convert it to a 3D digital model.
- Robots: For moving, assembling or welding parts together.¹³
- Vacuum Forming: This process is a quick way to create parts from a mold. The mold can be made using additive or subtractive manufacturing methods.¹⁴

¹³ (Thurlow 2011)

¹⁴ (Gershenfeld 2005) p. 94.

Table 2: Inventory of digital fabrication methods

Subtractive Methods	Materials and Making Process	Dimensions	Advantages
Laser Cutter	Thin, flat sheet goods including: <ul style="list-style-type: none"> ▪ wood ▪ wood composites and laminates ▪ pulp-based materials (chipboard, cardstock) ▪ plastics ▪ metal (with high power) ▪ glass (high power) 	2D	<ul style="list-style-type: none"> ▪ Fast and accurate. ▪ Can cut sharp interior corners (unlike CNC). ▪ Can be operated from many different CAD and image-editing programs, and is typically run from a standard computer. ▪ Easy to learn; no CAM interface required. ▪ Can also etch or engrave surfaces.
Water Jet Cutter	<ul style="list-style-type: none"> ▪ Usually sheet or block material of almost any kind, including plastics, rubbers, wood, metal, glass, and masonry. Cannot cut ceramic, tempered glass, and diamonds. ▪ Can cut material up to 18 inches thick. 	2D+3D	<ul style="list-style-type: none"> ▪ Can cut metal and masonry, unlike laser cutters. ▪ Can cut thicker materials than laser cutter without burnt edges. ▪ Similar to laser cutter, can cut sharp interior corners. ▪ Operated from many different CAD programs; typically runs on standard computer. ▪ No CAM interface required. ▪ Does not induce high temps in the material during cutting.
Plasma Cutter	Flat, metal sheet goods up to 6 inches thick.	2D	<ul style="list-style-type: none"> ▪ Better than mechanical saws for cutting steel plates.
CNC Router	Usually wood and wood-based products; also machinable plastics	2D+3D	<ul style="list-style-type: none"> ▪ Most models cut in 2D, although there are 3D CNC routers. ▪ Very precise. ▪ Depending on the material, it can cut rather quickly. ▪ Good surface finishes on cuts. ▪ Many models can accommodate 4' x 8' sheets of material
CNC Mill	Just about anything machinable, including wood, plastics, and metal. Not usually masonry.	3D	<ul style="list-style-type: none"> ▪ Can cut in three dimensions, thus enabling complex 3D curvature ▪ Very precise ▪ Using different mills, almost any type of carving or engraving is possible.
Additive Methods			
3D Printers			
Powder/Liquid Resin	Z Corporation technology: A thin layer of powder is deposited on a tray; an adhesive is sprayed from an ink-jet-type printhead to create the mass. Another thin layer of powder is placed on top, and the adhesive applied again. The part is built up in a series of very thin (.1 mm) 2D layers.	3D	<ul style="list-style-type: none"> ▪ No waste. ▪ Can be colored. ▪ Good for models + prototypes. ▪ Can print multiple-part assemblies in one print session.
Liquid/Heat	Objet technology: A thin layer of liquid is sprayed from an ink-jet- type printhead to create a solid mass when it is immediately subjected to UV light. Builds up the part in thin 2D layers.	3D	<ul style="list-style-type: none"> ▪ Better surface finish than Z Corp due to thinner layers (.02 mm vs. .1 mm). ▪ Stronger part that can be used in production. ▪ Capable of more materials, including hard plastics and elastomers. ▪ Can create wax models for use in investment cast (investment cast tooling is very expensive!)

Wire Feed/Heat (Fused Deposition Modeling)	A wire (plastic, elastomeric, or metal) is fed through a print head. The wire is heated to increase viscosity, and is then deposited in thin layers to form a part.	3D	<ul style="list-style-type: none"> ▪ Cheaper material ▪ Lots of open-source designs and equipment for making economical FDM machines (RepRap, Makerbot, etc.)
Laser Sintering	A fine metal powder is deposited on a tray a high- powered laser applies a quick pulse to melt the metal to form the part geometry. Another thin layer of powder is placed on top, and the process is repeated again until the part is fully formed.	3D	<ul style="list-style-type: none"> ▪ Produces a fully-formed, dense, homogeneous metal part this is capable of use in production. ▪ Can create complex parts with ease that would be very difficult or impossible to do with traditional machining operations.
Stereolithography	Uses a laser to heat a photopolymer liquid to harden it.	3D	<ul style="list-style-type: none"> ▪ Good for prototypes only; not production parts. ▪ Parts can be used for investment casting.
Specialized Material Deposition Systems (in research)	<ul style="list-style-type: none"> ▪ Lightweight concrete secreted in thin layers that hardens quickly. (Contour Crafting/Khoshnevis- USC; also U of Nottingham) ▪ Stone dust powder with a resin applied that results in homogeneous sandstone with good structural properties. (Enrico Dini's D-Shape) 	3D	<ul style="list-style-type: none"> ▪ Can make much larger parts for full-scale building components, such as small structural members or façade components. ▪ Next step from taking digi-fab from model making to full production of building materials.
Vacuum Forming/Molding	A fast way to make parts from a mold that could be 3D printed.	3D	
Casting	Make production castings from 3D printed parts; this would work for investment and sand casting processes.	3D	
Robotic Assembly, Fastening, and Welding	Can use robotic arms for assembly of parts that are 2D or 3D formed. Also use robotic arms to fasten or weld multiple parts together.	3D	
Laser 3D Scanning	Laser scanning can be used to quickly create a 3D virtual model of an actual part or building. This would be useful for planning digital fabrication on existing structures, or if you wanted to recreate a physical part but didn't have a digital model of it. (This is where an architect could hand-make a model if that was their preference, and then digitize it for subsequent production.)	3D	

2.4 Advantages of Digital Fabrication

Digital fabrication offers many advantages over conventional fabrication methods:

- Freedom of design
- Localized fabrication; democratize and decentralize manufacturing
- Much less waste
- Simpler components; fewer secondary operations
- Create complex assemblies already assembled¹⁵
- Suitable for offsite prefabricated components¹⁶
- Mass customization
- Automated building for disaster victims, refugees, and workers in harsh, inhospitable environments¹⁷

2.5 Disadvantages of Digital Fabrication

There are also drawbacks to digital fabrication, such as size, material and speed limitations that have kept it from completely taking over fabrication:

- Size and material limits
- 3D printers can be slow
- May require specialized knowledge, especially for CAM processing
- Tectonic shift in thinking and making
- Current building contract structure discourages risk¹⁸

¹⁵ (Gershenfeld 2005) p. 100.

¹⁶ (Carbone 2011)

¹⁷ (Khoshnevis 2007)

- Popular CAD programs not precise enough for steel structures
- Mass customization – Customizing everything could be overwhelming
- Mechanistic output, although this can be mitigated by good design.

¹⁸ (Murphy 2011)

CHAPTER 3

DIGITAL FABRICATION IMPLEMENTATION

3.1 Educational Use

Digital fabrication is currently used as training tools for schools of architecture, engineering, and manufacturing. It imparts powerful lessons about how parts are fabricated, and it helps the students learn how to design feasible parts. For example, students learn that making certain areas of a part too thin could make the part break either during or shortly after the digital fabrication process. This is instructive for learning the weak points in their designs.

In architectural pedagogy, digital fabrication is mainly used for model making. The act of model making can impart some lessons about the tectonic capabilities of their designs, but in general it is regarded as another way to make small-scale building models.

More schools and colleges are seeing the benefits of using digital fabrication as a way to inform students about fabrication and manufacturing methods, which if mastered, can help them be immeasurably better designers.

3.2 Professional Use

In the architectural industry, firms use digital fabrication mainly for model making. Firms use 3D printers to make building models for design exploration and client satisfaction.

When it comes to building components, progress has been limited. Some firms have made small-scale items such as furnishings and small structural components. Some have also made medium-scale components such as furniture or wall systems.

Other industries are producing many parts using digital fabrication. These products include, but are not limited to:

- aircraft parts, unmanned aerial vehicle parts
- automobile parts
- manufacturing parts and tooling
- dental and orthopedic implants
- fashion: clothing, shoes, and jewelry
- furniture: chairs and lights
- retail products: cell phone covers, toys.

3.4 Implications of Digital Fabrication

Digital fabrication will have a profound impact on architecture. In explicit terms, it will change the way architects design buildings, and how they work with the builders who build them.

In implicit terms, it will also have sociological, economic, and geopolitical effects in all areas of life. Some may have immediate impact, while others may evolve more slowly over time. For example, this will change the current paradigm of ordering already-built, physical items from centralized locations.¹⁹ It is more likely that people will order digital designs that they can either print themselves or have printed at a local shop. The emphasis would move from manufactured parts to the digital, virtual version of parts.²⁰ The innovation and litigation that currently

¹⁹ (Gershenfeld 2005) p. 42.

²⁰ (Gershenfeld 2005) p. 42.

surrounds digital property like music and electronic books would also extend to digital product models used for fabrication.

High-volume manufacturing currently done internationally in poorer countries would also be affected. Historically, means of production shift from more developed countries to those less developed economically as a way to decrease the cost of wages. Over time, this enables the economy of the poorer nations to grow, thus helping to lift the country into higher standards of living. What will happen to local and global economies if large manufacturing capabilities are dispersed locally throughout first-world nations with thriving economies?

It is also interesting to contemplate the blessing and curse that is mass-customization. How will this affect user behavior? Is customization that desirable, and at what point does it become counterproductive? It brings to mind the popular phrase of “paralysis by analysis”. What if you could design everything you use on a daily basis? That could seem daunting to many people, and spending too much time customizing your everyday items could become a hindrance.

While the promise of digital fabrication is great, it will also be disruptive on many levels, just as the many technological advancements in computing and communications have been.

CHAPTER 4

FABRICATION PROJECT PRECEDENTS

4.1 Whole Building Printing from Contour Crafting

Dr. Behrokh Khoshnevis, professor of industrial and civil engineering at the University of Southern California, has conceived a machine to print whole buildings. Khoshnevis' machine, which he has named Contour Crafting, is a large 3D printer. A large gantry could be trucked to a site and set up where the building would be fabricated. The print head travels on the gantry, just as it does in smaller 3D printers, and deposits a quick-set ceramic or cementitious material in thin, successive layers. Khoshnevis also envisions a robotic arm to place elements such as lintils or headers over openings for doors and windows.²¹

Khoshnevis has experimented with small-scale prototypes of his Contour Crafting machine.²² A major challenge seems to be creating a concrete or ceramic material that is viscous enough to flow through a nozzle, hardens quickly after deposition, and has a structural strength that approaches concrete. As shown in Figure 1, the exterior surface of the material is smoothed by a trowel-type attachment to the nozzle, while the interior surface reveals the slumps created before the material fully hardens.

²¹ (Khoshnevis 2007)

²² (Khoshnevis 2007)

Figure 1: Prototype of Contour Crafting machine

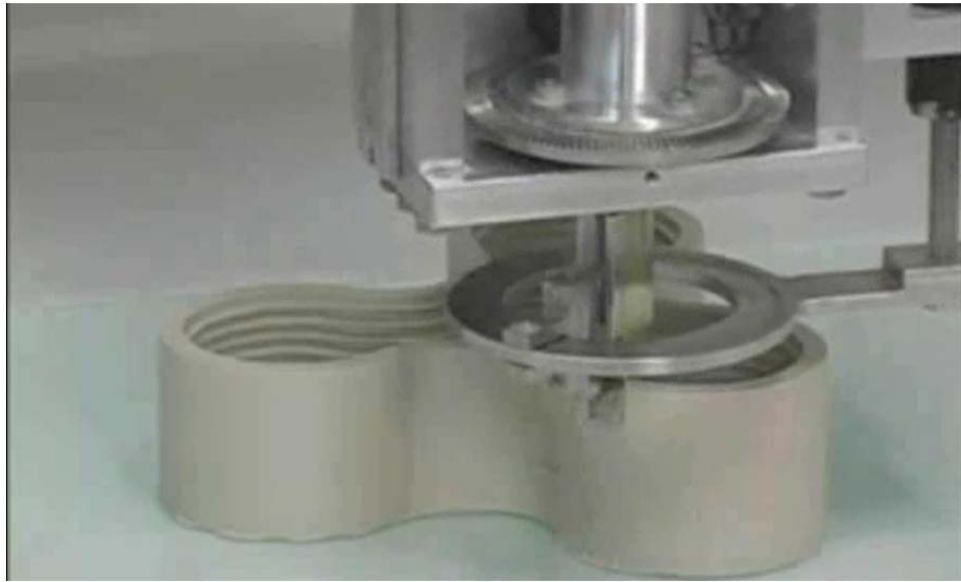

While not without challenges, Khoshnevis' research holds great promise. The ability to “print” buildings has applications beyond just regular housing; it could be used to create emergency housing in disaster areas and could even be used to create space colonies.²³

4.2 Radiolaria Installation

Shiro Studio, an architecture firm in London, is working with Enrico Dini, the creator of the D-Shape 3D printer, to create a large (approximately 10 m high) pavilion that will be completely 3D-printed.²⁴ The D-Shape printer uses regular sand and an inorganic binding ink to create solid sandstone shapes whose structural qualities can rival reinforced concrete.²⁵ When completed, this would likely be the largest 3D-printed object in the world.

²³ (Khoshnevis 2007)

²⁴ (Fallon 2009)

²⁵ (Abrahams 2010)

Figure 2: 3-meter high prototype of Radiolaria pavilion by Shiro Studio



4.3 Beijing National Stadium

Completed in 2008, the Beijing National Stadium, designed by the firm of Herzog and de Meuron in Switzerland, used digital fabrication to prove the design and fabricate some of the structural components. Working together with structural engineering firm ArupSport, Herzog and de Meuron used digital modeling, analysis, and fabrication of models to design and construct this iconic stadium featured throughout the 2008 Olympic Games.²⁶

²⁶ (Alvarado and Bruscatto 2009)

Figure 3: The "Bird's Nest": Beijing National Olympic Stadium



Digital fabrication was mostly employed on small-scale models to not only evaluate the design, but also to evaluate the fabrication and installation process. With such a complex structure, the models proved invaluable when determining the installation sequence.²⁷ The structural elements were constructed of panels. These panels were digitally-fabricated from digital models that were designed on CATIA and refined through structural simulation analysis using ANSYS software.²⁸

4.4. Office Renovation by Because We Can

Because We Can, a design firm in Oakland, CA, did an office renovation for the computer game company Three Rings in 2007. Instead of the typical office interior consisting of

²⁷ (Alvarado and Bruscatto 2009)

²⁸ (Alvarado and Bruscatto 2009)

cubicles, Because We Can embarked on an eclectic design where furniture, partitions, light fixtures, and decorative motifs were digitally designed and manufactured, mostly with laser cutters and CNC routing machines. The direct-to-manufacture approach yielded a cost savings when compared to the equivalent amount of standard office furniture, while also providing a client with a highly-customized interior that reflected their vision and helped them attain and retain good employees.²⁹

This precedent is instructive as Because We Can is a combination design/fabrication firm. They do fabricate much of their design work in their West Oakland, California studio using a variety of tools such as CNC routers, laser cutters, and mills. In this case, their knowledge of fabrication methods seems to be an integral consideration when they approach a design project. A firm consisting of design and fabrication services is not common now, but in a future with digital fabrication, it could be.

4.5 Cleveland Medical Mart

One of the more profuse applications of digital fabrication in a large-scale building project is the Cleveland Medical Mart and Convention Center currently being constructed in Cleveland, Ohio. Located in downtown Cleveland, it is a large facility, approximately 235,000 square feet, which will contain showrooms and offices for medical suppliers above ground and a convention center below ground.³⁰

²⁹ (Because We Can 2008)

³⁰ (Crawford, LMNTs - Med Mart: Introduction 2011)

Figure 4: Rendering of Cleveland Medical Mart and Convention Center by LMN Architects in Seattle, WA



The design team at LMN Architects was looking to create an enclosure around the floating, monolithic block that was both solid and permanent, and would reveal different textures and scalar details depending on one's distance from the building and angle of view.³¹ Digital fabrication was an integral part of their design goal:

“Our interest in digital design and fabrication immediately led us to embracing the use of precast concrete. Precast concrete is a cost-effective way of enclosing a building, and it complements the building's historic context with its monolithic, permanent quality.”³²

LMN took an interesting approach to using digital fabrication. First, they used a 3D printer to fabricate a scaled version of the panel and then used this model to create a casting mold. Second, they used CNC machine tools to create a full-scale master panel that was then used to create the concrete casting molds for all the panel designs used in the façade.

³¹ (Crawford, LMNTs - Med Mart: Introduction 2011)

³² (Crawford, LMNTs - Med Mart: Introduction 2011)

Using digital design tools such as Rhinoceros 3D, Revit, and Grasshopper, LMN created a custom panel design that would create different patterns depending on direction of view.³³ To study the effects of light on the panel system, LMN developed a small-scale model of a portion of the wall. They used a 3D printer to make the panels, and upon further investigation, they found a small bit of translucency in the material affected the lighting studies. They wanted panels whose opacity was closer to the actual concrete material that would be used on the building.

The design team devised a clever way to create the scaled panels for lighting evaluation: they poured a liquid silicone rubber around the 3D printed panel, and after the silicone hardened, they had a mold. For the last step, they poured plaster into the mold to create a panel that had light and surface qualities much more similar to concrete than the 3D printed plastic material.³⁴

Figure 5: Process of using a 3D printed part to create a rubber mold



³³ (Crawford, LMNTs - Med Mart 4: Facade Design Coordination 2011)

³⁴ (Crawford, LMNTs - Med Mart 5: Panel Fabrication 2011)

Figure 6: Small-scale physical model with plaster panels

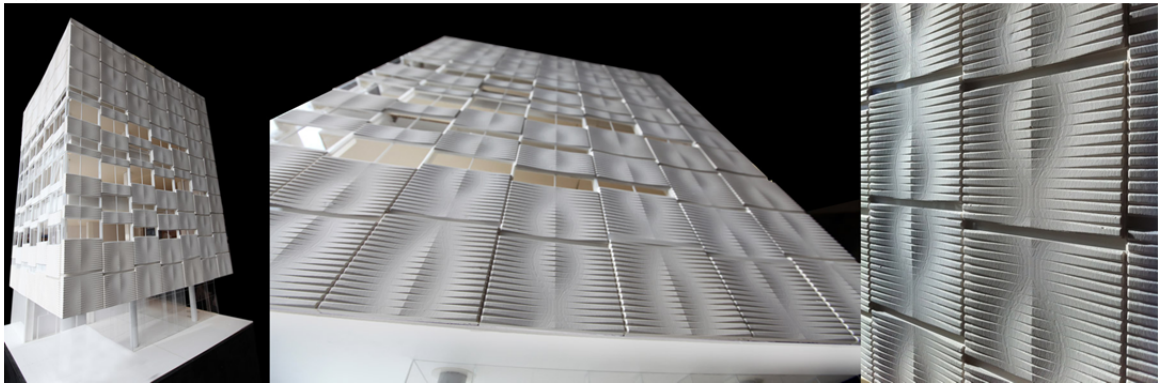

LMN found the process of making the model very helpful for the design team, the fabricators, and the constructors:

“The process gave us insight into some of the tectonic issues that the actual builders would face in the field. Moreover, the model proved to our in-house design team that the subtlety of the surface texture would indeed produce some widely varying and exciting visual effects that complemented the project’s larger design goals. After building the model, the team possessed full confidence that the results of an almost completely digital design process would be well worth the risks of execution.”³⁵

The actual panels were created using a process very similar to the one used to create the plaster model panels. A master panel was machined from high-density foam on a CNC router. This master panel was used to create rubber molds for all the panel designs used in the façade. The final precast concrete panels were then made using these molds.³⁶ The length of time from the design concept to the creation of final shop drawings was only three and a half months.³⁷

³⁵ (Crawford, LMNTs - Med Mart 5: Panel Fabrication 2011)

³⁶ (Crawford, LMNTs - Med Mart 5: Panel Fabrication 2011)

³⁷ (Crawford, LMNTs - Med Mart 5: Panel Fabrication 2011)

Figure 7: Full-size panels cast in a rubber mold made from a master panel



**Master panel CNC-cut
from high density foam**

**Rubber form liner
cast against Master**

Freshly cast panel (8'x10')

Comparison of surface finishes

CHAPTER 5

DESIGN PROJECT EXPLORATION: SITE

5.1 Design Project Introduction

In this chapter, I will explain the background material that led to the specific design project that I undertook as part of this research project. I will also explain and explore the project site in detail. In the next chapter, I will step through the design process and final result.

I created a project called CityHike to explore the application of digital design and fabrication methods on a large-scale building project. CityHike is a multi-use, urban hiking park located on a challenging location in the heart of Boston, MA. It features hill-type walking paths on an exterior structure that provides shading for a park-like setting below. The lower ground level contains more walking paths, an amphitheater, a playground, and playing courts. It is an injection of a distinctly urban greenspace into a dense, highly-trafficked urban area.

This project is very suitable for digital fabrication for many reasons. It is best served by a diverse program which should be unfettered from conventional, rectilinear design forms. Several digital design and fabrication methods are applicable to this project, including 2D profile cutting and 3D printing. It supports realistic material options, such as steel, aluminum, and plastic composites. It also offers ample opportunity for the mass customization of discrete component parts and assemblies.

In addition to exploring the design and fabrication of the built structure, I concurrently applied widely-accepted architectural design practices to ensure that the final output would achieve a level of architecture worthy of this endeavor. In addition to creating an efficient process

for fabricating building components, I also wanted to create a desirable space that would be well-designed and well-used.

5.2 Previous Design Project Precedent

I first conceived of the idea for an urban hiking park while working on a project for a previous studio course. The assignment was to design a psycho-atmospheric environment in the spirit of the Orgone Box as conceived by Wilhelm Reich. Reich's idea was a constrictive, human-sized box, the shape and materiality of which purportedly intensified natural energy fields (which Reich called "orgone" energy) that was then transmitted to the occupant sitting enclosed in the orgone box.³⁸ In addition to the heightened libidinal state, Reich thought the resulting effect would be "generally healthful...on the blood and body tissue."³⁹

Not one to sit still for long, let alone in a tiny, enclosed box, I realized my idea of an energy-intensifying activity was actually to go for a walk or a short hike. It would be an extensive exercise rather than an intensive experience. Preferring natural environments with irregular, rising and falling surfaces to long, flat stretches of asphalt, I theorized that an urban hiking park would provide people with an engaging environment where they would be infused with a freeing, restorative energy.

I derived inspiration for the form and layout of the park from natural schooling and flocking patterns of fish and birds. This park would be inserted into a busy urban area. As a result, I thought the patterns of park users would be similar to those of the animal groupings;

³⁸ (Lavin 2007) p. 75.

³⁹ (Lavin 2007) p. 75.

masses of users streaming along in defined patterns, yet intimately aware and responsive not only to the others within the group, but to external natural forces as well. Just as the fish school around the ocean-bottom terrain, and alter course due to changing currents, water temperatures, or predators, the hikers would also alter their course based on other hikers, the weather, nearby automobile traffic, and the programmatic attractants of the terrain, such as the amphitheater, street vendors, or playground courts.

Figure 8: Schooling fish and flocking birds inspired the ideas and patterns of the urban hiking park

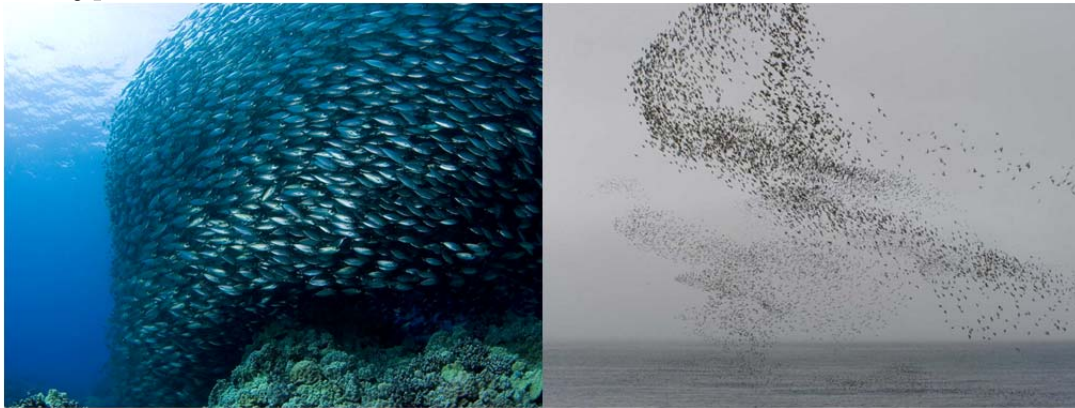

I utilized digital design tools to designate certain areas of the site as electromagnetic poles; the resulting forms would be shaped by their attractions to certain areas of importance on the site, such as access from the upper street level and the enclosed areas on the lower level. The resulting swirling mass of structure, when viewed from above (Figure 9), does resemble the flocking paths of ocean birds.

Figure 9: Aerial view of an earlier incarnation of urban hiking park

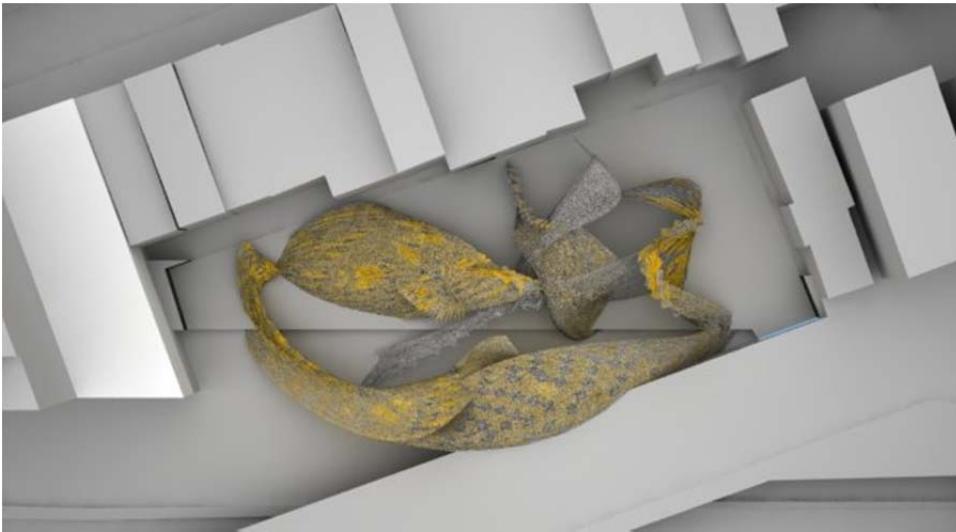

The structure is a panelized grid; metal framing is clad in grated panels. The grating injects porosity and lightness into a geographical typography, that of rolling hills and mountains, which usually implies extreme density under the exterior. Here, the grating allows external elements to filter through from above to the park areas below. The resulting effect is filtered shading of the ground level; a welcome respite from the accumulated heat of asphalt and masonry found in the city on a sunny, summer day.

Figure 10: Lower level of urban hiking park

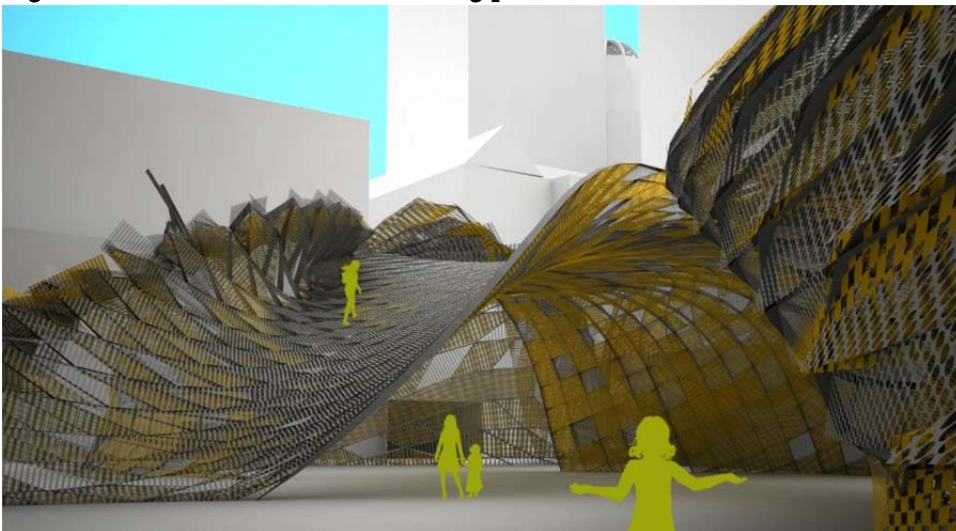

Each surface panel is flat and singularly planar, as is each framing member. The human-sized scale of the panels enables a collection of flat, planar elements to resemble very curvilinear, flowing shapes when assembled into a large structure such as this. The resulting faceting of the linear edges virtually dissolves into a curve when viewed from some distance.

The grated cladding allows views to all other parts of the park, thus alleviating a dark, cave-like effect that would occur if the cladding was solid and opaque. It also provides a sense of security by enabling visual access to ingress/egress routes throughout the park; there are no dark corners or passages. The infiltration of wind, sound, rain, and sights encourages constant activity, energizing the park through directing the surrounding energy throughout the site.

Figure 11: Walking along the lower level

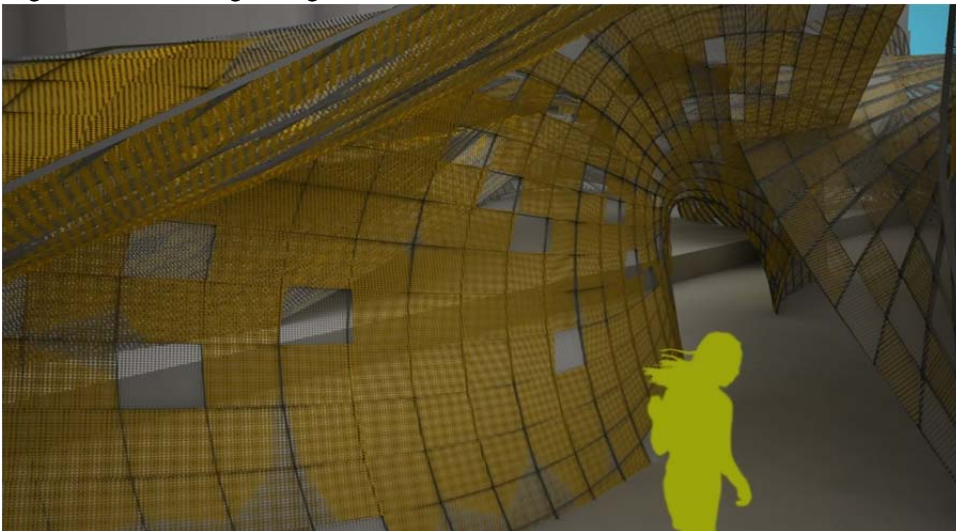

The ambiguous hiking routes will give users the chance to forge their own trails. Less ambitious hikers, or those unable to climb graded surfaces due to health conditions, can find gentler hiking underneath the structure at ground level.

Figure 12: Ascending an incline

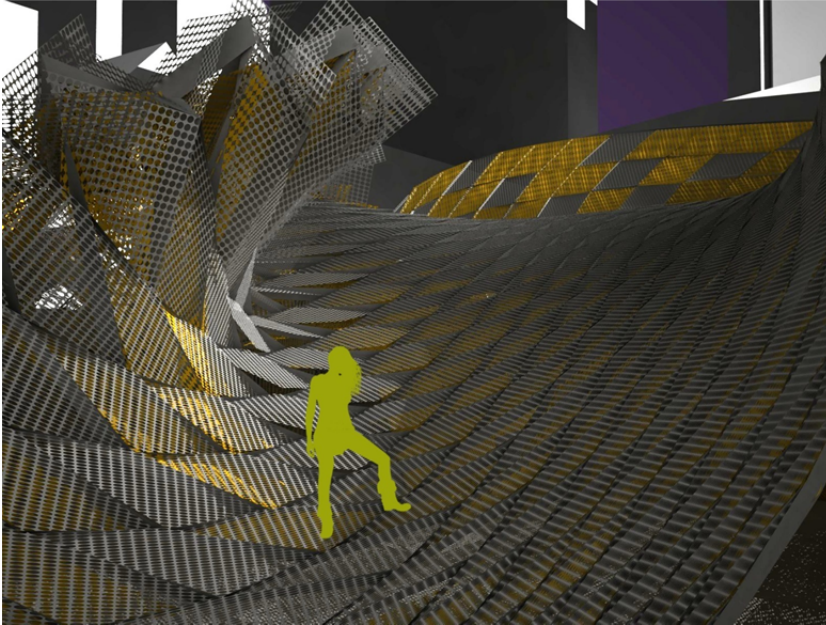

Glimpses to openings within the structure suggest paths rather than dictate them. This is a park that encourages exploration.

Figure 13: Structure and grated decking serves as a walking surface on the exterior above while providing shading and screening below.



The large size of the structure is downplayed by the smaller grid size of the framing and cladding panels. Another level of detail is added by the grating patterns. The result of the differing scales yields a structure that coexists nicely with the variety of its surroundings. Even though this form uses a natural, mountainous topography, the industrial material makeup and inherent lightness in the design give it a distinctly urban feel.

Figure 14: The grating ensures a degree of lightness while providing elemental filtration for a large structure that could otherwise be quite oppressive

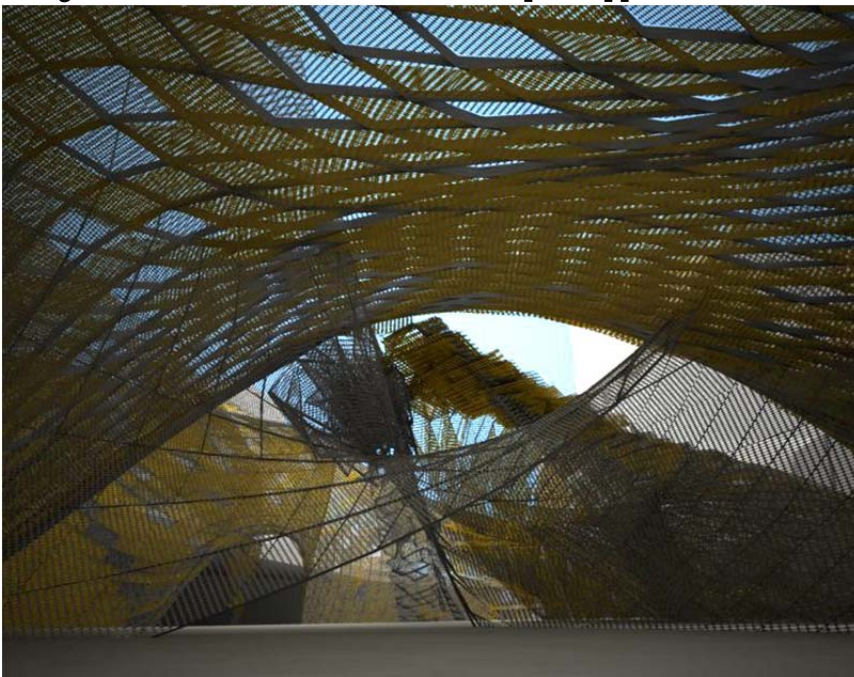

This was an enjoyable project to work on. Many aspects of it were very relevant to a deeper exploration in fabrication. It is a large, irregular shaped structure, comprised of linear components of a smaller scale to yield flowing curves when assembled into a larger shape. The resulting custom shapes of the framing and cladding panels would be very difficult to manually design and fabricate; hence this is an excellent candidate to explore how a similar structure could be digitally-designed and fabricated.

5.3 Site Introduction

For the design project exploration, I used the same Boston site from the project described in the previous section. Here I will provide a more complete description of the site so that readers may better understand where the site is, what its surroundings are, and what aspects of it influenced the programmatic portions of my design.

The site is located in Boston's Back Bay area. The lowest ground level on the site is the area of land between the Massachusetts Turnpike and the back of a block of buildings that front Newbury Street. The site ground level is shown as the white area in Figure 15. Boylston Street provides access to the site from a higher elevation, about 25 feet above the turnpike below. The translucent white area indicates the region of the site that is contiguous with Boylston Street, yet 'hangs' over the turnpike below. This area can also be used.

Figure 15: Aerial view of site location



Figure 16 shows a view of the site with a diagram of adjacent circulation highlights. The site abuts the very vibrant Back Bay community on Newbury Street. This area is densely populated with mixed-use buildings and urban infrastructure. In addition to the renowned retail,

dining, and commercial district along Newbury, there are two colleges that abut the site: Boston Architectural College to the northeast, and the Berklee College of Music to the southwest. The Hynes Convention Center and Prudential Center complexes are located across from the southeast corner. Garages around the site provide parking for the Boston Red Sox professional baseball team. As a result of all these factors, there are an incredible number of pedestrians within the vicinity of the site during most waking hours.

Figure 16: Wider view of site location and diagram of adjacent buildings and circulation

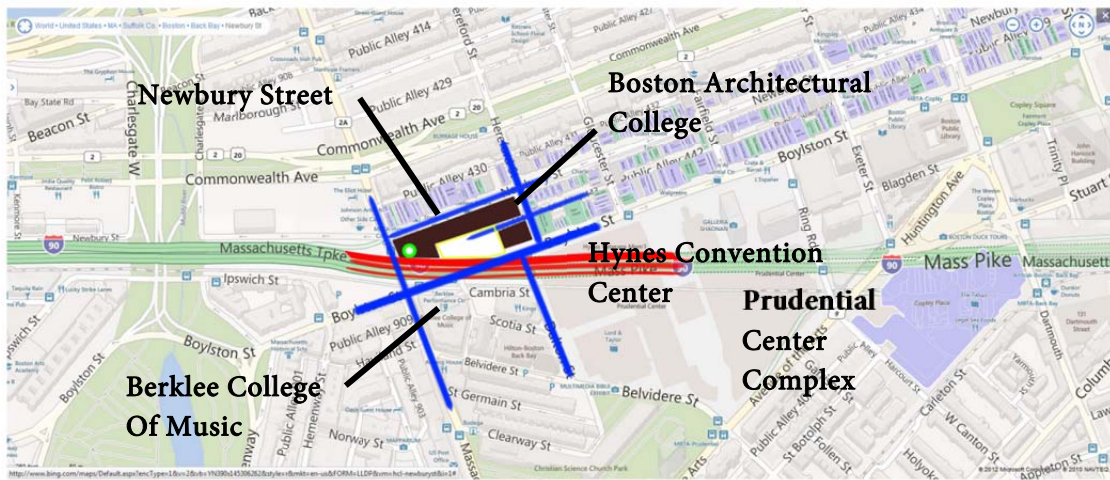

The Massachusetts Turnpike obviously forms a hard border at ground level to the south. The buildings on Newbury Street, Hereford Street, and Massachusetts Avenue form hard borders at ground level on the north, east and west. Boylston Street provides pedestrian access from an upper level. A public alley off Hereford Street provides pedestrian access directly to ground level. There is a subway stop, the Hynes Convention Center station, on Massachusetts Avenue.

Figure 17: Close-up view of site location and diagram

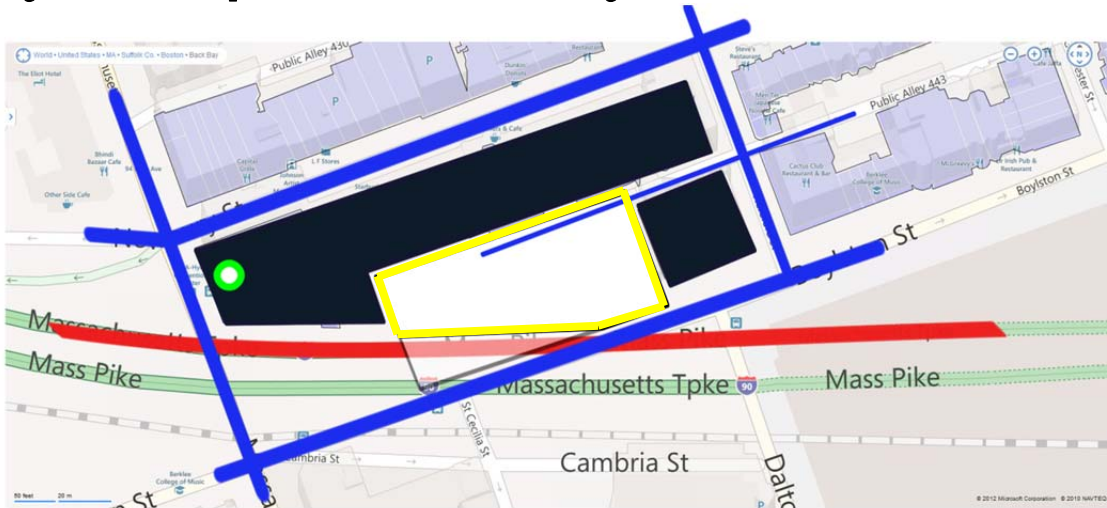

- Site boundary at lowest ground level
- Streets with pedestrian access and low-speed vehicular traffic (highest elevation)
- Massachusetts Turnpike (high-speed vehicular traffic) lowest elevation
- Adjacent buildings that front Newbury Street
- Subway station (Hynes Convention Center stop)

As shown by Figure 18, the ground level of the site is a mix of parking and unused buildings. The surrounding buildings, mostly brick, provide a wide variety of texture and urban fabric to the site.

Figure 18: View of the site from the south, looking north



At the upper level of Boylston Street, what at first seems inaccessible becomes more accessible on closer inspection. The structure supporting Boylston over the turnpike (blue steel beams in Figure 19) provides initial planes that could be used not only to bridge the divide between Boylston and the site ground level, but also provide surfaces for hiking, seating, playing, and street vending.

Building additional infrastructure over the turnpike is not a hindrance. Cars travel through that area at a rapid rate, averaging 70 miles per hour, so enclosing another two hundred feet of the turnpike is of little consequence to the average driver who will spend mere seconds driving through there. Conversely, adding two hundred feet of useable surface would be a boon to the urban hiking park. Bringing the park all the way to the intersection of Massachusetts Avenue and Boylston Street also provides crucial connectivity to Mass. Ave. pedestrian traffic.

Figure 19: Looking east from the intersection of Massachusetts Avenue and Boylston Street

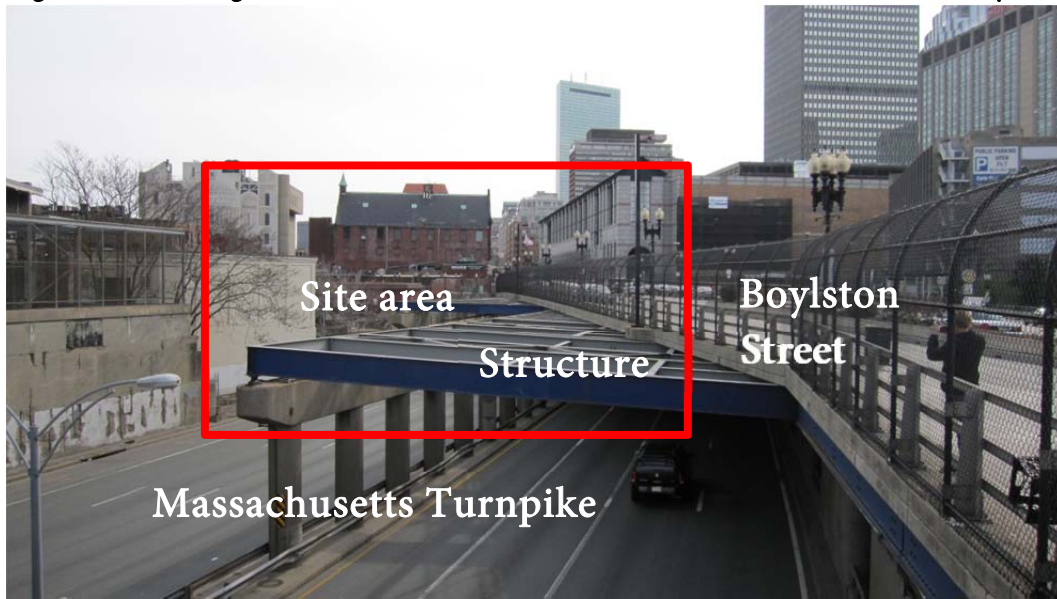

Pedestrian access to the site is currently provided at two locations. At the southeast corner, there is a stairway (Figure 20) leading from Boylston Street into the site, although this is currently locked up due to the building being unused. On the east end, there is a public alley off Hereford Street that leads directly into the heart of the site (Figure 21).

Figure 20: Stair access into the site from Boylston

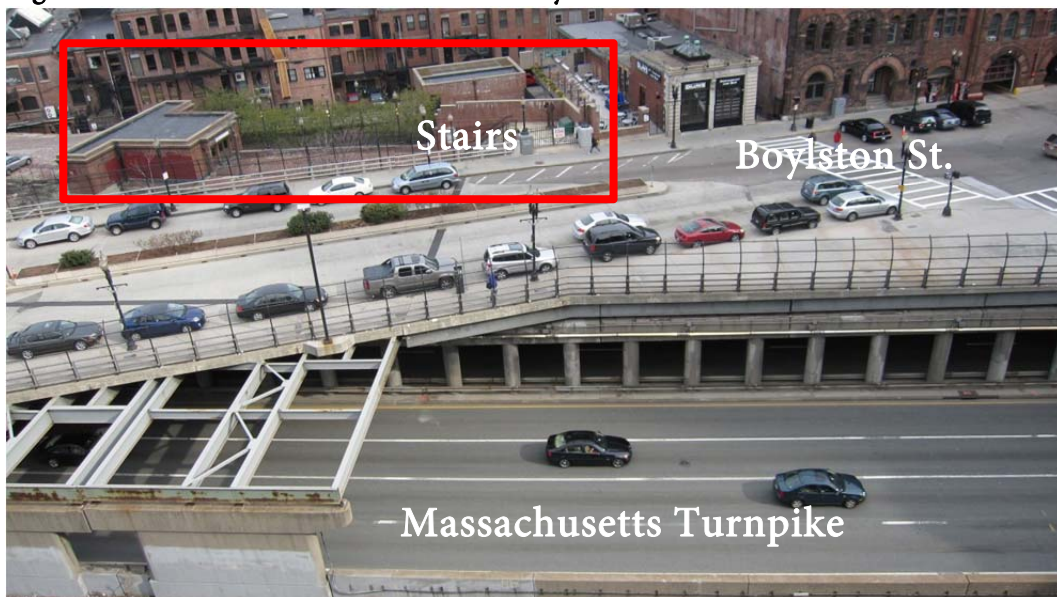

Figure 21: Looking west down into the site from the public alley located off Hereford Street



The current content of the site is unremarkable. It is a mélange of parking, miscellaneous buildings, and service access. It lacks definition and purpose, yet is within a stone's throw of many of Boston's iconic landmarks. This site abounds with promise, and it provides an enticing challenge to the ambitious designer.

Figure 22: Looking east from the west end of the site; public alley is in the middle



CHAPTER 6

DESIGN PROJECT EXPLORATION: PROCESS

In this chapter, I will describe not only the finished project, but also the processes used to program and design it. The programming phase uses conventional techniques such as observation, analysis, and proposed use, while the design phase attempts to bring together the conventional architectural programming with direct, digital design-to-fabrication processes. A goal of the resulting design is to reflect a harmonic convergence of these two aspects.

6.1 Design Considerations

For a project as complex as CityHike, I formulated the following considerations to serve as the design framework:

- **Program:** a multi-use urban hiking park, with variable trails on the exterior, and a park-like, shaded setting underneath at ground level. Uses may include playground space, playing courts, an amphitheater built into the hiking surfaces, and street vending and seating at the upper street levels. Basic restroom facilities and possibly a conditioned, indoor gathering room would be included.
- **Materials:** The strong, lightweight structure requires metals, likely steel for the main structure and steel or aluminum for the decking surfaces. The decking surfaces would be exposed to sunlight, so aluminum is a more likely material. It is lightweight and does not hold heat like steel does, so it is likely to stay cooler during the summer. Plastics could also be considered for the decking.

- Human scale & comfort: For such a large structure, it is necessary to make the scale of the hiking surfaces distinctly human-sized, for all sizes of humans, and make it approachable and easily navigable. For comfort, I considered making the hiking surfaces of variable difficulties so that one could indulge in an easy or relatively difficult hike, depending on their conditioning and ambition.
- Resultant forms not bound by traditional forms: The wonderful aspect of digital fabrication is the notion of unbridled design freedom. The forms to be considered did not need to be restrained by conventional rectilinear materials and tools. However, I did self-impose some necessary traits in the resulting form, as noted in the next item.
- Inhabitable and reflects human influence: The resulting spaces should be desirable and not foreboding. As noted in my previous hiking park design, the grated cladding made the spaces underneath eminently habitable, especially on hot, sunny days. I wanted to carry that quality forward into this project. As to human influence, I desired results that were recognizable at some level to most people, and alluded to terrestrial origins. Again, in the previous design project, the resulting forms were quite organic and reflective of local terrain that was naturally shaped by millennia of weather, water, tectonic activity, and glacial shaping. This explicit, indigenous typology will likely foster a sense of belonging rather than provoke a negative reaction from a more alien form.

- Contextual urban fabric: While my structure will be a radical insertion in an area of rather staid architecture, I will endeavor to create something that does enhance or reflect the urban fabric of the larger area.
- Connectivity: This park will provide three-dimensional, non-linear pedestrian connections between four highly-trafficked streets in the area. It will also provide another direct, pedestrian-only link from Massachusetts Avenue into the Back Bay.
- Architectonic: The outcome will likely be a distinct metal structure, but will be imbued with architectural qualities to make it a highly-desirable and highly-used space. The porous structure proposed will provide a balance between the dense, static buildings and the open, flowing circulation routes that border the south end of the site.
- No drastic impositions on human behavior: I don't want to indulge in a social experiment to force extreme or highly-unusual human behavior. Walking along natural surfaces, walking in filtered shade, or enjoying playground games are desirable activities that are in short supply in a dense, urban setting.
- Craft versus commodity: As it is a large structure made from man-made materials, considerations for craft must be included lest the structure becomes a boring, monolithic form. The digital design and fabrication tools lend themselves naturally to creating components that reflect craft rather than commodity. A large number of customized components automatically suggests craft over the sameness of commoditized components.

6.2 Digital Design Process

The design process involved making manual forms that were then used to create the virtual models of the building components. One thing that became abundantly clear early on in was the need to automate the creation of the building components from the forms. Manually extracting shapes and modeling them into building components would be extremely time-consuming and error-prone. Using scripting, which is a way to program software to perform certain actions, was necessary to automate the task of transforming the building forms into 3D building components. Scripting was also used to convert these virtual components into fabrication files that could be used to directly manufacture them from their CAD model.

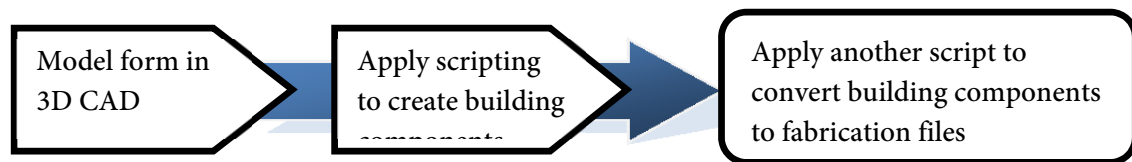

The CAD software used for this design was Rhinoceros[®]. Rhinoceros includes powerful capabilities for creating non-uniform geometric models, thus making it a good CAD tool for irregular shapes. Rhinoceros also works well with a visual scripting tool called Grasshopper[®]. Grasshopper is a good tool for non-programmers. Commands are bundled as visual elements, which you place, configure, and connect together. The underlying programming result is the same as if you wrote the script conventionally, but the WYSIWYG (what you see is what you get) interface is helpful for non-programmers.

6.2.1 Form making

The first step was to create the forms that would serve as the basis for the building design. I manually created the 3D surface forms in Rhinoceros by shaping them and refining

them directly within a virtual model of the site area and the surrounding infrastructure. Figure 23 shows the programming considerations that helped shape the forms. Some other considerations were to use an explicit typology that would evoke rolling New England hills. As noted earlier, I did extend the western form all the way to Massachusetts Avenue to provide a critical link to that busy intersection. The two main forms are separated so as to open up some of the bottom level directly to the outside.

Figure 23: Rhinoceros model of the two main forms used to create the hiking/shading structure

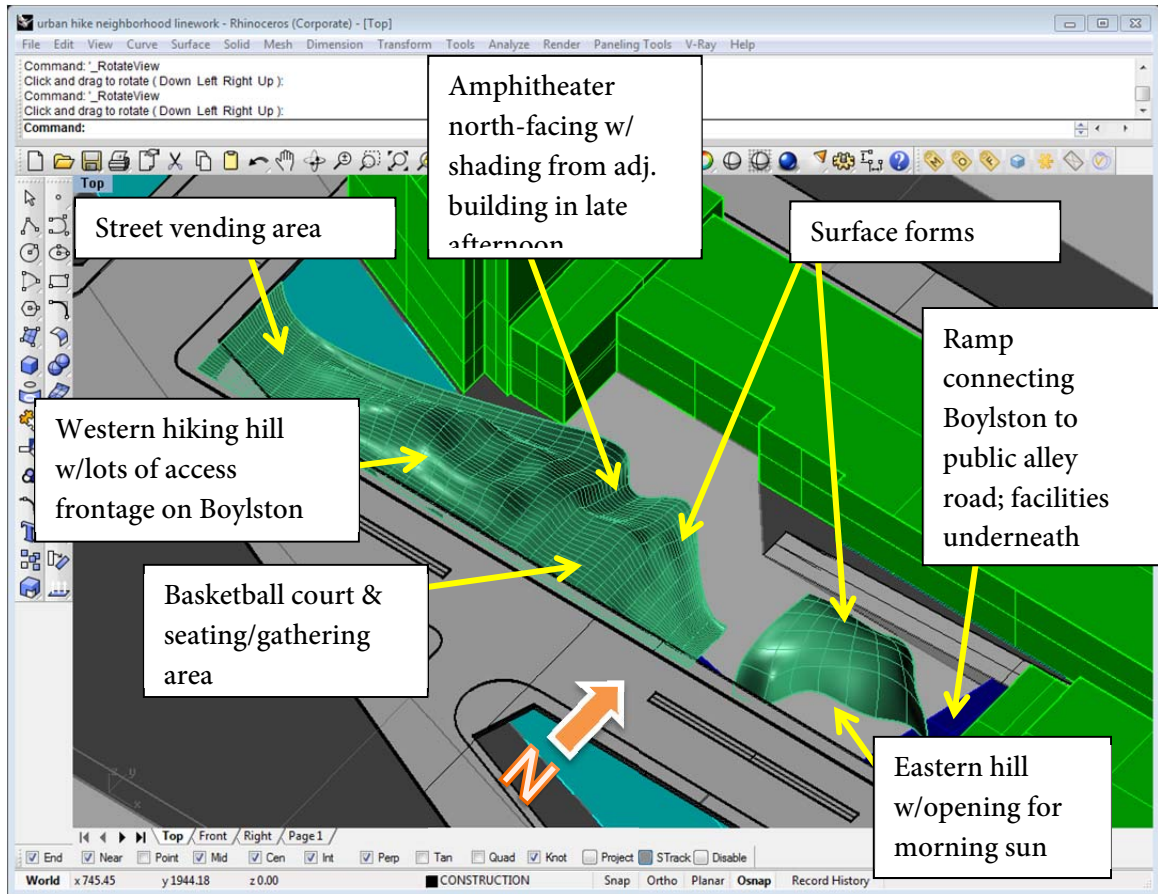

The height of the hiking hills only extends up to approximately 25 feet above Boylston Street, yet some of the inclines are steep enough to provide a challenging hike. Since the hiking

surfaces then descend down into the site, the total elevation traversed from top to bottom is about 50 feet. Figure 24 shows a view of the forms closer to street level.

Figure 24: Perspective view of forms

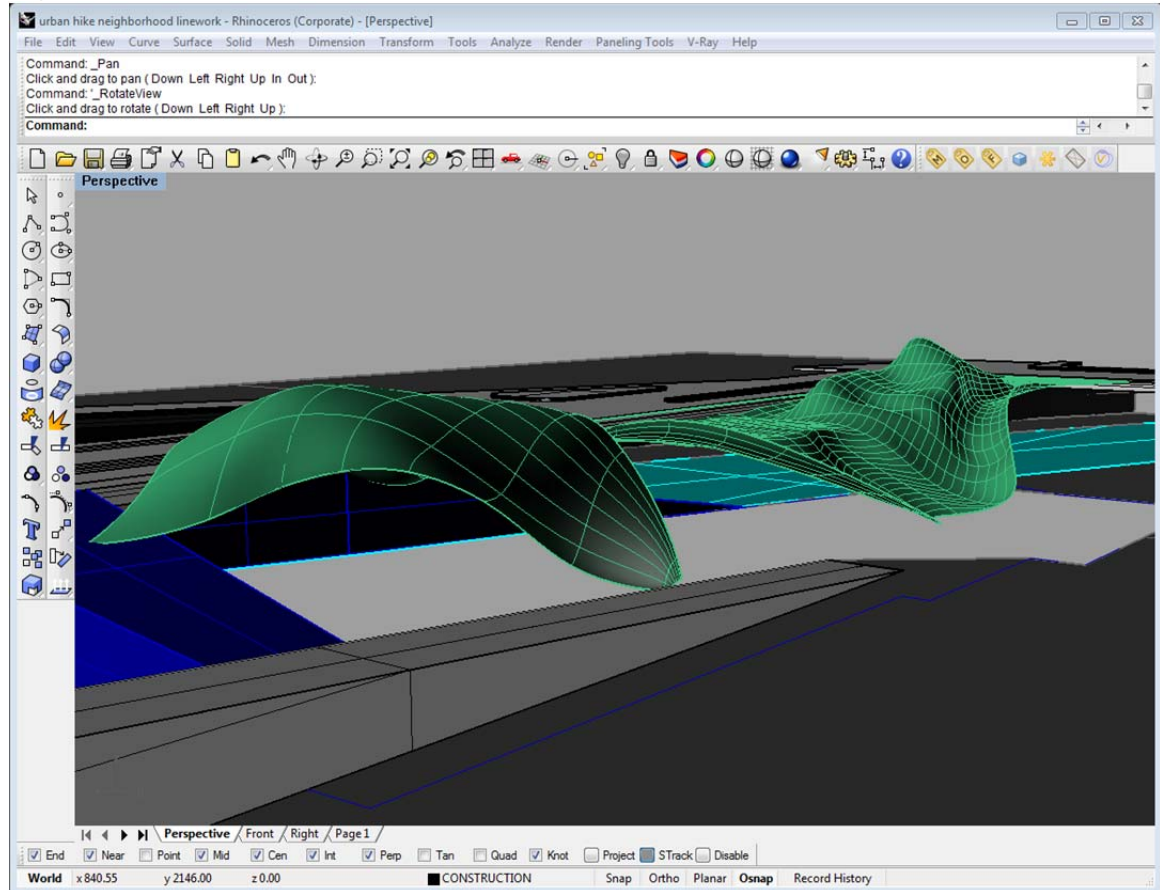

The eastern form is smaller in area but a little steeper in slope. It will cover/shade a playground area beneath. I created an opening on the southeast side of the form to allow sunlight in the morning into the area, while the rest of the form provides more shade as the sun travels westward during the day. That way the playground space would warm in the morning, and then be shaded during the height of day when the sun is hottest. As parents of small children know, exposed playgrounds are no fun on summer afternoons due to the playground equipment getting dangerously hot. I envision this area to be a welcome respite for anyone, not just families, who

wants to come and enjoy the shade on a hot day, whether they are just passing through as tourists or are long-time residents of the area.

6.2.2 Scripting to Create Components

After much experimenting and refining of various surface forms, I applied a script that I created in Grasshopper. This script automatically created the building components from the forms based on the geometry that I chose to extract. In this case, I chose to use flat, planar profiles for the horizontal decking components and vertical structural components. The irregular form could still be conveyed through the organization of these shapes, and these shapes were the most likely to be reproducible by current digital fabrication methods.

Figure 25: A portion of the Grasshopper script used to create the components from the forms

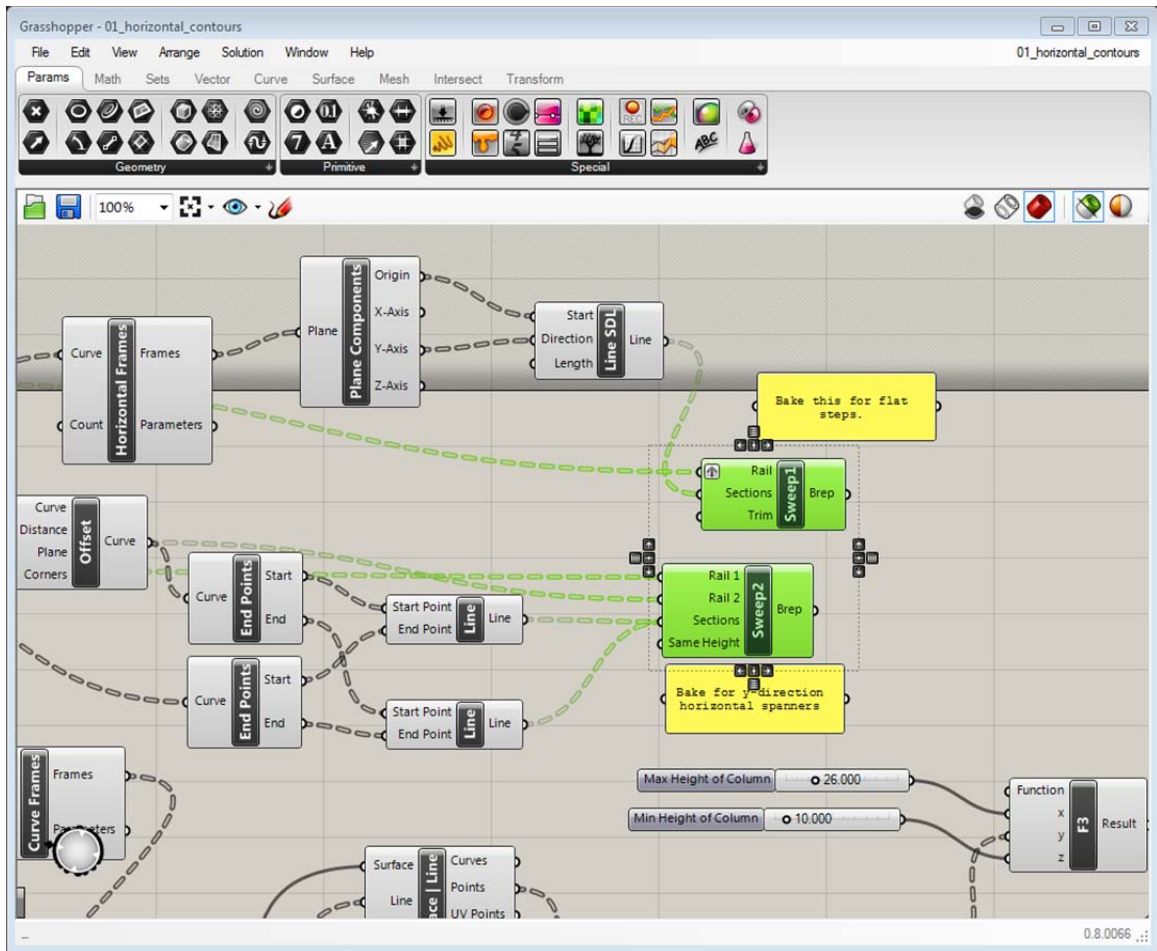
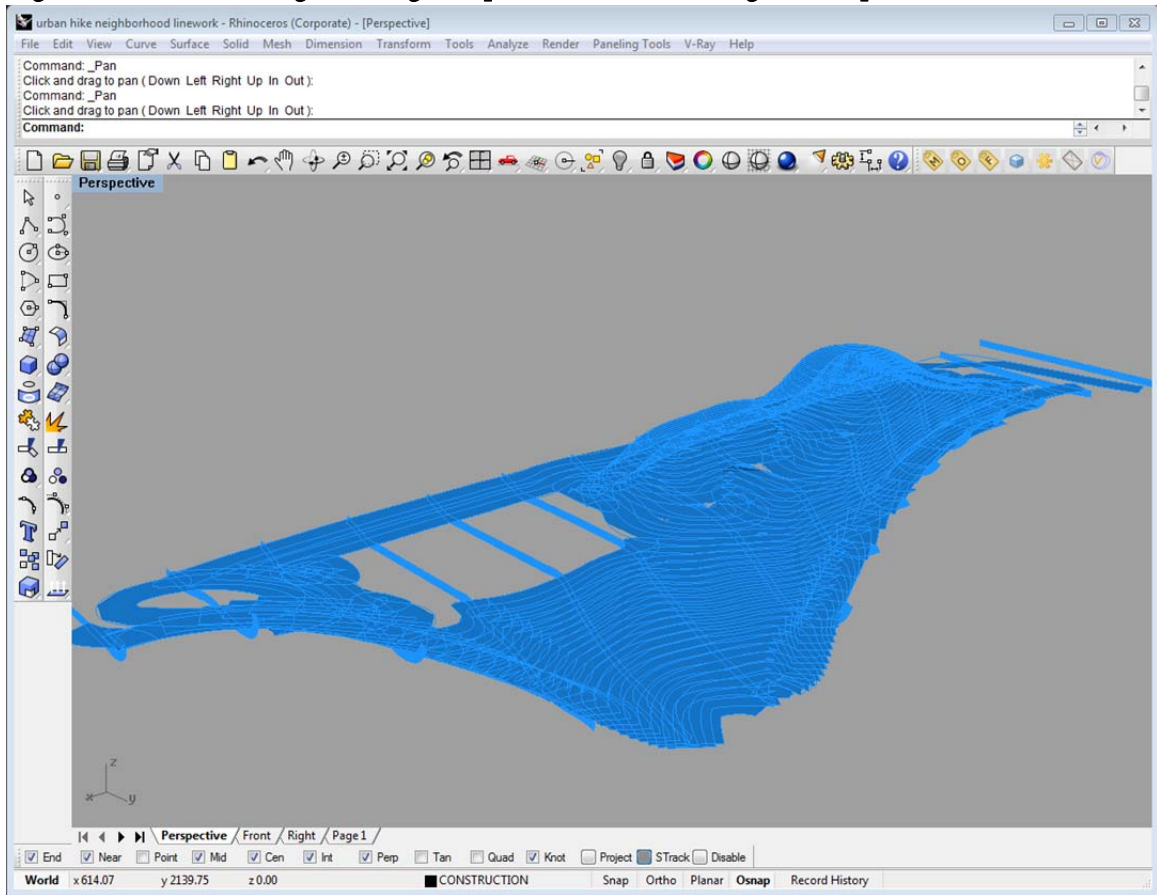

Figure 26: The resulting building components after running the script



Grasshopper enables you to preview the script actions before committing to running the actions. This is very helpful for troubleshooting and tuning your scripts to get your desired output. Once I got a satisfactory output on the building components, I ‘baked’ them, thus running the script actions to create virtual models of the parts. (Figure 27)

The flat decking provides a natural series of stairs that park users can traverse easily, whether going up, down or sideways. I did two small manual refinements of the building components: I added a flat surface at the Boylston Street level, as my script only created the decking surfaces with a width of 8 feet, and I added the stage at the bottom of the natural amphitheater. Other than that, the creation of the virtual building components was completely

automated. The flat decking at the top of the hiking hills organically created the holes at each peak. This was an unintended by positive consequence, as not only would hikers be rewarded with a nice view of the city once they reached the top, but they would also be able to peer down into the lower level of the park.

Figure 27: The 'baked' building components (adjacent buildings not shown for clarity)

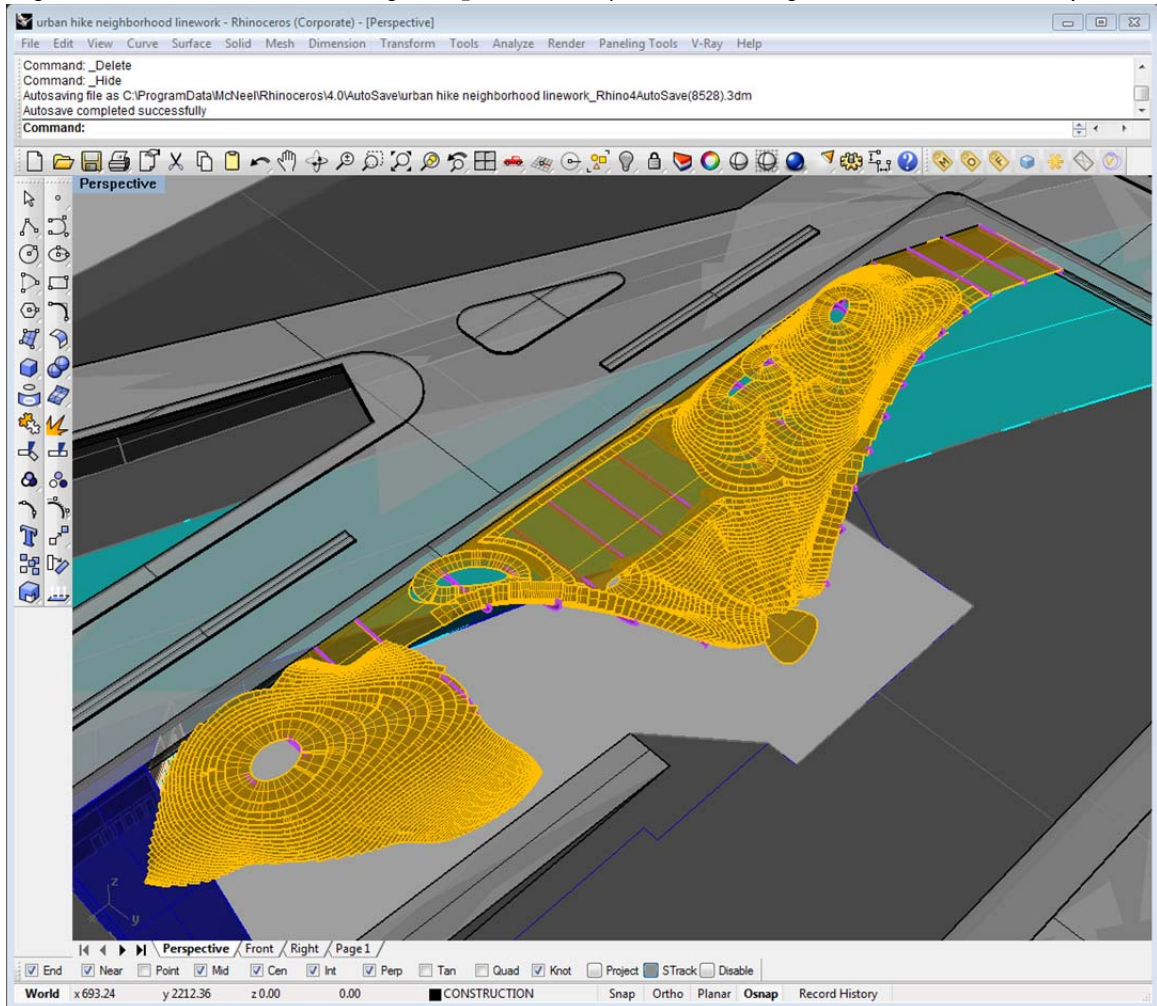

6.2.3 Scripting to Automate Fabrication Output

I created a second script to convert the form directly into 2D profiles that could be used on a plasma, laser, or waterjet cutter, or could be used on a CNC roller to roll structural steel beams. This script was similar to the previous script in that it would extract geometry directly

from the form at specified distances, and it would also add additional geometry to create a fully-developed profile of all parts, including their connections. The additional step included reorienting these profiles on a single surface that would be used in the fabrication machines. The final 'baked' output was a 2D CAD file that included all of the building component profiles. I manually refined the output file to move the profiles as close together as possible, thus minimizing the waste that would be generated if these parts were cut from sheet materials using a subtractive process.

This script was also run on the horizontal decking components. Those could be fabricated using plasma, laser, or water jet cutters. The grating patterns could be cut during this process.

This script marked each of the locations where the vertical structural supports intersected with the horizontal decks. One action I didn't script, but is possible, is to automatically mark each component with a unique identification number. This is critical for making sure the structure is assembled properly.

Figure 28: Results of a script used to create fabrication profiles of the building components

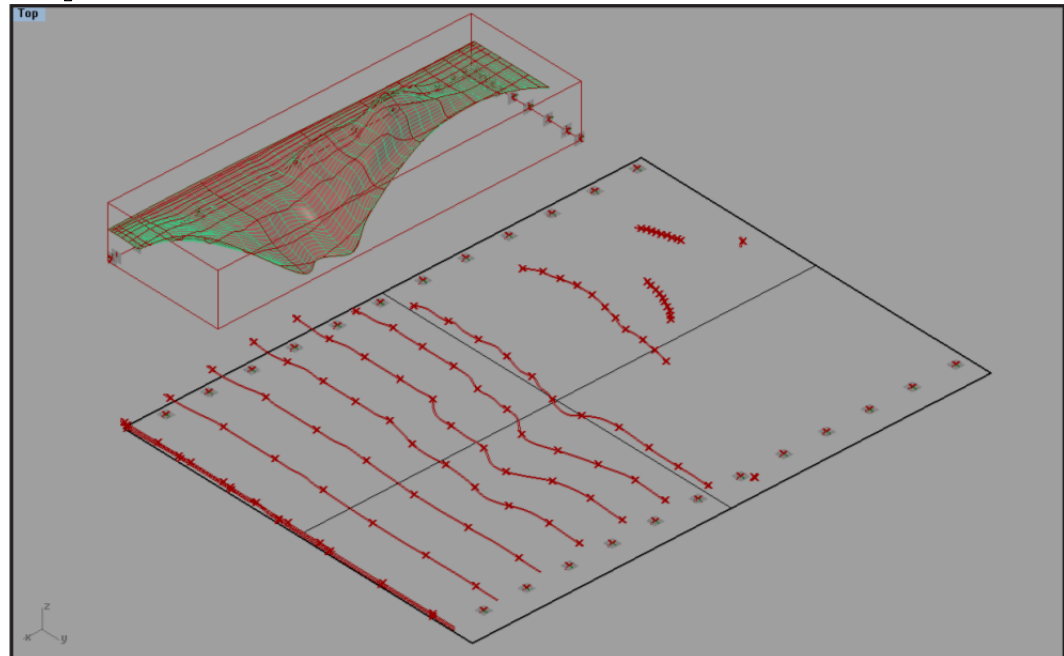

The exciting part about the script that generates the fabrication files is the elimination of hundreds or thousands of shop drawings that would be required if this were manufactured by conventional methods. Going directly from CAD design to fabrication would save a lot of time generating shop drawings, especially for one like this with such an irregular structure. For this project, the parts could be fabricated directly from the CAD files, and then assembled by referring to the 3D virtual model on a laptop computer at the site.

6.2.4 Lower level site design

The lower level of the site also required design work, which I did manually. I created ground surfaces that rose and fell more gently than the upper hills, but I still wanted irregular walking paths. I added a walking path around the perimeter of the park for people with less physical capability. It is partially shaded and partially exposed. I added a basketball court and

handball court on the lower level, both partially shaded by the hills. The restroom and indoor gathering facilities are housed under a ramp that provides a direct pedestrian link from Boylston Street to the public alley.

6.3 Final Design with Digitally-Fabricated Components

In the following section I reveal and describe the final design of CityHike.

Figure 29: Rendering of CityHike superimposed on aerial photo of the site

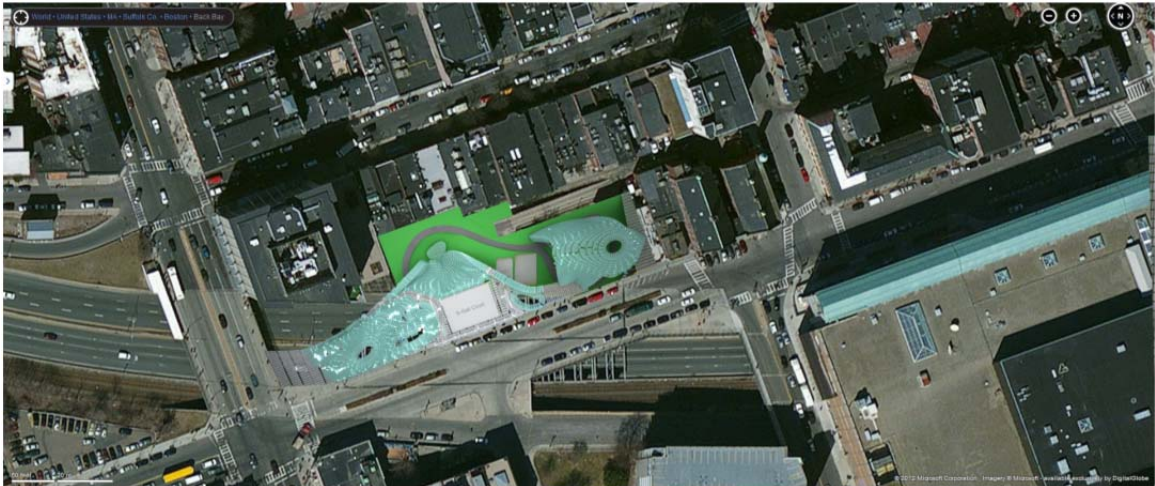

This site plan drawing of City Hike highlights the landforms of the hiking hills, which resemble natural landforms throughout New England. This plan view (Figure 30) resembles topographical map details.

Figure 30: Top level plan of CityHike

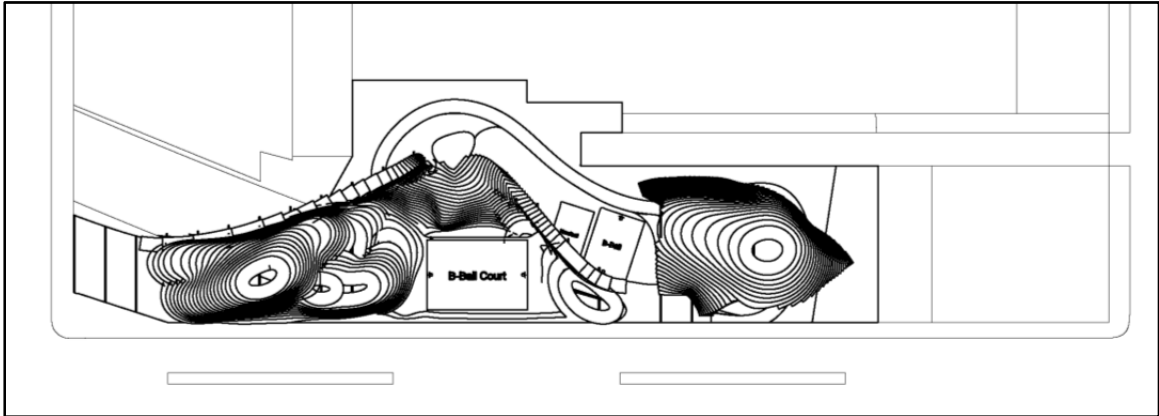

The lower level (Figure 31) includes the walking path, courts, a stage, and open areas. Most of the open areas are shaded by the hiking structures. The restroom and indoor facility are in the southeast corner.

Figure 31: Lower level plan of CityHike

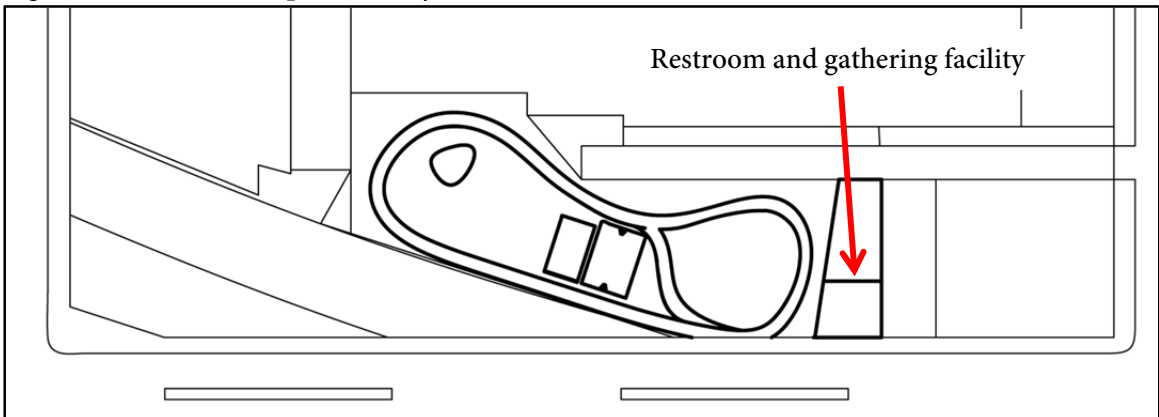
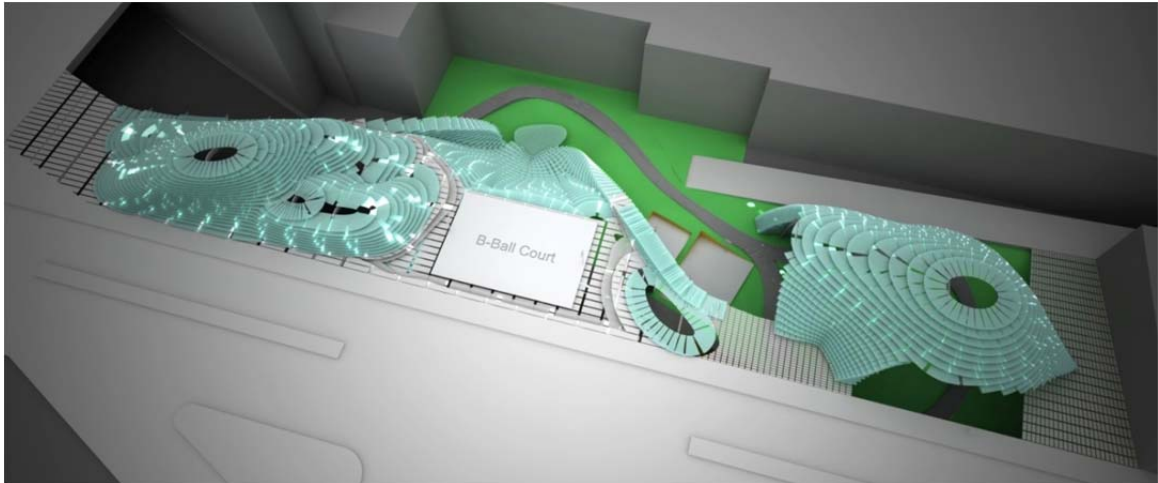

Figure 32 shows a rendering of the completed project. Forming the structure from profiles of cut parts results in a level of complexity and granularity that helps it to mesh with the various level of detail in the surrounding urban fabric.

Figure 32: Aerial view of CityHike rendering



The rendered image in Figure 33 starts to reveal the grating design I applied to the horizontal decking surfaces. There are intermediate radiating breaks in the decking sections, while there are also grate lines that run laterally through each deck section. The light aqua color of the hill decking is a result of a protective coating applied to the aluminum decks. This will reduce heat gain in sunny weather, and keep the decking from getting too hot. The lighter color will also minimize a cave-like feel underneath the structure.

Figure 33: View from the west hilltop looking east

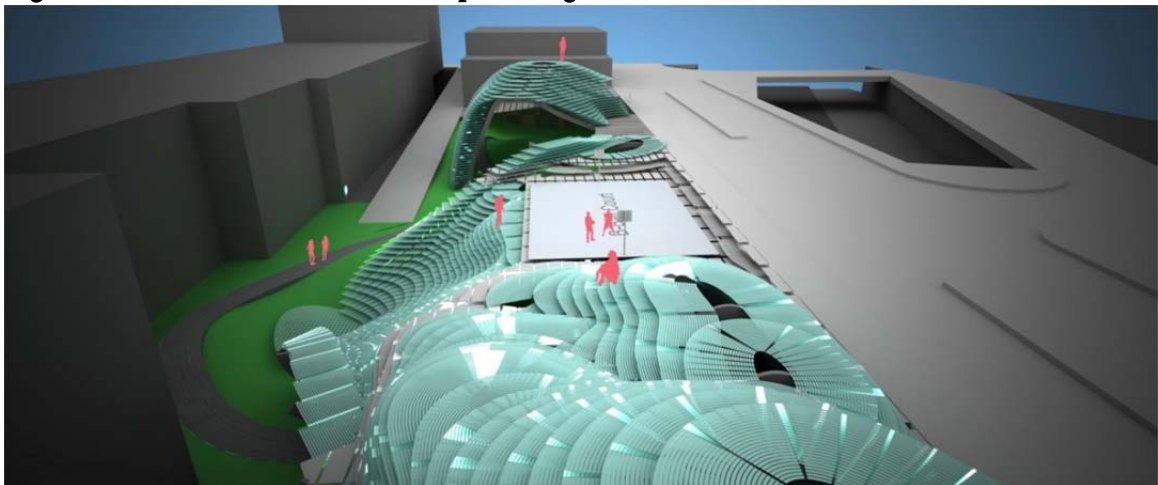
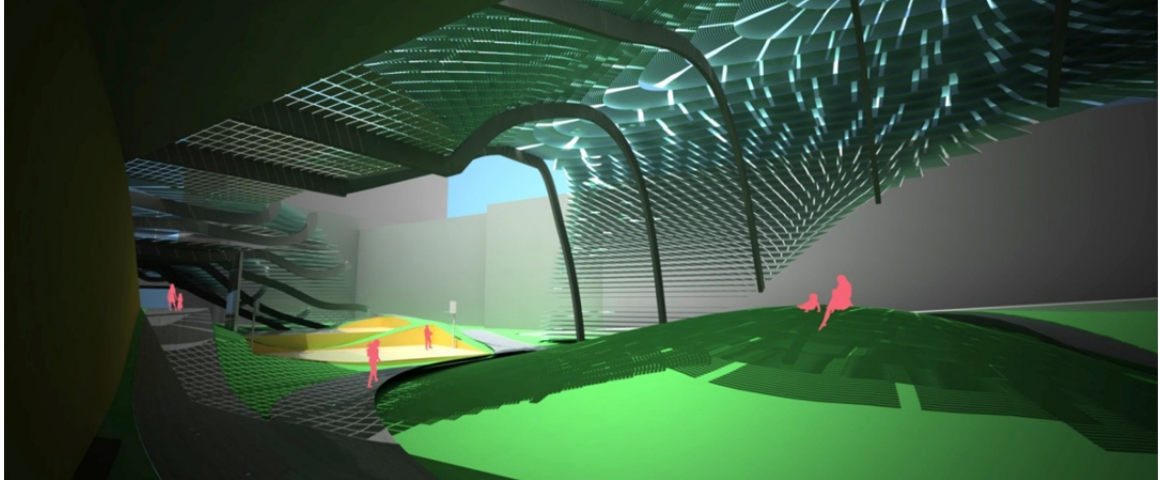

Figure 34 highlights the shaded hill that I have earmarked for a playground space. The shading provided by the grating is filtered and provides beautiful shadow patterns on the ground.

Figure 34: Underneath the structure, looking east to west



The amphitheater and stage provide a wonderful venue for all types of performances. Its location is quite removed from the turnpike noise, and its orientation and location keep attendees and performers out of the sun in the late afternoon and evening hours. The horizontal decks provide natural seating. Impromptu concerts by Berklee College students would be a wonderful draw.

Figure 35: View of amphitheater and stage

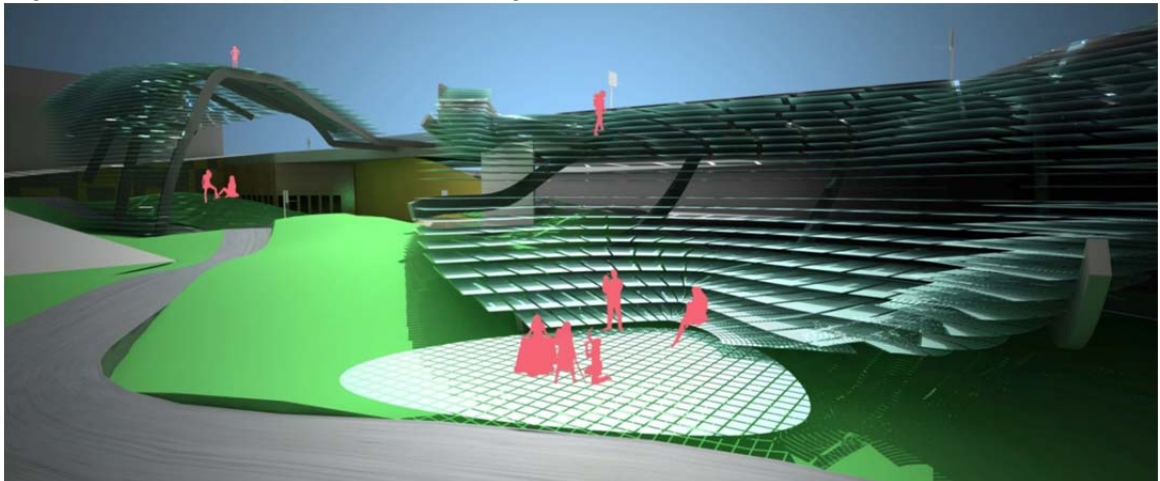

From street level, the hiking park forms provide natural wayfinding cues in the form of gently-rising steps (Figure 36). I ultimately chose the explicit form to help offset the insertion of a radical, modern structure into a traditional Boston neighborhood. These forms bring a little bit of suburban and rural New England topography into its signature city. The flat area at street level could be used by street vendors.

Figure 36: Approaching CityHike from Boylston Street near Massachusetts Avenue intersection

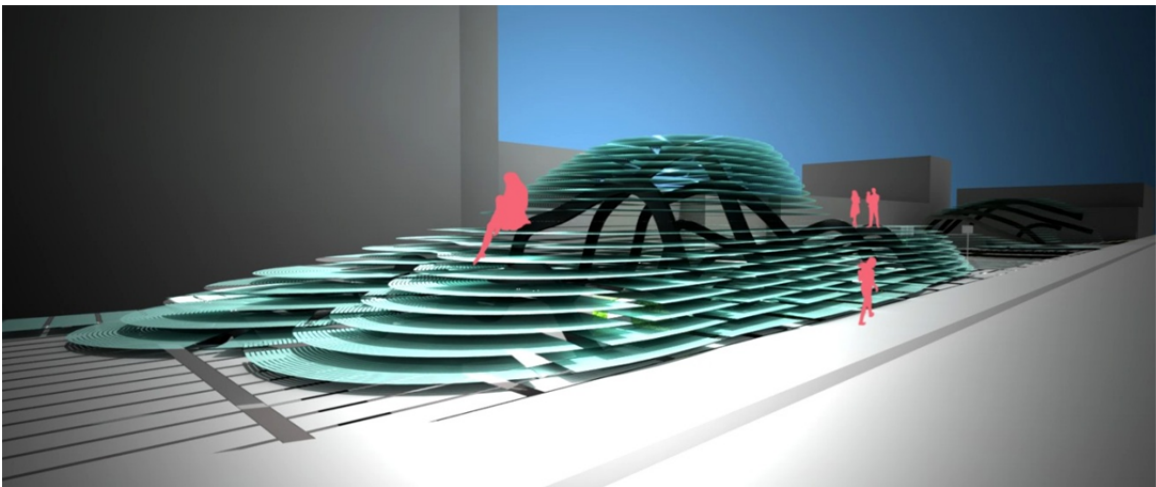
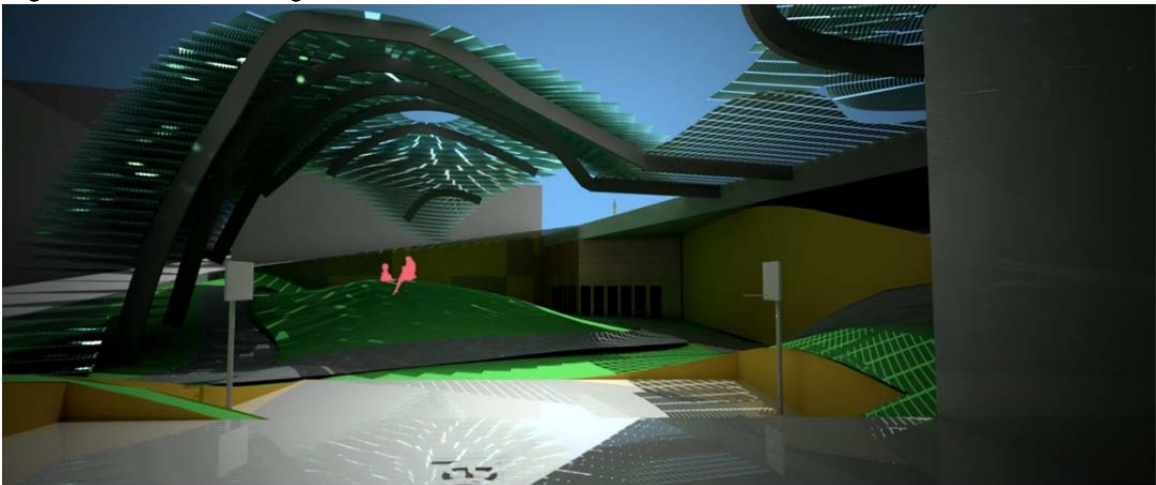
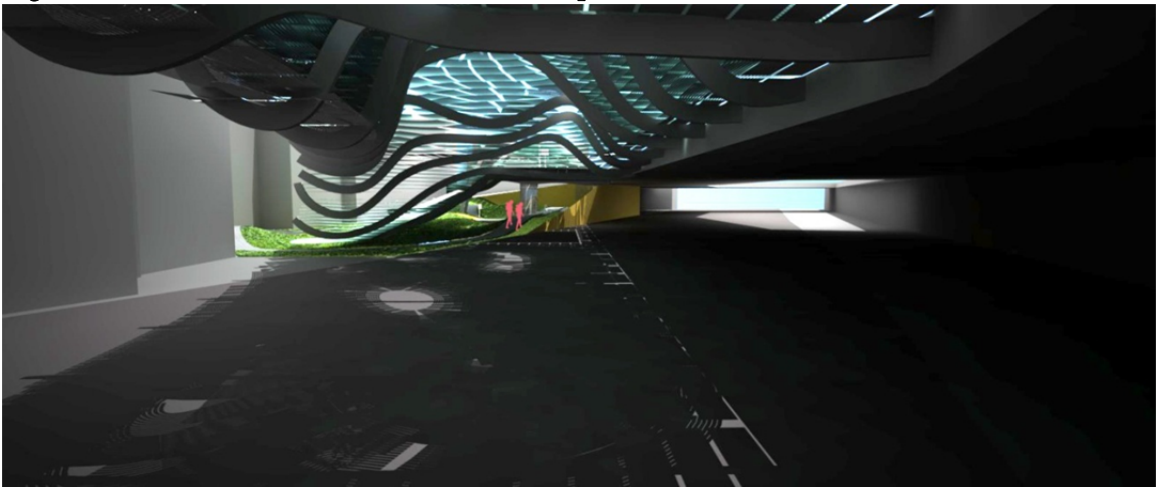

Figure 37: View looking east from the handball court



The turnpike posed an interesting challenge. It funnels a lot of high-speed vehicle traffic directly along the south edge of the lower level. I chose to erect a wall partially along the border, starting at the southeast corner, but it slopes down to the ground before reaching the other end. I didn't want this structure to completely shield or block out the site surroundings; hearkening back to the fish and bird patterns, I wanted the park users to be aware of their surroundings and react as they deemed fit. The partial wall blunts the noise and visibility of the west-bound car traffic when the cars first enter the site, but it allows some of the noise and visibility into the site before the cars have completely passed by. Similar to the grated decking, it serves to filter rather than obstruct.

Figure 38: View from the Massachusetts Turnpike, west to east



While the hill heights won't compete with the neighboring high-rises when it comes to skyline supremacy, they nonetheless provide long, inviting views to their surroundings. Visibility into other areas of the park is also provided from the exterior surfaces of CityHike.

Figure 39: View from eastern hilltop, looking west

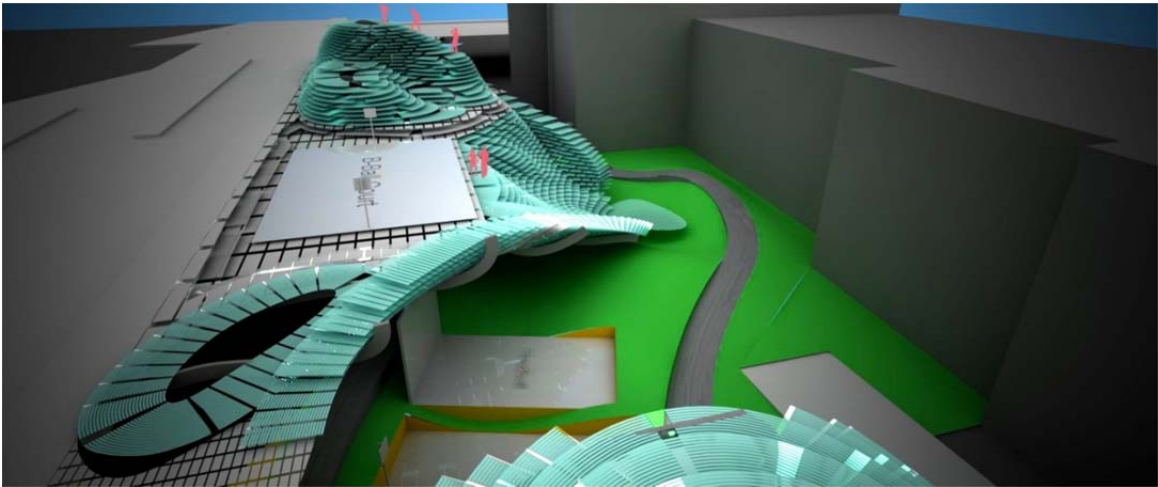

6.4 Structural Joint Details

Figure 40 shows a potential configuration for the joinery between the vertical structural elements and the horizontal decking. The vertical beams are CNC-rolled to their profile shapes, and then cut to interlock with the flat decking. The decking is also notched so that its location is not ambiguous. Each cut could be uniquely marked to virtually eliminate incorrect assemblies. The decking slides directly into the beam cuts and then is attached to the beam by a weld, or mechanically fastened to a bracket that was welded to the beam in a secondary operation.

The beams could be consistent lengths, such as 16 feet, and then welded or bolted together. An issue with a full penetration weld is that it could reduce the overall length of the beams, thus introducing dimensional errors that could affect the rest of the assembly. Since the proposed cuts would structurally weaken the top side of the beam, the lower section of the beam profile is thickened to compensate.

Figure 40: Joint detail proposal

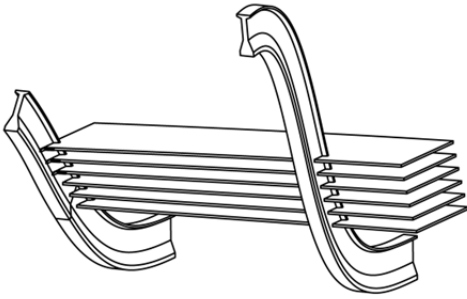

**CNC HOT-ROLLED STEEL BEAMS,
COATED ALUMINUM OR
PLASTIC COMPOSITE DECKING,
DECKING IS GRATED**

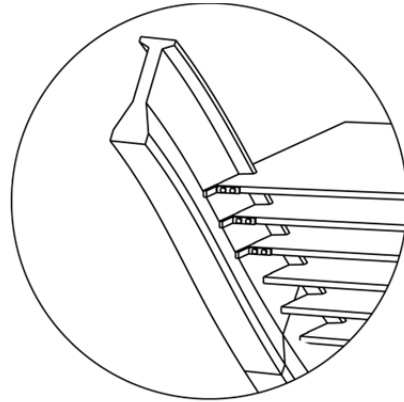

**DECKING BOLTED
TO STRUCTURAL BEAMS**

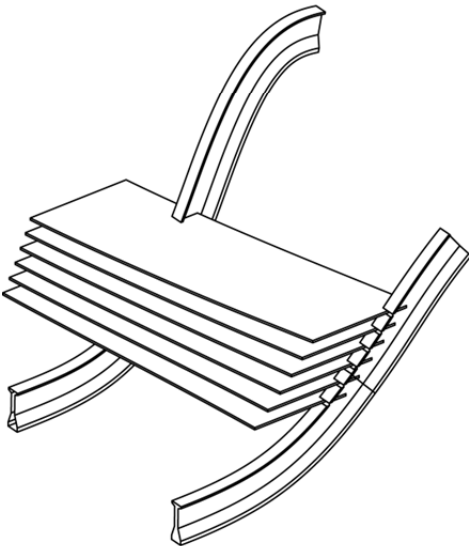

**BEAMS AND DECKS
NOTCHED TO FIT TOGETHER,
CUTS DONE BY WATER-JET OR
PLASMA CUT**

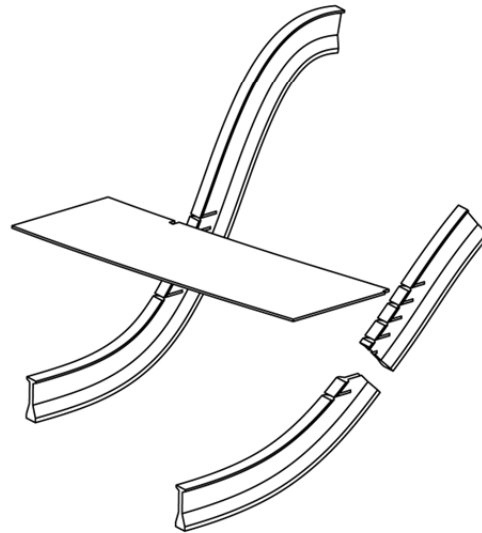

**BEAM SEGMENTS 16' LONG,
WELDED TOGETHER AT JOINTS**

CHAPTER 7

CONCLUSION

Based on my research and design project exploration, I have drawn the following conclusions regarding the current state of digital fabrication in architecture:

- Pure versus hybrid approach: The limitations of 3D printing, especially size and materials, make it difficult currently to create parts that require no further assembly or secondary operations. The “pure” approach would be to print, in 3D, whole systems at once. The more likely short-term approach is a “hybrid” one. Some larger parts can be digitally-fabricated now, especially shapes based on 2D profiles, and then manually joined or assembled to other parts to create a finished system.
- 2D and 3D: As noted in the previous post, there are limitations to using 3D printed parts in building projects. A more likely approach is to cut 2D profiles, or roll or extrude beams with 2D curvilinear profiles. CNC cutters and rollers that can do this are readily available, as are all sizes of raw materials and sheet stocks that can be cut or rolled into finished shapes.
- Issues with complex geometry: During the design project, I experienced difficulties with form that were too complex. For example, if the form contained extreme convexity and concavity in close proximity, the resulting building component output either would not work or was unachievable. Through iteration and experimentation, I learned what forms lent themselves the best to the direct-design-to-fabrication process.

- Adding intelligence to scripting: My design exploration relied heavily on scripting to produce both the building components and fabrication output. It would be helpful to program more “intelligence” into the script. Using the previous point of too-complex geometry as an example, it would be possible to program the script to automatically smooth out parts of the form where the creases are too sharp. I could also program the script to eliminate horizontal decking on parts of the structure where the slope exceeds a certain amount. This would save material on parts of the structure that were too steep for people to climb.
- Balance with architecture: It was critical to continually evaluate the digital output for architectural legitimacy. It would be easy to focus more on the technology and application, and neglect architectural planning principles that have been developed over centuries.
- Integrate analysis tools: For my design project, integrating a structural analysis tool into the scripting would be highly desirable in order to evaluate the structural capabilities of the design. Feedback on the structural analysis could also be fed back into the script: if an area would fail structurally, commands could be executed to remedy the failure.
- Reduction of 2D design drawings: An exciting result of the design project was to realize the reduction of shop drawings that would be required for a typical building project. Scripting is definitely a viable way to take a digital model, create building components from it, and then automatically create the fabrication files for those

components. Assembly on site could be guided by a 3D virtual model on a computer.

2D drawings would be drastically reduced or eliminated.

In closing, despite the current drawbacks and limitations, digital fabrication is proceeding apace, and it will transform the process of designing and building.

BIBLIOGRAPHY

- Abrahams, Tim. "The World's First Printed Building." *Blueprint*. March 08, 2010.
<http://www.blueprintmagazine.co.uk/index.php/architecture/the-worlds-first-printed-building/> (accessed April 23, 2011).
- Alvarado, Rodrigo Garcia, and Underlea Miotto Bruscato. "Three Recent Experiences of Architecture and Digital Fabrication." *Prostor / Arhitektonski fakultet Sveučilišne u Zagrebu* 17, no. 2(38) (2009): 404-415.
- Because We Can. *Steampunk office interior design and fabrication*. February 10, 2007.
http://www.becausewecan.org/Office_interior_with_custom_desks (accessed June 26, 2011).
- Bell, Lynn, and et al. "Educational Implications of the Digital Fabrication Revolution." *TechTrends* (Association for Educational Communications and Technology) 54, no. 5 (September/October 2010): 2-5.
- Bradshaw, Bruce, Director of U.S. Marketing for Objet, interview by Kris Weeks. (July 13, 2011).
- Bullis, Kevin. *Buildings Made with a Printer*. Massachusetts Institute of Technology. April 7, 2011. <http://www.technologyreview.com/business/37218/page1/> (accessed April 15, 2011).
- Carbone, Chris, Structural Engineer at Bensonwood Homes, interview by Kris Weeks. (September 26, 2011).
- Chodikoff, Ian. "Measuring for Success." *Canadian Architect*, June 2007: 26-32.
- Crawford, Scott and Stephen Van Dyck. *LMNts - Med Mart 4: Facade Design Coordination*. June 20, 2011. <http://lmnts.lmnarchitects.com/parametrics/mm-documentation/> (accessed September 23, 2011).
- . *LMNts - Med Mart 5: Panel Fabrication*. July 5, 2011.
<http://lmnts.lmnarchitects.com/fabrication/mm-fabrication/> (accessed September 23, 2011).
- . *LMNts - Med Mart: Introduction*. May 11, 2011.
<http://lmnts.lmnarchitects.com/featured/mm-intro/> (accessed September 23, 2011).
- Digital Fabrication Library. *Digital Fabrication Library*. Society for Information Technology and Teacher Education. January 1, 2010. <http://fablib.org/> (accessed April 7, 2011).
- Fab@Home. *Fab@Home: The Open Source Personal Fabricator Project*. January 1, 2006.
<http://www.fabathome.org/> (accessed April 21, 2011).

- Fallon, Sean. "World's Largest CNC Machine Fabricates Large-Scale Building Prototypes." *GIZMODO*. June 23, 2009. <http://gizmodo.com/radiolaria/> (accessed July 20, 2011).
- Gershensfeld, Neil A. *Fab: the coming revolution on your desktop--from personal computers to personal fabrication*. New York: Basic Books, 2005.
- GPI Prototype & Manufacturing Services. *GPI Prototype & Manufacturing Services*. 2011. <http://gpiprototype.com/> (accessed April 23, 2011).
- Ingram, Carl L., Technical Education Coordinator at Chicopee Comprehensive High School, interview by Kris Weeks. (August 22, 2011).
- Jensen, Eric, Manager of the Center for Design and Fabrication, interview by Kris Weeks. (May 25, 2011).
- Khoshnevis, Dr. Behrokh. *Welcome to Construction by Contour Crafting*. January 1, 2007. <http://www.contourcrafting.org/> (accessed April 1, 2011).
- Kieran, Stephen and James Timberlake. *Refabricating Architecture*. New York: McGraw-Hill, 2003.
- Lavin, Sylvia. *Form Follows Libido: Architecture and Richard Neutra in a Psychoanalytic Culture*. Cambridge, MA: MIT Press, 2007.
- Leonard, Mark, Northeast Regional Sales Manager at Technical Education Concepts, interview by Kris Weeks. (July 30, 2011).
- MakerBot Industries. *MakerBot Industries: Robots that Make Things*. January 1, 2009. <http://www.makerbot.com/> (accessed April 19, 2011).
- McGrew, Jeffrey, Architect & CEO at Because We Can, interview by Kris Weeks. (June 27, 2011).
- Murphy, Ken, BIM Director at Thornton Tomasetti, interview by Kris Weeks. (October 3, 2011).
- Prentice, Reginald, Digital Applications Support at Gensler, interview by Kris Weeks. (September 23, 2011).
- RepRap.org. *Welcome to RepRap.org*. June 30, 2008. http://reprap.org/wiki/Main_Page (accessed April 18, 2011).
- Society for Information Technology and Teacher Education. *Resources*. August 1, 2009. <http://www.digitalfabrication.org/resources/> (accessed April 21, 2011).
- St. John Wilson, Colin. *The other tradition of modern architecture: the uncompleted project*. London: Academy Editions, 1995.

Stephen Van Dyck, Principal at LMN Architects, interview by Kris Weeks. (September 21, 2011).

The Economist. "A factory on your desk." *The Economist*. September 3, 2009.
<http://www.economist.com/node/14299512> (accessed April 21, 2011).

—. "The printed world." *The Economist*. February 10, 2011.
<http://www.economist.com/node/18114221> (accessed April 23, 2011).

Thurlow, Andrew, Associate Professor of Architecture at Roger Williams University, interview by Kris Weeks. (June 2, 2011).