

Winter 2015

Wireless Networking for Vehicle to Infrastructure Communication and Automatic Incident Detection

Sarwar Aziz Sha-Mohammad
Old Dominion University

Follow this and additional works at: https://digitalcommons.odu.edu/computerscience_etds

 Part of the [Computer Sciences Commons](#), and the [Digital Communications and Networking Commons](#)

Recommended Citation

Sha-Mohammad, Sarwar A.. "Wireless Networking for Vehicle to Infrastructure Communication and Automatic Incident Detection" (2015). Doctor of Philosophy (PhD), dissertation, Computer Science, Old Dominion University, DOI: 10.25777/7grv-2t93
https://digitalcommons.odu.edu/computerscience_etds/63

This Dissertation is brought to you for free and open access by the Computer Science at ODU Digital Commons. It has been accepted for inclusion in Computer Science Theses & Dissertations by an authorized administrator of ODU Digital Commons. For more information, please contact digitalcommons@odu.edu.

**WIRELESS NETWORKING FOR VEHICLE TO
INFRASTRUCTURE COMMUNICATION AND
AUTOMATIC INCIDENT DETECTION**

by

Sarwar Aziz Sha-Mohammad
B.Sc. June 2001, University of Sulaimani, Iraq
M.Sc. February 2005, University of Sulaimani, Iraq

A Dissertation Submitted to the Faculty of
Old Dominion University in Partial Fulfillment of the
Requirements for the Degree of

DOCTOR OF PHILOSOPHY

COMPUTER SCIENCE

OLD DOMINION UNIVERSITY
December 2015

Approved by:

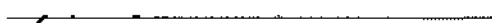
Hussein M. Abdel-Wahab (Director)

Dimitrie Popescu (Co-Director)

Ravi Mulkamala (Member)

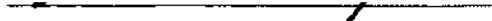
Kurt J. Maly (Member)

ProQuest Number: 10128808

All rights reserved

INFORMATION TO ALL USERS

The quality of this reproduction is dependent upon the quality of the copy submitted.

In the unlikely event that the author did not send a complete manuscript and there are missing pages, these will be noted. Also, if material had to be removed, a note will indicate the deletion.



ProQuest 10128808

Published by ProQuest LLC(2016). Copyright of the Dissertation is held by the Author.

All rights reserved.

This work is protected against unauthorized copying under Title 17, United States Code.
Microform Edition © ProQuest LLC.

ProQuest LLC
789 East Eisenhower Parkway
P.O. Box 1346
Ann Arbor, MI 48106-1346

ABSTRACT

WIRELESS NETWORKING FOR VEHICLE TO INFRASTRUCTURE COMMUNICATION AND AUTOMATIC INCIDENT DETECTION

Sarwar Aziz Sha-Mohammad
Old Dominion University, 2015
Directors: Dr. Hussein M. Abdel-Wahab
Dr. Dimitrie Popescu

Vehicular wireless communication has recently generated wide interest in the area of wireless network research. Automatic Incident Detection (AID), which is the recent focus of research direction in Intelligent Transportation System (ITS), aims to increase road safety. These advances in technology enable traffic systems to use data collected from vehicles on the road to detect incidents. We develop an automatic incident detection method that has a significant active road safety application for alerting drivers about incidents and congestion. Our method for detecting traffic incidents in a highway scenario is based on the use of distance and time for changing lanes along with the vehicle speed change over time. Numerical results obtained from simulating our automatic incident detection technique suggest that our incident detection rate is higher than that of other techniques such as integrated technique, probabilistic technique and California Algorithm. We also propose a technique to maximize the number of vehicles aware of Road Side Units (RSUs) in order to enhance the accuracy of our AID technique. In our proposed Method, IEEE 802.11 standard is used at RSUs with multiple antennas to assign each lane a specific channel. To validate our proposed approach, we present both analytical and simulation scenarios. The empirical values which are obtained from both analytical and simulation results have been compared to show their consistency. Results indicate that the IEEE 802.11 standard with its beaconing mechanism can be successfully used for Vehicle to Infrastructure (V2I) communications.

Copyright, 2016. by Sarwar Aziz Sha-Mohammad. All Rights Reserved.

ACKNOWLEDGEMENTS

This work could not be completed without Professor Popescus' advice and support. I am grateful for the time he gave to help me complete this work. His office has always been open for me. He also gave me a clear route to achieve my goals. Also, I would like to express my great thanks to Professor Hussein M. Abdel-Wahab who supported me since I started my PhD program. I will not forget the support that I got from both of them. Next, I would like to send great thanks to my PhD committee Professor Kurt J. Maly, and Professor Ravi Mukkamala. I also highly appreciate the role of Professor Michele C. Weigle for her recommendations that helped improve my PhD proposal and her feedback about my research ability report. I also want to thank PhD student Samuel Rompis and the Transportation Engineering department for letting me use the labs. This work would not be completed without support from many other individuals, especially Ms. Amanda Daniel for discussions on the DSRC evaluation. I am grateful to my loving parents and siblings for their patience during my study and work.

TABLE OF CONTENTS

	Page
LIST OF TABLES	vii
LIST OF FIGURES	x
Chapter	
1. INTRODUCTION	1
1.1 MOTIVATION AND FACTS	1
1.2 VEHICLE ARCHITECTURE	3
1.3 VEHICLE EMBEDDED NETWORK BUS	4
1.4 WAVE PROTOCOL STACK	10
1.5 WAVE PHYSICAL LAYER	11
1.6 CHANNEL LOAD ASSESSMENT	12
1.7 DATA TRAFFIC CONGESTION CONTROL	14
1.8 VEHICULAR NETWORK MAC LAYER MODELING AND STRUCTURE	15
1.9 OBJECTIVES	20
1.10 ORGANIZATION	21
2. TECHNICAL BACKGROUND AND LITERATURE REVIEW	22
2.1 IEEE 802.11P	22
2.2 IEEE 802.11P CHANNEL WIDTH	24
2.3 DSRC DATA CONGESTION	28
2.4 INFRASTRUCTURE-TO-VEHICLE COMMUNICATION	29
2.5 VEHICLE TO INFRASTRUCTURE STUDIES	30
2.6 WAVE BEACONING MECHANISM	33
2.7 DSRC IN THE EUROPEAN UNION AND JAPAN	34
2.8 VEHICULAR SAFETY APPLICATIONS	34
2.9 CICAS-V SYSTEM DESIGN	37
2.10 GID MESSAGE FORMAT	38
2.11 THE CICAS-V HARDWARE	39
2.12 THE IMPACT OF INCIDENT DETECTION	41
2.13 INCIDENT DETECTION MODE	42
2.14 AID RELATED WORK	44
3. VEHICLE TO INFRASTRUCTURE COMMUNICATION	46
3.1 SCENARIO ASSUMPTIONS AND SPECIFICATIONS	46
3.2 IEEE 802.11 PROTOCOL FOR USING V2I COMMUNICATION ...	47
3.3 ANALYTICAL FORMULA	49
3.4 SIMULATION SCENARIO DESCRIPTION	58

3.5	NUMERICAL RESULTS AND DISCUSSION	60
3.6	SUMMARY	66
4.	INCIDENT DETECTION	68
4.1	SYSTEM MODEL AND PROBLEM STATEMENT	68
4.2	CHANGING LANE DISTANCE (CLD) METHOD	69
4.3	CHANGING LANE SPEED (CLS) METHOD	71
4.4	NUMERICAL RESULTS	73
4.5	SUMMARY	79
5.	CONCLUSION AND FUTURE WORK	82
5.1	SUMMARY	82
5.2	DISSERTATION CONTRIBUTION	83
5.3	FUTURE WORK	84
	REFERENCES	85
	APPENDICES	
	A. SIMULATION TOOLS	101
	B. ABBREVIATIONS AND DESCRIPTION	104
	VITA	105

LIST OF TABLES

Table	Page
1. WAVE spectrum mask requirements (from [1])	24
2. Comparison of wireless communication technologies(from [2])	49
3. Default and simulation parameter values	65

LIST OF FIGURES

Figure	Page
1. Vehicular network communication and application illustration	5
2. WAVE Protocol Stack (based on figure from [3])	10
3. Carrier sensing and transmission ranges (based on figure from [2])	14
4. WAVE MAC Layer Modeling(based on figure from [2])	16
5. Channel State Manager (based on figure from [2])	17
6. Back-off State Manager (based on figure from [4])	18
7. Transmission Coordination Manager State Machine (based on figure from [2])	19
8. Reception Coordination Manager State Machine (based on figure from [2])	20
9. Dedicated Short Range Communication spectrum band and channels in the U.S.(based on figure from [5])	23
10. IEEE 1609.4 in the WAVE protocol(based on figure from [6])	25
11. Synchronization, control channel, Service channel, and guard intervals(based on figure from [7])	27
12. IEEE 1609.4 Multichannel operation state machine [8]	27
13. Channel access diagram (based on figure from [9])	31
14. Highway segment with three RSUs in each traffic direction.	35
15. DSRC overlapping channels in the EU and USA	35
16. Japan DSRC channels	36
17. The CICAS-V illustration	38
18. The GID Map.	39
19. RSU CICAS-V Hardware	40
20. Vehicle CICAS-V Hardware	40

21.	Driver-vehicle Application Interface (based on figure from [10])	41
22.	Illustrating the radio coverage area for a RSU.	47
23.	Timing diagram for establishing connection and data exchange between a vehicle and a RSU using IEEE 802.11 based beaconing.	48
24.	The integration region for obtaining the CDF of D_e	52
25.	The integration region for obtaining the DCF of D_e in case 2	54
26.	Probability of successful data exchange as a function of the beaconing interval for average vehicle speed $v_{avg} = 70$ mph.	60
27.	Probability of successful data exchange as a function of the beaconing interval for average vehicle speed $v_{avg} = 70$ mph.	61
28.	Probability of successful data exchange as a function of data rate for vehicle speed interval 50 – 85 mph for beaconing interval 700 ms	64
29.	Probability of successful data exchange as a function of the average vehicle speed for beacon interval $T_b = 700$ ms and data 8 kbps.	64
30.	Assigned each lane with different channel	66
31.	Schematic descrip. of params associated with changing lane variation.	70
32.	Schematic description of parameters associated with speed variation for changing lanes.	71
33.	Average time versus average distance for changing lanes.	74
34.	Average speed variation versus average time when changing lanes.	74
35.	Detection rate	75
36.	Comparison with respect to lane change.	77
37.	Q length when the AID enable and disable	77
38.	Q length when the AID enable and disable and compare to other algorithms ...	78
39.	Q length when the AID enable with rate of changing route rate	78
40.	Q length when the AIDs enable with 20% rate of changing route rate	80
41.	Q length when the AIDs enable with 30% rate of changing route rate	80

42. Q length when the AIDs enable with 40% rate of changing route rate . . .	81
--	----

CHAPTER 1

INTRODUCTION

It has been few decades since Information Technology (IT) has been employed in education, health care, and government sectors to enhance the quality and efficiency of services. Nowadays, the transportation industry utilizes IT to improve functionality and safety in equipment and roadways. For example, IT is used in the building of roads and development of critical safety and transportation devices. For instance as a prominent breakthrough in the area, Intelligent Transportation Systems (ITS) enable vehicles and roadside infrastructure to share and exchange information with each other through microchips and sensors. This technology has changed the way transportation systems are studied and approached. One of the most important aspects of ITS is their ability to detect incidents so as to alert drivers to impending traffic problems to avoid congestion.

1.1 MOTIVATION AND FACTS

In 2007, 2,392,061 intersection car crashes caused thousands of deaths and more than one million injuries [2]. In 2009, the National Highway Traffic Safety Administration statistics and analysis in the United States also showed that vehicle crashes caused one death every 16 minutes [11]. In [12], Paniati concluded that detecting barriers to traffic flow could save 70 billion dollars and 8.5 billion gallons of fuel that is wasted due to congested traffic. Results presented by Kittelson [13] show that the annual car crash per person costs in small, large, and very large urban areas are \$1946, \$1579 and \$1392 respectively. Papageorgiou [14] also showed that more than 50% of primary incidents cause secondary traffic incidents and slowdowns. Thus, it

is very important to alert drivers about impending incidents, not only to reduce the congestion, but also to maintain safety for drivers and passengers.

Vehicle safety was born after the Mercedes company built passive safety cages in their vehicles shortly after World War II. The safety cage is a strong central cell flexibly connected to the deformable front and rear vehicle crash cell to absorb kinetic energy during the collision. Air bags and seat belts are also passive vehicle safety systems. These passive safety systems could have saved 255,115 lives since 1975 [11].

The automotive company engineers and vehicle safety researchers and developers moved vehicle safety to a new level called active safety. The passive safety purposes minimize vehicle passenger harm during the collision, but active safety is designed to avoid the collision and minimize the damage if the collision is unavoidable, for example through Antilock Brake System (ABS), Electronic Stability Control (ESC), or Brake Assist. The ABS controls vehicle wheels and prevents vehicles from skidding through monitoring the hydraulic pressure on the individual wheels. The ESC is a computerized technology that detects vehicle's steering control and assists the driver in controlling the vehicle by utilizing the ABS on individual wheels.

After vehicle electronic systems developed to the level that can collect data about the vehicle area, the advanced safeties came up. The advanced safety in vehicles analyzes the collected data to detect potential risks and sends instructions to the electronic embedded systems such as ESC to avoid such risks, using, for example, Adaptive Cruise Control (ACC). The ACC is a cruise control that can maintain the safety distance, and accelerate speed to the set speed after the vehicle in front switches to the other lane or the traffic returns to normal. Also, the blind spot assist is one of the advanced vehicle safety applications that alerts the driver about entering an occupied space. This application gives a visual alert to the driver first. If the driver ignores it, it will give a sound alert. If the driver continues to ignore it, it will activate the ESC to gently bring the vehicle back into its lane.

1.2 VEHICLE ARCHITECTURE

Today, modern vehicle functions are electronically controlled by Electronic Control Units. The embedded ECU system analyzes the collected data from vehicles' onboard sensors to make decisions and then distributes the instructions to the subsystems to perform the proper action in the vehicle [15]. For example, the vehicle embedded radar sensors can be used for detecting object position and velocity [16]. In addition to radar sensor, vehicle safety uses camera sensors to achieve more accurate information about the movement and position of objects [2]. These sensors can be used to collect data about the area close to the current position of the vehicle. Vehicles need some traffic information about the road miles away from their current position to perform the correct actions to avoid unexpected events such as incidents or congestion. This information cannot be provided by short range vehicle radars, nor can it be obtained from vehicle camera sensors. Therefore, wireless sensor network becomes a very important resource for collecting data from other vehicles and the RSUs. When vehicles receive emergency messages about incidents or unsafe conditions ahead, the drivers have enough time to avoid them or at least minimize the risks.

1.3 VEHICLE EMBEDDED NETWORK BUS

Modern vehicles are equipped with many electronic systems. The cost of such systems are estimated at 40% of the total price of today's vehicles and drives 90% of its innovations [17]. The ECUs communicate with the onboard sensors. These communications are controlled by different onboard network buses, for example Control Area Network (CAN), Local interconnect Network (LIN), FlexRay, and Media Oriented System Transport (MOST). The ECUs communicate through the CAN bus with each other. This network bus is short message-based standard, and it is designed for in-vehicle network communication with 1 Mbps data rate [18]. It is also self-diagnostic and repairs communication errors. The LIN bus is designed for communication between smart sensors [19]. It is easy to implement and is a low-cost communication bus. It could also be used for systems which do not require a high-speed data rate. ECU could use it as a gateway to enter the CAN bus. The FlexRay is a highly expensive but high-speed data rate bus: it is faster than the CAN bus. The FlexRay can offer 10Mbps data rate. It can also support two channels, but requires redesign network architecture [20]. The MOST bus network is a cheap and high-speed fiber optical network bus. The CAN and LIN are designed in a way that are not accessible by the vehicle owner or mechanics for customization, diagnostic, or repair. The Onboard is designed as self-diagnostic and repair.

Accurate and reliable data could be conveyed to the traffic management center to provide better traffic service. Today's vehicle data information is extended beyond basic standard vehicle activity information.

The vehicle application reads data through CAN. The data formats depend on the originated equipment manufacture. Vehicles may have different data formats

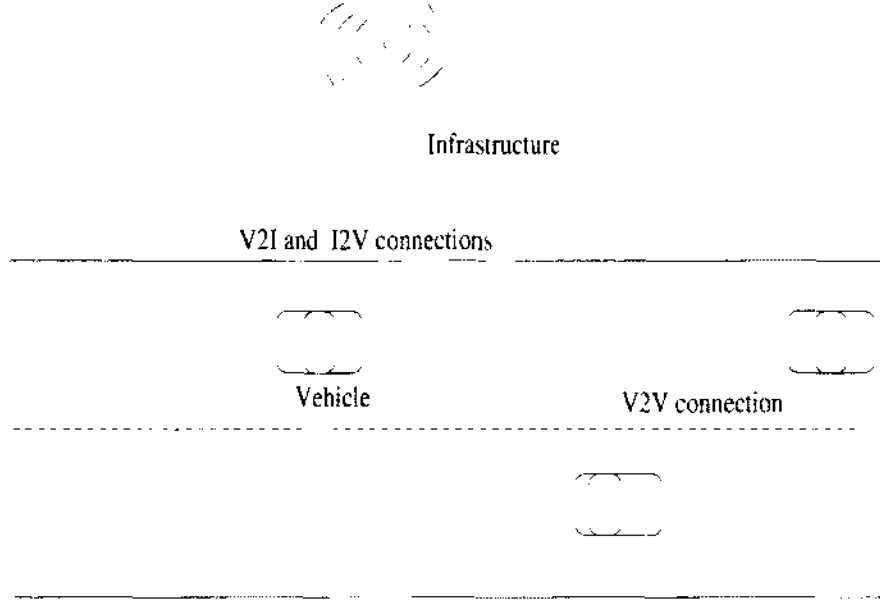

FIG. 1: Vehicular network communication and application illustration

for defining and calculating data, and different data formats are possible for different models by the same automaker. Aggregating and collecting data is difficult from different sources. In United States, the data format and message setting are standardized to overcome interoperability issues. This also gives old model vehicles communication ability with new vehicles [21]. Vehicles have independent CAN buses to protect different onboard subsystems. The CAN buses communicate with each other through the gateways. These gateways are vulnerable to attack. False messages could be injected and sent from one CAN bus to another. Therefore, the attacker could control all the vehicle's components that are monitored by these CAN buses, such as the cooling system, lock, head lights, radio, and even vehicle engine and transmission [22]. While the ECUs are designed so as not to be accessible by vehicle owners or mechanics, only the automaker, the attacker could reverse the ECU engineered functions through the parts available at a car dealership. The more electronic controls are developed, the more security is required. Therefore, more security techniques and methods must be developed to ensure vehicle passenger safety.

Today most applications are developed based on the data collected by the vehicles' sensors. The vehicle position is one of the most important pieces of information used in many vehicle applications such as the Global Positioning System (GPS). The vehicle position can be calculated based on GPS satellite signals or on data collected by vehicle sensors or cameras. The lane accuracy is sufficient enough to determine the lane that vehicle travels on. This means that it is also easy to show the vehicle position to the driver on the on-screen map. The user range error based on the GPS satellites is around 1.5 m. In [23], Kaplan et al. showed that the positioning accuracy error is currently minimized to submeter and further minimization is under development.

Some safety applications have been developed to alert drivers about the road condition ahead of time while miles away. For example, there are applications that alert about congestion or incidents. These applications require communications between vehicle and vehicle, and vehicle with roadside units. These applications are divided into two classes based on time delay tolerance of receiving the required information: hard safety and soft safety applications. The hard safety applications cannot tolerate delay because it may alert the driver about immediate risks such as emergency electronic brake light. Time delay should be minimized to give enough time to the driver for the immediate reaction. The soft safety applications are more tolerant of time delay such as congestion detection, construction zones, or potholes. Hard and soft applications have high quality user interfaces to minimize interruption to drivers. Vehicular wireless network features are different from the regular wireless networks. These features were not addressed well in Wireless Local Area Network (WLAN). The vehicle wireless network is developed based on WLAN. This makes use of decades of experience in WLAN in vehicular wireless network. The topology changes frequently in vehicular wireless network. Vehicles stay for very short times in the communication range of each other in addition to the high speed mobility nodes.

Vehicles do not know each other addresses. On the other hand, security is a really big challenge that developers and automaker engineers are facing. In addition, developing vehicle techniques and devices requires older vehicles to return for updates and installations of new hardware. Therefore, the vehicle owners should bring their vehicle to the service center for maintenance which is time consuming and costly. So the developers must minimize the changing requirements as much as they can.

In this new area of study, researchers face many challenges because of high speed mobility of nodes and short communication lifetime. In the light of these challenges, modification of IEEE 802.11 standard (later developed to IEEE 802.11p standard) has been defined by IEEE (Institute of Electrical and Electronics Engineers) for Wireless Access in Vehicular Environment (WAVE) with minimum change requirement in a regular IEEE 802.11 standard in wireless LAN network specifications [21]. As a regular wireless network has ad hoc and infrastructure modes, the study of wireless communication systems for ITS also has two main modes: vehicle-to-vehicle (V2V) communication and vehicle-to-infrastructure (V2I) communication. The former mode has the advantage of being able to achieve very low-latency and is useful for disseminating emergency messages in traffic safety systems [24]. Figure 1 illustrates V2V and V2I communications. There are several wireless communication technologies that could be used in vehicular network as short-range radios such as Bluetooth, Wi-Fi, and Dedicated Short Range Communication(DSRC) and as long-range radios such as cellular network, satellite services and digital radio broadcast networks [2].

While there are many basic concepts that are shared between regular wireless networks and vehicular networks, the latter have some specific characteristics that may directly or indirectly affect the efficiency and feasibility of specific networking protocols. In the following section, we outline two characteristics of vehicle communication systems that are relevant to our study.

1.3.1 MOBILITY AND RELIABILITY

Mobility is an important characteristic of both regular wireless networks and vehicular networks. The higher mobility in vehicular networks causes mobile terminals that are associated with moving vehicles to be in the radio range of an access point associated with a RSU or other vehicles only for a very short time, especially when vehicles travel at highway speeds. Therefore, there is only a very short period of time to establish the connection and exchange information between vehicular network terminals. It is also hard for vehicular network nodes to establish a trusted connection to avoid malicious messages and protect their privacy in a short period of time.

1.3.2 COMPUTATIONAL CAPABILITY

In WAVE, nodes (vehicles or RSUs) could be equipped with processors, large memory capacity, antennas, sensors, Global Position System and computational resources. These capacities increase computational ability to determine accurate position, speed and direction of the vehicles. The WAVE communication protocols must be sufficient to support minimum delay giving enough time for the driver to react. Biswas et al. showed that the driver needs less than 2.5 seconds to react after receiving the emergency alert [25, 26]. Vehicle to vehicle is mostly used for emergency message dissemination, while local broadcast is used for message disseminations. The primary issue is gaining media share among the vehicles in heavy traffic. This increases the message delivery time delay. Many message dissemination techniques are proposed, such as topology-based multicast, Geocast, Enhanced broadcast and Stochastic Dissemination. In topology-based multicast, the topology of multicast is established and maintained for a group of vehicles based on multicast trees [27]. In Geocast, the vehicles are divided into multicast zones or groups based on the geographic location information [28, 29, 30]. The enhanced broadcast takes the advantage of lower delay

and ease of implementation of broadcast in non-heavy traffic. A vehicle may decide to rely on distances between source and destinations. In Stochastic Dissemination [31] each vehicle independently calculates the relay message probability based on random graph theory. Because the WAVE topology is very dynamic, the vehicle must maintain and update its information about the other vehicles continuously. This overhead expensive process increases the communication delay. In [31, 32], the authors indicated that the optimal dissemination delay with a much lower overhead process could be obtained by the Stochastic Dissemination methods.

The messages such as the road condition, traffic signal phase, time information, service advertisement, and security credential could be broadcasted by RSUs. Short or long range radio technologies could be used for vehicular wireless networks, such as DSRC, Wifi, and Bluetooth. Bluetooth operates on 2.4 GHz and is usually used for pairing drivers' cell phone with their vehicles. This enables hands-free calling. Also, mobile phone vehicle safety applications could use the vehicle sound system to alert the driver about road conditions ahead. It also enables the vehicle to use the passenger or driver cell phone to make an emergency call when the driver loses his/her ability during a crash. It is possible to use Bluetooth for V2I communication when the vehicle is stationary or move very slowly. Bluetooth's high latency makes it impossible to be used for vehicle safety communication [2]. Wi-Fi can also be used for vehicle-to-vehicle and vehicle-to-infrastructure. Because vehicles stand still for a very short period of time, modification of the Wi-Fi overhead process is required to minimize the latency. Wi-Fi is close to meeting most vehicular network specifications. The modification of Wi-Fi (IEEE 802.11 standard) has led to dedicated short range communication protocol about which we will give details in the next chapter. On the other hand, 3G cellular networks meet most of the hard and soft safety applications but unpredictable delay is expected in sharing bandwidth with the voice

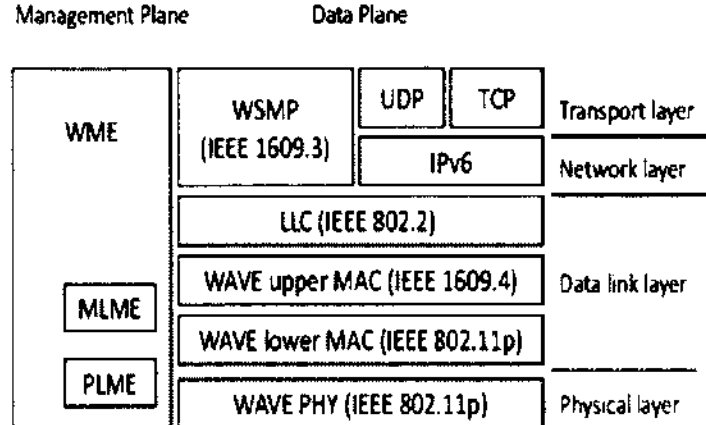

FIG. 2: WAVE Protocol Stack (based on figure from [3])

Concl

communication. Choosing radio technology for WAVE depends on the application specification requirements. For example, Bluetooth could be used to find a parking spot in a parking lot.

1.4 WAVE PROTOCOL STACK

The WAVE protocol stack contains protocols to support vehicular communication for both hard and soft applications. The protocol stack is divided into two parts: management plane and data plane. The over-the-air communication is provided by the data plane. Data plane protocols could transmit data in the traditional way through the transportation layer (UDP or TCP) to Network layer (IPv6) and then to the data layer and PHY layer. It can transmit data as a WAVE Short Message Protocol if the IP is not available or not required for the transmission. Figure 2 shows the WAVE protocol stack in vehicular network.

The data link layer consists of three sublayers. The top sublayer is the logic link

control (LLC), which provides the standard interface for the lower MAC layers and IEEE 802.2 [33]. The second sublayer is the WAVE upper MAC layer (IEEE 1609.4), which provides the channel switching operations for the DSRC [1]. The bottom data link sublayer is the lower MAC (IEEE 802.11p), which comprises the lower MAC layer with the physical layer (PHY) [1].

The Management plane is a set of functions that WAVE Management Entity (WME) is performing for IPv6 configurations, service advertisement, and WAVE management frame. A management information base (MIB) is also maintained by the WME. The MIB contains the information about the DSRC stations and status. The MAC Layer Management Entity and the Physical Layer Management Entity are supporting the WME. The security functions are also provided by the WAVE protocol stack and meet the IEEE 1609.2 standard [34]. Kenney gave a complete description of the WAVE standard in [21].

1.5 WAVE PHYSICAL LAYER

The orthogonal frequency division multiplex (OFDM) is used to transfer data by IEEE 802.11a standard [35]. The channel spectrum is divided into narrow sub-channels in OFDM method. Each sub-channel conveys a part of information. The frequencies and transmission time will be assigned to each sub-channel to avoid interference, hence the name "orthogonal frequency." The inter-symbol interference guard can be used to eliminate symbol interference virtually by setting the sub-channels to operate at low symbol rates. This gives high reliability at high data rates. signal distortion that is caused by multi path could also be efficiently dealt with by OFDM. In addition, the modulation schemes and coding rates determine the IEEE 802.11a radio data rates [36]. Varying periodic waveform to convey information through the channel is called modulation scheme. The high data rate is very important in a vehicular network to minimize the time delay, but the high data rates require a clear signal

at a receiver. The high data rate signal is error-prone at receiver side. In order to successfully receive frame, the modulation and coding rate must be known at receivers to distinguish frame from the noise when signals are detected through the channel. Usually the IEEE 802.11 standard uses the modulation scheme binary phase-shift keying (BPSK) with zero coding rate for the preamble part of frame header which contains the imminent arrival of the frame. The BPSK with 1/2 coding rate is used for physical layer convergence procedure which contains information about the frame payload, such as the frame length, modulation and coding rate.

When the receiver PHY layer detects the value of Signal to Interference Noise Ratio which is bigger than the BPSK threshold, the frame signal is detected. Then the receiver starts decoding the preamble and PLCP header. It is very important to mention when the PHY layer is at a receiving state, the MAC layer does not send a send command to the PHY layer. A body frame capture technique is used, which is not a part of the IEEE 802.11 standard but implemented in the IEEE 802.11 standard radio chipsets and is optional [2]. In the body capture technique, the PHY layer is continuously monitoring the Interference Noise Ratio value while PHY is receiving frame body. If the powerful received signal strength arrives while the PHY is in a body-capturing state, the PHY layer moves to the preamble and PLCP capture state to receive the header parts of the new frame. This technique is very useful in vehicular networking because the powerful signal most likely originates from the nearby vehicles. The nearby vehicles impose more likely immediate risk than far away vehicles. The IEEE 802.11p essentially is IEEE 802.11a standard with minimum change.

1.6 CHANNEL LOAD ASSESSMENT

One of biggest challenges in vehicular networking and regular wireless network is media access control. The Institute of Electrical and Electronics Engineers (IEEE) developed a clear channel assessment function that can assess current channel load at IEEE 802.11 MAC layer WAVE radios [37]. Availability of media is detected by the clear channel assessment functions, and it is available on all IEEE 802.11 devices. In a regular WLAN, the busy media will be determined by checking the physical layer and the network allocate vector. The network allocate vector, which is used to check the media, is not virtually busy. When the received power in a certain time interval exceeds the certain value, that called carrier sensing threshold. The channel will be declared busy. The same carrier sensing threshold will be shared by all nodes for consistency overall the network.

Different tools and technologies such as radio frequency chipsets of different sensitivity in addition to antennas and cables are calibrated to keep the channel busy with report indications in a consistent manner [38]. The fraction channel busy time, channel busy ration (CBR), is calculated by invoking the clear channel assessment function periodically. In this way, a convenient metric to assess channel load conditions will be provided by the CBR. In [39], it has been concluded that the broadcast reception rate at receivers degrades rapidly as CBR increases. In [40], Weifield et al. showed that the average CBR is 73% and the reception rate degrades to 45% for frames received with an received signal strength equal to -85 dB for the scenario 378-byte messages were broadcasted by 180 vehicles at 10 Hz with 20 dBm transmission power. This is unacceptable reception rate for many vehicle safety applications. In figure 3, R_{CS} is carrier sensing range and R_{TX} is the transmission range. In [41], Yang et al. showed the R_{CS} optimal values are two to three times smaller than the R_{TX} . For the congestion control algorithms, the space dimension must be considered

[38].

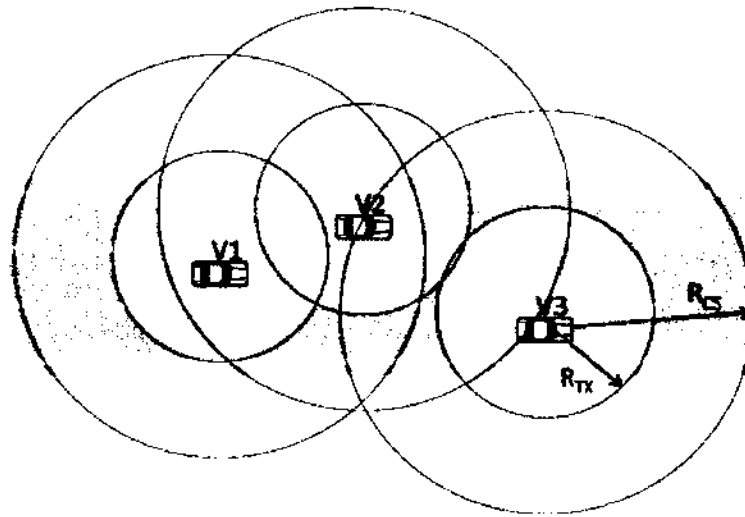

FIG. 3: Carrier sensing and transmission ranges (based on figure from [2])

1.7 DATA TRAFFIC CONGESTION CONTROL

In [42], authors described a general framework for designing congestion control solutions. Many algorithms and techniques were developed recently for data traffic congestion control [43, 44, 45, 46, 47, 48, 49, 50, 51]. These developed methods and techniques aim at keeping overall channel loads under a specific threshold value. The purpose of reducing congestion is to make a fraction of bandwidth available for safety message dissemination on top of the periodic broadcasts. These algorithms are divided into two categories: proactive and reactive. In the first place, channel congestions are prevented by proactive algorithms. The functions that are able to detect the channel overload in imminent future are used. The means to assess current channel loads are used in reactive algorithms to achieve their goal. In this method, it is vehicles' responsibility to minimize their contributions to the overall channel load when congestions are detected.

Transmission power is one of the way to control channel congestions. In [52], D-FPAV was developed for adjusting beacon transmission power dynamically. D-FPAV

scheme is a proactive algorithm that keeps the transmission power below predefined threshold called Maximum Beaconing Load, which is the main focus in D-FPAV scheme. D-FPAV scheme relies on accurate information and suitable models for channel load prediction. Message rate adjustment is used in D-FPAV scheme. A fixed message rate is used first, and then the transmission power will be adjusted based on the other vehicles within its carrier sensing range.

1.8 VEHICULAR NETWORK MAC LAYER MODELING AND STRUCTURE

Vehicular MAC layer model consists of six sub-models: Transmission, Reception, Channel State Manager, Back-off Manager, Transmission Coordination, and Reception Coordination [53]. These module designs and abstractions were derived by IEEE 80.11 standards. Figure 4 shows the illustration of the MAC layer module operations, relations and association to each other in addition to the connection with PHY layer Modules.

1.8.1 TRANSMISSION

The MAC layer interface to wireless PHY is a transmission module. The frames from upper layer to the PHY layer for transmission consists of Request to Send (RTS) and data frames from the transceiver side and acknowledgement (ACK) and Clear to Send (CTS) frames from the receiver side. The state machine for this module consists only two states idle and transmitting.

1.8.2 RECEPTION

The frame reception process initiated by wireless PHY layer will be completed by the reception module. In this module, successful reception of the frame will be verified by performing cyclic redundancy check. A node that received a bad, unknown or incomplete frame should wait for extended inter-frame space interval which is longer

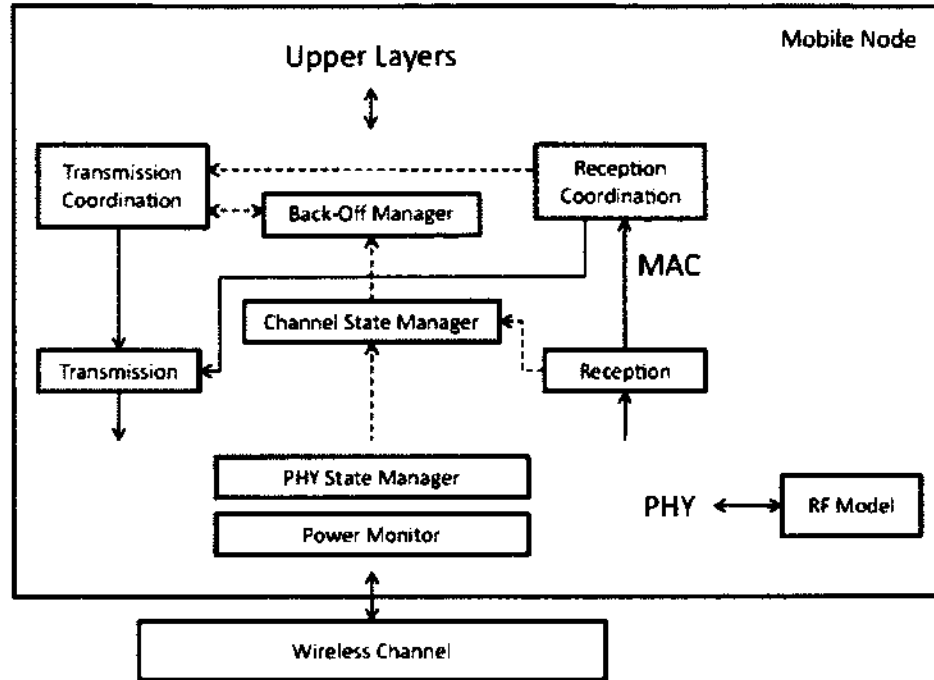

FIG. 4: WAVE MAC Layer Modeling(based on figure from [2])

than distributed inter-frame space (DIFS), and then Channel State Manager will be confirmed. In reception module, there are two main processes which address filtering and discarding of the frames not intended for the node. If the NAV duration is found in any frame, it would be passed to the channel state manager. So the node knows how long to delay its transmission. The state machine for reception module also consists of two states: idle state or receiving state. The channel manager is responsible for providing info about its status when the other modules so request.

1.8.3 CHANNEL STATE MANAGER

Maintaining PHY layer and virtual carrier sensing status for the Carrier sense multiple access with collision avoidance (CSMA/CA) mechanism will be managed by the channel state manager. When the total value of received signal strength is bigger than the carrier sensing threshold or the node is in a transmission state, channel-busy

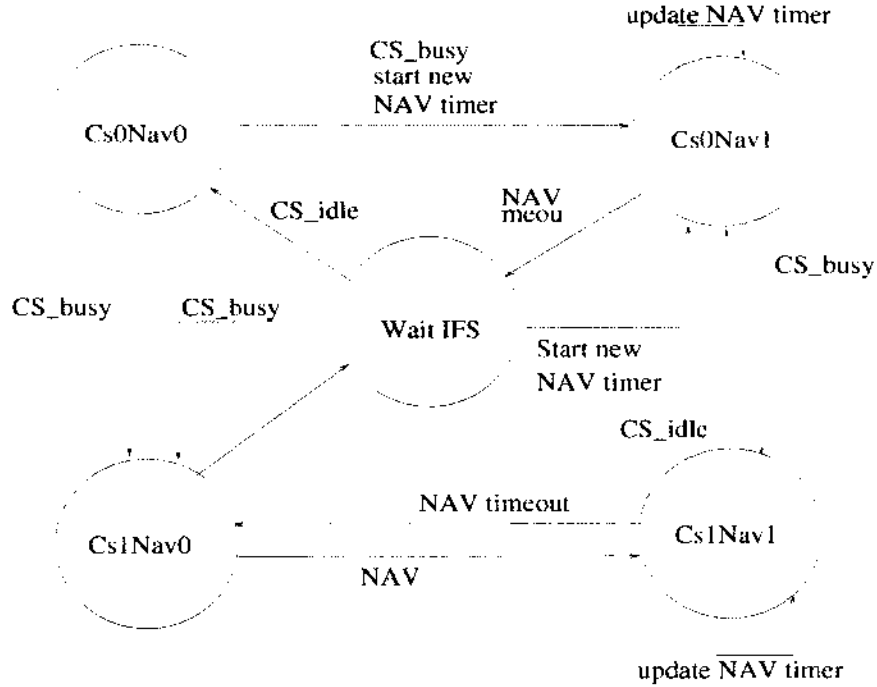

FIG. 5: Channel State Manager (based on figure from [2])

will be announced. channel-clear will be announced if these two conditions are not satisfied. It is also possible to stay in a channel-busy state after receiving the virtual carrier sensing update from the reception module. Figure 5 illustrates the channel manager states.

1.8.4 BACK-OFF MANAGER

The back-off manager monitor the back-off counter to avoid collision. The back-off counter will be set to a random value, and then it will be decremented when the media is idle. When the counter value reaches zero and the channel is idle, the frame will be transmitted. The back-off counter will not be decremented when the channel is busy.

1.8.5 TRANSMISSION COORDINATION

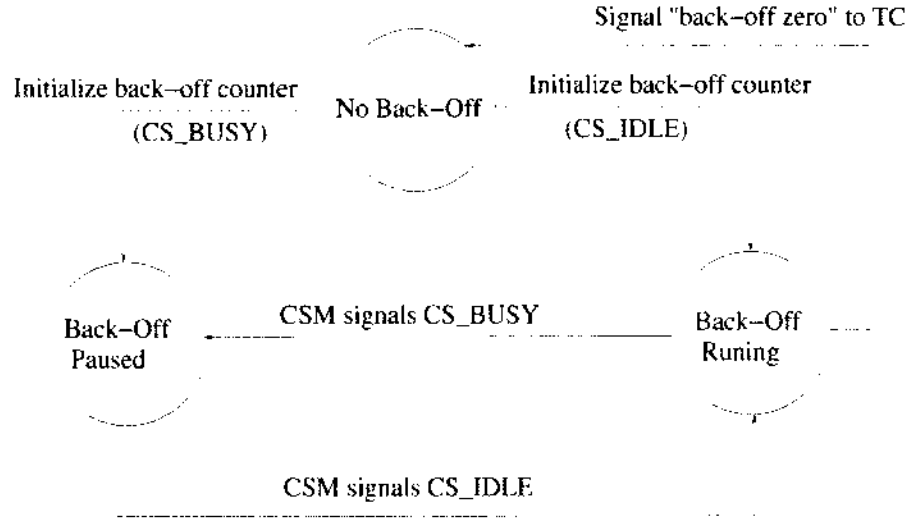

FIG. 6: Back-off State Manager (based on figure from [4])

The packet transmission request and medium access from upper layer will be managed by the transmission coordination module management. In this module, if the data frame that would be transmitted is smaller than the RTS frame, the data frame will be transmitted directly. Otherwise, the RST/CTS handshake will be necessary to avoid the hidden node problem. Figure 7 shows the transmission coordination state machine. When the transmission request comes from the upper layer, transmission coordination leaves TC_IDLE and starts back-off process at the Back-off manager. It moves to RTS Pending or data pending based on the data frame size as we mentioned earlier. When the transmission coordination receives the signal shows that back-off counter reached zero, the transmission coordination instructs to send the RTS or data frame. If no back-off process remains and the channel manager reports that the carrier sensing is idle, the RTS or data frame transmission will start immediately. The transmission coordination moves to the waiting CTS state after the RTS is transmitted.

1.8.6 RECEPTION COORDINATION

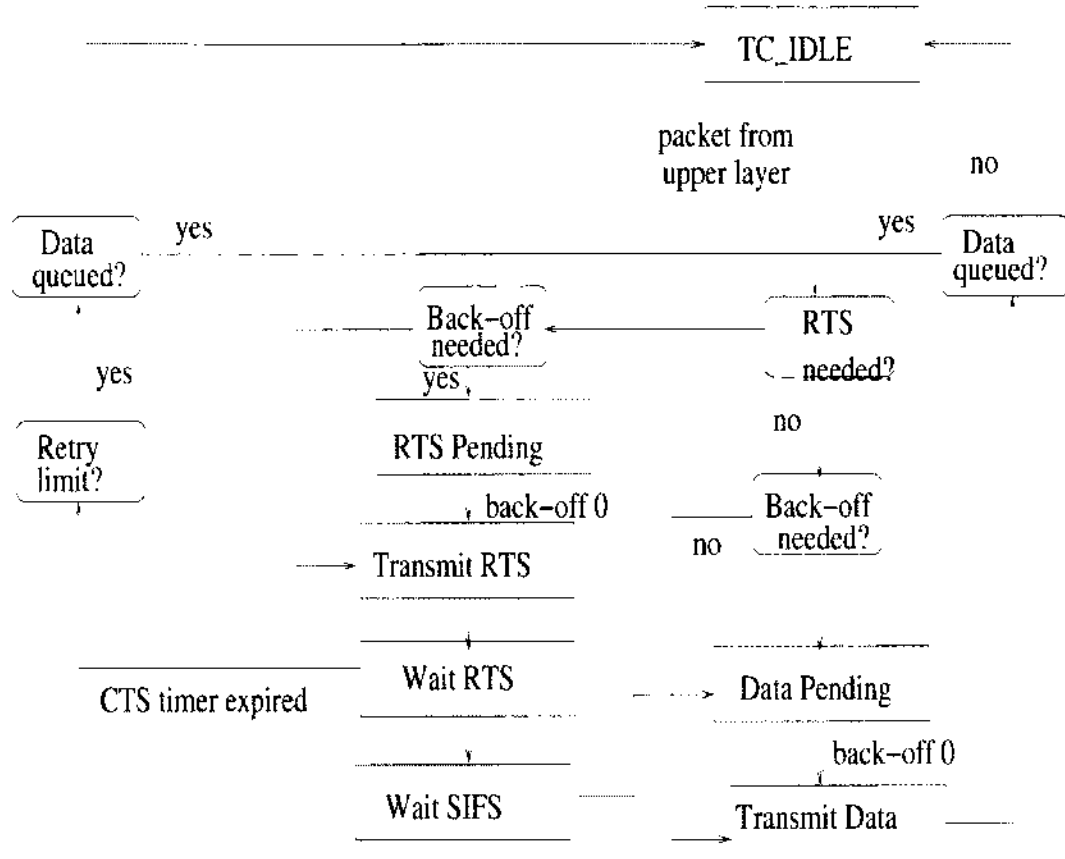

FIG. 7: Transmission Coordination Manager State Machine (based on figure from [2])

The reception coordination module manages the frame filtering and it also conforms with the transmission manager about receiving CTS or ACK frames in addition to creating the CTS and ACK frames. It consists of three states: **RC_IDLE**, **Wait SIFS**, and **Waiting TX**. Figure 8 shows the reception coordination manager state machine. When the RTS is received, reception coordination extracts the NAV and queries the Channel State Manager to learn about the current NAV status. If the RTS is not addressed to the receiver, it will be discarded. Otherwise, the CTS will be created and move to SIFS state and the SIFS timer will be set. Once the SIFS timer elapses, CTS frame will be sent and then it will move to **Wait TX** state until the transmission is complete. When the transmission is completed, it will go back to

TC_IDLE. The same process will be taken for transmission of ACK frame.

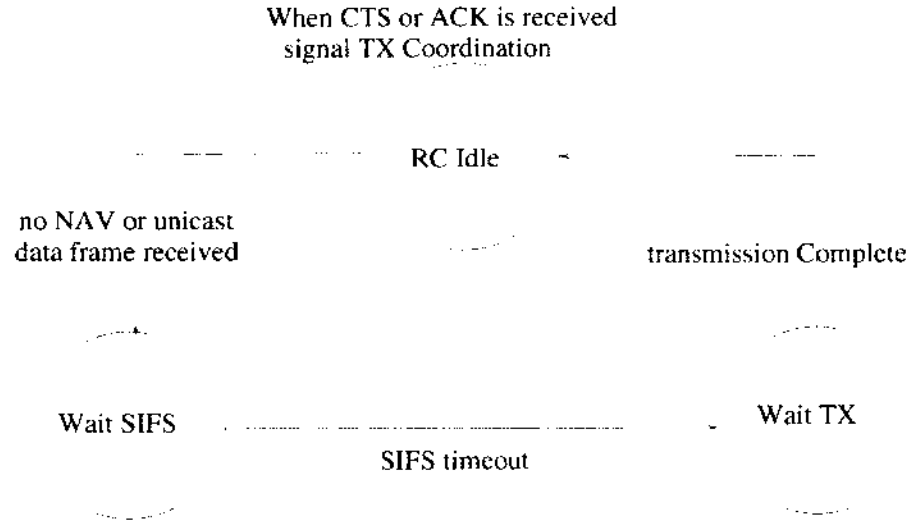

FIG. 8: Reception Coordination Manager State Machine (based on figure from [2])

The vehicular wireless communication and Wireless LAN have many similar mechanisms and schemes. The WAVE stack protocol could send the data frame in the traditional way (the data frame go through the transport layer, Network layer, Data link layer and Physical layer). or it may transmit the data frame through the WAVE Short Message Protocol when the IP address is not required or does not exist. In a later chapter, the detail about the WAVE stack protocols will be given.

1.9 OBJECTIVES

Our main objective is to propose a technique to avoid negative impact of channel switching IEEE 1609.4 standard on the top of IEEE 802.11p standard. The second goal is to maximize the number of vehicles that a roadside infrastructure component can interact with. We will also perform an evaluation based on IEEE 802.11 standard for probability of success of data exchange in V2I. We will finally develop AID

algorithms and alert message dissemination schemes to detect incidents in low traffic conditions on a freeway to avoid congestion.

1.10 ORGANIZATION

The following is an outline of the organization of this thesis. In chapter two, the technical background of the vehicular network structure is given. In addition, the literature review about the vehicle to infrastructure as well as that of research in automatic incident detection is given. The analytical study for the IEEE 802.11 assessment is given in chapter 3. In order to corroborate the analytical study, a simulation scenario is developed. In chapter 4, two new traffic parameters are defined. Two AID algorithms are also developed based on these newly defined parameters. Finally in chapter 5, we thoroughly present the conclusion of our whole work as well as points of our contribution and recommendations for future work. The table of abbreviations and the information about used simulation tools could be found in appendix sections.

CHAPTER 2

TECHNICAL BACKGROUND AND LITERATURE REVIEW

In the previous chapter we gave a detailed background of the progress that has been made so far in the area of vehicular networks. In this chapter, we will through the technical details of those protocols designed in the area specifically for automatic incident detection and explain their negative impacts.

The bidirectional mode communication between vehicles and RSUs have an important role in alerting drivers about dangerous road conditions ahead, security, and service advertisement. In addition, V2I could be used for V2V communication or Internet access. As we mentioned in the previous chapter, a short range communication technology Wi-Fi which is defined by IEEE 802.11 standard could be used for V2I and V2V communications [2]. The high node speed and limited coverage range in vehicular wireless network make it difficult for the nodes to exploit available services. Therefore, academic researchers, standardization groups, and vehicle manufacturers tried to define a standard to overcome some difficult experiences in WAVE. Such difficulties resulted in the definition of IEEE 802.11p for WAVE [21, 5], and it is further recognized as the Dedicated Short Range Communications (DSRC). The 75 MHz spectrum at 5.9 GHz is assigned for Intelligent Transportation Systems (ITS). This band is structured into seven ten-MHz channels. The 5.9 GHz frequency band is licensed but it is free. This frequency band is restricted, and it can be used only for vehicular communications. The first 5 MHz are used as a guard band for protecting from the adjacent frequencies. The even numbers from 172 through 184 is used to identify DSRC channels.

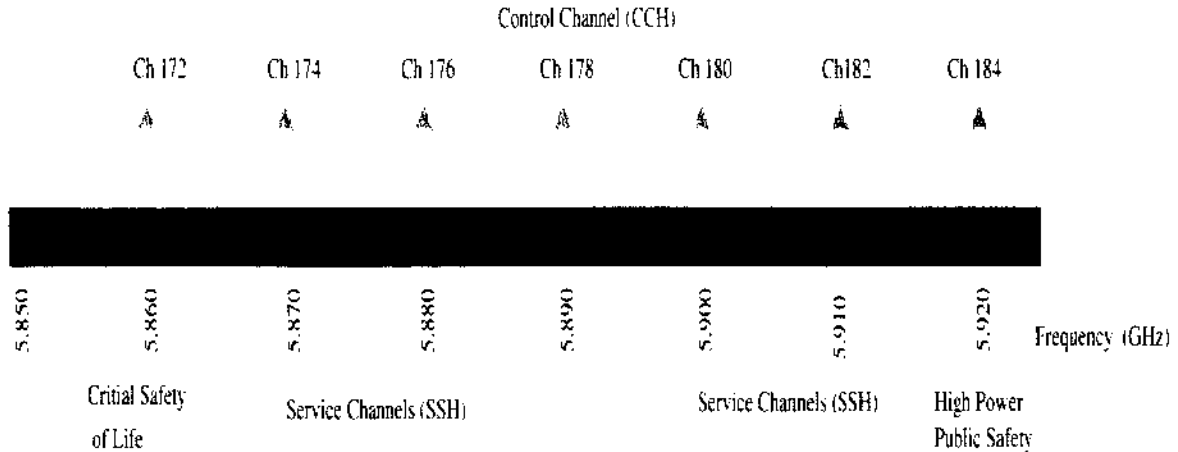

FIG. 9: Dedicated Short Range Communication spectrum band and channels in the U.S. (based on figure from [5])

2.1 IEEE 802.11P

In IEEE 802.11p standard, the expensive authentication and association operations are not required. IEEE 802.11p standard data packets could be exchanged with all Base Service Set Identification values made 1's as wildcard Base Service Set Identification, which is only usable for the duration of probe requests in a regular wireless LAN network.

Because IEEE 802.11p physical and MAC layers are limited to work within a single channel, the multi-channel operations are provided by IEEE 1609.4 on top of IEEE 802.11p [9, 54]. Operations are switched between channels by dividing the available access time into Control Channel (CCH) and Service Channel (SCH) intervals as in figure 9. The CCH is used for safety communications [55]. The two end channels of DSRC spectrum are reserved for special uses [56] and the rest are service channels. The SCHs could be used for safety and non-safety usage. The DSRC spectrum in the European Union is structured into five ten-MHz channels. The different frequency band is used for CCHs. The main reason for this difference is to have a guard zone between CCH and SCH to avoid interference. While IEEE 802.11p

standard does not have such expensive overhead time for establishing the connection, it has some drawbacks. Spectrum masks are used to protect the adjacent channels from interference. The four class masks A, B, C, and D for the 5.9 GHz DSRC are specified by IEEE 802.11p amendments. For vehicle-to-vehicle communications, class C will be adopted. The spectrum mask requirements at different offsets for each class from channel centers are shown in Table 1. A 0 dBr bandwidth not exceeding 9 MHz must be used for each 10 MHz channel as the transmitted spectrum.

TABLE 1: WAVE spectrum mask requirements (from [1])

Class	Limit at 5 MHz Offset (dBr)	Limit at 5.5 MHz Offset (dBr)	Limit at 10 MHz Offset (dBr)	Limit at 15 MHz Offset (dBr)
A	-10	-20	-28	-40
B	-16	-20	-28	-40
C	-26	-32	-40	-50
D	-35	-45	-55	-65

In [57], Rai et al. showed that interference occurs when two vehicles are operating over adjacent channels in adjacent lanes. For instance, V1 transmission causes interference at V2 in the adjacent lane (2.5 m apart) when they are operating on adjacent channels 172 and 178.

2.2 IEEE 802.11P CHANNEL WIDTH

The orthogonal frequency-division multiplexing scheme as IEEE 802.11a is used as a base IEEE 802.11p PHY. In IEEE 802.11a, the OFDM scheme operates over 20 MHz channels, but it operates over 10 MHz channels in IEEE 802.11p. Therefore, the timing parameters must be doubled, and the frequency parameters must be half of the frequency parameters used for 20 MHz IEEE 802.11a transmissions, and hence doubling guard interval size between transmitted symbols.

As we mentioned earlier, the time division scheme for multi-channel operations is specified by IEEE 1609.4 which sits on top of IEEE 802.11p as in figure 10. This protocol is designed for operating on a single radio over multiple DSRC channels. Regarding the time synchronization, all devices are required to limit time synchronization within seconds with a common time reference. For example, the pulses-per-second signal which Global Positioning System devices issued are exploited to keep exact timing.

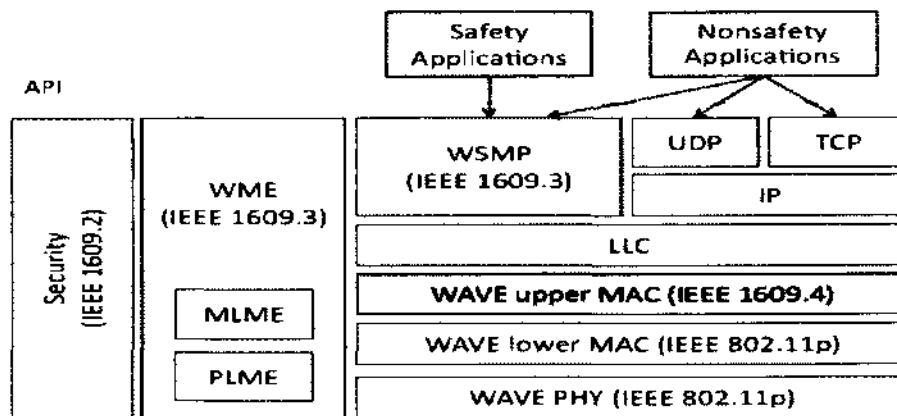

FIG. 10: IEEE 1609.4 in the WAVE protocol(based on figure from [6])

The IEEE 1609.4 allows the timing information to be obtained from other WAVE radios when the radios do not have direct access to exact timing sources. For example, the time information in WAVE Timing Advertisement frames could be read to achieve this goal. The timing information provider must meet the minimum requirements of coordinated universal time synchronization. As we mentioned, the synchronization time interval is divided into a CCH interval and follow by a SCH interval as in figure 11.

WAVE spectrum mask requirements The CCH is used to broadcast safety messages, and the SCH is used for advertisement service availability. In addition, safety messages are also permitted to be transmitted over the CCH. Vehicles are equipped

with a single radio tuned to SCH will not be able to receive these messages. The front and rear guard intervals are defined by IEEE 1609.4 at the beginning and end of each CCH and SCH intervals. Synchronization tolerance and maximum channel switching time define the front guard interval. The expected precision of a device's internal clock is the synchronization tolerance. Maximum channel switching time is the overhead introduced by the operation of switching from one physical channel to another. MAC layer temporarily prevents activities during CCH or SCH guard interval and then resume the suspended activities. In other words, all the frame transmissions will be postponed until the guard time interval elapsed. All incomplete transmission frames will be dropped before the next guard interval starts. The local queue stored data frames that are not transmitted during the CCH or SCH interval will be transmitted in next cycle. There is also a mechanism to assign an expiration time to individual data frames. Regarding the channel switching state machine, the vehicle starts in the No Sync state. When the time synchronization is achieved, the vehicle moves to the CCH Guard state and tuned to CCH channel. As we mentioned earlier, all frames transmission will be postponed until the guard time interval elapse and are stored in a local queue. All data frames that are planned to be transmitted during CCH, will be transmitted and while the other frames that must be transmitted during the SCH time interval will be stored at a local queue. When the CCH interval is elapsed, all activities will be suspended until the SCH guard interval expired. In SCH state, all data frames planned to be transmitted during the SCH interval will be scheduled to transmit. When the SCH interval elapsed, the vehicle turns to the CCH guard interval. Figure 12 shows multichannel an operation state machine.

In [1, 58], authors showed that the poor CCH utilization degraded the performance of broadcast safety messages. The details about the negative impact of channel switching will be covered later in this chapter. Vehicles periodically broadcast

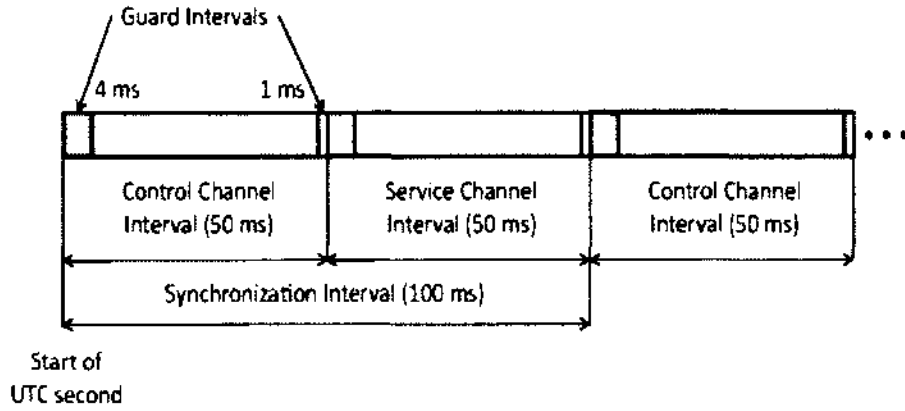

FIG. 11: Synchronization, control channel, Service channel, and guard intervals(based on figure from [7])

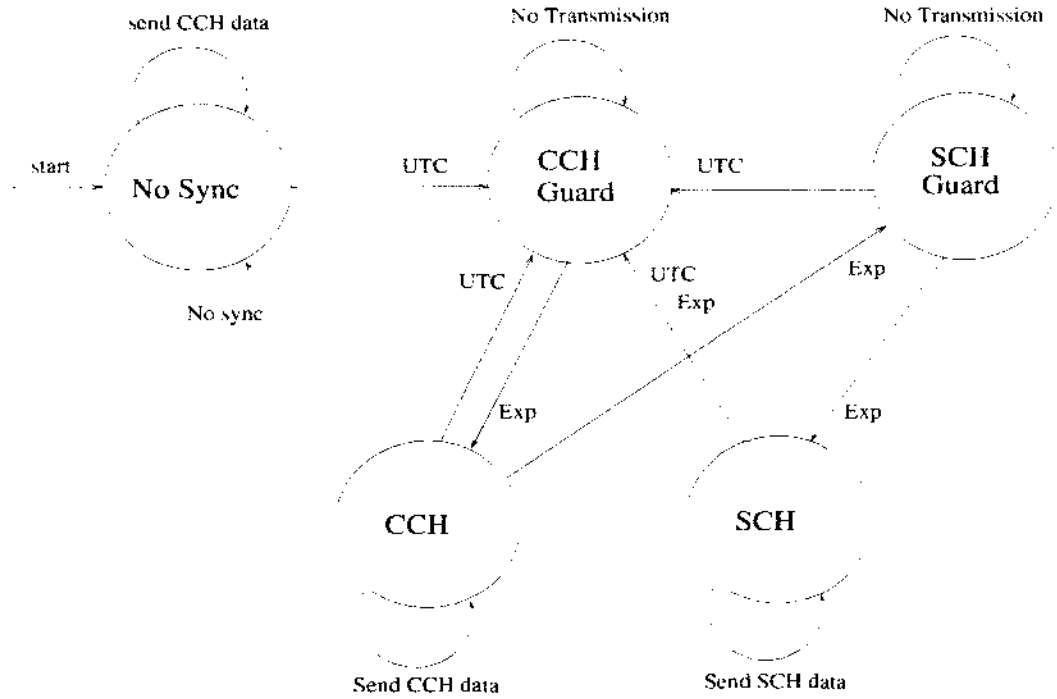

FIG. 12: IEEE 1609.4 Multichannel operation state machine [8]

information about their current status. The growing number of vehicles causes congestion of the radio link. This degrades the network performance. In [39], authors showed that even in a simple traffic scenario the DSRC channel congestion can occur. In [59, 60, 61, 62], many protocols and mechanisms were developed for MANETs. However, these solutions for highly dynamic change network topology and vehicle density are not well suited. Maximizing data through put is aimed primarily fWAVE spectrum mask requirementsor traditional MANETs in congestion control solution while leaving a fraction of the bandwidth is the main goal for transmitting safety messages. A number of mechanisms recently for vehicular network safety communication were developed. In the next section, an overview of the current state of traffic data will be given.

2.3 DSRC DATA CONGESTION

Current channel load conditions can be estimated by individual vehicles, and broadcasting safety messages over a DSRC channel is used for dominating vehicle safety communications. The DSRC safety messages such as basic safety messages (BSMS) are broadcasted periodically by vehicles. Also, event-driven safety messages are broadcasted about sudden sharp deceleration or control losses. On the other hand, signal phase and timing (SPAT), Radio Technical Commission for Maritime Services Corrections, Traffic Information Message, and Roadside Alert are broadcasted by RSUs in addition to the WAVE Service Advertisements.

In [39], authors showed that the traffic data load of channels depends on a series of transmission parameters such as message frequency, message size, transmission power (distance), and data rate. The vehicle safety applications determine the message frequency, size, and transmission power. Therefore, congestion control functions above wireless access could be defined in vehicular environments to avoid lower layer

communication protocols. The time intervals are longer between subsequent BSM messages for low message frequencies, and V2V applications require less timely support. Therefore, high frequencies must be used. This increases the risks of channel congestions.

Vehicle speed also has a direct connection with the proper message rates. For example, vehicles that travel 36 m/s at 80 mph. Significant new information will not be carried by the updated sent message every 2-3 m. The required V2V safety applications in a timely fashion will be met by broadcast BSMs at 10 Hz. The distance between the receivers is associated and determines the transmission power. Clear received signal strength is required at the receivers for high frequency channel bands. To reach faraway nodes, it requires high power transmission while it increases the channel interference and frame collision. Selecting power transmission is allowed to be chosen by the application for each individual BSM in WAVE stack protocols. The message size is contingent directly upon network performance, but the adaption of V2V safety message sizes is not practical in WAVE networking. Longer transmission time and longer channel busy intervals are required for transmitting longer messages. In [39], the author showed that overall performance improvements are confirmed by simulations and experiments for short messages. Therefore, dynamic adaption of message rate, transmission power, or both are focused on by congestion control algorithm developers.

2.4 INFRASTRUCTURE-TO-VEHICLE COMMUNICATION

In I2V mode, the local messages, such as traffic controller signal phase, timing information, dangerous road condition information, security credential, and service advertisements, will be broadcasted from the RSUs. The cellular, satellite, or digital radio can be used at RSUs for the local broadcasting as a short-range radio

transceiver. Widely available services in vehicle today are satellite and digital radio services. The real-time traffic and road condition information could be delivered through them to the drivers or navigation devices. There are some applications that require the vehicle-to-infrastructure communications such as browsing and email.

2.5 VEHICLE TO INFRASTRUCTURE STUDIES

In [9], the negative impact of IEEE 1609.4 channel switching has been shown on the IEEE 802.11p standard. Many techniques and schemes are proposed [63, 64] to minimize the impact of IEEE 1609.4 standard channel switching, but these solutions emphasize the SCH performance. The authors optimized the SCH performance by sacrificing CCH performance. If the estimated time for transmitting a packet exceeds the current SCH remaining time interval, the packet transmission would be prevented, and it would be transmitted in next SCH interval in IEEE 1609.4 standard specification. Thus the remaining time of the interval will be underutilized. This phenomena is called a bandwidth wastage problem and is caused by channel switching [63, 64].

Second, the WAVE BSS (WBSS) provider advertisement message in IEEE 802.11p standard is broadcast only in a CCH time interval [65]. Therefore, vehicles cannot be aware of a WBSS provider when the WBSS provider switches to one SCH channel or in the event of collision possibility of WBSS advertisement messages with the other traffic messages such as event-based safety messages and vehicle beacons that are broadcasting during CCH interval[65]. Vehicles must receive at least one WBSS advertisement message per each CCH time interval to tune to RSU-advertised SCH to exchange data with RSU. In IEEE 802.11p standard, the WBSS is initialized by either a vehicle or RSU. Therefore, it is possible for vehicles to be unaware of RSU while passing through RSU coverage area of IEEE 802.11p standard. Almalag et al. [66] referred to the probability of preventing the comfort service because of a

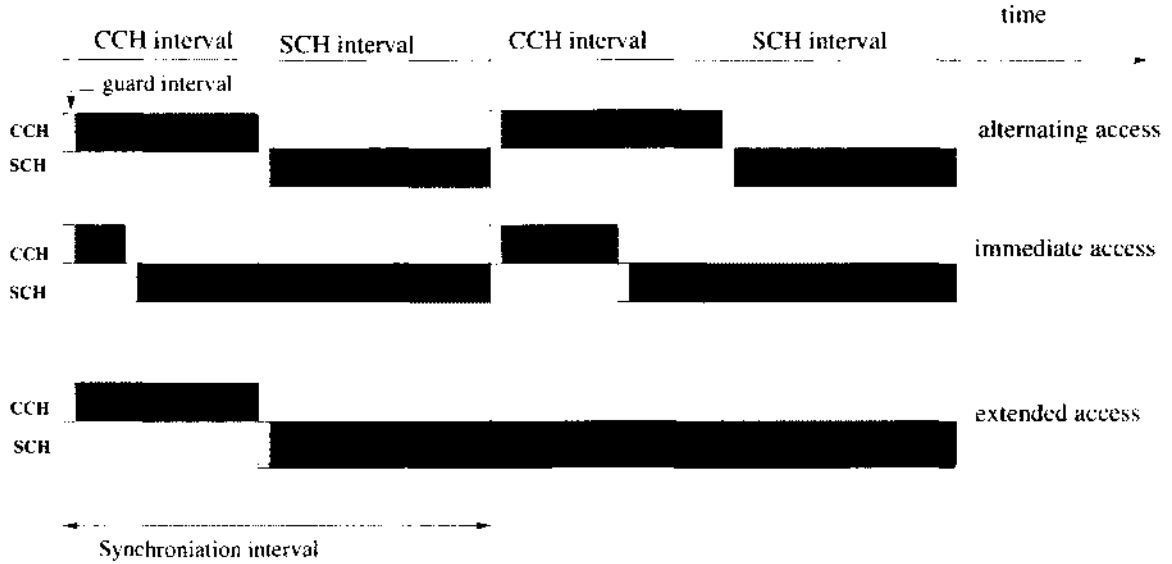

FIG. 13: Channel access diagram (based on figure from [9])

lower priority of non-safety messages in IEEE 802.11p standard.

Here we give a brief description of some proposed schemes to overcome the negative impacts of IEEE 1609.4 channel switching on the IEEE 802.11p beaconing performance, and we will also discuss some of their advantages and disadvantages. In [63], Immediate and Extended access schemes are proposed to minimize the SCH bandwidth wastage problem. In Immediate scheme, nodes can immediately switch to SCH without waiting for CCH time interval to elapse and complete its transmission. In Extended scheme, a node does not switch to CCH till it finishes its transmission. Both Immediate and Extended schemes optimize SCH performance by sacrificing CCH performance. Figure 13 shows the alternating, immediate and extended channel access diagrams.

In the fragmentation scheme [64], the remaining SCH time interval is used to transmit a fragment of a packet whose estimated transmission is bigger than the residual CCH time interval. In this scheme, SCH performance is optimized at the cost

of additional header for the fragment packets. Also, this scheme is not guaranteed to utilize the residual time interval because of the CSMA/CA random nature. In [64], Best-fit scheme is given. This scheme checks the transmission queue to find the packet with estimation transmission time less than the remaining time of SCH time interval to transmit. The first drawback of this scheme is the size of the packets in a transmitting queue should be known. Second, actual duration priority is difficult to determine by a node because of the random nature of back-off.

IEEE 802.11p/WAVE was also studied in terms of futures and capabilities by Campolo et al. in [67]. They also noted the possibilities of vehicles that are not aware of RSU in cases where RSU switches to one of SCHs. They also suggested a technique to increase the number of vehicles aware of RSUs by piggybacking the RSU beacon parameters to the vehicle aware of RSU beacon. This awareness rate increases at the cost of additional header for a vehicle's beacon. This in turn needs the modification in PHY and MAC procedures and techniques to capture a header and a frame body. In addition, Eichler showed that IEEE 802.11p standard has a low through put and high delay in his high density simulation scenarios [68]. In [69], the probability of preventing the comfort service was referred because of less priority of non-safety messages. In [69], Almalag et al. divided the control channel time period into time frame slots and assigned each active vehicle a time slot to broadcast beacons and receive non-safety messages. In their work, they focused only on V2V communication and techniques for selecting cluster-head to adjust inter-cluster communications. This also optimizes SCH performance at the cost of CCH performance. For the NOTICE system, the connection is established through physical contact when the vehicle passes over the sensors embedded in the roadway [70].

2.6 WAVE BEACONING MECHANISM

A RSU periodically broadcasts a short message (beacon) which contains information about the RSU and the link measurement data. Each vehicle in the RSU coverage range successfully receives at least one beacon and thus can be aware of the RSU and then can establish connection and exchange data with RSU [71].

The beaconing is currently used in IEEE 802.11 wireless local area networks. The 802.11 standard may not be suitable for establishing V2I wireless links due to the limited time a moving vehicle spends in the radio range of a wireless RSU [24].

At the same time, a beaconing mechanism in IEEE 802.11 has been studied in the context of V2V communications in [72]. Their numerical results show that the beaconing mechanism met the V2V application requirements. Capacity, efficiency and analytical formulas for IEEE 802.11 standard were studied in a context of wireless LANs in [73]. Analytically, they showed the degradation of IEEE 802.11 standard capacity when the number of active stations increased. They further showed that their analytical results are close to their numerical simulation result. Moreover, Bychkovsky et al. [74] showed that connecting to APs over 802.11 was feasible for vehicles. Jakob et al. [75] studied the Cabernet design implementation system for communication of moving vehicles with open 80.11 Wi-Fi in cities. Their evaluation from a real-world taxi test bed in the Boston area shows that Cabernet can achieve more than enough throughput for a large class of vehicular applications. The general approach presented in [71] was to study the probability of successful connection and data exchange between passing vehicles and RSUs. These studies inspire us to believe that using the beaconing mechanism is convenient to study IEEE 802.11 standard probability of success data exchange between RSU and the vehicle.

2.7 DSRC IN THE EUROPEAN UNION AND JAPAN

The European DSRC spectrum is divided into five ten-MHz channels while it is structured into seven ten-MHz in the United States [2]. Different frequencies are used for CCHs in the USA and the EU. Introducing guard zone between CCH (5.895-5.905 GHz) and SCH#1 (5.885-5.995 GHz) is used avoid interference which is the main reason for allocated CCHs difference frequencies. Mainly this guard interval is the second SCH (5.885-5.995 GHz) while it is usually used for low-priority, low-power messages. Also, the CCH and SCH# 1 is a heavily used channel for safety applications. Figure 15 shows the DSRC overlapping channels in the EU and the US.

In 1996, the comprehensive plan for ITS was released in Japan by the Japanese Ministries of Transport, Construction, Posts and Telecommunications, International Trade and Industry, and the National Police Agency jointly [76]. In 2001, the Radio Industries and Businesses STD-T75 standard was developed for DSRC. Figure 16 shows the structure DSRC channels in Japan which consist of 7 down-link and 7 up-link channels allocated at 5.770-5.850 GHz band.

2.8 VEHICULAR SAFETY APPLICATIONS

In the United States of America, 9,000 deaths were recorded for about 1.7 million vehicle crashes at intersections [77]. In 2004 in addition to the \$7.9 billion loss, 163,000 lives were lost due to the 302,000 vehicle crashes [78]. Red light and stop sign violations caused 250,000 of these collisions. The vehicle to roadside unit communication enables the vehicles' ability to alert the drivers about the potential

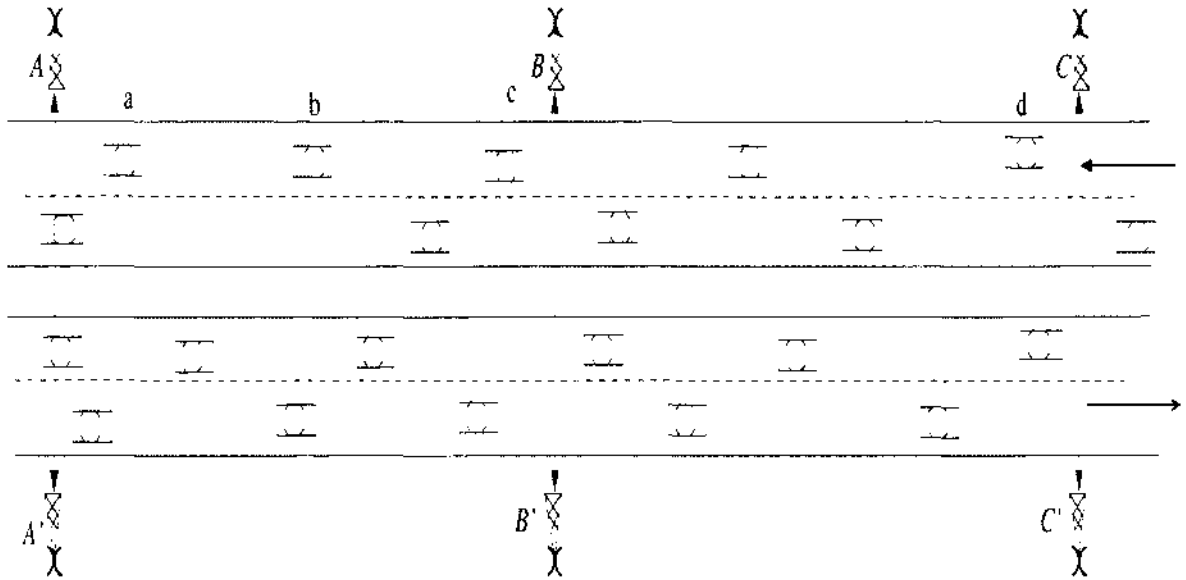

FIG. 14: Highway segment with three RSUs in each traffic direction.

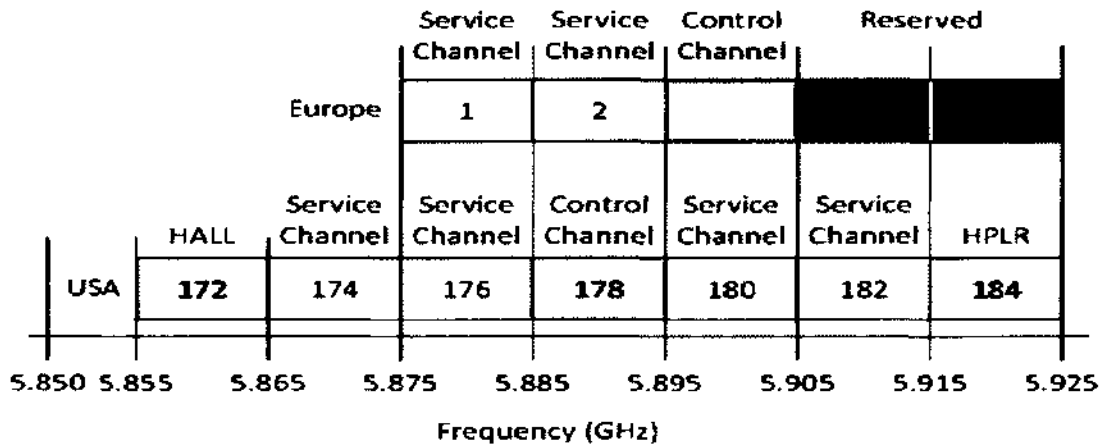

FIG. 15: DSRC overlapping channels in the EU and USA

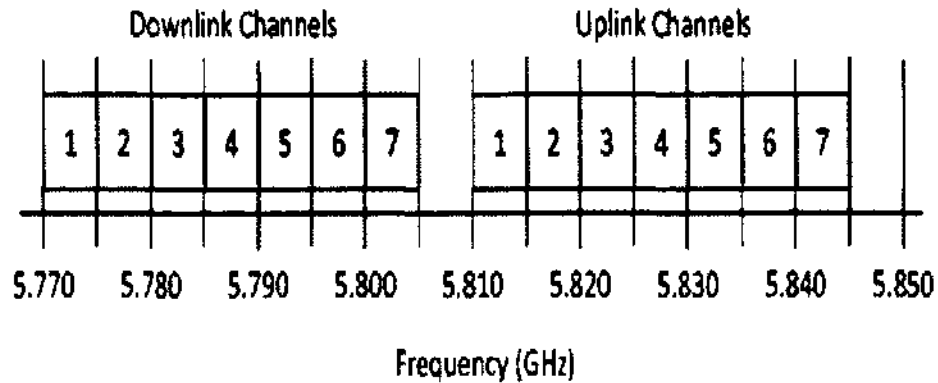

FIG. 16: Japan DSRC channels

accident in advance to avoid the collision especially at intersection crash box. The U.S. Department of Transportation (USDOT) and five automotive original equipment manufacturers (Ford, General Motors, Mercedes-Benz, Toyota, and Honda) have partnered up with The Cooperative Intersection Collision Avoidance System for Violations (CICAS-V) group to build the Crash Avoidance Metrics Partnership framework [79, 80, 81]. The CICAS-V aims at avoiding or minimizing the intersection collisions. This system's goal depends on the ability of communication between vehicle onboard unit and installed RSU at the intersections. The vehicle dynamics such as speed, distance, lane of the travel and position with the intersection traffic information could be used to estimate the potential collisions. The full function CICAS-V system protocols were designed and implemented in a real test bed and evaluated to check the feasibility of the project excitability. In this chapter, we will illustrate one of the V2I communication application functions, and we will also show the significant vehicle safety ability of this application which can save thousands of lives.

2.9 CICAS-V SYSTEM DESIGN

The CICAS-V system utilizes the vehicle to infrastructure communication concepts. When vehicles enter the coverage range, it receives safety messages from RSU 17. These safety messages consist of the current SPAT and digital map of the intersection called Geometric Intersection Description (GID) [81]. The Global Positioning System differential correction could be optionally broadcasted by the RSU. The vehicle safety applications read the information from onboard units. It calculates the possible violation based on the vehicle dynamic information such as speed and the vehicle distance from stop-bar of the vehicle lane traveled. It gives a warning to the driver to take a proper action when the potential collision is detected. Moreover, the vehicle would probably automatically takes an action if the driver ignores the raised alert. The positioning accuracy based on the GPS is sufficient to determine the violation estimation of vehicle to a stop bar. The GID map contains information about the intersection such as stop bar for each line, the road and lane geometry directed to the intersection and the individual lane traffic signal phase. The vehicle onboard must receive this information from RSU at CICAS-V application assumption. The RSU message size is restricted to minimize the time delay. Therefore, the GID map should be fitted into a single RSU message broadcast. The IEEE standard message size is limited to 1.4 KB and 400 bytes is reserved for the security purpose [21]. Therefore, GID maps has to be fitted into only 1 KB. This creates a challenge for developers to find a way to fit this information into an acceptable single message size.

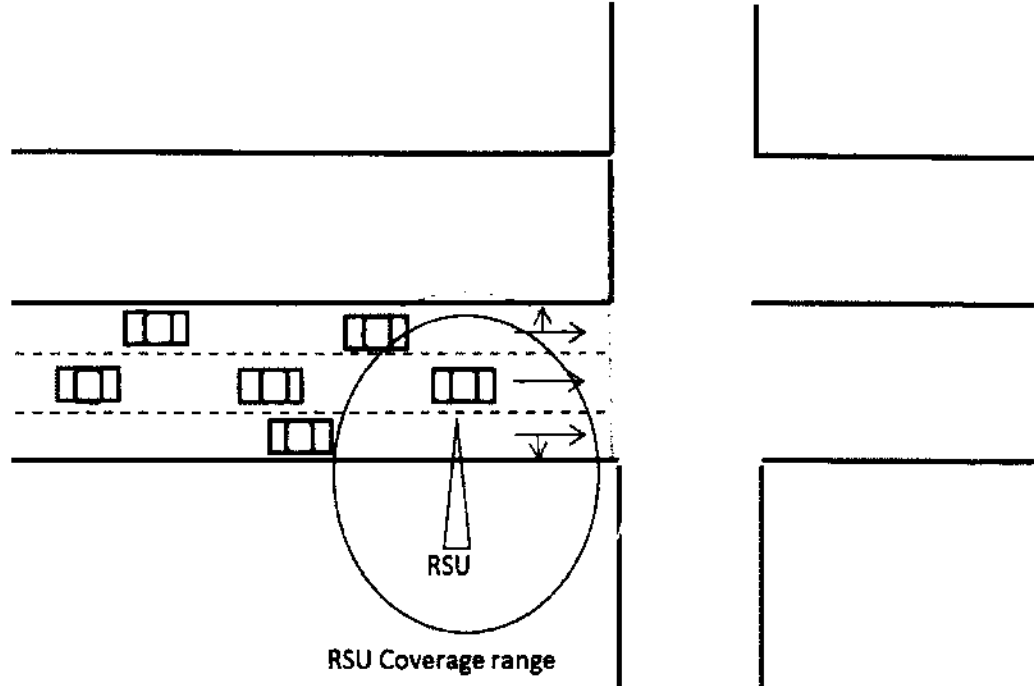

FIG. 17: The CICAS-V illustration

2.10 GID MESSAGE FORMAT

In [21], Society of automotive engineer SAE defined a standard to minimize the size for the above information as follows:

- Cartesian offsets are used to represent an intersection reference point (IRP).
- A set of points (nodes) with line width at each point is used to describe roads and lanes.
- Specifying the centerline of the lane describes the lane geometry.
- The first geometry point for the lane is used as the stop bar location.
- 300 distance from IRP will be represented.

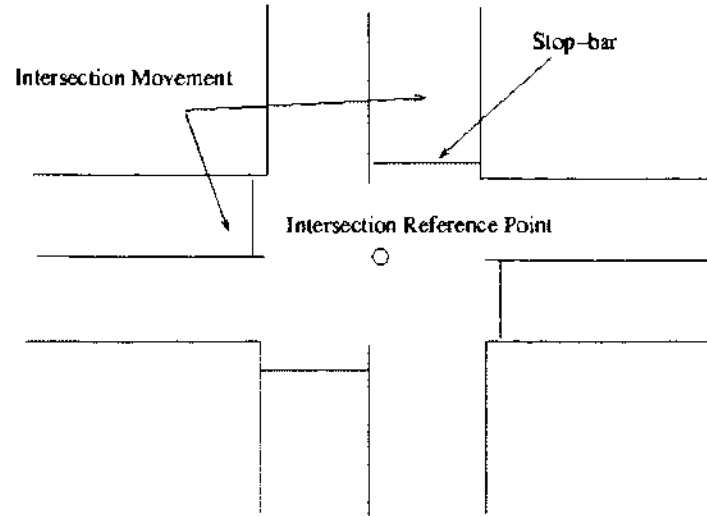

FIG. 18: The GID Map

In general, the GID map consists of a set of nodes. One of the nodes is the IRP and the others describes the lanes. There are two types of lanes: based lane and derived lanes. The based lane is described by the nodes, but the derived lanes is computed from the based lane. Figure 18 shows a simple sample of a GID map.

The signal phase and time will be sent in the same GID map message to the vehicle. It consists of the current signal phases and the signal phase change time. It is dependent on the vehicle onboard to extract the correct signal phase and time related to the vehicle movement direction.

2.11 THE CICAS-V HARDWARE

The roadside units at the signalized intersection consists of the antenna, GPS plus differential GPS antenna, which is optional. Figure 19 shows the RSU CICAS-V hardware and its connection with the other required devices. The RSU is connected to the traffic control through the LAN bus network. Further, RSU might be connected to backbone Internet Protocol (IP) networks. This helps control the RSU

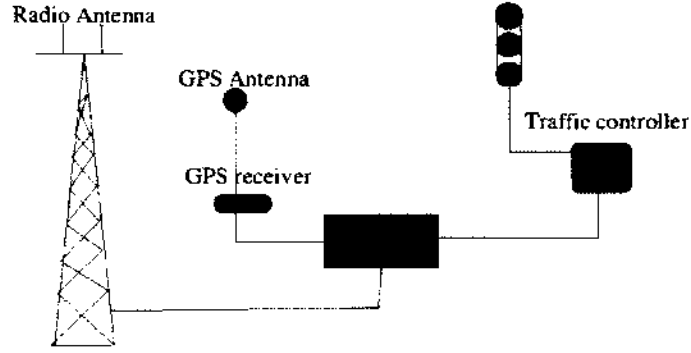

FIG. 19: RSU CICAS-V Hardware

remotely. On the other side, CICAS-V vehicles are equipped with onboard unit computing devices. It is connected via the CAN bus to the vehicle radio antenna, GPS receiver, and the driver-vehicle interface. Figure 20 shows the vehicle side CICAS-V system.

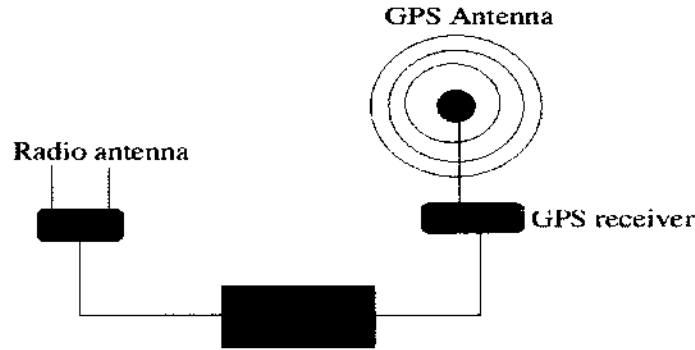

FIG. 20: Vehicle CICAS-V Hardware

The SPAT, DGPS and GID message will be sent to the vehicle. The vehicle safety application uses this information to estimate the intersection's potential violations. First, the applications show the signal phase and the vehicle's distance from the intersection. By the time the vehicle gets closer to the intersection, the application shows a stop ahead. Afterwards, it shows the stoplight when the vehicle gets closer and will automatically stop the vehicle if the driver ignores the last warning. This application was implemented in a Mercedes-Benz at the Intelligent Transportation World Congress in New York City. The detail of this application can be found in

[10].

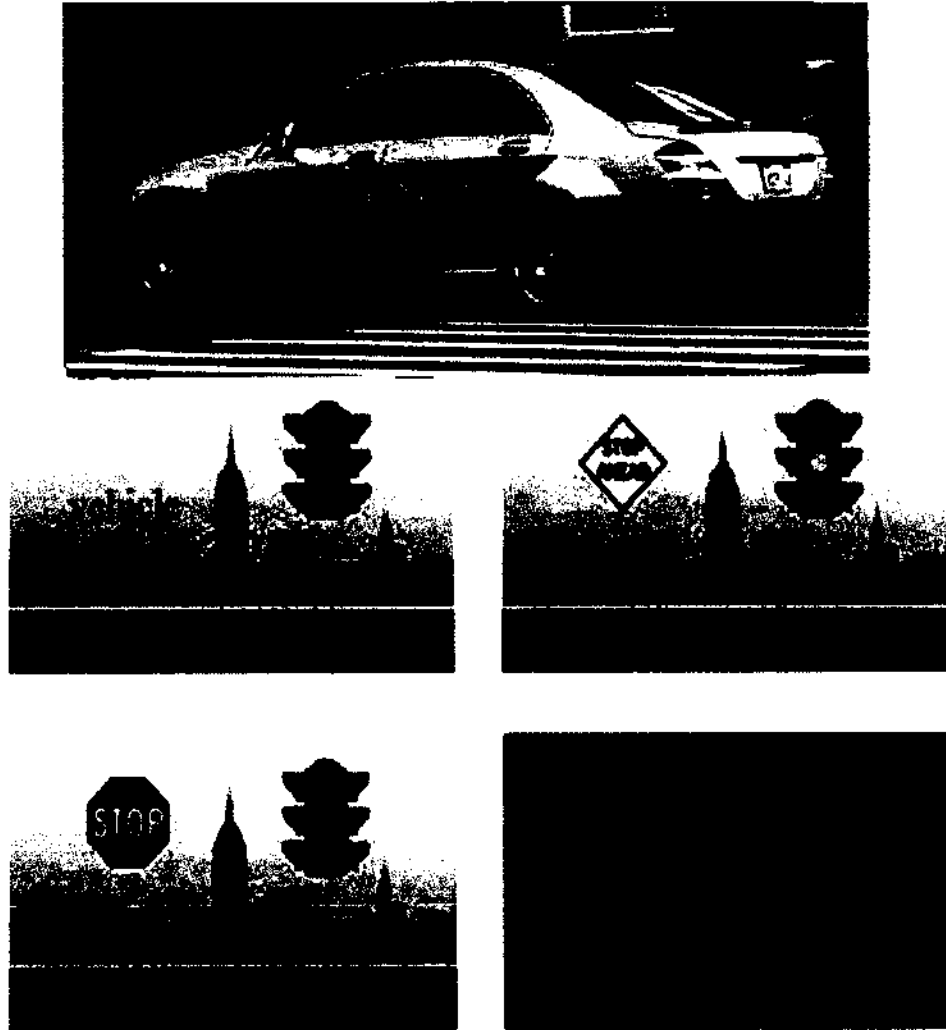

FIG. 21: Driver-vehicle Application Interface (based on figure from [10])

Figure 21 shows the vehicle intersection driver assistance application interface. The application gives a warning about the red-light violations. When the applications are ignored by the driver and the red-light violation is expected, ESC will be activated to avoid the violation. The Pre-Crash is also activated. This application tightens the seat belts, rolls up windows and also raises the headrests. These applications were implemented and installed on different devices. They communicate through the CAN bus which makes these devices work independently. The crash or malfunctions of one device does not impact the others.

2.12 THE IMPACT OF INCIDENT DETECTION

In [82], Busch showed that more than 50 percent of accidents are caused by another accident which would happen a few minutes before the subsequent accident. This shows that it is important to alert drivers about the incident not only to reduce the congestion, but also to provide safety for drivers and passengers on a road. In [83], Robinson highlighted incidents as a major reason for traffic congestion. He also showed that its delay is higher than rush hour traffic delay. In addition, the US Department of Transportation (US-DOT) [12] showed that billions of dollars are wasted due to incidents and traffic congestion. These impacts motivate researchers to develop techniques and methods to detect and alert drivers to avoid the possible incident consequences. In the next section, we will give a brief background of incident detection algorithms and also its modes.

2.13 INCIDENT DETECTION MODE

Incident detection algorithms are divided into two classes: automatic and non-automatic algorithms. An algorithm triggers an alert whenever the traffic data collected from the RSU satisfies certain conditions. Non-automatic incident detection triggers an alert based on reported incidents [84]. Both automatic and non-automatic incident detection may be used for incident detection on freeway or arterial routes.

There are two critical components involved in creating a traffic alert system: one involves data collection from passing vehicles, while the other deals with the analysis of collected data and detecting traffic trends and patterns.

The data collection process uses vehicle-to-vehicle and vehicle-to-infrastructure networking and its performance depends on various factors related to the reliability and validity of the vehicle safety communication systems. Because we are developing Automatic Incident Detection, we will focus on AID algorithms and technique

characteristics. Therefore, we give a description of AID algorithm categories. AID algorithms are divided into two categories: time series and comparative.

Time Series Categories: In time series categories, the current traffic condition could be estimated based on past traffic observations. So, statistics or time series models are used by time series AID algorithms. For example, Standard Deviation algorithm [85] and the TRANSCOM System were used for Managing Incidents and Traffic (TRANSMIT) System [86].

Comparative Categories: In comparative categories, the new values for traffic parameters are calculated from the current collected data. The new values are compared to the pre-identified thresholds to detect incidents. For example, California Algorithms [87] and the McMaster Algorithm [88, 89]

Traffic safety depends not only on the algorithm rate of false-alarms, but also depends on the reliability and validity of the Vehicle Safety Communications. It also has an important role in providing minimum latency of not more than 100 ms for safety messages. In addition, safety messages should travel at least 150 meters [90]. Simplicity and easy implementation are also other important criteria to judge AID algorithms. Two important terms are defined here:

- *Detection Rate :*

The percentage of total capacity-reducing incidents detected during a specified time period is the detection rate [91].

- *False Alarm Rate :*

False Alarm Rate is the percentage of false detection alert for a specific algorithm in a specific period of time [91].

The accuracy of AID algorithms depends not only on the algorithm false alarm rate, but also on the reliability and validity of the V2I connection. This plays an important role to minimize latency of receiving or communicating safety alert messages. Simplicity and ease of implementation are additional factors by which AID algorithms are evaluated and compared.

2.14 AID RELATED WORK

In order to make traffic management systems effective, they must possess the ability to detect barriers to traffic flow. The AID system is one of the tools that can be used to detect these barriers. Incidents cause the majority of disruptions of freeway traffic flow rather than rush hour traffic [12]. As we mentioned many traffic parameters have been defined for the purpose of developing AID system such as volume, changing lanes, average speed and traffic density. Most automatic incident detection algorithms adopt these parameters slightly in order to achieve the desired result. In addition, many techniques and schemes were also invented based on video detection cameras, cellular phones and inductive loop detectors.

Traffic information such as occupancy between two adjacent detectors at upstream and downstream of the traffic flow were compared to detect incidents in California Algorithm [90]. We note that the California Algorithm is facing challenges in quickly detecting incidents in non-dense traffic cases because the occupancy change occurrence takes a long period of time. Picking appropriate traffic parameters raises a challenge for AID algorithm developers to reduce the incident detection delay, which is very important in transportation systems to make the right action at the right time. The NOTICE system [70] uses short-range wireless communications between sensors embedded in the roadway and passing vehicles to collect traffic-related data, as well as providing drivers with advance notification about potential incidents. NOTICE was developed for enhancing incident detection algorithms. The suspected

incident position p with an interested time interval I would be used as an input to improve incident believe.

The AUTOPIA system [92] uses similar V2I wireless communications to reduce congestion by determining the speed of vehicles and distance between them. In the AUTOPIA system, false alarm is raised easily by individual vehicle speed variation such as a truck or slow vehicle. In [93], Robert et al. proposed a vision-based technique. While today the video-based AIDs is a popular technique in ITS, they have difficulty in many situations such as shadows, snow, rain, fog, and glares[94]. The cell phone call incident detection has some issues such as minor incident event observers may not report. In [95], Alexander et al. also showed that the false alarm rate based on cellular phones is higher than 32%. an AID system with such a high ratio false alarm is really hard to be accepted in ITS. In [96], Zhen et al. showed that a large amount of traffic data availability increase the accuracy of those applications used to apply the data for different purposes.

CHAPTER 3

VEHICLE TO INFRASTRUCTURE COMMUNICATION

In this chapter, our main focus will be on constructing an analytical formula as well as simulation results for IEEE 802.11 standard. We will conduct an assessment for IEEE 802.11 standard for V2I communications for intelligent transportation systems. Specifically, we will consider a beaconing mechanism for establishing connection between passing vehicles and RSU's for traffic monitoring between which the probability of successful data exchange is evaluated. Analytical results together with results obtained from ns3 simulator are being compared. Our results show that IEEE 802.11 with its beaconing mechanism can be successfully used for V2I communications. We will begin by describing our simulation assumptions and specifications.

3.1 SCENARIO ASSUMPTIONS AND SPECIFICATIONS

In our study, we consider the V2I communication system shown in figure 14, in which it is assumed that vehicles are equipped with Event Data Recorders as mandated by the National Highway Transportation Safety Administration (NHTSA) [97]. These are expected to collect information about the vehicle dynamics and other required operating parameters related to vehicle mobility such as acceleration, deceleration, current lane, lane change position, and lane change time. The vehicles exchange this information with RSUs placed at regular intervals along the road for various purposes such as incident detection or traffic congestion notification.

We assume that RSUs are placed on opposite sides of the roadway for each traffic direction, and that they are connected by wire under the median. However, adjacent

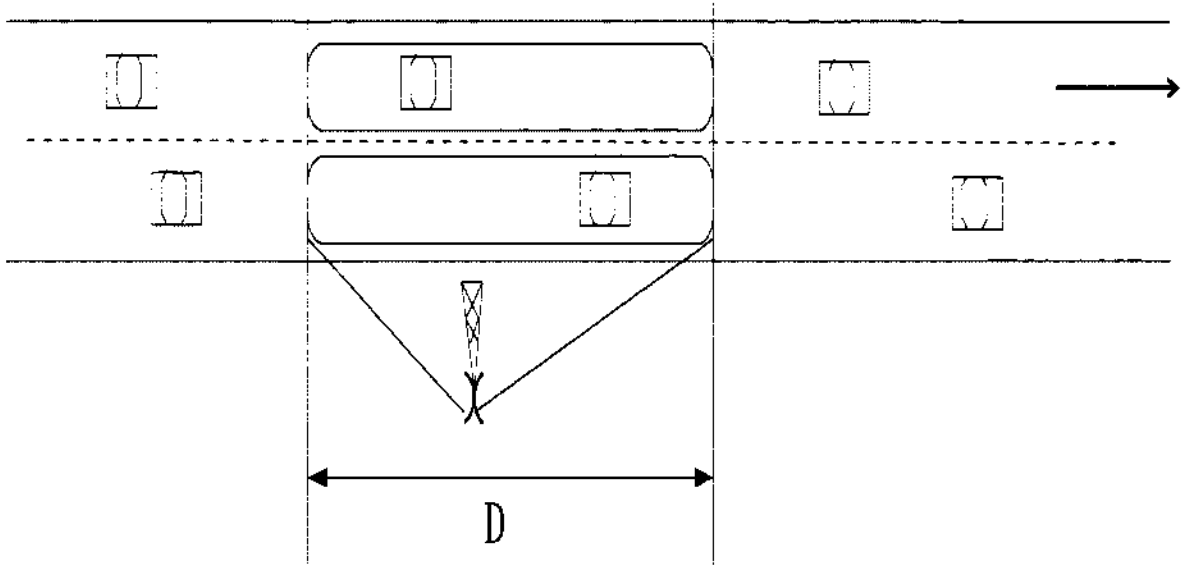

FIG. 22: Illustrating the radio coverage area for a RSU.

RSUs along the roadway are not connected with each other in order to reduce the overall infrastructure cost. We also assume that each RSU contains a GPS device (for time synchronization), a radio transceiver, and an embedded computing device that processes the data collected by passing vehicles to detect traffic-related events. As shown in figure 22, a given RSU has only a limited radio coverage area (of the order of tens of meters) much smaller than the distance between two consecutive RSUs, and vehicles can exchange information with the RSU only inside this coverage area.

3.2 IEEE 802.11 PROTOCOL FOR USING V2I COMMUNICATION

Several technologies can be used in WAVE (Wireless Access in Vehicular Environment) such as DSRC, Wi-Fi, Bluetooth, 3G, 4G LTE, and SDARS. Table 2 shows the capacity of these technologies and their usages in vehicular networks. To enable connection with passing vehicles, the RSUs use an IEEE 802.11 type networking

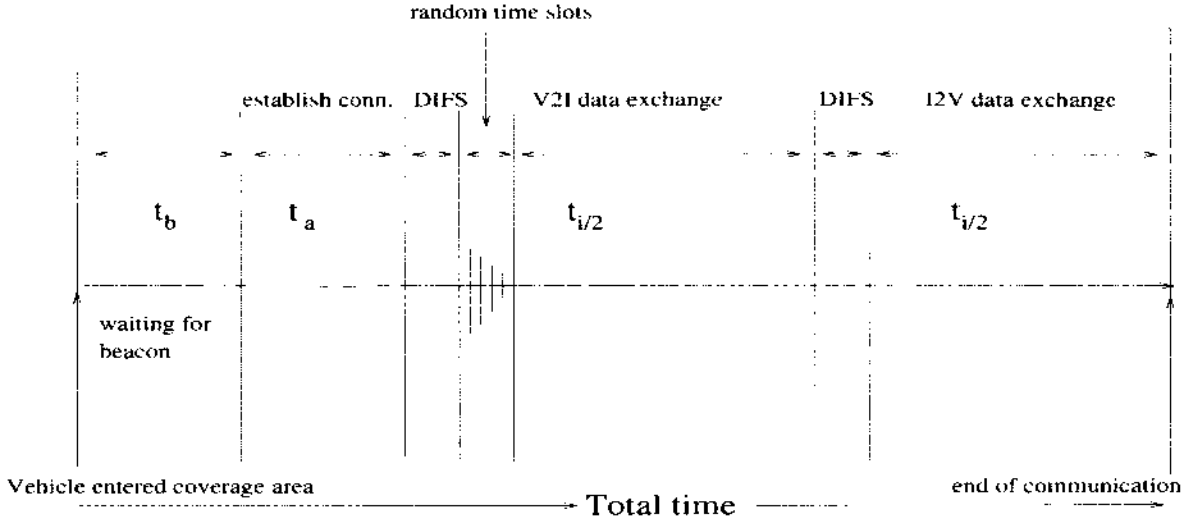

FIG. 23: Timing diagram for establishing connection and data exchange between a vehicle and a RSU using IEEE 802.11 based beaconing.

protocol, and they act as wireless access points to which passing vehicles will connect as mobile terminals when entering radio range. Connection is established using the IEEE 802.11 beaconing mechanism by which the wireless access point transmits beacon signals spaced at regular intervals of T_b seconds. When a vehicle enters the coverage area of the RSU and receives the beacon signal, a wireless link is established and information is exchanged between the vehicle and the RSU as shown in the timing diagram of figure 23. We note that, as the vehicles pass by the RSU, they will be inside the coverage area of the RSU only for a limited time, and we assume that the link between vehicle and RSU suffers no power outages during this period. This assumption implies that the signal power and the corresponding signal-to-interference plus noise ratio at the receiver are above given thresholds to ensure a specific bit error rate, and also that the shift in frequencies due to the Doppler effect is tracked and compensated.

Furthermore, we note that even when connection is established successfully between a passing vehicle and RSU, it is possible that not all traffic information is exchanged as the vehicle may travel outside the RSU coverage area before the traffic

data is completed. Our goal in this section is to provide an analytical evaluation of the probability of successful information exchange between a passing vehicle and a RSU under the assumption that the vehicles randomly get under the RSU coverage area.

TABLE 2: Comparison of wireless communication technologies(from [2])

	DSRC	Wi-Fi	Bluetooth	3G	4G LTE	SDARS
Range	Hundreds of meters	Hundreds of meters	Up to 100 meters	Tens of kilometers	Tens of meters up to 100 km	Countrywide
End-to-end message delay	10 ms	10 ms	10 ms	From 50 to hundreds of milliseconds	Tens of milliseconds	10-20 seconds
V2V local broadcast	yes	yes	Impractical	With a server	With a server	No
V2V multihop messaging	yes	yes	Impractical	With a Server	With a server	No
I2V local broadcast	yes	yes	Impractical	Not offered by all network operators	Not offered by all network operators	Yes
V2I bidirectional	yes	yes	Impractical	Yes	Yes	No

3.3 ANALYTICAL FORMULA

Based on our model, the probability of receiving any arbitrary beacon at time instant t_b is constant within the interval $[0, T_b]$, which implies that t_b is uniformly distributed within the beaconing interval $[0, T_b]$. Therefore, the probability distribution function that governs the events occurring within such time interval is uniform. This is due to the fact that when a beacon is broadcasted under the coverage area, any vehicle moving thereunder may receive the beacon regardless of the time instant it might have entered the coverage area. Let I_{\max} be the maximum amount of traffic information exchanged between the passing vehicle and the RSU with data rate R . The distance traveled by the vehicle while exchanging the I_{\max} amount of information with RSU denoted by d_i can be calculated as follows:

$$d_i = v \frac{I_{\max}}{R} = vt_i \quad \text{and} \quad d_b = t_b v \quad (1)$$

where v is the vehicle speed and d_b is the distance traveled by the vehicle up to receiving the first beacon. Also, since R is the data rate (byte/sec) so I_{max}/R has unit time. Using the timing diagram in figure 23, we can calculate the total distance travelled by the vehicle:

$$d_e = d_b + d_a + (2 \text{ DIFS} + t_a)v \quad (2)$$

where t_a is the period of time the vehicle needs to associate and establish the connection with RSU, and DIFS is a distributed inter-frame space in IEEE 802.11 standard time line for DCF Medium Access.

From the classical formula of velocity from classical mechanics $v = d/t$ which yields $t = d/v$, by dividing both sides of the above equation by v we can calculate the total time needed for the vehicle to establish the connection and exchange information which is the time lapse during which the vehicle completes its total distance d_e :

$$t_e = t_b + t_i + t_a + 2 \text{ DIFS} \quad (3)$$

The distributed inter-frame space is the time delay between the time when the connection has been established and the time the RSU starts to send data. Likewise, before receiving the data, the RSU slacken (back off) for the same short period of one DIFS. Therefore, we have added double DIFS to the whole total time period.

3.3.1 PROBABILITY ANALYSIS

We now turn to our major goal of this section which is to derive a formula to calculate the probability of successful data exchange and connection establishment between the vehicle and the RSU. To achieve this goal, we have conducted the same methodology conducted in [71]. As we mentioned above, the probability distribution

function (PDF) that governs the whole situation is uniform distribution. The random variable that the PDF takes as an argument is d_e which must be less than or equal to the diameter (D) of the geometrical shape covered by the RSU along the hypothetical highway to successfully exchange the information. Accordingly, probability of successful data exchange and connection establishment between the vehicle and the RSU is given by:

$$P_s = \text{Prob}[d_e \leq D] \quad (4)$$

In order to give a clear description of the above formula, we recall the basics of the probability theory and formal definition of probability distribution function. Accordingly, the above function P_s that seems to be implicitly defined, yields the probability of successful data exchange and connection establishment at any time t_e corresponding to the total distance d_e passed by the vehicle. This gives the likelihood for the random variable d_e to take on a certain value. This likelihood is constant as we mentioned earlier based on our presumed model since the PDF is uniform distribution. However, our goal is to calculate the probability within a certain range. This can be calculated using the integral of the variable's function over that range. In probability theory, the integration of the PDF within a variable range is another function that takes on a different argument. Such function is called Cumulative Distribution Function, abbreviated to CDF.

In order to extract a formula for the CDF, we have to obtain an explicit formula for the PDF and then subject it to integral. This will be the main subject of the following subsection which is completed for several cases depending on the range within which the extreme points of the time interval fall.

3.3.2 CONSTRUCTION OF CDF

When a CDF takes on a value as its argument, that numerical value corresponds to

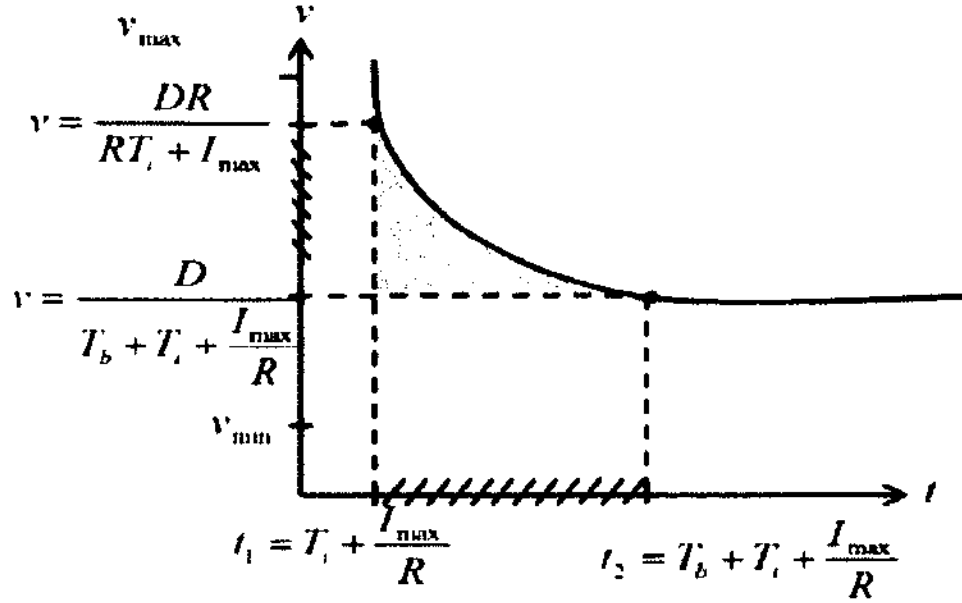

FIG. 24: The integration region for obtaining the CDF of D_e

the maximum boundary point of the range that the random variable of its underlying PDF takes. As the CDF is the integral of the PDF, the value that the CDF takes on is geometrically the area under the curve of the PDF covered by the certain range. In order to determine the cumulative distribution function of random variable d_e , we will have to find a formula for it. We denote our CDF by $F_{D_e}(d_e)$. The random variable d_e depends on both time t_e and the velocity of the vehicle v as we explained earlier in this section. So for the sake of convenience, we use the functions of both t_e and v which are $f_{t_e}(t_e)$ and $f_v(v)$ respectively. The CDF is thus given by:

$$F_{D_e}(d_e) = \iint_{\mathcal{D}} f_{t_e}(t_e) f_v(v) dt_e dv \quad (5)$$

where \mathcal{D} is the region in which d_e is defined. Figure 24 shows the integration area \mathcal{D} in a typical case. The curve shows the classical equation of $v = \frac{D}{t}$ together the boundary points which we later use in constructing our formula for the CDF using

double integration. The locations of the boundary points in each of the following cases vary depending on the motion of the vehicle. Let

$$T_i = T_a + 2DIFS \quad (6)$$

where T_a is the period of time which the vehicle needs to establish the connection with roadside units. T_b is the maximum period of time which the vehicle waits to receive a beacon. The waiting time period for receiving the first beacon when the vehicle gets under the RSU coverage area is bounded by 0 and T_b . Therefore, The time for successful data exchange between RSU and vehicle is bounded by $0 + T_i + \frac{I_{\max}}{R}$ and $T_b + T_i + \frac{I_{\max}}{R}$. As we mentioned, D is distance the vehicle passes within RSU coverage area. Therefore, we can bound the vehicle speed for successful data exchange between vehicle and RSU under RSU coverage area by $\frac{D}{T_b + T_i + I_{\max}/R}$ and $\frac{DR}{RT_i + I_{\max}}$. We can apply traditional rules of inequalities in math. to conclude that $\frac{D}{T_b + T_i + I_{\max}/R}$ is always smaller than $\frac{DR}{RT_i + I_{\max}}$. Since R is the data rate, in our case it is equal to 8 Kbps. So

$$RT_i \leq RT_i \quad (7)$$

and $T_b > 0$ which implies that

$$T_b + T_i + \frac{I_{\max}}{R} > T_i + \frac{I_{\max}}{R} \quad (8)$$

which gives

$$\frac{1}{T_b + T_i + \frac{I_{\max}}{R}} < \frac{1}{T_i + \frac{I_{\max}}{R}} \quad (9)$$

Multiplying both sides by D , yields

$$\frac{D}{T_b + T_i + \frac{I_{\max}}{R}} < \frac{DR}{RT_i + \frac{I_{\max}}{R}} \quad (10)$$

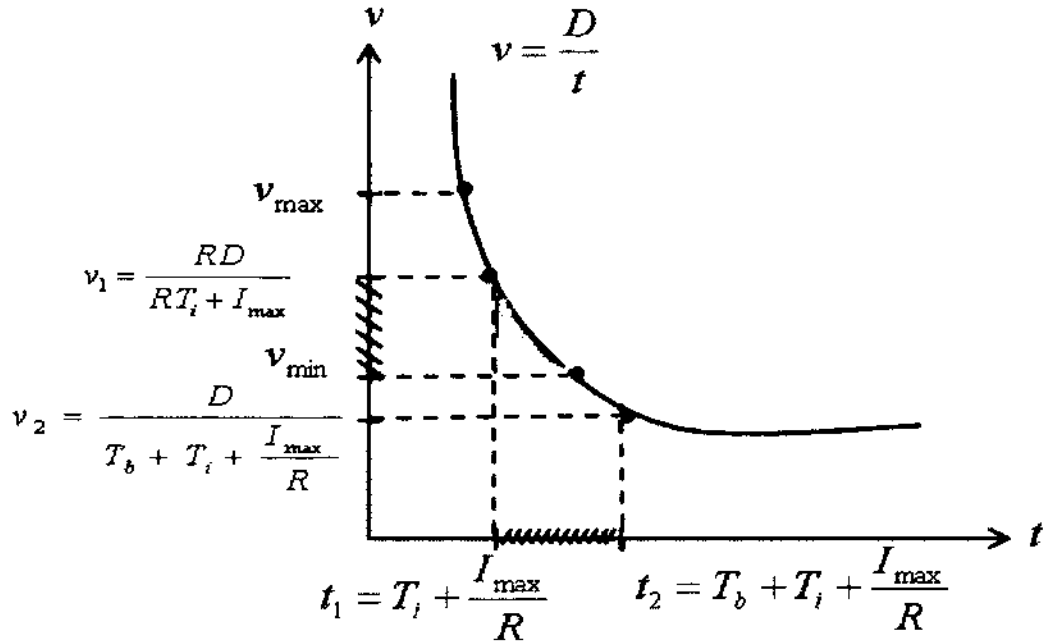

FIG. 25: The integration region for obtaining the DCF of D_e in case 2

Then, following [71] the CDF of d_e is obtained as:

Case 1: For $\frac{D}{T_b + T_i + \frac{I_{\max}}{R}} < \frac{DR}{RT_i + I_{\max}} < V_{\min} < V_{\max}$

This case does not arise in our model as we have set V_{\min} to be the average minimum speed that each vehicle attains while passing through the coverage area.

Therefore we would have:

$$F_{D_e}(D) = 0 \quad (11)$$

by the DCF definition.

Case 2: For $\frac{D}{T_b + T_i + \frac{I_{\max}}{R}} < V_{\min} < \frac{DR}{RT_i + I_{\max}} < V_{\max}$

The subject enclosed area that we are going to calculate is shown in figure 25. We apply equation 5. so we can calculate the highlighted area which is the probability of success.

$$\begin{aligned}
F_{D_\epsilon}(d_\epsilon) &= \iint_{\mathcal{D}} f_{t_\epsilon}(t_\epsilon) f_v(v) dt_\epsilon dv \\
&= \frac{1}{T_b(v_{\max} - v_{\min})} \iint_{\mathcal{D}} dt_\epsilon dv \\
&= \frac{1}{T_b(v_{\max} - v_{\min})} \int_{v_{\min}}^{RT_i + I_{\max}} \int_{T_i - \frac{I_{\max}}{R}}^{\frac{D}{v}} dt_\epsilon dv \\
&= \frac{1}{T_b(v_{\max} - v_{\min})} \int_{v_{\min}}^{RT_i + I_{\max}} t \Big|_{T_i + \frac{I_{\max}}{R}}^{\frac{D}{v}} dv \\
&= \frac{1}{T_b(v_{\max} - v_{\min})} \int_{v_{\min}}^{RT_i + I_{\max}} \left(\frac{D}{v} - \left(T_i + \frac{I_{\max}}{R} \right) \right) dv \\
&= \frac{1}{T_b(v_{\max} - v_{\min})} \left(D \ln v - \left(T_i + \frac{I_{\max}}{R} \right) v \right) \Big|_{v_{\min}}^{RT_i + I_{\max}}
\end{aligned}$$

hence,

$$F_{D_\epsilon}(D) = \frac{1}{T_b(V_{\max} - V_{\min})} \left(D \ln \frac{D}{T_i * V_{\min}} - D + T_i V_{\min} \right) \quad (12)$$

We can calculate the CDF $F_{D_\epsilon}(D)$ is the same for all other cases as in the following. In the rest of the cases, the locations of the boundary points will change and thus the limits of the double integration accordingly.

Case 3: For

$$V_{\min} < \frac{D}{T_b + T_i + \frac{I_{\max}}{R}} < \frac{DR}{RT_i + I_{\max}} < V_{\max}$$

$$\begin{aligned}
F_{D_\epsilon}(d_\epsilon) &= \iint_{\mathcal{D}} f_{t_\epsilon}(t_\epsilon) f_v(v) dt_\epsilon dv \\
&= \frac{1}{T_b(v_{\max} - v_{\min})} \iint_{\mathcal{D}} dt_\epsilon dv
\end{aligned}$$

$$\begin{aligned}
&= \frac{1}{T_b(v_{\max} - v_{\min})} \int_{\frac{DR}{T_b + T_i + \frac{I_{\max}}{R}}}^{\frac{DR}{RT_i + I_{\max}}} \int_{T_i + \frac{I_{\max}}{R}}^{\frac{D}{v}} dt_e dv \\
&= \frac{1}{T_b(v_{\max} - v_{\min})} \int_{\frac{DR}{T_b + T_i + \frac{I_{\max}}{R}}}^{\frac{DR}{RT_i + I_{\max}}} t \left[\frac{D}{v} \right]_{T_i + \frac{I_{\max}}{R}} dv \\
&= \frac{1}{T_b(v_{\max} - v_{\min})} \int_{v_{\min}}^{\frac{DR}{T_i + I_{\max}}} \left(\frac{D}{v} - \left(T_i + \frac{I_{\max}}{R} \right) \right) dv \\
&= \frac{1}{T_b(v_{\max} - v_{\min})} \left(D \ln v - \left(T_i + \frac{I_{\max}}{R} \right) v \right) \Big|_{\frac{DR}{T_b + T_i + \frac{I_{\max}}{R}}}^{\frac{DR}{RT_i + I_{\max}}}
\end{aligned}$$

we get:

$$\begin{aligned}
F_{D_e}(D) &= \frac{1}{T_b(V_{\max} - V_{\min})} \times \left(D \ln \frac{T_b + T_i}{T_i} - D + \right. \\
&\quad \left. + \frac{T_i D}{T_b + T_i} + \frac{T_b D}{T_b + T_i} - T_b V_{\min} \right) \tag{13}
\end{aligned}$$

Case 4: For $\frac{D}{T_b + T_i + \frac{I_{\max}}{R}} < V_{\min} < V_{\max} < \frac{DR}{RT_i + I_{\max}}$

$$\begin{aligned}
F_{D_e}(d_e) &= \iint_{\mathcal{D}} f_{t_e}(t_e) f_v(v) dt_e dv \\
&= \frac{1}{T_b(v_{\max} - v_{\min})} \iint_{\mathcal{D}} dt_e dv \\
&= \frac{1}{T_b(v_{\max} - v_{\min})} \int_{v_{\min}}^{v_{\max}} \int_{T_i + \frac{I_{\max}}{R}}^{\frac{D}{v}} dt_e dv \\
&= \frac{1}{T_b(v_{\max} - v_{\min})} \int_{v_{\min}}^{v_{\max}} t \left[\frac{D}{v} \right]_{T_i + \frac{I_{\max}}{R}} dv \\
&= \frac{1}{T_b(v_{\max} - v_{\min})} \int_{v_{\min}}^{v_{\max}} \left(\frac{D}{v} - \left(T_i + \frac{I_{\max}}{R} \right) \right) dv \\
&= \frac{1}{T_b(v_{\max} - v_{\min})} \left(D \ln v - \left(T_i + \frac{I_{\max}}{R} \right) v \right) \Big|_{v_{\min}}^{v_{\max}}
\end{aligned}$$

we get:

$$F_{D_e}(D) = \frac{1}{T_b(V_{\max} - V_{\min})} \left(D \ln \frac{V_{\max}}{V_{\min}} - T_i V_{\max} + T_i V_{\min} \right) \quad (14)$$

Case 5: For $V_{\min} < \frac{D}{T_b + T_i + \frac{I_{\max}}{R}} < V_{\max} < \frac{DR}{RT_i + I_{\max}}$

$$\begin{aligned} F_{D_e}(d_e) &= \iint_{\mathcal{D}} f_{t_e}(t_e) f_v(v) dt_e dv \\ &= \frac{1}{T_b(v_{\max} - v_{\min})} \iint_{\mathcal{D}} dt_e dv \\ &= \frac{1}{T_b(v_{\max} - v_{\min})} \int_{\frac{D}{T_b + T_i + \frac{I_{\max}}{R}}}^{v_{\max}} \int_{T_i + \frac{I_{\max}}{R}}^{\frac{D}{v}} dt_e dv \\ &= \frac{1}{T_b(v_{\max} - v_{\min})} \int_{\frac{D}{T_b + T_i + \frac{I_{\max}}{R}}}^{v_{\max}} t \Big|_{T_i + \frac{I_{\max}}{R}}^{\frac{D}{v}} dv \\ &= \frac{1}{T_b(v_{\max} - v_{\min})} \int_{v_{\min}}^{v_{\max}} \left(\frac{D}{v} - \left(T_i + \frac{I_{\max}}{R} \right) \right) dv \\ &= \frac{1}{T_b(v_{\max} - v_{\min})} \left(D \ln v - \left(T_i + \frac{I_{\max}}{R} \right) v \right) \Big|_{\frac{D}{T_b + T_i + \frac{I_{\max}}{R}}}^{v_{\max}} \end{aligned}$$

we get:

$$\begin{aligned} F_{D_e}(D) &= \frac{1}{T_b(V_{\max} - V_{\min})} \times \left(D \ln \frac{V_{\max}(T_b + T_i)}{D} - \right. \\ &\quad \left. - T_i V_{\max} + \frac{T_i D}{T_b + T_i} + \frac{T_b D}{T_b + T_i} - V_{\min} T_b \right) \quad (15) \end{aligned}$$

Case 6: For $V_{\min} < V_{\max} < \frac{D}{T_b + T_i + \frac{I_{\max}}{R}} < \frac{DR}{RT_i + I_{\max}}$

This case is beyond the scope of our probability calculations as no speed should go over V_{\max} . Even if we consider the real world system, if a vehicle goes over the speed limit when there is an incident ahead, despite being rear, it does not give out any information regarding the impact of the incident on the speed of the rest of the

other vehicles moving with normal speed. Therefore, in this case, there is no need to calculate the probability as our main objective is to detect incidence.

The six cases outlined above enable us to calculate the probability of successful data exchange between a vehicle and a RSU for different values of D , I_{max} , T_b , v_{avg} , and R .

3.4 SIMULATION SCENARIO DESCRIPTION

To corroborate the analytical approach and expressions presented in the previous section, we used the ns3 simulator to model the information exchange between a RSU and vehicles passing by it when IEEE 802.11 protocol is used to establish the wireless link and to numerically evaluate the probability of successful information exchange between passing vehicles and RSU. A total number of 1,000 simulations were performed and the coverage area of the RSU was set to $D = 28$ m in order to be consistent with the short coverage areas of the IEEE 802.11 standard for enabling successful authentication, establishing connection, and information exchange between a passing vehicle and a RSU. Similar to [71], we have a list of assumptions stated below:

- We assumed that non-overlapping channels are assigned to each lane in order to avoid interference with vehicles in adjacent lanes, but Daniel et al. studied general approach for only one lane.
- We assumed that RSUs use Distributed Coordination Function (DCF) based on Carrier Sense Multiple Access with Collision Avoidance as required by the IEEE 802.11 standard medium access mechanism.
- The RSU broadcasts beacon frames periodically, such that, when a vehicle enters the RSU coverage area and receives the beacon frame, it will attempt to establish the connection and exchange information with the RSU.

- We assumed that the RSU channel will not be released until the vehicle completes the information exchange or travels outside the RSU radio range.

Thus, successful information exchange depends on:

- the time the vehicle remains in the RSU coverage area, which depends on the actual speed of the vehicle:
- the waiting time for receiving the first beacon frame, which depends on time interval between beacons:
- the amount of information that is exchanged between the vehicle and RSU:
- the data rate at which the RSU communicates with the vehicle.

In our simulations, we set the length of the time interval between two consecutive beacons t_b to start from 0.1 s up to 1.1 s, and we note that because vehicles enter the RSU coverage area at random instances, they will receive the first beacon after a random time interval which is less than or equal to the beaconing interval length. After the vehicle receives the first beacon, the vehicle will establish the connection with the RSU, and information exchange takes place after the vehicle gains access to the communications medium. We also set a maximum amount $I_{\max} = 8$ kb, which is more than an order of magnitude higher than the maximum information value chosen in [98]. The vehicle first uploads its information to the RSU and then downloads the RSU information intended for it. As shown in figure 23, the total time to complete the information exchange between vehicle and RSU t_e - consists of t_b (initial delay waiting for beacon) plus the information exchange time t_i (delay busy period). Let d_b be the distance the vehicle drives through to receive the first beacon from RSU and d_i be the distance the vehicle drives while exchanging traffic information, such that the total distance traveled by the vehicle while completing the information exchange is $d_e = d_b + d_a + d_i$. In our simulations, we account for a successful information

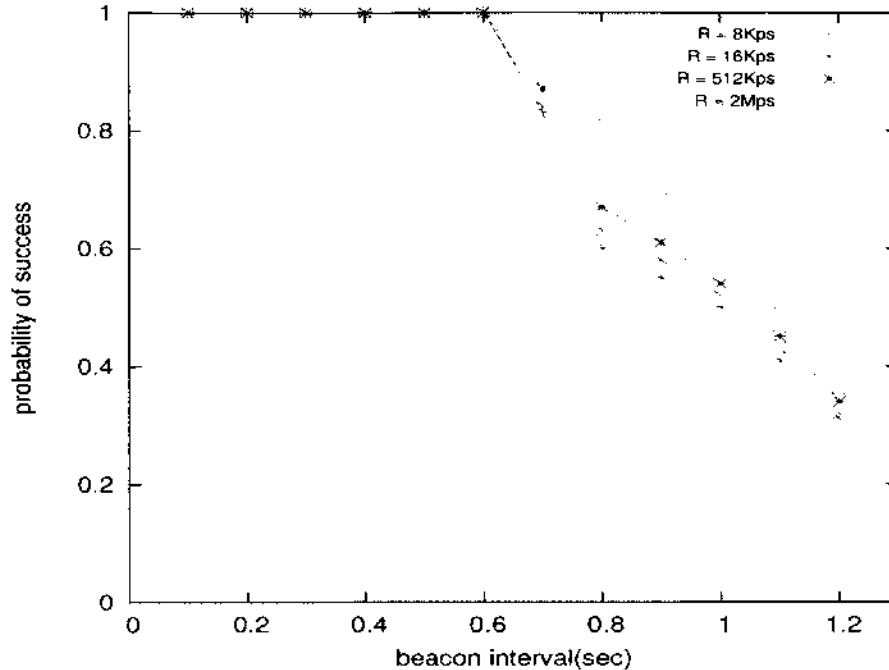

FIG. 26: Probability of successful data exchange as a function of the beaconing interval for average vehicle speed $v_{avg} = 70$ mph.

exchange each time $d_e < D$ which is equivalent to $t_e = t_b + t_a + t_i \leq \frac{D}{v}$ where $\frac{D}{v}$ is actual time the vehicle needs to drive through the RSU coverage area. This is based on a fact from physics that velocity is the distance per unit time t , i.e $v = \frac{D}{t}$ which implies that $t = \frac{D}{v}$.

In order to ensure more efficient use of the wireless link, we did not consider in the simulations the Distributed Inter Frame Space (DIFS) and randomly selected slots of time back-off in DCF mechanism. We note that, in IEEE 802.11 standard with DCF, even when the media is idle, the access point waits for a DIFS period which is not randomly selected by the station. Since we assume that only one vehicle communicates with the RSU on a given channel, random back-off time period was set to zero in our scenario.

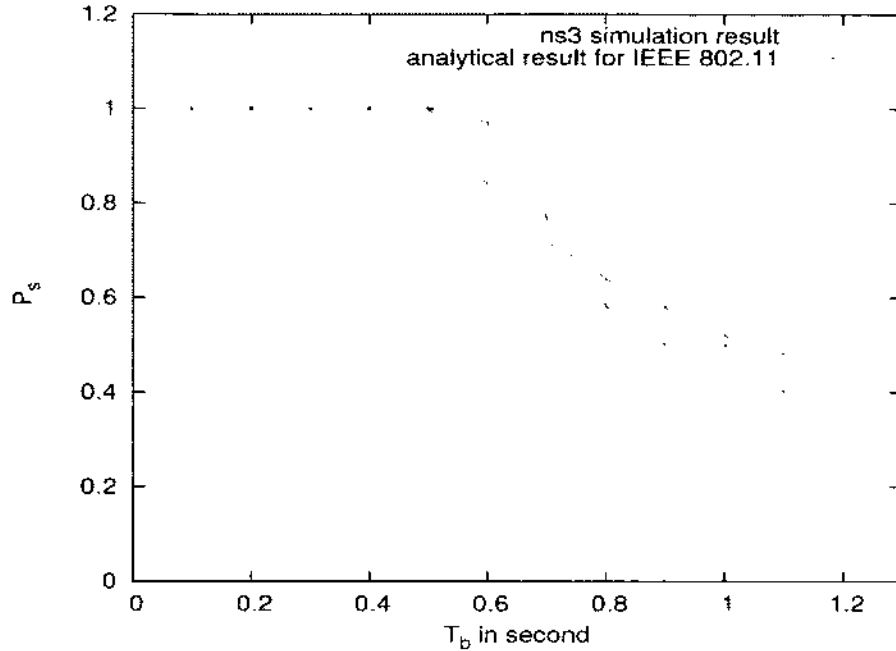

FIG. 27: Probability of successful data exchange as a function of the beaoning interval for average vehicle speed $v_{avg} = 70$ mph.

3.5 NUMERICAL RESULTS AND DISCUSSION

A typical experiment of our simulation using **ns3** has been plotted in figure 26. It shows the probability of successful data exchange P_s as function of different beaoning intervals tested for different data rates R . It is obvious that at the beginning the beaoning intervals are too small which make the success one hundred percent. This is due to the fact that with such small intervals, the vehicle would have ample opportunity to receive the beacon and start a successful data exchange with the issuing RSU regardless of the amount of data rate R . As the beaoning interval gets wider from 0.6 and above, we notice that the probability of successful data exchange decreases depending on the amount of data rate. The amount of data rate plays a positive role in increasing the probability of success until it gets capped by much wider beaoning intervals at around 1.2. From this point, the probability of success

declines regardless of the amount of the data rate. The real world interpretation for this phenomena is that long beaconing intervals do not leave enough room for the vehicles to successfully receive beacons and hence increases the likelihood of data exchange failure.

We now come to comparison of our numerical results with that of IEEE 802.11. Figure 27 shows the probability of successful information exchange between a vehicle and RSU versus different beaconing intervals having the average speed fixed at 70 mph. It shows how the probability of successful connection varies when the beaconing interval is increased from 0.1 s to 1.2 s. We note that our results are pretty close to those of IEEE 802.11. This comparison between our numerical results and the analytical ones of IEEE 802.11 makes us believe that our simulation scenario is pretty close to real world system. We also note that, as expected, as the beaconing interval increases, the probability of successful information exchange decreases as more time is spent waiting for the beacon after the vehicle enters the RSU radio range, leaving less time available for the actual information exchange. Thus, it is important to set the beaconing interval at a suitable value, as decreasing the beaconing interval (that is increasing the number of beacons) will consume available bandwidth, while increasing the beacon interval (lowering the number of beacons) creates long periods of dead air which reduces the probability of successful information exchange. We note that an alternative approach may be to use active scanning by which the vehicle sends probe requests instead of waiting to receive a beacon from the RSU. We note that in IEEE 802.11 standard, in active scanning mode, the vehicle would send probe request frames over all 11 channels, which will either render all channels busy or cause interference in the channels which are already assigned to vehicles in adjacent lanes.

On the other hand, the speed of the vehicle is another important factor to be considered. We have conducted an independent experiment by changing the vehicle's

speed and then extracting the corresponding probability of success for different data rates having fixed the beaconing interval at 700 ms. The plotted data is shown in 28.

It is obvious from the figure that at the beginning the vehicle is too slow which makes the success one hundred percent. This is due to the fact that with such low speeds, the vehicle would stay longer under the coverage area and have ample opportunity to receive the beacon and start a successful data exchange with the issuing RSU regardless of the amount of data rate. As the vehicle moves faster above 60 mph, we notice that the probability of successful data exchange decreases depending on the amount of data rate. Again in such circumstances, the amount of data rate plays a positive role in increasing the probability of success until it gets capped by high speed at around 85 mph. From this point, the probability of success declines regardless of the amount of the data rate. The real world interpretation for this phenomena is that at high speeds, the vehicle will not have enough opportunity to successfully receive beacons, which increases the likelihood of data exchange failure.

Likewise, we have compared our numerical results obtained from **ns3** simulator, to the analytical results of IEEE 802.11. We have tested the vehicle speed versus probability of information exchange having fixed the beaconing interval and data rates at 700 ms and 8 Kbps respectively. We have plotted our results in figure 28.

In Figure 29, we show how the probability of successful connection varies when the average vehicle speed varies from 45 to 85 mph for a beaconing interval $T_b = 700$ ms. In this case as well, we observe closeness between analytical and simulated results for speeds up to 70 mph, after which the total number of simulations should be increased to observe performance similar to the analytical values. Average speeds above 70 mph imply many more unsuccessful information exchange attempts between vehicles and RSU. As expected, the higher the vehicle speed, the lower the probability

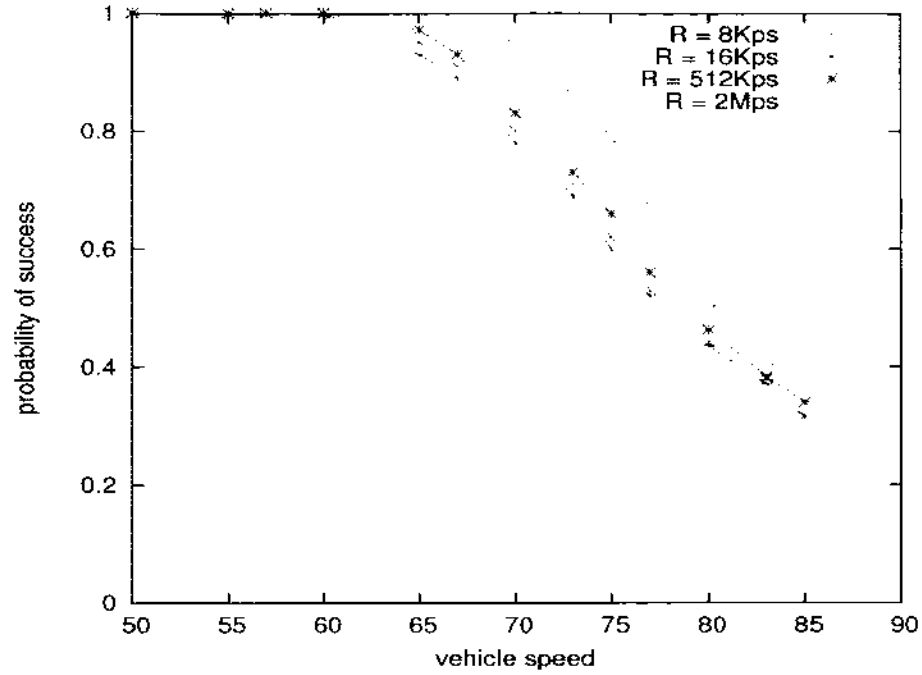

FIG. 28: Probability of successful data exchange as a function of data rate for vehicle speed interval 50 – 85 mph for beaconing interval 700 ms

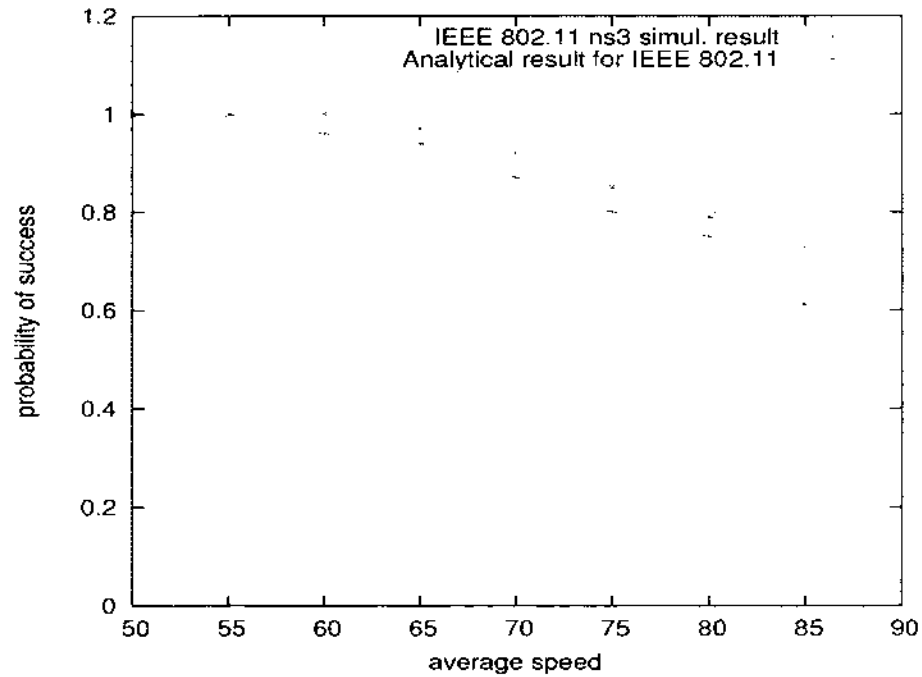

FIG. 29: Probability of successful data exchange as a function of the average vehicle speed for beacon interval $T_b = 700$ ms and data 8 kbps.

of successful information exchange since vehicles will travel through the RSU coverage area faster. However, at 70 mph, which is the speed limit posted on most highways in the US, the probability of successful information exchange is quite high. Table 3 shows the default and our simulation parameter values. The IEEE 802.11 standard assessment shows the feasibility of IEEE 802.11 standard for vehicle-to-infrastructure communication.

TABLE 3: Default and simulation parameter values

Parameters	Default value	Simulation value
RxPowerThreshold	0.1 dBm	0.1 dBm
rss	-80 dBm	-80 dBm
cRange	-100 m	14 m
tpower	0.9 dBm	0.9 dBm
txGain	0.2 dB	0.2 dB
rxGain	0.2 dB	0.2 dB
datarate	2 Mbps	8Kbps

Table 3 shows those parameters used in ns-3 simulator which is our preferred tool for this methodology. The default values of the parameters in the above table are used for Wireless LAN while we have configured it to fit our own purpose for only two parameters. ns-3 is the most popular network simulation tool used by educational institutes and software organizations. We believe that the use of this tool is very potential in our work and as well in extracting our numerical results. Through ns-3 we have implemented RSUs and the vehicles. We set the coverage range to 14 meters and data rate to 8 kbps to study the probability of success data exchange in a shortest radio range with lowest speed data rate to create a similar scenario as in [71]. We published this work in IEEE GLOBECOM conference on Dec. 2013 [99].

For the purpose of increasing the number of vehicles aware of the RSUs and the probability of successful data exchange, each lane is assigned to partial or no overlapping channels to avoid collision between adjacent lanes. omnet++ was used to see the feasibility of our assumption. Figure 30 gives the clear picture of the

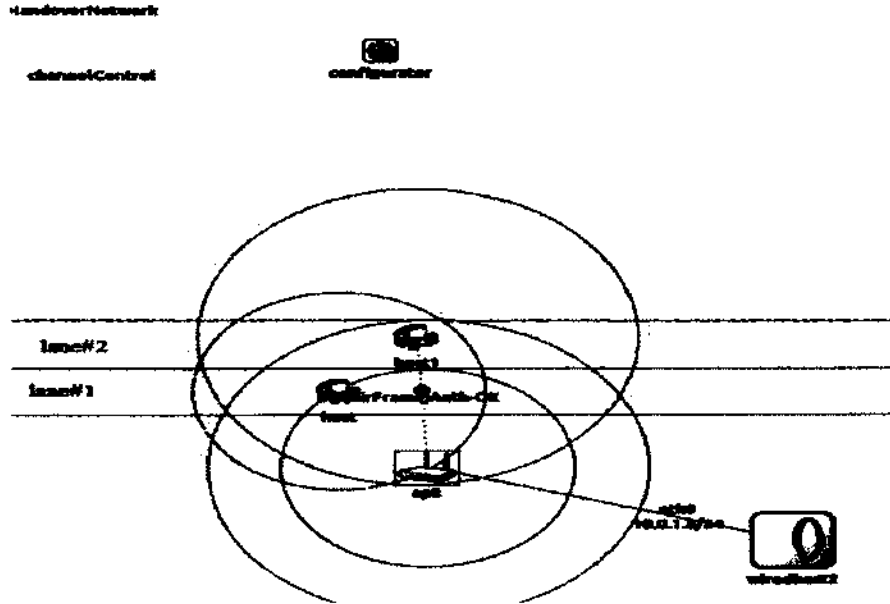

FIG. 30: Assigned each lane with different channel

scenario events. In our scenario, two vehicles on two adjacent lanes randomly generate packets, and they send them to the RSUs through the assigned channel for their lane. Two regular access points are set very close to each other represent a RSU. Figure 30 is the omnet++ simulation graphic interface for our scenario assumption. Table 3 shows the simulation scenario channel parameters. Below is the omnet++ simulation AP1 and AP2 scalars for our assumption from result General-0.sca file in the omnet++ simulation project result directory. The number of collisions is zero for both APs. This implies that we get same probability of successful data exchange between vehicles in different lanes and RSU as in figure 30.

3.6 SUMMARY

In this chapter, we assessed the IEEE 802.11 standard with DCF for V2I communication and information exchange. We presented an analytical approach for calculating the probability of successful information exchange between vehicles and RSUs, and corroborated the analysis with numerical results obtained from simulations. We observed that a suitable beaconing interval has an important role in increasing the probability of successful information exchange in the considered V2I communications system, and that the results from our analysis indicate that IEEE 802.11 standard with its beaconing mechanism is suitable for information exchange in V2I communications.

CHAPTER 4

INCIDENT DETECTION

The ability of detecting an incident and its position is important in traffic management systems to take the proper action at the right time. Current methods for automatic incident detection are not void of defects as they yield high percentages of false alarms. Minimizing the number of such false alarms is currently the main concern of research in the area. According to a study conducted in [100], Parkany et al. have shown that incident detection alarms were disabled at many traffic management centers because of high rates of false alarms. This creates challenges for the researchers to develop an automatic incident detection system with a lower rate of false alarms. The traffic parameters such as volume, number of changing lanes, average speed and density have been used by developers in their automatic incident detection applications. Also, many techniques and schemes were invented based on video detection cameras, cellular phones and inductive loop detectors. Most automatic incident detection algorithms adopt these parameters slightly in order to achieve the desired result. Today, Automatic Incident Detection is one of the top research topics after smart devices were built in vehicles and roads to provide road safety. These smart devices enable vehicles to communicate with each other and roadside units as well. Many traffic parameters and methods were developed and defined to detect incidents on the roads and alert drivers in advance to avoid congestion [101].

4.1 SYSTEM MODEL AND PROBLEM STATEMENT

The system proposed for AID in our work uses V2I communications between passing vehicles and RSUs placed at regular intervals on the highway as shown in

figure 14. It is assumed that vehicles are equipped with Event Data Recorders, as mandated by the National Highway Transportation Safety Administration (NHTSA) [102], which are expected to collect information about the vehicle dynamics and other required operating parameters related to vehicle mobility such as acceleration, deceleration, a current lane, lane change positions, and the lane change time. The vehicles exchange this information with RSUs placed at regular intervals along the road for various purposes which include AID and traffic congestion notification. This system for V2I communication has been studied in [71, 103] and has been suitable for rapid information exchange between vehicles traveling at highway speeds and RSUs.

In this framework, our goal is to define and aggregate relevant traffic parameters at RSUs to establish new AID techniques. Specifically, we consider the average lane changing distance and average changing speed, and we study the variation of these parameters in both incident and non-incident conditions. We also state formal AID algorithms based on these parameters that issue alerts to drivers about incidents, and we illustrate the proposed algorithms with numerical results obtained from simulations.

4.2 CHANGING LANE DISTANCE (CLD) METHOD

In this method, the RSU processes the information collected from vehicles related to the coordinates of the vehicle as it changes lanes, illustrated schematically in figure 31. The RSU then calculates the distance each vehicle needs to change the lane to be used later in the incident detection algorithm. In reality, observing lane change within a short distance suggests the occurrence of an incidence.

Let **A** and **B** be two vehicles, and assume that vehicle **A** moves from lane 1 to lane 2 to pass vehicle **B** as shown in figure 31. If vehicle **B** is involved in an incident and/or traffic slowdown, the move of vehicle **A** from one lane to the other occurs usually when the two vehicles are closer to each other. In other words, the distance

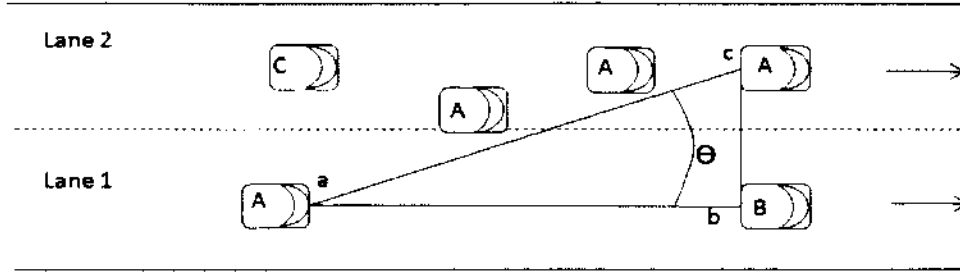

FIG. 31: Schematic descrip. of params associated with changing lane variation.

between “a” and “b” is shorter when incidents are present rather than having normal traffic flow. From analyzing the triangle “abc”, where “c” is the point on lane 2 where vehicle **A** passes **B**, one can estimate the length $|ab|$ of “ab” segment corresponding to the distance vehicle **A** needs for changing lanes. This distance depends on the angle θ and the distance $|bc|$ between “c” and “b” as

$$\tan \theta = \frac{|bc|}{|ab|} \quad (16)$$

Now $|ab|$ can be easily calculated by knowing θ (which the vehicle provides the RSU with) and $|bc|$, which must be almost the width of the lane (typically 3.5 meters). The value of θ depends on the driver’s behavior and should be large enough to allow vehicle **A** to change lanes safely without hindering and/or colliding with the vehicle in the other lane **C** or the vehicle **B** involved in the slowdown.

For each vehicle $\mathbf{A} \in A$, where A is the set of all vehicles that successfully uploaded their lane change information to the RSU, let B_a be the set of all ordered pairs (d_a, t_a) where d_a is the distance and t_a is the time that vehicle **A** needs for changing lanes. The RSU then calculates the average distance and time μ_{d_a}, μ_{t_a} for

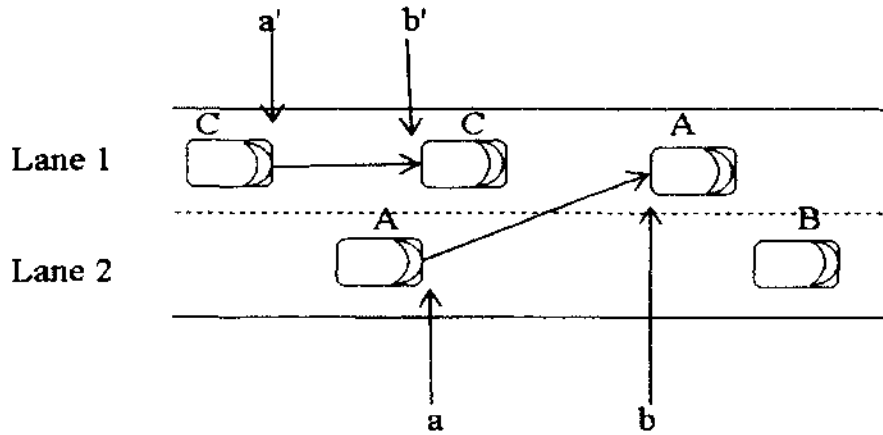

FIG. 32: Schematic description of parameters associated with speed variation for changing lanes.

all ordered pairs. If the average ordered pair (μ_{d_a}, μ_{t_a}) lies within a certain predefined critical region, namely R_d , the RSU will increase its belief that an incident is present. This process is repeated by the RSU periodically with a constant time in between each repetition which depends on the speed limit of the roadway. The proposed incident detection procedure, formally stated as Algorithm 1 is then applied on filtered and restructured traffic collected data, by discarding any irrelevant data. Synchronization is also performed between the current time and the time needed for the filtering process.

Algorithm 1 Changing Lane Distance Method

- 1: Filter the data collected at RSU.
 - 2: For all $a \in A$ calculate B_a a set of all (d_a, t_a) s
 - 3: Calculate μ_{d_a}, μ_{t_a} for B_a
 - 4: **if** pair (μ_{d_a}, μ_{t_a}) is in pre-defined critical region R_d **then**
 - 5: increase incident belief.
 - 6: **end if**
 - 7: **if** incident belief \geq the pre-identified threshold **then**
 - 8: raise incident flag and issue traffic alert.
 - 9: **end if**
 - 10: Go to Step 1.
-

4.3 CHANGING LANE SPEED (CLS) METHOD

In this method, the RSU processes the information collected from vehicles related to their speed changes in both incident and non-incident conditions. Specifically, as outlined in figure 32, the speed variation for a given vehicle **A** between the beginning position of the lane change “a” to the finishing position “b” is related to the speed variation of vehicle **C** between positions “a” and “b”. The reasoning behind this approach is based on the fact that when vehicle **A** changes lanes, it will cause variation of vehicle **C**’s speed, too. During normal conditions, the speed variation depends on several factors, among which we note are the behavior of the drivers, the vehicle classes, and the current traffic conditions. The average of speed variation μ_{v_a} and the related average time μ_{t_a} will be calculated at RSU and if these parameters are in a pre-defined critical region R_c for speed variation, the belief that an incident has occurred will be increased.

Algorithm 2 – Changing Lane Speed Method

- 1: Filter the data collected at RSU.
 - 2: For all $a \in A$ calculate B_a a set of all (v_a, t_a) s
 - 3: Calculate μ_{v_a}, μ_{t_a} for B_a
 - 4: **if** pair (μ_{v_a}, μ_{t_a}) is in pre-defined critical region R_c , **then**
 - 5: increase incident belief.
 - 6: **end if**
 - 7: **if** incident belief \geq the pre-identified threshold **then**
 - 8: raise incident flag and issue traffic alert.
 - 9: **end if**
 - 10: Go to Step 1.
-

The CLS method is formally stated as Algorithm 2, which is similar to Algorithm 1, except that in this case the information about the speed of vehicle v_a (and its variation in time) collected at the RSU is processed instead of the lane change distance d_a used in the CLD method. We note that the upstream volume at the RSU can be used to identify the non-incident congestion, in which case the variation of vehicle speeds when changing lanes will be low. More precisely, when the upstream

volume is larger than the road capacity, it causes congestion and corresponds to a different traffic state, for which there is a lot of research related to the identification of congestion using the shockwave diagram such as: [104, 105, 89, 106].

4.4 NUMERICAL RESULTS

To illustrate the effectiveness of the proposed AID techniques, we simulated traffic on a segment of a 1-mile 3-lane highway with two roadside units at the both ends collecting the required traffic information (vehicle lane and speed changes over time). Simulations were performed using the *veins* simulator [107], which combines road traffic micro-simulation and network simulation. We simulated traffic flows corresponding to 360, 400, 450, 514, 600, 720, 900, 1200, 1350 and 3600 vehicles per-hour per-lane for 100 times for both incident and non-incident traffic conditions. In incident condition, we have created an incident 400 meters close to the RSU at the down-stream end. Each vehicle uploads all collected information into the RSU for analysis and incident detection decision processes.

For the CLD method, figure 33 shows that in non-incident traffic conditions, lane changes for most vehicles occur outside the critical region, while when incidents are present, the lane change parameters are situated in the critical region corresponding to short distances over short periods of time for changing lanes.

For the CLS method, figure 34 shows that the average speed in non-incident condition for changing lanes is faster than that of when incident conditions are present. Note that the critical region lies in a different location unlike figure 33. This is because we have different parameters here. This has clearly classified and categorized the incident and non-incident collected data around our identified threshold. In figure 35, we have compared our numerical results with those for Integrated Technique, Probabilistic Technique and California algorithm. We have observed that the incident detection rate of our algorithm is higher for low flow-traffic than that of other

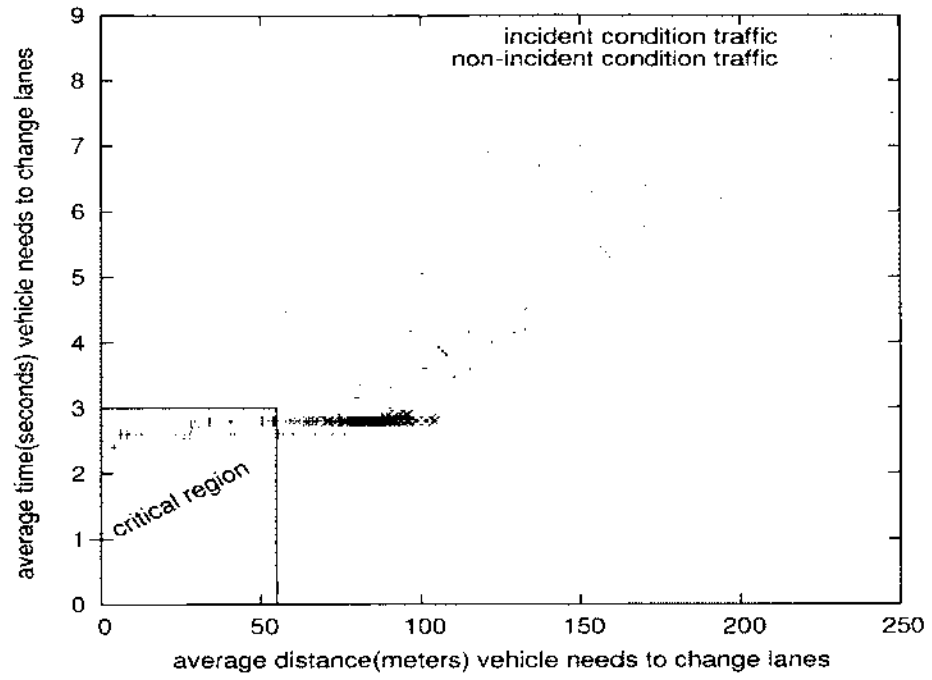

FIG. 33: Average time versus average distance for changing lanes.

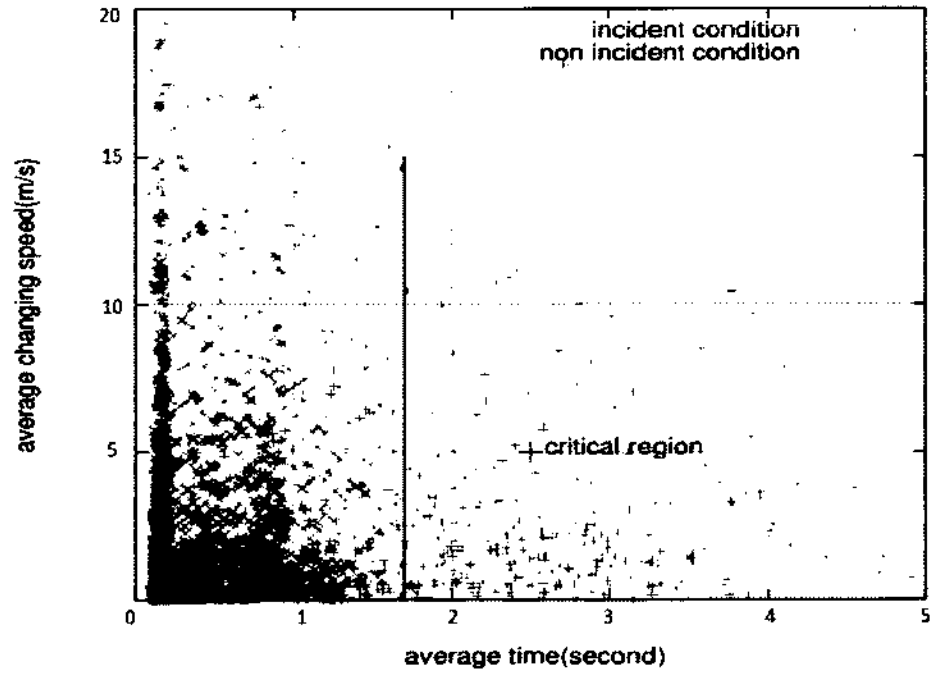

FIG. 34: Average speed variation versus average time when changing lanes.

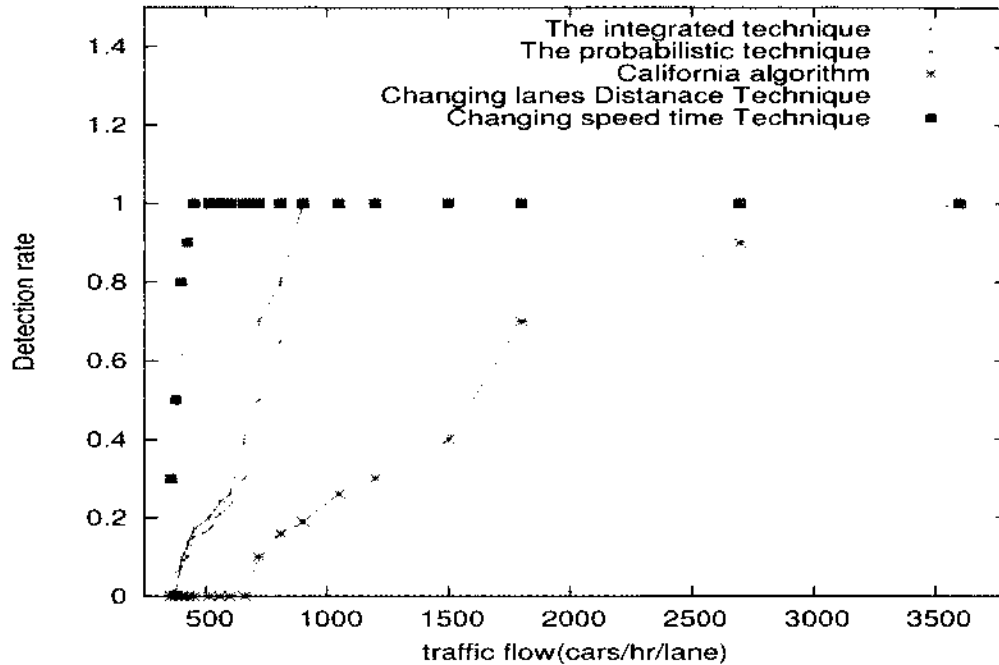

FIG. 35: Detection rate

techniques. We note that usually the traffic flow has direct impact on detection rate and detection time because collecting enough information to detect incidents exceeds the threshold in a short period of time. From our simulation, we note that incident detection based on changing speed related to time is slower than incident detection based on lane changing distance. This is because changing speeds involving acceleration and deceleration in both non-incident and incident conditions are very close to each other. Therefore, it is quite a challenge to identify threshold based on the speed changing method. So, in sum, our algorithm yields better results for low density traffic because in the event of such traffic, less information is in general available to detect incidents. However, in figure 36 we have shown the comparison with respect to changing lane distance in a separate data plot.

We now come to another test to verify the effectiveness of our AID. We have configured VEIN simulator to conduct a test for a typical incident detection. In

figure 37. we have plotted the queue length of the vehicles as the function of time lapse during a typical traffic flow. In the figure, we note that the queue length rapidly grows in the absence of AID. Meanwhile, if the AID is enabled, the queue length slowly increases when the AID imposes either the change-lane solution or the change-speed solution. The reason is that when the vehicles receive alerts for the incident, they change their routes so that the congestion on the road would decrease. Note that in our simulated test, the capacity of the road is 5.000 vehicles with 4 lanes and the incident has caused the blockage of 2 lanes.

Another test that we have conducted is to verify the effectiveness in case a certain percentage of the vehicles pay attention to the incident alert. We have plotted our results of the queue length in figure 39 for different percentages. In the figure, we note that prior to resolving the incident, the queue length behaves almost like what we have shown in figure 37. However, as soon as the incident is resolved after time I, the queue length rapidly declines in case the AID being enabled while slowly declines in the absence of the AID. There is another time duration the traffic flow which we have denoted by II. At this point, the negative impact of the incident is gone.

The simulation scenario was also developed for both our methods and the other three methods. We set up a three-lane freeway with the capacity of 5000 vehicles/h with the vehicles' arrival rate 4500 vehicles/h and average speed 60 miles/h. Figure 38 shows queue length when the incident is not resolved. The queue length in our method increases very slowly compared to the other methods. Figures 40, 41, and 42 show the traffic queue length when the incident is resolved after a specific period of time. From the time the incident occurs to the time the incident is resolved, the queue length increases with all AIDs, which is the natural behavior, but the method we developed yields a shorter queue length compared to the other methods

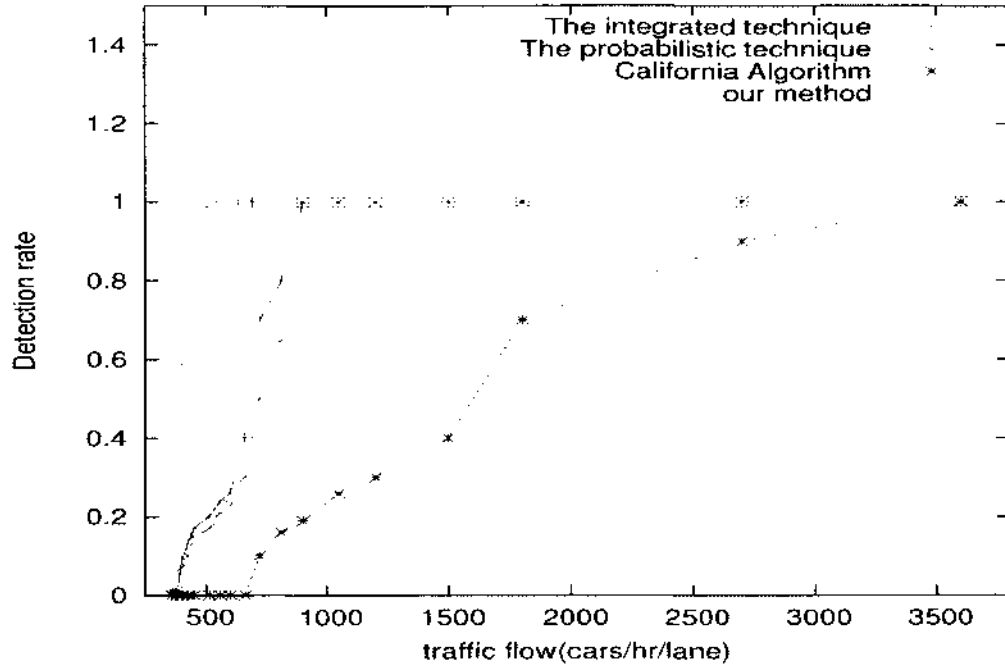

FIG. 36: Comparison with respect to lane change.

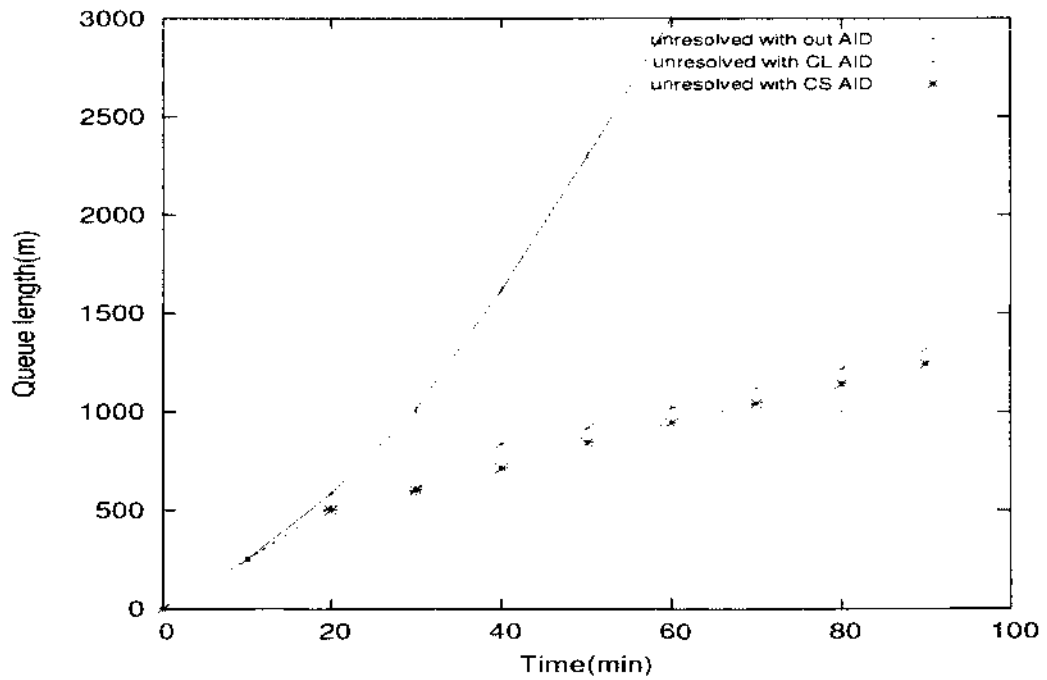

FIG. 37: Q length when the AID enable and disable

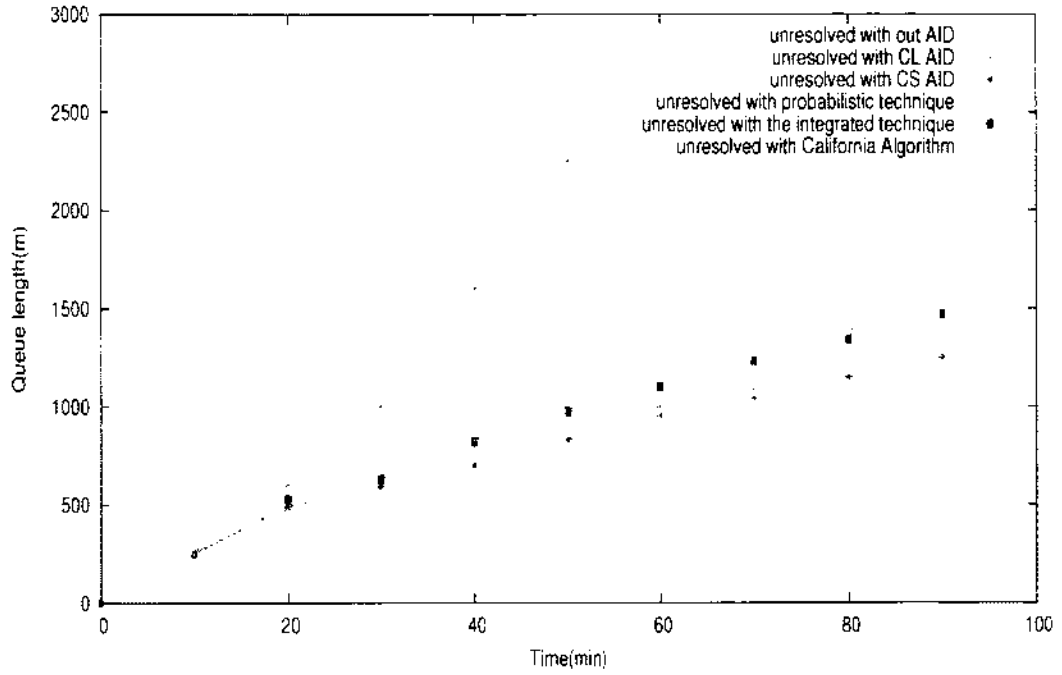

FIG. 38: Q length when the AID enable and disable and compare to other algorithms

...

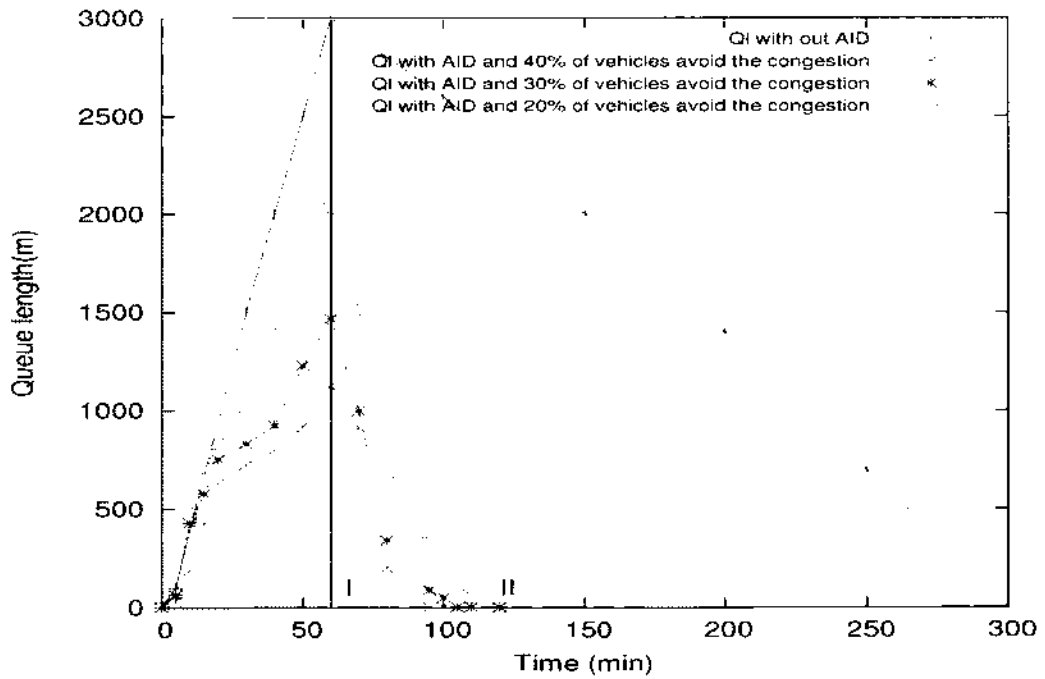

FIG. 39: Q length when the AID enable with rate of changing route rate . . .

with varying rates of route changes. The vertical line represents the time when the incident is resolved (cleaned up), but congestion decreases gradually until normal traffic flow resumes, with the shortest queue reverting to a natural traffic pattern the quickest.

4.5 SUMMARY

In this chapter, we defined two new traffic parameters: average speed and average distance vehicles need for changing lanes. We also developed an automatic incident detection based on these new traffic parameters. The simulation results showed that the detection rate of our method on a freeway is higher than that of integrated technique, probabilistic technique, and the California Algorithm detection rate for low-density traffic streams. We also used a wireless LAN network with multiple antennas at RSUs to assign each lane a specific channel for the purpose of providing reliability and validity of the vehicle safety communications.

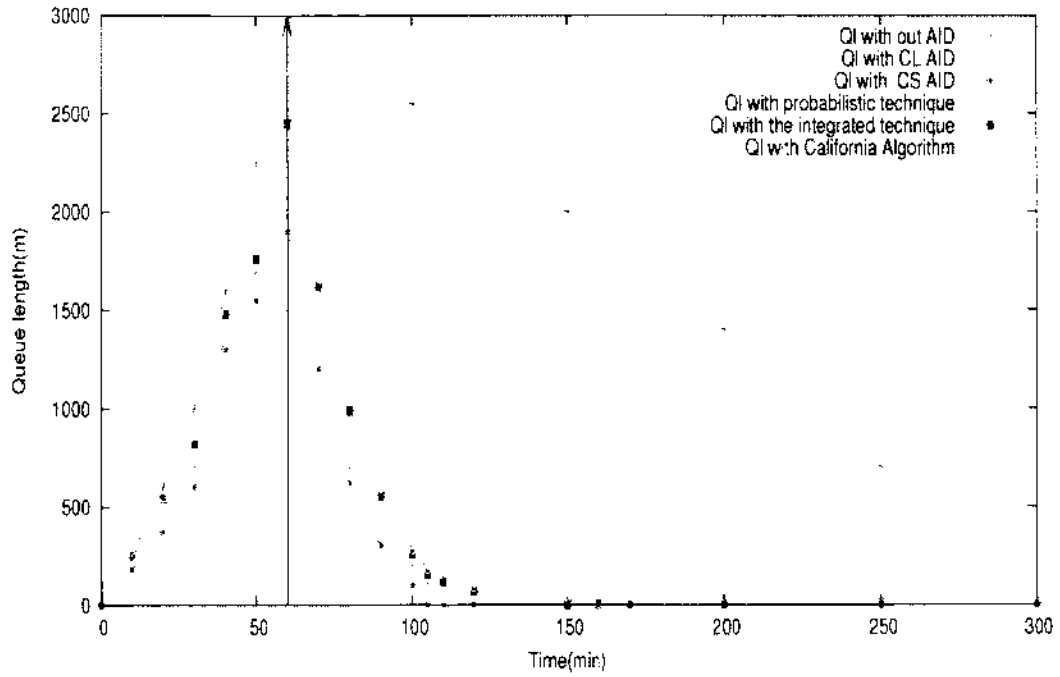

FIG. 40: Q length when the AIDs enable with 20% rate of changing route rate . . .

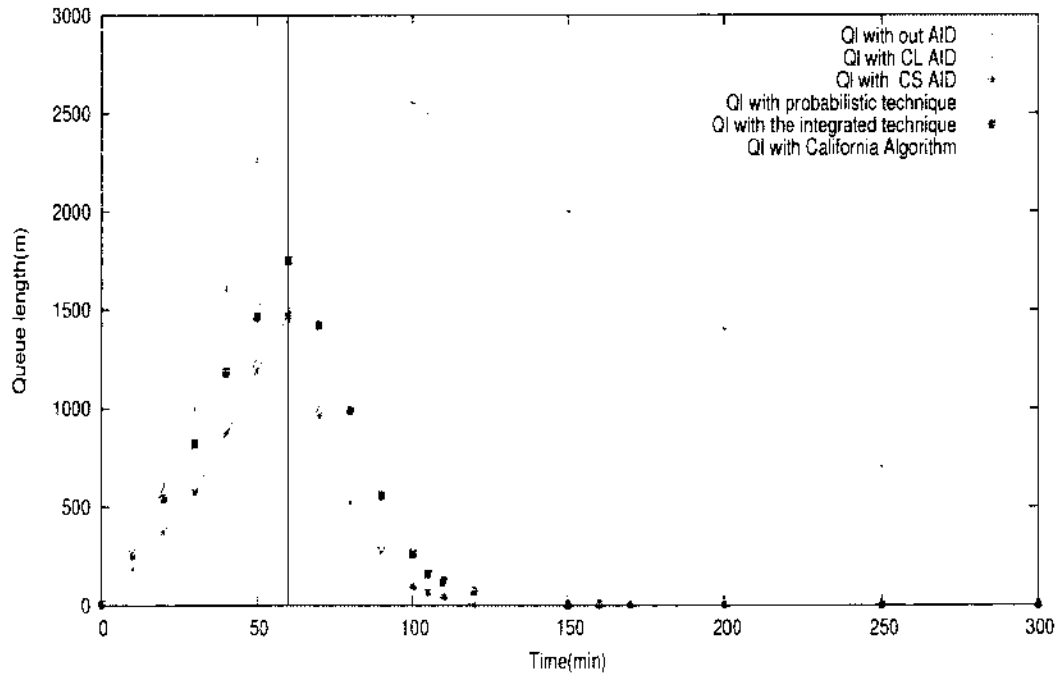

FIG. 41: Q length when the AIDs enable with 30% rate of changing route rate

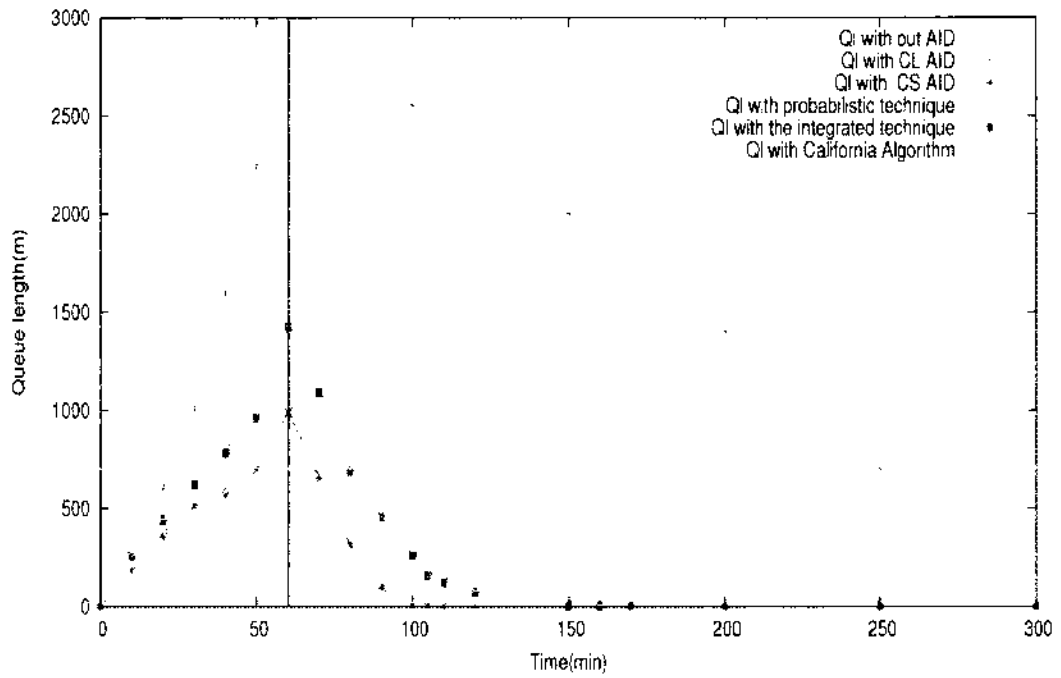

FIG. 42: Q length when the AIDs enable with 40% rate of changing route rate . . .

CHAPTER 5

CONCLUSION AND FUTURE WORK

Finally in this chapter, we are going to summarize the proposed technique as well as evaluation. We will also make a number of recommendations for future work.

5.1 SUMMARY

We assessed the IEEE 802.11 standard with DCF for V2I communication and information exchange. We presented an analytical approach for calculating the probability of successful information exchange between vehicles and RSU and corroborated the analysis with numerical results obtained from simulations. We observed that a suitable beaconing interval has an important role in increasing the probability of successful information exchange in V2I communication systems, and that the results from our analysis indicate that IEEE 802.11 standard with its beaconing mechanism is suitable for information exchange in V2I communications.

As for our automatic incident detection technique, we have defined two new traffic parameters, namely the average speed and the average distance vehicles need for changing lanes. Our automatic incident detection is based on these new traffic parameters that provide information about incident. Our simulation results showed that our method has detection rates on a freeway higher than that of integrated technique, probabilistic technique, and the California Algorithm detection rate for low-density traffic streams. The major drawback of the California Algorithm is that it cannot quickly detect incidents in non-dense traffic. We also used a wireless local area network with multiple antennas at Road side units to assign each lane a specific

channel for the purpose of providing reliability and validity of the Vehicle Safety Communications.

5.2 DISSERTATION CONTRIBUTION

Low probability of success data exchange between RSUs and vehicles in IEEE 802.11p can be effected by several factors. Those factors are but are not limited to, high mobility nodes (vehicles) in wireless access in vehicular environment, limited coverage range of RSUs, and channel switching in IEEE 802.11p which is provided by IEEE 1609.4 standard. In IEEE 802.11p, vehicles must also broadcast beacons to keep accurate environment awareness because of dynamic behavior network topology in WAVE. This also raises the collision probability and delay in WAVE. Those vehicles which are willing to communicate with RSU must receive at least one RSU-generated WAVE Service Advertisement short message to exchange data with the RSU on the subsequent service channel interval. Having probability of not receiving the WSA message as well as a short period of time under the RSU coverage range, vehicles cannot detect the RSU to upload (download) data to (from) RSU. In IEEE 802.11p, RSU-awareness vehicle percentages are %60 to %80 based on traffic density. Losing some important information can reduce the accuracy of the outcome of the algorithms. This cannot represent real world system. Proposition of a technique to avoid negative impact of channel switching IEEE 1609.4 standard on the top IEEE 802.11p standard is a major issue in a vehicular network communication. For this purpose, the IEEE 802.11 standard is used to increase the portability of success data exchange between RSU and the vehicle passing under the RSUs coverage area. The beaconing mechanism was used for the analytical evaluation based on the IEEE 802.11 standard specification timelines.

Finally, we developed AID algorithms to detect incidents in a low-traffic condition

on a free-way and alert drivers ahead of time to avoid the congestion. In our methodology, reliability of communication between vehicle and RSUs has been maximized. This is very important for several safety applications. Collected data from several vehicles maximizes the accuracy of vehicle safety applications. Our designated goal concerns automatic incident detection achieved through collecting data from as many vehicles as possible hooked up with RSUs, as well as analyzing the collected data and making a decision based on the pre-identified threshold. To increase the number of vehicles to be aware of the RSUs, multiple antennas are used at RSUs with IEEE 802.11 standard for media access control instead of IEEE 802.11p. These antennas are placed close to each other to form RSUs, and they are connected to one common central service station. The collected raw data is stored, arranged, integrated, and set in a new data format at RSU central service. At RSU central service, our AID algorithms take this new data format as input to make a decision. The developed AID algorithms extracted required features (the distance and speed vehicle needed for switching lanes related to time) from the collected data. Results in this thesis have been published in references [109] and [110]

5.3 FUTURE WORK

The beaconing mechanism was very important in our developed automatic incident detection method. A recommendation for future work accordingly, may be a planned scheme to study the use of the active scanning mode of IEEE 802.11 as an alternative to the beaconing mechanism, where vehicles send a probe request to RSUs only on channels that are available and not actively used. In our work, we did not take non-incident congestion into consideration. A recommendation for a following work in this regard is to develop methods and techniques to distinguish between non-incident and incident triggered congestions. Also, Bayesian Statistics

may be applied to update our incident assumption to increase the detection rates. We are also planning to estimate the incident location based on the collected lane changing information.

Further, researchers could develop a protocol to disseminate message alerts that signal traffic congestion. The protocol might operate in such a way that as time passes, the vehicle would be enabled to update the alerts depending on the status of the incident.

In general as for automatic incident detection, the length of the queue of the vehicles in traffic flow can also be used to develop a method. This is a factor by which one can expect incidents and even estimate the expected delay due to the incident. The length of the queue can be inserted into the message alert and updated at any time during the traffic flow.

BIBLIOGRAPHY

- [1] D. Jiang and L. Delgrossi. "IEEE 802.11 p: Towards an international standard for wireless access in vehicular environments." *Vehicular Technology Conference, VTC Spring 2008*. pp. 2036–2040. 2008.
- [2] T. Zhang and L. Delgrossi. *Vehicle Safety Communications: Protocols, Security, and Privacy*. John Wiley & Sons. 2012. vol. 103.
- [3] S. Gräßling, P. Mahonen, and J. Riihijarvi. "Performance evaluation of IEEE 1609 wave and IEEE 802.11p for vehicular communications." *Ubiquitous and Future Networks (ICUFN), 2010 Second International Conference on. IEEE*. pp. 344–348. 2010.
- [4] L. F. Van Hoeseel and P. J. Havinga. "A lightweight medium access protocol (LMAC) for wireless sensor networks: Reducing preamble transmissions and transceiver state switches." *Society of Instrument and Control Engineers (SICE)*. pp. 205–208, 2004.
- [5] D. Jiang and L. Delgrossi. "IEEE 802.11p: Towards an International Standard for Wireless Access in Vehicular Environments." *Vehicular Technology Conference, VTC Spring 2008. IEEE*. pp. 2036–2040. 2008.
- [6] A. J. Ghandour, M. Di Felice, L. Bononi, and H. Artail, "Modeling and simulation of WAVE 1609.4-based multi-channel vehicular ad hoc networks." *Institute for Computer Sciences, Social-Informatics and Telecommunications Engineering (ICST)*. pp. 148–156. 2012.
- [7] Q. Chen, D. Jiang, and L. Delgrossi. "IEEE 1609.4 DSRC multi-channel operations and its implications on vehicle safety communications." *Vehicular Networking Conference (VNC). IEEE*. pp. 1–8. 2009.

- [8] S. U. Eichler. "Performance evaluation of the IEEE 802.11 p wave communication standard." *Vehicular Technology Conference. VTC-2007. IEEE*, pp. 2199-2203. 2007.
- [9] M. van Eenennaam, A. van de Venis, and G. Karagiannis. "Impact of IEEE 1609.4 channel switching on the IEEE 802.11p beaconing performance." *Wireless Days (WD), 2012 IFIP, IEEE*, pp. 1-8, 2012.
- [10] C. Robinson and L. Delgrossi. "Integrating In-Vehicle Safety with Dedicated Short Range Communications for Intersection Collision Avoidance." SAE Technical Paper. Tech. Rep., 2010.
- [11] N. H. T. S. Administration. "Traffic safety facts 2009." *National Center for Statistics and Analysis. US Department of Transportation. Available at: <http://www-nrd.nhtsa.dot.gov/Pubs/811402.pdf>*. 2011.
- [12] J. Paniati. "Traffic congestion and sprawl," Federal Highway Administration," preprint (Nov. 2002). available at <http://www.fhwa.dot.gov/congestion/congress.htm>.
- [13] M. J. Kittelson, "The Economic Impact of Traffic Crashes." Ph.D. dissertation, Georgia Institute of Technology. 2010.
- [14] M. Papageorgiou. *Concise encyclopedia of traffic & transportation systems*. Pergamon Press Oxford, 1991.
- [15] D. K. Nilsson, P. H. Phung, and U. E. Larson. "Vehicle classification based on safety-security characteristics." *Road Transport Information and Control-RTIC 2008 and ITS United Kingdom Members' Conference. IET*, pp. 1-7. 2008.

- [16] C. Ias. "Electronic sensing technologies for autonomous ground vehicles: A review." *Advanced Topics in Electrical Engineering (ATEE). 2013 8th International Symposium on. IEEE*. pp. 1-6. 2013.
- [17] R. Shorey. "Emerging Trends in Vehicular Communications: Communications in Electric Vehicles." *IEEE New York Monitor*. pp. 8-15. 2011.
- [18] W. Lawrenz., *CAN System Engineering*. Springer, 2013.
- [19] W. Lawrenz and T. Roskam, "LIN Protocol Conformance Test." SAE Technical Paper. Tech. Rep., 2005.
- [20] J. Voelcker. "Environment's Stupid Top 10 Tech Cars." *Spectrum, IEEE*. vol. 45. no. 4. pp. 26-35, 2008.
- [21] J. B. Kenney. "Dedicated short-range communications (DSRC) standards in the united states." *Proceedings of the IEEE*. vol. 99. no. 7. pp. 1162-1182. 2011.
- [22] K. Koscher, A. Czeskis, F. Roesner, S. Patel, T. Kohno, S. Checkoway, D. McCoy, B. Kantor, D. Anderson, H. Shacham *et al.*. "Experimental Security Analysis of a Modern Automobile." *Security and Privacy (SP), 2010 IEEE Symposium on. IEEE*. pp. 447-462, 2010.
- [23] E. D. Kaplan and C. J. Hegarty, *Understanding GPS: Principles and Applications*. Artech house, 2005.
- [24] K. Bilstrup, E. Uhlemann, E. Ström, and U. Bilstrup. "On the Ability of the 802.11p MAC Method and STDMA to Support Real-Time Vehicle-to-Vehicle Communication." *EURASIP Journal on Wireless Communications and Networking*. pp. 1-13. 2009.

- [25] S. Biswas, R. Tatchikou, and F. Dion. "Vehicle-to-vehicle Wireless Communication Protocols for Enhancing Highway Traffic Safety." *Communications Magazine, IEEE*, vol. 44, no. 1, pp. 74-82, 2006.
- [26] D. V. McGehee, E. N. Mazzae, and G. S. Baldwin. "Driver reaction time in crash avoidance research: Validation of a driving simulator study on a test track." *SAGE Publications*, vol. 44, no. 20, pp. 3-320, 2000.
- [27] E. M. Royer and C. E. Perkins. "Multicast operation of the ad-hoc on-demand distance vector routing protocol." *Proceedings of the 5th annual ACM/IEEE international conference on Mobile computing and networking*, pp. 207-218, 1999.
- [28] C. T. Cheng, H. L. Lemberg, S. J. Philip, E. van den Berg, and T. Zhang. "Slalom: A scalable location management scheme for large mobile ad-hoc networks." *Wireless Communications and Networking Conference (WCNC), IEEE*, vol. 2, pp. 574-578, 2002.
- [29] G. Jayakumar and G. Gopinath. "Ad hoc mobile wireless networks routing protocols-a review." *Journal of Computer science*, vol. 3, no. 8, p. 574, 2007.
- [30] M. Kihl, M. Sichitiu, and H. P. Joshi. "Design and evaluation of two geocast protocols for vehicular ad-hoc networks." *Journal of Internet Engineering*, vol. 2, no. 1, 2008.
- [31] T. Zhang and W. Chen. "Soft mobile ad-hoc networking." *Springer*, pp. 233-238, 2001.
- [32] A. Vahdat, D. Becker *et al.*. "Epidemic routing for partially connected ad hoc networks." Technical Report CS-200006, Duke University, Tech. Rep., 2000.

- [33] I. E. W. Group. "IEEE standard for information technology telecommunications and information exchange between systems—local and metropolitan area networks specific requirements—part 11: Wireless lan medium access control (mac) and physical layer (phy) specifications amendment 6: Wireless access in vehicular environments." *IEEE Std. IEEE*, vol. 802, p. 11p, 2010.
- [34] H. Zhu, R. Lu, X. Shen, and X. Lin. "Security in service-oriented vehicular networks." *Wireless Communications, IEEE*, vol. 16, no. 4, pp. 16–22, 2009.
- [35] M. Zargari, M. Terrovitis, S.-M. Jen, B. J. Kaczyuski, M. Lee, M. P. Mack, S. S. Mehta, S. Mendis, K. Onodera, and H. Samavati. "A single-chip dual-band tri-mode CMOS transceiver for IEEE 802.11 a/b/g wireless LAN." *Solid-State Circuits, IEEE Journal of*, vol. 39, no. 12, pp. 2239–2249, 2004.
- [36] A. Doufexi, S. Armour, M. Butler, A. Nix, D. Bull, J. McGeehan, and P. Karlsson. "A comparison of the HIPERLAN/2 and IEEE 802.11 a wireless LAN standards." *Communications Magazine, IEEE*, vol. 40, no. 5, pp. 172–180, 2002.
- [37] G. R. Hiertz, S. Max, Y. Zang, T. Junge, and D. Denteneer. "IEEE 802.11 s mac fundamentals." *MASS 2007. IEEE International Conference on Mobile Adhoc and Sensor Systems, IEEE*, pp. 1–8, 2007.
- [38] Q. Chen, D. Jiang, T. Tielert, and L. Delgrossi. "Mathematical modeling of channel load in vehicle safety communications." *Vehicular Technology Conference (VTC Fall), 2011 IEEE*, pp. 1–5, 2011.
- [39] A. Weinfeld. "Methods to reduce dsrc channel congestion and improve v2v communication reliability." in *17th ITS World Congress*, 2010.
- [40] A. Weinfeld, J. Kenney, and G. Bansal. "An adaptive dsrc message transmission interval control algorithm." in *ITS World Congress*, 2011.

- [41] X. Yang and N. Vaidya. "On physical carrier sensing in wireless ad hoc networks." *INFOCOM 2005. 24th Annual Joint Conference of the IEEE Computer and Communications Societies, IEEE*. vol. 4. pp. 2525–2535. 2005.
- [42] R. K. Schmidt, A. Brakemeier, T. Leinmüller, B. Böddeker, and G. Schäfer. "Architecture for decentralized mitigation of local congestion in vanets." in *10th International Conference on ITS Telecommunications (ITST), Kyoto*. Citescer. 2010.
- [43] G. Bansal, J. B. Kenney, and C. E. Rohrs. "LIMERIC: A linear adaptive message rate algorithm for DSRC congestion control." *IEEE Transactions on Vehicular Technology*. vol. 62, no. 9. pp. 4182–4197. 2013.
- [44] M. S. Bouassida and M. Shawky. "A cooperative congestion control approach within VANETs: formal verification and performance evaluation." *EURASIP Journal on Wireless Communications and Networking*, p. 11. 2010.
- [45] R. Baldessari, D. Scaferla, L. Le, W. Zhang, and A. Festag. "Joining forces for vanets: A combined transmit power and rate control algorithm." in *6th international workshop on intelligent transportation (WIT)*, 2010.
- [46] H. Busche, C. Khorakhun, and H. Rohling. "Self-organized update rate control for inter-vehicle networks." in *Proc. of the 10th International Workshop on Intelligent Transportation (WIT)*. 2010.
- [47] X. Guan, R. Sengupta, H. Krishnan, and F. Bai. "A feedback-based power control algorithm design for VANET." *IEEE*. pp. 67–72. 2007.
- [48] J. He, H.-H. Chen, T. M. Chen, and W. Cheng. "Adaptive Congestion Control for DSRC Vehicle Networks." *IEEE Communications Letters*. vol. 14, no. 2. pp. 127–129. 2010.

- [49] Y. P. Fallah, C. Huang, R. Sengupta, and H. Krishnan. "Design of cooperative vehicle safety systems based on tight coupling of communication, computing and physical vehicle dynamics." *The 1st ACM/IEEE International Conference on Cyber-Physical Systems*, pp. 159-167, 2010.
- [50] C. Khorakhun, H. Busche, and H. Rohling. "Congestion control for VANETs based on power or rate adaptation." in *Proceedings of the 5th international workshop on intelligent transportation (WIT)*, 2008.
- [51] J. Mittag, F. Schmidt-Eisenlohr, M. Killat, J. Härri, and H. Hartenstein. "Analysis and design of effective and low-overhead transmission power control for VANETs." *Fifth ACM international workshop on Vehicular Inter-networking*, pp. 39-48, 2008.
- [52] M. Torrent-Moreno, J. Mittag, P. Santi, and H. Hartenstein. "Vehicle-to-vehicle communication: fair transmit power control for safety-critical information." *IEEE Transactions on Vehicular Technology*, vol. 58, no. 7, pp. 3684-3703, 2009.
- [53] Q. Chen, D. Jiang, V. Taliwal, and L. Delgrossi, "IEEE 802.11 based vehicular communication simulation design for NS-2." *Proceedings of the 3rd international workshop on Vehicular ad hoc networks*, pp. 50-56, 2006.
- [54] S. Zeadally, R. Hunt, Y.-S. Chen, A. Irwin, and A. Hassan. "Vehicular Ad hoc Networks (VANETS): Status, Results, and Challenges." *Telecommunication Systems*, vol. 50, no. 4, pp. 217-241, 2012.
- [55] "FCC Report and Order 03-324: Amendment of the Commissions Rules Regarding Dedicated Short-Range Communication Services in the 5.850-5.925 GHz Band." 2003.

- [56] "FCC Report and Order 06-110: Amendment of the Commissions Rules Regarding Dedicated Short-Range Communication Services in the 5.850-5.925 GHz Band." 2006.
- [57] K. Hong, J. B. Kenney, V. Rai, and K. P. Laberteaux. "Evaluation of Multi-Channel Schemes for Vehicular Safety Communications." *Vehicular Technology Conference (VTC 2010-Spring)*, *IEEE*, pp. 1-5, 2010.
- [58] T. K. Mak, K. P. Laberteaux, and R. Sengupta. "A multi-channel vanet providing concurrent safety and commercial services." *Proceedings of the 2nd ACM international workshop on Vehicular ad hoc networks*, *ACM*, pp. 1-9, 2005.
- [59] A. M. Abbas and O. Kure. "Quality of service in mobile ad hoc networks: a survey." *International Journal of Ad Hoc and Ubiquitous Computing*, vol. 6, no. 2, pp. 75-98, 2010.
- [60] V. T. M. Do, L. Landmark, and Ø. Kure. "A survey of qos multicast in ad hoc networks." *Future Internet*, vol. 2, no. 3, pp. 388-416, 2010.
- [61] A. Grundy. "Congestion control framework for delay-tolerant communications." Ph.D. dissertation. University of Nottingham, 2012.
- [62] C. Lochert, B. Scheuermann, and M. Mauve. "A survey on congestion control for mobile ad hoc networks." *Wireless Communications and Mobile Computing*, vol. 7, no. 5, pp. 655-676, 2007.
- [63] C. Campolo, A. Molinaro, and A. Vinel. "Understanding the performance of short-lived control broadcast packets in 802.11p/WAVE vehicular networks." *Vehicular Networking Conference (VNC)*, *IEEE*, pp. 102-108, 2011.
- [64] S.-Y. Wang, H.-L. Chao, K.-C. Liu, T.-W. He, C.-C. Lin, and C.-L. Chou. "Evaluating and improving the TCP/UDP performances of IEEE

- 802.11(p)/1609 networks." *IEEE Symposium on Computers and Communication (ISCC)*. IEEE, pp. 163–168, 2008.
- [65] C. Campolo and A. Molinaro. "On vehicle-to-Roadside Communications in 802.11 p/WAVE VANETs." *Wireless Communications and Networking Conference (WCNC)*. IEEE, pp. 1010–1015, 2011.
- [66] M. S. Almalag, S. El-Tawab, S. Olariu, and M. C. Weigle. "A modified TC-MAC protocol for multi-hop cluster communications in VANETs." in *Connected Vehicles and Expo (ICCVE), 2013 International Conference on*. IEEE, 2013, pp. 832–837.
- [67] C. Campolo and A. Molinaro. "The I-880 Field Experiment: Effectiveness of Incident Detection Using Cellular Phones." *California Partners for Advanced Transit and Highways (PATH)*, pp. 1010–1015, 1998.
- [68] S. Eichler. "Performance evaluation of the IEEE 802.11p WAVE communication standard." *Vehicular Technology Conference (VTC)*. IEEE, pp. 2199–2203, 2008.
- [69] M. Almalag. "TDMA Slot Reservation in Cluster-Based VANETs." Ph.D. dissertation, Old Dominion University, May 2013.
- [70] D. Trecumuk, D. C. Popescu, and S. Olariu, "Requirements for the Physical Layer of the NOTICE System for Vehicular Communications." *Proceedings 2009 IEEE Global Telecommunications Conference GLOBECOM*, pp. 3–7, December 2009.
- [71] A. Daniel, D. C. Popescu, and S. Olariu. "A Study of Beaconing Mechanism for Vehicle-to-Infrastructure Communications." *IEEE ICC 2012 Workshop on Intelligent Vehicular Networking: V2V/V2I Communications and Applications - WIVN 2012*, pp. 7146–7150, June 2012.

- [72] A. Vinel, A. Turlikov, and D. Staehle. "Study of Beaconing for Car-to-Car Communication in Vehicular Ad-Hoc Networks." in *Proceedings 2009 ICC Workshops Communications Workshops*. Dresden. June 2009.
- [73] F. Cali, M. Conti, and E. Gregori. "IEEE 802.11 wireless LAN: capacity analysis and protocol enhancement." *INFOCOM '98. Seventeenth Annual Joint Conference of the IEEE Computer and Communications Societies, IEEE*. vol. 1. pp. 142–149 vol.1. Mar-2 Apr 1998.
- [74] V. Bychkovsky, B. Hull, A. Miu, H. Balakrishnan, and S. Madden. "A measurement study of vehicular internet access using in situ Wi-Fi networks." *The 12th annual international conference on Mobile computing and networking, ACM*. pp. 50–61. 2006.
- [75] J. Eriksson, H. Balakrishnan, and S. Madden. "Cabernet: Vehicular Content Delivery Using WiFi." *Proceedings of the 14th ACM international conference on Mobile computing and networking, ACM*. pp. 199–210, 2008.
- [76] Y. Liu, F. Dion, and S. Biswas. "Dedicated short-range wireless communications for intelligent transportation system applications: State of the art." *Transportation Research Record: Journal of the Transportation Research Board*. vol. 1910, no. 1, pp. 29–37. 2005.
- [77] N. H. T. S. Administration, "Traffic safety facts 2004: A compilation of motor vehicle crash data from the fatality analysis reporting system and the general estimates system (DOT HS 809 919)." *US Department of Transportation, Washington, DC*. 2006.
- [78] W. G. Najm, J. D. Smith, and M. Yanagisawa. "Pre-crash Scenario Typology for Crash Avoidance Research." in *DOT HS*. Citeseer. 2007.

- [79] M. Maile, F. Ahmed-Zaid, C. Basnyake, L. Caminiti, S. Kass, M. Losh, J. Lundberg, D. Massclink, E. Mc-Glohou, P. Mudalige *et al.*. "Final Report: Cooperative Intersection Collision Avoidance System for Violations (CICAS-V)." Technical Report, National Highway Traffic Safety Administration (NHTSA), Washington, DC. Tech. Rep., 2008.
- [80] M. Maile and L. Delgrossi. "Cooperative intersection collision avoidance system for violations (CICAS-V) for avoidance of violation-based intersection crashes." *Enhanced Safety of Vehicles*. 2009.
- [81] M. Stearns and L.-G. Vega. "Independent Evaluation of the Driver Acceptance of the Cooperative Intersection Collision Avoidance System for Violations (CICAS-V) Pilot Test." National Technical Information Service. Tech. Rep., 2011.
- [82] F. Busch, "Concise Encyclopedia of Traffic Transportation Systems." *Pergamon Press*, pp. 219-225, 1991.
- [83] M. D. Robinson. "A model for Evaluating the Safety Implications of Advanced Traveler Information Systems." Ph.D. dissertation, M.Sc. Thesis, Queen's University, 1995.
- [84] E. Parkany and C. Xie. "A complete review of incident detection algorithms & their deployment: what works and what doesn't." National Technical Information Service. Tech. Rep., 2005.
- [85] C. L. Dudek, C. J. Messer, and N. B. Nuckles. "Incident Detection on Urban Freeways." *Transportation Research Record 495*. pp. 12-24, 1974.
- [86] E. Niver, K. C. Mouskos, T. Batz, and P. Dwyer. "Evaluation of the TRANSCOM's system for managing incidents and traffic (TRANSMIT)."

- IEEE Transactions on Intelligent Transportation Systems*, vol. 1, no. 1, pp. 15–31, 2000.
- [87] H. Payne and S. Tignor. “Freeway incident-detection algorithms based on decision trees with states.” *Transportation Research Record*, no. 682, 1978.
- [88] F. L. Hall, Y. Shi, and G. Atala. “On-line Testing of the McMaster Incident Detection Algorithm Under Recurrent Congestion.” *Transportation Research Record 1394*, pp. 1-7, 1993.
- [89] A. I. Gall and F. L. Hall. “Distinguishing between incident congestion and recurrent congestion: a proposed logic.” *Transportation Research Record*, no. 1232, 1989.
- [90] G. Karagiannis, O. Altintas, E. Ekici, G. Heijenk, B. Jarupan, K. Lin, and T. Weil. “Vehicular networking: A survey and tutorial on requirements, architectures, challenges, standards and solutions .” *IEEE Communications Surveys & Tutorials*, 2011.
- [91] H. S. Mahmassani, C. Haas, S. Zhou, and J. Peterman. “Evaluation of Incident Detection Methodologies.” University of Texas at Austin, Tech. Rep., 2011.
- [92] V. Milanés, J. Villagra, J. Godoy, J. Simó, J. Pérez, and E. Onieva. “An Intelligent V2I-based Traffic Management System.” *IEEE Transactions on Intelligent Transportation Systems*, vol. 13, no. 1, pp. 49–58, 2012.
- [93] K. Robert. “Video-based traffic monitoring at day and night vehicle features detection tracking.” *ITSC’09, 12th International IEEE Conference on Intelligent Transportation Systems, IEEE*, pp. 1–6, 2009.
- [94] M. S. Shchata, J. Cai, W. M. Badawy, T. W. Burr, M. S. Pervez, R. J. Johannesson, and A. Radmanesh. “Video-based automatic incident detection for

- smart roads: the outdoor environmental challenges regarding false alarms.” *IEEE Transactions on Intelligent Transportation Systems*, vol. 9, no. 2, pp. 349–360, 2008.
- [95] A. Skabardomis, T. Chira-Chavala, and D. Rydzewski, “The I-880 field experiment: effectiveness of incident detection using cellular phones.” *California Partners for Advanced Transit and Highways (PATH)*, 1998.
- [96] J. Zhang, F.-Y. Wang, K. Wang, W.-H. Lin, X. Xu, and C. Chen, “Data-driven intelligent transportation systems: A survey.” *Intelligent Transportation Systems, IEEE Transactions on*, vol. 12, no. 4, pp. 1624–1639, 2011.
- [97] National Highway Traffic Safety Administration, “Traffic Safety Facts – Preliminary 2009 Report.” <http://www-nrd.nhtsa.dot.gov/Pubs/811255.pdf>, 2010.
- [98] M. Abuelela, S. Olariu, and M. C. Weigle, “NOTICE: An architecture for the notification of traffic incidents.” *Vehicular technology conference, VTC Spring 2008, IEEE*, pp. 3001–3005, 2008.
- [99] S. Sha-Mohammad, H. M. Abdel-Wahab, and D. Popescu, “A study of IEEE 802.11 standard for use in vehicle to infrastructure communication.” *Globecom Workshops (GC Wkshps), 2013 IEEE*, pp. 1303–1307, 2013.
- [100] C. Xie and E. Parkany, “Use of driver-based data for incident detection.” *Applications of Advanced Technologies in Transportation, ASCE*, pp. 143–150, 2002.
- [101] B. M. Williams and A. Guin, “Traffic management center use of incident detection algorithms: Findings of a nationwide survey.” *Intelligent Transportation Systems, IEEE Transactions on*, vol. 8, no. 2, pp. 351–358, 2007.

- [102] N. H. T. S. Administration. "Traffic Safety Facts: 2007 Data: Pedestrians." *Annals of Emergency Medicine*, vol. 53, no. 6, pp. 824-824, 2009.
- [103] S. A. Sha-Mohammed, D. C. Popescu, and H. M. Abdel-Wahab. "A new technique for automatic incident detection in intelligent transportation systems using aggregation of traffic parameters." *Wireless Communications and Networking Conference (WCNC), 2015 IEEE*, pp. 2144-2148, 2015.
- [104] P. Izadpanah, B. Hellenga, and L. Fu. "Automatic traffic shockwave identification using vehicles trajectories." in *Proceedings of the 88th Annual Meeting of the Transportation Research Board (CD-ROM)*, 2009.
- [105] D. Huang, S. Shere, and S. Ahn. "Dynamic highway congestion detection and prediction based on shock waves." *Proceedings of the seventh ACM international workshop on Vehicular Internet networking*, ACM, pp. 11-20, 2010.
- [106] Y. Wang and F. Li. "Vehicular ad hoc networks." *Springer*, pp. 503-525, 2009.
- [107] C. Sommer, R. German, and F. Dressler. "Bidirectionally coupled network and road traffic simulation for improved IVC analysis." *Mobile Computing, IEEE Transactions on*, vol. 10, no. 1, pp. 3-15, 2011.
- [108] K. Fall and K. Varadhan. "The NS Manual (formerly ns Notes and Documentation)." *The VINT Project*, vol. 47, 2005.
- [109] F. Schmidt-Eisenlohr, J. Letamendia-Murua, M. Torrent-Moreno, and H. Hartenstein. *Bug Fixes on the IEEE 802.11 DCF module of the Network Simulator ns-2.28*. Universität Karlsruhe, Fakultät für Informatik, 2006.
- [110] Q. Chen, F. Schmidt-Eisenlohr, D. Jiang, M. Torrent-Moreno, L. Delgrossi, and H. Hartenstein. "Overhaul of IEEE 802.11 modeling and simulation in ns-2,"

The 10th ACM Symposium on Modeling, analysis, and simulation of wireless and mobile systems. ACM, pp. 159–168. 2007.

- [111] B. Musznicki and P. Zwierzykowski. “Survey of Simulators for Wireless Sensor Networks.” *International Journal of Grid and Distributed Computing*, vol. 5, no. 3, pp. 23–50. 2012.
- [112] A. Varga. “Omnet++: Objective Modular Network Testbed in C++.” *Discrete event simulation system*. <http://www.omnetpp.org>.
- [113] S. Eichler, C. Schroth, and J. Eberspächer. “Car-to-car communication.” *Cite-seer*, vol. 1, pp. 35–40. 2006.
- [114] H. Noori. “Realistic Urban Traffic Simulation as Vehicular Ad-Hoc Network (VANET) via Veins Framework.” in *12th Conference of Open Innovations Framework Program. FRUCT*. 2012.

APPENDIX A

SIMULATION TOOLS

For the purpose of evaluating the probability of success data exchange in vehicle to infrastructure communications, **ns – 3** network simulation tool was used. Discrete event network simulator **ns – 3** is one of the most used network simulation tools [108]. Many education institutes and software organizations such as Sun Microsystems, University of California at Berkeley, and Carnegie Mellon University strongly influenced the original implementation of IEEE 802.11 networks in **ns – 2**. While it has a limited accuracy in simulating radio behaviors [109], it was not critical typically for higher protocol layers. In [110], the remodeling of PHY and MAC layer is designed. Today, **ns – 3** is a free source network simulation tool and is available online at <https://www.nsnam.org>. The ns-3 can be installed on unix shell with ubuntu Linux platform. The unix shell script was used to run the **ns – 3** implemented simulation codes and to generate random numbers within the beacon interval to calculate random vehicle entering RSU coverage area. The probability of success is calculated in the same implemented unix shell script tool.

To calculate the successful communication between vehicle and road side unit, the **packet capture (pcap)** which is an API for capturing network traffic was used. The **tcpdump** unix command was used to print out the contents of captured packet on a network interface.

It is important to use the correct simulation tool that can fit within the requirements of a certain research. Because of the limitations imposed by **ns – 3** and **ns – 2** as we mentioned above as well as the fact that their models cannot make vehicular networks much realistic [111], OMNet++ was used to simulate the proposed technique. OMNet++ is a network simulation tool that contains all **ns – 2** features [112].

It is a better choice for simulating physical layer. Therefore, OMNet++ was used to test the proposed technique.

The automatic incident detection can be completed in a large test bed [113]. Today, vehicle in network simulation (viens) simulator is one of the most comprehensive tools to make the vehicular network simulations as realistic as possible. It is also an open source software. One of the very important features of viens is reliance on the mobility model that was implemented by Transportation and Traffic Science community. The OpenStreetMap could be imported to simulate. OpenStreetMap is the full data set of the street maps in almost all the cities in the world. Viens coupled the two types of simulators: network simulator OMNet++ and mobility SUMO. The most interesting feature of viens for AID scenario implementation is re-routing of cars in a reaction to network simulator [114].

The road side units and the vehicle wireless capability were created by using network simulator OMNet++ which the viens can couple with the mobility simulator sumo. The scenario area was extracted from the OpenStreetMap fulldataset at www.OpenStreetMap.org. The sumo road network file was created by command `netconvert` and then random trips were created for the vehicles by the command `randomTrips`. The routes and traffic flows are created by command `duarouter`. The mobility simulation part setup was completed by creating configuration file which combined the road nets, routes and vehicles. In these processes, several configured files will be created such as `.ned.xml` and `.edg.xml` for `netconvert`, and the routing files `.net.xml`, `.poly.xml` and `.rou.xml` and the last file, which contains the beginning and ending time plus the simulation time steps. For creating the network simulation parts, OMNet++ is supported in viens. The messages, gates, connections, and self messages models were implemented in OMNet++. The NED file was implemented for the vehicle, which contains the submodels. For example module interface `manetRouting` was used as `manet` routing. Regarding the RSUs, they were created

as the same vehicle network structures except for the mobility which is set to zero in a fixed location. The last step is the set up runtime parameters in a OMNetpp.ini. In viens simulation, the TCP socket at port 9999 is created for connecting OMNet++ implemented part and SUMO parts. After both OMNet++ and sumo portions are implemented, first sumo-launched.py is used to create the TCP socket at port 9999 in a listening state for connecting to the OMNet portion. When the completed configure file is run in a different unix shell, automatically the OMNet++ and sumo will be launched and wait for the developer to run it.

APPENDIX B

ABBREVIATIONS AND DESCRIPTION

Abbreviations	Description
ACK	Acknowledgement
BPSK	Binary Phase-Shift Keying
BSS	Basic Service Set
CBR	Channel Busy Ratio
CCH	Control Channel
CDF	Cumulative Distribution Function
CLD	Changing Lane Distance
CLS	Changing Lane Speed
CSMA/CA	Carrier Sense Multiple Access with Collision Avoidance
CTS	Clear to Send
DIFS	Distributed Inter Frame Space
DSRC	Dedicated Short Range Communication
GPS	Global Position System
IEEE	Institute of Electrical and Electronics Engineers
ITS	Intelligent Transportation Systems
LIN	Local Interconnect Network
MLME	MAC Layer Management Entity
MOST	Media Oriented System Transport
NHTSA	National Highway Transportation Safety Administration
OFDM	Orthogonal Frequency Division Multiplex
PHY	Physical Layer
PLCP	Physical Layer Convergence Protocol
RSU	Road Side Units
RTS	Request to Send
SCH	Service Channel
SPAT	signal phase and timing
US-DOT	US Department of Transportation
V2I	Vehicle-to-Infrastructure
V2V	Vehicle-to-Vehicle
WAVE	Wireless Access in Vehicular Environments
WLAN	Wireless Local Area Network
WME	WAVE Management Entity

VITA

Sarwar Aziz Sha-Mohammad
Department of Computer Science
Old Dominion University
Norfolk, VA 23529

Sarwar Sha-Mohammad obtained his BSc in Math in July, 2001 from University of Sulaimany, department of Mathematics. He obtained his MSc in Feb. 2005 in Computer Science from University of Sulaimany, department of Computer Science under the supervision, of Professor Parosh Aziz Abdulla from Uppsala University in Sweden. His MSc dissertation work addressed formal verification methods to model infinite state systems induced by real time computing using timed Petri nets. He joined the PhD Computer Science program of ODU during Fall, 2010.