



January 2015

Survey Of Southern Amazonian Bird Helminths

Kaylyn Patitucci

Follow this and additional works at: <https://commons.und.edu/theses>

Recommended Citation

Patitucci, Kaylyn, "Survey Of Southern Amazonian Bird Helminths" (2015). *Theses and Dissertations*. 1945.
<https://commons.und.edu/theses/1945>

This Thesis is brought to you for free and open access by the Theses, Dissertations, and Senior Projects at UND Scholarly Commons. It has been accepted for inclusion in Theses and Dissertations by an authorized administrator of UND Scholarly Commons. For more information, please contact zeinebyousif@library.und.edu.

SURVEY OF SOUTHERN AMAZONIAN BIRD HELMINTHS

by

Kaylyn Fay Patitucci
Bachelor of Science, Washington State University 2013
Master of Science, University of North Dakota 2015

A Thesis

Submitted to the Graduate Faculty

of the

University of North Dakota

in partial fulfillment of the requirements

for the degree of

Master of Science

Grand Forks, North Dakota
December
2015

This thesis, submitted by Kaylyn F. Patitucci in partial fulfillment of the requirements for the Degree of Master of Science from the University of North Dakota, has been read by the Faculty Advisory Committee under whom the work has been done and is hereby approved.



Dr. Vasyl Tkach



Dr. Robert Newman



Dr. Jefferson Vaughan

This thesis is being submitted by the appointed advisory committee as having met all of the requirements of the School of Graduate Studies at the University of North Dakota and is hereby approved.

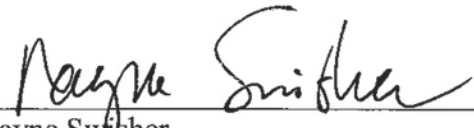

Wayne Swisher
Dean of the School of Graduate Studies



Date

PERMISSION

Title Survey of Southern Amazonian Bird Helminths

Department Biology

Degree Master of Science

In presenting this thesis in partial fulfillment of the requirements for a graduate degree from the University of North Dakota, I agree that the library of this University shall make it freely available for inspection. I further agree that permission for the extensive copying for scholarly purposes may be granted by the professor who supervised my thesis work or, in his absence, by the Chairperson of the department or the dean of the School of Graduate Studies. It is understood that any copying or publication or other use of this thesis or part thereof for financial gain shall not be allowed without my written permission. It is also understood that due recognition shall be given to me and to the University of North Dakota in any scholarly use which may be made of any material in my thesis.

Kaylyn Patitucci
December, 2015

TABLE OF CONTENTS

LIST OF FIGURES.....	vi
LIST OF TABLES.....	ix
ACKNOWLEDGMENTS.....	x
ABSTRACT.....	xi
CHAPTER	
I. INTRODUCTION.....	1
Background.....	2
Helminths.....	4
Amazonian Bird Helminths.....	8
II. METHODS.....	11
Study Design.....	11
Specimen Collection.....	12
Morphological Studies.....	13
Molecular Studies.....	14
Phylogenetic Studies.....	19
Statistical Analyses.....	20
III. RESULTS/DISCUSSION.....	21
Systematic survey of helminths in southern Amazon.....	21
Comparative analysis between areas of endemism.....	74
REFERENCES	87

APPENDICES.....	99
Appendix A. <i>Moesia ovalis</i> n. sp. (Digenea: Phaneropsolidae) from the green manakin <i>Xenopipo holochlora</i> from Peruvian Amazon with notes on morphology of <i>Moesia moesi</i> Travassos, 1921.....	100
Appendix B. Helminths of birds found in the present study.....	92

LIST OF FIGURES

Figure	Page
1. Map outlining the major areas of endemism of southern Amazonia.....	3
2. Generalized life cycle of digenean.....	7
3. Generalized life cycle of cestode.....	7
4. Generalized life cycle of nematode.....	7
5. Generalized life cycle of acanthocephalan.....	7
6. Areas of endemism within Southern Amazonian Brazil identified by Silva et al. (2005).....	11
7. Gene layout and positions of PCR and sequencing primers.....	18
8. <i>Glaphyrostomum</i> n. sp. from <i>Xenops minutus</i>	24
9. Dicrocoeliidae sp. from <i>Rhynchocyclus olivaceus</i>	24
10. <i>Lutztrema</i> sp. from <i>Turdus lawrencii</i>	26
11. Morphometric analysis of some morphological characteristics commonly used in dicrocoeliid systematics.....	28
12. <i>Uvulifer</i> sp. from <i>Chloroceryle inda</i>	30
13. Bayesian analysis of 28S sequences of the family Eucotylidae.....	34
14. Bayesian analysis of 28S sequences of the family Eucotylidae, including host orders and the geographic location from which the species were obtained.....	34
15. <i>Tamerlania parva</i> . from <i>Rhegmatorhina melanosticta</i>	36
16. <i>Tamerlania</i> sp. from <i>Xenops minutus</i>	36
17. <i>Bakkeius moragai</i> from <i>Microbates cinereiventris</i>	36

18. <i>Mosesia ovalis</i> from <i>Xenopipo holochlora</i>	36
19. <i>Phaneropsolus</i> sp. from <i>Xenopipo holochlora</i>	39
20. Renschtreematidae sp. from <i>Thalurania furcate</i>	39
21. Phylogenetic tree resulted from bayesian analysis of 28S sequences of the superfamily Microphallidea.....	42
22. Phylogenetic tree resulted from Bayesian analysis of 28S sequences of the family Schistosomatidae.....	44
23. <i>Stomylotrema vicarium</i> from <i>Sclerurus mexicanus</i>	45
24. <i>Arostellina reticulata</i> from <i>Taphrospilus hypostictus</i>	48
25. Dilepididae sp. from <i>Galbula cyanescens</i>	48
26. Dilepididae sp. scolex hooks from <i>Megascops watsonii</i>	48
27. Hymenolepididae sp. from <i>Thamnomanes ardesiacus</i>	51
28. Hymenolepididae sp. scolex hooks from <i>Megascops watsonii</i>	51
29. <i>Passerilepis</i> sp. from <i>Rhynchocyclus olivaceus</i>	51
30. <i>Mesocestoides</i> sp. from <i>Thamnomanes ardesiacus</i>	53
31. (A) <i>Mesocestoides</i> with inverted scolex, total view. (B) Inverted scolex. (C) Posterior end and excretory system of <i>Mesocestoides</i> with inverted scolex. (D) Posterior end and excretory system of <i>Mesocestoides</i> with everted scolex. (E) <i>Mesocestoides</i> with everted scolex, total view.....	54
32. Phylogenetic tree resulted from Bayesian analysis of available 12S sequences of <i>Mesocestoides</i>	55
33. Phylogenetic tree resulted from Bayesian analysis of available mitochondrial (cox1) sequences of <i>Mesocestoides</i>	56
34. Phylogenetic tree resulted from Bayesian analysis of available mitochondrial (nad1) sequences of <i>Mesocestoides</i>	56
35. Metadilepididae sp. scolex hooks from <i>Formicivora grisea</i>	57
36. <i>Schmidneila</i> sp. from <i>Formicivora grisea</i>	59
37. <i>Biuterina</i> sp. from <i>Lepidothrix coronata</i>	59
38. Paruterinidae sp. from <i>Ramphocelus melanogaster</i>	67
39. <i>Aproctella</i> sp. 1 from <i>Tolmomyias flaviventris</i>	67

40. <i>Subulura travassosi</i> from <i>Notharchus tectus</i>	67
41. Phylogenetic tree resulted from Bayesian analysis of 18S sequences of ascaridoid nematodes.....	71
42. <i>Sphaerirostris</i> sp. from <i>Catharus ustalatus</i>	73
43. Proportion of different avian orders among samples from Belém.....	76
44. Proportion of different avian orders among samples from Inambari.....	76
45. Prevalence of infection with all helminths between the two areas of endemism.....	77
46. Prevalence of infection by major helminth groups between the two areas of endemism.....	78
47. Prevalence of acanthocephalan families between the two areas of endemism.....	78
48. Prevalence of cestode families between the two areas of endemism.....	80
49. Prevalence of digenean families between the two areas of endemism.....	80
50. Prevalence of nematode families between the two areas of endemism.....	81
51. Prevalence of infection with all helminths species among passerine samples.....	81
52. Number of helminth species within individual avian hosts.....	83
53. Estimated bird species richness for both areas of endemism using five different estimators (BOOT: bootstrap; CHAO2: Chao 2; JACK1: first order jackknife; ACE: abundance-based coverage estimator; and ICE: incidence-coverage estimator).....	83
54. Estimated helminth species richness for both areas of endemism using five different estimators (BOOT: bootstrap; CHAO2: Chao 2; JACK1: first order jackknife; ACE: abundance-based coverage estimator; and ICE: incidence-coverage estimator).....	84
55. Ventral view of the holotype of <i>Mosesia ovalis</i> n. sp. from <i>Xenopipo holochlora</i>	110

LIST OF TABLES

Table	Page
1. PCR and sequencing primers for 18S, ITS, 28S, Cox1, Nad1, and 12S genes.....	16
2. Comparative morphological metric data for Renschtreematidae n. sp. Measurements marked by asterisk are inferred from the drawing provided by Rhode (1964), Matskási (1973) and Kifune (1984).....	41
3. Number (above diagonal) and percentage (below diagonal) of variable sites based on pairwise comparison of 416-base-pair-long fragment of mitochondrial cox 1 gene <i>Subulura travassosi</i> and <i>Subulura</i> sp.....	69
4. Distribution of examined birds among bird orders in Belém and Inambari areas of endemism.....	75
5. Distribution of infected birds among bird orders in Belém and Inambari areas of endemism.....	77
6. Jaccard, Sorenson, and Chao-Sorensen estimator indices calculated for birds and helminths among Belém and Inambari areas of endemism.....	84
7. Comparative morphological metric data for <i>Mosesia mosesi</i> (Travassos, 1921).....	89
8. Acanthocephalan survey within two areas of endemism of southern Amazonia.....	91
9. Cestode survey within two areas of endemism of southern Amazonia.....	91
10. Digenean survey within two areas of endemism of southern Amazonia.....	94
11. Nematode survey within two areas of endemism of southern Amazonia.....	96

ACKNOWLEDGMENTS

First and foremost, I have to thank my parents, James and Kathy Patitucci, for their love and encouragement throughout my life, and for supporting me both emotionally and financially. They have always believed in me and wanted the best for me. Thank you for teaching me that my job in life is to learn and to be happy. Thank you for guiding me as a person and for giving me the strength to follow my dreams.

I would like to express my gratitude to my advisor Dr. Vasyl Tkach for his support of my master's study and related research, and for his immense knowledge. His guidance helped me throughout all the time of research and writing of this thesis. Besides my advisor, I would like to thank my other thesis committee members: Dr. Robert Newman and Dr. Jefferson Vaughan for their insightful comments. My sincerest thanks also go to Dr. John Bates and Dr. Jason Weckstein who provided me the opportunity to join their team. Without their support it would not have been possible to conduct this research. I thank my fellow lab mates and graduate students for the stimulating discussions, moral support, and for all the fun we have had in the last two and a half years. Also, I would especially like to thank Chris Felege for the all pep talks and advice he gave me in times of struggle and to Jeffrey Bell for the time, guidance, respect, friendship, and unfailing help he provided me throughout my time at UND.

ABSTRACT

Very little is known about the diversity, distribution, and host associations of avian helminths in southern Amazonia. The majority of avian species, families and even orders in the region have not been examined for parasitic worms so far. At the same time, the expected helminth diversity is high, given that Amazonian birds are extremely diverse and their fauna is characterized by a high level of endemism. In this work, we studied helminth fauna of birds from the westernmost region of endemism, Inambari and from the easternmost region, Belém. Two hundred and thirty-four birds belonging to 9 orders were examined for endoparasites in Inambari in November, 2013 and 199 birds belonging to 15 orders were examined in Belém in July, 2013. Birds were examined and parasites were fixed following standard endoparasite collecting protocols. Specimens were processed in the laboratory for morphological and molecular analyses. Morphology was studied on total permanent (cestodes, digeneans) or temporary (nematodes, acanthocephalans) mounts. When necessary, DNA sequences of nuclear ribosomal and mitochondrial genes were obtained to aid in species differentiation and/or phylogenetic analysis. In Inambari, 68 birds (29%) were infected with helminths. Cestodes were the most prevalent group of parasites. They were found in 42 birds (18%), followed by digeneans (23; 10%), nematodes (12; 5%) and acanthocephalans (2; 1%). In Belém, 51 birds (26%) were infected with helminths. Prevalence of infection with nematodes (28 birds; 14%) was nearly equal to that of cestodes (26; 13%), followed by digeneans (7;

4%) and acanthocephalans (6; 3%). The prevalence of infection with digeneans in Inambari was more than twice higher than in Belém which can be explained by the close proximity of Inambari collecting sites to water bodies. Taxonomic diversity and distribution of helminths among systematic and ecological groups of birds are discussed. Our study revealed several new species belonging to the families Brachylaimidae, Diplostomidae, Renschtreematidae and a likely new genus of the Schistosomatidae. Among other notable discoveries, *Mesocestoides* tethrathiridia have been found for the first time in South American birds. DNA sequences obtained in our study have been incorporated into broader phylogenetic analyses of corresponding groups. The resulting phylogenies are discussed.

CHAPTER I

INTRODUCTION

The Amazonia biome of Brazil is the largest and most diverse tropical forest on earth (Mittermeier et al. 2003). It contains 40% of the world's remaining rainforest (Laurance et al. 2001) with more than 10% of the world's species (Rylands et al. 2002). Despite this vast array of known species, we still do not fully understand the scope of species biodiversity across this tropical forest. This includes not only larger animals, such as vertebrates or small and large free-living invertebrates, but also the "hidden" diversity represented by their endosymbionts, including viruses, bacteria, and parasites.

The diversity and distribution of Amazonian birds have been extensively studied and are relatively well known (Ridgely and Tudor 1989a, 1989b). The region is home to at least 1300 resident bird species, 263 of which are endemic (Mittermeier et al. 1999, Marini and Garcia, 2005). However, compared to their avian hosts, very limited data are available on bird parasites from Amazonia. Even baseline information on diversity, distribution, and host associations are lacking for many bird groups and most regions. It can be assumed that parasite diversity is high given both the high diversity of Amazonian birds and that most bird species are usually infected by multiple species of parasites (Mittermeier et al. 2003, Marini and Garcia 2005). By examining collected bird specimens for parasites, biologists increase the value of those specimens and provide essential background data for work necessary to evaluate fully the impact of parasites on avian evolution and ecology (Garvin et al. 1997).

Given the paucity of information on helminth parasites of Amazonian birds, my project has the following objectives:

- provide an account of helminth fauna of Southern Amazonian birds,
- compare helminth fauna among different areas of endemism and avian taxonomic groups,
- describe any new species discovered, and
- use phylogenies to clarify systematic questions and reveal evolutionary relationships among selected groups of parasites.

Background

This study is a component of a larger project looking at all the symbionts of Amazonian birds including viruses, bacteria, protozoan and metazoan endoparasites (including blood parasites), and ectoparasites. The larger study entitled “Southern Amazonian Birds and their Symbionts” is being conducted in collaboration with the University of North Dakota, Drexel University, Philadelphia, the Field Museum of Natural History, Chicago, Illinois and the Museu Paraense Emílio Goeldi, Belém, Brazil. Although the larger project will survey most of southern Amazonia, this study only focuses on two areas of endemism within the Amazon, namely Inambari and Belém, the westernmost and the easternmost areas of endemism, accordingly (Figure 1).

The Amazonia was originally divided into four biotic districts by Alfred Russel Wallace (1852) who identified the borders of the districts by analyzing primate ranges. Subsequent research refined the pattern as comprising seven to eight distinct areas of endemism, all nested within Wallace’s districts. The boundaries of these areas coincide largely with major Amazonian rivers (Haffer 1978, Cracraft 1985, Haffer 1985, 1987, Silva et al. 2002). The Inambari area of endemism is on the westernmost side of Amazonia and has the highest avian host diversity. The

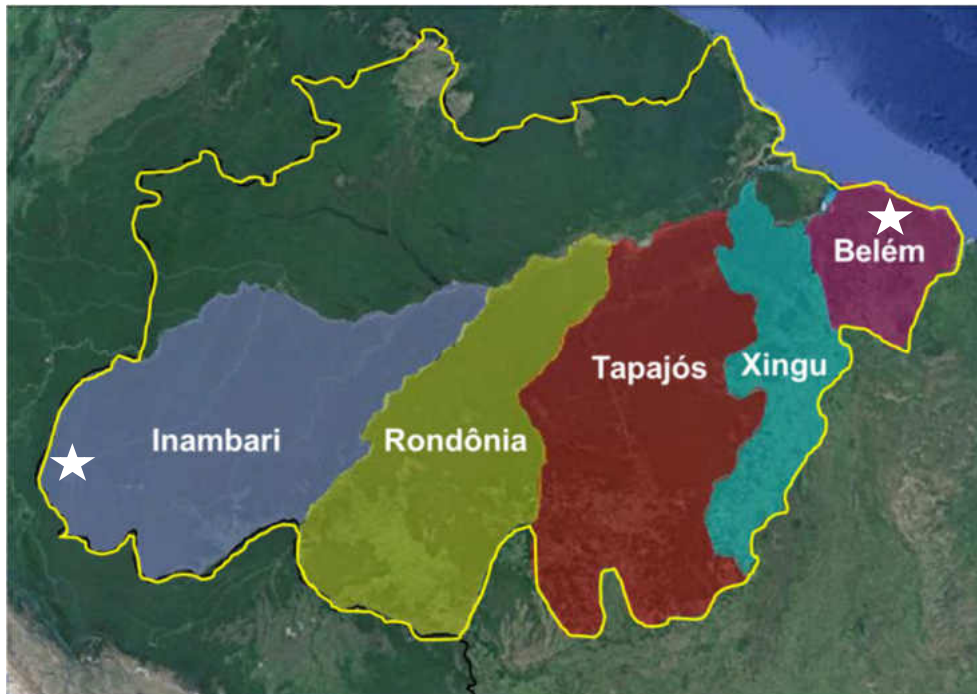

Figure 1. Map outlining the major areas of endemism of southern Amazonia. Stars represent the relative areas in which the expeditions took place. Retrieved from Google Earth.

boundaries of this district are defined by the Rio Madeira to the east, the Andes to the west, the Rio Madre de Dios or Rio Beni to the south, and the Rio Marañon to the north (Cracraft 1985), covering a total area of 1,326,684 km² (Silva et al. 2005).

The Belém region is on the north-east side of the southern Amazon and is the smallest area of endemism in Amazonia. The boundaries of this district are defined by the Atlantic Ocean to the east, the Rio Tocantins to the west, the Rio Mearim to the south, and the Baía de Marajó to the north (Cracraft 1985), covering a total area of 199,211 km² (Silva et al. 2005).

Despite the fact that the main type of habitat of both areas is tropical lowland forest, we expect to see substantial differences in helminth faunas between the two regions for a variety of reasons, with the first and most obvious being that they are on completely opposite sides of the Amazonia. Other reasons include that the Inambari region is almost seven times larger than Belém, is at a much higher altitude, and borders the Andes mountain range. Belém also has a

much higher human population, and less than one-third of its forests are still standing, compared to more than 90% of forest still preserved in Inambari. Climate, topography and biogeographic variations are crucial determinants to the distribution of helminth infections (Brooker 2007). Differences in the diversity and composition of invertebrate intermediate hosts are also very important for parasites with complex life cycles, such as all parasitic flatworms, acanthocephalans, and at least some nematodes.

Helminths

In this study, we examined the endoparasitic worms (helminths) of Southern Amazonian birds, including digeneans (flukes), cestodes (tapeworms), nematodes (roundworms) and acanthocephalans (thorny-headed worms). Below I provide the overview of these helminth groups. While the morphology of all helminths was studied, the morphology of particular groups is not presented due to extreme morphological diversity across all concerned groups of helminths. In short, there is no “typical” cestode, digenean or nematode that would sufficiently represent the whole group.

Digeneans

Digenea is a sub-class of Trematoda and represents the largest group of internal parasites, comprising well over 18,000 nominal species (Cribb et al. 2001 and subsequent literature). They parasitize all major vertebrate groups as definitive hosts (Khalil et al. 1994, Olson et al. 2003). Digeneans are flatworms that lack a coelom and usually possess an incomplete digestive tract. They have a complex life cycle involving at least one intermediate host (a mollusk) and alternation of sexual and asexual generations. Asexual reproduction occurs in the first intermediate host, a mollusk (usually a gastropod), while sexual reproduction normally occurs in vertebrate definitive hosts, such as birds, with few exceptions. Eggs produced by adults pass out

in feces, urine, or sputum. Eventually they hatch either in water or in the intestine of a mollusk, releasing free-swimming, ciliated miracidium larva. The miracidium penetrates into the mollusk through the body or gut wall, and develops into a mother sporocyst. Embryos within the mother sporocyst undergo asexual reproduction to become rediae or daughter sporocysts, depending on the group of digeneans. The next stage, cercariae, develop within the redia/daughter sporocysts. Cercariae exit the mollusk and swim freely. With the exception of a few families, most digeneans utilize a second intermediate host, often another mollusk, in which development of cercaria into infective encysted metacercaria occurs. When a bird eats this infected host, the metacercariae are digested and mature into adult flukes. Adult digeneans usually occur in the intestine, although they can also be found in the liver, kidney, cloaca, air sacs, bursa fabricii, or occasionally in the mouth or esophagus. With exception of some blood flukes, digeneans are hermaphroditic (have a set of female and male organs), but reproduction still requires two worms that exchange sperm (Roberts et al. 2013, Sullivan 2009; Figure 2).

Cestodes

Cestodes are another entirely parasitic group of Platyhelminths. They are a monophyletic group of hermaphroditic parasites of vertebrates (Roberts et al. 2013, Khalil et al. 1994, Waeschenbach et al. 2007). Although there are at least 14 orders of Cestoda (Khalil et al. 1994, Hoberg et al. 1997), birds are parasitized primarily by the members of the largest and most taxonomically diverse order Cyclophyllidea (Khalil et al. 1994). They are characterized by the presence of repeating sets of both male and female reproductive organs in each segment (proglottid). Tapeworms are composed of three regions: the scolex, the undifferentiated neck which produces new proglottids, and the strobila which consists of immature, mature, pre-gravid and gravid proglottids, the latter normally containing fully formed eggs. In primitive groups of

tapeworms, eggs can be laid through pores in the tegument. In the majority of cestodes, however, eggs are dispersed inside a whole gravid proglottid that detaches from the strobila and is passed out of the intestine with feces. In cyclophyllideans, larvae hatch inside an intermediate host, usually an arthropod, and become metacestode larvae. If this host gets eaten by a suitable definitive host (e.g., a bird) the metacestodes develop into adult tapeworms in the intestine. Most tapeworms are hermaphroditic with few having separate sexes (Schmidt and Roberts 1996, Sullivan 2009; Figure 3).

Nematodes

Roundworms belong to the phylum Nematoda. Nematodes are an extremely diverse group of animals, with estimates ranging from 100,000 to 100 million species (May 1988, Hammond 1992, Lambshhead 1993, Coomans 2000). The majority of nematode species are free-living and are found in every aquatic and moist terrestrial habitat (Convey and McInnes 2005) while many are parasitic. They have a complete digestive tract, are non-segmented, and have a pseudocoelomic body cavity. Nematodes are covered with a cuticle that they must molt in order to grow, usually have separate sexes, and have four larval stages with four molts. Different species of parasitic roundworms infect different areas of the body and their life cycles are very diverse. In general, adult roundworms lay eggs inside the infected definitive host. The eggs are usually voided from the host with feces and they frequently (but not always) incubate in soil before becoming infective. An intermediate host may or may not be required. The eggs or intermediate hosts must usually then be consumed by the definitive host. Some nematode larvae penetrate directly through the vertebrate skin, and some are transmitted by blood sucking vectors. Once the infective stage makes its way to the final site in the body of its host, the development cycle is complete (Schmidt and Roberts 1996, Sullivan 2009; Figure 4).

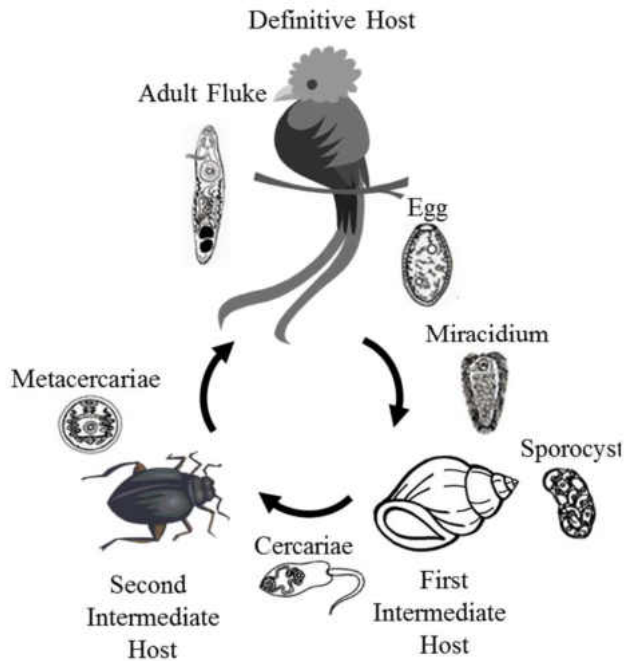

Figure 2. Generalized life cycle of a digenean. Adapted from a CDC diagram of philophthalmiasis. Retrieved from <http://www.dpd.cdc.gov/dpdx/HTML/Philophthalmiasis.htm>

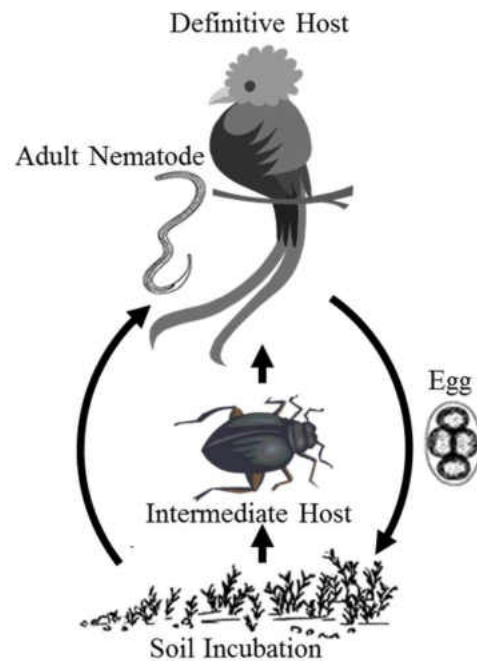

Figure 4. General life cycle of a nematode. Adapted from a CDC diagram of strongyloidiasis. Retrieved from <http://www.cdc.gov/dpdx/strongyloidiasis/index.htm>.

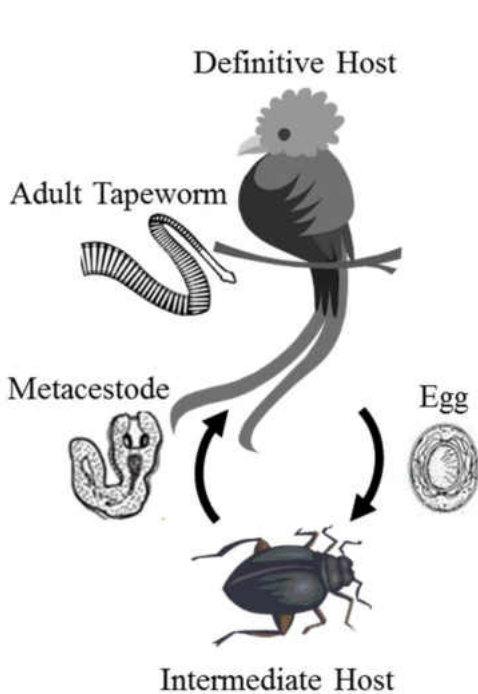

Figure 3. General life cycle of a cestode. Adapted from a CDC diagram of hymenolepiasis. Retrieved from <http://www.dpd.cdc.gov/dpdx/HTML/Hymenolepiasis.htm>.

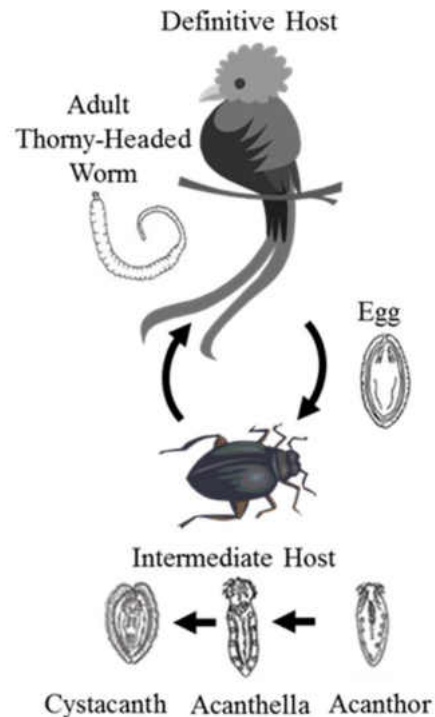

Figure 5. General life cycle of an acanthocephalan. Adapted from a CDC diagram of Acanthocephaliasis. Retrieved from http://www.dpd.cdc.gov/dpdx/HTML/Frames/AF/Acanthocephaliasis/body_Acanthocephaliasis_page1.htm

Acanthocephalans

Acanthocephalans belong to the phylum Acanthocephala. Acanthocephalans are a small group of obligate parasites that utilize arthropods as intermediate hosts and vertebrates as definitive hosts in a conserved two-host life cycle (Near 2002). Only about 1,000 species of acanthocephalans have been described worldwide (Amin 1985). Their defining feature is their spiny proboscis. Each species of acanthocephalan uses at least two hosts in its life cycle. The first is a crustacean or an insect which must eat an egg that was voided with the feces of a definitive host. Within the arthropod, a fully embryonated larva called an acanthor hatches from the egg and penetrates the gut wall of the intermediate host. There it develops into an acanthella and the internal organs start to take form. The final larval stage is the cystacanth which possesses the proboscis of the adult form. Development ceases until the intermediate host containing the cystacanth is eaten by the definitive host. Then the cystacanth excysts, the parasite is freed, and it attaches to the intestine of the definitive host (Schmidt and Roberts 1996, Sullivan 2009; Figure 5).

Amazonian Bird Helminths

Literature on the fauna, taxonomy, systematics, distribution and natural history of avian parasites from Amazonia is scarce. This is particularly true for helminths. No surveys covered broad geographic areas or assessed patterns of diversity and endemism of Amazonian bird parasites. To date, published data are mostly based on opportunistic collections which were limited in avian host diversity and/or geographic coverage. Travassos et al. (1969) and Thatcher (1993) have provided most of the available taxonomic descriptions of digeneans for South America, listing 150 avian trematodes found in Brazil. Thatcher specifically identifies 21 worms as coming from the Amazon, but none were described from birds. Other contributions containing

information about adult and larval forms of digeneans from Brazilian birds include Freitas (1951, 1955, 1959), Wright (1954), Franco (1965), Freitas & Costa (1972), Leite et al. (1978), and Pinto et al. (2013). Nevertheless, almost none of them report digeneans from Amazonian birds. The only species from Amazon mentioned in these publications are *Paratanaisia bragai* (Santos, 1934) Freitas, 1959 and *Tanaisia inopina* Freitas 1951, both found in orioles (Freitas 1951, 1959). Although there are many avian cestodes described from South America, only a few came from Peru and Brazil (Rego, 1973; Rodrigues et al., 1990; Bona, 1994; Arruda et al., 2001; Phillips et al., 2014). Nematodes had the most records of any helminths reported from Southern Amazonian birds. Vicente et al. (1995) lists *Subulura travassosi* Barreto 1919, *Capillaria venusta* Freitas & Mendonca 1958, *Thelazia anolabiata* (Molin 1860) Railliet & Henry 1910, *Procyrnea leptoptera* (Rudolphi 1819) Chabaud 1975, and *Diplotrriaena bargusinica* Skrjabin 1917 from birds in Belém. Other important contributions to our knowledge of avian nematodes from Brazil and Peru are Strachan (1957), Vicente et al. (1983), Pinto and Gomes (1985), Elias et al. (2008), Rodrigues et al. (1990), Vicente et al. (1995), Rodrigues (1996), and Hon et al. (2013). There are few records of acanthocephalans from birds in Brazil; Monteriro et al. (2006) described *Andracantha tandemtesticulata* from *Phalacrocorax brasilianus*, Mascarenhas et al. (2009) who identified *Mediorhynchus* sp. from a *Paroaria coronata*, Buehler et al. (2010) who identified *Proflicollis* sp. from species of *Calidris*, and Andery et al. (2013) who identified *Centrorynchus* sp. from many different species of raptors.

Franco Bona collected avian cestodes in various areas around South America, but only published data based on material from Argentina (e.g. Bona 1983, Bona and Maffi 1984, Bona and Bionaz 1990, Bona 1994). Garvin et al. (1997) identified 12 species of avian nematodes from Amazonian sites in Bolivia, but only a few of those records came from southern Amazonia.

And recently, Phillips, Georgiev, Waeschenbach, and Mariaux (2014) collected material from Brazilian birds and described two new taxa (*Anonchotaenia prolixa* and *Anonchotaenia vaslata*), but neither of them came from the Amazon. Thus, very little is known about host associations in this region and many undescribed taxa undoubtedly await to be found and described.

CHAPTER II

METHODS

Study Design

As mentioned above, this study is a component of a larger project looking at all the symbionts of Amazonian birds including viruses, bacteria, blood parasites, endoparasites, and ectoparasites. My research focused only on helminths collected as part of the project. Fieldwork took place during two, one-month surveys. Samples were collected from the westernmost area of endemism, Inambari, in Peru ($S8^{\circ}10.694$, $W76^{\circ}13.422$) and the easternmost area of endemism, Belém in Brazil ($S3^{\circ}42.128$, $W46^{\circ}45.44$) (Figure 6). Collecting in the Belém area of endemism (Gurupi nature reserve) took place in July of 2013 and collecting in the Inambari area of endemism (Cordillera Azul National Park) took place in November 2013.

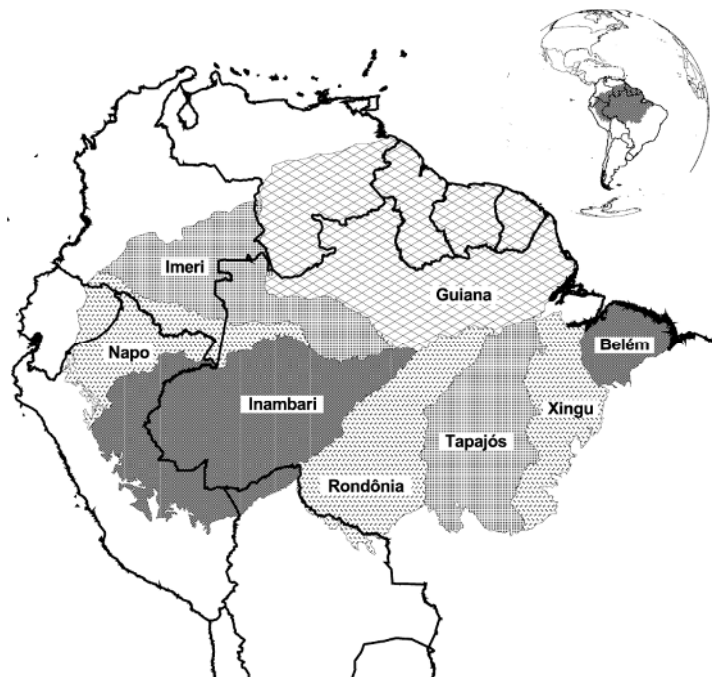

Figure 6. Areas of endemism within Southern Amazonian Brazil identified by Silva et al. (2005).

Specimen Collection

Birds were collected by mist netting or taken by gun shot. Mist net positions were chosen based on the choice of expert ornithologists. Caught birds were identified to species, and then placed into separate, clean cotton bags until ready to be processed as soon as possible on the same day. During processing, the birds were first humanely euthanized by thoracic compression and assigned a field number. Guidelines set by The American Ornithologists' Union for humanely collecting and euthanizing birds was strictly followed (Fair et al. 2010). The IACUC protocol for the project has been approved by the UND IACUC and the IACUC at the Field Museum of Natural History. Blood was then drawn from the brachial vein and saved on FTA cards. Blood smears were made on slides when possible. Swabs were also taken for virological and bacteriological analysis. The birds then underwent fumigation in ziplock bags containing ethyl acetate and feather ruffling to collect ectoparasites. Ornithologists took measurements, weighed the birds, made museum skins and kept skeletons when necessary. Bird tissues were saved in liquid nitrogen and ethanol. Then the carcasses were passed to an endoparasitologist for necropsy. Birds were necropsied following standard endoparasite collecting procedures (Bennett 1970, Garvin et al. 1997) that have been further optimized in Dr. Vasyl Tkach's laboratory. Processing of birds was prioritized on the basis of freshness in order to increase the chances of obtaining quality helminth specimens. The pleural cavity, peritoneal cavity and eye sockets were examined for helminths and the liver, kidneys, spleen, cloaca with bursa fabricii, lungs (airsacs) and complete gastrointestinal tract was removed and placed in clean Petri dishes or pans with saline. The gastrointestinal tract was carefully dissected by cutting lengthwise down the intestine, before being scraped with a clean microscope slide and examined using a stereo microscope. The

body cavities of waterbirds were rinsed with citrated saline and mesenteric veins screened for blood flukes.

Traditional methods were used to preserve helminth specimens for morphological and molecular study. Live cestodes and trematodes were killed with hot water, nematodes killed with hot saline, and acanthocephalans relaxed in distilled water prior to fixation to ensure proboscis evagination. Most specimens were fixed in 70% ethanol. In the case when large numbers of specimens belonging to the same species were available, some of them were fixed in 96% ethanol specifically for molecular studies.

Morphological Studies

For morphological studies and identification, cestodes and trematodes were stained, mounted and photographed. Adult worms preserved in 70% ethanol were first rehydrated in distilled water and then stained with alum carmine or Mayer's hematoxylin. Acid ethanol (after carmine staining) or a 1% solution of hydrochloric acid (after hematoxylin staining) was used to remove any excess stain. Hematoxylin staining required an extra step of placing the worm in a 1% ammonia solution after de-staining. Worms were then dehydrated in a graded ethanol series of increasing concentration: 70%, 80%, 90%, 95%, and 100% (2x). Afterward, specimens were cleared in methyl salicylate (after hematoxylin staining) or clove oil (after carmine staining), and mounted permanently in Damar gum. Nematodes and acanthocephalans were cleared in Berlese's medium and studied in temporary mounts. Measurements were taken using a DIC-equipped Olympus BX-51 microscope and Rincon HD software (Imaging Planet, Goleta, California). Drawings were made with the aid of a drawing tube on a Leica DM5000 compound microscope.

Digeneans and cestodes were identified to the lowest possible taxonomic level using keys specific to each helminth group (i.e. Keys to the Cestode parasites of Vertebrates by Khalil et al. 1994, Keys to the Trematoda, vol. 1 by Gibson et al. 2002, Keys to the Trematoda, vol. 2 by Jones et al. 2005, and Keys to the Trematoda, vol. 3 by Bray et al. 2008). Nematodes were identified by our collaborator Dr. Mike Kinsella and acanthocephalans were identified by collaborators Dr. Olga Lisitsyna and Dr. Omar Amin.

Specimens used for scanning electron microscopy were initially fixed in 70% ethanol, dehydrated in a graded series of ethanol, and dried in a graded series of hexamethyldisilazane (Ted Pella Inc., Redding, CA) as transition fluid. The specimens were mounted on aluminum stubs using conductive double-sided tape, coated with gold-palladium, and examined with the use of a Hitachi 4700 scanning electron microscope (Hitachi U.S.A., Mountain View, California) at an accelerating voltage of 10 kV.

Molecular Studies

DNA sequences were used for species differentiation and phylogenetic analysis. A single worm or section of a worm was used for each DNA extraction after preliminary morphological examination. DNA was extracted using guanidine thiocyanate lysis buffer according to Tkach and Pawlowski (1999) or using commercial kits from either Zymo or Qiagen. In the case of the guanidine buffer, the protocol included the following steps: (1) drying the specimens, (2) lysis in guanidine thiocyanate buffer, (3) precipitation of the DNA with isopropanol for at least two hours or overnight in freezer, (4) centrifugation and removal of the supernatant, (5) rinsing of the resulting DNA pellet with 70% ethanol twice and (5) drying of the DNA pellet in a heat block at 60°C to remove any traces of ethanol. Commercial kits were used according to manufacturers'

instructions. At the final step of both extraction methods, the DNA was eluted with greater than 25 microliters (μ l) of pure water and stored at -20°C .

Various nuclear and/or mitochondrial DNA regions were amplified depending on the need and the group of parasites. For the majority of digeneans and cestodes, a 1400 base pair DNA fragment spanning the 28S nuclear ribosomal DNA gene was amplified by polymerase chain reaction (PCR) in a thermal cycler. The nuclear 28S gene has been used in numerous molecular systematic and phylogenetic studies of parasitic flatworms (reviews by Nolan and Cribb 2005, Olson and Tkach, 2005 and numerous other publications) and has both conserved and variable domains useful for both differentiation among congeneric species and phylogenetic analyses at higher taxonomic levels. PCR reactions were conducted according to protocols described by Tkach and Snyder (2003). PCRs were performed in a total volume of 25 μ l, typically containing 7.5-9.5 μ l of pure water, 12.5 μ l of New England Biolabs' OneTaq Quick-Load 2X Master Mix with Standard Buffer, 1 μ l of each primer at a concentration 10 pM/ μ l, and 1-3 μ l of template genomic DNA extract. The thermocycling profiles were as follows: (28S) 30 sec initial denaturation at 94°C ; 40 cycles of 30 sec denaturation at 94°C , 30 sec annealing at 53°C , 1 min 45 sec extension at 68°C ; and 5 min final extension at 68°C . Please refer to Table 1 for a list of the 28S primers used.

If the amplification of the 28S gene proved successful, we would often also attempt to amplify the nuclear ribosomal ITS1+5.8S+ITS2 region which is characterized by greater variability than nuclear 28S gene, but lower than most mitochondrial genes. The PCR protocol remained the same and the thermocycling profile was as follows: (ITS) 30 sec initial denaturation at 94°C ; 40 cycles of 30 sec denaturation at 94°C , 1 min, 45 sec annealing at 55°C ,

Table 1: PCR and sequencing primers for 18S, ITS, 28S, Cox1, Nad1, and 12S genes. A = Acanthocephalan, C = Cestode, D = Digenean, and N = Nematode.

Primer Name	Primer Type	Direction	Helminth Group(s)	Primer Sequence (5' – 3')
18S Primers				
SSUA	PCR	forward	N	AAAGATTAAGCCATGCATG
D-1R	PCR	reverse	N	CCGGTTCAAGCCACTGCGATTA
SUB28R	Internal	reverse	N	CAAGGGAACCTTGGGTGAGCG
ITS Primers				
ITSF	PCR	forward	C, D	CGCCCGTCGCTACTACCGATTG
ITSF1	Internal	forward	C, D, N	GTCCCTGCCCTTTGTACACACCG
ITS5	PCR	forward	C, D	GGAAGTAAAAGTCGTAACAAGG
M18F1	Internal	forward	C, D	CGTAACAAGGTTTCCGTAG
D58F	Internal	forward	C, D	GCGGTGGATCACTCGGCTCGTG
D58R	Internal	reverse	C, D	CACGAGCCGAGTGATCCACCGC
DIGL2R	PCR	reverse	D	CCGCTTAGTGATATGCTT
SUB58R	Internal	reverse	N	CCGATGGCGCAATGTGCG
28S Primers				
LSU5	PCR	forward	C, D, N	TAGGTCGACCCGTGAAAYTTAAGCA
1500R	PCR	reverse	C, D	CGAAGTTTCCCTCAGGATAGC
300F	Internal	forward	C, D	CAAGTACCGTGAGGGAAAGTTG
300R	Internal	reverse	C, D	CAACTTTCCTCACGGTACTTG
900F	Internal	forward	C, D	CCGTCTTGAAACACGGACCAAG
ECD2	Internal	reverse	C, D	CCCGTCTTGAAACACGGACCAAG
DIGL2	PCR	forward	D	AAGCATATCACTAAGCGG
1500R1	PCR	reverse	D	GCTACTAGATGGTTCGATTAG
CESTL2	PCR	forward	C	AAGCATATCAATAAGCGG
1500RC	PCR	reverse	C	GACGATCGATTTGCACGTC
AC58F	PCR	forward	A	ACAAGGTTTCCGT
AC1500R1	PCR	reverse	A	CGATTGATTTGCACGTC
N900R	PCR	reverse	N	GGTTCGATTAGTCTTTCGCC
Cox1 Primers				
JB5	PCR	forward	C, D, N	AGCACCTAAACTTAAAACATAATGAAAATG
JB3	PCR	reverse	C, D, N	TTTTTTGGGCATCCTGAGGTTTAT
COX1_SCHISTO5'	PCR	forward	D	TCTTTRGATCATAAGCG
COX1_SCHISTO3'	PCR	reverse	D	TAATGCATMGGAAAAAACA
Nad1 Primers				
NAD1F	PCR	forward	C	GGNTATTSTCARTNTCGTAAGGG
TRNNR	PCR	reverse	C	TTCYTGAAGTTAACAGCATCA
12S Primers				
60FOR	PCR	forward	C	TTAAGATATATGTGGTACAGGATTAGATACCC
375R	PCR	reverse	C	AACCGAGGGTGACGGGCGGTGTGTACC

2 min extension at 68°C; and 5 min final extension at 68°C. Please refer to Table 1 for a list of the ITS primers used.

In some helminth taxa, the interspecific variability of nuclear ribosomal genes is not sufficient for reliable species differentiation. In these cases additional, more variable mitochondrial genes (*cox1*, *12S*, *nad1*) were sequenced. The thermocycling profiles were as follows for the mitochondrial genes (*cox1*, *12S*, *nad1*): 30 sec initial denaturation at 94°C; 40 cycles of 30 sec denaturation at 94°C, 30 sec annealing at 45°C, 1 min extension at 68°C; and 5 min final extension at 68°C. Please refer to Table 1 for a list of the mitochondrial primers used.

In zooparasitic nematodes, the nuclear 18S gene is best represented in public sequence databases and is traditionally used for phylogenetic inference at higher taxonomic levels. We used this gene in order to study phylogenetic affinities and clarify systematic positions of the nematodes of genus *Subulura*, which have not been sequenced previously despite the cosmopolitan distribution of this genus. The thermocycling profile for 18S gene was as follows: 30 sec initial denaturation at 94°C; 40 cycles of 30 sec denaturation at 94°C, 35 sec annealing at 53°C, 2 extension min at 68°C; and 5 min final extension at 68°C. Please refer to Table 1 for a list of the 18S primers used.

Various combinations of primers (Table 1) were used for amplification depending on the gene and the group of helminths involved. Figure 7 shows the gene layout and the regions that were amplified and sequenced, as well as the positioning of PCR and sequencing primers.

PCR products were visualized using electrophoresis in 1.2% agarose gels. Five microliters (μ l) of PCR product were loaded into a 1.5% agarose gel and run at 96V for 45 minutes. The addition of loading dye was not needed because the master mix used in PCR already included dye. The gel was then stained with ethidium bromide for 10 minutes, rinsed in distilled water for 12 minutes, visualized on a UV transilluminator, and photographed using a digital gel documentation system.

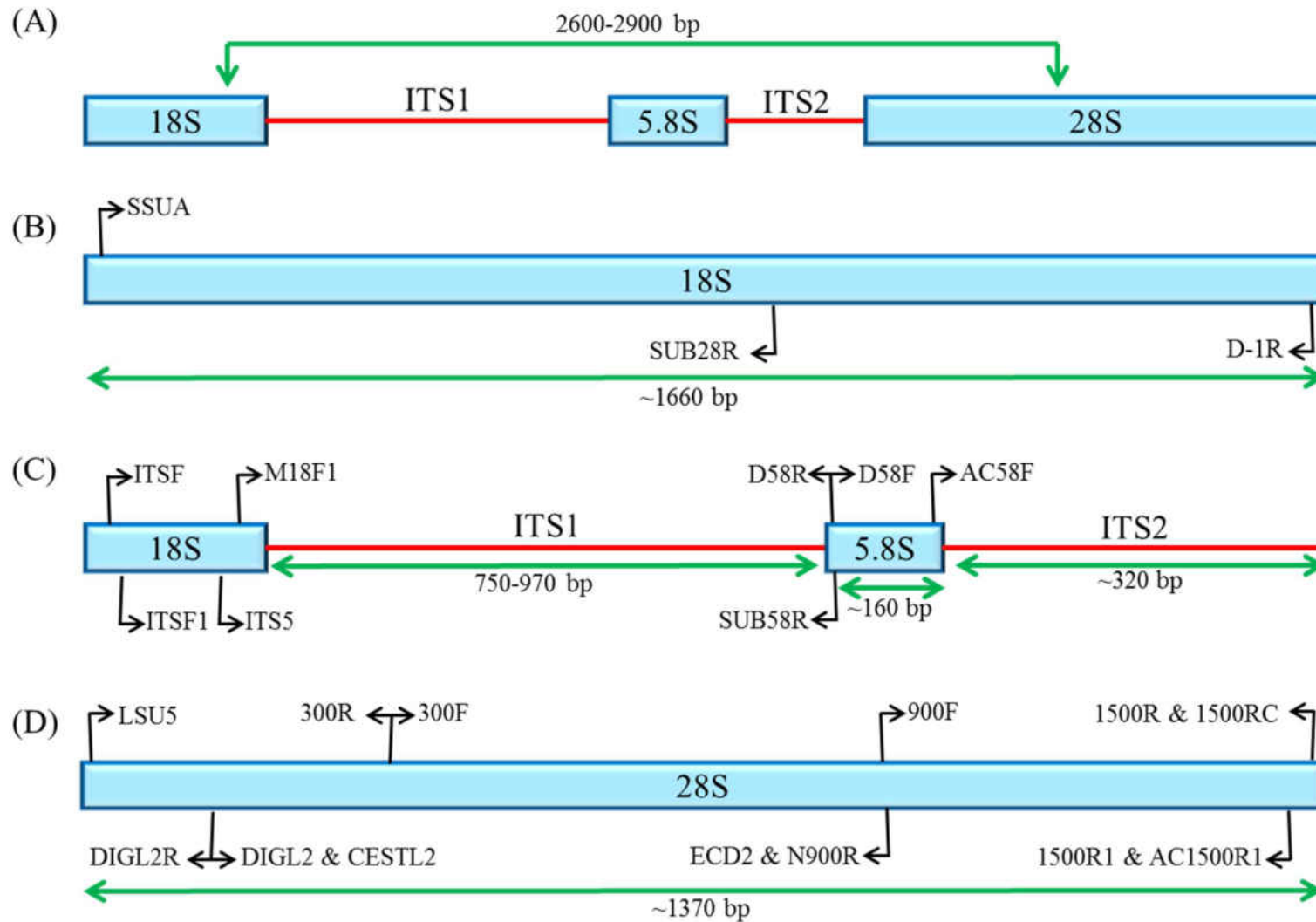

Figure 7. Gene layout and positions of PCR and sequencing primers. (A) Ribosomal complete ITS and 28S nuclear regions showing the 2600-2900bp region that was sequenced. (B) Positions of PCR and sequencing primers in the fragment of 18S gene. (C) Positions of PCR and sequencing primers at the 5' end of 18S gene and 5.8S gene. (D) Positions of PCR and sequencing primers in the fragment of 28S gene.

PCR products were purified using DNA Clean & Concentrator™ kit from Zymo Research (Irvine, CA, USA) or ExoSap PCR clean-up enzymatic kit from Affimetrix (Santa Clara, CA, USA) according to the manufacturer's instructions. The PCR products were cycle-sequenced directly using ABI BigDye™ (Foster City, California) chemistry, ethanol-precipitated, and sequenced directly on an ABI Prism 3100™ automated capillary sequencer. PCR primers and additional internal primers (when needed) were used in sequencing reactions. Thermocycling conditions for sequencing were identical for all genes and helminth groups and included: 25 cycles of 15 sec denaturation at 96°C, 10 sec annealing at 50°C, and 4 min extension at 60°C. Contiguous sequences were assembled using Sequencher™ ver. 4.2 (GeneCodes Corp., Ann Arbor, Michigan) and submitted to GenBank.

Phylogenetic Studies

Contiguous sequences were aligned using BioEdit software, version 7.0.1 (Hall 1999) using ClustalW plug-in with default. Subsequent manual adjustment in BioEdit was done when needed. All chromatograms were verified by eye to ensure quality of resulting contigs. Poor quality sequences with background interference were not used. Levels of inter- or intraspecific variability were calculated as the absolute numbers of variable sites and as a ratio of the variable sites to the total length of the alignment.

Phylogenetic analysis was carried out using Bayesian inference as implemented in the MrBayes program (ver. 3.1). The appropriate model of nucleotide substitution was selected using the program jModelTest software, version 0.1.1 (Guindon and Gascuel 2003, Posada 2008). The Bayesian inference analysis used the parameters required by corresponding models. Posterior probabilities were approximated over 1,000,000-3,000,000 generations depending on the dataset. Log-likelihood scores were plotted and only the final 75% of trees were used to produce the

consensus trees by setting the “burnin” parameter at a quarter of the number of generations used. Trees were visualized using the FigTree ver. 1.4 software (Rambaut, 2012. Molecular evolution, phylogenetics and epidemiology: Fig-Tree. URL: (<http://tree.bio.ed.ac.uk/software/figtree/>)). The maximum likelihood analysis was conducted in MEGA 6.0 software (Tamura et al. 2013) using the same substitution model and a heuristic search algorithm, usually with 1,000 bootstrap replicates.

Statistical Analyses

Comparisons between areas of endemism were made with a chi-square test, with the differences considered significant at $P < 0.05$.

Measures of bird and helminth family richness, diversity, and community similarity were calculated using ESTIMATES software (Colwell 2009). We decided to measure richness at the family level because of the relatively low sample size of birds at the species level and low prevalences of the majority of parasites. Richness was calculated using bootstrap, abundance-based coverage estimator, Chao 1, first order jack-knife, and incidence-coverage estimator. These techniques are intended to provide accurate estimates of true richness based on small sample sizes (Colwell & Coddington 1994).

To estimate similarity of the avian and helminth family communities between the two sites, we used the Chao-Sorensen abundance based similarity index (Chao et al. 2005). Classical indices of similarity, such as the Sorensen and Jaccard indices, are highly sensitive to sample size, especially if rare species are present. The Chao-Sorensen abundance based similarity is a probabilistic derivation of the Sorensen index that compensates for the presence of unseen, shared species among samples and helps to correct for the under-sampling bias of the classical approaches (Chao et al. 2005). Values of this index range between 0 (no shared species) and 1 (complete species overlap).

CHAPTER III
RESULTS/DISCUSSION

Systematic Survey of Helminths in Southern Amazon

The following section lists all helminth taxa obtained from southern Amazonian birds collected for this project. Information on host, locality, site of infection, prevalence of infection, and remarks (if any) is given for each helminth. For a comparative analysis of bird helminth fauna and the infection rates between areas of endemism, please see the next section “Comparative analysis between areas of endemism”.

Subclass Digenea

Family Cyathocotilidae

***Mesostephanus* sp.**

Host: Rufous-capped Antthrush, *Formicarius colma* Boddaert, 1783 (Passeriformes: Formicariidae)

Locality: San Martín, Province Tocache, Cordillera Azul N. P., Río Pescadero, NE of Shapaja: S8°10.694, W76°13.422, elev. 953m.

Site of infection: Intestine.

Prevalence of infection: (1/1)

Family Brachylaimidae

***Glaphyrostomum* n. sp.**

(Figure 8)

Host: Plain Xenops, *Xenops minutus* Sparrman, 1788 (Passeriformes: Furnariidae)

Site of infection: Ureters, kidney.

Locality: Belém, Brazil: S3°42.128, W46°45.44

Prevalence of infection: (1/3)

Remarks: The family Brachylaimidae (Joyeux and Foley, 1930) is the central family of the superfamily Brachylaimoidea (Joyeux and Foley, 1930) and is comprised of digenetic trematodes occurring in mammals and birds.

Our sample from *Xenops minutus* in the Gurupi collecting site contained a single specimen of brachylaimid digenean. Based on its morphological characteristics such as intertesticular cirrus sac and genital pore, extensive vitelline fields, uterine coils reaching to the pharynx or level of oral sucker, and an especially well developed ventral sucker, this specimen belongs to the genus *Glaphyrostomum* (Pojmańska, 2002). It was morphologically distinct from other members of *Glaphyrostomum* described from South America, namely *Glaphyrostomum pinto* (Travassos & Kohn 1964) Yamaguti 1971, *Glaphyrostomum adhaerens* Braun 1901, and *Glaphyrostomum propinquum* Braun 1901, as well *Neomichajlovia guanacastensis*, Zamparo and Brooks 2007, described from Costa Rica. The most prominent differentiating feature of the new species is its enormous pharynx. *Glaphyrostomum* n. sp. is the most morphologically similar to *G. pinto* in terms of the overall measurements of features. However, the oral sucker:body width ratio is much lower in *G. pinto* (1:2.1-2.5) compared to *Glaphyrostomum* n. sp. (1:1.6).

Unfortunately, due to the lack of sequence data on any other previously described species of *Glaphyrostomum*; we were unable to use DNA sequence data for differentiation. We hope to be able to collect additional specimens of this species as part of the ongoing project that would allow for a quality description of this new species.

Family Dicrocoeliidae

***Brachylecithum* sp. (Inambari)**

Hosts: Hairy-crested Antbird, *Rhegmatorhina melanosticta* Sclater & Salvin, 1880

(Passeriformes: Thamnophilidae), two Olivaceous Flatbills, *Rhynchocyclus olivaceus* Temminck,

1820 (Passeriformes: Tyrannidae), two White-plumed Antbirds, *Pithys albifrons* Linnaeus, 1766

(Passeriformes: Thamnophilidae), and Yellow-margined Flycatcher, *Tolmomyias assimilis*

Pelzeln, 1868 (Passeriformes: Tyrannidae)

Locality: San Martín, Province Tocache, Cordillera Azul N. P., Río Pescadero, NE of Shapaja:

S8°10.694, W76°13.422, elev. 953m.

Site of infection: Liver.

Prevalence of infection: *Rhegmatorhina melanosticta* (1/1), *Rhynchocyclus olivaceus* (2/3),

Pithys albifrons (2/3), and *Tolmomyias assimilis* (1/1).

***Brachylecithum* sp. (Belém)**

Host: Kiskadee, *Pitangus* sp. (Passeriformes: Tyrannidae)

Locality: Belém, Brazil: S3°42.128, W46°45.44

Site of infection: NA

Prevalence of infection: (1/1)

Dicrocoeliidae sp.

(Figure 9)

Host: Olivaceous Flatbill, *Rhynchocyclus olivaceus* Temminck, 1820 (Passeriformes:

Tyrannidae)

Locality: San Martín, Province Tocache, Cordillera Azul N. P., Río Pescadero, NE of Shapaja:

S8°10.694, W76°13.422, elev. 953m



Figure 8. *Glaphyrostomum* n. sp. from *Xenops minutus*.



Figure 9. *Dicrocoeliidae* sp. from *Rhynchocylus olivaceus*

Site of infection: Liver.

Prevalence of infection: (1/3)

Lubens lubens Braun, 1901

Host: Blue-crowned Motmot, *Momotus momota* Linnaeus, 1766 (Coraciiformes: Momotidae)

Locality: Belém, Brazil: S3°42.128, W46°45.44

Site of infection: Liver.

Prevalence of infection: (1/1)

***Lubens* sp.**

Host: Lawrence's Thrush, *Turdus lawrencii* Coues, 1880 (Passeriformes: Turdidae)

Locality: San Martín, Province Tocache, Cordillera Azul N. P., Río Pescadero, NE of Shapaja:

S8°10.694, W76°13.422, elev. 953m.

Site of infection: Gallbladder.

Prevalence of infection: (1/3)

***Lutztrema* sp.**

(Figure 10)

Hosts: Lawrence's Thrush, *Turdus lawrencii* Coues, 1880 (Passeriformes: Turdidae) and

Undulated Antshrike, *Frederickena unduligera* Pelzeln, 1868 (Passeriformes: Thamnophilidae)

Locality: San Martín, Province Tocache, Cordillera Azul N. P., Río Pescadero, NE of Shapaja:

S8°10.694, W76°13.422, elev. 953m.

Site of infection: Gallbladder.

Prevalence of infection: *Turdus lawrencii* (1/3) and *Frederickena unduligera* (1/1).

Remarks: This species demonstrates remarkable morphological variability (Figure 10). Because of this and in the absence of molecular data, previous researchers described different

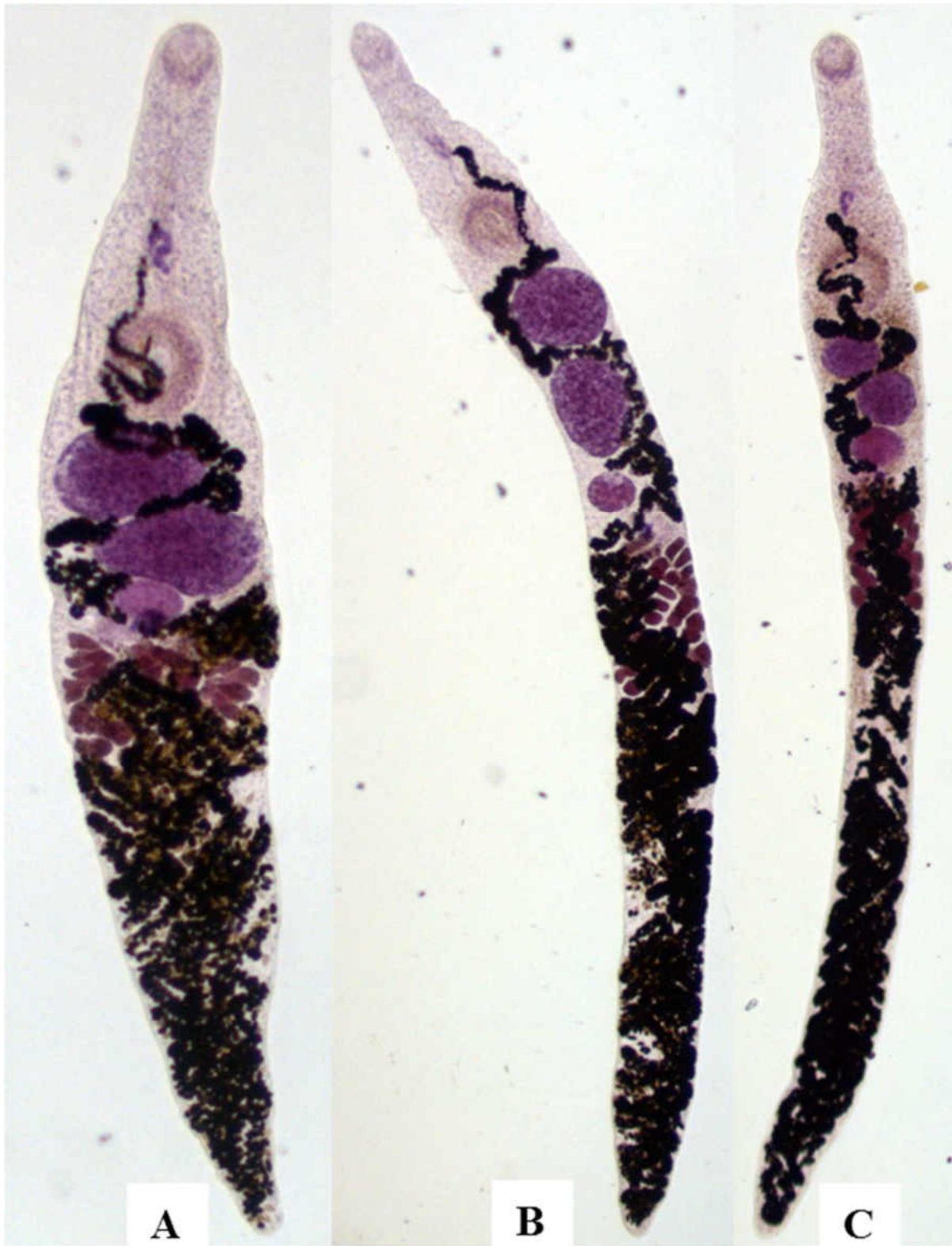

Figure 10. *Lutztrema* sp. from *Turdus lawrencii*. (A) Morphotype 1. (B) Morphotype 2. (C) Morphotype 3.

morphotypes of this digenean as separate species. We have obtained molecular data from all three main morphotypes, and they unequivocally showed that all of them belong to the same species. To be certain of our conclusions, we have sequenced both the nuclear ribosomal regions (ITS and 28S) and mitochondrial (cox1) genes. In addition, our morphological analysis (Figure 11) has shown that even the morphological differences are rather superficial. The fact that the values in the scatterplots do not cluster into distinct groups allows us to conclude that morphometric characters do not provide a clear differentiation between these morphotypes. The studied morphological characteristics demonstrate wide, but gradual variability, which is consistent with the results of molecular analysis suggesting that all these forms belong to a single species of *Lutztrema*.

Zonorchis confusus Travassos, 1944

Host: Thrush-like Antpitta, *Myrmothera campanisona* Hermann, 1783 (Passeriformes: Grallariidae)

Site of infection: Gallbladder.

Type locality: San Martín, Province Tocache, Cordillera Azul N. P., Río Pescadero, NE of Shapaja: S8°10.694, W76°13.422, elev. 953m

Prevalence of infection: (1/1)

***Zonorchis* sp.**

Host: Striped Cuckoo, *Tapera naevia* Linnaeus, 1766 (Cuculiformes: Cuculidae)

Locality: Belém, Brazil: S3°42.128, W46°45.44

Site of infection: Gallbladder.

Prevalence of infection: (1/1)

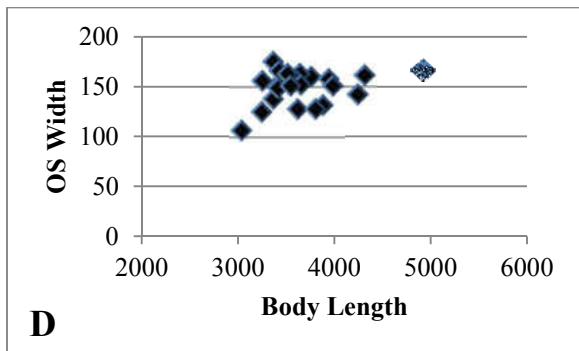
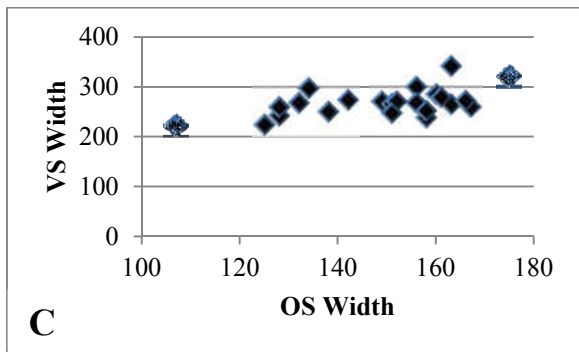
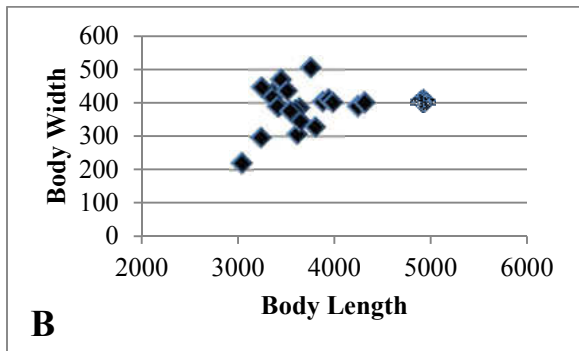
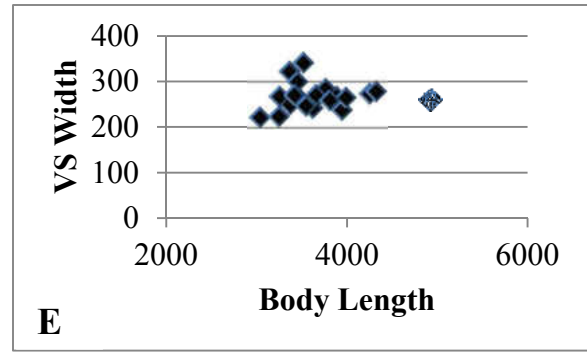
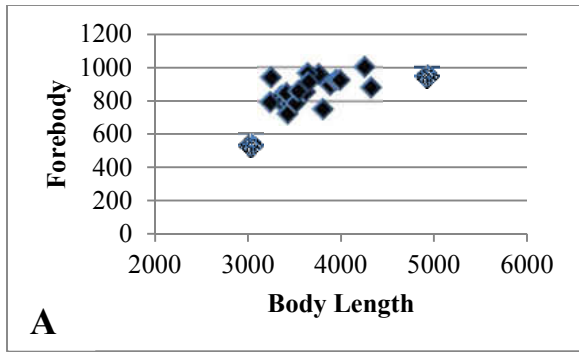

Figure 11. Morphometric analysis of some morphological characteristics commonly used in microcoeliid systematics. (A) Scatter plot of forebody versus body length measurements of *Lutztrema* sp. (B) Scatter plot of body width versus body length measurements of *Lutztrema* sp. (C) Scatter plot of ventral sucker versus oral sucker measurements of *Lutztrema* sp. (D) Scatter plot of oral sucker versus body length measurements of *Lutztrema* sp. (E) Scatter plot of ventral sucker versus body length measurements of *Lutztrema* sp.

Family Diplostomidae

Diplostomidae sp.

Host: Cryptic Forest Falcon, *Micrastur mintoni* Whittaker, 2003 (Falconiformes: Falconidae)

Locality: Belém, Brazil: S3°42.128, W46°45.44

Site of infection: NA

Prevalence of infection: (1/1)

***Uvulifer prosocotyle* (Lutz, 1928) Dubois, 1937**

Host: Green-and-rufous Kingfisher, *Chloroceryle inda* Linnaeus, 1766 (Passeriformes: Alcedinidae)

Locality: San Martín, Province Tocache, Cordillera Azul N. P., Río Pescadero, NE of Shapaja: S8°10.694, W76°13.422, elev. 953m

Site of infection: Intestine.

Parasite identification:

Prevalence of infection: (1/2)

Uvulifer n. sp.

(Figure 12)

Host: Green-and-rufous Kingfisher, *Chloroceryle inda* Linnaeus, 1766 (Passeriformes: Alcedinidae)

Locality: San Martín, Province Tocache, Cordillera Azul N. P., Río Pescadero, NE of Shapaja: S8°10.694, W76°13.422, elev. 953m

Site of infection: Intestine.

Prevalence of infection: (1/2)

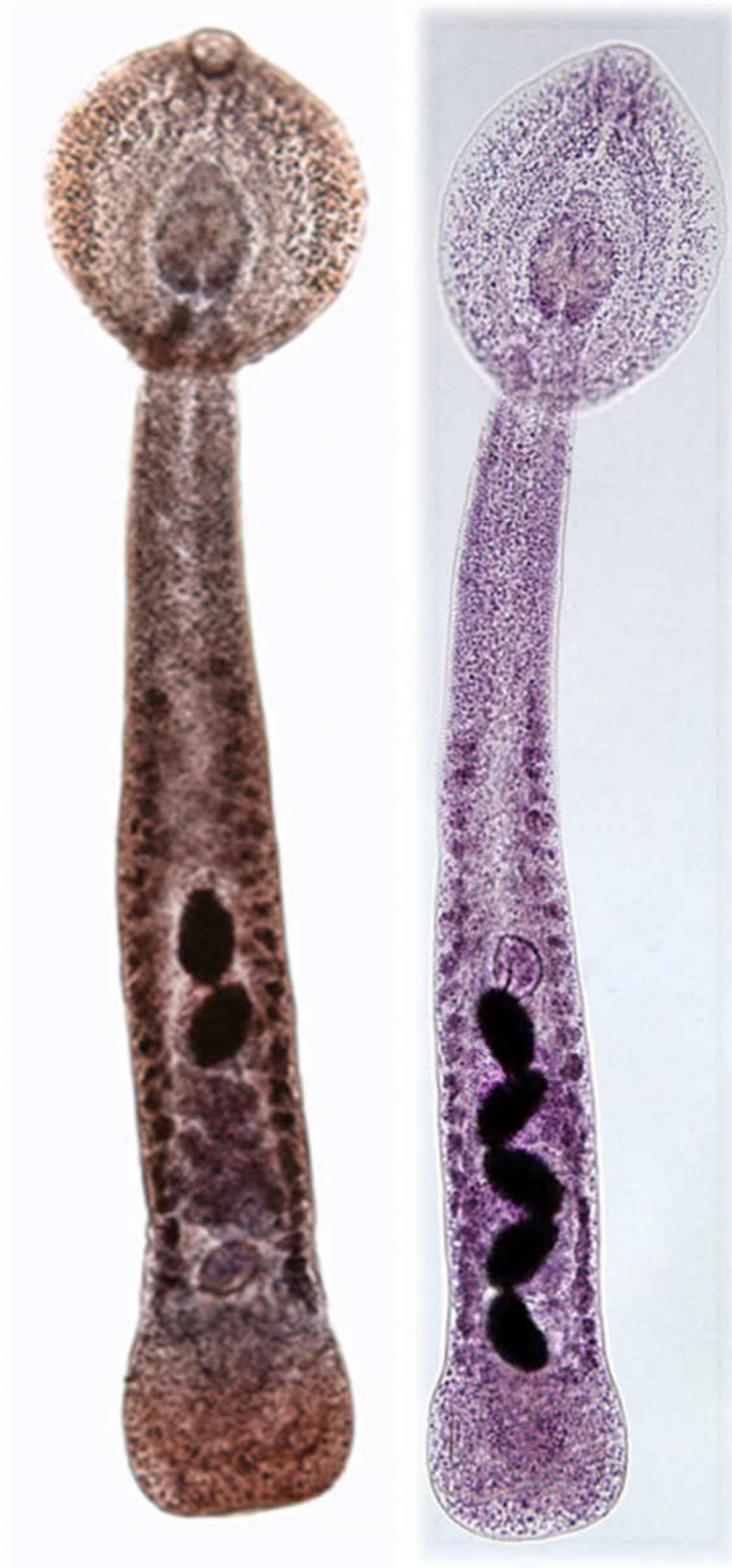

Figure 12. *Uvulifer* sp. from *Chloroceryle inda*.

Remarks: The family Diplostomidae Poirier 1886 is comprised of digeneans that commonly parasitize the digestive tracts of vertebrates that have fish and/or amphibians in their diet. Diplostomidae is divided into four subfamilies, one of which is Crassiphialinae Sudarikov, 1960. Crassiphialinae differentiates itself from the other families by lacking pseudosuckers and having its vitellarium confined to the hindbody (Niewiadomska 2002). *Uvulifer* Yamaguti, 1934 is the most broadly distributed genus of the Crassiphialinae. It is characterized by the spoon-shaped forebody, separated from the longer hindbody by a slender constriction (Niewiadomska 2002).

We have found three specimens of a new species of *Uvulifer* in *Chloroceryle inda* in the Peruvian Amazon. One of the specimens was used for molecular analysis. Morphological features of the two remaining mounted specimens have demonstrated clear differences from previous known species of the genus. Its body shape and proportions (with a very short forebody and long hindbody), sucker ratio (ventral sucker smaller than oral sucker), and the position and extent of vitelline fields were among the main distinguishing features separating our specimens from all Central and South American species in this genus. These include *Uvulifer elongatus* Dubois 1988, *Uvulifer prosocotyle* (Lutz, 1928) Dubois, 1937, and *Uvulifer weberi* Dubois 1986. Although the body shape of the new species is similar to that of *U. elongatus* described from Venezuela, the two species are readily differentiated by the topology of the internal organs. They may be phylogenetically related, but the lack of molecular data on any of the South American and Central American species of *Uvulifer* does not allow for a phylogenetic analysis at this point. Obtaining DNA sequences from all known species of *Uvulifer* from different geographical regions is critical for clarifying taxonomic questions within this genus. This new species will be formally described in a later manuscript.

***Uvulifer* sp.**

Host: Cinnamon Attila, *Attila cinnamomeus* Gmelin, 1789 (Passeriformes: Tyrannidae)

Locality: Belém, Brazil: S3°42.128, W46°45.4

Site of infection: NA

Prevalence of infection: (1/2)

Remarks: This is likely a new species that will be described in a later manuscript.

***Posthodiplostomum* sp.**

Host: Cinnamon Attila, *Attila cinnamomeus* Gmelin, 1789 (Passeriformes: Tyrannidae)

Locality: Belém, Brazil: S3°42.128, W46°45.44

Site of infection: Intestine.

Prevalence of infection: (1/2)

Family Eucotyliidae

Remarks: Due to the availability of specimens from other hosts and continents in our laboratory, we were able to produce for the first time a phylogenetic tree of the family Eucotyliidae. This is a somewhat enigmatic family whose phylogenetic position has only been revealed recently (Olson et al. 2003). The trees in Figures 13-14 are based on the Bayesian analysis of 28S rDNA sequences. One species from Inambari, *Tamerlania parva* (Freitas, 1951), and one species from Belém, *Tamerlania* sp., were incorporated into this tree. Two other sequences from eucotyliids in Brazil identified as *Paratanaisia bragai* (Santos, 1934) Freitas 1959, have been included using data from GenBank. Despite the overall morphological similarity between our two species from Inambari and Belém, they belong to distinctly different, well supported clades (Figure 13). This tells us that one of the common features traditionally used to distinguish between members of Eucotyliidae, namely the extension of the vitelline fields, may not be as important as previously thought. Representatives of the two major clades within Eucotyliidae have either two ceca or a

single cyclocoel which indicates that this particular feature is very meaningful in this family. The phylogenetic tree and basepair sequence comparison has also shown that the two 28S sequences of *Paratanaisia bragai* deposited in the GenBank (Unwin et al. 2013) are clearly different species (Figure 13). In the absence of morphological vouchers, it is not clear which of them, if any, actually represents *Paratanaisia bragai*. One important systematic conclusion that stems from the results of our phylogenetic analysis is that the current genera *Tamerlania* and *Paratanaisia* appear to be paraphyletic (Figure 13). While species of *Tanaisia* form a monophyletic clade, it is nested within the larger cluster of *Tamerlania*. Considering the lack of any significant morphological differences between the three genera, other than the extent of the vitelline fields, we consider all three genera synonymous. However, naming of the single remaining genus is complicated because both *Tamerlania* and *Tanaisia* were established in the same paper by Skrjabin (1924). The genus *Tanaisia* appears in Skrjabin's paper first, therefore under circumstances *Tanaisia* persists as the valid genus while *Tamerlania* and *Paratanaisia* (established much later by Freitas, 1959) become junior synonyms.

The second tree (Figure 14) shows the avian host order from which the species were collected, as well as the geographic location from which the species were obtained. The pattern of the tree suggests multiple host switching events in the evolutionary history, with only a few clades specific to a certain bird order, (e.g., Gruiformes and Passeriformes). There is no clear geographic pattern in the distribution of eucoty lids, which is likely due to two main reasons. One of them is birds' ability to fly and migrate over long distances seasonally and/or annually. The other is likely the relatively old evolutionary history of this group of digeneans. This can be judged from the phylogenetic position of this family in the Plagiorchioidea and its global distribution.

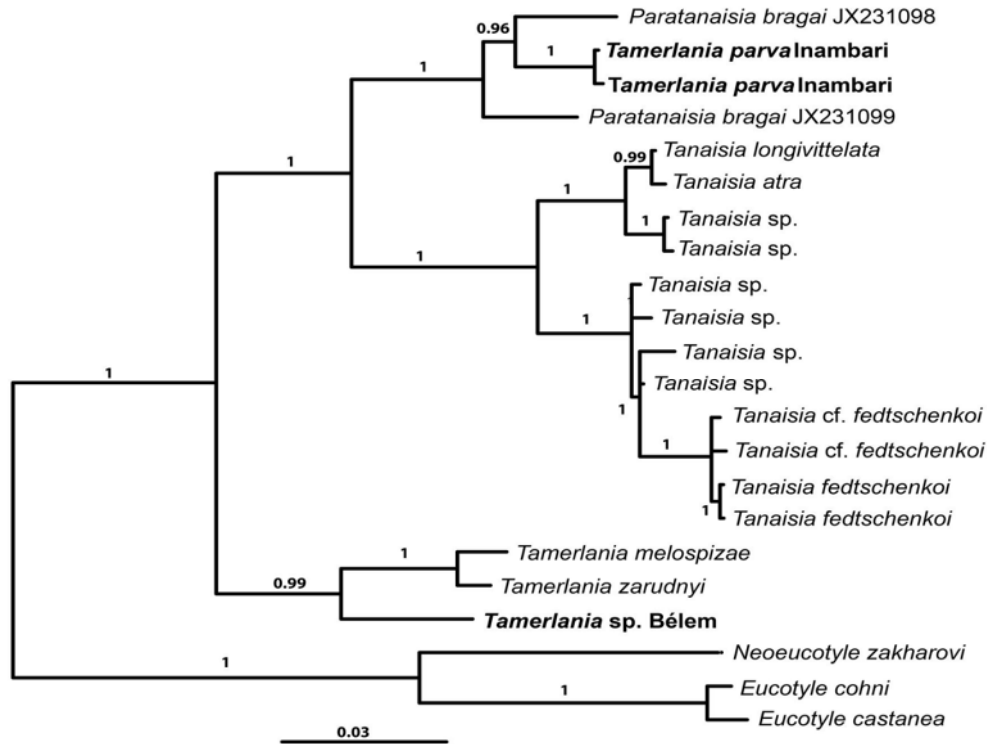

Figure 13. Bayesian analysis of 28S sequences of the family Eucotylidae.

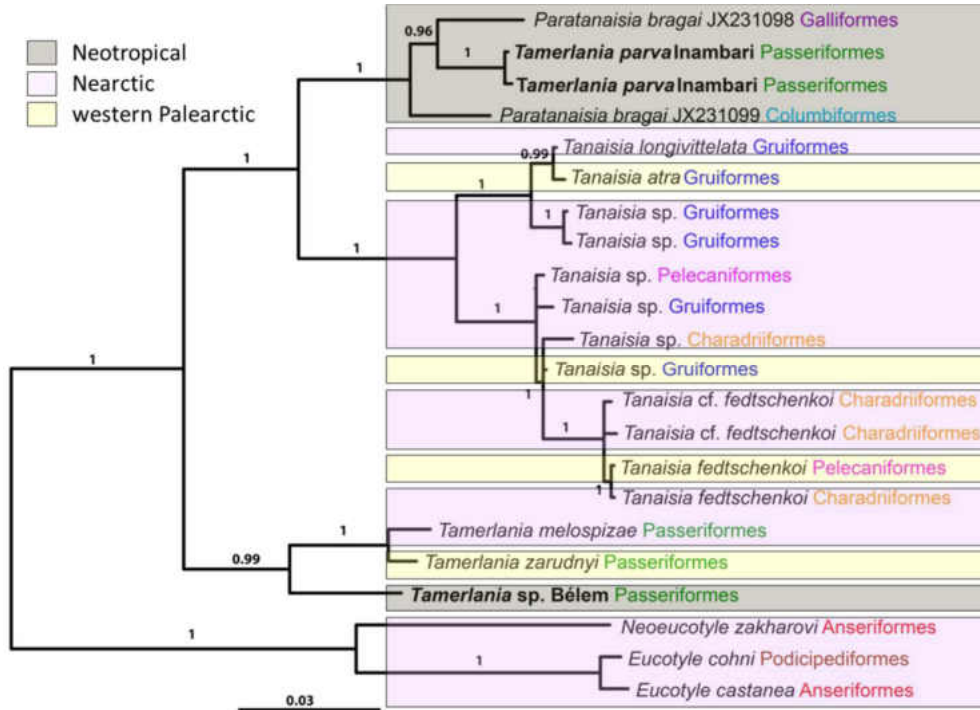

Figure 14. Bayesian analysis of 28S sequences of the family Eucotylidae, including host orders and the geographic location from which the species were obtained.

Tamerlania parva (Freitas, 1951)

(Figure 15)

Hosts: Hairy-crested Antbird, *Rhegmatorhina melanosticta* Sclater & Salvin, 1880

(Passeriformes:Thamnophilidae) and Spot-backed Antbird, *Hylophylax naevius* Gmelin, 1789

(Passeriformes:Thamnophilidae)

Locality: San Martín, Province Tocache, Cordillera Azul N. P., Río Pescadero, NE of Shapaja:

S8°10.694, W76°13.422, elev. 953m

Site of infection: Kidney.

Prevalence of infection: *Rhegmatorhina melanosticta* (1/1) and *Hylophylax naevius* (1/4).

***Tamerlania* sp.**

(Figure 16)

Host: Plain Xenops, *Xenops minutus* Sparrman, 1788 (Passeriformes: Furnariidae)

Locality: Belém, Brazil: S3°42.128, W46°45.44

Site of infection: Ureters, kidney.

Prevalence of infection: (1/3)

Family Leucochloridiidae

Bakkeius moragai Zamparo et. al. 2003

(Figure 17)

Hosts: Blue-crowned Manakin, *Lepidothrix coronata* Spix, 1825 (Passeriformes: Pipridae),

Green Manakin, *Xenopipo holochlora* Sclater, 1888 (Passeriformes: Pipridae), Round-tailed

Manakin, *Ceratopipra chloromeros* Tschudi, 1844 (Passeriformes: Pipridae), and Tawny-faced

Gnatwren, *Microbates cinereiventris* Sclater, 1855 (Passeriformes: Troglodytidae)



Figure 15. *Tamerlania parva*. from *Rhegmatorhina melanosticta*.



Figure 17. *Bakkeius moragai* from *Microbates cinereiventris*.



Figure 16. *Tamerlania* sp. from *Xenops minutus*.



Figure 18. *Mosesia ovalis* from *Xenopipo holochlora*.

Locality: San Martín, Province Tocache, Cordillera Azul N. P., Río Pescadero, NE of Shapaja: S8°10.694, W76°13.422, elev. 953m.

Site of infection: Intestine.

Prevalence of infection: *Lepidothrix coronata* (1/3), *Xenopipo holochlora* (1/3), *Ceratopipra chloromeros* (1/2), and *Microbates cinereiventris* (1/2).

Leucochloridiidae sp.

Hosts: Musician Wren, *Cyphorhinus arada* Hermann, 1783 (Passeriformes: Troglodytidae) and Spot-backed Antbird, *Hylophylax naevius* Gmelin, 1789 (Passeriformes: Thamnophilidae)

Site of infection: Body cavity.

Type locality: San Martín, Province Tocache, Cordillera Azul N. P., Río Pescadero, NE of Shapaja: S8°10.694, W76°13.422, elev. 953m

Prevalence of infection: *Cyphorhinus arada* (1/2) and *Hylophylax naevius* (1/4).

Family Phanerosolidae

Moesia ovalis Patitucci, Bates and Tkach, 2016

(Figure 18)

Host: Green Manakin, *Xenopipo holochlora* Sclater, 1888 (Passeriformes: Pipridae)

Locality: San Martín, Province Tocache, Cordillera Azul N. P., Río Pescadero, NE of Shapaja:

S8°10.694, W76°13.422, elev. 953m

Site of infection: Gallbladder.

Prevalence of infection: (1/3)

Remarks: please see Appendix A.

Phaneropsolus sp.

(Figure 19)

Host: Green Manakin, *Xenopipo holochlora* Sclater, 1888 (Passeriformes: Pipridae)

Locality: San Martín, Province Tocache, Cordillera Azul N. P., Río Pescadero, NE of Shapaja:

S8°10.694, W76°13.422, elev. 953m

Site of infection: Gallbladder.

Prevalence of infection: (1/3)

Family Renschtreematidae

Renschtreematidae n. sp.

(Figure 20)

Type Host: Fork-tailed Woodnymph, *Thalurania furcata* Gmelin, 1788 (Apodiformes: Trochilidae)

Type Locality: San Martín, Province Tocache, Cordillera Azul N. P., Río Pescadero, NE of Shapaja: S8°10.694, W76°13.422, elev. 953m

Site of infection: Stomach.

Prevalence of infection: (1/1)

Remarks: Renschtreematidae Yamaguti, 1971 is a very small family of trematodes, comprising of only two genera and four formally described species; *Renschtrema malayi* Rohde 1964, *Renschtrema rohdei* Matskási 1973, *Renschtrema indicum* Kifune 1984, and *Rohdetrema sandoshami* (Rohde 1964) Deblock, 2008. They have only ever been found in the intestine of bats from southern Asia, including Malaysia, India, and Vietnam, until now. In the course of parasitological examination of birds in the Cordillera Azul National Park, Peru, we have obtained two specimens that we believe to be a new genus and a new species of the family Renschtreematidae, hereafter referred to as Renschtreematidae n. sp. One of the two specimens was used for DNA isolation, while the other was mounted for morphological description.

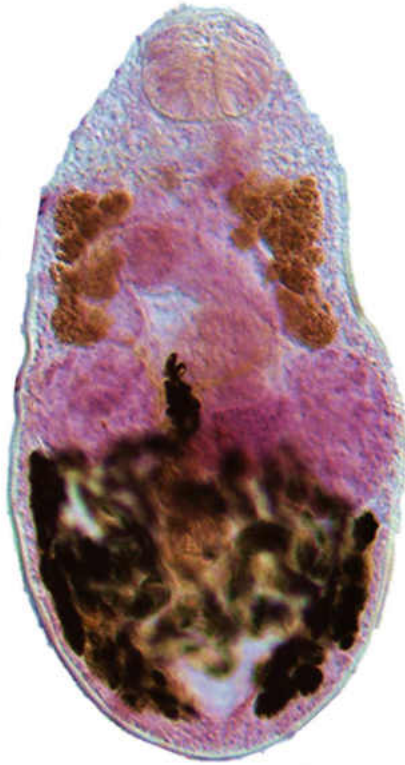

Figure 19. *Phaneropsolus* sp. from *Xenopipo holochlora*.

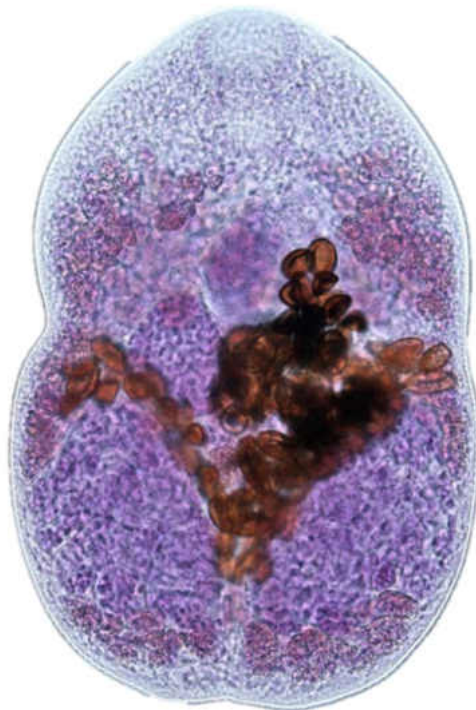

Figure 20. Renschtreematidae sp. from *Thalurania furcate*.

The new species is most morphologically similar to *Renschtrema indicum* described from India. *Renschtrema* n. sp. differs from *R. indicum* in the shape and proportions of the body (Table 2). The body shape in *Renschtrema* n. sp. is distinctly oval, while *R. indicum* shows a piriform body that narrows towards the anterior end. The forebody:body length ratio in the new species (1:2.5) is lower than that in *R. indicum* (1:1.7). The pharynx in the new species (44 x 42) is larger than in *R. indicum* (25-30). The esophagus is significantly longer in *R. indicum* (70) compared to the new species (30). Another important feature considered to be a strong differentiating character between *Renschtrema* n. sp. and *R. indicum* is the shape and size of the cirrus sac. The cirrus sac of the new species (125 x 50) is crescent-shaped and nearly completely overlays the ventral sucker, while in *R. indicum*, the cirrus sac (248 x 19) is long, strongly curved at the posterior third, which is elliptically swollen, extending dextral-longitudinally to the ventral sucker, its proximal end nearly reaching the cecal bifurcation and its distal end just anterior to the ovary. See Table 2 for a morphological comparison of *Renschtrema* n. sp. and previously known species of the family.

Renschtrema n. sp. is about a third smaller in body length compared to *Renschtrema rohdei*, although the body width:length ratio in the new species is greater (1:1.6) than that of *R. rohdei* (1:2.1-2.5). The oral sucker:body width ratio in the new species (1:4.1) is also higher than in *R. rohdei* (1:5.6). The pharynx in *Renschtrema* n. sp. (see above) is larger than in *R. indicum* (19-25 x 28-38). The ovary of *R. indicum* (89-108 x 112-128) is much larger than the new species (83 x 67). Egg size between the two is also different with *R. indicum* being smaller (23-25 x 13-15) than *Renschtrema* n. sp. (38-39 x 17-19) (Table 2).

Similar to *R. indicum*, the forebody:body length ratio is much lower and the esophagus is shorter in the new species (see Table 2) than in *Renschtrema malayi*. The ovary in *R. malayi* (30-

Table 2. Comparative morphological metric data for Renschtrematidae n. sp. Measurements marked by asterisk are inferred from the drawing provided by Rhode (1964), Matskási (1973) and Kifune (1984).

Species	Renschtrematidae n. sp.	<i>Renschtrema malayi</i>	<i>Renschtrema rohdei</i>	<i>Renschtrema indicum</i>	<i>Rohdetrema sandoshami</i>
Host	<i>Thalurania furcate</i>	<i>Rhinolophus</i> sp.	<i>Rhinolophus affinis</i>	<i>Myotis nipalensis</i> & <i>Myotis muricola</i>	<i>Tylonycteris</i> sp. & <i>Kerivoula</i> sp.
Origin	Peru	Malaya	Vietnam	India	Malaya
Source	Present study	Rhode 1964	Matskási 1973	Kifune 1984	Rhode 1964
Body length	495	320-470 (380)	670-840	360-440	440-530 (480)
Body width	302	240-370 (270)	320-330	220-270	450-570 (510)
Body width:body length	1:1.6	1:1.3	1:2.1-2.5	1:1.6	1.02-1.1:1
Forebody	196			263*	
Hindbody	299			183*	
Forebody:body length	1:2.5	1:1.8*	1:2.1*	1:1.7*	
Oral sucker length	59	37-55 (47)	38-51	56-63	90-120 (101)
Oral sucker width	74	58-72 (62)	57-60	47-56	120-129 (122)
Oral sucker:body width	1:4.1	1:4.4	1:5.6	1:4.8	1:5.05
Pharynx length	44	29-32 (30)	19-25	25-30	39-48 (43)
Pharynx width	42	26-47 (33)	28-38	25-30	33-31 (33)
Esophagus length	30	60-96 (83)	-	70*	-
Ventral sucker length	66	39-54 (46)	38-51	50-53	100-123 (113)
Ventral sucker width	65	45-54 (48)	38-39	45-50	100-129 (117)
Cirrus sac	125 x 50		208-204	248*x19*/52*x24*	
Rear cirrus sac length		73-118 (89)			
Rear cirrus sac width		43-56 (39)			
Front cirrus sac length		60-110 (80)			
Front cirrus sac width		36-31 (26)			
Ejaculatory duct		54-114 (77)			
Ceca		120-160 (140)			
Ovary length	83	30-41 (33)	89-108	68-75	123-150 (140)
Ovary width	67	86-140 (113)	112-128	46-52	75-120 (95)

Table 2 Cont.

	Renschtrematidae n. sp.	<i>Renschtrema malayi</i>	<i>Renschtrema rohdei</i>	<i>Renschtrema indicum</i>	<i>Rohdetrema sandoshami</i>
Right testis length	169	54-104 (78)	160	68-75	117-165 (144)
Right testis width	125	27-50 (40)	80-96	100-122	124-120 (113)
Left testis length	201	54-104 (78)	169-185	62-94	117-165 (144)
Left testis width	125	27-50 (40)	108	120	124-120 (113)
Right vitellaria length		50-72 (59)			102-132 (120)
Left vitellaria length		50-72 (59)			102-132 (120)
Egg length	38-39	25-30	23-25	32-36	27-30
Egg width	17-19	16 (18)	13-15	20-24	18 (21)

42

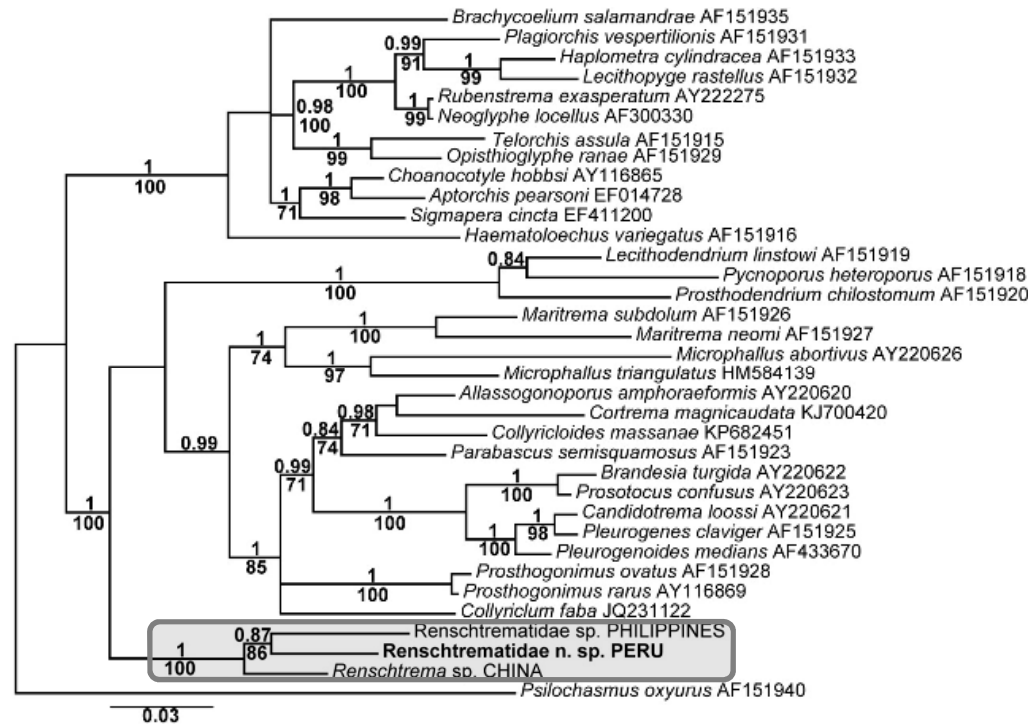

Figure 21. Phylogenetic tree resulted from bayesian analysis of 28S sequences of the superfamily Microphallidea.

41 x 86-140) is transversally elongated, while in *Renschtreumatidae n. sp.*, it is more compact (83 x 67). The testes of *R. malayi* are of oval or spherical shape and substantially smaller compared with the irregularly shaped testes of *Renschtreumatidae n. sp.* The new species also has larger eggs (see above) compared to *R. malayi* (25-30 x 16-18). Thus, morphological data strongly supports the status of *Renschtreumatidae n. sp.* as a new species (Table 2).

The morphology of the single specimen as well as the positioning of this species in the molecular phylogenetic tree (Figure 21) suggests that these specimens belong to *Renschtreumatidae*. It is the first species of this family found outside Asia as well as the first species from birds anywhere. Considering that the collecting sites (e.g. Asia versus Peru) are separated by the Pacific Ocean, we can infer that there is a very ancient radiation in this family. Our phylogeny also supports the family status of the *Renschtreumatidae*, which has not been clear ever since the family was established (Figure 21).

Family Schistosomatidae

Schistosomatidae n. sp.

Type hosts: Torrent Tyrannulet, *Serporphaga cinerea* Tschudi, 1844 (Passeriformes: Tyrannidae) and Tawny-breasted Flycatcher, *Myiobius villosus* Sclater, 1860 (Passeriformes: Tyrannidae)

Type locality: San Martín, Province Tocache, Cordillera Azul N. P., Río Pescadero, NE of Shapaja: S8°10.694, W76°13.422, elev. 953m

Site of infection: Veins of liver and intestine.

Remarks: One complete male and one partial female (missing posterior end), and several fragments were obtained, which allowed for both morphological and molecular analysis. Based on general morphology, we expected our specimens to belong to the genus *Trichobilharzia*. Fourteen species of *Trichobilharzia* have been described from North American waterfowl;

however, there is only one species reported from South America, *Trichobilharzia jequitibaensis* (Leite, Costa, and Costa, 1978). This species was described in Brazil from naturally infected domesticated ducks. Another possible *Trichobilharzia* species was described from Chile (Valdovinos and Balboa, 2008), but morphological features were not consistent with the species of *Trichobilharzia* and in all likelihood represent a different genus of Schistosomatidae. When we placed our species into a Bayesian analysis of 28S sequences, it did not fall into the *Trichobilharzia* clade, but instead formed a clade with *Bilharziella*, a genus not known in the Americas (Figure 22). At the same time, the morphology of our specimens differs dramatically from that of *Bilharziella*. This suggests that our new species represents a new genus as well. A full description of this species will be provided in a later manuscript.

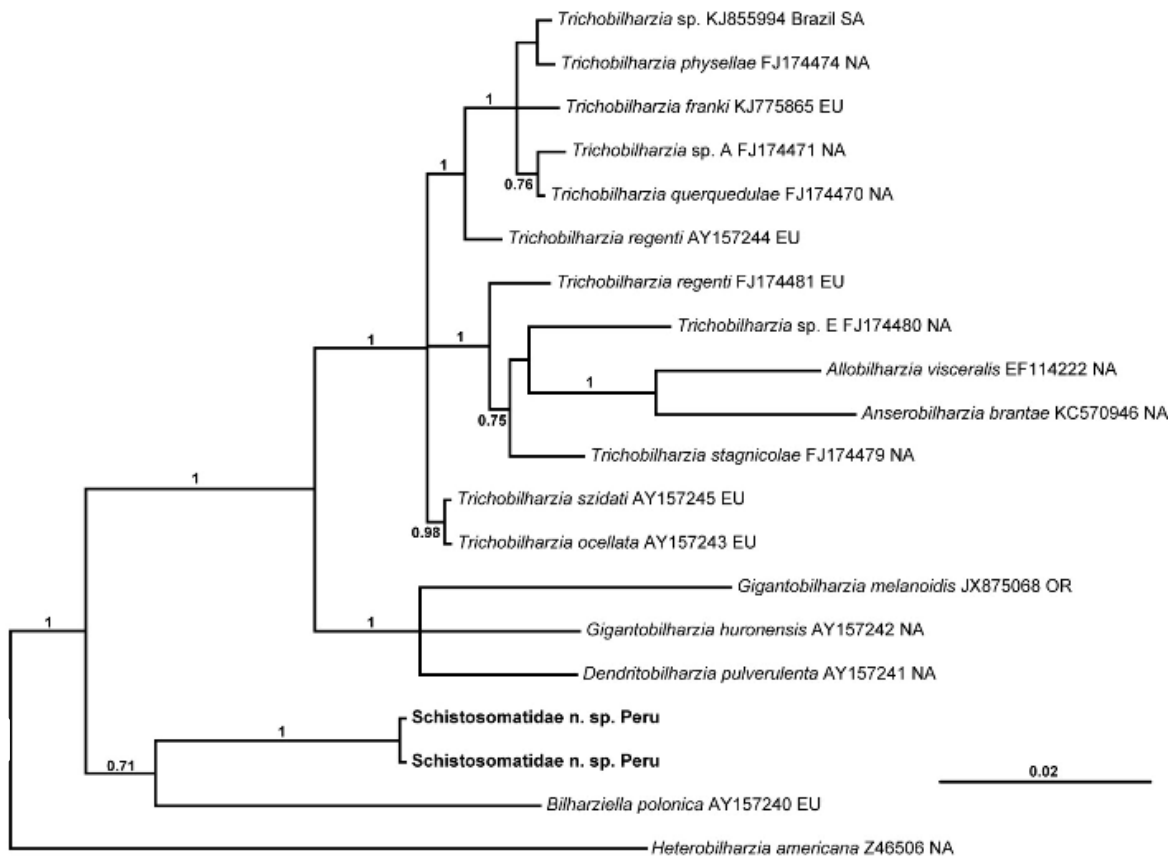

Figure 22. Phylogenetic tree resulted from Bayesian analysis of 28S sequences of the family Schistosomatidae.

Family Stomylotrematidae

Stomylotrema vicarium Braun, 1901

(Figure 23)

Host: Tawny-throated Leaf Tosser, *Sclerurus mexicanus* Sclater, 1857 (Passeriformes: Furnariidae).

Locality: San Martín, Province Tocache, Cordillera Azul N. P., Río Pescadero, NE of Shapaja: S8°10.694, W76°13.422, elev. 953m

Site of infection: Intestine.

Prevalence of infection: (1/2)



Figure 23. *Stomylotrema vicarium* from *Sclerurus mexicanus*.

Class Cestoda

Family Davaineidae

Davaineidae sp.

Host: Tawny-breasted Flycatcher, *Myiobius villosus* Sclater, 1860 (Passeriformes: Tyrannidae)

Locality: San Martín, Province Tocache, Cordillera Azul N. P., Río Pescadero, NE of Shapaja:

S8°10.694, W76°13.422, elev. 953m

Site of infection: Intestine.

Prevalence of infection: (1/3)

Family Dilepididae

Arostellina reticulata Neiland, 1955

(Figure 24)

Host: Many-spotted Hummingbird, *Taphrospilus hypostictus* Gould, 1862 (Apodiformes: Trochilidae)

Locality: San Martín, Province Tocache, Cordillera Azul N. P., Río Pescadero, NE of Shapaja:

S8°10.694, W76°13.422, elev. 953m

Site of infection: Intestine.

Prevalence of infection: (1/1)

Dilepididae sp. (Inambari)

(Figure 25)

Hosts: two Tawny-faced Gnatwren, *Microbates cinereiventris* Sclater, 1855 (Passeriformes:

Troglodytidae), Gray Antwren, *Myrmotherula menetriesii* d'Orbigny, 1837 (Passeriformes:

Thamnophilidae), Swainson's Thrush, *Catharus ustulatus* Nuttall, 1840 (Passeriformes:

Turdidae), White-fronted Nunbird, *Monasa morphoeus* Hahn & Kuster, 1823 (Galbuliformes:

Bucconidae), Green Manakin, *Xenopipo holochlora* Sclater, 1888 (Passeriformes: Pipridae), Bluish-fronted Jacamar, *Galbula cyanescens* Deville, 1849 (Galbuliformes: Galbulidae), and Tawny-throated Leaf-tosser, *Sclerurus mexicanus* Sclater, 1857 (Passeriformes: Furnariidae)

Locality: San Martín, Province Tocache, Cordillera Azul N. P., Río Pescadero, NE of Shapaja: S8°10.694, W76°13.422, elev. 953m

Site of infection: Intestine.

Prevalence of infection: *Microbates cinereiventris* (2/2), *Myrmotherula menetriesii* (1/3), *Catharus ustulatus* (1/12) 8.3%, *Monasa morphoeus* (1/2), *Xenopipo holochlora* (1/3), *Galbula cyanescens* (1/2), and *Sclerurus mexicanus* (1/2).

Dilepididae sp. (Belém)

(Figure 26)

Hosts: Plain Antvireo, *Dysithamnus mentalis* Temminck, 1823 (Passeriformes: Thamnophilidae), Squirrel Cuckoo, *Piaya cayana* Linnaeus, 1766 (Cuculiformes: Cuculidae), Royal Flycatcher, *Onychorhynchus coronatus* Statius Müller, 1776 (Passeriformes: Tyrannidae), Blue-crowned Motmot, *Momotus momota* Linnaeus, 1766 (Coraciiformes: Momotidae), Short-billed Leaf-tosser, *Sclerurus ruficularis* Pelzeln, 1868 (Passeriformes: Scleruridae), Moustached Wren, *Pheugopedius genibarbis* Swainson, 1838 (Passeriformes: Troglodytidae), Tawny-bellied Screech Owl, *Megascops watsonii* Cassin, 1848 (Strigiformes: Strigidae), Chestnut-bellied seed finch, *Sporophila angolensis* Linnaeus, 1766 (Passeriformes: Emberizidae), and Pied Puffbird, *Notharchus tectus* Boddaert, 1783 (Piciformes: Bucconidae)

Locality: Belém, Brazil: S3°42.128, W46°45.44

Site of infection: intestine

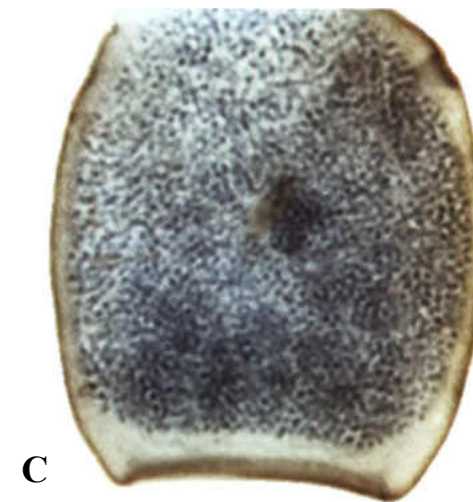

Figure 24. *Arostellina reticulata* from *Taphrospilus hypostictus*. (A) Scolex. (B) Pre-gravid proglottid. (C) Gravid proglottid.

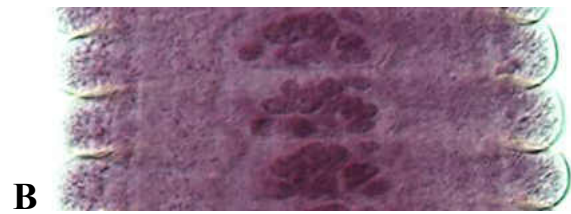
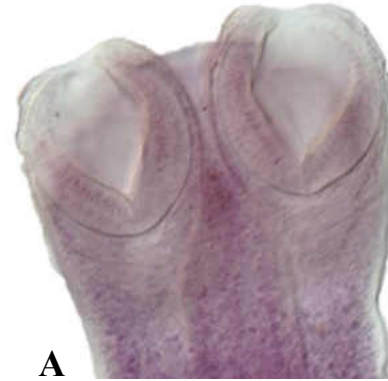

Figure 25. *Dilepididae* sp. from *Galbula cyanescens*. (A) Scolex. (B) Mature proglottid. (C) Gravid proglottid.

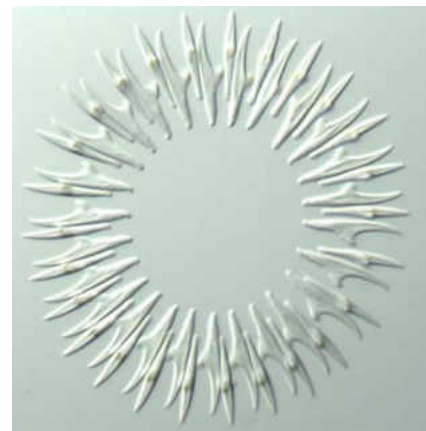

Figure 26. *Dilepididae* sp. scolex hooks from *Megascops watsonii*.

Prevalence of infection: Dysithamnus mentalis (1/2), *Piaya cayana* (1/1), *Onychorhynchus coronatus* (1/1), *Momotus momota* (1/1), *Sclerurus rufigularis* (1/1), *Pheugopedius genibarbis* (1/3), *Megascops watsonii* (1/1), *Sporophila angolensis* (1/4), and *Notharchus tectus* (1/3).

Family Hymenolepididae

Hymenolepididae sp. (Inambari)

(Figure 27)

Hosts: Bluish-fronted Jacamar, *Galbula cyanescens* Deville, 1849 (Galbuliformes: Galbulidae), Dusky-throated Antshrike, *Thamnomanes ardesiacus* Sclater & Salvin, 1868 (Passeriformes: Thamnophilidae), Tawny-faced Gnatwren, *Microbates cinereiventris* Sclater, 1855 (Passeriformes: Troglodytidae), Carmiol's Tanager, *Chlorothraupis carmioli* Lawrence, 1868 (Passeriformes: Cardinalidae), Spot-backed Antbird, *Hylophylax naevius* Gmelin, JF, 1789 (Passeriformes: Thamnophilidae), Sooty Antbird, *Myrmeciza fortis* Sclater & Salvin, 1868 (Passeriformes: Thamnophilidae), Swainson's Thrush, *Catharus ustulatus* Nuttall, 1840 (Passeriformes: Turdidae), Blue-throated Piping-Guan, *Pipile cumanensis* Jacquin, 1784 (Galliformes: Cracidae), Orange-billed Sparrow, *Arremon aurantirostris* Lafresnaye, 1849 (Passeriformes: Emberizidae), Foothill Antwren, *Epinecrophylla spodionota* Sclater & Salvin, 1880 (Passeriformes: Thamnophilidae), Golden-bellied Warbler, *Myiothlypis chrysogaster* Tschudi, 1844 (Passeriformes: Parulidae), and Thick-billed Euphonia, *Euphonia lanirostris* d'Orbigny & Lafresnaye, 1837

Locality: San Martín, Province Tocache, Cordillera Azul N. P., Río Pescadero, NE of Shapaja: S8°10.694, W76°13.422, elev. 953m

Site of infection: Intestine.

Prevalence of infection: Galbula cyanescens (1/2), Thamnomanes ardesiacus (1/5), Microbates cinereiventris (1/2), Chlorothraupis carmioli (1/2), Hylophylax naevius (1/4), Myrmeciza fortis (1/2), Catharus ustulatus (1/12) 8.3%, Pipile cumanensis (1/1), Arremon aurantirostris (1/4), Epinecrophylla spodionota (1/3), Myiothlypis chrysogaster (1/5), and Euphonia laniirostris (1/1).

Hymenolepididae sp. (Belém)

(Figure 28)

Hosts: Amazonian Barred-Woodcreeper, Dendrocolaptes medius Todd, 1920 (Passeriformes: Dendrocolaptidae), White-Backed Fire-Eye, Pyriglena leuconota Spix, 1824 (Passeriformes: Thamnophilidae), Scale-backed Antbird, Willisornis poecilinotus Cabanis, 1847 (Passeriformes: Thamnophilidae), Rufous-tailed Flatbill, Ramphotrigon ruficauda Spix, 1825 (Passeriformes: Tyrannidae), Cocoa thrush, Turdus fumigatus Lichtenstein, 1823 (Passeriformes: Turdidae), and Silver-beaked Tanager, Ramphocelus carbo Pallas, 1764 (Passeriformes: Thraupidae).

Locality: Belém, Brazil: S3°42.128, W46°45.44

Site of infection: intestine.

Prevalence of infection: Dendrocolaptes medius (1/1), Pyriglena leuconota (1/5), Willisornis poecilinotus (1/6), Ramphotrigon ruficauda (1/3), Turdus fumigatus (1/1), and Ramphocelus carbo (1/3)

Passerilepis sp. (Inambari)

(Figure 29)

Hosts: Tawny-throated Leaf-tosser, Sclerurus mexicanus Sclater, 1857 (Passeriformes: Furnariidae) and Olivaceous Flatbill, Rhynchocyclus olivaceus Temminck, 1820 (Passeriformes: Tyrannidae)



A

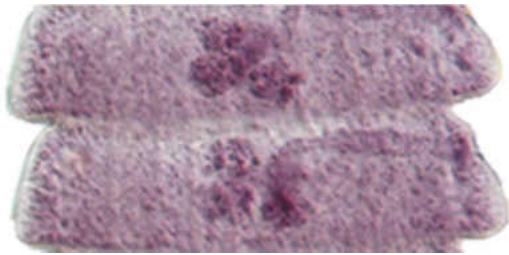

B

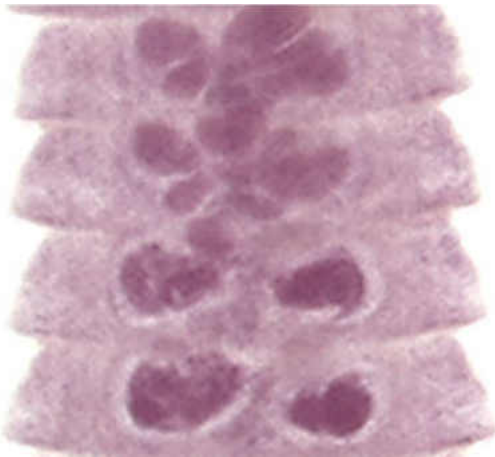

C

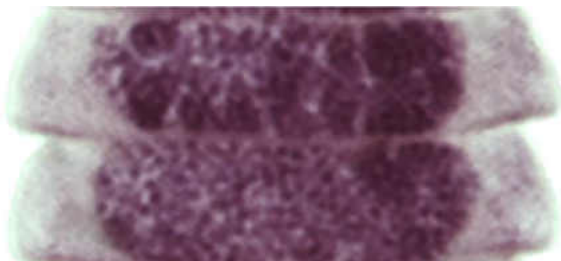

D

Figure 27. Hymenolepididae sp. from *Thamnomanes ardesiacus*. (A) Scolex. (B) Pre-mature proglottids. (C) Mature proglottids transforming to pre-gravid proglottids. (D) Gravid proglottids.



Figure 28. Hymenolepididae sp. scolex hooks from *Megascops watsonii*.



A



B

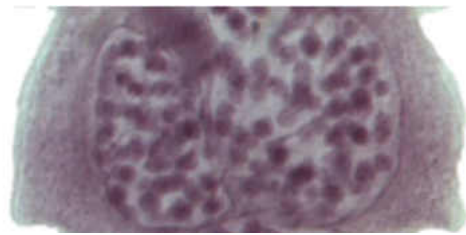

C

Figure 29. *Passerilepis* sp. from *Rhynchocylus olivaceus*. (A) Scolex. (B) Mature proglottid. (C) Gravid proglottid.

Locality: San Martín, Province Tocache, Cordillera Azul N. P., Río Pescadero, NE of Shapaja:
S8°10.694, W76°13.422, elev. 953m

Site of infection: Intestine.

Prevalence of infection: *Sclerurus mexicanus* (1/2) and *Rhynchocyclus olivaceus* (1/3).

***Passerilepis* sp.** (Belém)

Host: Silver-beaked Tanager, *Ramphocelus carbo* Pallas, 1764 (Passeriformes: Thraupidae)

Locality: Belém, Brazil: S3°42.128, W46°45.44

Site of infection: intestine.

Prevalence of infection: (1/3)

Family Mesocestoididae

***Mesocestoides* n. sp.**

(Figure 30)

Hosts: two Dusky-throated Antshrike, *Thamnomanes ardesiacus* Sclater & Salvin, 1868

(Passeriformes: Thamnophilidae), Spot-winged Antbird, *Schistocichla leucostigma* Pelzeln, 1868

(Passeriformes: Thamnophilidae), Orange-billed Sparrow, *Arremon aurantirostris* Lafresnaye,

1847 (Passeriformes: Emberizidae), Black-faced Antthrush, *Formicarius analis* d'Orbigny &

Lafresnaye, 1837 (Passeriformes: Formicariidae), and Chestnut-tailed Antbird, *Myrmeciza*

hemimelaena Sclater, 1857 (Passeriformes: Thamnophilidae)

Locality: San Martín, Province Tocache, Cordillera Azul N. P., Río Pescadero, NE of Shapaja:

S8°10.694, W76°13.422, elev. 953m

Site of infection: Body Cavity.

Prevalence of infection: *Thamnomanes ardesiacus* (2/5), *Schistocichla leucostigma* (1/3),

Arremon aurantirostris (1/4), *Formicarius analis* (1/2), and *Myrmeciza hemimelaena* (1/1).



Figure 30. *Mesocestoides* sp. from *Thamnomanes ardesiacus*.

Remarks: Numerous tetrathyridia of *Mesocestoides* were discovered in five species of passerine birds in Peru. A majority of them had inverted scoleces, while specimens from one bird had everted scoleces (Figure 31). This is the first record of *Mesocestoides* in Peru as well as the first record of tetrathyridia in any bird from the Americas. A single sequence of each target gene (12S, cox1, and nad1) was obtained from forms with both inverted and everted scolex. The sequences of all four target genes differed very substantially from all previously published *Mesocestoides* sequences available in the GenBank and unpublished data available in Dr. Vasyl Tkach's lab. This was not surprising considering that no DNA sequences were available from any South American *Mesocestoides* species prior to our study. Our Bayesian and maximum likelihood analyses resulted in trees that are essentially unresolved above species level, as has been seen in previous studies (e.g. Crosbie et al. 2000; Literak et al. 2004; Padgett et al. 2005). However, species level clades are strongly supported (Figures 32-34). Sampling and sequencing specimens from potential definitive hosts (carnivorous mammals) will reveal the taxonomic identity of our specimens found in birds.

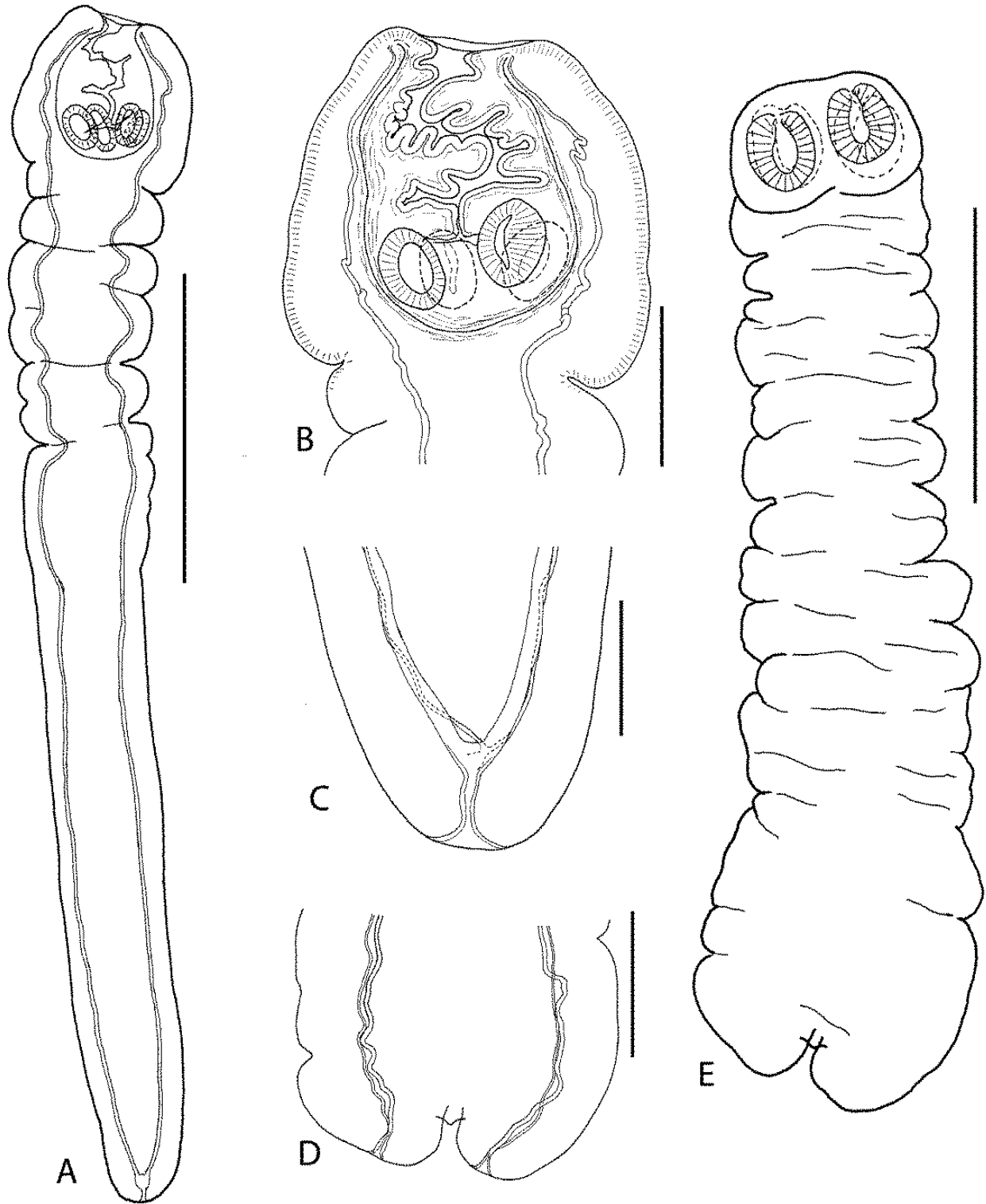

Figure 31. (A) *Mesocestoides* with inverted scolex, total view. (B) Inverted scolex. (C) Posterior end and excretory system of *Mesocestoides* with inverted scolex. (D) Posterior end and excretory system of *Mesocestoides* with everted scolex. (E) *Mesocestoides* with everted scolex, total view.

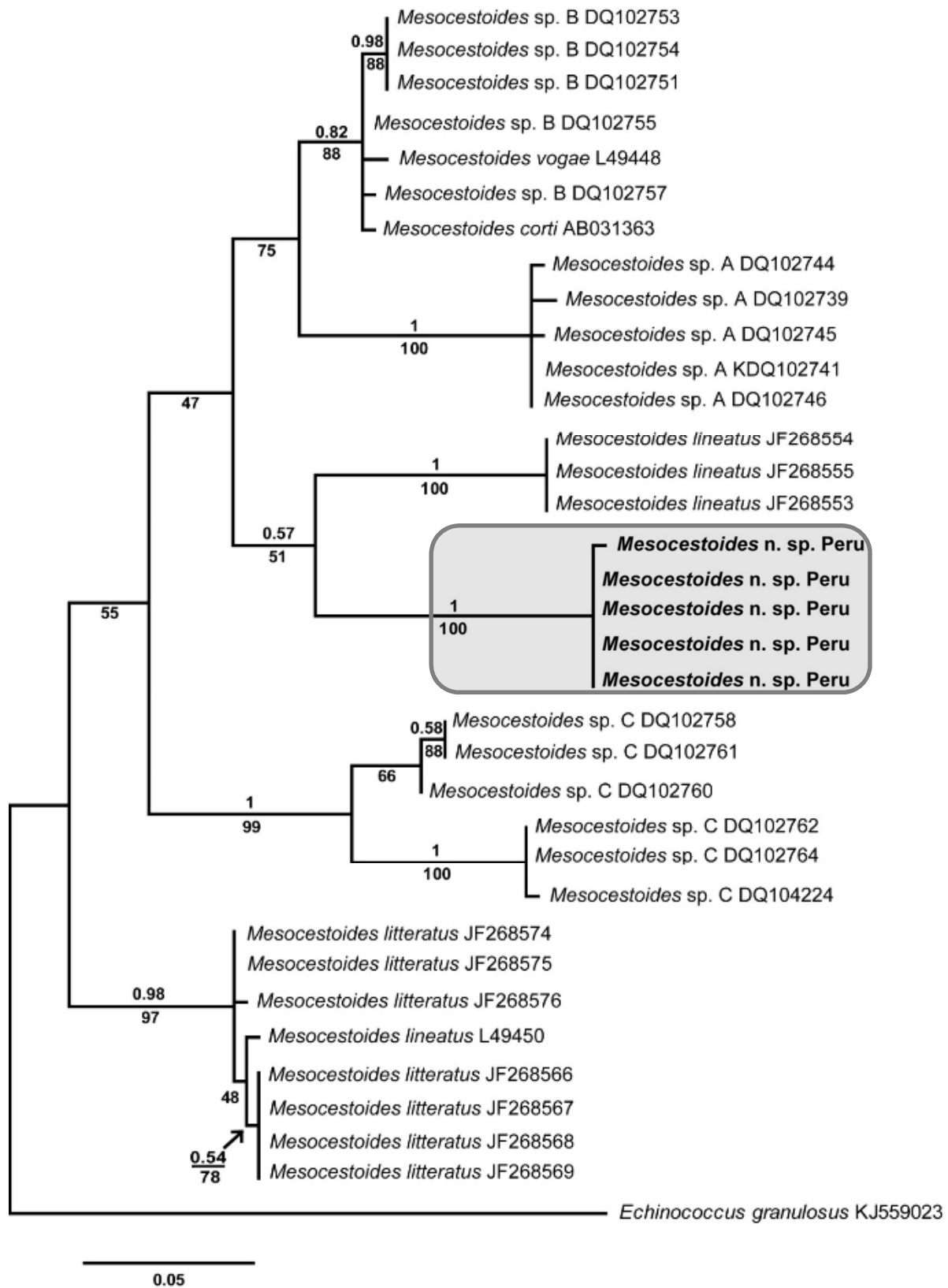

Figure 32. Phylogenetic tree resulted from Bayesian analysis of available 12S sequences of *Mesocestoides*.

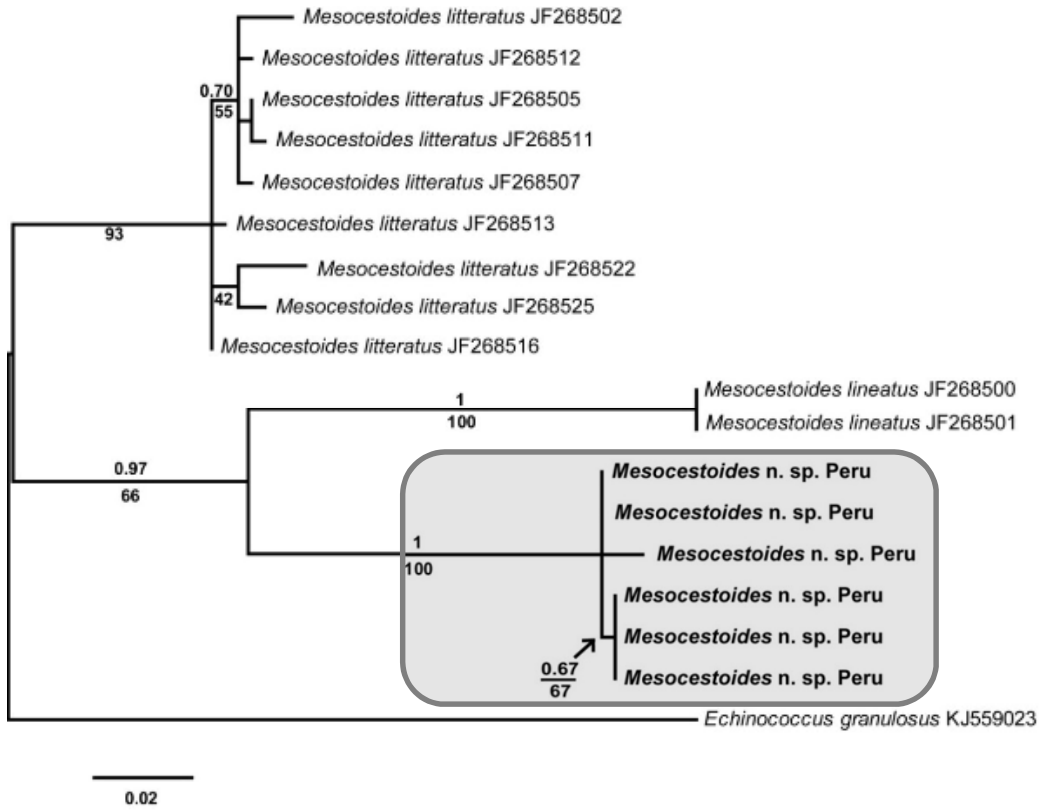

Figure 33. Phylogenetic tree resulted from Bayesian analysis of available mitochondrial (cox1) sequences of *Mesocestoides*.

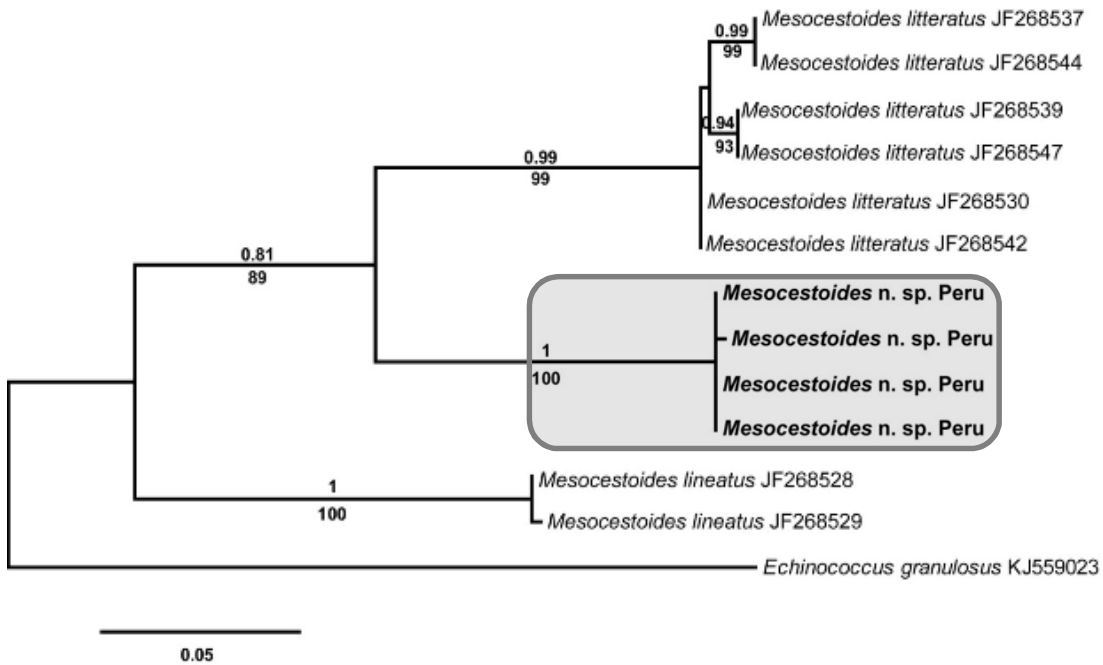

Figure 34. Phylogenetic tree resulted from Bayesian analysis of available mitochondrial (nad1) sequences of *Mesocestoides*.

Family Metadilepididae

Metadilepididae sp.

(Figure 35)

Host: Black-spotted Bare-eye, *Phlegopsis nigromaculata* d'Orbigny & Lafresnaye, 1837

(Passeriformes: Thamnophilidae)

Locality: Belém, Brazil: S3°42.128, W46°45.44

Site of infection: intestine

Prevalence of infection: (1/3)



Figure 35. Metadilepididae sp. scolex hooks from *Formicivora grisea*.

***Schmidneila* sp.**

(Figure 36)

Host: White-fringed Antwren, *Formicivora grisea* Boddaert, 1783 (Passeriformes:
Thamnophilidae)

Locality: Belém, Brazil: S3°42.128, W46°45.44

Site of infection: intestine.

Prevalence of infection: (1/2)

Family Paruterinidae

***Anonchontaenia* sp.**

Hosts: Olivaceous Flatbill, *Rhynchocyclus olivaceus* Temminck, 1820 (Passeriformes: Tyrannidae) and Undulated Antshrike, *Frederickena unduligera* Pelzeln, 1868 (Passeriformes: Thamnophilidae)

Locality: San Martín, Province Tocache, Cordillera Azul N. P., Río Pescadero, NE of Shapaja: S8°10.694, W76°13.422, elev. 953m

Site of infection: Intestine.

Prevalence of infection: *Rhynchocyclus olivaceus* (1/3) and *Frederickena unduligera* (1/1).

***Anonchontaenia* sp.**

Host: Yellow-breasted Flatbill, *Tolmomyias flaviventris* Wied-Neuwied, 1831 (Passeriformes: Rhynchocyclidae)

Locality: Belém, Brazil: S3°42.128, W46°45.44

Site of infection: intestine

Prevalence of infection: (1/1)

***Biuterina* sp. (Inambari)**

(Figure 37)

Hosts: Black-faced Dacnis, *Dacnis lineata* Gmelin, 1789 (Passeriformes: Thraupidae) and Blue-crowned Manakin, *Lepidothrix coronata* Spix, 1825 (Passeriformes: Pipridae)

Locality: San Martín, Province Tocache, Cordillera Azul N. P., Río Pescadero, NE of Shapaja: S8°10.694, W76°13.422, elev. 953m

Site of infection: Intestine.

Prevalence of infection: *Dacnis lineata* (1/1) and *Lepidothrix coronata* (1/3).

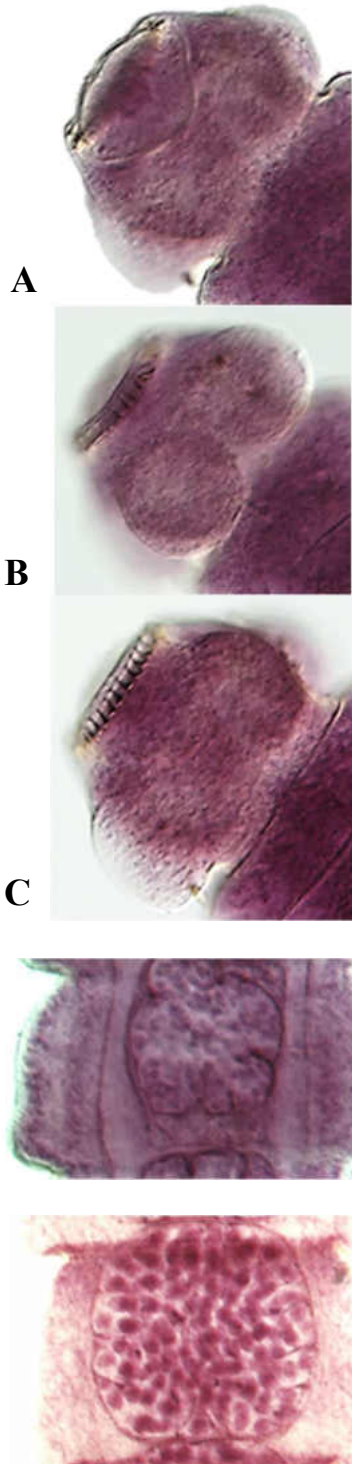

Figure 36. *Schmidneila* sp. from *Formicivora grisea*. (A) Acetabulum of scolex. (B) Suckers of scolex. (C) Hooks of scolex. (D) Pre-gravid proglottid. (E) Gravid proglottid.

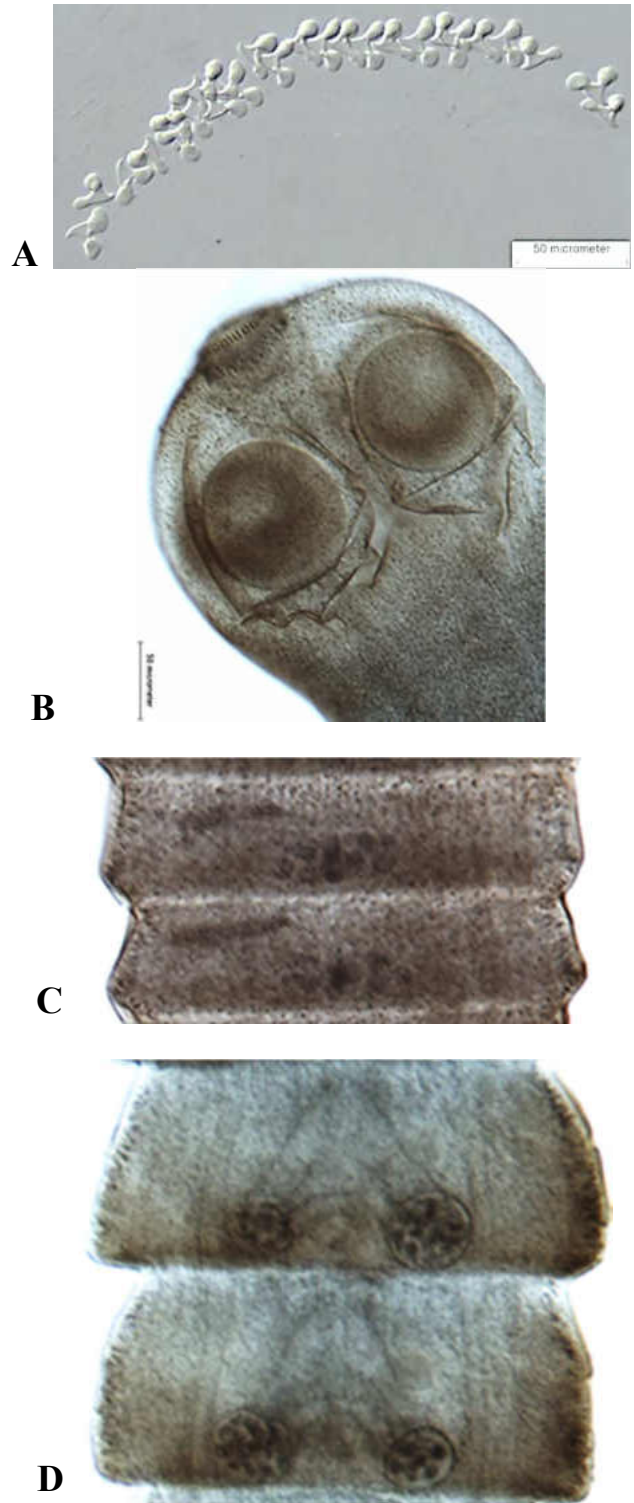

Figure 37. *Biuterina* sp. from *Lepidothrix coronata*. (A) Scolex hooks. (B) Scolex. (C) Mature proglottids. (D) Gravid proglottids.

***Biuterina* sp.** (Belém)

Host: White-crowned Manakin, *Dixiphia pipra* Linnaeus, 1758 (Passeriformes: Pipridae)

Locality: Belém, Brazil: S3°42.128, W46°45.44

Site of infection: intestine

Prevalence of infection: (1/2)

***Francobona* sp.**

Host: Elegant Woodcreeper, *Xiphorhynchus elegans* Pelzeln, 1868 (Passeriformes: Furnariidae)

Locality: San Martín, Province Tocache, Cordillera Azul N. P., Río Pescadero, NE of Shapaja:
S8°10.694, W76°13.422, elev. 953m

Site of infection: Intestine.

Prevalence of infection: (1/4)

***Paruterinidae* sp.** (Inambari)

(Figure 38)

Hosts: Green Manakin, *Xenopipo holochlora* Sclater, 1888 (Passeriformes: Pipridae), Common Scale-backed Antbird, *Willisornis poecilinotus* Cabanis, 1847, (Passeriformes:

Thamnophilidae), Tawny-breasted Flycatcher, *Myiobius villosus* Sclater, 1860 (Passeriformes:

Tyrannidae), Black-bellied Tanager, *Ramphocelus melanogaster* Swainson, 1838 (Passeriformes:

Thraupidae), Long-winged Antwren, *Myrmotherula longipennis* Pelzeln, 1868 (Passeriformes:

Thamnophilidae), Green-and-gold Tanager, *Tangara schrankii* Spix, 1825 (Passeriformes:

Thraupidae), two Scaly-breasted Wrens, *Microcerculus marginatus* Sclater, 1855,

(Passeriformes: Troglodytidae), and Tawny-crowned Greenlet, *Hylophilus ochraceiceps* Sclater,

1860 (Passeriformes: Vireonidae).

Locality: San Martín, Province Tocache, Cordillera Azul N. P., Río Pescadero, NE of Shapaja: S8°10.694, W76°13.422, elev. 953m

Site of infection: Intestine.

Prevalence of infection: *Xenopipo holochlora* (1/3), *Willisornis poecilinotus* (1/5), *Myiobius villosus* (1/3), *Ramphocelus melanogaster* (1/4), *Myrmotherula longipennis* (1/2), *Tangara schrankii* (1/2), *Microcerculus marginatus* (2/4), and *Hylophilus ochraceiceps* (1/2).

Paruterinidae sp. (Belém)

Hosts: Flame-crested tanager, *Lanio cristatus* Linnaeus, 1766 (Passeriformes: Thraupidae), Cinereous Mourner, *Laniocera hypopyrra* Vieillot, 1817 (Passeriformes: Cotingidae), Silky-tailed Nightjar, *Antrostomus sericocaudatus* Cassin, 1849 (Caprimulgiformes: Caprimulgidae), Rufous-tailed Jacamar, *Galbula ruficauda* Cuvier, 1816 (Piciformes: Galbulidae), Black-capped Donacobius, *Donacobius atricapilla* Linnaeus, 1766 (Passeriformes: Donacobiidae), and Moustached Wren, *Pheugopedius genibarbis* Swainson, 1838 (Passeriformes: Troglodytidae)

Locality: Belém, Brazil: S3°42.128, W46°45.44

Site of infection: intestine.

Prevalence of infection: *Lanio cristatus* (1/2), *Laniocera hypopyrra* (1/1), *Antrostomus sericocaudatus* (1/1), *Galbula ruficauda* (1/3), *Donacobius atricapilla* (1/1), and *Pheugopedius genibarbis* (1/3).

Phylum Nematoda

Family Anisakidae

Contraecaecum microcephalum Rudolphi, 1809

Host: Fasciated Tiger-Heron, *Tigrisoma fasciatum* Such, 1825 (Pelicaniformes: Ardeidae)

Locality: San Martín, Province Tocache, Cordillera Azul N. P., Río Pescadero, NE of Shapaja:
S8°10.694, W76°13.422, elev. 953m

Site of infection: Esophagus.

Prevalence of infection: (1/1)

Porrocaecum reticulatum Linstow, 1899

Host: Fasciated Tiger-Heron, *Tigrisoma fasciatum* Such, 1825 (Pelicaniformes: Ardeidae)

Locality: San Martín, Province Tocache, Cordillera Azul N. P., Río Pescadero, NE of Shapaja:
S8°10.694, W76°13.422, elev. 953m

Site of infection: Esophagus.

Prevalence of infection: (1/1)

Family Ascarididae

***Ascaridia* sp.**

Host: Rufous-rumped Foliage-gleaner, *Philydor erythrocerum* Pelzeln, 1859 (Passeriformes:
Furnariidae)

Locality: San Martín, Province Tocache, Cordillera Azul N. P., Río Pescadero, NE of Shapaja:
S8°10.694, W76°13.422, elev. 953m

Site of infection: Stomach.

Prevalence of infection: (1/2)

Family Capillariidae

***Capillaria* sp.** (Inambari)

Hosts: Swainson's Thrush, *Catharus ustulatus* Nuttall, 1840 (Passeriformes: Turdidae), Ruddy
Quail-Dove, *Geotrygon montana* Linnaeus, 1758 (Columbiformes: Columbidae), Tawny-faced
Gnatwren, *Microbates cinereiventris* Sclater, 1855 (Passeriformes: Troglodytidae), Buff-throated

Saltator, *Saltator maximus* Statius Müller, PL, 1776 (Passeriformes: Thraupidae), Olivaceous Flatbill, *Rhynchocyclus olivaceus* Temminck, 1820 (Passeriformes: Tyrannidae)

Locality: San Martín, Province Tocache, Cordillera Azul N. P., Río Pescadero, NE of Shapaja: S8°10.694, W76°13.422, elev. 953m

Site of infection: Capillaries.

Prevalence of infection: *Catharus ustulatus* (1/12) 8.3%, *Geotrygon montana* (1/4), *Microbates cinereiventris* (1/2), *Saltator maximus* (1/1), and *Rhynchocyclus olivaceus* (1/3).

***Capillaria* sp.** (Belém)

Hosts: Cryptic Forest Falcon, *Micrastur mintoni* Whittaker, 2003 (Falconiformes: Falconidae), Blue-crowned Motmot, *Momotus momota* Linnaeus, 1766 (Coraciiformes: Momotidae), and two Ruddy ground doves, *Columbina talpacoti* Temminck, 1810 (Columbiformes: Columbidae)

Locality: Belém, Brazil: S3°42.128, W46°45.44

Site of infection: capillaries

Prevalence of infection: *Micrastur mintoni* (1/1), *Momotus momota* (1/1), and *Columbina talpacoti* (1/3).

Family Diplotriaenidae

***Diplotriaena* sp.** (Inambari)

Host: White-fronted Nunbird, *Monasa morphoeus* Hahn & Kuster, 1823 (Galbuliformes: Bucconidae)

Locality: San Martín, Province Tocache, Cordillera Azul N. P., Río Pescadero, NE of Shapaja: S8°10.694, W76°13.422, elev. 953m

Site of infection: Body cavity.

Prevalence of infection: (1/2)

***Diplotriaena* sp.** (Belém)

Hosts: Olive Oropendola, *Psarocolius bifasciatus* Spix, 1824 (Passeriformes: Icteridae) and

Yellow-throated Woodpecker, *Piculus flavigula* Boddaert, 1783 (Piciformes: Picidae)

Locality: Belém, Brazil: S3°42.128, W46°45.44

Site of infection: NA

Prevalence of infection: *Psarocolius bifasciatus* (1/2) and *Piculus flavigula* (1/2).

Family Habronematidae

Procyrnea pileata Walton, 1928

Host: Amazonian Barred-Woodcreeper, *Dendrocolaptes medius* Todd, 1920 (Passeriformes: Dendrocolaptidae)

Locality: Belém, Brazil: S3°42.128, W46°45.44

Site of infection: stomach

Prevalence of infection: (1/1)

***Procyrnea* sp.**

Host: Green-backed Trogon, *Trogon viridis* Linnaeus, 1766 (Trogoniformes: Trogonidae)

Locality: San Martín, Province Tocache, Cordillera Azul N. P., Río Pescadero, NE of Shapaja:
S8°10.694, W76°13.422, elev. 953m

Site of infection: NA

Prevalence of infection: (1/2)

Family Onchocercidae

***Aproctella* sp. 1**

(Figure 39)

Hosts: Greyish Mourner, *Rhytipterna simplex* Lichtenstein, 1823 (Passeriformes: Tyrannidae), White-lined Tanager, *Tachyphonus rufus* Boddaert, 1783 (Passeriformes: Thraupidae), Green-backed Trogon, *Trogon viridis* Linnaeus, 1766 (Trogoniformes: Trogonidae), Kiskadee, *Pitangus sp.* (Passeriformes: Tyrannidae), Vermilion-crowned flycatcher, *Myiozetetes similis* Spix, 1825 (Passeriformes: Tyrannidae), Yellow-breasted flatbill, *Tolmomyias flaviventris* Wied-Neuwied, 1831 (Passeriformes: Tyrannidae), and Cinnamon Attila, *Attila cinnamomeus* Gmelin, 1789 (Passeriformes: Tyrannidae)

Locality: Belém, Brazil: S3°42.128, W46°45.44

Site of infection: body cavity

Prevalence of infection: *Rhytipterna simplex* (1/1), *Tachyphonus rufus* (1/2), *Trogon viridis* (1/1), *Myiozetetes similis* (1/1), *Tolmomyias flaviventris* (1/1), and *Attila cinnamomeus* (1/2).

Aproctella sp. 2 (Inambari)

Hosts: two Swainson's Thrush, *Catharus ustulatus* Nuttall, 1840 (Passeriformes: Turdidae)

Locality: San Martín, Province Tocache, Cordillera Azul N. P., Río Pescadero, NE of Shapaja: S8°10.694, W76°13.422, elev. 953m

Site of infection: body cavity.

Prevalence of infection: (2/12) 16.6%

Aproctella sp. 2 (Belém)

Hosts: Buff-throated saltator, *Saltator maximus* Statius Müller, 1776 (Passeriformes: Thraupidae), Bananaquit, *Coereba flaveola* Linnaeus, 1758 (Passeriformes: Coerebidae), Chestnut-bellied seed finch, *Sporophila angolensis* Linnaeus, 1766 (Passeriformes: Emberizidae), Bran-colored Flycatcher, *Myiophobus fasciatus* Statius Müller, 1776

(Passeriformes: Tyrannidae), and Cocoa thrush, *Turdus fumigatus* Lichtenstein, 1823

(Passeriformes: Turdidae)

Locality: Belém, Brazil: S3°42.128, W46°45.44

Site of infection: body cavity

Prevalence of infection: *Saltator maximus* (1/1), *Coereba flaveola* (1/3), *Sporophila angolensis* (1/4), *Myiophobus fasciatus* (1/2), and *Turdus fumigatus* (1/1).

Family Ornithostrongylidae

Ornithostrongylus minutus Travassos 1940

Host: Ruddy ground dove, *Columbina talpacoti* Temminck, 1810 (Columbiformes: Columbidae)

Locality: Belém, Brazil: S3°42.128, W46°45.44

Site of infection: intestine

Prevalence of infection: (1/3)

Family Seuratidae

Skrjabinura spiralis Gnédina, 1933

Host: Squirrel cuckoo, *Piaya cayana* Linnaeus, 1766 (Cuculiformes: Cuculidae)

Locality: Belém, Brazil: S3°42.128, W46°45.44

Site of infection: NA

Prevalence of infection: (1/1)

Family Subuluridae

Subulura sp.

Host: Undulated Antshrike, *Frederickena undiligera* Pelzeln, 1868 (Passeriformes: Thamnophilidae)

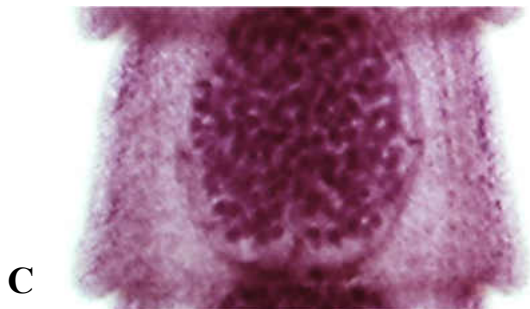
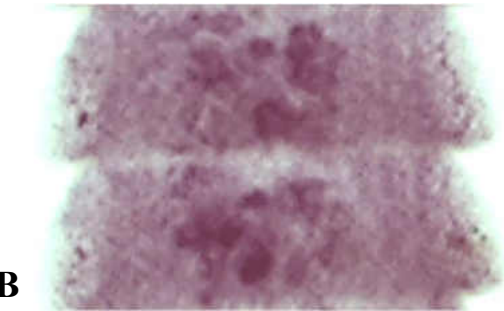

Figure 38. Paruterinidae sp. from *Ramphocelus melanogaster*. (A) Scolex. (B) Mature proglottids. (C) Gravid proglottid.



Figure 39. *Aproctella* sp. 1 from *Tolmomyias flaviventris*.

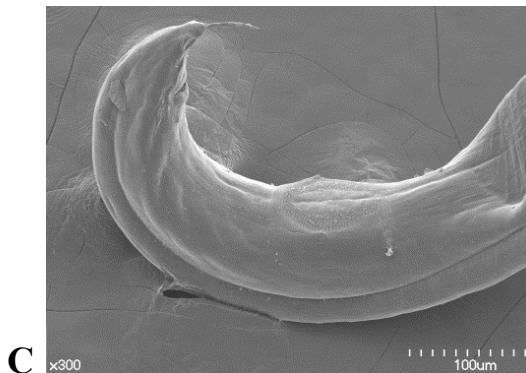
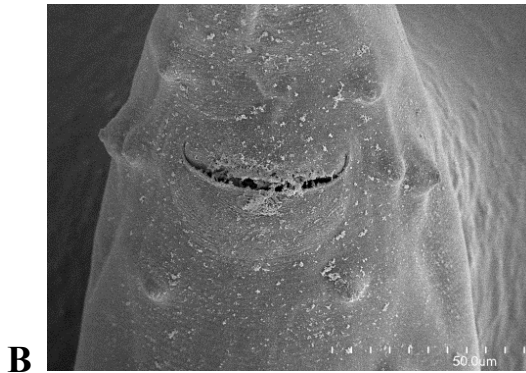
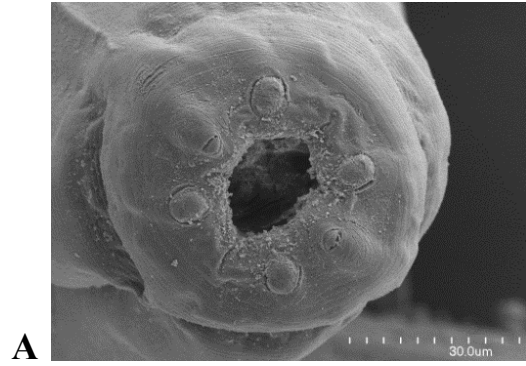

Figure 40. *Subulura travassosi* from *Notharchus tectus*. (A) Anterior end of nematode. (B) Anus and pre- and postanal papillae. (C) Posterior end of nematode.

Locality: San Martín, Province Tocache, Cordillera Azul N. P., Río Pescadero, NE of Shapaja:
S8°10.694, W76°13.422, elev. 953m

Site of infection: Intestine.

Prevalence of infection: (1/1)

Subulura travassosi Barreto, 1919

(Figure 40)

Host: Squirrel cuckoo, *Piaya cayana* Linnaeus, 1766 (Cuculiformes: Cuculidae), two White-fronted Nunbirds, *Monasa morphoeus* Hahn & Kuster, 1823 (Piciformes: Bucconidae), two Pied Puffbirds, *Notharchus tectus* Boddaert, 1783 (Piciformes: Bucconidae), Smooth-billed ani, *Crotophaga ani* Linnaeus, 1758 (Cuculiformes: Cuculidae), Silky-tailed Nightjar, *Antrostomus sericocaudatus* Cassin, 1849 (Caprimulgiformes: Caprimulgidae), and Tawny-bellied Screech Owl, *Megascops watsonii* Cassin, 1848 (Strigiformes: Strigidae).

Locality: Belém, Brazil: S3°42.128, W46°45.44

Site of infection: NA

Prevalence of infection: *Piaya cayana* (1/1), *Monasa morphoeus* (2/2), *Notharchus tectus* (2/3), *Crotophaga ani* (1/2), *Antrostomus sericocaudatus* (1/1), and *Megascops watsonii* (1/1).

Remarks: *Subulura* is one of the ascaridoid genera considered to have uncertain placement or “incertae sedis” by Inglis (1958). Records of subuluriids in South American birds are scattered and fragmentary. We have found numerous specimens of *Subulura travassosi* in five species of birds from Brazil. We also found what we thought to be *Subulura travassosi* in a species of bird from Peru. The pairwise sequence comparison among all sequenced specimens from both Brazil and Peru has shown differences ranging from 0.96 to 8.2% (Table 3). It should be noted that differences among Brazilian isolates ranged only from 0.96 to 2.2% while the Peruvian isolate

Table 3. Number (above diagonal) and percentage (below diagonal) of variable sites based on pairwise comparison of 416-base-pair-long fragment of mitochondrial cox 1 gene *Subulura travassosi* and *Subulura* sp.

Nematode Species	<i>Subulura travassosi</i> from <i>Notharchus tectus</i> , BRAZIL	<i>Subulura travassosi</i> from <i>Piaya cayana</i> , BRAZIL	<i>Subulura travassosi</i> from <i>Antrostomus sericocaudatus</i> , BRAZIL	<i>Subulura travassosi</i> from <i>Monasa morphoeus</i> , BRAZIL	<i>Subulura travassosi</i> from <i>Megascops watsonii</i> , BRAZIL	<i>Subulura</i> sp. from <i>Frederickena undiligera</i> , PERU
<i>Subulura travassosi</i> from <i>Notharchus tectus</i> , BRAZIL	–	4	7	6	9	31
<i>Subulura travassosi</i> from <i>Piaya cayana</i> , BRAZIL	0.96%	–	7	4	9	31
<i>Subulura travassosi</i> from <i>Antrostomus sericocaudatus</i> , BRAZIL	1.7%	1.7%	–	3	8	34
<i>Subulura travassosi</i> from <i>Monasa morphoeus</i> , BRAZIL	1.4%	0.96%	0.72%	–	7	31
<i>Subulura travassosi</i> from <i>Megascops watsonii</i> , BRAZIL	2.2%	2.2%	1.9%	1.7%	–	33
<i>Subulura</i> sp. from <i>Frederickena undiligera</i> , PERU	7.5%	7.5%	8.2%	7.5%	7.9%	–

differed from Brazilian isolates ranging from 7.5% to 8.2% (Table 3). There were no pairwise differences between Brazilian isolates in the much more conserved nuclear ribosomal 18S gene, with only a 0.27% difference between the Brazilian and Peruvian isolates. The level of divergence in the cox1 gene suggests that the Peruvian specimen represents a different, morphologically similar, species of *Subulura*. Although all previously available sequences of *Subulura* represent the 18S gene, our data demonstrate

that it is not suitable for species differentiation in this group of nematodes due to its very limited interspecific variability. The *cox1* gene is clearly a better target for this purpose. Sequencing other South American species of *Subulura* will stabilize the systematics and taxonomy of these nematodes.

On the other hand, the 18S gene is very useful for phylogenetic inference at higher taxonomic levels. We have combined our 18S sequences of *Subulura* with those of other ascaridoid nematodes and conducted a Bayesian analysis of the resulting alignment. The family appears as one of the main lineages within this large group of parasitic nematodes (Figure 41). Also, with the images acquired from both light microscopy and scanning electron microscopy, we will be able to give this species a more complete description in a later manuscript.

Phylum Acanthocephala

Family Centrorhynchidae

Centrorhynchus kuntzi Schmidt & Neiland, 1966

Host: Bright-rumped Attila, *Attila spadiceus* Gmelin, 1789 (Passeriformes: Tyrannidae)

Locality: Belém, Brazil: S3°42.128, W46°45.44

Site of infection: NA

Prevalence of infection: (1/1)

Centrorhynchus microcephalus Bravo, 1947

Host: Smooth-billed ani, *Crotophaga ani* Linnaeus, 1758 (Cuculiformes: Cuculidae)

Locality: Belém, Brazil: S3°42.128, W46°45.44

Site of infection: NA

Prevalence of infection: (1/2)

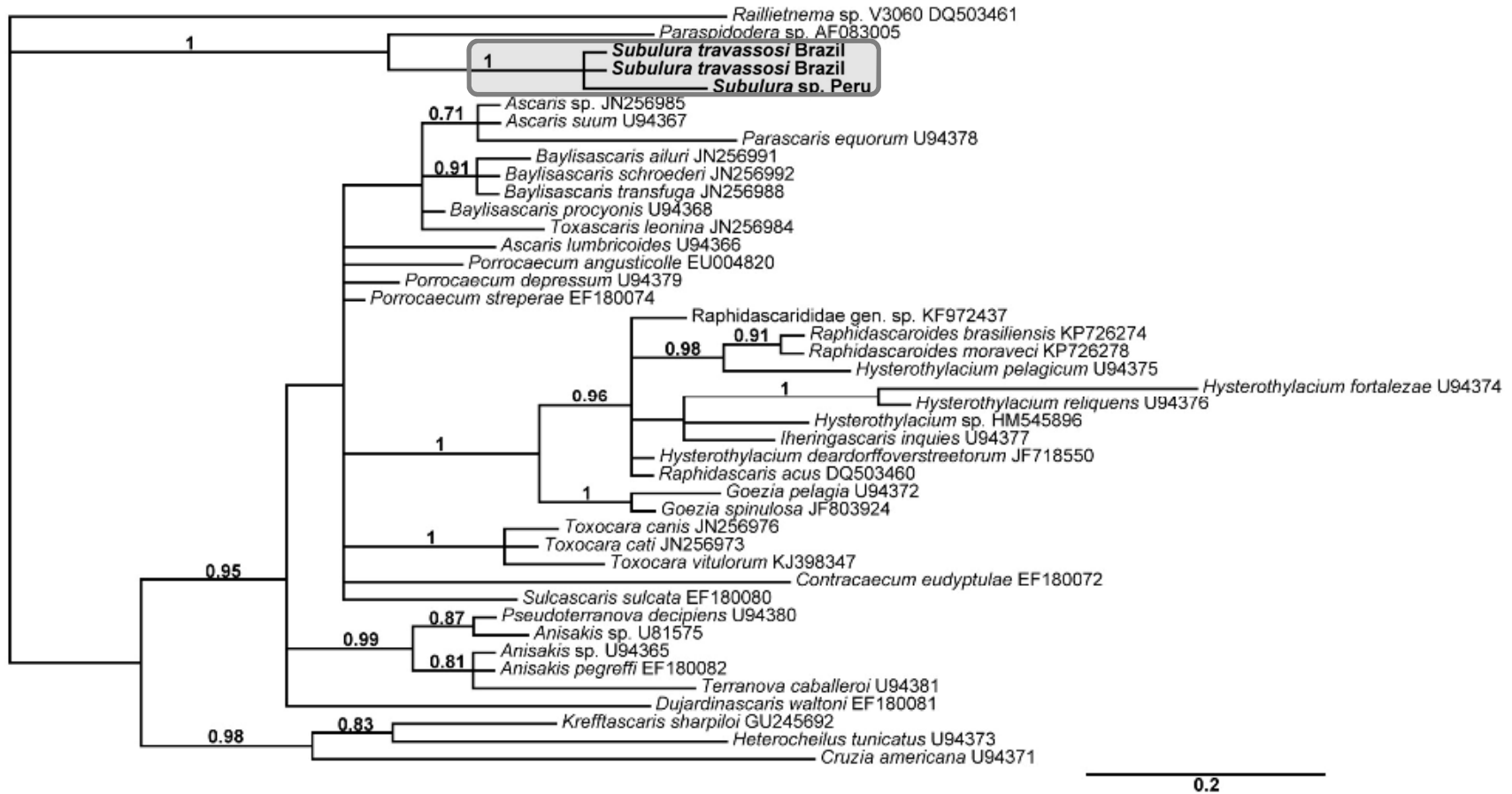

Figure 41. Phylogenetic tree resulted from Bayesian analysis of 18S sequences of closely related GenBank

***Centrorhynchus* sp. (Inambari)**

Host: Fasciated Tiger-Heron, *Tigrisoma fasciatum* Such, 1825 (Pelicaniformes: Ardeidae)

Locality: San Martín, Province Tocache, Cordillera Azul N. P., Río Pescadero, NE of Shapaja:

S8°10.694, W76°13.422, elev. 953m

Site of infection: Intestine.

Prevalence of infection: (1/1)

***Centrorhynchus* sp. (Belém)**

Type host: Tawny-bellied screech owl, *Megascops watsonii* Cassin, 1848 (Strigiformes:

Strigidae), Plain Xenops, *Xenops minutus* Sparrman, 1788 (Passeriformes: Furnariidae), and

Cryptic Forest Falcon, *Micrastur mintoni* Whittaker, 2003 (Falconiformes: Falconidae)

Locality: Belém, Brazil: S3°42.128, W46°45.44

Site of infection: NA

Prevalence of infection: *Megascops watsonii* (1/1), *Xenops minutus* (1/3), and *Micrastur mintoni* (1/1).

***Sphaerostris* sp.**

(Figure 42)

Host: Swainson's Thrush, *Catharus ustulatus* Nuttall, 1840 (Passeriformes: Turdidae)

Locality: San Martín, Province Tocache, Cordillera Azul N. P., Río Pescadero, NE of Shapaja:

S8°10.694, W76°13.422, elev. 953m

Site of infection: Intestine.

Prevalence of infection: (1/12) 8.3%



Figure 42. *Sphaerirostris* sp. from *Catharus ustalatus*.

Family Giganthorhynchidae

***Mediorhynchus* n.sp.**

Host: Spix's Woodcreeper, *Xiphorhynchus spixii* Lesson, 1830 (Passeriformes:

Dendrocolaptidae)

Locality: Belém, Brazil: S3°42.128, W46°45.44

Site of infection: NA

Prevalence of infection: (1/1)

Comparative Analysis of Bird Helminth Fauna and Infection Rates Between Areas of Endemism

Birds Examined

In this work, we studied helminth fauna of birds from two sites in the southern Amazon; one in Gurupi, Brazil, belonging to the easternmost region of endemism, Belém and one in the Cordillera Azul, Peru, belonging to the westernmost region of endemism, Inambari. In Brazil, 190 birds belonging to 15 orders were examined for endoparasites during July, 2013. In Peru, 234 birds belonging to 9 orders were examined for endoparasites during November, 2013. Distribution of examined birds among bird orders in both areas of endemism is presented in Table 4 and Figures 43 and 44.

Helminths

Prevalence of infection with helminths among bird orders is presented in Table 5 and Figure 45. In Belém, 51 birds (26%) were infected with helminths. Nematodes and cestodes were the most prevalent among all helminths, followed by digeneans, and acanthocephalans (Figure 46). In Inambari, 68 birds (29%) were infected with helminths. Cestodes were the most prevalent among all helminths, followed by digeneans, nematodes, and acanthocephalans (Figure 46). There was a statistically significant difference in the prevalence of nematodes ($P = 0.0014$) and digeneans ($P = 0.0099$) between the areas of endemism.

Acanthocephalans were the least prevalent group of helminths in both areas of endemism. In Inambari, only one family of acanthocephalans, Centrorhynchidae, was found. In Belém, two families were found: Centrorhynchidae and Gigantorhynchidae (Figure 47).

Table 4. Distribution of examined birds among bird orders in Belém and Inambari areas of endemism. Absolute number of bird specimens and their percentage of the total number of birds examined in each order are provided.

Bird orders	Belém		Inambari	
	#	%	#	%
Accipitriformes	1	0.5%	1	0.4%
Anseriformes	1	0.5%	0	0%
Apodiformes	17	8.5%	20	8.5%
Caprimulgiformes	1	0.5%	0	0%
Charadriiformes	2	1%	0	0%
Columbiformes	5	2.5%	4	1.7%
Coraciiformes	2	1%	6	2.6%
Cuculiformes	4	2%	0	0%
Falconiformes	2	1%	0	0%
Galbuliformes	0	0%	7	3%
Galliformes	0	0%	2	0.9%
Gruiformes	1	0.5%	0	0%
Passeriformes	142	71.4%	191	81.6%
Pelecaniformes	0	0%	1	0.4%
Piciformes	14	7%	0	0%
Psittaciformes	3	1.5%	0	0%
Strigiformes	3	1.5%	0	0%
Trogoniformes	1	0.5%	2	0.9%

Cestodes were the most prevalent group of helminths in Inambari, with the most common family being Paruterinidae. Other cestode families in Inambari included Davaineidae, Dilepididae, Hymenolepididae, and Mesocestoididae. Cestodes were one of the most prevalent helminth groups in Belém, with Dilepididae being the most common family. Other cestode families in Belém included Hymenolepididae, Metadilepididae, and Paruterinidae (Figure 48).

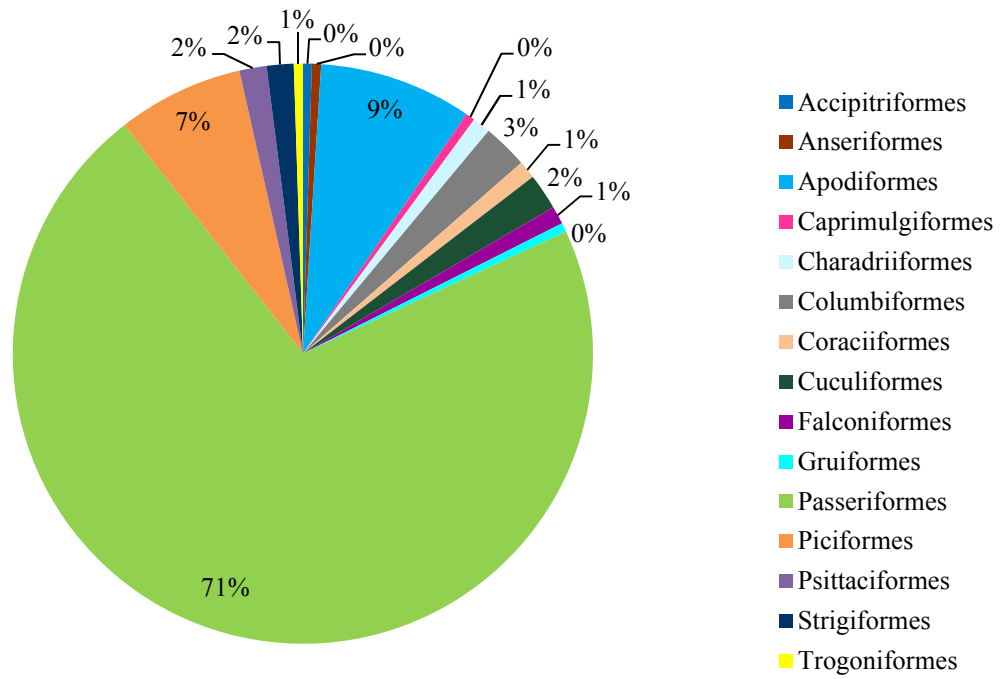

Figure 43. Proportion of different avian orders among samples from Belém.

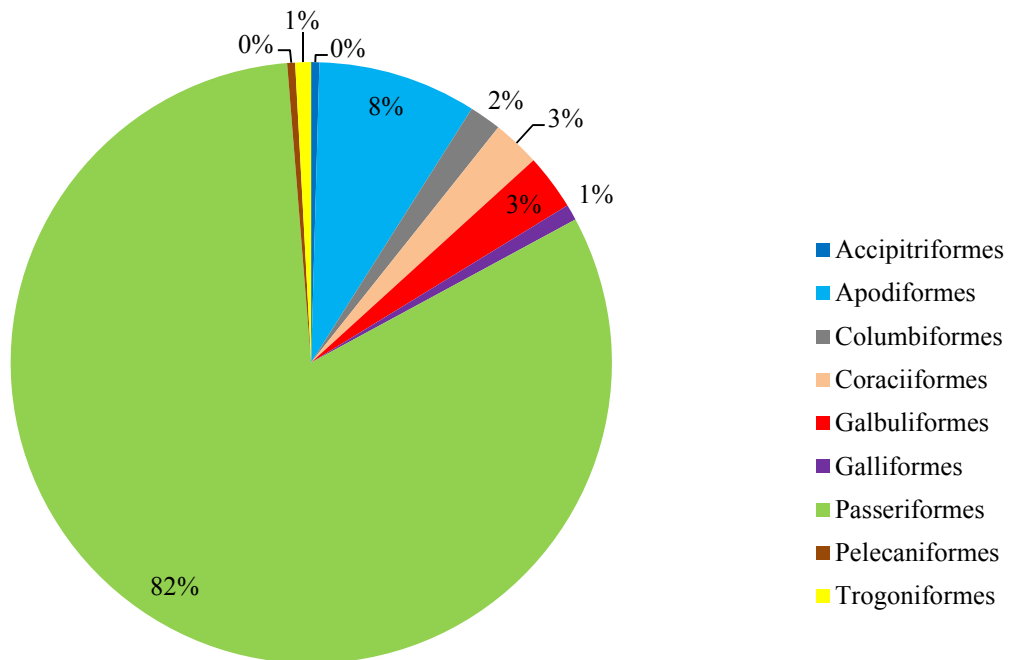

Figure 44. Proportion of different avian orders among samples from Inambari.

Table 5. Distribution of infected birds among bird orders in Belém and Inambari areas of endemism. Infected number of bird specimens with helminths and the total number of birds examined in each order are provided.

Bird orders	Belém		Inambari	
	infected	examined	infected	examined
Apodiformes	0	17	2 (10%)	20
Caprimulgiformes	1	1	0	0
Columbiformes	3	5	1	4
Coraciiformes	1	2	1	6
Cuculiformes	3	4	0	0
Falconiformes	1	2	0	0
Galbuliformes	0	0	2	7
Galliformes	0	0	1	2
Passeriformes	34 (24%)	142	59 (31%)	191
Pelecaniformes	0	0	1	1
Piciformes	6 (43%)	14	0	0
Strigiformes	1	3	0	0
Trogoniformes	1	1	1	2

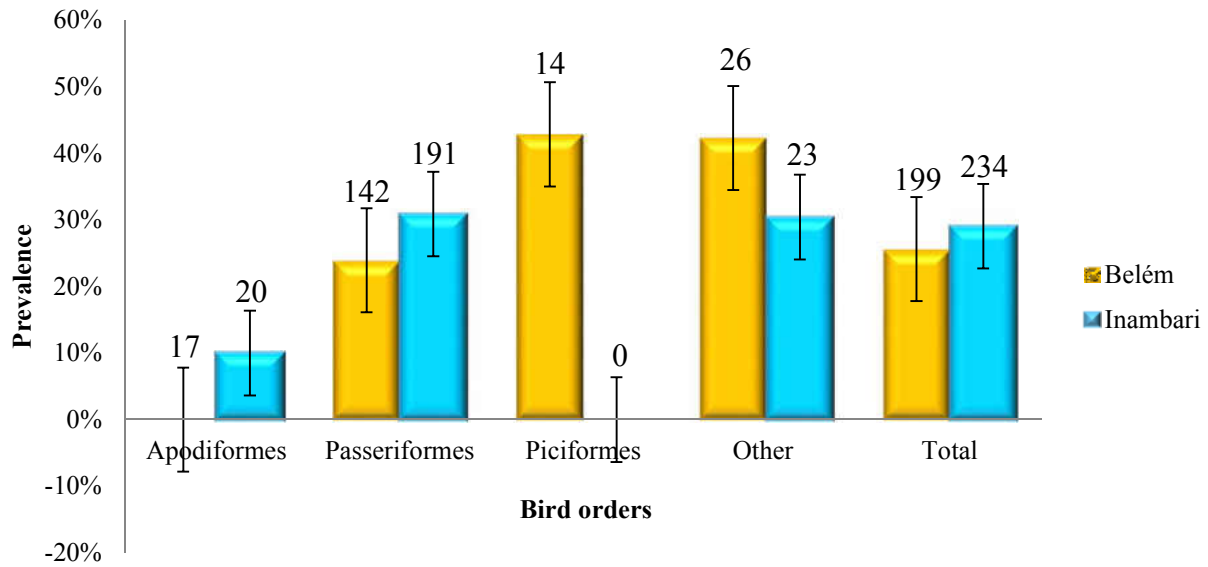

Figure 45. Prevalence of infection with all helminths between the two areas of endemism. “Other” includes: Accipitriformes, Anseriformes, Caprimulgiformes, Charadriiformes, Columbiformes, Coraciiformes, Cuculiformes, Falconiformes, Galbuliformes, Galliformes, Gruiformes, Pelecaniformes, Psittaciformes, Strigiformes, and Trogoniformes. Bird sample size is above each bar.

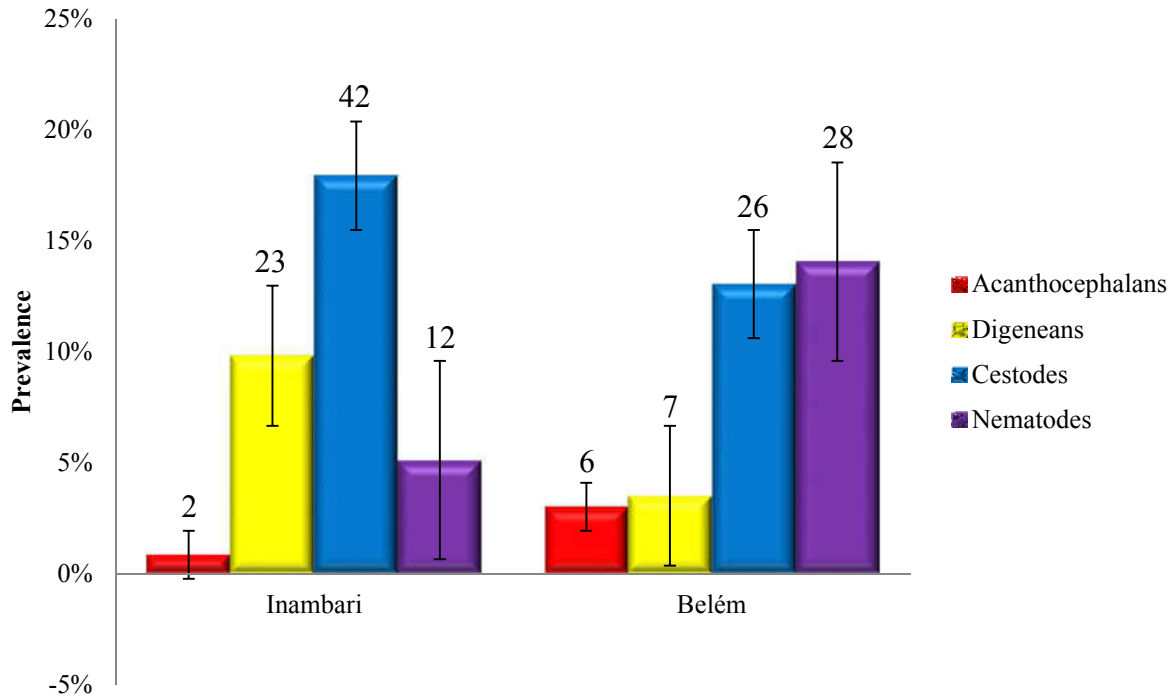

Figure 46. Prevalence of infection by major helminth groups between the two areas of endemism. Absolute number of infected birds is above each bar.

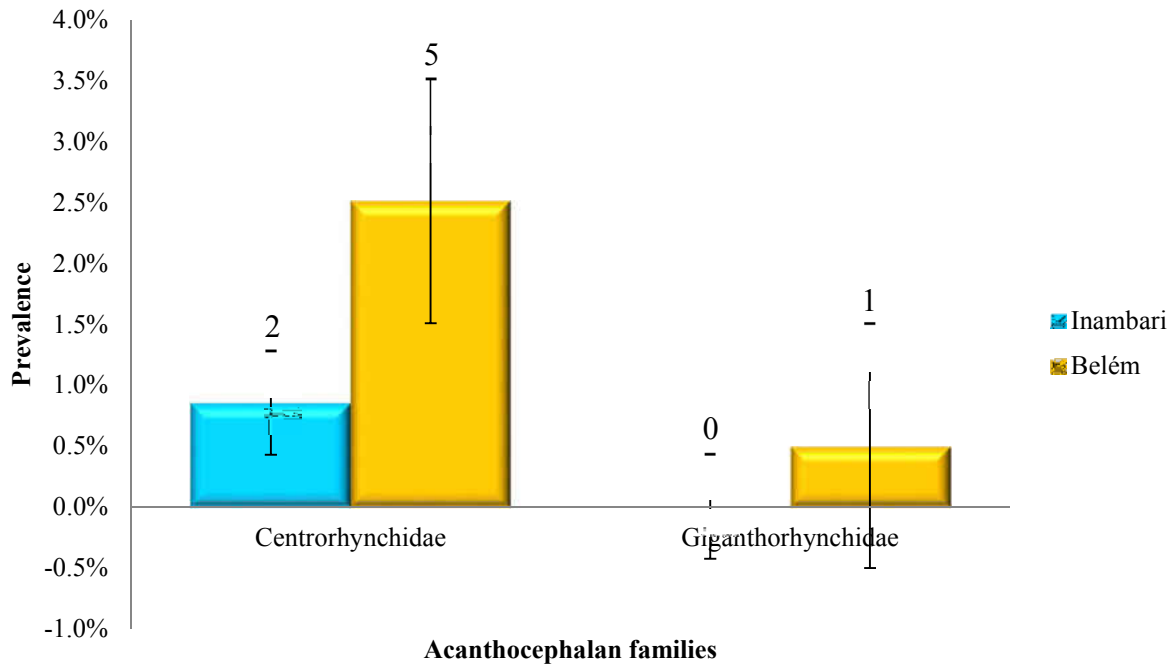

Figure 47. Prevalence of acanthocephalan families between the two areas of endemism. Absolute number of infected birds is above each bar.

Digeneans were the second most prevalent helminth group in Inambari, but the second least prevalent group in Belém. In Inambari, digeneans had the greatest diversity with Dicrocoelidae as the most common family, followed by Leucochloridiidae, Eucotylidae, Phaneropsolidae, Schistosomatidae, Cyathocotilidae, Diplostomidae, Renschtreematidae, and Stomylotrematidae. In Belém, the most common family was also Dicrocoelidae, followed by Diplostomidae, Brachylaimidae, and Eucotylidae (Figure 49).

Nematodes and cestodes are almost equally prevalent in Belém, but nematodes are only the third most prevalent group in Inambari. Belém and Inambari had nearly equal nematode diversity at the family level with Onchocercidae being the most common family in Belém, followed by Subuluridae, Capillariidae, Diplotriaenidae, Habronematidae, and Ornithostrongylidae. Capillariidae was the most common family in Inambari, followed by Onchocercidae, Anisakidae, Ascarididae, Diplotriaenidae, Habronematidae, and Subuluridae (Figure 50).

Passeriformes were the only bird order examined in high enough numbers to allow for comparison of helminth prevalence between areas of endemism. Cestodes were the most prevalent group of helminths in passerines for both areas of endemism, however, there was a statistically significant difference in digenean ($P = 0.012$), nematode ($P = 0.0024$), and acanthocephalan ($P = 0.042$) infections (Figure 51).

Figure 52 shows the infection pattern of helminths in individual host species. The majority of hosts had either no infection or were infected with only one species of helminth. Of the 51 birds in Belém infected with helminths, 37 were infected with a single species, followed by 10 with a dual infection and 3 with a triple infection. A similar pattern was seen for Inambari, with 58 of the 68 infected hosts having a single infection, followed by 6 with a dual infection,

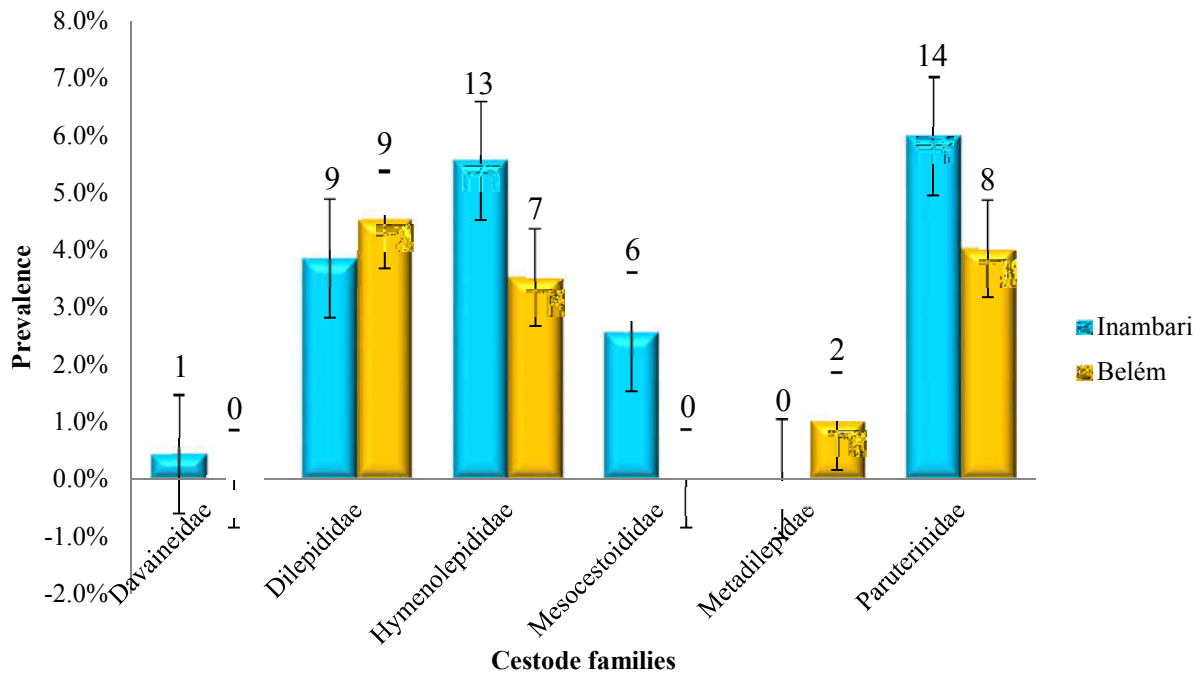

Figure 48. Prevalence of cestode families between the two areas of endemism. Absolute number of infected birds is above each bar.

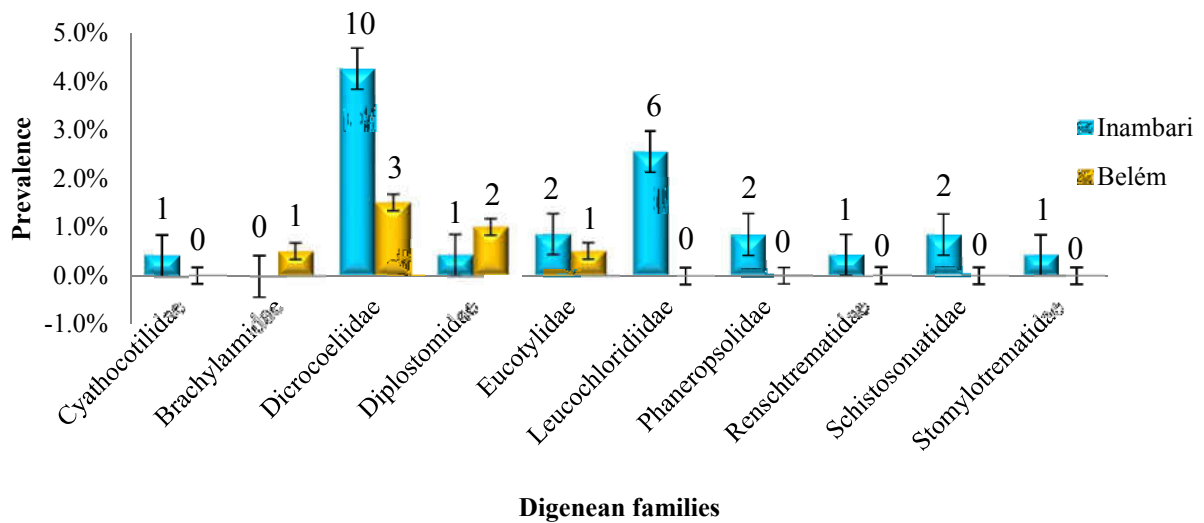

Figure 49. Prevalence of digenean families between the two areas of endemism. Absolute number of infected birds is above each bar.

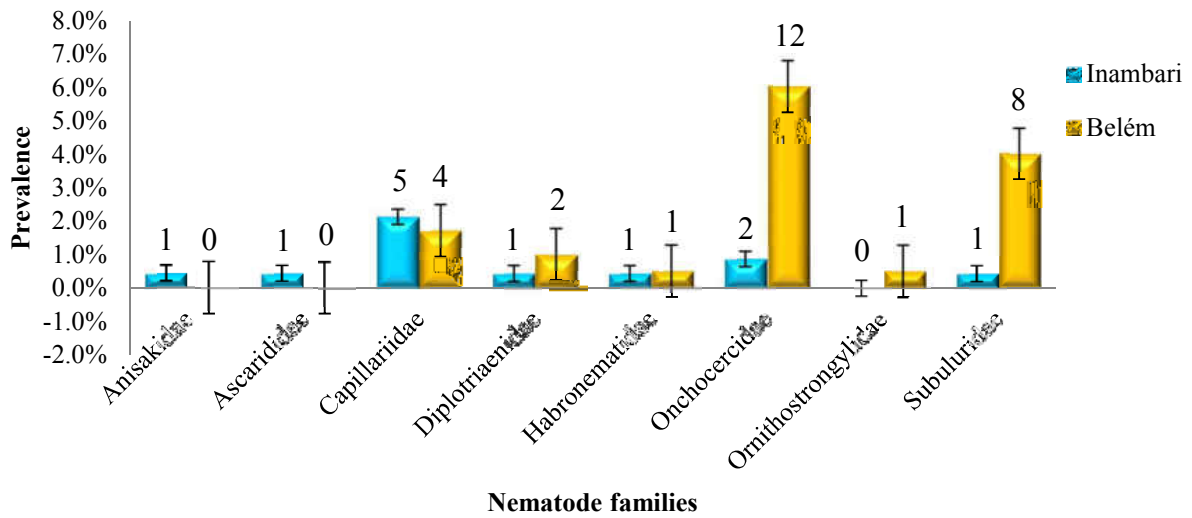

Figure 50. Prevalence of nematode families between the two areas of endemism. Absolute number of infected birds is above each bar.

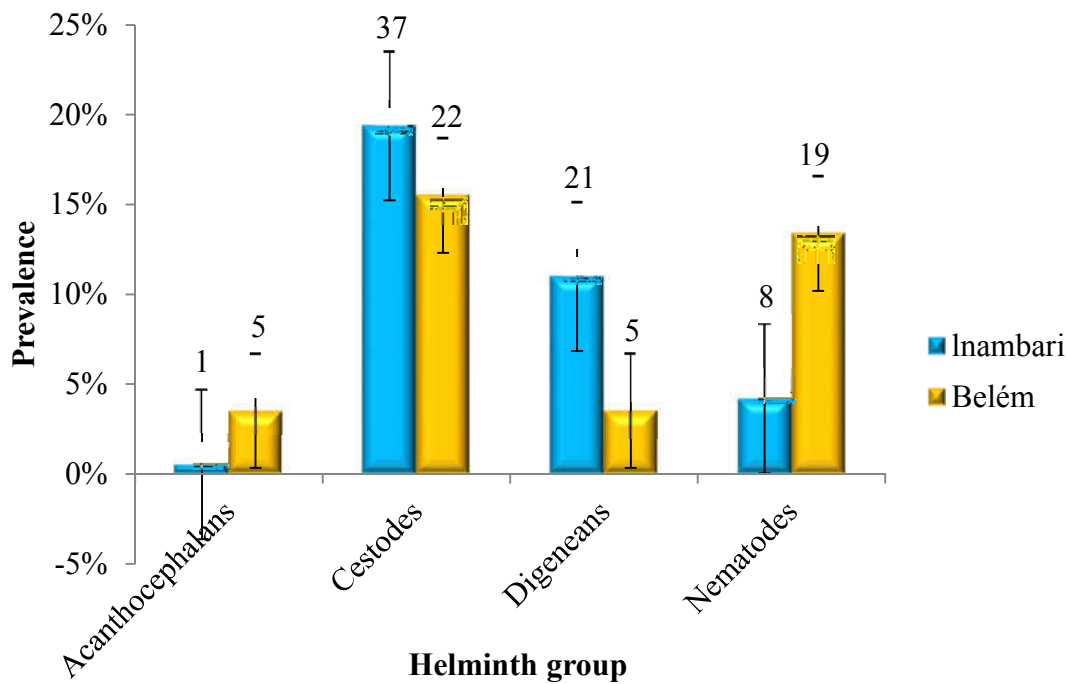

Figure 51. Prevalence of infection with all helminths species among passerine samples. Absolute number of infected birds is above each bar.

and 4 with a triple infection. None of the hosts from either area of endemism had more than 3 helminth species.

Taxonomic richness analysis

Avian family richness amongst both areas of endemism is presented in Figure 53. All five estimators (bootstrap, Chao 2, first order jackknife, abundance-based coverage estimator, and incidence-coverage estimator) predicted that Inambari is more species-rich than Belém, with estimates ranging from 50 to 127 bird families in Inambari and 28 to 38 families in Belém. It should be noted that the incidence-coverage estimator predicted 127 birds for Inambari, but all other estimators for this area of endemism ranged from 50 to 60 families.

Helminth family richness amongst both areas of endemism is presented in Figure 54. As was seen with bird families, Inambari was predicted to be more species-rich with helminth families when compared to Belém. Estimates ranged from 30 to 50 in Inambari and 20 to 30 in Belém. All but one of the estimators for Belém predicted 20 helminth families for this area of endemism, while the abundance-based coverage estimator predicted 30.

Estimates of bird and helminth family similarity between Inambari and Belém were determined with Jaccard, Sorenson, and Chao-Sorensen estimator indices (Table 6). For both birds and helminths, almost all the Jaccard and Sorensen index values were below 0.5, suggesting few shared species of both birds and helminths between the two areas of endemism. However, the Chao-Sorensen estimator predicted 0.68 for similarity in bird families and 0.75 for similarity in helminth families, indicating more species overlap than anticipated by the other estimators.

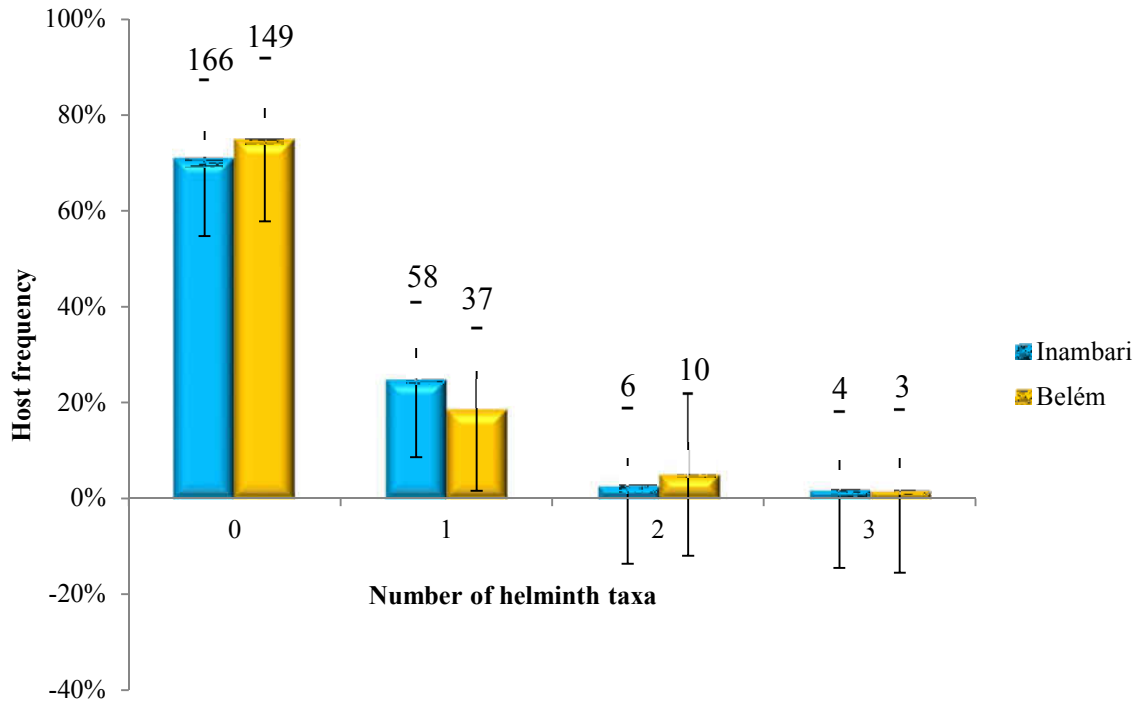

Figure 52. Number of helminth species within individual avian hosts. Absolute sample size is above each bar.

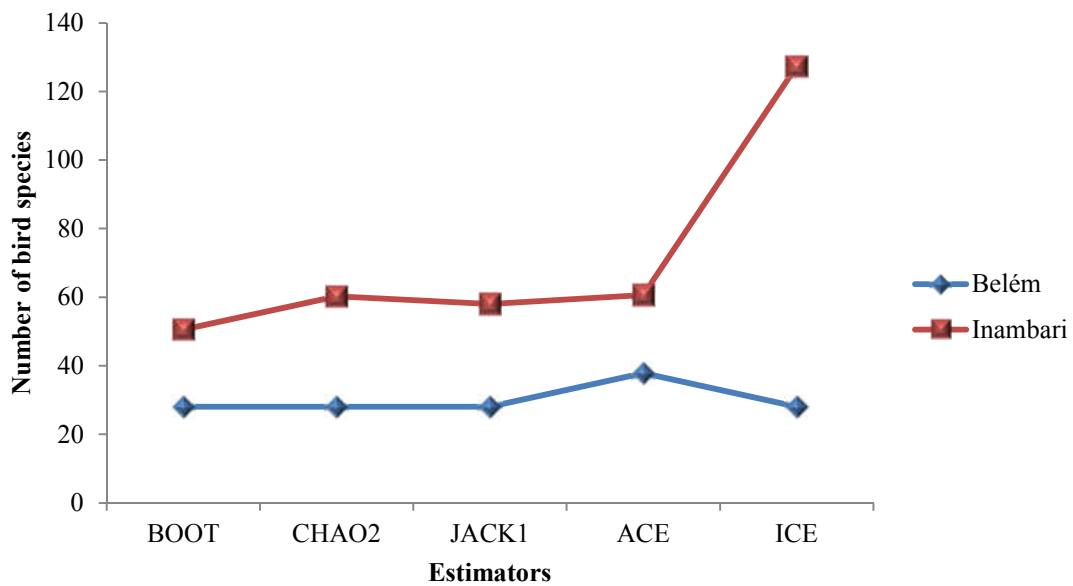

Figure 53. Estimated bird species richness for both areas of endemism using five different estimators (BOOT: bootstrap; CHAO2: Chao 2; JACK1: first order jackknife; ACE: abundance-based coverage estimator; and ICE: incidence-coverage estimator).

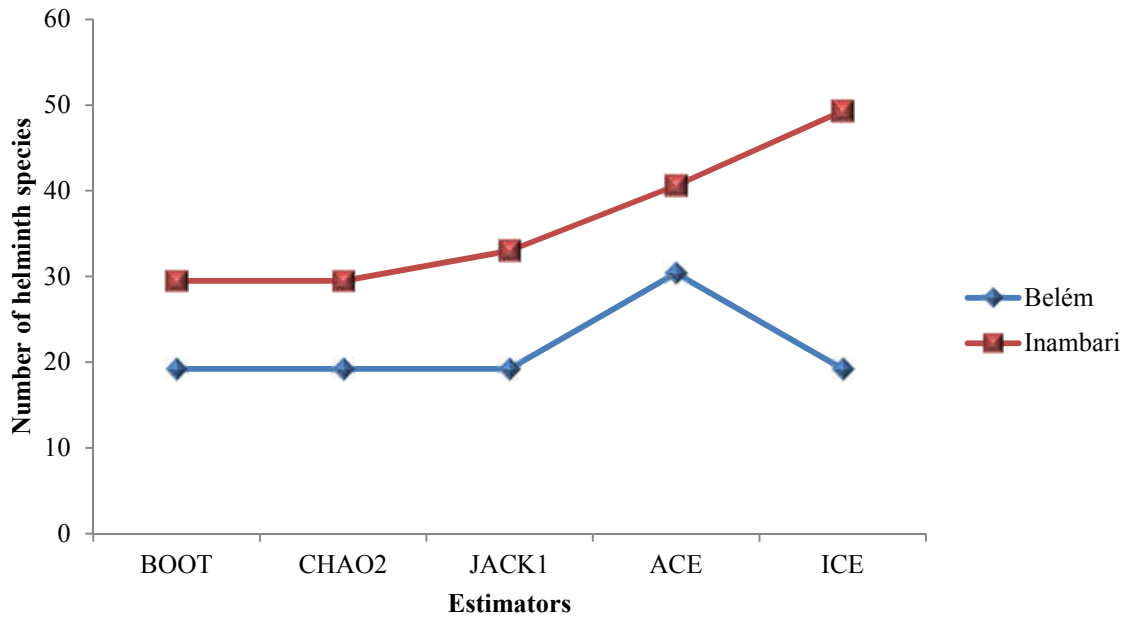

Figure 54. Estimated helminth species richness for both areas of endemism using five different estimators (BOOT: bootstrap; CHAO2: Chao 2; JACK1: first order jackknife; ACE: abundance-based coverage estimator; and ICE: incidence-coverage estimator).

Table 6. Jaccard, Sorensen, and Chao-Sorensen estimator indices calculated for birds and helminths among Belém and Inambari areas of endemism.

	Jaccard Classic	Sorensen Classic	Chao-Sorensen Estimated Abundance
Birds	0.3	0.46	0.68
Helminths	0.46	0.6	0.75

Discussion

Only 29% of birds in Inambari, and 26% of birds in Belém were infected with helminths. Considering the enormous diversity of birds and potential intermediate hosts of helminths in the tropical forest, we initially anticipated higher prevalence with helminths in general and with major helminth groups. However, at present we do not have sufficient data regarding the population densities of individual bird species in either of the studied areas. Helminth circulation strongly depends on their chances to encounter (e.g., being eaten by) their hosts and is frequently a function of

population density. High host specificity of many avian parasites further complicates the situation. High bird diversity does not necessarily translate into high density. Thus, some host-specific parasites might be unable to maintain viable populations in their low-density tropical hosts (Dobson et al. 2008). Moreover, in cases of birds that are generalist feeders (as is the case with many birds we examined), their diet is likely to be too diverse to ensure a stable, repeatable pathway for helminth circulation. This aggravates the “dilution effect” and may disrupt the life cycles. In other words, some of these communities may be simply too diverse to provide conditions for reliable helminth circulation. In contrast, oligotrophic environments with high host population densities (e.g., robins and earthworms in North Dakota) form “helminth circulation friendly” systems.

We also expected somewhat higher diversity of parasitic worms in the studied collecting sites. The relatively low diversity may be at least partially explained with the global pattern of biodiversity that is currently receiving attention in the literature. As a general rule, there are more species in the tropics than at higher latitudes (Gaston, 2000, Willig et al. 2003, Hillebrand, 2004, Poulin, 2010). In principle, parasites should be no exception. However, several studies on latitudinal gradients of parasite diversity have not revealed strong patterns (Poulin and Morand, 2000, 2004). One explanation for this could be the disproportionately low effort to find and identify helminths in animals from tropical regions. Helminth biodiversity surveys require both taxonomic expertise and a greater time investment compared to surveys of free-living animals. This is because additional effort is needed for dissection, locating the helminths within the hosts’ body, and correctly preparing them for microscopy. Although these types of surveys are frequently conducted in temperate areas such as North America or Europe, they have only been initiated more recently in the tropics which may contend for records of low parasite diversity.

Between the two areas of endemism, there was a statistically significant difference in prevalence of nematodes and digeneans. The author can only speculate as to why these differences occurred, but one likely reason could be geographical/landscape peculiarities of the two locations.

The collecting site at Inambari is at a higher altitude than Belém and borders the Andes mountain range. Differences in geography affects both definitive and intermediate host composition. The greater prevalence of digeneans in Inambari is probably due to the close proximity of the collecting site to a water body (a larger river and a stream). Hosts that rely on or incorporate aquatic species into their diet generally have digenean-dominated helminth communities because a majority of digeneans require an aquatic mollusk as an intermediate host. The greater prevalence of nematodes in Belém is likely due to the greater proportion of terrestrial arthropods in the diet of definitive hosts due to deforestation and lack of substantial water bodies in close proximity. All digeneans found in Belém were collected from birds trapped around a small marsh. In contrast, eggs and larvae of nematodes with either direct or indirect life cycles frequently incubate in soil before becoming infective.

Relationships between birds and helminths are also linked to the life history characteristics of the hosts involved. Although this research does not focus on the development of these species, the author suggests a future study involving analysis of correlations between helminth groups and functional groups of the avian community. Individual bird species could be classified by habitat (rainforest, wetland), nest location (ground, understory, sub canopy, canopy, cliff/bank), nest type (open cup, closed cup, cavity), flocking (solitary/family group, single species, mixed species), breeding (monogamy, polygamy), migratory status (resident, migrant), foraging habitat (ground, understory, sub canopy, canopy), and diet (insectivore, frugivore/granivore, nectavore, omnivore/carnivore). The ordination could then be performed to determine which variables are the most important in determining prevalence of specific helminth groups and possibly to even lower taxonomic levels. Admittedly, a somewhat greater sample size is needed to conduct this type of study.

REFERENCES

- AMIN, O. M. 1985. Classification. *In* Biology of the Acanthocephala (D. W. T. Crompton and B.B. Nickol, Eds.). Cambridge University Press, Cambridge, U.K., p. 27–71.
- ANDERY, D. A., F. C. FERREIRA JUNIOR, A.V. ARAÚJO, D. A. R. VILELA, M. V. R. MARQUES, S. Y. MARIN, R. S. HORTA, M. C. ORTIZ, J. S. RESENDE AND N. R. S. MARTINS. 2013. Health assessment of raptors in triage in Belo Horizonte, MG, Brazil. *Brazilian Journal of Poultry Sciences* **15**: 169-286.
- ARRUDA, V. S., R. M. PINTO AND L. C. MUNIZ-PEREIRA. 2001. New host and geographical records for helminths parasites of Ardeidae (Aves, Ciconiiformes) in Brazil. *Revista Brasileira de Biologia* **18**: 225-232.
- BENNETT, G. F. 1970. Simple techniques for making avian blood smears. *Canadian Journal of Zoology* **48**: 585-586.
- BONA, F. V. 1983. Variability and growth of cestodes; premises to a biometric analysis. *Dendrouterina pilherodiae meridionalis* n. subsp., parasites of *Egretta alba* (Ciconiiformes) in Argentina and redescription of the type of *D. pilherodiae* Mahon, 1956 (Cestoda, Dilepididae). Part I. *Rivista di Parassitologia* **44**: 279-297.
- BONA, F. V. 1994. Three new species and genera of Dilepididae (Cestoda, Cyclophyllidea) from neotropical Picidae (Aves). *Revue Suisse de Zoologie* **101**: 195-213.

- BONA, F. V. 1994. Family Dilepididae Railliet & Henry, 1909. *In* Keys to the Cestode parasites of Vertebrates, L. F. Khalil, A. Jones, and R. A. Bray (eds.). CABI Publishing, Wallingford, U.K., p. 443-554.
- BONA, F. V., AND S. BIONAZ. 1990. Revisione el genere *Liga* Weinland, 1857 (Cestoda: Dilepididae) parassita di picchi. *Parassitologia* **32**: 21-22.
- BONA, F. V., AND A. V. MAFFI. 1984. *Paruterina similita* n. sp. (Cestoda, Paruterinidae) en Cuculidae (Aves) del Norte de Argentina. *Bollettino del Museo Regionale di Scienze Naturali. Italy: Torino* **2**: 181-198.
- BRAY, R. A., D. I. GIBSON, AND A. JONES. 2008. Keys to the Trematoda, Volume 3. CABI Publishing, London, U.K.
- BROOKER, S. 2007. Spatial epidemiology of human schistosomiasis in Africa: risk models, transmission dynamics and control. *Transactions of the Royal Society of Tropical Medicine & Hygiene* **101**: 1-8.
- BUEHLER, D. M., L. BUGONI, G. M. DORRESTEIN, P. M. GONZÁLEZ, J. PEREIRA JUNIOR, L. PROENÇA, I. L. SERRANO, A. J. BAKER AND T. PIERSMA. 2010. Local mortality events in migrating sandpipers (*Calidris*) at a staging site in southern Brazil. *Wader Study Group Bulletin* **117**: 150-156.
- CENTERS FOR DISEASE CONTROL AND PREVENTION (CDC). 2009. Acanthocephaliasis. http://www.dpd.cdc.gov/dpdx/HTML/frames/AF/Acanthocephaliasis/body_Acanthocephaliasis_page1.htm.
- CDC. 2009. Hymenolepiasis. <http://www.dpd.cdc.gov/dpdx/HTML/Hymenolepiasis.htm>.
- CDC. 2009. Philophthalmiasis. <http://www.dpd.cdc.gov/dpdx/HTML/Philophthalmiasis.htm>.
- CDC. 2009. Strongyloidiasis. <http://www.cdc.gov/dpdx/strongyloidiasis/index.htm>.

- CHAO, A., R. L. CHAZDON, R. K. COLWELL, AND T. J. SHEN. 2005. A new statistical approach for assessing compositional similarity based on incidence and abundance data. *Ecology Letters* **8**: 148-159.
- COLWELL, R. K., AND J. A. CODDINGTON. 1994. Estimating terrestrial biodiversity through extrapolation. *Philosophical Transactions of the Royal Society B: Biological Sciences* **345**: 101-118.
- COLWELL, R. K. 2009. EstimateS: Statistical Estimation of Species Richness and Shared Species from Samples. Version 8.2, URL <http://viceroy.eeb.uconn.edu/estimates>.
- COOMANS, A. 2000. Nematode systematics: past, present and future. *Nematology* **2**: 3–7.
- CONVEY, P., AND S. J. MCINNES. 2005. Exceptional tardigrade-dominated ecosystems in Ellsworth Land, Antarctica. *Ecology* **86**: 519–527.
- CRACRAFT, J. 1985. Historical biogeography and patterns of diversification within South American areas of endemism. *Ornithological Monographs* **36**: 49-84.
- CRIBB, T. H., R. A. BRAY, D. T. J. LITTLEWOOD, S. P. PICHELIN, AND E. A. HERNIOU. 2001. The Digenea. *In* *Interrelationships of the Platyhelminthes*, D. T. J. Littlewood, and R. A. Bray (eds.). Taylor and Francis, London, U.K., p. 168–185.
- CROSBIE, P. R., S. A. NADLER, E. G. PLATZER, C. KERNER, J. MARIAUX, AND W. M. BOYCE. 2000. Molecular systematics of *Mesocestoides* spp. (Cestoda: Mesocestoididae) from domestic dogs (*Canis familiaris*) and coyotes (*Canis latrans*). *Journal of Parasitology*, **86**: 350-357.
- DOBSON, A., K. D. LAFFERTY, A. M. KURIS, R. F. HECHINGER, AND W. JETZ. 2008. Homage to Linnaeus: How many parasites? How many hosts? *Proceedings of the National Academy of Sciences* **105**: 11482-11489.

- ELIAS, R., J. MAMANI, C. HERMOZA, AND J. KINSELLA. 2008. First report of thelaziosis (*Thelazia anolabiata*) in an Andean Cock of the Rock (*Rupicola peruviana*) from Peru. *Veterinary Parasitology* **158**: 382–383.
- FAIR, J, E. PAUL, J. JONES. 2010. Guidelines for the use of wild birds in research. Washington D. C.: Ornithological Council. www.nmnh.si.edu/BIRDNET/guide.
- FRANCO, S.R.N.S. 1965. Nota sobre trematódeos eucotilídeos (Trematoda, Eucotylidae). *Memórias do Instituto Oswaldo Cruz* **63**: 59-65.
- FREITAS, J. F. T. 1951. Revisão da família Eucotylidae Skrjabin, 1924 (Trematoda). *Memórias do Instituto Oswaldo Cruz* **49**: 33-271.
- FREITAS, J. F. T. 1955. Sobre dois trematódeos parasitos de aves: *Philophthalmum lachrymosus* Braun, 1902 e *Renicola mirandaribeiroi* n. sp. *Arquivos do Museu Nacional Rio de Janeiro* **42**: 585-610.
- FREITAS, J. F. T. 1959. Nota sobre *Tanaisia inopina* Freitas, 1959 (Trematoda, Eucotylidae). *Atas Sociedade de Biologia do Rio de Janeiro* **3**: 2-4.
- FREITAS, M. G. AND H. M. A. COSTA. 1972. *Dendritobilharzia anatinarum* Cheatum, 1941 em pato doméstico, no Brasil. *Revista Brasileira Biologia* **32**: 343–345.
- GARVIN, M. C., J. M. BATES, J. M. KINSELLA. 1997. Field techniques for collecting and preserving helminth parasites from birds, with new geographic and host records of parasitic nematodes from Bolivia. *Ornithological Monographs* **48**: 261-266.
- GASTON, K. J. 2000. Global patterns in biodiversity. *Nature* **405**: 220-227.
- GIBSON, D. I., A. JONES, AND R. A. BRAY. 2002. Keys to the Trematoda, Volume 1. CABI Publishing, London, U.K.

- GUINDON, S. AND O. GASCUEL. 2003. A simple, fast, and accurate algorithm to estimate large phylogenies by maximum likelihood. *Systems Biology* **52**: 696-704.
- HALL, T.A. 1999. BioEdit: a user-friendly biological sequence alignment editor and analysis program for Windows 95/98/NT. *Nucleic Acids Symposium Series* **41**: 95-98.
- HAFFER, J. 1978. Distribution of Amazon birds. *Bonner Zoologischen Beiträge* **29**: 38-78.
- HAFFER, J. 1985. Avian zoogeography of the Neotropical lowland. *Neotropical Ornithology* **36**: 133-146.
- HAFFER, J. 1987. Biogeography of Neotropical birds. *In* *Biogeography and Quaternary history of tropical America*, T. C. Whitmore and G. T. Prance (eds.). Clarendon Press, Oxford, U.K.
- HAMMOND, P. M. 1992. Species inventory. *In* *Global Diversity, Status of the Earth's Living Resources*. Chapman & Hall, London, U.K., p. 17-39.
- HILLEBRAND, H. 2004. On the generality of the latitudinal diversity gradient. *American Naturalist* **163**: 192-211.
- HOBERG, E. P., J. MARIAUX, J. L. JUSTINE, D. R. BROOKS, AND P. J. WEEKES. 1997. Phylogeny of the orders of the Eucestoda (Cercomeromorphae) based on comparative morphology: historical perspectives and a new working hypothesis. *Journal of Parasitology* **83**: 1128-1147.
- HON, Y.E.O., J. IANACONE, AND L.SÁNCHEZ. 2013. Nematodes in wild birds of the private conservation area "Gotas de agua" Jaen, Cajamarca, Peru. *Neotropical Helminthology* **7**: 289 -310.

- INGLIS, W. G. 1958. The comparative anatomy of the subulurid head (Nematoda): with a consideration of its systematic importance. *Proceedings of the Zoological Society, London* **130**: 577-604.
- JONES, A., R. A. BRAY, AND D. I. GIBSON. 2005. *Keys to the Trematoda, Volume 2*. CABI Publishing, London, U.K.
- KHALIL, L. F., A. JONES, AND R. A. BRAY. 1994. *Keys to the Cestode Parasites of Vertebrates*. CABI Publishing, Wallingford, U.K.
- LAMBSHEAD, P. L. D. 1993. Recent developments in marine benthic biodiversity research. *Océanis* **19**: 5–24.
- LAURANCE, W. F., M. A. CHOCHRANE, S. BERGAN, P. M. FEARNside, P. DELMÔNICA, C. BARBER, S. D'ANGELO, AND T. FERNANDES. 2001. The future of the Brazilian Amazon. *Science* **291**: 438.
- LEITE, A. C. R., H. M. A. COSTA AND J. O. COSTA. 1978. *Trichobilharzia jequitibaensis* n. sp. (Trematoda: Schistosomatidae) in *Cairina moschata domestica* (Anatidae). *Revista Brasileira de Biologia* **38**: 843–846.
- LITERÁK, I., P. D. OLSON, B. B. GEORGIEV, AND M. SPAKULOVÁ. 2004. First record of metacestodes of *Mesocestoides* sp. in the common starling (*Sturnus vulgaris*) in Europe, with an 18S rDNA characterization of the isolate. *Folia parasitologica*, **51**: 45-49.
- MASCARENHAS, C. S., C. KRÜGER, AND G. MÜLLER. 2009. The helminth fauna of the red-crested cardinal (*Paroaria coronata*) Passeriformes: Emberizidae in Brazil. *Parasitology Research* **105**: 1359–1363.
- MARINI M.Â. AND F.I. GARCIA. 2005. Bird conservation in Brazil. *Conservation Biology* **19**: 665-671.

- MAY, R.M. 1988. How many species are there on Earth? *Science* **241**: 1441–1449.
- MITTERMEIER, R. A., N. MYERS, AND C. G. MITTERMEIER. 1999. Hotspots. Earth's Biologically Richest and Most Endangered Terrestrial Ecoregions. Mexico City, Cemex, MX.
- MITTERMEIER, R. A., C. G. MITTERMEIER, T. M. BROOKS, J. D. PILGRIM, W. R. KONSTANT, G. A. B. DA FONSECA, AND C. KORMOS. 2003. Wilderness and biodiversity conservation. *Proceedings of the National Academy of Sciences* **100**: 10309-10313.
- MONTEIRO C. M., J. F. R. AMATO, AND S. B. AMATO. 2006. A new species of *Andracantha* Schmidt (Acanthocephala, Polymorphidae) parasite of Neotropical cormorants, *Phalacrocorax brasilianus* (Gmelin) (Aves, Phalacrocoracidae) from southern Brazil. *Revista Brasileira de Zoologia* **23**: 807–812.
- NEAR T.J. 2002. Acanthocephalan phylogeny and the evolution of parasitism. *Integrative and Comparative Biology* **42**: 668-677.
- NIEWIADOMSKA, K. 2002. Family Diplostomidae Poirier, 1886. *In* Keys to the Trematoda Volume 1, D. I. Gibson, A. Jones, and R. A. Bray (eds.). Commonwealth Agricultural Bureau International and Natural History Museum, London, p. 167-196.
- NOLAN M. J. AND T. H. CRIBB. 2005. The Use and Implications of Ribosomal DNA Sequencing for the Discrimination of Digenean Species. *Advances in Parasitology* **60**: 101–163.
- OLSON, P. D., T. H. CRIBB, V. V. TKACH, R. A. BRAY, AND D. T. J. LITTLEWOOD. 2003. Phylogeny and classification of the Digenea (Platyhelminthes: Trematoda). *In*

- Interrelationships of the Platyhelminthes, D.T.J. Littlewood and R.A. Bray, (eds.). Taylor and Francis, London, U.K. p.733–755.
- OLSON, P. D. AND V.V.TKACH. 2005. Advances and trends in the molecular systematics of the parasitic Platyhelminthes. *Advances in Parasitology* **60**: 167–246.
- PADGETT, K. A., S. A. NADLER, L. MUNSON, B. SACKS, AND W. M. BOYCE. 2005. Systematics of Mesocestoides (Cestoda: Mesocestoididae): evaluation of molecular and morphological variation among isolates. *Journal of Parasitology*, **91**: 1435-1443.
- PHILLIPS, A. J., B. B. GEORGIEV, A. WAESCHENBACH, AND J. MARIAUX. 2014. Two new and two redescribed species of *Anonchotaenia* (Cestoda: Paruterinidae) from South American birds. *Folia Parasitologica* **61**: 441–461.
- PINTO, R. M. AND D. C. GOMES. 1985. Nematodes of Amazonian birds, with a description of *Hoazinstrongylus amazonensis* n. gen. n. sp (Trichostrongylidae, Libyostrongylinae). *Memórias do Instituto Oswaldo Cruz* **80**: 213-217.
- PINTO, H. A., V. L. T. MATI, AND A. L. DE MELO. 2013. New records and a checklist of trematodes from *Butorides striata* (Aves: Ardeidae). *Revista Mexicana de Biodiversidad* **84**: 1100-1110.
- POJMAŃSKA, T. 2002. Family Brachylaimidae Joyeux & Foley, 1930. *In* Keys to the Trematoda Volume 1, D. I. Gibson, A. Jones, and R. A. Bray (eds.). Commonwealth Agricultural Bureau International and Natural History Museum, London, p. 37-43.
- POSADA, D. 2008. jModelTest: Phylogenetic Model Averaging. *Molecular Biology and Evolution* **25**: 1253-1256.
- POULIN, R. AND S. MORAND. 2000. The diversity of parasites. *Quarterly Review of Biology* **75**: 277-293.

- POULIN, R. AND S. MORAND. 2004. Parasite biodiversity. Smithsonian Institution Press, Washington, DC, USA.
- POULIN, R. 2010. Latitudinal gradients in parasite diversity: bridging the gap between temperate and tropical areas. *Neotropical Helminthology* **4**: 169-177.
- RAMBAUT A. 2009. FigTree v1. 4.0: Tree Figure Drawing Tool. <http://tree.bio.ed.ac.uk/software/figtree/>.
- REGO, A. A. 1973. *Echinocotyle ibanezi* sp. n. parasito de ave do Perú (Cestoda, Hymenolepididae). *Atas da Sociedade Biologia do Rio de Janeiro*, **162**: 63-65.
- RIDGELY, R. S. AND G. TUDOR. 1989a. The birds of South America: Volume I: The oscine passerines. University of Texas Press, Austin, Texas, U.S.A.
- RIDGELY, R. S. AND G. TUDOR. 1989b. The birds of South America: Volume II: The suboscine passerines. University of Texas Press, Austin, Texas, U.S.A.
- ROBERTS, L., J. JANOVY, AND S. NADLER. 2013. Gerald D. Schmidt & Larry S. Roberts' foundations of parasitology (9th ed.). McGraw Hill, New York, New York, U.S.A.
- RODRIGUES, H. D. O., S. S. RODRIGUES, AND Z. FARIA. 1990. Contributions to the knowledge of the helminthological fauna of vertebrates of Marica, Rio de Janeiro State, Brazil. *Memórias do Instituto Oswaldo Cruz* **85**: 115–116.
- RODRIGUES, H. D. O. 1996. Espécies de Thelaziinae (Skrjabin) Baylly & Daubney (Nematoda, Thelazioidea) referidas para o Brasil. *Revista Brasileira de Zoologia* **13**: 343-350.
- RYLANDS, A. B., R. A. MITTERMEIER, J. D. PILGRIM, C. GASCON, G. A. B. FONSECA, J. M. C. D. SILVA, C. G. MITTERMEIER, T. BROOKS, J. V. RODRÍGUEZ, J. SINGH, W. UDENHOUT, L. FAMOLARE, N. WALDRON, S. MALONE, V. H. INCHAUSTY, C. P. DEL PRADO, R. ROCA, R. CAVALCANTI, F. ARJONA, F.

- LÓPEZ, C. HUTCHINSON, M. G. M. VAN ROOSMALEN, J. M. AYRES, A. FORSYTH, I. BOWLES, C. KORMOS, A. MEKLER, R. WALLER, E. PALACIOS, F. MIRANDA, A. L. FLORES, L. DÁVALOS, R. NELSON, N. TJON SIE FAT, J. CHUN, T. AKRE, AND J. V. RUEDA. 2002. Amazonia. *In* Wilderness: Earths last wild places, R. A. Mittermeier, C. G. Mittermeier, P. R. Gill, J. D. Pilgrim, G. Fonseca, T. Brooks, and W. R. Konstant, (eds.). CEMEX, Agrupación Serra Madre, S. C., Mexico, p. 56-107.
- SILVA, J. M. C., F. C. NOVAES, AND D. C. OREN. 2002. Differentiation of *Xiphocolaptes* (Dendrocolapitade) from eastern Amazonia. *Bulletin of the British Ornithologists' Club* **115**: 200-206.
- SILVA, J. M. C., A. B. RYLANDS, AND G. A. B. FONSECA. 2005. The fate of the Amazonian areas of endemism. *Conservation Biology* **19**: 689-694.
- SKRJABIN, K. I. 1924. Nieretrematoden der vögel rußlands. *Centralblatt für Bakteriologie, Parasitenkunde und Infektionskrankheiten* **62**: 80-90.
- STRACHAN, A. A. 1957. Eye worms of the family thelaziidae from Brazilian birds. *Canadian Journal of Zoology* **35**: 179-187.
- SULLIVAN, J. T. 2009. *A color atlas of parasitology* (9th ed). University of San Francisco, San Francisco, California, U.S.A.
- TAMURA, K., G. STECHER, D. PETERSON, A. FILIPSKI, AND S. KUMAR. 2013. MEGA6: molecular evolutionary genetics analysis version 6.0. *Molecular biology and evolution* **30**: 2725-2729.
- THATCHER, V. E. 1993. Trematódeos neotropicais. Instituto Nacional de Pesquisa da Amazônia, Manaus, Brazil, p.1-553.

- TKACH, V.V. AND J. PAWLOWSKI. 1999. A new method of DNA extraction from the ethanol-fixed parasitic worms. *Acta Parasitology* **44**: 147-148.
- TKACH V. V. AND S. D. SNYDER. 2003. *Acanthostomum macroclemys* n. sp. (Digenea: Tryptogonimidae: Acanthostomidae) from the alligator snapping turtle, *Macroclemys temmincki*. *Journal of Parasitology* **89**: 159-167.
- TRAVASSOS, L., J. F. K. FREITAS, AND A. KOHN. 1969. Trematódeos do Brasil. *Memorias Do Instituto Oswaldo Cruz* **67**: 1-886.
- UNWIN, S., J. CHANTREY, J. CHATTERTON, J. A. ALDHOUN AND D. T. J. LITTLEWOOD. 2013. Renal trematode infection due to *Paratanaisia bragai* in zoo housed Columbiformes and a red bird-of-paradise (*Paradisaea rubra*). *International Journal for Parasitology: Parasites and Wildlife* **2**: 32-41.
- VALDOVINOS, C. AND C. BALBOA. 2008. Cercarial dermatitis and lake eutrophication in south-central Chile. *Epidemiology and Infection*, **136**: 391-394.
- VICENTE, J. J., R. M. PINTO, AND D. NORONHA. 1983. Estudo das espécies brasileiras do gênero *Diplotrriaena* Henry & Ozoux, 1909 (Nematoda, Filarioidea). *Memorias Do Instituto Oswaldo Cruz* **78**: 165-182.
- VICENTE, J. J., H. O. RODRIGUES, D. C. GOMES, AND R. M. PINTO. 1995. Nematóides Do Brasil. Parte IV: Nematóides De Aves. *Revista Brasileira de Zoologia* **12**: 1-273.
- WAESCHENBACH, A., B. L. WEBSTER, AND R. A. BRAY. 2007. Added resolution among ordinal level relationships of tapeworms (Platyhelminthes: Cestoda) with complete small and large subunit nuclear ribosomal RNA genes. *In Molecular Phylogenetics and Evolution*, D. T. J. Littlewood, **45**: 311-325.

- WALLACE, A. R. 1852. On the monkeys of the amazon. Proceedings of the Zoological Society of London **20**: 107-110.
- WILLIG, M. R., D. M. KAUFMAN, AND R. D. STEVENS. 2003. Latitudinal gradients of biodiversity: pattern, process, scale and synthesis. Annual Review of Ecology, Evolution, and Systematics **34**: 273-309.
- WRIGHT, C. A. 1954. Trematodes of the genus *Renicola* from the kidneys of birds in Brazil. Revista Brasileira de Biologia **14**: 61-64.

APPENDICES

Appendix A

***Moesia ovalis* n. sp. (Digenea: Phaneropsolidae) from the green manakin *Xenopipo holochlora* from Peruvian Amazon with notes on morphology of *Moesia moesi* Travassos, 1921**

KAYLYN F. PATITUCCI¹, JOHN M. BATES², VASYL V. TKACH^{1*}

¹Department of Biology, University of North Dakota, 10 Cornell Street, Grand Forks, North Dakota 58202, USA. (email: vasyt.tkach@email.und.edu)

²Life Sciences, Center for Integrated Research, 1400 S. Lake Shore Dr., Chicago, Illinois 60605, USA

*Corresponding author.

ABSTRACT: *Moesia ovalis* n. sp. (Digenea: Phaneropsolidae) is described based on one specimen found in the intestine of a green manakin, (Pipridae: *Xenopipo holochlora* Sclater, 1888), collected in the Cordillera Azul National Park, Peru. *Moesia ovalis* n. sp. differs from the morphologically similar species *Moesia moesi* (Travassos, 1921) and *Moesia chordeilesia* McMullen, 1936 in the body shape and proportions, shape of testes and extent of ceca. The morphological description of the new species and notes clarifying some morphological features of *Moesia moesi*, the type species of *Moesia*, are provided.

Key Words: *Moesia ovalis* n. sp., *Moesia moesi*, Digenea, Phaneropsolidae, *Xenopipo holochlora*, Peru, morphology

The Phaneropsolidae Mehra, 1935 is a large digenean family belonging to the superfamily Microphalloidea Ward, 1901. According to the most recent revision by Lotz and Font (2008), it included 26 genera of species that parasitize mammals and, though only rarely, birds and reptiles. *Mosesia* Travassos, 1928 is one of the phaneropsolid genera that infect birds and includes several species described from different parts of the world (Skarbilovich, 1948; Khotenovsky, 1970; Sharpilo and Iskova 1989; Lotz and Font, 2008; González-Acuña et al, 2011). Its type species, *Mosesia mosesi* (Travassos, 1928), was originally described as *Phaneropsolus mosesi* Travassos, 1921 from an unidentified bird in Brazil, but then Travassos (1928) established the new genus *Mosesia* for this species. To the best of our knowledge, the only other record of *Mosesia* from South America was provided by González-Acuña et al. (2011) who mentioned that they collected digeneans somewhat resembling *M. mosesi*, from the green-backed firecrown (*Sephanoides sephanoides*), a hummingbird from Chile. These authors stated that their specimens differed from *M. mosesi* in the size and the position of the cirrus sac and the shape of the ovary.

In the course of parasitological investigations of birds in Cordillera Azul National Park in the low outlying foothills of the Amazon, we have found a new species of *Mosesia* in a green manakin (Pipridae: *Xenopipo holochlora* Sclater, 1888). This is a fairly common bird in certain local areas along the east slope of the Andes, and on outlying ridges, at 400-1100 m. (Schulenberg et al., 2007). They are understory insectivores and frugivores (Dauphiné, 2008; unpublished thesis, University of Georgia, Georgia, USA). Herein, we provide a description of the new species of *Mosesia* from Peru and notes on the morphology of the type species *M. mosesi*.

Materials and Methods

A single specimen of the new species was obtained from the intestine of *X. holochlora*, collected in the Cordillera Azul, Peru under permit #002-2013-SERNAP-DGANP-JPNCAZ from the Peruvian government. The specimen was rinsed in saline and then heat-killed with hot water and fixed in 70% ethanol. The specimen was stained with aqueous alum carmine, dehydrated in a graded ethanol series, cleared in clove oil and mounted permanently in Damar gum.

Measurements were taken using a DIC-equipped Olympus BX-51 microscope and Rincon HD software (Imaging Planet, Goleta, California). Drawings were made with the aid of a drawing tube on a Leica DM5000 compound microscope. All measurements are in micrometers.

The specimen on slide was deposited in the collection of the Harold W. Manter Laboratory (HWML) of the University of Nebraska, Lincoln, Nebraska, U.S.A. under accession number HWML 101642. For comparative purposes, we have examined photographs of the holotype and paratypes of *M. mosesi* (Instituto Oswaldo Cruz, Laboratório de Helminthos Parasitos de Vertebrados, Brazil, accession numbers CHIOC 2123).

Results

Moesia ovalis n. sp.

(Fig. 55; Table 7)

Description: Body small, pyriform, widest at level of middle of testes. Tegumental spines not observed, probably due to loss prior to fixation. Forebody shorter than hindbody, occupying 38% of total body length. Oral sucker subterminal, rounded. Prepharynx absent; pharynx small, slightly overlapped by oral sucker; esophagus approximately 3 times longer than pharynx; ceca end posterior to middle of testes. Ventral sucker round of nearly equal size to oral sucker,

between first and second thirds of body. Large testes of irregular shape in middle third of body, just posterior to level of ventral sucker. Cirrus-sac question mark shaped, its proximal end extending to level of middle of testes and its distal end curving around sinistral margin of ventral sucker. Genital pore submedian, opens into common genital atrium between antero-dextral margin of ventral sucker and right cecum. Cirrus-sac contains large, somewhat convoluted seminal vesicle. Ovary deeply lobed, mostly pretesticular, postero-lateral, sinistral to ventral sucker. Vitellarium extracaecal in forebody, consisting of numerous small follicles, extending from level of middle of testes to level of middle of esophagus. Seminal receptacle prominent, oval, between ovary and right testis. Uterus fills most of body posterior to testes. Metraterm thick walled, its length was difficult to measure due to overlap with uterus. Female genital pore opens next to the male pore. Eggs numerous. Excretory vesicle begins with a short thin stem that almost immediately widened into what looks like an inflated V-shaped vesicle.

Taxonomic Summary

Type host: green manakin *Xenopipo holochlora* Sclater, 1888 (Passeriformes: Pipridae).

Type locality: San Martín, Province Tocache, Cordillera Azul National Park, Río Pescadero, NE of Shapaja (S8°10.694, W76°13.422), Peru, elev. 953m above sea level.

Site of infection: Intestine.

Type specimen deposited: Holotype: HWML 101642 (labeled: San Martín, Province Tocache, Cordillera Azul N. P., Río Pescadero, NE of Shapaja: S8°10.694, W76°13.422, 953 m a.s.l., coll. K. Patitucci).

Etymology: the specific epithet refers to the oval body shape in this species.

Remarks

Our specimen might have been dead at the time of fixation because it lacked tegumental spines that are normally present in members of *Mosesia*. Therefore we do not consider this

feature among differentiating characters. The new species is morphologically similar to *M. mosesi* described from Brazil and *Mosesia chordeilesia* McMullen, 1936, described from an experimental infection in USA. *Mosesia ovalis* n. sp. differs, however, from *M. mosesi* in the shape of body and testes and in the proportions of body (Table 7). The body shape in *Mosesia ovalis* n. sp. is distinctly oval with the anterior portion of the body narrowing very gradually and the anterior end remaining rounded. The holotype and paratypes of *Mosesia mosesi* show a piriform body that narrows rather sharply towards the anterior end. A photograph of one of the specimens reported in Chile as very similar to *M. mosesi* (Gonzalez et al., 2011) presents the body shape of *M. mosesi*. The body width to length ratio (1:1.88) in the new species is much lower than that in *M. mosesi* (1:1.37). The testes in the new species have an irregular, not-lobed shape while in *M. mosesi* the testes are deeply lobed. Some additional important features that may have been considered as strong differentiating characters between the new species and *M. mosesi*, such as the length of intestinal ceca and the shape of the cirrus sac, proved to be similar upon examination of the photographs of type specimens of *M. mosesi* (see discussion below).

Mosesia ovalis n. sp. differs from *M. chordeilesia* in having testes situated more anteriorly, a lobed ovary (vs entire in *M. chordeilesia*), an intestinal ceca that reach further posteriorly, and a cirrus sac with a curved proximal part (vs straight in *M. chordeilesia*). Additionally, there are several metric characteristics that differentiate the two species (McMullen, 1936; Table 7).

Discussion

In this study, we described a new species of *Mosesia* from Peru. We recognize that description of a new species based on a single specimen is usually not warranted because intraspecific variability cannot be properly assessed. However, the morphological features of the only currently available specimen did not fit into the diagnosis of *Mosesia mosesi* or any other

species of the genus. Despite our continuing collecting efforts, the probability of finding additional specimens of the new species in near future may be low, therefore we describe the species based on the available morphological evidence. We believe that future studies will provide additional morphological and molecular data in support of our conclusions.

We also revised some morphological characteristics of the type species *Mosesia mosesi*, most importantly the ceca and the cirrus sac. Travassos (1921) described the ceca of *M. mosesi* as terminating at the posterior margin of the ventral sucker. Based on the original description this would be an obvious major difference between our new species and *M. mosesi*. However, examination of photographs of the *M. mosesi* holotype has revealed that it has longer ceca that reach the level of posterior margins of testes. The extent of the ceca is quite variable among species within the genus *Mosesia*. For instance, *Mosesia megabursata* Oschmarin in Khotenovsky, 1970, *Mosesia sittae* Oschmarin in Khotenovsky, 1970, and *Mosesia insolens* Bhalerao, 1926 all have ceca that only reach the level of the ventral sucker. In contrast, *Mosesia riparia* Malega, 2006 and *Mosesia fusiformis* Zhang, 1995 have ceca that extend well past the testes into the hindbody. Therefore, the length of ceca is one of the most varying morphological characteristics of the species currently included in *Mosesia*.

The shape of the cirrus sac was not clearly described or illustrated in the original description of *M. mosesi* (Travassos, 1921). As a result, this feature has been entirely lost in some of the subsequent works that copied the Travassos' figure (e.g., Khotenovsky, 1970). Examination of the holotype and paratypes showed that the proximal part of the cirrus sac in *M. mosesi* is curved, as in *Mosesia ovalis* n. sp.

Interestingly, the genital atrium in the new species is dextral while at least in the majority, if not all, of the previously described species of the genus, the genital atrium is sinistral. Unfortunately, not all descriptions clearly indicate the position of the genital atrium.

According to the most recent revision by Lotz and Font (2008), members of the genus *Mosesia* possess a spinous tegument, submedian to mid-lateral genital pore, uterine loops occupying most of the posttesticular space, and a V-shaped excretory vesicle. At the same time, as mentioned above, many of the morphological features (e. g., relative position and shape of testes, shape of ovary, position of the genital pore, and extent of intestinal ceca) vary significantly among species currently included in the genus. Some of the differences cause a concern regarding the congeneric status of the species. The shape of the excretory vesicle is one of the important characters that is normally shared within genera and even families. The generic diagnosis of *Mosesia* by Lotz and Font (2008) stated that the excretory vesicle is V-shaped. This feature is well demonstrated in some descriptions (e. g., McMullen, 1936). Nonetheless, the illustration in the original description of *M. mosesi* by Travassos (1921) shows the beginning of what looks like a long thin stem and thus suggests that the excretory vesicle is unlikely to be V-shaped. On the other hand, Malega (2006) described the excretory vesicle in *M. riparia* as bulbous at the proximal end with long thin distal stem. In *M. ovalis* n. sp. the excretory vesicle looked like a much enlarged V-shaped type with a short thin stem. Therefore, we anticipate that the systematic position of some species currently included in *Mosesia* may change in future when more morphological, life cycle and/or molecular data are available.

In addition, the systematic position of the genus is not entirely certain. The molecular phylogenetic study by Kanarek et al. (2014) has demonstrated that at least two genera previously included in the Phanerosolidae, namely *Parabascus* Looss, 1907 and *Microtrema* Sitko, 2013

are not closely related to *Phaneropsolus* Looss, 1899 and thus do not belong to the Phaneropsolidae. At present, DNA sequence data are not available for any species of *Mosesia*. Obtaining such data and inclusion of representatives of this genus in future phylogenetic studies should clarify these questions regarding the systematic position and content of this genus.

Acknowledgements

The authors are grateful to Dr. Marcelo Knoff (Instituto Oswaldo Cruz, Laboratório de Helintos Parasitos de Vertebrados, Brazil) for kindly providing photographs of type specimens of *Mosesia mosesi*. This study was supported by the National Science Foundation grants DEB1050525 to VT and DEB-1120055 to JMB, Field Museum's Marshall Field Fund, and the Field Museum's Emerging Pathogens Project. We thank our field crew and our collaborators Patricia Consuelo Alvarez Loayza and CIMA director Tatiana Pequeña, director of Centro de Conservación, Investigación, y Manejo de Areas Naturales Cordillera Azul (CIMA) for their support.

Literature Cited

- Bhalerao, G. D. 1926. The trematodes of *Corvus insolens* (A Burmese house crow), with a description of four new species. *Parasitology* 18:387-398.
- González-Acuña, D., C. Silva, M. Soto, S. Mironov, L. Moreno, P. L. González-Gómez, H. Badrul, and M. Kinsella. 2011. Parasites of the green-backed Firecrown (*Sephanoides sephaniodes*) in Chile. *Revista Mexicana de Biodiversidad* 82:1333-1336.
- Kanarek, G., G. Zalesny, J. Sitko, and V. Tkach. 2014. Phylogenetic relationships and systematic position of the families Cortrematidae and Phaneropsolidae (Platyhelminthes: Digenea) *Folia Parasitologica* 61:523–528.

- Khotenovsky, I. A. 1970. Family Pleurogenidae. In: Foundations of Trematodology. Vol. 23. Nauka, Moscow. 137-306 pp.
- Lotz, J. M. and W. F. Font. 2008. Family Phaneropsolidae Mehra, 1935. Pages 591-594 in R. A. Bray, D. I. Gibson and Jones A., eds. Keys to the Trematoda Vol. 3. Commonwealth Agricultural Bureau International and Natural History Museum, London.
- Malega, A. M. 2006. [*Mosesia riparia* sp. n. (Trematoda, Pleurogenidae) - the parasite of intestine of the sand martin in Ukraine]. Vestnik Zoologii, 40:263-266, 288. (in Russian)
- McMullen, D. B. 1936. A note on the life cycle of *Mosesia chordeilesia* n. sp. (Lecithodendriidae). Journal of Parasitology 22:295-298.
- Schulenberg, T.S., Stotz, D.F., Lane, D.F., O'Neill, J.P., and Parker III, T.A. 2007. Birds of Peru. Princeton University Press, Princeton, New Jersey. 664 pp.
- Sharpilo, V. P., and N. I. Iskova. 1989. [Fauna Ukrainy. Vol 34. Trematodes. Issue 3. Plagiorchiates] Naukova Dumka, Kiev. 279 pp. (in Russian)
- Skarbilovich, T. S. 1948. [Family Lecithodendriidae Odhner, 1911] Pages 337 – 590 in Skrjabin, K. I., ed. Trematodes of animal and man. Principles of Trematodology. Vol. 2. Nauka, Moscow. (in Russian)
- Travassos, L. 1921. Contribuicoes para o conhecimento da fauna helminthologica brasileira. XII. Sobre as especies brasileiras da subfamilia Brachycoelinae. Archivos da Escola Superior de Agricultura e Medicina Veterinaria 5:59-67.
- Travassos, L. 1928. Contribuição para o conhecimento dos Lecithodendriidae do Brasil. Memórias do Instituto Oswaldo Cruz 21:24-26.
- Zhang, T. 1995. A new species of the family Lecithodendriidae from birds in Sichuan Province, China (Trematoda: Digenea). Acta Zootaxonomica Sinica 20:153-156.

Table 7. Comparative morphological metric data for *Mosesia mosesi* (Travassos, 1921). Measurements marked by asterisk are inferred from the drawing provided by Travassos (1921) and McMullen (1936).

Species	<i>Mosesia ovalis</i> n. sp. our data	<i>Mosesia mosesi</i> (Travassos, 1921) Unidentified bird	<i>Mosesia chordeilesia</i> McMullen 1936 Canary (experimental)
Host	<i>Xenopipo holochlora</i>	host	USA
Origin	Peru	Brazil	USA
Source	Present study	Travassos 1928	McMullen (1936)
Body length	955	717	1090
Body width	508	525	640
Body width:body length	1:1.88	1:1.37	1:1.7
Forebody	360	243*	415*
Hindbody	595	334*	687*
Forebody:body length	1:2.65	1:2.37*	1:2.66
Oral sucker length	95	57	73*
Oral sucker width	100	57	84*
Oral sucker:body width	1:5.08	1:7.37*	1:7.75
Pharynx length	50	27*	30*
Pharynx width	42	27*	41*
Esophagus length	85	91*	127*
Ventral sucker length	88	57	66*
Ventral sucker width	91	71	67*
Cirrus sac length	457	280*	471*
Cirrus sac width	62	49*	88*
Seminal receptacle length	143	113*	102*
Seminal receptacle width	89	67*	32*
Ovary length	180	241*	176*
Ovary width	129	71*	151*
Right testis length	200	166*	249*
Right testis width	166	183*	166*
Left testis length	187	121*	268*
Left testis width	194	122*	193*
Right vitellaria length	341	211*	356*
Left vitellaria length	318	179*	329*
Egg length	19-21	18-22	29
Egg width	9-11	11-12	16

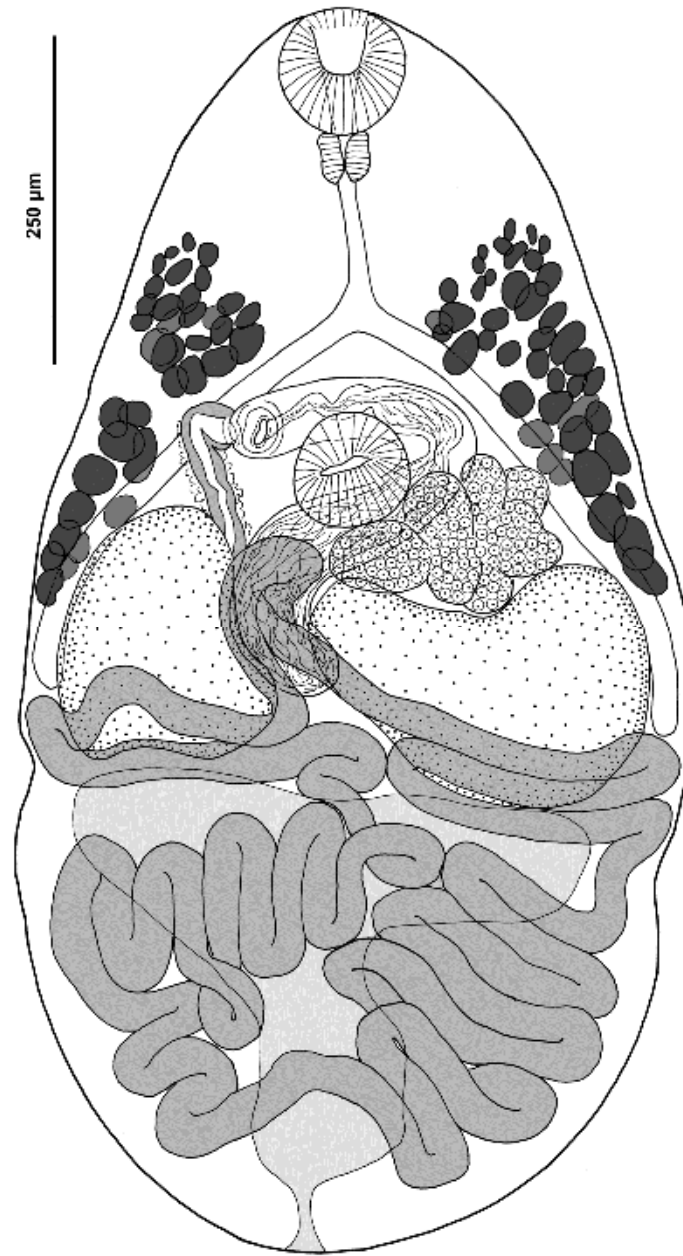

Figure 55. Ventral view of the holotype of *Moesia ovalis* n. sp. from *Xenopipo holochlora*.

Appendix B
Helminths of birds found in the present study

Table 8. Acanthocephalan survey within two areas of endemism of southern Amazonia. Loc = Locality.

Host	Host Family	Host Order	Loc	Site of Infection	Acanthocephalan Family	Acanthocephalan ID
<i>Attila spadiceus</i>	Tyrannidae	Passeriformes	Brazil	-	Centrorhynchidae	<i>Centrorhynchus kuntzi</i>
<i>Catharus ustulatus</i>	Turdidae	Passeriformes	Peru	intestine	Centrorhynchidae	<i>Sphaerirostris</i> sp.
<i>Crotophaga ani</i>	Cuculidae	Cuculiformes	Brazil	-	Centrorhynchidae	<i>Centrorhynchus microcephalus</i>
<i>Megascops watsonii</i>	Strigidae	Strigiformes	Brazil	-	Centrorhynchidae	<i>Centrorhynchus millerae</i>
<i>Micrastur mintoni</i>	Falconidae	Falconiformes	Brazil	-	Centrorhynchidae	<i>Centrorhynchus</i> sp.
<i>Tigrisoma fasciatum</i>	Ardeidae	Pelicaniformes	Peru	intestine	Centrorhynchidae	<i>Centrorhynchus</i> sp.
<i>Xenops minutus</i>	Furnariidae	Passeriformes	Brazil	-	Centrorhynchidae	<i>Centrorhynchus</i> sp.
<i>Xiphorhynchus spixii</i>	Dendrocolaptidae	Passeriformes	Brazil	intestine	Giganthorhynchidae	<i>Mediorhynchus</i> sp.

Table 9. Cestode survey within two areas of endemism of southern Amazonia. Loc = Locality.

Host	Host Family	Host Order	Loc	Site of Infection	Cestode Family	Cestode ID
<i>Antrostomus sericocaudatus</i>	Caprimulgidae	Caprimulgiformes	Brazil	-	Paruterinidae	-
<i>Arremon aurantirostris</i>	Emberizidae	Passeriformes	Peru	intestine	Hymenolepididae	-
<i>Arremon aurantirostris</i>	Emberizidae	Passeriformes	Peru	intestine	Mesocestoididae	<i>Mesocestoides</i> sp.
<i>Catharus ustulatus</i>	Turdidae	Passeriformes	Peru	intestine	Dilepididae	-
<i>Catharus ustulatus</i>	Turdidae	Passeriformes	Peru	intestine	Hymenolepididae	-
<i>Chlorothraupis carmioli</i>	Cardinalidae	Passeriformes	Peru	intestine	Hymenolepididae	-
<i>Dacnis lineata</i>	Thraupidae	Passeriformes	Peru	intestine	Paruterinidae	<i>Biuterina</i> sp.
<i>Dendrocolaptes medius</i>	Dendrocolaptidae	Passeriformes	Brazil	intestine	Hymenolepididae	-
<i>Dixiphia pipra</i>	Pipridae	Passeriformes	Brazil	-	Paruterinidae	<i>Biuterina</i> sp.
<i>Donacobius atricapilla</i>	Donacobiidae	Passeriformes	Brazil	-	Paruterinidae	-
<i>Dysithamnus mentalis</i>	Thamnophilidae	Passeriformes	Brazil	-	Dilepididae	-

Table 9. cont.

Host	Host Family	Host Order	Loc	Site of Infection	Cestode Family	Cestode ID
<i>Epinecrophylla spodionota</i>	Thamnophilidae	Passeriformes	Peru	intestine	Hymenolepididae	-
<i>Euphonia laniirostris</i>	Fringillidae	Passeriformes	Peru	intestine	Hymenolepididae	-
<i>Formicarius analis</i>	Formicariidae	Passeriformes	Peru	intestine	Mesocestoididae	<i>Mesocestoides</i> sp.
<i>Formicivora grisea</i>	Thamnophilidae	Passeriformes	Brazil		Metadilepidae	<i>Schmidneila</i> sp.
<i>Frederickena undiligera</i>	Thamnophilidae	Passeriformes	Peru	intestine	Paruterinidae	<i>Anonchontaenia</i> sp.
<i>Galbula cyanescens</i>	Galbulidae	Galbuliformes	Peru	intestine	Dilepididae	-
<i>Galbula ruficauda</i>	Galbulidae	Piciformes	Brazil	intestine	Paruterinidae	-
<i>Hylophilus ochraceiceps</i>	Vireonidae	Passeriformes	Peru	intestine	Paruterinidae	-
<i>Hylophylax naevius</i>	Thamnophilidae	Passeriformes	Peru	intestine	Hymenolepididae	-
<i>Lanio cristatus</i>	Thraupidae	Passeriformes	Brazil	-	Paruterinidae	-
<i>Laniocera hypopyrra</i>	Cotingidae	Passeriformes	Brazil	-	Paruterinidae	-
<i>Lepidothrix coronata</i>	Pipridae	Passeriformes	Peru	intestine	Paruterinidae	<i>Biuterina</i> sp.
<i>Megascops watsonii</i>	Strigidae	Strigiformes	Brazil	-	Dilepididae	-
<i>Microbates cinereiventris</i>	Troglodytidae	Passeriformes	Peru	intestine	Dilepididae	-
<i>Microbates cinereiventris</i>	Troglodytidae	Passeriformes	Peru	intestine	Dilepididae, Hymenolepididae	-
<i>Microcerculus marginatus</i>	Troglodytidae	Passeriformes	Peru	intestine	Paruterinidae	-
<i>Microcerculus marginatus</i>	Troglodytidae	Passeriformes	Peru	intestine	Paruterinidae	-
<i>Momotus momota</i>	Momotidae	Coraciiformes	Brazil	intestine	Dilepididae	-
<i>Monasa morphoeus</i>	Bucconidae	Galbuliformes	Peru	intestine	Dilepididae	-
<i>Myiobius villosus</i>	Tyrannidae	Passeriformes	Peru	intestine	Davaineidae	-
<i>Myiobius villosus</i>	Tyrannidae	Passeriformes	Peru	intestine	Paruterinidae	-
<i>Myiothlypis chrysogaster</i>	Parulidae	Passeriformes	Peru	intestine	Hymenolepididae	-
<i>Myrmeciza fortis</i>	Thamnophilidae	Passeriformes	Peru	intestine	Hymenolepididae	-

Table 9. cont.

Host	Host Family	Host Order	Loc	Site of Infection	Cestode Family	Cestode ID
<i>Myrmeciza hemimelaena</i>	Thamnophilidae	Passeriformes	Peru	intestine	Mesocestoididae	<i>Mesocestoides</i> sp.
<i>Myrmotherula longipennis</i>	Thamnophilidae	Passeriformes	Peru	intestine	Paruterinidae	-
<i>Myrmotherula menetriesii</i>	Thamnophilidae	Passeriformes	Peru	intestine	Dilepididae	-
<i>Notharchus tectus</i>	Bucconidae	Piciformes	Brazil	-	Dilepididae	-
<i>Onychorhynchus coronatus</i>	<u>Tyrannidae</u>	Passeriformes	Brazil	-	Dilepididae	-
<i>Pheugopedius genibarbis</i>	Troglodytidae	Passeriformes	Brazil	-	Dilepididae	-
<i>Pheugopedius genibarbis</i>	Troglodytidae	Passeriformes	Brazil	-	Paruterinidae	-
<i>Phlegopsis nigromaculata</i>	Thamnophilidae	Passeriformes	Brazil	-	Metadilepidae	-
<i>Piaya cayana</i>	Cuculidae	Cuculiformes	Brazil	-	Dilepididae	-
<i>Pipile cumanensis</i>	Cracidae	Galliformes	Peru	intestine	Hymenolepididae	-
<i>Pithys albifrons</i>	Thamnophilidae	Passeriformes	Peru	intestine	Hymenolepididae	-
<i>Pyriglena leuconota</i>	Thamnophilidae	Passeriformes	Brazil	-	Hymenolepididae	-
<i>Ramphocelus carbo</i>	Thraupidae	Passeriformes	Brazil	-	Hymenolepididae	<i>Passerilepis</i> sp.
<i>Ramphocelus carbo</i>	Thraupidae	Passeriformes	Brazil	-	Hymenolepididae	-
<i>Ramphocelus melanogaster</i>	Thraupidae	Passeriformes	Peru	intestine	Paruterinidae	-
<i>Ramphotrigon ruficauda</i>	Tyrannidae	Passeriformes	Brazil	-	Hymenolepididae	-
<i>Rhynchocyclus olivaceus</i>	Tyrannidae	Passeriformes	Peru	intestine	Hymenolepididae	<i>Passerilepis</i> sp.
<i>Rhynchocyclus olivaceus</i>	Tyrannidae	Passeriformes	Peru	intestine	Paruterinidae	<i>Anonchontaenia</i> sp.
<i>Schistocichla leucostigma</i>	Thamnophilidae	Passeriformes	Peru	intestine	Mesocestoididae	<i>Mesocestoides</i> sp.
<i>Sclerurus mexicanus</i>	Furnariidae	Passeriformes	Peru	intestine	Dilepididae	-
<i>Sclerurus rufigularis</i>	Scleruridae	Passeriformes	Brazil	-	Dilepididae	-

Table 9. cont.

Host	Host Family	Host Order	Loc	Site of Infection	Cestode Family	Cestode ID
<i>Sporophila angolensis</i>	Emberizidae	Passeriformes	Brazil	-	Dilepididae	-
<i>Tangara schrankii</i>	Thraupidae	Passeriformes	Peru	intestine	Paruterinidae	-
<i>Taphrospilus hypostictus</i>	Trochilidae	Apodiformes	Peru	intestine	Dilepididae	<i>Arostellina reticulata</i>
<i>Thamnomanes ardesiacus</i>	Thamnophilidae	Passeriformes	Peru	intestine	Hymenolepididae	-
<i>Thamnomanes ardesiacus</i>	Thamnophilidae	Passeriformes	Peru	intestine	Mesocestoididae	<i>Mesocestoides</i> sp.
<i>Thamnomanes ardesiacus</i>	Thamnophilidae	Passeriformes	Peru	intestine	Mesocestoididae	<i>Mesocestoides</i> sp.
<i>Tolmomyias flaviventris</i>	Rhynchocyclidae	Passeriformes	Brazil	-	Paruterinidae	<i>Anonchontaenia</i> sp.
<i>Turdus fumigatus</i>	Turdidae	Passeriformes	Brazil	intestine	Hymenolepididae	-
<i>Willisornis poecilinotus</i>	Thamnophilidae	Passeriformes	Brazil	-	Hymenolepididae	-
<i>Willisornis poecilinotus</i>	Thamnophilidae	Passeriformes	Peru	intestine	Paruterinidae	-
<i>Xenopipo holochlora</i>	Pipridae	Passeriformes	Peru	intestine	Dilepididae	-
<i>Xenopipo holochlora</i>	Pipridae	Passeriformes	Peru	intestine	Paruterinidae	-
<i>Xiphorhynchus elegans</i>	Furnariidae	Passeriformes	Peru	intestine	Paruterinidae	<i>Francobona</i> sp.

114

Table 10. Digenean survey within two areas of endemism of southern Amazonia. Loc = Locality.

Host	Host Family	Host Order	Loc	Site of Infection	Digenean Family	Digenean ID
<i>Attila cinnamomeus</i>	Tyrannidae	Passeriformes	Brazil	-	Diplostomidae	<i>Uvulifer</i> , <i>Posthodiplostomum</i>
<i>Ceratopipra chloromeros</i>	Pipridae	Passeriformes	Peru	Intestine	Leucochloridiidae	<i>Bakkeius moragai</i>
<i>Chloroceryle inda</i>	Alcedinidae	Coraciiformes	Peru	Intestine	Diplostomidae	<i>Uvulifer prosocotyle</i>
<i>Cyphorhinus arada</i>	Troglodytidae	Passeriformes	Peru	body cavity	Leucochloridiidae	
<i>Formicarius colma</i>	Formicariidae	Passeriformes	Peru	Intestine	Cyathocotilidae	<i>Mesostephanus</i> sp.

Table 10. cont.

Host	Host Family	Host Order	Loc	Site of Infection	Digenean Family	Digenean ID
<i>Frederickena undiligera</i>	Thamnophilidae	Passeriformes	Peru	liver	Dicrocoeliidae	<i>Lutztrema</i> sp.
<i>Hylophylax naevius</i>	Thamnophilidae	Passeriformes	Peru	Body Cavity, kidney	Leucochloridiidae, Eucotylidae	-
<i>Lepidothrix coronata</i>	Pipridae	Passeriformes	Peru	Intestine	Leucochloridiidae	<i>Bakkeius moragai</i>
<i>Micrastur mintoni</i>	Falconidae	Falconiformes	Brazil	-	Diplostomidae	-
<i>Microbates cinereiventris</i>	Troglodytidae	Passeriformes	Peru	Intestine	Leucochloridiidae	<i>Bakkeius moragai</i>
<i>Momotus momota</i>	Momotidae	Coraciiformes	Brazil	liver	Dicrocoeliidae	<i>Lubens lubens</i>
<i>Myiobius villosus</i>	Tyrannidae	Passeriformes	Peru	hepatic blood vessels	Schistosomatidae	n. gen. n. sp.
<i>Myrmothera campanisona</i>	Grallariidae	Passeriformes	Peru	gallbladder	Dicrocoeliidae	<i>Zonorchis confusus</i>
<i>Pitangus</i> sp.	Tyrannidae	Passeriformes	Brazil	liver	Dicrocoeliidae	<i>Brachylethum rarum</i>
<i>Pithys albifrons</i>	Thamnophilidae	Passeriformes	Peru	liver	Dicrocoeliidae	<i>Brachylecithum</i> sp.
<i>Pithys albifrons</i>	Thamnophilidae	Passeriformes	Peru	liver	Dicrocoeliidae	<i>Brachylecithum</i> sp.
<i>Rhegmatorhina melanosticta</i>	Thamnophilidae	Passeriformes	Peru	kidney, liver	Eucotylidae, Dicrocoeliidae	<i>Tanaisia</i> sp., <i>Brachylecithum</i> sp.
<i>Rhynchocyclus olivaceus</i>	Tyrannidae	Passeriformes	Peru	liver	Dicrocoeliidae	<i>Brachylecithum</i>
<i>Rhynchocyclus olivaceus</i>	Tyrannidae	Passeriformes	Peru	liver	Dicrocoeliidae	<i>Brachylecithum</i>
<i>Sclerurus mexicanus</i>	Furnariidae	Passeriformes	Peru	-	Stomylotrematidae	<i>Stomylotrema vicarium</i>
<i>Serpophaga cinerea</i>	Tyrannidae	Passeriformes	Peru	hepatic blood vessels	Schistosomatidae	n. gen. n. sp.
<i>Tapera naevia</i>	Cuculidae	Cuculiformes	Brazil	gallbladder	Dicrocoeliidae	<i>Zonorchis</i>
<i>Thalurania furcata</i>	Trochilidae	Apodiformes	Peru	Stomach	Renschtremitidae	-
<i>Tolmomyias assimilis</i>	Tyrannidae	Passeriformes	Peru	liver	Dicrocoeliidae	<i>Brachylecithum</i>
<i>Turdus lawrencii</i>	Turdidae	Passeriformes	Peru	Gallbladder	Dicrocoeliidae	<i>Lubens</i>
<i>Turdus lawrencii</i>	Turdidae	Passeriformes	Peru	Gallbladder	Dicrocoeliidae	<i>Lutztrema</i>
<i>Xenopipo holochlora</i>	Pipridae	Passeriformes	Peru	Gallbladder Intestine	Phaneropsolidae	-
<i>Xenopipo holochlora</i>	Pipridae	Passeriformes	Peru	Intestine	Phaneropsolidae, Leucochloridiidae	<i>Moesia ovalis</i> n. sp., <i>Bakkeius moragai</i>

Table 10. cont.

Host	Host Family	Host Order	Loc	Site of Infection	Digenean Family	Digenean ID
<i>Xenops minutus</i>	Furnariidae	Passeriformes	Brazil	-	Eucotylidae	<i>Tanaisia minax</i>
<i>Xenops minutus</i>	Furnariidae	Passeriformes	Brazil	ureters, kidney	Brachylaimidae	<i>Glaphyrostomum</i> n. sp.

Table 11. Nematode survey within two areas of endemism of southern Amazonia. Loc = Locality.

Host	Host Family	Host Order	Loc	Site of Infection	Nematode Family	Nematode ID
<i>Antrostomus sericocaudatus</i>	Caprimulgidae	Caprimulgiformes	Brazil	-	Subuluridae	<i>Subulura travassosi</i>
<i>Attila cinnamomeus</i>	Tyrannidae	Passeriformes	Brazil	-	Onchocercidae	<i>Aproctella</i> sp. 1
<i>Catharus ustulatus</i>	Turdidae	Passeriformes	Peru	capillary	Capillariidae	<i>Capillaria</i> sp.
<i>Catharus ustulatus</i>	Turdidae	Passeriformes	Peru	Intestine	Onchocercidae	<i>Aproctella</i> sp. 2
<i>Catharus ustulatus</i>	Turdidae	Passeriformes	Peru	Intestine	Onchocercidae	<i>Aproctella</i> sp. 2
<i>Coereba flaveola</i>	Coerebidae	Passeriformes	Brazil		Onchocercidae	<i>Aproctella</i> sp. 2
<i>Columbina talpacoti</i>	Columbidae	Columbiformes	Brazil	intestine	Capillariidae	<i>Capillaria</i> sp.
<i>Columbina talpacoti</i>	Columbidae	Columbiformes	Brazil	intestine	Ornithostrongylidae	<i>Ornithostrongylus minutus</i>
<i>Columbina talpacoti</i>	Columbidae	Columbiformes	Brazil	intestine	Capillariidae	<i>Capillaria</i> sp.
<i>Crotophaga ani</i>	Cuculidae	Cuculiformes	Brazil		Subuluridae	<i>Subulura travassosi</i>
<i>Dendrocolaptes medius</i>	Dendrocolaptidae	Passeriformes	Brazil	stomach	Habronematidae	<i>Procyrnea pileata</i>
<i>Frederickena undiligera</i>	Thamnophilidae	Passeriformes	Peru	Intestine	Subuluridae	<i>Subulura</i> sp.
<i>Geotrygon montana</i>	Columbidae	Columbiformes	Peru	capillary	Capillariidae	<i>Capillaria</i> sp.
<i>Megascops watsonii</i>	Strigidae	Strigiformes	Brazil	-	Subuluridae	<i>Subulura travassosi</i>
<i>Micrastur mintoni</i>	Falconidae	Falconiformes	Brazil	-	Capillariidae	<i>Capillaria</i> sp.
<i>Microbates cinereiventris</i>	Troglodytidae	Passeriformes	Peru	capillary	Capillariidae	<i>Capillaria</i> sp.
<i>Momotus momota</i>	Momotidae	Coraciiformes	Brazil	-	Capillariidae	<i>Capillaria</i> sp.
<i>Monasa morphoeus</i>	Bucconidae	Galbuliformes	Peru	intestine	Diplotriaeidae	<i>Diplotriaeoid</i> sp.
<i>Monasa morphoeus</i>	Bucconidae	Piciformes	Brazil	intestine	Subuluridae	<i>Subulura travassosi</i>

Table 11. cont.

Host	Host Family	Host Order	Loc	Site of Infection	Nematode Family	Nematode ID
<i>Monasa morphoeus</i>	Bucconidae	Piciformes	Brazil	body cavity	Subuluridae	<i>Subulura travassosi</i>
<i>Myiophobus fasciatus</i>	Tyrannidae	Passeriformes	Brazil	body cavity	Onchocercidae	<i>Aproctella</i> sp. 2
<i>Myiozetetes similis</i>	Tyrannidae	Passeriformes	Brazil	-	Onchocercidae	<i>Aproctella</i> sp. 1
<i>Notharchus tectus</i>	Bucconidae	Piciformes	Brazil	intestine	Subuluridae	<i>Subulura travassosi</i>
<i>Notharchus tectus</i>	Bucconidae	Piciformes	Brazil	intestine	Subuluridae	<i>Subulura travassosi</i>
<i>Philydor erythrocercum</i>	Furnariidae	Passeriformes	Peru	stomach lining	Ascarididae	<i>Ascaridia</i> sp.
<i>Piaya cayana</i>	Cuculidae	Cuculiformes	Brazil	-	Subuluridae	<i>Skrjabinura spiralis</i> , <i>Subulura travassosi</i>
<i>Piculus flavigula</i>	Picidae	Piciformes	Brazil	-	Diplotriaeidae	<i>Diplotriaeoid</i> sp.
<i>Pitangus</i> sp.	Tyrannidae	Passeriformes	Brazil	-	Onchocercidae	<i>Aproctella</i> sp. 1
<i>Psarocolius bifasciatus</i>	Icteridae	Passeriformes	Brazil	-	Diplotriaeidae	<i>Diplotriaeina</i> sp.
<i>Rhynchocyclus olivaceus</i>	Tyrannidae	Passeriformes	Peru	stomach lining	Capillariidae	<i>Capillaria</i> sp.
<i>Rhytipterna simplex</i>	Tyrannidae	Passeriformes	Brazil	intestine	Onchocercidae	<i>Aproctella</i> sp. 1
<i>Saltator maximus</i>	Thraupidae	Passeriformes	Brazil	intestine	Onchocercidae	<i>Aproctella</i> sp. 2
<i>Saltator maximus</i>	Thraupidae	Passeriformes	Peru	intestine	Capillariidae	<i>Capillaria</i> sp.
<i>Sporophila angolensis</i>	Emberizidae	Passeriformes	Brazil	intestine	Onchocercidae	<i>Aproctella</i> sp. 2
<i>Tachyphonus rufus</i>	Thraupidae	Passeriformes	Brazil	body cavity	Onchocercidae	<i>Aproctella</i> sp. 1
<i>Tigrisoma fasciatum</i>	Ardeidae	Pelicaniformes	Peru	esophagus	Anisakidae	<i>Contraecum microcephalum</i> , <i>Porrocaecum reticulatum</i>
<i>Tolmomyias flaviventris</i>	Rhynchocyclidae	Passeriformes	Brazil	-	Onchocercidae	<i>Aproctella</i> sp. 1
<i>Trogon viridis</i>	Trogonidae	Trogoniformes	Brazil	-	Onchocercidae	<i>Aproctella</i> sp. 1
<i>Trogon viridis</i>	Trogonidae	Trogoniformes	Peru	-	Habronematidae	<i>Procyrnea</i> sp.
<i>Turdus fumigatus</i>	Turdidae	Passeriformes	Brazil	body cavity	Onchocercidae	<i>Aproctella</i> sp. 2