



January 2012

Development Of A Spreadsheet For Bar Graph Softening

James Norberg

Follow this and additional works at: <https://commons.und.edu/theses>

Recommended Citation

Norberg, James, "Development Of A Spreadsheet For Bar Graph Softening" (2012). *Theses and Dissertations*. 1308.
<https://commons.und.edu/theses/1308>

This Thesis is brought to you for free and open access by the Theses, Dissertations, and Senior Projects at UND Scholarly Commons. It has been accepted for inclusion in Theses and Dissertations by an authorized administrator of UND Scholarly Commons. For more information, please contact zeinebyousif@library.und.edu.

DEVELOPMENT OF A SPREADSHEET FOR BAR GRAPH SOFTENING

by

James Norberg
Bachelor of Science, University of North Dakota, 2010

A Thesis

Submitted to the Graduate Faculty

of the

University of North Dakota

In partial fulfillment of the requirements

for the degree of

Master of Science

Grand Forks, North Dakota

August

2012

Copyright 2011 James Norberg

This thesis, submitted by James Norberg in partial fulfillment of the requirements for the Degree of Master of Science from the University of North Dakota, has been read by the Faculty Advisory Committee under whom the work has been done, and is hereby approved.

Harvey A. Bullis

Chairperson

[Signature]

Charles J. Molette

This thesis is being submitted by the appointed advisory committee as having met all of the requirements of the Graduate School at the University of North Dakota and is hereby approved.

Rayne E. Swisher

Dean of the Graduate School

July 26, 2012

Date

Title Development of a Spreadsheet for Bar Graph Softening
Department Civil Engineering
Degree Master of Science

In presenting this thesis in partial fulfillment of the requirements for a graduate degree from the University of North Dakota, I agree that the library of this University shall make it freely available for inspection. I further agree that permission for extensive copying for scholarly purposes may be granted by the professor who supervised my thesis work or, in his absence, by the Chairperson of the department or the dean of the Graduate School. It is understood that any copying or publication or other use of this thesis or part thereof for financial gain shall not be allowed without my written permission. It is also understood that due recognition shall be given to me and to the University of North Dakota in any scholarly use which may be made of any material in my thesis.

James Norberg
July 4, 2012

TABLE OF CONTENTS

LIST OF FIGURES	ix
LIST OF TABLES	xii
LIST OF EQUATIONS	xiii
LIST OF ACRONYMS	xvi
ACKNOWLEDGEMENTS	xviii
ABSTRACT	xix
CHAPTER	
I. INTRODUCTION.....	1
Hardness	1
Treatment Plant Scenarios.....	2
Chemical Softening.....	4
Basic Principles.....	5
Removal of Free Carbon Dioxide	6
Removal of CH with Lime Feed Only	6
Removal of Noncarbonate Hardness with Lime and Na ₂ CO ₃	7
Removal of Carbonate and Noncarbonate Hardness with NaOH.....	8
Stabilization of Softened Water	9
Other Chemistry Considerations.....	9
Solubility Product.....	9

	Kinetics of Product Formation.....	11
	Stoichiometric Model.....	12
	Bar Graph Model.....	13
	Applicability of This Work.....	13
	Existing Stoichiometric Trial Methods.....	13
	Proposed Final Hardness Target Goal Method.....	15
II.	METHODS.....	16
	Available Chemical Dosage Estimation Methods.....	16
	Stoichiometric Method.....	16
	CH Removal Only.....	18
	Simple Lime Treatment.....	18
	Excess Lime Treatment.....	19
	Noncarbonate Hardness Removal.....	20
	Lime with Na ₂ CO ₃ Treatment.....	20
	Excess Lime with Na ₂ CO ₃ Treatment.....	20
	Problem Solutions Using the Stoichiometric Method.....	22
	Bar Graph Method.....	22
	Method Modifications in this Work.....	27
	Chemical Purity.....	29
III.	RESULTS: MICROSOFT EXCEL SPREADSHEET.....	30
	Spreadsheet Outline.....	30
	Step 1: Parameters.....	32
	Step 2: Concentration Form.....	33

	Step 3: Lab Concentrations.....	34
	Step 4: Final Recarbonation and Final Report Format.....	35
	Challenges	35
	Incomplete Data.....	36
	Inaccurate Data.....	40
	Invalid Data.....	42
	Other Practical Considerations.....	42
	Case 1: Single Stage, Caustic Soda, High Hardness with Low Alkalinity.....	43
	Case 2: Only CH Present in Influent Water	44
	Case 3: Two Stage, Low Hardness with High Alkalinity.....	45
	Summary of Spreadsheet.....	46
IV.	EXAMPLE PROBLEMS	47
	Input Data.....	47
	Assumptions for Problem Solutions	48
	Program pre-calculations.....	49
	Calculate CO ₂	49
	Convert Concentrations from mg/l to meq/l.....	49
	Calculate Cation/Anion Percent Difference	50
	Create Bar Graph.....	50
	Sample Problems	51
	Example 1: Single Stage with CH Removal Only	51
	Bar Graph Method Solution	51
	Stoichiometric Method Solution.....	55

Example 2: Single Stage with Lime and Na ₂ CO ₃ Feed.....	56
Bar Graph Method Solution	56
Stoichiometric Method Solution.....	58
Example 3: Two Stage with Lime and Na ₂ CO ₃ Feed	60
Bar Graph Method Solution	60
Stoichiometric Method Solution.....	62
Example 4: Two Stage Split Treatment with Lime and Na ₂ CO ₃ Feed.....	63
Bar Graph Method Solution	63
Stoichiometric Method Solution.....	67
V. DISCUSSION.....	68
Comparison of Problem Solutions	68
Problem Preliminary Calculations	68
Chemical Feed and Final Hardness.....	69
Comparison of Stoichiometric Methods to Live WTP Data.....	73
Methods for Comparison	74
Summary of Predicted vs. Observed Data.....	79
Comparison on Hardness	80
Comparison on Alkalinity	80
Potential Explanations of Issues	80
Final Conclusions	82
APPENDICES.....	84
WORKS CITED.....	101

LIST OF FIGURES

Figure	Page
1. Bar Graph	2
2. Single Stage Treatment	2
3. Two Stage Treatment	3
4. Two Stage with Split Treatment	3
5. Typical Bar Diagram.....	22
6. Variation of K_1' with Temperature.....	27
7. Spreadsheet Flowchart	31
8. Userform for Entering Treatment Parameters	33
9. Userform for Entering Form of Hardness and Alkalinity	34
10. Userform for Entering Concentration Data	34
11. Userform for Entering Desired Final pH and Units for Output Report	35
12. Error Message for Incomplete Userform	36
13. Single Stage Treatment Options Flowchart.....	38
14. Two Stage Treatment Options	39
15. Minimum Required Concentration Data Error Message	40
16. Inaccurate Concentration Data Error Message	41
17. Excessively Inaccurate Concentration Data Error Message.....	41
18. Error Message for Negative Values in Userform	42
19. Final Hardness Goal not met Due to Treatment Methods.....	44

20.	Alkalinity Greater than TH.....	45
21.	Two Stage Treatment, Alkalinity Greater than TH	45
22.	Alkalinity Significantly Greater than Total Hardness.....	46
23.	Influent Bar Graph with Explanation of Bar Graph Elements	51
24.	Intermediate Bar Graph.....	52
25.	Reactor 1 Effluent Bar Graph.....	53
26.	Single Stage Bar Graph Series for CH Removal	55
27.	Single Stage Bar Graph Series for NCH Removal	56
28.	Series Bar Graphs for Two Stage Treatment with Lime and Soda Ash	61
29.	Split Treatment Stage 1 and Reactor1/Untreated Bypass Blending	64
30.	Split Treatment Stage 2 and Final Recarbonation	66
31.	Theoretical Bar Graph for Grand Forks Water, February 18, 2012	75
32.	Actual Bar Graph from Grand Forks Influent and Effluent Concentration Data, February 18, 2012	77
33.	Equilibria Constants for Carbonate Species at 1 atm Pressure (Fetter 357)	86
34.	Carbonate Species Log Concentration as a Function of pH at 25 °C and 1 atm Pressure (MWH et al. 68)	86
35.	Carbonate Species Percent Concentration as a Function of pH at 20 °C (Fetter 358)	86
36.	Carbonic Species Concentration Distribution at 20 °C (Fetter 357)	87
37.	Theoretical Bar Graph with Effluent Concentrations Predicted from Observed Influent, Feb. 27, 2012	93
38.	Bar Graph from Observed Influent and Effluent Water Qualities, Feb. 27, 2012.....	94
39.	Theoretical Bar Graph with Effluent Concentrations Predicted from Observed Influent, March 1, 2012.....	95

40.	Bar Graph from Observed Influent and Effluent Water Qualities, March 1, 2012.....	96
41.	Theoretical Bar Graph with Effluent Concentrations Predicted from Observed Influent, March 6, 2012.....	97
42.	Bar Graph from Observed Influent and Effluent Water Qualities, March 6, 2012.....	98
43.	Theoretical Bar Graph with Effluent Concentrations Predicted from Observed Influent, March 15, 2012.....	99
44.	Bar Graph from Observed Influent and Effluent Water Quality, March 15, 2012.....	100

LIST OF TABLES

Table	Page
1. Excess Hydroxide Based on Magnesium Hardness Goals.....	17
2. Conversion Factors for Obtaining Concentrations in meq/l.....	23
3. Acceptable Error for Laboratory Samples (MWH et al. 43).....	24
4. K1' Value for Various Temperatures	26
5. Industrial Softening Chemicals Available (Gullicks 24)	29
6. Significance of Various Final Total Hardness Goals (Gullicks interview).....	33
7. Acceptable Value Ranges for Selected Parameters (Gullicks interview)	42
8. Input Parameter Data for Example Problems	47
9. Spreadsheet Concentrations with Error Correction	50
10. Chemical Feed Estimations and Final Water Quality for Different Methods.....	69
11. Grand Forks WTP Softening Basin Data	73
12. Predicted vs. Observed Softened Effluent Water Quality (Before Recarbonation).....	79
13. Parameters for Method Comparison	90

LIST OF EQUATIONS

Equation	Page
1. Mass Balance Equation for Split Treatment Bypass Flow Fraction, X	4
2. Conversion of Quicklime to Hydrated Lime	4
3. Aqueous CO ₂	6
4. Generation of Bicarbonate Ions	6
5. Generation of Carbonate Ions	6
6. Reaction of Carbon Dioxide with Hydrated Lime	6
7. Reaction of Bicarbonate Calcium with Hydrated Lime	7
8. Reaction of Bicarbonate Magnesium with Hydrated Lime	7
9. Reaction of Carbonate Magnesium with Hydrated Lime	7
10. Reaction of Magnesium Sulfate NCH with Hydrated Lime	7
11. Reaction of Magnesium Chloride NCH with Hydrated Lime	7
12. Reaction of Calcium Sulfate (NCH) with Na ₂ CO ₃	8
13. Reaction of Calcium Chloride (NCH) with Na ₂ CO ₃	8
14. Reaction of Carbon Dioxide with NaOH	8
15. Reaction of Bicarbonate Calcium with NaOH	8
16. Reaction of Bicarbonate Magnesium with NaOH	9
17. Reaction of Magnesium Sulfate (NCH) with NaOH	9
18. Conversion of Excess Hydroxide to Carbonate	9
19. Conversion of Carbonate to Bicarbonate	9
20. Basic Equation Format of Chemical Reaction	10

21.	Solubility Product	10
22.	Precipitation and Solubilization Equation of CaCO_3	10
23.	Precipitation and Solubilization Equation of $\text{Mg}(\text{OH})_2$	10
24.	Solubility Product of CaCO_3	10
25.	Solubility Product of $\text{Mg}(\text{OH})_2$	11
26.	Arrhenius Equation	11
27.	Stoichiometric Lime Requirements for Single Stage Treatment (MWH et al. 1610)	18
28.	Stoichiometric CO_2 Requirements for Single Stage Treatment (MWH et al. 1610)	19
29.	Stoichiometric Lime Requirements for Excess Lime Treatment (MWH et al. 1610)	19
30.	Stoichiometric CO_2 Requirements for Excess Lime Treatment (MWH et al. 1610)	19
31.	Stoichiometric Na_2CO_3 Requirements for Single Stage Treatment (MWH et al. 1610).....	20
32.	Stoichiometric CO_2 Requirements for Single Stage Treatment with Na_2CO_3 (MWH et al. 1610).....	20
33.	Stoichiometric Lime Requirements for Excess Lime/ Na_2CO_3 Treatment (MWH et al. 1611).....	21
34.	Stoichiometric Na_2CO_3 Requirements for Excess Lime/ Na_2CO_3 Treatment (MWH et al. 1611).....	21
35.	Stoichiometric CO_2 Requirements for Stage 1 Excess Lime/ Na_2CO_3 Treatment (MWH et al. 1611)	21
36.	Stoichiometric CO_2 Requirements for Stage 2 Excess Lime/ Na_2CO_3 Treatment (MWH et al. 1611)	22
37.	Percentage Difference in Chemical Analysis (MWH et al. 42)	24
38.	Hydroxide Requirements for CH Removal Scenario (Gullicks 7)	24
39.	Hydroxide Requirements for NCH Removal Scenario (Gullicks 7)	24
40.	Na_2CO_3 Requirements for Single Stage Treatment Sceneario (Gullicks 10).....	25

41.	Na ₂ CO ₃ Requirements for Two Stage and Split Treatment Scenarios (Gullicks 16).....	25
42.	NaOH Requirements for Single Stage Treatment Scenario (Gullicks 12).....	26
43.	NaOH for Two Stage and Split Treatment Scenarios.....	26
44.	Estimation of Free CO ₂ in mg/l.....	26
45.	Empirical Relationship Between K ₁ ' and Temperature.....	27
46.	Modified Hydroxide Requirements for NCH Removal (Gullicks interview).....	27
47.	Modified NaOH Requirements for Split Treatment Scenario (Gullicks interview).....	28
48.	Mass Balance Equation for Split Treatment Blend.....	64
49.	First Dissociation Constant for Carbonic Acid.....	89
50.	Second Dissociation Constant for Carbonic Acid.....	89
51.	First Dissociation Constant for Carbonic Acid, Temperature Dependent.....	89
52.	Second Dissociation Constant for Carbonic Acid, Temperature Dependent.....	89
53.	Total Carbonic Species, mole/L.....	89
54.	Ionization Fraction for Carbonic Species.....	90
55.	Carbonic Species Ionization Fraction Based on Acid Reactions.....	90

LIST OF ACRONYMS

BGM: Bar Graph Method

Ca_i^{2+} : Ca^{2+} Concentration in Untreated Raw Water

Ca_f^{2+} : Calcium Concentration in Softening Effluent

CH: Carbonate Hardness

$(\text{CO}_2)_B(\text{pseudo})$: estimated CO_2 concentration immediately after treated and un-treated bypass waters have blended and prior to any mixing reactions

gpm: Gallons Per Minute

$(\text{HCO}_3^-)_B(\text{pseudo})$ = estimated HCO_3^- concentration immediately after treated and un-treated bypass waters have blended and prior to any mixing reactions

meq/l: Milliequivalents Per Liter

MGD: Million Gallons Per Day

mg/l: Milligrams Per Liter

Mg_F^{2+} : Final Mg^{2+} Concentration of Softening Reactor Effluent

$\text{Mg}_{F\text{Int}}^{2+}$ (split treatment only): Final Magnesium Goal for Blended Reactor 1 Effluent and Untreated Bypass Flow

Mg_R^{2+} : Raw Water Magnesium

Mg_1^{2+} : Reactor 1 Magnesium Goal

NCH: Noncarbonate Hardness

NCH_f : Noncarbonate Hardness of Softening Basin Effluent

NCH_i : Noncarbonate Hardness of Untreated Source Water

OH_B^- (actual): OH^- concentration of blended treated and un-treated bypass water, after mixing reactions have taken place

OH_B^- (pseudo): estimated OH^- concentration immediately after treated and un-treated bypass waters have blended and prior to any mixing reactions

P Alk: Phenolphthalein Alkalinity

pH_i : Influent pH

pH_f : Desired Effluent pH of Treated Water

SM: Stoichiometric Method

T: Temperature

T Alk: Total Alkalinity

T_i : Influent Temperature

T_f : Effluent Temperature

T_K : Temperature, Kelvin

TDS: Total Dissolved Solids

TH: Total Hardness

TH_{raw} : Total Hardness in Raw Water

TH_f : Desired Final Total Hardness in Treated Water

VB: Microsoft Excel Visual Basic

WTP: Water Treatment Plant

X: Treated Fraction of Water for Split Treatment Scenario

Z_B : Blended Concentration of Constituent "Z"

Z_R : Influent Concentration of Constituent "Z"

Z_1 : Reactor 1 Effluent Concentration of Constituent "Z"

ACKNOWLEDGEMENTS

I would like to express my sincere gratitude to my graduate committee for their help throughout my academic career.

I would especially like to thank my advisor, Dr. Harvey Gullicks. He has spent countless hours sharing his own experience and wealth of knowledge. Without him, I would never have been able to complete my thesis.

I would like to acknowledge Dr. Charles Oulman, who first introduced Dr. Gullicks to a bar graph softening approach, which Dr. Gullicks has further developed over the years.

Many thanks to Hazel Sletten, John “Fred” Goetz, and all the other employees at the Grand Forks Water Treatment Plant. Together, they invested many hours helping me to better understand my work by showing me how a water softening plant actually works, and by reviewing and providing the data used as a comparison to this work.

I would like to thank my parents, Gary and Stephanie Norberg, as well as my three siblings, whose support throughout my schooling has been priceless.

Finally, I would like to express special thanks to my brother, Jonathan Norberg, who has helped me extensively with his advice. He has always been there for me, ready to provide guidance in my schooling, and to help me through the difficult times.

ABSTRACT

Lime softening has been commonly used for decades for hardness removal in water treatment. Many methods are used for controlling lime feed to a water treatment system. Concentrations in influent to or effluent from a water softener are most often determined manually by physical measurements, though they can also be automatically measured by various devices. Based on influent concentrations, hand calculations can be made for determination of the required chemical feed. Alternatively, required lime dosage can be estimated and then adjusted until the desired effluent quality is attained. This type of iterative method requires special attention and multiple adjustments under circumstances where raw water quality fluctuates. The purpose of this study is to develop a spreadsheet that can work with existing equipment to improve on these existing methods for lime softening. A spreadsheet, utilizing the Bar Graph Method (Gullicks) could perform the necessary calculations for determining chemical feed based on user inputs. On-line measuring devices (hardness, alkalinity, pH, temperature and conductivity) would determine influent water quality to softening basins on a continuous basis. Supplemented with periodic analyses of Na^+ , SO_4^{2-} and Cl^- and small adjustments for conductivity variation, this software and hardware would then work together to automatically adjust chemical feed on a more continuous basis, providing a more consistent treated effluent, and a more efficient use of chemicals.

CHAPTER I

INTRODUCTION

Hardness

Hardness in water is caused by metal ions including calcium, magnesium, iron, manganese, strontium, and aluminum. However, calcium and magnesium are the only metals present in significant quantities in natural waters. Therefore, total hardness is often considered to be simply the sum of calcium and magnesium hardness. Hardness can be expressed in terms of the metal ions, or in terms of CaCO_3 . High hardness is undesired in public water supply as it results in high soap consumption and scaling in pipes and water heaters. For these reasons, total and magnesium hardness should be kept below 150 and 40 mg/L, respectively, as CaCO_3 (Viessman et al. 407).

Water contains both cations (positively charged ions) and anions (negatively charged ions). According to electroneutrality, the positive charges must be numerically equal to the negative charges in any water. Calcium and magnesium both contain charges of positive two ($2+$). Calcium and magnesium may be associated with hydroxide (OH^-), carbonate (CO_3^{2-}), or bicarbonate (HCO_3^-) anions and called carbonate hardness (CH) or may be associated with sulfate (SO_4^{2-}), chloride (Cl^-), or other anions and called noncarbonate hardness (NCH). CH and NCH components of a water sample are distinguished by construction of a milliequivalent per liter (meq/l) bar graph. An example bar graph is shown in Figure 1 below.

Cations	Anions
Ca ²⁺	CO ₃ ²⁻
3.2000	0.0000
Mg ²⁺	HCO ₃ ⁻
2.4000	5.0000
Na ⁺	SO ₄ ²⁻
0.1000	0.7000
K ⁺	Cl ⁻
0.4000	0.4000
Fe ²⁺	F ⁻
0.0000	0.0000
Mn ²⁺	NO ₃ ⁻ N
0.0000	0.0000
Σ = 6.1	Σ = 6.1
meq/l	meq/l

Figure 1. Bar Graph

Treatment Plant Scenarios

Water treatment plant (WTP) schematics vary significantly from one plant to the next. The three basic schematic layouts for water softening are single stage, two stage, and two stage with split treatment.

In single stage softening (Figure 2 below), lime only (CaO or Ca(OH)₂), lime and caustic soda (NaOH), or lime and soda ash (Na₂CO₃) are added to a single reactor where precipitation reactions take place. The softened water effluent then undergoes recarbonation, where CO₂ stabilizes the pH.

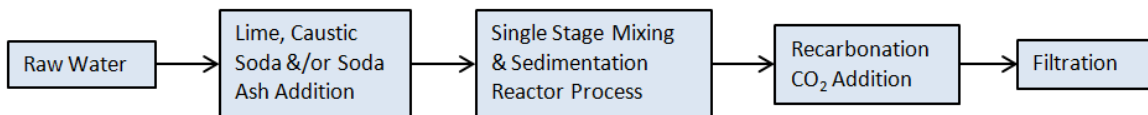

Figure 2. Single Stage Treatment

When two stage water treatment is used (Figure 3 below), two reactors act in series to soften the water. Typically, this is done by treating with lime only in the first reactor, precipitating magnesium to selected practical solubility limit and leaving excess

hydroxide in the first reactor effluent. Intermediate recarbonation converts excess hydroxide to CO_3^{2-} . Together with Na_2CO_3 addition, calcium can then be precipitated to the desired goal in the second reactor. Following the second reactor treatment, final recarbonation lowers the pH, stabilizing the final effluent prior to filtration.

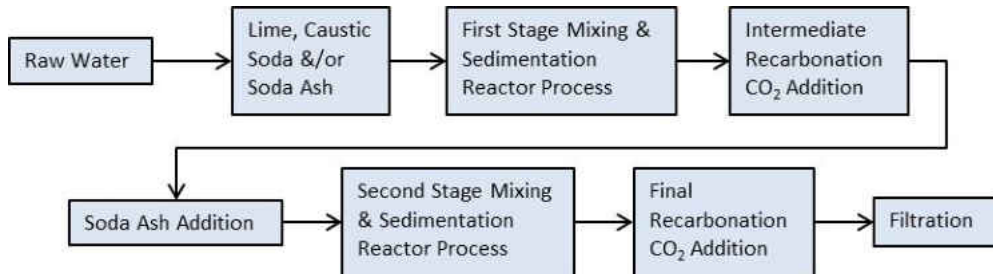

Figure 3. Two Stage Treatment

In two stage treatment with bypass flow (split treatment), all lime feed is added in the first reactor, treating some fraction of the influent water. The remaining fraction of water is bypassed, untreated, and blended with the first reactor effluent. This allows the first stage reactor to remove magnesium hardness to a low level, typically 0.16 to 0.2 meq/l in Mg^{2+}_1 .

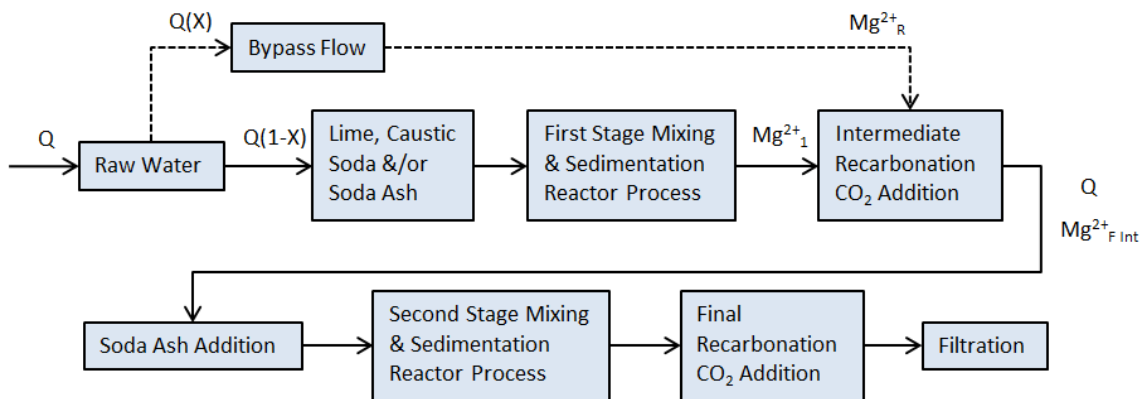

Figure 4. Two Stage with Split Treatment

Where

- Q = total influent flow
- Q(X) = flow rate of bypass flow
- Q(1-X) = flow rate of Stage 1 treated flow
- Mg^{2+}_1 = Stage 1 treated effluent Mg^{2+} goal
- Mg^{2+}_R = bypass flow untreated Mg^{2+} concentration

$Mg^{2+}_{F\text{ Int}} = \text{final } Mg^{2+} \text{ goal of mixed untreated bypass and Stage 1 treated water}$

The fraction of water bypassed in split treatment, X, is determined by a mass balance of magnesium, as shown in Equation 1 below. Bypass flow and reactor 1 effluent blend to achieve the final selected magnesium hardness goal and to react reactor 1 excess OH⁻ with bypassed CO₂ and HCO₃⁻ to create CO₃²⁻. Na₂CO₃ is then added before the second reactor. Intermediate recarbonation may be used as well, though it may often prove unnecessary. Final recarbonation is used to stabilize the second reactor effluent prior to filtration (Gullicks 18).

Equation 1. Mass Balance Equation for Split Treatment Bypass Flow Fraction, X

$$X = \frac{Mg_F^{2+} - Mg_1^{2+}}{Mg_R^{2+} - Mg_1^{2+}}$$

Chemical Softening

Lime softening was first used in 1841 to treat hard water on the Thames River. The addition of lime raises the pH (provides OH⁻), converting bicarbonate hardness to carbonate hardness and precipitating hardness in the form of CaCO₃ and Mg(OH)₂. Currently, the lime softening treatment process is referred to as the cold lime process, and operates under the same principles (United States Lime Softening 1). In lime softening, either quicklime (CaO) or hydrated lime (Ca(OH)₂) can be used. If quicklime is used, the CaO reacts with water in a process called slaking. This reaction is shown in Equation 2 below.

Equation 2. Conversion of Quicklime to Hydrated Lime

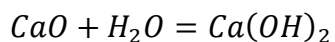

The hydrated lime produced in this reaction is then free to begin the precipitation reactions detailed in following paragraphs. Alternatively, hydrated lime may be added directly in the softening process.

Water softening can also incorporate other chemicals including Na_2CO_3 and NaOH . While lime removes only CH , Na_2CO_3 is beneficial in removing NCH in a process known as second stage softening (United States Lime Softening 2). NaOH can be used either in replacement of or in supplement to lime, though its use depends on several factors including economy, ease of handling, and magnesium content of the water to be treated (MWH et al. 1597).

Chemical water softening removes hardness (calcium and magnesium) by precipitating calcium as CaCO_3 and magnesium as $\text{Mg}(\text{OH})_2$. A pH of 9.5 to 10.3 is optimum to achieve CaCO_3 precipitation. Magnesium precipitation as $\text{Mg}(\text{OH})_2$ requires a pH of 11.0 to 11.3 (United States, Lime Softening 1). The chemicals used for the reactions are lime (as CaO or $\text{Ca}(\text{OH})_2$), NaOH , and Na_2CO_3 and can be used singly or in combination. The following equations show the chemical reactions for lime- Na_2CO_3 softening.

Basic Principles

The entire lime-softening process is possible through the manipulation of the carbonate-bicarbonate system in water. The basic equations for the series of reactions can be seen below.

Equation 3 below shows the formation of carbonic acid (H_2CO_3) from aqueous CO_2 in water. It is difficult to analytically determine actual concentrations of $\text{CO}_2(\text{aq})$ and H_2CO_3 in water. Thus, for practical purposes, an arbitrary species (H_2CO_3^*) is taken

to represent the total concentration of $\text{CO}_2(\text{aq})$ and H_2CO_3 . Since carbonic acid is actually much lower than aqueous CO_2 , one can take $\text{H}_2\text{CO}_3^* \cong \text{CO}_2(\text{aq})$ (MWH et al. 67).

Equation 3. Aqueous CO_2

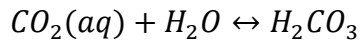

Addition of hydroxide (OH^-) in the form of lime or NaOH raises the pH of the solution and pushes the reactions shown in Equation 4 and Equation 5 from left to right. The final result is the formation of carbonate ions which act as a metal complexing agent and precipitate Ca^{2+} out of solution.

Equation 4. Generation of Bicarbonate Ions



Equation 5. Generation of Carbonate Ions

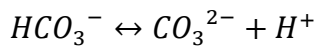

Removal of Free Carbon Dioxide

Carbon dioxide (CO_2) does not constitute hardness in water. However, it consumes lime and therefore its reaction must be considered in lime softening (Viessman 408). Removal of free CO_2 by precipitation of calcium from lime and production of water is shown in Equation 6 below.

Equation 6. Reaction of Carbon Dioxide with Hydrated Lime

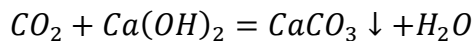

Removal of CH with Lime Feed Only

Calcium present in bicarbonate form, as well as calcium present from lime addition, is precipitated as calcium carbonate as shown in Equation 7 below.

Equation 7. Reaction of Bicarbonate Calcium with Hydrated Lime



Removal of magnesium bicarbonate first requires a conversion to carbonate form.

Equation 8 below shows the conversion of bicarbonate magnesium to soluble carbonate magnesium and the precipitation of calcium carbonate from lime addition.

Equation 8. Reaction of Bicarbonate Magnesium with Hydrated Lime

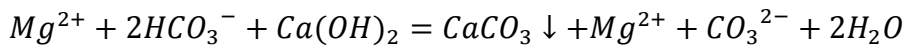

Carbonate magnesium (product species of Equation 8) is precipitated directly as magnesium hydroxide by further lime addition. This reaction also provides for the precipitation of calcium added from lime as $CaCO_3$ and is shown in Equation 9 below.

Equation 9. Reaction of Carbonate Magnesium with Hydrated Lime

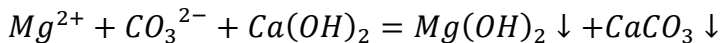

Removal of Noncarbonate Hardness with Lime and Na_2CO_3

Magnesium NCH can be present in many forms, the most common being sulfate, and chloride (Viessman 407). Removal of magnesium NCH is achieved directly with lime addition, leaving calcium NCH in solution. The two most common reactions are shown in Equation 10 and Equation 11 below.

Equation 10. Reaction of Magnesium Sulfate NCH with Hydrated Lime

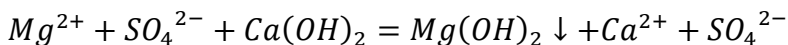

Equation 11. Reaction of Magnesium Chloride NCH with Hydrated Lime

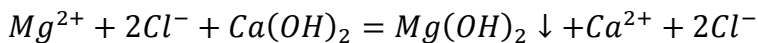

Calcium NCH remaining after magnesium NCH removal must be precipitated with Na_2CO_3 . Like magnesium NCH, calcium NCH may be present in many forms but

most commonly exists as calcium sulfate or calcium chloride (Viessman 407).

Precipitation of these two forms of calcium NCH are shown in Equation 12 and Equation 13 below. Sodium in solution is increased as a result of Equation 12 and Equation 13.

Equation 12. Reaction of Calcium Sulfate (NCH) with Na_2CO_3

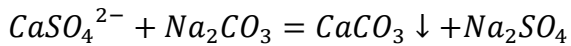

Equation 13. Reaction of Calcium Chloride (NCH) with Na_2CO_3

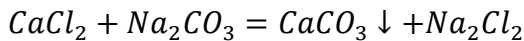

Removal of Carbonate and Noncarbonate Hardness with NaOH

NaOH may replace or supplement lime feed. NaOH reacts with CO_2 , forming Na_2CO_3 as shown in Equation 14 below.

Equation 14. Reaction of Carbon Dioxide with NaOH

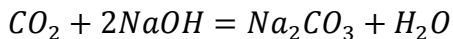

NaOH reacts with calcium and magnesium bicarbonate hardness, directly precipitating hardness as CaCO_3 and $\text{Mg}(\text{OH})_2$ and forming Na_2CO_3 (Equation 15 and Equation 16 below). It also reacts with magnesium NCH, further precipitating magnesium hardness as $\text{Mg}(\text{OH})_2$ and resulting in the production of more sodium in solution (Equation 17 below). The Na_2CO_3 formed from Equation 15 and Equation 16 is then free to react with calcium NCH as shown in Equation 12 and Equation 13 above. However, if more carbonate is formed than there is calcium NCH to precipitate, the Na_2CO_3 excess remains in solution. This can result in high carbonate alkalinity which then must be lowered by other means (MWH et al. 1598).

Equation 15. Reaction of Bicarbonate Calcium with NaOH

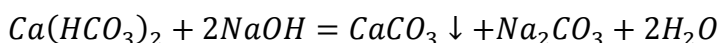

Equation 16. Reaction of Bicarbonate Magnesium with NaOH

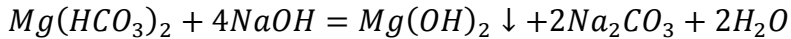

Equation 17. Reaction of Magnesium Sulfate (NCH) with NaOH

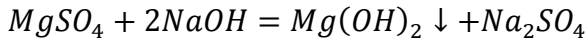

Stabilization of Softened Water

Water softening effluent has a high pH due to carbonate and hydroxide ions present in the water. This effluent is unstable and would result in scaling in the distribution system, if left un-checked (Hammer and Hammer 251). Thus acidification (recarbonation) is used to convert excess hydroxide to carbonate, lowering the pH to about 10 to 10.5. (See Equation 18 below.) Further acidification is used to convert carbonate to bicarbonate (Equation 19 below), lowering the pH to an optimal level of about 8.4 to 8.6 (MWH et al. 1598).

Equation 18. Conversion of Excess Hydroxide to Carbonate

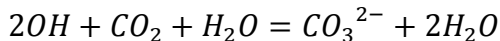

Equation 19. Conversion of Carbonate to Bicarbonate

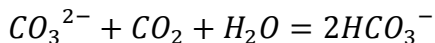

Other Chemistry Considerations

Solubility Product

In the process of lime softening treatment, some $CaCO_3$ and $Mg(OH)_2$ that is initially formed remains in solution as soluble. The concentration that can remain soluble in solution is a function of the solubility product or solubility constant (K_{sp} or K_{s0}). If the product of the reactants molar concentration in lime softening is less than K_{sp} , precipitation will not occur. If the product of the reactants molar concentration is greater

than K_{sp} , precipitation will occur until K_{sp} is reached. A basic chemical reaction can be written as follows, where capital letters represent chemical constituents and lowercase letters represent molar coefficients (Equation 20 below).

Equation 20. Basic Equation Format of Chemical Reaction

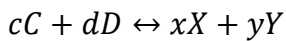

From Equation 20, the basic equation for equilibrium constant, K , is shown in Equation 21 below (Fetter 349).

Equation 21. Solubility Product

$$K = \frac{[X]^x[Y]^y}{[C]^c[D]^d} \Rightarrow \frac{[X]^x[Y]^y}{K'} \Rightarrow K'K = [X]^x[Y]^y$$

where $[X]$ = the molal concentration of the X ion
 $K'K = K_{sp}$

The precipitation and solubilization of CaCO_3 and $\text{Mg}(\text{OH})_2$ in solution is a two-way reaction shown in Equation 22 and Equation 23 below.

Equation 22. Precipitation and Solubilization Equation of CaCO_3

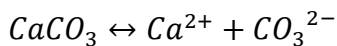

Equation 23. Precipitation and Solubilization Equation of $\text{Mg}(\text{OH})_2$

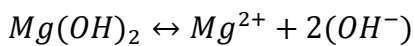

At equilibrium, $[\text{CaCO}_3]$ and $[\text{Mg}(\text{OH})_2]$, represented by K' in Equation 21, are constant. Thus, from Equation 21, the solubility product can be further developed and simplified for softening problems. Calcium and magnesium solubility products are shown below in Equation 24 and Equation 25, respectively.

Equation 24. Solubility Product of CaCO_3

$$K_{sp \text{ CaCO}_3} = [\text{Ca}^{2+}][\text{CO}_3^{2-}]$$

Equation 25. Solubility Product of Mg(OH)₂

$$K_{sp \text{ Mg(OH)}_2} = [\text{Mg}^{2+}][\text{OH}^-]^2$$

Several variables and uncertainties exist involving the solubility of calcium and magnesium. There are multiple forms of CaCO₃, the two common forms being calcite and aragonite. The solubility product for calcium carbonate varies depending on the species present. For each species, the theoretical solubility product varies with temperature (see Figure 33 in Appendix A). Additionally, the actual solubility of calcium and magnesium is roughly five times the theoretical solubility product. Observed values are roughly 30 to 40 mg/l for CaCO₃ and 10 mg/l for Mg(OH)₂, as CaCO₃ (Hammer and Hammer 251). The literature shows that in general, solubility of calcium and magnesium increases with decreasing temperature (Fetter 357). However, the theoretical values are not used here for practical purposes, since they are not supported by actual lime softening observations.

Kinetics of Product Formation

The kinetics of CaCO₃ and Mg(OH)₂ precipitation are not instantaneous. Rather, the species of CaCO₃ and Mg(OH)₂ have varying rates of reaction, or rates at which they will form. For lime softening, these are zero-order rate constants, denoted k , where k is given in mole/L•s. Temperature is known to have an effect on reaction rates. The relationship between temperature and reaction rates (the Arrhenius' equation) is shown in Equation 26 below.

Equation 26. Arrhenius Equation

$$k = Ae^{-E_a/RT}$$

where A = frequency factor, same units as k
 E_a = activation energy, kJ/mole

R = gas constant
T = temperature, K

The Arrhenius equation shows that decreasing temperature results in a slower reaction rate, k . Therefore, temperature can be of significance in colder climates. A solution to this potential problem is to vary detention time to accommodate the slower rates of formation of CaCO_3 and $\text{Mg}(\text{OH})_2$.

Stoichiometric Model

The stoichiometric method for lime softening calculations is accurate both chemically and mathematically. MWH et al. (1610-1611) has established estimations of required lime and Na_2CO_3 for several treatment scenarios. However, these estimations are based on “the assumption that all of the relevant reactions go to completion.” (MWH et al. 1604) Although MWH et al. (1597) states that the amount of Na_2CO_3 required depends upon the amount of NCH to be removed, no equation is provided to show any empirical relationship. Many textbooks will teach water softening using the stoichiometric method in conjunction with some sort of bar graph or bar diagram. However, these models still prescribe the addition of Na_2CO_3 (or NaOH) equal to the amount of NCH, and the maximum amount of excess lime (Viessman et al. 411). This results in the maximum amount of hardness removal. However, this is not always the most efficient method as it may result in a higher chemical cost than needed and in the production of a much higher volume of sludge (Gullicks).

No equations are developed in textbooks for accurate hardness removal to a point other than the solubility level. In real-world scenarios, treatment plants usually do not want to push precipitation reactions to completion due to chemical costs and other factors. Thus, the equations provided in textbooks are only useful from an academic

standpoint, and are relatively ineffectual in actual treatment scenarios, particularly when NCH removal is desired. If a mathematical model is to be used in a practical scenario, further equations are needed.

Bar Graph Model

The Bar Graph Method developed by Gullicks is based on the stoichiometric method together with the idea of chemical electroneutrality of the water. The Bar Graph Method allows for a continuous check on the accuracy of the process calculations by simply summing cations and anions in each step and ensuring electroneutrality is maintained.

The main advantage of the Bar Graph Method over the traditional stoichiometric method is in NCH removal. It provides an accurate, non-iterative mathematical model that allows a user to calculate chemical feed based on defined final total hardness and magnesium hardness goals. Thus, Na_2CO_3 feed is optimized based on user-defined water quality, rather than fed to the maximum point of hardness removal.

Applicability of This Work

Existing Stoichiometric Trial Methods

Currently, the water industry relies on various manual methods for controlling lime feed. Manual titrations are often used to determine the amount of hardness and alkalinity present in the water. Other water quality parameters such as pH, NTU and temperature are also typically determined by running grab-samples through analytical tests. Analysis of the water may be done either on the influent or effluent side of the water softening basin. If analysis is done prior to water softening, calculations may then be made to determine required lime and Na_2CO_3 feed. If the analysis is done after water

softening and chemical feed dosages are known, a check of theoretical calculations is available. The operator must iterate by choosing an initial chemical dosage and then analyzing effluent after the applicable detention time, making adjustments to the chemical dosage until the desired effluent quality is achieved.

Some of the potential issues or inefficiencies of these methods are as follows:

1. Though raw water sources frequently maintain some sort of equilibrium, several events may occur either by themselves or together, causing a high variation in water quality. High runoff caused by flood events, snowmelt in colder climates, and raw water source blending (wellfields or surface waters) ratio variations are a few examples where high variation can occur. In situations of rapid water quantity demand or quality changes, manually determining water quality at intervals that could sufficiently represent the actual change in water quality may often be impossible or inefficient.
2. Manual titrations introduce error due to human subjectivity. Titrations are based on endpoints which are detected simply by color changes or predefined pH values. These endpoints are not always clear, and thus leave room for interpretation by different users.
3. The mathematical method typically employed requires removal of all NCH, which is not always necessary.

It is not surprising that many WTPs spend un-necessary resources on achieving the desired effluent due to over-use of chemicals and the manual control of the entire lime softening schematic.

Proposed Final Hardness Target Goal Method

This work proposes the development of a computer program that would calculate the required amount of lime and other chemical feed needed based on an accurate adaptation of the bar graph chemical analysis model. Automated water quality sensors would provide continuous influent water quality data to the spreadsheet for data analysis. User inputs would be minimal and would include final hardness goal, magnesium hardness goal, and desired final pH. Once set at the desired values, these would not need to be changed.

This combination of hardware and software would work in conjunction with existing user controls to monitor water quality and adjust chemical feed on a much more constant basis. There are several major benefits of this automated system. First, the automated water quality sensors would remove human error and subjectivity that is common in lab titrations. Second, equations would provide a more empirical method for chemical feed, again removing subjectivity or experience-based judgment. Third, the automated sensors would be able to process data on a continuous basis, better representing the actual water quality for any given period of time. Fourth, it would be able to adjust chemical feed on a flow proportional, feed forward and/or automatic residual feedback control timeline that would better represent the water that it is intended to treat at any given time and the effluent goal attainments.

CHAPTER II

METHODS

Available Chemical Dosage Estimation Methods

Chemical dosages can be estimated using several methods including chemical stoichiometry, simultaneous solution of equilibria equations, softening diagrams, and laboratory studies. Chemical stoichiometry is typically employed for pre-design and preliminary cost estimation. Laboratory studies can be of great use in determining more precise chemical dosage requirements for a specific water source. The most rigorous method is that of solution of simultaneous equilibria equations. This solution can be performed by a number of computer programs, though they are typically used for research in the field of equilibrium and kinetics. Softening diagrams (Caldwell-Lawrence Diagrams) have been developed to enable the solution of equilibrium equations with more ease (MWH et al. 1603-1604).

Of the available chemical dosage estimation methods, only two are really practical for solving a water softening problem. Therefore, this study focuses on the stoichiometric model and laboratory studies.

Stoichiometric Method

The Stoichiometric method is the most common method taught in textbooks for solving lime softening problems. Because of this, equations used for determining required lime, Na_2CO_3 , and NaOH are typically the same amongst recognized sources. An important property of this method is its assumption that all lime softening reactions

go to completion (MWH et al. 1604). This assumption will be addressed later in more detail.

One minor variation between sources is the standard amount of excess lime recommended. For mathematical purposes, this value varies only slightly by source, from 28 mg/L (Droste 462) to 35 mg/L (Hammer 253). In practical terms, the amount of excess lime needed can vary significantly from one location to another depending on many factors including raw water quality, temperature, and desired magnesium hardness goals. MWH et al. reports that excess lime can vary from 30 to 70 mg/l depending upon source waters (1596-1597). Gullicks provides practical excess hydroxide recommendations based on final magnesium hardness goals in Table 1 below (7), though these values will vary from one water to another. For any given water source, a jar test is recommended to determine the effective amount of excess lime required for $Mg(OH)_2$ precipitation (MWH et al. 1597).

Table 1. Excess Hydroxide Based on Magnesium Hardness Goals

Mg²⁺ Finished Water Goal Concentration, meq/l	Excess OH⁻ Required, meq/l
> 1.4	0.1 or less
0.8	0.5
0.2	1.35

In the stoichiometric method, one can work with constituent concentrations in terms of moles/volume (mol/l), milligrams/volume (mg/l), equivalents or milliequivalents/volume (eq or meq/l). In demonstration of this method, concentrations are typically reported in terms of mg/l, to reflect how they are most often reported from a lab analysis. Values are then converted to meq/l, using equivalent weights. These values are usually left in meq/l for the remainder of the problem solution, though they are

sometimes converted to mg/l as CaCO₃ (MWH et al. 1605). If this is to be done, all constituent concentrations including sodium, sulfate, etc., must be converted to mg/l in terms of CaCO₃ to maintain consistency. Applicable chemical reaction equations are shown in Equation 3 to Equation 19 above. Estimations of required chemical feed are shown in the following equations.

CH Removal Only

For CH removal only, MWH et al. provides two sets of equations (1610); the first for waters with high calcium and low magnesium CH, and the second for high calcium and high magnesium CH. Chemical dosage estimations are greatly simplified for waters with high calcium CH and low magnesium. Estimations are slightly more difficult for waters with high calcium and high magnesium CH and necessitate a greater amount of lime for the magnesium removal.

Simple Lime Treatment

If high calcium CH and low magnesium hardness is present, then a simple lime addition is sufficient for softening. This type of treatment would likely be used in single stage treatment only. The lime requirements for these criteria can be estimated from Equation 27 below. The amount of carbon dioxide required for final recarbonation of softened effluent can then be estimated from Equation 28 below. Note that if raw water HCO₃⁻ concentration exceeds the raw water Ca²⁺ concentration, Equation 28 results in over-estimating the required CO₂ for pH adjustment.

Equation 27. Stoichiometric Lime Requirements for Single Stage Treatment (MWH et al. 1610)

$$CaO = \left(\begin{array}{c} \text{carbonic} \\ \text{acid} \\ \text{concentration} \end{array} \right) + \left(\begin{array}{c} \text{calcium} \\ \text{carbonate} \\ \text{hardness} \end{array} \right)$$

Equation 28. Stoichiometric CO₂ Requirements for Single State Treatment (MWH et al. 1610)

$$CO_2 = \left(\begin{array}{c} \textit{estimated} \\ \textit{carbonate alkalinity} \\ \textit{of softened water} \end{array} \right) \\ = \left(\begin{array}{c} \textit{source} \\ \textit{water} \\ \textit{alkalinity} \end{array} \right) - \left(\begin{array}{c} \textit{source} \\ \textit{water calcium} \\ \textit{hardness} \end{array} \right) + \left(\begin{array}{c} \textit{estimated residual} \\ \textit{calcium hardness} \\ \textit{of softened water} \end{array} \right)$$

Excess Lime Treatment

Excess lime treatment must be used for magnesium precipitation and can be used either as a single or two stage treatment system. Lime requirements for this scenario are significantly higher than for precipitating calcium only, even if all hardness to be removed is in the form of CH. Estimations for CH removal using excess lime treatment can be made from Equation 29 below. Carbon dioxide requirements must be adjusted to compensate for the excess OH⁻ and CO₃²⁻ produced in softened water effluent. CO₂ requirements can be estimated from Equation 30 below.

Equation 29. Stoichiometric Lime Requirements for Excess Lime Treatment (MWH et al. 1610)

$$CaO = \left(\begin{array}{c} \textit{carbonic acid} \\ \textit{concentration} \end{array} \right) + \left(\begin{array}{c} \textit{total} \\ \textit{alkalinity} \end{array} \right) + \left(\begin{array}{c} \textit{magnesium} \\ \textit{hardness} \end{array} \right) + \left(\begin{array}{c} \textit{excess} \\ \textit{lime dose} \end{array} \right)$$

Equation 30. Stoichiometric CO₂ Requirements for Excess Lime Treatment (MWH et al. 1610)

$$CO_2 = \left(\begin{array}{c} \textit{source} \\ \textit{water} \\ \textit{alkalinity} \end{array} \right) - \left(\begin{array}{c} \textit{source} \\ \textit{water total} \\ \textit{hardness} \end{array} \right) - \left(\begin{array}{c} \textit{excess} \\ \textit{lime} \\ \textit{dose} \end{array} \right) + \left(\begin{array}{c} \textit{estimated residual} \\ \textit{calcium hardness} \\ \textit{of softened water} \end{array} \right) \\ + 2 \left(\begin{array}{c} \textit{excess} \\ \textit{lime} \\ \textit{dose} \end{array} \right) + \left(\begin{array}{c} \textit{estimated residual} \\ \textit{magnesium hardness} \\ \textit{of softened water} \end{array} \right)$$

Noncarbonate Hardness Removal

Lime with Na_2CO_3 Treatment

As with CH removal only, chemical dosage estimations are greatly simplified for NCH removal if influent waters contain high calcium and low magnesium hardness. For these criteria, single stage treatment is sufficient for all hardness removal. Lime feed can be estimated from the same equation as provided for lime only treatment with high calcium CH and low magnesium hardness (see Equation 27 above). Na_2CO_3 requirements can be estimated using Equation 31 below. Note that this equation indicates the addition of Na_2CO_3 equal to the total NCH. With the addition of Na_2CO_3 , carbon dioxide requirements for single stage treatment are different from the lime only treatment scenario above. The new carbon dioxide requirements can be estimated from Equation 32 below.

Equation 31. Stoichiometric Na_2CO_3 Requirements for Single Stage Treatment (MWH et al. 1610)

$$\text{Na}_2\text{CO}_3 = \left(\begin{array}{c} \text{calcium} \\ \text{noncarbonate} \\ \text{hardness} \end{array} \right) \text{ and/or } \left(\begin{array}{c} \text{magnesium} \\ \text{noncarbonate} \\ \text{hardness} \end{array} \right)$$

Equation 32. Stoichiometric CO_2 Requirements for Single Stage Treatment with Na_2CO_3 (MWH et al. 1610)

$$\text{CO}_2 = \left(\begin{array}{c} \text{source} \\ \text{water} \\ \text{alkalinity} \end{array} \right) + \left(\begin{array}{c} \text{soda} \\ \text{ash} \\ \text{dose} \end{array} \right) - \left(\begin{array}{c} \text{source} \\ \text{water calcium} \\ \text{hardness} \end{array} \right) + \left(\begin{array}{c} \text{estimated residual} \\ \text{calcium hardness} \\ \text{of softened water} \end{array} \right)$$

Excess Lime with Na_2CO_3 Treatment

Excess lime and Na_2CO_3 treatment should be used for waters with high calcium, high magnesium and high NCH. This type of treatment can be performed in a single or two stage treatment system. Lime requirements can be estimated from Equation 33 below. Na_2CO_3 requirements can be estimated from Equation 34 below.

Equation 33. Stoichiometric Lime Requirements for Excess Lime/ Na₂CO₃ Treatment (MWH et al. 1611)

$$CaO = \left(\begin{array}{c} \text{carbonic} \\ \text{acid} \\ \text{concentration} \end{array} \right) + \left(\begin{array}{c} \text{calcium} \\ \text{carbonate} \\ \text{hardness} \end{array} \right) + 2 \left(\begin{array}{c} \text{magnesium} \\ \text{carbonate} \\ \text{hardness} \end{array} \right) + \left(\begin{array}{c} \text{magnesium} \\ \text{noncarbonate} \\ \text{hardness} \end{array} \right) \\ + \left(\begin{array}{c} \text{excess} \\ \text{lime} \\ \text{requirements} \end{array} \right)$$

Equation 34. Stoichiometric Na₂CO₃ Requirements for Excess Lime/ Na₂CO₃ Treatment (MWH et al. 1611)

$$Na_2CO_3 = \left(\begin{array}{c} \text{calcium} \\ \text{noncarbonate} \\ \text{hardness} \end{array} \right) + \left(\begin{array}{c} \text{magnesium} \\ \text{noncarbonate} \\ \text{hardness} \end{array} \right)$$

Excess lime with Na₂CO₃ treatment can be performed in a single or two-stage treatment. In accommodation of this, soda ash addition and recarbonation can be performed in stage 1 or stage 2 of the treatment, or a combination of both locations. A different equation is required for CO₂ estimation, depending on the location of recarbonation. Equation 35 and Equation 36 below show the estimated values of required CO₂ for stage 1 and 2, respectively. Note that Equation 36 assumes intermediate recarbonation in stage 1 has occurred. Thus, Equation 36 may result in underestimating the amount of CO₂ required for final recarbonation, unless the value from Equation 35 is also considered.

Equation 35. Stoichiometric CO₂ Requirements for Stage 1 Excess Lime/ Na₂CO₃ Treatment (MWH et al. 1611)

$$CO_2 = \left(\begin{array}{c} \text{estimated} \\ \text{hydroxide alkalinity} \\ \text{of softened water} \end{array} \right) = \left(\begin{array}{c} \text{excess} \\ \text{lime} \\ \text{dose} \end{array} \right) + \left(\begin{array}{c} \text{estimated residual} \\ \text{magnesium hardness} \\ \text{of softened water} \end{array} \right)$$

Equation 36. Stoichiometric CO₂ Requirements for Stage 2 Excess Lime/ Na₂CO₃ Treatment (MWH et al. 1611)

$$CO_2 = \left(\begin{array}{c} \textit{estimated} \\ \textit{hydroxide alkalinity} \\ \textit{of softened water} \end{array} \right) \\ = \left(\begin{array}{c} \textit{source} \\ \textit{water} \\ \textit{alkalinity} \end{array} \right) + \left(\begin{array}{c} \textit{soda} \\ \textit{ash} \\ \textit{dose} \end{array} \right) - \left(\begin{array}{c} \textit{source} \\ \textit{water total} \\ \textit{hardness} \end{array} \right) + \left(\begin{array}{c} \textit{estimated residual} \\ \textit{hardness of} \\ \textit{softened water} \end{array} \right)$$

Problem Solutions Using the Stoichiometric Method

The literature often includes a bar graph or bar diagram as a visual aid to a problem solution. A typical bar diagram is shown in Figure 5 below. These bar diagrams are typically used to demonstrate influent and/or effluent water quality.

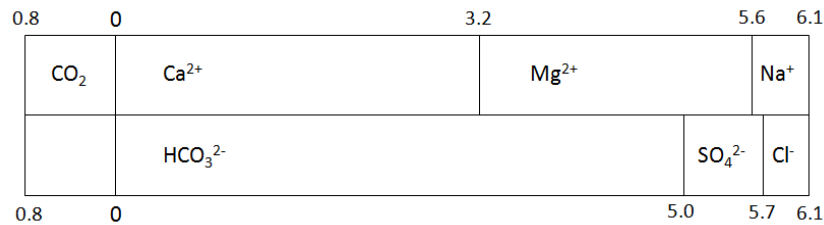

Figure 5. Typical Bar Diagram

Bar Graph Method

Gullicks' Bar Graph Method utilizes the approach of chemical stoichiometry for lime, Na₂CO₃ or NaOH, and CO₂ dosage estimation. The basic approach of this method is to utilize electroneutrality for ease of problem solving, chemical optimization, and error checking and to create a series of simple bar graphs for visualization of the problem.

In the Bar Graph Method, the first step in bar graph construction is to convert laboratory determined parameter concentrations to milliequivalents per liter, or meq/l (Gullicks 3). When performing these conversions, it is important to determine whether the laboratory has reported the various concentrations in terms of the parameter molecule or as calcium carbonate (CaCO₃) equivalent. Concentrations as meq/l can be obtained

using Table 2 below, by dividing the lab concentration, in mg/l, by the equivalent weight, in mg/meq. Note that calcium, magnesium, hydroxide, carbonate and bicarbonate all have multiple values given for equivalent weight; the first value for the ionic form equivalent weight and the second for equivalent weight as calcium carbonate (CaCO₃).

Table 2: Conversion Factors for Obtaining Concentrations in meq/l

Parameter	Lab Conc., mg/l	Equivalent Weight, mg/meq
Calcium (Ca ²⁺)	as calcium	20.04
	as CaCO ₃	50.04
Magnesium (Mg ²⁺)	as magnesium	12.16
	as CaCO ₃	50.04
Sodium (Na ⁺)	as sodium	22.99
Potassium (K ⁺)	as potassium	39.10
Iron (Fe ²⁺)	as iron	27.92
Manganese (Mn ²⁺)	as manganese	27.47
Free Carbon Dioxide (CO ₂) non-ionic	as CO ₂	22.00
Hydroxide (OH ⁻)	as OH ⁻	17.01
	as CaCO ₃	50.04
Carbonate (CO ₃ ²⁻)	as CO ₃ ²⁻	30.01
	as CaCO ₃	50.04
Bicarbonate (HCO ₃ ⁻)	as HCO ₃ ⁻	61.02
	as CaCO ₃	50.04
Sulfate (SO ₄ ²⁻)	as SO ₄ ²⁻	48.03
Chloride (Cl ⁻)	as Cl ⁻	35.45
Fluoride (F ⁻)	as F ⁻	19.00
Nitrate-N (NO ₃ ⁻ -N) or Nitrite-N (NO ₂ -N)	as N	14.00

All lab analyses contain a degree of error, sometimes significant. Since the bar graph method is based on electroneutrality of a solution, it is necessary to correct any error associated with the lab sample, distributing it proportionately into each constituent. The result of this type of correction is a perfectly electroneutral chemical analysis. However, these numerical error corrections should be performed discriminately. Percent difference in the chemical analysis should be calculated from Equation 37 below. The

value obtained can then be compared to values in Table 3 below, which shows the degree of acceptable error for any analysis. Re-analysis should be considered if errors exist in excess of those shown in this table.

Equation 37. Percentage Difference in Chemical Analysis (MWH et al. 42)

$$\text{Percent difference} = \frac{\Sigma \text{ cations} - \Sigma \text{ anions}}{\Sigma \text{ cations} + \Sigma \text{ anions}} \times 100$$

Table 3. Acceptable Error for Laboratory Samples (MWH et al. 43)

Σ anions, meq/L	Acceptable Difference
0-3.0	± 0.2 meq/L
3.0-10.0	$\pm 2\%$
10-800	$\pm 5\%$

Following error correction, the amount of required chemical feed may be obtained from one or two simple equations, depending upon the type of treatment used. For CH removal only, the general equation for lime, NaOH, or a combination of the two is shown in Equation 38 below.

Equation 38. Hydroxide Requirements for CH Removal Scenario (Gullicks 7)

$$\frac{\text{meq}}{l} \text{ of } OH^- \text{ Required} = \text{Free } CO_2 + HCO_3^- + Mg^{2+} \text{ CH portion only}$$

If NCH removal is desired, the general equation for lime, NaOH, or a combination of the two is shown in Equation 39 below.

Equation 39. Hydroxide Requirements for NCH Removal Scenario (Gullicks 7)

$$\begin{aligned} \frac{\text{meq}}{l} \text{ of } OH^- \text{ Required} \\ = \text{Free } CO_2 + HCO_3^- + Mg^{2+} \\ + \text{Excess } OH^- \text{ needed to achieve } Mg^{2+} \text{ goal} \end{aligned}$$

The major benefit of the Bar Graph Method (Gullicks) over the typical stoichiometric method is its ability to optimize chemical usage for NCH removal. Rather than requiring the removal of all NCH, the Bar Graph Method provides an empirical

relationship between desired final total hardness and magnesium hardness and chemical dosage, limiting the quantity of Na₂CO₃ or NaOH used. Equation 40 below shows the empirical relationship between finished water quality goals and required Na₂CO₃ for the single stage treatment scenario. Equation 41 below shows the relationship for two stage treatment and two stage with split treatment scenarios, when intermediate recarbonation is applied between stages 1 and 2.

Equation 40. Na₂CO₃ Requirements for Single Stage Treatment Scenario (Gullicks 10)

$$\begin{aligned} \frac{meq}{l} \text{ Soda Ash Required} &= NCH_i - NCH_f \\ &= NCH_i - (TH_f - CaCO_3 \text{ solubility} - Mg_f^{2+} \text{ goal} - Excess OH^-) \end{aligned}$$

where
NCH_i = noncarbonate hardness in the untreated source water
NCH_f = noncarbonate hardness of softening basin effluent
TH_f = final total hardness goal for the treated water

Equation 41. Na₂CO₃ Requirements for Two Stage and Split Treatment Scenarios (Gullicks 16)

$$\begin{aligned} \frac{meq}{l} \text{ Soda Ash Required} &= NCH_i - NCH_f \\ &= NCH_{raw\ water} - (TH_f - CaCO_3 \text{ solubility}) \end{aligned}$$

NaOH can replace Na₂CO₃ on a meq per meq basis for the purpose of NCH removal for the total flow for either single, two stage, or split treatment (Gullicks 7).

Estimated NaOH dosage used in single stage treatment is shown in Equation 42 below.

Note that this equation is the same as Equation 40 above. NaOH can be used in excess of this value, and could even replace all lime addition by using Equation 38 or Equation 39. However, Equation 42 allows for two benefits over that type of usage. First, it allows for NaOH to be used as a supplement to lime, providing for chemical cost savings. Second, it provides an empirical relationship between final hardness goals and required chemical addition. As stated previously, this relationship provides for a facility to push chemical

reactions to a user-defined point, rather than to completion of all chemical reactions which would achieve maximum hardness removal.

Equation 42. NaOH Requirements for Single Stage Treatment Scenario (Gullicks 12)

$$\frac{meq}{l} \text{ Caustic Soda Required} = NCH_i - NCH_f$$

$$= NCH_i - (TH_f - CaCO_3 \text{ solubility} - Mg_f^{2+} \text{ goal} - Excess OH^-)$$

Although Gullicks did not explicitly provide an equation for estimated NaOH dosage in lieu of Na₂CO₃ for two stage or split treatment, Equation 43 (identical to Equation 41 and also based on intermediate recarbonation between stage 1 and stage 2) can be used to calculate NaOH requirements for this treatment scenario since it has been established that NaOH can replace Na₂CO₃ on a meq per meq basis. Note, however that NaOH addition for two-stage and split treatment should occur in stage 1.

Equation 43. NaOH for Two Stage and Split Treatment Scenarios

$$\frac{meq}{l} \text{ Caustic Soda Required} = NCH_i - NCH_f = NCH_i - (TH_f - CaCO_3 \text{ solubility})$$

The Bar Graph Method uses the Modified Tillman Equation (Equation 44 below) to estimate free CO₂, or H₂CO₃* (MWH et al. 67) in solution. The value of K₁' varies with temperature (T) as shown in Table 4 below.

Equation 44. Estimation of Free CO₂ in mg/l

$$H_2CO_3^* = 0.88 \frac{[H^+][Alkalinity]}{K_1'}$$

where [H⁺] = moles of hydrogen ion
 [alkalinity] = total alkalinity in mg/l as CaCO₃
 K₁' = value estimated from Table 4 below

Table 4. K₁' Value for Various Temperatures

T (°C)	K ₁ '
0	2.61 x 10 ⁻⁷
10	3.34 x 10 ⁻⁷
20	4.05 x 10 ⁻⁷

Values from Table 4 have been plotted (Figure 6 below) and exhibit a linear correlation with an R^2 value of 0.9999. Therefore, for $0 \leq T \leq 20^\circ\text{C}$ an equation can be used to determine the exact value for K_1' . This empirical relationship is shown in Equation 45 below.

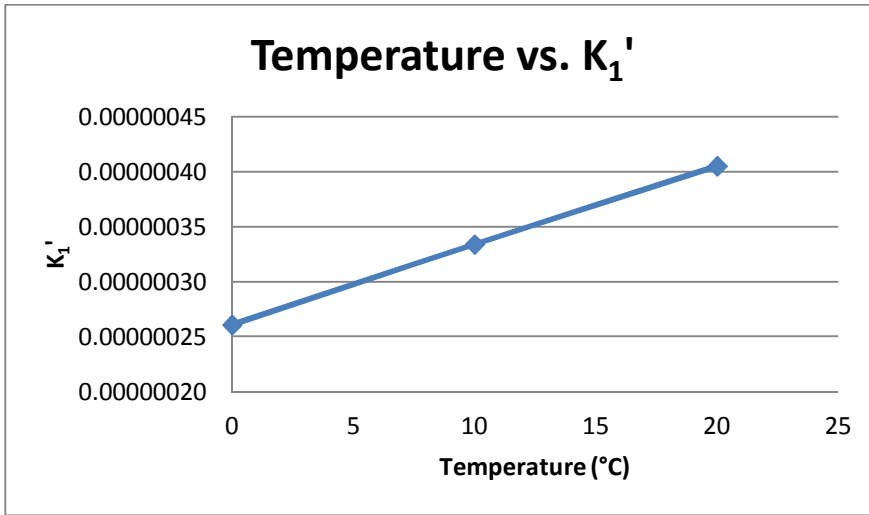

Figure 6. Variation of K_1' with Temperature

Equation 45. Empirical Relationship Between K_1' and Temperature

$$K_1' = (7.2 \times 10^{-9}) \times (\text{Temperature}, ^\circ\text{C}) + (2.6133 \times 10^{-7})$$

Method Modifications in this Work

Multiple terms from Equation 39 have been modified to a more general form, as reflected in Equation 46 below.

Equation 46. Modified Hydroxide Requirements for NCH Removal (Gullicks interview)

$$\begin{aligned} \frac{\text{meq}}{\text{l}} \text{ of } \text{OH}^- \text{ Required in Reactor 1 Influent Flow} \\ = \text{Free } \text{CO}_2 + (\text{Bicarbonate Hardness}) + \text{Mg}^{2+} \\ + (\text{Split Treatment Fraction of Alkalinity and } \text{CO}_2) \end{aligned}$$

where $(\text{Split treatment fraction of alkalinity}) = \frac{x}{(1-x)} (\text{CO}_2 + \text{HCO}_3^-)$

Modifications to Equation 39 are detailed as follows:

1. This modified equation shows lime added only for bicarbonate hardness, rather than for the total amount of bicarbonate present in solution. This change is made to account for the scenario where bicarbonate alkalinity may exceed total hardness.
2. The term “Split Treatment Fraction of Alkalinity” has been added. Bar Graph Method implied this relationship, as demonstrated in Example 4 (Gullicks 18). Thus, the term has been added to properly reflect the intentions of the author, and to make the general equation more versatile. (Gullicks interview)

When NaOH is used for two stage treatment, it is typically used in the first stage, as this achieves the best results. NaOH can replace Na₂CO₃ on a meq per meq basis for the purpose of NCH removal. However, if split treatment is used, NaOH feed concentration as expressed in terms of stage 1 flow must be increased to account for the untreated bypass flow. Gullicks did not provide an original equation for NaOH requirements for split treatment. Equation 43 for total flow still applies in this work for two stage treatment, but has been modified for the split treatment scenario to reflect a stage 1 dosage. This modification is shown in Equation 47 below. The issue has been corrected by dividing Equation 43 by (1 – X), where X is the fraction of flow bypassing stage 1 treatment.

Equation 47. Modified NaOH Requirements for Split Treatment Scenario (Gullicks interview)

$$\frac{meq}{l} \text{ Stage 1 Caustic Soda Required Dosage} = \frac{NCH_{raw\ water} - (TH_f - CaCO_3\ solubility)}{(1 - X)}$$

Chemical Purity

Softening chemicals may be obtained in many different forms. Most available chemicals contain some sort of impurity which varies depending on source and manufacturer. Whatever chemical dosage estimation method is used, the user must be aware of impurities and take these into account in their estimation. Estimation of typical chemical purity can be obtained from the manufacturer and is given as percent of active product, though actual purity of a given load may still vary. Estimations of chemical dosages can be accurately adjusted based on Table 5 below.

Table 5. Industrial Softening Chemicals Available (Gullicks 24)

Chemical	Molecular Formula	Typical Purity (%)	Equivalent Weight
Hydrated Lime	Ca(OH) ₂	98+	37.05
Quick Lime	CaO	88-95	28.04
Caustic Soda Liquid	NaOH	25-50	39.99
Caustic Soda Pellets	NaOH	100	39.99
Soda Ash	Na ₂ CO ₃	98+	52.99
Carbon Dioxide	CO ₂	100	22.00

CHAPTER III

RESULTS: MICROSOFT EXCEL SPREADSHEET

Spreadsheet Outline

The spreadsheet has three basic components that allow it to perform a mathematical analysis. These are mathematical equations, logical equations, and Microsoft Excel Visual Basic (VB). These components work in conjunction to accept user inputs, determine appropriate application of those inputs, and perform the necessary calculations to produce reliable output in terms of required chemical feed and predicted effluent water quality. Numerous checks and analyses are included in the steps to ensure proper analysis. The data input and analysis process does not move directly from one component of the spreadsheet to another. Rather, data is shared between the worksheet and visual basic for coordinated analysis. The flowchart for this process can be seen in Figure 7 (following page).

The inter-relationship of the various components of the spreadsheet creates a complex dynamic that can be difficult to handle. Manual control over certain of these elements in the spreadsheet could result in faulty analysis or in the lack of proper checks throughout the process of a given analysis. Therefore, the spreadsheet has been created to eliminate user control over the actual running of the program while still allowing the user to maintain full control over the all treatment inputs. Various aspects of user control over the spreadsheet are detailed in Figure 7.

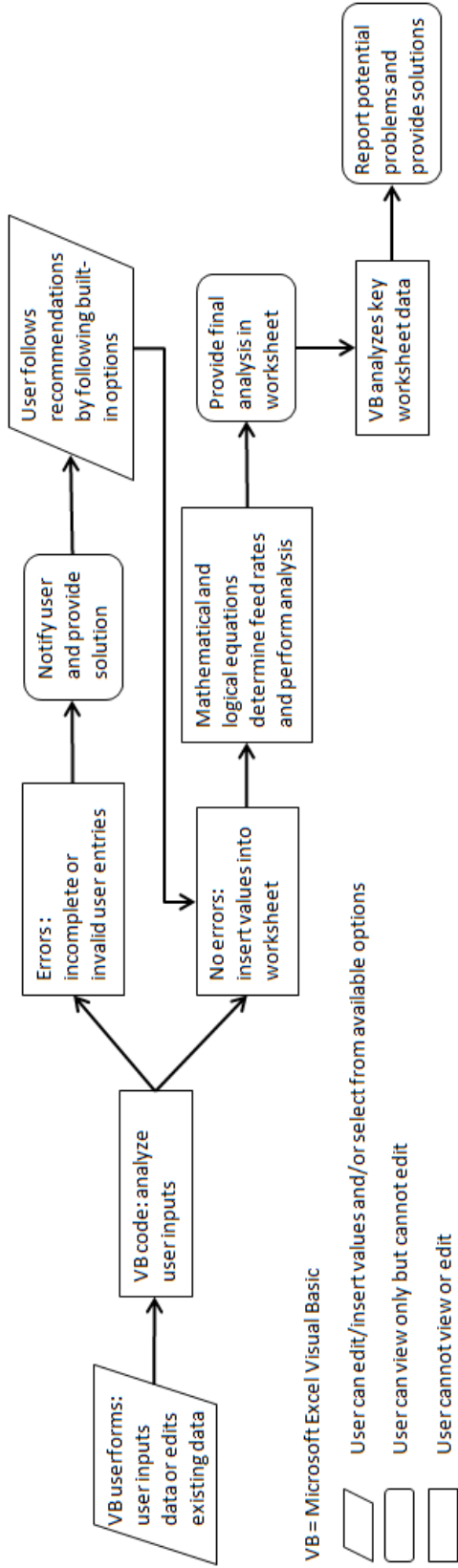

Figure 7. Spreadsheet Flowchart

The spreadsheet has four steps which must be completed in order to run an analysis for determining chemical feed. Each of the four steps is completed in a Microsoft Excel userform. Each userform has been designed to require as little information as possible in order to make each step easier and more intuitive, while still requiring sufficient information for analysis. The four steps are detailed in following paragraphs.

Step 1: Parameters

This step requires two types of data: simple water data including influent pH (pH_i) and influent temperature (T_i, °C), treatment scenario type (single stage, etc.) and final hardness goals (Mg²⁺ and TH), as shown in Figure 8 below. In this step, all values for final magnesium or total hardness are expressed as CaCO₃. Final total hardness goal can be defined from 50 to 150 mg/l in increments of 10 mg/l, as well as a few other significant options shown in Table 6 below. It is recommended that total hardness and magnesium be kept below 150 and 40 mg/l respectively (Viessman et al. 407). Thus, these values have been chosen as the maximum values for user defined hardness. The value for recommended final total hardness has been provided slightly below this (135 mg/l or 2.7 meq/l) for practical purposes. Two options have been provided for the final magnesium hardness goal. A final magnesium hardness of 40 mg/l is typical for desired final magnesium hardness, and is therefore used as the recommended final magnesium hardness goal in this spreadsheet. A magnesium hardness goal of 8 mg/l (0.16 meq/l) has been provided as the lowest practical solubility limit of magnesium.

Figure 8. Userform for Entering Treatment Parameters

Table 6. Significance of Various Final Total Hardness Goals (Gullicks interview)

TH Goal (mg/l as CaCO ₃)	TH Goal (meq/l)	Significance
150	3	Maximum desired TH
135	2.7	Recommended practical TH goal
75	1.5	Minimum Ca ²⁺ goal (0.7 meq/l) plus practical Mg ²⁺ goal (0.8 meq/l)
43	0.86	Lowest possible TH goal Minimum Ca ²⁺ goal (0.7 meq/l) plus minimum Mg ²⁺ goal (0.16 meq/l)

Step 2: Concentration Form

As mentioned previously, hardness and alkalinity can be expressed either as their respective ionic species or as CaCO₃. Since lab analyses can report these values in either form, the spreadsheet allows a user to define whether their lab provided values are expressed in terms of ionic species or CaCO₃ (Figure 9 below). The option chosen by the user determines which conversion factors (in meq/mg from Table 2) will be used. It is

important that the user know the form in which their lab values have been reported as an incorrect choice in this step will lead to an incorrect analysis.

Step 2: Concentration

Select method of entering constituent concentrations

Enter concentrations as ions

Enter concentrations as alkalinity and hardness as Calcium Carbonate

Previous Finish Next

Figure 9. Userform for Entering Form of Hardness and Alkalinity

Step 3: Lab Concentrations

Figure 10 below is the main form for data entry. This is where all water constituent concentration data are entered. This step does not require all text boxes to be used in order to run an analysis. However, all major constituents in the water being treated should be entered in this form in order to perform an accurate analysis.

Step 3: Concentrations

Enter concentrations in mg/L

Calcium	140	Carbonate	0
Magnesium	115	Bicarbonate	231
Sodium	84	Sulfate	150
Potassium	0	Chloride	25
Iron	0	Fluoride	0
Manganese	0	Nitrate	0

Previous Clear Form Finish Next

Figure 10. Userform for Entering Concentration Data

Step 4: Final Recarbonation and Final Report Format

Desired final pH can be input into the spreadsheet in Step 4 (Figure 11 below). Desired final pH is the value that drives the amount of CO₂ used in final recarbonation. Below a pH of 8.3, essentially all alkalinity will be in the form of HCO₃⁻. A pH higher than that is acceptable as it will still convert most alkalinity to the desired form and will result in a lower treatment cost. MWH et al. recommend a pH_f (desired final pH of treated effluent) between 8.4 and 8.6 (1598).

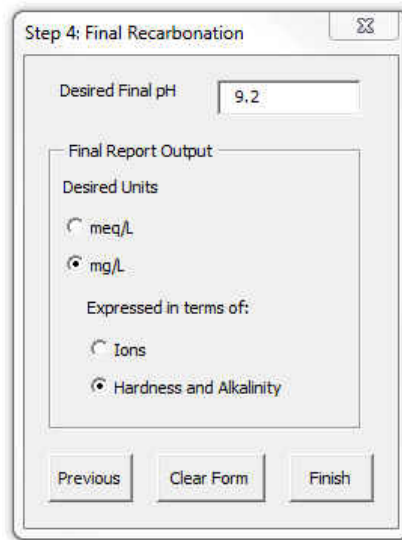

Figure 11. Userform for Entering Desired Final pH and Units for Output Report

Step 4 also allows the user to select desired format for the final analysis. Final analysis is shown in the worksheet and shows water chemistry of important stages of the treatment process including influent, theoretical intermediate chemistry, effluent, and additional stages as appropriate. In the userform shown in Figure 11, the user can select to report this summary analysis in terms of meq/l, mg/l in ionic form, or mg/l as CaCO₃.

Challenges

The goal of the project is to create a spreadsheet that universally applies to all water softening problems involving lime, Na₂CO₃, NaOH, or any combination of the

three. However, designing the spreadsheet to take every possible scenario into account is a great challenge. Water chemistry can vary drastically in many ways including total dissolved solids (TDS), total hardness, magnesium hardness, alkalinity, pH, temperature, etc. Treatment of choice (single stage with lime, two stage with lime and Na_2CO_3 , etc.) can vary significantly to accommodate specialized purposes of the treated water and/or changes in individual water source chemistry. Since the spreadsheet is designed to remove all user control over the actual mathematical operations, it must also be designed to properly handle any and all scenarios given only the user inputs that have been enabled in the spreadsheet.

In summary, the spreadsheet must be able to appropriately handle water treatment train, any combination of softening chemicals, and any water chemistry. In doing so, it must be able to analyze the given water chemistry information, comparing it to user-defined treatment choices. In this process, a number of potential issues arise.

Incomplete Data

It is important that all userforms be entered completely before the spreadsheet will run any analyses on the water. In step 1, there are a number of sub-options provided for the various main options. Unless all sub-options have been completed, an error message such as that in Figure 12 below will appear when the user clicks “Finish.”

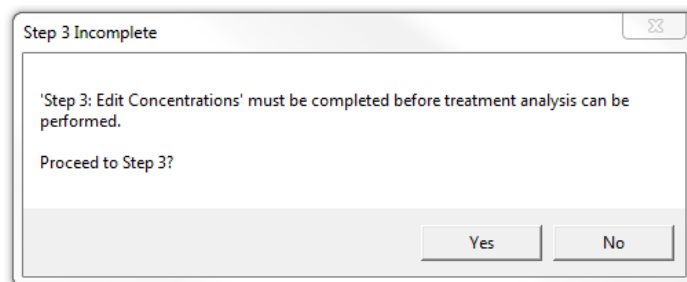

Figure 12. Error Message for Incomplete Userform

The hierarchy for all combinations of user selected treatment options for single stage treatment is shown in Figure 13 Figure 13. Single Stage Treatment Options Flowchart. Using Figure 13 as a reference, the user must complete options from the beginning of flowchart up to any of the “Finished” boxes or analysis will not be performed in the spreadsheet. Similarly, Figure 14 Figure 14. Two Stage Treatment Options provides the hierarchy for all available combinations of user defined treatment choices for two stage treatment that must be completed.

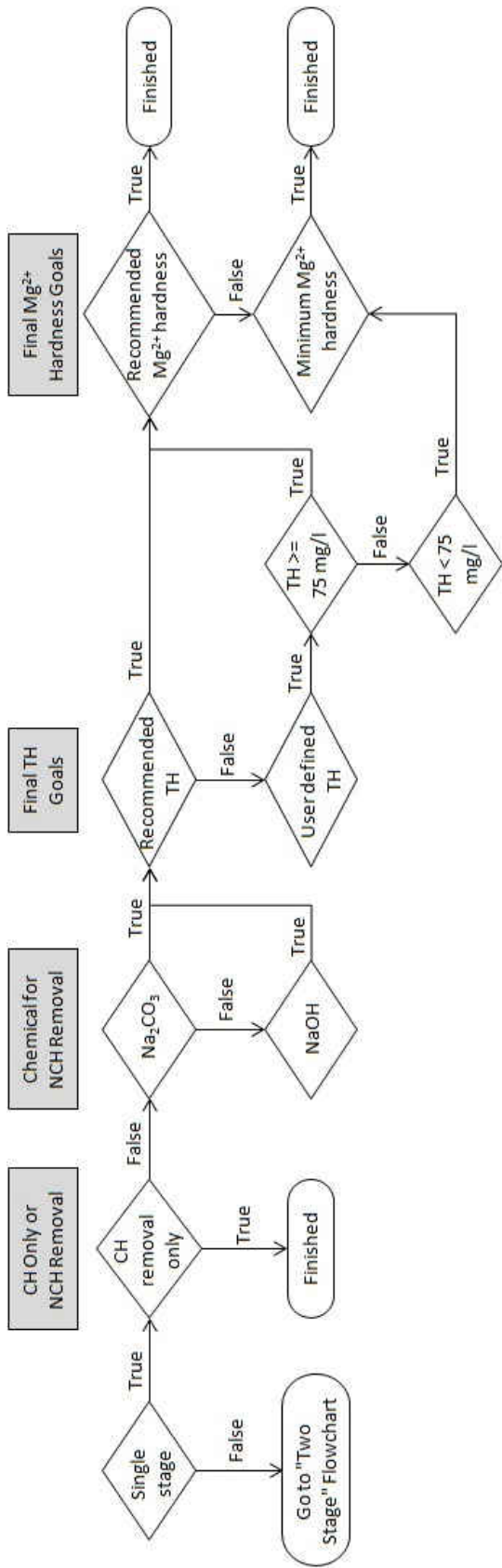

Figure 13. Single Stage Treatment Options Flowchart

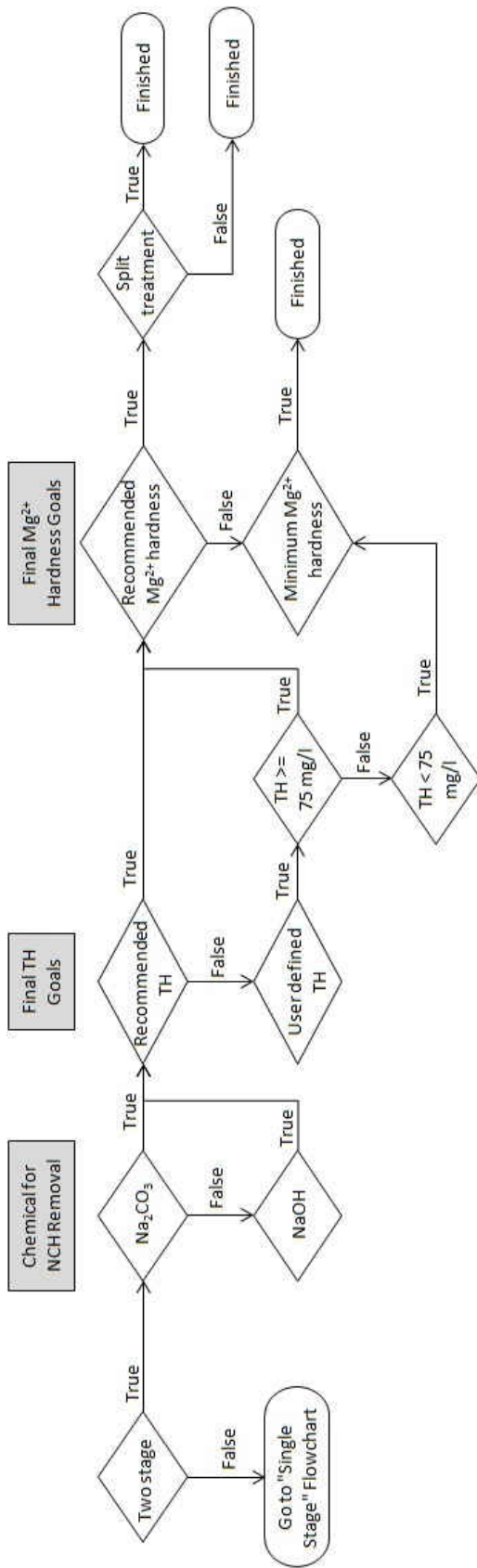

Figure 14. Two Stage Treatment Options

It is possible to estimate chemical softening feed based only on hardness and alkalinity concentrations with the provided Bar Graph Method equations, but is not recommended. Since the method is based on electroneutrality, the first step in performing analysis is error correction. The spreadsheet will always perform error correction, however extreme it may be. Most waters contain at least seven elements of significance. Therefore, these seven elements have been required prior to analysis. If these values are not included, the error message shown in Figure 15 below will appear.

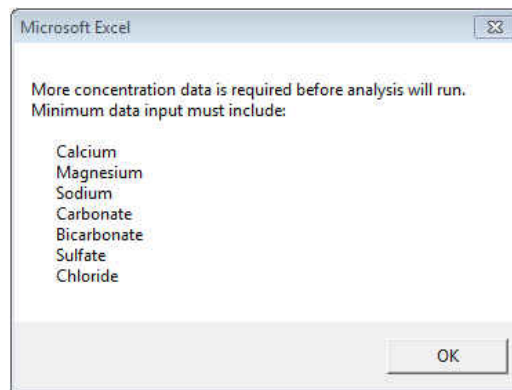

Figure 15. Minimum Required Concentration Data Error Message

The spreadsheet requires values for the seven elements shown in Figure 15 to bring the initial concentration data as close as possible to electroneutrality as this increases the accuracy of the Bar Graph Method. The program will run given only these seven elements as inputs. However, if other elements exist in significant quantities for some water, concentrations of these elements should be input into the program to improve accuracy in terms of electroneutrality. Thus, user discretion should be used for identifying additional elements of significance for data entry.

Inaccurate Data

As previously noted, all lab analyses contain errors which must be corrected prior to performing the Bar Graph Method. Error in concentration data may result from three

causes: incorrect data entry, incorrect selection of reported form of hardness and alkalinity, and/or poor lab analysis. Regardless of the source of error, the spreadsheet will perform a check on the percent error of a sample. This value is then compared to those in Table 3 to determine acceptability of the source error. If the percent difference in solution exceeds values in Table 3, an error message will appear (Figure 16 below), recommending new lab analysis.

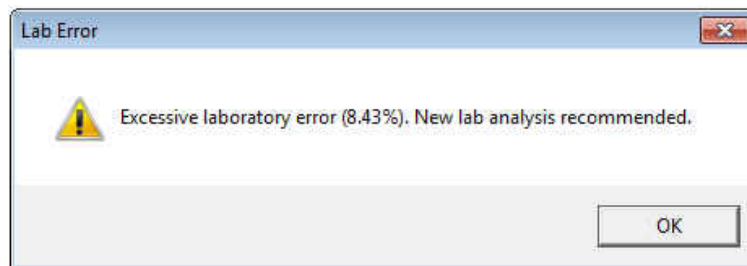

Figure 16. Inaccurate Concentration Data Error Message

Any cation/anion percent difference exceeding 10% will result in another error message, this time stating that new lab analysis is required. Error messages are provided for the users' benefit so that they may be aware of potential inaccuracy of the spreadsheet analysis. However, the spreadsheet will continue to run an analysis even in the presence of electroneutrality errors. Clearly, the closer the chemical analysis is to 100% accurate, the more beneficial the spreadsheet is in terms of efficiency. Therefore, the user should be advised to take special note of these errors. If extreme errors occur (>30%), a likely cause is incorrect selection of the form of the given concentration data in Step 2.

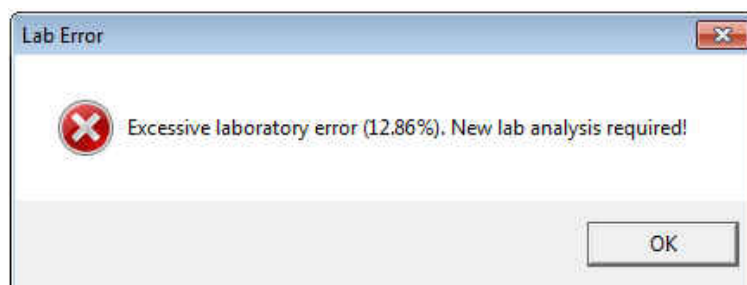

Figure 17. Excessively Inaccurate Concentration Data Error Message

Invalid Data

In computer models, inaccurate data entry is always a potential issue. While some errors are difficult or impossible to detect in a computer model (eg. entering “15” instead of “18”), other errors can be easily identified as being outside of their normal ranges (eg. entering “180” instead of “18”). For this reason, the spreadsheet has been designed to accept values within certain pre-defined ranges for several parameters. All values including pH, temp, and concentration data must be entered as positive values or the user will be given an error message such as Figure 18 below.

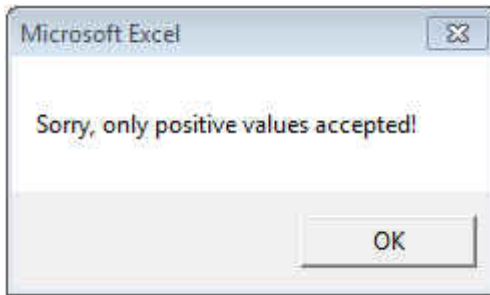

Figure 18. Error Message for Negative Values in Userform

Other values which can be entered by the user include pH_i , T_i , and pH_f . The ranges of acceptable values for these parameters are shown in Table 7 below. The values shown in this table have been chosen to accommodate potential high or low extreme values that could occur in any treatment scenario.

Table 7. Acceptable Value Ranges for Selected Parameters (Gullicks interview)

	Min.	Max.
pH_i	5	9.5
T_i , °C	>0	30
pH_f	7	9.5

Other Practical Considerations

Several options from Figure 13 and Figure 14 are noteworthy. If a total hardness below 75 mg/l is desired, magnesium hardness must be precipitated below 40 mg/l (see

Table 6 above). Thus, if this option is chosen, VB automatically selects “Minimum Mg hardness” as the final magnesium hardness goal.

CH removal only is not available for two stage treatment for practical reasons, as previously mentioned. Note that an extra option (Split Treatment) is available for two stage treatment that is not available for single stage treatment. This option can only be selected in conjunction with recommended magnesium hardness goals, and not with minimum magnesium hardness goals, for practical reasons. “Mg Hardness (minimum)” is to achieve Mg^{2+} solubility in final treated effluent. Split treatment, on the other hand, works by achieving Mg^{2+} solubility levels in the first reactor and blending this with untreated water to achieve recommended Mg^{2+} hardness goals.

Thus far, all problems that have been discussed have been related to data and options during the data input part of the program. However, there are several potential issues involving treatment scenario and influent water chemistry that are detected during and after chemical analysis. As mentioned previously, data is shared between the excel worksheet and VB. Immediately after the spreadsheet validates data and performs the treatment analysis, VB performs a series of checks to determine if any special cases apply. These checks are designed to do two things: determine if the desired effluent can be achieved with the selected treatment methods, and/or determine if there is a more efficient method of achieving these same results. An explanation of each of the special cases is detailed below.

Case 1: Single Stage, Caustic Soda, High Hardness with Low Alkalinity

In this treatment scenario, both lime and caustic soda are added in a single reactor for hardness precipitation. This situation can be problematic if influent alkalinity is

significantly lower than influent hardness. In this scenario, available CO_3^- (influent concentration plus converted HCO_3^-) precipitates as CaCO_3 , and remaining OH^- added from lime and caustic soda remains in solution as excess OH^- . Hence, CaCO_3 levels are not precipitated to the desired levels and the resultant effluent may be high in both hardness and alkalinity. Assuming influent water quality cannot be adjusted, the problem can be solved in at least two different ways simply by changing the treatment method.

In the event of the above-mentioned, the program provides options shown in Figure 19 below. The first option (treating with Na_2CO_3) works by providing enough CO_3 to precipitate CaCO_3 to desired levels in the absence of influent alkalinity. The second option (treating in two stages) allows intermediate recarbonation (CO_2 addition) to convert high OH^- levels to CO_3^- , allowing for CaCO_3 precipitation in a second reactor.

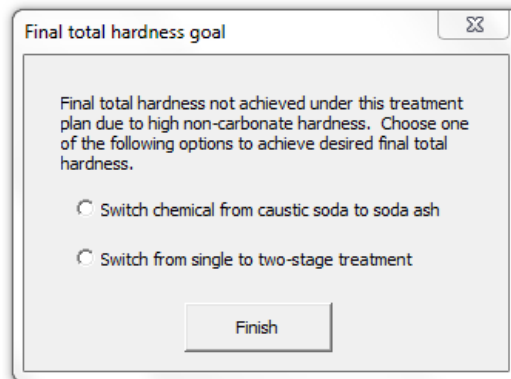

Figure 19. Final Hardness Goal not met Due to Treatment Methods

Case 2: Only CH Present in Influent Water

If only CH is present in influent water, final Mg^{2+} and Ca^{2+} concentrations will be difficult to predict due to unconverted HCO_3^- present throughout the treatment process. Final TH can be predicted, but final Mg^{2+} and Ca^{2+} will vary depending on the source waters. In this scenario, VB will display the notification shown in Figure 20 below.

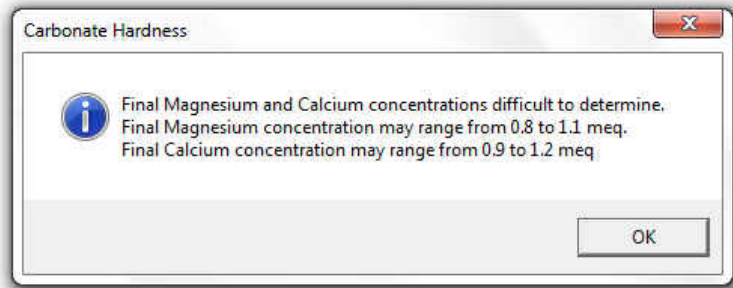

Figure 20. Alkalinity Greater than TH

High alkalinity and lower hardness water can also result in low efficiency. Single stage treatment is the most efficient softening method for CH removal only, with additional stages acting only as holding basins and resulting in additional energy consumption. If it is determined that only CH is present and two stage treatment has been selected, VB will automatically change the treatment type to single stage treatment and display the notification shown in Figure 21 below.

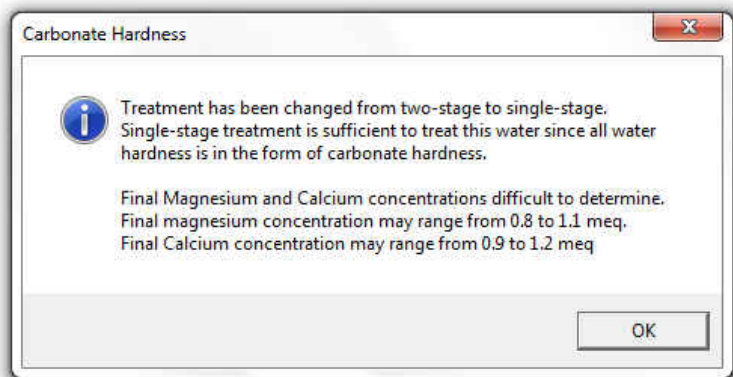

Figure 21. Two Stage Treatment, Alkalinity Greater than TH

Case 3: Two Stage, Low Hardness with High Alkalinity

A special condition of Case 2 is when influent total alkalinity is significantly greater than influent total hardness. Lime softening can remove some excessive alkalinity as CaCO_3 or even $\text{Mg}(\text{OH})_2$. However, this may result in no change to, or even an increase in TH. Therefore, lime softening is considered a poor solution for treating

this type of water and other treatment options should be considered. If VB detects that this scenario is true, it will display the notification shown in Figure 22 below.

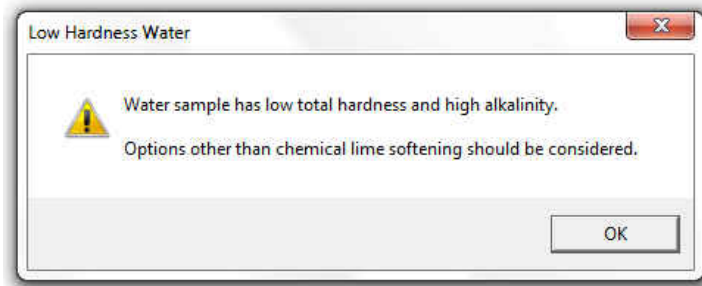

Figure 22. Alkalinity Significantly Greater than Total Hardness

Summary of Spreadsheet

In short, the spreadsheet is an efficient, functioning model. It not only applies criteria to perform analysis on a given water sample, but also analyzes the applicability and efficiency of the selected treatment type, informs users of potential problems and inefficiencies, and whenever possible provides solutions to make the softening system more efficient.

CHAPTER IV
EXAMPLE PROBLEMS

Input Data

This chapter will address solutions to specific water softening problem scenarios for a given water quality that will be provided. As discussed, numerous methods exist for estimating chemical dosage for water softening. However, the literature shows that the stoichiometric method is a common, readily accepted solution. Therefore, the stoichiometric method and the Bar Graph Method will be the two methods used to estimate chemical feed and final water quality, and compare solutions. Since the stoichiometric method has been well accepted in the literature, it can also be used as a metric for determining the relative accuracy and/or acceptability of the Bar Graph Method.

For comparison of the two solution methods and of the various treatment scenarios, the same water quality data will be used for all examples. This water quality data is shown in Table 8 below. Following, four example problems will be solved that best demonstrate the applicability of the Bar Graph Method Spreadsheet.

Table 8. Input Parameter Data for Example Problems

Parameter	Value
pH, units	7.3
Total Dissolved Solids, mg/L	1300
Total Hardness, mg/L as CaCO ₃	717
Calcium, mg/L as CaCO ₃	418
Magnesium, mg/L as CaCO ₃	298
Iron, mg/L	3

Table 8. Cont.

Manganese, mg/L	0.3
Sodium, mg/L	62
Alkalinity, mg/L as CaCO ₃	357
Sulfate, mg/L	457
Chloride, mg/L	21.7

Assumptions for Problem Solutions

Typically, little to no manual data manipulation or hand calculations are required prior to inputting data directly into the spreadsheet. A minor calculation that is often required is the calculation of magnesium hardness in solution. As stated previously, the expression of TH is assumed to be equal only to the sum of Ca²⁺ plus Mg²⁺. Since TH and Ca²⁺ are customarily reported in water quality analyses, Mg²⁺ may be easily calculated as TH – Ca²⁺. Thus, using Table 8 data, Mg²⁺ is calculated as:

$$Mg^{2+} = (717 - 418) \frac{mg}{l} = 299 \frac{mg}{l} \text{ as } CaCO_3.$$

This value is essentially the same as that given in Table 8. Therefore, the assumption that TH is equal to Ca²⁺ plus Mg²⁺ is shown to be reliable.

Prior to solving example problems using Table 8 data, another assumption is required. Typically, temperature is a parameter that can be easily obtained for any given water. However, in the report from which this data was taken, temperature was not provided. The water source is well water which does not vary significantly due to the depth of its source (i.e. groundwater). For example problems to follow, temperature will be assumed to be 10 °C.

An additional item that is noteworthy is the source of alkalinity in this report. Alkalinity is only reported as “total alkalinity” with no additional data regarding phthalein or phenolphthalein alkalinity. However, at a pH of 7.3, it can be determined

that essentially all alkalinity is present in the form of HCO_3^- . (See Figure 34 and Figure 35 in Appendix A.) This principle is in agreement with the literature which states that CO_3^{2-} will not be present in natural waters (Fetter 357).

Program pre-calculations

Calculations to follow are all performed by the spreadsheet and do not represent hand calculations for the user. These details and calculations are shown merely to demonstrate the calculations performed by the spreadsheet.

Calculate CO_2

Free CO_2 is estimated using Equation 44. First, the molar concentration of hydrogen ions is calculated from pH, then K_1' is calculated from influent temperature data. CO_2 is then calculated using these values together with total alkalinity.

$$[H^+] = \frac{1}{10^{pH}} = \frac{1}{10^{7.3}} = 5.011872 \times 10^{-8} \text{ mol}$$

$$K_1' = (7.2 \times 10^{-9}) \times (10 \text{ }^\circ\text{C}) + (2.613\bar{3} \times 10^{-7}) = 3.333333 \times 10^{-7}$$

$$CO_2 = 0.88 \times \frac{(5.011872 \times 10^{-8}) \times \left(7.1059 \frac{\text{meq}}{\text{l}} \times 50.04 \frac{\text{mg}}{\text{l}}\right)}{3.333333 \times 10^{-7}}$$

$$= \left(47.0479 \frac{\text{mg}}{\text{l}}\right) \div \left(22.00 \frac{\text{mg}}{\text{meq}}\right) = 2.1385 \text{ meq/l}$$

Convert Concentrations from mg/l to meq/l

After all required data have been entered into the spreadsheet userforms, the spreadsheet automatically corrects all differences in electroneutrality, making the values such that they represent a perfectly electroneutral solution. For demonstration purposes, the spreadsheet displays a table showing original entered values (in mg/l), values after conversion to meq/l, and meq/l values that have been corrected for error. For Table 8

data, these values are shown in Table 9 below. (See Appendix B for sample calculations of error correction.)

Table 9. Spreadsheet Concentrations with Error Correction

Cation Concentrations				Anion Concentrations			
	mg/L	meq/l	meq/L Error Adjusted		mg/L	meq/L	meq/L Error Adjusted
Ca ²⁺	418	8.3533	8.3869	CO ₃ ²⁻	0	0.0000	0.0000
Mg ²⁺	298	5.9552	5.9792	HCO ₃ ⁻	357	7.1343	7.1059
Na ⁺	62	2.6968	2.7077	SO ₄ ²⁻	457	9.5149	9.4770
K ⁺	0	0.0000	0.0000	Cl ⁻	21.7	0.6121	0.6097
Fe ²⁺	3	0.1074	0.1079	F ⁻	0	0.0000	0.0000
Mn ²⁺	.3	0.0109	0.0110	NO ₃ ⁻ N	0	0.0000	0.0000
	Σ Cations	17.1237	17.1925		Σ Anions	17.2613	17.1925

Calculate Cation/Anion Percent Difference

After all values have been entered and the analysis has been performed, the worksheet calculates the cation/anion percent difference which is then analyzed by VB to determine acceptability of the lab analysis. (See Figure 7 Figure 7. Spreadsheet Flowchart.) For the given chemical analysis, the calculation of percent difference is shown below. Since this value is well within the acceptable ±5% shown in Table 3, the laboratory chemical analysis is shown to be accurate and VB does not display any type of warning.

$$\text{Percent difference} = \frac{17.1237 - 17.2613}{17.1237 + 17.2613} \times 100 = -0.40\%$$

Create Bar Graph

Based on the information and calculations given above, the spreadsheet creates a series of bar graphs. The first stage of the bar graph is shown in Figure 23 below, with an explanation of the different elements shown.

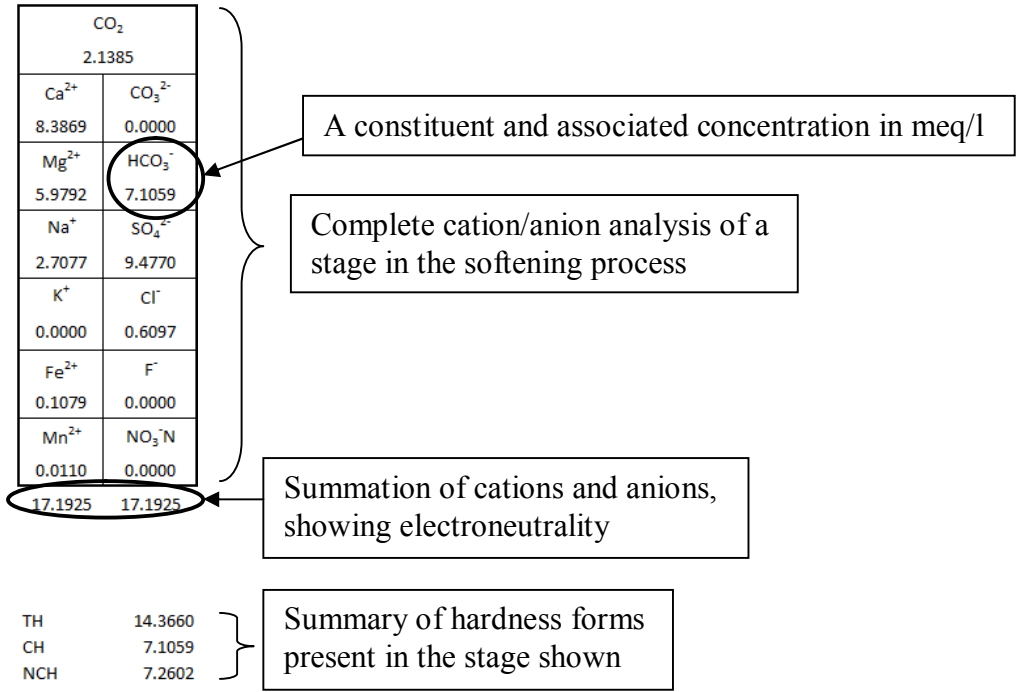

Figure 23. Influent Bar Graph with Explanation of Bar Graph Elements

Sample Problems

The operations in previous paragraphs remain the same for all treatment types chosen. Thus, these calculations only need be performed once for example problems to follow. Example problems will use values in Table 8 to demonstrate four different treatment types. Note that values may vary slightly between those calculated in the spreadsheet and those calculated in this work due to rounding.

For uniformity of comparison, excess lime requirements and solubility levels for the stoichiometric method are assumed to be the same as for the Bar Graph Method.

Example 1: Single Stage with CH Removal Only

Bar Graph Method Solution

Removal of only CH can be accomplished in one stage by using a single reactor or multiple reactors in parallel. It is accomplished with the addition of lime only which is

determined from a simple calculation using Equation 38. In this application, lime addition is equal to the sum of CO_2 and HCO_3^- (see below)

$$\begin{aligned} \frac{\text{meq}}{\text{l}} \text{ of } \text{OH}^- \text{ Required} &= \text{Free } \text{CO}_2 + \text{HCO}_3^- + \text{Mg}^{2+} \text{ CH portion only} \\ &= 2.1385 + 7.1059 = 9.2444 \end{aligned}$$

Lime addition beyond this point results only in trading of Ca^{2+} ions for Mg^{2+} ions. This may be desired in some applications in order to reach a specific final Mg^{2+} goal, but for this solution it is assumed that there is no such goal.

Ca^{2+}	CO_3^{2-}
17.6313	16.3503
Mg^{2+}	HCO_3^-
5.9792	0.0000
Na^+	OH^-
2.7077	0.0000
K^+	SO_4^{2-}
0.0000	9.4770
Fe^{2+}	Cl^-
0.1079	0.6097
Mn^{2+}	F^-
0.0110	0.0000
	$\text{NO}_3^- \text{N}$
	0.0000
26.4369	26.4369
TH	23.6104
CH	16.3503
NCH	7.2602

Figure 24. Intermediate Bar Graph

Elements in the intermediate bar graph in Figure 24 are calculated as follows:

$$\begin{aligned} (\text{Intermediate } \text{Ca}^{2+}) &= (\text{Influent } \text{Ca}^{2+}) + \text{Ca}(\text{OH})_2 = 8.3869 + 9.2444 \\ &= 17.6313 \text{ meq/l} \end{aligned}$$

$$\begin{aligned} (\text{Intermediate } \text{CO}_3^{2-}) &= (\text{Influent } \text{CO}_3^{2-}) + (\text{Free } \text{CO}_2) + 2 \times (\text{Influent } \text{HCO}_3^-) \\ &= 0 + 2.1385 + 2 \times 7.1059 = 16.3503 \text{ meq/l} \end{aligned}$$

All HCO_3^- is converted to CO_3^{2-} by the lime addition. All other cations and anions in the intermediate bar graph remain unchanged by the chemical addition.

In this example, all hardness is in the form of CH. Furthermore, all CH can be removed simply as CaCO₃, precipitating CaCO₃ to the solubility level and leaving Mg²⁺ hardness in solution. In this example, CO₃²⁻ concentration is the limiting factor since there is less CO₃²⁻ than Ca²⁺ in solution. Thus, CaCO₃ precipitation is calculated as:

$$\begin{aligned} (\text{CaCO}_3 \text{ precipitation}) &= (\text{Intermediate CO}_3^{2-}) - (\text{CO}_3^{2-} \text{ solubility}) \\ &= 16.3503 - 0.7000 = 15.6503 \end{aligned}$$

The reactor 1 effluent bar graph (Figure 25 below), shows the effluent from the softening reactor where CaCO₃ has been precipitated to solubility where:

$$\begin{aligned} (\text{Effluent Ca}^{2+}) &= (\text{Intermediate Ca}^{2+}) - \text{CaCO}_3 = 17.6313 - 15.6503 \\ &= 1.9810 \text{ meq/l} \end{aligned}$$

$$\begin{aligned} (\text{Effluent CO}_3^{2-}) &= (\text{Intermediate CO}_3^{2-}) - \text{CaCO}_3 = 16.3503 - 15.6503 \\ &= 0.7000 \text{ meq/l} \end{aligned}$$

Ca ²⁺	CO ₃ ²⁻
1.9810	0.7000
Mg ²⁺	HCO ₃ ⁻
5.9792	0.0000
Na ⁺	OH ⁻
2.7077	0.0000
K ⁺	SO ₄ ²⁻
0.0000	9.4770
Fe ²⁺	Cl ⁻
0.1079	0.6097
Mn ²⁺	F ⁻
0.0110	0.0000
	NO ₃ -N
	0.0000
10.7867	10.7867
TH	7.9602
CH	0.7000
NCH	7.2602

Figure 25. Reactor 1 Effluent Bar Graph

Final recarbonation is required to convert reactor 1 effluent carbonate alkalinity to bicarbonate alkalinity. Following with the recommendation by MWH et al., assume a

pH_f of 8.5. Since final alkalinity from reactor 1 effluent is known, and a value has been assumed for pH_f, CO₂ is calculated as follows:

$$\begin{aligned} \frac{(\text{Desired Final } CO_3^{2-})}{(\text{Desired Final } HCO_3^-)} &= \frac{C}{B} = e^{(pH_f - 9.9740597)/0.452269} \\ &= e^{(8.5 - 9.9740597)/0.452269} = 0.038417 \end{aligned}$$

$$\begin{aligned} (\text{Desired Final } CO_3^{2-}) &= \frac{(\text{Reactor 1 Total Effluent Alkalinity})}{1 + \frac{1}{C/B}} \\ &= \frac{0.7000}{1 + \frac{1}{0.038417}} = 0.0259 \text{ meq/l} \end{aligned}$$

$$\begin{aligned} (\text{Desired Final } HCO_3^-) &= (\text{Reactor 1 } CO_3^{2-} \text{ Effluent}) - (\text{Desired Final } CO_3^{2-}) \\ &= 0.7000 - 0.0259 = 0.6741 \text{ meq/l} \end{aligned}$$

CO₃²⁻ fraction of alkalinity is found to be 3.7% (see calculation below). For the final pH given, this value is in agreement with Figure 36, Appendix A.

$$\begin{aligned} (\text{CO}_3^{2-} \text{ fraction of alkalinity}) &= \frac{CO_3^{2-}}{(\text{total alkalinity})} \times (100) \\ &= \frac{0.0259}{0.7000} \times (100) = 3.7\% \end{aligned}$$

There is no excess OH⁻ in the reactor 1 effluent. Thus, from Equation 19, the amount of CO₂ required for final recarbonation (in meq/l) is equal to the amount of CO₃²⁻ that needs to be converted to HCO₃⁻ (see Figure 26 below). The series of bar graphs for single stage from influent to post final recarbonation, for CH removal only is shown in Figure 26.

CO ₂ 2.1385										
Ca ²⁺	CO ₃ ²⁻		Ca ²⁺	CO ₃ ²⁻		Ca ²⁺	CO ₃ ²⁻		Ca ²⁺	CO ₃ ²⁻
8.3869	0.0000		17.6313	16.3503		1.9810	0.7000		1.9810	0.0259
Mg ²⁺	HCO ₃ ⁻		Mg ²⁺	HCO ₃ ⁻		Mg ²⁺	HCO ₃ ⁻	Final	Mg ²⁺	HCO ₃ ⁻
5.9792	7.1059	Add	5.9792	0.0000	Precipitates	5.9792	0.0000	Recarbonation	5.9792	0.6741
Na ⁺	SO ₄ ²⁻	Ca(OH) ₂	Na ⁺	OH ⁻	CaCO ₃ Mg(OH) ₂	Na ⁺	OH ⁻	CO ₂	Na ⁺	OH ⁻
2.7077	9.4770	9.2444 0.0000	2.7077	0.0000	15.6503 0.0000	2.7077	0.0000	0.6741	2.7077	0.0000
K ⁺	Cl ⁻		K ⁺	SO ₄ ²⁻		K ⁺	SO ₄ ²⁻		K ⁺	SO ₄ ²⁻
0.0000	0.6097		0.0000	9.4770		0.0000	9.4770		0.0000	9.4770
Fe ²⁺	F ⁻		Fe ²⁺	Cl ⁻		Fe ²⁺	Cl ⁻		Fe ²⁺	Cl ⁻
0.1079	0.0000		0.1079	0.6097		0.1079	0.6097		0.1079	0.6097
Mn ²⁺	NO ₃ ⁻		Mn ²⁺	F ⁻		Mn ²⁺	F ⁻		Mn ²⁺	F ⁻
0.0110	0.0000		0.0110	0.0000		0.0110	0.0000		0.0110	0.0000
17.1925	17.1925			NO ₃ ⁻			NO ₃ ⁻			NO ₃ ⁻
			26.4369	26.4369		10.7867	10.7867		10.7867	10.7867
TH	14.3660		TH	23.6104		TH	7.9602		TH	7.9602
CH	7.1059		CH	16.3503		CH	0.7000		CH	0.7000
NCH	7.2602		NCH	7.2602		NCH	7.2602		NCH	7.2602

Figure 26. Single Stage Bar Graph Series for CH Removal

Stoichiometric Method Solution

For CH removal only, suggested chemical dosages are calculated as follows, using Equation 27:

$$CaO = 2.1385 + 7.1059 = 9.2444$$

This value is the same as that provided by the Bar Graph method Equations. Thus, reactor 1 effluent will be the same for this method as for the Bar Graph Method. CO₂ requirements for the stoichiometric method are calculated from Equation 28 as follows:

$$CO_2 = 7.1059 - 8.3869 + 1.9810 = 0.7 \text{ meq/l}$$

This value represents very little difference from the 0.6741 meq/l recommended by the Bar Graph Method, due to influent Ca²⁺ hardness being greater in concentration than influent HCO₃⁻. Thus, for this scenario, the Bar Graph Method and traditional stoichiometric method are essentially the same for CH removal only.

In this example, all HCO_3^- is converted to CO_3^{2-} . The remaining alkalinity added as Ca(OH)_2 stays in solution as excess OH^- . Intermediate Ca^{2+} , CO_3^{2-} , OH^- and are calculated as follows:

$$\begin{aligned} (\text{Intermediate } \text{Ca}^{2+}) &= (\text{Influent } \text{Ca}^{2+}) + \text{Ca(OH)}_2 = 8.3869 + 15.7236 \\ &= 24.1105 \text{ meq/l} \end{aligned}$$

$$\begin{aligned} (\text{Intermediate } \text{CO}_3^{2-}) &= (\text{Influent } \text{CO}_3^{2-}) + (\text{Free } \text{CO}_2) + 2 \times (\text{Influent } \text{HCO}_3^-) \\ &+ (\text{Na}_2\text{CO}_3) = 0 + 2.1385 + 2 \times 7.1059 + 6.5602 \\ &= 22.9105 \text{ meq/l} \end{aligned}$$

$$\begin{aligned} (\text{Intermediate } \text{OH}^-) &= \text{Ca(OH)}_2 - (\text{Free } \text{CO}_2) - (\text{Influent } \text{HCO}_3^-) \\ &= 15.7236 - 2.1385 - 7.1059 = 6.4792 \text{ meq/l} \end{aligned}$$

CaCO_3 precipitation is controlled by intermediate CO_3^{2-} concentration, since it is lower than intermediate Ca^{2+} concentration, and is calculated as follows:

$$\begin{aligned} (\text{CaCO}_3 \text{ precipitation}) &= (\text{Intermediate } \text{CO}_3^{2-}) - (\text{CO}_3^{2-} \text{ solubility}) \\ &= 22.9104 - 0.7000 = 22.2104 \text{ meq/l} \end{aligned}$$

Mg(OH)_2 precipitation is controlled by Mg^{2+} concentration and is calculated as follows:

$$\begin{aligned} (\text{Mg(OH)}_2 \text{ precipitation}) &= (\text{Intermediate } \text{Mg}^{2+}) - (\text{Mg}^{2+} \text{ solubility}) \\ &= 5.9792 - 0.8000 = 5.1792 \text{ meq/l} \end{aligned}$$

Next, Reactor 1 effluent concentrations are calculated as follows:

$$\begin{aligned} (\text{Effluent } \text{Ca}^{2+}) &= (\text{Intermediate } \text{Ca}^{2+}) - \text{CaCO}_3 = 24.1104 - 22.2104 \\ &= 1.9000 \text{ meq/l} \end{aligned}$$

$$\begin{aligned} (\text{Effluent } \text{CO}_3^{2-}) &= (\text{Intermediate } \text{CO}_3^{2-}) - \text{CaCO}_3 = 22.9104 - 22.2104 \\ &= 0.7000 \text{ meq/l} \end{aligned}$$

$$\begin{aligned}
 (\text{Effluent } Mg^{2+}) &= (\text{Intermediate } Mg^{2+}) - (Mg(OH)_2 \text{ precipitation}) \\
 &= 5.9792 - 5.1792 = 0.8000 \frac{meq}{l} = Mg_f^{2+} \text{ Goal}
 \end{aligned}$$

$$\begin{aligned}
 (\text{Effluent } OH^-) &= (\text{Intermediate } OH^-) - (Mg(OH)_2 \text{ precipitation}) \\
 &= 6.4792 - 5.1792 = 1.3000 \text{ meq/l}
 \end{aligned}$$

For final recarbonation, again assume a desired pH_f of 8.5. Since there is Mg^{2+} solubility and excess OH^- in this effluent, this must be converted to CO_3^{2-} using Equation 18. Thus, the 1.300 meq/l of OH^- requires 1.3 meq/l of CO_2 for conversion to CO_3^{2-} . The method used in Example 1 can then be used to calculate the 1.9260 meq/l of CO_2 required to convert CO_3^{2-} to HCO_3^- to achieve the desired final pH. Total CO_2 required for this example is shown to be 3.2260 in Figure 27.

Stoichiometric Method Solution

For the example values shown above, the typical solution would recommend $Ca(OH)_2$ and Na_2CO_3 in the following quantities using Equation 33 and Equation 34 respectively. Chemical dosages are calculated as follows:

$$\begin{aligned}
 Ca(OH)_2 &= \left(\frac{\text{carbonic acid concentration}}{\text{concentration}} \right) + \left(\frac{\text{calcium carbonate hardness}}{\text{hardness}} \right) + 2 \left(\frac{\text{magnesium carbonate hardness}}{\text{hardness}} \right) \\
 &+ \left(\frac{\text{magnesium noncarbonate hardness}}{\text{hardness}} \right) + \left(\frac{\text{excess lime requirements}}{\text{requirements}} \right) \\
 &= 2.1385 + 7.1059 + 5.9792 + 0.5 = 15.7236 \text{ meq/l}
 \end{aligned}$$

$$\begin{aligned}
 Na_2CO_3 &= \left(\frac{\text{calcium noncarbonate hardness}}{\text{hardness}} \right) + \left(\frac{\text{magnesium noncarbonate hardness}}{\text{hardness}} \right) \\
 &= (8.3869 - 7.1059) + 5.9792 = 7.2602 \text{ meq/l}
 \end{aligned}$$

Lime dosage recommended by the stoichiometric method is equal to that recommended by the Bar Graph Method. However, note that the Na_2CO_3 dosage is higher than that recommended by the Bar Graph Method. Using these recommended dosages, intermediate and final hardness are calculated as follows:

$$\begin{aligned} (\text{Intermediate } \text{Ca}^{2+}) &= (\text{Influent } \text{Ca}^{2+}) + \text{Ca}(\text{OH})_2 = 8.3869 + 15.7236 \\ &= 24.1105 \text{ meq/l} \end{aligned}$$

$$\begin{aligned} (\text{Intermediate } \text{CO}_3^{2-}) &= \left(\begin{array}{c} \text{Influent} \\ \text{CO}_3^{2-} \end{array} \right) + \left(\begin{array}{c} \text{carbonic} \\ \text{acid} \\ \text{concentration} \end{array} \right) + 2 \times \left(\begin{array}{c} \text{calcium} \\ \text{carbonate} \\ \text{hardness} \end{array} \right) \\ &+ \left(\begin{array}{c} \text{Na}_2\text{CO}_3 \\ \text{Feed} \end{array} \right) = 0 + 2.1385 + 2 \times 7.1059 + 7.2602 \\ &= 23.6105 \frac{\text{meq}}{\text{l}} (\text{controls precipitation}) \end{aligned}$$

$$\begin{aligned} (\text{Intermediate } \text{OH}^-) &= \text{Ca}(\text{OH})_2 - \left(\begin{array}{c} \text{carbonic} \\ \text{acid} \\ \text{concentration} \end{array} \right) - \left(\begin{array}{c} \text{calcium} \\ \text{carbonate} \\ \text{hardness} \end{array} \right) \\ &= 15.7236 - 2.1385 - 7.1059 = 6.4792 \text{ meq/l} \end{aligned}$$

$$\begin{aligned} (\text{CaCO}_3 \text{ precipitation}) &= (\text{Intermediate } \text{CO}_3^{2-}) - (\text{CO}_3^{2-} \text{ solubility}) \\ &= 23.6105 - 0.7000 = 22.9105 \text{ meq/l} \end{aligned}$$

$$\begin{aligned} (\text{Mg}(\text{OH})_2 \text{ precipitation}) &= (\text{Intermediate } \text{Mg}^{2+}) - (\text{Mg}^{2+} \text{ solubility}) \\ &= 5.9792 - 0.8000 = 5.1792 \text{ meq/l} \end{aligned}$$

$$\begin{aligned} (\text{Effluent } \text{Ca}^{2+}) &= (\text{Intermediate } \text{Ca}^{2+}) - \text{CaCO}_3 = 24.1105 - 22.9105 \\ &= 1.2000 \text{ meq/l} \end{aligned}$$

$$\begin{aligned} (\text{Effluent } \text{Mg}^{2+}) &= (\text{Intermediate } \text{Mg}^{2+}) - (\text{Mg}(\text{OH})_2 \text{ precipitation}) \\ &= 5.9792 - 5.1792 = 0.8000 \text{ meq/l} \end{aligned}$$

CO₂ requirements can be calculated from Equation 35 and Equation 36 combined as follows:

$$\text{Eq. 35: } CO_2 = 0.8000 + 0.5000 = 1.3000 \text{ meq/l}$$

$$\begin{aligned} \text{Eq. 36: } CO_2 &= 7.1059 + 7.2602 - (8.3869 + 5.9792) + (1.2 + 0.8) \\ &= 2 \text{ meq/l} \end{aligned}$$

$$\text{Total } CO_2 \text{ required} = 1.3 + 2 = 3.3 \text{ meq/l}$$

This value for CO₂ dosage agrees closely with that provided by the Bar Graph Method.

Example 3: Two Stage with Lime and Na₂CO₃ Feed

Bar Graph Method Solution

For this example solution, the series of bar graphs is shown in Figure 28 below. This figure shows reactions in both reactors and the final effluent after recarbonation. For this treatment schematic, Ca(OH)₂ is added in the first reactor, while Na₂CO₃ and CO₂ (intermediate recarbonation) are added just prior to the second reactor. Ca(OH)₂ dosage is calculated using Equation 46 as follows:

$$\begin{aligned} \frac{\text{meq}}{\text{l}} \text{ of } OH^- \text{ Required} &= 2.1385 + 7.1059 + 5.9792 + 0.5 \\ &= 15.7236 \text{ meq/l} \end{aligned}$$

Intermediate bar graphs are calculated as in previous examples. Since Mg²⁺ hardness is precipitated to the desired goal in the first reactor, Mg²⁺ solubility and excess OH⁻ in Reactor 1 effluent can be converted to CO₃²⁻ in the second reactor via intermediate recarbonation (CO₂ addition). Intermediate CO₂ dosage is equal to the amount of Mg²⁺ solubility and excess OH⁻. Soda ash feed is calculated from Equation 41 as follows:

CO ₂			CO ₂			CO ₂			CO ₂			CO ₂			CO ₂		
2.1385			24.1104	16.3503		8.4602	7.2602		8.4602	7.2602		8.4602	7.2602		8.4602	7.2602	
Ca ²⁺	CO ₃ ²⁻		Mg ²⁺	HCO ₃ ⁻		Mg ²⁺	HCO ₃ ⁻		Mg ²⁺	HCO ₃ ⁻		Mg ²⁺	HCO ₃ ⁻		Mg ²⁺	HCO ₃ ⁻	
8.3869	0.0000		5.9792	7.1059		5.9792	0.0000		5.9792	0.0000		5.9792	0.0000		5.9792	0.0000	
Add			Add			Add			Add			Add			Add		
Ca(OH) ₂	Na(OH)		Ca(OH) ₂	Na(OH)		CaCO ₃	Mg(OH) ₂		CO ₂	Na ₂ CO ₃		CaCO ₃	Na ₂ CO ₃		CaCO ₃	Na ₂ CO ₃	
15.7236	0.0000		15.7236	0.0000		15.6503	5.1792		1.3000	5.2602		1.3000	5.2602		1.3000	5.2602	
Ca ²⁺	CO ₃ ²⁻		Ca ²⁺	CO ₃ ²⁻		Ca ²⁺	CO ₃ ²⁻		Ca ²⁺	CO ₃ ²⁻		Ca ²⁺	CO ₃ ²⁻		Ca ²⁺	CO ₃ ²⁻	
24.1104	16.3503		8.4602	7.2602		8.4602	7.2602		8.4602	7.2602		8.4602	7.2602		8.4602	7.2602	
Mg ²⁺	HCO ₃ ⁻		Mg ²⁺	HCO ₃ ⁻		Mg ²⁺	HCO ₃ ⁻		Mg ²⁺	HCO ₃ ⁻		Mg ²⁺	HCO ₃ ⁻		Mg ²⁺	HCO ₃ ⁻	
5.9792	7.1059		5.9792	0.0000		5.9792	0.0000		5.9792	0.0000		5.9792	0.0000		5.9792	0.0000	
Na ⁺	SO ₄ ²⁻		Na ⁺	OH ⁻		Na ⁺	OH ⁻		Na ⁺	OH ⁻		Na ⁺	OH ⁻		Na ⁺	OH ⁻	
2.7077	9.4770		2.7077	6.4792		2.7077	1.3000		2.7077	1.3000		2.7077	1.3000		2.7077	1.3000	
K ⁺	Cl ⁻		K ⁺	SO ₄ ²⁻		K ⁺	SO ₄ ²⁻		K ⁺	SO ₄ ²⁻		K ⁺	SO ₄ ²⁻		K ⁺	SO ₄ ²⁻	
0.0000	0.6097		0.0000	9.4770		0.0000	9.4770		0.0000	9.4770		0.0000	9.4770		0.0000	9.4770	
Fe ²⁺	F ⁻		Fe ²⁺	Cl ⁻		Fe ²⁺	Cl ⁻		Fe ²⁺	Cl ⁻		Fe ²⁺	Cl ⁻		Fe ²⁺	Cl ⁻	
0.1079	0.0000		0.1079	0.6097		0.1079	0.6097		0.1079	0.6097		0.1079	0.6097		0.1079	0.6097	
Mn ²⁺	NO ₃ -N		Mn ²⁺	F ⁻		Mn ²⁺	F ⁻		Mn ²⁺	F ⁻		Mn ²⁺	F ⁻		Mn ²⁺	F ⁻	
0.0110	0.0000		0.0110	0.0000		0.0110	0.0000		0.0110	0.0000		0.0110	0.0000		0.0110	0.0000	
17.1925	17.1925		32.9161	32.9161		12.0867	12.0867		17.3468	17.3468		17.3468	17.3468		10.7867	10.7867	
TH	14.3660		TH	30.0896		TH	9.2602		TH	9.2602		TH	9.2602		TH	2.7000	
CH	7.1059		CH	22.8294		CH	2.0000		CH	7.2602		CH	7.2602		CH	0.7000	
NCH	7.2602		NCH	7.2602		NCH	7.2602		NCH	2.0000		NCH	2.0000		NCH	2.0000	

Figure 28. Series Bar Graphs for Two Stage Treatment with Lime and Soda Ash

$$\frac{meq}{l} \text{ Soda Ash Required} = 7.2602 - (2.7 - 0.7) = 5.2602 \text{ meq/l}$$

Final recarbonation CO₂ dosage is determined as in Example 1, assuming a desired pH_f of 8.5, to be roughly 0.6741 meq/l. Total CO₂ dosage required for both the 1.3 meq/l intermediate and 0.6741 meq/l final recarbonation is 1.9741 meq/l. Note that final NCH is 2 meq/l. Thus, all NCH was not removed, but hardness goals were achieved with Na₂CO₃ and CO₂ chemical savings.

Stoichiometric Method Solution

For the stoichiometric model, Ca(OH)₂ and Na₂CO₃ requirements are calculated from Equation 33 Equation 34, respectively, as follows:

$$Ca(OH)_2 = 2.1385 + 7.1059 + 5.9792 + 0.5 = 15.7236 \text{ meq/l}$$

$$Na_2CO_3 = (8.3869 - 7.1059) + 5.9792 = 7.2602 \text{ meq/l}$$

Both intermediate and final recarbonation can be estimated by the stoichiometric model. Assuming that both intermediate and final recarbonation will be used, these CO₂ dosages are calculated from Equation 35 and Equation 36, respectively, as follows:

$$CO_2 = 0.8 + 0.5 = 1.3 \text{ meq/l}$$

$$CO_2 = 7.1059 + 7.2602 - (8.3869 + 5.9792) + 1.5 = 1.5 \text{ meq/l}$$

$$\text{Total } CO_2 \text{ Required} = 2.8 \text{ meq/l}$$

TH_f values are estimated to be 0.7 and 0.8 for Ca²⁺ and Mg²⁺, respectively, using stoichiometric chemical dosages. All NCH was removed, and softer water was produced, but at the cost of more Na₂CO₃ and CO₂ than the Bar Graph Method's optimization allows.

Example 4: Two Stage Split Treatment with Lime and Na₂CO₃ Feed

Bar Graph Method Solution

The two stage split treatment process involves several additional steps over the traditional two stage treatment without bypass. First, Equation 1 must be used to calculate X, the required fraction of untreated bypass flow. For this, assume Mg²⁺_F goal is 0.8 meq/l and Mg²⁺₁ is 0.16 meq/l and calculate as follows:

$$X = \frac{Mg_F^{2+} - Mg_1^{2+}}{Mg_R^{2+} - Mg_1^{2+}} = \frac{0.8 - 0.16}{5.9792 - 0.16} = 0.10998$$

Ca(OH)₂ dosage is calculated from Equation 46. Unlike single stage or simple two stage treatment, for split treatment, lime added to reactor 1 includes lime for the split treatment bypass fraction of alkalinity and free CO₂, and therefore excess lime for Mg²⁺_f goal attainment is not required. See calculation below:

$$\begin{aligned} \frac{\text{meq}}{\text{l}} \text{ of } OH^- \text{ Required in Reactor 1 Influent Flow} &= \text{Free } CO_2 + (\text{Bicarbonate Hardness}) + Mg^{2+} \\ &+ \frac{X}{(1-X)}(CO_2 + HCO_3^-) \\ &= 2.1385 + 7.1059 + 5.9792 \\ &+ \frac{0.10998}{(1-0.10998)}(2.1385 + 7.1059) = 16.3659 \text{ meq/l} \end{aligned}$$

This is equivalent to a lime dose of 14.566 meq/l based on total flow (Reactor 1 + Bypass Flows). It is clear, therefore, that split treatment reduces lime dosage for treating high Mg²⁺ waters (15.7236 meq/l lime was required for two-stage treatment).

Z_R = Influent concentration of constituent "Z"

Z_1 = Reactor 1 effluent concentration of constituent "Z"

Thus, the blended concentration for calcium is calculated as follows:

$$\begin{aligned}Ca_B^{2+} &= (X)(Ca_R^{2+}) + (1 - X)(Ca_1^{2+}) \\ &= (0.10998) \left(8.3869 \frac{meq}{l} \right) + (1 - 0.10998) \left(9.1025 \frac{meq}{l} \right) \\ &= 9.0238 \text{ meq/l}\end{aligned}$$

The intermediate blended water chemistry shown in Figure 29 is not an actual chemistry, but a mathematical model for determining predicted blended chemistry.

When these waters are blended, further reactions take place between untreated bypass flow CO_2 and HCO_3^- and the softened water OH^- , forming CO_3^{2-} and allowing more $CaCO_3$ formation. A more accurate model of the blended reactor effluent and untreated bypass (after mixing reactions have occurred) is shown in Figure 30 below. This figure shows actual predicted blended water chemistry, intermediate recarbonation, Na_2CO_3 addition, final precipitation, Reactor 2 effluent, final recarbonation, and final water chemistry. Note that the intermediate blend shown in Figure 29 shows free CO_2 , HCO_3^- , CO_3^{2-} , and OH^- . The excess OH^- from the treated fraction of flow is free to react with the free CO_2 and HCO_3^- from the untreated bypass fraction, as it is being blended. Thus, the actual OH^- in the blended water is calculated as follows:

$$\begin{aligned}OH_B^-(actual) &= OH_B^-(pseudo) - (CO_2)_B(pseudo) - (HCO_3^-)_B(pseudo) \\ &= 1.1591 - 0.2352 - 0.7815 = 0.1424 \text{ meq/l}\end{aligned}$$

where $OH_B^-(actual)$ = OH^- concentration of blended treated and un-treated bypass water, after mixing reactions have taken place
 $OH_B^-(pseudo)$ = estimated OH^- concentration immediately after treated and un-treated bypass waters have blended and prior to any mixing reactions

$(CO_2)_B (pseudo)$ = estimated CO_2 concentration immediately after treated and un-treated bypass waters have blended and prior to any mixing reactions

$(HCO_3^-)_B (pseudo)$ = estimated HCO_3^- concentration immediately after treated and un-treated bypass waters have blended and prior to any mixing reactions

Reactor 1 Effluent and Bypass Water Blended	Ca ²⁺	CO ₃ ²⁻	Add		Ca ²⁺	CO ₃ ²⁻	Precipitate	Ca ²⁺	CO ₃ ²⁻	Final Recarb	Ca ²⁺	CO ₃ ²⁻
	Mg ²⁺	HCO ₃ ⁻	CO ₂	Na ₂ CO ₃	Mg ²⁺	HCO ₃ ⁻		CaCO ₃	Mg ²⁺		HCO ₃ ⁻	CO ₂
	9.0238	2.4212			9.0238	7.8238		1.9000	0.7000		1.9000	0.0259
	0.8000	0.0000			0.8000	0.0000		0.8000	0.0000		0.8000	0.6741
	Na ⁺	OH ⁻	CO ₂	Na ₂ CO ₃	Na ⁺	SO ₄ ²⁻	CaCO ₃	Na ⁺	SO ₄ ²⁻	CO ₂	Na ⁺	SO ₄ ²⁻
	2.7077	0.1424	0.1424	5.2602	7.9678	9.4770	7.1238	7.9678	9.4770	0.6741	7.9678	9.4770
	K ⁺	SO ₄ ²⁻			K ⁺	Cl ⁻		K ⁺	Cl ⁻		K ⁺	Cl ⁻
	0.0000	9.4770			0.0000	0.6097		0.0000	0.6097		0.0000	0.6097
	Fe ²⁺	Cl ⁻			Fe ²⁺	F ⁻		Fe ²⁺	F ⁻		Fe ²⁺	F ⁻
	0.1079	0.6097			0.1079	0.0000		0.1079	0.0000		0.1079	0.0000
	Mn ²⁺	F ⁻			Mn ²⁺	NO ₃ ⁻ N		Mn ²⁺	NO ₃ ⁻ N		Mn ²⁺	NO ₃ ⁻ N
	0.0110	0.0000			0.0110	0.0000		0.0110	0.0000		0.0110	0.0000
		NO ₃ ⁻ N										
		0.0000			17.9105	17.9105		10.7867	10.7867		10.7867	10.7867
	12.6503	12.6503										
	TH	9.8238			TH	9.8238		TH	2.7000		TH	2.7000
	CH	2.5636			CH	7.8238		CH	0.7000		CH	0.7000
	NCH	7.2602			NCH	2.0000		NCH	2.0000		NCH	2.0000

Figure 30. Split Treatment Stage 2 and Final Recarbonation

From this reaction, it is clear that the blending process of bypass flow with softened effluent increases the concentration of CO_3^{2-} . This reaction is beneficial as it lowers the amount of Na_2CO_3 required for second stage treatment. Na_2CO_3 dosage can now be estimated from Equation 41 as seen below.

$$\frac{meq}{l} \text{ Soda Ash Required} = 7.2602 - (2.7 - 0.7) = 5.2602 \text{ meq/l}$$

After final hardness precipitation, CO_2 addition is estimated as in Example 1 to achieve the desired pH_f . Note that final NCH is 2 meq/l. Thus, all NCH was not removed, but hardness goals were achieved with demonstrated lime, Na_2CO_3 and CO_2 chemical savings.

Stoichiometric Method Solution

Most texts utilizing the traditional stoichiometric model, including MWH, do not provide specific equations for chemical dosage estimation for split treatment. Although the topic of split treatment is mentioned by several authors (MWH et al. 1602-1603, Hammer and Hammer 252-253), only basic concepts are discussed as to the feasibility and most appropriate applications of this treatment method. The only equation for split treatment that is provided by most texts utilizing the traditional stoichiometric methods is the mass balance equation for determining bypass flow. Since equations have not been provided for estimating chemical dosages, the traditional stoichiometric method will not be used to solve a problem.

CHAPTER V

DISCUSSION

Comparison of Problem Solutions

In the previous chapter, four example problems were solved, applying both the Bar Graph Method solution and the traditional stoichiometric solution. Following, a comparison will be made between the two solution methods, with discussion of similarities and differences. Additionally, the stoichiometric method that is used to predict softened effluent will be compared with sampling data from the Grand Forks, ND WTP.

Problem Preliminary Calculations

As discussed previously, several parameters had to be investigated prior to estimating softening chemical feed or final effluent. These include percent difference of the lab analysis, error correction if necessary, free CO₂ estimation, and others. For each of these parameters, methods utilized by the Bar Graph Method and the stoichiometric method are almost entirely the same, since the Bar Graph Method is simply a modification of the more well-known stoichiometric method. One difference between the two methods is found in the calculation of free CO₂. The Bar Graph Method uses the Modified Tillman Method, whereas MWH et al. use an approach that is based on dissociation constants, total carbonic species and ionization fractions (1608-1609). Investigation shows only about a five percent difference between the two methods for the

given raw water data. Details of the comparison between these two methods are shown in Appendix B.

Chemical Feed and Final Hardness

Table 10 below summarizes chemical feed and final hardness as estimated by the two different solution methods.

Table 10. Chemical Feed Estimations and Final Water Quality for Different Methods

	Example 1		Example 2		Example 3		Example 4	
	BGM meq/l	SM meq/l	BGM meq/l	SM meq/l	BGM meq/l	SM meq/l	BGM meq/l	SM meq/l
Ca(OH) ₂ feed	9.24	9.24	15.72	15.72	15.72	15.72	14.57	N/A
Na ₂ CO ₃ feed	None	None	6.56	7.26	5.26	7.26	5.26	N/A
CO ₂ feed	0.67	0.70	3.23	3.30	1.97	2.80	0.82	N/A
TH _f	7.96	7.96	2.70	2.00	2.70	1.50	2.70	N/A
NCH _i	7.26	7.26	7.26	7.26	7.26	7.26	7.26	N/A
NCH _f	7.26	7.26	0.70	0.00	2.00	0.00	2.00	N/A
Alk _f	0.70	0.70	2.00	2.00	0.70	6.76	0.70	N/A
Ca ²⁺ _i	8.39	8.39	8.39	8.39	8.39	8.39	8.39	N/A
Ca ²⁺ _f	1.98	1.98	1.90	1.20	1.90	0.70	1.90	N/A
Mg ²⁺ _i	5.98	5.98	5.98	5.98	5.98	5.98	5.98	N/A
Mg ²⁺ _f	5.98	5.98	0.80	0.80	0.80	0.80	0.80	N/A
TH _f user defined	no	no	yes	no	yes	no	yes	N/A

BGM = Bar Graph Method

SM = Stoichiometric Method

NCH_f = Noncarbonate Hardness of Softening Basin Effluent

Alk_f = Total Alkalinity of Softening Basin Effluent

Ca²⁺_i = Untreated Influent Ca²⁺ Concentration

Ca²⁺_f = Ca²⁺ Concentration of Softening Basin Effluent

Mg²⁺_i = Untreated Influent Mg²⁺ Concentration

Mg²⁺_f = Mg²⁺ Concentration of Softening Basin Effluent

From Table 10, it is seen that Example 1 (single-stage CH removal) is almost identical for the two methods. The only difference between the two methods is that the Bar Graph Method estimated a slightly lower dosage of CO₂ for final recarbonation. Either of these values for CO₂ could be considered good estimations, to be adjusted as necessary to accommodate for actual water quality at a WTP.

Example 2 (single-stage CH and NCH removal) very well demonstrates the benefits of using the Bar Graph Method over the stoichiometric method. $\text{Ca}(\text{OH})_2$ dosage estimation is equal for the two methods. However, as previously discussed, the main benefit of the Bar Graph Method is found in its ability to optimize chemical feed based on user-defined goals, rather than specifying removal of all hardness. This extra Na_2CO_3 chemical dosage recommended by the stoichiometric method can translate to significant treatment cost. Thus, the stoichiometric method, although it yields a softer final water, is a much more expensive method of treatment and results in a higher sodium concentration in the finished water. Bar Graph Method equations, on the other hand, can be used to specify the same final water quality (i.e. removal of all NCH), but provide the flexibility of a higher TH_f if desired by less NCH removal.

Example 3 (two-stage CH and NCH removal) is very similar to Example 2 in its general results and in showing the Bar Graph Method's ability to specify final hardness. However, the benefits of the Bar Graph Method are more significant for this example. It provides a second equation for determining Na_2CO_3 feed for second stage treatment, which capitalizes on the conversion of OH^- to CO_3^{2-} in intermediate recarbonation resulting in a lower estimation of Na_2CO_3 dosage than in single stage treatment. The stoichiometric method, on the other hand, recommends the same amount of Na_2CO_3 for two stage treatment as for single stage treatment, both representing a significant extra treatment cost and adding beyond the point of maximum hardness removal. Also, because the stoichiometric method over-estimates Na_2CO_3 feed, additional CO_2 must be added for final recarbonation to lower pH_f to the desired state. Thus, for two stage

treatment, the Bar Graph Method more accurately estimates Na_2CO_3 feed and will result in chemical savings for both Na_2CO_3 and CO_2 .

Example 4 (two-stage, split treatment of high Mg^{2+} water) represents the greatest benefit for the Bar Graph Method as a mathematical model. Most texts that use stoichiometric methods do not provide specific equations for solving split treatment type problems, though it is likely that estimations would be similar to simple two stage treatment.

For all example problems, chemical feed dosage estimations for the two methods discussed are in the same general range. Thus, the Bar Graph Method can be considered an accurate model when compared to the accepted stoichiometric method. The primary reason for the chemical savings achieved by the Bar Graph Method is the reduction of Na_2CO_3 by setting final hardness goals (TH_f and Mg^{2+}_f) that can be achieved without complete removal of NCH and capitalizing on two-stage intermediate recarbonation. The chemical cost savings may be significant when used to treat large quantities of water. It should be noted that the Bar Graph Method may result in a lower finished water alkalinity of 0.7 meq/l ($\approx 35 \text{ mg CaCO}_3/\text{l}$). If a utility wishes to have greater finished water alkalinity, additional Na_2CO_3 can be added to achieve a desired final alkalinity.

From the example problems provided, the Bar Graph Method has been shown to be a better mathematical model for estimating chemical feed, both in terms of accuracy and chemical savings. The stoichiometric method is rarely used in actual treatment plant scenarios for determining chemical feed control for multiple reasons. It is a poor method for the typical treatment plant that typically has its final hardness goals much higher than what the stoichiometric method would dictate. But also, applying a feed rate to an actual

treatment scenario can be difficult, especially when applying it to a water with frequent fluctuation in flow rate or water quality, including blending of water sources.

The Bar Graph Method can be viewed as a good working model for actual treatment scenarios in terms of chemical dosage estimation. However, without automation of the entire feed control system, there is little benefit to this method. Therefore, an automated system is recommended that would monitor different parameters throughout the system and communicate with the spreadsheet which, in turn, would control actual chemical dosages, adjusting them as necessary.

The most important parts of the automation system setup are the sensors on the influent end of the softening basin. Here, sensors would regularly analyze influent water quality for pH, temperature, Ca^{2+} and Mg^{2+} hardness, and alkalinity. Na^+ , SO_4^{2-} , and Cl^- , would also require monitoring, though fluctuations of these parameters are not critical for softening of most natural waters and hence could be monitored on a less frequent basis, perhaps from a weekly grab sample and adjusted based on conductivity representation of total dissolved solids. All concentrations from automated sensors would then be sent directly to the spreadsheet. Less frequent grab sample concentrations would be manually entered into the spreadsheet as applicable. The spreadsheet would then determine the appropriate feed dosage(s) from this data, delivering a new value each time water quality varies outside of given ranges. This feed dosage (in meq/l) would then be calculated in terms of actual flow (i.e. lb/hr etc.), coordinating the chemical feed with the lime slaker and/or Na_2CO_3 feeder based on the actual flow through the softening basin. The sensitivity required for changing chemical feed could be adjusted based on user goals. If the water quality changes very little, the system could be set to adjust feed based on

longer interval readings. If, however, the plant is going through a period of high fluctuation in quantity or quality of water, it could be adjusted to a shorter time frame.

Comparison of Stoichiometric Methods to Live WTP Data

The Grand Forks single-stage softening plant often feeds only lime and has provided actual influent and effluent data from one of their softening basins. Some of these data are provided in Table 11. In following paragraphs, this data will be used as a basis of comparison to the traditional stoichiometric model and the Bar Graph Method. The accepted stoichiometric method will be used to solve problems with the given influent data from Table 11, and its predicted effluent will be compared to the observed effluent at the Grand Forks WTP.

Table 11. Grand Forks WTP Softening Basin Data

	Time	P Alk, mg/l as CaCO ₃	T Alk, mg/l as CaCO ₃	TH, mg/l as CaCO ₃	Ca ²⁺ , mg/l as CaCO ₃	pH	Temp, ° C	CaO dosage, mg/l as pure
18-Feb								
Influent	10:30 AM	0	236	270	149	7.49	7.7	6.91
Effluent	10:30 AM	81	103	148	104	11.3 *	n/a	n/a
27-Feb								
Influent	2:30 PM	0	232	244	146	7.53	6.3	6.78
Effluent	2:30 PM	89	126	148	112	11.3 *	n/a	n/a
1-Mar								
Influent	6:30 PM	0	244	254	147	7.51	8	6.80
Effluent	6:30 PM	86	129	148	106	11.3 *	n/a	n/a
6-Mar								
Influent	2:30 PM	0	221	248	140	7.71	7	6.78
Effluent	2:30 PM	69	123	152	100	11.3 *	n/a	n/a
15-Mar								
Influent	10:30 AM	0	200	220	140	7.3	6.8	6.33
Effluent	10:30 AM	89	109	139	105	11.3 *	n/a	n/a

* = values estimated from treatment plant data

P Alk = phenolphthalein alkalinity

T Alk = total alkalinity

Methods for Comparison

Bar graphs have been constructed from Table 11 data. Figure 31 shows the theoretical bar graph that has been constructed by using influent data from the Grand Forks WTP single-stage softener, and lime feed concentration only. The stoichiometric method has been used to determine all theoretical intermediate and final constituent concentrations. Note the terms used in this bar graph designated as “Other.” These terms have been added to both cation and anion concentrations to zero the electroneutrality of the solution. Since no other concentrations (such as Na^+ , SO_4^{2-} , Cl^- , or TDS) were measured or recorded, it must be assumed, for mathematical modeling purposes, that measured concentrations are 100% accurate. Specific values designated under “Other” have been chosen arbitrarily to create conditions of initial electroneutrality and do not represent any measured concentrations. In this figure, CaCO_3 and $\text{Mg}(\text{OH})_2$ solubility have been assumed to be equal to 0.7 and 0.2 meq/l, respectively.

Figure 32 has been constructed from both influent and effluent data from Table 11. Influent data (including influent concentrations, pH, temperature, and lime feed) have been inserted as per the usual method. Effluent concentrations have been inserted manually into the “softening effluent” portion of the bar graph. Final recarbonation CO₂ addition is calculated as usual, and the final bar graph is produced without further adjustments. Concentrations in the intermediate bar graph, and of precipitates, have been calculated from a combination of the given influent and effluent data. Calculations for these concentrations are detailed in following paragraphs.

Softener effluent concentrations are calculated from Table 11 data, taking CaCO₃ as 50 mg/meq. Softener effluent pH has been measured in the Grand Forks WTP to range in the mid-11’s, with an average of 11.60. Thus, all alkalinity exists in the form of OH⁻ and CO₃²⁻, where OH⁻ = 2(P Alk) – (T Alk), and CO₃²⁻ = (T Alk) – (OH⁻).

Intermediate Ca²⁺ is easily calculated as influent Ca²⁺ + Ca(OH)₂ as follows:

$$(Intermediate\ Ca^{2+}) = (Influent\ Ca^{2+}) + (Ca(OH)_2\ Feed\ Concentration)$$

Intermediate Mg²⁺ remains unchanged from the influent concentration.

Precipitation is calculated next for both CaCO₃ and Mg(OH)₂ as (Intermediate Cationic Species Concentration) – (Final Cationic Species Concentration).

$$(CaCO_3\ Precipitation) = \left(9.8876 \frac{meq}{l}\right) - \left(2.08 \frac{meq}{l}\right) = 7.8076 \frac{meq}{l}$$

$$(Mg(OH)_2\ Precipitation) = \left(2.4181 \frac{meq}{l}\right) - \left(0.88 \frac{meq}{l}\right) = 1.5381 \frac{meq}{l}$$

CO ₂		0.9643													
Ca ²⁺	CO ₃ ²⁻	2.9776	0.0000	Ca ²⁺	CO ₃ ²⁻	9.8876	8.6876	Ca ²⁺	CO ₃ ²⁻	2.0800	0.8800	Ca ²⁺	CO ₃ ²⁻	2.0800	0.0762
Mg ²⁺	HCO ₃ ⁻	2.4181	4.7162	Mg ²⁺	HCO ₃ ⁻	2.4181	0.2205	Mg ²⁺	HCO ₃ ⁻	0.8800	0.0000	Mg ²⁺	HCO ₃ ⁻	0.8800	1.9838
Add				Precipitates								Final			
Other	Ca(OH) ₂	6.9100	0.0000	CaCO ₃	Mg(OH) ₂	7.8076	1.5381	Other	OH ⁻	2.6043	1.1800	Other	OH ⁻	2.6043	0.0000
2.6043	3.2838	2.6043	2.7181	2.6043	2.7181	2.6043	2.7181	2.6043	1.1800	2.6043	3.1638	2.6043	0.0000	2.6043	0.0000
				Other		Other		Other				Other		Other	
				3.2838		3.2838		3.2838				3.2838		3.2838	
8.0000		8.0000		14.9100		14.9100		5.5643		5.5643		5.5643		5.5643	
TH	5.3957	TH	12.3057	TH	12.3057	TH	12.3057	TH	2.9600	TH	2.9600	TH	2.9600	TH	2.9600
CH	4.7162	CH	11.6262	CH	11.6262	CH	11.6262	CH	2.0600	CH	2.0600	CH	2.0600	CH	2.0600
NCH	0.6795	NCH	0.6795	NCH	0.6795	NCH	0.6795	NCH	0.9000	NCH	0.9000	NCH	0.9000	NCH	0.9000

Figure 32. Actual Bar Graph from Grand Forks Influent and Effluent Concentration Data, February 18, 2012

From these precipitation calculations, intermediate carbonate species (CO_3^{2-} and OH^-) can be calculated as (Amount Precipitated) + (Final Anionic Species Concentration). See below:

$$(\text{Intermediate } \text{CO}_3^{2-}) =$$

$$(\text{CaCO}_3 \text{ Precipitation}) + (\text{Final } \text{CO}_3^{2-} \text{ Concentration}) =$$

$$7.8078 \frac{\text{meq}}{\text{l}} + 0.88 \frac{\text{meq}}{\text{l}} = 8.6878 \frac{\text{meq}}{\text{l}}$$

$$(\text{Intermediate } \text{OH}^-) =$$

$$(\text{Mg(OH)}_2 \text{ Precipitation}) + (\text{Final } \text{OH}^- \text{ Concentration}) =$$

$$1.5381 \frac{\text{meq}}{\text{l}} + 1.18 \frac{\text{meq}}{\text{l}} = 2.7181 \frac{\text{meq}}{\text{l}}$$

No HCO_3^- should be present in the Figure 32 intermediate bar graph. However, due to errors in titration measurements, the alkalinity and/or hardness may be slightly in error. This concept can be demonstrated by comparing the softening influent to effluent. The arbitrary values that have been chosen to make the influent water quality electroneutral should also result in an electroneutral softened effluent. However, summations of cations and anions are not equal for the softened effluent. Thus, the intermediate bar graph shows a HCO_3^- concentration equal to 0.2205 meq/l. This value represents the concentration of influent HCO_3^- that apparently has not been converted to CO_3^{2-} (see below) due to the addition of lime dose less than the theoretical dose required. Since this error represents the error in both influent and effluent hardness and alkalinity concentrations, it can be considered minor. However, it demonstrates a potential danger, since it is effluent concentrations that are often used by WTPs to determine feed rate changes.

$$\begin{aligned}
 (\text{Intermediate } \text{HCO}_3^-) &= (\text{Influent } \text{HCO}_3^- + \text{Ca}(\text{OH})_2 \text{ addition}) - \\
 (\text{Intermediate } \text{CO}_3^{2-} \text{ plus } \text{OH}^- \text{ Concentrations}) &= (4.7162 + \\
 6.91) \frac{\text{meq}}{\text{l}} - (8.6876 + 2.7181) \frac{\text{meq}}{\text{l}} &= 0.2205 \frac{\text{meq}}{\text{l}}
 \end{aligned}$$

Summary of Predicted vs. Observed Data

Data from all five days shown in Table 11 have been used to construct bar graphs using the same methods demonstrated in Figure 31 and Figure 32. These additional bar graphs are provided in Appendix C. Effluent data from all of these bar graphs has been compiled and is shown in Table 12.

Table 12. Predicted vs. Observed Softened Effluent Water Quality (Before Recarbonation)

		Ca^{2+} meq/l	Mg^{2+} meq/l	CO_3^{2-} meq/l	HCO_3^- meq/l	OH^- meq/l
18-Feb						
Predicted Effluent	10:30 AM	0.70	1.39	1.21	0.00	0.20
Observed Effluent	10:30 AM	2.08	0.88	0.88	0.00	1.18
27-Feb						
Predicted Effluent	2:30 PM	0.70	0.91	1.17	0.00	0.20
Observed Effluent	2:30 PM	2.24	0.72	1.48	0.00	1.04
1-Mar						
Predicted Effluent	6:30 PM	0.70	1.36	1.66	0.00	0.20
Observed Effluent	6:30 PM	2.12	0.84	1.72	0.00	0.86
6-Mar						
Predicted Effluent	2:30 PM	0.89	0.55	1.52	0.00	0.20
Observed Effluent	2:30 PM	2.00	1.04	2.16	0.00	0.30
15-Mar						
Predicted Effluent	10:30 AM	0.70	0.76	0.86	0.00	0.20
Observed Effluent	10:30 AM	2.10	0.68	0.80	0.00	1.38

From Table 12 it is clear that there is a major discrepancy between effluent water quality that has been predicted using stoichiometry and that which is observed. Of all parameters of alkalinity and hardness that are shown, the only correlation between the

stoichiometric method and observed data is that both show an effluent HCO_3^- concentration of 0 meq/l.

Comparison on Hardness

Table 12 shows that there is a major discrepancy in both Ca^{2+} and Mg^{2+} hardness. While the stoichiometric method regularly predicts CaCO_3 precipitating to a solubility level of 0.7 meq/l, this is not shown to be the case with observed data. Actual Ca^{2+} effluent concentration never falls below 2.00 meq/l. Observed Mg^{2+} concentrations, on the other hand, are almost always below the predicted values. In general, the actual chemistry shows that it is feasible to achieve Mg^{2+} goals, but CaCO_3 precipitation is less likely.

Comparison on Alkalinity

Investigation shows that the stoichiometric method preferentially uses all available lime feed to convert CO_2 and HCO_3^- to CO_3^{2-} , with any remaining $\text{Ca}(\text{OH})_2$ producing a OH^- excess for Mg^{2+} CH precipitation. Observed data indicates that the chemistry preferentially forms OH^- excess for immediate $\text{Mg}(\text{OH})_2$ precipitation, with the remaining feed converting CO_2 and HCO_3^- . As a result, a high excess OH^- concentration is routinely observed in the effluent. The observed concentration of effluent excess OH^- is higher than the predicted value by a factor ranging between 1.5 – 6.9, with an average of 4.8. This high a degree of discrepancy demonstrates a major short-coming of the largely accepted stoichiometric model and suggests that further research is necessary.

Potential Explanations of Issues

There are likely many different aspects at work, causing the chemistry of lime-only water softening to behave differently than theorized. Two major issues that are most

likely affecting the precipitation reactions are the interplay between the relative kinetics of product formation of CaCO_3 and $\text{Mg}(\text{OH})_2$, and ion pairing.

It appears that for lime only single-stage softening the OH^- from lime addition has a tendency to fully convert CO_2 to CO_3^{2-} . However, it appears that there is competition for available OH^- between Mg^{2+} pairing and HCO_3^- conversion to CO_3^{2-} . In general, this results in actual final softened water Ca^{2+} concentrations that are significantly higher than the Bar Graph Method predictions. Conversely, the actual final softened water Mg^{2+} concentrations are generally significantly lower than the Bar Graph Method predictions. Therefore, the Mg^{2+} competition for OH^- appears to be favored over HCO_3^- conversion to CO_3^{2-} .

In addition there is competition for ion pairing between Ca^{2+} , Mg^{2+} and CO_3^{2-} and between Ca^{2+} and CO_3^{2-} , SO_4^{2-} and Cl^- that reduces the efficiency of CaCO_3 precipitation.

The Arrhenius equation has been used to show that for zero-order rate reactions, there is a direct relationship between temperature and reaction rates. That is, increase in temperature results in an increased rate of product formation and decrease in temperature results in a decreased rate of product formation. This is seen to be true in Figure 33 (Appendix A) which shows rate reactions for CaCO_3 at varying temperatures. While some principles regarding reaction rates have been established, the literature does not address the product formation of CaCO_3 and $\text{Mg}(\text{OH})_2$ relative to each other.

Ca^{2+} and Mg^{2+} chemistry can get complicated in terms of ion pairing and attraction between molecules. Mg^{2+} , in particular, has a tendency to pair preferentially with certain anions such as the CO_3^{2-} ion. This reduces CO_3^{2-} free concentration, increasing the solubility of CaCO_3 and makes its precipitation more difficult. Mg^{2+} also

attaches itself to the surface of growing CaCO_3 , which has the effect of preventing the continued further growth of that CaCO_3 crystal (Holmes-Farley).

The explanations listed above are only some of the potential explanations for what is occurring at the Grand Forks WTP. However, in light of the data that have been observed, these explanations do help explain why the WTP is seeing higher $\text{Mg}(\text{OH})_2$ precipitation, and less CaCO_3 precipitation than expected.

Final Conclusions

The Bar Graph Method has been shown to behave the same as the traditional stoichiometric method in regard to chemical reactions and the prediction of final water quality from a known lime feed rate. Thus, the Bar Graph Method should be readily accepted from the perspective that it is merely an elaboration on the traditional method, making it more efficient. However, data from the Grand Forks WTP has been used to show that the stoichiometric method does not accurately represent precipitation reactions for lime-feed only water treatment. The error between the theoretical prediction of effluent quality and actual effluent quality is significant for several parameters, with no apparent correlation between the two scenarios.

The Bar Graph Method has the potential to be of great service in water softening treatment plants. It provides feed estimating equations that have previously not been traditionally used in the literature. Together with automation hardware and software, it could be used to make WTPs much more efficient in terms of chemical feed rates and final water quality. However, the problem of inaccurate modeling must be researched and an accurate model provided, before the water softening automation process can be implemented. Chemical softening continues to be a widely used treatment method as it is

still the most efficient method available for treating many waters. Therefore, these currently unresolved issues should be considered a priority for the benefit it could provide to the water treatment industry.

APPENDICES

Appendix A
Supplemental Figures for Chemical Analysis

Temperature °C	K_{CO_2}	$K_{\text{H}_2\text{CO}_3}$	$K_{\text{HCO}_3^-}$	$K_{\text{CaCO}_3} \text{ (cal.)}$	$K_{\text{CaCO}_3} \text{ (arag.)}$
0	$10^{-1.11}$	$10^{-6.58}$	$10^{-10.63}$	$10^{-8.38}$	$10^{-8.22}$
5	$10^{-1.19}$	$10^{-6.52}$	$10^{-10.55}$	$10^{-8.39}$	$10^{-8.24}$
10	$10^{-1.27}$	$10^{-6.46}$	$10^{-10.49}$	$10^{-8.41}$	$10^{-8.26}$
15	$10^{-1.34}$	$10^{-6.42}$	$10^{-10.43}$	$10^{-8.43}$	$10^{-8.28}$
20	$10^{-1.41}$	$10^{-6.38}$	$10^{-10.38}$	$10^{-8.45}$	$10^{-8.31}$
25	$10^{-1.47}$	$10^{-6.35}$	$10^{-10.33}$	$10^{-8.48}$	$10^{-8.34}$
30	$10^{-1.52}$	$10^{-6.33}$	$10^{-10.29}$	$10^{-8.51}$	$10^{-8.37}$
45	$10^{-1.67}$	$10^{-6.29}$	$10^{-10.20}$	$10^{-8.62}$	$10^{-8.49}$
60	$10^{-1.78}$	$10^{-6.29}$	$10^{-10.14}$	$10^{-8.76}$	$10^{-8.64}$

Figure 33. Equilibria Constants for Carbonate Species at 1 atm Pressure (Fetter 357)

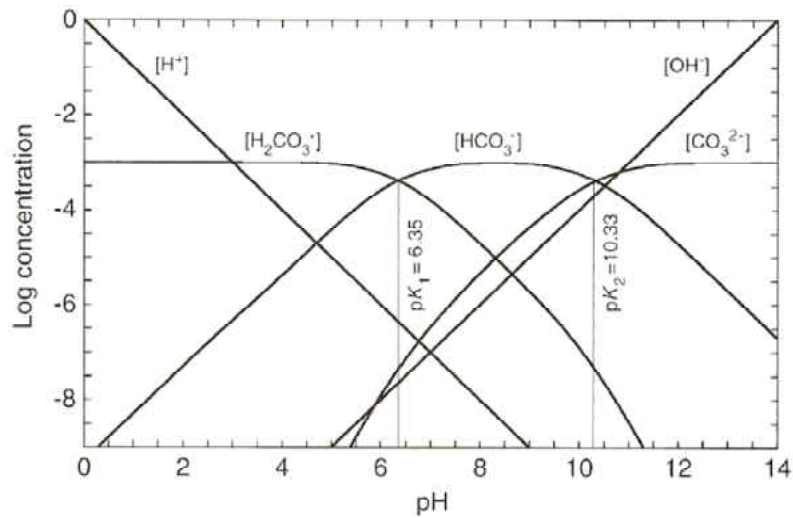

Figure 34. Carbonate Species Log Concentration as a Function of pH at 25 °C and 1 atm Pressure (MWH et al. 68)

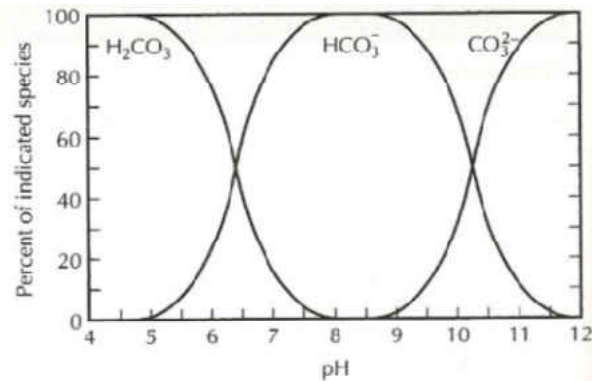

Figure 35. Carbonate Species Percent Concentration as a Function of pH at 20 °C (Fetter 358)

pH	Carbonic Acid	Bicarbonate Ion	Carbonate Ion
2.00	99.99%	0.01%	
3.00	99.96%	0.04%	
4.00	99.6%	0.4%	
5.00	96.0%	4.0%	
6.00	70.6%	29.4%	
6.38	50.0%	50.0%	
7.00	5.2%	94.8%	
8.00	2.3%	97.7%	
9.00		96.0%	4.0%
10.00		70.6%	29.4%
10.38		50.0%	50.0%
11.00		5.2%	94.8%
12.00		2.3%	97.7%
13.00		0.2%	99.8%

Figure 36. Carbonic Species Concentration Distribution at 20 °C (Fetter 357)

Appendix B
Example Calculations

Method Provided by MWH et al. for Estimating $H_2CO_3^*$

First and second dissociation constants for $H_2CO_3^*$ are shown in Equation 49 and Equation 50, respectively.

Equation 49. First Dissociation Constant for Carbonic Acid

$$K_1 = \frac{[H^+][HCO_3^-]}{[H_2CO_3^*]}$$

Equation 50. Second Dissociation Constant for Carbonic Acid

$$K_2 = \frac{[H^+][CO_3^{2-}]}{[HCO_3^-]}$$

Dissociation constants are directly related to temperature. These relationships are shown in Equation 51 and Equation 52.

Equation 51. First Dissociation Constant for Carbonic Acid, Temperature Dependent

$$K_1 = 10^{14.8435 - 3404.71/T_K - 0.032786T_K}$$

where T_K = water temperature, K

Equation 52. Second Dissociation Constant for Carbonic Acid, Temperature Dependent

$$K_2 = 10^{6.498 - 2909.39/T_K - 0.02379T_K}$$

Total carbonic species can then be shown in a single expression as seen in Equation 53.

Equation 53. Total Carbonic Species, mole/L

$$C_T = [H_2CO_3^*] + [HCO_3^-] + [CO_3^{2-}]$$

Ionization fractions can then be found for the various carbonic species. For natural waters, the ionization fraction for HCO_3^- is of particular importance, and is shown in Equation 54. This fraction is re-arranged in terms of dissociation constants and H^+ concentration, as shown in Equation 55.

Equation 54. Ionization Fraction for Carbonic Species

$$\alpha_1 = \frac{[HCO_3^-]}{C_T}$$

Equation 55. Carbonic Species Ionization Fraction Based on Acid Reactions

$$\alpha_1 = \frac{1}{[H^+]/K_1 + 1 + K_2/[H^+]}$$

For natural waters, carbonic acid concentration can be estimated given the above equations. Below is a comparison of the method used by MWH et al. and that used in the Bar Graph Method. For ease of comparison, use values shown in Table 13.

Table 13. Parameters for Method Comparison

Parameter	Value
pH	7.3
T (°C)	10
Alk (mg/l as CaCO ₃)	357

H₂CO₃ Estimation by MWH et al.*

1. $K_1 = 10^{14.8435 - 3404.71/(273+10) - 0.032786(273+10)} = 3.4220 \times 10^{-7}$
2. $K_2 = 10^{6.498 - 2909.39/(273+10) - 0.02379(273+10)} = 3.0542 \times 10^{-11}$
3. $\alpha_1 = \frac{1}{[1.0 \times 10^{-7.3}]/3.4220 \times 10^{-7} + 1 + 3.0542 \times 10^{-11}/[1.0 \times 10^{-7.3}]} = 0.8718$
4. $C_T = \frac{(357 \text{ mg/l}) \left[\frac{1}{100 \text{ g/mole}} \right] \left(\frac{1 \text{ g}}{1000 \text{ mg}} \right)}{0.8718} = 4.095 \times 10^{-3} \text{ mole/l}$
5. $[H_2CO_3^*] = C_T - [HCO_3^-] - [CO_3^{2-}] = 4.095 \times 10^{-3} - 3.570 \times 10^{-3} - 0 =$
 $(0.525 \times 10^{-3} \frac{\text{mole}}{\text{l}}) \left(100 \frac{\text{g}}{\text{mole}} \right) \left(1000 \frac{\text{mg}}{\text{g}} \right) = 52.5 \frac{\text{mg}}{\text{l}} \text{ as CaCO}_3$

H₂CO₃ Estimation by Modified Tillman Method*

1. $K_1' = (7.2 \times 10^{-9}) \times (10 \text{ °C}) + (2.6133 \times 10^{-7}) = 3.333333 \times 10^{-7}$

$$2. \quad H_2CO_3^* = 0.88 \frac{(1.0 \times 10^{-7.3})(357 \frac{mg}{l})}{3.333333 \times 10^{-7}} = 47.2 \frac{mg}{l}$$

$$\text{Percent Difference between the two Methods} = \frac{(52.5 - 47.2)}{(52.5 + 47.2)} \times 100 = 5.32\%$$

Sample Error Correction

$$\text{Cation error} = \text{Anion Error} = \frac{(17.2613 - 17.1237)}{2} = 0.0688 \frac{meq}{l}$$

$$\begin{aligned} \text{Corrected } Mg^{2+} \text{ concentration } \left(\frac{meq}{l} \right) &= 5.9552 + 0.0688 \times \left(\frac{5.9552}{17.1237} \right) \\ &= 5.9791 \frac{meq}{l} \end{aligned}$$

Note: Corrected Mg^{2+} concentration slightly different from spreadsheet value due to rounding.

$$\begin{aligned} \text{Corrected } HCO_3^- \text{ concentration } \left(\frac{meq}{l} \right) &= 7.1343 - 0.0688 \times \left(\frac{7.1343}{17.2613} \right) \\ &= 7.1059 \frac{meq}{l} \end{aligned}$$

Appendix C
Example Bar Graphs of Grand Forks WTP Data

CO ₂		CO ₂		CO ₂		CO ₂		CO ₂		CO ₂		CO ₂	
Ca ²⁺	2.9177	Ca ²⁺	9.6977	Ca ²⁺	0.7000	Ca ²⁺	0.7000	Ca ²⁺	0.7000	Ca ²⁺	0.7000	Ca ²⁺	0.7000
Mg ²⁺	1.9584	Mg ²⁺	1.9584	Mg ²⁺	0.9077	Mg ²⁺	0.9077	Mg ²⁺	0.9077	Mg ²⁺	0.9077	Mg ²⁺	0.9077
Other	3.1239	Other	3.1239	Other	3.1239	Other	3.1239	Other	3.1239	Other	3.1239	Other	3.1239
CO ₃ ²⁻	0.0000	CO ₃ ²⁻	10.1656	CO ₃ ²⁻	1.1679	CO ₃ ²⁻	1.1679	CO ₃ ²⁻	1.1679	CO ₃ ²⁻	1.1679	CO ₃ ²⁻	0.0506
HCO ₃ ⁻	4.6363	HCO ₃ ⁻	0.0000	HCO ₃ ⁻	0.0000	HCO ₃ ⁻	0.0000	HCO ₃ ⁻	0.0000	HCO ₃ ⁻	0.0000	HCO ₃ ⁻	1.3173
Other	3.3637	Other	0.0000	Other	0.0000	Other	0.0000	Other	0.0000	Other	0.0000	Other	0.0000
Ca(OH) ₂	6.7800	Ca(OH) ₂	0.0000	Ca(OH) ₂	0.0000	Ca(OH) ₂	0.0000	Ca(OH) ₂	0.0000	Ca(OH) ₂	0.0000	Ca(OH) ₂	0.0000
CO ₂	0.8930	CO ₂	0.0000	CO ₂	0.0000	CO ₂	0.0000	CO ₂	0.0000	CO ₂	0.0000	CO ₂	0.0000
TH	4.8761	TH	11.6561	TH	1.6077	TH	1.6077	TH	1.6077	TH	1.6077	TH	1.6077
CH	4.6363	CH	11.4163	CH	1.3679	CH	1.3679	CH	1.3679	CH	1.3679	CH	1.3679
NCH	0.2398	NCH	0.2398	NCH	0.2398	NCH	0.2398	NCH	0.2398	NCH	0.2398	NCH	0.2398
8.0000	8.0000	14.7800	14.7800	4.7316	4.7316	4.7316	4.7316	4.7316	4.7316	4.7316	4.7316	4.7316	4.7316

Figure 37. Theoretical Bar Graph with Effluent Concentrations Predicted from Observed Influent, Feb. 27, 2012

CO ₂		CO ₂		CO ₂		CO ₂		CO ₂		CO ₂		CO ₂	
Ca ²⁺	2.9177	Ca ²⁺	9.5977	Ca ²⁺	2.2400	Ca ²⁺	2.2400	Ca ²⁺	2.2400	Ca ²⁺	2.2400	Ca ²⁺	2.2400
Mg ²⁺	1.9584	Mg ²⁺	1.9584	Mg ²⁺	0.7200	Mg ²⁺	0.7200	Mg ²⁺	0.7200	Mg ²⁺	0.7200	Mg ²⁺	0.7200
Other	3.3637	Other	3.1239	Other	3.1239	Other	3.1239	Other	3.1239	Other	3.1239	Other	3.1239
CO ₃ ²⁻	0.0000	CO ₃ ²⁻	8.9377	CO ₃ ²⁻	1.4800	CO ₃ ²⁻	1.4800	CO ₃ ²⁻	1.4800	CO ₃ ²⁻	1.4800	CO ₃ ²⁻	1.4800
HCO ₃ ⁻	4.6363	HCO ₃ ⁻	0.2002	HCO ₃ ⁻	0.0000	HCO ₃ ⁻	0.0000	HCO ₃ ⁻	0.0000	HCO ₃ ⁻	0.0000	HCO ₃ ⁻	0.0000
Add		Add		Precipitates		Precipitates		Final		Recarbonation		CO ₂	
Ca(OH) ₂	6.7800	Ca(OH) ₂	0.0000	CaCO ₃	7.4577	CaCO ₃	1.2384	CaCO ₃	1.2384	CO ₂	3.4668	CO ₂	3.4668
Other	8.0000	Other	3.3637	Other	3.3637	Other	3.3637	Other	3.3637	Other	3.3637	Other	3.3637
TH	4.8761	TH	11.6561	TH	11.6561	TH	2.9600	TH	2.9600	TH	2.9600	TH	2.9600
CH	4.6363	CH	11.4163	CH	11.4163	CH	2.5200	CH	2.5200	CH	2.5200	CH	2.5200
NCH	0.2398	NCH	0.2398	NCH	0.2398	NCH	0.4400	NCH	0.4400	NCH	0.4400	NCH	0.4400
8.0000		14.7800		14.7800		6.0839		6.0839		6.0839		6.0839	
8.0000		14.7800		14.7800		6.0839		6.0839		6.0839		6.0839	

Figure 38. Bar Graph from Observed Influent and Effluent Water Qualities, Feb. 27, 2012

CO ₂		0.9457													
Ca ²⁺	CO ₃ ²⁻	2.9376	0.0000	Ca ²⁺	CO ₃ ²⁻	9.7376	10.6979	Ca ²⁺	CO ₃ ²⁻	0.7000	1.6602	Ca ²⁺	CO ₃ ²⁻	0.7000	0.0688
Mg ²⁺	HCO ₃ ⁻	2.1383	4.8761	Mg ²⁺	HCO ₃ ⁻	2.1383	0.0000	Mg ²⁺	HCO ₃ ⁻	1.3601	0.0000	Mg ²⁺	HCO ₃ ⁻	1.3601	1.7914
Other	Other	2.9241	3.1239	Other	OH ⁻	2.9241	0.9782	Other	OH ⁻	2.9241	0.2000	Other	OH ⁻	2.9241	0.0000
		8.0000	8.0000			14.8000	14.8000			4.9841	4.9841			4.9841	4.9841
Add				Add				Precipitates				Final			
Ca(OH) ₂		6.8000 0.0000		Ca(OH) ₂		9.0376 0.7782		CaCO ₃ Mg(OH) ₂				Recarbonation			
												CO ₂			
TH	5.0759	TH	11.8759	TH	11.8759	TH	2.0601	TH	2.0601	TH	2.0601	TH	2.0601	TH	2.0601
CH	4.8761	CH	11.6761	CH	11.6761	CH	1.8602	CH	1.8602	CH	1.8602	CH	1.8602	CH	1.8602
NCH	0.1998	NCH	0.1998	NCH	0.1998	NCH	0.1998	NCH	0.1998	NCH	0.1998	NCH	0.1998	NCH	0.1998

Figure 39. Theoretical Bar Graph with Effluent Concentrations Predicted from Observed Influent, March 1, 2012

CO ₂		0.9457													
Ca ²⁺	CO ₃ ²⁻	2.9376	0.0000	Ca ²⁺	CO ₃ ²⁻	9.7376	9.3376	Ca ²⁺	CO ₃ ²⁻	2.1200	1.7200	Ca ²⁺	CO ₃ ²⁻	2.1200	0.0954
Mg ²⁺	HCO ₃ ⁻	2.1383	4.8761	Mg ²⁺	HCO ₃ ⁻	2.1383	0.1802	Mg ²⁺	HCO ₃ ⁻	0.8400	0.0000	Mg ²⁺	HCO ₃ ⁻	0.8400	2.4846
Add				Precipitates				Final		Recarbonation					
Other	Ca(OH) ₂	6.8000	0.0000	Other	OH ⁻	2.9241	2.1583	Other	OH ⁻	2.9241	0.8600	Other	OH ⁻	2.9241	0.0000
2.9241	3.1239	8.0000	0.0000	CaCO ₃	Mg(OH) ₂	7.6176	1.2983	CO ₂	3.3446	2.9241	0.8600	Other	OH ⁻	2.9241	0.0000
				Other	Other			Other	Other			Other	Other		
8.0000	8.0000	14.8000	14.8000	14.8000	14.8000	5.8841	5.7039	5.8841	5.7039	5.8841	5.7039	5.8841	5.7039	5.8841	5.7039

TH	5.0759	TH	11.8759	TH	2.9600	TH	2.9600
CH	4.8761	CH	11.6761	CH	2.5800	CH	2.5800
NCH	0.1998	NCH	0.1998	NCH	0.3800	NCH	0.3800

Figure 40. Bar Graph from Observed Influent and Effluent Water Qualities, March 1, 2012

CO ₂		1.2922											
Ca ²⁺	CO ₃ ²⁻	2.7978	0.0000	9.1278	9.2858	0.7000	0.8580	0.7000	0.8580	0.7000	0.0391	0.7000	0.0391
Mg ²⁺	HCO ₃ ⁻	1.5987	3.9968	1.5987	0.0000	Mg ²⁺	HCO ₃ ⁻	Mg ²⁺	HCO ₃ ⁻	Mg ²⁺	HCO ₃ ⁻	Mg ²⁺	HCO ₃ ⁻
Add						Precipitates				Final			
Other	Ca(OH) ₂	3.6035	4.0032	Other	OH ⁻	CaCO ₃	Mg(OH) ₂	Other	OH ⁻	CO ₂	OH ⁻	Other	OH ⁻
						8.4278	0.8410	3.6035	0.2000	1.2189	0.0000	3.6035	0.0000
8.0000	8.0000	14.3300	14.3300	14.3300	14.3300	5.0612	5.0612	5.0612	5.0612	5.0612	5.0612	5.0612	5.0612
TH	4.3965	TH	10.7265	TH	10.7265	TH	1.4577	TH	1.4577	TH	1.4577	TH	1.4577
CH	3.9968	CH	10.3268	CH	10.3268	CH	1.0580	CH	1.0580	CH	1.0580	CH	1.0580
NCH	0.3997	NCH	0.3997	NCH	0.3997	NCH	0.3997	NCH	0.3997	NCH	0.3997	NCH	0.3997

Figure 43. Theoretical Bar Graph with Effluent Concentrations Predicted from Observed Influent, March 15, 2012

CO ₂		CO ₂		CO ₂		CO ₂		CO ₂		CO ₂		CO ₂	
1.2922		1.2922		1.2922		1.2922		1.2922		1.2922		1.2922	
Ca ²⁺	CO ₃ ²⁻	Ca ²⁺	CO ₃ ²⁻	Ca ²⁺	CO ₃ ²⁻	Ca ²⁺	CO ₃ ²⁻	Ca ²⁺	CO ₃ ²⁻	Ca ²⁺	CO ₃ ²⁻	Ca ²⁺	CO ₃ ²⁻
2.7978	0.0000	9.1278	7.8278	9.1278	7.8278	2.1000	0.8000	2.1000	0.8000	2.1000	0.8000	2.1000	0.8000
Mg ²⁺	HCO ₃ ⁻	Mg ²⁺	HCO ₃ ⁻	Mg ²⁺	HCO ₃ ⁻	Mg ²⁺	HCO ₃ ⁻	Mg ²⁺	HCO ₃ ⁻	Mg ²⁺	HCO ₃ ⁻	Mg ²⁺	HCO ₃ ⁻
1.5987	3.9968	1.5987	0.2003	1.5987	0.2003	0.6800	0.0000	0.6800	0.0000	0.6800	0.0000	0.6800	2.0993
Add		Add		Add		Add		Add		Add		Add	
Other	Ca(OH) ₂	Other	OH ⁻	Other	OH ⁻	Other	OH ⁻	Other	OH ⁻	Other	OH ⁻	Other	OH ⁻
3.6035	4.0032	3.6035	2.2987	3.6035	2.2987	3.6035	1.3800	3.6035	1.3800	3.6035	1.3800	3.6035	0.0000
8.0000		8.0000		8.0000		8.0000		8.0000		8.0000		8.0000	
8.0000		14.3300		14.3300		6.3835		6.3835		6.3835		6.3835	
TH	4.3965	TH	10.7265	TH	10.7265	TH	2.7800	TH	2.7800	TH	2.7800	TH	2.7800
CH	3.9968	CH	10.3268	CH	10.3268	CH	2.1800	CH	2.1800	CH	2.1800	CH	2.1800
NCH	0.3997	NCH	0.3997	NCH	0.3997	NCH	0.6000	NCH	0.6000	NCH	0.6000	NCH	0.6000

Figure 44. Bar Graph from Observed Influent and Effluent Water Quality, March 15, 2012

WORKS CITED

- Droste, Ronald L. *Theory and Practice of Water and Wastewater Treatment*. New York: J. Wiley, 1997. Print.
- Fetter, C. W. *Applied Hydrogeology*. 4th ed. Upper Saddle River, NJ: Prentice Hall, 2001. Print.
- Gullicks, Harvey A. *Bar Graph Method Water Softening Chemistry for Operators and the Practicing Engineer*. Working paper. 1st ed. Grand Forks, ND: AE2S, 2001. Print.
- Gullicks, Harvey A. "Equation Modifications in the Bar Graph Method and Determination of Spreadsheet Logistics." Personal interview. 17 Feb. 2011 – 20 June 2012.
- Hammer, Mark J., and Mark J. Hammer. *Water and Wastewater Technology*. 6th ed. Upper Saddle River, NJ: Pearson/Prentice Hall, 2008. Print.
- Holmes-Farley, Randy. "Chemistry and the Aquarium: Calcium." *Advanced Aquarist*. Pomecanthus Publications, LLC., Mar. 2002. Web. 23 June 2012.
<<http://www.advancedaquarist.com/2002/3/chemistry>>.
- MWH, John C. Crittenden, R. Rhodes Trussel, David W. Hand, Kerry J. Howe, and George Tchobanoglous. *Water Treatment: Principles and Design*. Second ed. Hoboken, NJ: John Wiley & Sons, 2005. Print.

United States. Department of the Interior. Bureau of Reclamation. *Reclamation:*

Managing Water in the West. By Water Treatment Engineering Research Team.

Vol. 68. Denver: Technical Service Center, 2010. Print. Desalination.

Viessman, Warren, Mark J. Hammer, Elizabeth M. Perez, and Paul A. Chadik. *Water*

Supply and Pollution Control. 8th ed. Indianapolis, IN: Prentice Hall, 2008. Print.