

# Output power levelling for DFIG wind turbine system using intelligent pitch angle control

Ehsan Hosseini & Ghazanfar Shahgholian

To cite this article: Ehsan Hosseini & Ghazanfar Shahgholian (2017) Output power levelling for DFIG wind turbine system using intelligent pitch angle control, *Automatika*, 58:4, 363-374, DOI: [10.1080/00051144.2018.1455017](https://doi.org/10.1080/00051144.2018.1455017)

To link to this article: <https://doi.org/10.1080/00051144.2018.1455017>



© 2018 The Author(s). Published by Informa UK Limited, trading as Taylor & Francis Group.



Published online: 10 Apr 2018.



Submit your article to this journal [↗](#)



Article views: 838



View related articles [↗](#)



View Crossmark data [↗](#)



Citing articles: 1 View citing articles [↗](#)



# Output power levelling for DFIG wind turbine system using intelligent pitch angle control

Ehsan Hosseini<sup>a</sup> and Ghazanfar Shahgholian<sup>b</sup>

<sup>a</sup>Smart Microgrid Research Center, Najafabad Branch, Islamic Azad University, Najafabad, Iran; <sup>b</sup>Department of Electrical Engineering, Najafabad Branch, Islamic Azad University, Najafabad, Iran

## ABSTRACT

Blade pitch angle control, as an indispensable part of wind turbine, plays a part in getting the desired power. In this regard, several pitch angle control methods have been proposed in order to limit aerodynamic power gained from the wind turbine system (WTS) in the high-wind-speed regions. In this paper, intelligent control methods are applied to control the blade pitch angle of doubly-fed induction generator (DFIG) WTS. Conventional fuzzy logic and neuro-fuzzy-particle swarm optimization controllers are used to get the appropriate wind power, where fuzzy inference system is based on fuzzy c-means clustering algorithm. It reduces the extra repetitive rules in fuzzy structure which in turn would reduce the complexity in neuro-fuzzy network with maximizing efficiently. In comparing the controllers at any given wind speed, adaptive neuro-fuzzy inference systems controller involving both mechanical power and rotor speed revealed better performance to maintain the aerodynamic power and rotor speed at the rated value. The effectiveness of the proposed method is verified by simulation results for a 9 MW DFIG WTS.

## ARTICLE HISTORY

Received 1 November 2017  
Accepted 14 March 2018

## KEYWORDS

Blade pitch angle control;  
ANFIS controller; fuzzy logic  
controller; PI controller

## 1. Introduction

Nowadays, there is a growing interest in using renewable energies due to some exceptional benefits such as global availability, low initial costs, being environmentally friendly and the high rate of technological development [1,2]. Wind energy is the most accessible variable source and is one of the fastest growing renewable energy systems [3]. Moreover, wind turbines play a vital role in micro-grids as energy sources and can be considered as an alternative instead of global network [4,5].

Control systems for variable-speed wind turbines are continuously evolving toward innovative and more efficient solutions [6,7]. The blade pitch angle control is the most important controller applied in wind turbine in the purpose of getting the desired output power from wind [8]. To achieve this objective, various control methods are proposed, among which the proportional–integral–derivative (PID) controller has been often implemented for pitch angle regulation on the basis of the turbine model. Due to its simplicity, linearity in functionality and easy implementation in control systems, PID controller is considered as the most versatile one [9,10]. Gains of the controller will be regulated either on the basis of human experience and intuition of engineers or by using intelligent methods, or a combination of both. In [11], PID controller with modified gains has used to improve the performance of wind-energy conversion system that it is proposed

to compensate for changes in the sensitivity of the aerodynamic torque to the blade pitch angle. PID controller has desirable accuracy just in a limited range around the operating points since the controller is linearized at the operating points and often leads to some problems in such nonlinear systems [12].

Sliding mode control is one of the appropriate methods of nonlinear control since it provides the system with a reliable dynamic robustness when the system faces uncertainties in turbine parameters [13]. In controlling wind turbines, the sliding mode provides a close fit between changes in efficiency and torque fluctuations. Sliding mode controllers have demonstrated a good robustness against uncertainties of turbine parameters, and have improved the stability properties. Nevertheless, they depend on the mathematical models of the wind turbines and need the wind data. Moreover, if the control parameters encounter with sudden change(s), a considerable pressure will be imposed on turbine and as a result, the chattering effect increases. Linear quadratic Gaussian is one of the most basic optimization methods able to design linear feedback control for unknown nonlinear systems [14]. This method has been applied in [15] to control the blade angle. This combined method includes a linear quadratic estimator accompanied with a linear quadratic regulator which are calculated and designed separately. The performance of this controller is limited because of nonlinear characters on the top of the wind turbines

and is not reliable as an automatic optimizer. In [16], control gains are adjusted by the changes in operating conditions of the systems. However,  $H\infty$  does not need any system performance momentary estimator and offers an almost rapid response to changes in operating conditions. The main drawback of these control methods is that its function depends on the turbine of linear model. Designing a programming function for the control gains in different functional points is not easy.

Fuzzy logic control is a wise choice as an overcoming factor with respect to lack of information compared to the PI controller [17]. One of the conventional strategies of the variable speed wind turbine control is the use of the rotor speed as a function of the wind speed. The factors of rotor speed, torque and dynamic of system heavily depend on the wind speed, which are very problematic like, distraction in system parameters and changes in environmental condition; consequently, fuzzy logic is an effective approach for controlling wind turbines functionality [18]. Ensuring fast convergence and independence in changing the parameters even in the presence of noise signals and non-integer types are the main factors of this controller [19].

There exist several reports on blade pitch angle control through fuzzy logic. In [20], rotor speed variations and their derivatives are added to wind speed factor, where the data of wind speed and anemometer are needed. In [21], a blade pitch controller is designed for PM generator wind turbines. The main advantage of this design is related to the replacement of rotor speed in the controller input. Mechanical power ( $\Delta p$ ), the derivative of mechanical power ( $\dot{\Delta p}$ ), and rotor speed are considered as the inputs of fuzzy systems. Mechanical power generators compared with the reference value and generate ( $\Delta p$ ) [22]. Next, the fuzzy controller converts the numerical errors, the changes thereof and rotor speed error into fuzzy and then forms the linguistic variables. In continuation, a variety of control PID and fuzzy controller in wind speed with an average of 12 and 14 metres per second are compared with one another and results indicate the superiority of the fuzzy controller, especially when the wind changes in a sudden manner. In [23], the only fuzzy input applied is the mechanical power variations and during sudden changes in wind speed low fluctuation is observed in the aerodynamic response in comparison with that of the conventional controller. Moreover, no discussion is run on maximum power point tracking (MPPT) and more power tracking in comparison to PI controller, in fact, pitch angle control must be able to meet both the requirements of fluctuation reduction and yield maximum energy, simultaneously. In [24], fuzzy controller is applied together with a dead zone to reduce voltage fluctuations and frequency in island mode. However, difficulties in regulating a fuzzy system might reduce its benefits. To overcome these difficulties, neuro-fuzzy controllers have been applied in

controlling pitch angle [25]. In [26], a fuzzy-neural controller is used to adjust the angle between input wind direction and chord line of the blades. The main advantage of this approach is that, in the case of new changes, the fuzzy-neural adaptive networks can obtain new learning methods and adapt themselves to the new data. From the outcome of this assessment it can be deduced that a more reliable performance is evident in the response of rotor speed and output power of generator. But this is not at all helpful in optimizing efforts to increase the number of membership functions. By choosing the more efficient type of membership functions and finding the best locations for them, even in the least number, the best structure of neuro-fuzzy could be achieved.

In this paper, on the basis of using the minimum number of membership functions, adaptive neuro-fuzzy inference systems (ANFIS) controller is designed to keep the rotor speed of doubly-fed induction generator (DFIG) wind turbine system (WTS) at the rated value at any instance. To achieve a better clustering for ANFIS controller, FCM algorithm clustering is modified through receiving data from conventional fuzzy controller. The initial fuzzy inference systems (FIS) is built and optimized with particle swarm optimization (PSO) algorithm. By using ANFIS controller in different case of inputs, and comparing them with conventional fuzzy logic controller, a proper assessment will be achieved.

## 2. Modelling of wind turbines

Exploiting mechanical power by turbine and converting this power into the electrical power by generator are two main sections of the WTSs [27]. In studying transient stability for modelling the connection between the mechanical and electrical systems of wind turbines, the two-mass model is usually applied. This model is expressed by the following equations [28]:

$$\frac{d\omega_r}{dt} = \frac{1}{2H_R} (T_E + T_{sh}) \quad (1)$$

$$\frac{d\omega_t}{dt} = \frac{1}{2H_T} (T_M - T_{sh}) \quad (2)$$

$$\frac{d\beta}{dt} = \omega_b (\omega_t - \omega_r) \quad (3)$$

where  $T_{sh}$  is the shaft torque,  $T_E$  and  $T_M$  are the machine electromagnetic torque and mechanical turbine torques, respectively.  $H_R$  and  $H_T$  are the rotor and turbine constant inertia, respectively.  $\omega_r$  and  $\omega_t$  are the angular frequency of the rotor and turbine, and  $\beta$  is the shaft twist angle. Turbine mechanical torque equation is expressed as the following [29]:

$$T_M = \frac{0.5 \rho \pi R^2 C_p V_W^3}{S_b \omega_T} \quad (4)$$

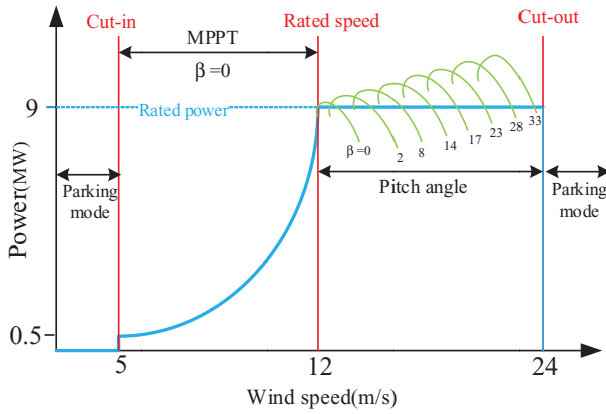

**Figure 1.** Qualitative wind turbine mechanical power versus wind speed curve.

where  $\rho$  is the air density ( $\text{kg/m}^3$ ),  $R$  is the radius of blade (m),  $V_w$  is the wind speed (m/s),  $S_b$  is the nominal power and  $C_p$  is called power coefficient WTS with this equation

$$C_p = 0.22 \left( \frac{116}{\lambda_i} - 0.4 \beta_p - 5 \right) e^{-\frac{12.5}{\lambda_i}} \quad (5)$$

where  $\beta_p$  is the pitch angle and  $\lambda_i$  is given by

$$\lambda_i = \left( \frac{1}{\lambda + 0.08 \beta_p} - \frac{0.035}{\beta_p^3 + 1} \right)^{-1} \quad (6)$$

where  $\lambda$  is the ratio of the blade tip speed to wind speed:

$$\lambda = \frac{\omega_t R}{V_w} \quad (7)$$

Controlling (7), it is observed that at a certain wind speed, there is just a unique rotational speed named MPPT. Using the derivative of (5), the extreme points of  $C_p$  as a function of  $\lambda$  can be found as

$$\lambda_{\text{OPT}} = \left( \frac{14.28 + 0.4 \beta_p}{116} + \frac{0.035}{\beta_p^3} \right)^{-1} - 0.8 \beta_p \quad (8)$$

Therefore, for different pitch angles  $\beta_p$ , the ratio of the blade tip speed and the wind speed can be obtained. A typical power curve is demonstrated in Figure 1, where the power limitation is started in pitch angle sector.

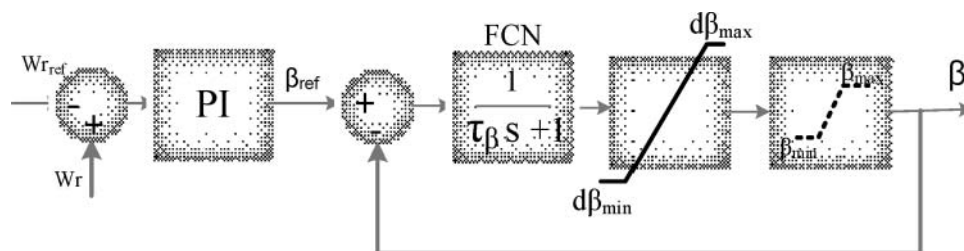

**Figure 2.** Block diagram of the pitch control system using PI controllers.

Once the rotor speed exceeds its upper limit, the blade's angle should be increased for reducing aerodynamic pressure. In a closed-loop system, actuator can be considered as an integrator or a delayed first-order system with a time constant ( $\tau_c$ ). The angle actuator dynamic behaviour is presented by the following equation:

$$\frac{d\beta}{dt} = \frac{1}{\tau_c} (-\beta + \beta_{\text{ref}}) \quad (9)$$

where  $\beta$  is the pitch angle and  $\beta_{\text{ref}}$  is the reference value achieved through different methods. The pitch angle response depends on time constant of the pitch actuator, which usually ranges between 0.2 and 0.25 s [30]. The rate limiter is necessary to represent a real output of the controller's response. The real power is determined by the following equation:

$$\beta_{p \text{ ref}} = K_{p\beta}(P_t - P_{t \text{ ref}}) + x_\beta \quad (10)$$

$$\frac{dx_\beta}{dt} = K_{i\beta}(P_t - P_{t \text{ ref}}) \quad (11)$$

where  $K_{p\beta}$  and  $K_{i\beta}$  are the proportional and integrator gains. The block diagram of typical pitch control system is shown in Figure 2.

### 3. Fuzzy logic controller

A fuzzy controller consists of four main sections: fuzzifier, fuzzy rule base, fuzzy inference engine and defuzzifier. The input and output of the fuzzy inference system are fuzzy, while the input and output of the proposed system is Crisp. The fuzzifier changes the Crisp input to fuzzy in order to make it ready for inference engine, while defuzzifier changes the fuzzy output to Crisp. The fuzzy rules are adjusted based on the human experience and expressed by the linguistic variables. Inference engine is the heart of the fuzzy system that would make decisions, do calculations and also set rules [22]. By considering the following fuzzy rule:

If  $X_1$  is  $A_1^1$  and  $\dots$   $X_n$  is  $A_n^1$ , then  $y$  is  $B^1$ ,  $1 = 1, \dots, M$ . (12)

If fuzzy set  $B^l$  is normal with  $y^l$  centre, for product inference engine, singleton fuzzifier and centre of

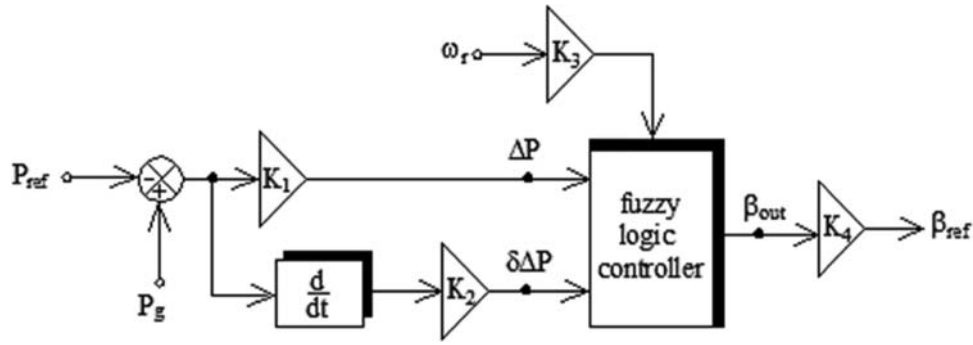

Figure 3. Block diagram of the FLC pitch angle control.

gravity defuzzifier, the calculations of the fuzzy system will be obtained [31]

$$f(x) = \frac{\sum_{l=1}^M y^l \left( \prod_{i=1}^l \mu_{A_i}^l(x_i) \right)}{\sum_{l=1}^M \left( \prod_{i=1}^l \mu_{A_i}^l(x_i) \right)} \quad (13)$$

Here, product inference engine, singleton fuzzifier and centre of gravity defuzzifier are used in Mamdani-type inference. The block diagram of the fuzzy logic controller applied in DFIG WTS is shown in Figure 3, where the error in the generator output power ( $\Delta p$ ), the variation of the output power error ( $\delta\Delta p$ ) and rotor speed ( $\omega_r$ ) are considered as inputs for the proposed fuzzy controller. The generator output power will be compared with reference value ( $P_{ref}$ ) and it provides the  $\Delta p$ . The error in the generator output power ( $\Delta p$ ), the variation of the output power error ( $\delta\Delta p$ ) and rotor speed ( $\omega_r$ ) are considered as inputs for the proposed fuzzy controller.

$\Delta p$  and  $\delta\Delta p$  are calculated as the following [32]:

$$\Delta p(i) = p_g(i) - p_{ref}(i)Z \quad (14)$$

$$\delta(\Delta p) = \Delta p(i) - \Delta p(i - 1) \quad (15)$$

At first, fuzzy controller converts numerical error to fuzzy one. Linguistic variables are defined on the basis of the human experience. Linguistic variables are expressed by positive small (PS), positive medium (PM), positive big (PB), very negative (VN), medium negative (MN), slightly negative (SLN), zero (ZE), slightly positive (SLP), medium positive (MP), very positive (VP). Fuzzy rules is tabulated in Table 1. For

example, one of the rules is that it can be interpreted as: If  $\Delta p$  is VERY NEGATIVE and  $\delta\Delta p$  is ZERO and  $\omega_r$  is PM, then  $\beta_{ref}$  will be SLIGHTLY NEGATIVE. The triangular membership functions used for input and output are shown in Figure 4. Figure 5 shows the block diagram of the DFIG WTS, where the fuzzy controller is applied as a pitch angle controller.

#### 4. Design of ANFIS controller

##### 4.1. Clustering of fuzzy c-mean

The fuzzy c-mean (FCM) is a data clustering method in which the process begins with one initial guess for the clusters' centres, which is usually incorrect [33].

FCM partitions a collection of  $n$  vectors (data:  $x_1, x_2, \dots, x_i, \dots, x_n \in R^d$ ) into fuzzy group. By considering  $A_1, A_2, \dots, A_j, \dots, A_k \{x_j \in A_j \Leftrightarrow j = \text{argmin } D(x_i, c_j)\}$  as clusters,  $c_1, c_2, \dots, c_j, \dots, c_k \in R^d$  as clusters' centres {where  $R^d$  is a  $d$  dimension space,  $k$  is the number of clusters and or the number of cluster centres,  $n$  is the number of data and  $A_j, c_j$  and  $x_i$  constitute the general statement}, and setting objective in minimizing the Euclidean distance between  $x_i$  and  $A_j$  cluster centre, objective function is defined as

$$O.f = \begin{cases} \frac{1}{n} \sum D(x_i, c_j(i)) \\ \text{OR} \\ \frac{1}{n} \sum D(x_i, c_j(i))^2 \end{cases} \quad (16)$$

The FCM determines the membership degree for each one of the clusters. The degree of membership of

Table 1. Fuzzy rules.

$\omega_r$	PS						PM						PB					
	VN	SLN	ZE	SLP	VP		VN	SLN	ZE	SLP	VP		VN	SLN	ZE	SLP	VP	
$\Delta p$																		
$\delta\Delta p$	VN	VN	VN	VN	VN	MN	SLN	SLN	SLN	MP	MP	SLP	SLP	SLP	MP	MP	VP	
	SLN	VN	VN	VN	MN	MN	SLN	SLN	ZE	MP	MP	SLP	SLP	SLP	MP	MP	VP	
	ZE	VN	VN	MN	SLN	SLN	SLN	ZE	ZE	MP	MP	SLP	MP	MP	MP	VP	VP	
	SLP	VN	MN	MN	SLN	SLN	SLN	ZE	ZE	MP	SLP	MP	MP	MP	VP	VP	VP	
	VP	MN	MN	SLN	MN	SLN	ZE	ZE	SLP	SLP	SLP	MP	MP	MP	VP	VP	VP	



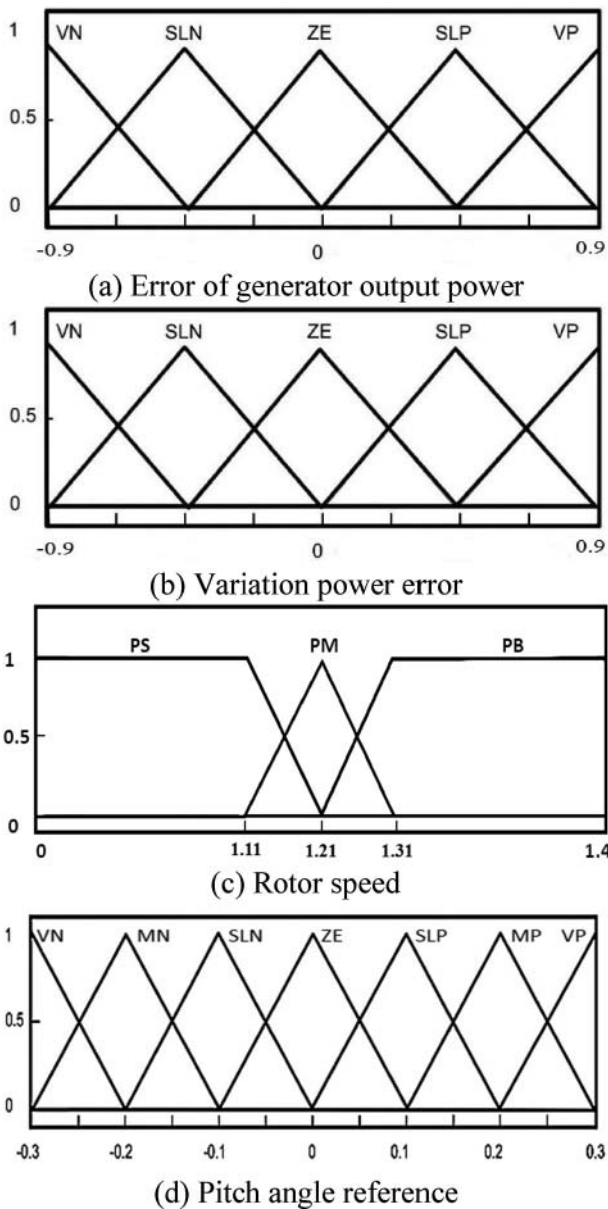

Figure 4. Membership functions of FLC.

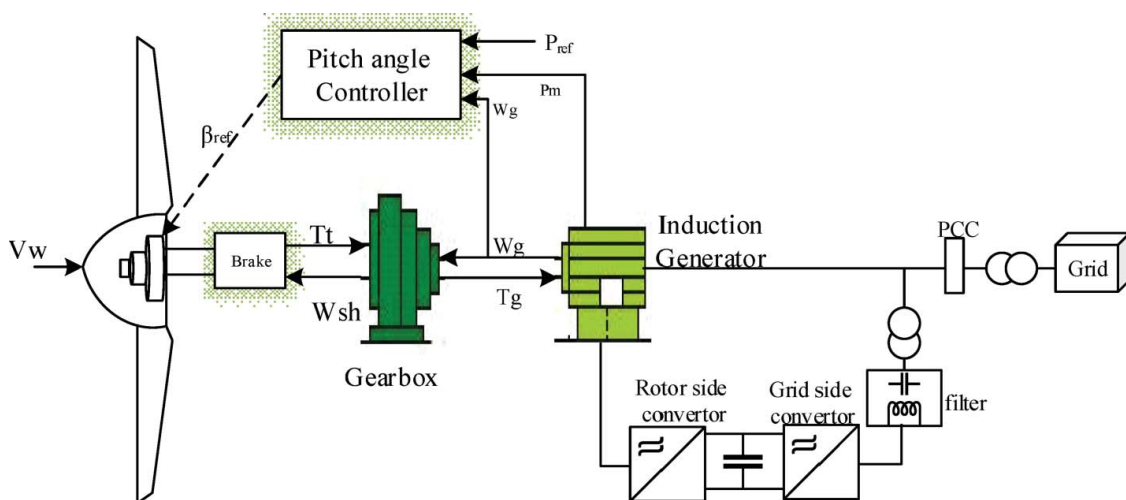

Figure 5. The block diagram of the fuzzy pitch angle controller.

$x_i$  in cluster  $j$ th is expressed as follows:

$$u_j(x) = \frac{1}{\sum_k \left[ \frac{D(c_j, x)}{D(c_k, x)} \right]^{\frac{2}{m-1}}} \quad 0 \leq u_j(x) \leq 1 \quad (17)$$

According to Equation (17), the objective function in Equation (16) can be rewritten as

$$O.f = \frac{1}{n} \sum D(x_i, c_j(i))^2 * u_j(x) \quad (18)$$

Finally, the new  $c$ -fuzzy clusters centre is calculated

$$c_j = \frac{\left[ \sum_i u_j(x) \right] x_i}{\sum_i u_j(x)} \quad (19)$$

#### 4.2. Neuro-fuzzy inference system

ANFIS structure takes advantage of both artificial neural network (ANN) and fuzzy logic theory. By employing the fuzzy inference, the input data can generate output data, easy to understand and interpret [34,35]. By applying the ANN, parameters of the Takagi-Sugeno inference model can be updated in a desirable manner. The ANFIS structure consists of five distinct layers' and two basic parts: constructing and training [36]. To reach a better understanding of ANFIS concept, the following example of radial basis Gaussian function as transfer function is given as

$$\mu_{A_i}(x) = \frac{1}{1 + \left[ \left( \frac{x-c_i}{\sigma_i} \right)^2 \right]^{b_i}} = \exp \frac{-0.5(x-c_j)^2}{\sigma_j^2} \quad (20)$$

where  $X$  is the input node  $i$ ,  $A_i$  per language tag (short, long, ...) accompanying the node and  $b_i$ ,  $c_i$  and  $\sigma_i$  are the set of premise parameters, where  $c$  is the centre

and  $\sigma$  is the variance of the membership functions. The ANFIS structure is applied in following five layers [37]:

At the first layer, every node produces one degree of membership for a language tag. At the second layer, every node calculates the firing power (weighted) of every rule according to the product of the following:

$$W_i = \mu_{A_i}(x) \cdot \mu_{B_i}(y) \quad (21)$$

At the third layer, the  $i$ th node calculates the firing power rule (weighted) in relation to the  $i$ th node of the firing powers of all rules as follows:

$$\bar{W}_i = \frac{w_i}{\sum w_j} \quad (22)$$

The output of this layer is used in the next layer. At the fourth layer, consequent parameters are taken into account to calculate output. Consider a linear SUGENO structure, where the fuzzy rules follow the if-then rule and expressed as follows for a two input-one output system:

- Rule 1: if  $x_1$  is  $A_1$  and  $x_2$  is  $B_1$  then  $Y_1 = a_1x_1 + b_1x_2 + c_1$
- ...
- ...
- ...
- Rule 5: if  $x_1$  is  $A_5$  and  $x_2$  is  $B_5$  then  $Y_5 = a_5x_1 + b_5x_2 + c_5$

By taking into account the membership function's output, the output of fourth layer is presented as

$$\bar{W}_i Y_i = \bar{W}_i (a_i x_1 + b_i x_2 + c) \quad (23)$$

The last layer calculates the general output layer as the total of all received signals as follows:

$$\text{OverallOutput} = \sum \bar{W}_i Y_i = \frac{\sum w_i Y_i}{\sum w_i} \quad (24)$$

### 5. Neuro-fuzzy PSO

In optimization process, determining weight coefficients is of great importance in order to get appropriate optimization, specifically in about tunable parameters. For this purpose, the necessary data is received from input and output of PI controller. Through the FCM algorithm, the basic FIS structure is built and the weight coefficients of input for ANFIS controller are specified and cost function optimized through PSO algorithm. For better coverage of uncertainty, clustering is repeated again in the base of neuro fuzzy clustering. The tunable input parameters ( $c, \sigma$ ) and the output parameters ( $a, b, c$ ) became updated in a graded manner. In the first part, applying neuro-fuzzy-PSO controller for the purpose of pitch angle control, rotor speed and its deviation are considered as inputs. The

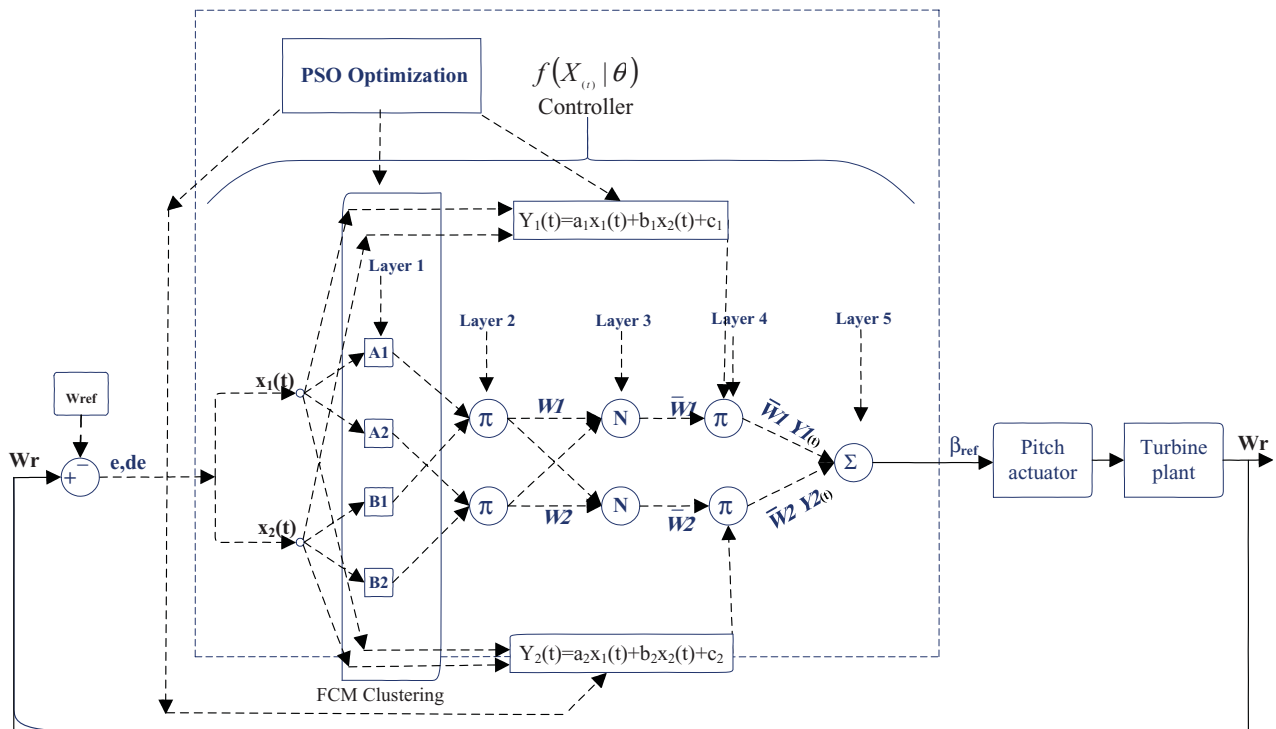

Figure 6. Structure of ANFIS 1 controller in proposed wind turbine.

**Table 2.** Generator and grid parameters.

Parameters	Values
Nominal power	9 MW
Grid voltage and frequency	575 V–60 Hz
Infinite bus-voltage	120 kV
Nom. dc bus voltage	1200 V
DC-bus capacitor	0.06 F
Grid gains [Kp Ki]	[1.25 300]
Rotor gains [Kp Ki]	[1 100]
Line length	20 km

**Table 3.** Parameters of wind turbine.

Rated power	9 MW
Rated wind speed	12 m/s
Max. pitch angle	40 deg
Max. rated of pitch angle	2 deg/s
Cut-in speed	5 m/s
Cut-out speed	24 m/s

rotor speed is compared with the reference value ( $w_{ref}$ ) and builds error in order to consider as the controller's input. Here, neuro-fuzzy-PSO controller with two inputs is named ANFIS 1. Figure 6 shows the structure of ANFIS 1 controller in proposed wind turbine. As shown in Figure 6, if the structure of neuro-fuzzy is assumed as a two-input one-output, for each  $X_b$ , the error is determined through the  $W_r$  and its reference. The cost function of error is obtained through the following equation [38]:

$$E = \frac{1}{N} \sum_{t=1}^T e_t^2 \quad (25)$$

By analysing (23) and (24) the  $\beta_{ref}$  is yielded

$$\beta_{ref} = \frac{\sum_r \left[ \sum_{j=1}^m (a_j x_1 + b_j x_2 + c_j) \exp \left( -\frac{1}{2} \sum_{i=1}^n \left( \frac{x_i - c_i}{\sigma} \right)^2 \right) \right]}{\sum_r \exp \left( -\frac{1}{2} \sum_{i=1}^n \left( \frac{x_i - c_i}{\sigma} \right)^2 \right)} \quad (26)$$

To guarantee that the system works well at every operating point, the tunable input parameters ( $c, \sigma$ ) and the output parameters ( $a, b, c$ ) should be redesigned. On the other hand, although the operating point is changed, the pitch angle control using the

proposed method still gives good performance. The tunable parameters become updated in a graded manner and acquired adaptive states with PSO algorithm. In the simulations made here, the manner of applying PSO algorithm resembles that of [39]. The searching process of PSO-tuning parameter is implemented as follows:

(a) Specifying the lower and upper bounds of the controller parameters and initializing randomly the individuals of the population. (b) Employing the Routh–Hurwitz criterion for each initial individual of the population. (c) Calculating fitness values for each particle. (d) Modifying the member velocity of each individual according to its equation. (e) Changing the velocity of each particle toward its best position at each time step. (f). Generating an optimal controller parameter set.

In the second part,  $\Delta p$ ,  $\sigma \Delta p$  and rotor speed are considered as the inputs of controller to reach efficient utilization of main parameters by participating mechanical power in control process and the controller is named ANFIS.2.

## 6. Simulation results

To verify the efficiency of the proposed controller, the simulation is performed for a DFIG wind power system. For the fuzzy scheme, control parameters are set according to the fuzzy range, where  $K_1 = 10e^{-6}$ ,  $K_2 = 10e^{-2}$ ,  $K_3 = 1$ ,  $K_4 = 100$ . The parameters of the wind turbine and induction generator are listed in Tables 2 and 3, respectively. Figure 7 shows the pattern of the wind speed, of which the rated value is 13 m/s. Considering the regular pattern for wind speed is another advantage of this design for observance of more differences in performance. Both the MPPT and pitch angle

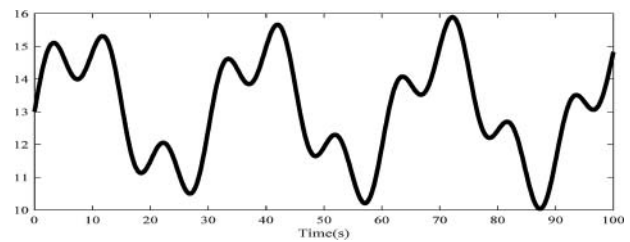
**Figure 7.** Pattern of wind speed at the mean of 13 m/s.**Table 4.** Optimized parameters in ANFIS 1.

Params/MF	$\sigma$		C		OUTPUT		
	IN1	IN2	IN1	IN2	A	B	C
MF1	0.02729	0.5459	-0.019	8.9e-5	741.9	0.00053	-0.00024
MF2	0.09085	0.01446	-0.5155	0.5711	592.1	0.0054	-0.0006
MF3	0.04229	0.04069	-0.1769	0.003697	465.2	-0.00066	-0.0013
MF4	0.03165	0.07162	0.03603	4.433e-5	200	-0.00011	0.00034



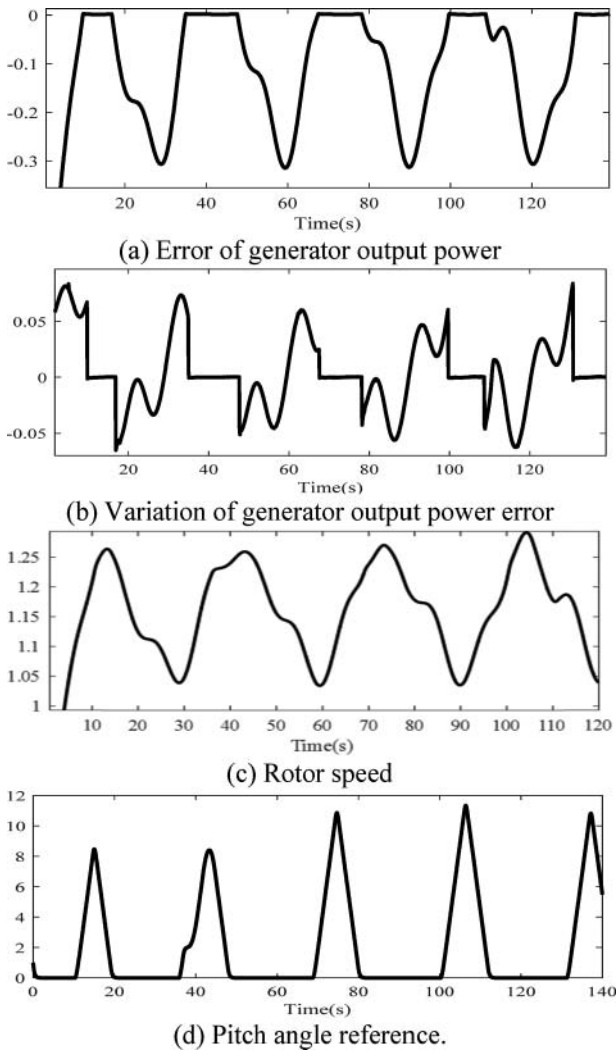

Figure 8. Control's signal of ANFIS 2 controller.

modes are assessed to ensure the good performance of the proposed controller.

In the first part of applying neuro-fuzzy in DFIG pitch angle control, ANFIS 1 is presented. The tunable input and output parameters in ANFIS 1 are optimized through PSO and tabulated in Table 4. By considering four Gaussian membership functions for fuzzy structure and finding their best location through PSO, better coverage of uncertainty could be achieved. In the second part, ANFIS 2 controller is applied to control the pitch angle. The input variables for the proposed ANFIS 2 controller, which are the error of the

Table 6. Parameters of different techniques.

Mean	PI	ANFIS 1	Fuzzy	ANFIS 2
Pmec	0.7410	0.7539	0.7552	0.7626
Cp	0.4028	0.4106	0.4112	0.4146

generator output power, the variation of the power error, the rotor speed and the pitch angle reference are shown in Figure 8(a–d), respectively. Table 5 shows the input and output tunable parameters in ANFIS 2 which are optimized through PSO. Figure 9 shows the generator output power, rotor speed and mechanical torque, respectively. Figure 9(c) shows the power coefficient for different methods. The maximum power coefficient  $C_{pmax}$  corresponds to the optimal tip-speed ratio  $\lambda_{opt}$ , with a zero-pitch angle. It should be noted that

$C_p(max) = 0.48$  for the wind turbine in this simulation. The rotor speed for different methods is shown in Figure 9(b). It can be seen that the proposed method is able to track the optimal power coefficient better than the conventional methods and thus is able to track the desired rotor speed better. Figure 9(a) shows the generator power. It is found that this proposed controller outperforms other controllers. It is kept almost at the rated value by the proposed pitch control strategy. The average generator power for the three methods in the full-load region is tabulated and evaluated in Table 6, where the proposed method gives the highest output power. This table compares the percentages of improvement in the mean of Pmec and Cp.

To find better validation and assessing proposed controllers, a more realistic wind pattern is applied in the system shown in Figure 10. Both of the MPPT and pitch angle sectors are evaluated to prove the controllers' performance. Figure 11(a) shows the performance comparison of the conventional and advanced pitch angle controllers. It shows that efficient pitch angle gives better performance in limiting the generator power and rotor speed to their rated values. Figure 11 (b,c) shows the mechanical power and rotor speed, which is kept at the maximum value of 0.9 and 1.25 pu, respectively. Figure 11(d,e) shows the power conversion coefficients and mechanical torque, respectively.

Overall, it shows the rotor speed which is not well maintained at the rated value and has the high ripple

Table 5. Optimized parameters in ANFIS 2.

Params/MF	$\sigma$			C			OUTPUT			
	IN1	IN2	IN3	IN1	IN2	IN3	A	B	C	D
MF1	0.02907	0.03475	0.01337	-0.05654	0.0081	1.199	41.05	-1.205	27.38	-50.58
MF2	0.02929	0.04231	0.02975	0.00303	-0.0010	0.7985	-68.85	5.229	340.2	-522.9
MF3	0.00922	0.02597	0.0175	0.00354	-0.00663	1.186	79.28	-11.97	112.1	-132.2
MF4	0.09269	0.04689	0.03637	-0.2349	0.03638	0.68	15.32	6.915	-21.04	12.74

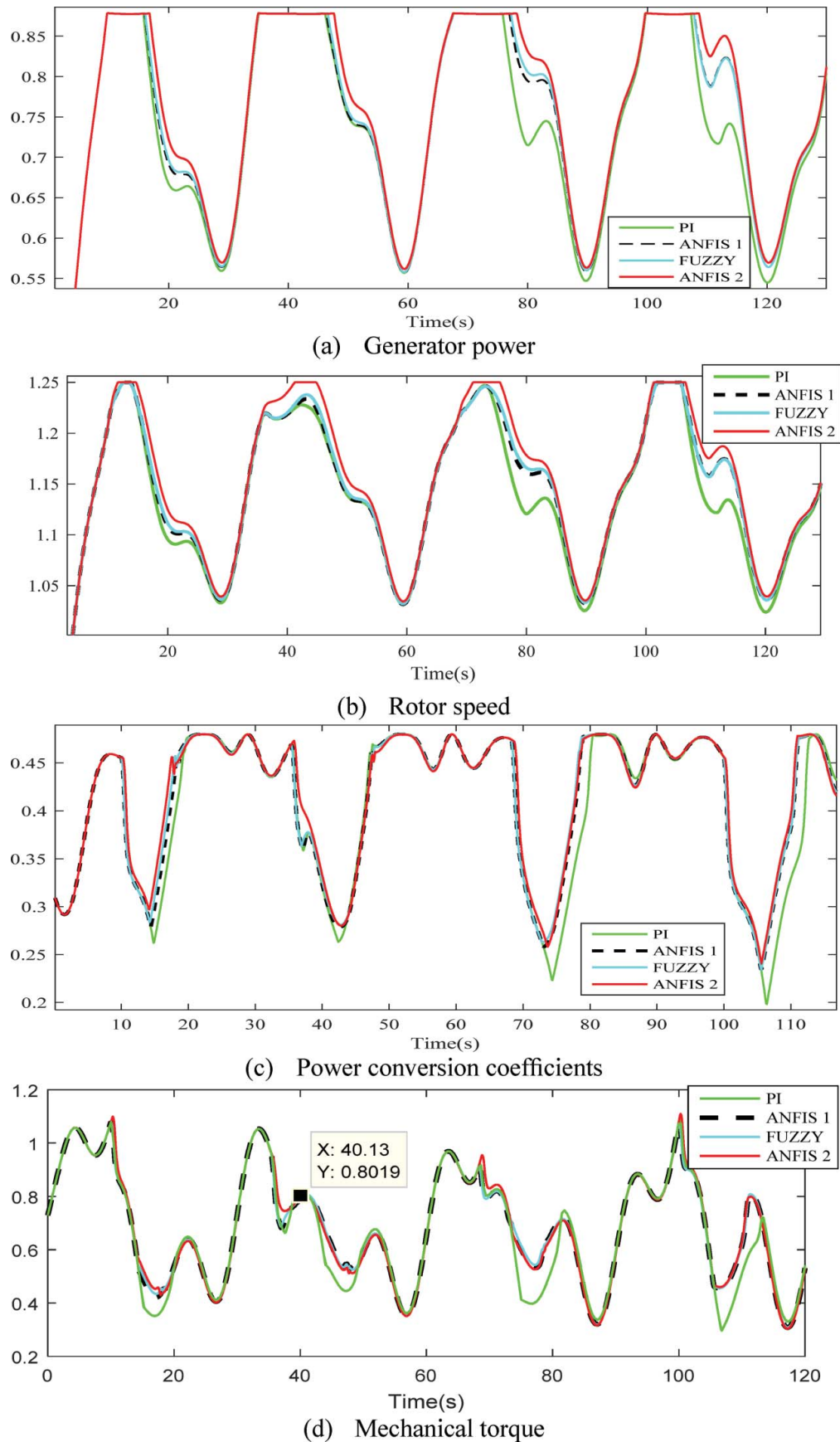

Figure 9. Simulation results for PI controller and proposed controllers at the mean wind speed of 13 m/s.

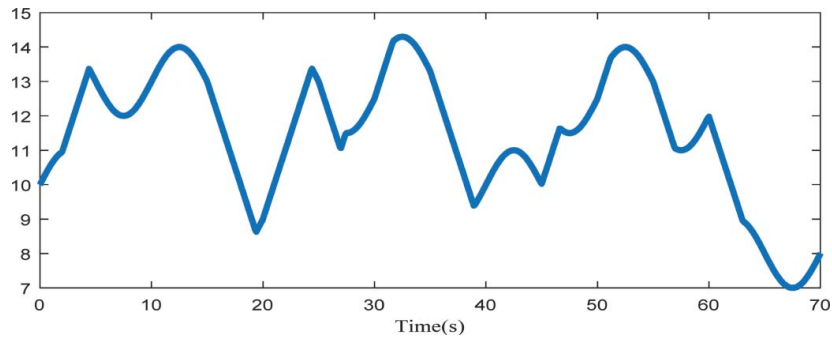
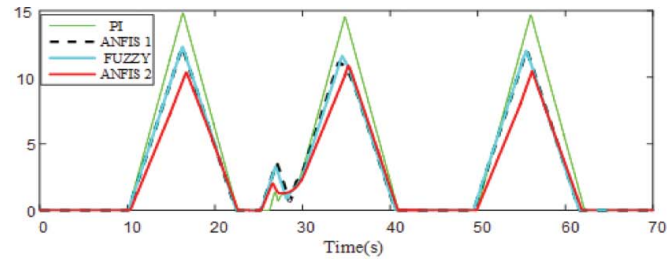
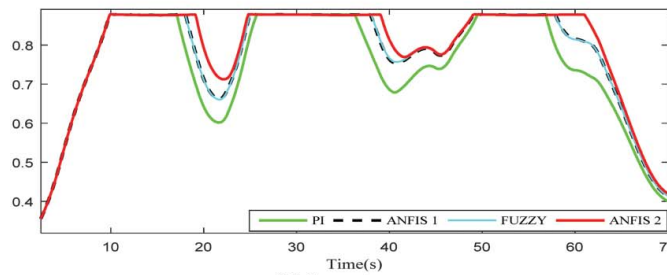

Figure 10. Pattern of realistic wind speed.



(a) Pitch angle



(b) Generator power

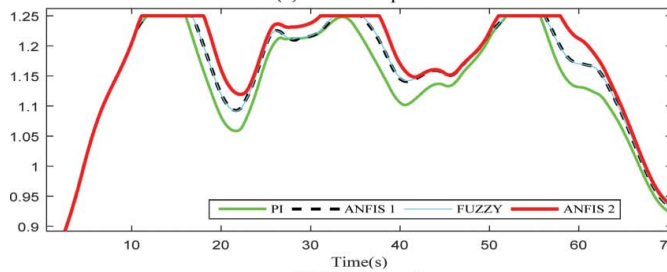

(c) Rotor speed

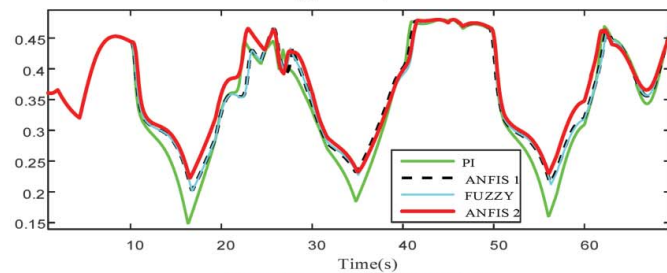

(d) Power conversion coefficients

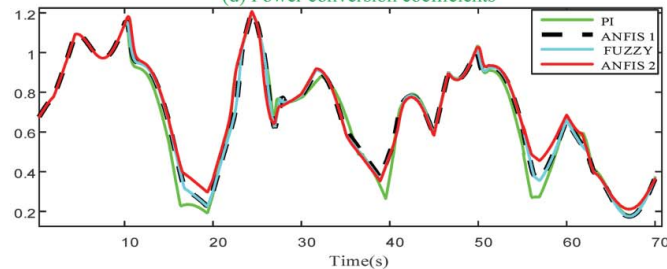

(e) Mechanical torque

Figure 11. Simulation results for PI controller and proposed controllers at realistic wind speed.

components with the conventional controllers, whereas the rotor speed and the generator power are kept almost at the rated value by the proposed pitch control strategies. It represents that clustering on the base of best data, contributes in finding best performance of pitch angle controller by redesigning the control parameters.

## 7. Conclusion

In this article, three automatic controllers are designed through fuzzy and neuro-fuzzy-PSO structure for the pitch angle of a DFIG wind turbine and are simulated in Matlab/Simulink. The obtained results are compared with the typical PI controller. By focusing on the outputs of the simulation, it is observed that the ANFIS controller outperforms its counterparts in tracking the wind speed, limiting the rotor speed and fixing the mechanical torque, especially when there are sudden changes in the wind speed. By comparing average values of the controllers, at the mean wind speed of 13 m/s, the average generator output power of the system using ANFIS 2 controller is 2.91% higher than that of the PI controller and the Power conversion coefficients is higher than that of the PI controller by 2.93%. The proposed methods could exploit more power from wind and better dynamic response in torque.

## Acknowledgments

The authors would like to thank the journal editor and anonymous referees for their valuable comments and suggestions which effectively improved the quality of this paper. This research work has been extracted from the research project in smart microgrid research center, Najafabad Branch, Islamic Azad University, Najafabad, Iran.

## Disclosure statement

No potential conflict of interest was reported by the authors.

## References

- [1] Mozafarpour-Khoshrodi SH, Shahgholian G. Improvement of perturb and observe method for maximum power point tracking in wind energy conversion system using fuzzy controller. *Energy Equipment Syst.* **2016**;4(2):111–122.
- [2] Mahdavian M, Shahgholian G, Janghorbani M, et al. Load frequency control in power system with hydro turbine under various conditions. *Proceeding of the IEEE/ECTICON, Hua Hin, Thailand.* **June 2015**. p. 1–5.
- [3] Hosseini E, Shahgholian G. Partial- or full-power production in WECS: a survey of control and structural strategies. *Euro Power Elect Drives.* **2017**;27(3):125–142.
- [4] Lajouad R, El Magri A, El Fadili A, et al. Adaptive nonlinear control of wind energy conversion system involving induction generator. *Asian J Control.* **2015**;17(4):1365–1376.
- [5] Spudić V, Jelavić M, Baotić M. Wind turbine power references in coordinated control of wind farms. *J Control Meas Elect Comput Communi.* **2017**;52(2):82–94.
- [6] Mahmoud TK, Dong ZY, Ma J. A developed integrated scheme based approach for wind turbine intelligent control. *IEEE Trans Sustain Energy.* **2017**;8(3):927–937.
- [7] Jafari A, Shahgholian G. Analysis and simulation of a sliding mode controller for mechanical part of a doubly-fed induction generator based wind turbine. *IET Gener Transm Distrib.* **2017**;11(10):2677–2688.
- [8] Tazil M, Kumar V, Bansal RC, et al. Three-phase doubly fed induction generators: an overview. *IET Electr Power Appl.* **2010**;4(2):75–89.
- [9] Astrom KJ, Hagglund T. The future of PID control. *Control Eng Pract.* **2001**;9(11):1163–1175.
- [10] Jelavić M, Petrović V, Perić N. Estimation based individual pitch control of wind turbine. *J Control Meas Elect Comput Communi.* **2017**;51(2):181–192.
- [11] Muhando EB, Senjyu T, Uehara A, et al. Gain-scheduled  $H_\infty$  control for WECS via LMI techniques and parametrically dependent feedback Part II: Controller design and implementation. *IEEE Trans Indust Elect.* **2011**;58(1):57–65.
- [12] Huang CN, Chung A. An intelligent design for a PID controller for nonlinear systems. *Asian J Control.* **2016**;18(2):447–455.
- [13] Shahgholian G, Karimi H, Mahmoodian H. Design a power system stabilizer based on fuzzy sliding mode control theory. *Int Rev Model Simul.* **2012**;5(5):2191–2196.
- [14] Zhang R, Venkatasubramaniam P. Stealthy control signal attacks in linear quadratic Gaussian control systems: detectability reward tradeoff. *IEEE Trans Info Forensics Security.* **2017**;12(7):1555–1670.
- [15] Ekelund T. Speed control of wind turbines in the stall region. *IEEE Conference on Control Applications*, pp. 227–232. **1994**.
- [16] Scherer C, Gahinet P, Chilali M. Multiobjective output-feedback control via LMI optimization. *IEEE Trans Autom Con.* **1997**;42(7):896–911.
- [17] Shahgholian G, Mahdavian M, Emami A, et al. Improve power quality using static synchronous compensator with fuzzy logic controller. *Proceeding of the IEEE/ICEMS.* **2011**; p. 1–5.
- [18] Doumi M, Aissaoui AG, Abid M, et al. Robust fuzzy gains scheduling of RST controller for a WECS based on a doubly-fed induction generator. *J Control Meas Elect Comput Commun.* **2016**;57(3):617–626.
- [19] Galdi V, Piccolo A, Siano P. Designing an adaptive fuzzy controller for maximum wind energy extraction. *IEEE Trans Energy Convers.* **2008**;28(2):559–569.
- [20] Musyafa A, Harika A, Negara IMY, et al. Pitch angle control of variable low rated speed wind turbine using fuzzy logic controller. *Int J Eng Technol.* **2010**;10(5):22–25.
- [21] Van TL, Nguyen TH, Lee DC. Advanced pitch angle control based on fuzzy logic for variable-speed wind turbine systems. *IEEE Trans Energy Convers.* **2015**;30(2):578–587.
- [22] Veeramani C, Mohan G. A fuzzy based pitch angle control for variable speed wind turbines. *Int J Eng Technol.* **2013**;5(2):1699–1703.
- [23] Macedo AVA, Mota WS. Wind turbine pitch angle control using fuzzy logic. *Proceeding of the IEEE/TDC-LA, Montevideo, Uruguay, Sep.* **2012**. p. 1–6.

- [24] Kamel RM, Chaouachi A, Nagasaka K. Enhancement of micro-grid performance during islanding mode using storage batteries and new fuzzy logic pitch angle controller. *Energy Convers Manag.* 2011;52(5):2204–2216.
- [25] Lin W, Hong C, Ou T, et al. Hybrid intelligent control of PMSG wind generation system using pitch angle control with RBFN. *Energy Convers Manag.* 2011;52(2):1244–1251.
- [26] Aldair MD. Pitch angle control design of wind turbine using fuzzy-art network. *J Eng Dev.* 2014;18(4):39–51.
- [27] Guo W, Xiao L, Dai S. Fault current limiter-battery energy storage system for the doubly-fed induction generator: analysis and experimental verification. *IET Gener Transm Dis.* 2016;10(3):653–660.
- [28] Yang L, Xu Z, Ostergaard J, et al. Oscillatory stability and eigenvalue sensitivity analysis of a DFIG WT system. *IEEE Trans Energy Convers.* 2011;26:328–339.
- [29] Song YD, Dhinakaran B, Bao XY. Variable speed control of wind turbines using nonlinear and adaptive algorithms. *J Wind Eng Indust Aerodyn.* 2000;85(3):293–308.
- [30] Muhando EB, Senjyu T, Uehara A, et al. LQG design for megawatt-class WECS with DFIG based on functional model's fidelity prerequisites. *IEEE Trans Energy Convers.* 2009;24(4):893–904.
- [31] Bhattacharjee C, Roy BK. Advanced fuzzy power extraction control of wind energy conversion system for power quality improvement in a grid tied hybrid generation system. *IET Gener Transm Distrib.* 2016;10(5):1179–1189.
- [32] Chen WL, Hsu YY. Unified voltage and pitch angle controller for wind-driven induction generator system. *IEEE Trans Aerosp Elect Syst.* 2008;44(3):913–926.
- [33] Abdulshahed M, Longstaff P, Fletcher S, et al. Thermal error modelling of machine tools based on ANFIS with fuzzy c-means clustering using a thermal imaging camera. *Appl Math Modell.* 2014;39(7):1–16.
- [34] Shahgholian G, Movahedi A. Coordinated control of TCSC and SVC for system stability enhancement using ANFIS method. *Int Rev Model Simul.* 2011;4(5):2367–2375.
- [35] Aghadavoodi E, Shahgholian G. A new practical feed-forward cascade analyze for close loop identification of combustion control loop system through RANFIS and NARX. *Appl Therm Eng.* 2018;133:381–395.
- [36] Abdulshahed M, Longstaff P, Fletcher S, et al. Thermal error modelling of machine tools based on ANFIS with fuzzy c-means clustering using a thermal imaging camera. *Appl Math Modell.* 2014;39(7):1–16.
- [37] Wei M, Bai B, Sung AH, et al. Predicting injection profiles using ANFIS. *Info Sci.* 2007;177(20):4445–4461.
- [38] Jang R. ANFIS: adaptive-network-based fuzzy inference system. *IEEE Trans Syst Man Cybern.* 1993;23(3):665–684.
- [39] Sheikhan M, Shahnazi R, Nooshad Yousefi A. An optimal fuzzy PI controller to capture the maximum power for variable-speed wind turbines. *Neural Comput Appl.* 2012;1359–1368.