

A quasi-universal practical IMC algorithm

Vasile Cirtoaje

To cite this article: Vasile Cirtoaje (2017) A quasi-universal practical IMC algorithm, *Automatika*, 58:2, 168-181, DOI: [10.1080/00051144.2017.1383581](https://doi.org/10.1080/00051144.2017.1383581)

To link to this article: <https://doi.org/10.1080/00051144.2017.1383581>



© 2017 The Author(s). Published by Informa UK Limited, trading as Taylor & Francis Group



Published online: 09 Oct 2017.



Submit your article to this journal [↗](#)



Article views: 511



View related articles [↗](#)



View Crossmark data [↗](#)



Citing articles: 3 View citing articles [↗](#)



A quasi-universal practical IMC algorithm

Vasile Cirtoaje

Department of Automatic Control and Computers, University of Ploiesti, Ploiesti, Romania

ABSTRACT

The control algorithm incorporates a process feedback path of pure proportional type (only for integral-type or unstable processes), a process model of second order plus time delay and a realizable second-order internal controller which has not a tuning filter time constant as usual in the classical IMC design, but a tuning gain with standard value 1, that can be used by the human operator to get a strong or weak control action. The model parameters (steady-state gain, time delay and transient time) can be easily experimentally determined and can be online verified and corrected. The algorithm is practical and quasi-universal because it is easily tunable, has a unique form and can be applied to almost all process types: stable proportional processes (with or without time delay, with or without overshoot, of minimum or nonminimum phase), integral processes and even some unstable processes. The proposed algorithm is better than the proportional-integral-derivative (PID) algorithm (which is also quasi-universal and practical) due to its robustness, high control performance (especially for processes with time delay) and simple experimental procedure for determining the controller parameters. Some applications are presented to highlight the main features of the algorithm and the tuning procedure for all process types.

ARTICLE HISTORY

Received 20 February 2017
Accepted 12 September 2017

KEYWORDS

Control algorithm; quasi-universal practical algorithm; compensated process model; IMC structure; tuning gain; online tuning; time delay; transient time

1. Introduction

The internal model control (IMC) approach involves a process model embedded in the controller structure. In its standard and advanced variants, the IMC was introduced and thoroughly studied in 1982 by Garcia and Morari [1] and in 1986 by Rivera et al. [2], but similar concepts have been used previously by other researchers [3,4]. The classical IMC method offers advanced control procedures that can be applied with very good performance to any process with known model, but the found particular control algorithm cannot be used for other processes. Thus, the controller complexity depends mainly on the complexity of the process model and the control system performance stated by the designer [5–10]. For these reasons, the control algorithms of IMC type are not widely used in current industrial practice.

On the other hand, hundreds of significant papers have been written in the last decades on the proportional-integral-derivative (PID) control algorithm, which is the most widely used in practice. It is well known that the IMC design can provide robustness and control performance better than the PID design, especially for processes with large time delay. For some particular processes of low order, without time delay or with time delay approximated by a low-order series expansion, the IMC design can lead to a PID controller structure (or an ideal PID controller cascaded with a first- or second-order filter) and an intuitive procedure for tuning the PID controller [11–16]. Certainly, an

IMC-based PID algorithm leads to weaker control performance than a genuine IMC algorithm. This is the first starting point of our paper.

The configuration of a standard IMC system is shown in Figure 1 [1–5], where $G_P(s)$ is the process transfer function, $G_M(s)$ – process model transfer function, $G_i(s)$ – internal controller transfer function, $Y(s)$ – controlled variable, $U(s)$ – control variable, $R(s)$ – reference (setpoint) variable, $E(s)$ – error variable and $V(s)$ – disturbance variable. For both equivalent diagrams A and B, the transfer function between the controlled variable Y and the reference variable R has the expression

$$G_{YR} = \frac{G_P G_i}{1 + (G_P - G_M) G_i}, \quad (1)$$

while the transfer function between the controlled variable Y and the disturbance variable V is

$$G_{YV} = 1 - G_{YR} = \frac{1 - G_M G_i}{1 + (G_P - G_M) G_i}. \quad (2)$$

Under the assumption that the internal controller gain is the inverse of the model gain, that is

$$G_i(0) = \frac{1}{G_M(0)}, \quad (3)$$

it follows that

$$G_{YR}(0) = 1, \quad G_{YV}(0) = 0. \quad (4)$$

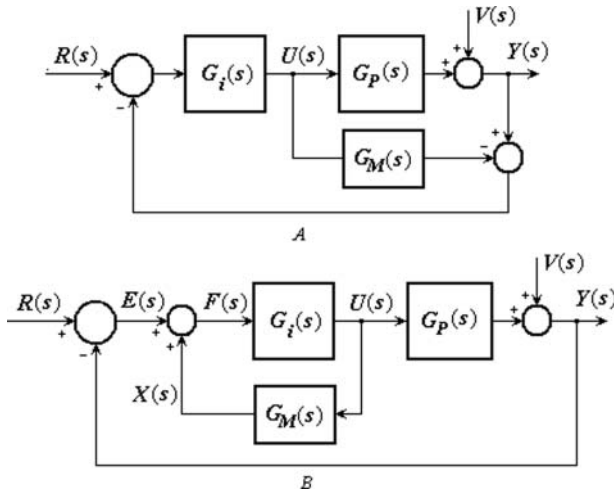

Figure 1. IMC system structure.

According to this result, even if the process model is imperfect, the steady-state value of the controlled variable y is equal to the steady-state value of the reference r whatever the steady-state value of the disturbance v . In addition, it is possible to design an overall IMC controller without concern for the closed-loop system stability, but only for the control performance [1,4,5].

An ideal control system suppresses completely the disturbance effect on the controlled variable and forces it to track instantaneously the reference. This is possible if and only if the transfer function of the internal controller $G_i(s)$ is the inverse of the model transfer function $G_M(s)$, i.e.

$$G_i(s) = \frac{1}{G_M(s)}. \quad (5)$$

Indeed, if this condition is satisfied, then

$$G_{YR}(s) = 1, \quad G_{YV}(s) = 0, \quad (6)$$

therefore, $y(t) = r(t)$ for any reference $r(t)$ and disturbance $v(t)$. Thus, to design an ideal control system, it is not necessary to have a perfect model. Unfortunately, no controller can perfectly invert the process dynamic model. Therefore, the classical IMC design methodology seeks to find a more accurate process model and an approximate proper inverse of the process model. As a consequence, the control algorithms designed by this methodology have a form which depends on the process model.

On the other hand, for a *perfect model*, it follows from Equation (1) that

$$G_{YR}(s) = G_p(s)G_i(s), \quad (7)$$

hence,

$$G_{UR}(s) = G_i(s). \quad (8)$$

The paper presents a quasi-universal and practical approach of the IMC method, in which the model has

a unique structure (of second order plus time delay) irrespective of the controlled process type. This is possible because the model addresses the compensated process, which is always stable and of proportional type (with the steady-state gain finite and nonzero or, equivalently, with no pole and zero at the origin). Such a control technique based on process compensation has been introduced in [17] for unstable processes (under the name of “modified IMC”), in [18] for integral-type processes, and in [19] for unstable integral processes.

The proposed algorithm is quasi-universal because it has a unique form and can be used to control almost all process types: stable processes of proportional type (with or without time delay, with or without overshoot, of minimum or nonminimum phase), integral processes and unstable processes. The model parameters (steady-state gain, time delay and transient time) can be experimentally determined from the compensated process response to a step input, and can be verified and adjusted online; in addition, by setting a suitable tuning gain K , the control performance can be good or very good even if the model parameters have no accurate values. The use of the tuning gain K (with standard value 1) instead of a filter time constant (as usual) is also a practical feature of the presented algorithm.

Using MATLAB/SIMULINK environment, six numerical applications for different process types are presented to show the performance and the tuning procedure of the control algorithm.

2. Primary form of the control algorithm

A model of second order with two lag time constants plus time delay has the transfer function

$$G_M(s) = \frac{K_M e^{-\tau_M s}}{(T_1 s + 1)(T_2 s + 1)}, \quad (9)$$

where K_M is the model steady-state gain, τ_M is the model time delay, and T_1 and T_2 are the model time constants satisfying

$$T_1 = \gamma T_2, \quad 0 \leq \gamma \leq 1.$$

For $\gamma = 1$, the two lag time constants are equal to each other [20], whereas for $\gamma = 0$, the model becomes of first order. In this paper, we will consider the middle case with $\gamma = 1/2$.

For a stable proportional-type process with the step response $y(t)$ monotonic and finite (called P1-type), the model parameters K_M , τ_M , T_1 and T_2 can be easily experimentally determined as follows:

$$K_M \approx K_P, \quad \tau_M \approx \tau_P, \quad (10)$$

$$T_1 = \frac{T_{trM}}{8.4} \approx \frac{T_{trP}}{8.4}, \quad T_2 = 2T_1. \quad (11)$$

where K_p is the process steady-state gain, τ_p – the process time delay, and T_{trp} – the transient time of the response $y(t)$ (which does not include the time delay); more precisely,

$$T_{trp} = t_1 - \tau_p, \quad (12)$$

where t_1 is the settling time (when the response is approximately 98% of its steady-state value):

$$y(t_1) \approx 0.98y(\infty). \quad (13)$$

Note that a first-order plus time delay model is too simple to describe with sufficient accuracy the process sluggishness, whereas a third-order plus time delay model is too complicated to be used to increase the model accuracy. For the internal controller, we have chosen the inverse of the model transfer function

$$G_i(s) = \frac{(T_1s + 1)(T_2s + 1)}{K_M(T_3s + 1)(T_4s + 1)}, \quad (14)$$

where the filter time constants T_3 and T_4 are introduced to make the internal controller realizable (with a number of poles equal to the number of zeros). These time constants need to be lower bounded to avoid excessive noise amplification and to accommodate to the modelling error. In the classical IMC design, these filter time constants are equal to each other and considered as tuning parameter (used by the process human operator to modify the intensity of the control action).

Using the substitution

$$T_3 = \frac{T_1}{\sqrt{K}}, \quad T_4 = \frac{T_2}{\sqrt{K}} = 2T_3, \quad (15)$$

a new practical tuning parameter (the gain K with the standard value 1) is introduced. Thus, the internal controller (14) becomes

$$G_i(s) = \frac{(T_1s + 1)(T_2s + 1)}{K_M \left(\frac{T_1}{\sqrt{K}}s + 1 \right) \left(\frac{T_2}{\sqrt{K}}s + 1 \right)}. \quad (16)$$

Because

$$G_i(0) = \frac{1}{K_M} = \frac{1}{G_M(0)}, \quad (17)$$

the relation (3) is satisfied, therefore the steady-state error is zero for a step reference or disturbance. On the other hand, since $G_M(s)$ and $G_p(s)$ are strictly proper, it follows from Figure 1 that the initial value $u(0_+)$ of the closed-loop control system response $u(t)$ to a unit step reference is

$$u(0_+) = G_i(\infty) = \frac{K}{K_M}. \quad (18)$$

Also, since the steady-state error is zero, the final value of $u(t)$ is equal to the inverse of the process steady-state gain:

$$u(\infty) = \frac{1}{K_p}. \quad (19)$$

Therefore, the magnitude coefficient M of the closed-loop control system response $u(t)$ to a unit step reference, defined as the ratio between the initial value $u(0_+)$ and the final value $u(\infty)$, has the expression

$$M = \frac{u(0_+)}{u(\infty)} = \frac{K_p}{K_M} \cdot K. \quad (20)$$

When the human operator increases/decreases the tuning gain K , the control action becomes stronger/weaker.

According to (10) and (11), one may consider that the model parameters are the gain K_M , the time delay τ_M and the transient time T_{trM} .

In the particular case $K = 1$, the internal controller (16) is purely proportional:

$$G_i(s) = \frac{1}{K_M}. \quad (21)$$

In this case, according to (18) and (19), the initial and final values of the control response $u(t)$ to a unit step reference are $u(0_+) = 1/K_M$ and $u(\infty) = 1/K_p$. If K_M and K_p are equal to each other, then $u(0_+) = u(\infty)$. In addition, for a perfect model with $G_M(s) = G_p(s)$, it follows from (8) and (21) that

$$G_{UR}(s) = 1/K_M = 1/K_p,$$

therefore, the ideal control response $u_{id}(t)$ to a unit step reference is a step function of magnitude $1/K_p$.

For a perfect model and $K > 0$, having in view (8) and (16), the ideal control response $u_{id}(t)$ to a unit step reference has the expression

$$u_{id}(t) = \frac{1 + A_1 e^{-\sqrt{K} t/T_1} + B_1 e^{-\sqrt{K} t/T_2}}{K_M}, \quad (22)$$

where

$$A_1 = (\sqrt{K} - 1)(2\sqrt{K} - 1), \quad (23)$$

$$B_1 = (\sqrt{K} - 1)(2 - \sqrt{K}). \quad (24)$$

Figure 2 shows this ideal response for $K_M = 1$ and $T_{trM} = 84$, when

$$u_{id}(t) = 1 + A_1 e^{-\sqrt{K} t/10} + B_1 e^{-\sqrt{K} t/20}. \quad (25)$$

The response $u_{id}(t)$ is increasing on $(0, \infty)$ for $0 < K \leq 1$, is decreasing on $(0, \infty)$ for $1 \leq K \leq 4$, and is

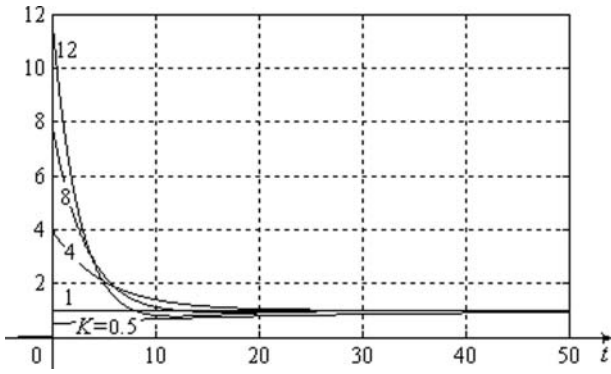

Figure 2. Control response $u_{id}(t)$ to a unit step reference for $K_M = 1$, $T_{trM} = 84$ and $K = 0.5, 1, 4, 8, 12$.

decreasing on $(0, t_0]$ and increasing on $[t_0, \infty)$ for $K > 4$, where

$$t_0 = \frac{T_{trM}}{4.2\sqrt{K}} \ln \frac{4\sqrt{K} - 2}{\sqrt{K} - 2}. \quad (26)$$

For $K = 1$, the response $u_{id}(t)$ given by (22) is a step function of magnitude $1/K_M$. Actually, due to the model inaccuracy, the form of the closed-loop system response $u(t)$ to a step reference is not a perfect step function. By comparing the response $u(t)$ with the ideal response in step form, the human operator can verify online if the model parameters have appropriate values, and can adjust these parameters to improve the model accuracy. So, if the initial value $u(0_+)$ is larger/smaller than its final value $u(\infty)$, then the model gain K_M needs to be proportionally increased/decreased to have $K_M \approx K_p$. Then, for $K_M \approx K_p$, analyzing the new response $u(t)$ to a step reference, if $u(t)$ is larger/smaller than $u(0_+)$ in a time range $t > \tau_M$, then the model parameter T_{trM} needs to be increased/decreased.

In its primary (standard) form, used to control stable proportional-type processes (with or without time delay, with or without overshoot, of minimum or non-minimum phase), the algorithm has four parameters:

- tuning gain K (with standard value 1);
- model steady-state gain K_M ;
- model time delay τ_M ;
- transient time of the model step response T_{trM} .

The discrete-time equivalent of the continuous model (9) with $T_2 = 2T_1$ has the discrete transfer function

$$G_M^0(z) \approx \frac{K_M(1-p_1)(1-p_2)z^{-l_M-1}}{(1-p_1z^{-1})(1-p_2z^{-1})}, \quad (27)$$

where

$$p_1 = e^{-T/T_1} = e^{-8.4T/T_{trM}}, \quad (28)$$

$$p_2 = e^{-T/T_2} = \sqrt{p_1}, \quad (29)$$

T is the sampling period, and l_M is the integer value of the ratio between the model time delay and the sampling period; that is,

$$l_M = \left\lceil \frac{\tau_M}{T} \right\rceil. \quad (30)$$

The discrete-time equivalent of the continuous internal controller (16) has the discrete transfer function

$$G_i^0(z) \approx \frac{1}{K_M} \cdot \frac{(\sqrt{K} + Az^{-1})(\sqrt{K} + Bz^{-1})}{(1-p_3z^{-1})(1-p_4z^{-1})}, \quad (31)$$

where

$$p_3 = e^{-T/T_3} = p_1^{\sqrt{K}}, \quad (32)$$

$$p_4 = e^{-T/T_4} = p_2^{\sqrt{K}} = \sqrt{p_3}, \quad (33)$$

$$A = 1 - p_3 - \sqrt{K}, \quad (34)$$

$$B = 1 - p_4 - \sqrt{K}. \quad (35)$$

The discrete-time primary form of the control algorithm has the equations

$$\begin{cases} e_k = r_k - y_k \\ x_k = (p_1 + p_2)x_{k-1} - p_1p_2x_{k-2} + K_M P u_{k-l_M-1} \\ f_k = e_k + x_k \\ u_k = (p_3 + p_4)u_{k-1} - p_3p_4u_{k-2} + \frac{1}{K_M} f \end{cases}, \quad (36)$$

where

$$p_1 = e^{-8.4T/T_{trM}}, \quad p_2 = \sqrt{p_1}, \quad (37)$$

$$p_3 = p_1^{\sqrt{K}}, \quad p_4 = \sqrt{p_3}, \quad (38)$$

$$P = (1 - p_1)(1 - p_2), \quad (39)$$

$$f = K f_k + \sqrt{K}(A + B)f_{k-1} + A B f_{k-2}. \quad (40)$$

Example 2.1: Consider the proportional process with the transfer function

$$G_P(s) = \frac{2(s+1)e^{-5s}}{(4s+1)(8s+1)(10s+1)}.$$

From the process unit step response in Figure 3, it follows the process model parameters

$$K_M = 2, \quad \tau_M = 6, \quad T_{trM} = t_1 - \tau_p = 60 - 6 = 54.$$

Figures 4 and 5 show the closed-loop system responses $y(t)$ and $u(t)$ to a unit step reference for $K = 0.5, 1, 2.5, 8$. A good control performance is achieved for $K = 2.5$. The control response $u(t)$ is too strong for

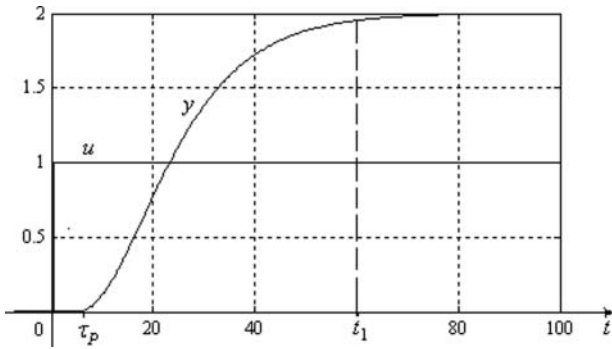

Figure 3. Process response to a unit step input.

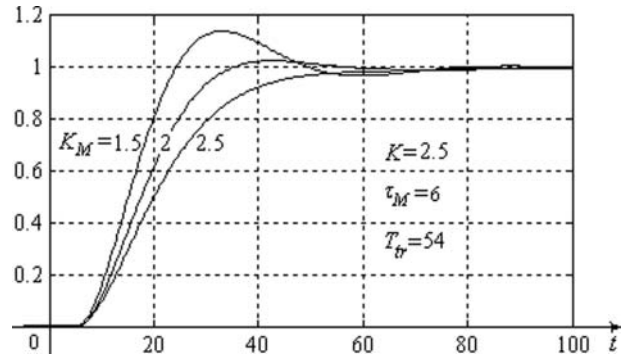

Figure 6. Control system responses $y(t)$ to a unit step reference for $K_M = 1.5, 2, 2.5$.

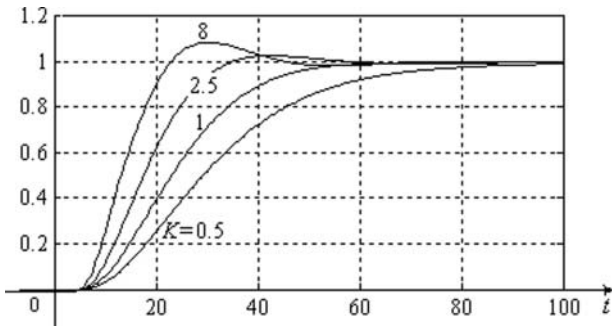

Figure 4. Closed-loop system responses $y(t)$ to a unit step reference for $K = 0.5, 1, 2.5, 8$.

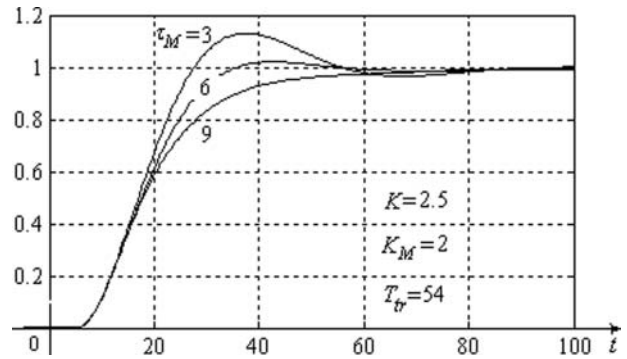

Figure 7. Control system responses $y(t)$ to a unit step reference for $\tau_M = 3, 6, 9$.

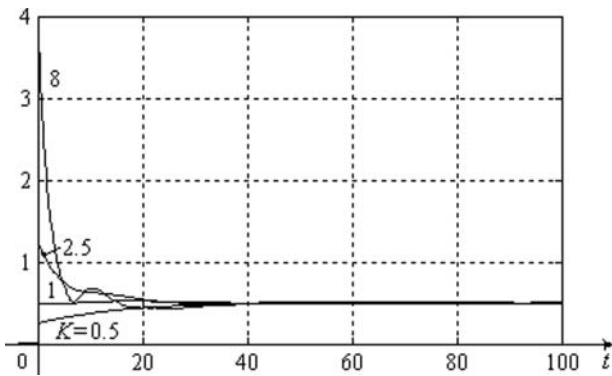

Figure 5. Control responses $u(t)$ to a unit step reference for $K = 0.5, 1, 2.5, 8$.

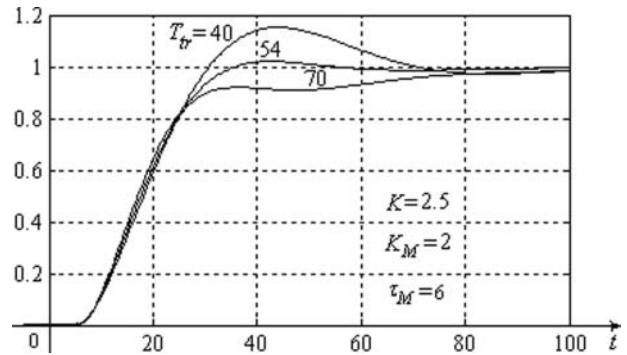

Figure 8. Control system responses $y(t)$ to a unit step reference for $T_{trM} = 40, 54, 70$.

$K = 8$, when

$$u(0_+) = K/K_M = 4, \quad u(\infty) = 1/K_p = 0.5,$$

and too weak for $K = 0.5$, when

$$u(0_+) = 0.25, \quad u(\infty) = 0.5.$$

For $K = 1$, the response $u(t)$ is close to a step function; this confirms that the model parameters have been suitably chosen. Note that the closed-loop system is stable for all positive $K < 3600$.

Figures 6–8 show the closed-loop system responses $y(t)$ to a unit step reference for $K = 2.5$ and different

values of the model gain K_M , model time delay τ_M and model transient time T_{trM} , respectively. All these responses show that the control performance is robust with respect to the model parameters K_M , τ_M and T_{trM} . The closed-loop control system is respectively stable for $K_M > 0.54$, for all $\tau_M > 0$, and for $T_{trM} > 6$.

Figures 9–11 show the closed-loop system responses $y(t)$ to a unit step reference for the best values of the tuning parameter K and various values of the model parameters K_M , τ_M and T_{trM} , respectively. The control performance remains good even for wrong values of the model parameters. Moreover, we claim that the control

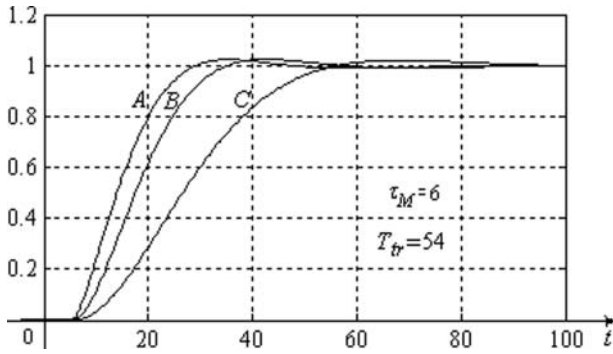

Figure 9. Control system responses $y(t)$ to a unit step reference for A: $K_M = 2.5$, $K = 11$; B: $K_M = 2$, $K = 2.5$; C: $K_M = 1.5$, $K = 0.4$.

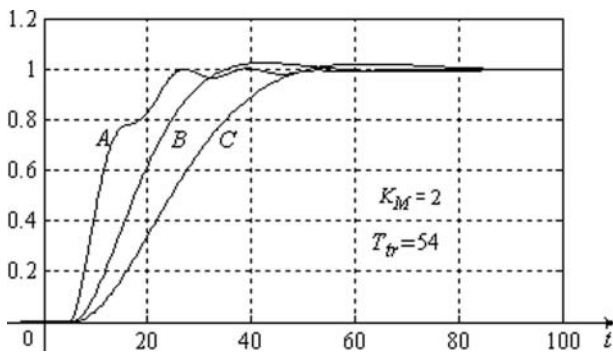

Figure 10. System responses $y(t)$ to a unit step reference for A: $\tau_M = 9$, $K = 25$; B: $\tau_M = 6$, $K = 2.5$; C: $\tau_M = 3$, $K = 0.75$.

performance is better for $K_M > K_P$ than for $K_M < K_P$, for $\tau_M > \tau_P$ than for $\tau_M < \tau_P$, and for $T_{trM} > T_{trP}$ than for $T_{trM} < T_{trP}$.

The response A in Figure 9 shows that for the wrong value $K_M = 2.5$, if the process-operator selects $K = 11$, then the control system performance is even better than the one obtained for $K_M = 2$ and $K = 2.5$ (response B). The closed-loop system with $K_M = 2.5$ is stable for $K < 4600$.

Figure 10 shows that for the wrong value $\tau_M = 9$, by choosing $K = 25$ (response A), the control system performance is better than the one obtained for $\tau_M = 6$ and $K = 2.5$ (response B). Note that the closed-loop system with $\tau_M = 9$ is stable for $K < 240$.

Figure 11 shows that for the wrong value $T_{trM} = 70$, if the process-operator chooses $K = 7$ (response A),

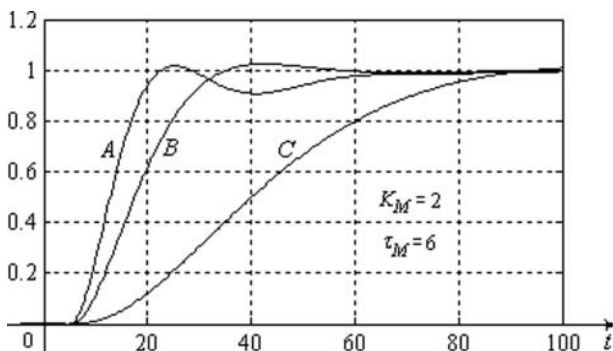

Figure 11. System responses $y(t)$ to a unit step reference for A: $T_{trM} = 70$, $K = 7$; B: $T_{trM} = 54$, $K = 2.5$; C: $T_{trM} = 40$, $K = 0.16$.

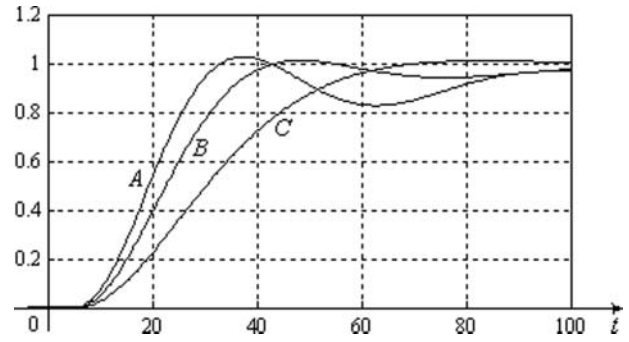

Figure 12. Control loop-system responses $y(t)$ to a unit step reference for a PI controller with A: $K_R = 0.1$, $T_i = 6.2$; B: $K_R = 0.2$, $T_i = 10$; C: $K_R = 0.3$, $T_i = 16$.

then the control system performance is comparable with the one obtained for $T_{trM} = 54$ and $K = 2.5$ (response B). The closed-loop system with $T_{trM} = 70$ is stable for $K < 3400$.

Using the designed controller, the control performance is better than the one achieved using a PI controller with the transfer function

$$G_{PI}(s) = K_R \left(1 + \frac{1}{T_i s} \right).$$

This follows immediately from Figure 12, where are depicted the responses $y(t)$ to a unit step reference for $K_R = 0.1, 0.2, 0.3$ and the best values of the integral time constant T_i , namely $T_i = 6.2, 10, 16$, respectively.

Remark 2.1: The proposed algorithm can be also used to control stable proportional-type processes with overshoot. Let P be a such process, whose input step response has the maximum value at the time t_0 . In order to choose the model parameters, this process (with or without oscillations) is approximated by a process \tilde{P} of $P1$ type (with the unit step response monotonic and finite), whose step response $\tilde{y}(t)$ remains constant (at its maximum value) for $t \geq t_0$ (Figures 13 and 16). From the step response $\tilde{y}(t)$, we can easily choose the steady-state gain \tilde{K}_P , the time delay τ_P and the transient time

$$\tilde{T}_{trP} = t_0 - \tau_P. \quad (41)$$

Thus, the model parameters are

$$K_M = \tilde{K}_P, \quad \tau_M = \tau_P, \quad T_{trM} = \tilde{T}_{trP}. \quad (42)$$

Since $\tilde{K}_P > K_P$, the closed-loop system response $u(t)$ to a step reference has a smaller initial value, namely

$$u(0+) = K/K_M = K/\tilde{K}_P < K/K_P, \quad (43)$$

which reduces the overshoot of the closed-loop system response $y(t)$.

By suitably modifying the tuning gain K , a good control system response to a step reference can be obtained.

Example 2.2: Consider the following non-oscillatory process with overshoot

$$G_p(s) = \frac{1.5(24s + 1)e^{-5s}}{(4s + 1)(8s + 1)(9s + 1)}$$

From the process unit step response $\tilde{y}(t)$ in Figure 13, it follows that

$$\begin{aligned} \tilde{K}_p &= 1.98, \quad \tau_p = 5, \\ \tilde{T}_{trp} &= t_0 - \tau_p = 24 - 5 = 19, \end{aligned}$$

therefore,

$$\begin{aligned} K_M = \tilde{K}_p &= 1.98, \quad \tau_M = \tau_p = 5, \\ T_{trM} = \tilde{T}_{trp} &= 19. \end{aligned}$$

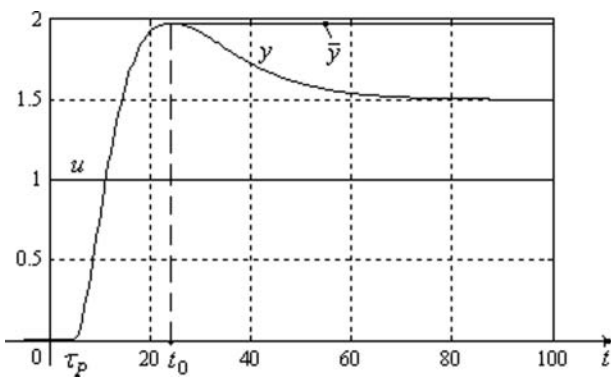

Figure 13. Process response to a unit step input.

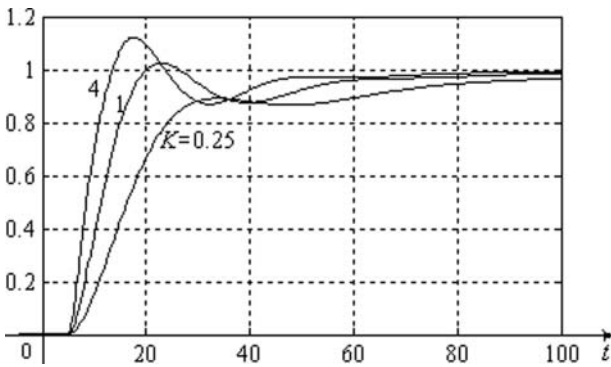

Figure 14. Control system responses $y(t)$ to a unit step reference for $K = 0.25, 1, 4$.

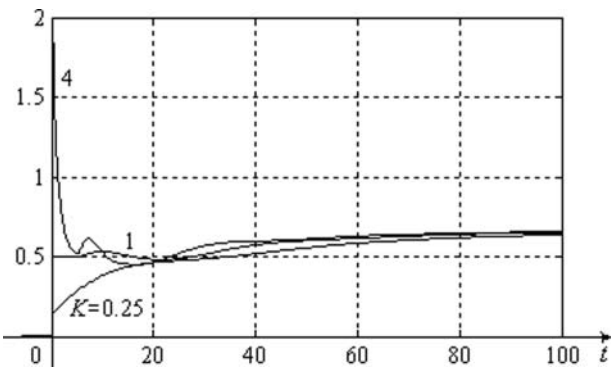

Figure 15. Control system responses $u(t)$ to a unit step reference for $K = 0.25, 1, 4$.

The closed-loop system responses $y(t)$ and $u(t)$ to a unit step reference are shown in Figures 14 and 15 for $K = 0.25, 1, 4$. The control variable $u(t)$ is too strong for $K = 4$ – when $u(0_+) = K/K_M \approx 2$, and too weak for $K = 0.25$ – when $u(0_+) = K/K_M \approx 0.125$. Note that the system is stable for all $K > 0$.

Example 2.3: Consider the oscillatory process with overshoot

$$G_p(s) = \frac{1.5(2s + 1)e^{-5s}}{(3s + 1)(4s + 1)(6s^2 + 3s + 1)}$$

From the process unit step response in Figure 16, it follows that

$$\begin{aligned} \tilde{K}_p &= 1.98, \quad \tau_p = 7, \\ \tilde{T}_{trp} &= t_0 - \tau_p = 29 - 7 = 22, \end{aligned}$$

therefore,

$$\begin{aligned} K_M = \tilde{K}_p &= 1.98, \quad \tau_M = \tau_p = 7, \\ T_{trM} = \tilde{T}_{trp} &= 22. \end{aligned}$$

The closed-loop system responses $y(t)$ and $u(t)$ to a unit step reference for three different values of the tuning gain K are shown in Figures 17 and 18. The control response $u(t)$ is too strong for $K = 0.4$ – when $u(0_+) \approx 0.2$, and too weak for $K = 0.1$ – when $u(0_+) \approx 0.05$. The control system is stable for $K < 2.5$.

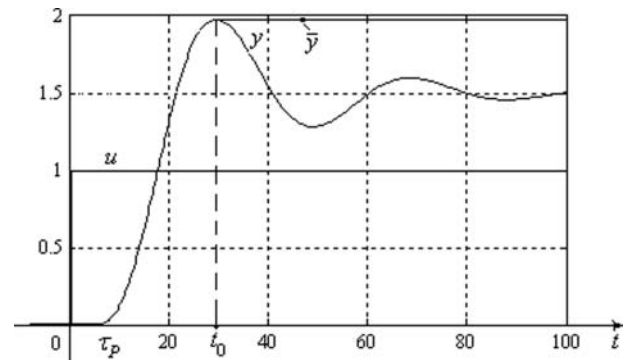

Figure 16. Process response to a unit step input.

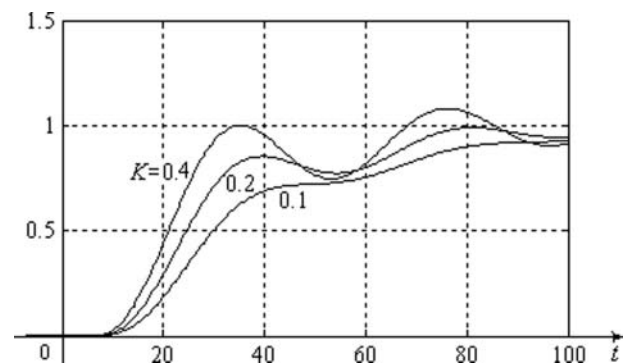

Figure 17. Control system responses $y(t)$ to a unit step reference for $K = 0.4, 0.2, 0.1$.

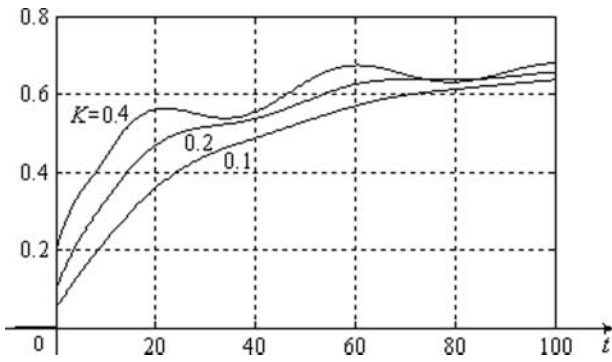

Figure 18. Control system responses $u(t)$ to a unit step reference for $K = 0.4, 0.2, 0.1$.

Remark 2.2: The proposed algorithm can be also used to control stable proportional-type processes of nonminimum phase. To control a stable nonminimum-phase process, we will consider that the process time delay includes the interval where the sign of the process step response is opposite to the sign of the final value.

Example 2.4: Consider the nonminimum-phase process

$$G_P(s) = \frac{2(1 - 4s)e^{-2s}}{(4s + 1)(8s + 1)(10s + 1)}.$$

From the process unit step response shown in Figure 19, it follows the model parameters

$$K_M = 2, \quad \tau_M = 11, \\ T_{trM} = t_1 - \tau_p = 65 - 11 = 54.$$

Figures 20 and 21 show the closed-loop system responses $y(t)$ and $u(t)$ to a unit step reference for three values of the tuning gain K . The best response is achieved for $K = 10$. The closed-loop system is stable for $K < 36.6$.

3. Extended form of the control algorithm

The algorithm can be extended to control integral-type processes and unstable processes. The main idea is to turn the original process into a stable process of

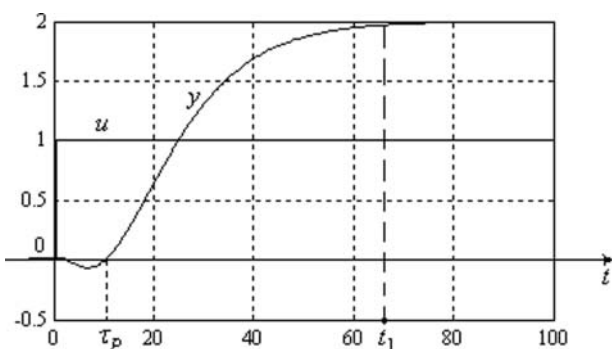

Figure 19. Process response to a unit step input.

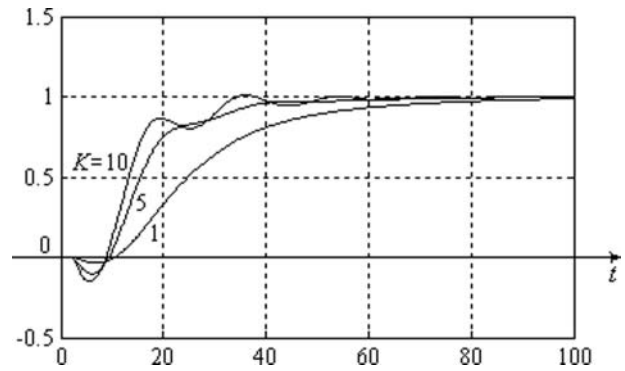

Figure 20. Control system responses $y(t)$ to a unit step reference for $K = 10, 5, 1$.

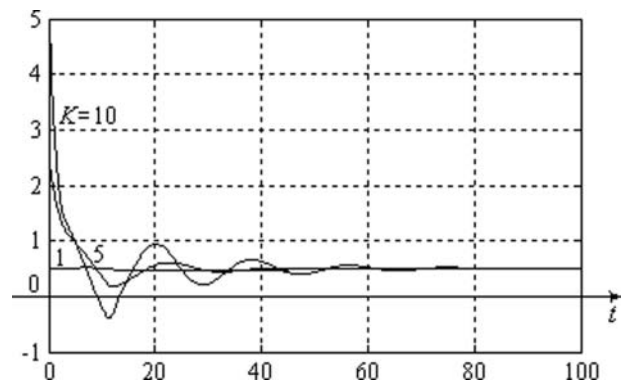

Figure 21. Control system responses $u(t)$ to a unit step reference for $K = 10, 5, 1$.

proportional type (called the compensated process) by means of a feedback path of pure proportional type, as shown in Figure 22.

As a rule, for an *integral-type process*, the step response of the compensated process has zero overshoot for small values of the feedback gain K_f and non-zero overshoot for large values of K_f . A suitable variant is to choose the gain K_f as large as possible such that the overshoot of the step response of the compensated process remains zero. Then, for selected K_f , the model parameters K_M , τ_M and T_{trM} are determined from the compensated process response $y(t)$ to a step change of the input c . If $K = 1$ and the model parameters have appropriate values, then the closed-loop control system response $c(t)$ to a step reference is close to a step function.

Note that the steady-state error is zero for a step and even for a ramp disturbance added to the process output.

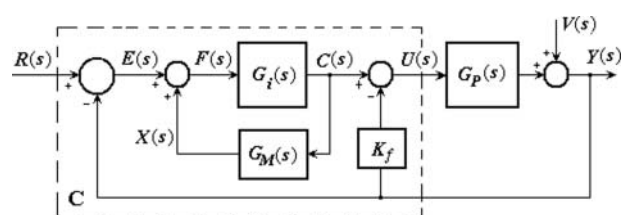

Figure 22. Closed-loop system with compensated process.

According to Equations (36)–(40) and the controller structure in Figure 22, the discrete-time control algorithm has the following equations:

$$\begin{cases} e_k = r_k - y_k \\ x_k = (p_1 + p_2)x_{k-1} - p_1p_2x_{k-2} + K_M P c_{k-l_M-1} \\ f_k = e_k + x_k \\ c_k = (p_3 + p_4)c_{k-1} - p_3p_4c_{k-2} + \frac{1}{K_M} f \\ u_k = c_k - K_f(y_k - y_0) \end{cases}, \quad (44)$$

where y_0 is the value of y just before switching to automatic mode. Notice that for $K_f = 0$, the extended control algorithm (44) reduces to the primary form (36).

Let u_0 and e_0 be the values of u and e before switching to automatic mode, and

$$x_0 = K_M u_0. \quad (45)$$

To have a bumpless transfer only for $e_0 = 0$, the following settings are needed to be made before switching to automatic mode:

$$c_{k-1} = c_{k-2} = \dots = c_{k-l_M-1} = u_0 \quad (46)$$

$$x_{k-1} = x_{k-2} = x_0, \quad f_{k-1} = f_{k-2} = x_0. \quad (47)$$

To have a bumpless transfer for any $e_0 \neq 0$, it needs in addition to replace the equation $f_k = e_k + x_k$ in (44) with

$$f_k = (e_k - e_0) + x_k.$$

In automatic mode, a bumpless transfer should be achieved whenever the human operator changes a parameter of the control algorithm.

A practical controller needs to have three operating modes: AUTOMATIC, MANUAL and COMPENSATORY. In COMPENSATORY and MANUAL modes, the human operator can directly set any value for the compensated process input c and the controlled process input u , respectively. Before switching to COMPENSATORY mode (from MANUAL or AUTOMATIC mode), the variable c should be set to the value of u . For $K_f = 0$, the MANUAL and COMPENSATORY modes are the same.

Example 3.1: Consider the integral-type process

$$G_P(s) = \frac{(s + 1)e^{-5s}}{10s(2s + 1)(5s + 1)}.$$

Using a negative feedback path with $0 < K_f < 0.65$, the integral-type process turns into a compensated process of proportional type whose response y to a unit step

input c is monotonic and bounded (Figure 23). Choosing $K_f = 0.6$, it follows that

$$K_M = 1.67, \quad \tau_M = 7, \\ T_{trM} = t_1 - \tau_p = 82 - 7 = 75.$$

For $K_f = 0.6$ and $K = 1, 3, 8$, the closed-loop control system responses $y(t)$, $c(t)$ and $u(t)$ to a unit step reference are shown in Figures 24–26. The control variables $c(t)$ and $u(t)$ are too strong for $K = 8$, when

$$u(0_+) = c(0_+) = K/K_M \approx 4.79,$$

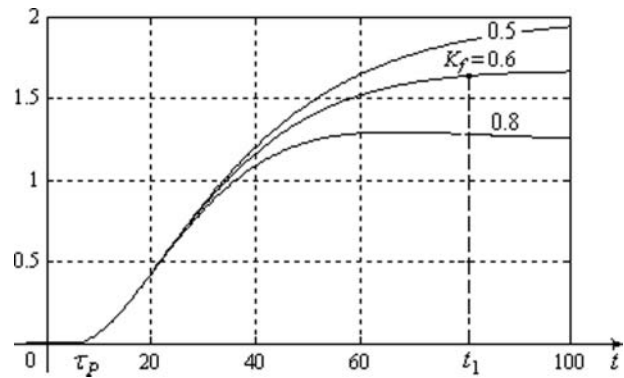

Figure 23. Compensated process responses $y(t)$ to a unit step input $c = 1(t)$ for $K_f = 0.5, 0.6, 0.8$.

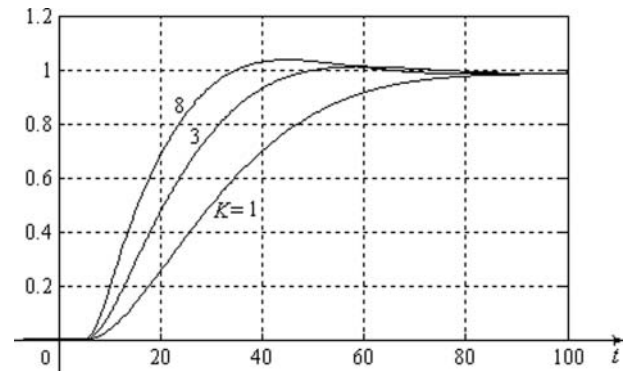

Figure 24. Control system responses $y(t)$ to a unit step reference for $K_f = 0.6$ and $K = 1, 3, 8$.

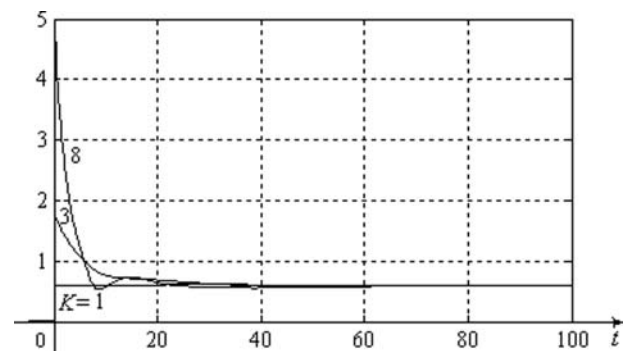

Figure 25. Control system responses $c(t)$ to a unit step reference for $K_f = 0.6$ and $K = 1, 3, 8$.

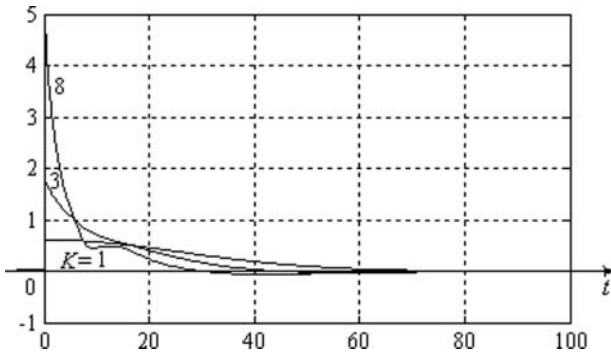

Figure 26. Control system responses $u(t)$ to a unit step reference for $K_f = 0.6$ and $K = 1, 3, 8$.

and too weak for $K = 1$, when

$$u(0_+) = c(0_+) = K/K_M \approx 0.599.$$

For $K = 1$, the control response $c(t)$ is close to a step function. The closed-loop system is stable for $K < 1140$.

For $K_f = 0.6$ and $K = 3$, the closed-loop system response $y(t)$ to the ramp disturbance $v(t) = t/10$ is shown in Figure 27.

For $K_f = 0.5$, from the compensated process response to a unit step input in Figure 23, it follows that

$$K_M = 1.925, \quad \tau_M = 7, \quad T_{trM} = 100 - 7 = 93.$$

Setting $K = 25$, the system response $y(t)$ to a unit step reference (Figure 28) is even better than the response obtained for $K_f = 0.6$ and $K = 3$ (Figure 24). The closed-loop system is stable for $K < 4500$.

Example 3.2: Consider the unstable process

$$G_P(s) = \frac{(s + 1)e^{-2s}}{2(1 + 3s)(1 - 6s)}.$$

Using a feedback path with $K_f = -2.13$, the unstable process turns into a stable compensated process whose

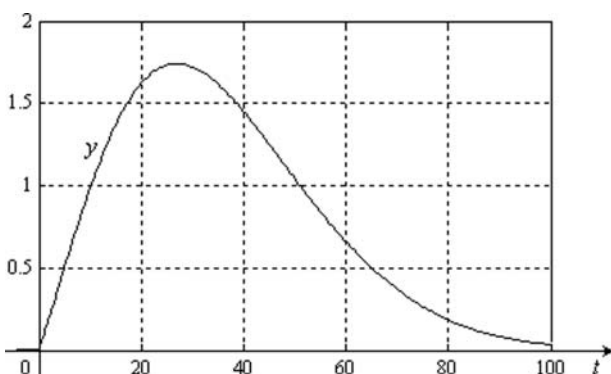

Figure 27. Control system responses $y(t)$ to the ramp disturbance $v(t) = t/10$ for $K = 3$.

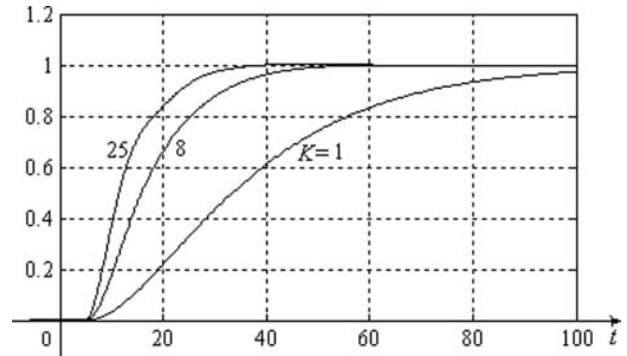

Figure 28. Control system responses $y(t)$ to a unit step reference for $K_f = 0.5$ and $K = 1, 8, 25$.

response y to a unit step input c is monotonic and bounded (Figure 29). From this compensated process response, it follows that

$$K_M = -7.7, \quad \tau_M = 3, \\ T_{trM} = t_1 - \tau_P = 83 - 3 = 80.$$

The closed-loop system responses to a unit step reference are shown in Figures 30–32 for $K = 1, 4, 8$. The control responses $c(t)$ and $u(t)$ are too strong for $K = 8$, when

$$u(0_+) = K/K_M \approx -1.04,$$

and too weak for $K = 1$, when

$$u(0_+) = K/K_M \approx -0.13.$$

If $K = 1$, then the control response $c(t)$ is close to a step function. The closed-loop system is stable for $K < 460$.

Remark 3.1: A similar but simpler control algorithm can be obtained by replacing the second-order internal controller (16) with the first-order controller

$$G_{H1}(s) = \frac{T_M s + 1}{K_M \left(\frac{T_M}{K} s + 1 \right)}, \quad (48)$$

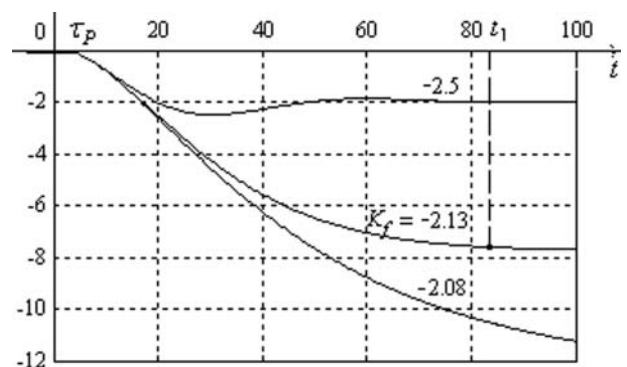

Figure 29. Compensated process responses $y(t)$ to input $c = 1(t)$ for $K_f = -2.08, -2.13, -2.5$.

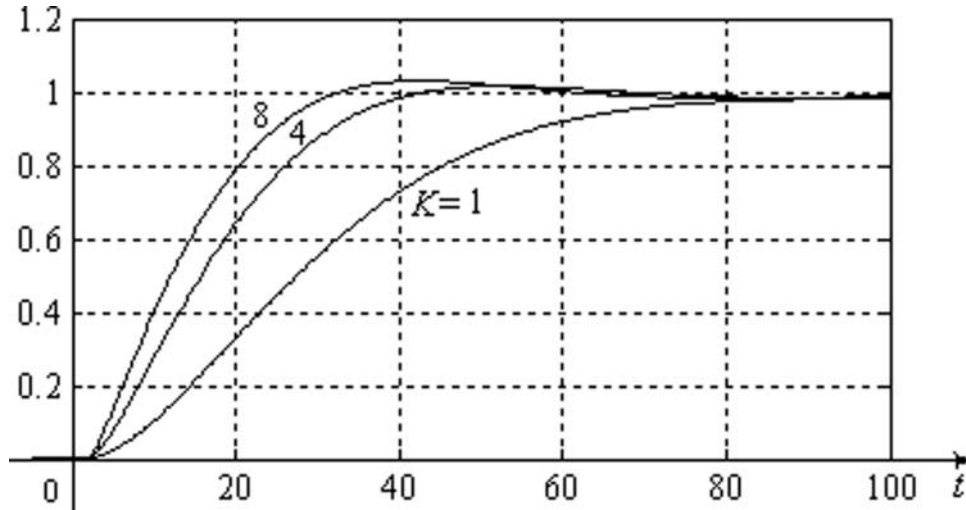

Figure 30. Control system responses $y(t)$ to a unit step reference for $K_f = -2.13$ and $K = 1, 4, 8$.

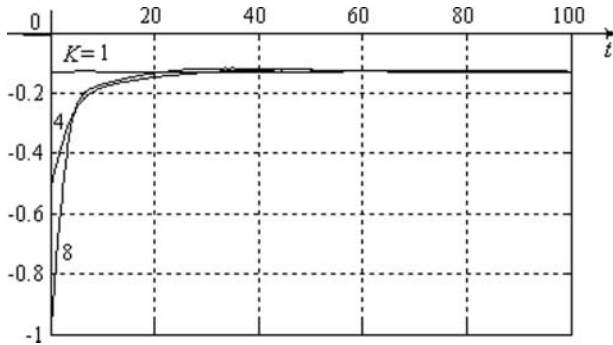

Figure 31. Control system responses $c(t)$ to a unit step reference for $K_f = -2.13$ and $K = 1, 4, 8$.

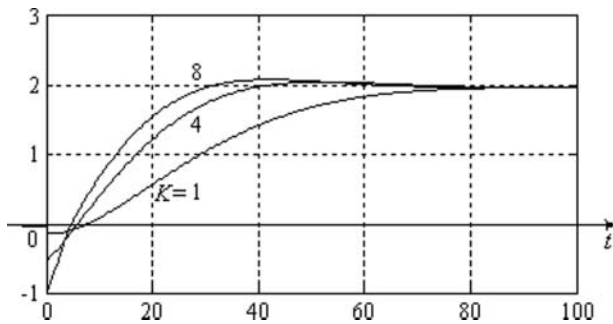

Figure 32. Control system responses $u(t)$ to a unit step reference for $K_f = -2.13$ and $K = 1, 4, 8$.

where

$$T_{M1} = \frac{T_{trM}}{4} \approx \frac{T_{trP}}{4}. \quad (49)$$

For a perfect model, the ideal control response $u_{id1}(t)$ to a unit step reference has the expression

$$u_{id1}(t) = \frac{1 + (K - 1)e^{-4Kt/T_{trM}}}{K_M}. \quad (50)$$

The response $u_{id1}(t)$ is monotonic for all $K > 0$ (increasing for $K < 1$, decreasing for $K > 1$, in step form for $K = 1$).

The discrete-time equivalent of the internal controller has the transfer function

$$G_{i1}^0(z) = \frac{1}{K_M} \cdot \frac{K + (1 - r_1 - K)z^{-1}}{1 - r_1z^{-1}}, \quad (51)$$

where

$$r_1 = e^{-KT/T_{M1}} = e^{-4KT/T_{trM}}. \quad (52)$$

The discrete-time control algorithm has the following equations:

$$\begin{cases} e_k = r_k - y_k \\ x_k = (p_1 + p_2)x_{k-1} - p_1p_2x_{k-2} + K_M P c_{k-l_M-1} \\ f_k = e_k + x_k \\ c_k = r_1 c_{k-1} + \frac{K}{K_M} f_k + \frac{1 - r_1 - K}{K_M} f_{k-1} \\ u_k = c_k - K_f (y_k - y_0) \end{cases} \quad (53)$$

Based on many real-time control simulations on software and physical processes (in laboratory and two refineries), we may state that the robustness and control performance of this algorithm are comparable with the ones of the control algorithm with second-order internal controller.

4. Summary of rules for choosing the controller parameters

For a proportional process of P1 type (with the step response monotonic and finite), the model parameters

(steady-state gain K_M , time delay τ_M and transient time T_{trM}) can be easily determined from the process step response (always starting from an initial steady-state behaviour). These parameters can be verified and corrected online by analyzing the deviation of the controller response $u(t)$ to a reference step for $K = 1$ from the step shape. So, if the initial value $u(0_+)$ is greater/smaller than its final value $u(\infty)$, then K_M needs to be proportionally augmented/diminished. Then, for $K_M \approx K_P$, analyzing the new response $u(t)$ to a step reference, if $u(t)$ is greater/smaller than $u(0_+)$ in a time range $t > \tau_M$, then T_{trM} needs to be augmented/diminished.

For a proportional process with overshoot (with or without oscillations) or of nonminimum phase, the model parameters are determined by approximating the process with one of $P1$ type. For a process with overshoot, if the step response has the maximum value at time t_0 , then the response is assumed to remain constant at its maximum value for $t \geq t_0$. For a nonminimum-phase process, we assume that the time delay includes the time interval where the sign of the process step response is opposite to the sign of the final value.

For an integral or unstable process, the model parameters are determined by turning the process into a compensated process of $P1$ type, using a suitable feedback process gain K_f . For an integral-type process, it is recommended to choose the gain K_f as large as possible such that the step response of the compensated process has zero overshoot. Then, for selected K_f , the model parameters K_M , τ_M and T_{trM} are determined from the compensated process response $y(t)$ to a step change of the input c . If $K = 1$ and the model parameters have appropriate values, then the form of the closed-loop system response $c(t)$ to a step reference is close to a step shape.

To have a stronger/weaker control action, the process operator increases/decreases the tuning gain K (with the standard value 1).

5. Future research

For many practical applications, it is not recommended to use high values (larger than 10) of the tuning gain K , which lead to a very sharp form of the controller output to a step reference. Such situations can appear, for instance, by using an inaccurate process model with $K_M > K_P$ (Figures 9) or $\tau_M > \tau_P$ (Figure 10). To avoid such cases, we propose as future research a more general control algorithm whose structure is illustrated in Figure 33, where $\alpha \in [0, 1]$ and

$$G_i(\alpha, s) = \frac{(T_1 s + 1)(T_2 s + 1)}{K_M \left(\frac{T_1}{K_1} s + 1 \right) \left(\frac{T_2}{K_1} s + 1 \right)}, \quad (54)$$

$$K_1 = K^{\frac{1-\alpha}{2}}. \quad (55)$$

The initial and final values of the closed-loop system response $c(t)$ to a unit step reference are the same as

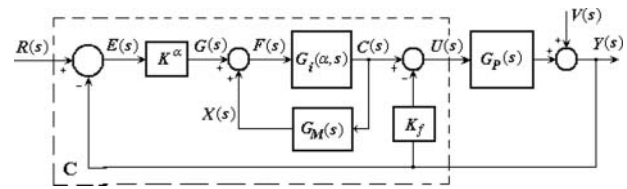

Figure 33. General structure of the closed-loop system with compensated process.

those from the presented control algorithm (where $\alpha = 0$), namely

$$c(0_+) = K/K_M, \quad c(\infty) = 1/K_P. \quad (56)$$

Note that for $\alpha = 1$, the internal controller has the transfer function $G_i(1, s) = 1/K_M$.

We claim that for any fixed K , $K > 1$, the control action is stronger for larger α . Therefore, in the case $\alpha \neq 0$, the best performance of the control system will be achieved for a smaller value of the tuning gain K than for $\alpha = 0$. In our opinion, $\alpha = 0.2$ is a suitable value to get robust and high control performance.

6. Conclusions

The proposed quasi-universal practical algorithm incorporates a process feedback block of pure proportional type, a process model of second order plus time delay, and a realizable internal controller of second order. By means of the process feedback path, if the original process is of integral-type or unstable, then it is turned into a stable compensated process of proportional type.

In its extended form, the proposed algorithm has five parameters: three model parameters (the model steady-state gain K_M , the model time delay τ_M and the transient time T_{trM} of the model response to a step input), a tuning gain K with standard value 1 (which can be easily used by the human process operator to increase or decrease the magnitude of the control action) and a process feedback gain K_f (which is zero for stable processes of proportional type). The industrial use of the proposed algorithm will have an instructive effect on the process operators, who need to know the main dynamic parameters of the processes or compensated processes: the steady-state gain, the time delay and the transient time of the step response.

If the model steady-state gain K_M is equal to the compensated process steady-state gain K_P , then the internal controller response $c(t)$ to a step reference has the initial value K times larger than its final value. Furthermore, if the dynamic model of the compensated process has a high accuracy, then the internal controller response $c(t)$ for $K = 1$ is close to a step form. By analyzing the deviation of this response from the ideal step form, the model parameters can be easily adjusted online to improve the model accuracy.

The practical feature of the control algorithm follows from the following considerations:

- whatever the process to be controlled, the control algorithm has the unique form (44);
- the algorithm has a tuning gain K (with standard value 1) instead of a tuning filter time constant (as usual in the IMC design), which achieves a natural trade-off between closed-loop performance and robustness to model uncertainties;
- the controller parameters can be easily determined from the step response of the process (or compensated process), and can be verified and adjusted online; in addition, due to the tuning gain K , it is not necessary to estimate with high accuracy the model parameters in order to have good control performance (as shown in the simulation [Example 2.1](#), it is better to select $K_M > K_P$ than $K_M < K_P$, $\tau_M > \tau_P$ than $\tau_M < \tau_P$, and $T_{trM} > T_{trP}$ than $T_{trM} < T_{trP}$);
- as the PID algorithm, the proposed control algorithm is quasi-universal because it can be applied to control almost all process types: proportional processes (with or without time delay, with or without overshoot, with or without oscillation, of minimum or nonminimum phase), integral processes, stable or unstable processes.

The main original contributions of the paper are the following:

- an extension of the proposed algorithm to control all or almost all industrial processes;
- an experimental procedure of tuning the controller parameters much simpler than the procedures used for the PID controllers;
- the use of a tuning gain with standard value 1 instead of a filter time constant that is usually used in the classical IMC design;
- the use of the process transient time as model parameter (together with the process steady-state gain and process time delay);
- a design of the discrete-time control algorithm as a set of difference equations which can be easily implemented on a real time controller;
- a design of the conditions of bumpless transfer between the three controller modes: MANUAL, COMPENSATORY and AUTOMATIC;
- a proposal to generalize and improve the control algorithm in order to avoid some unusual situations where the controller output to a step reference has a very sharp shape.

Due to its robustness, high control performance (especially for the processes with time delay) and tuning procedure simplicity, the proposed control

algorithm is better than the popular PID algorithm. In addition, for integral-type processes, the proposed algorithm achieves zero steady-state error for a ramp disturbance added to the process output.

Disclosure statement

No potential conflict of interest was reported by the author.

References

- [1] Garcia C, Morari M. Internal model control. A unifying review and some new results. *Ind Eng Chem Proc Des Dev.* **1982**;21(2):308–323.
- [2] Rivera D, Morari M, Skogestad S. Internal model control - PID controller design. *Ind Eng Chem Process Des Dev.* **1986**;25:252–265.
- [3] Francis B, Wonham W. The internal model principle of control theory. *Automatica.* **1976**;12(5):457–465.
- [4] Bengtsson G. Output regulation and internal models - a frequency domain approach. *Automatica.* **1977**;13(4):333–345.
- [5] Horn I, Arulandu J, Gombas C, et al. Improved filter design in internal model control. *Ind Eng Chem Res.* **1996**;35:3437–3441.
- [6] Brosilow C, Joseph B. *Techniques of model-based control.* Upper Saddle River (NJ): Prentice Hall; **2002**.
- [7] Chia TL, Lefkowitz I. Internal model-based control for integrating processes. *ISA Trans.* **2010**;49(4):519–527.
- [8] Zhou W, Yu M, Huang DQ. A high-order internal model based iterative learning control scheme for discrete linear time-varying system. *Int J Autom Comput.* **2015**;12(3):330–336.
- [9] Hiromitsu O, Ryo T, Takahiro M, et al. Design of IMC based on an optimal control for a servo-system. *J Control Sci Eng.* **2015**;1–5.
- [10] Yao F, Xinggao L. Adaptive IMC of a high-purity heat-integrated air separation column. *Chem Eng Des J Control Sci Eng.* **2015**;38(9):1599–1607.
- [11] Chien IL, Fruehauf PS. Consider IMC tuning to improve controller performance. *Chem Eng Progress.* **1990**;10:33–41.
- [12] Skogestad S. Simple analytic rules for model reduction and PID controller tuning. *Model Ident Control.* **2004**;25(2):85–120.
- [13] Xiang L, Dai Y, Lu X. Novel IMC-PID controller design and parameter tuning with improving control performance for the SOPTD. 10th IEEE International Conference on Control and Automation (ICCA); Hangzhou, China; **2013**.
- [14] Vanavil B, Anusha AV, Perumalsamy M, et al. Enhanced IMC-PID controller design with lead-lag filter for unstable and integrating process with time delay. *Chem Eng Commun.* **2014**;201(11):1468–1496.
- [15] Kurmar DB, Padma SR. Tuning of IMC based PID controllers for integrating systems with time delay. *ISA Trans.* **2016**;63:242–255.
- [16] Ghousiya BK, Seshagiri RA, Radhakrishnan TK. Enhanced IMC based PID controller design for non-minimum phase integrating processes with time delay. *ISA Trans.* **2017**;68:223–234.
- [17] Yamada K. Modified internal model control for unstable system. *Proceeding of the 7th Mediterranean*

- Conference on Control and Automation (MED99); Haifa, Israel; 1999. p. 293–302.
- [18] Cirtoaje V. Process compensation based control. Bul Univ “Petrol-Gaze” din Ploiesti, Seria Tehnica. 2006; LVIII(1):48–53.
- [19] Shibasaki H, Endo J, Hikichi Y, et al. A modified internal model control for an unstable plant with an integrator in continuous-time system. Int J Info Electron Eng. 2013;3(4):357–360.
- [20] Cirtoaje V, Baiesu A. Comparative study of three practical IMC algorithms with inner controller of first and second order. JEEE Control Comput Sci. 2016; 2(2):21–28.