

---

Electronic Theses and Dissertations, 2004-2019

---

2007

## The Effects Of Increasing Family Involvement On Student Achievement In Scientific Inquiry

Patricia DeNoon  
*University of Central Florida*

 Part of the [Science and Mathematics Education Commons](#)  
Find similar works at: <https://stars.library.ucf.edu/etd>  
University of Central Florida Libraries <http://library.ucf.edu>

This Masters Thesis (Open Access) is brought to you for free and open access by STARS. It has been accepted for inclusion in Electronic Theses and Dissertations, 2004-2019 by an authorized administrator of STARS. For more information, please contact [STARS@ucf.edu](mailto:STARS@ucf.edu).

---

### STARS Citation

DeNoon, Patricia, "The Effects Of Increasing Family Involvement On Student Achievement In Scientific Inquiry" (2007). *Electronic Theses and Dissertations, 2004-2019*. 3137.  
<https://stars.library.ucf.edu/etd/3137>

THE EFFECTS OF INCREASING FAMILY INVOLVEMENT  
ON STUDENT ACHIEVEMENT IN SCIENTIFIC INQUIRY

by

PATRICIA Y'VETTE DE NOON  
B.S. Southern Illinois University at Carbondale, 1997

A thesis submitted in partial fulfillment of the requirements  
for the degree of Master of Education in K-8 Mathematics and Science Education  
in the College of Education  
at the University of Central Florida  
Orlando, Florida

Spring Term  
2007

## **ABSTRACT**

Research has shown that there is a positive correlation with student performance when there are members of the family, primarily a parent, who are actively involved with the student and their education. The following action research plan was designed to determine how increasing parental involvement affected student performance in a scientific inquiry program. This was done by offering “parenting a middle school student” workshops, encouraging family run practices at home, and inviting parents to attend a class with their student. This research was conducted in a large middle school in a central Florida school district with two 7<sup>th</sup> grade classrooms. One classroom served as the control group, while the second served as the experimental group.

The teacher researcher was responsible for increasing communication with the parents in regards to student behavior and/or performance. Implementation of increased communications are associated with keeping parents informed, however they only work to increase student performance if the parent uses the increased communication and applies the information to use at home.

Analysis of the data indicated that there was no difference between the two classes. The majority of the invited parents in the experimental group did not participate in the parent workshops. Students in the experimental groups showed little or no difference in grades on the post unit exam or in their overall grades.

Additional research with smaller sampling sizes would be a recommendation of this researcher. When working with an average of one hundred and twenty students on a regular basis, working with twenty five sets of parents to increase communication was a daunting task. The researcher would recommend having an experimental group of no more than ten for future

studies. Although a small sample may be sufficient for a descriptive study, it's recognized that a small sample will likely not have sufficient power to detect statistically significant differences if they exist.

## ACKNOWLEDGMENTS

Education is a continuing process that everyone encounters throughout their lives. I am fortunate to have had a life filled with opportunities to learn, both informally and in the formal education process. I am also very fortunate to have had a great deal of support along the way. Throughout all of my education experiences, my parents have always stood by me and encouraged me to continue forward. They have always been a strong support system in my life and for that I thank them.

During this particular experience there are others that have helped me. I would like to first acknowledge my son, Mason, for his patience during a very stressful time. He has allowed me to work when I know how much he wanted to spend time with his mommy. And being five to six years old just shows what a special soul he truly is. Second, I would like to thank all my friends from home, work, and school who have always been there to listen to me when I just needed to let off some steam. In addition, I would like to thank Heather for all her examples and help while working on this thesis. I would like to thank the members of my church and my bishop for their support and blessings. Without the church and God, I'm not sure I would have made it this far.

Finally, I would like to thank the chairman of my committee, Dr. Robert Everett, for being so positive and kind throughout this process. He truly has been a positive light when things were at their darkest. I would also like to thank my other committee members, Dr. Debbie Hahs-Vaughn and Dr. Gina Gresham for the many hours of work they contributed to making this what it has become.

# TABLE OF CONTENTS

LIST OF FIGURES .....	viii
LIST OF TABLES .....	ix
CHAPTER ONE: INTRODUCTION.....	1
Rationale .....	2
Significance .....	3
Assumptions.....	5
Descriptions .....	6
Limitations .....	7
Overview.....	8
CHAPTER TWO: LITERATURE REVIEW .....	9
Parental Involvement and Academics.....	9
Future Aspirations.....	10
Academic Performance .....	11
Interactive Homework .....	12
Parental Involvement and Behavior.....	14
Demographic Factors .....	15
Socioeconomic Status .....	15
Ethnicity .....	17
CHAPTER THREE: METHODOLOGY .....	19
Setting.....	20
Classroom Setting .....	21
Procedures.....	22

Parent Night Workshops .....	22
Homework.....	23
Communication.....	23
Instruments.....	24
Survey .....	24
Unit One Exam and Overall Grades .....	24
Homework.....	25
Data Analysis .....	26
CHAPTER FOUR: ANALYSIS.....	29
Introduction.....	29
Pre and Post Survey .....	30
Unit One Examination Results .....	36
First Quarter Overall Grades.....	38
Parent Participation and Attitudes .....	40
Case Studies of Two Students .....	42
Summary of Data .....	43
CHAPTER FIVE: CONCLUSION.....	44
Student Success.....	45
Conclusion .....	46
Recommendations.....	50
APPENDIX A: PARENT LETTER .....	52
APPENDIX B: STUDENT ASSENT FORM .....	55
APPENDIX C: STUDENT SURVEY .....	57

APPENDIX D: PARENT SURVEY .....	60
APPENDIX E: UNIT ONE EXAM.....	63
APPENDIX F: EXAM USE PERMISSION .....	73
APPENDIX G: IRB APPROVAL.....	76
REFERENCES .....	79



## LIST OF FIGURES

Figure 1: Unit One Post Examination Grades for Control Group .....	37
Figure 2: Unit One Post Examination Grades for Experimental Group .....	38
Figure 3: Student Overall Grades for Control Group, First Quarter .....	39
Figure 4: Student Overall Grades for Experimental Group, First Quarter .....	40

## LIST OF TABLES

<i>Table 1.</i> Student Expectations.....	30
<i>Table 2.</i> Student Reported Hours of Work .....	31
<i>Table 3.</i> Student Opinion on Parent Involvement with Homework.....	31
<i>Table 4.</i> Parent Reported Hours of Work .....	32
<i>Table 5.</i> Parent Opinion on Involvement with Homework.....	33
<i>Table 6.</i> Parent Report of Classroom Volunteering.....	33
<i>Table 7.</i> Parent Report of Ability to Volunteer.....	34
<i>Table 8.</i> Parent Report on Learning Effective Motivation .....	34
<i>Table 9.</i> Student Report on Learning Effective Motivation .....	35
<i>Table 11.</i> Parent Report on Receiving Information.....	36

## CHAPTER ONE: INTRODUCTION

Research has shown that when there is an increase in parent and community partnerships in the schools the gaps in achievement close (NEA, 2005, p. 6-1). In a central Florida county, there have been three high schools that have repeatedly received a low state grade. These schools have tried numerous interventions to improve student scores on the Florida Comprehensive Assessment Test (FCAT), including switching administration, teachers, starting earlier in the day, and extending the school day. Students with the means to leave the school and travel to another high school were given the opportunity to attend a higher rated school, often leaving only those in the lower socioeconomic groups behind. Many of these families do not have the means or the education to properly help their children succeed in school. Coming from homes where one parent has to raise the children on his/her own and work two or three full time jobs has not left a lot of time for the parent to become involved in the child's education. Others have not had the education themselves and do not know what is needed for their child to perform at their best and succeed.

The purpose of the study was to investigate the effects of increasing family involvement on student performance in scientific inquiry. Sometimes it is difficult for teachers to exercise appropriate classroom management techniques for effective teaching to occur. Having parental involvement can be helpful in the management of students. Therefore, the following questions were investigated:

Question #1: How does the increase in parental involvement in their student's science classes at the middle school level affect student performance?

Question #2: How does the implementation of science homework with parental involvement affect student performance of scientific inquiry?

Question #3: How does the implementation of increased communication between parents and the teacher affect student performance in science?

Question #4: How does the implementation of increased forms of communication change the amount of parental involvement with a student's work at home?

### Rationale

Growing up in my home, there was always a strong emphasis placed on education. Both my parents came from homes where education was not a priority, but they overcame those obstacles and became college educated. My father worked at the college level in athletics, while my mom taught elementary school. I always knew that education was important and that I was to obtain a college degree. As I have continued past my college days, I have discovered that furthering one's education past high school is not emphasized in many of my students' homes as it was in my family.

Since I started teaching, I have observed a variety of parenting styles. These include parents who: a) Completely believe that their child(ren) would never lie to them and only believe the child(ren)'s side. b) Work hard with their child(ren) and their teacher(s) to ensure success. c) Are able to promote education during conferences, but do not follow through with steps that were set up during the parent/teacher conferences. d) Push their child to perform well in school. In some cases push too hard. e) Offer little or no guidance to their children and are often unavailable when needed.

Through my teaching years, I have witnessed students struggle at the beginning of the year because the parent(s), revealed during a later conference, that they believed as a middle school student they should be left on their own to explore their capabilities. Many times, as a

team of teachers, we set up conferences and offered strategies that would work for their child. Most of these strategies involved the parent being a crucial part of their child's education. Parents who actively worked on these strategies, tended to see a significant amount of improvement from their child.

I have always tried to have an open line of communication between myself and the parents of my students. With modern technology, I have been able to email parents on a regular basis. Unfortunately, there are still many parents who do not have email, so in these instances a phone call is necessary. Making phone calls to the student's home has always been a difficult thing for me to do. I have been very apprehensive about talking with a parent for an extended length of time. But in order to increase parental involvement I realized that I needed to increase teacher communication with the parents. In this study, I wanted to determine that if increased communication with parents, whether through emails, phone calls, or letters and flyers home, would affect the quality of work and learning of my students. The benefit of this study was to see if an increase in communication with students' parents would increase the performance of students in a science inquiry classroom.

### Significance

*"No Child Left Behind (NCLB)* requires schools to develop ways to get parents more involved in their child's education and in improving the school" (U.S. Department of Education, 2005, p.1). With this statute placed in federal law, it is increasingly more important to find ways to increase the involvement of parents.

According to Child Trends (2003), parent participation declines as students move from elementary to secondary education. Studies have shown that 90% of parents are active in the K-5

grades, which reduces to 75% in the middle grades and declines further to 59% in 9-10 grades and ends with only 53% in grades eleven and twelve. Although these figures do show a significant decrease in participation as students rise in grade levels, data also shows that there has been an overall increase in participation by parents between 1999 and 2003. In 1999, reports showed that 78% of parents in the K-12 education system were involved in some way. That number increased to 88% in 2003. Parent involvement was measured by attendance at general meetings, a meeting with a teacher, attending a school event or by volunteering or serving on a committee.

Data from the U.S. Department of Education also shows a relation to the percentage of parents that reported participating in their child's K-12 education and the level of education the students received. Of students that did not graduate from high school, only 42% of the parents reported involvement. This trend increased as the level of education procured increased. High school graduates or equivalent reported 62% of parent participation, college, or technical school participation jumped to 70% parent participation, and those students that received a bachelor's or graduate degree reported 80% participation (Child Trends, 2003).

In field studies and surveys of teachers, parents, and students at the primary and secondary education levels, Epstein, Sanders, Simon, Salinas, Jansorn, & Van Voorhis (2002), note that there are some patterns that have emerged:

- Affluent communities have more positive family involvement than economically distressed communities.
- Schools in lower socioeconomic areas tend to contact parents about problems they are having with the students, rather than positive accomplishments.

- Parents who work outside the home, live far from the school, are single parents, or are less involved fathers, are less likely to be involved with their child's education, unless the schools and teachers work to build the positive partnerships and give the parents opportunities to volunteer.

Research has also shown that most parents care about their children and want to be actively involved in their education. Most students would like their parents to be more informed and knowledgeable about school events and their education. However, most parents do not have the information on how the school works with this family partnership (Epstein et al., 2002), because teachers and administrators do not know how to take action and involve parents.

This research shows that caring communities between parents and schools can be built, but needs to be done intentionally and with effort. Many families are not aware of what they can do to build this relationship and become actively involved. That is where finding programs and communicating those programs becomes essential in an effort to improve the performance of our students (Epstein et al., 2002).

### Assumptions

I approached this study with the assumption that by increasing the parental or family participation of my students, there would be a positive effect on student participation in, and attitudes towards, inquiry science education. I based this assumption on a thorough review of the literature and upon my professional experience as an educator. I assumed that students and parents would be honest when completing their pre and post surveys and would not feel they would be penalized for negative answers. Finally, I assumed that my predisposition regarding

parental involvement would not interfere with my ability to report my findings in an unbiased manner.

### Descriptions

**Attitude:** Student attitude related to their interest level toward a specific content and their opinion regarding science education in general.

**Communication:** A way to distribute information from one person to another and then to be able to receive feedback from others about the information.

**Instructional methods:** Instructional methods included material manipulations, whole group discussions, independent activities, use of technology, scientist consensus ideas readings and evidence, and observations.

**National Science Foundation (NSF):** The NSF is an independent agency whose goal is to promote science education through research and educational projects.

**Parental or Family Involvement:** Participation of parents in regular, two-way, and meaningful communication involving student academic learning and other school activities, including ensuring that they play an integral role in assisting their child's learning. Parents are encouraged to be actively involved in their child's education at schools, and are full partners in their child's education and are included, as appropriate, in decision making and on advisory committees to assist in the education of their child.

**Participation:** Participation included student interaction with the teacher, contributions to small group work, contributions to whole group discussions, and completion of a daily work in a clear, concise, and honest manner.



**Science inquiry:** Science inquiry is a teaching methodology that involved students in gathering information, collecting and interpreting data, formulating hypotheses, drawing logical conclusions, and sharing their findings with their peers.

**Income and social status:** Categorized as upper class: those with abundant amounts of money, middle class: enough to live comfortably, and lower class: difficulty meeting the needs of the family.

**Teacherease:** This program, located at [www.teacherease.com](http://www.teacherease.com), is a secure program that requires a parent email address (entered by the teacher) and password enabling the parents to keep track of their student's grades in real time. Also included is a behavior and attendance log allowing parents to see data that the teacher entered about their child.

**Team of Teachers:** In middle school, four teachers are grouped together and share students. Each teacher is in charge of one content area including math, science, language arts and social studies. Generally there is one teacher that reports information between the administrator and the team and is given the title of Team Leader. A team of teachers' works together to provide a high-quality education for their students and will talk on a regular basis about strategies to improve student learning.

### Limitations

Although only two variables were studied in this research, other variables may have been a part of the differences in unit one exam and overall grade scores. The control group was the first period of the day. This was the time that announcements for the school were given and was the first time that the teacher would give a lesson. At times the announcements would run long, leaving less time for the lesson. As well as the shortened time, the teacher would learn things in

the lesson that did or did not work and modify the lesson for the other classes. The teacher would reflect on her teaching practices and find new ways to introduce material or guide the students during an activity. The experimental group was during the third class of the day. Time was not interrupted by announcements and lessons were modified from first and second periods' reflections. These factors were uncontrolled variables that played a part in the differences of the results between the control group and the experimental group.

### Overview

Determining the effects of increasing parental participation on student achievement in and attitudes towards inquiry science education was the primary focus of this study. Chapter two is the literature review that addresses parental involvement findings from other researchers. It also discusses what kinds of parental involvement opportunities have been used and found to be good strategies for success. Finally, it discusses the challenges involved when trying to encourage parental involvement and participation. Chapter three discusses the organization of research, the participants and how they were selected, the instruments used, and demographic information. Chapter four is the interpretation of the data found in chapter three and its effects on student achievement in and attitudes towards inquiry science education. Finally, chapter five discusses the conclusions drawn from the data analysis and recommendations for future research in regards to increasing parental involvement and its effects on student understanding in scientific inquiry.

## CHAPTER TWO: LITERATURE REVIEW

The review of literature is meant to help provide a background on the topics analyzed within my action research. “The research evidence is compelling in its support of the idea that partnerships which increase engagement of parents and the community in the public schools are essential to closing the Achievement Gaps” (NEA, 2005, p. 6-1). In a society where it is increasingly more difficult for many parents to stay involved in their child’s education, and more pressure is placed on teachers to make sure their students are performing at grade level, we need to refocus our attention as to why students are not performing as expected.

Another trend that has been shown is the decline in parent participation as the child grows older. While 90% of parents participate in the kindergarten through fifth grades, that number reduces to 75% in the middle grades and continues to decline to 53% by the time students are ready to graduate from high school (Child Trends, 2003). Two areas of parental involvement such as, how parental involvement affects academics and how it affects behavior seem to reoccur through the literature are addressed in the review of literature.

### Parental Involvement and Academics

Parent academic involvement is defined as the parent being actively involved and aiding in the future success of their children in conjunction with the school, administrators, and teachers (Hill, Castellino, Landsford, Nowlin, Dodge, Bates, et al., 2004). According to research done by the Child Trends Data Bank (2003), students who have both parents involved perform better in school. This includes non-custodial fathers. Many times we view non-custodial parents as not part of the picture, but according to Epstein (2001), many of these parents, usually fathers, want

to be more actively involved in their child's academic life. Callison (2004) reported that when fathers are involved in their child's education, the student is more likely to do better in school. Callison continues to report that single fathers are more likely to play an active role in their child's education than that of fathers in a dual parent family. While only 27% of fathers in a dual parent family are active, 46% of single parent fathers are involved, which is similar to the mother's activity in a dual parent family and that of a single mother. Unfortunately, many schools only record one parent's contact information and send home information to the custodial or resident parent (Epstein, 2001). Within this realm of involvement, studies have shown that there is an affect on academic and future performance of students. Three areas of involvement are prevalent in academics; the affects of future aspirations, the effects on academic performance, and how interactive homework effects understanding.

### *Future Aspirations*

A recent study by Hill et al. (2004) correlated that student academic involvement was directly related to future aspirations of students across all areas, including socioeconomic status, ethnicity, and parent education. The study also showed a negative correlation between academic involvement and behavior. This has implications that students may feel pressured to do well academically, but choose instead to use negative behaviors as an outlet for the pressures they experience.

Hill et al. (2004) showed that parents of higher academic levels did not show a significant relation to student aspirations, but those of lower education of parents that were academically involved showed a positive relation to eleventh grade aspirations. They indicated that academic involvement of parents did increase aspirations, but did not improve the behavior and

achievement levels of students. This aspiration was directly linked with parents of lower education levels, but indirectly linked to students with parents of higher educational levels.

Data from Child Trends did show a correlation with the percentage of parents that were involved in their child's education and the degree to which the student continued their education. For non-graduating students, only 42% of parents were actively involved in any way during their education. This number jumped to 62% for parent involvement for students who obtained a high school diploma or equivalent. Reported parent participation continued to rise to 70% for those students with some college or technical school. For those who graduated with a bachelor's degree or higher 80% of parents reported attending school events (Child Trends, 2003).

### *Academic Performance*

Research has shown that involving families at home in a specific subject do have an affect on student achievement (Epstein, 2001). An earlier research study by Epstein (1980, 1981), showed that most practices involving parents were limited to reading, English or other similar activities. She also found that reading scores improved with increased involvement of home learning activities, but math scores were not affected.

Further, studies showed that there is little difference in the type of home (single parent or dual parents) in which a student belongs (Epstein, 2001). What did matter was what occurred within the family. Students were less at risk of failing or trouble if their families were involved in their school, provided support in social areas and monitored their children's lives (Benson, 1993).

### *Interactive Homework*

One of the most important practices for success in high school is homework (Epstein, 1990; Van Voorhis, 2003). Coleman, Hoffer, and Kilgore (1982) found that homework and discipline were features of private schools that were different than that of public schools. They concluded that if public schools assigned more homework, the students would learn more. This idea may be too simple. Homework that is inappropriate, assigned too frequently, or given in amounts that may be more than they can complete may have the opposite effects of student achievement (Epstein, 1990).

Epstein (1990) came up with 10 reasons why teachers assign homework. She called these the 10 Ps as each of them start with the letter p. They are: practice, preparation, participation, personal development, parent-child relations, parent-teacher communication, peer interactions, policy, public relations, and punishment. Homework may be the only form of serious communication between parents and children. It provides a way for students and parents to exchange information and attitudes about school. It also provides a way for teachers to communicate with families about what they are teaching and how students are progressing. Epstein suggested questions that should be asked in future studies about homework as a parent, student and teacher communication tool. These included teachers advising the parents on how to monitor, check and interact with their children on their homework, whether parents are asked to help with specific weaknesses or needs of their child, and if there is a difference in improvement of achievement when parents are guided in how to help their children.

Further research has shown that there is little guidance or instruction on how parents can help their child with homework (Balli, Demo, & Wedman, 1998; Dauber & Epstein, 1993; Epstein & Dauber 1991; Epstein & Lee, 1995; Hoover-Dempsey, Bassler, & Burow 1995;

Hoover-Dempsey & Sandler, 1997; Scott-Jones, 1995; Xu & Corno, 1998). Without this guidance, studies have shown that an average of two-thirds of parents provide a negative or inappropriate experience with helping their child on homework. These included completing homework too quickly, parents helping despite knowing the work should be done independently, and making the work harder for the student than originally intended (Van Voorhis, 2003).

Tension at home when working with their parents also plays a factor in the success or failure of student understanding of the material (Epstein, 1990). In some cases, there has been an association between parent involvement with homework and stress within the family (Delgado-Gaitan, 1992; Epstein, 1990; Hoover-Dempsey et al., 1995). Students who are struggling with their understanding of the content material are reported to spend more time on their homework with a parent. This data may show that it is important to show parents how to help their children at home and improve academic achievement (Epstein, 1990).

An interesting study by Keith and Keith (1993) noted that parental involvement in homework affected student achievement more than the socioeconomic status of the family. In correlation, Ho and Willms (1996) noted that parental involvement reduced the effect of socioeconomic status on achievement by 7%. In a study by Van Voorhis (2003), the researcher was able to show that interactive homework in science that involved parents increased student understanding of the content, opened communication in the home, and earned students higher science grades. Some limitations to this study included not having standardized science tests, lack of teacher implementation and homework introduction, and the need of more survey questions to address the emotions about working together on homework.

## Parental Involvement and Behavior

There is an abundance of literature that shows that there is a relation between school behavior problems and achievement (Deslandes, 2005, Henderson & Berla, 1994, Hill et al., 2004, Sheldon & Epstein, 2002, Tan & Leach, 1996). Research has shown that students who have parental involvement in their education tend to have fewer behavioral problems (Henderson & Berla, 1994). Sheldon and Epstein (2002) showed that the more parent involvement with the school, the fewer students that needed discipline no matter what the prior discipline records revealed.

A father's influence in a child's education is also important to the behavior of the student. In dual parent households, a fathers' involvement in their children's schools has an independent and distinct influence on children's achievement over and above that of mothers (Callison, 2004). Low participation by fathers in dual parent families offers opportunity for schools to increase the overall involvement of parents. This can be done by targeting fathers, while continuing to welcome mothers, in the educational process of their children.

Epstein et al. (2002) offered expected results for improving the communication between schools and parents. The expected results of students were that they would become more aware of their own progress and the actions they needed to maintain or improve grades, they would become more understanding of the policies on behavior, attendance and other areas of student conduct at school, and they would be able to make more informed decisions. Epstein et al. continued to report that when there was improved communication between the school and parents it also increased the trend of monitoring behavior of students. When parents were actively involved and had an open line of communication, they also understood school policies



and were able to respond effectively to problems. These results allow for decreased behavioral issues and allows for an increase in learning.

### Demographic Factors

Demographics included economics of the parents, social status, and ethnicity. Although these factors did not always affect each student the same way, they did play a role in the development and achievement of many students. The amount of parental involvement is directly linked to demographics, education, and income of parents. The amount of involvement in lower economic and lower education households has been shown to be lower than that of parents with college degrees and middle or upper class environments. The good news is that between 1999 and 2003 there was an increase in parental involvement in the schools. However, data indicated that children of lower socioeconomic status and minority demographics were less likely to have parents participate in their education in comparison to those of non-Hispanic white parents living above the poverty level (Child Trends, 2003).

### *Socioeconomic Status*

Socioeconomic status is defined as the family's income, parental education level, parental occupation, and social status in the community (NCREL, 2004). For those of lower class or poverty level, students can be classified as either generational or situational. Those that are generational have families that have lived in poverty for more than two generations (parents and grandparents). Those that are categorized as situational are those where a hardship has occurred to the family and in many cases they will figure out a way out of poverty (Payne, 2003). In 2001 the Census Bureau reported that there were 16.3% of children living in poverty (2000).

Caucasians accounted for 13.4% of the total, while African Americans were 30.2% and Hispanics were reported at 28% (U.S. Bureau of the Census, 2000).

According to the Educational Testing Service (ETS, 2003), there were 14 correlates of student achievement. Of these 14 correlates, 11 of these are correlated to the education gaps between low income and higher income families. Seven of the 11 gaps related to the out of school environment, including parent participation, student mobility, hunger and nutrition, and parent availability.

Child Trends (2003) reported that 45% of parents of children living above the poverty line acted as a volunteer or served on a committee at their child's school, while only 27% of parents of children living at or below the poverty line did the same. The National Center for Family & Community Connections with Schools (2002) reported that the general, middle class mother knew more about her child's progress, had more contact with teachers, and steered her child toward higher-level courses. The report continues to state that working-class parents struggle to get transportation and childcare, and encounters with teachers were strained and awkward.

According to Payne (2003), schools were geared toward the middle class society. The rules and procedures were based on middle class behaviors and norms. Some of the rules included: what language was used (American English versus 'street' English), how students should dress, and the way students should sit in their chairs. This made it very difficult for those of lower class society as they were unaware of the rules of school and the appropriate behaviors they needed to exhibit while in the learning environment. Payne continued that in order to help those of poverty, teachers and administrators must teach the 'hidden rules' of middle class society and make the students aware of expectations from an early age.

## *Ethnicity*

As stated in socioeconomic status, the ETS (2003) found 14 correlates of student achievement. While 11 of the 14 correlates were responsible for achievement gaps in students when looking at socioeconomic status, 14 of 14 were responsible for gaps between minority and majority student populations.

While one third of public high school students drop out of high school on a yearly basis, the statistics for African Americans, Hispanics, and Native Americans are nearly one half. To better understand the reasons students drop out, Bridgeland, Dilulio, Jr. & Morison (2006) conducted surveys of 16-25 year old high school drop out focus groups around the United States. The students were selected based on ethnically and racially diverse populations, but did not necessarily represent the nation's demographics as a whole.

While their research did not show why students drop out of high school, however they reported influences that contributed to drop out rates, such as: (a) lack of connection to the school, (b) boredom or being unmotivated, (c) academic challenges, and (d) the weight of real world events. Surprisingly, less than 45% reported that dropping out was due to academic problems. On the other end, 71% of those students surveyed, mentioned that one of the keys to reducing the amount of drop outs was improving the communication between parents and the school and increasing involvement of parents in their education (Bridgeland, Dilulio, Jr. & Morison, 2006).

Many times parental awareness of these students was very low and did not occur until disciplinary problems occurred or the prospect of leaving school was voiced. Of those students surveyed, only 23% reported that their parents were very aware of attendance and grades, while

the other 27% were between not at all aware and fairly aware (Bridgeland, Dilulio, Jr. & Morison, 2006).

Parent participation was reported to be a significant factor in the performance of students in school. As students progressed in the education system from elementary through high school, it was reported that there was a decrease in the amount of involvement by parents (Child Trends, 2003). Students whose parents continued to play an active role in their education through high school had a higher rate of graduation, better performance in school, and fewer behavioral issues. Knowing these factors was important when trying to develop a process for increasing communication with parents. It was also important for teachers to understand these factors in order to keep parents involved and offer strategies to increase the students' academic performance in the schools.

## CHAPTER THREE: METHODOLOGY

The purpose of the study was to investigate the effects of increasing family involvement on student performance in scientific inquiry. In this study there are four key questions the researcher investigated:

Question #1: How does the increase in parental involvement in their student's science classes at the middle school level affect student performance?

Question #2: How does the implementation of science homework with parental involvement affect student performance of scientific inquiry?

Question #3: How does the implementation of increased communication between parents and the teacher affect student performance in science?

Question #4: How does the implementation of increased forms of communication change the amount of parental involvement with a student's work at home?

### Design of Study

This study was designed to determine whether increasing parental communication would affect student performance in science inquiry. The study was conducted over a 16 week period beginning in August 2006 and ending in January 2007. The study was conducted using action research. Action research is "systematic inquiry conducted by teachers, principals, school counselors, or other stakeholders in the teaching-learning environment, to gather information about the ways in which their particular schools operate, the teachers teach and the students learn" (Gay, Mills, & Airasian, 2006, p. 499).

This study was a qualitative action research study that included quantitative data in its results. I looked at the achievement of students over one quarter in relation to the extra effort of

the researcher/teacher in parent communication beyond which is normally accepted. The qualitative data included student answers from an attitudinal survey developed by the researcher (see Appendices C and D) and the discussions from individual parents with the teacher. The quantitative data included the overall grades for the quarter and unit one exam (see Appendix E) changes.

Qualitative and quantitative data collections were used throughout this study. Using qualitative measures enabled me to have a better understanding of the student's attitude towards science and school. Quantitative data allowed for the descriptive comparison of grades on the pre and post unit exams as well as the overall first quarter grades of the students.

To establish credibility and trustworthiness of data, data were gathered and triangulated from multiple sources: student surveys, pre and post unit examinations, parent/teacher conversations, and overall first quarter grades. Triangulation entails "the use of multiple methods, data collection strategies, and data sources in order to get a more complete picture of what is being studied and to cross-check information" (Gay, Mills & Airasian, 2006, p. 603). Triangulation enabled the researcher to establish consistency and determine common themes.

### Setting

This study was conducted at a middle school consisting of 1700 students in a large urban district in central Florida. The county school system consisted of 35 middle schools. The county demographic breakdown consisted of 36.5% Caucasian, 28% African American, 29% Hispanic, and 6.5% other nationalities. Forty-eight percent of students in the district were female and 52% were male. Approximately 45% of the school's students received free or reduced lunch, countywide it was 48.5%. The school's demographics breakdown consisted of 60% Caucasian,

18% African American, 18% Hispanic, and 4% other nationalities. Forty-eight percent of the students in the school were male and 52% were female.

### *Classroom Setting*

Two similar seventh grade classes were selected. The classes were chosen based on similarities in class size, school demographics and the class average for student achievement levels as measured by Florida Comprehensive Assessment Test (FCAT). The average FCAT Math score for each class is level 2.1 on an achievement level system of 1 through 5. The average age of the students was 12.8 years. One class served as the control group (first period class) with 24 students and one class served as the treatment group (third period class) with 25 students. The control group had 11 females (46%) and 13 males (54%) participating, containing 11 Caucasian (46%), 8 African American (33.3%), 2 Hispanic (8.3%), and 3 students from other nationalities (13.4%). The experimental group had 13 females (52%) and 12 males (48%) participating, containing 11 Caucasian (44%), 4 African American (16%), 5 Hispanic (20%), and 5 students from other nationalities (20%). Students were assigned to the control and experimental groups prior to the research study by the guidance counselor using a student management system.

The teacher researcher determined of which class became the control or experimental group by choosing that the first period class would be the control group, while the third period class would become the experimental group. This was done prior to the start of the school year, which allowed for an unbiased view of the students and their parents.

## Procedures

At the end of the 2005/2006 school year, the principal from the researcher's school was contacted and permission was gained to perform this study. The researcher contacted the research and accountability office for the district for approval. They were given a copy of the Internal Review Board application (see Appendix G for approval letters) with details explaining the action research that was to be conducted. For their participation, they had access to the final copy of the thesis results.

Parents from the two classes received letters sent home with the students describing the details of the research and their potential role in the study during the first week of school (see Appendix A). Parents were asked to return the letter of consent within three school days after receiving the letter. All students in the two groups were given a letter of assent (see Appendix B) on the second school day and the teacher/researcher read the parent letter of consent aloud to the students and answered any questions they had. Students were asked to return the letter of assent by the end of the class period. Students that entered the classes after the first week of school were not included in the study.

### *Parent Night Workshops*

Parents in the experimental group were invited to a series of three parent night workshops. Invitations were sent home with the students describing the content and dates of the three workshops. Prior to each workshop, an additional email was sent home to the parents of the experimental group. Food was provided by the researcher as an incentive to participate, however no other benefits were given for participation, nor did repercussions occur for those that did not attend. Each workshop focused on a separate aspect of being involved with their child and



strategies of helping their child in math and science. The workshops were designed by Barber (2000) from the University of California. These workshops were offered on three consecutive Thursdays during the first quarter of the school year, from 6pm to 8pm.

### *Homework*

All students received homework that was tied to the curriculum to reinforce what the students were learning in class from InterActions in Physical Science (It's About Time, 2006). These assignments were given after completion of the activity in class and were due the next day. This allowed the students to reinforce what they had learned in class. The idea for the assignments was not to take more than 30 minutes but to give the students ample time to work with parents. Students in the control group were not given direction to work with parents. They were instructed to complete the assignment and return it within the specified time. Students in the experimental group were verbally instructed in class to work with at least one parent or guardian on the homework.

### *Communication*

Communication of performance and behaviors of students was done through the "Teacherease" web based grading program for all participants. Data cannot be accessed without the user's email and password. The teacher is the only one who can access all students and the parent can access only their own child based on the teacher entering the parent's information. This application is an additional program to the school districts' grading and web based parent communication program.

## Instruments

### *Survey*

Students completed an attitudinal survey, created by the researcher (see Appendix C). A parent version of the survey and an envelope were sent home with the students (see Appendix D). Twenty-three items on the pre- and post-surveys used a five-point Likert scale from strongly disagrees to strongly agree. The remaining questions were demographic items.

Both parents and students were asked about the number of hours per week they spent working together on science homework, whether they felt this was an adequate amount of time, and what their performance expectations for science was based on their ability. Other questions that were asked were on the types of resources students had available to complete their work and whether they understood what it took to be successful in middle school. Questions were also asked about behavior and motivation, including their understanding and fairness of the county code of conduct and whether they would be interested in learning new ways to motivate the students. The final area assessed in the surveys was on the attitudes of the students and parents in regards to the amount of communication there was between the classroom and the home. Family demographic information was also obtained from the survey. Both the parent and student surveys were similar; however wording was different in order for it to be pertinent to the person taking the survey.

### *Unit One Exam and Overall Grades*

The student pre- and posttest was based on the curriculum in unit one. Scores received reflected percentage of items correct on the exam. Grades, or student achievement, are based on

the percentage of points students received in class based on home work, class work, participation, quizzes, and tests.

Students in all classes took a pre-test, created by “It’s About Time”, the exam designed for the end of unit one for the InterActions in Physical Science curriculum that represents material they were to learn during the first quarter (see Appendix E). The exam included 22 questions, with 19 multiple choice questions and the remaining 3 questions pertaining to collecting data from a laboratory exploration. Questions were based on applying the information gathered during the unit to similar situations throughout the exam. Students were required to be able to demonstrate their knowledge of scientific inquiry by apply it towards other areas not demonstrated in class. Permission for inclusion of the test was given via email from the president of the publishing company (see Appendix F).

### *Homework*

In class, students would complete activity record sheets gathering information on explorations and activities. They would analyze their data and come to conclusions, based on the data. Homework would then tie in with the activity completed in class. Students would be required to answer questions using the information they learned in class to analyze new situations, create and label diagrams, or answer multiple choice questions related to the material.

## Data Analysis

Data were analyzed by first segmenting the information. Each segment was based on one idea in the study. After all the data were segmented, it was further labeled into topics, giving the segments a descriptive name. Then the topics were categorized into similar topics. Finally, all labeled categories were analyzed for patterns.

In this study there were four key questions the researcher investigated and analyzed:

Question #1: How does the increase in parental involvement in their student's science classes at the middle school level affect student performance?

Three areas were investigated and researched for question #1. These included: (a) Comparing the quarter grades of both the control group and the experimental group. (b) Investigating the difference of the unit one examination pre- and posttest results for progress differences. (c) Student progress of those students whose parents were actively and directly involved in parent night workshops.

Question #2: How does the implementation of science homework with parental involvement affect student performance of scientific inquiry?

For question #2 the researcher investigated the following: (a) The overall grades of the participating students to ascertain if there was a difference between the control group and the experimental group based on the work that was completed both in the classroom and at home. (b) The unit one examination pre- and posttest results to determine if there was a difference in progress between the two groups, based on homework.

Question #3: How does the implementation of increased communication between parents and the teacher affect student performance in science?

Question #3 investigated: (a) The overall grades of the students to discover if there was a difference between the control group and the experimental group based on discussions and emails with their parents about the progress of the students. (b) Survey results to determine if there was a difference in the attitudes of the students and the parents from the beginning to the end of the study.

Question #4: How does the implementation of increased forms of communication change the amount of parental involvement with a student's work at home?

Question #4 investigated the results of the survey to ascertain if there was a difference in the attitudes of the students and the parents from the beginning to the end of the study and to observe progress in those students whose parent were actively involved in parent night workshops.

The surveys, the unit one exam, the overall first quarter grades, and the participation in the parent night workshops were analyzed in order to determine if increasing parental involvement affected the performance of students in science class. Qualitative analysis was used in describing the conversations of parents during the parent night workshops as well as describing the performance of students throughout the first semester. The teacher used observations during class and related it to student performance on exams, homework and class work. Quantitative data were used in measuring the results of the surveys by placing the responses in one of three categories. Students and parents placed their answers to 23 of the 33 questions as either strongly agree, agree, neutral, disagree, or strongly disagree. Strongly agree

and agree, as well as strongly disagree and disagree were grouped together in the results.

Quantitative data were also used in reporting the overall first quarter and unit one exam grades.

## CHAPTER FOUR: ANALYSIS

### Introduction

Data were collected using pre and post surveys for students and parents, unit one examination, overall student grades for the first quarter, and the participation of the parents in the invited activities.

The pre and post survey results show the differences or similarities of attitudes, work habits and opinion on a variety of topics. Some questions were not answered due to copy issues and therefore were not reported. Data were collected for demographic purposes as reported in chapter three. Several questions were found to be more focused on school issues and did not pertain to the research needed for this report and therefore deleted from analysis.

Student unit one examinations were compared to see growth of students from the beginning of the first quarter and the end of the unit one instruction on scientific method and inquiry. Overall grades reported for the first quarter were used to show a comparison of the two classes. Grades were based on the average of the students in the study and no individual grades were reported.

The final area of datum was the qualitative information on attendance and attitudes of parents to the invited events for the experimental group. In this section it will be reported how many parents in the experimental group took the opportunity to participate in the parent's night activities and of those that attended, what their response to the activities were and their attitudes towards the material and information that was presented. Data were reported on the number of parents that took advantage of the invitation to visit their child's class.

### Pre and Post Survey

Both students and parents from the control and experimental groups received pre and post surveys (see Appendixes C and D) that asked a variety of questions ranging from the amount of work that was spent on science homework with parental help on a weekly basis to the attitudes of how they felt about the school's code of conduct. The pre survey was given during the first week of school (August 2006) and the post survey was given during the week after winter break (January 2007). Although there were 19 questions not relating to demographics, the following questions were selected as vital to the conclusion of the action research.

The first question related to the expectation of performance in science of the student. It was reported on both the pre and post surveys for parents and students that the student was expected to perform to the best of his/her ability. All parents reported that they expected their child to perform to the best of their ability, while 8% of students in the control group disagreed with this statement (see Table 1). There was very little, if any difference between the pre and post surveys for this question.

*Table 1. Student Expectations*

	Control Group Student Pre	Control Group Student Post	Experimental Group Student Pre	Experimental Group Student Post
I expect to perform to the best of my ability				
Agree	92%	100%	100%	100%
Neutral	0%	0%	0%	0%
Disagree	8%	0%	0%	0%

The next questions reported were based on the amount students worked at home with a parent during an average week on science assignments. The student data showed that the amount



of time spent with a parent on their science assignments decreased from the beginning of the study to the end of the study (see Table 2). Students also reported a difference between the beginning of the study and the end of the study as to the amount of time their parents spent with them on their science homework.

*Table 2. Student Reported Hours of Work*

Number of hours per week spent doing science homework – student report

	Control Group Student Pre	Control Group Student Post	Experimental Group Student Pre	Experimental Group Student Post
0 hours/week	0%	40%	23%	80%
Less than 1hour/week	25%	50%	23%	0%
1-2 hours/week	67%	10%	23%	20%
More than 2 hours/week	8%	0%	31%	0%

At the beginning of the study, a majority of the students reported that they either agreed or were neutral that there was an adequate amount of time spent with parents helping with their homework in science. During the post survey, students in both classes reported a change stating that more disagreed that they spend an adequate amount of time with a parent on their science homework (see Table 3).

*Table 3. Student Opinion on Parent Involvement with Homework*

My parent spends adequate time assisting me with science homework

	Control Group Student Pre	Control Group Student Post	Experimental Group Student Pre	Experimental Group Student Post
Agree	58%	40%	40%	40%
Neutral	42%	20%	30%	0%
Disagree	0%	40%	30%	60%

Parent data on the number of hours per week spent working together on science showed a similar trend. Parents also reported spending less time with their child on the post survey than they did on the pre survey (see Table 4).

*Table 4. Parent Reported Hours of Work*

Number of hours per week spent doing science homework together – parent report

	Control Group Parent Pre	Control Group Parent Post	Experimental Group Parent Pre	Experimental Group Parent Post
0 hours/week	18%	20%	0%	20%
Less than 1 hour/week	18%	40%	18%	20%
1-2 hours/week	64%	30%	36%	60%
More than 2 hours/week	0%	10%	46%	0%

Although they showed a decline in the amount of work they spent with their child on their work in science, parents reported similarities in that they felt that they were spending an adequate amount of time with their child on their work. This was more relevant for the experimental group than that of the control group. In the experimental group, 9% of parents reported that they did not spend enough time with their child on science work at home at the beginning of the study, while at the end of the study, no parents disagreed that they spent adequate time with their child. In contrast, the control group increased in the number of parents that reported not spending adequate time on science homework with their child. The control group reported a 9% disagreement rate on the pre survey with an increase of 14% by the mid year post survey (see Table 5).

*Table 5. Parent Opinion on Involvement with Homework*

I spend adequate time assisting my child with science homework

	Control Group Parent Pre	Control Group Parent Post	Experimental Group Parent Pre	Experimental Group Parent Post
Agree	73%	44%	91%	25%
Neutral	18%	33%	0%	75%
Disagree	9%	23%	9%	0%

Parents were asked whether they have volunteered in the student’s science class and whether they would be willing to volunteer in the current class. The majority of parents reported that they have not volunteered in the science class (see Table 6).

*Table 6. Parent Report of Classroom Volunteering*

Currently volunteer in the science classroom

	Control Group Parent Pre	Control Group Parent Post	Experimental Group Parent Pre	Experimental Group Parent Post
Yes	17%	10%	15%	0%
No	83%	90%	85%	100%

In addition, most parents also reported that they would not be able to volunteer in the science classroom (see Table 7). Parents who reported that they would not volunteer in the science class added that time constraints with work were the reason they would not be able to participate.

*Table 7. Parent Report of Ability to Volunteer*

	Control Group Parent Pre	Control Group Parent Post	Experimental Group Parent Pre	Experimental Group Parent Post
Would be willing to volunteer in the science classroom				
Yes	45%	20%	38%	40%
No	55%	80%	62%	60%

When asked whether parents would like to learn ways of effectively motivating their child, it was agreed that the majority would like to learn strategies for effectively motivating the student to succeed (see Table 8).

*Table 8. Parent Report on Learning Effective Motivation*

	Control Group Parent Pre	Control Group Parent Post	Experimental Group Parent Pre	Experimental Group Parent Post
I would like help learning ways to effectively motivate				
Agree	90%	100%	67%	60%
Neutral	10%	0%	25%	40%
Disagree	0%	0%	8%	0%

The data was similarly reported by the students when asked if they would like their parents to learn effective motivation (see Table 9). Although parents reported that they would like to learn strategies to effectively motivate their students, when given the opportunity during the first semester, they did not (or were not able to) take advantage of the opportunity as shown in the section on parent night activities.

*Table 9. Student Report on Learning Effective Motivation*

I would like my parents to learn ways to effectively motivate me				
	Control Group Student Pre	Control Group Student Post	Experimental Group Student Pre	Experimental Group Student Post
Agree	83%	90%	82%	80%
Neutral	17%	10%	9%	20%
Disagree	0%	0%	9%	0%

The final survey question being reported was based on the amount of information that was being given to parents and students. Students and parents were asked if they received the information they needed in order for the student to be successful. While nearly all the students in both classes agreed that they did receive the information they needed to succeed (see Table 10).

*Table 10. Student Report on Receiving Information*

I receive information to help me succeed				
	Control Group Student Pre	Control Group Student Post	Experimental Group Student Pre	Experimental Group Student Post
Agree	80%	90%	75%	100%
Neutral	20%	10%	8%	0%
Disagree	0%	0%	17%	0%

The parents of those students reported a decrease in the information they received (see Table 11). Parents in both classes had access to student grades at any time, they received emails pertaining to assignments and work in science, and had access to the homework hotline.

Table 11. Parent Report on Receiving Information

I receive information I need to help my child succeed

	Control Group Parent Pre	Control Group Parent Post	Experimental Group Parent Pre	Experimental Group Parent Post
Agree	82%	90%	83%	60%
Neutral	9%	0%	17%	40%
Disagree	9%	10%	0%	0%

### Unit One Examination Results

Students in both the control and experimental group showed improvement between the pre- and posttest for unit one. All students in both the control and experimental groups scored under 59.5% for the pretest. The average score for the control group changed from 24.65% to 57%, giving the class an average increase of 32.35 percentage points. The data in Figure 1 represents the results of the posttest for the control group.

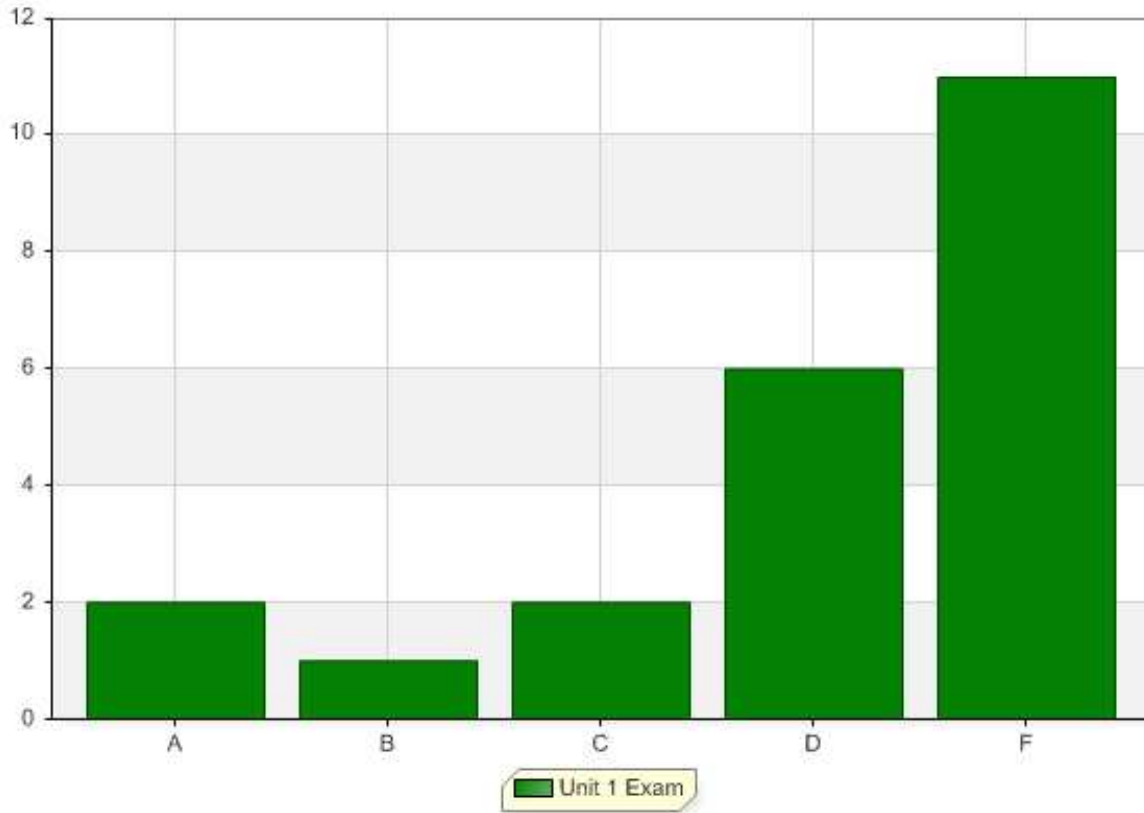

Unit 1 Exam	Class Average 57%=F	2(9%)=A	1(5%)=B	2(9%)=C	6(27%)=D	11(50%)=F
-------------	---------------------	---------	---------	---------	----------	-----------

Figure 1. Unit One Post Examination Grades for Control Group

The average score for the experimental group changed from 21.71% to 62% (see Figure 2), giving the class an average increase of 40.29 percentage points. The data in Figure 2 represents the results of the posttest for the experimental group. The results of the pre- and posttest show that experimental group did have an increase of 7.94 percentage points over that of experimental group, although the control group did show to have two students achieve a grade of over 90% where the experimental group's highest grades were between 80 and 89.5%. The experimental group had more students out of the lower 50% range and more students in the 70 to 89% than that of control group.

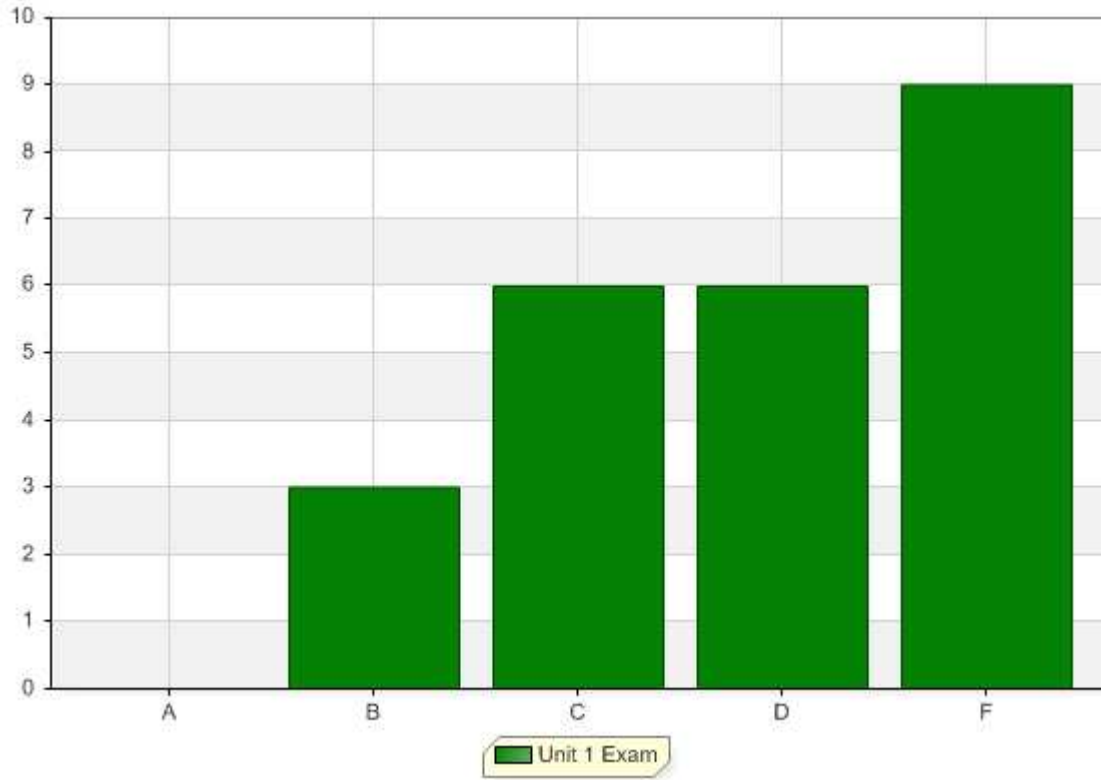

Unit 1 Exam	Class Average 62%=D	0(0%)=A	3(13%)=B	6(25%)=C	6(25%)=D	9(38%)=F
-------------	------------------------	---------	----------	----------	----------	----------

Figure 2. Unit One Post Examination Grades for Experimental Group

### First Quarter Overall Grades

Taking into account that all the assignments were the same for both the control and experimental group classes, the overall scores for the classes show that control group had a class average of 68%. Figure 3 illustrates the frequency of grades received by students in the control group for all assignments during the first quarter.



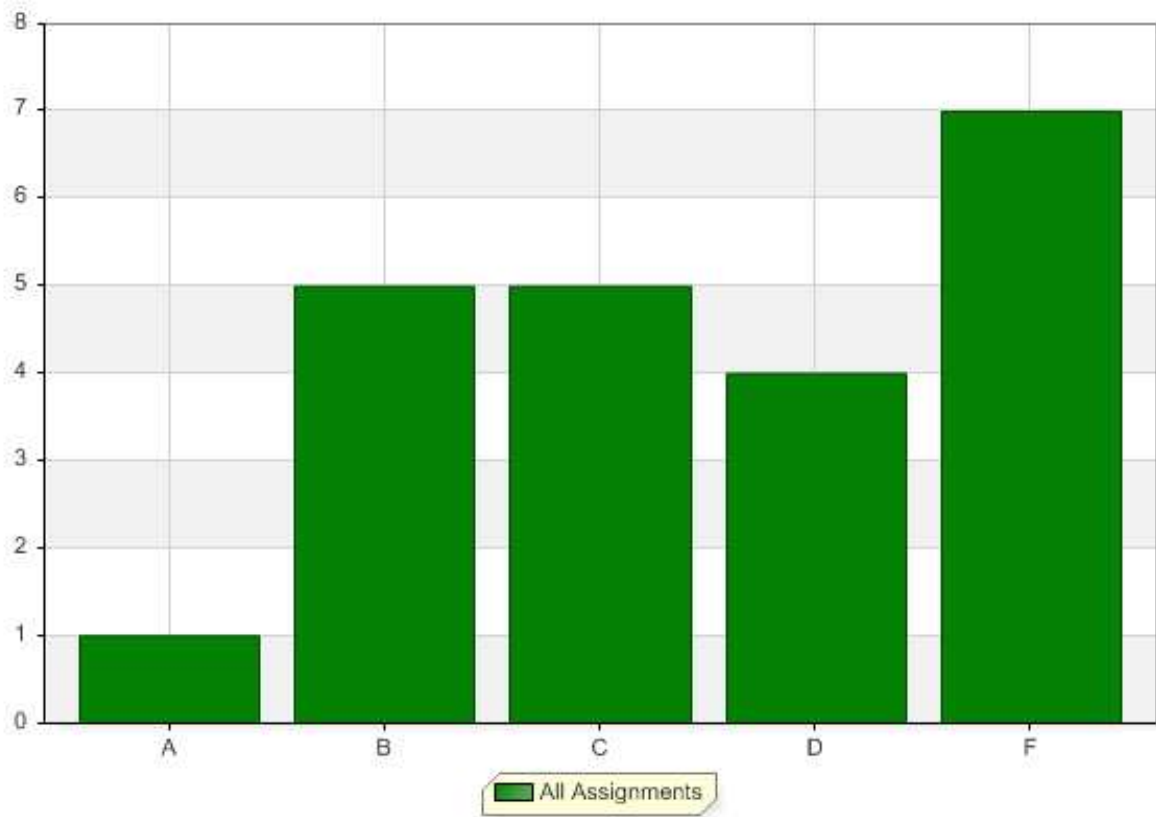

Overall Grades	Class Average 68%=D	1(5%)=A	5(23%)=B	5(23%)=C	4(18%)=D	7(32%)=F
----------------	------------------------	---------	----------	----------	----------	----------

*Figure 3.* Student Overall Grades for Control Group, First Quarter

The experimental group had a class average of 63%. Figure 4 illustrates the frequency of grades received by students in the experimental group for all assignments during the first quarter. These data show that control group had a five percentage point higher average than that of the experimental group. These averages were contributed by assignments turned in. Students that did not turn in assignments automatically received a zero, which brought the average for that assignment down for the entire class. All assignments were graded on a point system, and therefore no weighted categories were assigned.

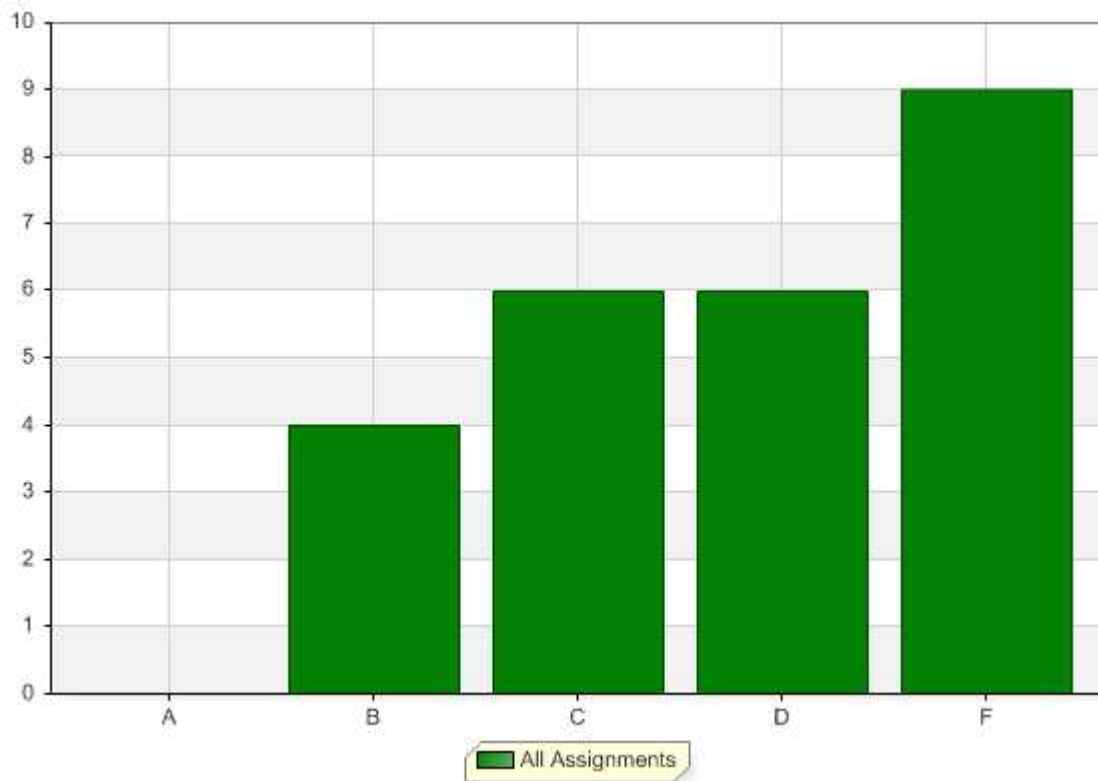

Overall grades	Class Average 63%=D	0(0%)=A	4(16%)=B	6(24%)=C	6(24%)=D	9(36%)=F
----------------	------------------------	---------	----------	----------	----------	----------

Figure 4. Student Overall Grades for Experimental Group, First Quarter

#### Parent Participation and Attitudes

During the first quarter of the 2006-2007 school year, parents from the experimental group were invited to attend parent’s night activities. There were three workshops scheduled for parents to attend based on the publication, *Parent Partners* (Barber, 2000). For the first workshop an email was sent to all parents that had provided an email address and a flyer was sent home to all students in the experimental group class. Dinner was provided as advertised.

Attendance for the first class was one set of parents. Material on “How parents make a difference” was given to the one set of parents and an informal discussion was held between the teacher and the parents concerning the information.

A second night was scheduled for one month later to again present information on “How parents make a difference”. At this time one parent showed up. This was a different parent than that of the September workshop. Again information as outlined in the Parent Partners workshop book was discussed. Both sets of parents reported that the information was very useful and they took home handouts provided by the author to read and continue to find ways to work with their children.

One night was set up in between the two nights to present information on making a difference, but was canceled due to a lack of interest. A fourth night was scheduled for a month later at 6 p.m. to present material on “How students learn best”. No parents showed for this workshop. Emails and flyers were sent home and parents were asked to RSVP. Despite no response, the teacher waited 40 minutes for parents to arrive. Due to the lack of interest and participation on the previous four attempts, the third workshop, “Testing: knowing what your child knows” was never scheduled.

Although all parents were allowed to visit a class, with proper notification, the experimental group was given verbal invitations to join their child during the first quarter for one of their science classes. No parents took advantage of this opportunity. There was also no information as to why they did not participate.

### Case Studies of Two Students

As mentioned in the section on parent participation, two parents/guardians did attend one of the parent night workshops. One set of parents/guardians that participated were that of “Charlie” (names have been changed for confidentiality). Charlie came from an upper middle class Caucasian family. The parents discussed the ways they were involved and the changes they made for that school year. Although they discussed changes, such as selling of a business, moving and the father taking a more active role in Charlie’s education, little change was seen during the first quarter. Also discussed during the parent night activities was the role the mother would play to help Charlie. It was discussed that the mother was willing to volunteer in the classroom and be available to call when needed. However no number or email address was given to the teacher researcher in order to contact the mother. Charlie’s overall grade of 69% for the first quarter was below his ability level. The second quarter showed a drop with an overall grade of 61%. Charlie did show an increase in unit one exam results, increasing from 5% in the pre test to 65% in the post test, which was to be expected given the low percentage correct on the pretest. This was a 60 percentage point increase during the semester, therefore showing learning gains.

The second parent/guardian that showed was “Sierra’s” aunt. Sierra came from a low socioeconomic African American family whose parents died from drug problems within the last few years. She then moved in with her grandparents, whom the aunt reported allowed her to do what she wanted at any time. Sierra did not perform well at school, had a negative attitude with adults, including her grandparents and teachers, and was in danger of failing. Over the summer of 2006, Sierra’s aunt decided to take her into her family and work with her to increase her performance in school and give her a more promising future than the path that she was on.

Sierra's aunt and family were middle class African Americans. This information was given to the teacher researcher during the parent night activity after the end of the first quarter. Although Sierra struggled the first semester, a large improvement between the first quarter and the second quarter was recorded. Sierra received a 60% overall grade the first quarter, but increased to 70% the second quarter. Sierra's unit one exam grade also showed a significant increase, as expected, from 5% to 63%, showing an increase of 58 percentage points.

### Summary of Data

Parents and students both reported that they wanted to see success in science and those parents expected their child to perform to the best of their ability. Data were consistent throughout the surveys, however when given the opportunity to learn strategies and to show their abilities, the results of the post test and the overall grades showed differently.

Although there was a significant increase in the results of the pre- to the posttest, the overall grades did not show a complete grasp of the knowledge learned during the first quarter. The results of the overall grades also showed less effort than students reported on the survey. Most grades were based upon completion of the assignments and turning in the work. The low overall grades show that many assignments were not completed or not turned in.

Parent participation for the experimental group also did not correlate to that of the survey. Although parents reported that they would like to learn strategies to effectively motivate their child, only two of 25 sets of parents attended one each of four workshops.

## CHAPTER FIVE: CONCLUSION

The purpose of the study was to investigate the effects of increasing family involvement on student performance in scientific inquiry. Two classes were chosen based on the FCAT math levels of the students from the researcher's five classes she taught during the 2006 – 2007 school year. Students and parents from the two classes were pre and post surveyed (see Appendices C and D) to determine if there were any differences between the amounts of work the students did at home with parental involvement. They were also surveyed to determine if the attitudes of the students and the parents changed.

In addition to the survey, students in both classes took part in a pre and post unit one examination (see Appendix E) to determine what amount the students increased, if any, in their understanding of scientific inquiry. The overall grades of the students at the end of the first quarter were also averaged to determine if there was a difference between the two classes.

Parents from the experimental group class were invited to attend one or more of four nights of parent workshops, discussing topics on “how parents make a difference” and “how students learn best” (Barber, 2000). Due to low attendance, the third workshop on “testing: knowing what your child knows” was not offered.

This study was descriptive in nature, and no inferences can be made to a larger population. Descriptive analysis of the data indicated very little difference between the two groups. Students in the experimental group increased their unit one examination grade by more than that of the control group. However, the overall grades at the end of the first quarter of the control group were slightly higher than that of the experimental group. Of the 25 families that

were invited to the four workshops, only two attended one each of the four workshops. This may have been based on a breakdown of communication, where the flyer sent home through the students did not reach its final destination or the email was not read in time for the workshop, or on a lack of time or interest from the student's families. This data was not obtained by the researcher and cannot be made conclusive. Of the parents that did attend the first workshop on making a difference, the parents reported finding the information very valuable and said they looked forward to learning more. However, neither attended the second workshop on "how students learn best." Attendance to the workshops was contradictory to the survey results that showed that the majority of parents would like information on how to effectively motivate their child.

#### Student Success

Of the two students (Charlie and Sierra) reported in the results, both showed significant learning gains on the unit one exam, showing the potential for success in science. The student scores on the unit one post exam were above the class average for the experimental group. Charlie's overall grades for the first two quarters showed a decline, while Sierra showed an increase. Observations of the teacher researcher showed that the guardian of Sierra was playing an active role in her education and was easily accessible when needed. On the other hand, Charlie's parents were difficult to reach and only emailed when they felt that Charlie's grade on a project was worse than the effort that he and his father put in, no matter if the details of the project were followed and completed based on the rubric provided.

In a comparison of the two students, there was an increase in work of the student, Sierra, whose guardian showed an increase in involvement after the workshop, while Charlie's work

declined in which there was little contact made after the parent workshop. Sierra's progress correlates with the work of Epstein et al. (2002), which states that when there is effective communication between the parents and the teacher, there is a positive trend in the student's progress both academically and behavioral. Van Voorhis (2003) concluded that without proper guidance on homework the student is more likely to do poorly in school. This was evident in Charlie's progress. Charlie's work was often uncompleted, showing either that he worked too quickly on the homework or simply just did not do the work. Tension at home when working with their parents also played a factor in the success or failure of student understanding of the material (Epstein, 1990). The teacher researcher noticed that there was a great deal of tension between the parents of Charlie. This may have also played a role in Charlie's lack of progress during the first semester.

### Conclusion

Four questions were asked by the teacher researcher. These questions were:

Question #1: How does the increase in parental involvement in their student's science classes at the middle school level affect student performance?

Question #2: How does the implementation of science homework with parental involvement affect student performance of scientific inquiry?

Question #3: How does the implementation of increased communication between parents and the teacher affect student performance in science?

Question #4: How does the implementation of increased forms of communication change the amount of parental involvement with a student's work at home?

The teacher researcher did not find a difference in the performance of the students in their science classes between the control group and the experimental group. No difference in student



understanding of scientific inquiry was found by asking for an increase in parental involvement in homework by the experimental group over that of the control group. This may be due in part to little or no parental involvement by the experimental group on the student's homework, despite being asked by the teacher to work with their students on their homework. Van Voorhis (2003) reported that increased interactive homework improved the understanding of science inquiry of students. In this study, the effects of homework on student understanding were inconclusive due to poor grades on the homework as reported in the overall first quarter grades.

There was an increase in parental involvement of one student, showing that with an increase of communication between the teacher and the parent/guardian, there was an improvement in the performance and the behavior of the student. Benson (1993) concluded that with parent support, student progress would increase. This was evident in one student's progress, but was not apparent in the other students. The teacher researcher's conclusion that increasing communication between the parent and the teacher requires a two way communication and not just an increase on the teacher's part as the teacher researcher did not have participation by a majority of the parents in the invited activities.

Research in the literature review gave evidence that if parents were more involved, that students would to perform better in school (Hill et al., 2004). This was evident with Sierra's progress in school. What the research did not tell is how the teacher or a school got parents involved that were either not able to be involved due to job and time constraints, or were unwilling to play an active role in their child's education. It is the job of this teacher researcher to increase the understanding of scientific inquiry of her students.

Many different methods were used in class to help students understand what it takes to think about the world around them. The teacher researcher also tried to include the parents in the

experimental group by increasing communication with the parents through emails and sent invitations to encourage parents to help their students in science. The researcher did not find an increase of involvement by the parents and no affect of student performance in science or understanding of scientific inquiry.

All parents and students agreed that they expected the student to perform to the best of their ability in their science class. One of the key questions would be what was defined as “the best of their ability?” Students in both the control group and the experimental group did not show end grades that were what the researcher expected to be the best of their ability. Many students did not turn in work on time, taking a zero or lower grade than if they did turn in the work on time. The researcher expected that part of working to the best of their ability would be turning in work that was completed either in class or as homework. Whether all the work was correct would then be able to reflect what the student was able to understand.

The researcher gave homework assignments to all students to practice skills and ideas learned in class. These assignments were given after an activity from the InterActions in Physical Science (It’s About Time, 2006) curriculum and were designed to take no more than 20 minutes. Appropriate homework has been shown to be an important piece in the success in high school. In order for students to be successful in high school, they must start in elementary and continue to work hard in middle school. The low overall grade of both the experimental group and the control group shows that the students did not complete the assignments and therefore did not use the practice to reinforce the concepts and ideas taught in class. The lack of homework that was completed and returned also shows that parents may not have been involved in the work at home.

One of the most important practices for success in high school is homework (Epstein, 1990; Van Voorhis, 2003). Middle school is the transition ground for students between

elementary and high school. Learning to use homework effectively in middle school will help them be successful in high school. Requiring the signature of a parent or guardian would be one way to encourage more involvement at home. Even if the parent did not help with the homework, they would have had the opportunity to see the work and become involved.

Student behavior is also affected by the amount of parental involvement. Those students who have parents who are actively involved in their child's education have a positive correlation with behavior (Henderson & Berla, 1994). Both classes showed no difference in the types of behaviors exhibited. In many cases, disrespect for fellow students by talking over each other was observed by the researcher. The teacher researcher also noticed that students had difficulty focusing on the material and would often discuss things that did not pertain to the assigned work. According to the research in the literature review, these behaviors would show that there is a lack of appropriate involvement at home that supports the education of the students (Deslandes, 2005; Henderson & Berla, 1994; Hill et al., 2004; Sheldon & Epstein, 2002; Tan & Leach, 2006).

Parents reported in the survey that they were not willing to volunteer in the classroom. Many of those that reported this stated, in addition, that they worked and did not have the time to volunteer or come into the class. Parents that are in the low socioeconomic class and have to work two or more jobs in order to meet the needs of their family do have a more difficult time being involved with their children. Some of these parents not only worked during the day, but were not able to be home when the student arrived after school. This inhibited their ability to be actively involved in their child's home and class work.

## Recommendations

There is an increasing amount of work required of teachers. This makes it very difficult to make parent communication a priority. The use of email has helped with parents who have access to this resource. However, phone calls home were still preferable for most parents. With more than 120 students, making the necessary phone call is increasingly more difficult. Even if the teacher researcher only made calls to the students in the experimental group, it would still be expected that there would be 25 parents to reach on a regular basis. This would mean calling each home to invite the parents to attend the parent night workshops, to come in and visit the science classroom, and to discuss the issues and concerns of the student. Figuring in 10 minutes per conversation on average, the teacher would then be spending more than 250 minutes, over four hours, every two weeks. This is in addition to the other work that the teacher must accomplish during the teaching day.

One suggestion for future research would be to have a control group versus an experimental group within the same the classroom. Group one would be the control group, where the parents were not invited to the parent night workshops or to visit the science class during the time of the study. The second group, or experimental group, would receive additional phone calls about student performance and behavior, both positive and negative. They would receive invitations by mail and email to attend the parent night workshops and to volunteer their time in the classroom. Another difference in choosing students from one class instead of two would be consistency in how things were taught in the curriculum. One uncontrolled variable mentioned in chapter 3 was changes in strategies the teacher would use as the day progressed. By having both groups in one classroom, this variable would be controlled. It is recognized that by having the

control and experimental group in the same classroom this may create an increased threat to internal validity. It is also identified that having a smaller sample may not provide sufficient power to find a difference between the groups if a difference does exist.

A second recommendation would be to conduct the research during the second quarter, instead of the first quarter. This would allow the researcher to identify students that do not have actively involved parents in their education. Identification of students would be a result of evaluating student performance and behaviors. The researcher would contact the parents to discuss their involvement. The researcher could then determine if there was an increase in academic performance and behavior as a result of increased parental involvement.

A final recommendation would be to attempt this research, if possible, with a co-teacher or student teacher. This would allow the extra time for the researcher to make phone contact and arrange meetings with parents. Time constraints were an issue that this researcher experienced.

Parental involvement does increase the performance of students according to the research (Benson, 1993 & Epstein, 2001). Based upon anecdotal records collected over several years, the researcher has observed an increase in student performance as a result of increased parental involvement. Students whose parents attend conferences and assist with homework tend to improve their grades and their understanding of the curriculum. In this study, there was no difference between the two classes to support the prior experiences of the teacher and research as reviewed in chapter two. Additional research is needed in order to determine strategies to involve parents who may find involvement difficult due to time constraints and lack of understanding of their child's academic needs.

## **APPENDIX A: PARENT LETTER**

August 3, 2006

Dear Parent/Guardian,

I am a graduate at the University of Central Florida under the supervision of faculty member, Dr. Robert M. Everett, conducting action research on family involvement in science inquiry and the effects on student achievement. The purpose of this study is to examine the effects of increasing family involvement both at home and in the classroom by using weekly home-based science labs, parents' night activities and lessons, and increasing forms of communication between the teacher and the family. The results of this study may help teachers and administrators better understand what types of communication with family will help in promoting student understanding and interest in their child's education.

Some of the students' parents will be asked to be a part of a parent's night where we will discuss ways to be involved in your child's education, ways to communicate with the teachers and other expectations of the research and science program. All students will be given weekly science lab assignment regardless of participation in the program; a select number of students will be instructed to work on the lab with a member of the family and a short questionnaire will be attached that the contributing family member will be asked to complete and return with the assignment. Students and parents will also be asked to complete a pre and post survey on attitudes and knowledge of science, current parental involvement levels and demographics. All students will complete a pre- and posttest on their knowledge of scientific inquiry. A select number of students and parents will be invited to participate in one to two science nights, where we will have fun, interactive and educational family science labs. Select parents will also be asked to participate in one classroom period during the first quarter. Some parent-teacher communications may be tape recorded for use by the researcher in recalling specific details of the conversation. Parents will be informed prior to recording and may ask that recording stop at any time. The child's grades will not be affected by participation or nonparticipation in this study.

You and your child have the right to withdraw consent for your child's participation at any time without consequence. Withdrawal from the research portion will not mean withdrawal from the actual activities that are a part of the normal day. The potential benefit of the study will be increased student participation in science class and an increase in academic performance, a reduction in behavioral issues and an increase in parental involvement; however there are no known risks or immediate benefit to the students by participating in this research. No compensation is offered for participation in the study. Selection of the group in which you and you child are placed will be based on random draw of one of two classes. Parents do not have a choice which group their child will be placed. Information about students and parents will remain confidential; pseudonyms will be used for all participants. Results will be done in group format, so no individuals will be identified. Results of the study will be available in May 2007 upon request. If you have any questions about this research project; please contact me at (321) 297-6174 or my faculty supervisor, Dr. Robert M. Everett, at (407) 283-5788. Questions or concerns about research participants' rights may be directed to the UCF IRB office, University of Central Florida Office of Research, Office of Research and Commercialization, 12201 Research Parkway, Suite 501, Orlando, FL 32826-3246. The hours of operation are 8:00 am until 5:00 pm, Monday through Friday except on University of Central Florida official holidays. The phone number is (407) 283-2901 and the email is IRB@mail.ucf.edu.

Sincerely,

Patricia DeNoon

\_\_\_\_\_/\_\_\_\_\_  
Parent/Guardian Date

\_\_\_\_ I have read the procedure as described above.

\_\_\_\_ I voluntarily give my consent for my child, \_\_\_\_\_, to participate in Patricia DeNoon's study of the effects of student achievement in scientific inquiry

\_\_\_\_ I understand that parent-teacher

2<sup>nd</sup> Parent/Guardian                      Date  
(Or witness if no 2<sup>nd</sup> Parent/Guardian)

conversations may be taped, and give initial permission for this recording.



## **APPENDIX B: STUDENT ASSENT FORM**

## Student Assent Form

My name is Ms. Patricia DeNoon, and I am a graduate student at the University of Central Florida. I would like to ask you to participate in my study. Your participation is strictly voluntary and whether or not you participate in the study will not affect your grade. All information will remain confidential and pseudonyms will be used. During the study, you will take assessment tests, pre and post surveys and I will be asking you to work with your parents on home assignments. You may ask at any time to be removed from the study. Would you be willing to allow me to use your data in my study?

\_\_\_\_\_  
Student Signature / \_\_\_\_\_  
Date

\_\_\_\_ I will allow data taken about me during this study to be used in Patricia DeNoon's action research.

\_\_\_\_ I do not want my data to be used for Patricia DeNoon's action research.

## **APPENDIX C: STUDENT SURVEY**



MS. PATRICIA DENOON | 7<sup>TH</sup> GRADE SCIENCE – ACTION RESEARCH FAMILY INVOLVEMENT SURVEY

Dear student:  
 I am asking that you please take the time to complete the survey in class. All information will remain confidential and will be compared to information you provide at the end of the quarter to be used in my action research thesis in comparing the amount of involvement in the home and academic performance as well as noting any changes at the end of the quarter.

Date: \_\_\_\_\_  
 Your name \_\_\_\_\_  
 Parent's name: \_\_\_\_\_

Area of Service	QUALITY RATING				
	Strongly Agree	Agree	Neutral	Disagree	Strongly Disagree
<b>ACADEMICS</b>					
I expect that I will perform to the best of my ability					
The amount of time I spend working with my parents at home on science homework:					
0 hours per week					
Less than 1 hour per week					
1 to 2 hours per week					
More than 2 hours per week					
I spend an adequate amount of time working with a parent on my science homework					
I would be willing to have my parent(s) volunteer in my science class					
I am familiar with the term Scientific Inquiry					
My familiarity of Scientific Inquiry is (please indicate your understanding of scientific inquiry):					
<b>RESOURCES</b>					
I have access to a variety of resources at home to help me learn. Please circle resources available: computer, printer, internet, encyclopedia set, other (please explain) _____					
I have access to the public library when needed					
<b>MEETING MY NEEDS</b>					
I understand the support needed from my parents for academic success in middle school					
I feel that middle school is the time to see what I can do academically with little intervention					
My parents play an active roll in my education					

Area of Service	QUALITY RATING				
	Strongly Agree	Agree	Neutral	Disagree	Strongly Disagree
<b>BEHAVIOR/MOTIVATION</b>					
I understand that I need to accept the teacher's decision when there is a behavioral situation in the classroom					
I have read and understand the OCP's code of conduct					
I believe that the OCP's code of conduct is fair					
I am disciplined in the home for when there is a problem at school					
I would like my parents to learn ways to effectively motivate me					
<b>FAMILY DEMOGRAPHICS</b>					
I am on the free/reduced lunch program		Yes	No		
Please provide your ethnic heritage (please circle): Hispanic, Caucasian, African American, Asian, Native American, Other					
How many adults are living in the home with the you:					
Please note what adults are living in the household (mother, father, grandparent, aunt, etc):					
Please indicate the relationship and level of involvement of any adult outside the home in your education:					
How many adults in the household work at least one job outside the home (circle one)	One	Two	Three or more	Work from the home	
What hours does each member of the household work (times they work)?					
What is the highest level of education in your household? (circle one)	Less than a High School Diploma	High School Diploma	Some College	College Degree or Technical School	Advanced Degree(s)
<b>Area of Service</b>	Strongly Agree	Agree	Neutral	Disagree	Strongly Disagree
<b>COMMUNICATION</b>					
I feel welcome in the classroom.					
My views are seriously considered when there is a problem in the class.					
I have a good understanding of the science classroom's programs and operations.					
I receive information I need to help me succeed.					
<b>MORE COMMENTS?</b>					
Please attach a separate sheet of paper to add any additional information or comments.					

## APPENDIX D: PARENT SURVEY



MS. PATRICIA DEHOON | 7<sup>TH</sup> GRADE SCIENCE -- ACTION RESEARCH PARENTAL INVOLVEMENT SURVEY

Dear parent or guardian:

I am asking that you please take the time to complete the survey and return with your child in the envelope provided by August 13th. All information will remain confidential and will be compared to information you provide at the end of the quarter to be used in my action research thesis in comparing the amount of involvement in the home and academic performance as well as noting any changes at the end of the quarter.

Date:

Your child's name

Parent's name:

Area of Service	QUALITY RATING				
	Strongly Agree	Agree	Neutral	Disagree	Strongly Disagree
<b>ACADEMICS</b>					
I expect my child to perform to the best of his/her ability					
The amount of time we spend working together at home on science homework:					
0 hours per week					
Less than 1 hour per week					
1 to 2 hours per week					
More than 2 hours per week					
I spend an adequate amount of time assisting my child with their science homework					
I currently volunteer in my child's science class	YES	NO			
If no, would you be willing to volunteer in your child's science class	YES	NO			
I am familiar with the term Scientific Inquiry					
My familiarity of Scientific Inquiry is (please write what your understanding of scientific inquiry is):					
<b>RESOURCES</b>					
My child has access to a variety of resources at home to help him/her learn. Please circle resources available: computer, printer, internet, encyclopedia set, other (please explain)					
My child has access to the public library when needed					
<b>MEETING THE NEEDS OF MY CHILD</b>					
I understand the support needed for academic success of my middle school child					
I feel that middle school is the time to see what my child can do academically with little intervention					
I play an active role in my child's education					

Area of Service	QUALITY RATING				
	Strongly Agree	Agree	Neutral	Disagree	Strongly Disagree
<b>BEHAVIOR/MOTIVATION</b>					
I understand that I need to support the teacher's decision when there is a behavioral situation in the classroom.					
I have read and understand the OCPS code of conduct					
I believe that the OCPS code of conduct is fair					
I believe in discipline in the home for addressing problems at school					
I would like help in learning ways to effectively motivate my child					
<b>FAMILY DEMOGRAPHICS</b>					
My child is on the free/reduced lunch program	Yes	No			
Ethnic heritage (circle one): Hispanic, Caucasian, African American, Asian, Native American, Other, please specify					
How many adults are living in the home with the child					
Please note what adults are living in the household (mother, father, grandparent, aunt, step parent, etc):					
Please indicate the relationship and level of involvement of any adult outside the home in your child's education:					
How many adults in the household work at least one job outside the home (circle one)	One	Two	Three or more	Work from the home	
What hours does each member of the household work (times at work)?					
What is the highest level of education in your household? (circle one)	Less than a High School Diploma	High School Diploma	Some College	College Degree or Technical School	Advanced Degree(s)
<b>Area of Service</b>					
<b>PARENT-SCHOOL COMMUNICATION</b>					
I feel welcome in the classroom.	Strongly Agree	Agree	Neutral	Disagree	Strongly Disagree
My views are seriously considered when class decisions are made.					
I have a good understanding of the science classroom's programs and operations.					
I receive information I need to help my child succeed.					
<b>MORE COMMENTS?</b>					
Please attach a separate sheet of paper to add any additional information or comments.					



## APPENDIX E: UNIT ONE EXAM

InterActions in Physical Science 161  
Unit 1, Cycle 3 Exam A  
7<sup>th</sup> grade  
CYCLE 3

**Part I: There is only *one* correct answer for each multiple-choice question.**

1. How do you measure **mass**?

- a) Mass is measured with a balance.
- b) Mass is measured with a ruler.
- c) Mass is measured with a graduated cylinder.
- d) Mass is measured by counting the number of unit cubes.
- e) Mass is measured with a compass.

2. In one of the explorations done in class, the mass of a soccer ball was measured before and after air was pumped into it. You observed that the ball had a greater mass after the air was pumped into it. This observation provided evidence for which idea?

- a) Mass and volume both describe the amount of material of something like air.
- b) Mass is different from volume.
- c) Air has volume.
- d) Air has mass.
- e) Density is the mass of a standard unit of volume.

3. Which pair of measurable quantities below are **characteristic properties** of materials?

- a) mass and volume
- b) length of wire and electric current
- c) energy and force
- d) magnetism and electric charge
- e) density and electrical conductivity

4. Betty measures the volume of three solid blocks each made of a different material: brass (yellow), aluminum, and oak wood. She finds that all three blocks have the same **volume**. Using your Table of Densities from the last page of this exam, rank the blocks from least to greatest **mass**.

- a) (least mass) brass, aluminum, oak wood (greatest mass)
- b) (least mass) aluminum, brass, oak wood (greatest mass)
- c) (least mass) oak wood, brass, aluminum (greatest mass)
- d) (least mass) oak wood, aluminum, brass (greatest mass)
- e) All three blocks have the same mass.

5. How is the interaction between two magnets different from an interaction between a magnet and a magnetic metal?

- a) Two magnets always attract each other, while a magnet and a magnetic metal repel each other.
- b) Two magnets may attract or repel each other, while a magnet and a magnetic metal only attract each other.
- c) Two magnets may attract or repel each other, while a magnet and a magnetic metal only repel each other.
- d) Both the two magnets and the magnet and magnetic material may attract or repel each other, so there is no difference.
- e) Both the two magnets and the magnet and magnetic material always attract each other, so there is no difference.

6. Which of the following statements is **true**?

- a) An electrically-charged object attracts objects that are not charged.
- b) An electrically-charged object repels objects that are not charged.
- c) An electrically-charged object always attracts other charged objects.
- d) An electrically-charged object always repels other charged objects.
- e) Electrically-charged objects have to be touching in order to interact with each other.

7. Which of these changes to this series (single loop) circuit would cause the electric current in the circuit to **increase**?

- a) Add more bulbs in the series circuit.
- b) Insert a piece of nichrome wire in the series circuit.
- c) Add more cell batteries in the series circuit.
- d) Insert an ammeter in the series circuit.
- e) Unscrew one of the bulbs in the loop.

8. In attempting to measure the electrical conductivity of different materials, which variable would **not** be kept the same (controlled)?

- a) the number of cell batteries
- b) the number and type of circuit devices (bulbs, etc.)
- c) the length of the wire
- d) the thickness of the wire
- e) the kind of material the wire is made of

**Questions 9–11 are based on the following situation.**

A group of students were studying electromagnets. They wanted to know whether the strength of the electromagnet depended on the amount of iron that the wire was wrapped around. They designed an exploration to answer the following question: *If the amount of iron in the electromagnet increases, what happens to the strength of the electromagnet?* To measure the strength of the electromagnet, they measured the number of degrees a compass needle deflected when placed near the electromagnet. To measure the amount of iron, they used different numbers of nails. Their setup with one nail is shown here. They closed the switch and measured the compass deflection. They repeated their measurement three times, calculated the average, and recorded the best value in their data Table 1 (below). Then they repeated the exploration using two nails, then three nails, and then four nails. In all cases, the tips of the nails were the same distance from the compass. All the best values were recorded in the Table 1 below. Assume their exploration was a **fair test**. Each value of the average compass deflection had an uncertainty of 2 degrees.

9. The **manipulated variable** in this exploration was:

- a) the number of batteries.
- b) the amount of iron (number of nails).
- c) the number of wires.
- d) the compass deflection.
- e) the closing of the switch.

Number of nails	Average compass deflection (degrees)
1	33
2	52
3	60
4	66

**Questions #10 and 11.** Juan and Marie each wrote their own conclusion from the exploration. After evaluating their conclusions, choose the **best answer**.

**10. Juan’s conclusion:**

*I conclude that when the amount of iron increases, the strength of the electromagnet also increases. My reason is that when the number of nails increased from one to two, the average compass deflection increased from 33 degrees to 52 degrees.*

- a) Juan’s conclusion is **valid** because his supporting reason was based on all of the available data as evidence.
- b) Juan’s conclusion is **not valid** because his reason is an opinion instead of being based on evidence from the exploration.
- c) Juan’s conclusion is **not valid** because his reason uses just part of the available evidence instead of all the data.

### 11. Marie's conclusion:

*I conclude that when the amount of iron increases, the strength of the electromagnet also increases. My reason is that when you have more stuff, you will have a greater effect. Therefore, the more iron you have, the greater is the compass deflection.*

- a) Marie's conclusion is **valid** because her supporting reason was based on all of the available data as evidence.
- b) Marie's conclusion is **not valid** because her reason is an opinion instead of being based on evidence from the exploration.
- c) Marie's conclusion is **not valid** because her reason uses just part of the available evidence instead of all the data.

### Questions 12 and 13 are based on the following situation.

A class wanted to find out how “bouncy” different kinds of balls and surfaces would be when a ball was dropped and rebounded from a surface. The teams used two types of balls (a “superball” and a tennis ball). They dropped the balls onto different types of surfaces, and dropped the balls from different heights.

Table 2 shows the best value of the rebound height of the balls recorded by each team under different conditions. The uncertainty in the measurement of the rebound height was 2 centimeters.

Team	Type of material	Surface	Drop height (cm)	Rebound height (cm)
1	superball	tile floor	30	23
2	superball	rug	50	23
3	superball	tile floor	70	52
4	tennis ball	rug	50	17
5	tennis ball	tile floor	50	22
6	superball	tile floor	100	74
7	tennis ball	concrete	50	24

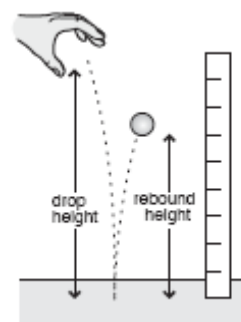

12. Which teams' exploration would you choose to make a fair test if you wanted to answer the following question: *If the surface is changed, what happens to the rebound height?*

- a) only teams 1, 2, and 7
- b) only teams 2 and 4
- c) only teams 1, 2, 3, and 6
- d) only teams 4, 5, and 7
- e) only teams 1, 3, 5, and 6

13. Which teams' exploration would you choose to make a fair test if you wanted to answer this different experimental question: *If the drop height is increased, what happens to the rebound height?*

- a) only teams 4, 5, and 7
- b) only teams 2 and 4
- c) only teams 1, 2, and 3
- d) only teams 1, 2, 3, and 6
- e) only teams 1, 3, and 6

**Part II: Measuring and Calculating Volume of a Rectangular Solid Object and a Liquid (Questions 14–16)**

Suppose you needed to calculate the volume of a rectangular solid box, like the one shown in the picture. You line a ruler along its three dimensions: length, width, and height, as shown below. In the magnified views of the ruler, the downward arrows point to where the edge of the box lines up with the ruler.

14. From the pictures shown below, read the length, width, and height of the box. Record their values (in cm) in the blanks below the scales and include units.

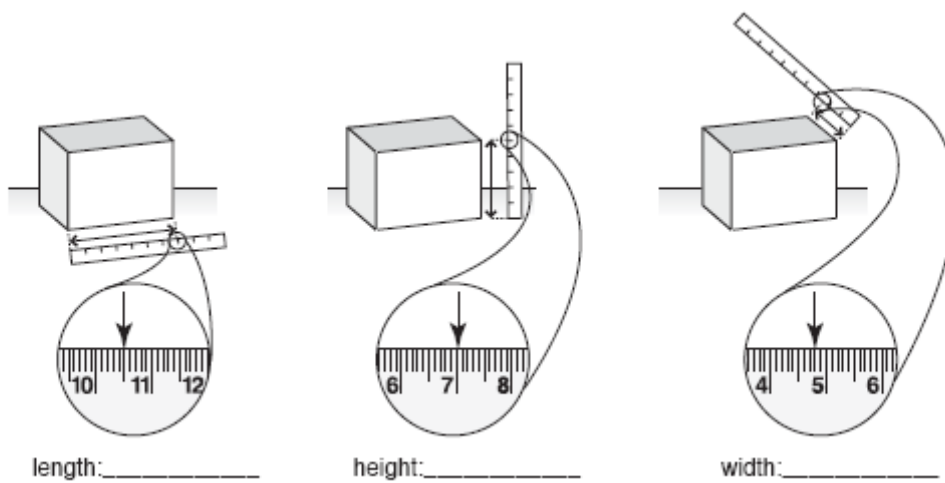

- a) Length = 10.3 cm, Height = 7 cm, Width = 4.5 cm
- b) Length = 10.5 cm, Height = 7 cm, Width = 4.8 cm
- c) Length = 11 cm, Height = 7.3 cm, Width = 5 cm
- d) Length = 10 cm, Height = 6.8 cm, Width = 4.6 cm

15. Use the formula below to calculate the volume of the rectangular object, and **record this value with its proper units** in the blank on your answer sheet.

**Volume of Rectangular Solid = (length) x (height) x (width) = \_\_\_\_\_**

- a) 352.8 cm<sup>3</sup>
- b) 400.1 cm<sup>3</sup>
- c) 361.3 cm<sup>3</sup>
- d) 354.5 cm<sup>3</sup>

16. Using this picture of the liquid in the 100 mL graduated cylinder. Read and record on your answer sheet the **value and units** of the volume of this liquid.

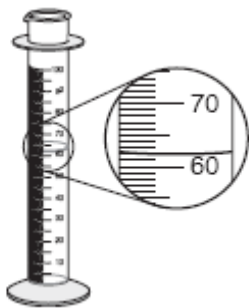

The **volume** is \_\_\_\_\_.

- a) 60 mL
- b) 58 mL
- c) 62 mL
- d) 64 mL

**Part III: Performing and Analyzing an Exploration (Questions 17–19)**

(Around the room you should find several stations where you will be able to perform the lab exploration described below. Your teacher will let you know when you can perform the exploration. Write all your answers in the spaces provided on your answer sheet.)

Some companies that make magnets claim that both sides of their magnets have the same strength in their interactions with magnetic materials. In this exploration, you will test this claim by investigating the difference in the strength of each side of the magnet.

The strength of the magnet will be determined by measuring the distance when the magnet attracts a paper clip. The longer this distance, the stronger the magnetic interaction.

**Exploration Question:** *If the side of the magnet facing a paper clip is turned around, does the strength of the magnetic interaction between the magnet and the paper clip change?*

**You will need:**

- a large (2.5 cm or 1" diameter) magnet
- a paper clip
- special exploration sheet on which to place magnet and to make measurements
- 2 pieces of tape
- access to a calculator

17. As you work through the exploration, complete Table 3 below.

Table 3: Strength of Magnet Sides		
Distance when magnet attracted to paper clip (mm)	Side of magnet facing paper clip	
	Side A	Side B
Trial 1		
Trial 2		
Trial 3		
Best Value		
Uncertainty		

*To do this exploration correctly, you will need to follow the directions carefully and you will need to be able to read the ruler on the exploration sheet.*

**STEP 1.** Tape the exploration sheet to the table so it won't move.

**STEP 2.** Take the wider end of a paper clip, and touch it to Side A of the magnet. This will make the exploration work better.

**STEP 3.** Lay the paper clip directly on top of its outline. Make sure the end of the paper clip lines up with the zero on the printed ruler.

**STEP 4.** With the arrow mark on Side A pointing place the edge of Side A of the magnet at the 6.0 cm (60 mm) mark as shown above. (Don't lay the magnet flat on the paper.)

**STEP 5.** Slowly slide the edge of Side A of the magnet along the ruler's edge towards the paper clip. When the paper clip is attracted to the magnet, stop sliding the magnet.

- Record the distance (in mm) between the edge of Side A of the magnet and the zero position in Table 3.

**STEP 6. Repeat** Steps 3 through 5 for two more trials. Make sure the same side of the magnet is facing the paper clip and the arrow mark is pointing down.

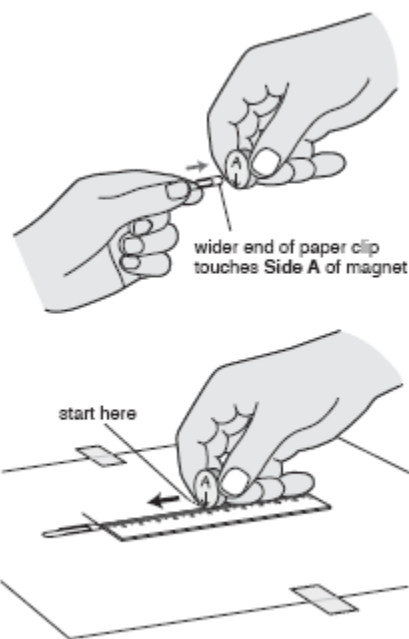

down,



**STEP 7.** Calculate the **best value** and **uncertainty** for the measurement of the distance that the magnet was from the zero position when it attracted the paper clip. To make the numbers easier to work with, round each number to the nearest millimeter so that there are no digits after the decimal point. (For example, an uncertainty calculation of 2.5 mm or 2.6 mm would each be rounded up to 3 mm.)

- Record the best value and uncertainty in Table 3.

**STEP 8. Repeat** Step 2 for Side B (other side) of the magnet.

**STEP 9. Repeat** Steps 3–7, but **substitute** Side B (other side of the magnet) for Side A in each step.

**STEP 10.** Determine the highest and lowest values of the range. Refer to *How To Make and Interpret Experimental Measurements* for help. Use these values to answer Questions 18 and 19.

**18. Complete the blanks** in these sentences.

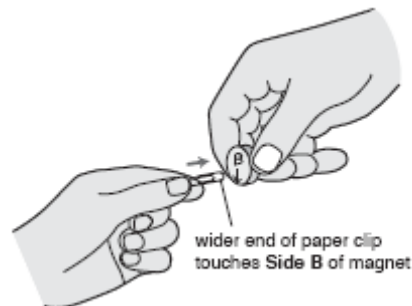

The true value of the distance from Side A of the magnet is probably within the range between \_\_\_\_\_ mm (lowest value) and \_\_\_\_\_ mm (highest value).

The true value of the distance from Side B of the magnet is probably within the range between \_\_\_\_\_ mm (lowest value) and \_\_\_\_\_ mm (highest value).

**19.** Put a **check mark** beside the best conclusion statement for your exploration. To receive credit, the conclusion you select **must agree** with your answer to Question 18.

\_\_\_\_\_ **Conclusion A:** *Because there is no overlap between the ranges of distance values for Side A and Side B, I conclude that the two values are **different**. So the claim that each side of the magnet has the same strength is probably **not valid**.*

\_\_\_\_\_ **Conclusion B:** *Because there is an overlap between the ranges of distance values for Side A and Side B, I conclude that the two values could be the **same**. So the claim that each side of the magnet has the same strength is probably **valid**.*

#### Part IV: Learning About Questions

20. A block of aluminum has a mass of 8.1 g. What is the volume of the block?

- a) 3.0 cm<sup>3</sup>
- b) 5.4 cm<sup>3</sup>
- c) 10.8 cm<sup>3</sup>
- d) 21.9 cm<sup>3</sup>

21. Erica uses the water displacement method to find the volume and density of a small, solid object that has a mass of 38.0 g. Erica puts the object in a graduated cylinder that holds 50.0 mL (= 50 cm<sup>3</sup>) of water. The object completely sinks in the water. She then determines that the combined volume of the water and small object is 55.0 mL. What is the **density** of the object?

- a) 7.6 g/cm<sup>3</sup>
- b) 5.0 g/cm<sup>3</sup>
- c) 1.4 g/cm<sup>3</sup>
- d) 17.0 g/cm<sup>3</sup>

22. A rectangular solid has a volume of 100 cm<sup>3</sup> and a mass of 900 g. What substance is the block probably made of?

- a) brass
- b) copper
- c) oak wood
- d) steel

Table of Densities*	
(Remember that 1 mL = 1 cm <sup>3</sup> )	
Material	Density
Aluminum	2.7 g/cm <sup>3</sup>
Brass (yellow)	8.5 g/cm <sup>3</sup>
Copper	9.0 g/cm <sup>3</sup>
Oak Wood	0.6–0.9 g/cm <sup>3</sup>
Steel	7.6 g/cm <sup>3</sup>
Tin (gray)	5.8 g/cm <sup>3</sup>
Water	1.0 g/mL <sup>3</sup>

## **APPENDIX F: EXAM USE PERMISSION**

From: Laster, Thomas A  
Sent: Tuesday, March 13, 2007 10:17 PM  
To: Jensen, Mary-Lynn K  
Cc: Zahm, Barbara; Marottoli, Salvatore H  
Subject: RE: Permission to reprint.  
Importance: High

Mary-Lynn,

It is fine for Pat DeNoon to use it to support her thesis as long as it says on the bottom, "copyright It's About Time, Herff Jones Education.

Sounds exciting. It is great that we will be able to see her paper and quote her findings. Mary-Lynn, I assume that you will forward a copy of it. Sorry it took awhile to get back to you. Lots going on!

Tom

**From:** Jensen, Mary-Lynn K [mailto:mkjensen@herffjones.com]  
**Sent:** Mon 3/12/2007 8:55 PM  
**To:** DeNoon, Patricia Y.  
**Subject:** RE: Permission

I've gotten a tentative OK from the products development VP, but was waiting to hear from our President. Since he did not object to Barbara's OK, I'm going to say yes, go ahead with it. There won't be any problems.

Regards,

ML

Mary-Lynn Jensen, Ph.D.  
Education Consultant  
It's About Time/Herff Jones Education Division  
888-435-8463 toll free  
407-654-6668 fax  
MKJensen@herffjones.com  
www.its-about-time.com

Ask me about our Guided-Inquiry Programs  
For High School

- \* Active Physics \* Active Chemistry \* Active Physical Science
- \* EarthComm \* Investigations in Environmental Science\* Math Connections

For Middle School

- \* Investigating Earth Systems \* InterActions in Physical Science
- \* Project Based Inquiry-Science

We also offer Professional Development and Equipment Kits!

-----Original Message-----

From: DeNoon, Patricia Y. [mailto:[denoonp@ocps.k12.fl.us](mailto:denoonp@ocps.k12.fl.us)]  
Sent: Tuesday, February 27, 2007 6:33 PM  
To: Jensen, Mary-Lynn K  
Subject: Permission

Ms. Jensen,

I am currently finishing up my thesis on the effects of increasing parental involvement on student understanding in science inquiry. Part of my thesis involves comparing student scores on a pretest and a posttest, which I used the Unit one exam for the InterActions in Physical Science. I am writing because I need permission to add the test to my appendix for my thesis. Its About Time has been cited throughout the paper and I feel it would be a benefit for the potential reader to be able to see the test to understand what was expected of the students to learn during the first quarter.

I was referred to you by Mrs. Susie Quillin, the physical science resource teacher for Orange County. Thank you for your time.

Ms. Patricia DeNoon

## **APPENDIX G: IRB APPROVAL**



July 5, 2006

Ms. Patricia DeNoon  
4557 Lakeway Drive  
Orlando, FL 32839

Dear Ms. DeNoon:

With reference to your protocol #06-3556 entitled, "The effects of increased family involvement on middle school student performance in scientific inquiry" I am enclosing for your records the approved, expedited document of the UCFIRB Form you had submitted to our office. **This study was approved on 7/5/2006. The expiration date for this study will be 7/4/2007.** Should there be a need to extend this study, a Continuing Review form must be submitted to the IRB Office for review by the Chairman or full IRB at least one month prior to the expiration date. This is the responsibility of the investigator.

Please be advised that this approval is given for one year. Should there be any addendums or administrative changes to the already approved protocol, they must also be submitted to the Board through use of the Addendum/Modification Request form. Changes should not be initiated until written IRB approval is received. Adverse events should be reported to the IRB as they occur.

---

Should you have any questions, please do not hesitate to call me at 407-823-2901.

Please accept our best wishes for the success of your endeavors.

Cordially,

*Barbara Ward*

Barbara Ward, CIM  
IRB Coordinator

Copies: IRB File  
Robert M. Everett, Ph.D.



# UCF IRB Addendum/Modification Request Form

This addendum form does NOT extend the IRB approval period or replace the Continuing Review form for renewal of the study.

**INSTRUCTIONS:** Please complete the upper portion of this form and attach all revised/new consent forms, altered data collection instruments, and/or any other documents that have been updated. **The proposed changes on the revised documents must be clearly indicated by using bold print, highlighting, or any other method of visible indication. Attach a highlighted and a clean copy of each revised form.** This Addendum/Modification Request Form may be emailed to [IRB@mail.ucf.edu](mailto:IRB@mail.ucf.edu) or mailed to the IRB Office: ATTN: IRB Coordinator, 12201 Research Parkway, Suite 501, Orlando, FL 32826-3246 or campus mail 32816-0150. Phone: 407-823-2901 or 407-882-2276, Fax: 407-823-3299.

▪ **DATE OF ADDENDUM:** August 4, 2006\_\_ to IRB#\_06-3556\_ IRB Addendum # 063688

**PROJECT TITLE:** The effects of increased family involvement on middle school student performance in scientific inquiry

▪ **PRINCIPAL INVESTIGATOR:** Patricia DeNoon

▪ **MAILING ADDRESS:** 4557 Lakeway Dr.; Orlando, FL 32839

▪ **PHONE NUMBER & EMAIL ADDRESS:** 407-422-0207 or 321-297-6174 & denoonp@ocps.net

▪ **REASON FOR ADDENDUM/MODIFICATION:** Change in pre/post test

▪ **DESCRIPTION OF WHAT YOU WANT TO ADD OR MODIFY:** I need to change the test that I will be using for evaluating student performance in scientific inquiry. I will be using the InterActions for Physical Science unit one test for both the pretest and the posttest to evaluate the increase in learning for the students, instead of the county benchmark test that was originally submitted. I need to make the change based on the type of curriculum that is being used and the effectiveness of the newer test.

PI will use same procedures, just changing test.  
*Patricia DeNoon* 8/10/2006

**SECTION BELOW - FOR UCF IRB USE ONLY**

Approved     Disapproved  
 Full Board     Chair Expedited

*Patricia F. DeNoon*    8/10/2006  
IRB Chair Signature    Date

IRB Member/Designated Reviewer    Date



## REFERENCES

- Balli, S. J., Demo, D. H., & Wedman, J. F. (1998). Family involvement with children's homework: An intervention in middle grades. *Family Relations, 47*, 149-157.
- Barber, J. (2000). *Parent partners: Workshops to foster school/home/family partnerships: A guide to presenting parent education workshops*. Berkeley, CA: Lawrence Hall of Science.
- Benson, P., & Roehlkepartain, E. (1993). Youth in single-parent families: Risk and resiliency. Background Paper. Retrieved Saturday, July 22, 2006 from the ERIC database.
- Bridgeland, J. M., Dilulio, J. J. Jr., & Morison, K. B. (2006). *The silent epidemic: Perspectives of high school dropouts*: Civic Enterprises.
- Callison, W.L. (2004). *Raising test scores using parent involvement*. Lanham, MD: Scarecrow Education.
- Child Trends Data Band*. (2003). Retrieved on February 12, 2007 from <http://www.childtrendsdatbank.org/indicators/39ParentalInvolvementinSchools.cfm>
- Coleman, J. S., Hoffer, T., & Kilgore, S. (1982). *High school achievement*. New York, NY: Basic Books.
- Community support for C.A.R.E. strategies*. (2005). Washington D.C.: National Education Association (NEA).
- Dauber, S. L., & Epstein, J. L. (1993). Parents' attitudes and practices of involvement in inner-city elementary and middle schools. In *Families and schools in a pluralistic society* (pp. 53-71). Albany, NY: SUNY Press.

- Delgado-Gaitan, C. (1992). School matters in the Mexican-American home: Socializing children to education. *American Educational Research Journal*, 29, 495-513.
- Deslandes, R., & Bertrand, R. (2005). Motivation of parent involvement in secondary-level schooling. *The Journal of Educational Research*, 98(3), 164-175.
- Epstein, J. L. (1990). Homework practices, achievements, and behaviors of elementary school students. In J. L. Epstein (Ed.), *School, family, and community partnerships: Preparing educators and improving schools* (pp. 236-252). Boulder, CO: Westview Press.
- Epstein, J. L. & Dauber, S. L. (1991). School programs and teacher practices of parent involvement in inner-city elementary and middle schools. *The Elementary School Journal*, 91(3), 289-305.
- Epstein, J. L. & Lee, S. (1995). National patterns of school and family connections in the middle grades. In B. Ryan, Adams, G., Gulotoa, T., Weissberg, R., & Hampton, R. (Ed), *The family-school connection: Theory, research, and practice* (pp. 108-154). Thousand Oaks, CA: Sage.
- Epstein, J. L. (2001). *School, family, and community partnerships: Preparing educators and improving schools*. Boulder, CO: Westview Press.
- Epstein, J.L., Sanders, M.G., Simon, B.S., Salinas, K.C., Jansorn, N.R., & Van Voorhis, F.L. (2002). *School, family, and community partnerships: Your handbook for action*. Thousand Oaks, CA: Corwin Press, Inc.
- Gay, L. R., Mills, G. E., & Airasian, P. (2006). *Educational research: Competencies for analysis and applications* (8th ed.). Upper Saddle River: Pearson Prentice Hall.
- Henderson, A. T., & Berla, N. (1994). *A new generation of evidence: The family is critical to student achievement*. Washington D.C.: National Committee for Citizens in Education.

- Hill, N. E., Castellino, D. R., Lansford, J. E., Nowlin, P., Dodge, K. A., Bates, J. E., et al. (2004). Parent academic involvement as related to school behavior, achievement, and aspirations: Demographic variations across adolescence. *Child Development, 75*(5), 1491-1509.
- Ho, E. S., & Willms, J. D. (1996). Effects of parental involvement on eighth-grade achievement. *Sociology of Education, 69*, 126-141.
- Hoover-Dempsey, K. V., Bassler, O. C., & Burow, R. (1995). Parents' reported involvement in students' homework: Strategies and Practices. *The Elementary School Journal, 95*(5), 435-450.
- Hoover-Dempsey, K. V., & Sandler, H. M. (1997). Why do parents become involved in their children's education. *Review of Educational Research, 67*, 3-42.
- Keith, T. Z., & Keith, P. B. (1993). Does parental involvement affect eighth-grade student achievement? Structural analysis of national data. *Psychology Review, 22*(3), 474-495.
- InterActions in physical science*. (Vol. 1-3). (2006). Armonk, CA: Herff Jones Education Division.
- North Central Regional Education Laboratory (2006). Retrieved July 2, 2006 from <http://www.learningpt.org>.
- Payne, R. K. (1996). *A framework for understanding poverty* (Third ed.). Highlands: aha! Process, Inc.
- Scott-Jones, D. (1995). Parent-child interactions and school achievement. In B. Ryan, Adams, G., Gulotoa, T., Weissberg, R., & Hampton, R. (Ed), *The family-school connection: Theory, research, and practice* (pp. 75-107). Thousand Oaks, CA: Sage.

- Tan, R., & Leach, D. J. (1996). The effects of sending positive and negative letters to parents on the classroom behavior of secondary school students. *Educational Psychology, 16*(2), 141-154.
- Teacherease*. (2001). [Internet application]. Retrieved July 20, 2006, from [www.teacherease.com](http://www.teacherease.com).
- U.S. Census 2000*. (Feb 8, 2006). Retrieved July 2, 2006 from <http://www.census.gov>.
- U.S. Department of Education*. (2005). Retrieved February 11, 2007 from <http://www.ed.gov/nclb/overview/intro/parents/parentfacts.html>.
- Van Voorhis, F. L. (2003). Interactive homework in middle school: Effects on family involvement and science achievement. *The Journal of Educational Research, 96*(6), 323-338.
- Xu, J., & Corno, L. (1998). Case studies of families doing third-grade homework. *Teachers College Record, 100*(2), 402-436.