

Electronic Theses and Dissertations, 2004-2019

2019

Development of Decision Support System for Active Traffic Management Systems Considering Travel Time Reliability

Whoibin Chung
University of Central Florida

 Part of the [Civil Engineering Commons](#), and the [Transportation Engineering Commons](#)
Find similar works at: <https://stars.library.ucf.edu/etd>
University of Central Florida Libraries <http://library.ucf.edu>

This Doctoral Dissertation (Open Access) is brought to you for free and open access by STARS. It has been accepted for inclusion in Electronic Theses and Dissertations, 2004-2019 by an authorized administrator of STARS. For more information, please contact STARS@ucf.edu.

STARS Citation

Chung, Whoibin, "Development of Decision Support System for Active Traffic Management Systems Considering Travel Time Reliability" (2019). *Electronic Theses and Dissertations, 2004-2019*. 6467.
<https://stars.library.ucf.edu/etd/6467>

**DEVELOPMENT OF DECISION SUPPORT SYSTEM FOR ACTIVE
TRAFFIC MANAGEMENT SYSTEMS CONSIDERING TRAVEL TIME
RELIABILITY**

by

WHOIBIN CHUNG

B.S., Ajou University, South Korea, 1998

M.S., Ajou University, South Korea, 2000

A dissertation submitted in partial fulfillment of the requirements
for the degree of Doctor of Philosophy
in the Department of Civil, Environmental and Construction Engineering
in the College of Engineering and Computer Science
at the University of Central Florida
Orlando, Florida

Summer Term
2019

Major Professor: Mohamed Abdel-Aty

ABSTRACT

As traffic problems on roadways have been increasing, active traffic management systems (ATM) using proactive traffic management concept have been deployed on freeways and arterials. The ATM aims to integrate and automate various traffic control strategies such as variable speed limits, queue warning, and ramp metering through a decision support system (DSS). Over the past decade, there have been many efforts to integrate freeways and arterials for the efficient operation of roadway networks. It has been required that these systems should prove their effectiveness in terms of travel time reliability. Therefore, this study aims to develop a new concept of a decision support system integrating variable speed limits, queue warning, and ramp metering on the basis of travel time reliability of freeways and arterials.

Regarding the data preparation, in addition to collecting multiple data sources such as traffic data, crash data and so on, the types of traffic data sources that can be applied for the analysis of travel time reliability were investigated. Although there are many kinds of real-time traffic data from third-party traffic data providers, it was confirmed that these data cannot represent true travel time reliability through the comparative analysis of measures of travel time reliability. Related to weather data, it was proven that nationwide land-based weather stations could be applicable.

Since travel time reliability can be measured by using long-term periods for more than six months, it is necessary to develop models to estimate travel time reliability through real-time traffic data and event-related data. Among various matrix to measure travel time reliability, the standard deviation of travel time rate [minute/mile] representing travel time variability was chosen because it can represent travel time variability of both link and network level. Several models were

developed to estimate the standard deviation of travel time rate through average travel time rate, the number of lanes, speed limits, and the amount of rainfall.

Finally, a DSS using a model predictive control method to integrate multiple traffic control measures was developed and evaluated. As a representative model predictive control, METANET model was chosen, which can include variable speed limit, queue warning, and ramp metering, separately or combined. The developed DSS identified a proper response plan by comparing travel time reliability among multiple combinations of current and new response values of strategies. In the end, it was found that the DSS provided the reduction of travel time and improvement of its reliability for travelers through the recommended response plans.

ACKNOWLEDGMENTS

Foremost, I would like to express my sincere gratitude to my advisor Prof. Mohamed Abdel-Aty for the continuous support of my Ph.D. study and research, for his patience, motivation, enthusiasm, and immense knowledge. His guidance helped me in all the time of research and writing of this dissertation. Besides my advisor, I would like to thank the rest of my thesis committee: Dr. Naveen Eluru, Dr. Samiul Hasan, Dr. Qing Cai, and Dr. Hsin-Hsiung Huang.

I thank my fellow labmates: Yaobang Gong, and Mdhasibur Rahman, for the AIMSUN stimulation in the IATM project. In particular, I am grateful to Dr. Hochul Park for helping me the data analysis.

Last but not the least, I would like to thank my wife and daughter, for always supporting me throughout my Ph.D. course.

TABLE OF CONTENTS

LIST OF FIGURES	xi
LIST OF TABLES	xv
CHAPTER 1. INTRODUCTION	1
1.1 Overview.....	1
1.2 Research Objectives.....	4
CHAPTER 2. LITERATURE REVIEW	6
2.1 Active Traffic Management (ATM)	6
2.2 Integrated Corridor Management (ICM)	13
2.3 Decision Support Systems (DSS)	16
2.3.1 Knowledge-based DSS	17
2.3.2 DSS using real-time traffic simulation	19
2.3.3 Case-based DSS without real-time traffic simulation.....	23
2.3.4 Other DSS	24
2.4 Travel Time Reliability.....	26
2.4.1 Measures of travel time reliability	26
2.4.2 Impact factors of travel time reliability	28
2.4.3 Estimation of travel time distribution or reliability	30

2.5 Summary	32
CHAPTER 3. AVAILABILITY OF HERE DATA FOR TRAVEL TIME RELIABILITY	34
3.1 Introduction.....	34
3.2 Study locations.....	38
3.3 Data Preparation.....	39
3.4 Analysis Scenarios	40
3.5 Travel Time Data Distribution of AVI and HERE	41
3.6 Analysis Results.....	45
3.7 Conclusion	51
CHAPTER 4. THE EFFECTIVE COVERAGE OF LAND-BASED WEATHER STATIONS .	54
4.1 Introduction.....	54
4.2 Literature Review.....	56
4.3 Data Preparation.....	59
4.3.1 Nationwide QCLCD	59
4.3.2 Nationwide fatal crashes	61
4.3.3 Nationwide AADT of the Highway Performance Monitoring System (HPMS).....	62
4.3.4 Grouping of weather types of QCLCD and FARS data	62
4.4 Regional Characteristics of Weather and Weather-related Fatal Crashes	63
4.5 Viability of QCLCD for Traffic Safety Evaluation	66

4.6 Model Development to Estimate Weather-related Fatal Crashes	72
4.7 Discussion and Conclusions	76
CHAPTER 5. METHOD FOR ESTIMATING VEHICLE-TO-VEHICLE TRAVEL TIME VARIABILITY MODELS AT THE LINK AND NETWORK LEVELS OF FREEWAYS/EXPRESSWAYS	
80	
5.1 Introduction.....	81
5.2 Study Area	84
5.3 Methodology	87
5.3 Data preparation.....	92
5.3.1 Mean Travel Time and its SD of Links on CFX’s Expressways.....	93
5.3.2 Link Travel Time of I-4 and expressways of FTE.....	95
5.3.3 MVDS Data	95
5.3.3 Crash Location and its Duration	96
5.3.4 Geometry features	97
5.3.5 Precipitation Data.....	97
5.4 TTV of freeways and expressways in the Orlando area	98
5.5 Modeling results and their implication	103
5.6 Discussion and conclusion.....	108
CHAPTER 6. IDENTIFICATION OF CRITICAL ROADWAYS AND SEGMENTS	
112	
6.1 Identification methods	112

6.1.1 Performance measures	113
6.1.2 Performance Measure Estimation by Direction of Roadways.....	115
6.1.3 Normalization and combination of performance measures	116
6.1.4 Categorization and combination of performance measures.....	117
6.2 Data preparation.....	119
6.3 Evaluation results.....	122
6.3.1 Identification of critical roadways	124
6.3.2 Identification of Critical Segments	127
 CHAPTER 7. DEVELOPMENT OF DECISION SUPPORT SYSTEM (dss) TO MITIGATE TRAVEL TIME VARIABILITY THROUGH THE COMBINATION OF VARIABLE SPEED LIMITS, QUEUE WARNING, and RAMP METERING.....	
7.1 Introduction.....	130
7.2 Decision Support System.....	131
7.3 Rules of Active Traffic Management Strategies.....	132
7.3.1 VSL (Variable Speed Limits) Control Rule.....	132
7.3.2 QW (Queue Warning) Control Rule	134
7.3.3 RM (Ramp Metering) Control Rule.....	137
7.4 Study Site	138
7.4.1 Selection of VSL and QW Deployment Location	139
7.4.2 Selection of RM Deployment Location	141

7.5 A Macroscopic Traffic Flow Model for the Freeway and Arterial Network.....	144
7.5.1 Freeway Traffic Model	144
7.5.2 Arterial Traffic Model.....	146
7.6 Travel Time Reliability Model	148
7.7 AIMSUN Simulation Setup	152
7.8 Development of possible simulation scenarios related to IATM.....	155
7.9 Evaluation Results of possible operational strategies of IATM	157
7.9.1 Extreme Traffic Congestion.....	158
7.9.2 Heavy Traffic Congestion.....	159
7.9.3 Moderate Traffic Congestion.....	160
7.9.4 Non-congested Traffic Congestion	161
7.9.5 Discussion	162
7.10 Effectiveness of Integrated ATM strategies with DSS	164
7.10.1 Extreme Traffic Congestion.....	165
7.10.2 Heavy Traffic Congestion.....	166
7.10.3 Moderate Traffic Congestion.....	167
7.11 Conclusions.....	169
CHAPTER 8. CONCLUSIONS	171
REFERENCES	173

LIST OF FIGURES

Figure 1. Continuum of operations strategies (Neudorff and McCabe, 2015)	2
Figure 2. Gantry with speed displays, lane control and supplemental signs	10
Figure 3. I-66 ATM project segments and treatments	11
Figure 4. Intelligent lane control signals on I-35W	12
Figure 5. Active Traffic Management system on I-94 (Source: http://ungemah.com/sh_projects/i-94-managed-lanes-study-phase-1/)	13
Figure 6. Generic view about DSS	17
Figure 7. Working process of the real-time evaluation and decision support system (Hu et al., 2003)	20
Figure 8. Framework of TrEPS-based decision support system for weather-responsive traffic signal operations (Kim et al., 2014).....	21
Figure 9. Overall structure of the intelligent traffic control decision support system (Almejalli et al., 2007)	24
Figure 10. AVI and HERE segments on Florida State Road 417	38
Figure 11. Scatter plots of 5-minute travel rates for all segments	43
Figure 12. Empirical Cumulative Distributions (ECD) of average travel rate for time of day in 5- minutes increment	44

Figure 13. Locations of weather stations in the USA	60
Figure 14. USA Climate Regions	63
Figure 15. Annual average percentages of observation duration of rain, snow, and fog (2008-2014)	64
Figure 16. Annual average fatal crash frequency under rain, snow, and fog by climate region (2007- 2014)	65
Figure 17. Method of matching time and weather conditions between FARS and QCLCD.....	68
Figure 18. Regional Sensitivity and Positive Predictive Value (PPV) by weather conditions.....	72
Figure 19. Freeways and expressways in Orlando area (CFX, 2016)	85
Figure 20. Locations of MVDS and AVI near 8 mainline toll plazas	86
Figure 21. A framework estimating both vehicle-to-vehicle and day-to-day TTV	89
Figure 22. Prepared data structure for vehicle-to-vehicle and day-to-day TTV analysis.....	92
Figure 23. Link travel time estimation steps from AVI raw data	93
Figure 24. Individual travel times before/after removing outliers	94
Figure 25. Mean TTR and SD at 5-minute intervals	95
Figure 26. Spatial Join with Links and MVDS.....	96
Figure 27. The relationship between mean TTR and its SD representing vehicle-to-vehicle TTV at the link and network levels	98

Figure 28. The relationship between mean TTR and its SD representing day-to-day TTV at the link and network levels	100
Figure 29. Day-to-day TTV with or without vehicle-to-vehicle TTV, or of only vehicle-to-vehicle TTV	101
Figure 30. Relationship between NFD and SD of TTR at the network level	102
Figure 31. Density versus SD of TTR and TTR	105
Figure 32. Final vehicle-to-vehicle and day-to-day TTV at the network level	107
Figure 33. The relationship among TTI, PTI, and BTI of 2017	116
Figure 34. Normalized TTI, PTI, and BTI of 2017	117
Figure 35. 50 th and 75 th percentile of performance measures: TTI, PTI, and BTI	118
Figure 36. Travel Time data sources used for roadways	120
Figure 37. TTI, PTI, and BTI at the freeway/expressways network level	122
Figure 38. TTI, PTI, and BTI at the arterial network level.....	123
Figure 39. Categorization of TTI, PTI, and BTI on segments for AM and PM peak periods	128
Figure 40. Critical segments in Orlando area	129
Figure 41. Decision Support System Configuration	132
Figure 42. VSL Control Logic	133

Figure 43. An example of the gradual speed reduction of upstream segments	137
Figure 44. Study site	139
Figure 45. The Location of Metered Ramps	143
Figure 46. METANET for arterial	147
Figure 47. Microscopic simulation area in Downtown Orlando (I4, SR 408 etc.)	152
Figure 48. GEH value representation for Downtown Orlando area	154
Figure 49. TTR and TTI at the entire network under the extreme traffic condition (I-4)	166
Figure 50. Scatter plot of TTR and TTI of freeways and arterials under the extreme traffic condition (I-4)	166
Figure 51. TTR and TTI at the entire network under the heavy traffic condition (I-4)	167
Figure 52. Scatter plot of TTR and TTI of freeways and arterials under the heavy traffic condition (I-4)	167
Figure 53. TTR and TTI at the entire network under the moderate traffic condition (I-4)	168
Figure 54. Scatter plot of TTR and TTI of freeways and arterials under the moderate traffic condition (I-4)	168
Figure 55. The suggested new conceptual DSS for active traffic management systems	171

LIST OF TABLES

Table 1. Potential benefits of Active Traffic Management (Mirshahi et al., 2007).....	6
Table 2. All paired t-test results of travel time reliability measures between AVI and HERE	46
Table 3. Paired t-test results of travel time reliability measures between AVI and HERE of the southbound direction.....	47
Table 4. Paired t-test results of travel time reliability measures between AVI and HERE of the northbound direction.....	49
Table 5. Paired t-test results (p-value) of travel time reliability measures between AVI and HERE of each segment.....	50
Table 6. Weather-related fatal crashes by year (2007-2014).....	61
Table 7. Reclassification of weather types of QCLCD and FARS data	63
Table 8. 2x2 contingency table and statistical measurements	68
Table 9. Contingency tables for matching QCLCD and FARS weather data by coverage (May 2007 to Dec 2014).....	70
Table 10. Detail statistics between QCLCD and FARS data by weather types and ranges	71
Table 11. Negative binomial model of regional annual fatal crash frequency by each weather condition including clear and cloud.....	74

Table 12. Regional relationship between total fatal crashes and duration of adverse weather type	75
Table 13. Descriptive statistics of independent variables.....	104
Table 14. Tobit model estimation results.....	104
Table 15. List of the evaluated roadways	121
Table 16. Ranking results of freeways/expressways	124
Table 17. Ranking Results of arterials.....	126
Table 18. Local Actuated Metering Rates as a Function of Mainline Occupancy	138
Table 19. Geometric and Operational Features of the VSL and QW segments	140
Table 20. Results of the Tobit Model to Calculate the SD of TTR for Freeways/Expressways	150
Table 21. Results of the Tobit Model to Calculate the SD of TTR for Arterials/Collectors	150
Table 22. Aimsun Next Calibration Parameters for Microscopic Simulation Areas.....	153
Table 23. Generated traffic conditions for I4.....	156
Table 24. TTR and TTI of the I-4 EB under the extreme traffic congestion.	159
Table 25. TTR and TTI of the I-4 EB under the heavy traffic congestion	160
Table 26. TTR and TTI of the I-4 under the moderate traffic congestion	161
Table 27. Average travel time rate of the I-4 under the Non-congested traffic condition.....	162

Table 29. Generic rules to select a proper ATM strategy 169

LIST OF ACRONYMS/ABBREVIATIONS

Average Absolute Speed Error	AASE
Active Demand Management	ADM
Analytical Hierarchical Process	AHP
Automated Number Plate Recognition	ANPR
Active Parking Management	APM
Adaptive Ramp Metering	ARM
Automated Surface Observing System	ASOS
Active Transportation and Demand Management	ATDM
Active Traffic Management	ATM
Advanced traffic management system	ATMS
Adaptive Traffic Signal Control	ATSC
Automated Vehicle Identification	AVI
Automated Vehicle Location	AVL
Automated Weather Observing System	AWOS
Buffer Index	BI
Center to Center	C2C
Climatological Data	CD
Confidence Interval	CI
Cooperative Observer Network	COOP
Climate Reference Network	CRN

Coefficient of Variation	CV
Degreed of Freedom	DF
Dynamic Junction Control	DJC
Dynamic Lane Assignment	DLA
Dynamic Lane Reversal	DLR
Dynamic Merge Control	DMC
Dynamic Message Signs	DMS
Department of Transportation	DOT
Day of Week	DOW
Dynamic Shoulder Lane	DShL
Dynamic Speed Limits	DSpL
Decision Support System	DSS
Dynamic Traffic Assignment	DTA
Empirical Cumulative Distribution	ECD
Fatality Analysis Reporting Systems	FARS
Florida Department of Transportation	FDOT
Federal Highway Administration	FHWA
Federal Motor Carrier Safety Administration	FMCSA
Highway Advisory Radio	HAR
Highway Capacity Manual	HCM
Hourly Precipitation Data	HPD
Highway Performance Monitoring System	HPMS
Hard Shoulder Running	HSR

Integrated Active Traffic Management Systems	IATM
Integrated Corridor Management	ICM
Intelligent Lane Control Signals	ILCS
Intelligent Network Flow Optimization	INFLO
Intelligent Roadway Information System	IRIS
Knowledge-based Intelligent Traffic Control Systems	KITS
Local Climatological Data	LCD
Median Absolute Deviation	MAD
Microcomputer-Aided Paperless Surface Observations	MAPSO
METEorological Aerodrome Report	METAR
Mean-Excess Traffic Equilibrium	METE
Misery Index	MI
Maryland State Highway Administration	MSHA
Minnesota Department of Transportation	MnDOT
Measures Of Effectiveness	MOE
National Climatic Data Center	NCDC
National Centers for Environmental Information	NCEI
National Highway Traffic Safety Administration	NHTSA
National Oceanic and Atmospheric Administration	NOAA
National Performance Measure Research Dataset	NPMRDS
National Transportation Operations Coalition	NTOC
National Weather Service	NWS
On-Time Arrival	OTA

Planning Time Index	PTI
Quality Controlled Local Climatological Data	QCLCD
Queue Warning	QW
Road Weather Information System	RWIS
Traffic Estimation and Prediction System	TrEPS
Standard Deviation	SD
Storm Data	SD
State Data System	SDS
Speed Error Bias	SEB
Storm Events Database	SED
Strategic Highway Research Program 2	SHRP2
Simulation-based Optimization	SO
Time of Day	TOD
Time Period	TP
Transportation Systems Management and Operations	TSM&O
Transit Signal Priority	TSP
Travel Time Index	TTI
Travel Time Reliability	TTR
Travel Time Rate	TTR
Travel Time Variability	TTV
United States Department of Transportation	USDOT
Coordinated Universal Time	UTC
Virginia State Department of Transportation	VDOT

Vehicle-Miles-Traveled	VMT
Vehicle Probe Project	VPP
Variable Speed Limits	VSL
Washington State Department of Transportation	WSDOT

CHAPTER 1. INTRODUCTION

1.1 Overview

Advanced traffic management systems (ATMS) are evolving rapidly toward integrating Active Transportation and Demand Management (ATDM) and Integrated Corridor Management (ICM) to enhance travel time reliability, improve traffic safety, and contribute to eco-friendly society. The ATDM, based on real-time and predicted traffic conditions, is a comprehensive concept including Active Traffic Management (ATM) for recurrent and non-recurrent traffic congestion management, Active Demand Management (ADM) redistributing and reducing vehicle trips, and Active Parking Management (APM) managing available parking facilities to optimize their performance and utilization (Kuhn et al., 2013). In terms of integration of at least freeways, arterials, and public transit, the ICM is a collection of operational strategies and advanced technologies that allow transportation subsystems, managed by one or more transportation agencies, to operate in a coordinated and integrated manner (Spiller et al., 2014). Furthermore, new state-of-art traffic management system, which is Intelligent Network Flow Optimization (INFLO) using connected vehicle technologies, has been suggested for future development (Stephens et al., 2015). Figure 1 shows these development directions of operations strategies.

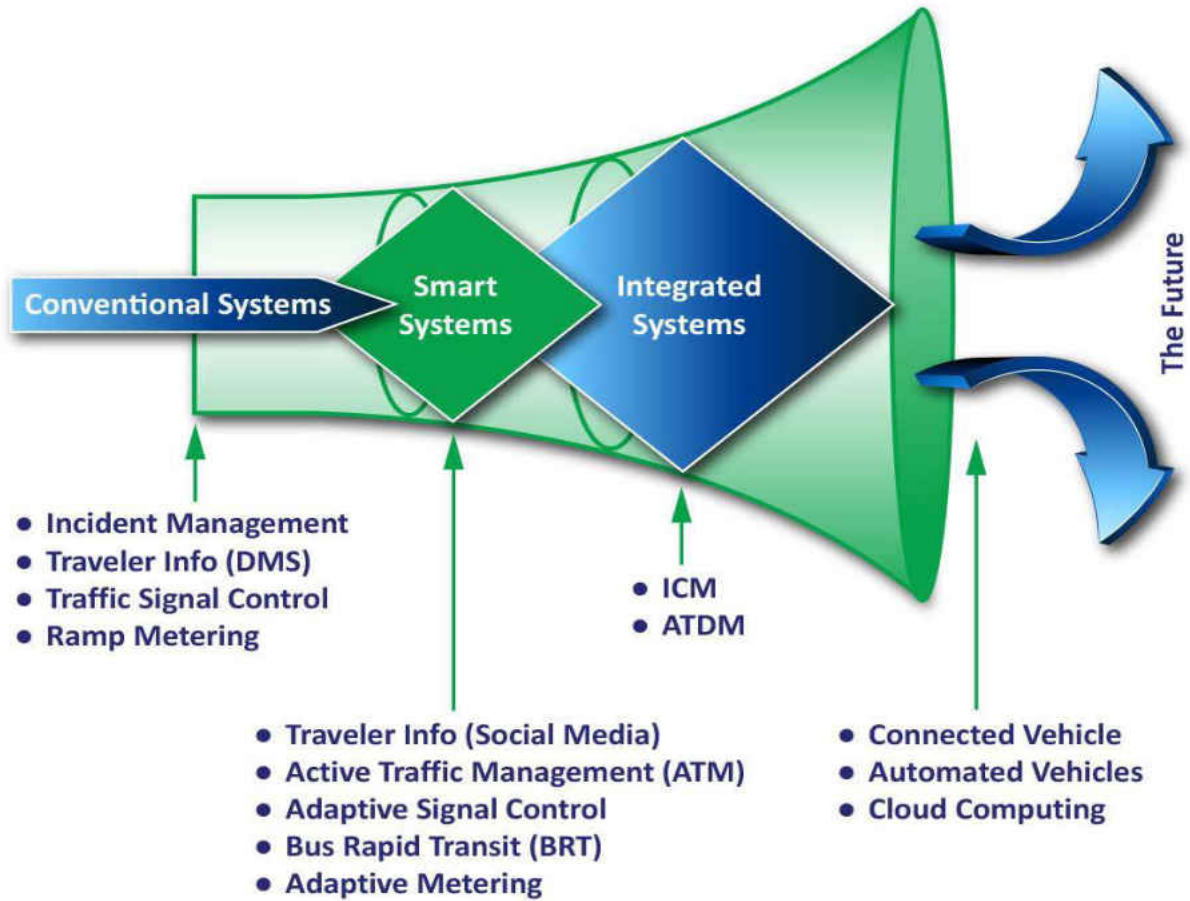

Figure 1. Continuum of operations strategies (Neudorff and McCabe, 2015)

For the successful implementation of the new concept of ATMS, it is inevitable to use a Decision Support System (DSS) since the integration of roadway networks and the combination of various traffic management strategies will make it difficult for human operators to decide a proper response plan or control measure. So, the DSS is required to provide the integrated, coordinated, automated, and intensive traffic management ability for the human operators. The Integrated Active Traffic Management (IATM) is a concept that we developed to combine many of the above concepts. In a broad scope, the DSS aims to recommend a best suitable control measure among multiple alternatives or their combinations for recurring and non-recurring traffic congestion mitigation (Hegyi et al., 2001, Almejalli et al., 2007). In a narrow scope, the DSS was developed to support the specific decisions such as prediction-based route guidance, optimal

detour routes, safety and efficiency of a work zone, detection of traffic events, and weather-responsive traffic operation (Adeli, 2004, Paisalwattana and Tanaboriboon, 2005, Kim et al., 2017, Kim et al., 2014). These kinds of DSSs were developed through various algorithms and techniques: Analytical Hierarchical Process (AHP), knowledge-based decision support, simulation-based decision support, and intelligent-systems-based decision support (Adeli, 2004, Shah et al., 2008, Hu et al., 2003, Kim et al., 2017, Klein et al., 2002, Ritchie, 1990, Ruiz, 2000, Chen et al., 2005, Cuenca et al., 1995, Hernández et al., 2002, Borne et al., 2003, Ossowski et al., 2005, Dunkel et al., 2011, Hegyi et al., 2001, Almejalli et al., 2007, Casas et al., 2014). Overall, the DSSs for traffic management have functionalities to identify current and near-future traffic conditions in real time and recommend a proper response plan regarding the identified event.

Among various effectiveness of ATDM and ICM, a representative performance measure is travel time reliability, which has become an important topic of the transportation systems management and operations (TSM&O) community since one of many goals of TSM&O is established to improve the travel time reliability on their roadway networks. The concept and metrics of the travel time reliability have been defined and developed in various perspectives which can be categorized statistical range measures, buffer time measures, tardy-trip measures, and probabilistic measures (Arroyo and Kornhauser, 2005, Taylor, 2013, Chase Jr et al., 2013, Haghani et al., 2014, Van Lint et al., 2008, Lomax and Margiotta, 2003). It was confirmed that the travel time reliability is affected by uncertainty due to time-varying traffic demand, crashes, different control measures and weather conditions (Bhourri et al., 2013, Yazici et al., 2013, Tu et al., 2008, Tu et al., 2007, Tu et al., 2006, Margiotta and Taylor, 2006). In terms of the reliability analysis of link/segment/route/network travel time, modeling of the travel time uncertainty has been developed through analytical approach (Zheng and Van Zuylen, 2011, Zheng et al., 2012, Zheng

and Van Zuylen, 2014), statistical approach (Kim and Mahmassani, 2015, Clark and Watling, 2005, Chen et al., 2014, Park et al., 2011, Al-Deek and Emam, 2006, Pu, 2011, Emam and Ai-Deek, 2006, Zheng et al., 2017), and simulation (Chen and Zhou, 2010, Kim et al., 2013). Metrics of the travel time reliability can be derived through the statistical distribution models. Some experts developed estimate metrics of the travel time reliability through risk assessment techniques, regression models or data mining techniques (Javid, 2017, Tu et al., 2012). During the recent years, the Strategic Highway Research Program 2 (SHRP2) program has led to conducting much research to use the travel time reliability. Through the efforts of research, the travel time reliability has been incorporated into highway capacity manual (HCM) in the USA (Zegeer et al., 2014, TRB, 2016).

Up to now, research about travel time reliability was conducted to find suitable measures of the travel time reliability, to estimate well-fitted models representing travel time distributions, and to describe the effectiveness of traffic management strategies. However, there is no research about how to directly use the travel time reliability in DSS for traffic management systems. Considering the travel time reliability at the time of decision of ATDM strategies, it will be expected for travelers to get more reliable travel time, and for operators to manage traffic in terms of travel time reliability.

1.2 Research Objectives

The main goal of this research is to develop a DSS to make decisions by considering travel time reliability with other performance measures into the integration of the concept of ATM and ICM (IATM). The DSS will integrate traffic management of freeways and arterials by using two main functions: identification of traffic conditions and recommendation of traffic strategy. The identification of traffic conditions is performed to analyze travel time and its reliability to identify

recurring and non-recurring traffic congestion at segment or network levels. When non-recurring or atypical recurring congestion occurs, the recommendation of traffic strategy would recommend the best alternative among the predefined response plans improving the travel time reliability.

CHAPTER 2. LITERATURE REVIEW

2.1 Active Traffic Management (ATM)

In the United States, the ATM was first introduced through an international technology scanning program in 2007 (Mirshahi et al., 2007). The team of international technology scanning program examined best ATM practices of European countries including congestion management programs, policies, and experiences. From the scanning program, the team found out various ATM strategies and their potential benefits as shown in Table 1. The strategies for ATM were provided as methods to improve traffic congestion in the U.S.

Table 1. Potential benefits of Active Traffic Management (Mirshahi et al., 2007)

Active Traffic Management Strategy	Potential Benefits												
	Increased throughput	Increased capacity	Decrease in primary incidents	Decrease in secondary incidents	Decrease in incident severity	More uniform speeds	Decreased headways	More uniform driver behavior	Increased trip reliability	Delay onset of freeway breakdown	Reduction in traffic noise	Reduction in emissions	Reduction in fuel consumption
Speed harmonization	●		●		●	●	●	●	●	●	●	●	●
Temporary shoulder use	●	●							●	●			
Queue warning			●	●	●	●	●	●	●		●	●	●
Dynamic merge control including ramp metering	●	●	●			●		●	●	●	●	●	●
Construction site management	●	●							●		●	●	●
Dynamic truck restrictions	●	●				●		●	●			●	●
Dynamic rerouting and traveler information	●		●	●				●	●			●	●
Dynamic lane markings	●	●							●				
Automated speed enforcement			●		●	●		●	●			●	●

According to the ATM description of the technical report (Mirshahi et al., 2007), FHWA also defines ATM as follows:

“ATM is the ability to dynamically manage recurrent and non-recurrent congestion based on prevailing and predicted traffic conditions. Focusing on trip reliability, it maximizes the effectiveness and efficiency of the facility. It increases throughput and safety through the use of integrated systems with new technology, including the automation of dynamic deployment to optimize performance quickly and without delay that occurs when operators must deploy operational strategies manually. ATM approaches focus on influencing travel behavior with respect to lane/facility choices and operations. ATM strategies can be deployed singularly to address a specific need such as the utilizing adaptive ramp metering to control traffic flow or can be combined to meet system-wide needs of congestion management, traveler information, and safety resulting in synergistic performance gains.” (FHWA, 2017a)

Several states have developed and implemented various ATM strategies as below (Kuhn et al., 2017, Neudorff and McCabe, 2015):

- Adaptive Ramp Metering (ARM): This aims to control the rate of vehicle entering a freeway facility by installing traffic signal(s) on ramps. Different from pre-timed or fixed time rates, adaptive ramp metering makes use of traffic responsive or adaptive algorithms to optimize either local or system-wide conditions. Adaptive ramp metering can also utilize advanced metering technologies such as dynamic bottleneck identification, automated incident detection, and integration with adjacent arterial traffic signal operations.
- Adaptive Traffic Signal Control (ATSC): This strategy continuously monitors arterial traffic conditions and the queuing at intersections and dynamically adjusts the signal timing to

smooth the flow of traffic along coordinated routes and to optimize one or more operational objectives (such as minimize overall stops and delays or maximize green bands). ATSC approaches typically monitor traffic flows and modifies specific timing parameters to achieve operational objectives.

- **Dynamic Junction Control (DJC):** This strategy consists of dynamically allocating lane access on mainline and ramp lanes in interchange areas where high traffic volumes are present, and the relative demand on the mainline and ramps change throughout the day. For off-ramp locations, this may consist of assigning lanes dynamically either for through movements, shared through-exit movements, or exit-only. For on-ramp locations, this may involve a dynamic lane reduction on the mainline upstream of a high-volume entrance ramp.
- **Dynamic Lane Assignment (DLA):** This strategy, also known as dynamic lane use control, involves dynamically closing or opening of individual traffic lanes as warranted and providing advance warning of the closure(s), typically through dynamic lane control signs, to safely merge traffic into adjoining lanes. DLA is often installed in conjunction with dynamic speed limits and also supports the ATM strategies of Dynamic Shoulder Lane (DShL) and DJC.
- **Dynamic Lane Reversal (DLR):** This strategy, also known as or contraflow lane reversal, involves, consists of the reversal of lanes in order to dynamically allocate the capacity of congested roads, thereby allowing capacity to better match traffic demand throughout the day.
- **Dynamic Merge Control (DMC):** This strategy, also known as dynamic late merge or dynamic early merge, consists of dynamically managing the entry of vehicles into merge areas with a series of advisory messages approaching the merge point that prepare motorists for an upcoming merge and encouraging or directing a consistent merging behavior. Applied

conditionally during congested (or near congested) conditions, such as a work zone, DMC can help create or maintain safe merging gaps and reduce shockwaves upstream of merge points.

- **Dynamic Speed Limits (DSpL):** This strategy adjusts speed limits based on real-time traffic, roadway, and/or weather conditions. Dynamic speed limits can either be enforceable (regulatory) speed limits or recommended speed advisories, and they can be applied to an entire roadway segment or individual lanes. In an ATDM approach, real-time and anticipated traffic conditions are used to adjust the speed limits dynamically to meet an agency's goals/objectives for safety, mobility, or environmental impacts. At UCF DSpL algorithms have been developed to adjust speed based also on real-time crash risk (Abdel-Aty et al., 2006a, Abdel-Aty et al., 2006b, Abdel-Aty et al., 2008).
- **Dynamic Shoulder Lane (DSHL):** This strategy, which has also been called hard shoulder running or temporary shoulder use, allows drivers to use the shoulder as a travel lane(s) based on congestion levels during peak periods and in response to incidents or other conditions as warranted during nonpeak periods. This strategy is frequently implemented in conjunction with DSpL and DLA. This strategy may also be used as a managed lane (e.g., opening the shoulder as temporary bus-only lane).
- **Queue Warning (QW):** This strategy involves real-time displays of warning messages (typically on dynamic message signs and possibly coupled with flashing lights) along a roadway to alert motorists that queues or significant slowdowns are ahead, thus reducing rear-end crashes and improving safety. In an ATDM approach, as the traffic conditions are

monitored continuously, the warning messages are dynamic based on the location and severity of the queues and slowdowns.

- Transit Signal Priority (TSP): This strategy manages traffic signals by using sensors or probe vehicle technology to detect when a bus nears a signal controlled intersection, turning the traffic signals to green sooner or extending the green phase, thereby allowing the bus to pass through more quickly and help maintain scheduled transit vehicle headways and overall schedule adherence.

Washington State Department of Transportation (WSDOT) started to build the ATM to reduce collisions associated with congestion and blocked lanes because about 25% of traffic congestion is due to events such as collisions or disabled vehicles after developing the concept of operation of ATM in 2008 (Brinckerhoff et al., 2008). In the concept of operation of ATM, WSDOT had considered several ATM techniques such as variable speed limits, queue warning, hard shoulder running, travel time signs, and junction control. Currently, variable speed limits, queue warning, lane control measures, ramp metering, and junction control have been being operated. In particular, variable speed limits, queue warning, and lane control measures are integrated on a gantry (see Figure 2).

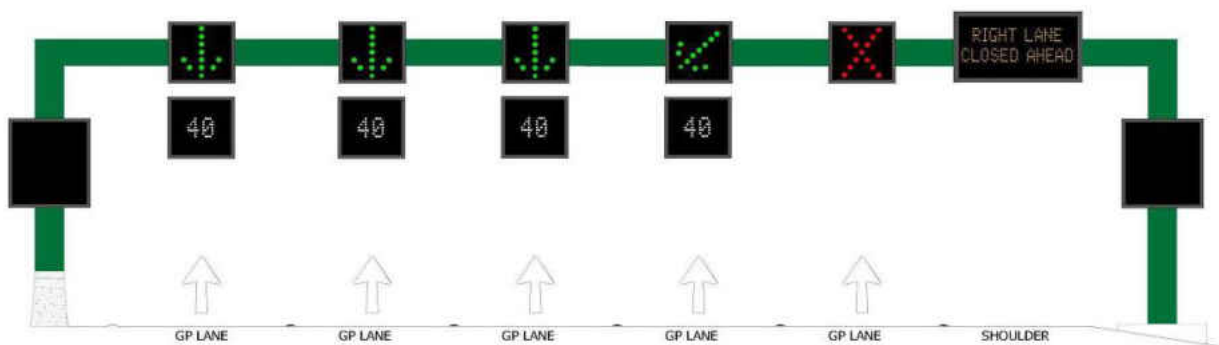

Figure 2. Gantry with speed displays, lane control and supplemental signs

Virginia State Department of Transportation (VDOT) started to consider ATM from 2010 and selected I-66 to deploy ATM in 2011 (Fontaine and Miller, 2012). Because the I-66 corridor was one of the most congested Interstate highway corridors, and construction improvements of I-66 are restricted due to the constrained right-of-way and limited funding. The ATM project for I-66 has started in August 2013 and completed in March 2016. Virginia's ATM mainly refers to an integrated set of operating strategies and technologies for managing traffic. ATM treatments for I-66 included lane control signal systems including advisory variable speed limits (VSL), hard shoulder running (HSR, or shoulder lane management systems), adaptive ramp metering, enhanced detection and camera systems, queue warning systems, and others. Several combinations of ATM treatments were deployed on about 34 miles from District of Columbia (Exit 74) to Haymarket (Exit 40/US-15). The corridor was divided into five segments including different combinations of ATM techniques planned for each segment (See Figure 3).

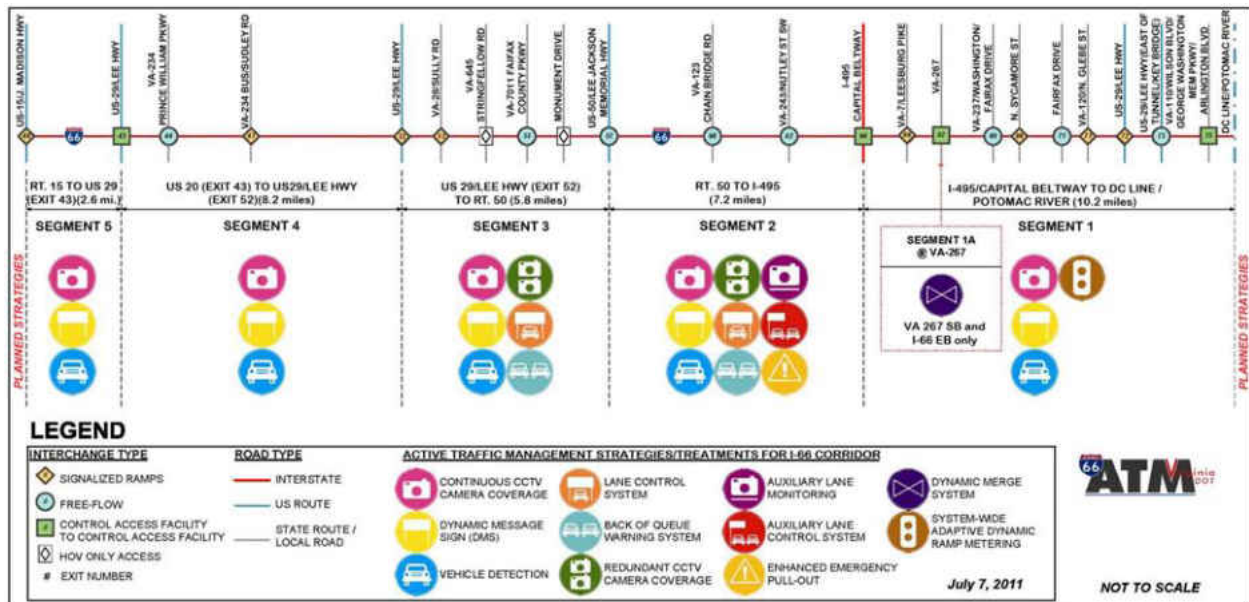

Figure 3. I-66 ATM project segments and treatments

The ATM of Minnesota Department of Transportation (MnDOT) was introduced as part of their priced dynamic shoulder lane project called Minnesota's Smart Lanes (MnDOT, Fuhs, 2010). MnDOT is operating the ATM system within eighteen-mile section on Interstate 35 West (I-35W) in the Twin Cities Metro Area and within eight-mile section on Interstate 94 (I-94) between downtown Minneapolis and downtown St. Paul (FHWA, 2017b). The ATM on I-35W was deployed to provide dynamic speed limit, dynamic shoulder lane, and dynamic lane assignment for HOT through a series of overhead signs known as Intelligent Lane Control Signals (ILCS) (See Figure 4). The ILCS is controlled through a freeway traffic management system software known as Intelligent Roadway Information System (IRIS), which also controls loop detectors, DMS, and ramp meters. ATM on I-94 is located between I-35W and I-35E and is providing advisory variable speed limits, traffic control messages using lane control systems, and queue warnings (See Figure 5).



Figure 4. Intelligent lane control signals on I-35W



Figure 5. Active Traffic Management system on I-94 (Source: http://ungemah.com/sh_projects/i-94-managed-lanes-study-phase-1/)

2.2 Integrated Corridor Management (ICM)

Integrated Corridor Management (ICM) is a collection of operational strategies and advanced technologies that allow transportation subsystems, managed by one or more transportation agencies, to operate in a coordinated and integrated manner. Through ICM, transportation professionals manage the transportation corridor as a multimodal system rather than taking the more traditional approach of managing individual assets. A transportation corridor of ICM can have several types of networks: freeway roadway network, arterial roadway network, bus transit network, rail transit network (heavy rail and light rail), commuter rail network, freight rail network, and ferry network. According to the ICM implementation Guide, all corridors will have at least three networks: freeway, arterial, and bus transit (Christie et al., 2015).

The ICM has four primary goals to increase corridor throughput, improve travel time reliability, improve incident management, and enable intermodal travel decisions. The ICM provides the following capabilities:

- To deal with congestion and travel time reliability within specific travel corridor.
- To optimize the use of existing infrastructure assets and leverage unused capacity along our nation's urban corridors.
- To support transportation network managers and operators

In particular, the ICM concentrate on the following behaviors:

- Daily operations (no incident)
- Major freeway incident
- Major arterial incident
- Transit incident
- Special event
- Disaster response scenario

The ICM has four strategic areas: demand management, load balancing, event response, and capital improvement. Demand management deals with patterns of usage of transportation networks. Load balancing handles how travelers use the transportation networks in a corridor. Events can be classified either by their duration or by their effects: reduction of capacity, increase in demand, or change in demand pattern. Major improvement may be required to solve corridor-related traffic problems in the long-term perspective (Christie et al., 2015). Major stakeholders interacting with the ICM correspond on five areas: travelers and other transportation network users, commercial and government entities, transportation network operators and their staff, public safety personnel, and

other service providers. Several interfaces with the ICM are media feeds, Dynamic Message Signs (DMS), Highway Advisory Radio (HAR), 511 systems, and traffic and transit web sites (Christie et al., 2015).

Several key aspects for the successful ICM program were identified as institutional integration including inter-agency cooperation and funding, technical integration including traveler information and data fusion, and operational integration having performance measures and decision support system. Thus, an institutional partnership is needed among the operating agencies, basic ITS infrastructure and technology should be coordinated, and the agencies within the corridor need a cooperative operational mindset (Spiller et al., 2014). Multiagency information sharing can be accomplished through manual methods or through systems that are automated. ITS standards-based C2C (Center to Center) systems were used to share data automatically (Spiller et al., 2014). Traveler information is provided to the public through 511 services, web sites, media feeds, mobile applications, and personalized information (Spiller et al., 2014).

Decision Support System (DSS) for ICM identifies sudden or pending nonrecurring events or atypical recurring congestion beyond the norm via predictive modeling, and finds a best alternative among various ICM strategies. The Dallas ICM system uses expert rules system to select a pre-agreed response plan based on numerous variables and then uses a real-time model to validate that the selected plan will provide a benefit. The San Diego system relies on its real-time model much more and allows the model to use engineering principles and algorithms to generate a response plan for an event within the corridor. The system has the capability to be fully automated or fully manual in responding to the event (Spiller et al., 2014).

In the first stage, the eight Pioneer Sites developed their Concept of Operations and System Requirements Specification. In the second stage, three sites – Dallas, Minneapolis, and San Diego – were selected to model the potential impact of ICM on their corridors. In the third stage, two sites – Dallas and San Diego – were selected as ICM Pioneer Demonstration Sites to design, build, operate, and maintain their respective ICMSs (Integrated Corridor Management Systems) and evaluate the impact on the corridors. Currently, several states are trying to implement ICM systems. In case of Florida, two projects are on-going: I-95 ICM in Broward County and I-4 ICM in Orlando.

2.3 Decision Support Systems (DSS)

Decision Support Systems have been developed and used to assist operators' decision-making in various traffic circumstances. Casas et al. (2014) presented today's generic architecture of decision support systems for traffic management systems, which consists of several components: real-time data, historical data, monitoring, predictive system, and strategy analysis (see Figure 6). The real-time data include all kinds of data such as traffic data, weather data, incidents, special events and so on. The historical data is to be accumulated from the real-time data. The monitoring identifies and classifies the state of traffic network in real time. The predictive system is to predict the state of traffic networks through analytical models and simulation-based models using real time data and historical data. Finally, strategy analysis is to determine a set of strategies and recommend a best strategy through a set of performance measures for the strategy evaluation. Selecting a set of strategies depends on the operators' knowledge and indicators evaluating strategies can be determined in various.

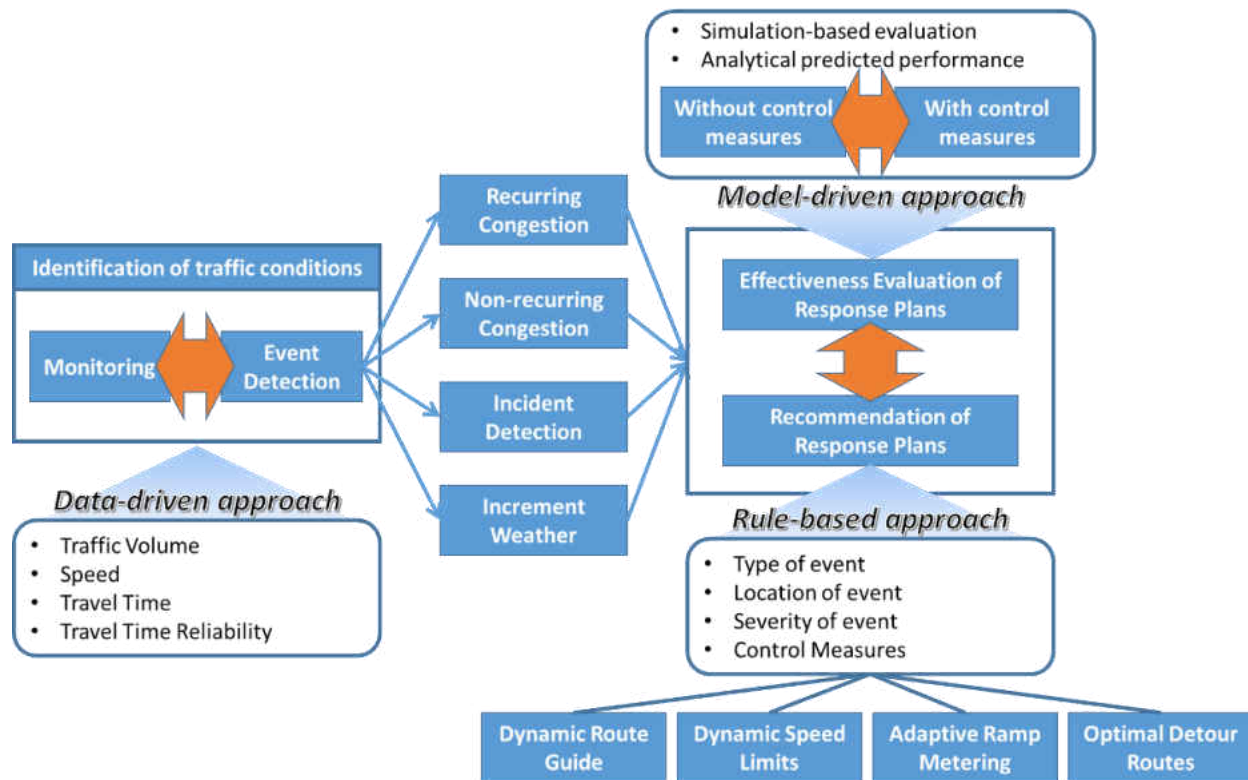

Figure 6. Generic view about DSS

2.3.1 Knowledge-based DSS

First decision support system based on expert system approach was introduced to aid traffic signal control operation for urban traffic control in 1987 (Foraste and Scemama, 1987). The initial expert system approach made the knowledge base using the fact base to contain objects representing network (links, intersections, routes, zones, and subzones), and the rule base to make the expert lines of reasoning. Cuenca (1989) presented the AURA (Accesor Urbanos Regulados Automaticamente) expert system for traffic control in urban motorways. AURA's knowledge representation includes a prediction knowledge, an interpretation knowledge to identify traffic incidents, and a knowledge base to recommend traffic control decisions. These were formulated in role form. Cuenca et al. (1992) showed KITS (Knowledge-based Intelligent Traffic Control Systems) architecture to model and apply traffic control knowledge. KITS' functionalities, roles,

and modeling approach were presented (Boero et al., 1994, Cuenca et al., 1994, Boero, 1993, Cuenca et al., 1992). For adaptive traffic management systems, Cuenca et al. (1995) proposed a general structure for real-time traffic management support using knowledge-based models. The decision support model for real-time traffic management is based on agent models and used traffic signal operations and VMS (Variable Message Signboard) as treatments of traffic management. Especially, a traffic simulator was used to build traffic models in the offline mode. To enhance agent-based models, Hernandez et al. (2002) proposed multi-agent architectures for intelligent traffic management systems including congestion warning, weather information, incident notification with diversion of traffic, speed control and so on. Ossowski et al. (2005) presented an abstract architecture for multi-agent DSS and showed examples to deal with real-world problems. Considering a new conceptual architecture, Dunkel et al. (2011) proposed a reference architecture for event-driven traffic management systems.

To provide decision support for traffic management center operators in integrated freeway and arterial traffic management systems, Ritchie suggested a knowledge-based decision support architecture, using a new artificial intelligence-based solution approach, for advanced traffic management (Ritchie, 1990). Considered main functions are incident detection by algorithmic methods, incident verification by CCTV, identification and evaluation of predefined alternative responses and actions, implementation of selected response(s), and monitoring recovery through the selected measures of effectiveness (MOE's). Representative possible responses are as follows:

- Modifying surface street signal timing plans
- Initiating ramp metering changes
- Coordination of ramp meters and surface street traffic signal timing
- Activating freeway major incident traffic management teams

- Locating and activating freeway mobile and ground-mounted changeable message signs (including composition of messages)
- Activating changeable message signs on surface streets and approaches to freeway access ramps (including composition of messages)
- Selecting and implementing signed traffic detours
- and so on

2.3.2 DSS using real-time traffic simulation

Some experts concentrated on research of decision support systems for effective traffic incident management. Hu et al. (2003) proposed a real-time evaluation and decision support system for incident management, which is composed of preprocess module, decision support module and monitoring module (see Figure 7). The preprocess module has three functions: data screening, data fusion, and incident detection. The decision support module includes neural-network-based expert system, which can overcome the fuzziness of decision-making in rule-based expert systems, data mining, real-time microscopic traffic simulation (PARAMICS; PARAllel MICroscopic Simulator) to estimate the impacts of the incident (e.g. delay and queue length), and comprehensive evaluation. The monitoring module has functions of traffic monitoring and before/after evaluation. The neural networks have self-study abilities in adjusting their own parameters to changing situations.

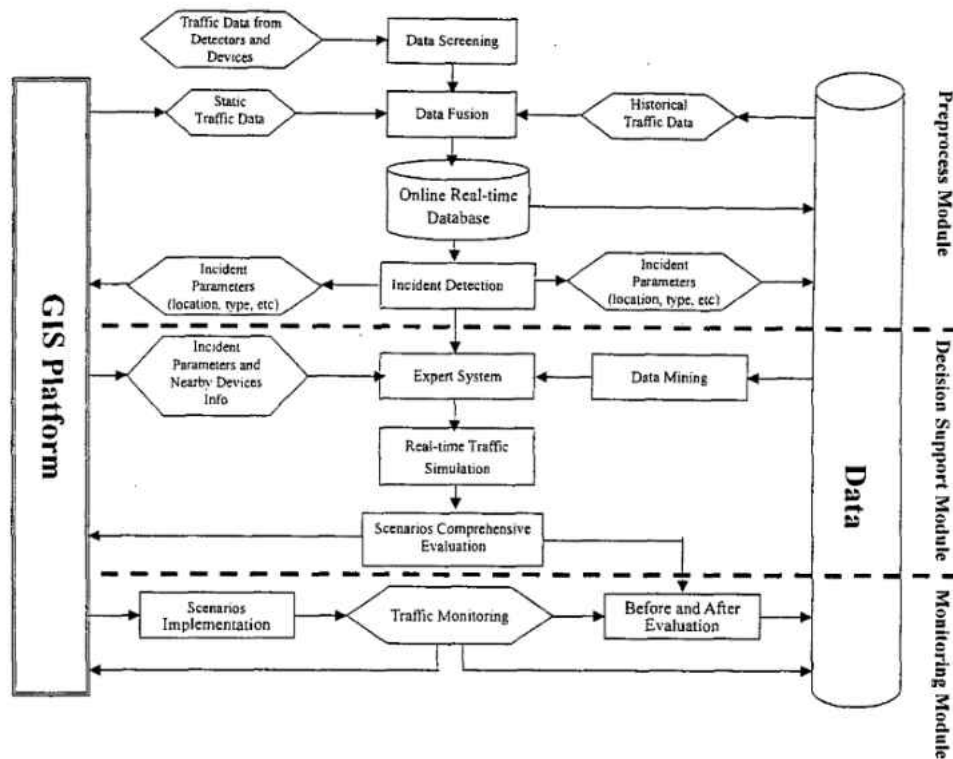

Figure 7. Working process of the real-time evaluation and decision support system (Hu et al., 2003)

Similarly, Chen et al. (2005) suggested a self-learning-process based decision support system, which contains expert knowledge-based choice, case-based reasoning, and real-time simulation, for Beijing traffic management. A mesoscopic large-scale network dynamic simulation was used to identify problems and evaluation was performed by indicators. The simulation is based on Dynamic Traffic Assignment (DTA) technology.

Shah et al. (2008) proposed a system architecture of a decision support system for freeway incident management in Republic of Korea, which is based on traffic simulation. The main function of the decision support system is to predict impacts of traffic incidents by using traffic volume and speed. There was no explanation of decision support algorithms or techniques.

For weather responsive traffic signal operations, Kim et al. (2014) developed real-time simulation-based decision support system to reduce the impact of weather and keep the target network service level (see Figure 8). The decision support system consists of real-time traffic estimation and prediction system (TrEPS), scenario manager, and scenario library. The TrEPS, which prototype is DYNASMART-X (Mahmassani, 1998) and DynaMIT-R (Ben-Akiva et al., 1998), estimates current traffic conditions and predicts the future traffic conditions with or without an alternative control strategy. The scenario manager provides functions to identify and assess alternative signal control strategies based on TrEPS-predicted network states. The scenario library stores predetermined weather-responsive signal timing plans, which the scenario manager uses in real-time. As performance measures to decide an alternative traffic signal control, mean travel time, total travel time, mean stopped time, and standard deviation of travel time were used.

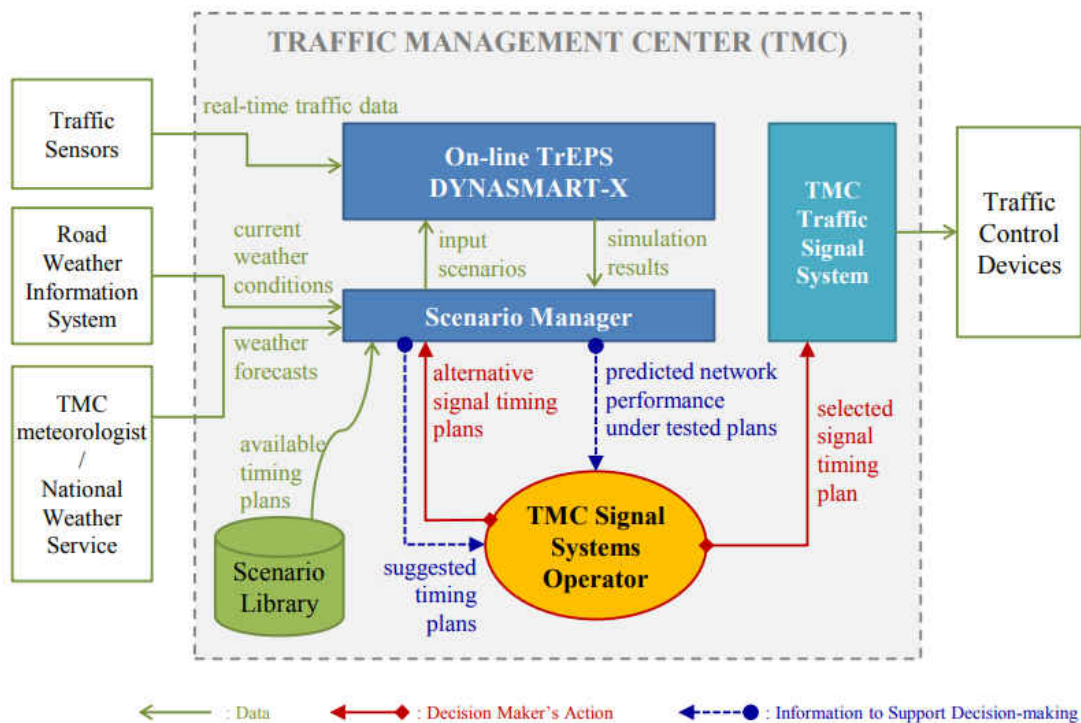

Figure 8. Framework of TrEPS-based decision support system for weather-responsive traffic signal operations (Kim et al., 2014)

Still, real-time traffic simulation has a limitation which is to analyze many strategies in real time within allowable computational budgets. Osorio and Bidkhorji (2012) proposed a simulation-based optimization (SO) algorithm to execute on-line traffic simulation under few runs. The simulation-based optimization algorithm uses a Metamodel approach combining information from the simulation model with information from an analytical probabilistic traffic model, which is a network model based on finite capacity queueing theory.

2.3.3 Case-based DSS without real-time traffic simulation

Although many decision support systems have used real-time traffic simulation, simulating various traffic scenarios for many control measures in complicated traffic situations is difficult to provide operators with the best control strategy on time. So, case-based decision support systems were proposed (Hoogendoorn et al., 2003, Hegyi et al., 2001). The case-based approach has an a-priori database including most of cases with traffic conditions and control scenarios. When a traffic incident occurs, the real traffic condition is used to find the several cases in the database. Scenarios in the cases are generated by traffic simulation. The alternative control measures with the best performance in terms of a selected objective function can be recommended. Hegyi et al. (2001) proposed a fuzzy decision support system for traffic control centers in order to optimize the number of combinations of traffic control measures. The fuzzy case-based system can provide ranking of control scenarios based on traffic conditions and control objectives. METANET macroscopic traffic simulation was used to generate control scenarios (cases) with performance measures. Furthermore, Hoogendoorn et al. (Hoogendoorn et al., 2003) developed a prediction system, which is referred to as Fuzzy Multi-Agent Case-Base Reasoning, to forecast the effects of many candidate control scenarios under the recurrent and non-recurrent traffic conditions in the network. So, the prediction system uses case-based approach, fuzzy logic, and agent-based approach. METANET simulation was used to create cases with performance measures and evaluate the decision support system. Almejalli et al. (Almejalli et al., 2007) extended the idea of the fuzzy decision support system into the fuzzy neural network in order to organize and initialize the fuzzy sets and membership functions. Figure 9 shows the overall structure of the proposed system. METANET was also used to train the developed model.

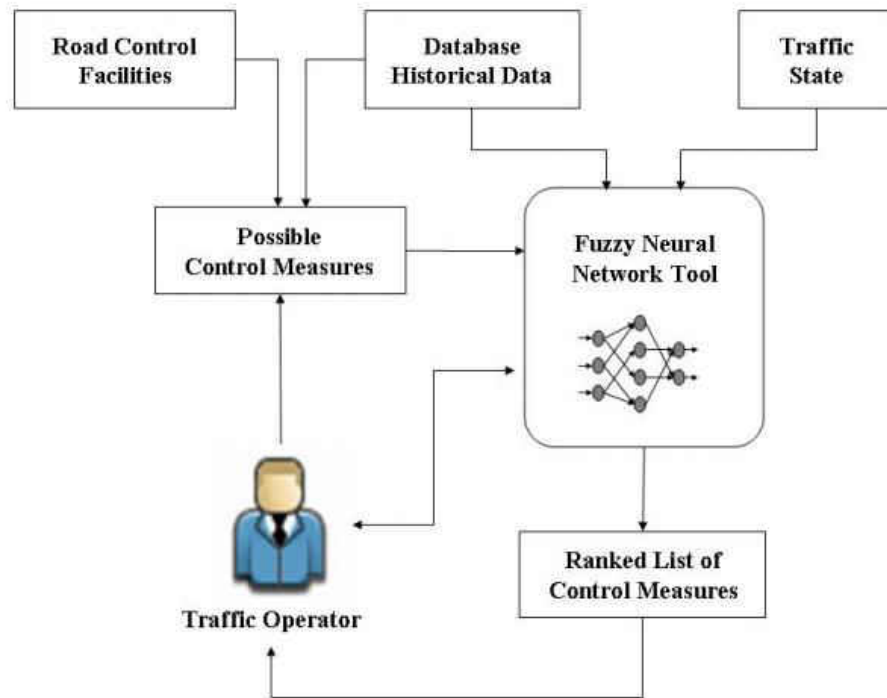

Figure 9. Overall structure of the intelligent traffic control decision support system

(Almejalli et al., 2007)

2.3.4 Other DSS

As a part of DSS, Klein et al. (2002) developed a decision support system through more advanced data fusion algorithm using the Dempster-Shfer theory to detect traffic events that occur normal traffic operations. Related to generating traffic incident response plan automatically, Ma et al. (2014) developed a method to build traffic incident response plan by using case-based reasoning and Bayesian theory. Kim et al. (2017) developed an integrated multi-criteria support system for assessing detour decisions during non-recurrent freeways congestion. The integrated multi-criteria support system is based on the prediction algorithm of incident clearance times and analytical hierarchy process (AHP).

In addition, decision support systems for effective and safe work zone management were developed. Adeli (2004) conducted to develop an intelligent decision support system for work

zone traffic management and planning, which focused on developing models: Case-based reasoning model for freeway work zone traffic management, freeway work zone traffic delay and cost optimization model, radial basis function neural network for work zone capacity and queue estimation, neuro-fuzzy logic model for freeway work zone capacity estimation; object-oriented model for freeway work zone capacity and queue delay estimation; and clustering-neural network models and parametric study of work zone capacity. Paisalwattana and Tanaboriboon (2005) presented a decision support system for work zone safety management in Thailand, which is to help design and select safe and proper traffic control for work zone. The DSS used the fact-rule-resolution relationships of work zone management system and developed according to the following steps: problem identification; database conceptualization, and model formalization.

2.4 Travel Time Reliability

2.4.1 Measures of travel time reliability

Based on the previous research (Taylor, 2013, Chase Jr et al., 2013, Haghani et al., 2014, Van Lint et al., 2008, Lomax and Margiotta, 2003), travel time reliability metrics were selected within four classifications, which are statistical range measures, buffer time measures, tardy-trip measures, and probabilistic measures. Currently, several agencies are using different travel time reliability measures considering their own mobility policies. These measures can also be distinguished by robust statistics, which are insensitive to the effects of outliers or events, and non-robust statistics. The robust statistics are based on medians instead of means and use more information from the center than from the outlying data (2017). A skew statistic, width statistic, buffer index based on median and probabilistic measures use robust statistics.

2.4.1.1 Statistical Range Measures

Statistical range measures include standard deviation (SD), coefficient of variation (CV), skew statistic (λ^{skew}) and width statistic (λ^{var}), which are an attempt to quantify travel time reliability in a statistical perspective. The CV is one metric to measure data variability, which can be used to identify links or corridors to experience the higher travel time variation over long periods of time than other links (Turner et al., 2011a). According to analytic relationships between travel time measures, the CV is a good proxy for planning time index, median-based buffer index, and skew statistic (Pu, 2011). The skew statistic and the width statistic follow the concept that asymmetric, wider, and larger distribution relative to median will be able to be unreliable (Van Lint and Van Zuylen, 2005). Thus, the two statistics should be considered together for travel time reliability.

$$CV = SD/mean(\mu) \times 100$$

$$\lambda^{skew} = \frac{TT_{90th} - TT_{50th}}{TT_{50th} - TT_{10th}}, \lambda^{var} = \frac{TT_{90th} - TT_{10th}}{TT_{50th}}$$

where TT_{90th} , TT_{50th} , and TT_{10th} stand for the 90th, 50th, and 10th percentile travel time, respectively. Although FHWA does not recommend to use statistical range measures since it is not easy for the public to understand, Van Lint and Van Zuylen (2005) used the skew statistic and width statistic of the day-to-day travel time distribution in order to monitor and predict freeway travel time reliability.

2.4.1.2 Buffer Time Measures

As buffer time measures, buffer index (BI) based on average, BI based on median, and planning time index (PTI) were selected. The BI implies that as a traveler should allow an extra percentage of travel time to arrive at a destination on time, and the PTI provides an expected travel time budget, which could be used as a trip planning measure for journeys that require punctuality (Lomax and Margiotta, 2003). FHWA, Georgia Regional Transportation Authority, Georgia Department of Transportation (DOT), and Maryland State Highway Administration (MSHA) introduced BI and PTI to represent travel time reliability (FHWA, 2006). Florida DOT and the National Transportation Operations Coalition (NTOC) are using BI (Turner et al., 2011b). Washington State DOT chose PTI to provide the best time for travelers to leave (WSDOT, 2017).

$$BI_{mean} = \frac{TT_{95th} - Average\ Travel\ Time}{Average\ Travel\ Time} \times 100(\%)$$

$$BI_{median} = \frac{TT_{95th} - Median\ Travel\ Time}{Median\ Travel\ Time} \times 100(\%)$$

$$PTI = \frac{TT_{95th}}{TT_{free\ flow\ or\ posted\ speed\ limit}}$$

2.4.1.3 Tardy Trip Measures

Tardy trip measures can explain the unreliability of travel time through late-arrival trips. Misery Index (MI) and On-Time Arrival (OTA) were used in this study. The MI focuses on the extra delay that occurred during the worst trip (Lomax and Margiotta, 2003). The OTA measure can be estimated by the proportion of travel times less than a designated travel time, which can be defined on “speed limit – 10 mph” (OTA(a)) or “1/3 × speed limit” (OTA(b)) speed (Elefteriadou and Cui, 2007).

$$MI = \frac{\text{Average Travel Time for the longest 20\% of trips} - \text{Average Travel Time}}{\text{Average Travel Time}}$$

2.4.1.4 Probabilistic Measures

The probabilistic measure was used by the Dutch Ministry of Transport, Public Works and Water Management (Van Lint et al., 2008). It calculates the probability that the observed travel times happen greater than α times predefined travel time threshold, which in this case is the median travel time on a given time of day or day of week. For this study, the parameter α is chosen as 1.2, which means the probability that travel time is larger than the median travel time + 20% (Van Lint et al., 2008).

$$PR(\alpha) = P(TT_i \geq \alpha TT_{50th})$$

2.4.2 Impact factors of travel time reliability

Impact factors of travel time reliability can be explained by travel time variations. The travel time variations were identified as three types: regular condition-dependent variations, irregular condition-dependent variations, and random variations (Wong and Sussman, 1973). The

regular condition-dependent variations are predictable and repeatable changes by time-of-day, day-of-week, and season of year. The irregular condition-dependent variations are unpredictable cases in traffic incident conditions such as adverse weather, traffic crashes, road work and so on. The random variations represent the minor variations related to interactions between individual drivers. To be specific, seven types of the impact factors were classified (Kwon et al., 2011):

- Traffic incidents and crashes
- Work zone activity
- Weather and environmental conditions
- Fluctuations in (day-to-day) demand
- Special events
- Traffic control devices, especially at-grade railway crossings and inappropriately timed traffic signals and
- Inadequate base capacity (i.e. traffic bottlenecks)

Most of the sources of traffic congestion are consistent with the above impact factors of travel time reliability (Margiotta and Taylor, 2006). Thus, quantification of the impact of the above types on travel time reliability is necessary to develop strategies to reduce traffic congestion.

Through empirical travel time reliability analyses, traffic incidents have a high impact on travel time reliability through empirical analysis, and geometrical features and traffic controls have the influence on travel time reliability (Tu et al., 2006, Wright et al., 2015, Tu et al., 2008). On the contrary, Shi and Abdel-Aty (2016) investigated the impact of travel time reliability on crash frequency using Bayesian hierarchical Poisson lognormal framework, and suggested that the improvement of the travel time reliability might improve safety on expressways. Besides, it was

confirmed that travel time reliability in work zones was degraded statistically significantly when it was compared with the baseline group (Edwards and Fontaine, 2012). Especially, regarding the impact on travel time reliability of weather, Tu et al. (2007) conducted empirical investigation about weather impact on the travel time variability of freeway corridors, and showed that adverse weather such as rain, snow, ice, fog and storm makes travel time unreliable although rain has little or no effect on travel time below a certain critical inflow. Chien and Kolluri (2012) studied travel time variability on New Jersey freeways by using TRANSMIT data, and found that the impact of adverse weather on travel time reliability is more significant during peak periods than during off-peak periods. Kwon et. al. (2011) found that weather has relatively little impact on travel time unreliability, and weather is not significant for the “noon” period. Zhao and Chien (2012) analyzed weather impact on travel time reliability, which is measured by BI, by using weather data of road weather information system (RWIS) and speed data of INRIX. It was shown that adverse weather make travel time reliability worse and the impact on the travel time reliability of precipitation varies with the amount of precipitation (Zhao and Chien, 2012). Yazici et al. (2012, 2013) investigated the impact of weather on travel time reliability in New York City and discovered that travel time distribution patterns in New York City are different with freeways of the previous research, and weather has a higher impact on travel time variability during less congested periods.

2.4.3 Estimation of travel time distribution or reliability

As travel time reliability has become an important part of traffic operation and management, there have been many studies to estimate many kinds of travel time reliability through the modeling of travel time distribution. Zheng et al. (2011, 2012, 2014) developed models to predict distribution of link travel times for urban arterials by considering stochastic arrivals and departures at signalized intersections, traffic signal timing, delay distribution, and queue distribution. Further,

Chen et al. (2014) provided a finite mixture of regression model with varying mixing probabilities to estimate urban arterial travel times through the travel time distribution considering traffic signal timing at signalized intersections. Kim and Mahmassani (2015) proposed a method to model travel time reliability through a compound representation of both vehicle-to-vehicle and day-to-day variability, which is based on the product of two Gamma distributions. Kim et al. (2013) showed an approach to build travel time distributions through scenario-based approach using traffic simulation models, and performed scenario-based reliability analysis. The four scenarios were considered: normal day, heavy rain only, accident only, and accident and heavy rain. Estimated travel time reliability measures are standard deviation (min), coefficient of variation, 80th percentile (min), 95 percentile (min), buffer index (%), buffer time (min), percentage on time (%), and misery index. Park et al. (2011) made a three-state mixture travel time distribution model to quantify the impact of traffic incidents on travel time reliability for freeways, using the INTEGRATION microscopic traffic simulation software. Three states were defined as a non-congestion, a medium-level congestion, and a medium level congestion, which were assumed to follow normal distributions. The developed model was assessed by the 90th percentile travel times.

To identify network-level travel time reliability, Clark and Watling (2005) proposed an analytic technique to estimate probability distribution of total network travel time based on a standard traffic assignment model. The technique was proved through a conceptual example network, and actual networks was not applied because of implementation issues such as computational loads. Besides, Al-deek and Emam (2006) developed a methodology to estimate link capacity reliability, link travel time reliability and network reliability, which are based on a virtual small size network. The link travel time reliability is estimated through the Bureau of Public Roads formula considering travel demand and capacity, and the network system reliability is the

probability of the union of successful paths for a system. The developed link travel time and network reliability models were tested on one corridor, Interstate 4, using dual-loop detector data (Emam and Ai-Deek, 2006). As a similar concept, Tu et al. (2012) used risk assessment technique to model travel time reliability and variability to identify the performance of transport systems. In practical, Zheng et al. (2017) developed a network-level travel time distribution model through a Johnson curve system and actual travel time data collected by Automated Number Plate Recognition (ANPR) cameras. The network-level travel time distribution model showed the possibility that the travel time reliability can be used as traffic management and control measures through the relationship between network travel time reliability measures and network traffic features such as network traffic density and flow.

Reliability and unreliability of travel time was applied to develop a new traffic equilibrium model, which is called the alpha-reliable mean-excess traffic equilibrium (METE) model. The METE model used travelers' mean-excess travel times defined as the conditional expectation of travel times beyond the travel time budget. The mean-excess travel times include the combination of the buffer time measure and the tardy time measure to represent travelers' behavior (Chen and Zhou, 2010).

2.5 Summary

ATM strategies were introduced to automate and intensify advanced traffic management related to traffic congestion and incident on freeways and expressways. Further, the concept of the ATM strategies was extended to arterials using adaptive signal control systems. Even, ICM was implemented in order to maximize the efficiency of the existing transportation systems by integrating freeways, arterials, and transit networks. However, there are still research needs to focus on.

- It is necessary to integrate freeways and arterials through the advanced new concept as advanced traffic management systems have been more complicated.
- Travel time reliability was not considered directly in strategies, algorithm, and DSS of the ATM and ICM although previous ATM and ICM projects showed their successful implementation and deployments in terms of travel time reliability's improvement.
- Integrated Freeway/Arterial Active Traffic Management (IATM) should use a case-based DSS without real-time traffic simulation because the real-time traffic simulation cannot execute all kinds of combination of traffic control measures on time in real time.

CHAPTER 3. AVAILABILITY OF HERE DATA FOR TRAVEL TIME RELIABILITY

Recently, private-sector data have been considered to estimate travel time reliability of major road infrastructure. However, there is no study evaluating the difference of travel time reliability between the private-sector data and Automated Vehicle Identification (AVI) based on radio frequency identification. As ground truth data, the AVI data were collected from an AVI system using toll tags and aggregated into 5-minutes intervals. As one of the representative traffic information providers, the HERE data calculated in 5-minutes intervals were obtained through the Regional Integrated Traffic Information System. For comparison, four kinds of measures were selected and estimated on the basis of the day of the week, specific time periods, and time of day in 5-minute, 15-minute, and one hour periods. The statistical difference in travel time reliability was assessed through paired t-tests. According to the results, AVI and HERE data are comparable based on day of the week, specific time periods, and time of day in one hour, whereas in the time of day in 5-minute and 15-minute, HERE and AVI data are not generally comparable. Thus, when estimating travel time reliability in real time, travel time reliability derived from HERE data may be different from the true travel time reliability. Considering that private-sector traffic data can be used to estimate travel time reliability measures, the measures should be harmonized on the basis of robust statistics so that it can provide more consistent measures related to the true travel time reliability.

3.1 Introduction

Many transportation researchers have been interested in travel time reliability to make preparation for uncertainty due to unexpected traffic demand, crashes, and weather because travel time reliability can provide buffers to sustain unfailling travel time for drivers, travelers, traffic operators and even planners. For the past decades, they defined the concept of travel time reliability

and developed several metrics and models with regard to it in various perspectives (Taylor, 2013). Based on the metrics and models, diverse impact on factors of nonrecurring congestion has been investigated. As a representative case, the Strategic Highway Research Program 2 (SHRP2) and the Federal Highway Administration (FHWA) sponsored much research in travel time reliability (TRB).

Basically, these research studies have used three types of traffic data sources: infrastructure-based detectors such as loop and radar detectors, automated vehicle identification (AVI) systems such as Bluetooth readers, license plate readers, and radio-frequency identification, and automated vehicle location (AVL) systems tracking vehicle's location (List et al., 2014). Generally, the infrastructure-based detectors and the AVI systems have already been used in traffic management systems of many regions, whereas the AVL systems have not been deployed fully to provide sufficient data on a regional scale. As the data collection ability and coverage of the private sector using AVL systems improve, some researchers started to use the private-sector traffic data to study travel time reliability and to analyze its performance measures.

In 2011, the United States Department of Transportation (USDOT) started to consider using the private sector data for national transportation performance management and several public agencies jointly developed and published guidelines for evaluating the accuracy of travel time and speed data of commercial traveler information services (Turner et al., 2011a, Turner et al., 2011b). Among traffic information providers, HERE, INRIX, and TomTom were selected as three highly qualified vendors in the I-95 Corridor Coalition's Vehicle Probe Project (VPP) (VPP, 2017). The VPP has validated the three vendors' data on freeways and arterials in four flow regimes (0-30 mph, 30-45 mph, 45-60 mph, more than 60 mph) by using a Bluetooth technology. The data quality measures were average absolute speed error (AASE) and Speed Error Bias (SEB)

(2010). The qualified traffic data require that the AASE should be less than 10 mph and the SEB should be within +/- 5 mph in each of the four-speed ranges. Nevertheless, there were not many studies to use and validate the private-sector data for travel time reliability.

One study investigated travel time reliability in work zones by using 15-minute traffic data of INRIX (Edwards and Fontaine, 2012). As travel time reliability measures, 95th percentile travel time, a buffer index (BI) based on the average travel rate (minute/mile), and a planning time index (PTI) were used. Through the travel time reliability measures, it was statistically quantified that work zones have a negative impact on travel time reliability during non-peak periods as well as peak periods. Furthermore, there was a detail analysis of thirteen travel time reliability measures based on 15-minute space mean speed data of INRIX (Chase Jr et al., 2013). It was recommended that ideal comparisons of reliability measures should use all 24 hours of the day and time of day analysis should be conducted to find what time periods will be effective to improve travel time reliability through traffic management strategies. Besides, it was shown that there is no single best performance measure for travel time reliability and statistical range measures for travel time reliability have the lowest correlation with the average travel rate than other measures.

At the same time, users including public agencies can still have a question whether the travel time reliability performance measures can be trustfully estimated under the condition that processing algorithms and quality assessment methods of private data sources are unknown (List et al., 2014). Related to the question, one comparative study was conducted to analyze the effect of data source selection on travel time reliability assessment by using 15-minute aggregation data (Haghani et al., 2014). The research analyzed travel time reliability derived from Bluetooth and INRIX data on interstate 95 (I-95) and interstate 207 (I-207) with HOV lanes. According to the results, travel time reliability of I-95 is not statistically significantly different between the two data

sources, but I-207 has significantly different travel time reliability because of HOV lanes. Thus, it was found that some reliability metrics are more sensitive to the data source than others.

TomTom's historical traffic data were evaluated in terms of travel time reliability through a comparative study in Calgary, Canada (Tahmasseby, 2015). Travel time reliability was measured by the 95th percentile travel time, the BI, the travel time index (TTI) and the PTI. Although this study found that TomTom provides travel time reliability estimates with reasonable accuracy, the validation was not proven statistically since the sample size was not adequate.

Apart from travel time reliability, there were several comparison or evaluation research related to the travel time and speed of HERE. A comparison study of several data collection methods to estimate travel time of freeways and arterials in Florida was conducted. According to the research results, HERE provides more accurate travel times on freeways for oversaturated conditions than INRIX and the Bluetooth system, but INRIX and Bluetooth are better than HERE for uncongested periods (Elefteriadou et al., 2014). In the case of arterials, all methods were not accurate. Furthermore, there were research comparing arterial speeds of Bluetooth, HERE and INRIX in Southeast Florida to find alternatives for transportation planning measures (Rapolu and Kumar, 2015). The study showed that Bluetooth and HERE data sets are similar, but INRIX speeds are 5 to 10 mph lower than Bluetooth and HERE.

Recently, FDOT is trying to use multiple data sources for mobility performance measures, such as travel time reliability, travel time variability, vehicle hours of delay and so on (FDOT, 2015b). In terms of data availability, cost-effectiveness, and usability of the multiple data sources, the National Performance Measure Research Dataset (NPMRDS) and HERE, instead of TomTom and INRIX, were chosen for the mobility performance measures of Florida. The research had a

plan to evaluate and compare the estimated mobility performance measures, not with actual travel time collected by other truthful systems, but the existing model based method. However, the evaluation and comparison results have so far not been confirmed.

Whereas, this study aims to compare travel time reliability of HERE’s data with the actual truthful system, the AVI system, which differs with the previous research using Bluetooth. The AVI system uses toll tags, which provide much better, stable, and qualified data than Bluetooth. For comparison, it explores travel time reliability performance measures based on several analysis scenarios including each weekday of the year, time period of an average weekday, day of the week, and time of day of an average weekday.

3.2 Study locations

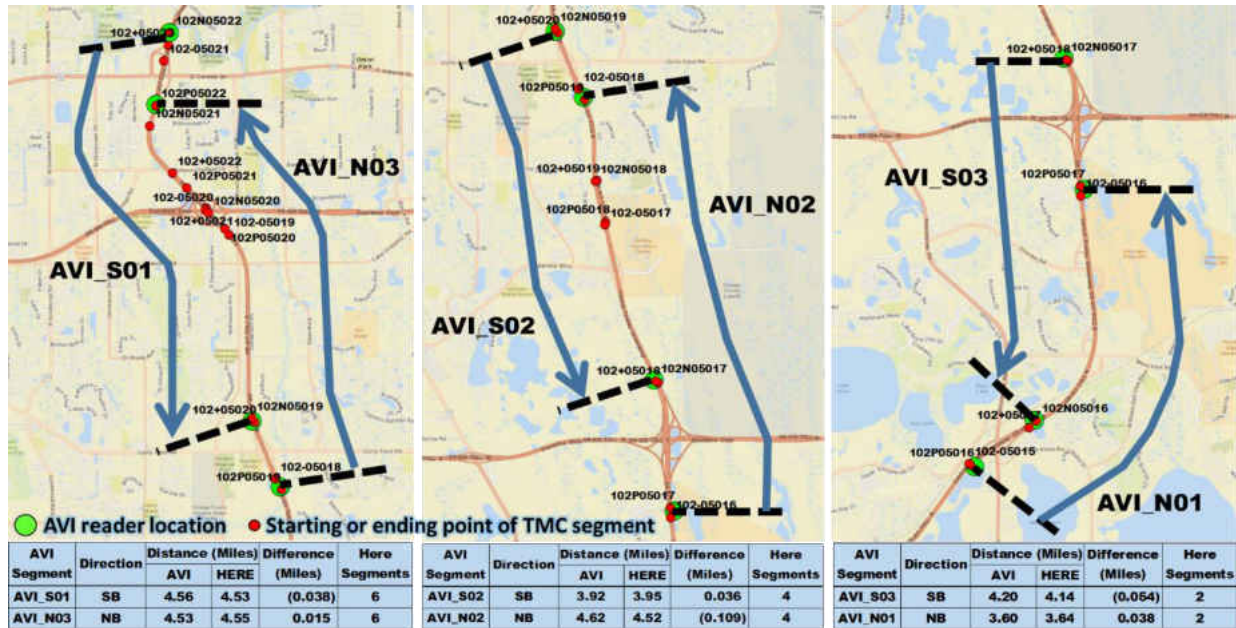

Figure 10. AVI and HERE segments on Florida State Road 417

Six segments on Florida State Road 417 (SR 417) managed by Central Florida Expressway (CFX) Authority operating with the speed limit of 70 mph were selected for the analysis because it was found that locations of AVI readers are practically identical with the starting or ending points

HERE segments (see Figure 10). Each AVI segment contains two to six segments of HERE and has an average length of about 4 miles. The node information of HERE segments was collected from the Regional Integrated Transportation Information System (RITIS) (CATT, 2008). The road-widening construction has been underway within AVI S01 and N03 segments since December 2015 (CFX, 2015).

3.3 Data Preparation

AVI data of 2016 were obtained from CFX's AVI system archiving the encrypted tag IDs and the passage timestamps of vehicles with toll tags since September 2012 (Abdel-Aty et al., 2014). Uncapped raw AVI data, which is not adjusted by the speed limit, were archived for this research and used because more tangible travel time can be estimated as ground-truth data. The uncapped raw AVI data were aggregated in five-minute intervals and their outliers were eliminated through the median absolute deviation (MAD) approach. The MAD approach provides a high accuracy and low computational efforts (Leys et al., 2013). The removal criterion of outliers becomes:

$$Median - b * MAD < travel\ time(i) < Median + b * MAD$$

where b is a threshold, in which 3 was applied very conservatively (Miller, 1991). In addition, it was confirmed whether the count of the data used in each aggregation period satisfy the required sample size, which is estimated by the following equation (May, 1990):

$$n = \left(\frac{tS}{\varepsilon}\right)^2$$

where n = required sample size

s = standard deviation, which was estimated in each five-minute aggregation

ε = user-specified allowable error, in which 5 mph was applied

$t = 1.96$ at 95 percent confidence was used

If the number of data in 5-minute increments is less than the required sample size, the corresponding time periods were removed. Among one-year data, approximately 5-minute traffic data of 7.2% were removed through the MAD approach.

The travel times of HERE, which were aggregated in five-minutes intervals, were downloaded via the RITIS platform (Vandervalk, 2014). The raw travel times are generated through data fusion processing of various data sources including state sensor data, probe vehicle data, GPS data and historical data, but the traffic data processing algorithms are not published (Elefteriadou et al., 2014). The data is estimated at Traffic Message Channel (TMC) segments, which are divided at physical or logical geometric changes. Each AVI segment is composed of several TMC segments (see Figure 10). On the basis of the AVI segments, each travel time of TMC segments was added at five-minute intervals in order to be compared with AVI data. Finally, all travel times of AVI and HERE were normalized by the distance of segments as follows (Jenks et al., Lomax and Margiotta, 2003):

$$\text{Actual Travel Rate (minute/mile)} = \frac{\text{Actual Travel Time (minute)}}{\text{Distance of segments (mile)}}$$

3.4 Analysis Scenarios

Travel time reliability measures can be calculated according to various viewpoints. For example, the travel time reliability measures of each segment or corridor can be aggregated by day of week (DOW), time period (TP) such as AM peak, PM peak, Mid-day, and late PM of an average

weekday, and time of day (TOD) of an average weekday. They can also be separated and analyzed depending on events including weather, incidents, and so on, but the events were not distinguished in this study. With reference to previous research (Lomax and Margiotta, 2003), several analysis scenarios were established as follow:

- Average travel time reliability by DOW of the whole year: the travel time reliability measures are aggregated for each DOW and analysis section.
- Average travel time reliability by TP (AM Peak, Mid-day, PM Peak, and Late PM) of an average weekday
- Average travel time reliability by TOD in an hour intervals of an average weekday
- Average travel time reliability by TOD in 15-minute increments of an average weekday
- Average travel time reliability by TOD in 5-minute increments of an average weekday

To analyze the difference of travel time reliability measures between the two data sources, it is necessary to confirm whether travel time reliability measures derived from two data sources are equal statistically. As a general statistical method, the paired t-test was applied.

3.5 Travel Time Data Distribution of AVI and HERE

This study concentrated on travel rates during weekdays of 2016, which can provide obvious travel patterns with incidents such as crashes, road work, and adverse weather. After abnormal data of AVI were removed through MAD approach and the statistical effective sample size, scatter plots were used to confirm whether the overall tendency of travel times between AVI

and HERE are similar. Figure 11 shows travel time patterns by the direction of SR 417. S01 and N03 segments are the most congested in the southbound and northbound, respectively, due to the road-widening construction since December 2015, and they have obvious AM and PM peak time periods. Other segments also have a traffic pattern that travel rates increase during commuting time periods, but the magnitude of the increment is much less than S01 and N03. Comparing scatter plots of AVI with HERE, it seems that both AVI and HERE have similar traffic patterns although some travel rates of HERE, which could have occurred under nonrecurring congestion during the day, were estimated lower during the day and were spread more during the late night and early morning than AVI data.

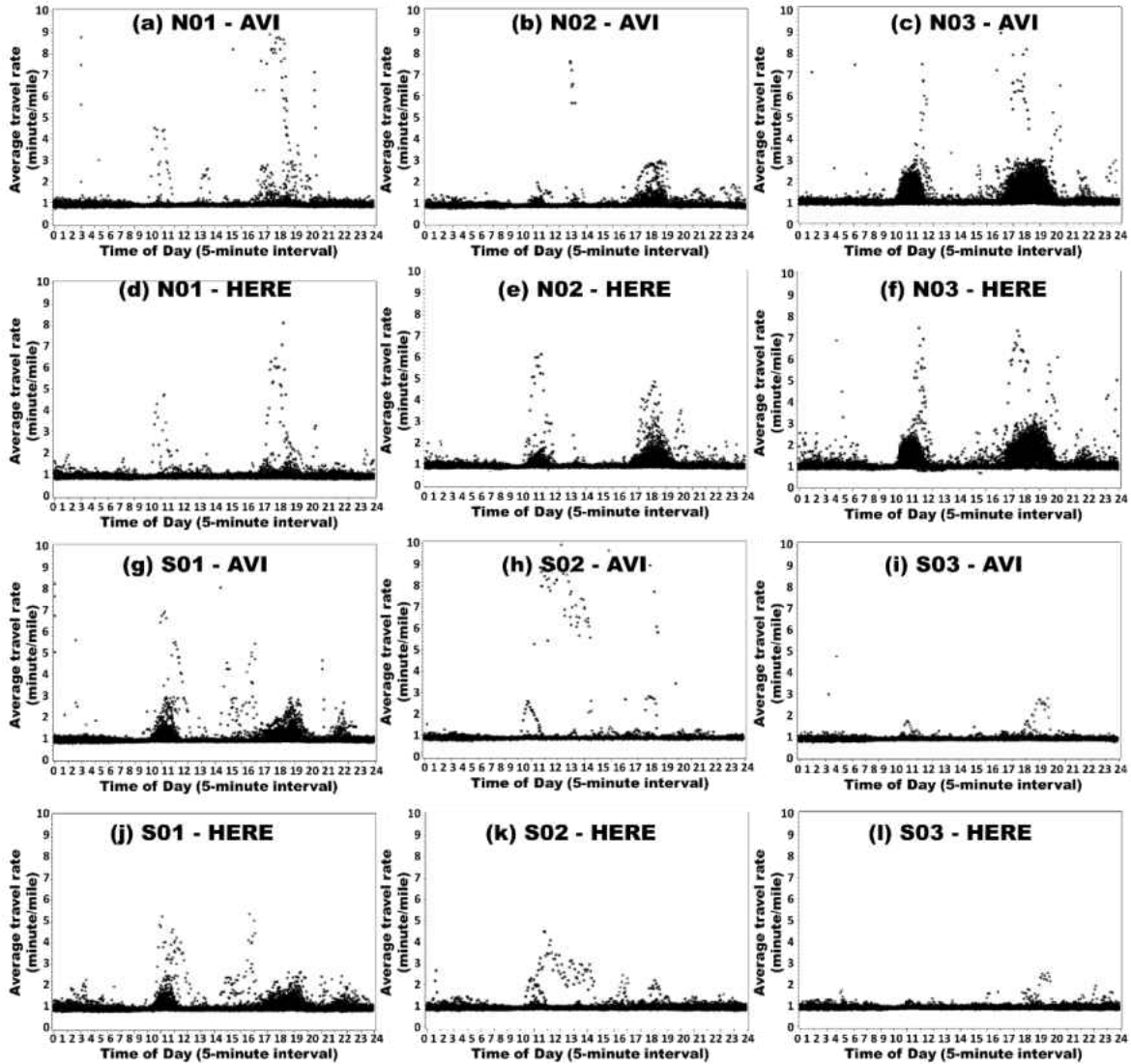

Figure 11. Scatter plots of 5-minute travel rates for all segments

To observe additional features between AVI and HERE, cumulative distributions of travel rates by direction were used. For the clear view, this study used average travel rates for 5-minute time of day of an average weekday to make the cumulative distribution. According to the cumulative distribution of all average travel rates for all times of day (see Figure 12-(a) and Figure 12-(c)), it is evident that the range of the average travel rate is different between the southbound and northbound directions, so it is necessary to distinguish between both directions in the comparative study.

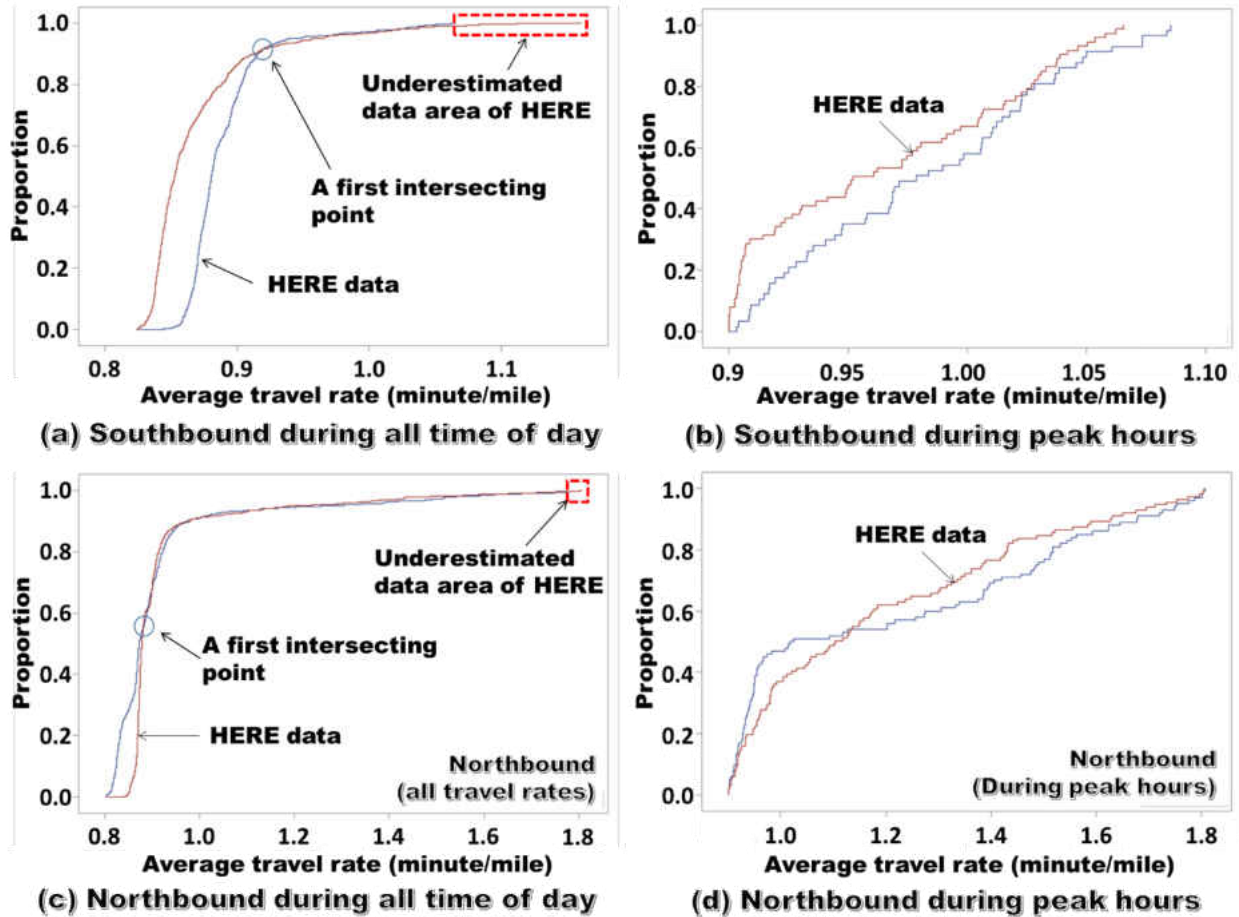

Figure 12. Empirical Cumulative Distributions (ECD) of average travel rate for time of day in 5-minute increments

More specifically, HERE data seem to fall behind AVI data until before a point of the first tangency because HERE travel times were capped, but AVI travel times were not capped by the speed limit of 70 mph, which is the travel rate of 0.867 minutes/mile. After the point of tangency, in which the impact of the adjusted speed disappears, HERE and AVI data are moving in the same trend although HERE underestimated some radically increased travel times due to events. Additionally, the cumulative distributions of average travel rates during the AM and PM peaks (see Figure 12-(b) and Figure 12-(d)) focus on the phenomenon after first intersecting points. It shows again that HERE and AVI have similar travel rate distribution during peak hour periods,

although HERE has a possibility to estimate lower travel times than the actual travel times. Therefore, it is necessary that different traffic data sources be evaluated in terms of travel time reliability as well as travel times because they can have different data distributions depending on their own processing algorithms.

3.6 Analysis Results

By using travel times and rates of 2016 on SR 417 based on the analysis scenarios, four types of travel time reliability measures between AVI and HERE were compared through the paired t-test. As with the review of travel rate distributions, the paired t-test was conducted by distinguishing southbound and northbound direction. The null hypothesis is that there is no significant mean difference of travel time reliability performance measures between AVI and HERE.

According to the results of the paired t-test of all data regardless of driving direction and segments (see Table 2), SD, CV, MI, and OTA(a) represent that AVI and HERE are statistically significantly different in all test scenarios. However, the skew statistics, the width statistics, BI based on median, and PR (1.2) show that AVI and HERE are not different until TOD in an hour increment. It seems that this kind of separation caused by characteristics of robust statistics. Considering various travel time distribution under different traffic conditions (Guessous et al., 2014), this result showed that travel time reliability measures with robust statistics can explain the relationship better between different data sources having the same purpose.

Table 2. All paired t-test results of travel time reliability measures between AVI and HERE

Test scenarios		Statistical range measure				Buffer time measure			Tardy trip measure			PR(1.2)
		SD	CV	λ_{skew}	λ_{var}	BI_{mean}	BI_{median}	PTI	MI	OTA(a)	OTA(b)	
DOW	p-value	0.000	0.000	0.292*	0.060*	0.313*	0.502*	0.478*	0.002	0.623*	0.000	0.456*
	t-value	7.230	6.690	1.070	1.950	-1.030	0.680	-0.720	3.470	0.500	-4.440	0.760
	Δ	0.812	0.224	0.171	0.038	-1.040	1.102	-0.015	0.041	0.003	-0.001	0.003
	CI	0.582	0.155	-0.155	-0.002	-3.113	-2.216	-0.057	0.017	-0.009	-0.001	-0.006
		1.042	0.292	0.497	0.078	1.033	4.420	0.027	0.065	0.014	0.000	0.012
DF	29	29	29	29	29	29	29	29	29	29	29	
TP	p-value	0.000	0.000	0.718*	0.699*	0.110*	0.586*	0.041	0.040	0.181*	0.021	0.442*
	t-value	6.120	5.880	-0.360	-0.390	-1.650	-0.550	-2.130	2.150	1.370	-2.440	-0.780
	Δ	0.754	0.211	-0.054	-0.004	-1.516	-0.710	-0.037	0.021	0.014	0.000	-0.004
	CI	0.502	0.138	-0.354	-0.024	-3.395	-3.348	-0.072	0.001	-0.007	-0.001	-0.015
		1.006	0.284	0.247	0.016	0.364	1.929	-0.002	0.041	0.035	0.000	0.007
DF	29	29	29	29	29	29	29	29	29	29	29	
TOD (Hour)	p-value	0.000	0.000	0.043	0.933*	0.003	0.421*	0.000	0.000	0.079*	0.000	0.180*
	t-value	7.290	7.360	-2.040	-0.080	-3.020	-0.810	-4.330	4.450	1.770	-3.800	-1.350
	Δ	0.629	0.171	-0.178	0.000	-1.203	-0.444	-0.032	0.027	0.008	-0.001	-0.003
	CI	0.458	0.125	-0.350	-0.009	-1.991	-1.533	-0.046	0.015	-0.001	-0.001	-0.006
		0.799	0.217	-0.006	0.009	-0.416	0.644	-0.017	0.039	0.018	0.000	0.001
DF	143	143	143	143	143	143	143	143	143	143	143	
TOD (15-min)	p-value	0.000	0.000	0.000	0.565*	0.000	0.060*	0.000	0.000	0.001	0.000	0.017
	t-value	8.860	9.230	-4.430	-0.580	-5.590	-1.880	-8.530	6.620	3.300	-5.350	-2.400
	Δ	0.454	0.120	-0.175	-0.001	-1.176	-0.474	-0.032	0.026	0.008	-0.001	-0.002
	CI	0.353	0.095	-0.253	-0.005	-1.589	-0.969	-0.039	0.019	0.003	-0.001	-0.004
		0.555	0.146	-0.097	0.003	-0.762	0.021	-0.024	0.034	0.013	0.000	0.000
DF	575	575	575	575	575	575	575	575	575	575	575	
TOD (5-min)	p-value	0.000	0.000	0.000	0.175*	0.000	0.000	0.000	0.000	0.000	0.000	0.000
	t-value	10.290	10.980	-7.390	-1.360	-9.450	-4.170	-15.440	8.070	5.580	-6.820	-3.690
	Δ	0.318	0.081	-0.181	-0.002	-1.225	-0.614	-0.033	0.023	0.008	-0.001	-0.002
	CI	0.258	0.066	-0.229	-0.004	-1.479	-0.903	-0.037	0.017	0.005	-0.001	-0.003
		0.379	0.095	-0.133	0.001	-0.970	-0.325	-0.029	0.029	0.011	0.000	-0.001
DF	1,727	1,727	1,727	1,727	1,727	1,727	1,727	1,727	1,727	1,727	1,727	

* This indicates no rejection of the null hypothesis, there is no mean difference between paired measures, at $\alpha = 0.05$.
 Δ : Mean difference

CI: Confidence Interval
 DF: Degree of Freedom
 OTA(a): speed limit – 10 mph
 OTA(b): 1/3 × speed limit

In the next analysis, the travel time reliability measures were compared by driving directions. Table 3 shows the comparison results of the southbound direction and Table 4 is about the northbound direction. Among statistical range measures of Tables 3 and 4, the standard deviation and the coefficient of variance are statistically significantly different between AVI and HERE in all test scenarios, whereas the width statistic (λ_{var}) are not statistically different in most test scenarios except for TOD (5-minute). However, the skew statistic (λ_{skew}) shows conflicting

results in two different travel rate distributions. At least, the ratio of the range of travel times between 90th percentile travel time and 10th percentile travel time and the median is statistically consistent in AVI and HERE in all test scenarios except for TOD (5-minute).

Table 3. Paired t-test results of travel time reliability measures between AVI and HERE of the southbound direction

Test scenarios		Statistical range measure				Buffer time measure			Tardy trip measure			PR(1.2)
		SD	CV	λ_{skew}	λ_{var}	BI_{mean}	BI_{median}	PTI	MI	OTA(a)	OTA(b)	
DOW	p-value	0.000	0.000	0.045	0.262 *	0.156 *	0.828 *	0.000	0.007	0.000	0.004	0.373 *
	t-value	6.150	5.750	2.200	-1.170	-1.500	0.220	-6.000	3.160	7.870	-3.500	0.920
	Δ	0.829	0.233	0.191	-0.006	-0.847	0.138	-0.036	0.027	0.007	-0.001	0.001
	CI	0.540	0.146	0.005	-0.017	-2.057	-1.200	-0.049	0.009	0.005	-0.001	-0.002
		1.118	0.320	0.377	0.005	0.363	1.477	-0.023	0.045	0.009	0.000	0.005
DF	14	14	14	14	14	14	14	14	14	14	14	
TP	p-value	0.002	0.002	0.115 *	0.737 *	0.658	0.589 *	0.009	0.022	0.001	0.005	0.451 *
	t-value	3.800	3.690	1.680	-0.340	-0.450	0.550	-3.010	2.570	4.470	-3.360	0.780
	Δ	0.657	0.186	0.311	-0.003	-0.458	0.654	-0.033	0.024	0.008	-0.001	0.002
	CI	0.286	0.078	-0.086	-0.021	-2.629	-1.880	-0.056	0.004	0.004	-0.001	-0.004
		1.028	0.295	0.709	0.015	1.712	3.187	-0.009	0.043	0.012	0.000	0.009
DF	14	14	14	14	14	14	14	14	14	14	14	
TOD (Hour)	p-value	0.000	0.000	0.947 *	0.770 *	0.021	0.486 *	0.000	0.001	0.000	0.000	0.868 *
	t-value	4.990	4.980	-0.070	-0.290	-2.360	-0.700	-6.430	3.530	3.900	-4.850	-0.170
	Δ	0.529	0.147	-0.005	-0.001	-1.112	-0.366	-0.038	0.022	0.007	-0.001	0.000
	CI	0.317	0.088	-0.168	-0.011	-2.051	-1.408	-0.049	0.010	0.003	-0.001	-0.003
		0.740	0.206	0.157	0.008	-0.173	0.676	-0.026	0.035	0.010	0.000	0.002
DF	71	71	71	71	71	71	71	71	71	71	71	
TOD (15-min)	p-value	0.000	0.000	0.485 *	0.399 *	0.000	0.403 *	0.000	0.000	0.000	0.000	0.828 *
	t-value	6.570	6.670	-0.700	-0.840	-3.920	-0.840	-11.370	5.110	5.730	-6.740	0.220
	Δ	0.400	0.108	-0.030	-0.002	-1.024	-0.244	-0.037	0.021	0.007	-0.001	0.000
	CI	0.280	0.076	-0.114	-0.007	-1.539	-0.818	-0.043	0.013	0.004	-0.001	-0.002
		0.521	0.140	0.054	0.003	-0.509	0.330	-0.030	0.030	0.009	-0.001	0.002
DF	287	287	287	287	287	287	287	287	287	287	287	
TOD (5-min)	p-value	0.000	0.000	0.282 *	0.096 *	0.000	0.031	0.000	0.000	0.000	0.000	0.784 *
	t-value	7.630	8.030	-1.080	-1.660	-6.750	-2.160	-20.060	5.910	8.900	-8.540	0.270
	Δ	0.285	0.074	-0.029	-0.003	-1.099	-0.368	-0.038	0.019	0.007	-0.001	0.000
	CI	0.212	0.056	-0.082	-0.005	-1.419	-0.703	-0.042	0.013	0.005	-0.001	-0.001
		0.358	0.092	0.024	0.000	-0.779	-0.034	-0.034	0.026	0.008	-0.001	0.001
DF	863	863	863	863	863	863	863	863	863	863	863	
^a This indicates no rejection of the null hypothesis, there is no mean difference between paired measures, at $\alpha = 0.05$. Δ : Mean difference						CI: Confidence Interval DF: Degree of Freedom OTA(a): speed limit – 10 mph OTA(b): 1/3 \times speed limit						

In the buffer time measures, BI based on mean and BI based on median show a consistent result in the two distributions. The BI based on mean has no difference between AVI and HERE

in the only DOW and TP test scenarios, but the BI based on median has no difference in the DOW, TP, TOD (Hour) and TOD (15-minute). On the other hand, PTI has no statistical difference between AVI and HERE in only the North Direction's travel time distribution. The BI based on median using one of the robust estimators shows that there is no difference between AVI and HERE till the test scenarios from DOW to TOD (15-minute). This is the same result as the width statistic. The only difference is that the width statistic uses 90th, 10th, and 50th percentile travel time, and the buffer index is based on the median and uses the 95th and 50th percentile travel time.

Furthermore, it was found that all tardy travel measures are not different between AVI and HERE in only the northbound travel time distribution with DOW, TP, and TOD (Hour) test scenarios. Finally, the probabilistic measure, PR(1.2), had the same results in three test scenarios, DOW, TP and TOD (Hour), on the distribution of both directions. PR(1.2) also uses the 50th percentile travel time.

Table 4. Paired t-test results of travel time reliability measures between AVI and HERE of the northbound direction

Test scenarios		Statistical range measure				Buffer time measure			Tardy trip measure			PR(1.2)
		SD	CV	λ_{skew}	λ_{var}	BI_{mean}	BI_{median}	PTI	MI	OTA(a)	OTA(b)	
DOW	p-value	0.001	0.002	0.636*	0.053*	0.544*	0.532*	0.874*	0.024	0.912*	0.016	0.568*
	t-value	4.310	3.930	0.480	2.110	-0.620	0.640	0.160	2.530	-0.110	-2.730	0.580
	Δ	0.796	0.214	0.151	0.081	-1.233	2.065	0.007	0.055	-0.001	-0.001	0.005
	CI	0.400	0.097	-0.519	0.163	-5.487	-4.845	-0.081	0.008	-0.025	-0.001	-0.013
		1.192	0.331	0.821	-0.001	3.021	8.976	0.094	0.102	0.023	0.000	0.024
DF	14	14	14	14	14	14	14	14	14	14	14	
TP	p-value	0.000	0.000	0.045	0.793*	0.113*	0.380*	0.240*	0.316*	0.354*	0.421*	0.304*
	t-value	4.780	4.540	-2.200	-0.270	-1.690	-0.910	-1.230	1.040	0.960	-0.830	-1.070
	Δ	0.851	0.236	-0.419	-0.006	-2.573	-2.073	-0.041	0.018	0.020	0.000	-0.011
	CI	0.469	0.124	-0.827	0.043	-5.836	-6.980	-0.113	-0.019	-0.024	-0.001	-0.032
		1.232	0.347	-0.010	-0.055	0.690	2.834	0.031	0.056	0.064	0.000	0.011
DF	14	14	14	14	14	14	14	14	14	14	14	
TOD (Hour)	p-value	0.000	0.000	0.024	0.446*	0.049	0.593*	0.061*	0.003	0.289*	0.114*	0.173*
	t-value	5.370	5.430	-2.310	0.770	-2.000	-0.540	-1.900	3.040	1.070	-1.600	-1.380
	Δ	0.729	0.195	-0.350	0.007	-1.295	-0.523	-0.026	0.031	0.010	0.000	-0.005
	CI	0.458	0.123	-0.653	0.026	-2.583	-2.465	-0.052	0.011	-0.009	-0.001	-0.012
		1.000	0.266	-0.047	-0.012	-0.007	1.419	0.001	0.052	0.029	0.000	0.002
DF	71	71	71	71	71	71	71	71	71	71	71	
TOD (15-min)	p-value	0.000	0.000	0.000	0.081*	0.000	0.088*	0.000	0.000	0.043	0.021	0.004
	t-value	6.160	6.480	-4.890	1.750	-4.020	-1.710	-3.980	4.640	2.030	-2.330	-2.910
	Δ	0.507	0.132	-0.320	0.007	-1.328	-0.704	-0.026	0.032	0.010	0.000	-0.005
	CI	0.345	0.092	-0.449	0.016	-1.978	-1.512	-0.040	0.018	0.000	-0.001	-0.008
		0.669	0.172	-0.191	-0.001	-0.678	0.105	-0.013	0.045	0.020	0.000	-0.002
DF	287	287	287	287	287	287	287	287	287	287	287	
TOD (5-min)	p-value	0.000	0.000	0.000	0.011	0.000	0.000	0.000	0.000	0.001	0.004	0.000
	t-value	7.130	7.640	-8.290	2.550	-6.690	-3.580	-7.310	5.710	3.460	-2.880	-4.360
	Δ	0.351	0.087	-0.332	0.006	-1.350	-0.859	-0.028	0.027	0.010	0.000	-0.005
	CI	0.255	0.065	-0.411	0.011	-1.747	-1.330	-0.035	0.017	0.004	-0.001	-0.007
		0.448	0.110	-0.253	0.001	-0.954	-0.388	-0.020	0.036	0.016	0.000	-0.002
DF	863	863	863	863	863	863	863	863	863	863	863	
<p>* This indicates no rejection of the null hypothesis, there is no mean difference between paired measures, at $\alpha = 0.05$. Δ: Mean difference</p>						<p>CI: Confidence Interval DF: Degree of Freedom OTA(a): speed limit – 10 mph OTA(b): 1/3 × speed limit</p>						

Finally, the comparison of travel time reliability measures between AVI and HERE was conducted for each segment (see Table 5). For this test, DOW and TP test scenarios were not included because the sample size is too small. When the size of the interval of time of day is decreased, the number of measures, representing two distributions are not different, is decreased. Based on Table 5, travel time reliability measures of HERE are not different with AVI at most

segments except for SB02 in TOD (Hour). The SB02 does not have any measure with p-value more than 0.05 in all TOD, which means AVI and HERE data in the SB02 segment is definitely different or there may be some error between AVI and HERE.

Table 5. Paired t-test results (p-value) of travel time reliability measures between AVI and HERE of each segment

Test scenarios		Statistical range measure				Buffer time measure			Tardy trip measure			PR(1.2)
		SD	CV	λ_{skew}	λ_{var}	BI_{mean}	BI_{median}	PTI	MI	OTA(a)	OTA(b)	
TOD (Hour)	NB01	0.002	0.002	0.051 *	0.664 *	0.012	0.380 *	0.600 *	0.009	0.381 *	0.002	0.406 *
	NB02	0.060 *	0.043	0.091 *	0.323 *	0.042	0.093 *	0.000	0.808 *	0.050 *	0.838 *	0.053 *
	NB03	0.001	0.001	0.309 *	0.079 *	0.763 *	0.462 *	0.251 *	0.031	0.086 *	0.855 *	0.972 *
	SB01	0.010	0.010	0.332 *	0.061 *	0.468 *	0.185 *	0.333 *	0.005	0.112 *	0.003	0.412 *
	SB02	0.000	0.000	0.001	0.003	0.000	0.000	0.000	0.028	0.000	0.004	0.000
	SB03	0.136 *	0.131 *	0.452 *	0.617 *	0.145 *	0.220 *	0.000	0.730 *	0.006	0.047	0.349 *
TOD (15-min)	NB01	0.000	0.000	0.000	0.360 *	0.000	0.116 *	0.328 *	0.000	0.111 *	0.000	0.159 *
	NB02	0.034	0.020	0.015	0.064 *	0.000	0.003	0.000	0.495 *	0.000	0.988 *	0.000
	NB03	0.001	0.001	0.009	0.000	0.846 *	0.403 *	0.043	0.003	0.003	0.795 *	0.425 *
	SB01	0.000	0.000	0.164 *	0.002	0.102 *	0.005	0.144 *	0.000	0.019	0.000	0.096 *
	SB02	0.000	0.000	0.000	0.000	0.000	0.000	0.000	0.001	0.000	0.000	0.000
	SB03	0.038	0.035	0.163 *	0.247 *	0.009	0.030	0.000	0.605 *	0.000	0.006	0.154 *
TOD (5-min)	NB01	0.000	0.000	0.000	0.128 *	0.000	0.003	0.053 *	0.000	0.019	0.000	0.080 *
	NB02	0.009	0.003	0.000	0.001	0.000	0.000	0.000	0.533 *	0.000	0.913 *	0.000
	NB03	0.001	0.001	0.000	0.000	0.827 *	0.371 *	0.002	0.001	0.000	0.891 *	0.292 *
	SB01	0.000	0.000	0.045	0.000	0.047	0.000	0.002	0.000	0.000	0.000	0.008
	SB02	0.000	0.000	0.000	0.000	0.000	0.000	0.000	0.000	0.000	0.000	0.000
	SB03	0.043	0.037	0.244 *	0.050 *	0.000	0.000	0.000	0.710 *	0.000	0.004	0.093 *

* This indicates no rejection of the null hypothesis, there is no mean difference between paired measures, at $\alpha = 0.05$.
OTA(a): speed limit – 10 mph
OTA(b): $1/3 \times$ speed limit

3.7 Conclusion

This study compared HERE data with AVI data using toll tags for electronic toll collection and also providing sufficient sample size with high accuracy in terms of travel time reliability. So far, traffic data of INRIX and TomTom as private sector data have been compared in terms of travel time reliability, but HERE data has not been evaluated (Tahmasseby, 2015, Haghani et al., 2014). In addition, these studies evaluated the private data using data at 15-minute intervals because they use Bluetooth sensors that do not provide enough samples. On the other hand, this study compared the reliability of travel time in more details using AVI's 5-minute interval data with statistically sufficient samples.

In order to understand the characteristics of the travel-time data collected from AVI and HERE, data of three sections by direction were combined. Scatter plots and cumulative empirical distributions were used to visualize travel rates of AVI with HERE. Through the scatter plots, the most congested sections and peak time periods were verified. The visualized cumulative distributions showed the difference between capped speeds of HERE data and uncapped speeds of AVI data. The difference disappeared at the first intersection points between the cumulative distributions of AVI and HERE.

The selected travel time reliability measures for this study was divided into four groups, statistical range measures, buffer time measures, tardy trip measures, and probabilistic measures. According to the predefined test scenarios, all travel time reliability measures were estimated and then tested through the paired t-test on whether the travel time reliability measures estimated from the two data sources are statistically different or not. The test was conducted into two groups, southbound travel times and northbound travel times.

According to the statistical test results of the two groups, it was confirmed that the results were different depending on elements of performance measures. It is shown that SD and CV, which are representative of non-robust estimators using an average, have statistically significant differences between AVI and HERE. In addition, most of the PTI, MI, and OTA using non-robust estimators, average travel time, did not provide consistent evaluation results in AVI and HERE, although BI based on mean travel times shows that the two data sources are not different in travel time reliability of day of week and time periods of an average weekday. Conversely, it was found that there is no statistical difference between AVI and HERE according to the test results of the width statistic, buffer index based on median, and PR (1.2), which are using the robust estimator, although the skew statistic did not yield a consistent conclusion in both distributions.

Considering the results of the previous research, robust statistics should be used for travel time having compound distributions according to traffic conditions, there is no statistically significant difference between HERE and AVI in terms of travel time reliability using day of the week, time periods, and time of day in an hour unit. However, the travel time reliability measures calculated from the two different data sources at 5 minute and 15 minute units can yield different results. It is obvious that HERE data as a real-time feed will have differences with AVI data since the HERE data can be estimated for all time periods through unopened modeling methods including smoothing, filtering, and imputation using historical data when the collected data are insufficient. The differences will be revealed more obviously when the aggregation time span shortens. However, if raw traffic data without modeling will be used, the differences will be reduced although there might be irreducible errors. On the other hand, on the basis of the average-based BI, PTI, and OTA, which are currently used by public agencies in the USA, AVI and HERE cannot estimate consistent travel time reliability measures.

Based on the results of this study, travel time reliability measures should be changed to use robust statistics such as median and percentiles. Thus, travel time reliability estimated through different data sources can be consistent from a macroscopic perspective such as transportation planning not real-time systems, such as Active Traffic Management strategies. This study compared two different data sources in terms of travel time reliability using six short segments on one corridor. This may not represent most of the freeways and expressways. For more general conclusions, more types of road segments should be added and analyzed. Also changes in travel reliability due to events should be studied in the future.

CHAPTER 4. THE EFFECTIVE COVERAGE OF LAND-BASED WEATHER STATIONS

This chapter investigates the effective spatial coverage of nationwide land-based weather stations of the National Oceanic Atmospheric Administration (NOAA) for traffic crash analysis. The weather data were collected from the Quality Controlled Local Climatological Data (QCLCD) and the fatal crashes were obtained from the Fatality Analysis Reporting Systems (FARS) during the year of 2007 to 2014. Both QCLCD and FARS contain geographic coordinates for locations and weather condition information as a categorical variable. The spatial coverage of weather stations for the analysis was made by geoprocessing, which uses multiple buffers (i.e. radii 5, 10, 15, and 20 miles), and then was evaluated via Cohen's κ statistics, which is used to determine an agreement of weather between QCLCD and FARS within the buffer. The applicability of the weather station's data by nine climate regions was assessed by developing a series of negative binomial models. According to the estimated Cohen's κ statistics, the rain and snow weather conditions have a moderate agreement up to 20 miles. However, in the case of fog weather condition, it has a slight agreement. The statistical modeling results showed that weather stations data can be a good exposure measure for weather-related fatal crashes along with the vehicle-miles-traveled. Considering one geographical feature that approximately more than 75% of all fatal crashes are located within 20-miles radius of the weather stations in the USA, it is evident that the data from the existing weather stations can be cost-effective to develop geospatial crash risk analysis model.

4.1 Introduction

It is well known that weather has a significant impact on road transportation. For the systematic weather-related research, the committee on weather research for the road transportation

at the National Research Council of the National Academies (2004) had arranged a research agenda for improving road weather services. The impact of weather on traffic operation has been considered from the perspective of traffic flow (Maze et al., 2006) and traffic safety (Qiu and Nixon, 2008, Andrey et al., 2001).

Regarding the impact of weather on traffic flow, there are many studies using weather data which are collected from land-based weather stations near roadways (Ibrahim and Hall, 1994, Cools et al., 2010, Smith et al., 2004, Agarwal et al., 2005, Hall and Barrow, 1988). These types of studies verified that weather has an impact on highway capacity, speed, and density. As a result, traffic engineers and operators have recognized quantified influences of weather on traffic flow according to weather intensity from the land-based weather stations.

Furthermore, for the purpose of investigating the relationship between weather-related crashes and weather, various studies have been conducted for several weather conditions. Some studies conducted several comprehensive explorations using nationwide data in the United States to understand the relationship between historical data of traffic crashes from the National Highway Traffic Safety Administration (NHTSA) and archived weather data from the National Climatic Data Center (NCDC) of the National Oceanic and Atmospheric Administration (NOAA) (Eisenberg, 2004, Eisenberg and Warner, 2005, Pisano et al., 2008, Rossetti and Johnsen, 2011, Ashley et al., 2015, Black and Mote, 2015a, Black et al., 2017). Other studies evaluated weather-related crash risk based on hourly data provided by weather stations of NOAA, but the studies were restricted to specific areas or roads (Abdel-Aty and Pemmanaboina, 2006, Black and Mote, 2015b, Black et al., 2017). Even, there was no study to confirm the quality of hourly weather data collected by nationwide land-based weather stations in the USA.

This study aims to assess the nationwide reliability of the hourly Quality Controlled Local Climatological Data (QCLCD), which are the representative qualified weather data in the United States. It uses contingency table analysis to match the NHTSA's FARS (Fatality Analysis Reporting Systems) weather data (NHTSA, 2014) with the NOAA's QCLCD data (NCEI, 2016) to evaluate the usability of the QCLCD. This is achieved through the development of models to estimate the number of annual fatal traffic crashes based on the duration of weather conditions, and vehicle-miles-traveled (VMT)¹ by weather conditions. Additionally, based on the developed models and aggregated data, regional characteristics of weather-related fatal crashes are discussed.

4.2 Literature Review

With regards to nationwide rain-related and snow-related traffic crashes in the United States, Eisenberg (2004) analyzed the mixed effects of precipitation, and Eisenberg and Warner (2005) investigated the impact of snowfall. The study used fatal crashes for the 48 contiguous states during 1975-2000, property-damage-only and injury crashes of 17 states during the 1990s and daily state weather data from NCDC's Cooperative Observer Network (COOP) (NCEI, 2016). According to the results, snow days had fewer fatal crashes than dry days, but more injury crashes and property-damage-only crashes. The first snow day of the year was substantially more dangerous than other snow days regarding the number of fatalities, particularly for elderly drivers. Also, the lagged effects of precipitation across days were found through nationwide weather-related crash analysis.

Regarding the overall tendency analysis about US highway crashes in adverse weather conditions, Pisano et al. (2008) handled weather exposure and severity and described statistics and

¹ VMT = AADT (Annual Average Daily Traffic) × (segment length), vehicle-miles-traveled per day

regional variance of weather-related crashes, injuries, and fatalities during 1995-2005. To confirm regional variance of weather-related crashes, the authors used only mean total precipitation and snowfall as weather information at the macroscopic level. Also, the authors confirmed that many weather-related crashes occurred during rainfall or under wet pavement condition, and most weather-related crashes take place in the South and the Midwest. To be specific, the South had many rainfall- or wet-pavement-related crashes. On the other hand, the Midwest had relatively more winter-weather-related crashes.

Further, related to the traffic safety policy of commercial vehicles, Federal Motor Carrier Safety Administration (FMCSA) investigated weather-related fatal crash trends and climate-change-related impacts through fatal crash data of FARS during 1975-2009 and climatic and weather data from Storm Events Database (SED) of the National Climatic Data Center (NCDC) (Rossetti and Johnsen, 2011). It is reported that all kinds of weather conditions can influence fatal crashes of commercial vehicles, but when normalized by VMT, the fatal crash risk is less. Moreover, the fatal crashes of commercial vehicles have a declining trend from 1975 to 2009, with a leveling off since 1999. However, it was not possible to analyze a relation and a trend between fatal crashes of commercial vehicles and weather events from SED because it includes only deaths related to special weather phenomena.

Recently, Ashley et al. (2015) addressed a nationwide analysis of visibility-related fatal crashes in the United States from 1994 to 2011. It showed that about 70% of visibility-related fatal crashes occurred in the area without weather hazard advisories of the National Weather Service (NWS). Additionally, Black and Mote (2015a) conducted another study about spatial and temporal characteristics of winter-precipitation-related fatalities for the period 1975-2011. They reported that the magnitude of fatalities caused by winter weather conditions is more than fatal counts

reported from storm data of the NCDC for unusual weather phenomena. Both Ashley et al. (2015) and Black and Mote (2015a) emphasized that measures for weather-related fatal crashes should be established for different adverse weather conditions as well as special weather events.

In order to better figure out the impact of winter precipitation and rainfall on road traffic crashes, Black and Mote (2015b) explored the impact of the winter precipitation on crashes in 13 cities in the United States. They used Automated Surface Observing System (ASOS) for weather data and State Data System (SDS) for crash data during 1996-2010. It was confirmed that a higher winter precipitation increases the numbers of traffic crashes and injuries, and the relative risks of crash and injury rise when the intensity of the precipitation goes up. However, contrary to the result of Eisenberg and Warner (2005), the relative risk of the first three precipitation events is not different with subsequent precipitation events. In addition, Black and Villarini (2017) analyzed the effects of rainfall on traffic crashes using gauge-based daily precipitation and NHTSA's SDS of six states in the USA during 1996-2010. It was proven that crash and injury rates increase during rainfall between May and September, and the crash risk of crashes and injuries also rise. Both studies showed that it is hard to explain all the relative risk of crashes due to the high precipitation through only meteorological factors according to various spatial patterns or cities.

From a different angle, there have been efforts to assess or predict real-time crash risk using archived weather data observed at airports' weather stations. Abdel-Aty and Pemmanaboina (2006) developed a real-time crash prediction model related to rainfall for the 36-mile freeway section on I-4 in Central Florida through weather data from three airports. Moreover, Ahmed et al. (2014) assessed the viability of airport weather data in real-time road crash risk assessment using eight airports in the fog-prone area of Florida. Nevertheless, they did not investigate the feasibility of weather stations' data at the national level.

4.3 Data Preparation

Three data sources were used for the nationwide weather data analysis: 1) weather data from the hourly QCLCD (May 2007 to December 2014) (NCEI, 2017), 2) fatal crashes from NHTSA's FARS (2007 to 2014) (NHTSA, 2014), and 3) AADT from the Highway Performance Monitoring System (HPMS) (2011 to 2012) (FHWA, 2014).

4.3.1 Nationwide QCLCD

Related to surface weather information, NOAA's National Centers for Environmental Information (NCEI) provides enormous weather observation data including Local Climatological Data (LCD), Climatological Data (CD), Hourly Precipitation Data (HPD), Storm Data (SD), COOP data and so on, which are observed from land-based stations. In the previous studies, Eisenberg (2004), and Eisenberg and Warner (2005) utilized COOP data for monthly and daily precipitation. Pisano et al. (2008) applied CD for mean total precipitation and snowfall. Rossetti and Johnsen (2011), Ashley et al. (2015), and Black and Mote (2015a) used CD and SD for their weather-related crash analysis. Abdel-Aty and Pemmanaboina (2006) used hourly rainfall data from NOAA. Also, Ahmed et al. (2014) employed QCLCD (NCEI, 2016) to match weather conditions observed at airports with the recorded weather-related crashes.

QCLCD is suitable for this study because it includes both categorical data and numerical data related to all kinds of weather conditions every hour and whenever a weather-change event occurs, whereas other weather data sources do not have direct categorical data for weather conditions.

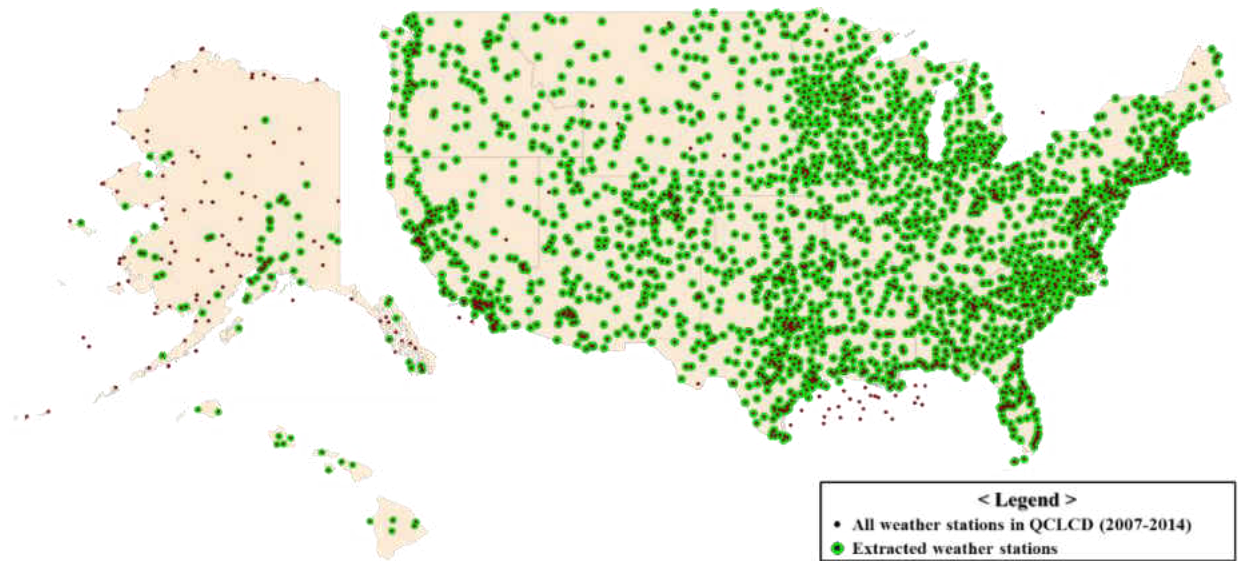

Figure 13. Locations of weather stations in the USA

QCLCD on the NOAA’s official website were archived from 2,466 weather stations operated between May 2007 and December 2014, and the number of observations is more than 3.3 billion counts (Figure 13). The weather stations include many types of land-based weather stations: AWOS (Automated Weather Observing System), MAPSO (Microcomputer-Aided Paperless Surface Observations), Navy METAR (METeorological Aerodrome Report), ASOS (Automated Surface Observing System), CRN (Climate Reference Network) and so on. Data from 2,271 weather stations, which had fatal crashes within the radius of 20 miles from weather stations, were extracted.

QCLCD’s hourly observations with variables include categorical variables such as weather types as well as numerical variables such as precipitation, visibility, and wind speed. In this study, only three variables, which are the date, time, and weather-type, were used to compare with the weather-type variable of fatal crashes in the FARS database. All date and time were converted to coordinated universal time (UTC) to identify the criteria of comparing time.

4.3.2 Nationwide fatal crashes

This study amassed the nationwide fatal crashes of 2007-2014 from the FARS. Weather types of FARS during 2010-2014 were also grouped according to the classification criteria of 2007-2009 (NHTSA, 2015) (for consistency as criteria changed after 2009): Clear/Cloud, Rain/Sleet/Hail, Snow or Blowing Snow, Fog/Smog/Smoke, Severe Crosswinds, and Blowing Sand/Soil/Dirt. According to the frequency analysis of weather-related fatal crashes (see Table 6), most weather-related fatal crashes, approximately 98%, took place in rain, snow, and fog weather conditions and accounted for on average 11% of all fatal crashes. The proportions of fatal crashes regarding severe crosswinds and blowing sand/soil/dirt are minuscule and even are smaller than total cases of other, not reported, or unknown fatal crashes. Thus, we focused on rain-, snow-, and fog-related fatal crashes.

Table 6. Weather-related fatal crashes by year (2007-2014)

Weather Type \ Year	2007	2008	2009	2010	2011	2012	2013	2014	Mean
Clear/Cloud	32,281	29,519	26,759	26,576	26,098	27,366	26,256	26,356	27,651
Rain/Sleet/Hail	2,459	2,596	2,495	2,067	2,132	2,092	2,234	2,140	2,277
Snow or Blowing Snow	639	624	467	567	462	359	506	491	514
Fog/Smog/Smoke	408	408	303	293	325	364	372	318	349
Severe Crosswinds	74	55	46	41	49	55	51	47	52
Blowing Sand/Soil/Dirt	13	10	12	10	8	12	7	13	11
Other/Unknown	201	179	200	171	186	197	217	242	199
Total Fatal Crashes	36,075	33,391	30,282	29,725	29,260	30,445	29,643	29,607	31,054
Weather-related fatal crashes ratio (%)	10.5	11.6	11.6	10.6	10.8	10.1	11.4	11.0	11.0
Ratio of rain, snow, and fog among weather-related fatal crashes (%)	97.6	98.2	98.3	98.3	98.1	97.7	98.2	98.0	98.0

4.3.3 Nationwide AADT of the Highway Performance Monitoring System (HPMS)

National data sets of HPMS's AADT data were collected from the Federal Highway Administration. Although officially the national data sets are open from 2011 to 2014, unfortunately, the national data sets in 2013 and 2014 had technical errors and could not be used in this study. The national data set is based on national highway system (NHS) composed of important roadways for the nation's economy, defense, and mobility: interstate highways, other principal arterials, strategic highway network, major strategic highway network connectors, and intermodal connectors. Thus, the NHS does not include all kinds of roadways. For example, all state highways or local roads are not allocated in the NHS.

Different from VMT for each state-year of the previous study (Eisenberg, 2004), this study estimated more specific VMT by using AADT and segment length of highways within the specific radius, e.g. 5 miles, from weather stations, that makes possible the weather-station-based analysis.

4.3.4 Grouping of weather types of QCLCD and FARS data

The weather classification of QCLCD and FARS is different since the QCLCD aims to provide various stakeholders with more accurate and detail weather information and FARS purpose to record the more simplified weather types for situation explanation of road traffic crashes. Thus, this study reclassified weather types of the QCLCD and FARS to build contingency tables according to several coverage radii. Through the FARS data preparation, it was confirmed that average 98% of all weather-related fatal crashes occurred under the three major weather conditions: rain, snow, and fog (see Table 6). Based on the majority of weather types related to fatal crashes, all weather types of the QCLCD and FARS data were grouped into new weather classification: clear/cloud, rain, snow, fog, and others (see Table 7).

Table 7. Reclassification of weather types of QCLCD and FARS data

New Classification	Weather types of QCLCD	Weather types of FARS
Clear/Cloud	Null values	Clear/Cloud
Rain	Rain, Unknown Precipitation, Hail, Drizzle, Small Hail &/OR Snow Pellets, Spray, Squall, and Shower	Rain/Sleet/Hail
Snow	Snow, Blowing Snow, and Grains	Snow or Blowing Snow
Fog	Fog or Heavy Fog, Mist, Haze, and Smoke	Fog, Smog, Smoke
Others	Widespread Dust, Dust Storm, Sand/Dust Whirls, Sand, and Sandstorm, Funnel Cloud, Thunderstorm, Ice Pellets, Freezing, Shallow, Partial, Patches, Blowing and so on	Severe Crosswinds, Blowing Sand/Soil/Dirt, Other/Unknown

4.4 Regional Characteristics of Weather and Weather-related Fatal Crashes



Figure 14. USA Climate Regions

Cumulative observation duration of rain, snow, and fog were aggregated based on nine climate regions, which were classified by Karl and Koss (1984) to envisage regional characteristics.

The nine climate regions are used to analyze the regional applicability of QCLCD through the negative binomial regression model. The nine climate regions are (see Figure 14):

- Central: Illinois, Indiana, Kentucky, Missouri, Ohio, Tennessee, and West Virginia
- East North Central: Iowa, Michigan, Minnesota, and Wisconsin
- Northeast: Connecticut, Delaware, Maine, Maryland, Massachusetts, New Hampshire, New Jersey, New York, Pennsylvania, Rhode Island, and Vermont
- Northwest: Idaho, Oregon, and Washington
- South: Arkansas, Kansas, Louisiana, Mississippi, Oklahoma, and Texas
- Southeast: Alabama, Florida, Georgia, North Carolina, South Carolina, and Virginia
- Southwest: Arizona, Colorado, New Mexico, and Utah
- West: California, and Nevada
- West North Central: Montana, Nebraska, North Dakota, South Dakota and Wyoming

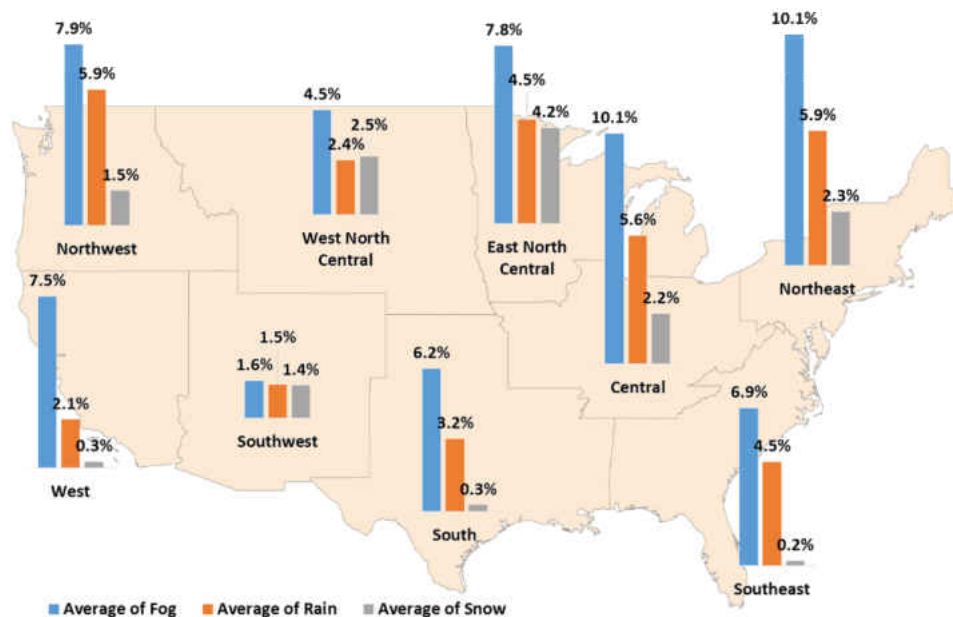

Figure 15. Annual average percentages of observation duration of rain, snow, and fog (2008-2014)

According to the QCLCD, annual average cumulative observation duration of fog (based on total minutes in a year) is longer than rain and snow regardless of climate regions. Also, as expected, there are little snowfall records in West, South, and Southeast (Figure 15).

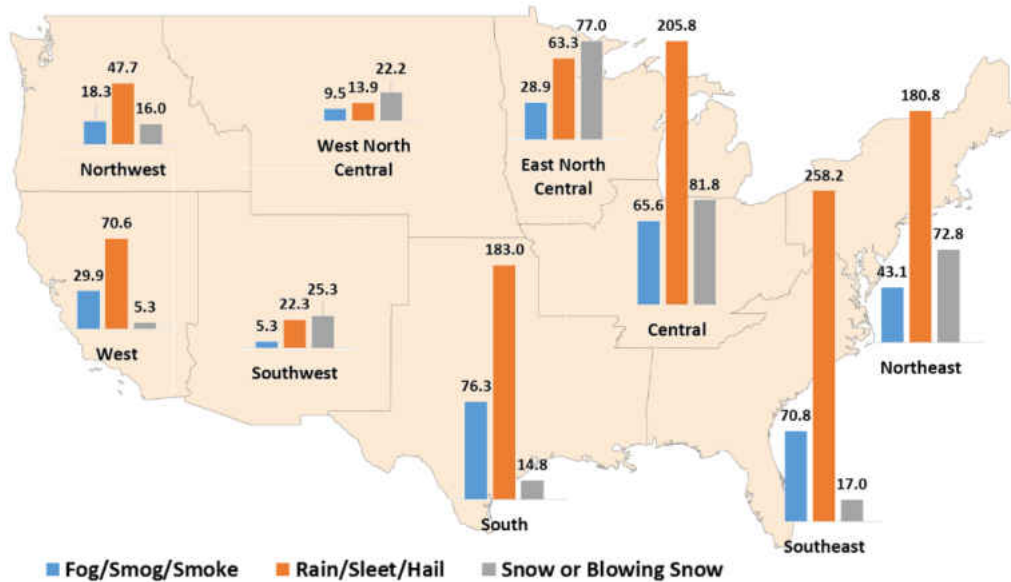

Figure 16. Annual average fatal crash frequency under rain, snow, and fog by climate region (2007-2014)

In addition, the nationwide weather-related crashes have regional features as displayed in Figure 16. Many weather-related fatal crashes occur in the Central, Southeast, Northeast, South, and East North Central region. Looking more specifically, East North Central, Central, and Northeast have high frequency regarding snow-related fatal crashes. Nationally, rain-related fatal crashes account for high ratio among total fatal crashes. Although fog observation duration is the highest, its effect on fatal crashes is second or third based on the region. The frequency of fog-related fatal crashes is low in West North Central, and Southwest because of their meteorological characteristics.

4.5 Viability of QCLCD for Traffic Safety Evaluation

Recently, a Florida DOT (FDOT) study considered how to provide visibility-related weather information to drivers through weather stations at airports in Florida as well as a development of new visibility sensors to predict visibility conditions. Related to this research, Ahmed et al. (2014) conducted a feasibility analysis. It proved that weather stations at airports could be used to assess real-time visibility-related crash risk. However, the project had several limitations that the scope was limited to Florida where only eight weather stations were used to calculate the sensitivity for validation of visibility-related weather conditions.

Through the extension of regional scope and weather types, this study analyzed the overall validity and reliability of QCLCD. The analysis area was extended from Florida to the whole USA, and weather types were classified as rain, snow as well as fog. Validity and reliability of systems including classification results can be evaluated through sensitivity, specificity, positive predictive value (PPV), negative predictive value (NPV) and Cohen's Kappa using contingency tables by weather types and several coverage ranges (from 5 to 20 miles). The measures are the most regularly used descriptive statistics to evaluate the performance of classification results in clinical fields developing medical surveillance systems. Several projects related to road and traffic engineering used them to evaluate the performance of newly developed sensor systems (Wang and Gong, 2007, Stephan et al., 2006). According to Table 8, the statistics are defined and calculated:

- True Positive (TP): the number of correctly matched adverse weather conditions in QCLCD and FARS
- True Negative (TN): the number of correctly matched no adverse weather conditions
- False Positive (FP): the number of incorrectly matched adverse weather conditions, which implies false alarms (Type I error) in the case of forecasting systems.

- False Negative (FN): the number of incorrectly matched no adverse weather conditions, which implies missing events (Type II error).
- Sensitivity: the proportion of true (FARS') adverse weather conditions classified by QCLCD ($TP/(TP+FN)$), which indicates the ability of weather stations to screen a weather condition correctly as adverse weather conditions.
- Specificity: the proportion of true non-adverse weather conditions classified by QCLCD ($TN/(TN+FP)$), which indicates the ability of weather stations to screen a weather condition correctly as non-adverse weather conditions.
- PPV: the proportion of true adverse weather conditions among observed adverse weather conditions of QCLCD (e.g. false alarm rates in detection systems)
- NPV: the proportion of true non-adverse weather conditions among observed non-adverse weather conditions of QCLCD
- Kappa: the measurement of observer agreement for categorical data which can be used as a measure of the reliability of multiple determinations on the same subjects (Sim and Wright, 2005). Landis and Koch (1977) have suggested the following as criteria for the strength of agreement as the kappa statistics: <0.00=poor, 0.00-0.20=slight, 0.21-0.40=fair, 0.41-0.60=moderate, 0.61-0.80=substantial, and 0.81-1.00=almost perfect. The kappa can be estimated as follows:

$$\kappa = \frac{\text{observed agreement} - \text{chance agreement}}{1 - \text{chance agreement}} = \frac{P_o - P_c}{1 - P_c}$$

$$\text{where, } P_o = \text{Accuracy} = \frac{TP+TN}{TP+FN+FP+TN}$$

$$P_c = \frac{(TP+FP)(TP+FN)+(FN+TN)(FP+TN)}{(TP+FN+FP+TN)^2}$$

Table 8. 2x2 contingency table and statistical measurements

FARS \ QCLCD		Observed Condition		Statistical measures
		Adverse weather conditions	No adverse weather conditions	
True Condition	Adverse weather conditions	True Positive (TP)	False Negative (FN)	Sensitivity $TP/(TP+FN)$
	No adverse weather conditions	False Positive (FP)	True Negative (TN)	Specificity $TN/(TN+FP)$
Statistical measures		PPV: $TP/(TP+FP)$	NPV: $TN/(FN+TN)$	Accuracy: $\frac{TP + TN}{TP + FN + FP + TN}$

Contingency tables (Table 8) and overall measures such as sensitivity, PPV and kappa were made and calculated for each radius, 5, 10, 15, and 20 miles from the weather station (Figure 17). Each contingency table represents a combination of weather conditions between fatal crashes and QCLCD. Moreover, the contingency tables were formulated in several 2x2 contingency tables based on the adverse weather condition including rain, snow, and fog.

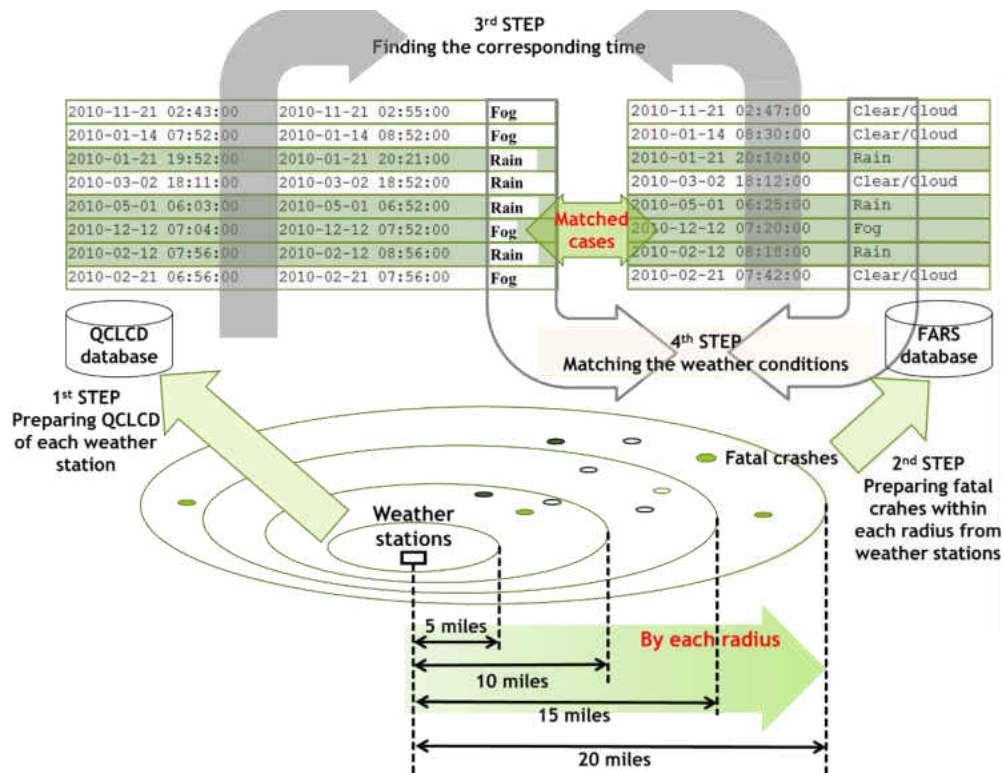

Figure 17. Method of matching time and weather conditions between FARS and QCLCD

Table 9 includes results of the overall statistics of the contingency tables. According to Cohen's kappa, 0.418, 0.426, 0.438, and 0.445, the reliability of QCLCD corresponds to the moderate agreement (0.41-0.60) regardless of radius, 5, 10, 15, and 20 miles. Although the best kappa value is 0.445 in the 5-miles radius, it is acceptable to utilize QCLCD within 20-miles radius from the weather stations. The total accuracy is too high (about 88%) because of the prevalence of the clear/cloudy weather conditions. It also shows that the sensitivity is high in the order of fog, snow, and then rain. Whereas, the PPV is less than 50%, and is high in the sequence of rain, snow, and then fog. It is surprising that the PPV of fog is extremely low, about 9%, except for others, which means QCLCD has the good validity to distinguish 60-67% real fog weather, but it has the low reliability related to fog because about 91% of fog events can be false.

Table 9. Contingency tables for matching QCLCD and FARS weather data by coverage (May 2007 to Dec 2014)

Within 5 miles from weather stations (Kappa=0.445 [0.435-0.456] at 95% confidence)							
FARS \ QCLCD	Clear/Cloud	Rain	Snow	Fog	Others	Total	Sensitivity
Clear/Cloud	48,707	786	125	2,438	133	52,189	93.33%
Rain	1,646	2,057	45	344	42	4,134	49.76%
Snow	217	28	366	32	-	643	56.92%
Fog	121	18	5	299	-	443	67.49%
Others	341	28	9	35	2	415	0.48%
Total	51,032	2,917	550	3,148	177	57,824	n/a
PPV	95.44%	70.52%	66.55%	9.50%	1.13%	Accuracy = 88.94%	
Within 10 miles from weather stations (Kappa=0.438 [0.432-0.444] at 95% confidence)							
FARS \ QCLCD	Clear/Cloud	Rain	Snow	Fog	Others	Total	Sensitivity
Clear/Cloud	147,895	2,363	363	7,623	379	158,623	93.24%
Rain	5,060	6,145	127	1,074	129	12,535	49.02%
Snow	643	106	1,108	91	-	1,948	56.88%
Fog	448	45	7	910	-	1,410	64.54%
Others	1,093	86	24	98	10	1,311	0.76%
Total	155,139	8,745	1,629	9,796	518	175,827	n/a
PPV	95.33%	70.27%	68.02%	9.29%	1.93%	Accuracy = 88.76%	
Within 15 miles from weather stations (Kappa=0.426 [0.422-0.431] at 95% confidence)							
FARS \ QCLCD	Clear/Cloud	Rain	Snow	Fog	Others	Total	Sensitivity
Clear/Cloud	267,663	4,310	715	13,970	675	287,333	93.15%
Rain	9,471	10,811	263	1,945	232	22,722	47.58%
Snow	1,179	189	2,002	170	-	3,540	56.55%
Fog	902	92	11	1,624	1	2,630	61.75%
Others	2,123	155	35	166	17	2,496	0.68%
Total	281,338	15,557	3,026	17,875	925	318,721	n/a
PPV	95.14%	69.49%	66.16%	9.09%	1.84%	Accuracy = 88.52%	
Within 20 miles from weather stations (Kappa=0.418 [0.414-0.422] at 95% confidence)							
FARS \ QCLCD	Clear/Cloud	Rain	Snow	Fog	Others	Total	Sensitivity
Clear/Cloud	400,712	6,586	1,100	21,361	977	430,736	93.03%
Rain	14,654	15,930	405	2,975	356	34,320	46.42%
Snow	1,876	288	3,024	264	-	5,452	55.47%
Fog	1,490	146	15	2,524	1	4,176	60.44%
Others	3,161	226	51	253	25	3,716	0.67%
Total	421,893	23,176	4,595	27,377	1,359	478,400	n/a
PPV	94.98%	68.73%	65.81%	9.22%	1.84%	Accuracy = 88.26%	

To be specific, the more detailed statistics from the 2×2 contingency tables between FARS data and QCLCD were also analyzed regarding particular rain, snow, and fog according to ranges from weather stations (Table 10). Specificity, NPV, and Accuracy are extremely high because of the extreme prevalence of non-adverse weather conditions. According to kappa related to the

reliability, rain and snow are equivalent in the value range of moderate association, but fog corresponds in the range of the slight agreement. The low reliability of fog was confirmed through the sensitivity and the PPV. Therefore, it is expected that fog-related data from weather stations would have many false alarms.

Table 10. Detail statistics between QCLCD and FARS data by weather types and ranges

Range (Miles)	Weather Type	Statistics (95% confidence interval)					
		Sensitivity (%)	Specificity (%)	PPV (%)	NPV (%)	Accuracy (%)	Kappa
5	Rain	49.76% (48.23, 51.28)	98.40% (98.29, 98.50)	70.52% (68.86, 72.17)	96.22% (96.06, 96.38)	94.92% (94.74, 95.10)	0.56
	Snow	56.92% (53.09, 60.75)	99.68% (99.63, 99.72)	66.55% (62.60, 70.49)	99.52% (99.46, 99.57)	99.20% (99.13, 99.28)	0.61
	Fog	67.49% (63.13, 71.86)	95.03% (94.86, 95.21)	9.50% (8.47, 10.52)	99.74% (99.69, 99.78)	94.82% (94.64, 95.00)	0.16
10	Rain	49.02% (48.15, 49.90)	98.41% (98.35, 98.47)	70.27% (69.31, 71.23)	96.18% (96.08, 96.27)	94.89% (94.78, 94.99)	0.55
	Snow	56.88% (54.68, 59.08)	99.70% (99.67, 99.73)	68.02% (65.75, 70.28)	99.52% (99.49, 99.55)	99.23% (99.18, 99.27)	0.62
	Fog	64.54% (62.04, 67.04)	94.91% (94.80, 95.01)	9.29% (8.71, 9.86)	99.70% (99.67, 99.73)	94.66% (94.56, 94.77)	0.15
15	Rain	47.58% (46.93, 48.23)	98.40% (98.35, 98.44)	69.49% (68.77, 70.22)	96.07% (96.00, 96.14)	94.77% (94.70, 94.85)	0.54
	Snow	56.55% (54.92, 58.19)	99.68% (99.66, 99.69)	66.16% (64.47, 67.85)	99.51% (99.49, 99.54)	99.20% (99.17, 99.23)	0.61
	Fog	61.75% (59.89, 63.61)	94.86% (94.78, 94.94)	9.09% (8.66, 9.51)	99.67% (99.64, 99.69)	94.59% (94.51, 94.66)	0.15
20	Rain	46.42% (45.89, 46.94)	98.37% (98.33, 98.410)	68.73% (68.14, 69.33)	95.96% (95.90, 96.02)	94.64% (94.58, 94.71)	0.53
	Snow	55.47% (54.15, 56.79)	99.67% (99.65, 99.68)	65.81% (64.44, 67.18)	99.49% (99.47, 99.51)	99.16% (99.14, 99.19)	0.60
	Fog	60.44% (58.96, 61.92)	94.76% (94.70, 94.82)	9.22% (8.88, 9.56)	99.63% (99.62, 99.65)	94.46% (94.39, 94.52)	0.15

Figure 18 shows the regional analysis of overall adverse weather conditions. Weather stations in the southwest region have the lowest sensitivity less than 40%, and West region has low PPV less than 30%. Regarding rain weather conditions, the Southwest region has low sensitivity and PPV, and northwest region has higher sensitivity than other areas. Climate regions

with low sensitivity related to snow weather conditions are northwest, south, southwest, southeast, and west, which have low snowfall records. Fog-related sensitivity shows that there are big differences between sensitivity and PPV in all regions, especially, the Southeast region.

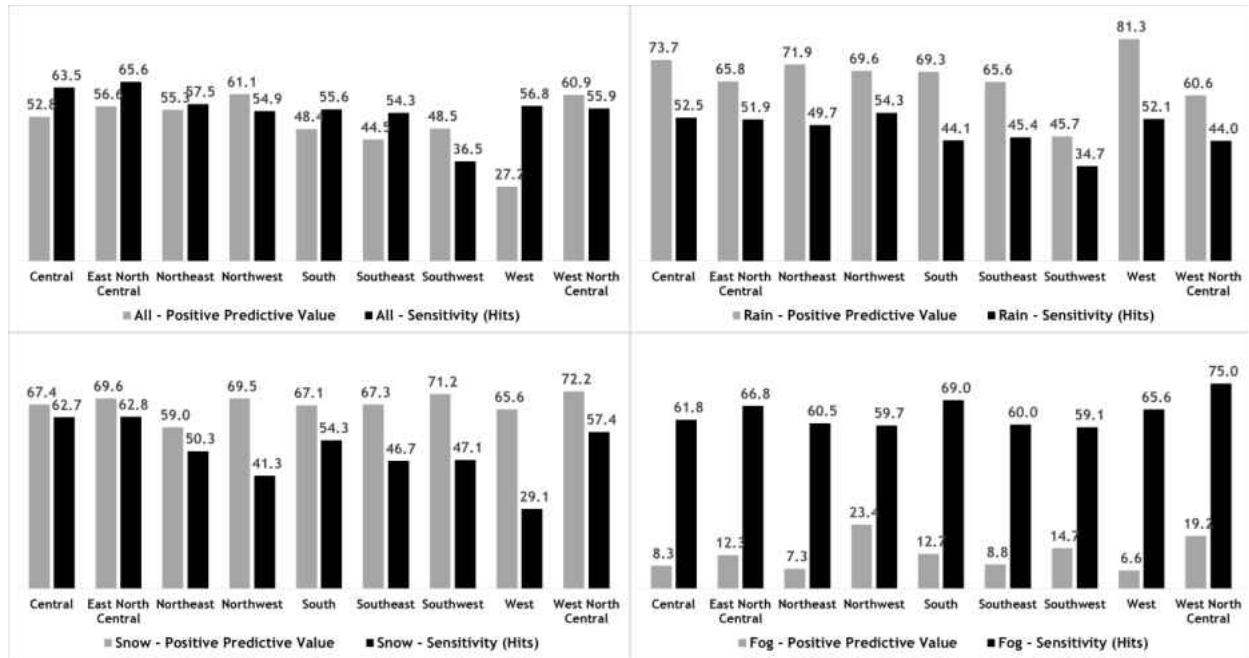

Figure 18. Regional Sensitivity and Positive Predictive Value (PPV) by weather conditions

4.6 Model Development to Estimate Weather-related Fatal Crashes

To analyze of the regional applicability of QCLCD, the negative binomial regression model was used. The negative binomial modeling method is extended from the Poisson regression to overcome the possible over-dispersion and thus commonly employed in the crash-frequency analysis (Lord and Mannering, 2010). Poisson regression models have been adopted in traffic safety analysis since they can handle non-negative integer crash frequency data. The over-dispersion is a phenomenon when the crash count variance is larger than the mean. The expected fatal crash count is specified as follows:

$$\ln \lambda_i = \beta x_i + \varepsilon_i$$

where λ_{ij} is the Poisson mean indicating the expected fatal crash counts for a given observation within the specific radius from weather station i ; x_i is the explanatory variables within the buffer of weather station i in region j ; ε_i is the error term, where $\exp(\varepsilon_i)$ follows a gamma distribution with mean one and variance α . The x_i includes the natural log of VMT and annual total duration related to clear/cloud, rain, snow, and fog in terms of each weather station i .

In this study, two kinds of models were developed. The first type of models relates total fatal crashes under specific weather conditions to the annual total length of the corresponding weather as follows:

$$\ln\lambda_i = \beta_0 + \beta_1 \ln(VMT_i * Duration_i)$$

The first model aims to verify general tendency that the increase of VMT during specific weather duration will increase fatal crashes related to the specific weather. This can be checked via whether the β_1 coefficients are statistically positive significant. The second type of models investigates the relationship between annual total fatal crashes and duration of each weather condition as follows:

$$\ln\lambda_i = \beta_0 + \beta_1 \ln VMT_i + \beta_2 Rain_i + \beta_3 Snow_i + \beta_4 Fog_i$$

where *Rain, Snow, and Fog* are the annual total duration of each weather condition. The second model will provide whether there is a different regional impact of weather on fatal crashes through the statistical significance of the coefficient of weather-related duration variables.

The results of the first model revealed a general tendency of the increased fatal crash risk due to larger VMT during each weather condition (Table 11). For most regions, the increase of VMT during specific weather duration has a significant positive relationship with weather-related

fatal crashes. However, the West North Central Region has no evidence of the positive relationship related to rain and snow at 90% confidence level, and the Northeast Region has no evidence of the positive relationship related to fog at 95% confidence level. This result also confirms the feasibility of the QCLCD for use in traffic safety analysis as the sensitivity and positive predicted values are verified in the previous section.

Table 11. Negative binomial model of regional annual fatal crash frequency by each weather condition including clear and cloud

Climate Region	Variable	Clear/Cloud		Rain		Snow		Fog	
		Coefficient	p-value	Coefficient	p-value	Coefficient	p-value	Coefficient	p-value
Central	Intercept	-5.1631	<.0001	0.6860	0.0043	-2.0451	0.0005	-1.2887	0.0041
	ln (VMT*D)	0.4633	<.0001	0.07498	<.0001	0.1582	<.0001	0.06719	0.0101
	α	0.2868		0.8528		0.4676	0.0055	0.000049	
East North Central	Intercept	-9.5490	<.0001	-1.7720	<.0001	-1.8041	<.0001	-3.2652	<.0001
	ln (VMT*D)	0.6513	<.0001	0.1636	<.0001	0.1347	<.0001	0.1541	0.0012
	α	0.3717		1.8544		0.6683		0.6577	
North-east	Intercept	-4.9785	<.0001	1.5238	<.0001	0.002112	0.9908	-0.6333	0.0089
	ln (VMT*D)	0.4663	<.0001	0.05913	<.0001	0.03381	0.0064	#0.02586	0.0769
	α	0.6212		0.9290		0.3844		0.3726	
North-west	Intercept	-9.1769	<.0001	0.3731	0.2754	-1.7548	0.0037	-1.6099	0.0035
	ln (VMT*D)	0.6273	<.0001	0.06815	0.0014	0.08459	0.0422	0.06932	0.0400
	α	0.4152		1.9388		1.996E-7		0.2244	
South	Intercept	-8.0777	<.0001	0.2673	0.1539	-3.6732	<.0001	-1.5394	<.0001
	ln (VMT*D)	0.6084	<.0001	0.06623	<.0001	0.1526	0.0200	0.06508	0.0025
	α	0.4152		1.2223		1.1733		1.4359	
South-east	Intercept	-4.9149	<.0001	0.8522	<.0001	-5.2586	<.0001	-1.3640	<.0001
	ln (VMT*D)	0.4611	<.0001	0.06573	<.0001	0.2379	0.0021	0.07869	<.0001
	α	0.4769		0.6116		2.4132		0.2949	
South-west	Intercept	-7.3319	<.0001	-1.1484	0.0012	-2.4865	<.0001	-12.1799	<.0001
	ln (VMT*D)	0.5706	<.0001	0.08783	0.0009	0.1470	<.0001	0.6636	<.0001
	α	1.0355		3.4204	<.0001	1.5607		3.333E-6	
West	Intercept	-6.3014	<.0001	0.01858	0.9562	-4.1764	<.0001	-6.1521	<.0001
	ln (VMT*D)	0.5411	<.0001	0.1198	<.0001	0.2034	0.0016	0.3724	<.0001
	α	0.8809		1.7348		1.8565		0.1770	
West North Central	Intercept	-9.6524	<.0001	-1.5738	0.0054	-1.2109	0.0144	-7.8874	<.0001
	ln (VMT*D)	0.6329	<.0001	##0.04819	0.2292	##0.008660	0.8128	0.3913	<.0001
	α	0.3489		0.9159		1.3443	0.1191	1.011E-7	

Note:
D means the average annual duration of each weather condition.
indicates that the variable is not significant at 10% level.
indicates that the variable is significant only at 10% level, and all other variables are significant at 5% level.

Table 12 presents the second negative binomial modeling results for inclement weather including rain, snow, and fog, which shows the impact of the adverse weather conditions on the

number of total fatal crashes by region. The variables with no coefficient indicate insignificant impact on the total fatal crashes in the corresponding region.

The results in Table 12 show that there are no meaningful weather effects on fatal crashes in the Central region. The rain weather has a significant positive relationship with fatal crashes in the East North Central, Northeast, Northwest, South, and West North Central in contrast with the West region. The snow weather has a significant negative relationship with fatal crashes in the East North Central, Northeast, Southeast, West, and West North Central regions. While the fog weather has no significant association with fatal crashes in most regions, it has a significant negative relationship with regional fatal crashes in the Northwest and Southwest, and it has a significant positive correlation in the West at 90% significance level.

Table 12. Regional relationship between total fatal crashes and duration of adverse weather type

	Central		East North Central		Northeast	
Variables	Coefficient	p-value	Coefficient	p-value	Coefficient	p-value
Intercept	-4.4562	<.0001	-8.0054	<.0001	-4.0116	<.0001
ln (VMT)	0.4404	<.0001	0.5705	<.0001	0.4244	<.0001
% of rain duration	-	-	0.02770	<.0001	0.009015	0.0018
% of snow duration	-	-	-0.02439	<.0001	-0.03060	<.0001
% of fog duration	-	-	-	-	-	-
α	0.3191		0.2561		0.3966	
	Northwest		South		Southeast	
Variables	Coefficient	p-value	Coefficient	p-value	Coefficient	p-value
Intercept	-8.3583	<.0001	-7.7137	<.0001	-4.3752	<.0001
ln (VMT)	0.5920	<.0001	0.5950	<.0001	0.4496	<.0001
% of rain duration	0.00776	0.0022	0.01028	0.0074	-	-
% of snow duration	-	-	-0.08391	<.0001	-0.07796	<.0001
% of fog duration	-0.00412	0.0207	-	-	-	-
α	0.3280	<.0001	0.3936	<.0001	0.3930	<.0001
	Southwest		West		West North Central	
Variables	Coefficient	p-value	Coefficient	p-value	Coefficient	p-value
Intercept	-7.3920	0.7422	-6.1194	<.0001	-10.0059	<.0001
ln (VMT)	0.5902	0.04040	0.5503	<.0001	0.6546	<.0001
% of rain duration	-	-	-0.02573	<.0001	0.03622	<.0001
% of snow duration	-	-	-0.03812	<.0001	-0.02722	0.0009
% of fog duration	-0.02535	0.00690	0.00352	0.0609	-	-
α	0.9055	<.0001	0.6420	<.0001	0.2745	<.0001

4.7 Discussion and Conclusions

This study investigated the possibility of using the Quality Controlled Local Climatological Data (QCLCD), which are collected from land-based weather stations, in safety and operation. Two types of analysis were used: categorical data analysis and negative binomial modeling. The QCLCD include quality-controlled weather data as a form of categorical data, which can be compared with FARS' weather data directly. The comparison was conducted under the assumption that there are no weather changes during a weather-reporting interval of QCLCD and no recording-errors due to weather variation between the occurrence time of crashes and the arrival time of police officials.

Using the prepared fatal crash data from the FARS and the QCLCD, regional characteristics were reviewed as the first step. According to the annual average total duration of three typical types of adverse weather (i.e., rain, snow, and fog), the durations are higher in the order of fog, rain, and then snow. Fatal crashes are more frequent in the sequence of rain, snow, and then fog. It is confirmed that many of weather-related fatal crashes are connected to rain weather conditions and occurred in the Central, Southeast, Northeast, South, and East North Central regions. This finding is coherent with one of the previous studies by Pisano et al. (2008). The percentage of snow-related fatal crashes is the highest in the Central, East North Central, and Northeast. On the other hand, the percentage of fog-related fatal crashes is the highest in the Southeast, South, and West regions.

The reliability of the QCLCD was validated according to a range of coverage (i.e., 5, 10, 15, and 20 miles) of weather stations by using sensitivity, positive predictive value (PPV), and Cohen's Kappa. The results show that the difference in sensitivity, PPV, and Cohen's Kappa by ranges and weather type is negligible. The sensitivities of rain, snow, and fog weather conditions

are 46-50%, 56-57%, and 60-68%, respectively, that means QCLCD has the validity to distinguish real rain, snow, and fog. Also, the positive predictive values of those are 69-71%, 66-68%, and 9-10%, correspondingly. This means the reliability of fog data from QCLCD is low. These results were also confirmed through Cohen's Kappa. According to the Cohen's kappa values, which were analyzed through a contingency table that comprehensively considers all weather types, QCLCD has a moderate agreement with FARS up to a radius of 20 miles. However, when rain, snow, and fog were analyzed individually, the rain and snow showed a similar moderate agreement as the comprehensive analysis, but the fog showed a slight agreement result from 5 to 20 miles. It is possible that the slight agreement was attributed to the unique characteristics of fog, which has a wide variety of temporal and spatial variations. Although the weather stations' data in Florida were sufficiently accurate for fog-related crashes as shown in the previous study (Ahmed et al., 2014), it should be cautiously used since it provides excessive false alarms.

The first type of negative binomial models confirmed that VMT under the duration of each weather condition of QCLCD has a significant positive relationship with the number of fatal crashes of each weather condition. The second type of negative binomial modeling results revealed the different effects of vehicle-mile-traveled under the particular adverse weather type on the number of annual fatal crashes by region. The effect of annual total duration of rain has different effects on fatal crash occurrence by region, which is similar to previous studies (Brodsky and Hakkert, 1988, Eisenberg, 2004, Fridstrøm et al., 1995). Though the rain conditions increase the number of fatal crashes in East North Central, Northeast, Northwest, South, and West North Central, it is not significant in the Central, Southeast, and Southwest regions. Conversely, it is shown that the rain conditions decrease the number of fatal crashes in the West region. Additionally, similar to prior research (Eisenberg, 2004, Eisenberg and Warner, 2005, Fridstrøm

et al., 1995), snow weather conditions decrease fatal crash counts in 6 regions whereas the number of fatal crashes in Central, Northwest, and Southwest are not significantly affected by snow weather. Finally, fog weather conditions have no evidence to impact fatal crash occurrence in six regions. In contrast, fog conditions decrease the number of fatal crashes in the Northwest and Southwest and increase the fatal crash counts in the West.

In conclusion, this study revealed it via Cohen's Kappa that land-based weather stations in the USA have a moderate agreement at 95% confidence until 20-miles radius of the weather stations when all weather types were analyzed, although the fog conditions from the QCLCD may have a weakness that the positive predictive value is very low, and Cohen's Kappa corresponds to slight agreement. In addition, this study proved that there are regional differences in the relationship between the weather conditions and the fatal crash occurrence. Thus, it is advised that localized surface traffic management policies and strategies for road safety should be established with a consideration of regional climate features.

Considering that about 75% of fatal crashes had occurred within 20-miles radius of land-based weather stations, the existing weather stations for weather observation could be utilized more effectively. Based on the effective coverage of the weather station, location suitability of weather stations could be considered and various weather-related traffic models can be developed and analyzed for proactive traffic safety and operation. Obviously, it will be more cost-effective to develop geospatial crash risk models based on the historical data of the legacy weather stations. Furthermore, if the weather stations can disseminate weather data in real time through wireless communication technologies, various reliable weather-related applications can be derived in terms of cooperative intelligent transport systems, connected vehicles, and the internet of things (IoT).

This research used only FARS data for the evaluation of QCLCD. Additionally, other datasets such as General Estimates System (GES) of National Automotive Sampling System (NASS) and State Data System (SDS) including injury and PDO (Property Damage Only) data can be applied more to identify the effective coverage of the QCLCD. Except for the QCLCD archived from land-based stations, NOAA is operating the Next Generation Weather Radar (NEXRAD) on the land to collect precipitation information (Heiss et al., 1990). The estimated precipitation data of the NEXRAD were utilized as an alternative approach to analyzing the impact of precipitation on traffic crashes (Dai, 2011, Jaroszweski and McNamara, 2014). Thus, the quality of precipitation condition derived from the NEXRAD can be evaluated through Cohen's Kappa statistics on the basis of weather conditions of crash reports. Furthermore, other land-based weather stations of non-NOAA providers are monitoring weather and the data is merged in Meteorological Assimilation Data Ingest System (MADIS) (Miller et al., 2005). Likewise, the weather data archived in the MADIS can also be assessed in the comparison with the weather conditions of crash report data.

CHAPTER 5. METHOD FOR ESTIMATING VEHICLE-TO-VEHICLE TRAVEL TIME VARIABILITY MODELS AT THE LINK AND NETWORK LEVELS OF FREEWAYS/EXPRESSWAYS

In this chapter, a method was proposed to estimate vehicle-to-vehicle travel time variability (TTV) at the link and network levels of the entire freeway network. Standard deviation (SD) of travel time rate (TTR) was selected for the TTV. Models estimating the TTV were developed through a Tobit model using a left-censored limit. For the analysis of impact factors on TTV including day-to-day, the model included various types of variables: density, occupancy, traffic flow, link lengths, lane count, speed limits, rainfall amount, crash indicator, weekend indicator, and holiday indicator. According to the exploration and modeling results, TTR and its SD (vehicle-to-vehicle and day-to-day) have a statistical positive significant relationship at the link and network levels. Furthermore, it was confirmed that there is Network Fundamental Diagram (NFD) at the network level. According to the modeling results, the increase in the number of lanes and speed limits, and crash occurrence raise vehicle-to-vehicle and day-to-day TTV. Whereas, TTV decreases if the link length is long. The high rainfall amount would reduce vehicle-to-vehicle TTV, but raise day-to-day TTV. Weekends and Holidays increase vehicle-to-vehicle TTV but diminish day-to-day TTV. Finally, a linear regression model between TTV and TTR at the network level was developed. Through the relationship between the linear regression model and NFD, it is possible to develop new traffic management strategies and algorithms optimizing the vehicle-to-vehicle TTV at the network level. The developed vehicle-to-vehicle TTV models can be applied to validate the mobility improvement potential of vehicle-to-everything (V2X) communication applications on a segment, corridor, and regional scale.

5.1 Introduction

As transportation professionals realized the importance and value of travel time reliability, it has become essential to consider travel time reliability as a key performance indicator to evaluate the mobility of the transportation network system. Among various travel time reliability analysis methods, travel time variability (TTV) has been used to explore the travel time reliability from day-to-day (or from period-to-period) to vehicle-to-vehicle. Recently, several experts have started to have an interest in vehicle-to-vehicle TTV at the link and network levels by using the data accumulated through individual vehicle data collection technologies. According to the previous research (Li et al., 2006, Mahmassani et al., 2012, Mahmassani et al., 2013, Kim and Mahmassani, 2014), the vehicle-to-vehicle TTV is useful to understand complicated driver behavior at the link level depending on various circumstances and also to evaluate the effectiveness of new transportation systems or traffic management strategies at the network level in the relationship between TTV and travel time. However, there is no research to develop vehicle-to-vehicle TTV models including other impact factors except for travel time and also considering a left-censored limit of zero because the standard deviation does not have negative values.

Travel time reliability is the consistency or dependability of travel times (FHWA, 2006). It is quantified through TTV measuring travel time variations since the TTV can be depicted on statistical distribution with a central tendency (mean and median), dispersion (standard deviation: SD), moments, and quantile values. The travel time variations occur from several impact factors: traffic incidents and crashes, work zone activity, weather and environmental conditions, fluctuations in demand, special events, traffic control devices, and inadequate base capacity (Systematics, 2005, Kwon et al., 2011). The travel time variation results from regular condition-dependent variations, irregular condition-dependent variations, and random variations (Wong and

Sussman, 1973). The regular condition-dependent variations are predictable and repeatable changes by time-of-day, day-of-week, and season of the year. The irregular condition-dependent variations are unpredictable cases in traffic incident conditions such as adverse weather, traffic crashes, road work and so on. The random variations represent the minor variations due to different individual drivers' behavior, traffic signal control on arterials, or other unpredictable cases.

Travel time reliability can be described through TTV from day-to-day, from period-to-period, and from vehicle-to-vehicle (Noland and Polak, 2002). Usually, most of the travel time reliability has focused on variations in terms of day-to-day and period-to-period. Lomax et al. (2003) proposed how to select travel time reliability metrics and aggregate section-based index values. FHWA recommended to use planning time index (PTI) and buffer time index (BI) for the assessment of roadway performance in terms of day-to-day or period-to-period (FHWA, 2006). To make a model for network-level travel time reliability, Clark and Watling (2005) proposed an analytic method to estimate the probability distribution of total network travel time depicting day-to-day variations over a road traffic network. Peer et al. (2012) developed models to predict TTV for cost-benefit analysis by using day-to-day TTV. Chen et al. (2017) analyzed the urban-network travel time reliability of Beijing through the travel time rate (TTR; minute/mile) of origin-destination (O/D) pairs collected from on-demand ride service data. In order to describe the urban-network travel time reliability of Beijing, network free flow time rate, network TTR, network planning time rate, network buffer time rate, and network buffer time rate index were employed.

On the other hand, few researchers investigated the vehicle-to-vehicle TTV as it becomes possible to archive the individual vehicle data. Initially, Jones (1988) confirmed the correlation between mean and SD of travel times through the manually collected commuting data of individual drivers at the link level. Li et al. (2006) showed that the average travel time of automatic vehicle

identification (AVI) data has a nonlinear relationship with the coefficient of variation on two different days in terms of vehicle-to-vehicle TTV. Mahmassani et al. (2012) comprehensively explored the vehicle-to-vehicle TTV in the relation between mean TTR and its SD, through traffic simulation data of three vehicular traffic networks and one real-field data collected from GPS probe vehicles. It was confirmed that the relationship is linear at multiple levels: link, path, O/D (Origin and Destination), and network. Based on the confirmed linear relationship, Furthermore, Mahmassani et al. (2013) showed a method to connect network-wide travel time reliability using SD and the network fundamental diagram (NFD), which is a well-defined relationship among network-wide average flow, average density, and average speed. This means the TTV can be used to evaluate traffic management strategies and policies at a network level without detailed micro-level analysis. Recently, by using Automated Number Plate Recognition devices, Zheng et al. (2017) also showed a network-level travel time distribution model for an arterial network by using a flexible system of Johnson curves, confirmed the linear relationship between distance-weighted SD of TTR and its distance-weighted mean, and finally investigated the relation between network travel time reliability and network traffic characteristics such as volume and density. Even, Kim and Mahmassani (2014, 2015) provided a modeling method combining both vehicle-to-vehicle and day-to-day TTV of traffic networks by using Gamma-Gamma distribution. Parameters for the compound Gamma distribution model was derived with the linearity assumption for the relationship between mean and SD of travel delay.

Overall, it is usual that both vehicle-to-vehicle and day-to-day TTV at the network level were aggregated through the VMT-weighted average of TTV at the link, path, or trip level. Especially, it was confirmed that vehicle-to-vehicle TTV using the SD of travel time is an important measure to realize network-level travel time reliability and operate network-level traffic

management and control strategies more effectively (Kim and Mahmassani, 2014, Mahmassani et al., 2013, Kim and Mahmassani, 2015, Mahmassani et al., 2012, Zheng et al., 2017). Still, the previous research about vehicle-to-vehicle TTV concentrated on the statistical relationship with only travel time or TTR at the link or network levels. Furthermore, it was overlooked that the vehicle-to-vehicle TTV does not have negative values.

Therefore, at the link level, this study aims to develop more sophisticated vehicle-to-vehicle TTV models including several impact factors: traffic data, geometric/operational features, crashes, and weather. In order to identify whether there are dissimilarities between vehicle-to-vehicle and day-to-day travel time variability models, day-to-day travel time variability models were also developed. At the entire freeway/expressway network level, this research purpose is to build a linear regression model between TTV and TTR after estimating TTVs on links with only travel times. Finally, the estimated vehicle-to-vehicle TTV at the network level was investigated in the relationship with Network Fundamental Diagram (NFD).

5.2 Study Area

As of 2017, Orlando area has one freeway and 7 expressways: Interstate 4 (I-4), Florida's Turnpike, SR 408, SR 414, SR 417, SR 429, SR 451, and SR 528 (See Figure 19). Within around 20-mile radius from the center of Orlando city, there are three airports with land-based weather stations. Three agencies, Florida Department of Transportation (FDOT) District 5, Florida's Turnpike Enterprise (FTE), and Central Florida Expressway Authority (CFX), are operating and managing the freeway and expressways in cooperation with each other. The three agencies are monitoring the traffic condition through traffic data collected by microwave vehicle detection system (MVDS), AVI readers using toll tags, and Bluetooth readers. The collection of travel time

data are different a little among them: CFX has been using AVI readers detecting toll transponders, whereas FDOT and FTE started to use Bluetooth readers instead of AVI readers.

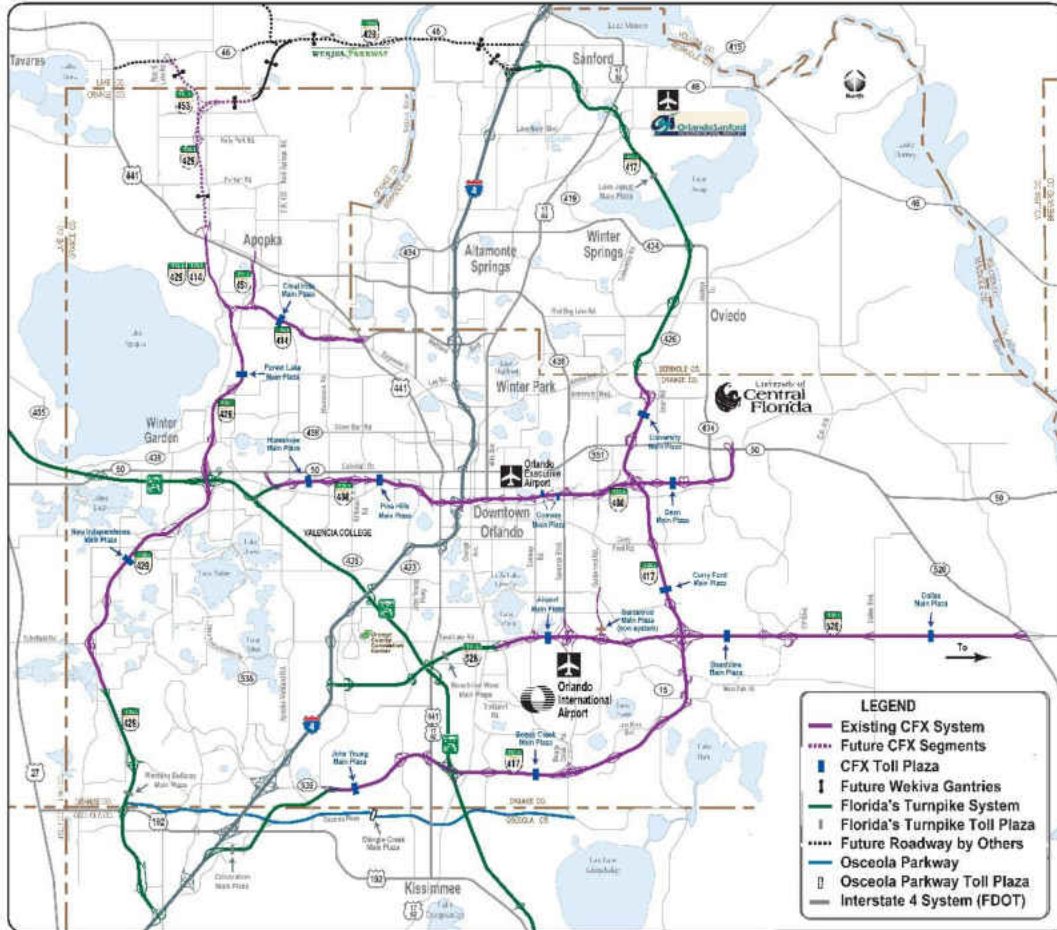

Figure 19. Freeways and expressways in Orlando area (CFX, 2016)

Especially, CFX installed more frequent AVI readers to collect more timely and accurate travel time (Haas, 2009). In addition, CFX has archived passing times of individual vehicles at each AVI reader, so that it provides an opportunity to analyze vehicle-to-vehicle TTV. Eight mainline toll plazas have MVDS and AVI at their upstream and downstream. By using transaction data at each toll plaza on mainlines, it is possible to analyze the penetration ratio of transponders and their detection rates (see Figure 20). According to the analyses results using one month of

September 2017, the penetration ratio of transponders for electronic toll collection (ETC) was about 83% on the basis of the average daily volume of MVDS. At the same period, the average detection rate of AVI readers is about 75% of transactions of ETC. It was confirmed that about 62% among the average daily volume of MVDS is detected by AVI readers. This means that the AVI system can provide highly accurate individual drivers' travel time based on their high detection rate.

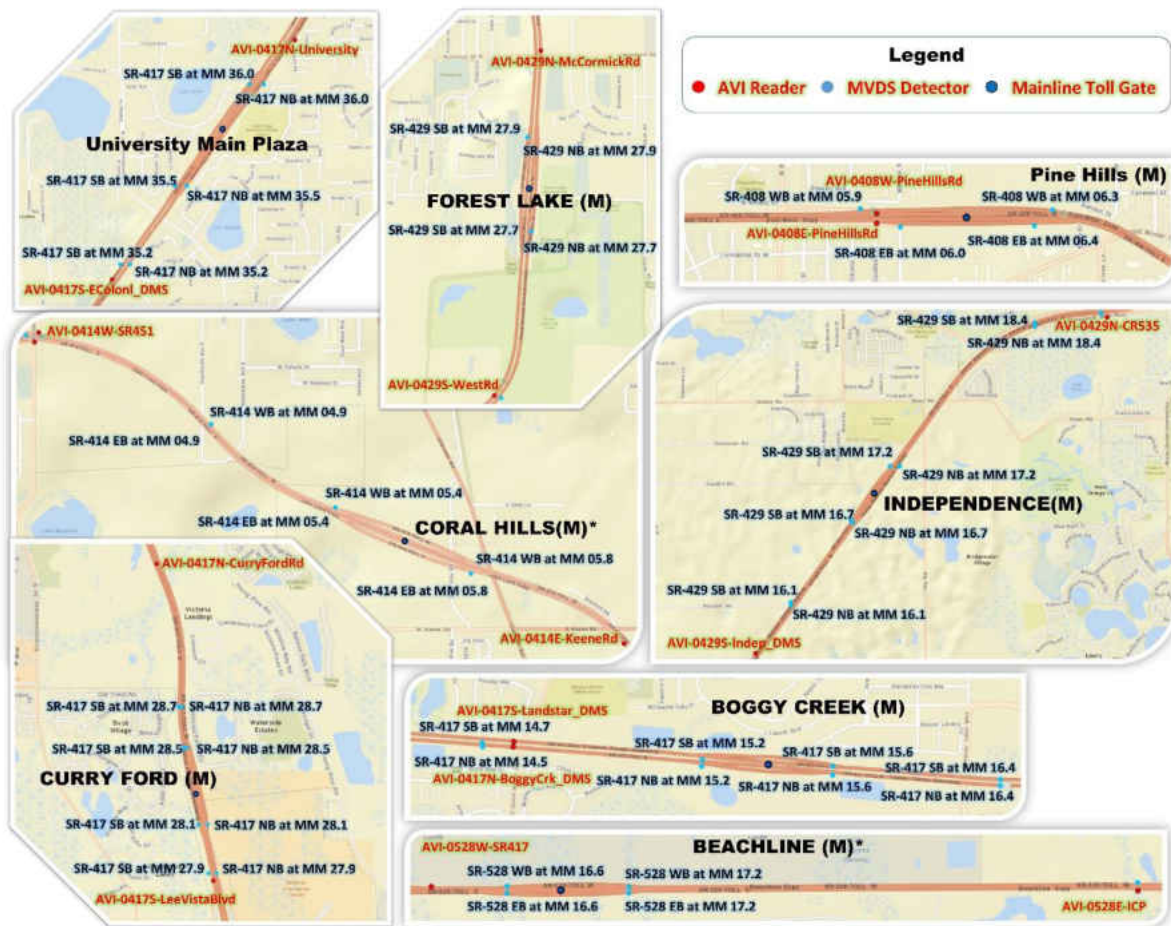

Figure 20. Locations of MVDS and AVI near 8 mainline toll plazas

Recently, FDOT started to use the National Performance Management Research Data Set (NPMRDS) providing link travel times in order to monitor the mobility and reliability performance

of freeways and expressways based on historical traffic data. Different from the Bluetooth systems, NPMRDS uses only raw observed probe-based traffic data including passenger cars and trucks regardless of data modeling and smoothing. However, the NPMRDS does not have any SD of mean travel times so it cannot be used to analyze vehicle-to-vehicle TTV at the network level.

5.3 Methodology

According to the definition of TTV of Noland and Polak (2002), Li et al. (2006) decomposed the TTV in order to consider vehicle-to-vehicle TTV and day-to-day TTV. The concept of the decomposition stems from the basic statistical theory to combine mean and SD for different groups. For instance, each group can correspond to each time slot at a specific link. The TTV can be formulated as follows:

$$V(k) = \frac{1}{N(k)} \sum_{i=1}^{S(k)} \sum_{j=1}^{n_i(k)} (t_{ij}(k) - \bar{t}_i(k))^2 + \frac{1}{N(k)} \sum_{i=1}^{S(k)} n_i(k) \cdot (\bar{t}_i(k) - \bar{T}(k))^2$$

where, k = indication of link, path, or OD pair on the traffic network

i = indication of time slots aggregated at a specific time period

j = indication of individual travel times

$N(k) = \sum_{i=1}^{S(k)} n_i(k)$ = the total number of individual travel times that passed the link “ k ”

$S(k)$ = the total number of the time slot of the link “ k ”

$n_i(k)$ = the total number of individual travel times at time slot “ i ” in the link k

$t_{ij}(k)$ = j -th individual travel time at the time slot “ i ” in the link “ k ”

$$\bar{t}_i(k) = \frac{1}{n_i(k)} \sum_{j=1}^{n_i(k)} t_{ij}(k) = \text{mean travel time at the time slot "i" in the link "k"}$$

$\bar{T}(k) = \frac{1}{N(k)} \sum_{i=1}^{S(k)} \sum_{j=1}^{n_i(k)} t_{ij}(k) = \text{mean travel time in the link "k" during the whole time period.}$

In equation (1), the first part includes vehicle-to-vehicle TTV and the second part is related to day-to-day TTV. Regarding the vehicle-to-vehicle TTV, Kim and Mahmassani (2014, 2015) concentrated more on travel time variation among drivers departing within the same time slot. Mahmassani et al. (2012) confirmed that there is a linear relationship between the mean TTR and its SD at multiple levels in the traffic network.

The travel time variation is represented as the SD:

$$\sigma_i(k) = \sqrt{V_i(k)} = \sqrt{\frac{1}{n_i(k)} \sum_{j=1}^{n_i(k)} (t_{ij}(k) - \bar{t}_i(k))^2}$$

By using the equation (2), equation (1) is transformed as follows:

$$V(k) = \frac{1}{N(k)} \sum_{i=1}^{S(k)} n_i(k) \cdot \sigma_i^2(k) + \frac{1}{N(k)} \sum_{i=1}^{S(k)} n_i(k) \cdot (\bar{t}_i(k) - \bar{T}(k))^2$$

Usually, most of the agencies and researchers have dealt with the day-to-day TTV or reliability because of the restriction of the traffic data collection. However, according to equation (3), it is obvious that more accurate TTV can be estimated if the SD of each time slot at each link is considered. Practically, there will be some difficulty to estimate actual travel time variance without collecting $n_i(k)$ and $\bar{T}(k)$ through individual raw travel times.

Figure 21 shows the overall framework to consider both vehicle-to-vehicle and day-to-day TTV. First, possible data sources should be identified whether individual vehicle travel times can be collected in a certain region of a freeway/expressway network of the study area. Among the possible data sources, some data sources can provide only mean travel time at a specific time interval without the exact sample size. In this study, FDOT can use NPMRDS, which provides space mean speed and mean travel time for 5-minute intervals to one-hour intervals, but does not provide the actual sample size. In this case, it is useful to use traffic volume collected by MVDS.

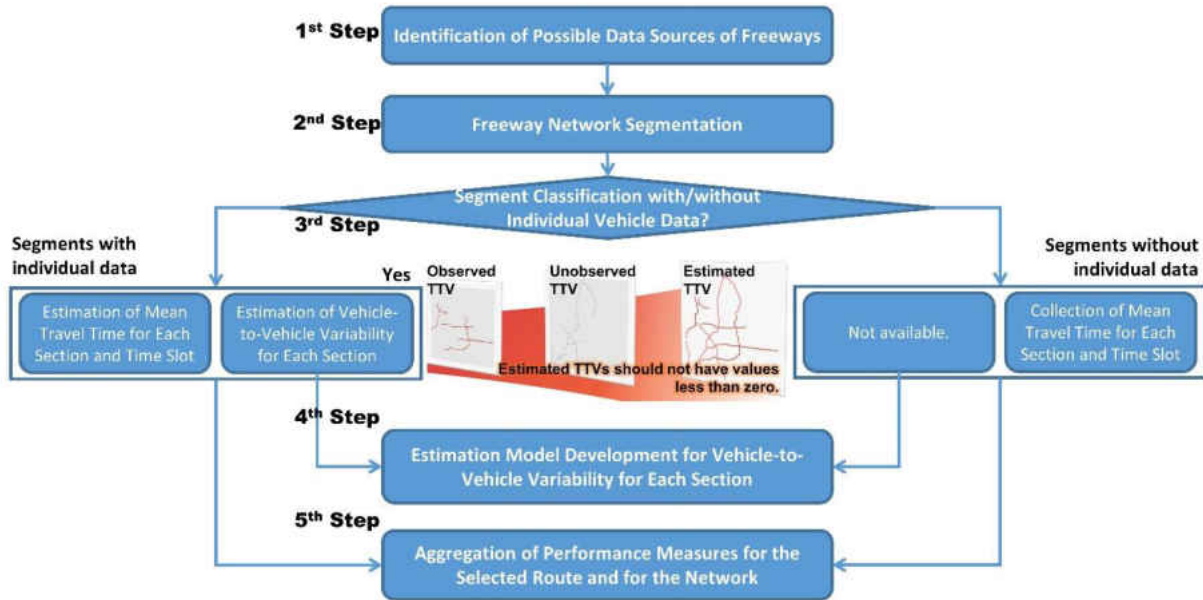

Figure 21. A framework estimating both vehicle-to-vehicle and day-to-day TTV

Second, it is required to adjust segments overlapped at the common area covered by different travel time collection systems. In this research, the AVI system of CFX defines links based on AVI readers, but NPMRDS uses Traffic Message Channel (TMC) segments, which are divided at physical or logical geometric changes. So, the overlapped segments in the connection area of AVI and NPMRDS were modified and their data also were adjusted according to the changed length of segments.

Third, after acquiring the individual travel times, the mean and SD of travel time for each segment are estimated at a specific time interval. The specific time interval should be the same as the aggregation interval of other data sources with only mean travel time.

Forth, in order to develop a model to estimate the SD of mean travel time, a Tobit model with censored data was applied. The censoring concept can be used when data on the dependent variable is limited but not data on the independent variables (Breen, 1996). In the case of the SD, which is the dependent variable in this study, the value cannot become less than zero. Therefore, it will be proper to use the Tobit model as a censored regression model:

$$y_i^* = \boldsymbol{\beta} \mathbf{X}_i + \varepsilon_i, i = 1, 2, \dots, N$$

$$y_i = \begin{cases} y_i^* & \text{if } y_i^* > 0 \\ 0 & \text{if } y_i^* \leq 0 \end{cases}$$

where y_i^* is a latent variable,

N is the number of observations,

\mathbf{X}_i indicates a vector of independent variables: travel time, volume, speed, etc.,

$\boldsymbol{\beta}$ is a vector of estimated parameters, and

$$\varepsilon_i \sim N(0, \sigma^2).$$

Finally, the TTV considering vehicle-to-vehicle TTV and day-to-day TTV can be aggregated for the selected routes or for the network. Usually, VMT-weighted or distance-weighted mean values will be computed. Depending on methods collecting and aggregating travel times at the network, the weighted-mean method will be different. If it is possible to collect trip

data of individual drivers based on their O/D, distance-weighted mean will be useful. In this study, the VMT-weighted mean method is used because AVI data should be collected and processed on the basis of each segment.

5.3 Data preparation

Four kinds of data of 2017 were prepared: traffic data, crash data, weather data, and geometry data since this study concentrated on investigating the relationship between the vehicle-to-vehicle TTV and other impact factors: mean travel time, traffic volume, precipitation, crash, and so on (see Figure 22). The traffic data were obtained from the AVI systems of CFX for individual travel times, NPMRDS for mean travel time, and MVDS of RITIS for traffic volume, speed, and occupancy at each location of MVDS (2018, CATT, 2008). The precipitation data were collected from the Quality Controlled Local Climatological Data (QCLCD) (NCEI, 2017), and the crash data were gathered from the Signal Four Analytics (S4A) system (UF, 2017). Finally, related to the geometry data, speed limits and the number of lanes of each link were collected.

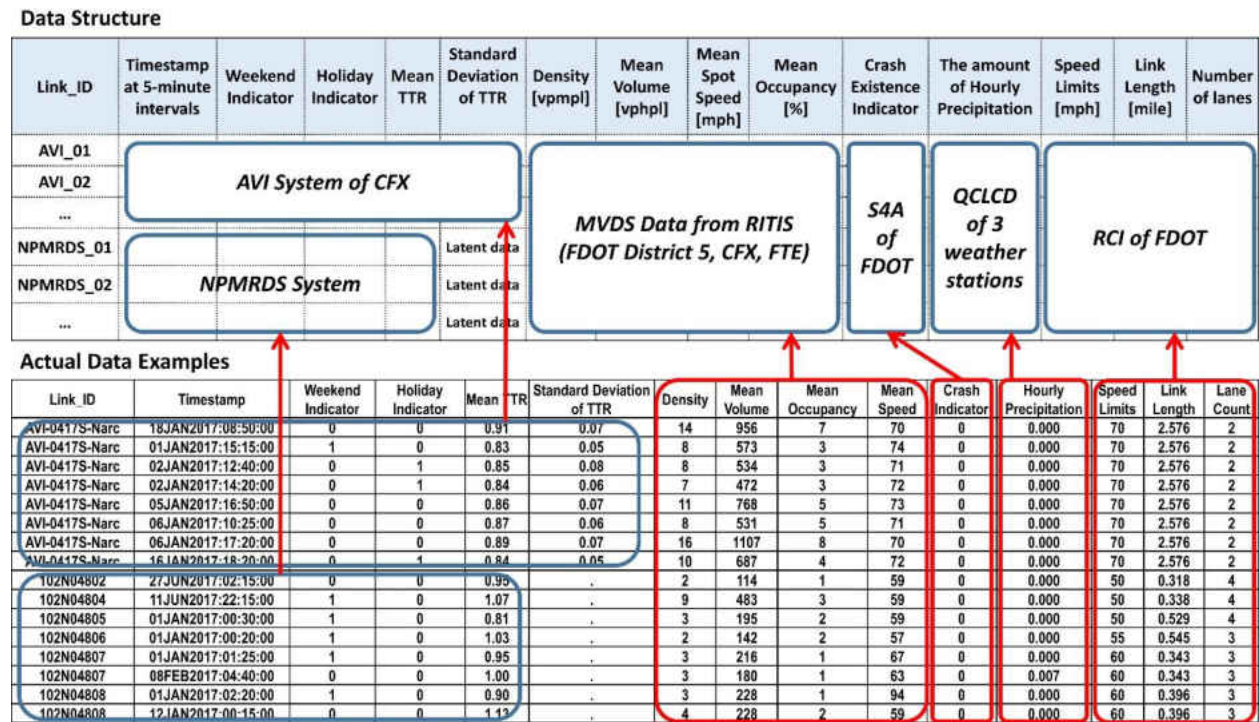

Figure 22. Prepared data structure for vehicle-to-vehicle and day-to-day TTV analysis

5.3.1 Mean Travel Time and its SD of Links on CFX's Expressways

In this project, AVI raw data including the passing times of the encrypted toll tag IDs at each AVI reader is a very important data source because it is assumed that the processed travel times are ground-truth data that are not adjusted by the speed limit. Because of the encryption of transponders' ID, some noise in the data were included in the AVI raw data. Therefore, through three steps, the mean travel time and SD of links were estimated (see Figure 23).

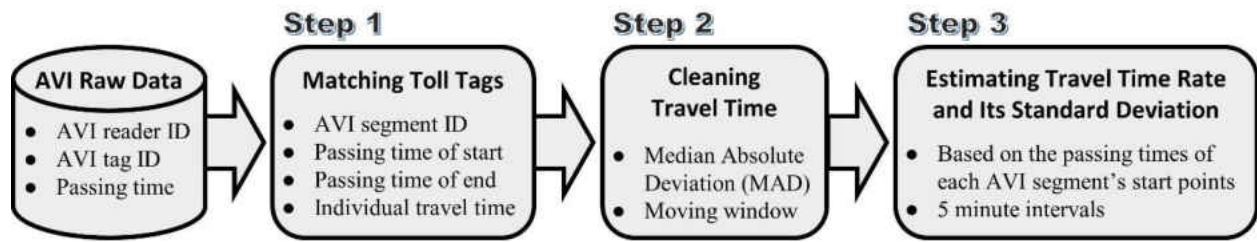

Figure 23. Link travel time estimation steps from AVI raw data

By matching the encrypted toll tag IDs between an AVI reader and its adjacent AVI reader, individual vehicles' travel time was calculated through the passing time difference between two readers. One constraint was considered: the maximum travel time of each link will not exceed two hours. The constraint will avoid many duplicated matching results of one transponder.

Next, outliers among individual vehicle's travel times were identified and eliminated through a moving-window implementation of the Hampel identifier based on the median absolute deviation (MAD) approach (Davies and Gather, 1993). Twenty consecutive observations were used as the size of a window. The MAD approach provides high accuracy and low computational effort. The removal criterion of outliers becomes:

$$abs(travel\ time(i) - Median(i)) \leq b * MAD$$

where b is a threshold, in which 3 was applied conservatively (Miller, 1991). Figure 24 shows the plot of individual travel times before and after removing outliers at a specific link. All travel times were converted into Travel Time Rate (TTR) through the normalization by the distance of each link as follows (Jenks et al., Lomax and Margiotta, 2003):

$$\text{Travel Time Rate (TTR; minute/mile)} = \frac{\text{Travel Time (minute)}}{\text{Distance of each Link (mile)}}$$

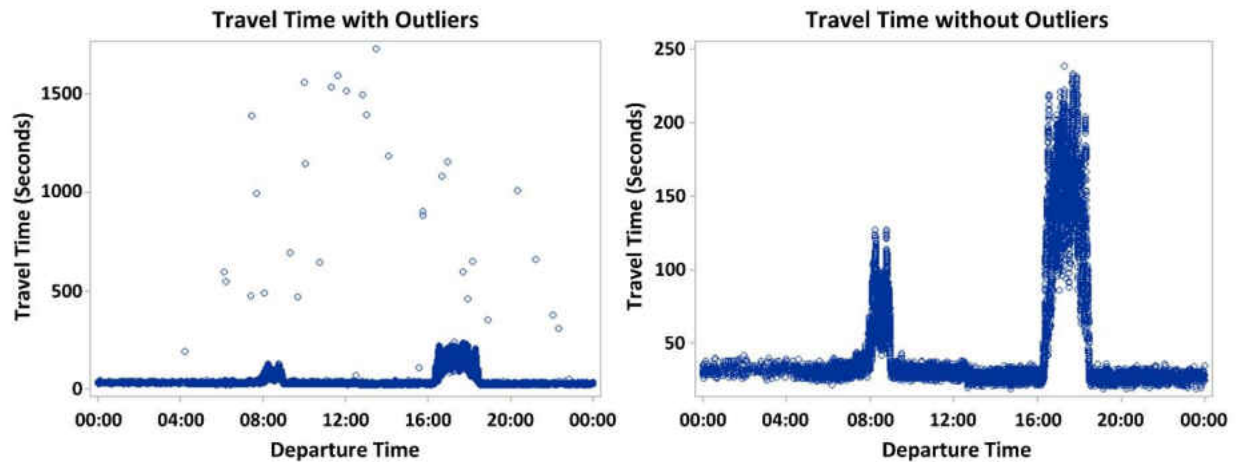

Figure 24. Individual travel times before/after removing outliers

Finally, mean link TTR and its SD were aggregated at five-minute intervals on the basis of the departure time of individual vehicles at each AVI link’s start point. Figure 25 shows an example of the mean TTR and its SD between Orange Blossom Trail and I-4 on SR 408 at 5-minute intervals.

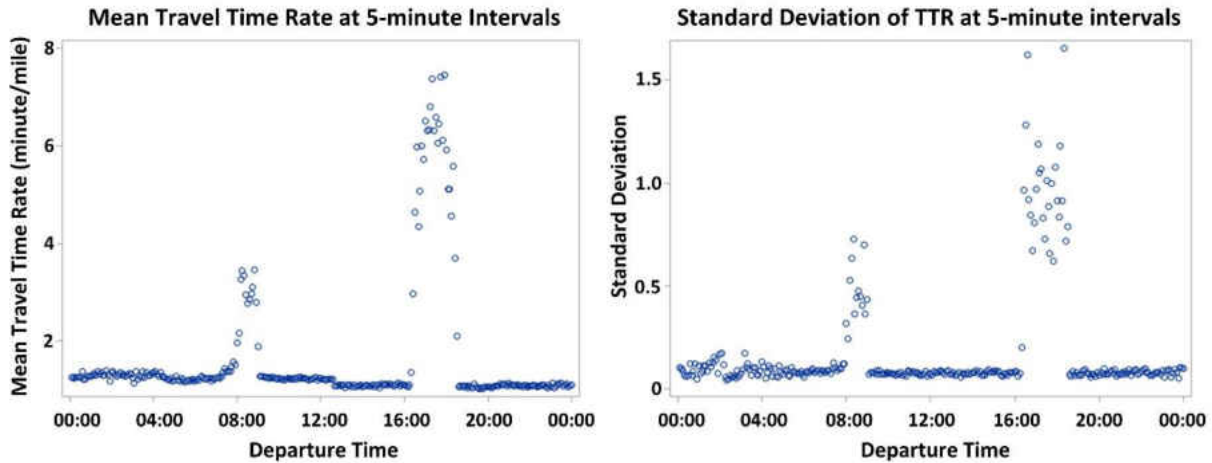

Figure 25. Mean TTR and SD at 5-minute intervals

5.3.2 Link Travel Time of I-4 and expressways of FTE

Although there are many methods to estimate link travel times through MVDS data, the methods have limitations to estimating true travel times. In addition, I-4 and FTE are using Bluetooth readers, but the travel times estimated from the Bluetooth system cannot represent actual drivers' travel time because of the smoothing or prediction algorithms. Whereas, NPMRDS' travel time can be used as the link travel time ground truth of I-4 and FTE expressways because it is based on only raw observed probe vehicle data including passenger cars and trucks regardless of data modeling and smoothing. Therefore, travel times aggregated at 5-minute intervals were downloaded for this research and then converted into the TTR by using the distance of each NPMRDS link. The data included both trucks and passenger vehicles.

5.3.3 MVDS Data

I-4 and all expressways are covered by MVDS collecting traffic flow, occupancy, and spot speed. The MVDS data aggregated at 5-minute intervals were downloaded via the Regional Integrated Transportation Information System (CATT, 2008). Each MVDS was connected to links of AVI and NPMRDS through the spatial join within 100 meters radius on the basis of the location

of the MVDS (see Figure 26). Based on the matching table between links and MVDSs, the traffic volume of each link was calculated through the simple average of traffic volume of MVDSs connected to each link, and the occupancy and speed of each link were computed through the volume-weighted average of MVDSs.

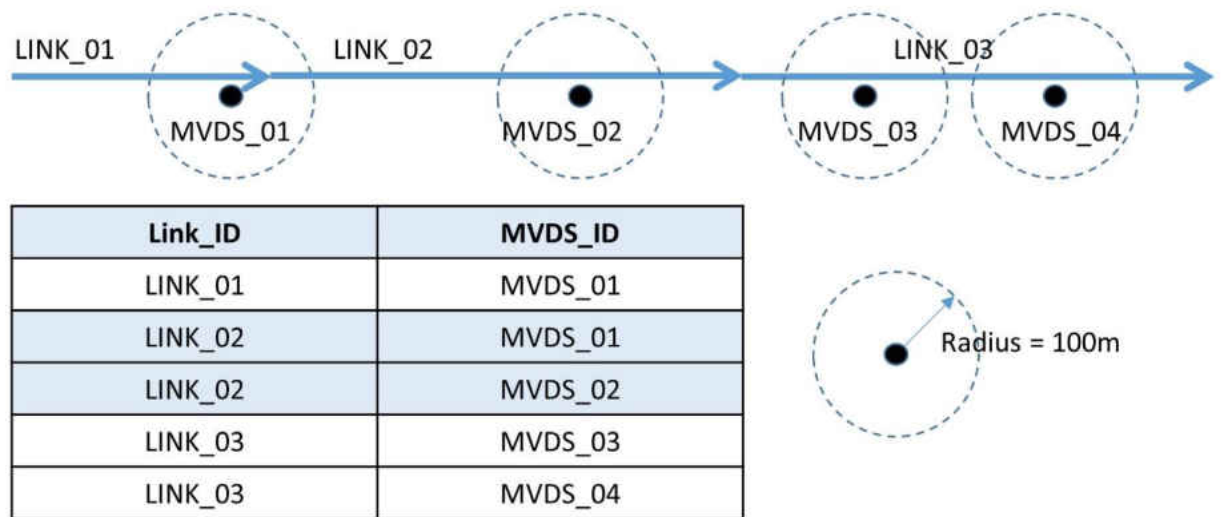

Figure 26. Spatial Join with Links and MVDS

5.3.3 Crash Location and its Duration

There are many types of incidents on freeways. Among the types of incidents, only crash data was used. The crash data of 2017 was obtained via the S4A system, which stores crash time, coordinate, crash type, crash severity and so forth (UF, 2017). The acquired crash data with longitude and latitude was assigned to each link on I-4 and expressways through the geospatial joining process. However, in order to use the crash data as an impact factor of travel time, it is necessary to gather crash-related incident duration including incident verification time, incident response time, and incident clearance time (open roads) (Farradyne, 2000). Unfortunately, since the S4A system does not have the duration of each crash. So, the average duration of the incident in Florida was applied for this analysis. According to the statewide ITS performance measures of

2016, the average incident duration was 44.1 minutes ranging from 27 to 57 minutes (Heery, 2016). The actual target time for clearing roadways after incidents is 90 minutes (Heery, 2016). Considering the average incident duration and the target clearing time of incidents, the incident duration of one hour was conservatively applied.

5.3.4 Geometry features

Among many geometry features, speed limits, and the number of lanes and the length of a link were included in this study to identify an impact on TTV. Especially, the speed limits can be an endogenous variable of TTV because variable speed limits are a strategy to control TTV. Whereas, the number of lanes and the length of a link are an exogenous variable. The geometry features were collected from the Roadway Characteristics Inventory (RCI) database of FDOT.

5.3.5 Precipitation Data

Weather is one of the important impact factors on TTV. Orlando has three airports: Orlando International Airport, Orlando Executive Airport, and Orlando Sanford International Airport (See Figure 19). The three airports have land-based weather stations, which are providing hourly weather data through QCLCD. Among various weather data, this study focused on precipitation data because most of the adverse weather condition in Orlando is related to rain. According to the previous research, the QCLCD can represent weather of area within a 20-mile radius on the basis of each weather station (Chung et al., 2018). Thus, the average value of three weather stations is processed as weather conditions of each link.

5.4 TTV of freeways and expressways in the Orlando area

TTV of the freeway network in the Orlando area was explored from three aspects: vehicle-to-vehicle TTV, day-to-day TTV, and the relationship between vehicle-to-vehicle TTV and the network fundamental diagram (NFD) regarding density and flow.

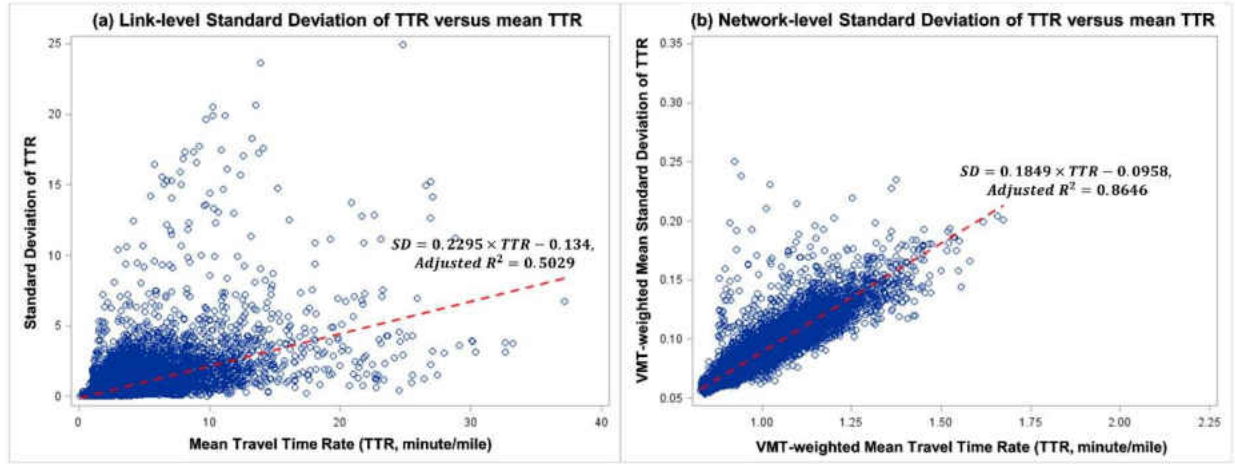

Figure 27. The relationship between mean TTR and its SD representing vehicle-to-vehicle TTV at the link and network levels

To understand the characteristics related to vehicle-to-vehicle TTV on freeways in the Orlando area, mean TTR and its SD of one-year data acquired from CFX were aggregated because only the CFX system can collect individual vehicles' travel times. Figure 27 presents scatter plots of the mean TTR and its SD at the link level and network level. For the data aggregation at the network-level of Figure 27-(b), VMT (Vehicle Miles Traveled)-weighted mean at each time slot was applied as follows:

$$\overline{TTR}_{network}(t) = \frac{\sum_{i=1}^n VMT_i(t) \times TTR_i(t)}{\sum_{i=1}^n VMT_i(t)}$$

$$\overline{SD}_{network}(t) = \frac{\sum_{i=1}^n VMT_i(t) \times SD_i(t)}{\sum_{i=1}^n VMT_i(t)}$$

where, $\overline{TTR}_{network}(t)$ = Network-level VMT-weighted Mean TTR at time slot “t”,
 $\overline{SD}_{network}(t)$ = Network-level VMT-weighted Mean SD of TTR at time slot “t”,
 $VMT_i(t)$ = Vehicle Miles Traveled of link “i” at time slot “t”,
 $TTR_i(t)$ = Mean TTR of vehicles passing link “i” at time slot “t”,
 $SD_i(t)$ = Standard Deviation between vehicles of link “i” at time slot “t”.

Figure 27-(a) shows a tendency that the SD of mean link TTR increases when the mean link TTR rises. However, the SD of mean link TTR is a little broadly dispersed since the TTR can be affected by the various impact factors such as weather, incidents, and special events during the year. On the other hand, Figure 27-(b) shows a more strong linear relationship between the link mean TTR and its SD at the network level because the data aggregation at the network level reduces the influence of impact factors. These kinds of trends between the travel time or TTR and its SD had been found in the previous research (Zheng et al., 2017, Mahmassani et al., 2012, Mahmassani et al., 2013, Kim and Mahmassani, 2015, Kim and Mahmassani, 2014).

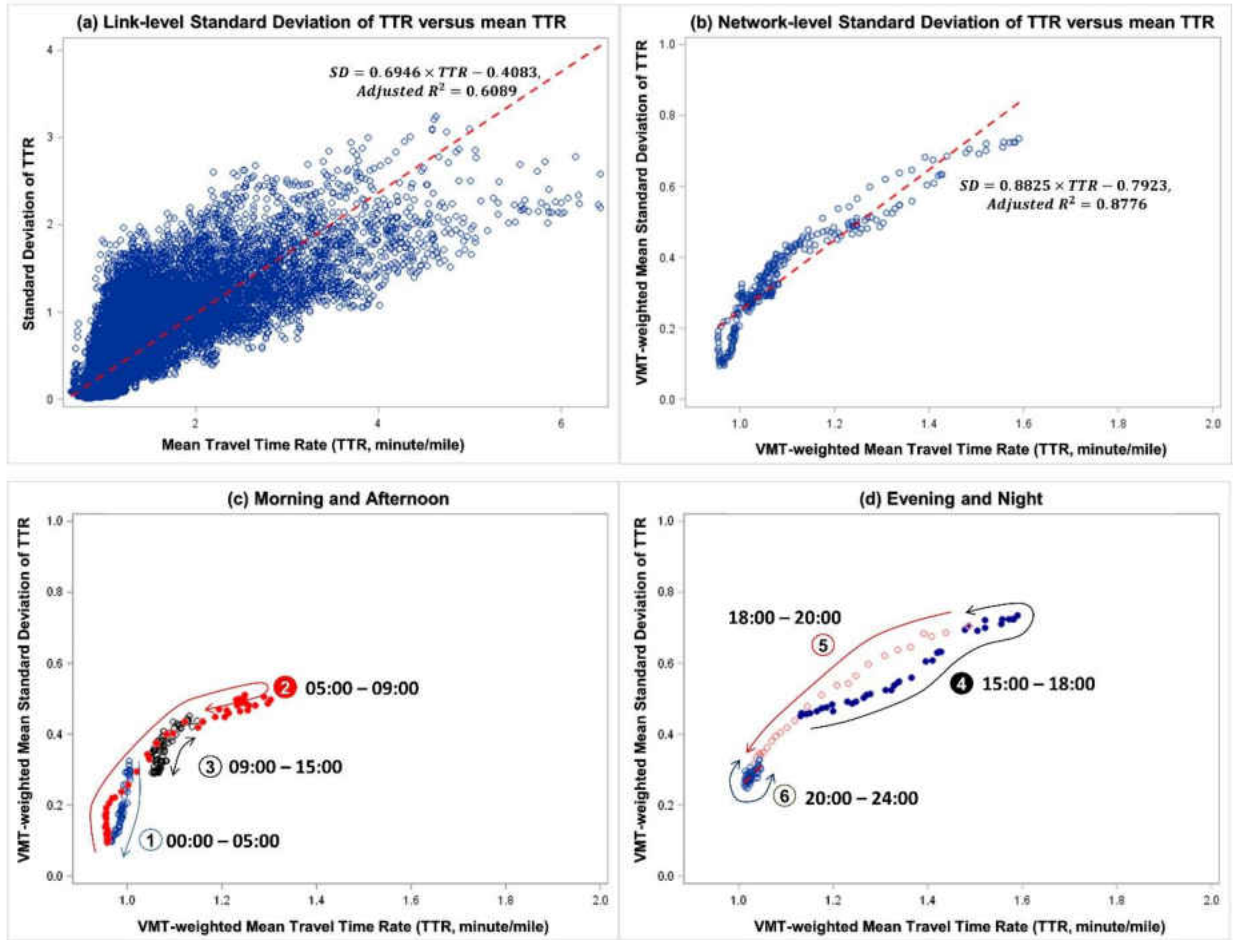

Figure 28. The relationship between mean TTR and its SD representing day-to-day TTV at the link and network levels

Next, mean travel times for 5-minute of each link in the AVI and NPMRDS systems were used to analyze day-to-day TTV on I-4 and expressways. Figure 28-(a) shows the SD of each link at 5-minute time slots and Figure 28-(b) offers VMT-weighted mean SDs of 288-time intervals at the network level. Usually, the prediction models of the TTV to quantify the socio-economic benefits of transportation vary from simple linear to non-linear models on the basis of 15-minute intervals (Peer et al., 2012, Kouwenhoven and Warffemius, 2017). In this study, the linear regression models are added in both Figure 28-(a) and 28-(b) to show the tendency of the simple positive relationship. Looking at Figure 28-(b) in detail, it reveals that hysteresis loops exist in the

freeway network in Orlando (see Figure 28-(c) and (d)). This means that a distribution model of day-to-day TTV at the network level can be developed as Kim and Mahmassani (2015) developed Gamma-Gamma models with time-varying shape parameters.

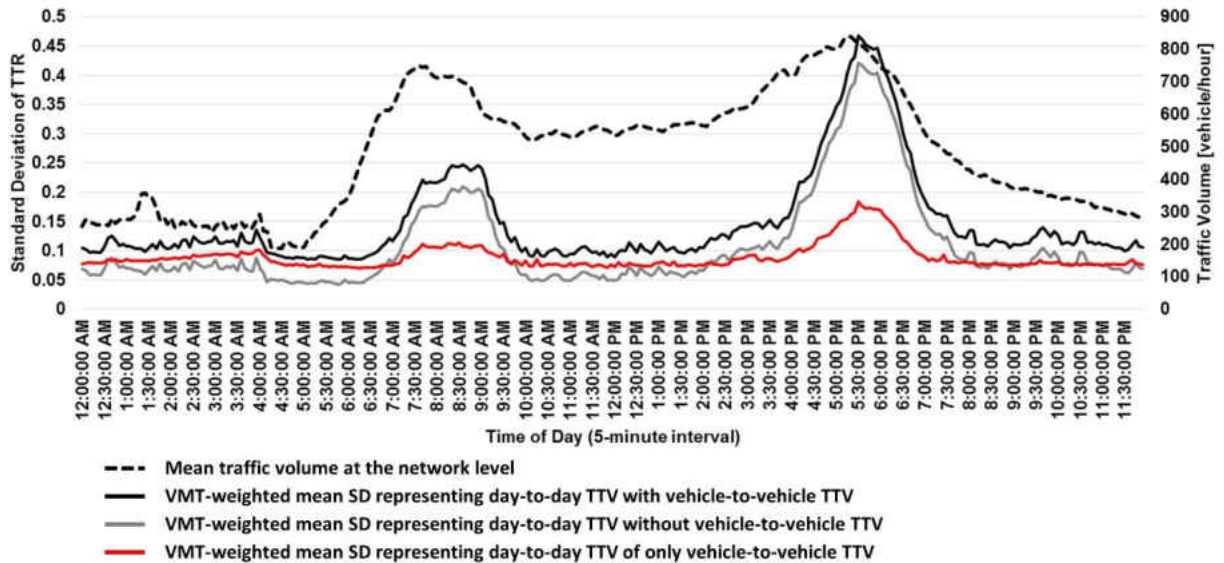

Figure 29. Day-to-day TTV with or without vehicle-to-vehicle TTV, or of only vehicle-to-vehicle TTV

The true day-to-day TTV of a link is to include the vehicle-to-vehicle TTV using mean and SD of individual travel times in each time slot, and the day-to-day TTV using mean and SD of each time slot on the basis of the time of day. If both vehicle-to-vehicle TTV and day-to-day TTV are considered, the true TTV of each time of day can be estimated. Figure 29 shows the clear meaning of the true day-to-day TTV. Although the day-to-day TTV not including vehicle-to-vehicle TTV depicts the true day-to-day TTV well, it is obvious that there is a difference related to vehicle-to-vehicle TTV. The development of the model to estimate the vehicle-to-vehicle TTV at the link level will reduce the difference between the true day-to-day TTV and the day-to-day TTV without vehicle-to-vehicle TTV.

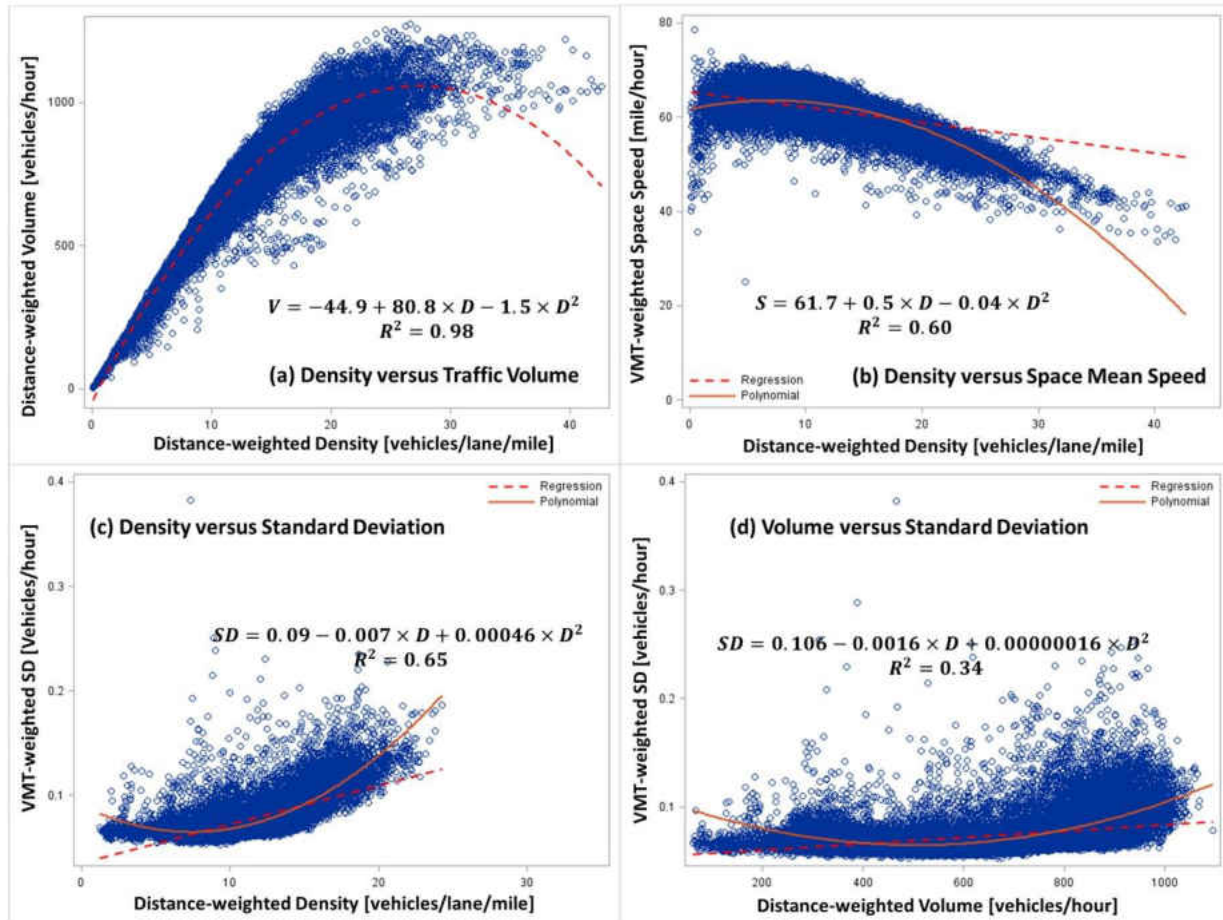

Figure 30. Relationship between NFD and SD of TTR at the network level

Actually, it will be more valuable to use the vehicle-to-vehicle TTV with the network fundamental diagram (NFD) regarding the relationship among speed, density, and flow. According to previous research (Mahmassani et al., 2013, Mahmassani et al., 2012), it was revealed that the vehicle-to-vehicle TTV using SD can be used to evaluate travel time reliability at a network level. To investigate the NFD features, MVDS, AVI, and NPMRDS data aggregated at 5-minute intervals were used. Figure 30-(a) and (b) depict obviously that NFD exists in the freeway network in the Orlando Area. For the additional analysis of the relationship between vehicle-to-vehicle TTV and two traffic descriptors: density and flow, AVI data with individual travel times and MVDS of CFX were utilized. Figure 30-(c) and (d) present the nonlinear relationship between the

SD of travel time and density and between the SD of travel time and traffic flow, which is different from the previous research presenting the linear relationships (Mahmassani et al., 2013, Mahmassani et al., 2012).

5.5 Modeling results and their implication

The Tobit model using a left-censored limit of zero is estimated to produce two types of TTV: vehicle-to-vehicle and day-to-day. Tables 13 and 14 present summary statistics and modeling results, respectively. Table 13 shows that a freeway (I-4) has a little higher travel time rate, volume, and density than other expressways, but the value range of I-4 is covered by other expressways. The most congested section is the eastbound I-4 with 1.2 TTR. Additionally, I-4 has links with low-speed limits and short lengths comparing to the expressways. Although TTR, density, and traffic flow have a theoretical relationship in terms of traffic flow theory, all variables are included to achieve goodness-of-fit of the developed Tobit model. For the detailed understanding of the TTV of vehicle-to-vehicle and day-to-day in the Orlando area, four Tobit models are developed.

The estimated parameters in Table 14 are statistically significant and of a reasonable sign at 95% confidence level. The missing values at vehicle-to-vehicle TTV are the number of data elements of NPMRDS data because the NPMRDS does not have the SD, and the missing values at day-to-day TTV are the number of the SD that is not generated in the combination of the grouping criteria: link, time slice, holiday indicators, and weekend indicators. Both the SD of NPMRDS and the un-aggregated SD for day-to-day TTV are to be considered as latent data elements.

Table 13. Descriptive statistics of independent variables

Variable	Mean	SD	Minimum	Maximum
Mean Travel Time Rate (TTR, minute/mile)	1.05	0.44	0.08	26.88
Mean Density of Link (vehicle/lane/mile)	13	11	0	73
Mean Traffic Flow of Link (vehicle/lane/hour)	694	418	2	3000
Length of Link (mile)	1.05	0.95	0.03	7.60
Number of Lane of Link	2.99	0.86	1.00	6.00
Speed Limits of Link (mile per hour, mph)	61.23	7.47	50.00	70.00
Hourly Amount of Precipitation (Inches)	0.01	0.05	0.00	1.30
Crash Indicator Variable (1 if crashes occurred, 0 otherwise)	0.0016	0.04	0	1
Weekend Indicator Variable (1 if day of week is Saturday and Sunday, 0 otherwise)	0.27	0.44	0	1
Holiday Indicator Variable (1 if the day corresponds the holiday, 0 otherwise)	0.04	0.20	0	1

Table 14. Tobit model estimation results

Parameter	Vehicle-to-Vehicle TTV				Day-to-Day TTV			
	Model 1		Model 2		Model 3		Model 4	
	Estimate	Pr> t	Estimate	Pr> t	Estimate	Pr> t	Estimate	Pr> t
Intercept	-0.19273	<.0001	-0.28857	<.0001	-0.81441	<.0001	-1.09816	<.0001
Mean TTR	0.24422	<.0001	0.33491	<.0001	0.74003	<.0001	0.97815	<.0001
Density	n/a	n/a	-0.01027	<.0001	n/a	n/a	-0.01784	<.0001
Occupancy	n/a	n/a	0.00585	<.0001	n/a	n/a	0.00587	<.0001
Traffic Flow	n/a	n/a	0.00010	<.0001	n/a	n/a	0.00030	<.0001
Length of Link	-0.00038	<.0001	-0.00056	<.0001	-0.00131	<.0001	-0.00241	<.0001
Number of Lanes	0.00644	<.0001	0.00791	<.0001	0.01203	<.0001	0.01159	<.0001
Speed Limits	0.00046	<.0001	0.00066	<.0001	0.00327	<.0001	0.00380	<.0001
Amount of Precipitation	-0.01704	<.0001	-0.02806	<.0001	0.01251	<.0001	0.00787	<.0001
Crash Indicator	0.03074	<.0001	0.02133	<.0001	0.01038	<.0001	0.00991	<.0001
Weekend Indicator	0.00296	<.0001	0.00511	<.0001	-0.01040	<.0001	-0.00915	<.0001
Holiday Indicator	0.00058	<.0001	0.00192	<.0001	-0.02209	<.0001	-0.02622	<.0001
Error Variance	0.06811	<.0001	0.06694	<.0001	0.15726	<.0001	0.15507	<.0001
Number of Observations	5,939,706		5,939,706		335,124		335,124	
Missing Values	16,869,583		16,869,583		23,846		23,846	
AIC	-15,060,153		-15,264,695		-284,817		-294,194	

* AIC: Akaike Information Criterion

With regard to traffic flow characteristics, all Tobit models show that TTR has a statistically significant positive relationship with the SD. However, Models 2 and 4 show that density does not provide a plausible sign different from Figure 31-(a) because of the multicollinearity between density and TTR. Figure 31-(b) presents the near-linear relationship between density and TTR although the theoretical relationship is not linear. In the case of occupancy and traffic flow, it was revealed that the increase of them increase the TTV of both vehicle-to-vehicle and day-to-day.

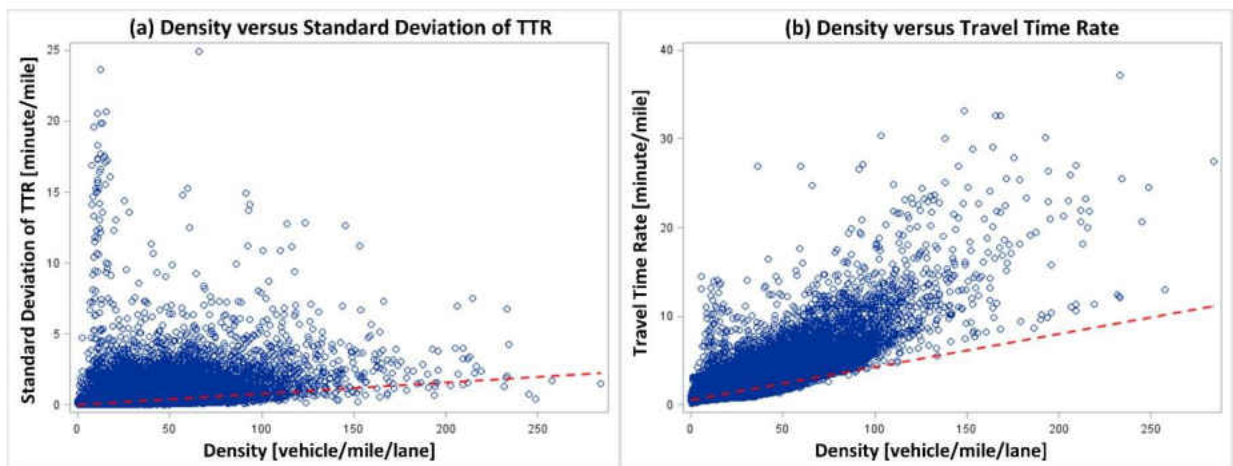

Figure 31. Density versus SD of TTR and TTR

In terms of geometric and operational factors of roadways, the length, the number of lanes, and speed limits have an influence on TTV of both vehicle-to-vehicle and day-to-day. The TTV of drivers traveling long segments is smaller than the short segments. Considering that a road segment or link on freeways will be usually a uniform section of road, it seems that frequent changes of traffic environment may increase TTV. Links with many lanes increase the TTV. High-

speed limits would lead to high TTV. In this aspect, variable speed limits lower than that on the signpost would be able to control low TTV.

Usually, it is well-known that crashes and precipitation would lead to unreliable travel times with respect to day-to-day TTV. The developed Tobit models also show the same trends in day-to-day TTV. However, in terms of vehicle-to-vehicle TTV, the amount of precipitation has a statistically negative impact on vehicle-to-vehicle TTV, which implies travel time variation of drivers will be reduced when the rainfall increases. Whereas, in terms of day-to-day TTV, the days with high precipitation would lead to high TTV compared to days with low precipitation or without precipitation.

Seeing an impact on TTV of the day of week and holidays, the vehicle-to-vehicle and day-to-day TTV revealed the opposite results. During weekends and holidays, vehicle-to-vehicle TTV increases than working days, but day-to-day TTV among weekends and holidays decreases than TTV among weekdays.

Finally, vehicle-to-vehicle TTV at the network level was built by predicting the SD of NPMRDS segments at each time slot. Actually, NPMRDS does not provide SD as vehicle-to-vehicle TTV. So, through the developed Tobit model 2, the SD was estimated, and then the results were aggregated at the network level. Figure 32-(a) shows the relationship between the vehicle-to-vehicle TTV and actual TTR at the network level, and also reveals the nonlinear relationship between the estimated SD and density. Furthermore, it is possible to get more accurate day-to-day TTV at the network level or corridor level by considering vehicle-to-vehicle TTV. Figure 32-(b) depicts the overall accuracy improvement of 20.5% of the estimated day-to-day TTV including the vehicle-to-vehicle TTV.

(a) Vehicle-to-Vehicle TTV versus TTR and NFD at a Network Level

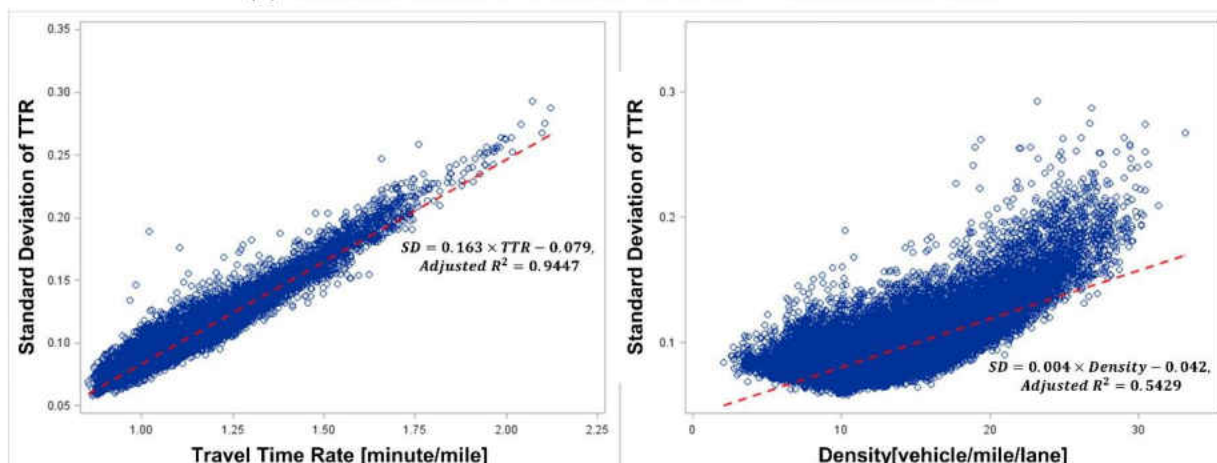

(b) Estimation of Day-to-Day TTV with Vehicle-to-Vehicle TTV

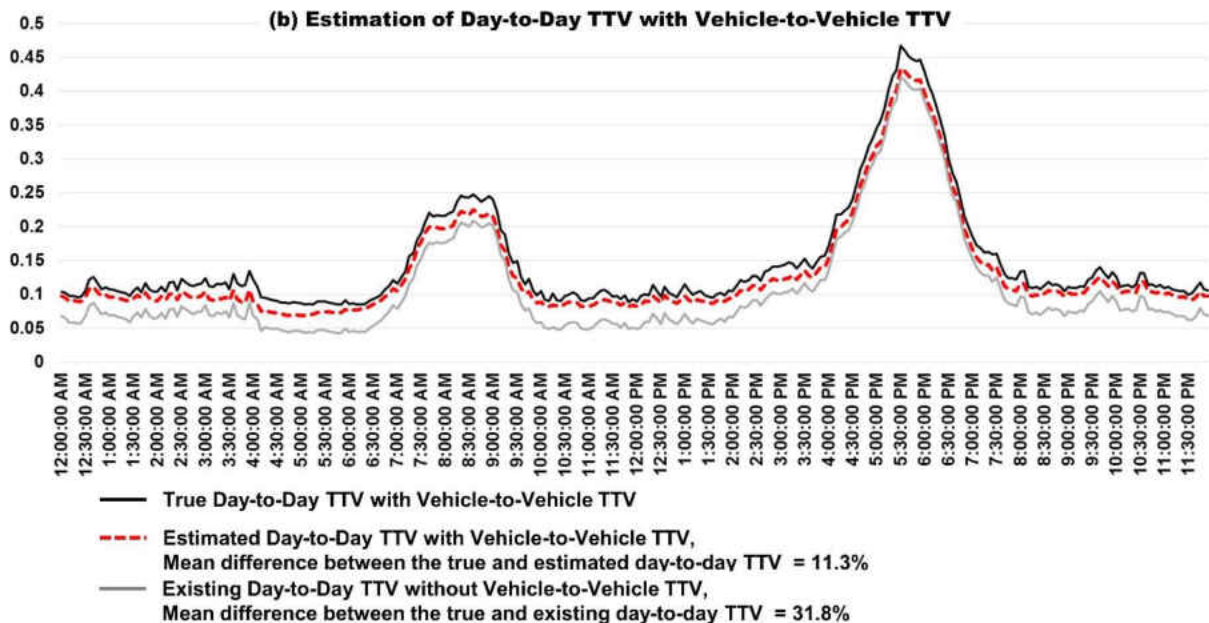

Figure 32. Final vehicle-to-vehicle and day-to-day TTV at the network level

5.6 Discussion and conclusion

As individual vehicle data can be collected, it has become possible to explore the travel time variability (TTV) of vehicle-to-vehicle from the link level to the network level by using travel time of individual vehicles collected in at least some areas. Although many types of sensors to collect individual vehicle trajectories are expected to be deployed and expanded on the roadway network, they cannot always cover the whole network in practice without perfect cooperation with connected vehicle technologies to collect individual vehicle data on the entire network. Given the practical limitation, this study proposed a method to develop models estimating vehicle-to-vehicle TTV of the whole freeway network through individual vehicle travel times collected by the CFX network at the link level.

At least, the collection system of individual drivers' travel times and its sufficient coverages representing the entire network should exist in the target region for the vehicle-to-vehicle TTV analysis. Particularly, Orlando freeways and expressways have a good AVI system having a high toll transponder penetration ratio, about 75%, and are located in the middle area of Orlando. Raw data collected by the AVI system can be used for vehicle-to-vehicle TTV analysis representing actual drivers' behavior. Except for the coverage of the AVI system, travel time data of other freeways were also collected from NPMRDS, which is used for national performance measures to evaluate travel time reliability in terms of day-to-day TTV at a specific time increment. The NPMRDS can represent actual drivers' behaviors because the travel times of the NPMRDS are aggregated without applying data modeling and smoothing.

As a measure for the vehicle-to-vehicle TTV, standard deviation (SD) of travel time rate (TTR; minute/mile) was selected, which corresponds to one of the statistical measures to quantify travel time reliability. According to previous research, the SD of TTR has been dealt with on both

sides: vehicle-to-vehicle and day-to-day TTV. In the study area, the SD of TTR for each link at each time interval can be estimated through the AVI system, but NPMRDS does not provide the actual sample size and SD of TTR. Thus, it is required to develop a model to estimate the SD of TTR, which should be addressed as a latent variable considering both non-negative value and unobserved data of the dependent variable.

Before developing the model to estimate the SD of TTR, characteristics of vehicle-to-vehicle and day-to-day TTV of expressways managed by CFX were explored at the link and network levels. According to the exploration results, it seems that TTR and its SD of vehicle-to-vehicle and day-to-day have a linear relationship at both link and network levels. The day-to-day SD at the freeway network showed hysteresis loops and the difference with the true day-to-day TTV including vehicle-to-vehicle TTV. Finally, the existence of Network Fundamental Diagram (NFD) and its relation with the SD of TTR were investigated. According to the investigation, the expressways of CFX have NFD at the network level. However, it was confirmed that there is a nonlinear relationship between the SD of TTR and density and between the SD of TTR and volume which is different from the previous research (Zheng et al., 2017, Mahmassani et al., 2013).

By using Tobit models, the SD of TTR as a latent dependent variable was addressed. For the implication of the analysis of the estimated parameters, four Tobit models were estimated: two are for vehicle-to-vehicle TTV with/without traffic descriptors and the other two are for day-to-day TTV with/without traffic descriptors. According to the analysis results, various active traffic management strategies can make different vehicle-to-vehicle TTV in real time traffic operations. Dynamic speed limits would be able to reduce vehicle-to-vehicle TTV, but dynamic lane assignment and frequent change of traffic control on stretches of freeways would be able to increase vehicle-to-vehicle TTV. Like the previous research, the occurrence of crashes elevates

both vehicle-to-vehicle and day-to-day TTV (Tu et al., 2006, Wright et al., 2015, Tu et al., 2008). Whereas, the rainfall effect on TTV showed opposite phenomena: vehicle-to-vehicle TTV goes down, but day-to-day TTV goes up as the precipitation increases. Finally, a linear regression model between vehicle-to-vehicle TTV and TTR at the freeway network level in Orlando was developed. The model can be used to evaluate various traffic management strategies and operational policies for the Orlando freeway network. By cooperating NFD and vehicle-to-vehicle TTV, the various strategies and algorithms of traffic control or management for freeways can be optimized in terms of TTV.

There will be various applications of the developed models to estimate the SD of TTR at the link and network level. The models can be applied to quantify travel time reliability measures using percentile values through the well-known travel time distributions with the estimated SD and average TTR (Kim and Mahmassani, 2014, Kim and Mahmassani, 2015). Also, the models can be applied to driver behavior modeling for mode choice and route choice including the SD into a cost function (Peer et al., 2012, Kouwenhoven and Warffemius, 2017). Furthermore, the models can be used to calibrate traffic simulation models by comparing estimates of TTV from the simulation runs with estimates from the models (Park and Schneeberger, 2003, Hollander and Liu, 2005). Although there have been several efforts to calibrate traffic simulation models in terms of the mean and distribution of travel time, there was the actual limitation to collect vehicle-to-vehicle TTV. By using the developed models, it is possible to adjust traffic simulation models' parameters in terms of vehicle-to-vehicle TTV. Based on the calibrated traffic simulation models, it is possible to validate the mobility improvement potential of connected and automated vehicles using vehicle-to-everything (V2X) communication applications on a segment, corridor and regional scale (Smith et al., 2015).

It should be noted that the findings of this research are restricted to the freeways/expressways. So, it is necessary to include arterials for the actual TTV study at a network level. Based on the proposed framework, the study area for the vehicle-to-vehicle TTV can be extended to the urban arterials if individual vehicle data can be sufficiently collected through AVI technology, automated vehicle location technologies or connected vehicle technologies. To enhance the estimation accuracy of vehicle-to-vehicle TTV, more independent variables can be employed, and also more advanced modeling techniques such as machine learning techniques can be utilized. Additionally, different network data of various areas should be considered to generalize the statistically significant impact factors of vehicle-to-vehicle TTV.

CHAPTER 6. IDENTIFICATION OF CRITICAL ROADWAYS AND SEGMENTS

6.1 Identification methods

It is necessary to find critical roadways and segments with high potential benefits related to the implementation of the integrated active traffic management systems. In general, the roadways and segments with high potential for improvement would have significantly high traffic congestion and unreliability. Thus, the critical roadways and segments are investigated through the traffic congestion and reliability analysis. The segments of roadways were defined depending on the data source. Expressways managed by CFX or arterials covered by Bluetooth systems were segmented on the basis of AVI or Bluetooth readers' locations. Whereas, the segmentation of other freeways/expressways and arterials was based on NPMRDS, which is standardized as Traffic Message Channel (TMC) segments used to deliver and share traffic information among traffic management centers. In order to quantify the traffic congestion and reliability from the segment level to roadways and network level of freeways/expressways and arterials, the following evaluation methods were considered:

- Selection of performance measures in terms of traffic congestion and reliability
- Aggregation of each performance measure by direction of roadways
- Normalization and combination of performance measures to identify critical roadways
- Categorization and combination of performance measures to identify critical segments

6.1.1 Performance measures

In the data preparation stage, travel time and speed of freeways, expressways, and arterials have been collected and archived. Especially, there has been various research that addressed travel time to analyze both traffic congestion and reliability. Therefore, performance measures related to the travel time were selected as follows

- Travel Time Index (TTI)
- Planning Time Index (PTI)
- Buffer Time Index (BTI)

Currently, FHWA and most of states including Florida are using the above three measures to evaluate the performance of roadways (FHWA, 2006, Chen, 2010, FDOT, 2015a, Heery, 2016, Turner et al., 2011b, WSDOT, 2017).

The traffic congestion of roadways and their segments can be measured by the travel time index (TTI). The TTI is defined as the ratio of average travel time to a free-flow or speed-limit travel time:

$$TTI = \frac{\textit{Average Travel Time}}{\textit{Travel Time}_{\textit{free flow or speed limit}}}$$

The TTI represents how much longer travel time is spent on average on the basis of the ideal traffic condition.

Related to the reliability, travel time reliability can be used and estimated by various measures. Particularly, it is well-known that reliability measures can capture the benefits of traffic management well. In this project, planning time index (PTI) and buffer time index (BTI) were selected to assess the travel time reliability according to the FWHA's recommendation (2006).

The PTI is defined as the ratio of the 95th travel time to a free-flow or speed-limit travel time (USDOT, 2013):

$$PTI = \frac{95th\ percentile\ Travel\ Time}{Travel\ Time_{free\ flow\ or\ speed\ limit}}$$

The PTI provides an expected travel time budget, which could be used as a trip planning measure for journeys that require punctuality (Lomax and Margiotta, 2003).

Instead of considering the total travel time to preserve punctuality of travelers, the additional travel time can be used as the difference between the 95th percentile and the average travel time. Usually, the additional travel time is named as buffer time. The BTI is the ratio of the buffer time to the average travel time:

$$BTI = \frac{95th\ percentile\ Travel\ Time - Average\ Travel\ Time}{Average\ Travel\ Time}$$

The BTI implies that as a traveler should allow an extra percentage of travel time to arrive at a destination on time.

To calculate TTI and PTI, it is required to determine the ideal travel time of each segment. The ideal travel time can be based on the free flow speed or speed limit. In this project, speed limits will be used to estimate TTI and PTI. In summary, TTI is used for evaluating traffic congestion and PTI and BTI are used for evaluating travel time reliability.

6.1.2 Performance Measure Estimation by Direction of Roadways

After the performance measures were calculated at each segment on the basis of analysis time slots, each performance measure was aggregated based on the direction of roadways through the VMT (Vehicle Miles Traveled)-weighted average of all segments as follows:

$$TTI_{mean\ by\ direction} = \frac{\sum_{i=1}^n (TTI_i * VMT_i)}{\sum_{i=1}^n VMT_i}$$

$$PTI_{mean\ by\ direction} = \frac{\sum_{i=1}^n (PTI_i * VMT_i)}{\sum_{i=1}^n VMT_i}$$

$$BTI_{mean\ by\ direction} = \frac{\sum_{i=1}^n (BTI_i * VMT_i)}{\sum_{i=1}^n VMT_i}$$

The analysis time slots of 288 were determined based on 5-minute intervals, from 00:00:00 to 23:59:59. To estimate VMT, traffic volume of 5-minute intervals was collected from MVDS for freeways and expressways. Whereas, in the case of arterials, Annual Average Daily Traffic (AADT) was used to estimate the VMT because there are no traffic volume collection systems collecting traffic volume in 5-minute intervals. Thus, the same VMT of each segment on arterials was applied throughout all analysis time slots. Figure 33 shows the estimated three performance measures of westbound Interstate 4 (I-4) based on one-year data of 2017.

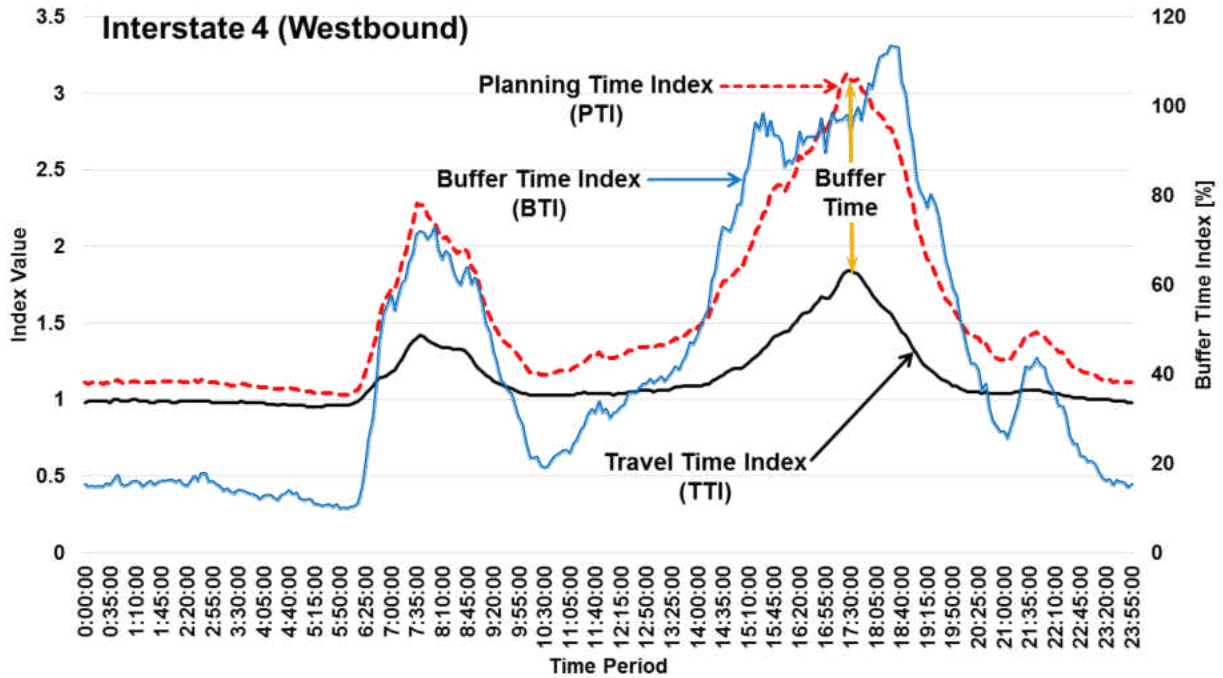

Figure 33. The relationship among TTI, PTI, and BTI of 2017

6.1.3 Normalization and combination of performance measures

Before the three measures (i.e., TTI, PTI, and BTI) are combined, it is required to normalize them because they have different data scale. Among many normalization methods, the min-max normalization method was applied to transform the data of the three measures into a new range as follows:

$$x' = \frac{x - \min(X)}{\max(X) - \min(X)}$$

where, x indicates an observation of X variable,

x' indicates the transformed observation of x ,

$\min(X)$ is the minimum value among values of X variable,

$\max(X)$ is the maximum value among values of X variable,

By normalization, three measures could have the same scale, which ranges from 0 to 1. Figure 34 shows the normalized TTI, PTI, and BTI of westbound I-4 as an example. Comparing with Figure 33, Figure 34 provides a clearer view of the three variables, and we can notice that they have similar trends or fluctuations according to the time series. In this case, TTI and PTI have very similar trends and normalized values, but BTI is a little different than TTI and PTI. Finally, the normalized values were combined through a simple average method.

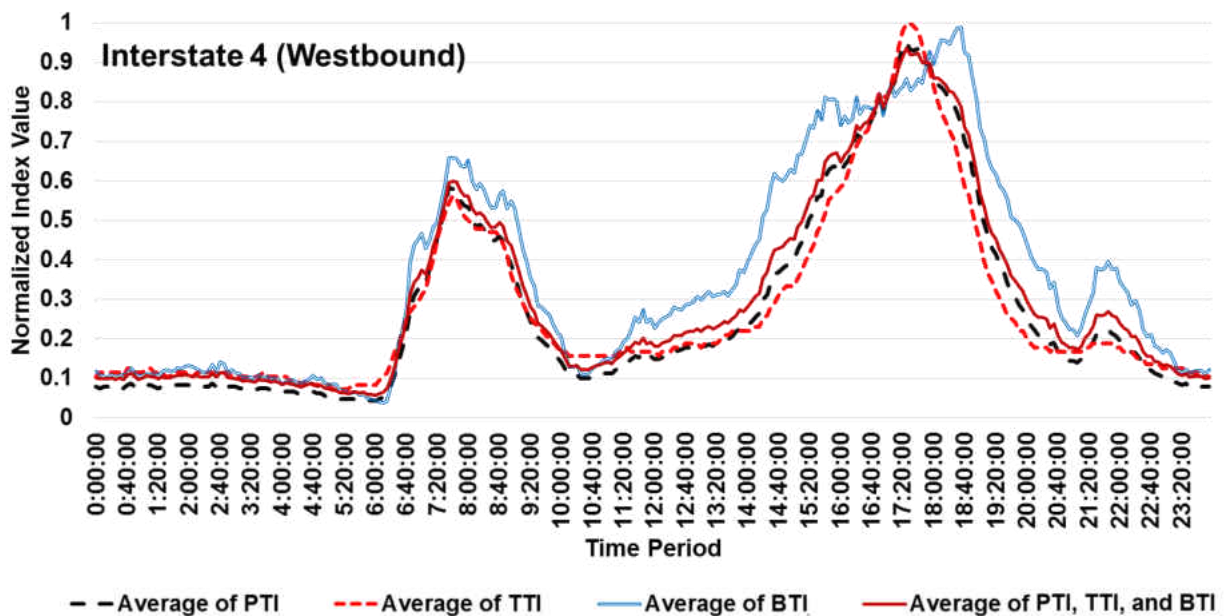

Figure 34. Normalized TTI, PTI, and BTI of 2017

6.1.4 Categorization and combination of performance measures

Categorization of performance measures was applied to identify the critical segments with moderate and high categories. Regardless of freeways and arterials, the selected performance measures were categorized in three groups by considering the following values:

- Low congestion or High reliability (Green): less than the 50th percentile
- Moderate congestion or Moderate reliability (Yellow): greater than or equal to the 50th percentile and less than the 75th percentile

- High congestion or Low reliability (Red): greater than or equal to the 75th percentile value

Considering to using 50 % and 75% of speed to group speeds of RITIS, this research determined the 50th percentile and 75th percentile as criteria to distinguish the low, medium, and high levels. Figure 35 shows the 50th and 75th percentile value of performance measures: TTI, PTI, and BTI. The distributions of TTI, PTI, and BTI included all data of freeways/expressways and arterials. Values in parentheses were applied as criteria to categorize TTI, PTI, and BTI. It should be noted that the criteria of TTI is not significantly different from the previous research on freeways, in which three types of congestion levels are classified on the basis of TTI: less than 1.25, greater than or equal to 1.25 and less than 2.00, and greater than or equal to 2.00 (Griffin). So, the categorization of TTI is consistent with the criteria of previous research.

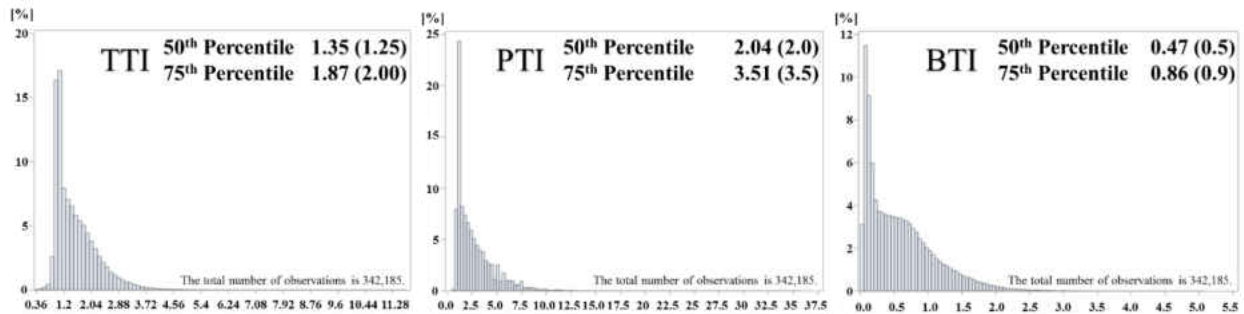

Figure 35. 50th and 75th percentile of performance measures: TTI, PTI, and BTI

For each measure, a scoring paradigm is used for the three categories:

Category	Score
Low congestion or High reliability	1
Moderate congestion or Moderate reliability	2
High congestion or Low reliability	3

Finally, the comprehensive score could be obtained by calculating the average of scores of the three measures (i.e., TTI, PTI, and BTI). Since the average scores have a decimal point, the final scores were rounded to be assigned into three levels (i.e., 1, 2, and 3). Then, the critical segments with medium and high categories were indicated if the rounded final average scores are greater than or equal to 2.

6.2 Data preparation

Three types of data in 2017 were prepared: travel time data, traffic volume data, and geometry data. To estimate more actual traffic conditions, various data sources of freeways, expressways, and arterials were used. If multiple data sources are available for one segment, the data source with the best performance is selected. The travel time data of expressways and arterials covered by the AVI systems of CFX or Bluetooth system were estimated from their raw data. Otherwise, the travel time data of other freeways and arterials were acquired from NPMRDS. Figure 36 demonstrates the data source used for each segment. Note that several segments without any available data are also included to ensure the completeness of the roadways.

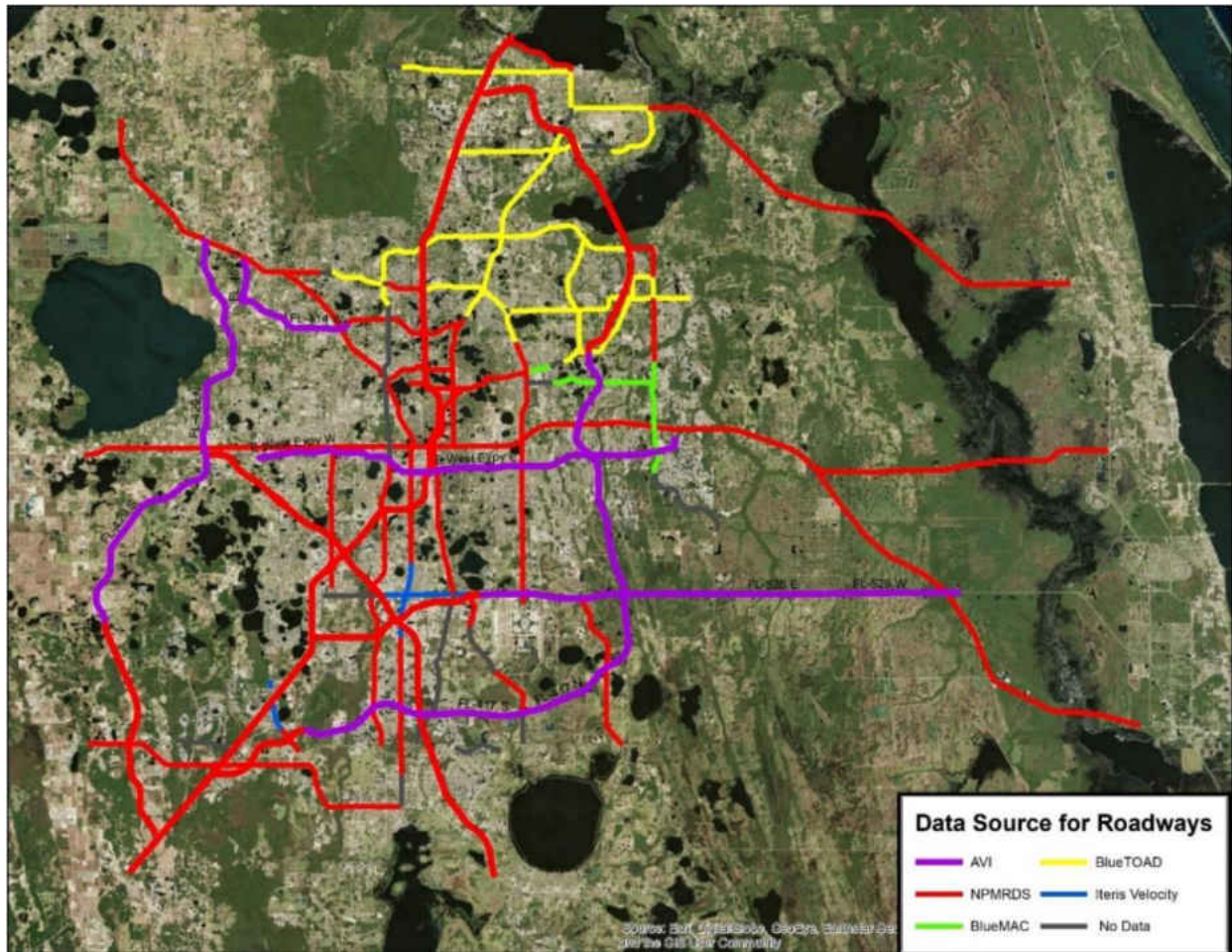

Figure 36. Travel Time data sources used for roadways

Related to the traffic volume data, MVDS data of RITIS archived at 5-minute interval was used for expressways. However, traffic volume of other arterials and freeways, which are not monitored by MVDS, was derived from Annual Average Daily Traffic (AADT) of NPMRDS. Finally, related to the geometry data, speed limits and the number of lanes of each segment were collected from the Roadway Characteristics Inventory (RCI) of FDOT.

After considering the functional classification and data availability, a total of 6 freeways/ expressways and 21 arterials were selected in our study area. Totally, travel time from around 600 miles of roadways (around 1200 segments) were evaluated. Table 15 lists the information of the studied roadways including roadway type, roadway name, length, number of segments of both

directions, and minimum/maximum speed limits along the roadway. It should be noted that speed limit varies across segments for a roadway. Hence, minimum and maximum speed limits of all segments on each are listed.

Table 15. List of the evaluated roadways

Roadway Type	Roadway Name	Length per direction (mile)	Number of Segments*	Speed Limit	
				Min	Max
Freeway	I-4	54.68	136	50	65
	Florida's Turnpike	29.28	31	70	70
	SR 408	23.63	43	55	65
	SR 417	61.91	84	55	70
	SR 429	37.11	46	70	70
	SR 528	35.56	44	55	70
Arterial	SR 46	37.22	22	40	55
	Lake Mary Blvd	11.49	19	35	45
	SR 434	35.02	69	35	50
	US 17-92 North	22.83	51	35	55
	Red Bug Lake Rd-Mitchell	9.12	12	45	45
	SR 436	25.41	73	35	50
	Tuskawilla Rd	5.66	4	45	45
	SR 426	14.53	43	30	45
	Maitland Blvd	5.97	14	45	55
	SR 423-CR 423	21.38	70	35	55
	US 441 N	22.3	56	35	55
	US 17-92-441	17.17	71	35	55
	SR 527	18	44	30	45
	SR 50	50.11	116	30	65
	Kirkman Rd	6.76	35	35	50
	Narcoossee Rd	7.75	9	40	45
	SR 527 A	8.13	13	35	55
	Sand Lake-Mc Coy Rd	7.09	22	45	55
	US 192	16.57	30	40	55
	SR 535	3.79	12	40	50
University Blvd	6.07	20	45	45	
Total	-	594.54	1,189	-	-

* Two directions in total

6.3 Evaluation results

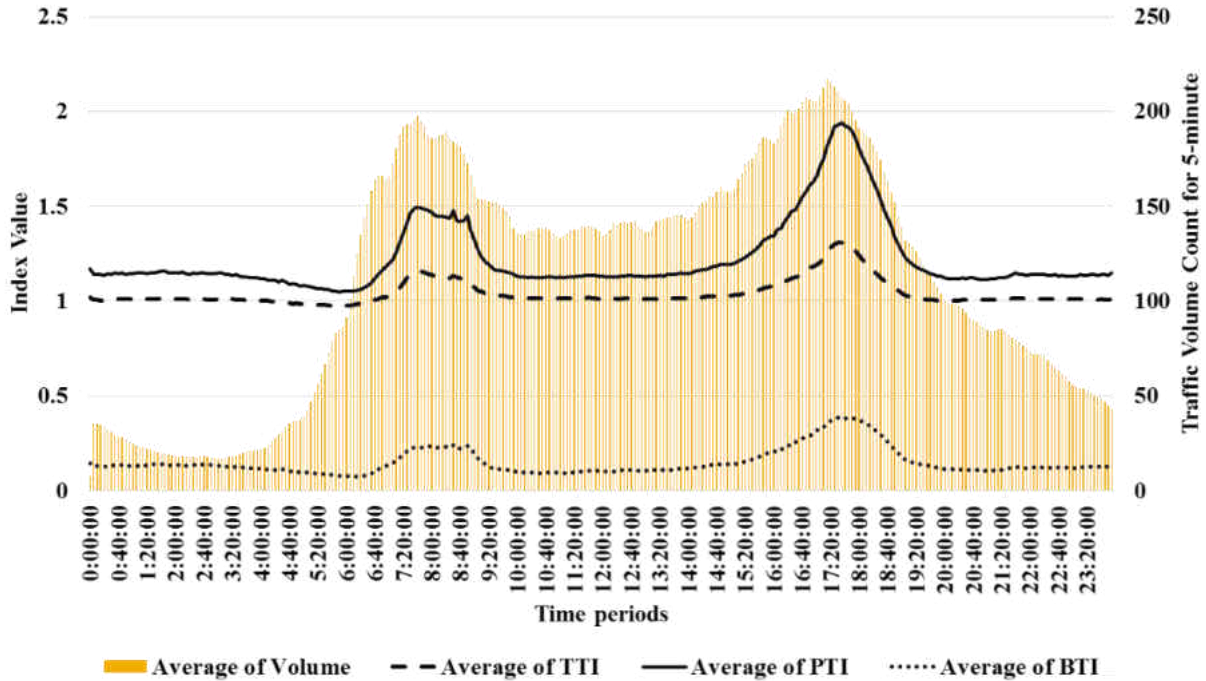

Figure 37. TTI, PTI, and BTI at the freeway/expressways network level

Before ranking roadways and identifying critical segments, analysis was conducted to investigate the overall traffic conditions in the study area. As shown in Figure 37, there are obvious AM and PM peak periods during the day at the freeway/expressway network level. The overall traffic volume of AM and PM peak periods are not significantly different, but the trends of travel time are significantly different: travel time performance of the PM peak periods gets much worse than the AM peak periods. Likewise, arterials at a network level have two peak time periods: AM and PM (see Figure 38). Overall, arterials have higher values of overall TTI, PTI, and BTI than the freeways/expressways, which means that traffic conditions of arterials are worse than freeways/expressways. The TTI at the freeway/expressway network level has low congestion range between 1 and 1.3, whereas the TTI of the arterial network is between about 1.3 and 2.1 corresponding to the medium and high congestion levels. In the case of PTI, the freeway/expressway network has high travel time reliability which is between 1 and 2. On the

other hand, the arterial network has higher records between 2 and 4, corresponding to the medium travel time reliability during the non-peak hours and the low travel time reliability during peak hours. In terms of BTI, the freeway/expressway network is in the range of high travel time reliability (between 0.1 and 0.4), but the arterial network has medium travel time reliability which is between 0.5 and 0.8.

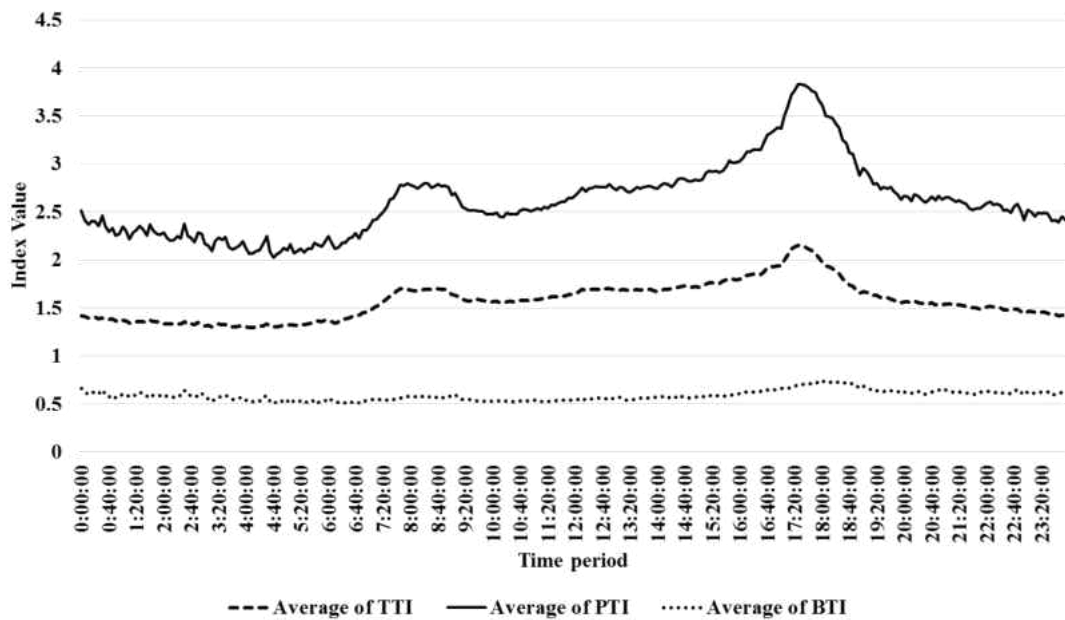

Figure 38. TTI, PTI, and BTI at the arterial network level

Based on the overall trends, critical roadways and segments were analyzed by using the collected data during AM and PM peak periods, when the network has the most serious problem. By considering the change of the average volume of freeways/expressways network (see Figure 37), the AM and PM peak periods were determined as follows:

- AM peak period: 06:00-09:00
- PM peak period: 16:00-19:00

6.3.1 Identification of critical roadways

Critical roadways were identified through ranking roadways based on the normalization and combination of performance measures by direction of roadways. Table 16 shows the results related to ranking freeways/expressways. Based on the AM and PM peak periods, TTI, PTI, and BTI by the direction of each roadway were estimated. The estimated values were normalized by using the minimum and maximum values of each measure. The normalized values correspond to AM (Normalization) and PM (Normalization) columns. The normalized six variables were combined through the simple average. The rank of freeways/expressways were prioritized in descending order. According to the analysis results, it is indicated that both directions of Interstate 4 are mostly congested and unreliable, followed by Florida turnpike (SR 91) and SR 408. It was revealed that the most uncongested and reliable roadway is SR 414 and SR 429, which are in the western outskirts and the west-northern outskirts of Orlando city, respectively.

Table 16. Ranking results of freeways/expressways

Roadway	Dir.	AM			PM			AM (Normalization)			PM (Normalization)			Mean	Rank
		TTI	PTI	BTI	TTI	PTI	BTI	TTI	PTI	BTI	TTI	PTI	BTI		
Interstate-4	WB	1.24	1.79	36.99	1.61	2.75	65.56	0.85	0.96	1.00	1.00	1.00	0.98	0.96	1
Interstate-4	EB	1.24	1.68	28.67	1.55	2.70	66.85	0.83	0.82	0.72	0.90	0.98	1.00	0.88	2
Turnpike	NB	1.30	1.83	31.26	1.16	1.63	38.16	1.00	1.00	0.81	0.37	0.38	0.52	0.68	3
Turnpike	SB	1.11	1.28	13.58	1.41	2.10	40.42	0.53	0.35	0.21	0.72	0.64	0.56	0.50	4
SR 408	WB	1.13	1.47	26.45	1.14	1.46	23.07	0.56	0.58	0.64	0.35	0.29	0.27	0.45	5
SR 408	EB	1.05	1.36	22.54	1.13	1.60	34.24	0.37	0.45	0.51	0.33	0.36	0.46	0.42	6
SR 417	SB	1.08	1.27	15.60	1.12	1.49	29.44	0.44	0.35	0.28	0.32	0.30	0.38	0.34	7
SR 417	NB	1.02	1.12	7.77	1.19	1.63	31.46	0.30	0.17	0.01	0.41	0.38	0.41	0.28	8
SR 528	WB	1.01	1.20	15.74	1.09	1.41	21.41	0.27	0.26	0.28	0.28	0.26	0.25	0.27	9
SR 528	EB	0.98	1.09	10.88	1.10	1.45	25.95	0.19	0.13	0.12	0.29	0.28	0.32	0.22	11
SR 429	SB	1.06	1.20	12.51	1.08	1.32	17.88	0.39	0.27	0.17	0.26	0.21	0.19	0.25	10
SR 429	NB	1.02	1.10	7.47	1.06	1.22	14.40	0.30	0.14	0.00	0.23	0.15	0.13	0.16	12
SR 414	EB	0.96	1.03	8.30	0.94	1.03	9.40	0.14	0.07	0.03	0.08	0.05	0.05	0.07	13
SR 414	WB	0.90	0.98	8.68	0.89	0.95	6.65	0.00	0.00	0.04	0.00	0.00	0.00	0.01	14

Like the ranking of freeways/expressways, arterials were also prioritized. Table 17 shows the ranking results of 21 arterials separated by the main road direction. It should be noted that the directions change along SR 434 and the corresponding directions are N-W-SB (North-West-South Bound) and N-E-SB (North-East-South Bound). The columns of AM and PM are the actual estimated values of TTI, PTI, and BTI of the two peak periods and AM (Normalization) and PM (Normalization) are the normalized values through the min-max method. Finally, the arterials distinguished by their main direction were ranked after the normalized values were averaged.

According to the ranking results of arterials (see Table 17), the critical arterials in the top 10 ranks were identified as follows: Kirkman Road (Southbound and Northbound), SR 527 (Southbound and Northbound), Maitland Boulevard (Eastbound), University Boulevard (Eastbound and Westbound), SR 423-CR 423 (Westbound), and SR 50 (Eastbound and Westbound of Colonial Road). Except for University Boulevard, most critical arterials pass through near the central business district or amusement parks in Orlando city. In addition, it was revealed that arterials in the bottom 10 ranks are as follows: Red Bug Lake Rd-Mitchell Hammock Road (Eastbound and Westbound), Lake Mary Boulevard (Eastbound and Westbound), SR 46 (Eastbound and Westbound), Tuskawilla Road (Southbound and Northbound), US 441 N (Northbound), and US 17-92 North (Southbound), which are located in Oviedo city or in the suburban area of Orlando.

Table 17. Ranking Results of arterials

Roadway	Dir.	AM			PM			AM (Normalization)			PM (Normalization)			Mean	Rank
		TTI	PTI	BTI	TTI	PTI	BTI	TTI	PTI	BTI	TTI	PTI	BTI		
Kirkman Rd	NB	1.92	3.6	0.86	2.65	5.36	1.00	0.71	0.89	1.00	0.99	1.00	0.97	0.93	1
Kirkman Rd	SB	1.99	3.73	0.83	2.13	4.12	0.91	0.77	0.94	0.96	0.67	0.70	0.86	0.82	2
SR 527	SB	1.81	3.22	0.76	2.46	4.83	0.94	0.62	0.75	0.86	0.87	0.87	0.90	0.81	3
Maitland Blvd	EB	2.27	3.89	0.65	2.47	4.22	0.67	1.00	1.00	0.69	0.88	0.72	0.57	0.81	4
SR 527	NB	1.91	3.39	0.75	2.19	4.27	0.93	0.70	0.81	0.85	0.71	0.74	0.89	0.78	5
University Blvd	EB	1.69	3.32	0.86	1.97	4.18	1.03	0.52	0.78	1.00	0.58	0.71	1.00	0.77	6
SR 423-CR 423	WB	1.71	2.96	0.70	2.52	4.8	0.87	0.54	0.65	0.76	0.91	0.86	0.82	0.76	7
University Blvd	WB	1.63	3.07	0.79	2.15	4.34	0.97	0.48	0.69	0.90	0.68	0.75	0.93	0.74	8
SR 50	WB	1.83	3.26	0.74	2.14	4.02	0.85	0.64	0.76	0.83	0.68	0.68	0.80	0.73	9
SR 50	EB	1.73	3.02	0.71	2.23	4.32	0.91	0.56	0.67	0.79	0.73	0.75	0.86	0.73	10
SR 423-CR 423	EB	1.85	3.29	0.72	2.12	3.95	0.83	0.66	0.77	0.80	0.67	0.66	0.76	0.72	11
Maitland Blvd	WB	1.71	2.81	0.58	2.48	4.66	0.89	0.54	0.59	0.58	0.88	0.83	0.84	0.71	12
US 17-92-441	SB	1.62	2.56	0.57	2.67	4.95	0.84	0.47	0.50	0.57	1.00	0.90	0.78	0.70	13
US 17-92-441	NB	1.79	3	0.61	2.25	4.19	0.81	0.61	0.66	0.64	0.75	0.72	0.74	0.69	14
SR 434	N-E-SB	1.65	2.84	0.63	2.09	3.95	0.75	0.49	0.60	0.66	0.65	0.66	0.67	0.62	15
SR 535	SB	1.27	2.09	0.58	2.29	4.55	0.95	0.18	0.32	0.58	0.77	0.80	0.91	0.60	16
SR 434	N-W-SB	1.6	2.77	0.64	1.95	3.52	0.70	0.45	0.58	0.67	0.56	0.56	0.61	0.57	17
US 192	EB	1.53	2.5	0.60	2.04	3.74	0.78	0.39	0.48	0.62	0.62	0.61	0.71	0.57	18
SR 436	NB	1.66	2.65	0.56	2.17	3.63	0.63	0.50	0.53	0.57	0.70	0.58	0.53	0.57	19
SR 426	EB	1.52	2.58	0.63	2.15	3.63	0.63	0.39	0.51	0.66	0.68	0.58	0.53	0.56	20
US 192	WB	1.51	2.36	0.53	2.04	3.8	0.79	0.38	0.42	0.52	0.62	0.62	0.72	0.55	21
Sand Lake-Mc Coy Rd	EB	1.38	2.18	0.58	2.01	3.76	0.84	0.27	0.35	0.59	0.60	0.61	0.78	0.54	22
Narcoossee Rd	SB	1.5	2.39	0.57	1.82	3.42	0.81	0.37	0.43	0.58	0.48	0.53	0.74	0.52	23
SR 436	SB	1.65	2.59	0.52	2.01	3.37	0.63	0.49	0.51	0.50	0.60	0.52	0.52	0.52	24
Narcoossee Rd	NB	1.52	2.58	0.66	1.7	3.04	0.76	0.39	0.51	0.70	0.41	0.44	0.68	0.52	25
Sand Lake-Mc Coy Rd	WB	1.61	2.55	0.56	1.81	3.18	0.70	0.46	0.49	0.56	0.48	0.47	0.61	0.51	26
SR 535	NB	1.46	2.23	0.47	1.77	3.39	0.92	0.34	0.37	0.42	0.45	0.52	0.87	0.50	27
SR 426	WB	1.56	2.51	0.54	1.75	2.92	0.61	0.42	0.48	0.53	0.44	0.41	0.50	0.46	28
US 17-92 North	NB	1.45	2.28	0.51	1.9	3.21	0.63	0.33	0.39	0.48	0.53	0.48	0.53	0.46	29
US 441 N	SB	1.58	2.48	0.53	1.57	2.64	0.63	0.43	0.47	0.51	0.33	0.34	0.52	0.44	30
SR 527 A	SB	1.42	2.08	0.46	1.65	3.09	0.79	0.30	0.32	0.42	0.38	0.45	0.72	0.43	31
SR 527 A	NB	1.5	2.28	0.48	1.58	2.62	0.61	0.37	0.39	0.45	0.34	0.34	0.51	0.40	32
US 17-92 North	SB	1.49	2.26	0.47	1.69	2.75	0.55	0.36	0.38	0.42	0.41	0.37	0.43	0.40	33
US 441 N	NB	1.41	2.12	0.47	1.76	2.88	0.58	0.30	0.33	0.43	0.45	0.40	0.46	0.40	34
SR 46	WB	1.27	1.63	0.28	1.58	2.27	0.42	0.18	0.15	0.14	0.34	0.25	0.27	0.22	35
Lake Mary Blvd	EB	1.27	1.71	0.30	1.45	1.93	0.30	0.18	0.18	0.18	0.26	0.17	0.13	0.18	36
Red Bug Lake Rd-Mitchell Hammock Rd	EB	1.28	1.56	0.21	1.56	2.09	0.32	0.19	0.12	0.05	0.33	0.21	0.16	0.17	37
Tuskawilla Rd	SB	1.37	1.71	0.24	1.48	1.86	0.26	0.26	0.18	0.09	0.28	0.15	0.08	0.17	38
Tuskawilla Rd	NB	1.31	1.64	0.24	1.46	1.85	0.27	0.21	0.15	0.09	0.27	0.15	0.09	0.16	39
SR 46	EB	1.29	1.63	0.26	1.36	1.79	0.31	0.20	0.15	0.12	0.21	0.14	0.14	0.16	40
Lake Mary Blvd	WB	1.24	1.64	0.29	1.37	1.8	0.28	0.16	0.15	0.16	0.21	0.14	0.10	0.15	41
Red Bug Lake Rd-Mitchell Hammock Rd	WB	1.25	1.59	0.25	1.34	1.68	0.24	0.16	0.13	0.10	0.19	0.11	0.05	0.13	42

6.3.2 Identification of Critical Segments

Although the critical roadways with high normalized numeric index will have most of the critical segments indicated by medium and high categories, several critical segments can be located on other roadways. In order to find critical segments, all segments on freeway/expressways and arterials in study area were analyzed through categorization of TTI, PTI, and BTI according to the defined criteria in Figure 35. Segments with medium and high categories were indicated to critical segments.

The classification of TTI, PTI, and BTI for all segments was conducted for both AM and PM peak periods. As shown in Figure 39, it is clear that arterials have much more critical segments and more critical segments could be identified during the PM peak period.

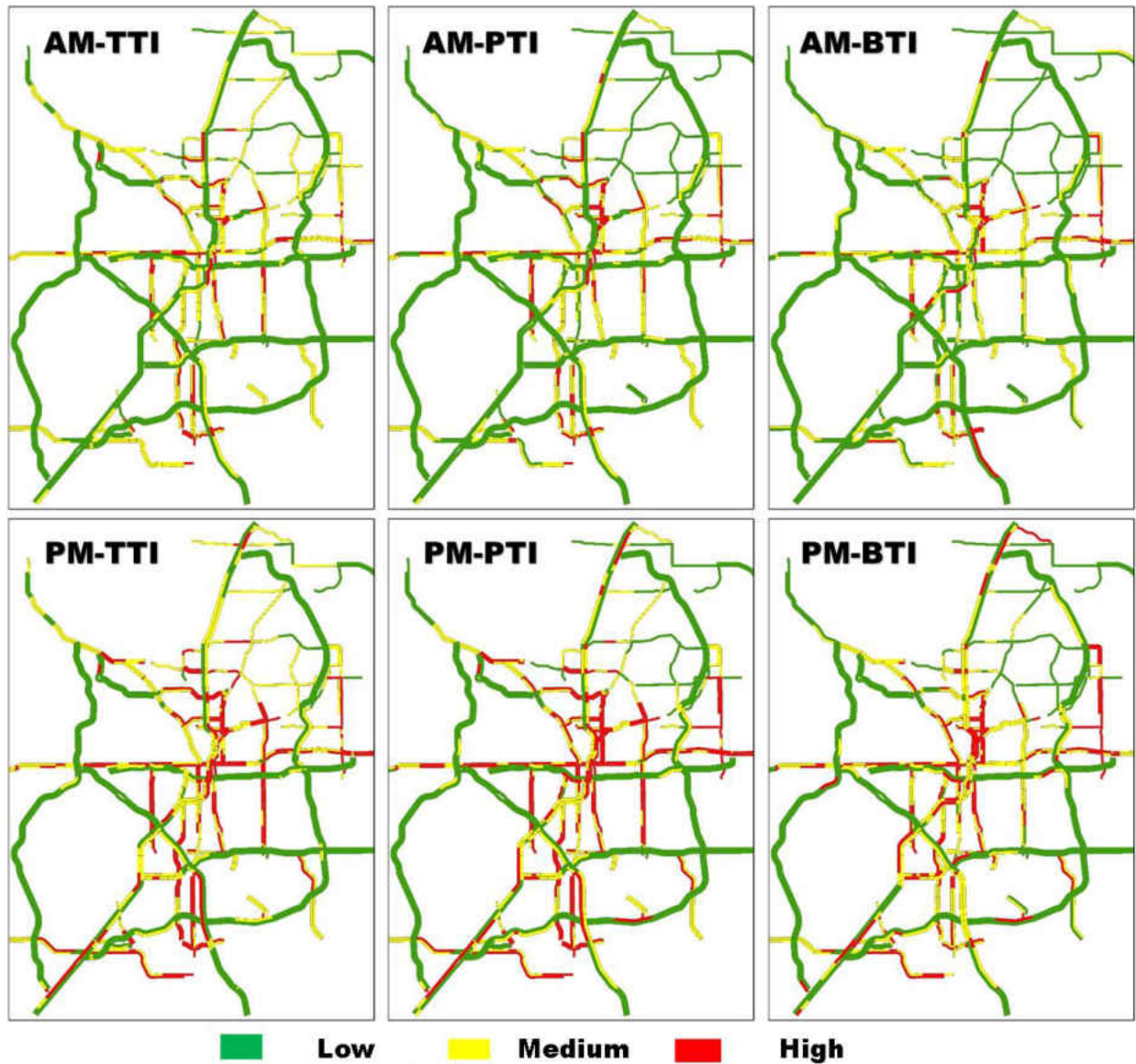

Figure 39. Categorization of TTI, PTI, and BTI on segments for AM and PM peak periods

To obtain comprehensive results related to the critical segments, all category values of the above were aggregated through the simple average for both AM and PM periods. Figure 40 shows clearly critical segments on freeway/expressways and arterials. The overall length of critical segments by each freeway/expressway is similar to the ranking results of freeway/expressways. Especially, I-4 has the longest critical segments, followed by Turnpike (SR-91). SR-408, SR-528, and SR-417 appear to have a similar critical segment length. Finally, SR-429 has only two critical

segments near major junctions, but SR-414 does not have any critical segment. Likewise, major arterials have more critical segments. Arterials in Oviedo city have less critical segments than Orlando city during peak periods. Arterials near CBD, universities, amusement parks, and Orlando airport have many critical segments. Most of the segments on SR-50, which is a major east - west arterial in the study area, are critical segments.

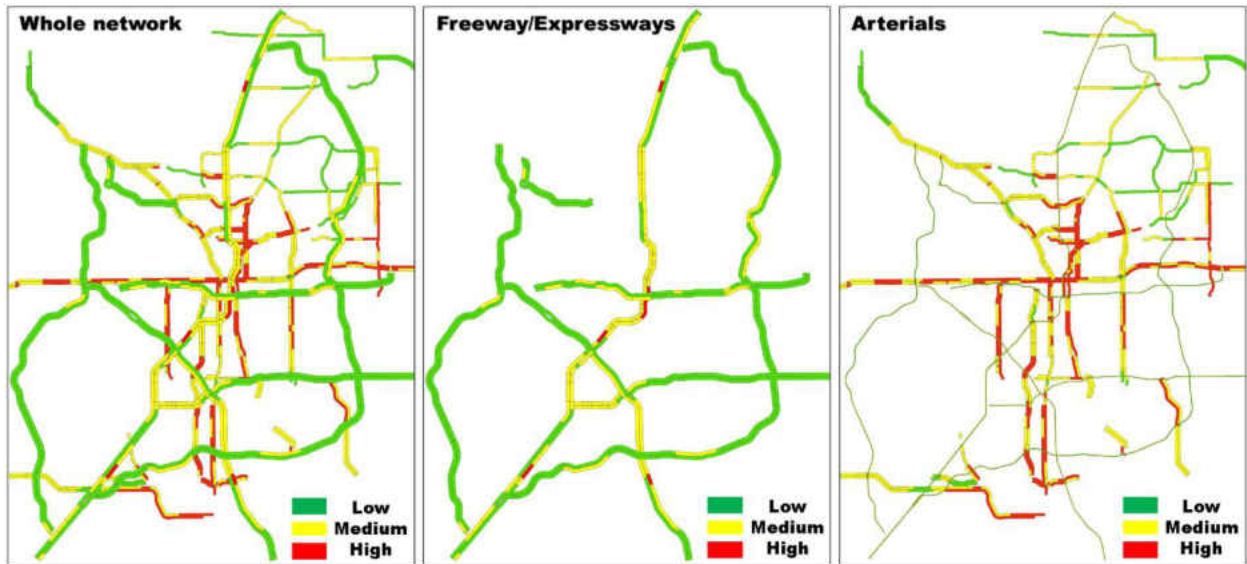

Figure 40. Critical segments in Orlando area

CHAPTER 7. DEVELOPMENT OF DECISION SUPPORT SYSTEM (DSS) TO MITIGATE TRAVEL TIME VARIABILITY THROUGH THE COMBINATION OF VARIABLE SPEED LIMITS, QUEUE WARNING, AND RAMP METERING

7.1 Introduction

Over the past few decades, road traffic management has been gradually evolved toward more active traffic management through various advanced traffic management. The type of traffic management can be classified into three categories: static management, responsive management, and proactive management. At the static management, predefined traffic controls will be operated on a time of day basis. The responsive management responds to current traffic conditions occurring on roadways, reducing the time of degraded operation. Proactive management aims to respond to anticipated changes to traffic conditions and to delays or eliminate breakdowns of the infrastructure facilities. Therefore, it is necessary that proactive management use new tools, such as decision support systems (DSS) and predictive models to eliminate or delay the breakdown of infrastructure facilities.

Various DSSs have been operated for the advanced traffic management systems integrating roadway networks through the combination of various traffic management strategies. According to the techniques and methodologies applied into the DSS, the DSS can be categorized into knowledge-based DSS, real-time simulation-based DSS, and case-based DSS. The basic functions of DSS are to identify current and near-future traffic conditions and recommend a proper response plan. Related to the near-future traffic condition, real-time traffic simulation can be used, but it has the limitation of the time-consuming process of real-time traffic simulation. So, usually, traffic-state prediction models such as METANET and DynaTAM have been used. In addition, DSS should use performance measures to determine the best response or control plans. So far, the most DSSs have considered the total travel time or delay of the specific area of the roadway network.

As performance regarding the travel time reliability has been considered in the objectives of the current study ATMICM, and TSM&O, it is required that DSS should contribute to improving travel time reliability. Among various measures to quantify the travel time reliability, standard deviation (SD) of travel time rate (TTR; minute per mile) as a statistical range measure was adopted in this research. Although there are many approaches of ATM strategies, representative three strategies, variable speed limits (VSL), queue warning (QW), and ramp metering (RM), were selected in order to develop the DSS considering travel time reliability during recurring traffic congestion. Although detour routing and adaptive signal control strategies should be applied in DSS to maximize the effectiveness of IATM, the two strategies are not included in DSS because the two strategies related to signal control are out of the scope of this project.

7.2 Decision Support System

The developed decision support system consists of several components: collection of real-time traffic data, recommendation of response plans, effectiveness evaluation of response plans, and selection of a response plan (see Figure 41). Since the current DSS cannot be linked to the real traffic operation system, AIMSUN traffic simulation was used instead. Possible response plans were created on the basis of the control rules of VSL, QW, and RM strategies. In the practical aspect, the logic of each strategy was selected and adjusted for this research.

As a core part of the DSS, the effective evaluation of response plans uses two models: METANET to predict the near-future traffic status depending on control values of three strategies and travel time variability estimation model using the standard deviation of travel time rate.

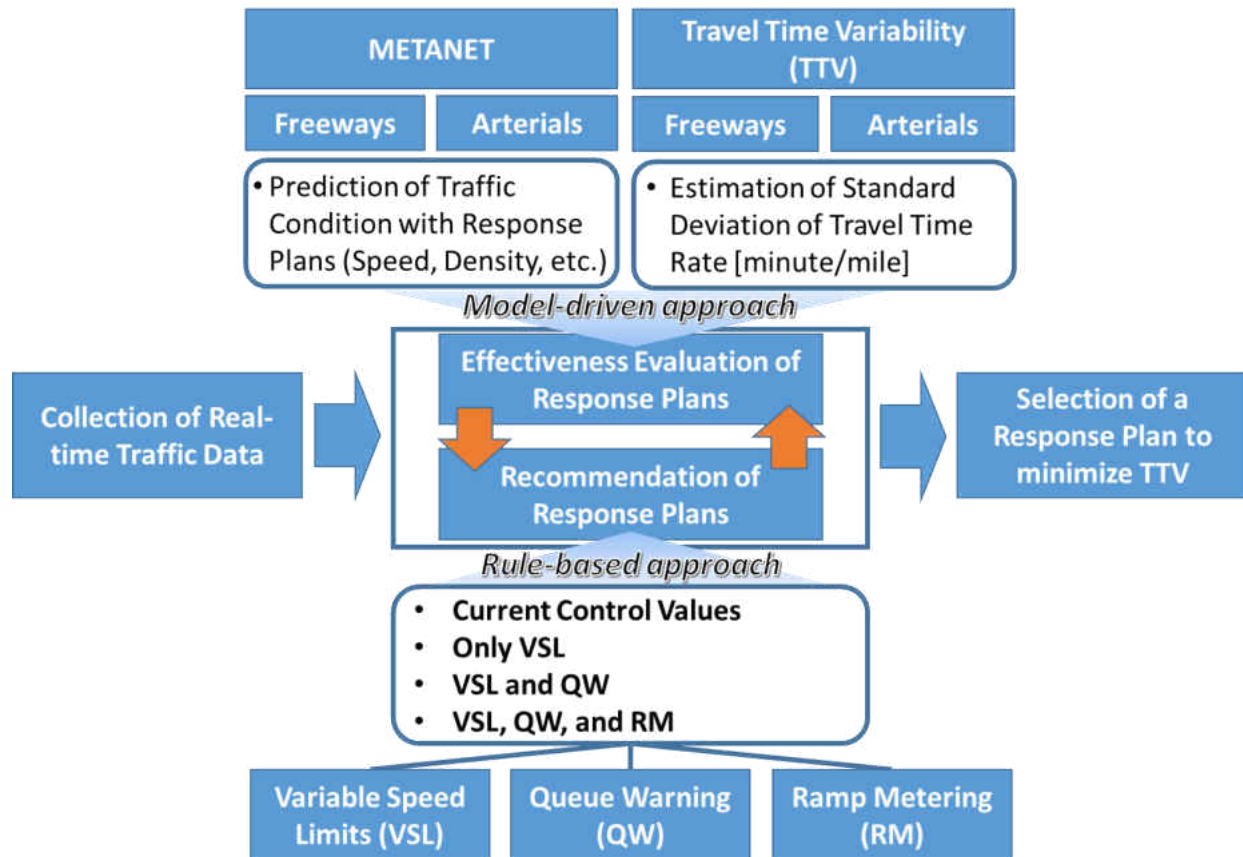

Figure 41. Decision Support System Configuration

7.3 Rules of Active Traffic Management Strategies

7.3.1 VSL (Variable Speed Limits) Control Rule

Variable Speed Limits (VSL), which is sometimes referred to as Dynamic Speed Limits (DSpL) or speed harmonization, is a vital active traffic management system (ATM) strategy. It is used to provide appropriate speed limits to drivers, who are required to respond to the change in traffic conditions due to bottlenecks, low visibility, slippery pavement, etc. Specifically, it is known that the VSL has been applied to defer or prevent the onset of traffic congestion, decrease speed variation, mitigate shockwaves, increase throughput, and smoothen traffic flow. In order to find the appropriate speed limits, real-time or predicted traffic conditions should be used on the basis of the goals/objectives of traffic management. So far, many algorithms have been developed

to select the appropriate speed limits. Regarding the drivers' acceptance of VSL, the VSL can be regulatory or advisory, depending on local traffic control policies. Usually, it is recommended to use regulatory speed limits to achieve high compliance rate to maximize the benefits of the VSL.

Although numerous advanced VSL algorithms were developed, still many agencies are using simple reactive rule-based algorithms and showed various benefits on traffic safety or efficiency in previous research (Bham et al., 2010, Khondaker and Kattan, 2015, Bryan Katz, 2017). Considering applicability in the field and also scalability in the traffic simulation, a simple, but representative, online VSL algorithm was provided and developed in this study (see Figure 42). The basic logic is that speed limits are changed toward the 85 percentile speed if there is a difference between the posted speed limit and the 85 percentile speed. This logic was applied in Florida, Oregon, and Washington states (Bryan Katz, 2017).

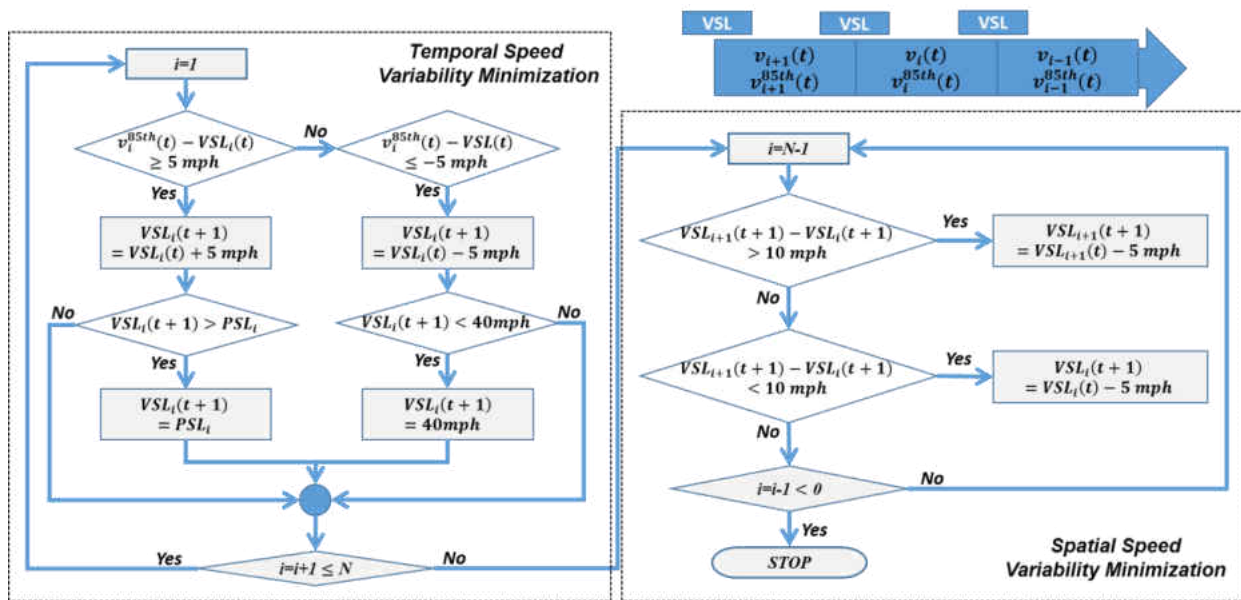

Figure 42. VSL Control Logic

Additionally, operational constraints proved in the previous research were considered to make sure that the implemented VSL would not introduce any negative safety impacts. The constraints are as follows:

- The maximum difference between two neighboring posted speed limits should be 10 mph (spatial constraint) (Yu and Abdel-Aty, 2014).
- The maximum difference between two consecutive VSL control time steps should be 10 mph (temporal constraint) (Abdel-Aty et al., 2008, Yu and Abdel-Aty, 2014).
- An increment of VSL should be 5 mph (Abdel-Aty et al., 2006b).
- Variable Speed Limit should be updated by 5 minutes (Yu and Abdel-Aty, 2014).
- The minimum variable speed limit should be 40 mph (Abdel-Aty et al., 2008).
- The posted speed limit should never exceed the design speed on the freeway.

7.3.2 QW (Queue Warning) Control Rule

Queues occur due to three major causes: recurring traffic congestion, work zones, and incidents (Wiles et al., 2003). Basically, the queue warning (QW) strategy has been used to alert drivers to the existence of the queue in downstream or guide them to choose proper lanes. So, it was deployed with the intention of to reducing rear-end crashes and improving traffic safety, and also improving the available roadway capacity. The alerts and guidance can be provided through various methods: static signing, variable message sign (VMS), lane control signals (LCSs), incident response vehicles, and in-vehicle devices. In terms of active traffic management (ATM) strategies, static signs are not included in the QW strategy. Especially, the QW strategy in this research considered LCS and VMS.

Recently, QW systems in ATM can be regarded as an extension of VSL systems (Strömgren and Lind, 2016, Tignor et al., 1999, Fuhs, 2010, Mirshahi et al., 2007, HNTB, 2013). It is because the queue warning signs can be displayed as warning messages with either recommended speeds or lane control signs. In Europe, most of queue warning is integrated as one of the components in a speed harmonization system. A queue warning system on a motorway in

Denmark is activated when speed is less than 50 km/h (31 mph) (Wiles et al., 2003). The queue warning is displayed as speed limits and drivers see successive VMS with predefined speed limits of 90, 70, and 50 km/h (56, 44, and 31 mph) until they meet the end of queue. In Sweden, motorway control systems on the E4 employed QW system (recommended speed without a red ring) and dynamic speed limits (with a red ring). In the system, the QW was activated and a speed of 70 km/h (44 mph) was recommended when the automatic accident detection algorithm detected that the speed was lower than 45 km/h (28 mph). Otherwise, speed harmonization can be activated in the dense traffic condition and then the advisory speed limits were displayed as 80 km/h (50 mph).

QW can be provided by alert messages (e.g., “STOPPED VEHICLE AHEAD”, and “SLOW VEHICEL AHEAD”) or recommended speeds. In this study, the recommended speed was used for precise traffic control. The QW strategy using recommended speeds can be implemented in the simulation for the effectiveness analysis.

In order to implement a QW algorithm with recommended speeds, three aspects were considered:

- Detecting segments in which queues exist
- Deciding recommended speeds in segments with queues
- Guiding speed reduction gradually

For the QW activation, segments with queues should be detected. The queue existence of a segment was determined when the average speed of the segment is less than 40 mph. Thus, VSL and QW could be activated and separated at different speed ranges consistently. When the average speed of segments is more than 40 mph, speed limits would be determined through a VSL algorithm. On the contrary, the QW algorithm would work in case of less than 40 mph.

Additionally, recommended speeds in segments with queues were more specified in this project as follows:

- The recommended speed is 40 mph, if the average speed of a segment is between 35 and 40 mph
- The recommended speed is 35 mph, if the average speed of a segment is between 30 and 35 mph
- The recommended speed is 30 mph, if the average speed of a segment is between 25 and 30 mph
- The recommended speed is 25 mph, if the average speed of a segment is between 20 and 25 mph
- The recommended speed is 20 mph, if the average speed of a segment is less than 20 mph

For the gradual speed reduction of upstream traffic from a segment under queue state, the size of the gradual speed reduction was determined as a constant value of 5 mph. Maximum 2 upstream segments from the segment under queue state were controlled for the gradual speed reduction. Depending on the recommended speed of segments with queues, if the upstream segments are not under queue state, the upstream segments' recommended speeds can be determined as follows:

- When the recommended speed for the queue segment is 40 mph, the first upstream segment is 45 mph and the second upstream segment is 50 mph.
- When the recommended speed for the queue segment is 35 mph, the first upstream segment is 40 mph and the second upstream segment is 45 mph.

- When the recommended speed for the queue segment is 30 mph, the first upstream segment is 35 mph and the second upstream segment is 40 mph.
- When the recommended speed for the queue segment is 25 mph, the first upstream segment is 30 mph and the second upstream segment is 35 mph.
- When the recommended speed for the queue segment is 20 mph, the first upstream segment is 25 mph and the second upstream segment is 30 mph.

Figure 43 shows an example of the gradual speed reduction of upstream segments when the average speed of the segment with a queue state is 30 mph.

2 nd upstream segment	1 st upstream segment	Segment under queue state
Recommended Speed 40 mph	Recommended Speed 35 mph	Recommended Speed 30 mph

Figure 43. An example of the gradual speed reduction of upstream segments

7.3.3 RM (Ramp Metering) Control Rule

Ramp meters are traffic signals installed on the on-ramps of limited-access freeways/expressways to control vehicles entering the freeway/expressway mainline. It is well-accepted that ramp metering allows efficient use of freeways/expressways mainline capacity by managing the inflows and reduces the crash risk of freeway merging area by breaking up platoons of merging vehicles considering the limited gaps (Papageorgiou and Kotsialos, 2002).

The ramp metering algorithms can be divided into pre-planned metering algorithms and traffic responsive metering algorithms. The pre-planned metering algorithms recommend a fixed metering rate that is not related to the current traffic state on mainline. In contrast, the traffic responsive metering is directly affected by the current traffic state on mainline and ramp. The metering rate is selected based on the real-time traffic variable (e.g., occupancy). In the traffic

responsive metering, the control logic also can be divided into closed loop and open loop control. The closed loop control is a feedback control to incorporate updated measurements in addition to the initial state (e.g., ALINEA). In the open loop control, one of many predefined metering rates is selected based on the current measurement and, which can be easily integrated with other strategies.

In this study, an open loop control method was selected, which can provide predefined metering rates based on traffic variables such as occupancy and volume. With reference to the previous studies (Blumentritt et al., 1981, McDermott et al., 1979), local actuated metering rates was applied. Table 18 shows that the actuated metering rates can be selected according to the mainline occupancy. The cycle length and green time were tested and adjusted to generate the pre-defined metering rate in the microscopic traffic simulation.

Table 18. Local Actuated Metering Rates as a Function of Mainline Occupancy

Occupancy (%)	Metering Rate (Vehicle/Minute)	Metering Rate (Vehicle/Hour)	Cycle Length	Green Time
≤ 10	12	720	10	6
11 – 16	10	600	10	5
17 – 22	8	480	10	4
23 – 28	6	360	15	6
29 – 34	4	240	15	4
> 34	3	180	20	4

7.4 Study Site

An Interstate 4 corridor network in the Orlando CBD area between West Michigan Street and East Par Street was chosen, which has the most congested bottlenecks in the Orlando Metropolitan area (see Figure 44). So, the study site is a location to provide different effectiveness analysis under the dynamic traffic conditions. The posted speed limit on this 6-mile freeway is 55 mph. There are 9 and 8 on-ramps on the eastbound and westbound in the study site, respectively.

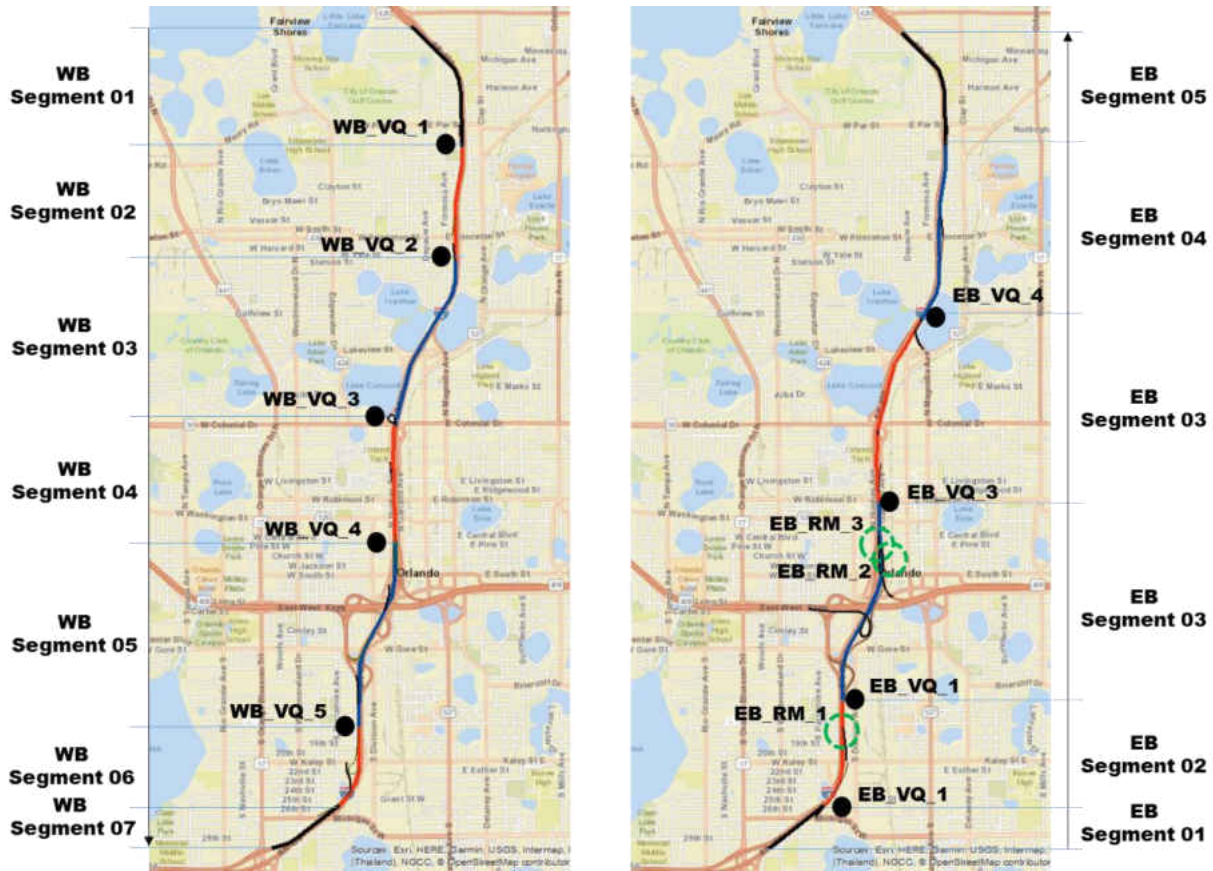

Figure 44. Study site

7.4.1 Selection of VSL and QW Deployment Location

Harbord (Harbord, 1998) recommended that standard gantries displaying VSL should not be located more than 1 km apart in order to help drivers see the next VSL signs. In addition, Abdel-Aty et al. (Abdel-Aty et al., 2006a) suggested that speed limits should be displayed within a short distance (2 miles) for traffic safety improvement. According to the deployment guideline of VSL harmonizing European ITS services, speed limits should be showed repeatedly and also the spacing between the VSL gantries should not be exceeded more than 10 km (6 miles) (EasyWay, 2015). FHWA (Federal Highway Administration) guided that VSL should be installed at regular intervals and the reduced speed limits should not be displayed more than 1 mile upstream from the

critical sections related to wet weather (Katz et al., 2012). In conclusion, VSL should be located at a certain distance so that drivers can recognize and react to it.

Considering the general guide deploying VSL, the VSL locations were placed at major segments. Nine locations were selected at 4 and 5 for the eastbound and westbound, respectively. The average installation spacing is about 1 mile. Table 19 is the summary of geometric and operational features based on the segments defined by the VSL locations, Figure 44 shows the exact locations and segments of VSL. In addition, QW signs are located in the same location of VSL because usually, VSL and QW would be integrated in a composite gantry and also the QW strategy could be implemented as an extension of VSL. When the queue is detected in the downstream segments, QW signs and advisory speeds would be provided concurrently according to the QW control method.

Table 19. Geometric and Operational Features of the VSL and QW segments

Segment ID	Direction	Length [miles]	Lane Count		Static Speed Limit [mph]
			Min	Max	
SE-1	Eastbound	0.47	4	4	55
SE-2	Eastbound	0.74	4	4	55
SE-3	Eastbound	1.39	3	4	55
SE-4	Eastbound	1.29	3	4	55
SE-5	Eastbound	1.20	3	4	55
SE-6	Eastbound	0.86	4	4	55
SW-1	Westbound	0.94	4	4	55
SW-2	Westbound	0.77	4	4	55
SW-3	Westbound	1.20	4	4	55
SW-4	Westbound	0.78	4	4	55
SW-5	Westbound	1.29	4	4	55
SW-6	Westbound	0.57	4	4	55
SW-7	Westbound	0.55	4	4	55

7.4.2 Selection of RM Deployment Location

While RM has many benefits, it might not be applicable for every freeway on-ramp. It is required that a rigorous selection of the potential locations of RM deployment was conducted. Then, the proposed RM strategies are deployed on the selected on-ramps in the microscopic traffic simulation. The following ramp metering warrants developed in 2011 for the State of Florida (Gan et al., 2011) were considered:

- **Mainline Speed:** Ramp signaling is warranted at a location where the average mainline speed during the peak hour is less than 50 mph.
- **Ramp Volume:** Ramp signaling is warranted at a location if the following conditions are met:
 - For a ramp with a single lane, ramp signaling is considered when the peak hour on ramp volume is between 240 and 1,200 vph.
 - For a ramp with multiple lanes, ramp signaling is considered when the peak hour onramp volume is between 400 and 1,700 vph.
- **Ramp Storage:** Ramp signaling is warranted at a location where the ramp storage distance is longer than the queuing length estimated by the following equation:

$$L = 0.25V - 0.00007422V^2$$

where, L: required single-lane storage distance (meter)

V: peak hour ramp demand (vph)

- **Total Mainline and Ramp Volume:** Ramp signaling is warranted when any of the following conditions is met:

Condition 1: The summation of peak hour mainline volume and ramp volume exceeds the following threshold values depending on the total number of mainline lanes including auxiliary lanes:

- If there are two lanes, warrant is met when total volume is greater than 2,650 vph
- If there are three lanes, warrant is met when total volume is greater than 4,250 vph
- If there are four lanes, warrant is met when total volume is greater than 5,850 vph
- If there are five lanes, warrant is met when total volume is greater than 7,450 vph
- If there are six lanes, warrant is met when total volume is greater than 9,050 vph
- If there are more than six lanes, warrant is met when total volume is greater than 10,650 vph

The summation of peak hour mainline volume and ramp volume exceeds the following threshold values

Condition 2: Peak hour volume of the rightmost lane exceeds 2,050 vph.

According to the ramp metering warrants, only three ramps, which are the on-ramp connecting Kaley St with I-4 Eastbound (EB_RM_1), the on-ramp connecting Anderson St with I-4 Eastbound (EB_RM_2) and the on-ramp connecting South St with I-4 Eastbound (EB_RM_3), meet the warrants. Figure 45 shows the locations of the selected on-ramps for the ramp metering strategy.

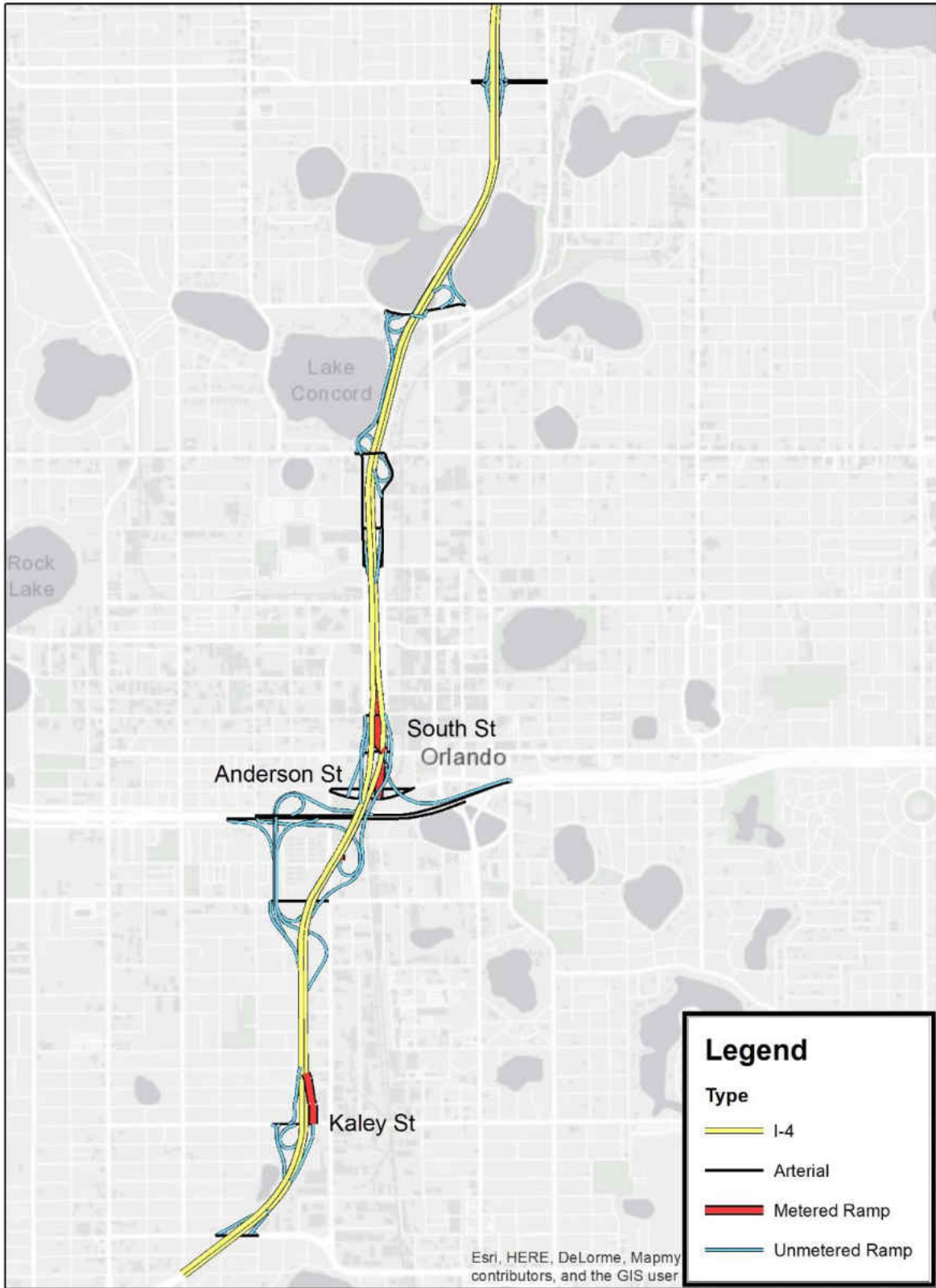

Figure 45. The Location of Metered Ramps

7.5 A Macroscopic Traffic Flow Model for the Freeway and Arterial Network

This research uses a model predictive control (MPC) approach, which has been applied to various ATM strategies of freeway networks (Hegyi, 2004). Usually, model predictive control uses a model to anticipate the near-future change of the traffic flow when a control is applied to the existing traffic flow status. The most important part of the MPC approach is to select a model to well represent the change of traffic flow according to the control values of traffic strategies. Considering the applicability of various ATM strategies and the integration of freeways and arterials, the well-known METANET model was utilized, a deterministic macroscopic modeling tool using a second-order traffic flow model. The METANET model is able to simulate all types of traffic statuses, incidents reducing capacity, and also traffic control actions such as ramp metering, variable speed limits, and so on.

7.5.1 Freeway Traffic Model

In the METANET model, the macroscopic traffic flow is described through the definition of adequate variables representing the average behavior of the vehicles at certain freeway segments “ i ” and times “ t ” (Papageorgiou et al., 1990, Papageorgiou et al., 1989). Freeway stretches are split into segments with length of L_i and λ_i lanes, which have traffic density, mean speed, and traffic volume (see Figure 46). By using the discretized time and space, traffic density $\rho_i(k)$ [vehicle/lane/mile] is defined as the number of vehicles in the segment at time $t = kT$ divided by the segment length L_i where $k = 0, 1, 2, \dots$ is the discrete time index, and T indicates the simulation time interval. In the same way, $v_i(k)$ denotes the mean speed [mph] of vehicles in the segment at time $t = kT$. Finally, traffic volume $q_i(k)$ [vehicle/hour] is the number of vehicle leaving the segment during $kT < t < (k + 1)T$, divided by T . T is the time step used for traffic

flow prediction, chosen $T=(1/60)$ hour in this study. The macroscopic traffic flow model for each segment i is composed of the following equations:

$$\rho_i(k+1) = \rho_i(k) + \frac{T}{L_i \lambda_i} [q_{i-1}(k) - q_i(k) + r_i(k) - s_i(k)]$$

$$q_i(k) = \rho_i(k) \cdot v_i(k) \cdot \lambda_i$$

$$v_i(k+1) = v_i(k) + \frac{T}{\tau} [V[\rho_i(k)] - v_i(k)] + \frac{T}{L_i} v_i(k) [v_{i-1}(k) - v_i(k)]$$

$$- \frac{\nu * T}{\tau * L_i} \frac{\rho_{i+1}(k) - \rho_i(k)}{\rho_i(k) + \kappa} - \frac{\delta * T}{L_i \lambda_i} \frac{q_{\mu}(k) * v_{m,1}(k)}{\rho_i(k) + \kappa}$$

$$- \frac{\phi * T * \Delta \lambda \rho_{i, N_i}(k) * v_{i, N_i}(k)^2}{L_i \lambda_i \rho_{cr, i}}$$

$$V[\rho_i(k)] = v_f * \exp \left[-\frac{1}{a} \left(\frac{\rho_i(k)}{\rho_{cr}} \right)^a \right]$$

where v_f , ρ_{cr} denotes the free-flow speed, and the critical density of freeways, respectively.

a , τ , ν , κ , δ and ϕ are constant parameters to be estimated.

To illustrate flow-density diagram regarding speed limit, a quantified model was used, which was developed by Papageorgiou et al. (1989). The impact of the control of speed limits on the flow-density diagram is quantified as follows:

$$v'_f = v_f \cdot b(k)$$

$$\rho'_{cr} = \rho_{cr} \cdot [1 + A \cdot (1 - b_i(k))]$$

$$a' = a \cdot [E - (E - 1) \cdot b_i(k)]$$

where v_f , ρ_{cr} , and a represent the condition under the posted speed limits; A and E are constant parameters that represent the impact of the changed speed limit on the fundamental diagram. The value of A and E was chosen as 0.69 and 1.76 estimated by the previous study (Yu and Abdel-Aty, 2014). $b_i(k)$ denotes the optimal VSL rates that should be implemented for segment i at time step k , where $b_i(k) \in [b_{min}, 1]$ as $b_{min} \in (0,1)$ is the lowest admissible bound for the VSL rates.

By using traffic data collected from AIMSUN simulation, constant parameters of METANET were calibrated through the deterministic Nelder-Mead algorithm, which can provide converged robust model parameter sets and also reduce computation time (Spiliopoulou et al., 2017). The calibrated parameters are $v_f = 61 \text{ mph}$, $\rho_{cr} = 51 \text{ veh/lane/mile}$, $a = 3.315$, $\tau = 0.019$, $\kappa = 33.52$, $\delta = 0.838$ and $\phi = 0.784$.

7.5.2 Arterial Traffic Model

In this study, it is necessary not to consider only freeways but also arterials to develop the decision support system. Therefore, a METANET for arterials should be developed and integrated with a METANET for freeway. The METANET for arterials should describe traffic congestion realistically and reflect the effect of strategies on arterials. For example, when a ramp metering is being implemented on a freeway, it should reflect the effect of the queue on the arterial. However, a complicated model for arterials could cause a computational inefficiency, so a simple model is needed.

This study presented a simple model to estimate travel time in a link based on density. This method is similar to volume-delay function (VDF) or link-congestion function that reproduces traffic speed or travel time in a link based on traffic volume. The VDF can reproduce congestion effects in macroscopic models and can be applied for various purposes. However, there was a

limitation in the application to the operational level (i.e., controlled by vehicle unit) due to the assumption that the volume can exceed capacity (Kucharski and Drabicki, 2017). This assumption could lead to unrealistic results in congested traffic in terms of traffic operations (Kucharski and Drabicki, 2017). To overcome this issue, we presented the METANET for arterials by using density instead of volume.

This model considered the traffic flows of adjacent arterials and ramps entering and leaving a target link. As shown in Figure 46, in the target link i , the inflow, f_{in} , is the sum of the entering flows from arterials ($f_{in,j}$) and off-ramp (r_{off}), and the outflow, f_{out} , is the sum of the leaving flows to arterials ($f_{out,j}$) and on-ramp (r_{on}). The density of link i is calculated as follows:

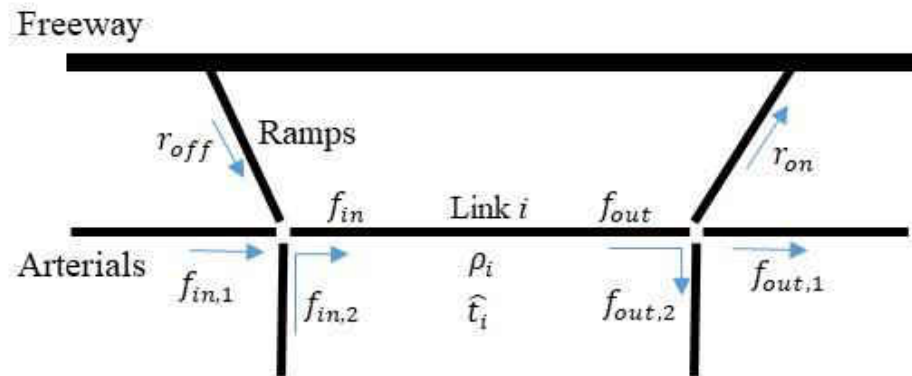

Figure 46. METANET for arterial

$$\rho_i(k+1) = \rho_i(k) + f_{in}(k) - f_{out}(k)$$

$$f_{in}(k) = \sum_j f_{in,j}(k) + r_{off}$$

$$f_{out}(k) = \sum_j f_{out,j}(k) + r_{on}$$

where, ρ is density and k is time step. Based on the density, the travel time in the link i is estimated as follows, and this equation is called as density-based delay function (Kucharski and Drabicki, 2017, Olszewski et al., 1995):

$$\widehat{t}_i(k) = L \times t_0 \left(1 + a \left(\frac{\rho_i(k)}{\rho_c} \right)^b \right)$$

where, \hat{t} , and t_0 are estimated travel time and free-flow travel time. L is link length, ρ_c is critical density, and a and b are calibrated parameters. In the study, we used the following calibrated parameters: $t_0 = 104.189768$ (sec), $\rho_c = 51.066247$ (veh/km), $a = 2.540349$, and $b = 0.991533$.

7.6 Travel Time Reliability Model

For the evaluation of travel time reliability through simulation results, it is required to develop a model to convert the results to travel time reliability measures based on historical data. However, it is practically impossible to reproduce all kinds of real-world traffic conditions related to traffic demand, incidents, events and weather conditions through traffic simulation. Instead, the travel time reliability can be estimated through models estimating measures related to travel time reliability. Among various measures for the travel time reliability, standard deviation (SD) of travel time rate regarding travel time variability was selected in this project. Because it was proved and well-known that there is a linear relationship between travel time rate and its standard deviation (Mahmassani et al., 2013).

Based on the previous research in which there is a linear relationship between the TTR and its SD (Jones, 1988, Mahmassani et al., 2012), additional impact factors were considered. A model to estimate the SD of mean travel time was developed using the Tobit modeling method with censored data. The censoring concept can be used when data on the dependent variable is

limited but not data on the independent variables (Breen, 1996). In the case of the SD, which is the dependent variable in this study, the value cannot become less than zero. Therefore, it will be proper to use the Tobit model as a censored regression model:

$$y_i^* = \beta X_i + \varepsilon_i, i = 1, 2, \dots, N$$

$$y_i = \begin{cases} y_i^* & \text{if } y_i^* > 0 \\ 0 & \text{if } y_i^* \leq 0 \end{cases}$$

where y_i^* is a latent variable, N is the number of observations, X_i indicates a vector of independent variables: travel time, volume, speed, etc., β is a vector of estimated parameters, and $\varepsilon_i \sim N(0, \sigma^2)$.

Regarding the data preparation, traffic data, crash data, weather data, and geometry data were collected to develop a model between the SD of TTR and other impact factors: mean travel time, traffic volume, precipitation, crash, and so on. The traffic data were obtained from the AVI systems of CFX for individual travel times, NPMRDS for mean travel time, and MVDS of RITIS for traffic volume, speed, and occupancy at each location of MVDS. The precipitation data were collected from the Quality Controlled Local Climatological Data (QCLCD) (NCEI, 2017), and the crash data were gathered from the Signal Four Analytics (S4A) system. Finally, speed limits and the number of lanes of each link were collected from the Roadway Characteristics Inventory (RCI) database of FDOT.

The collected all travel times were converted into travel time rate (TTR) by the distance of each link as follows:

$$\text{Travel Time Rate (TTR; minute/mile)} = \frac{\text{Travel Time (minute)}}{\text{Distance of each Link (mile)}}$$

After link-mean TTR and its SD were aggregated at five-minute intervals, the SD estimation model was developed. Tables 20 and 21 show the results for the Tobit model to

calculate the SD of TTR for freeways/expressways and arterials/collectors, respectively. The developed model for arterials/collectors included three variables: TTR, the length of the link, and the number of lanes. Based on the model, travel time reliability could be evaluated. According to the exploration and modeling results, TTR and its SD have a positive statistical significant relationship at the link level.

Table 20. Results of the Tobit Model to Calculate the SD of TTR for Freeways/Expressways

Parameter	Estimated results of the model	
	Estimates	Pr> t
Intercept	-0.8144	<.0001
Mean TTR	0.7400	<.0001
Length of Link	-0.0013	<.0001
Number of Lanes	0.0120	<.0001
Speed Limits	0.0033	<.0001
Amount of Rainfall	0.0125	<.0001
Crash Indicator	0.0104	<.0001
Weekend indicator	-0.0104	<.0001
Holiday Indicator	-0.0221	<.0001
Observations	335,124	
Missing Values	23,846	
AIC	-284,817	
* AIC: Akaike Information Criterion		

Table 21. Results of the Tobit Model to Calculate the SD of TTR for Arterials/Collectors

Parameter	Estimated results of the model	
	Estimates	Pr> t
Intercept	-0.563831	<.0001
Mean TTR	0.753237	<.0001
Length of Link	-0.007830	<.0001
Number of Lanes	0.054012	<.0001
Observations	192290	
Missing Values	1744	
AIC	310157	
* AIC: Akaike Information Criterion		

Finally, SDs of TTR were aggregated for the selected routes or network. Usually, VMT-weighted or distance-weighted mean values were computed to get the aggregated evaluation measures for freeways and arterials/collectors. In this study, the VMT-weighted mean method at each time slot was used as follows:

$$\overline{TTR}_{network}(t) = \frac{\sum_{i=1}^n VMT_i(t) \times TTR_i(t)}{\sum_{i=1}^n VMT_i(t)}$$

$$\overline{SD}_{network}(t) = \frac{\sum_{i=1}^n VMT_i(t) \times SD_i(t)}{\sum_{i=1}^n VMT_i(t)}$$

where, $\overline{TTR}_{network}(t)$ = Network-level VMT-weighted Mean TTR at time slot “t”,

$\overline{SD}_{network}(t)$ = Network-level VMT-weighted Mean SD of TTR at time slot “t”,

$VMT_i(t)$ = Vehicle Miles Traveled of link “i” at time slot “t”,

$TTR_i(t)$ = Mean TTR of vehicles passing link “i” at time slot “t”,

$SD_i(t)$ = Standard Deviation between vehicles of link “i” at time slot “t”.

7.7 AIMSUN Simulation Setup

Traffic counts and the travel time aggregated in each 15-minutes interval were used to calibrate and validate the microscopic area with lower acceptable bound of error. Figure 47-(a) shows 93 locations of traffic count detector in Downtown Orlando areas. Figure 47-(b) shows the travel time detector locations as sub-path system (red segments) in AIMSUN simulation for Downtown Orlando microsimulation areas.

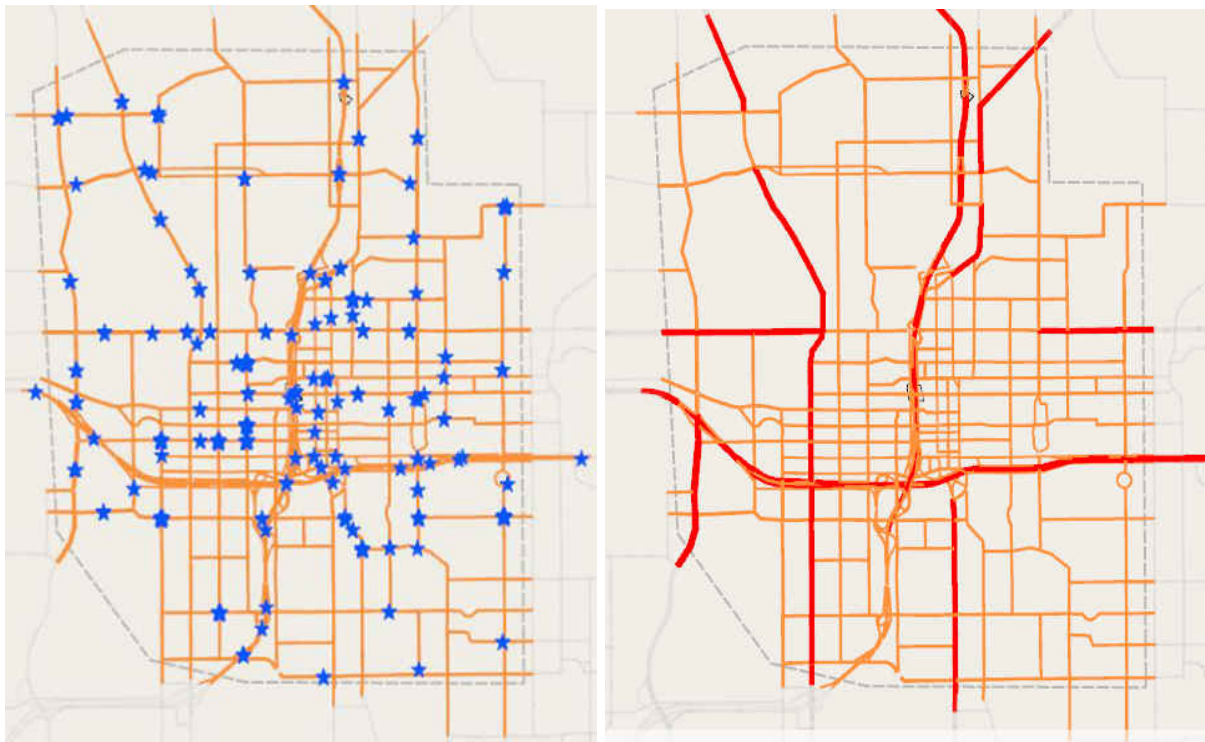

(a) Downtown Orlando (I4, SR 408 etc.)

(b) Downtown Orlando (I4, SR 408 etc.)

Figure 47. Microscopic simulation area in Downtown Orlando (I4, SR 408 etc.)

There are two main parts to calibrate the parameters in order to achieve good validation criteria: (1) dynamic traffic assignment or route choice and (2) microscopic parameters. The microscopic model includes a much larger number of parameters that should be calibrated which are not included in the mesoscopic model. Hence, a sensitivity analysis was also conducted to

calibrate both traffic assignment and microscopic parameters to achieve good validation of the microscopic model. The calibrated values of both traffic assignment parameters and the microscopic parameters are presented in Table 22.

Table 22. Aimsun Next Calibration Parameters for Microscopic Simulation Areas

Parameters	Unit	Default value	Calibrated value based on Travel Time
Microscopic Calibration Parameters (Downtown Orlando Area)			
Traffic assignment parameter			
Model selection	N/A	uniform	C-logit
Attractiveness weight	N/A	0	5
Maximum number of initial paths to consider	N/A	All	3
Maximum Paths per interval	N/A	3	5
Microscopic parameters			
Reaction time	s	1.2	0.8
Reaction time at traffic light	s	1.6	1.2
Look ahead distance variability	%	40	50
Speed acceptance for Car	N/A	1.1	1.5
Speed acceptance for Truck	N/A	1.0	1.4

After calibrating the parameters, the GEH values were calculated for both microsimulation areas. From the microscopic calibration results, Downtown Orlando area achieved 86% of GEH less than 10, which represents reasonable calibration for the microscopic area based on simulation guidelines. Figure 48 shows the GEH value representation from AIMSUN Next including both microscopic simulation areas highlighting the maps of microscopic areas with different colors.

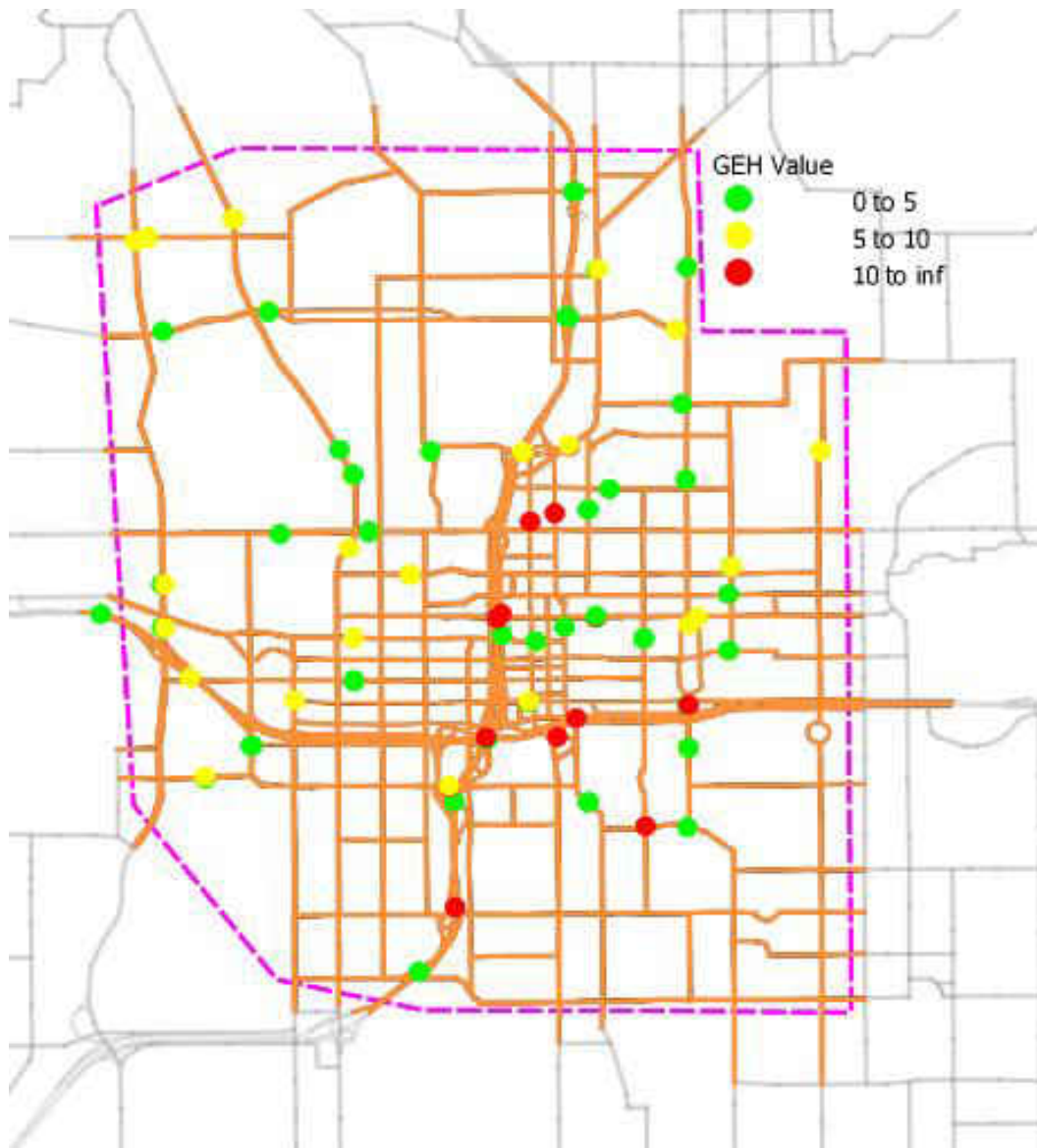

Figure 48. GEH value representation for Downtown Orlando area

7.8 Development of possible simulation scenarios related to IATM

In order to create reasonable simulation scenarios representing real-world traffic flow in the Orlando area, possible scenarios related to IATM can be created on the basis of traffic condition and possible operational strategies of IATM. In this research, IATM is an integrated system of ATM strategies that not only evaluated in real-time the traffic operation performance of both freeways and arterials, but also integrate them.

The effectiveness of IATM system on a corridor network linking freeways/expressways and arterials was analyzed according to the different traffic conditions. Especially, the effect of IATM system was evaluated under the traffic congestion. The traffic congestion of freeway/expressway in corridor networks was categorized into three classes:

- Extreme Traffic Congestion: Average vehicle speed less than 25 mph
- Heavy Traffic Congestion: Average vehicle speed between 25 mph and 35 mph
- Moderate Traffic Congestion: Average vehicle speed between 35 mph and 45 mph

Additionally, a non-congested traffic condition was added to analyze the impact of the IATM strategies.

According to the calibrated and validated traffic condition (see Table 23), the eastbound and westbound of I-4 experience extreme and moderate traffic conditions. In order to generate different traffic conditions, the traffic demand of I4 was adjusted. The traffic demand of I-4 was reduced by 80% and 90% of the original traffic demand to examine the IATM strategies and the Decision Support System (DSS), and to reach generic DSS rules that are implementable in Florida. Table 23 includes the generated traffic conditions created from the adjusted traffic demand.

Table 23. Generated traffic conditions for I4

Roadway	Traffic Demand	Direction	Mean Speed [mph]	Mean Travel Time Rate [minute/mile]	Traffic Condition	Case
I-4	07:00 – 09:00	Eastbound	24.0	2.534	Extreme	Case-1
		Westbound	38.5	1.558	Moderate	Case-2
I-4	90% of 07:00 – 09:00	Eastbound	29.8	2.015	Heavy	Case-3
		Westbound	53.5	1.122	Non-congestion	Case-4
I-4	80% of 07:00 – 09:00	Eastbound	40.6	1.479	Moderate	Case-5
		Westbound	59.6	1.007	Non-congestion	Case-6

Based on VSL, QW, and RM, the possible operational scenarios of ATM strategies were evaluated as follows:

- Only VSL
- Only QW
- Only RM
- VSL and QW (VSL/QW)
- VSL and RM (VSL/RM)
- QW and RM (QW/RM)
- VSL, QW, and RM (VSL/QW/RM)

The effectiveness of the above IATM strategies was analyzed based on the predetermined traffic conditions: extreme, heavy, and moderate traffic congestion. These analyses would help to determine the appropriate combination of strategies for the different traffic conditions.

For the effectiveness analysis of the possible operational strategies, the traffic simulation was run 10 times by the combinations between three IATM strategies and different traffic demand of the downtown I-4 area. Initial results also accounted for route diversion, but any increase of traffic volume on an already congested arterials might not be feasible without other measures that are beyond the scope of this project, e.g., new adaptive signal control algorithms. Thus in this work we check the effect of the three above mentioned strategies on the arterials and the whole network to guarantee no detrimental effects beyond the freeways occur. A total of 420 simulations were conducted. Considering that the average running time is about 30 minutes, totally 210 hours were taken.

7.9 Evaluation Results of possible operational strategies of IATM

This research focuses on the effectiveness evaluation of IATM integrating freeways and arterials with VSL, QW, and RM. So, the westbound of I-4 was not analyzed because it does not have on-ramp metering. According to the generated traffic conditions for I-4 (see Table 23), the westbound of I-4 has three types of traffic congestion: extreme, heavy, and moderate.

Though there are many kinds of roadway traffic condition indicators to evaluate transportation problems and solutions, this research focused on the travel time index (TTI) and travel time rate (TTR, minute/mile). The traffic congestion of roadways and their segments can be measured by the travel time index (TTI). The TTI is defined as the ratio of average travel time to a free-flow or speed-limit travel time:

$$\text{Travel Time Index (TTI)} = \frac{\text{Average Travel Time}}{\text{Travel Time}_{\text{free flow or speed limit}}}$$

The TTI represents how much longer travel time is spent on average on the basis of the ideal traffic condition. All travel times were converted into Travel Time Rate (TTR) through the normalization by the distance of each link as follows (Jenks et al., Lomax and Margiotta, 2003):

$$\text{Travel Time Rate (TTR; minute/mile)} = \frac{\text{Travel Time (minute)}}{\text{Distance of each Link (mile)}}$$

7.9.1 Extreme Traffic Congestion

In the study sites, the eastbound of the downtown I-4 (Case-1) has extreme traffic congestion. There are three on-ramps that were metered in the eastbound of I-4. The three on-ramps were selected by referring the ramp metering installation warrants of FDOT (see Section 7.4.2 and Figure 45). Table 24 shows the result of the effect of IATM strategies under extreme traffic congestion. QW significantly improved overall TTR of I-4 at a 90% confidence interval and TTI of I-4 at a 95% confidence interval, which did not have a negative impact on arterials. Furthermore, RM or other strategies including RM improved the TTR and TTI, which are statistically significantly different from the traffic condition without any ATM strategies at a 95% confidence interval. In cases of QW/RM and VSL/QW/RM, it seems that QW slightly expedites the effect of RM. However, RM or other strategies including RM have a negative impact on arterials in the downtown I-4 corridor network, which is also statistically significant. It represents that the traffic capacity of arterials under extreme traffic congestion cannot accommodate additional traffic flow due to the traffic capacity reduction of on-ramps caused by RM.

Table 24. TTR and TTI of the I-4 EB under the extreme traffic congestion.

CASE-1		No strategy	VSL alone	QW alone	RM alone	VSL /QW	VSL /RM	QW /RM	VSL/Q W/RM
EB I-4	TTR	2.534	2.449	2.399*	2.205*	2.436**	2.237*	2.196*	2.179*
	TTI	2.360	2.281	2.235*	2.056*	2.268**	2.087*	2.048*	2.063*
Arterials	TTR	3.920	3.910	3.872	4.083*	3.921	4.120*	4.109*	4.134*
	TTI	1.951	1.947	1.929	2.024*	1.953	2.044*	2.039*	2.030*
<p>Note:</p> <ul style="list-style-type: none"> - The value of each cell is the average TTI or TTR of 10 replications with different random seeds. - * This indicates rejection of the null hypothesis, there is mean difference between no-strategy and each strategy at 95% confidence interval. - ** This indicates rejection of the null hypothesis, there is mean difference between no-strategy and each strategy at 90% confidence interval. 									

7.9.2 Heavy Traffic Congestion

The effects of IATM strategies under the heavy traffic congestion of I-4 were analyzed through Case-3 (the eastbound of I-4 with 90% of the original traffic demand). Table 25 shows the result of the effect of IATM strategies under the heavy traffic congestion. As with the results of the extreme traffic congestion, RM and other strategies including RM statistically significantly improved travel time rate on the eastbound of I-4 at a 95 confidence interval. However, RM, VSL/RM, and QW/RM do not have a negative impact on arterials. In the corridor networks with the heavy traffic congestion, it shows that RM for some of the on-ramps based on the ramp metering selection warrants of FDOT can improve the traffic flow condition of freeways/expressways while minimizing a negative impact on arterials. However, VSL/QW/RM has a negative impact on arterials at a 90% confidence interval.

Table 25. TTR and TTI of the I-4 EB under the heavy traffic congestion

CASE-3		No strategy	VSL alone	QW alone	RM alone	VSL /QW	VSL /RM	QW /RM	VSL/Q W/RM
I4 EB	TTR	2.015	1.972	2.027	1.884**	1.969	1.742	1.730	1.855**
	TTI	1.877	1.831	1.872	1.753**	1.827	1.625	1.614	1.730**
Arterials	TTR	3.654	3.535	3.553	3.665	3.540	3.606	3.627	3.690**
	TTI	1.820	1.766	1.773	1.824	1.767	1.797	1.807	1.836**

Note:

- The value of each cell is the average TTR or TTI of 10 replications with different random seeds.
- * This indicates rejection of the null hypothesis, there is mean difference between no-strategy and each strategy at 95% confidence interval.
- ** This indicates rejection of the null hypothesis, there is mean difference between no-strategy and each strategy at 90% confidence interval.

7.9.3 Moderate Traffic Congestion

The effects of ATM strategies under the moderate traffic congestion of I-4 were analyzed through Case-2 (the westbound of I-4 with the original traffic demand) and Case-5 (the eastbound of I-4 with 80% of the original traffic demand). Table 26 shows the result of the effect of IATM strategies under the moderate traffic congestion. Although VSL improved TTR in both CASE-2 and CASE-5, CASE-5 did not show statistically significant improvement but CASE-2 showed significant reduction of TTR at a 90% confidence interval. Also, RM, VSL/RM, and VSL/QW/RM reduced TTR significantly at a 90% or 95% confidence interval without a negative impact on arterials. When RM is required, it seems that the integrated operation of VSL/QW/RM is more proper for moderate traffic congestion than RM-alone or VSL/RM. Otherwise, VSL can be applicable to the corridor network with moderate traffic congestion.

Table 26. TTR and TTI of the I-4 under the moderate traffic congestion

		No strategy	VSL alone	QW alone	RM alone	VSL /QW	VSL /RM	QW /RM	VSL/Q W/RM
I4 WB (CASE-2)	TTR	1.558	1.494**	1.538	n/a	1.567	n/a	n/a	n/a
	TTI	1.459	1.397**	1.443	n/a	1.473	n/a	n/a	n/a
Arterials (CASE-2)	TTR	3.920	3.910	3.872	n/a	3.921	n/a	n/a	n/a
	TTI	1.951	1.947	1.929	n/a	1.953	n/a	n/a	n/a
I4 EB (CASE-5)	TTR	1.479	1.460	1.494	1.414**	1.482	1.418**	1.437	1.414*
	TTI	1.375	1.359	1.390	1.317**	1.379	1.321**	1.338	1.317*
Arterials (CASE-5)	TTR	3.243	3.232	3.243	3.240	3.201	3.231	3.234	3.232
	TTI	1.627	1.623	1.628	1.625	1.609	1.621	1.622	1.623

Note:

- The value of each cell is the average TTR or TTI of 10 replications with different random seeds.
- * This indicates rejection of the null hypothesis, there is mean difference between no-strategy and each strategy at 95% confidence interval.
- ** This indicates rejection of the null hypothesis, there is mean difference between no-strategy and each strategy at 90% confidence interval.

7.9.4 Non-congested Traffic Congestion

For reference, the effects of ATM strategies under the non-congestion traffic condition of I-4 were analyzed through Case-4 (the westbound of I-4 with 90% of the original traffic demand) and Case-6 (the westbound of I-4 with 80% of the original traffic demand). Table 27 shows the result of the effect of IATM strategies under non-congested traffic congestion. Under the non-congestion traffic condition, VSL, QW, and VSL/QW do not have significant improvement of both TTR and TTI. Rather, CASE-8 shows that the instant activation of QW might have an adverse impact on the freeway when some segments have a queue without significant impact on the overall corridor in terms of traffic efficiency.

Table 27. Average travel time rate of the I-4 under the Non-congested traffic condition

		No strategy	VSL alone	QW alone	RM alone	VSL /QW	VSL /RM	QW /RM	VSL/Q W/RM
I4 WB (CASE-6)	TTR	1.122	1.104	1.136	n/a	1.110	n/a	n/a	n/a
	TTI	1.053	1.037	1.068	n/a	1.042	n/a	n/a	n/a
Arterials (CASE-6)	TTR	3.920	3.910	3.872	n/a	3.921	n/a	n/a	n/a
	TTI	1.820	1.766	1.773	n/a	1.767	n/a	n/a	n/a
I4 WB (CASE-8)	TTR	1.007	1.008	1.011**	n/a	1.008	n/a	n/a	n/a
	TTI	0.948	0.948	0.951**	n/a	0.948	n/a	n/a	n/a
Arterials (CASE-8)	TTR	3.243	3.232	3.243	n/a	3.201	n/a	n/a	n/a
	TTI	1.627	1.623	1.628	n/a	1.609	n/a	n/a	n/a

Note:

- The value of each cell is the average TTR or TTI of 10 replications with different random seeds.
- * This indicates rejection of the null hypothesis, there is mean difference between no-strategy and each strategy at 95% confidence interval.
- ** This indicates rejection of the null hypothesis, there is mean difference between no-strategy and each strategy at 90% confidence interval.

7.9.5 Discussion

According to the effectiveness analyses results of seven types of ATM strategies on the downtown I-4 corridor network, it is obvious that the integration of IATM strategies is more favorable than stand-alone individual ATM strategies. Furthermore, it can be seen that it is difficult to determine only one ATM strategy for the different types of traffic congestion. Effects of each ATM strategy are as follows:

- VSL-alone strategy achieve the improvement of TTR and TTI in the moderate and heavy traffic conditions (see Case-2) without a negative impact on arterials.

- QW-alone improved TTR and TTI of the mainline of freeways/expressways in the extreme traffic condition (see Case-1).
- In all cases, RM-alone improved TTR and TTI of the mainline of freeways/expressways. Even, Case-3 and Case-5 did not deteriorate the overall TTR and TTI of arterials. Therefore, related to the RM implementation, it is not necessary to select all on-ramps for the target corridor network., Choice of on-ramps based on the ramp metering selection warrants of FDOT can improve TTR and TTI on the mainline of freeways and also can avoid the increase of TTR and TTI on the arterials.
- The integration of VSL and QW does not have a statistically significant improvement in travel time rate in any types of traffic congestion.
- RM-integrated ATM strategies of Case-3 and Case-5 have a negative impact on arterials adjacent to freeways/expressways.

7.10 Effectiveness of Integrated ATM strategies with DSS

The IATM system on a corridor network linking freeways/expressways and arterials can be built in various forms. Considering that the integrated ATM should have at least more than 2 strategies, the stand-alone systems such as VSL-alone, QW-alone, and RM-alone was not included in the possible operation strategies of IATM. Also, VSL/QW was excluded since it is related to the only freeways. So, for the evaluation of the developed DSS, four types of system regarding the IATM strategies can be established as follows:

- VSL and RM (VSL/RM)
- QW and RM (QW/RM)
- VSL, QW, and RM (VSL/QW/RM): IATM without DSS
- DSS using VSL, QW and RM with METANET: IATM with DSS

Each type was executed 10 times with different random seeds and the average result was reported for the final evaluation. Simulation results were analyzed into three aspects: freeway, arterial, and overall network. The effects of DSS are analyzed in two scopes: the eastbound I-4 and the I-4 adjacent arterials. Specifically, DSS on the eastbound of I-4 was operated to select the best control value balancing traffic congestion of both freeways and arterials among the combinations of control values of VSL, QW, and RM. The westbound of I-4 was excluded because there is no RM.

The effectiveness of DSS was separately analyzed according to the traffic congestion level: extreme, heavy, and moderate. The effectiveness of DSS was compared with VSL/RM, QW/RM, and VSL/QW/RM individually at the entire network, freeway, and arterials. The comparison results were tested statistically through the paired test. To help understand the comparison results,

scatter charts were used to show intuitively whether the traffic conditions at the corridor network level was improved or not. In the scatter charts, x-axis represent TTR or TTI of freeways and y-axis TTR or TTI of arterials. For example, it can be interpreted that if some points are positioned at the bottom left of the reference data, the performance of the points was better than the reference data in both aspects: freeways and arterials.

7.10.1 Extreme Traffic Congestion

Figure 49 looks like that DSS has higher TTR and TTI than the base condition in the extreme traffic condition at the entire network in the downtown I-4 corridor network, but the difference is not significant statistically. Rather, DSS has smaller TTR and TTI than VSL/RM, QW/RM, and VSL/QW/RM. Statistically, DSS has significantly improved performance than VSL/RM and QW/RM at a 90% confidence interval. Specifically, Figure 50 shows how DSS has impact on freeways and arterials. All types of IATM are located at the top left of the base condition, which means they improved the traffic condition of freeways, but they didn't improve arterials. Relatively, DSS mitigated the adverse impact of VSL/RM, QW/RM, and VSL/QW/RM. Because of that, DSS achieved high improvement of freeways by mitigating the adverse impact on the entire network. In addition, in the extreme traffic congestion on the corridor network, there may be a limitation to improve both freeways and arterials. Nevertheless, DSS achieved more balanced traffic conditions at the entire network than VSL/RM, QW/RM, and VSL/QW/RM. Moreover, it would be expected if adaptive signal control strategies integrated with the ATM strategies would even further improve the whole network. However, this could be a possible extension as it is not within the scope of this study.

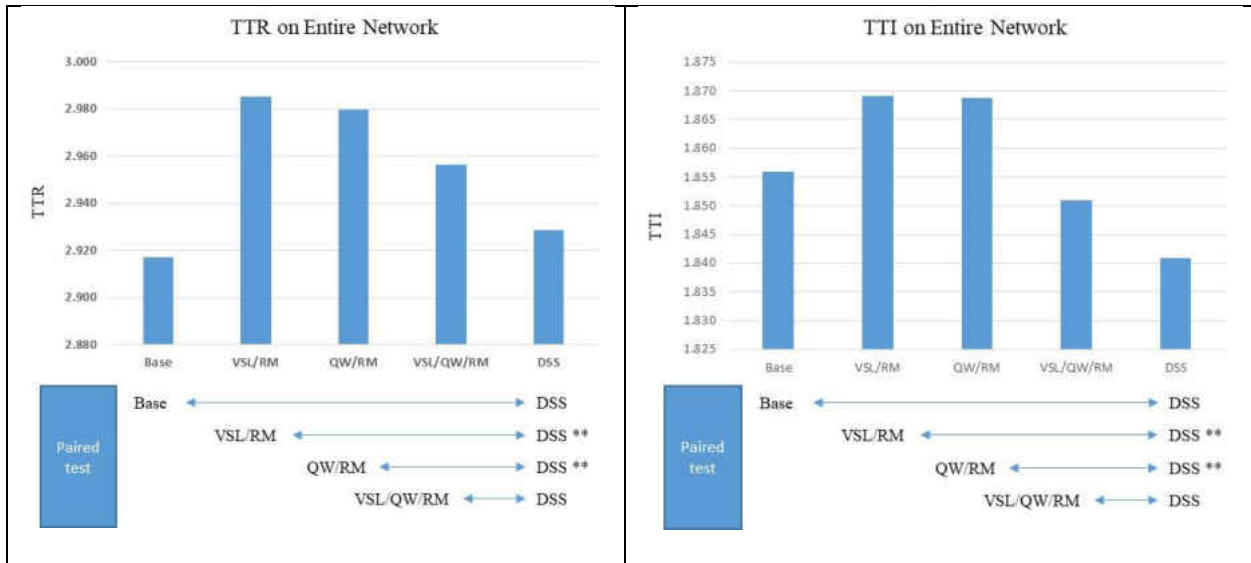

(a) TTR on Entire Network

(b) TTI on Entire Network

Note: ** This indicates rejection of the null hypothesis, there is mean difference between no-strategy and each strategy at a 90% confidence interval.

Figure 49. TTR and TTI at the entire network under the extreme traffic condition (I-4)

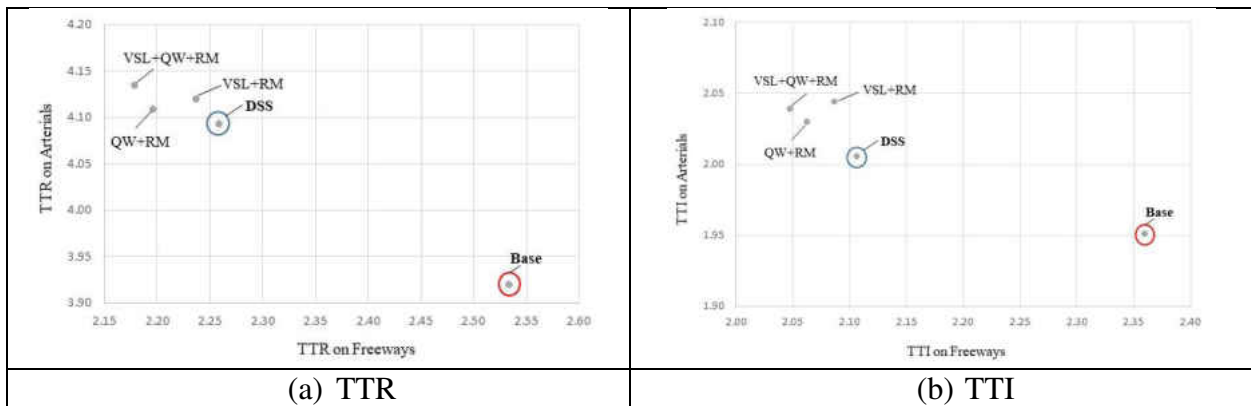

(a) TTR

(b) TTI

Figure 50. Scatter plot of TTR and TTI of freeways and arterials under the extreme traffic condition (I-4)

7.10.2 Heavy Traffic Congestion

Figure 51 shows that DSS, VSL/RM, and QW/RM improved the traffic condition of the entire network with freeways under the heavy traffic congestion. Notably, it can be seen an example that the independent operation of VSL, QW, and RM in the integration of VSL/QW/RM without DSS cannot reduce both TTR and TTI. As seeing the improvement of freeways and

arterials, individually, DSS has better performance to balance between freeways and arterials than other types of IATM.

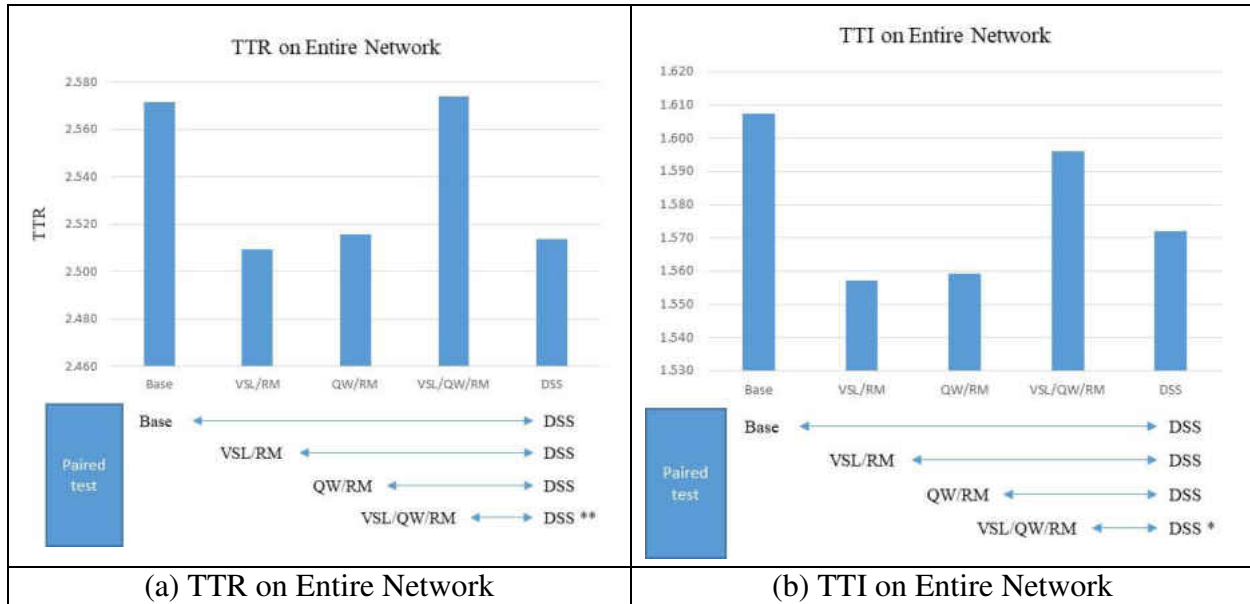

Note:

- * This indicates rejection of the null hypothesis, there is mean difference between no-strategy and each strategy at a 95% confidence interval.
- ** This indicates rejection of the null hypothesis, there is mean difference between no-strategy and each strategy at a 90% confidence interval.

Figure 51. TTR and TTI at the entire network under the heavy traffic condition (I-4)

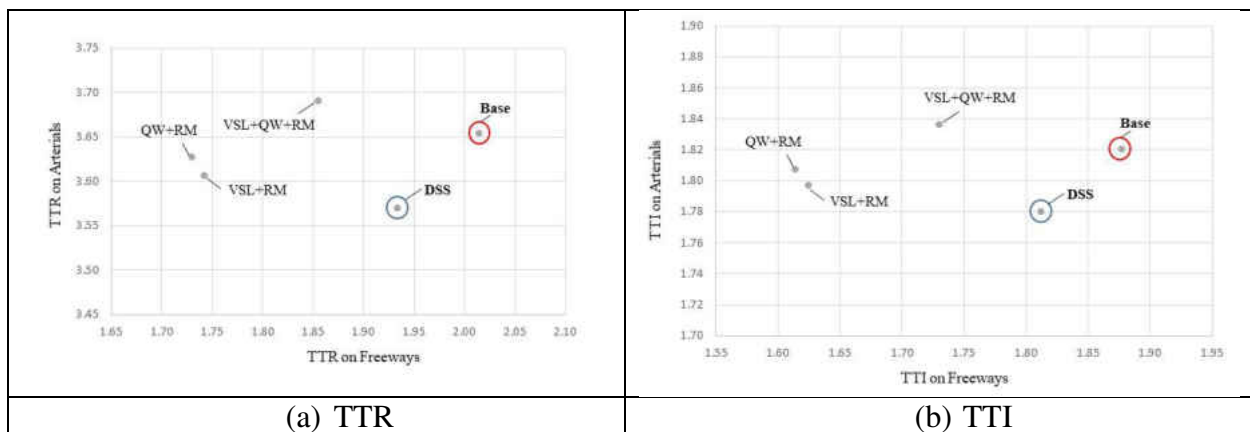

Figure 52. Scatter plot of TTR and TTI of freeways and arterials under the heavy traffic condition (I-4)

7.10.3 Moderate Traffic Congestion

Figure 53 shows obvious improvement of DSS. Comparing DSS with other types of IATM, the improvement of DSS is significantly different at a 90% confidence interval. As with the results

of the heavy traffic condition, Figure 54 shows a similar scatter plot. That is, DSS has the ability to balance the traffic conditions of both freeways and arterials.

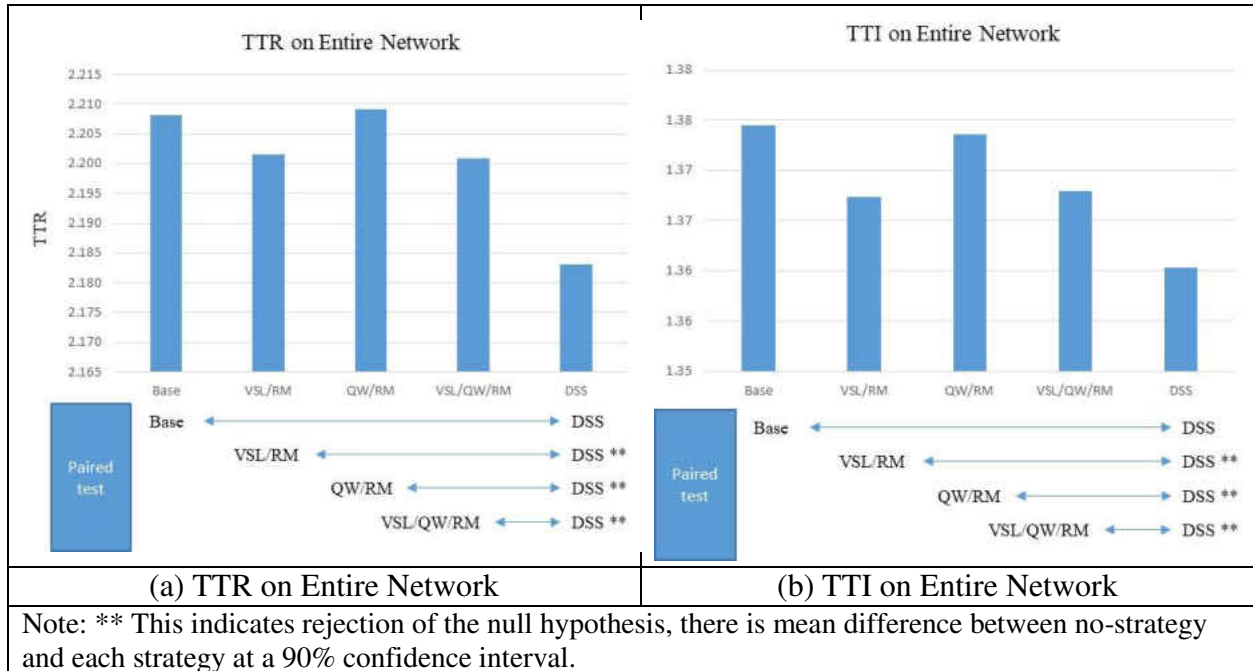

Figure 53. TTR and TTI at the entire network under the moderate traffic condition (I-4)

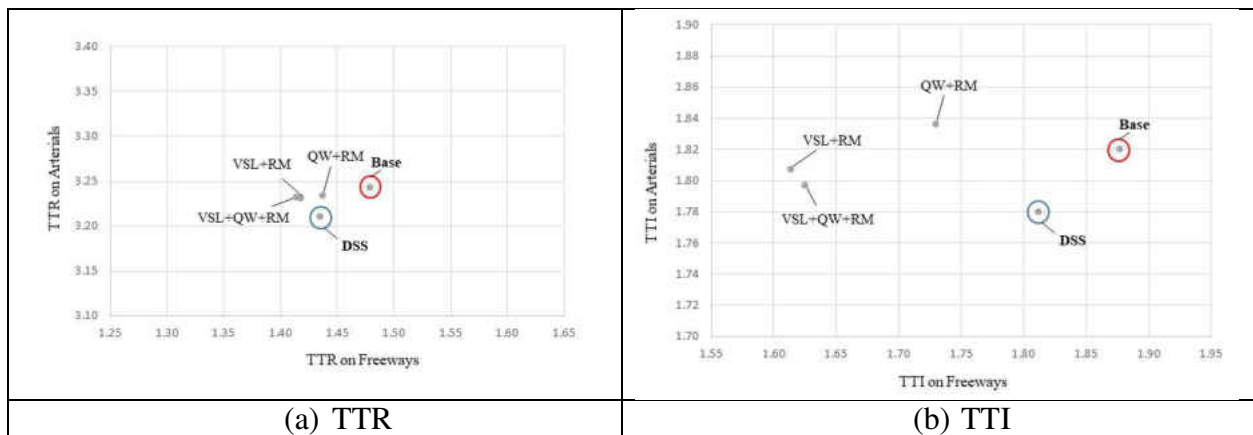

Figure 54. Scatter plot of TTR and TTI of freeways and arterials under the moderate traffic condition (I-4)

7.11 Conclusions

In this research, a decision support system for active traffic management systems integrating freeways and arterials was developed and evaluated. The DSS with three representative ATM strategies, VSL, QW, and RM, was implemented for the I-4 corridor networks in the Downtown Orlando area. For VSL and QW, a new logic was developed to recommend variable speed limits. RM logic was based on the local actuated control method. For the prediction of near-future traffic condition with/without traffic control strategies, METANET model was employed and calibrated for freeway and arterial.

This research evaluated all kinds of combination of VSL, QW, and RM. Through the effectiveness analysis of the possible operational strategies, the generic rules were developed (see Table 28). In order to use the suggested generic rules, IATM should analyze the traffic congestion level of a corridor network. And then, according to the necessity of the balanced control between freeways and arterials, proper strategy can be selected.

Table 28. Generic rules to select a proper ATM strategy

Freeway Traffic Congestion Level of a corridor network	Freeway Traffic Priority Policy	Freeway and Arterial Balance Policy
Extreme (speed \leq 25mph)	QW and RM	QW
Heavy (25 mph < speed \leq 35 mph)	VSL/RM or QW/RM	QW and RM
Moderate (35 mph < speed \leq 45 mph)	VSL/RM or QW/RM	VSL-alone or QW and RM

The generic rules can help to choose proper strategies according to the traffic condition and the requirements of the balanced control between freeways and arterials. However, static decision rule always cannot dynamically reflect all kinds of traffic situations. Thus, DSS using METANET was developed, which was evaluated in terms of the balanced control ability between freeways and arterials. According to the evaluation results, the developed DSS successfully balanced traffic condition between freeways and arterials in all types of traffic congestion: extreme, heavy, and moderate. Therefore, for the balanced traffic operation between freeways and arterials, it is effective to use DSS considering travel time reliability.

CHAPTER 8. CONCLUSIONS

As traffic problems on roadways have been increased, advanced traffic management systems have been deployed on freeways and arterials to resolve traffic problems related to traffic congestion, traffic incident, and adverse weather (see Figure 55). For instance, dynamic message signs, ramp metering system, queue warning system, variable speed limits, traffic signal control system, and so on are deployed under the umbrella of the advanced traffic management systems.



Figure 55. The suggested new conceptual DSS for active traffic management systems

As the advanced traffic management systems have been expanded, integrated and evolved, active traffic management systems have been initiated to provide the integrated, coordinated, automated, and intensive traffic management ability for the human operators. Accordingly, it has been necessary for traffic operators to utilize a decision support system to determine a proper response plan or control measure. An important part of the decision support system is performance measures to determine the best response plans or control measures. Usually, most decision support

systems use a simple average delay. Based on the simple average delay, the system cannot consider actual travelers' much different unexpected delay from day to day.

Therefore, this research used travel time reliability representing the extent of the unexpected delay into the performance measure of the decision support system, and then to develop the decision support system using travel time reliability. As representative traffic congestion, this research focused on recurring congestion. After building rule-based response plans, the alternative response plans were evaluated through a model-driven approach. Based on the travel time reliability, the decision support system recommended proper response plans and balanced the overall traffic condition on the corridor network including freeways and arterials. In the end, it is expected that the developed decision support system will help traffic operators to provide more consistent travel time for travelers through the recommended response plans.

REFERENCES

2010. *Confidence Value and Smoothing* [Online]. I-95 Corridor Coalition, Vehicle Probe Project. Available: http://i95coalition.org/wp-content/uploads/2015/03/VP_Conf_value_White_Paper-4_14_2010_final-4.pdf?652af7 [Accessed].
2017. *robust statistics* [Online]. Encyclopedia.com. Available: <http://www.encyclopedia.com/computing/dictionaries-thesauruses-pictures-and-press-releases/robust-statistics> [Accessed 07/27 2017].
2018. National Performance Management Research Data Set (NPMRDS). FHWA.
- ABDEL-ATY, M., CUNNINGHAM, R., GAYAH, V. & HSIA, L. 2008. Dynamic variable speed limit strategies for real-time crash risk reduction on freeways. *Transportation Research Record: Journal of the Transportation Research Board*, 108-116.
- ABDEL-ATY, M., DILMORE, J. & DHINDSA, A. 2006a. Evaluation of variable speed limits for real-time freeway safety improvement. *Accident analysis & prevention*, 38, 335-345.
- ABDEL-ATY, M., DILMORE, J. & HSIA, L. 2006b. Applying variable speed limits and the potential for crash migration. *Transportation Research Record: Journal of the Transportation Research Board*, 21-30.
- ABDEL-ATY, M., RADWAN, E., SHI, Q. & WANG, L. 2014. Efficient utilization of the existing ITS system and the viability of a proactive traffic management system for the central Florida expressway authority system.
- ABDEL-ATY, M. A. & PEMMANABOINA, R. 2006. Calibrating a real-time traffic crash-prediction model using archived weather and ITS traffic data. *IEEE Transactions on Intelligent Transportation Systems*, 7, 167-174.
- ADELI, H. 2004. An intelligent decision support system for work zone traffic management and planning. Ohio Department of Transportation.
- AGARWAL, M., MAZE, T. H. & SOULEYRETTE, R. Impacts of weather on urban freeway traffic flow characteristics and facility capacity. Proceedings of the 2005 mid-continent transportation research symposium, 2005. 18-19.
- AHMED, M. M., ABDEL-ATY, M., LEE, J. & YU, R. 2014. Real-time assessment of fog-related crashes using airport weather data: A feasibility analysis. *Accident Analysis & Prevention*, 72, 309-317.
- AL-DEEK, H. & EMAM, E. B. 2006. New methodology for estimating reliability in transportation networks with degraded link capacities. *Journal of intelligent transportation systems*, 10, 117-129.
- ALMEJALLI, K., DAHAL, K. & HOSSAIN, M. A. Intelligent traffic control decision support system. Workshops on Applications of Evolutionary Computation, 2007. Springer, 688-701.
- ANDREY, J., MILLS, B. & VANDERMOLEN, J. 2001. Weather information and road safety. *Institute for Catastrophic Loss Reduction, Toronto, Ontario, Canada*.
- ARROYO, S. & KORNHAUSER, A. L. Modeling travel time distributions on a road network. Proceedings of the 2005 TRB annual conference, 2005.
- ASHLEY, W. S., STRADER, S., DZIUBLA, D. C. & HABERLIE, A. 2015. Driving blind: Weather-related vision hazards and fatal motor vehicle crashes. *Bulletin of the American Meteorological Society*, 96, 755-778.

- BEN-AKIVA, M., BIERLAIRE, M., KOUTSOPOULOS, H. & MISHALANI, R. DynaMIT: a simulation-based system for traffic prediction. DACCORD Short Term Forecasting Workshop, 1998. 1-12.
- BHAM, G. H., LONG, S., BAIK, H., RYAN, T., GENTRY, L., LALL, K., AREZOUMANDI, M., LIU, D., LI, T. & SCHAEFFER, B. 2010. Evaluation of variable speed limits on I-270/I-255 in St. Louis. Missouri. Dept. of Transportation. Organizational Results.
- BHOURI, N., HAJ-SALEM, H. & KAUPPILA, J. 2013. Isolated versus coordinated ramp metering: Field evaluation results of travel time reliability and traffic impact. *Transportation Research Part C: Emerging Technologies*, 28, 155-167.
- BLACK, A. W. & MOTE, T. L. 2015a. Characteristics of winter-precipitation-related transportation fatalities in the United States. *Weather, climate, and society*, 7, 133-145.
- BLACK, A. W. & MOTE, T. L. 2015b. Effects of winter precipitation on automobile collisions, injuries, and fatalities in the United States. *Journal of transport geography*, 48, 165-175.
- BLACK, A. W., VILLARINI, G. & MOTE, T. L. 2017. Effects of Rainfall on Vehicle Crashes in Six US States. *Weather, Climate, and Society*, 9, 53-70.
- BLUMENTRITT, C., ROSS, D., GLAZER, J., PINNELL, C. & MCCASLAND, W. 1981. Guidelines for selection of ramp control systems. Final report. Texas Transportation Inst., College Station (USA).
- BOERO, M. KITS, A General Approach for Knowledge-based Traffic Control Models. Advanced transport telematics: proceedings of technical days Brussels, 8-9-10 March 1993. Vol. 2, 1993.
- BOERO, M., CUENA, J., KIRSCHFINK, H., TRAETTEBERG, H. & WILD, D. The role of knowledge-based models in traffic management and their design. Towards an Intelligent Transport System. Proceedings of the First World Congress on Applications of Transport Telematics and Intelligent Vehicle-Highway Systems, November 30 - December 3, 1994 Paris.
- BORNE, P., FAYECH, B., HAMMADI, S. & MAOUCHE, S. 2003. Decision support system for urban transportation networks. *IEEE Transactions on Systems, Man, and Cybernetics, Part C (Applications and Reviews)*, 33, 67-77.
- BREEN, R. 1996. *Regression models: Censored, sample selected, or truncated data*, Sage.
- BRINCKERHOFF, P., FARRADYNE, T. & BURGESS, J. C. 2008. Active Traffic Management Concept of Operations. *Seattle, WA: Washington State Department of Transportation*.
- BRODSKY, H. & HAKKERT, A. S. 1988. Risk of a road accident in rainy weather. *Accident Analysis & Prevention*, 20, 161-176.
- BRYAN KATZ, J. M., HEATHER RIGDON, KAYLA SYKES, ZHITONG HUANG, KELLI RABOY 2017. Synthesis of Variable Speed Limit Signs. FHWA (Federal Highway Administration).
- CASAS, J., TORDAY, A., PERARNAU, J., BREEN, M. & DE VILLA, A. R. 2014. Decision Support Systems (DSS) for traffic management assessment: Notes on current methodology and future requirements for the implementation of a DSS. *Transport Research Arena*.
- CATT 2008. RITIS (Regional Integrated Transportation Information System). CATT (Center for Advanced Transportation Technology) at the University of Maryland.
- CFX. 2015. *SR 417 Widening between Berry Dease Road And SR 408* [Online]. CFX. Available: <https://www.cfxway.com/for-travelers/projects/sr-417-widening-between-berry-dease-road-and-sr-408/> [Accessed 07/17 2017].

- CFX. 2016. *CFX System Map* [Online]. Central Florida Expressway Authority (CFX). [Accessed 07/30 2018].
- CHASE JR, R. T., WILLIAMS, B. M. & ROUPHAIL, N. M. Detailed Analysis of Travel Time Reliability Performance Measures from Empirical Data. Transportation Research Board 92nd Annual Meeting, 2013.
- CHEN, A. & ZHOU, Z. 2010. The α -reliable mean-excess traffic equilibrium model with stochastic travel times. *Transportation Research Part B: Methodological*, 44, 493-513.
- CHEN, M. 2010. Travel Time Based Congestion Measures for Freeway Corridors.
- CHEN, P., YIN, K. & SUN, J. 2014. Application of finite mixture of regression model with varying mixing probabilities to estimation of urban arterial travel times. *Transportation Research Record: Journal of the Transportation Research Board*, 96-105.
- CHEN, X., CHEN, X., ZHENG, H. & CHEN, C. 2017. Understanding network travel time reliability with on-demand ride service data. *Frontiers of Engineering Management*, 4, 388-398.
- CHEN, Y.-S., VAN ZUYLEN, H. J. & LEE, R. 2005. A Self-Learning Process Based Decision Support System for Beijing Traffic Management. *Advanced OR and AI methods in transportation*, 579-586.
- CHIEN, S. I. & KOLLURI, K. K. 2012. Evaluation of freeway travel time variability and reliability under adverse weather with TRANSMIT data. *Journal of Civil Engineering and Architecture*, 6, 1.
- CHRISTIE, B., HARDESTY, D., HATCHER, G. & MERCER, M. 2015. Integrated Corridor Management: Implementation Guide and Lessons Learned (Final Report Version 2.0).
- CHUNG, W., ABDEL-ATY, M. & LEE, J. 2018. Spatial analysis of the effective coverage of land-based weather stations for traffic crashes. *Applied geography*, 90, 17-27.
- CLARK, S. & WATLING, D. 2005. Modelling network travel time reliability under stochastic demand. *Transportation Research Part B: Methodological*, 39, 119-140.
- COOLS, M., MOONS, E. & WETS, G. 2010. Assessing the impact of weather on traffic intensity. *Weather, Climate, and Society*, 2, 60-68.
- CUENA, J. AURA: A second generation expert system for traffic control in urban motorways. Proceedings of the Congress on Expert Systems and Application, 1989.
- CUENA, J., AMBROSINO, G. & BOERO, M. A general knowledge-based architecture for traffic control: The KITS approach. International Conference on Artificial Intelligence Applications in Transportation Engineering (1992: Ventura, Calif.). Conference preprints, 1992.
- CUENA, J., HERNÁNDEZ, J. & MOLINA, M. Case Presentation of the Use of Knowledge Based Models for Traffic Management-Madrid. Towards an Intelligent Transport System. Proceedings of the First World Congress on Applications of Transport Telematics and Intelligent Vehicle-Highway Systems, November 30 - December 3, 1994 Paris.
- CUENA, J., HERNÁNDEZ, J. & MOLINA, M. 1995. Knowledge-based models for adaptive traffic management systems. *Transportation Research Part C: Emerging Technologies*, 3, 311-337.
- DAI, C. 2011. Exploration of Weather Impacts on Freeway Traffic Operations and Safety Using High-Resolution Weather Data.
- DAVIES, L. & GATHER, U. 1993. The identification of multiple outliers. *Journal of the American Statistical Association*, 88, 782-792.

- DUNKEL, J., FERNÁNDEZ, A., ORTIZ, R. & OSSOWSKI, S. 2011. Event-driven architecture for decision support in traffic management systems. *Expert Systems with Applications*, 38, 6530-6539.
- EASYWAY 2015. Traffic Management Services: VARIABLE SPEED LIMITS (Deployment Guideline). EasyWay.
- EDWARDS, M. & FONTAINE, M. 2012. Investigation of travel time reliability in work zones with private-sector data. *Transportation Research Record: Journal of the Transportation Research Board*, 9-18.
- EISENBERG, D. 2004. The mixed effects of precipitation on traffic crashes. *Accident analysis & prevention*, 36, 637-647.
- EISENBERG, D. & WARNER, K. E. 2005. Effects of snowfalls on motor vehicle collisions, injuries, and fatalities. *American Journal of Public Health*, 95, 120-124.
- ELEFTERIADOU, L. & CUI, X. A framework for defining and estimating travel time reliability. Transportation Research Board 86th Annual Meeting, 2007.
- ELEFTERIADOU, L., KONDYLI, A. & GEORGE, B. S. 2014. Comparison of methods for measuring travel time at Florida freeways and arterials. *Transportation Research Center, Univ. of Florida, Gainesville, FL*.
- EMAM, E. & AI-DEEK, H. 2006. Using real-life dual-loop detector data to develop new methodology for estimating freeway travel time reliability. *Transportation Research Record: Journal of the Transportation Research Board*, 140-150.
- FARRADYNE, P. 2000. Traffic incident management handbook. *Prepared for Federal Highway Administration, Office of Travel Management*.
- FDOT 2015a. 2015 Performance Report (Florida Department of Transportation). Office of Policy Planning.
- FDOT 2015b. Use of Multiple Data Sources for Monitoring Mobility Performance. FDOT.
- FHWA 2006. Travel time reliability: Making it there on time, all the time. US Department of Transportation, Federal Highway Administration (FHWA).
- FHWA 2014. HPMS Public Release of Geospatial Data in Shapefile Format. Office of Highway Policy Information.
- FHWA. 2017a. *Active Traffic Management* [Online]. Available: <http://ops.fhwa.dot.gov/atdm/approaches/atm.htm> [Accessed].
- FHWA. 2017b. *Minnesota DOT I-35W Smart Lanes: Active Traffic Management* [Online]. Available: https://ops.fhwa.dot.gov/publications/fhwahop12046/rwm17_minnesota1.htm [Accessed 2/15 2017].
- FONTAINE, M. D. & MILLER, J. S. 2012. Planning for active traffic management in virginia: International Best Practices and Implementation Strategies.
- FORASTE, B. & SCEMAMA, G. 1987. An expert System approach to congestion. *RECHERCHE TRANSPORTS SECURITE*.
- FRIDSTRØM, L., IFVER, J., INGEBRIGTSEN, S., KULMALA, R. & THOMSEN, L. K. 1995. Measuring the contribution of randomness, exposure, weather, and daylight to the variation in road accident counts. *Accident Analysis & Prevention*, 27, 1-20.
- FUHS, C. 2010. Synthesis of Active Traffic Management Experiences in Europe and the United States.
- GAN, A., ZHU, X., LIU, K., ALLURI, P. & ROBBINS, C. 2011. Integrated database and analysis system for the evaluation of freeway corridors for potential ramp signaling.

- GRIFFIN, L. Year. Enhancing expressway operations using travel time performance data. Proceedings of the Facilities Management and Maintenance Workshop, Nashville, TN.
- GUESSOUS, Y., ARON, M., BHOURI, N. & COHEN, S. 2014. Estimating travel time distribution under different traffic conditions. *Transportation Research Procedia*, 3, 339-348.
- HAAS, R. 2009. iFlorida model deployment final evaluation report. United States. Joint Program Office for Intelligent Transportation Systems.
- HAGHANI, A., ZHANG, Y. & HAMED, M. 2014. Impact of Data Source on Travel Time Reliability Assessment.
- HALL, F. L. & BARROW, D. 1988. *Effect of weather on the relationship between flow and occupancy on freeways*.
- HARBORD, B. 1998. M25 controlled motorway-results of the first two years.
- HEERY, F. H. 2016. Statewide Intelligent Transportation Systems Performance Measures. *Annual Report (Fiscal Year 2015/2016)*.
- HEGYI, A. 2004. *Model predictive control for integrating traffic control measures*, Netherlands TRAIL Research School.
- HEGYI, A., DE SCHUTTER, B., HOOGENDOORN, S., BABUSKA, R., VAN ZUYLEN, H. & SCHUURMAN, H. A fuzzy decision support system for traffic control centers. *Intelligent Transportation Systems*, 2001. Proceedings. 2001 IEEE, 2001. IEEE, 358-363.
- HEISS, W. H., MCGREW, D. L. & SIRMANS, D. 1990. NEXRAD: next generation weather radar (WSR-88D). *Microwave Journal*, 33, 79-89.
- HERNÁNDEZ, J. Z., OSSOWSKI, S. & GARCÍA-SERRANO, A. 2002. Multiagent architectures for intelligent traffic management systems. *Transportation Research Part C: Emerging Technologies*, 10, 473-506.
- HNTB 2013. Active Traffic Management Case Study (Draft). Georgia Department of Transportation.
- HOLLANDER, Y. & LIU, R. Calibration of a traffic microsimulation model as a tool for estimating the level of travel time variability. 10th meeting of Euro Working Group on Transportation (EWGT), Poznan, Poland, 2005. Citeseer, 14.
- HOOGENDOORN, S. P., DE SCHUTTER, B. & SCHUURMAN, H. 2003. Decision support in dynamic traffic management. Real-time scenario evaluation. *European Journal of Transport and Infrastructure Research*, 3, 21-38.
- HU, M., LEE, D.-H. & SHI, Q. Development of the real-time evaluation and decision support system for incident management. *Intelligent Transportation Systems*, 2003. Proceedings. 2003 IEEE, 2003. IEEE, 426-431.
- IBRAHIM, A. T. & HALL, F. L. 1994. *Effect of adverse weather conditions on speed-flow-occupancy relationships*.
- JAROSZWESKI, D. & MCNAMARA, T. 2014. The influence of rainfall on road accidents in urban areas: A weather radar approach. *Travel behaviour and society*, 1, 15-21.
- JAVID, R. J. 2017. Online estimation of travel time variability using the integrated traffic incident and weather data.
- JENKS, C. W., JENCKS, C. F., SUNDSTROM, L. L. & DELANEY, E. P. 2008. *Cost effective performance measures for travel time delay, variation and reliability*, Transportation Research Board. National Academy.
- JONES, E. G. 1988. *The variability of travel times in a commuting corridor during the evening peak period*. University of Texas at Austin.

- KARL, T. & KOSS, W. J. 1984. *Regional and national monthly, seasonal, and annual temperature weighted by area, 1895-1983*, National Climatic Data Center.
- KATZ, B., O'DONNELL, C., DONOUGHE, K., ATKINSON, J., FINLEY, M., BALKE, K., KUHN, B. & WARREN, D. 2012. Guidelines for the use of variable speed limit systems in wet weather.
- KHONDAKER, B. & KATTAN, L. 2015. Variable speed limit: an overview. *Transportation Letters*, 7, 264-278.
- KIM, J., MAHMASSANI, H., VOVSHA, P., STOGIOS, Y. & DONG, J. 2013. Scenario-based approach to analysis of travel time reliability with traffic simulation models. *Transportation Research Record: Journal of the Transportation Research Board*, 56-68.
- KIM, J. & MAHMASSANI, H. S. 2014. A finite mixture model of vehicle-to-vehicle and day-to-day variability of traffic network travel times. *Transportation Research Part C: Emerging Technologies*, 46, 83-97.
- KIM, J. & MAHMASSANI, H. S. 2015. Compound Gamma representation for modeling travel time variability in a traffic network. *Transportation Research Part B: Methodological*, 80, 40-63.
- KIM, J., MAHMASSANI, H. S., HOU, T. & ALFELOR, R. M. Development of real-time simulation-based decision support system for weather responsive traffic signal operations. Intelligent Transportation Systems (ITSC), 2014 IEEE 17th International Conference on, 2014. IEEE, 810-815.
- KIM, W., KIM, H., WON, M. & CHANG, G.-L. 2017. Development of a Traffic Management Decision Support Tool for Freeway Incident Traffic Management (FITM) Plan Deployment. Maryland. State Highway Administration.
- KLEIN, L., YI, P. & TENG, H. 2002. Decision support system for advanced traffic management through data fusion. *Transportation Research Record: Journal of the Transportation Research Board*, 173-178.
- KOUWENHOVEN, M. & WARFFEMIUS, P. 2017. Forecasting travel-time reliability in road transport: A new model for the Netherlands. *ITF Roundtable Reports Quantifying the Socio-economic Benefits of Transport*, 1, 57.
- KUCHARSKI, R. & DRABICKI, A. 2017. Estimating Macroscopic Volume Delay Functions with the Traffic Density Derived from Measured Speeds and Flows. *Journal of Advanced Transportation*, 2017.
- KUHN, B., BALKE, K. & WOOD, N. 2017. Active Traffic Management (ATM) Implementation and Operations Guide. FHWA.
- KUHN, B., GOPALAKRISHNA, D. & SCHREFFLER, E. 2013. The Active Transportation and Demand Management Program (ATDM): Lessons Learned.
- KWON, J., BARKLEY, T., HRANAC, R., PETTY, K. & COMPIN, N. 2011. Decomposition of travel time reliability into various sources: incidents, weather, work zones, special events, and base capacity. *Transportation Research Record: Journal of the Transportation Research Board*, 28-33.
- LANDIS, J. R. & KOCH, G. G. 1977. The measurement of observer agreement for categorical data. *biometrics*, 159-174.
- LEYS, C., LEY, C., KLEIN, O., BERNARD, P. & LICATA, L. 2013. Detecting outliers: Do not use standard deviation around the mean, use absolute deviation around the median. *Journal of Experimental Social Psychology*, 49, 764-766.

- LI, R., ROSE, G. & SARVI, M. 2006. Using automatic vehicle identification data to gain insight into travel time variability and its causes. *Transportation Research Record*, 1945, 24-32.
- LIST, G., WILLIAMS, B., ROUPHAIL, N., HRANAC, R., BARKLEY, T., MAI, E., CICCARELLI, A., RODEGERDTS, L., KARR, A. & ZHOU, X. 2014. Guide to establishing monitoring programs for travel time reliability, SHRP 2 Report S2-LO2-RR2. *Transportation Research Board, Washington, DC*.
- LOMAX, T. & MARGIOTTA, R. 2003. *Selecting travel reliability measures*, The Institute.
- LOMAX, T., SCHRANK, D., TURNER, S. & MARGIOTTA, R. 2003. *Selecting travel reliability measures*.
- LORD, D. & MANNERING, F. 2010. The statistical analysis of crash-frequency data: a review and assessment of methodological alternatives. *Transportation Research Part A: Policy and Practice*, 44, 291-305.
- MA, Y., ZHANG, W., LU, J. & YUAN, L. 2014. Automated generation of traffic incident response plan based on case-based reasoning and Bayesian theory. *Discrete dynamics in nature and society*, 2014.
- MAHMASSANI, H., HOU, T. & DONG, J. 2012. Characterizing travel time variability in vehicular traffic networks: deriving a robust relation for reliability analysis. *Transportation Research Record: Journal of the Transportation Research Board*, 141-152.
- MAHMASSANI, H., HOU, T. & SABERI, M. 2013. Connecting networkwide travel time reliability and the network fundamental diagram of traffic flow. *Transportation Research Record: Journal of the Transportation Research Board*, 80-91.
- MAHMASSANI, H. S. 1998. Dynamic traffic simulation and assignment: Models, algorithms and application to ATIS/ATMS evaluation and operation. *Operations Research and Decision Aid Methodologies in Traffic and Transportation Management*. Springer.
- MARGIOTTA, R. & TAYLOR, R. 2006. Traffic Congestion and Reliability: Making the Connection with Operations: Part 1: Measuring and Tracking Reliability. *Institute of Transportation Engineers. ITE Journal*, 76, 24.
- MAY, A. D. 1990. *Traffic flow fundamentals*.
- MAZE, T., AGARWAI, M. & BURCHETT, G. 2006. Whether weather matters to traffic demand, traffic safety, and traffic operations and flow. *Transportation research record: Journal of the transportation research board*, 170-176.
- MCDERMOTT, J. M., KOLENKO, S. J. & WOJCIK, R. J. 1979. *Chicago area expressway surveillance and control*, Illinois Department of Transportation Bureau of Materials and Physical Research.
- MILLER, J. 1991. Reaction time analysis with outlier exclusion: Bias varies with sample size. *The quarterly journal of experimental psychology*, 43, 907-912.
- MILLER, P. A., BARTH, M., BENJAMIN, L., ARTZ, R. & PENDERGRASS, W. The Meteorological Assimilation and Data Ingest System (MADIS): Providing value-added observations to the meteorological community. 21st Conference on Weather Analysis and Forecasting, 2005.
- MIRSHAHI, M., OBENBERGER, J. T., FUHS, C. A., HOWARD, C. E., KRAMMES, R. A., KUHN, B. T., MAYHEW, R. M., MOORE, M. A., SAHEBJAM, K. & STONE, C. J. 2007. Active traffic management: the next step in congestion management.
- MNDOT. *Smart Lanes* [Online]. Available: <http://www.dot.state.mn.us/smartlanes/> [Accessed].
- NCEI 2016. Cooperative Observer Network (COOP). NOAA.
- NCEI 2017. Quality Controlled Local Climatological Data (QCLCD). NOAA.

- NEUDORFF, L. & MCCABE, K. 2015. Active Traffic Management (ATM) Feasibility and Screening Guide.
- NHTSA 2014. Fatality Analysis Reporting System (FARS). National Highway Traffic Safety Administration (NHTSA).
- NHTSA 2015. Fatality Analysis Reporting System (FARS) Analytical User's Manual 1975–2014. *Washington: Department of Transportation (US)*.
- NOLAND, R. B. & POLAK, J. W. 2002. Travel time variability: a review of theoretical and empirical issues. *Transport reviews*, 22, 39-54.
- OLSZEWSKI, P., FAN, H. S. & TAN, Y.-W. 1995. Area-wide traffic speed-flow model for the Singapore CBD. *Transportation Research Part A: Policy and Practice*, 29, 273-281.
- OSORIO, C. & BIDKHORI, H. Combining metamodel techniques and Bayesian selection procedures to derive computationally efficient simulation-based optimization algorithms. Proceedings of the Winter Simulation Conference, 2012. Winter Simulation Conference, 422.
- OSSOWSKI, S., HERNÁNDEZ, J. Z., BELMONTE, M.-V., FERNÁNDEZ, A., GARCÍA-SERRANO, A., PÉREZ-DE-LA-CRUZ, J.-L., SERRANO, J.-M. & TRIGUERO, F. 2005. Decision support for traffic management based on organisational and communicative multiagent abstractions. *Transportation Research part C: emerging technologies*, 13, 272-298.
- PAISALWATTANA, S. & TANABORIBOON, Y. 2005. Decision support system for work zone safety management: a case study in Thailand. *Journal of the Eastern Asia Society for Transportation Studies*, 6, 3341-3356.
- PAPAGEORGIU, M., BLOSSEVILLE, J.-M. & HADJ-SALEM, H. 1989. Macroscopic modelling of traffic flow on the Boulevard Périphérique in Paris. *Transportation Research Part B: Methodological*, 23, 29-47.
- PAPAGEORGIU, M., BLOSSEVILLE, J.-M. & HADJ-SALEM, H. 1990. Modelling and real-time control of traffic flow on the southern part of Boulevard Peripherique in Paris: Part I: Modelling. *Transportation Research Part A: General*, 24, 345-359.
- PAPAGEORGIU, M. & KOTSIALOS, A. 2002. Freeway ramp metering: An overview. *IEEE transactions on intelligent transportation systems*, 3, 271-281.
- PARK, B. & SCHNEEBERGER, J. 2003. Microscopic simulation model calibration and validation: case study of VISSIM simulation model for a coordinated actuated signal system. *Transportation Research Record: Journal of the Transportation Research Board*, 185-192.
- PARK, S., RAKHA, H. & GUO, F. Multi-state travel time reliability model: Impact of incidents on travel time reliability. Intelligent Transportation Systems (ITSC), 2011 14th International IEEE Conference on, 2011. IEEE, 2106-2111.
- PEER, S., KOOPMANS, C. C. & VERHOEF, E. T. 2012. Prediction of travel time variability for cost-benefit analysis. *Transportation Research Part A: Policy and Practice*, 46, 79-90.
- PISANO, P. A., GOODWIN, L. C. & ROSSETTI, M. A. US highway crashes in adverse road weather conditions. 24th Conference on International Interactive Information and Processing Systems for Meteorology, Oceanography and Hydrology, New Orleans, LA, 2008.
- PU, W. 2011. Analytic relationships between travel time reliability measures. *Transportation Research Record: Journal of the Transportation Research Board*, 122-130.

- QIU, L. & NIXON, W. 2008. Effects of adverse weather on traffic crashes: systematic review and meta-analysis. *Transportation Research Record: Journal of the Transportation Research Board*, 139-146.
- RAPOLU, S. & KUMAR, A. 2015. *Comparing Arterial Speeds from “Big-Data” Sources in Southeast Florida (Bluetooth, HERE and INRIX)* [Online]. AECOM. Available: [https://www.trbappcon.org/2015conf/presentations/191_Travel%20Speed%20Data%20Comparison%20\(HERE,INRIX%20and%20Bluetooth\)%20-%20TRBApp%202015.pdf](https://www.trbappcon.org/2015conf/presentations/191_Travel%20Speed%20Data%20Comparison%20(HERE,INRIX%20and%20Bluetooth)%20-%20TRBApp%202015.pdf) [Accessed 07/25 2017].
- RITCHIE, S. G. 1990. A knowledge-based decision support architecture for advanced traffic management. *Transportation Research Part A: General*, 24, 27-37.
- ROSSETTI, M. A. & JOHNSEN, M. 2011. Weather and Climate Impacts on Commercial Motor Vehicle Safety. Federal Motor Carrier Safety Administration.
- RUIZ, B. M. F. 2000. *Architecture for the Integration of Dynamic Traffic Management Systems*. Master of Science in Transportation, Massachusetts Institute of Technology.
- SHAH, S. A. A., KIM, H., BAEK, S., CHANG, H. & AHN, B. H. 2008. System architecture of a decision support system for freeway incident management in Republic of Korea. *Transportation Research Part A: Policy and Practice*, 42, 799-810.
- SHI, Q. & ABDEL-ATY, M. 2016. Evaluation of the Impact of Travel Time Reliability on Urban Expressway Traffic Safety. *Transportation Research Record: Journal of the Transportation Research Board*, 8-17.
- SIM, J. & WRIGHT, C. C. 2005. The kappa statistic in reliability studies: use, interpretation, and sample size requirements. *Physical therapy*, 85, 257-268.
- SMITH, B. L., BYRNE, K. G., COPPERMAN, R. B., HENNESSY, S. M. & GOODALL, N. J. An investigation into the impact of rainfall on freeway traffic flow. 83rd annual meeting of the Transportation Research Board, Washington DC, 2004. Citeseer.
- SMITH, S., BELLONE, J., BRANSFIELD, S., INGLES, A., NOEL, G., REED, E. & YANAGISAWA, M. 2015. Benefits estimation framework for automated vehicle operations. United States. Dept. of Transportation. ITS Joint Program Office.
- SPILIOPOULOU, A., PAPAMICHAIL, I., PAPAGEORGIOU, M., TYRINOPOULOS, Y. & CHRYSOULAKIS, J. 2017. Macroscopic traffic flow model calibration using different optimization algorithms. *Operational Research*, 17, 145-164.
- SPILLER, J. N., COMPIN, N., RESHADI, A., UMFLEET, B., WESTHUIS, T., MILLER, K. & SADEGH, A. 2014. Advances In Strategies For Implementing Integrated Corridor Management (ICM).
- STEPHAN, K., HOSKING, S., REGAN, M., VERDOORN, A., YOUNG, K. & HAWORTH, N. 2006. The relationship between driving performance and the Johns Drowsiness Scale as measured by the Optalert system. *Monash University Accident Research Centre*, 1-43.
- STEPHENS, D., GIBBS, W., TIMCHO, T., BALKE, K., CHARARA, H., SUNKARI, S. & SMITH, T. 2015. Intelligent Network Flow Optimization (INFLO) Prototype Acceptance Test Summary.
- STRÖMGREN, P. & LIND, G. 2016. Harmonization with variable speed limits on motorways. *Transportation Research Procedia*, 15, 664-675.
- SYSTEMATICS, C. 2005. Traffic congestion and reliability: Trends and advanced strategies for congestion mitigation. *Final Report, Texas Transportation Institute*. http://ops.fhwa.dot.gov/congestion_report_04/index.htm.

- TAHMASSEBY, S. 2015. Traffic data: Bluetooth sensors vs. crowdsourcing—A comparative study to calculate travel time reliability in calgary, alberta, canada. *Journal of Traffic and Transportation Engineering*, 3, 63-79.
- TAYLOR, M. A. 2013. Travel through time: the story of research on travel time reliability. *Transportmetrica B: transport dynamics*, 1, 174-194.
- TIGNOR, S. C., BROWN, L., BUTNER, J., CUNARD, R., DAVIS, S., HAWKINS, H. G., FISCHER, E., KEHRLI, M., RUSCH, P. & WAINWRIGHT, W. 1999. Innovative Traffic Control Technology and Practice in Europe.
- TRB. *Strategic Highway Research Program 2 (SHRP 2) Reliability Research Reports* [Online]. Available: <http://www.trb.org/Publications/PubsSHRP2ResearchReportsReliability.aspx> [Accessed 07/15 2017].
- TRB 2016. *Highway Capacity Manual (HCM 2010)*, Transportation Research Board.
- TU, H., LI, H., VAN LINT, H. & VAN ZUYLEN, H. 2012. Modeling travel time reliability of freeways using risk assessment techniques. *Transportation Research Part A: Policy and Practice*, 46, 1528-1540.
- TU, H., VAN LINT, H. & VAN ZUYLEN, H. Travel time variability versus freeway characteristics. Intelligent Transportation Systems Conference, 2006. ITSC'06. IEEE, 2006. IEEE, 383-388.
- TU, H., VAN LINT, H. & VAN ZUYLEN, H. The effects of traffic accidents on travel time reliability. Intelligent Transportation Systems, 2008. ITSC 2008. 11th International IEEE Conference on, 2008. IEEE, 79-84.
- TU, H., VAN LINT, H. W. & VAN ZUYLEN, H. J. 2007. Impact of adverse weather on travel time variability of freeway corridors.
- TURNER, S., RICHARDSON, J., FONTAINE, M. & SMITH, B. 2011a. Guidelines for evaluating the accuracy of travel time and speed data.
- TURNER, S., SADABADI, K., HAGHANI, A., HAMED, M., BRYDIA, R., SANTIAGO, S. & KUSSY, E. 2011b. Private Sector Data for Performance Management. FHWA.
- UF 2017. Signal Four Analytics (S4A). 01/30/2017 ed.: The Geoplan Center, University of Florida (UF).
- USDOT 2013. Integrated Corridor Management (ICM) - Demonstration Sites. *In: ADMINISTRATION*, U. R. R. A. I. T. (ed.).
- VAN LINT, J. & VAN ZUYLEN, H. 2005. Monitoring and predicting freeway travel time reliability: Using width and skew of day-to-day travel time distribution. *Transportation Research Record: Journal of the Transportation Research Board*, 54-62.
- VAN LINT, J., VAN ZUYLEN, H. J. & TU, H. 2008. Travel time unreliability on freeways: Why measures based on variance tell only half the story. *Transportation Research Part A: Policy and Practice*, 42, 258-277.
- VANDERVALK, A. 2014. *Data for Mobility Performance Measures* [Online]. FDOT. Available: <http://www.fdot.gov/planning/statistics/symposium/2014/Fl-natlPerformData.pdf> [Accessed 07/17 2017].
- VPP. 2017. *Vehicle Probe Project* [Online]. VPP. Available: <http://i95coalition.org/projects/vehicle-probe-project/> [Accessed 07/25 2017].
- WANG, K. C. & GONG, W. 2007. Automated real-time pavement crack detection and classification.

- WILES, P. B., COONER, S., WALTERS, C. & PULTORAK, E. 2003. Advance warning of stopped traffic on freeways: Current practices and field studies of queue propagation speeds.
- WONG, H.-K. & SUSSMAN, J. M. 1973. Dynamic travel time estimation on highway networks. *Transportation Research*, 7, 355-370.
- WRIGHT, B., ZOU, Y. & WANG, Y. 2015. Impact of traffic incidents on reliability of freeway travel times. *Transportation Research Record: Journal of the Transportation Research Board*, 90-98.
- WSDOT. 2017. *Best Time To Leave* [Online]. Available: <http://www.wsdot.com/traffic/seattle/traveltimes/reliability/> [Accessed 07/25 2017].
- YAZICI, M., KAMGA, C. & MOUSKOS, K. 2012. Analysis of travel time reliability in New York city based on day-of-week and time-of-day periods. *Transportation Research Record: Journal of the Transportation Research Board*, 83-95.
- YAZICI, M. A., KAMGA, C. & SINGHAL, A. 2013. Weather's impact on travel time and travel time variability in New York City. *Transportation Research*, 40, 41.
- YU, R. & ABDEL-ATY, M. 2014. An optimal variable speed limits system to ameliorate traffic safety risk. *Transportation research part C: emerging technologies*, 46, 235-246.
- ZEGEER, J., BONNESON, J., DOWLING, R., RYUS, P., VANDEHEY, M., KITTELSON, W., ROUPHAIL, N., SCHROEDER, B., HAJBABAIE, A. & AGHDASHI, B. 2014. Incorporating Travel Time Reliability into the Highway Capacity Manual.
- ZHAO, L. & CHIEN, S. I.-J. 2012. Analysis of Weather Impact on Travel Speed and Travel Time Reliability. *CICTP 2012: Multimodal Transportation Systems—Convenient, Safe, Cost-Effective, Efficient*.
- ZHENG, F., LIU, X., ZUYLEN, H. V., LI, J. & LU, C. 2017. Travel Time Reliability for Urban Networks: Modelling and Empirics. *Journal of Advanced Transportation*, 2017.
- ZHENG, F. & VAN ZUYLEN, H. 2011. Modeling variability of urban travel times by analyzing delay distribution for multiple signalized intersections. *Transportation Research Record: Journal of the Transportation Research Board*, 80-95.
- ZHENG, F. & VAN ZUYLEN, H. 2014. The development and calibration of a model for urban travel time distributions. *Journal of Intelligent Transportation Systems*, 18, 81-94.
- ZHENG, F., VAN ZUYLEN, H. & PU, Y. 2012. Model for predicting distribution of link travel times for urban signalized roads. *Transportation Research Record: Journal of the Transportation Research Board*, 59-72.