

2013

Solubility improvement by solid dispersion and their characterization : indomethacin and phenytoin

Vishak Sridhar
The University of Toledo

Follow this and additional works at: <http://utdr.utoledo.edu/theses-dissertations>

Recommended Citation

Sridhar, Vishak, "Solubility improvement by solid dispersion and their characterization : indomethacin and phenytoin" (2013). *Theses and Dissertations*. 216.
<http://utdr.utoledo.edu/theses-dissertations/216>

This Thesis is brought to you for free and open access by The University of Toledo Digital Repository. It has been accepted for inclusion in Theses and Dissertations by an authorized administrator of The University of Toledo Digital Repository. For more information, please see the repository's [About page](#).

A Thesis

entitled

Solubility improvement by Solid Dispersion and Their Characterization: Indomethacin

and Phenytoin

by

Vishak Sridhar

Submitted to the Graduate Faculty as partial fulfillment of the requirements for the
Master of Science Degree in Pharmaceutical Science with Industrial Pharmacy option

Dr. Kenneth S. Alexander, Committee Chair

Dr. Mariann Churchwell, Committee Member

Dr. Caren L. Steinmiller, Committee Member

Dr. Patricia R. Komuniecki, Dean
College of Graduate Studies

The University of Toledo

May, 2013

Copyright 2013, Vishak Sridhar

This document is copyrighted material. Under copyright law, no parts of this document may be reproduced without the expressed permission of the author.

An Abstract of

Solubility improvement by Solid Dispersion and Their Characterization: Indomethacin
and Phenytoin

by

Vishak Sridhar

Submitted to the Graduate Faculty as partial fulfillment of the requirements for the
Master of Science Degree in Pharmaceutical Science with industrial pharmacy option

The University of Toledo

January, 2013

The objective of this project was to improve the solubility of two poorly water soluble drugs, namely indomethacin and phenytoin by formulating ternary solid dispersions with a carrier and an adsorbent. Urea was used as the dispersing agent for indomethacin, while Kollidon[®]VA64 was used for both indomethacin and phenytoin. Solid dispersions with urea and indomethacin were prepared by the hot melt method while the ones with Kollidon[®]VA64 were prepared by the solvent extraction method. Various techniques were used to characterize the solid dispersions, immediately after they were made and after two months of elevated temperature and relative humidity, including Differential Scanning Calorimetry (DSC), X-Ray Powder Diffraction (PXRD), Scanning Electron Microscopy (SEM) and in vitro dissolution studies.

The DSC data showed thermograms for all the ingredients, physical mixtures and solid dispersions. It indicated that the physical mixtures tend to have the drugs in their crystalline form. However, the solid dispersions gave formulations that were completely amorphous. PXRD studies confirmed these results. PXRD results for the drugs show their crystalline nature which could not be seen with the solid dispersions. It also confirmed that the formulations were stable over the two month period when they were kept at elevated temperature and controlled relative humidity conditions. SEM images indicated that the solid dispersion of the drug and carrier were coated on the Nuesilin[®]US2 well, showing it was possible to coat the solid dispersion on the Nuesilin[®]US2 by both the fusion method and solvent extraction method. In vitro dissolution studies reveal that

there is an increase in both the quantity of drug solubilized and the rate of dissolution after formulation into their solid dispersions. The stability studies for two months under various temperatures (30⁰C, 35⁰C, 40⁰C, and 45⁰C) and relative humidity conditions (100%, 75.29 ±0.12%, 54.38 ±0.23 and 23.11 ±0.25% RH) indicated that the formulations might be stable. It also indicated that as the quantity of drug in the formulations increased, there was a tendency for some formulations to be unstable. The accelerated stability studies also helped to determine the trends with the shelf life of the formulations using the Arrhenius equation. It also gave some idea about the tendency of relative humidity to affect the degradation rate of the drug.

Acknowledgements

I would like to thank Dr. Kenneth Alexander, my instructor and advisor for giving me the opportunity to work in his laboratory and to pursue the Master's degree in the College of Pharmacy and Pharmaceutical Sciences at The University of Toledo. I would like to express my deepest gratitude for his guidance and encouragement which he provided me during the past two and a half years.

I am thankful to Dr. Mariann Churchwell and Dr. Caren L. Steinmiller, my thesis committee members, for their priceless advice. I am also thankful to Dr Ming Liu for taking out time to be the graduate school representative for the thesis defense. I would also like to express my gratitude to Dr. Pannee Burckel for her support and help in using the PXRD and SEM instruments.

I do not have enough words to express my gratitude towards my parents for their endless love, care and support. Their confidence and faith in me always provided motivation to work hard and achieve my goals. I owe a special thanks to my family for their endless support and encouragement. I would like to also thank my friends Sonia, Priti, Sukanya, Varsha, Rohan, Prathamesh, Prakhyat and Romir who are my second family. They have supported me and encouraged me at every step and helped me achieve my goals. I would also like to thank, Sylie, Ashish, Chirjiv, Swetha, Prathyusha, Nikhilesh, Sarath, Vishwanath, Stephanie, Megan and my other friends who have made my life in Toledo interesting and fun. Above all, I would like to thank the Almighty for blessing me with such a wonderful life.

Table of Contents

Abstract.....	iii
Table of Contents.....	vi
List of Tables	xvii
List of Figures.....	xviii
1. Introduction.....	1
2. Solid Dispersions	4
2.1 Introduction.....	4
2.2 Methods Used to Increase Solubility	5
2.2.1 Particle Size Reduction	6
2.2.1. a Micronization.....	6
2.2.1. b Nanosuspension	6
2.2.1. c Sonocrystallization.....	7
2.2.1. d Supercritical fluid (SCF) processing.....	7
2.2.2 Polymorphism and Pseudopolymorphism	7
2.2.3 Complexation.....	8
2.2.3. a Stacking complexation.....	8
2.2.3. b Inclusion complexation.....	8

2.2.4 Solubilization by Surfactants	8
2.2.4. a Microemulsions.....	8
2.2.4. b Self microemulsifying drug delivery systems.....	8
2.2.5 Chemical Methods	9
2.2.5. a Salt formation.....	9
2.2.5. b Hydrotrophy	9
2.2.6 Solubilizing Agent	9
2.2.7 Nanotechnology	10
2.2.8 Drug Dispersed in a Matrix.....	10
2.3 Classification of Solid Dispersions.....	12
2.3.1 Simple Eutectic Mixture	12
2.3.2 Solid Solutions.....	13
2.3.3 Glass Solution or Suspension.....	15
2.3.4 Compound or Complex Formation	15
2.3.5 Amorphous Precipitation	16
2.4 Carriers for Solid Dispersions.....	16
2.4.2 Polymers	16
2.4.3 Urea.....	17
2.4.4 Surfactants.....	17
2.5 Methods of Preparation.....	17

2.5.1 Fusion Method	18
2.5.2 Solvent Method	19
2.5.3 Fusion Solvent Method	20
2.6 Characterization of Solid Dispersions	21
3. Differential Scanning Calorimetry.....	22
3.1 Introduction.....	22
3.2 Types of DSC.....	23
3.2.1 Power-Compensated DSC	24
3.2.2 Heat Flux DSC.....	24
3.3 Instrumentation and Important Considerations.....	26
3.3.1 The Sensor	26
3.3.2 Crucibles or Pans	26
3.3.3 Temperature Control and Atmosphere or Purge Gas.....	27
3.3.4 Computer and Display	28
3.3.5 Calvet-Type Equipment.....	28
3.3.6 Reference Material.....	28
3.3.7 Sample Preparation	29
3.3.8 Maintenance and Care.....	29
3.4 Calibration.....	30

3.4.1 Temperature Calibration	31
3.4.2 Energy Calibration	31
3.5 Application.....	32
4. Powder X-Ray Crystallography	34
4.1 Introduction.....	34
4.2 Principle	34
4.2.1 Bragg's Law.....	37
4.3 Instrumentation	38
4.3.1 X-ray Generator	39
4.3.2 X-Ray Tube.....	39
4.3.3 Filters and Monochromators	39
4.3.4 Sample Holder	40
4.3.5 Detector.....	40
4.4 Sample Preparation	41
4.5 Application.....	41
5. Scanning Electron Microscopy	42
5.1 Introduction.....	42
5.2 Principle	43
5.3 Instrumentation	46

5.3.1 Vacuum Systems.....	46
5.3.2 Electron Beam Generator and Focusing	47
5.3.3 Detectors	47
5.4 Sample Preparation.....	49
5.5 Application.....	50
6. Dissolution Studies	51
6.1 Introduction.....	51
6.2 Instrumentation	52
6.2.1 Dissolution Apparatus 1 (Basket Apparatus).....	52
6.2.2 Apparatus 2 (Paddle Apparatus)	54
6.2.3 Apparatus 3 (Reciprocating Cylinder)	56
6.2.4 Apparatus 4 (Flow-Through Cell)	56
6.3 Procedure for Dissolution	58
6.3.1 Immediate Release Formulations.....	58
6.3.2 Delayed Release Formulations	59
6.3.3 Extended Release Formulations.....	60
7. Ultraviolet-Visible Spectroscopy.....	61
7.1 Introduction.....	61
7.2 Principle	63

7.2.1 Energy Absorption	65
7.2.3 Electronic Transitions	66
7.2.4 Beer-Lambert Law	67
7.3 Instrumentation	68
7.4 Applications	70
8. Materials and Methods.....	72
8.1 Materials	72
8.1.1 Indomethacin.....	72
8.1.1. a. Introduction.....	72
8.1.1. b. Physical Properties.....	73
8.1.1. c. Pharmacodynamics	73
8.1.1. d. Uses, Side Effects and Contraindication.....	74
8.1.1. e. Available Dosage Forms and Doses	74
8.1.2 Phenytoin	75
8.1.2. a. Introduction.....	75
8.1.2. b. Physical Properties.....	75
8.1.2. c. Pharmacodynamics	76
8.1.2. d. Uses, Side Effects and Contraindication.....	76
8.1.2. e. Available Dosage Forms and Doses	77

8.1.3 Ethanol.....	77
8.1.3. a. Introduction.....	77
8.1.3. b. Physical Properties [11].....	77
8.1.3. c. Description and Uses.....	78
8.1.4 Kollidon [®] VA64.....	79
8.1.4. a Introduction.....	79
8.1.4. b. Physical Properties.....	79
8.1.4. c. Description and Uses.....	80
8.1.5 Urea.....	80
8.1.5. a. Introduction.....	80
8.1.5. b. Physical Properties.....	81
8.1.5. c. Description and Uses.....	81
8.1.6 Neusilin [®] US2.....	82
8.1.6. a. Introduction.....	82
8.1.6. b. Physical Properties.....	82
8.1.6. c. Description and Uses.....	83
8.1.7 Water.....	84
8.1.8 Sodium Chloride.....	84
8.1.8. a. Introduction.....	84

8.1.8. b Physical Properties.....	84
8.1.8. c Description and Uses.....	85
8.1.9 Potassium Acetate.....	86
8.1.9. a. Introduction.....	86
8.1.9. b. Physical Properties.....	86
8.1.9. c. Description and Uses.....	87
8.1.10 Magnesium Nitrate.....	87
8.1.10. a. Introduction.....	87
8.1.10. b. Physical Properties.....	87
8.1.10. c. Description and Uses.....	88
8.1.11 Hydrochloric Acid.....	88
8.1.11. a. Introduction.....	88
8.1.11. b Physical Properties.....	89
8.1.11. c Description and Uses.....	89
8.1.12 Sodium Phosphate Monobasic.....	90
8.1.12. a. Introduction.....	90
8.1.12. b. Physical Properties.....	90
8.1.12. c. Description and Uses.....	91
8.1.13 Dibasic Sodium Phosphate Heptahydrate.....	91

8.1.13. a. Introduction.....	91
8.1.12. b. Physical Properties.....	92
8.1.13. c. Description and Uses.....	92
8.1.14 Acetone	92
8.1.14. a. Introduction.....	92
8.1.14. b. Physical Properties.....	93
8.1.14. c Description and Uses.....	93
8.2 Method for Preparation of Solid Dispersions	94
8.2.1 Method for Preparing the Solid Dispersions with Indomethacin and Urea	94
8.2.2 Method for Preparing the Solid Dispersions with Indomethacin and Kollidon [®] VA64.....	95
8.2.3 Method for Preparing the Solid Dispersions with Phenytoin and Kollidon [®] VA64.....	96
8.3 Methods for Analytical Techniques.....	96
8.3.1 Differential Scanning Calorimetry.....	96
8.3.2 Powder X-Ray Diffraction (PXRD).....	97
8.3.4 Scanning Electron Microscopy (SEM)	97
8.3.5 Ultraviolet-Visible Absorption Spectroscopy.....	98
8.3.6 Dissolution Testing	98
8.3.7 Humidity and Temperature Studies	99
9. Results and Discussion	101

9.1 Indomethacin and Urea Solid Dispersion	101
9.1.1 Differential Scanning Calorimetry.....	101
9.1.2. Scanning Electron Microscopy	103
9.1.3. Powder X-Ray Crystallography	106
9.1.4 Dissolution Studies	112
9.1.5. Stability Studies	115
9.2 Indomethacin and Kollidon [®] VA64 Solid Dispersion	119
9.2.1 Differential Scanning Calorimeter.....	120
9.2.2 Scanning Electron Microscopy:.....	122
9.2.3 Powder X-Ray Crystallography	124
9.2.4 Dissolution Studies	131
9.2.5 Stability Studies	132
9.3 Phenytoin Solid Dispersion.....	136
9.3.1. Differential Scanning Calorimetry.....	137
9.3.2 Powder X-Ray Crystallography.....	139
9.3.3 Scanning Electron Microscopy	145
9.3.4 Dissolution Studies	148
9.3.5 Stability Studies	150
10.Conclusions and Future Work	155
10.1 Future Work	159

References..... 160

List of Tables

Table 9.1 Data for calibration curve for indomethacin.....	113
Table 9.2. Data for the dissolution profiles of formulations containing phenytoin	114
Table.9.3. Shelf life determined for I+U using Arrhenius equation	117
Table 9.4 Data for the dissolution profile for formulations with Indoemthacin and Kollidon	132
Table 9.5. Shelf life in years for foemulations made with indomethacina nd Kollidon .	135
Table 9.6 Data for calibration curve for Phaenytion.....	149
Table 9.7 Data for the dissolution profiles for phenytoin and its formulations	149
Table 9.8. Shelf life, in years for formulations made with Phenytoin and Kollidon	152

List of Figures

Figure 2-1 Biopharmaceutical classification system	6
Figure 2-2 Phase diagram: continuous solid solution	13
Figure 2-3 Phase Diagram: Discontinuous solid solution	13
Figure 2-4 Substitutional Crystalline Solid Solution	14
Figure 2-5 Interstitial Crystalline Solid Solution: crystalline carrier.....	14
Figure 2-6 Interstitial Crystalline Solid solution: Polymer carriers.....	14
Figure 2-7 Amorphous Solid Solution.....	15
Figure 3-1 Differential scanning calorimetry scan of sucrose (undried), showing the glass transition temperature, (T_g), recrystallization exotherm temperature (T_c) and enthalpy (DH_c), melting endotherm temperature (T_m) and enthalpy (DH_f) and onset of degradation 10K /min 21. Endothermic transitions are down.	23
Figure 3-2 Power compensated DSC	24
Figure 3-3 Heat Flux DSC	25
Figure 4-1 Unit Cell.....	35
Figure 4-2 Interference of electromagnetic waves.....	36
Figure 4-3 X-Rays being reflected off a crystal surface.	37
Figure 4-4 Schematic of PXRD	39
Figure 5-1 Scanning electron microscope.....	43
Figure 5-2 Scintillating detector	48
Figure 5-3 Light Proof Detector	49
Figure 6-1 Specifications for the basket and shaft of type 1 apparatus	54
Figure 6-2 Sinkers for solid dosage forms that float.....	55

Figure 6-3 Paddle for type 2 apparatus	55
Figure 6-4 Type 3 dissolution apparatus.....	57
Figure 6-5 Type 4 dissolution apparatus liquid inlet tube	57
Figure 7-1 Different processes leading to light attenuation.....	62
Figure7-2 Energy level of orbitals	66
Figure7-3 Electronic Transitions	66
Figure 7-4 Vibrational translations occurring with electrical transitions	67
Figure 7-5 1 micron cell; flow through cell; regular rectangular cell; Aperture cell	69
Figure 7-6 (a) Conventional Spectrophotometer	70
Figure 7-6 (b) Photodiode array spectrophotometer.....	70
Figure 7-6 (c) Double beam spectrophotometer	70
Figure 8-1 Structure of Indomethacin.....	72
Figure 8-2 Phenytoin Structure.....	75
Figure 8-3 Ethyl Alcohol	77
Figure 8-4 Structure of Kollidon [®] VA 64.....	79
Figure 8-5 Urea	80
Figure 8-6 Structure of Neusilin [®] US2	82
Figure 8-7 Sodium Chloride	84
Figure 8-8 Potassium Acetate	86
Figure 8-9 Magnesium nitrate.....	87
Figure 8-10 Hydrochloric Acid.....	88
Figure 8-11 Monobasic Sodium Phosphate	90
Figure 8-12 Dibasic Sodium Phosphate.....	91

Figure 8-13 Acetone	93
Figure 8-14 Set up used for relative humidity studies	100
Figure 9-1 DSC Thermogram showing from top to bottom Neusilin [®] US2, Urea, Indomethacin, 10% I+U PM, 30% I+U PM, 50% I+K PM, 70% I+U PM.	102
Figure 9-2 DSC Thermogram showing from top to bottom Neusilin [®] US2, Urea, Indomethacin, 10% I+U SD, 30% I+U SD, 50% I+K SD, 70% I+U SD.	102
Figure 9-3 SEM images (A) Indomethacin, (B) Urea, (C) Neusilin [®] US2, (D) PM I+U	104
Figure 9-4 SEM image (A) 10% I+U SD, (B) 30% I+U SD, (C) 50% I+U SD, (D) 70% I+U SD	105
Figure 9-5 PXRD for indomethacin and the four physical mixtures: a- indomethacin; b- 10% I+U PM; c- 30% I+U PM; d- 50% I+U PM; e- 70% I+U PM	107
Figure 9-6 PXRD for indomethacin and four solid dispersions: a- indomethacin; b- 10% I+U SD; b- 30% I+U SD; c- 50% I+U SD; e- 70% I+U SD	107
Figure 9-7 PXRD Solid dispersions kept at 30 ⁰ C for a period of two months: a- indomethacin; b- 10% I+U; b- 30% I+U; c- 50% I+U; e- 70% I+U	108
Figure 9-8 PXRD Solid dispersions kept at 35 ⁰ C for a period of two months: a- indomethacin; b- 10% I+U; b- 30% I+U; c- 50% I+U; e- 70% I+U	108
Figure 9-9 PXRD Solid dispersions kept at 40 ⁰ C for a period of two months: a- indomethacin; b- 10% I+U; b- 30% I+U; c- 50% I+U; e- 70% I+U	109
Figure 9-10 PXRD Solid dispersions kept at 45 ⁰ C for a period of two months: a- indomethacin; b- 10% I+U; b- 30% I+U; c- 50% I+U; e- 70% I+U	109
Figure 9-11 PXRD Solid dispersions kept 23.11±0.25% RH for a period of two months: a- indomethacin; b- 10% I+U; b- 30% I+U; c- 50% I+U; e- 70% I+U	110

Figure 9-12 PXRD Solid dispersions kept $54.38 \pm .23$ RH for a period of two months: a- indomethacin; b-10%I+U; b-30% I+U; c-50% I+U; e- 70% I+U 110

Figure 9-13 PXRD Solid dispersions kept $75.29 \pm .12\%$ RH for a period of two months: a- indomethacin; b-10%I+U; b-30% I+U; c-50% I+U; e- 70% I+U 111

Figure 9-14 PXRD Solid dispersions kept 100%RH for a period of two months: a- indomethacin; b-10%I+U; b-30% I+U; c-50% I+U; e- 70% I+U 111

Figure 9-15 Dissolution: \square 10% I+U SD, \blacktriangle 30% I+U SD, X 50% I+U SD, \blacklozenge 70% I+U SD and \blacksquare pure I..... 114

Figure 9-16-a Arrhenius plot 10% I+U, with slope -24.713, intercept of 70.636 and R^2 of 0.9383..... 116

Figure 9-16-b Arrhenius plot 30% I+U SD, with slope -25.811, intercept of 74.006 and R^2 of 0.9336 116

Figure 9-16-c Arrhenius plot 50% I+U SD, with slope -23.182, intercept of 65.439 and R^2 of 0.9431..... 117

Figure 9-16-d Arrhenius plot 70% I+U SD, with slope -25.265, intercept of 71.962 and R^2 of 0.9281 117

Figure 9-16-e Arrhenius plot Pure I, with slope -25.265, intercept of 71.962 and R^2 of 0.9281..... 117

Figure 9-17-a k v/s %RH 10% I+U SD, with slope .00002, intercept of 0.0012 and R^2 of 0.9758..... 118

Figure 9-17-b k v/s %RH 30% I+U SD, with slope .00002, intercept of 0.0009 and R^2 of 0.8909..... 118

Figure 9-17-c k v/s %RH 50% I+U SD, with slope .00001, intercept of 0.0002 and R^2 of 0.9542.....	118
Figure 9-17-d k v/s %RH 70% I+U SD, with slope .00001, intercept of 3×10^{-18} and R^2 of 0.9481.....	118
Figure 9-17-e k v/s %RH Pure I, with slope 6×10^{-5} , intercept of 8×10^{-5} and R^2 of 0.9356.	119
Figure 9-18 DSC thermogram showing from top to bottom: Neusilin [®] US2, Kollidon [®] VA64, Indomethacin, 10% I+K PM, 30% I+K PM, 50% I+K PM, 70% I+K PM.....	120
Figure 9-19 DSC thermogram showing from top to bottom: Neusilin [®] US2, Kollidon [®] VA64, Indomethacin, 10% I+K SD, 30% I+K SD, 50% I+K SD, 70% I+K SD	121
Figure 9-20 SEM images (A) Indomethacin; (B) Kollidon [®] VA64; (C) Neusilin [®] US2; (D) PM I+K	123
Figure 9-21 SEM image (A) 10% I+K SD, (B) 30% I+K SD, (C) 50% I+K SD, (D) 70% I+K SD	124
Figure 9-22 PXRD for Indomethacin and the four physical mixtures: a- I ; b- 10% I+K PM; c- 30% I+K PM; d-50% I+K PM; e- 70% I+K PM	125
Figure 9-23 PXRD for Indomethacin and the four solid dispersions a- I; b-10%I+K SD; b-30% I+K SD; c-50% I+K SD; e- 70% I+K SD	126
Figure 9-24 PXRD Solid dispersions kept at 30 ⁰ C for a period of two months a- I; b- 10%I+K; b-30% I+K; c-50% I+K; e- 70% I+K	126
Figure 9-25 PXRD Solid dispersions kept at 35 ⁰ C for a period of two months: a- I; b- 10%I+K; b-30% I+K c-50% I+K; e- 70% I+K.....	127

Figure 9-26 PXRD Solid dispersions kept at 40 ⁰ C for a period of two months a- I; b- 10%I+K; b-30% I+K; c-50% I+K; e- 70% I+K	127
Figure 9-27 PXRD Solid dispersions kept at 45 ⁰ C for a period of two months a- I; b- 10%I+K; b-30% I+K; c-50% I+K; e- 70% I+K	128
Figure 9-28 PXRD Solid dispersions kept 23.11±0.25% RH for a period of two months: a- I; b-10%I+K; b-30% I+UK c-50% I+K; e- 70% I+K.....	128
Figure 9-29 PXRD Solid dispersions kept 54.38± .23 RH for a period of two months: a- I; b-10%I+K; b-30% I+UK c-50% I+K; e- 70% I+K	129
Figure 9-30 PXRD Solid dispersions kept 75.29 ±.12%RH for a period of two months: a- I; b-10%I+K; b-30% I+UK c-50% I+K; e- 70% I+K.....	129
Figure 9-31 PXRD Solid dispersions kept 100%RH for a period of two months: a- I; b- 10%I+K; b-30% I+UK c-50% I+K; e- 70% I+K.....	130
Figure 9.32 Dissolution: from top to bottom: □10% I+U SD, ▲30% I+U SD, X50% I+U SD, ◆70% I+U SD and ■pure I.....	131
Figure 9-33-a Arrhenius plot 10% I+K, with slope-24.901, intercept 71.076, R ² 0.9531.....	134
Figure 9-33-b Arrhenius plot 30% I+K, with slope-24.15, intercept 68.731, R ² 0.9481. 134	
Figure 9-33-c Arrhenius plot 50% I+K, with slope-24.192, intercept 68.639, R ² 0.9378.....	134
Figure 9-33-d Arrhenius plot 70% I+K, with slope-26.332, intercept 75.363, R ² 0.9373	134
Figure 9-34-e Arrhenius plot Pure I, with slope -25.265, intercept of 71.962and R ² of 0.9281.....	135

Figure 9-34-a k v/s %RH 10% I+K SD, with slope $2E-5$, intercept 0.0003, R^2 0.9846...	135
Figure 9-34-b k v/s %RH 0% I+K SD, with slope $1E-5$, intercept 0.0011, R^2 0.8692....	135
Figure 9-34-c k v/s %RH 50% I+K SD, with slope $1E-5$, intercept 0.0002, R^2 0.9856...	136
Figure 9-34-d k v/s %RH 70% I+K SD, with slope $9E-6$, intercept 0.0002, R^2 0.9409...	136
Figure 9-17-e k v/s %RH Pure I, with slope $6 E-5$, intercept of $8E-5$ and R^2 of 0.9356.....	136
.....	136
Figure 9-35 DSC thermogram showing from top to bottom: Neusilin [®] US2, Kollidon [®] VA64, Phenytoin, 10%P+K PM, 30% P+K PM, 50% P+K PM, 70% P+K PM	137
.....	137
Figure 9-36 DSC thermogram showing from top to bottom: Neusilin [®] US2, Kollidon [®] VA64, Phenytoin, 10%P+K SD, 30% P+K SD, 50% P+K SD, 70% P+K SD	138
.....	138
Figure 9-37 PXRD for phenytoin and the four physical mixtures: a- P; b- 10% P+K PM; c- 30% P+K PM; d-50% P+K PM; e- 70% +K PM.....	140
Figure 9-38 PXRD for phenytoin and the four solid dispersions: a- P; b-10%P+K SD; c- 30% P+K SD; d-50% P+K SD; e- 70% P+K SD	140
Figure 9-39 PXRD Solid dispersions kept at 30 ⁰ C for a period of two months: a- P; b- 10%P+K; c-30% P+K; d-50% P+K; e- 70% P+K.....	141
Figure 9-40 PXRD Solid dispersions kept at 35 ⁰ C for a period of two months: a- P; b- 10%P+K; c-30% P+K; d-50% P+K; e- 70% P+K.....	141
Figure 9-41 PXRD Solid dispersions kept at 40 ⁰ C for a period of two months: a- P; b- 10%P+K; c-30% P+K; d-50% P+K; e- 70% P+K.....	142

Figure 9-42 PXRD Solid dispersions kept at 45 ⁰ C for a period of two months: a- P; b- 10%P+K; c-30% P+K; d-50% P+K; e- 70% P+K.....	142
Figure 9-43 PXRD Solid dispersions kept 23.11±0.25% RH for a period of two months: a- P; b-10%P+K; c-30% P+K; d-50% P+K; e- 70% P+K	143
Figure 9-44 PXRD Solid dispersions kept 54.38± .23 RH for a period of two months: a- P; b-10%P+K; b-30% P+K; c-50% P+K; e- 70% P+K	143
Figure 9-45 PXRD Solid dispersions kept 75.29 ±.12%RH for a period of two months: a- P; b-10%P+K; b-30% P+K; c-50% P+K; e- 70% P+K	144
Figure 9-46 PXRD Solid dispersions kept 100%RH for a period of two months: a- P; b- 30% P+K; c-50% P+K; d- 70% P+K.....	144
Figure 9-47 SEM images (A) Phenytoin; (B) Kollidon [®] VA64; (C) Neusilin [®] US2; (D) PM P+K	146
Figure 9-48 SEM image (A) 10% P+K SD, (B) 30% P+K SD, (C) 50% P+K SD, (D)70% P+K SD.....	147
Figure 9-49 Calibration curve for phenytoin at λ=258,; having a slope of 2.3753, intercept of -0.0025, and R2 value of 0.9995	148
Figure 9-50 Dissolution: □ 10% P+K SD; ▲ 30% P+K SD; X 50% P+K SD; ◆ 70% P+K SD, ■ Pure Phenytoin	150
Figure 9-51-a Arrhenius plot 10% P+K, with slope -10.852, intercept 24.154, R ² 0.9609	151
Figure 9-51-b Arrhenius plot 30% P+K, with slope -12.2, intercept 28.595, R ² 0.9849.....	151

Figure 9-51-c Arrhenius plot 50% P+K, with slope -10.932, intercept 24.216, R^2 0.9781	152
Figure 9-51-d Arrhenius plot 70% P+K, with slope -10.83, intercept 21.3, R^2 0.9941...	152
Figure 9-51-e Arrhenius plot for pure P, with slope -11.006, intercept 24.099, R^2 0.9895	152
Figure 9-52-a Plot of K v/s %RH 10% P+K, with slope 2E-5, intercept 0.0005, R^2 0.8881	153
Figure 9-52-b Plot of K v/s %RH 30% P+K SD, with slope -3E-5, intercept 0.0002, R^2 0.9323	153
Figure 9-52-c Plot of K v/s %RH 50% P+K, with slope 1E-5, intercept 0.0003, R^2 0.983	153
Figure 9-52-d Plot of K v/s %RH 70% P+K, with slope 6E-6, intercept 0.0002, R^2 0.9468	153
Figure 9-52-e Plot of K v/s %RH Pure P, with slope 4E-6, intercept 6E-5, R^2 0.9878...	154

Chapter 1

Introduction

Drugs that are administered orally go through a dissolution process and then permeation across the gastric membrane before they can appear in the blood stream. Some factors that affect the amount of drug available for its effect (the bioavailability of the drug) other than solubility and permeability are dissolution rate of the drug, first-pass effect, pre-systemic metabolism of the drug in any other organ, and susceptibility to efflux mechanisms. Solubility of the drug in the gastric media is a major problem with most drugs [1]. At least 40% of the new chemical molecules tested are drugs having poor aqueous solubility. This leads to erratic bioavailability and possible toxicity when eventually absorbed through the gastric mucosa. Thus, solubility of new drug molecules is the biggest challenge for formulation scientists [2]. In spite of these issues, the oral route of drug administration has been the most sought after route due to its ease of administration, high patient compliance, cost-effectiveness, least need for maintenance of sterile conditions, and flexibility in design of the dosage form. The first attempt by pharmaceutical companies in making generic drugs is to formulate the drug as an oral dosage form [1, 3].

The pharmaceutical industry is experimenting with various techniques for improving the solubility of the drug post oral administration. The techniques used for improving the solubility characteristics of a drug can be very broadly classified as either physical or chemical processes [4]. The methods include particle size reduction by micronization using either a ball mill [5], fluidized energy micronization [6], ultrasonic size reduction

techniques [7], or by making a nanosuspension [8-12]. Other methods include the use of polymorphic or pseudo polymorphic forms [13], complexations [14, 15] and the use of surfactants [16]. The use of pH adjustment [13], salt formation [17], use of solubilizing agents [18], nanotechnology [19, 20], and solid dispersions [21] can also be considered. Most of these techniques have disadvantages. Some methods give products that have improved solubility but the solubility decreases over time, or the methods are complicated and expensive.

Sekiguchi and Obi demonstrated in 1961 [21] that a eutectic mixture can be formed by melting a drug that has poor solubility with another material that has good solubility in water and solidifying them, by cooling the molten mixture. The resulting solid showed higher solubility of the drug in the dissolution media [21]. Solid dispersions can be defined as a dispersion of one or more active ingredients in an inert carrier or matrix in the solid state prepared by co-melting or solvent extraction or by the solvent-melt method. The definition has now been broadened to include certain nanoparticles, microspheres, microcapsules and other dispersions of drugs in polymers [22]. Solid dispersion technology is a technique which has comparatively fewer problems. It does have some disadvantages associated with it such as the possibility of recrystallization upon storage or during the various pharmaceutical processes. Moisture might increase the mobility of the drug, thereby increasing the chances of recrystallization. Some other drawbacks include not being able to scale up the process satisfactorily and requiring extra processing steps before the product can be put through any other process [23].

Some of the problems associated with the properties of the solid dispersions and the need for more processing can be easily overcome by using an adsorbent and forming a ternary solid dispersion. Materials such as silicone dioxide and Neusilin[®]US2 have been used to make ternary phase solid dispersions [24-26].

For this study, two drugs, indomethacin and phenytoin, were used to prepare a total of three formulations each with four different ratios of drug and matrix contributors for each formulation. Two materials (Urea and Kollidon[®]VA64) were used in the matrix to make the solid dispersions. The solid dispersions were coated on to Neusilin[®]US2 which was used as the adsorbent, while the solid dispersions were formed. Neusilin[®]US2 has a specific surface area of 300 m²/g [27] which helped in adsorbing the solid dispersion. It also has good compressibility, thereby making the product a good candidate for direct tablet compression. The products had good flow properties thereby eliminating the need for any processing before use to make final dosage forms. The formulations were characterized using Differential Scanning Calorimetry (DSC), Scanning Electron Microscopy (SEM), Powder X-Ray crystallography (PXRD) and dissolution testing. The products were subjected to accelerated stability studies to determine the effect of storage.

Chapter 2

Solid Dispersions

2.1 Introduction

Bioavailability of drugs administered orally for systemic effect depends on two key phenomenon which occur post administration of that drug. First is dissolution of the drug in the gastrointestinal fluid to produce a solution of the drug and second, transportation of the dissolved drug across the gastrointestinal membrane. Each of these two steps can be a rate limiting factor [2, 3]. The Biopharmaceutical Classification System (BCS) divides drugs into one of four classes according to their solubility and permeability. The four classes are listed below.

Class I- Drugs show high solubility and high permeability. These Active Pharmaceutical Ingredients (APIs) show very good solubility and ability to cross the GI membrane. The bioavailability of these drugs is affected only by the gastric motility and gastric emptying time or due to the first pass effect. The dissolution rate for immediate release formulations of these drugs would be more than 85% dissolved in less than 15 minutes [2, 4].

Class II- Drugs show low solubility and high permeability. These APIs exhibit a good ability to cross the GI membrane. The solubility of these drugs in the gastric medium is the rate limiting step for their absorption. Since the intestinal membrane and intestinal lumen are different, the dissolution profile for these molecules should be tested under different physiological pH conditions.

Dissolution of at least 85% should be seen over a period of several time points in the various media. An improvement in the dissolution profile should increase the bioavailability of these APIs which is the basic concept driving this study [2, 4].

Class III- Drugs showing high solubility and low permeability. These APIs exhibit a good solubility profile but a poor ability to permeate the GI membrane. The permeability of these drugs becomes the rate limiting step in its absorption and affects the bioavailability of the drug. These molecules show dissolution profiles similar to the drugs included in Class-I of the BCS classification and is not the rate limiting [2, 4].

Class IV- Drugs with low solubility and low permeability. These APIs present significant problems when it comes to oral administration. Depending on which of the two steps causes a slower rate of absorption, the rate limiting step will vary between solubility and permeability [2, 4]. Figure 2.1 sums up the permeability and solubility properties observed for the four BCS Classes of drugs.

The focus of this study will concern itself with drugs in BCS Class II. Increasing the solubility of these APIs will also increase the bioavailability of the drug in the body. One important factor that affects the solubility of any chemical is its surface area or in other words the area that is presented for the process of solubilization. Surface area can be increased by reducing the particle size [5].

2.2 Methods Used to Increase Solubility

Various techniques that help in increasing the solubility of drugs can be divided into the following groups [6].

Class	Solubility	Permeability
Class I	High	High
Class II	Low	High
Class III	High	Low
Class IV	Low	Low

Figure 2.1 Biopharmaceutical classification system[6]

2.2.1 Particle Size Reduction:

2.2.1. a Micronization: Particle size reduction can be achieved by using milling techniques such as: ball mill [7]; fluidized energy micronization [8]; ultrasonic size reduction techniques [9]; controlled precipitation by changing the solvents or the temperature [10]; and spray drying [7]. Though it is very easy to reduce the particle size using milling or fluidized energy, it might lead to the particles aggregating or forming agglomerates due to the increased surface energy and increased Van der Waals' attraction between the nonpolar molecules [11]. Another inherent problem that these fine powders have is wettability. Drugs with plastic properties tend to stick together thereby making it difficult to subdivide them into smaller particles.

2.2.1. b Nanosuspension: Formation of submicron colloidal suspensions with the pure drug particles, which can be stabilized by surfactants. This gives rise to a formulation showing increased solubility due to higher surface area availability for solubilization. A very uniform particle size range is obtained. Techniques used for making these types of formulations include homogenization and wet milling, spray

drying a solution of the drug in a volatile solvent into a heated aqueous solution [12]. Drugs such as nimesulide, buparvaquone, amphotericin B and naproxen have shown good results when formulated into a nanosuspension [12-16].

2.2.1. c Sonocrystallization: Recrystallization to reduce particle size has been successfully used to reduce particle size and increase dissolution. Using ultrasound to recrystallize fine crystals of the drug is called sonocrystallization [17].

2.2.1. d Supercritical fluid (SCF) processing: A fluid created by having the temperature and pressure above the critical values allows the fluid to assume properties of both a gas and a liquid. Once the drug is solubilized in the SCF, minute changes to the pressure would allow for formation of fine crystals within a narrow size range [18].

2.2.2 Polymorphism and Pseudopolymorphism

Depending on the internal structure of the solids they can be classified as either crystalline or amorphous. When a substance exists in more than one crystalline form then the different crystalline forms are called polymorphs.

Substances that can change form one form to another by alteration of the temperature are called enantiomers. Substances that are unstable at all temperatures and pressures are called monotrops. Polymorphs that are not stable forms are called metastable polymorphs and have lower melting points, different compressibility factors and higher solubility as compared to the stable form. Pseudopolymorphism is observed in substances which have a solvent as a part of the crystal lattice. The substances having water as the solvent are called hydrates. Anhydrous forms of these substances are found to be more soluble in water as compared to the hydrate form [6].

2.2.3 Complexation

Association between molecules formed because of weak forces such as London forces, hydrogen bonding or hydrophobic bonds are called complexes. There are two types of complexation processes.

2.2.3. a Stacking complexation: Non-polar moieties are generally pushed out due to the hydrogen bonding in water molecules from aqueous solutions. The planar regions of aromatic compounds tend to overlap and minimize their contact with water molecules. They can either be homogeneous or heterogeneous. Some compounds known to form this type of complexation include benzoic acid, salicylic acid, and purine [19].

2.2.3. b Inclusion complexation: The complex that is formed by insertion of the non-polar molecule into another molecule or group of molecules. The most common host used for this type of complexation is cyclodextrin [20].

2.2.4 Solubilization by Surfactants

2.2.4. a Microemulsions: These are formed by dissolving the drugs that are not soluble in an aqueous medium in an oil phase and forming an emulsion with the oil. It is an effective system to deliver drugs that are insoluble in an aqueous medium. Even if the concentration of the surfactant drops below the Critical Micellar Concentration (CMC), the resulting precipitates are fine and show good solubility [21].

2.2.4. b Self microemulsifying drug delivery systems: SMEDDS are formulations made using a drug with surfactants and co-surfactants. They have the ability of forming microemulsions in situ after administration as a tablet or a capsule [22].

2.2.5 Chemical Methods

pH Adjustment: adjusting the pH of the micro-environment around the drug particles will change its ionization behavior. The drug might form an in situ salt that might later convert into respective acid or base in the GI tract [6].

2.2.5. a Salt formation: Forming water soluble salts [23] of the acidic or basic drugs increases its solubility in the gastric medium. The problem with producing salt forms is that sometimes the salt form of the drug has been shown to react with atmospheric carbon dioxide, thereby forming a surface layer leading to a reduction in the rate of dissolution and absorption. The alkalinity of some salts causes epigastric distress following administration [24, 25].

2.2.5.b Hydrotrophy: The addition of large amounts of a second solute affecting the solubility of our drug is called hydrotropism. The increase in solubility by this method is called salting in and a reduction in the solubility is called a salting out effect [26].

2.2.6 Solubilizing Agent

Substances like PEG 400 and modified gum karaya have been studied for their property of increasing solubility of some drugs such as hydrochlorthiazide and nimodipine [27].

2.2.7 Nanotechnology

Nanotechnology is a term generally used for the study of substances or particles that are nanoscale size. Generally, particles that have a size of less than a 1000 nm (1 μm) are considered to be nanoparticles. There are two types of nanoparticles, in general the first type is called nanocrystals.

These are particles that are crystalline in nature and the particle size is in the range of 1-1000 nm. There are two methods that can be used for the formation of nanocrystals. One is called a top down approach where we start with particles that are in the micro size range and reduce the particle size by micronization or by high pressure homogenization. Another approach is called a bottom up approach. In this method the nano sized material is made with atoms or molecules as building blocks. The second type is called nanomers. These are materials that are amorphous in nature. These are made by having the drug in solution in one solvent and then rapidly pumping the solution into another solution. There is a polymer that is used that keeps the particles from forming agglomerates [28, 29].

2.2.8 Drug Dispersed in a Matrix

This is the method that has been used for this study. Although there are a number of methods which can be used to increase solubility, each has its own disadvantage. The chemical methods have a risk of the ingredients interacting with each other. The physical methods discussed so far can give a product that might recrystallize over time.

Using surfactants or making a nano size formulation is a complicated process and formulation might have its own challenges. A physical process technique that retards the recrystallization to a greater extent is accomplished by incorporating the drug in a matrix. The incorporation of the drug in a matrix that is soluble in an aqueous medium provides particles that are submicron in size and cannot easily come in contact to recrystallize. In 1961 Sekiguchi and Obi [3] demonstrated that a physical mixture of a drug which is poorly soluble in water and an inert, freely water soluble carrier when melted and then cooled to form a solid, forms a eutectic mixture that shows higher solubility of the drug than the pure drug by itself. In 1965 Tachibana and Nakamura prepared a colloidal dispersion using a coprecipitate method [30]. They dissolved the drug and a water soluble polymer in a common solvent and evaporated the solvent to form a coprecipitate. The drug in the coprecipitate showed higher aqueous solubility as compared to the pure drug [30].

The term solid dispersion can be defined as a dispersion of one or more active ingredients in an inert carrier or matrix in the solid state prepared by the melt, solvent or solvent-melt method. The definition has now been extended to include certain nanoparticles, microspheres, microcapsules and other dispersions of drugs in polymers [31].

2.3 Classification of Solid Dispersions

Solid dispersions can be classified as follows [32]:

1. Simple eutectic mixture
2. Solid solution
3. Glass solution or suspension
4. Compound or complex formation
5. Amorphous precipitation
6. Combination of any of the above

Solid solutions can be further divided based on whether the formulation is a continuous or a discontinuous solid solution.

Further they can be divided based on whether the formulation is a substitutional crystalline, interstitial crystalline or amorphous solid solution [1].

2.3.1 Simple Eutectic Mixture

Simple eutectic mixtures are made using two components that are completely miscible when they are in their liquid state but are only partially miscible in their solid form.

When a comelt of the two components are in a eutectic composition and are cooled, both the components solidify simultaneously. When other compositions are used one of the components would solidify before the other. Typically a eutectic comelt is cooled rapidly to form fine crystals of the two components [3, 33]. Figure 2.2 represents a typical phase diagram of a system that represents a eutectic mixture.

2.3.2 Solid Solutions

A formulation in which the resulting product is in one phase irrespective of the number of components. The solution of a poorly water soluble drug in a readily water soluble solvent is of great importance to study the increase in bioavailability of the drug. Solid solutions are divided or further classified by two methods. First according to the miscibility of the components of the solution and second according to the way in which the solvate molecules are distributed in the solvendum.

- a) In a continuous solid solution the two components are miscible with each other in all proportions. In a discontinuous solid solution the solubility of each component in the other component is limited. A typical phase diagram for a discontinuous solid solution will look like Figure 2.3. Each region shows complete dissolution of one component in the other component. It has been noted that as the temperature drops the solubility of each component in the other component decreases.

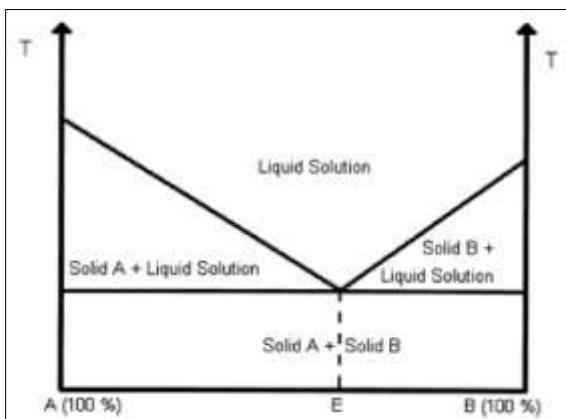

Figure 2.2 Phase diagram: continuous solid solution [1]

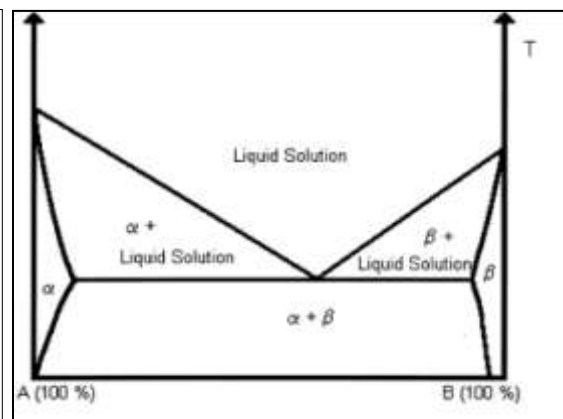

Figure 2.3 Phase Diagram: Discontinuous solid solution [1]

- b) Substitutional crystalline solid solutions are solid solutions in which the solute molecules replace the solvent molecules in the crystal lattice of the solvent. A depiction of this type of solid dispersion is in Figure 2.4.

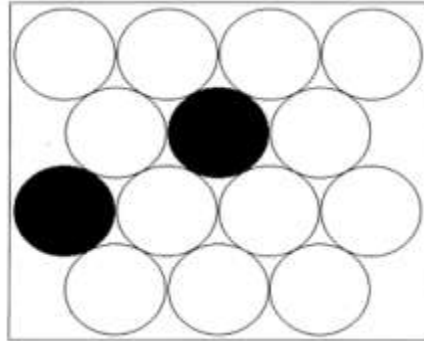

Figure 2.4 Substitutional Crystalline Solid Solution [1]

An interstitial crystalline solid solution occurs when the solute molecules fit in the interstitial space in the crystal lattice of the solvent molecules. For this process to occur effectively the diameter of the solute molecules should not be more than 0.59 of the diameter of the solvent molecules and the concentration of the solute should not be more than 20% of the solvent. Figures 2.5 and 2.6 show the typical schematic representation of an interstitial solid solution in a crystalline carrier and a polymeric carrier, respectively.

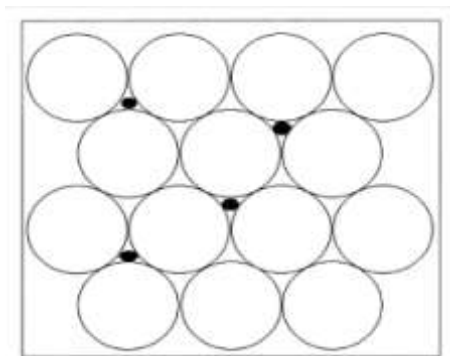

Figure 2.5 Interstitial Crystalline Solid Solution: crystalline carrier [1]

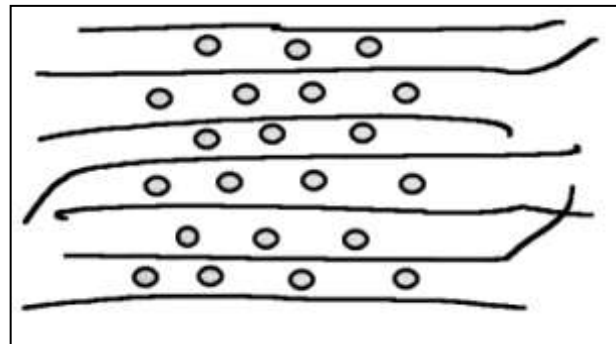

Figure 2.6 Interstitial Crystalline Solid solution: Polymer carriers [1]

An amorphous solid solution is when the solute is dispersed within the amorphous solvent molecules. Polymer carriers generally form this kind of a solid solution.

Figure 2.7 shows how an amorphous solid solution may be depicted [1].

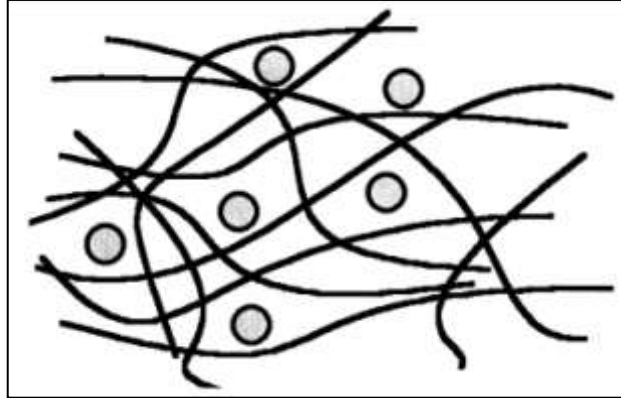

Figure 2.7 Amorphous Solid Solution [1]

2.3.3 Glass Solution or Suspension

A formulation which consists of a drug dissolved or suspended in a homogeneous system which has a glassy or a vitreous consistency forming a matrix around the drug molecules [34].

2.3.4 Compound or Complex Formation

When the two components in a solid dispersion form a complex then this formation of a solid dispersion is called a compound or a complex formation. The rate of dissolution of the drug from the complex formed is governed by the solubility, dissolution constant and the intrinsic absorption of the complex.

2.3.5 Amorphous Precipitation

In this form of solid dispersion the drug precipitates out as an amorphous material in the matrix. Since the drug is in its high energy form, unlike the low energy crystalline form, the drug shows a much higher solubility [24].

2.4 Carriers for Solid Dispersions

A wide variety of substances have been used as a carrier for solid dispersions. They can be widely classified into five classes namely: sugar polyols and their polymers; polymers; urea; surfactants; organic acids and their derivatives; and other compounds [1].

2.4.1 Sugars, Polyols and Their Polymers

Some common examples of sugars used include mannitol, sorbitol, and chitosan which is a derivative of a polysaccharide chitin [1, 35, 36].

2.4.2 Polymers

A number of polymers have been used as carriers for solid dispersions. Initially, only water soluble polymers such as polyethylene glycols (PEGs) and polyvinylpyrrolidone (PVP) were used. However, today some hydrophobic polymers such as Gelucire® and Eudragit® have been used for making solid dispersions. Other polymers which can be used to make solid dispersions include polyvinyl alcohol (PVA), polyvinylpyrrolidone and polyvinyl acetate copolymer (PVP-PVA), crosspovidone (PVP-CL), hydroxypropyl cellulose (HPC), hydroxypropyl-methylcellulose (HPMC) [1].

2.4.3 Urea

Urea is a by-product of protein metabolism in humans and is considered non-toxic. It has a high water solubility and has proven to be a good carrier for a great number of drugs [33].

2.4.4 Surfactants

Surfactants are another important class of substances used for increasing the solubility of drugs. Due to their toxicity problems such as damaging the mucosal cells, the amount of surfactants that can be used is limited. They are generally used in conjunction with other carriers.

One example for the use of surfactants is sodium lauryl sulfate (SLS) or Tween® 80 (a polyethylene sorbitan fatty acid ester) with PEG 4000 or 6000 to increase the solubility of indomethacin and phenylbutazone [37]. Bile salts are surfactants naturally found in the body. They are synthesized in the liver to solubilize fat molecules in the digestive process. They have been shown to increase the activity of reserpine when administered together [38].

2.5 Methods of Preparation

There are two basic methods used to prepare solid dispersions. The first is called the fusion method or the hot melt method. The second type is the solvent evaporation

method. Now a third method, which is a combination of these two methods, has been developed. It is called the fusion solvent method.

2.5.1 Fusion Method

In this method the matrix is heated above its melting point to form a liquid matrix. The drug or API is incorporated into the matrix and then the matrix is cooled to form a homogeneous solid dispersion. This method gives the best possible particle size reduction. The particles are reduced to their molecular state. One problem with this method is that the drug may separate out if not properly mixed with the matrix. Continuous stirring while cooling the mix is necessary. This can be avoided by quench cooling the mix. It can easily be achieved with the help of an ice bath [3]. Quench cooling also helps in reducing the time that the drug endures heat or elevated temperature. Cooling the mix on a stainless steel surface is thus favored as it gives rapid congealing and forms the best possible product [34]. Another method which involves the use of a specially designed spray system allows spraying the mixture onto a cooled stainless steel surface. This method would form pellets that do not need any further pulverization [39].

Advantages

1. The product made does not provide for easy recrystallization and the resultant product is one of the finest subdivisions of the drug molecule possible.
2. It is a simple method. It is easy to make and does not need any special technology

Disadvantages

1. One important limitation is that the drug would be exposed to high temperatures when it comes in contact with the molten carrier.
2. Immiscibility of the two components in the molten state is a problem when it comes to making a product using this method.
3. Sublimation or polymorphic transformations are other problems.
4. Extra processing before the formulation can be used for any further pharmaceutical process is another issue [39].
5. The crystallite size and hardness of the dispersion is affected by the solidification temperature
6. The product might be tacky and hard to handle. It may require making use of innovative techniques to make the process manageable and usable [40].

2.5.2 Solvent Method

This method basically consists of making a coprecipitate of the drug and the carrier dissolved in a common solvent system. When the solvent is evaporated under elevated temperatures or under vacuum, a super saturated solution is formed. The two components then recrystallize or precipitate out simultaneously.

Advantages

1. This method can be useful for drugs that are thermolabile
2. The melting point of the carrier is not going to be a deciding factor in choosing the ingredients.

3. The use of freeze drying can eliminate the use of heat.

Disadvantages

1. Finding a solvent that could solubilize both the components can be a challenge at times.
2. Complete removal of solvents is another thing that cannot be achieved easily. Most solvents considered to be toxic will necessitate its complete removal.
3. Sometimes a large quantity of solvent is required making the process very expensive.
4. The temperature control and time for removal of the solvents is important as it would affect the dissolution profile greatly [39, 40].

2.5.3 Fusion Solvent Method

A combination of the above two methods will give rise to a method called the fusion-solvent method. The drug to be incorporated into a matrix is in solution form with a solvent, which is preferable. The carrier on the other hand is in a molten state. The drug solution is added to the molten carrier and the carrier is cooled to form the product. The carrier should be able to incorporate some amount of solvent. If the solvent is not innocuous, complete removal of the solvent is necessary.

Advantages

1. It is a useful method when formulating a drug that has a high melting point or if it is thermolabile.

Disadvantages

1. Miscibility of the solvent or solvent system in the carrier melt is a factor that affects the product.
2. Only low drug loading can be obtained by this method, thus making this method useful for those drugs that have a low dose [39, 40].

2.6 Characterization of Solid Dispersions

Various characterization methods have been used to test solid dispersions. The aim behind characterizing solid dispersions is making sure that the formulation gives an increase in the solubility of the drug or API.

Differential Scanning Calorimetric (DSC) studies are performed to determine the amount of energy required and to determine what kind of formulation is formed [10, 32, 34]. The degradation of the API should not be very fast thereby making it usable. Looking at the surface morphology and determining what type of formulation occurs is done with Scanning Electron Microscopy (SEM). X-ray diffraction studies are used to determine changes in the crystal structure. The studies used in this particular research project were dissolution using the UPS apparatus, Powder X-ray Diffraction (PXRD), Differential Scanning Calorimetry (DCS), Scanning Electron Microscopy (SEM), and UV-Visible Spectroscopy.

Chapter 3

Differential Scanning Calorimetry

3.1 Introduction

Differential Scanning Calorimetry (DSC) and Differential Thermal Analysis (DTA) are the most widely used of all the thermal techniques [2]. DSC is a more recent method and is replacing DTA since it allows for the measurement of caloric values [2]. Every chemical has its own set of chemical and physical properties. A change in these properties would become evident if the thermal and caloric values for any physical or chemical process, such as melting or vaporization are studied [2-4]. These changes can be determined by recording temperature or energy changes, while the sample is heated or cooled, alongside another substance that can be used as a reference [2]. DSC is frequently used in the pharmaceutical field since it is an easy technique for obtaining detailed information about physical and energetic properties of materials. No other technique provides equal amounts of information with the ease that DSC allows [1]. The temperature difference of the sample is due to exothermic or endothermic changes that occur within the sample. Some examples of endothermic changes are phase transition, dehydration, some decompositions and reduction. Some exothermic changes would include crystallization, oxidation and other types of decomposition [4].

DSC can be defined as a technique in which the difference in the heat flow to a sample and a reference is measured against time or against temperature while the temperature of the sample in a specific atmosphere is programmed. [3] Figure 3.1 gives a typical DSC thermogram showing different transitions.

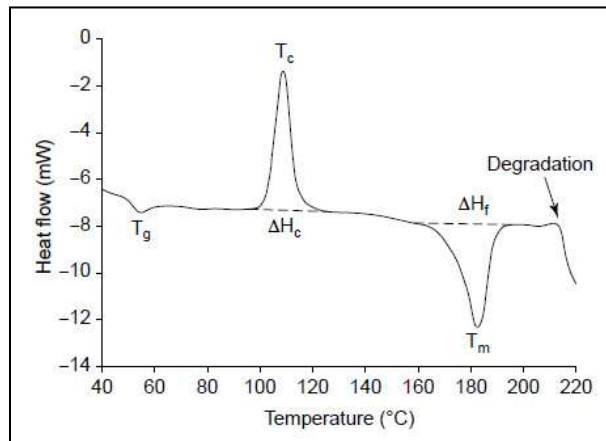

Figure 3.1 Differential scanning calorimetry scan of sucrose (undried), showing the glass transition temperature, (T_g), recrystallization exotherm temperature (T_c) and enthalpy (ΔH_c), melting endotherm temperature (T_m) and enthalpy (ΔH_f) and onset of degradation 10K /min 21. Endothermic transitions are down.[1]

Differential thermal analysis (DTA) is an instrument that uses the difference in the temperature readings between the sample and the reference and DSC uses the difference between the energy values of the sample and the reference [1, 5].

3.2 Types of DSC

Differential scanning calorimetric methods can be divided into two types. Both types have the same method of representing its data where the difference in electrical power needed (ΔP) is the ordinate and the temperature or time on the abscissa [1, 5, 6].

3.2.1 Power-Compensated DSC

In this technique there are two separate pans which are designated as either sample or reference. Each pan has a heating element under it.

The instrument tries to keep the temperature of the two pans at a specified value. While doing so, the instrument measures the difference in electric power needed to maintain the equal temperature. Mathematically, what is measured can be denoted as:

$$\Delta P = d(\Delta Q)/dt \quad [1, 3, 5, 6] \quad \text{Eqn. 3.1}$$

The peak area given by the curve would be the heat of reaction and the conversion factor would be a constant factor irrespective of the temperature [3]. A schematic representation of a Power compensated DSC is seen in Figure 3.2.

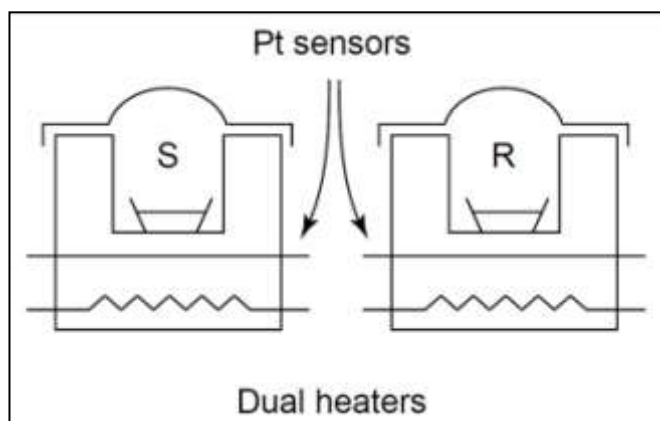

Figure 3.2 Power compensated DSC [1]

3.2.2 Heat Flux DSC

In this technique the two pans have the sample and the reference substance are heated using the same source and the difference in temperature is noted. This signal is converted to a power difference using calorimetric sensitivity [3]. It has been observed that placing the thermocouple under the sample and reference pans gives the best possible

thermograms. The only two variables that affect the curve are, the reactions or changes occurring with the sample, or the pans used for the sample and the reference.

The other advantage in having the thermocouple below the pan is that they are not damaged by the reactions happening inside the pan.

To eliminate any errors which may occur due to the pan, it is important to run a calibration for the instrument using a substance that can be used as a reference material [3]. The area under the peak is directly proportional to the heat of the reaction and can be calculated using the following equation [1, 3, 5-7].

$$\Delta H = K \int \Delta T dt = K \times (\text{Peak Area}) \quad \text{Eqn.3.3}$$

Where H is the heat of the reaction

T is the temperature

t is time

K is the calibration constant which converts peak areas into joules.

'K' is a thermal factor which might change with temperature [3]. Figure 3.3 gives a schematic diagram for a heat flux DSC.

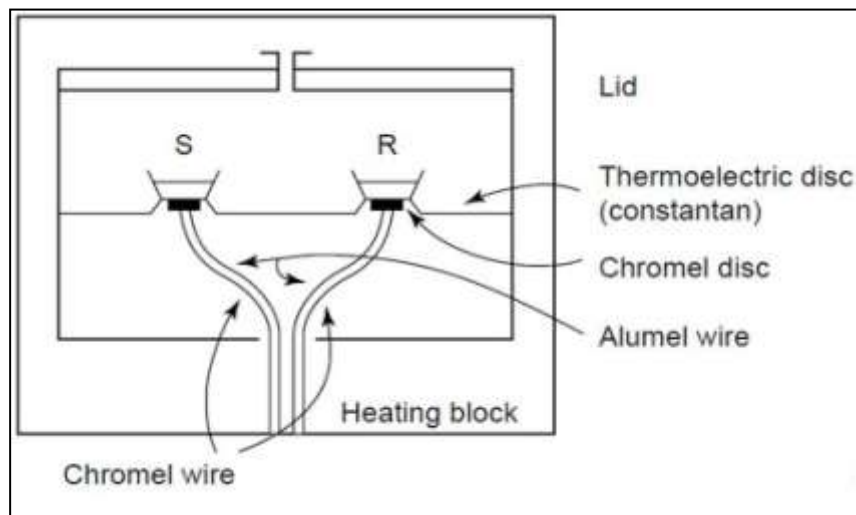

Figure 3.3 Heat Flux DSC [1]

3.3 Instrumentation and Important Considerations

There are a number of different types of equipment made by a number of manufacturers. The basic concept is to have a sample area as small as 2 X 2 mm in size and have sensors that can measure parameters such as temperature which can range from -150°C to 1600°C. The apparatus can be broken down into the following components to study it in somewhat detail.

3.3.1 The Sensor

Thermocouples are commonly used as sensors for DSC and DTA instruments to measure temperature changes. Copper-constantan or chromel-alumel is used for low temperature measurements and Pt-(Pt/13% Rh) has been used for high temperature measurements. Multiple thermocouples or thermopiles have been used in some instruments for better sensitivity [3]. Some instruments now have up to 20-junction, Au/Au-Pd thermocouple assemblies. W-W/Re thermocouples have been used in DTA instruments to measure temperatures of up to 1600°C [2]. Other than instruments which work on the power-compensated theory, most instruments use thermocouples. Power-compensated instruments use platinum resistors as the sensors and the sample and reference pans have separate heating element [3].

3.3.2 Crucibles or Pans

Pans and crucibles of various materials have been used. The most common materials being aluminum, platinum or ceramic pans. Aluminum pans can be used if the

temperature of the experiment is not going to exceed 600°C , as aluminum melts at 660°C . A standard experiment would have a pan which has about 10-20 mg of sample in a pan that is sealed with the help of a crimper and an aluminum lid. This apparatus can take a pressure of up to 2 atmospheres. If vaporization is not an issue, this method can be used with a small pin hole for any gases that might be released during the experiment. For a high pressure run, there are specialized pans that can take pressures of approximately 70 atmospheres.

There are also specialized pans for mixing liquids and pans for studying samples during heating. Liquids may be injected into some pans using a syringe [2, 3].

3.3.3 Temperature Control and Atmosphere or Purge Gas

Many small DSC units use a furnace enclosure that is made of silver. The heating is from a resistance heating system. Most DSC systems have a special feature where a temperature below room temperature can be attained. For this a separate cooling unit is attached which cools the furnace below room temperature. Normally DSC units have the capacity to heat the furnace at a temperature of between 0 and 100 K/min.

The normal heating rate is about 10 K/min [2, 3]. Normal atmosphere settings can range from 10 to 100 cm^3 . Use of an inert atmosphere is the easiest condition achievable with the help of gases such as nitrogen or argon. Some experiments call for a reactive atmosphere. A reaction that might affect the materials used for construction of the equipment should be considered before such experiments are performed [1, 2].

3.3.4 Computer and Display

In order to perform the calculations it is important to convert the data collected by the sensors into ΔP values using the calorimetric sensitivity information. The other use of a computer is to analyze the data obtained, by differentiation of the onset temperature and integration of the peak area [3].

3.3.5 Calvet-Type Equipment

It is important to consider this type of equipment. This type of equipment has a larger furnace which allows a larger sample size, as compared to most equipment.

The thermocouple is in between the furnace and the sample thus measuring the heat flux from the furnace to the samples. The downside for this equipment is that it will require much more time for the instrument to display the results. The equipment will also take much more time to heat or cool [2].

3.3.6 Reference Material

A reference material is extremely important when running any experiment. The reference should have thermal properties similar to that of the sample being tested. The sample should not react with anything given off by the reference.

Sometimes a small amount of the reference is added to the sample, for better results. Often an empty pan is used as a reference pan, but using a reference generally gives better results [3].

3.3.7 Sample Preparation

Sample preparation is an important part of any experiment. It is very important to choose an appropriate pan, and to pick an optimum weight for the sample. Too little or too much sample is going to result in a curve which is difficult to interpret. The weight of the sample and the reference material should almost be the same in order to get comparable results. It is important to use appropriate pans that would show minimal reaction with the sample. The pan might be open or sealed or it might have a pin hole.

A pan that is sealed might be used when trying to prevent any vapors escaping during the experiment. But there is a possibility that the lid might be blown off just by heating the instrument to a high temperature. The sample should have maximum contact with the bottom of the pan to maximize the heat flux and obtain the best measurements from the sensors. This is specifically important in cases when materials have a low density.

Accurate weighing of the samples is very important when trying to determine the heat of a reaction or calorimetric properties of the sample [1].

3.3.8 Maintenance and Care

It is important to make sure that everything is done to minimize the deposition of any material on the sensors in the instrument. It is very common to have deposits on the sensors when testing organic samples. A yearly calibration of the instrument and a quarterly check with all the available standards should be performed.

Overheating will cause the material to overflow from the pan. Care should be taken to have minimal amounts of sample in the pan.

To remove any residues from the sensors, a cotton swab with acetone and methanol can be placed on the sensor for a few minutes, allowing it to absorb any dissolved residues. If this does not work then a burn in excess of 500°C with the nitrogen flow at 100 cm³ to vent all the vaporized substances should be tried. The final cleaning process if nothing else works, can be sanding the sensors with a glass filament sander [1].

3.4 Calibration

The reliability of the results obtained with the instrument is ensured by calibration near the temperature at which it is to be used. One should make sure that the reference used for calibration is of utmost purity [1]. Most standards used are metals such as tin, zinc, indium, etc. Some organic materials and pharmaceutical materials have also been used as calibration standards [1, 8]. Though it is not a one-time activity, calibration is not done very often.

Generally any user should look out for any abnormalities with the thermograms obtained. Frequent checks should be run with the help of standards, to determine if the temperature and heat values lie within the acceptable range. One general type of calibration would be the calibration for the base line. For this to be done for the DCS, it is run without any pans, so that the instrument can determine the slope of the base line and correct the baseline when thermograms are recorded. The other two types of calibrations performed are temperature calibration and heat flow calibration.

3.4.1 Temperature Calibration

We need to use at least two samples that have well determined transition temperatures. Organic calibrants should be in a sealed pan to make sure no vapors leak out, thereby ensuring a good curve and minimal damage due to vapors. The two calibrants should bracket nearly the whole range of the operation on the DSC. The relationship between the correct temperature (T) and the experimental temperature (T_{exp}) is given by the equation:

$$T = T_{\text{exp}} S + I \quad \text{Eqn. 3.5}$$

Where $S = (T_1 - T_2) / (T_{\text{exp1}} - T_{\text{exp2}})$ Eqn. 3.6

And $I = [(T_{\text{exp1}} \times T_2) - (T_2 \times T_{\text{exp1}})] / (T_{\text{exp1}} - T_{\text{exp2}})$ Eqn.3.7

Here the subscripts 1 and 2 are for the two calibrants being used. The T-values are the known values for the substance used for calibration.

And the T_{exp} -values are experimentally obtained by heating the pans to a temperature of 30°C below the transition temperature and then increasing the temperature slowly after the instrument has stabilized [2]. Another method to do the temperature calibration is by using the quasi-iso-thermal conditions by stepwise heating. [9]

3.4.2 Energy Calibration

This calibration is done to relate the instrument signal to the thermal power. Most chemical entities that are used for the temperature calibration also have known specific enthalpy values for transitions. Thus, the same calibrants can be used for both types of calibration. Most transitions used for calibrations are fusions. The equation giving the relationship between the experimental values and actual values is:

$$d\Delta q/dt = k(d\Delta q/dt)_{exp} \quad \text{Eqn. 3.8}$$

Where k is the calibration constant.

An integral of the above equation with respect to time over which the fusion reaction takes place would give the total heat change:

$$\int (d\Delta q/dt) dt = Q = \int (d\Delta q/dt)_{exp} dt \quad \text{Eqn. 3.9}$$

Where Q is the total heat change as follows.

It is assumed that (k) does not change over the temperature range thereby making it possible to determine (k) using the equation:

$$Q = m\Delta_{fus}H \quad \text{Eqn. 3.10}$$

Where 'm' is the mass of the sample and ' $\Delta_{fus}H$ ' is the specific enthalpy of fusion.

The DSC system used for this study has a software system which allows the use of indium and zinc to automatically check if the instrument lies within limits, for temperature and heat measurements.

3.5 Application

A single component when tested can show good peaks for melting, crystallization, boiling, sublimation, dehydration, desolvation, solid-solid transformation, glass transition and polymorphic transition [1, 10-12]. DSC can play a very important role when it comes to mixtures or multi-component samples. Using DSC for testing drug–excipient compatibility has a number of advantages.

The test can be done much before any interaction indicating chromatographic method is available with small quantities of the sample without the long wait associated with stability studies [1, 13]. Glass transition of the two components can be studied. It helps us understand the miscibility of the two components making up the sample. If the mixtures are miscible without any major interaction, there is going to be a glass transition between that of the two components [1, 14, 15]. Water and hydrates can be studied using DSC thermograms. In many circumstances pharmaceutical ingredients are hygroscopic or there are water molecules entrapped in the crystal lattice as hydrates [16, 17].

Chapter 4

Powder X-Ray Crystallography

4.1 Introduction

When considering methods of analysis in material science, the list of techniques would not be complete without mentioning X-ray diffraction (XRD) or Powder X-ray Diffraction (PXRD) studies when the material being studied is a solid that can be powdered [1]. No two substances will have the exact three dimensional spacing in its crystal form [2]. X-ray diffraction studies can provide information about the crystal phase, lattice pattern, grain size and texture of the material being studied. Any method that is used for elemental analysis would provide data regarding the composition of the material, however it would provide no data about the crystal phase. Materials having two or more phases might have the same composition but different electrical, thermal, mechanical and physical properties for each phases. Thus, a study of a crystalline material that exists in two or more phases can never be complete without studying its phase. X-ray diffraction can also be used to study thermal expansion, grain growth, texture change and formation of a solid solution. One drawback that prevents the study of fast processes is the amount of time taken for their measurements.[1]

4.2 Principle

A unit cell is a basic structural unit of a crystal which has one or more atoms or molecules in it arranged in a periodic or symmetrical pattern.

The concept of a unit cell is very important since it is used not only to characterize the symmetry of crystals, but also to specify crystallographic directions and to measure interatomic distances. The concept of a unit cell considers three axes, namely “a, b and c”, just like the conventional x, y and z axes, but having angles of ‘ α , β and γ ’ between them instead of being at right angles. These axes also represent the length of each side of the cell. Figure 4.1 depicts one of these types of unit cells.

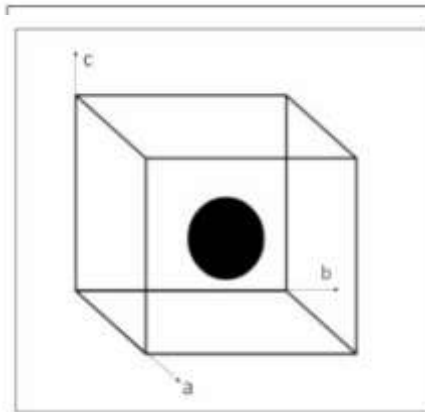

Figure 4.1 Unit Cell

This axis system can be used to describe the lattice points in relation to each other. The Miller Index is an important parameter when trying to understand the principle underlying the operation of XRD. The concept of the Miller Index uses imaginary planes having different orientations and intercepting the translational vector (a, b and c) at various points. These planes are members of a set that cuts all the cells identically. To represent a plane, integers that are obtained by taking reciprocals of the axial intercepts are used. For example, to represent a plane that intercepts the ‘a’ axis at $\frac{1}{2}$ its total length and that is parallel to the ‘b’ and ‘c’ axis the Miller index will be $\frac{1}{2}, \frac{1}{\infty}, \frac{1}{\infty}$ or it can also be written as 200.

The Miller index assumes that if a plane is parallel to any axis the plane in consideration and the axis will meet at infinity or the Miller index value will be 0 [3]. When electromagnetic wave scatters off of an object are studied together, they either interfere constructively or destructively. This phenomenon is called diffraction. Waves are characterized based on their wavelength denoted by (λ). Wavelength or (λ) is defined as the distance between two consecutive peaks or troughs of a wave. If waves from a source of electromagnetic radiation, such as x-rays, are scattered by an object, it will do so in all directions. Two waves scattered in the same direction can interfere constructively or destructively. X-rays are electromagnetic waves that have a wavelength of about 1 Å. X-rays interact with charged particles in a solid molecule because of its inherent electric field. This interaction with the charged particles causes the electrons to release wavelets that interact with each other [1]. When two waves travelling in the same direction have their crests and troughs lined up it is called constructive interference giving rise to a higher signal when detected. All other signals can be called as non-constructive giving a signal not as big an intensity as constructive or as less a signal as destructive interference. Figure 4.2 demonstrates what happens when constructive and destructive interferences occur.

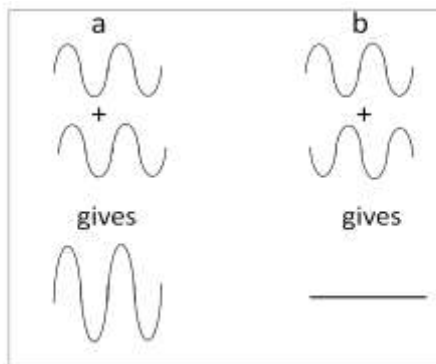

Figure 4.2 Interference of electromagnetic waves. (a) constructive interference. (b) destructive interference.

4.2.1 Bragg's Law

It was suggested by Bragg in 1913 that diffraction looks similar to reflection and we can consider reflection for studying the process of diffraction. Figure 4.3 shows how x-rays are reflected from a set of atomic planes with indices 'h, l and k'. As observed in the image x-ray 2 has to travel an extra distance of A to B and B to C as compared to x-ray 1. This means that x-ray 2 is going to be out of phase by a distance of ABC, unless the distance ABC is the same as the wavelength (λ) of the x-rays. In other words when $ABC = 1 \lambda$ or 2λ , or $n \lambda$ then the two rays are going to be in phase leading to a constructive interference of the two rays. We can write the distance AB as ' $d \sin \theta$ ', or ABC as ' $2d \sin \theta$ ' as the triangle ABO is a right angle triangle. Bragg's law can be stated mathematically as follows [3].

$$n\lambda = 2d \sin \theta \quad \text{Eqn. 4.1}$$

Where (λ) is the wavelength of the x-ray;

d is the spacing between the planes of the solid;

θ is the angle of incidence.

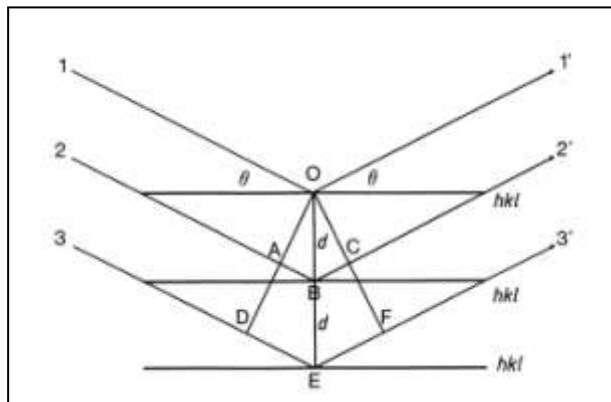

Figure 4.3 X-Rays being reflected off a crystal surface.

There are two basic criteria that have to be satisfied for constructive interference. One criteria is that Bragg's Law should be satisfied [1]. The second criteria is that the planes should be arranged in such a way that constructive interference will be allowed [1]. In Bragg's Law wavelength or (λ) is a constant value; (d) is an inter-atomic distance and a constant characteristic value for the crystal. The angle of incidence or (θ) can be changed. At certain angles the Bragg's Law will be satisfied giving rise to a high intensity of detection. These incident angles are characteristic to any substance and its crystals. The principle mentioned above is the basis for X-ray diffraction studies. However, most substances in use do not occur as single crystal forms but rather they are in powder form. In the powder form the planes of symmetry are going to have different orientations. Thus, this will not give a diffractogram as single crystals should. For measuring powders the instrument is modified where the source will change the angle of incident x-ray and the detector will also move to increase the angle at which it is placed with regard to the sample. The angle of the detector with respect to the sample is called the (2θ) angle as shown in Figure 4.4. It is called the (2θ) angle since the angle between the extrapolation of the incident ray and the detector is also ($2\theta^\circ$) [3]. The source, the sample and the detector lay on the circumference of a circle called the focusing circle. As (θ) increases, the radius of the circle decreases. A computer will give a readout of the detected data [3].

4.3 Instrumentation

The Powder X-ray diffraction instrument consists of an x-ray generator, an x-ray tube, filters and monochromators, sample holders and detectors. Figure 4.4 shows a schematic diagram of a powder X-ray diffractometer.

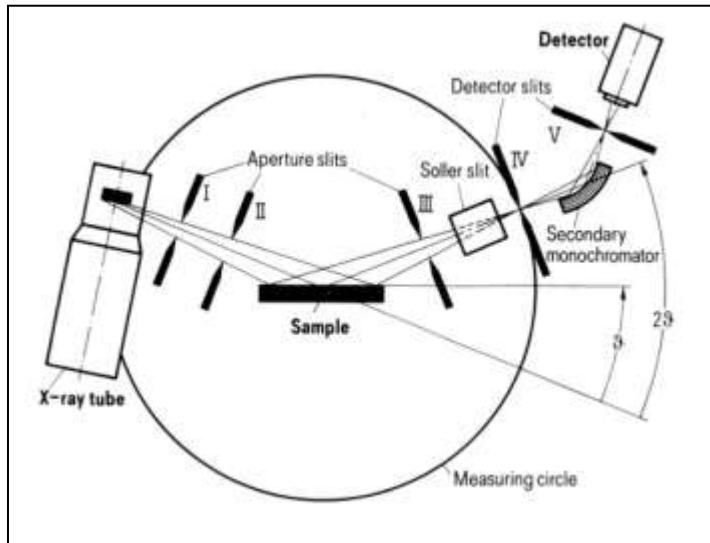

Figure 4.4 Schematic of PXRD

4.3.1 X-ray Generator

An X-ray generator consists of everything that is needed to generate an x-ray beam, including the X-ray tube, equipment that regulates the intensity of the beam such as high-voltage transformers, measuring instruments, stabilizers, etc.

4.3.2 X-Ray Tube

A tube with a hot filament cathode is used to generate X-rays. The anode would determine the voltage that is required to generate the X-ray. Depending on the anode the voltage varies from 30,000 to 80,000 volts.

4.3.3 Filters and Monochromators

The beam emitted by the X-ray tube consists of electromagnetic waves of a number of characteristic wavelengths, which includes some visible white light as well.

The X-ray diffraction experiment needs X-rays to be at one wavelength, without any other electromagnetic waves along with it. To achieve this monochromators such as an absorption edge filter, or a single crystal monochromator or energy discrimination monochromator are used. In an absorption edge monochromator, a metal sheet having an absorption edge of between the (K_{α}) and (K_{β}) is used. This would reduce the intensity of the (K_{β}) lines and the continuous radiation of white light. Normally the atomic number of the filter is one less than that of the anode. For example a Cu anode with Ni filters or a Co anode with Fe filters is used.

4.3.4 Sample Holder

The sample to be tested can be placed on holders that are made of plastic, glass or light metal such as aluminum.

4.3.5 Detector

Detectors used for detection can be divided into two types. The first type is where a sensitive photographic film is used to detect the diffraction in the entire angle range. The second type is in which the diffraction at only one angle is measured with the help of suitable detectors such as semiconductors or a scintillation counting tube. The second method just presented is especially used when measuring diffractions for a powder X-ray diffractometer. [4]

4.4 Sample Preparation

Sample preparation should receive proper consideration in order to ensure reproducible results. Crystal size is an important aspect when looking into sample preparation.[5, 6]

An appropriate crystallite size is important to avoid preferred orientations.

Too small a size will also lead to the broadening of the x-ray lines. Grinding the crystals to get it to a preferred size can sometimes disrupt the crystal lattice. Care should be taken to avoid this occurrence [5-7]. When the powder is put into the sample holder, sometimes the planes of the crystals are not randomly oriented. This is called preferred orientation. Everything should be done to avoid preferred orientation [5, 6]. The way the sample is packed in the sample holder is also an important factor. Normally a sample holder is a rectangular piece of glass, plastic or aluminum having a rectangular window in the center for the sample. The powder sample can be loaded from the top, the bottom or the side. It is preferable to load it from the side to avoid the possibility of preferred orientation. [5]

4.5 Application

X-ray powder diffraction is an important tool when studying the stability of any pharmaceutical or chemical entity by observing the changes in the crystal structure of the chemical moiety [8]. It is used to determine the polymorphic character, crystal phase and its orientation and extent of crystallinity of a specimen [2]. It is a non-destructive technique, widely used across various scientific fields. Variable Temperature PXRD or Elevated Temperature PXRD is a variation of the normal PXRD useful in studying the thermally induced morphological changes in the sample. The method can complement the findings from thermal methods of analysis [5, 9].

Chapter 5

Scanning Electron Microscopy

5.1 Introduction

Scanning electron microscopy is a method that is commonly used to study the morphology of substances. Though by itself it is not always very useful since it gives images and descriptions about the substance, when coupled with other techniques it can prove to be very useful [3]. Scanning Electron Microscope (SEM) can reveal details about the topography of the specimen with clarity and detail that is seldom achieved by any other technique. SEM can also detect surface potential distribution, subsurface conductivity, surface luminescence, surface composition and crystallography [2].

Structurally an electron microscope can be thought of as an inverted conventional light microscope. It consists of an electron gun, a column with lenses which focuses the beam, a sample chamber and detectors. The conventional electron microscope has a resolution of up to a 100 Å. The sample can be large in size. The SEM can give three dimensional images of the specimen, provided the specimen is conductive or is coated with a conductive material and provided the sample is measured in a vacuum. Another type of instrument called the environmental scanning electron microscope does not need the specimen to be conductive or be in a vacuum [3].

5.2 Principle

SEM uses signals generated by the interaction of the primary electron beam with the specimen, to generate the image. Figure 5.1 shows the schematic diagram of a typical SEM. The instrument has an electron beam that has energy of around 1 to 50 keV.

The beam passes through a set of lenses that focus it and reduces its diameter to the required size.

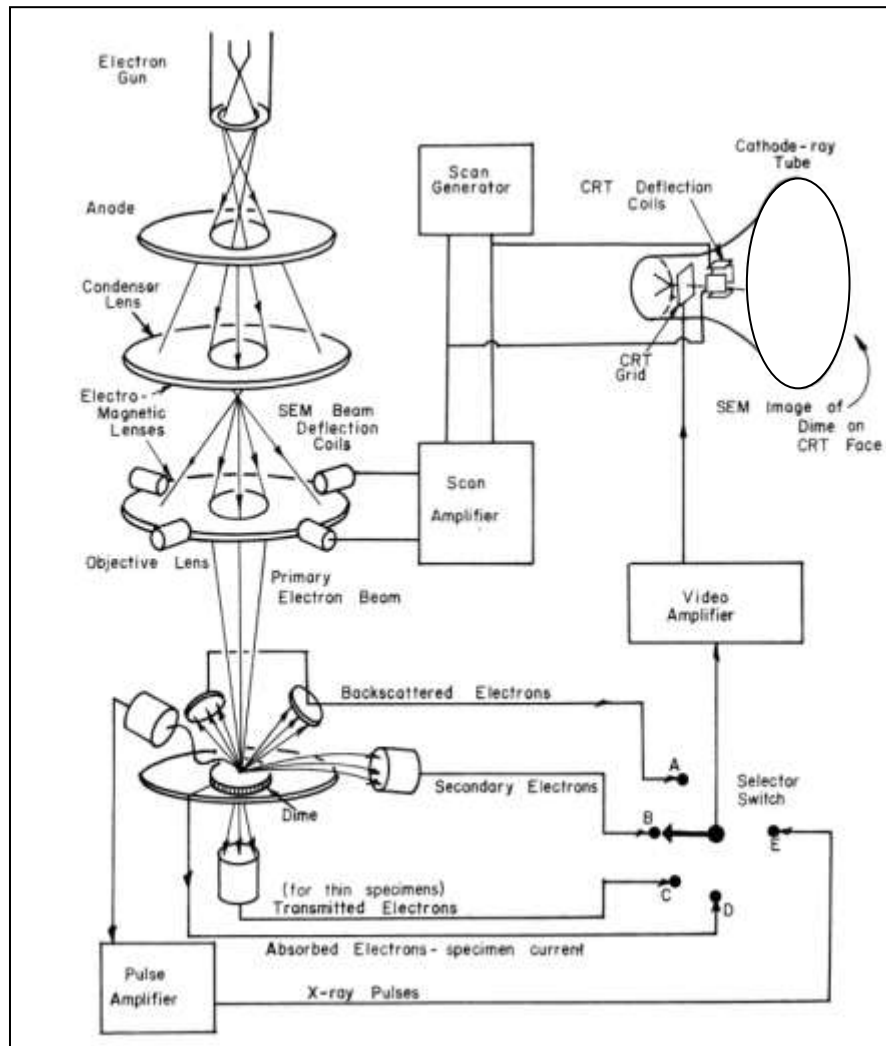

Figure 5.1 Scanning electron microscope [2]

This beam, known as the primary electron beam or the electron probe, then interacts with the specimen and produces a number of signals. Any of these signals can be used to generate a micrograph. Secondary electrons have very low energy and can escape from surfaces that are only about 50 Å thick. Most of the secondary electrons are reabsorbed by the specimen surface. Those that are not reabsorbed have an effective area that is very small and very close to the surface-beam interface. The diameter of the incident beam is important when the resolution of the SEM is being determined [2]. The diameter of the beam focused on the specimen surface is very small. At times it is 0.01 μm in diameter [4]. The interaction between the beam and the specimen also produces backscatter, X-rays, specimen current, Augur electrons, or photons [2]. The formation of the secondary electrons and the backscatter electrons are the basis for the formation of images in a SEM. Electrons in the inner orbitals, that are ejected when the primary beam interacts with the specimen are called secondary electrons. These electrons have a low energy, some of them being as low as 59 eV. Due to their low energy they escape the surface and are also sensitive to the topography of the specimen [3]. As the depressions or holes on the surface of the specimen can easily capture the secondary electrons, they will appear as dark spots and hills or higher areas will appear bright [2]. A lot of the electrons reaching the detector are secondary electrons [2]. As the secondary electrons are released before the primary electron beam spreads in the sample, they show high spatial resolution. Thus, they are the electrons of choice for studying the topography [3]. Though they are good for topographical imaging, secondary electrons give very little information about the chemical composition of the specimen. For this purpose backscatter electrons are used.

Backscatter electrons are given out when the primary beam interacts with the nucleus of the element. The higher the atomic number the brighter is the backscatter. However backscatter is not used to study pharmaceutical samples [2]. In topographical imaging, a portion of the secondary electron after leaving the surface of the specimen reaches a detector[4]. The signal from the detector is used to modulate the power provided to the electrode of the cathode ray tube [4]. There are deflection coils in the electron beam generator and in the cathode ray tube, which are controlled by saw tooth generators. Normally these coils are in-between the second and the third lenses or in the third lens of the microscope. This causes the electron beam in the microscope as well as the spot on the face or screen of the cathode ray to deflect. This allows the electron probe to scan the surface of the specimen by creating zig-zag rasters. Since the coils in the microscope and in the cathode ray tube are attached to the same generator, the scanning and the display on the screen are synchronized. Any variation on the surface of the specimen such as change in its shape, composition, changes the electric signal reaching the detector and thus the brightness of the spot on the face or screen of the cathode ray tube [2, 4]. A compilation of the full scan of the surface will give a picture of the surface. By choosing different coils for deflection, we can alter the size of the raster on the specimen and the screen, thereby changing the magnification of the image. Many microscopes can magnify up to a 100,000 times [4].

5.3 Instrumentation

5.3.1 Vacuum Systems

Vacuum systems are a very important part of the microscope. The vacuum prevents erosion of the filament in the electron gun thereby increasing its life. The other effect that is prevented by the vacuum is the formation of oxygen or nitrogen monolayer on the specimen. Contamination of the specimen surface will affect the analysis [1]. One system used for this purpose is an oil pumped vacuum system. An oil diffusion pump backed by a rotary mechanical pump is used in this system. One problem with this system is that, it is very easy to contaminate the vacuum with hydrocarbons from o-rings of the vacuum system or from fingerprints. Contamination changes the potential on the surface and thereby reducing the time available for analysis of a sample. The solution to this problem is the use of a cold trap to capture all the hydrocarbons introduced into the microscope. The trap can be placed close to the vacuum system or close to the specimen that is being examined. Other solutions can include a jet of oxygen or nitrogen on the sample surface, if we know that the sample will not get eroded due to the jet stream [1]. Another type of pump is a turbomolecular pump. These are oil free pumps. With proper cleaning, the possibility of contamination by hydrocarbons from the o-rings and the grease from the pump is minimized [1]. The third type of pump system is an ion pumped system. This system is free from the main source of contamination present in the other two sources. When a field emission gun is used, a higher vacuum is needed, which can be achieved only by using an ion pumped system.

5.3.2 Electron Beam Generator and Focusing

The illumination system, which is responsible for the electron beam generation consists of an electron gun and a set of lenses to focus the electron beam. Some materials that are used for making thermionic filaments for the electron gun are tungsten, lanthanum hexaboride and cerium hexaboride. These substances, when heated using an electric current, emit electrons. It is ideal that electrons be ejected as a narrow stream called a crossover from the tip of the filament. Electrons are accelerated through the illumination system due to a potential difference created due to voltage difference between the Wehnelt cylinder and the anode plate. The Wehnelt cylinder is the housing that covers the cathode. The three lenses focus the beam into a point the size of a needle for the scan [1, 3].

5.3.3 Detectors

One type of detector uses scintillators coupled with photomultiplier tubes. The scintillating material can be either plastic or glass. This type of system has the advantage of being noise free. Scintillators have an advantage over phosphors which have an afterglow of as low as 2×10^{-9} seconds, thereby making it useful for television rate of scan [1, 5]. A number of plastic and glass materials have been used for this purpose. A scintillation detector is a metal box with a grid on the side that faces the specimen. This apparatus, held at a positive potential, will draw all the secondary electrons emitted.

The other set up consists of a scintillator placed at a positive potential of +12 kV, without a grid, at a distance of 2 cm inside a grounded tube that is 2.5 cm in diameter and at a distance of 2.5 cm from the specimen.

The signals are obtained from secondary electrons that have energy between 0 to about 10 eV, or from the backscatter that reaches the detector or from the secondaries released by the interaction of the backscatter with metal objects in the surrounding. Figure 5.2 shows the basic structure of a scintillating detector.

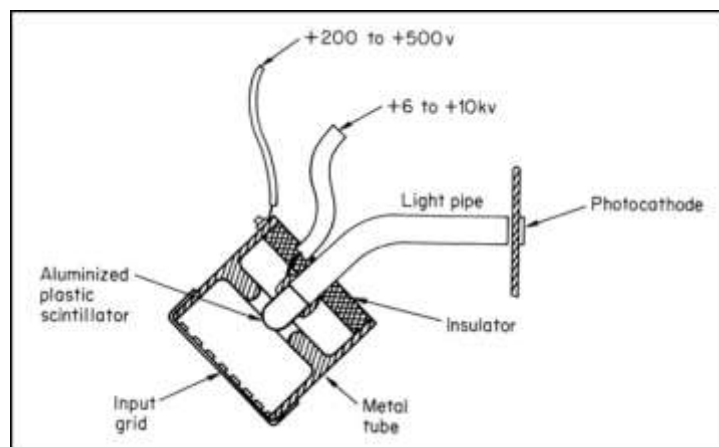

Figure 5.2 Scintillating detector [1]

A second type of detector is called the light proof detector which is used when trying to take measurements at a temperature of about 1600⁰C. At this temperature it is impossible to get an image with the secondary electrons so the detector or the scintillator has to be placed in such a way that it will be able to detect any backscatter and the image is made analyzing the backscatter. Fluorescent glass scintillators are used due to the temperature of operation. The light pipe is optically shielded to prevent any radiation other than that coming from the scintillators from entering the photomultiplier tube [1, 6]. Figure 5.3 shows this kind of detector.

A turret collector is used when images formed by multiple detectors have to be compared. Another type of detector is an energy analyzer detector. It is useful when studying the surface potential or to study image contrast. [1]

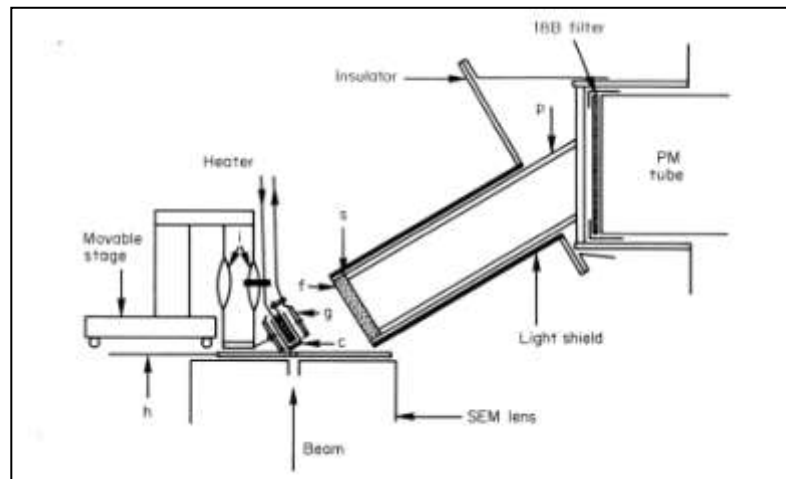

Figure5.3 Light Proof Detector [1]

5.4 Sample Preparation

Preparing the sample for analysis is an important part for SEM imaging, since the sample is expected to have certain features. The sample has to be dry for it to be analyzed by SEM. The samples are mounted on the sample mount with the help of a double sided tape or with carbon paint. Conductivity of the material plays a key role in imaging. Most pharmaceutical materials are insulators. These materials have to be coated by a conductive material such as silver or gold or gold-palladium combination [7, 8].

This is done by a method called sputter coating, giving a coat of about 200 Å on the sample surface. Some other studies use elevated temperature, magnetic field, mechanical manipulation and other factors according to the need of the study [3].

5.5 Application

SEM plays a vital role in pharmaceutical science and gives a new understanding to a number of pharmaceutical processes by showing the differences in the morphology, conductivity and properties that are the outcome of the specific process. SEM is a technique not only useful in pharmaceutical science but used in almost all other scientific fields. Some of the applications for which SEM has been used are listed below.

1. It is used to study different pharmaceutical processes and see the effect of these processes on the specimen [3].
2. It is used to study the structures of cells, patterns observed with trauma wounds on bones with or without flesh, lifestyle patterns of Neanderthal man, and to study specimens or fossils from the Paleozoic era [9-12].
3. It is a technique used while studying semi-conductive materials [13].
4. It is used in forensic analysis of vehicular paint [14].
5. It is used to study the inactivation of micro-organisms in and on interplanetary space vehicles [15].
6. It is used to study and authenticate objects that form a part of the cultural heritage of any kind [16].

Chapter 6

Dissolution Studies

6.1 Introduction

Any drug or API goes through a number of different processes before it appears in the blood stream after being delivered from a solid dosage form. These processes are disintegration, disassociation, dissolution and then absorption. Post absorption the drug goes through the first pass effect and then into the blood stream to be distributed to different parts of the body. Each of these steps can be a rate limiting step. For a very long time disintegration was considered to be an important step in preformulation stages and for quality assurance tests. Recently it has been realized that drugs cannot pass through the gastric cell wall until they are dissolved in the medium in that part of the GI system. Though disintegration plays an important role, it does not directly affect the rate of absorption. Another reason to scrap the disintegration system is that dissolution occurs even before the complete disintegration of the dosage form is complete. This greatly decreases the relevance of the disintegration test. Thus, in-vitro and in-vivo correlations from dissolution studies have become a very important part of all preformulation, quality assurance and quality control and research activities. [2] The best possible test to determine the bioavailability of the drug would be an in-vivo test. The problem associated with in-vivo tests is that it would be a very expensive and time consuming method. It would be a challenge to conduct the test on a regular basis.

It would be difficult to get consistent results due to a vast number of factors that can affect the final results. The assumption that the results can be correlated between a normal person and a patient is not true. The technique would need highly trained personnel. The use of human subjects for this kind of research cannot be justified. Thus, it is important to have an in-vitro method and it is important to study in-vitro and in-vivo correlation. The objective of the in-vitro dissolution studies is to have an easy, fast, inexpensive method that does not require any cumbersome and expensive training, during research and development of a formulation. It is also useful in demonstrating the drugs availability for absorption. It is important to have a method which shows that different batches have the same dissolution. [2]

6.2 Instrumentation

There are a number of systems that are approved by the USP for use with the dissolution apparatus.

6.2.1 Dissolution Apparatus 1 (Basket Apparatus)

This apparatus consists of a vessel made out of glass or any other inert transparent material, and may or may not be covered to prevent loss of fluid by evaporation. There is a motor, a metallic shaft and a cylindrical basket.

A transparent vessel is partially immersed in a water bath and is heated with a suitable mechanism to keep the temperature of the system at a suitable temperature to mimic body conditions, wherein the temperature of the media inside the vessel is at a temperature of $37 \pm 0.5^\circ\text{C}$. The bath fluid should be in a constant smooth motion throughout the experiment. No part of the assembly or the environment in which the assembly is placed should have any significant motion, since this can affect the results. The dimensions for the vessel are also specified. For a vessel that has a capacity of about 1 L, the height should be between 160 mm and 210 mm, while the inside diameter should be between 98 mm and 106 mm. For a vessel that has a capacity of 2 L, the height should be between 280 mm and 300 mm and its inside diameter should be 98 mm to 106 mm. For a container to have a capacity of 4 L, the height has to be between 280 mm and 300 mm, and the inside diameter has to be between 145 mm and 155 mm. The sides of the vessel have to be flanged at the top. The axis of the shaft has to be positioned in such a way that it is not away by more than 2 mm in any direction from the axis of the vessel. The motion of the shaft should be smooth, without any vibrations or wobble. Every monograph would specify a speed of rotation and the speed should be within $\pm 4\%$ of the speed specified. The shaft and the basket have to be made with stainless steel, type 316, or other inert material. The specifications that are to be followed for making the shaft and the basket are shown in Figure 6.1. The distance between the bottom of the vessel and the basket is kept at a constant 25 ± 2 mm [1].

6.2.2 Apparatus 2 (Paddle Apparatus)

This apparatus is exactly like the apparatus in assembly 1, except that it uses a paddle formed from a blade and a shaft, which is used as a stirring element. Again the axis of the shaft should not be away from the axis of the vessel by more than 2 mm. The shaft should rotate smoothly without any vibrations or wobbles that will cause the results to be erroneous. The specifications for the paddle are shown in Figure 6.3 [1]. The distance between the bottom of the blade and the inside bottom of the vessel should be kept at 25 ± 2 mm. The shaft and the blade is a single attached component made of an inert material.

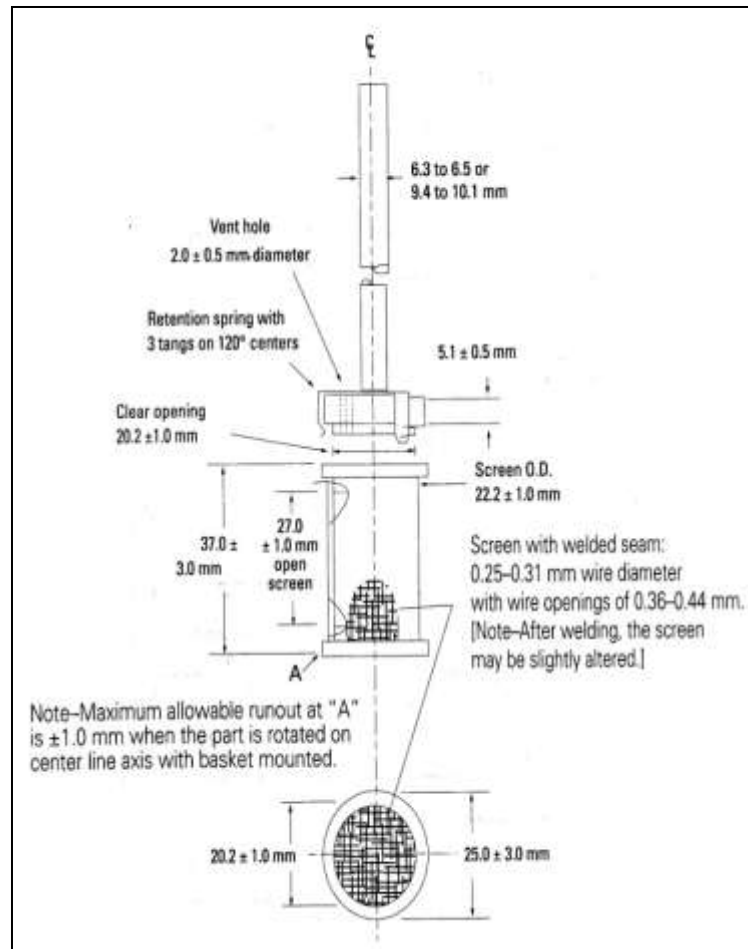

Figure 6.1. Specifications for the basket and shaft of type 1 apparatus [1]

A convenient two piece shaft and blade may be used provided it does not give any significant vibrations or wobbles. The blade and the shaft may be coated with an inert material. When required a sinking device may be used post validation. A device approved by the USP is shown in Figure 6.2 [1].

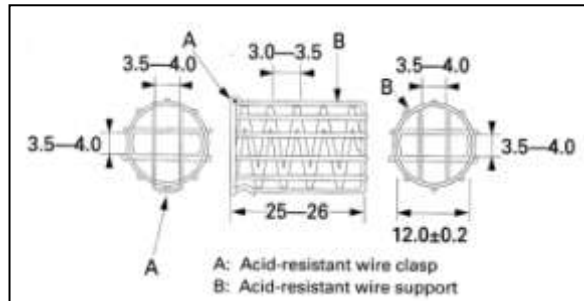

Figure 6.2. Sinks for slid dosage forms that float [1]

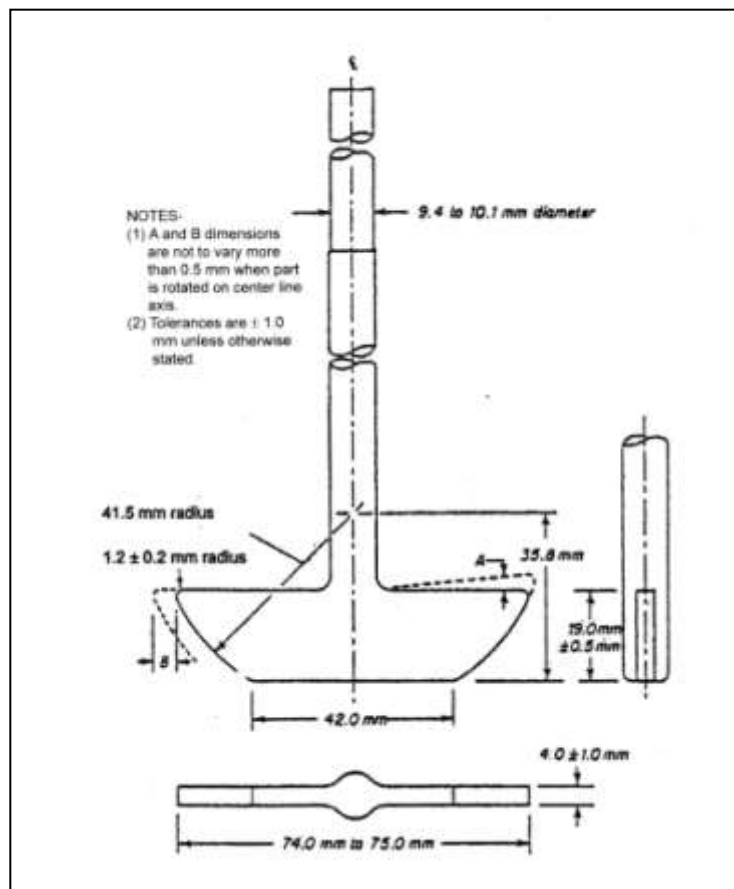

Figure 6.3 Paddle for type 2 apparatus [1]

6.2.3 Apparatus 3 (Reciprocating Cylinder)

This assembly consists of a set of flat glass vessels, with a set of glass reciprocating cylinders with inert fittings made of Stainless Steel Type 316 or any other material that is suitable. The reciprocating glass tubes have screens on the top and the bottom of the tube. The screens are made with a suitable nonsorptive and nonreactive material. There is a motor that moves the reciprocating cylinder in a vertical motion. If desired it would index the cylinder into another vessel. The vessel containing the reciprocating cylinder is partially immersed in to a water bath or any other appropriate heating mechanism to keep the temperature of the contents of the vessel at $37 \pm 0.5^\circ\text{C}$. No part of the assembly or the environment where the apparatus is placed should cause any major vibrations that would affect the results. A device that allows the adjustment of the reciprocating speed as specified by the individual monograph. The reciprocating speed should be within $\pm 5\%$ of the specified value. It will be preferred to have an apparatus that allows viewing of the process as it happens. Figure 6.4 gives the dimensions for a typical apparatus of this type [1].

6.2.4 Apparatus 4 (Flow-Through Cell)

The apparatus consists of a reservoir, a pumping mechanism, a flow cell, and a water bath that keeps the dissolution medium at a required temperature of $37 \pm 0.5^\circ\text{C}$. The specification of the cell is given in the individual monograph. The pump forces the dissolution medium through the cell.

The pump has a flow rate of 240 to 960 mL per hour with an error of not more than $\pm 5\%$. It has a standard flow rate of 4, 8 or 16 mL/ min. the flow is a pulsed flow with a frequency of 120 ± 10 pulses per minute. The flow cell is mostly a transparent tube made with any inert material with dimensions of 12 and 22.6 mm that have a filter on the top that prevents any particle that has not dissolved from passing through. There are beads at the bottom cone that protects the fluid entry tube. Figure 6.5 is a schematic diagram of this apparatus [1].

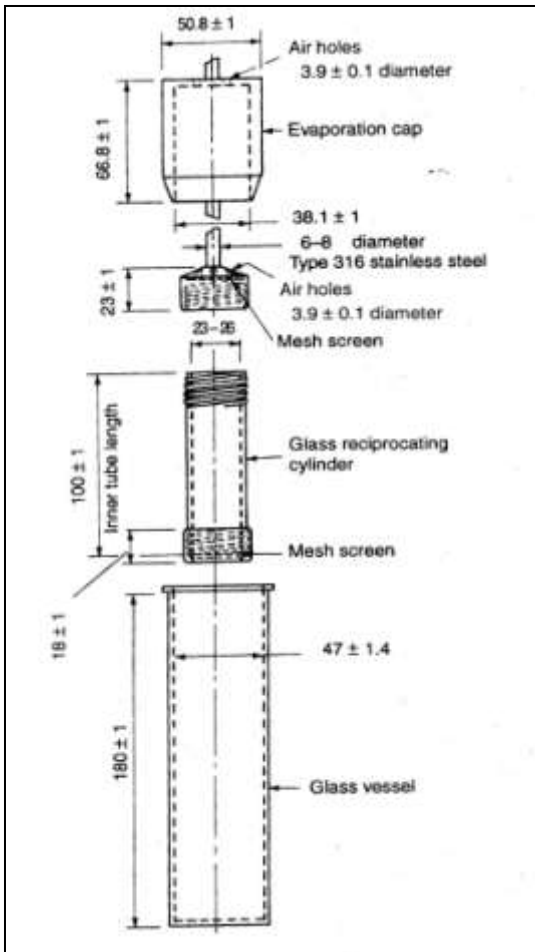

Figure 6.4 Type 3 dissolution apparatus[1]

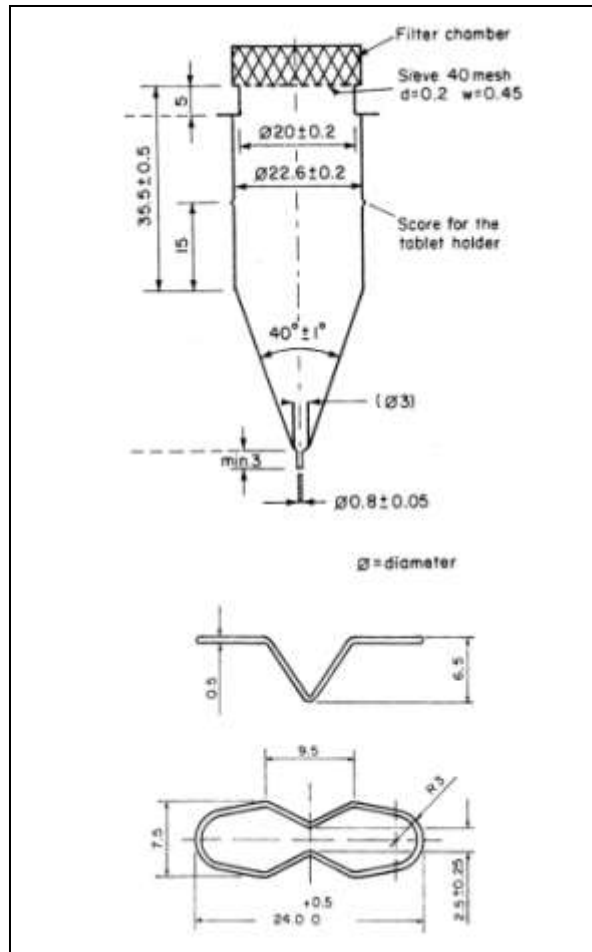

Figure 6.5 Type 4 dissolution apparatus liquid inlet tube [1]

6.3 Procedure for Dissolution

It is of utmost importance that the procedure for dissolution previously mentioned in the USP and within the individual monographs be followed totally for results that are accurate and reproducible [1].

6.3.1 Immediate Release Formulations

For immediate release formulations the procedure dictates that the apparatus be readied before the test is started. If the Type 1 or Type 2 apparatus has to be used, make sure that the medium is loaded into the vessel. The medium in the vessel has to be equilibrated at $37\pm 5^{\circ}\text{C}$, making sure that the rate of rotation has been set to the required speed. In the Type 3 apparatus, the frequency of the upward and downward motion is set to the required speed. Make sure that the cylinder moves a distance of between 9.9 and 10.1 cm. In the Type 4 apparatus ascertain that the rate of flow is monitored and is at the required rate. In all the apparatus, care should be taken to make sure that the dissolution medium is at $37\pm 5^{\circ}\text{C}$. Once the dissolution media has been equilibrated, one could remove the thermometer. Place a unit dosage form into the appropriate apparatus making sure to remove any air that may become entrapped on the surface of the unit dosage form. Once the dosage form is inserted into the apparatus, immediately start the rotation of the basket or the paddle in the case of Type 1 or Type 2 apparatus. For the Type 3 apparatus start the upward and downward motion. In the Type 4 apparatus start the medium flow. Remember to check the rate of rotation or the rate of the upward and downward motion or the rate of flow of the medium at regular intervals.

Measure the temperature of the dissolution medium at regular intervals. Take samples from the dissolution medium at times specifically mentioned. If no time is mentioned, withdraw samples at regular intervals. In the case of Type 1 or Type 2 apparatus, make sure the aliquot is drawn from the center of the top of the media and the top of the basket or paddle. Make sure that the withdrawal is from a position that is at least 1 cm from the wall of the vessel.

In the Type 3 apparatus, raise the reciprocating cylinder and withdraw an aliquot from midway through the vessel. For the Type 4 apparatus, collect the aliquot from the eluate at the appropriate time interval. Specifications for the dissolution media are mentioned in the individual monographs. Make sure that the media is free from any gases in cases where the dissolved gases can affect the results. If the solution is in a buffered solution, make sure that the pH is within 0.05 pH units of the mentioned pH [1].

6.3.2 Delayed Release Formulations

There are two different methods that can be used for a delayed release formulation. The first method calls for 750 mL of dissolution medium, which is made of 0.1N HCl at $37\pm 5^{\circ}\text{C}$. The dosage form is tested in this medium by withdrawing aliquots at regular intervals for 2 hours. Once the two hours is over, 250 mL of 0.2N solution of tribasic sodium phosphate at $37\pm 5^{\circ}\text{C}$ is added. A 2N HCl or 2N NaOH solution is used to adjust the pH to 6.8. then aliquots are withdrawn at a specified time [1].

In the second method 100 mL of dissolution medium, which is made of 0.1N HCl at $37\pm 5^{\circ}\text{C}$ is used for the first two hours with aliquots taken at regular intervals up to 120 minutes.

This medium is then drained and another 100 mL of 0.2N solution of tribasic sodium phosphate at $37\pm 5^{\circ}\text{C}$ is used for further testing. As before, 2N HCl or 2N NaOH solution is used to adjust the pH to 6.8. One variation that can be used is to transfer the dosage form if it is intact instead of changing the dissolution media [1].

6.3.3 Extended Release Formulations

In extended release formulations the procedure is the same as that used for immediate release formulations. The only difference would be the time for which the aliquots are withdrawn. It is going to be much longer than the time for immediate release formulations. In the Type 3 or Type 4 apparatus the procedure is similar to Type 1 or 2 apparatus. The only difference is that in the Type 3 apparatus there can be different vessels with different media arranged one after the other [1].

Chapter 7

Ultraviolet-Visible Spectroscopy

7.1 Introduction

Most atoms and molecules have the capability of absorbing energy. The ability of the molecule to absorb energy is dependent on the structure of the molecule. Electromagnetic radiation can be one source of this energy. One common source of electromagnetic radiation is visible light. Others include ultraviolet radiation, x-rays or infra red radiation. The analyte and its concentration determine the type of radiation and the amount of radiation absorbed [4]. Ultraviolet or visible (UV-Vis) absorption spectroscopy is certainly one of the most widely used quantitative determination techniques used for organic, inorganic and biological specimens [3, 4]. It is expected to remain one of the important techniques because of its various advantages including speed, sensitivity, specificity and ease [4]. There are certain principles and phenomenon of electromagnetic radiation, which play an important role in UV-Vis Spectroscopy. One of these principles is called the Beer-Lambert's Law. It gives a linear relationship between the concentration of the absorbing material and the absorption of electromagnetic radiation [3]. Another important concept is transmittance. It can be defined as a ratio of the power of the radiation transmitted through a sample, to that of the incident radiation. Absorbance is the negative log of transmittance or in mathematical terms can be represented by $\log (P_0/P)$, where (P_0) is the intensity of the incident radiation and (P) is the intensity of the transmitted radiation [3].

The intensity of the incident radiation can be reduced by a number of factors such as: the absorption of energy by the molecules or atoms, scattering of the incident beam by large particles; the absorption of the energy by the sample holder; or the reflection at the container-air and container-solution interfaces. Therefore the reduction in intensity of the transmitted radiation might not only be due to the solute or the specimen in the solution. It can also be due to the solvent or the container as well. Figure 7.1 demonstrates the various reasons for the attenuation in the power of the transmitted beam. A simple solution to this problem is to measure the sample solution against a reference or blank which is a sample cell or sample holder made with the same material and having the same dimensions as the holder having the analyte in it and also containing any other ingredients other than the analyte.

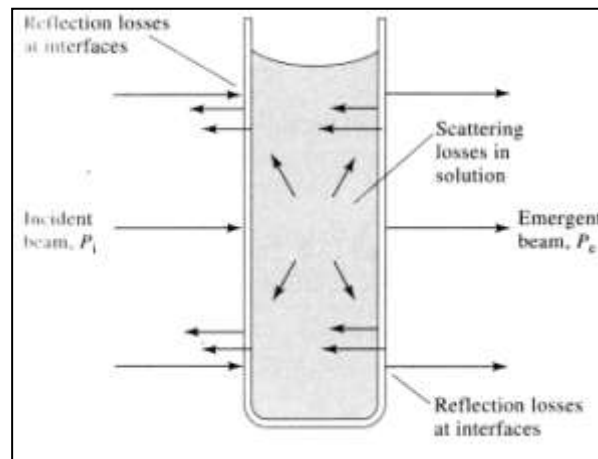

Figure 7. 1 Different processes leading to light attenuation [3]

Comparing the transmittance from the sample with the transmittance through the blank would give the true absorption by the sample alone.

A formula that gives us the transmittance and absorbance is [3]:

$$T = \frac{P_{\text{solution}}}{P_{\text{solvent}}} \quad \text{Eqn. 7.1}$$

where (T) is transmittance, (P_{solution}) is the power of the radiation passing through the solution and (P_{solvent}) is the power of the radiation passing through the solvent or the blank.

Therefore:

$$A = \log \frac{P_{\text{solvent}}}{P_{\text{solution}}} \quad \text{Eqn. 7.2}$$

where (A) is the absorbance of the sample [3]

7.2 Principle

Electromagnetic radiation can be thought of as energy travelling as a wave. The waves can be described by various terms, which will form its identity. Some common ones are wavelength (λ) and wave number, which is the reciprocal of wavelength or frequency (γ) [4]. Electromagnetic radiation in the UV-Visible region consists of radiation in the 190 nm to 880 nm range and is frequently used for quantitative analysis [3]. In the visible region the wavelengths can be further divided according to what is seen as colors. Each wavelength is seen as a color. The combinations of all the colors or a continuous spectrum of all the visible wavelengths forms white light or the color white. Each color has a complimentary color. The concept is that when one wavelength is absorbed by any material, the complimentary color is seen by the person seeing the object. The product of the wavelength and the frequency will give the distance travelled by a wave in one second or the velocity of the wave [4].

$$v = \nu\lambda \quad \text{Eqn. 7.3}$$

where (v) is the velocity, (ν) is the frequency in hertz or sec^{-1} , and (λ) is the wavelength in meters or centimeters or nanometers [4].

But all the properties of electromagnetic radiation cannot be explained by considering it to be a wave. Some properties are explained better when the radiation is considered a packet of energy or photons [4].

The energy of a photon can be written as

$$E = h\nu \quad \text{Eqn. 7.4}$$

where (E) is the energy of the photon, (h) is universal Planck's Constant, which is 6.625×10^{-27} ergs.sec and (ν) is the frequency.

Putting equations 7.3 and 7.4 together we derive an equation which is:

$$E = \frac{hc}{\lambda} \quad \text{Eqn.7.5}$$

(In vacuum all the electromagnetic waves travel at the speed of light 'c')

This means that the shorter the wavelength, the higher would be the energy of the electromagnetic wave. Therefore UV rays have more energy as compared to visible light, which in turn has more energy as compared to IR radiation. Different transitions require different energies. Depending on the transition that has been observed a suitable energy source should be chosen [4].

7.2.1 Energy Absorption

Each molecule has its own internal energy. This energy is due to movement of the molecules. These movements include translational, vibration and rotational motion. The fourth type of energy is electronic which is associated with the electronic configuration of the molecule. The total energy of a molecule can be expressed as

$$E = E_{tran} + E_{vib} + E_{rot} + E_{elec} \quad \text{Eqn. 7.6}$$

where 'E' is total energy, (E_{tran}) is translational energy, (E_{vib}) is vibrational energy, (E_{rot}) is rotational energy and (E_{elec}) is energy due to the electronic state.

These transitions are not random but are very definite from one level to the other. Due to the rules set in quantum mechanics, the molecule being studied can take on only certain vibrational, rotational, translational or electrical energy values.

This is due to as the orbitals being quantized. When a molecule absorbs energy or photons it moves from a lower energy state to a higher energy state. But these transitions will occur only at certain wavelengths, since a certain amount of energy will be required for the transition. Equation 7.7 shows how the difference in energy levels can be associated with wavelength.

$$E_2 - E_1 = h\nu \quad \text{Eqn.7.7}$$

where (E_2) is the higher energy level and (E_1) is the lower energy level.

A mathematical plot of the absorbance or intensity of the transmitted light against the frequency of the incident radiation would give a simple absorption spectra. This would be like a signature pattern for that particular molecule in question. This forms the basis for qualitative analysis by spectroscopy [3, 4].

Far IR radiation can provide energy required for rotational transitions. Absorption of near IR radiation leads to vibrational transition. Though near IR leads to vibrational transitions the spectrum is seldom sharp transition peaks. There are rotational transitions that occur also. Thus, IR spectroscopy is also called vibrational-rotational spectroscopy. UV and visible radiation generally lead to electronic transitions [4].

7.2.3 Electronic Transitions

UV and visible radiations generally show transitions in the electronic energy levels. The most probable transition is from the highest occupied molecular orbital (HOMO) to lowest unoccupied molecular orbital (LUMO). Figure 7.2 shows the energy levels for the various orbitals. The lowest energy levels are demonstrated by the (σ) orbital. The next highest energy level is of π orbital. After (π) orbitals come the non-bonding orbitals and finally come the unoccupied orbitals. Figure 7.3 shows the different transitions [2].

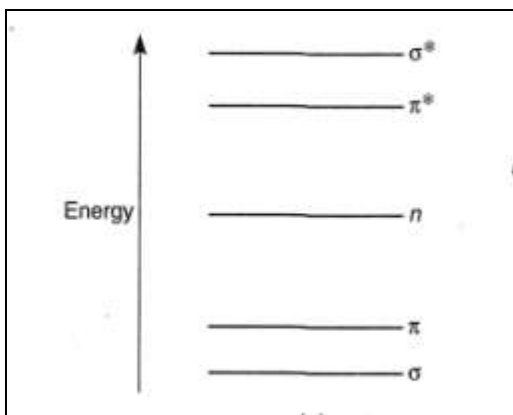

Figure 7.2 Energy level of orbitals [2]

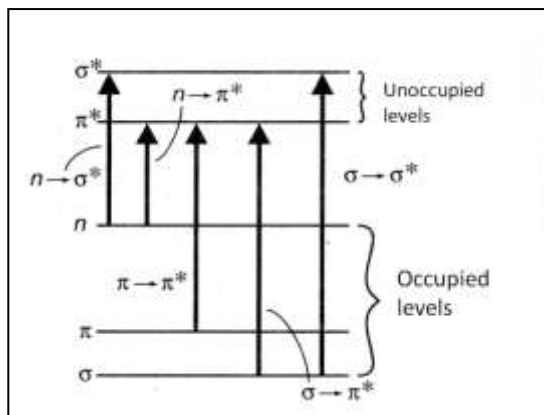

Figure 7.3 Electronic Transitions [2]

Unlike measurements of atoms which give sharp peaks, analysis of molecules leads to the formation of bands. This can be attributed to the vibrational and rotational transitions that occur with the electronic transition.

The energy levels are so close that the spectroscope instead of giving a number of sharp peaks gives one enveloped broad band. Figure 7.4 shows an energy level diagram showing this process [2].

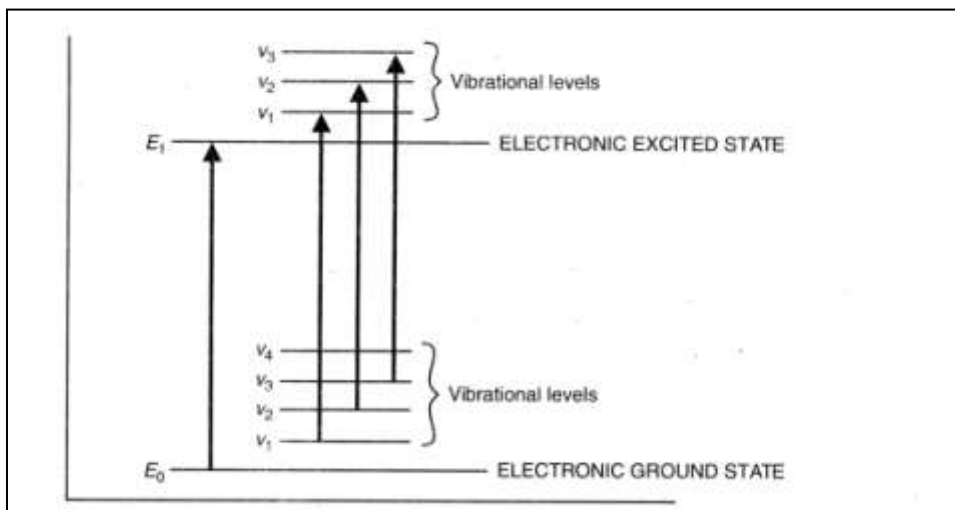

Figure 7.4 Vibrational translations occurring with electrical transitions [2]

7.2.4 Beer-Lambert Law

With the help of a simple derivation, Beer demonstrated the relationship between absorbance 'A' and the molar concentration of the analyte. Mathematical representation of Beer's Law is as follows:

$$A = -\log T = \log \frac{P_0}{P} = \epsilon bc \quad \text{Eqn.7.8}$$

where (ϵ) is a constant

(ϵ) is the molar absorptive of the analyte. If we keep the distance through which the radiation passes, thereby having a constant value for probability of the interaction of the radiation with the particles, the absorption or attenuation of the transmitted radiation will solely depend on the concentration of the solute in the solution [2-5].

In solutions which have one solute or one molecule that absorbs energy the Beer-Lambert's Law is followed absolutely. When a mixture of two or more molecules is studied, the results are sometimes erroneous. This happens when the (λ_{\max}), the wavelength of maximum absorption of the two molecules, are very close or when there exists a thermal equilibrium between two consecutive orbitals, or when the molecules form a complex, or when the compound is a fluorescent compound or when the compounds change by irradiation the results are incorrect [2].

7.3 Instrumentation

The most basic instrument for measurement of UV-Vis spectra consists of a source of radiation, monochromators, a sample holder and a detector. A deuterium lamp is used very frequently for UV radiation. Another tungsten lamp is used for the visible range. Very frequently the monochromator is a diffraction grating monochromator. It spreads out the different wavelengths, thereby making it possible to select a particular wavelength. A set of slits will help in selecting a wavelength. Very frequently when the analyte is a liquid or is in solution, a blank or reference is used, to negate the effect of decreasing the transmitted light due to scattering or reflection off of various surfaces. When measuring spectra in the visible region, a glass or plastic sample holder can be used. When measuring spectra in the UV region a quartz sample holder is often used because quartz will not absorb radiation in the UV region. If the sample is in the solid form, it would be preferable to not use a sample holder [2].

There are different types of sample cells that are available for use. Some important ones would include a regular rectangular cell. These cells can have a width of 1 mm to 100 mm. the most popular size is a 10 mm cell. Other types of cells include those that are aperture or micro cells when the volume of the analyte solution available is very small. Flows through cells are used for studying ongoing processes. Figure 7.5 shows some of the various types of cells used in spectrophotometers [1]. Figure 7.6 shows how these types of sample cells are used in some spectrophotometers. The most basic detector is a photomultiplier tube. Modern instruments use photodiode array. The photomultiplier tube can measure absorbance for one particular wavelength.

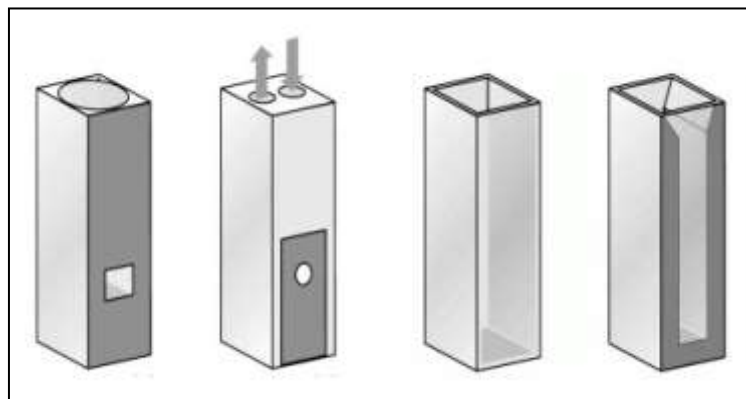

Figure 7.5 1 micron cell; flow through cell; regular rectangular cell; Aperture cell [1]

For a scan over a range of wavelengths the instrument would have to move the grating through all the wavelengths and the photomultiplier tube would record the absorbance for all the wavelengths one at a time. In instruments that are photodiode array spectrophotometers, there are multiple arrays or sets of photodiode detectors. Each array will measure the intensity of the transmitted ray over a certain range of wavelengths. A set of arrays can measure the whole range at once.

This method is very fast for measuring a whole spectrum. Dual beam instruments measures the sample and the reference at the same time. Figure 7.6 (a-c) gives us a schematic diagram for some of these instruments.

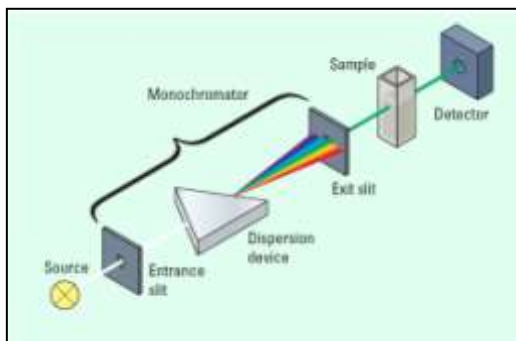

Figure 7.6 (a) Conventional Spectrophotometer [1]

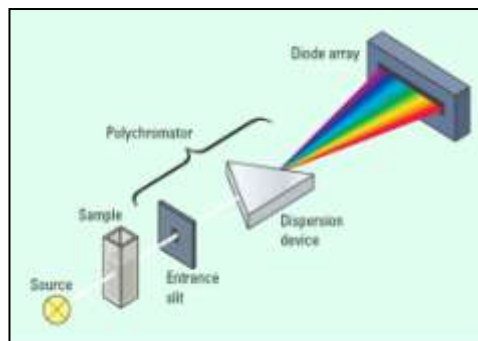

Figure 7.6 (b) Photodiode array spectrophotometer [1]

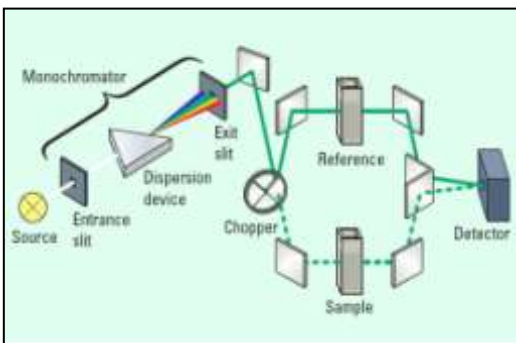

Figure 7.6 (c) Double beam spectrophotometer [1]

7.4 Applications

UV-Vis spectroscopy has found much application in the field of science because of the inexpensive nature of the experiment, ease and speed of analysis. Very little preparation time is required once the instrument has been allowed to stabilize. Some of the applications include:

1. Quantitative and qualitative analysis of analyte from solid matrix [6].

2. Used as a detector in different instruments or for post separation analysis after liquid chromatography, HPLC[7, 8]
3. Used for monitoring and checking for contaminants [9].
4. Quantitative analysis of material in solution form is one of the very prevalent use for this technique [10].
5. Determination of rate of reactions.

Chapter 8

Materials and Methods

8.1 Materials

8.1.1 Indomethacin

8.1.1. a. Introduction

Source: Letco

Chemical Name: 1-(4-Chlorobenzoyl)-5-methoxy-2-methyl-3-indoleacetic acid [4]

1-(4-Chlorobenzoyl)-5-methoxy-2-methyl-1H-indole-3-acetic acid

Empirical Formula: $C_{19}H_{16}ClNO_4$ [4]

Molecular Weight: 357.79 g/mol [4]

CAS-No. 53-86-1

Structure:

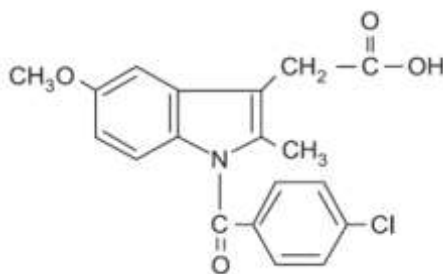

Figure 8.1 Structure of Indomethacin [5]

8.1.1. b. Physical Properties

Physical Appearance:

Form: powder [4]

Color: beige [4]

Melting point: 155 °C (311 °F) [4]

Solubility: about 0.1mg/mL in 0.1M Na₂CO₃ (with warming), about 6.5mg/mL in ethanol, about 17.5 mg/mL in DMF and DMSO [6] . Solution in ethanol is slightly greenish yellow in color [7].

8.1.1. c. Pharmacodynamics

Indomethacin is a non-selective, non-steroidal, anti-inflammatory agent. It is very potent and the effect is comparable to phenylbutazone. It also has antipyretic action. It relieves inflammatory or tissue injury related pain. It is a highly potent inhibitor of prostaglandin synthesis and suppresses neutrophil motility. In toxic doses it uncouples oxidative phosphorylation. It is generally well absorbed orally and is up to 90% plasma protein bound. It is metabolized in the liver to inactive metabolites which are then excreted by the kidneys. It has a plasma half-life of about 3-5 hours. It also crosses the placenta and the blood brain barrier. Concentration in the synovial fluid is found to be around 20% [8].

8.1.1. d. Uses, Side Effects and Contraindication

Indomethacin is used for management of inflammatory diseases, rheumatoid disorders, moderate pain, acute gout, arthritis, acute bursitis/tendonitis, moderate to severe osteoarthritis, rheumatoid arthritis, and ankylosing spondylitis [9].

Adverse effects include gastric irritation, nausea, anorexia, gastric bleeding, and diarrhea. Frontal headaches are very common. Depression, psychosis, hallucination, and dizziness are other adverse effects. It may lead to hypersensitivity reactions. Overall the incidences of side effects are lower than those for aspirin [8]. Drug interactions include an increase in serum potassium levels when administered with potassium sparing diuretics.

Probenecid may increase indomethacin serum concentrations. Other NSAIDs may increase GI adverse effects. It may cause an increase in the nephrotoxicity of cyclosporine and ACE inhibitors. Indomethacin increases the concentration of a number of drugs such as methotrexate, lithium, aminoglycosides, glimepiride, glypizide, etc. It decreases the effect of antihypertensive agents such as ACE inhibitors, beta-blockers, Angiotensin II antagonists and thiazide diuretics [9].

8.1.1. e. Available Dosage Forms and Doses

It is available as capsules, oral suspension, powder for reconstitution, and sustained release capsules. Its tablets tend to harden over time. The normal dose for adults is 25 to 50 mg, it is available as a 75mg sustained release formulation [9].

8.1.2 Phenytoin

8.1.2. a. Introduction

Source: Letco

Chemical Formula: $C_{15}H_{12}N_2O_2$ [10]

Chemical Name: 5,5- Diphenylhydantoin or 5,5-Diphenyl-2,4-imidazolidinedione

Molecular Weight: 252.27 g/mole [10]

Structure:

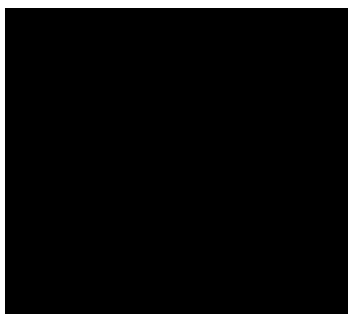

Figure 8.2 Phenytoin Structure [2]

8.1.2. b. Physical Properties

Color: white [2]

Physical state and appearance: Solid [2, 10]

Melting point: $> 300\text{ }^{\circ}\text{C}$ ($> 572\text{ }^{\circ}\text{F}$) [2]

Solubility: Insoluble in cold water [10], 10 mg/mL in acetone.

8.1.2. c. Pharmacodynamics

It is 80-90% plasma protein bound. Absorption is slow due to poor aqueous solubility.

The release from different formulations might differ as well. It is metabolized in the liver by hydroxylation and glucuronide conjugation.

Typical half-life ranges from 12 to 24 hours. This may increase with an increase in the dose due to saturation of the metabolizing enzyme [8].

8.1.2. d. Uses, Side Effects and Contraindication

Phenytoin is one of the most widely used antiepileptic drugs for generalized tonic-clonic simple and complex partial seizures. Occasionally it is used as a slow I.V. drip for treating status epilepticus. It is also a second choice of drug after carbamazepine for trigeminal neuralgia. It is used to treat cardiac arrhythmias [8]. Side effects include gum hypertrophy, hirsutism, coarsening of facial tissue, rashes, lymphadenopathy, neutropenia, etc. It may also cause megaloblastic anemia. Some drug interactions include carbamazepine, where both phenytoin and carbamazepine increase each others metabolism. Valproate displaces phenytoin from plasma protein. Chloramphenicol, isoniazide, cimetidine, dicumarol, and warfarin inhibit phenytoin metabolism. Phenytoin increases the degradation of steroids, digitoxin, doxycyclin, and theophylline. Sucralfate binds to phenytoin in the G.I tract and decreases its absorption [8].

8.1.2. e. Available Dosage Forms and Doses

Doses range from 30mg to 300 mg. Capsules, suspensions and chewable tablets for oral administration and solution as sodium salt for injection are available. Extended release capsules are also available [9].

8.1.3 Ethanol

8.1.3. a. Introduction

Source: Pharmaco Aapers

Chemical Name: Ethyl Alcohol

Chemical Formula: $\text{CH}_3\text{CH}_2\text{OH}$ [11], $\text{C}_2\text{H}_5\text{OH}$ [12]

Empirical Formula: $\text{C}_2\text{H}_6\text{O}$

Molecular Weight: 46.07 g/mole [11]

CAS#: 64-17-5 [11]

Structure:

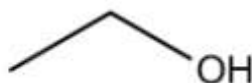

Figure 8.3 Ethyl Alcohol

8.1.3. b. Physical Properties [11]

Physical state and appearance: Liquid

Odor: Mild to strong, rather pleasant; like wine or whiskey. Alcohol-like; Ethereal, vinous.

Taste: Pungent, burning

Color: Colorless, clear

Boiling Point: 78.5°C (173.3°F)

Melting Point: -114.1°C (-173.4°F)

Critical Temperature: 243°C (469.4°F)

Specific Gravity: 0.789 (Water = 1)

Vapor Pressure: 5.7 kPa (@ 20°C)

Vapor Density: 1.59 (Air = 1)

Odor Threshold: 100 ppm

Solubility: Easily soluble in cold water, hot water, soluble in methanol, diethyl ether, and acetone.

8.1.3. c. Description and Uses

Ethyl alcohol (95%v/v) or anhydrous alcohol (100%v/v) is a clear, colorless, very mobile, flammable liquid, which has a pleasant odor and a burning taste.

It is miscible with water and many organic solvents in different proportions. It is used in alcoholic beverages, used as a solvent in industry and laboratories, and used in various pharmaceutical preparations. In medicine it is used as a nerve block and as a local anesthetic and as a peripheral vasodilator. It has also found use as an external antiseptic [13].

8.1.4 Kollidon[®] VA64

8.1.4. a Introduction [3]

Source: BASF

Chemical Name: Copolymer of Vinyl pyrrolidone and vinyl Acetate, Copovidone,

Copolyvionum, Kollidon[®] VA64

CAS#: 25086-89-9

Structure:

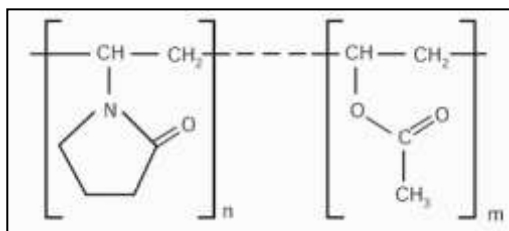

Figure 8.4 Structure of Kollidon[®] VA 64 [3]

8.1.4. b. Physical Properties [3]

Relative viscosity (1% in water): 1.178 –1.255

Loss on drying: < 5%

pH value (5 % in water): 3 – 7

Solubility: Soluble in a number of solvents ranging from water and other hydrophilic solvents to hydrophobic solvents like butane.

8.1.4. c. Description and Uses

Kollidone[®]VA64 is a pharmaceutical grade product. It is white or yellowish-white in color and has a peculiar mild odor and faint taste in aqueous solution. Kollidone[®]VA64 has been used for a wide variety of pharmaceutical applications. It has been used as an additive to tablets when made by the wet granulation or direct compression method. It is used in gelatin capsules. It has been used in tablet coatings for a variety of purposes, including that of a material that forms a film coat around the tablet. It has also found use as a matrix for sustained release or immediate release formulations. It has also been used in making bioadhesive films [3].

8.1.5 Urea

8.1.5. a. Introduction

Source: Fisher Biotech

Chemical Name: carbonyldiamide [14]

Chemical Formula: $(\text{NH}_2)_2\text{CO}$ or $\text{CH}_4\text{N}_2\text{O}$ [14]

Molecular Weight: 60.06 g/mole [14]

CAS#: 57-13-6

Structure:

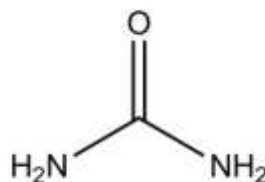

Figure 8.5 Urea

8.1.5. b. Physical Properties [14]

Physical state and appearance: Solid (crystals solid)

Odor: Almost odorless; Develops slight ammonia like odor, especially when exposed to moisture

Taste: cooling, saline

Color: white.

Melting Point: 132.7°C (270.9°F)

Specific Gravity: 1.323 (Water = 1)

Vapor Density: 2.07 (Air = 1)

pH: 7.5-9.5 (10% aq. solution) [15]

Solubility: Easily soluble in cold water, hot water.

8.1.5. c. Description and Uses

Urea is a natural product of protein metabolism that is eliminated from the body in the urine. A solution of urea in water decomposes when heated.

It is used in fertilizers due to the abundance of nitrogen it contains. It is used in animal feed and in the manufacture of resins and plastics. It is used in the paper industry to soften cellulose. It is also used in medicine as a diuretic, to reduce intra cranial and intraocular pressure. It has been used as a topical antiseptic and to test renal functioning [13].

8.1.6 Neusilin[®]US2

8.1.6. a. Introduction [1]

Source: Fugi Chemical Industry Co., Ltd.

Chemical Name: magnesium aluminometasilicate

Empirical Formula: $\text{Al}_2\text{O}_3 \cdot \text{MgO} \cdot 1.7\text{SiO}_2 \cdot x\text{H}_2\text{O}$

CAS#: 12511-31-8

Structure: Aluminum is present as the tetrahedron or octahedron, Magnesium is present as the octahedrons, Silicone is present as the tetrahedron.

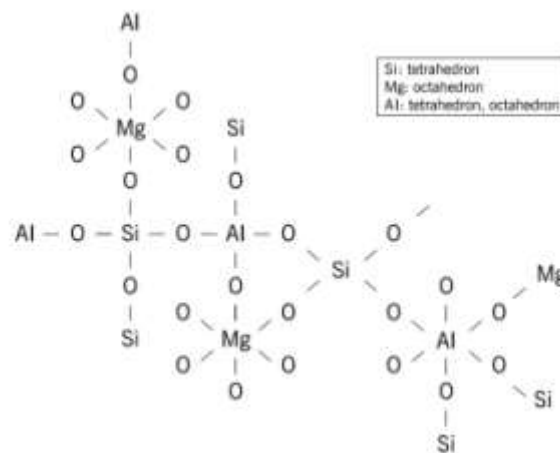

Figure 8.6 Structure of Neusilin[®]US2 [1]

8.1.6. b. Physical Properties [1]

Appearance: White granules

Physical Form: Amorphous

Specific Gravity: 2.2

Bulk Density: 0.12-0.18g/mL

Tap Density: 0.16- 0.22

Loss on drying: less than 7%

Specific surface area: 300m²/g

Particle size distribution: 44-177 μm

Water absorption capacity: 2.4-3.1 mL/g

pH of 4% slurry: 6.0-8.0

Solubility: Physically insoluble in water or in alcohol

8.1.6. c. Description and Uses

Neusilin[®]US2 is a brand name for the amorphous form of magnesium aluminometasilicate. It is a material that can be useful as an excipient in a number of pharmaceutical formulations. It does not form a gel when in an aqueous solution like magnesium aluminosilicate. Neusilin[®]US2 is a very fine amorphous or granular material that has a very large specific surface area that can absorb oil or water. It has very good compressibility and thus gives very hard tablets at very low compression force even when used in small amounts with other fillers. It helps in stabilizing moisture sensitive and lipophilic API's. It is stable against heat and has a long shelf life.

An important use of Neusilin[®]US2 is to improve the properties of formulations such as solid dispersions and self micro-emulsifying drug delivery systems [1].

8.1.7 Water

Deionized water was obtained from the D.I. water plant at the University of Toledo, Health Science Campus. Water was used to maintain a constant relative humidity condition of 100% RH at 25⁰C.

8.1.8 Sodium Chloride

8.1.8. a. Introduction

Source: J.T. Baker

Chemical Name: Sodium Chloride

Chemical Formula: NaCl

Empirical Formula: NaCl

Molecular Weight: 58.44 g/mole [16]

CAS#: 7647-14-5

Structure:



Figure 8.7 Sodium Chloride

8.1.8. b Physical Properties [16]

Physical state and appearance: Solid (solid crystalline powder.)

Odor: Slight

Taste: Saline

Color: White

pH (1% solution in water): 7 (neutral)

Boiling Point: 1413°C (2575.4°F)

Melting Point: 801°C (1473.8°F)

Specific Gravity: 2.165 (Water = 1)

Solubility: Easily soluble in cold water (360 g/L at 20°C [17]), hot water. Soluble in glycerol, and ammonia. Very slightly soluble in alcohol. Insoluble in Hydrochloric Acid.

8.1.8. c Description and Uses

It exists as white cubic crystals, granules or powder. It is transparent or translucent when in the form of large crystals.

The naturally occurring form has some magnesium and calcium chloride associated with it which absorbs water and forms a cake. It is an important source of sodium and chloride along with a number of other ingredients in common salt. It is used as a preservative, for salting out in the manufacture of dyes, in printing fabric, in freezing mixtures, curing hides, and in metallurgy. Medically, sodium chloride is used for prophylactic treatment of salt deprivation, orally as an emetic and in enemas. It is used topically for inflammatory lesions [13]. It is used for making solutions isotonic for intravenous administration. Uses also include rehydration therapy, inhalation for rehydrating the trachea, and as an optical solution for corneal edema [9]. It is used as a salt for maintaining a constant relative humidity atmosphere of $75.29 \pm 12\%$ RH at 25°C [18].

8.1.9 Potassium Acetate

8.1.9. a. Introduction

Source: Fisher Biotech

Chemical Name: Potassium acetate

Chemical Formula: CH_3COOK [13]

Empirical Formula: $\text{C}_2\text{H}_3\text{KO}_2$ [19]

Molecular Weight: 98.15 [19]

CAS#: 127-08-2

Structure:

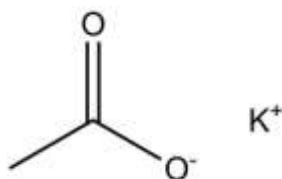

Figure 8.8 Potassium Acetate

8.1.9. b. Physical Properties [19]

Physical State: Powder

Appearance: colorless to white

Odor: acetic odor

pH of 0.1molar solution: 9.7 [13]

Freezing/Melting Point: 292 deg C

Specific Gravity/Density: 1.80

Solubility: Easily soluble in cold water

8.1.9. c. Description and Uses

It is a colorless, lustrous; rapidly deliquescent crystal or white crystalline powder. It has been used medically in cardiac arrhythmias, as expectorant and diuretic. A saturated solution of potassium acetate can be used to maintain a constant relative humidity condition of $23.11 \pm 0.25\%$ at 25°C [18].

8.1.10 Magnesium Nitrate

8.1.10. a. Introduction

Source: Fisher Biotech

Chemical Name : Magnesium Nitrate Hexahydrate [20]

Chemical Formula: $\text{Mg}(\text{NO}_3)_2 \cdot 6\text{H}_2\text{O}$ [20]

Molecular Weight: 256.41 g/mole [20]

CAS#: 13446-18-9[20]

Structure:

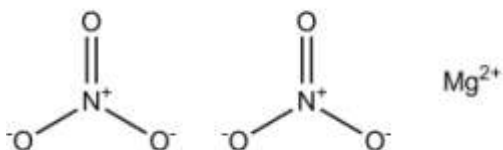

Figure 8.9 Magnesium nitrate

8.1.10. b. Physical Properties [20]

Physical state and appearance: Solid, hygroscopic in nature

Color: White

Boiling Point: Decomposition temperature: 330°C (626°F)

Melting Point: 89°C (192.2°F)

Specific Gravity: 1.64 (Water = 1)

Dispersion Properties: See solubility in water

Solubility: Easily soluble in cold water (420 g/L) [21]

8.1.10. c. Description and Uses

It is a colorless clear, deliquescent crystalline material. An aqueous solution has a neutral pH. It is used in pyrotechnics [13]. A saturated solution of magnesium nitrate can be used for maintaining a constant relative humidity condition of $54.38 \pm .23\%$ RH at 25⁰C [18].

8.1.11 Hydrochloric Acid

8.1.11. a. Introduction

Source: Chempure

Chemical Name: Hydrochloric Acid

Chemical Formula: HCl

Molecular Weight: 36.46 [22]

CAS#: 7647-01-0 [22]

Structure:



Figure 8.10 Hydrochloric Acid

8.1.11. b Physical Properties [23]

Appearance Clear liquid.

Odor Pungent odor.

Specific Gravity 1.18 g/mL @ 20°C.

Vapor Density (air=1) 1.27.

Solubility Completely soluble in water.

Melting Point -114°C.

Boiling Point/Range 85°C.

Vapor Pressure (20°C) 15 mm Hg.

pH 0 to 1(very acid & corrosive).

8.1.11. c Description and Uses

Hydrochloric acid (HCl) can be called a solution of hydrogen chloride gas in water. It may be yellow colored due to iron, chloride or organic matter. A 1N solution of HCl has a pH of 0.1 and a 0.1 N has a pH of 1.1. It is used to produce chlorides. It is used in ore refining. It is used in the production of tin and tantalum. It is also used for hydrolyzing starch and protein to make various food products. Other uses include pickling; cleaning metallic surfaces; solvent in organic synthesis. Medically it is used as a treatment for achlorhydria. Dose is 0.6 to 8 mL of 10% solution well diluted given orally. Contact of concentrated solution to the skin can cause severe burns. Prolonged contact can lead to dermatitis and photosensitization. Inhalation can lead to coughing, and ulceration of the respiratory tract.

Ingestion can cause the mucous membrane, esophagus, stomach to corrode. Can cause, diarrhea, intense thirst nausea and vomiting [13]. In this study they were used to mimic gastric conditions for dissolution studies.

8.1.12 Sodium Phosphate Monobasic

8.1.12. a. Introduction [24]

Source: Spectrum Chemicals

Chemical Name: Sodium phosphate monobasic, Anhydrous

Chemical Formula: NaH_2PO_4

Molecular Weight: 119.98 g/mole

CAS#: 7558-80-7

Structure:

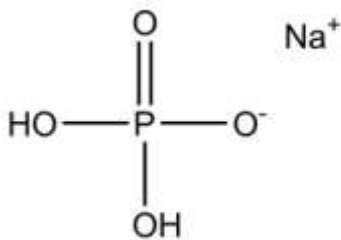

Figure 8.11 Monobasic Sodium Phosphate

8.1.12. b. Physical Properties [24]

Physical state and appearance: Solid. (crystalline powder)

Odor: Odorless.

Taste: Not available.

Color: White.

Solubility: Easily soluble in cold water, hot water.

8.1.12. c. Description and Uses

At room temperature its form with two water molecules is white crystalline in nature. It is freely soluble in water and almost insoluble in alcohol. It is used in baking powder and boiler water treatment. Medically it is used as a urinary acidifier [13]. In this study it was used to make phosphate buffer for dissolution studies.

8.1.13 Dibasic Sodium Phosphate Heptahydrate

8.1.13. a. Introduction [25]

Source: Spectrum Chemicals

Chemical Name: Sodium Monohydrogen Phosphate heptahydrate

Chemical Formula: $\text{Na}_2\text{HPO}_4 \cdot 7\text{H}_2\text{O}$

Molecular Weight: 268.07 g/mole

CAS#: 7782-85-6

Structure:

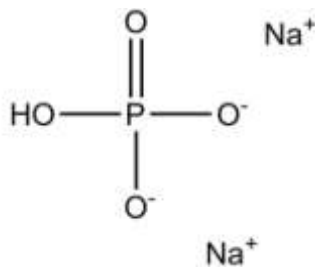

Figure 8.12 Dibasic Sodium Phosphate

8.1.12. b. Physical Properties [25]

Physical state and appearance: Solid. (Solid powder.)

Odor: Odorless.

Color: White.

Specific Gravity: Density: 1.7 (Water = 1)

Solubility: Easily soluble in cold water, hot water. Solubility in water: 104 g/100 mL @
40 deg. C

8.1.13. c. Description and Uses

Sodium phosphate, dibasic is crystals or granules that are soluble in 4 parts of water. It is used as a mordant in dyeing, for weighting silk or in manufacture of enamel. Medically it is used as a mild saline cathartic. It is used to treat phosphorous deficiency or in lead poisoning [13]. In this study it was used to make phosphate buffer.

8.1.14 Acetone

8.1.14. a. Introduction [26]

Source: Fisher Chemicals

Chemical Name: Acetone

Chemical Formula: C_3H_6O

Molecular Weight: 58.08 g/mole

CAS#: 67-64-1

Structure

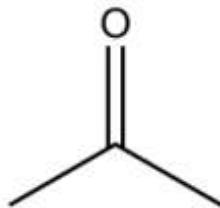

Figure 8.13 Acetone

8.1.14. b. Physical Properties [26]

Physical state and appearance: Liquid.

Odor: Fruity. Mint-like. Fragrant. Ethereal

Taste: Pungent, Sweetish

Color: Colorless. Clear

Boiling Point: 56.2°C (133.2°F)

Melting Point: -95.35 (-139.6°F)

Critical Temperature: 235°C (455°F)

Specific Gravity: 0.79 (Water = 1)

Vapor Pressure: 24 kPa (@ 20°C)

Vapor Density: 2 (Air = 1)

Odor Threshold: 62 ppm

Solubility: Easily soluble in cold water, hot water

8.1.14. c Description and Uses

Acetone is a volatile, highly flammable liquid, characteristic odor, pungent and sweetish taste. It is miscible with water, ethanol, dimethyl formamide and most oils.

It is used as solvent for fats, oils, waxes, resins, rubber, plastic, lacquers, and varnishes. It is used in the manufacture of a number of chemicals like rayon, chloroform, bromoform, iodoform, and methyl isobutyl ketone. It is also used in photographic films as well. Medically it is used topically as a cleansing agent prior to injections. Inhalation may cause headache, fatigue, excitement, and bronchial irritation [13]. In this study it is used as a solvent for preparing phenytoin solid dispersions.

8.2 Method for Preparation of Solid Dispersions

Two different methods were used to prepare the three solid dispersions, two for indomethacin and one for phenytoin. Four different concentrations were prepared for each of the three solid dispersions to determine the effect of change of concentrations of the drug and the carrier on the release rate of the drug from the dose. Neusilin[®] US2 was used as an adsorbent to make the solid dispersions ready for any further pharmaceutical preparation, without any processing.

8.2.1 Method for Preparing the Solid Dispersions with Indomethacin and Urea

Four formulations utilizing various ratios of indomethacin and urea were made. The ratios for indomethacin and urea used to make the solid dispersions were 1:9, 3:7, 1:1 and 7:3 for indomethacin and urea, respectively. An amount of Neusilin[®]US2 was double the weight of indomethacin used in that formulation. These solid dispersions were made by the hot melt method. In this method urea (the carrier) was heated to a temperature of

135⁰C and melted. Once the carrier was molten, the drug, indomethacin was added to the molten carrier and mixed thoroughly until a clear solution was formed. Once a clear solution was formed, Neusilin[®]US2 which was pre-heated to 135⁰C was added to the solid dispersion. The mix was then thoroughly mixed to obtain an even dispersion of the solid dispersion on the adsorbent and then quench cooled by placing the mixture into a freezing mixture made with ice and salt. The finished product was then stored in an air tight container in a dark and cool place for further testing.

8.2.2 Method for Preparing the Solid Dispersions with Indomethacin and Kollidon[®]VA64

This formulation was made using the solvent evaporation method. The four different ratios of indomethacin (drug) to Kollidone[®]VA64 (carrier) were 1:9; 3:7; 1:1 and 7:3. Indomethacin and Kollidone[®]VA64 were added to a beaker containing the required amount of ethanol (solvent). Once these two components were dissolved in the solvent, Neusilin[®]US2 (adsorbent) was added and thoroughly mixed. The amount of Neusilin[®]US2 was double the amount in weight of indomethacin used. In the case of the first combination which is 1:9 indomethacin: KollidonVA64[®], the amount of Neusilin[®]US2 was four times the weight of indomethacin. This was done to ensure that there was enough Neusilin[®]US2 for the amount of solution present. The slurry formed with the solution of indomethacin and Kollidon[®]VA64 in ethanol, and Neusilin[®]US2 was then subjected to solvent removal by heat. The finished product is left in a desiccator for a period of 24 hours in order for the complete removal of the solvent used. The product is then stored in an air tight container in a dark cool place until further analysis.

8.2.3 Method for Preparing the Solid Dispersions with Phenytoin and Kollidon[®] VA64

This formulation was made using the solvent evaporation method. Four different ratios of phenytoin (drug) to Kollidone VA64 (carrier) were 1:9; 3:7; 1:1 and 7:3. Phenytoin and Kollidone-VA64 were added to a beaker containing the required amount of acetone (solvent). Once these two components were dissolved in the solvent, the required amount of Neusilin[®]US2 (adsorbent) was added and thoroughly mixed to form a slurry.

This slurry is then subjected to solvent removal by heat. The finished product is left to air dry in a desiccator for a period of 24 hours to facilitate the removal of any residual solvent. The product is then stored in an air tight container in a dark cool place until further analysis.

8.3 Methods for Analytical Techniques

8.3.1 Differential Scanning Calorimetry

A Mettler Toledo DSC 822[°] with a TS0801RO Sample Robot and a TS0800GCI Gas Controller from Mettler-Toledo. Inc., 1900 Polaris Parkway, Columbus, OH, 43240 was used for all the DSC studies performed on the raw materials, physical mixtures and solid dispersions. The DSC uses Star[°] Software V8.10 for its operation. Samples ranging from 8 to 15 mg were used and the results were normalized using Star[°] software so that the results could be compared. The samples were placed in a 100 μ L pan. The pans are covered with a lid and the lid is crimped into place.

A pinhole is made on the lid to vent out any gas which might result while heating. The pan is then placed inside the furnace using an empty pan as a blank. The DSC was calibrated using indium (5-10 mg) with a melting onset temperature at 156 ± 0.2 °C and zinc with a melting onset temperature of 419.6 ± 0.7 °C as the standards. The two processes show a heat flow of 28.45 ± 0.6 J/g and 107.5 ± 3.2 J/g for indium and zinc, respectively.

8.3.2 Powder X-Ray Diffraction (PXRD)

PXRD studies were performed to check for any crystallinity in the formulation after it was made and after the stability studies were performed. Avoiding recrystallization of the drug in the formulation was one of the goals of this study. PAN analytical X-Pert Pro V1.6 with X-Pert Data Collector V2.1 software was used equipped with a CuK α 2 anode tube and diffractometer of radius 240 mm. The XRD scan was performed using BB004 flatstage. The powdered sample was placed in an aluminum sample holder which had a one inch square with a depth of 0.5 mm. Data were collected by scanning the sample at 45 kV and 40 mA. Samples were scanned from $5-35^\circ 2\theta$ at a step size of 0.0084 and scan rate of 1.00°/min.

8.3.4 Scanning Electron Microscopy (SEM)

Surface morphology of the raw materials and the formulated product were studied using a scanning electron microscope equipped with JOEL JSM 7500. Snappy 4[®] software was used to obtain the digital picture. Samples were placed on brass stubs using double sided adhesive tape.

The samples were coated with a layer of gold using a gold sputter technique to improve the conductivity of the surface of the sample to obtain good images. A Denton Vacuum Desk II was used for the gold sputter technique. Pictures were taken at magnifications whereby they could be compared with each other, which best shows the surface features of the various materials.

8.3.5 Ultraviolet-Visible Absorption Spectroscopy

Genesys-6[®] UV Spectrophotometer from Thermo Scientific Inc. was used for all UV-Visible spectroscopic studies. For the quantitative determination of the drug in various samples, the Beer-Lambert's Law was used. The first step was to create a standard calibration curve. To prepare a calibration curve 110 mg of the drug was dissolved in 100 mL of a suitable solvent. A 10 mL aliquot was withdrawn from this and diluted to 100 mL. Various concentrations were made by serial dilution of this basic stock solution. The various solutions were measured, in triplicate, using UV-Visible absorption spectroscopy to get absorption data. The data, which was a mean of the three readings obtained was used to prepare a calibration curve. This curve was further used for the determination of the concentration of the drug in any formulation or during the dissolution studies.

8.3.6 Dissolution Testing

All the dissolution tests were performed in triplicate. Dissolution studies for the solid dispersion granules were carried out using USP Type II apparatus (Vanderkamp[®] 600 six spindle dissolution apparatus) at $37 \pm 0.5^\circ\text{C}$ with a paddle rotation speed adjusted to 100

rpm. A 900 mL portion of buffer at pH 1 made by mixing 7 mL of 12 N hydrochloric acid to water to make up 1L was used for the dissolution studies for phenytoin. Phosphate buffer at pH 7.6 made by dissolving 4.8 grams of Monobasic sodium phosphate and 14.7 grams of dibasic sodium phosphate in 1 L of water, was used to study the dissolution of indomethacin. The sample size was chosen so as to keep the amount of drug constant at 50 mg for indomethacin and 100 mg for phenytoin. Samples were drawn from the dissolution media at regular intervals and replaced with equal amounts of the buffer to maintain sink conditions. The withdrawn samples were passed through a 0.2 micron filter to get rid of any undissolved particles. This solution was then tested using UV-Visible spectroscopy to determine the dissolved amount of drug in the dissolution media.

8.3.7 Humidity and Temperature Studies

It is important that the formulation is stable for its entire shelf life time. To ensure that this occurs, accelerated stability studies for the formulations were conducted. For this purpose the 12 formulations (Four each for the three drug and carrier combination) were subjected to various temperature and humidity conditions for a period of two months. Four different hot air ovens were used to maintain the temperature of the samples at four temperatures (30⁰C; 35⁰C; 40⁰C and 45⁰C) for a period of two months. The samples were also placed in different relative humidity conditions for the same amount of time. This was achieved by using saturated solutions of different salts at 25⁰C. Saturated solutions of sodium chloride, magnesium nitrate and potassium acetate were used to obtain a relative humidity of 75.29 ±0.12%, 54.38± 0.23% and 23.11±0.25% respectively. Deionized water was used to attain a relative humidity of 100%. In order to prepare the saturated

solutions of the various salts, the salts were placed in appropriate containers and deionized water was used to moisten the salts. The samples in smaller open containers were placed in a larger container having the saturated salt solution or water in it. The larger container was then closed and sealed. Figure 8.10 shows the apparatus used for the controlled relative humidity conditions. The larger jar was the size of baby food jars which contained the saturated salt solution and the smaller container was an open container. Both of them were made from glass and the larger container had a metal lid and rubber seal which would screw into place. Opening the container lead to a change in the relative humidity condition, so opening the containers was only done when sampling. Samples were withdrawn at predetermined time intervals. The jars were then closed and allowed to re-equilibrate before the next sampling time.



Figure 8.14 Set up used for relative humidity studies

Chapter Nine

Results and Discussion

9.1 Indomethacin and Urea Solid Dispersion

Four ternary solid dispersions were prepared using 10% w/w, 30% w/w, 50% w/w and 70% w/w of indomethacin (I) and 90% w/w, 70% w/w, 50% w/w and 30% w/w of urea (U) respectively, coated on 20%w/w (the total weight of I and U) of Neusilin[®]US2 (adsorbent). Physical mixtures containing these same concentrations of afore mentioned ingredients were also prepared as comparisons. The solid dispersions and the physical mixtures were subjected to tests in order to study the changes that take place with the drug when formulated into a solid dispersion. Powder X-ray Diffraction (PXRD), Scanning Electron Microscopy (SEM), Differential Scanning Calorimetry (DSC), dissolution studies and stability studies were performed on the solid dispersions. PXRD was performed on the physical mixtures as well.

9.1.1 Differential Scanning Calorimetry

Differential Scanning Calorimetric (DSC) studies were performed on the ingredients used to make the ternary solid dispersions, which included indomethacin (I), urea (U), and Neusilin[®]US2 (N). Physical mixtures (PM) of indomethacin and urea in the ratios previously given and ternary solid dispersions were prepared using indomethacin (I), urea (U) and Neusilin[®]US2 as previously described, and used to obtain their thermograms. DSC studies were performed with the intension of observing any interaction between the various ingredients and to study the change in crystallinity.

Figure 9.1 shows the comparison between the thermogram for Neusilin[®]US2 (N), indomethacin (I), urea (U), and the physical mixtures (PMs I+U).

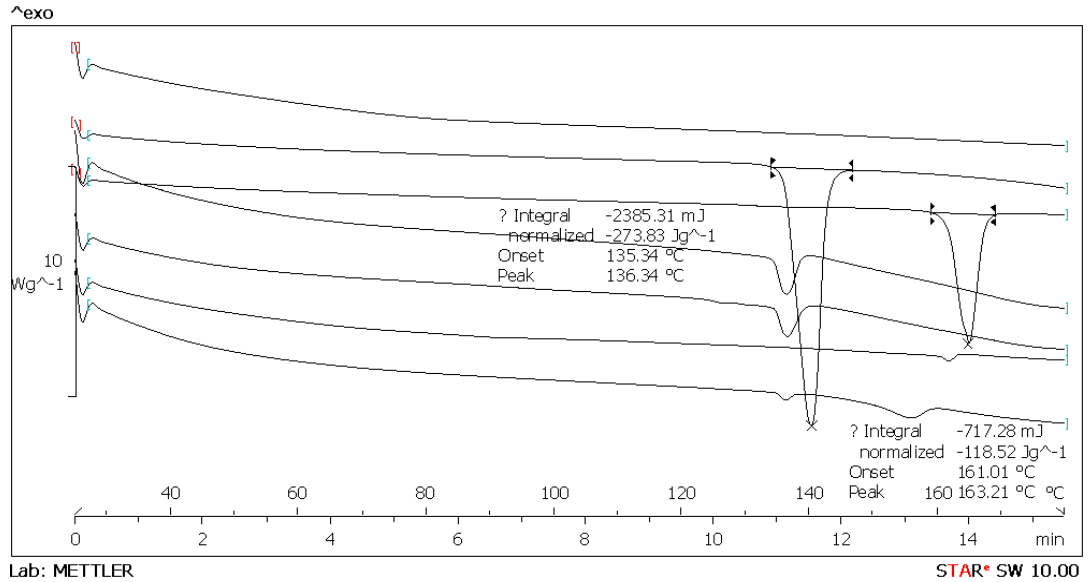

Figure 9.1 DSC Thermogram showing from top to bottom Neusilin[®]US2, Urea, Indomethacin, 10% I+U PM, 30% I+U PM, 50% I+K PM, 70% I+U PM.

Figure 9.2 shows a comparison between the thermograms for Neusilin[®]US2 (N), indomethacin (I), urea (U), and the four solid dispersions.

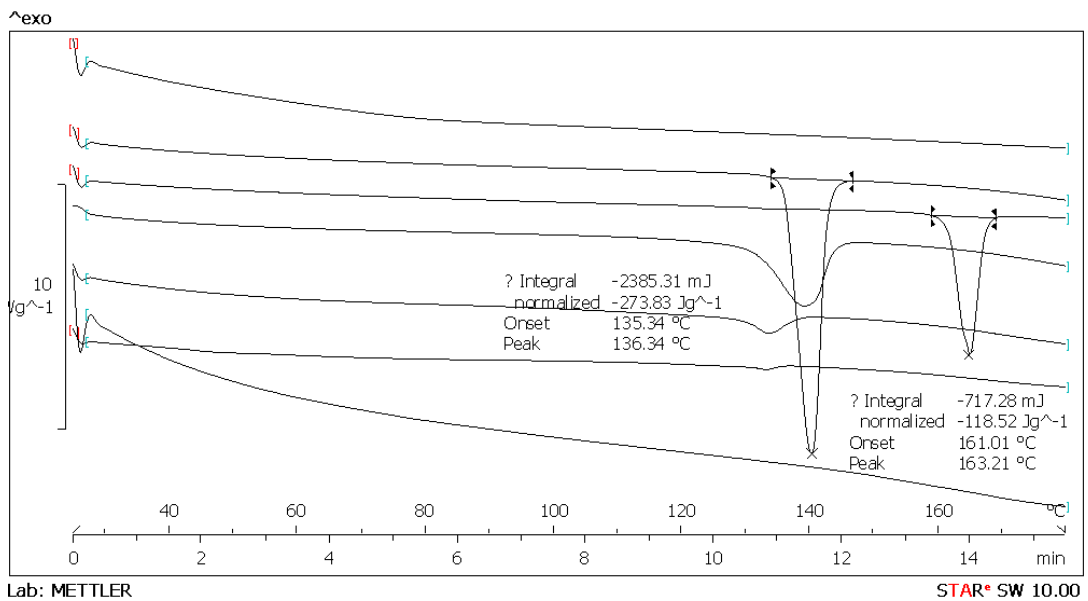

Figure 9.2 DSC Thermogram showing from top to bottom Neusilin[®]US2, Urea, Indomethacin, 10% I+U SD, 30% I+U SD, 50% I+K SD, 70% I+U SD.

The thermograms show the melting peak of indomethacin at 163.21⁰C. The thermograms for the physical mixture seen in Figure 9.1 shows that the intensity of the peak for urea decreases from physical mixtures containing 10% indomethacin to physical mixtures containing 70% indomethacin. This means that there might be more urea in the mix than is required in order to achieve a good solid dispersion. The thermograms for the physical mixtures containing 50% and 70% indomethacin show peaks of very low intensity for indomethacin. The thermograms suggest that as the amount of indomethacin in the physical mixtures increases, some of drug stays in its crystalline form in the physical mixtures. The thermograms for solid dispersions seen in, Figure 9.2, shows that the peak intensity for urea decreases as the quantity of drug in the solid dispersion increases. None of them shows any peak of any intensity for indomethacin, suggesting that indomethacin might be in its completely amorphous form in the solid dispersion. Powder X-Ray Diffraction (PXRD) studies will help in confirming the results suggested by the DSC studies. Results from the PXRD studies are discussed a little later in this chapter.

9.1.2. Scanning Electron Microscopy

Scanning Electron Microscopy (SEM) was performed in order to characterize the surface morphology of indomethacin (I), urea (U) , Neusilin[®]US2 (N), and the physical mixture (PM I+U) containing 10% w/w indomethacin, 90% w/w urea and Neusilin[®]US2 equal to the combined weight of urea and indomethacin. Ternary solid dispersions prepared as previously described were also studied using SEM. The images for the solid dispersions showed that the Neusilin[®]US2 particles were coated with the solid dispersion suggesting that Neusilin[®]US2 can be coated by the technique used in the study. Figure 9.3 shows

SEM images for indomethacin (I), urea (U) , Neusilin[®]US2 (N), and physical mixture (PM I+U). Figure 9.4 shows the four solid dispersions.

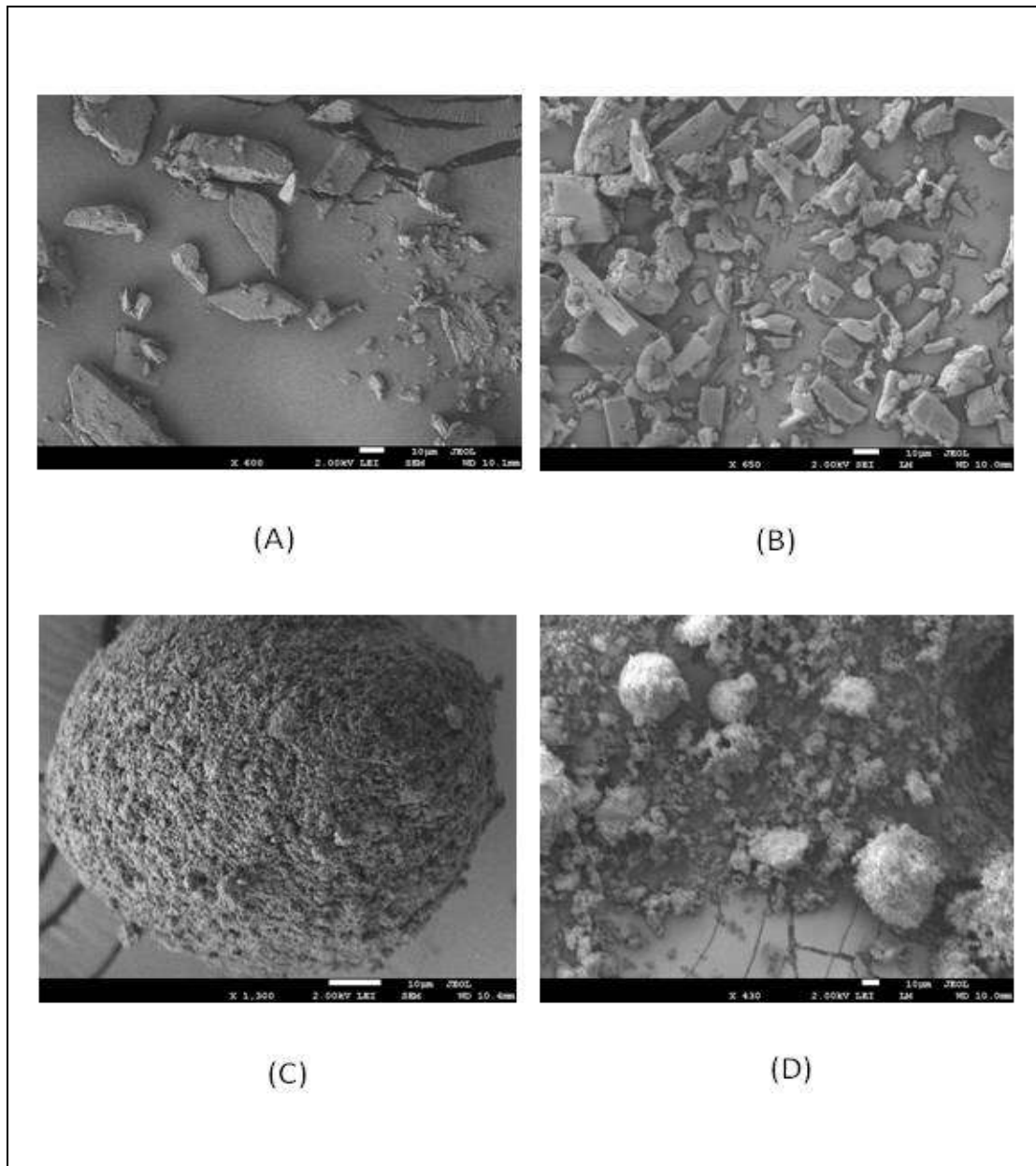

Figure 9.3 SEM images (A) Indomethacin, (B) Urea, (C) Neusilin[®]US2, (D) PM I+U

The SEM pictures for the drug indomethacin shows the crystalline nature of the drug.

The SEM picture for urea shows that it is also crystalline in nature.

The SEM picture for Neusilin[®]US2 reveals that it is spherical in nature and has a very large surface area due to its porosity.

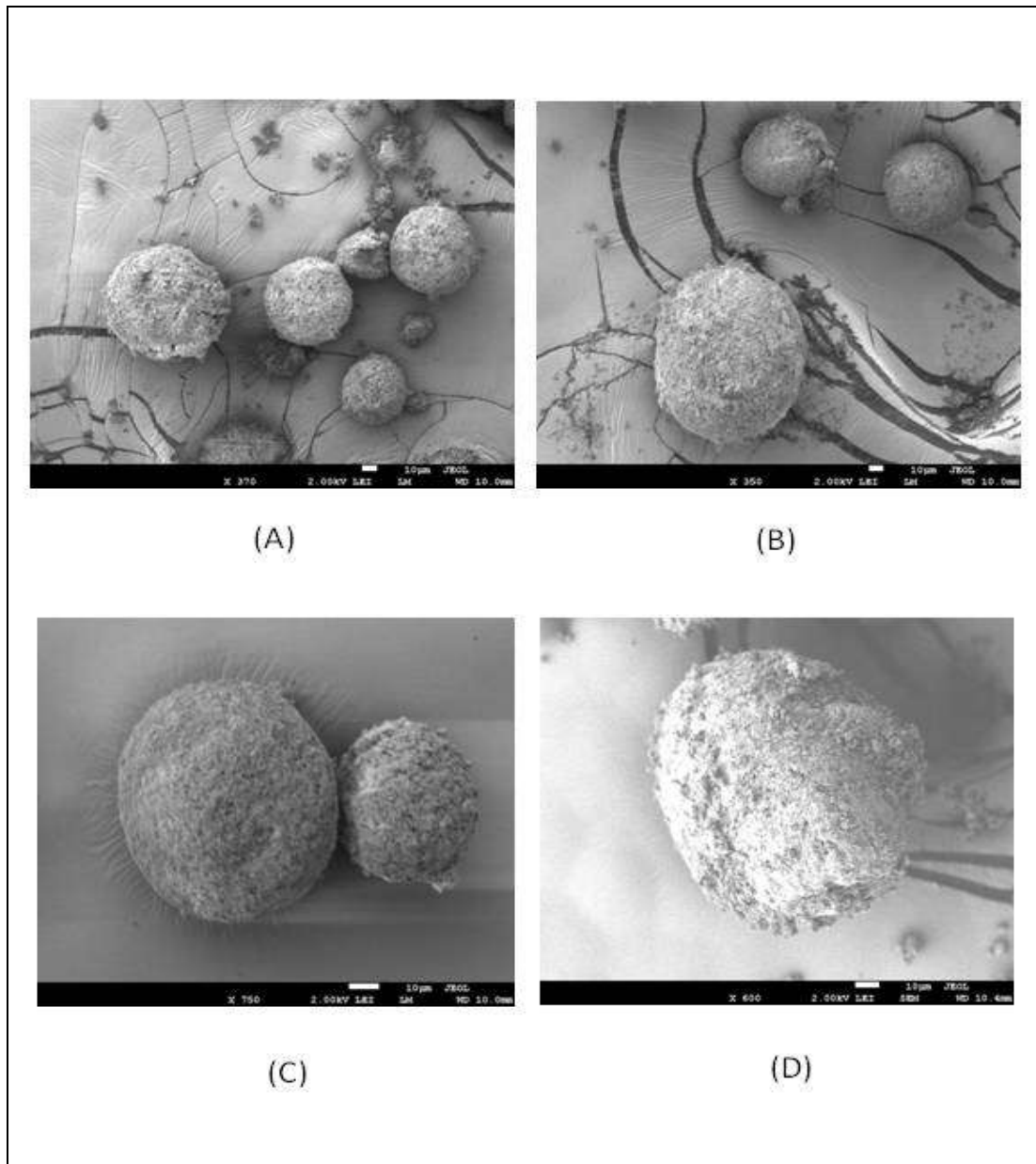

Figure 9.4 SEM image (A) 10% I+U SD, (B) 30% I+U SD, (C) 50% I+U SD, (D)70% I+U SD

The SEM image for the physical mixtures indicates that there might be a reduction in the crystal structure, which will have to be confirmed using other studies like PXRD.

The SEM images for the solid dispersions shows spherical structures which have Neusilin[®]US2 as the core coated with the solid dispersion of indomethacin and urea on its surface.

9.1.3. Powder X-Ray Crystallography

Powder X-Ray Crystallography (PXRD), gives a true picture of any crystallinity occurring with a substance when the crystallograph is recorded. The crystallograph of the drug indomethacin (I) was compared with that of the various physical mixtures and solid dispersions. This gives insight into how crystalline or amorphous the drug has become. Solid dispersions were subjected to stress under accelerated stability conditions and subsequently tested for recrystallization. For this purpose the four solid dispersions, prepared as described previously, were kept at temperatures of 30⁰C, 35⁰C, 40⁰C, and 45⁰C and in relative humidity conditions of 100%, 75.29 ±.12%, 54.38± .23 and 23.11±0.25%, for a period of two months. Samples were taken at the end of the two month time period and tested for recrystallization. Figure 9.5 shows the crystallograph for the physical mixtures. Figure 9.6 shows the crystallograph for the four solid dispersions prepared. Figures 9.7 to 9.10 show the crystallographs for the solid dispersions kept at 30⁰C, 35⁰C, 40⁰C, and 45⁰C for two months. Figures 9.11 to 9.14 show the crystallographs for the solid dispersions kept in 100%, 75.29 ±.12%, 54.38± .23 and 23.11±0.25% relative humidity (RH) for two months.

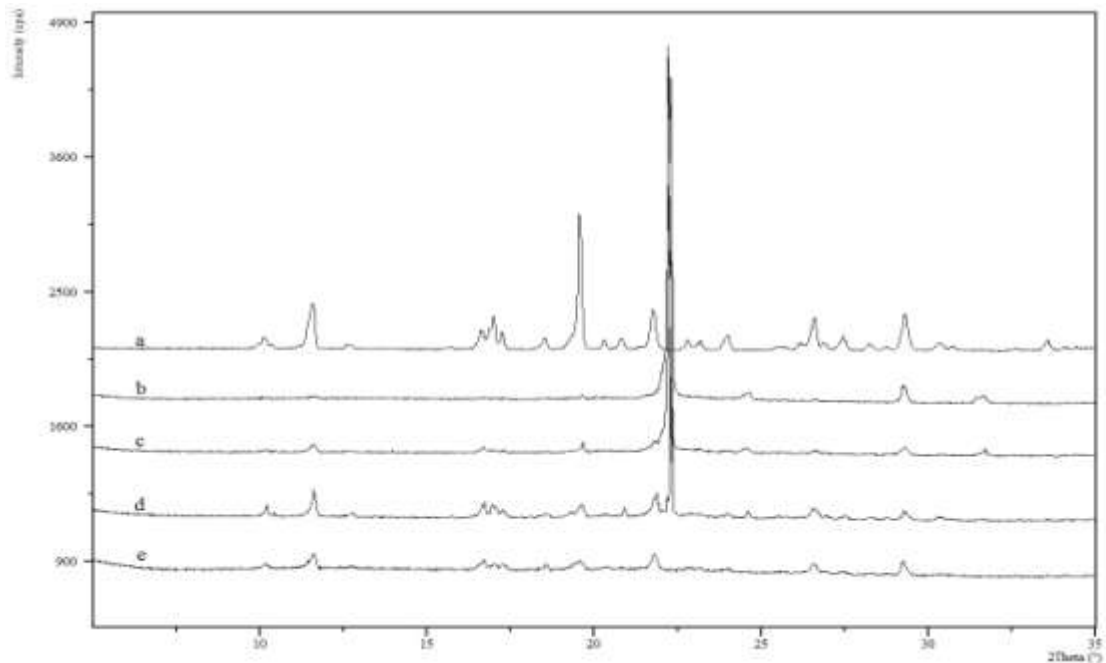

Figure 9.5 XRD for Indomethacin and the four physical mixtures: a- indomethacin; b- 10% I+U PM; c- 30% I+U PM; d-50% I+U PM; e- 70% I+U PM

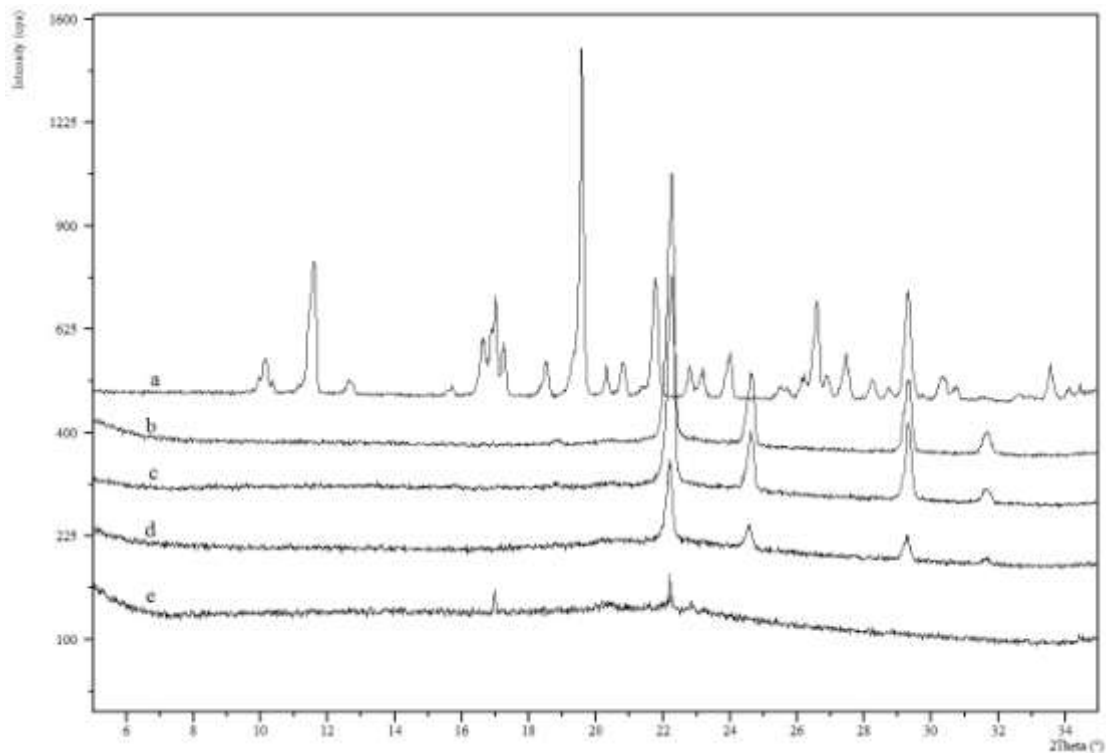

Figure 9.6 XRD for indomethacin and four solid dispersions: a- indomethacin; b-10%I+U SD; c-30% I+U SD; d-50% I+U SD; e- 70% I+U SD

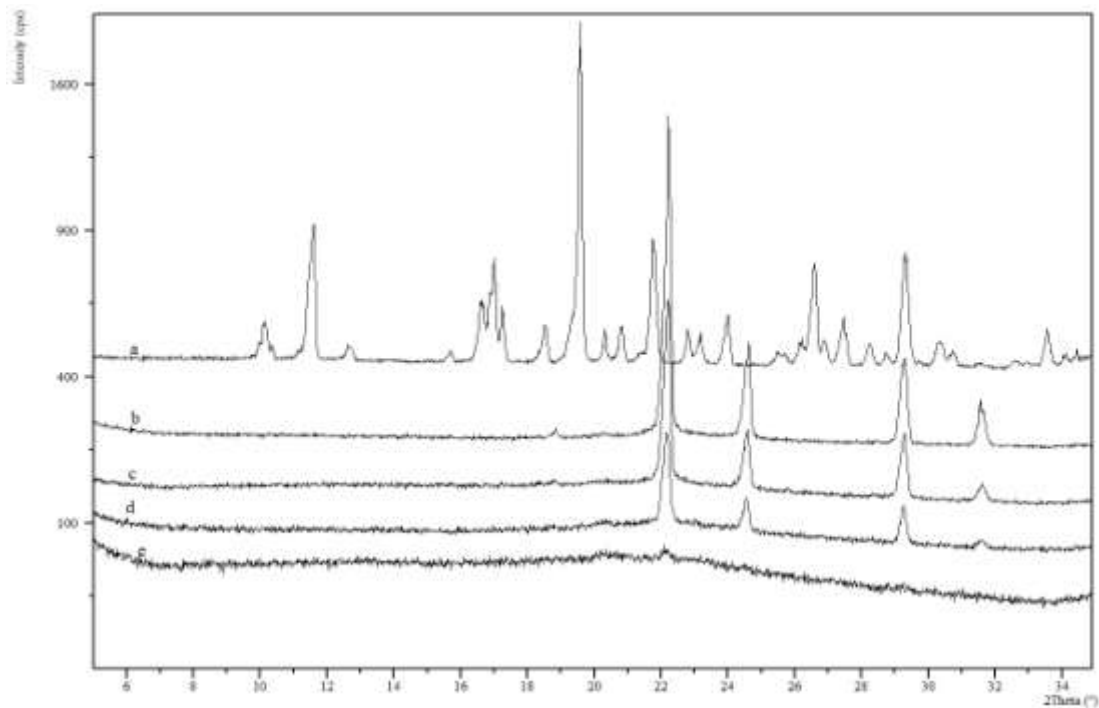

Figure 9.7 PXR Solid dispersions kept at 30⁰C for a period of two months:
 a- indomethacin; b-10%I+U; c-30% I+U; d-50% I+U; e- 70% I+U

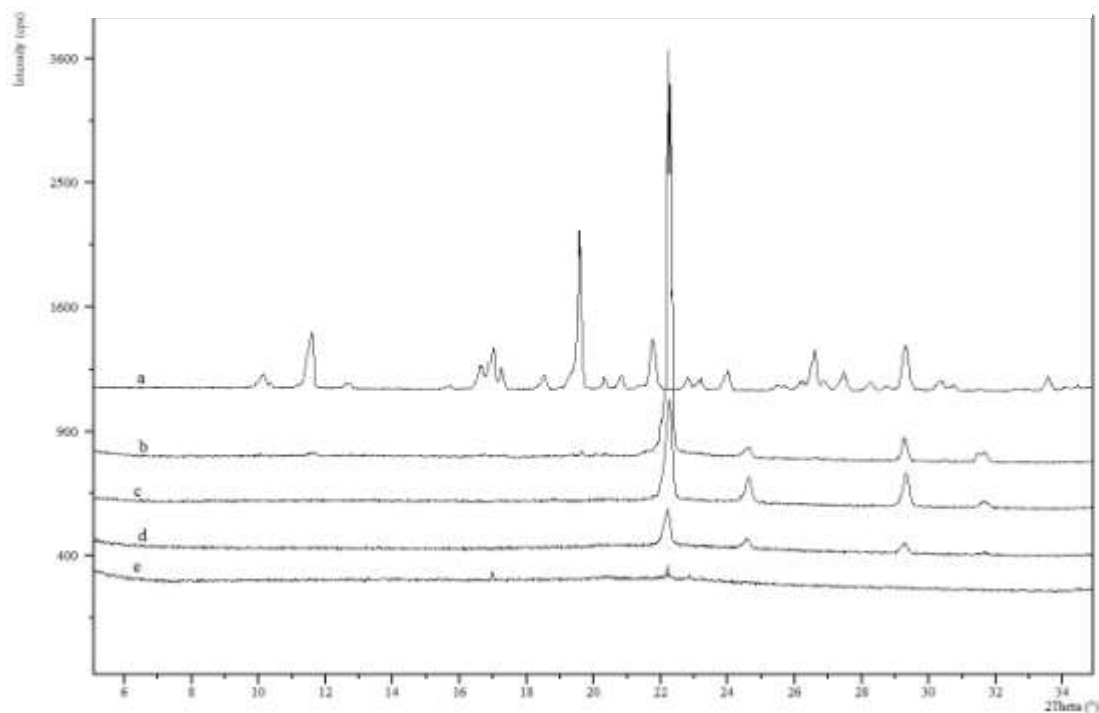

Figure9.8 PXR Solid dispersions kept at 35⁰C for a period of two months:
 a- indomethacin; b-10%I+U; c-30% I+U; d-50% I+U; e- 70% I+U

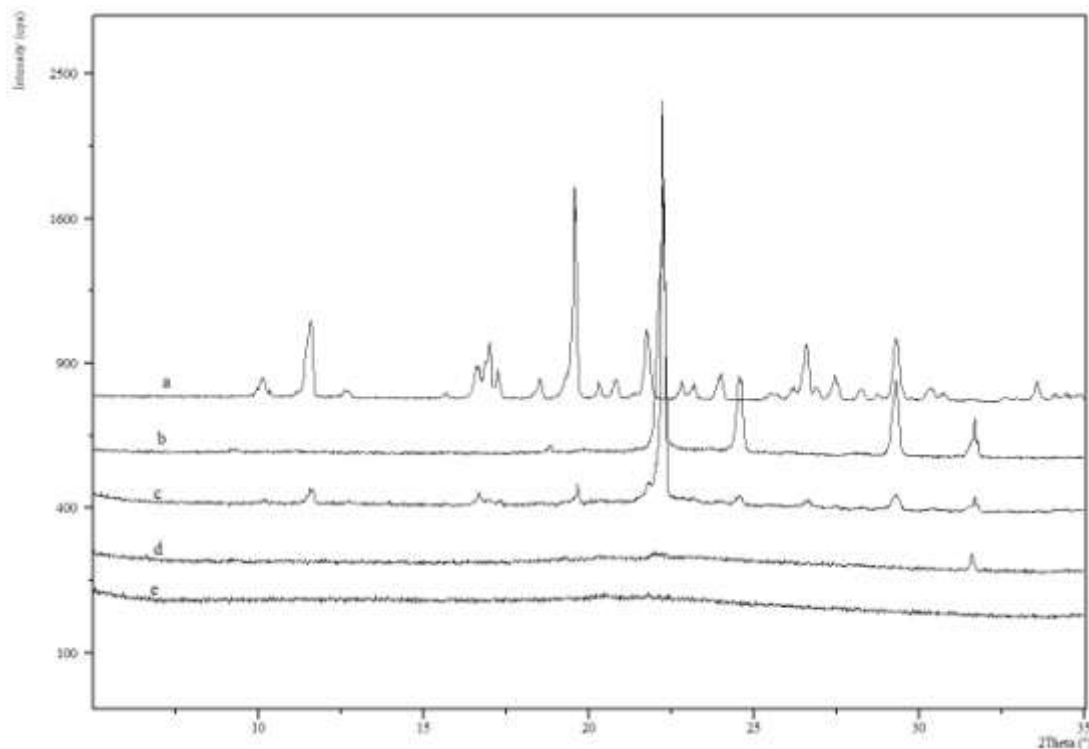

Figure 9.9 PXRd Solid dispersions kept at 40⁰C for a period of two months: a- indomethacin; b-10%I+U; c-30% I+U; d-50% I+U; e- 70% I+U

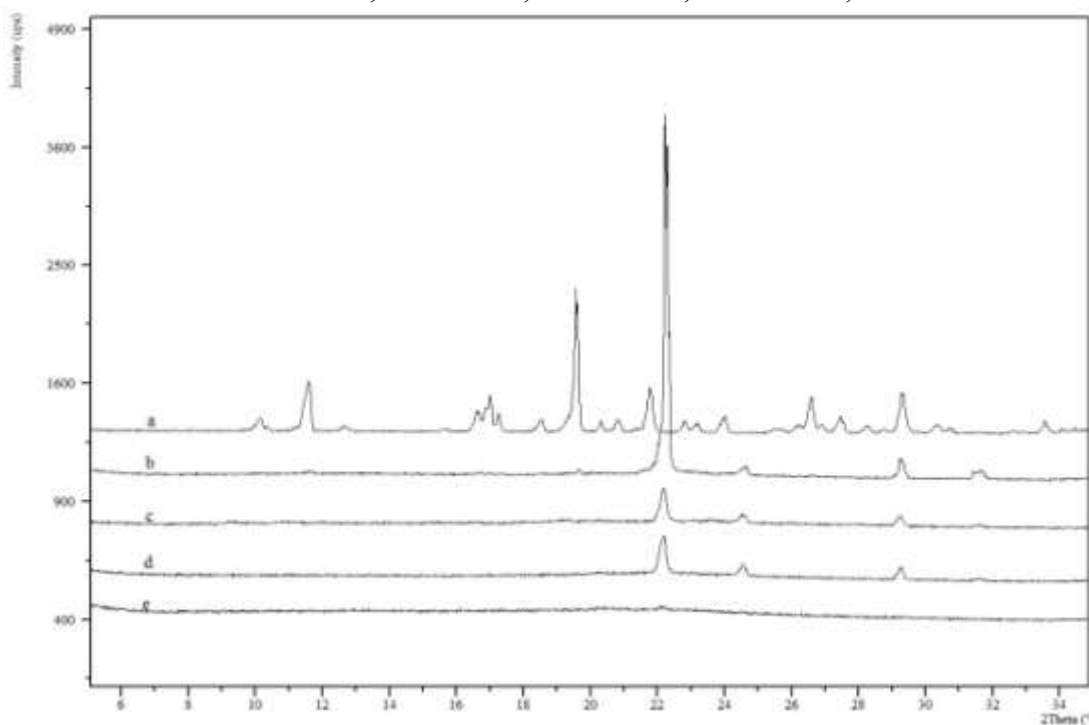

Figure 9.10 PXRd Solid dispersions kept at 45⁰C for a period of two months: a- indomethacin; b-10%I+U; c-30% I+U; d-50% I+U; e- 70% I+U

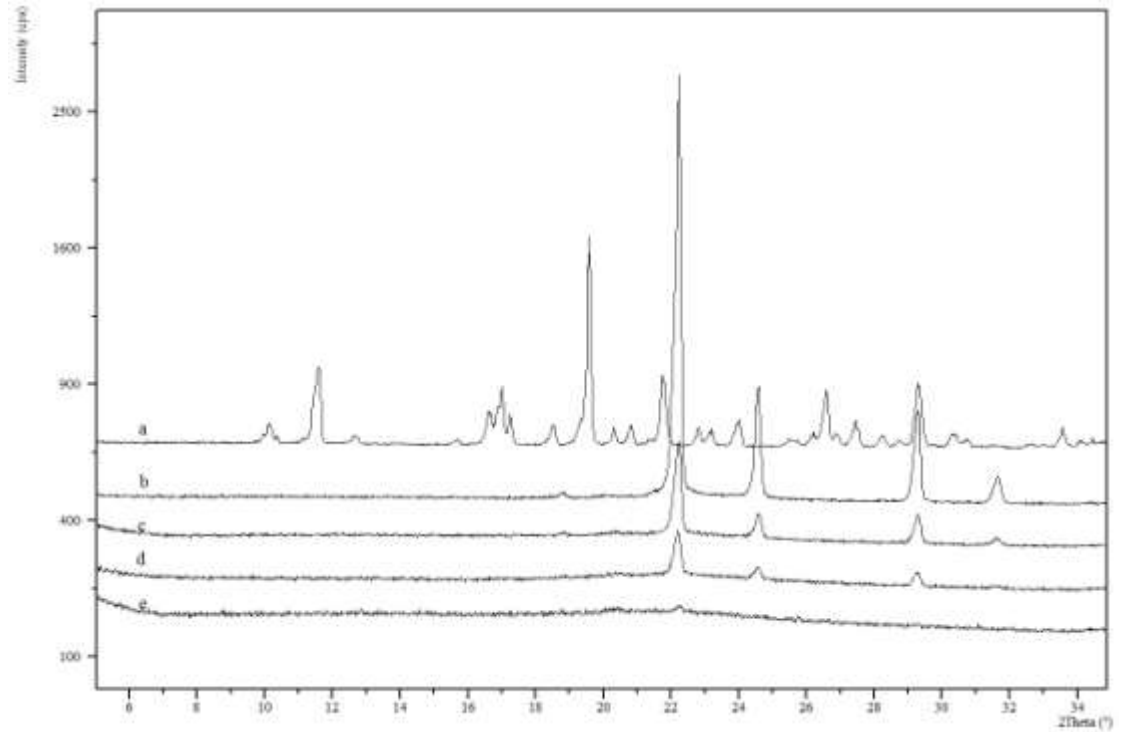

Figure 9.11 PXRD Solid dispersions kept $23.11 \pm 0.25\%$ RH for a period of two months: a- indomethacin; b-10%I+U; c-30% I+U; d-50% I+U; e- 70%

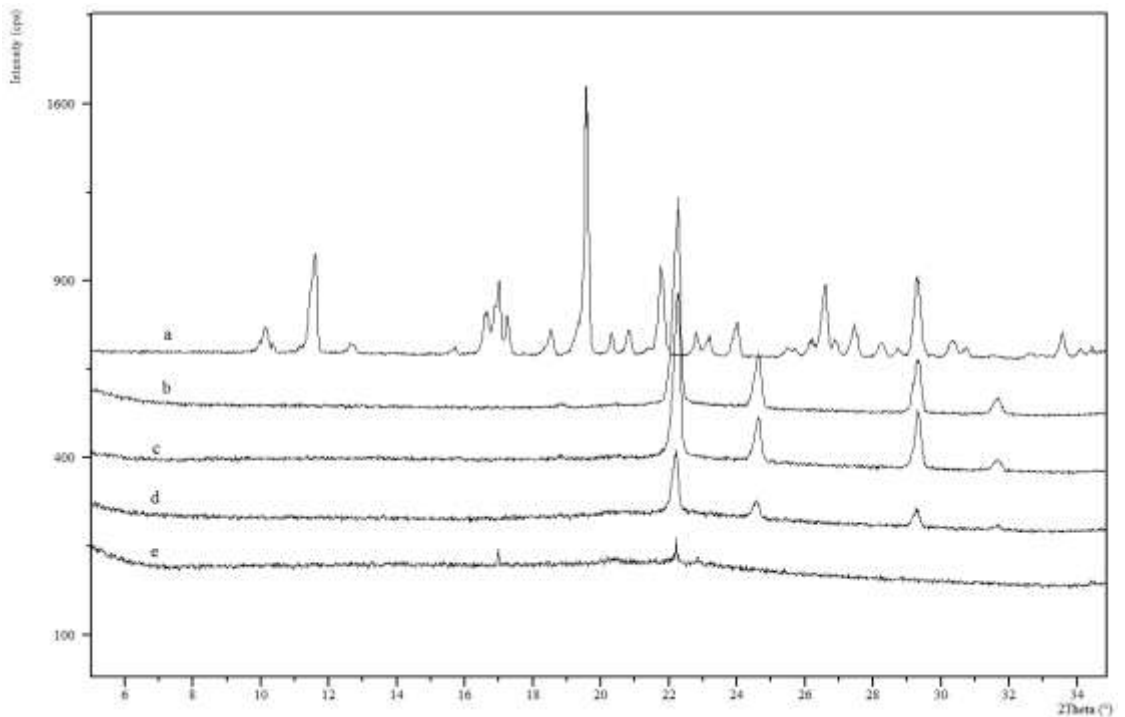

Figure 9.12 PXRD Solid dispersions kept $54.38 \pm 0.23\%$ RH for a period of two months: a- indomethacin; b-10%I+U; c-30% I+U; d-50% I+U; e- 70% I+U

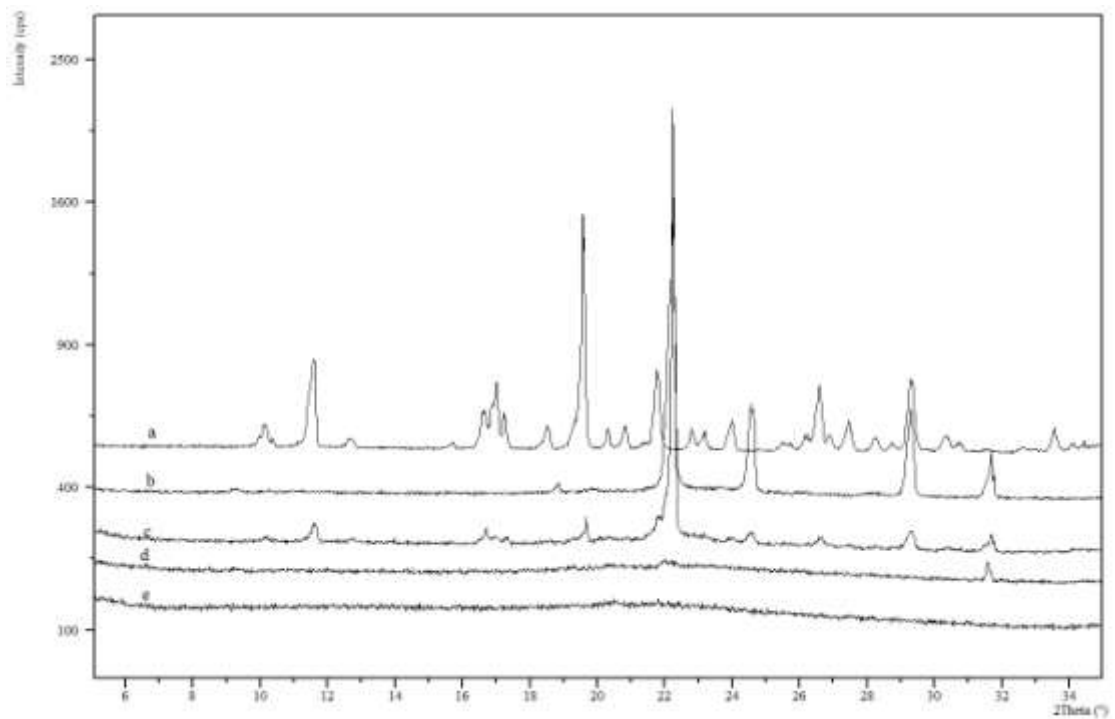

Figure 9.13, PXR D Solid dispersions kept $75.29 \pm 12\%RH$ for a period of two months: a- indomethacin; b-10%I+U; c-30% I+U; d-50% I+U; e-70% I+U

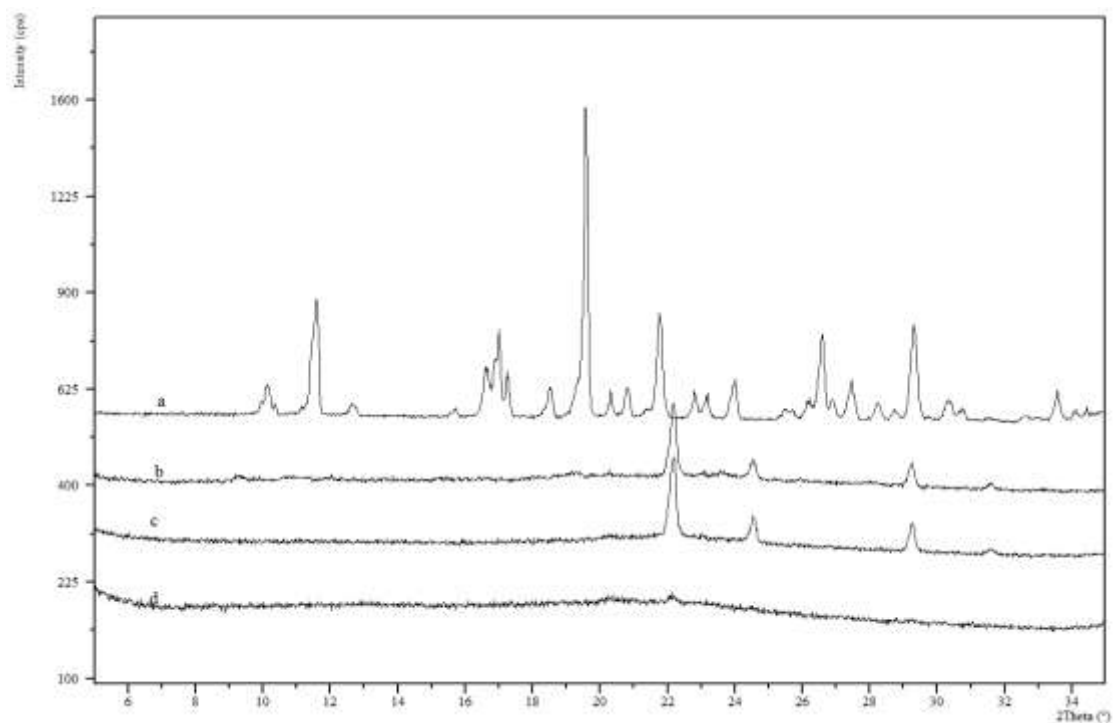

Figure 9.14. PXR D Solid dispersions kept 100%RH for a period of two months: a- indomethacin; b-10%I+U; c-30% I+U; d-50% I+U; e-70% I+U

The graphs for indomethacin show a number of peaks, proving that the drug is crystalline. The different physical mixtures seen in Figure 9.5 show that as the quantity of drug in the physical mixture increases some very low intensity peaks for indomethacin are seen. Physical mixtures made with 50% and 70% indomethacin show some crystallinity for indomethacin suggesting that the entire drug present might not be in its amorphous form. The graph also shows peaks for urea in almost all the physical mixtures. The crystallograph seen in Figure 9.6 are for the solid dispersions and almost no peaks other than those for urea are seen. This suggests that the entire drug present is in its amorphous form. Figures 9.7 to 9.14 show the solid dispersions after stability testing. None of the formulations show any peaks for indomethacin after the two month time period under accelerated stability conditions. We do not see a 10I+U SD peak for formulations kept at 100% RH as the sample was not testable after the stress conditions. This suggests that the solid dispersions might be relatively stable and may not lose any solubility as the formulation ages.

9.1.4 Dissolution Studies

Dissolution studies were performed on the solid dispersions and the drug to determine how the dissolution profile of the drug changes in the solid dispersions, in contrast to the drug alone. Four solid dispersions as previously described and indomethacin alone were used for the dissolution studies. A 50 mg sample of indomethacin or powder containing its equivalent was used for the studies. The dissolution medium, which was kept at $37\pm 0.5^{\circ}\text{C}$ was used for the study. The aliquots withdrawn were evaluated using UV-Visible spectroscopy. The absorbance was measured at a wavelength (λ) of 318 nm.

Figure 9.15 gives the calibration curve, which was made with data in Table 9.1 and used to determine the concentration of the drug in the samples drawn. Table 9.2 Shows data used to make the dissolution profiles. Figure 9.16 shows the dissolution profiles

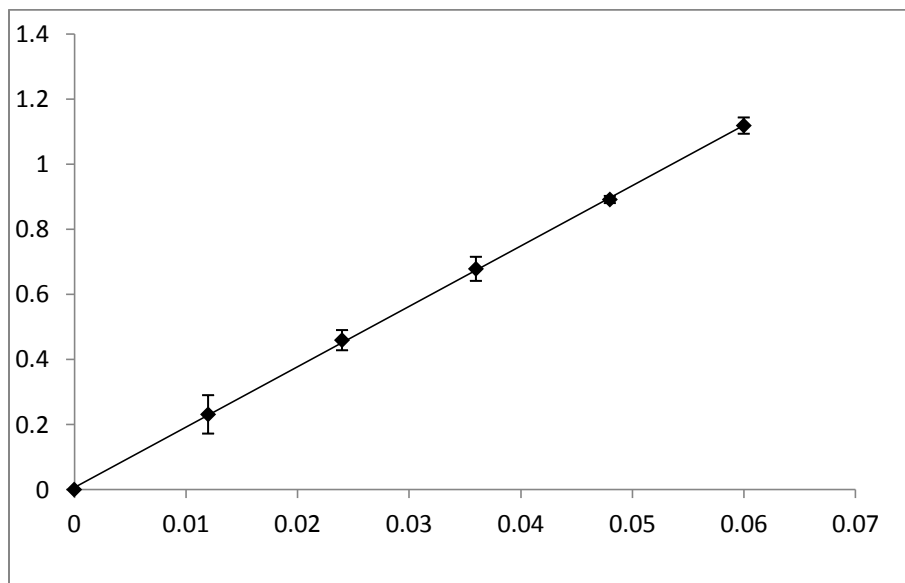

Figure 9.15 Calibration curve for indomethacin at 318 nm; having a slope of 18.545, intercept of 0.0065, and R2 value of 0.9998

Table 9.1 Data for calibration curve for indomethacin

Concentration (mg/ml)	Absorbance (mean of 3 readings)	Standard Deviation
0	0	0
0.012	0.231	0.059
0.024	0.459	0.031
0.036	0.678	0.037
0.048	0.891	0.011
0.06	1.118	0.025

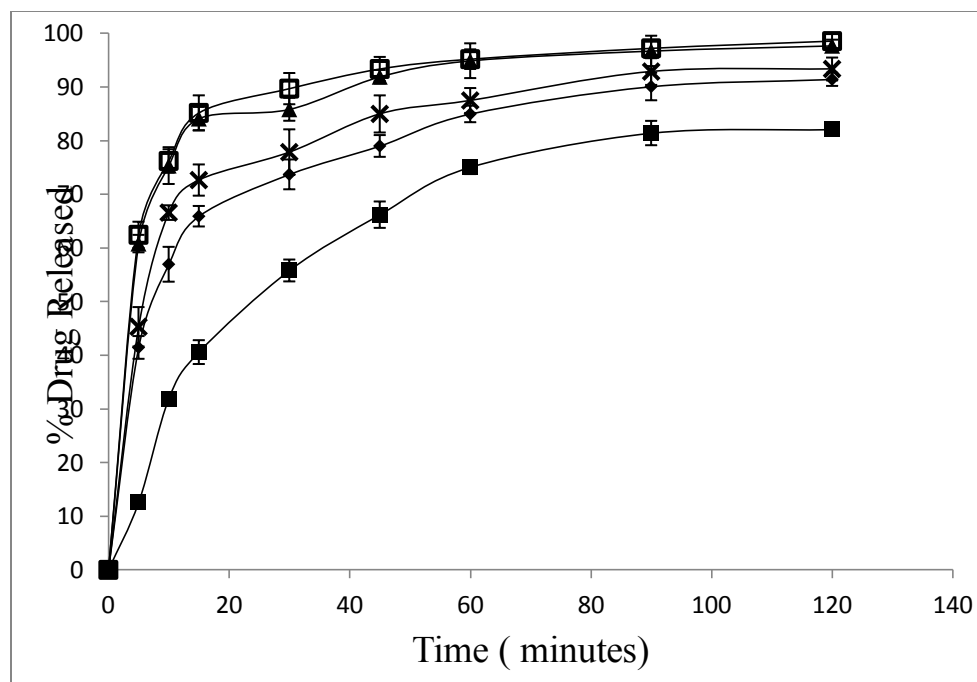

Figure 9.15 Dissolution: □10% I+U SD,▲ 30% I+U SD,X 50% I+U SD, ◆ 70% I+U SD and ■ pure I

Table 9.2. Data for the dissolution profiles of formulations containing phenytoin*

Time (Mins)	Pure Indomethacin		10%I+U		30% I+U		50% I+U		70%I+U	
	cum. % rel.	S.D.	cum. % rel.	S.D.	cum. % rel.	S.D.	cum. % rel.	S.D.	cum. % rel.	S.D.
0	0	0	0	0	0	0	0	0	0	0
5	12.6	1.2	62.4	2.1	60.8	3.7	45.3	1.6	41.5	2.4
10	31.9	1.0	76.2	3.3	75.3	1.4	66.6	3.4	57.0	2.2
15	40.6	2.2	85.2	1.9	84.1	2.9	72.7	2.2	65.9	3.3
30	55.8	2.0	89.7	2.8	85.8	4.3	77.9	2.1	73.7	2.9
45	66.2	2.5	93.4	2.0	91.9	3.5	85.0	1.3	79.0	2.3
60	75.1	1.3	95.2	1.5	94.9	2.3	87.5	3.2	85.0	1.8
90	81.4	2.3	97.2	2.6	96.7	2.5	92.9	2.8	90.1	1.3
120	82.1	1.2	98.6	1.2	97.7	2.1	93.4	1.1	91.4	1.7

* The cumulative % release data is a mean of three readings for all the formulations and the drug

The dissolution profiles seen in Figure 9.16 clearly show an increase in the amount of drug that is dissolved. As the percentage of indomethacin drops, there is an increase in the amount of drug dissolving and subsequent increase in the dissolution rate. Peak plasma concentration is also dependent on the amount of indomethacin and urea in the formulation.

9.1.5. Stability Studies

Stability studies were performed by placing the formulations under accelerated stability conditions. The formulations were kept at temperatures of 30⁰C, 35⁰C, 40⁰C, and 45⁰C as well as under controlled humidity conditions of 100%, 75.29 ± .12%, 54.38± .23 and 23.11±0.25% relative humidity, for a period of two months. Samples from the formulations kept at these high temperatures were collected at 4, 8, 12, 24, 36, 48, 72 hours and at 5, 10, 15, 30, and 60 days. Samples from the formulations which were kept at different relative humidities were drawn at 15, 30, 45 and 60 days. The rate of degradation was determined using UV-Visible spectroscopy. They were studied with the aid of the Arrhenius equation and the shelf lives for the various formulations were determined. Figure 9.16.a to Figure 9.16.e show the Arrhenius plots (lnK v/s 1/T) which were used for shelf life determinations. The shelf life for the four formulations might be as given in Table 9.3. The shelf life of the formulation which had 50% indomethacin and 50% urea showed a shelf life of only 2.8 years, which was lower than the shelf life for the formulation that had 30% indomethacin and urea. This might be because of some faults with the container in which the specimen and the sample was stored. The trend indicates that the problem might be with the results of the formulation that contained 50% indomethacin and urea. The specimens kept at the selected relative humidity conditions

were studied to obtain a perspective of the effect of relative humidity on the degradation of the specimens. The study revealed a trend which suggested that as the relative humidity increases there might be an increase in the rate of degradation. Figure 9.17.a to Figure 9.17.e show plots of K v/s %RH. Since the shelf life for the formulations is not of long duration any technique that would retard the degradation process would be useful in making the formulation more usable. The study also suggested that a 10% reduction in the relative humidity might increase the shelf life by around 500 days in some cases.

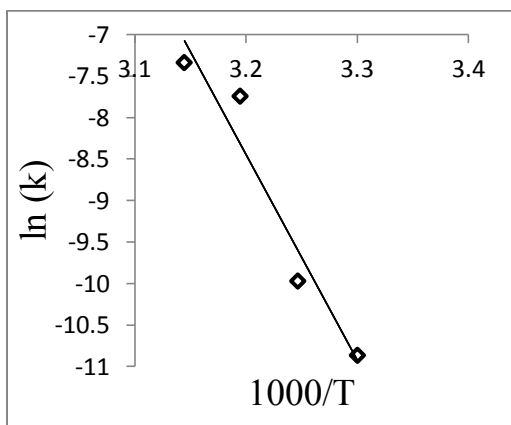

Figure 9.16.a Arrhenius plot 10% I+U, with slope -24.713, intercept of 70.636 and R^2 of 0.9383

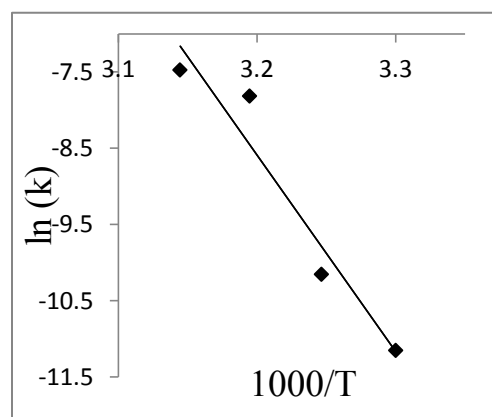

Figure 9.16.b Arrhenius plot 30% I+U SD, with slope -25.811, intercept of 74.006 and R^2 of 0.9336

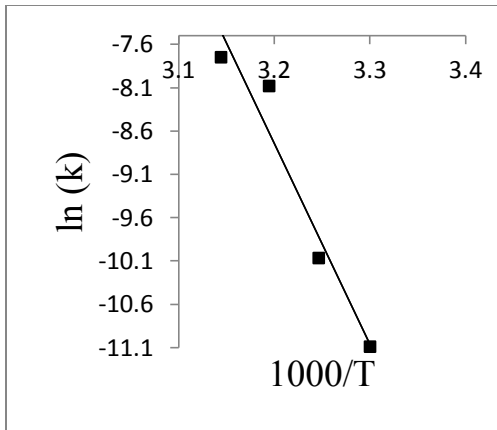

Figure 9.16.c Arrhenius plot 50% I+U SD, with slope -23.182, intercept of 65.439 and R^2 of 0.9431

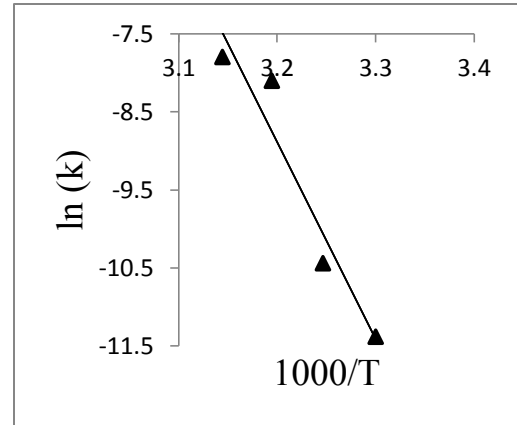

Figure 9.16.d Arrhenius plot 70% I+U SD, with slope -25.265, intercept of 71.962 and R^2 of 0.9281

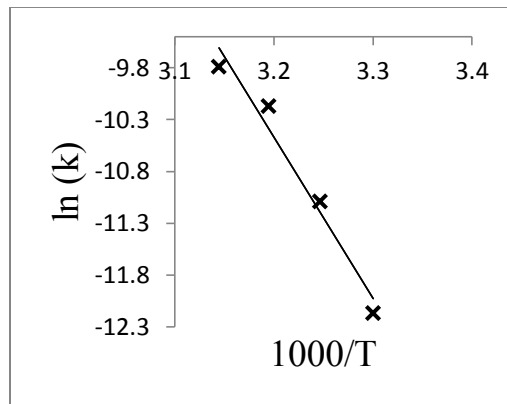

Figure 9.16.e Arrhenius plot Pure I, with slope -25.265, intercept of 71.962 and R^2 of 0.9281

Table.9.3. Shelf life determined for I+U using Arrhenius equation

SD	10%I+U	30%I+U	50%I+U	70%I+U	PI
t.90 (yrs)	2.6	3.5	2.8	4.4	4.7

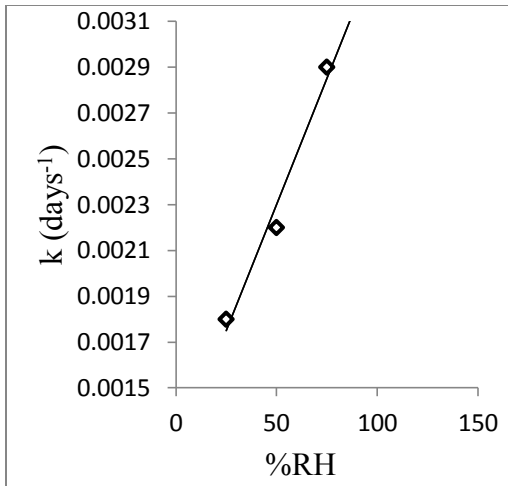

Figure 9.17.a k v/s %RH 10% I+U SD, with slope .00002, intercept of 0.0012 and R^2 of 0.9758

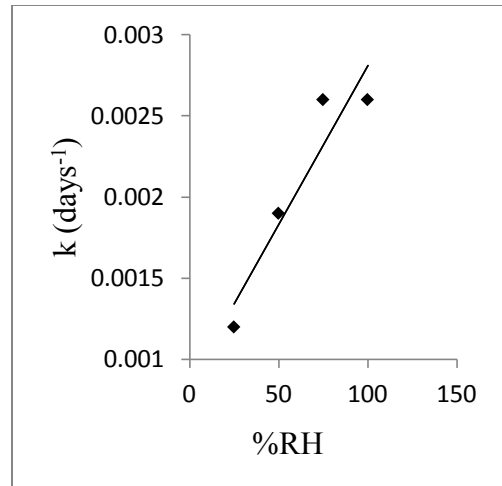

Figure 9.17.b k v/s %RH 30% I+U SD, with slope .00002, intercept of 0.0009 and R^2 of 0.8909

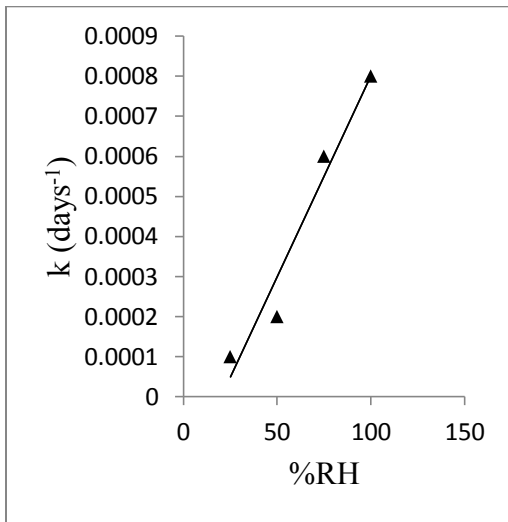

Figure 9.17.c k v/s %RH 50% I+U SD, with slope .00001, intercept of 0.0002 and R^2 of 0.9542

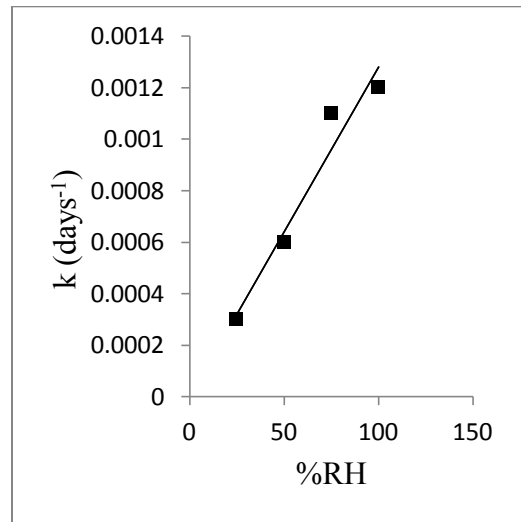

Figure 9.17.d k v/s %RH 70% I+U SD, with slope .00001, intercept of 3×10^{-18} and R^2 of 0.9481

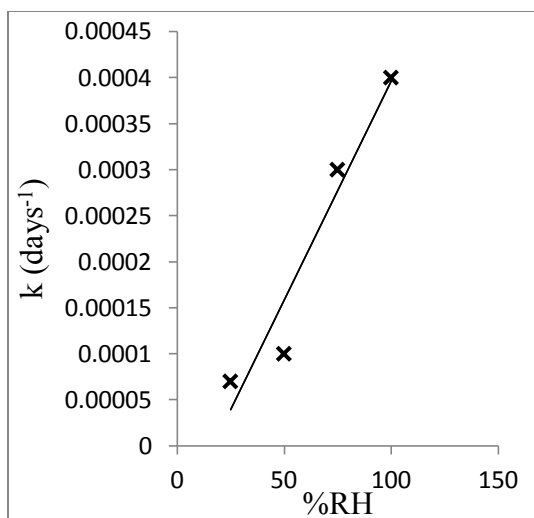

Figure 9.17.e k v/s %RH Pure I, with slope 6 E-5, intercept of 8E-5 and R² of 0.9356

9.2 Indomethacin and Kollidon[®] VA64 Solid Dispersion

Four ternary solid dispersions were prepared using 10% w/w, 30% w/w, 50% w/w and 70% w/w of indomethacin and 90% w/w, 70% w/w, 50% w/w and 30% w/w of Kollidon[®] VA64 respectively, coated on 20%w/w (the total weight of I and K) of Neusilin[®] US2 (adsorbent). Physical mixtures containing the same concentration as those used above were prepared as well. The solid dispersions and the physical mixtures were subjected to tests in order to study the changes that might take place with the drug when formulated into a solid dispersion. Powder X-Ray Diffraction (PXRD), Scanning Electron Microscopy (SEM), Differential Scanning Calorimetry (DSC), dissolution studies and stability studies were performed on these solid dispersions. PXRD was performed on the physical mixtures as well.

9.2.1 Differential Scanning Calorimeter

Differential Scanning Calorimetric (DSC) studies were performed on the ingredients used to make the ternary solid dispersions which are indomethacin (I), Kollidon[®]VA64 (K), and Neusilin[®]US2 (N). Physical mixtures prepared and ternary solid dispersions prepared as described previously were also used for obtaining the required thermograms. DSC studies were performed with the intension of observing any interaction between the various ingredients and in order to study the changes in crystallinity. Figure 9.18 shows the comparison between the thermograms for Neusilin[®]US2 (N), indomethacin (I), Kollidon[®] VA64 (K), and the physical mixtures (PMs I+K).

Figure 9.19 shows a comparison between the thermograms for Neusilin[®]US2 (N), indomethacin (I), Kollidon[®]VA64 (K), and the four solid dispersions.

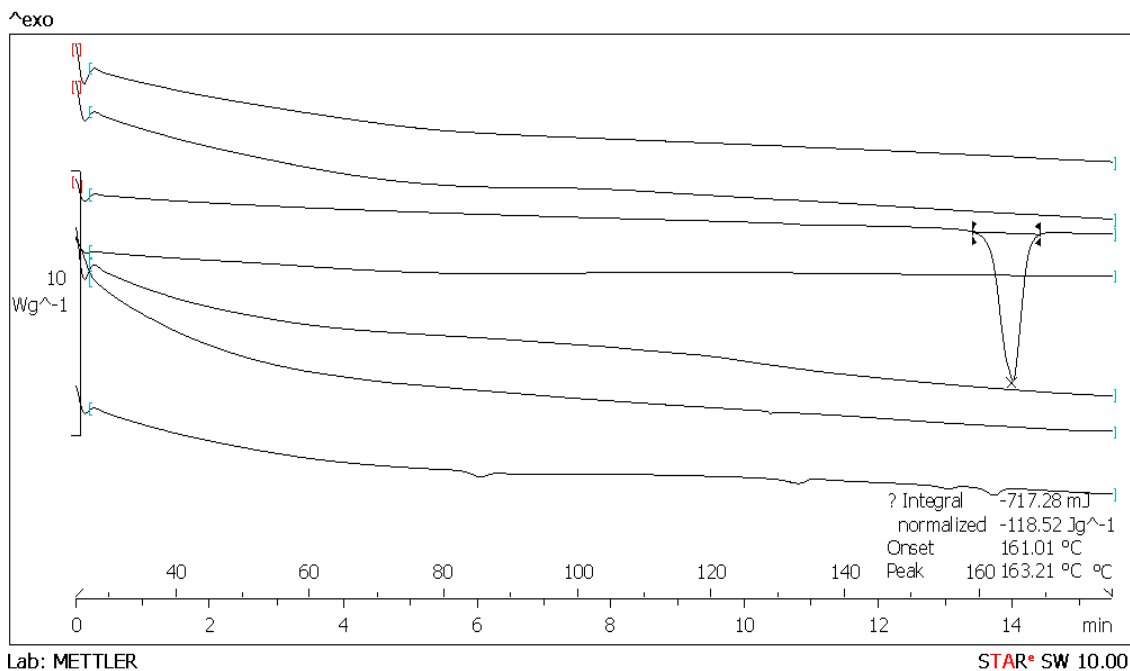

Figure 9.18 DSC thermogram showing from top to bottom: Neusilin[®]US2, Kollidon[®]VA64, Indomethacin, 10% I+K PM, 30% I+K PM, 50% I+K PM, 70% I+K PM

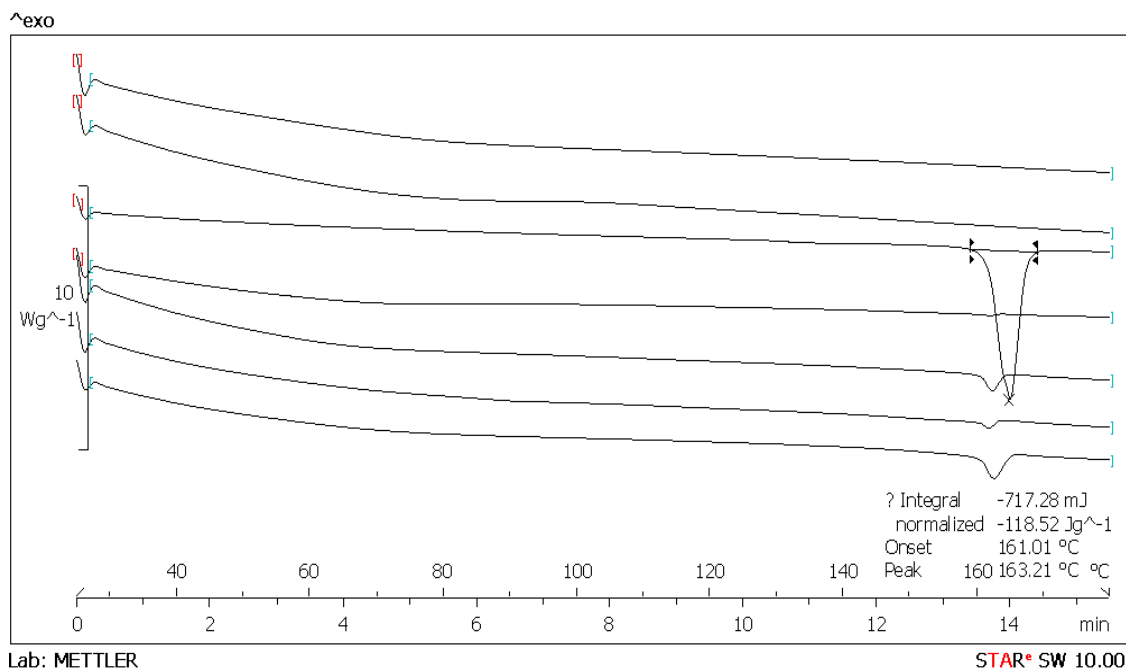

Figure 9.19 DSC thermogram showing from top to bottom: Neusilin[®]US2, Kollidon[®]VA64, Indomethacin, 10% I+K SD, 30% I+K SD, 50% I+K SD, 70% I+K SD

The thermogram images show the melting peak of indomethacin at 163.21⁰C. No peaks are seen for the melting of Kollidon[®]VA64 as it melts at a very low temperature and due to the scale of the thermograms shown here. The thermograms for the physical mixtures containing 30% w/w, 50% w/w and 70% w/w indomethacin show peaks of very low intensity for indomethacin. This suggests that as the quantity of indomethacin in the physical mixtures increases, the drug starts to exhibit crystalline properties. Figure 9.19 the thermograms for the solid dispersions. Thermograms for formulations containing 10%w/w, 30% w/w and 50% w/w Indomethacin show flat lines, indicating that the drug might be completely amorphous. The one for the solid dispersions containing 70% w/w indomethacin and 30% w/w Kollidon[®]VA64 shows peak of very small intensity for indomethacin, suggesting that some indomethacin might be crystalline.

Powder X-Ray Diffraction (PXRD) studies will help in confirming the results suggested by DSC studies. Results from PXRD studies are discussed later in this chapter.

9.2.2 Scanning Electron Microscopy:

SEM studies were performed to study the characteristics and surface morphology of indomethacin (I), Kollidon[®]VA64 (K), Neusilin[®]US2 (N), a physical mixture (PM I+K) containing 10% w/w indomethacin, 90% w/w Kollidon[®]VA64 and Neusilin[®]US2 equal to the combined weight of Kollidon[®]VA 64 and indomethacin. Ternary solid dispersions prepared as previously described were also studied using SEM. The images for the solid dispersions showed that the solid dispersion was coated on Neusilin[®]US2 successfully, thereby suggesting that it is possible to coat the solid dispersion on Neusilin[®]US2 by the technique used in the study. Figure 9.20 shows the SEM for indomethacin (I), Kollidon[®]VA64 (K), Neusilin[®]US2 (N), and the physical mixture (PM I+K). Figure 9.21 shows SEM for the four solid dispersions. The SEM pictures for the drug indomethacin shows the crystalline nature of the drug. The SEM picture for Kollidon[®]VA64 Shows structures that look like pieces of sphere. It is not crystalline in nature nor is it porous. The SEM picture for Neusilin[®]US2 reveals that it is spherical in nature and has a very large surface area due to its porosity. The SEM image for the solid dispersions shows spherical structures which have Neusilin[®]US2 as the core coated with the solid dispersion of indomethacin and Kollidon[®]VA 64 on its surface.

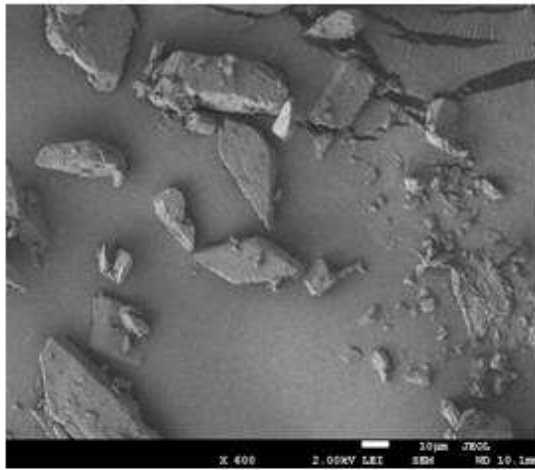

(A)

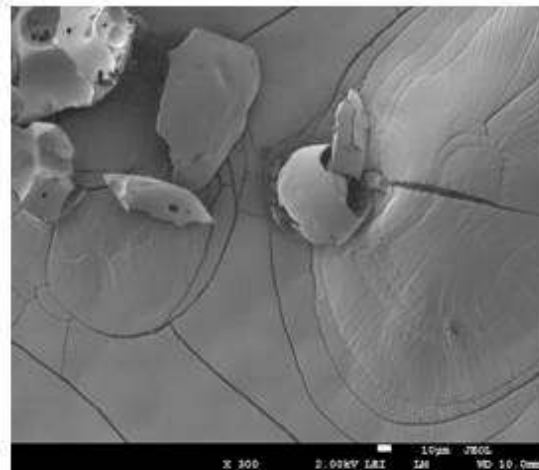

(B)

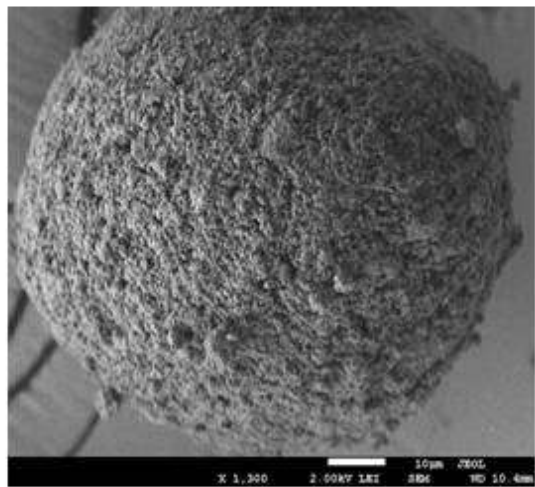

(C)

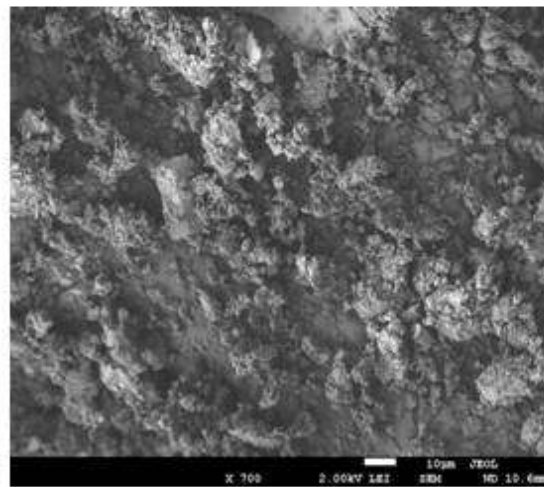

(D)

Figure 9.20 SEM images (A) Indomethacin; (B) Kollidon[®]VA64; (C) Neusilin[®]US2; (D) PM I+K

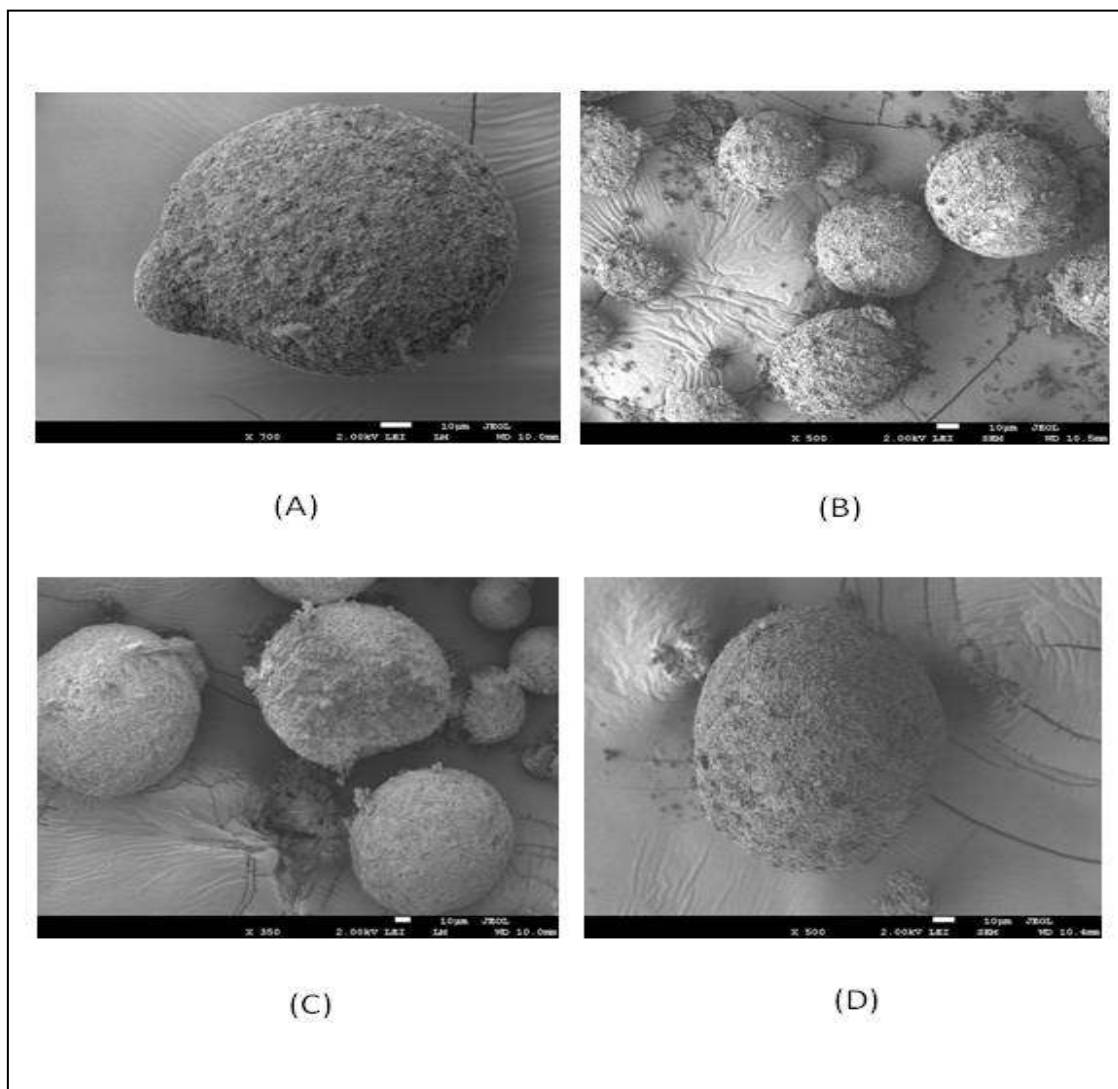

Figure 9.21 SEM image (A) 10% I+K SD, (B) 30% I+K SD, (C) 50% I+K SD, (D) 70% I+K SD

9.2.3 Powder X-Ray Crystallography

The crystallograph for the drug indomethacin (I) was compared with the crystallograph for the various physical mixtures and solid dispersions. This gives an insight into how crystalline or amorphous the drug has become. Solid dispersions were subjected to stress under accelerated stability conditions and were tested for crystallinity.

For this purpose the four solid dispersions prepared as previously described were kept at temperatures of 30⁰C, 35⁰C, 40⁰C, and 45⁰C and under relative humidity conditions of 100%, 75.29 ±.12%, 54.38± .23 and 23.11±0.25%, for a period of two months. Samples were taken at the end of the two month time period and evaluated using PXRD. Figure 9.22 shows the PXRD results for the physical mixtures. Figure 9.23 shows the PXRD results for the four solid dispersions prepared. Figures 9.24 to 9.27 shows the crystallographs for the solid dispersions kept at 30⁰C, 35⁰C, 40⁰C, and 45⁰C for two months.

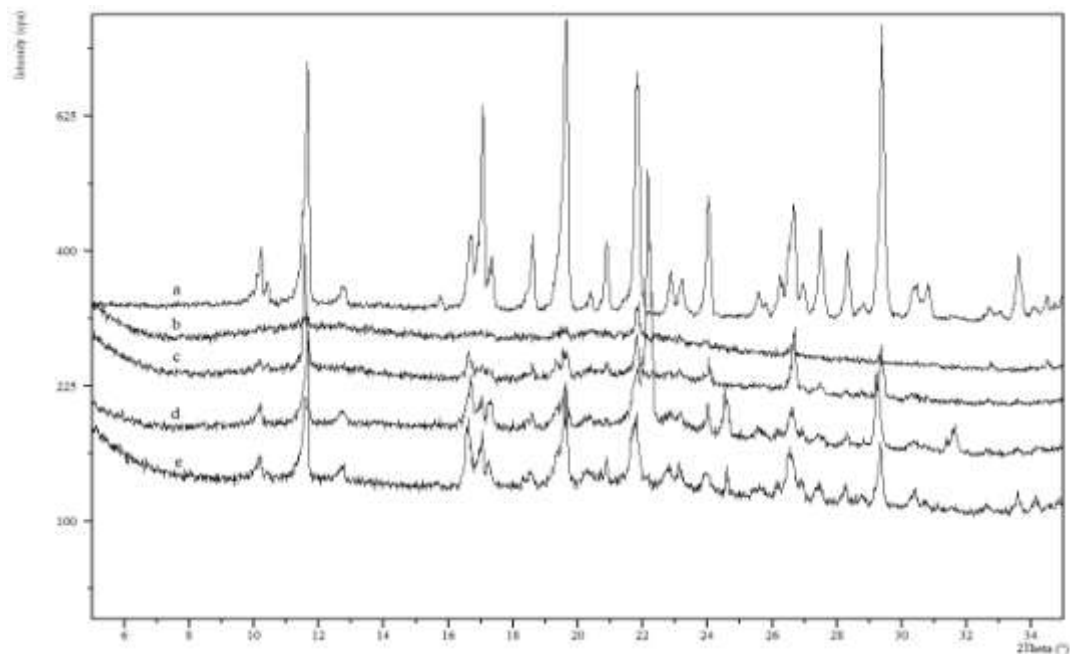

Figure 9.22 PXRD for Indomethacin and the four physical mixtures: a- I ; b- 10% I+K PM; c- 30% I+K PM; d-50% I+K PM; e- 70% I+K PM

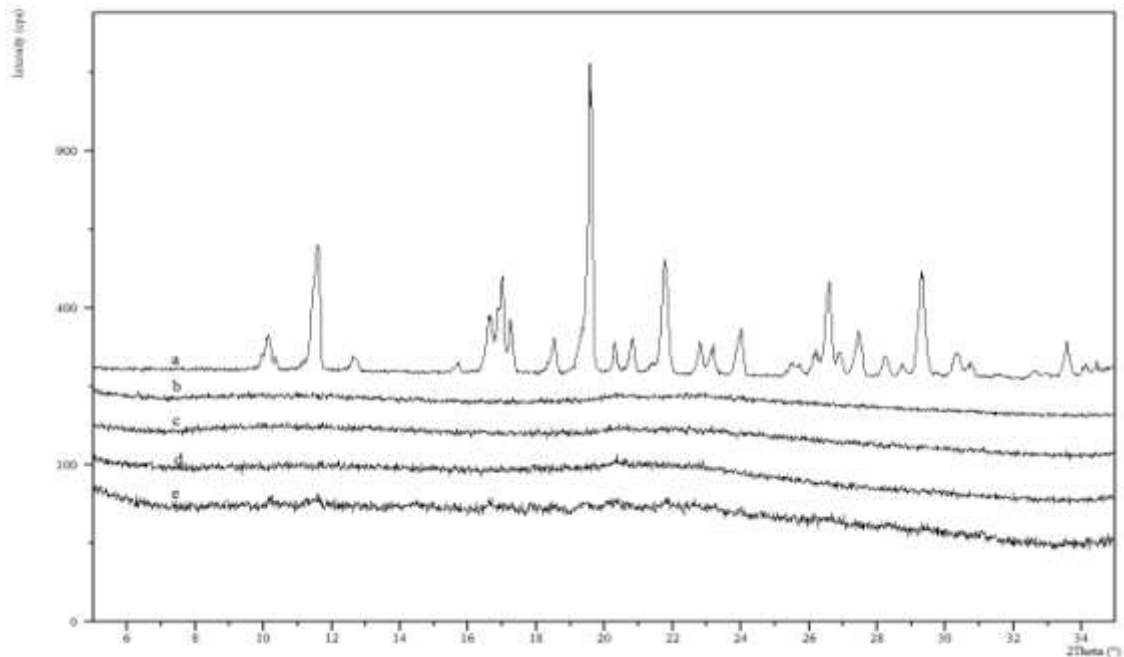

Figure 9.23 PXR D for Indomethacin and the four solid dispersions a- I; b- 10%I+K SD; c-30% I+K SD; d-50% I+K SD; e- 70% I+K SD

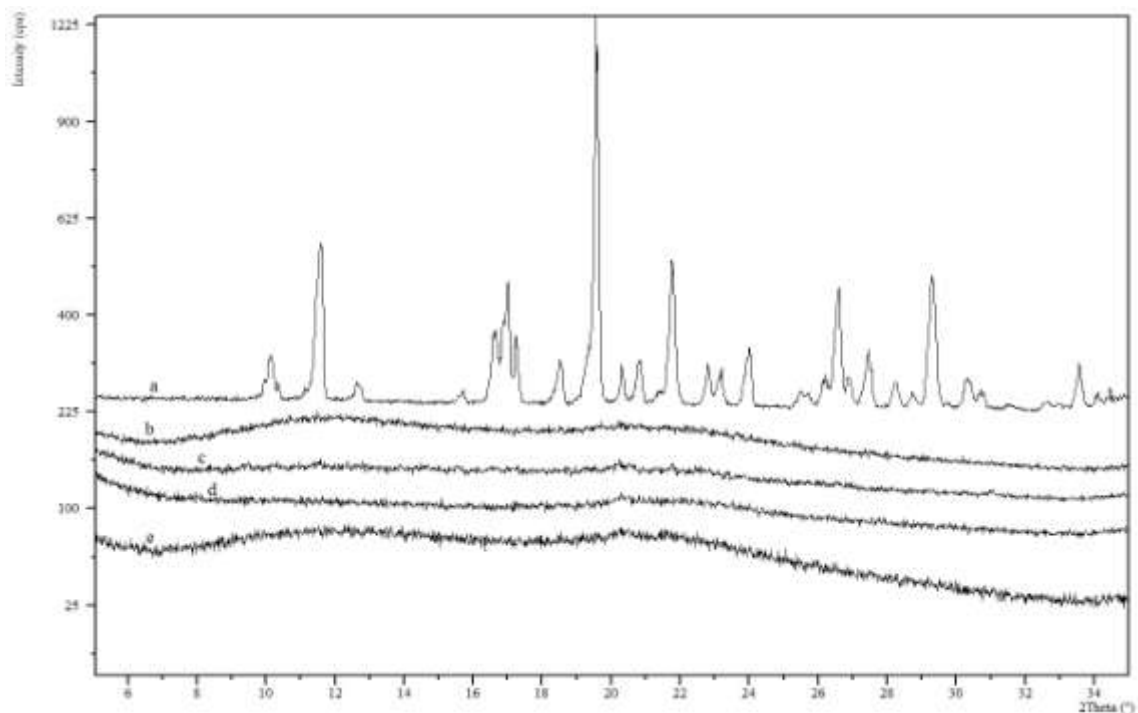

Figure 9.24 PXR D Solid dispersions kept at 30⁰C for a period of two months a- I; b- 10%I+K; c-30% I+K; d-50% I+K; e- 70% I+K

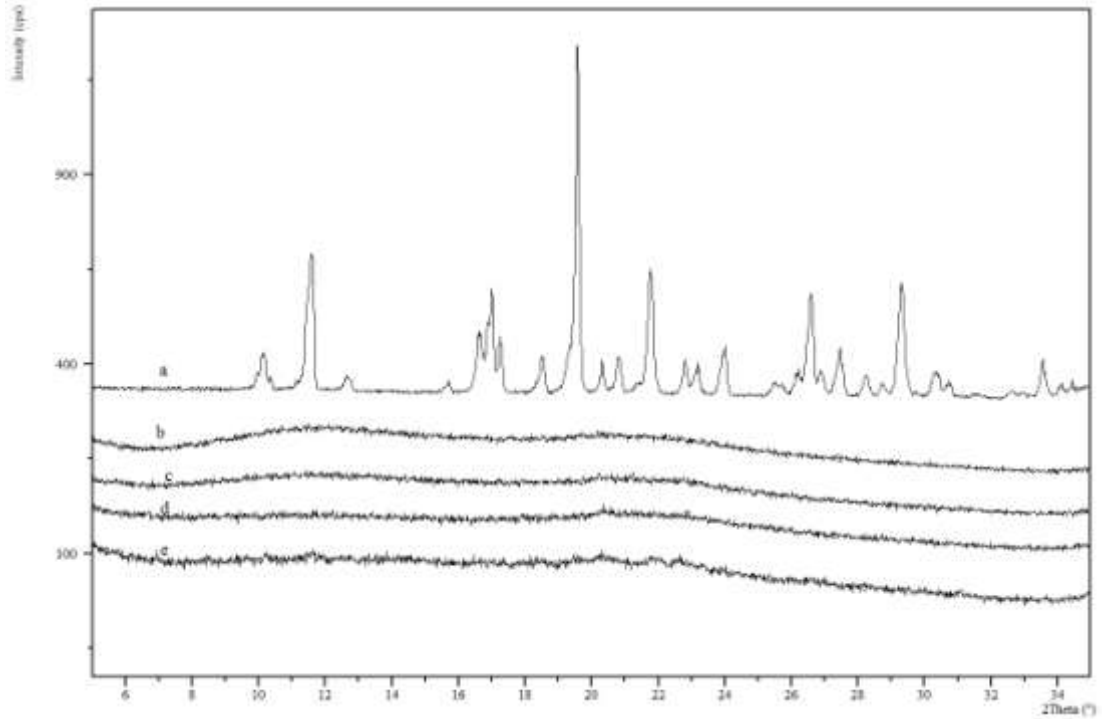

Figure 9.25 PXR D Solid dispersions kept at 35⁰C for a period of two months:
a- I; b-10%I+K; c-30% I+K d-50% I+K; e- 70% I+K

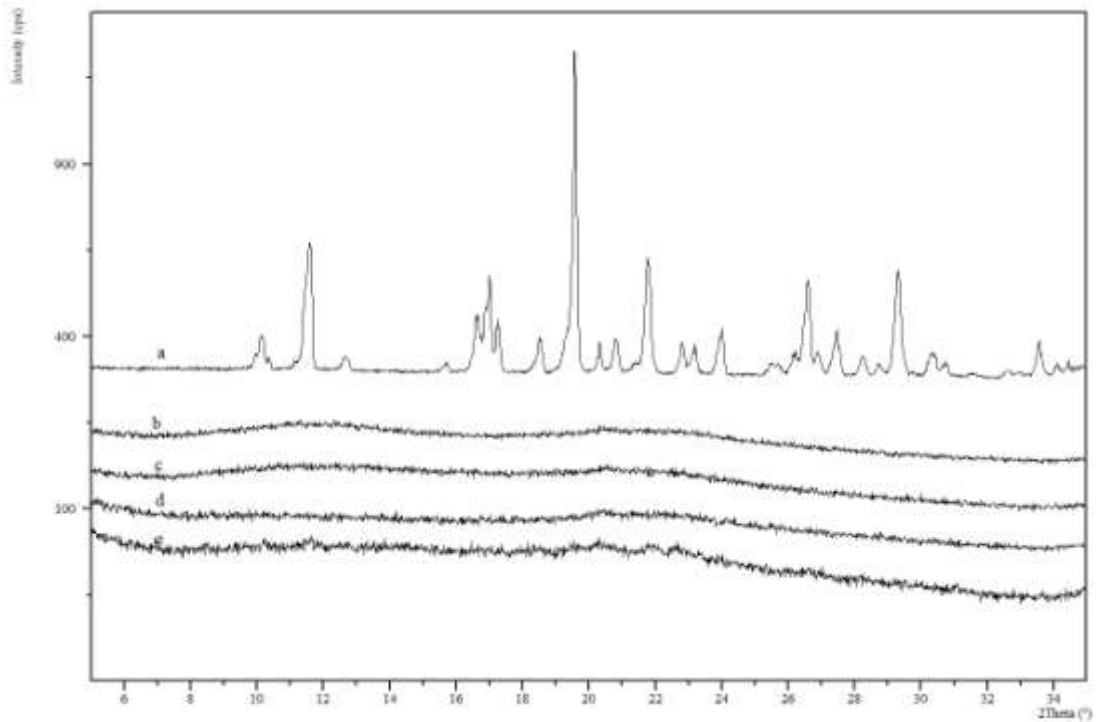

Figure 9.26 PXR D Solid dispersions kept at 40⁰C for a period of two months a-
I; b-10%I+K; c-30% I+K; d-50% I+K; e- 70% I+K

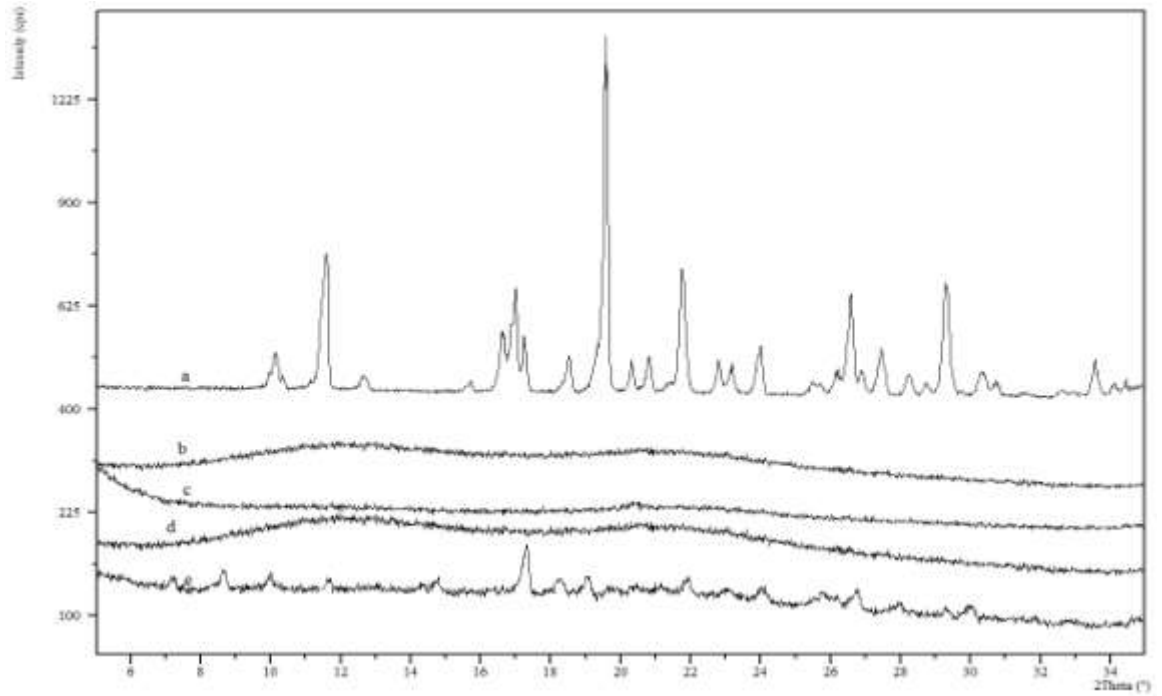

Figure 9.27 PXRd Solid dispersions kept at 45⁰C for a period of two months a- I; b-10%I+K; c-30% I+K; d-50% I+K; e- 70% I+K

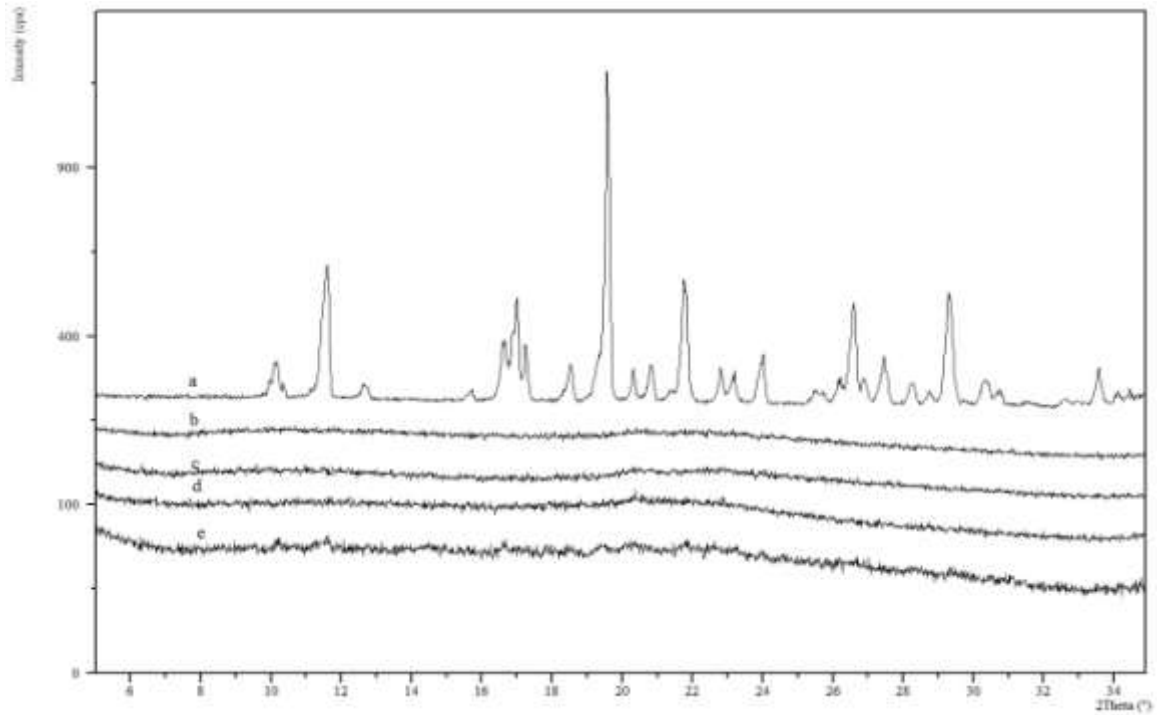

Figure 9.28 PXRd Solid dispersions kept 23.11±0.25% RH for a period of two months: a- I; b-10%I+K; c-30% I+UK d-50% I+K; e- 70% I+K

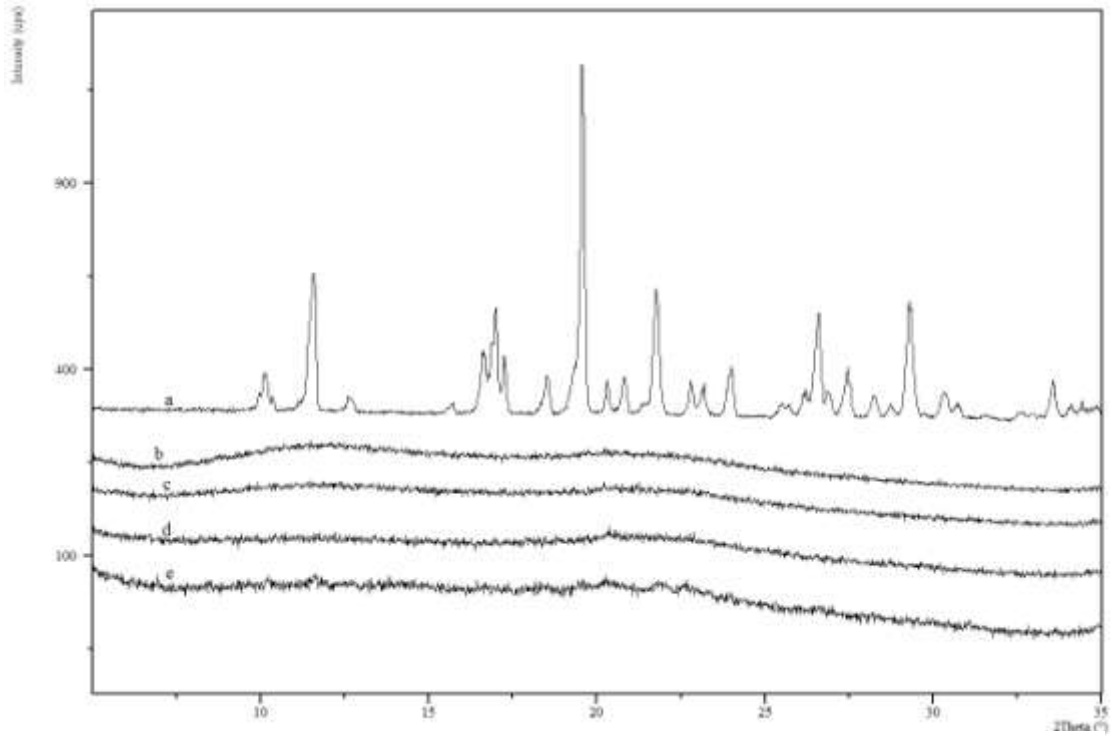

Figure 9.29 PXR D Solid dispersions kept $54.38 \pm .23$ RH for a period of two months: a- I; b-10%I+K; c-30% I+UK d-50% I+K; e- 70% I+K

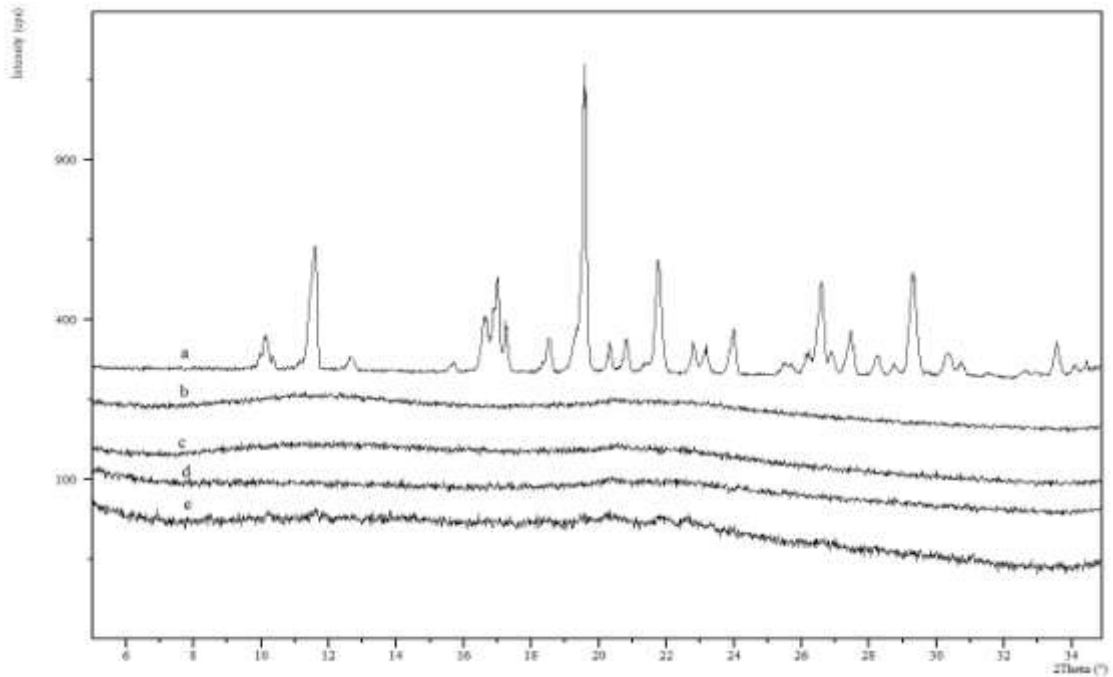

Figure 9.30 PXR D Solid dispersions kept $75.29 \pm .12\%$ RH for a period of two months: a- I; b-10%I+K; c-30% I+UK d-50% I+K; e- 70% I+K

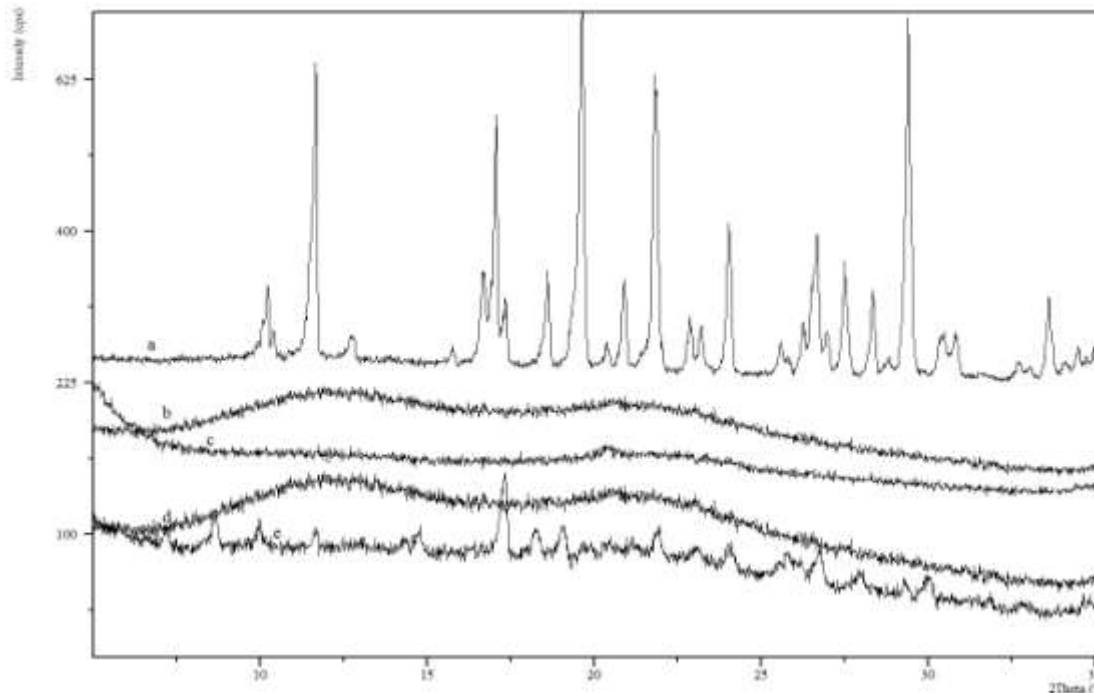

Figure 9.31 PXRd Solid dispersions kept 100%RH for a period of two months: a- I; b-10%I+K; c-30% I+UK d-50% I+K; e- 70% I+K

Figures 9.28 to 9.31 shows the crystallographs for the solid dispersions kept in 100%, 75.29 ±.12%, 54.38± 0.23 and 23.11±0.25% relative humidity (RH) for two months. Figure 9.22 shows the PXRd results for the physical mixtures of indomethacin and Kollidon[®]VA64. Peaks for indomethacin are seen in physical mixtures containing 30%, 50% and 70% indomethacin. The PXRd results for solid dispersions, seen in Figure 9.23 show no peaks for indomethacin suggesting a good reduction in the crystallinity of indomethacin in the solid dispersions. Figures 9.24 to 9.32 show PXRd results for the accelerated stability studies and suggest that the solid dispersion is relatively stable. No recrystallization is seen in any solid dispersion samples. A very small increase in crystallinity in some of the 70% w/w indomethacin and 30% w/w Kollidon[®]VA64 solid dispersion is seen.

9.2.4 Dissolution Studies

Dissolution studies were performed on the solid dispersions and the drug to determine how the dissolution profile for the drug changes in the solid dispersion, in contrast to the drug alone. Four solid dispersions prepared as previously described and indomethacin alone were used for the dissolution studies. A 50 mg sample of indomethacin or formulation containing its equivalent was used for the studies. The dissolution medium which was kept at $37 \pm 0.5^\circ\text{C}$ was used for the study. The aliquots withdrawn were evaluated using UV-Visible spectroscopy. The absorbance was measured at a wavelength (λ) of 318 nm. Figure 9.15 gives the calibration curve used to determine the concentration of the drug in the samples.

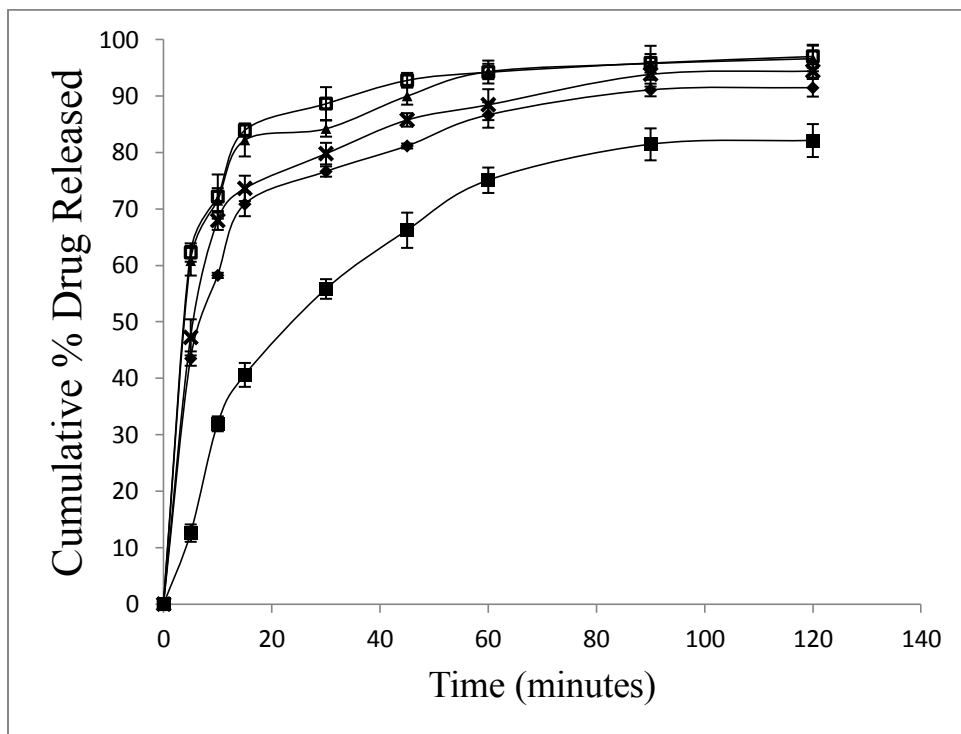

Figure 9.32 Dissolution: from top to bottom: □10% I+U SD, ▲30% I+U SD, X50% I+U SD, ◆70% I+U SD and ■pure I

Table 9.4 Data for the dissolution profile for formulations with Indomethacin and Kollidon*

Time (Mins)	Pure Indomethacin		10%I+K		30% I+K		50% I+K		70%I+K	
	cum. % rel.	S.D.	cum. % rel.	S.D.	cum. % rel.	S.D.	cum. % rel.	S.D.	cum. % rel.	S.D.
0	0	0	0	0	0	0	0	0	0	0
5	12.6	1.5	62.3	1.3	60.8	3.2	47.2	2.6	43.5	1.6
10	31.9	1.3	72.2	3.5	71.5	1.7	67.9	2.2	58.2	3.9
15	40.6	2.1	83.9	2.1	82.2	2.3	73.6	2.9	70.8	1.2
30	55.8	1.7	88.6	2.9	84.2	1.9	79.8	1.4	76.6	2.9
45	66.2	3.1	92.8	3.4	90.0	1.9	85.7	1.5	81.1	1.9
60	75.1	2.3	94.2	2.3	94.3	2.7	88.4	1.4	86.6	2.0
90	81.4	2.8	95.9	2.1	95.8	2.2	93.8	1.7	91.0	3.0
120	82.1	2.9	97.0	1.6	96.6	3.2	94.4	2.3	91.4	2.0

* The cumulative % release data is a mean of three readings in for all the formulations

Table 9.4 shows the data used for plotting the dissolution profile seen in Figure 9.32.

Figure 9.32 shows the dissolution profiles of indomethacin and the four solid dispersions.

Figure 9.32 clearly shows an increase in the amount of drug that is dissolved as compared to the drug alone. As the percentage indomethacin drops, there is an increase in the amount of drug dissolving and the dissolution rate. Solid dispersions show very high increase in the amount of drug released and the rate at which it is released.

9.2.5 Stability Studies

Stability studies were performed by placing the formulations in accelerated stability conditions. The formulations were kept at temperatures of 30°C, 35°C, 40°C, and 45°C and under controlled humidity conditions of 100%, 75.29 ± 12%, 54.38 ± 23 and 23.11 ± 0.25% relative humidity for a period of two months.

Samples from the formulation kept at high temperatures were collected at 4, 8, 12, 24, 36, 48, 72 hours and at 5, 10, 15, 30, and 60 days. Samples from the formulations which were kept at different relative humidities were drawn at 15, 30, 45 and 60 days. The rate of degradation was determined using UV-Visible spectroscopy. The rates were studied with the help of Arrhenius equation and the shelf life for the formulations was determined. Figure 9.33.a to Figure 9.33.e show the Arrhenius plots ($\ln K$ vs $1/T$) used for shelf life determination. The shelf life for the four formulations is given in Table 9.5. The specimens kept in different relative humidity conditions were studied to get an idea of the effect of relative humidity on the degradation of the specimens. Figure 9.34.a to Figure 9.34.e show plots of K v/s %RH and gives some idea about the relationship between the relative humidity and the degradation rate of the drug. It indicated that relative humidity might affect the shelf life of the drug. Since the shelf life for the formulations is not very long, any technique that would retard the degradation process would be useful in making the formulation more usable. Trends show that a 10% reduction in the relative humidity might increase the shelf life of the formulations by up to 500 days in some cases.

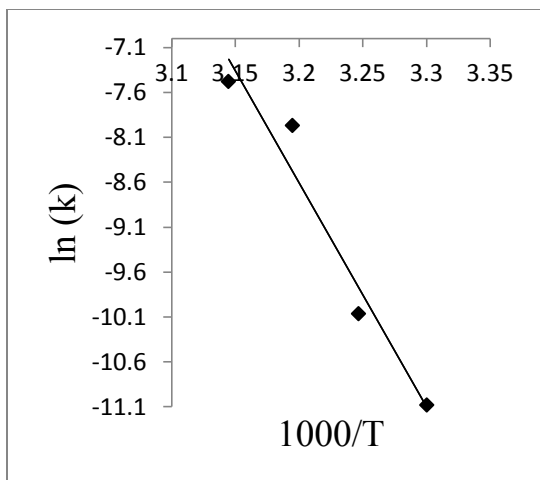

Figure 9.33.a Arrhenius plot 10% I+K, with slope-24.901, intercept 71.076, R^2 0.9531

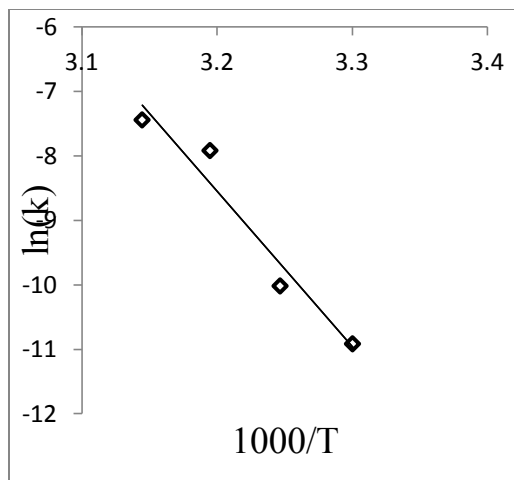

Figure 9.33.b Arrhenius plot 30% I+K, with slope-24.15, intercept 68.731, R^2 0.9481

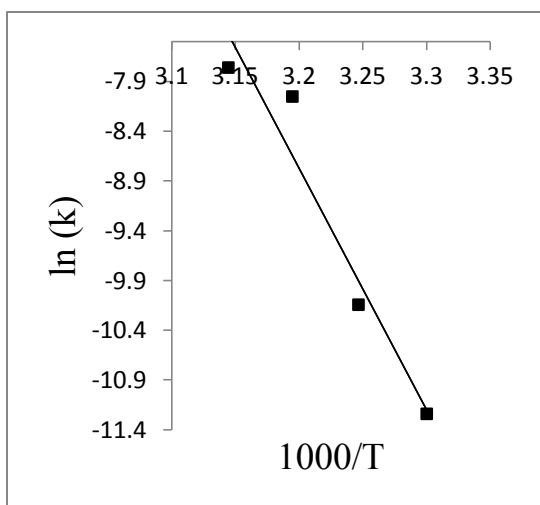

Figure 9.33.c Arrhenius plot 50% I+K, with slope-24.192, intercept 68.639, R^2 0.9378

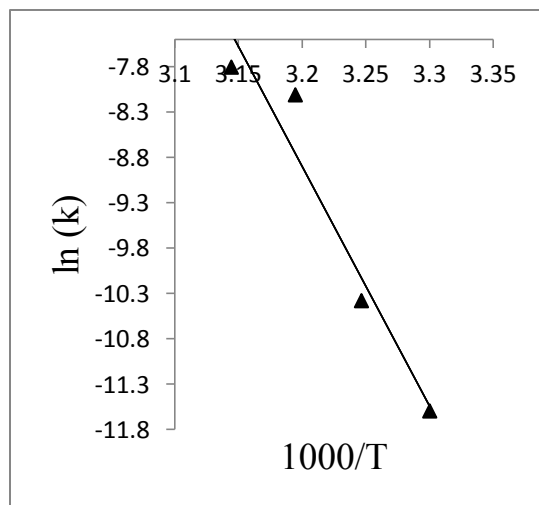

Figure 9.33.d Arrhenius plot 70% I+K, with slope-26.332, intercept 75.363, R^2 0.9373

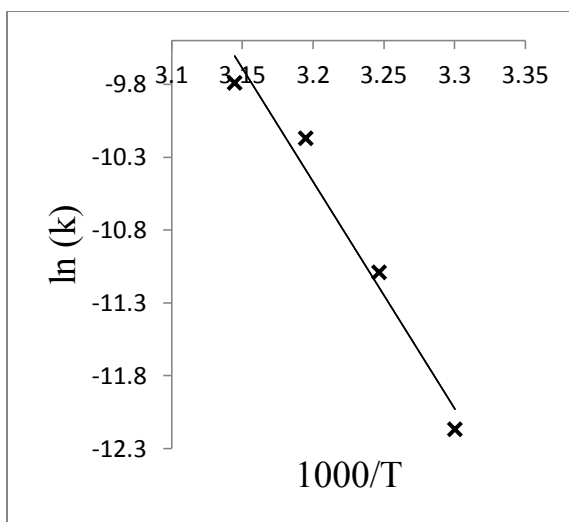

Figure 9.34.e Arrhenius plot Pure I, with slope -25.265, intercept of 71.962 and R^2 of 0.9281

Table 9.5. Shelf life in years for formulations made with indomethacin and Kollidon

SD	10%I+K	30%I+K	50%I+K	70%I+K	PI
t90	2.63255	3.13644	3.32308	4.41576	4.70114

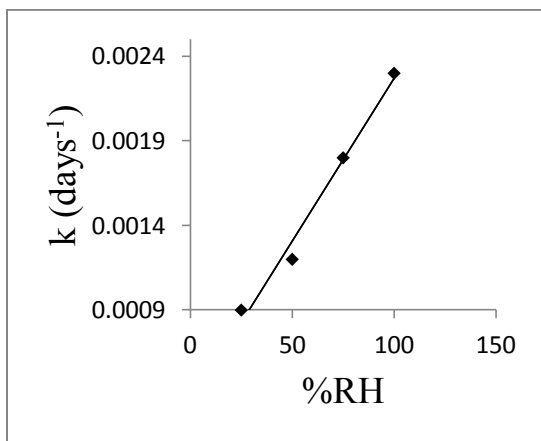

Figure 9.34.a k v/s %RH 10% I+K SD, with slope 2×10^{-5} , intercept 0.0003, R^2 0.9846

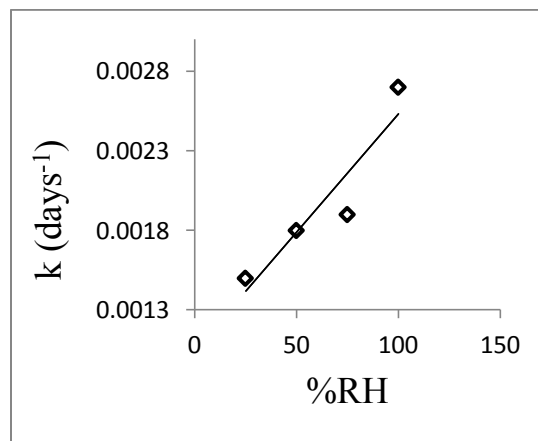

Figure 9.34.b k v/s %RH 0% I+K SD, with slope 1×10^{-5} , intercept 0.0011, R^2 0.8692

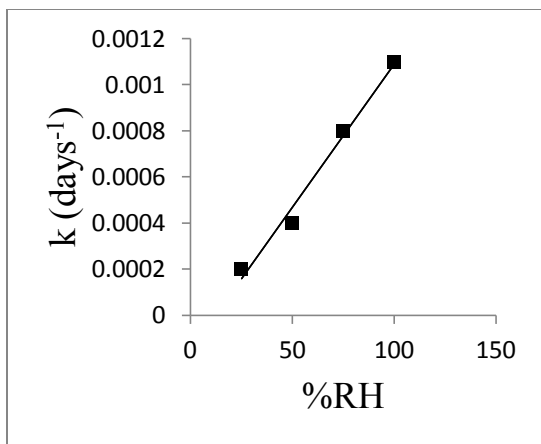

Figure 9.34.c k v/s %RH 50% I+K SD, with slope $1E-5$, intercept 0.0002 , $R^2 0.9856$

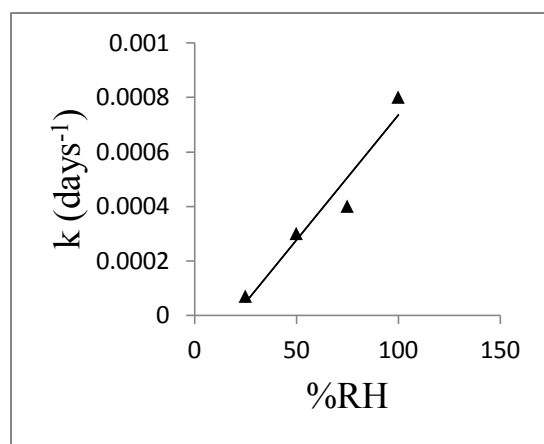

Figure 9.34.d k v/s %RH 70% I+K SD, with slope $9E-6$, intercept 0.0002 , $R^2 0.9409$

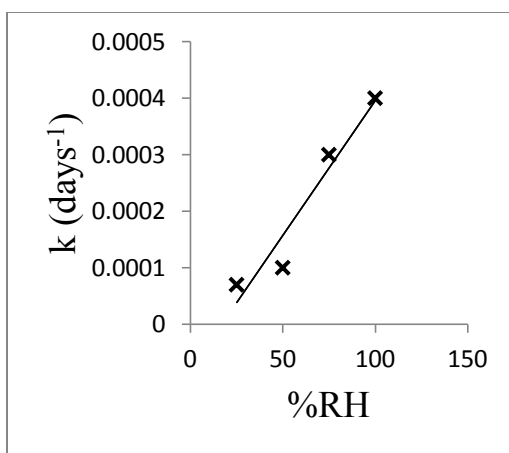

Figure 9.17.e k v/s %RH Pure I, with slope $6 E-5$, intercept of $8E-5$ and R^2 of 0.9356

9.3 Phenytoin Solid Dispersion

Four ternary solid dispersions prepared using 10% w/w, 30% w/w, 50% w/w and 70% w/w of phenytoin and 90% w/w, 70% w/w, 50% w/w and 30% w/w of Kollidon[®] VA64 respectively, coated on 20% w/w (the total weight of P and K) of Neusilin[®] US2 (adsorbent). Physical mixtures containing these same concentrations of afore named ingredients were also prepared.

The solid dispersions and the physical mixtures were subjected to tests in order to evaluate the changes that take place with the drug when formulated into a solid dispersion. Powder X-Ray Diffraction (PXRD), Scanning Electron Microscopy (SEM), Differential Scanning Calorimetry (DSC), dissolution studies and stability studies were performed on the solid dispersions. PXRD was performed on the physical mixtures as well.

9.3.1. Differential Scanning Calorimetry

Differential Scanning Calorimetric (DSC) studies were performed on the ingredients used in order to make the ternary solid dispersions which include phenytoin (P), Kollidon[®] VA64 (K), and Neusilin[®] US2 (N). Physical and ternary solid dispersions were prepared as previously described and were also used for obtaining thermograms. DSC studies were performed to observe any interaction between the various ingredients and to study the change in crystallinity should it occur.

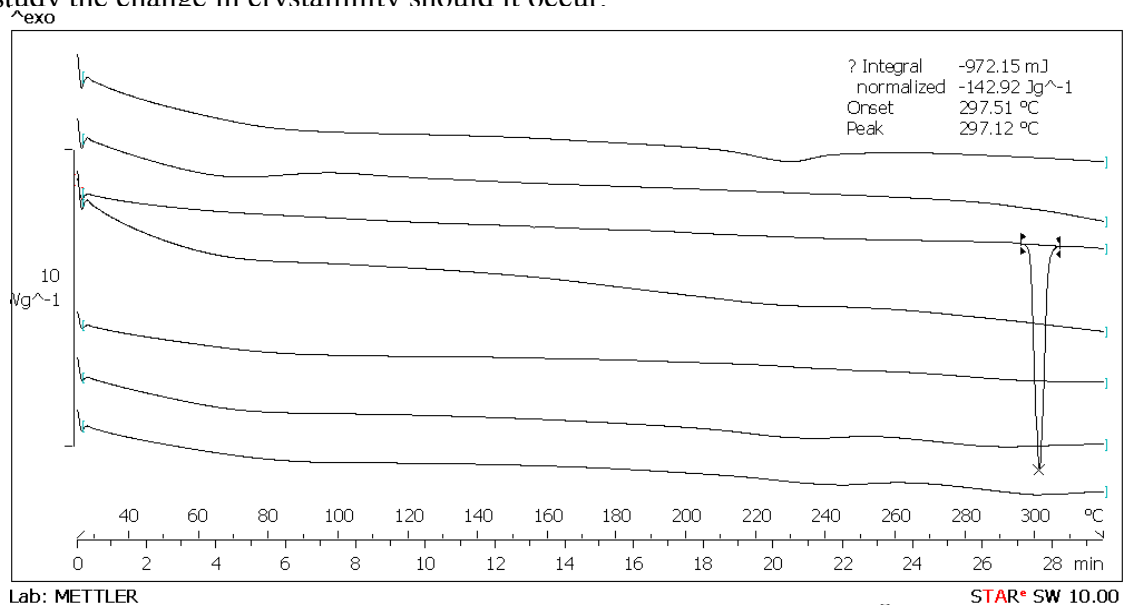

Figure 9.35 DSC thermogram showing from top to bottom: Neusilin[®] US2, Kollidon[®] VA64, Phenytoin, 10%P+K PM, 30% P+K PM, 50% P+K PM, 70% P+K PM

Figure 9.35 shows the comparison between the thermograms for Neusilin[®]US2 (N), phenytoin (P), Kollidon[®]VA64 (K), and the physical mixtures (PMs P+K). Figure 9.36 shows a comparison between the thermograms for Neusilin[®]US2 (N), phenytoin (P), Kollidon[®]VA64 (K), and the four solid dispersions. The thermogram images show the melting peak for phenytoin (P) at 297.12^oC.

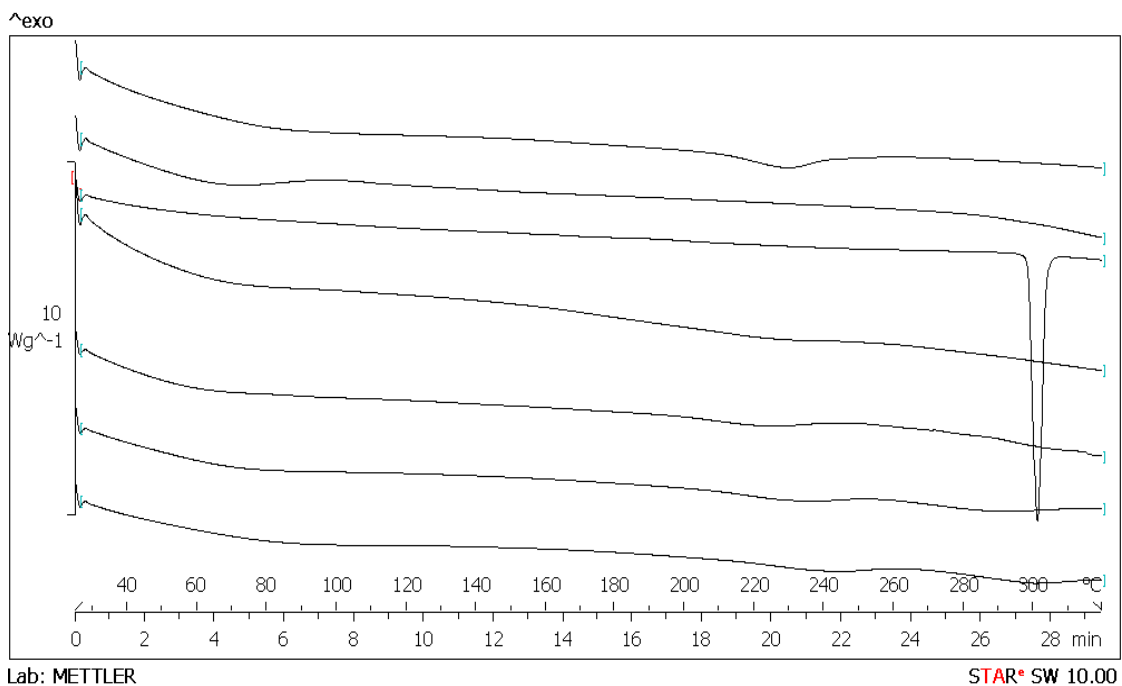

Figure 9.36 DSC thermogram showing from top to bottom: Neusilin[®]US2, Kollidon[®]VA64, Phenytoin, 10%P+K SD, 30% P+K SD, 50% P+K SD, 70% P+K SD

The thermograms for the physical mixtures seen in Figure 9.35 do not show any peaks since it melts at a much lower temperature and due to the scale of the thermograms. None of the thermograms for the physical mixtures show any peaks suggesting that the physical mixture might also be an effective means of improving solubility. The thermograms for the solid dispersions, seen in Figure 9.36 have no peaks for phenytoin.

This indicates that the drug might be completely amorphous. Powder X-Ray Diffraction (PXRD) studies will help in confirming the results suggested by the DSC studies. Results from the PXRD studies are discussed later in this chapter.

9.3.2 Powder X-Ray Crystallography

Powder X-Ray Crystallography (PXRD), gives a better picture when crystallinity of a substance has to be evaluated.

The crystallograph of the drug indomethacin (I) was compared with the crystallograph of the various physical mixtures and solid dispersions. This gives an insight into how crystalline or amorphous the drug has become. Solid dispersions were subjected to stress under accelerated stability conditions and were tested for recrystallization. For this purpose the four solid dispersions prepared as previously described were kept at temperatures of 30⁰C, 35⁰C, 40⁰C, and 45⁰C and in relative humidity conditions of 100%, 75.29 ±.12%, 54.38± .23 and 23.11±0.25%, for a period of two months. Samples were taken at the end of the two month time period and tested for recrystallization. Figure 9.37 shows the crystallographs for physical mixtures. Figure 9.38 shows crystallographs for the four solid dispersions prepared. Figures 9.39 to 9.42 shows the crystallographs for the solid dispersions kept at 30⁰C, 35⁰C, 40⁰C, and 45⁰C for two months. Figures 9.43 to 9.46 shows the crystallographs of the solid dispersions kept in 100%, 75.29 ±.12%, 54.38± .23 and 23.11±0.25% relative humidity (RH) for two months.

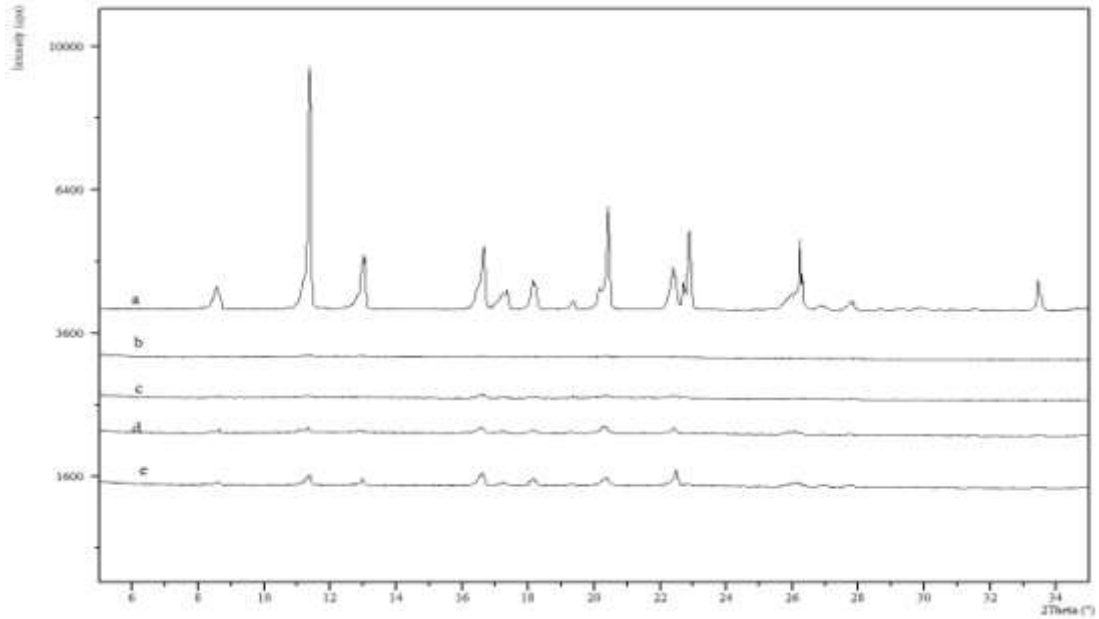

Figure 9.37 PXR for Phenytoin and the four physical mixtures: a- P; b- 10% P+K PM; c- 30% P+K PM; d-50% P+K PM; e- 70% +K PM

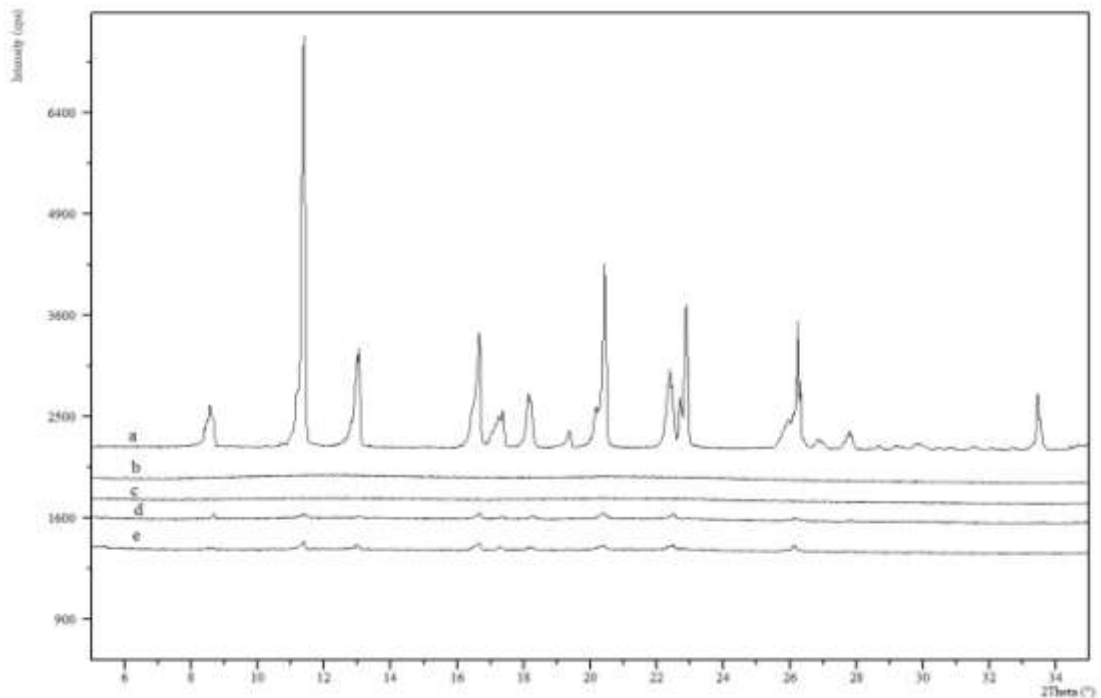

Figure 9.38 PXR for Phenytoin and the four solid dispersions: a- P; b-10%P+K SD; c-30% P+K SD; d-50% P+K SD; e- 70% P+K SD

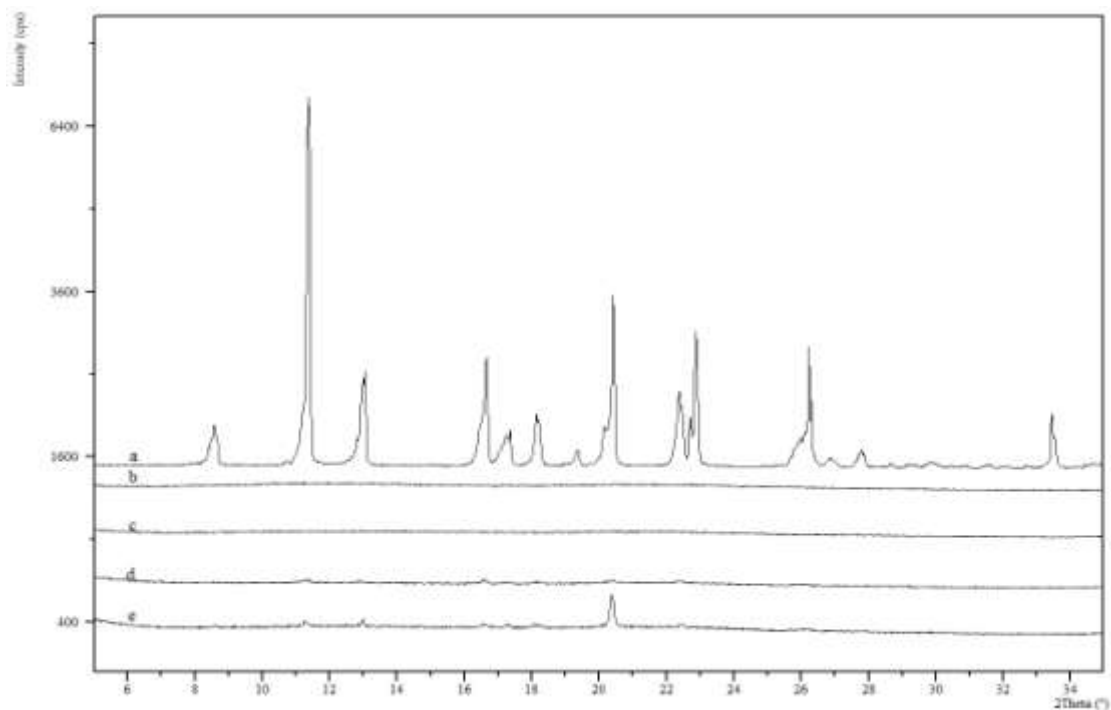

Figure 9.39 PXR Solid dispersions kept at 30⁰C for a period of two months: a- P; b-10%P+K; b-30% P+K; c-50% P+K; e- 70% P+K

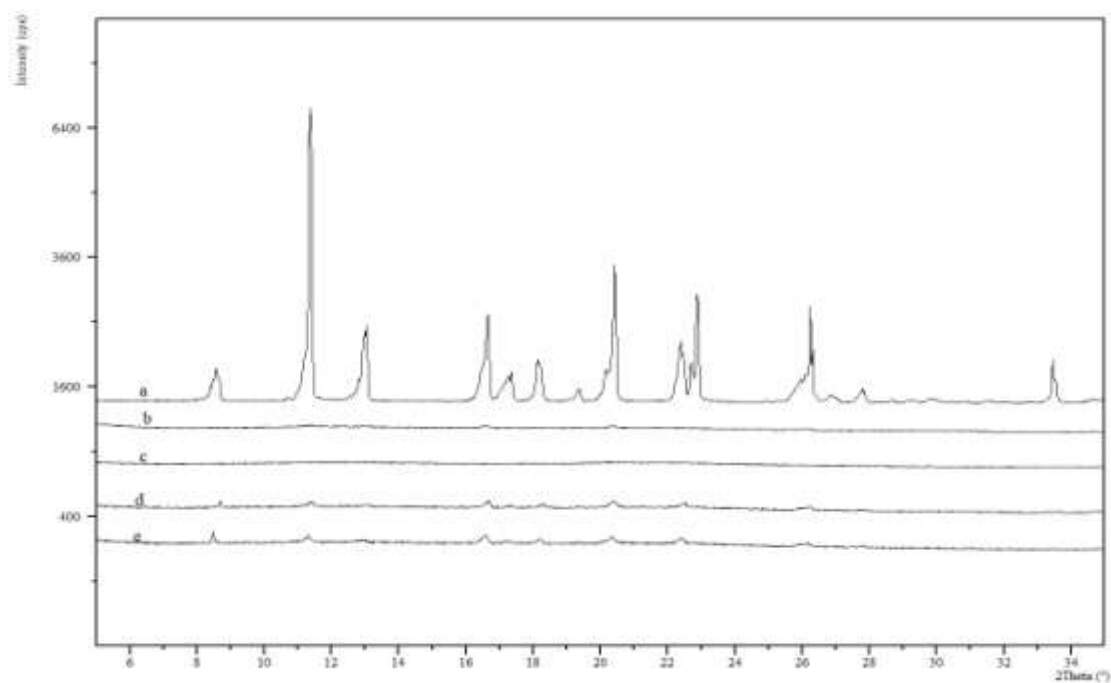

Figure 9.40 PXR Solid dispersions kept at 35⁰C for a period of two months: a- P; b-10%P+K; b-30% P+K; c-50% P+K; e- 70% P+K

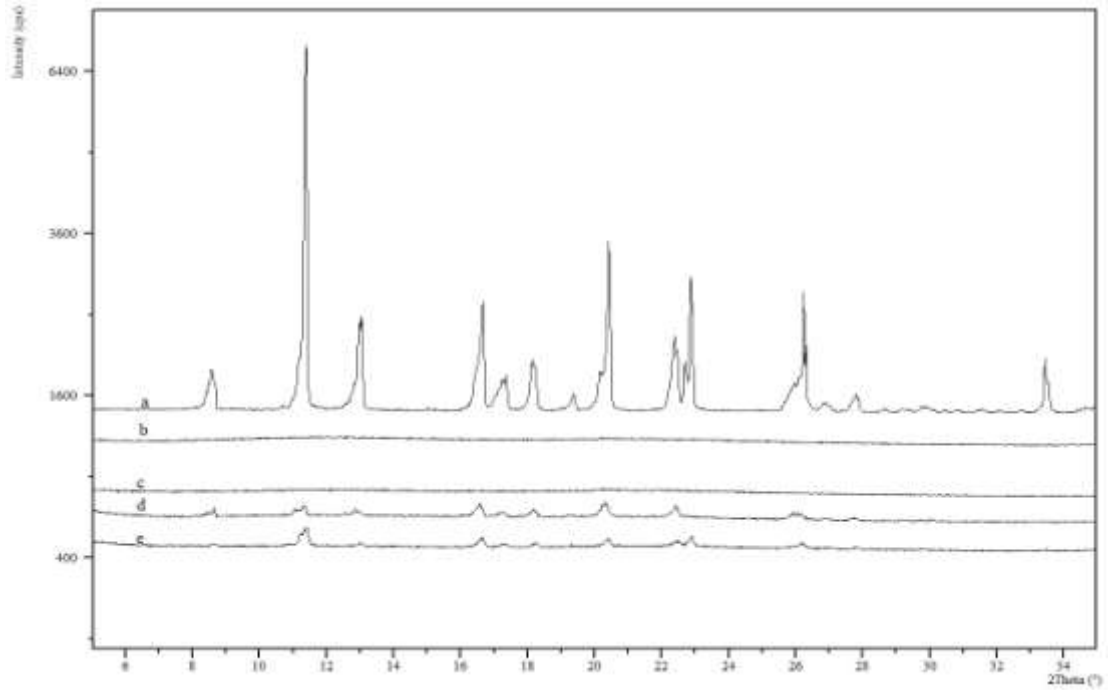

Figure 9.41 PXR D Solid dispersions kept at 40⁰C for a period of two months: a- P; b- 10%P+K; c-30% P+K; d-50% P+K; e- 70% P+K

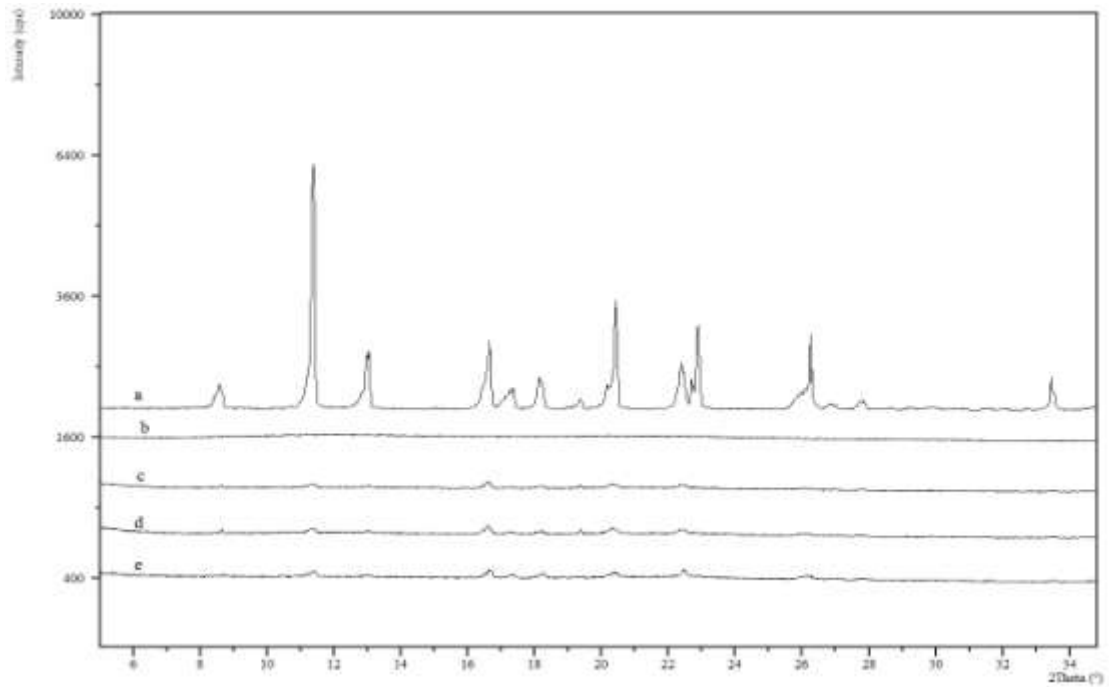

Figure9.42 PXR D Solid dispersions kept at 45⁰C for a period of two months: a- P; b- 10%P+K; c-30% P+K; d-50% P+K; e- 70% P+K

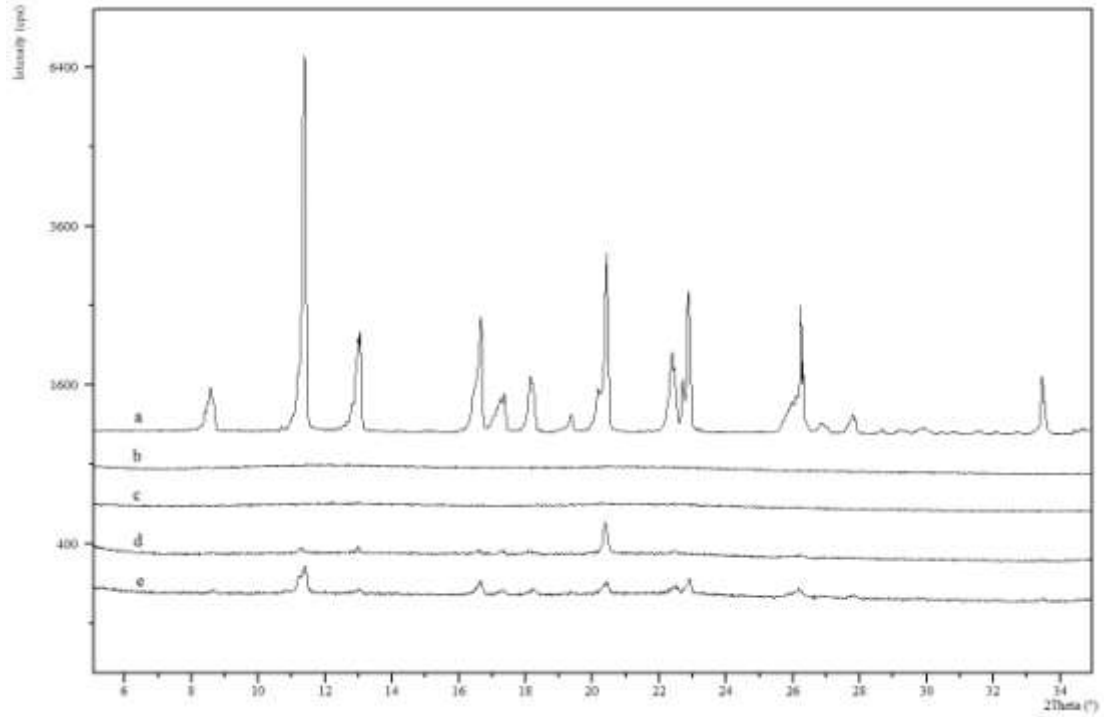

Figure 9.43 PXRD Solid dispersions kept $23.11 \pm 0.25\%$ RH for a period of two months: a- P; b-10%P+K; c-30% P+K; d-50% P+K; e- 70% P+K

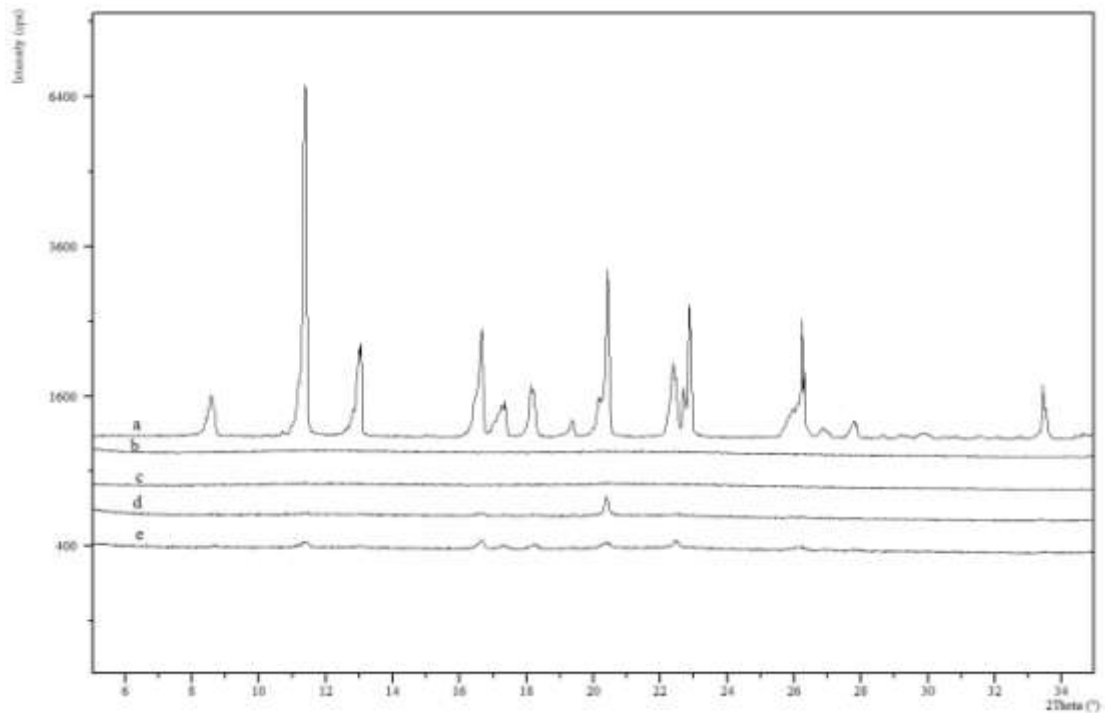

Figure 9.44 PXRD Solid dispersions kept $54.38 \pm .23$ RH for a period of two months: a- P; b-10%P+K; c-30% P+K; d-50% P+K; e- 70% P+K

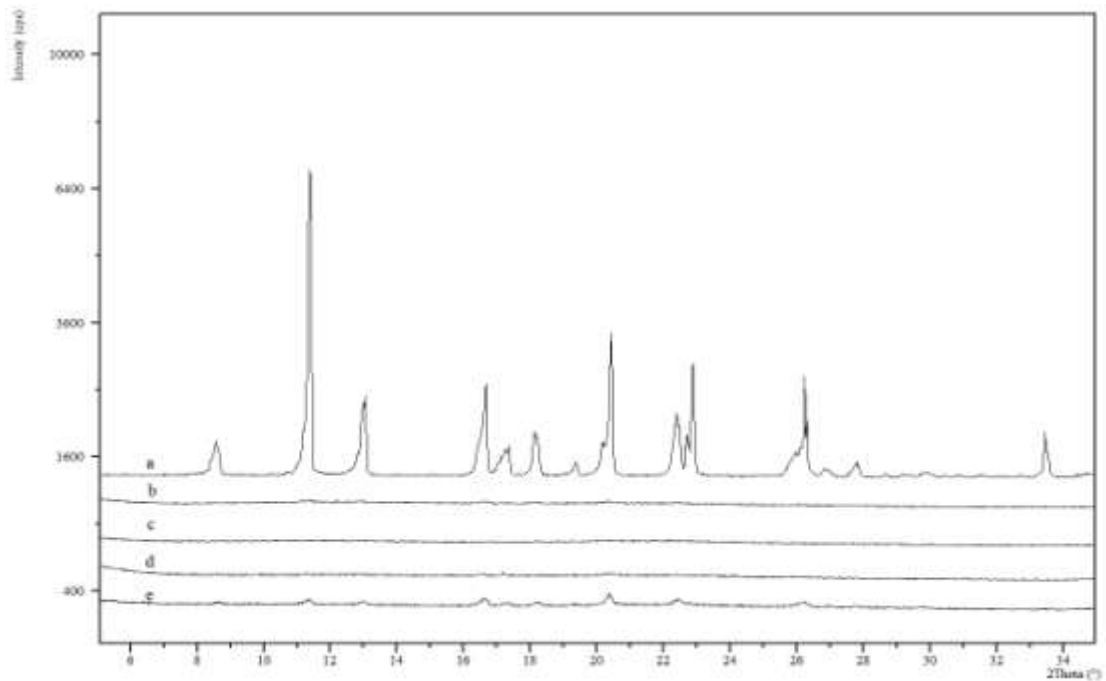

Figure 9.45 PXRD Solid dispersions kept $75.29 \pm .12\%RH$ for a period of two months: a- P; b-10%P+K; c-30% P+K; d-50% P+K; e- 70% P+K

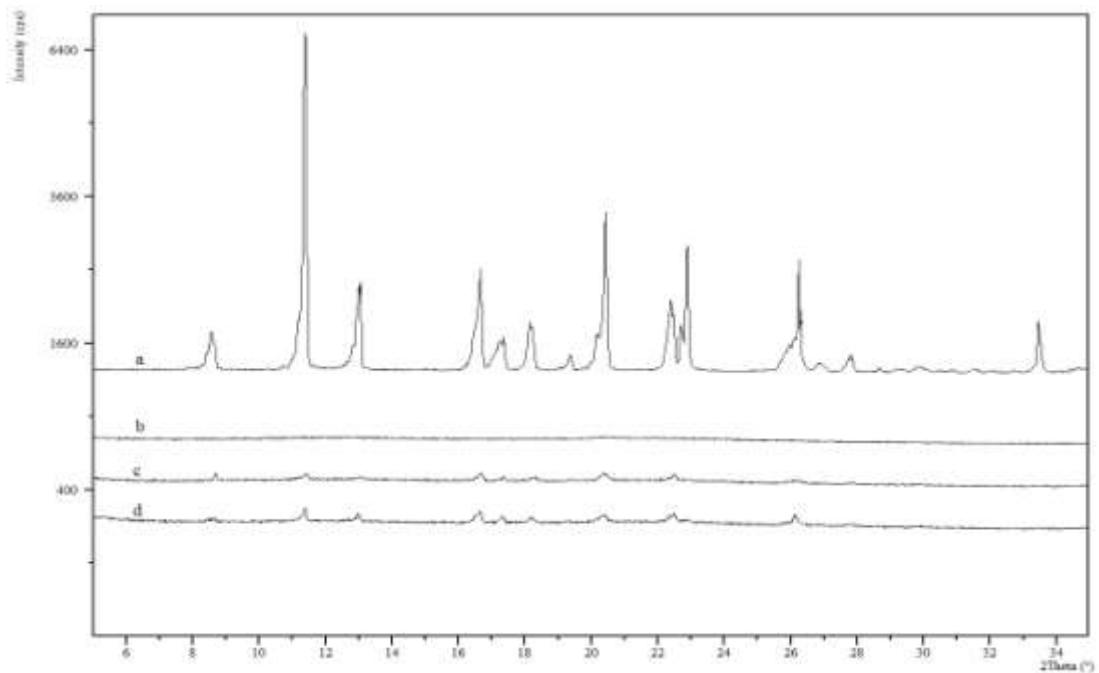

Figure 9.46 PXRD Solid dispersions kept 100%RH for a period of two months: a- P; c-30% P+K; d-50% P+K; d- 70% P+K

Figure 9.38 shows that as the quantity of phenytoin increases, the physical mixtures start showing peaks for phenytoin. Peaks are seen in physical mixtures containing 30%, 50% and 70% phenytoin. Figure 9.39 shows the crystallographs for solid dispersions.

Formulations with 10% w/w and 30% w/w phenytoin show no crystallinity, but ones with 50% w/w and 70% w/w phenytoin show a small amount of crystallinity. Figures 9.39 to 9.46 with results from the accelerated stability studies show that formulations made with 50% w/w and 70% w/w demonstrate some peaks of very small intensity. This indicates that some drug might be recrystallizing as the formulation ages.

9.3.3 Scanning Electron Microscopy

SEM studies were performed in order to study the characteristics and surface morphology of phenytoin (P), Kollidon[®]VA64 (K), Neusilin[®]US2 (N) and a physical mixture (PM P+K) containing 10% w/w phenytoin, 90% w/w Kollidon[®]VA64 and Neusilin[®]US2 equal to the combination weight of Kollidon[®]VA64 and phenytoin. Ternary solid dispersions prepared as previously described were also studied using SEM. The images of the solid dispersions showed that the solid dispersion was well coated on the Neusilin[®]US2 indicating that the technique used for the study can be successfully used to make ternary solid dispersions of this type. Figure 9.47 shows phenytoin (P), Kollidon[®]VA64 (K), Neusilin[®]US2 (N), a physical mixture (PM P+K) and Figure 9.48 shows the four solid dispersions. The SEM pictures for the drug phenytoin shows the crystalline nature of the drug. The SEM picture for Kollidon[®]VA64 Shows structures that look like pieces of sphere. It is not crystalline in nature nor is it porous.

The SEM picture for Neusilin[®]US2 reveals that it is spherical in nature and has a very large surface area due to its porosity. The SEM image for the solid dispersions shows spherical structures which have Neusilin[®]US2 as the core coated with the solid dispersion of indomethacin and urea on its surface.

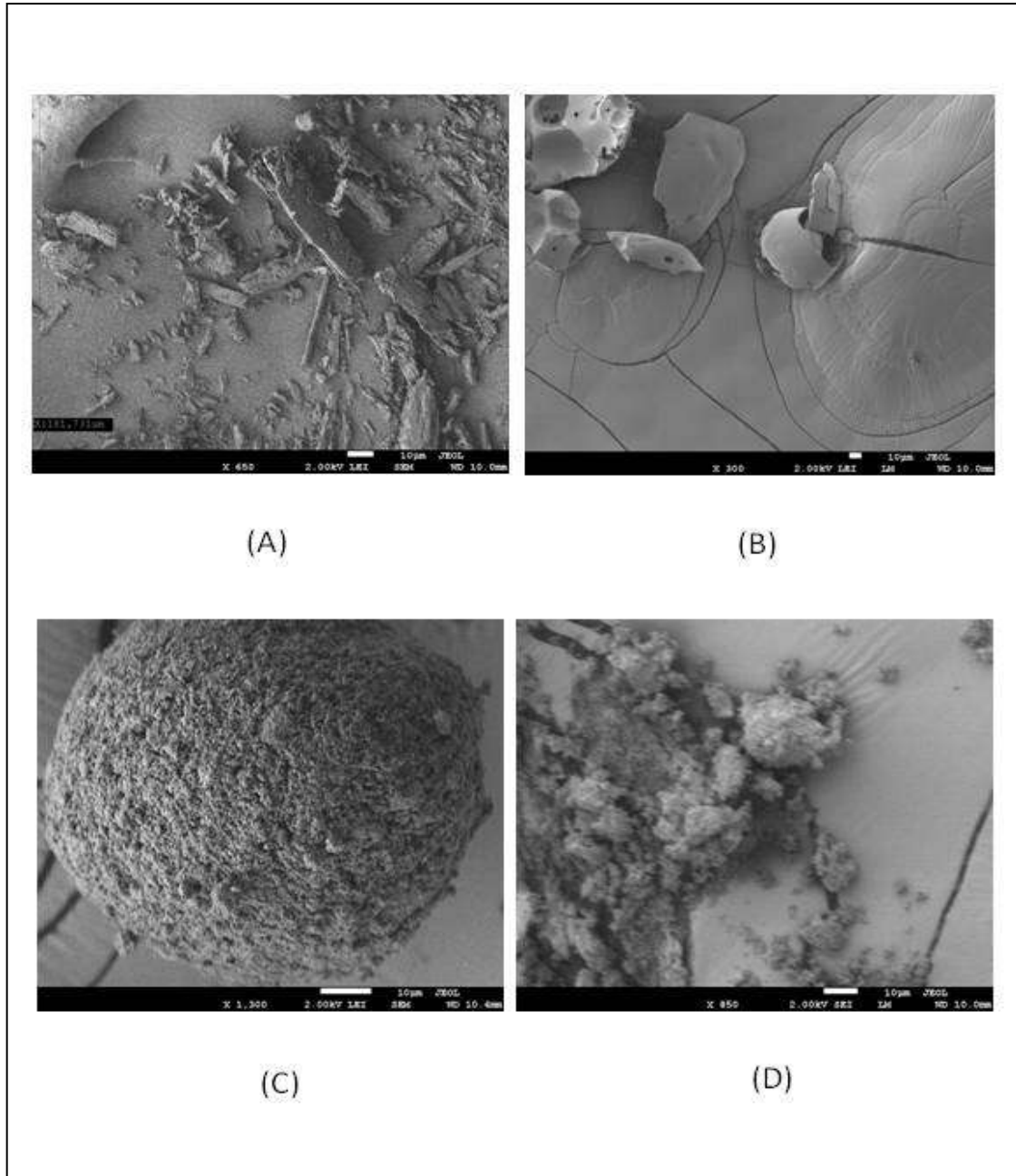

Figure 9.47 SEM images (A) Phenytoin; (B) Kollidon[®]VA64; (C) Neusilin[®]US2; (D) PM P+K

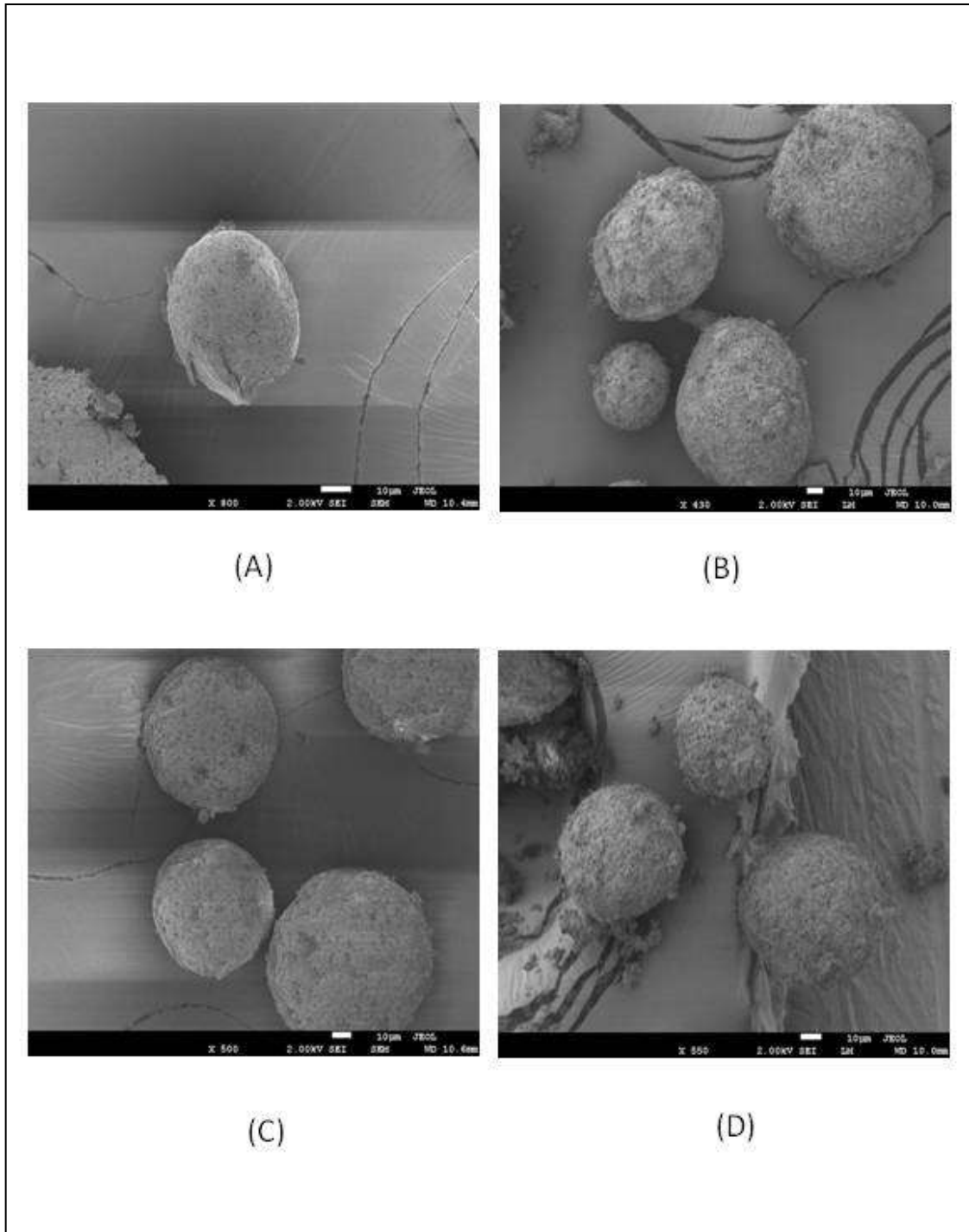

Figure 9.48 SEM image (A) 10% P+K SD, (B) 30% P+K SD, (C) 50% P+K SD, (D)70% P+K SD

9.3.4 Dissolution Studies

Dissolution studies were performed on the solid dispersions and the drug to determine the dissolution profile of the drug and how it changes in the solid dispersion, in contrast to the drug alone. Four solid dispersions prepared as previously described and phenytoin alone were used for the dissolutions studies. 100 mg phenytoin or formulation containing its equivalent was used for the studies. The dissolution medium kept at $37\pm 0.5^{\circ}\text{C}$ was used for the study. The aliquots withdrawn were evaluated using UV-Visible spectroscopy. The absorbance was measured at a wavelength (λ) of 259 nm. Table 9.6 Shows the mean data used to make the calibration curves. Figure 9.49 gives the calibration curve used to determine the concentration of the drug in the samples. Table 9.7 provides the data that were used to make the graphs that gives the dissolution profile for phenytoin and its formulations.

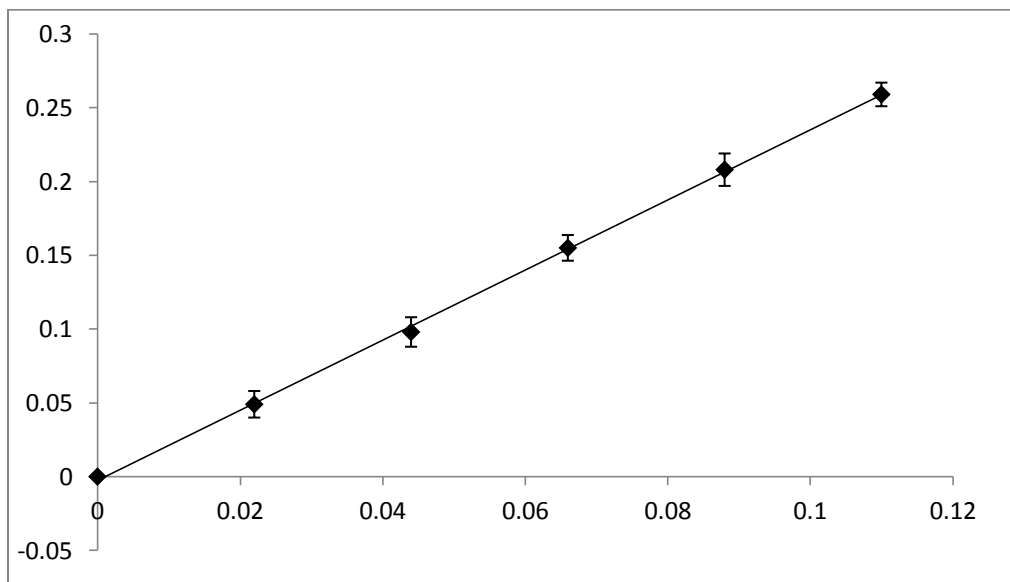

Figure 9.49 Calibration curve for phenytoin at $\lambda=258$,; having a slope of 2.3753, intercept of -0.0025, and R2 value of 0.9995

Table 9.6 Data for calibration curve for Phenytoin

Concentration (mg/m)	Absorbance*	SD
0	0	0
0.022	0.049	0.009
0.044	0.098	0.01
0.066	0.155	0.0087
0.088	0.208	0.011
0.11	0.259	0.008

Table 9.7 Data for the dissolution profiles for phenytoin and its formulations*

Time (Mins)	Pure Phenytoin		10%P+K		30% P+K		50% P+K		70%P+K	
	cum. % rel.	S.D.	cum. % rel.	S.D.	cum. % rel.	S.D.	cum. % rel.	S.D.	cum. % rel.	S.D.
0	0	0	0	0	0	0	0	0	0	0
5	17.2	1.3	30.2	2.2	19.9	2.4	18.8	1.5	18.0	0.5
10	23.2	2.4	50.3	2.9	38.3	2.2	30.2	1.2	26.2	2.7
15	27.7	1.8	65.2	1.5	56.6	1.1	38.0	1.4	33.5	2.8
30	33.8	2.2	72.0	2.0	64.4	1.5	46.8	1.2	42.4	1.2
45	36.4	2.7	74.8	1.1	67.5	2.3	50.2	1.9	47.1	1.1
60	37.5	2.3	75.6	1.2	68.1	2.8	52.4	2.3	48.8	2.3
90	38.7	1.9	77.1	2.8	68.1	1.5	53.3	2.3	48.7	1.8
120	39.0	1.3	79.2	2.2	68.6	1.1	53.6	1.1	48.8	2.5

* The cumulative % release data is a mean of three readings for all the formulations

Figure 9.50 shows the dissolution profiles. The dissolution profiles seen in Figure 9.50 clearly show an increase in the amount of drug that is dissolved. As the percentage of phenytoin drops there is an increase in the amount of drug dissolving and an increase in

dissolution rate. Solid dispersions with 10% w/w and 30% w/w phenytoin show a very large increase in the amount of drug released and the rate at which it is released.

The amount of drug dissolving increases from about 30% to about 75% in the case of formulations containing 10% w/w and 30% w/w phenytoin. Formulations having 50% w/w and 70% w/w phenytoin shows an increase to about 40% to 45% drug release.

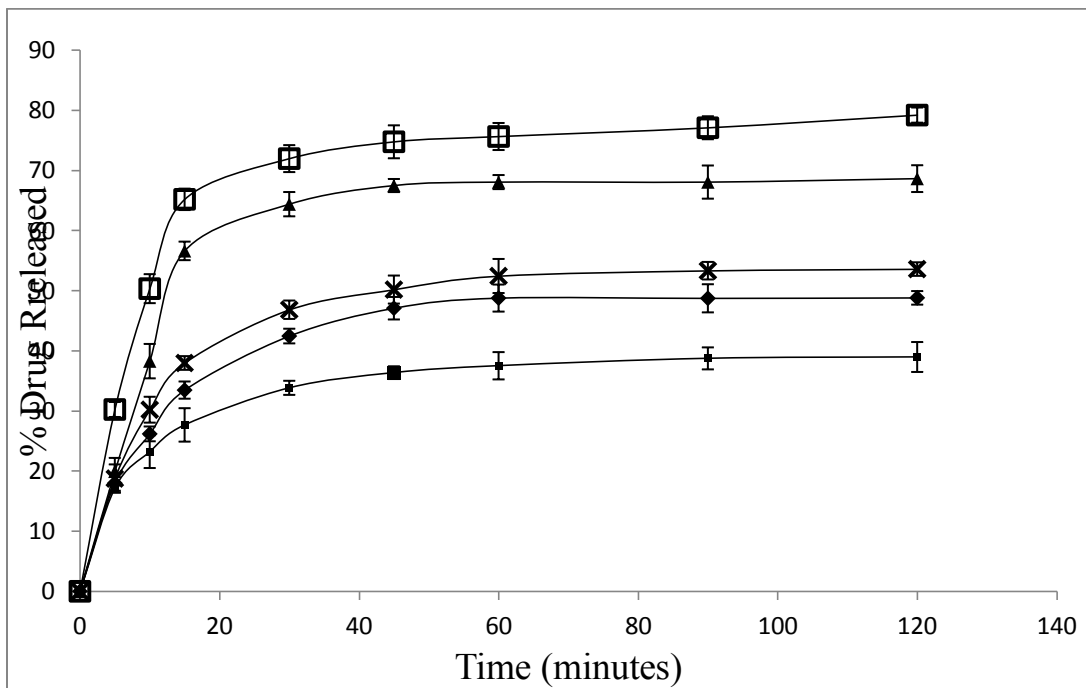

Figure 9.50 Dissolution: □ 10% P+K SD; ▲ 30% P+K SD; X 50% P+K SD; ◆ 70% P+K SD, ■ Pure Phenytoin

9.3.5 Stability Studies

Stability studies were performed by placing the formulations under accelerated stability conditions. The formulations were kept at temperatures of 30°C, 35°C, 40°C, and 45°C and under controlled conditions of 100%, 75.29 ± 12%, 54.38 ± .23 and 23.11 ± 0.25% relative humidity for a period of two months.

Samples from the formulation kept at high temperatures were collected at 4, 8, 12, 24, 36, 48, and 72 hours and at 5, 10, 15, 30, and 60 days. Samples from the formulations which were kept at different relative humidities were drawn at 15, 30, 45 and 60 days. The rate of degradation was determined using UV-Visible spectroscopy. The rates were studied with the aid of the Arrhenius equation and the shelf life for the various formulations was determined. Figure 9.51.a to Figure 9.51.e. show the Arrhenius plots ($\ln K$ vs $1/T$) used for shelf life determination. The trends seen by the study indicates that the shelf life for the four formulations might be as given in Table 9.8

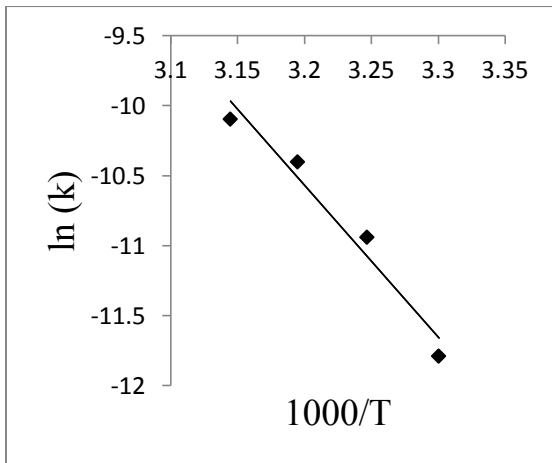

Figure 9.51.a Arrhenius plot 10% P+K, with slope -10.852, intercept 24.154, R^2 0.9609

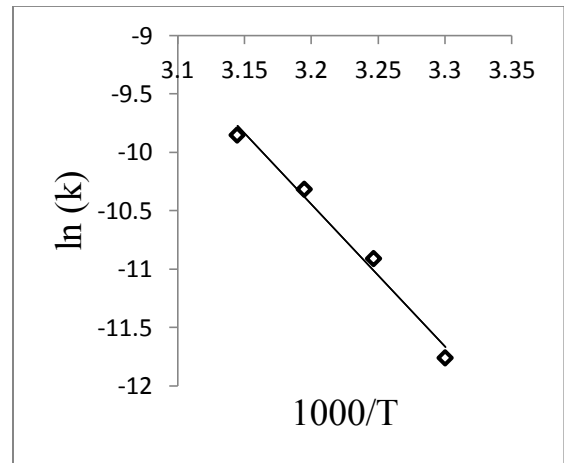

Figure 9.51.b Arrhenius plot 30% P+K, with slope -12.2, intercept 28.595, R^2 0.9849

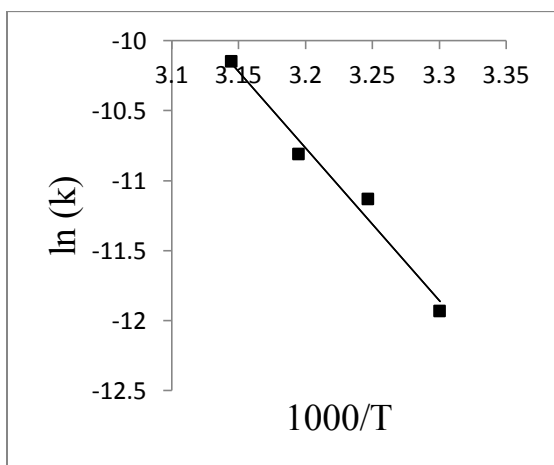

Figure 9.51.c Arrhenius plot 50% P+K, with slope -10.932, intercept 24.216, R^2 0.9781

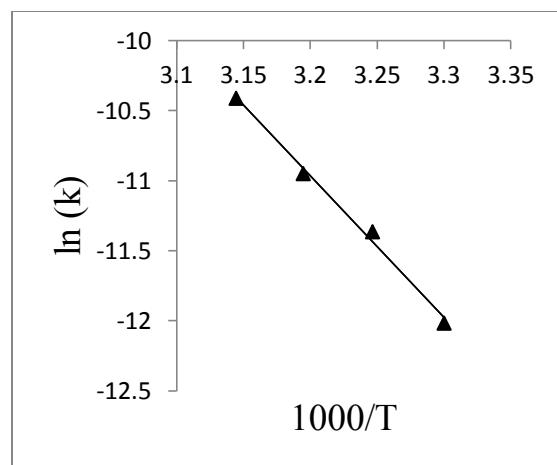

Figure 9.51.d Arrhenius plot 70% P+K, with slope -10.83, intercept 21.3, R^2 0.9941

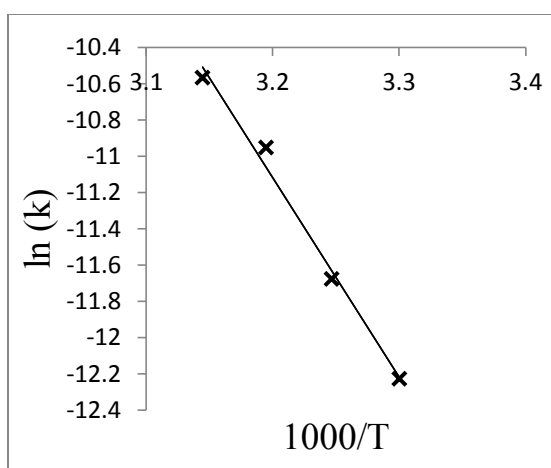

Figure 9.51.e Arrhenius plot for pure P, with slope -11.006, intercept 24.099, R^2 0.9895

Table 9.8. Shelf life, in years for formulations made with Phenytoin and Kollidon

SD	10%P+K	30%P+K	50%P+K	70%P+K	PP
t90	2.7	2.5	3.1	3.3	4.4

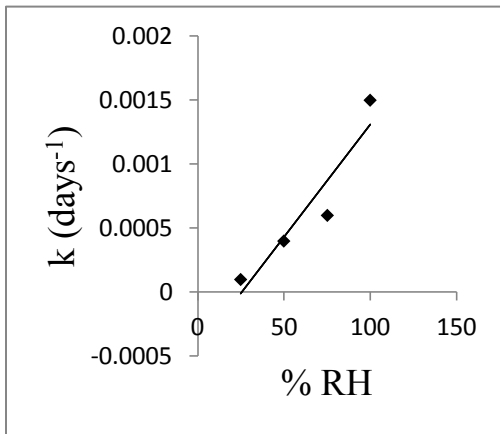

Figure 9.52.a Plot of K v/s %RH 10% P+K, with slope $2E-5$, intercept 0.0005. $R^2=0.8881$

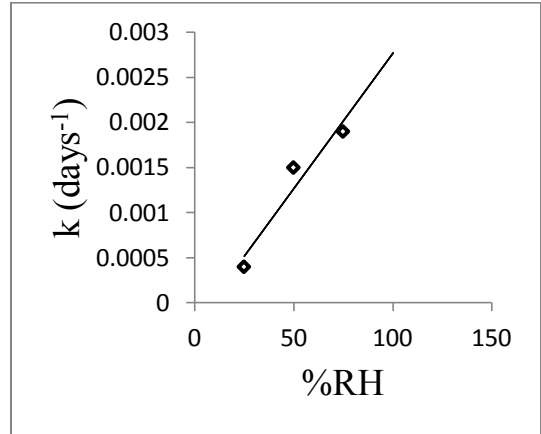

Figure 9.52.b Plot of K v/s %RH 30% P+K SD, with slope $-3E-5$, intercept 0.0002. $R^2=0.9323$

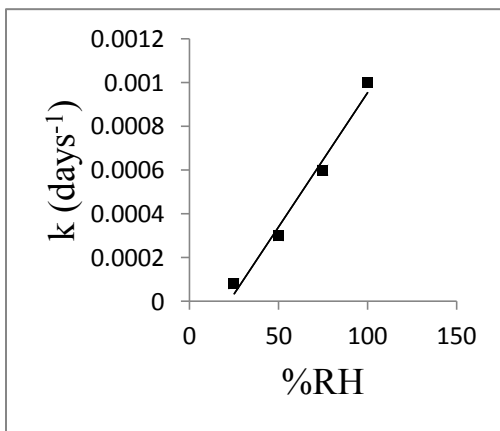

Figure 9.52.c Plot of K v/s %RH 50% P+K, with slope $1E-5$, intercept 0.0003. $R^2=0.983$

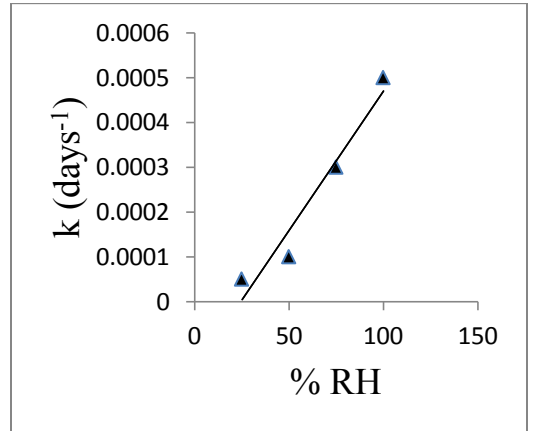

Figure 9.52.d Plot of K v/s %RH 70% P+K, with slope $6E-6$, intercept 0.0002. $R^2=0.9468$

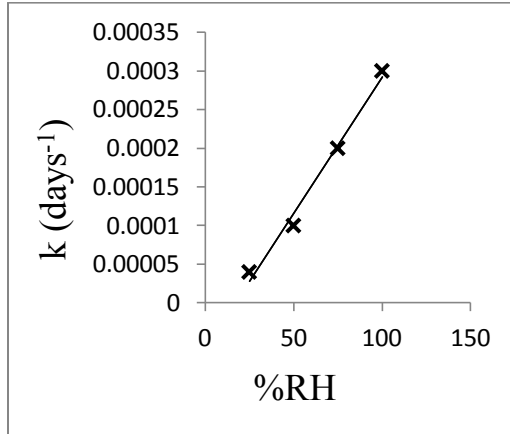

Figure 9.52.e Plot of K v/s %RH Pure P, with slope 4E-6, intercept 6E-5, R²0.9878

The specimens kept at various relative humidity conditions were studied to determine the effect of relative humidity on the degradation of the formulation. The study suggested that as the relative humidity increased, the rate of degradation might tend to increase. Figure 9.52a to Figure.9.52.e show the relationship between the relative humidity and K. Since the shelf life for the formulations is not very long any technique that would retard the degradation process would be useful in making the formulation more usable. The study also suggests that a 10% decrease in relative humidity might be able to increase the shelf life of the formulation by up to 800 days in some cases.

Chapter 10

Conclusions and Future Work

The aim of this study was to prepare ternary solid dispersions granules for two poorly water-soluble drugs (indomethacin and phenytoin), in order to improve their solubility. The study also included the characterization of the ternary solid dispersion granules with respect to their physicochemical properties. Urea and Kollidon[®]VA64 were used as carriers for the solid dispersions. Neusilin[®]US2, which is a porous material having large surface area, was used as an adsorbent. In order to obtain a ternary solid dispersion, the melt prepared with indomethacin and urea was added to the Neusilin[®]US2 which was preheated to the same temperature. After thorough mixing, the mix was quench cooled to form the final granules. When preparing the solid dispersions by the solvent evaporation method, a slurry was made with Neusilin[®]US2 and the solution of the drug (indomethacin or phenytoin) and Kollidon[®]VA64. This slurry was subjected to solvent removal by heating. These solid dispersion formulations were characterized using Differential Scanning Calorimetry (DSC), X-Ray Powder Diffraction (XRPD), Scanning Electron Microscopy (SEM) and in vitro dissolution studies. The ternary solid dispersions were also subjected to stability studies for two months under different temperatures (30⁰C, 35⁰C, 40⁰C, and 45⁰C) and relative humidity conditions (100%, 75.29 ±.12%, 54.38± .23 and 23.11±0.25% RH).

Differential Scanning Calorimetry (DSC) gives an idea about the energy used for a physical or chemical change. The basic principle underlying this study is that amorphous

forms of drugs have higher solubility than their crystalline forms. Amorphous substances also need less energy for changes to occur in their physical state, such as melting. A DSC thermogram can give us information about the crystallinity of the drug in the formulation. If the formulation shows sharp melting peaks for the drug, it is most likely because the drug is still crystalline. DSC studies for all the solid dispersion formulations show almost no peaks for the drugs (indomethacin and phenytoin), indicating that they may be in their amorphous form. A number of physical mixtures studied using DSC showed peaks for the drugs, indicating that though the crystallinity of the drug might have been reduced; there was further need for the reduction in the crystallinity of the drug and thereby improving the solubility profile.

Powder X-Ray Diffraction (PXRD) studies provide a true test of the crystallinity of any substance. When an X-ray is beamed at a crystalline substance, at certain angles the rays are diffracted to interfere constructively with each other. When the intensity of the diffracted x-rays is plotted against the angle ($2\theta^0$), a characteristic pattern emerges, which is particular for that crystal lattice of that substance. Since the instrument detects the crystalline nature of the powder, even very fine crystals can be easily detected by this method. A slight crystallinity in a formulation does not necessarily indicate that there isn't improvement in the solubility. Rather it demonstrates that there is a room for further improvement. If a formulation shows no initial crystallinity starts to show a crystalline nature post stability studies, it sometimes indicates that some instability with the formulation may have occurred. Crystallographs for indomethacin and urea physical mixtures showed peaks for the physical mixtures containing 50% or 70% indomethacin. Physical mixtures made with 10% and 30% indomethacin, all the solid dispersions and

solid dispersions after undergoing accelerated stability testing, showed no peaks for indomethacin. This indicated that the various formulations made with indomethacin and urea are relatively stable. Physical mixtures of indomethacin and Kollidon[®]VA64, which have 30% or more indomethacin showed crystalline peaks when studied. All the solid dispersions show complete conversion of the drug to its amorphous form. The drug shows slight recrystallization only in the formulation containing 70% indomethacin and 30% Kollidon[®]VA 64 when kept for two months at 45⁰C or at 100% RH. The crystallograph for the physical mixtures for phenytoin and Kollidon[®]VA 64 show peaks for phenytoin. This indicates that physical mixtures might not show a marked increase in the dissolution of the drug. When the crystallographs for the solid dispersions were studied, it was found that the formulations containing 50% or 70% phenytoin showed a few peaks of very low intensity for phenytoin. This showed that a small amount of drug remained in the crystalline form in the formulation. All the formulations were relatively stable. None of them showed an increase in the intensity of the peaks.

Scanning Electron Microscopy studies helped us understand and compare the surface morphology of the formulations, drugs, and other ingredients. Both the drugs and urea showed crystalline structure in their native form. Kollidon[®]VA 64 is a polymer and showed structures which looked like fragments from a sphere. Neusilin[®]US2 has a spherical structure and is highly porous. This means it has a very high surface area and can act as an adsorbent. All the solid dispersions showed spherical granules of Neusilin[®]US2 coated with the solid dispersion.

A dissolution study is very important since the aim of this project is to increase the dissolution or improve the dissolution profile of the drug (indomethacin or phenytoin). In

vitro sink conditions with the right dissolution medium gives us insight as to how the drug will act inside the body. Two aspects which are studied along with the dissolution studies are the amount of drug solubilize and the dissolution rate. The two formulations for indomethacin showed similar results. Formulations having 10% and 30% indomethacin show an increase in both the dissolution rate and the amount of drug dissolved. The other two formulations with 50% and 70% indomethacin show an increase in the dissolution rate but not as great an increase in the quantity of drug dissolved. In the case of phenytoin, all four formulations show an increase in the rate and quantity of drug dissolved. Formulations with 10% and 30% phenytoin show an increase in the quantity of phenytoin dissolved. Formulations made with 50% and 70% phenytoin do not do not show as much of an increase in the quantity of phenytoin dissolved.

A formulation showing an increase in the rate and quantity of drug dissolved should be stable for the period of its shelf life. If the shelf life is not long enough a good formulation will not be useful since it will not be feasible to market the formulation. To test if the drug would be stable over the shelf life, or to determine the trends with shelf life of the formulation, accelerated stability studies are performed on the formulations to determine how well they endure aging. Another use for accelerated stability studies is to make sure that the drug stays in its amorphous form in the formulation since this is paramount for a good solubility profile. Formulations were kept under accelerated stability conditions and their shelf life was determined using the Arrhenius equation. Formulations were also kept under various controlled relative humidity conditions to study its effect on the degradation rate of the drug. The trend suggested that the shelf life might decrease as the concentration of the drug in the formulation increases. The study

suggested that the formulations made with indomethacin and urea the shelf life might be between 2.5 and 4.3 years. Formulations made with indomethacin and Kollidon[®]VA64 may have a shelf life of between 2.6 and 4.4 years. Formulations for phenytoin might have a shelf life of between 2.7 and 3.3 years.

Overall the 30% formulations for indomethacin and phenytoin have the potential to be a successful formulation. They showed an increase in the rate and quantity of drug dissolved. They are also stable and do not recrystallize. Trends from the stability studies show that they might have a shelf file of approximately 3 years. Formulations having 10% drug show a good dissolution profile and stability. Their shelf life might be a problem when trying to market them. Formulations with 50% and 70% drugs show some instability and do not have as much of an increase in their dissolution rate or drug dissolution quantity as compared to the other two formulations.

10.1 Future Work

Formulating solid dispersions into a dosage form and studying its characteristics could be the next step for this project. Stability of the formulations might differ in another formulation and should be studied. The onset time and duration of action of the formulation can also be studied. Another type of formulation can be made by coating the drug directly onto Neusilin[®]US2 or other adsorbent material. Various proportions of adsorbent and drug can give different results. A long term stability study for the formulations should be conducted.

References

References for Chapter 1

1. Savjani, K.T., A.K. Gajjar, and J.K. Savjani, *Drug Solubility: Importance and Enhancement Techniques*. ISRN pharmaceutics, 2012. **2012**.
2. Sharma, D., et al., *Solubility enhancement- eminent role in poorly soluble drugs*. Research Journal of Pharmacy and Technology, 2009. **2**(2): p. 220-224.
3. Krishnaiah, Y.S.R., *Pharmaceutical technologies for enhancing oral bioavailability of poorly soluble drugs*. J Bioequiv Availab, 2010. **2**(2): p. 28-36.
4. Moore, M.D. and P.L.D. Wildfong, *Aqueous solubility enhancement through engineering of binary solid composites: pharmaceutical applications*. Journal of Pharmaceutical Innovation, 2009. **4**(1): p. 36-49.
5. Jinno, J., et al., *Effect of particle size reduction on dissolution and oral absorption of a poorly water-soluble drug, cilostazol, in beagle dogs*. Journal of controlled release, 2006. **111**(1): p. 56-64.
6. Bansal, K., et al., *Micronization and Dissolution Enhancement of Norethindrone*. International Journal Of Research In Pharmacy And Chemistry, 2011. **1**(3).
7. Habib, M.J., *Historical background of solid dispersion, in pharmaceutical solid dispersion technology* 2001, Technomic Publishing Company, Inc. : Lancaster, Pa 17604, U.S.A. p. 2-3.

8. Debuigne, F., et al., *Synthesis of Nimesulide Nanoparticles in the Microemulsion Epikuron/Isopropyl Myristate/Water/n-Butanol (or Isopropanol)*. Journal of colloid and interface science, 2001. **243**(1): p. 90-101.
9. Jacobs, C., O. Kayser, and R. Müller, *Production and characterisation of mucoadhesive nanosuspensions for the formulation of bupravaquone*. International journal of pharmaceutics, 2001. **214**(1): p. 3-7.
10. Kayser, O., et al., *Formulation of amphotericin B as nanosuspension for oral administration*. International journal of pharmaceutics, 2003. **254**(1): p. 73-75.
11. Kocbek, P., S. Baumgartner, and J. Kristl, *Preparation and evaluation of nanosuspensions for enhancing the dissolution of poorly soluble drugs*. International journal of pharmaceutics, 2006. **312**(1): p. 179-186.
12. Liversidge, G.G. and P. Conzentino, *Drug particle size reduction for decreasing gastric irritancy and enhancing absorption of naproxen in rats*. International journal of pharmaceutics, 1995. **125**(2): p. 309-313.
13. Sharma, D., *A REVIEW ON INNOVATIVE APPROACHES TO ENHANCE SOLUBILITY AND DISSOLUTION RATE OF HYDROPHOBIC DRUGS*. Novel Science International Journal of Pharmaceutical Sciences, 2012. **1**(7).
14. Sanghvi, R., D. Evans, and S.H. Yalkowsky, *Stacking complexation by nicotinamide: A useful way of enhancing drug solubility*. International journal of pharmaceutics, 2007. **336**(1): p. 35-41.
15. Loftsson, T. and M.E. Brewster, *Pharmaceutical applications of cyclodextrins. I. Drug solubilization and stabilization*. Journal of pharmaceutical sciences, 1996. **85**(10): p. 1017-1025.

16. Podlogar, F., et al., *Structural characterisation of water–Tween 40[®]/Imwitor 308[®]–isopropyl myristate microemulsions using different experimental methods*. International journal of pharmaceutics, 2004. **276**(1): p. 115-128.
17. Serajuddin, A., *Salt formation to improve drug solubility*. Advanced drug delivery reviews, 2007. **59**(7): p. 603-616.
18. Murali Mohan Babu, G., C.D.S. Prasad, and K. Ramana Murthy, *Evaluation of modified gum karaya as carrier for the dissolution enhancement of poorly water-soluble drug nimodipine*. International journal of pharmaceutics, 2002. **234**(1): p. 1-17.
19. Keck, C.M. and R.H. Müller, *Drug nanocrystals of poorly soluble drugs produced by high pressure homogenisation*. European journal of pharmaceutics and biopharmaceutics, 2006. **62**(1): p. 3-16.
20. Salvadori, B., et al., *A novel method to prepare inorganic water-soluble nanocrystals*. Journal of colloid and interface science, 2006. **298**(1): p. 487-490.
21. Sekiguchi, K.a.O., N., *Studies on Absorption of Eutectic Mixture. I. A Comparison of the Behavior of Eutectic Mixture of Sulfathiazole and that of Ordinary Sulfathiazole in Man*. Chemical & pharmaceutical bulletin, 1961. **9**(11): p. 866-872.
22. Habib, M.J., *Fundamentals of Solid dispersions, in pharmaceutical solid dispersion technology*2001, Technomic Publishing Company, Inc. : Lancaster, Pa 17604, U.S.A. p. 16-17.

23. Vasconcelos, T., B. Sarmiento, and P. Costa, *Solid dispersions as strategy to improve oral bioavailability of poor water soluble drugs*. Drug discovery today, 2007. **12**(23): p. 1068-1075.
24. Das, S.K., et al., *Solid Dispersions: An Approach to Enhance the Bioavailability of Poorly Water-Soluble Drugs*.
25. Serajuddin, A., *Solid dispersion of poorly water-soluble drugs: early promises, subsequent problems, and recent breakthroughs*. Journal of pharmaceutical sciences, 1999. **88**(10): p. 1058-1066.
26. Sriamornsak, P., et al., *Manufacture of Ternary Solid Dispersions Composed of Nifedipine, Eudragit® E and Adsorbent*. Advanced Materials Research, 2011. **317**: p. 185-188.
27. *Neusilin*, L. Fuji Chemical Industry Co., Editor 2009.

References for Chapter 2

1. Leuner, C. and J. Dressman, *Improving drug solubility for oral delivery using solid dispersions*. European journal of pharmaceutics and biopharmaceutics, 2000. **50**(1): p. 47-60.
2. Amidon, G.L., et al., *A theoretical basis for a biopharmaceutic drug classification: the correlation of in vitro drug product dissolution and in vivo bioavailability*. Pharmaceutical research, 1995. **12**(3): p. 413-420.
3. Sekiguchi, K.a.O., N., *Studies on Absorption of Eutectic Mixture. I. A Comparison of the Behavior of Eutectic Mixture of Sulfathiazole and that of Ordinary Sulfathiazole in Man*. Chemical & pharmaceutical bulletin, 1961. **9**(11): p. 866-872.
4. *Guidance for Industry: Waiver of In Vivo Bioavailability and Bioequivalence Studies for Immediate-Release Solid Oral Dosage Forms Based on a Biopharmaceutics Classification System*. 2000 [cited 2005 02/03]; Available from:
<http://www.fda.gov/downloads/Drugs/GuidanceComplianceRegulatoryInformation/Guidances/UCM070246.pdf>.
5. Fincher, J.H., *Particle size of drugs and its relationship to absorption and activity*. Journal of pharmaceutical sciences, 1968. **57**(11): p. 1825-1835.
6. Sharma, D., *A REVIEW ON INNOVATIVE APPROACHES TO ENHANCE SOLUBILITY AND DISSOLUTION RATE OF HYDROPHOBIC DRUGS*. Novel Science International Journal of Pharmaceutical Sciences, 2012. **1**(7).

7. Jinno, J., et al., *Effect of particle size reduction on dissolution and oral absorption of a poorly water-soluble drug, cilostazol, in beagle dogs*. Journal of controlled release, 2006. **111**(1): p. 56-64.
8. Bansal, K., et al., *Micronization and Dissolution Enhancement of Norethindrone*. International Journal Of Research In Pharmacy And Chemistry, 2011. **1**(3).
9. Habib, M.J., *Historical background of solid dispersion, in pharmaceutical solid dispersion technology*2001, Technomic Publishing Company, Inc. : Lancaster, Pa 17604, U.S.A. p. 2-3.
10. Rogers, T.L., et al., *Development and characterization of a scalable controlled precipitation process to enhance the dissolution of poorly water-soluble drugs*. Pharmaceutical research, 2004. **21**(11): p. 2048-2057.
11. Lin, S.L., J. Menig, and L. Lachman, *Interdependence of physiological surfactant and drug particle size on the dissolution behavior of water-insoluble drugs*. Journal of pharmaceutical sciences, 1968. **57**(12): p. 2143-2148.
12. Kocbek, P., S. Baumgartner, and J. Kristl, *Preparation and evaluation of nanosuspensions for enhancing the dissolution of poorly soluble drugs*. International journal of pharmaceutics, 2006. **312**(1): p. 179-186.
13. Debuigne, F., et al., *Synthesis of Nimesulide Nanoparticles in the Microemulsion Epikuron/Isopropyl Myristate/Water/< i> n</i>-Butanol (or Isopropanol)*. Journal of colloid and interface science, 2001. **243**(1): p. 90-101.
14. Jacobs, C., O. Kayser, and R. Müller, *Production and characterisation of mucoadhesive nanosuspensions for the formulation of bupravaquone*. International journal of pharmaceutics, 2001. **214**(1): p. 3-7.

15. Kayser, O., et al., *Formulation of amphotericin B as nanosuspension for oral administration*. International journal of pharmaceutics, 2003. **254**(1): p. 73-75.
16. Liversidge, G.G. and P. Conzentino, *Drug particle size reduction for decreasing gastric irritancy and enhancing absorption of naproxen in rats*. International journal of pharmaceutics, 1995. **125**(2): p. 309-313.
17. Banga, S., G. Chawla, and A.K. Bansal, *New Trends in the Crystallisation of Active Pharmaceutical Ingredients*. Businessbriefing: Pharmagenetics, 2004: p. 70-74.
18. Kumar, A., et al., *Review on solubility enhancement techniques for hydrophobic drugs*. Pharmacie Globale, 2011. **3**(3): p. 001-007.
19. Sanghvi, R., D. Evans, and S.H. Yalkowsky, *Stacking complexation by nicotinamide: A useful way of enhancing drug solubility*. International journal of pharmaceutics, 2007. **336**(1): p. 35-41.
20. Loftsson, T. and M.E. Brewster, *Pharmaceutical applications of cyclodextrins. 1. Drug solubilization and stabilization*. Journal of pharmaceutical sciences, 1996. **85**(10): p. 1017-1025.
21. Podlogar, F., et al., *Structural characterisation of water-Tween 40[®]/Imwitor 308[®]-isopropyl myristate microemulsions using different experimental methods*. International journal of pharmaceutics, 2004. **276**(1): p. 115-128.
22. Shah, N., et al., *Self-emulsifying drug delivery systems (SEDDS) with polyglycolized glycerides for improving in vitro dissolution and oral absorption of lipophilic drugs*. International journal of pharmaceutics, 1994. **106**(1): p. 15-23.

23. Serajuddin, A., *Salt formation to improve drug solubility*. Advanced drug delivery reviews, 2007. **59**(7): p. 603-616.
24. Habib, M.J., *Fundamentals of Solid dispersions, in pharmaceutical solid dispersion technology*2001, Technomic Publishing Company, Inc. : Lancaster, Pa 17604, U.S.A. p. 19.
25. Mullins, J.D. and T.J. Macek, *Some pharmaceutical properties of novobiocin*. Journal of the American Pharmaceutical Association, 1960. **49**(4): p. 245-248.
26. Savjani, K.T., A.K. Gajjar, and J.K. Savjani, *Drug Solubility: Importance and Enhancement Techniques*. ISRN pharmaceutics, 2012. **2012**.
27. Murali Mohan Babu, G., C.D.S. Prasad, and K. Ramana Murthy, *Evaluation of modified gum karaya as carrier for the dissolution enhancement of poorly water-soluble drug nimodipine*. International journal of pharmaceutics, 2002. **234**(1): p. 1-17.
28. Keck, C.M. and R.H. Müller, *Drug nanocrystals of poorly soluble drugs produced by high pressure homogenisation*. European journal of pharmaceutics and biopharmaceutics, 2006. **62**(1): p. 3-16.
29. Salvadori, B., et al., *A novel method to prepare inorganic water-soluble nanocrystals*. Journal of colloid and interface science, 2006. **298**(1): p. 487-490.
30. Tachibana, T. and A. Nakamura, *A methode for preparing an aqueous colloidal dispersion of organic materials by using water-soluble polymers: dispersion of β -carotene by polyvinylpyrrolidone*. Colloid & Polymer Science, 1965. **203**(2): p. 130-133.

31. Habib, M.J., *Fundamentals of Solid dispersions, in pharmaceutical solid dispersion technology* 2001, Technomic Publishing Company, Inc. : Lancaster, Pa 17604, U.S.A. p. 16-17.
32. Chiou, W.L. and S. Riegelman, *Pharmaceutical applications of solid dispersion systems*. Journal of pharmaceutical sciences, 1971. **60**(9): p. 1281-1302.
33. Goldberg, A.H., M. Gibaldi, and J.L. Kanig, *Increasing dissolution rates and gastrointestinal absorption of drugs via solid solutions and eutectic mixtures II: Experimental evaluation of a eutectic mixture: Urea-acetaminophen system*. Journal of pharmaceutical sciences, 1966. **55**(5): p. 482-487.
34. Chiou, W.L. and S. Riegelman, *Preparation and dissolution characteristics of several fast-release solid dispersions of griseofulvin*. Journal of pharmaceutical sciences, 1969. **58**(12): p. 1505-1510.
35. Ali, A. and A. Gorashi, *Absorption and dissolution of nitrofurantoin from different experimental formulations*. International journal of pharmaceutics, 1984. **19**(3): p. 297-306.
36. Portero, A., C. Remunan-Lopez, and J. Vila-Jato, *Effect of chitosan and chitosan glutamate enhancing the dissolution properties of the poorly water soluble drug nifedipine*. International journal of pharmaceutics, 1998. **175**(1): p. 75-84.
37. Ford, J.L., A.F. Stewart, and J.L. Dubois, *The properties of solid dispersions of indomethacin or phenylbutazone in polyethylene glycol*. International journal of pharmaceutics, 1986. **28**(1): p. 11-22.

38. Stoll, R.G., et al., *Some physical factors affecting the enhanced blepharoptotic activity of orally administered reserpine-cholanic acid coprecipitates*. Journal of pharmaceutical sciences, 1969. **58**(12): p. 1457-1459.
39. Habib, M.J., *Fundamentals of Solid dispersions, in pharmaceutical solid dispersion technology*2001, Technomic Publishing Company, Inc. : Lancaster, Pa 17604, U.S.A. p. 21-25.
40. Habib, M.J., *Use of Polymers i solid dispersion technology, in pharmaceutical solid dispersion technology*2001, Technomic Publishing Company, Inc. : Lancaster, Pa 17604, U.S.A. p. 65-70.

References for chapter 3

1. Clas, S.D., C.R. Dalton, and B.C. Hancock, *Differential scanning calorimetry: applications in drug development*. Pharmaceutical science & technology today, 1999. **2**(8): p. 311-320.
2. Haines, P.J., *Principles of thermal analysis and calorimetry*. RSC paperbacks 2002, Thomas Graham PHuse, science Park, Milton Road, Cambridge CB OWF, UK: The Royal society of Chemistry. 220.
3. Haines, P.J., *Thermal methods of analysis: principles, applications and problems*1995: Blackie Academic & Professional.
4. Wandlandt, W.W., *Thermal Analysis*. 3rd ed. Chemical Analysis1986, New York: Wiley- Interscience Publication. 814.
5. Turi, E.A. and H.E. Bair, *Thermal characterization of polymeric materials*: ACS Publications.
6. Ford, J.L. and P. Timmins, *Pharmaceutical thermal analysis: techniques and applications*1989: Ellis Horwood Chichester.
7. Wilburn, F., D. Dollimore, and J. Crighton, *A study of the thermal effects observed in DTA: Part 2. The influence of sample and reference system parameters on a typical DTA curve*. Thermochimica acta, 1991. **181**: p. 173-190.
8. Zaky, M.T. and N.H. Mohamed, *Influence of low-density polyethylene on the thermal characteristics and crystallinity of high melting point macro-and micro-crystalline waxes*. Thermochimica acta, 2010. **499**(1): p. 79-84.
9. Gillham, J. and J. Enns, *On the cure and properties of thermosetting polymers using torsional braid analysis*. Trends Polym. Sci., 1994. **2**(12): p. 406-418.

10. Duddu, S.P. and D.J.W. Grant, *The use of thermal analysis in the assessment of crystal disruption*. *Thermochimica acta*, 1995. **248**: p. 131-145.
11. Gehenot, A., et al., *Value of thermal analysis in the critical evaluation of classical methods of melting point determination*. *International journal of pharmaceutics*, 1988. **45**(1): p. 13-17.
12. Giron, D., *Thermal analysis and calorimetric methods in the characterisation of polymorphs and solvates*. *Thermochimica acta*, 1995. **248**: p. 1-59.
13. Dürig, T. and A. Fassihi, *Identification of stabilizing and destabilizing effects of excipient-drug interactions in solid dosage form design*. *International journal of pharmaceutics*, 1993. **97**(1): p. 161-170.
14. Hancock, B.C. and G. Zografi, *Characteristics and significance of the amorphous state in pharmaceutical systems*. *Journal of pharmaceutical sciences*, 1997. **86**(1): p. 1-12.
15. Schneider, H., J. Rieger, and E. Penzel, *The glass transition temperature of random copolymers: 2. Extension of the Gordon-Taylor equation for asymmetric T_g vs composition curves*. *Polymer*, 1997. **38**(6): p. 1323-1337.
16. Bettinetti, G., et al., *Thermal analysis of the dehydration process of cross-linked polyvinylpyrrolidone and its mixtures with naproxen*. *Drug development and industrial pharmacy*, 1994. **20**(14): p. 2215-2225.
17. Khankari, R.K., D. Law, and D.J.W. Grant, *Determination of water content in pharmaceutical hydrates by differential scanning calorimetry*. *International journal of pharmaceutics*, 1992. **82**(1): p. 117-127.

References for Chapter 4

1. Chung, D.D.L. and e. al.], *Review of X-ray Diffraction*, in *X-ray diffraction at elevated temperatures : a method for in situ process analysis*, A. H. and C. D.D.L., Editors. 1993, VCH publisher, Inc. : New York, NEw York-10010. p. 1-6.
2. Harry, B.G., *Overview of physical characterization methodology*, in *Physical Characterization of Phrmaceutical Solids*B.G. Harry, Editor 1995, Marcel Dekker New York, NY-10016p. 1-35.
3. Snyder, R.L., *Introduction*, in *X-ray characterization of materials* E. Lifshin, Editor 1999, Wiley-VCH: Weinheim ; New York p. 24-26.
4. Pungor, E., *X-ray diffraction techniques*, in *A practical guide to instrumental analysis* 1995, CRC Press: Boca Raton
5. Harry, B.G., *X-ray powder diffractometry*, in *Physical Characterization of Phrmaceutical Solids*, S. Raj, Editor 1995, Marcel Dekker: New York, NY-10016. p. 187-220.
6. Klug, H.P. and L.E. Alexander, *X-ray diffraction procedures: for polycrystalline and amorphous materials*. *X-Ray Diffraction Procedures: For Polycrystalline and Amorphous Materials*, 2nd Edition, by Harold P. Klug, Leroy E. Alexander, pp. 992. ISBN 0-471-49369-4. Wiley-VCH, May 1974., 1974. 1.
7. Haleblan, J. and W. McCrone, *Pharmaceutical applications of polymorphism*. *Journal of pharmaceutical sciences*, 2006. **58**(8): p. 911-929.

8. Yonemochi, E., et al., *Evaluation of the physical stability and local crystallization of amorphous terfenadine using XRD–DSC and micro-TA*. *Thermochimica acta*, 2005. **432**(1): p. 70-75.
9. Lavigneur, C., E.J. Foster, and V.E. Williams, *A simple and inexpensive capillary furnace for variable-temperature X-ray diffraction*. *Journal of Applied Crystallography*, 2008. **41**(1): p. 214-216.

References for Chapter 5

1. Wells, O.C., *Instrument Design*, in *Scanning Electron Microscopy* 1974, McGraw-Hill inc. : New York. p. 420.
2. M.A., H., *The scanning electron microscope: operating principle*, in *Principles and techniques of scanning electron microscopy Biological Applications* J.T. Black, Editor 1974, Van Nostrand Reinhold Company: New York. p. 1-43.
3. G., B.H., *Particle morphology: Optical and electron microscopies*, in *Physical Characterization of Pharmaceutical Solids*, N.A. W. and B.H. G., Editors. 1995, Marcel Dekker: New York, NY-10016. p. 127-156.
4. C.W., O., *Historical introduction*, in *The Scanning Electro Microscope* 1972, Cambridge university Press: Cambridge, Great Britain. p. 1-13.
5. Robinson, V., *The construction and uses of an efficient backscattered electron detector for scanning electron microscopy*. *Journal of Physics E: Scientific Instruments*, 2001. **7**(8): p. 650.
6. Wells, O.C. and C.G. Bremer, *Collector turret for scanning electron microscope*. *Review of Scientific Instruments*, 1970. **41**(7): p. 1034-1037.
7. Daskal, Y., et al., *Use of direct current sputtering for improved visualization of chromosome topology by scanning electron microscopy*. *Experimental cell research*, 1976. **100**(1): p. 204-212.
8. Mills, A., *Silver as a Removable Conductive Coating for Scanning Electron Microscopy. (Retroactive Coverage)*. *Scanning Microscopy(USA)*, 1988. **2**(3): p. 1265-1271.

9. Doughty, M.J., *Analyses of areas and shapes of cells on the corneal surface of the albino rabbit by scanning electron microscopy*. Current eye research, 1990. **9**(4): p. 295-306.
10. Lynn, K.S. and S.I. Fairgrieve, *Microscopic Indicators of Axe and Hatchet Trauma in Fleshed and Defleshed Mammalian Long Bones**. Journal of Forensic Sciences, 2009. **54**(4): p. 793-797.
11. Tillier, A.M., *Facts and Ideas in Paleolithic Growth Studies (Paleoauxology)*. Continuity and Discontinuity in the Peopling of Europe, 2011: p. 139-153.
12. Tucker, B.K., et al., *Microscopic characteristics of hacking trauma*. Journal of Forensic Sciences, 2001. **46**(2): p. 234-240.
13. REEVES, C., *The uses of scanning electron microscopy for studying semiconductor devices†*. International journal of electronics, 1994. **77**(6): p. 919-928.
14. MacQueen, H., G. Judd, and S. Ferriss, *The application of scanning electron microscopy to the forensic evaluation of vehicular paint samples*. J. Forensic Sci, 1972. **17**(4): p. 659-667.
15. CAMPBELL, J., *Ecology and thermal inactivation of microbes in and on interplanetary space vehicle components(examined with a scanning electron microscope)[Quarterly Progress Report, 1 Jan.- 31 Mar. 1974]*. 1974.
16. Schreiner, M., M. Melcher, and K. Uhlir, *Scanning electron microscopy and energy dispersive analysis: applications in the field of cultural heritage*. Analytical and bioanalytical chemistry, 2007. **387**(3): p. 737-747.

References for chapter 6

1. *USP34/NF29*. Vol. 1. 2011, Rockville: United States Pharmacopoeial Convention. 1421.
2. Banker, G.S. and N.R. Anderson, *Tablets*, in *the theory and Practice of Industrial Pharmacy*, L. Lachman, H.A. Liberman, and J.L. Kanig, Editors. 1987, Varghese Publishing House: Bombay 400014. p. 302-303.

References for chapter 7

1. Owen, T., *Fundamentals of modern UV-visible spectroscopy* 2000: Agilent Technologies.
2. Pavia, D.L., et al., *Ultraviolet Spectroscopy*, in *Spectroscopy* 2007, Cengage learning india Pvt. Ltd.: New Delhi. p. 367-397.
3. Skoog, D.A., F.J. Holler, and S.R. Crouch, *An introduction to Ultraviolet-Visible Molecular absorption Spectroscopy*, in *Instrumental analysis* 2007, Cengage Learning India Private Limited: New Delhi. p. 378-409.
4. Connors, K.A., *Absorption Spectroscopy*, in *A Text Book of Pharmaceutical Analysis* 1982, Wiley-Interscience Toronto. p. 173-233.
5. Fuwa, K. and B. Valle, *The Physical Basis of Analytical Atomic Absorption Spectrometry. The Pertinence of the Beer-Lambert Law*. *Analytical Chemistry*, 1963. **35**(8): p. 942-946.
6. Secchieri, M., et al., *Rapid pentachlorophenol evaluation in solid matrixes by second derivative UV spectroscopy for application to wood and leather samples*. *J. Assoc. Off. Anal. Chem*, 1991. **74**: p. 674-678.
7. BRISTOW, P.A., *Liquid-Chromatography Hardware: A Consolidation Phase?* *Anal. Chem*, 1975. **47**: p. 1503-1505.
8. Toraño, J.S. and S. van Hattum, *Quantitative analysis of active compounds in pharmaceutical preparations by use of attenuated total-reflection Fourier transform mid-infrared spectrophotometry and the internal standard method*. *Fresenius J. Anal. Chem*, 2001. **371**: p. 532-535.

9. Herman, M., et al., *A flow method with spectrophotometric detection for determination of chlorite ions in drinking water*. Chem. Anal.(Warsaw), 2009. **54**: p. 907-919.
10. Watanabe, T., et al., *Comparison between polyvinylpyrrolidone and silica nanoparticles as carriers for indomethacin in a solid state dispersion*. International journal of pharmaceutics, 2003. **250**(1): p. 283-286.

References for Chapter 8

1. *Neusilin*, L. Fuji Chemical Industry Co., Editor 2009.
2. Sigma-Aldrich, *Material Safety Data Sheet: Phenytoin*. 2012.
3. Buhler, V., *Kollidon VA 64 (copolyvidone)*, in *Kollidon^(R) Polyvinykpyrrolidone for Pharmaceutical Industry*1998, BASF aktiengesellschaft Ffine chemicals. p. 191-231.
4. Corporation, S.-A., *Materal Safety Data sheet*, in *Indomethacin Product Safety-americas Region*2012, Sigma- Aldrich
5. Valizadeh, H., et al., *Physicochemical characterization of solid dispersions of indomethacin with PEG 6000, Myrj 52, lactose, sorbitol, dextrin, and Eudragit® E100*. *Drug development and industrial pharmacy*, 2004. **30**(3): p. 303-317.
6. Company, C.C., *Safety Data Sheet Indomethacin*, 2011, Cayman Chemical Company: Ann Arbor, MI.
7. Sigma-Aldrich, *Material Safety Data Sheet- Indomethacin*, 2004, Sigma-Aldrich: Saint Louis, MO.
8. Tripathi, K., *Essentials of Medical Pharmacology*. 5th ed1985, New Delhi: Jaypee /brothers Medical Publications Pvt. Ltd.
9. Lacy, C.F., et al., *Drug Information Handbook*. 13 ed2005, Hudson, OH: FormuLex™. 1947.
10. Lab, S., *Material Safety Data Sheet: Phenytoin*, 2005, Sciennce Labs.
11. Sciencelab.com, *Material Safety Data Sheet: Ethyl Alcohol*, 2012, Scencelab.com, Inc.: Houston, TX.
12. Scientific, F., 2003, Fisher Scientific: Fair Lawn, NJ.

13. *The Merck Index*. 8th ed, ed. P.G. Stecher 1968, Rahway: Merck and Co., Inc.
14. sciencelab.com, *Material Safety Data Sheet: Urea MSDS*, 2012, Sciencelab.com, Inc.: Houston, TX.
15. Scientific, F., *Material Safety Data Sheet: Urea*, 2008, Fisher Scientific Fair Lawn, NJ.
16. Sciencelab.com, *Material Safety Data Sheet : sodium chloride*, 2012, Sciencelab.com, Inc.: Houston, TX.
17. Scientific, F., *Material Safety Data Sheet: Sodium Chloride*, 2008, Fisher Scientific: Fair Lawn, NJ.
18. Greenspan, L., *Humidity fixed points of binary saturated aqueous solutions*. Journal of Research of the National Bureau of Standards, 1977. **81**(1): p. 89-96.
19. Scientific, F., *Material Safety Data sheet: potassium acetate*, 2004, Fisher Scientific: Fair Lawn, NJ.
20. Sciencelab.com, *Material Safety Data Sheet : Magnesium nitrate Hexahydrate MSDS*, 2012, Sciencelab.com, Inc.: houston, TX.
21. Sigma-Aldrich, *Material Safety Data Sheet*, 2012, Sigma-Aldrich: Saint Louis, MO.
22. Baker, S.S.D.M., *MSDS: Hydrochloric Acid*, 1999, Mallinckrodt Baker, Inc
23. Chemistry, S., *Material Safety Data Sheet hydrochloric acid 12N*, 2008, ScholAR Chemistry Rochester, NY.
24. Sciencelab.com, *Material Safety Data Sheet Sodium Phosphate monobasic, Anhydrous MSDS*, 2012, Sciencelab.com, inc. : Houston, TX.

25. Sciencelab.com, *Material Safety Data Sheet Sodium phosphate, dibasic heptahydrate MSDS*, 2012, sciencelab.com, inc. : Houston, TX.
26. Sciencelab.com, *Material Safety Data Sheet Acetone MSDS*, 2012, sciencelab.com,inc.: Houston, TX.