

August 2018

# Effects of Life History and Brain Size on Cognition and Behavior: Studies on Prey-searching in the Spider *Pholcus Phalangioides*

Joseph Kilmer

*University of Wisconsin-Milwaukee*

Follow this and additional works at: <https://dc.uwm.edu/etd>



Part of the [Biology Commons](#), [Evolution Commons](#), and the [Social and Behavioral Sciences Commons](#)

---

## Recommended Citation

Kilmer, Joseph, "Effects of Life History and Brain Size on Cognition and Behavior: Studies on Prey-searching in the Spider *Pholcus Phalangioides*" (2018). *Theses and Dissertations*. 1845.

<https://dc.uwm.edu/etd/1845>

This Dissertation is brought to you for free and open access by UWM Digital Commons. It has been accepted for inclusion in Theses and Dissertations by an authorized administrator of UWM Digital Commons. For more information, please contact [open-access@uwm.edu](mailto:open-access@uwm.edu).

EFFECTS OF LIFE HISTORY AND BRAIN SIZE ON COGNITION AND BEHAVIOR: STUDIES  
ON PREY-SEARCHING IN THE SPIDER *PHOLCUS PHALANGIOIDES*

by

Joseph Theodore Kilmer

A Dissertation Submitted in  
Partial Fulfillment of the  
Requirements for the Degree of

Doctor of Philosophy  
in Biological Sciences

at

The University of Wisconsin-Milwaukee

August 2018

## ABSTRACT

EFFECTS OF LIFE HISTORY AND BRAIN SIZE ON COGNITION AND BEHAVIOR: STUDIES ON PREY-SEARCHING IN THE SPIDER *PHOLCUS PHALANGIOIDES*

by

Joseph Theodore Kilmer

The University of Wisconsin-Milwaukee. 2018  
Under the Supervision of Professor Rafael L Rodríguez

There is tremendous diversity in body size across animals, including many examples of derived miniaturization. A reduction in body size is accompanied by a reduction in brain size, which is predicted to lead to limitations in cognition, but we have yet to find empirical evidence indicating what these limitations might be. I used a behavioral assay common in web spiders to explore this topic. I observed spiders as they searched for prey that they recently captured and lost. This assay has the advantage of being easily quantifiable while reflecting a spider's evaluation and memory of lost prey. I conducted a series of experiments with the cellar spider, *Pholcus phalangioides*, using natural variation in body size between juveniles and adults. This allowed me to study effects of brain size on memory content and memory duration without potential confounding effects of cross-species differences in behavior. At the same time, it required a strong understanding of how behavior naturally changes with maturity. Therefore, I began by studying ontogenetic change in this behavior in order to better understand the patterns of change and their causes. In a comparison across age groups, from naïve spiderlings to mature adults, I found that even the youngest, smallest, least experienced spiders were

capable of remembering and searching for prey (suggesting a lack of size-based limitations to memory content), and of all the age groups, they were the ones most motivated to recover lost prey. With these results in mind, I turned my attention to the question of memory duration. I ran an experiment in which I imposed a gap of time between memory formation and memory use. I found that although the smallest spiders had been the most motivated to recover prey, they were also the ones most negatively affected by a delay in the onset of searching. This points to either a higher rate of memory decay or a greater susceptibility to distraction in small brains. These results are among the first findings of size-based limitations to cognition, and they reveal specific ecological and evolutionary challenges faced by miniature animals.

© Copyright by Joseph Theodore Kilmer, 2018  
All Rights Reserved

To my mother, Robin,  
who prepared me for this journey,  
and my wife, Allie,  
who supported me through it.

# TABLE OF CONTENTS

List of Figures .....	viii
List of Tables .....	ix
Acknowledgments.....	x
Chapter 1.....	1
<i>Ontogenetic approach reveals how cognitive capability and motivation shape prey-searching behavior in Pholcus phalangioides cellar spiders</i>	
Abstract.....	1
Introduction .....	2
<i>Changing capability hypothesis</i> .....	4
<i>Changing motivation/need hypothesis</i> .....	5
Methods.....	6
<i>Overview of trials</i> .....	8
<i>Prey used in trials</i> .....	11
<i>Spider size measurements</i> .....	12
<i>Data Analysis</i> .....	12
<i>Statistical analysis</i> .....	14
Results.....	15
Discussion.....	21
Literature Cited .....	24
Chapter 2 .....	26
<i>Miniature brains forget sooner: size-based limitations on memory retention time in cellar spiders</i>	
Abstract.....	26
Introduction .....	28
Methods.....	33
<i>Testing for variation in memory retention</i> .....	35
<i>Search resumption</i> .....	38

<i>Testing motivation against cognition</i> .....	39
Results .....	40
Discussion.....	45
Literature Cited .....	49
APPENDIX: Variation in search time .....	53
CURRICULUM VITAE.....	54



## LIST OF FIGURES

Figure 1.1 Experimental setup .....	9
Figure 1.2 Example visualization of a spider’s behavioral data from a trial .....	13
Figure 1.3 Time that spiders spent searching for lost prey, plotted by spider age category .....	17
Figure 1.4 Prey-size discrimination for spiders of different ages and sexes.....	18
Figure 2.1 A mother <i>P. phalangioides</i> with her second-instar offspring .....	31
Figure 2.2 Ranges of final body masses for spiders used in our experiments.....	36
Figure 2.3 Effects of delay on search time in <i>P. phalangioides</i> spiders.....	41
Figure 2.4 Late-stage time in <i>P. phalangioides</i> spiders.....	42
Figure 2.5 Effects of hunger and handling time on search time for <i>P. phalangioides</i> .....	44

## LIST OF TABLES

Table 1.1 Descriptions of spider behaviors observed during trials.....	10
Table 1.2 Effects of maturity and prey size on search time in <i>P. phalangioides</i> spiders.....	16
Table 1.3 Effects of maturity, prey size, and sex (and their interactions) on search time .....	19
Table 1.4 A closer look at the random effect from the model in Table 1.2.....	20
Table 2.1 Variation in the retention of memory of lost prey in <i>P. phalangioides</i> .....	42
Table 2.2 Variation in resumed searches for lost prey in <i>P. phalangioides</i> .....	43
Table 2.3 Effects of motivation and information acquisition on the search time .....	45

## ACKNOWLEDGMENTS

First and foremost, I thank my advisor, Dr. Rafael Rodríguez, who taught me, guided me, frustrated me, and inspired me for over seven years. I owe a lot to his patience, his wisdom and his generosity. I thank Margo and Allie Kilmer, whose never-ending love and support kept me afloat during this whole process. Many thanks also to my committee members, Dr. Gerlinde Höbel, Dr. Emily Latch, Dr. Peter Dunn and Dr. Linda Whittingham for their feedback throughout the years.

I owe a huge debt of gratitude to my research assistants: Alannah Crabb, Maurice Mananga, Zachary Havens and David Vogel for their help collecting data and for making research season less lonely. I also appreciate all the kind folks who opened up their houses for me to take away their spiders (I'm sure in some cases the appreciation is mutual). I thank Dr. Bill Eberhard for the suggestion to experiment with delaying the onset of searching, I thank Dr. Michael Draney for his help checking our species identification and storing vouchers, and I thank Dr. Kasey Fowler-Finn for her mentorship early on.

This research was made possible with the financial support of multiple awards from the University of Wisconsin-Milwaukee, including the Ruth Walker Graduate Grant-In-Aid Award, the Chancellor's Graduate Student Award, and the Graduate School Research Committee Award.

## Chapter 1 – Ontogenetic approach reveals how cognitive capability and motivation shape prey-searching behavior in *Pholcus phalangioides* cellar spiders

### Abstract

An important part of understanding the evolution of behavior is understanding how and why behavior develops and changes throughout ontogeny. Patterns of behavior are shaped by an animal's capabilities as well as its motivations, both of which are subject to selection. We ran an experiment to see how spiders' efforts to recover lost prey change with age, and to determine the relative contributions of shifts in capability and motivation. We found that as spiders mature, they spend less time searching to recover lost prey, and they discriminate less between prey of different sizes. We also found that even the youngest, least experienced spiders are cognitively equipped to search for lost prey. Thus, predatory behavior in spiders fluctuated primarily with each age group's motivations to capture and consume prey, and did not seem to be hindered by behavioral or cognitive limitations at young ages.

## Introduction

Behavior sits at the intersection of capability and motivation. An animal can only perform actions that its anatomy and cognition allow for, and it should only perform actions that are necessary or rewarding. Throughout an animal's life, these two aspects change. Capability tends to increase with maturity (up to a point), while motivation fluctuates based on context—it can change over months and years (e.g., during sexual maturation), or over seconds (e.g., after the sudden appearance of a predator).

Developing capabilities and varying motivations influence the ontogeny of animal behavior, and exploring this interplay is one of the major goals of the evolutionary study of behavior (Tinbergen 1963). A key challenge in this enterprise is to elucidate the precise mechanisms that are involved in ontogenetic change in behavior (Ryan & Wilczynski 2011). This is a difficult task, for two main reasons. On the one hand, behavior is the consequence of neural processes that constitute a special kind of trait—cognitive phenotypes (Mendelson *et al.* 2016). These traits determine behavior, decision-making, and how animals engage with their surroundings, yet they are ephemeral and difficult to study objectively. On the other hand, the ontogeny of a given behavior can be affected by the development of various other capabilities. In other words, not only must a capability be present, but the ability to exhibit the capability must also be present—for example, experimental tests for object permanence generally require that the animal be capable of either searching for an object or showing surprise (Baillargeon *et al.* 1985; Dore & Dumas 1987; Hoffmann *et al.* 2011; Singer & Henderson 2015). Understanding the ontogeny of behavior thus requires untangling webs of inter-related developing capabilities that are influenced in their expression by changing motivations.

In this paper we analyze the ontogeny of memory in a web spider. Memory is a basic cognitive capability that allows animals to gather and use information in order to improve their behavioral responses to a range of contexts (Shettleworth 2010). Working with a web spider affords a particularly clear analysis in terms of changes in capability and motivation.

Our assay of the contents of memory is based on the searching behavior that many web spiders perform when they lose prey that they have captured (Rodríguez & Gamboa 2000; Rodríguez & Gloudeman 2011; Rodríguez *et al.* 2013, 2015). Searching for lost prey can help spiders reduce rates of prey loss caused by wind disturbances, or prey escaping, or by kleptoparasites that steal captured prey (Rodríguez & Gamboa 2000; Rodríguez & Gloudeman 2011).

When a web spider searches for lost prey, it moves about the web and tugs or plucks the threads, sending out vibrations that help it locate objects in its web. The effort put into recovering the lost prey is a function of the spider's memory of the features of the prey and its preference for those features (e.g., searching longer for more valuable or preferred prey items) (Rodríguez & Gamboa 2000; Rodríguez & Gloudeman 2011; Rodríguez *et al.* 2013, 2015). Therefore, spider prey-searching behavior is an illuminating measurement of a cognitive phenotype; specifically, it allows us to analyze the contents of spiders' memories of prey features. We used this assay of memory of captured prey to test for variation between individuals across life stages.

We studied the ontogeny of the formation of memory of captured prey and its use in prey recovery efforts in long-bodied cellar spiders, *Pholcus phalangioides* (Fuesslin 1775). We tested two hypotheses to analyze change in searching behavior in terms of potential changes in

capability and motivation. The two hypotheses are not mutually exclusive. Our goal is to determine which factor is the principal driver of behavioral change for these spiders. The hypotheses are as follows:

### *Changing capability hypothesis*

This hypothesis states that young spiders are limited in their ability to evaluate prey and form memories, and that ontogenetic changes in behavior are driven by improvements in capability as spiders grow older. Development in many species involves orders-of-magnitude increases in brain size (Quesada *et al.* 2011), as well as substantial changes to patterns of neuronal connectivity (Supekar *et al.* 2009), both of which are likely to have direct impacts on cognition (Eberhard 2007; Chittka & Niven 2009; Eberhard & Wcislo 2011). The changing-capabilities hypothesis makes the following predictions: (i) young spiders will search very little upon losing prey they have captured, and searching efforts will increase with the age of the spider; (ii) young spiders will discriminate less strongly between prey of different sizes than older spiders. A lack of prey-size discrimination in young spiders could indicate that they have trouble either evaluating or remembering the size of prey.

The test of this hypothesis is confounded by the possibility that experience may help shape spider prey-searching behavior. If this is the case, then an increase in search behavior with age could be attributed to spiders learning how to search, which is downstream of the ability to form and use memories. We suspect that prey-loss events like those we create in this experiment (where the spider has already subdued and secured its prey before the prey goes missing) are relatively rare in nature, so it is unlikely that the spiders we test have much

experience. Nevertheless, we deal with this potential confound in three ways. First, many of our trials involve testing individuals twice. This allows us to test for short-term experience effects— if experience is important, we would expect to see spiders consistently searching differently in trial 2 compared to trial 1. Second, a subset of our spiders are lab-hatched naïve spiderlings, which have absolutely zero experience capturing or losing prey. Comparing this group to more experienced groups will help shed light on the effects of experience. Third, we consider the effects of long-term experience. Many of the spiders in this experiment were caught in the wild, and so we have no way of knowing their previous experience with capturing and losing prey. However, because this experience is uncommon, it is likely that some of the spiders we tested had multiple experiences losing prey while others had absolutely none. This range of variation in experience across individuals is only likely to increase with age, so if long-term experience has a strong effect on behavior, we would expect to see behavioral variation increase with age.

#### *Changing motivation/need hypothesis*

This hypothesis states that all individuals are similar in their memory capabilities, but that the needs of the spiders change over ontogeny. This hypothesis makes the following predictions: (i) young spiders will search the most, as they have greater need of energy for growth and development, whereas mature spiders will search the least, as they have more energy reserves and motivation to engage in sexual behavior rather than in foraging. (Note that it might be argued that adult females have a high need of nutrients for developing eggs (cf. Rickers *et al.* 2006); however our prediction is based on the fact that females that consume more prey as juveniles grow to larger sizes and reach higher fecundity (Skow & Jakob 2003). Therefore,



females are preparing for reproduction well before maturity). (ii) Young spiders will discriminate more strongly between prey of different sizes than older spiders.

Note that as with the previous hypothesis, experience is a potential confound for the age-based tests outlined here. Specifically, spiders could learn that searching for lost prey is not worthwhile. If this is the case, then an decrease in search behavior with age could be attributed to spiders learning not to search, which is similar to, but distinct from, a shift in motivation. The predictions described above that are designed to detect effects of experience apply here as well.

Differences in the life history of males and females in our spiders suggest additional predictions for this hypothesis. Juvenile *P. phalangioides* males grow more quickly than females (Uhl *et al.* 2004), and so are likely to place a higher premium on prey; therefore: (iii) juvenile males will search more than females for preferred prey. Additionally, when males reach sexual maturity their behavior shifts away from capturing prey toward actively seeking mates (Uhl 1998; Foelix 2011; Escalante 2013); therefore: (iv) mature males will exert particularly little search effort.

## Methods

*Pholcus phalangioides* is a widespread synanthropic spider (Uhl 1998). We collected *P. phalangioides* spiders from populations in six houses in Milwaukee, Wisconsin (USA) during the summers of 2015 and 2016. The spiders ranged in age from juveniles to adults. We recorded the mass of each spider on the day of capture, and then we immediately set them up in individual rectangular plastic shoe boxes. Each box measured approximately 30 × 17 × 10 cm (L

× W × H) and was lined with a 6 cm-wide strip of poster board along the sides (to give spiders a better surface to climb on and attach silk to). We also placed a thin sheet of plastic wrap under the lid of each box to discourage spiders from attaching silk to the lid of the box.

Among the collected spiders were eight gravid females, which we did not test, but rather set aside and tested their spiderlings after they hatched. We separated spiderlings from their mothers once they reached their second instar (at approximately one week of age), which is when they naturally disperse (Uhl 1998; Uhl *et al.* 2004). At this point, we recorded the mass of each spiderling, and we excluded any that weighed considerably more than its siblings (over 20% greater than the family median), as we took this to be a sign of cannibalism, and we wanted spiderlings with no experience of capturing or eating prey of any kind. We housed spiderlings in individual, clean, round plastic takeout containers (approximately 8 cm high and 11 cm in diameter at the top), each with a flat-bottom standard coffee filter pressed flat along the bottoms and sides to give spiderlings a decent surface to climb on and attach silk to. Spiderlings were ready for testing as soon as they built their first web.

For the rest of the spiders, we standardized hunger prior to running trials. First we withheld food from spiders for at least four days after capturing them, then we fed them a single cricket whose mass was one quarter of the spider's mass at capture, and then we waited an additional two days before testing them. This controlled feeding, combined with the standardized periods without food, ensured that spiders started their trials at similar levels of satiation.

We kept all spiders (including spiderlings) in an environmental chamber (Percival Scientific, Inc., Perry, Iowa, USA), where we controlled the light:dark cycle (14:10 hr) and the

temperature, which ranged from 21.4 to 27.6°C. In preliminary versions of the statistical models presented below, we included temperature as a term and found that it had no effect, so we removed it from our final analyses. The interior dimensions of the chamber were 2.54 × 2.39 × 2.1 m (L × W × H).

### *Overview of trials*

All trials involved us giving a cricket to a spider as prey, then stealing the cricket and recording the spider's behavior as it searched for the lost prey (described in detail below). We tested spiderlings only once in order to observe their behavior in the complete absence of prey-capture experience. We tested all other spiders twice, two days apart, once with a relatively small prey and once with a relatively large prey (prey size details below) in random sequence. In our preliminary analyses, we included trial sequence in our statistical models to look at short-term effects of experience. It had no effect, so we removed it from the final analyses presented below.

Each trial began with us attaching a cricket to a miniature crane that we used to lower prey onto the horizontal webs of our spiders (Fig. 1.1). If the spider did not promptly respond to the arrival of the cricket, we used an electric toothbrush (Colgate 360° Total Advanced) to vibrate the cricket and simulate struggling in order to attract the attention of the spider. (We used the toothbrush in 84% of trials. In preliminary versions of our models, we included whether or not the toothbrush had been used. We found that it had no statistical effect, so we removed it from our final analyses).

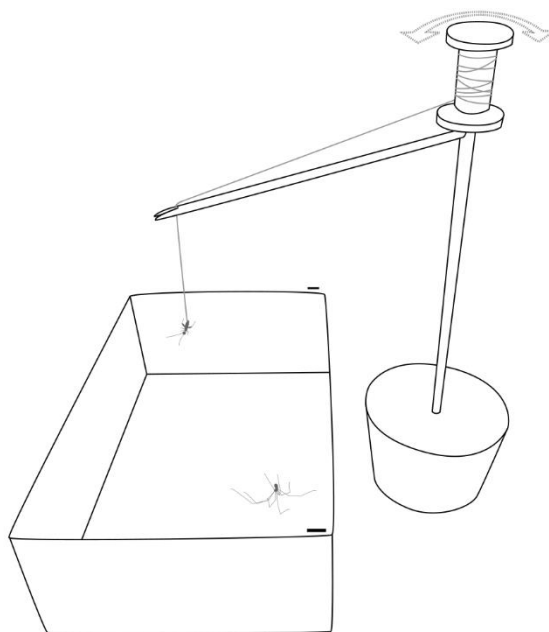

**Figure 1.1** *Experimental setup, including a plastic shoe box holding one of the spiders hanging from its horizontal web (web not shown), and the crane we used to lower crickets onto the spider's web. Scale bars along the lip of the box indicate 1 cm. The crane is made of bamboo garden stakes with a spool of thread mounted on top. Rotating the spool clockwise or counterclockwise (indicated by arrows) raises and lowers the cricket, which is attached to the end of the thread by a tiny hook.*

We allowed the spider two minutes to wrap up its prey before we scared it away with several sharp puffs of air from a 2 ml plastic pipette. The spider would retreat, leaving the tethered prey behind, at which point we used the crane to raise the cricket off from the web, and we used a hot soldering iron to gently cut any strands of silk that attached it to the web.

After stealing each spider's prey, we took note of behaviors indicative of searching (e.g., tugging, defined in Table 1.1), as well as non-searching behaviors (e.g., attaching threads or grooming, defined in Table 1.1). We recorded video of each trial (using a Canon VIXIA HF R600 camcorder). We also entered behavior data in real-time into a custom computer program that we created for this purpose. To enter data quickly and efficiently, we programmed keyboard

**Table 1.1** Descriptions of spider behaviors observed during trials. See Fig. 1.2. Not every behavior was used in the final analysis of search behavior—for that, we primarily looked at tugs and descents—but all together, they helped expand our general view of how each spider spent time during trials.

Behavior	Description
tug	The spider quickly and sharply contracts all of its legs in and then immediately returns them to a resting state. This is a typical single tug. When a spider performs multiple tugs over a short period of time, it is indicative of search behavior. We defined a bout of searching as a series of tugs in which each tug was no more than 20 seconds apart from the next.
build	The spider works on constructing or maintaining its web. We recorded every time a spider attached a new thread to its web and every time it cut old strands with its chelicerae.
descend	The spider drops down, tethered by a silk dragline, from its web to the floor of its enclosure. Often when the spider is on the floor, it waves its front legs around in an apparent exploration of its surroundings. The spider usually returns up its silk line back to its web after several seconds. Sometimes the spider attaches a thread to the floor of the box before returning to the web. If it does, we consider this and the entire trip down as web-building behavior. On the other hand, when a spider descends and only explores, we count this as searching behavior.
move	The spider moves around its web, usually hanging from the underside of the web, with its ventral side up.
handle debris	The spider encounters a piece of debris in the web, and spends time investigating it and removing it from the web.
groom	The spider stops moving around and cleans its legs. It brings a leg up to its mouthparts and pulls the tarsus through its chelicerae, presumably to remove tiny bits of dirt or silk.
rest	Periods of inactivity.

hotkeys to correspond to different behaviors, and we used a one-handed keyboard (Twiddler 3 by Tek Gear) for our input. This allowed us to record behavior while keeping one hand and both eyes free for the trial. With this setup, we created behavior logs with precision down to a

fraction of a second that were digitized and ready for analysis as soon as the trial was complete, and we had video recordings that we double-checked afterwards to resolve any inconsistencies or unusual sequences in our behavior logs.

We ended each trial when the spider had finished searching. Our criterion was when it had gone five minutes without tugging on its web. Our observations ranged in duration from a little over 5 minutes up to 52 minutes. In the event that a spider did not search at all (which happened in 16 of 144 trials), we waited a full 15 minutes after stealing the prey to declare the trial over. After running a spider through its final trial, we euthanized it, recorded its mass, and preserved it in 75% EtOH. We deposited voucher specimens at the personal collection of M. Draney at the University of Wisconsin-Green Bay.

#### *Prey used in trials*

The prey used for the trials were commercially acquired crickets (*Gryllodes sigillatus*). For each trial, we selected a cricket based on its size relative to the spider. After euthanizing spiders, we were able to take more precise measurements of relative prey size, using spider sternum width as a proxy for spider body size (Lee *et al.* 2011; Suter & Stratton 2011). A spider's sternum is a single sclerotized plate, and unlike other measurements, like mass or body length, sternum width does not change based on how recently or how much a spider has eaten. Additionally, it is an external structure with clear landmarks (measurement procedures described below). Our measure of cricket size was the length of its body from the front of its head to the end of its abdomen. Finally, our measure of relative prey size was the ratio of cricket body length over

spider sternum width. The relative prey size values in all of our trials varied across a range from about 4 to 8.

### *Spider size measurements*

After preserving the spiders (including the spiderlings), we measured their sternums using an Olympus SZ61 microscope (Olympus Corporation, Tokyo, Japan) with a Moticam 2500 digital camera (Motic, Causeway Bay, Hong Kong) attached that was hooked up to a computer running Motic Images Plus 2.0.10. We photographed the sternum of each spider and a calibration slide for scale, and then we used ImageJ 1.51j8 (National Institutes of Health, USA) to measure the widths of the sternums.

### *Data Analysis*

We used custom scripts written in Python 3.5.2 (<https://www.python.org>) and R 3.4.2 (R Core Team 2017) to process the behavior logs from the trials and calculate the total amount of time spiders spent actively searching for prey (e.g., Fig. 1.2, Table 1.1). To do this, the scripts looked for two main things: periods of frequent tugging, and time spiders spent exploring the floors of their enclosures. Tugging is a conspicuous component of searching behavior, but spiders tug on their webs in other contexts as well, for example when testing the tension of their threads or when orienting themselves in their web. The main difference is that during searching, a spider tugs frequently over a period of time, as opposed to performing infrequent and isolated tugs. Therefore, we only counted tugs that occurred within 20 seconds of other tugs. Each sequence of tugs that was not broken by a gap of 20 seconds or more was considered to be a bout of

searching behavior. In addition to tugging, spiders sometimes descend from their webs and search the ground for fallen prey (Table 1.1). We counted this as searching behavior as well, as long as the spider did not attach any threads to the floor before returning to its web (we did not want to mistakenly count web building as prey searching).

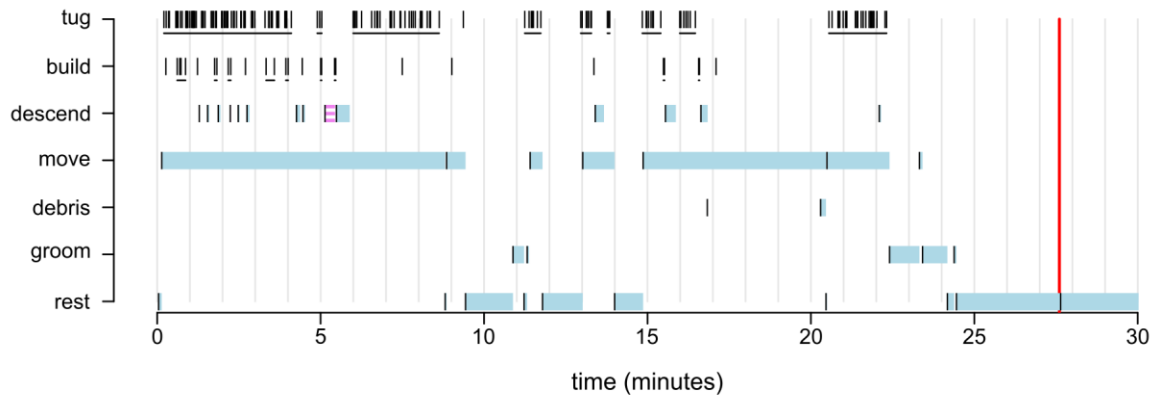

**Figure 1.2** Example visualization of a spider’s behavioral data from a trial. Categories of behaviors (defined in Table 1.1) are labeled along the y-axis, with markers showing instances of those behaviors through time, starting from when the spider’s prey was stolen. Horizontal lines under the markers for tug and build indicate sequences broken by no more than 20 seconds (for tug, this was our major criterion for search behavior). For the behaviors that continue over time (descend, move, debris, groom and rest), markers indicate the start of the behavior, and light trailing bars indicate the duration. Note that for the descend category, we make the distinction between descents in which spiders attached threads (striped) and those in which they did not (solid) (see Table 1.1). The thick vertical line near the end indicates that five minutes have passed since the last tug—our usual criterion for ending observation.

For our analyses, we divided spiders into four groups based on age: i) spiderlings, which were hatched and raised in the lab and were tested during their second instar post-hatching; ii) early juveniles, which were older than spiderlings, but were still too small for us to distinguish their sexes; iii) advanced juveniles, which were old enough that we could tell them apart by sex, but were not yet fully mature; and iv) adults, who were sexually mature (see Fig. 1.3 below for sample size and mass).



### *Statistical analysis*

We used linear mixed models implemented in JMP Pro 13.0.0. To test the first prediction of each hypothesis, we tested for variation in overall searching behavior with spider age. We used a model with search time as the dependent variable, and the following fixed independent terms: age, relative prey size, and the age  $\times$  relative prey size interaction. The model also included a random term for replicate: this represented family identity for spiderlings and individual identity for all other spiders.

To test the second prediction of each hypothesis, we tested for variation in how strongly spiders of different ages discriminated between prey of different relative size. Our measure of discrimination was the slope of the line representing change in search time over change in relative prey size. A flat slope indicates low importance of prey size, while a steep slope (either positive or negative) indicates high importance. We analyzed differences in the absolute value of slopes across three age groups: early juveniles, advanced juveniles and adults (we omitted spiderlings from the formal analysis because their slopes came from family-level regressions, not the individual-level). We did this by running a one-way ANOVA with the absolute values of slopes as the dependent variable and age group as the independent variable. We used Tukey HSD post-hoc analysis to determine which groups were statistically different from the others.

The changing motivation hypothesis has two additional predictions that deal with differences in search behavior between males and females, so we ran a model that explicitly tested for the effects of sex. Since sex is indistinguishable in spiderlings and early juveniles, this model only included advanced juveniles and adults. The dependent variable was search time. The fixed independent variables were age, relative prey size, sex, and their interactions. We

also included a random term for spider identity, since each spider was tested twice. We do not know for sure whether any of the adult females we tested were gravid, because we caught them as adults from the wild. We also do not know what effects being gravid would have on search behavior. All of our adult females decreased in mass from the beginning of the experiment to the end, but two in particular decreased proportionately less than the others. In case this was a sign of them being gravid, we ran our models with these individuals excluded. These additional models were qualitatively identical to the models that included these females (data not shown).

One test for the effects of experience involves looking at changes in variance of search behavior as a function of age. We ran a Brown-Forsythe test for unequal variances across the four groups. We also ran a mean-corrected test, looking at the correlation between the coefficient of variation (CV) and age group.

Finally, we were curious about family-level and individual-level sources of variation in search behavior, as this would help give us a broad sense for the variation available for natural selection to potentially act on. To measure family-level variation, we ran a model that only included spiderlings. It used relative prey size as a main term, family as a random term, and it included a family  $\times$  prey size interaction. Our exploration of individual-level variation comes from the random terms in the model described above.

## Results

In evaluating the age-related predictions from the two hypotheses, we found that spider maturity had a significant effect on search time, with younger spiders spending more time

searching than older spiders (Table 1.2, Fig. 1.3). We found a marginally significant effect of relative prey size on search time, with spiders overall tending to search longer for relatively smaller prey (Table 1.2, Fig. 1.3). There was no significant interaction between maturity and prey size (Table 1.2).

The analyses for the discrimination-related predictions yielded similar results. The *search time ~ prey size* slopes revealed that early juveniles had much steeper differences in their search behavior between large and small prey (Fig. 1.4). These slopes were significantly steeper than those of the advanced juveniles and the adults ( $F_{2,46} = 9.14, p < 0.005$ ).

**Table 1.2** Statistical results from a linear mixed model looking at the effects of maturity and prey size on search time in *P. phalangioides* spiders. Maturity is broken into four categories (spiderling, early juvenile, advanced juvenile, and adult, as described in the text), and relative prey size is a continuous variable calculated from linear measurements of the prey and the spider. We included an interaction between these two variables to test for differences in prey-size preferences between age groups, and we included replicate as a random variable. Replicate codes for family in spiderlings (which were all tested once) and for individual in all other spiders (which were tested multiple times). Significant and marginally significant terms indicated with bold text. Data visualized in Fig. 1.3.

Fixed effects	DF num, DF den	F-ratio	p-value	
Spider maturity	3, 49.80	<b>3.11</b>	<b>0.035</b>	
Relative prey size	1, 93.95	<b>3.72</b>	<b>0.057</b>	
Maturity × prey size	3, 116.0	0.75	0.522	
Random effect	Var. comp.	95% CI	% of total var.	Wald p-value
Replicate	15049	2354 – 27744	28.1	<b>0.020</b>

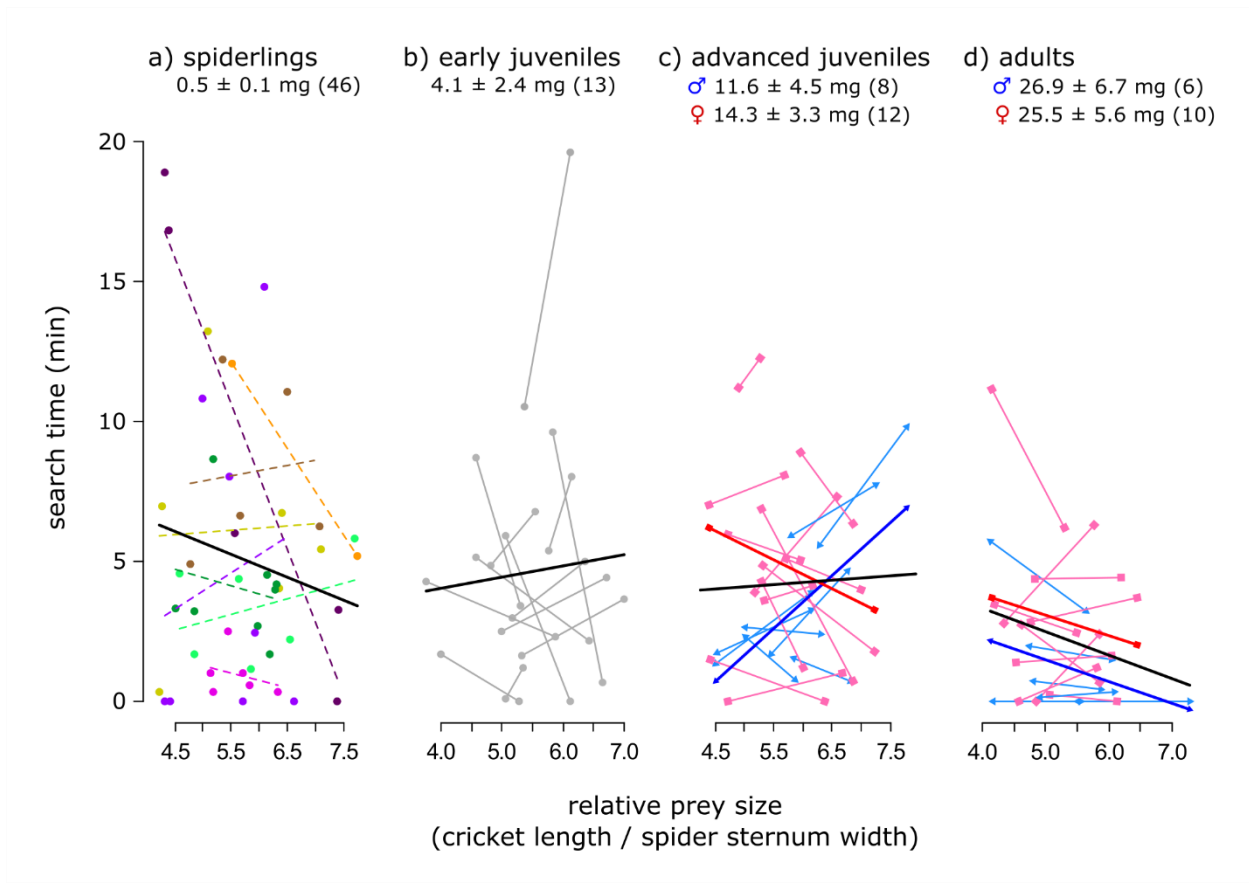

**Figure 1.3** Time that spiders (*Pholcus phalangioides*) spent searching for lost prey of varying relative sizes, plotted by spider age category. Each panel displays the average mass  $\pm$  sd for the corresponding categories, followed by sample size in parentheses. a) Spiderlings were naïve second-instar spiders that were raised in the lab. They are grouped by family (eight families total, distinguished by color). Dashed lines show simple linear regressions for each family, and a solid black line shows the regression across all spiderlings. b) Early juveniles were young spiders caught in the wild that had not yet developed sexual characteristics. Each juvenile was tested twice, and each thin gray line connects data points for an individual's two trials. A thick black line shows the simple linear regression through all points. c) Advanced juveniles were young spiders caught in the wild that were not yet mature, but old enough for us to be able to distinguish the sexes. Thin lines connect data points from two trials for males (triangles) and females (squares). Thick colored lines represent the linear regression for the sexes, and a thick black line represents the linear regression through all the points. d) Like panel c), but for fully mature spiders.

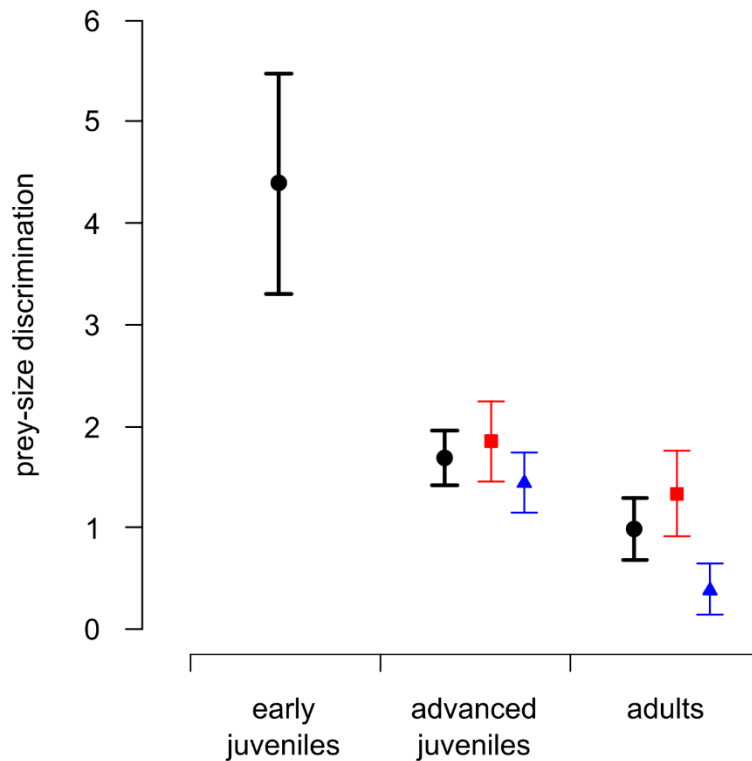

**Figure 1.4** Prey-size discrimination, measured as the steepness of search time ~ prey size relationships, for spiders of different ages and sexes. Data are calculated from the absolute values of the slopes in Fig. 1.3. Black points represent the overall mean for the group. Squares and triangles represent the means for females and males, respectively, in those groups where the spiders are old enough to be told apart by sex. Error bars indicate standard error. Spiderlings were omitted from the analysis, because they were tested only once each, and so their slopes (mean  $\pm$  se =  $1.53 \pm 0.65$ ) come from family-level regressions, not individual-level behavior, like the groups plotted here. A one-way ANOVA, with age group as the independent variable, followed by a Tukey HSD post-hoc analysis, showed early juveniles to be significantly higher than the advanced juvenile and adult age groups ( $F_{2,46} = 9.14$ ,  $p < 0.05$ ).

When we looked at only those life stages for which we could tell the sexes apart (to evaluate additional predictions of the motivation hypothesis), we continued to see the significant effects of maturity (Table 1.3). We also found that males and females searched differently for prey of different sizes (significant prey size  $\times$  sex interaction), with juvenile males preferring larger prey and juvenile females preferring smaller prey (Fig. 1.3c; Table 1.3).

Furthermore, these differences between the sexes varied across maturity levels (significant maturity  $\times$  prey size  $\times$  sex interaction), with males sharply decreasing their search behavior once reaching full maturity (Fig. 1.3c,d; Table 1.3).

**Table 1.3** Statistical results from a linear mixed model looking at the effects of maturity, prey size, and sex (and their interactions) on search time in advanced juvenile and adult *P. phalangioides*. Spider identity was included as a random term because each spider was tested twice. Significant and marginally significant terms indicated with bold text. Data visualized in Fig. 1.3.

Fixed effects	DF num, DF den	F-ratio	p-value
Spider maturity	1, 33.18	<b>5.19</b>	<b>0.029</b>
Relative prey size	1, 39.49	0.69	0.410
Spider sex	1, 33.24	2.76	0.106
Maturity $\times$ prey size	1, 37.92	1.25	0.270
Maturity $\times$ sex	1, 33.18	0.01	0.934
Prey size $\times$ sex	1, 39.49	<b>9.96</b>	<b>0.003</b>
Maturity $\times$ prey size $\times$ sex	1, 37.92	<b>5.83</b>	<b>0.021</b>

Random effect	Var. comp.	95% CI	% of total var.	Wald p-value
Spider identity	18224	5748 – 6959	68.7	<b>0.002</b>

Adult males were the group that searched the least, and the nature of their searching was distinctly different from any other group—we observed tugging search behavior in only one male trial out of twelve. Search behavior in males almost exclusively manifested as exploring the bottoms of their enclosures. Compare this with mature females, who used tugs in their search behavior in 16 of 20 trials—similar to spiders in the other age groups.

Our sample size of males is relatively low, and is lower than our sample of females (Fig. 1.3), so there is a risk that we under-sampled variation in males. However, based on the F-ratios

in our statistical models (Table 1.2), we believe that the patterns we report are real.

Additionally, we should address the possibility that two of the mature females we tested could have been gravid. This is based on the fact that their final masses were a bit higher (relative to their mass at capture) compared to the other mature females. However, their search behavior was no different from other females, and their exclusion from statistical models did not change any patterns. Therefore, one of two things is true: either i) being gravid has little effect on search behavior, or ii) these individuals were not gravid.

In our tests for the effects of experience, we looked at how variance in search time changed with age. We found a significant difference in variance across the four age groups, with higher variance in the younger spiders and lower variance in older spiders (see Appendix). When correcting for changes in the mean, we found no correlation between age and CV of search time (see Appendix).

Lastly, we evaluated sources of variation in search behavior. There was a high degree of individual variation (as seen in the identity term in Table 1.3 as well as Fig. 1.3b-d), whereas family was not a significant source of variation (Table 1.4).

**Table 1.4** A closer look at the random effect from the model in Table 1.2. We ran a similar model looking only at spiderlings in order to see if there were family-level differences in search behavior. We used relative prey size as a fixed effect, family ID as a random term, and an interaction between the two.

Fixed effects	DF num, DF den	F-ratio	p-value	
Relative prey size	1, 8.94	0.55	0.479	
Random effects	Var. comp.	95% CI	% of total var.	Wald p-value
Family ID	22187	-14320 – 58694	25.6	0.234
Family × prey size	12254	-8697 – 33207	14.2	0.252

## Discussion

We tested hypotheses about the relative roles of capability and motivation in ontogenetic change in memory of captured prey in a web spider. The first hypothesis was that spiderlings would be limited in their ability to evaluate and remember lost prey, and so would spend less time searching for it compared to older spiders. Our results refute this, as spiderlings searched just as long or longer than older spiders. This hypothesis also predicted that younger spiders would be less discriminating between prey of different sizes. This was also refuted by the fact that the early juveniles had the steepest search time vs prey size slopes. Thus, early developmental stage was neither a limiting factor in the formation of memories of captured prey, nor a limiting factor in the use of those memories in the regulation of searching efforts. This is rather remarkable, considering that the brains of the adults are over 5.5 times the size of the brains of spiderlings (based on the average masses that we measured, and the spider *brain-volume* ~ *body-mass* relationship described by Quesada *et al.* (2011)). The results from this study also indicate that previous experience with prey is not necessary for a spider to search for lost prey (as none of the spiderlings had ever caught prey before). The lack of trial sequence effects on the spiders' behavior suggests that short-term experience was not a confounding variable in our experiment. Additionally, both the decrease in search time variance with age, and the relatively flat CV across age groups, suggests that long-term experience does not have a strong effect on search time, relative to the other effects that we tested.

The second hypothesis was that as spiders approached adulthood and their growth slowed down, their motivation to recover prey would decrease. This was supported by our results, as fully mature spiders spent less time searching than spiders in other groups. The



motivation hypothesis also predicted the greatest amount of prey-size discrimination among young spiders and the least among adults. This too was supported by our results.

The motivation hypothesis made additional predictions about the effects of sex on search behavior. Males grow more quickly than females, and so it is predicted that they would place a premium on larger prey. This prediction was supported by our data, specifically by the significant interaction between prey size and sex in advanced juveniles (Fig. 1.3). It is unclear precisely when this difference first appears. It could be present in the early juveniles—certainly other sex-based differences in behavior, like activity level or prey-capture rate, are known to arise early on for this species (Hoefler *et al.* 2010). If so, it might help explain the high variation in slopes across individuals in this group (Fig. 1.3b).

Finally, this hypothesis predicted a decrease in search behavior for mature males, whose priorities shift heavily towards seeking a mate after reaching maturity. The lower search time that we observed in mature males, plus their qualitative change in search behavior (the reduced use of tugging), support this prediction. Males still readily attacked prey, and there is nothing about their morphology that would prevent them from being able to tug, so it seems that they simply have a reduced interest in recovering prey.

Looking at individual differences in search behavior, we find that nearly half of the spiders in our study actually preferred prey from the lower end of the range of sizes we tested (i.e., had negative slopes). The high amount of individual variation in search time, including in inexperienced spiderlings, suggests a diversity of prey-size preferences across individuals on which selection may act to shape prey recover efforts.

In short, when it comes to prey-searching in spiders, it is motivation, not capability, that drives ontogenetic change in behavior. Without a doubt, there is some point in a spider's development when it is incapable of searching, but as soon as spiderlings disperse from their mother's web, they essentially fill the same ecological niche as adults, and they perform many of the same actions—they build webs, capture prey, and seek to recapture it when lost. Analyzing the causes of ontogenetic variation in behavior is greatly facilitated with species like this, where direct comparison of similar behavior and tasks is possible. For example, many species of fish allow ontogenetic studies across stages that are ecologically equivalent in many respects, with newborns being miniature adults (Agrillo & Bisazza 2017). Even in such cases, interesting cognitive limitations may be revealed in younger animals. Guppies, for instance, are safest when swimming in large shoals, but young guppies are not as good as adults at evaluating shoal size; consequently, they face the greatest risk of making wrong shoaling decisions at the most vulnerable stage of their lives (Petrazzini *et al.* 2014). Other animals may reach the state of adult-equivalence at older ages and yet still face the risk of performing suboptimal behaviors due to both cognitive limitations and lack of experience. For example, in ravens, caching behavior is affected both by their sense of object permanence and their experience of conspecifics stealing their prey (Bugnyar *et al.* 2007).

In conclusion, the interplay of capability and motivation along ontogeny varies in multiple dimensions between species, and this variation requires explanation. We suggest that progress can be made by using behavioral assays to test hypotheses about the evolution and expression of cognitive phenotypes (Mendelson *et al.* 2016).

## Literature Cited

- Agrillo C, Bisazza A (2017). Understanding the origin of number sense: a review of fish studies. *Philosophical Transactions of the Royal Society B* 373:20160511.
- Baillargeon R, Spelke ES, Wasserman S (1985). Object permanence in five-month-old infants. *Cognition* 20:191–208.
- Bugnyar T, Stöwe M, Heinrich B (2007). The ontogeny of caching in ravens, *Corvus corax*. *Animal Behaviour* 74:757-767.
- Dore FY, Dumas C (1987). Psychology of animal cognition: Piagetian studies. *Psychological Bulletin* 102:219–233.
- Chittka L, Niven J (2009). Are bigger brains better? *Current Biology* 19:R995-R1008.
- Eberhard WG (2007). Miniaturized orb-weaving spiders: behavioural precision is not limited by small size. *Proceedings of the Royal Society B* 274:2203-2209.
- Eberhard WG, Wcislo WT (2011). Grade changes in brain-body allometry: morphological and behavioural correlates of brain size in miniature spiders, insects and other invertebrates. *Advances in Insect Physiology* 40:155-214.
- Escalante I (2013). Ontogenetic and sexual differences in exploration and web construction in the spider *Physocyclus globosus* (Araneae: Pholcidae). *Arachnology* 16:61–68.
- Foelix RF (2011). *Biology of spiders* (3rd ed.). New York, NY: Oxford University Press.
- Hoefler CD, Keiser CN, Rypstra AL (2010). Sex differences in early instar behavior in *Pholcus phalangioides* (Araneae: Pholcidae). *Journal of Arachnology* 38:581–583.
- Hoffmann A, Rüttler V, Nieder A (2011). Ontogeny of object permanence and object tracking in the carrion crow, *Corvus corone*. *Animal Behaviour* 82:359–367.
- Lee JE, Somers MJ, Chown SL (2011). Density, body size and sex ratio of an indigenous spider along an altitudinal gradient in the sub-Antarctic. *Antarctic Science* 24:15-22.
- Mendelson TC, Fitzpatrick CL, Hauber ME, Pence CH, Rodríguez RL, Safran, RJ, Stern CA, Stevens JR (2016). Cognitive phenotypes and the evolution of animal decisions. *Trends in Ecology & Evolution* 31:850–859.
- Petrzazzini MEM, Agrillo C, Piffer L, Bisazza A (2014). Ontogeny of the capacity to compare discrete quantities in fish. *Developmental Psychobiology* 56:529–536.
- Quesada R, Triana E, Vargas G, Douglass JK, Seid MA, Niven JE, Eberhard WG, Wcislo WT (2011). The allometry of CNS size and consequences of miniaturization in orb-weaving and cleptoparasitic spiders. *Arthropod Structure and Development* 40:521–529.
- R Core Team (2017). *R: A language and environment for statistical computing*. R Foundation for Statistical Computing, Vienna, Austria. <https://www.r-project.org/>

- Rickers S, Langel R, Scheu S (2006). Dietary routing of nutrients from prey to offspring in a generalist predator: effects of prey quality. *Functional Ecology* 20:124-131.
- Rodríguez RL, Kolodziej RC, Höbel G (2013). Memory of prey larders in golden orb-web spiders, *Nephila clavipes* (Araneae; Nephilidae). *Behaviour* 150:1345–1356.
- Rodríguez RL, Briceño RD, Briceño-Aguilar E, Höbel G (2015). *Nephila clavipes* spiders (Araneae: Nephilidae) keep track of captured prey counts: testing for a sense of numerosity in an orb-weaver. *Animal Cognition* 18:307–314.
- Rodríguez RL, Gamboa E (2000). Memory of captured prey in three web spiders (Araneae: Araneidae, Linyphiidae, Tetragnathidae). *Animal Cognition* 3:91–97.
- Rodríguez RL, Gloudeman MD (2011). Estimating the repeatability of memories of captured prey formed by *Frontinella communis* spiders (Araneae: Linyphiidae). *Animal Cognition* 14:675–682.
- Ryan MJ, Wilczynski W (2011). *An introduction to animal behavior: an integrative approach*. Cold Spring Harbor, NY: Cold Spring Harbor Laboratory Press.
- Shettleworth SJ (2010). *Cognition, evolution, and behavior* (2nd ed.). New York, NY: Oxford University Press.
- Singer R, Henderson E (2015). Object permanence in marine mammals using the violation of expectation procedure. *Behavioural Processes* 112:108–113.
- Skow CD, Jakob EM (2003). Effects of maternal body size on clutch size and egg weight in a Pholcid spider (*Holocnemus pluchei*). *The Journal of Arachnology* 31:305-308.
- Supekar K, Musen M, Menon V (2009). Development of large-scale functional brain networks in children. *PLoS Biology* 7:e1000157.
- Suter RB, Stratton GE (2011). Does allometric growth explain the diminutive size of the fangs of *Scytodes* (Araneae: Scytodidae)? *The Journal of Arachnology* 39:174-177.
- Tinbergen N (1963). On aims and methods of ethology. *Zeitschrift für Tierpsychologie* 20:410–433.
- Uhl G (1998). Mating behaviour in the cellar spider, *Pholcus phalangioides*, indicates sperm mixing. *Animal Behaviour* 56:1155–1159.
- Uhl G, Schmitt S, Schäfer MA, Blanckenhorn W (2004). Food and sex-specific growth strategies in a spider. *Evolutionary Ecology Research* 6:523–540.

## Chapter 2 – Miniature brains forget sooner: size-based limitations on memory retention time in cellar spiders

### Abstract

There exists a longstanding expectation that animals with tiny brains must face some cognitive limitations. On the physiological level, decreasing the size or number of neurons impacts traits such as signal transmission and neuronal connectivity that are associated with basic brain functions. On the organismal level, however, evidence of specific size-related limitations to cognition remains elusive. We examined memory content and retention time, which are likely to subtend a large variety of cognitive abilities, such as learning. Working with web spiders, we used an established and easily quantifiable behavioral assay of memory: how they search for lost prey. In our study species, variation in memory content has an order of magnitude stronger effect on variation in searching behavior than hunger. We compared individuals of different instars belonging to a single species (varying 2-5-fold in brain size) to reduce possible confounding variation due to ecological differences between species varying in size. Small spiders were perfectly motivated and capable of searching for lost prey when allowed to start searching immediately after losing it, but when a delay was introduced between memory formation and memory use, search time in small spiders decreased more steeply than in big spiders. Small spiders also performed much less additional searching after their primary bout of searching was over. Thus, memory retention, but not memory content, was limited in spiders with small brains. Our results suggest that miniature animals with miniature brains sacrifice not the ability to perceive and acquire information about their environments, but rather the ability

to hold on to that information and use it to establish connections between their behavior and associated costs and benefits.

## Introduction

Brains are metabolically expensive, and small animals can only afford small brains (Striedter 2005). Yet small animals have proportionately large brains (Haller's rule; Rensch 1948). Thus, the most extreme aspect of miniature animals is not their body size (striking though that may be, with lungless salamanders as small as a wasp, and parasitoid wasps as small as a *Paramecium*; Hanken 1985; Evans 2008; Polilov 2012). More remarkable, however, is the increasing proportion of body mass taken up by brains in smaller animals. Across mammals, brain mass varies 20,000-fold, and relative to body mass, the brains of the smallest species are over 600 times bigger than those of the largest species (Striedter 2005). In miniature arthropods the brain accounts for up to 16% of body mass (compared to 2% in humans), and in some cases it protrudes into the thorax or legs (Eberhard & Wcislo 2011, 2012; Quesada *et al.* 2011).

The repeated evolution of miniature animals with absolutely smaller but relatively larger brains presents a problem. While it seems straightforward to understand the advantage of reduced body size (smaller animals have lower absolute energy requirements and quicker time to maturity; Peters 1983), reduced brain size seems likely to bring manifold disadvantages. Neural tissue is energetically expensive because of the need to establish and maintain membrane potentials (Rolfe & Brown 1997; Attwell & Laughlin 2001; Niven & Laughlin 2008). Thus, as animals decrease in size and carry proportionally larger brains, a greater percentage of their energy must be spent maintaining their central nervous system—when it comes to brain size, small animals pay relatively more for absolutely less. Furthermore, brain size may be decreased by reducing either the size or the number of its neurons. As neurons get smaller,

they tend to have slower transmission rates, noisier signals and fewer dendrites to connect with other neurons (Purves & Lichtman 1985; Faisal *et al.* 2005; Perge *et al.* 2012). And reducing the number of neurons may diminish certain abilities like parallel processing and memory storage (Spaethe *et al.* 2006; Chittka & Niven 2009). Either way, tiny animals are expected to face neurological constraints in sensory acuity, decision making, and cognitive and behavioral capabilities (Eberhard & Wcislo 2011; Niven & Farris 2012).

In light of the above considerations, it has been surprisingly difficult to identify what, if any, limitations arise from miniature brains (Eberhard 2007, 2011; Eberhard & Wcislo 2011). Consider hummingbirds. These are not only miniature birds, but miniature dinosaurs, and yet they have astonishing flight control, and song-learning to boot (Price 2008; Dakin *et al.* 2018). Or recall that possibly the most complex courtship displays known for any animal are produced by minuscule jumping spiders (Girard *et al.* 2011; Elias *et al.* 2012).

This is the problem of miniaturization: Does miniaturization reduce an animal's cognitive or behavioral capabilities? And if not, how do miniature animals escape such limitations? These questions are fundamental for understanding the evolution of body and brain size. They are also of practical interest, as for example in the field of miniature technology.

Part of the difficulty in testing for limitations associated with miniaturization is identifying appropriate measures of cognitive and behavioral capability. Measures of general intelligence, behavioral complexity, or size of behavioral repertoire suffer from being too vague or hard to compare across species (Healy & Rowe 2007; Chittka & Niven 2009). Questions like, "how complex is this behavior?" are hard to answer because it is difficult to quantify discrete units of behavior objectively (and to do so consistently across species) (Eberhard 2007; Healy &



Rowe 2007). The clearest evidence to date comes from an artificial selection experiment that specifically targeted brain size relative to body size in guppies, and found that small-brained fish performed less well than large-brained ones in a numerical learning test (females) and a maze learning test (males) (Kotrschal *et al.* 2013, 2015). However, the detected difference may reflect the advantage of evolving larger brains (for which there is more abundant evidence; e.g., Madden 2001; Day *et al.* 2005; Sol *et al.* 2005; Benson-Amran *et al.* 2015), rather than the disadvantage of evolving miniature brains, especially as the range of brain sizes was limited (9-14% difference) compared to the orders of magnitude that miniaturized animals and their ancestors may span (Striedter 2005; Eberhard & Wcislo 2012). Furthermore, it is not clear whether the limitation detected represents a difficulty in keeping track of numbers (for females), or in learning. Ideally, measures of cognitive and behavioral ability should relate as directly as possible to specific mental features and be comparable across different species and groups.

Here we test for cognitive limitations in miniature animals with an assay that measures variation in the information content and retention time of memory. Memory is a basic capability that subtends many other cognitive processes such as learning and decision-making (Squire & Kandel 2009; Shettleworth 2010). We explore the effects of brain size on memory with web spiders and their behavior of searching for prey that they have captured and lost. This has become a model assay of memory content, and has revealed that a broad variety of spiders form memories about the prey they have captured that include details about their size and numbers (Rodríguez & Gamboa 2000; Rodríguez & Gloudeman 2011; Rodríguez *et al.* 2013,

2015; Kilmer *et al.* 2018). It also has the advantages of both being easy to quantify and yielding continuous measures that allow for fine-scaled comparisons.

We took advantage of the difference in body size (and hence brain size) that occur across developmental instars in web spiders (Fig. 2.1). Comparing the behavior of juvenile and adult stages in web spiders is possible because, starting at a very young age, juvenile spiders are completely independent, and essentially function as adults, as far as foraging with webs is concerned. This approach can be very fruitful when the juveniles and adults of a given species are ecologically equivalent except for their size (Agrillo & Bisazza 2017; Kilmer *et al.* 2018).

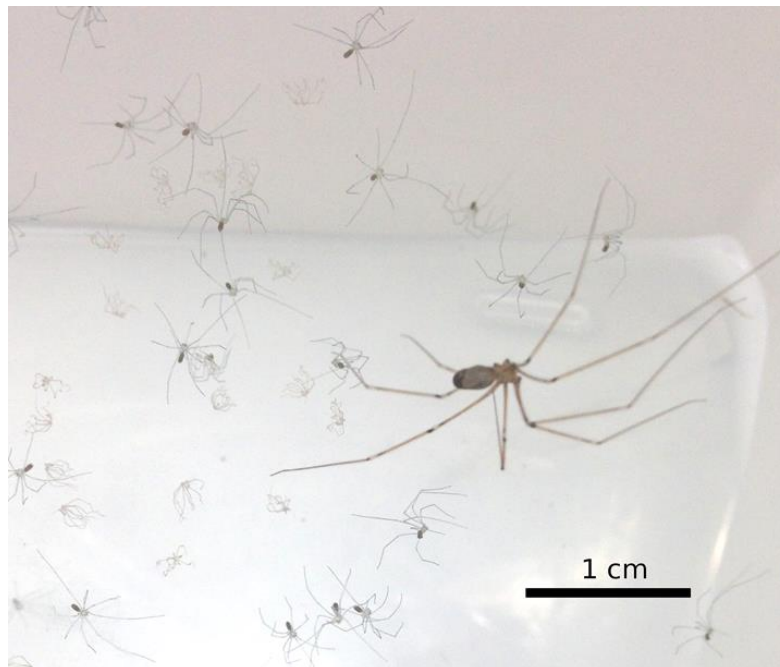

**Figure 2.1** A mother *P. phalangioides* (approximately 25 mg) with her second-instar offspring (approximately 0.5 mg; 1-2 weeks old), illustrating the difference in size between adults and spiderlings that have reached the age of dispersal, which is when they begin living independently. Note: the juvenile spiders used in this study were older than the spiderlings shown here; see Fig. 2.2 for body sizes.

There are two main ways in which brain size could limit memory: it could limit the information content of memories, or it could limit the retention of memories over time. The hypothesis that brain size limits memory content predicts that smaller spiders (with smaller brains) will: spend less time searching or be less likely to search at all (signs that they don't remember their captured prey very well); and show little distinction in search behavior between large and small prey (a sign that they don't remember the features of their prey very well). These predictions have already been tested and rejected in a prior study with our study species (Kilmer *et al.* 2018). Across a 5-fold difference in brain size (estimated from an approximately 50-fold difference in body size across instars; Quesada *et al.* 2011), it was the smallest spiders that searched the most and that showed the greatest prey-size discrimination.

The hypothesis that brain size limits the retention time of memories makes two predictions. First, smaller (juvenile instar) spiders will spend less time searching or be less likely to search at all following a period of time in which they are not allowed to search. We tested this prediction with an experiment in which we imposed a delay between memory formation (prey capture) and memory use (prey searching) (this type of experimental delay is also known as a "retention interval" in the literature; Shettleworth 2010). We manipulated the length of the delay across large and small spiders. With a long enough delay, search time for all spiders should drop to zero, regardless of brain size, but this hypothesis predicts that the *search time ~ delay* function will drop to zero more quickly for small spiders than for large spiders. In other words, it should take less of a delay to see any given drop in search time for small spiders than for large spiders. Second, if brain size limits memory retention, small spiders should be less likely to resume searching or search for less time than large spiders; and they should show less

of a difference according to the size of the prey that they lost. We tested this prediction in a separate experiment in which we checked whether spiders resume searching after giving up their initial search.

A potential concern with our assay of memory content and retention is that it may be confounded by non-cognitive influences, such as differences in motivation and hunger between spiders. Indeed, prior work with our study species shows that motivation to search varies across life stages in our study species (Kilmer *et al.* 2018). Therefore, we ran an additional experiment to gauge the relative effects of proximate non-cognitive motivational cues (e.g., hunger) versus cognitive information acquisition in our searching assay.

## Methods

Our study species was the long-bodied cellar spider, *Pholcus phalangioides* (Araneae: Pholcidae), a widespread synanthropic spider that often weaves messy horizontal webs in basements and garages. We collected spiders from 8 different locations in Milwaukee, WI in the summers of 2014, 2015 and 2016. Upon collecting spiders, we recorded their mass and housed them in our lab in individual clear plastic shoe boxes (30 × 17 × 10 cm) in a walk-in environmental chamber (Percival Scientific, Inc., Perry, Iowa, USA) with a 14:10 hour light:dark cycle and a temperature of  $24.6 \pm 0.9^{\circ}\text{C}$  (mean  $\pm$  sd). We kept spiders on the same feeding regimen to standardize hunger levels.

All experiments shared a core set of methods: we gave spiders prey, we removed the prey, and we observed and recorded the spiders' behavior as they searched for the lost prey. We used commercially acquired *Gryllodes sigillatus* crickets as prey for all experiments (with

one exception, as noted below). We had crickets that spanned a range of ages (and therefore sizes), and we selected crickets for trials based on their size relative to the spider. To deliver a cricket to a spider web, we attached the cricket to a hook at the end of a thread suspended from a small crane, and spooled it down onto the web (details in Kilmer *et al.* 2018). Sometimes the spider would respond immediately to the arrival of the cricket, but most of the time, we had to draw spider's attention by vibrating the prey (to simulate struggling) with a tuning fork (in the case of the memory retention experiment below) or electric toothbrush (in the cases of the search resumption and the handling time experiments below).

We allowed the spider a full two minutes (unless specified otherwise below) to subdue and secure the cricket. We then scared the spider away from the cricket by puffing it with air from a 2 ml plastic pipette. The spider would retreat to a corner of its box, leaving behind the cricket, which was tethered in place by the crane's string. We removed the cricket by raising it up off the web, and we used a hot soldering iron to cut any strands that kept it attached to the web, but we made sure not to disturb the web any more than necessary in this process.

As soon as the cricket was removed, we began our observation of the spider's behavior. All trials were video-recorded from start to finish. We also actively took note of each spider's behavior during the trial. Like many spiders, *P. phalangoides* have poor eyesight, and rely instead on sensing vibrations in their web. When they search for lost prey, they move around their web, tugging the threads every several seconds, effectively sending out vibrations to feel for objects caught in the web (Kilmer *et al.* 2018). This behavior is unique to this context (spiders do not initiate prolonged periods of frequent tugging spontaneously), and it is similar to the searching behavior of other species of web spiders tested to date, including araneids,

linyphiids, tetragnathids, and uloborids (Rodríguez & Gamboa 2000; Opell 2001; Rodríguez & Gloudeman 2011; Rodríguez *et al.* 2013, 2015). We tracked every instance of tugging, and counted every sequence of tugs broken by no more than 20 seconds as a bout of search behavior. Sometimes spiders drop down from their web to search the nearby ground for lost prey, so we also took note of every time a spider made exploratory descents to the bottom of its box (Kilmer *et al.* 2018). Our criterion for ending observations was when the spider had gone 5 minutes without tugging; or if the spider did not tug at all, we observed it for a full fifteen minutes after removing its prey. We preserved the spiders in 75% EtOH. Later, we took precise measurements of each spider's sternum width as a measure of body size. We ran all of our statistical analyses (described below) in JMP Pro 13.0.0 (SAS Institute Inc.).

#### *Testing for variation in memory retention*

To test the prediction that large spiders can retain memories for a longer period of time than small spiders, we ran an experiment in which we imposed a delay between memory formation (prey capture) and memory use (searching for prey). We divided spiders into two categories based on body size (Fig. 2.2a). Based on allometric slopes of brain size on body size (Quesada *et al.* 2011), this nearly 7-fold difference in average body mass in our spiders translates to roughly a 2.3-fold difference in brain mass.

We tested each spider twice: once with a relatively small cricket (mean  $\pm$  sd =  $0.68 \pm 0.19$  times the spider's mass), and once with a relatively large cricket ( $1.36 \pm 0.40$  times the spider's mass). We size-matched crickets to spiders based on mass, and then after the trials were complete, we took linear measurements of both spiders and crickets for a more precise

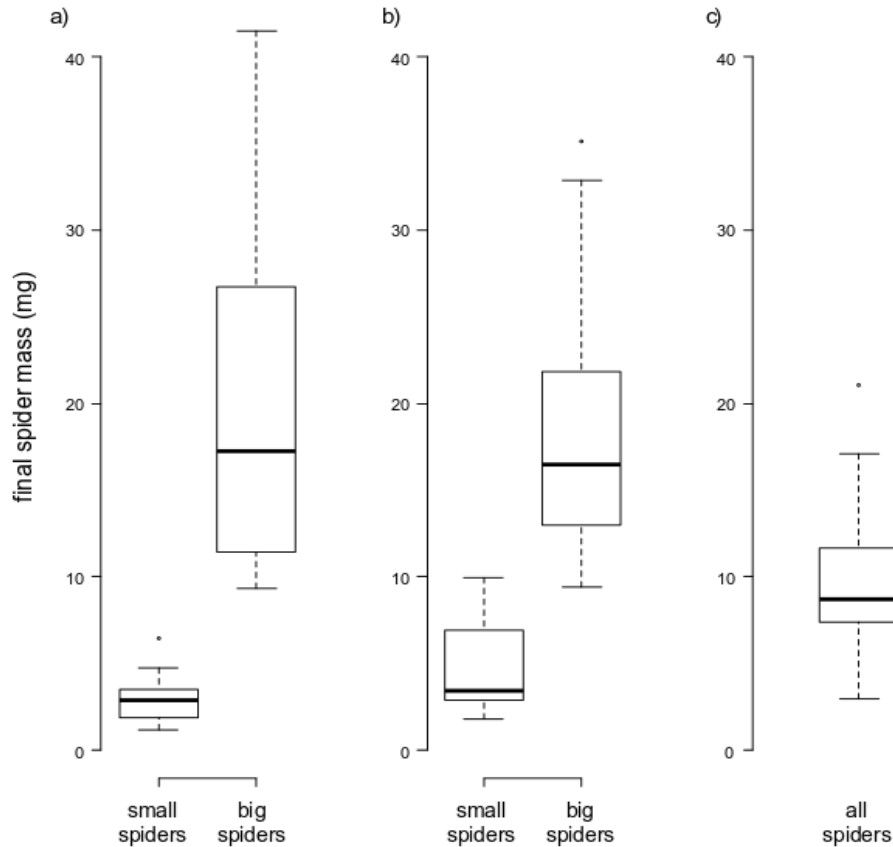

**Figure 2.2** Ranges of final body mass measurements for *P. phalangioides* spiders used in our experiments. a) Big ( $n = 23$ ) and small ( $n = 24$ ) spiders used in the memory retention experiment, b) big ( $n = 29$ ) and small ( $n = 16$ ) spiders used in the search-resumption experiment, and c) all spiders used in the hunger vs handling time experiment ( $n = 22$ ).

measure of relative prey size to use in our analysis (note that in some trials, we used *Acheta domesticus* crickets instead of *G. sigillatus*; during analysis, we tested for statistical differences in spider behavior between the two prey species, and we found absolutely no difference, so we combined them into a single dataset). The trials were two days apart and conducted in random sequence. Each trial was as described above with the addition of an imposed delay between when the cricket was removed and when the spider was allowed to search for the cricket. We

randomly assigned spiders to one of six categories, varying the length of this delay: 0 (no delay), 1, 2, 4, 8 and 16 minutes. To prevent spiders from searching during the delay, we kept them confined to their retreat position—if they started moving before their assigned delay was complete, we gave them a small puff of air with our pipette. Each spider only received the minimum amount of disturbance that was required to keep it from searching, and these puffs did not significantly affect search time (below). Once the delay treatment was complete, the spider was free to search its web for the lost prey, and we observed its behavior as normal.

We estimated the spiders' memory retention with their "total search time," which is the length of time starting from when we allowed the spider to start searching for prey, and ending with the last bout of search behavior in the trial. Our rationale for this measure is that as long as a spider is still searching, its memory of the lost prey is still active in its mind.

We analyzed variation in total search time using a linear mixed model with the following terms: spider identity (a random effect to account for each spider being tested twice), spider size (big, small), length of delay, a delay  $\times$  spider size interaction, and relative prey size, measured as: *cricket body length / spider sternum width*, following Kilmer *et al.* (2018). Additionally, because total search time is bound on one side by zero and we were specifically interested in rates of decrease in the *search time*  $\sim$  *delay* function, we included the following terms looking at curvature in the function:  $\text{delay}^2$ , and  $\text{delay}^2 \times$  spider size. Preliminary versions of the model included both trial sequence and number of puffs administered to enforce the delay, but neither of these effects were significant, so we removed them for statistical power.



### *Search resumption*

Next, we tested the predictions that small spiders are less likely to resume searching after their main bout of search behavior, or search for less time than large spiders; and that prey size has less of an effect on search time for small spiders than for large spiders. To do this, we conducted a separate experiment in which we observed spiders for an extended period of time. We divided spiders into two categories based on body size (Fig. 2.2b), and based on allometric slopes of brain size on body size (Quesada *et al.* 2011), the approximately 4-fold difference in average body mass in our spiders translated to roughly a 1.9-fold difference in brain mass. As with the previous experiment, we tested each spider twice with large and small prey in random order. Each trial was as described above with the following modifications. We randomly assigned spiders to one of two groups. For one group, when spiders reached our usual stopping criterion, we continued to observe them for at least an additional five minutes. If the spiders tugged at all during this additional time, we continued watching until five minutes passed since the last tug. For the second group, when spiders reached our usual stopping criterion, we attempted to reactivate their search behavior by gently vibrating the web with an electric toothbrush to simulate the presence of struggling prey. When we did this, spiders readily charged toward the vibration the same way they would attack prey. We removed the toothbrush before they reached it, and, as with the first group, we continued to observe until a further five minutes passed without any tugging.

From the data we collected, we calculated active search time (not to be confused with total search time, defined above), which is the sum of all the periods in which the spider was actively performing search behaviors (i.e., tugging in quick succession or exploring the bottom

of its box), and it excludes periods in which the spider was not searching (e.g., when it was maintaining its web or resting). Broadly, active search time is a measure of effort exerted over the course of the trial. Whereas total search time is a measure of the length of time that a memory remains active in the brain, active search time is a measure of how much time and effort a spider is willing to invest in recovering its prey. We used this measure because it gives us information about the value that the spider put on its lost prey.

We determined: the percentage of spiders that resumed searching in the additional observation period, the active search time of this additional phase, and whether the application of a vibration made any difference. To determine this last point, we ran a mixed model in which the dependent variable was active search time of the additional observation period, the fixed effect was vibration treatment, and spider identity was included as a random variable, because each spider was tested twice.

We analyzed the data with a linear mixed model, using active search time from the additional phase as the dependent variable and the following fixed effects: spider size (big or small), cricket size (big or small), and spider size  $\times$  cricket size. We also included spider identity as a random term.

### *Testing motivation against cognition*

In order to assess relative contributions of proximate motivation and information acquisition on search time, we ran an experiment with full-factorial design, manipulating both spider hunger and prey handling time. We used non-mature spiders that covered the species' mid-range of body sizes (Fig. 2.2c). We randomly assigned each spider to a high-hunger or low-hunger

experimental group. The low-hunger spiders were tested two days after their last meal, and the high-hunger spiders were tested eight days after their last meal. Each spider was tested once with a cricket that was half the spider's mass. We allowed the spider to wrap up its prey for a set amount of time, according to a randomly assigned treatment group—either short handling time (30 seconds) or long handling time (120 seconds). Once the handling time was up, we removed the prey, and observed the spider's searching behavior (as described above).

We analyzed our results with a standard least squares model in which the dependent variable was active search time, and the main effects were hunger level (high, low), handling time (long, short), and a hunger level  $\times$  handling time interaction. We also included terms for spider size, measured as sternum width, and prey body size measured relative to spider body size.

## Results

As we increased the delay between memory formation and memory use, search time in all spiders decreased, and it decreased more quickly in small spiders than in big spiders (Fig. 2.3, Table 2.1). For example, to see a 50% reduction in search time, it would take a delay of approximately 3 minutes in small spiders, but approximately 11 minutes in big spiders. This effect was most likely caused by the delay itself, and not the methods used to enforce the delay, because: the number of puffs it took to prevent spiders from searching was not a significant term in our initial model; spiders only received as many puffs as necessary to keep them from searching; and all spiders were administered similar puffs of air when we drove

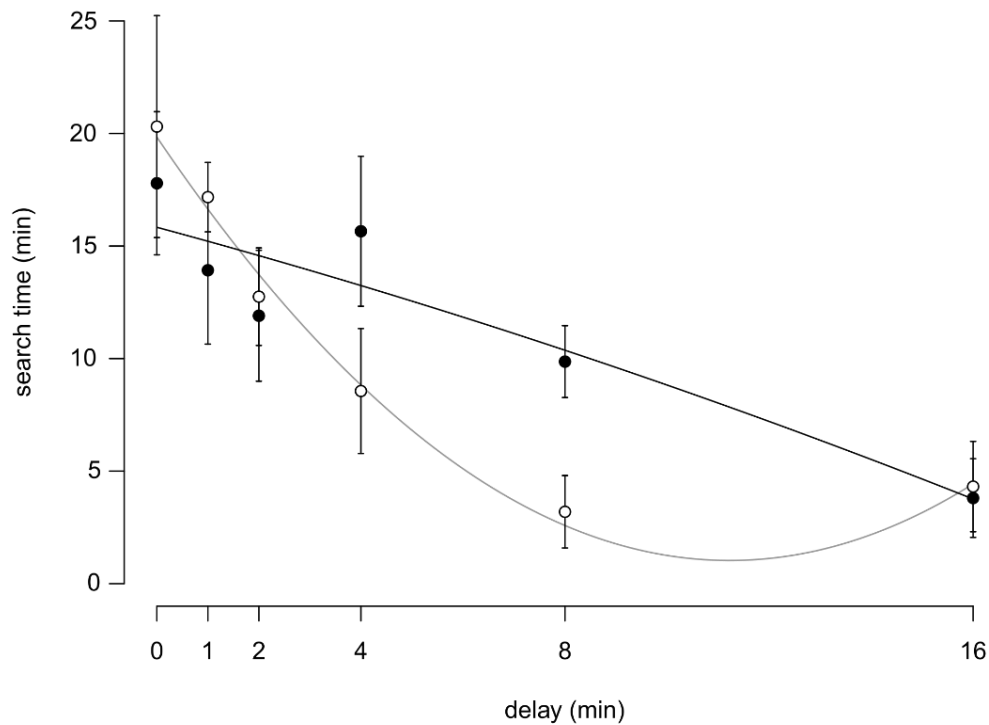

**Figure 2.3** Effects of delay on total search time in *P. phalangioides*. We imposed delays of varying length between memory formation and memory use. We measured total search time as the length of time from the end of the delay until the end of the spider’s search behavior. With increasing delay, search time for small spiders (open circles;  $n = 24$ ) dropped off more steeply than it did for big spiders (filled circles;  $n = 23$ ). Each spider was tested twice at a single delay value—once with large prey and once with small prey (as reported in Table 2.1, but not shown here). Error bars represent standard error. Note that the apparent increase in search time for small spiders at 16 minutes of delay is only an artifact of the quadratic regression used to fit the curve, which we chose to model the drop-off followed by the flattening-out at zero seen here. Corresponding statistics reported in Table 2.1.

them away from their prey during the prey-removal phase of each trial, and these had no apparent effect. Finally, our analyses found no significant effect of prey size.

When we extended observations beyond the usual cutoff (regardless of whether we vibrated the web or not), small spiders searched less compared to big spiders, and they showed virtually no discrimination between prey sizes, while large spiders showed significantly higher search times for larger prey (Fig. 2.4, Table 2.2, significant spider size and spider size  $\times$  prey size

**Table 2.1** Variation in the retention of memory of lost prey in *P. phalangioides*. The dependent variable was total search time and the fixed effects were spider size (big or small), delay imposed before searching, spider size  $\times$  delay, delay<sup>2</sup> (included because search times do not decay linearly), spider size  $\times$  delay<sup>2</sup> (included to look for differences in decay between spider sizes), and prey size (relative to spiders size). We also included a random term, spider identity, because each spider was tested twice (once with each prey size). Significant terms indicated with bold text.

Fixed effects	DF num, DF den	F-ratio	p-value
Spider size	1, 40.75	<b>4.89</b>	<b>0.033</b>
Delay	1, 40.04	<b>21.46</b>	<b>&lt; 0.0001</b>
Spider size $\times$ delay	1, 40.68	<b>4.26</b>	<b>0.045</b>
Delay <sup>2</sup>	1, 40.05	<b>4.38</b>	<b>0.043</b>
Spider size $\times$ delay <sup>2</sup>	1, 40.05	<b>5.20</b>	<b>0.043</b>
Prey size	1, 84.59	0.84	0.360

Random effect	Var. comp.	95% CI	% of total var.	Wald p-value
Spider identity	92247	21587-162907	44.0	<b>0.011</b>

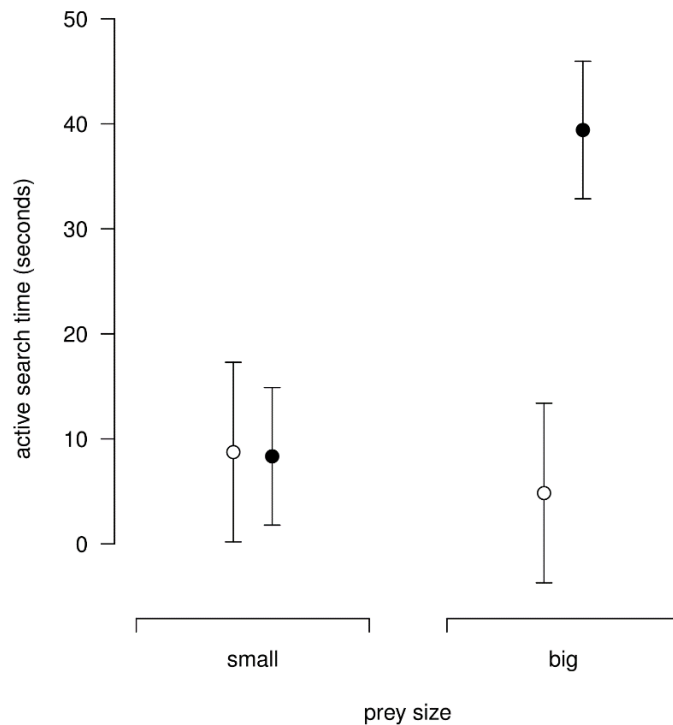

**Figure 2.4** Late-stage search time in *P. phalangioides* spiders. We measured active search time for small spiders (open circles;  $n = 16$ ) and big spiders (filled circles;  $n = 29$ ) as they searched for large and small prey. Each spider was tested twice, once with each prey size. The data shown here are means  $\pm$  SE of search behavior that occurred in the additional observation periods—that is, after the normal criterion for ending observations had passed. Statistical results presented in Table 2.2.

**Table 2.2** Variation in resumed searches for lost prey in *P. phalangioides*. The dependent variable was active search time, and the fixed effects were spider size (big or small), prey size (big or small), and spider size × prey size. We also included a random term for spider identity, because each spider was tested twice (once with each prey size). Significant terms indicated with bold text.

Fixed effects	DF num, DF den	F-ratio	p-value	
Spider size	1, 43	<b>4.16</b>	<b>0.048</b>	
Prey size	1, 43	3.20	0.081	
Spider size × prey size	1, 43	<b>5.48</b>	<b>0.024</b>	
Random effect	Var. comp.	95% CI	% of total var.	Wald p-value
Spider identity	104	-277—486	8.2	0.592

terms). Mainly, however, spiders were unlikely to resume searching. There was no resumption in nearly two thirds of trials (56 of 90, with each spider going through two trials), meaning that our criterion of ending trials after five minutes of no searching was mostly sufficient for capturing the behavior. In the 34 trials that spiders did resume searching, they did so only briefly: 50% had an active search time under 30 seconds, and spiders actively searched longer than two minutes in only four trials. The addition of prey cues (in the form of a vibration) affected neither the percentage of spiders that resumed searching (36.4% of the spiders in the vibration group, compared to 37.5% in the no-vibration group) nor the length of search time (LS means ± SE: no-vibration = 21.0 ± 5.7 seconds ( $n = 23$  spiders, 46 trials); vibration = 14.7 ± 5.8 seconds ( $n = 22$  spiders, 44 trials);  $F_{1,43} = 0.60$ ,  $p = 0.44$ ).

When we measured the relative contributions of hunger vs handling time on search behavior, we found that a 90-second difference in the opportunity to gather information had an effect that was 6-7 times larger than a 6-day difference in hunger (Fig. 2.5, Table 2.3). This was

true regardless of prey size and spider size. The analysis hinted at a possible interaction between these two variables (whereby the hungriest spiders that had the most opportunity to acquire information about their prey searched the most), but the effect was not significant ( $p = 0.127$ ; Table 2.3).

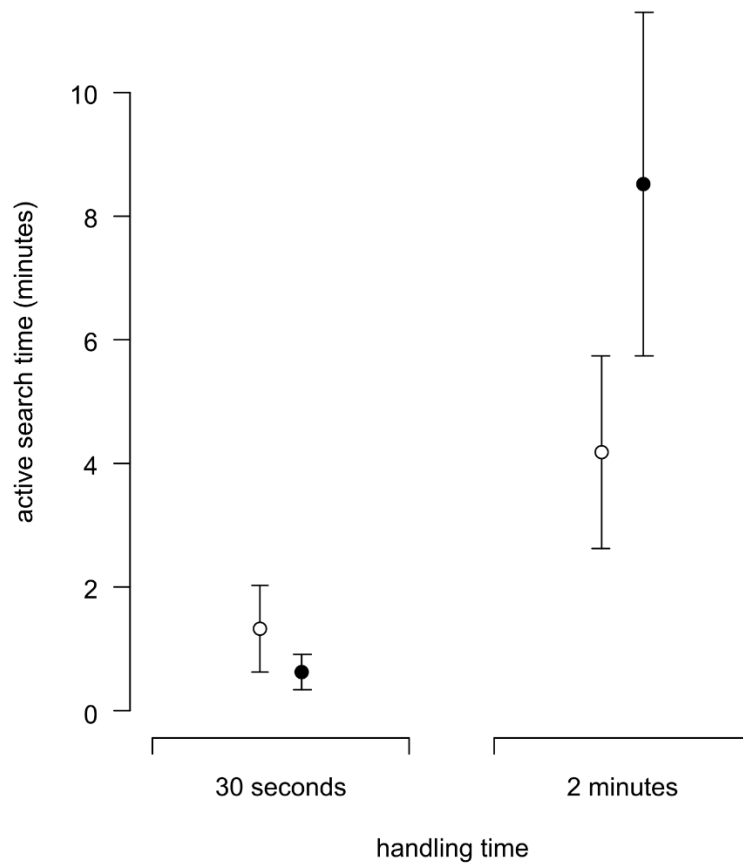

**Figure 2.5** Effects of hunger (physiological motivation) and handling time (information acquisition) on active search time for *P. phalangioides*. Spiders in the low-hunger group (open circles;  $n = 6$  and  $6$  for low and high handling time, respectively) went two days without food before the trial, while spiders in the high-hunger group (filled circles;  $n = 5$  and  $5$  for low and high handling time, respectively) went eight days without food. Handling time (30 seconds vs 120 seconds) had a much larger effect on search behavior than did hunger. Statistical results presented in Table 2.3.

**Table 2.3** Effects of motivation and information acquisition on the time that *P. phalangioides* spiders search for lost prey. The dependent variable was active search time and the fixed effects were hunger (2 days or 8 days since last meal), handling time (30 seconds or 120 seconds subduing and wrapping prey), hunger × handling time, spider size (sternum width), prey size (prey body length / spider size). Significant terms indicated with bold text.

Effects	DF num, DF den	F-ratio	p-value
Hunger	1, 21	0.25	0.625
Handling time	1, 21	<b>12.50</b>	<b>0.003</b>
Hunger × handling time	1, 21	2.59	0.127
Spider size	1, 21	0.71	0.413
Prey size	1, 21	1.17	0.296

## Discussion

We report evidence of a cognitive limitation in miniature animals. Testing over an approximately 2-fold difference in brain size across juvenile and adult *P. phalangioides*, we find that memory retention time, but not memory content, is limited in the smaller instars. Smaller spiders searched similarly or longer than larger spiders for prey they had captured and lost (Kilmer *et al.* 2018; this study). This shows that memory formation and content are not limited by brain size; and that even very small spiders can be highly motivated and both physically and cognitively capable of forming memories of captured prey and using them to regulate searching efforts. By contrast, in two separate experiments, smaller spiders showed a steeper decline in searching when we imposed a delay between memory formation and use; i.e., they had worse performance on a delayed memory task (Fig. 2.3). Thus, memory retention time is limited by brain size. Interestingly, when large spiders searched without delay between memory formation and use, they did not prefer large over small prey (Kilmer *et al.* 2018; present study, Fig. 2.3). But they did search longer for large prey in resumed searches (Fig. 2.4). We interpret



this not as a loss of the ability to distinguish between remembered large and small prey, but rather as a difference in the memorability of large and small prey, which is only expressed in spiders with brains large enough for memory retention time not to be compromised. An alternative explanation might be that, as the delay between memory formation and use increased, small spiders reached the decision not to search sooner than larger spiders (perhaps driven by reduced experience or motivation). However, the overall greater motivation and search times of small spiders in the absence of a delay—combined with evidence that past experience has little effect on search time—argue against this interpretation (Kilmer *et al.* 2018). An additional experiment assessed the relative contribution to search times of information stored in memory versus motivation (hunger), finding that the effect of memory is at least an order of magnitude stronger.

Why should memory retention time (but not information content) be limited by brain size? Perhaps it is energetically cheaper or neuronally simpler to form memories than to retain them over time. The mechanisms of forgetting will be key to address these questions. To the extent that our results reflect a passive-decay model of forgetting (e.g., Brown 1958, Ricker *et al.* 2014), small brains may simply be less capable of holding on to memories. Alternatively, under an interference model of forgetting (e.g., Lewandowsky *et al.* 2008), small brains may instead be limited in their ability to hold attention on a given object or aim, and be more susceptible to distraction.

Either way, limitations in memory retention in miniature animals are likely to have downstream consequences for other abilities. Learning, for instance, may be limited if the interval between an event and its consequence exceeds the retention of the memory of the

event. This may be part of the explanation for the poor performance in a numerical learning tasks of small-brained guppies, even if their numerosity per se was not compromised (Kotrschal *et al.* 2013). On the flip side, forgetting itself may be an adaptation that allows for adjusting behavior and decision-making in the face of change (West-Eberhard 2003: 350-352). Even here, though, a limited retention time would constrain the range over which miniature animals could modulate learning and forgetting.

The scarcity of evidence in the literature for limitations in small brains is not for lack of effort—indeed, biologists have been curious about brain size for decades (e.g., Rensch 1956; Eisenberg & Wilson 1978; Harvey *et al.* 1980; Cole 1985; Garamszegi *et al.* 2005, Eberhard 2007, Eberhard & Wcislo 2011), and some have found compelling results (Kotrschal *et al.* 2013, 2015). The endeavor of identifying limitations in miniature species has proven to be a challenge, in part because some cognitive abilities have turned out to not be as neurologically complex as initially thought (Chittka & Niven 2009; Roper *et al.* 2017; Skorupski *et al.* 2017). Simulations of neural networks have shown that seemingly complex cognitive functions, like selective attention or visual categorization, can each be accomplished with fewer than 20 neurons (Beer 2003; Goldenberg *et al.* 2004; Roper *et al.* 2017). Some abilities, like pattern recognition, may actually be adaptations that allow brains to process information more efficiently with fewer neurons, rather than being complex functions that require large neural machinery (Srinivasan 2006). Perhaps larger brains do not add new functions so much as they increase existing abilities, such as memory capacity, sensory resolution and parallel processing (Chittka & Niven 2009). Additionally, there are some areas in which small animals are truly not limited, for

example in movement precision movement precision and error correction (Eberhard 2007, 2011).

We consider that two features of the present study increase our ability to assess animal cognitive and behavioral capabilities across brain sizes. First, using within-species variation in size (juvenile to adult instars) allowed us to compare animals greatly varying in body and brain size with no confounds arising from potential species differences in ecology. Second, our searching assay directly reflects the content and use of memory in the regulation of behavior and is easily quantifiable. We suggest that integrating the ontogenetic approach and behavioral assays will enhance comparative work on the evolution of cognition.

In conclusion, we provide evidence that the ability to retain memories over time is a main factor in the selective trade-offs influencing brain size and cognitive ability when animals evolve miniature body sizes. In turn, limitations in memory retention may influence other variables, such as the time window over which miniature animals have the opportunity to learn relationships between their behavior and its consequences.

## Literature Cited

- Agrillo C, Bisazza A (2017). Understanding the origin of number sense: a review of fish studies. *Philosophical Transactions of the Royal Society B* 373:20160511.
- Attwell D, Laughlin SB (2001). An energy budget for signaling in the grey matter of the brain. *Journal of Cerebral Blood Flow & Metabolism* 21:1133–1145.
- Beer R (2003). The dynamics of active categorical perception in an evolved model agent. *Adaptive Behavior* 11:209–243.
- Benson-Amran S, Dantzer B, Stricker G, Swanson EM, Holekamp KE (2015). Brain size predicts problem-solving ability in mammalian carnivores. *Proceedings of the National Academy of Sciences* 113:2532-2537.
- Brown J (1958). Some tests of the decay theory of immediate memory. *Quarterly Journal of Experimental Psychology* 10:12-21.
- Chittka L, Niven J (2009). Are bigger brains better? *Current Biology* 19:R995-1008.
- Cole B (1985). Size and behavior in ants: constraints on complexity. *Proceedings of the National Academy of Sciences* 82:8548–8551.
- Dakin R, Segre PS, Straw AD, Altshuler DL (2018). Morphology, muscle capacity, skill, and maneuvering ability in hummingbirds. *Science* 359:653-657.
- Day LB, Westcott DA, Olster DH (2005). Evolution of bower complexity and cerebellum size in bowerbirds. *Brain, Behavior and Evolution* 66:62-72.
- Eberhard WG (2007). Miniaturized orb-weaving spiders: behavioural precision is not limited by small size. *Proceedings of the Royal Society B* 274:2203-2209.
- Eberhard WG (2011). Are smaller animals behaviourally limited? Lack of clear constraints in miniature spiders. *Animal Behaviour* 81:813-823.
- Eberhard WG, Wcislo WT (2011). Grade changes in brain-body allometry: morphological and behavioural correlates of brain size in miniature spiders, insects and other invertebrates. *Advances in Insect Physiology* 40:155-214.
- Eberhard WG, Wcislo WT (2012). Plenty of room at the bottom? *American Scientist* 100:226–233.
- Eisenberg JF, Wilson DE (1978). Relative brain size and feeding strategies in the Chiroptera, *Evolution* 32:740-751.
- Elias DO, Maddison WP, Peckmezian C, Girard MB, Mason AC (2012). Orchestrating the score: complex multimodal courtship in the *Habronattus coecatus* group of *Habronattus* jumping spiders (Araneae: Salticidae). *Biological Journal of the Linnean Society* 105:522-547.

- Evans AV (2008). *Field Guide to Insects and Spiders of North America*. Sterling Publishing Co., Inc., New York, NY.
- Faisal AA, White JA, Laughlin SB (2005). Ion-channel noise places limits on the miniaturization of the brain's wiring. *Current Biology* 15:1143–1149.
- Garamszegi L, Eens M, Erritzøe J, Møller A (2005). Sexually size dimorphic brains and song complexity in passerine birds. *Behavioral Ecology* 16:335–345.
- Girard MB, Kasumovic MM, Elias DA (2011). Multi-modal courtship in the peacock spider, *Maratus volans* (O.P.-Cambridge, 1874). *PLoS ONE* 6:e25390.
- Goldenberg E, Garcowski J, Beer R (2004). May we have your attention: Analysis of a selective attention task. *From Animals to Animats 8: Proceedings of the Eighth International Conference on the Simulation of Adaptive Behavior* 8:49-56.
- Hanken J (1985). Morphological novelty in the limb skeleton accompanies miniaturization in salamanders. *Science* 229:871-874.
- Harvey PH, Clutton-Brock TH, Mace GM (1980). Brain size and ecology in small mammals and primates. *Proceedings of the National Academy of Sciences* 77:4387-438.
- Healy SD, Rowe C (2007). A critique of comparative studies of brain size. *Proceedings of the Royal Society B* 274:453-464.
- Kilmer JT, Havens ZS, Rodríguez RL (2018). Ontogenetic approach reveals how cognitive capability and motivation shape prey-searching behavior in *Pholcus phalangioides* cellar spiders. *Ethology* 124:657-666.
- Kotrschal A, Rogell B, Bundsen A, Svensson B, Zajitschek S, Brännström I, Immler S, Maklakov AA, Kolm N (2013). Artificial selection on relative brain size in the guppy reveals costs and benefits of evolving a larger brain. *Current Biology* 23:168-171.
- Kotrschal A, Corral-Lopez A, Amcoff M, Kolm N (2015). A larger brain confers a benefit in a spatial mate search learning task in male guppies. *Behavioral Ecology* 26:527-532.
- Lewandowsky S, Oberauer K, Brown GDA (2008). No temporal decay in verbal short-term memory. *Trends in Cognitive Science* 13:120-126.
- Madden J (2001). Sex, bowers and brains. *Proceedings of the Royal Society of London B* 268:833-838.
- Niven JE, Farris SM (2012). Miniaturization of nervous systems and neurons. *Current Biology* 22:R323–R329.
- Niven JE, Laughlin SB (2008). Energy limitation as a selective pressure on the evolution of sensory systems. *Journal of Experimental Biology* 211:1792–804.
- Opell DB (2001). Egg sac recognition by female *Miagrammopes animotus* (Araneae, Uloboridae). *Journal of Arachnology* 29:244-248.

- Perge JA, Niven JE, Mugnaini E, Balasubramanian V, Sterling P (2012). Why do axons differ in caliber? *Journal of Neuroscience* 32:626–638.
- Peters RH (1983). The Ecological Implications of Body Size. *Cambridge University Press*, New York, NY.
- Polilov AA (2012). The smallest insects evolve anucleate neurons. *Arthropod Structure & Development* 41:29-34.
- Price T (2008). *Speciation in birds*. Roberts and Co., Greenwood Village, CO.
- Purves D, Lichtman JW (1985). Geometrical differences among homologous neurons in mammals. *Science* 228:298–302.
- Quesada R, Triana E, Vargas G, Douglass JK, Seid MA, Niven JE, Eberhard WG, Wcislo WT (2011). The allometry of CNS size and consequences of miniaturization in orb-weaving and cleptoparasitic spiders. *Arthropod Structure & Development* 40:521-529.
- Rensch B (1948). Histological changes correlated with evolutionary changes of body size. *Evolution* 2:218–230.
- Rensch B (1956). Increase of learning capability with increase of brain-size. *The American Naturalist* 90:81–95.
- Ricker TJ, Vergauwe E, Cowan N (2016). Decay theory of immediate memory: from Brown (1958) to today (2014). *The Quarterly Journal of Experimental Psychology* 69:1969-1995.
- Rodríguez RL, Gamboa E (2000). Memory of captured prey in three web spiders (Araneae: Araneidae, Linyphiidae, Tetragnathidae). *Animal Cognition* 3:91-97.
- Rodríguez RL, Gloudeman MD (2011). Estimating the repeatability of memories of captured prey formed by *Frontinella communis* spiders (Araneae: Linyphiidae). *Animal Cognition* 14:675-682.
- Rodríguez RL, Kolodziej RC, Höbel G (2013). Memory of prey larders in golden orb-web spiders, *Nephila clavipes* (Araneae: Nephilidae). *Behaviour* 150:1345-1356.
- Rodríguez RL, Briceño RD, Briceño-Aguilar E, Höbel G (2015). *Nephila clavipes* spiders (Araneae: Nephilida) keep track of captured prey counts: testing for a sense of numerosity in an orb-weaver. *Animal Cognition* 18:307-314.
- Rolfe D, Brown G (1997). Cellular energy utilization and molecular origin of standard metabolic rate in mammals. *Physiological Reviews* 77:731–758.
- Roper M, Fernando C, Chittka L (2017). Insect bio-inspired neural network provides new evidence on how simple feature detectors can enable complex visual generalization and stimulus location invariance in the miniature brain of honeybees. *PLOS Computational Biology* 13:e1005333.
- Shettleworth, SJ (2010). *Cognition, Evolution, and Behavior*, 2<sup>nd</sup> ed. Oxford University Press, New York, NY.
- Skorupski P, MaBouDi H, Dona HSG, Chittka L (2017). Counting insects. *Philosophical Transactions of the Royal Society B* 373:20160513.

- Sol D, Duncan RP, Blackburn TM, Cassey P, Lefebvre L (2005). Big brains, enhanced cognition, and response of birds to novel environments. *Proceedings of the National Academy of Sciences USA* 102:5460-5465.
- Spaethe J, Tautz J, Chittka L (2006). Do honeybees detect colour targets using serial or parallel visual search? *Journal of Experimental Biology* 209:987–993.
- Squire LR, Kandel ER (2009). *Memory: From Mind to Molecules*, 2nd ed. Roberts & Co., Greenwood Village, CO.
- Srinivasan, MV (2006). Honeybee vision: in good shape for shape recognition. *Current Biology* 16:R58–R60.
- Striedter G (2005). *Principles of Brain Evolution*. Sinauer Associates, Inc., Sunderland, MA.
- West-Eberhard MJ (2010). *Developmental Plasticity and Evolution*. Oxford University Press, New York, NY.

## APPENDIX: Variation in search time

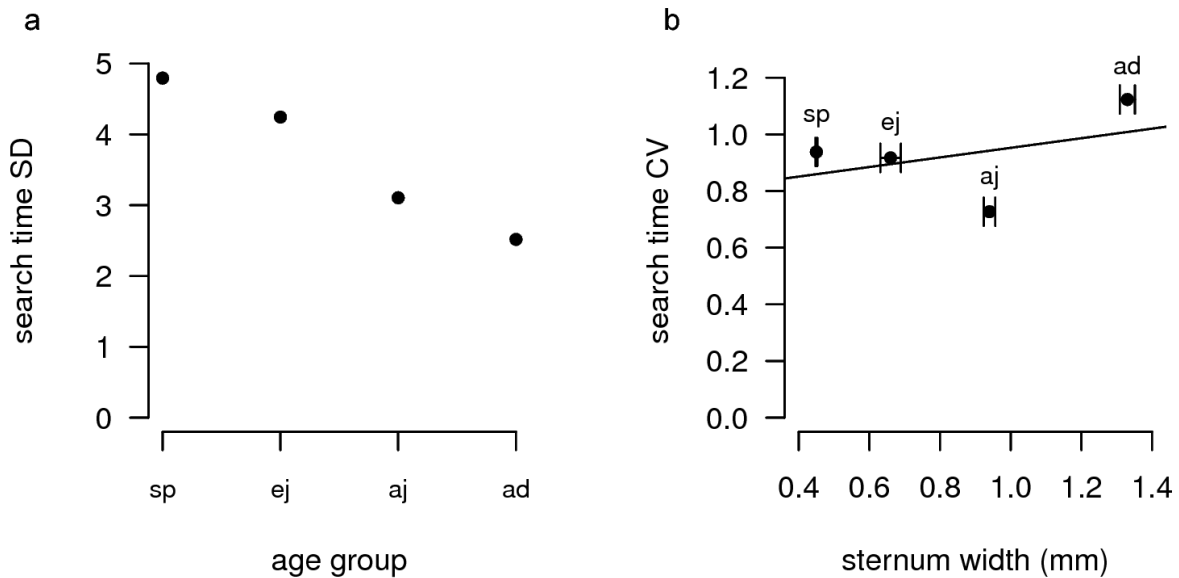

Variation in search time, measured as a) standard deviation and b) coefficient of variation ( $CV = sd / \text{mean}$ ), across four levels of maturity in our spiders: spiderlings (sp), early juveniles (ej), advanced juveniles (aj), and adults (ad). a) A Brown-Forsythe test for unequal variance found significant differences in standard deviation between the groups ( $F_{3, 140} = 2.82$ ,  $p = 0.041$ ), with older spiders showing less variance in their behavior. b) For each of the four age groups, we calculated the CV of search time and the average sternum width ( $\pm 1 SE$ ) of the spiders in the group. Sternum width is a rough proxy for age that we used in order to have a continuous independent variable for the regression. A simple linear regression between these two variables found no relationship ( $R^2 = 0.16$ ,  $t\text{-ratio} = 0.61$ ,  $p = 0.60$ ). Note that by using a series means as our dependent variable in (b), we violate an assumption of linear regressions. However, given that the standard errors are so small relative to the whole range, we find it unlikely that this variation in the x-axis is masking a significant non-zero relationship between the variables.



## CURRICULUM VITAE

Joseph T. Kilmer

### EDUCATION

BA in Biology (2010) Kalamazoo College, *Kalamazoo, MI*

Senior thesis: *A comparison of two Necturus maculosus populations in northeastern Ohio prior to lampricide treatment*

PhD in Biological Sciences (2018) University of Wisconsin-Milwaukee, *Milwaukee, WI*

Dissertation: *Effects of life history and brain size on cognition and behavior: studies on prey-searching in the spider Pholcus phalangioides*

### PUBLICATIONS

**Kilmer J**, Havens Z & Rodríguez R. 2018. Ontogenetic approach reveals how cognitive capability and motivation shape prey-searching behavior in *Pholcus phalangioides* cellar spiders. *Ethology*, 124: 657-666.

Fowler-Finn K, **Kilmer J**, Cruz D & Rodríguez R. 2018. Female mate choice of male signals is unlikely to promote ecological adaptation in *Enchenopa* treehoppers (Hemiptera: Membracidae). *Ecol Evol*, 2018: 2146-2159.

**Kilmer J**, Fowler-Finn K, Gray D, Höbel G, Rebar D, Reichert M & Rodríguez R. 2017. Describing mate preferences and other function-valued traits. *J Evol Biol*, 30: 1658–1673.

**Kilmer J** & Rodríguez R. 2017. Ordinary least squares (OLS) regression is indicated for studies of allometry. *J Evol Biol*, 30: 4-12.

**Kilmer J** & Rodríguez R. 2017. Do structures with sexual contact functions evolve negative static allometries? A case study with the harvestman *Leiobunum vittatum* (Opiliones Sclerosomatidae). *Ethol Ecol Evol*, 29: 64-73.

Rodríguez R, Burger M, Wojcinski J & **Kilmer J**. 2015. Vibrational signals in the mating behavior of Japanese beetles, *Popillia japonica* (Coleoptera: Scarabaeidae). *Ann Entomol Soc Am*, 108: 986-992.

Fowler-Finn K, **Kilmer J**, Hallett A & Rodríguez R. 2015. Variation in signal-preference genetic correlations in *Enchenopa* treehoppers (Hemiptera: Membracidae). *Ecol Evol*, 5: 2774-2786.

Rodríguez R, Hallett A, **Kilmer J** & Fowler-Finn K. 2013. Curves as traits: genetic and environmental variation in mate preference functions. *J Evol Biol*, 26: 434-442.

### SELECTED PRESENTATIONS

**Kilmer J**. 2018. Effects of life history and brain size on cognition and behavior in the spider *Pholcus phalangioides*. *UW-Milwaukee Department of Biological Sciences Colloquium* in Milwaukee, WI.

- Kilmer J.** 2016. Ontogeny of sex differences in *Pholcus* cellar spiders searching for lost prey. *Animal Behavior Society* meeting in Columbia, MO.
- Kilmer J.** 2016. Tell your computer to do the boring stuff (it's better at it than you are). *UW-Milwaukee Biological Sciences Research Symposium* in Milwaukee, WI.
- Kilmer J** 2016. Brain size and memory of captured prey in the cellar spider *Pholcus phalangioides* (Araneae: Pholcidae). *The Society for Integrative and Comparative Biology* meeting in Portland, OR.
- Kilmer J & Rodríguez R.** 2015. Brain size and memory of captured prey in the cellar spider *Pholcus phalangioides* (Araneae: Pholcidae). *Animal Behavior Society* meeting in Anchorage, AK.
- Kilmer J** 2015. Brain size and memory of prey capture in the cellar spider *Pholcus phalangioides*. *UW-Milwaukee Biological Sciences Research Symposium* in Milwaukee, WI.
- Kilmer J & Rodríguez R.** 2013. Contact function may explain shallow scaling of genitalia. *UW-Milwaukee Biological Sciences Research Symposium* in Milwaukee, WI.
- Kilmer J & Rodríguez R.** 2012. Contact function explains negative allometries of copulatory structures. *American Arachnological Society* meeting in Green Bay, WI.

#### **FUNDED GRANT PROPOSALS**

- American Arachnological Society – Arachnological Research Fund. “Web-building behavior and vibrational cues: Do spiders eavesdrop on their prey?” **PI: Joseph Kilmer.** \$200 (2012)
- Sigma Xi – Grant-in-Aid of Research #G20120315160879. “Web-building behavior and vibrational cues: Do spiders eavesdrop on their prey?” **PI: Joseph Kilmer.** \$400 (2012)

#### **SELECTED HONORS AND AWARDS**

- UWM Distinguished Dissertation Fellowship (2017)
- UWM Biological Sciences Symposium Research Talk Award. \$200 (2016)
- Ruth Walker Grant-in-Aid Graduate Student Award. \$1,500 (2013, 2014, 2015, 2016)
- Chancellor's Graduate Student Award. \$4,000 (2013, 2014, 2015), \$6,000 (2016)
- Field course scholarship through the Organization for Tropical Studies. \$500 (2013)

#### **POSITIONS AND EMPLOYMENT**

- |             |                                                                      |
|-------------|----------------------------------------------------------------------|
| 2011 – 2018 | Graduate Teaching & Research Assistant – UW-Milwaukee, Milwaukee, WI |
| 2009 – 2010 | Undergraduate Teaching Assistant– Kalamazoo College, Kalamazoo, MI   |
| 2009        | Research Intern – Cleveland Museum of Natural History, Cleveland, OH |