

## Data model for system conceptualization in groundwater studies

Xiaoying Yang , David R. Steward , Willem J. de Lange , Simon Y. Lauwo ,  
Richard M. Chubb & Eric A. Bernard

To cite this article: Xiaoying Yang , David R. Steward , Willem J. de Lange , Simon Y. Lauwo ,  
Richard M. Chubb & Eric A. Bernard (2010) Data model for system conceptualization in  
groundwater studies, International Journal of Geographical Information Science, 24:5, 677-694,  
DOI: [10.1080/13658810902967389](https://doi.org/10.1080/13658810902967389)

To link to this article: <https://doi.org/10.1080/13658810902967389>



Copyright Taylor and Francis Group, LLC



Published online: 13 Apr 2010.



Submit your article to this journal [↗](#)



Article views: 3507



View related articles [↗](#)



Citing articles: 1 View citing articles [↗](#)

## Data model for system conceptualization in groundwater studies

Xiaoying Yang<sup>a\*</sup>, David R. Steward<sup>a</sup>, Willem J. de Lange<sup>b</sup>, Simon Y. Lauwo<sup>a</sup>,  
Richard M. Chubb<sup>c</sup> and Eric A. Bernard<sup>d</sup>

<sup>a</sup>Department of Civil Engineering, Kansas State University, Manhattan, KS, USA; <sup>b</sup>Institute for Inland Water Management and Waste Water Treatment, RIZA, Lelystad, The Netherlands; <sup>c</sup>Office of Mediated Education, Kansas State University, Manhattan, KS, USA; <sup>d</sup>Department of Landscape Architecture/Regional and Community Planning, Kansas State University, Manhattan, KS, USA

(Received 25 July 2008; final version received 6 April 2009)

Development of a conceptualization of a hydrogeologic system serves as the basis of groundwater modeling. While existing groundwater data models are designed to store groundwater system information, none is designed to capture its conceptual view. This study addresses this need by presenting a new object-oriented Conceptualization Groundwater Data Model that represents a groundwater system as a series of aquifer layers with defined aquifer properties and water boundary conditions. A case study is presented that develops the conceptual view of the groundwater system beneath Konza Prairie. This single conceptualization is used to support groundwater models across existing technologies of finite difference, finite element, and analytical element methods. While the models each employ different mathematics, data input files, and formats, all models are founded on the same conceptualization process that is represented using this new data model. The case study illustrates the data model's promise as an effective mechanism for groundwater system conceptualization and data storage, and utility for various groundwater computational models. This conceptualization of a groundwater data model suggests a new focus on incorporating system conceptualization into data model design.

**Keywords:** data model; conceptualization; groundwater; simulation

### 1. Introduction

One key issue in Geographic Information Science (GIS) is the representation of geographic phenomena in a digital environment (Goodchild 1992a, UCGIS 1996, Goodchild *et al.* 1999, Mennis *et al.* 2000). Providing the conceptual basis of the system by defining objects, relationships, operations, and rules, data models determine the ways to represent real-world phenomena and the possible levels of processing, analysis, and modeling within GIS (Goodchild 1992b). Spatial information has been used in different disciplines in many ways (Goodchild *et al.* 1993). Discipline-specific spatial data models are needed to appropriately represent and conceptualize the phenomena of interest (Kemp 1997, Wise 2000, Worboys 1994, Worboys 2004). Failure to incorporate discipline-specific concepts into the spatial data model schema often leads to confusion, application disappointment, and representational compromises (Burrough and Frank 1995). The focus of this study is the development of a data model for groundwater study.

---

\*Corresponding author. Email: xiaoying@ksu.edu

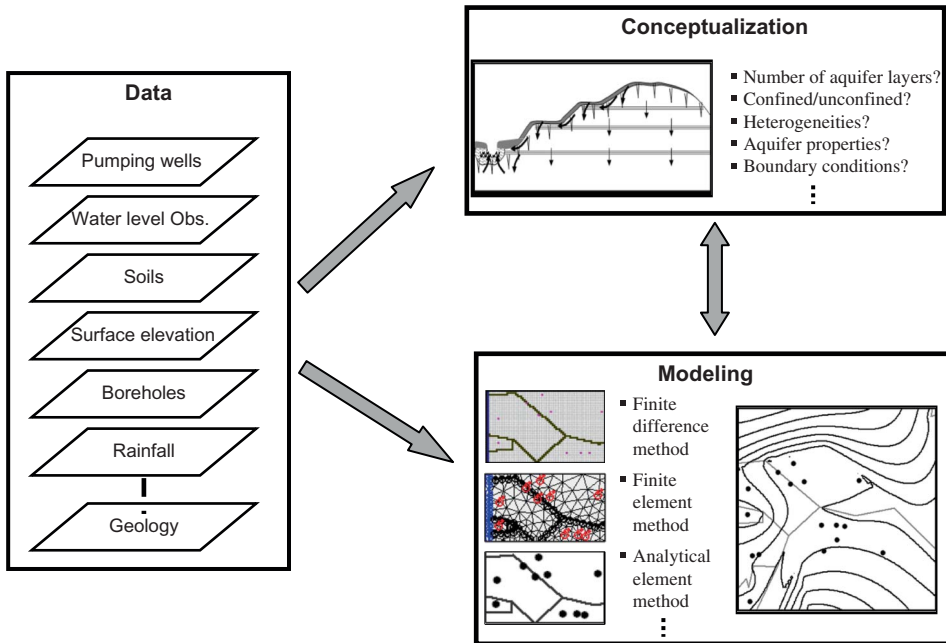

Figure 1. Three Components of Groundwater Studies (adapted from Maidment and Hooper 2005).

Like many other disciplines, groundwater study comprises three main components: data, conceptualization, and modeling (Figure 1). A variety of data are used to study a groundwater system, such as borehole records, well pumping rates, groundwater levels, soil properties, rainfall, and river networks. Before simulation models are developed with these data, there needs to be a careful conceptualization process to simplify the targeted groundwater system due to its complexity. The conceptualization process relies on the review of existing studies, the analysis of the background data, and the model developer's own expert judgment. Among other things, the resulting conceptual view from the process specifies the number of aquifer layers in the groundwater system, and each layer's type, aquifer properties, and boundary conditions.

One single conceptual view could be realized with different numerical methods such as the finite difference method (McDonald and Harbaugh 1988), the finite element method (Townley 1990), the boundary element method (Liggett and Liu 1983), and the analytical element method (AEM) (Strack 1989, Kraemer 2007). Likewise, one single numerical method could be implemented through different numerical codes and software applications (Table 1). Nevertheless, regardless of its type, the validity of its underlying conceptual view dictates the groundwater model's performance (Anderson and Woessner 1992, Richards and Jones 1997).

A number of groundwater related data models have been developed (Grise and Brodaric 2004, NADM 2004, Strassberg 2005, Steward and Bernard 2006, Horsburgh *et al.* 2008). Most follow the traditional spatial data model design by stacking a series of thematic layers related to a groundwater system with defined attributes, relationships, and rules. However, the high-level concepts formulated through the conceptualization process do not always correspond with the concrete real-world entities that can be measured directly and represented with thematic layers. As a result, although they are well suited

Table 1. Examples of numerical groundwater codes and softwares.

Numerical method	Simulation models
Analytical element	CZAEM, GFlow, MLAEM, SPLIT, Tim, TwoDan, Visual Bluebird, WHAEM, 3DFlow
Boundary element	TARGET
Finite difference	FLOWPATH, FTWORK, HST2D/3D, INVFD, MODFLOW, PLASM, SWIFT
Finite element	ABCFEM, AQUIFEM-N, FEFLOW, FEMWATER, MicroFEM, MODFE, MULAT, PTC

for storing and managing the heterogeneous source groundwater datasets, the existing groundwater data models lack the capability to convey the conceptual view of the groundwater system. There is a need to develop new types of spatial data models that reflect the modeling conceptualization of the target system, extending current models that mainly serve as the data storage utility for real-world observations.

This article presents a new groundwater data model designed for storing the conceptual view of a groundwater system. Section 2 of the article elaborates the new Conceptualization Groundwater Data Model, including its design rationale, components, relationships, and implementation using relational spatial databases. In Section 3, a study of the Konza Prairie illustrates the use of the Conceptualization Groundwater Data Model to store the conceptual view of a real-world groundwater system, and to interface with three types of groundwater models: finite difference, finite element, and analytical element methods. The subsequent discussion section assesses the Conceptualization Groundwater Data Model and explores its potential applications, and the conclusion section summarizes the study results.

## 2. Conceptualization groundwater data model

### 2.1. Conceptualization of groundwater system

Conceptualization means the formulation of a simplified view of the groundwater system. In theory, the closer the conceptual view approximates the real-world conditions, the more accurate the groundwater modeling results. However, due to the complexity of field conditions, parsimony is often desired in practice. In other words, the conceptual view should be as simple as possible, as long as it remains adequate to reproduce the system's behavior (Anderson and Woessner 1992, Hill 1998, Hill 2006).

Conceptualization of a groundwater system usually starts with identifying the hydrostratigraphic units that contain similar hydrogeologic properties in the study area. The hydrostratigraphic units are then categorized as either aquifers or aquitards depending on their capabilities of conveying water. The resulting conceptual view conceives the groundwater system as a series of aquifer or aquitard layers, each with its own aquifer properties and water boundary conditions. Aquifer properties characterize the geological medium through which groundwater flows such as hydraulic conductivity, porosity, and specific yield; water boundary conditions characterize water flux between the aquifer layers and surface features such as well pumping schedule and groundwater recharge rate. Figure 2 gives examples of common types of aquifer properties and water boundary conditions.

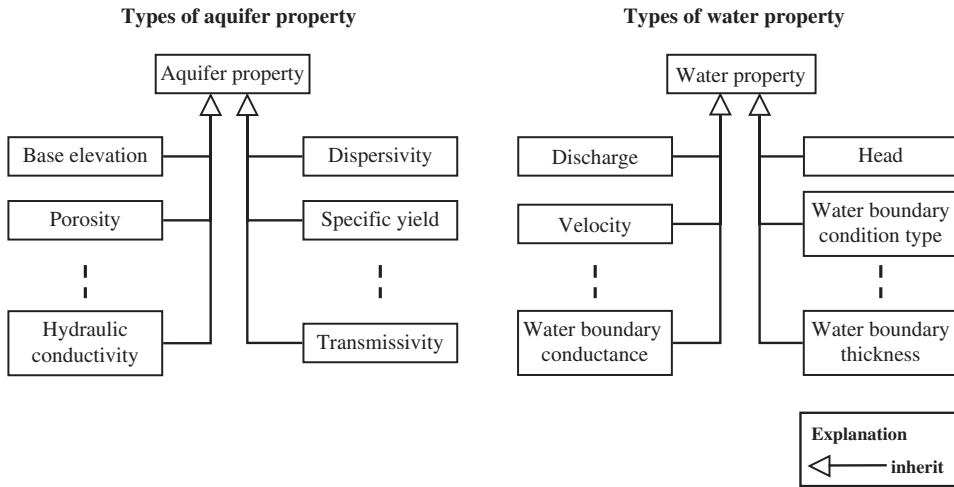

Figure 2. Representation of aquifer properties and water properties.

## 2.2. Lack of groundwater data models for conceptualization

Two fully functional data models exist for representing groundwater systems: the Arc Hydro Groundwater Data Model (Strassberg 2005) and the AEM Groundwater Data Model (Steward and Bernard 2006). They are briefly described to illustrate their relationships to the Conceptualization Groundwater Data Model presented in this article.

The Arc Hydro Groundwater Data Model consists of three major components: hydrogeology, time series, and simulation. The hydrogeology component includes a number of spatial objects, the GeoRasters raster catalog, and two nonspatial tables – *HydroGeologicUnit* and *VerticalMeasurements*. The spatial objects characterize both two-dimensional hydrogeological features such as wells and aquifer boundaries, and three-dimensional features such as cross-sections and solid volumes; the GeoRasters raster catalog stores gridded hydrogeologic properties such as transmissivity and hydraulic conductivity; and the *VerticalMeasurements* and the *HydroGeologicUnit* tables describe measurements and associated attributes of wells (boreholes) referenced in the vertical dimension. The time series component stores temporal information such as water level and contaminant concentration. The simulation component stores common objects used in numerical groundwater simulation models to facilitate data transfer from the data model to numerical models. So far, this component includes grid cells for finite difference models and mesh nodes for finite element models (Figure 3). Overall, the Arc Hydro Groundwater Data Model is primarily designed to store physical hydrogeological features and their measurement, and not to store the conceptual groundwater system view. For example, the spatial object *Aquifer* and its directly associated spatial object *Well* and indirectly associated spatial objects *BorePoint* and *BoreLine* can store the vertical distribution of geological formations, which serve as one important basis for identifying similar hydrostratigraphical units and delineating aquifer layers during groundwater system conceptualization. However, the Arc Hydro Groundwater Data Model does not define objects and relationships to store the conceptualized aquifer layers and their associated aquifer properties and boundary conditions.

The AEM Groundwater Data Model is designed for the vector-based numerical groundwater models using the AEM. In the AEM, vector-shaped features are used to describe inhomogeneities in aquifer properties and to represent sources and sinks such as wells,

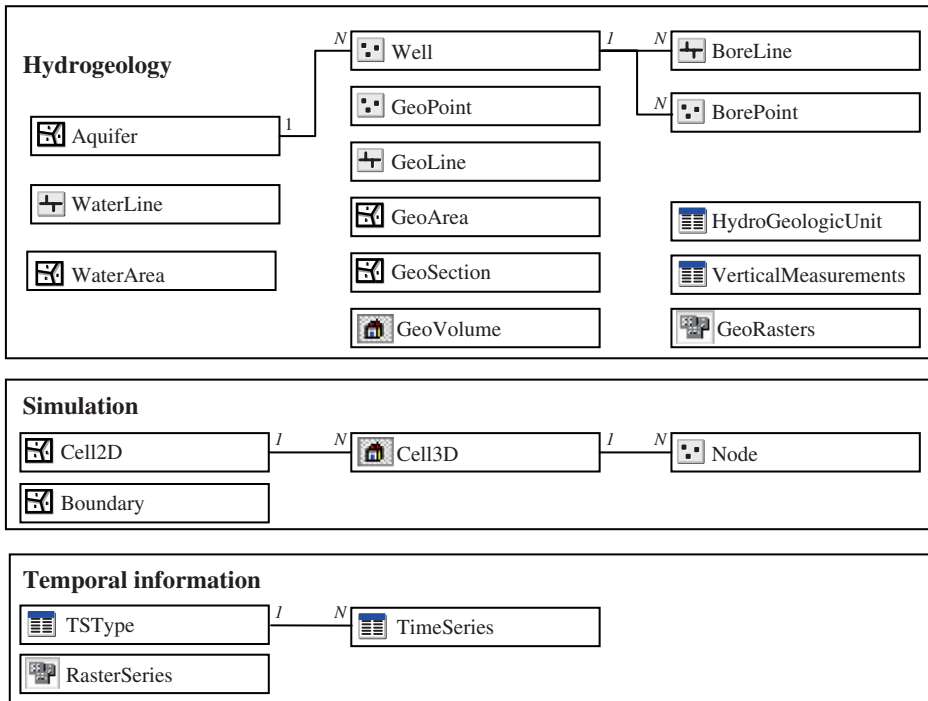

Figure 3. Arc hydro groundwater data model (Strassberg 2005).

streams, drains, and recharge areas. The AEM Groundwater Data Model contains two components: hydrogeology and modeling. The hydrogeology component contains information about the hydrogeological medium through which groundwater flows and the interchanging fluxes with surface water features such as wells and rivers. The modeling component contains information necessary to construct the AEM groundwater simulation model, such as boundary conditions, and to store the modeling outputs (Figure 4). Although capable of storing a groundwater conceptual view, this data model is designed mostly for the AEM method with objects specifically devoted to AEM numerical simulation such as the *RegionalInteraction* spatial object. This compromises its utility to work as an independent data model for groundwater system conceptualization and to interface with different groundwater modeling methods.

### 2.3. Design and implementation of the conceptualization groundwater data model

An object-oriented approach allows the usage of rich semantics to characterize the real-world phenomena (Raper and Livingstone 1995, Tang *et al.* 1996, Ling 2000, Maidment 2002, Arctur and Zeiler 2004). Figure 5 gives an object-oriented representation of the groundwater system conceptual view. It consists of a series of aquifer layers that are categorized as either aquifer or aquitard. Each aquifer layer is associated with some aquifer properties and water boundary conditions.

In the real world, aquifer properties are generally heterogeneous with different degrees of variation. A suitable degree of generalization in aquifer property distribution needs to be determined during conceptualization, and it differs by aquifer property as well as aquifer

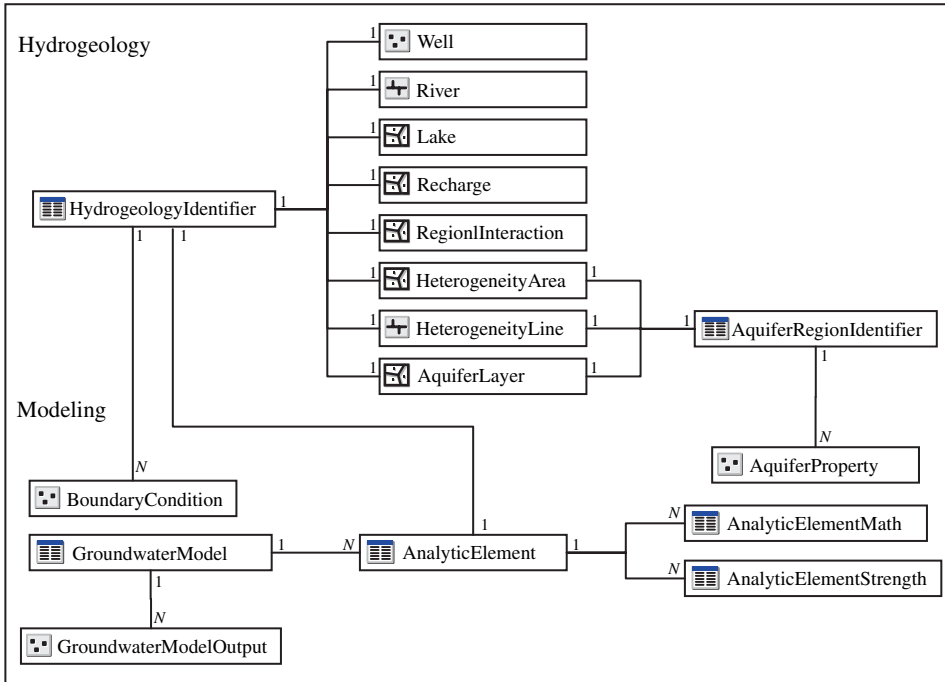

Figure 4. AEM groundwater data model (Bernard *et al.* 2005).

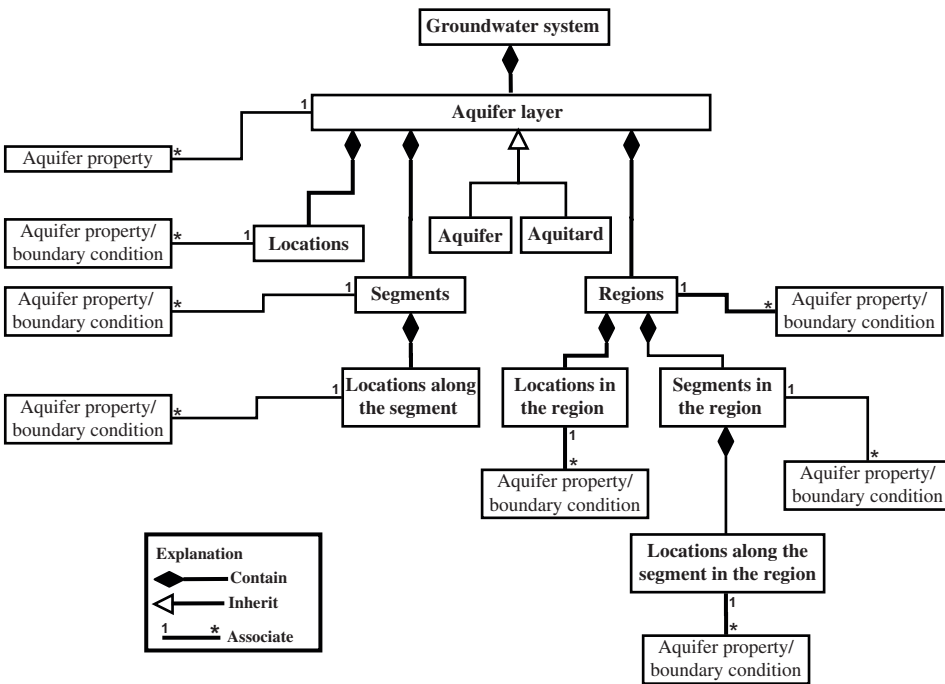

Figure 5. Object-oriented representation of the groundwater system conceptual view.

layer. If considered homogeneous, a single aquifer property value is associated with the aquifer layer. If considered heterogeneous, the aquifer property values can be specified at points, along lines, or across regions within an aquifer layer.

Likewise, water boundary conditions can be defined at point locations (e.g. wells), along line segments (e.g. river segments), or across regions (e.g. recharge zones) depending on the way each aquifer layer exchanges water with surface features. To represent the heterogeneity in the groundwater data model, each aquifer layer could contain point locations, line segments, or regions. Furthermore, each region can specify properties along line segments or point locations, and each line segment can contain point locations. All of these spatial entities could be associated with aquifer property or water boundary values.

The Conceptualization Groundwater Data Model has been implemented within the relational spatial database framework, specifically a geodatabase, developed by ESRI (Zeiler 1999, Arctur and Zeiler 2004) (Figure 6). A series of nonspatial tables and spatial objects are defined. Like the Arc Hydro data model, a *HydroID* field is defined to uniquely identify various spatial objects as well as the records on aquifer layers (Maidment 2002). The nonspatial table *AquiferLayer* contains records on the system's aquifer layers, each with a unique *HydroID* value; the nonspatial table *AquiferProperty* contains aquifer property values; and the nonspatial table *WaterProperty* contains water boundary condition data. With a nullable field *BDDateTime* for storing temporal information, the boundary conditions saved in the *WaterProperty* table can either be constant or vary with time. This enables storage of hydrogeological information necessary for groundwater models, such as pumping schedules, variable recharge, etc. (Steward *et al.* 2009a). Both the table *AquiferProperty* and

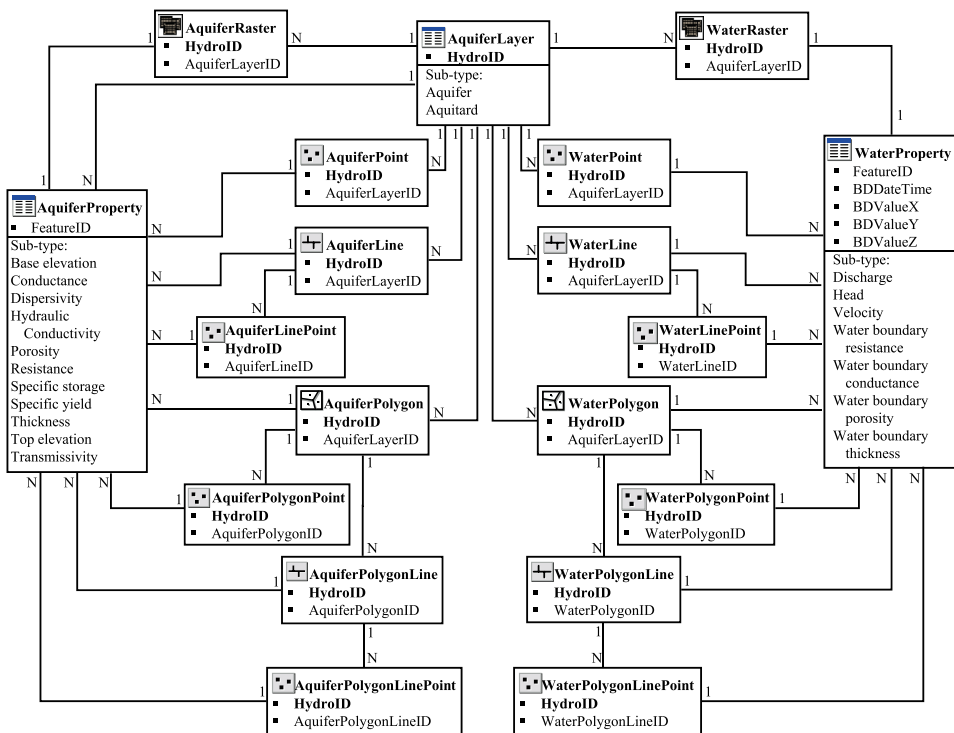

Figure 6. Implementation of the conceptualization groundwater data model within the relational spatial database framework (1-N represents one-to-many relationship).



the table *WaterProperty* are ‘abstract’, and serve as the basis to create the ‘child’ tables on specific types of aquifer property and water boundary condition.

Each aquifer layer could be associated with certain uniform aquifer properties. Within each aquifer layer, both aquifer property (*AquiferProperty*) and water boundary (*WaterProperty*) values can be associated with various spatial objects including a point (*AquiferPoint* and *WaterPoint*), a whole line (*AquiferLine*, *AquiferPolygonLine*, *WaterLine*, and *WaterPolygonLine*), and a whole region (*AquiferPolygon* and *WaterPolygon*). In addition, these properties could be associated with specific locations along a line (*AquiferLinePoint*, *AquiferPolygonLinePoint*, *WaterLinePoint*, and *WaterPolygonLinePoint*) or within an area (*AquiferPolygonPoint* and *WaterPolygonPoint*). Finally, two raster catalogs are included to store aquifer property and water boundary values at gridded locations (*AquiferRaster* and *WaterRaster*). A series of relationships are defined to enforce the above associations (Figure 6).

### 3. Case study

Figure 7 illustrates the use of the Conceptualization Groundwater Data Model in groundwater studies. Based on data, knowledge, and understandings of the groundwater system, a conceptual view is first formulated. Groundwater data from various sources, such as regional groundwater datasets or existing geodatabases, are then structured according to the Conceptualization Groundwater Data Model and stored in the geodatabase to be translated into numerical codes. If available, graphical user interfaces (GUIs) developed for numerical groundwater methods can be used to facilitate the translation process (Shapiro *et al.* 1997, Tsou and Whittemore 2001, Chen *et al.* 2002, Pinder 2002, Baird *et al.* 2005, Silavisesrith and Matott 2005, Carrera-Hernandez and Gaskin 2006).

As a case study, the Conceptualization Groundwater Data Model was used to simulate groundwater flow beneath Konza Prairie. Owned by the Nature Conservancy and Kansas State University, the prairie is an experimental nature preserve operated for environmental research, education, and preservation. It covers more than 34 square kilometers in the tall

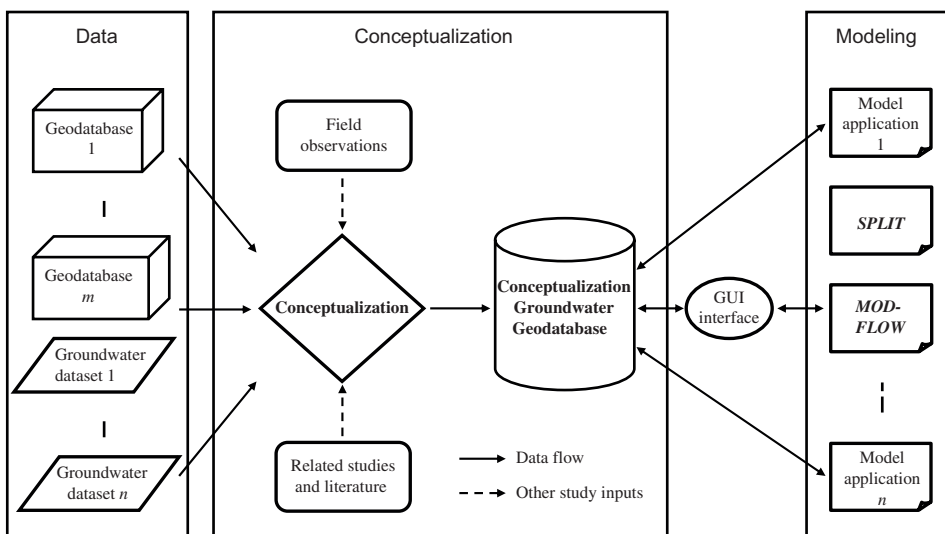

Figure 7. Use of the conceptualization groundwater data model in groundwater studies.

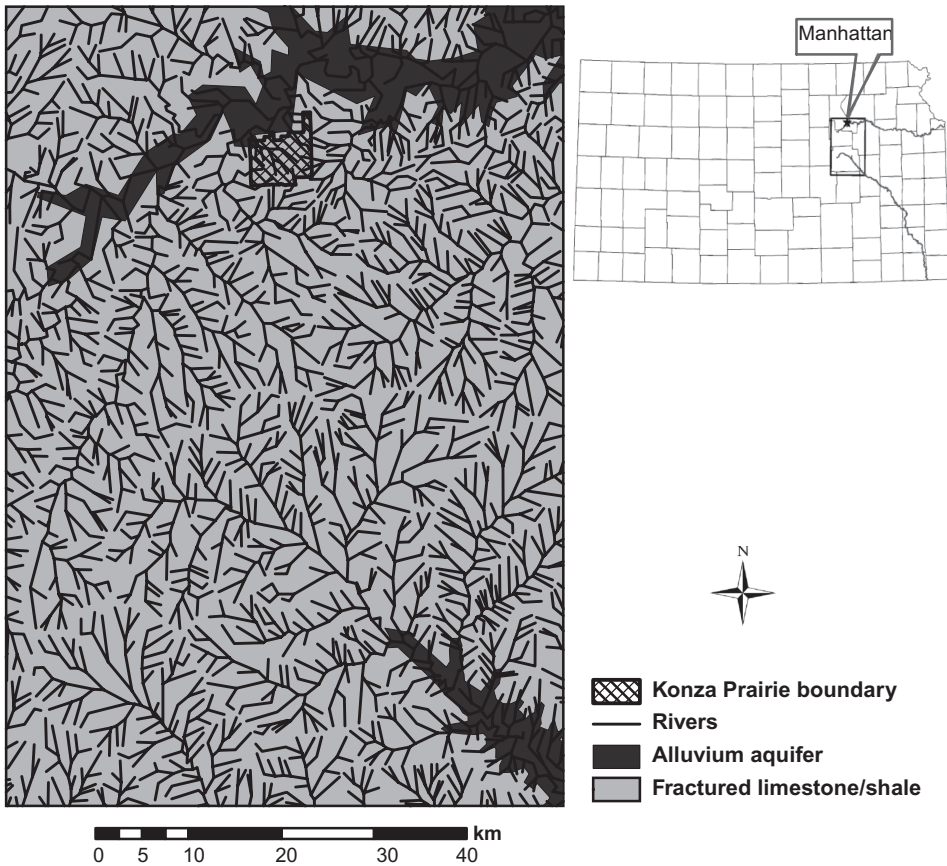

Figure 8. Single-layer conceptual view of Konza Prairie groundwater system.

grass prairie of the Flint Hills Ecoregion in northeastern Kansas. In view of the potential impacts of the surrounding hydrogeological features on the flow system, the Konza Prairie groundwater model covers an area much larger than the prairie itself (Figure 8).

The Konza Prairie groundwater system was conceptualized as a single-layer unconfined aquifer with two regions of different hydrogeological properties: the alluvial aquifer underlying Kansas and Neosho river beds with a higher hydraulic conductivity, and the fractured limestone/shale aquifer with a lower hydraulic conductivity (Figure 8). Annual precipitation at Konza Prairie averages 835 mm, 15% of which directly recharges to the groundwater system, resulting in an average recharge rate of 0.00034 m/d (Gray *et al.* 1998). Depending on their sizes, river segments interact differently with the groundwater system, with larger river segments exchanging more water.

The Conceptualization Groundwater Data Model was used to store the groundwater system conceptual view, which was then used for developing three common types of numerical groundwater simulation models: FEFLOW implementing the finite element method, SPLIT implementing the AEM, and MODFLOW implementing the finite difference method. Table 2 summarizes the parameters for the three simulation models. Their values were estimated based on the existing studies of the region including Pomes (1995), Macpherson (1996), Gray *et al.* (1998), Oviatt (1998), and Macpherson and Sophocleus (2004).

Table 2. Model parameters for Konza Prairie groundwater system.

Model parameters	SPLIT	MODFLOW	FEFLOW
Bottom elevation (m)	250	250	250
Top elevation (m)	450	450	450
Hydraulic conductivity – alluvium (m/d)	24	24	24
Hydraulic conductivity – fractured limestone and shale (m/d)	1	1	1
Porosity	0.25	0.25	0.25
Recharge (m/d)	0.00034	0.00034	0.00034
Conductance – large river segments (m <sup>2</sup> /d)	–	212.1	–
Conductance – small river segments (m <sup>2</sup> /d)	–	0.021	–
Resistance – large river segments (d)	1	–	–
Resistance – small river segments (d)	100,000	–	–
In/out transfer rate – large river segments (1/d)	–	–	1
In/out transfer rate – small river segments (1/d)	–	–	0.00001

The data model was populated similarly for the three simulation models except in a few steps when they required the specification of different aquifer properties and water boundary conditions. Since the Konza Prairie groundwater system was conceptualized as a single-layer system, there was one aquifer layer record in the table *AquiferLayer*. The aquifer properties on top elevation, bottom elevation, and porosity were assumed to be uniform across the modeling area, and hence were all represented with a single record under appropriate type in the table *AquiferProperty*. The field *FeatureID* of these records was equal to the *HydroID* of the aquifer layer in the table *AquiferLayer* (see Figure 9 for the SPLIT, MODFLOW, and FEFLOW implementation).

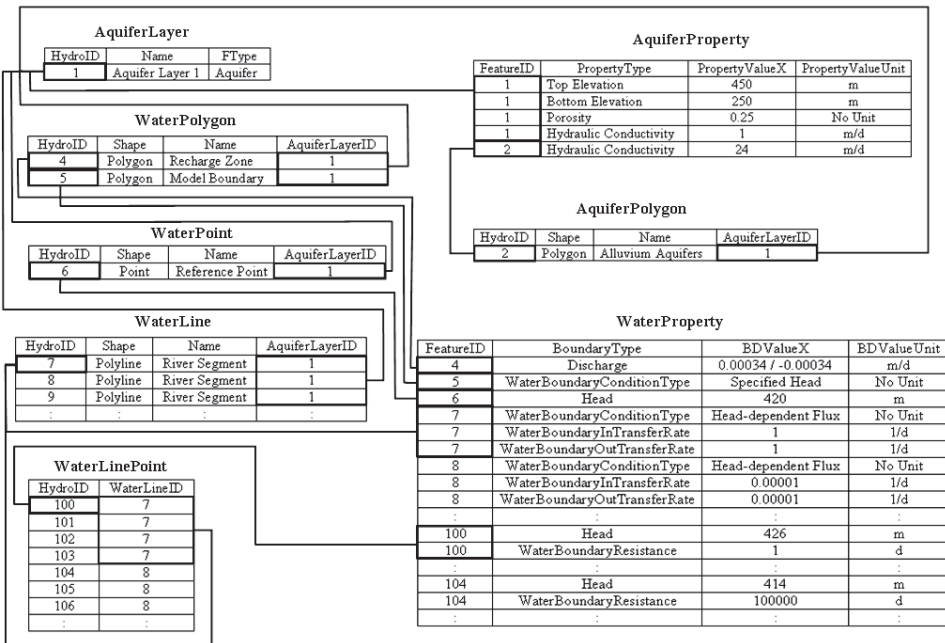

Figure 9. Implementation of Konza Prairie groundwater data model.

To represent the inhomogeneities, one record on hydraulic conductivity was first included in the table *AquiferProperty* defining a default value of 1 m/d for the whole aquifer layer. The boundary of alluvium aquifers, which have a different hydraulic conductivity value, was then delineated based on the local geological maps and saved in the spatial object *AquiferPolygon* with appropriate aquifer layer number. Its hydraulic conductivity value of 24 m/d was saved as one additional record in the table *AquiferProperty*, whose field *FeatureID* was assigned with the corresponding aquifer polygon feature's *HydroID* value (Figure 9).

Among the three numerical groundwater models, MODFLOW and FEFLOW require an explicit definition of the outer boundary of the groundwater model, which can be saved in the spatial object *WaterPolygon* with appropriate aquifer layer number. SPLIT does not require a model boundary as its model domain is infinite, but it does require defining a reference point with known hydraulic head. The reference point was saved in the spatial object *WaterPoint*, and its hydraulic head value was saved in the table *WaterProperty* under the type of *Head*. In addition, recharge rate was assumed to be uniform across the modeling area. Correspondingly, for all three numerical models, a record defining the boundary of the groundwater recharge zone was added to the spatial object *WaterPolygon*, and a single recharge rate of 0.00034 m/d was added in the table *WaterProperty* under the type of *Discharge*. Depending on the simulation model sign conventions, the recharge rate was either positive or negative (Figure 9).

Finally, the river network of the region was extracted from US Geological Survey's National Hydrography Dataset, corrected and simplified as needed, and saved in the spatial object *WaterLine* (Figure 8). In all three models, rivers were assigned with the head-dependent flux boundary condition, but with different boundary values. SPLIT requires the user to specify hydraulic head and resistance values at the end points of each river segment. Hence, during data model population for SPLIT, the end points of each river segment were derived and saved in the spatial object *WaterLinePoint*. The hydraulic head values, estimated based on the 30-meter Digital Elevation Model, and resistance values at the river segment end points were saved in the *WaterProperty* table under the type of *Head* and *WaterBoundaryResistance*, respectively. MODFLOW requires the user to specify hydraulic head and conductance values at the designated grid cells along the river segments. Since the locations of grid cells depend on simulation configuration and the conductance values depend on the grid cell size, they are not part of the conceptual view. The simulation component of the Arc Hydro Groundwater Data Model, for example, stores the location of the grid cells and mesh nodes (Figure 3). Hence, during data model population for MODFLOW, only records that specified the type of river segments' water boundary conditions were added to the *WaterProperty* table. FEFLOW requires the user to specify hydraulic head values at mesh nodes along the river segments and their in-transfer and out-transfer rates. Since the mesh nodes' locations depend on simulation configuration, their head values are not part of the conceptual view. The in-transfer and out-transfer rates for each river segment were saved in the *WaterProperty* table under the type of *WaterBoundaryInTransferRate* and *WaterBoundaryOutTransferRate*. The *WaterProperty* table also included records specifying the type of river segments' water boundary conditions (Figure 9).

Existing GUI interfaces were used to translate the conceptual view of Konza Prairie groundwater system from the Conceptualization Groundwater Data Model to numerical codes. While FEFLOW has a built-in GUI interface (Diersch 2005), PMWIN was used for MODFLOW (Chiang 2001) and ArcAEM for SPLIT (Silavisesrith and Matott 2005). Python scripts as well as models were created in the ESRI ArcGIS environment to automate the process of extracting data from the groundwater data model to provide input files required by various GUI interfaces. Figure 10 shows the simulated groundwater level of

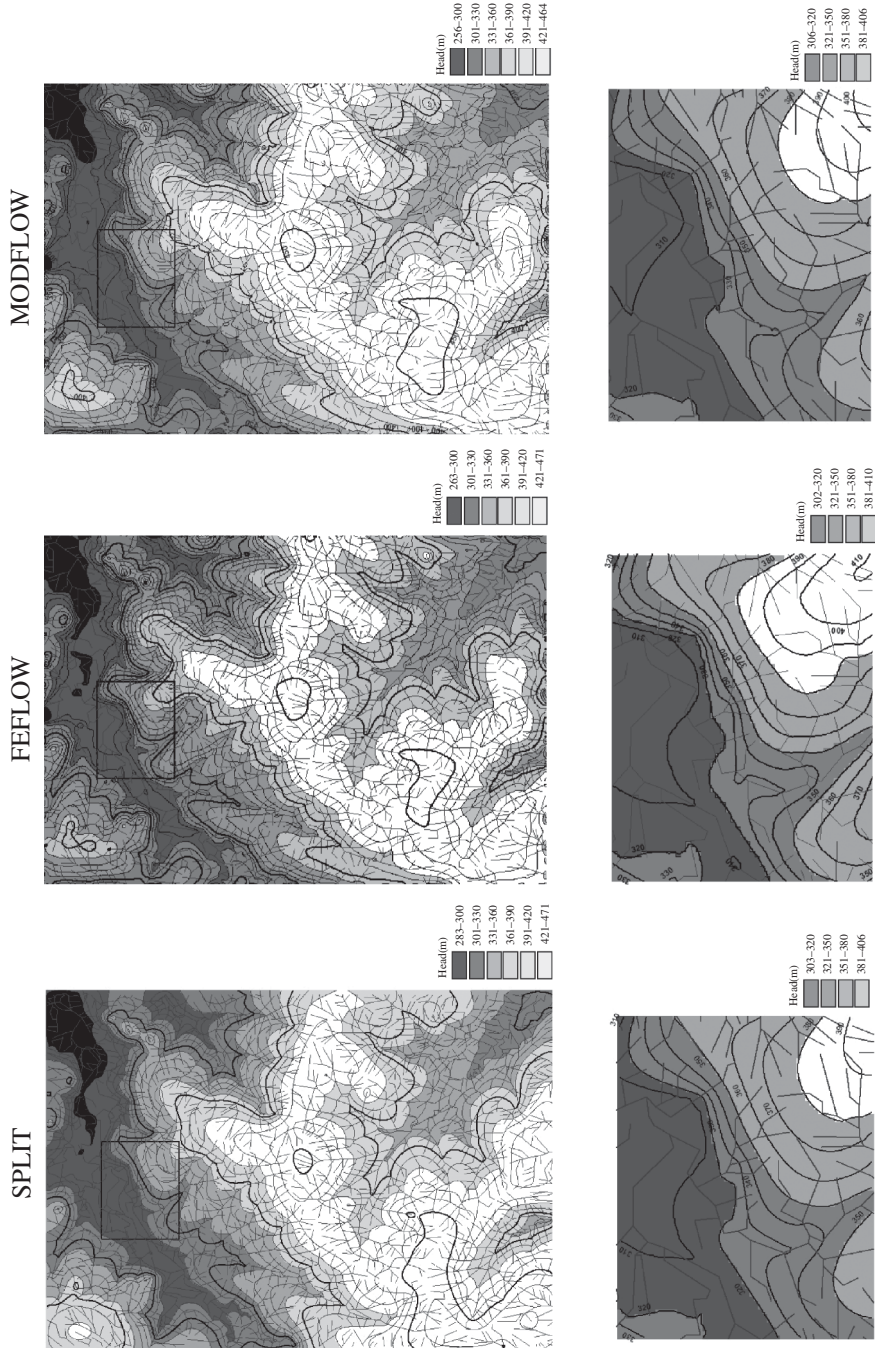

Figure 10. Simulated hydraulic head by SPLIT, FEFLOW, and MODFLOW.

the Konza Prairie groundwater system as well as the close-up views of the Kings Creek area. Except for some local differences, simulated groundwater flow exhibits similar patterns among the three models, with a groundwater divide extending from the southwestern corner to the middle eastern boundary of the model domain and groundwater flowing north to the Kansas River and south to the Neosho River. In the Kings Creek area, groundwater generally flows in the direction of SE–NW.

## 4. Discussion

### 4.1. Comparison between the conceptualization groundwater data model and two existing groundwater data models

Although they could be used to store similar information such as well pumping records, the Conceptualization Groundwater Data Model and the Arc Hydro Groundwater Data Model are very different in their design objectives and serving purposes. The Arc Hydro Groundwater Data Model is designed mainly to store the hydrogeological features as observed in the real world. Based on the information that the Arc Hydro Groundwater Data Model contains, as well as background information from other sources and their expert judgment, model developers need to formulate a conceptual view of the targeted groundwater system and realize this conceptual view with their choice of numerical groundwater methods. Unlike the Arc Hydro Groundwater Data Model, the Conceptualization Groundwater Data Model is not designed to depict the physical hydrogeological features of the system, but to store the formulated groundwater system conceptual view that is ready to be translated to numerical codes.

Like the Conceptualization Groundwater Data Model, the AEM Groundwater Data Model is capable of storing the groundwater system conceptual view, but it is mainly designed to serve the AEM Method. Built upon the AEM Groundwater Data Model, the Conceptualization Groundwater Data Model makes refinement in both logical design and physical implementation. Logically, the Conceptualization Groundwater Data Model gives a clearer representation of the common conceptual view shared by various numerical groundwater modeling methods, which is composed of a series of aquifer layers with defined aquifer properties and boundary conditions. In the AEM Groundwater Data Model, however, the association between aquifer layers and their aquifer properties and boundary conditions are obscured due to the use of intermediate *HydrogeologyIdentifier* and *AquiferRegionIdentifier* tables and the lack of direct relationships between aquifer layers and their water boundary and aquifer property objects. Additionally, the Conceptualization Groundwater Data Model removes the objects that are specific to the AEM method, and defines general spatial and nonspatial objects to store aquifer properties and water boundary conditions required by various numerical methods. Since they could use different aquifer property and water property parameters, the Conceptualization Groundwater Data Model ensures its utility for the variety of groundwater modeling methods by defining a series of aquifer property and water property subtypes and allowing users to extend the list with their own. In physical implementation, the Conceptualization Groundwater Data Model eliminates the need for the intermediate tables *HydrogeologyIdentifier* and *AquiferRegionIdentifier* by employing a unique *HydroID* to identify spatial and nonspatial features across the groundwater system. It also stores the water boundary and aquifer property values in nonspatial tables associated with corresponding water boundary and aquifer property spatial objects instead of in the spatial objects themselves to reduce storage redundancy and enforce data integrity.

#### 4.2. Limitations and advantages of the conceptualization groundwater data model

Like most of the existing groundwater studies, the Conceptualization Groundwater Data Model adopts the 'layered-approach' to conceptualize the three-dimensional groundwater system. This approximation of grouping common geological units into layers was pioneered by Kooper (1914) and serves as the basis for regional groundwater modeling today. There is recent interest in characterizing and visualizing three-dimensional heterogeneities in aquifers; however, the majority of geoscientists do not embrace such three-dimensional models 'because they are not convinced that the investment in time, effort and funds will yield a dividend or result in better science' (Turner 2006). As our knowledge of the geological structure of three-dimensional heterogeneity and our ability to visualize and model this increase, it is expected that the Conceptualization Groundwater Data Model will develop and expand to incorporate these features.

Despite its limitations, the Conceptualization Groundwater Data Model facilitates groundwater modeling in several ways. First, groundwater studies require a wide range of datasets available in various formats and from various sources. Processing and transforming these datasets into usable formats tend to be both time-consuming and error-prone. The use of the Conceptualization Groundwater Data Model to structure and organize the heterogeneous datasets streamlines the process. Once data have been loaded according to the groundwater data model's specifications, they are syntactically similar and ready to be integrated for various purposes. Second, the built-in database management capabilities and topology rules of the spatial database help improve data storage efficiency and enforce data integrity. For example, one tedious task in groundwater modeling using SPLIT is to ensure water boundary points denoting river hydraulic head values to fall on river segments. Within the spatial data model, this can be realized by specifying a topology rule between two spatial objects: *WaterLinePoint* and *WaterLine*. Furthermore, once finalized, the structure of the groundwater data model is consistent and open to the public. Any third party can develop tools or interfaces on top of the data model to meet its specific needs.

In addition, by storing groundwater conceptual views, the Conceptualization Groundwater Data Model makes groundwater modeling extensible, traceable, and interoperable. First, there are many types of groundwater modeling methods, each with its own advantages and disadvantages. On the surface, these methods may seem quite different, with the finite difference method dividing the target system into grid cells, the finite element methods discretizing the system into meshes and nodes, and the AEM representing the groundwater system with point, line, and polygon elements. In essence, however, all these methods are rooted in similar groundwater system concepts such as aquifer layers, aquifer properties, and water boundary conditions. By capturing these essential concepts, the Conceptualization Groundwater Data Model is able to work with different types of groundwater modeling methods with little modification, as shown in the case study on the Konza Prairie groundwater system. Using the data model, users may develop different types of groundwater models with minimum repetitious work, make comparisons, and choose the best model or a combination of models for the study.

Second, formulation of the groundwater system conceptual view is an iterative process subjected to further refinement based on new insights into the target system, which could be gained, for example, by the comparison between modeling results and real-world observations. The conceptualization data model and its metadata provide a mechanism for users to record and track the change in groundwater system conceptual view, as well as communicate it to others.

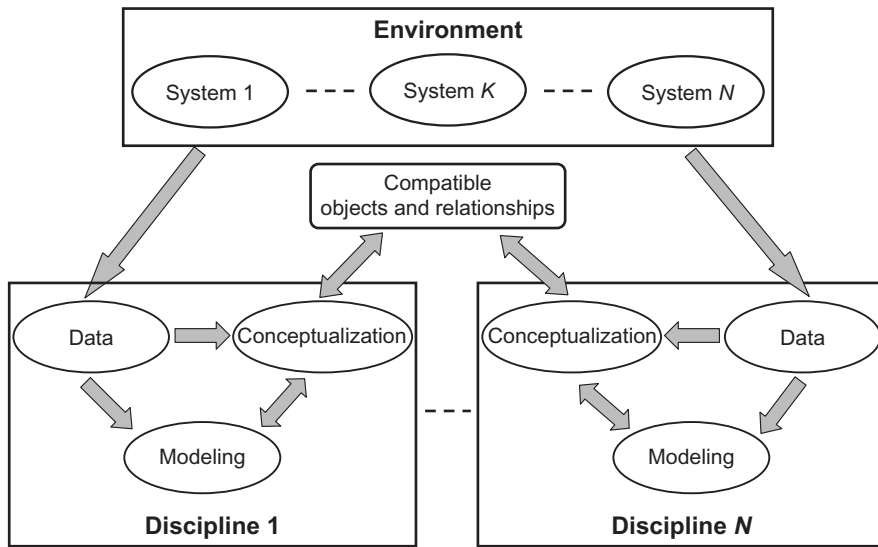

Figure 11. Model integration across disciplines.

Finally, groundwater is an integral component of a larger complex natural-social-economic system characterized by interactions, feedbacks, and nonlinearities. Understanding of this complex system requires inputs from many disciplines such as hydrogeology, economics, sociology, and ecology. Although state-of-the-art models have been developed in different disciplines, it is hard to couple them effectively to generate meaningful results for guiding policy-makers because of the incompatibility in scale, data, or format. Data models designed to capture each discipline's modeling concepts can help identify compatible objects and establish relationships across the disciplines, and hence serve as the intermediate medium for exchanging data and model results (Figure 11). For example, in a recent study on groundwater decline in Sheridan County, Kansas, the Conceptualization Groundwater Data Model and data models designed for parcels, agriculture, and crop production economy are used to facilitate data transfer between hydrogeological and agro-economical models by relating groundwater level to the crop choice and irrigation depth in each parcel (Steward *et al.* 2009b). In addition, interdisciplinary model integration for simulating complex system behavior implies a vast demand on computational power. Future activities will couple the developments presented here with the computational power of distributed computing to take advantage of networked computers to model a virtual computer architecture and distribute process execution across a parallel infrastructure.

## 5. Conclusions

Conceptualization of hydrogeological systems constitutes the basis of groundwater modeling. Although groundwater models may vary in many ways, they are founded on the same groundwater system concepts such as aquifer layers, aquifer properties, and water boundary conditions. So far, few efforts have been made to design groundwater data models for storing these modeling concepts. This need is addressed by developing a new Conceptualization Groundwater Data Model that allows users to store, update, and convey their conceptual views of the targeted groundwater system (Figures 5 and 6). For the time being, this



Conceptualization Groundwater Data Model inherits the conventional ‘layered-approach’ to conceptualize the three-dimensional groundwater system. It is expected that the data model will incorporate additional three-dimensional features with advances in incorporating three-dimensional geological features and heterogeneities into groundwater modeling. The case study on Konza Prairie groundwater system illustrates the use of the data model in groundwater studies (Figure 7), and its capability of communicating with a variety of groundwater modeling methods (Figure 9). Overall, the Conceptualization Groundwater Data Model facilitates groundwater studies by making groundwater modeling extensible, traceable, and interoperable.

Lack of representing modeling concepts in spatial data model design is not an issue exclusive to groundwater studies. Data models designed for many disciplines have been based on thematic layers and focused on storing real-world measurements. Like the work presented in this study, experts from other disciplines may distill the concepts underlying their diverse modeling methods and design conceptualization data models based on these concepts. These conceptualization data models can help identify compatible objects, establish relationships, and facilitate model coupling across disciplines (Figure 11).

### Acknowledgments

The authors gratefully acknowledge financial support provided by the Provost Office’s Targeted Excellence Program at Kansas State University, the National Science Foundation (grants EEC0203133 and EPS0553722), and the United States Department of Agriculture/Agricultural Research Service (Cooperative Agreement 58-6209-3-018).

### References

- Anderson, M.R. and Woessner, W.W., 1992. *Applied groundwater modeling: simulation of flow and advective transport*, First Edition. San Diego, CA: Academic Press.
- Arctur, D. and Zeiler, M., 2004. *Designing geodatabases: case studies in GIS data modeling*, First Edition. Redlands, CA: ESRI Press.
- Baird, K.J., Stromberg, J.C., and Maddock, T., 2005. Linking riparian dynamics and groundwater: an ecohydrologic approach to modeling groundwater and riparian vegetation. *Environmental Management*, 36, 551–564.
- Bernard, E.A., Steward, D.R., and LeGrand, P., 2005. A geodatabase for groundwater modeling in MLAEM and MODFLOW. In: *Proceedings of the 2005 ESRI international user conference*, 22–29 July, San Diego, CA.
- Burrough, P. and Frank, A., 1995. Concepts and paradigms in spatial information: are current geographical information-systems truly generic? *International Journal of Geographical Information Systems*, 9, 101–116.
- Carrera-Hernandez, J.J. and Gaskin, S.J., 2006. The groundwater modeling tool for GRASS (GMTG): open source groundwater flow modeling. *Computers & Geosciences*, 32, 339–351.
- Chen, Z., et al., 2002. Application of a GIS-based modeling system for effective management of petroleum-contaminated sites. *Environmental Engineering Science*, 19, 291–303.
- Chiang, W.H., 2001. *3D-groundwater modeling with PMWIN: a simulation system for modeling groundwater flow and transport processes*, Second Edition. New York: Springer.
- Diersch, H.J., 2005. *FEFLOW reference manual*. Berlin: WASY GmbH Institute for Water Resources Planning and Systems Research.
- Goodchild, M.F., 1992a. Geographical data modelling. *Computers & Geosciences*, 18, 401–408.
- Goodchild, M.F., 1992b. Geographical information science. *International Journal of Geographical Information Systems*, 6, 31–45.
- Goodchild, M.F., et al., 1999. Introduction to the Varenus project. *International Journal of Geographical Information Science*, 13, 731–745.
- Goodchild, M.F., Parks, B.O., and Steyaert, L.T., 1993. *Environmental modeling with GIS*. New York: Oxford University Press.

- Gray, L.J., et al., 1998. Hydrology and aquatic chemistry. In: A.K. Knapp, et al., eds., *Grassland dynamics: long-term ecological research in tallgrass prairie*, chap. 10. Oxford: Oxford University Press.
- Grise, S. and Brodaric, B., 2004. *ArcGIS geology data model* [online]. Available from: <http://support.esri.com/index.cfm?fa=downloads.dataModels.filteredGateway/&dmid=30> [Accessed 25 January 2010].
- Hill, M.C., 1998. *Methods and guidelines for effective model calibration*. USGS Water-Resources Investigations Report, 98–4005.
- Hill, M.C., 2006. The practical use of simplicity in developing groundwater models. *Ground Water*, 44, 775–781.
- Horsburgh, J.S., et al., 2008. A relational model for environmental and water resources data. *Water Resources Research*, 44, W05406, doi:10.1029/2007WR006392.
- Kemp, K.K., 1997. Integrating traditional spatial models of the environment with GIS. In: *Proceedings of the 1997 ACSM/ASPRS annual convention & exposition*, 5–10 April, Seattle, WA, 23–32.
- Kooper, J., 1914. Beweging van het water in den bodem bij onttrekking door bronnen [The movement of water in the soil under extraction by wells]. *De Ingenieur*, 38–39, 697–706, 710–716.
- Kraemer, S.R., 2007. Analytic element ground water modeling as a research program (1980 to 2006). *Ground Water*, 45, 402–408.
- Liggett, J.A. and Liu, P.L., 1983. *The boundary integral equation method for porous media flow*. London: George Allen & Unwin.
- Ling, B., 2000. Object-oriented representation for modeling mobile objects in an aquatic environment. *International Journal of Geographical Information Science*, 14, 603–623.
- MacPherson, G.L., 1996. Hydrogeology of thin limestones - the Konza Prairie LTER site. *Journal of Hydrology*, 186, 191–228.
- MacPherson, G.L. and Sophocleus, M., 2004. Fast ground-water mixing and basal recharge in an unconfined, alluvial aquifer, Konza LTER Site, Northern Kansas. *Journal of Hydrology*, 286, 271–299.
- Maidment, D.R., ed., 2002. *Arc hydro: GIS for water resources*, First Edition. Redlands, CA: ESRI Press.
- Maidment, D.R. and Hooper, R.P., 2005. Conceptual Framework. In: D.R. Maidment, ed. *Hydrologic information system status report*, chap. 2. Washington, DC: Consortium of Universities for the Advancement of Hydrologic Science, Inc (CUAHSI), pp. 7–23.
- McDonald, M. and Harbaugh, A., 1988. *A modular three-dimensional finite-difference ground-water flow model: US geological survey techniques of water-resources investigations, Book 6, Chapter A1* [online]. Available from: <http://pubs.water.usgs.gov/twri6a1> [Accessed 25 January 2010].
- Mennis, J.L., Peuquet, D.J., and Qian, L., 2000. A conceptual framework for incorporating cognitive principles into geographical database representation. *International Journal of Geographical Information Science*, 14, 501–520.
- NADM, 2004. *North American Geologic Map Data Model Steering Committee (NADM) conceptual model 1.0 - a conceptual model for geologic map information* [online]. US Geological Survey Open-File Report 2004–1334, 58. Available from: <http://pubs.usgs.gov/of/2004/1334> [Accessed 25 January 2010].
- Oviatt, C.G., 1998. Geomorphology of the Konza Prairie. In: A.K. Knapp, et al., eds. *Grassland dynamics: long-term ecological research in tallgrass prairie*, chap. 3. Oxford: Oxford University Press.
- Pinder, G.F., ed., 2002. *Groundwater modeling using geographical information systems*, First Edition. New York: John Wiley & Sons.
- Pomes, M.L., 1995. A study of the aquatic humic substances and hydrogeology in a Prairie Watershed: use of humic material as a tracer of recharge through soils. Thesis (PhD). University of Kansas.
- Raper, J. and Livingstone, D., 1995. Development of a geomorphological spatial model using object-oriented design. *International Journal of Geographical Information Systems*, 9, 359–383.
- Richards, D. and Jones, N., 1997. A conceptual model approach to modeling groundwater with GMS. In: A.N. Findikakis and F. Stauffer, eds. *Proceedings of the groundwater: an endangered resource*, 10–15 August. San Francisco, CA. New York: American Society of Civil Engineers, 325–330.
- Shapiro, A.M., et al., 1997. *A graphical user interface for the US Geological Survey Modular three dimensional finite difference groundwater flow model (MODFLOW-96) using Argus Numerical Environments*. U.S. Geological Survey Open File Report 97–121.
- Silavisesrith, W. and Matott, L.S., 2005. *ArcAEM: GIS-based application for analytic element ground-water modeling* [online]. Available from: <http://www.groundwater.buffalo.edu/software/ArcAEM/ArcAEMMain.html> [Accessed 25 January 2010].

- Steward, D.R. and Bernard, E.A., 2006. The synergistic powers of AEM and GIS geodatabase models in water resources studies. *Ground Water*, 44, 56–61.
- Steward, D., et al., 2009a. Groundwater ecohydrology: GIScience tools to forecast change and sustainability of global ecosystems, studies in Africa, Europe and North America. *Hydrology and Earth System Sciences Discussion*, 6, 2795–2844.
- Steward, D.R., et al., 2009b. Groundwater economics: an object oriented foundation for integrated studies of irrigated agricultural systems. *Water Resources Research*, 45, W05430, doi: 10.1029/2008WR007149.
- Strack, O.D.L., 1989. *Groundwater mechanics*. Englewood Cliffs, NJ: Prentice Hall, Inc.
- Strassberg, G., 2005. A geographic data model for groundwater systems. Thesis (PhD). University of Texas at Austin.
- Tang, A.Y., Adams, T.M., and Usery, E.L., 1996. A spatial data model design for feature-based geographic information systems. *International Journal of Geographical Information Systems*, 10, 643–659.
- Townley, L., 1990. *AQUIFEM-N: a multi-layered finite element aquifer flow model, user's manual and description*. Australia: CSIRO Division of Water Resources.
- Tsou, M.S. and Whittemore, D.O., 2001. User interface for ground-water modeling: ArcView extension. *Journal of Hydrologic Engineering*, 6, 251–257.
- Turner, A.K., 2006. Challenges and trends for geological modelling and visualization. *Bulletin of Engineering Geology and the Environment*, 65, 109–127.
- UCGIS, 1996. Research priorities for geographic information science. *Cartography and Geographic Information Systems*, 23, 115–127.
- Wise, S., 2000. GIS data modeling - lessons from the analysis of DTMs. *International Journal of Geographical Information Science*, 14, 313–318.
- Worboys, M.F., 1994. Object-oriented approaches to geo-referenced information. *International Journal of Geographical Information Systems*, 8, 385–399.
- Worboys, M.F., 2004. *GIS: a computing perspective*. Boca Raton, FL: CRC Press.
- Zeiler, M., 1999. *Modeling our world*. Redlands, CA: ESRI Press.