



Effects of falling weight impact on industrial safety helmets used in conjunction with eye and face protection devices

Krzysztof Baszczyński

To cite this article: Krzysztof Baszczyński (2018) Effects of falling weight impact on industrial safety helmets used in conjunction with eye and face protection devices, International Journal of Occupational Safety and Ergonomics, 24:2, 171-180, DOI: [10.1080/10803548.2017.1373987](https://doi.org/10.1080/10803548.2017.1373987)

To link to this article: <https://doi.org/10.1080/10803548.2017.1373987>



© 2017 Central Institute for Labour Protection – National Research Institute (CIOP-PIB). Published by Informa UK Limited, trading as Taylor & Francis Group.



Published online: 22 Sep 2017.



Submit your article to this journal [↗](#)



Article views: 6677



View related articles [↗](#)



View Crossmark data [↗](#)



Citing articles: 2 View citing articles [↗](#)

Effects of falling weight impact on industrial safety helmets used in conjunction with eye and face protection devices

Krzysztof Baszczyński *

Central Institute for Labour Protection – National Research Institute (CIOP-PIB), Poland

Industrial workplaces pose concurrent hazards to the upper part of the head and the eyes. Under the circumstances, workers may use protective helmets in conjunction with protective goggles or spectacles. In order to assess the compatibility of this equipment, a method and a test stand for evaluating the behavior of safety helmets and protective goggles/spectacles upon the impact of a falling weight were designed. The results of tests concerning the displacement and deformation of helmets and spectacles/goggles, the forces acting on the helmets, as well as the forces exerted by the spectacles/goggles on the headform upon falling weight impact are presented. The results revealed the ways in which the tested equipment interacted with each other. The influence of equipment construction on the test results was analyzed and inferences concerning the safety of the studied protective devices were made. Some general construction guidelines were formulated for the compatibility of the equipment.

Keywords: safety; mechanical testing; simulation tests; impact energy

1. Introduction

Data on workplace accidents in Poland published by the Central Statistical Office (GUS) [1] indicate that falling weight impacts are some of the most serious hazards faced by workers. This hazard can be reduced by appropriate work organization (keeping workers out of the danger zone), collective protection measures (e.g., protective structures) or personal protective equipment (PPE), such as industrial safety helmets.

Protective helmets meeting the requirements of Standard No. EN 397:2012+A1:2012 [2], due to their good protective properties and relatively low prices, have been widely used in a variety of industries. Their most important tasks include protection of the user's head against impacts inflicted by falling objects or bumping the head on the dangerous elements of the worksite structure. The most important areas of industry where safety helmets are used include construction, mining, power engineering, forestry, etc. The specificity of the jobs in these industries and the hazards occurring there cause industrial safety helmets to often be used in combination with other PPE, such as eye and face protectors devices, respiratory protective equipment, thermal protective clothing and hearing protectors. Data from questionnaire surveys conducted at workplaces, presented by Baszczyński et al. [3], as well as information from occupational safety and health officers and the National Labour Inspectorate (PIP) show that one of the most frequently used PPE assemblies consists of a safety helmet and protective spectacles/goggles. Confirmation of the frequent

use of industrial protective helmets with equipment protecting the eyes and face is provided in Bahadori's study [4], which presents the use of PPE in industrial facilities involved in the extraction and processing of oil and gas. This issue is also addressed in advertising materials issued by the manufacturers of PPE, who offer various types of integrated structures and sets of equipment [5–7]. According to Fernandes and Alves de Sousa [8], the problem of simultaneous protection of the eyes and face concerns not only the equipment used in industrial conditions but also the equipment used by motorcyclists.

In addition to the obvious benefits from the point of view of the user's safety, the concomitant use of helmets with eye and face protectors also leads to new problems. The most important of these issues include compatibility, considered from the point of view of the user's comfort, as well as the possibility of posing additional risks that do not occur in the situation when the equipment is used separately. The attention paid to this problem has been confirmed by provisions of the Occupational Safety and Health Administration [9], which require that additional equipment mounted to the helmet must not impair its protective properties.

The problem of convenience can be largely resolved by the users of the equipment, who are able to assess whether the appropriate protective set is comfortable and whether it is possible to use in the workplace. In the latter case, the appropriate laboratory tests and the application of accurately formulated evaluation criteria are necessary.

*Email: krbas@ciop.lodz.pl

In European Economic Area countries, the basic document specifying the requirements and testing methods for industrial safety helmets is Standard No. EN 397:2012+A1:2012 [2]. In the case of eye protective equipment, such requirements are contained in Standard No. EN-166:2002 [10]. Both standards are harmonized with Directive 89/686/EEC [11]. However, these Standards do not address the simultaneous use of safety helmets and eye and face protective devices. No requirements or testing methods for the compatibility of such devices are given. The issue of testing protective helmets has been developed in various research centers dealing with PPE for many years. According to Gilchrist and Mills [12], Hulme and Mills [13] and Mills and Gilchrist [14] one of the most important problems is absorption of energy and mitigation of the effects of an impact considered from the point of view of the user's safety. Research has led to the emergence of two major methods of testing the shock-absorbing properties based on:

- impact of a moving object on a fixed headform with a helmet [15];
- impact of a falling headform with a helmet on a fixed obstacle [15].

These methods are used according to the nature of the hazard against which the helmet is intended to protect. Another very important issue associated with the performance of the helmet during the impact is the deformation of its shell and energy-absorbing material. Research results [16–21] indicate that deformities of the helmet elements during absorption of the impact energy can be transferred to other equipment used together with protective helmets.

Baszczyński's article [22], reporting on certain aspects of the deformation of helmets (cradles and shells) upon impacts exerted by falling weights, deserves special attention. Due to the magnitude of the deformation, this may have significant safety ramifications for workers using helmets in conjunction with protective spectacles/goggles.

The performance of the helmet, and hence the effectiveness of its protection on impact of a moving object, depends on the direction from which the impact is exerted. The test results presented by Korycki [23] and Baszczyński [24] demonstrate that industrial safety helmets meeting the requirements of Standard No. EN 397:2012+A1:2012 [2] fail to provide the user with effective protection in terms of side impacts. By analyzing the performance of industrial protective helmets during the side impact, the effect on eye and face protectors in the event of their simultaneous use can be expected.

One of the main tasks of glasses and protective goggles used both in industrial applications and in sports and recreation is protection against mechanical factors such as the impact of fast-moving objects with a small weight and hitting slow-moving objects with high weight. Napier et al. [25] reported these problems. The issues associated

with the performance of eye and face protector equipment during such impacts are described by McMahon and Beckerman [26] and Pościk and Jachowicz [27]. The phenomena analyzed therein relate mainly to mechanical strength aspects of eye protectors as a separate item of PPE not combined, e.g., with protective helmets.

Summing up the cited publications, it can be noticed that they relate mainly to research and analysis of the performance of protective helmets and eyes and face protectors treated as independent equipment. Nevertheless, the presented results indicate that concurrent use of helmets and spectacles/goggles while hitting a moving object can be the cause of additional hazards to their users. For this reason, in 2014 the Central Institute for Labour Protection – National Research Institute (CIOP-PIB) undertook a research project aimed at the study of, amongst others, the use of industrial safety helmets in conjunction with other types of PPE including eye and face protection devices, respiratory protective equipment and thermal protective clothing. As a result, efforts were undertaken to develop an appropriate research method and a test stand that would enable determination of the phenomena occurring upon falling weight impact on safety helmets used in combination with protective spectacles/goggles. The evaluation of their potential hazard to the users of such PPE assemblies is of great importance. These issues are addressed in the present article.

2. Materials

Five types of industrial safety helmets manufactured in the European Union (Germany, the UK and Poland) were selected for the study (Figure 1). Helmets designated A, B, C and D complied with Standard No. EN 397:2012+A1:2012 [2], and helmet E complied with standard No. EN 14052:2012+A1:2012 [28]. All of the selected helmets were Conformité Européenne (CE)-type examined.

The selected helmets varied in terms of construction and materials. Their basic characteristics are presented in Table 1. The common design characteristics for all of the selected helmets included the presence of a shell, cradle and headband, as presented in Figure 2. In this kind of helmet construction, a deformation of the shell and the cradle is responsible for absorbing impact energy.

The selected eye and face protection devices included one type of protective goggles, designated (1) in Figure 3, and four types of protective spectacles, designated (2), (3), (4) and (5). The mass of the spectacles/goggles is presented in Table 2.

3. Selection of the parameters characterizing the behavior of assemblies of safety helmets and spectacles/goggles upon falling weight impact

Previous research into the behavior of helmets upon falling weight impact [22] showed that in such situations both

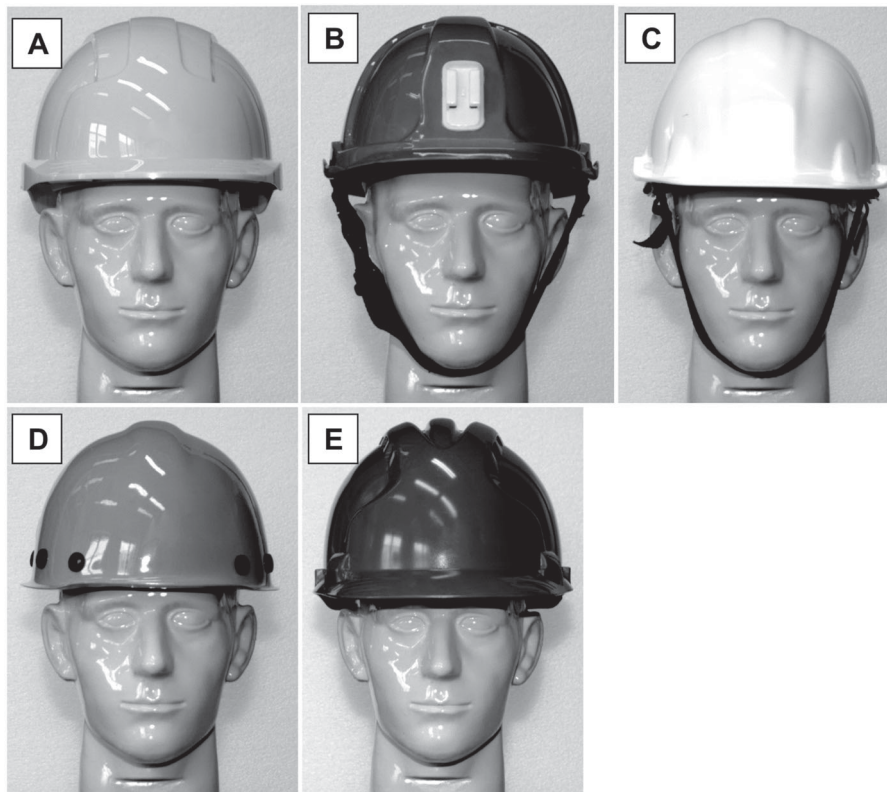

Figure 1. Tested safety helmets A–E.
Note: See Table 1 for information on each helmet.

Table 1. Construction of tested safety helmets.

Symbol	Shell material	Cradle material	Cradle construction
A	ABS	Textile tapes	Six-point
B	ABS	Polyethylene	Six-point
C	Polyethylene Polyester–glass	Textile tapes	Six-point
D	composite	Textile tapes Textile tapes + protective padding	Four-point
E	Polyethylene		Four-point

Note: ABS = acrylonitrile butadien styrene.

the shell and the cradle undergo significant deformation dependent on the helmet construction. Consequently, elements of the helmet, such as the peak or headband, transfer the impact to the eye and face protective devices situated below it. As a result, spectacles/goggles impacted from above may injure the user's face, especially if they break and create sharp surfaces. Therefore, the developed test method should enable observation of helmet behavior, i.e., its displacement and deformation upon falling weight impact, as well as of the effects this has on the spectacles/goggles worn by the user. The following mechanical parameters were selected for studying the phenomena accompanying falling weight impact on safety helmets used in conjunction with protective spectacles/goggles:

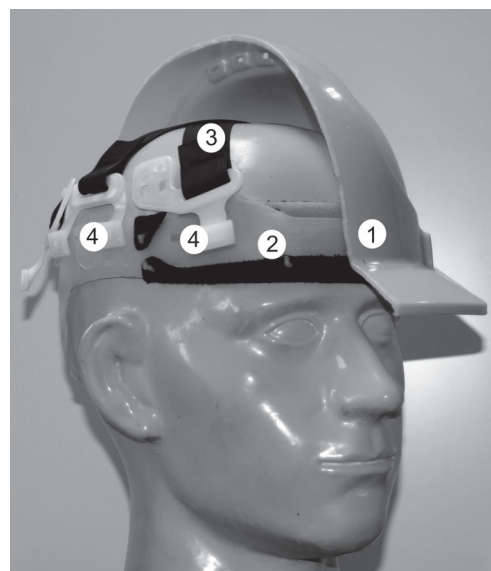

Figure 2. Cross-section of an industrial safety helmet.
Note: 1 = shell; 2 = headband; 3 = cradle; 4 = elements connecting the cradle with the shell.

- maximum force acting on the helmet upon falling weight impact;
- maximum helmet displacement and deformation upon impact;

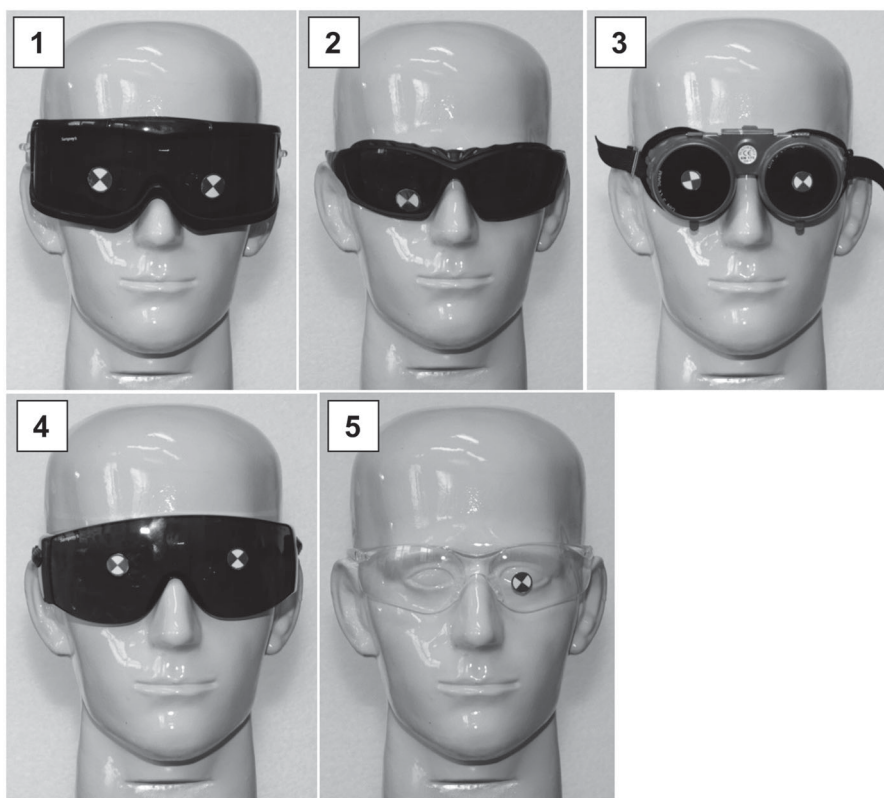

Figure 3. Tested protective spectacles/goggles (1)–(5).
Note: See Table 2 for information on each protective equipment.

Table 2. Mass of tested protective spectacles/goggles.

Symbol	Mass (g)
(1)	98.6
(2)	43.7
(3)	122.5
(4)	40.7
(5)	21.6

- maximum force exerted by the spectacles/goggles on the headform upon falling weight impact on the helmet;
- displacement and damage to spectacles/goggles.

4. Method and test stand

Measurement of the various parameters affecting the safety of the users of protective helmets and spectacles/goggles required the development of an appropriate testing method, which was based on the following assumptions:

- the safety helmet and spectacles/goggles should be tested on a stationary headform simulating the human head (containing features such as the nose, superciliary arches, etc.);

- the safety helmet and spectacles/goggles should be fitted to the headform (according to the manufacturer's instructions);
- the top of the helmet should be impacted vertically;
- the impact energy should be 49 J, in line with the test standard for industrial safety helmets according to Standard No. EN 397:2012+A1:2012 [2].

The tests were conducted according to these assumptions on the test stand presented in Figure 4.

The mechanical part of the test stand is installed on a monolithic base (1) with a mass greater than 500 kg designed to absorb the dynamic forces generated during the impact of the striker (7) on the helmet (9) mounted on the headform (2). The trolley (4) moves along vertical slideways (3), carrying a spherical striker (7) with a mass of 5 kg and dimensions as specified in Standard No. EN 397:2012+A1:2012 [2]. Prior to the test, the trolley (4) is lifted by means of a hoist (5) to a height that ensures appropriate kinetic energy upon the impact of the striker (7) and blocked with an electromagnetic latch. The latch is released by a signal from the control unit (6), which causes the striker to fall. Striker velocity upon impact on the helmet (9) is measured using a gauge (17), which also generates a signal to start measurement. The stand is equipped with a metal headform, as shown in Figure 5, which meets the specifications of Standard No. EN 168:2002 [29]. The

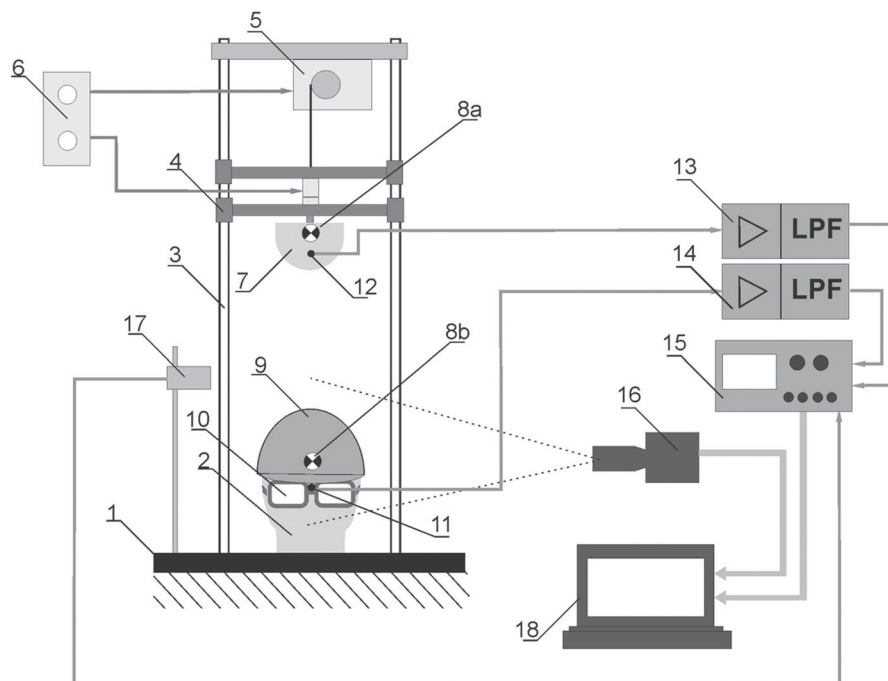

Figure 4. Stand for testing assemblies consisting of a safety helmet and eye and face protective devices.

Note: 1 = test stand base; 2 = headform; 3 = slideways; 4 = trolley with an electromagnetic latch; 5 = hoist; 6 = control system; 7 = striker; 8a, 8b = markers for high-speed camera recording; 9 = tested safety helmet; 10 = tested protective spectacles/goggles; 11 = accelerometer on the spectacles; 12 = accelerometer integrated with the striker; 13, 14 = amplifiers with low-pass filters (LPF); 15 = digital oscilloscope; 16 = high-speed digital video camera; 17 = gauge measuring final velocity of the striker and initiating measurement; 18 = computer.



Figure 5. Headform compliant with Standard No. EN 168:2002 [29], used at the test stand.

metal headform was applied in order to avoid the reduction of the force acting on a helmet during impact of the striker (Figure 4, 6). The helmet (9) and spectacles/goggles (10) are mounted on the headform.

The stand is equipped with an electronic system for measuring the acceleration of the striker (7) and of the protective spectacles/goggles (10) upon striker impact on the helmet. The system consists of a unidirectional accelerometer (12) installed at the center of mass of the striker (7) in such a way that its maximum sensitivity axis is coincident with the axis of symmetry of the striker and the helmet top (9). The accelerometer (12) is connected to an amplifier and a low-pass analog filter (13), which amplifies and filters the signal from the transducer. From the point of view of frequency parameters, the acceleration measurement circuit meets the requirements for channel CFC 600 specified in Standard No. ISO 6487:1987 [30]. Another element of the measurement circuit is an oscilloscope (15), which records the time course of striker acceleration and visualizes it directly. The other part of the measurement circuit consists of a three-directional accelerometer (11) with a mass of 0.4 g, mounted in the middle of the protective spectacles/goggles (10), which is connected to an amplifier and a low-pass analog filter (14), with frequency characteristics meeting the CFC 600 requirements. Thanks to its low mass, the accelerometer does not affect the behavior of the protective eyewear upon striker impact on the helmet. The amplifier output is fed to another channel of the digital oscilloscope (15).

The second measurement system installed at the test stand consists of a fast-speed digital video camera (16), which records the displacement of the marker (8a) on the

striker (7) and of the marker (8b) on the tested helmet (9), as well as the behavior of the safety helmet and spectacles/goggles. The camera (16) is connected to a computer (18), which is used for programming the camera operating mode, storing the images recorded by the camera and processing them. During the tests, the camera was set to 2000 frames/s with the field of vision covering the striker, helmet and headform with spectacles/goggles. The computer is also used to store the acceleration time courses recorded by the oscilloscope (15) and to process them.

Prior to the tests, helmets and protective spectacles/goggles were preconditioned at 22 ± 2 °C and a relative humidity of $65 \pm 5\%$ for at least 6 h. A marker (8b) was affixed to the front part of the helmet above the peak to enable measurements performed with the high-speed digital video camera. Furthermore, a transducer for acceleration measurement (11) was attached in the middle of the spectacles/goggles using wax. The helmet and spectacles/goggles were mounted on the headform in line with the manufacturer's instructions. The striker was lifted on a trolley (4) to a height of approximately 1 m, so that its kinetic energy upon impact against the helmet was 49 J, pursuant to Standard No. EN 397:2012+A1:2012 [2].

The movement of markers (8a) and (8b) was analyzed using Tema Motion Starter II version 3.5 [31]. As a result, the digital time courses of marker movements were obtained, which were subsequently analyzed using Origin version 9.5 [32].

5. Test results

In the conducted tests, every safety helmet–spectacles/goggles assembly was loaded by a falling weight three times. A new safety helmet was used for each repetition due to the permanent changes to its construction caused by a heavy blow. As a result, the presented results are mean values. Examples of helmet and spectacles behavior in the consecutive phases of striker impact are shown in Figure 6.

In the presented images, striker displacement upon impact on the helmet is marked $D_{1\max}$, while the displacement of the bottom part of the helmet upon impact is denoted $D_{2\max}$. The displacement of protective spectacles/goggles resulting from helmet impact is marked $D_{4\max}$.

The first step of analysis involved determination of helmet behavior upon falling weight impact. This behavior

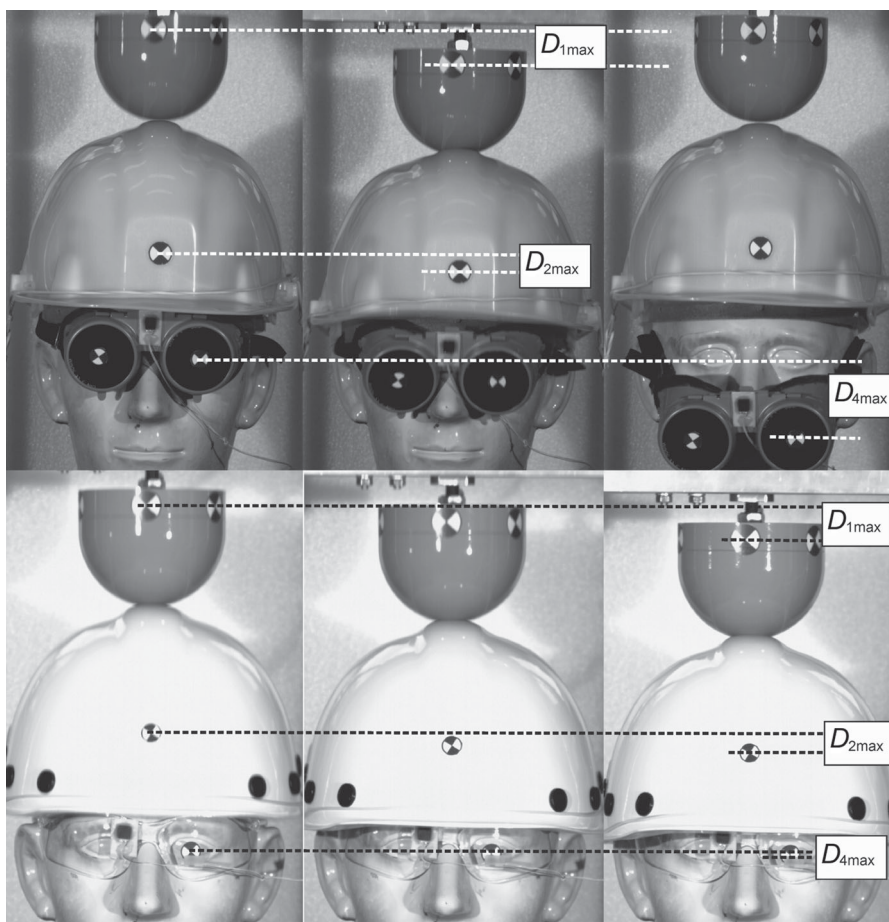

Figure 6. Displacement of the striker, helmet and spectacles/goggles upon impact on the top of the helmet.

Note: $D_{1\max}$ = striker displacement upon impact on the helmet; $D_{2\max}$ = displacement of the bottom part of the helmet upon impact; $D_{4\max}$ = displacement of protective spectacles/goggles resulting from helmet impact.

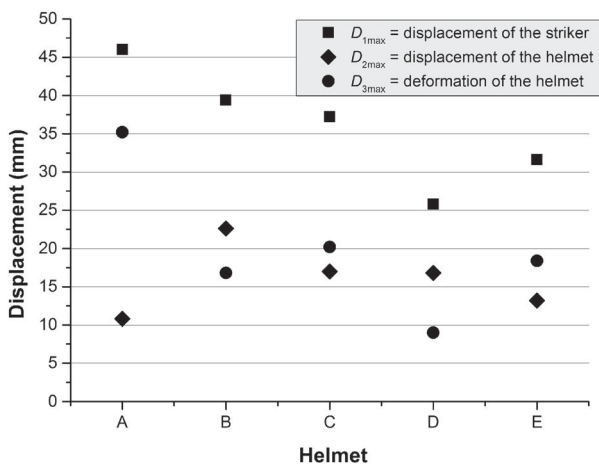

Figure 7. Displacement of the striker and helmet upon striker impact. Note: D_{1max} = striker displacement upon impact on the helmet; D_{2max} = displacement of the bottom part of the helmet upon impact; D_{3max} = maximum helmet deformation, defined as the difference between D_{1max} and D_{2max} .

was characterized by the following data, as shown in Figure 7:

- maximum striker displacement, D_{1max} , measured from the moment of impact to cessation of striker movement;
- maximum helmet displacement, D_{2max} (bottom edge of the helmet shell);
- maximum helmet deformation, D_{3max} , defined as the difference between D_{1max} and D_{2max} .

As can be seen from the figure, the greatest deformation and the smallest displacement were found for helmet A. This means that its shell was the least rigid among those studied. In turn, the smallest deformation was found for helmet D. That helmet was made of polyester–glass composite, which is more rigid than polyethylene and acrylonitrile butadien styrene (ABS) (see Table 1). The deformation and displacement figures for helmets B, C and E were similar.

Striker and helmet displacements are also presented in the form of a chart in Figure 8. As can be seen, the highest displacement values were found for spectacles (2), (4) and (5), which means that they did not significantly oppose the movement of the helmet shell and striker.

Figure 9 presents the maximum levels of force, F_{max} , acting on the helmet upon striker impact. The greatest force was recorded for helmet D because, as was already mentioned, its shell was the most rigid. Analysis of the forces acting on the helmets shows that F_{max} for the same type of helmet varied depending on the type of spectacles/goggles with which it was used. The highest forces for helmets were obtained for spectacles (4) and (5), which means that they absorbed the least energy from striker impact, leading to a greater loading on the helmet.

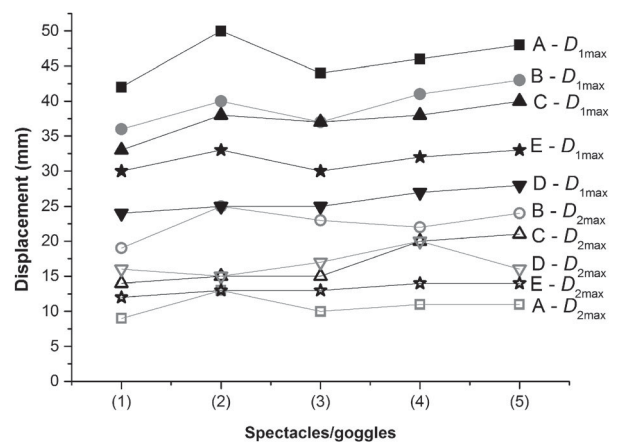

Figure 8. Displacement of the striker and helmet depending on the type of safety helmet and spectacles/goggles. Note: D_{1max} = striker displacement upon impact on the helmet; D_{2max} = displacement of the bottom part of the helmet upon impact.

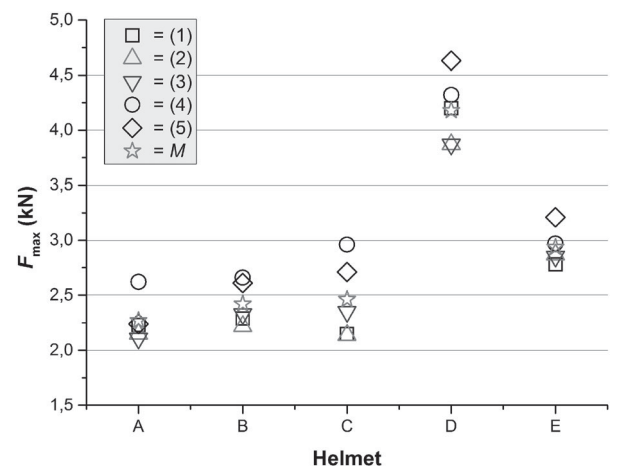

Figure 9. Maximum forces, F_{max} , acting on the helmet upon striker impact.

One of the most important elements of the study was determination of the maximum forces, F_{0max} , exerted by protective spectacles/goggles on the headform upon striker impact on the top of the helmet. The results of these tests are shown in Figure 10. Forces were calculated based on the recorded acceleration and the mass of spectacles/goggles presented in Table 2. The lowest forces were found for spectacles (5) due to their smallest mass and dimensions. As a result, helmet displacement affected those spectacles to the least degree. The highest forces were calculated for protective goggles (1) and welding spectacles (3), which is attributable to the fact that they are the heaviest and the largest (especially in the direction perpendicular to the face). This resulted in a considerable area of contact with the moving helmet. The maximum helmet displacement upon striker impact did not directly affect the maximum forces exerted on the headform by the spectacles/goggles. This is caused by the

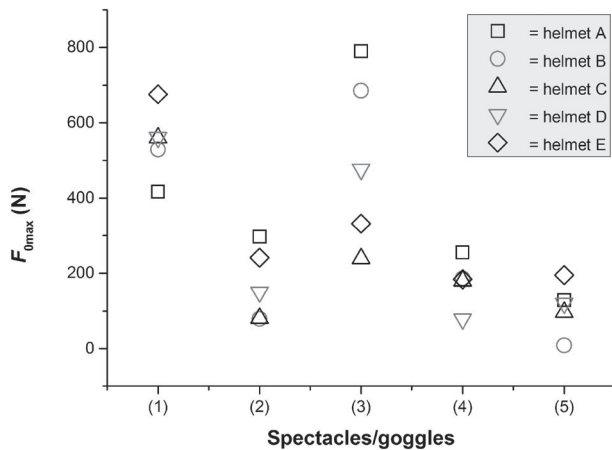

Figure 10. Maximum forces, F_{0max} , exerted by spectacles/goggles on the headform upon striker impact.

Table 3. Maximum displacement of spectacles/goggles as a result of striker impact on the helmet, D_{4max} (mm).

Helmet	Spectacles/goggles				
	(1)	(2)	(3)	(4)	(5)
A	11.0	6.0	41.0	11.0	8.0
B	16.0	5.0	31.0	34.0	1.0
C	8.0	7.0	57.0	12.0	5.0
D	4.0	6.0	48.0	42.0	3.0
E	7.0	6.0	18.0	28.0	3.0

spatial relationship between the shape of the upper edge of the spectacles/goggles and the bottom part of the helmet in the peak region. In practice, upon helmet displacement, small spectacles partially slid between the headband and the shell without exerting forces that would be harmful to the wearer.

Analysis of the video material recorded by the high-speed camera enabled evaluation of the maximum displacement of spectacles/goggles, D_{4max} , resulting from impact of the bottom part of the helmet, and especially the peak and the headband. The mean displacement values are presented in Table 3.

The presented data clearly show that the greatest displacement occurred for the welding spectacles (3) due to their large size and the considerable area of contact with the moving helmet. Moreover, as a result of their high mass, spectacles (3) also exhibited high inertia, and continued the downward movement even after the pressure from the helmet ceased. In contrast, spectacles (5) revealed the smallest displacement owing to their low mass and dimensions.

6. Summary

To summarize the test results, striker impact on safety helmets resulted in their displacement on the headform as well as deformation of the shell and cradle. As a result, shell

displacement was transferred to the spectacles/goggles mounted on the same headform. The displacement of the bottom part of the helmet shell caused by a 49-J impact ranged from approximately 10 to 25 mm, depending on the helmet construction and materials. The displacement of the bottom part of the shell should be considered the most important factor in the transfer of the impact to the spectacles/goggles. The tests showed that the presence of spectacles/goggles also affected the force acting on the helmet upon falling weight impact, which confirms the occurrence of interactions between the studied personal protective products. The key factors influencing the force exerted by the spectacles/goggles on the headform upon striker impact on the helmet were as follows:

- the shape and dimensions of the helmet and spectacles/goggles;
- the mass of the spectacles/goggles;
- the initial distance between the bottom part of the helmet shell and the upper edge of the spectacles/goggles.

The maximum forces recorded were approximately 800 N.

An example of the initial relative position of a helmet and spectacles/goggles is shown in Figure 11, which shows a 3D scan of the headform with a helmet and welding goggles as well as outlines of four parallel sagittal sections through the assembly. As can be seen from the outlines, the initial clearance between the helmet peak and the goggles amounts to as little as several millimeters.

Considering these phenomena from the standpoint of PPE users, it should be noted that the use of helmets in conjunction with eye and face protection devices may pose significant risks unless these products are mutually compatible. The results show that it is impossible to formulate one simple condition for helmet–spectacles/goggles compatibility and safety. The general guidelines are as follows:

- Helmets to be used in conjunction with spectacles/goggles should be designed so that a falling weight impact would primarily deform the parietal region. The cradle should not undergo significant elongation to prevent vertical displacement of the helmet peak.
- The construction of spectacles/goggles should ensure the maximum possible clearance from the bottom edge of the helmet. Moreover, the parts of spectacles/goggles which come into direct contact with the user's face (including the nose) should be made of an elastic material, such as silicone, to prevent injury in the event of an impact to the helmet. The weight of spectacles/goggles should be reduced to the greatest possible extent.

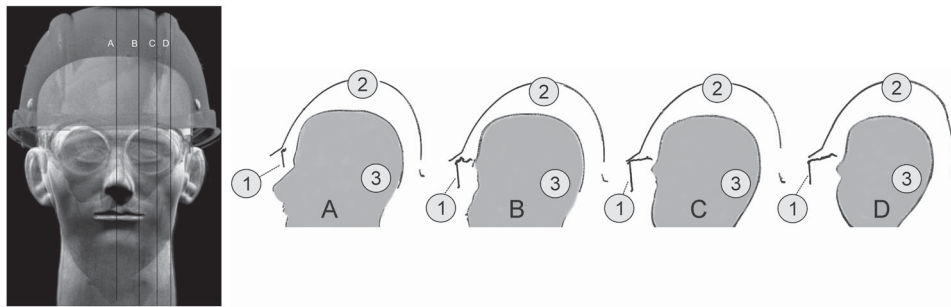

Figure 11. 3D scan of the headform with a helmet and welding goggles.

Note: 1 = outline of section through goggles; 2 = outline of section through helmet; 3 = outline of section through headform; A, B, C, D = sagittal sections.

Since these guidelines are of a general nature, each combination of spectacles/goggles and a helmet should be evaluated individually. The optimum solution would be to test the behavior of every configuration under conditions of falling weight impact. The impact should be executed according to the method described in Standard No. EN 397:2012+A1:2012 [2] and the headform should comply with Standard No. EN 168:2002 [29]. The safety aspects of the behavior of the helmet and spectacles/goggles upon impact should be analyzed based on video material recorded by means of a high-speed camera.

Taking into account the presented results on the effects of impacts to helmets used in conjunction with spectacles/goggles, it would also seem advisable to consider the implementation of other types of protective equipment, e.g., face shields mounted onto or under the outer rim of helmet peaks. An example of such a solution is shown in Figure 12.

As face shields are positioned at a safe distance from the user's face, they do not pose a hazard even upon a strong impact to the parietal region of the helmet shell. In order to evaluate safety parameters of such equipment during CE-type examination it should be tested as a kit.

The presented issue of the compatibility of protective helmets with eye and face protectors should also be considered from the point of view of the responsibility for launching safe solutions of PPE on the European market. The simplest solution to this problem is specification by the manufacturer of the protective helmet of the accessories such as eye and face protectors, which can be used at the same time. Such a declaration must be preceded by the manufacturer's own research, e.g., according to the methodology presented in this article. The declaration may concern, e.g., the specific types of glasses/goggles or specific design features such as the shape, dimensions, weight, etc. The next step that verifies the information supplied by the manufacturer should be laboratory tests conducted in an accredited laboratory. The results of these tests should be the basis for the assessment of compliance with Directive 89/686/EEC [11]. In the case of confirmation, in the CE-type examination process, of the safety helmet–glasses/goggles set compliance with the requirements of



Figure 12. Protective helmet equipped with a face shield retractable inside the helmet.

the Directive [11] (in the future with the requirements of Regulation 2016/425 [33]), this information should be revealed to the user in the appropriate instructions supplied with the equipment.

Disclosure statement

No potential conflict of interest was reported by the author.

Funding

This article is based on the on the results of a research task carried out within the scope of the third stage of the National Programme 'Improvement of safety and working conditions' partly supported in the years 2014–2016 – within the scope of state services – by the Ministry of Labour and Social Policy. The Central Institute for Labour Protection – National Research Institute (CIOP-PIB) was the Programme's main coordinator.

ORCID

Krzysztof Baszczyński  <http://orcid.org/0000-0002-9572-2705>

References

- [1] Główny Urząd Statystyczny (GUS). Monitoring rynku pracy. Wypadki przy pracy w 2014 r [Monitoring of the labour market. Occupational accidents in 2014]. Warszawa: GUS; 2015. Polish.
- [2] European Committee for Standardization (CEN). Industrial safety helmets. Brussels: CEN; 2012. Standard No. EN 397:2012+A1:2012.
- [3] Baszczyński K, Jachowicz M, Jabłońska A, et al. Opracowanie wytycznych dla użytkowników oraz wymagań i metod badań hełmów ochronnych przeznaczonych do równoczesnego stosowania z innymi rodzajami środków ochrony indywidualnej [Guidelines for users and the requirements and test methods for protective helmets simultaneously used with other types of personal protective equipment]. Warszawa: Central Institute for Labour Protection – National Research Institute (CIOP-PIB); 2014. (Report 3.Z.12). Polish.
- [4] Bahadori A. Personnel protection and safety equipment for the oil and gas industries. Amsterdam: Elsevier; 2015. Chapter 4, Personnel safety and protective equipment; p. 91–191.
- [5] 3M Occupational Health & Environmental Safety Division. Catalogue for head and face protection products [Internet]. Bracknell: 3M; [cited 2017 Jun 15]. Available from: <http://multimedia.3m.com/mws/media/5761700/head-and-face-protection-catalogue.pdf>
- [6] Scott Safety. Safety helmets. Head protection range [Internet]. Skelmersdale: Scott Safety; [cited 2017 Jun 15]. Available from: https://www.scottsafety.com/fr/emea/DocumentandMedia1/Safety_Helmets_Brochure_English_72_dpi.pdf
- [7] uvex group. Catalogue [Internet]. uvex [cited 2017 Sep 12]; Available from: https://d3rbxgeqn1ye9j.cloudfront.net/fileadmin/www.uvex-safety.com/Media/catalogues_and_brochures/en/uvex_safety_catalogue_2017_en.pdf
- [8] Fernandes FAO, Alves de Sousa RJ. Motorcycle helmets – a state of the art review. *Accid Anal Prev.* 2013;56:1–21. doi:10.1016/j.aap.2013.03.011
- [9] Occupational Safety and Health Administration (OSHA). Personal protective equipment. Washington (DC): OSHA; 2004. (OSHA 3151-12R).
- [10] European Committee for Standardization (CEN). Personal eye protection. Specifications. Brussels: CEN; 2002. Standard No. EN 166:2002.
- [11] Council Directive 89/686/EEC of 21 December 1989 on the approximation of the laws of the Member States relating to personal protective equipment. *OJ.* 1989;L399:18–38.
- [12] Gilchrist A, Mills NJ. Improved side, front and back impact protection for industrial helmets. Bootle: HSE Books; 1989. (HSE contract research report No. 13/1989).
- [13] Hulme AJ, Mills NJ. The performance of industrial helmets under impact. An assessment of the British Standard BS 5240 PT. 1, 1987. Sunbury: HSE Books; 1996. (Health & Safety Executive contract research report No. 91/1996).
- [14] Mills NJ, Gilchrist A. Oblique impact testing of bicycle helmets. *Int J Impact Eng.* 2008;35:1075–1086. doi:10.1016/j.ijimpeng.2007.05.005
- [15] European Committee for Standardization (CEN). Protective helmets. Test methods. Shock absorption. Brussels: CEN; 2012. Standard No. EN 13087-2:2012.
- [16] Shuaeib FM, Hamouda AMS, Hamdan MM, et al. Motorcycle helmet – Part II. Materials and design issues. *J Mater Process Technol.* 2002;123:422–431. doi:10.1016/S0924-0136(02)00047-X
- [17] Shuaeib FM, Hamouda AMS, Wong SV, et al. A new motorcycle helmet liner material: the finite element simulation and design of experiment optimization. *Mater Des.* 2007;28:182–195. doi:10.1016/j.matdes.2005.04.015
- [18] Forero Rueda MA, Cui L, Gilchrist MD. Optimisation of energy absorbing liner for equestrian helmets. Part I: layered foam liner. *Mater Des.* 2009;30:3405–3413. doi:10.1016/j.matdes.2009.03.037
- [19] Di Landro L, Sala G, Olivieri D. Deformation mechanisms and energy absorption of polystyrene foams for protective helmets. *Polym Test.* 2002;21(2):217–228. doi:10.1016/S0142-9418(01)00073-3
- [20] Tinard V, Deck C, Willinger R. New methodology for improvement of helmet performances during impacts with regards to biomechanical criteria. *Mater Des.* 2012;37:79–88. doi:10.1016/j.matdes.2011.12.005
- [21] Pinnoji PK, Mahajan P. Analysis of impact-induced damage and delamination in the composite shell of a helmet. *Mater Des.* 2010;31(8):3716–3723. doi:10.1016/j.matdes.2010.03.011
- [22] Baszczyński K. The effect of temperature on the capability of industrial safety helmets to absorb impact energy. *Eng Fail Anal.* 2014;46:1–8. doi:10.1016/j.engfailanal.2014.07.006
- [23] Korycki K. The damping of off-central impact for selected industrial safety helmets used in Poland. *Int J Occup Saf Ergon.* 2002;8(1):51–70. doi:10.1080/10803548.2002.11076514
- [24] Baszczyński K. Przemysłowe hełmy ochronne a zabezpieczenie głowy przed uderzeniami bocznymi [Industrial safety helmets and protection of the head against side impacts]. *Bezpieczeństwo Pracy.* 2002;(5):10–13. Polish.
- [25] Napier SM, Baker RS, Sanford DG, et al. Eye injuries in athletics and recreation. *Surv Ophthalmol.* 1996;41(3):229–244. doi:10.1016/S0039-6257(96)80025-7
- [26] McMahon JM, Beckerman S. Testing safety eyewear: how frame and lens design affect lens retention. *Optometry J Am Optometry Assoc.* 2007;78(2):78–87. doi:10.1016/j.optm.2006.07.011
- [27] Pościk A, Jachowicz M. Mechanical properties of protective spectacles fitted with corrective lenses. *Int J Occup Saf Ergon.* 2016;23(3):440–446. <http://doi.org/10.1080/10803548.2016.1234131>
- [28] European Committee for Standardization (CEN). High performance industrial helmets. Brussels: CEN; 2002. Standard No. EN 14052:2012 + A1:2012.
- [29] European Committee for Standardization (CEN). Personal eye-protection. Non-optical test methods. Brussels: CEN; 2002. Standard No. EN 168:2002.
- [30] International Organization for Standardization (ISO). Road vehicles. Measurement techniques in impact tests. Instrumentation. Geneva: ISO; 1987. Standard No. ISO 6487:1987.
- [31] Tema Motion Starter II [CD-ROM]. Version 3.5, Build number: 3.5 – 014. Linköping: Image System. 1 CD-ROM: 120 mm.
- [32] Origin 9 [CD-ROM]. Version 9. Northampton (MA): OriginLab; 2012. 1 CD-ROM: 120 mm. Accompanied by: 1 user manual.
- [33] Regulation (EU) 2016/425 of the European Parliament and of the Council of 9 March 2016 on personal protective equipment and repealing Council Directive 89/686/EEC (text with EEA relevance). *OJ.* 2016:L81:51–98.