

May 2013

Characterization of the Distribution, Abundance, and Fate of Metals in Sediment

April Grant

University of Wisconsin-Milwaukee

Follow this and additional works at: <https://dc.uwm.edu/etd>



Part of the [Analytical Chemistry Commons](#)

Recommended Citation

Grant, April, "Characterization of the Distribution, Abundance, and Fate of Metals in Sediment" (2013). *Theses and Dissertations*. 317.
<https://dc.uwm.edu/etd/317>

This Thesis is brought to you for free and open access by UWM Digital Commons. It has been accepted for inclusion in Theses and Dissertations by an authorized administrator of UWM Digital Commons. For more information, please contact open-access@uwm.edu.

CHARACTERIZATION OF THE
DISTRIBUTION, ABUNDANCE, AND FATE
OF METALS IN SEDIMENT

by

April R. Grant

A Thesis Submitted in
Partial Fulfillment of the
Requirements for the Degree of

Master of Science

in Chemistry

at

The University of Wisconsin-Milwaukee

May 2013

ABSTRACT
CHARACTERIZATION OF THE DISTRIBUTION, ABUNDANCE, AND FATE OF
METALS IN SEDIMENT

by

April R. Grant

The University of Wisconsin-Milwaukee, 2013
Under the Supervision of Professor Dr. J. Aldstadt

This research describes the mobility of heavy metals in river sediment through characterization of metal-sediment association by a sequential extraction procedure. The most abundant isotopes of As, Cd, Cu, Cr, Pb and Zn were measured by Inductively Coupled Plasma-Mass Spectrometry (ICP-MS) in four sediment extraction phases: a) exchangeable, b) carbonate-bound, c) metal-oxide-bound, and d) organic-bound. The measured concentrations were compared to the Wisconsin Department of Natural Resources' "Sediment Quality Guidelines" to determine whether the metals were present at toxic levels. Two reference techniques, Potentiometric Stripping Analysis and Graphite Furnace Atomic Absorption Spectroscopy, were used to validate the concentrations of metals measured by ICP-MS. The six analytes were found to fall below the DNR's "levels of concern", thereby suggesting that either the metals are not present or that they are

tightly bound to the sediment interface and thus, that the potential for their release into the environment at toxic levels is unlikely under typical environmental conditions.

In addition, a column-leaching experiment to simulate the influence of ionic strength on the mobility of Pb in Green Bay sediment was also performed. A different sediment was used because the concentration of exchangeable Pb in any of the Pike River sediment samples was too low. Unexpectedly, lower ionic strength solutions released a greater amount of Pb from sediment. The most plausible explanation for the trend observed is that all of the readily exchangeable Pb was loosely bound by the sediment. However, other factors that influence sediment-metal sorption, such as organic matter mobilization, colloid transport, and the sediment surface characteristics should also be further explored to obtain a greater understanding of the molecular mechanisms of metal release as a result of changing ionic strengths in natural systems.

TABLE OF CONTENTS

ABSTRACT

Chapter 1. Introduction	1
1.1 Toxic Metals in the Environment	2
1.2 Utility of the Sequential Extraction Method for Metals in Sediment	3
1.2.1 Operationally-defined Extractions	5
1.2.2 Validation of the BCR Method	6
1.3 The Pike River — Background	8
1.4 Road Salt and Ionic Strength	13
1.4.1 Green Bay – Background	15
1.5 Published Studies of the Effect of Road Salt on the Mobility of Pb(II) in Soils.....	17
1.5.1 Amrhein (1992)	18
1.5.2 Norrstrom (2005)	21
1.5.3 Nelson (2009)	23
1.6 Instrumental Techniques	26
1.6.1 Inductively Coupled Plasma-Mass Spectrometry	26
1.6.2 Graphite Furnace Atomization Absorption Spectroscopy	32
1.6.3 Potentiometric Stripping Analysis	38
Chapter 2. Experimental	40
2.1 Reagents	40
2.1.1 Reagents for Sequential Extraction Study	40
2.1.1.1 Exchangeable Fraction for Sequential Extraction Method	41

2.1.1.2 Carbonate Fraction for Sequential Extraction Method	41
2.1.1.3 Metal-Oxide Fraction for Sequential Extraction Method	41
2.1.1.4 Organic Fraction for Sequential Extraction Method	41
2.1.1.5 Reagents for Column Study	44
2.1.1.6 Reagents for Inductively Coupled Plasma-Mass Spectrometry	44
2.1.1.7 Reagents for Atomic Absorption Spectroscopy Method – Graphite Furnace.....	45
2.1.1.8 Reagents for Potentiometric Stripping Analysis	45
2.2 River and Lake Sediment Sampling	45
2.3 Modified Sequential Extraction Procedure	46
2.4 Instrumentation	48
2.4.1 ICP-MS	48
2.4.2 Graphite Furnace Atomic Absorption Spectroscopy	50
2.4.3 Potentiometric Stripping Analysis	51
2.5 Data Acquisition	51
2.6 Column Leaching Study	52
Chapter 3. Results and Discussion	60
Part I: Characterization of 6 Heavy Metals in River Sediment by ICP-MS	61
3.1 Inductively Coupled Plasma-Mass Spectrometry	61
3.1.1 Sequential Extraction Results and Trends	62
3.2 Comparison of Methods: ICP-MS, GFAAS, and PSA	80
3.2.1 Calibration Comparison for Pb: ICP-MS, GFAA and PSA	82
3.3 Column Study Results for PSA and Trends in Pb Release	85

Chapter 4. Conclusions and Future Work	90
4.1 Conclusions on the Pike River Sediment BCR Study.....	90
4.2 Conclusions on Column Study; Influence of Ionic Strength Pb(II) Mobility ...	93
References	95

LIST OF FIGURES

Figure 1 Pike River Watershed in Southeastern Wisconsin [21].....	10
Figure 2. Select Mainstem Sites [5].....	11
Figure 3. Select Tributary Sites [5].....	12
Figure 4. Map of the Menominee Watershed and Green Bay [33].....	16
Figure 5. Norrstrom Study, Measured Fe and TOC Content [25].....	23
Figure 6. Nelson Study, Richland and Spokane Soils leached with NaCl and MgCl ₂ [29]	25
Figure 7. ICP-MS System Schematic [36].....	29
Figure 8. Nebulizer/Spray Chamber Schematic [36].....	30
Figure 9. Plasma Interface [36].....	31
Figure 10. Schematic of GFAA basic components [40].....	34
Figure 11. GFAA schematic [35, 40].....	35
Figure 12. Diagram of Hollow Cathode Lamp [40].....	36
Figure 13. Graphite Platform Cuvette, Sample Holder [40].....	37
Figure 14. Chronopotentiogram, PSA [44].....	39
Figure 15. Schematic of a Modified Sequential Extraction Scheme [9].....	43
Figure 16. Photograph of the Micromass Platform ICP instrument [37].....	57
Figure 17. Schematic of the ICP-MS instrument [37].....	58
Figure 18. Schematic Diagram of the M5 Series ET-AAS [40].....	59
Figure 19. PSA Sample Cell Set-Up [44].....	59
Figure 20. Calibration Plots for Selected Metals via ICP-MS.....	66
Figure 21. Observed Metal Concentration: Exchangeable.....	69

Figure 22. Observed Metal Concentration: Carbonate.....	72
Figure 23. Observed Metal Concentration: Metal-Oxide.....	75
Figure 24. Observed Metal Concentration: Organic.....	78
Figure 25. Green Bay Sediment; Release of Pb(II) as a Function of Ionic Strength.....	88

LIST OF TABLES

Table 1. Amrhein Study Table of Results [27].....	20
Table 2. Operating Condition for ICP-MS [77, 51-58]	55
Table 3. GFAAS Operating Condition [40].....	56
Table 4. PSA Operating Conditions [44].....	57
Table 5. WI-DNR TEC levels, Sediment Quality Guidelines [62].....	65
Table 6. Comparison of Calibration Model Parameters for Pb(II) [35]	84
Table 7. Column Study by PSA Results.....	88
Table 8. Column Study Design; Three Studies [25, 27, 29].....	89
Table 9. Column Design for the Determination of Pb(II) by PSA.....	89

ACKNOWLEDGMENTS

Special thanks to my committee members Dr. J. Aldstadt, Dr. M. Dietz and Dr. T.

Ehlinger. I would also like thank my, UW-Milwaukee Department of Chemistry and

Biochemistry, 2010 (Spring) – 2012 (Winter) analytical chemistry research group under

the supervision and instruction of Dr. J. Aldstadt.

Chapter 1

Introduction

Heavy metal contamination in the environment is an important interdisciplinary concern because of the toxicity of these metals, even at low concentrations.

Anthropogenic sources of heavy metals and the introduction of other species that may mobilize naturally occurring heavy metals like Pb(II) have resulted in dramatically greater levels of available heavy metals in soils and sediment. In order to assess the extent of heavy metal contamination, the method used must be able to both measure heavy metals and assess their mobility, toxicity, speciation and bioavailability. This work utilizes a modified sequential extraction procedure to characterize the mobility of six metals in river sediment. In addition, the influence of an outside species, NaCl, on the mobility of Pb(II) in a lacustrine sediment obtained from a section of Green Bay in northeastern Wisconsin, was evaluated by conducting a column leaching experiment and measuring Pb(II) released by three instrumental techniques. The presence of As, Cd, Cr, Cu, Pb, and Zn in river sediment from the Pike River in southeastern Wisconsin was characterized by the sequential extraction procedure.¹

¹ N.B. For simplicity, Arsenic will be described as a "metal" even though, technically, it is classified as a "metalloid".

1.1 Toxic Metals in the Environment

The presence of toxic metals in the environment at or above regulatory levels is a primary concern that impacts the quality of groundwater and aquatic systems on a local, state, regional and international level. Toxic metals, particularly Pb(II), occur naturally from sources like the weathering of geological materials and atmospheric emissions from volcanoes and wind blown dust [1]. Significant concentrations of Pb(II) are reported to be contained in various rocks, most notably black shale (a sedimentary rock) [1]. Sedimentary rocks have been reported to be significant sources of naturally occurring Pb(II), containing Pb(II) ranging from approximately 1- 150 $\mu\text{g g}^{-1}$, with black shale containing the higher levels of Pb(II) [20]. Pb(II) also occurs naturally in the earth's crust at levels approximately between 10-20 $\mu\text{g g}^{-1}$ [1, 2, 3].

Anthropogenic activity is also an important contributor of Pb(II) into the environment and often mobilizes Pb(II) that naturally exists in geological materials such as sediment. Input of Pb(II) into the environment by anthropogenic activity is a major concern primarily because of an increase in the prevalence of Pb(II) and the toxicity of Pb(II) [1, 2]. Toxic exposure to Pb(II) is most commonly associated with detrimental effects on nervous systems. Pb(II) has also been shown to negatively impact the cardiovascular system, cause reproductive complications, and hinder kidney function [2]. Because of the potential harm of excessive Pb(II) in the environment, it is necessary to understand how Pb(II) moves through the environment and to develop methods to quantify it. In this way, better risk assessments can be made to mitigate the impact of Pb(II) on the environment.

Historically, the primary anthropogenic sources of Pb(II) emissions have been from motor vehicle fuel and industrial activities such as mining, smelting, and the manufacturing and disposal of Pb(II)-containing products [2]. In the mid-1970s, the US EPA enforced regulations restricting the use of Pb(II) in motor vehicle fuel. Pb(II), in the form of tetraethyllead (TEL), had been used throughout the US in fuel as an "anti-knocking" agent since the 1930's [2]. According to the EPA, following the ban of TEL in 1974, emissions of Pb(II) from motor vehicles significantly declined (95% decrease) [2]. However, anthropogenic sources of Pb(II) continue to be a major concern because of the use of Pb(II) in certain industrial operations (e.g., battery manufacture) and the unfortunate use of Pb(II) (as TEL and related compounds) in motor-vehicle fuels internationally [2].

The six toxic metals were chosen for this work because of their prevalence in the environment, toxicity, and data from the Wisconsin Department of Natural Resources (WI DNR) that indicated that these metals were present at significant levels [4, 5].

1.2 Utility of the Sequential Extraction Method for Metals in Sediment

Studies of the abundance and distribution of trace metals in river sediment provide important insights into metal mobility, bioavailability, toxicity and speciation. These are all factors that impact water quality and the health of aquatic biota. Prior to the late 1980's, mainly because of limitations in the analytical techniques available, the metal content of sediment and soil was typically expressed as the total metal concentration, which assumes that all forms of metal have an equal impact on the environment [6, 7, 8]. Such an assumption gives an incomplete assessment because it does not supply

information regarding exactly how metals partition among various forms in which they may exist in soil or sediment. Moreover, the toxicity of metals is a direct function of their physicochemical speciation [6, 7, 8, 9].

Sequential extraction procedures have been developed as a means to identify the chemical forms of metals and how they are associated with different "compartments" in environmental solids [6]. Fractions are operationally defined based on the various chemical and physical phases that are present in sediment. For instance, metals in sediment or soil may be bound by metal hydroxides (e.g., Fe or Mn) or associated with carbonate minerals; the extent of these interactions governs whether the metal will be released under various environmental conditions [6]. Factors such as redox potential, pH, and salinity must also be considered because they are among the factors that influence the release, and thereby the mobility, of metals associated with the various chemical phases present [1, 6]. Sequential extractions are a means to operationally define the metals based on these interactions and to thereby measure their concentrations in defined fractions [6, 9, 10].

The first sequential extraction procedure was proposed by Tessier in 1979 [6]. Tessier's work allowed for a more accurate evaluation of the extent of metal contamination in sediments and other solid environmental media. Tessier's work was an important alternative to the determination of total metal concentration, and has continued to be used, albeit with various modifications, to the present day [6, 10, 11, 12]. Depending on the goals of a particular study, the total metal concentration is insufficient because it assumes that all forms of a given metal which are present will have the same impact on the environment. Tessier's pioneering work and more recent studies have

shown that the different forms of metals that are associated with various chemical phases are the main driving forces in determining the extent of metal mobility and toxicity [7, 9, 10].

1.2.1 Operationally-defined Extractions

Toxic metals are selectively extracted from operationally-defined solid fractions by using selective reagents. Each phase is associated with a reagent that will mobilize metals from that phase based upon conditions that will promote metal release. Tessier originally proposed a five-step sequential extraction procedure in which metals were released by specific reagents based upon the chemistry of the reagents used [6].

The first step is designed to isolate the so-called "exchangeable fraction" because it mimics the release of the most easily accessible metals. Essentially, the solid sample is washed with "simulated rain". Exchangeable metals are associated with electrolytes in aqueous solution that promote mobilization by weak ion-exchange interactions. Metals released in the second step, known as the "carbonate fraction", use reagents that release metals associated with carbonate minerals, and of course these interactions can be disrupted as a function of pH. The third step isolates the "metal oxide" fraction, most notably iron and manganese oxides, as described in Tessier's original work [6, 13]. Iron and manganese oxides, are known to have very strong binding interactions with metals, thus making the metals bound to metal oxides much more resistant to mobilization than the "exchangeable" and "carbonate" fractions. Reagents typically used for the "metal oxide fraction" are reducing agents such as hydroxylamine or oxalic acid. The most tightly bound metals are found in the "organic fraction", which is the fourth and final

fraction in the sequential extraction procedure used herein. To release metals from this fraction, a more severe treatment is necessary. Metals sorbed to organic matter are released under harsh oxidizing conditions to ensure the decomposition of the organic matter. One of the most common oxidizing reagents is hydrogen peroxide. It is important to note that Tessier's original sequential extraction procedure included a fifth step comprising the determination of the residual (very tightly bound or "refractory") metals [6, 10, 11, 12, 13]. Residual metals represent the remaining species that are not removed in the first four fractions and are presumably bound within the crystal lattice of the minerals. In nature, these metals are considered to be inaccessible and immobile because their release would only be possible under extreme changes to a natural environment, such as a spill of concentrated acids. In Tessier's fifth step, strong mineral acids such as HNO_3 and HCl are used to mobilize metals held in the crystal lattice. Thus, in the work described herein, the residual fraction was not examined. For this work, a sequential extraction procedure is described in detail in Chapter 2, Experimental [6, 14].

1.2.2 Validation of the BCR Method

Many variations of Tessier's sequential extraction procedure have been published since his original paper appeared in 1979 [7, 15, 16, 17, 18]. These have been shown to be useful tools for understanding the toxicity and mobility of metals in environmental solids [15, 16, 17]. Concerns with the various sequential extraction procedures that are now available are primarily the lack of uniformity among them and the lack of established validation procedures [12, 18, 19]. One of the most significant issues with

Tessier's sequential extraction method is that the procedure is operationally defined — Tessier's method assumes that there are only five compartments in which the partitioning of metals in sediments takes place [6, 7, 19]. Because of the complex nature of the potentially many chemical processes that take place at and between the metal-sediment interface, such an assumption is clearly not true. Although Tessier knew this, his goal was to create a procedure (however flawed) that would bring some degree of uniformity to a field that was tending toward chaos. Thus, Tessier's "compartments" provide a reasonable (albeit simplistic) representation of the key interactions found in nature [6].

In an effort to standardize the many sequential extraction methods developed on the basis of Tessier's foundation, the BCR method was proposed by the European Community Bureau of Reference (BCR) in 1987 [7, 19]. The BCR was charged with developing and distributing standard (i.e., certified) reference materials (SRMs) for the validation of results, that is, to reduce errors in the analysis of samples [7, 12]. The BCR procedure is similar to Tessier's original procedure with the exception of combining the "exchangeable" and "carbonate" phases. For validation, SRM 601 was certified for the BCR protocol for soil and SRM 701 was specifically certified for metals in sediment [7, 12, 19]. Most researchers use a sequential extraction scheme that follows the specific operationally-defined steps as described in the BCR procedure [7]. Nevertheless, despite this effort at standardization, researchers tend to make further modifications to the BCR procedure for a variety of reasons, such as reducing sample preparation time or the use of more selective reagents [15, 17, 20].

1.3 The Pike River — Background

The determination of selected toxic trace metals in river sediment was carried out with sediment samples from the Pike River, located in southeast Wisconsin. The area of investigation is part of the Pike River watershed, encompassing ~65 square kilometers in Kenosha and Racine counties (Figure 1) [5, 21]. The once heavily forested and wetland watershed has experienced rapid population growth over the past 30 years, drastically changing the health of the Pike River for the worst [5, 21]. Today, 46% of the land is used for agriculture, followed by suburban and urban use, both at 27%, only 8% remains forested [5, 21]. The transforming landscape is susceptible to sources of anthropogenic contamination, primarily from agricultural and urban runoff, as well as industrial and landfill runoff [5, 21]. In addition, the changes in land use have led to growing concerns about declining water quality, loss of aquatic habitat, and flooding [5, 21]. One important aspect of evaluating the integrity of the Pike River watershed is how the sediment quality correlates to the health of the fish and benthic invertebrate communities [5]. Various organic and metal pollutants are major contaminants in freshwater sediment and have the potential of being re-suspended and released into water bodies [3, 4, 5, 10]. Sources of toxic metal contamination are most likely anthropogenic, originating from agricultural and urban areas [4, 5, 17]. For example, many fertilizers used in agriculture contain toxic metals such as Cr, Pb, and As [1, 23].

Thirteen stations including three reference stations were selected for the investigation. The Pike River North watershed, which included ten stations, was the main area of study [16]. Five mainstem (PN 7, PN 4, PN 3.5, PN 3, and PN 2 – Figure 2) and five tributary stations (Bartlet, Steele, Waxdale, Lamparek, and Chickory – Figure 3)

were used for sampling. It should be noted that each mainstem station was selected downstream from a tributary, a key part of the sampling design, to give insight to possible pattern of downstream contamination. The reference stations included a "worst case" reference stream (Lincoln Creek), a "best case" reference stream (Nichols Creek) and a "regional" reference stream (South Pike) [5].

The central goal of this work is to study the abundance and distribution of toxic metals in surficial freshwater sediments and to determine if there is a correlation to the ecological health of the watershed. The toxic metals of interest for this study were As, Cd, Cr, Cu, Pb, and Zn.

Figure 1. Pike River Watershed in Southeastern Wisconsin – Kenosha and Racine Counties [21].

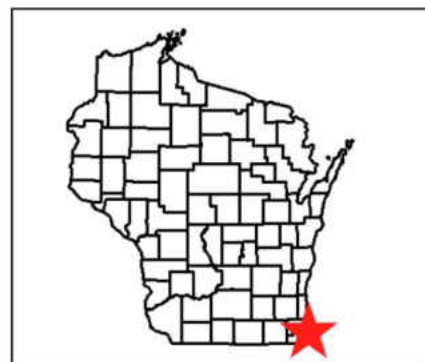
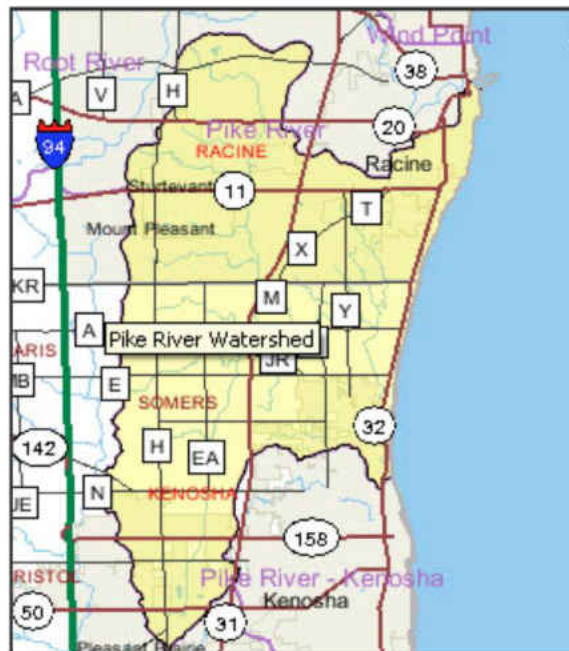


Figure 2. Select Mainstem Sites – Pike River [5].

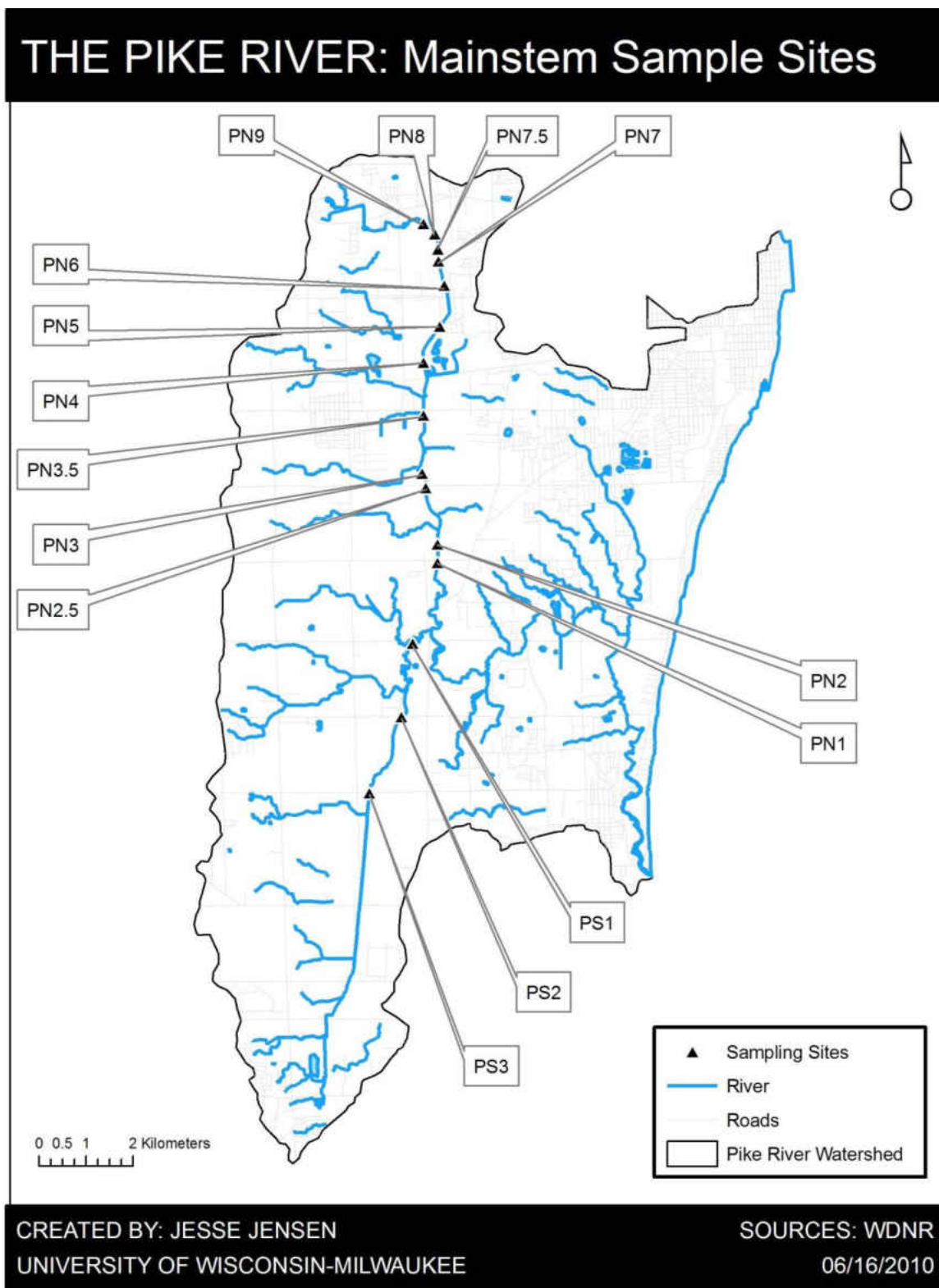
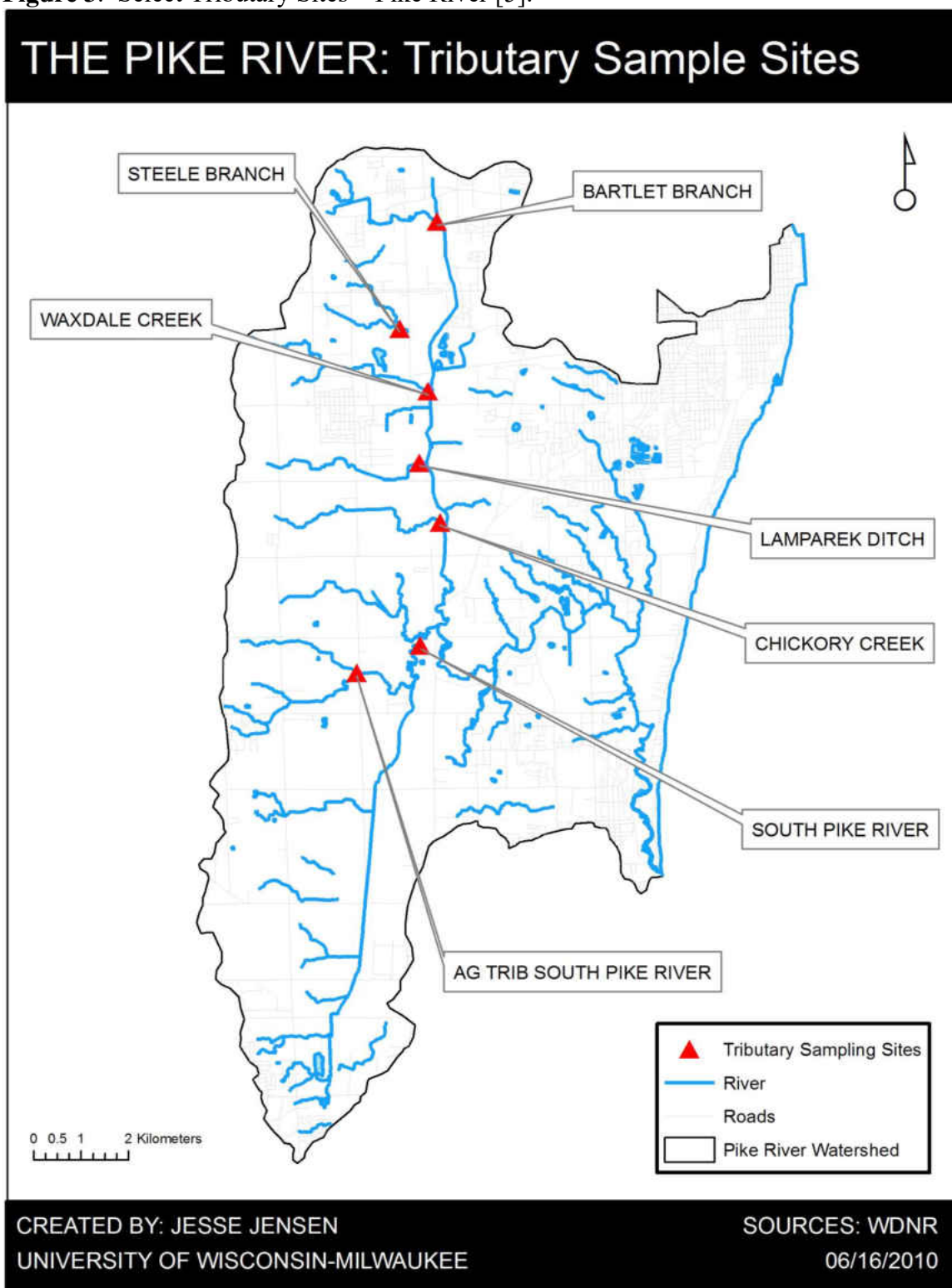


Figure 3. Select Tributary Sites – Pike River [5].



1.4 Road Salt and Ionic Strength

The use of various modified sequential extraction procedures have played a key role during the past 30 years in studies evaluating factors that influence the presence of toxic metals in the environment [24]. Ionic strength has been a crucial component in studies that have evaluated the influence of road salt in aquatic systems [25 - 29]. A great deal of research has been dedicated to examining the impact of increasing chloride concentrations from changes in ionic strength or high salinity in aquatic systems and its effects are far more well known in comparison to the impact of toxic metals [30]. Evaluating metal mobility as a function of changes in ionic strength is important to analyze potential threats to water quality.

Wisconsin is among the many northern mid-west states that use large amounts of road salt each winter to combat icy roads. It has been reported that the city of Milwaukee alone averages about 40,000 tons of applied road salt per year [31]. The use of road salt and its contribution to changing the natural chemistry in freshwater systems (lakes, rivers, streams, groundwater, etc.) is an issue that currently appears to most directly impact aquatic life [30]. However, the annual use of road salt may have a further affect in threatening water quality because of the chemical changes in aquatic systems to which enormous amounts of road salt may contribute [30, 31].

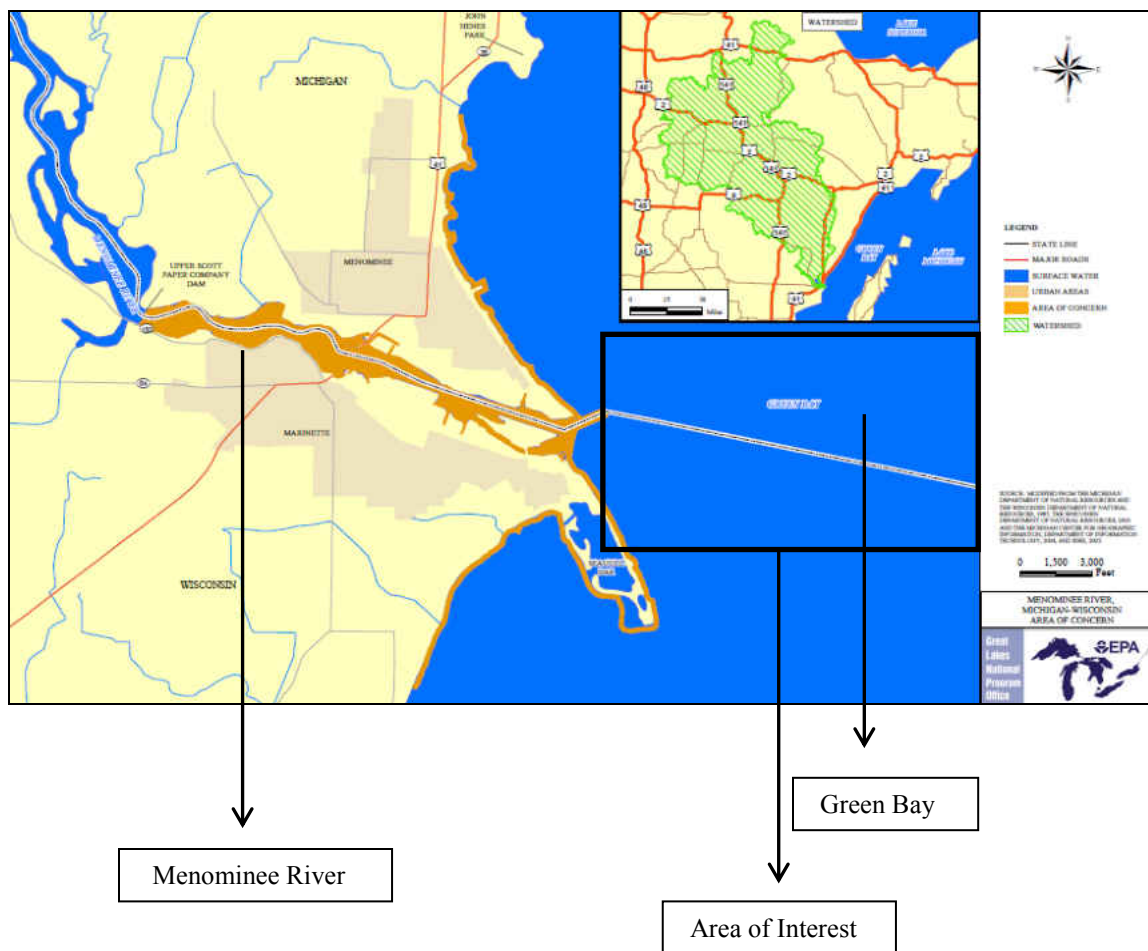
The Causal Analysis/Diagnosis Decision Information System, CADDIS, an assessment information system produced by the EPA, attempts to evaluate environmental stressors associated with aquatic systems and determine causes and resolutions [32]. Ionic strength is on the list of main stressors or candidate causes that may directly or indirectly result in "responses of concern" [32]. Road salt is suggested as one of the

"activities of consideration" that may be responsible for a change in aquatic systems [32]. In addition, metals and sediment are included as factors to consider when ionic strength is determined to be a candidate cause [32]. The dominant chemical component in road salt used in the southeast Wisconsin is NaCl, hence it was used in this thesis to evaluate the influence of ionic strength on the metal mobility. Understanding the influence of factors like ionic strength on metal mobility in sediment is a complex issue because of the wide array of chemical processes which toxic metals may undergo, such as competition with other cations for sediment sorption sites, complexation with various anions, and general ion-exchange processes [25 - 29]. For this work, a column study was done to simulate the influence of ionic strength on the mobility of Pb(II) in sediment from Green Bay. The second goal of this work was to study the influence of seasonal variations in salinity on the transport and fate in a representative model system.

1.4.1 Green Bay – Background

In addition to river sediment, lake sediment was also studied. The sediment was collected at a site located in central Green Bay, approx. 10 km southeast of Marinette, Wisconsin (Figure 4). For several decades, the watershed and overall habitat has been subjected to land-use change and severe pollution [33, 34, 35]. Paper mills, waste-treatment facilities, a former arsenic herbicide factory, and various other industrial and manufacturing activities along the Menominee River have contributed to the presence of often high levels of metals in the groundwater and sediment within and near the Lower Green Bay watershed [33, 35]. On-going efforts to remediate the area have been and continue to be conducted by the US EPA and the sponsors of the international Great Lakes Water Quality Agreement (GLWQA) [33]. The GLWQA, established in 1987 by the United States and Canada, designates the Lower Menominee River and sections of Green Bay, north and south of the river mouth, as "Areas of Concern" (AOCs) [33]. The main goal of the agreement is to remediate the affected areas and address issues concerning habitat loss and residual pollution [33].

Figure 4. Map of the Menominee Watershed and Green Bay [33].



1.5 Published Studies of the Effect of Road Salt on the Mobility of Pb(II) in Soils

In published work involving the use of packed columns to study metal mobility, the experimental designs varies widely. Three studies that examined the mobilization of metals in soils by road salt utilizing a column experiment share the same basic approach [25, 27, 29]. In these studies (*vide infra*), similar levels of ionic strength were examined [25, 27, 29]. It should be noted that the influence of ionic strength was evaluated for soils, not sediment, in each study. Not surprisingly, however, the experimental designs vary greatly.

1.5.1 Amrhein (1992)

In 1992, Amrhein *et al.* evaluated the effect of two different road salts on metal and organic matter mobilization [27]. The deicing salts used for the study included NaCl and CMA (calcium magnesium acetate). Amrhein *et al.* considered CMA due to its growing influence in regions of the United States and Europe as an alternative to NaCl to combat the effects of using NaCl on roadways such as corrosion of road surfaces, bridges and its negative effects of aquatic life and vegetation near roadsides. For this thesis, emphasis was placed on the Amrhein system design and results. Pb(II) was among the metals evaluated which also included Cr, Ni, Fe, Cd (II) and Cu (II) [27]. Total trace metals leached from four different soils, taken from four different sites, were determined by Graphite Furnace Atomic Absorption Spectroscopy (GFAAS). Column soil samples were obtained from Donner Pass, CA; Albany and Buffalo, NY; and Cape Cod, MA [27]. Each soil sample was collected within at least 3 m of a road and was sampled at three different depths, 0-5 cm, 5-15 cm, and greater than 15 cm (as determined by a change in the vertical soil structure) [27]. The physical composition of each soil was taken into consideration and other factors were measured, including cation-exchange capacity, exchangeable Na, pH, CaCO₃ content, and organic matter content [27]. Approximately 30 g of soil was packed into each column followed by a total of 180 mL of leachate which consisted of 90 mL of an initial NaCl or CMA solution and 90 mL of distilled water [27]. Amrhein *et al.* utilized an ionic strength leachate scheme for NaCl of 0.01 M, 0.05 and 0.1 M (Table 1). Total Pb(II) leached from each soil column revealed a linear relationship between the release of Pb(II) and increase in ionic strength, hence the 0.1 M

solution leached the greatest amount of Pb(II) from the Albany, NY roadside soil column – 2.2 $\mu\text{g/g}$ (Table 1) [27].

The attempt to demonstrate a relationship between organic matter mobilization and trace metal concentration was not completely successful [27]. The Buffalo, NY soil showed the most linear correlation between organic matter mobilization and total metal concentration. An array of complex processes and factors were considered in explaining why different soils revealed different organic matter and total metal content [27]. These factors included the structure and properties of soils and clays, the availability of free or exchangeable Na, and varying electrolyte concentrations [27]. Amrhein and co-workers concluded that Pb(II) mobilization is most likely controlled by organic matter mobilization where highly exchangeable Na and low electrolyte concentrations exist [27]. Amrhein and co-workers reported that none of the metals analyzed were measured above U.S. drinking water quality limits [27].

Table 1. Obtained from Amrhein; Total metal content leached from study soils with emphasis on Pb(II) [27].

init solutn, mol _e L ⁻¹	amount, μg					
	Pb	Cd	Cu	Cr	Ni	Fe
	Albany Soil					
DW	0.44	0.040	3.1	0.22	0.67	48
0.10 CMA	2.2	0.093	2.6	0.48	0.42	15
0.01 CMA	0.21	0.038	1.9	0.16	0.17	3.0
0.1 NaCl	0.92	0.095	9.1	1.04	1.1	168
0.05 NaCl	0.58	0.044	7.7	0.69	0.99	105
0.01 NaCl	0.17	0.037	5.6	0.36	0.71	34
total in 30 g of soil	8150	32.4	2190	2460	1170	8.8 × 10 ⁵
	Donner Soil					
DW	1.17	0.028	2.00	0.15	1.3	75
0.10 CMA	1.51	0.30	0.38	0.12	0.51	4.9
0.01 CMA	0.20	0.10	0.76	0.025	0.23	4.5
0.1 NaCl	0.65	0.45	1.39	0.094	0.91	28
0.05 NaCl	0.47	0.31	1.54	0.080	1.3	20
0.01 NaCl	0.28	0.042	1.28	0.056	0.77	11
total in 30 g of soil	2180	7.58	638	1020	214	7.0 × 10 ⁵
	Buffalo Soil					
DW	0.339	0.040	5.5	0.38	1.3	77
0.10 CMA	1.2	0.097	3.8	0.26	0.60	13
0.01 CMA	1.6	0.046	3.3	10	0.68	3.5
0.1 NaCl	2.2	0.20	24	1.90	4.9	509
0.05 NaCl	0.57	0.080	10	0.74	2.5	87
0.01 NaCl	0.24	0.055	5.4	0.23	0.83	19
total in 30 g of soil	6430	63.7	2270	2090	945	10.9 × 10 ⁵

^a Leachate: 180 ml (90 mL initial solution followed by 90 mL of DW).

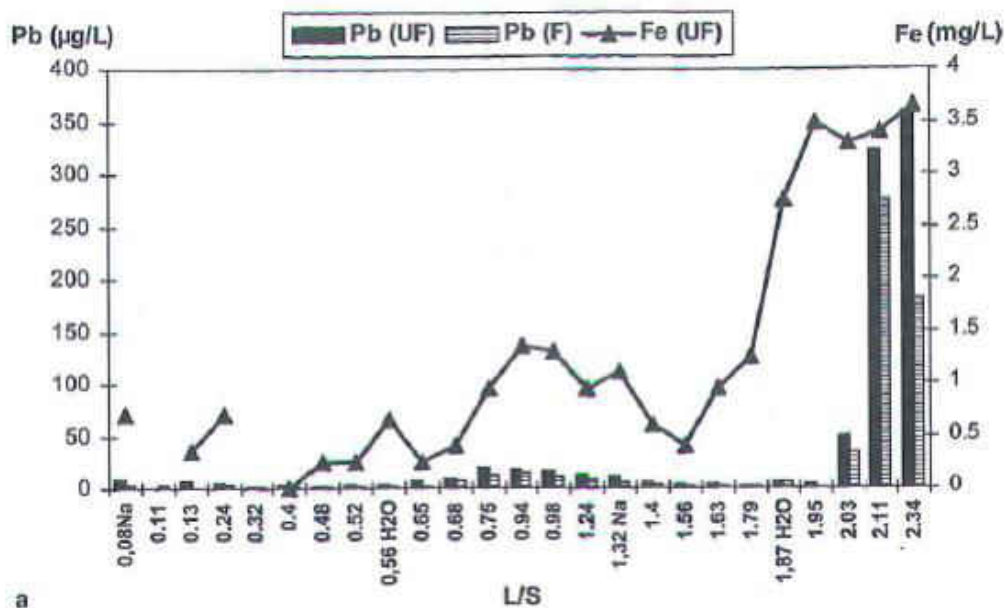
1.5.2 Norrstrom (2005)

Over a decade after Amrhien's work, Norrstrom carried out a similar study in 2005 examining the influence metal ion mobility by road salt in soil samples from a highway trench in Sweden [25]. The scale of soil sampling was much greater than that performed in the Amhrein study [25, 27]. The weight of soil used in Norrstrom's columns was about 6 kg – in comparison to a total of about 30 g of soil used in Amhrein's work [25, 27]. Norrstrom utilized four columns packed with soil from the same infiltration trench sampling site. Two columns (C1 and C2) were leached with 0.1 M NaCl followed by de-ionized water. The leaching procedure for C1 was repeated once in C1 and twice in C2 [25]. Two additional columns (C3 and C4) were leached with de-ionized water only [25]. Specific volumes of leachant were not specified by Norrstrom, however, and a liquid to solid (L/S) ratio of 2 was used in both C1 and C3 whereas a L/S of 3 was used in both C2 and C4 [25]. Total metal content for Pb(II), Zn, Cu, and Cd was determined by ICP-MS [25]. In addition, Fe content was analyzed by AAS, Na ion was analyzed by flame emission spectrophotometry, and total organic carbon (TOC) was determined as well [25]. Ion-exchange high pressure liquid chromatography (abbreviated simply as "IC") was used to determine concentrations of Cl^- and SO_4^{2-} [25]. The pH was also monitored throughout each experiment. Norrstrom's results indicated significant Pb(II) mobilization in C1 and C2, i.e., the two columns leached with 0.1 M NaCl followed by de-ionized water [25]. The highest concentrations of Pb(II) were measured towards the end of the column leaching experiment for both C1 and C2, thereby suggesting that most Pb(II) was released under lower ionic strength conditions [25]. An issue with the

Norrstrom study is that the exact value of the ionic strength at the end of column leaching is difficult to assess because a single ionic strength was not clearly specified [25].

In Norrstrom's study, high Pb(II) mobilization corresponded to increases in TOC and Fe content [25]. Furthermore, the Pb(II) content was measured in both filtered and unfiltered samples [25]. Figure 5 displays Norrstrom's results comparing the Fe content and leached Pb(II) concentration in both filtered and unfiltered samples [25]. The unfiltered samples had higher Pb(II) mobilization, which is important because column leachates for the work described herein were filtered ($< 0.45 \mu\text{m}$) [25]. The highest amount of Pb(II) leached came from C1 measured at approximately 350 ppb [25]. The amount of Pb(II) mobilized in C1 and C2 towards the end of leaching exceed Swedish limits for drinking water quality, which is $10 \mu\text{g/L}$ [25].

Figure 5. Norrstrom's results for measured Fe content and Pb(II) leached in unfiltered (UF) and filtered (F) leachant [25].

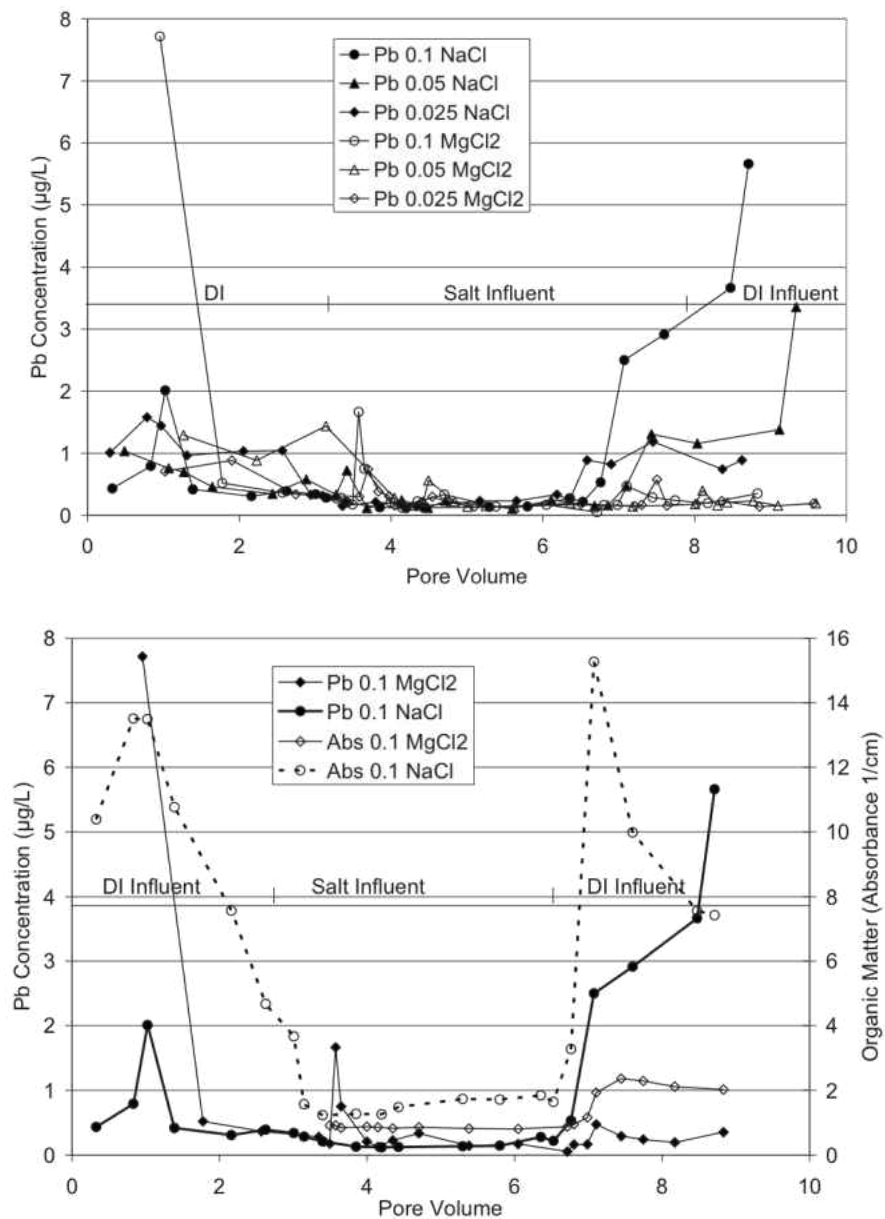


1.5.3 Nelson (2009)

The most recent column study considered was that by Nelson *et al.* in 2009 in which the effect of road salt was evaluated in two roadside soils in the state of Washington [29]. Similar to the Amrhein study, an additional salt ($MgCl_2$) was used. However, for the purpose of this thesis, only the results for NaCl were considered for comparison. Soil columns for each soil sample (Spokane soil and Richland soil) were prepared and leaching was performed with NaCl solutions that were 0.025 M, 0.050 M and 0.10 M [29]. Prior to leaching with NaCl, each soil column was subjected to three to five pore volumes of de-ionized water which was done to remove the most mobile constituents and stabilize the flow rate [29]. Pb(II) content was measured by ICP-MS [29]. In addition, soil structure was analyzed along with cation exchange capacity, exchangeable Na, Cl^- content, and pH [29]. The Spokane soil released the greatest

amount of Pb(II) when subjected to 0.10 M NaCl, reaching a maximum concentration of just under 6 $\mu\text{g}/\text{kg}$ (6 parts per thousand, ppt) [29]. A general trend was observed in which more Pb(II) was released with an increase in ionic strength [29]. The opposite effect was seen in the Richland soil in which lower concentrations of NaCl released a greater amount of Pb(II) (Figure 6) [29]. The greatest amount of Pb(II) release in the Richland soil was just over 4 $\mu\text{g}/\text{kg}$ (4 ppt) [29]. Nelson suggested that Pb(II) mobilization is overall relatively difficult because of the low amounts of Pb(II) release, thereby demonstrating strong sorption characteristics of Pb(II) in the soils that were studied [29].

Figure 6. Richland (top) and Spokane Soils, respectively, leached with NaCl and MgCl₂ (29).



1.6 Instrumental Techniques

A molecular mass spectrometric technique, Inductively Coupled Plasma-Mass Spectrometry (ICP-MS), was applied to the determination of the six metals examined using a modified BCR extraction method. In addition to the mass spectrometric method, an atomic optical spectroscopic technique, Graphite Furnace Atomic Absorption Spectrometry (GFAAS, also known as Electrothermal AAS), and an electrochemical method, Potentiometric Stripping Analysis, were applied to the determination of Pb(II) and As in the study of the influence of ionic strength on the metal (metalloid) mobility in lacustrine sediment. Further information and detailed instrumental factors for each method can be found in Chapter 2, Experimental.

1.6.1 Inductively Coupled Plasma-Mass Spectrometry

Inductively Coupled Plasma-Mass Spectrometry (ICP-MS) is the state-of-the-art technique for multi-elemental analysis. The technique was developed in the early 1980's and is a preferred method for analysis because of its low detection limits, high sensitivity, and multi-element and isotopic quantitative capabilities [36, 37, 38]. ICP-MS is an atomic MS technique, involving the following sequence of operations: sample introduction by nebulization, atomization, ionization, and separation of ions according to their mass-to-charge (m/z) ratios prior to detection [36, 37, 38].

Sample introduction is a critical step in ICP-MS analysis because the success of any measurement is dependent upon how efficiently the analyte enters the ICP-MS [36]. ICP-MS most commonly uses but is not limited to liquid samples [36, 37, 38]. Liquid

samples are initially pumped at a method-specific flow rate into a nebulizer where the liquid sample is converted to a fine aerosol in a spray chamber (Figure 7, also shown in Figure 8 and Figure 9) [36]. The aerosol droplets are then introduced to a high temperature ($\sim 8,000$ - $10,000$ K) Argon ICP source (Figure 8) [36, 37]. The high temperature plasma is responsible for destroying molecular species ("atomization") and creating positive ions from the sample aerosol. The Ar gas forms a high temperature plasma through interaction of Ar cations with electrons in the radio frequency field, as depicted in Figure 7 and Figure 9 [36, 37].

Coupling of the high-pressure plasma with the low-pressure MS is accomplished by use of an ingenious interface [36]. The "Plasma" and "Interface" regions in Figure 8 and Figure 9 show where the analyte ions formed in the plasma are carried into the MS. Two metal (Ni) cones with small (~ 1 mm) orifices, the "skimmer cone" and the "sampler cone", sample the plasma and select for the positive ions to form into an "ion beam" [36, 37]. The pressure in the interface region (i.e., between the cones) is maintained by a mechanical pump at approximately 10^{-4} torr. The plasma gas first moves through the sampler cone into the low pressure interface region, where the gas cools. Next, the cooler ion beam passes through the skimmer cone where the ions are directed by a sequence of "ion lenses" (i.e., electrically charged plates) into the low vacuum environment of the MS. The ion beam is ideally composed of a stream of only analyte cations — neutral species are pumped away within the interface whereas negatively charged species are lost to the ion lenses [36, 37].

The ultimate goal in MS is to separate analyte ions according to their m/z ratio [36, 39]. Discrimination among analyte and non-analyte ions occurs as a result of the DC

potential and RF voltage that is applied to the four electrodes ("rods") [36, 37, 38]. The nature of the electrical waveforms that are applied to the rods is such that the entire m/z range can be rapidly scanned. Specific ions then are detected by an ion detector and the signal is further processed [37, 38].

An electron multiplier detector is incorporated into an ICP-MS instrument to convert the number of ions striking the detector into an electrical signal (Figure 3) [36, 38]. Electron multipliers consist of a series of dynodes which emit electrons when their surface is struck by analyte ions [38]. The ejection of electrons from the dynodes occurs sequentially and leads to amplification because each impact event release several electrons, i.e., after an analyte ion hits the first dynode, multiple electrons are released and directed by a positive potential gradient to strike the next dynode further down the chain [38]. After conversion into an electrical signal, data reduction yields a mass spectrum used for quantitative and qualitative purposes [38]. The large amplification of the signal that occurs is one of the key reasons that ICP-MS is remarkably sensitive to most elemental analytes [36, 38]. ICP-MS is a powerful technique for simultaneous multi-element analysis because of its ability to rapidly perform sensitive and selective isotopic-specific measurements over a wide concentration range, which in certain methods can be over six orders of magnitude [36, 38, 39].

Figure 7. ICP-MS system schematic, general instrument set-up [36].

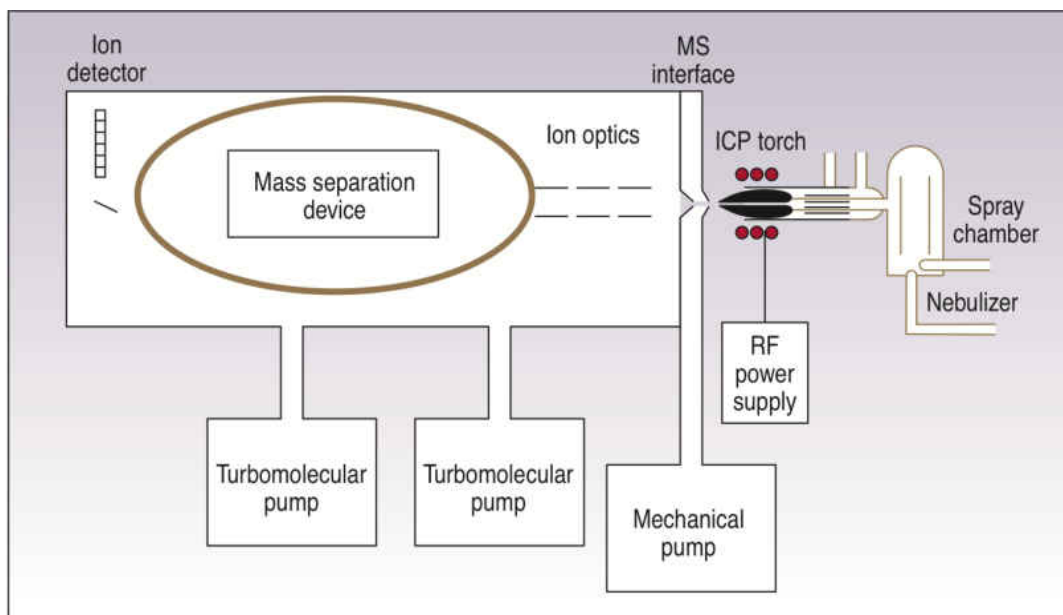


Figure 8. Nebulizer/Spray Chamber Schematic [36].

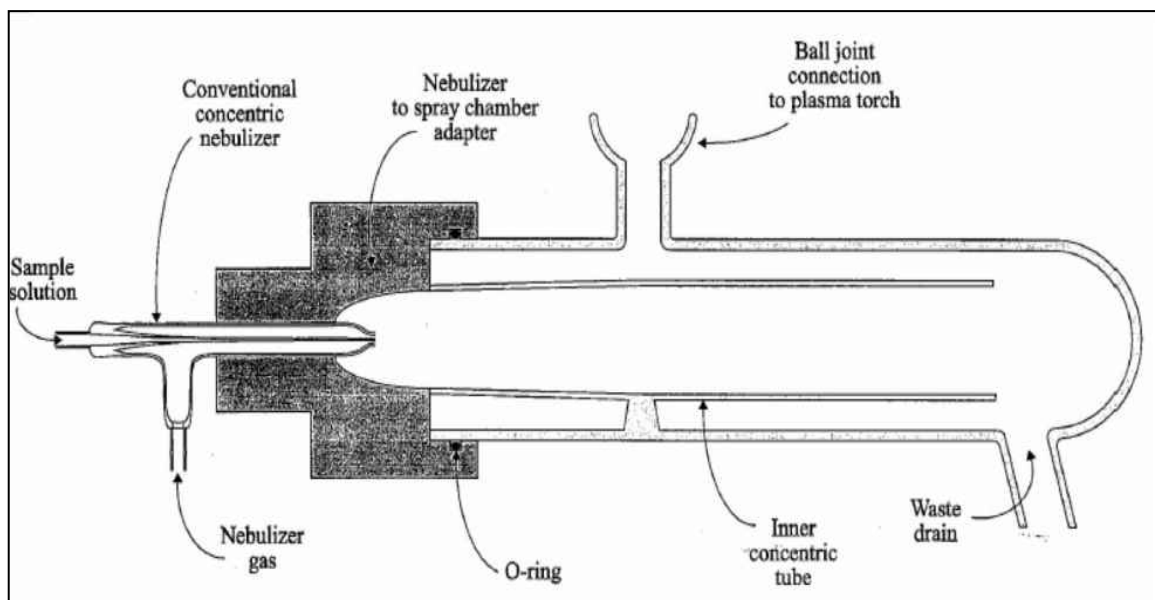
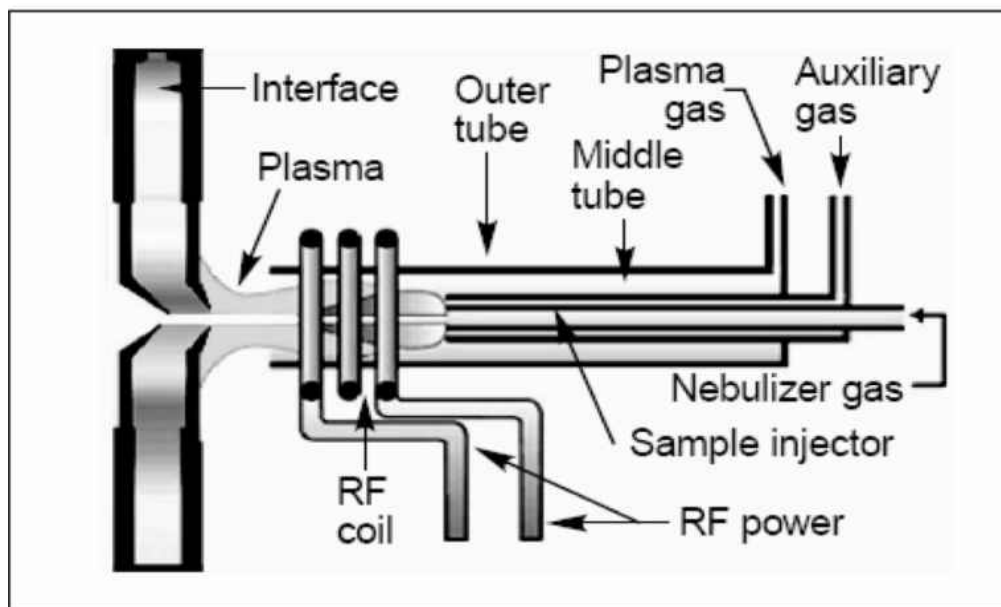


Figure 9. Plasma – Interface Components Schematic [36].



1.6.2 Graphite Furnace Atomization Absorption Spectroscopy

GFAAS, also known as Electrothermal Atomization Absorption Spectroscopy (ET-AAS), is a powerful technique because of its greater sensitivity, lower detection limits (ppb), and low sample volume requirement [38, 40, 41]. Its primary difference versus ICP-MS is that it cannot measure elements simultaneously [38, 40]. Despite this, for applications such as the determination of Pb(II) in sediment, GFAAS is the preferred approach.

The central theory in any absorption spectroscopy is the Beer-Lambert-Bouguer Law, which mathematically illustrates a linear relationship between analyte concentration (C) and the amount of light absorbed (A) by an analyte over a given pathlength (b), with a proportionality constant (ϵ) that is related to the probability of absorption occurring at a specific energy [38, 41, 42, 43]:

$$A = \epsilon bC$$

By comparing the absorption and concentration values of a known set of standards for the analyte at a particular wavelength, a calibration model can be created and then used for quantitative analysis [38]. In AAS, ground state (i.e., neutral) analyte atoms are exposed to an incident source of light [38]. If the energy of the incident light equals a quantized electronic transition, absorption occurs. The analyte atoms in the excited state are unstable and rapidly ($< 10^{-9}$ seconds) return to their more stable ground state configuration [38]. Experimentally, the degree of absorption depends on the number of atoms in the path of the source light. Quantitation of the amount of analyte present can be done by measuring the ratio of the incident light power (P_0) and the transmitted power

(P) [38]. The P/P_0 ratio is the transmittance (T), and is related to absorbance by the negative of its base 10 logarithm ($A = -\log_{10}T$) [38].

There are four basic components in the AAS instrument: a light source, an atomizer, a monochromator, and a detector (Figure 10 and Figure 11) [38, 40, 41, 42]. Hollow cathode lamps (HCLs) serve as high-intensity, monochromatic light sources in AAS. A schematic diagram of a typical HCL (here, Pb(II)) is presented in Figure 12. For background correction, a high-intensity D_2 (deuterium) arc lamp is used widely as a continuum source. Background correction is commonly used in spectroscopic methods to address issues with species that may interfere with the analyte signal [38, 41]. In GFAAS, atomization occurs after sample introduction into an electrothermal graphite tube (Figure 11 and Figure 13). Liquid samples (approximately 20 μ L) are directly introduced through an opening in the graphite tube (Figure 13) [40]. To efficiently create the gas-phase neutral analyte atoms that are needed for the absorption measurement, the graphite furnace heats the sample through an analyte-specific temperature program [38, 40, 42]. This program has four distinct phases: drying, pyrolysis, ashing, and atomization, which generates gas-phase atoms in the ground state [38, 40, 42]. Once the sample is atomized, it remains in the graphite tube for a brief time period that is long enough to be exposed to the incident light from the HCL, which is later isolated by a monochromator. [38, 40, 42] The central role of the monochromator is to isolate a specific wavelength of light to be measured by a detector [38, 40, 42]. The monochromator used in this work contained two dispersing elements: an echelle-type of reflection grating and a prism for removing higher order energies produced during the diffraction process at the grating [38].

Conceptually similar to an electron multiplier, the detector used for GFAAS is typically a photomultiplier tube (PMT) detector [38]. When exposed to incident photons, electrons are emitted from the photocathode surface [38]. A series of successive dynodes and a gradually increasing potential field are also central to the design [38]. The first dynode maintains a higher potential than that of the photocathode surface and therefore has the ability to emit a greater number of electrons, thereby creating a "cascade amplification" effect [38]. Incoming photoelectrons hit the first dynode surface and create a burst of emitted electrons. The emitted electrons then impact the next dynode surface, thereby causing even more electrons to be ejected from its surface [38]. A cascade of increasing electrons is emitted from one dynode to the next until the ejected electrons are collected at the anode, resulting in an electronically amplified current that is measured [38]. The analyte absorbance versus time is used for quantitation, with the response reported as either peak height or peak area [38, 40, 41, 42].

Figure 10. Schematic of GFAA basic components [40].

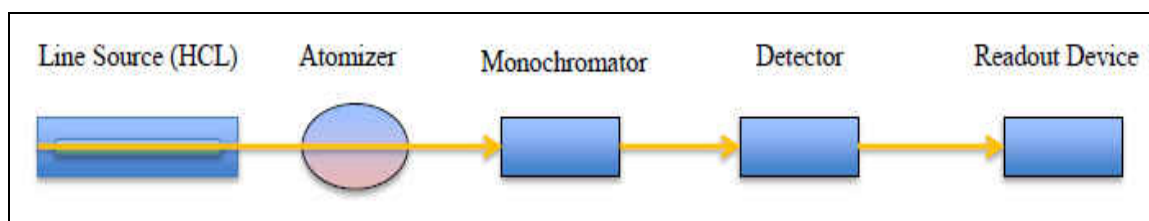


Figure 11. Cross-sectional schematic of a graphite furnace atomizer [35, 40].

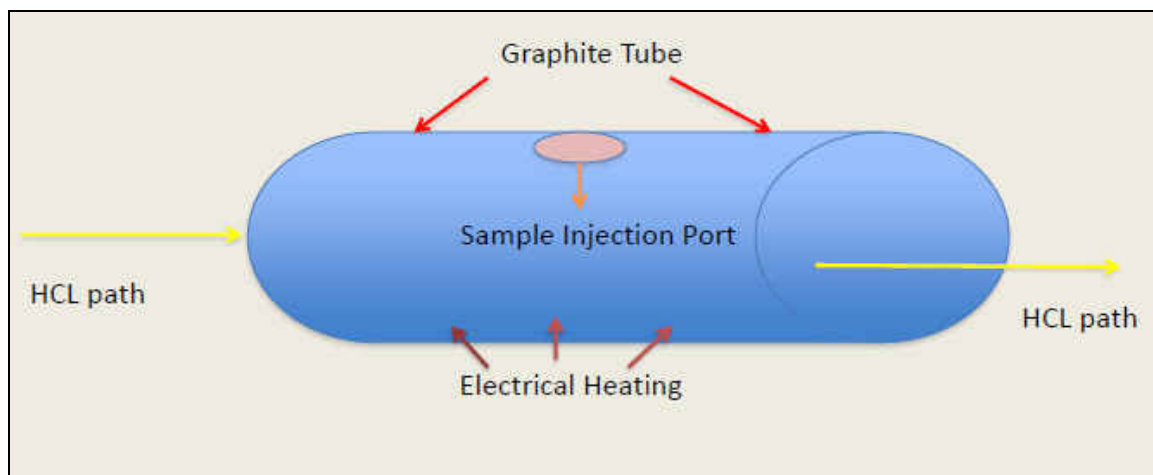


Figure 12. Schematic diagram of the Pb(II) hollow cathode lamp [40].

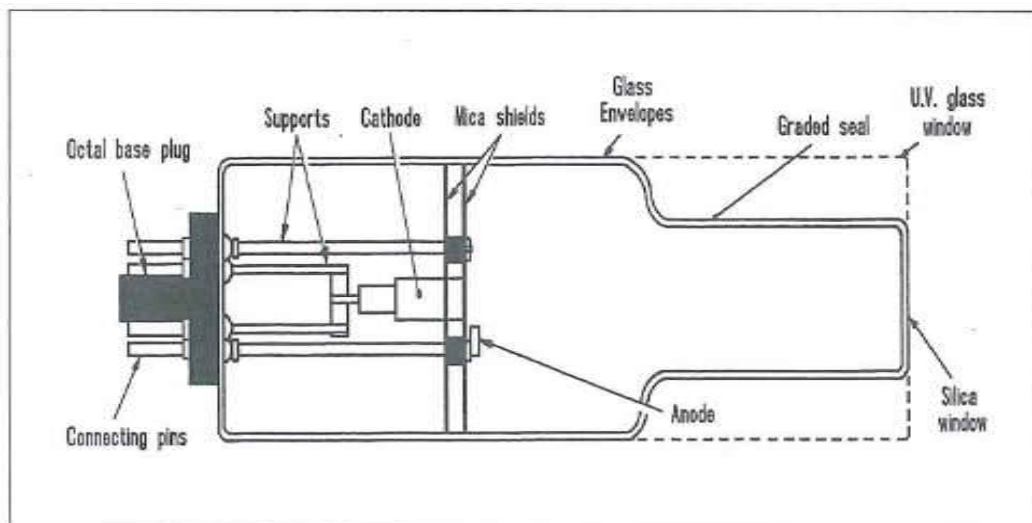
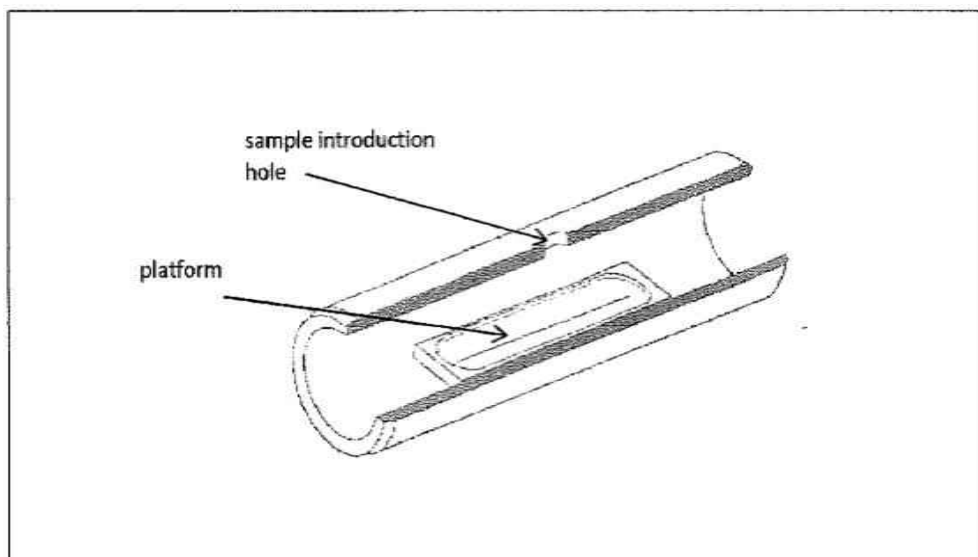


Figure 13. Graphite platform cuvette (furnace) used as the sample holder [40].

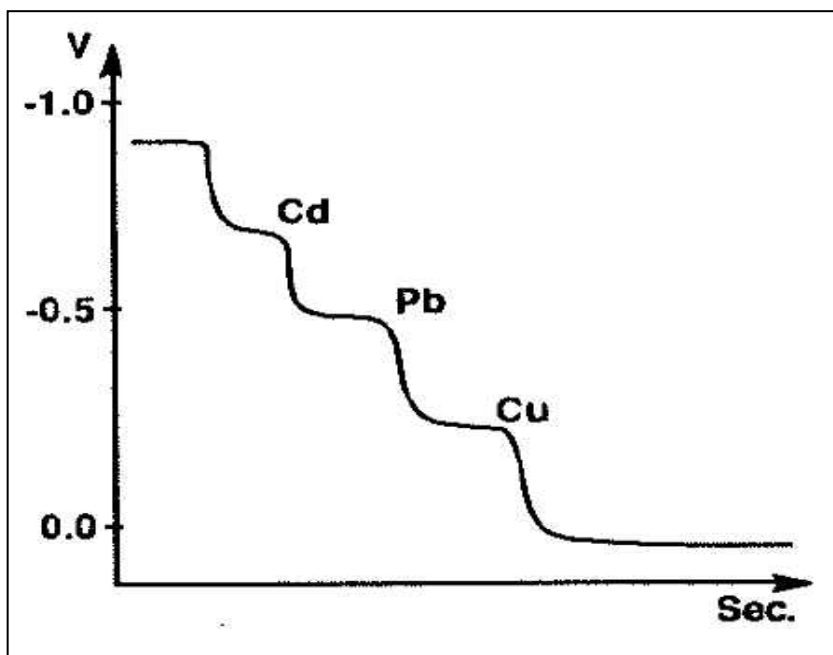


1.6.3 Potentiometric Stripping Analysis

In addition to the optical spectroscopic and mass spectrometric methods, an electrochemical method, Potentiometric Stripping Analysis (PSA), was applied to the determination of Pb(II) in river and lake sediment extracts. PSA offers comparable detection limits (low ppb) to those exhibited in ICP-MS and GFAAS, high selectivity with appropriate sample pre-treatment, and a multi-element capability (though not as powerful as ICP-MS in that regard) [38, 43, 44]. As an electroanalytical technique, PSA allows for speciation by valence, something which cannot be accomplished by the other methods and which can be very useful in the determination of elements with multiple oxidation states [43]. A significant practical advantage of PSA over ICP-MS and GFAAS is the relatively simple instrumentation and operational procedures [43, 44, 45].

There are two main steps in the PSA experiment: deposition and stripping [43, 44, 45]. During deposition, metal ions in the sample solution are reduced at a negative potential and then dissolved into the working electrode [43, 44]. During the stripping step, the reduced form of the analyte is re-oxidized back into the sample solution. Oxidation is accomplished chemically by the presence of dissolved oxygen in solution; additionally, a small oxidizing current, typically +1 μA , is applied to improve the precision of the measurement [43, 44]. The change in potential of the working electrode is monitored and recorded over time, as depicted schematically in Figure 14. The amount of time to strip the metal from the working electrode is related to the amount of Pb(II) in the original sample solution [43, 44]. For computational ease, the response shown in Figure 14 is typically transformed to E vs $\Delta t/\Delta E$ to allow for representation of the quantitative signal as a peak rather than a plateau [43, 44].

Figure 14. Schematic diagram showing the creation of the chronopotentiogram [44].



Chapter Two

Experimental

2.1 Reagents

Chemical reagents used in this work were of Analytical Reagent (AR) grade or better [14]. Reagent water (18 M Ω -cm) was prepared using a NanoPure™ Infinity filtration system equipped with an ultraviolet (254 nm) lamp (Barnstead-Thermolyne, Dubuque, IA, USA) [14]. All glassware and plasticware were washed with Citranox (Alcanox, New York, NY, USA) and soaked for a minimum of 36 hr in 5% (v/v) HNO₃ in reagent water (Trace Metal grade, Fisher Scientific, Pittsburgh, PA, USA) followed by copious rinsing with reagent water [14]. Stock standards (1000 mg L⁻¹) were stored in opaque high-density polyethylene (HDPE) bottles (Fisher Scientific) [14].

2.1.1 Reagents for Sequential Extraction Study

High-density polyethylene (HDPE) sample bottles (Wheaton, IL, USA) were used to store the liquid extracts at 4°C until analysis [14]. Before analysis, all extracts were filtered through 0.45 μ m cellulose (Whatman Brand™); therefore, the concentrations of metals sorbed to particles greater than approximately 450 nm could not be determined [14].

2.1.1.1 Exchangeable Fraction for Sequential Extraction Method

The first extraction step required a 0.010 M CaCl₂ solution (Fisher Scientific, ACS reagent grade) stored in glass at room temperature (RT) (hereafter referred to as “Solution A”) (Figure 15) [14].

2.1.1.2 Carbonate Fraction for Sequential Extraction Method

The second extraction step required Glacial Acetic Acid (Fisher Scientific) in reagent water, stored in HPDE at RT (hereafter referred to as “Solution B”) (Figure 15) [14].

2.1.1.3 Metal-Oxide Fraction for Sequential Extraction Method

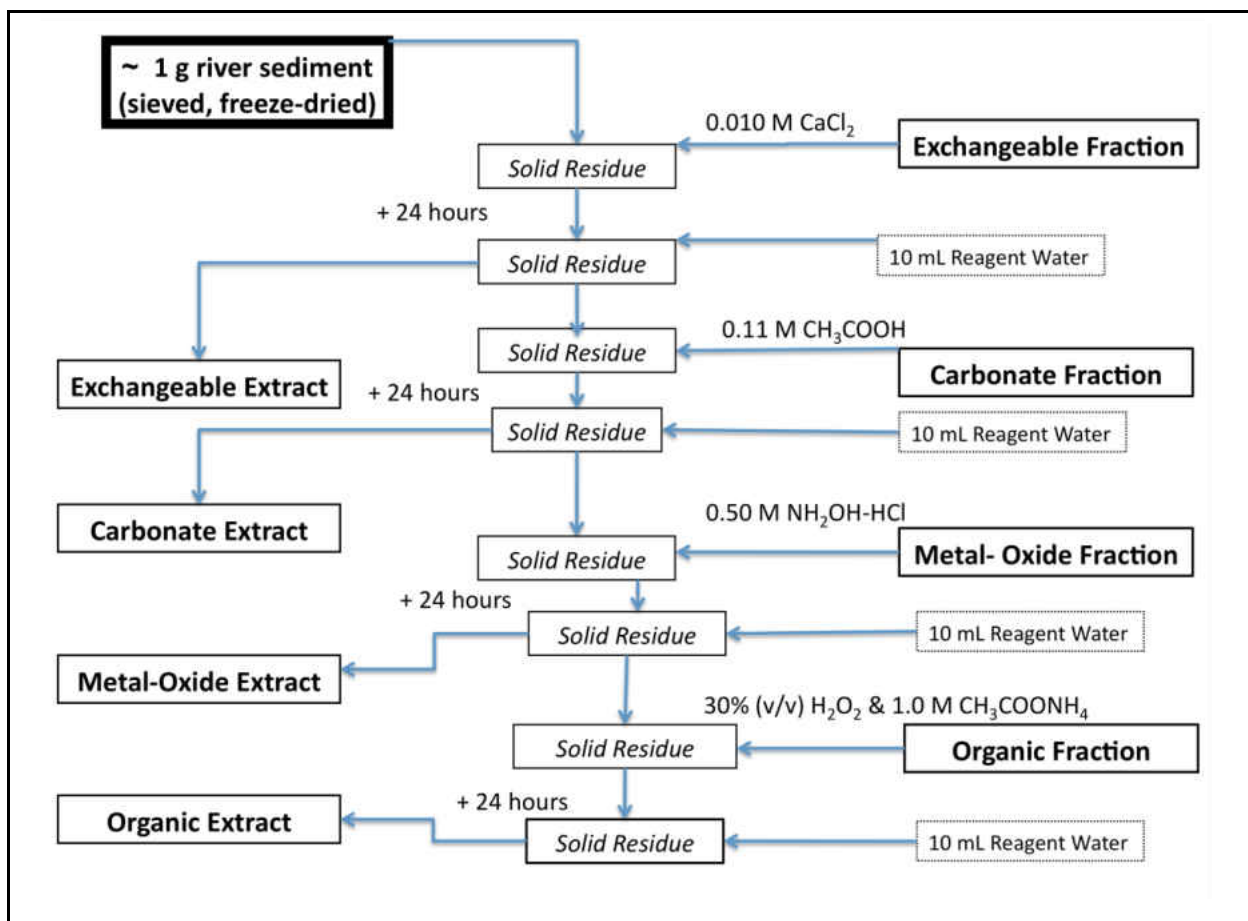
NH₂OH-HCl (Acros Organics, Fair Lawn, NJ, USA) was prepared with reagent water and 1.0 M HNO₃, stored in glass at RT, freshly prepared on the day of use (hereafter referred to as “Solution C”) (Figure 15) [14].

2.1.1.4 Organic Fraction for Sequential Extraction Method

Hydrogen peroxide (H₂O₂) (acid-stabilized, pH 2-3) (Acros Organics) and ammonium acetate (CH₃COONH₄) (Acros Organics) dissolved in reagent water were used as the organic fraction leachant [14]. The pH of the latter was adjusted to 2.00 ± 0.10 with HNO₃ [14]. Both solutions were stored at RT [14]. The H₂O₂ solution was

stored in an opaque plastic bottle (hereafter referred to as “Solution D”) and the $\text{CH}_3\text{COONH}_4$ was stored in glass (hereafter referred to as “Solution E”) (Figure 15) [14].

Figure 15. Schematic of a Modified Sequential Extraction Scheme [14].



2.1.1.5 Reagents for Column Study

Prior to analysis, the sediment was dried for 1 hr at 110° C [14]. After drying, approximately 100 g of sediment was weighed and transferred into an OmniFit glass column (Supelco, Bellefonte, PA, USA) as a slurry mix with reagent water. After the sediment was level in the column, solutions of high purity (99.999% w/w) NaCl (Acros Organics) at various concentrations were pumped through the column using a peristaltic pump (Alitea Model S2 Series, Seattle, WA) at a flow rate of varying between 0.30 - 0.50 mL/min. The post-column leachate was collected in 250 mL HPDE containers and immediately stored at 4°C.

2.1.1.6 Reagents for Inductively Coupled Plasma-Mass Spectrometry (ICP-MS)

Trace Metal grade HNO₃ (2% v/v) was used to make all standard solutions for the ICP-MS work. Stock standards were stored in opaque HPDE bottles. Certified Standards for As, Bi, Cd (II), Cr, Cu (II), In, Pb(II), Yt, and Zn (II) were obtained from Aldrich Chemical (Milwaukee, WI, USA), Fisher Scientific, Ricca Chemical Company (Arlington, TX, USA), and Lab SPEX (SPEX, Metuchen, NJ, USA) [37, 47].

2.1.1.7 Reagents for Atomic Absorption Spectroscopy Method – Graphite Furnace (GFAAS)

Lead standards and other solutions used for GFAAS analysis were prepared in the same manner as the ICP-MS standards [40].

2.1.1.8 Reagents for Potentiometric Stripping Analysis (PSA)

Trace Metal grade acids were also used to make standard solutions for the PSA work. The Pb(II) and As standards were obtained from Aldrich Chemical. A 100 mg/L (ppm) Hg plating solution prepared in 0.10 M HNO₃ was used for the determination of Pb(II) [44, 46, 48].

2.2 River and Lake Sediment Sampling

Surficial lake sediment samples (approximately 25 cm in depth) were collected from Green Bay at Station 40 (~15 km southeast of Marinette, WI) from R/V Neeskay using a PONAR (grab) sampler [34]. River sediment samples were collected from 13 locations along the Pike River in Kenosha and Racine counties in southeastern Wisconsin [5]. Sample sites were selected along six tributaries and at seven locations along the main river. Sediment was also obtained from two control sites; one from Lincoln Creek in Milwaukee, WI and one from Nichols Creek located in Sheboygan County, WI. Duplicate grab samples were collected using an Bottom Grab Sampler (Eckman, Columbus, OH, USA) [5]. Immediately after collection, samples were transferred to clear round-bottom HPDE bottles and stored at 4°C until they were dry-sieved and freeze-dried. Note: all sediment was dry-sieved, freeze-dried and stored in accordance with the United States Geological Survey procedure [5].

2.3 Modified Sequential Extraction Procedure

Sediment samples were subjected to a sequential leaching method.

Approximately 1.0 ± 0.1 g of sediment from each site was weighed and dried at 110°C for 1 hr. The dried sediment was transferred to 50 mL polypropylene centrifuge tubes (Becton Dickinson Labware, Franklin Lakes, NJ, USA) then subjected to successive sequential leaching, as described below [14].

A schematic diagram of the modified sequential extraction procedure is shown in Figure 15 [14]. Into 50 mL polypropylene centrifuge tubes containing the sediment, 40.0 mL of Solution A was added, followed by continuous tumbling (Brother Gearmotor, Inc., Bridgewater, NJ, USA) at approximately 1 Hz for a minimum of 24 hr [14]. After tumbling, the liquid extracts were separated from the solid residue by centrifugation at 3000 g for 20 min. (Eppendorf Model 5702 centrifuge, Hamburg, Germany) [14]. The supernatant liquid was then decanted into 125 mL (HDPE) bottles. The solid residue remaining in the 50 mL centrifuge tubes was washed with approximately 10 mL of reagent water, tumbled for 15 min and centrifuged for 20 min at 3000 g [14]. The supernatant was quantitatively added to the previous extract and stored at 4°C until analysis [14]. This procedure was used for the first three steps of the BCR method [9].

For the fourth extraction step (organic fraction), 10.0 mL of Solution D was added slowly because of the potential for rapid evolution of gas during the oxidation reaction [14]. The solution was digested for 1 hr at RT along with gentle shaking by hand every 10 min [14]. The solution was transferred to a water bath at approximately 85°C in which digestion continued for another hour. Next, the leachant volume was reduced to approximately 3 mL over several hours by further heating of the uncapped centrifuge

tubes [14]. An additional aliquot of 10.0 mL of Solution D was added at the end of this period. The extracts were vortexed briefly and returned to the water bath for another hour with occasional swirling during the first 30 min [14]. Next, the caps were removed and volume reduced, again for several hours, to approximately 1.0 mL [14]. After cooling, 50.0 mL of Solution E was added to dissolve the residue [14]. The procedure described above for the previous steps (i.e., rotating, centrifuging, and storage) was also used for the organic extracts [14].

2.4 Instrumentation

2.4.1 Inductively Coupled Plasma-Mass Spectrometry

A Micromass Platform ICP-MS (Micromass, Manchester, United Kingdom) (Figure 16) was used for the determination of the trace metal analytes [37]. To aid in the prevention of secondary reactions and other interferences that may occur during the mass discrimination process, two hexapole gases, He and H₂ were utilized [37]. An electron multiplier Dynolite™ detector is incorporated into the ICP-MS instrument used for this work, to convert the number of ions striking the detector into an electrical signal (Figure 17) [37]. The Micromass Platform-ICP utilized a Meinhard concentric nebuliser and a standard Scott double pass type spray chamber made from quartz glass [37].

The Pike River sediment extracts were subjected to elemental analysis over the m/z range of 50-238 as "full scans" and, additionally, for Cu (II), Zn (II), Cr, As, Cd (II), and Pb(II), as "single ion monitoring" (SIM) scans at the following m/z values: ⁵²Cr, ⁶⁴Zn, ⁶⁶Zn, ⁶³Cu, ⁶⁵Cu, ⁷⁵As, ¹¹²Cd, ¹¹⁴Cd, ²⁰⁸Pb. The SIM scans provided lower detection limits than the full scan measurements because during a SIM scan, the detector spends more time integrating the signal at specific ion masses, thereby increasing sensitivity [37]. Additional isotopes were also selected for SIM to examine the influence of possible interferences and to ensure more accurate determination of the primary metals [37, 47]. The additional isotopes were chosen based on suggestions from EPA Method 6020 for ICP-MS determination and various studies that carried out modified sequential extraction procedure for the evaluation of various metals [37, 39, 47]. In most studies, a justification for the isotopes selected was not provided, however, studies that did explain their choices for analysis alluded to the fact that they were hoping to prevent spectral

interferences [51-58]. Table 2, summarizes the isotopes commonly utilized in ICP-MS for the analysis of metals in sediment, is presented at the end of this chapter. Multi-element standards containing As, Cd, Cr, Cu, Pb(II) and Zn over the concentration range of 0-500 ppb ($\mu\text{g/L}$) were used to construct calibration models for the major isotope of each metal.

2.4.2 Graphite Furnace Atomic Absorption Spectroscopy (GFAAS)

The determination of Pb(II) in select Pike River sediment extracts was accomplished on a ThermoElemental M5 series Atomic Absorption Spectrometer (Thermo Fisher Scientific, Waltham, MA, USA) as a "referee" method to the ICP-MS measurements that are described above.

A Pb(II) HCL (Varian, Model S81105) set at a current of 10 mA with a wavelength of 283.3 nm as the primary emission line was used for this work [40]. A schematic diagram of the Pb(II) HCL is presented in Figure 12 and Figure 18 [40]. For background correction, a high-intensity D₂ (deuterium) arc lamp (Varian, Model AWM I A/B) was used as a continuum source [40]. Atomization of liquid samples occurs after sample introduction into an electrothermal graphite tube (Thermo Model GF95) (Figure 18) [40]. Liquid samples (~ 20 µL) are directly introduced through an opening in the graphite tube (Figure 11 and Figure 18) [40]. Furnace and sampling conditions for determining Pb(II) on the ThermoElemental M5 spectrometer are presented in Table 2 [40]. As shown in Table 3, to efficiently create the gas-phase neutral analyte atoms that are needed for the absorption measurement, the graphite furnace heats the sample through an analyte-specific temperature program [40]. Recall, this program has four distinct phases outlined in CH 1, Introduction.

2.4.3 Potentiometric Stripping Analysis (PSA)

Pb(II) in river and lake sediment extracts was determined by PSA using a Model PSU 22 "Trace Lab™" Potentiometric Stripping system (Radiometer, Copenhagen, Denmark) [44]. The PSA method used for Pb(II) determination was based on EPA Method 7063. In addition, ICP-MS and GFAA was used here as a referee techniques.

For the PSA procedure, approximately 20 mL of the sample sediment extracts were added to HDPE vials and adjusted to a pH of 2.00 with Trace Metal grade mineral acids [44]. A mercury electrode was used as the working electrode for the determination of Pb(II) (Figure 19). The electrode was in the form of a thin film that had been plated beforehand onto a polished glassy carbon electrode surface (3 mm diameter). The glassy carbon electrode was polished for 15 minutes with 0.050 μm alumina prior to the plating of Hg. In addition, the reference (Ag|AgCl) electrode was stored in 3 M KCl and the counter (auxiliary) electrode (Pt) was lightly polished with fine emery paper.

2.5 Data Acquisition

Mass spectrometric data were acquired by using MassLynx software (Version 3.4, Micromass) on a PC (Professional Workstation AP200, Compaq/HP, Palo Alto, CA, USA) [37]. Atomic absorbance data were acquired by using the SOLAAR M/S Series software (Version 10.14, Thermo) on a PC (Dell, Client Pro 385, Round Rock, TX, USA) [40]. Chronopotentiometric data was acquired using Radiometer's TAP2 software on a PC (IBM, San Jose, CA, USA) [44].

2.6 Column Leaching Study

The impact of ionic strength on the mobility of Pb(II) in sediment collected from Green Bay was studied by means of a column leaching experiment. Surficial sediment from the Pike River that had been used in the initial characterization of metals by the BCR study was inadequate for the column-leaching experiment because of the absence of detectable (< 0.50 ppb) levels of Pb(II) in the batch extract samples. Instead, surficial lake sediment collected in a previous study from Green Bay was used for the column work [59]. Batch tests, done in triplicate by PSA, revealed Pb(II) at levels that were above the detection limit at a concentration of ~ 2.5 ppb. The detection limit was calculated at three times the standard deviation of the blank (2% (v/v) HNO_3), that is: $\langle x \rangle + 3\sigma$ where $\langle x \rangle$ is the average value that was observed for the blank standard. Green Bay extracts were filtered through $0.45 \mu\text{m}$ cellulose acetate; hence, the concentrations of metals sorbed to particles greater than approximately 450 nm could not be determined.

A calibration model covering a concentration range of 0 to 100 ppb was developed. Emphasis, in regards to the number of standards, was put on the lower end of the concentration range because the concentration of Pb(II) would likely be < 50 ppb. Based on the BCR studies, Pb(II) is among the metals that are the most tightly retained in soils and sediment [9, 11, 13]. Release by a change in ionic strength required careful monitoring of the lower concentration range. The concentration of Pb(II) in all standards and column extracts was determined at the redox potential of Pb(II) at -450 mV as referenced to a Ag|AgCl electrode [44]. Peak area was the quantitative signal for construction of calibration models for determination of Pb(II) [44].

For the leaching scheme, an ionic strength of 0.010 M, 0.050 M, or 0.10 M NaCl was applied. Three columns were prepared, one for each ionic strength level, and each was subjected to the same flow rate and volume of leachant [60, 61]. Approximately 100 mL of reagent water was allowed to flow through the column prior to introduction of the leaching solution. The scheme used for this work is based upon suggested values from other studies, taking into account measured ionic strength of NaCl in natural (expected), moderate, and extreme conditions [25, 27, 29]. Moderate to extreme conditions are usually exhibited after a spring snowmelt when ionic strength values of NaCl in various freshwater samples have been measured greater than or equal to approximately 0.030 M [29]. Natural or normal conditions for many freshwater river or lake sediments have been reported at 0.010 M NaCl [29]. Additional factors such as the type of column, column dimension, and the amount of soil and leachant were modified slightly based on what was present in the literature because the latter components significantly varied among the published studies [25, 27, 29, 60, 61]. The additional factors taken into consideration for the column design are outlined in Chapter 3, Results and Discussion [25, 27, 29]. The column design for this thesis work was based on a combination of models from the leaching studies chosen for comparison. The dimensions used for the glass column were based on the minimum amount of sediment needed to yield a detectable amount of Pb(II). An optimal flow rate between 0.3 mL/min and 0.5 mL/min was chosen based on similar values in past column studies and to give a leachant flow that would not dramatically disrupt the sediment within the column. Emphasis on L/S, liquid to solid ratio, was especially prevalent in the Norrstrom study. Liquid to solid ratio is defined as the ratio of a specified volume of leachant (L) and the corresponding dry

mass (kg) [25, 60]. A L/S of 2 was utilized in this work because of the limited input of leachant; Norrstrom's works suggests that a L/S of 2 is recommended in leaching tests for material exposed to a limited input of water [25, 60].

Table 2. Operating Conditions for the Micromass ICP-MS [47, 51 - 58].

ICP-MS Operating Conditions	Micromass Platform ICP
Number of Replicates	4
Dwell Time	4 sec
Integration Time	1.5 min
Plasma Conditions:	
Gas Flow	13.00 L/min
Nebulizer Gas Flow	1.00 L/min
Sample Flow	1.00 mL/min
Hexapole Gas Flow - He	3.5 L/min
Hexapole Gas Flow – H ₂	3.5 L/min
Forward Power	1350 W
Ion Energy	2 eV
Element	Mass-to-charge values (secondary ions are shown in parentheses)
As	75 (77, 82)
Cd	114 (110, 111, 112)
Cr	52 (53, 54, 58)
Cu	63 (65)
Pb(II)	208 (206, 207)
Zn	64 (66)

Table 3. GFAAS Operating Conditions [40].

GFAAS Operating Conditions - Pb(II)			
Furnace Conditions			
Phase	Temperature (°C)	Time (sec)	Gas Flow (L/min)
1	100	30.0	0.2 L/min
2	800	20.0	0.2 L/min
3	1200	5.0	off
4	2500	3.0	0.2 L/min
Spectrometer Settings			
	Wavelength	283.3 nm	
	Background Correction	D ₂	
	Measurement Time	3.0 sec	
	Bandpass	0.5 nm	
	Gas Type	Argon (99.999%)	
	Measurement Mode	Absorbance	

Table 4. PSA Operating Conditions [44].

PSA Operating Conditions (Radiometer TAP2) - Pb(II)	
Rest Potential (mV)	-100
Electrolysis Potential (mV)	-750
Quantitation/Integration Potential (mV)	-450
Current	1
Plating Solution	Hg on Glassy Carbon
Reference	Ag/AgCl

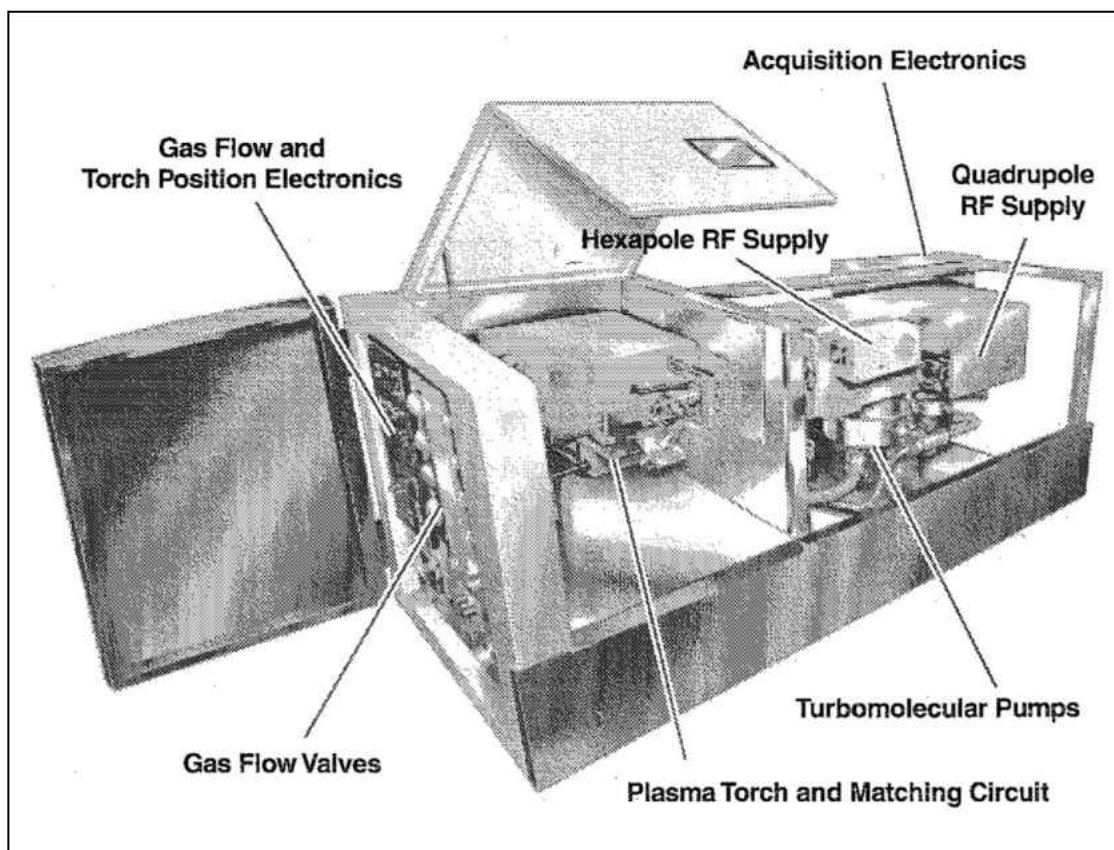
Figure 16. Photograph of the Micromass Platform ICP instrument [37].

Figure 17. Schematic diagram of the ICP-MS instrument [37].

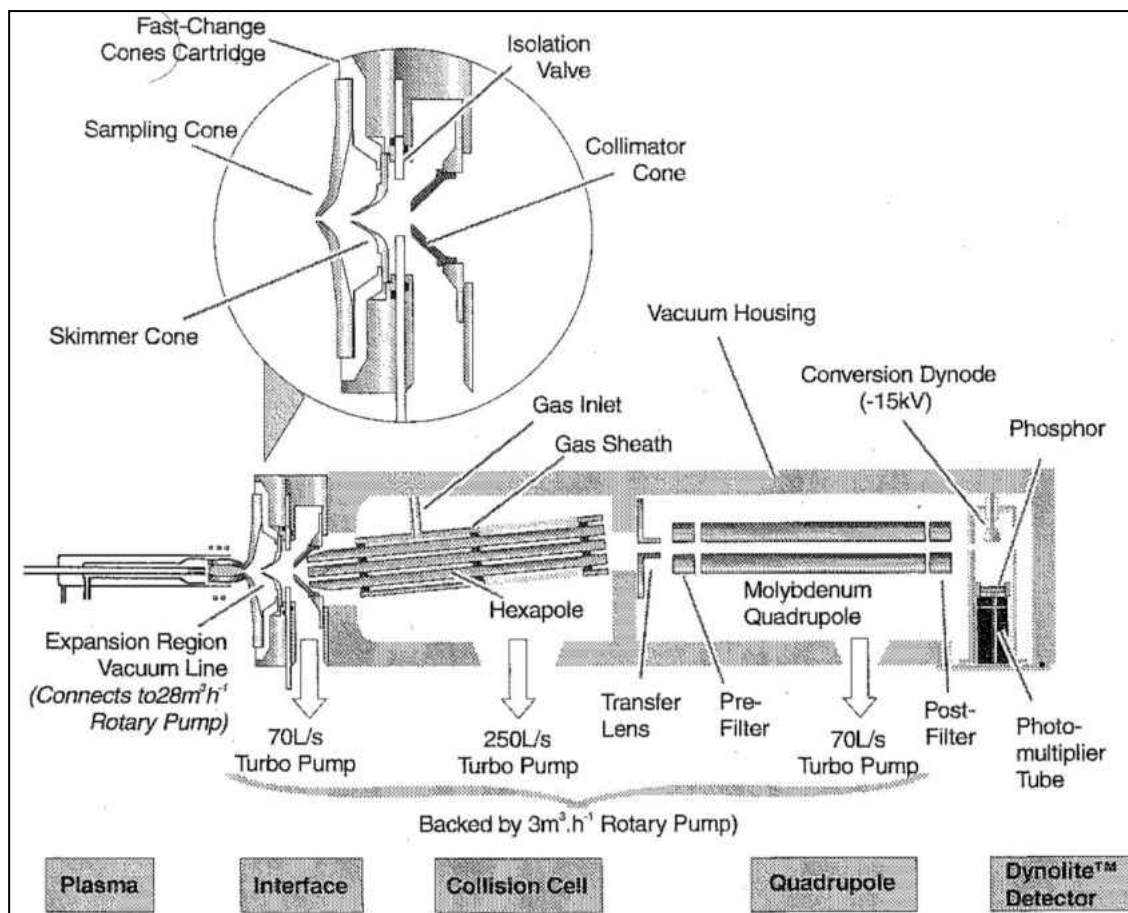


Figure 18. Schematic Diagram of the M5 Series ET-AAS [40].

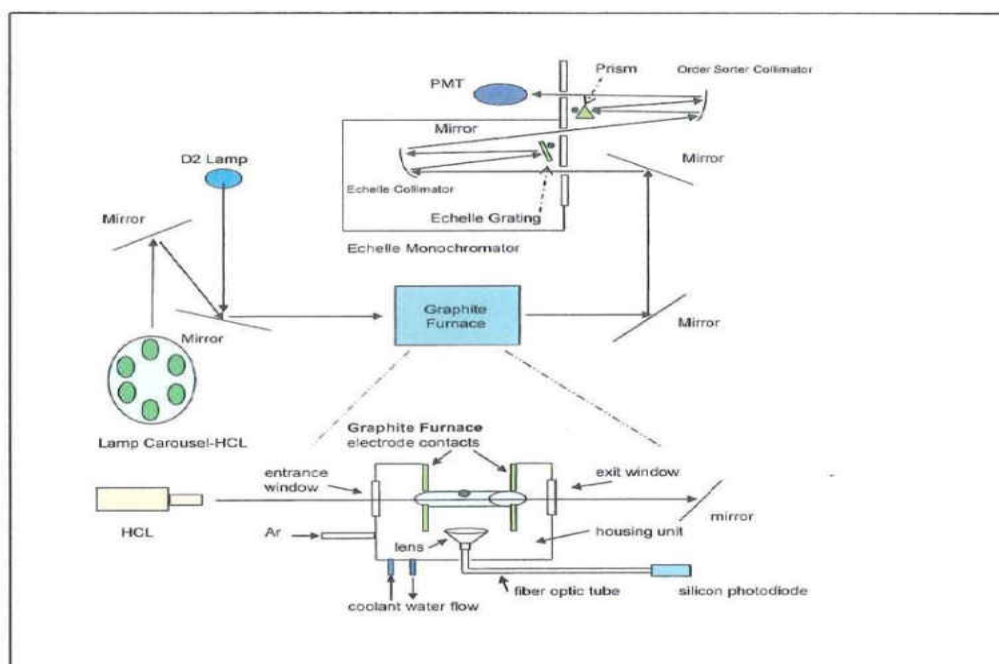
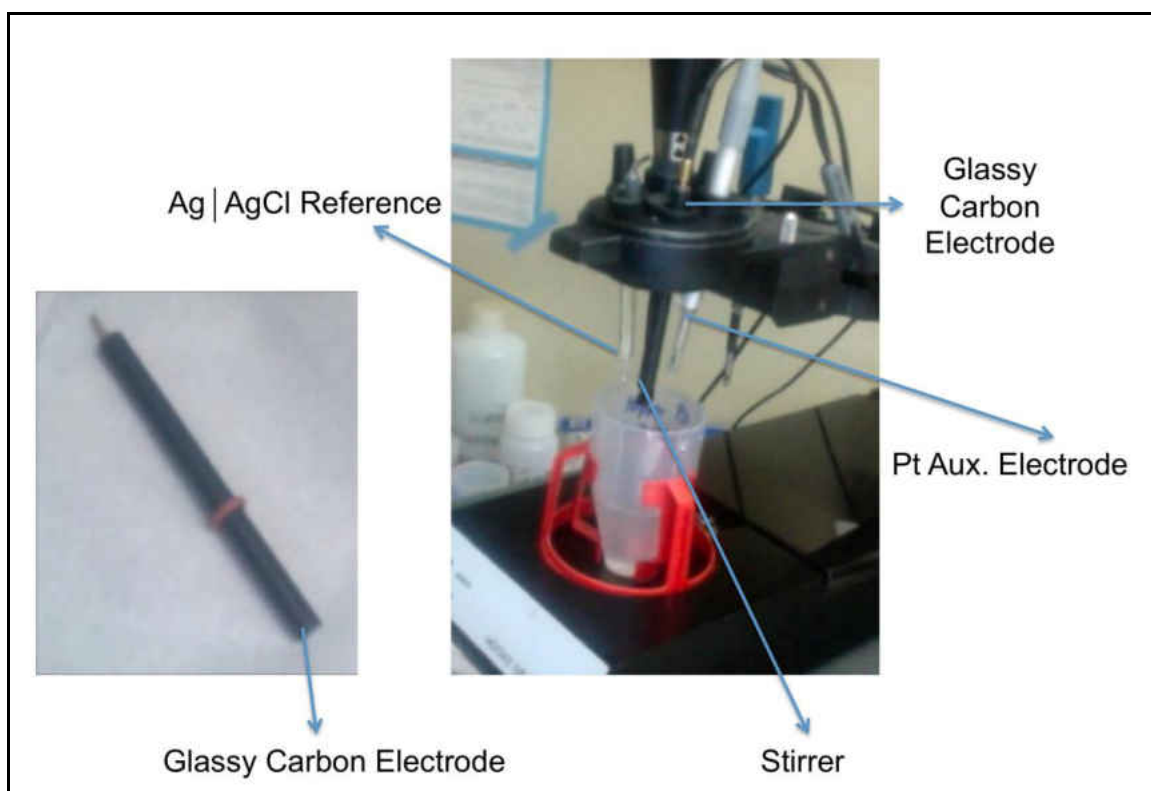


Figure 19. PSA Sample Cell Set-Up [44].



Chapter 3

Results and Discussion

This investigation entailed the study of the abundance and distribution of various toxic metals (As, Ba, Cd, Cr, Cu, Pb, Sr, and Zn) in riverine and lacustrine sediments. The sediment samples were subjected to a standard method for sequential extraction to determine their distribution in the mobile, carbonate-bound, metal oxide-bound, and organic fractions. The sediment samples were also studied by use of a column leaching experiment as a means to better understand their degree of association with the sediment and, in particular, the extent to which high ionic strength solution conditions influenced their release from the sediment particles. Analytical methods were developed for metal determinations in this study by atomic mass spectrometry, atomic absorption spectroscopy, and electrochemical stripping analysis.

Part I: Characterization of Six Heavy Metals in River Sediment by ICP-MS

3.1 Inductively Coupled Plasma-Mass Spectrometry

Analysis of select Pike River sediment extracts showed there to be measurable levels of the following metals: As, Ba, Cd (II), Cr, Cu (II), Pb(II), Sr, and Zn (II). These metals were found in sediment from all thirteen sites on the Pike River, including the two control sites (Lincoln Creek and Nichols Creek). Full scan m/z measurements (from m/z 50 to 238) and single ion monitoring (SIM) scans of As, Cd (II), Cr, Cu (II), Pb(II), and Zn (II) were done. The following isotopes were monitored during the SIM scans: ^{52}Cr , ^{64}Zn , ^{66}Zn , ^{63}Cu , ^{65}Cu , ^{75}As , ^{112}Cd , ^{114}Cd , and ^{208}Pb . Full scan measurements showed that a broad range of metal ions were present in the samples. Each isotope measured corresponded to an intensity value which was measured as counts per second [37, 47]. The intensity of each isotope is proportional its concentration. The intensity values from the SIM measurements were used to quantify each metal [37]. Multi-element standards containing each metal were used to construct calibration plots (Figure 20). Intensity values for the most abundant isotope of each metal were used to construct calibration models in which the concentration of each isotope was determined based upon the linear regression equation that was calculated (Figure 20) [37, 47].

Some significant points should be considered in interpreting the ICP-MS data: (1) spectral interferences were evident, particularly for As from the formation of $^{40}\text{Ar}^{35}\text{Cl}^+$ at m/z 75; (2) the extracts were filtered through 0.45 μm cellulose disks, therefore, the concentrations of metals sorbed to particles greater than approximately 450 nm were not determined; (3) although full scan analysis revealed significant levels of Ba and Sr, statistical analysis of the data was not done because they are alkaline earth metals

commonly found in the environment in sources such as soil, minerals, and water. The presence and toxicity of the two metals is often not of major environmental concern in comparison to the other five heavy metals and metalloid As chosen for this work. Hence, emphasis was placed on those elements whose presence in the environment is often monitored based on their toxicity and significant impact on the environment.

Consideration of significant spectral interferences was taken into account when determining the concentration of each metal isotope, in particular As. A calculation correction for monoisotopic ^{75}As was done to ensure measurement was free of spectral interferences caused by polyatomic species formed from the interaction between the Argon plasma and various matrix components according to EPA Method 6020A for ICP-MS [36, 37, 47]. In particular, the well-known polyatomic interference at m/z 75 that is caused by the presence of low levels of Cl^- in a sample that results in the formation of $^{40}\text{Ar}^{35}\text{Cl}^+$ [36, 37 50]. Correction of the As signal is based upon the subtraction of the signal for ^{77}Se from ^{82}Se that is confounded by the formation of $^{40}\text{Ar}^{37}\text{Cl}^+$. The calculation used to correct for the ^{75}As signal is [36, 37, 47]:

$$^{75}\text{As signal} = ^{75}\text{As} - 3.127 \times (^{40}\text{Ar}^{77}\text{Cl} - (0.815 \times ^{82}\text{Se}))$$

3.1.1 Sequential Extraction Results and Trends

ICP-MS was used to examine the trace metal content of several sediment extracts prior to being subject to the BCR procedure. An overall geographical trend of metal concentration was not evident; however, a more general trend may have been more evident if sampling was done on a much larger scale. As mentioned in the Experimental section, triplicate grab samples of sediment were collected at each site in a small defined

area which may or may not have been a reflection on the extent of sources of detectable metals at each site [21]. Among the 11 Pike River sites, one tributary (Waxdale) and two mainstem sites (PN 2 and PN 3) consistently had some of the highest concentrations of selected metals in each fraction. According to the WI-DNR, Waxdale Creek is considered an "impaired water" because of extensive pollution and other factors that impact the quality of the ecosystem [21]. PN 3, followed by PN 2, are both located downstream of Waxdale and it is clear that Waxdale is the source of the metals that were detected directly downstream; further evidence is found by comparing the lack of metal pollution at sites that are north of Waxdale and south of PN 2. The "exchangeable" phase contained the lowest levels of metals, i.e., metals that are readily released from sediment. The highest concentration of metal detected in the mobile phase was $65 \mu\text{g}/\text{kg} \pm 5.2 \mu\text{g}/\text{kg}$ for Zn, indicating that Zn is the most easily released or extractable metal among the six species studied under the conditions of the BCR extraction procedure. Most of the metals, except for As, were detected at or near $5.0 \mu\text{g}/\text{kg} \pm 4.1 \mu\text{g}/\text{kg}$ (Figure 21). In fact, As was not detected in the exchangeable, carbonate, or metal-oxide extracts – only in the organic fraction (vide infra). Because "absence of evidence does not mean evidence of absence", As may have been bound to the $>450 \text{ nm}$ particle fraction, for example.

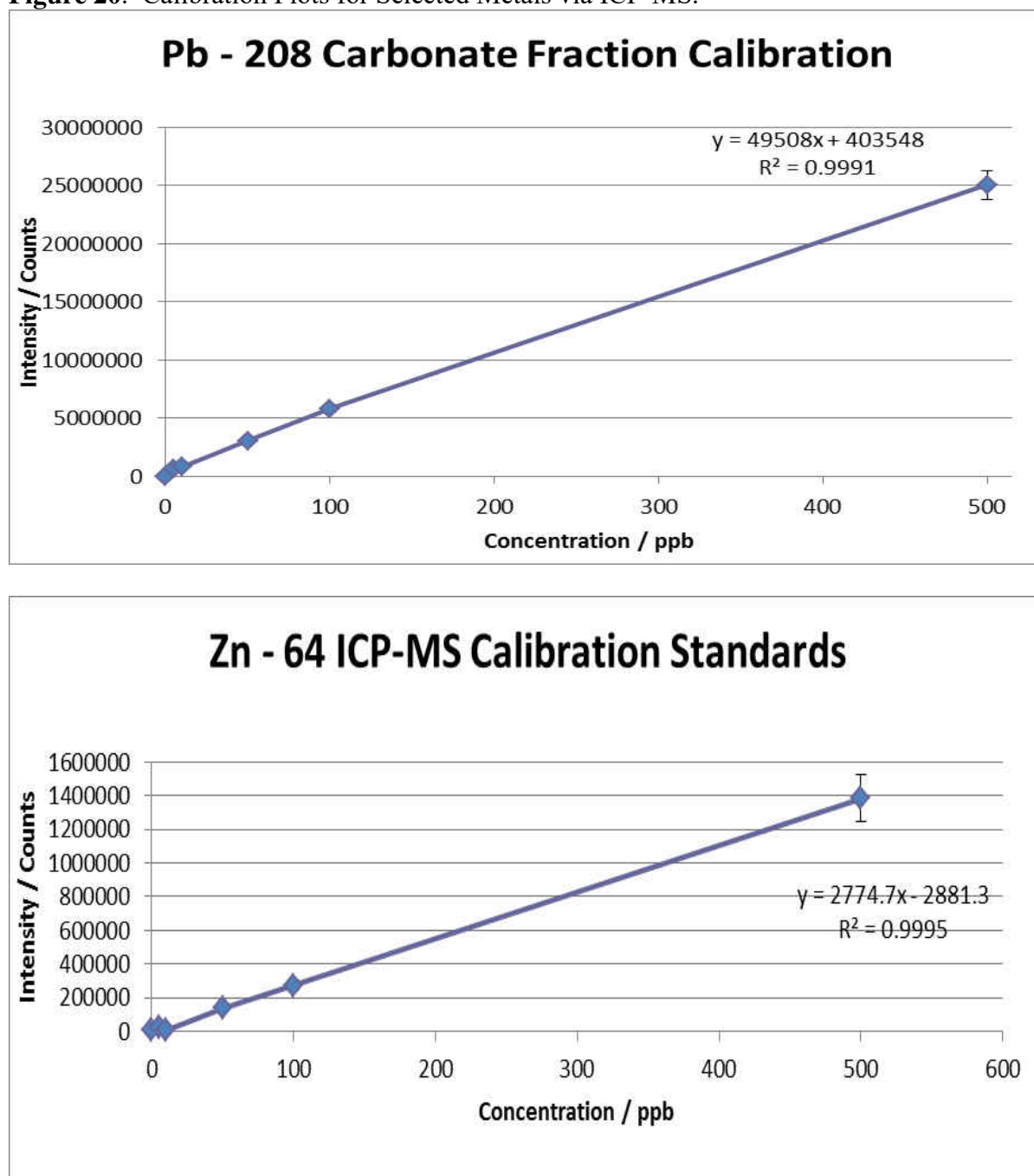
Among the six metals, Pb(II) in addition to Cr, Cu and Zn, were detected in all four phases (Figures 21, 22, 23, 24). The highest concentrations were found at sites PN2 and Waxdale for Pb(II)-208 and Zn-64 at 186 ppb and 1072 ppb respectively (Figure 24 and Figure 22). The highest Pb(II)-208 level was measured in the organic fraction; however, it should be noted that a significant amount ($176 \pm 4.7 \mu\text{g}/\text{kg}$ ppb) of Pb(II)-208 was measured in the carbonate fraction (Figure 22). The tracking of Pb(II) in all four

fractions is presented in Figures 2 showing each site in geographical order going from north to south. Note: only three of the 11 Pike River sites were chosen for exchangeable fraction analysis because the three sites had measureable levels of each metal except for As in an initial ICP-MS run. As was the case for all six metals, generalizations regarding metal-sediment association for the entire Pike River should be not made based on these results. However the potential extent of metal mobility can be estimated at isolated sites, such as PN-2 and Waxdale, in which Pb(II) was detected at much higher levels than most other metals in the more tightly bound sediment fractions.

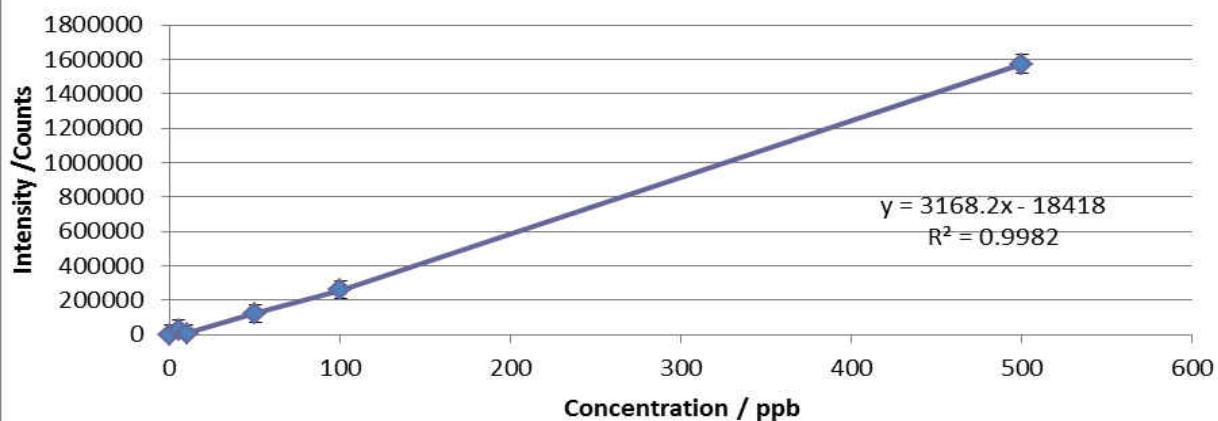
The ICP-MS work alone is not enough to formally characterize the extent of contamination or metal mobility for the entire Pike River but the work gives some insight into mobility at individual sites. Table 5 contains the threshold effect concentration levels (TEC) for each metal as mg/kg per dry weight in sediment according to a Wisconsin Department of Natural Resources consensus guideline issued in December 2003 [62]. The TEC levels are based on a four-level sediment guideline, with the TEC being the lowest probable level for contamination concern in the evaluation of sediment toxicity in freshwater systems [62]. None of the selected heavy metals detected by ICP-MS were above the TEC's, revealing that the extent of contamination is relatively low. The US EPA does not promulgate a national standard for maximum contaminant levels (MCLs) for these metals in sediment. The MCLs that exist are appointed on a regional watershed or more local scale (i.e., state, city, or local municipalities) [62].

Table 5. WI-DNR TEC levels and measured Pike River extract concentrations of six heavy metals [62].

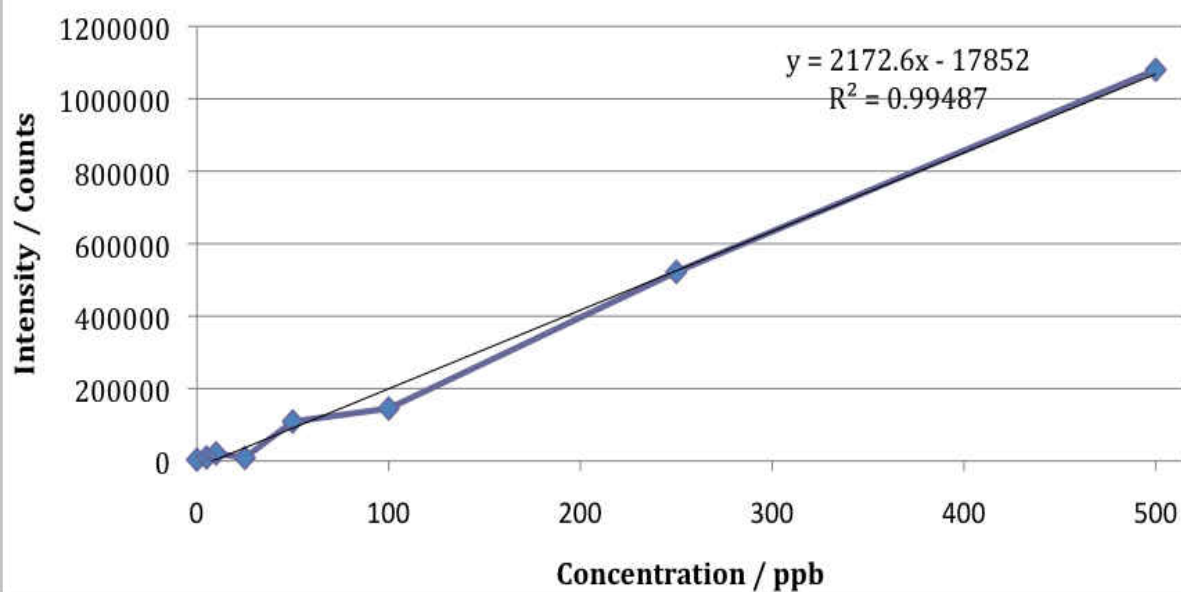
Consensus Based Sediment Quality Guidelines Comparison to Highest Observed Metal Concentrations			
<i>Metal</i>	<i>TEC Level (ug/kg (ppb) - dry weight)</i>	<i>Highest Observed Conc. (ug/kg)</i>	<i>Ratio of TEC to Observed Highest Concentration</i>
As	1.98E+04	9.91E+01	5.00E-03
Cd	9.90E+02	3.42E+01	3.45E-02
Cr	4.30E+04	4.43E+01	1.03E-03
Cu	3.20E+04	5.48E+01	1.71E-03
Pb	3.60E+04	1.87E+02	5.19E-03
Zn	1.20E+05	1.08E+03	8.96E-03

Figure 20. Calibration Plots for Selected Metals via ICP-MS.

Cu - 63 ICP-MS Calibration Standards



Cr - 52 ICP-MS Calibration Standards



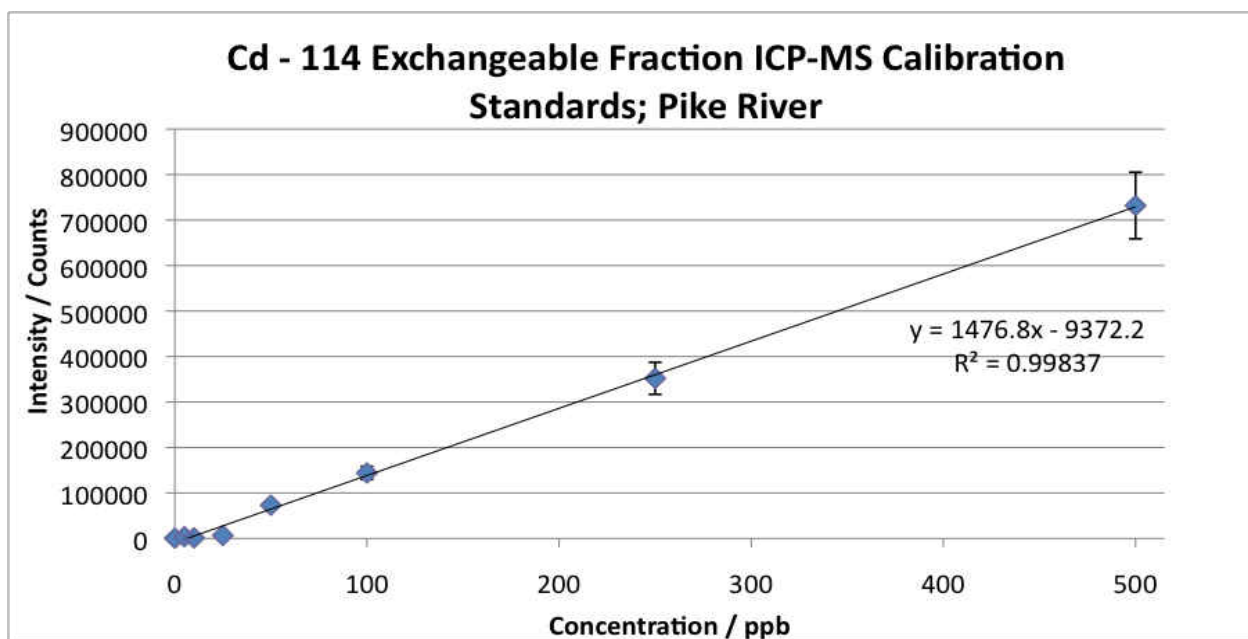
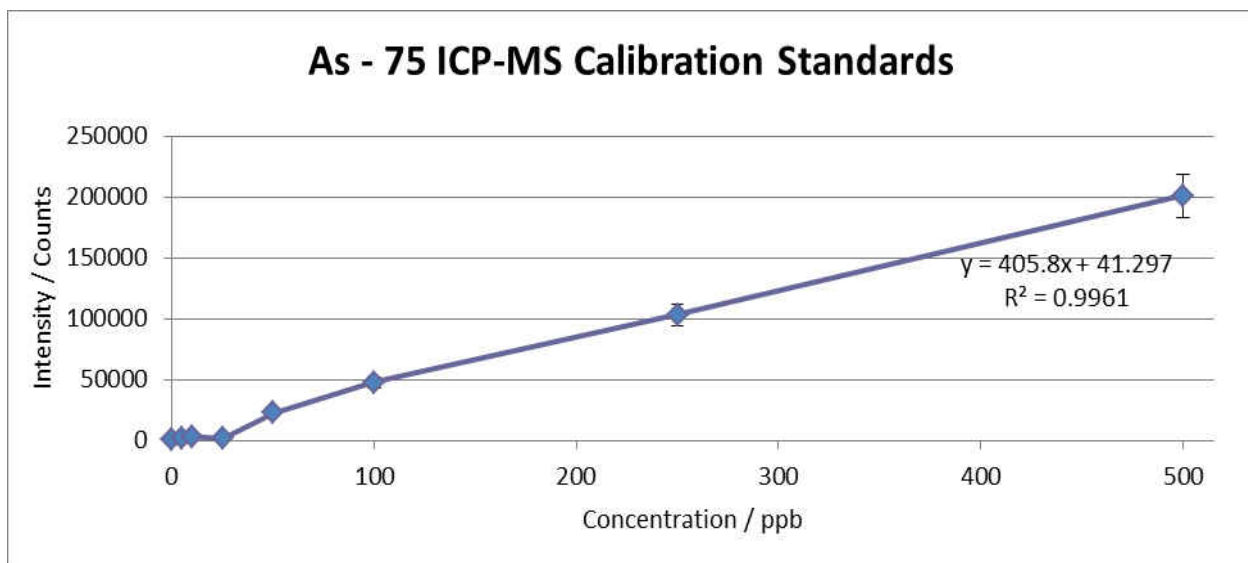
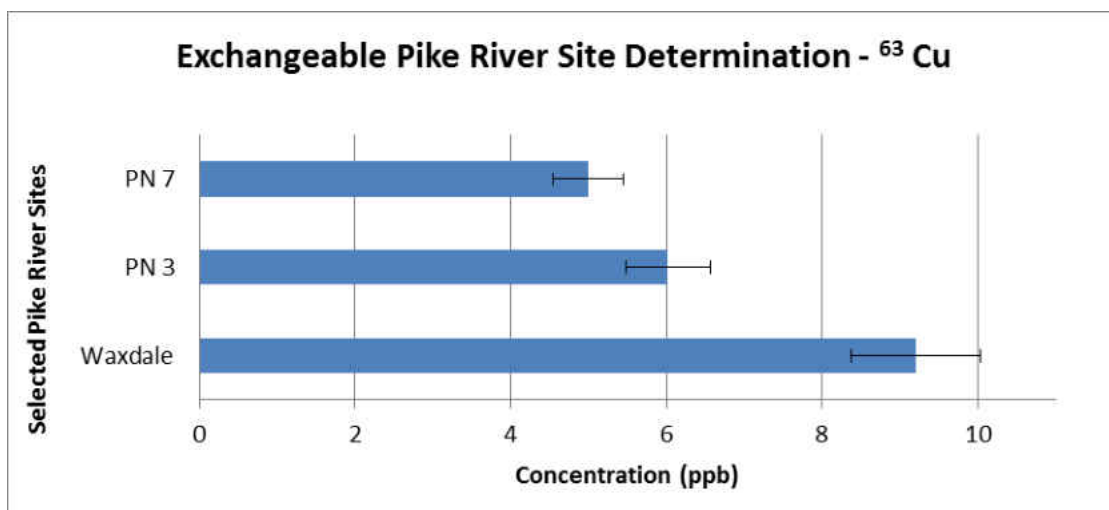
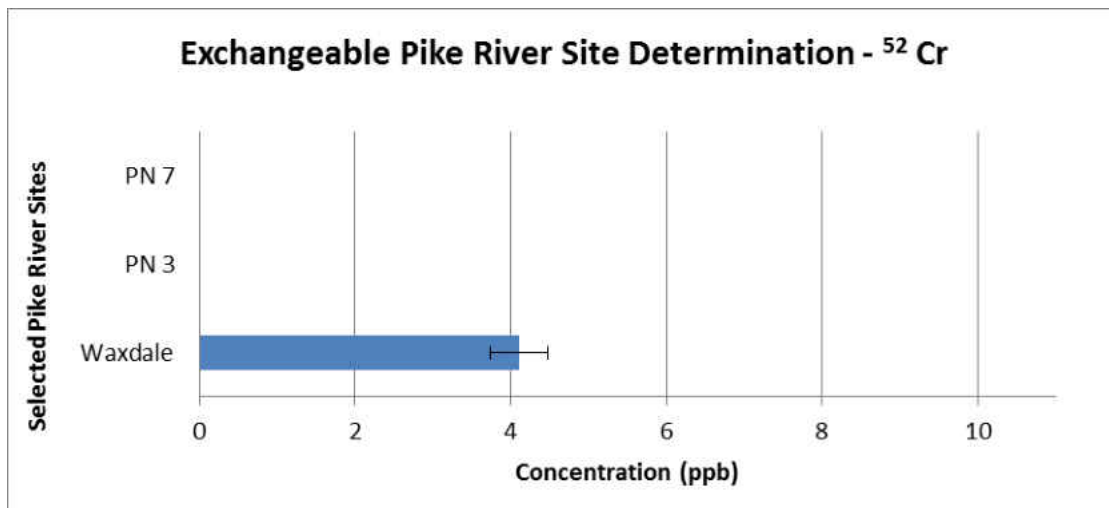
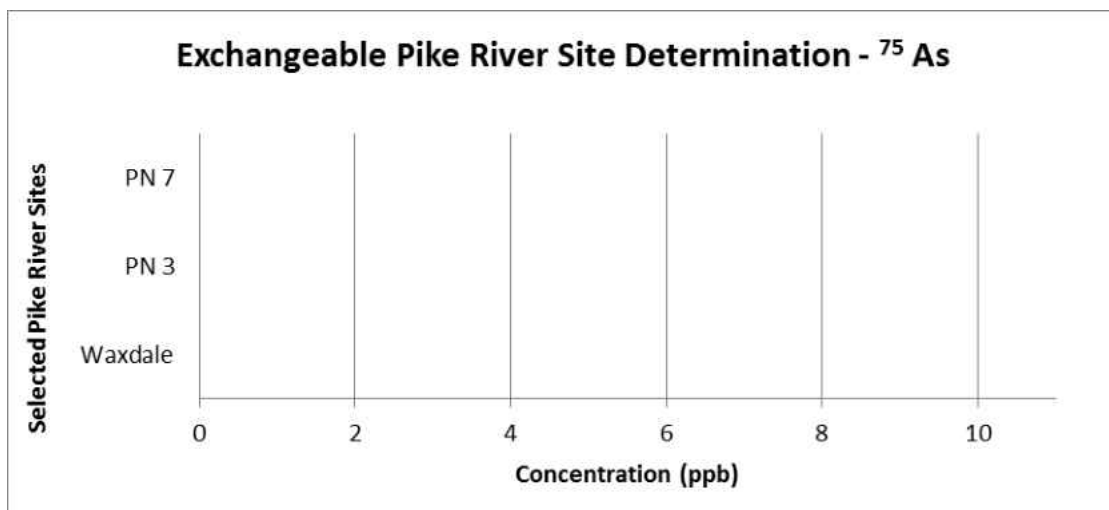
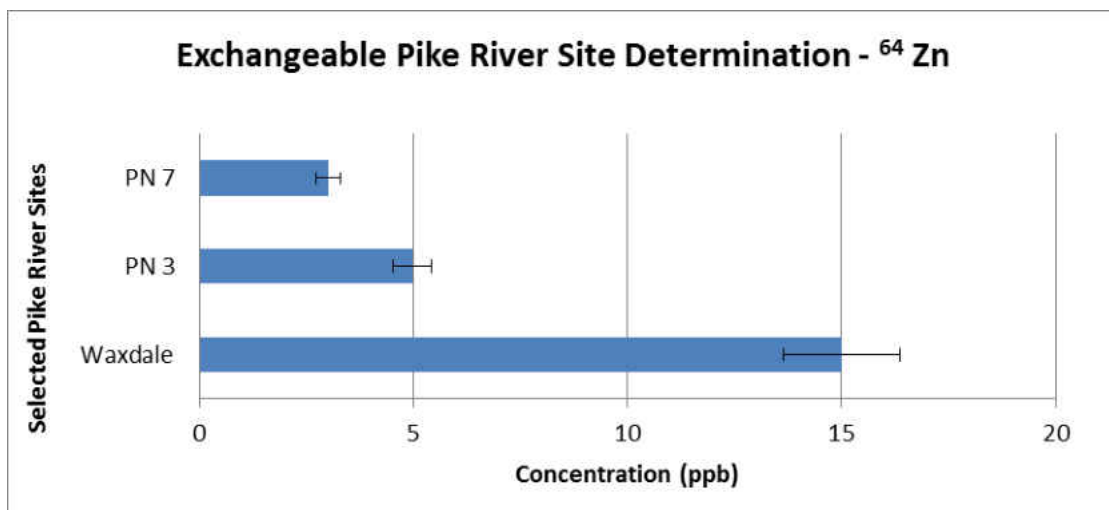


Figure 21. Observed metal concentrations: Exchangeable.





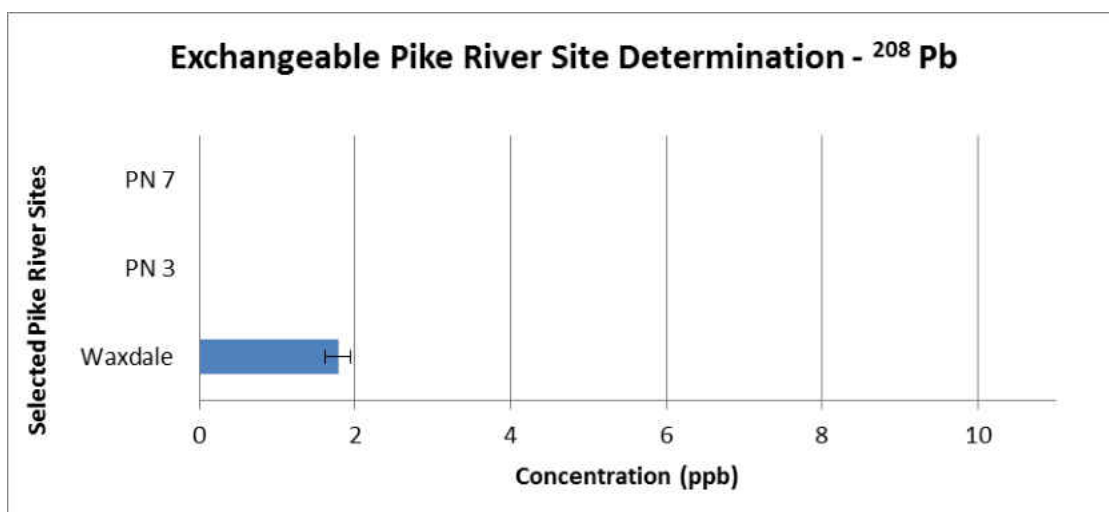
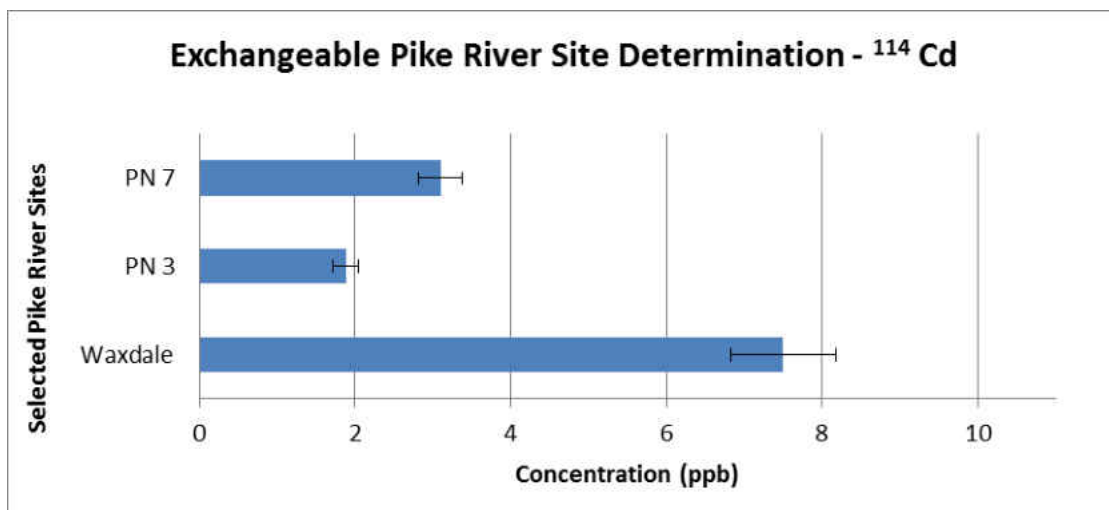
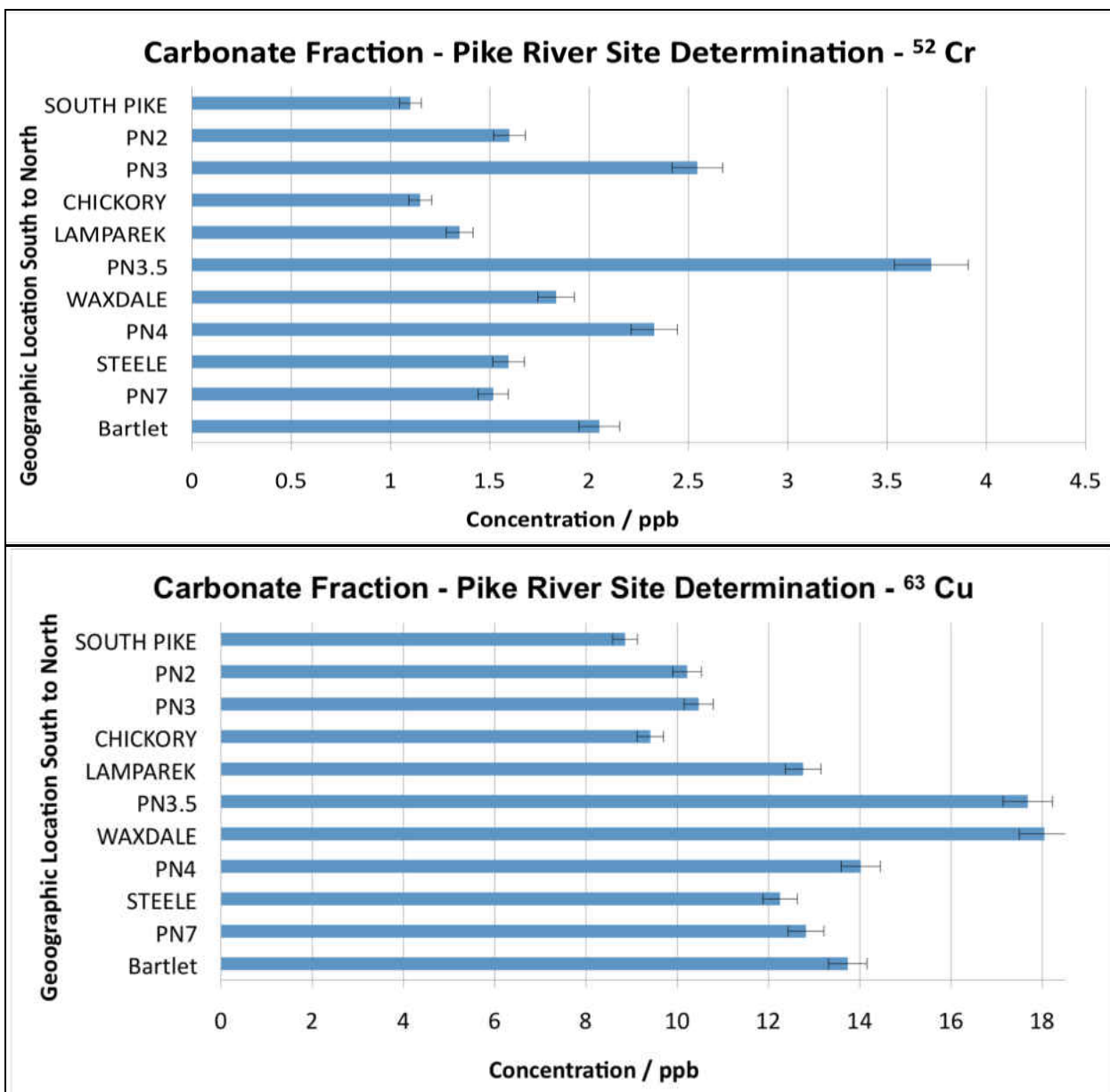
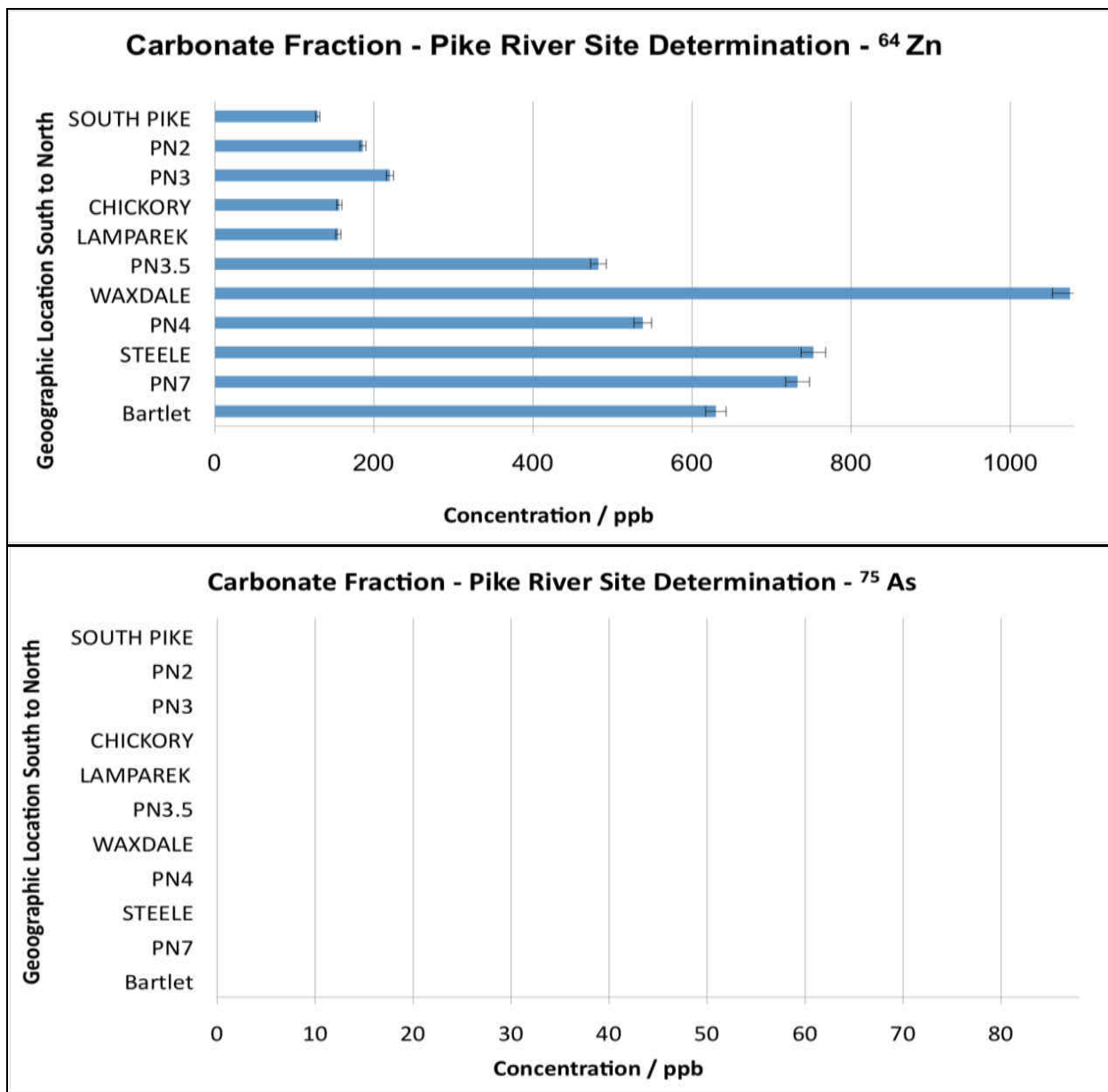


Figure 22. Observed metal concentrations: Carbonate.





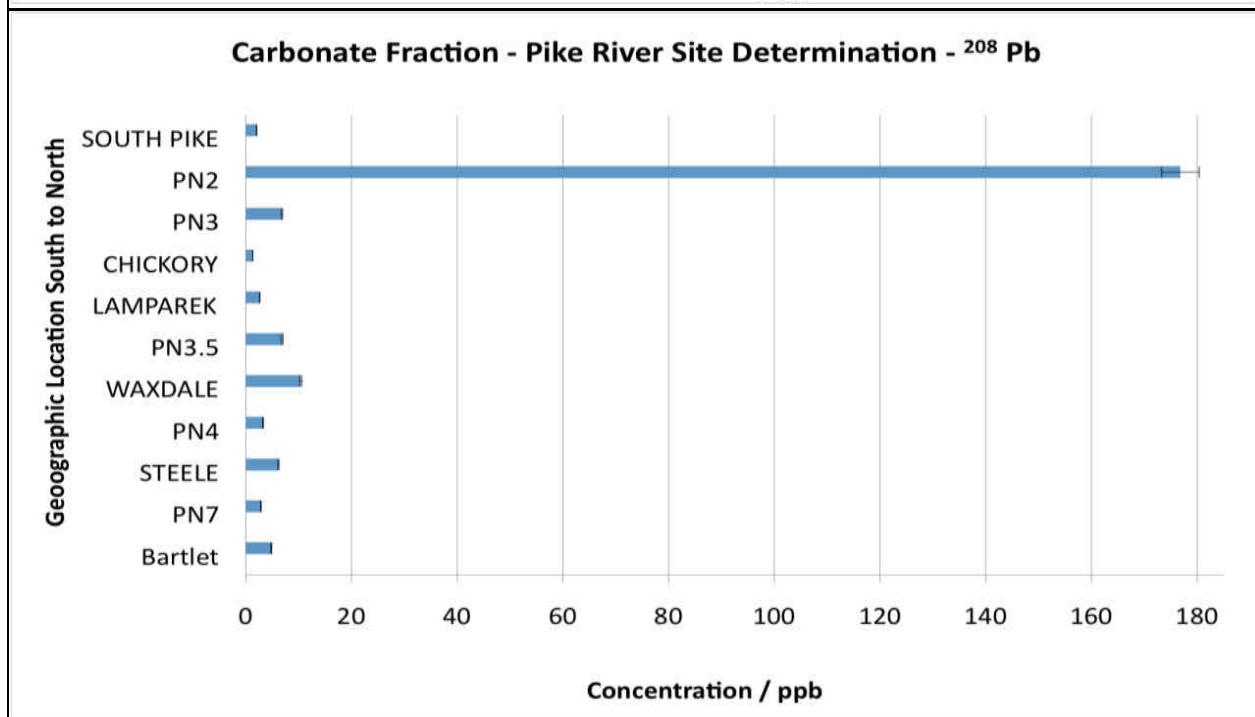
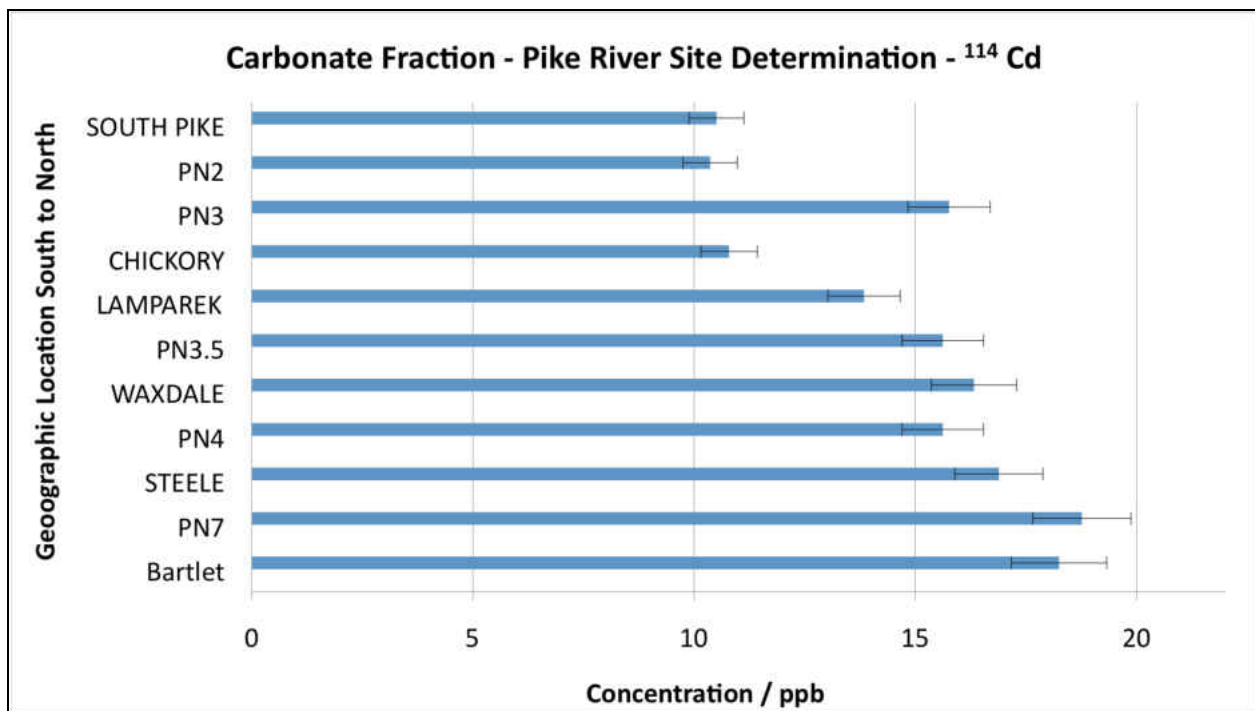
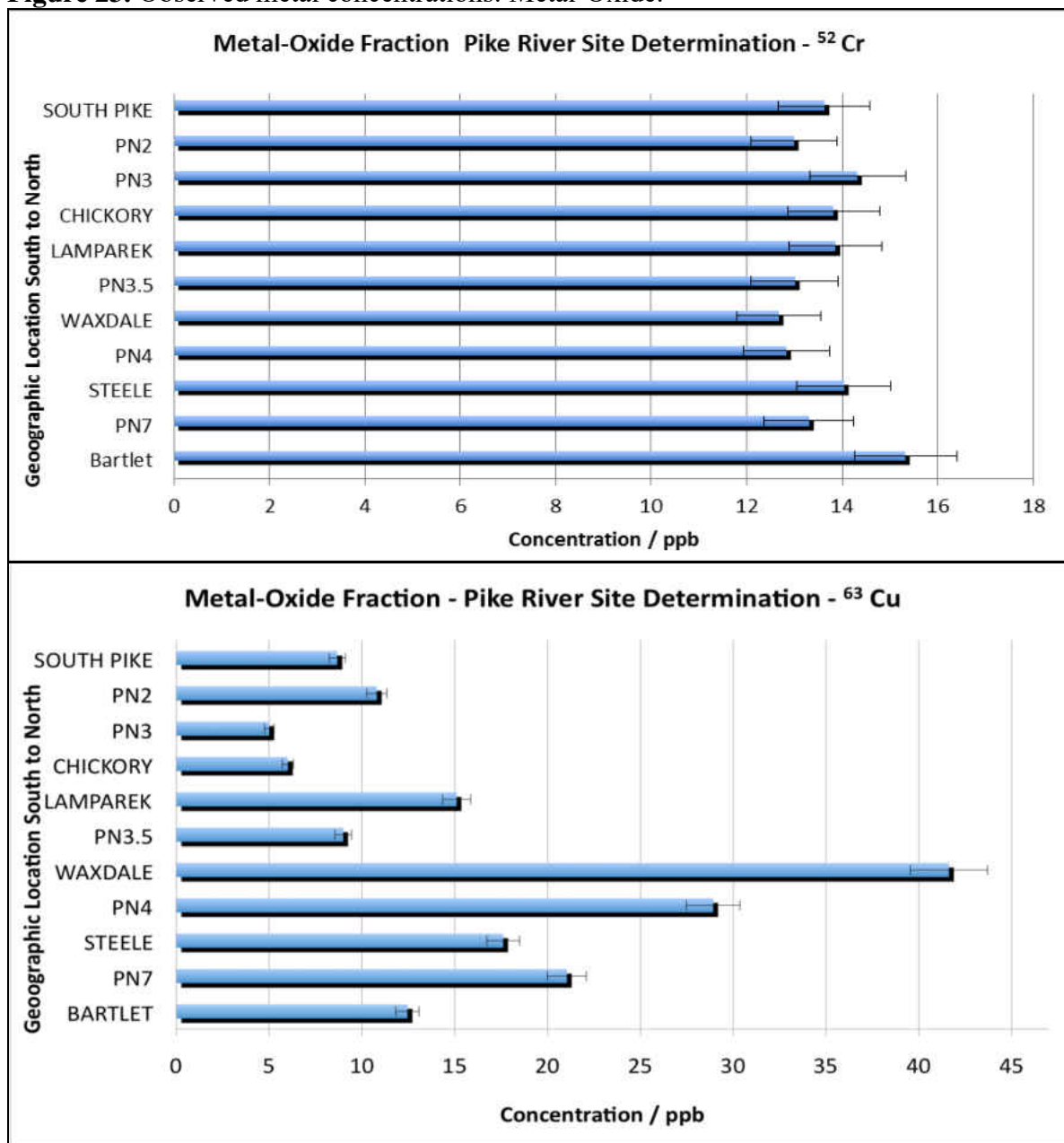
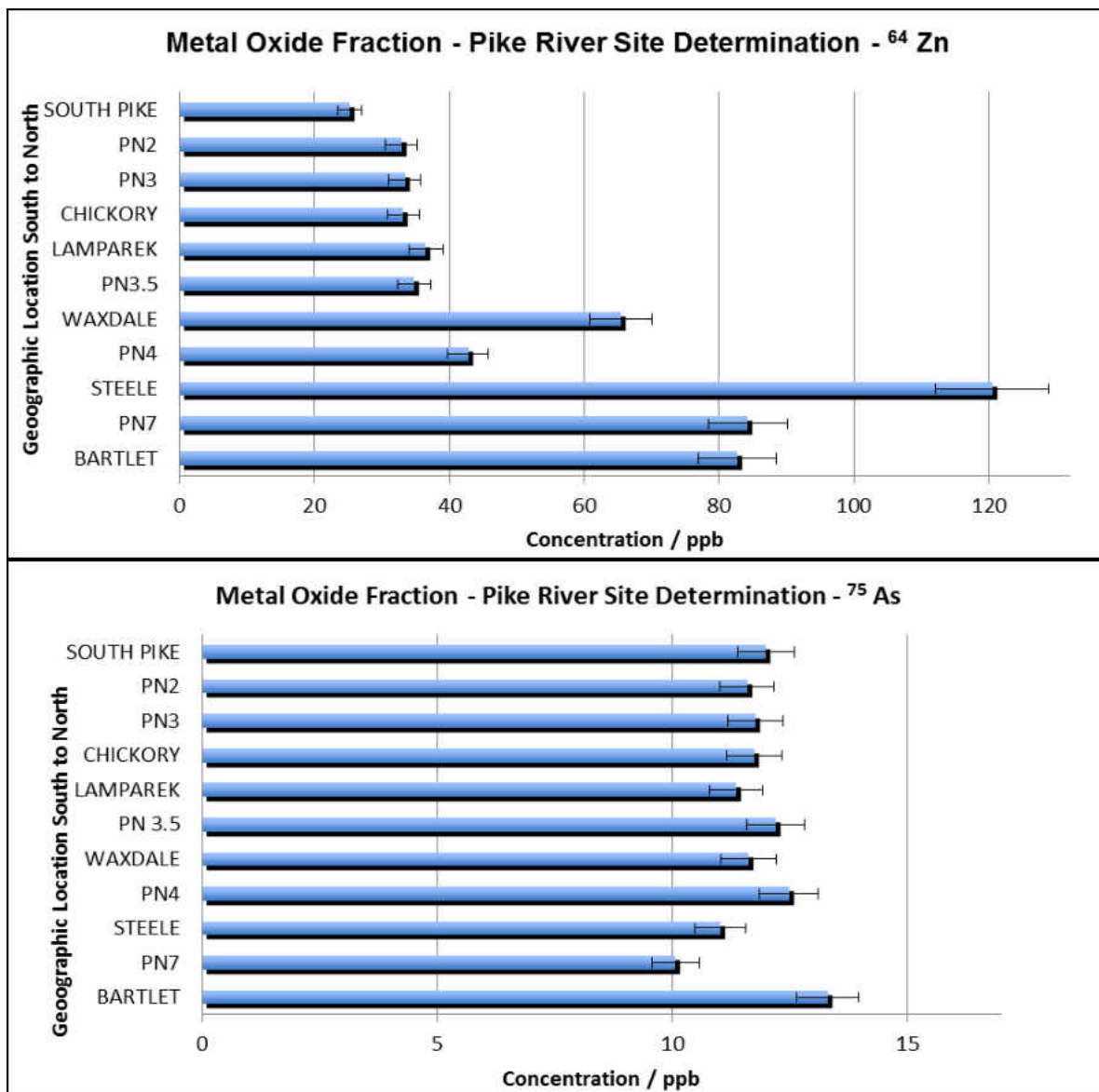


Figure 23. Observed metal concentrations: Metal-Oxide.





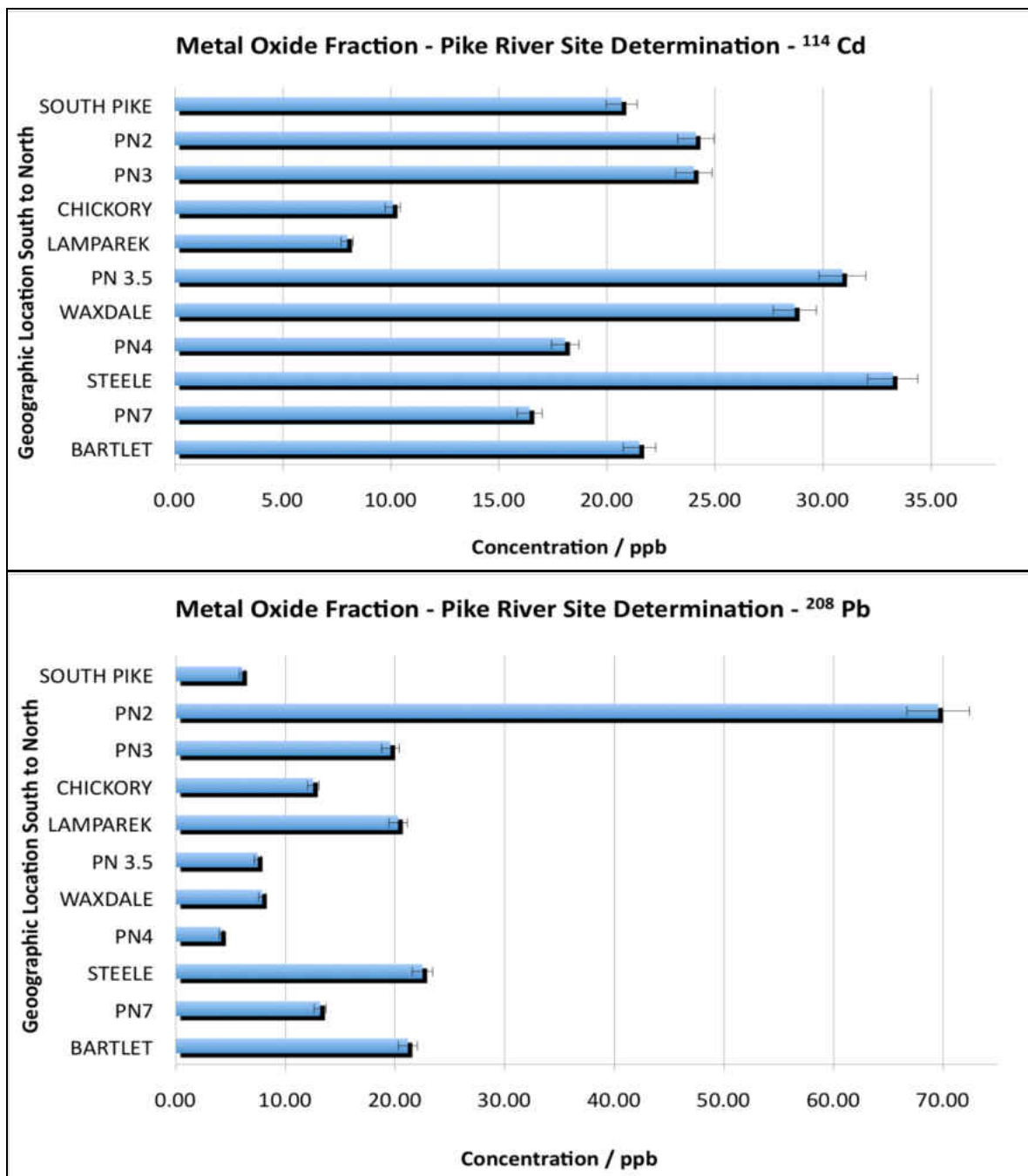
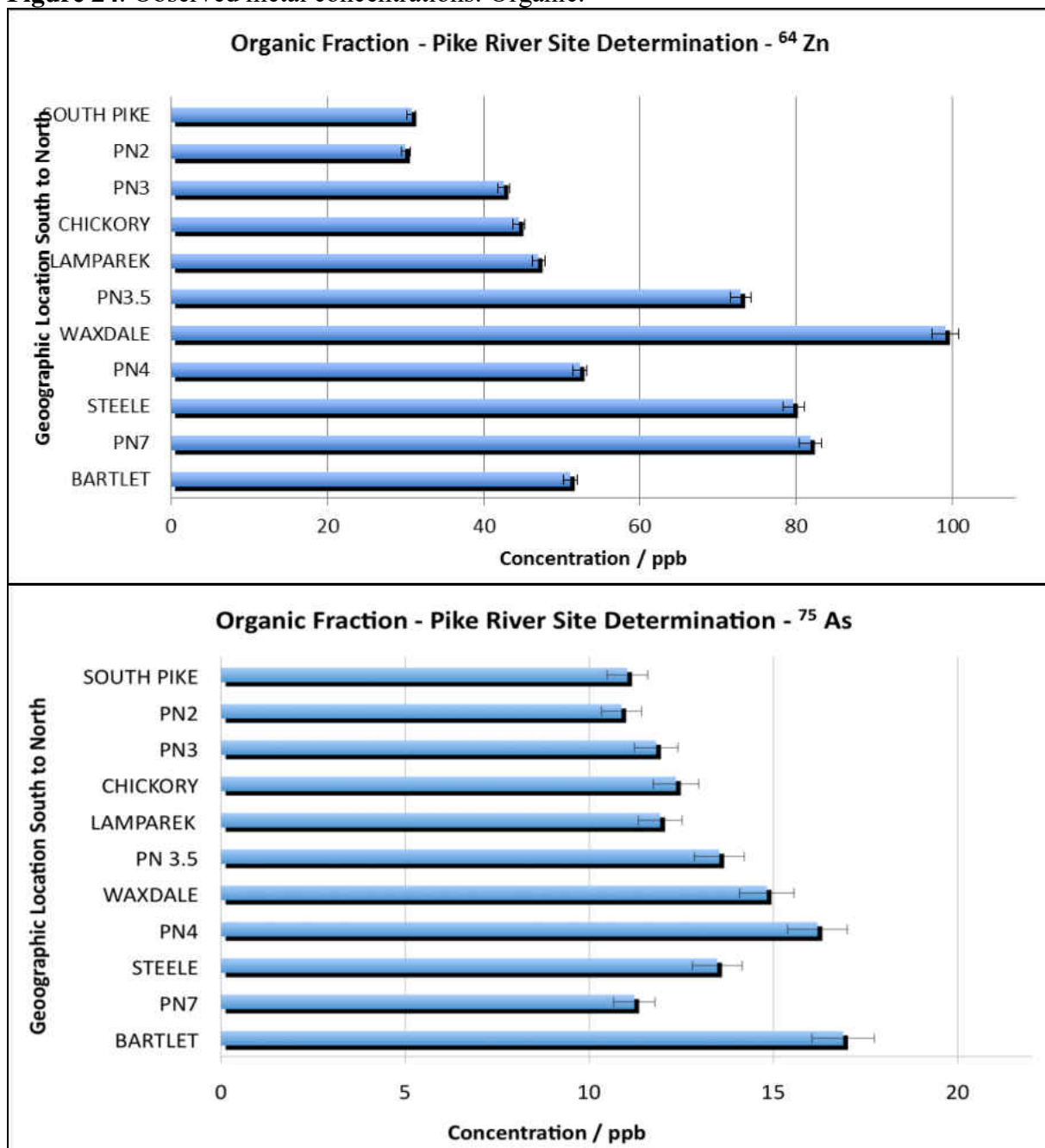
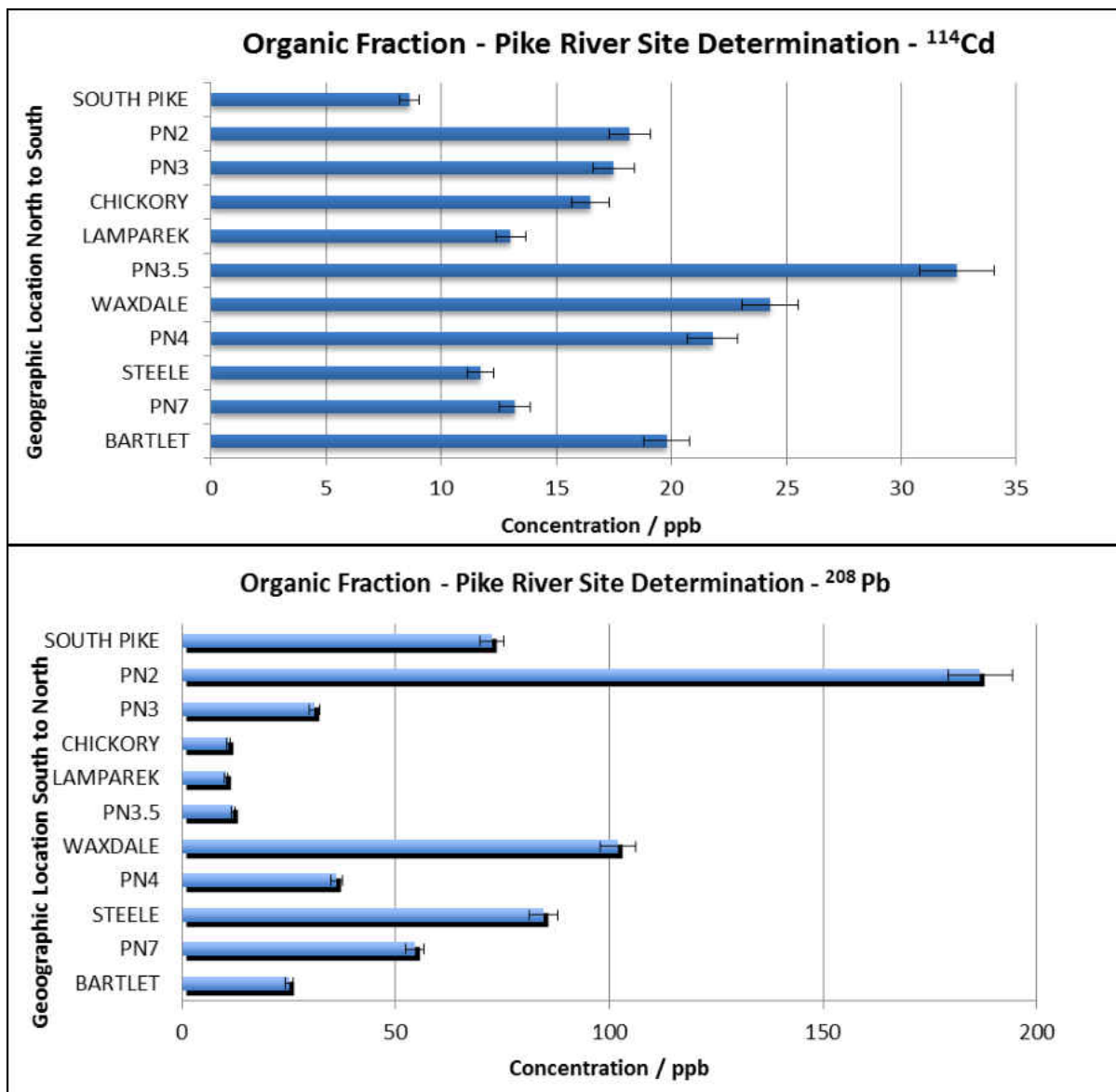


Figure 24. Observed metal concentrations: Organic.





3.2 Comparison of Methods: ICP-MS, GFAAS, and PSA

Two Pike River sediment extracts representing the carbonate, metal-oxide, and organic fractions were used for to compare the ICP-MS results for Pb(II) to GFAAS and PSA. Pb(II) was the heavy metal of choice because it was found at sufficient levels in the sediment and could therefore be readily measurable by each of the techniques. It should be noted that the extracts subjected to GFAAS and PSA were used for analysis 9 months after the samples that were analyzed using ICP-MS. The extracts remained refrigerated at 4°C during the 9 month period. Waxdale extracts from each BCR defined fraction were used to maintain consistency by site and the additional sites were chosen because they had relatively high levels of Pb(II). As mentioned before, a general trend in contamination or in the presence of Pb(II) or any other heavy metal along the selected Pike River sites was not evident.

The most significant difference in quantitation was evident in the organic fraction. Measurement of Pb(II) in the organic fraction by PSA was not possible most likely because of matrix interferences from the BCR ammonium acetate medium [43]. Additional sources of organic matter could be present in solution since several studies in criticism of the use H₂O₂ in the BCR procedure suggest that <100% of the organic matter is destroyed by H₂O₂ [10, 18, 20]. Organic matter may interfere with deposition and the re-oxidation of Pb(II) in PSA during the stripping step through the absorption of organic matter at the Hg electrode surface hindering the transport of Pb(II) to the electrode surface [43].

The carbonate fraction extracts had the most repeatable concentrations with a standard deviation less than 1.0 for PN 7, which was not obtained for any other fraction.

The preparation of the carbonate extracts using acetic acid may have effectively released Pb(II) from Fe and Mn oxyhydroxides and carbonate minerals into solution without a significant amount of acid-soluble species co-precipitating into solution causing possible signal interferences [7, 9, 18, 20, 63].

Among the three methods, ICP-MS is the most useful for BCR analysis because of the ability to measure metals simultaneously at sub-ppb limits of detection with high sensitivity [36, 38]. In PSA, measuring more than one or two elements simultaneously often leads to resolution problems, which may be further complicated in complex media such as the BCR [43]. In regards to stripping analysis, deposition and stripping of heavy metals such as Pb(II) on a Hg electrode is a delicate process in which a solution containing additional heavy metals may interfere with ability to obtain a resolve peak [43]. This occurs primarily due to the fact that several metals are oxidized over a narrow potential range allowing for the chance of peak potential overlapping or unresolved peaks [43]. The instrumentation required for ICP-MS is by far more expensive than GFAAS and PSA [36, 40, 43]. Nevertheless, its utility is beneficial for a time-consuming sample preparation method like the BCR.

3.2.1 Calibration Comparison for Pb(II): ICP-MS, GFAA and PSA

Calibration models were compared to evaluate the performance of the analytical techniques. Analytical sensitivity, determined from the slope of the calibration model, reflects the ability of an instrumental technique to measure small differences in concentration [35, 38]. Analytical sensitivity is also related to detection limit which was determined as three times the standard deviation of the blank standard [38]. Detection limits and slope are closely related parameters and it was expected that the three techniques would show correlating results for observed slopes and intercept values [38]. Based on observed detection limits of approximately 0.1 ppb, 0.5 ppb and 1 ppb for ICP-MS, GFAA, and PSA, respectively, it was expected that the slopes would be correlated based upon typical detection limits for each technique, that is, ICP-MS would have the highest slope followed by GFAA and lastly PSA [36, 38, 40, 43].

Calibration models revealed an unexpected trend in which the observed slope values decreased in the following order: ICP-MS, PSA, GFAA. It was not expected for GFAA to exhibit lower sensitivity than PSA however, the results may be attributed to the level of optimization for the GFAA analysis. The GFAA instrument model used for this work was also utilized in a similar work which examined Pb(II) in BCR soil extract. Two significant differences should be noted: (a) A chemical modifier to aid in the prevention of matrix interferences was used in the Schlipp study but not for this thesis, and (b) The Pb(II) standards for this work were prepared in 2% (v/v) HNO₃ in contrast to the Pb(II) standards for the Schlipp study which were prepared in BCR extraction media [3]. The Schlipp calibration models that were used for the comparison of the slope and intercept values were from BCR extracts prepared in the carbonate

fraction medium, prepared with same BCR method for this work [3]. Illustrated in Table 6, the slope values observed in this work were approximately 30% higher and the intercept values were approximately 70% higher in comparison to the Schlipp study [3]. The significant difference in the intercept values may be attributed to a much greater level of noise, increasing the detection limit for this work [38]. Factors that may have contributed to such a significant increase in noise for the work described herein may be the absence of a chemical modifier and the need for temperature programming in GFAA to remove solvent and matrix components before atomization [36, 38, 40, 43].

An additional point to consider is that the correlation coefficients for ICP-MS were unexpectedly lower than the values reported for PSA. A possible explanation for the unexpected observations is the issue with sample introduction in ICP-MS than expected in PSA [36, 37]. In addition, sample introduction is also a key factor in ICP-MS may be a factor in why the reported correlation coefficients are slightly lower than that by PSA. As stated in the Introduction (Chapter 1), only approximately 1-2% of the sample is converted into the fine aerosol that makes its way to the Ar plasma [36]. Hence, there may have been a greater chance for less of the sample to be measured reproducibly via ICP-MS in comparison to PSA due to sample uptake methods. Overall, there is no significant difference in precision among the three techniques.

Table 6. Comparison of Calibration Model Parameters for Pb(II) [3].

Parameters of Comparison for Pb by GFAA					
Pb in Soil 2010-2011 (Schlipp)	Slope (m)	Intercept (b)	Pb in Sediment 2012 (Grant)	Slope (m)	Intercept (b)
	0.00360	0.0544		0.00830	0.0567
	0.00405	0.00599		0.00920	0.0198
	0.00436	0.00525		0.0175	0.0164
Average:	0.00400	0.0219		0.0117	0.0310
	Ratio of the Two Studies:		(m)	(b)	
			0.343	0.707	
			34.30%	70.70%	

Results and Discussion Part II – Column Work

3.3 Column Study Results for PSA and Trends in Pb(II) Release

For the work described herein, the highest amount of extractable Pb(II) was measured in the lowest ionic strength effluent, 0.010 M NaCl. The release of Pb(II) from Green Bay sediment as a function of ionic strength is shown in Figure 25. This result is consistent with sample batch analysis by PSA completed prior to the column work and the findings of Nelson *et al.*, in which Pb(II) was observed to be weakly associated with the soil types that were studied [29]. It is important to note that all of the ionic strength studies described above were directed towards soil extracts and not sediment extracts. Sediment composition, particularly the amount of organic matter present, is different from that of soil, however the same general adsorption and desorption processes which are central to the release of metals apply to both media [64].

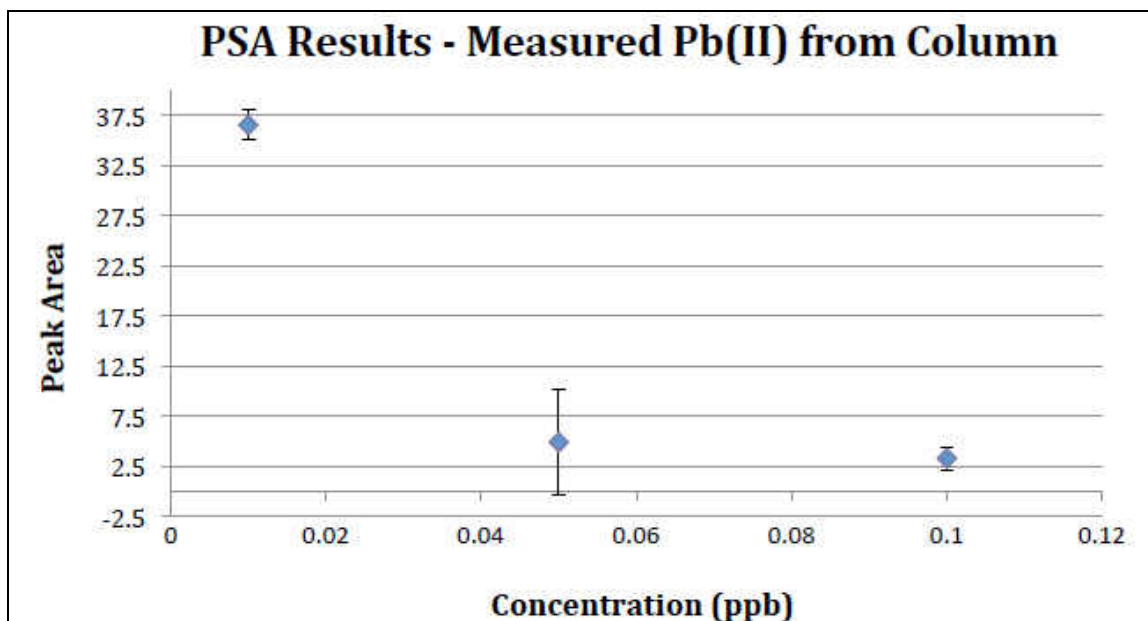
Similar to what was observed in the study by Nelson *et al.*, the highest amount of Pb(II) was reported at a peak area of 61.08 s/V, corresponding to a concentration of 36.8 ppb for the 0.010 M ionic strength leachant (Table 7 and Figure 25). As the ionic strength increased, the Pb(II) content decreased, thereby indicating that Pb(II) is released at a low ionic strength that corresponds to rain water. However, a logical explanation for the decrease in Pb(II) release as ionic strength increases because it is weakly bound is evident. However, some of the mechanisms that may contribute to a certain sediment or soil sediment easily releasing Pb(II) under low ionic strength conditions are not completely clear and may vary with soil or sediment type [27, 64, 65, 66]. Such mechanisms include organic matter mobilization, colloid facilitated transport, competition of ion exchange sites, and variation in the source of Pb(II) [64, 65, 66, 67].

Many studies have documented the importance of organic matter and colloid transport in the mobilization of Pb(II) particularly in soils [68, 69, 70, 71]. According to McBride *et al.* soils with high organic matter and clay content tend to sorb and retain metals more than soils with fewer charge sites [68]. It is assumed that organic matter mobilization or colloid transport played little to no role in the release of Pb(II) in all of the leachant solutions that were studied, primarily because of the low amount of Pb(II) that was released overall. A similar conclusion was made by Amrhein *et al.* particularly because of a lack of similar correlations of metal concentration and organic matter mobilization [25, 67]. However, even low amounts of Pb(II), which have the potential to build up over time, may have an impact on the environment if released to groundwater [72, 73, 74, 75]. Norrstrom revealed a positive correlation between Pb(II) release from soils into groundwater and colloid transport in soils that were exposed to an influx of road salt composed primarily of NaCl [23].

Other key aspects of these studies to consider are (a) the degree of existing contamination at each sediment or soil sampling site and (b) the nature of the sampling location [25, 27, 29]. Very little detail was included describing the extant metal contamination in each study. However, each site was described as being exposed to applications of road salt during the winter season. Table 8 represents the nature of the experimental design for the three cited studies. Table 9 depicts key factors used in the column design for this thesis.

Pb(II) was measured at concentrations that were approximately seven-fold and eleven-fold lower in the 0.050 M and 1.0 M NaCl solutions, respectively. It is evident that there was a notable but not significant difference in detection between the 0.10 M

leachant and the higher ionic strength solutions [76]. The 0.50 M and 1.0 M column extracts had levels of Pb(II) that were an average of 4.89 ppb and 3.29 ppb, respectively. It is possible that a threshold influence of ionic strength was initially reached at 0.10 M and that slight increases in ionic strength after the threshold had little effect on Pb(II) release – as is evident by the ~1.5 ppb Pb(II) measurable difference between the 0.50 M and 1.0 M solutions [76]. In comparison to the 0.10 M solution, the 0.50 M and 1.0 M extracts had considerably higher %RSD values (43.4% and 23.7%, respectively) in comparison to 3.77% RSD that was observed for the 0.10 M extracts (Table 7). The higher %RSD values are likely because Pb(II) was present near the PSA detection limit (2.5 ppb), which is also the likely reason for less precise measurements in the 0.50 M and 1.0 M extracts in comparison to those measured for the 0.10 M column extracts. Nevertheless, the values were very low in comparison to the 0.010 extracts. In conclusion, Pb(II) is bound to the sediment quite weakly, and a decrease in the release of Pb(II) as a function of increasing ionic strength was evident [76, 77, 78].

Figure 25. Green Bay Sediment; Release of Pb(II) as a Function of Ionic Strength.**Table 7.** Column Study by PSA Results.

Column NaCl Effluent Concentration of Pb(II)				
NaCl Ionic Strength Scheme (M)	Average Concentration (ppb)	Standard Deviation (s)	%RSD	t_{calc} (95% C.I)
0.010	36.5	1.37	3.77	1.47
0.050	4.89	2.07	42.4	1.15
0.100	3.29	0.780	23.7	5.28

Table 8. Column Study Design; Three Studies [23, 25, 27]:

Literature Column Studies Comparison			
Factors Considered	Amrhein (1992)	Norrstrom (2005)	Nelson (2009)
Column Type/Material	Plastic Syringes	Not Specified	Plastic
Ionic Strength Scheme	0.01 M, 0.05 M, & 0.10 M	Varied, .151 M – 0.001 M	0.025 M, 0.05 M, & 0.10 M
Type of Road Salt	NaCl, CMA	NaCl	NaCl, MgCl ₂
Flow Rate	0.08 L/min	Approx. 0.1 L/min	Not Specified
Leachant Flow Type	Vacuum Apparatus	Not Specified	Vacuum Apparatus
Column Dimensions	50 mL plastic syringe, dimensions not specified	14.5 cm x 60 cm	6.4 cm x 20.25 cm
Use of De-Ionized Water	After NaCl	After NaCl	Before and After NaCl

Table 9. Column Design for the Determination of Pb(II) by PSA.

Column Study by PSA Factors	
Column Type	Glass
Dimensions	25 mm x 250 mm
Amount of Sediment	50 g
L/S	2
Flow Rate	0.3 - 0.5 mL/min

Chapter 4

Conclusions and Future Work

The intention of this study was to try to better understand the abundance and distribution of As, Cd (II), Cr, Cu (II), Pb(II), and Zn (II) in river sediment. Sediment samples were subjected to a standardized sequential extraction method (BCR procedure of the European Union) by the use of selective reagents. Determination of each metal by ICP-MS provided insight into chemical processes which bring about metal release from sediment for each analyte. The study was able to identify one possible source of downstream contamination from a polluted tributary, Waxdale Creek. Downstream of Waxdale, two mainstem sites (PN 3 and PN 2) showed some of the highest levels of Zn and Pb(II), most likely the result of upstream contaminant input. Among the Pike River sites, Zn appeared to be the most mobile and was consistently measured at higher concentrations (such as Waxdale, PN2 and PN3) in comparison to other metals – with the exception of Pb(II) in the carbonate fraction at PN 2. Overall, a large-scale, long-term sampling program along the Pike River would lead to more comprehensive results about the potential for metal's mobility and possible sources of contamination.

4.1 Conclusions on the Pike River Sediment BCR Study

One of the most significant drawbacks of the BCR procedure is that metals are limited to only four sediment-metal phases (or "compartments"), while in Nature, chemical processes at the sediment-metal interface are quite complex [64, 65, 66].

Further studies are needed to better understand the sorption processes that are at work, especially those involving metal-hydroxides on the sediment surface and the composition of organic matter, to more thoroughly address the fate of metals after a change in the physico-chemical state (i.e., change in pH, colloid transport, decomposition of organic matter) [64, 65, 66]. Under normal conditions (i.e., little or no contamination) in the environment, metals bound to the organic phase are of little to no concern because their release is highly unlikely [6, 7, 9]. This is significant because a greater proportion of metals tend to be the more tightly bound phases like the organic fraction [11, 13, 20]. However, areas exposed to high levels of contamination may be at risk for the release of organic-bound metals into the environment. Other flaws in the BCR procedure include a lack of uniformity among the specific steps in the methodology and reagents and the possibility for sample degradation or contamination because of transport from the field to a laboratory [12, 17, 18, 19]. Despite there being certified BCR reference standards, not all extract fractions or metals are certified [19].

Future investigations employing on-site metal characterization with field-portable techniques should be useful in terms of providing rapid sample analysis and the prevention of sample contamination and degradation. Recent literature shows promising advances and the utility of electrochemical techniques for on-site determination of metals [79, 80]. In a 2012 study, Rueda-Holgado *et al.* successfully quantified Cu (II) in atmospheric samples by employing an on-site Anodic Stripping Voltammetry (ASV) technique using screen-printed Au electrodes (SPGEs) [79]. The electrochemical method was able to monitor Cu (II) in samples over a two-week period. The results proved to be in agreement with a standard ICP-MS method [79].

A second study, in which ASV was also applied but by using microfluidic system, determined the concentration of Pb(II) in soil pore-water and ground water samples on-site with a limit of detection of 0.55 ppb [80]. It should be noted that such studies have determined metals species in liquid or atmospheric samples but not in solids [79, 80]. The production of a rapid, reproducible, reliable, on-site technique, preferably electrochemical because of the simplicity of the instrumentation, would provide more accurate means of studying the mobilization and fate of heavy metals in the environment, particularly in sediments and soils [79, 80].

4.2 Conclusions on Column Study; Influence of Ionic Strength on Pb

A second goal of this work was to mimic the effect of road salt addition into a natural system and in so doing, to determine the influence of varying ionic strength on the mobility of Pb(II). Successful measurement of Pb(II) was achieved through Potentiometric Stripping Analysis in 0.010 M, 0.05 M and 0.10 M solutions. Results indicated an inverse correlation between ionic strength and Pb(II) release; Pb(II) release or observed amounts decreased as ionic strength increased. The reason for the release from the lower ionic strength solution is that apparently the exchangeable Pb(II) is not tightly bound. This study was concerned with measuring Pb(II) and no emphasis was put on sediment type or other factors introduced in other studies (such as Total Organic Carbon or Fe speciation) [23, 24, 25, 66].

Movement towards the development and use of less harmful de-icers or decreased use of current de-icers may take effect in locations such as southeastern Wisconsin in which road salt run-off after the spring snowmelt has been shown to be a culprit in adversely affect water quality [28]. Studies have been reported that are based upon the use of alternatives to NaCl, such as Calcium Magnesium Acetate (CMA) and MgCl₂, however, both alternatives were not without concerns – both are more costly than NaCl and both exhibited a greater impact on the mobilization of Cd [23].

Several studies have been conducted evaluating the effect of ionic strength on cations such as Pb(II), Cd (II), and Cu (II); however, not as much emphasis appears to have been placed upon anionic metals like As and Cr (i.e., which exist as their oxyanions under typical environmental conditions) [23, 24, 25]. Future work could be done to compare the influence of ionic strength and general sorption mechanisms (i.e.,

interactions between metal oxides and organic matter, in particular) as well as the molecular mechanism of the interaction between anionic versus cationic metals and environmental solids [64, 65, 66]. The influence of redox state in the environmental solid upon the mobilization of metal oxide-bound metals would be particularly interesting for As and Cr because of their multiple oxidation states and widely varying toxicities.

References:

1. Alloway, B.J. *Heavy Metals in Soils*. Springer. 1995.
2. U.S. Department of Interior, *Lead Fact Sheet*, Bureau of Reclamation, Ed. 2001.
3. Schlipp, S. *Determination of Trace Levels of Pb(II) in Battlefield Soil Extracts by Sequential Extraction and Electrothermal Atomic Absorption Spectroscopy (ET-AAS)*. Master of Science in Chemistry, Thesis. University of Wisconsin-Milwaukee, Department of Chemistry and Biochemistry. August 2011.
4. Ehlinger TJ, Ortenblad AL, Schmitz MH. 2009. Monitoring of Stream Habitat & Aquatic Biotic Integrity: Pike River North and South Branches, Racine and Kenosha Counties, Wisconsin. (Mount Pleasant Stormwater Utility District). University of Wisconsin-Milwaukee Department of Biological Science.
5. Jensen, J. *Sediment toxicity and the recovery of biological integrity in a restored stream channel*. Master of Biological Science; Thesis. University of Wisconsin-Milwaukee, Department of Biological Sciences. May 2011.
6. Tessier, A., Campbell, P.G.; Bisson, M. Sequential extraction procedure for the speciation of particulate trace metals. *Anal. Chem.* **1979**, *51*(7), 844-851.
7. Quevauviller, Ph., ed. *Methodologies in Soil and Sediment Fractionation Studies: Single and Sequential Extraction Procedures*. Royal Society of Chemistry: Cambridge, UK, **2002**.
8. M. Pueyo, J. Sastre, E. Hernandez, M. Vidal, J. F. Lopez-Sanchez, G. Rauret. Prediction of trace element metal mobility in contaminated soils by sequential extraction. *J. Environ. Qual.* **2003**. *32*(6), 2054-2066.
9. Zerbe, J., Sobczynski, T., Elanowska H., Siepak, J. Speciation of heavy metals in bottom sediments of lakes. *J. Environ. Studies.* **1999**, *8*(5), 331-339.
10. Tessier, A., Campbell, P.G.C. Partitioning of trace metals in sediments: Relationship with bioavailability. *Hydrobiologia.* **1987**, *49*, 43-52.
11. Rauret, G.; Extraction procedures for the determination of heavy metals in contaminated soil and sediment. **1998**. *46*, 449-455,
12. Rauret, G.; Sanchez, J.F.; Sahuquillo, A.; Rubio, R.; Davidson, C.M.; Ure, A.M.; Quevauviller, Ph. Improvement of the BCR three step sequential extraction procedure prior to the certification of new sediment and soil reference materials. *J. Environ. Mon.*, **1999**, *1*, 57-61.

13. Zemberyova, M., Bartekova, J., Haragova, I. The utilization of modified BCR three-step sequential extraction procedure for the fractionation of Cd, Cr, Cu, Ni, Pb and Zn in soil reference materials of different origins. *Talanta*. **2006**, *20*, 973-978.
14. Aldstadt, J. H. *BCR Sequential Extraction Procedure (Modified): Version 4*. University of Wisconsin-Milwaukee, Department of Chemistry and Biochemistry. June 4th, 2008.
15. Fernandez, E., Jimenez, R., Lallena, A.M., Aguilar, J. Evaluation of the BCR sequential extraction procedure applied for two unpolluted Spanish soils. *Environ. Pollution*. **2004**. *131*, 355-364.
16. Quevauviller, P.; Rauret, G.; Ure, A.M.; Rubio, R.; Lopez-Sanchez, J.F., Fiedler, H.D., Griepink, B. Evaluation of a sequential extraction procedure for the determination of extractable trace metal contents in sediments. *J. Anal. Chem.* **1994**. *349*, 808-814.
17. Yusuf, K.A., Evaluation of the three-stage BCR (European Community Bureau of Reference) sequential extraction procedure to assess the potential mobility and toxicity of heavy metals in roadside soils. *Pak. J. Sci. Ind. Res.*, **2006**, *49* (3), 181-183.
18. Gleyzes, C.; Tellier, S.; Astruc, M. Fractionation Studies of trace elements in contaminated soils and sediments: a review of sequential extraction procedures. *Trends in Anal. Chem.* **2002**, *21* (6 & 7), 451-467.
19. Sutherland, R.A.; BCR-701: A review of 10-years of sequential extraction analysis. *Analytica Chimica Acta*. **2010**. *680*. 10-20.
20. Arain, M.B.; Kazi, T.G.; Jamali, M.K., Jalbani, N., Afridi, H., Baig, J.A. Speciation of heavy metals in sediment by conventional, ultrasound and microwave assisted single extraction methods: A comparison with modified sequential extraction procedure. *Journal of Hazardous Materials*. **2008**, *154*, 998-1006.
21. Pike River Watershed – 2010 Water Quality Management Plan Update Report. Wisconsin Department of Natural Resources. 1-11.
22. Castillo, M.L.A.; Alonso, V.; Cordero, M.T.S.; Pavon, C.J.M.; Garcia de Torres, A. Fractionation of heavy metal in sediment by using microwave assisted sequential extraction procedure and determination by inductively coupled plasma mass spectrometry. *Microchemical Journal*. **2011**, *98*, 234-239.

23. Hutton, M.; Symon, C. The quantities of cadmium, lead, mercury, and arsenic entering the U.K. environment from human activities. *Science of the Total Environment*. **1986**, *57*, 129-150.
24. Howards, J.; Sova, J.E. Sequential Extraction Analysis of Lead in Michigan Roadside Soils: Mobilization in the Vadose Zone by Deicing Salts? *Journal of Soil Contamination*. **1993**, *2(4)*, 1-17.
25. Norrstrom, A.C.; Metal Mobility by de-icing salt from an infiltration trench for highway runoff. *Applied Geochemistry*. **2005**, *20*, 1907-1919.
26. Backstrom, M.; Karlsson, S.; Backman, L.; Folkesson, L.; Lind, B. Mobilisation of heavy metals by deicing salts in a roadside environment. *Water Research*. **2004**, *38*, 720-732.
27. Amrhein, C.; Strong, J.E.; Mosher, P.A. Effect of Deicing Salts on Metal and Organic Matter Mobilization in Roadside Soils. *Environ. Sci. Technol.* **1992**, *26*, 703-709.
28. Kim, S.Y.; Koretsky, C. Effects of road salt deicers on sediment biogeochemistry. *Biogeochemistry*. **2012**.
29. Nelson, S.S.; Yonge, D.R.; Barber, M.E. Effects of Road Salts on Heavy Metal Mobility in Two Eastern Washington Soils. *Journal of Environmental Engineering*. **2009**. 505-510.
30. Corsi, S.R.; Graczyk, D.J.; Geis, S.W.; Booth, N. L.; Richards, K.D. A Fresh Look at Road Salt: Aquatic Toxicity and Water-Quality Impacts on Local, Regional and National Scales. *Environ. Sci. Technol.* **2010**, *44*, 7376-7382
31. Lins, T.J. Keeping roads on a low salt diet. Wisconsin Natural Resources Magazine. February 2010.
32. CADDIS: The Causal Analysis/Diagnosis Decision Information System. United States Environmental Protection Agency. 2012. <http://www.epa.gov/caddis/>.
33. Great Lakes Area of Concern, Menominee River. United States Environmental Protection Agency. **2012**. <http://www.epa.gov/greatlakes/aoc/menominee.html>.
34. Johnson, R.L. *Development and Optimization of High-Resolution Chromatographic Methods for Speciation of Arsenicals in the Environment*. Master of Science in Chemistry, Thesis. University of Wisconsin-Milwaukee, Department of Chemistry and Biochemistry. December 2001.

35. Christensen, E.R.; Chien, N.K. Fluxes of Arsenic, Lead, Zinc, and Cadmium to Green Bay and Lake Michigan Sediments. *Environ. Sci. Technol.* **1981**, *15*(5), 553-558.
36. Thomas, R. *A Practical Guide to ICP-MS*. Marcel Dekker, Inc. New York, NY, 2004.
37. Platform-ICP User's Guide. Micromass UK Limited. Issue 1, 2003.
38. Skoog, D.A.; Leary, J.J. *Principles of Instrumental Analysis*. 4th ed, Saunders College Publishing: Orlando, FL, 1992.
39. Horlick, G. Plasma-Source Mass Spectrometry for Elemental Analysis. *Spectroscopy*. **1992**. *7*(1) 22-29.
40. Atomic Absorption Spectrometry Methods Manual. Thermo Scientific. Cambridge, United Kingdom. Issue 5, 2008.
41. Robinson, J.W., *Atomic Spectroscopy*. 2nd ed. Marcel Dekker Inc.: New York, NY, 1996.
42. Jackson, K. Electrothermal Atomic Absorption Spectrometry and Related Techniques. *Analytical Chemistry*, 2000. *72*(12).
43. Wang, J. Stripping Analysis: Principles, Instrumentation, and Applications. VCH Publishers, Inc. Deerfield Beach, FL. 1985.
44. TraceLab™ Trace Element Laboratory, Instrumentation Manual. Radiometer, Copenhagen. 1992.
45. Potentiometric Stripping Analysis, A Review. Jagner, D. *The Analyst*. **1982**. *107*(1275), 593-599.
46. Aldstadt, J.H.; King, D.F.; Dewald, H.D. Flow Injection Potentiometric and Voltammetric Stripping Analysis Using a Dialysis Membrane Covered Mercury Film Electrode. *Analyst*. **1994**, *119*, 1813-1818.
47. Method 6020A, Inductively Coupled Plasma Mass Spectrometry. United States Environmental Protection Agency. Revision 1, Feb. 2007.
48. Stankovic, S.; Cickaric, D., Markovic, J. Determination of Pb and Cd in water by potentiometric stripping analysis (PSA). *Desalination*. **2007**. *213*, 282-287.

49. Dijkstra, J.J.; Meeuseen, J.C.L.; Comans, R.N.J. Leaching of heavy metals from contaminated soils: An experimental and modeling study. *Environ. Sci. Technol.* **2004**, *38*, 4390-4395.
50. Ko, I.; Chang, Y.Y.; Lee, C.H.; Kim, K.W.; Assessment of polio-scale acid washing of soil contaminated with As, Zn, and Ni using the BCR three-step sequential extraction. *Journal of Hazardous Materials.* **2003**, *127*, 1-12.
51. Farinas, J.C; Coedo, A.G., Dorado, T. Influence of relative abundance of isotopes on depth resolution for depth profiling of metal coating by laser ablation inductively coupled plasma mass spectrometry. *Talanta.* **2010**, *81*, 301-308.
52. Yang, L.; Mester, Z.; Abranko, L., Sturgeon, R. Determination of Total Chromium in Seawater Isotope Dilution Sector Field ICP-MS Using Sample Introduction. *Anal. Chem.* **2004**, *76*, 3510-3516.
53. Schneteger, B. Trace element analysis of sediments by HR-ICP-MS using low and medium resolution and different acid digestions. *Fresenius' J. Anal. Chem.* **1997**, *359(4-5)*, 468-472.
54. Gregoire, D.; Lee, J. Determination of cadmium and zinc isotope ratios in sheep's blood and organ tissue by electrothermal vaportiation inductively couple plasma mass spectrometry. *J. Anal. Chem.* **1994**, *9(3)*, 303-397.
55. Cubadda, F.; Raggi, A. Determination of cadmium, iron, nickel and chromium in selected food matrices by plasma spectrometric techniques. *Microchemical Journal.* **2005**, *79*, 91-96.
56. Holliday, A.E.; Beauchemin, D. Preliminary investigation of direct sea-water analysis by inductively coupled plasma mass spectrometry using a mixed-gas plasma, flow injection and external calibration. *J. Anal. At. Spectrom.* **2003**, *18*, 1109-1112.
57. Gerken, B.; Barnes, R.M. Determination of Lead and Other Trace Element Species in Blood by Size Exclusion Chromatography and Inductively Coupled Plasma/Mass Spectrometry. *Anal. Chem.* **1991**, *63(3)*, 283-287.
58. Cook, J.M.; Robinson, J.J.; Chenery, S.R.N.; Miles, D.L. Determining Cadmium in Marine Sediments by Inductively Coupled Plasma Mass Spectrometry: Attacking the Problems or the Problems With the Attack? *Analyst.* **1997**, *122*, 1207-1210.
59. D.R. Killelea, J.H. Aldstadt. "Identification of dimethylchloroarsine near a former herbicide factory by headspace solid-phase microextraction gas chromatography-mass spectrometry", *Chemosphere* 2002, *48*, 1003-1008

60. Wahlstrom, M. Nordic recommendation for leaching tests for granular waste materials. *The Science of the Total Environment*. **1996**. 178, 95-102.
61. Kruger, O.; Kalbe, U.; Berger, W.; Simon, F.G.; Meza, S.L. Leaching experiments on the release of heavy metals and PAH from soil and waste materials. *Journal of Hazardous Materials*. **2011**.
62. Consensus-Based Sediment Quality Guideline, Recommendations for Use and Application, Interim Guidance. Wisconsin Department of Natural Resources, Contaminated Sediment Standing Team. December 2003.
63. Priadi, C.; Ayrault, S.; Pacini, S.; Bonte, P. Urbanization impact on metals mobility in riverine suspended sediment: Role of metal oxides. *Int. J. Environ. Sci. Technol.* **2011**, 8(1), 1-18.
64. Grundl, T.; Sparks, D.L. Mineral-Water Interfacial Reaction, Kinetics and Mechanisms. American Chemical Society Symposium Series 715. Washington, D.C., United States. 1998.
65. Merian, E., Ed. *Metals and their compounds in the environment: occurrence, analysis, and biological relevance*; VCH: Weinheim, 1990, pp 971-1014.
66. Evans, L.J.; Chemistry of metal retention by soils. *Environ. Sci. Technol.* **1989**, 23(9), 1047-1057.
67. Amrhein, C.; Mosher, P.A.; Strong, J.E.; Pacheco, P.G. Heavy Metals in the Environment, Trace Metal Solubility in Soils and Waters Receiving Deicing Salts. *Journal of Environmental Quality*. **1994**, 23(2), 219-226.
68. McBride, M.B. 1994. Environmental chemistry in soils. Oxford Univ. Press, Oxford.
69. Lang, G.; Vos, R.; Vandecasteele, B.; Lesage, E.; Tack, E.M.G.; Verloo, M.G. Effect of Salinity on heavy metal mobility and availability in intertidal sediments of the Scheldt estuary. *Estuarine, Coastal and Shelf Science*. **2008**, 77, 589-602.
70. Yong, R.N.; Yaacob, W.Z.W.; Bentley, S.P., Harris, C., Tan, B.K.; Partitioning of heavy metals on soil samples from column tests. *Engineering Geology*. **2001**, 60, 307-322
71. Sahuquillo, A., Rigol, A., Rauet, G.; Comparison of leaching tests for the study of trace metal remobilization in soils and sediments. *J. Environ. Monit.* **2002**, 4, 1003-1009.

72. Perez, G.; Lopez-Mesas, M.; Valiente, M. Assessment of Heavy Metals Remobilization by Fractionation: Comparison of Leaching Tests Applied to Roadside Sediments. *Environ. Sci. Technol.* **2008**, *42*, 2309-2315.
73. Norrstrom, A.C.; Bergstedt, E. The impact of Road De-icing Salts (NaCl) on Colloid Dispersion and Base Cation Pools in Roadside Soils. *Water, Air and Soil Pollution.* **2001**, *127*, 281-299.
74. He, J.; Xue, H.X.; Lu, C.W.; Fan, Q.Y.; Liang, Y.; Sun, Y.; Shen, L.L.; Bai, S. The impacts of common ions on the adsorption of heavy metal. *Environ. Geol.* **2009**, *58*, 1499-1508.
75. Kim, S.Y.; Koretsky, C. Influence of NaCl and CaCl₂ on lake sediment biogeochemistry. *Applied Geochemistry.* **2011**, *26*, 198-201.
76. Acosta, J.A.; Jansen, B.; Kalbitz, K.; Faz, A.; Martinez-Martinez, S. Salinity increases mobility of heavy metals in soils. **2011**, *85*, 1318-1324.
77. Norrstrom, A.C.; Jacks, G. Concentration and fractionation of heavy metals in roadside soils receiving de-icing salts. *The Science of the Total Environment.* **1998**, *218*, 161-174.
78. Ramakrishna, D.; Viraraghavan, T. Environmental Impact of Chemical Deicers, A Review. *Water, Air and Soil Pollution.* **2005**, *166*, 49-63.
79. Rueda-Holgado, F.; Bernalte, E.; Palomo-Marin, M.R.; Calvo-Blazquez, L.; Cereceda-Balic, F.; Pinilla-Gil, E. Miniaturized voltammetric stripping on screen printed gold for field determination of copper in atmospheric deposition. *Talanta.* **2012**, *101*, 435-439.
80. Jung, W.; Jang, A.; Bishop, P.L.; Ahn, C.H. A polymer lab chip sensor with microfabricated planar silver electrode for continuous and on-site heavy metal measurement. *Sensors and Actuators.* **2011**, *B 155*, 145-153.