



SCHOOL of  
GRADUATE STUDIES  
EAST TENNESSEE STATE UNIVERSITY

East Tennessee State University  
Digital Commons @ East  
Tennessee State University

Electronic Theses and Dissertations

Student Works

8-2018

# Investigating the Interaction of Monoamines and Diel Rhythmicity on Anti-Predator Behavior in an Orb-Weaving Spider, *Larinioides cornutus* (Araneae: Araneae)

Rebecca Wilson

*East Tennessee State University*

Follow this and additional works at: <https://dc.etsu.edu/etd>



Part of the [Bioinformatics Commons](#), and the [Integrative Biology Commons](#)

## Recommended Citation

Wilson, Rebecca, "Investigating the Interaction of Monoamines and Diel Rhythmicity on Anti-Predator Behavior in an Orb-Weaving Spider, *Larinioides cornutus* (Araneae: Araneae)" (2018). *Electronic Theses and Dissertations*. Paper 3441. <https://dc.etsu.edu/etd/3441>

This Dissertation - Open Access is brought to you for free and open access by the Student Works at Digital Commons @ East Tennessee State University. It has been accepted for inclusion in Electronic Theses and Dissertations by an authorized administrator of Digital Commons @ East Tennessee State University. For more information, please contact [digilib@etsu.edu](mailto:digilib@etsu.edu).

Investigating the Interaction of Monoamines and Diel Rhythmicity on Anti-Predator Behavior in  
an Orb-Weaving Spider, *Larinioides cornutus* (Araneae: Araneae)

---

A dissertation

presented to

the faculty of the Department of Biomedical Sciences

East Tennessee State University

In partial fulfillment

of the requirements for the degree

Doctor of Philosophy in Biomedical Sciences

---

by

Rebecca Jane Wilson

August 2018

---

Thomas C. Jones, Ph.D., Chair

Michelle Duffourc, Ph.D.

Donald Hoover, Ph.D.

Darrell J. Moore, Ph.D.

David S. Roane, Ph.D.

Keywords: *Larinioides cornutus*, spider behavior, monoamines, octopamine, serotonin, HPLC-

ECD, spider neurochemistry, transcriptome, behavioral neurobiology, aggression

## ABSTRACT

Investigating the Interaction of Monoamines and Diel Rhythmicity on Anti-Predator Behavior in an Orb-Weaving Spider, *Larinioides cornutus* (Araneae: Araneae)

by

Rebecca Jane Wilson

Circadian rhythms are ubiquitous among organisms, influencing a wide array of physiological processes and behaviors including aggression. While many neurophysiological mechanisms are involved in the regulation of aggressive behaviors, relatively few studies have investigated the underlying components involved in the interplay between circadian rhythms and aggression. Spiders are an ideal model system for studying circadian regulation of aggression as they are ecologically both predators and prey. Recent studies have revealed a nocturnal orb-weaving spider *Larinioides cornutus* exhibits a diel and circadian rhythm in anti-predator behavior (i.e. boldness) that can be manipulated by administration of octopamine (OA) and serotonin (5-HT). Dosing of OA increases boldness of an individual while 5-HT decreases boldness levels. Thus, it appears the serotonergic and octopaminergic system are playing a key role in the daily fluctuations of boldness. This study took a holistic approach to investigate OA and 5-HT levels of head tissue and hemolymph (i.e. blood) as well as the genes involved in synthesis, signaling, and degradation of these monoamines throughout the day (0100, 0700, 1300, and 1900 hours) using HPLC-ED and RNA-sequencing. Although endogenous and circulating levels of OA did not significantly fluctuate, putative transcripts involved in synthesis and signaling did increase in relative expression levels at dusk when *L. cornutus* begins to actively forage for prey. Endogenous and circulating levels of 5-HT also did not significantly change at the four different time points, but clear patterns of upregulation of 5-HT synthesis enzymes as well as some

receptor transcripts were upregulated during the day when *L. cornutus* would be mostly inactive in its retreat. Lastly, monoamine oxidase, a major catabolic enzyme of monoamines in vertebrates and some invertebrates, was identified in *L. cornutus* and exhibited substrate specificity for OA compared to 5-HT. Together with the higher enzymatic activity at mid-day compared to dusk, MAO appears to be playing a significant role in regulating the OA and 5-HT signaling in *L. cornutus*. In conclusion, these results allow a unique preliminary perspective on how OA and 5-HT are influencing the diel shifts in aggression-related behaviors in an ecologically dynamic arthropod.

Copyright 2018 by Rebecca Jane Wilson

All Rights Reserved

## ACKNOWLEDGMENTS

I would like to express my deep gratitude to my mentor Dr. Thomas Jones for his patient guidance, enthusiastic encouragement, and always reminding me to “stay on target”. I would like to thank my committee members for all of their advice and assistance in keeping my progress on schedule. For her generous advice and vital guidance with transcriptome analysis, I would like to sincerely thank Dr. Nadia Ayoub. To my undergraduate advisor Dr. George Uetz, I want to extend my grateful thanks for introducing me to the fascinating world of spiders and igniting my love for research. To my friends, I want to share my sincere gratitude for your endless support over these last couple of years. I have been lucky to form fantastic friendships in graduate school, from the laboratory to the volleyball court, and I could not have finished this degree without them. A special thank you to Brian M. Cartwright for his overwhelming amount of advice and aid regarding experimental design and allowing this project to come to fruition. To Tahmina H. Ahmed and Md Mabuhbar Rahman, I want to express my sincere appreciation and gratitude<sup>1</sup> for their hard work and guidance with qPCR and enzymatic activity experiments. To my family, I give my unending appreciation for the mental and emotional support you have given me during not only graduate school but throughout my life. My family’s never-ending love, support, and compassion have allowed me to grow into the person I am today. Lastly, I would like to thank our funding sources, ETSU Research and Development Committee and the National Science Foundation (IOS-7278284), that allowed this project to be completed. I would also like to thank ETSU School of Graduate Studies for the Graduate Student Research Grants I received.

I dedicate this dissertation to my grandmothers, Mary Ann and Virginia, who taught me one of the most valuable lessons in life: to always keep an open mind.

## TABLE OF CONTENTS

	Page
ABSTRACT.....	2
ACKNOWLEDGMENTS .....	5
LIST OF TABLES .....	12
LIST OF FIGURES .....	13
CHAPTER	
1. INTRODUCTION .....	15
Preface.....	15
Circadian Rhythms.....	15
Aggression and Foraging Theory.....	17
Monoamines: Neurotransmitters, Neurohormones, and Neuromodulators .....	18
Octopamine: A master manipulator .....	19
Octopamine Synthesis, Transport, and Signaling .....	19
Serotonin (5-HT) : Influence on aggression .....	21
Serotonin Synthesis, Transport, and Signaling.....	21
Catabolism Pathways of Monoamines in Invertebrates.....	22
Monoamines, Behavior, and Spiders .....	24
The furrow orb-weaver <i>Larinioides cornutus</i> .....	24
Questions and Hypotheses .....	25
Overarching Concept .....	25
Experimental Foci.....	26
Specific Aims and Hypotheses .....	26



General Research Methods .....	28
2. TRANSCRIPTOME CHARACTERIZATION AND PROFILING OF DIURNAL	
VARIATION IN AGGRESSION-RELATED BEHAVIORS IN AN ORB-WEAVING	
SPIDER.....	28
ABSTRACT.....	30
INTRODUCTION .....	30
METHODS .....	34
Samples for High Performance Liquid Chromatography with Electrochemical Detection	
(HPLC-ED): Hemolymph and Cephalothorax Collection.....	34
HPLC-ECD Analysis .....	35
Sample preparation and RNA sequencing .....	35
De novo transcriptome assembly, read mapping, and sequence annotation.....	36
RNASeq differential expression between time points .....	37
Putative Transcript Identification .....	37
Validation of Transcriptome Analysis by Quantitative Real-Time PCR analysis.....	38
Statistical Analysis.....	39
RESULTS .....	39
HPLC-ECD of octopamine levels in cephalothorax and hemolymph of <i>L. cornutus</i> .....	39
Sequencing and de novo assembly of <i>L. cornutus</i> transcriptome.....	40
Annotation of the <i>L. cornutus</i> transcriptome .....	41
Differential gene expression of all transcripts at four time points.....	43
Identification of Putative Orthologs for TDC, TBH, OAT, and OA-Receptor in <i>L. cornutus</i>	
transcriptome.....	43

DISCUSSION.....	55
CONCLUSIONS.....	60
3. INVESTING THE ROLE OF THE SEROTONERGIC SYSTEM ON DIURNAL VARIATION IN AGGRESSION-RELATED BEHAVIORS IN AN ORB-WEAVING SPIDER.....68	
ABSTRACT.....	69
INTRODUCTION .....	69
METHODS .....	73
Samples for High Performance Liquid Chromatography with Electrochemical Detection (HPLC-ED): Hemolymph and Cephalothorax Collection.....	73
HPLC-ECD Analysis of Serotonin .....	74
Putative Transcript Identification .....	74
Validation of Transcriptome Analysis by Quantitative Real-Time PCR analysis.....	75
Statistical Analysis.....	76
RESULTS .....	77
HPLC-ECD Analysis of 5-HT levels in cephalothorax and hemolymph of <i>L. cornutus</i> .....	77
Identification of Putative Orthologs for TPH, Transporters, and 5-HTRs in <i>L. cornutus</i> transcriptome.....	78
Normalized expression levels of <i>L. cornutus</i> homologs of TPH, Transporters, and 5-HT- Receptors.....	79
Quantitative PCR validation of transcriptome analysis .....	82
DISCUSSION .....	84
CONCLUSIONS.....	86

SUPPLEMENTAL FIGURES.....	92
4. IDENTIFICATION AND ACTIVITY OF MONOAMINE OXIDASE IN THE ORB- WEAVING SPIDER <i>LARINIOIDES CORNUTUS</i> .....	96
ABSTRACT.....	97
INTRODUCTION .....	98
METHODS .....	100
Female <i>L. cornutus</i> collection and conditioning for MAO experiments .....	100
Identification of Putative Monoamine Oxidase Transcripts from de novo assembled transcriptome.....	101
Validation of Transcriptome Analysis by Quantitative real-time PCR analysis .....	101
Measurement of MAO activity in cephalothorax tissue .....	102
Measurement of MAO activity in the presence of MAO-inhibitors.....	103
Measurement of MAO activity of cephalothorax tissue collected at 13 and 19 hours .....	104
Measurement of MAO activity of cephalothorax tissue with octopamine or serotonin .....	104
RESULTS .....	105
Identification of Putative MAO Transcripts from de novo assembled transcriptome .....	105
qPCR validation of transcriptome analysis.....	106
Protein concentration curve of MAO activity with two substrates.....	110
Measurement of monoamine oxidase activity in the presence of MAO-inhibitors .....	112
Measurement of monoamine oxidase activity of cephalothorax tissue collected.....	112
Protein concentration curve of MAO activity with octopamine and serotonin .....	114
DISCUSSION .....	114
CONCLUSIONS.....	117

5. DISCUSSION.....	123
Conclusions and future directions.....	126
REFERENCES .....	128
VITA.....	137

## LIST OF TABLES

Table	Page
2.1. Primers used for qPCR validation of transcriptome analysis.....	39
2.2. <i>L. cornutus</i> transcriptome sequencing and assembly statistics.....	41
3.1. Primers used for qPCR validation of putative TPH, SERT, and 5-HTR transcripts.....	76
4.1. Primers used for qPCR validation of putative MAO transcript .....	102

## LIST OF FIGURES

Figure	Page
1.1. Synthesis of OA from tyrosine via TDC and TBH enzymes.....	20
1.2. Synthesis of serotonin from tryptophan via tryptophan hydroxylase (TPH) and 5-hydroxytryptophan decarboxylase enzymes .....	22
1.3. Enzymatic inactivation of OA in insects .....	23
2.1. Synthesis of OA from tyrosine via TDC and TBH enzymes.....	32
2.2. Boxplot of peak height of OA in cephalothorax and hemolymph.....	40
2.3. Venn diagram of DE transcripts and GO analysis.....	42
2.4. Box shade and phylogenetic tree of TDC protein alignment.....	45
2.5. Box shade of tyramine beta hydroxylase (TBH) protein alignment .....	47
2.6. Box shade and phylogenetic tree OAT protein alignment.....	49
2.7. Box shade and phylogenetic tree of octopamine receptor protein alignment.....	51
2.8. Normalized gene expression values for sequences .....	53
2.9. qPCR validation for selective genes of <i>L. cornutus</i> .....	55
3.1. Synthesis of Serotonin .....	71
3.2. Boxplot of peak height of 5-HT in cephalothorax and hemolymph .....	78
3.3 Normalized gene expression values of TPH.....	80
3.4. Normalized gene expression values for putative SERT .....	81
3.5. Normalized gene expression values for putative 5-HT receptor .....	81
Supplemental 3.1. Box shade of TPH protein regions in alignment.....	92
Supplemental 3.2. Box shade of 5-HT transporter .....	93
Supplemental 3.3. Box shade of 5-HT receptor protein .....	94

4.1. Normalized gene expression values for putative MAO sequences.....	107
4.2. Box shade of MAO protein alignment.....	108
4.3. CLUSTAL alignment of <i>L.cornutus</i> and Human MAO protein sequences.....	109
4.4. Protein concentration curve of MAO activity from two different substrates .....	111
4.5. Protein concentration curve of detection of MAO activity, 13h VS. 19H.....	113

CHAPTER 1  
INTRODUCTION

*“There is no such thing as a failed experiment, only experiments with unexpected outcomes.”*

*– Richard Buckminster Fuller*

*Preface*

Most organisms rely on an endogenous time keeping system to keep them in tune with their surroundings. This internal clock not only aids in allowing the organism to anticipate changes in their external environment, but also maintains an equilibrium within the body in terms of physiological processes. While there are huge implications in how this clock impacts the organismal health, the influence of the clock on behavior, particularly aggression levels, is vital to an organism’s fitness and survival. Our lab uses spiders as a model system to study the neurophysiology, ethology, and chronobiology of an organism in order to answer both proximate and ultimate questions about how this internal timekeeping system impacts daily behavior. Although spiders are a relatively novel system to some of these fields of study, they offer a unique perspective on how an organism carefully regulates its behavior as both a predator and prey.

*Circadian Rhythms*

A circadian clock has been identified to regulate the majority of organisms through their metabolism, physiology, and behavior (Marcheva et al. 2013). While this circadian clock has



evolved across multiple phyla based on external cues, the circadian rhythm is defined by its entrainment to external cues ( *i.e.* light, humidity) and endogenous 24-hour cycle even in the absence of such cues (Dunlap 1999; Bhadra et al. 2017; Kumar 2017). This internal timekeeping system arises at the most basic molecular levels from “clock” genes that influence downstream processes through a transcriptional-feedback loop (Reppert and Weaver 2001). While these individual components may diverge, this genetic circuitry that regulates the internal pacemaker or clock are conserved from bacteria to plants (Aschoff 1965; Bell-Pedersen et al. 2005; McClung 2006).

The global influence these internal clocks have on organisms is exemplified in diel rhythms of behavior in many arthropods. In *Drosophila*, diel rhythms are seen in locomotion, egg-laying, courtship, and learning and memory (Aschoff 1966; Shaw et al. 2000; Chatterjee et al. 2010; Gilestro 2012). These rhythms promote better fitness for an organism in order to inform the individual when to venture for consuming prey, when to seek shelter from predation, and even when to reproduce (Panda et al. 2002). Daily patterns in aggression and aggressive behaviors have been studied quite extensively in several taxa, including fruit flies, crickets, crayfish (Lema et al. 2010; Suzaki and Miyatake 2014; Watts et al. 2014). While these behavioral studies of aggression in arthropods are quite numerous, many of the underlying mechanisms of these behaviors are still not well documented or understood (Kravitz and Huber 2003).

Evolutionary pressures and natural selection have helped shape underlying genetic circuitry to allow an organism to anticipate changes in their environment as to adapt to daily changes in temperature and light (Panda et al. 2002). It is often assumed that these circadian rhythms have adaptive value to an organism as circadian rhythms have intrinsic value (Hurd and

Ralph 1998; Johnson 2005). Circadian rhythms have allowed temporal organization of internal events in coordination with one another. In cyanobacteria, species that have clocks most closely match their external environment are the most successful in adapting and surviving (Woelfle et al. 2004; Johnson 2005). In mammalian species, activity of voles has not only diel rhythms, but these patterns vary among species and across seasons (Pita et al. 2011). In spiders, diel patterns in behavior have been identified and shown to influence form environmental cues in terms of web building activity and aggression (Watts et al. 2014; Moore et al. 2016).

### *Aggression and Foraging Theory*

All animals must forage for food to survive, whether that entails grazing or actively hunting prey. However, as organisms attempt to forage or consume nutrients, there are a number of selection pressures that are apparent, including internal and external factors. External factors include the most obvious influence of environment, i.e. habitat structure, time of day, weather and climate, prey abundance, predator abundance. Internal factors can include characteristics of the foraging organism itself, such as physiological and neurochemical influences. Ultimately, these selection factors shape when, where, and how an animal pursues obtaining food to survive. As these factors are quite numerous and innately variable, several theories have emerged to aid in predicting how an organism will behave in terms of foraging strategy. Optimal foraging theory assumes the most economically advantageous foraging pattern will be selected for an organism through natural selection (Werner and Hall 1974; Charnov 1976; Pyke 1984). Thus, there is a relationship in risks and rewards and theoretically an organism will forage when the risks are minimal and rewards are the highest. Classic studies of optimal foraging theory have been done in honey bees (Wolf and Schmid-Hempel 1989), starlings (Tinbergen 1981; Kacelnik 1984; Bautista et al. 1998), and mussels (Meire and Eryvynck 1986; Sinervo 2006).

Arthropods are exceptional organismal systems to study foraging pattern and aggression due to their wide array of behaviors and relatively simple nervous systems. Aggressive behaviors are imperative for survival and reproduction, however they are energetically expensive and there must likely be a balance between energy and risk (Georgiev et al. 2013). Much of the work investigating neurobiology and genetics of aggression in arthropods has focused on establishing a role of neurotransmitters and modulating levels of aggression. Monoamines and the genes that affect their biosynthesis and metabolism have been associated with aggressive behavior in invertebrates and have been a major area of research (Jacobs 1978; Edwards and Kravitz 1997; Huber et al. 1997a; Baier et al. 2002; Miczek et al. 2003; Certel et al. 2007; Dierick and Greenspan 2007; Hoyer et al. 2008).

#### *Monoamines: Neurotransmitters, Neurohormones, and Neuromodulators*

##### *What are monoamines?*

Monoamines are small nitrogenous compounds that contain one amine group and are derived from amino acids. They include tyrosine-derived compounds like norepinephrine, epinephrine, and dopamine as well as tryptophan-derived compounds like serotonin. These compounds act as critical neurotransmitters, neuromodulators, and neurohormones across the animal world. From a cellular to a whole organismal system, they have been found to influence physiology and behavior through excitatory or inhibitory effects. In vertebrates, they are well recognized to influence flight-or-fight response with the adrenergic system, inducing a physiological and behavioral reaction to a stimulus. In the invertebrate world, they are crucial for maintaining metabolism, mobility, and behaviors.

### *Octopamine: A master manipulator*

Octopamine is present in both vertebrates and invertebrates. While it is at minimal concentrations and acts in a limited fashion on lipolysis in mammals, other additional roles are not known (Fontana et al. 2000). OA, on the other hand, is ubiquitously present and essential across invertebrates, often being characterized as the equivalent to the noradrenaline in the vertebrate world (Roeder et al. 2003a). OA influences locomotion and flight in many insects including locusts and flies (Linn et al. 1992; Saraswati et al. 2004; Roeder 2005a). It has been associated with vision in crayfish (Rodríguez-Sosa et al. 2017). While OA is also associated with aggression and aggression-related behaviors, its effects can often be contradicting across arthropod taxa. In crayfish, OA lowers aggressive fighting tactics (Kravitz et al. 1980; Huber et al. 1997b), but it increases aggression in crickets, fruit flies, and stalk-eyed flies (Adamo et al. 1995; Baier et al. 2002; Hoyer et al. 2008; Bubak et al. 2013). Although the collection of studies is much more limited in arachnids, OA has been associated with aggressive mounting tactics and agonistic encounters in wolf spiders and tarantulas (Grega 1978; Widmer et al. 2006; Torkkeli et al. 2011; Hebets et al. 2015).

### *Octopamine Synthesis, Transport, and Signaling*

Octopamine is synthesized in a two-step process, originating from the amino acid tyrosine. Tyrosine undergoes a decarboxylation event via the enzyme tyrosine decarboxylase (TDC). Tyrosine decarboxylase produces the monoamine tyramine. The OA intermediate tyramine is an important signaling molecule of its own in invertebrates (Roeder 2005b). Tyramine is then further hydroxylated on the fourth carbon by tyramine-beta hydroxylase (TBH). While both of these enzymes are needed to synthesize octopamine, the rate-limiting step

of this synthesis is TBH. This synthesis is somewhat analogous to the vertebrate synthesis of catecholamines in regard to multiple enzymatic steps modifying the amino acid tyrosine into biologically active intermediates like dopamine before being further modified into norepinephrine. Like all other enzymes, the major synthesis steps to produce octopamine can be sites of regulation of this compound. In fact, tyrosine decarboxylase has been implicated in aggression in arthropods while tyramine beta-hydroxylase has been implicated in development (Lehman et al. 2000; Baier et al. 2002).

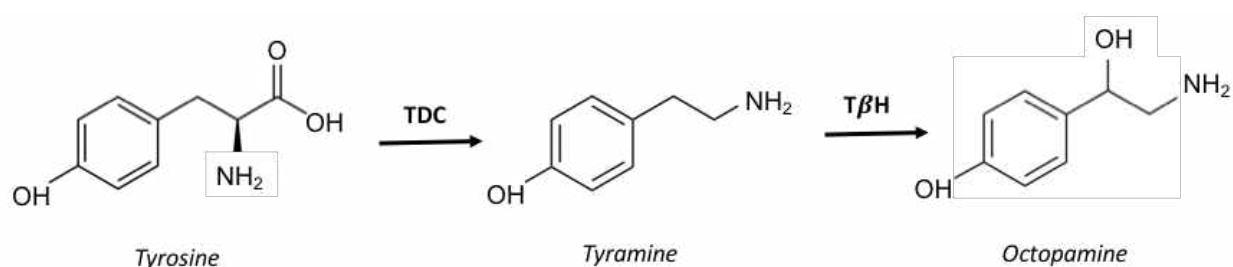

Figure 1.1. Synthesis of OA from tyrosine via TDC and TBH enzymes.

Octopamine is produced in the cytosol of the cell and is sequestered in vesicles until release. After release, octopamine can be recycled using specific sodium-dependent transporters (Caveney et al. 2006). Octopamine dependent transporters have been implicated in circadian rhythms and behaviors in many invertebrates. These transporters can fluctuate in expression (Gallant et al. 2003). The binding capability of octopamine also has been shown to vary under certain circumstances. Octopamine receptors have been studied quite extensively in some invertebrates (Balfanz et al. 2005; Lim et al. 2014; Awata et al. 2016). They show a high similarity to other G-protein coupled receptors such as adrenergic receptors in vertebrates (Li et al. 2016).

### *Serotonin (5-HT) : Influence on aggression*

Serotonin, or 5-hydroxytryptamine, is a well-known neurotransmitter in plants and animals, in both vertebrates and invertebrates alike (Barker et al. 1994; Edwards and Kravitz 1997; Gatellier et al. 2004; Curran and Chalasani 2012). The evolutionarily ancient monoamine is vital for many physiological processes in many bilaterians. In crustaceans, serotonin is implicated in suppressing escape response in crayfish (Glanzman and Krasne 1983). In addition, exogenous amounts of serotonin increase and lengthen aggressive interactions (Huber et al. 1997a; Kravitz and Huber 2003). However, relatively few studies have examined the role of 5-HT outside of crustaceans (Stevenson et al. 2000; Baier et al. 2002; Dierick and Greenspan 2007; Bubak et al. 2013; Dyakonova and Krushinsky 2013).

### *Serotonin Synthesis, Transport, and Signaling*

The molecular machinery involved in serotonin signaling has been well characterized in several invertebrate systems. Serotonin is synthesized from the amino acid tryptophan by the enzyme tryptophan hydroxylase (TPH) in the cytoplasm of serotonergic neurons. TPH belongs to a superfamily of bipterin-dependent aromatic L-amino acid hydroxylases (AAAH) and requires iron as a cofactor. In vertebrates, two isoforms of TPH have been identified, each differentiated based on localization in the central nervous system or gastrointestinal tract (Sakowski et al. 2006). Similar to the serotonergic neural circuitry in vertebrates, some invertebrate species appear to have two different isoforms of TPH, with localization in serotonergic neurons in the nervous system or in the peripheral organ systems (Coleman and Neckameyer 2005). Serotonin is then stored via vesicular monoamine transporters and transported to the synapse. After its release into the synapse, serotonin can bind to specific receptors or be cleared from the synaptic

cleft via reuptake by sodium-dependent serotonin-specific transporters. High-affinity transporters of serotonin (SERTs), like other monoamine transporters are members of the solute-linked carrier family 6 membrane transporters family. Transporters of serotonin can be found through bilaterians as it is one of the most ancient monoamines (Caveney et al. 2006).

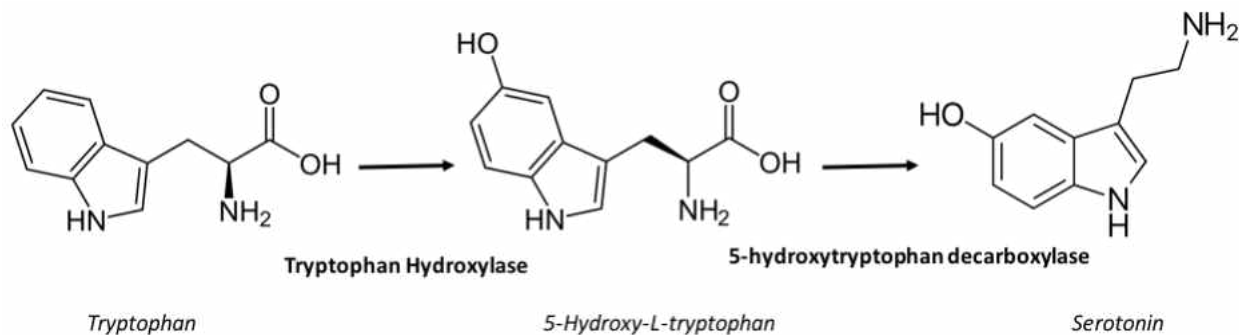

Figure 1.2. Synthesis of serotonin from tryptophan via tryptophan hydroxylase (TPH) and 5-hydroxytryptophan decarboxylase enzymes.

### *Catabolism Pathways of Monoamines in Invertebrates*

While reuptake of monoamines from the synapse by transporters is an important aspect of monoamine signaling, the ultimate catabolism or breakdown of monoamines is necessary in all organisms. Although many of the synthesis enzymes are relatively conserved across invertebrates and vertebrates, the degradation pathways of monoamines utilized among invertebrates and vertebrates are quite divergent (Kaufman and Sloley 1996; Sloley 2004). In vertebrates, it is generally recognized that majority of neurotransmitters and circulating monoamines are metabolized by monoamine oxidase (MAO). Thus, many studies have reflected the production of corresponding acidic metabolites of serotonin (Sloley and Juorio 1995). In contrast, monoamine catabolism can result in many different products in invertebrates including

N-acetylated,  $\gamma$ -glutamyl-conjugated, sulphated, B-alanyl conjugated and sugar conjugated amines as well as MAO-derived amines mentioned earlier (Sloley and Downer 1990; L.R.C. Kempton et al. 1992; Zhou et al. 1993; Sloley 2004; Hiragaki et al. 2015). In insects alone, there are a multitude of ways OA is degraded as seen below in Figure 3. In arachnids, only a few studies have investigated catabolism of monoamines with some conflicting results among the different taxonomic orders (Meyer and Jehnen 1980; L. R.C. Kempton et al. 1992; Kaufman and Sloley 1996; Roeder et al. 2003b). Some studies have documented MAO activity in spiders (Meyer and Jehnen 1980), but have not seen the presence of the enzyme in ticks (L.R.C. Kempton et al. 1992). Studies have clearly documented acetylated products of octopamine in tick species, yet genes for arylalkylamine n-acetyltransferases were not detected in several arachnid genomes (Sloley 2004; Hiragaki et al. 2015).

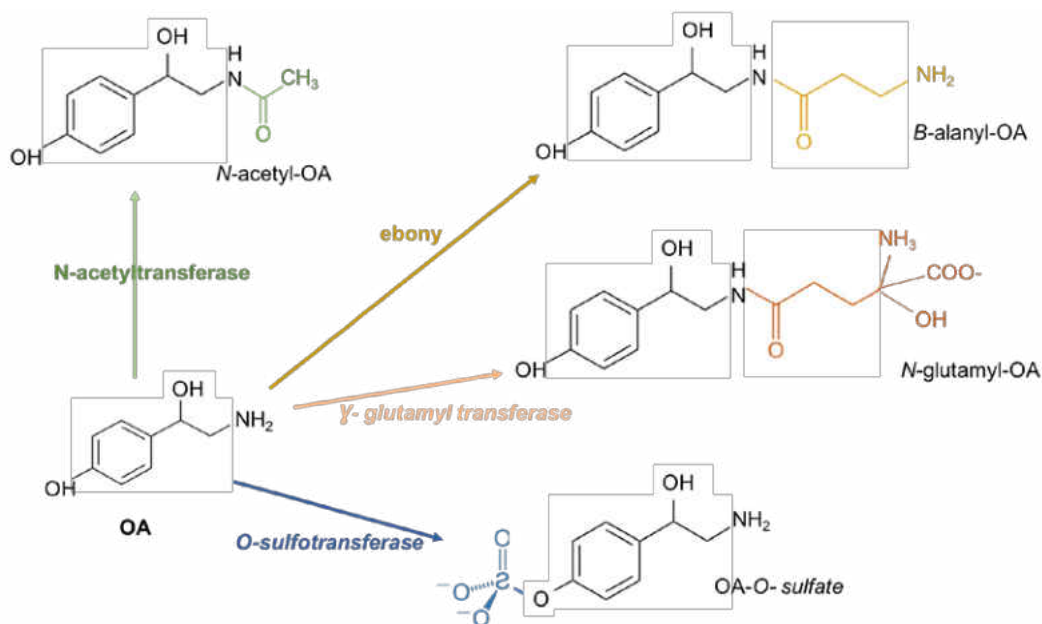

Figure 1.3. Enzymatic inactivation of OA in insects. The arrows indicate an individual enzymatic pathway with the enzyme utilized listed.



### *Monoamines, Behavior, and Spiders*

Although there is a large body of research on the influence of monoamines on behavior and physiology of insects and crustaceans, there is a paucity of research investigating this topic in arachnids. In spiders, the distribution of OA neurons has been mapped out in one species of wandering spider *Cupiennius salei*. This study eludes to the compound potentially having dual action as both a neurotransmitter and neurohormone (Seyfarth et al. 1993). This was further corroborated with studies revealing increased amplitude of skeletal muscle contraction in tarantulas (Grega 1978) and enhanced mechanosensory sensitivity in *C. salei* (Höger et al. 2005; Torkkeli et al. 2011). Decreased OA levels were also identified in the tarantula *Aphonopelma hentzi* after aggressive interactions with a conspecific (Punzo and Punzo 2001). Both OA and 5-HT have been associated with social behavior in colonial web-building spiders (Price 2010). Lastly, increasing 5-HT levels decreased overall activity and aggression levels in the black widow spider *Latrodectus hesperus* (DiRienzo et al. 2015).

### *The furrow orb-weaver Larinioides cornutus*

The common furrow orb-weaver *Larinioides cornutus* is a holarctic species commonly found throughout North America, Europe and West Asia (Marusik and Koponen 2005). *L. cornutus* is a nocturnal forager, constructing its web at dusk preferably near a body of water and foraging throughout the night. Not only is this nocturnal behavior documented in terms of activity pattern (Jones, *unpublished*), but this species also exhibits a circadian anti-predator behavior or “huddle” response (Thomas C. Jones et al. 2011). When exposed to a predator stimulus, such as a puff of air as if a predator (i.e. flying bird) is swooping upon the web, the spider will pull in all of its limbs to form a tight ball and proceeds to drop from the web. The occurrence and frequency of this huddle response has been identified as a part of a larger

behavioral syndrome related to aggression and personality (Pruitt et al. 2008; Pruitt et al. 2010). This “death-feigning” behavior correlates with its foraging strategy and has been associated with an individual’s level of boldness and aggression. The spider is bolder, breaking its huddle response sooner, at night when it would otherwise be actively hunting prey in its web and more wary, holding its huddle posture much longer during the day, when the spider would otherwise be in retreat (Thomas C. Jones et al. 2011). This huddle response can also be manipulated with the monoamines octopamine and serotonin. When dosed with serotonin, the spider will maintain the huddle position for a much longer period of time, while octopamine decreases its duration (Thomas C Jones et al. 2011). Presumably, there are underlying controls of this behavioral response and they are under circadian regulation.

## Questions and Hypotheses

### *Overarching Concept*

Based on the previous studies on the diel rhythms in aggression-related behaviors in *L.cornutus*, it appears there are underlying mechanisms at work that influence the oscillation in behavior. Due to the OA and 5-HT capacity to manipulate this behavior, an over-arching question arises: *How are OA and 5-HT’s influences maintained throughout the day in L.cornutus? Our over-arching hypothesis is that either overall levels of OA and 5-HT are changing or components of the octopaminergic and/or serotonergic system change throughout the day to produce behavioral shift in L.cornutus. Within the context of these two monoaminergic systems, components involved in synthesis, transport, signaling, and/or degradation may be changing to produce a shift in behavioral state.*

### *Experimental Foci*

In order to focus on separate components of the over-arching question, we asked several specific questions:

Q1: Do OA and/or 5-HT levels fluctuate at different times of day?

Q2: Do components involved in synthesis, transport, and/or signaling of OA fluctuate at different times of the day?

Q3: Do components involved in synthesis, transport and/or signaling of 5-HT fluctuate at different times of day?

Q4: Do components involved in the degradation or catabolism of OA and/or 5-HT oscillate at different times of the day?

### *Specific Aims and Hypotheses*

From the experimental foci, two main hypotheses were designed to be tested within specific aims:

H<sub>1</sub>: Oscillations of monoamine levels underlie changes in aggressive behavior in *L. cornutus*.

Specific Aim 1: To characterize circulating/brain levels of monoamines over a 24-hour period using high performance liquid chromatography (HPLC-ED).

OA and 5-HT Levels (Q1). Previous studies in other arthropods have demonstrated direct changes in monoamine levels in different behavioral states (Huber et al. 1997b; Hoyer et al. 2008). Because dosing of 5-HT decreased boldness while OA increased boldness in *L. cornutus*, we hypothesized 5-HT levels in the head tissue and hemolymph would be higher during the day when the boldness was lower and OA levels would be higher in the head tissue and hemolymph at night when the boldness was higher.

H<sub>2</sub>: Oscillations in expression of monoamine-related proteins underlie diel changes in aggressive behavior in *L. cornutus*.

Specific Aim 2: Analyze levels of transcripts involved in synthesis, transport, and degradation over a 24-hour period using RNA sequencing.

Sub Aims:

2.1 The components of synthesis, transport, and signaling of OA and 5-HT systems will be analyzed. Chapter 2 and 3 are comprised of the OA system and 5-HT system, respectively.

Components of octopaminergic system (Q2). Proteins involved in OA synthesis, transport, and/or signaling have been implicated in aggression-related behaviors in many arthropods (Roeder 2005b). As OA increases boldness in *L. cornutus*, we predicted there would be an upregulation of the components involved in OA synthesis, transport, and signaling at night when boldness levels were increased. However, as transporter and synthesis proteins can vary on temporal upregulation prior to utilization, the upregulation of these components may not be uniform.

Components of serotonergic system (Q2). Proteins involved in 5-HT synthesis, transport, and/or signaling have been implicated in aggression-related behaviors in many arthropods (Haselton et al. 2009; Giang et al. 2011; Dyakonova and Krushinsky 2013). As 5-HT decreases boldness in *L. cornutus*, we predicted there would be an upregulation of the components involved in 5-HT synthesis, transport, and signaling during the day when boldness levels were decreased.

2.2 The components involved in the degradation of OA and 5-HT were analyzed. Chapter 4 discusses both OA and 5-HT degradation.

Catabolic pathways of OA and 5-HT (Q4). Due to previous studies demonstrating MAO activity in spiders (Meyer and Jehnen 1980), we predict to find MAO homologs in *L. cornutus*. As selectivity of this enzyme in the presence of 5-HT and OA as substrates has not been established in spiders, it is difficult to postulate how the gene functions. However, based on previous selectivity of MAO in some invertebrates (Sloley 2004), we predict there will be a selectivity difference between 5-HT and OA. In addition, MAO activity is directly influenced by clock genes in some organisms (Hampp et al. 2008), therefore we predict the enzymatic activity of MAO will vary throughout the day.

### *General Research Methods*

Individuals of *L. cornutus* were collected from multiple populations along waterways in Washington County, TN and maintained in our laboratory facility in 12:12 light: dark conditions at 20-22 degrees Celsius. Spiders were housed in individual containers, were misted every 2-3 days, and fed twice a week. Prior to experiments listed in the following chapters, spiders were weighed (body mass, g), and were sacrificed according to the individual procedure either by liquid nitrogen or carbon dioxide (CO<sub>2</sub>). Statistical analysis of data collected in the following chapters were performed using GraphPad Prism 7 or Microsoft Excel. Bioinformatics analysis discussed in the following chapters was performed using NCBI BLAST, Geneious 8 Software, or CLC Genomics Workbench.

## CHAPTER 2

### TRANSCRIPTOME CHARACTERIZATION AND PROFILING OF DIURNAL VARIATION IN AGGRESSION-RELATED BEHAVIORS IN AN ORB-WEAVING SPIDER

Rebecca J. Wilson<sup>1</sup>, Tahmina H. Ahmed<sup>2</sup>, Brian M. Cartwright<sup>3</sup>, Jennifer B. Price<sup>1</sup>, Garron Wright<sup>4</sup>, Nadia A. Ayoub<sup>5</sup> and Thomas C. Jones<sup>1</sup>

<sup>1</sup>Department of Biological Sciences, East Tennessee State University, Johnson City, TN 37601

<sup>2</sup>Department of Biochemistry, Virginia Polytechnic Institute and State University, Blacksburg, VA

<sup>3</sup>Department of Biomedical Sciences, Quillen College of Medicine, Johnson City, TN 37601

<sup>4</sup>D. Murdoch Research Institute, Kannapolis, NC

<sup>5</sup>Department of Biological Sciences, Washington and Lee University, Lexington, VA

## ABSTRACT

The biogenic amine octopamine (OA) is widely accepted as a key regulator of aggression in invertebrates. While many studies have identified how OA can directly influence an aggressive behavior or suite of behaviors, few investigations have analyzed how diel rhythms influence OA synthesis, signaling, and overall endogenous levels in regard to aggressive behaviors. Recent studies have shown that the species *Larinioides cornutus*, a nocturnal orb-weaving spider, exhibits a diel and circadian rhythm in anti-predator behavior that can be manipulated by exogenous levels of OA. Thus, it appears the octopaminergic system may be playing a key role in the organism shifting between heightened levels of boldness. This study took a holistic approach to investigate OA levels and genes involved in synthesis, transport, and signaling of OA at four time points throughout the day (0100, 0700, 1300, and 1900 hours) using HPLC-ED and RNA-seq. Although OA and 5-HT levels did not significantly fluctuate in the cephalothorax or hemolymph, several orthologs of genes involved in OA synthesis, transport, and signaling fluctuate throughout the day.

## INTRODUCTION

An organism's level of aggression and ability to successfully forage for food is vital for its survival. Ideally, an organism should actively forage when prey is the most abundant and predation risk is minimal[1]. However, to ensure complex behaviors like foraging and aggression-related behaviors occur in a timely manner, many underlying neurochemical or physiological events must take place. Biogenic amines (BA), or simple nitrogenous compounds derived from amino acids like tyrosine and tryptophan, have been widely accepted as master regulators in the physiology and behavior of organisms[2–4]. These compounds, which include

noradrenaline, dopamine, and serotonin, are ubiquitous in both vertebrate and invertebrates[5]. In invertebrates, the biogenic amine octopamine (OA) is implicated in moderating not only many physiological processes in arthropods such as flight and locomotion, but it is also a key component to how an organism tightly controls its aggression level [6–11]( Reviews : [2,11]). While OA is implicated in aggression, its effects can vary, sometimes having opposite outcomes among different groups of arthropods[11]. In some crayfish, OA is associated with lowering aggressive fighting tendencies [12], while it increases boldness in crickets[6,13] and fruit flies[14,15]. Another aspect of OA that is not well understood is how its levels or signaling are influenced by or even optimized temporal and seasonal shifts[16,17].

As OA is a key regulator in many critical behaviors and physiological processes, OA levels and signaling must be carefully regulated[17]. Regulation of octopaminergic signaling can occur at many levels, modulation of transcription, translation, and degradation of the enzymes involved in OA biosynthesis are major components to its control[18]. In arthropods, OA is produced in a three-step process, with the first step being the conversion of phenylalanine to tyrosine[19]. The conversion of tyrosine to octopamine involves two enzymes: tyrosine decarboxylase (TDC) which converts tyrosine to the compound tyramine, and tyramine beta-hydroxylase (TBH), which converts tyramine to octopamine (Figure 2.1). While this synthesis process can directly influence behavior and physiology of an organism, relatively few studies have rigorously analyzed proximal regulatory mechanisms in the context of aggression or temporal shifts[15,20,21]. Thus, further studies are needed to understand how these two enzymes are expressed in conjunction with one another in reference to temporal shifts in aggression-related behaviors.



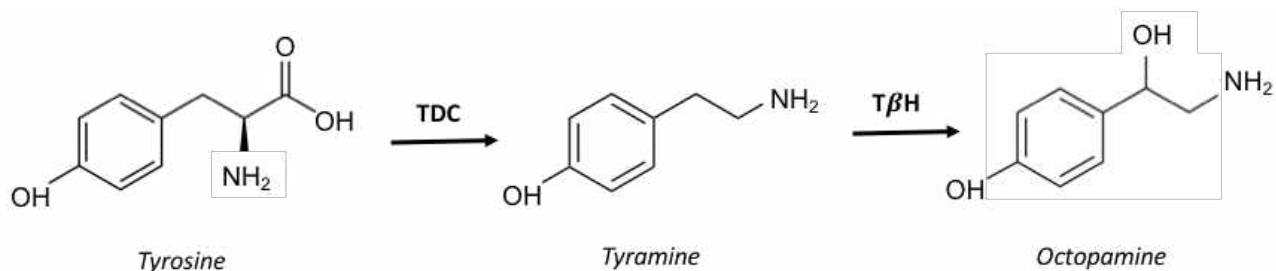

Figure 2.1. Synthesis of OA from tyrosine via TDC and TBH enzymes.

While regulation of synthesis enzymes like TDC and TβH can directly influence OA levels, other components involved in OA's effect at the synapse can also be potential sites of regulation[22]. OA-dependent transporters which reabsorb/recycle and clear OA from the neuronal synapse can attenuate the OA effect. In addition, the expression of OA receptors at the synapses can influence the actual signaling ability of the OA, irrespective of changing OA levels[23]. Although neither of these potential areas of diurnal regulation have been studied previously in reference to OA, many studies have shown diurnal variation in biogenic amine receptors like serotonin [24] and other monoamine transporters like dopamine [25]. Thus, while extracellular levels of biogenic amine compounds may or may not fluctuate, the tone or level of impact this concentration of compounds can have can be finely tuned with regulation of re-uptake or signaling receptors[25].

Recent research in our lab has investigated how ecologically dynamic organisms, specifically spiders, modify their behavior throughout the day to optimize foraging while avoiding predation. One spider species, *Larinioides cornutus*, has revealed circadian control on locomotor activity and aggression[26]. A nocturnal forager, *L. cornutus*, is mostly active at night and this pattern in locomotor activity persists in constant conditions (DD). When threatened by a

predator stimulus, the spider will form a tight-ball formation and exhibit a death-feigning behavior, or a “huddle” response. This huddle response reflects a diel and circadian pattern, with the spider huddling longer during the day while in a less aggressive state, and breaking out of this huddle more rapidly at night while in an apparent more aggressive state when the spider would otherwise be actively hunting prey[26]. These varied aggressive states can also be induced using exogenous amounts of the biogenic amines, serotonin and octopamine. When octopamine levels were artificially increased, the boldness level of the individual increased[27]. Thus, it appears the octopaminergic system is playing a key role in the organism shifting between heightened levels of boldness.

To test the hypothesis that the octopaminergic system is involved in the diurnal changes of aggression levels in *L.cornutus*, we first investigated endogenous and circulating levels of octopamine in the head tissue and hemolymph at four times throughout the day (01:00 – mid scotophase, 07:00- onset of photophase, 13:00-mid photophase, and 19:00- onset of scotophase). A shot-gun transcriptome approach was then utilized to identify orthologs of octopamine synthesis enzyme, octopamine transporter, and octopamine receptor genes in this species: *tyrosine decarboxylase (TDC)*, *tyramine  $\beta$  hydroxylase (T $\beta$ H)*, *octopamine receptor (OAR)*, and *octopamine-dependent transporter (OAT)*. We next examined gene expression of the orthologs at four different times throughout the day (01:00 – mid scotophase, 07:00- onset of photophase, 13:00-mid photophase, and 19:00- onset of scotophase). We predicted that the components of the octopaminergic system should be upregulated at night when aggression levels are the highest. Thus, overall levels of octopamine would be elevated at night and the enzymes involved in biosynthesis of OA would be upregulated, succeeded by an increase in expression of transporters and OA receptors. This is the first study to analyze the gene expression profile of a spider over a

time course. Furthermore, the design of this study sheds light on the potential downstream influence of transcriptional regulation of aggression or aggression related behaviors.

## METHODS

### *Samples for High Performance Liquid Chromatography with Electrochemical Detection (HPLC-ED): Hemolymph and Cephalothorax Collection*

Modified from methods used in a previous study[28], hemolymph and cephalothoraxes were collected at 01:00, 07:00, 13:00, and 19:00 hours. Each spider was anesthetized in a clean plastic chamber using CO<sub>2</sub>. Using a pair of dissecting shears, the right second walking leg of each individual was cut approximately in the middle of the tibia with dissecting scissors. 5uL of hemolymph was collected using a micropipette and transferred to an appropriately labeled Eppendorf tube from the cut leg (pre-labeled with each spider's unique identification number) with buffer solution (0.1 M perchloric acid with 1  $\mu$ g/ ml synephrine as an internal standard for OA and 2ug/ml alpha methyl serotonin as an internal standard for 5-HT). Prior to analysis, all hemolymph samples were filtered using Costar Spin-X Centrifuge tube with a 0.22um cellulose acetate filter (13,000RPM for 6 minutes). This filtered hemolymph sample was stored at -20 °C until analysis was performed.

After the hemolymph was collected, the abdomen, pedipalps, and remaining walking legs were removed from the cephalothorax using dissecting shears. The cephalothorax was immediately flash frozen using liquid nitrogen and weighed (g) on a balance before being placed in a labeled Eppendorf tube (with buffer solution (0.1 M perchloric acid with 10  $\mu$ g/ ml synephrine as an internal standard for OA and 20ug/ml alpha methyl serotonin as an internal standard for 5-HT). Cephalothorax samples were then homogenized using ceramic beads and a

bead grinder system for 2 minutes before a 10-minute centrifugation at 13,000 RPM to pellet all physical debris. The supernatant was then filtered using a Costar Spin-X Centrifuge tube with a 0.22µm cellulose acetate filter (13,000RPM for 6 minutes). This filtered cephalothorax sample was stored at -20 °C until analysis was performed.

#### *HPLC-ECD Analysis*

Cephalothorax and haemolymph samples were analyzed using high-performance liquid chromatography with electrochemical detection using parameters to a previous study[28] (HPLC-ECD; Alexys Monoamines Analyzer). The mobile phase consisted of 10% MeOH with 50 mM phosphoric acid, 50 mM citric acid, 500 mg/ml 1-octane sulphonic acid sodium salt, at a pH of 3.25 (Antec, Boston, MA, USA 180.7050A rev 02). Samples were injected using an AS110 autosampler at a rate of 50µl/min at 191.7kg/cm through an ALF-115 microbore column (150 x 1mm) with porous silica C(18) 3 µm particle size at 4 C. Biogenic amine detection in haemolymph samples was acquired at a 5 nA range for 90 min with a VT-03 cell set at 850 mV. Peaks were confirmed against known standards. Chromatogram analysis was performed with Clarity software (Solihull, U.K.). Peak heights of each monoamine were normalized against internal standard peak for statistical analysis. Cephalothorax samples were normalized initially by mass of the tissue sample and protein concentration[29].

#### *Sample preparation and RNA sequencing*

Female specimens of *L. cornutus* were collected from Johnson City, Washington County, Tennessee (Coordinates for Lakeview Marina) during the summer of 2016. Individuals were housed in plastic containers for a minimum of 7 days prior to sacrifice and were fed once a week with water *ad libitum*. Specimens were entrained to 12:12 light:dark cycle with constant

humidity. 4 individuals were sacrificed via flash-freezing at -80°C every 6 hours for 24 hours for a total of 4 time points (0100, 0700, 1300, and 1900 hours). Cephalothoraces (head tissue) were removed from each specimen and were homogenized over ice and RNA was extracted using Maxwell® 16 LEV simplyRNA Tissue Kit (Promega, Lot #082114). Cephalothoraces from four individuals were pooled at each time point.

#### *De novo transcriptome assembly, read mapping, and sequence annotation*

Four RNA libraries were constructed with indexing using unique molecular barcodes. The libraries were quantified using Real Time PCR. A single library pool was generated by combining all 4 libraries and loaded into one lane of a flowcell for cluster generation and sequencing. The flowcell was then sequenced on a paired-end, 100 base pair run using the Illumina HiSeq2500 platform (Illumina, San Diego, CA, USA). Quality assessment of the raw sequencing reads was performed using CLC Genomics Server (v 7.5.1) using ENCODE2 guidelines for sequencing quality (mean>Q30) and throughput (100 million reads/transcriptome)[30]. The raw reads were trimmed in CLC to remove any sequencing artifacts and low-quality end base pairs. All reads from each time point were then pooled for *de novo* assembly of the *L. cornutus* reference transcriptome using the Trinity transcriptome software suite (v 2.1.1)[31]. The *de novo* assembly was annotated using the Trinotate annotation suite (v 3.0)[32]. The first step in this pipeline generated most likely ORF (open reading frame) peptide candidates using Transdecoder (v 2.0.1)[33]. HMMR/PFAM are then used to identify potential protein domains from the Transdecoder output[33]. BLASTp and BLASTx searches were performed on the Transdecoder annotated assembly for known homologous annotations[34].

### *RNASeq differential expression between time points*

A limited differential expression analysis was performed on the annotated assembly. The experimental design does not include individual biological replicates per time point. This lack of replication places strong limitations on the ability to make statistical inferences with respect to differential expression (DE) since biological and experimental coefficients of variation cannot be estimated. Consequently, estimates of differential expression presented here must be treated cautiously.

Differential expression analysis was performed within the CLC Genomics Server using its RNASeq expression pipeline. Reads from each time point were aligned; expression values were calculated and normalized. Statistical analyses were performed on all pairwise comparisons; any transcript that exhibited an absolute fold change over 2x and a FDR-corrected p-value less than 0.05 was determined to be a potential differentially expressed transcript.

### *Putative Transcript Identification*

The de novo assembled transcriptome was mined for transcripts encoding proteins involved in octopamine biosynthesis, transport, and signaling. Using known arthropod proteins as templates, putative *Larinioides cornutus* homologs of tyrosine decarboxylase (TDC), tyramine beta-hydroxylase (TBH), octopamine transporter (OAT), and octopamine receptors were identified. Accession numbers of the query sequences are reported in the figures. Transcripts were then analyzed for reading frames and domains as well as reverse BLASTed against the NCBI database to confirm identity. This process ensured proteins deduced from these transcripts possessed sequence homology and structural hallmarks of their respective enzyme families. Transcripts were then aligned with homologous proteins from other arthropod species using

ClustalW alignment algorithm on the Geneious™ software. After the first protein alignment, transcripts or protein homologs were analyzed and removed if there was poor alignment or the protein was a partial fragment of the protein. A second protein alignment was then performed using Consensus Alignment tools using Geneious™ software. Phylogenetic trees were constructed from the protein alignments via Neighbor-Joining and maximum-likelihood with bootstrapping with 1000 replicates using Geneious™ software (Version 8.0). For each phylogenetic tree produced for each protein of interest (TDC, TBH, OAT, and OA-receptor), the respective protein sequence from *Drosophila melanogaster* was utilized as the root.

#### *Validation of Transcriptome Analysis by Quantitative Real-Time PCR analysis*

Quantitative real-time PCR (qPCR) was performed to verify the transcriptome results of *L. cornutus*. Total RNA was extracted from cephalothoraces of female *L. cornutus* at four defined time points (0100, 0700, 1300, and 1900 hours) as described in a previous section. RNA was primed with oligo (dT) primer and reverse transcription was carried out using Omniscript reverse transcriptase kit (Qiagen, cat #205113). Quantitative measurements were performed in triplicate on an ABI 7300 system (Applied Biosystems) using the GoTaq qPCR Master Mix (Promega) and gene-specific primers (TDC, TBH, OAT, OAR). Primers were designed using Geneious™ software (Version 8.0). Transcript abundance was normalized to the internal control Actin for each sample. As a housekeeping gene, actin has been used as an endogenous reference gene in qPCR analysis in a number of studies with arthropods, including spiders[35–39]. All qPCR primers were designed using Geneious™ software (Table 2.1).

Table 2.1. Primers used for qPCR validation of transcriptome analysis

Putative Gene Name	Primer Name	Nucleotide Sequence 5' --> 3'	Transcript ID
Actin	Forward_Actin_L.cor	CATTACAGTGAGTGGGCGC	Trinity_DN_56919_c0_g2_i8
	Reverse_Actin_L.cor	TCCACCTTCCAGCAGATGTG	
Octopamine Receptor	Forward_OAR_L.cor	ATCGTGAACCTAGCAGTGGC	Trinity_DN_58054_c0_g1_i3
	Reverse_OAR_L.cor	CAAAGGGCGTCTCCAAACAC	
Octopamine-dependent Transporter	Forward_OAT_L.cor	GGAGCGATATGTCTTGACGC	Trinity_DN_55723_c3_g1_i1
	Reverse_OAT_L.cor	GCATACGAAAAGAGCTAGCGC	
Tyramine Beta Hydroxylase	Forward_TBH_L.cor	CCACCACGTGTTGCTTTACG	Trinity_DN_58971_c1_g2_i2
	Reverse_TBH_L.cor	GCATCTGGCATGTTGGAACG	
Tyrosine Decarboxylase	Forward_TDC_L.cor	TAGCCGACTACTTGGAGTCC	Trinity_DN_54328_c2_g2_i5
	Reverse_TDC_L.cor	CGTCCCAGTCTTCTCCCTTC	

### *Statistical Analysis*

All statistical analysis was performed using GraphPad Prism 7. All data sets were initially tested for normal distribution using Shapiro-Wilkes test for normality. Based on distribution, an ANOVA or a non-parametric Kruskal-Wallis test was performed to analyze the data for significance.

## RESULTS

### *HPLC-ECD Analysis of octopamine levels in cephalothorax and hemolymph of L. cornutus*

Levels of OA in the cephalothorax appear to vary throughout the day, however, not significantly (Figure 2A; Kruskal-Wallis, p-value = 0.13; K.W. statistic (4, 57) = 5.527). The median levels were lowest during the day at 1300hours, with similar levels maintained at the other three time points in the day. There was quite a large amount of variation in the octopamine measurements in the cephalothorax, perhaps due to individual variation in these levels in the



head tissue. Levels of OA in the hemolymph did not vary among the four time points significantly (Figure 2B; Kruskal-Wallis, p-value = 0.72; K.W. statistic (4, 60) = 1.347).

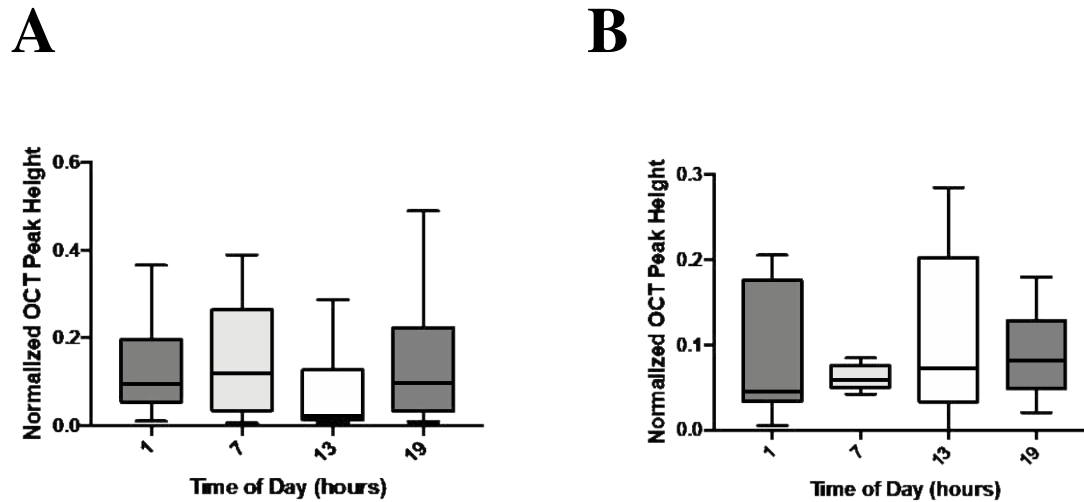

Figure 2.2. A. Boxplot of peak height of OA normalized to internal standard at four time points in cephalothorax (0100 hours, 0700 hours, 1300 hours and 1900 hours). B. Boxplot of peak height of OA normalized to internal standard at four time points in hemolymph (0100 hours, 0700 hours, 1300 hours and 1900 hours).

#### *Sequencing and de novo assembly of L. cornutus transcriptome*

Over 500 million initial reads were generated using Illumina RNA-seq. The transcriptome was assembled from Illumina RNA-seq short-read data. The transcriptome assembly file is available as Additional File 1 (*L. cornutus* transcriptome). The TRINITY – derived assembly produced a large number of contigs clustered into a number of genes. The number of reads and contigs at each step in the assembly process are listed in Table 2.2. The assembly for *L. cornutus* consisted of 201,350 contigs in 153,812 components (Butterfly; 42,264 components via Transdecoder). The maximum contig length was 27,195 bp. The mean contig length for *L. cornutus* was 769.92 bp and the N50 contig length was 1441 bp. The mean and N50 coding contig length were 613.54 bp and 904 bp, respectively. The GC content of the

coding regions of the assembled transcriptome was 34.83%. This is comparable to other sequenced spider transcriptomes, with *Parasteatoda tepidariorum* at 35.9%[40], *Theridion californicum* at 36.43%[41], and *Theridion grallator* at 35.17%[41].

**Table 2.2. *L. cornutus* transcriptome sequencing and assembly statistics**

<b>Initial reads<sup>1</sup> RNA-seq</b>	553,813,388
<b>Total initial reads<sup>1</sup></b>	553,813,388
<b>Preprocessed reads</b>	541,004,868
<b>Combined reads</b>	541,004,868
<b>Reads entering assembly</b>	541,004,868
<b>Inchworm Kmers</b>	274,041,238
<b>Butterfly Contigs</b>	201,350
<b>Butterfly Components (genes)</b>	153,812 (Butterfly); 42,264 (Transdecoder CDS/BLAST)
<b>Mean contig length (bp)</b>	769.92
<b>Median contig length (bp)</b>	373
<b>N50 contig length (bp)</b>	1441
<b>Maximum transcript length (bp)</b>	27195
<b>Mean coding contig length (bp)</b>	613.54
<b>N50 coding contig length (bp)</b>	904
<b>Coding Transcriptome %GC</b>	34.83
<b>Total Transcripts</b>	<b>201,350</b>

<sup>1</sup>all counts are expressed as “single” reads

#### *Annotation of the L. cornutus transcriptome*

The *L. cornutus* transcriptome was annotated using CLC Genomics Workbench© software and several gene and protein databases including SwissProt, BLAST2GO, and NCBI BLAST. Of the 153,812 genes sequenced, 50.65% BLASTed without hits, 21.2% had positive BLAST hits, 18.7% were annotated using GO Mapping, and 9.3% were BLAST2GO annotated. Due to a large number of short length contigs (<100 or 200 bp), BLAST annotation from protein

databases can be difficult. The transcripts that had positive hits for GO annotation were further analyzed for GO term differentiation (Figure 2.3B).

**A**

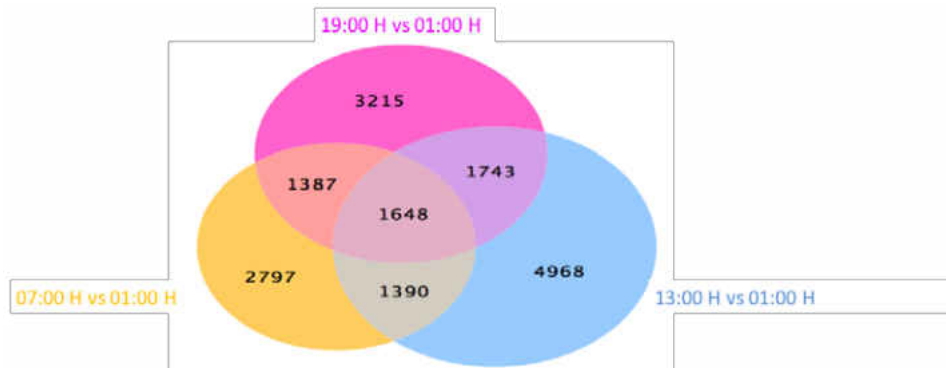

**B**

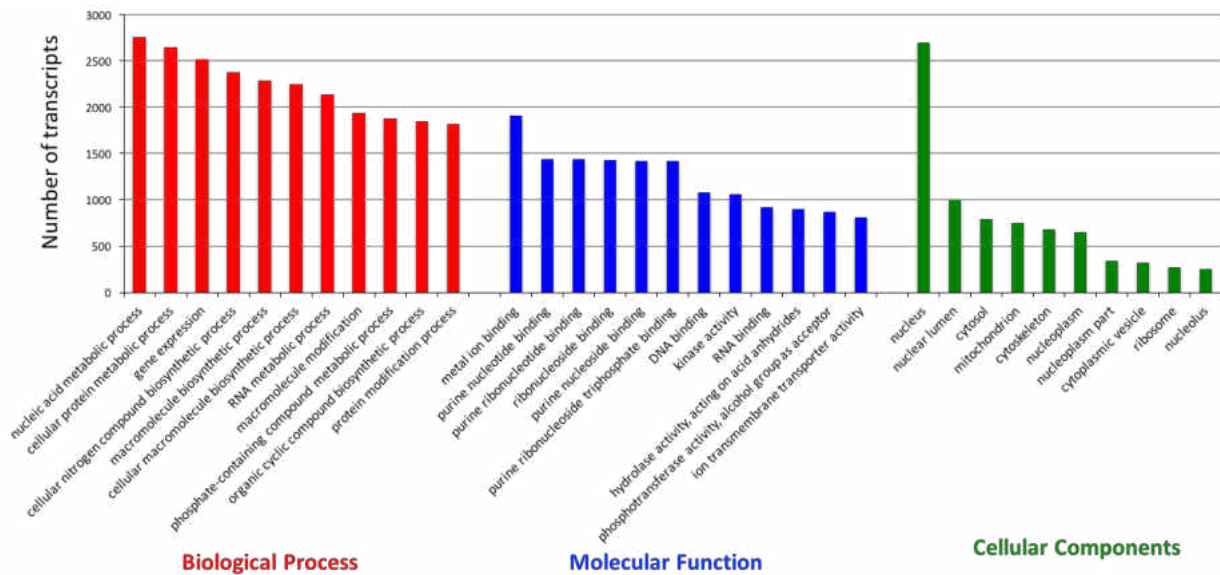

Figure 2.3. A. Venn diagram of differentially expressed transcripts across the four time points via EdgeR using CLC Genomics Workbench analysis software. B. Gene ontology analysis of the *Larinioides cornutus* assembly. The bar graph charts show the distribution of the number of transcripts of each GO type.

### *Differential gene expression of all transcripts at four time points*

When pairwise comparisons were performed among the sequenced cDNA libraries at the four time points (01:00vs. 07:00H,01:00vs. 13:00H, 01:00 vs. 19:00H, 07:00vs. 13:00H, 07:00H vs. 19:00H, 13:00vs. 19:00H) using EdgeR software, 1,648 transcripts had a significant fold change absolute value over 1.5 over the course of all four time points (Figure 2.3A; FDR correct p-value <0.05). Among the pairwise comparisons, 4,968 transcripts had a significant fold change absolute value between 13:00H and 01:00H, 3,215 transcripts had a significant fold change absolute value between 19:00H and 01:00H and 2,797 transcripts had a significant fold change absolute value between 07:00H and 01:00H (Figure 2.3A).

### *Identification of Putative Orthologs for TDC, TBH, OAT, and OA-Receptor in L. cornutus transcriptome*

#### *Putative Orthologs of TDC*

Homolog sequences of *L. cornutus* TDC were isolated from the transcriptome assembly using a TBLASTX query of known TDC protein sequences from other organisms (list of query sequences in figure legend). Using the ClustalW alignment program in Geneious, multiple alignments were performed and the result revealed amino acid sequences of TDC was highly conserved among the arthropod species (Fig. 2.4A). The transcripts isolated all had several conserved residues for all TDC proteins in addition to a pyridoxal-phosphate attachment site. In addition, a phylogenetic tree, constructed by neighbor-joining method, showed the grouping of the identified homologs in *L. cornutus* among two different nodes separated TDC subtype 1 and TDC subtype 2 (Fig. 2.4B). Within TDC subtype 1, it appears the arachnid homologs of TDC-1

are more derived while the *L. cornutus* isoforms for transcript DN54328\_c2\_g2 appears to be more similar to the insect TDC-subtype 2 of *Drosophila* and *Orchesella* (Fig. 2.4B). The relatively high bootstrap value for each node support these results. Mr. Bayes plug-in was used to construct Bayesian trees in Geneious Software[42] .

**A**

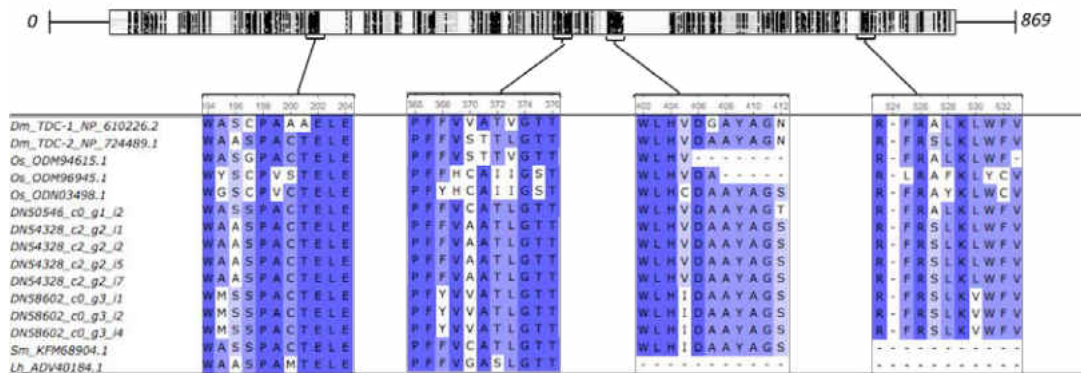

**B**

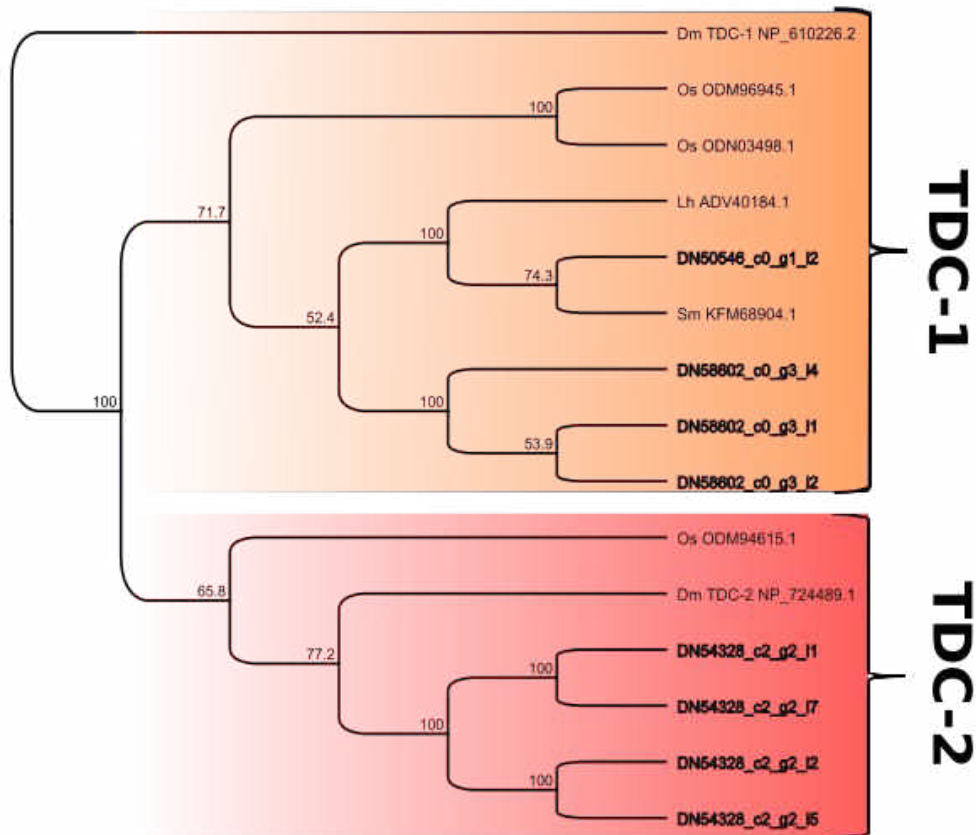

Figure 2.4. A. Box shade of tyrosine decarboxylase (*Tdc*) protein regions in alignment. Proteins were aligned with the ClustalW alignment algorithm on the Geneious™ software with default settings and the box shade was produced with Unipro Ugene. Shading is determined by the conservation of a residue at a position by percentage; dark blue = 100% of residues share identity, medium blue = 75% of residues share identity, light blue = 50% of residues share identity. The number at the end of each line of each protein sequence is the number of residues that a protein has up to the end of that line. Species abbreviations: Os, *Orchesella species*; Dm, *Drosophila melanogaster*; Lh, *Latrodectus hesperus*; Sm, *Stegodyphus mimsarum*; B. Phylogenetic tree constructed in Geneious™ using Neighbor-Joining Maximum-likelihood analysis with bootstrapping values (1000 replicates). Accession numbers: Os(ODM96945.1), Os(ODN03498.1), Os(ODM94615.1), Dm(NP\_610226.2), Dm(NP\_724489.1), Sm(KFM81141.1, KFM68904.1), Lh(ADV40184.1).

*Putative Orthologs of TBH*

Homolog sequences of *L. cornutus* TBH were isolated from the transcriptome assembly using a TBLASTX query of known TBH protein sequences from other organisms (list of query sequences in figure legend). Using the ClustalW alignment program in Geneious, multiple alignments were performed and the result revealed amino acid sequences of TBH was highly conserved among the arthropod species (Fig. 2.5A). While the *L. cornutus* transcript DN58971\_c1\_g2 isoforms isolated for TBH identification appear to share homology in the regions shown in the figure, there are several sites of polymorphisms in the region AA position 332 -341. In addition, a phylogenetic tree, constructed by neighbor-joining method, shows the transcripts of *L. cornutus*, along with protein sequences from the spiders *Parasteatoda tepidariorum* and *Stegodyphus mimasarum* appear more derived (Fig. 2.5B). The relatively high bootstrap value for each node support these results.

**A****B**

Figure 2.5. A. Box shade of tyramine beta hydroxylase (TBH) protein regions in alignment. Proteins were aligned with the ClustalW alignment algorithm on the Geneious™ software with default settings and the box shade was produced with Unipro Ugene. Shading is determined by the conservation of a residue at a position by percentage; dark blue = 100% of residues share identity, medium blue = 75% of residues share identity, light blue = 50% of residues share identity. The number at the end of each line of each protein sequence is the number of residues that a protein has up to the end of that line. B. Phylogenetic tree constructed in Geneious™ using Neighbor-Joining Maximum-likelihood analysis with bootstrapping values (1000 replicates). Species abbreviations: Dm, *Drosophila melanogaster*; Pa, *Periplanta americana*; Tm, *Tropilaelaps mercedesae*; Sm, *Stegodyphus mimsarum*; Pt, *Parasteatoda tepidariorum*; Em, *Euroglyphus maynei*; Dpm: *Daphnia magna*; Gm, *Gryllus bimaculatus*; Tu, *Tetranychus urticae*. Accession numbers: Dm (TAAO41640, CAA94391.2), Gm (BAO52001), Pa (AFO63079), Bm (BAK09201), Tu(XP\_015783011), Tm(OQR67915), Sm(KFM67340), Em (OTF80724), Dpm(JAN71135), Pt (XP015917689, XP\_015922088).



### *Putative Orthologs of OAT*

Homolog sequences of *L. cornutus* OAT were isolated from the transcriptome assembly using a TBLASTX query of known OAT protein sequences from other organisms (list of query sequences in figure legend). Using the ClustalW alignment program in Geneious, multiple alignments were performed and the result revealed amino acid sequences of OAT was highly conserved among the arthropod species (Fig. 2.6A). Although there is a very high level of conservation of the protein sequences among the *L. cornutus* transcripts isolated and the arthropod queries, it appears there may have been a duplication of this gene and one transcript in particular, DN 53562\_c1\_g1\_i1, showed a high degree of polymorphisms (Fig. 2.6A). In a phylogenetic tree, constructed by neighbor-joining, the five different *L. cornutus* transcripts do not cluster in the same node (Fig. 2.6B). Rather, two transcripts (DN59028 and DN55221) group with other arachnid TBH homologs, while the remaining *L. cornutus* homologs of OAT appear more ancestral among the OAT sequence of *Drosophila* (Fig. 2.6B). The relatively high bootstrap value for each node support these results.

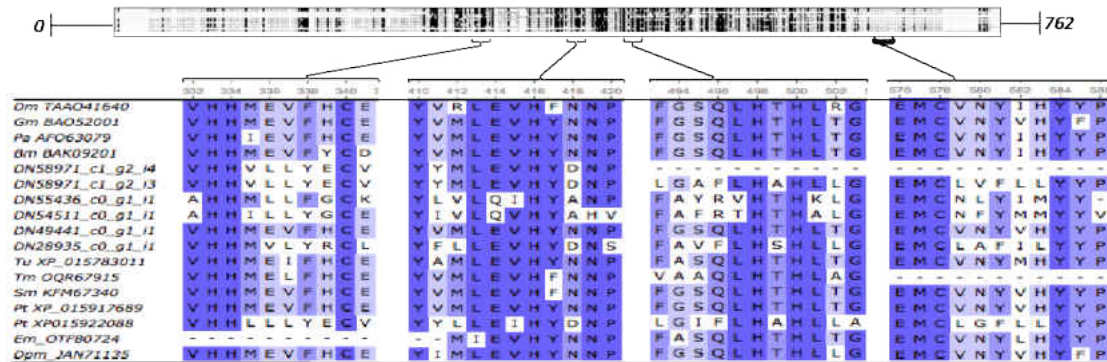
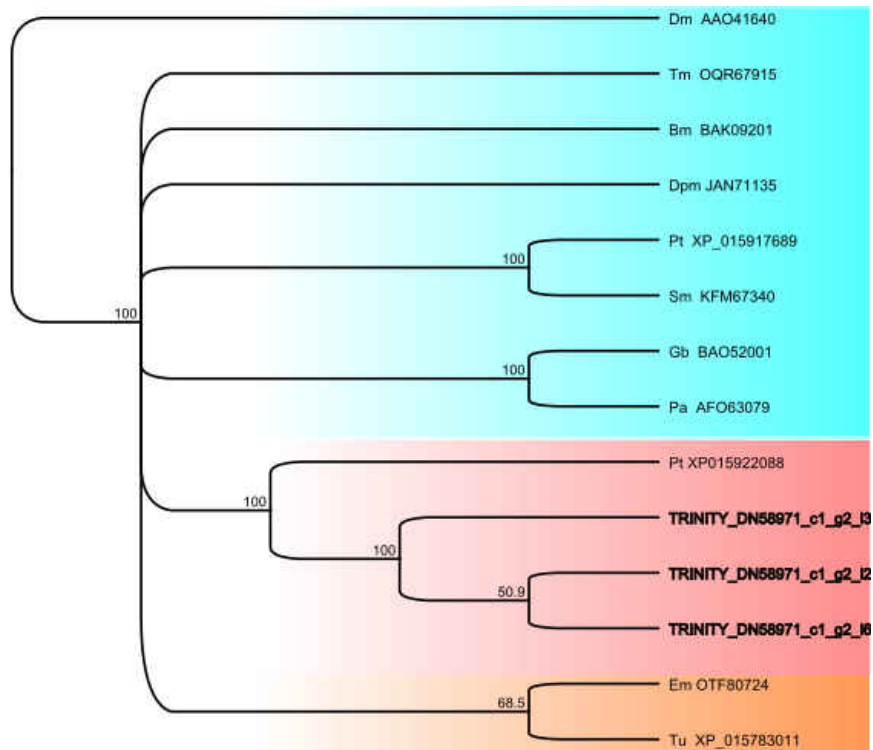
A

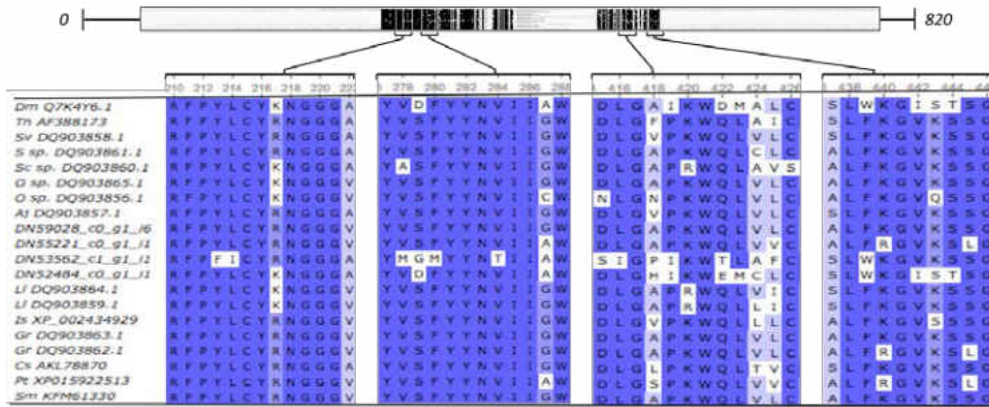

B

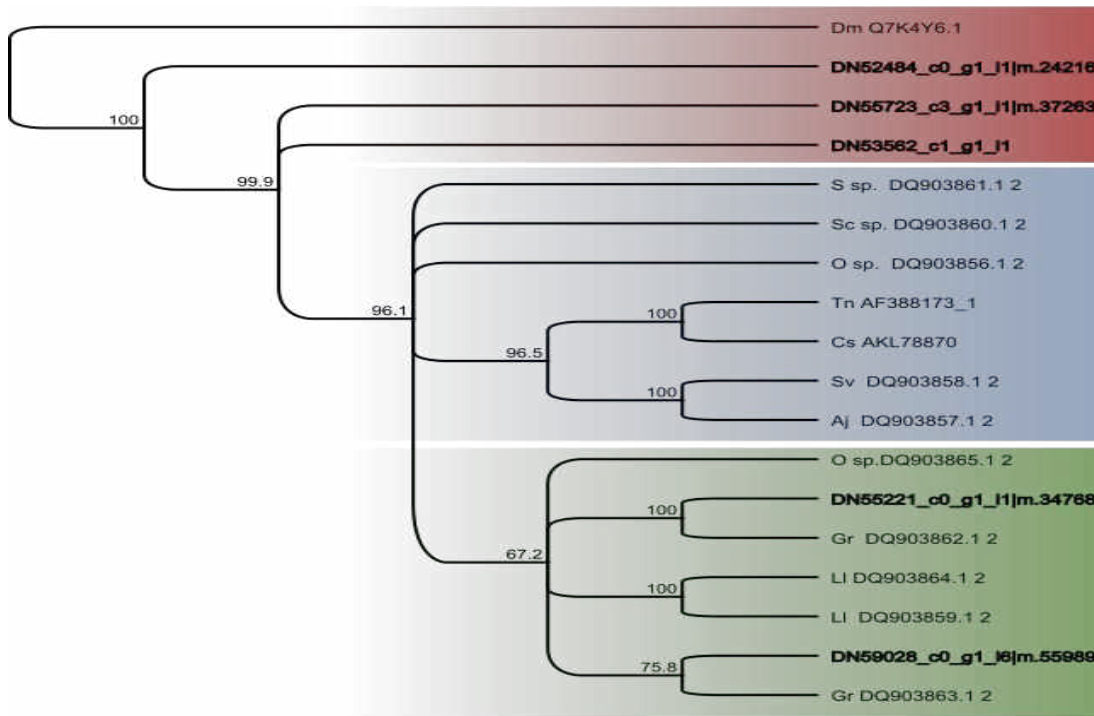
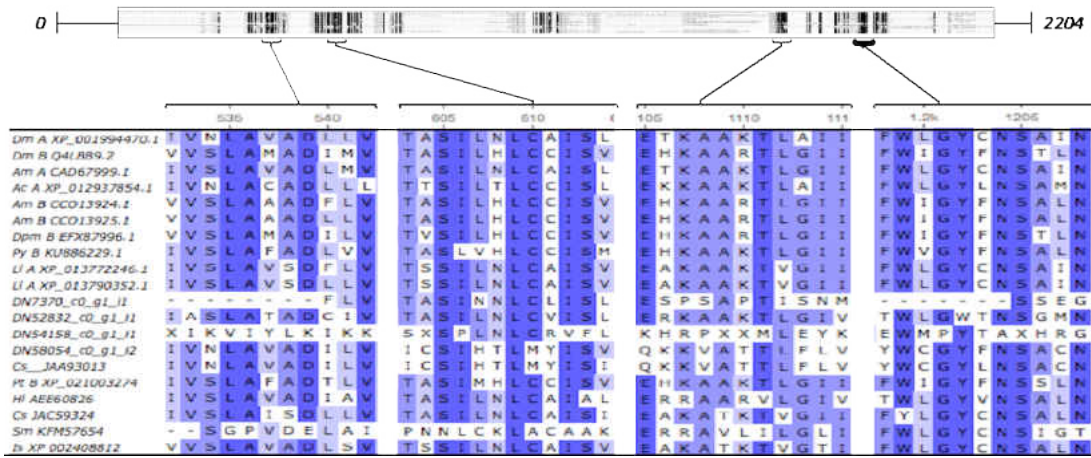

Figure 2.6. A. Box shade of octopamine-dependent transporter (*OAT*) protein regions in alignment. Proteins were aligned with the ClustalW alignment algorithm on the Geneious™ software with default settings and the box shade was produced with Unipro Ugene. Shading is determined by the conservation of a residue at a position by percentage; dark blue = 100% of residues share identity, medium blue = 75% of residues share identity, light blue = 50% of residues share identity. The number at the end of each line of each protein sequence is the number of residues that a protein has up to the end of that line. B. Phylogenetic tree constructed in Geneious™ using Neighbor-Joining Maximum-likelihood analysis with bootstrapping values (1000 replicates). *L. cornutus* transcripts in bold. Species abbreviations and accession numbers: Dm, *Drosophila melanogaster* (Q7K4Y6.1), S sp., *Spirostreptus species* (DQ903861.1), Sc sp., *Scolopendra species* (DQ903860.1), O sp., *Opisththalmus species* (DQ903865.1, DQ903856.1), Tn, *Trichoplusia ni* (AF388173), Cs, *Cupiennius salei* (AKL78870), Sv *Sympetrum vicinum* (DQ903858.1), Aj *Anax junius* (DQ903857.1), LI *Limulus limulus* (DQ903864.1, DQ903859.1), Gr *Grammostola rosea* (DQ903862.1, DQ903863.1).

### *Putative Orthologs of OA-Receptors*

Homolog sequences of *L. cornutus* OA receptors were isolated from the transcriptome assembly using a TBLASTX query of known OA receptor protein sequences from other organisms (list of query sequences in figure legend). In arthropods, there are two subtypes of OA receptors, alpha and beta subtypes, based on similar structural and molecular characteristics of adrenergic receptors[43]. For identification of potential subtypes in *L. cornutus*, sequences from both alpha and beta subtypes were used. Using the ClustalW alignment program in Geneious, multiple alignments were performed and the result showed amino acid sequences of OA receptors were not as highly conserved as other proteins investigated in this paper. Rather, while there is some degree of highly homologous residues, the subtypes of OA receptors do appear among the query sequences and the isolated *L. cornutus* transcripts (Fig. 2.7A). This is also reflected in the phylogenetic tree, constructed using neighbor-joining with a *Drosophila* 5-HT receptor as a root, in which alpha and beta OA receptors characterized in other arthropod species separate into different nodes. Interestingly, several transcripts of *L. cornutus* cluster independently (Fig. 2.7B). The relatively high bootstrap value for each node support these results.

**A**



**B**

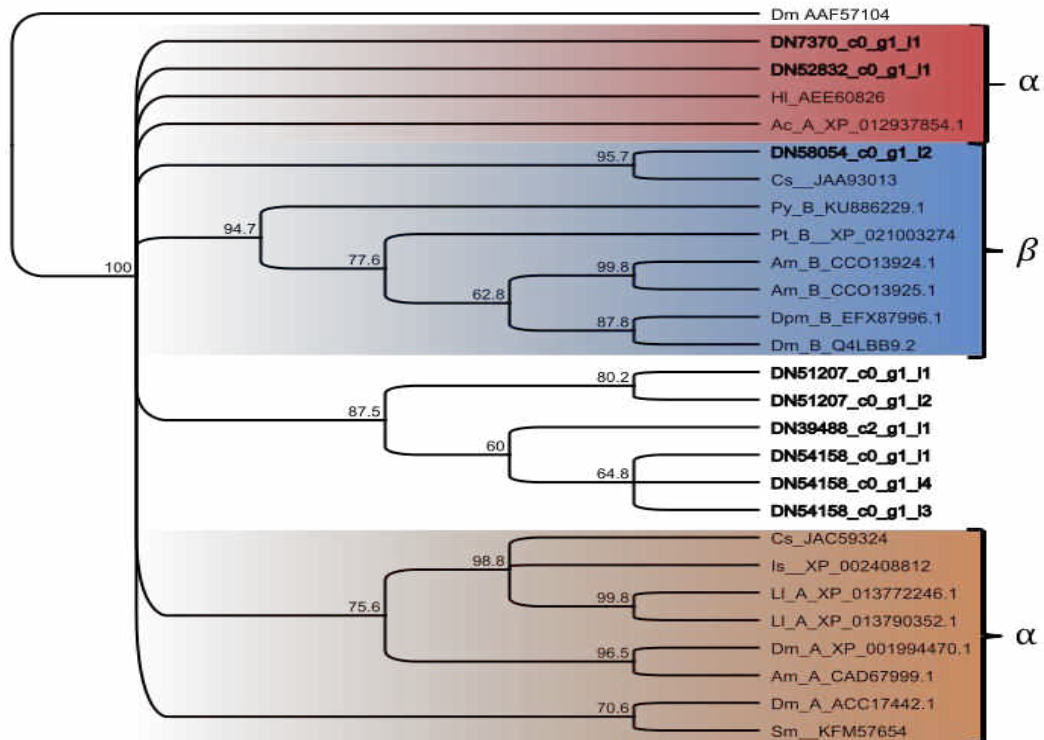

Figure 2.7. Box shade of octopamine receptor (OA-R) protein regions in alignment, labeled with alpha or beta subtype. Proteins were aligned with the ClustalW alignment algorithm on the Geneious™ software with default settings and the box shade was produced with Unipro Ugene. Shading is determined by the conservation of a residue at a position by percentage; dark blue = 100% of residues share identity, medium blue = 75% of residues share identity, light blue = 50% of residues share identity. The number at the end of each line of each protein sequence is the number of residues that a protein has up to the end of that line. Species abbreviations and accession numbers: Dm, *Drosophila melanogaster* (AAF57104, Q4LBB9.2, ACC17442.1); Hi, *Haemaphysalis longicornis* (AEE60826); Ac, *Aplysia californica* (XP012937854.1); Cs, *Cupiennius salei* (JAA93013, JAC59324); Py, *Platynereis dumerilii* (KU886229.1); Pt, *Parasteatoda tepidariorum* (XP021003274); Am, *Apis mellifera* (CC013924.1, CCO13925.1, CAD67999.1); Dpm, *Daphnia magna* (EFX87996.1); Is, *Ixodes scalpularis* (XP002408812); Li, *Limulus limulus* (XP013772246.1, XP013790352.1); Sm, *Stegodyphus mimasarum* (KFM57654); B. Phylogenetic tree constructed in Geneious™ using Neighbor-Joining Maximum-likelihood analysis with bootstrapping values (1000 replicates).

### *Normalized expression levels of L. cornutus homologs of TDC, TBH, OAT, and OA-Receptors*

The transcripts isolated as putative homologs of TDC (DN54328, DN58602, DN50546) and all the isoforms of these transcripts were analyzed for expression values among the four different time points (Fig. 2.8A). Some of the transcripts had very low expression at all-time points which can be expected that some genes are not constitutively expressed in all tissues. DN58602 and DN50546 shared more homology with *Drosophila* TDC subtype 1, which is expressed in a tissue-specific manner in non-neuronal tissues[44]. However, the transcript DN54328 was expressed at its lowest levels in the middle of the day and appears to increase again at dusk (Fig. 2.8A). DN54328 is more similar to TDC-subtype 2 in *Drosophila*, identified to be highly expressed in neuronal tissue. Because the cephalothorax contains the central nervous system, this transcript could be exhibiting similar tissue-specific expression. It is interesting to note that when analyzing the nucleotide sequence for all the isoforms of DN54328, some isoforms had alternate start codons (isoform 3 and isoform 5), however, they were still expressed at high levels. The transcript DN59701 isolated as putative homolog of TBH appears to have significant changes in expression levels throughout the day, however the diurnal patterns of expression were quite different among the isoforms of this transcript (Fig. 2.8B). Overall, the expression values of TBH transcripts were much lower than TDC transcripts. Putative transcripts of OA-receptors of *L. cornutus* (DN52832, DN39488, DN51207, DN7370, DN54148, DN58054) fluctuate across the four time points, however the transcript DN39488 appears to be expressed at relatively high levels throughout the day, with its highest expression level at dusk (Fig. 2.8C). Lastly, some of the transcripts isolated as putative homologs of OAT (DN5221, DN59028,

DN55723) demonstrated fluctuations in expression levels, with one transcript (DN55723) having nearly a 2-fold increase at 13:00H (Fig. 2.8D).

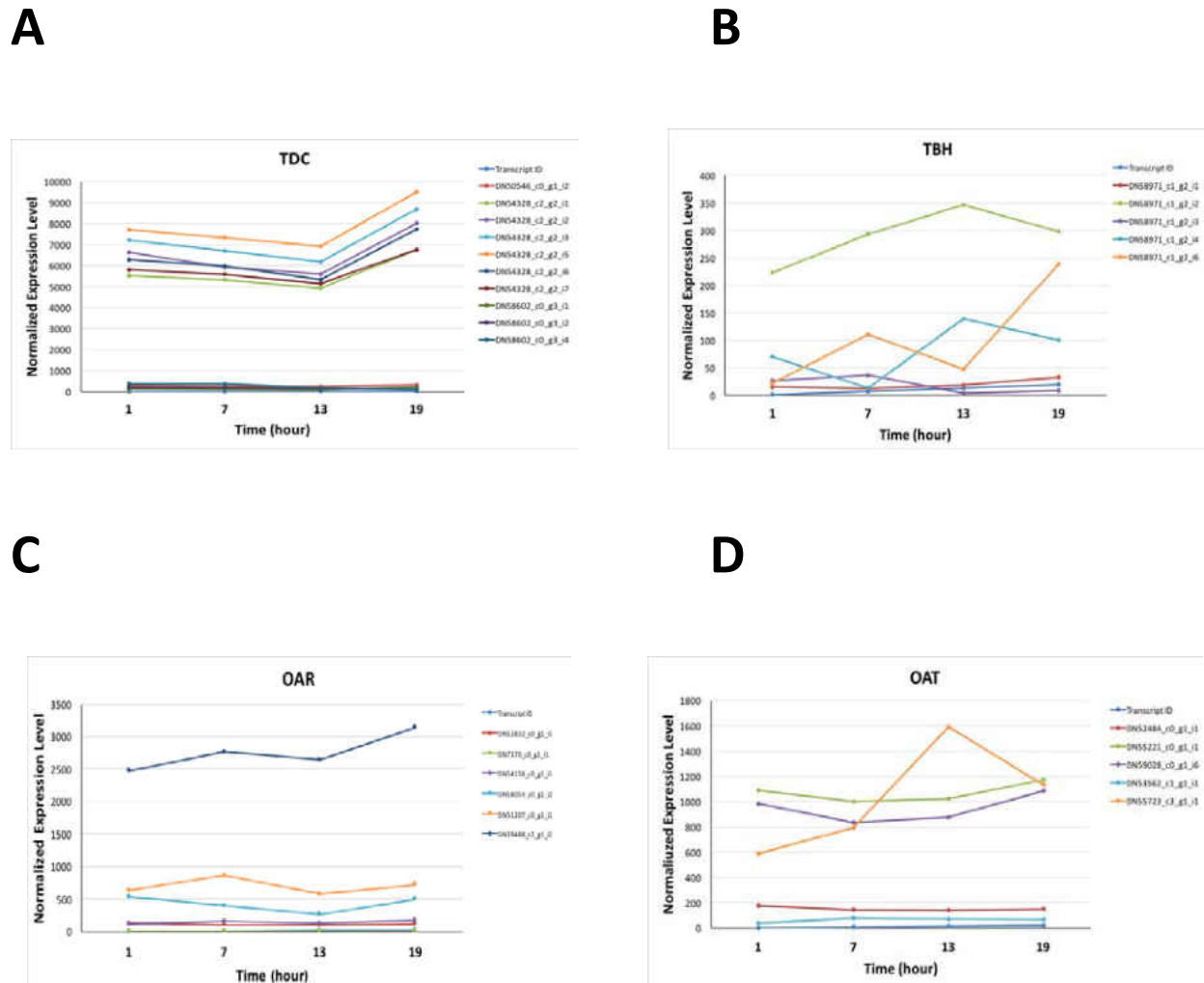

Figure 2.8. Normalized gene expression values for putative ortholog protein sequences of *L. cornutus* of TDC, TBH, OAT, and OA Receptor (labeled A, B, C, D, respectively) over time (01:00H, 07:00H, 13:00H, 19:00H).

### Quantitative PCR validation of transcriptome analysis

In order to verify the accuracy of the differential expression analysis of *L. cornutus* transcriptome, tyrosine decarboxylase (putative TDC ortholog, Transcript ID:

Trinity\_DN\_54328\_c2\_g2\_i5), tyramine beta-hydroxylase (putative TBH ortholog, Transcript

ID: Trinity\_DN58971\_c1\_g2\_i2), octopamine transporter (putative OAT ortholog, Transcript ID: Trinity\_DN55723\_c3\_g1\_i1), and octopamine receptor (putative OAR ortholog, Transcript ID: Trinity\_DN\_58054\_c0\_g1\_i3) genes were selected for qPCR validation. Relative expression of these selected genes was quantitatively measured over four time points (1,7,13, and 19 hours) and the results were analyzed considering scotophase (1hr) as the control time point (Figure 2.9. A-D). qPCR results displayed that during mid-photophase (13hr), the putative transcript of TDC (Figure 2.9A, Kruskal-Wallis,  $p = 0.001$ , Dunn's test,  $p < 0.0001$ ) and the putative octopamine receptor transcript, OAR, expression were at their lowest level (Figure 2.9C, ANOVA,  $p = 0.0375$ , Dunnett's test,  $p = 0.0248$ ) compared to scotophase (1hr). However, another octopamine synthesis enzyme, TBH expression exhibited a biphasic oscillation, decreasing at 7hr and 13hr (Figure 2.9B, Kruskal-Wallis,  $p = 0.0165$ ). Lastly, the transcript level of OAT increased during mid-photophase (13hr) than the control time point (Figure 2.9C, ANOVA,  $p = 0.0927$ ). Except for TBH, the qPCR results are consistent with those observed in the transcriptome analysis, validating the reproducibility of our transcriptome data.

While BLAST homology retrieves several different transcripts with each query, the transcripts used in qPCR validation showed interesting patterns in relative fold change throughout the day (Figure 2.9). In qPCR validation, putative transcripts for both synthesis enzymes (TDC and TBH) appeared to increase at dusk and decrease in the morning or during the day. The putative transcript of an octopamine-like receptor used in qPCR validation also appear to be expressed at lower levels during the day with an increase at dusk. Lastly, the putative transcript of an octopamine-dependent transporter appears to increase expression during the middle of the day, allowing a potential mechanism of increasing turnover of OA from signaling.

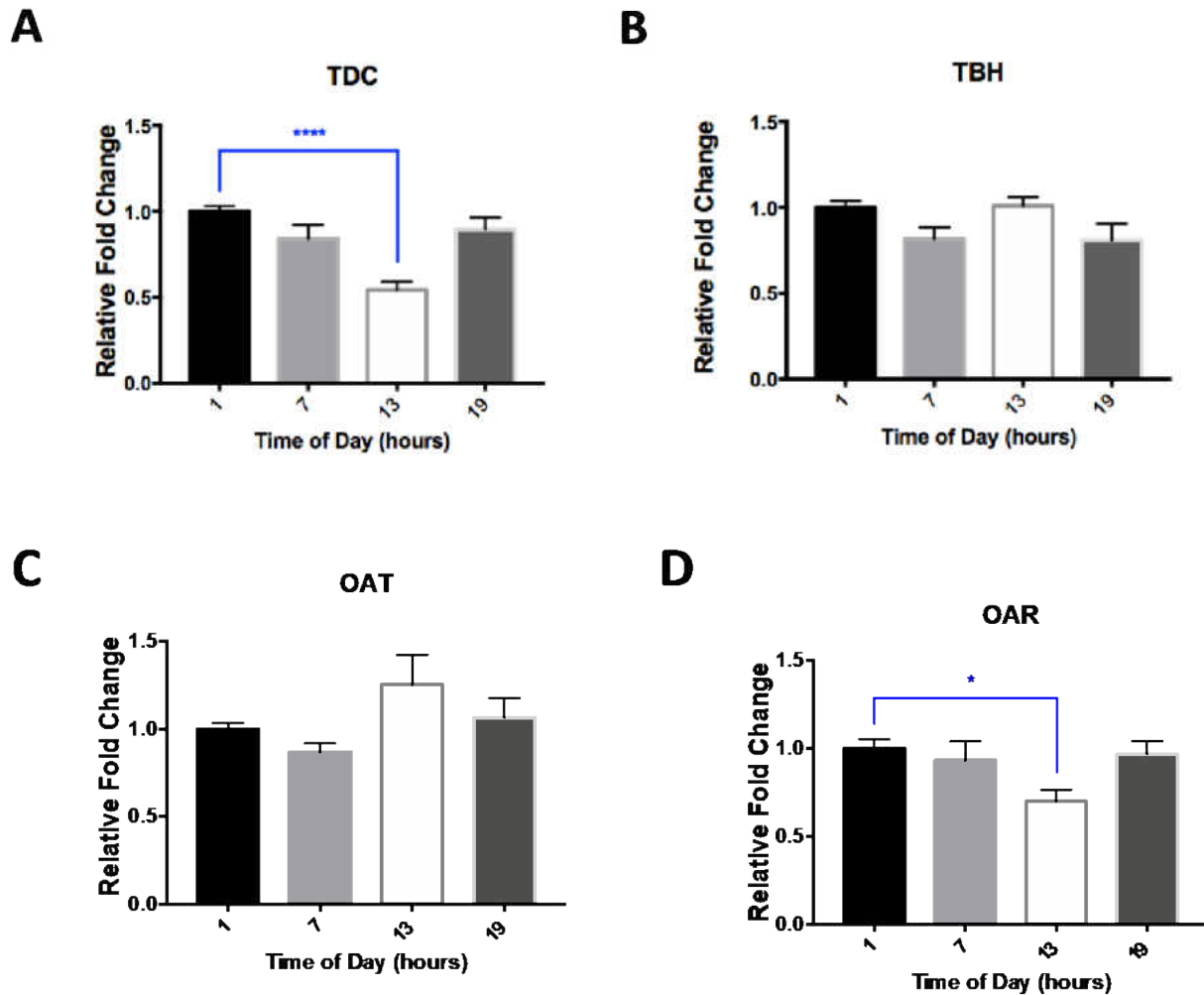

Figure 2.9. qPCR validation for selective genes of *L. cornutus*. Relative expression of TDC, TBH, OA Receptor, and OAT (labeled A, B, C, D, respectively) over time (01:00H, 07:00H, 13:00H, 19:00H) were measured in a group of three spider cephalothoraces. Results are the mean  $\pm$  S.D. of three replicates ( $n = 3$ ). Statistical analysis was conducted by ANOVA or Kruskal-Wallis (\*, $p < 0.05$ ; \*\*\*\*, $p < 0.0001$ ).

## DISCUSSION

In many arthropods, a tremendous amount of genes are up or down regulated in a diurnal or circadian pattern in relation to eye physiology, metabolism, or movement[45–49]. Majority of neurotransmitters, both excitatory and inhibitory, are directly influenced by an organism's



internal timekeeping system which allow efficient sleep/wake cycles and allow metabolism to function effectively[50]. However, building upon these vital physiological roles, these same neurotransmitters, specifically serotonin and octopamine, are also heavily involved in complex behavioral states in arthropods[27,28,51–53]. While the octopaminergic system has been studied in terms of its individual components (synthesis, reception, metabolism, etc.) in reference to a specific behavior or physiological process[15,54], few studies have taken a holistic approach to understand how these components act in concert with one another to tune an organism's behavioral state[55,56].

There appeared to be no significant fluctuation in OA levels in the cephalothorax or hemolymph of *L. cornutus* individuals at the four different time points throughout the day. These results are in contrast to many studies investigating monoamine levels in brain tissue in other arthropods in relation to the circadian clock[57–63]. In the field cricket *A. domesticus*, fluctuations in OA occurred under LD (light:dark) and DD (dark:dark) conditions, with its highest levels being at night. In cabbage looper moths, you see a contrast from this with OA levels in hemolymph peaking during the day [60]. However, as the cephalothorax contains the brain, sucking stomach, venom glands, and some initial innervations to peripheral limbs, there could be more localized changes in octopamine levels. A similar analysis performed in honeybees revealed that while overall endogenous levels of OA did not fluctuate in the brain as a whole tissue, individual areas of the nervous system (i.e. mushroom bodies and antennal lobes) showed significant differences[64]. The shifts in monoamines could be much larger in specific ganglia types in spiders, for example sub esophageal versus supra esophageal ganglia. While extensive dissection has been done in arthropods, the cephalothorax of spiders is quite difficult to dissect due to its hard exoskeleton coupled with a hydrostatic pressure. However, future studies

involving fixations could help elucidate the individual tissues in efforts to stain or quantify changes in specific brain regions. In addition, fluctuations in OA levels could be occurring between the time points selected in this study (every 6 hours). While this study aimed at identifying significant fluctuations at the four major times of day in terms of position of scotophase and photophase, additional experiments could take a more frequent sampling of brain tissue and hemolymph (i.e. every 2 or 4 hours).

Our results reflected a significant variation in expression levels of TDC-like transcripts across the different times of day. While we initially were investigating potential TDC transcripts in general, it appears there is evidence for two subtypes of this enzyme in the *L. cornutus* transcriptome. TDC plays a crucial role in tyramine production, and the subtype TDC-2's role in neuronal tissue allows substantial increase of this biogenic amine across potential blood brain barriers[44]. Our findings support previous studies showing oscillations in tyrosine decarboxylase protein in neural tissue of *Drosophila* [20] as well as studies reflecting diurnal variations in expression of amino acid decarboxylase enzymes[65]. It is important to note that diurnal variations have only been documented in the neural TDC-2 protein, but not the TDC-1 protein in non-neuronal tissue[44]. Tyramine synthesis has been previously documented to be influenced by the internal clock, as *period* gene mutants showed a decrease in tyrosine decarboxylase activity[19]. While TDC-2 expression did not appear to be cycling in whole-head tissues analysis in *Drosophila*, we were able to detect significant shifts in expression in spite of using a non-cell-specific technique [46,66–69]. Although we were interested in identifying TDC in reference to octopamine synthesis, the intermediate tyramine is implicated in a wide array of behavioral and physiological effects in arthropods including aggressive behaviors in termites and ants[70,71]. With such a marked increase in TDC transcript levels at dusk in *L. cornutus*, further

studies are needed to investigate the role of tyramine and its interaction with octopamine in modulating the anti-predator behavior.

This study revealed diurnal variation in putative transcripts of TBH in the transcriptome analysis, however this was not able to be validated with qPCR. Unlike the other genes investigated in this study, all putative TBH orthologs identified in the *L. cornutus* transcriptome were all isoforms of a single transcript (Trinity\_DN58971\_c1\_g2) and the primer for the isoform chosen for validation (Trinity\_DN58971\_c1\_g2\_i6) was not specific. Thus, there is some discontinuity in validating the expression levels across the time points. While TBH expression levels were not significant, there was a clear pattern of upregulation at dusk in conjunction with the putative TDC orthologues. Thus, this may be evidence of more specific regulation of OA levels or underlying interactions with its precursor tyramine. A similar pattern of diurnal variation was identified in the synthesis enzyme of dopamine, tyrosine hydroxylase, in rats[72]. It is important to note that synthesis enzymes do not always dictate the only form of regulation, and in many cases other factors must also be involved in the in vivo regulation of the neurotransmitters[73]. Although TBH is the rate limiting enzyme for octopamine synthesis, it has also been implicated in reproduction, stress response, learning, and aggression in invertebrates[14,15,74–77]. In *Drosophila*, aggressive behaviors are almost abolished in TBH mutants, independent of whether tyramine is increased or depleted[15]. Thus, TBH expression levels would presumably influence daily shifts in aggression. However, TBH has only been investigated for temporal regulation in relation to development [21].

Putative octopamine dependent transporters appear to show variation in expression throughout the day in *L. cornutus*. Transporters are necessary for reuptake of compounds and offer a substantial level of regulation of a compound's influence on physiology and behavioral

response of organisms[78,79]. While octopamine dependent transporter transcripts have not been investigated for diurnal fluctuations, our findings are similar to diurnal fluctuations in dopamine-dependent transporters in rats[25]. It is important for transporter expression to be upregulated in anticipation of and during peak times of a compound or peptide being released. This has been reflected in several studies of oligopeptide transporters involved in ion, drug, and peptide transporters[80–82]. In many cases, mRNA expression of nutrient transporters peak in anticipation and during time of peak uptake[83]. In the case of monoamine-dependent transporters, dopamine-dependent transporters are key regulators in tone[25,84], with the amount of transporters expressed at cell surface increase during peak times of dopamine levels and fluctuate under circadian control[25,85]. In our results, while most transcripts did not increase in transcription significantly throughout the day, one transcript was upregulated throughout the daytime. Furthermore, this upregulation was validated and found to significantly increase to its highest level in mid-day. This may reflect transcription of these transporters in anticipation of an increase in monoamines being upregulated at dusk and nighttime when *L. cornutus* would be the most active and alert, building or re-building their web and actively hunting prey. Although OA transporters allow clearance of the monoamine from the synapse, OA clearance is still not very well understood in arthropods in general, and other alternate pathways could be used for metabolizing OA, including less selective cationic amino acid transporters[86–88].

In *L. cornutus*, it appeared that some putative transcripts for octopamine receptors do fluctuate in their expression throughout the day. Receptor sensitivity and expression is implicated in allowing organisms to perceive sensory information and physiologically tuned in different behavioral states[89,90]. In insects, OA receptors have been implicated in appetitive reinforcement[91,92], ovulation[93], memory storage and behavioral plasticity[94], and diel

fluctuations in antennal sensitivity detection of pheromones[95]. Similar to some vertebrate studies, this change in expression of mRNA coding for particular receptors seen in *L. cornutus* may influence daily foraging behavior[89]. Constitutive expression of some receptor transcripts for OA receptors among increases in one or two transcripts appear to give rise to the possibility that OA receptor signaling would be highest at dusk. As OA is implicated in aggression and activity[15,71,96], this increase in receptor expression would help modulate an increase of OA signaling when *L. cornutus* would be actively hunting prey.

## CONCLUSIONS

In this study, we took an initial step toward understanding the role the octopaminergic system plays in diurnal variation in anti-predator behavior in the spider *L. cornutus* through first identifying putative genes involved (TDC, TBH, OAT, and OAR) and how their expression levels fluctuate throughout the day. While *L. cornutus* is a novel system in studying aggression and its underlying mechanisms, it provides an opportunity to further elucidate how ecologically dynamic organisms carefully regulate their behavioral state. However, it is important to note the transcripts identified in this study were based on protein homology, and not fully characterized. In future studies, it would be important to characterize the transcripts identified in this study in terms of specificity of signaling molecules in the case of receptors and transporters, while quantifying activity of the synthesis enzymes. This study aimed at quantifying gene expression, but additional work would need to quantify how these levels influence downstream protein translation as well as how they are influenced by the internal time keeping system of *L. cornutus*. Although the cephalothorax tissue was used to analyze more nervous system related changes in the octopaminergic system, additional studies will be needed to analyze individual components

of the brain and if transcripts of interest are tissue-specific. Lastly, this study allowed a broad perspective of how different components of the octopaminergic system are transcribed in reference to the time of day and perhaps more behavioral or physiological studies will take a holistic approach to studying these genes in concert with each other in organisms.

## REFERENCES

1. Cowie R, Krebs J. Optimal foraging in patchy environments. *Popul Dyn.* 1979;256: 183–205.
2. Roeder T. Tyramine and octopamine: ruling behavior and metabolism. *Annu Rev Entomol. Annual Reviews;* 2005;50: 447–77. doi:10.1146/annurev.ento.50.071803.130404
3. Huber R. Amines and motivated behaviors: A simpler systems approach to complex behavioral phenomena. *Journal of Comparative Physiology A: Neuroethology, Sensory, Neural, and Behavioral Physiology.* 2005. pp. 231–239. doi:10.1007/s00359-004-0585-5
4. Sloley BD, Juorio A V. Monoamine neurotransmitters in invertebrates and vertebrates: an examination of the diverse enzymatic pathways utilized to synthesize and inactivate biogenic amines. *Int Rev Neurobiol.* 1995;38: 253–303. Available: <http://www.ncbi.nlm.nih.gov/pubmed/8537202>
5. dos Santos R, Rosa SASL, Aires-Barros MR, Tover A, Azevedo AM. Phenylboronic acid as a multi-modal ligand for the capture of monoclonal antibodies: development and optimization of a washing step. *J Chromatogr A.* 2014;1355: 115–24. doi:10.1016/j.chroma.2014.06.001
6. Adamo SA, Linn CE, Hoy RR. The role of neurohormonal octopamine during “fight or flight” behaviour in the field cricket *Gryllus bimaculatus*. *J Exp Biol.* 1995;198: 1691–700. Available: <http://www.ncbi.nlm.nih.gov/pubmed/7636443>
7. Stevenson PA, Hofmann HA, Schoch K, Schildberger K. The fight and flight responses of crickets depleted of biogenic amines. *J Neurobiol.* 2000;43: 107–120. doi:10.1002/(SICI)1097-4695(200005)43:2<107::AID-NEU1>3.0.CO;2-C
8. Potter CJ, Luo L. Octopamine fuels fighting flies. *Nat Neurosci.* 2008;11: 989–990. doi:10.1038/nn0908-989
9. Evans PD. Biogenic Amines in the Insect Nervous System. *Adv In Insect Phys.* 1980;15: 317–473. doi:10.1016/S0065-2806(08)60143-5
10. David JC, Coulon JF. Octopamine in invertebrates and vertebrates. A review. *Progress in Neurobiology.* 1985. pp. 141–185. doi:10.1016/0301-0082(85)90009-7
11. Roeder T. Octopamine in invertebrates. *Prog Neurobiol.* 1999;59: 533–61. Available: <http://www.ncbi.nlm.nih.gov/pubmed/10515667>
12. Kravitz EA, Glusman S, Harris-Warrick RM, Livingstone MS, Schwarz T, Goy MF. Amines and a peptide as neurohormones in lobsters: actions on neuromuscular preparations and preliminary behavioural studies. *J Exp Biol.* 1980;89: 159–175.

13. Stevenson PA. Octopamine and Experience-Dependent Modulation of Aggression in Crickets. *J Neurosci.* 2005;25: 1431–1441. doi:10.1523/JNEUROSCI.4258-04.2005
14. Baier A, Wittek B, Brembs B. *Drosophila* as a new model organism for the neurobiology of aggression? *J Exp Biol.* 2002;205: 1233–1240. doi:10.1007/s003590050134
15. Hoyer SC, Eckart A, Herrel A, Zars T, Fischer SA, Hardie SL, et al. Octopamine in male aggression of *Drosophila*. *Curr Biol. Elsevier;* 2008;18: 159–67. doi:10.1016/j.cub.2007.12.052
16. Sujkowski A, Ramesh D, Brockmann A, Correspondence RW, Wessells R. Octopamine Drives Endurance Exercise Adaptations in *Drosophila*. *CellReports.* 2017;21: 1809–1823. doi:10.1016/j.celrep.2017.10.065
17. The role of octopamine in locusts and other arthropods. *J Insect Physiol. Pergamon;* 2010;56: 854–867. doi:10.1016/J.JINSPHYS.2010.05.018
18. Crocker A, Sehgal A. Octopamine Regulates Sleep in *Drosophila* through Protein Kinase A-Dependent Mechanisms. *J Neurosci.* 2008;28: 9377–9385. doi:10.1523/JNEUROSCI.3072-08a.2008
19. Livingstone MS, Tempel BL. Genetic dissection of monoamine neurotransmitter synthesis in *Drosophila*. *Nature.* 303: 67–70. Available: <http://www.ncbi.nlm.nih.gov/pubmed/6133219>
20. Huang Y, Ainsley JA, Reijmers LG, Jackson FR. Translational profiling of clock cells reveals circadianly synchronized protein synthesis. *PLoS Biol. Public Library of Science;* 2013;11: e1001703. doi:10.1371/journal.pbio.1001703
21. Lehman HK, Murguic CM, Hildebrand JG. Characterization and developmental regulation of tyramine-beta-hydroxylase in the CNS of the moth, *Manduca sexta*. *Insect Biochem Mol Biol.* 2000;30: 377–386. doi:S0965174800000114 [pii]
22. Koon AC, Budnik V. Inhibitory control of synaptic and behavioral plasticity by octopaminergic signaling. *J Neurosci. NIH Public Access;* 2012;32: 6312–22. doi:10.1523/JNEUROSCI.6517-11.2012
23. Troppmann B, Balfanz S, Krach C, Baumann A, Blenau W. Characterization of an invertebrate-type dopamine receptor of the American cockroach, *Periplaneta americana*. *Int J Mol Sci.* 2014;15: 629–53. doi:10.3390/ijms15010629
24. Takeuchi K, Mohammad S, Ozaki T, Morioka E, Kawaguchi K, Kim J, et al. Serotonin-2C receptor involved serotonin-induced Ca<sup>2+</sup> mobilisations in neuronal progenitors and neurons in rat suprachiasmatic nucleus. *Sci Rep. Nature Publishing Group;* 2015;4: 4106. doi:10.1038/srep04106
25. Ferris MJ, España RA, Locke JL, Konstantopoulos JK, Rose JH, Chen R, et al. Dopamine transporters govern diurnal variation in extracellular dopamine tone. *Proc Natl Acad Sci U S A. National Academy of Sciences;* 2014;111: E2751-9. doi:10.1073/pnas.1407935111
26. Jones TC, Akoury TS, Hauser CK, Moore D. Evidence of circadian rhythm in antipredator behaviour in the orb-weaving spider *Larinioides cornutus*. *Anim Behav.* 2011;82: 549–555. doi:10.1016/j.anbehav.2011.06.009
27. Jones TC, Akoury TS, Hauser CK, Neblett MF, Linville BJ, Edge AA, et al. Octopamine and serotonin have opposite effects on antipredator behavior in the orb-weaving spider, *Larinioides cornutus*. *J Comp Physiol A Neuroethol Sens Neural Behav Physiol.* 2011;197: 819–25. doi:10.1007/s00359-011-0644-7
28. Hebets EA, Hansen M, Jones TC, Wilgers DJ. Octopamine levels relate to male mating tactic expression in the wolf spider *Rabidosa punctulata*. *Anim Behav.* 2015;100: 136–

142. doi:10.1016/j.anbehav.2014.11.023
29. Bubak AN, Swallow JG, Renner KJ. Whole brain monoamine detection and manipulation in a stalk-eyed fly. *J Neurosci Methods*. 2013;219: 124–130. doi:10.1016/j.jneumeth.2013.07.006
  30. ENCODE2 Project. ENCODE Consortium [Internet].
  31. Grabherr MG, Haas BJ, Yassour M, Levin JZ, Thompson DA, Amit I, et al. Full-length transcriptome assembly from RNA-Seq data without a reference genome. *Nat Biotechnol*. 2011;29: 644–652. doi:10.1038/nbt.1883
  32. Haas BJ, Papanicolaou A, Yassour M, Grabherr M, Blood PD, Bowden J, et al. De novo transcript sequence reconstruction from RNA-seq using the Trinity platform for reference generation and analysis. *Nat Protoc*. Nature Publishing Group; 2013;8: 1494–1512. doi:10.1038/nprot.2013.084
  33. Finn RD, Clements J, Arndt W, Miller BL, Wheeler TJ, Schreiber F, et al. HMMER web server: 2015 update. *Nucleic Acids Res*. 2015;43. doi:10.1093/nar/gkv397
  34. Altschul SF, Gish W, Miller W, Myers EW, Lipman DJ. Basic local alignment search tool. *J Mol Biol*. Academic Press; 1990;215: 403–410. doi:10.1016/S0022-2836(05)80360-2
  35. Yang C, Pan H, Noland JE, Zhang D, Zhang Z, Liu Y, et al. Selection of reference genes for RT-qPCR analysis in a predatory biological control agent, *Coleomegilla maculata* (Coleoptera: Coccinellidae). *Sci Rep*. Nature Publishing Group; 2016;5: 18201. doi:10.1038/srep18201
  36. Chang Y-W, Chen J-Y, Lu M-X, Gao Y, Tian Z-H, Gong W-R, et al. Selection and validation of reference genes for quantitative real-time PCR analysis under different experimental conditions in the leafminer *Liriomyza trifolii* (Diptera: Agromyzidae). Gao Y, editor. *PLoS One*. Public Library of Science; 2017;12: e0181862. doi:10.1371/journal.pone.0181862
  37. Ma K-S, Li F, Liang P-Z, Chen X-W, Liu Y, Gao X-W. Identification and Validation of Reference Genes for the Normalization of Gene Expression Data in qRT-PCR Analysis in *Aphis gossypii* (Hemiptera: Aphididae). *J Insect Sci*. 2016;16: 17. doi:10.1093/jisesa/iew003
  38. Xiao R, Wang L, Cao Y, Zhang G. Transcriptome response to temperature stress in the wolf spider *Pardosa pseudoannulata* (Araneae: Lycosidae). *Ecol Evol*. Wiley-Blackwell; 2016;6: 3540–3554. doi:10.1002/ece3.2142
  39. Li C-C, Wang Y, Li G-Y, Yun Y-L, Dai Y-J, Chen J, et al. Transcriptome Profiling Analysis of Wolf Spider *Pardosa pseudoannulata* (Araneae: Lycosidae) after Cadmium Exposure. *Int J Mol Sci*. Multidisciplinary Digital Publishing Institute (MDPI); 2016;17. doi:10.3390/ijms17122033
  40. Posnien N, Zeng V, Schwager EE, Pechmann M, Hilbrant M, Keefe JD, et al. A comprehensive reference transcriptome resource for the common house spider *Parasteatoda tepidariorum*. *PLoS One*. 2014;9. doi:10.1371/journal.pone.0104885
  41. Croucher PJ, Brewer MS, Winchell CJ, Oxford GS, Gillespie RG. De novo characterization of the gene-rich transcriptomes of two color-polymorphic spiders, *Theridion grallator* and *T. californicum* (Araneae: Theridiidae), with special reference to pigment genes. *BMC Genomics*. BioMed Central; 2013;14: 862. doi:10.1186/1471-2164-14-862
  42. Huelsenbeck JP, Ronquist F. MRBAYES: Bayesian inference of phylogenetic trees.



- Bioinformatics. 2001;17: 754–5. Available:  
<http://www.ncbi.nlm.nih.gov/pubmed/11524383>
43. Evans PD, Maqueira B. Insect octopamine receptors: a new classification scheme based on studies of cloned *Drosophila* G-protein coupled receptors. *Invertebr Neurosci*. Springer-Verlag; 2005;5: 111–118. doi:10.1007/s10158-005-0001-z
  44. Cole SH, Carney GE, McClung CA, Willard SS, Taylor BJ, Hirsh J. Two functional but noncomplementing *Drosophila* tyrosine decarboxylase genes: distinct roles for neural tyramine and octopamine in female fertility. *J Biol Chem. American Society for Biochemistry and Molecular Biology*; 2005;280: 14948–55. doi:10.1074/jbc.M414197200
  45. Kovoor J, Ortega-Escobar J, Munoz-Cuevas A. Circadian Structural Changes in the Retina of *Lycosa tarentula* (Araneae: Lycosidae). *Biol Rhythm Res*. 1999;30: 407–423. doi:10.1076/brhm.30.4.407.1412
  46. Claridge-Chang A, Wijnen H, Naef F, Boothroyd C, Rajewsky N, Young MW. Circadian regulation of gene expression systems in the *Drosophila* head. *Neuron*. 2001;32: 657–671. doi:10.1016/S0896-6273(01)00515-3
  47. Leming MT, Rund SS, Behura SK, Duffield GE, O’Tousa JE. A database of circadian and diel rhythmic gene expression in the yellow fever mosquito *Aedes aegypti*. *BMC Genomics*. 2014;15: 1128. doi:10.1186/1471-2164-15-1128
  48. Rund SS, Gentile JE, Duffield GE. Extensive circadian and light regulation of the transcriptome in the malaria mosquito *Anopheles gambiae*. *BMC Genomics*. 2013;14: 218. doi:10.1186/1471-2164-14-218
  49. Rund SSC, Yoo B, Alam C, Green T, Stephens MT, Zeng E, et al. Genome-wide profiling of 24 hr diel rhythmicity in the water flea, *Daphnia pulex*: network analysis reveals rhythmic gene expression and enhances functional gene annotation. *BMC Genomics. BioMed Central*; 2016;17: 653. doi:10.1186/s12864-016-2998-2
  50. Feillet CA, Albrecht U, Challet E. “Feeding time” for the brain: a matter of clocks. *J Physiol Paris*. 2006;100: 252–60. doi:10.1016/j.jphysparis.2007.05.002
  51. Glanzman DL, Krasne FB. Serotonin and octopamine have opposite modulatory effects on the crayfish’s lateral giant escape reaction. *J Neurosci*. 1983;3: 2263–9. Available: <http://www.ncbi.nlm.nih.gov/pubmed/6415242>
  52. Roeder T. TYRAMINE AND OCTOPAMINE: Ruling Behavior and Metabolism. *Annu Rev Entomol*. 2005;50: 447–477. doi:10.1146/annurev.ento.50.071803.130404
  53. Saraswati S, Fox LE, Soll DR, Wu C-F. Tyramine and octopamine have opposite effects on the locomotion of *Drosophila* larvae. *J Neurobiol*. 2004;58: 425–441. doi:10.1002/neu.10298
  54. Li H-M, Jiang H-B, Gui S-H, Liu X-Q, Liu H, Lu X-P, et al. Characterization of a  $\beta$ -Adrenergic-Like Octopamine Receptor in the Oriental Fruit Fly, *Bactrocera dorsalis* (Hendel). *Int J Mol Sci. Multidisciplinary Digital Publishing Institute (MDPI)*; 2016;17. doi:10.3390/ijms17101577
  55. Alaux C, Sinha S, Hasadsri L, Hunt GJ, Guzman-Novoa E, DeGrandi-Hoffman G, et al. Honey bee aggression supports a link between gene regulation and behavioral evolution. *Proc Natl Acad Sci*. 2009;106: 15400–15405. doi:10.1073/pnas.0907043106
  56. Whitfield CW, Cziko AM, Robinson GE. Gene expression profiles in the brain predict behavior in individual honey bees. *Science (80- )*. 2003;302: 296–299. doi:10.1126/science.1086807
  57. Fowler, D.J., Goodnigh, C.J., Labrie MM. Circadian rhythms of 5-hydroxytryptamine

- (serotonin) production in larvae, pupae, and adults of *Drosophila melanogaster* (Diptera-Drosophilidae). *Ann Entomol Soc Am.* 1972;65: 138–141. Available: <https://www.scopus.com/record/display.uri?eid=2-s2.0-84872870567&origin=inward&txGid=a69538ce63b55aa4a284d4ea2fcfe75f>
58. Natsukawa T, Tanigawa T, Takeda M. Circadian Fluctuation of Catecholamines in the Cockroach Brain-Subesophageal Ganglion Complex detected by HPLC-ECD. *Biol Rhythm Res.* 1996;27: 138–147. doi:10.1076/brhm.27.2.138.12948
  59. Gatellier L, Nagao T, Kanzaki R. Serotonin modifies the sensitivity of the male silkworm to pheromone. *J Exp Biol.* 2004;207: 2487–2496. doi:10.1242/jeb.01035
  60. Linn CE, Poole KR, Roelofs WL. Studies on biogenic amines and their metabolites in nervous tissue and hemolymph of adult male cabbage looper moths-I. Quantitation of photoperiod changes. *Comp Biochem Physiol Part C Pharmacol.* 1994;108: 73–85. doi:10.1016/1367-8280(94)90092-2
  61. Page TL. Serotonin Phase-Shifts the Circadian Rhythm of Locomotor Activity in the Cockroach. *J Biol Rhythms.* Sage PublicationsSage CA: Thousand Oaks, CA; 1987;2: 23–34. doi:10.1177/074873048700200103
  62. Woodring JP, Meier OW, Rose R. Effect of development, photoperiod, and stress on octopamine levels in the house cricket, *Acheta domesticus*. *J Insect Physiol.* 1988;34: 759–765. doi:10.1016/0022-1910(88)90149-7
  63. Yuan Q, Lin F, Zheng X, Sehgal A. Serotonin Modulates Circadian Entrainment in *Drosophila*. *Neuron.* 2005;47: 115–127. doi:10.1016/j.neuron.2005.05.027
  64. Schulz DJ, Barron AB, Robinson GE. A role for octopamine in honey bee division of labor. *Brain Behav Evol.* Karger Publishers; 2002;60: 350–9. doi:10.1159/000067788
  65. Ishida Y, Yokoyama C, Inatomi T, Yagita K, Dong X, Yan L, et al. Circadian rhythm of aromatic L-amino acid decarboxylase in the rat suprachiasmatic nucleus: gene expression and decarboxylating activity in clock oscillating cells. *Genes Cells.* 2002;7: 447–59. Available: <http://www.ncbi.nlm.nih.gov/pubmed/12047348>
  66. McDonald MJ, Rosbash M. Microarray analysis and organization of circadian gene expression in *Drosophila*. *Cell.* 2001;107: 567–78. doi:10.1016/S0092-8674(01)00545-1
  67. Lin Y, Han M, Shimada B, Wang L, Gibler TM, Amarakone A, et al. Influence of the period-dependent circadian clock on diurnal, circadian, and aperiodic gene expression in *Drosophila melanogaster*. *Proc Natl Acad Sci U S A.* 2002;99: 9562–7. doi:10.1073/pnas.132269699
  68. Ceriani MF, Hogenesch JB, Yanovsky M, Panda S, Straume M, Kay SA. Genome-wide expression analysis in *Drosophila* reveals genes controlling circadian behavior. *J Neurosci.* 2002;22: 9305–19. doi:22/21/9305 [pii]
  69. Ueda HR, Matsumoto A, Kawamura M, Iino M, Tanimura T, Hashimoto S. Genome-wide transcriptional orchestration of circadian rhythms in *Drosophila*. *J Biol Chem.* 2002;277: 14048–14052. doi:10.1074/jbc.C100765200
  70. Ishikawa Y, Aonuma H, Sasaki K, Miura T. Tyraminerigic and Octopaminergic Modulation of Defensive Behavior in Termite Soldier. Blenau W, editor. *PLoS One.* 2016;11: e0154230. doi:10.1371/journal.pone.0154230
  71. Szczuka A, Korczyńska J, Wnuk A, Symonowicz B, Gonzalez Szwacka A, Mazurkiewicz P, et al. The effects of serotonin, dopamine, octopamine and tyramine on behavior of workers of the ant *Formica polyctena* during dyadic aggression tests. *Acta Neurobiol Exp (Wars).* 2013;73: 495–520. Available: <http://www.ncbi.nlm.nih.gov/pubmed/24457641>

72. Sleipness EP, Sorg BA, Jansen HT. Diurnal differences in dopamine transporter and tyrosine hydroxylase levels in rat brain: Dependence on the suprachiasmatic nucleus. *Brain Res.* 2007;1129: 34–42. doi:10.1016/j.brainres.2006.10.063
73. Cahill AL, Ehret CF. Circadian Variations in the Activity of Tyrosine Hydroxylase, Tyrosine Aminotransferase, and Tryptophan Hydroxylase: Relationship to Catecholamine Metabolism. *J Neurochem.* Blackwell Publishing Ltd; 1981;37: 1109–1115. doi:10.1111/j.1471-4159.1981.tb04660.x
74. Monastirioti M, Linn CE, White K. Characterization of *Drosophila* tyramine beta-hydroxylase gene and isolation of mutant flies lacking octopamine. *J Neurosci. Society for Neuroscience*; 1996;16: 3900–11. Available: <http://www.ncbi.nlm.nih.gov/pubmed/8656284>
75. Chatel A, Murillo L, Bourdin CM, Quinchard S, Picard D, Legros C. Characterization of tyramine  $\beta$ -hydroxylase, an enzyme upregulated by stress in *Periplaneta americana*. *J Mol Endocrinol.* 2013;50: 91–102. doi:10.1530/JME-12-0202
76. Nishimura K, Kitamura Y, Inoue T, Umesono Y, Yoshimoto K, Taniguchi T, et al. Characterization of tyramine  $\beta$ -hydroxylase in planarian *Dugesia japonica*: Cloning and expression. *Neurochem Int.* 2008;53: 184–192. doi:10.1016/j.neuint.2008.09.006
77. Iliadi KG, Iliadi N, Boulianne GL. *Drosophila* mutants lacking octopamine exhibit impairment in aversive olfactory associative learning. *Eur J Neurosci.* 2017;46: 2080–2087. doi:10.1111/ejn.13654
78. Giros B, Jaber M, Jones SR, Wightman RM, Caron MG. Hyperlocomotion and indifference to cocaine and amphetamine in mice lacking the dopamine transporter. *Nature.* 1996;379: 606–612. doi:10.1038/379606a0
79. Koepsell H, Lips K, Volk C. Polyspecific Organic Cation Transporters: Structure, Function, Physiological Roles, and Biopharmaceutical Implications. *Pharm Res.* Kluwer Academic Publishers-Plenum Publishers; 2007;24: 1227–1251. doi:10.1007/s11095-007-9254-z
80. Murakami Y, Higashi Y, Matsunaga N, Koyanagi S, Ohdo S. Circadian Clock-Controlled Intestinal Expression of the Multidrug-Resistance Gene *mdr1a* in Mice. *Gastroenterology.* 2008;135: 1636–1644.e3. doi:10.1053/j.gastro.2008.07.073
81. Saito H, Terada T, Shimakura J, Katsura T, Inui K. Regulatory mechanism governing the diurnal rhythm of intestinal H<sup>+</sup>/peptide cotransporter 1 (PEPT1). *Am J Physiol Liver Physiol.* 2008;295: G395–G402. doi:10.1152/ajpgi.90317.2008
82. Saifur Rohman M, Emoto N, Nonaka H, Okura R, Nishimura M, Yagita K, et al. Circadian clock genes directly regulate expression of the Na<sup>+</sup>/H<sup>+</sup> exchanger NHE3 in the kidney. *Kidney Int.* 2005;67: 1410–1419. doi:10.1111/j.1523-1755.2005.00218.x
83. Balakrishnan A, Tavakkolizadeh A, Rhoads DB. Circadian clock genes and implications for intestinal nutrient uptake. *J Nutr Biochem.* NIH Public Access; 2012;23: 417–22. doi:10.1016/j.jnutbio.2012.01.002
84. Katsura T, Inui K-I. Intestinal absorption of drugs mediated by drug transporters: mechanisms and regulation. *Drug Metab Pharmacokinet.* 2003;18: 1–15. Available: <http://www.ncbi.nlm.nih.gov/pubmed/15618714>
85. Daws LC, Callaghan PD, Morón JA, Kahlig KM, Shippenberg TS, Javitch JA, et al. Cocaine Increases Dopamine Uptake and Cell Surface Expression of Dopamine Transporters. *Biochem Biophys Res Commun.* 2002;290: 1545–1550. doi:10.1006/bbrc.2002.6384

86. Sloan JL, Mager S. Cloning and functional expression of a human Na(+) and Cl(-)-dependent neutral and cationic amino acid transporter B(0+). *J Biol Chem.* 1999;274: 23740–5. Available: <http://www.ncbi.nlm.nih.gov/pubmed/10446133>
87. Gründemann D, Gorboulev V, Gambaryan S, Veyhl M, Koepsell H. Drug excretion mediated by a new prototype of polyspecific transporter. *Nature.* 1994;372: 549–552. doi:10.1038/372549a0
88. Pörzgen P, Park SK, Hirsh J, Sonders MS, Amara SG. The antidepressant-sensitive dopamine transporter in *Drosophila melanogaster*: a primordial carrier for catecholamines. *Mol Pharmacol.* 2001;59: 83–95. Available: <http://www.ncbi.nlm.nih.gov/pubmed/11125028>
89. Lema SC, Wagstaff LJ, Gardner NM. Diurnal rhythms of behavior and brain mRNA expression for arginine vasotocin, isotocin, and their receptors in wild *Amargosa* pupfish (*Cyprinodon nevadensis amargosae*). *Mar Freshw Behav Physiol.* 2010;43: 257–281. doi:10.1080/10236244.2010.498632
90. Rex E, Molitor SC, Hapiak V, Xiao H, Henderson M, Komuniecki R. Tyramine receptor (SER-2) isoforms are involved in the regulation of pharyngeal pumping and foraging behavior in *Caenorhabditis elegans*. *J Neurochem.* Blackwell Science Ltd; 2004;91: 1104–1115. doi:10.1111/j.1471-4159.2004.02787.x
91. Schwaerzel M, Monastirioti M, Scholz H, Friggi-Grelin F, Birman S, Heisenberg M. Dopamine and octopamine differentiate between aversive and appetitive olfactory memories in *Drosophila*. *J Neurosci.* 2003;23: 10495–502. doi:Copyright © 2012 by the Society for Neuroscience
92. Awata H, Wakuda R, Ishimaru Y, Matsuoka Y, Terao K, Katata S, et al. Roles of OAI1 octopamine receptor and Dop1 dopamine receptor in mediating appetitive and aversive reinforcement revealed by RNAi studies. *Sci Rep. Nature Publishing Group;* 2016;6: 29696. doi:10.1038/srep29696
93. Lim J, Sabandal PR, Fernandez A, Sabandal JM, Lee H-G, Evans P, et al. The Octopamine Receptor Oct $\beta$ 2R Regulates Oviposition in *Drosophila melanogaster*. Broughton S, editor. *PLoS One. Public Library of Science;* 2014;9: e104441. doi:10.1371/journal.pone.0104441
94. Han KA, Millar NS, Davis RL. A novel octopamine receptor with preferential expression in *Drosophila* mushroom bodies. *J Neurosci.* 1998;18: 3650–8. Available: <http://www.ncbi.nlm.nih.gov/pubmed/9570796>
95. Schendzielorz T, Schirmer K, Stolte P, Stengl M. Octopamine Regulates Antennal Sensory Neurons via Daytime-Dependent Changes in cAMP and IP3 Levels in the Hawkmoth *Manduca sexta*. Frye MA, editor. *PLoS One. Public Library of Science;* 2015;10: e0121230. doi:10.1371/journal.pone.0121230
96. Yang Z, Yu Y, Zhang V, Tian Y, Qi W, Wang L. Octopamine mediates starvation-induced hyperactivity in adult *Drosophila*. *Proc Natl Acad Sci.* 2015;112: 5219–5224. doi:10.1073/pnas.1417838112

## CHAPTER 3

### INVESTING THE ROLE OF THE SEROTONERGIC SYSTEM ON DIURNAL VARIATION IN AGGRESSION-RELATED BEHAVIORS IN AN ORB-WEAVING SPIDER

Rebecca J. Wilson<sup>1</sup>, Tahmina H. Ahmed<sup>2</sup>, Brian M. Cartwright<sup>3</sup>, Jennifer B. Price<sup>1</sup>, Garron Wright<sup>4</sup>, Nadia Ayoub<sup>5</sup> and Thomas C. Jones<sup>1</sup>

<sup>1</sup>Department of Biological Sciences, East Tennessee State University, Johnson City, TN 37601

<sup>2</sup>Department of Biochemistry, Virginia Polytechnic Institute and State University, Blacksburg, VA

<sup>3</sup>Department of Biomedical Sciences, Quillen College of Medicine, Johnson City, TN 37601

<sup>4</sup>D. Murdoch Research Institute, Kannapolis, NC

<sup>5</sup>Department of Biological Sciences, Washington and Lee University, Lexington, VA

## ABSTRACT

The biogenic amine serotonin (5-HT) is widely utilized signaling molecule in organisms for many physiological and behavioral processes. While 5-HT is both influential in regulating circadian rhythms and aggression, few studies have investigated the interplay between these areas of research with attention to individual components of the serotonergic system. Recent studies have demonstrated the species *Larinioides cornutus*, a nocturnal orb-weaving spider, displays a diel and circadian rhythm in anti-predator behavior that can be manipulated by exogenous levels of 5-HT. Thus, it appears the serotonergic system may be playing a key role in the organism shifting between heightened levels of boldness. This study took a holistic approach to investigate 5-HT levels and genes involved in synthesis, transport, and signaling of 5-HT at four time points throughout the day (0100, 0700, 1300, and 1900 hours) using HPLC-ED and RNA-seq. Although 5-HT levels did not significantly fluctuate in the cephalothorax or hemolymph, several orthologs of genes involved in 5-HT synthesis, transport, and signaling appear to fluctuate throughout the day.

## INTRODUCTION

The biogenic amine serotonin (or 5-hydroxytryptamine, 5-HT) is an evolutionarily ancient signaling molecule found across metazoan organisms. In the invertebrate nervous system, 5-HT acts as a neurotransmitter, neurohormone, and neuromodulator of a wide array of physiological and behavioral processes[1]. While this compound has quite a ubiquitous presence, it has been strongly associated with mediating aggression-related behaviors in mammals, birds, and arthropods[2–4]. In crustaceans, infusion of 5-HT elicits a socially dominant posture in

lobsters, while the rate of 5-HT application in crayfish can determine individual social status[5–7]. Similar studies investigating the impact of 5-HT on aggression have been conducted in insects, but the effects of 5-HT on aggression are not uniform. In stalk-eyed flies, 5-HT decreases aggression levels of males and reduces the success of fighting outcomes[8]. In contrast, activation of the serotonergic system in fruit flies resulted in faster escalation of fights with a higher level of intensity among individuals[9]. Thus, while the effects of 5-HT have been studied in many arthropods extensively, the way in which the molecule elicits these behavioral responses in terms of individual components of the serotonergic system is still unclear.

The serotonergic system is comprised of several components including biosynthetic enzymes, transporters, and receptors. 5-HT is first synthesized in the cytoplasm by tryptophan hydroxylase in a rate-limiting fashion (Fig. 3.1) [10]. After synthesis, the compound can be stored in a vesicle until its eventual release. After its release into the extracellular space, the molecule can bind to a receptor (5-HTR), be reabsorbed into the cell by serotonin-dependent transporters (SERTs), or be degraded. In mammals, many aspects of this serotonin system including synthesis, metabolism, and receptor inactivation, have been implicated in modulated aggressive behaviors [4]. Similar work has been done in arthropods, particularly crustaceans. When synthesis enzymes were inhibited, an increase in aggressive tactics was observed in crayfish[11]. SERTs, the smallest and most conserved structure of the three known monoamine transporters, have been implicated in modulating tone of serotonin signaling in reference to aggression[4]. Lastly, 5-HT receptors demonstrate a role in a wide range of physiological and behavioral processes, including aggression, in both invertebrates and vertebrates alike, however, the degree of this effect varies based on type of receptors and location[12,13].

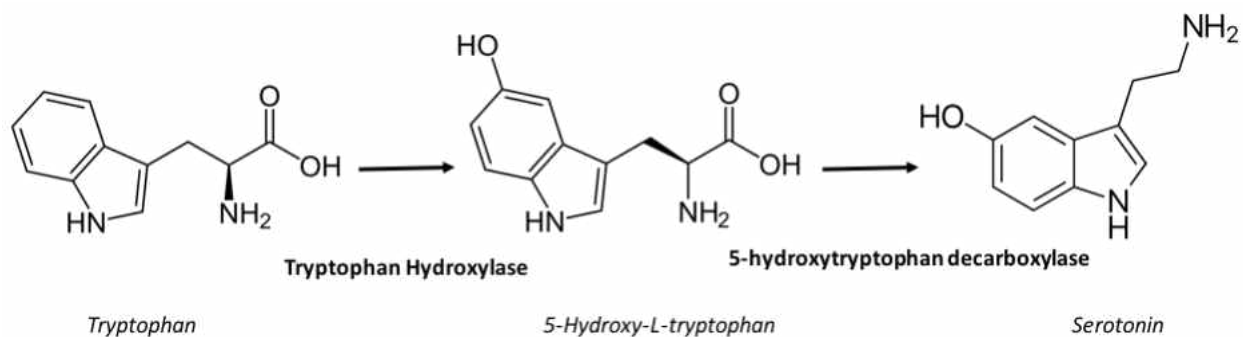

Figure 3.1. Synthesis of serotonin from tryptophan via tryptophan hydroxylase (TPH) and 5-hydroxytryptophan decarboxylase enzymes. 5-hydroxy-L-tryptophan is an intermediate product.

Spiders are ecologically dynamic organisms as both a predator and prey, making them ideal systems to study the components of 5-HT and aggression-related behaviors. Serotonin levels have been involved with more docile, social individuals of the species *Anelosimus*, as well as less aggressive mating displays and agonistic encounters in tarantulas [14,15]. Recent research in our lab revealed locomotor activity and aggression-related behavior in the orb-weaver *Larinioides cornutus* is under circadian control [16]. A nocturnal forager, *L. cornutus*, is mostly active at night and this pattern of locomotor activity persists under constant conditions (constant darkness). When threatened by a predator stimulus, the spider will display a death-feigning behavior or “huddle” response, pulling in all of its legs to form a tight-ball formation. This huddle response exhibits a diel and circadian pattern, with the spider huddling longer during the day while in a less aggressive state, and breaking out of this huddle more rapidly at night while in an apparent more aggressive state when the spider would otherwise be actively hunting prey [16]. These varied aggressive states can also be induced using exogenous amounts of serotonin. When serotonin levels were artificially increased, the boldness level of the individual



decreased[17]. Thus, it appears the serotonergic system is playing a key role in the organism shifting to lower levels of boldness.

To test the hypothesis that the serotonergic system is involved in the diurnal changes of aggression levels in *L. cornutus*, we first investigated endogenous and circulating levels of serotonin in the head tissue and hemolymph at four times throughout the day (01:00 – mid scotophase, 07:00- onset of photophase, 13:00-mid photophase, and 19:00- onset of scotophase). These four time points represent different times throughout the day in which the behavioral state fluctuates, with *L. cornutus* individuals becoming bolder at dusk and during nighttime (1900 and 0100 hours) and warier or less aggressive during the day (0700 and 1300 hours). A shot-gun transcriptome approach was then utilized to identify orthologs of serotonin synthesis enzyme, serotonin transporter, and serotonin receptor genes in this species: *tryptophan hydroxylase (TPH)*, *serotonin receptor (5-HTR)*, and *serotonin-dependent transporter (SERT)*. We next examined gene expression of the orthologs at four different times throughout the day (01:00 – mid scotophase, 07:00- onset of photophase, 13:00-mid photophase, and 19:00- onset of scotophase). We predicted that the components of the serotonergic system should be upregulated during the day when aggression levels are the lowest. Thus, turnover levels of serotonin would be elevated during the day and the enzymes involved in biosynthesis of 5HT would be upregulated.

## METHODS

### *Samples for High Performance Liquid Chromatography with Electrochemical Detection (HPLC-ED): Hemolymph and Cephalothorax Collection*

Modified from methods used in a previous study[18], cephalothoraces were collected at 01:00, 07:00, 13:00, and 19:00 hours. Each spider was anesthetized in a clean plastic chamber using CO<sub>2</sub>. Using a pair of dissecting shears, the right second walking leg of each individual was cut approximately in the middle of the tibia with dissecting scissors. 5uL of hemolymph was collected using a micropipette from the cut leg and transferred to an appropriately labeled Eppendorf tube (pre-labeled with each spider's unique identification number) with buffer solution (0.1 M perchloric acid with 1 µg/ml synephrine as an internal standard for 5-HT and 2ug/ml alpha methyl serotonin as an internal standard for 5-HT). Prior to analysis, all hemolymph samples were filtered using Costar Spin-X Centrifuge tube with a 0.22um cellulose acetate filter (13,000RPM for 6 minutes). This filtered hemolymph sample was stored at -20 °C until analysis was performed.

After the hemolymph was collected, the abdomen, pedipalps, and remaining walking legs were removed from the cephalothorax using dissecting shears. The cephalothorax was immediately flash frozen using liquid nitrogen and massed (g) on a balance before being placed in a labeled Eppendorf tube (pre-labeled with each spider's unique identification number) with buffer solution (0.1 M perchloric acid with 20ug/ml alpha methyl serotonin as an internal standard for 5-HT). Cephalothorax samples were then homogenized using ceramic beads and a bead grinder system for 2 minutes before a 10-minute centrifugation at 13,000 RPM to pellet all physical debris. The supernatant was then filtered using a Costar Spin-X Centrifuge tube with a

0.22µm cellulose acetate filter (13,000RPM for 6 minutes). This filtered cephalothorax sample was stored at -20 °C until analysis was performed.

#### *HPLC-ECD Analysis of Serotonin*

Cephalothorax and haemolymph samples were analyzed using high-performance liquid chromatography with electrochemical detection using parameters to a previous study[18] (HPLC-ECD; Alexys Monoamines Analyzer). The mobile phase consisted of 10% MeOH with 50 mM phosphoric acid, 50 mM citric acid, 500 mg/ml 1-octane sulphonic acid sodium salt, at a pH of 3.25 (Antec, Boston, MA, USA 180.7050A rev 02). Samples were injected using an AS110 autosampler at a rate of 50µl/min at 191.7kg/cm through an ALF-115 microbore column (150 x 1mm) with porous silica C(18) 3 µm particle size at 4 °C. Biogenic amine detection in haemolymph samples was acquired at a 5 nA range for 90 min with a VT-03 cell set at 850 mV. Peaks were confirmed against known standards. Chromatogram analysis was performed with Clarity software (Solihull, U.K.). Peak heights of each monoamine were normalized against internal standard peak for statistical analysis. Cephalothorax samples were normalized initially by mass of the tissue sample and protein concentration[8].

#### *Putative Transcript Identification*

The de novo assembled transcriptome of *L. cornutus* (Wilson *et al.*, unpublished) was mined for transcripts encoding proteins involved in serotonin biosynthesis, transport, and signaling. Using known arthropod proteins as templates, putative *Larinioides cornutus* homologs of tryptophan hydroxylase (TPH), serotonin-dependent transporter (SERT), and serotonin

receptors (5-HTR) were identified. Accession numbers of the query sequences reported in the figures. Transcripts were then analyzed for reading frames and domains as well as reverse BLASTed against the NCBI database to confirm identity. This process ensured proteins deduced from these transcripts possessed sequence homology and structural hallmarks of their respective enzyme families. Transcripts were then aligned with homologous proteins from other arthropod species using ClustalW alignment algorithm on the Geneious™ software. After the first protein alignment, transcripts or protein homologs were analyzed and removed if there was poor alignment or the protein was a partial fragment of the protein. A second protein alignment was then performed using Consensus Alignment tools using Geneious™ software. Phylogenetic trees were constructed from the protein alignments via Neighbor-Joining and maximum-likelihood with bootstrapping with 1000 replicates using Geneious™ software (Version 8.0).

#### *Validation of Transcriptome Analysis by Quantitative Real-Time PCR analysis*

Quantitative real-time PCR (qPCR) was performed to verify the transcriptome results of *L. cornutus*. Total RNA was extracted from cephalothoraces of female *L. cornutus* at four defined time points (1,7,13, and 19 hours). Cephalothoraces (head tissue) were removed from each specimen and were homogenized over ice and RNA was extracted using Maxwell® 16 LEV simplyRNA Tissue Kit (Promega, Lot #082114). RNA was primed with oligo (dT) primer and reverse transcription was carried out using Omniscript reverse transcriptase kit (Qiagen, cat #205113). Quantitative measurements were performed in triplicate on an ABI 7300 system (Applied Biosystems) using the GoTaq qPCR Master Mix (Promega) and gene-specific primers (TPH, SERT, 5-HTR). Primers were designed using NCBI Primer 3 and Primer-BLAST[19].

Transcript abundance was normalized to the internal control Actin for each sample. As a housekeeping gene, actin has been used as an endogenous reference gene in qPCR analysis in a number of studies with arthropods, including spiders[20–24]. All qPCR primers were designed using Geneious™ software (Table 3.1).

Table 3.1. Primers used for qPCR validation of putative TPH, SERT, and 5-HTR transcripts.

Putative Gene	Primer Name	Sequence 5'--> 3'	Transcript ID
Actin	Forward_Actin_L.cor	CATTACAGTGAGTGGGCGC	DN56916_c0_g2_i8
	Reverse_Actin_L.cor	TCCACCTCCAGCAGATGTG	
Tryptophan Hydroxylase	Forward_TPH_L.cor	TTTACCCTCCGACCTGTAG	DN55191_c2_g1_i3
	Reverse_TPH_L.cor	CGAAACTTGGATCTGCGAAT	
Serotonin-dependent transporter (SERT)	Forward_SERT_L.cor	CAATGTTGCCACGGATGGAC	DN53562_c1_g1_i1
	Reverse_SERT_L.cor	CCAGTCCACCAAACGTGCTA	
Serotonin-dependent transporter (SERT)	Forward_SERT2_L.cor	TCTTTGAGTGCGGAGCAGTT	DN51156_c5_g2_i1
	Reverse_SERT2_L.cor	CGTCACGGGCTTATACGTGA	
5-HT Receptor	Forward_5HTR_L.cor	GTGCCCTGATGGTCATTCT	DN12680_c0_g1_i1
	Reverse_5HTR_L.cor	GCTTGTTTTGGCGGATCCAT	
5-HT Receptor	Forward_5HTR2_L.cor	TCCGTCGCACCTTTATTGG	DN23475_c0_g1_i1
	Reverse_5HTR2_L.cor	GCCACTCGGAAGATTCTCCA	
5-HT Receptor	Forward_5HTR3_L.cor	TGTGGGTGCCACATGTAGTT	DN43050_c0_g1_i1
	Reverse_5HTR3_L.cor	CTTCGCGAAACGTCTCGTTC	
5-HT Receptor	Forward_5HT4_L.cor	CTTATCGGAGCTGTTTGGGC	DN9776_c0_g1_i1
	Reverse_5HT4_L.cor	CTGGTGCACGTGGCAAAAA	

### *Statistical Analysis*

All statistical analysis was performed using GraphPad Prism 7. All data sets were initially tested for normal distribution using Shapiro-Wilkes test for normality. Based on distribution, an ANOVA or a non-parametric Kruskal-Wallis test was performed to analyze the data for

significance. If possible, multiple comparisons were performed using Dunnett's multiple comparison statistical test.

## RESULTS

### *HPLC-ECD Analysis of 5-HT levels in cephalothorax and hemolymph of L. cornutus*

Levels of 5-HT in the cephalothorax appear to vary throughout the day, however, no significant differences were detected between the time points (Figure 3.2A; Kruskal-Wallis, p-value=0.07; K.W. statistic (4,45) = 6.834;  $n = 9-16$ ). Given the reduced power of non-parametric tests in addition to the significant amount of variation in the data, 5-HT may indeed be having a significant reduction in level at 0100 hours and increase at 1300 hours, but additional experiments are needed. Levels of 5-HT in the hemolymph did not vary throughout the day significantly (Figure 3.2B; Kruskal-Wallis, p=0.9, K.W. test statistic= 0.08391;  $n = 10-12$ ). There appears to be relatively similar median values throughout the day with a large amount of variation among the samples.

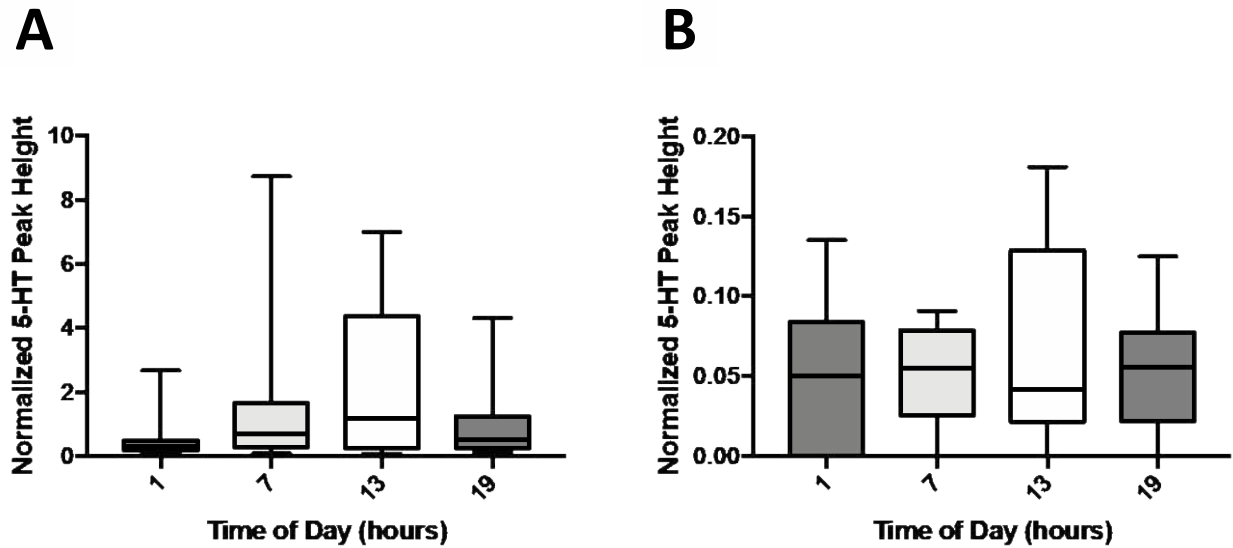

Figure 3.2. Boxplot of peak height of 5-HT normalized to internal standard at four time points (0100 hours, 0700 hours, 1300 hours and 1900 hours) in cephalothorax (A) and hemolymph (B).

*Identification of Putative Orthologs for TPH, Transporters, and 5-HTRs in L. cornutus transcriptome*

*Putative Orthologs of TPH*

Orthologs of *L. cornutus* TPH were isolated from the transcriptome assembly using a TBLASTX query of known TPH protein sequences from other organisms (list of query sequences in figure legend). Using the ClustalW alignment program in Geneious, multiple alignments were performed and the result revealed amino acid sequences of TPH was highly conserved among the arthropod species (Supplemental Fig. 3.1).

*Putative Orthologs of Non-selective 5-HT Transporters*

Orthologs of *L. cornutus* non-selective 5-HT transporters were isolated from the transcriptome assembly using a TBLASTX query of known protein sequences from other organisms (list of query sequences in figure legend). Using the ClustalW alignment program in

Geneious, multiple alignments were performed and the result revealed amino acid sequences of SERT was highly conserved among the arthropod species (Supplemental Fig. 3.2). Two transcripts (DN53562 and DN51156) were selected to confirm expression levels using qPCR. Transcript DN53562 was selected based on potentially high selectivity for serotonin based on protein homology and transcript DN51156 was selected due to its significant increase in expression level during the day. Transcript DN51156 did share a higher homology with sodium-dependent GABA symporters than serotonin-selective protein query sequences in the NCBI BLAST database.

#### *Putative Orthologs of 5-HT Receptors*

Orthologs of *L. cornutus* 5-HTR were isolated from the transcriptome assembly using a TBLASTX query of known serotonin receptor protein sequences from other organisms (list of query sequences in figure legend). Using the ClustalW alignment program in Geneious, multiple alignments were performed and the result revealed amino acid sequences of high similarity among some arthropod species (Supplemental Fig. 3.3).

#### *Normalized expression levels of L. cornutus homologs of TPH, Transporters, and 5-HT-Receptors*

When the *L. cornutus* transcriptome was BLAST'd with protein query sequences for TPH, several transcripts had positive homology scores (DN12283, DN46108, DN55191, DN71751, DN8209; Fig. 3.3A). However, most of these transcripts did not appear to have significant fluctuations in expression levels throughout the day. The transcript DN55191 appeared to have significant fluctuations in all of its isoforms, though the patterns were not uniform (Fig. 3.3A). The transcripts isolated as putative homologs of non-selective serotonin-



dependent transporters (DN51156, DN53562, DN59457, DN53215, DN53235) and all the isoforms of these transcripts were analyzed for expression values among the four different time points (Fig. 3.4A). Some of the transcripts had very low expression at all-time points which can be expected that some genes are not constitutively expressed in all tissues. Putative transcripts for 5-HT receptors (DN12680, DN23475, DN43050, and DN9776) appeared to fluctuate in normalized expression levels across the four time points, however the overall expression levels of these receptors were much lower compared to the transcripts identified for synthesis and transport of serotonin (Fig. 3.5A).

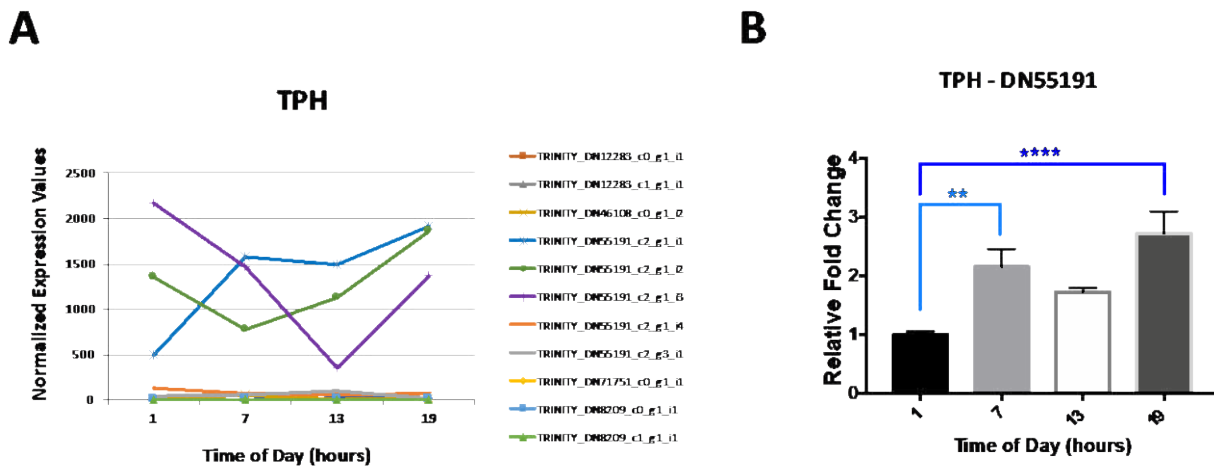

Figure 3.3 A. Normalized gene expression values for putative orthologous transcript sequences of *L. cornutus* transcriptome of TPH over time (01:00H, 07:00H, 13:00H, 19:00H). B. qPCR validation of relative fold change of transcript DN55191 over time (01:00H, 07:00H, 13:00H, 19:00H). Results are the mean  $\pm$  S.E. of three replicates ( $n = 3$ ). Statistical analysis was conducted by ANOVA and Dunnett's multiple comparisons (\*\*,  $p < 0.005$ ; \*\*\*\*,  $p = 0.0001$ ).

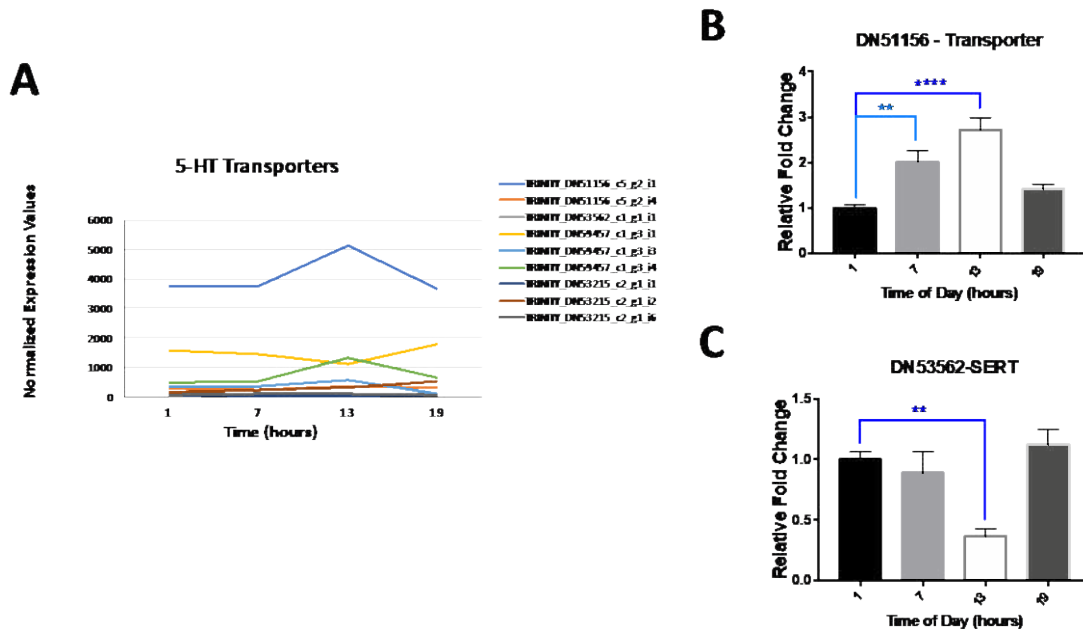

Figure 3.4. A. Normalized gene expression values for putative SERT orthologous transcript sequences of *L. cornutus* transcriptome over time (01:00H, 07:00H, 13:00H, 19:00H). B. qPCR validation of relative fold change of transcript DN51156 and DN53562 over time (01:00H, 07:00H, 13:00H, 19:00H). Results are the mean  $\pm$  S.E. of three replicates ( $n = 3$ ). Statistical analysis was conducted by Kruskal-Wallis and Dunnett's multiple comparisons (\*\*,  $p < 0.005$ ; \*\*\*\*,  $p = 0.0001$ ).

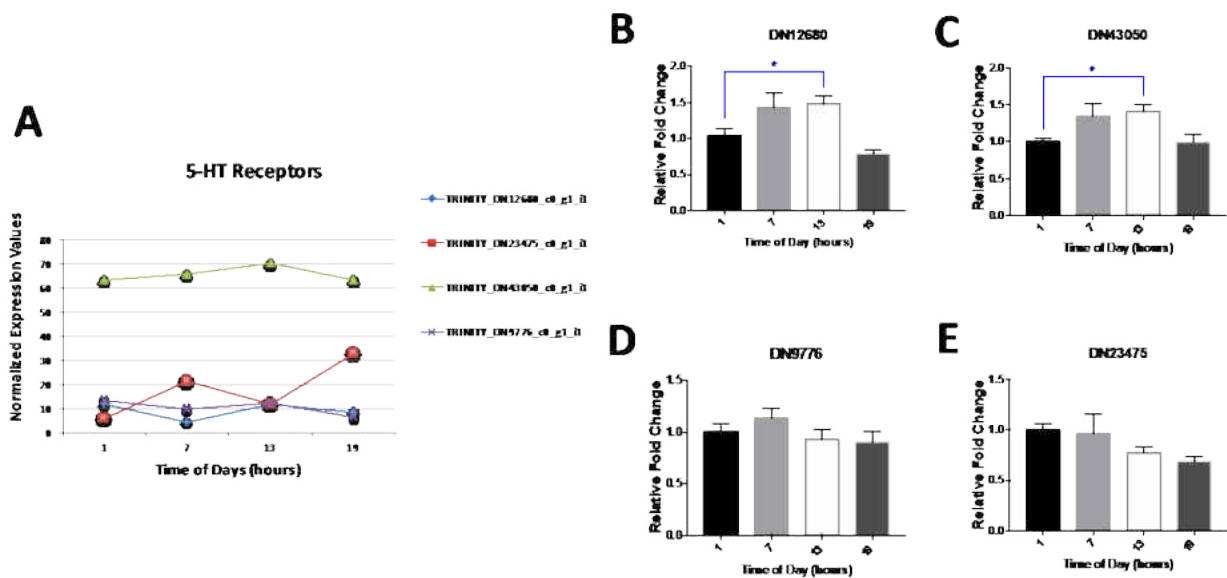

Figure 3.5. A. Normalized gene expression values for putative 5-HT receptor orthologous transcript sequences of *L. cornutus* transcriptome over time (01:00H, 07:00H, 13:00H, 19:00H). B. qPCR validation of relative fold change of 5-HT receptor transcripts DN12680, DN43050, DN9776, and DN23475 over time (01:00H, 07:00H, 13:00H, 19:00H). Results are the mean  $\pm$  S.E. of three replicates ( $n = 3$ ). Statistical analysis was conducted by ANOVA and Dunnett's multiple comparisons (\*,  $p < 0.05$ ).

### *Quantitative PCR validation of transcriptome analysis*

In order to verify the accuracy of the differential expression analysis of *L. cornutus* transcriptome, tryptophan hydroxylase (putative TPH ortholog, Transcript ID: Trinity\_DN55191\_c2\_g1\_i3), serotonin-dependent transporter ( Transcript ID: Trinity\_DN53562\_c1\_g1\_i1, TRINITY\_DN51156\_c5\_g2\_i1), serotonin receptor (putative 5-HTR orthologs, Transcript ID: Trinity\_DN12680c1\_g1\_i1, Trinity\_DN43050\_c0\_g1\_i1, Trinity\_DN9776\_c0\_g1\_i1, Trinity\_DN23475\_c0\_g1\_i1), genes were selected for qPCR validation. Due to the TPH ortholog isoforms of DN55191 having significantly different patterns in expression, a non-specific primer was utilized in order to quantify total transcript expression. Relative expression of these selected genes was quantitatively measured over four time points (1,7,13, and 19 hours) and the results were analyzed considering mid-scotophase (1hr) as the control time point (Figure 3.3-3.5). Putative ortholog of TPH (Transcript ID: Trinity\_DN55191) appeared to have a biphasic oscillation, increasing at 0700 and 1300 hours compared to 0100 hours (Fig. 3.3B; One-Way ANOVA:  $p = 0.002$ ; Dunnett's multiple comparisons: 0100 vs. 0700 hours:  $p = 0.0051$ ; 0100 vs 1300 hours:  $p = 0.0001$ ;). The RNA-sequencing data reflected a variety of fluctuations among the different isoforms of DN55191. Thus, while the qPCR data does not validate one isoform or another due to non-specific primers, this data is influential in identifying overall expression pattern of this putative serotonin synthesis enzyme.

One of the putative transcripts isolated for serotonin transporters (Trinity\_DN51156\_c5\_g2\_i1) had a significant increase in expression at 13 hours in the RNA-seq data, and this pattern was validated with qPCR revealing significant differences between 0100 hours and 0700 hours, and 0100 hours and 1300 hours (Fig. 3.4B; Kruskal-Wallis,  $P < 0.001$ ; Dunnett's

multiple comparison: 1hr vs 7hr,  $p = 0.004$ , 1hr vs 13hr,  $p = 0.0001$ ). When the transcript was reanalyzed through NCBI BLAST database, however, it showed a higher potential selectivity for GABA based on sequence identity. The other transcript selected DN53562\_c1\_g1\_i1 had much lower level of expression in RNA-seq data, however, the transcript had the highest level of homology of the transcripts to other arthropods serotonin-selective transporter query sequences. The qPCR data revealed a significant fold decrease at 1300hours, which did not validate the lowest expression level at 0100 hours in the RNA-seq expression data (Fig. 3.4C; ANOVA  $p < 0.001$ ; Dunnett's multiple comparisons, 1hr vs. 13hr  $p = 0.0014$ ). Similar to other transcripts investigated in this study, low expressed transcripts tend to have less reliable values due to an inherent biasness in the process of sequencing [25]. Thus, the qPCR reveals a more accurate account of fluctuations of this particular transcript. It is interesting to note the relationship in relative expression pattern between these two transporter transcripts. Because there is a potential difference in selectivity of these two transporters based on protein homology, while DN53562 only showed a slight, non-significant decrease in relative fold-change, there could still be a significant amount of serotonin being left in the synaptic cleft as it is not able to be brought back up into the cell while more GABA is potentially being repackaged and resent out, producing a more inhibitory effect overall[26].

The putative transcripts identified for 5-HT receptors had varying expression levels across the different time points, some of which could be validated using q-PCR. Transcript DN12680 showed a marked increase in expression between 0100 and 1300 hours (3.5B; One-Way ANOVA,  $p < 0.001$ ; Dunnett's multiple comparisons: 0100 vs 1300 hours:  $p < 0.05$ ). Transcript DN43050 showed a significant increase at 1300 hours (Fig. 3.5C; Dunnett's multiple comparisons: 0100vs. 1300 hours:  $p < 0.05$ ). Transcript DN9776 and DN23475 did not have

significant changes in fold change (Fig. 3.5 D-E). Taken together, it appears that two transcripts are upregulated in the daytime (onset of photophase and mid-photophase).

## DISCUSSION

Serotonin is implicated in regulating aggression in many arthropods, yet how each component of the serotonergic system interacts in this regulation is not clear. This study took a global approach to investigating what aspects of the serotonergic system are fluctuating throughout the day to produce the endogenous diel rhythmicity in anti-predator behavior in the orb-weaving spider *L. cornutus*. Not only were physiological levels of 5-HT quantified, but putative transcripts involved in the serotonergic system were identified using transcriptomic analysis. Although there were not significant changes in endogenous levels in head tissue or hemolymph, there were several transcripts putatively involved in synthesis, transport, and signaling that appear to fluctuate throughout the time of day.

A putative transcript for TPH was isolated from the *L. cornutus* transcriptome and the expression levels, both in RNA-seq analysis and qPCR validation, dramatically shifted between the time points analyzed in this study. Putative TPH transcripts, the rate-limiting synthesis enzyme of 5-HT, is upregulated during the onset of photophase and reaches its peak expression level at 1300 hours. This result aligned with our initial hypothesis that synthesis enzymes of 5-HT would be upregulated during the day when the spider was the most docile as 5-HT reduced boldness in previous studies[17]. TPH expression undergoes circadian variation in expression in several taxa, however this expression pattern has been attributed not to TPH's role in 5-HT production, but rather its downstream influence on melatonin[27–31]. TPH expression, if reduced pharmacologically or by inducing a mutation to the gene, does directly influence

aggression levels in both mammals and invertebrates, including insects and crustaceans[11,32,33]. However, studies that have analyzed TPH expression in relation to both circadian oscillations and aggression-related behaviors are less common. This study revealed that TPH fluctuates throughout the day as seen in other organisms in relation to influencing aggression levels in an organism. Presumably, this upregulation of synthesis enzyme would produce a marked increase in overall levels of 5-HT in the head tissue or hemolymph. Significant differences in levels of 5-HT were not detected in cephalothorax tissue or hemolymph in *L. cornutus* between the time points in this study. These results could be attributed to the high level of variation among the individuals assessed in this study or the methodology utilized. While many studies have identified circadian fluctuations of 5-HT levels in other organisms, these same studies analyzed specific brain regions of the organism versus whole head homogenate[34–37]. Future work further investigating the activity of TPH as well as quantifying 5-HT in discrete brain regions would allow a clear understanding the specific role of TPH on behavior in *L. cornutus*.

Putative serotonin-dependent transporters appear to show variation in expression throughout the day in *L. cornutus*. Transporters are essential for reuptake of compounds and offer a substantial level of regulation of a compound's influence on physiology and behavioral response of organisms[38,39]. SERTs influence aggression in many organisms including mice and humans[40,41]. In mice lacking a functional SERT, there is a reduction in aggression[40]. Some studies have investigated SERTs in arthropods, but there is paucity of research targeting the role these transporters play in aggression-related behavior. Our results describe the potential of a SERT-like transcript altering expression quite significantly throughout the day. This transporter would appear to influence daytime behavior and physiology of *L. cornutus*, possibly

modulating the tone of serotonin signaling to produce the decreased level of aggression. Further studies are needed to confirm the direct impact of this transporter, particularly pharmacological manipulation as done in several vertebrate models[4,42,43]

In *L. cornutus*, it appeared that some putative transcripts for 5-HT receptors do fluctuate in their expression throughout the day. Monoamine receptor expression and their sensitivity is implicated in allowing organisms to perceive sensory information and physiologically tuned in different behavioral states[44,45]. In several organisms investigated, the expression of 5-HT receptors is influenced by the endogenous clock and photoperiod length[46–48]. Like mammals, several different types of 5-HT receptors have been characterized in invertebrates, including *Drosophila* and *Caenorhabditis*[12]. These receptors are implicated in regulating the tone of the 5-HT signal in many physiological and behavioral processes. Often, the expression patterns of different receptor subtypes are not uniform[13,47,49]. Our results have identified several potential 5-HT like receptors in *L. cornutus* which display varying patterns of gene expression. Two transcripts, DN12680 and DN43050 appear to be drastically upregulated during the day which could influence the overall signal of 5-HT. It is difficult to postulate the specific signaling capacity of these receptors without future work, however, it would be expected to see an upregulation of receptors when signaling molecules are the most numerous. Receptor expression would be down regulated after a higher level of signaling activity occurred. Thus, two putative transcripts for 5-HT receptors, DN12680 and DN43050 appear intriguing.

## CONCLUSIONS

The results of this study illustrate an initial descriptive view of the individual components of the serotonergic system in *L. cornutus* and how they fluctuate in transcript levels throughout

the day. There is a tremendous body of work investigating 5-HT's impact on exclusive aspects of either aggression or circadian rhythms, but not in congruence with each other. While this study took an initial descriptive approach, the genes investigated are still very much at the surface of the serotonin signaling pathway. Downstream signaling molecules and their effector cells are just as critical in efforts to understand the full impact 5-HT plays on the behavior and physiology of an organism[50]. It is also important to note that 5-HT plays a multifaceted role in a wide array of behavioral and physiological processes and thus analyzing the influence of 5-HT on anti-predator behavior is not mutually exclusive from those other effects. Finally, future studies are needed to investigate each transcript of interest in an isolated manner, paying particular attention to characterizing the gene and identifying localization.

## REFERENCES

1. Frazer A, Hensler JG. Serotonin Involvement in Physiological Function and Behavior. Lippincott-Raven; 1999; Available: <https://www.ncbi.nlm.nih.gov/books/NBK27940/>
2. Kravitz EA. Serotonin and aggression: insights gained from a lobster model system and speculations on the role of amine neurons in a complex behavior. *J Comp Physiol A Sensory, Neural, Behav Physiol*. Springer-Verlag; 2000;186: 221–238. doi:10.1007/s003590050423
3. Sperry TS, Thompson CK, Wingfield JC. Effects of Acute Treatment with 8-OH-DPAT and Fluoxetine on Aggressive Behaviour in Male Song Sparrows (*Melospiza melodia morphna*). *J Neuroendocrinol*. Wiley/Blackwell (10.1111); 2003;15: 150–160. doi:10.1046/j.1365-2826.2003.00968.x
4. Popova NK. From genes to aggressive behavior: the role of serotonergic system. *BioEssays*. 2006;28: 495–503. doi:10.1002/bies.20412
5. Livingstone MS, Harris-Warrick RM, Kravitz EA. Serotonin and octopamine produce opposite postures in lobsters. *Science*. 1980;208: 76–9. doi:10.1126/science.208.4439.76
6. Yeh SR, Fricke RA, Edwards DH. The effect of social experience on serotonergic modulation of the escape circuit of crayfish. *Science*. 1996;271: 366–9. Available: <http://www.ncbi.nlm.nih.gov/pubmed/8553075>
7. Edwards DH, Kravitz EA. Serotonin, social status and aggression. *Curr Opin Neurobiol*. 1997;7: 812–9. Available: <http://www.ncbi.nlm.nih.gov/pubmed/9464985>
8. Bubak AN, Swallow JG, Renner KJ. Whole brain monoamine detection and manipulation in a stalk-eyed fly. *J Neurosci Methods*. 2013;219: 124–130. doi:10.1016/j.jneumeth.2013.07.006



9. Alekseyenko O V., Lee C, Kravitz EA. Targeted Manipulation of Serotonergic Neurotransmission Affects the Escalation of Aggression in Adult Male *Drosophila melanogaster*. McCabe BD, editor. PLoS One. 2010;5: e10806. doi:10.1371/journal.pone.0010806
10. Mckinney J, Teigen K, Ge Frøystein NA °, Salaün C, Knappskog PM, Haavik J, et al. Conformation of the Substrate and Pterin Cofactor Bound to Human Tryptophan Hydroxylase. Important Role of Phe313 in Substrate Specificity. doi:10.1021/bi015722x
11. Panksepp JB, Huber R. Chronic alterations in serotonin function: dynamic neurochemical properties in agonistic behavior of the crayfish, *Orconectes rusticus*. J Neurobiol. NIH Public Access; 2002;50: 276–90. Available: <http://www.ncbi.nlm.nih.gov/pubmed/11891663>
12. Tierney AJ. Structure and function of invertebrate 5-HT receptors: a review. Comp Biochem Physiol Part A Mol Integr Physiol. Pergamon; 2001;128: 791–804. doi:10.1016/S1095-6433(00)00320-2
13. Shukla R, Watakabe A, Yamamori T. mRNA expression profile of serotonin receptor subtypes and distribution of serotonergic terminations in marmoset brain. Front Neural Circuits. Frontiers; 2014;8: 52. doi:10.3389/fncir.2014.00052
14. Price JB. Neurochemical Levels Correlate with Population Level Differences in Social Structure and Individual Behavior in the Polyphenic Spider,. East Tennessee State University. 2010.
15. Punzo F, Punzo T. Monoamines in the Brain of Tarantulas (*Aphonopelma Hentzi*) (Araneae, Theraphosidae): Differences Associated With Male Agonistic Interactions. J Arachnol. 2001;29: 388–395. doi:10.1636/0161-8202(2001)029[0388:MITBOT]2.0.CO;2
16. Jones TC, Akoury TS, Hauser CK, Moore D. Evidence of circadian rhythm in antipredator behaviour in the orb-weaving spider *Larinioides cornutus*. Anim Behav. 2011;82: 549–555. doi:10.1016/j.anbehav.2011.06.009
17. Jones TC, Akoury TS, Hauser CK, Neblett MF, Linville BJ, Edge AA, et al. Octopamine and serotonin have opposite effects on antipredator behavior in the orb-weaving spider, *Larinioides cornutus*. J Comp Physiol A Neuroethol Sens Neural Behav Physiol. 2011;197: 819–25. doi:10.1007/s00359-011-0644-7
18. Hebets EA, Hansen M, Jones TC, Wilgers DJ. Octopamine levels relate to male mating tactic expression in the wolf spider *Rabidosa punctulata*. Anim Behav. 2015;100: 136–142. doi:10.1016/j.anbehav.2014.11.023
19. Ye J, Coulouris G, Zaretskaya I, Cutcutache I, Rozen S, Madden TL. Primer-BLAST: a tool to design target-specific primers for polymerase chain reaction. BMC Bioinformatics. 2012;13: 134. doi:10.1186/1471-2105-13-134
20. Yang C, Pan H, Noland JE, Zhang D, Zhang Z, Liu Y, et al. Selection of reference genes for RT-qPCR analysis in a predatory biological control agent, *Coleomegilla maculata* (Coleoptera: Coccinellidae). Sci Rep. Nature Publishing Group; 2016;5: 18201. doi:10.1038/srep18201
21. Chang Y-W, Chen J-Y, Lu M-X, Gao Y, Tian Z-H, Gong W-R, et al. Selection and validation of reference genes for quantitative real-time PCR analysis under different experimental conditions in the leafminer *Liriomyza trifolii* (Diptera: Agromyzidae). Gao Y, editor. PLoS One. Public Library of Science; 2017;12: e0181862. doi:10.1371/journal.pone.0181862
22. Ma K-S, Li F, Liang P-Z, Chen X-W, Liu Y, Gao X-W. Identification and Validation of

- Reference Genes for the Normalization of Gene Expression Data in qRT-PCR Analysis in *Aphis gossypii* (Hemiptera: Aphididae). *J Insect Sci.* 2016;16: 17. doi:10.1093/jisesa/iiew003
23. Xiao R, Wang L, Cao Y, Zhang G. Transcriptome response to temperature stress in the wolf spider *Pardosa pseudoannulata* (Araneae: Lycosidae). *Ecol Evol.* Wiley-Blackwell; 2016;6: 3540–3554. doi:10.1002/ece3.2142
  24. Li C-C, Wang Y, Li G-Y, Yun Y-L, Dai Y-J, Chen J, et al. Transcriptome Profiling Analysis of Wolf Spider *Pardosa pseudoannulata* (Araneae: Lycosidae) after Cadmium Exposure. *Int J Mol Sci.* Multidisciplinary Digital Publishing Institute (MDPI); 2016;17. doi:10.3390/ijms17122033
  25. Zheng W, Chung LM, Zhao H. Bias detection and correction in RNA-Sequencing data. *BMC Bioinformatics.* BioMed Central; 2011;12: 290. doi:10.1186/1471-2105-12-290
  26. Ciranna L. Serotonin as a modulator of glutamate- and GABA-mediated neurotransmission: implications in physiological functions and in pathology. *Curr Neuropharmacol.* Bentham Science Publishers; 2006;4: 101–14. Available: <http://www.ncbi.nlm.nih.gov/pubmed/18615128>
  27. Shibuya H, Toru M, Watanabe S. A circadian rhythm of tryptophan hydroxylase in rat pineals. *Brain Res.* 1978;138: 364–368. Available: <https://www.sciencedirect.com/sdfe/pdf/download/eid/1-s2.0-0006899377907545/first-page-pdf>
  28. Privat K, Ravault JP, Chesneau D, Fevre-Montange M. Day/night variation of tryptophan hydroxylase and serotonin N-acetyltransferase mRNA levels in the ovine pineal gland and retina. *J Pineal Res.* 1999;26: 193–203. Available: <http://www.ncbi.nlm.nih.gov/pubmed/10340721>
  29. Valenciano AI, Alonso-Gómez AL, Iuvone PM. Diurnal rhythms of tryptophan hydroxylase activity in *Xenopus laevis* retina: opposing phases in photoreceptors and inner retinal neurons. *Neuroreport.* 1999;10: 2131–5. Available: <http://www.ncbi.nlm.nih.gov/pubmed/10424687>
  30. Chong NW, Cassone VM, Bernard M, Klein DC, Iuvone PM. Circadian expression of tryptophan hydroxylase mRNA in the chicken retina. *Brain Res Mol Brain Res.* 1998;61: 243–50. Available: <http://www.ncbi.nlm.nih.gov/pubmed/9795235>
  31. Yeung Lam P, Chen K, Shih JC. The circadian rhythm of 5-HT biosynthetic and degradative enzymes in immortalized mouse neuroendocrine pineal cell line—a model for studying circadian rhythm. *Life Sci.* 2004;75: 3017–3026. doi:10.1016/j.lfs.2004.04.052
  32. Alekseyenko O V, Lee C, Kravitz EA, McCabe BD. Targeted Manipulation of Serotonergic Neurotransmission Affects the Escalation of Aggression in Adult Male *Drosophila melanogaster*. *PLoS One.* 2010;5. doi:10.1371/journal.pone.0010806
  33. Manuck SB, Flory JD, Ferrell RE, Dent KM, Mann JJ, Muldoon MF. Aggression and anger-related traits associated with a polymorphism of the tryptophan hydroxylase gene. *Biol Psychiatry.* 1999;45: 603–14. Available: <http://www.ncbi.nlm.nih.gov/pubmed/10088047>
  34. Arechiga H, Banuelos E, Frixione E, Picones A, Rodriguez-Sosa L. Modulation of crayfish retinal sensitivity by 5-hydroxytryptamine. *J Exp Biol.* 1990;150.
  35. Escamilla-Chimal EG, Van Herp F, Fanjul-Moles ML. Daily variations in crustacean hyperglycaemic hormone and serotonin immunoreactivity during the development of crayfish. *J Exp Biol.* 2001;204.

36. Wildt M. Regulation of serotonin levels by multiple light-entrainable endogenous rhythms. *J Exp Biol.* 2004;207: 3765–3774. doi:10.1242/jeb.01205
37. Mateos SS, Sánchez CL, Paredes SD, Barriga C, Rodríguez AB. Circadian Levels of Serotonin in Plasma and Brain after Oral Administration of Tryptophan in Rats. *Basic Clin Pharmacol Toxicol.* 2009;104: 52–59. doi:10.1111/j.1742-7843.2008.00333.x
38. Giros B, Jaber M, Jones SR, Wightman RM, Caron MG. Hyperlocomotion and indifference to cocaine and amphetamine in mice lacking the dopamine transporter. *Nature.* 1996;379: 606–612. doi:10.1038/379606a0
39. Koepsell H, Lips K, Volk C. Polyspecific Organic Cation Transporters: Structure, Function, Physiological Roles, and Biopharmaceutical Implications. *Pharm Res.* Kluwer Academic Publishers-Plenum Publishers; 2007;24: 1227–1251. doi:10.1007/s11095-007-9254-z
40. Holmes A, Murphy D, Crawley J. Reduced aggression in mice lacking the serotonin transporter. *Psychopharmacology (Berl).* 2002;161: 160–167. doi:10.1007/s00213-002-1024-3
41. Beitchman JH, Baldassarra L, Mik H, De Luca V, King N, Bender D, et al. Serotonin Transporter Polymorphisms and Persistent, Pervasive Childhood Aggression. *Am J Psychiatry.* 2006;163: 1103–1105. doi:10.1176/ajp.2006.163.6.1103
42. Prosser RA, Stowie A, Amicarelli M, Nackenoff AG, Blakely RD, Glass JD. Cocaine modulates mammalian circadian clock timing by decreasing serotonin transport in the SCN. *Neuroscience.* NIH Public Access; 2014;275: 184–93. doi:10.1016/j.neuroscience.2014.06.012
43. Caveney S, Cladman W, Verellen L, Donly C. Ancestry of neuronal monoamine transporters in the Metazoa. *J Exp Biol.* The Company of Biologists Ltd; 2006;209: 4858–68. doi:10.1242/jeb.02607
44. Lema SC, Wagstaff LJ, Gardner NM. Diurnal rhythms of behavior and brain mRNA expression for arginine vasotocin, isotocin, and their receptors in wild Amargosa pupfish (*Cyprinodon nevadensis amargosae*). *Mar Freshw Behav Physiol.* 2010;43: 257–281. doi:10.1080/10236244.2010.498632
45. Rex E, Molitor SC, Hapiak V, Xiao H, Henderson M, Komuniecki R. Tyramine receptor (SER-2) isoforms are involved in the regulation of pharyngeal pumping and foraging behavior in *Caenorhabditis elegans*. *J Neurochem.* Blackwell Science Ltd; 2004;91: 1104–1115. doi:10.1111/j.1471-4159.2004.02787.x
46. Nilaweera KN, Archer ZA, Campbell G, Mayer C-D, Balik A, Ross AW, et al. Photoperiod Regulates Genes Encoding Melanocortin 3 and Serotonin Receptors and Secretogranins in the Dorsomedial Posterior Arcuate of the Siberian Hamster. *J Neuroendocrinol.* Wiley/Blackwell (10.1111); 2009;21: 123–131. doi:10.1111/j.1365-2826.2008.01810.x
47. Yuan Q, Joiner WJ, Sehgal A. A Sleep-Promoting Role for the *Drosophila* Serotonin Receptor 1A. *Curr Biol.* Cell Press; 2006;16: 1051–1062. doi:10.1016/J.CUB.2006.04.032
48. Lovenberg TW, Baron BM, de Lecea L, Miller JD, Prosser RA, Rea MA, et al. A novel adenylyl cyclase-activating serotonin receptor (5-HT<sub>7</sub>) implicated in the regulation of mammalian circadian rhythms. *Neuron.* Cell Press; 1993;11: 449–458. doi:10.1016/0896-6273(93)90149-L
49. Aoki N, Watanabe H, Okada K, Aoki K, Imanishi T, Yoshida D, et al. Involvement of 5-HT<sub>3</sub> and 5-HT<sub>4</sub> receptors in the regulation of circadian clock gene expression in mouse

- small intestine. *J Pharmacol Sci.* 2014;124: 267–75. Available:  
<http://www.ncbi.nlm.nih.gov/pubmed/24492464>
50. Polter AM, Li X. 5-HT1A receptor-regulated signal transduction pathways in brain. *Cell Signal.* 2010;22: 1406–1412. doi:10.1016/j.cellsig.2010.03.019

SUPPLEMENTAL FIGURES

A

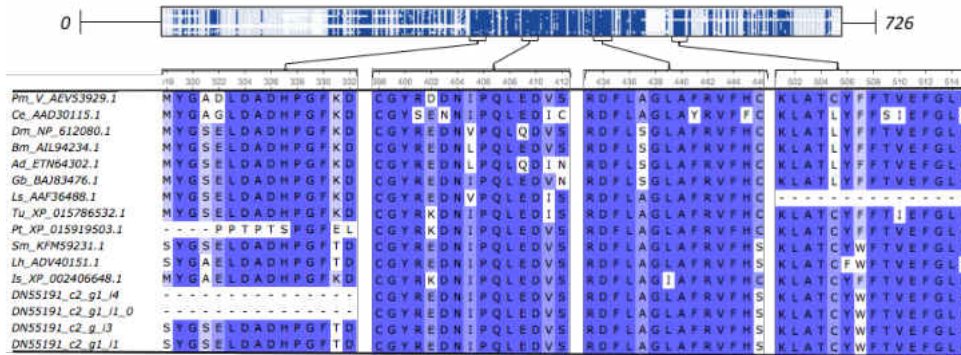

B

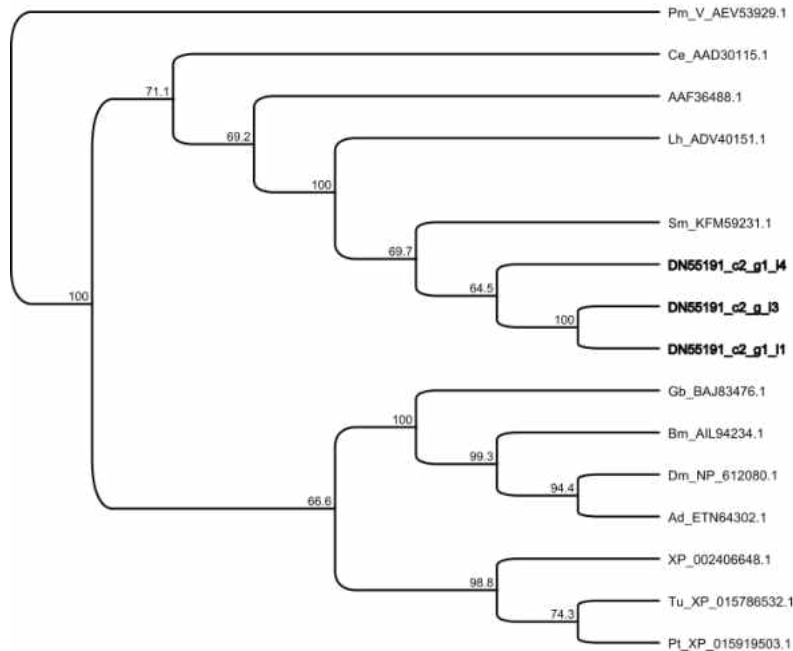

Supplemental Figure 3.1. A) Box shade of TPH protein regions in alignment. Proteins were aligned with the ClustalW alignment algorithm on the Geneious™ software with default settings and the box shade was produced with Unipro Ugene. Shading is determined by the conservation of a residue at a position by percentage; dark blue = 100% of residues share identity, medium blue = 75% of residues share identity, light blue = 50% of residues share identity. The number at the end of each line of each protein sequence is the number of residues that a protein has up to the end of that line. Species abbreviations and accession numbers: Dm\_NP\_612080.1 [Drosophila melanogaster], Bm\_AIL94234.1 tryptophan hydroxylase [Bombyx mori], Ad\_ETN64302.1 Tryptophan hydroxylase, partial [Anopheles darlingi], Gb\_BAJ83476.1 tryptophan hydroxylase [Gryllus bimaculatus], Ls\_AAF36488.1 tryptophan hydroxylase, partial [Lymnaea stagnalis], Tu\_XP\_015786532.1 PREDICTED: tryptophan 5-hydroxylase 1-like [Tetranychus urticae], Pt\_XP\_015919503.1 PREDICTED: tryptophan 5-hydroxylase 1-like, partial [Parasteatoda tepidariorum], Sm\_KFM59231.1 Protein henna, partial [Stegodyphus mimosarum], Lh\_ADV40151.1 phenylalanine hydroxylase, partial [Latrodectus hesperus], Is\_XP\_002406648.1 phenylalanine hydroxylase, putative, partial [Ixodes scapularis], Ce\_AAD30115.1 tryptophan hydroxylase [Caenorhabditis elegans], Pm\_V\_AEV53929.1 tryptophan hydroxylase [Petromyzon marinus]. B) Phylogenetic tree

constructed in Geneious™ using Neighbor-Joining Maximum-likelihood analysis with bootstrapping values (1000 replicates).

**A**

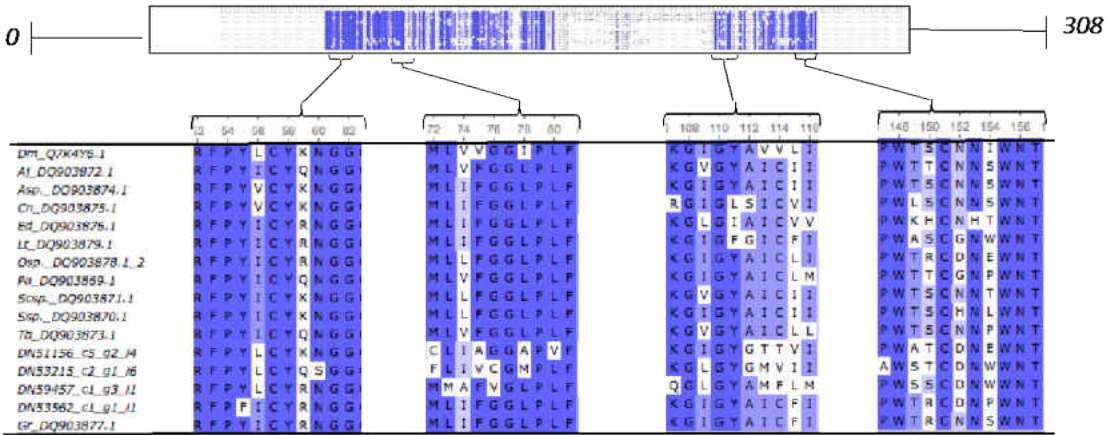

**B**

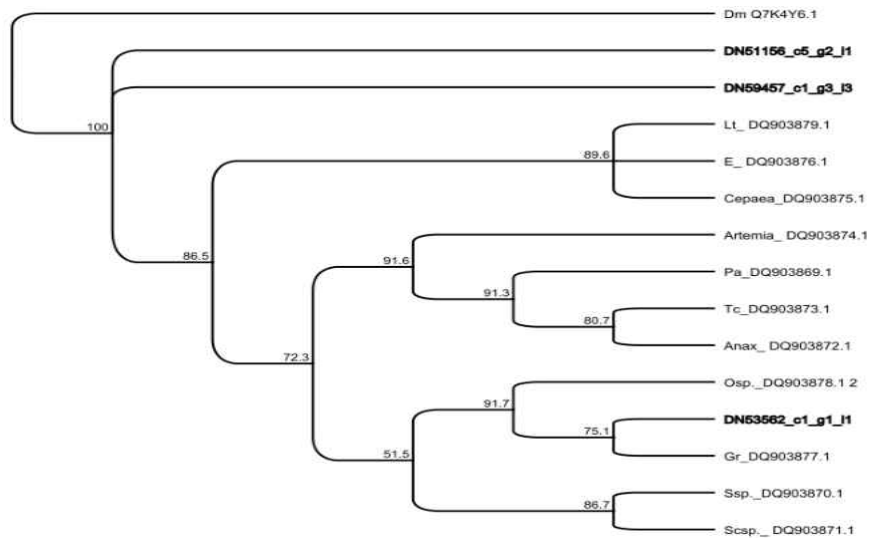

Supplemental Figure 3.2. A) Box shade of 5-HT transporter protein regions in alignment. Proteins were aligned with the ClustalW alignment algorithm on the Geneious™ software with default settings and the box shade was produced with Unipro Ugene. Shading is determined by the conservation of a residue at a position by percentage; dark blue = 100% of residues share identity, medium blue = 75% of residues share identity, light blue = 50% of residues share identity. The number at the end of each line of each protein sequence is the number of residues that a protein has up to the end of that line. Species abbreviations and accession numbers:

Tc: DQ903873.1 [Tibicen canicularis], Ssp.: DQ903870.1 [Spirostreptus sp.], Scsp.: DQ903871.1 [Scolopendra sp.], Pa: DQ903869.1 [Periplaneta Americana], Osp.: DQ903878.1\_2 [Opisthophthalmus sp.], Lt: DQ903879.1

[*Lumbricus terrestris*], Gr: DQ903877.1 [*Grammostola rosea*], Cn: DQ903875.1 [*Cepaea nemoralis*], As: DQ903874.1 [*Artemia* sp.], Aj: DQ903872.1 [*Anax junius*].

**A**

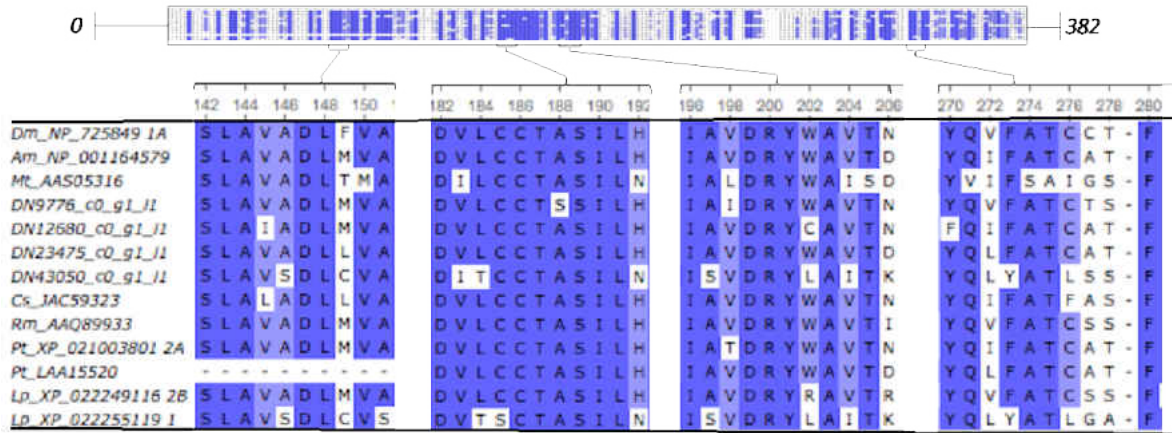

**B**

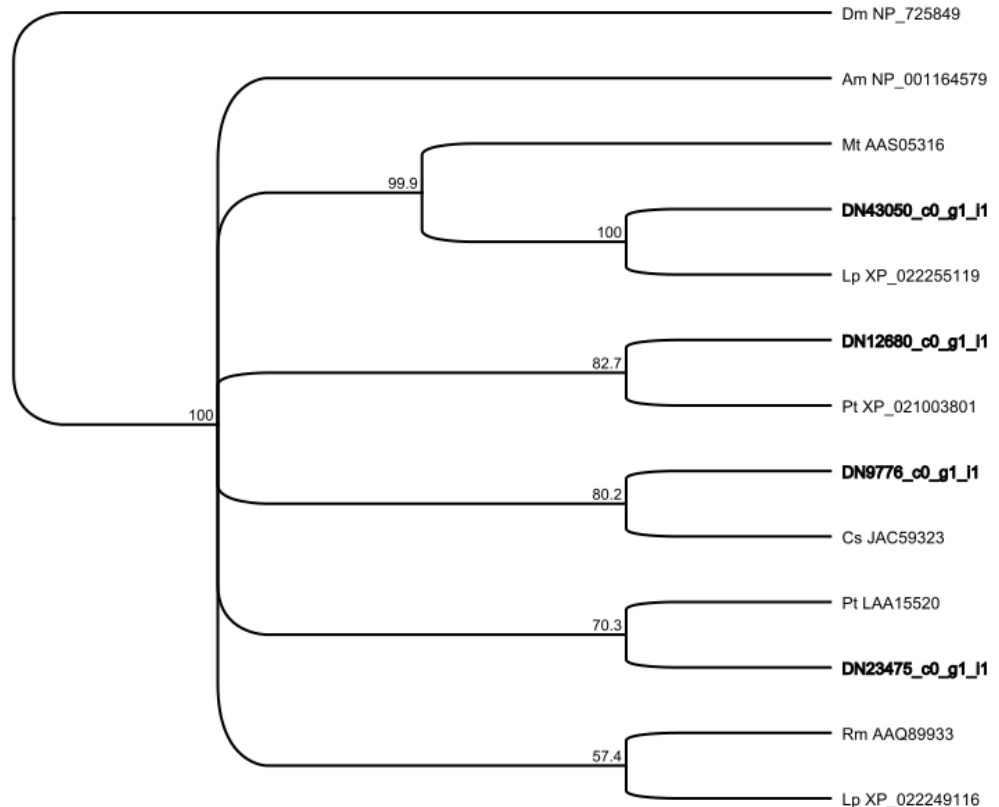

Supplemental Figure 3.3. A) Box shade of 5-HT receptor protein regions in alignment. Proteins were aligned with the ClustalW alignment algorithm on the Geneious™ software with default settings and the box shade was produced with Unipro Ugene. Shading is determined by the conservation of a residue at a position by percentage; dark

blue = 100% of residues share identity, medium blue = 75% of residues share identity, light blue = 50% of residues share identity. The number at the end of each line of each protein sequence is the number of residues that a protein has up to the end of that line. Species abbreviations and accession numbers: Pt\_XP\_021003801 and Pt\_LAA15520 [*Parasteatoda tepidariorum*], Lp\_XP\_022249116 and Lp\_XP\_022255119 [*Limulus polyphemus*], Am\_NP\_001164579 [*Apis mellifera*], Dm\_NP\_725849 [*Drosophila melanogaster*], Cs\_JAC59323 [*Cupiennius salei*], Mt\_AAS05316 [*Metapenaeus ensis*], Rm\_AAQ89933 [*Rhipicephalus microplus*]. B) Phylogenetic tree constructed in Geneious™ using Neighbor-Joining Maximum-likelihood analysis with bootstrapping values (1000 replicates).



## CHAPTER 4

### IDENTIFICATION AND ACTIVITY OF MONOAMINE OXIDASE IN THE ORB- WEAVING SPIDER *LARINIOIDES CORNUTUS*

Rebecca J. Wilson<sup>1</sup>, Tahmina H. Ahmed<sup>3</sup>, Md Mabuhbar Rahman<sup>1</sup>, Brian M. Cartwright<sup>2</sup>, Nadia Ayoub<sup>4</sup>, Garron Wright<sup>5</sup>, and Thomas C. Jones<sup>1</sup>

<sup>1</sup>Department of Biological Sciences, East Tennessee State University, Johnson City, TN 37601

<sup>2</sup>Department of Biomedical Sciences, Quillen College of Medicine, Johnson City, TN 37601

<sup>3</sup>Department of Biochemistry, Virginia Polytechnic Institute and State University, Blacksburg, VA

<sup>4</sup>Department of Biological Sciences, Washington and Lee University, Lexington, VA

<sup>5</sup>D. Murdoch Research Institute, Kannapolis, NC

## ABSTRACT

Monoamine oxidase (MAO) is a mitochondrial-bound protein that catalyzes the oxidative deamination of monoamine neurotransmitters in vertebrates and some invertebrates. While the enzyme monoamine oxidase has been studied extensively in its role in moderating behavior in mammals, there is paucity of research investigating this role in invertebrates that utilize the enzyme as a major pathway in degradation of monoamines. *Larinioides cornutus* is a species of orb-weaving spider that exhibits diel fluctuations in behavior, specifically levels of aggression. The monoamines octopamine and serotonin have been shown to influence aggressive behaviors in *L. cornutus*. Because previous studies revealed monoamine oxidase degradation of monoamines in arachnids, this study investigated monoamine oxidase in *L. cornutus* as a potential site of regulation of monoamines throughout the day. Not only did gene expression of MAO orthologs and MAO activity fluctuate at different times of day, but the enzymatic activity was substrate-specific producing a higher level of degradation of octopamine as compared to serotonin *in vitro*. This study further supports evidence that MAO has an active role in monoamine inactivation in invertebrates and provides a first look at how MAO ultimately may be regulating behavior in an invertebrate.

## INTRODUCTION

Monoamine oxidase (MAO) is a mitochondrial-bound protein that catalyzes the oxidative deamination of monoamine neurotransmitters in vertebrates[1]. MAO is essential in the regulation of neurotransmitter levels and thus plays an instrumental role in the physiology, metabolism, and behavior of an organism[2]. MAO has two isoenzymes, MAO-A and MAO-B, which are characterized by their regional distribution, substrate preference and physiological roles in mammals[3]. Although these two isoenzymes share 70% structural identity, MAO-A has a high affinity for serotonin and norepinephrine while MAO-B primarily catabolizes 2-phenylethylamine (PEA) and aids in the degradation of trace amines and dopamine[3,4]. MAO-A has largely been associated with impulsive and reactive aggression in humans[5,6]. In fact, a number of studies have found robust associations between low activity MAO-A variants and psychopathy and criminal behavior[7–11]. Similar findings have also been discovered in rodents, revealing a proclivity to aggressive responses toward intruders when MAO-A activity is pharmacologically blockaded[12–14]. Moreover, MAO-A is also influenced by the circadian clock components[15]. Clock proteins *Per2* and *BMAL* positively upregulate MAO-A gene expression, producing daily fluctuations in levels of the enzyme which ultimately impact the likelihood of aggressive behaviors throughout the day[16].

Invertebrates use a wide array of enzymatic routes to degrade monoamines including N-acetylation,  $\gamma$ -glutamyl conjugation, sulphation, and beta-alanyl conjugation [17–22]. Like chordates, MAO is also utilized in some invertebrates including echinoderms[23,24], molluscs[25–29], and some arachnids[30–33]. In echinoderms and molluscs, congruent studies have established MAO as the principle enzyme in providing effective metabolism of monoamines. Specifically, MAO plays a key role in sperm cells and development in sea urchins

[34] as well as providing effective metabolism of monoamines in both the optic ganglia and the hepatopancreas of cephalopods[28,35]. However, while MAO activity has also been established within the Class Arachnida, the conclusions have not been consistent between ticks, mites, and spiders [30,31,33,36,37]. Some studies in ticks reported the primary presence of MAO as an enzymatic pathway for dopamine and 5-HT, with very little N-acetylated or  $\gamma$ -glutamyl conjugated amines[38,39]. Also, MAO activity was inhibited by MAO-B inhibitor deprenyl, but not MAO-A inhibitor clorgyline, similar to findings with echinoderms[38]. However, studies in spiders revealed a prominent presence of the MAO enzyme throughout different brain regions of various species, but showed significant reduction in MAO activity using clorgyline and no effect with the MAO-B inhibitor pargyline[40]. While these invertebrate studies have been influential in establishing the presence and activity of MAO, very few studies have investigated MAO's role in diel behavioral processes and enzymatic fluctuations outside of mammals[41,42].

The orb-weaver *Lariniodes cornutus* is a pan-arctic species that has diel patterns of locomotor activity and aggression that appear to be under circadian control[43]. A nocturnal forager, *L. cornutus*, is mostly active at night and this pattern in locomotor activity persists in constant conditions (Jones and Moore, *unpublished work*). When threatened by a predator stimulus, the spider forms a tight-ball formation and exhibits a death-feigning behavior or a "huddle" response. This "huddle" response reflects a diel and circadian pattern, with the spider huddling longer during the day while in a less aggressive state, and breaking out of this huddle more rapidly at night while in an apparent more aggressive state when the spider would otherwise be actively hunting prey[43]. These varied aggressive states can also be induced using exogenous amounts of the biogenic amines, serotonin, and octopamine. When octopamine levels were artificially increased, the boldness level of the individual increased[44]. Thus, it appears the

monoamines OA and 5-HT play a role in these diel shifts in behavior. As some previous studies show MAO activity in oxidizing 5-HT previously in arachnids[38], MAO may potentially be a source of regulation in the shift in behavioral states in *L. cornutus*. This study aimed at first identifying monoamine oxidase transcripts and characteristics of the enzyme in the spider *L. cornutus* and then investigated substrate preference, specificity of inhibition, and fluctuations in activity of the MAO enzyme during the day.

## METHODS

### *Female L. cornutus collection and conditioning for MAO experiments*

Individual *L. cornutus* females were collected from Washington County, Tennessee, USA during the month of October in 2017. Individuals were housed in plastic containers for a minimum of 7 days prior to sacrifice and were fed live crickets and misted with distilled water every 2-3 days. Specimens were entrained to 12:12 light: dark cycle with constant humidity. Fifteen individuals were sacrificed via flash-freezing in liquid nitrogen every 6 hours for 24 hours for a total of four time points (0100, 0700, 1300, and 1900 hours). Cephalothoraces (head tissue) were removed from each specimen and were homogenized over liquid nitrogen using a lysis buffer and bead grinder apparatus. Homogenized samples were then centrifuged for 10 minutes at 13,000 rpm. The supernatant was measured for protein concentration and samples were prepped according to the protocol for MAO activity (Thermo Fischer Amplex™ Red Monoamine Oxidase Assay Kit).

*Identification of Putative Monoamine Oxidase Transcripts from de novo assembled transcriptome*

Homolog sequences of *L. cornutus* MAO were isolated from the transcriptome assembly (Wilson *et al.*, unpublished) using a TBLASTX query of known MAO protein sequences from other organisms (List of query sequences Supplemental Figure #). Using the ClustalW alignment program in Geneious, multiple alignments were performed and the result revealed amino acid sequences of MAO are highly conserved among the arthropod species. After the first protein alignment, transcripts or protein homologs were analyzed and removed if there was poor alignment or the protein was a partial fragment of the protein. A second protein alignment was then performed using Consensus Alignment tools using Geneious™ software. Phylogenetic trees were constructed from the protein alignments via Neighbor-Joining and maximum-likelihood with bootstrapping with 1000 replicates using Geneious™ software. The putative transcripts were then analyzed for expression levels at four different time points (1, 7, 13, and 19 hours) using RNA-sequencing data of *L. cornutus* cephalothorax tissue (Wilson *et al.*, unpublished).

*Validation of Transcriptome Analysis by Quantitative real-time PCR analysis*

Quantitative real-time PCR (qPCR) was performed to verify the transcriptome results of *L. cornutus* (Wilson *et al.*, unpublished). Total RNA was extracted from cephalothoraces of female *L. cornutus* at four defined time points (1,7,13, and 19 hours). Cephalothoraces (head tissue) were removed from each specimen and were homogenized over ice and RNA was extracted using Maxwell® 16 LEV simplyRNA Tissue Kit (Promega, Lot #082114). RNA was primed with oligo (dT) primer and reverse transcription was carried out using Omniscript reverse

transcriptase kit (Qiagen, cat #205113). Quantitative measurements were performed in triplicate on an ABI 7300 system (Applied Biosystems) using the GoTaq qPCR Master Mix (Promega) and gene-specific primers (Table 1). Primers were designed using NCBI Primer 3 and Primer-BLAST[45]. Transcript abundance was normalized to the internal control Actin for each sample. As a housekeeping gene, actin has been used as an endogenous reference gene in qPCR analysis in a number of studies with arthropods[46–48]. All qPCR primers were designed using Geneious™ software.

Table 4.1. Primers used for qPCR validation of putative MAO transcript.

Putative Gene	Primer Name	Sequence 5'--> 3'	Transcript ID
Actin	Forward_Actin_L.cor	CATTACAGTGAGTGGGCGC	DN56916_c0_g2_i8
	Reverse_Actin_L.cor	TCCACCTTCCAGCAGATGTG	
Monoamine Oxidase (DN53)	Forward_MAO_L.cor	TGCTTCCTCCCGGTTTTCTC	DN53734_c3_g1_i3
	Reverse_MAO_L.cor	GCTTCCACTGCTCCACTCAT	

#### *Measurement of MAO activity in cephalothorax tissue*

Monoamine oxidase (MAO) activity was measured fluorimetrically in all of the experiments using the Amplex™ Red Monoamine Oxidase Assay Kit (Thermo Fischer Scientific) [49,50]. MAO activity was initially determined using *p*-tyramine or benzylamine as a substrate (unless specified in following experiments) and detecting hydrogen peroxide in horseradish peroxidase-coupled reaction. Both *p*-tyramine and benzylamine were provided in the Amplex™ Red Monoamine Oxidase Assay Kit (Thermo Fischer Scientific) as initial substrates to differentiate MAO subtypes [49,50]The supernatant collected from homogenized

samples were normalized using 1X Reaction Buffer provided in the assay kit and then mixed with equal amounts of Amplex™ red (100uM), horseradish peroxidase (0.5U/mL), and *p*-tyramine or benzylamine (0.1uM) and incubated at room temperature for 45 minutes. Fluorescence intensity was measured at excitation wavelength of 530nm and emission wavelength of 590nm using BioTek™ Synergy™ HTM Multi-Mode Microplate Reader. A positive control was used with 20mM hydrogen peroxide solution and a negative control was reaction buffer without hydrogen peroxide added. Background fluorescence was controlled by subtracting from the control without substrate. Three biological replicates (three individual *L. cornutus* cephalothoraxes) and three technical replicates were performed using cephalothorax tissue collected at 19 hours.

#### *Measurement of MAO activity in the presence of MAO-inhibitors parygline and clorygline*

The MAO activity was also measured in the presence of two inhibitors, parygline or clorygline, at varying concentrations (0-2uM). Parygline has been found to preferentially block MAO-B type proteins while clorygline preferentially blocks MAO-A type proteins[51]. These inhibitors have been used in several other studies to determine MAO activity in other arthropods [22,40,52]. Protein sample used was a fixed amount (15ug) from homogenized cephalothorax tissue samples collected at 19 hours. The protein samples were pre-incubated for 30 minutes with the respective inhibitor prior to adding the Amplex™ reaction mixture as previously listed with benzylamine (0.1 uM) as a substrate. Three biological replicates and three technical replicates were performed using cephalothorax tissue collected at 19 hours.



*Measurement of MAO activity of cephalothorax tissue collected at 13 and 19 hours*

The MAO activity was measured at two time points during the day at which the putative MAO transcript was expressed at its lowest and highest levels, 13 hours and 19 hours, respectively. The supernatant collected from homogenized samples were normalized then mixed with equal amounts of Amplex™ red (100uM), horseradish peroxidase (0.5U/ml), and Benzylamine (0.1uM) and incubated at room temperature for 45 minutes. Fluorescence intensity was measured at excitation wavelength of 530nm and emission wavelength of 590nm using BioTek™ Synergy™ HTM Multi-Mode Microplate Reader. Three biological replicates and three technical replicates were performed.

*Measurement of MAO activity of cephalothorax tissue with octopamine or serotonin as a substrate*

The MAO activity was measured as described previously, however, octopamine or serotonin were used as substrates; a 0.1mM concentration was used based on previous MAO kinetic studies[53]. Protein sample used was collected from homogenized cephalothorax tissue samples collected at 13 hours. Three biological replicates and three technical replicates were performed.

## RESULTS

### *Identification of Putative Monoamine Oxidase Transcripts from de novo assembled transcriptome*

Homolog sequences of *L. cornutus* MAO were isolated from the transcriptome assembly using a TBLASTX query of known MAO protein sequences from other organisms (list of query sequences in legend of Figure 4.2A legend and table in Supplemental Figures). While there were several transcripts initially pulled, only a few transcripts showed significant changes in expression among the time points (Figure 4.1A). Transcript DN53734\_c3\_g1\_i3, however, did show high homology with the query sequences and significant fluctuations in expression, thus it was utilized for further analysis (Figure 4.1A and 4.1B). Using the ClustalW alignment program in Geneious, multiple alignments were performed and the result revealed amino acid sequence of MAO is relatively well conserved among invertebrate and vertebrate species (Fig. 4.2A). The transcript isolated from *L. cornutus* (DN\_53734) had several conserved residues for all MAO proteins, but shared higher homology with MAO-B than MAO-A in humans (Figure 4.3). Previous studies have shown that the substrate selectivity if MAO-A and MAO-B appear to be determined by a single amino acid residue (Phe<sup>208</sup> in MAO A and Ile<sup>199</sup> in MAO B), which appears to be shared with the transcript DN53734 of *L. cornutus*[4]. In addition, a phylogenetic tree, constructed by Neighbor-Joining method, showed the grouping of the MAO homolog (DN53734) in *L. cornutus* with another putative MAO homolog from the spider *Parasteatoda tepidariorum* (Figure 4.2B). The MAO homologs of invertebrates group in a separate node from vertebrate MAOs, in spite of differentiation in subtype (MAO-A vs. MAO-B). The relatively high bootstrap value for each node support these results.

*qPCR validation of transcriptome analysis*

In order to verify the accuracy of the differential expression analysis of *L. cornutus* transcriptome (Wilson *et al*, unpublished), monoamine oxidase (putative MAO orthologs: Trinity\_DN 53734\_c3\_g1\_i3 transcript was selected for qPCR validation. Relative expression of these selected genes was quantitatively measured over four time points (1,7,13, and 19 hours) and the results were analyzed considering scotophase (1hr) as the control time point (Figure 4.1B). qPCR results displayed that during mid-photophase (13hr), the putative transcript of MAO was at the lowest level (Figure 4.1B) compared to onset of scotophase (19hr) than the control time point. The qPCR results are consistent with those observed in the transcriptome analysis, validating the reproducibility of our transcriptome data.

**A****B**

Figure 4.1. **A**) Normalized gene expression values for putative ortholog protein sequences of *L. cornutus* of MAO over time (01:00H, 07:00H, 13:00H, 19:00H). **B**) qPCR validation for MAO ortholog of *L. cornutus* (Transcript: DN53734\_c3\_g1\_i3). Relative expression of MAO ortholog over time (01:00H, 07:00H, 13:00H, 19:00H) were measured in a group of three spider cephalothoraces. Results are the mean  $\pm$  S.D. of three replicates. Statistical analysis was conducted by Kruskal-Wallis ( $p = 0.101$ ).

**A**



**B**

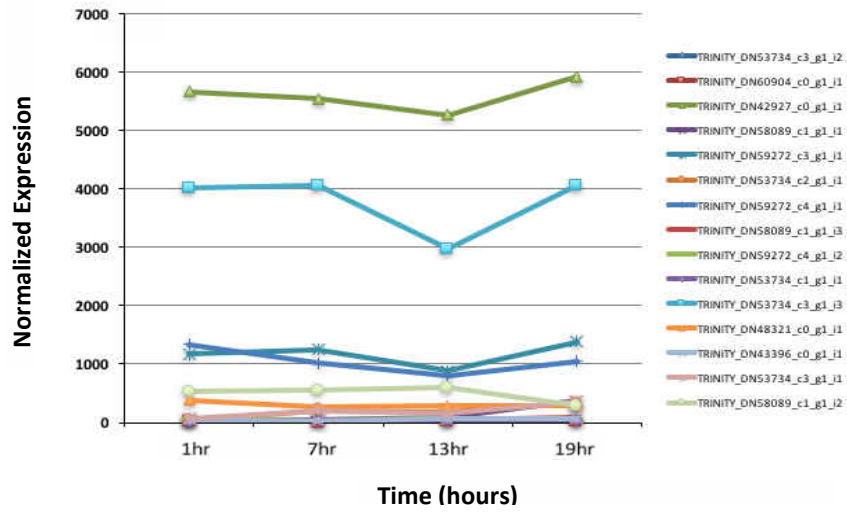
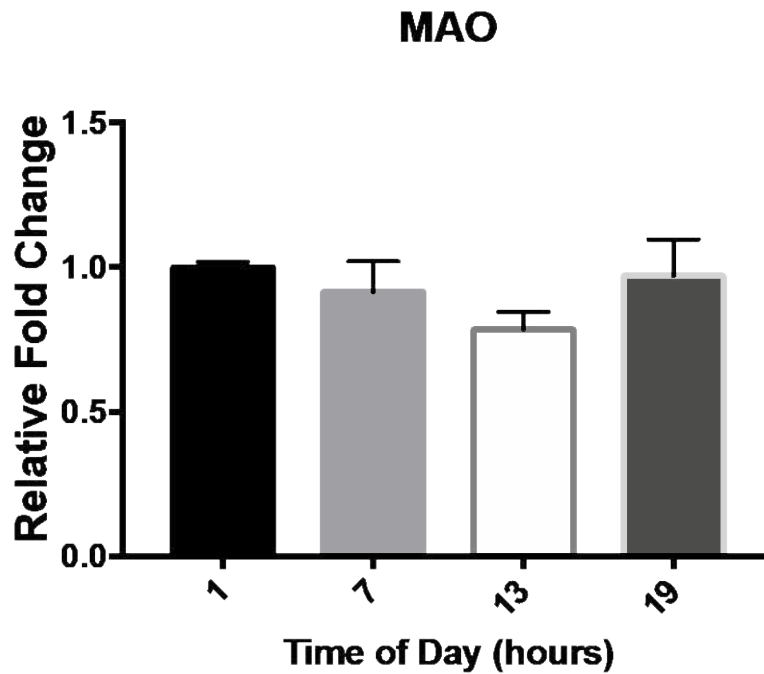
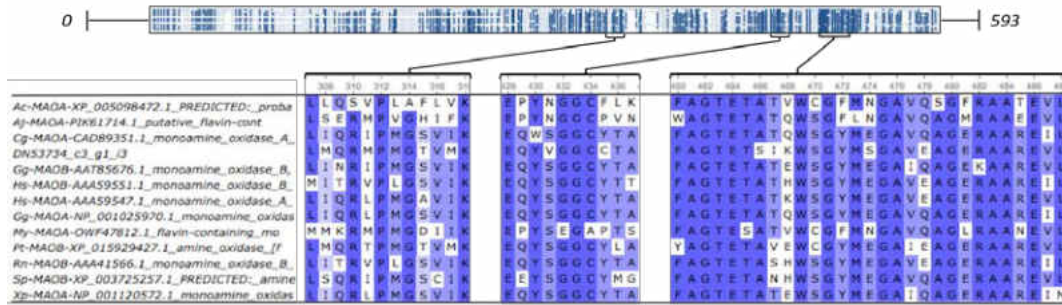
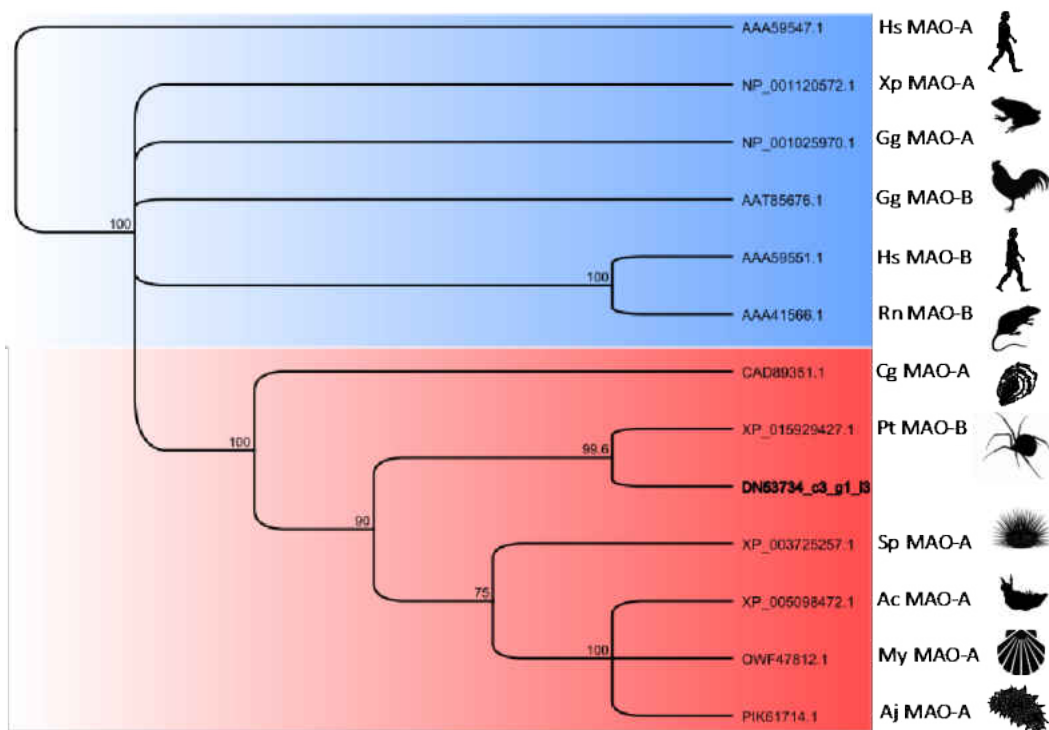

Figure 4.2. **A**) Box shade of MAO protein regions in protein sequence alignment, labeled with species abbreviations and subtype (MAO-A or MAO-B). Proteins were aligned with the ClustalW alignment algorithm on the Geneious™ software with default settings and the box shade was produced with Unipro Ugene. Shading is determined by the conservation of a residue at a position by percentage; dark blue = 100% of residues share identity, medium blue = 75% of residues share identity, light blue = 50% of residues share identity. The number at the end of each line of each protein sequence is the number of residues that a protein has up to the end of that line. Species abbreviations and accession numbers: Hs, *Homo sapiens* (AAA59547.1 and AAA59551.1) Xp, *Xenopus tropicalis* (NP001129572.1), Gg, *Gallus gallus* (NP001025970.1 and AAT85676.1); Rn, *Rattus norvegicus* (AAA41566.1); Cg, *Crassostrea gigas* (CAD89351.1); Pt, *Parasteatoda tepidariorum* (XP015929427.1); Sp, *Strongylocentrus purpuratus* (XP003725257.1); Ac, *Aplysia californica* (XP005098472.1); My, *Mizuhopecten yessvensis* (OWF47812.1); Aj, *Apostichopus japonicas* (PIK61914.1). **B**) Phylogenetic tree constructed in Geneious™ using Neighbor-Joining Maximum-likelihood analysis with bootstrapping values (1000 replicates), labeled with species abbreviations and subtype (MAO-A or MAO-B).

```

AA #60
DN53734_c3_g1_i3 -----MDADVIVVGAGISGLCAAKWLKESGVSVLVLEAMNRVGGRTFTKRDPKV
MAO-A-AAA59547.1 MENQEKASIAGHMFVGVVIGGGISGLSAKLLTEYGVSVLVLEARDRVGGRTYTIRNEHV
MAO-B-AAA59551.1 -----MSNKCDVVVVGGGISGMAAAKLLHDSGLNVVVLEARDRVGGRTYTLRNQKV
**:*:*.*****:.* ** : *:.*:***** :*****:* * : *
12
DN53734_c3_g1_i3 KYVDLGGAYVGPQTQDHLRLTKELGVENYKIYMDQKCVYYRNGRRLFHDATVSLYERNPF
MAO-A-AAA59547.1 DYVDVGGAYVGPQNRILRLSKELGIETYKVNVSERLVQYVKGKTYPFRGAF-PPVWNPI
MAO-B-AAA59551.1 KYVDLGGSYVGPQNRILRLAKELGLETYKVNEVERLIHHVKGKSYPFRGPF-PPVWNPI
.***:***:*****:..***:*****:*.** : : : : **: . . . **
18
DN53734_c3_g1_i3 VNMDLNHIIVRLIDKMGEIPENAPWDAPHAEEWDLMTVKDFLNKHCWTKRAAQFYRELCT
MAO-A-AAA59547.1 AYLDYNNLWRTIDNMGKEIPTDAPWEAQHADKWDKMTMKELIDKICWTKTARRFAYLFFVN
MAO-B-AAA59551.1 TYLDHNNFWRTMDDMGREIPSDAPWKAPLAEEDWNMTMKELLDKLCWTESAKQLATLFFVN
. : * ** : * : *.**_* ** : ****.* * : ** ** * : : : * ** : * : : .
24
DN53734_c3_g1_i3 TFITSEQYEASLLMFLWYIKQCGGSKRMINTINGGQERKFLGGSSQIASEKIAQKLGDGVV
MAO-A-AAA59547.1 INVTSEPEHVSALWFLWYVKQCGGTTRIFSVTNGGQERKFVGGSGQVSERIMDLLGDQVK
MAO-B-AAA59551.1 LCVTAETHEVSALWFLWYVKQCGGTTRIISTNGGQERKFVGGSGQVSERIMDLLGDRVK
:* : * : * * ** : ***** : . : . . . ***** : ** * : * : * : * *
FAD-binding
30
DN53734_c3_g1_i3 LTNSPVVGINQESKDVVLVKTLPGKEYKTKYVILACSPAVQOKIHFTPLPPIRNQLMQR
MAO-A-AAA59547.1 LN-HPVTHVDQS-SDNIIETLNHEHYECKYVINAIPPTLTAKIHFRPELPAERNQLIQR
MAO-B-AAA59551.1 LE-RPVIYIDQT-RENVLVETLNHEMYEAKYVISAIPPTLGMKIHFNPLPMMRNQMITR
* ** : * : : : : * : * : * * * * : * : * * * * * * * : *
36
DN53734_c3_g1_i3 MPMGTVMKVHLYYRTPFWKEKGLNGTHIILGDDEHPMFYSLDDTKPDGSFPPIIGFITGD
MAO-A-AAA59547.1 LPMGAVIKMYYKEAFWKKDYCGCMIIEDEDAPISITLDDTKPDGSLPAIMGFILAR
MAO-B-AAA59551.1 VPLGSVIKCIVYKPEFWRKKDYCGTMIIDGEEAPVAYTLDDTKPEGNYAAIMGFILAH
:* : ***** : * : * : * . * ** . : : * : ***** : * . ** : * * .
42
DN53734_c3_g1_i3 KCRKMCHMTPDQRKNAIVRSLEEATGYPEAKPIHYEKNWMEEQYVGGCCTAMLPPGF
MAO-A-AAA59547.1 KADRLAKLHKEIRKKICELYAKVLGSQALHPVHYEKNWCEEQYSGGCYTAYFPPGIM
MAO-B-AAA59551.1 KARKLARLTKEERLKKLCELYAKVLGSLEALEPVMHYEKNWCEEQYSGGCYTTFPPGIL
* . : : : : : * : : . . : * ** . : ***** * * * * * * * : : * : * : :
48
DN53734_c3_g1_i3 TRYGRALRTPIDRLYFAGTETS IKWSGYMSGAVEAGERAAAREVLCAMGKITANMIWIKP
MAO-A-AAA59547.1 TOYGRVIRQPVGRIFFAGTETATKWSGYMEGAVEAGERAAAREVLNGLGKVTEDIWVQEP
MAO-B-AAA59551.1 TOYGRVLRQPVDRIYFAGTETATHWSGYMEGAVEAGERAAAREILHAMGKIPEDIWQSEP
* : * * * : * : * : * : * : * : * : * : * : * : * : * : * : * : * : * : *
53
DN53734_c3_g1_i3 EFQDVPALPFEDTFGEKYTPSVSGFLKFSFTSILGAATFAFLKYPKYFRK--
MAO-A-AAA59547.1 ESKDVPAVEITHTFWERNLPSVSGLLKIIGFSTSV--TALGFVLYKYKLLPRS
MAO-B-AAA59551.1 ESDVDPAQPIITTFLEHRLPSVPGLLRLIGLTTIPSATALGFLAHKRGLLVRV
* * * * : * * * : * * * : * : : : : . : : : * : : :

```

Figure 4.3. CLUSTAL O(1.2.4) multiple sequence alignment of *L. cornutus* transcript DN53734\_c3\_g1\_i3 with of Human MAO-A and MAO-B protein sequences (Accession numbers: AAA59547.1 and AAA59551.1). An asterisk ( \* ) indicates positions which have a single, fully conserved residue. A colon ( : ) indicates conservation between groups of strongly similar properties. A period ( . ) indicates conservation between groups of weakly similar properties.

*Protein concentration curve of MAO activity with two substrates (p-tyramine and benzylamine)*

MAO activity was measured using three biological replicates, and three technical replicates were performed. MAO activity increased as the protein concentration increased with both p-tyramine and benzylamine as substrates (Figure 4.4A). These two substrates were provided with the Amplex Monoamine However, the MAO activity was significantly higher with p-tyramine as the substrate at all protein concentrations over 0ug of protein (Figure 4.4A; Shapiro-Wilks Normality test: p-tyramine, p-value= 0.12; Benzylamine, p-value= 0.1101; Two-way ANOVA: Column factor-Substrate type: <0.0001; Sidak's multiple comparisons: 0ug: p = 0.9971; 4ug: p = 0.0120; 8ug: p = 0.0002; 16ug: p <0.0001; 32ug: p <0.0001; 64ug: p <0.0001; 128ug: p <0.0001).

**A****B**

Figure 4.4. A) Protein concentration curve of detection of MAO activity from two different substrates, *p*-tyramine and benzylamine. Data are mean  $\pm$  SD of triplicate wells. B) MAO activity with inhibitor concentration curve using the two inhibitors pargyline and clorgyline. Data are mean  $\pm$  SD of triplicate wells. (\*,  $p < 0.05$ ; \*\*,  $p < 0.01$ ; \*\*\*,  $p < 0.001$ ; \*\*\*\*,  $p < 0.0001$ )



*Measurement of monoamine oxidase activity in the presence of MAO-inhibitors pargyline and clorgyline*

The MAO activity was measured from three biological replicates and three technical replicates using benzylamine as a substrate in the presence of two different MAO inhibitors: pargyline and clorgyline. Both MAO inhibitors decreased MAO activity at concentrations of 0.4uM or greater (Figure 4.4B). Pargyline showed a greater decrease in MAO activity compared to clorgyline, showing a significant difference in reduction of MAO activity at the 2uM concentration (Shapiro-Wilks Normality test: pargyline:  $p = 0.6808$ ; clorgyline:  $p = 0.2578$ ; Two-way ANOVA: Column factor (Inhibitor type):  $p < 0.0001$ ; Sidak's multiple comparisons: 2uM concentration:  $p < 0.0001$ ).

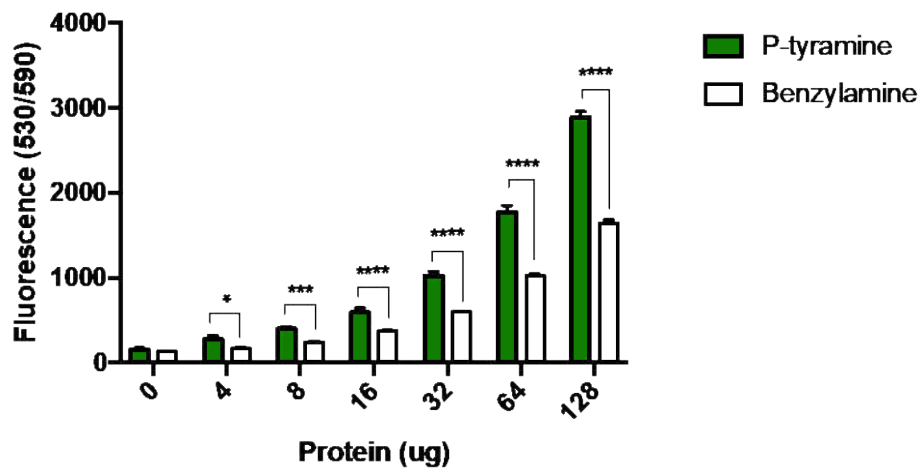
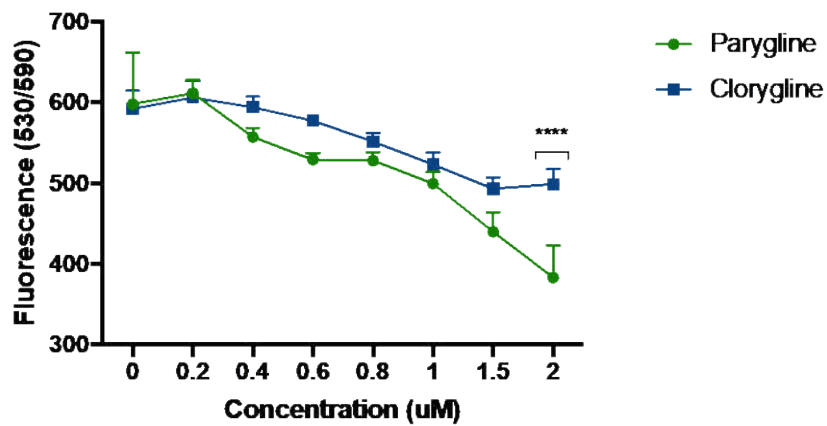
*Measurement of monoamine oxidase activity of cephalothorax tissue collected at 13 and 19 hours*

The MAO activity was measured from three biological replicates and three technical replicates using p-tyramine as a substrate with protein samples collected at two different time points (13 and 19hours). MAO activity was higher at 13 hours than 19 hours at all protein concentrations, showing significant differences at both 128ug and 256ug protein concentrations (Figure 4.5A; Shapiro-Wilks normality test:13H :  $p = 0.08$ ; 19H:  $p = 0.12$ ; Two-way ANOVA: Column factor (Time of Day)  $F(1,14)$ :  $p < 0.0001$ ; Sidak's multiple comparisons: 128ug protein,  $p < 0.0001$ ; 256ug of protein,  $p < 0.0001$ ).

A

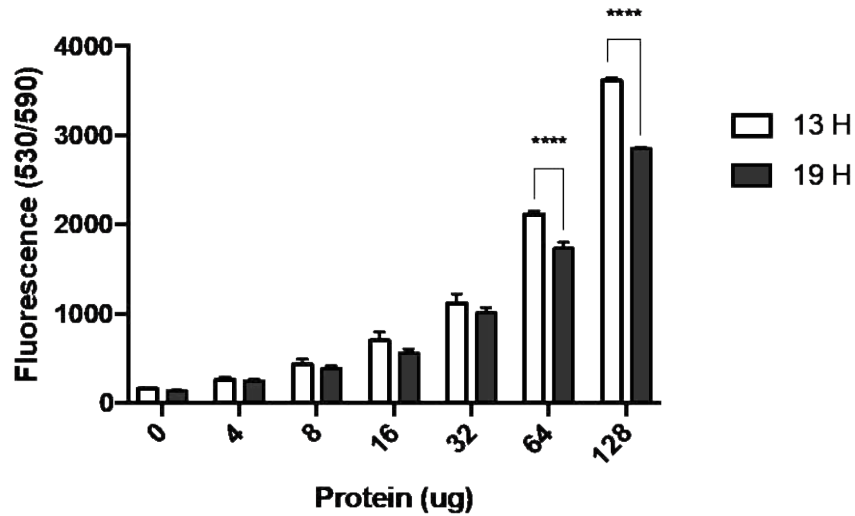

B

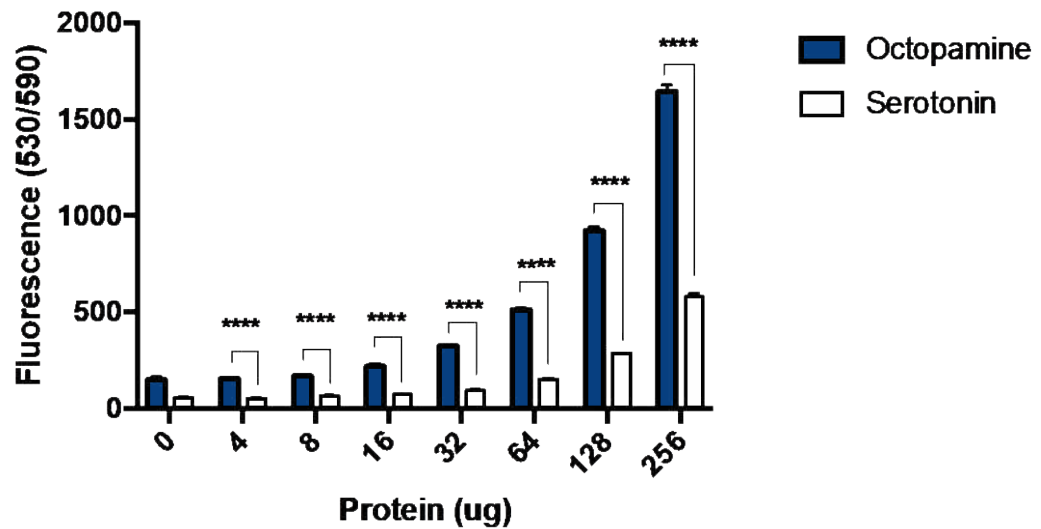

Figure 4.5. A) Protein concentration curve of detection of MAO activity from protein samples collected at 13 hours and 19hours. Data are mean  $\pm$  SD of triplicate wells. B) Protein concentration curve of detection of MAO activity of octopamine and serotonin as substrates (0.1mM). Data are mean  $\pm$  SD of triplicate wells. (\*, $p$ <0.05; \*\*,  $p$ <0.01; \*\*\*,  $p$ <0.001; \*\*\*\*, $p$ <0.0001)

### *Protein concentration curve of MAO activity with octopamine and serotonin*

The MAO activity was measured from three biological replicates and three technical replicates using octopamine or serotonin as a substrate. MAO activity occurred with both substrate types, however, the activity was significantly higher with octopamine (Figure 4.5B; Two-way ANOVA: Column factor-Substrate type:  $F(1,31) p < 0.0001$  Sidak's multiple comparisons: 0ug:  $p < 0.0001$ ; 4ug:  $p < 0.0001$ ; 8ug:  $p < 0.0001$ ; 16ug:  $p < 0.0001$ ; 32ug:  $p < 0.0001$ ; 64ug:  $p < 0.0001$ ; 128ug:  $p < 0.0001$ ).

## DISCUSSION

While a significant amount of research has focused on the role MAO plays in behavior in vertebrates, very few studies have evaluated this same role in invertebrates. In order to address this disparity, MAO activity must be investigated in organisms that exhibit fluctuations in behavioral state and utilize the enzyme for inactivating of monoamines. This study investigated the presence and expression of MAO at different time points throughout the day in *L. cornutus*, a spider that exhibits diel shifts in behavioral state[43]. Our results indicate *L. cornutus* does express a putative MAO gene and activity of MAO did vary throughout the day. In addition, the MAO enzyme appears to exhibit inhibitor selectivity as well as substrate preference, revealing potentially a key site of regulation in the degradation of octopamine.

In *L. cornutus*, the expression of MAO transcripts and activity did fluctuate throughout the day, and had significant differences between 13 hours and 19 hours. It is interesting to note that gene expression values remained relatively high throughout the day, and lowest at 13 hours. As *L. cornutus* is a nocturnal forager, it appears the expression of this MAO transcript increases at dusk and remains high until dawn, when the spider would be actively foraging[43]. In

mammals, MAO-A gene expression fluctuates throughout the day, with peaks of gene expression levels at dawn in mice[54]. However, this expression pattern in mammals can vary across different brain regions while MAO-B gene expression does not appear to fluctuate at all[54]. While the putative MAO transcript expression was lowest at 13 hours, MAO activity was significantly higher at 13 hours compared to 19 hours in *L. cornutus*. This finding could be the result of negative feedback from heightened protein levels due to a high transcript expression pattern at the other time points (1, 7, and 19 hours), a signal delay between mRNA and protein levels, or delayed translation on demand[55,56]. MAO-A activity fluctuates throughout the day in various parts of the mammalian brain, which have been found to be associated with clock gene expression (*period 2* and *BMAL* gene)[16]. From our results, similar clock components could be influencing the expression and activity of MAO in *L. cornutus*.

Protein alignments and phylogenetic tree analysis revealed a high homology between invertebrate and vertebrate MAO sequences, however there was a clear distinct grouping of vertebrate MAOs and invertebrate MAOs, regardless of the subtype characterize for these sequences in invertebrates. There is a high amount of homology in MAO sequences across the taxa in general, but amino acid residue differences in MAO-A and MAO-B produce slightly different binding pockets[57]. Thus, different binding pockets dictate which type of substrate the enzyme can oxidize (i.e. octopamine, serotonin, dopamine). When compared to MAOs of humans, it is clear *L. cornutus* MAO transcripts shares key residue similarities with MAO-B. Human MAO-B mainly processes phenylethylamine and other trace amines (i.e. octopamine)[58]. This homology is important to consider when discussing our results regarding substrate specificity and effective inhibition of the enzyme in this study.

Inhibition of MAO activity has been used to characterize potential subtypes in arachnids, however there is not a clear picture due to some contradicting results[22]. MAO activity has been documented several times in ticks and this activity is greatly decreased in the presence of MAO-B inhibitor deprenyl[38]. However, this same inhibitor deprenyl showed no effect in previous studies of MAO activity in spiders in the presence of noradrenaline, adrenaline, and dopamine as substrates[33]. In *L. cornutus*, there was a decrease of activity in the presence of either selective inhibitor, however pargyline (MAO-B specific inhibitor) had a greater effect. This result disagrees with previous studies on pargyline in the cattle tick which suggesting MAO-B deamination was minimal[59]. This discrepancy could be due to several different factors, including lack of specificity in earlier studies as a majority of earlier work was based on immunohistochemical techniques on frozen tissues. Because you see inhibition from both compounds, there could be a lack of specificity with the MAO enzyme that you see in other invertebrate taxa[22].

MAO activity did appear to be substrate specific, with a higher level of oxidation occurring with p-tyramine compared to benzylamine. As benzylamine is more specific for MAO-B enzymes, it appears that MAO activity is somewhat mixed in *L. cornutus* if considering substrate performance alone. In echinoderms and mollusks, substrate specificity has not been thoroughly investigated[22]. Previous studies in ticks and spiders show MAO activity with a range of substrates, including noradrenaline, adrenaline, dopamine, serotonin, and octopamine[30,33,36,38,39]. There were also differences in substrate specificity, but it is difficult to compare these affinities as benzylamine and p-tyramine were not used. It can be extrapolated from MAO activity in vertebrates that MAO-A preferentially oxidizes serotonin and NE, while MAO-B oxidizes phenylethylamine and benzylamine. Thus, this study sheds some

light on mixed abilities of this MAO enzyme in invertebrates to process different substrates that may not necessarily be uniform with the behavior of these enzymes in vertebrates.

Enzymatic activity of MAO also revealed a significantly higher level of oxidation with octopamine when compared to serotonin as a substrate *in vitro*. This finding was interesting for several reasons. First, it further supports substrate specificity for the MAO enzyme in *L. cornutus*. Second, MAO appears to be a much more potent regulator of octopamine levels than serotonin, in contrast to earlier studies in spiders showing little to no effect on octopamine by MAO activity[33]. When MAO in *L. cornutus* is expressed at higher activity levels, presumably octopamine will be degraded at a much faster rate, reducing the overall signal of the monoamine. Since previous findings show an increase in aggression from exogenous octopamine[44], it would be expected to see a higher amount of activity of enzymes degrading octopamine during times of day when *L. cornutus* is the least aggressive (i.e. in the middle of the day). When taken together with the marked decrease in activity between 13 hours and 19 hours, MAO may be playing an important role in attenuating the signaling of octopamine, quickly degrading the compound to produce a less aggressive behavioral state during the day.

## CONCLUSIONS

This study demonstrated diel fluctuations of MAO gene expression and activity in an invertebrate, similar to what is observed in vertebrates[54]. While further studies are needed to investigate in more detail how this activity influences *L. cornutus* aggression and activity state, MAO is a potential site of regulation of monoamine signaling and aggression in this spider based on our *in vitro* studies. There is evidence for other metabolic pathways for monoamines in arachnids including N-acetylation and sulphation[60,61]. Although these pathways have been studied previously in terms of mechanistic action, it would be important to investigate how these

degradation pathways interact in concert with each other to produce diel or circadian effects on behavior in arthropods.

## REFERENCES

1. Edmondson DE, Binda C, Wang J, Upadhyay AK, Mattevi A. Molecular and mechanistic properties of the membrane-bound mitochondrial monoamine oxidases. *Biochemistry*. NIH Public Access; 2009;48: 4220–30. doi:10.1021/bi900413g
2. Shih JC, Chen K, Ridd MJ. Monoamine oxidase: from genes to behavior. *Annu Rev Neurosci*. NIH Public Access; 1999;22: 197–217. doi:10.1146/annurev.neuro.22.1.197
3. Bach AW, Lan NC, Johnson DL, Abell CW, Bembenek ME, Kwan SW, et al. cDNA cloning of human liver monoamine oxidase A and B: molecular basis of differences in enzymatic properties. *Proc Natl Acad Sci U S A*. 1988;85: 4934–8. Available: <http://www.ncbi.nlm.nih.gov/pubmed/3387449>
4. Tsugeno Y, Ito A. A key amino acid responsible for substrate selectivity of monoamine oxidase A and B. *J Biol Chem*. American Society for Biochemistry and Molecular Biology; 1997;272: 14033–6. doi:10.1074/JBC.272.22.14033
5. Godar SC, Fite PJ, McFarlin KM, Bortolato M. The role of monoamine oxidase A in aggression: Current translational developments and future challenges. *Prog Neuro-Psychopharmacology Biol Psychiatry*. 2016;69: 90–100. doi:10.1016/j.pnpbp.2016.01.001
6. Alia-Klein N, Goldstein RZ, Kriplani A, Logan J, Tomasi D, Williams B, et al. Brain monoamine oxidase A activity predicts trait aggression. *J Neurosci*. NIH Public Access; 2008;28: 5099–104. doi:10.1523/JNEUROSCI.0925-08.2008
7. Guo G, Ou X-M, Roettger M, Shih JC. The VNTR 2 repeat in MAOA and delinquent behavior in adolescence and young adulthood: associations and MAOA promoter activity. *Eur J Hum Genet*. 2008;16: 626–634. doi:10.1038/sj.ejhg.5201999
8. Beaver KM, Holtfreter K. Biosocial Influences on Fraudulent Behaviors. *J Genet Psychol*. 2009;170: 101–114. doi:10.3200/GNTP.170.2.101-114
9. Beaver KM, Sak A, Vaske J, Nilsson J. Genetic risk, parent–child relations, and antisocial phenotypes in a sample of African-American males. *Psychiatry Res*. Elsevier; 2010;175: 160–164. doi:10.1016/J.PSYCHRES.2009.01.024
10. Beaver KM, Wright JP, Boutwell BB, Barnes JC, DeLisi M, Vaughn MG. Exploring the association between the 2-repeat allele of the MAOA gene promoter polymorphism and psychopathic personality traits, arrests, incarceration, and lifetime antisocial behavior. *Pers Individ Dif*. Pergamon; 2013;54: 164–168. doi:10.1016/J.PAID.2012.08.014
11. Beaver KM, Barnes JC, Boutwell BB. The 2-Repeat Allele of the MAOA Gene Confers an Increased Risk for Shooting and Stabbing Behaviors. *Psychiatr Q*. 2014;85: 257–265. doi:10.1007/s11126-013-9287-x
12. Mejia JM, Ervin FR, Palmour RM, Tremblay RE. Aggressive behavior and Brunner syndrome: no evidence for the C936T mutation in a population sample. *Am J Med Genet*. 2001;105: 396–7. Available: <http://www.ncbi.nlm.nih.gov/pubmed/11378857>
13. Whitaker-Azmitia PM, Zhang X, Clarke C. Effects of Gestational Exposure to Monoamine Oxidase Inhibitors in Rats: Preliminary Behavioral and Neurochemical

- Studies. *Neuropsychopharmacology*. 1994;11: 125–132. doi:10.1038/npp.1994.42
14. Shih JC. Cloning, After Cloning, Knock-out Mice, and Physiological Functions of MAO A and B. *Neurotoxicology*. Elsevier; 2004;25: 21–30. doi:10.1016/S0161-813X(03)00112-8
  15. Bhaskaran D, Radha E. Circadian variations in the monoamine levels and monoamine oxidase activity in different regions of the rat brain as a function of age. *Exp Gerontol*. Pergamon; 1984;19: 153–170. doi:10.1016/0531-5565(84)90034-2
  16. Hampp G, Ripperger JA, Houben T, Schmutz I, Blex C, Perreau-Lenz S, et al. Regulation of Monoamine Oxidase A by Circadian-Clock Components Implies Clock Influence on Mood. *Curr Biol*. 2008;18: 678–683. doi:10.1016/j.cub.2008.04.012
  17. Sloley BD, Juorio A V., Durden DA. High-performance liquid chromatographic analysis of monoamines and some of their  $\gamma$ -glutamyl conjugates produced by the brain and other tissues of *Helix aspersa* (gastropoda). *Cell Mol Neurobiol*. Kluwer Academic Publishers-Plenum Publishers; 1990;10: 175–192. doi:10.1007/BF00734572
  18. McCaman MW, Stetzler J, Clark B. Synthesis of  $\gamma$ -Glutamyl-dopamine and Other Peptidoamines in the Nervous System of *Aplysia californica*. *J Neurochem*. 1985;45: 1828–1835. doi:10.1111/j.1471-4159.1985.tb10540.x
  19. Bodnaryk RP, Brunet PC. 3-O-hydrosulphato-4-hydroxyphenethylamine (dopamine 3-O-sulphate), a metabolite involved in the sclerotization of insect cuticle. *Biochem J*. 1974;138: 463–469. doi:10.1042/bj1380463
  20. Hopkins TL, Morgan TD, Aso Y, Kramer KJ. N-beta-Alanyldopamine: Major Role in Insect Cuticle Tanning. *Science*. 1982;217: 364–366. doi:10.1126/science.217.4557.364
  21. Hayashi S, Murdock LL, Florey E. Octopamine metabolism in invertebrates (*Locusta*, *Astacus*, *Helix*): evidence for N-acetylation in arthropod tissues. *Comp Biochem Physiol C*. 1977;58: 183–91. Available: <http://www.ncbi.nlm.nih.gov/pubmed/23932>
  22. Sloley BD. Metabolism of Monoamines in Invertebrates: The Relative Importance of Monoamine Oxidase in Different Phyla. *NeuroToxicology*. 2004. pp. 175–183. doi:10.1016/S0161-813X(03)00096-2
  23. Nicotra A, Naccarato M. Monoamine oxidase activity in *Paracentrotus lividus* sperm cells. *Int J Invertebr Reprod*. Taylor & Francis Group ; 1982;5: 101–105. doi:10.1080/01651269.1982.10553459
  24. Nicotra A, Serafino AL, Senatori O. Monoamine oxidase activity in tissues of the starfish *marthasterias glacialis*. *Comp Biochem Physiol Part C, Comp*. 1986;84: 195–197. doi:10.1016/0742-8413(86)90189-1
  25. Pani AK, Croll RP. Pharmacological analysis of monoamine synthesis and catabolism in the scallop, *Placopecten magellanicus*. *Gen Pharmacol*. 1998;31: 67–73. doi:10.1016/S0306-3623(97)00448-5
  26. Pani AK, Croll RP. Catechol concentrations in the hemolymph of the scallop, *Placopecten magellanicus*. *Gen Comp Endocrinol*. 2000;118: 48–56. doi:10.1006/gcen.1999.7441
  27. Pani AK, Anctil M. Quantitative Survey of Biogenic Monoamines, their Precursors and Metabolites in the Coelenterate *Renilla Koellikeri*. *Biog Amin*. 1994;10: 161–180.
  28. Juorio A V., Killick SW. Monoamines and their metabolism in some molluscs. *Comp Gen Pharmacol*. 1972;3: 283–295. doi:10.1016/0010-4035(72)90005-5
  29. Juorio A V., Philips SR. Arylalkylamines in *Octopus* tissues. *Neurochem Res*. Kluwer Academic Publishers-Plenum Publishers; 1976;1: 501–509. doi:10.1007/BF00964211
  30. Atkinson PW, Binnington KC, Roulston WJ. High Monoamine Oxidase Activity in the



- Tick *Boophilus microplus*, and Inhibition By Chlordimeform and Related Pesticides. *Aust J Entomol*. Blackwell Publishing Ltd; 1974;13: 207–210. doi:10.1111/j.1440-6055.1974.tb02174.x
31. Sparks TC, Skomp JR, Babcock J, Geng C. Biogenic amines in the two-spotted spider mite. *Arch Insect Biochem Physiol*. Wiley Subscription Services, Inc., A Wiley Company; 1994;25: 1–8. doi:10.1002/arch.940250102
  32. Wong DL, Kaufman WR. Potentiation by spiperone and other butyrophenones of fluid secretion by isolated salivary glands of ixodid ticks. *Eur J Pharmacol*. 1981;73: 163–73. Available: <http://www.ncbi.nlm.nih.gov/pubmed/6273183>
  33. Meyer W, Jehnen R. The distribution of monoamine oxidase and biogenic monoamines in the central nervous system of spiders(Arachnida: Araneida). *J Morphol*. Wiley Subscription Services, Inc., A Wiley Company; 1980;164: 69–81. doi:10.1002/jmor.1051640106
  34. Nicotra A, Naccarato M. Monoamine oxidase activity in *Paracentrotus lividus* sperm cells. *Int J Invertebr Reprod*. Taylor & Francis Group ; 1982;5: 101–105. doi:10.1080/01651269.1982.10553459
  35. Nicotra A, Senatori O, Santangelo G. Monoamine-Oxidase Activity in Hepatopancreas of Octopus-Vulgaris. *Comp Biochem Physiol C-Pharmacology Toxicol Endocrinol*. 1993;106: 479–482. doi:10.1016/0742-8413(93)90166-i
  36. Holden JS, Hadfield JR. Chlorodimeform and its effect on monoamine oxidase activity in the cattle tick, *Boophilus microplus*. *Experientia*. 1975;31: 1015–7. Available: <http://www.ncbi.nlm.nih.gov/pubmed/1175733>
  37. Witt PN, Brettschneider L, Boris AP. SENSITIVITY TO D-AMPHETAMINE IN SPIDERS AFTER IPRONIAZID AND IMIPRAMINE. *J Pharmacol Exp Ther*. 1961;132.
  38. Kaufman R, Sloley D. Catabolism of dopamine and 5-hydroxytryptamine by monoamine oxidase in the ixodid tick, *Amblyomma hebraeum*. *Insect Biochem Mol Biol*. 1996;26: 101–109. doi:10.1016/0965-1748(95)00069-0
  39. Wong DL, Kaufman WR. Potentiation by spiperone and other butyrophenones of fluid secretion by isolated salivary glands of ixodid ticks. *Eur J Pharmacol*. 1981;73: 163–73. Available: <http://www.ncbi.nlm.nih.gov/pubmed/6273183>
  40. Meyer W, Jehnen R. The distribution of monoamine oxidase and biogenic monoamines in the central nervous system of spiders(Arachnida: Araneida). *J Morphol*. Wiley Subscription Services, Inc., A Wiley Company; 1980;164: 69–81. doi:10.1002/jmor.1051640106
  41. Kaushal S. Characterization of Three Putative Monoamine Oxidase Genes in *Caenorhabditis elegans* [Internet]. Ohio University. 2008. Available: [https://etd.ohiolink.edu/rws\\_etd/document/get/ohiou1218747926/inline](https://etd.ohiolink.edu/rws_etd/document/get/ohiou1218747926/inline)
  42. Basu R. Investigating Amine Oxidase Domain Containing Genes - amx-1 and amx-2 - in *Caenorhabditis elegans* [Internet]. Ohio University Thesis and Dissertation - OhioLINK. 2014. Available: [https://etd.ohiolink.edu/pg\\_10?0::NO:10:P10\\_ACCESSION\\_NUM:ohiou1417613961](https://etd.ohiolink.edu/pg_10?0::NO:10:P10_ACCESSION_NUM:ohiou1417613961)
  43. Jones TC, Akoury TS, Hauser CK, Moore D. Evidence of circadian rhythm in antipredator behaviour in the orb-weaving spider *Larinioides cornutus*. *Anim Behav*. 2011;82: 549–555. doi:10.1016/j.anbehav.2011.06.009
  44. Jones TC, Akoury TS, Hauser CK, Neblett MF, Linville BJ, Edge AA, et al. Octopamine and serotonin have opposite effects on antipredator behavior in the orb-weaving spider,

- Larinioides cornutus. *J Comp Physiol A Neuroethol Sens Neural Behav Physiol*. 2011;197: 819–25. doi:10.1007/s00359-011-0644-7
45. Ye J, Coulouris G, Zaretskaya I, Cutcutache I, Rozen S, Madden TL. Primer-BLAST: a tool to design target-specific primers for polymerase chain reaction. *BMC Bioinformatics*. 2012;13: 134. doi:10.1186/1471-2105-13-134
  46. Yang C, Pan H, Noland JE, Zhang D, Zhang Z, Liu Y, et al. Selection of reference genes for RT-qPCR analysis in a predatory biological control agent, *Coleomegilla maculata* (Coleoptera: Coccinellidae). *Sci Rep*. Nature Publishing Group; 2016;5: 18201. doi:10.1038/srep18201
  47. Chang Y-W, Chen J-Y, Lu M-X, Gao Y, Tian Z-H, Gong W-R, et al. Selection and validation of reference genes for quantitative real-time PCR analysis under different experimental conditions in the leafminer *Liriomyza trifolii* (Diptera: Agromyzidae). Gao Y, editor. *PLoS One*. Public Library of Science; 2017;12: e0181862. doi:10.1371/journal.pone.0181862
  48. Ma K-S, Li F, Liang P-Z, Chen X-W, Liu Y, Gao X-W. Identification and Validation of Reference Genes for the Normalization of Gene Expression Data in qRT-PCR Analysis in *Aphis gossypii* (Hemiptera: Aphididae). *J Insect Sci*. 2016;16: 17. doi:10.1093/jisesa/iew003
  49. Zhou M, Panchuk-Voloshina N. A One-Step Fluorometric Method for the Continuous Measurement of Monoamine Oxidase Activity. *Anal Biochem*. 1997;253: 169–174. doi:10.1006/abio.1997.2392
  50. Li G, Xu J, Wang P, Velazquez H, Li Y, Wu Y, et al. Catecholamines Regulate the Activity, Secretion, and Synthesis of Renalase. *Circulation*. 2008;117: 1277–1282. doi:10.1161/CIRCULATIONAHA.107.732032
  51. Finberg JP, Youdim MB. Selective MAO A and B inhibitors: their mechanism of action and pharmacology. *Neuropharmacology*. 1983;22: 441–6. Available: <http://www.ncbi.nlm.nih.gov/pubmed/6304562>
  52. Grega DS. The effects of monoamines on tarantula skeletal muscle. *Comp Biochem Physiol Part C, Comp*. 1978;61: 337–340. doi:10.1016/0306-4492(78)90065-5
  53. Ewen-Campen B, Shaner N, Panfilio KA, Suzuki Y, Roth S, Extavour CG. The maternal and early embryonic transcriptome of the milkweed bug *Oncopeltus fasciatus*. *BMC Genomics*. 2011;12: 61. doi:10.1186/1471-2164-12-61
  54. Hampp G, Ripperger JA, Houben T, Schmutz I, Blex C, Perreau-Lenz S, et al. Regulation of Monoamine Oxidase A by Circadian-Clock Components Implies Clock Influence on Mood. *Curr Biol*. 2008;18: 678–683. doi:10.1016/j.cub.2008.04.012
  55. McManus J, Cheng Z, Vogel C. Next-generation analysis of gene expression regulation – comparing the roles of synthesis and degradation. *Mol Biosyst*. The Royal Society of Chemistry; 2015;11: 2680–2689. doi:10.1039/C5MB00310E
  56. Liu Y, Beyer A, Aebersold R. On the Dependency of Cellular Protein Levels on mRNA Abundance. *Cell*. 2016;165: 535–550. doi:10.1016/j.cell.2016.03.014
  57. Gaweska H, Fitzpatrick PF. Structures and Mechanism of the Monoamine Oxidase Family. *Biomol Concepts*. NIH Public Access; 2011;2: 365–377. doi:10.1515/BMC.2011.030
  58. Kakimoto Y, Armstrong MD. On the identification of octopamine in mammals. *J Biol Chem*. 1962;237: 422–427. Available: <http://www.ncbi.nlm.nih.gov/pubmed/14453200>
  59. Kempton LRC, Isaac RE, Pillmoor JB, Willis RJ. Octopamine N-acetyltransferase activity

- from the cattle tick, *Boophilus microplus*. *Insect Biochem Mol Biol*. Pergamon; 1992;22: 777–783. doi:10.1016/0965-1748(92)90104-M
60. Kempton LRC, Isaac RE, Pillmoor JB, Willis RJ. Octapamine N-acetyltransferase activity from the cattle tick, *Boophilus microplus*. *Insect Biochem Mol Biol*. 1992;22: 777–783. doi:10.1016/0965-1748(92)90104-M
61. Pichu S, Yalcin EB, Ribeiro JM, King RS, Mather TN. Molecular characterization of novel sulfotransferases from the tick, *Ixodes scapularis*. *BMC Biochem*. BioMed Central; 2011;12: 32. doi:10.1186/1471-2091-12-32

## CHAPTER 5

### DISCUSSION

Research in the areas of circadian rhythms and aggression-related behaviors have been expanded immensely in their respective individual directions, yet the interplay of these two research topics has begun to appear more apparent over the last decade. The influence of circadian rhythms on aggression-related behaviors has not only been documented in simpler model systems like insects (Thomas C. Jones et al. 2011), but also in many psychological illnesses and disease states in human health (Todd et al. 2018 Apr 9). This study took a holistic approach to understanding underlying mechanisms involved in the entwinement of circadian control and aggression-related behaviors in the orb-weaving spider *L.cornutus*. Specifically, this research was a preliminary step in identifying potential sites of regulation in the influence of OA or 5-HT on the variation in boldness in *L.cornutus*.

While it was initially predicted endogenous levels of 5-HT and OA would fluctuate throughout the day (Q1), the significant amount of individual variation did not allow for significant fluctuations to be observed in spite of some clear patterns of 5-HT levels increasing and OA levels appearing lower during the day. A crude methodology of utilizing whole head tissue was employed due to several potential issues with discrete brain dissection in spiders, however, future experiments investigating localization of these monoamines in specific brain regions would be beneficial. In addition, it is interesting to note there were no significant changes in circulating levels of either monoamine. Although, these measurements were also accompanied by a high level of individual variation. Other studies have been successful investigating circulating levels of these same monoamines in wolf spiders, but these studies

were done with two contrasting behavioral states (aggressive mating tactics vs. non-aggressive mating tactics) in which fluctuations may be more noticeable than among time points separated by several hours (Hebets et al. 2015). Finally, the time points selected to observe such changes in monoamine levels were somewhat limiting in this study. Future experiments could benefit from the addition of more time points to better identify sharp fluctuations that may have been overlooked through the day.

A shot-gun transcriptome approach not only produced a plethora of information to be collected in the head tissue of this spider, but also established a foundation of transcript information to be mined in terms of monoaminergic systems employed at different times throughout the day. Components involved in the octopaminergic system of *L. cornutus* were preliminarily identified in this research and observed for relative fold changes in transcription throughout the day. As seen in other organismal systems, enzymes involved in OA synthesis appear to have variation in temporal expression. The two enzymes involved, tyrosine decarboxylase and tyramine beta-hydroxylase both decrease during the day, and are upregulated at their highest levels at dusk. This finding supported our initial predictions that as OA can increase boldness/aggression-related behavior in *L. cornutus*, you would see an upregulation of the synthesis enzymes involved at night when *L. cornutus* is the boldest. While the HPLC data did not corroborate this pattern, the methodology employed may have not been specific enough (i.e. specific brain regions).

In addition to changes in synthesis enzymes of OA, preliminary identification of octopamine transporters and receptors was achieved. The transcript of interest for an octopamine transporter exhibited a significant increase during the middle of that day. While this finding agrees with studies revealing transporter upregulation prior to the increase in signaling molecules (Saito et al.

2008), the specificity of this transporter transcript will need to be established to provide clear conclusions. Some putative homologs of octopaminergic receptors were also observed to be upregulated to their highest level at dusk. This finding aligned with our initial predictions, but there is a tremendous amount of complexity to consider when investigating receptor gene expression. Even though gene expression of neurotransmitter receptors is a site of regulation, changes in neurotransmitter receptor trafficking is also a key mechanism for altering the strength of synaptic signaling (Collingridge et al. 2004).

Temporal changes in expression of putative transcripts of proteins involved in 5-HT synthesis and signaling were also uncovered in this research. Tryptophan hydroxylase, the rate-limiting synthesis enzyme of 5-HT, has increased transcription during the day (0700 and 1300 hours) with reduced levels at night. This result was anticipated as 5-HT decreases boldness of individuals and *L.cornutus* individuals exhibit a lower level of boldness during the day. While the HPLC results of 5-HT levels were not statistically significant, levels of 5-HT in the cephalothorax of *L.cornutus* were highest during the day (1300 hours) which appears to be substantiated with an upregulation of tryptophan hydroxylase during that time. Although transcripts were initially isolated in reference to sodium-dependent serotonin-specific transporter query sequences, some of the transcripts identified for significant upregulation during the day (DN51156\_c5\_g2\_i1) had higher homology with transporters associated with GABA. Thus, when comparing two transporter transcripts, one with a higher potential selectivity for 5-HT (DN53562\_c1\_g1\_i1) and the other with a higher potential selectivity for GABA, a significant amount of serotonin could be left in the synaptic cleft as more GABA is being repackaged and resent out. While this event could potentially be producing more of an inhibitory effect on the organism, further work is needed to investigate specificity of these transporters and how they are

being actively translated during the day. Lastly, serotonergic receptor transcripts were isolated based on protein sequence homology and observed for fluctuations in expression level throughout the day. Some transcripts were upregulated significantly during the day (1300 hours), however, additional experimentation will be required to characterize these receptors as there are several types of 5-HT receptors with varying levels of influence on serotonergic tone.

In spite of mixed findings of previous studies investigating major catabolic pathways of monoamines in arachnids(Sloley 2004; Hiragaki et al. 2015), there is strong evidence for MAO expression and activity in *L.cornutus*. Our results established not only substrate specificity of MAO in *L. cornutus*, but also selectivity in inhibition using pharmacological antagonists. Similar to MAO-B subtype in humans(Grimsby et al. 1990; Zhou et al. 1998), the MAO in *L.cornutus* metabolizes trace amines like OA at higher protein concentrations more efficiently than 5-HT. In addition, there was a significant temporal difference in activity, with MAO activity being higher at 1300 hours than compared to 1900 hours, the time points that had the greatest fold change in MAO transcript expression. In summation, MAO has a higher activity level at 1300 hours and metabolizes OA more readily than 5-HT, ultimately allowing OA levels to decrease while 5-HT levels increase during the day. While this appears to be a potential intriguing mechanism of regulating downstream effects of OA and 5-HT, a more extensive approach is needed in the future to establish all other possible degradation pathways of these monoamines in arachnids.

### Conclusions and Future Directions

Spiders are exceptionally unique organisms for a multitude of reasons including species diversity and abundance, a wide array of behaviors, and complex physiological processes (i.e. silk production) (Foelix 2011). Like other spider species, *L. cornutus* offers a unique model system to study underlying mechanisms of aggression and chronobiology. This dissertation

research allowed a preliminary look into how genes involved in two monoaminergic systems are fluctuating throughout the day, revealing multiple facets of how aggressive behavior may be influenced transcriptionally and enzymatically in the common furrow orb-weaver *L.cornutus*. Synthesis, signaling, and degradation of OA and 5-HT all fluctuate transcriptionally at different time points throughout the day, prompting future studies to investigate these transcripts of interest more extensively, whether through protein characterization and/or localization.



## REFERENCES

- Adamo SA, Linn CE, Hoy RR. 1995. The role of neurohormonal octopamine during “fight or flight” behaviour in the field cricket *Gryllus bimaculatus*. *J Exp Biol.* 198:1691–700. [accessed 2017 Oct 3]. <http://www.ncbi.nlm.nih.gov/pubmed/7636443>.
- Aschoff J. 1965. Circadian Rhythms in Man. *Science* (80- ). 148:1427–1432. doi:10.1126/science.148.3676.1427.
- Aschoff J. 1966. Circadian Activity Pattern with Two Peaks. *Ecology.* 47:657–662. doi:10.2307/1933949. [accessed 2018 Jan 7]. <http://doi.wiley.com/10.2307/1933949>.
- Awata H, Wakuda R, Ishimaru Y, Matsuoka Y, Terao K, Katata S, Matsumoto Y, Hamanaka Y, Noji S, Mito T, et al. 2016. Roles of OA1 octopamine receptor and Dop1 dopamine receptor in mediating appetitive and aversive reinforcement revealed by RNAi studies. *Sci Rep.* 6:29696. doi:10.1038/srep29696. [accessed 2017 Dec 27]. <http://www.nature.com/articles/srep29696>.
- Baier A, Wittek B, Brembs B. 2002. *Drosophila* as a new model organism for the neurobiology of aggression? *J Exp Biol.* 205:1233–40. [accessed 2017 Dec 22]. <http://www.ncbi.nlm.nih.gov/pubmed/11948200>.
- Balfanz S, Strünker T, Frings S, Baumann A. 2005. A family of octapamine receptors that specifically induce cyclic AMP production or Ca<sup>2+</sup> release in *Drosophila melanogaster*. *J Neurochem.* 93:440–451. doi:10.1111/j.1471-4159.2005.03034.x. [accessed 2017 Dec 1]. <http://www.ncbi.nlm.nih.gov/pubmed/15816867>.
- Barker EL, Kimmel HL, Blakely RD, Sonders MS, Amara SG. 1994. Chimeric human and rat serotonin transporters reveal domains involved in recognition of transporter ligands. *Mol Pharmacol.* 46:799–807. doi:10.1124/mol.59.1.83. [accessed 2017 Dec 25]. <http://www.ncbi.nlm.nih.gov/pubmed/7969065>.
- Bautista LM, Tinbergen J, Wiersma P, Kacelnik A. 1998. Optimal Foraging and Beyond: How Starlings Cope with Changes in Food Availability. *Am Nat.* 152:543–561. doi:10.1086/286189.
- Bell-Pedersen D, Cassone VM, Earnest DJ, Golden SS, Hardin PE, Thomas TL, Zoran MJ. 2005. Circadian rhythms from multiple oscillators: Lessons from diverse organisms. *Nat Rev Genet.* 6:544–556. doi:10.1038/nrg1633.
- Bhadra U, Thakkar N, Das P, Pal Bhadra M. 2017. Evolution of circadian rhythms: from bacteria to human. *Sleep Med.* 35:49–61. doi:10.1016/J.SLEEP.2017.04.008. [accessed 2018 Jan 7]. <https://www.sciencedirect.com/science/article/pii/S1389945717301909>.
- Bubak AN, Swallow JG, Renner KJ. 2013. Whole brain monoamine detection and manipulation in a stalk-eyed fly. *J Neurosci Methods.* 219:124–130. doi:10.1016/j.jneumeth.2013.07.006. [accessed 2017 Dec 1].

- <http://www.ncbi.nlm.nih.gov/pubmed/23891953>.
- Caveney S, Cladman W, Verellen L, Donly C. 2006. Ancestry of neuronal monoamine transporters in the Metazoa. *J Exp Biol.* 209:4858–68. doi:10.1242/jeb.02607. [accessed 2018 Jan 10]. <http://www.ncbi.nlm.nih.gov/pubmed/11821492>.
- Certel SJ, Savella MG, Schlegel DCF, Kravitz EA. 2007. Modulation of *Drosophila* male behavioral choice. *Proc Natl Acad Sci U S A.* 104:4706–11. doi:10.1073/pnas.0700328104. [accessed 2018 Jan 8]. <http://www.ncbi.nlm.nih.gov/pubmed/17360588>.
- Charnov EL. 1976. Optimal foraging theory: the marginal value theorem. *Theor Popul Biol.* 9:129–136. doi:10.1016/0040-5809(76)90040-X.
- Chatterjee A, Tanoue S, Houli JH, Hardin PE. 2010. Regulation of Gustatory Physiology and Appetitive Behavior by the *Drosophila* Circadian Clock. *Curr Biol.* 20:300–309. doi:10.1016/J.CUB.2009.12.055. [accessed 2018 Jan 7]. <https://www.sciencedirect.com/science/article/pii/S0960982210000047>.
- Coleman CM, Neckameyer WS. 2005. Serotonin synthesis by two distinct enzymes in *Drosophila melanogaster*. *Arch Insect Biochem Physiol.* 59:12–31. doi:10.1002/arch.20050. [accessed 2018 Apr 14]. <http://doi.wiley.com/10.1002/arch.20050>.
- Collingridge GL, Isaac JTR, Wang YT. 2004. Receptor trafficking and synaptic plasticity. *Nat Rev Neurosci.* 5:952–962. doi:10.1038/nrn1556. [accessed 2018 Apr 15]. <http://www.ncbi.nlm.nih.gov/pubmed/15550950>.
- Curran KP, Chalasani SH. 2012. Serotonin circuits and anxiety: what can invertebrates teach us? *Invert Neurosci.* 12:81–92. doi:10.1007/s10158-012-0140-y. [accessed 2017 Oct 7]. <http://www.ncbi.nlm.nih.gov/pubmed/22918570>.
- Dierick HA, Greenspan RJ. 2007. Serotonin and neuropeptide F have opposite modulatory effects on fly aggression. *Nat Genet.* 39:678–682. doi:10.1038/ng2029. [accessed 2018 Jan 8]. <http://www.ncbi.nlm.nih.gov/pubmed/17450142>.
- DiRienzo N, McDermott DR, Pruitt JN. 2015. Testing the Effects of Biogenic Amines and Alternative Topical Solvent Types on the Behavioral Repertoire of Two Web-Building Spiders. Foster S, editor. *Ethology.* 121:801–812. doi:10.1111/eth.12395. [accessed 2018 Jan 14]. <http://doi.wiley.com/10.1111/eth.12395>.
- Dunlap JC. 1999. Molecular bases for circadian clocks. *Cell.* 96:271–290. doi:10.1016/S0092-8674(00)80566-8.
- Dyakonova VE, Krushinsky AL. 2013. Serotonin precursor (5-hydroxytryptophan) causes substantial changes in the fighting behavior of male crickets, *Gryllus bimaculatus*. *J Comp Physiol A Neuroethol Sensory, Neural, Behav Physiol.* 199:601–609. doi:10.1007/s00359-013-0804-z.

- Edwards DH, Kravitz EA. 1997. Serotonin, social status and aggression. *Curr Opin Neurobiol.* 7:812–9. [accessed 2018 Jan 8]. <http://www.ncbi.nlm.nih.gov/pubmed/9464985>.
- Foelix RF. 2011. *Biology of Spiders*.
- Fontana E, Morin N, Prévot D, Carpené C. 2000. Effects of octopamine on lipolysis, glucose transport and amine oxidation in mammalian fat cells. *Comp Biochem Physiol C Toxicol Pharmacol.* 125:33–44. [accessed 2018 Jan 20]. <http://www.ncbi.nlm.nih.gov/pubmed/11790328>.
- Gallant P, Malutan T, McLean H, Verellen L, Caveney S, Donly C. 2003. Functionally distinct dopamine and octopamine transporters in the CNS of the cabbage looper moth\*. *Eur J Biochem.* 270:664–674. doi:10.1046/j.1432-1033.2003.03417.x. [accessed 2017 Dec 25]. <http://doi.wiley.com/10.1046/j.1432-1033.2003.03417.x>.
- Gatellier L, Nagao T, Kanzaki R. 2004. Serotonin modifies the sensitivity of the male silkworm to pheromone. *J Exp Biol.* 207:2487–2496. doi:10.1242/jeb.01035. [accessed 2018 Jan 14]. <http://www.ncbi.nlm.nih.gov/pubmed/15184520>.
- Georgiev A V., Klimczuk ACE, Traficante DM, Maestriperi D. 2013. When Violence Pays: A Cost-Benefit Analysis of Aggressive Behavior in Animals and Humans. *Evol Psychol.* 11:147470491301100. doi:10.1177/147470491301100313. [accessed 2018 Jan 8]. <http://journals.sagepub.com/doi/10.1177/147470491301100313>.
- Giang T, Rauchfuss S, Ogueta M, Scholz H. 2011. The Serotonin Transporter Expression in *Drosophila melanogaster*. *J Neurogenet.* 25:17–26. doi:10.3109/01677063.2011.553002. [accessed 2018 Apr 11]. <http://www.tandfonline.com/doi/full/10.3109/01677063.2011.553002>.
- Gilestro GF. 2012. Video tracking and analysis of sleep in *Drosophila melanogaster*. *Nat Protoc.* 7:995–1007. doi:10.1038/nprot.2012.041. [accessed 2018 Jan 7]. <http://www.nature.com/doi/10.1038/nprot.2012.041>.
- Glanzman DL, Krasne FB. 1983. Serotonin and octopamine have opposite modulatory effects on the crayfish's lateral giant escape reaction. *J Neurosci.* 3:2263–9. [accessed 2017 Dec 1]. <http://www.ncbi.nlm.nih.gov/pubmed/6415242>.
- Grega DS. 1978. The effects of monoamines on tarantula skeletal muscle. *Comp Biochem Physiol Part C, Comp.* 61:337–340. doi:10.1016/0306-4492(78)90065-5.
- Grimsby J, Lan NC, Neve R, Chen K, Shih JC. 1990. Tissue distribution of human monoamine oxidase A and B mRNA. *J Neurochem.* 55:1166–9. [accessed 2018 Mar 7]. <http://www.ncbi.nlm.nih.gov/pubmed/2398352>.
- Hampp G, Ripperger JA, Houben T, Schmutz I, Blex C, Perreau-Lenz S, Brunk I, Spanagel R, Ahnert-Hilger G, Meijer JH, et al. 2008. Regulation of Monoamine Oxidase A by Circadian-Clock Components Implies Clock Influence on Mood. *Curr Biol.* 18:678–683. doi:10.1016/j.cub.2008.04.012. [accessed 2018 Mar 3].

<http://www.ncbi.nlm.nih.gov/pubmed/18439826>.

- Haselton AT, Downer KE, Zylstra J, Stoffolano JG. 2009. Serotonin inhibits protein feeding in the blow fly, *Phormia regina* (Meigen). *J Insect Behav.* 22:452–463. doi:10.1007/s10905-009-9184-1.
- Hebets EA, Hansen M, Jones TC, Wilgers DJ. 2015. Octopamine levels relate to male mating tactic expression in the wolf spider *Rabidosa punctulata*. *Anim Behav.* 100:136–142. doi:10.1016/j.anbehav.2014.11.023.
- Hiragaki S, Suzuki T, Mohamed AAM, Takeda M. 2015. Structures and functions of insect arylalkylamine N-acetyltransferase (iaaNAT); a key enzyme for physiological and behavioral switch in arthropods. *Front Physiol.* 6:113. doi:10.3389/fphys.2015.00113. [accessed 2018 Mar 7]. <http://www.ncbi.nlm.nih.gov/pubmed/25918505>.
- Höger U, Torkkeli PH, French AS. 2005. Calcium concentration changes during sensory transduction in spider mechanoreceptor neurons. *Eur J Neurosci.* 22:3171–8. doi:10.1111/j.1460-9568.2005.04506.x. [accessed 2015 Nov 7]. <http://www.ncbi.nlm.nih.gov/pubmed/16367783>.
- Hoyer SC, Eckart A, Herrel A, Zars T, Fischer SA, Hardie SL, Heisenberg M. 2008. Octopamine in male aggression of *Drosophila*. *Curr Biol.* 18:159–67. doi:10.1016/j.cub.2007.12.052. [accessed 2017 Dec 1]. <http://www.ncbi.nlm.nih.gov/pubmed/18249112>.
- Huber R, Smith K, Delago A, Isaksson K, Kravitz EA. 1997a. Serotonin and aggressive motivation in crustaceans: altering the decision to retreat. *Proc Natl Acad Sci U S A.* 94:5939–42. [accessed 2018 Jan 8]. <http://www.ncbi.nlm.nih.gov/pubmed/9159179>.
- Huber R, Smith K, Delago A, Isaksson K, Kravitz EA. 1997b. Serotonin and aggressive motivation in crustaceans: altering the decision to retreat. *Proc Natl Acad Sci U S A.* 94:5939–42. [accessed 2017 Dec 1]. <http://www.ncbi.nlm.nih.gov/pubmed/9159179>.
- Hurd MW, Ralph MR. 1998. The Significance of Circadian Organization for Longevity in the Golden Hamster. *J Biol Rhythms.* 13:430–436. doi:10.1177/074873098129000255. [accessed 2018 Jan 29]. <http://www.ncbi.nlm.nih.gov/pubmed/9783234>.
- Jacobs ME. 1978. Influence of beta-alanine on mating and territorialism in *Drosophila melanogaster*. *Behav Genet.* 8:487–502. [accessed 2018 Jan 8]. <http://www.ncbi.nlm.nih.gov/pubmed/103533>.
- Johnson CH. 2005. Testing the adaptive value of circadian systems. *Methods Enzymol.* 393:818–37. doi:10.1016/S0076-6879(05)93043-7. [accessed 2015 Jul 23]. <http://www.sciencedirect.com/science/article/pii/S0076687905930437>.
- Jones TC, Akoury TS, Hauser CK, Moore D. 2011. Evidence of circadian rhythm in antipredator behaviour in the orb-weaving spider *Larinioides cornutus*. *Anim Behav.* 82:549–555. doi:10.1016/j.anbehav.2011.06.009.

- Jones TC, Akoury TS, Hauser CK, Neblett MF, Linville BJ, Edge AA, Weber NO. 2011. Octopamine and serotonin have opposite effects on antipredator behavior in the orb-weaving spider, *Larinioides cornutus*. *J Comp Physiol A Neuroethol Sens Neural Behav Physiol.* 197:819–25. doi:10.1007/s00359-011-0644-7. [accessed 2015 Jul 23]. <http://www.ncbi.nlm.nih.gov/pubmed/21484264>.
- Kacelnik A. 1984. Central Place Foraging in Starlings (*Sturnus vulgaris*). I. Patch Residence Time. *J Anim Ecol.* 53:283. doi:10.2307/4357.
- Kaufman R, Sloley D. 1996. Catabolism of dopamine and 5-hydroxytryptamine by monoamine oxidase in the ixodid tick, *Amblyomma hebraeum*. *Insect Biochem Mol Biol.* 26:101–109. doi:10.1016/0965-1748(95)00069-0.
- Kempton LRC, Isaac RE, Pillmoor JB, Willis RJ. 1992. Octopamine N-acetyltransferase activity from the cattle tick, *Boophilus microplus*. *Insect Biochem Mol Biol.* 22:777–783. doi:10.1016/0965-1748(92)90104-M. [accessed 2018 Feb 6]. <https://www.sciencedirect.com/science/article/pii/096517489290104M>.
- Kempton LRC, Isaac RE, Pillmoor JB, Willis RJ. 1992. Octopamine N-acetyltransferase activity from the cattle tick, *Boophilus microplus*. *Insect Biochem Mol Biol.* 22:777–783. doi:10.1016/0965-1748(92)90104-M.
- Kravitz EA, Glusman S, Harris-Warrick RM, Livingstone MS, Schwarz T, Goy MF. 1980. Amines and a peptide as neurohormones in lobsters: actions on neuromuscular preparations and preliminary behavioural studies. *J Exp Biol.* 89:159–175.
- Kravitz EA, Huber R. 2003. Aggression in invertebrates. *Curr Opin Neurobiol.* 13:736–43. [accessed 2017 Dec 1]. <http://www.ncbi.nlm.nih.gov/pubmed/14662376>.
- Kumar V. 2017. Biological timekeeping: Clocks, rhythms and behaviour.
- Lehman HK, Murgiu CM, Hildebrand JG. 2000. Characterization and developmental regulation of tyramine-beta-hydroxylase in the CNS of the moth, *Manduca sexta*. *Insect Biochem Mol Biol.* 30:377–386. doi:S0965174800000114 [pii].
- Lema SC, Wagstaff LJ, Gardner NM. 2010. Diurnal rhythms of behavior and brain mRNA expression for arginine vasotocin, isotocin, and their receptors in wild *Amargosa* pupfish (*Cyprinodon nevadensis amargosae*). *Mar Freshw Behav Physiol.* 43:257–281. doi:10.1080/10236244.2010.498632. [accessed 2017 Dec 28]. [https://www.calpoly.edu/~slema/Lema\\_Laboratory/Publications\\_files/Lema\\_et\\_al\\_2010.pdf](https://www.calpoly.edu/~slema/Lema_Laboratory/Publications_files/Lema_et_al_2010.pdf).
- Li H-M, Jiang H-B, Gui S-H, Liu X-Q, Liu H, Lu X-P, Smagghe G, Wang J-J. 2016. Characterization of a  $\beta$ -Adrenergic-Like Octopamine Receptor in the Oriental Fruit Fly, *Bactrocera dorsalis* (Hendel). *Int J Mol Sci.* 17. doi:10.3390/ijms17101577. [accessed 2017 Oct 8]. <http://www.ncbi.nlm.nih.gov/pubmed/27669213>.
- Lim J, Sabandal PR, Fernandez A, Sabandal JM, Lee H-G, Evans P, Han K-A. 2014. The

- Octopamine Receptor Oct $\beta$ 2R Regulates Ovulation in *Drosophila melanogaster*. Broughton S, editor. PLoS One. 9:e104441. doi:10.1371/journal.pone.0104441. [accessed 2017 Oct 7]. <http://dx.plos.org/10.1371/journal.pone.0104441>.
- Linn CE, Campbell MG, Roelofs WL. 1992. Photoperiod cues and the modulatory action of octopamine and 5-hydroxytryptamine on locomotor and pheromone response in male gypsy moths, *Lymantria dispar*. Arch Insect Biochem Physiol. 20:265–284. doi:10.1002/arch.940200404.
- Marcheva B, Ramsey KM, Peek CB, Affinati A, Maury E, Bass J. 2013. Circadian clocks and metabolism. Handb Exp Pharmacol.:127–55. doi:10.1007/978-3-642-25950-0\_6. [accessed 2018 Jan 7]. <http://www.ncbi.nlm.nih.gov/pubmed/23604478>.
- Marusik YM, Koponen S. 2005. A survey of spiders (Araneae) with Holarctic distribution. J Arachnol. 33:300–305. doi:10.1636/04-115.1.
- McClung CR. 2006. Plant Circadian Rhythms. PLANT CELL ONLINE. 18:792–803. doi:10.1105/tpc.106.040980.
- Meire PM, Eryvynck A. 1986. Are oystercatchers (*Haematopus ostralegus*) selecting the most profitable mussels (*Mytilus edulis*)? Anim Behav. 34:1427–1435. doi:10.1016/S0003-3472(86)80213-5.
- Meyer W, Jehnen R. 1980. The distribution of monoamine oxidase and biogenic monoamines in the central nervous system of spiders(Arachnida: Araneida). J Morphol. 164:69–81. doi:10.1002/jmor.1051640106. [accessed 2018 Jan 4]. <http://doi.wiley.com/10.1002/jmor.1051640106>.
- Miczek KA, Fish EW, De Bold JF. 2003. Neurosteroids, GABAA receptors, and escalated aggressive behavior. Horm Behav. 44:242–57. [accessed 2018 Jan 8]. <http://www.ncbi.nlm.nih.gov/pubmed/14609546>.
- Moore D, Watts JC, Herrig A, Jones TC. 2016. Exceptionally short-period circadian clock in *Cyclosa turbinata* : regulation of locomotor and web-building behavior in an orb-weaving spider. J Arachnol. 44:388–396. doi:10.1636/JoA-S-16-014.1. [accessed 2018 Jan 20]. <http://www.bioone.org/doi/10.1636/JoA-S-16-014.1>.
- Panda S, Hogenesch JB, Kay SA. 2002. Circadian rhythms from flies to human. Nature. 417:329–335. doi:10.1038/417329a. [accessed 2018 Jan 7]. <http://www.ncbi.nlm.nih.gov/pubmed/12015613>.
- Pita R, Mira A, Beja P. 2011. Circadian activity rhythms in relation to season, sex and interspecific interactions in two Mediterranean voles. Anim Behav. 81:1023–1030. [accessed 2018 Jan 20]. <http://www.elsevier.com/copyright>.
- Price JB. 2010. Neurochemical Levels Correlate with Population Level Differences in Social Structure and Individual Behavior in the Polyphenic Spider,. East Tennessee State University.

- Pruitt JN, Riechert SE, Iturralde G, Vega M, Fitzpatrick BM, Avilés L. 2010. Population differences in behaviour are explained by shared within-population trait correlations. *J Evol Biol.* 23:748–756. doi:10.1111/j.1420-9101.2010.01940.x.
- Pruitt JN, Riechert SE, Jones TC. 2008. Behavioural syndromes and their fitness consequences in a socially polymorphic spider, *Anelosimus studiosus*. *Anim Behav.* 76:871–879. doi:10.1016/j.anbehav.2008.05.009.
- Punzo F, Punzo T. 2001. Monoamines in the Brain of Tarantulas (*Aphonopelma Hentzi*) (Araneae, Theraphosidae): Differences Associated With Male Agonistic Interactions. *J Arachnol.* 29:388–395. doi:10.1636/0161-8202(2001)029[0388:MITBOT]2.0.CO;2.
- Pyke GH. 1984. Optimal Foraging Theory: A Critical Review. *Annu Rev Ecol Syst.* 15:523–575. doi:10.1146/annurev.es.15.110184.002515. [accessed 2017 Dec 28]. <http://www.annualreviews.org/doi/10.1146/annurev.es.15.110184.002515>.
- Reppert SM, Weaver DR. 2001. Molecular Analysis of Mammalian Circadian Rhythms. *Annu Rev Physiol.* 63:647–676. doi:10.1146/annurev.physiol.63.1.647. [accessed 2018 Apr 14]. <http://www.ncbi.nlm.nih.gov/pubmed/11181971>.
- Rodríguez-Sosa L, Calderón-Rosete G, Ortega-Cambranis A, De-Miguel FF. 2017. Octopamine cyclic release and its modulation of visual sensitivity in crayfish. *Comp Biochem Physiol Part A Mol Integr Physiol.* 203:83–90. doi:10.1016/j.cbpa.2016.08.032. [accessed 2018 Jan 20]. <http://www.ncbi.nlm.nih.gov/pubmed/27593450>.
- Roeder T. 2005a. TYRAMINE AND OCTOPAMINE: Ruling Behavior and Metabolism. *Annu Rev Entomol.* 50:447–477. doi:10.1146/annurev.ento.50.071803.130404. [accessed 2017 Nov 28]. <http://www.ncbi.nlm.nih.gov/pubmed/15355245>.
- Roeder T. 2005b. Tyramine and octopamine: ruling behavior and metabolism. *Annu Rev Entomol.* 50:447–77. doi:10.1146/annurev.ento.50.071803.130404. [accessed 2015 Nov 13]. <http://www.annualreviews.org/doi/full/10.1146/annurev.ento.50.071803.130404>.
- Roeder T, Seifert M, Kähler C, Gewecke M. 2003a. Tyramine and octopamine: Antagonistic modulators of behavior and metabolism. *Arch Insect Biochem Physiol.* 54:1–13. doi:10.1002/arch.10102. [accessed 2017 Dec 1]. <http://www.ncbi.nlm.nih.gov/pubmed/12942511>.
- Roeder T, Seifert M, Kähler C, Gewecke M. 2003b. Tyramine and octopamine: Antagonistic modulators of behavior and metabolism. *Arch Insect Biochem Physiol.* 54:1–13. doi:10.1002/arch.10102.
- Saito H, Terada T, Shimakura J, Katsura T, Inui K. 2008. Regulatory mechanism governing the diurnal rhythm of intestinal H<sup>+</sup>/peptide cotransporter 1 (PEPT1). *Am J Physiol Liver Physiol.* 295:G395–G402. doi:10.1152/ajpgi.90317.2008. [accessed 2017 Dec 28]. <http://www.ncbi.nlm.nih.gov/pubmed/18583459>.
- Sakowski SA, Geddes TJ, Thomas DM, Levi E, Hatfield JS, Kuhn DM. 2006. Differential tissue

- distribution of tryptophan hydroxylase isoforms 1 and 2 as revealed with monospecific antibodies. *Brain Res.* 1085:11–18. doi:10.1016/j.brainres.2006.02.047. [accessed 2018 Apr 14]. <http://www.ncbi.nlm.nih.gov/pubmed/16581041>.
- Saraswati S, Fox LE, Soll DR, Wu C-F. 2004. Tyramine and octopamine have opposite effects on the locomotion of *Drosophila* larvae. *J Neurobiol.* 58:425–441. doi:10.1002/neu.10298. [accessed 2017 Oct 7]. <http://www.ncbi.nlm.nih.gov/pubmed/14978721>.
- Seyfarth EA, Hammer K, Spörhase-Eichmann U, Hörner M, Vullings HGB. 1993. Octopamine immunoreactive neurons in the fused central nervous system of spiders. *Brain Res.* 611:197–206. doi:10.1016/0006-8993(93)90503-F.
- Shaw PJ, Cirelli C, Greenspan RJ, Tononi G. 2000. Correlates of sleep and waking in *Drosophila melanogaster*. *Science.* 287:1834–7. doi:10.1126/SCIENCE.287.5459.1834. [accessed 2018 Jan 7]. <http://www.ncbi.nlm.nih.gov/pubmed/10710313>.
- Sinervo B. 2006. Optimal Foraging Theory: Constraints and Cognitive Processes. *Behav Ecol.* 1:105–130.
- Sloley BD. 2004. Metabolism of Monoamines in Invertebrates: The Relative Importance of Monoamine Oxidase in Different Phyla. *Neurotoxicology.* 25:175–183. doi:10.1016/S0161-813X(03)00096-2.
- Sloley BD, Downer RGH. 1990. Catabolism and disposition of exogenous 5-hydroxytryptamine in cockroach, *Periplaneta americana*, tissues. *Insect Biochem.* 20:165–171. doi:10.1016/0020-1790(90)90009-J.
- Sloley BD, Juorio A V. 1995. Monoamine Neurotransmitters in Invertebrates and Vertebrates: An Examination of the Diverse Enzymatic Pathways Utilized to Synthesize and Inactivate Biogenic Amines. *Int Rev Neurobiol.* 38:253–303. doi:10.1016/S0074-7742(08)60528-0.
- Stevenson PA, Hofmann HA, Schoch K, Schildberger K. 2000. The fight and flight responses of crickets depleted of biogenic amines. *J Neurobiol.* 43:107–120. doi:10.1002/(SICI)1097-4695(200005)43:2<107::AID-NEU1>3.0.CO;2-C.
- Suzaki Y, Miyatake T. 2014. Diurnal rhythm of male-male combat behavior in the bean bug *Riptortus pedestris* (Heteroptera: Alydidae). *Entomol Sci.* 17:359–363. doi:10.1111/ens.12066.
- Tinbergen JM. 1981. Foraging decisions in starlings (*Sturnus vulgaris* L.). *Ardea.* 69:1–67.
- Todd WD, Fenselau H, Wang JL, Zhang R, Machado NL, Venner A, Broadhurst RY, Kaur S, Lynagh T, Olson DP, et al. 2018 Apr 9. A hypothalamic circuit for the circadian control of aggression. *Nat Neurosci* 2018.:1. doi:10.1038/s41593-018-0126-0. [accessed 2018 Apr 11]. <https://www.nature.com/articles/s41593-018-0126-0>.
- Torkkeli PH, Panek I, Meisner S. 2011. Ca<sup>2+</sup>(+)/calmodulin-dependent protein kinase II mediates



- the octopamine-induced increase in sensitivity in spider VS-3 mechanosensory neurons. *Eur J Neurosci.* 33:1186–96. doi:10.1111/j.1460-9568.2011.07624.x. [accessed 2015 Nov 7]. <http://www.ncbi.nlm.nih.gov/pubmed/21366726>.
- Watts JC, Herrig A, Allen WD, Jones TC. 2014. Diel patterns of foraging aggression and antipredator behaviour in the trashline orb-weaving spider, *Cyclosa turbinata*. *Anim Behav.* 94:79–86. doi:10.1016/j.anbehav.2014.05.020.
- Werner EE, Hall DJ. 1974. Optimal Foraging and the Size Selection of Prey by the Bluegill Sunfish (*Lepomis Macrochirus*). *Ecology.* 55:1042–1052. doi:10.2307/1940354.
- Widmer A, Panek I, Höger U, Meisner S, French AS, Torkkeli PH. 2006. Acetylcholine receptors in spider peripheral mechanosensilla. *J Comp Physiol A Neuroethol Sens Neural Behav Physiol.* 192:85–95. doi:10.1007/s00359-005-0054-9. [accessed 2015 Nov 7]. <http://www.ncbi.nlm.nih.gov/pubmed/16184378>.
- Woelfle MA, Ouyang Y, Phanvijhitsiri K, Johnson CH. 2004. The adaptive value of circadian clocks: an experimental assessment in cyanobacteria. *Curr Biol.* 14:1481–6. doi:10.1016/j.cub.2004.08.023. [accessed 2015 Jul 24]. <http://www.sciencedirect.com/science/article/pii/S0960982204006062>.
- Wolf TJ, Schmid-Hempel P. 1989. Extra Loads and Foraging Life Span in Honeybee Workers. *Source J Anim Ecol.* 58:943–954. doi:10.2307/5134.
- Zhou BP, Wu B, Kwan SW, Abell CW. 1998. Characterization of a highly conserved FAD-binding site in human monoamine oxidase B. *J Biol Chem.* 273:14862–8. doi:10.1074/JBC.273.24.14862. [accessed 2018 Mar 2]. <http://www.ncbi.nlm.nih.gov/pubmed/9614088>.
- Zhou P, Watson DG, Midgley JM. 1993. Identification and quantification of ??-glutamyl conjugates of biogenic amines in the nervous system of the snail, *Helix aspersa*, by gas chromatography-negative-ion chemical ionisation mass spectrometry. *J Chromatogr B Biomed Sci Appl.* 617:11–18. doi:10.1016/0378-4347(93)80415-Z.

## VITA

### REBECCA JANE WILSON

- Education: B.S. Biology, University of Cincinnati, Cincinnati, Ohio, 2012
- B.A. Chemistry, University of Cincinnati, Cincinnati, Ohio, 2013
- Ph.D. Biomedical Sciences, East Tennessee State University,  
Johnson City, TN, 2018
- Professional Experience: Graduate Assistant, College of Arts and Sciences, Department of  
Biological Sciences, East Tennessee State University, Johnson  
City, Tennessee, 2013-2018
- Adjunct Faculty Instructor, College of Public Health, East  
Tennessee State University, Johnson City, Tennessee, 2014
- Research and Development Intern, Crown Laboratories Inc.,  
Johnson City, Tennessee, 2017
- Honors and Awards: ETSU School of Graduate Studies Research Grant Award, 2014,  
\$787.00
- American Arachnological Society Grant, 2016, \$350.00
- International Behavioral Ecology Society Travel Award, 2016,  
\$800.00
- ETSU School of Graduate Studies Research Grant Award, 2016,  
\$753.00
- 1<sup>ST</sup> Place Student Oral Presentation, Appalachian Student Research  
Forum, Johnson City, Tennessee, 2017