

---

Theses and Dissertations

---

Spring 2017

# Esthetic blending: visual vs. spectrophotometric data analysis for different bevels in class IV dental composite direct restorations

Tracy A. D'Antonio  
*University of Iowa*

Copyright © 2017 Tracy A. D'Antonio

This thesis is available at Iowa Research Online: <http://ir.uiowa.edu/etd/5450>

---

## Recommended Citation

D'Antonio, Tracy A.. "Esthetic blending: visual vs. spectrophotometric data analysis for different bevels in class IV dental composite direct restorations." MS (Master of Science) thesis, University of Iowa, 2017.  
<http://ir.uiowa.edu/etd/5450>.

---

Follow this and additional works at: <http://ir.uiowa.edu/etd>



Part of the [Oral Biology and Oral Pathology Commons](#)

ESTHETIC BLENDING:  
VISUAL VS. SPECTROPHOTOMETRIC DATA ANALYSIS FOR DIFFERENT BEVELS  
IN CLASS IV DENTAL COMPOSITE DIRECT RESTORATIONS

by

Tracy A. D'Antonio, D.D.S.

A thesis submitted in partial fulfillment  
of the requirements for the Master of Science  
degree in Oral Science in the  
Graduate College of  
The University of Iowa

May 2017

Thesis Supervisor: Assistant Professor Rodrigo Rocha Maia

Copyright by  
TRACY A. D'ANTONIO, D.D.S.  
2017  
All Rights Reserved

Graduate College  
The University of Iowa  
Iowa City, Iowa

CERTIFICATE OF APPROVAL

---

MASTER'S THESIS

---

This is to certify that the Master's thesis of

Tracy A. D'Antonio

has been approved by the Examining Committee for  
the thesis requirement for the Master of Science degree  
in Oral Science at the May 2017 graduation.

Thesis Committee:

\_\_\_\_\_  
Rodrigo Rocha Maia, Thesis Supervisor

\_\_\_\_\_  
Marcos Vargas

\_\_\_\_\_  
Fang Qian

\_\_\_\_\_  
Frederick Skiff

To my husband, Luke, for his unwavering support, unconditional love, and never ending selflessness and patience. I am so thankful to be on this journey with and to have married my best friend. Life with you makes perfect sense.

To my son, Leo, for always making me smile, keeping me grounded and making me realize how eternally grateful and blessed I am to be his Mama. I hope you realize that you can achieve all your dreams (at any age) with faith, hard work, and determination. You are my sunshine.

To my dog, Roni, for loaning my lap for the last three years to my laptop and still managing to squeeze herself into the space between me and the chair. You can have your lap back now.

To the rest of my family and friends for your love, support, ears and shoulders. Thank you.

“Do not go where the path may lead, go instead where there is no path and leave a trail.”

Ralph Waldo Emerson

## ACKNOWLEDGEMENTS

“A truly great mentor is hard to find, difficult to part with, and impossible to forget.” ~ Unknown

This journey has been a long and winding road and I would not have been able to navigate it without the support, guidance and expertise of my mentor, Dr. Rodrigo Maia. Dr. Maia, thank you for your mentorship, your leadership and your friendship throughout this entire process. I would also like to extend my gratitude to my thesis committee. Dr. Marco Vargas would always think outside of the box and brought a fresh perspective on anything we were having difficulty with. Dr. Fang Qian did an amazing job on the statistical analysis and I could not be more thankful to have a helpful and professional statistician on my committee. Dr. Frederick Skiff was extremely helpful in the planning process and gave great insight to the spectrophotometry portion of the study.

I would also like to extend many thanks to Dr. Deb Cobb for her unconditional support, in both my personal and professional lives while at the University of Iowa. Dr. Cobb has a heart of gold and a strong opinion, and I love and admire that about her. On that same note, I am also grateful to have had Dr. Sandra Guzman-Armstrong as a program director and friend. She spent many hours listening to me talk about school and life and gave great advice. I am thankful for the faculty, staff, and fellow graduate residents in the Department of Operative Dentistry. Everyone in the department is so caring and helpful; it really felt like I had family here, in Iowa.

Finally, I would to thank my amazing husband, Luke and my beautiful son, Leo. Luke, you were there to support me, in every way possible, throughout this entire process and I could not have done it without your patience, guidance, encouragement, motivation, and love. Leo, your smile lit up my darkest of days and your silliness always made me laugh. We came here when you were a baby and now we are leaving with you as your own kind-hearted, strong-willed person. I'm so thankful to have you both in my life. I love you, my favorite guys.

## ABSTRACT

The purpose of this study was to determine which type of bevel in a class IV dental composite restoration is the most esthetic and has the best blend to natural tooth structure via clinical and spectrophotometric evaluations. The null hypotheses were as follows: (1) there is no difference in visual evaluation rank scores among five groups of evaluators for each type of bevel; (2) there is no agreement in the visual evaluation rank scores of the seven groups of bevels among all evaluators or within each group of evaluators; (3) there is no difference in the lightness values among seven types of bevels at each of eight measurement points or for the whole tooth as measured by a spectrophotometer; and (4) there is no correlation between the visual evaluation and the spectrophotometric evaluation.

The class IV samples were made via CAD/CAM milling for standardization. There were seven groups: negative control (no bevel); short (1mm) and straight bevel; short (1mm) and scalloped bevel; long (2mm) and straight bevel; long (2mm) and scalloped bevel; infinite (3+mm) and straight bevel; and infinite (3+mm) and scalloped bevel. The fractures were restored with the same type of dental composite via a digitally designed mold fabricated with a 3D printer. Once completed, the samples were randomized and evaluated visually by 91 people in five groups (faculty, graduate residents, pre-doctoral dental students, assistants/hygienists, and auxiliary staff). Evaluators placed the samples in the order they deemed least to most esthetic within a lightbox set to CIE Standard Illumination D65. After the visual evaluation, the lightness ( $L^*$ ) values were measured optically with a reflectance spectrophotometer at eight points on each of the seven bevel groups, as well as on an un-prepared typodont tooth used for reference.

One-way ANOVA on ranked data with the post-hoc Bonferroni test was conducted to detect a significant difference in median rating score among five groups of evaluators, and Kendall's W was used to evaluate an agreement among multiple raters. One-way ANOVA with



the post-hoc Tukey's HSD was used to find a significant difference in mean lightness values among seven types of bevels. Dunnett's test was used to compare the reference group with each of the seven bevel groups when evaluating the lightness values. Pearson Correlation test along with the simple linear regression analysis were used to determine whether a significant relationship existed between visual evaluation scores and lightness values.

The groups were ranked from least to most esthetic as follows: no bevel, short and straight bevel, short and scalloped bevel, long and straight bevel, long and scalloped bevel, infinite and straight bevel, and infinite and scalloped bevel by the 91 evaluators and Kendall's W was 0.80 (strong agreement). Moreover, no significant difference in rating scores was found among the five groups of evaluators regarding each type of bevel ( $p > 0.05$ ). The overall mean lightness values observed in groups 1-3 were significantly higher than those in groups 6 and 7 ( $P < 0.05$ ), but no significant difference was noted among groups 1-5 or among groups 4-7. As the lightness values measured by the spectrophotometer decreased, the overall visual evaluation score increased. The Pearson Correlation Coefficient of -0.89 indicated there was a strong negative correlation between the two variables ( $p = 0.0066$ ). Linear regression analysis revealed that the predictor of lightness was significant (strong negative correlation, R-square 0.99,  $p < 0.0001$ ).

The first null hypothesis was accepted and the second, third, and fourth were rejected. There was no difference in median visual evaluation rank scores among five groups of evaluators for each type of bevel, however, there was agreement in the ranked order as the findings of this study indicated that infinite and scalloped bevel was the most preferred and no bevel was the least preferred via a strong agreement the evaluators. There was a significant difference in lightness values among the seven bevel groups; the shorter bevels had higher  $L^*$  values that were closer to the  $L^*$  values of the reference tooth while the longer bevels had lower  $L^*$  values.

The correlation data showed that placing a longer bevel (3+mm) allowed for a more gradual transition and better blending capabilities between the tooth structure and dental composite. The overall conclusion from this study was the longer the bevel, the more gradual the change in Lightness (L\*), which correlated to the more esthetic restoration, as determined by the evaluators.

## **PUBLIC ABSTRACT**

The purpose of this study was to find out the best way to fix/restore a broken front tooth in a conservative, yet esthetic manner.

We had seven different groups of beveled teeth (various lengths of bevels) that were restored with the same color of dental filling material. When the fillings were completed, we asked 91 people from five different groups of dental professionals (faculty, graduate residents, dental students, dental assistants, and administrative staff) to place them in order from what looked the worst (least esthetic) to what looked the best (most esthetic). After that was completed, we used a light measuring device to measure reflected light along 8 different areas of each restored sample tooth (5 per group for a total of 35 plus one reference tooth that was not broken). We worked with a statistician to see if there was any correlation between what the people chose as the most esthetic restoration with the data from the light measuring device.

First, we wanted to see if there was a specific order overall from least to most esthetic and if the different groups agreed on that order. Second, we were looking to see if the measured light was the same between all the groups. Finally, we wanted to see if what people thought looked the best had anything to do with the measured light. We found that the longest bevel was picked as the most esthetic and that it also had the best transition of measured light reflectance.

## TABLE OF CONTENTS

LIST OF TABLES .....	xiii
LIST OF FIGURES .....	xiv
CHAPTER I: INTRODUCTION .....	1
Statement of the Problem.....	2
Purpose of the Study.....	3
CHAPTER II: LITERATURE REVIEW.....	4
Background on Types of Dental Composites and Esthetic Qualities .....	4
Components of Dental Composites.....	4
Types of Dental Composite .....	5
Usage of Bevels in Dentistry.....	8
History .....	8
Current Criteria for Bevel Usage .....	18
Esthetics in Dentistry.....	19
Properties of Light.....	19
Reflection .....	20
Refraction .....	21
Refractive Index.....	21
Absorption.....	22
Diffraction .....	22
Transmission .....	23
Direct Transmission .....	23
Diffuse Transmission .....	23
Selective Transmission .....	23
Properties of Light in Tooth Structures .....	24
Properties of Light in Enamel .....	25
Properties of Light in Dentin .....	26
Properties of Light in Dental Composites.....	26
Color and Color Space .....	27
Munsell Color Classification .....	27
Three Dimensions of Color .....	28
Hue .....	28
Value .....	29
Chroma.....	29
The Three Dimensions of Color in Dentistry .....	30
Secondary Optical Components of Color .....	31
Light Transmission: Translucent, Transparent and Opaque.....	31
Opalescence .....	33
Fluorescence .....	34
Instruments Used in the Measurement of Color .....	36

Color Measuring Devices.....	36
Colorimeter .....	36
Spectroradiometer .....	37
Spectrophotometer.....	37
Digital Cameras .....	38
Plastic versus Mineralized Teeth.....	39
Color Classification Systems in Dentistry .....	40
1976 CIE L*a*b* Space.....	40
ISO/TR 28642:2016 Dentistry - Guidance on Color Measurement .....	43
CIE L*a*b* Usage in Dentistry.....	43
Optical Integration of Dental Composites.....	48
Overview .....	50
Research Questions.....	50
Null Hypotheses .....	50
Variables.....	51
Operational Definitions .....	51
Pilot Study .....	51
Initial Pilot Design.....	51
Division of Groups & Preparation of the Bevels.....	53
Putty Fabrication .....	55
Putty Dentin Matrix.....	56
3D Mold Fabrication.....	57
3D Mold Digital Design .....	57
Composite Materials .....	59
Restoration Process - Fabrication of Dentin Core .....	60
Finishing and Polishing .....	62
Sample Evaluation .....	63
Visual Evaluation .....	63
Spectrophotometer Evaluation .....	65
Power and Sample Size Analysis .....	67
Final Study.....	68
Procedural Changes.....	68
Changes to Visual Evaluations.....	69
Changes to Spectrophotometric Evaluation.....	71
An Overview of Statistical Methods for the Pilot and Final Studies.....	71
Statistical Analysis for Visual Evaluation .....	71
Statistical Analysis for Spectrophotometric Measurements of Lightness.....	72
Statistical Analysis on Correlation between Visual and Spectrophotometric Evaluations....	73
CHAPTER IV: RESULTS.....	75
Statistical Results from Pilot Study.....	75
Detecting the Difference in Visual Evaluation Rank Scores Among Five Groups of Evaluators with regard to Seven Teeth .....	80
A. Negative Control- No Bevel.....	80
B. Short and Straight Bevel.....	81

C. Short and Scalloped Bevel .....	81
D. Long and Straight Bevel .....	81
E. Long and Scalloped Bevel .....	82
F. Infinite and Straight Bevel .....	82
G. Infinite and Scalloped Bevel.....	82
Assessing an Agreement Among Evaluators .....	82
A. All Evaluators.....	82
B. Assistants .....	83
C. Faculty .....	83
D. Graduate Residents.....	83
E. Staff .....	83
F. Dental Students .....	83
Graphs for Lightness at Seven Spectrophotometric Measurement Points .....	83
Statistical Results for the Evaluation of Correlation between the Visual and Spectrophotometric Evaluations from the Pilot Study.....	87
Statistical Results of the Visual Evaluation for the Final Study .....	87
Detecting the Difference in Visual Evaluation Rank Scores Among Five Groups of Evaluators with regard to Seven Types of Bevels .....	93
A. Negative Control- No Bevel.....	93
B. Short and Straight Bevel.....	93
C. Short and Scalloped Bevel.....	93
D. Long and Straight Bevel .....	94
E. Long and Scalloped Bevel .....	94
F. Infinite and Straight Bevel .....	94
G. Infinite and Scalloped Bevel.....	94
Assessing an Agreement Among Evaluators .....	95
A. All Evaluators.....	95
B. Assistants .....	95
C. Faculty .....	95
D. Graduate Residents.....	95
E. Staff .....	95
F. Dental Students .....	95
Statistical Results for Spectrophotometric Evaluation for the Final Study .....	96
Descriptive Statistics .....	96
Assessing the Differences in Lightness Values Among the Experimental Groups at Each Measurement Point .....	96
A. First Measurement (M1) .....	96
B. Second Measurement (M2) .....	96
C. Third Measurement (M3).....	97
D. Fourth Measurement (M4) .....	97
E. Fifth Measurement (M5).....	97
F. Sixth Measurement (M6).....	98
G. Seventh Measurement (M7).....	98
H. Eighth Measurement (M8).....	99

I. Whole Tooth.....	99
Graphs for Lightness at Eight Spectrophotometric Points .....	103
An Overview of the Statistical Methods for the Correlation of the Visual Evaluation and the Spectrophotometric Evaluation Data for the Final Study .....	106
Statistical Results for the Correlation of the Visual Evaluation and the Spectrophotometric Evaluation Data for the Final Study.....	107
Linear Regression Analysis on Visual Evaluation Scores and Lightness.....	107
CHAPTER V: DISCUSSION.....	109
Acceptance or Rejection of Null Hypotheses .....	109
First Null Hypothesis ( $H_01$ ) .....	109
Second Null Hypothesis ( $H_02$ ).....	109
Third Null Hypothesis ( $H_03$ ) .....	112
Fourth Null Hypothesis ( $H_04$ ).....	116
Purpose of Performing This Study.....	117
Experimental Design .....	118
Typodont versus Natural Teeth.....	118
Choice of Dental Composite.....	119
Varying Degrees of Beveled Margins .....	122
Types of Bevels Used – Length and Finish Line Design.....	128
Fabrication of 3D Matrices .....	129
Usage of 3D Matrices in the Lab.....	130
Changes Made Due to Pilot Study .....	130
Increase in Sample Size and Number of Evaluators .....	131
Changes to the Spectrophotometric Evaluation .....	131
Spectrophotometer.....	131
Optical Integration of Dental Composites.....	132
Correlating Data Between Visual and Spectrophotometric Evaluations.....	133
Strengths .....	134
Limitations.....	135
Generalizations.....	136
Future Directions.....	137
CHAPTER VI: CONCLUSION .....	139
REFERENCES .....	140

LIST OF TABLES

Table 1. Types of Restorations and Recommended Dental Composites(7) ..... 7

Table 2. Division of Study Groups ..... 53

Table 3. Group Identification for Visual Evaluation..... 64

Table 4. Frequency Distribution of Rating by Types of Evaluators and Types of Bevel (Pilot Study) ..... 75

Table 5. Descriptive Statistics of Rating Scores by Types of Examiners and Types of Bevel (Pilot Study) ..... 79

Table 6. Correlation Data for Pilot Study..... 87

Table 7. Frequency Distribution of Rating by Types of Evaluators and Types of Bevel (Final Study) ..... 88

Table 8. Descriptive Statistics of Rating Scores by Types of Examiners and Types of Bevel (Final Study)..... 91

Table 9. Descriptive Statistics for the Lightness Values by the Types of Bevels for Each Measurement Point ..... 100

Table 10. Descriptive Statistics for the Lightness Values by the Types of Bevels (Overall Lightness Values by the Tooth) ..... 103



## LIST OF FIGURES

Figure 1. Featheredge, chamfer and bevel preparations(9).....	11
Figure 2 (left). Sample preparation showing three different bevel lengths and butt joint(13).....	12
Figure 3 (right). Sample restoration showing matrix in place and three different restoration lengths(13). .....	12
Figure 4. Prepared samples showing proximal view of three different restoration thicknesses(14).....	14
Figure 5. Electromagnetic Spectrum (19).....	20
Figure 6. A. Specular Reflection from a Smooth Surface, B. Diffuse Reflection from a Rough Surface(21). .....	21
Figure 7. Properties of Light (26).....	24
Figure 8. Munsell Color System (32). .....	28
Figure 9. Demonstration of Opalescence in a Ceramic Restoration(7). .....	34
Figure 10. Demonstration of Light Properties within a Tooth(37). .....	35
Figure 11. A schematic drawing representing the CIELAB color space(33). .....	42
Figure 12. A. <i>My Shade Guide</i> by Smile Line(48). B. Estelite Omega Custom Shade Guide by Tokuyama(47).....	52
Figure 13. CAD/CAM Class IV Fractured Sample. ....	53
Figure 14. A. Measurement of 1mm on Facial Surface. B. Measurement of 2mm on Facial Surface. C. Measurement of 3mm on Facial Surface. D. Measurement of 1mm on Incisal Surface.....	54
Figure 15. Example of a Completed Bevel.....	54
Figure 16. Example of a Putty Dentin Matrix. ....	56
Figure 17. Final 3D Printed Acrylic Molds; Dentin Core (left) and Enamel Shell (right). ....	58
Figure 18. Steps for Dentin Core Placement. ....	61
Figure 19. Steps for Enamel Layer Placement. ....	62
Figure 20. Written Instructions for Visual Evaluation Participants (Pilot Study).....	64
Figure 21. Diagram of the Ranked Order Transparency from within the Light Box. ....	65
Figure 22. Spectro Shade Spectrophotometer with Grid Attached and Image of the Typodont. .	67
Figure 23. Placement of BisCover LV on Sample. ....	69

Figure 24. Written Instructions for Visual Evaluation Participants (Final Study). .....	70
Figure 25. Lightness Values for All Samples from Group 1 - the Non-Bevel/Control Group. ....	84
Figure 26. Lightness Values for All Samples from Group 2 - Short and Straight Bevel Group.....	84
Figure 27. Lightness Values for All Samples from Group 3 - Short and Scalloped Bevel Group. ....	85
Figure 28. Lightness Values for All Samples from Group 4 - Long and Straight Bevel Group.....	85
Figure 29. Lightness Values for All Samples from Group 5 - Long and Scalloped Bevel Group. ....	85
Figure 30. Lightness Values for All Samples from Group 6 – Infinite and Straight Bevel Group. ...	86
Figure 31. Lightness Values for All Samples from Group 7 - Infinite and Scalloped Bevel Group.	86
Figure 32. Lightness Values from Group 8 - Original, Unprepared Sample.....	86
Figure 33. Lightness Values for All Samples from Group 1 - the Non-Bevel/Control Group. ....	104
Figure 34. Lightness Values for All Samples from Group 2 - Short and Straight Bevel Group.....	104
Figure 35. Lightness Values for All Samples from Group 3 - Short and Scalloped Bevel Group. .	104
Figure 36. Lightness Values for All Samples from Group 4 - Long and Straight Bevel Group.....	105
Figure 37. Lightness Values for All Samples from Group 5 - Long and Scalloped Bevel Group. ...	105
Figure 38. Lightness Values for All Samples from Group 6 – Infinite and Straight Bevel Group.	105
Figure 39. Lightness Values for All Samples from Group 7 - Infinite and Scalloped Bevel Group. ....	106
Figure 40. Lightness Values for All Samples from Group 8 - Original, Unprepared Sample. ....	106
Figure 41. Relationship between Lightness and Visual Evaluation Scores .....	108

## CHAPTER I: INTRODUCTION

Dental resin based composites were developed in the 1960's by Dr. R. L. Bowen as an alternate for traditional esthetic restorations. Prior to the discovery of resin based composites, silicate cements and acrylic resins (polymethylmetacrylate [PMMA]) were used as esthetic options for restoring teeth. Each material had multiple shortcomings that caused early and frequent failures of the restorations. Dr. Bowen discovered that using a bisphenol A glycidyl methacrylate (bis-GMA), a dimethacrylate resin and a coupling agent made from organic silane would constitute a bonded resin matrix with filler particles to be used as a final restoration in esthetic areas of the mouth(1).

Throughout the following decades, the quality and durability as well as the ability to retain the composite resins had increased tremendously. Dr. Buonocore introduced the acid-etch technique to create better bonding with enamel and resin based composites by increasing the porosity of the enamel and thus, the surface area of the enamel rods(2). Without the development of these materials and procedures, esthetic dentistry would not be where it is today.

Aside from the esthetics and durability, one of the major advantages of using resin based composites is their role in minimally invasive dentistry. They can be used to restore carious defects but can also be used with discolorations, fractures and esthetic defects. Due to the stresses from the forces of occlusion, class IV restorations tend to have shorter lifespans than do class III or class V composites restorations(3). Research has been done in the past to test which types and lengths of finish lines are the most retentive for class IV restorations. The most

common finish line used to gain maximum retention of the resin based composite to the natural tooth structure is the bevel.

The use of bevels in anterior direct resin restorations has been advocated for both improved retention and esthetics. As defined by Merriam-Webster, to bevel is “to cut or shape (a surface or edge) at an angle or slant(4).” Historically the use of bevels in dentistry began in an attempt to achieve better retention of the newly developed, self-cured composite resins to acid-etched enamel prisms.

While retention is a very important characteristic of a finish line, another aspect is the esthetic transition from restoration to natural tooth. Not only do bevels expose the ends of enamel rods for acid etching, enabling better adhesive bonding and reduced microleakage, they also allow the resin based composite to blend better with the natural tooth structure(5). The optical properties of the tooth substructures (especially enamel) can be replicated and simplified with the use of bevels.

#### Statement of the Problem

The goal in restoring a tooth with an anterior fracture is to make the restoration match the adjacent teeth in color and form so that it is undetectable to the naked eye. There is a lack of literature available on what type of bevel to use on a fractured incisor to make the finish line disappear. Clinicians, as well as patients, want there to be optimal surface integration between tooth and composite to make the restoration as esthetic as it is functional and retentive.

Direct resin based composites provide an excellent option for conservative dentistry as compared with indirect porcelain restorations. Arguably, porcelain restorations are less esthetically challenging because the entire facial surface is more often than not veneered with

the lab-fabricated material. With resin based composite, one can utilize the remaining facial enamel to blend the surfaces together, but with that comes its own set of difficulties. It is important to know the optical properties of both the natural tooth structure as well as the composite systems in order to best match the restoration to the substrate.

There are many optical properties that influence the color and appearance of teeth. These optical properties include, "lighting conditions, translucency, opacity, light scattering, gloss and the human eye and brain influencing the overall perception of tooth color(6)." There are both subjective and objective ways to determine the color of a tooth. The most commonly used is subjective and that is visual shade determination via a composite resin based shade guide system. Some objective ways to measure tooth color include: spectrophotometry, spectroradiometry, and colorimetry.

#### Purpose of the Study

The purpose of this research is to find the most esthetic finish line for resin based composite placement in the anterior region for a class IV direct restoration. This will be determined subjectively through a visual evaluation and ranking by dental professionals and an objectively through a spectrophotometric measurement of lightness values from multiple points on the composite/bevel interface.

## CHAPTER II: LITERATURE REVIEW

### Background on Types of Dental Composites and Esthetic Qualities

#### Components of Dental Composites

Dental composites have been used in dentistry for over 50 years. They have gone through many modifications throughout the years and have become a restoration of choice among many practitioners. Not only do they fit the esthetic demands of today's society, but they are durable and also allow for very conservative restorations(3).

Dental composites are made of a polymer matrix, filler particles, initiators, and a coupling agent. The matrix is generally made of bisphenol glycidyl methacrylate (bis-GMA) but can also be made of urethane dimethacrylate (UDMA) or a combination of both. Due to the high level of viscosity of the bis-GMA material, triethylene glycol dimethacrylate (TEGDMA) can be added to dilute the matrix and lower its viscosity. The function of the matrix is to provide a continuous phase that enables the addition of the other particles(3).

Within the resin matrix, fillers act to enhance the physical properties of the dental composite. By adding fillers, the dental composite has less polymerization shrinkage and thermal expansion, increased strength of material, better wear resistance, and increased translucency(2, 3). All particles are radiopaque glasses and can be made of aluminum or zirconium oxides, as well as silicon dioxide(3).

In order for the polymer matrix and filler particles to become a cohesive unit, a coupling agent is necessary. The coupling agent, organosilane, is applied to the outer surface of the filler particle to create a chemical bond to the matrix(3). The coupling agent reduces water absorption and solubility, thus increasing the strength of the restoration(2).

Due to the gel-like nature of the uncured dental composite materials, a chemical or physical reaction is necessary to cure the dental composite to produce its final restorative properties. There are three types of dental composites: self-cure, dual-cure, and light-cure. The self-curing dental composites require a chemical reaction by an initiator (benzoyl peroxide) and an accelerator (amine molecule) when the two pastes are mixed together to polymerize the methacrylate monomers(3). In contrast, light polymerized dental composites require a photoinitiator (usually camphorquinone) that is activated by visible blue light in the 460-480nm range. An amine molecule is also present in the light cured dental composites to accelerate the polymerization reaction in the presence of camphorquinone. Both chemical and light activation are used to polymerize dual-cure dental composites(3, 7).

#### Types of Dental Composite

Throughout the history of dental composites, there have been many types developed to suit the needs of different clinical situations. Each type of dental composite developed was made in order to improve upon the qualities of the previous kinds of dental composite. One variety of dental composite may be more suitable for anterior use due to its esthetics and polishability, while another may be better in the posterior because of its durability. Dental composites are named base on the size of their fillers.

The first type of dental composite used was classified as macrofill (or conventional) composite due to its large filler particle size of 8 micrometers ( $\mu\text{m}$ ). Macrofill composites were extremely hard but the resin matrix would wear faster than the filler particles, which left a rough surface that was prone to discoloration(2). The restorations placed were also rather opaque(7). Because of this, macrofills are no longer available on the market(2).

The next available type of dental composite was classified as microfill because of its submicron filler particle size. Microfill composites were developed to be more comparable to enamel with a smooth, highly polished surface; they were less receptive to staining and plaque retention. The problem with the 0.01 to 0.04  $\mu\text{m}$  filler size was that microfill composites had a greater amount of surface area in relation to the volume of particles. As a result, they were much weaker in regards to wear resistance than the macrofill composites. Microfill composites are still in use today but are limited to non-stress bearing, esthetic, or areas of high flexural stress such as small class III and class V restorations(2).

In order to get the best characteristics of macrofill and microfill composites, hybrid composites were developed. The size of the filler particles in hybrid composites range from a submicron size of 0.04  $\mu\text{m}$  to 4.0  $\mu\text{m}$ . The higher gradation of filler allows for more strength than a microfill but it can still be highly polished and resist discoloration. The hybrid composites can be further divided into microhybrid (< 1  $\mu\text{m}$ ) and nanohybrid ( $\sim 0.005 \mu\text{m}$ ) composites(3).

A newer type of dental composite that is currently available is the nanofill composite. The filler particle size can range from 0.005 to 0.01  $\mu\text{m}$ , which allows for higher overall filler content(2). Higher filler content allows for good sculptability and also leads to good wear and fracture resistance(8). The size of the fillers allows for more translucency of the dental composite due to less scattering or absorption of visible light. There are two main types of nanofillers that have been synthesized: nanometric particles (nanomers), which are either zirconia (2–20nm) or silica particles (2–75nm), and nanoclusters. Nanomers are non-aggregated or non-agglomerated and are primarily monodisperse(8).

Nanoparticles are versatile, in that they can be used in a wide range of opacities and shades(8). Overall, the nanofilled composites have better esthetics, physical properties, handling



characteristics, and they are easier to polish than are the hybrid composites(3). According to the textbook, *Sturdevant's Art and Science of Operative Dentistry*, "These composites have almost universal clinical applicability..." which makes them a great dental composite to use in all areas of the dentition(2).

There are many types of dental composites available on the market today. Each has their own unique properties and qualities. While nanofills are considered a universal composite, microfills still produce the most esthetic looking restorations. Often, in the anterior portion of the mouth, it may be desirable to have a restoration that has good wear resistance and strength, as well as excellent esthetic properties. In this type of situation, a hybrid or nanofilled composite can be used as a core material to increase strength, and a microfill can be used as the most superficial portion, or veneer, for the esthetic qualities(3). Table 1 below is an adaptation from the book, *Craig's Restorative Dental Materials* to help guide the clinician on what type of dental composite is appropriate for different types of restorations.

Table 1. Types of Restorations and Recommended Dental Composites(7)

Types of Restoration	Recommended Dental Composite
Class 1	Hybrids (microhybrid or nanohybrid), nanofill
Class 2	Hybrids (microhybrid or nanohybrid), nanofill
Class 3	Hybrids (microhybrid or nanohybrid), nanofill, microfill
Class 4	Hybrids (microhybrid or nanohybrid), nanofill
Class 5	Hybrids (microhybrid or nanohybrid), nanofill, microfill
Class 6	Nanofill

## Usage of Bevels in Dentistry

### History

In traditional dentistry, restorations required mechanical retention in order to be retained within the preparation design of tooth structure after caries or other defects were removed. Based on the surfaces involved, the preparation would require certain angles, degrees of convergence or divergence, and minimum amounts of tooth structure remaining to retain a restoration. These guidelines were reasonable for posterior teeth but left little leeway when it came to fractured anterior teeth. The options available for anterior teeth were limited, aggressive, and according to Black et al. (1981) included, "intracoronal gold inlay restorations, compacted gold or gold foil, fused ceramic porcelain, full coverage crowns, or pin-retained composite or acrylic restorations(9)." It was not until the invention of acid etching, adhesive dentistry, and dental composites that predictable and reliable esthetic restorations could be readily placed in the anterior region.

After the development of adhesive dentistry, there were various options available to restore a fractured anterior tooth. Arguably, the most conservative outcome for a class IV fractured incisor would be adhesive reattachment of the fractured segment with the use of either a bevel or a chamfer for the finish line. Reattaching the original tooth fragment would give an esthetic result because the original color, anatomy and texture of the tooth would be preserved(10). While no technique could achieve the original mechanical strength of sound tooth structure, a tooth prepared with a chamfer or bevel prior to bonding the fragment was nearly comparable(11). Although this may be the ideal treatment for a fractured incisor, this procedure is not always an option. The tooth fragment may not be available or if it is, it may not be limited to one viable piece. The fragment would also need to be easily re-approximated to

the remaining tooth structure in order for it to look natural. If using the original tooth fragment is not a treatment option in restoring the tooth, one must consider other possibilities such as the placement of a direct or indirect restoration.

A conservative and minimally invasive option for the restoration of a class IV fractured incisor would be to place a direct restoration with dental composite. Around the time period when adhesives were developed, it was uncertain as to how to prepare the tooth effectively (or what type of finish line to use) in order for it to have the best chance at retaining a dental composite. It was established that enamel was essential in order to bond dental composites to the tooth structure. Up until the late 1970's and early 1980's, there was little documented research available on the finish line of choice for the placement of a direct dental composite on a class IV fracture. Different types of finish lines had been advocated based only on clinical experiences and case studies. There were some studies, like that by Yates et al., which used a 1mm bevel before the bevel was documented to be effective(12). The authors gave no justification as to the reason they chose the bevel as a part of their preparation design. Seemingly, the most common finish line in the literature was the bevel, followed by a chamfered margin(9, 12).

An early *in vitro* study was published in 1981 by Black et al. (1981) from the University of Alabama School of Dentistry(9). They studied the retentive strength of three different finish lines to use when restoring a class IV fractured maxillary incisor, which included: a featheredge, a chamfer, and a beveled margin (see Figure 1). The featheredge was 90° to the cavosurface margin and it was restored with an over-contoured dental composite restoration that went 2mm beyond the margin. For the chamfered margin, the enamel was reduced to half of its original depth with a 2-mm circumferential chamfer positioned apical to the cavosurface margin. Finally, the bevel finish line was placed at a 45° angle through the entire thickness of

enamel from the dentinoenamel junction (DEJ) to the enamel surface, circumferentially around the tooth(9).

The authors used 30 extracted maxillary incisors that were free of caries and prepared them to have equivalent perpendicular “fractures” that were 7 mm incisal to the cementoenamel junction (CEJ). A uniform matrix was used to restore the defect, which resulted in 4 mm restorations (plus the length of the finish line, if applicable). The teeth were randomly assigned to the finish line groups, resulting in 10 teeth per group. The samples were all acid etched with 37% phosphoric acid, then Concise Enamel Bond and Concise dental composite were placed. The restorations were finished after placement in water for 48 hours and were re-measured to verify overall 11 mm lengths. The samples were tested after placement in water for one week using an Instron testing machine with a speed of 0.2 in/min; a loading force was applied to the lingual with a 6-inch stainless steel rod. The samples were examined via microscopy and were placed into one of three categories for the labial and lingual surfaces based on the location of the fracture: within the restoration, within the interface between the restoration and tooth, or a combination of both(9).

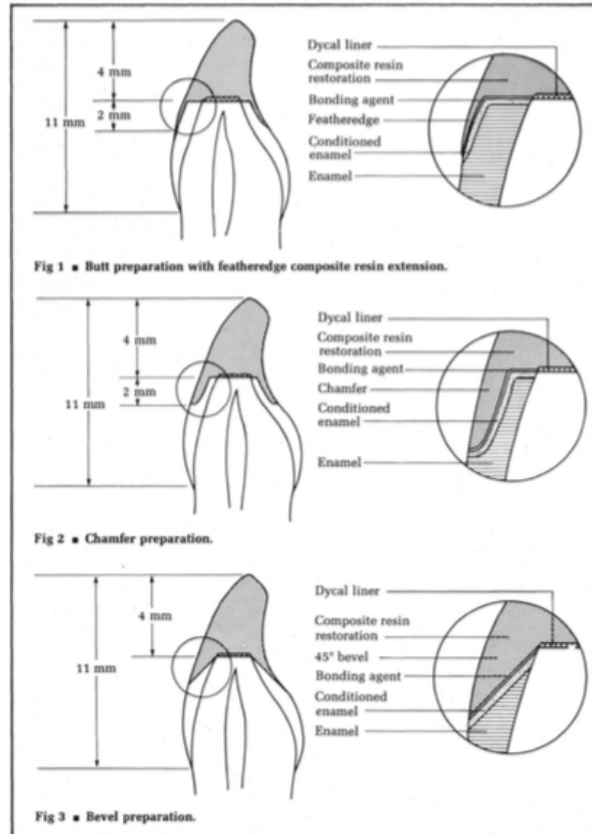

Figure 1. Featheredge, chamfer and bevel preparations(9).

The results of the study by Black et al. (1981) found that the bevel had the highest mean load failure, followed by the chamfer, and then the featheredge(9). The only statistically significant difference was found between the bevel and featheredge groups.

Bagheri et al. from The University of Iowa - College of Dentistry, published another early *in vitro* study in 1983; they compared the shear bond strength of different enamel bevels and restoration lengths of class IV dental composite restorations(13). Seventy extracted maxillary central incisors were prepared to have a 7mm mesiodistal width and a 3mm faciolingual width for uniformity. They were then randomly divided into 10 groups; there were three groups with bevel lengths of 1, 2, or 3mm (see Figure 2) and each of those groups were subdivided into a

group of 2, 3, or 4mm restorations (see Figure 3). The last group was a butt joint with a 3mm restoration. The teeth were restored by the following procedures: acid etched with 37% phosphoric acid for one minute, washed with water for 20 seconds, then the placement of auto-curing dental composite system was completed(13).

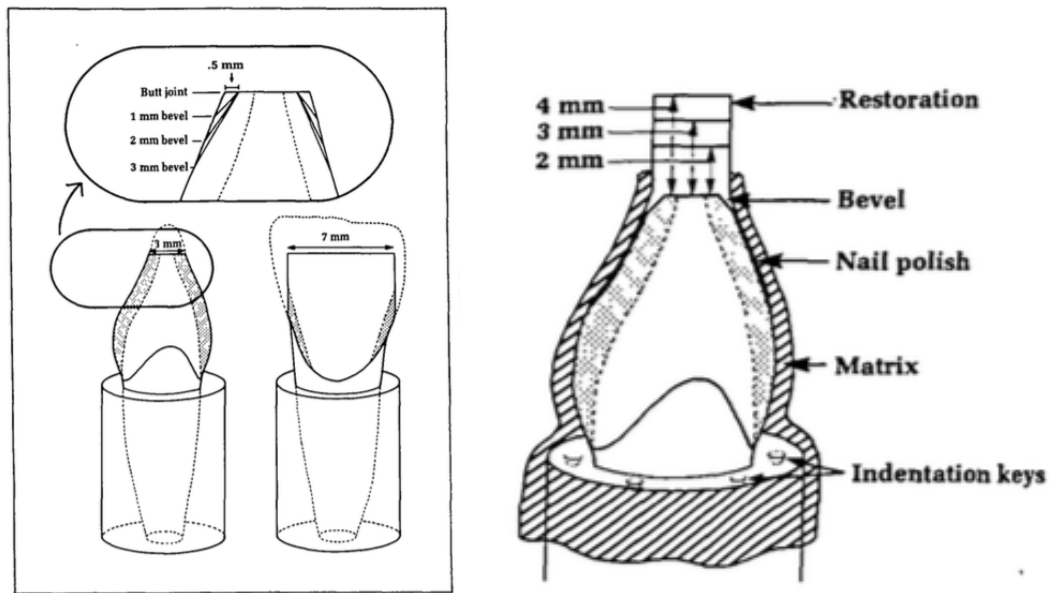

Figure 2 (left). Sample preparation showing three different bevel lengths and butt joint(13).

Figure 3 (right). Sample restoration showing matrix in place and three different restoration lengths(13).

Following the restoration of the samples, Bagheri et al. (1983) completed the testing procedures. Finish lines of Class IV fractures were tested and the shear bond strength of the dental composites bonded to the enamel surfaces were compared between the groups. The samples were tested using an Instron testing machine at a 45-degree angle with a speed of 5mm/min and a 500kg load cell was used. The data were analyzed via two-way and one-way analysis of variance (ANOVA), Duncan's multiple range test, and Tukey's HSD test. The alpha level was set at a standard of 0.05 but the only p values given were for the shear bond strength of the two-way ANOVA that compared the results for bevel and restoration length(13).

The results of the study by Bagheri et al. (1983), found that there was a statistically significant difference in the shear bond strength of the bevel versus the butt margin (all bevels were superior to the butt margin). The authors also found that there was no statistical difference of shear bond strength between the different bevel lengths. And finally, they found an inverse relationship between the length of the restoration and the shear bond strength; the longer the restoration, the more inferior the shear bond strength. When the authors calculated the difference of means from 2mm to 3mm restoration lengths and from 3mm to 4mm restoration lengths, the difference was not statistically significant. But when they compared the means of the 2mm to 4mm restoration lengths, the difference was statistically significant. Thus, the 2mm restorations with bevels had statistically significant higher shear bond strength as compared with the 4mm restorations(13).

The same authors went on to publish another article in 1985 where they tested (*in vitro*) the effect of the thickness of a class IV dental composite restoration on enamel shear bond strength at the cavosurface bevel. Forty extracted maxillary lateral incisors were cut down to a 6mm mesiodistal width and a 3mm faciolingual width in order to be uniform. Teeth were randomly assigned to four groups. The groups were named based on the depth of the bevel (0.5, 1, or 2mm) or butt joint (0mm and 90 degree angle) as shown in Figure 4. The bevels were on the facial surface only and all cut to a 0.5mm depth and 1mm length. The teeth were all etched with 37% phosphoric acid, washed, and air-dried. They were restored with the Concise dental composite system by 3M, which is self-curing and has both filled and unfilled resins. In order to get the greater depths needed, the dental composite was over-contoured in the 1 and 2 mm depth groups. The samples were tested using an Instron testing machine at a 45-degree angle with a speed of 5mm/min and a 50kg load cell. ANOVA and Duncan's multiple range test were

used to analyze the data. Again, the alpha level was set at a standard of 0.05 but the only p values given were for the ANOVA test on bevel width(14).

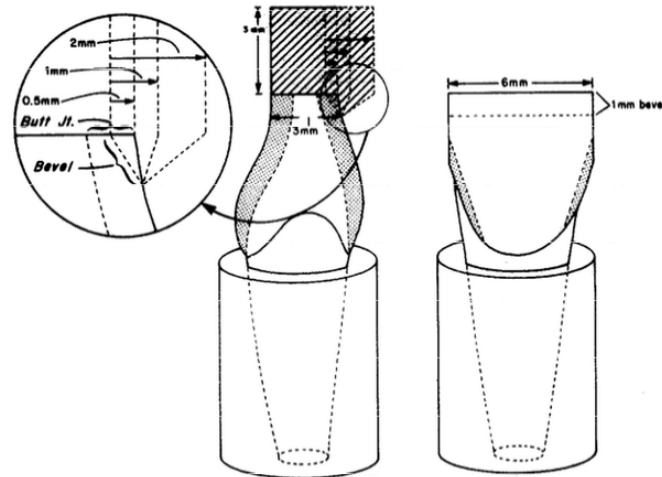

Figure 4. Prepared samples showing proximal view of three different restoration thicknesses(14).

In this article by Bagheri et al. (1985), data analysis using ANOVA resulted in a statistically significant difference between the groups. The Duncan's multiple range test subsequently showed a statistically significant difference between the 2mm group and the other groups, as well as with the butt joint group and all other groups. The data provided evidence that a 2mm bevel depth is superior to the 1, 0.5 or 0mm bevel (butt joint) in statistically significant manner. There was not a statistically significant difference between the 1mm and 0.5mm bevels(14).

These early studies laid the framework for the bevel as a retentive tool used to restore anterior class IV fractures. They found the beveled margin to be more retentive than a 90° featheredge (also known as the butt margin). Despite this information being available to the dental profession for decades, there is still research being done on whether or not the bevel is



retentive. The following study was published in 2013 and evaluated the retentive strength of bevels in direct and indirect restorations.

The study by Poojary et al. (2013) evaluated whether the type of restorative technique, presence of a bevel, and aging of the restoration would have an effect on fracture resistance. They compared the fracture resistance for the following four groups: direct dental composite with bevel, direct dental composite without bevel, indirect dental composite with bevel, and indirect dental composite without bevel. Eighty extracted maxillary incisors (without caries, fractures, or attrition) were used in the study. Specimens had approximately 2.5mm of the incisal third removed with a diamond disk. Forty teeth had a 1mm bevel placed with a flame shaped diamond bur. All teeth had roots placed in acrylic resin up to the CEJ. The direct restoration teeth were etched, adhesive placed, restored incrementally with Filtek Z350 dental composite resin, and light cured. The indirect restoration teeth had KY Jelly applied as a separator, then the Filtek Z350 dental composite resin was placed incrementally and light cured. The restoration was removed from the teeth and microetched on the intaglio surface. The tooth was etched, adhesive placed, and the restoration was luted to the tooth with Rely X ARC cement. All restorations were polished with sof-lex discs(15).

Upon completion of the restoration samples, the lab tests were started. Ten teeth from each group were placed in distilled water for 24 hours. The other ten teeth from each group were placed in distilled water for 180 days, with two thermocycling treatments. All samples were tested for fracture resistance with the universal testing machine using a shear device with a cross head speed of 0.5mm/min. Post-fracture, they were examined with a stereomicroscope at 10 times magnification (15).

In order to test the statistical significance of their *in vitro* findings, Poojary et al. (2013) used multiple different statistical tests including: ANOVA, Bonferroni test, and Student's t-test. There were no set alpha levels or p values mentioned in the study. They gave little information on how the Bonferroni test was used, which groups they compared, or which type of ANOVA test they used. There also was no statistical analysis done on the information pertaining to the failure patterns in the groups at 24 hours and 180 days.

Poojary et al. (2013) found that after 24 hours and 180 days in distilled water, the direct, beveled dental composite restorations had the highest shear bond strength, while the indirect, non-beveled dental composite restoration had the lowest. ANOVA showed that there was a statistically significant difference demonstrating that beveled restorations were more fracture resistant as compared to the non-beveled restorations. Mixed (adhesive and cohesive) failures were more common in both groups of beveled teeth after 24 hours and 180 days. More adhesive failures occurred in the non-beveled groups; there was a 40% increase at the 180-day mark in the direct non-beveled group and a 30% increase in the indirect non-beveled group(15).

The previous four studies tested whether or not the bevel was the most retentive finish line for a class IV dental composite restoration, and what criteria should be followed when placing the bevel. There were other studies that attempted to find whether another type of finish line might be more practical than the bevel. The following study was done to compare the bevel to the chamfer and stair step chamfer.

Eid (2002) published a study that evaluated the bond strength of a different type of preparation design, the stair step chamfer technique, against bevels and chamfers. The author used 88 extracted bovine incisors and divided them into 4 different groups: bevel preparation (45 degree inclination/2mm length), chamfer preparation (chamfer shoulder/2mm length; ½

enamel thickness), stair step chamfer (1mm depth/2mm width; steps followed anatomy of tooth) and a control group (untreated). The teeth were mounted in a cylinder of acrylic resin and given a 3mm “fracture” with a diamond bur on the mesioincisal portion of the tooth. The non-control group samples were etched, adhesive placed, restored incrementally with Tetric Ceram dental composite resin, light cured, polished, and sealed with Fortify (Bisco Corp). The samples were placed in water for one week. They were then tested for fracture resistance on an Instron testing machine at a 90-degree angle (simulation of force to facial of incisor) with a speed of 0.5mm/min until they fractured. The samples were evaluated visually and then the data were analyzed by one-way ANOVA and a Chi-Square analysis(16).

Eid (2002) found that there was a statistically significant difference in the shear bond strength between the control and all other groups. There was no statistical difference between a bevel, a chamfer and a stair step chamfer design in shear bond strength. The author also analyzed the site of fracture within each preparation design. They found that there was a statistically significant difference between the stair step chamfer and the chamfer/bevel in fracture site of bonded dental composite in that the stair step chamfer had more failures within the restoration and not at the adhesive interface(16).

In summary, each of the study designs from Black et al. (1981), Bagheri et al. (1983), Bagheri et al. (1985), Poojary et al. (2013), and Eid (2002) was different, but they all examined bevels and retention. The general trend suggests that bevels of at least 1mm (or chamfers) are necessary for retention, whether placing a direct or indirect restoration. With all of this information, it is clear that a beveled margin on a class IV restoration has high shear bond strength and is an efficient, predictable way to place a dental composite restoration.

## Current Criteria for Bevel Usage

According to *Summitt's Fundamentals of Operative Dentistry*, a bevel with a minimum length of 1mm is an effective finish line for the retention of a class IV restoration(3). Bevels greater than 1mm in length have not been shown to provide additional retentive strength to the restoration but may provide better esthetics. On the facial surface, it has been recommended to have a longer, scalloped bevel (2-3mm) at a 60-degree angulation with an infinite margin to make the transition between dental composite and natural tooth structure undetectable.

The bevel has many advantages and Coelho-de-Souza et al. (2008) stated it best:

The bevel was initially proposed to increase the retention of dental composite restorations. Besides this improvement, additional advantages obtained with bevel preparation are: removal of the superficial enamel layer, which is aprismatic and fluoride-rich, favoring acid etching; increase in the surface area of adhesion; increase in the surface energy, favoring wettability by the adhesive agent; better marginal sealing; improved esthetics, masking the transition between dental structure and dental composite. In addition, a bevel allows cutting the enamel rods perpendicularly to their long axis, which improves the resin adhesion. Bevel placement provides the restoration a fracture resistance similar to that of the intact teeth(17).

From this excerpt, it is easy to justify why bevels have a prominent place in adhesive dentistry. There has been a plethora of research to support the fact that bevels are more retentive than butt margins and are, arguably, more retentive than chamfers, as well. It also seems to be common knowledge that a bevel is considered to be more esthetic than other marginal designs. This seems logical since the bevel allows for a gradual transition from tooth structure to dental composite, while a butt margin leaves a line that is often detectable to the

eye. Although it is generally assumed and accepted that bevels produce the most esthetic margins, there has not been adequate research done to verify this assumption.

### Esthetics in Dentistry

While the style of preparation of a class IV restoration is important for both retention and possibly esthetics, choosing the proper material is also crucial. There are many physical properties that are important to consider when choosing a dental composite to restore a class IV fracture. The following sections will discuss different properties to aid in selecting the right materials for restoration.

### Properties of Light

It is important to understand some of the physical characteristics and properties of light when referencing esthetic properties of teeth and dental materials. Photons, exhibiting properties of particles, make up the unit of light as they transfer energy via electromagnetic waves. Light is measure by its wavelength; the wavelengths that can be perceived by humans lie between 400-700 nanometers on the electromagnetic spectrum (see Figure 5)(18). Visible light, also known as white light, is mix of different wavelengths, while monochromatic light is made of a short span of wavelengths and can be perceived as a single color.

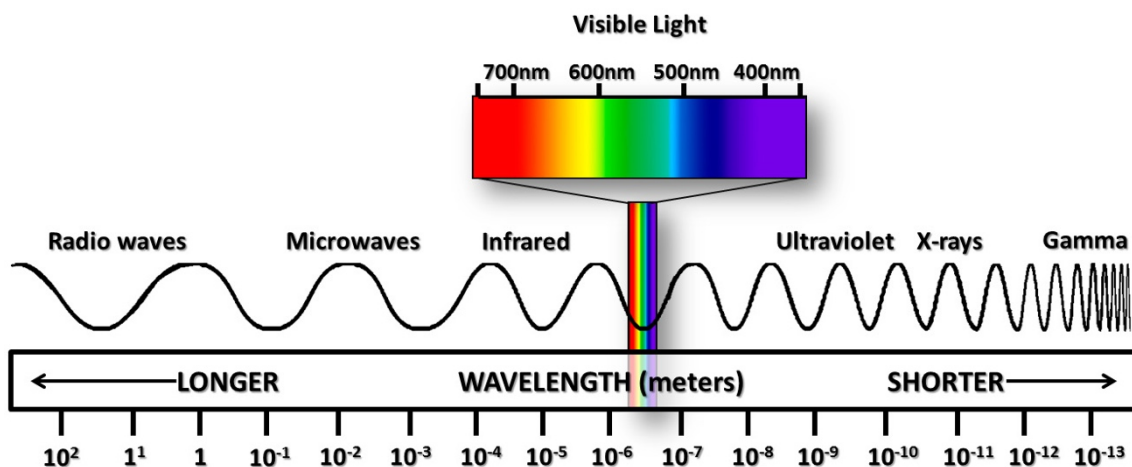

Figure 5. Electromagnetic Spectrum (19).

There are multiple phenomena associated with the interaction of light and matter, including absorption, transmission, refraction, diffraction, and reflection. The trajectory of interacting rays can be described as regular (direct), diffuse, or a mixture of regular and diffuse(18). The properties of light that are applicable to dentistry are described in the following sections and shown in Figure 7.

### Reflection

Light is reflected when it is rejected from the surface of an object(20). When incident light strikes a flat surface, it is known as regular or specular reflection because the angle of the light approaching the object is the same as the angle of light being reflected from the object (as shown in Figure 6A)(18). Depending on the surface of the object and the angle at which the light hits the object, the light can be redirected or reflected into another direction. The wavelength of incident light can also vary the amount of reflectance the object has(8). Light can be irregularly reflected in several different directions due to a rough or uneven surface, which is known as

diffuse reflection (as shown in Figure 6B)(18). When light is reflected in different angles but in the same direction from a flat surface, it is known as semi-specular or mixed reflection because it is both specular and diffuse(18).

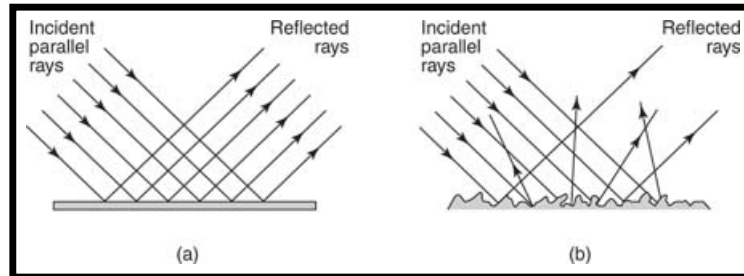

Figure 6. A. Specular Reflection from a Smooth Surface, B. Diffuse Reflection from a Rough Surface(21).

## Refraction

Refraction refers to the travel of light to an object in one direction, with speed suddenly changing once the object has been reached(20). When the light passes from one medium to another at varying speeds, the rays may change direction and light is refracted(18).

## Refractive Index

According to the book, *Esthetic Color Training in Dentistry*, “the refractive index of a material is the ratio of the speed of light within a vacuum to the speed of light in the material(22).” If a material is very dense, the speed of light will be slowed as compared to a material that is less dense(23). The refractive index (n) is different for each dental tissue and dental restorative material and is representative of its light scattering properties(24). Light can be reflected from the surface of a material because of the change in refractive index between

the air and the object(22). Particle size of the dental composite determines the scattering but the scattering can vary with different wavelengths of incident light(8).

The refractive index of dental composites should be similar to that of enamel in order to replicate the light properties of enamel. According to the study by Meng et al., the refractive index of enamel and dentin were measured to be  $1.631\pm 0.007$  and  $1.540\pm 0.013$ (25). However, the average refractive index of ceramics and dental composite is 1.5, which is more similar to glass at 1.52 than enamel at 1.63(23, 25). When the dental composite has a lower refractive index than enamel, a thicker layer will lead to a decreased value (darker appearance)(23).

#### Absorption

White light can be absorbed into an object when the rays collide with an opaque object or across transparent surfaces, decreasing the energy output of the luminous radiations(18). Most objects have selective absorption because they do not absorb all of the frequencies equally from the light spectrum, thus the absorption varies with different wavelengths of incident light(8, 20).

#### Diffraction

With diffraction, once a light strikes an object, the light no longer travels in a straight line and begins to interfere with other light beams that followed. The diffracted light essentially creates an alteration or scattering of subsequent light pathways(20).



## Transmission

Transmission is also considered double refraction and can be subdivided into direct, diffuse or selective transmission(18).

### Direct Transmission

Direct transmission (also known as regular or total transmission) of light is similar to the transparent effect of an object; light is able to pass freely through said object without disruption(20).

### Diffuse Transmission

With diffusion transmission, light may pass through an object but is sent in many different directions upon exiting the object(20). This type of transmission is seen when light passes through a translucent object(18).

### Selective Transmission

In selective transmission, the object only permits certain wavelengths to pass through(20).

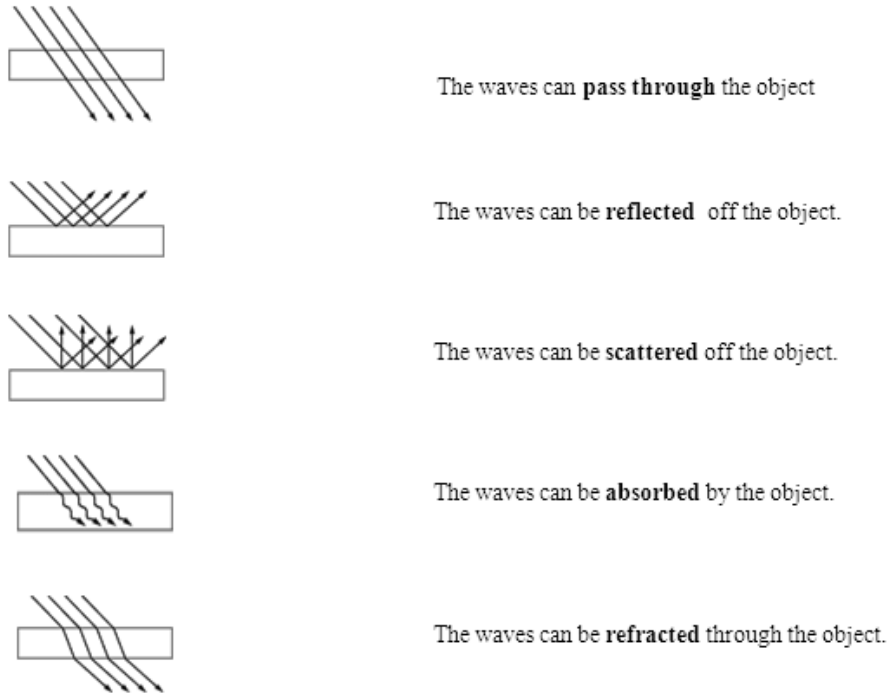

Figure 7. Properties of Light (26).

According to Villarroel, “it is understood that the optical behavior of each medium is determined by not one, but rather many different factors, including the degree of dispersion, refraction, transmission, and absorption of light rays(18).”

#### Properties of Light in Tooth Structures

When discussing light in dental structures, there are many properties of light that occur simultaneously. The components of tooth structure are very complex due to the multidirectional nature of enamel rods and surrounding tissues. A tooth is considered semi-transparent due to the physical qualities of enamel and dentin, as well as their optical properties. These characteristics cause the light that hits the teeth to be either absorbed, transmitted, reflected,

refracted and/or diffracted(18). These actions were best described in the article by Pecho et al., in which they state the following:

When light strikes a semi-translucent object, four phenomena can result from this interaction: (1) specular light reflection and (2) diffuse light reflection at the object surface, (3) absorption and scattering of light within the object structure, and (4) transmission of the light flux through object structure. The light resulting from the interaction of these phenomena will reach the observer eyes with the object color information(8).

### Properties of Light in Enamel

Enamel has unique qualities when it comes to light propagation. The phenomena of light reflection, refraction, absorption, and transmission, as well as surface texture and thickness of the enamel attenuate the color of the underlying dentin(18, 23). Light is able to pass freely within the enamel prisms and crystalline structure; however, light is unable to infiltrate the interprismatic substance as easily and thus is not fully transparent(23). Enamel rods run mostly perpendicular from the DEJ except for the cervical and incisal areas, where they angle obliquely toward the cervical or almost vertical toward the incisal. With the changes of orientation of the enamel rods, the light has less opportunity for transmission and teeth appear less translucent. With the combination of internal light diffusion and partial light transmission, enamel is considered a translucent system(23).

The value (or lightness) of enamel is dependent on the translucency; the translucency is affected by the thickness of the enamel, which changes over time with aging(23). Thicker enamel, that is present in younger teeth, tends to be more dense and reflective and thus less translucent which translates to having higher value (lighter)(23, 27). This is the opposite of what happens to enamel in older teeth that have become thinner due to the various factors of aging.

Younger teeth with thicker enamel have external layers that have more space between crystals and are less mineralized; which can make the appearance of the tooth more opaque(28).

#### Properties of Light in Dentin

Dentin has very distinctive and very different light properties than does enamel. Dentin tubules take on an “s” shape from the pulp to the DEJ, with the portion nearest to the DEJ being the straightest. This sigmoid curve allows for more light diffraction, which creates a more opaque structure. As dentin ages, the once large diameter tubules become more narrow or even sclerotic, which increases the saturation of color and decreases the transmission of light(18).

#### Properties of Light in Dental Composites

Dental composites can vary immensely in their optical properties depending on filler size, matrix material, etc. As discussed in the dental composite section, nanofillers are not very opaque due to their particle size; they are unable to absorb or scatter visible light(8). These properties are welcomed except when there is too much translucency, especially at the incisal edge. The background color can be perceived through the material, which can change the overall color appearance of the dental composite(8). Materials that are more opaque scatter light due to reflection and refraction at the interface of the inclusions, pigments, and porosities within the resin matrix. Scattering, reflectance, and absorption can change with different incident light wavelengths as well as the pigments from the colorant(8).

The refractive index can also change based on the type and manufacturer of dental composites. As previously stated, the refractive index of enamel is approximately 1.63 while most dental composite systems are approximately 1.5. With the dental composite having a

lower refractive index than the enamel, the value decreases (darkens) as the thickness of the restoration increases(25). This is the opposite effect that enamel has.

The goal in restorative dentistry is to have the optical properties of dental composites, as well as ceramics, nearly identical to those of the natural tooth structure. There are advances being made in the dental materials that are bridging the gap of the optical properties between the dental composite systems and the enamel/dentin complex. New techniques involving multiple layers of different particle size dental composites are being utilized to help make the restorations look more natural(29, 30)

### Color and Color Space

White light is a mixture of all of the color in the spectrum. An object takes on a specific color when all color wavelengths are absorbed except the one wavelength that is reflected back; this is the color of that object(18). The color spectrum is designated by the wavelength range of 400nm – 700nm (shorter-longer). The shortest wavelength appears violet, followed by blue, green, yellow, orange, and red, which is the longest wavelength(7). Lips appear to be in the red family of color, so the red color is reflected back to the eye while all of the other colors like orange, yellow, green, blue, and violet are absorbed by the lips. When all of the wavelengths are absorbed, the object appears black.

### Munsell Color Classification

Albert Henry Munsell, an American artist, began designing a system to describe color in 1898 and published *A Color Notation* in 1905(31). Munsell chose to describe colors based on a decimal system rather than by naming individual colors (see Figure 8). The study of color, or

colorimetry, and most color systems are still based upon the concepts presented by Munsell(31). Munsell divided color into three different dimensions: hue, chroma, and value.

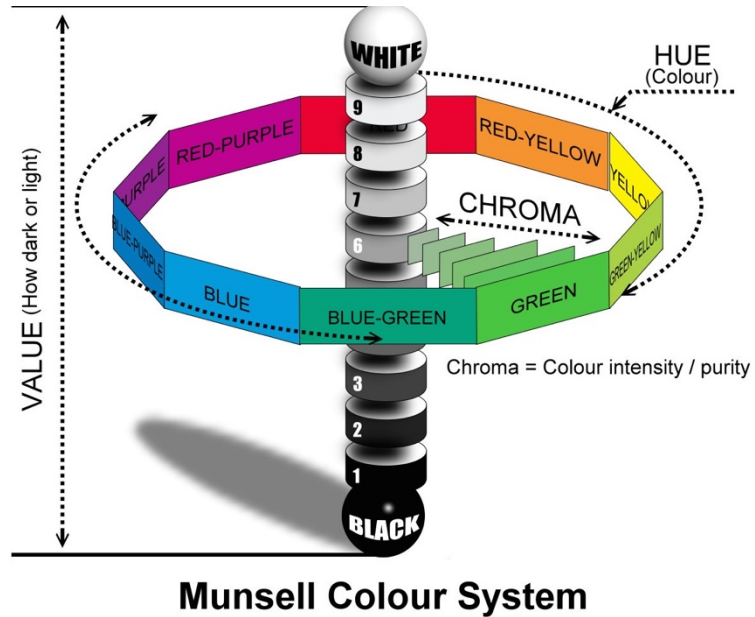

Figure 8. Munsell Color System (32).

### Three Dimensions of Color

#### Hue

Hue is the category or name of the color, which can be differentiated from other color families (for example, red, green, and blue)(20). Munsell named five principal colors and five intermediate colors which are halfway between the neighboring principle colors(31, 33). He arranged a 100 point compass and each color (principal and intermediate) had a 10 degree interval(34). The principal colors included red, yellow, green, blue, and purple and the intermediate colors were yellow-red, green-yellow, blue-green, purple-blue, and red-purple. He arranged them around the wheel so that complementary colors would be opposite each other and there would be balance(31).

## Value

Value describes the lightness (sometimes referred to as luminosity) or brightness of the color. Value could be thought of as the range from pure white to pure black(6). If the color has a high amount of white, then it is referred to as having a high value (10 on the scale). If the color has a low amount of white (or a high amount of black), then it has a low value (0 on the scale)(20, 35). According to Sproull, technically, pure white or pure black are unattainable, and thus only nine value steps are used in practice(35). The scale that Munsell used is not based on a measurement of light, but on the visual perceptibility or relative light(31).

## Chroma

Chroma is the category that encompasses the amount of saturation per color. Chroma describes how vivid, intense or strong a color is(6). Colors with high chromaticity or saturation are stronger or more pure in their color, while weaker colors have a lower saturation or chromaticity(20). If one were to take the purest color (high chroma) and add the same value of gray to it (low chroma), it would reduce the chroma of the color but not change the hue or value(35).

The Munsell Color system could be imagined as an asymmetric sphere or cylinder with the colorless value axis running through the center of a number of stacked color wheels. The top of the cylinder is white and slowly transitions by descending shades of gray to black at the bottom. The color wheels (hues) are arranged around the axis with darker colors toward the bottom of the cylinder and lighter colors toward the top. Within each hue, the more chromatic colors are toward the outside of the cylinder while the less pure (more grayed) are towards the center(35).

## The Three Dimensions of Color in Dentistry

Color and shade selection are a major consideration in dental esthetics. According to Magne, "Of the three components of color, value (also called luminosity or brightness) is most influential, followed by chroma (also called saturation or intensity) and hue (the color itself or "name" of the color)(36)." When it comes to dentistry, there is not a wide range of available hues as evidenced by the Vita shades of A, B, C and D on the classic shade guide(37). This is a reason as to why hue is least influential component on the overall esthetics of the restoration. Hue generally refers to the color of the body of dentin which is most often in the yellow or orange family(20).

Value is extremely important when picking a tooth shade, as there can be a wide range of value present within the same tooth. The incisal area usually has the lowest value due to its transparency and translucency. The cervical region has the next lowest value due to the increased chroma of the cervical and root dentin. The remaining middle third region of the crown generally has the highest value(36). The value of the tooth is represented by the transparency (or opacity) and whiteness of the enamel(20). When comparing chroma to value, there is an inverse relationship. The higher level of color saturation leads to less light and thus, less brightness(36). The chroma of the tooth comes from the saturation level of the dentin body(20). The numbers on the Vita Classic shade guide represents the chroma; lower numbers are equivalent to a lower chroma and vice versa(37).

Though value may arguably be the most important component for color matching, it is also more difficult to find a difference in value versus hue when a comparison is made by the human eye(38). There are two different types of color differences that can be perceived by the human eye. The first is the difference in chroma or lightness, which is known as quantitative.



The second color difference is qualitative which detects the difference in hue. According to Pecho et al., “general observers believe color means hue and they do not seem to perceive a difference in lightness and/or chroma as a difference in color(38).” Thus the quantitative color difference is more difficult to find but may be of greater importance when evaluating color or shade matching in dentistry.

Aside from the primary components of color (hue, chroma, and value), there are a few secondary optical properties that will be discussed as well. The secondary optical properties consist of translucency, opalescence, and fluorescence.

### Secondary Optical Components of Color

Light Transmission: Translucent, Transparent and Opaque

A translucent object is one that allows light to pass through but it may be in varying degrees. Translucency is the scale between transparent and opaque. Whichever light is not transmitted through the object, will be reflected(20). Opaque objects, on the other hand, allow no transmission of light through them because all light is either reflected or absorbed(18). According to Villarroel, “Although there are variations of composition and mineralization, it is known that enamel allows a 70.1% average light passage, whereas 52.6% of light can be transmitted through the dentin structure(18).”

Transparent objects allow complete passage of light without interference or modification of the light wave. There is no visual distortion of objects on the other side of a transparent material(18). Transparent objects can be chromatic or achromatic; if chromatic, the color of the object viewed through the transparent medium will be affected. There are four factors to determine whether or not the object is chromatic or achromatic, which include:

surface texture, degree of translucency, material thickness, and presence or absence of color(18).

The texture on the surface of an object can affect how the light is reflected from it, thus affecting what color the object appears to be. If a white light is directed at a smooth surface, it will reflect the white light mixed with the chroma of the object. If the surface is rough, the object will actually appear lighter as less of the chroma mixes with the white light(7).

Chromatic translucency is represented in dentistry by dentin. The level of saturation in dentin varies but increases over time. It has been suggested that enamel is colorless, but many experts in the field contend that enamel has a yellow-white or gray-white hue. With that in mind, enamel can have either achromatic or chromatic translucency(18). These concepts are extremely important when it comes to the restoration of the tooth; the dental composite that is used for the enamel layer can change the perception of or modify the color of dentin. The thickness of the enamel layer also influences its translucency. An enamel layer that is too thick will appear to have a grayish hue. A thicker layer of dental composite can also lead to more opacity of the material(7). Generally speaking, the amount of enamel decreases with age and younger teeth not only have a higher value due to thicker enamel, they also tend to be less translucent(18).

Dental tissues have different levels of opacity based upon organic content, thickness, and location. When a restoration is being placed, the more translucent the material is, the less the light is able to return to the eye and the lower the value will be(37). According to Fondriest, "The translucency of enamel varies with the angle of incidence, surface luster, wavelength, and level of dehydration(37)." This could provide many levels of translucency within the same tooth.

## Opalescence

Opals are gemstones that are known for their quality of reflecting different colors from the visible light spectrum, depending on which way the light strikes it. The optical property of opalescence or the “opal effect,” has similar qualities in that it describes how a translucent material appears to be one color when light is transmitted or refracted through it but another color when light is reflected from it(28, 37). This is demonstrated in Figure 9; when light is transmitted, the tooth appears yellow-brown but when the light is reflected, it appears blue. The opalescent materials are able to take shorter wavelengths of light and scatter them(7). When the object is illuminated with light from the visible light spectrum, the opalescence creates an iridescent appearance(20).

The opalescent qualities of the tooth are present in enamel only and appear to give the tooth vitality and more depth(20, 37). When light is focused on enamel, the opalescent quality of it allows red light to be transmitted through while blue light is reflected back or scattered within the tooth structure (see figure 9). This is most apparent in (but not limited to) areas of enamel only, such as the incisal edge(23, 28). If the light were to be transmitted from the lingual surface, the blue color would not be apparent; the tooth would appear to be more orange or brown in color(7, 39).

The arrangement of enamel consists of millions of enamel rods or enamel prisms; it is a crystalline structure that is highly mineralized(39). Fondriest explains that enamel acts as a prism due to the hydroxyapatite crystals and, “the shorter wavelengths [blue spectrum] bend more and require a higher critical angle to escape an optically dense material than the reds and yellows(37).” This is why enamel can appear blue or gray-like but in actuality, enamel is,

arguably, colorless. This is most evident at the incisal portion of the tooth because there is no dentin present and light is allowed to pass through the full thickness of enamel(20).

The most important aspect of opalescence in regards to the dental field is that dental materials like dental composites and porcelains, as well as enamel, can change their hue, chroma and value without affecting the translucency when viewed in different types of light(28).

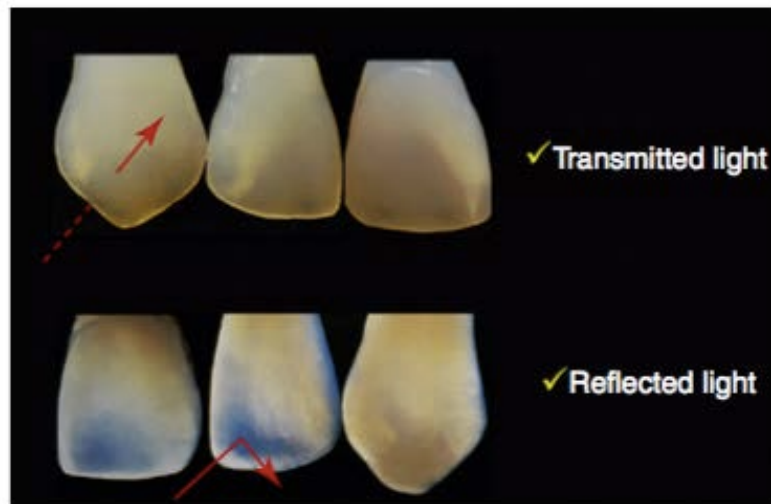

Figure 9. Demonstration of Opalescence in a Ceramic Restoration(7).

## Fluorescence

Ultraviolet light can cause teeth to fluoresce, which makes them appear brighter and whiter in daylight(36). Fluorescence has been defined as, “absorption of light by a material and the spontaneous emission of light in a longer wavelength(37).” When teeth are exposed to ultraviolet radiation (365nm), the wavelength that is generally reflected is at the blue end of the spectrum (450nm)(7). The dentin has a higher organic content and thus can be up to three times more fluorescent than enamel(36, 37). This fluorescence makes the tooth appear to have a “internal luminescence” which makes the tooth appear more vital (also termed

vitaescence)(36). Dentin with higher amounts of chroma fluoresce less than those with lower amounts of chroma. Fluorescing particles are often added to restorative materials to increase the value and decrease the chroma while not affecting the translucency of the tooth and restoration(28, 37).

When comparing the overall light properties of both enamel and dentin, they vary due to their compositional structure. As discussed earlier, due to the higher organic content, dentin fluoresces more than enamel but also has more hue and chroma(40). Enamel contains a high amount of inorganic content and tends to exhibit some level of transparency (achromatic or chromatic) or translucency; the hydroxyapatite crystals allow for its opalescent qualities due to their prism-like structure(37, 40). The combination of these properties between enamel and dentin are what give the tooth structure its vital appearance. The appearance of a tooth is the summation of reflected, transmitted, and opalesced light(37).

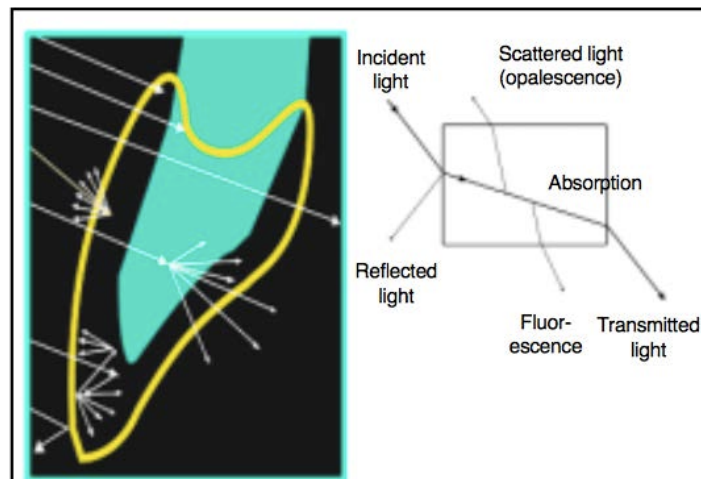

Figure 10. Demonstration of Light Properties within a Tooth(37).

## Instruments Used in the Measurement of Color

Color measurement, or perception, requires three main components: the source of light, the observer (or measuring device), and the surface being measured(41). When there is a human observer, there can be a high amount of subjectivity involved in color perception. In contrast, when a color measuring instrument is used, the findings are more objective. There are extraneous components that affect color measurement as well. Angulation of light, surrounding colors, the size of the field of view, etc., are all components that should be controlled when trying to measure objectively.

The different types of color measuring devices currently available include: colorimeters, spectrophotometers, spectroradiometers, and digital cameras. These devices either measure the amount of light reflected or absorbed from the object being measured or they measure the object in three color dimensions. They all have optical elements (light source, photoreceptors, wavelength selection device, integrating spheres, etc.) but their arrangement varies based on the objects that need to be measured(22).

### Color Measuring Devices

#### Colorimeter

A colorimeter can measure color only in tristimulus values: red, green, and blue, which is filtered light from the visible spectrum. The colorimeter has a light source that is projected onto the object. The reflected light is passed through the red, green, and blue filters and the color is determined by how much light is reflected or absorbed by the object. The filters reduce the light to a few fundamental wavelengths, that which are similar to what the human eye

perceives. The colorimeter does not measure the reflectance of the light and for that reason, can be less accurate than other color measuring instruments, mainly spectrophotometers(22, 42). Colorimeters are useful for quality control when it comes to shade comparison between samples or specimens. Both measurement of surface colors and self-luminous colors can be accomplished by the colorimeter(22). An advantage of the colorimeter is that they tend to be less expensive than other color measuring devices. However, they can also be inaccurate when it comes to repeatability due to aging detectors, and reproducibility due to the filters not matching the CIE (*Commission internationale de l'éclairage*) parameters because of the aging(22).

#### Spectroradiometer

A spectroradiometer measures spectral radiance ( $W/(m^2Sr)$ ), and the units are expressed by luminance ( $cd/m^2$ ). It also measures spectral irradiance ( $W/m^2$ ), and the units are expressed by illuminance (lux). Generally speaking, measurements are made in intervals of 5, 10, or 20nm over the visible light spectrum(22). The data measured from a spectroradiometer can be calculated from the spectral radiance to find the color coordinates in CIELAB color space(8).

#### Spectrophotometer

A spectrophotometer is a device that breaks down visible light directed at an object into consecutive monochromatic beams(41). It measures and records the ratio of visible radiant energy that is reflected or absorbed from the sample versus that energy reflected from a white reference point at 1-25nm intervals along the visible spectrum(22, 41, 42). According to Chu et al., "A spectrophotometer contains a source of optical radiation, a means of dispersing light, an

optical system for measuring, a detector and a means of converting light obtained to a signal that can be analyzed(42).” The data that is obtained from a spectrophotometer is converted into the hue, value, and chroma that is equivalent to those of shade guide tabs(42).

Spectrophotometers, frequently used for quality control, are among the most accurate devices used in dentistry for color matching(22, 42). The accuracy of the spectrophotometer was 33% higher than the human eye and other conventional techniques and the matches were more objective in 93.3% of cases in a study completed by Paul et al(43).

A benefit to the spectrophotometer is that it can take measurements and analyze color over the whole tooth, divided areas (cervical thirds), or small, localized areas. Additionally, the spectrophotometer has the ability to analyze and measure the optical transition between dental composite and natural tooth structure, which is an esthetically problematic region(30).

#### Digital Cameras

Digital camera use for shade acquisition is the most basic way to perform electronic shade matching. With more dentists owning or having access to digital cameras for their clinical practice, it has become more popular to use them for documenting and measuring color. The majority of digital camera systems still utilize the red, green, blue (RGB) color model to create the image(42). The advantage of the digital camera is that it does not only measure a localized area, but the whole tooth(22). However, with the digital camera, there comes some subjectivity with shade selection from the eyes of the clinician. There are software systems available on the market that analyze the shades of the entire tooth and compare them with reference shades in the system(42).



## Plastic versus Mineralized Teeth

There have been many studies done to compare the optical properties between tooth structure and dental composites. The following study was initiated to compare the translucency between two different dental composite systems where a spectrophotometer was used to measure the total transmittance and the diffuse transmittances. Akbar et al. (2012) compared the translucency and color from two different popular esthetic dental composite systems (in dentin, body, and enamel shades) via a spectrophotometer. The study was an analytical, *in vitro* study done on dental composite samples. Each sample from each shade was tested with a spectrophotometer to find the total transmittance and the diffuse transmittance of light at every wavelength from 380-700nm(44).

The dental composite systems that were compared were Filtek Supreme and Esthet-X. Filtek Supreme in shades A4D, A6D, C4D, C6D, A2B, C2B, D2B, A2E, B2E, and D2E and Esthet-X in shades A4, B2, C4 (opaque dentine), A2, B2, C2 (regular body), clear enamel (CE), yellow enamel (YE), and gray enamel (GE) were used for the study. Three samples of each shade were condensed into 15.5mm x 1.1mm discs by a glass-encased polycarbonate mold and light cured with an Elipar TriLight light curing system. The samples were cured for twenty seconds each, from five different angles. The curing light was tested prior to each use to make sure that it had an equal energy output for each sample ( $750 \text{ mW/cm}^2$ ). The thickness of each sample was verified at five sites with a micrometer. Each sample was polished with silicon carbide grinding paper, diamond compounds on a grinder-polisher, and then washed with water. The thickness was re-measured to verify the dimension of 15x1mm and was checked on a light box to rule out porosities(44).

After completion of the samples, Akbar et al. (2012) measured the optical properties (transmittance values) with a UV/VIS spectrophotometer with an integrating sphere and a standard illuminant (D65). To measure total transmittance, a white material was placed at the reference port and the sample at the entry port. For the diffuse transmittance, the light trap was left open so that the only light recorded was that which scattered. Both of the transmittances were recorded at every wavelength from 380-700nm. Both one-way ANOVA and Tukey's test were used for statistical analysis (via Minitab software)(44).

The results of this study by Akbar et al. (2012) found that dentin shades had the lowest transmittance (both total and diffuse) while the enamel shades had the highest in both the Esthet-X and Filtek Supreme dental composites. They also found that there was a significant decrease in both transmittances from A2 to C2 (body shades) and from A4 to C4 (opaque dentin shades) in the Esthet-X dental composites, while there was a significant decrease in both transmittances from A2B to D2B and in diffuse transmittance from A4D to C6D shades in the Filtek Supreme dental composites. The gray enamel had a significantly higher diffuse translucency than the other two enamel shades in the Esthet-X dental composites, yet there was no significant difference in total transmittance in the dentin shades or in the total and diffuse of the enamel shades in the Filtek Supreme dental composites. There were no p-values listed for the study(44).

### Color Classification Systems in Dentistry

#### 1976 CIE L\*a\*b\* Space

Color can be difficult to measure because it is both objective and subjective. Objectively, visible light is broken down into different wavelengths of color. The color of the object is

dependent on which wavelength is reflected. These are the physical properties of color. There are also psychologic properties of color that are based on the perception of the observer. The measurements of the two properties have been combined (psychophysical) and include a standard observer and standardized light sources in order to make colorimetry more objective(20, 35).

In 1931 the *Comission Internationale de l'Eclairage* (International Commission on Illumination) was formed as an organization to set standards for lighting and its properties(31). The division of the commission that focused on colorimetry was known as the Vision and Color technical committee. The recommendation from the CIE in 1931 originally utilized three different illuminants, which were: A - incandescent light, B - direct sunlight (present at noon) and C - average daylight(22). Illuminant A can have an absolute temperature of 2856K, and can represent either incandescent light or it can also represent a tungsten light source(39). In 1964, the recommendations shifted to D illuminants (D65 and D50) in place of B and C(22). The D illuminants represent daylight with a correlated color temperature of 6504K(39). During that same time period, it was discovered that retinal color stimuli can be broken down into divisions between light and dark ( $L^*$ ), red and green ( $a^*$ ), and blue and yellow ( $b^*$ )(31). The CIE  $L^*a^*b^*$  (also written as CIELAB) space remains popular today based on its acceptance of the theory that the eye perceives red, green, and blue based on its receptors(6).

There are three different axes based on these divisions. When placed on the vertical axis, the lightness and darkness somewhat resemble the value scale from the Munsell Color System(31). The vertical axis runs from a value of 0 to represent black to 100 to represent white (or a perfect reflecting diffuser). There are two horizontal axes that represent the color divisions. Opposite colors are on each end of the axis due to the fact that they cannot be both colors simultaneously. The  $a^*$  axis represents red, which has a positive value and green, which

has a negative value. The  $b^*$  axis represents yellow, which has a positive value and blue, which has a negative value. The center of each axes is 0, which represents a neutral color and the magnitude increases based on the amount of intensity or saturation of the color(6, 31). The CIE  $L^*a^*b^*$  color space is uniform and the perceived color differences parallel equal distances. The combination of the coordinates from the  $L^*a^*b^*$  axes represent a specific color(33). According to Joiner, “The advantage of the CIE  $L^*a^*b^*$  system is that color differences can be expressed in units that can be related to visual perception and clinical significance(6).” Thus, it makes the viewing of color more objective.

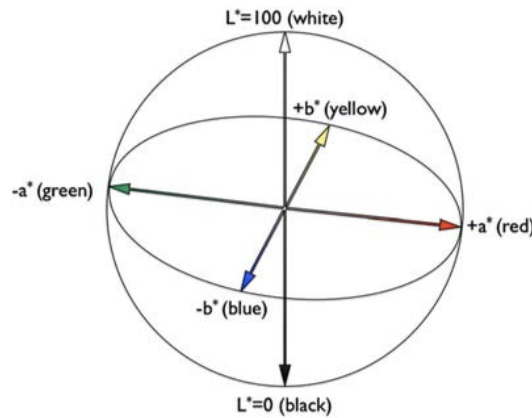

Figure 11. A Schematic Drawing Representing the CIELAB Color Space(33).

The CIE  $L^*a^*b^*$  values are used to calculate  $\Delta E$  which is used to measure and, “evaluate the accuracy and acceptability of the true and measured color differences(33).” The  $\Delta E$  (or total color difference) is determined by the following equation:

$$\Delta E = (\Delta L^{*2} + \Delta a^{*2} + \Delta b^{*2})^{1/2} \quad (33)$$

The human eye can detect a  $\Delta E$  greater than 1 if the conditions are controlled. The minimum total color difference ( $\Delta E = 1$ ) is what can be perceived in a controlled environment with two

objects next to each other. If the environment is changed to a less controlled clinical situation, a maximum total color difference of  $\Delta E = 3.3$  is the color difference the human eye can detect. A  $\Delta E$  of greater than 3.7 can be easily seen in a clinical situation and differences of this magnitude are considered insufficient matches(33).

#### ISO/TR 28642:2016 Dentistry - Guidance on Color Measurement

According to the International Organization for Standardization (ISO) standards, the blending of dental materials is a psycho-physical phenomenon. The CIELAB mathematical model does not encompass measurement in this capacity. The blending effect is not measurable optically by an instrument but is still considered visually perceptible(45).

#### CIE L\*a\*b\* Usage in Dentistry

CIE L\*a\*b\* color data are commonly used in dentistry to calculate coverage errors in shade selections as well as to compare values among different teeth or restorative materials. The following study used the information from the CIE L\*a\*b\* values to determine visual shade selection errors from different shade guides.

Shade matching dental composite to natural tooth structure can be a very difficult process considering variances in operatory lighting, as well as the quality of the practitioner's eyesight. In the study by Li et al. (2009), the investigators evaluated visual shade selection errors from five different shade guide systems. Ten prosthodontists were split into two groups based on experience (more or less than 5 years) and all passed a test for visual color deficiencies. They were asked to use shade guide systems for clinical shade matching of 60 patients with an

unrestored maxillary left central incisor (#9). The shade guide systems tested were: Vita Lumin Vacuum, Vitapan 3D-Master, Vintage Halo, Vintage Halo NCC, and Chromascop(46).

The procedures of the study by Li et al. (2009) were objectively straightforward. The patients consisted of an equal distribution of males and females with a balanced age range of 21 to 50 years. Their tooth had to be caries free with no restorations, no periodontal or orthodontic history, and no history of bleaching. Anyone with discoloration was not included in the study. The subjects were told to not use tobacco products, bleaching toothpastes, or colored beverages during the one-week duration of the study. Before selection of shade, both the tooth and shade guide were cleaned with pumice and a rubber prophylactic cup. A random number blocked out the names of the shade on each tab so the providers could not recall the shade by name and their order was changed (except for the 3D and NCC systems). The shade selection was done with one system per day on sunny days from 10am-2pm. The subjects were told to remove lipstick, wear a gray towel around their neck, and stand against a white wall. The shade tab was used to match the middle third of tooth #9 and the clinician was told to select the best shade. This was blinded to the other observers. If three or more observers chose the same shade tab, this shade was chosen for the tooth. If there was no agreement, than a consensus was taken from the observers(46).

After the shade of the tooth was selected, the shade tab and the tooth were optically measured. That measurement was done with a spectroradiometer and two fiber optic light cables (45 degrees illumination to the object), and was calibrated beforehand with a white reflectance tile. The aperture was set at 1.5mm and the distance to each object was 91.4mm. Spectral reflectance was converted to CIE L\*a\*b\* values (380-780nm in 2mm intervals). The shade tabs were held with a gingival shade guide and the subjects were placed in a fixed positioned with an apparatus normally used for eye treatments. The spectroradiometer was

able to move in all directions and five measurements were made on each tooth (after saliva removal) and on each shade tab(46).

After the evaluations were completed, the data were analyzed. Coverage error (CE) was calculated to find the average color difference of each shade guide. The significance between each shade guide was calculated with Tukey's procedure. Color differences between the shade tabs and teeth were also calculated. Independent t-test and a two-way ANOVA were used to test the color differences calculated and differences in clinical experience. Tukey's test was used again, after other analyses, to check shade guide differences. The reported p-values were listed as significant at or below 0.05(46).

The study by Li et al. (2009) was done to see coverage errors (CE) among five different shade guides in their clinical application by prosthodontists. The results of the study were that the CE was significantly lower in the Vintage Halo NCC (NCC) and Vitapan 3D-Master (3D) shade guides. The CE for the Vita shade guide was the highest of all five, which meant that it had the most errors. They also found that the average difference of color ( $\Delta E$ ) was significantly decreased with the NCC and 3D systems when consensus was used. The two-way ANOVA showed that there was a significant difference ( $p < 0.001$ ) among the shade guides and among the clinicians ( $P = 0.013$ ) but that there was no difference when they were combined. The  $\Delta E$  was the highest with the Vita guide and the lowest with the 3D (with no significant difference among the remaining systems). Even though the 3D and NCC systems showed the best shade matching capabilities, none of the shade guide systems achieved a clinically compatible shade match(46).

In a study by Dietschi et al. (2006), investigators compared the optical properties in various shades of teeth to those of the Miris dental composite system. The design of the study

was an analytical, two-phase, *in vitro* study that developed a new method to apply direct dental composites in a way that was optically similar to the color of natural teeth(27). The method was based on the contrast ratio and colorimetric L\*a\*b\* data of the enamel and dentin from human teeth as well as the Miris dental composite system by Coltene Whaledent.

The methods for this study by Dietschi et al. (2006) utilized both natural teeth as well as teeth fabricated out of resin. Eight extracted teeth (arranged via Vita shade system from A1-4 and B1-3) were evaluated based on their color and opacity with both a white and a black background. They were categorized as young, adult, or old enamel (not by actual age but by presentation of enamel wear and tint). The roots were embedded into a clear, epoxy resin. A superficial slice was removed from the widest plane of enamel and a section of about 1mm thick (under this enamel) was also removed by a slow-rotating saw. The sections were measured with a reflectance colorimetric device (Minolta CR-21). During the second phase, standardized samples were made from Miris dental composite (which was developed according to data produced from human teeth). The optical properties of the Miris dental composites were also tested in the same way as the natural teeth. There were five samples of each dentin shade (S1-7) and enamel shade (white bleach - WB, white regular - WR, neutral regular - NR, neutral transparent - NT, ivory regular - IR and ivory transparent - IT)(27).

Descriptive statistics were computed for the natural and dental composite teeth data. The unpaired student t-test was used to test the differences between the dentin L\*a\*b\* values and the vita shades in the same chroma range (Vita A and B shades). Dietschi et al. (2006) stated that they did not want to test the natural teeth against the Miris teeth because the visual properties of the dental composite change once placed intraorally(27).



The results of the study by Dietschi et al. (2006) showed a general trend that younger teeth had a higher value than older teeth and older teeth had more of a yellow hue than did the younger teeth. More specifically, the dentin color of the natural teeth showed that they were slightly on the green side (negative  $a^*$ ) with no variation between the A or B Vita shades, the color yellow increased in the darker shades (positive  $b^*$ ), and the lightness varied inversely to the chroma (as the chroma increased from A1-4 and B1-3, the  $L^*$  decreased). Dietschi et al. (2006) also found that the recorded mean of contrast ratio (opacity) for enamel was 0.435 and for dentin was 0.66. Thus, dentin was found to be more opaque than enamel. The enamel varied from age of tooth (higher value in the young teeth, lower in the old teeth). The dentin color of the Miris dental composite showed that  $L^*$  values diminish,  $a^*$  values shift from green to red, and  $b^*$  values increase with increased chroma. There were no p-values listed within the study, only means and standard deviations. The mean values and distribution of  $L^*a^*b^*$  values of the natural teeth categorized into vita shades and the Miris teeth were given separately for dentin and enamel(27).

The differences in enamel were primarily due to the age of the teeth; younger teeth had a higher value, less translucency, and high opalescence, while older teeth had higher translucency with a yellow tint and less value. Dietschi et al. (2006) used this information to establish a “natural layering concept, which embraces more accurately the optical and anatomic characteristics of natural teeth” (Dietschi 2006). The authors noted that Miris is not the only available product on the market that has these properties - Vitalscence (Ultradent) and Ceram-X duo (Dentsply) have similar features(27).

## Optical Integration of Dental Composites

A study by Dietschi et al. (2012) evaluated the optical integration of dental composites on class IV restorations with visual and spectrophotometric measurements. It was an analytical, randomized *in vivo* study of eight patients that received 11 class IV restorations on maxillary incisors (including up to ½ of the incisal edge) by fourth and fifth year dental students. The operators (both students and faculty) were calibrated for the assessment of visual observation per the optical United States Public Health Service (USPHS) evaluation scale. Intraoral photographs were taken before and a week after the procedure for proof of visual evaluations. The shade was selected by the student for the Miris2 dental composite system and confirmed with the faculty. The subjects were evaluated both visually and with a calibrated reflectance spectrophotometer (CIE 1976 L\*a\*b\* measurements were taken of restoration and natural tooth without any background)(30).

Dietschi et al. (2012) measured the color one week after final polish was completed on the restoration. The teeth were measured in multiple locations to compare the surface integration of the natural tooth to the restoration. The entire restoration was compared to contralateral half of the natural tooth, spot measurements were taken to compare tooth and restoration, and spot measurements were also taken to compare tooth and bevel (both in the incisal, middle and cervical thirds of the restoration). The data were analyzed via the Kruskal–Wallis non-parametric test. To establish the agreement between the values of color differences and their corresponding visual scores, a Kendall's tau coefficient of concordance was used(30).

The authors found that a statistically significant degree of correlation could be made by visual and spectrophotometric evaluation of color on maxillary anterior teeth restored with direct class IV dental composites. Their findings of color integration and what correlated to

clinically optimal, acceptable, and unacceptable scores confirmed the range of color differences ( $\Delta E$ ) in L\*a\*b\* values from the literature. The overall results showed that dental composite, by direct application, can be shown to have esthetic results and satisfactory levels of optical integration between natural tooth and restoration(30).

## CHAPTER III: MATERIALS AND METHODS

### Overview

The purpose of this study was to determine which type of bevel in a class IV dental composite restoration is the most esthetic and most closely mimics the optical properties of natural tooth structure via clinical and spectrophotometric evaluations.

### Research Questions

What type of beveled finish line is the most esthetic when directly restoring a class IV anterior tooth using a dental nanocomposite? Does the bevel that appears to be most esthetic clinically, correlate to the best (most like tooth structure) when measured optically with a spectrophotometer?

### Null Hypotheses

H<sub>0</sub>1. There is no difference in visual evaluation rank scores among five groups of evaluators for each type of bevel.

H<sub>0</sub>2. There is no agreement in the visual evaluation rank scores of the seven groups of bevels among all evaluators or within each group of evaluators.

H<sub>0</sub>3. There is no difference in the lightness values among seven types of bevels at each of eight measurement points or for the whole tooth as measured by a spectrophotometer.

H<sub>0</sub>4. There is no correlation between the visual evaluation and the spectrophotometric evaluation.

## Variables

Independent variable – bevel type (6 types, positive control, and a negative control)

Dependent variables – level of esthetics and measurements of optical properties (lightness)

## Operational Definitions

1. Clinical evaluation of seven types of class IV bevels will be done by various evaluators with different educational levels and backgrounds to determine the least to most esthetic bevel.
2. A bevel is defined as a slanted surface (not perpendicular) and this will be placed on each sample in varying degrees.
3. An esthetic bevel would be defined as visually undetectable so that it would appear as a natural tooth without restoration.
4. Class IV fracture involves a proximal area along with the adjacent incisal, facial and lingual surfaces on an anterior tooth.

## Pilot Study

A pilot study was conducted to evaluate the fabrication of the samples, to test the spectrophotometer and to determine the necessary sample size via statistical analyses.

### Initial Pilot Design

There are a variety of custom shade guide templates on the market today. These allow the practitioner to fabricate samples of different color combinations of dental composites with

uniform layers of dentin and enamel shade composites. Some examples (shown in Figure 12) include *My Shade Guide* by Smile Line (Smile Line USA, Inc., Wheat Ridge, CO, USA), Estelite Omega Custom Shade Guide by Tokuyama (Tokuyama Dental America Inc., Encinitas, CA, USA)(47), and Custom Shade Guide by 3M (3M, St. Paul, MN, USA)(47, 48).

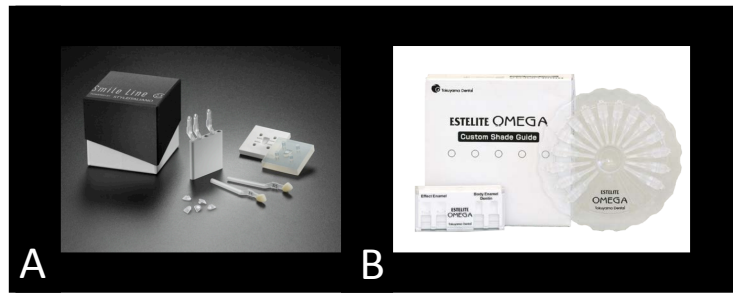

Figure 12. A. *My Shade Guide* by Smile Line(48). B. Estelite Omega Custom Shade Guide by Tokuyama(47).

The original protocol was designed to use the custom shade guide by 3M ESPE to fabricate virtually identical samples made of dental composite. After further investigation, it was found that the template would create samples that were far too thin (buccal-lingually) to create a proper beveled finish line and thus, an esthetic, natural-looking restoration similar to that which would be seen *in vivo*. It was decided that a custom matrix would be necessary to create the ideal thickness and contours of each sample.

Kilgore International, Inc. made the original, unprepared tooth out of melamine and its intended use was for the 200 series typodont (Kilgore International, Inc., Coldwater, MI, USA). The anterior left maxillary incisor (tooth #9) was prepared with a class IV fracture to simulate a fracture within the enamel and dentin of a natural tooth (Ellis class II fracture). After preparation, it was sent back to the company in order for them to replicate it via computer aided design/computer aided manufacturing (CAD/CAM). The order was placed for customized

replacement teeth with an anatomic crown and a straight root. This was done to create samples with class IV fractures that were as identical as possible (Figure 13).



Figure 13. CAD/CAM Class IV Fractured Sample.

#### Division of Groups & Preparation of the Bevels

The samples were divided into seven groups (listed in Table 2) with the original, unprepared typodont tooth, used for reference. In order to achieve the same bevel length within each group with a bevel (groups 2-7), the teeth were measured from the fracture line on the facial-incisal angle toward the lingual and onto the facial with a digital caliper (Series 500, Mitutoyo America Corporation, Aurora, IL, USA).

Table 2. Division of Study Groups

Group 1	Group 2	Group 3	Group 4	Group 5	Group 6	Group 7	Original
Negative Control	Short	Short, scalloped	Long	Long, scalloped	Infinite	Infinite, scalloped	Positive Control
No Bevel	1mm F x 1mm I	1mm F x 1mm I	2mm F x 1mm I	2mm F x 1mm I	3mm F x 1mm I	3mm F x 1mm I	No fracture

\*F – facial surface; I – incisal surface

All beveled teeth were measured and marked 1mm from the facial-incisal fracture line, on the incisal but toward the lingual (see Figure 13). After the incisal portion was marked, each

sample was measured and marked from the facial-incisal fracture line on the facial; 1mm for groups 2 and 3, 2mm for groups 4 and 5, and 3mm for groups 6 and 7. After they were marked, the lines were connected with a high-speed handpiece and long flame diamond bur (8863.FG.012 - Komet USA LLC, Rock Hill, SC, USA) to achieve the desired bevel length (see Figure 14).

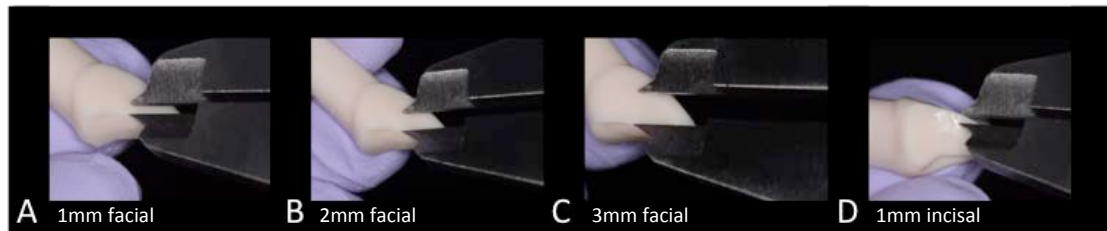

Figure 14. A. Measurement of 1mm on Facial Surface. B. Measurement of 2mm on Facial Surface. C. Measurement of 3mm on Facial Surface. D. Measurement of 1mm on Incisal Surface.

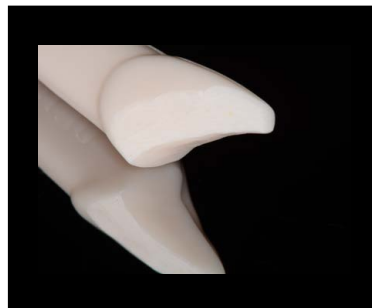

Figure 15. Example of a Completed Bevel.

If the group called for a scalloped margin, the scallop was made including and beyond the most cervical margin in a wave-like design. Each sample that was scalloped had three “wave” extensions that were no more than 1mm toward the cervical area of the tooth; and the furthest projections were located along each facial lobe. Along with the use of the diamond bur, the infinite margins were smoothed with dark orange Sof-Lex Extra-Thin (XT) Contouring and



Polishing Discs (3M, St. Paul, MN, USA) to blend the margin and make the finish line invisible (see Figure 15).

### Putty Fabrication

In order to recreate the lost tooth structure in a predictable and precise way, two matrices were made. The first one was based on the original, un-prepared typodont tooth. The second was the negative control (fractured typodont tooth with no bevel) that had the dentin core layer build up completed. For both typodont teeth, the bottom half of the matrix was made with Exaflex VPS Putty (GC America, Alsip, IL, USA) by combining the catalyst/base to replicate the lingual half of the typodont tooth.

The top part of each matrix (facial surface) was made with Copyplast 1.0x125mm stent material (Scheu Dental, Iserlohn, Germany) used in a Biostar VI Positive Pressure Thermal-Forming Machine (Scheu Dental, Iserlohn, Germany). The stents were trimmed well beyond the borders of the typodont teeth in order to overlap the putty base. The goal was to place the class IV fractured typodont teeth into these matrices and restore with dental composite (dentin core first, followed by the enamel layer). The top layer was found to be too pliable after the fabrication of a few samples. A new stent was made by placing two sheets of the Copyplast material in the Biostar machine at the same time to double the thickness of the matrix. To allow an escape path for excess composite, “v” shaped notches were cut into the putty portion of the matrix on the proximal surfaces of the sample impression after the fabrication of the top matrix.

## Putty Dentin Matrix

Using the negative control sample, a layer of composite was built to simulate the dentin layer of a natural tooth. After curing the composite, the sample was placed into the bottom portion of the putty matrix. A new top layer was fabricated in the same way as the original sample matrix, with the Copyplast material in the Biostar machine. This step enabled standardization of the size of the dentin layers within the samples. The only difference in the dentin layer between the samples was the interface where the actual bevel was prepared.



Figure 16. Example of a Putty Dentin Matrix.

After making and evaluating the samples, it was noted that even though a matrix was used for both the dentin core and the enamel shell, there was variance in the amount of dental composite in each. The reason for this was likely due to the lack of rigidity of the matrices. The amount of dental composite was noticeably different for each sample that was fabricated. There were many challenges with using this type of matrix; the main challenge was that it was very difficult to hold the matrix on top of the putty with one hand evenly, while utilizing the other hand for light curing. In order to make sure that even pressure was being applied, both hands would be needed to press the matrix together. Holding the sample and light curing the sample would have required two people and that was not possible at that point in the pilot study. It was

thought that a more rigid matrix would be necessary (similar to those of the shade tab makers) in order to make the samples with as little variance as possible.

### 3D Mold Fabrication

The staff at the University of Iowa Engineering Lab was consulted to utilize their Fortus 400mc 3-Dimensional (3D) Printer (Stratasys, Eden Prairie, MN, US). The thought was that if we could design and print two molds, one for the dentin core and one for the enamel layer, we would be able to reproduce samples with minimal variance. These molds would mimic that of the shade tab maker, but would be custom to our samples. The only area among the samples that would be different would be the area of the bevel. The original typodont tooth, as well as the negative control with the dentin core build up, were taken to the lab to be scanned. The Estelite Omega Custom Shade Guide (Tokuyama Dental America Inc., Encinitas, CA, USA) maker was also brought in as an example of what we were trying to construct(47). The teeth were scanned and the images were inverted to create a mold. The machinists at the engineering lab made multiple prototypes, but none of them met the needs of what we were trying to accomplish. The prototypes ended up being too large, too thick or not able to be re-approximated consistently for use on each sample. They had difficulty with the design aspect of the models and did not have staff available to help with it. After months of trials and prototypes, the lab decided it was beyond their designing capabilities to complete the molds.

### 3D Mold Digital Design

After the setback with the molds, it was decided that the next step was to meet with a 3D Design Graduate from the School of Art & Art History at the University of Iowa. The designer was able to scan the original tooth as well as the negative control with the dentin core build up.

He created prototype molds on the 3ds Max software (Autodesk, Inc., San Rafael, CA, USA) that were of similar design to the Tokuyama shade guide maker. After a few visits to his studio, and modifications on the design software, the designer was able to 3D print some prototypes. The prototypes were evaluated, and some small changes were made. There was an area added that acted as a fastener to allow for proper, reproducible closure. The channels that performed as vents for excess composite needed to be widened as well. Once those modifications were complete, the models were sent back to the Engineering Lab to be printed on acrylic material with their 3D printer.

After completion of the printing process (Figure 17), the molds were evaluated with the typodont tooth samples, to make sure they fit accurately. The coronal portion was an accurate fit but the “root” portion was slightly narrowed. There was something that was not translating with the calculations of the software so the designer suggested manually removing some of the acrylic with a bur. Once the root area of the mold was widened, the samples fit in perfectly and the molds were ready for the restoration process.

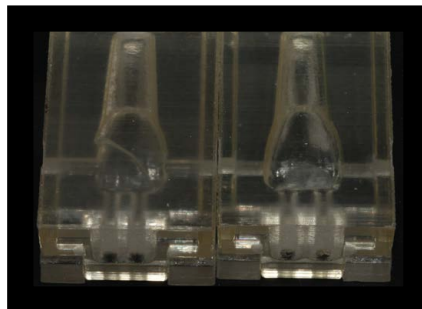

Figure 17. Final 3D Printed Acrylic Molds; Dentin Core (left) and Enamel Shell (right).

## Composite Materials

The dental composite that was chosen for use in the study was Filtek Supreme Ultra, which is a nanocomposite (3M, St. Paul, MN, USA). Filtek Supreme Ultra presents with 36 shades of composite and is divided into four different groups of opacities (from most opaque to least opaque): dentin, body, enamel and translucent. As the typodont tooth is completely opaque, the dentin group was chosen to comprise the bulk of the restoration, with the body group used for the final enamel layer. The shade was not as important because shade match was not being tested in this experiment. The study design required the evaluators to be able to tell the difference between the sample and the restoration and evaluate the blend of the restorative material onto the tooth structure.

The chosen shades were A1 dentin (A1D lot # N592130) for the dentin layer and B1 body (B1B lot # N597084) for the enamel layer. Prior to placement, the dental composite capsules were kept warm in a CALSET Composite Warmer (AdDent Inc., Danbury, CT, USA) to increase the flow of the material in to the molds. The dental composites were bonded to the typodont teeth with the use of microbrush applicators (Kerr Corporation, Orange, CA, USA) and Optibond FI adhesive system (lot #5256022 - Kerr Corporation, Orange, CA, USA) after etching the tooth with Ultraetch 35% Phosphoric Acid (Ultradent Products, Inc., South Jordan, UT, USA). As there was no dentin or enamel to bond to, the etchant was used purely to clean the surface of the typodont tooth. The molds were sprayed with Silicone Spray (Dentsply, York, PA, USA) to avoid chemical adhesion between the dental composite and the acrylic mold. The adhesive materials were light cured with the Valo LED Curing Light AF907 (Ultradent Products, Inc., South Jordan, UT, USA) to the required  $18 \text{ J/cm}^2$  of radiant exposure for the Optibond FI adhesive. The Filtek Supreme Ultra dental composites were light cured to a minimum of  $16 \text{ J/cm}^2$  of radiant

exposure for the A1 dentin and 8 J/cm<sup>2</sup> of radiant exposure for the B1 body shades. The dental composites were air abraded with Alumina 50 micron (Ivoclar Vivadent AG, Schaan, Liechtenstein) after finishing of dentin core, to enhance bonding with the enamel layer.

#### Restoration Process - Fabrication of Dentin Core

After completion of the new dentin layer matrix, the dentin cores were made for each sample in each group with the Filtek Supreme Ultra A1D dentin shade. The steps of the dentin core fabrication were as follows:

1. Acid etched with Ultraetch 35% phosphoric acid for 15 seconds, rinsed for 30 seconds with water, and then air-dried with 3-way syringe. (Figure 18A)
2. Applied Optibond FL adhesive to areas requiring bonding with microbrush applicator and light cured (18 J/cm<sup>2</sup>) with the Valo LED Curing Light. (Figure 18B)
3. Sprayed mold with Dentsply silicon spray to avoid adherence between acrylic mold and dental composite.
4. Placed sample in mold with Filtek Supreme Ultra shade: A1 Dentin. (Figure 18C)
5. Light cured with the Valo LED Curing Light; 16 J/cm<sup>2</sup> on buccal and lingual while in the mold and then 16 J/cm<sup>2</sup> on buccal and lingual once taken out of the mold. (Figure 18D/E)
6. Added A1D to the most incisal portion of the bevel and extended it about halfway up the facial surface of the bevel from bevel's cervical edge and light cured (16 J/cm<sup>2</sup>) with the Valo LED Curing Light. (Figure 18F)

7. Trimmed excess dental composite from vents with a long flame diamond bur (8863.FG.012 Komet) and dark orange Sof-Lex Extra-Thin (XT) Contouring and Polishing Discs.

8. Air abraded bonding surface (50micron Aluminum oxide) and rinsed with water.

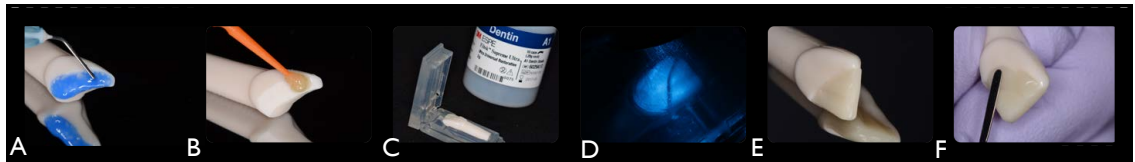

Figure 18. Steps for Dentin Core Placement.

After completion of the sample with the dentin layer, the matrix made from the original, uncut, sample was used to restore the remaining enamel layer. Filtek Supreme Ultra B1 body shade was placed over the dentin layer and on top of the bevel. The matrix was placed on top of the composite and digital pressure was used to force the surplus composite to the proximal vent areas. The entire sample (within the matrix) was light cured with the Valo LED curing light. These steps were repeated to restore the samples from all of the groups requiring restoration.

The detailed steps for the fabrication of the enamel layer were as follows:

1. Acid etched with Ultraetch 34% phosphoric acid for 15 seconds, rinsed for 30 seconds with water, and then air-dried with 3-way syringe.
2. Applied Optibond FL adhesive to areas requiring bonding with microbrush applicators and light cured  $18 \text{ J/cm}^2$  with the Valo LED Curing Light.
3. Sprayed mold with silicon spray to avoid adherence.
4. Placed sample in mold with Filtek Supreme Ultra - shade: B1 Body. (Figure 19 A/B)

5. Light cured 8 J/cm<sup>2</sup> on buccal/lingual twice (once in mold, once out) with the Valo LED Curing Light.

6. Trimmed excess RBC with a long flame diamond bur (8863.FG.012 Komet) and dark orange Sof-Lex Extra-Thin (XT) Contouring and Polishing Discs. (Figure 19C)

7. Polished surface. (Figure 19D) Steps detailed in Finishing and Polishing section.

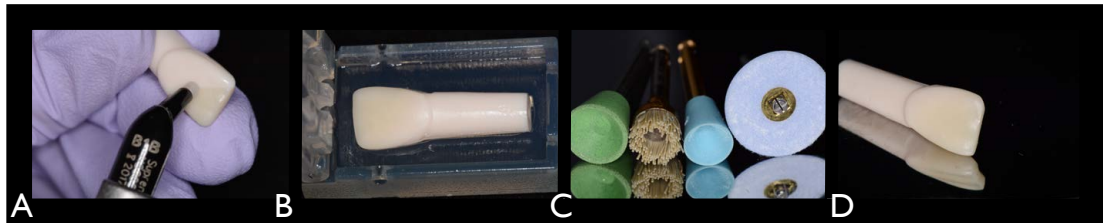

Figure 19. Steps for Enamel Layer Placement.

### Finishing and Polishing

The excess composite that was vented to the proximal and incisal areas of the sample required removal. Sof-Lex Extra-Thin (XT) Contouring and Polishing Discs in dark orange were used in to remove the excess composite. If any excess composite remained on the facial surface beyond the bevel, a series of finishing and polishing steps followed. First, a long flame diamond bur (8863.FG.012) was used to remove excess. Second, a green Jiffy cup pre-polisher (Ultradent Products, Inc., South Jordan, UT, USA) and then a blue aluminum oxide GlossPLUS Polisher from the KerrHawe HiLuster PLUS Polishing System (Kerr Corporation, Orange, CA, USA) were used, with water, to contour the composite. Finally, a FlexiBuff Mini disc (Cosmedent Inc., Chicago, IL, USA) with Enamelize Polishing Paste (Cosmedent Inc., Chicago, IL, USA) was used to polish the restoration. All samples were rinsed between and after final polishing steps. Upon completion of restoration, the samples were stored in distilled water.



## Sample Evaluation

### Visual Evaluation

After the samples were completed, a calibrated examiner selected the best one of the three samples (per group) to be represented in the visual evaluation. There were five groups of evaluators (n=5 per group) selected to participate in the visual evaluation. The five groups included faculty, graduate residents, dental students, dental assistants/hygienists, and auxiliary staff from the University of Iowa College of Dentistry & Dental Clinics. The participants were contacted via email and asked to participate in the study. The Institutional Review Board at the University of Iowa reviewed the study (IRB number: 201602762) and determined that the project described in the application *does not* meet the regulatory definition of human subjects research and does not require review by the IRB. This project did not involve human subjects as defined in the regulations; no human teeth were used, and the people that evaluated the samples did not provide any personally identifying information.

The visual evaluation was held in the Biomaterials lab in the Department of Operative Dentistry at the University of Iowa College of Dentistry & Dental Clinics. Each sample had the typodont screw placed in its root and a tag was placed on the screw. Each tag was labeled with a different shape, so that an order could not be achieved by just looking at the tags. The table identifying which shape was associated with each group was kept concealed from the study participants. The groups were labeled with the following shapes (see Table 3).

Table 3. Group Identification for Visual Evaluation

Group	Shape assigned
1. Negative control, no bevel	Heart
2. Short, straight bevel	Star
3. Short, scalloped bevel	Triangle
4. Long, straight bevel	Square
5. Long, scalloped bevel	Circle
6. Infinite, straight bevel	Moon
7. Infinite, scalloped bevel	Clover

One sample for each group was placed into a cup filled with water within a GTI Minimatcher (MM4e) light box (GTI Graphic Technology Inc., Newburgh, NY, USA). The light box was set to the daylight setting (CIE standard illumination D65, 6500 K). The instructions to the participant were given verbally as well as on a written document taped to the light box (Figure 20).

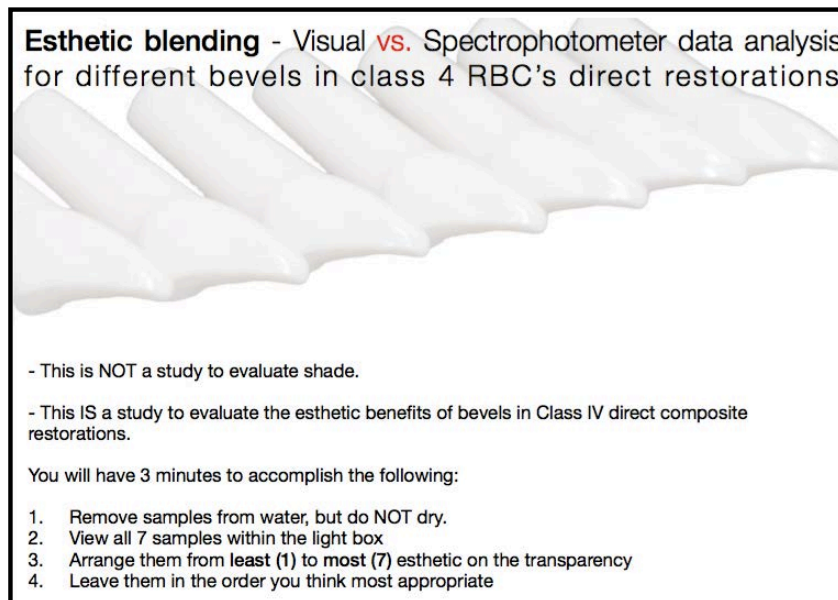

Figure 20. Written Instructions for Visual Evaluation Participants (Pilot Study).

A grid was made and printed on a transparency with boxes numbered 1-7 on which to place the samples (Figure 21), and was placed within the light box. The evaluators were asked to place the samples in the order they deemed least esthetic (1) to most esthetic (7); or what looked the worst (1) to what looked the best (7). After they confirmed the order of the samples, the data was documented in a spreadsheet using a 7-point Likert scale ranging from 1 = the least esthetic to 7 = the most esthetic for the statistical analysis. The samples were then removed from the transparency and placed back into the water cup to get ready for the next evaluator.

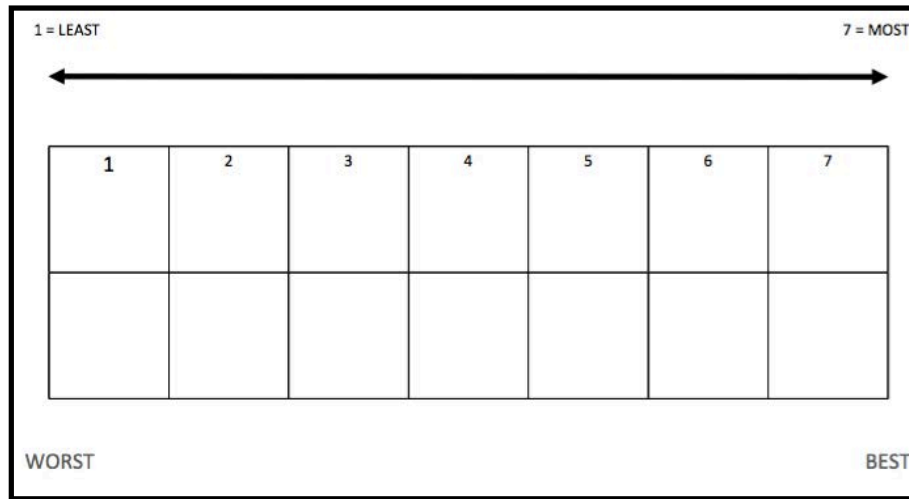

Figure 21. Diagram of the Ranked Order Transparency from within the Light Box.

The samples used in the visual evaluation had their tags removed and were returned to their respective groups. The subjective component of the pilot was completed and it was time to move on to the objective component - the evaluation via spectrophotometer.

#### Spectrophotometer Evaluation

The next phase of the pilot was to determine the objective measurement of Lightness ( $L^*$ ) on multiple points for each sample in each group, along with an un-prepared typodont

tooth that was used as a reference. Each of the seven bevel groups had three samples and they were all measured twice, once with a white background and once with a black background.

The samples were placed within a Kilgore hard gingivae typodont (D81SDP-200 – Kilgore International, Inc., Coldwater, MI, USA) and mounted on a Compact Bench Mounting Unit (CBM-3 - Kilgore International, Inc., Coldwater, MI, USA) with a black or white paper placed behind the anterior teeth. Each sample was scanned with the Spectro Shade (Clon 3D, Albuquerque, NM, USA). The spectrophotometer was turned on and prior to measuring each sample, it was calibrated by scanning the white, then the green calibration tiles from the prompts of the machine.

After the calibration was successful, the spectrophotometer's optic handpiece was placed 90 degrees to the facial surface of the sample so that the sample centered within the yellow-outlined target box and was flush against the typodont, to ensure equal distance for each measurement. Within that yellow target box was a yellow "plus sign" in the center. In order to get proper alignment on the screen of the spectrophotometer, there was a green horizontal line (horizontal alignment indicator) and a blue "plus sign" (vertical alignment indicator) that both needed to be superimposed on the yellow "plus sign" within the target box. Once all three were superimposed properly, a green light would come on, indicating that the spectrophotometer was in proper position to take the measurement/photo. If the measurement was taken and anything but a green light was apparent on the screen (red or yellow), then the measurement was repeated.

The sample was measured by pressing the measuring button on the optic handpiece for 3 seconds. Once the image was displayed on the screen of the optical handpiece, the "compare" button was selected, followed by the "measure" button. The square shape was selected to

measure 7 different points from incisal to cervical of each sample. There was a transparent grid taped to the viewing surface of the handpiece to reproduce the exact same points (labeled A-H) on measurement of each subsequent sample (Figure 22). When the point was selected, the LAB selection was chosen and the Lightness ( $L^*$ ) value for each point was recorded on a spreadsheet. This was done twice for each sample, once with a white background and once with a black background. The samples were labeled 1-22 with a marker on the root structure, starting with 1 in group one to 22 as the original, un-prepared tooth (reference). In the event that the sample would need to be re-measured, the correct sample could be easily retrieved.



Figure 22. Spectro Shade Spectrophotometer with Grid Attached and Image of the Typodont.

#### Power and Sample Size Analysis

A statistical power analysis was performed for sample size estimation based on data from pilot study. With an  $\alpha = 0.05$  and power = 90%, the projected sample size of 85 ( $n=17$ /per group) would be required to have the capability to distinguish the difference in visual evaluation rank scores (which differ by 0.80) between the groups of evaluators while assuming the standard deviation is 0.71 (effect size = 0.81), using specified contrast in a one-way ANOVA procedure.

## Final Study

### Procedural Changes

The light-curing device was changed from the Valo LED Curing Light AF907 (Ultradent Products, Inc., South Jordan, UT, USA) to the Smartlite Focus SLA C02786 (Dentsply, York, PA, USA), due to lack of availability of the Valo curing light during the timing of the research. The adhesive and composite materials were minimally light cured to the required  $18 \text{ J/cm}^2$  of radiant exposure for the Optibond FI adhesive and  $16 \text{ J/cm}^2$  and  $8 \text{ J/cm}^2$  of radiant exposure for the A1 dentin and B1 body Filtek Supreme Ultra dental composite, respectively.

The fabrication of the samples remained the same for all samples up until the point of finishing and polishing. The samples were still finished in the same manner as listed in the pilot study section. However, instead of using the Mini FlexiBuff disc (Cosmedent Inc., Chicago, IL, USA) with Enamelize (Cosmedent Inc., Chicago, IL, USA) polishing paste, each sample was again air abraded with Alumina 50 micron (Ivoclar Vivadent AG, Schaan, Liechtenstein). To make each sample look equally polished, BisCover Low Viscosity Liquid Polish (Lot#1600002973 - BISCO Dental Products, Schaumburg, IL, USA) was used as the final step (see Figure 22).

The directions for BisCover LV were taken from the manufacturers website for old/previously placed composites and were completed as follows(49):

1. Air abraded the entire coronal portion of the sample with alumina ( $\text{Al}_2\text{O}_3$ ) 50 micron air abrasive. Rinse and dry.
2. Acid etched with Ultraetch 35% phosphoric acid for 15 seconds.
3. Rinsed for 30 seconds with water, and then air-dried with 3-way syringe.

5. Dispensed BisCover LV into a mixing well. Dipped the microbrush applicators into the BisCover LV. Wiped excess from the brush onto the side of mixing well (so that the microbrush was not saturated, just wet enough to apply one thin coat).

6. Applied a thin coat of BisCover LV in one direction with a smooth stroke. Allowed 15 seconds for evaporation of solvent after application. (Figure 23)

7. Light cured with LED for 30 seconds at close range (0-2mm) on buccal, lingual, mesial, and distal surfaces of each sample.



Figure 23. Placement of BisCover LV on Sample.

After completion of the BisCover layer, samples were stored in an air-tight container until visual and spectrophotometric evaluation.

#### Changes to Visual Evaluations

Based on the power analysis on data from the pilot study as described previously, the number of evaluators was increased from 5 per group to a minimum of 17 per group. The total number of evaluators for the final study was as follows: 17 faculty, 18 graduate students, 18 pre-doctoral dental students, 19 dental assistants, registered dental hygienists, and dental lab technicians, and 20 auxiliary staff.

For sake of ease, the mounting of the samples was changed from the screw and tag in a cup of water. In order to be handled and easily placed on the transparency, the samples were embedded in a cube of Exaflex VPS Putty (GC America, Alsip, IL, USA) with the “root” portion in the putty and the crown exposed. The facial, mesial, distal, and lingual surfaces of the sample all were parallel to one surface of the putty cube. This enabled the evaluators to pick up the samples, without touching the crowns, and place them onto the grid in the lightbox with the facial surfaces facing up. The samples were not stored in water after each evaluation, but were placed back into a box in a random order before the next evaluator came. The instructions changed slightly from the pilot study, and were given to the participant verbally as well as on a written document taped to the light box as indicated in Figure 24.

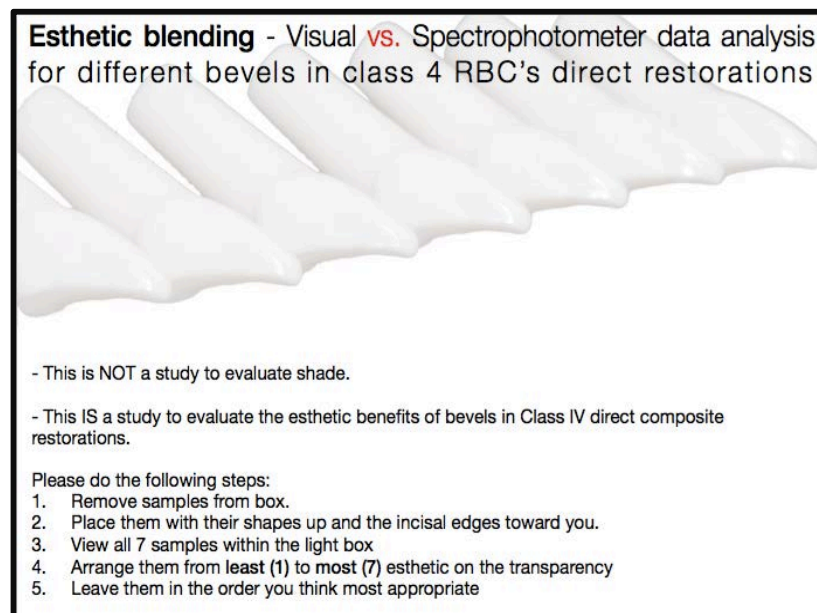

Figure 24. Written Instructions for Visual Evaluation Participants (Final Study).



## Changes to Spectrophotometric Evaluation

The overall procedure for the spectrophotometric evaluation remained the same. Each sample was scanned with the Clon 3D Spectro Shade spectrophotometer. Instead of taking the measurements separately with the black and the white backgrounds on each sample, only the black background was used behind the samples. There was minimal variance during the pilot study of the Lightness ( $L^*$ ) values when it came to the same sample on the white versus the black background. This is likely due to the opacity of the materials used.

The sample size increased by adding two more samples for each group. There was also an eighth measurement point added per sample to increase the amount of surface being measured. The samples were labeled 1-36 with a marker on the root structure, starting with 1 in group one to 36 as the original, un-prepared tooth (reference). In the event that the sample would need to be re-measured, the correct sample could be easily retrieved.

### An Overview of Statistical Methods for the Pilot and Final Studies

#### Statistical Analysis for Visual Evaluation

Descriptive statistics were computed. One-way ANOVA with the post-hoc Tukey's HSD (Honestly Significant Difference) was conducted to determine whether there was a significant difference in mean visual evaluation rank scores among the five different groups of evaluators for each type of bevel. The Shapiro-Wilk test was applied to verify normality of residuals whenever ANOVA model was conducted. If the assumption of normality was violated, a one-way ANOVA on the ranked data (i.e. equivalent to non-parametric Kruskal-Wallis test) followed by

the post-hoc Bonferroni test was used to determine whether there was a significant difference in visual evaluation rank scores among the five different groups of evaluators.

Additionally, Kendall's coefficient of concordance (Kendall's W) for ordinal responses was used to evaluate an agreement among multiple raters. Note that Kendall's W varies between 0, denoting no agreement, and 1 denoting perfect agreement. The following lists an approximate guide for interpreting an agreement that corresponds to Kendall's W:

- (i) 0=no agreement
- (ii) 0.00-0.19=weak agreement
- (iii) 0.20-0.39=fair agreement
- (iv) 0.40-0.59=moderate agreement
- (v) 0.60-0.79=good agreement
- (vi) 0.80-0.99=strong agreement
- (vii) 1.00=perfect agreement

All tests utilized a significance level of 0.05. SAS for Windows (v9.4, SAS Institute Inc., Cary, NC, USA) was used for the data analysis.

#### Statistical Analysis for Spectrophotometric Measurements of Lightness

Descriptive statistics were computed. One-way ANOVA with the post-hoc Tukey's HSD (Honestly Significant Difference) was conducted to determine whether there was a significant difference in mean lightness values among seven types of bevels at each of eight measurement points. Additionally, Dunnett's test was used to compare the reference group (untouched tooth) with each of the seven experimental groups.

The Shapiro-Wilk test was applied to verify normality of residuals whenever ANOVA model was conducted.

All tests utilized a significance level of 0.05. SAS for Windows (v9.4, SAS Institute Inc., Cary, NC, USA) was used for the data analysis.

#### Statistical Analysis on Correlation between Visual and Spectrophotometric Evaluations

Pearson correlation test was used to determine whether the significant relationship existed between the visual evaluation scores and lightness values, and the simple linear regression analysis was performed to generate an equation to describe the statistical relationship between the two variables.

Additionally, the following is an approximate guide for interpreting the strength of the relationship between two variables, based on the absolute value of the Pearson's correlation coefficient:

(i)  $\pm 1$ = perfect correlation

(ii)  $\pm 0.8$ =strong correlation

(iii)  $\pm 0.5$ =moderate correlation

(iv)  $\pm 0.2$ =weak correlation

(v)  $\pm 0.00$ =no correlation

**Note:** a negative coefficient indicates a negative correlation between the two variables, while a positive coefficient indicates a positive correlation between the two variables.

All tests utilized a significance level of 0.05. SAS for Windows (v9.4, SAS Institute Inc., Cary, NC, USA) was used for the data analysis.

## CHAPTER IV: RESULTS

### Statistical Results from Pilot Study

Twenty-five evaluators were selected, including 5 assistants, 5 faculty, 5 staff, 5 students, and 5 residents. Each evaluator was asked to rate seven images in rank order form 1 (least preferred choice) to 7 (most preferred choice). Descriptive statistics of ratings are presented in Tables 4 and 5.

Table 4. Frequency Distribution of Rating by Types of Evaluators and Types of Bevel (Pilot Study)

Bevel Types	Rating Scores						
	1	2	3	4	5	6	7
<b>All Evaluators (n=25)</b>							
No bevel (Negative control)	22 88%	2 8%	0 0%	1 4%	0 0%	0 0%	0 0%
Short and straight bevel	1 4%	16 64%	5 20%	2 8%	1 4%	0 0%	0 0%
Short and scalloped bevel	1 4%	0 0%	6 24%	7 28%	9 36%	1 4%	1 4%
Long and straight bevel	0 0%	6 24%	7 28%	7 28%	5 20%	0 0%	0 0%
Long and scalloped bevel	1 4%	1 4%	7 28%	6 24%	9 36%	0 0%	1 4%
Infinite and straight bevel	0 0%	0 0%	0 0%	1 4%	1 4%	15 60%	8 32%
Infinite and scalloped bevel	0 0%	0 0%	0 0%	1 4%	0 0%	9 36%	15 60%

Table 4 (continued)

Bevel Types	Rating Scores						
	1	2	3	4	5	6	7
<b>Assistants (n=5)</b>							
No bevel (Negative control)	3 60%	2 40%	0 0%	0 0%	0 0%	0 0%	0 0%
Short and straight bevel	1 20%	3 60%	1 20%	0 0%	0 0%	0 0%	0 0%
Short and scalloped bevel	0 0%	0 0%	2 40%	2 40%	1 20%	0 0%	0 0%
Long and straight bevel	0 0%	0 0%	1 20%	2 40%	2 40%	0 0%	0 0%
Long and scalloped bevel	1 20%	0 0%	1 20%	1 20%	2 40%	0 0%	0 0%
Infinite and straight bevel	0 0%	0 0%	0 0%	0 0%	0 0%	2 40%	3 60%
Infinite and scalloped bevel	0 0%	0 0%	0 0%	0 0%	0 0%	3 60%	2 40%
<b>Faculty (n=5)</b>							
No bevel (Negative control)	5 100%	0 0%	0 0%	0 0%	0 0%	0 0%	0 0%
Short and straight bevel	0 0%	5 100%	0 0%	0 0%	0 0%	0 0%	0 0%
Short and scalloped bevel	0 0%	0 0%	2 40%	1 20%	2 40%	0 0%	0 0%
Long and straight bevel	0 0%	0 0%	1 20%	2 40%	2 40%	0 0%	0 0%
Long and scalloped bevel	0 0%	0 0%	2 40%	2 40%	1 20%	0 0%	0 0%
Infinite and straight bevel	0 0%	0 0%	0 0%	0 0%	0 0%	4 80%	1 20%
Infinite and scalloped bevel	0 0%	0 0%	0 0%	0 0%	0 0%	1 20%	4 80%

Table 4 (continued)

Bevel Types	Rating Scores						
	1	2	3	4	5	6	7
<b>Graduate Residents (n=5)</b>							
No bevel (Negative control)	5 100%	0 0%	0 0%	0 0%	0 0%	0 0%	0 0%
Short and straight bevel	0 0%	4 80%	1 20%	0 0%	0 0%	0 0%	0 0%
Short and scalloped bevel	0 0%	0 0%	0 0%	3 60%	2 40%	0 0%	0 0%
Long and straight bevel	0 0%	1 20%	3 60%	1 20%	0 0%	0 0%	0 0%
Long and scalloped bevel	0 0%	0 0%	1 20%	1 20%	3 60%	0 0%	0 0%
Infinite and straight bevel	0 0%	0 0%	0 0%	0 0%	0 0%	3 60%	2 40%
Infinite and scalloped bevel	0 0%	0 0%	0 0%	0 0%	0 0%	2 40%	3 60%
<b>Staff (n=5)</b>							
No bevel (Negative control)	5 100%	0 0%	0 0%	0 0%	0 0%	0 0%	0 0%
Short and straight bevel	0 0%	1 20%	3 60%	1 20%	0 0%	0 0%	0 0%
Short and scalloped bevel	0 0%	0 0%	1 20%	0 0%	2 40%	1 20%	1 20%
Long and straight bevel	0 0%	3 60%	1 20%	0 0%	1 20%	0 0%	0 0%
Long and scalloped bevel	0 0%	1 20%	0 0%	2 40%	1 20%	0 0%	1 20%
Infinite and straight bevel	0 0%	0 0%	0 0%	1 20%	1 20%	1 20%	2 40%
Infinite and scalloped bevel	0 0%	0 0%	0 0%	1 20%	0 0%	3 60%	1 20%

Table 4 (continued)

Bevel Types	Rating Scores						
	1	2	3	4	5	6	7
<b>Dental Students (n=5)</b>							
No bevel (Negative control)	4 80%	0 0%	0 0%	1 20%	0 0%	0 0%	0 0%
Short and straight bevel	0 0%	3 60%	1 20%	1 20%	0 0%	0 0%	0 0%
Short and scalloped bevel	1 20%	0 0%	1 20%	1 20%	2 40%	0 0%	0 0%
Long and straight bevel	0 0%	2 40%	1 20%	2 40%	0 0%	0 0%	0 0%
Long and scalloped bevel	0 0%	0 0%	3 60%	0 0%	2 40%	0 0%	0 0%
Infinite and straight bevel	0 0%	0 0%	0 0%	0 0%	0 0%	5 100%	0 0%
Infinite and scalloped bevel	0 0%	0 0%	0 0%	0 0%	0 0%	0 0%	5 100%



Table 5. Descriptive Statistics of Rating Scores by Types of Examiners and Types of Bevel (Pilot Study)

Variable	N	Mean	Standard Deviation	Minimum	Maximum	Median
<b>Negative control and no bevel</b>						
Assistants	5	1.40	0.55	1.00	2.00	1.00
Faculty	5	1.00	0.00	1.00	1.00	1.00
Graduate Residents	5	1.00	0.00	1.00	1.00	1.00
Staff	5	1.00	0.00	1.00	1.00	1.00
Dental Students	5	1.60	1.34	1.00	4.00	1.00
<b>Short and straight bevel</b>						
Assistants	5	2.00	0.71	1.00	3.00	2.00
Faculty	5	2.00	0.00	2.00	2.00	2.00
Graduate Residents	5	2.20	0.45	2.00	3.00	2.00
Staff	5	3.00	0.71	2.00	4.00	3.00
Dental Students	5	3.00	1.41	2.00	5.00	2.00
<b>Short and scalloped bevel</b>						
Assistants	5	3.80	0.84	3.00	5.00	4.00
Faculty	5	4.00	1.00	3.00	5.00	4.00
Graduate Residents	5	4.40	0.55	4.00	5.00	4.00
Staff	5	5.20	1.48	3.00	7.00	5.00
Dental Students	5	3.60	1.67	1.00	5.00	4.00
<b>Long and straight bevel</b>						
Assistants	5	4.20	0.84	3.00	5.00	4.00
Faculty	5	4.20	0.84	3.00	5.00	4.00
Graduate Residents	5	3.00	0.71	2.00	4.00	3.00
Staff	5	2.80	1.30	2.00	5.00	2.00
Dental Students	5	3.00	1.00	2.00	4.00	3.00

Table 5 (continued)

Variable	N	Mean	Standard Deviation	Minimum	Maximum	Median
<b>Long and scalloped bevel</b>						
Assistants	5	3.60	1.67	1.00	5.00	4.00
Faculty	5	3.80	0.84	3.00	5.00	4.00
Graduate Residents	5	4.40	0.89	3.00	5.00	5.00
Staff	5	4.40	1.82	2.00	7.00	4.00
Dental Students	5	3.80	1.10	3.00	5.00	3.00
<b>Infinite and straight bevel</b>						
Assistants	5	6.60	0.55	6.00	7.00	7.00
Faculty	5	6.20	0.45	6.00	7.00	6.00
Graduate Residents	5	6.40	0.55	6.00	7.00	6.00
Staff	5	5.80	1.30	4.00	7.00	6.00
Dental Students	5	6.00	0.00	6.00	6.00	6.00
<b>Infinite and scalloped bevel</b>						
Assistants	5	6.40	0.55	6.00	7.00	6.00
Faculty	5	6.80	0.45	6.00	7.00	7.00
Graduate Residents	5	6.60	0.55	6.00	7.00	7.00
Staff	5	5.80	1.10	4.00	7.00	6.00
Dental Students	5	7.00	0.00	7.00	7.00	7.00

Detecting the Difference in Visual Evaluation Rank Scores Among Five Groups of Evaluators with regard to Seven Teeth

A. Negative Control- No Bevel

Results of one-way ANOVA based on the ranked data revealed that there was no significant effect of the type of evaluators on ratings for no bevel ( $F(4, 20)=1.5; p=0.2407$ ). That

is, no significant difference was found in median visual evaluation rank scores among 5 groups of evaluators (Tables 4 and 5).

#### B. Short and Straight Bevel

Results of one-way ANOVA based on the ranked data revealed that there was no significant effect of the type of evaluators on ratings for the short and straight bevel ( $F(4, 20)=2.36$ ;  $p=0.0878$ ). That is, no significant difference was found in median visual evaluation rank scores among 5 groups of evaluators, but the results could be considered marginally significant (Tables 4 and 5).

#### C. Short and Scalloped Bevel

Results of one-way ANOVA revealed that there was no significant effect of the type of evaluators on ratings for the short and scalloped bevel ( $F(4, 20)=1.43$ ;  $p=0.2610$ ). That is, no significant difference was found in mean visual evaluation rank scores among 5 groups of evaluators (Tables 4 and 5).

#### D. Long and Straight Bevel

Results of one-way ANOVA revealed that there was no significant effect of the type of evaluators on ratings for the long and straight bevel ( $F(4, 20)=2.65$ ;  $p=0.0634$ ). That is, no significant difference was found in mean visual evaluation rank scores among 5 groups of evaluators but the results could be considered marginally significant (Tables 4 and 5).

#### E. Long and Scalloped Bevel

Results of one-way ANOVA revealed that there was no significant effect of the type of evaluators on ratings for the long and scalloped bevel ( $F(4, 20)=0.40$ ;  $p=0.8079$ ). That is, no significant difference was found in mean visual evaluation rank scores among 5 groups of evaluators (Tables 4 and 5).

#### F. Infinite and Straight Bevel

Results of one-way ANOVA revealed that there was no significant effect of the type of evaluators on ratings for the infinite and straight bevel ( $F(4, 20)=1.00$ ;  $p=0.4307$ ). That is, no significant difference was found in mean visual evaluation rank scores among 5 groups of evaluators (Tables 4 and 5).

#### G. Infinite and Scalloped Bevel

Results of one-way ANOVA based on the ranked data revealed that there was no significant effect of the type of evaluators on ratings for the infinite and scalloped bevel ( $F(4, 20)=2.74$ ;  $p=0.0573$ ). That is, no significant difference was found in median visual evaluation rank scores among 5 groups of evaluators, though it could be considered marginally significant (Tables 4 and 5).

### Assessing an Agreement Among Evaluators

#### A. All Evaluators

Kendall's W was 0.78 which indicated good agreement among the 25 evaluators.

B. Assistants

Kendall's W was 0.84 which indicated strong agreement among 5 assistants.

C. Faculty

Kendall's W was 0.92 which indicated strong agreement among 5 faculty members.

D. Graduate Residents

Kendall's W was 0.93 which indicated strong agreement among 5 graduate residents.

E. Staff

Kendall's W was 0.70 which indicated good agreement among 5 staff.

F. Dental Students

Kendall's W was 0.75 which indicated good agreement among 5 dental students.

Graphs for Lightness at Seven Spectrophotometric Measurement Points

For each of the following graphs (Figures 25-32), all seven of the spectrophotometric measurement points are plotted for each sample within the group. The points are connected to show linearity. As viewed from left to right along the x-axis, the measurement points are moving from incisal to cervical on the facial portion of the sample. For each of the measurement points, the corresponding lightness readings generally increase from M1-M7. The greatest rate of

increase is seen in graphs from the first three groups. A more gradual change is seen in the graphs from the last two groups.

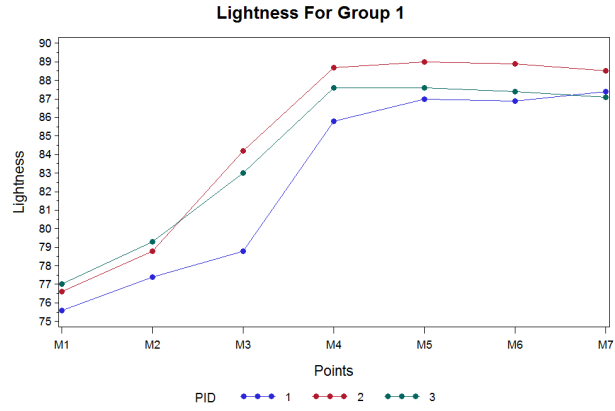

Figure 25. Lightness Values for All Samples from Group 1 - the Non-Bevel/Control Group.

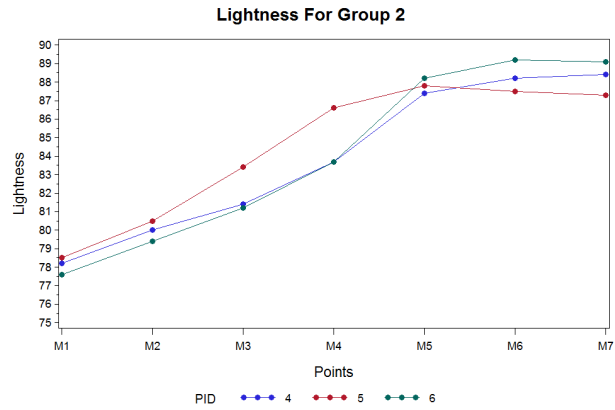

Figure 26. Lightness Values for All Samples from Group 2 - Short and Straight Bevel Group.

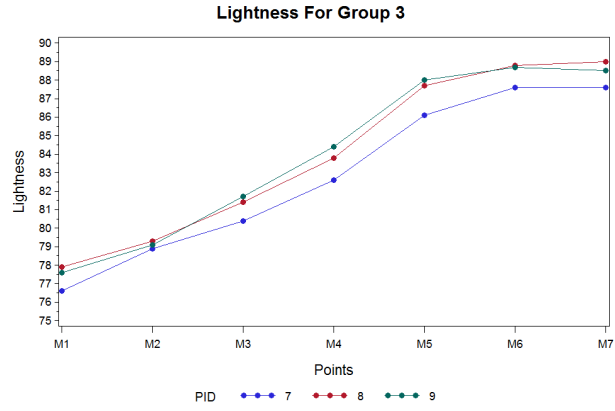

Figure 27. Lightness Values for All Samples from Group 3 - Short and Scalloped Bevel Group.

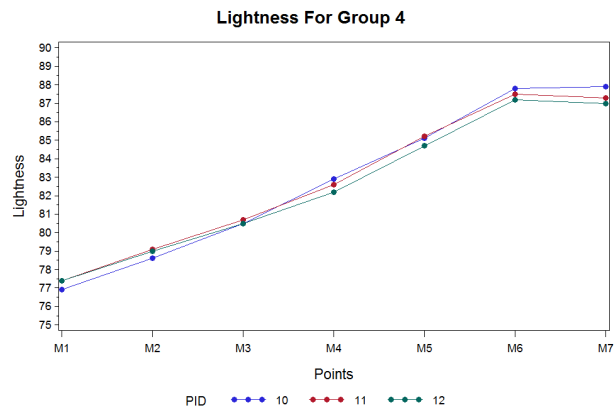

Figure 28. Lightness Values for All Samples from Group 4 - Long and Straight Bevel Group.

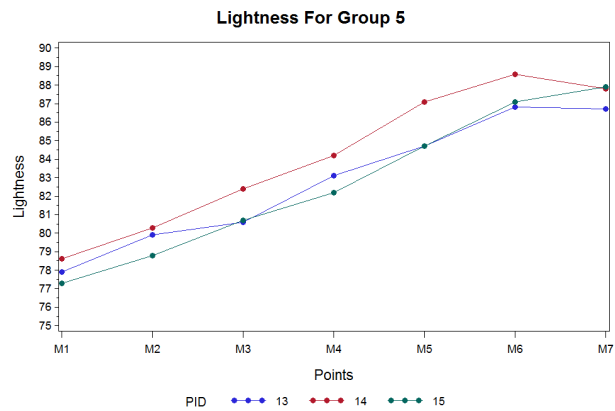

Figure 29. Lightness Values for All Samples from Group 5 - Long and Scalloped Bevel Group.

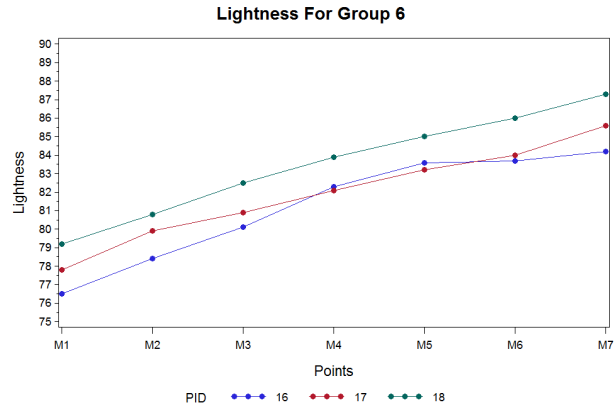

Figure 30. Lightness Values for All Samples from Group 6 – Infinite and Straight Bevel Group.

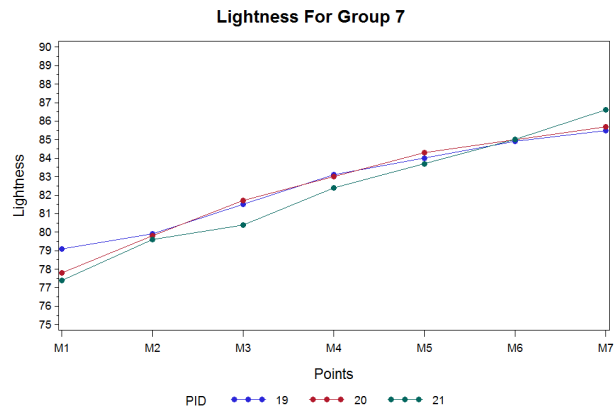

Figure 31. Lightness Values for All Samples from Group 7 - Infinite and Scalloped Bevel Group.

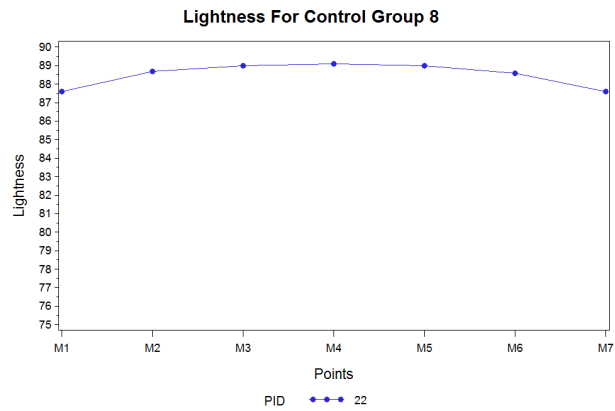

Figure 32. Lightness Values from Group 8 - Original, Unprepared Sample.



Statistical Results for the Evaluation of Correlation between the Visual and Spectrophotometric Evaluations from the Pilot Study

In this pilot study, the visual evaluation score is defined as an average of visual evaluation scores at each bevel level and lightness is defined as an average of lightness values at each measurement point.

The results showed that there was a significant correlation between the visual evaluation scores and the spectrophotometric evaluation values ( $p=0.0147$ ). The Pearson correlation coefficient of  $-0.85$  indicated there was a strong decreasing (or negative) relationship between the two variables. Note that this negative relationship shows the two variables tend to move in the opposite directions. That is, one variable increases, the other tends to decrease, and vice versa.

Table 6. Correlation Data for Pilot Study

Group	Visual Evaluation Score	Spectrophotometer L* Value
1. No bevel (Negative control)	1.2	83.93
2. Short and straight bevel	2.44	84.16
3. Short and scalloped bevel	4.2	83.60
4. Long and straight bevel	3.44	82.74
5. Long and scalloped bevel	4	83.21
6. Infinite and straight bevel	6.2	82.24
7. Infinite and scalloped bevel	6.52	82.20

Statistical Results of the Visual Evaluation for the Final Study

Ninety-one evaluators were selected, including 19 assistants, 17 faculty, 20 staff, 18 dental students, and 17 graduate residents. Each evaluator was asked to rate seven types of

bevel in rank order from 1 (least preferred choice) to 7 (most preferred choice). Descriptive statistics of rating scores are presented by each type of bevels and each group of evaluators in Tables 7 and 8.

Table 7. Frequency Distribution of Rating by Types of Evaluators and Types of Bevel (Final Study)

Bevel Type	Rating Scores						
	1	2	3	4	5	6	7
<b>All Evaluators (n=91)</b>							
No bevel (Negative control)	76 83.5%	9 9.9%	3 3.3%	2 2.2%	1 1.1%	0 0.0%	0 0.0%
Short and straight bevel	9 9.9%	72 79.1%	9 9.9%	1 1.1%	0 0.0%	0 0.0%	0 0.0%
Short and scalloped bevel	4 4.4%	6 6.6%	55 60.4%	15 16.5%	5 5.5%	5 5.5%	1 1.1%
Long and straight bevel	1 1.1%	3 3.3%	14 15.4%	55 60.4%	15 16.5%	1 1.1%	2 2.2%
Long and scalloped bevel	1 1.1%	0 0.0%	4 4.4%	9 9.9%	53 58.2%	14 15.4%	10 11.0%
Infinite and straight bevel	0 0.0%	1 1.1%	4 4.4%	5 5.5%	12 13.2%	56 61.5%	13 14.3%
Infinite and scalloped bevel	0 0.0%	0 0.0%	2 2.2%	4 4.4%	5 5.5%	15 16.5%	65 71.4%
<b>Assistants/RDH/Lab Technicians (n=19)</b>							
No bevel (Negative control)	16 84.2%	0 0.0%	1 5.3%	2 10.5%	0 0.0%	0 0.0%	0 0.0%
Short and straight bevel	1 5.3%	16 84.2%	2 10.5%	0 0.0%	0 0.0%	0 0.0%	0 0.0%
Short and scalloped bevel	0 0.0%	1 5.3%	10 52.6%	4 21.1%	2 10.5%	2 10.5%	0 0.0%
Long and straight bevel	1 5.3%	1 5.3%	3 15.8%	10 52.6%	4 21.1%	0 0.0%	0 0.0%
Long and scalloped bevel	1 5.3%	0 0.0%	1 5.3%	3 15.8%	9 47.4%	2 10.5%	3 15.8%
Infinite and straight bevel	0 0.0%	1 5.3%	1 5.3%	0 0.0%	2 10.5%	12 63.2%	3 15.8%
Infinite and scalloped bevel	0 0.0%	0 0.0%	1 5.3%	0 0.0%	2 10.5%	3 15.8%	13 68.4%

Table 7 (continued)

Bevel Type	Rating Scores						
	1	2	3	4	5	6	7
<b>Faculty (n=17)</b>							
No bevel (Negative control)	15 88.2%	1 5.9%	0 0.0%	0 0.0%	1 5.9%	0 0.0%	0 0.0%
Short and straight bevel	1 5.9%	14 82.4%	2 11.8%	0 0.0%	0 0.0%	0 0.0%	0 0.0%
Short and scalloped bevel	1 5.9%	1 5.9%	12 70.6%	2 11.8%	1 5.9%	0 0.0%	0 0.0%
Long and straight bevel	0 0.0%	1 5.9%	3 17.6%	11 64.7%	2 11.8%	0 0.0%	0 0.0%
Long and scalloped bevel	0 0.0%	0 0.0%	0 0.0%	3 17.6%	11 64.7%	2 11.8%	1 5.9%
Infinite and straight bevel	0 0.0%	0 0.0%	0 0.0%	0 0.0%	2 11.8%	15 88.2%	0 0.0%
Infinite and scalloped bevel	0 0.0%	0 0.0%	0 0.0%	1 5.9%	0 0.0%	0 0.0%	16 94.1%
<b>Graduate Residents (n=17)</b>							
No bevel (Negative control)	15 88.2%	1 5.9%	1 5.9%	0 0.0%	0 0.0%	0 0.0%	0 0.0%
Short and straight bevel	1 5.9%	15 88.2%	1 5.9%	0 0.0%	0 0.0%	0 0.0%	0 0.0%
Short and scalloped bevel	1 5.9%	0 0.0%	14 82.4%	1 5.9%	1 5.9%	0 0.0%	0 0.0%
Long and straight bevel	0 0.0%	1 5.9%	1 5.9%	14 82.4%	1 5.9%	0 0.0%	0 0.0%
Long and scalloped bevel	0 0.0%	0 0.0%	0 0.0%	2 11.8%	12 70.6%	3 17.6%	0 0.0%
Infinite and straight bevel	0 0.0%	0 0.0%	0 0.0%	0 0.0%	3 17.6%	10 58.8%	4 23.5%
Infinite and scalloped bevel	0 0.0%	0 0.0%	0 0.0%	0 0.0%	0 0.0%	4 23.5%	13 76.5%

Table 7 (continued)

Bevel Type	Rating Scores						
	1	2	3	4	5	6	7
<b>Staff (n=20)</b>							
No bevel (Negative control)	13 65.0%	6 30.0%	1 5.0%	0 0.0%	0 0.0%	0 0.0%	0 0.0%
Short and straight bevel	5 25.0%	12 60.0%	3 15.0%	0 0.0%	0 0.0%	0 0.0%	0 0.0%
Short and scalloped bevel	2 10.0%	2 10.0%	7 35.0%	5 25.0%	1 5.0%	3 15.0%	0 0.0%
Long and straight bevel	0 0.0%	0 0.0%	5 25.0%	10 50.0%	2 10.0%	1 5.0%	2 10.0%
Long and scalloped bevel	0 0.0%	0 0.0%	1 5.0%	0 0.0%	10 50.0%	4 20.0%	5 25.0%
Infinite and straight bevel	0 0.0%	0 0.0%	2 10.0%	3 15.0%	5 25.0%	7 35.0%	3 15.0%
Infinite and scalloped bevel	0 0.0%	0 0.0%	1 5.0%	2 10.0%	2 10.0%	5 25.0%	10 50.0%
<b>Dental Students (n=18)</b>							
No bevel (Negative control)	17 94.4%	1 5.6%	0 0.0%	0 0.0%	0 0.0%	0 0.0%	0 0.0%
Short and straight bevel	1 5.6%	15 83.3%	1 5.6%	1 5.6%	0 0.0%	0 0.0%	0 0.0%
Short and scalloped bevel	0 0.0%	2 11.1%	12 66.7%	3 16.7%	0 0.0%	0 0.0%	1 5.6%
Long and straight bevel	0 0.0%	0 0.0%	2 11.1%	10 55.6%	6 33.3%	0 0.0%	0 0.0%
Long and scalloped bevel	0 0.0%	0 0.0%	2 11.1%	1 5.6%	11 61.1%	3 16.7%	1 5.6%
Infinite and straight bevel	0 0.0%	0 0.0%	1 5.6%	2 11.1%	0 0.0%	12 66.7%	3 16.7%
Infinite and scalloped bevel	0 0.0%	0 0.0%	0 0.0%	1 5.6%	1 5.6%	3 16.7%	13 72.2%

Table 8. Descriptive Statistics of Rating Scores by Types of Examiners and Types of Bevel (Final Study)

Variable	N	Mean	Standard Deviation	Minimum	Maximum	Median
<b>Negative control and no bevel</b>						
Assistants	19	1.42	1.02	1.00	4.00	1.00
Dental Students	18	1.06	0.24	1.00	2.00	1.00
Faculty	17	1.29	0.99	1.00	5.00	1.00
Graduate Residents	17	1.18	0.53	1.00	3.00	1.00
Staff	20	1.40	0.60	1.00	3.00	1.00
<b>Short and straight bevel</b>						
Assistants	19	2.05	0.40	1.00	3.00	2.00
Dental Students	18	2.11	0.58	1.00	4.00	2.00
Faculty	17	2.06	0.43	1.00	3.00	2.00
Graduate Residents	17	2.00	0.35	1.00	3.00	2.00
Staff	20	1.90	0.64	1.00	3.00	2.00
<b>Short and scalloped bevel</b>						
Assistants	19	3.68	1.11	2.00	6.00	3.00
Dental Students	18	3.28	1.07	2.00	7.00	3.00
Faculty	17	3.06	0.83	1.00	5.00	3.00
Graduate Residents	17	3.06	0.75	1.00	5.00	3.00
Staff	20	3.50	1.47	1.00	6.00	3.00
<b>Long and straight bevel</b>						
Assistants	19	3.79	1.03	1.00	5.00	4.00
Dental Students	18	4.22	0.65	3.00	5.00	4.00
Faculty	17	3.82	0.73	2.00	5.00	4.00
Graduate Residents	17	3.88	0.60	2.00	5.00	4.00
Staff	20	4.25	1.21	3.00	7.00	4.00

Table 8 (continued)

Variable	N	Mean	Standard Deviation	Minimum	Maximum	Median
<b>Long and scalloped bevel</b>						
Assistants	19	4.95	1.43	1.00	7.00	5.00
Dental Students	18	5.00	0.97	3.00	7.00	5.00
Faculty	17	5.06	0.75	4.00	7.00	5.00
Graduate Residents	17	5.06	0.56	4.00	6.00	5.00
Staff	20	5.60	1.05	3.00	7.00	5.00
<b>Infinite and straight bevel</b>						
Assistants	19	5.68	1.25	2.00	7.00	6.00
Dental Students	18	5.78	1.06	3.00	7.00	6.00
Faculty	17	5.88	0.33	5.00	6.00	6.00
Graduate Residents	17	6.06	0.66	5.00	7.00	6.00
Staff	20	5.30	1.22	3.00	7.00	5.50
<b>Infinite and scalloped bevel</b>						
Assistants	19	6.42	1.07	3.00	7.00	7.00
Dental Students	18	6.56	0.86	4.00	7.00	7.00
Faculty	17	6.82	0.73	4.00	7.00	7.00
Graduate Residents	17	6.76	0.44	6.00	7.00	7.00
Staff	20	6.05	1.23	3.00	7.00	6.50

Detecting the Difference in Visual Evaluation Rank Scores Among Five Groups of Evaluators with  
regard to Seven Types of Bevels

A. Negative Control- No Bevel

Results of one-way ANOVA based on the ranked data revealed that there was no significant effect of the type of evaluators on ratings for no bevel ( $F(4, 86)=1.59$ ;  $p=0.1851$ ). That is, no significant difference was found in median visual evaluation rank scores among 5 groups of evaluators (see Tables 7 and 8).

B. Short and Straight Bevel

Results of one-way ANOVA based on the ranked data revealed that there was no significant effect of the type of evaluators on ratings for the short and straight bevel ( $F(4, 86)=0.42$ ;  $p=0.7947$ ). That is, no significant difference was found in median visual evaluation rank scores among 5 groups of evaluators (see Tables 7 and 8).

C. Short and Scalloped Bevel

Results of one-way ANOVA based on the ranked data revealed that there was no significant effect of the type of evaluators on ratings for the short and scalloped bevel ( $F(4, 86)=1.17$ ;  $p=0.3295$ ). That is, no significant difference was found in median visual evaluation rank scores among 5 groups of evaluators (see Tables 7 and 8).

#### D. Long and Straight Bevel

Results of one-way ANOVA based on the ranked data revealed that there was no significant effect of the type of evaluators on ratings for the long and straight bevel ( $F(4, 86)=0.80$ ;  $p=0.5282$ ). That is, no significant difference was found in median visual evaluation rank scores among 5 groups of evaluators (see Tables 7 and 8).

#### E. Long and Scalloped Bevel

Results of one-way ANOVA based on the ranked data revealed that there was no significant effect of the type of evaluators on ratings for the short and straight bevel ( $F(4, 86)=1.48$ ;  $p=0.2140$ ). That is, no significant difference was found in median visual evaluation rank scores among 5 groups of evaluators (see Tables 7 and 8).

#### F. Infinite and Straight Bevel

Results of one-way ANOVA based on the ranked data revealed that there was no significant effect of the type of evaluators on ratings for the infinite and straight bevel ( $F(4, 86)=1.38$ ;  $p=0.2460$ ). That is, no significant difference was found in median visual evaluation rank scores among 5 groups of evaluators (see Tables 7 and 8).

#### G. Infinite and Scalloped Bevel

Results of one-way ANOVA based on the ranked data revealed that there was no significant effect of the type of evaluators on ratings for the infinite and scalloped bevel ( $F(4, 86)=2.44$ ;  $p=0.0570$ ). That is, no significant difference was found in median visual evaluation



rank scores among 5 groups of evaluators (see Tables 7 and 8), however the result is marginally significant.

### Assessing an Agreement Among Evaluators

#### A. All Evaluators

Kendall's W was 0.80 which indicated strong agreement among the 91 evaluators.

#### B. Assistants

Kendall's W was 0.72 which indicated good agreement among 19 assistants.

#### C. Faculty

Kendall's W was 0.88 which indicated strong agreement among 17 faculty members.

#### D. Graduate Residents

Kendall's W was 0.92 which indicated strong agreement among 17 graduate residents.

#### E. Staff

Kendall's W was 0.71 which indicated good agreement among the 20 staff.

#### F. Dental Students

Kendall's W was 0.84 which indicated strong agreement among the 18 dental students.

## Statistical Results for Spectrophotometric Evaluation for the Final Study

### Descriptive Statistics

Thirty-five samples (n=5/per group) were used in the study. Each sample was measured at eight different points, and one group of original untouched tooth was included as a reference group for the analysis. Table 9 summarizes descriptive statistics of lightness values at eight measurement points by the types of bevels.

### Assessing the Differences in Lightness Values Among the Experimental Groups at Each Measurement Point

#### A. First Measurement (M1)

Results of one-way ANOVA revealed that there was a significant effect of the type of bevels on the lightness value at M1 ( $F(7, 32) = 150.79$ ;  $p < 0.0001$ ). The post-hoc Dunnett's test indicated that the mean lightness value was significantly higher in Reference Group than that observed in other seven type of bevel groups, while the post-hoc Tukey's HSD test showed that no significant differences were noted among the seven types of bevels (see Table 9).

#### B. Second Measurement (M2)

Results of one-way ANOVA revealed that there was a significant effect of the type of bevels on the lightness value at M2 ( $F(7, 32) = 188.75$ ;  $p < 0.0001$ ). The post-hoc Dunnett's test indicated that the mean lightness value was significantly higher in Reference Group than that observed in other seven type of bevel groups, while the post-hoc Tukey's HSD test showed that no significant differences were noted among the seven types of bevels (see Table 9).

### C. Third Measurement (M3)

Results of one-way ANOVA revealed that there was a significant effect of the type of bevels on the lightness value at M3 ( $F(7, 32) = 128.50; p < 0.0001$ ). The post-hoc Dunnett's test indicated that the mean lightness value was significantly higher in Reference Group than that observed in other seven type of bevel groups, while the post-hoc Tukey's HSD test showed that no significant differences were noted among the seven types of bevels (see Table 9).

### D. Fourth Measurement (M4)

Results of one-way ANOVA revealed that there was a significant effect of the type of bevels on the lightness value at M4 ( $F(7, 32) = 64.35; p < 0.0001$ ). The post-hoc Dunnett's test indicated that the mean lightness value was significantly higher in Reference Group than that observed in other seven type of bevel groups. Moreover, the post-hoc Tukey's HSD test showed that the mean lightness value observed in Group 1 was significantly higher than that in Groups 2, 3, 4, 5, 6, and 7, while no significant difference was noted among Groups 2, 3, 5 or among Groups, 2, 4, 5, 6, and 7 (see Table 9).

### E. Fifth Measurement (M5)

Results of one-way ANOVA revealed that there was a significant effect of the type of bevels on the lightness value at M5 ( $F(7, 32) = 26.09; p < 0.0001$ ). The post-hoc Dunnett's test indicated that the mean lightness value was significantly higher in Reference Group than that observed in Groups 2, 3, 4, 5, 6, and 7, while no significant difference was found between Reference Group and Group 1. Moreover, the post-hoc Tukey's HSD test showed that the mean lightness values observed in Groups 1, 2, and 3 were significantly higher than those in Groups 4,

5, 6, and 7, whereas no significant difference was noted among Groups 1, 2 and 3 or among Groups 4, 5, 6, and 7 (see Table 9).

#### F. Sixth Measurement (M6)

Results of one-way ANOVA revealed that there was a significant effect of the type of bevels on the lightness value at M6 ( $F(7, 32) = 9.6; p < 0.0001$ ). The post-hoc Dunnett's test indicated that the mean lightness value was significantly higher in Reference Group than that observed in Groups 5, 6, and 7, while no significant difference was found between Reference Group and Groups 1, 2, 3 and 4. Moreover, the post-hoc Tukey's HSD test showed that the mean lightness values observed in Groups 1, 2, and 3 were significantly higher than those in Groups 6, and 7, whereas no significant difference was noted among Groups 1, 2, 3, 4, and 5 or among Groups 4, 5, 6, and 7 (see Table 9).

#### G. Seventh Measurement (M7)

Results of one-way ANOVA revealed that there was a significant effect of the type of bevels on the lightness value at M7 ( $F(7, 32) = 8.4; p < 0.0001$ ). The post-hoc Dunnett's test indicated that the mean lightness value was significantly higher in Reference Group than that observed in Groups 6 and 7, while no significant difference was found between Reference Group and Groups 1, 2, 3, 4, and 5. Moreover, the post-hoc Tukey's HSD test showed that the mean lightness values observed in Groups 1, 2, 3, 4 and 5 were significantly higher than those in Groups 6, and 7, whereas no significant difference was noted among Groups 1, 2, 3, 4 and 5 or between Groups 6 and 7 (see Table 9).

#### H. Eighth Measurement (M8)

Results of one-way ANOVA revealed that there was a significant effect of the type of bevels on the lightness value at M8 ( $F(7, 32) = 4.96$ ;  $p = 0.0007$ ). The post-hoc Dunnett's test indicated that the mean lightness value was significantly higher in Reference Group than that observed in Groups 6 and 7, while no significant difference was found between Reference Group and Groups 1, 2, 3, 4, and 5. Moreover, the post-hoc Tukey's HSD test showed that the mean lightness values observed in Groups 2 and 4 were significantly higher than those in Groups 6 and 7, whereas no significant difference was noted among Groups 1, 2, 3, 4 and 5 or among Groups 1, 3, 5 and 6 or among Groups 1, 5, 6 and 7 (see Table 9).

#### I. Whole Tooth

An average of lightness values from eight measurement points was used for the analysis.

Results of one-way ANOVA revealed that there was a significant effect of the type of bevels on the lightness value at M6 ( $F(7, 32) = 31.32$ ;  $p < 0.0001$ ). The post-hoc Dunnett's test indicated that the mean lightness value was significantly higher in Reference Group than that observed in other seven type of bevel groups. Moreover, the post-hoc Tukey's HSD test showed that the mean lightness values observed in Groups 1, 2, and 3 were significantly higher than those in Groups 6, and 7, while no significant difference was noted among Groups 1, 2, 3, 4 and 5 or among Groups 4, 5, 6, and 7 (see Table 10).

Table 9. Descriptive Statistics for the Lightness Values by the Types of Bevels for Each Measurement Point

	N	Mean**	Standard Deviation	Minimum	Maximum	Median
<b>At M1 Point</b>						
Group1	5	75.44 <sup>a</sup>	0.70	74.60	76.20	75.80
Group2	5	75.86 <sup>a</sup>	0.78	75.20	76.80	75.50
Group3	5	75.74 <sup>a</sup>	0.62	75.10	76.70	75.70
Group4	5	75.56 <sup>a</sup>	0.93	74.60	76.60	75.70
Group5	5	76.02 <sup>a</sup>	0.99	74.80	76.90	76.50
Group6	5	75.70 <sup>a</sup>	0.90	74.30	76.70	75.80
Group7	5	75.98 <sup>a</sup>	0.71	75.00	76.70	76.00
Group8	5	87.60 <sup>b</sup>	0.00	87.60	87.60	87.60
<b>At M2 Point</b>						
Group1	5	77.72 <sup>a</sup>	0.32	77.30	78.10	77.80
Group2	5	78.50 <sup>a</sup>	0.66	77.70	79.10	78.70
Group3	5	78.80 <sup>a</sup>	0.37	78.30	79.20	78.80
Group4	5	78.08 <sup>a</sup>	0.77	77.10	78.70	78.60
Group5	5	78.68 <sup>a</sup>	0.89	77.60	79.60	78.70
Group6	5	78.24 <sup>a</sup>	0.66	77.20	78.80	78.30
Group7	5	78.66 <sup>a</sup>	0.60	77.80	79.30	78.90
Group8	5	88.70 <sup>b</sup>	0.00	88.70	88.70	88.70
<b>At M3 Point</b>						
Group1	5	79.96 <sup>a</sup>	0.23	79.60	80.20	80.00
Group2	5	80.10 <sup>a</sup>	0.80	79.20	80.90	80.40
Group3	5	80.44 <sup>a</sup>	0.55	80.00	81.30	80.10
Group4	5	79.66 <sup>a</sup>	0.79	78.30	80.30	79.90
Group5	5	80.06 <sup>a</sup>	0.98	78.80	81.10	80.10
Group6	5	79.60 <sup>a</sup>	0.50	78.80	80.10	79.70
Group7	5	79.96 <sup>a</sup>	0.61	79.20	80.70	80.10
Group8	5	89.00 <sup>b</sup>	0.00	89.00	89.00	89.00

Table 9 (continued)

	N	Mean**	Standard Deviation	Minimum	Maximum	Median
<b>At M4 Point</b>						
Group1	5	85.96 <sup>a</sup>	0.39	85.40	86.50	86.00
Group2	5	82.68 <sup>b,c</sup>	0.91	81.30	83.40	83.20
Group3	5	83.24 <sup>b</sup>	0.61	82.70	84.10	83.10
Group4	5	81.50 <sup>c</sup>	1.16	79.70	82.70	81.60
Group5	5	81.84 <sup>b,c</sup>	1.27	80.40	83.10	82.20
Group6	5	81.08 <sup>c</sup>	0.43	80.70	81.70	81.00
Group7	5	81.16 <sup>c</sup>	0.69	80.30	82.00	81.00
Group8	5	89.10 <sup>d</sup>	0.00	89.10	89.10	89.10
<b>At M5 Point</b>						
Group1	5	87.62 <sup>a,b</sup>	0.94	86.90	88.70	87.00
Group2	5	86.72 <sup>b</sup>	1.09	85.30	88.20	86.90
Group3	5	86.94 <sup>b</sup>	1.00	86.00	88.50	86.60
Group4	5	83.26 <sup>c</sup>	1.58	80.90	84.80	83.70
Group5	5	83.68 <sup>c</sup>	1.69	81.50	85.40	84.00
Group6	5	82.46 <sup>c</sup>	0.60	81.80	83.20	82.60
Group7	5	82.54 <sup>c</sup>	1.15	81.20	83.80	82.00
Group8	5	89.00 <sup>a</sup>	0.00	89.00	89.00	89.00
<b>At M6 Point</b>						
Group1	5	87.76 <sup>a,b</sup>	0.87	87.00	88.90	87.20
Group2	5	87.88 <sup>a,b</sup>	1.38	86.10	89.10	88.70
Group3	5	88.28 <sup>a,b</sup>	1.25	86.80	89.80	88.00
Group4	5	86.04 <sup>a,b,c</sup>	2.19	82.90	88.60	86.90
Group5	5	85.98 <sup>b,c</sup>	2.54	83.10	88.70	86.50
Group6	5	83.38 <sup>c</sup>	0.89	82.10	84.40	83.70
Group7	5	83.62 <sup>c</sup>	1.17	82.50	85.20	83.40
Group8	5	88.60 <sup>a</sup>	0.00	88.60	88.60	88.60

Table 9 (continued)

	N	Mean**	Standard Deviation	Minimum	Maximum	Median
<b>At M7 Point</b>						
Group1	5	87.46 <sup>a,b</sup>	0.91	86.80	88.60	86.80
Group2	5	88.08 <sup>a,b</sup>	1.47	86.20	89.40	88.80
Group3	5	88.20 <sup>a,b</sup>	1.18	86.80	89.60	88.00
Group4	5	88.08 <sup>a,b</sup>	1.49	86.20	89.60	88.90
Group5	5	87.48 <sup>a,b</sup>	1.85	85.20	89.30	88.40
Group6	5	84.52 <sup>c</sup>	0.54	83.80	85.30	84.60
Group7	5	84.24 <sup>c</sup>	1.46	82.80	86.50	83.80
Group8	5	87.60 <sup>a</sup>	0.00	87.60	87.60	87.60
<b>At M8 Point</b>						
Group1	5	87.06 <sup>a,b,c,d</sup>	0.97	86.30	88.50	86.60
Group2	5	87.98 <sup>a,b</sup>	1.53	86.00	89.40	88.70
Group3	5	87.90 <sup>a,b,c</sup>	1.39	86.00	89.50	87.60
Group4	5	88.08 <sup>a,b</sup>	1.30	86.70	89.50	88.70
Group5	5	87.36 <sup>a,b,c,d</sup>	1.45	85.60	89.00	87.80
Group6	5	85.28 <sup>c,d</sup>	0.82	84.20	86.40	85.10
Group7	5	84.96 <sup>d</sup>	1.57	83.30	87.50	84.70
Group8	5	87.60 <sup>a</sup>	0.00	87.60	87.60	87.60

**Note:** Group 1 = Negative control, no bevel; Group 2 = Short, straight bevel; Group 3 = Short, scalloped bevel; Group 4 = Long, straight bevel; Group 5 = Long, scalloped bevel; Group 6 = Infinite, straight bevel; Group 7 = Infinite, scalloped bevel; Group 8 = Untouched tooth (reference)



Table 10. Descriptive Statistics for the Lightness Values by the Types of Bevels (Overall Lightness Values by the Tooth)

	N	Mean**	Standard Deviation	Minimum	Maximum	Median
Group1	5	83.62 <sup>a</sup>	0.59	83.08	84.31	83.32
Group2	5	83.48 <sup>a</sup>	1.03	82.15	84.43	84.03
Group3	5	83.69 <sup>a</sup>	0.65	82.84	84.51	83.66
Group4	5	82.53 <sup>a,b</sup>	1.22	80.80	83.69	83.11
Group5	5	82.64 <sup>a,b</sup>	1.40	81.03	83.94	83.29
Group6	5	81.28 <sup>b</sup>	0.51	80.84	82.07	81.10
Group7	5	81.39 <sup>b</sup>	0.92	80.32	82.70	81.05
Group8	1	88.40 <sup>c</sup>	0.00	88.40	88.40	88.40

**Note:** Group 1 = Negative control, no bevel; Group 2 = Short, straight bevel; Group 3 = Short, scalloped bevel; Group 4 = Long, straight bevel; Group 5 = Long, scalloped bevel; Group 6 = Infinite, straight bevel; Group 7 = Infinite, scalloped bevel; Group 8 = Untouched tooth (reference)

\*\*At each measurement point, means with the same letter are not significantly different using the post-hoc Tukey's HSD test ( $p > 0.05$ )

#### Graphs for Lightness at Eight Spectrophotometric Points

For each of the following graphs (Figures 33-40), all eight of the spectrophotometric measurement points are plotted for each sample within the group. The points are connected to show linearity. As viewed from left to right along the x-axis, the measurement points are moving from incisal to cervical on the facial portion of the sample. For each of the measurement points, the corresponding lightness readings generally increase from M1-M8. The greatest rate of increase is seen in graphs from the first three groups. A more gradual change is seen in the graphs from the last two groups.

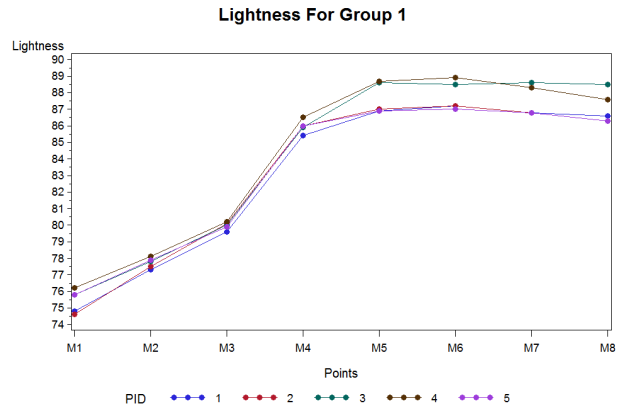

Figure 33. Lightness Values for All Samples from Group 1 - the Non-Bevel/Control Group.

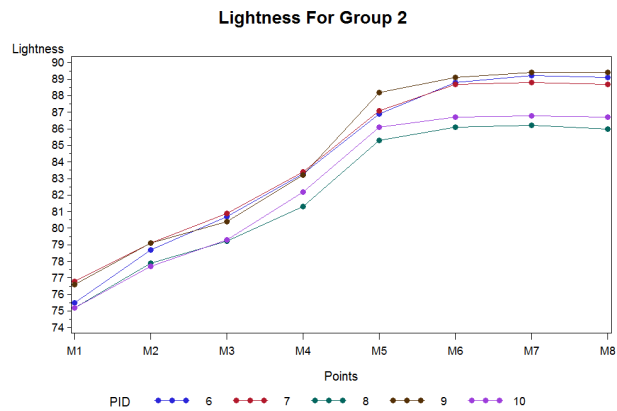

Figure 34. Lightness Values for All Samples from Group 2 - Short and Straight Bevel Group.

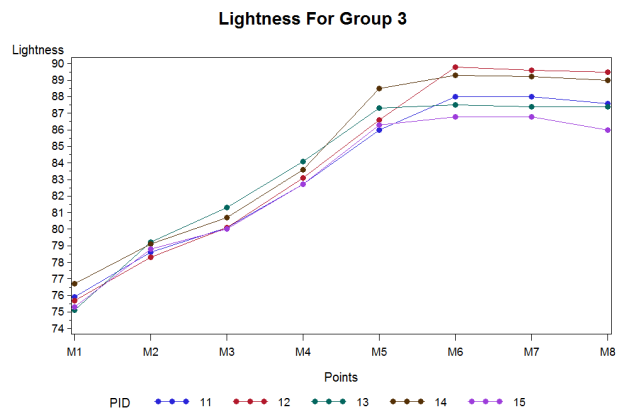

Figure 35. Lightness Values for All Samples from Group 3 - Short and Scalloped Bevel Group.

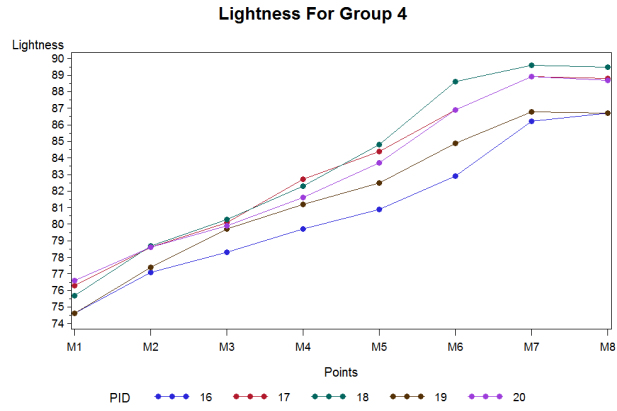

Figure 36. Lightness Values for All Samples from Group 4 - Long and Straight Bevel Group.

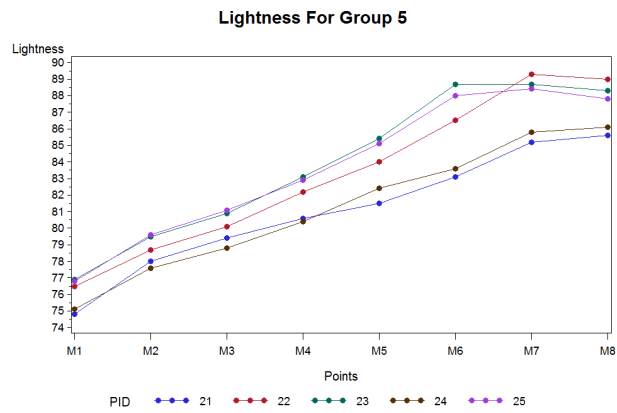

Figure 37. Lightness Values for All Samples from Group 5 - Long and Scalloped Bevel Group.

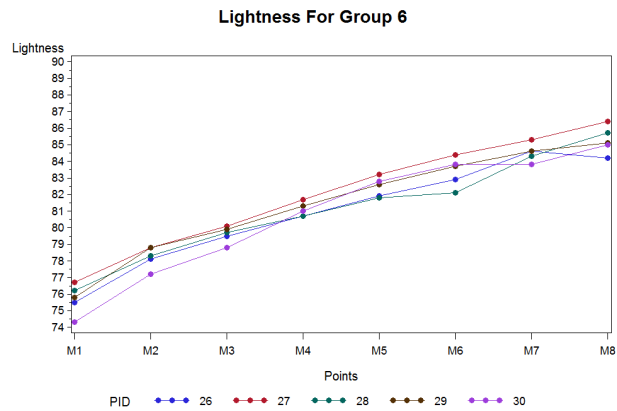

Figure 38. Lightness Values for All Samples from Group 6 – Infinite and Straight Bevel Group.

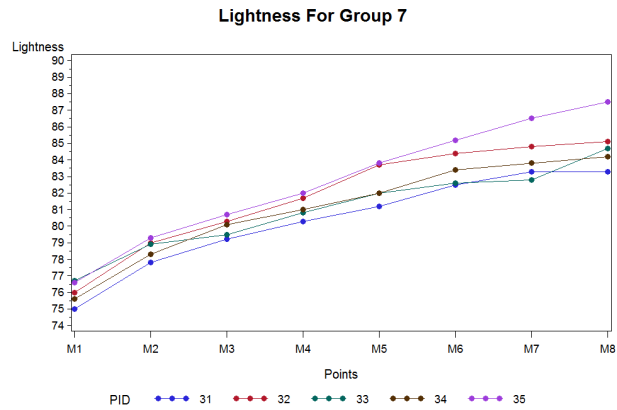

Figure 39. Lightness Values for All Samples from Group 7 - Infinite and Scalloped Bevel Group.

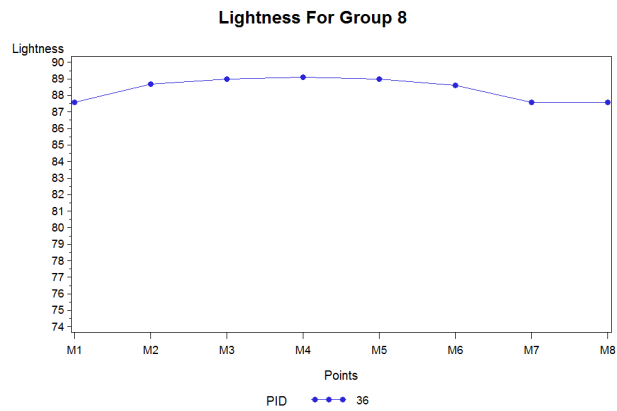

Figure 40. Lightness Values for All Samples from Group 8 - Original, Unprepared Sample.

An Overview of the Statistical Methods for the Correlation of the Visual Evaluation and the Spectrophotometric Evaluation Data for the Final Study

The Pearson correlation test was used to correlate the data for the visual evaluations scores and the lightness values. The Pearson correlation coefficient is a measure of correlation (or linear dependence) between two variables ranging from 0 to 1 or from -1 to 0; where a negative coefficient value indicates a negative correlation, 0 coefficient indicates no correlation, and a positive coefficient indicates a positive correlation.

A simple linear regression analysis (i.e. with one predictor variable in the model) on the visual evaluation rank scores and lightness values was completed as well with lightness being the predictor variable.

#### Statistical Results for the Correlation of the Visual Evaluation and the Spectrophotometric Evaluation Data for the Final Study

In this study, the visual evaluation score is defined as an average of visual evaluation scores at each bevel level and lightness is defined as an average of lightness values at each measurement point.

Based on the Pearson correlation test, the data showed that there was a significant relationship between the visual evaluation scores and lightness values ( $p=0.0066$ ). Moreover, the Pearson correlation coefficient of  $-0.89$  indicated there was a strong negative correlation between the two variables. Note that this negative correlation shows the two variables tend to move in the opposite directions. That is, one variable increases, the other tends to decrease, and vice versa.

#### Linear Regression Analysis on Visual Evaluation Scores and Lightness

With simple linear regression (i.e. with one predictor variable in the model), visual evaluation score was then regressed on lightness. Therefore, visual evaluation scores could be predicted from lightness by the following equation:

Visual Evaluation Score =  $-1.7$  Lightness + 145, with an overall model fit of  $R\text{-square}=0.99$ .

This analysis revealed that the predictor of lightness was significant (coefficient=-1.7,  $p < 0.0001$ ). That is, the equation shows that the coefficient for lightness is -1.7 which indicates that for every additional lightness unit you can expect visual evaluation score to decrease by an average of 1.7 unit of visual evaluation score. R-square is equal to 0.99 which means that 99% of the variance in visual evaluation score was explained by lightness value. The fitted line plot in Figure A shows the same regression results graphically.

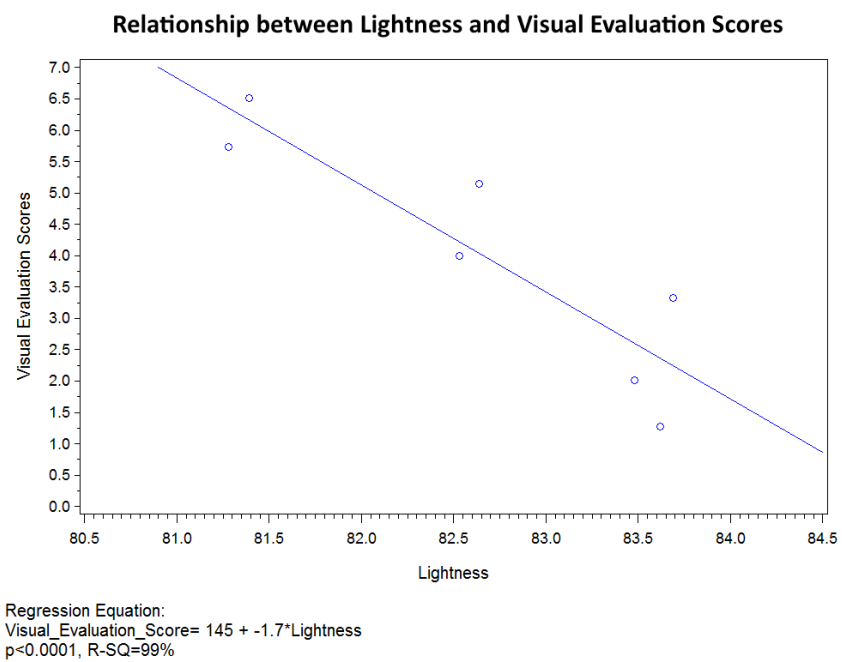

Figure 41. Relationship between Lightness and Visual Evaluation Scores

## CHAPTER V: DISCUSSION

### Acceptance or Rejection of Null Hypotheses

#### First Null Hypothesis ( $H_{o1}$ )

There is no difference in visual evaluation rank scores among five groups of evaluators for each type of bevel.

The results of the study showed that there was no difference in the median visual evaluation rank scores for the bevel types among the groups of evaluators at a significance level of 0.05, thus this hypothesis was accepted. However, for the infinite and scalloped bevel group, the data did signify the marginally significant difference in median visual evaluation rank scores among five groups of evaluators with a p-value = 0.0570, which could be considered suggestive. If there had been a higher number of evaluators, the type of evaluator could have made a difference on the ranked order for the infinite and scalloped bevel group.

#### Second Null Hypothesis ( $H_{o2}$ )

There is no agreement in the visual evaluation rank scores of the seven groups of bevels among all evaluators or within each group of evaluators.

Based on the findings from the statistical analysis, the second null hypothesis was rejected. There was agreement among all the evaluators and well as within each evaluator group for what was the least to most esthetic bevel groups. The most esthetic was the infinite and scalloped bevel, with 71.4% of the evaluators in agreement. This was followed by the infinite and straight bevel (61.5%), the long and scalloped bevel (58.2%), the long and straight

bevel (60.4%), the short and scalloped bevel (60.4%), the short and straight bevel (79.1%) and the negative control with no bevel was the least esthetic with 83.5% of evaluators in agreement.

There was a definite ranking order that was determined by the evaluators. The majority of the evaluators that did not choose the most common rating choice, seemed to choose either one group above or below the ranked group. This would indicate that small changes, like beveling with a straight edge or a scalloped edge within the same length of bevel or a scalloped shorter bevel versus a longer straight bevel might make it harder to distinguish a difference.

As the lengths of the bevels increased, the restorations were deemed more esthetic. When there is a longer bevel with an indistinguishable margin present, this allows for a more gradual transition from composite to typodont tooth structure without seeing a definitive “line” at the margin. The negative control group (with no bevel) had a very sharp edge and there was no transition between the composite and the typodont tooth. This was the least esthetic group chosen by the evaluators with over 85% in agreement. From this, we know that when speaking for esthetics only, it is necessary to have some sort of finish line added to a class IV fractured tooth. For the purposes of retention, at least 1mm of length is needed to retain the restoration.

When referring to the agreement within or among the groups of evaluators, it is remarkable to see the different levels of agreement. The five groups of evaluators consisted of 17 faculty, 17 graduate residents (mostly from the Operative and Prosthodontic Departments), 18 pre-doctoral dental students (with a sampling from each educational year), 19 dental hygienists/dental assistants/lab technicians, and 20 auxiliary administrative staff from the University of Iowa College of Dentistry and Dental Clinics.

Kendall’s coefficient of concordance (Kendall’s W) for ordinal responses was used to evaluate the agreement among all evaluators, as well as the different groups of evaluators. The



scale is fixed from 0-1, with 0 indicating no agreement and 1 indicating perfect agreement for Kendall's coefficient of concordance. The level of agreement among the 91 evaluators was 0.80, which indicated strong agreement overall. With four of the five groups having chair-side clinical experience and professional expertise within the dental field, this is not surprising that there was a strong agreement among the groups of evaluators.

One would expect that those with no chairside clinical experience would have the least amount of agreement. This was true as the agreement for the staff was 0.71, which is still considered good agreement. We chose the group of auxiliary staff to represent lay people or non-dental professionals within the population.

The level of agreement for the dental assistants, registered dental hygienists, and lab technicians group of evaluators was 0.72, which is also considered good agreement. This was a bit surprising as they all either have chairside experience or have a part in processing esthetic restorations; one would think they would have a higher agreement. The dental students had a strong agreement of 0.84. Even though the students are new to the field of dentistry, they undergo extensive restorative training. It is not surprising that they had a strong agreement overall. The sample of dental students was almost equally balanced between the four years of the pre-doctoral program. It would be expected that if only fourth year dental student were selected, the agreement would have been higher as the first year students had not yet begun their coursework in Operative Dentistry when this research was conducted.

It is most interesting to note that the highest level of agreement came from the graduate residents (0.92) instead of the faculty (0.88). One would assume that those who teach would have a sharper eye for detail (visual esthetics and blending of the materials). However,

the majority of the residents were younger than the faculty members and one would also expect that age and eyesight could play a role in this as well.

This study is unique in that, within the literature, there is not another study that has compared bevels or other types of finish lines for the purposes of esthetics. Yet, esthetic dentistry is one of the most demanding and detail oriented areas within the profession. There have been studies completed that addressed different types of finish lines and their requirements for retention, like that by Bagheri et al. (1983) and Poojary et al. (2013), both of which suggest 1mm as a minimum length of bevel for retention (13, 15). Some studies have presented clinical case scenarios, like that by Romero (2015), who suggested using a diamond bur to create a 1.5mm 75-degree functional esthetic enamel bevel, then using a Sof-flex disc to extend it to at least the middle third of the facial surface of the tooth for an infinite beveled margin on a class IV restoration(50). Yet, other authors, like de Araujo et al. (2003), suggest that due to the advances in both dental composites and dental adhesives there is no need for a bevel at all(51). Our study is not directly related and cannot be compared to the other studies because they did not investigate the esthetics of bevels nor did we investigate the retentive capabilities of bevels.

### Third Null Hypothesis (H<sub>0</sub>3)

There is no difference in the lightness values among seven types of bevels at each of eight measurement points or for the whole tooth as measured by a spectrophotometer.

The third null hypothesis was also rejected based on the measurements from the spectrophotometer. For the spectrophotometric data evaluation, an eighth group was added as a reference group. This group was an uncut, original typodont tooth that had no fracture and no

restoration present. This group was used only as a reference to compare the lightness ( $L^*$ ) values between the typodont teeth restored with dental composite and the original sample. Overall the  $L^*$  measurements on the reference group were higher than those with dental composite restorations.

For the first three measurement points, there was no statistically significant difference found between M1-M3 for the bevel groups (groups 1-7) but the mean lightness value was significantly higher in reference group (group 8). This could be explained in that the first 3 measurements were likely made within the dental composite in groups 1-7 and before the transition to the typodont tooth structure, while group 8 had no dental composite present.

For M4, the mean lightness value was significantly higher in the reference group (group 8) as well, but there was also a significant difference observed in group 1. The M4 measurement for group 1 was significantly higher than that in Groups 2, 3, 4, 5, 6, and 7. This could be explained by the fact that group 1 had no bevel and thus no transition from the dental composite to the typodont tooth structure. There was no blending effect, so the lightness values changed directly from that of the dental composite, straight to that of the typodont tooth structure. This is also visually evident in spectrophotometric data graphs (Figures 33-40 in Materials and Methods chapter).

At the measurement point M5, the mean lightness value was significantly higher in the reference group (group 8) than that observed in groups 2-7, while no significant difference was found between group 8 and group 1. The mean lightness values observed in groups 1-3 were significantly higher than those in groups 4-7, but there was no difference among groups 1-3 and 4-7. This would indicate that the groups 1-3 likely had the measurements taken on the typodont tooth structure as the bevel was already completed prior to that point on the sample, whereas

4-7 were within the beveled area or the transition portion of the dental composite and the typodont tooth structure.

For the sixth measurement point (M6), the mean lightness value was significantly higher in the reference group (group 8) than that observed in groups 5- 7, while no significant difference was found between group 8 and groups 1-4. This would also indicate that the M6 measurement point for groups 1-4 was no longer in dental composite as the bevel was completed. What is interesting with this measurement point is that groups 4 and 5 were both the long bevels with group 4 having a straight finish line and group 5 having a scalloped finish line. The point that the measurement was taken must have been within the scalloped area of the finish line in group 5, which only extended, at most, 1mm beyond the straight finish line. Regardless, this area would still be the transition area between the dental composite and the typodont tooth. At M6, the mean lightness values observed in groups 1-3 were significantly higher than those in groups 6 and 7, whereas no significant difference was noted among groups 1-5 or among groups 4-7. Again, this is likely due to the fact that groups 1-3 were taken on typodont tooth structure while 6 and 7 probably still had an adequate amount of dental composite present within the bevel/transition area.

At the measurement point M7, the mean lightness value was significantly higher in the reference group (group 8) than that observed in groups 6 and 7, while no significant difference was found between group 8 and groups 1-5. For the same reasons as mentioned earlier, the measurements at M7 for groups 1-5 and 8 were likely only in typodont tooth structure vice the dental composite transition. The difference between M7 and M6 is that group 5 is gains inclusion with 1-4, indicating that the scalloped area of the bevel was completed, and the measurement was taken beyond the restoration. It was also determined that the mean lightness values observed in groups 1-5 were significantly higher than those in groups 6 and 7, whereas

no significant difference was noted among groups 1-5 or between groups 6 and 7. At this point on the samples, the measurements were being taken toward the cervical area. Groups 6 and 7 were the infinite bevel groups, which included using the Sof-lex disc to extend the finish line and make it “disappear” into the tooth structure so there would not be an obvious finish line. It is safe to say, at this measurement point, that the infinite groups were the only ones still containing dental composite within the M7 point.

The final measurement point on the samples, M8, showed the same result as did M7 when factoring the reference group (group 8) into the calculations. Again, the mean lightness value was significantly higher in the reference group (group 8) than that observed in groups 6 and 7, while no significant difference was found between group 8 and groups 1-5. The mean lightness values observed in groups 2 and 4 were significantly higher than those in groups 6 and 7, whereas no significant difference was noted among groups 1-5 or among groups 1, 3, 5 and 6 or among groups 1, 5, 6 and 7. The reasoning for these results could possibly be, in part, because of the small sample size. It could also be due to the fact that the standard deviations were higher than in any of the previous measurement points and that there was more variation at the M8 point for all groups.

Aside from each individual measurement point (M1-M8), analysis of the whole sample was completed as well. The findings showed a significant effect by the type of bevels on the lightness value at M6. It was also found that the mean lightness value was significantly higher in reference group (group 8) than that observed in the other seven types of bevel groups. The overall mean lightness values observed in groups 1-3 were significantly higher than those in groups 6 and 7, while no significant difference was noted among groups 1-5 or among groups 4-7. This is likely due to groups 1-3 having either no bevel or the shortest bevel in comparison to

groups 4-7. More of the measurements were taken on typodont tooth structure, which was shown to have a higher lightness measurement than that of the dental composite.

The lightness values varied due to the type of material the spectrophotometer was measuring. The L\* values of the incisal most measurement points (M1) were between 75.44-76.02 for groups 1-7, as this measurement was taken within the composite. The L\* value of the incisal most measurement point (M1) for the original, unprepared typodont tooth was 87.60. This was because the measurement was taken within the melamine material of the typodont tooth. When comparing the overall lightness values by the tooth (Table 10 in Materials and Methods chapter), generally, there is a decrease in the mean value of lightness per group from groups 1-7 (83.82 in group 1 to 81.39 in group 7). There is also an increase in the length of the bevels from groups 1-7. As the length of the bevels increase, the L\* values decrease. This is showing that the dental composite is blending into the melamine typodont tooth better as the bevels are getting longer and the L\* values are decreasing. Overall, group 7 (infinite and scalloped bevel) had the best blend, but it was not significantly different from group 6 (infinite and straight bevel) or groups 4 or 5 with the long bevels.

All levels of significance for the measurement points of M1-M7 and the whole tooth were reported as  $p < 0.0001$ , however, the level of significance for M8 was reported as  $p = 0.0007$ . These levels of significance are quite substantial and show that the type of bevel is important when it comes to the measurement of lightness within a restoration, and that not all bevels perform equally.

#### Fourth Null Hypothesis ( $H_04$ )

There is no correlation between the visual evaluation and the spectrophotometric evaluation.

Based on the results of the statistical analysis, the final null hypothesis was also rejected. The results showed that there was a significant strong negative correlation (Pearson correlation coefficient of -0.89) between the visual evaluation scores and the spectrophotometric evaluation values ( $p=0.0066$ ). The negative correlation shows that the variables move in opposite directions; as the lightness values measured by the spectrophotometer decreased, the overall visual evaluation score increased. The samples that had higher lightness values also had less dental composite present (i.e. there was a shorter bevel present). The higher scores of the visual evaluations indicated that they were the preferred choice among the evaluators.

The correlation data is important to the study, as it shows that placing a longer bevel (3+mm), allows for a more gradual transition and better blending capabilities between the tooth structure and dental composite.

#### Purpose of Performing This Study

We chose to do this research because there is a lack of information in the literature regarding the best way to esthetically blend dental composites in class IV direct restorations. There are multiple case studies and opinion editorials in the literature, but none which had any scientific research to justify their choices or recommendations. As an operative dentist, we see numerous class IV fractured teeth and we wanted to determine the most conservative, predictable, and reproducible method to restore them.

Aside from the four main hypotheses, another goal of the research was to find the most conservative bevel that was also still considered esthetic. Our study showed that the infinite bevel was deemed the most esthetic but there was no statistically significant difference

between the straight versus scalloped finish line. Therefore, it is not necessary to add the scallop to the infinite bevel as adding the scallop removes more tooth structure.

When speaking of bevels and conserving tooth structure, one must keep in mind the patient's desires for an esthetic, natural-looking restoration. According to Baratieri et al. (2005), enlarged marginal configuration and removal of sound tooth structure are elements exchanged in order for a restoration to be esthetic; they argue that a bevel should not be mandatory(52). Baratieri et al. (2005) also goes on to state, "Functional and esthetic composite restorations without a bevel can be executed, provided there is sufficient knowledge of restorative procedures and efficient adhesive systems are used(52)."

As shown in this research project, the most esthetic restoration was that which blended the best into the tooth structure (group 7 – infinite, scalloped bevel) and the least esthetic restoration was that with the butt margin (group 1 – no bevel/butt margin). The correlation of the visual and spectrophotometric data had a statistically significant result. This data would not support the view of Baratieri et al. (2005). Our data showed that when evaluated by professionals within the dental field, an infinite bevel was most preferred.

### Experimental Design

#### Typodont versus Natural Teeth

While designing the study, we chose to use Kilgore melamine typodont teeth instead of natural teeth for many reasons. The first and probably most important reason was because of the lack of available intact, extracted maxillary central incisors. Finding 18 maxillary central incisors for the pilot study proved to be extremely difficult. The incisors that were identified presented with inherent issues as well. The sizes and shapes of the incisors were all quite



different. The thickness and translucency of the enamel was varied due, most likely, to the age of the patient when the tooth was extracted. The shades and characterizations of the teeth were all different; some of them presented with staining, hypocalcifications, enamel defects, or prominent craze lines. When doing a study on the blending effect of dental composite to tooth structure, taking these extraneous variables into account would be challenging to account for, if not impossible. Varying tooth sizes, shades, shapes, and characterizations could all lead to evaluator bias when assessing the blending capabilities of the different types of bevels. All of the samples would have had to be measured individually to assess the shade match, which could add another element of bias. There would be no way to standardize the esthetic properties of each sample and thus, the results would not be reliable or reproducible.

Due to those extraneous, uncontrollable variables, we chose to have the samples fabricated via CAD/CAM so that each sample would be identical. The only variation to each group of samples would be the type of bevel and the amount of dental composite needed to complete the restorations. The shades were identical for each layer of each sample and placed in as exact as possible quantities due to the molds printed from the 3D printer. The evaluators could focus solely on the blending effect of the dental composite with the typodont tooth.

#### Choice of Dental Composite

In this study, we chose to use Filtek Supreme Ultra dental composite because it is a universal nanocomposite that is widely used throughout clinical dentistry and thus, would have good appeal and application to restorative dentists in the United States of America as well as internationally. It is also the principal dental composite that is taught and used in the pre-doctoral and post-doctoral programs at the University of Iowa College of Dentistry and Dental Clinics.

According to the manufacturer, 3M, Filtek Supreme Ultra dental composite is the top sold universal nanocomposite in the United States due to its: performance of strength and wear resistance, esthetics including natural looking fluorescence, numerous shades and opacities available, and long term retention of polish, as well as its ease of use and material handling. Filtek Supreme Ultra dental composite also has the advantage that there are four different opacities available. We needed to have something more opaque due to the composition of the typodont tooth samples, which is the reason we chose body and dentin shades instead of using an enamel shade as the final increment(53).

The study by Akbar et al. (2012) found that enamel shades had the highest transmittance and the dentin shades had the lowest transmittance (both total and diffuse) in Filtek Supreme dental composites. They did not find a significant difference in total transmittance in the dentin shades or in the total and diffuse of the enamel shades in the Filtek Supreme dental composites(44). We chose to use a dentin shade as our dentin core because they have the lowest transmittance and the typodont tooth was very opaque.

Translucency is important in dental composites because naturally, enamel is translucent and the color and characterizations of the teeth come from the dentin. Dental composites with nanofillers, like those used in the study by Akbar et al., offer advantages in optical properties in that they can provide high translucency in low chroma/high value dental composites to allow for a broad array of opacities and shades(8, 44).

Since we chose to use typodont teeth instead of natural teeth, we needed to have a composite that would have some opacity but also blend well and have good esthetics and polishability. Dental composites are better suited to blend with natural tooth structure, rather than opaque, plastic teeth. In the article by Pecho et al. (2016), they state that nanocomposites

often scatter the shorter wavelengths of visible light (blue), which give the material opalescent qualities(8). While we used typodont teeth for this study, this is an important feature for restoring natural teeth. We did not use an enamel shade because it lacked the necessary opacity to somewhat match that of the typodont teeth used as samples.

The opacity of the Filtek Supreme Ultra dental composite material did not match that of the typodont tooth, but that was as expected due to the material content of the CAD/CAM samples (melamine). This is evident in the results of the L\* (lightness) spectrophotometer measurements for the control sample. When the original, uncut typodont tooth was measured, the L\* values were much higher overall in comparison to the dental composite measurements and the blended dental composite and melamine measurements. This signifies that the material was more opaque than the dental composite.

For ease of sample fabrication, we chose to keep the dental composite capsules warm in a CALSET Composite Warmer. There are many reported benefits to heating a highly filled dental composite prior to placement, including but not limited to: a decrease in viscosity due to composition, shape and filler content as well as lower polymerization shrinkage, and greater wear resistance than a traditional flowable resin(54). We chose to use the warmer to decrease the viscosity of the material and thus, increase the flow of it into the molds. When the dental composite was not heated, it was more difficult to manipulate within the mold. The molds had small vents that allowed for excess composite to flow away from the sample

While the polishability was good overall with the Filtek Supreme Ultra dental composite, in the final study we opted to use Biscover Low Viscosity Liquid Polish as the final step in the sample fabrication. We chose to do this because polishing every sample to the same luster proved to be extremely difficult in the pilot study. We did not want the varying degrees of glossy

surfaces to take away from the blending effect of the different types of bevels. The focus of the clinical evaluation was to rank the samples based on how well the dental composite blended into the prepared sample (typodont tooth). If one sample had a more thoroughly polished surface than another, the evaluator may have been more prone to select it based on the polish instead of the blend.

#### Varying Degrees of Beveled Margins

The reason we chose to bevel the margins was based on the findings from the literature review. The results of many of the studies led to the conclusion that the bevel is, arguably, the best choice for a finish line and the most conservative, depending on placement.

The study completed by Black et al. (1981) found that the group with the highest mean load failure group was the bevels. This was followed by the group with the chamfers and then the feathered edges were the group with the lowest mean load failure(9). Not only did the feathered edge margin fail the earliest, it also had an over-contoured restoration that may not be clinically acceptable in the realm of esthetics or health (if near the gingival margin *in vivo*). The authors stated that it was difficult to finish the feathered edge teeth due the lack of a definitive finish line(9).

While there may not have been a statistically significant difference between the chamfer and bevel groups, Black et al. (1981) found that, “beveling seems the simplest and most efficient means of removing crazed or disrupted enamel at the cavosurface angle, which is often caused by high speed instrumentation or fracture.(9)” The bevel provides enough bulk for the strength of the restoration but also allows a steady transition from tooth structure to dental composite(9).

There were some limitations to the study by Black et al. (1981). The results were presented without explanation of which type of statistical analysis was used. Also, because it was an *in vitro* study, the results may not directly compare to a clinical scenario. This study used a standard 45° degree bevel but there was not a predetermined length of the bevel, the only criteria was that it went from the DEJ to the enamel surface. Questions remained on the most effective bevel length, which is addressed in the following studies.

Two different studies were published by the same authors from the University of Iowa regarding whether the bevel finish line was superior to a butt joint and what type of restoration would be sufficiently retained by the bevel. The first study published by Bagheri et al. (1983), found that all bevel lengths (1mm, 2mm and 3mm) had higher shear bond strength than the butt margin and the difference was statistically significant. However, there was no statistically significant difference among the bevel groups(13). This would mean that for retentive purposes, beveling beyond 1mm added little benefit to the strength of the restoration. Nonetheless, the authors did state that the longer bevels have significance and may be necessary to, “permit a gradual transition of restorative material to tooth structure and a blending of color(13).” While providing a gradual transition, the bevels also limit the chance of an over-contoured restoration and are likely to be more esthetic.

Aside from the results of the finish line, Bagheri et al. (1983) also found that the shear bond strength had an inverse relationship with bevel length, when comparing a restoration of 2mm versus 4mm length. The longer restorations had statistically significant lower shear bond strength as compared to the shorter restorations(13). This would mean that shorter restorations are less likely to fracture or dislodge than longer restorations.

In the article by Bagheri et al. (1983), the limitations were not addressed, per se, but they did state that current research was underway to determine if an additional bulk of dental composite might require longer bevels for retention(13). It was stated in the article that the teeth were cut down to specific dimensions for uniformity. In reality, every tooth is different and it seems unlikely that all of the teeth had equal amounts of enamel remaining. At the time this research was completed, dentin bonding was not at the same level of predictability as it is currently. If too much enamel was removed and the shear bond strength had to rely on dentin bonding, the tooth may have fractured prematurely, thus skewing the results. The authors did not list what type of dental composite was used; they only stated that it was an auto-cured system that consisted of both unfilled and filled resin. While this would standardize a condition of the present study, it would limit the reproducibility of the study. There was no evidence in the study that statistical analysis of power was considered to determine sample size. It is possible that an increased number of samples could have produced a statistically significant difference between the groups of bevels.

The article by Bagheri et al. (1983) helped to determine that a bevel is a necessary element in the retention of dental composites in the anterior region; the minimum length needed would be 1mm and beyond that would be for esthetic purposes(13).

In the second article by Bagheri et al. (1985), the authors were testing the depths of the bevel to see which provided superior retention. The results showed that a 2mm bevel depth was statistically significantly superior to 1mm, 0.5mm or 0mm (butt joint). There was not a significant difference between the 0.5mm and 1.0mm bevel depth.

Limitations to the study were not addressed in the article by Bagheri et al. (1985). The author stated that the enamel thickness is usually around 1.5mm and that to achieve a depth of

2mm and to remain in enamel, the provider may need to over-contour the restoration. In over-contouring, they suggested overlapping the facial surface to create a consistent contour for esthetics and function. Standardizing the bevel depth at 0.5mm and over-contouring the restoration may not be clinically feasible or have the same bonding characteristics as preparing the tooth with the actual bevel depth. Over-contouring may also present an esthetic challenge to the clinician if only one anterior tooth needs to be restored, especially if that tooth is in proper alignment(14).

As in the first article by Bagheri et al. (1983), the samples in this article were also reduced to a uniform size for standardization(13, 14). This could lead to premature failure of the restoration or bond based on the amount of enamel remaining for good adhesive bonding. The *in vitro* results may not correlate to clinical settings very readily.

Decades later, research was still being done to find out if a bevel was retentive in the class IV dental composite restoration. Poojary et al. (2013) evaluated how the fracture resistance would be affected by the following variables: the presence of a bevel, direct vs. indirect restorative technique, and aging / thermocycling of the restoration. The authors found that the indirect, non-beveled dental composite restorations had the lowest shear bond strength, while the direct, beveled dental composite restorations had the highest. Overall, beveled restorations were more resistant to fracture than the non-beveled restorations and the results were statistically significant. They also stated that the majority of the failures of the beveled group were mixed (adhesive and cohesive), while the non-beveled group had more adhesive failures(15).

Poojary et al. (2013) stated that a limitation of the study was that an *in vitro* study does not simulate clinical conditions. Another limitation of this study is that while they mentioned in

the methods the use of a stereomicroscope to examine fractures, they did not specifically mention it in the results or discussion section. The authors stated that the teeth fractured due to adhesive, cohesive, or mixed failures, but did not define the meaning of each mode of failure as used in their study. The discussion section in the Poojary et al. (2013) article brought to question their use of the term “indirect restoration.” An indirect restoration typically means lab processed or milled. The technique described was the semi-direct technique with no mention of further polymerization. The occurrence of the “mixed” failure with this group could have to do with the polymerization of the “indirect” dental composite restoration. An indirect restoration has a much more predictable and thorough polymerization or degree of conversion than does a direct restoration(55).

Another somewhat recent study, completed by Eid (2002), evaluated the bond strength of different preparation designs where the stair step chamfer technique, bevels, and chamfers were compared. The author found that there was not a statistically significant difference between the three different preparation designs(16).

Eid (2002) stated that some of their limitations were that bond strength to bovine incisors is slightly lower than human incisors, and it would be difficult to complete a similar study *in vivo*. Additionally, the author stated that the stair step chamfer had a better esthetic outcome, but there was no mention of an esthetic evaluation of the restorations completed. The information on the results regarding the site of fracture between the finish lines was not included in the materials and methods. The author only stated that it was a visual assessment. It would be very hard to determine where the site of fracture truly is by visual assessment alone; a microscope would be needed to properly evaluate the specimen(16).



It is somewhat difficult to compare the results of the different study designs from Black et al. (1981), Bagheri et al. (1983), Bagheri et al. (1985), Poojary et al. (2013), and Eid (2002). They each used different criteria to compare bevels and the type of restorations placed. Black et al. (1981) found the mean load failure of the bevel to be the highest overall but only statistically significantly higher than a featheredge design (butt margin). While there was not a statistically significant difference between the beveled and chamfered margins, the authors found the placement of the bevel to be both easier and more efficient. The bevel also allowed for a more gradual transition from tooth structure to restoration than did the chamfer design(9). The results from Bagheri et al. (1983) demonstrated that a 1mm bevel was significantly superior to the butt margin (no bevel) and that the longer the restoration was, the poorer the shear bond strength(13). The results from Bagheri et al. (1985) demonstrated that an increased depth of dental composite at the enamel bevel increased the retention of the restoration(14). Poojary et al. (2013) found bevels significantly improved fracture resistance (in both direct and indirect dental composites) and that they reduced the impact of aging. They also found that long-term water storage decreased fracture resistance in all restorations(15). This information was also confirmed by another study by Coelho-de-Souza et al. (2008); they found that after 24 hours and 6 months, beveled teeth had a statistically higher fracture resistance (similar to the values for intact natural teeth) than non-beveled teeth and reduced effects of aging(17). The first four studies Black et al. (1981), Bagheri et al. (1983), Bagheri et al. (1985), and Poojary et al. (2013) provided *in vitro* evidence that a 1mm bevel placed prior to restoration had greater fracture resistance than a butt margin(13-15). Eid (2002) found that there was no statistical difference between the bevel, chamfer, and stair step chamfer for the quality of shear bond strength(16).

Taking this information into account is what helped guide our decision to use a 1mm bevel as our shortest finish line for the straight and scalloped bevel groups. In order to

determine which type of bevel is most esthetic, more research had to be done. There are not currently any studies that evaluate what type of finish line is most esthetic in a class IV direct dental composite.

#### Types of Bevels Used – Length and Finish Line Design

While researching journal articles on types of bevels as well as speaking with innovators and trained specialists in the field of operative dentistry, we chose to include three different lengths of bevels within the research. We opted to not classify them as 45 degrees, 60 degrees, etc., as it would be a challenge to reproduce a specific degree in the lab and it would be difficult to standardize the samples within each group. Instead, we opted to measure each sample with 1mm toward the lingual surface (on the incisal edge) and measure 1, 2, or 3mm on the facial surface. Then, by using a diamond bur to connect them, each would have the same angle.

The three lengths, short (1mm), long (2mm), and infinite (3+mm) were then split into straight and scalloped margins. We started with the short bevels (1mm) as the studies reviewed in the literature review chapter found that 1mm was the minimum bevel for optimal retention of the dental composite. The three lengths were easy to standardize in the lab as we used a digital caliper to mark the samples. The scalloping of the samples was more difficult to standardize and, with removal of more tooth structure, is less conservative. The infinite margins are also less conservative, but with this technique only the most superficial layers of enamel are removed to minimize the bluntness of a straight or scalloped beveled margin. This aids in a better blend from dental composite to tooth structure as there is no definitive “line” apparent between the two. As stated in earlier chapters, removing the superficial layer of aprismatic enamel has been shown to etch better and an increased surface area of enamel also leads to decreased microleakage(17).

## Fabrication of 3D Matrices

When trying to develop our materials and methods during the pilot study, a problem that kept occurring was samples were not standardized with the same amount of dental composite. After trying to make our own matrices out of putty bases and stent covers, we decided to consider other options. We wanted to fabricate a hard mold that could not flex when pressure was exerted on it so that the same amount of dental composite would be used for each sample. The mold needed to be able to restore the same fracture configuration that was the basis for each study group. These elements would allow limited variation among each sample and eliminate extraneous variables that could affect the fractured typodont tooth (with different types of bevels) and the dental composite buildups that were placed on them.

We chose to contact the University of Iowa College of Engineering Machine Shop to discuss making a mold via their 3D printer. We gave them two typodont teeth to scan into the software system; one had only a dentin layer build up adjacent to the class IV fracture and the other was an untouched typodont tooth (no fracture or composite added to it). We also gave them an Estelite Omega shade tab maker to show what type of mold we were looking to emulate. We received many prototypes, but none fit the description of what we were looking for and we were informed, after 6 months of trials, that they would be unable to complete our task.

After this major setback, we decided to contact a digital designer at the University of Iowa Studio Arts who was the 3D Design Prototype Director. After a few prototypes and with our input on what we desired for the study, he was able to design two molds to be used in our study. We were able to use those molds for both the pilot and final study without any further problems.

## Usage of 3D Matrices in the Lab

The matrices were made of an acrylic material (the actual composition was not known by the designer). When beginning to fabricate samples, a problem arose because the dental composite was adhering to the matrix. Each time it happened, the dental composite had to be drilled out of the mold. To not affect the overall shape of the mold and thus the amount of dental composite per sample, it was decided to use silicone spray before the fabrication of each sample in both the dentin core and the enamel shell matrices, to avoid the adhesion of the dental composite.

### Changes Made Due to Pilot Study

When measuring the L\* values for each sample, we originally scanned each sample with a white background and then a black background. According to Ardu et al. (2017), double evaluation with both black and white backgrounds can replicate two different clinical situations. The white background simulates a situation where there is still one wall remaining between the restoration and the oral cavity, whereas a black background simulates more of a class IV fracture situation with no wall between the restoration and the oral cavity(56).

After statistical analysis of the pilot study was completed, there was no significant difference in the values for the different backgrounds. This was likely due to the opacity of the sample teeth; the material had a high level of opacity and thus there was no effect from the background. For the final study, we continued to use the black background because that simulates, more closely, the intraoral background(57).

### Increase in Sample Size and Number of Evaluators

In the literature reviewed, there was no information available on how to select a relevant number of samples. Based on the pilot data for the visual evaluation, a power analysis was conducted using nQuery+nTerim 2.0. We began with three samples per group in the pilot study. Although the power analysis of the data from the pilot study showed that it was unnecessary to increase the number of samples per group, we decided to increase the sample size to five per group to try and produce more robust data in the results of the final study.

### Changes to the Spectrophotometric Evaluation

In the pilot study, there were only seven points on each sample that the L\* values were measured. For the final study, we changed the number of measurement points from seven to eight for the spectrophotometric readings for the same reason as we increased the number of samples, to try and produce more robust data in the results of the final study. The measurement points did not seem to make a big difference when it came to the results of the spectrophotometric readings, however.

### Spectrophotometer

For this study, we chose to use the SpectroShade Micro, which is an imaging reflectance spectrophotometer that can measure the complete tooth or designated areas(42). The device uses a combination of a digital camera and an LED for its measuring capabilities. The SpectroShade Micro has an LCD screen that allows the observer to reproducibly position the device properly during measurement while in “tool mode.” This ensures the standardization of measurement location between each sample. The SpectroShade Micro analyzes the sample

every 8nm and has analytical software within its internal computer that can be transferred to another computer to view the spectral data and/or images(57). The Spectroshade Micro also has the capability to choose which properties to be measured. In the case of our study, we wanted to measure the L\* value for 8 different points along each sample(58). We were able to view the image, select different points along the same section of each sample, and read the corresponding L\* value for future comparison. We chose to use the SpectroShade Micro because that is what was available to us at the University of Iowa College of Dentistry.

### Optical Integration of Dental Composites

While our study tested the blending capabilities of a specific type of dental composite to a typodont tooth, the ability of a dental composite system to blend to natural tooth structure is very important clinically. There are systems available on the market today that have more similar light properties to that of natural tooth structure. In the study by Dietschi et al. (2006), the *in vitro* L\*a\*b\* values suggested that the Miris dental composite closely mimics the natural tooth structures in hue, chroma, and opacity. They chose to compare to the various A and B Vita shades of extracted teeth because those shades were the most common among the selection of extracted teeth the authors had collected. The information the authors collected through their analyses led them to conclude that a large chroma scale, in addition to one hue and one opacity, would be the ideal replacement for dentin. There were not enough differences in the a\* and b\* values or the translucencies of the Vita A and B shade natural teeth to justify the need for different dentin colors or opacities in dental composite. The authors mentioned that they had to modify their color of dentin selection *in vivo* due to the effect of the surrounding colors intraorally. They also mentioned that because of the intraoral color changes, they made no

attempt to statistically correlate the values of the dental composite and natural tooth tissues *in vivo*(27).

### Correlating Data Between Visual and Spectrophotometric Evaluations

The design idea of integrating a visual evaluation with a spectrophotometric evaluation was modified from the study done by Dietschi et al. (2012). Their study focused more on the level of color integration between tooth and restoration, instead of the blending capabilities of the dental composite with different beveled finish lines. Dietschi et al. (2012) set out to compare whether subjective and objective measurements would correlate with each other with the evaluation of optical integration because there is little research available on the subject. Students utilized the Natural Layering Concept proposed in the article by Dietschi et al. (2006) and calibrated operators scored the restoration visually with the optical USPHS scale(27). They then measured each restoration/natural tooth seven times (in different areas) with a spectrophotometer. Overall, this pilot study had a limited sample size, but was able to show that there was good correlation between the two evaluations. One thing the authors made sure to mention was that the information from this study can only be useful for clinical research (not clinical practice) because there are currently no spectrophotometers on the market that have integrated values for dental composite systems(30).

The difference between the study by Dietschi et al. (2012) and our study was that we were not interested in finding the color integration. Our study was trying to find out which type of bevel would create the best overall blend between the dental composite and tooth structure. While we did not measure the overall color change, we did measure lightness ( $L^*$ ) from the CIELAB and there is not a way to measure the blending effect with an instrument, per se, according to the ISO standards(45). The psycho-physical phenomenon of blending is not

quantifiable, but with utilizing a design that integrated both visual evaluation along with a spectrophotometric evaluation, we were able to see the correlation between the subjective and objective data to understand what was the best blended bevel type.

### Strengths

A strength of the study is that, to our knowledge, this is the first experimental study that evaluated the esthetics of bevels on the restoration of class IV dental fractures and had a comparison of objective and subjective data. Most articles that include information on types of bevels used in class IV restorations are merely case studies. Our study correlated the visual perception of different groups of evaluators with a physical instrument to see if there was any relevance between those measurements.

The controlled method by which we measured and prepared the bevels would also be considered a strength of the study. Each one was precisely measured with a digital caliper on both the incisal edge and facial surface, so the lengths of each group were nearly identical within the group.

Another strength to our study is that because we used 3D printed matrices, the layering of the restorations was very consistent. Each sample had an almost identical amount of dentin shade composite as the dentin core and body shade composite as the enamel layer. The areas that would have been varied were the actual bevels, as the lengths and finish lines varied per groups of samples.

The texture on the surface of teeth and restorations can influence how the light interacts with the materials. A smooth surface will reflect light more while a textured surface diffuses the reflected light(28). An advantage to the design of our study was the use of a digital



scan of the original typodont tooth. When the molds were 3D printed, they were able to reproduce the surface texture and shape within the mold. Therefore, the surfaces of each sample should have been nearly identical. With using the BisCover resin coating to standardize the polished look, the texture on the surfaces should have been indiscernible and thus, not affected the overall ranking of the evaluators or the measurements from the spectrophotometer.

### Limitations

As in all *in vitro* studies, the major limitation is that all procedures were done in a lab setting, not in a clinical setting. The data may not be extrapolated to a clinical setting. With our study, we were limited to the use of typodont teeth instead of extracted natural teeth. This is problematic for two reasons. First, it would be difficult to standardize the blend on all natural teeth if only restoring with two layers of dental composite as we did in our study. Natural teeth have varying shapes, sizes, colors, thicknesses of enamel and dentin, opacities, etc., and there would not be a way to eliminate all bias that comes from these variables when choosing the best blending bevel. The other reason is that the typodont tooth is made of melamine, which in no way resembles a natural tooth structure. The optical properties are not like a natural tooth, and the blending effect seen with our study may not be equivalent to conditions seen clinically on a natural tooth.

Another limitation to the study would be that only two shades from one dental composite system were used in the study. Different types of dental composite may have the ability to mask the finish lines present at the end of a beveled edge. The results may have varied had we used a different dental composite system than Filtek Supreme Ultra. It was also difficult to test anything other than lightness ( $L^*$ ) for these samples, as the hue/chroma of the typodont

tooth was entirely different than that of a natural tooth structure. Using natural teeth would have an advantage because the shade match as well as the lightness of each sample could be evaluated.

This study is limited by the dry nature of all work done in a lab setting. Refractive index does not change whether the tooth is wet or dry but the light propagation and interaction can. If the tooth is dry, the translucency is lower than if the tooth is covered in water or saliva. Translucency increases when the lingual surface is covered in water, which would be a likely occurrence *in vivo*(28). Thus, our final study would not correlate to a clinical setting as for the final study, everything was done in a dry environment.

While the length of the bevels was considered a strength in the study, a limitation would be the standardization of the scalloped edges of groups 3, 5, and 7. It was difficult to make the scalloped margins identical within the groups. There were three waves of scalloping for each sample in the scalloped groups. The furthest point away from the beveled edge was designed to align with each lobe of the tooth. The areas between the lobes were roughly halfway between the beveled edge and the furthest point of the lobe. While we attempted to make them all identical, we are also aware of errors that could have been caused by the operator in trying to do so, including not making them the identical length or depth.

### Generalizations

Due to the nature of an *in vitro* study, the results cannot be generalized to *in vivo* situations. The samples were not natural tooth structure and it is unknown if the same bevels would have the same blending effect intraorally. It is also unknown if the L\* values would have the same correlation with a visual evaluation on the same procedure in natural teeth.

While the results may not be extrapolated directly to a clinical situation, the concept of composite blending could be carried over for clinical use. As there has not been a previous study looking at the esthetics of bevel lengths, it is still an important concept to understand how the length of a finish line can affect the overall appearance of the restoration.

Though our study found that the infinite bevels were the most preferred by the visual evaluators and had the best blend with the L\* values during the spectrophotometric evaluation, this does not mean that an infinite bevel is ideal in every clinical situation of a class IV fracture. A longer bevel is also considered less conservative due to more removal of tooth structure to accommodate for the blending effect. One would have to consider the size of the class IV fracture when deciding what type of bevel to use. For example, if there was just a 1x1mm chip on the mesial incisal of a maxillary lateral incisor, it may not be wise to have an infinite scalloped bevel as the preparation choice. Clinical judgment is imperative when deciding how much tooth structure to remove when restoring a class IV fractured tooth.

#### Future Directions

A future direction of the current study could be to test different type of bevels against other types of finish lines (stair step, chamfer, feather edge, etc.) to see what has the best blend and is considered the most esthetic. Another variation could use the same bevel types and test different types of dental composite to see if the blending effect of the bevel is universal to different dental composite systems. Some dental composite systems like Miris, Estelite Omega or Vitaescense, claim to have more similar optical properties to tooth structure. It would be interesting to see if any of those dental composite systems would have the same results as did the Filtek Supreme Ultra system or if it would be different based on its optical properties.

Instead of doing a study with the same types of bevels tested here, one could do a minimally invasive design and with more conservative bevels. Different types of dental composites could be evaluated to see if they are able to hide the transitional area between the dental composite and the fracture line of the class IV restoration. Multiple layers of dental composite including: effect shades (and tints), dentin shades, enamel shades, and translucent shades, could be used to mask the fracture instead of trying to blend it in with the natural tooth structure.

An alternative direction that could be considered is to compare different types of spectrophotometers to get more information about the fracture line and to analyze the scattering of light or the light propagation. The spectrophotometer that was used in this study was a calibrated reflectance spectrophotometer and would be unable to give us the information to that detail. There are newer types of fully functioning spectrophotometers available, like the Vernier Spectrometer, which can give precise measurements within the visible light spectrum (380-950nm) instantaneously(59).

For future studies, it would be difficult to complete a study of this nature *in vivo*, based on logistics. The number of participants needed with a class IV fractured tooth as well as the availability of a large number of evaluators would be extremely difficult to organize. There would be no way to standardize any of the extraneous variables, including size of fracture/amount of remaining tooth structure, the color, size, shape, opacity, and surface characterizations of the tooth, as well as the calibration of operators needed to restore the tooth or replace the existing failing restoration. It could also be difficult to get IRB approval on a *in vivo* study of this nature.

## CHAPTER VI: CONCLUSION

This study evaluated the blending effect of different types of beveled margins in class IV direct dental composite restorations via visual evaluation as well as spectrophotometric evaluation.

Within the limitations of an *in vitro* study, it was found that:

- There was no difference in visual evaluation rank scores for the bevel types among the groups of evaluators at a significance level of 0.05, thus the first null hypothesis was accepted.
- There was agreement in the visual evaluation rank scores of the seven groups of bevels among all evaluators or within each group of evaluators, therefore the second null hypothesis was rejected. The infinite scalloped bevel was ranked the most esthetic among the seven groups of bevels by all types of evaluators.
- There was a difference in the lightness ( $L^*$  - from CIE Lab Color Space) values among seven types of bevels at each of eight measurement points or for the whole tooth as measured by a spectrophotometer, thus the third null hypothesis was also rejected. The infinite scalloped bevel had the most gradual change in lightness between the dental composite and typodont tooth structure based on the mean  $L^*$  values from the eight measurement points.
- There was a significant correlation between the visual evaluation and the spectrophotometric evaluation, therefore the fourth null hypothesis was rejected. The bevel group that was chosen as the most esthetic from the visual evaluation (infinite scalloped) was also the bevel group that had the most gradual change in lightness values according to the spectrophotometric evaluation. The correlation of these results led to the conclusion that the infinite scalloped bevel had the best overall blend between dental composite and tooth structure.
- The final conclusion was that the longer the bevel, the more gradual the change in lightness ( $L^*$ ), which correlated to the more esthetic restoration, as determined by the evaluators.

## REFERENCES

1. Anusavice KP, R. . Phillips' Science of Dental Materials. 11th ed2003.
2. Heymann H, Swift, E., Ritter, A. Sturdevant's Art and Science of Operative Dentistry. 6th ed. St. Louis, MO: Elsevier Mosby; 2013. 548 p.
3. Hilton T, Ferracane, J., Broome, J, editor. Summitt's Fundamentals of Operative Dentistry. 4th ed. Hanover Park, IL: Quintessence Publishing Co Inc; 2013.
4. Merriam Webster [Available from: <http://www.merriam-webster.com/dictionary/bevel>].
5. Terry DL, K. Composite resin restorations: a simplified approach. Private Dentistry. 2008(April):24-38.
6. Joiner A. Tooth colour: a review of the literature. J Dent. 2004;32 Suppl 1:3-12.
7. Craig's Restorative Dental Materials. In: Sakaguchi RP, J., editor. Craig's Restorative Dental Materials. Thirteenth Edition ed: Elsevier Mosby; 2012. p. 54-60.
8. Pecho OE, Ghinea R, do Amaral EA, Cardona JC, Della Bona A, Perez MM. Relevant optical properties for direct restorative materials. Dent Mater. 2016;32(5):e105-12.
9. Black JB, Retief DH, Lemons JE. Effect of cavity design on retention of Class IV composite resin restorations. J Am Dent Assoc. 1981;103(1):42-6.
10. Macedo GV, Ritter AV. Essentials of rebonding tooth fragments for the best functional and esthetic outcomes. Pediatr Dent. 2009;31(2):110-6.
11. Bruschi-Alonso RC, Alonso RC, Correr GM, Alves MC, Lewgoy HR, Sinhoreti MA, et al. Reattachment of anterior fractured teeth: effect of materials and techniques on impact strength. Dent Traumatol. 2010;26(4):315-22.
12. Yates JL, Hembree JH, Jr. Fracture resistance of Class IV composite restorations. Ark Dent J. 1977;48(2):10-4.
13. Bagheri J, Denehy GE. Effect of enamel bevel and restoration lengths on Class IV acid-etch retained composite resin restoration. J Am Dent Assoc. 1983;107(6):951-2.
14. Bagheri J, Denehy G. Effect of restoration thickness at the cavosurface bevel on the class IV acid-etched retained composite resin restoration. J Prosthet Dent. 1985;54(2):175-7.
15. Poojary PK, Bhandary S, Srinivasan R, Nasreen F, Pramod J, Mahesh M. Influence of restorative technique, Beveling and aging on composite bonding to sectioned incisal edges: A comparative in vitro study. Journal of conservative dentistry : JCD. 2013;16(1):28-31.
16. Eid H. Retention of composite resin restorations in class IV preparations. J Clin Pediatr Dent. 2002;26(3):251-6.
17. Coelho-de-Souza FH, Camacho GB, Demarco FF, Powers JM. Influence of restorative technique, beveling, and aging on composite bonding to sectioned incisal edges. J Adhes Dent. 2008;10(2):113-7.
18. Villarroel M, Fahl N, De Sousa AM, De Oliveira OB, Jr. Direct esthetic restorations based on translucency and opacity of composite resins. Journal of esthetic and restorative dentistry : official publication of the American Academy of Esthetic Dentistry [et al]. 2011;23(2):73-87.
19. Investigations CS. Electromagnetic radiation [Available from: <http://www.ces.fau.edu/nasa/images/Energy/VisibleLightSpectrum.jpg>].
20. Manauta J, Salat, A. , editor. Layers: An Atlas of Composite Resin Stratification. Milan, Italy: Quintessenza Edizioni S.r.l.; 2012.
21. [Available from: <http://cliffsnotescms-v1.prd.techspa.com/assets/10321.jpg>].
22. Paravina RDP, J. M. Esthetic Color Training in Dentistry. St. Louis, Missouri: Elsevier Mosby; 2004.

23. Vanini L. Restorations that Mimic Nature: A Step-by-Step Anatomical Stratification Technique. *Journal of Cosmetic Dentistry*. 2010;26(3):80-101.
24. Hariri I, Sadr A, Nakashima S, Shimada Y, Tagami J, Sumi Y. Estimation of the enamel and dentin mineral content from the refractive index. *Caries Res*. 2013;47(1):18-26.
25. Meng Z, Yao XS, Yao H, Liang Y, Liu T, Li Y, et al. Measurement of the refractive index of human teeth by optical coherence tomography. *Journal of biomedical optics*. 2009;14(3):034010.
26. Tutorvista.com. Properties of Light [Available from: <http://physics.tutorvista.com/light.html>].
27. Dietschi D, Ardu S, Krejci I. A new shading concept based on natural tooth color applied to direct composite restorations. *Quintessence Int*. 2006;37(2):91-102.
28. Baratieri LN, Araujo E, Monteiro S, Jr. Color in natural teeth and direct resin composite restorations: essential aspects. *The European journal of esthetic dentistry : official journal of the European Academy of Esthetic Dentistry*. 2007;2(2):172-86.
29. Paravina RD, Westland S, Kimura M, Powers JM, Imai FH. Color interaction of dental materials: blending effect of layered composites. *Dent Mater*. 2006;22(10):903-8.
30. Dietschi D, Abdelaziz M, Krejci I, Di Bella E, Ardu S. A novel evaluation method for optical integration of class IV composite restorations. *Aust Dent J*. 2012;57(4):446-52.
31. Color Models: University of South Carolina School of Medicine; [Available from: [http://dba.med.sc.edu/price/irf/Adobe\\_tg/models/main.html](http://dba.med.sc.edu/price/irf/Adobe_tg/models/main.html)].
32. Basket TP. [Available from: <http://www.paintbasket.com/munsell/>].
33. Chang JY, Chen WC, Huang TK, Wang JC, Fu PS, Chen JH, et al. Evaluating the accuracy of tooth color measurement by combining the Munsell color system and dental colorimeter. *Kaohsiung J Med Sci*. 2012;28(9):490-4.
34. Pizzamiglio E. A color selection technique. *J Prosthet Dent*. 1991;66(5):592-6.
35. Sproull RC. Color matching in dentistry. Part I. The three-dimensional nature of color. 1973. *J Prosthet Dent*. 2001;86(5):453-7.
36. Magne P, Belser, U. Bonded Porcelain Restorations in the Anterior Dentition: A Biomimetic Approach. Carol Stream, IL: Quintessence Publishing Co, Inc; 2003. 406 p.
37. Fondriest J. Shade matching in restorative dentistry: the science and strategies. *Int J Periodontics Restorative Dent*. 2003;23(5):467-79.
38. Pecho OE, Perez MM, Ghinea R, Della Bona A. Lightness, chroma and hue differences on visual shade matching. *Dent Mater*. 2016;32(11):1362-73.
39. Yu B, Lee YK. Difference in opalescence of restorative materials by the illuminant. *Dent Mater*. 2009;25(8):1014-21.
40. Vichi A, Fraioli A, Davidson CL, Ferrari M. Influence of thickness on color in multi-layering technique. *Dent Mater*. 2007;23(12):1584-9.
41. Sproull RC. Color matching in dentistry. Part III. Color control. *J Prosthet Dent*. 1974;31(2):146-54.
42. Chu SJ, Trushkowsky RD, Paravina RD. Dental color matching instruments and systems. Review of clinical and research aspects. *J Dent*. 2010;38 Suppl 2:e2-16.
43. Paul S, Peter A, Pietrobon N, Hammerle CH. Visual and spectrophotometric shade analysis of human teeth. *J Dent Res*. 2002;81(8):578-82.
44. Naeimi Akbar H, Moharamzadeh K, Wood DJ, Van Noort R. Relationship between Color and Translucency of Multishaded Dental Composite Resins. *International journal of dentistry*. 2012;2012:708032.
45. ISO/TR 28642:2016 Dentistry - Guidance on color measurement [Available from: <https://www.iso.org/obp/ui/-iso:std:iso:tr:28642:ed-2:v1:en>].

46. Li Q, Yu H, Wang YN. In vivo spectroradiometric evaluation of colour matching errors among five shade guides. *J Oral Rehabil.* 2009;36(1):65-70.
47. Tokuyama Estelite Omega Custom Shade Guide [Available from: [http://www.tokuyama-us.com/Product/Composites/Estelite\\_Omega\\_Custom\\_Shade\\_Guide](http://www.tokuyama-us.com/Product/Composites/Estelite_Omega_Custom_Shade_Guide).
48. Style Italiano My Shade Guide [Available from: <http://www.smileline-by-styleitaliano.com/en/shade-taking-dental-photography/14-my-shade-guide-mini-kit.html>].
49. Biscover LV Instructions for Use: Bisco, Inc. ; [Available from: [https://www.bisco.com/instructions/IN-145R6\\_English.pdf](https://www.bisco.com/instructions/IN-145R6_English.pdf)].
50. Romero MF. Esthetic anterior composite resin restorations using a single shade: Step-by-step technique. *J Prosthet Dent.* 2015;114(1):9-12.
51. de Araujo Junior EM, Baratieri LN, Monteiro Junior S, Vieira LC, de Andrada MA. Direct adhesive restoration of anterior teeth. Part 1. Fundamentals of excellence. Practical procedures & aesthetic dentistry : PPAD. 2003;15(3):233-40; quiz 41.
52. Baratieri LN, Ritter AV. Critical appraisal. To bevel or not in anterior composites. *Journal of esthetic and restorative dentistry : official publication of the American Academy of Esthetic Dentistry [et al].* 2005;17(4):264-9.
53. [Available from: <http://multimedia.3m.com/mws/media/6279710/filtektm-supreme-ultra-universal-restorative.pdf>].
54. Blalock JS, Holmes RG, Rueggeberg FA. Effect of temperature on unpolymerized composite resin film thickness. *J Prosthet Dent.* 2006;96(6):424-32.
55. Magne P, Malta DA, Enciso R, Monteiro-Junior S. Heat Treatment Influences Monomer Conversion and Bond Strength of Indirect Composite Resin Restorations. *J Adhes Dent.* 2015;17(6):559-66.
56. Ardu S, Duc O, Di Bella E, Krejci I. Color stability of recent composite resins. *Odontology.* 2017;105(1):29-35.
57. Ardu S, Braut V, Di Bella E, Lefever D. Influence of background on natural tooth colour coordinates: an in vivo evaluation. *Odontology.* 2014;102(2):267-71.
58. Spectro Shade User Manual MHT; [Version 2.30:[Available from: [http://www.mht.ch/downloads/SpectroShade\\_Manual.pdf](http://www.mht.ch/downloads/SpectroShade_Manual.pdf)].
59. [Available from: <http://www.vernier.com/products/sensors/spectrometers/visible-range/v-spec/>].