

**The Islamic University – Gaza
Deanery of Postgraduate Studies
Faculty of Engineering
Architecture Department**



**BUILDING A SUSTAINABLE AND SMART
URBAN DEVELOPMENT MODEL**

BASED ON

TRANSIT ORIENTED DEVELOPMENT (TOD)

GAZA CITY (Implementation Area)

By
Shaymaa Ali Maher/ Abdela'al Abu Rass

Supervisor
Dr. Farid Sobeh Al-Qeeq

**A Thesis Submitted in Partial Fulfillment of the Requirements for the
Degree of
Master in Architectural Engineering**

2012- 1433

ABSTRACT

ABSTRACT

Gaza city suffers from unclear and unstable situation. Also, there is a growing concern about many social, economic, physical, environmental and urban problems that have been attributed to many circumstances. Therefore, an exhaustive development process has to be implemented and significant efforts have to be made toward reforming sustainable development.

Gaza city is taken as study area to model a new pattern of sustainable urban developmental planning, which supports land use, transportation planning, environment and all fields of growth management. While more empirical evidence is needed to verify cause and effect, and while all urban and technological aspects turn to reshape the starting point in planning process, Transit Oriented Development (TOD) is seen as efficient and energetic trend to resolve the existing hard situations and actualize sustainable urban developmental planning.

The thesis defines indicators, strategic transactions and scenarios that support the approach and help decision makers to identify priorities and develop quality of live. Also, it encourages community and stakeholders collaboration in developmental process. Besides, it explores new points for future development suggestions for further researches.

The approach toward smart and sustainable urban development, and Transit Oriented Development that presented in this study is different from a transportation planning that envisions a comprehensive and complete plan as the final product of the process. Rather, this approach recognizes that to be effective, planning must to be an integral, adaptable and ongoing part of the decision making framework. The resulting product is indicators, strategic transactions and scenarios that provide useful information for understanding problems facing Gaza City as a metropolitan area, identifying alternative actions, select the best alternative, and developing successful implementation strategies. Also, plans is part of the final product, that tells what kind of a system is desired, and provide some sense of satisfaction that today's problems are being addressed. All aspects are implemented in details on the South Remal district. Moreover, the thesis offers three tools; the first is a strategic transaction to draw a spatial movement system, allocate and design urban spaces, the second is a computerized model of three scenarios, which can be added to ArcGIS toolbox to be used in other cases and plans, and the third is an evaluation calculator tool in Excel format.

Keywords: urban development, urban planning, developmental planning, smart growth, sustainable development, transit oriented development, growth management, Gaza.

خضعت مدينة غزة لمجموعة من الظروف التي أدت إلى عدم وضوح وعدم استقرار الأوضاع العامة فيها، وهذا ما أدى بدوره إلى تنامي المشكلات المتعلقة بالاعتبارات الاجتماعية والاقتصادية والفيزيائية والبيئية والحضرية، والتي تحتاج إلى تكاتف الجهود للقيام بإعادة صياغة الواقع والظروف، ومن هذا المنطلق تم الاستقرار على اختيار مدينة غزة كمنقطة دراسية لبناء نموذج جديد للتنمية العمرانية المستدامة؛ يمثل ركيزة أساسية لعمليات توزيع استخدامات الأراضي وتخطيط المواصلات والتنمية البيئية، وغير ذلك من الموضوعات التي تساند عملية إدارة النمو في المدينة، وحيث أن هذا الإجراء الواسع يتطلب القيام بجمع المؤشرات والعناصر التجريبية التي من شأنها أن تحدد مسببات المشكلة والآثار المترتبة عليها، وفي ظل الامتداد العمراني الواسع والتطور التكنولوجي الهائل الذي أدى إلى إعادة النظر في التخطيط الحضري ووضع بدائل جديدة قد تكون أكثر تماشياً من العصر الحالي، تم الخلوص إلى أن يبني النموذج الجديد على أساس تنموي موجه إلى إعادة هيكلة نظام المواصلات والوصولية داخل المدينة، باعتبار أن هذا الجانب هو المحرك الأساسي والفعال للخروج من الأزمة، وتطبيق مفهوم النمو الذكي والتخطيط التنموي الحضري المستدام.

وتأتي هذه الدراسة لتحديد المؤشرات والاستراتيجيات والسيناريوهات الخاصة بموضوع الدراسة، وتعمل على مساعدة أصحاب القرار في تحديد الأولويات التنموية وتحسين الظروف الحياتية للمجتمع، إلى جانب أنها تشجع على أن تتحد جهود كل من أصحاب الشأن والمعنيين والفئات المجتمعية والمدنية خلال العملية التنموية الشاملة، هذا بالإضافة إلى أن هذه الدراسة قد تكشف عن نقاط مهمة لإجراء البحوث والدراسات فيما بعد.

وهنا لا بد من الإشارة إلى أن عمليات التنمية العمرانية والتنمية المبنية على أساس نظام المواصلات والوصولية والتي تناولتها الدراسة، تختلف عن عملية تخطيط المواصلات، إذ أن العمليات التنموية تتضمن بشكل أساسي اتخاذ مجموعة من القرارات التي تتصف بالتكامل والديمومة والقدرة على ملءمة جميع الظروف والمتغيرات، وهي تختلف عن تخطيط المواصلات الذي ينتهي إلى إعداد مجموعة من الخرائط والمخططات كمنتج نهائي، وبالتالي فإن هذه الدراسة تنتهي إلى صياغة مجموعة من المؤشرات والاستراتيجيات والسيناريوهات التي تقدم معلومات مهمة حول إدراك ماهية المشكلة التي تواجهها مدينة غزة باعتبارها مدينة عاصمية مكتظة بالسكان والأنشطة، ومن ثم تحديد البدائل المتاحة للتغلب على المشكلة، إلى أن يتم اختيار البديل الأفضل وتشكيل آلية منظمة للتطبيق، بالإضافة إلى إعداد مجموعة من الخرائط لحالة دراسية هي حي الرمال الجنوبي في مدينة غزة كأداة لتوضيح النظام المقترح وكيفية تغلبه على المشكلات القائمة، كما تقدم الدراسة ثلاث أدوات مهمة للتطبيق؛ الأداة الأولى هي عبارة عن نموذج استراتيجي يقدم مجموعة من المعادلات والحلول الممنهجة للخروج من الأزمة بشكل عام، أما الأداة الثانية فهي أداة محوسبة تحتوي ثلاث سيناريوهات مختلفة لبناء النظام المقترح، حيث يمكن إضافتها إلى قائمة الأدوات الموجودة في برنامج ArcGIS، وتطبيقها على حالات وخرائط أخرى لأي تجمع عمراني، أما الأداة الثالثة فهي أداة محوسبة للتقييم لأي نموذج قائم أو مقترح بحيث تعطي درجة معينة لأي نموذج وهي بصيغة Excel.

DEDICATION

TO WHOM IN HEART AND ALWAYS HAVE BEEN

I DEDICATE THIS THESIS

Shaymaa

Acknowledgement

Praise and foremost thanks are due to Allah the most beneficent and merciful who had helped me to accomplish this thesis, and present it in such way.

I would like to express my thanks, appreciation and gratitude to my supervisor Dr. Farid Sobeh Al-Qeeq for his concern, guidance and advice, as well as giving me the support to work on such a new and significant approach.

Finally, I would like to extend my sincere and serious thanks to all who helped me in this thesis, sharing kindly by their knowledge and experience.

Table of Contents

Abstract	I
ملخص	II
Dedication	III
Acknowledgement	IV
Table of Contents	V
List of Tables	X
List of Figures	XI
Chapter 1	
General Introduction	1
1.1 Introduction	2
1.2 Limitation of study area	2
1.3 Importance of the study	3
1.4 Goal and objectives	3
1.5 Problem statement	4
1.6 Research question	4
1.7 Hypothesis	4
1.8 Methodology	5
1.9 Previous studies	7
1.9.1 Building Transit Oriented Development in established communities	7
1.9.2 New transit town: Best practices in Transit Oriented Development (TOD)	7
1.9.3 Transit Oriented Development (TOD): Best practices handbook	7
1.9.4 Urbansim: Modeling urban development for land use, transportation and environmental planning	8
1.9.5 Scenarios and Indicators Supporting Urban Regional Planning	8
1.9.6 Trends in Development Planning of Nablus City in the Light of the Proposed Strategy for the City Development	8
1.9.7 Urban development and planning in the occupied Palestinian territories: Impacts on urban form	9
1.10 Study outlines	10
Chapter 2	
Smart Growth and Sustainable Urban Development... Tools for Controlling the Progress	11
2.1 Introduction	12
2.2 Sustainable development	12
2.2.1 Definition	12
2.2.2 The triple bottom line	12
2.2.3 Expected outcomes	13
2.3 Smart Growth framework	13
2.3.1 Definition	14

Table of Contents

2.3.2	Principles	14
2.4	Smart Growth meets the key goals of Sustainable Development	15
2.5	Sustainable and smart transportation	16
2.5.1	Environmental quality	17
2.5.2	Economic development	17
2.5.3	Social equity	17
2.6	The emergent need for Sustainable and Smart Growth	18
2.6.1	Definition of Urban Sprawl	18
2.6.2	Definition of Automobile Dependency	19
2.6.3	Associated traits of Urban Sprawl and Automobile Dependency	19
2.6.4	Factors that contribute to Urban Sprawl and Automobile Dependency	19
2.6.5	Criticisms and costs	20
2.7	TOD: A tool for Smart Growth	20

Chapter 3

	Transit Oriented Development (TOD)... A Popular Planning Paradigm	22
3.1	Introduction	23
3.2	Sustainable and smart goals of TOD	23
3.3	Definition of Transit Oriented Development (TOD)	24
3.4	Major elements of TOD	25
3.4.1	Enhanced mobility and environment	25
3.4.2	Pedestrian-friendliness	25
3.4.3	Alternative suburban living	25
3.4.4	Community revitalization	26
3.4.5	Public safety	26
3.4.6	Public recreation and celebration	26
3.5	Trends supporting TOD	26
3.5.1	Environmental trend	26
3.5.2	Demographics trend	26
3.5.3	Traffic congestion	26
3.5.4	Economic trends	26
3.6	TOD types and ranks	27
3.7	Specific and typical design features of TOD	27
3.8	Performance criteria for successful TOD	28
3.8.1	Travel behavior and location efficiency	28
3.8.2	Local income and financial return	29
3.8.3	The natural environment	29
3.8.4	The built environment	29
3.8.5	The social environment	29
3.8.6	Efficient regional land use patterns and redevelopment through the policy context	30
3.9	The factors influencing success	30
3.9.1	Local government policies	30
3.9.2	Strong and proactive institutions	30
3.9.3	Individual political champion	30

Table of Contents

3.9.4	Supportive neighborhoods and communities	31
3.9.5	High quality transit service	31
3.9.6	Availability of attractive developable land	31
3.9.7	Strong real estate markets	31
3.9.8	Parking management	31
3.10	Challenges and constraints facing implementing TOD	31
3.10.1	Transport and land use development challenges	31
3.10.2	Procedural and planning challenges	32
3.10.3	Economic and market-related challenges	33
3.10.4	Cultural and perceptual challenges	33
3.10.5	Physical and environmental challenges	33
3.11	Supportive market conditions	34
3.12	Stakeholders and responsibilities in TOD process	34
3.12.1	Local government	35
3.12.2	Transit agencies	35
3.12.3	Special interested community groups	35
3.12.4	Businesses	35
3.12.5	Residents	36
3.12.6	Central and regional government	36
3.12.7	Developers	36
3.13	TOD polices and design guidelines	36
3.13.1	Policy Objective - Ensured transit supportive land uses	37
3.13.2	Policy Objective - Increased density around transit stations	38
3.13.3	Policy objective – Pedestrian oriented design	40
3.13.4	Policy objective – Make each station area as a 'Place'	43
3.13.5	Policy objective – Manage parking, bus and vehicular traffic	43
3.13.6	Policy objective – Plan in context with local communities	46

Chapter 4

	Implementation Area... Identifications and Limitations	47
4.1	Introduction	48
4.2	The background and context of local physical planning	48
4.2.1	The current situation and its impact on physical Planning	48
4.2.2	Main issues and attentions of planning process	50
4.2.3	Related regulations and legislations that rule planning and land use	51
4.3	Regional Situation of Gaza City according to the regional plan of Gaza Strip (2005-2020)	51
4.3.1	Objectives of the regional plan	51
4.3.2	Main principles of the regional plan	52
4.4	Urban structure framework of Gaza City	53
4.4.1	Geographic characteristics of Gaza City	53
4.4.2	The importance of the city and its correlations	55
4.4.2	Urban structure description	57
4.5	Demographic profile	59
4.6	Roads and transportation network In Gaza City	60
4.6.1	Roads classification	60

Table of Contents

4.6.2	Limitations of roads' planning	61
4.6.3	Roads problems	62
4.7	Urban growth framework of Gaza City	62
4.7.1	Analyzing the limitations of horizontal urban growth using SWOT	62
4.7.2	Trends of urban growth	66

Chapter 5

Methodology... Methods, Analysis and Results		68
5.1	Introduction	69
5.2	Data collection	69
5.3	Local community questionnaire	69
5.3.1	Questionnaire design	69
5.3.2	Questionnaire results	72
5.3.2	Resulted indicators and criteria	78
5.4	Semi-structure interviews	80
5.4.1	The sample of the semi-structure interviews	80
5.4.2	Content of the semi-structure interviews	81
5.4.2	Results and responds of the semi-structure Interviews	81
5.5	Space Syntax analysis using UCL Depthmap v.10	91
5.5.1	Analytical approaches	91
5.5.2	Expected results	92
5.6	GIS analysis using ArcGIS v.9.3	92

Chapter 6

Making (TOD) Happens... The Implementation of a Sustainable and Smart Urban Development Pattern (Gaza City)		94
6.1	Introduction	95
6.2	Strategic transaction	96
6.2.1	Multi – Mode strategy	96
6.2.2	Multi – Scale strategy	97
6.2.3	Multi – Active strategy	98
6.2.4	Multi – Station strategy	99
6.3	Spatial movement and transportation system	99
6.3.1	Movement according roads' classification	101
6.3.2	Between-neighborhoods circulation and inner district circulation (Local circulation)	101
6.3.3	Between-districts circulation and inner city circulation (Major circulation)	105
6.3.4	Regional circulation (Global circulation)	107
6.3.5	Circulation related to the principal academic institutions campuses	109
6.4	Stations allocation by using ArcGIS and UCL Depthmap	111
6.4.1	Neighborhoods' stations (Local stations)	112
6.4.2	Districts' stations (Major stations)	114
6.4.3	Regional stations (Global stations)	115
6.5	Urban spaces design	116
6.5.1	Traffic design	117

Table of Contents

6.5.2	Corridors and streetscape design	118
6.5.3	Open spaces design	120
6.5.4	Parking	122
6.6	Evaluation tool and measuring success of TOD	123
Chapter 7		
Making (TOD) Happens... The Detailed Practice of The Implementation (South Remal District)		132
7.1	Introduction	133
7.2	Limitation of study area	133
7.2.1	Boundaries.	133
7.2.2	Urban content	134
7.2.3	Streets and transportation network	134
7.3	Challenges and opportunities facing development	135
7.3.1	Challenges	135
7.3.2	Opportunities	135
7.4	Methodological framework	136
7.4.1	Objective of the pattern	136
7.4.2	Decisions	136
7.4.3	Approach's progress	137
7.5	Space Syntax stimulation using UCL Depthmap v.10	137
7.5.1	Procedures of generating an axial map for the intended area	137
7.5.2	Integration	140
7.5.3	Connectivity	142
7.6	GIS Stimulation using ArcGIS v.9.3	144
7.6.1	Data entry (Inputs)	144
7.6.2	Major station allocation	149
7.6.3	Local stations allocation	153
7.7	Outputs and comments	154
Chapter 8		
Thesis Outcomes... Conclusions, Outputs and Recommendations		155
8.1	Introduction	156
8.2	Conclusions	156
8.3	Outputs	159
8.4	Recommendations	161
References		164
Appendices		171
Appendix 1	Local Community Questionnaire –Gaza City (English)	172
Appendix 2	استبيان موجه لفئات المجتمع المحلي - مدينة غزة (Arabic)	174
Appendix 3	Authoritative and official Local Agencies Semi-Structured Interview (English)	176
Appendix 4	مقابلة موجهة للمختصين العاملين في المؤسسات الحكومية والرسمية المحلية (Arabic)	188

List of Tables

Chapter 2

Smart Growth and Sustainable Urban Development... Tools for Controlling the Progress

2.1	Smart Growth benefits in the sustainability framework	16
2.2	Criticisms and Costs of Urban Sprawl and Automobile Dependency	20

Chapter 4

Implementation Area... Identifications and Limitations

4.1	Distances between Gaza City and other communities in Gaza Strip	56
4.2	Crossing points details that surround Gaza Strip	57
4.3	The adopted details of land use in the master plan of Gaza City	57
4.4	The spatial distribution and relative patterns of existing land uses in Gaza City, according to the latest statistics	59
4.5	The population of each district and community in Gaza City	59

Chapter 5

Methodology... Methods, Analysis and Results

5.1	Sample size for $\pm 10\%$ Precision Levels where confidence level is 95% and $P=5$	70
5.2	Sample size of the questionnaire	70
5.3	Scale of some questionnaire questions	70
5.4	The correlation coefficient between each paragraph in the field and the whole fields	71
5.5	Correlation coefficient between each filed and all the fields	72
5.6	General information results of the questionnaire	73
5.7	The trips and transportation means results of the questionnaire	74
5.8	Walking and using public transportation results of the questionnaire	76
5.9	Transportation Network, Services and Land Use results of the questionnaire	77
5.10	Resulted indicators and criteria of the questionnaire	79
5.11	Semi-structure interviews results	81

Chapter 6

Making (TOD) Happens... The Implementation of A Sustainable and Smart Urban Development Pattern (Gaza City)

6.1	The evaluation model of measuring TOD success	124
6.2	The score sheet of evaluation model	131

List of Figures

Chapter 1

General Introduction

1.1	The five methods that are used to achieve the final outputs	5
1.2	The flow chart of the methodology	6

Chapter 2

Smart Growth and Sustainable Urban Development... Tools for Controlling the Progress

2.1	The triple bottom line of sustainable development	13
2.2	The context of ideal smart transportation	17
2.3	Transportation and Land Use Cycle	18
2.4	Automobile dependency results from a self-reinforcing cycling of increased automobile ownership, reduced travel options and more dispersed automobile-oriented land use patterns	19

Chapter 3

Transit Oriented Development (TOD)... A Popular Planning Paradigm

3.1	Transit Oriented Development and Urban Sustainability	23
3.2	Ranks and types of TOD	27
3.3	Basic transport and land use correlation: TOD pursues a combination of car, transit, and walking and cycling environments	32
3.4	Stakeholders whom are responsible for implementing TOD	34
3.5	Mixing land uses can occur horizontally across a site, or vertically within a building	37
3.6	Medium to high density residential developments are transit-supportive and can come in a variety of forms	38
3.7	<u>Left:</u> compact city policy: build in or next to existing city; <u>Right:</u> Transit Oriented development: build within walking or cycling distance of station	39
3.8	Density around Transit Stations should be increased with the highest density near the station	39
3.9	Density should transit from high to lower density, ensuring compatibility with adjacent communities	40
3.10	Primary and secondary pedestrian connections provide access to the Station and throughout the area	41
3.11	Development patterns in TOD station areas should to be compact	41
3.12	Buildings in TOD stations areas should create a comfortable environment for the pedestrian	42
3.13	Parking areas should be located to minimize conflict with pedestrian	44
3.14	Parking areas should provide safe pedestrian access to the site, and safe circulation	45

List of Figures

Chapter 4

Implementation Area... Identifications and Limitations

4.1	Urban development of Gaza Strip based on two main centers	52
4.2	Elements of transportation system in Gaza Strip	53
4.3	Gaza Strip	54
4.4	Gaza City and its districts and borders	54
4.5	Governorates of Gaza Strip	55
4.6	Gaza Strip with its crossing points	56
4.7	Master plan (1997) of Gaza City	58
4.8	The regional roads of Gaza Strip	60
4.9	Roads classification of Gaza City	61
4.10	SOWT analysis framework	63
4.11	SOWT analysis of eastern horizontal urban growth of Gaza City	63
4.12	SOWT analysis of western horizontal urban growth of Gaza City	64
4.13	SOWT analysis of northern horizontal urban growth of Gaza City	64
4.14	SOWT analysis of southern horizontal urban growth of Gaza City	65
4.15	Trends of urban growth of Gaza City	66

Chapter 5

Methodology... Methods, Analysis and Results

5.1	Open space, convex map and axial map of an urban area	91
5.2	GIS applies geographic approach.	92

Chapter 6

Making (TOD) Happens... The Implementation of a Sustainable and Smart Urban Development Pattern (Gaza City)

6.1	The pursued proposal	95
6.2	The aspects that are taken in consideration to make sure that the design is exploiting the potential	95
6.3	The four major principles that are accomplished through the developmental urban planning	96
6.4	The four three modes of travel	96
6.5	Scales of planning work	97
6.6	The two elements of any trip	98
6.7	To-movement	98
6.8	Through-movement	98
6.9	The three types of proposed stations	99
6.10	The proposed circulation system within the city	100
6.11	The proposed circulation system within the city	101
6.12	Between-neighborhoods circulation and inner district circulation (Local circulation).	102
6.13	The complete trips of between-neighborhoods circulation (Local circulation)	103
6.14	The local trips that reach the districts' station	103
6.15	Calculating number of public vehicles of local circulations	104
6.16	The proposed sign of local movement	104
6.17	Between-districts circulation and inner city circulation (Major circulation)	105

List of Figures

6.18	Calculating number of public vehicles of major circulations.	106
6.19	The proposed sign of major movement	107
6.20	Regional Circulation (Global circulation).	108
6.21	The proposed sign of major movement	109
6.22	The adopted steps of stations allocation	112
6.23	Simplest bath with less angular changes	113
6.24	Shortest path with less metric distance	113
6.25	The allocation of the proposed two regional stations	116
6.26	The four aspects of urban space design	117
6.27	Conceptual plan of local station	117
6.28	Local road; pedestrians and bicyclists only	119
6.29	Local road; pedestrians, bicyclists and local private cars	119
6.30	Collective one-way road	119
6.31	Collective two-way road	119
6.32	Collective two-way road 'another cross section'	120
6.33	Local-main road	120
6.34	Major-main or regional road	120
6.35	Conceptual drawing of linear transit green space	121
6.36	Conceptual drawing of linear transit green space.	121
6.37	The proposed strategy of evaluation is erected on six categories about performance criteria and TOD outcomes	123

Chapter 7

Making (TOD) Happens ... The Detailed Practice Of The Implementation (South Remal District)

7.1	South Remal district's boundaries and its most important streets	133
7.2	The consecutive stages of building the approach	137
7.3	Expressing a study area CAD drawing by axial lines	138
7.4	Converting graph file into axial map	139
7.5	Converting axial map into segment map	139
7.6	Graph analysis as axial analysis to measure integration, with radius 'n'	140
7.7	Resulted axial map that shows the integration of each axis	141
7.8	Angular segment analysis on segment map to measure identify the most connective area with radius 1700m.	142
7.9	Resulted segment map that shows the most connective area within buffer with radius 1700m	143
7.10	The arranged layers that represent the reality	144
7.11	Vacant parcels in South Remal.	145
7.12	Streets integration in South Remal	146
7.13	Streets connectivity in South Remal	146
7.14	Streets width in South Remal	147
7.15	Land use in South Remal	147
7.16	Population of sub-zones of South Remal	148
7.17	Population density of sub-zones of South Remal	148
7.18	The resulted map after making queries upon the approved criteria	149
7.19	Resulted map and alternatives of the first scenario of allocating major station	150

List of Figures

7.20	Resulted map and the one choice of the second scenario of allocating major station.	151
7.21	Resulted map and alternatives of the third scenario of allocating major station	152
7.22	Resulted map of allocating and distributing local stations	153

Chapter 8

Thesis Outcomes... Conclusions, Outputs and Recommendations

8.1	The four major strategies and the secondary aspects of the proposed strategic transaction	159
-----	---	-----

CHAPTER 1

GENERAL INTRODUCTION

- 1.1** Introduction
- 1.2** Limitation of Study Area
- 1.3** Importance of the Study
- 1.4** Goal and Objectives
- 1.5** Problem Statement
- 1.6** Research Question
- 1.7** Hypothesis
- 1.8** Methodology
- 1.9** Literature Review
- 1.10** Study Outlines

1.1 Introduction

Urban planning involves process of making and implementing decisions about land use and related social, economic, and environmental policies. Because of the comprehensive nature of their responsibility, planners and decision makers tend to have a specific trend to actualize the development process. (Oana et al. 2011)

Metropolitan areas' physical health, quality of life and environment depend to a large extent on the performance of its transportation system. Not only does the transportation system provide opportunities for the mobility of people and goods, but over the long term it influences patterns of growth and the level of activities through the accessibility it provides to land. This approach make the ideal transportation system is a significant tool to implement Smart Growth. In recent years, changes to the urban transportation systems have been treated by many officials as means of meeting an assortment of communities' objectives. Within this context, it is realized that it is needed to study how to employ the concept of Transit Oriented Development (TOD) as a new innovative trend to guide urban development patterns and to build highly livable environment.

Transit Oriented Development (TOD) is an admitted tool to implement Smart Growth and Sustainable Development. It refers to a form of urban design that achieves pedestrian-friendly, mixed-use, mixed-income, high-density and location efficient communities centered on public transport nodes (Dittmar, & Ohland 2004). Hence, TOD has become a popular planning response to the impacts of metropolitan growth. Some planners believe that TOD will induce more pedestrian and transit trips and will reduce the average length and frequency of household auto-travel. This effect is assumed to result from improved accessibility to employment and non-work venues located in compact, mixed-use centers. Planning professionals also suggest that if multiple centers are linked by high quality transit, such as light or heavy rail, access is enabled to the broad range of activities (Goodwill & Hendricks 2002).

The approach toward urban development and TOD that presented in this study is indicators and scenarios that provide useful information for understanding problems facing Gaza city as a metropolitan area, identifying alternative actions, select the best alternative, and developing successful attainment strategies.

1.2 Limitation of Study Area

Gaza city is chosen as the study area for modeling the new model. It covers a total area of 45km², and consists of 17 districts. It is one of the most densely populated places in the world. The physical infrastructure is grossly inadequate, particularly for water, electricity and sewage. Also, the demand of land area for agriculture, infrastructure, economic activities, services and housing are growing. The urban planning of the city seems to be unique in its composition and context. This uniqueness is related to the fact that planning practice was controlled and experienced by external forces and not by local bodies. This is of course due to the long period of mandate and occupation by several nations. (Abdelhamid 2006)

1.3 Importance of the Study

The importance of this study stems from several factors:

- It is one of the innovative studies that highlights the urban conflict of unstable and unclear status of Gaza, and then it provides scenarios and dialogs to overstep all hard circumstances.
- It presents a new strategic transaction model and system of smart and sustainable urban development, which based on the emergent case of integration between land use, transportation, environment and quality of life as a term of Transit Oriented Development.
- It identifies some innovative analysis depending on Space Syntax and by using UCL Depthmap application.
- It attempts to arrange an important computerized model that can be assembled to ArcGIS toolbox to be used on other cases and plans. This developmental model can be used locally and globally.
- It provides an evaluation tool on Excel format, which can be used to identify for which the transit oriented development strategies succeed in carrying out the goals of sustainable urban developmental planning.
- It can be considered as starting point for scientists, researchers and decision makers to hold out active plans.

1.4 Goal and Objectives

The main goal of this study is to set a comprehensive and methodological framework for upraising the quality of life in Gaza city through building a new model of sustainable and smart urban developmental planning, which is based on Transit Oriented Development (TOD) and offer an evaluation tool to assess such projects and plans. In order to achieve this major goal, the following objectives are fulfilled:

- Exploring opportunities and limitations of the local situation now and in the future in relationship to the major goal and desired system performance.
- Giving a vision of what a community wants to be, and how the transportation system fits into this vision.
- Setting strategic transactions to provide an understandable and useful platform for a methodology to improve a better integration between planning of land use, transportation and environmental quality, and citizens concerns about managing side effects of growth such as sprawl, congestion housing affordability loss of open space and many other things.
- Helping decision makers to identify priorities and manage growth programs and offer a computerized model to be assembled and used.
- Establishing local and global cornerstone for future development and further researches to the two communities of scientists and decision makers.
- Assessing the final results of the model to examine the efficiency of it.

1.5 Problem Statement

There is a growing concern in Gaza city about high population density, uncontrolled urban sprawl, unorganized services distribution, traffic congestion, long and hard commutes, air pollution, harmful gas emission, foreign and domestic oil prices and availability, open space depletion, weakness of investment, and various other problems that have been attributed to many circumstances. Also, the urban form, physical environment and transportation network in Gaza enhance the auto-oriented system, discourage walkability and encourage private transportation.

So, there is an urgent need for new system that is based on the perception of transit oriented development. And then, an exhaustive development process is needed to be implemented and significant process is needed to be made towards modeling a new template of sustainable urban developmental planning, which is based on transportation planning and supports land use, environment and all fields of growth management.

1.6 Research Question

The main research question of the study is:

"How can the planner deal with all difficult situations in Gaza to reach significant strategies and scenarios that stand on the trend of Transit Oriented Development, which can improve all physical, social and environmental circumstances?"

The achievement of this question demands focusing attention on the following issues:

- Identifying a new system perspective
- Specifying system performance orientation
- Establishing a linkage between development and land use
- Establishing a linkage between development, environment quality and eco system health
- Establishing a linkage between development and community quality of life
- Adopting and implementation perspective
- Assessing the resulted overview

1.7 Hypothesis

The thesis hypothesizes the following aspects:

- The relationship between land use, transportation and environment is the heart of growth and welfare management.
- The growing concerns of congestion, unorganized sprawl, air pollution, open space depletion and many other problems demand general development process.

- Transit Oriented Development (TOD) is seen as an efficient trend which can be used to implement smart and sustainable developmental approach to urban planning and land use.

1.8 Methodology

This study is an applied research, which needs an integral approach. This approach is updated to study an urban phenomenon that based on the fact there is a correlation between scientific frame (theoretical trend) and practice (applied trend), and it permits maximum interaction between the two trends. Also, this approach allows the researcher to achieve depth by using literature and historical method, coverage by using descriptive manner, and balance by using analytical tools. Besides, the methodology takes into consideration all factors and variables at the same time in order to increase the possibility of generalization of findings and recommendations.

The research relies on a systematic and analytical method. It depends on collecting information about the phenomena in order to pinpoint the problem, analyzing all inputs, and then reproduce the results. A set of proposals, alternatives and design ideas is developed to solve the problem. Then, the proposed solution is evaluated, compared and verified in several ways including the use of guidelines and computer application.

There are five methods that are used to reach the final outputs of the thesis, these methods are shown in Figure (1.1):

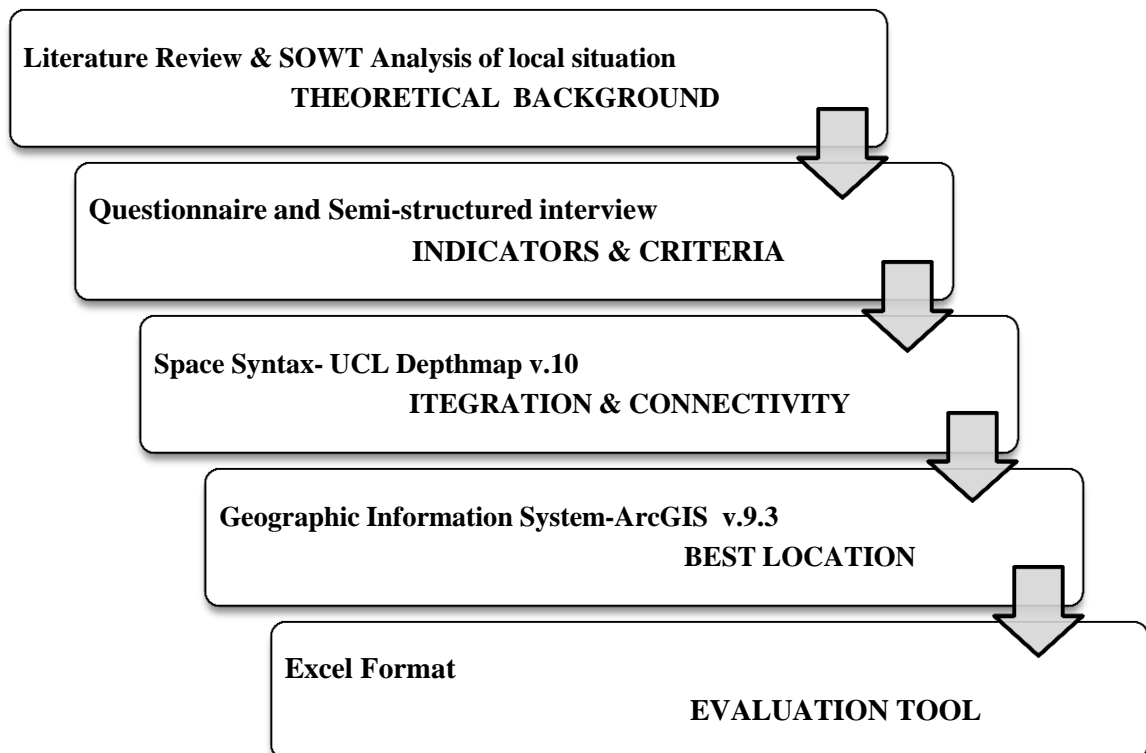

Figure (1.1); The five methods that are used to achieve the final outputs.
The following flow chart represents the methodology in details; Figure (1.2):

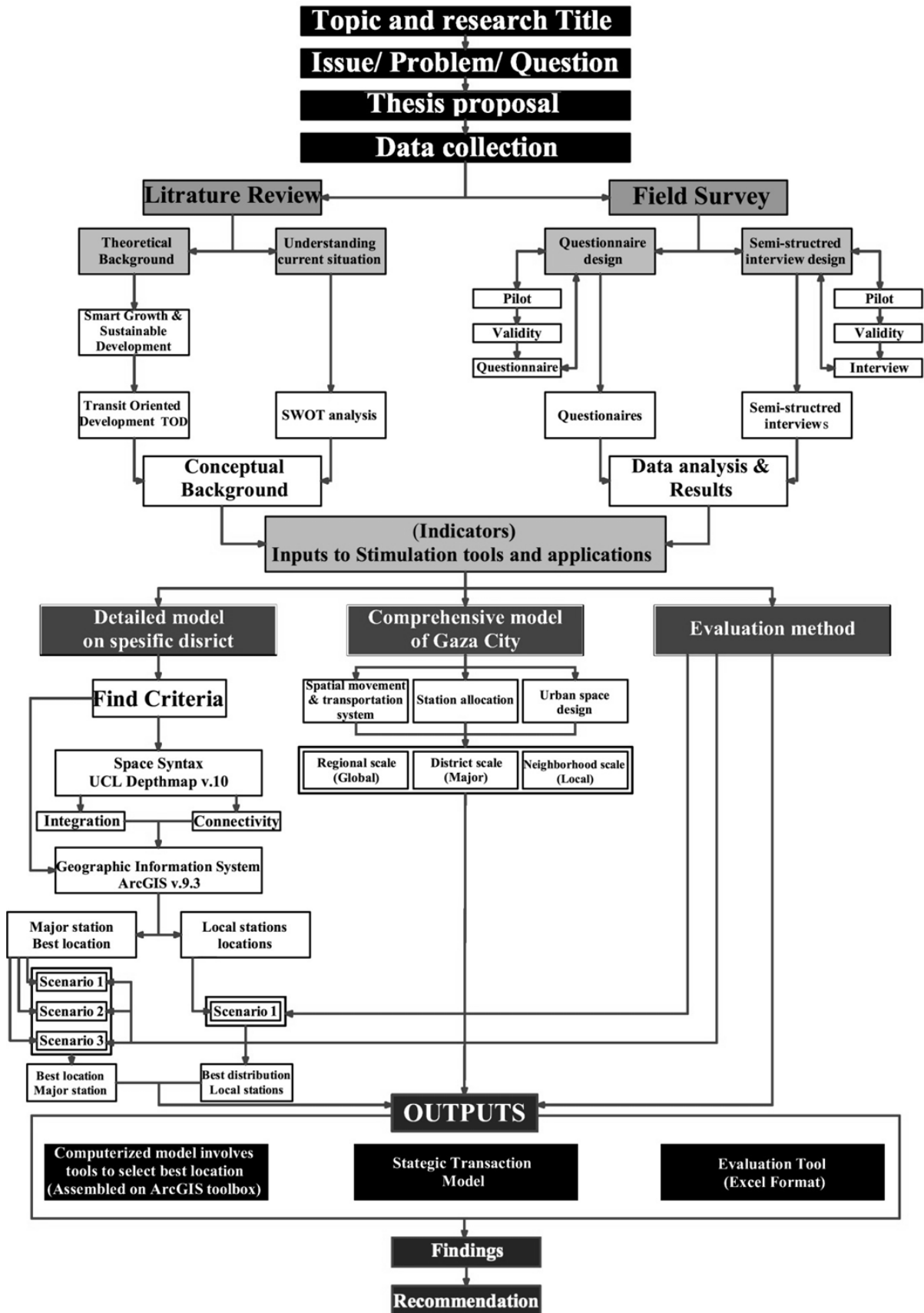

Figure (1.2); The flow chart of the methodology.

1.9 Previous Studies

There are many studies concerns the topic of urban development and sustainable development. Some are local which shed light on the current situations of Gaza city, presents the limitations and constrains, and offer range of recommendations and ideas. Although, much are written about transit-oriented development (TOD) in recent years, and give guidelines and tools to follow this trend. Besides, numbers of research efforts provide detailed evaluations of successful TOD projects in such diverse locations. All these studies can help to create a good view of the selected topic and set of these studies can be listed as:

1.9.1 Building Transit Oriented Development in Established Communities,
By Julie Goodwill and Sara J. Hendricks (2002).

This report provides a synthesis of the steps that established car oriented communities have taken to transform into transit oriented communities. The report identifies several approaches; such as, the use of transit oriented design, focusing Transit Oriented Development (TOD) around park-and-ride lots, making changes to land development regulations, parking management, offering development incentives, coordinating stakeholders, incorporating transit into future development/redevelopment, crafting TOD design guidelines, predesignating transit corridors, ensuring pedestrian and bicycle access, adapting transit services to the needs of suburban-style communities, offering location efficient mortgages and ideas for dealing with community resistance toward applying transit friendly measures to car oriented communities. This report presents a literature review with conclusions, an annotated bibliography and five case studies of communities that have taken steps to become transit oriented. (Goodwill & Hendricks 2002)

1.9.2 New Transit Town: Best Practices in Transit Oriented Development (TOD),
Edited by Hank Dittmar and Gloria Ohland (2000).

This book is one of the first generation of Transit Oriented Development reaches adolescence. It clarifies problems with the implementation of this lauded concept. In a series of essays, planners, researchers, and economists review the lessons of the first generation and set the standards for the next. As transit-oriented development has struggled with entrenched lifestyles, unfriendly ordinances, and uncertain financing, its early pioneers have begun to identify best (and worst) practices. The scholars and practitioners featured in this book use examples from Arlington County, Virginia; Dallas, Texas; Atlanta, Georgia; San Jose, California; and San Diego, to elucidate those practices. They examine zoning, financing, and jurisdiction in an attempt to define Transit Oriented Development and harness its potential. (Dittmar, & Ohland 2004)

1.9.3 Transit Oriented Development (TOD): Best Practices Handbook,
By The city of Calgary, Land Use Planning & Polices (2004).

This handbook defines Transit Oriented Development (TOD) as a walkable, and mixed use form of development focused around a transit station. The concentrating of higher density development near the station makes transit convenient and encourages ridership. This Best Practices Handbook introduces the key planning principles behind successful TOD. It summarizes some of the current practices for designing and

implementing TOD. In this handbook, it is found information on the following: Why plan for land use around transit stations? where does TOD occur? Why is TOD important for such city as Calgary? What are the TOD “best practices”? where is TOD being built? How are cities implementing TOD? and Where can one find out more about TOD? This handbook is intended as an information resource for developers, builders, planners, urban designers, communities and general public. Its purpose is to explain TOD, its characteristics, its benefits and its challenges. (The city of Calgary, Land Use Planning & Polices 2004a)

1.9.4 UrbanSim: Modeling Urban Development for Land Use, Transportation and Environmental Planning,

By *Paul Waddell (2000).*

This paper shows metropolitan areas that have come under intense pressure to respond to federal mandates to link planning of land use, transportation, and environmental quality; and from citizen concerns about managing the side effects of growth such as sprawl, congestion, housing affordability, and loss of open space. The planning models used by Metropolitan Planning Organizations (MPOs) were generally not designed to address these questions, creating a gap in the ability of planners to systematically assess these issues. UrbanSim is a new model system that has been developed to respond to these emerging requirements, and has now been applied in three metropolitan areas. This paper describes the model system and its application. Also, it identifies the development priorities. (Waddell & Evans ca.2000)

1.9.5 Scenarios and Indicators Supporting Urban Regional Planning,

By *Petrov Laura Oana, Shahunyan Harutyun, Williams Brendan and Convery Sheila (2011).*

It is a research paper that is prepared for urban regional planning. It offers tools for impact assessment to understand the current situation and to explore concerns about the future of the world. This paper presents the results of scenario modeling and relevant indicators for urban and regional development. Particularly, the paper investigates the Greater Dublin Region of Ireland where urban development has been intensive and poorly controlled, leading to changes in its spatial configuration and particularly the preponderance of a sprawl type pattern of development. These initial results provide a platform for a methodology to be used by the two communities of scientists and stakeholders in the application of scenario technique, modeling and indicators approaches towards developing solutions to real world environmental and land use management problems. Proposals for its future development and suggestions for further research are explored. (Oana et al. 2011)

1.9.6 Trends in Development Planning of Nablus City in the Light of the Proposed Strategy for the City Development,

By *Ibrahim Hammouz (2008).*

This is MSc thesis that aims to prepare a proposal for a 'City Development Strategy of Nablus City' as a basis for the development planning process of the city through the study and analysis of the current situation under the concept of strategic analysis. Then, the thesis offers formulation of a consensus vision for the city and

strategies to achieve this vision, as well as an investment plan and a number of development projects that work, to achieve the proposed development strategies. To achieve this aim some theoretical concepts related to development planning, city development strategy and community participation in planning are reviewed. Also, the experiences of some cities in preparing their development strategies are clarified.

The study recommended the need to develop the institutional and public understanding of the importance of development and strategic planning as an approach in the process of comprehensive development, in addition to strengthening the relationship between the city and its regional context through the preparation of the 'Greater Nablus Planning' project. (Hammouz 2008)

The study also emphasized the importance of promoting awareness and community participation, and activating the role of institutions, local bodies, and relevant agencies in the planning process, as well as their role in the identification of priorities and development needs of the city. (Hammouz 2008)

Moreover, it stressed on the need to develop and build the capacity of staff in the municipality of Nablus. Also, it emphasized the establishment of a strong and effective partnership between the municipality and civil society institutions. (Hammouz 2008)

Finally, the study recommended the need to develop the city within regional and international attention in coordination with the related organizations and regional and international bodies, especially in exchanging experiences and provide the necessary funding to implement the plans and development projects. (Hammouz 2008)

1.9.7 Urban Development and Planning in the Occupied Palestinian Territories: Impacts on Urban Form, **By Ali Abdelhamid (2006)**

This research paper focuses on analyzing the development and changes in urban form of Palestinian cities and towns as well as the determination of the major factors and impacts that affected urban morphology and urban form.

The paper proves that the limited available land, the rapidly growing population of Palestine, the misuse of urban development, and the decisions of policy makers and all planning issues associated with the changing and unstable political situation in the country played a major role in deteriorating the landscapes, cultural and historical sites, natural resources and environment, in addition to the spread of uncontrolled urban developments in the cities, and to the diffusion of urban sprawls within the landscapes and around the cities as well as impacting the urban form.

In order to limit and solve this deterioration and fragmented or uncontrolled urban development (urban form), the following recommendations are mentioned: (Abdelhamid 2006)

- Improving and upgrading the capacities (staff and equipment) of the Palestinian ministries and governmental institutions involved in planning issues.

- Reviewing and amending the existing planning laws and regulations, and having one comprehensive legislation.
- Enhancing public awareness and participation in physical planning towards respecting the building and planning laws and regulations;
- Increasing and expanding the role of the NGOs and private sector in the planning process.
- Developing and enhancing the coordination among the various actors and stakeholders in the planning process.
- Investigating the possibility and viability of orienting future developments toward sustainability through a sustainable land-use planning through developing applicable instruments, criteria, policies and strategies;
- Taking into consideration the economical, cultural, social, environmental, administrative and legislative dimensions of physical development within a general and comprehensive framework.

Finally, the study emphasizes that the political stability in the country is the most significant issue in achieving any progress or success in controlling or managing the development and expansion of the Palestinian cities and therefore having the proper urban form as well as adopting the sustainable land use planning. (Abdelhamid 2006)

1.10 Study Outlines

The thesis is divided into seven chapters; each chapter covered certain area and goes through as follows:

- **Chapter 1:** introduces the reader to the general features of the subject and represents the background, objectives and importance of the research.
- **Chapter 2:** presents the literature review that covers the terms of Smart Growth and Sustainable development and Transportation.
- **Chapter 3:** represents the literature review that demonstrates the trend of Transit Oriented Development (TOD) as a significant tool to implement smart and sustainable urban growth, and as a new innovative approach.
- **Chapter 4:** explains the details of study area, and identifies all limitation, circumstances, concentrations, and gives clear indicators of Gaza City.
- **Chapter 5:** conducts the design, results and analysis of the methodological tools; such as, questionnaires, semi-structured interviews and computerized stimulation tools.
- **Chapter 6:** presents the strategic transaction for building a comprehensive model of Gaza City and offers an evaluation tool for such projects and plans.
- **Chapter 7:** presents a detailed model that involve one specific district 'South Remal' to sorts out a scenarios of the design alternatives.
- **Chapter 8:** represents all conclusions, applied outputs and recommendations.

CHAPTER 2

SMART GROWTH AND SUSTAINABLE URBAN DEVELOPMENT ..

TOOLS FOR CONTROLLING THE PROGRESS

- 2.1** Introduction
- 2.2** Sustainable Development
- 2.3** Smart Growth Framework
- 2.4** Smart Growth Meets the Key Goals of Sustainable Development
- 2.5** Sustainable and Smart Transportation
- 2.6** The Emergent Need for Sustainable and Smart Growth
- 2.7** TOD: A Tool for Smart Growth

2.1 Introduction

Growth presents a huge opportunity for progress. Communities are looking for ways to get the most out of new development and to maximize their investments. Frustrated by development that requires residents to drive long distances between jobs and homes, many communities are challenging rules that make it impossible to put workplaces, homes, and services closer together. Many communities are questioning the fiscal wisdom of neglecting existing infrastructure while expanding new sewers, roads, and services into the fringe. Moreover, in many communities where development has improved daily life, the economy, and the environment, Smart Growth has been a key to that success.

When communities choose Smart Growth strategies, they expect to create new neighborhoods and maintain existing ones to be more attractive, convenient, safe, and healthy. Smart Growth strategies can foster design that encourages social, civic, and physical activity. Also, they can protect the environment while stimulating economic growth. Most of all, they can create more choices for residents, workers, visitors, children, families, single people, and older adults, and give them choices in where to live, how to get around, and how to interact with the people around them. When communities do this kind of planning, they preserve the best of their past while creating a bright future for generations to come, and this is the heart of sustainable development. (Smart Growth NetWork ca.2006)

2.2 Sustainable Development

Sustainability is not about threat analysis; but, it is about systems analysis. Specifically, it is about how environmental, economic, and social systems interact to their mutual advantage or disadvantage at various space-based scales of operation.

2.2.1 Definition

The Brundtland commission (1987) defined sustainable development, as *"The development that meets the needs of the present without compromising the ability of future generations to meet their own needs."* (DEP Web 2001)

Sustainable urban development is also about *"improving the quality of life in a city, including social, economic, environmental and cultural components, without leaving a burden on future generations"*. (The Department of Internal Affairs ca.2009)

2.2.2 The Triple Bottom Line

The core of mainstream sustainability thinking has become the idea of three dimensions, environmental, social and economic sustainability; as in Figure (2.1). From this point of view, the triple bottom line is a term coined to encourage sustainable development by evaluating performance on the basis of social, economic, and environmental impacts. Applying it to assess projects, programs, and policies sends a message that financial, cost-benefit, and economic considerations are not the sole drivers of projects. Under this approach, economic, social, and environmental factors are to be given equal consideration. (Poor & Lindquist 2009)

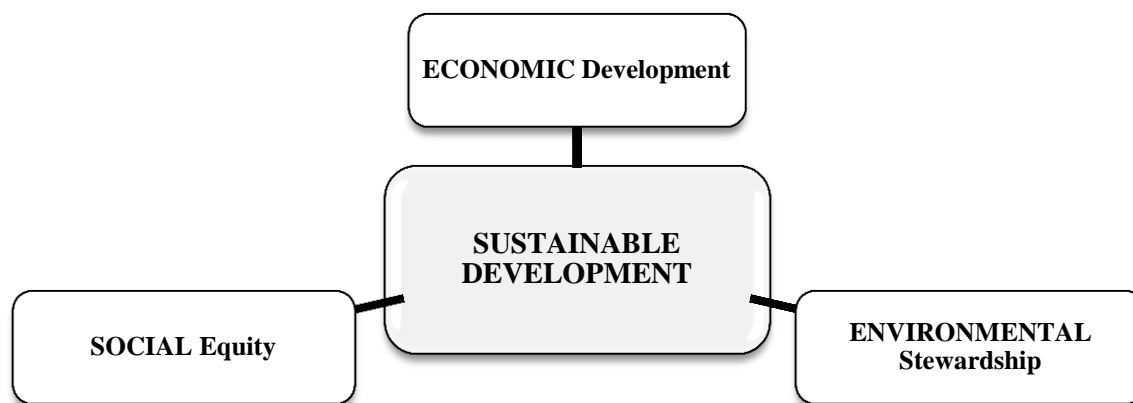

Figure (2.1);The triple bottom line of sustainable development.

2.2.3 Expected Outcomes

A number of communities have identified outcomes that relate to their aspirations for the urban environment, economy, and governance. Common themes in these outcomes include: (The Department of Internal Affairs ca.2009)

1. Infrastructure with the capacity to meet present and future needs
2. Attracting and retaining new and existing businesses
3. Having access to employment, and more specifically, local employment
4. Aspirations for prosperity, innovation or economic growth in general
5. Having a strong identity and/or positive community image
6. Valuing and/or recognizing cultural diversity
7. Managing the growth of the region/community
8. Ensuring accessibility to/from and within the community
9. Being able to access quality housing
10. Having a sustainable transport system
11. Having access to public transport
12. Ensuring the viability/utility/popularity of town centers
13. Collaborative leadership

2.3 Smart Growth Framework

Smart Growth means different things to different people. There is no clear definition of Smart Growth; its meaning depends on context, perspective and timeframe. The common thread among different views of Smart Growth is development that revitalizes central cities and older suburbs, supports and enhances public transit, promotes walking and bicycling, and preserves open spaces and agricultural lands. Smart Growth is never growth; rather, it seeks to revitalize the already-built environment and, to the extent necessary, to foster efficient development at the edges of the region, in the process creating more livable communities (Tucker et al. 2008).

2.3.1 Definition

Smart Growth can be defined as *"A range of development and conservation strategies that help protect our natural environment and make our communities more attractive, economically stronger, and more socially diverse."* (Clemons ca.2007)

Also, it can be described as "The development that revitalizes central cities and older suburbs, supports and enhances public transit, promotes walking and bicycling opportunities, and preserves open spaces and agricultural lands. Smart Growth is not 'no growth;' rather, it seeks to revitalize the already built environment and, to the extent necessary, foster efficient development at the edges of the region, in the process creating more livable communities." (Purvis 2003)

Moreover, it can be shown as *"Smart Growth is an urban planning and transportation theory that concentrates growth in compact walkable urban centers to avoid sprawl and advocates compact, transit-oriented, walkable, bicycle-friendly land use, including neighborhood schools, complete streets, and mixed-use development with a range of housing choices."* (Wikipedia 2011)

The term also can be defined as *"Smart Growth (also called New Urbanism and Location Efficient Development) is a general term for policies that integrate transportation and land use decisions, for example by encouraging more compact, mixed-use development within existing urban areas, and discouraging dispersed, automobile dependent development at the urban fringe. Smart Growth can help create more accessible land use patterns, improve transport options, create more livable communities, reduce public service costs and achieve other land use objectives. Smart Growth is an alternative to urban sprawl."* (TDM Encyclopedia 2011a)

2.3.2 Principles

The term Smart Growth has become ubiquitous in planning discussion over the last decade and a half, though, it seems to be only a hazy understanding of what exactly Smart Growth is. A natural first reaction might be to say: Not dumb growth. It's clearly more complex than that. In fact, the Smart Growth has been defined in ten principles that provide a framework for how development and growth can be executed in a superior way to the status quo. These principles are: (Tucker et al. 2008)

- 1. Mix Land Uses:** This is viewed as a vital component in the creation of vital, sustainable communities where transit options beyond the automobile are possible due to the proximity of a variety of day-to-day living needs.
- 2. Take Advantage of Compact Building Design:** This principle permits more open space to be preserved, and promotes the design of buildings that can be constructed to make more efficient use of land and resources
- 3. Create a Range of Housing Choices:** communities can mitigate the environmental costs of auto-dependent development, use their infrastructure resources more efficiently, ensure a better jobs-housing balance, and generate a strong foundation of support for neighborhood transit stops, commercial centers, and other services.
- 4. Create Walkable Neighborhoods:** Walkable communities make pedestrian activity possible, thus expanding transportation options, and creating a streetscape that better serves a range of users

- 5. Foster Distinctive, Attractive Communities:** Create interesting, unique communities that reflect the values and cultures of the people who reside there.
- 6. Preserve Open Space, Farmland, Beauty and Critical Environmental Areas:** Open space preservation supports Smart Growth goals by bolstering local economies, preserving critical environmental areas, improving our communities quality of life, and guiding new growth into existing communities.
- 7. Strengthen and Direct Development to Existing Communities:** Develop in or near communities already served by infrastructure, and seek to utilize the resources that existing neighborhoods offer; conserve open space and irreplaceable natural resources on the urban fringe.
- 8. Provide a Variety of Transportation Choices:** Congestion has worsened over the last two decades and there is little indication that current growth patterns can alleviate it. Providing a variety of transportation options removes cars from the road and reduces the strain on an overburdened system.
- 9. Make Development Decisions Fair, Consistent and Predictable:** Developers need to know what to expect from Smart Growth endeavors, so making it easy for such projects to occur is vital to the actual development of Smart Growth. Thus, zoning should be in place that encourages Smart Growth principles.
- 10. Encourage Community and Stakeholder Collaboration:** The needs of every community (and the programs to address them) are best defined by the people who live and work in the community.

2.4 Smart Growth Meets the Key Goals of Sustainable Development

Smart Growth values over long-range are comprehensive regional considerations of sustainability. Its goals intend to achieve a unique sense of community and place; expand the range of transportation, employment, and housing choices, equitably distribute the costs and benefits of development, preserve and enhance natural and cultural resources, and promote public health. (Wikipedia 2011)

According to what mentioned, Smart Growth meets the key goals of sustainable development through community design. Focusing new housing and commercial development within already developed areas requires more public investment in new roads, utilities and amenities. Investment in the urban core can reduce crime, promote affordable housing and create vibrant central cities and small towns. By coordinating job growth with housing growth, and ensuring a good match between income levels and housing prices, Smart Growth aims to reverse the trend toward longer commutes, particularly to communities beyond the region's boundaries. People who live within easy walking distance of shops, schools, parks and public transit have the option to reduce their driving and therefore pollute less than those living in car-dependent neighborhoods. (Tucker et al. 2008)

All researchers suggest a renewed emphasis comprehensive planning by focusing on inputs from affected people and on real outcomes (not just paper outputs). To the extent that those outcomes are cast in terms of the needs of both present and future people along the three aforementioned dimensions; economic, environmental, and social well-being; see Table (2.1). Comprehensive planning becomes congruent with planning for sustainability, sustainable development, and Smart Growth. (English, Peretz & Manderschied 1999)

Economic Benefits	Social Benefits	Environmental Benefits
Reduced development and service costs	Improved transportation options and choices, particularly for nondrivers	Green space and wildlife habitat preservation
Consumer transportation cost savings	Improved housing options and affordability	Reduced air pollution
Increased costs to provide public services	Community cohesion	Reduce resource consumption
More efficient transportation	Increased physical activity and health	Reduced water pollution
	Congestion reduction	Reduced 'heat island' effect

Table (2.1); Smart Growth benefits in the sustainability framework. (TDM Encyclopedia 2011a)

2.5 Sustainable and Smart Transportation System

Sustainable development seeks to create an urban environment that maximizes economic development and social equity, whilst minimizing negative externalities upon the natural environment. From a land use and transport perspective, this means reducing automobile dependence through mixed use and compact cities with an array of travel alternatives focused on walking, bicycling, and public transport

Sustainable and smart transportation can be viewed as an expression of sustainable development in the transportation sector. Sustainable transportation addresses local, regional, national, and global issues and therefore requires considerable coordination. It is important to apply sustainable transportation in a holistic and integrated manner across the various sectors to ensure the key concerns such as depletion of resources, global climate change, disruption of ecosystems, and toxic pollution are effectively addressed. (Poor & Lindquist 2009)

Sustainable transportation allows the basic access needs of individuals and societies to be met safely and in a manner consistent with human and ecosystem health, and with equity within and between generations. Also, it is affordable, operates efficiently, offers choices of transport modes, and supports a vibrant economy, limits emissions and waste within the planet's ability to absorb them and minimizes consumption of non-renewable resources. Moreover, sustainable transportation limits consumption of renewable resources to the sustainable yield level, reuses and recycles its components, and minimizes the use of land and the production of noise. (EPA 2011)

On the other hand, smart transportation as a term, recommends a new approach to roadway planning and design, that transportation investments are tailored to the specific needs of each project. The differences in financial contexts, community, land use, transportation and environmental issues, determine the design of the solution; as in Figure (2.2). The best transportation solution arises from a process in which a multi-disciplinary team, considering a wide range of solutions, works closely with the community. Inclusive of sensitive context solutions, Smart Transportation also encompasses network connectivity, and access and corridor management. (New Jersey and Pennsylvania Department of Transportation 2008)

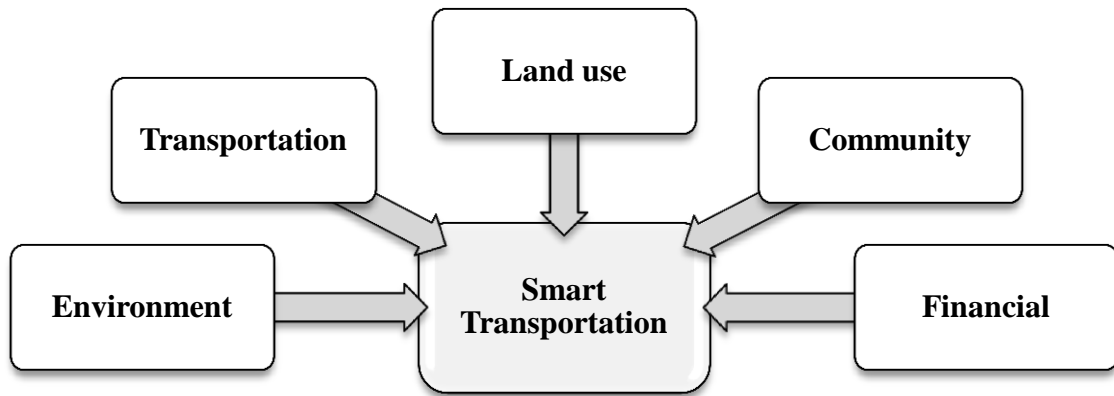

Figure (2.2);The context of ideal smart transportation.
(New Jersey and Pennsylvania Department of Transportation 2008)

To work towards sustainable and smart urban transport systems, five key thematic areas can be identified (Eickmans & Nasei 2011):

1. Linking transportation to urban planning to reduce motorized trips.
2. Non-motorized transport infrastructure.
3. Public transport systems.
4. Car traffic demand management.
5. Vehicle and fuel efficient technologies.

The breadth of sustainable and smart transportation development concerns three aspects: (EPA 2011)

2.5.1 Environmental Quality

While pollutant emissions from motor vehicles have dropped dramatically over the last three decades, air quality problems persist in many metropolitan areas, driven in part by growth in vehicle miles traveled. Recent scientific research has more clearly linked air pollution with public health problems. On a global scale, the looming threat of climate change has focused attention on the environmental impacts of the transportation sector.

2.5.2 Economic Development

Transportation has long been recognized as essential to economic development. Efficient and reliable movement of people and goods improves productivity and can spur economic growth. Moreover, with rising regional competition, quality of life has become increasingly important for drawing and retaining a talented and productive workforce. Transportation investments are keys to boosting a region's attractiveness to businesses and residents.

2.5.3 Social Equity

People who are economically, socially, or physically disadvantaged need transportation options to give them opportunities to work, learn, and participate in society. Transportation is a large and growing expense for many families. Households in locations with poor accessibility to employment's opportunities and other destinations and no alternatives of driving, tend to spend more on transportation. Then, the investments that improve accessibility and provide more transportation choices allow households to save money.

2.6 The Emergent Need for Sustainable and Smart Growth

The negative side effects of urban planning and transportation have become particularly apparent in the metropolitan areas of developed countries. Rising car traffic volumes are increasingly causing loss of economic productivity, environmental degradation and affect overall quality of life in cities. In developing countries, rapid urbanization and motorization, and inadequate urban transport planning and management have led to intolerable levels of traffic, congestion, air pollution and lost urban economic productivity. The growing use of largely inefficient private automobile transport in very densely populated cities to meet the increase in demand for urban transport has reduced the efficiency and effectiveness of public transport, also, the insufficient investment in infrastructure have led to similar problems, often exacerbated by urban poverty and social exclusion. Falling levels of resources to subsidize these systems has led to deteriorating service and revenue deficiencies. In the face of a rising global population, continuing urbanization and the emergence of megacities, there is heightened urgency to apply solutions in the urban transport sector that contribute to sustainable urban development and to provide a comprehensive response to the issue of global warming (Eickmans & Nasei 2011); (Cervero 2000). See Figure (2.3) to notice the side effects of transportation on land use planning.

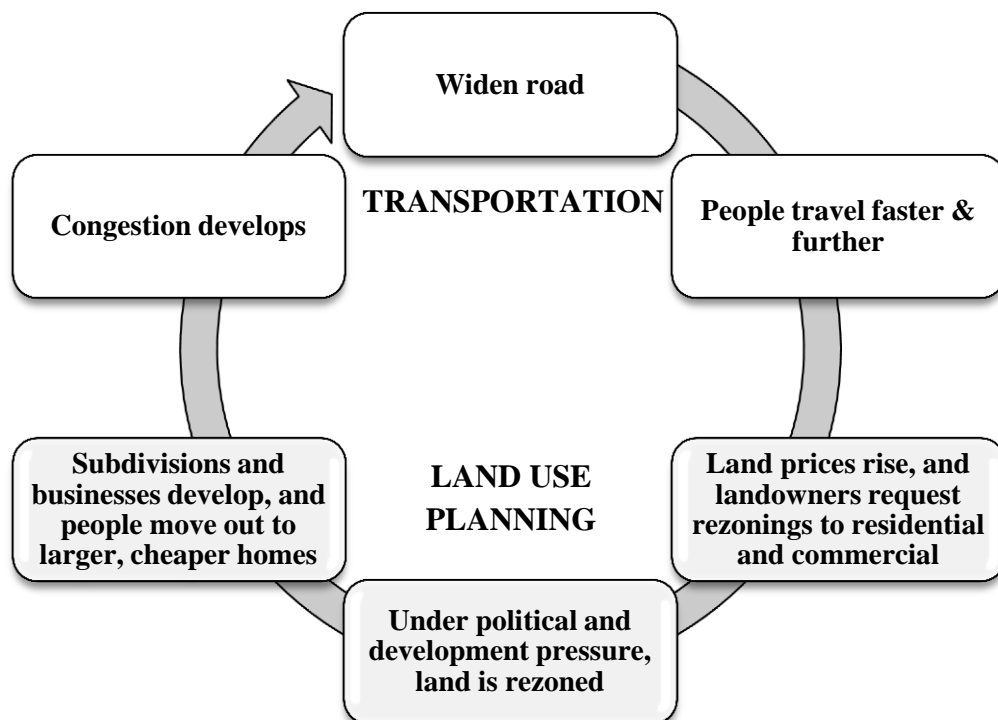

Figure (2.3); Transportation and Land Use Cycle.
(New Jersey and Pennsylvania Department of Transportation 2008)

2.6.1 Definition of Urban Sprawl

"Urban sprawl, also known as suburban sprawl, is a multifaceted concept, which includes the spreading outwards of a city and its suburbs to its outskirts to low density and auto-dependent development on rural land, high segregation of uses (e.g. stores and residential), and various design features that encourage car dependency. In developing countries, it occurs largely as a result of rapid growth of cities, which is often due to socially inequitable economic policies." (Cornell University 2010)

2.6.2 Definition of Automobile Dependency

"Automobile dependency (also called automobile oriented transportation and land use patterns) refers to transportation and land use patterns that favor automobile travel and provide relatively inferior transportation alternatives (in this case, 'automobile' includes cars, vans, light trucks, SUVs and motorcycles)." (TDM Encyclopedia 2010)

2.6.3 Associated Traits of Urban Sprawl and Automobile Dependency

Ten traits associated with sprawl (Sprawl Guide 2001):

1. Unlimited outward extension.
2. Low-density residential and commercial settlements.
3. Leapfrog or scattered development.
4. Fragmentation of powers over land use among many small localities.
5. Dominance of transportation by private automotive vehicles.
6. No centralized planning or control of land uses.
7. Widespread strip commercial development.
8. Great fiscal disparities among localities.
9. Segregation of types of land uses in different zones.
10. Reliance mainly on the trickle-down or filtering process to provide housing to low-income households.

2.6.4 Factors that Contribute to Urban Sprawl and Automobile Dependency

see Figure (2.4)

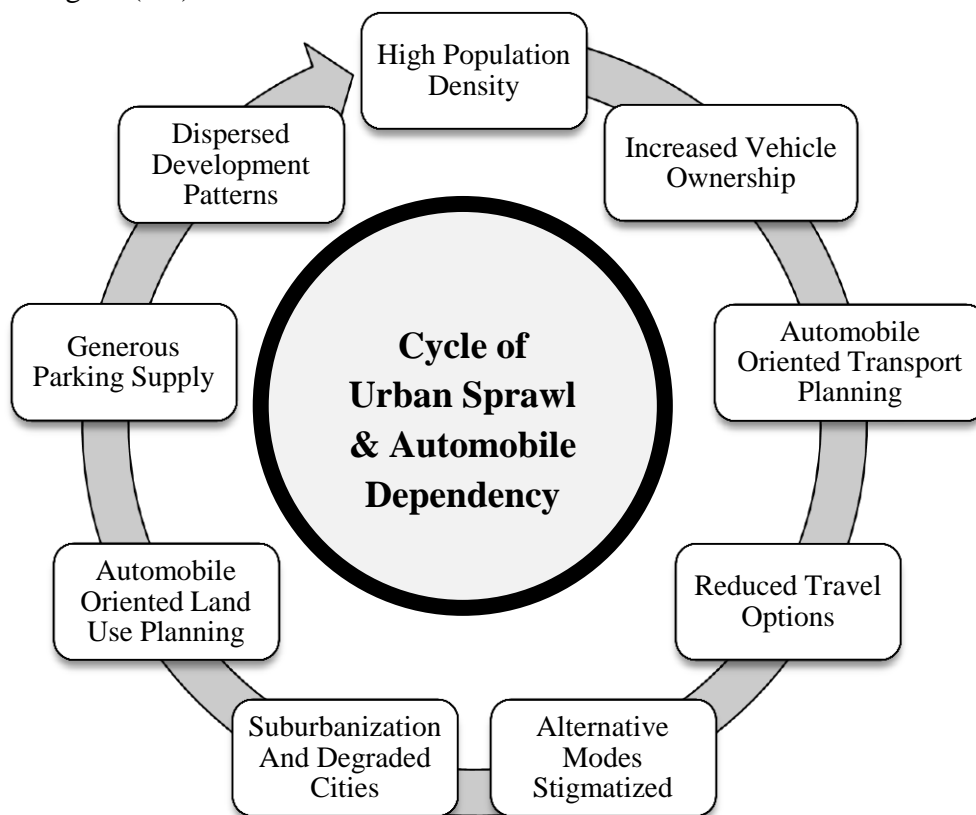

Figure (2.4); Automobile dependency results from a self-reinforcing cycling of increased automobile ownership, reduced travel options and more dispersed automobile-oriented land use patterns. (TDM Encyclopedia 2010)

2.6.5 Criticisms and Costs

These urban phenomena impose a number of economic, social and environmental costs, as summarized in the Table (2.2) below:

Economic costs	Social costs	Environmental costs
Reduced accessibility and higher transportation costs	Reduced accessibility for people who are transport disadvantaged.	Increased impervious surface
Increased land devoted to roads and parking facilities	Reduced housing options	Reduced green space and habitat
Increased costs to provide public services	Increased external transportation costs (crash risk, pollution, etc.)	Increased energy consumption and pollution emissions
Reduced regional business activity and employment	Degraded public realm	Aesthetic degradation
Reduced economies of agglomeration	Reduced neighborhood interaction and community cohesion	Increased water pollution
Reduced economies of scale in transit and other alternative modes	Reduced opportunities to preserve cultural resources	Increased 'heat island' effects
Threats to environmentally sensitive businesses (e.g. farming and resorts)	Reduced exercise by walking and cycling	Health impact

Table (2.2); Criticisms and Costs of Urban Sprawl and Automobile Dependency. (Lambert & Meyer 2006); (TDM Encyclopedia 2010)

2.7 TOD: A Tool for Smart Growth

The alternative to Automobile Dependency is not a total lack of private vehicles. Rather, it is a multi-modal transport system, often called Transit-Oriented Development (TOD), meaning that consumers have various transport options from which to choose, that these options are integrated effectively to provide a high degree of accessibility even for non-drivers, and incentives to use the most efficient option for each trip. (TDM Encyclopedia 2010)

The term Transit oriented Development has become the catch phrase of the planning world. TOD is only one tool that can be used to achieve Smart Growth principles, but it has become one of the most popular ones. As a result, TOD has been used to describe a variety initiatives and mixed use ideas. Most people make the mistake of thinking that TOD can be created through the design and development of one project, but in actuality, it usually takes multiple projects working together to create an urban fabric that seamlessly blends the ideals of Smart Growth. There are two strategies need to work together for a transit zone to live up to its potential. (Tucker et al. 2008)

- **TOD is a transit zone** (Tucker et al. 2008)
A better way of thinking about TOD is as a transit zone, instead of as a single project. This change in thinking is particularly important for city officials' responsible for zoning and transportation regulations.
- **TOD is a tool for achieving three goals** (Tucker et al. 2008)
Another way to think about TOD is as a tool for achieving three goals; walkable streets, building intensity and concentration, and the careful integration of transit. TOD cannot accomplish these goals alone. Walkable streets are important because the places where people take transit are also places where people walk. To achieve walkable streets, there must be some coordination and interplay between TOD and standards for street design, transit-stop design, and other contributing relevant elements of the public realm. Improving building intensity and concentration takes on an entirely different aspect when it is done to support transit. The intensity of individual sites and the cumulative activities surrounding the transit zone must be configured correctly to allow the various modes of transportation (i.e. pedestrians, bikers, cars, and transit) to flourish. The integration of transit into a zone is perhaps the most difficult of the three goals because it must juggle designing for place-making with designing for easy access to transit.

CHAPTER 3

TRANSIT ORIENTED DEVELOPMENT (TOD) ..

A POPULAR PLANNING PARADIGM

- 3.1** Introduction
- 3.2** Sustainable and Smart Goals of TOD
- 3.3** Definition of Transit Oriented Development (TOD)
- 3.4** Major Elements of TOD
- 3.5** Trends Supporting TOD
- 3.6** TOD Types and Ranks
- 3.7** Specific and Typical Design Features of TOD
- 3.8** Performance Criteria for Successful TOD
- 3.9** The Factors Influencing Success
- 3.10** Challenges and Constrains Facing Implementing TOD
- 3.11** Supportive Market Conditions
- 3.12** Stakeholders and Responsibilities in TOD Process
- 3.13** TOD Polices and Design Guidelines

3.1 Introduction

Transit Oriented Development (TOD) has gained popularity as a mean of redressing number of urban problems, including traffic congestion, affordable housing shortages, air pollution, and incessant sprawl. Several factors have heightened the public interest in TOD. One is a receptive policy environment, marked by recent legislation and grant funding-at all levels of government committed to promoting livable communities and Smart Growth.

3.2 Sustainable and Smart Goals of TOD

There are three main terms, density, diversity and design, so called 3Ds. (Chia-Nung 2003)

- **Density:** raising density around transit stations.
- **Diversity:** mixed land use, extensive choices of housing and commuting.
- **Design:** pedestrian or friendly oriented design.

Strategies of 3Ds are intended to increase transit ridership, walking and biking, and decrease the share of automobile trips. The design and mixed-use features of TOD may reduce both work and non-work automobile trips. TOD strategies are based on a theory that land uses near a rail transit stop will produce a different travel pattern than land uses in an automobile focused area. The best way to ensure that TOD can help solve urban challenges is to provide solid analytic evidence about its effectiveness. In other words, numerous and various benefits of TOD contain economical, environmental and social effectiveness. Thus, it can be seen that strategies of TOD are able to achieve goals of smart growth and sustainable development; as in Figure (3.1).

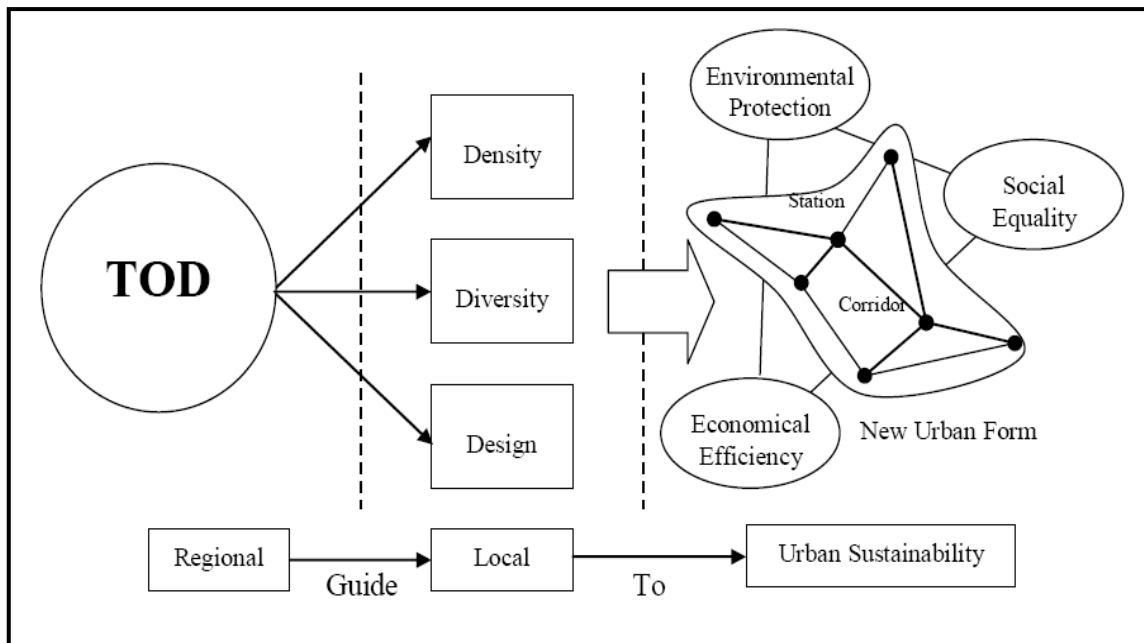

Figure (3.1); Transit Oriented Development and Urban Sustainability. (Chia-Nung 2003)

3.3 Definition of Transit Oriented Development (TOD)

Various terms is surfaced to convey the idea of Transit Oriented Development (TOD), such as transit villages, transit-supportive development, and transit-friendly design, but TOD is the most widely used term. The following review takes narrower definitions, referring to development near or oriented to mass transit facilities:

- *"A compact, mixed-use community, located around a transit station that, by design, invites residents, workers, and shoppers to drive their cars less and ride mass transit more. The transit village extends roughly 600m radius from a transit station, a distance that can be covered in about 5 minutes by foot. The centerpiece of the transit village is the transit station itself and the civic and public spaces that surround it. The transit station is what connects village residents to the rest of the region...The surrounding public space serves the important function of being a community gathering spot, a site for special events, and a place for celebrations". (Bernick & Cervero 1997)*
- *"A mixed-use community that encourages people to live near transit services and to decrease their dependence on driving". (Still 2002)*
- *"Development within a specified geographical area around a transit station with a variety of land uses and a multiplicity of landowners". (Salvesen 1996)*
- *"Moderate to higher density development, located within an easy walk of a major transit stop, generally with a mix of residential, employment, and shopping opportunities designed for pedestrians without excluding the auto. TOD can be new construction or redevelopment of one or more buildings whose design and orientation facilitate transit use". (California Department of Transportation 2001)*
- *"A place of relatively higher density that includes a mixture of residential, employment, shopping and civic uses and types located within an easy walk of a bus or rail transit center. The development design gives preference to the pedestrian and bicyclists, and may be accessed by automobiles". (Maryland Department of Transportation 2000)*
- *"A walkable, mixed-use form of development typically focused within a 600m radius of a transit station. Higher density development is concentrated near the station to make transit convenient for more people and encourage ridership. This form of development utilizes existing infrastructure, optimizes use of the transit network and creates mobility options for transit riders and the local community. Successful TOD provides a mix of land uses and densities that create a convenient, interesting and vibrant community for local residents and visitors alike". (The city of Calgary, Land Use Planning & Polices 2004a)*
- *"Residential and Commercial Centers designed to maximize access by transit and nonmotorized transportation, and with other features to encourage transit Ridership. A typical TOD has a rail or bus station at its center, surrounded by relatively high-density development, with progressively lower-density spreading outwards one-quarter to one-half mile, which represents pedestrian scale distances". (TDM Encyclopedia 2011b)*

- *"Transit-oriented development (TOD) has attracted interest as a tool for promoting smart growth, leveraging economic development, and catering to shifting market demands and lifestyle preferences". (Cervero et al. 2004)*

All definitions involve numerous and various benefits of TOD, which contain economical, environmental or social effectiveness. Thus, it can be seen that most accurate definition is the one that involves all the three goals of Sustainable Development and Smart Growth; economical, environmental and social effectiveness. Therefore, the last definition of Cervero 2004 is the most accurate one.

3.4 Major Elements of TOD

Transit oriented development improves the livability of communities and environment, and it increases accessibility and transportation options, with being successfully integrated into the economic pattern of the area. Successful TOD involves more than simply placing a transit stop in a residential neighborhood or a business park, or building a mixed-use TOD development next to a transit spot, it offers a greater portion of trips to be made by walking and cycling, allows some households to reduce their car ownership, and encourages the use of public transit. TOD creates places for community life, be a key force in the revitalization of neighborhoods, helps to create new businesses and improves access to job opportunities, and helps to make communities safer, in part by making them more comfortable and attractive. The hallmarks of transit oriented development are enhanced mobility and environment, pedestrian friendliness, alternative suburban living and working environments, neighborhood revitalization, public safety, and public celebration. While such definitions vary in scope and specificity, most TOD definitions share several major elements: (Bossard 2002)

3.4.1 Enhanced Mobility and Environment

The major element of TOD is a congregation of housing, jobs, shops, and other activities around transit. In addition to the improved access to these varied land uses, the physical environment is enhanced. For example, TOD is expected to improve air quality, as park-and-ride trips are converted to walk- or bike-and-ride trips.

3.4.2 Pedestrian-friendliness

TOD involves the development of land use that encourages walking, such as narrow streets with trees, wide sidewalks, an absence of surface parking lots, and large building setbacks. Typical structures are street oriented, mixed-use buildings that include a blend of residential, retail, and commercial uses.

3.4.3 Alternative Suburban Living

TOD enables people to live in the suburbs without being entirely dependent on the automobile to access the variety of activities and services associated with cities. The pedestrian-friendly scale and design features of transit oriented development promote social interaction.

3.4.4 Community Revitalization

TOD can stimulate economic growth in blighted or declining areas served by rail or other transit. Redevelopment agencies can promote transit-oriented development and improve the social and physical infrastructure of neighborhoods, providing needed housing and services to households from a mix of incomes.

3.4.5 Public Safety

TOD places a mix of residents, workers, and shopkeepers within a compact area, promoting a continual security presence by the constant activity.

3.4.6 Public Recreation and Celebration

TOD should include some public open space, such as a park or plaza, which is a gathering place for amusement and events.

3.5 Trends Supporting TOD

Four major trends are identified to push the TOD movement forward. These trends depend on the local vision of growth issues. They can be defines as: (Goodwill & Hendricks, 2002)

3.5.1 Environmental Trend

Today's public policy environment has become more receptive to the integration of transportation and land use planning with laws. Many global organizations have criteria that favorably reward transit-supportive local government policies and pay attention to projects held to integrate transit and land use with environmental aspects.

3.5.2 Demographics Trend

High populations and dense districts caused an unplanned and uncontrolled urban sprawl, and results unorganized services distribution. Also, young single adults, childless couples wanting smaller homes, and immigrants are emerging as new markets for transit-based housing.

3.5.3 Traffic Congestion

Due to the ever-increasing problem of traffic congestion, a lot of people are choosing to live near transit to make their commutes easier.

3.5.4 Economic Trends:

Companies are starting to relocate around transit station areas to provide clients with additional distinctions; such as easy accessibility. So, TOD with its characteristics becomes an attractive mean of investment.

3.6 TOD Types and Ranks

A major considerations that planning agencies need to consider when attempting to create policies that promote smart growth and TOD development is the various types of TOD that can be developed. Depending on the context of the site (downtown, suburb, regional center), where a TOD is located, its level of connectivity, housing density, and mix of uses, the ideal form a TOD takes on should differ. TOD types are categorized as in Figure (3.2) (Tucker et al. 2008):

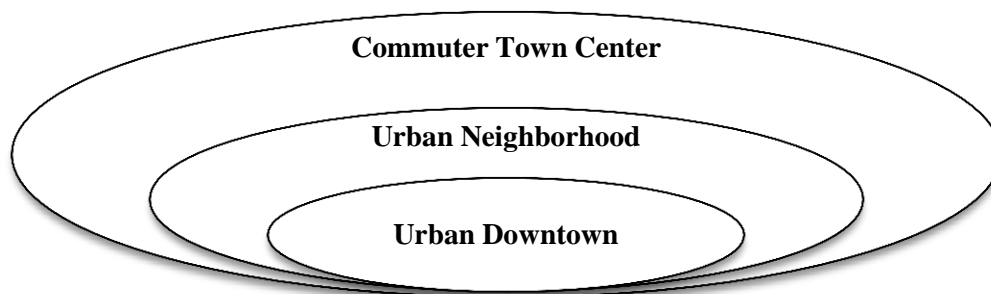

Figure (3.2); Ranks and types of TOD.

3.7 Specific and Typical Design Features of TOD

TOD approaches can differ significantly across regions due to various circumstances, such as differences in land development regulations and zoning ordinances, market factors, development/redevelopment opportunities, public transit services, resources, and the state of the present and future regional economy. These can determine whether a community can build large scale TOD projects or gradually implement smaller projects over time. Whether TOD is built on vacant land or utilizes existing structures for redevelopment, or whether TOD is based around bus or rail stations, every TOD project may not incorporate all of the design characteristics described below, but some features may be critical depending on the particular goals of that development (Goodwill & Hendricks, 2002). In general, transit-oriented development should promote walking and transit riding and discourage automobile use. A common theme of TODs is to create places that have design features such as landscaped sidewalks, parking in the rear, and retail streetwalls that make walking and transit riding more enjoyable. Some commonly accepted TOD design features as follows: (Bossard 2002); (Goodwill & Hendricks 2002)

- TOD involves a mix of land uses, including commercial/retail, business, residential housing (various types and prices), and community amenities, such as childcare centers, schools, libraries, public services, local government offices, and community parks.
- A key element of TOD is making streets attractive, convenient, and safe for pedestrians and bicyclists .Providing such pedestrian amenities as attractive landscaping, continuous and paved sidewalks, street furniture, urban art, screening of parking, building overhangs and weather protection, and safe street crossings.
- Quite often, a transit station is central to TOD with high-density development surrounding the stations while getting progressively less dense as it spreads outward.

- The development is compact, with maximum integration of major commercial centers with the transit facility.
- Continuous and direct physical linkages between major activities centers; siting of buildings and complementary uses to minimize distances to transit stops.
- Streetwalls of ground-floor retail, with businesses and housing above, and varied building heights, textures, and facades, that enhance the walking experience; siting commercial buildings near the edge of sidewalks.
- Gridlike street patterns that allow many origins and destinations to be connected by foot; avoiding cul-de-sacs, serpentine streets, and other curvilinear arrangements, which create circuitous walks and force buses to meander or retrace their paths. Also, these arrangements make direct and obvious sight lines to transit stops. Auto-oriented land uses, such as gas stations or restaurants with drive-through windows, are discouraged.
- To balance the needs of automobiles with the needs of other transportation modes, parking and access management is also an important component of TOD. It typically has a lower parking-to-occupant ratio compared to conventional suburban development. Shared parking is utilized, with off-street parking supplies, where land costs are high. Then parking is to be tucked behind buildings, underground, and in carefully designed external parking structures. In other cases, parking is sitting at the rear of buildings instead of in front.
- Convenient siting of transit shelters, benches, and route information.

As mentioned above, many of these pedestrian- and transit-friendly features are embodied in the designs of Smart Growth and sustainable projects.

3.8 Performance Criteria for Successful TOD

Definitions of TOD success often focus on the physical characteristics of its built form. A list of six performance criteria is prepared to be used in evaluating project outcomes, with relative importance of the criteria to be based on the major goals the TOD sets out to accomplish. While physical characteristics are necessary elements, focusing instead on project outcomes as a benchmark of success allows a framework for tradeoffs that most projects must make. These six criteria are summarized below: (Renne 2009); (Wander 2008); (Goodwill & Hendricks 2002)

3.8.1 Travel Behavior and Location Efficiency

A location efficient TOD plan is designed to optimize travel behavior. In essence, location efficiency gives people mobility choices, reduces congestion, enhances time savings through shorter commutes, improves pedestrian access (to retail, public services, recreation, culture, and public parks), and makes driving an automobile optional instead of being necessary. So, travel behavior can be evaluated and measured through TOD performance indicator, such as safety, easiness, pedestrian friendship, providing proximity to high-quality transit, and having a mix of uses and access to community amenities. (Renne 2009); (Wander 2008); (Goodwill & Hendricks 2002)

3.8.2 Local Income and Financial Return

The economic indicators focus on the range and success of investment for both public and private investors, the amount, affordability, and tenure of housing, property values, taxes, and percent of income spent on housing and transportation. TOD projects must be financially feasible to become a reality and be successful. Financial goals include a larger tax base for local governments due to increased property values, increased retail sales, and a larger number of taxpayers as a result of more property owners living in denser development. Other financial goals include higher transit revenues from fare boxes and ground leases, higher return on investment for the developer, shorter commute times and easier employee access for employers. The estimation of financial return is often the deciding factor whether or not to proceed with TOD. (Renne 2009); (Wander 2008); (Goodwill & Hendricks 2002)

3.8.3 The Natural Environment

An ideal TOD includes compact development and mixed land uses while still provided green and natural space. The potential indicators of measurement include regional air quality, harmful gas emission, energy usage, average and peak noise, and storm-water retention. (Renne 2009); (Wander 2008); (Goodwill & Hendricks 2002)

3.8.4 The Built Environment

Successful TOD seeks to reach the typical built environment through improving public health and safety. So, there are numbers of indicators have to be taken in consideration while designing. Vibrancy is an important factor, which is indicated by resident population (density), pedestrian counts, and area and number of vacant land parcels. Attractiveness is another meaningful factor, which is signed by façade quality, streetscape quality, number of heritage buildings preserved, and public Art. Safe and inviting area is another factor, and it can be actualized by quality of lighting, security at railway station, facilities at railway station, and crime prevention through environmental design. Mixture of uses is a significant factor, which is indicated by number of mixed use buildings, and housing density. Spaces for people rather than cars is an imperative factor, and it can be accomplished by enhancing area of plazas and parks, minimizing area and number of auto-oriented land uses, maximizing area and number of pedestrian-oriented land uses, improving bicycle parking spaces, organizing bicycle traffic volume, presenting on-street bicycle lanes, inducing number of traffic calming features, frustrating auto traffic speed and volume. (Renne 2009); (Wander 2008); (Goodwill & Hendricks 2002)

3.8.5 The Social Environment

TOD should provide people with platonic meanings that can raise the quality of life. Success indicators have to be followed to achieve this trend. Safety and security are very important, that can be recognized by public perception of neighborhood, crime, pedestrian and bicycle safety, and by recorded incidents of crime, pedestrian and cycle accidents. Ownership is another factor, which can be noticed through public perception of community, perceived quality of retail environment, and community support for further redevelopment. Residential diversity is also a significant factor, that it can be indicated by categorizing of population by age, education, ethnicity and income level and household formation (size). Opportunities for advancement is a purposeful factor,

which can signed by number of libraries, theatres galleries and other community facilities, perceived quality of community facilities, number and preserved quality of festivals and events, educational opportunities. Moreover, choice is an insistent criterion of successful TOD, which should provide people with a greater diversity of types and price ranges of housing to choose from, a large range of retail and commercial businesses within walking distance, and a balance of transportation options. One of the basic core problems of suburban style development is the lack of options it provides residents. This is most limiting to low and middle income residents. (Renne 2009); (Wander 2008); (Goodwill & Hendricks 2002)

3.8.6 Efficient Regional Land Use Patterns and Redevelopment Through The Policy Context

This criterion involves channeling growth to where it can best be handled. Results of efficient regional land use include less loss of farmland and open space, a better balance between jobs and housing, shorter commutes, less congestion and pollution, and more efficient delivery of essential community services.

While it is unlikely that any single project will excel in all the performance areas discussed, these criteria offer a more comprehensive definition of what TOD should offer, may help identify the challenges and necessary tradeoffs of TOD, represent a framework for evaluation of outcomes, and help form recommendations for future TOD. (Renne 2009); (Wander 2008); (Goodwill & Hendricks 2002)

3.9 The Factors Influencing Success

The ability of TOD to stimulate land use development and redevelopment is dependent upon a series of secondary factors: (Dittmar & Ohland 2004)

3.9.1 Local Government Policies

- **Development incentives:** providing density bonuses, up-zoning, transfer of development rights, fast-track approvals, etc. to stimulate development.
- **Appropriate zoning around stations:** ensuring that local zoning ordinances are consistent with the types of development desired for each station area.
- **Site design guidelines:** providing station area master plans and design guidelines to ensure the type of development appropriate for transit station areas.
- **Redevelopment agencies:** utilizing the powers of redevelopment agencies to assemble land, to institute tax increment financing districts, to finance infrastructure investments, or secure innovative financing provisions.

3.9.2 Strong and Proactive Institutions

Regional and local institutions with the leadership to proactively pursue Transit Oriented Developments enhance the possibility of development.

3.9.3 Individual Political Champion

Strong, individual leadership is often a common element in successful TOD projects and developments.

3.9.4 Supportive Neighborhoods and Communities

Few successful station area development projects have occurred where surrounding neighborhoods opposed higher density and residential development demands increase the opportunities of success.

3.9.5 High Quality Transit Service

The convenience, speed and extensiveness of the transit system enhance the accessibility advantages associated with station area properties and increase the possibility of development in these locations.

3.9.6 Availability of Attractive Developable Land

Little TOD is occurred around stations sites that are already largely developed, where surrounding land uses are unattractive and unsafe, primarily auto-oriented, or where station connections to surrounding neighborhoods are poorly designed. Larger parcels are also more economically viable for developers. Numerous, small parcels held by a variety of owners can create a barrier to station area development, but then, they can be important factor of other development trends.

3.9.7 Strong Real Estate Markets

Successful station area development requires strong regional real estate markets with an active demand for residential and commercial projects. In regions where transit investment has the greatest impact upon land use development, the investments occurred prior or during periods of rapid population growth.

3.9.8 Parking Management

Limiting the amount of parking in downtown areas and around station areas encourages transit ridership and more compact development around stations.

3.10 Challenges and Constraints Facing Implementing TOD

Challenges and constrains facing the implementation of TOD can be generally fallen within five categories:

3.10.1 Transport and Land use Development Challenges

Basic characteristics of the transport and land use system determine the competitive position of transit relative to the car, and thus set the backdrop to the spatial challenge of TOD. There are two basic correlations that represent the challenges; as in Figure (3.3):

- The basic correlation between the speed of a transportation system and the scale at which an urban system works, for instance, expressed in terms of distances between places of residence and places of work (Curtis, Renne & Bertolini 2009).

- The basic correlation between the capacity and flexibility of a transportation system and the degree of spatial concentration of activities. The car, which distinguished by low capacity, high flexibility, and high speed transportation means, is best fit to high spatial reach and low density urban environments. Transit matches the speed of the car, has higher capacity, but lower flexibility. Non-motorized modes have both high capacity and high flexibility but miss speed and spatial reach. In order to provide a competitive alternative to the car, the strengths of transit and slow modes need to be combined and developed. This is one central idea of TOD. However, this transport combination can only be successful in the presence of short distance and/or high density spatial patterns (Curtis, Renne & Bertolini 2009).

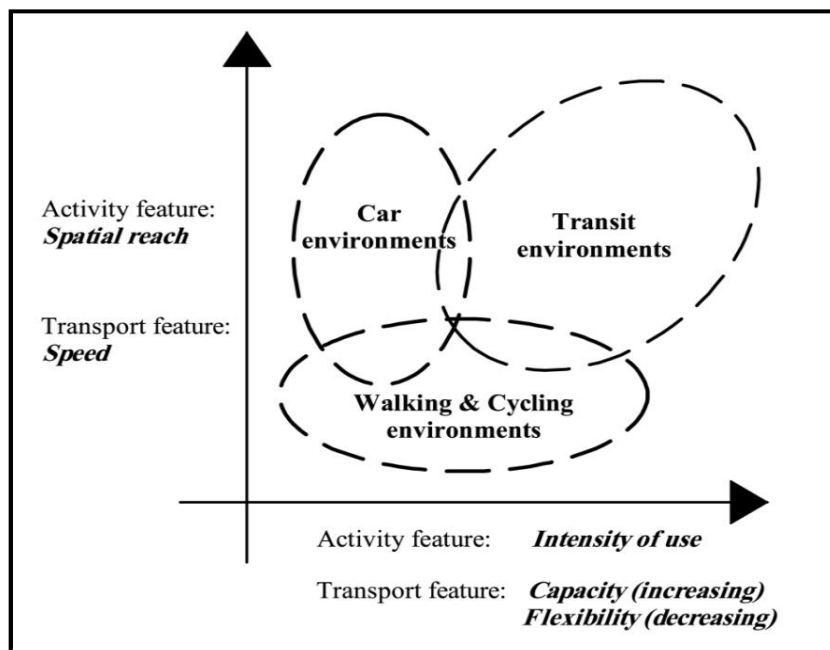

Figure (3.3); Basic transport and land use correlation: TOD pursues a combination of car, transit, and walking and cycling environments. (Curtis, Renne & Bertolini 2009)

3.10.2 Procedural and Planning Challenges

There are three major challenges related to the formal procedures, and they can impede the process of Transit Oriented Development and causing tensions and delays:

- Unsupportive regulatory framework; which is often common for cities to have zoning ordinances and land development codes designed for automobile oriented, single-purpose, suburban-scale development unfriendly to transit development (Wander 2008); (Goodwill & Hendricks 2002).
- The difficulties of coordination among the multiple parties involved; that no surprise that a multiplicity of agencies with different agendas and action protocols add a substantial layer of complication in the development process (Anastasia, Houston, & Bromberg 2007).
- The complexity of building joint development and infill projects; that TODs often involve joint development agreements where the public sector contributes in the funding and development of some segments of the project (e.g. affordable housing, parking structures, and public facilities). While joint development often

makes a project feasible by spreading the cost and risks of the development, it is also inherently more complicated (Anastasia, Houston & Bromberg 2007).

3.10.3 Economic and Market-related Challenges

Despite the efforts of planners, architects, and developers TOD projects at sometimes do not pencil out. Developers complained about the high costs of land and construction as well as the cost of development fees in certain areas. Also, the developers and investors complain of higher risks and costs due to the unconventional nature of TOD in comparison with traditional auto-oriented situation. There are two major challenges return to this issue (Anastasia, Houston, & Bromberg 2007):

- Financial risk To Developer; that although TOD is gradually gaining more acceptances in the development community, it is still often hard to convince developers and financiers that TOD can be profitable. Many developers and investors believe that TOD involves higher risks and costs than other types of development. Some conservative lending institutions require the facilities they invest in to have automobile oriented design features because they believe it will ensure a higher financial return.
- High Initial Public Investment Costs; that it is widely viewed that TOD can lower infrastructure costs in the long run but the initial TOD infrastructure needs can be considerable and can require extensive public investment. There is no single source of funds for TOD; instead, a number of funding sources are needed. Other municipal infrastructure development often competes with TOD for the same funding sources.

3.10.4 Cultural and Perceptual Challenges

Resistance from the local community can pose a challenge to the implementation of TOD. There are two major reasons for that resistance:

- Resistance which is targeted for transit improvements; that residents often have concerns that TOD will take away from the character of the neighborhood, create localized traffic congestion or lower property values. The resistance also comes from new residents (Goodwill & Hendricks 2002).
- Negative community perceptions and attitudes towards higher density near mass transit; that developers acknowledge that without education the public about accepting density, they are vulnerable to vocal opposition from public contingents large and small when their projects come up for review (Anastasia, Houston, & Bromberg 2007).

3.10.5 Physical and Environmental Challenges

Developers speak about numerous challenges related to physical and environmental constraints. Three major statements can cause this barrier: (Anastasia, Houston, & Bromberg 2007).

- Problem with Building codes; that they simply were not designed to account for mixed uses in one building.
- Noises; that many developers mentioned noise as a consideration that resultant from the design of TOD sites. Noise issue is related to the street, commercial facilities, and situations that joint to high density.

- Contaminated Sites is another challenge mentioned by developers; that in some cases, contamination prevents the development of an adjacent parcel that might otherwise be ideal for a high-density project.

3.11 Supportive Market Conditions

1. Strong regional market;
2. Competitive station area;
3. Vacant and re-developable land available;
4. Large parcels in single ownership or easily assembled;
5. Supportive public policies.

3.12 Stakeholders and Responsibilities in TOD Process

TOD requires a coordinated effort among all participants, including governmental and nongovernmental agencies, public and private sectors. With many involved stakeholders; individual agendas can be easily conflict. So, Coordinated and continuous communication during every stage of the TOD process can set realistic expectations and leads mutually beneficial outcomes. The conception, planning, and implementation of TOD demand a variety of stakeholders; as in Figure (3.4) (Policylink National Research and Action Institute 2008); (Slepian & Stephenson ca.2005); (RTD Fast Track 2006); (CTOD 2004):

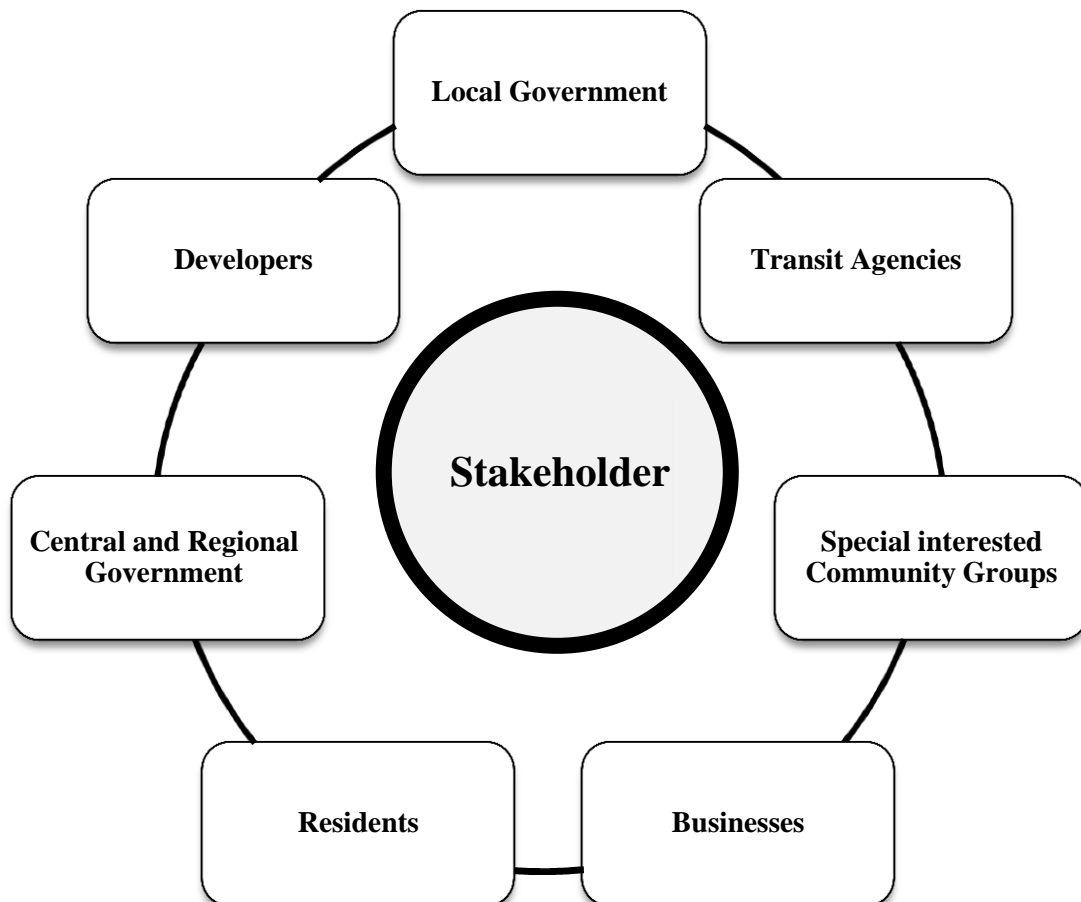

Figure (3.4); Stakeholders whom are responsible for implementing TOD.

3.12.1 Local Government; responsible for:

- Developing supportive regulatory framework that facilitate the process over the long term, that only local governments are authorized to adopt plans, enact zoning codes, implement financing tools, improve infrastructure, and issue development permits.
- Defining the implementation tools.
- Setting incentives for all key players.
- Dealing with land Owners.
- Operating local jurisdictions appreciate TOD's potential to support affordable housing, create jobs, reduce congestion, and increase the tax base.
- Establishing and facilitating public-private partnership.

3.12.2 Transit Agencies; responsible for:

- Holding integrated planning and joint development.
- Securing funds.
- Working in public-private partnership.
- Educating other key players, especially the residents.
- Designing and constructing.
- Advocating for local government.
- Offering transit services.

3.12.3 Special Interested Community Groups;

There are a wide range of interested community organizations, including; community development corporations, social service agencies, and environmental and transit advocacy groups. Generally, they are responsible for:

- Organizing local residents and business participation.
- Keeping developers accountable to the community.
- Preservation and monitoring of affordable housing, economic development, environmental issues, and social equity.
- Revitalization of neighborhoods.

3.12.4 Businesses;

Businesses in a station area often serve current transit riders and are interested in how TOD will affect their customer base; still, owners can:

- Establishing projects that influence the design of space.
- Provide insight on pedestrian and shopper patterns.
- Appoint the placement of business in some area; to be visible to transit and automobile users.
- Support local community.
- Encourage employees and customers to use alternative transport.
- Improve economic aspects.
- Attract other developmental trends and investment.

3.12.5 Residents; responsible for:

- Defining the real community needs.
- Setting the initial goals.
- Presenting invaluable input about how to reach the integration between TOD and the surrounding community.
- Providing feedback about for development design.
- Reviewing development proposals.
- Participating in construction.
- Working with neighborhood groups.
- Supporting local business.

3.12.6 Central and Regional Government; responsible for:

- Developing supportive regulatory framework that includes; land assembly, zoning considerations, infrastructure improvements, environmental regulation, and project financing.
- Setting polices and guidelines.
- Providing funds.
- Monitoring and assessing all procedures.

3.12.7 Developers;

Ultimately, developers need to be able to realize a certain level of profit on the development to maintain and grow their private business. Under all circumstances, the developers will be responsible for:

- Working with local government to draft and finalize a TOD site plan, obtain the necessary zoning and other approvals.
- Secure financing for projects.
- Complete any needed land assemblages.
- Manage construction and complete the final projects.

3.13 TOD Polices and Design Guidelines

In what follows, there are six policy objectives statements which provide the key policy that must be followed within a design. Following are TOD guidelines that provide direction and potential options on how to achieve the policy objective. Also, these guidelines are strategies that seek to accommodate projected growth and allow for a good integration between the station, the new developments, and the existing urban fabric. It is the intent that these guidelines can allow for a flexible and creative approach that achieves TOD in the wide variety of contexts (The city of Calgary, Land Use Planning & Polices 2004b); (Anastasia, Houston, & Bromberg 2007).

3.13.1 Policy Objective - Ensured Transit Supportive Land Uses

It is principal to ensure land uses that encourage high levels of transit use and provide mixed-use activity node for the local community and citywide transportation network benefits. This provides the local community with increased services, employment, and housing options within their community. The included guidelines are:

1. Mix land uses, see Figure (3.5)

- A station area should allow for a mix of residential, employment and supporting retail and service uses.
- The mix of land uses may be horizontally or vertically integrated; that is, the mix of uses may be found within a particular building, or incorporated in multiple buildings throughout the planning area. This provides a variety of uses within a compact, walkable station area and creates a synergy between the varying types of development.



Figure (3.5); Mixing land uses can occur horizontally across a site, or vertically within a building. (The city of Calgary, Land Use Planning & Policies 2004b)

2. Transit-supportive land uses

Transit-supportive land uses encourage transit use and increase transportation network efficiency. Also, the pattern of land uses should be characterized by: see Figure (3.6)

- High employee and/or residential densities.
- Promoting travel time outside of the am and pm peak periods.
- Attracting reverse-flow travel on roads.
- Encouraging extended hours of activity, throughout the day and week.
- Attracting pedestrian users and generates pedestrian traffic.

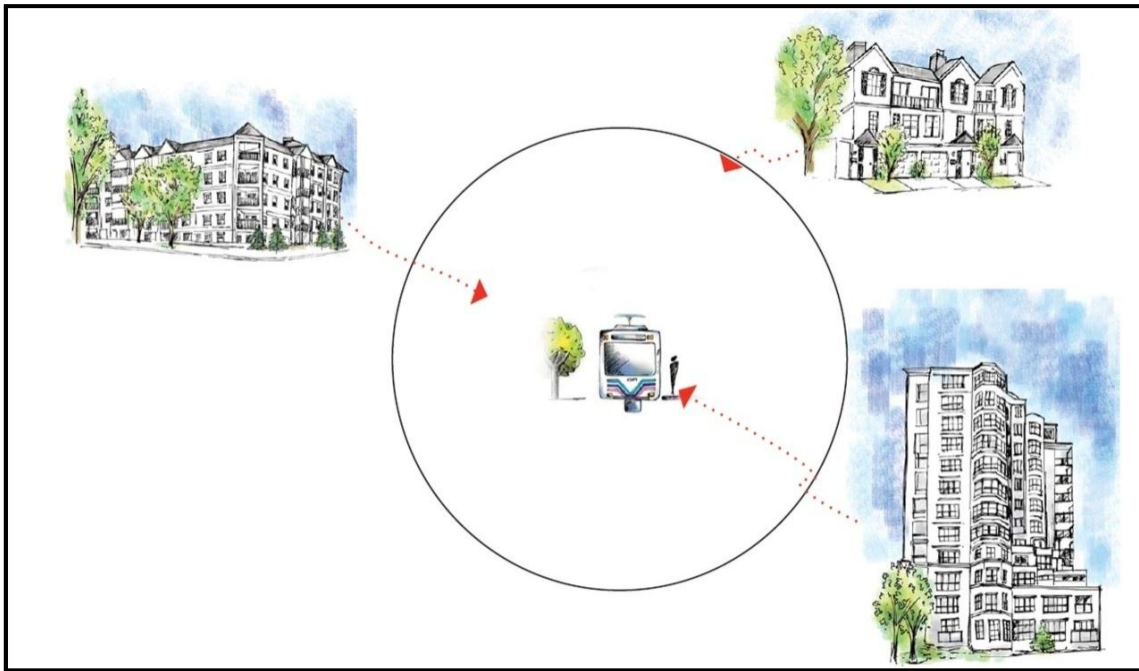

Figure (3.6); Medium to high density residential developments are transit-supportive and can come in a variety of forms. (The city of Calgary, Land Use Planning & Polices 2004b)

3. Limitation of non-transit supportive land uses

Non transit-supportive land uses are oriented primarily to the automobile and not the pedestrian or transit user. These limitations are such as:

- Frustrating high levels of vehicle activity
- Forbidding the consumption of large amount of land through low-density form
- Reducing of require extensive surface parking areas.
- Decreasing of negative impacts for pedestrians such as isolation from building frontages, long windswept walks, and numerous vehicle crossings on sidewalks.
- Preventing stand-alone auto-oriented uses and formats, such as gas and service stations, car washes automotive parts, repair and service, etc.
- Preventing Low intensity industrial.
- Preventing Low density commercial, such as big box retail.

3.13.2 Policy Objective - Increased Density Around Transit Stations

It is essential to increase density around all transit stations to support high frequency, rapid transit service and provide a base for a variety of housing, employment, local services and amenities that support a vibrant station area community. The included guidelines are:

1. **Optimization density around each station**, see Figures (3.7), (3.8)

- Higher densities should be encouraged in the immediate vicinity of a transit station through infill development and the utilization of existing vacant parcels. Also, density should be placed in locations with the best access to transit and local public systems.
- Density should be increased around transit stations, relating to the surrounding context and particular station type.

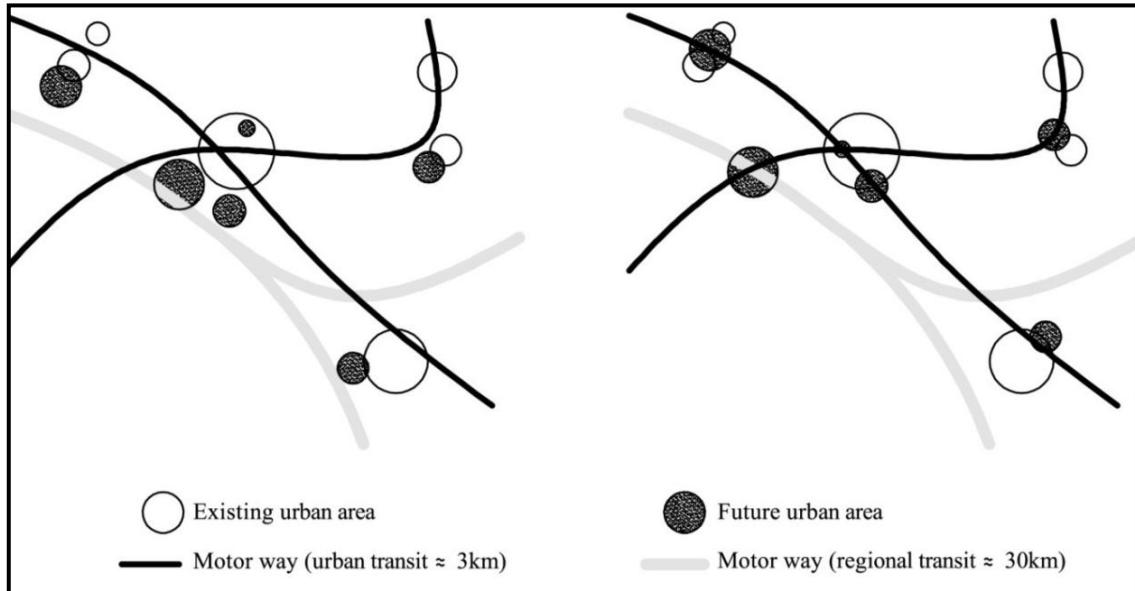

Figure (3.7); Left: compact city policy: build in or next to existing city;
Right: Transit Oriented development: build within walking or cycling distance of station.
(Curtis, Renne & Bertolini 2009)

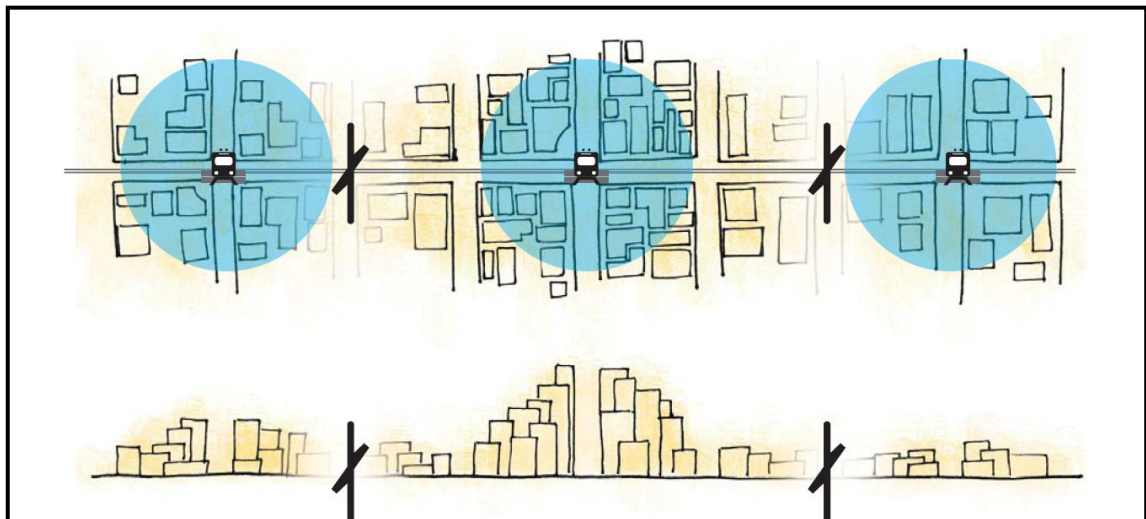

Figure (3.8); Density around Transit Stations should be increased with the highest density near the station. (The city of Calgary, Land Use Planning & Policies 2004b)

2. **Minimization the impacts of density**, see Figure (3.9)

- Consideration for impacts of height on shadowing and massing should be made in determining transitions.

- Shadow studies are required to ensure that new development creates significant shadowing on existing communities.
- Transit facilities, public spaces and roadways can be used as organizing elements for the placement of density, height and shadow.
- Creation of transition between higher and lower intensity development have to be made, and it can be happened by stepping down building heights and densities from the station area to the outer area.
- It is important to create proper edge treatments such as compatible building scale, parking location, and landscaping between new developments and existing communities to minimize impacts and ensure integration.
- The intrusion of high-rise structures in neighborhoods with low- and medium-rise buildings may alter the general character of a neighborhood and is likely to be vehemently opposed by existing residents. Appropriate treatments of building facades should be considered to break up monolithic mega-structures. When the development involves many structures a gradual blending of different densities and different building types is recommended.



Figure (3.9); Density should transittn from high to lower density, ensuring compatibility with adjacent communities. (The city of Calgary, Land Use Planning & Polices 2004b)

3.13.3 Policy Objective – Pedestrian Oriented Design

It is constitutional to create convenient, comfortable, direct, and safe pedestrian linkages to and from all transit stations in order to support a walkable station area and promote the use of transit. This objective can be achieved by:

- 1. Quality pedestrian connections, see Figure (3.10)**
 - A convenient, comfortable pedestrian-oriented route has to be designed. It must be short, barrier-free, safe, and easily navigable.
 - Primary and secondary pedestrian routes should be identified.
 - New streets and walkways should be incorporated into the existing local road pattern.
 - Streets should have sidewalks on both sides of the road that can accommodate high-volume pedestrian activity.

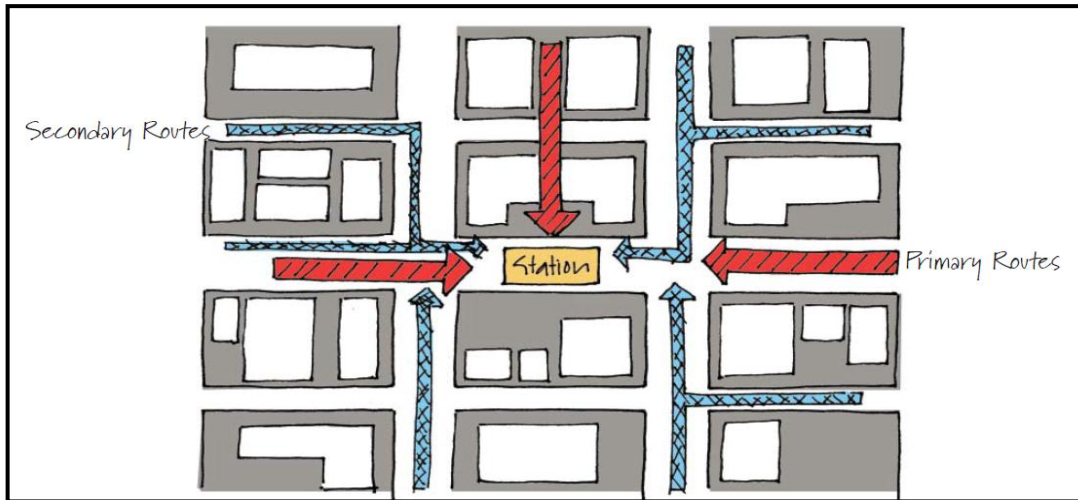

Figure (3.10); Primary and secondary pedestrian connections provide access to the Station and throughout the area. (The city of Calgary, Land Use Planning & Polices 2004b)

2. A compact development form:

- Buildings should be grouped together to allow for easy pedestrian access between buildings and to frame the pedestrian spaces, which makes easily legible routes; as in Figure (3.11).

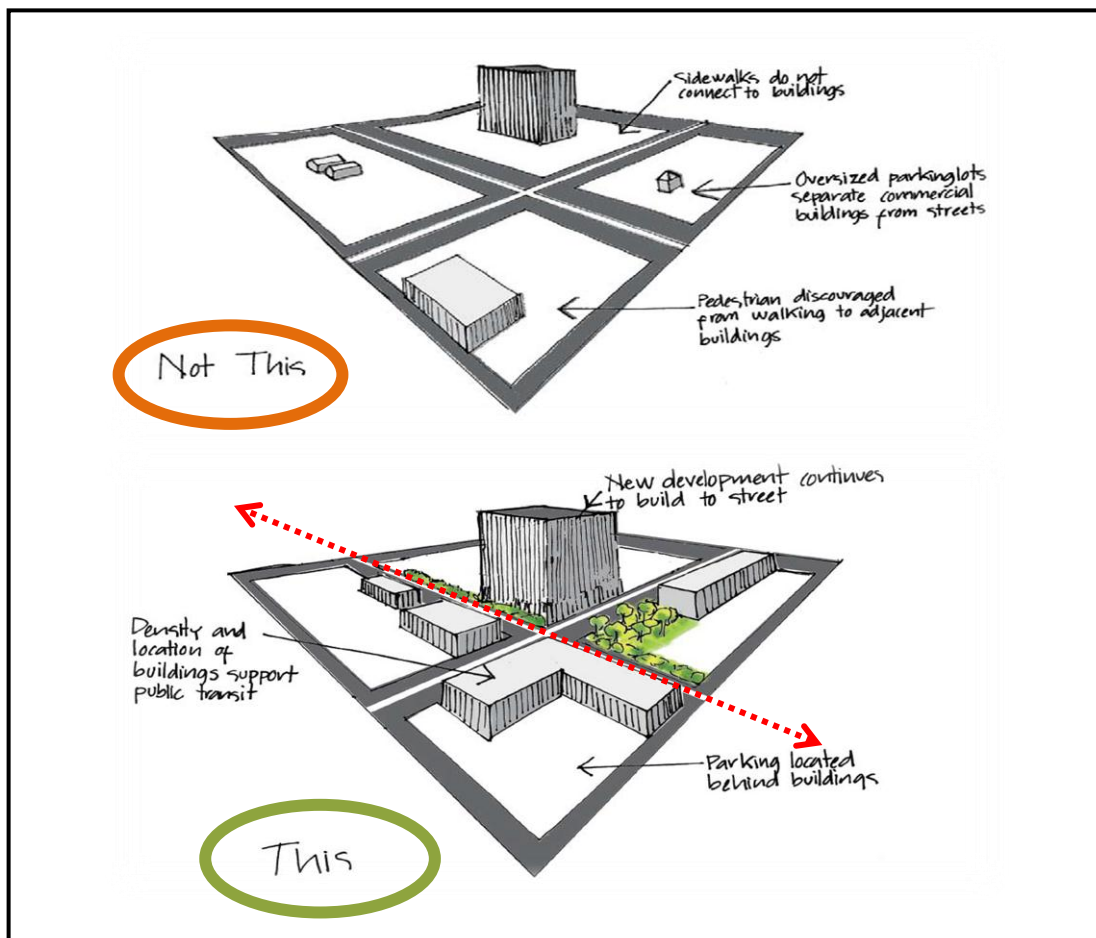

Figure (3.11); Development patterns in TOD station areas should be compact. (The city of Calgary, Land Use Planning & Polices 2004b)

3. Integrated public systems

- Public systems are essential to ensure a fully integration. Elements of the public systems should include; primary and secondary pedestrian routes, bicycle routes, roads, sidewalks, public open space, transit stations and bus stops.
- Development should be integrated with all elements of the public system in order to create pedestrian comfort and an effective network for all travel modes within the station area.
- Regional pathways and pedestrian routes should be located close to each other, but physically separated.

4. Locating pedestrian-oriented uses at the ground level

- As TOD is focused on pedestrian comfort, the ground floor should contain uses that are appealing to pedestrians, such as retail, personal service, restaurants, outdoor cafes, and residences.

5. Human scaled architecture

- Doorways and windows should be oriented to the street level in order provide ease of entrance, visual interest and increased security through informal viewing
- Architectural variety (windows, variety of building materials, projections) should be used on the lower storeys of a building in a TOD station area in order to provide visual interest to the pedestrian
- Buildings higher than 4 to 5 storeys should step back higher floors in order to maintain the more human scale along the sidewalk and reduce shadow impacts on the public street.

6. Incorporate climatic design

- Primary pedestrian routes, developments and transit facilities should incorporate climate and weather adjustment; as in Figure (3.12). This can include covered waiting areas, building projections and colonnades, awnings, bus stops, use of landscaping etc.

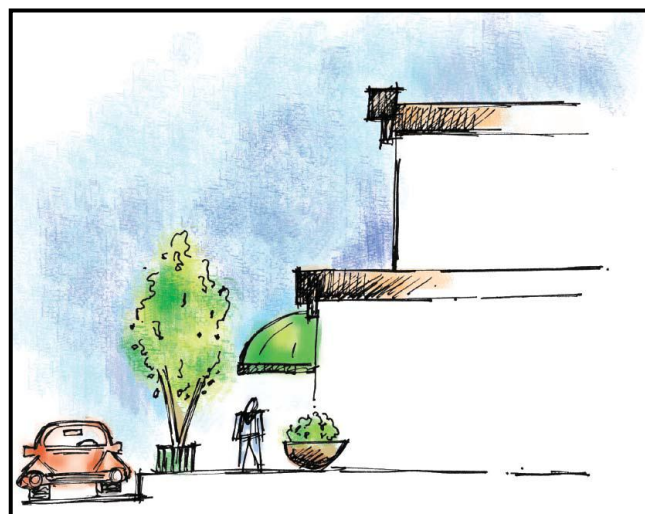

Figure (3.12); Buildings in TOD stations areas should create a comfortable environment for the pedestrian. (The city of Calgary, Land Use Planning & Polices 2004b)

3.13.4 Policy Objective – Make Each Station Area as a 'Place'

Each station area should be developed as a unique environment, with transforming a utilitarian transit node into a community gateway and a vibrant mixed-use hub of activity. The following guidelines should be adhered to achieve this topic:

1. Emphases of important buildings

- Public or high profile buildings (i.e. large commercial, prominent residential) should be highly visible landmarks within the TOD area, that it should be located on high exposure sites, at the terminus of a sight line or view.
- These buildings should be articulated creatively and have distinctive design features that can be easily identified. Also, taller buildings should have distinctive rooflines to further create a landmark location.

2. Street and block layout

- Street layout should be oriented toward the transit station.
- Where possible, street and building configuration should be designed to create vistas, or to terminate views with a landmark feature, building, or public space

3. Use open space creatively

- Public and private open space should be developed to complement the station area. This would emphasize the station as a public place, provide a comfortable and interesting waiting area, and give the community an attractive gathering point.
- In high density TOD areas parks should be developed to meet on-site population needs. Total open space acreage should be calculated based on the quantity of residential development. Open spaces should not be designed as residual or left-over spaces but should be easily accessible and well integrated to the existing urban fabric.

4. Creation a focus for the local community

- Development in the station area should provide a destination for both transit users and local residents.
- Elements should include local gathering places, shopping, services and transit connections.
- Amenities such as benches, mail boxes, newsstands, bike racks, and bus shelters should be provided on the station area and along pedestrian corridors.

3.13.5 Policy Objective – Manage Parking, Bus and Vehicular Traffic

It is fundamental to accommodate transit bus and private automobile circulation and parking needs while creating a comfortable and attractive pedestrian environment. All in all, parking management can be used to tip the balance toward making conditions more favorable to transit and less favorable to auto travel. This significance can be gotten by the following guidelines:

1. Reduction of standard parking requirements

- On-street short term parking can be provided to accommodate drop-off, pick up and taxi services.
- Longer-term secure bike parking with shower and locker facilities should be used to enhance this trend.
- Surface parking lots should be placed to the rear of buildings not front of them; this delivers entries and windows fronting on streets and sidewalks. The size of continuous surface parking lots should be limited.
- Shared parking is recommended for adjacent uses with different peak periods of demand.
- Parking structures can be used, but they should not be allowed to dominate the street frontage.
- Park-and-Ride sites could be considered for accommodating parking during off-peak hours. Though, this type of sites should not act as buffers between the station and its adjacent mixed-use and commercial areas.
- A cash-in-lieu policy for parking in TOD areas should be considered as part of a parking management strategies for a station area.

2. Placing parking in appropriate locations, see Figure (3.13)

- Parking areas should be designed appropriately in order to maintain the pedestrian comfort in the TOD station area.
- Major parking areas should be accessed from collector and arterial roads around the station areas, without impacting existing communities or the pedestrian environment closest to the station. Direct and convenient pedestrian connections should lead from these parking areas to primary destinations; such as, transit station, office areas, densely residential, etc.
- Along primary pedestrian routes, parking lots should be located to the rear or side of the building.
- Parking lots should be designed and located to minimize or prevent the vehicles crossings over primary pedestrian routes.

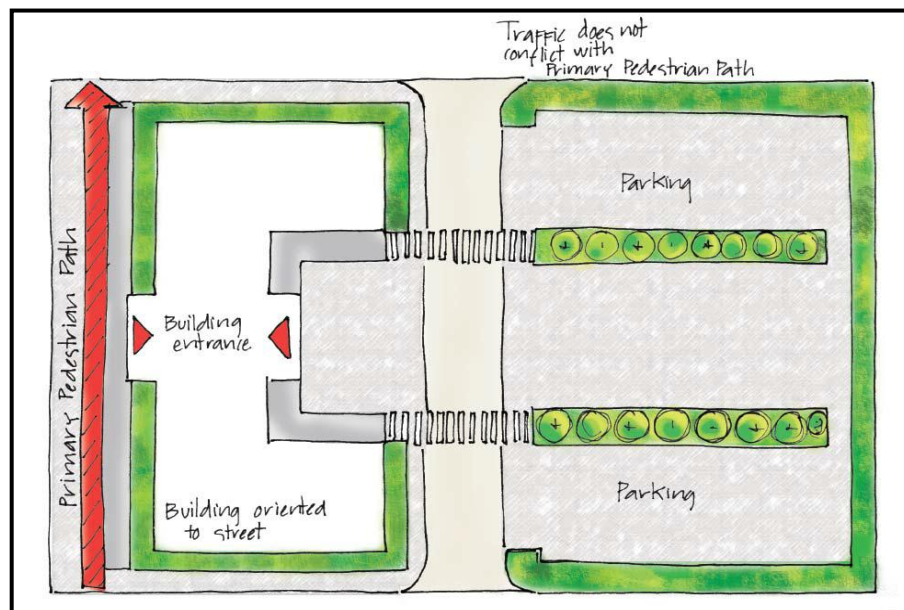

Figure (3.13); Parking areas should be located to minimize conflict with pedestrian. (The city of Calgary, Land Use Planning & Polices 2004b)

3. Developing parking forms that integrate with the pedestrian nature of the area

- Surface parking should be broken into smaller cells through landscaping and walkways.
- Lighting in surface parking areas should be directed within the site
- Surface parking areas must accommodate safe, direct pedestrian traffic through the provision of landscaped walkways to and from, as well as through the site.
- Parking structures should have active street-level facades, including commercial uses and/or building articulation and glazing.

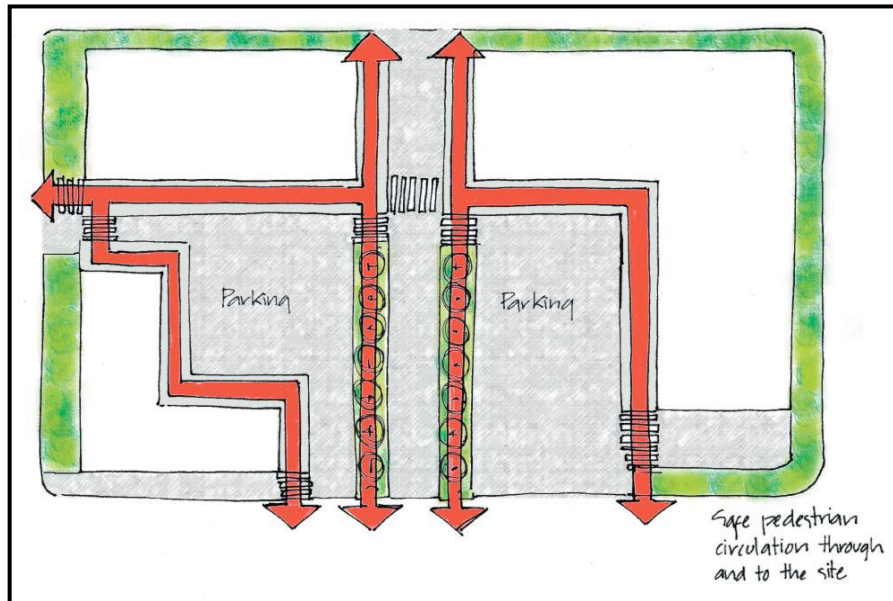

Figure (3.14); Parking areas should provide safe pedestrian access to the site, and safe circulation.
(The city of Calgary, Land Use Planning & Policies 2004b)

4. Encouraging transportation demand management strategies

- Encouraging local shuttle service for employment centers or shopping centers
- Facilitating community car-sharing and car-pooling by providing authorized car licenses, and preferential parking spots for car-share/car-pool vehicles
- Work with businesses to encourage transit ridership programs for employees.

5. Integrating design for transit circulation and drop-off zones

- Bus access and public transportation facilities to station areas should be a primary consideration in the design of the station and local roadways. This provides a more comfortable transition between modes of public transportation. Where possible, bus drop-off areas should be from local roadways with quick and direct access to the station platform.
- The drop-off sites for motorists, where they can drop off or wait for a transit passenger, should be provided where feasible. These facilities should provide quick and direct access to the station platform, but not to be the focus of the public systems design. These should avoid being placed prominently at the station, but rather placed in locations where the vehicle can enter and exit the station area conveniently and the passenger has a direct connection to the station.

6. Long term redevelopment

- Surface parking should be designed to allow redevelopment with parking structures and/or other development.

3.13.6 Policy Objective – Plan in Context with Local Communities

Transit Oriented Development should benefit the local community. Through consultation with local communities, TOD should provide a wide range of supporting benefits for local communities, including increased uses and services, a variety of housing, increased transportation options, and a more walkable environment and community amenities. To achieve this purpose, the following guidelines have to be accomplished:

1. Working with local communities

- Local communities can provide valuable and essential database input about services and amenities needed by the community, housing forms, key pedestrian destinations, current pedestrian habits, parking management concerns etc.
- Local landowners and communities should participate in station area plan planning processes. Information should be made available to them and opportunities to be consulted made available at opportune times.
- All communities within the catchment area of the transit station should provide input into station area planning processes. This database can be applied especially to the creation of station area plans, as other types of planning applications, which have established circulation processes.
- Stakeholders must to be encouraged to consult with local communities early in the planning process to ensure a common understanding of important community issues related to a particular site or area.

2. Providing needed community services and amenities

- New development in station areas should provide services and amenities needed by local communities. These could include new housing forms to support community demographics, employment options, convenience retail and personal services, day-care, public gathering spaces, etc.

3. Built form should complement the local structure context

- Each station exists in a particular community context. Development should complement the existing development and help to enhance the local character while creating a walkable, vibrant station area.
- Transitions between established residential areas and the new TOD area should provide a sensitive interface. Low rise, medium density residential or low-profile mixed use development may be used as an appropriate transitional use between adjacent low density residential and the TOD area.
- Public pedestrian systems should implement the integration between the new and existing developments in the area.

CHAPTER 4

IMPLEMENTATION AREA ..

IDENTIFICATIONS AND LIMITATIONS

- 4.1** Introduction
- 4.2** The Background and Context of Local Physical Planning
- 4.3** Regional Situation of Gaza City According to the Regional Plan of Gaza Strip (2005-2020)
- 4.4** Urban Structure Framework of Gaza City
- 4.5** Demographic Profile
- 4.6** Roads and Transportation Network in Gaza City
- 4.7** Urban Growth Framework of Gaza City

4.1 Introduction

Cities are large collections of buildings, which are held together by a network of space: the street network. The network of space is the largest thing in the city. It is what holds it all together. Space has an architecture; that is a certain geometry, topology and pattern of connections. Moreover, the spatial structure connections are represented by the streets network, which is generally the primary determinant of movement. Movement is the lifeblood of the city and creates the dense patterns of human contacts.

Gaza City is chosen to be as a study area to implement the innovative approaches of smart and sustainable urban development. But, it has a special case in its urban conformation, that it has been subjected to complicated geopolitical conditions, and its urban growth has been highly influenced by various colonization powers. Also, the city is characterized by high-density population and urban fabric. Gaza as any metropolitan region tends to spread and coalesce into new urban regions and public transport systems. The evolution of Gaza growth with a multitude of relations and dependencies requires not only new forms of transport, but also new methods of spatial planning. Herein, an understandable and analyzed platform is necessary to be structured.

4.2 The Background and Context of Local Physical Planning

In the light of urban and physical planning theories and literature, the physical planning process and building of planning institutions within political and administrative stability enable the local government to provide future vision and proposals for the spatial plenum parallel to establishing institutions and administrative bodies to manage the planning process using the available resources to achieve the attained goals and objectives. The question to be asked with regard to the Palestinian case is; how to manage the planning process in unstable and emergent circumstances in terms of controlling the resources and having the administrative power, without definite spatial plenum to be planned (Abdelhamid 2005).

4.2.1 The Current Situation and Its Impact on Physical Planning

Urban development and planning practice and experience in Palestine had passed through various changes and developments in terms of characteristics, policies, principles, and management. Also, the urban planning system in Palestine seems to be unique in its composition and context. This uniqueness is related to the fact that planning practice was controlled and experienced by external forces and occupations. This, of course, shifts the urban planning from being a developmental tool to a political control tool, which used to enhance and elongate the existence of the occupation. (Abdelhamid 2006)

With the formation of the Palestinian Authority in 1994 as a result of Oslo Peace Agreement, the planning responsibilities as well as other civilian issues and services were transferred to the related Palestinian ministries and institutions. Then, they attempt to develop the physical planning in the Palestinian cities and villages. (Abdelhamid 2006)

During (1994-2005), a regional plan for Gaza Strip was prepared by the Ministry of Local Government (MOPIC) with the pre-1967 borders. This plan represented the

basis for the national policies for physical development. The plan assumed a considerable number of returnees and a relatively high natural population growth. In addition, the plan provides a basis for further planning within sectors as well as planning on regional (governorate) and local levels. (Abdelhamid 2006)

Also, the Ministry of Planning and International Cooperation (MOPIC) prepared master plans for local communities in order to harmonize the existing planning system and modernize the already implemented planning law, as well as facilitate the formation of a new state, A draft proposal of a new plan and building act has developed in cooperation between MOPIC and MOLG. This act is focusing on the following issues: (Abdelhamid 2006)

- Developing a planning structure based on three main levels: National Plan, District (Regional) Plan and Local Level Plans, and corresponding administrative levels.
- The Ministerial Cabinet is at the top of the administrative levels and responsible for the National Physical Plan conducted by MOPIC.
- National guidelines and regulations are introduced as instruments for the centre government to state specific objectives for physical planning in order to secure national interests as well as avoiding obstructions and delays.
- Environmental Impact Assessments are introduced in order to maintain sustainable development for future generations and preserve both natural resources and cultural heritage of the nation.
- Ensure public participation in the planning process and representation in the planning administration.

These plans provided other Palestinian institutions and commissions with all aspects about land uses and building laws. However, these plans did not satisfy the demand for urban development. This situation returns to four main reasons: (Ministry of Local Government 2010)

1. Different and old laws and regulations, which need modernization and updating to be more suitable for the current urban situation.
2. The absence of legal basis for national physical and spatial planning, and weakness of the link between it and the regional rank of planning, which led to a general weakness in the authority and guidance on planning at the local and detailed level.
3. Lack of clear boundaries for local government bodies, and the consequent of ambiguity for areas to be covered by physical planning.
4. Constraints imposed by the Israeli occupation on the development process and sustainable planning in the Palestinian territories.

As a result of these contradictions and gaps, the current practice of physical planning is facing several problems and disadvantages have led to the following obstruction:

- Separation of the process of determining the limits of the planning area for the actual planning stages and intercept the planning with so-called (the borders of the organizational area) without the rest of the coverage limits of the local area.
- Lack of clarity in the potentiality and duties of local bodies.

- The long-term of master plans (15-20 years) without determining any stages or levels, makes them inflexible and gives wrong idea about the planning as a once time practice.
- Concentrating within planning process on data collection and surveys only, without making efficient and adequate analysis, and without defining the strategies, goals and development priorities, especially on local rank.
- Limited care about environmental issues and aspects.
- Confining the planning process on specific areas without taking into account the joint planning areas and its formal demands.
- Lack of community sharing and private sector sharing within preparing for planning or within planning, and confining their role on objection after plans design.
- Lack of references, standards and clear procedures for preparation the plans.
- Lack of awareness of many local agencies, and the public about the importance of physical planning, which led to the preference of individual interests over public interests.
- Long-term procedures for the adoption and ratification of the master plan (2-4 years).
- Changes and modifications that accrue on the master plans without adequate monitoring to the implications and complications of such changes on the urban environment over long-term.
- Variation and overlap in the application of different levels of planning, particularly in the replacement of master plans with detailed plans and the establishment of development projects outside the planning areas.

4.2.2 Main Issues and Attentions of Planning Process in Palestine

The overall context of urban planning imposes a set of core issues that must be agreed as a set of targets that should be directed by physical planning in the future: (Ministry of Local Government 2010)

- Giving more attention for regional and sub-regional links and service centers.
- Defining more real needs for urban sprawl and avoiding excessive use of land.
- Developing a higher level of flexibility to the plans by specifying the duration of these plans from 10 to 15 years, also, developing the concept of phased development within five-year plans, as well as making regular review and adjust for the plans every five years.
- Supplying with high quality infrastructure (water, electricity, management of sewage and solid waste) and taking into account the capacity of local infrastructure.
- Allocating of sufficient and appropriate areas for public services (educational, health, cultural and social services).
- Protecting the environment and natural resources.
- Making regional studies for the exposed area, and taking the advantages of all previous studies and plans that related to this area.
- Giving more attention to the ability of local authorities for funding and management by selecting and programming the development investments.

- Reliance on strategic development and investment planning (SDIP) within the preparation of master and detailed plans.

4.2.3 Related Regulations and Legislations that Rule Planning and Land use

The following specify current legal framework for physical planning laws and regulations: (Ministry of Local Government 2010)

- **The law of Town Planning Ordinance No.1 for year 1997:** It sets out the potentiality and duties of local authorities as follows: town planning, streets modifying, specifications for streets profiles, buildings and streets numbering, monitoring landscaping... etc.
- **The law of Town Ordinance No. 28 for year 1936 during the British Mandatory period**
- **Legislations of buildings and regulations No. 30 for year 1996:** It is dedicated to the buildings located within the area of the approved master plan.
- **Legislations of buildings and regulations No. 31 for year 1996:** It is dedicated to the buildings located out of the area of the approved master plan.
- **The master plan of Gaza City for year 1997**
- **The regional plan of Gaza Strip 2005-2020**

Generally, the current regulations and legislations for planning and construction need to be modified to fit the real circumstances and the future.

4.3 Regional Situation of Gaza City According to the Regional Plan of Gaza Strip (2005-2020)

The Ministry of Planning and International Cooperation (MOPIC) has completed a regional plan for the southern governorates (Gaza Strip) in order to be a framework for the actions for the years (1998 - 2015). But, because of the overlap between the works of relevant ministries at that time, the plan was not approved formally. However, the plan has been used as an entry point and basis for many of the operations of planning at the local and national levels (Ministry of Planning 2005). After the regression of the Israeli occupation from Gaza Strip, the regional plan was amended in 2005 to suit the new urban hypotheses. The timeframe was extended to 2020, or with any geopolitical change.

4.3.1 Objectives of the Regional Plan

The regional plan aims to achieve: (Ministry of Planning 2005)

- Creating a general framework for land use, attached to the recommendations and regulations in order to ensure optimal use of the land, highlighting the need to protect it, and announcing the important regional and national areas.
- Clarifying the needs of housing, infrastructure, public services, the development of industry and commerce, and other needs in order to avoid poverty and support community groups.
- Protection of natural resources and ensure optimal use of them.

- Creating an infrastructure and appropriate environment for job creation and higher employment.
- Protecting the cultural heritage and archaeological sites.
- Merging the evacuated settlements and re-use these areas according to the priorities and development needs.
- Defining the outlines of directions and priorities for the future projects and investment programs.
- Making a balance between urban and rural development within the hierarchy of the urban centers, based on the economic roles and careers.

4.3.2 Main Principles of the Regional Plan

The regional plan based on a group of principles: (Ministry of Planning 2005)

- The plan emphasizes the concept of two main cities as in Figure (4.1), Gaza City in the north and the city of Khan Younis in the south. Also, it proposed the establishment of sub-centers in the Northern Governorate, Deir Al-Balah, Rafah and its refugee camps. This arrangement provides possibilities for development and fair distribution of public services, and lead to a concentration of urban sprawl in a number of key areas to avoid random urban sprawl.
- The plan defines areas of the land needed for urban uses within no conflicting with the protection of important natural resources, in order to ensure sustainable development and direct the urban development to precise areas.
- The plan provides the necessary infrastructure to promote agricultural industrial, touristic and commercial development.
- The success of regional plan adopted on a transportation network; as in Figure (4.2). The regional transportation network consists of regional, main and secondary roads. Also, it links the different communities with each other and connects them with the main production and the most important sites.

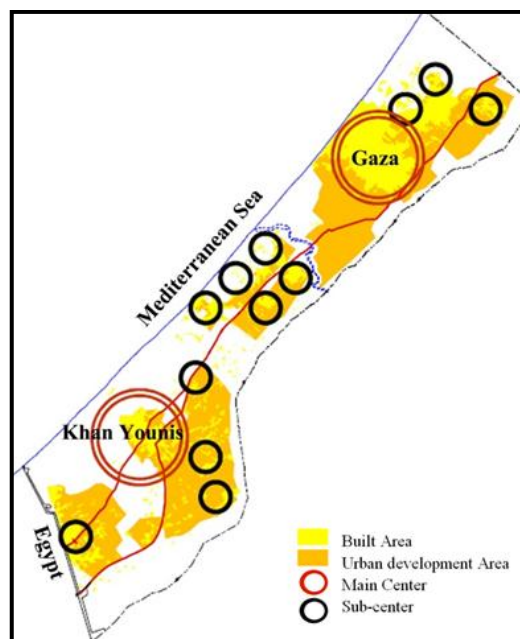

*Figure (4.1); Urban development of Gaza Strip based on two main centers.
(Ministry of Planning 2005)*

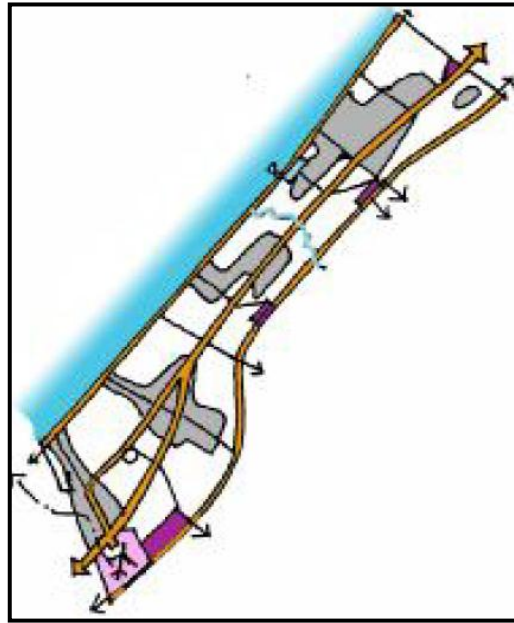

Figure (4.2); Main elements of transportation system in Gaza Strip. (Ministry of Planning 2005)

4.4 Urban Structure Framework of Gaza City

Understanding the urban structure framework of Gaza City is an essential stage in preparing any developmental approach. It can give the ability to analyze and determine the crisis, impacts and responses of urban planning work.

4.4.1 Geographic Characteristics of Gaza City

Gaza City is located within the territory of Gaza Strip (Southern Governorates of Palestinian Territories). The strip lies on the eastern coast of the Mediterranean Sea, at 31 25 N, 34 20 E. It occupies the far southern west of Palestine and extends from north to south with length of 45 km, width between 6-12 km, and with a total area of 360 km²; as in Figure (4.3). The strip takes its name from the Gaza City (Al-Moughani 2006). Also, it is divided administratively into five governorates; North Gaza Governorate, Gaza Governorate, middle Area Governorate, Khan Younis and Rafah Governorates. The city is located in the north of Wadi Gaza that passes through the middle of the strip. The city is bounded from the west with the Mediterranean Sea with coastal line about 6.5 km, bounded from the east with Green Line of the Occupied Palestine, bounded from the north with Jabalya City and bounded from the south with Az-Zahra' City, Joher Ad-Diek and Al-Moghraqa, with total area about 45 km² (Al-Moughani 2006). This geographical characteristics influence the urban sprawl, that the city is limited from eastern direction with political and administrative borders and limited from western direction with the coastal line. From this point of view, it can be seen that urban growth will have a linear form over the long term.

Gaza city is divided administratively into 17 districts; as in Figure (4.4), with various areas and various population densities.



Figure (4.3); Gaza Strip. (UN OCHA 2009)

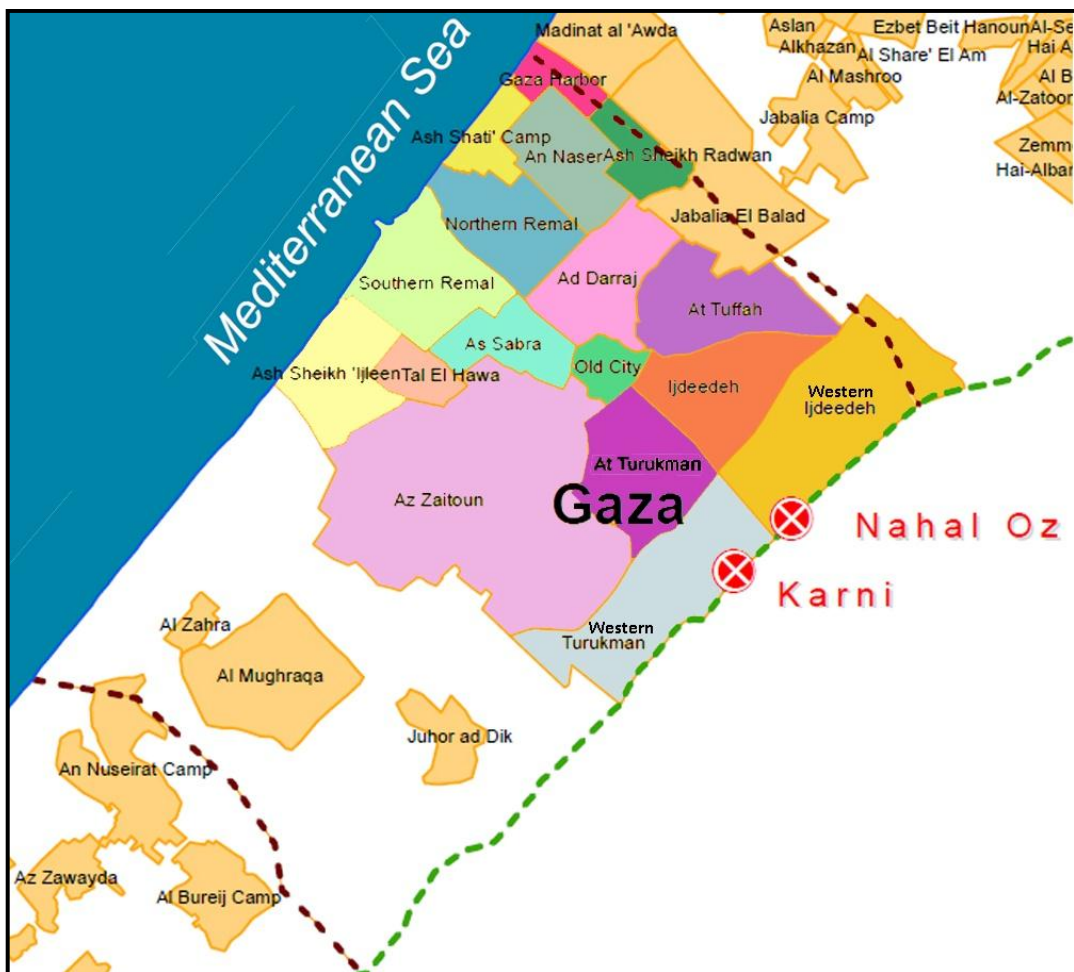

Figure (4.4); Gaza City and its districts and borders. (UN OCHA 2009)

4.4.2 The Importance of The City and Its Correlations

Gaza city is the main city and administrative center of Gaza Strip. So, it has a appreciable effects on the region, that is because of the following: (Salha 1994)

- Historical and political evidences, which made it an attractive area for immigration after the war of 1948.
- Defining the city as a focal point for governmental and non-governmental agencies and services, this arrangement makes the city a very attractive place for new residents and internal immigration from other towns and camps of the strip.
- The city can be considered as a commercial base of the strip.

Gaza is correlated with other towns and camps of the strip by a transportation network. As in Figure (4.5) and Table (4.1), the distances between Gaza and other urban clusters of the strip are illustrated.



Figure (4.5); Governorates of Gaza Strip. (UN OCHA 2009)

Name of the urban cluster	Distance from the center of Gaza City (km)
Jabalya	3.8
Beit Lahya	6.5
Beit Hanon	8.5
Al-Breij camp	9.5
An-Nosyrat camp	9.8
Al-Maghazi camp	12.9
Deir Al-Balah	10.2
Bani Suhaila	24
Khan Younis	24
Absan As- Sagheera	27
Absan Al- Kabeera	28
Khoza'a	29
Rafah	35

Table (4.1); Distances between Gaza City and other communities in Gaza Strip. (Salha 1994)

Also, the city is connected with Occupied Palestinian Territories and other countries with six crossing points; as in Figure (4.6) and Table (4.2):



Figure (4.6); Gaza Strip with its crossing points. (UN OCHA 2009)

Crossing Point	Location	Governorate	Usage
Beit Hanon	North	North Gaza	People
Ash-Shejaeya	North east	Gaza	Fuels
Al-Monttar	North east	Gaza	Goods
Al-Karara	South east	Rafah	Alternative for commercial and humanitarian goods
Karem Abo Salem	South east	Rafah	Alternative for goods, fuels and people
Rafah	South	Rafah	International terminal for passengers

Table (4.2); Crossing points details that surround Gaza Strip. (UN OCHA 2009)

4.4.3 Urban Structure Description for Gaza City

- **According to the master plan 1997** (Al-Moughani 2002)

After the advent of the Palestinian National Authority, a master plan for Gaza City was carried out, and it is adopted in 1998 to achieve several objectives. These objectives were tended to guide the processes of urbanization in the city, providing a healthy and safe residential environment, and develop the basic services to be corresponding with the increase of population. Also, the master plan attempted to prepare a high efficiency transportation network. Moreover, the plan aimed to protect the natural resources, and develop the infrastructure issues (sanitation, water and solid waste). It is clear from the objectives of the proposed master plan that it was done in order to address the urban troubles, and it can be seen as a contingency plan to deal with the urgent problems of planning, and therefore; it is not a comprehensive and detailed plan. See Figure (4.7) and table (4.3)

Land use	Area (Donum)	Percentage of total area (%)
Total area	45,000	% 100.0
Residential - medium density - class (B)	10,300	% 22.89
Residential - high density - class (C)	8,600	% 19.11
Old town	900	% 02.00
Agriculture zones	10,260	% 22.80
Freezed development zone (Al-Shate')	700	% 01.55
Shore zone	500	% 01.11
Main commercial center	2000	% 04.44
Touristic and recreation zones	1800	% 04.00
Public buildings	900	% 02.00
Sport	300	% 00.66
Industrial	2140	% 04.76
Green areas	390	% 00.87
Other (roads, rain collectors, cemeteries, regional transportation center)	6,210	% 13.81

Table (4.3); The adopted details of land use in the master plan of Gaza City. (Ministry of local government 1997)

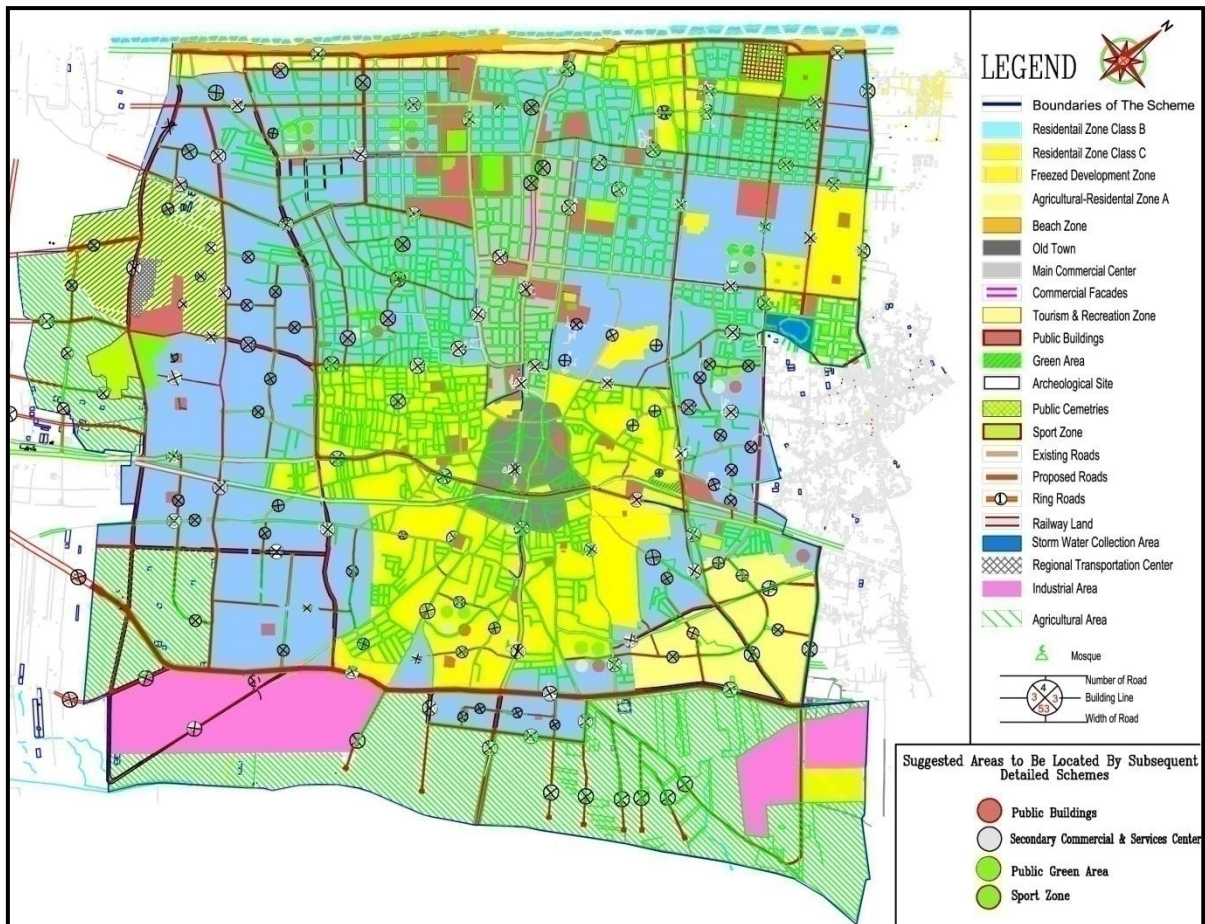

Figure (4.7); Master plan (1997) of Gaza City. (Ministry of local government 1997)

After the adoption of the master plan of Gaza, detailed plans for different areas were prepared. These plans aimed to achieve urban development within the social and economic needs. The plans were based on accurate studies to the needs of the current situation as well as the future. The preparation of detailed plans encountered problems that related to the established slums, in addition to the problem of private land ownership as well as problems of social and economic configuration.

- **Current situation of urban structure and land use**

Gaza City includes many land uses with size variation from time to time. Also, the population growth is increasing dramatically and this leads to the creation of other land uses related to the needs of the population. On the other hand, there is a reduction in green land and open spaces, which can be considered as an environmental and agricultural resource, and outlet for the city. Generally, the urban troubles of Gaza City can be summed up within the following points: (Mohaisen 2011)

- Population growth, which leads to a shortage of the available land for future expansion.
- Lack of services.
- Deficit in infrastructures.
- Environmental pollution especially in water (Contamination of the aquifer).
- Traffic congestion especially in the city center.

- Lack of recreational areas.
- The existence of Ash-Shate' refugee camp, which limits the development process for some parts of the coastal zone.

The following Table (4.4) shows the spatial distribution and relative patterns of existing land uses in Gaza City, according to the latest statistics carried out by the Municipality of Gaza and the Ministry of Local Government (MOLG):

Land use	Area (Donum)	Percentage of total area (%)
Total area	45,000	% 100.0
Agriculture uses	7,405	% 16.46
Residential and services uses	23,986.5	% 53.30
Al-Shate' refugee camp	700	% 01.55
Industrial uses	2,140	% 04.76
Roads	5,140	% 11.43
Railway land	140	% 00.30
Touristic and recreation uses	1,800	% 04.00
Adjunctive areas for agriculture uses	2,855	% 06.34
Shore Zone	500	% 01.11
Cemeteries	333.5	% 00.75

Table (4.4); The spatial distribution and relative patterns of existing land uses in Gaza City, according to the latest statistics. (Mohaisen 2011)

4.5 Demographic Profile

Gaza City is considered as one of the most densely populated places in the world with 4033 person/km². The total population of Gaza City is as the following Table (4.5): (Municipality of Gaza 2009)

Area	Population
Ijdeedah and West Ijdeedah	45810
At-Turukman and West Turukman	44390
At-Toffah	29573
Ash-Sheikh Radwan	41000
Madinat Al-A'wda	2900
An-Nasser	45986
Az-Zaitun	62495
Ash-Sheikh Ijleen	11756
Tal Al-Hawa	8841
As-Sabra	28687
North Remal	29905
South Remal	20852
Old City	14560
Ash-Shati' camp	34988
Al-Blakhya	4514
Ad-Daraj	41449
TOTAL	605760

Table (4.5); The population of each district and community in Gaza City. (Municipality of Gaza 2009)

4.6 Roads and Transportation Network In Gaza City

Functioning transportation networks is a key element for cities and towns, and precondition for economic activity and social participation. In addition to its importance as an urban service in terms of moving people and goods, the transport infrastructure and service sector itself is a significant generator of wealth and employment. However, the economic and social benefits of urban transport are frequently accompanied by negative side effects such as congestion, social exclusion, accidents, air pollution and energy consumption.

4.6.1 Roads Classification

Roads can be classified in Gaza City as follows, Figure (4.9): (El-Kahlout 2010)

- **Regional roads**

They connect Gaza City with the rest of cities in Gaza Strip, and there are three major regional roads in Gaza City; as in Figure (4.8):

1. **Salah Ed-Din:** It extends from Beit Hanoun crossing point in the north to Rafah in the south and runs through the city of Gaza. the traffic jams occur on this street in Al Shijaia where this street intersect in this region with Al Wahda, Omar Al Mukhtar, and Baghdad Street.
2. **Al Rashid Street:** Also is called the coastal road that extends parallel to the coast of the Mediterranean sea, the length of this street in Gaza city is about 6150 m and width of 40 m in the southern part, which extends from Omar Al Mukhtar street to Khalil al-Wazir mosque.
3. **Street No. 4 (Al-Karama street):** It is located east of Salah El-Din street, parallel to it, extends from the far north of Gaza strip on the border with the Green Line and extends through Gaza governorate, and intersects with Salah El-Din street at Al Shohada' crossroads. this street pass through the Gaza City from the east. it is a major important street that facilitate the movement between the north and south of Gaza strip without passing through the heart of Gaza City, its length in Gaza city is about 6000 m and is connected with many streets like Baghdad, Riyadh and Al Mansoura Street.

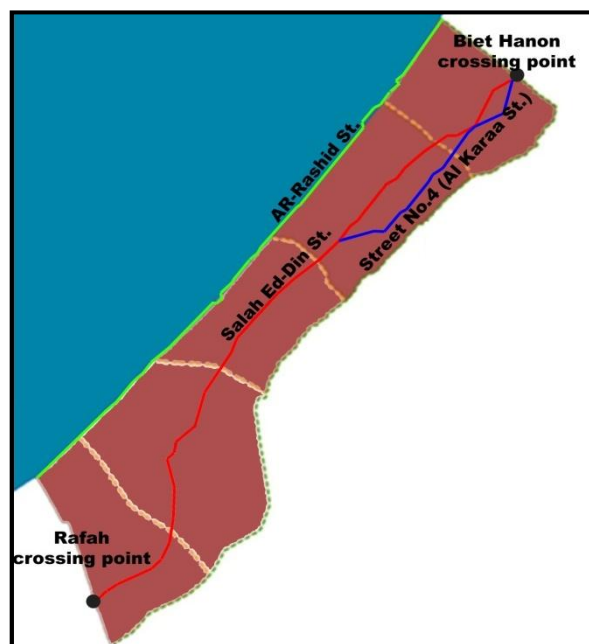

Figure (4.8); The regional roads of Gaza Strip. (UN OCHA 2009)

- **Main roads**
They fork from the regional roads to serve the cities and communities that are located on both sides of the regional roads. They called cities entrances upon their entry to the outskirts, and called major roads when they are located within the cities such as; Omar Mukhtar street, Al-Wehda street, Al-Jalaa' street, street No. (8), (9), (10).
- **Collective roads**
They are used to collect and distribute traffic to from local streets, and to ensure free accesses to the main roads.
- **Local roads**
These roads connect residential neighborhoods and the local services with the collective roads. They are characterized by low traffic and restricted speed of traffic, and they are linked to the collective roads to reach the public transportation network.

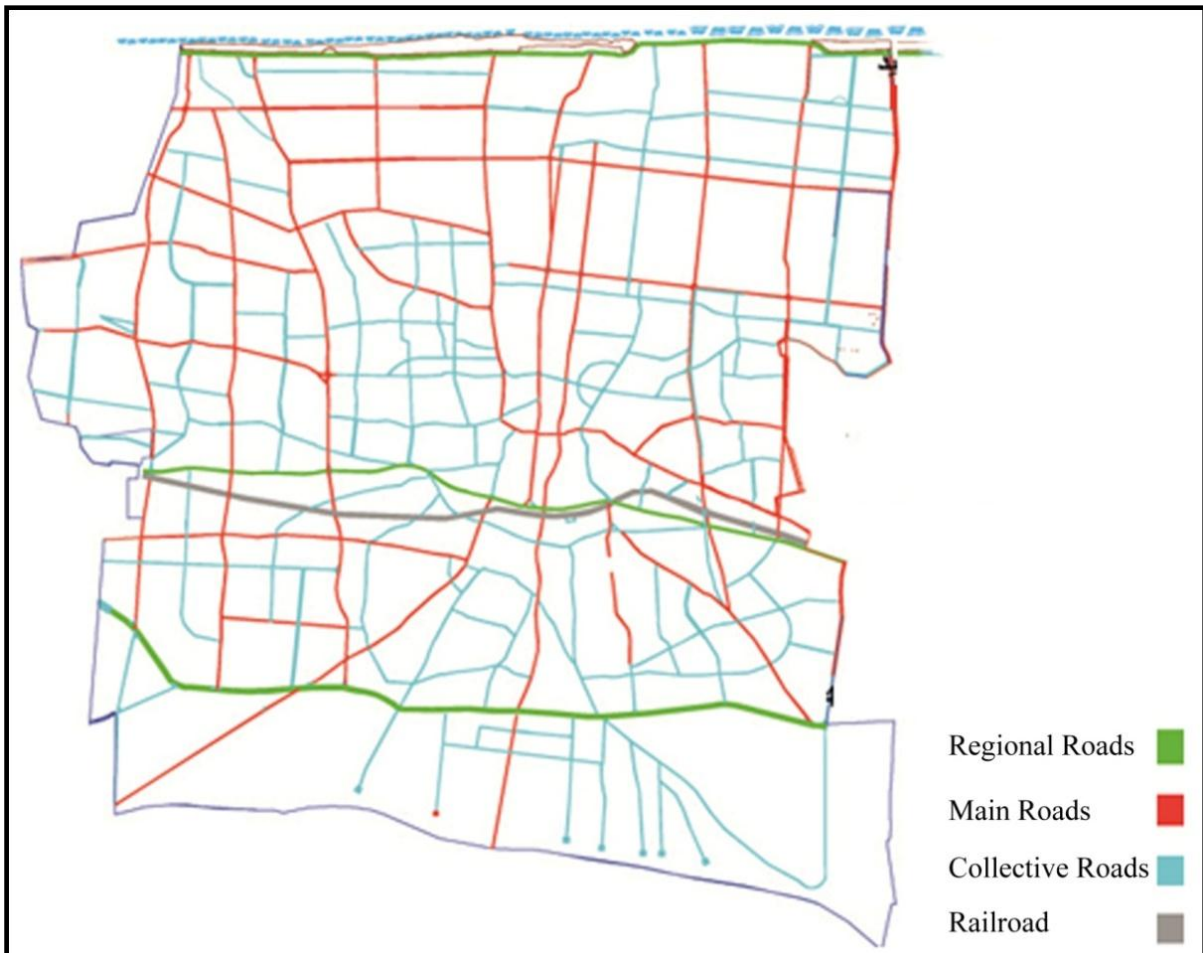

Figure (4.9); Roads classification of Gaza City. (Mohaisen 2011)

4.6.2 Limitations of Roads' Planning

Roads' planning in Gaza is subjected by some limitations that identify the features of the roads' network. These limitations are: (El-Kahlout 2010)

- **Area**
The small area of the Gaza Strip and the existence of such many cities in it without sufficient regional spaces between them, oblige some regional roads to penetrate the internal movement in Gaza City. This situation leads to to snarled traffic and movement in these areas.
- **Shape**
Gaza Strip extends longitudinally on the Mediterranean Sea from north to south. This shape strengthens north - south axes, which represented in the regional roads. The east - west axes, represent the main roads of Gaza City.

4.6.3 Roads Problems

There are many problems characterize the roads in Gaza City. These can be pointed as the following: (El-Kahlout 2010)

- 1. Planning problems;** it returns to:
 - Slums and random planning.
 - The absence of hierarchy.
 - The lack of homogeneity in urban fabric.
 - Central distribution of services.
- 2. Traffic congestion;** it returns to:
 - High number of vehicles on the roads.
 - Traffic high volume, which is caused by the high population and the desire of vehicles ownership.
 - The existence of heavy and slow vehicles on the network, which obstruct traffic flow and leads to traffic congestion.
- 3. The road itself and its medium;** it is represented in:
 - Penetration of regional roads and movement to the hearts of urban areas.
 - Weakness in Pavement Condition Index (PCI).
- 4. Human behavior**
- 5. Roads accidents;** it returns to:
 - Mechanical factors, such as; wrong design of crossroads and traffic signs.
 - Humanitarian factors, such as; high speeds and drivers behavior.

4.7 Urban Growth Framework of Gaza City

Gaza City is subjected to many circumstances that influence the urban growth and impose limitative framework. This framework directs the expansion and restricts any developmental aspirations. In order to highlight this situation, SOWT analysis is used to determine all positive and negative factors and to define the trends of growth.

4.7.1 Analyzing the Limitations of Horizontal Urban Growth using SWOT

In order to ensure the optimal placement of developmental projects, the urban growth must be understood. A SWOT analysis method is seen as an extremely useful tool for understanding the limitations of horizontal urban growth. SWOT is standing for strength, weakness, opportunities and threats; as in Figure (4.10). It is a general tool that designed to be used in the preliminary stages of decision-making and as a precursor to strategic planning in various kinds of applications. The tool is used while developing a strategic plan, planning a solution to a problem, or forming a vision of the future through understanding of all external factors; threats and opportunities, together with an internal examination of strengths and weaknesses. (Jyothi, Babu & Krishna 2008)

	POSITIVE	NEGATIVE	
Internal	Strengths	S	Weaknesses
External	Opportunities	O	Threats
		W	
		T	

Figure (4.10); SOWT analysis framework. (Jyothi, Babu & Krishna 2008)

SWOT analysis is used four times to shed light on the four borders of the city and determine the directions of growth. See figures (4.11), (4.12), (4.13) and (4.14).

East – Green Line of the Occupied Palestine			
S	Strengths <ul style="list-style-type: none"> • Available land for new projects 	W	Weaknesses <ul style="list-style-type: none"> • Environmental aspects related to natural resources, such as; agricultural areas and clay soil
O	Opportunities <ul style="list-style-type: none"> • No any opportunities with the current political situation 	T	Threats <ul style="list-style-type: none"> • Very risky political and martial circumstances • No any existing services nor infrastructure

Figure (4.11); SOWT analysis of eastern horizontal urban growth of Gaza City.

West – the Coastal Line of the Mediterranean Sea	
<p>S Strengths</p> <ul style="list-style-type: none"> • An attractive area for investors, developers and residents • High quality recreational area 	<p>W Weaknesses</p> <ul style="list-style-type: none"> • An attractive area for investors, developers and residents • High quality recreational area
<p>O Opportunities</p> <ul style="list-style-type: none"> • The area can be connected easily with the strip through the coastal line (Al-Rasheed regional street) 	<p>T Threats</p> <ul style="list-style-type: none"> • No any possibility for urban extension because of the existence of the Mediterranean Sea

Figure (4.12); SOWT analysis of western horizontal urban growth of Gaza City.

North – Jabalya City	
<p>S Strengths</p> <ul style="list-style-type: none"> • An established urban area • No environmental aspects related to natural resources • An existing services and infrastructure 	<p>W Weaknesses</p> <ul style="list-style-type: none"> • Very high population density • No available land for new developmental scenarios • The community has utilized all developmental opportunities
<p>O Opportunities</p> <ul style="list-style-type: none"> • High political and martial security 	<p>T Threats</p> <ul style="list-style-type: none"> • Solid cohesion between Gaza and Jabalya • No available land between the two clusters • The disjunctive elements are just collective and secondary roads

Figure (4.13); SOWT analysis of northern horizontal urban growth of Gaza City.

South – Az-Zahra' City, Al-Moghraqa, Joher Ad-Deik

<p>S Strengths</p> <ul style="list-style-type: none"> • Available land for new developmental projects • Low-density urban clusters, which make the area able to attract investors, developers and residents • According to the structural plan of Gaza City (1997) and the detailed plan of Western Zaituon district, there is a proposed regional transportation station, which can gather all developmental projects • No environmental aspects to be consideration in the area 	<p>W Weaknesses</p> <ul style="list-style-type: none"> • The existence of the sewage purification station • No clear and detailed urban structure of the area • No any existing infrastructure
<p>O Opportunities</p> <ul style="list-style-type: none"> • The area can be seen as the rational extension of the existing high populated districts, such as; Tal Al-Hawa district • The area is adjoined the liberated areas in the middle of the strip, these areas need developmental approaches and scenarios • The Municipality of Gaza is going to enlarge the influence of Gaza City forward the southern area • A lot of service projects is going to be constructed in the southern area, such as; the Turkish Hospital • The area is very close to the new urban nodes, such as; the new campuses of the IUG, PU, UCAS 	<p>T Threats</p> <ul style="list-style-type: none"> • The area needs an integrated efforts to be developed, also, it needs big financial support

Figure (4.14); SOWT analysis of southern horizontal urban growth of Gaza City.

Due to the previous analysis, the urban development has to be centered near the established urban clusters in order to ensure the optimal placement of services and infrastructure. Also, this arrangement does not scatter the residential areas and leads to exploit the minimum of ground surfaces. The rational and ideal direction of urban growth is towards southern areas.

4.7.2 Trends of Urban Growth, see Figure (4.15)

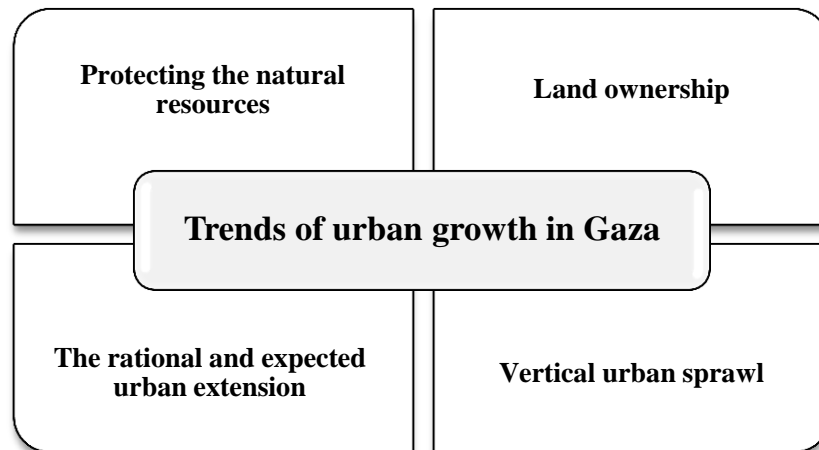

Figure (4.15); Trends of urban growth of Gaza City.

1. Land ownership

The scarcity of governmental land in the city limits the real development, where much of land is divided into small areas owned by large number of partners as a result of inheritance. This situation makes difficulties in the development of some of these properties, and thus there will be difficulties for the development of new services to the populated centers. The sale of the private land has played a prominent role in the form of land use in the city, where the construction extends clearly within housing and economic projects after the sale of lands. On the other hand, the governmental lands that were available in the west of the city did not developed under the current conditions and were used as administrative and military barracks of the foreign armies (El-Kahlout 2010).

Another starting factor of urban growth that related to land ownership is the form and direction of the sprawl. The availability and expenses of plots is very hard, which makes the growth and development of urban areas attributed with unorganized and inequalities shape.

So, there is an essential need for controlling scenarios that can regulate the unorganized and chaotic urban sprawl. These scenarios can be implemented through succeeding new innovative and developmental regulations and projects.

2. Protecting the natural resources

Many sites in Gaza Strip have high environmental and aesthetic values. These sites require protection from indiscriminate urban growth. The regional plan (2005-2020) classified these sites into three categories: (Ministry of Planning 2005)

- Nature reserves, such as; Wadi Gaza, northern and southern sand dunes.
- Significant natural resources, such as; aquifers, clay soil, agricultural areas
- Special natural resources, such as Al-Mwasi area in the southern coastal line and liberated areas in the middle of the strip.

Also, urban growth of Gaza City has to esteem the existence of the following sites: (Ministry of Planning 2005)

- Wadi Gaza in the southern area, which needs a special urban treatment and solutions because of its important in keeping the biodiversity of many plants and birds, also, the regional plan (2005-2020) assigned the area as a regional promenade.
- Agricultural areas with its clay soil in the western areas.

3. Vertical urban sprawl

According to the decision of the Central Committee of regulations - the Ministry of local Government MOLG No. 11/2011 on 8th June, 2011, it is authorized that the buildings height can be as ground floor + 5 floors instead of ground floor + 4 floors. Within this point, it can be noticed that city is going to extend through the vertical direction, also, there is a real expectation that the city is becoming to be the city of tall buildings.

This trend of urban sprawl can be seen as a natural result of extreme high population with limited available land. Therefore, the future developmental projects have to emphasize the concept of the organized high-density communities with positive mix land use and mix income resources.

4. The rational and expected urban extension

According to the analysis of limitation of horizontal urban growth, it is obvious that the new urban clusters of Gaza City will direct to the south area of the city. This point of view harmonizes and fits the main concept of the regional plan (2005-2020), that there are two main urban centers in Gaza Strip (Gaza City in north and Khan Younis in south) and these two centers have to grow forward each others.

CHAPTER 5

METHODOLOGY ..

METHODS, ANALYSIS AND RESULTS

- 5.1** Introduction
- 5.2** Data Collection
- 5.3** Local Community Questionnaire
- 5.4** Semi-Structure interviews
- 5.5** Space Syntax Analysis using UCL Depthmap v.10
- 5.6** GIS stimulation using ArcGIS v.9.3

5.1 Introduction

This study is an applied research, which needs an integral approach. This approach is updated to study an urban phenomenon that based on the fact there is a correlation between scientific frame (theoretical trend) and practice (applied trend), and it permits maximum interaction between the two trends. Also, this approach allows the researcher to achieve depth by using literature and historical method, coverage by using descriptive manner, and balance by using analytical tools. Besides, the methodology takes into consideration all factors and variables at the same time in order to increase the possibility of generalization of smart and sustainable urban development pattern, and achieving real findings and recommendations.

The research relies on a systematic and analytical method. It depends on collecting information about the phenomena in order to pinpoint the problem, analyzing all inputs, and then reproduce the results.

5.2 Data Collection

In order to collect the needed data for this research, there are two types of data sources are used:

- **Preliminary resources:** it is not available in the secondary resources and it is collected through questionnaires, semi-structured interviews, computerized stimulation tools that make spatial analysis.
- **Secondary resources:** such as; research papers, thesis, books, journals, reports, statistics and web pages. This data was collected and illustrated through the previous chapters

5.3 Local Community Questionnaire

A questionnaire is used as a tool to gather Preliminary data about community attributes about the proposed approach.

5.3.1 Questionnaire Design

Questionnaire design and distribute is a preliminary data source, which is applied on study population in order to get their opinions about the criteria that are needed to build a sustainable and smart pattern, that based on the term Transit Oriented Development (TOD). Research methodology depends on the analysis of data on the use of descriptive analysis, which depends on the poll and use the main program (SPSS).

1. Population and sample size

The population of the study is the people of Gaza City. Opercular sample is determined by choosing three different districts of Gaza City to distribute the questionnaires in. Then, sample size for each district is determined through the following Table (5.1):

Size of population	Sample size (n) for Precision (e) $\pm 10\%$
9,000	99
10,000	99
25,000	100
50,000	100

Table (5.1); Sample size for $\pm 10\%$ Precision Levels where confidence level is 95% and $P=5$. (Glenn 1992)

District	population	Sample size
At-Toffah	29573	100
Tal Al-Hawa	8841	99
North Remal	29905	100
Total	68319	299

Table (5.2); Sample size of the questionnaire.

Two hundreds and ninety-nine questionnaires were distributed to the research sample, and 100% of them are received.

2. Questionnaire Content

The questionnaire is provided with a covering letter explaining the purpose of the study, the way of responding, the aim of the research and the security of the information in order to encourage a high response. The questionnaire includes multiple-choice question, which used widely in the questionnaire. The variety in these questions aims first to meet the research objectives, and to collect all the necessary data that can support the criteria, decisions, results and recommendations in the research. Some questions are multiple-choice question, and some follow scale as Table (5.3):

Level	yes	Partly	No
Scale	3	2	1

Table (5.3); Scale of the questionnaire questions.

The sections in the questionnaire verify the objectives in this research related to building a sustainable and smart pattern, which based on the term Transit Oriented Development (TOD) as the following:

- A. General Information consists of 5 questions.
- B. The Trips and Transportation means consists of 4 questions.
- C. Walk and Using the Public Transport consists of 9 questions.
- D. Transportation Network, Services and Land Use consist of 4 questions.

3. Pilot Study

A pilot study for the questionnaire was conducted before collecting the results of the sample. It provides a trial run for the questionnaire, which involves testing the wordings of question, identifying ambiguous questions, testing the techniques that used to collect data, and measuring the effectiveness of standard invitation to respondents.

4. Content Validity of the Questionnaire

The validity of an instrument can be defined as a determination of the extent to which the instrument actually reflects the abstract construct being examined. Validity refers to the degree to which an instrument measures what it is supposed to be measuring. High validity is the absence of systematic errors in the measuring instrument. When an instrument is valid; it truly reflects the concept it is supposed to measure. Achieving good validity requires the care in the research design and sample selection.

So, the questionnaire is amended by the supervisor Dr. Farid Al-Qeeq and four experts. Content validity test was conducted by consulting three groups of experts. The first is requested to evaluate and identify whether the questions agreed with the scope of the items and the extent to which these items reflect the concept of the research problem, the experts of this aspect are Dr. Mohammad El-Kahlout, Dr. Mohammad Al-Eila. The second group is requested to evaluate if the used instrument is valid statistically, and if the questionnaire was designed well enough to provide relations and tests between variables, the experts of this aspect are Dr. Ali Abu Zaid and Dr. Nafez Barakat. The third group is requested to make a linguistic check, the expert of this aspect is Miss. Hanan Abu Rass. The experts agreed that the questionnaire was valid and suitable enough to measure the purpose that the questionnaire designed for.

5. Statistical Validity of the Questionnaire

To insure the validity of the questionnaire, two statistical tests should be applied. The first test is Criterion-related validity test (Pearson test), which measure the correlation coefficient between each item in the field and the whole field. The second test is structure validity test (Pearson test) that used to test the validity of the questionnaire structure by testing the validity of each field and the validity of the whole questionnaire. It measures the correlation coefficient between one filed and all the fields of the questionnaire that have the same level of similar scale. (Berenson ca. 2003)

- **Criterion Related Validity (Internal consistency)**

Internal consistency of the questionnaire is measured by a scouting sample, which consisted of thirty questionnaires (10%), through measuring the correlation coefficients between each paragraph in one field and the whole filed. The table below shows the correlation coefficient and p-value for each field items. As show in the table the P-values are less than 0.05 or 0.01, so the correlation coefficients of this field are significant at $\alpha = 0.01$ or $\alpha = 0.05$, then it can be said that the paragraphs of this field are consistent and valid to be measure what it was set for (Berenson ca. 2003). See Table (5.4).

No.	Question	Pearson coefficient	P-value	Sig. level
Walk and use the public transport				
1	Do you agree with walking for 200-600 m while going on any trip?	0.827	0.000	**
2	Do you agree with the pedestrians' corridors?	0.657	0.000	**
3	Do you agree with the establishment of pedestrians' and bicyclists' lanes within streets?	0.587	0.001	**

4	Is the idea of afforesting, lighting and furnishing streets encourage you to walk to reach your destinations?	0.627	0.000	**
5	Do you agree with the idea of depending on the public transportation means after develop it and reduce costs?	0.580	0.001	**
6	Do you think that idea of encouraging the walking and using the public transport can improve the social relationships between the citizens of the neighborhood?	0.767	0.000	**
7	Do you think that the depending on public transport can contribute in solving the fuel problem which affect on Gaza?	0.793	0.000	**
Transportation network, services and the uses of the lands				
1	Do you agree with the foreign vehicles that pass, enter and penetrate the heart of your neighborhood?	0.744	0.000	**
2	Do you agree the idea of existing all, educational, commercial, administrative, health and recreational services in your area?	0.686	0.000	**
3	Do you think that a good transportation network may increase the quality of the living environment of the area?	0.758	0.000	**
4	Do you think that the direct connection for your area with other areas and the city center by efficient transportation system may increase the degree of satisfaction of residents?	0.711	0.000	**
** Correlation coefficient is significant				

Table (5.4); The correlation coefficient between each paragraph in the field and the whole fields.

- **Structure Validity of the Questionnaire**

Structure validity is the second statistical test that used to test the validity of the questionnaire structure by testing the validity of each field and the validity of the whole questionnaire. It measures the correlation coefficient between one filed and all the fields of the questionnaire that have the same level of liker scale.

As shown in table below, the significance values are less than 0.05 or 0.01, so the correlation coefficients of all the fields are significant at $\alpha = 0.01$ or $\alpha = 0.05$, so it can be said that the fields are valid to be measured what it was set for to achieve the main aim of the study. See Table (5.5).

No.	Section	Correlation	P- value	Sig. level
1	Walk and use the public transport	0.827	0.000	**
2	Transportation network, services and the uses of the lands	0.900	0.000	**
** Correlation coefficient is significant				

Table (5.5); Correlation coefficient between each filed and all the fields.

5.3.2 Questionnaire Results

The collected raw data was first sorted, edited, coded and then entered into computer software. Two programs were used, the Excel sheet and SPSS software. Appropriate graphical representations and tables were obtained to understand and analyze the questions.

Also, the ordinal scale is used in the analysis process for the rating questions. The ordinal scale is a ranking or rating data, which normally use integers in a seconding or descending order. The relative importance index (RI) is used in the analysis in addition to other approaches such as the one way ANOVA and frequencies and percentiles. (Berenson ca. 2003)

The relative important index and the mean values are used in the thesis, that they are widely-used techniques in construction research for measuring attitudes with respect to surveyed variables. Triple scaling was used for ranking questions that have an agreement levels. The respondents are asked to give their perceptions in group of questions on Three-point scale (1 for no, 2 for partly and 3 for yes), which reflects their assessment regarding the factors affecting bidding process. This type of questions is used in the groups C and D.

The importance index was computed using the equation:
$$\frac{\sum W}{AN} = \frac{3n_3 + 2n_2 + 1n_1}{3N}$$

Where W is the weighting given to each factor by the respondent, ranging from 1 to 3, (n_1 = number of respondents for strongly disagree, n_2 = number of respondents for neutral, n_3 = number of respondents for strongly agree, A is the highest weight (i.e. 3 in the study) and N is the total number of samples. The relative importance index ranges from 0 to 1. (Berenson ca. 2003)

The following is the results and analysis of the questionnaire:

A. General Information, see Table (5.6)

No.	Question	Frequency	Percentages
1	Gender		
	Male	151	50.5
	Female	148	49.5
	Total	299	100
2	Age		
	Less than 18 year	40	13.4
	19-26 year	126	42.1
	27-45 year	74	24.7
	46-65 year	52	17.4
	more than 65 year	7	2.4
Total	299	100	

3	Educational degree	Frequency	Percentages
	Less than high-school	43	14.4
	High-school	48	16.1
	Diploma	64	21.4
	Bachelor's degree	120	40.1
	post graduated	24	8.0
	Total	299	100

4	Job	Frequency	Percentages
	Employee	81	27.1
	Student	113	38.8
	Private business	51	17.1
	Housewife	33	11.0
	Without work	16	5.4
	Other	5	1.7
	Total	299	100

5	Workplace	Frequency	Percentages
	Inside neighborhood	74	26.5
	outside neighborhood	121	43.4
	outside city	11	3.9
	Other	73	26.2
	Total	279	100

Table (5.6); General information results of the questionnaire.

B. The Trips and Transportation means, see Table (5.7)

No.	Question	Frequency	Percentages
1	What are the most trips that you do during a week?		
	Work trips	119	39.8
	Social trips	104	34.8
	Shopping trips	52	17.4
	Other trips	24	8
	Total	299	100

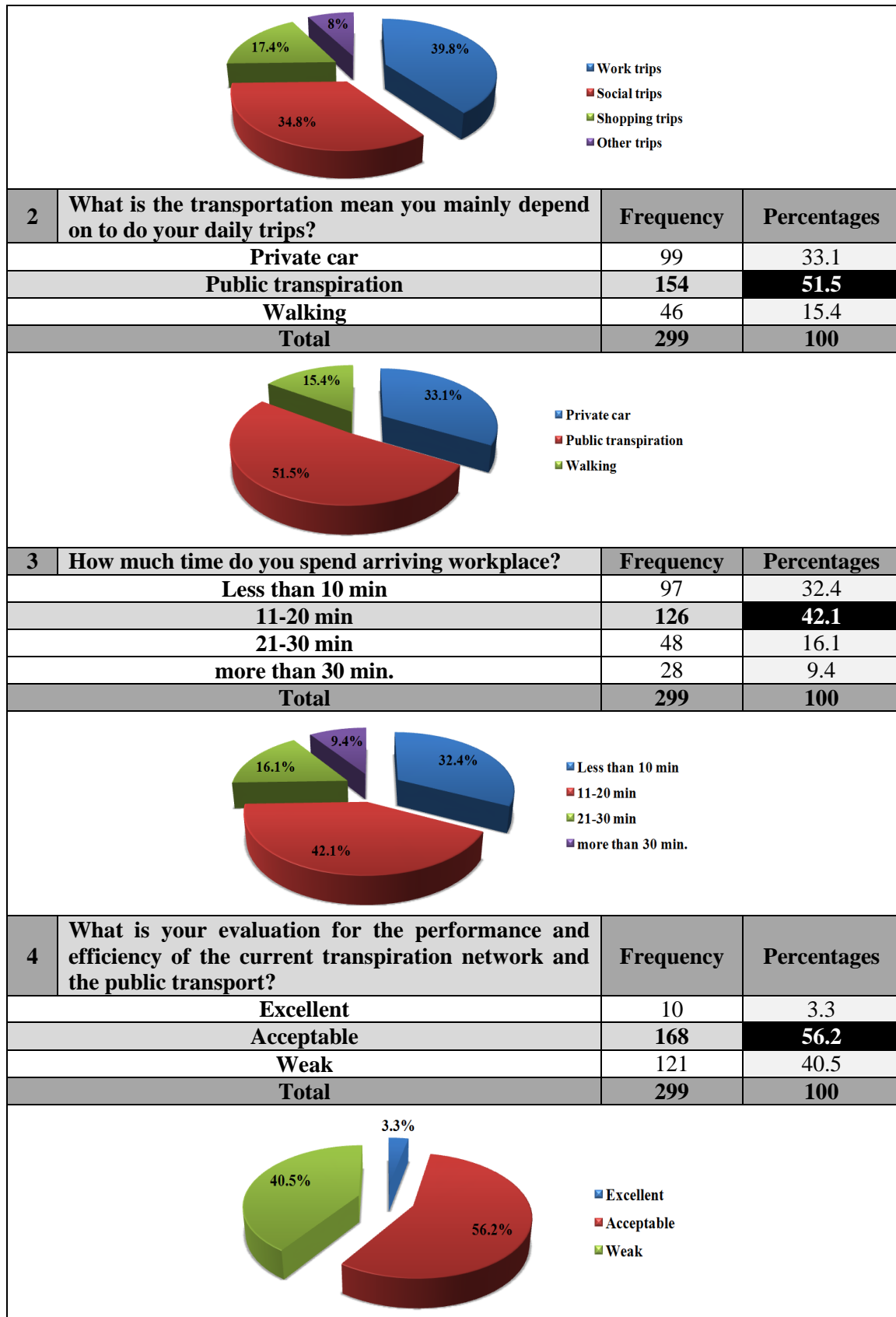
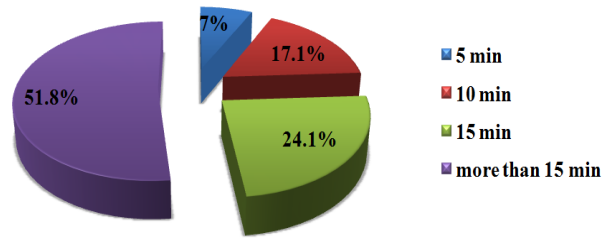

Table (5.7); The trips and transportation means results of the questionnaire.

C. Walking and Using the Public Transport, see Table (5.8)

No.	Question	Frequency	Percentages
1	How long can you walk on feet to the work, home or any other trip?		
	5 min	21	7
	10 min	51	17.1
	15 min	72	24.1
	more than 15 min	155	51.8
	Total	299	100



2	Which path is preferable for you to walk in?	Frequency	Percentages
	Shortest with least metric distance	68	22.7
	Simplest with least angular changes	231	77.3
	Total	299	100

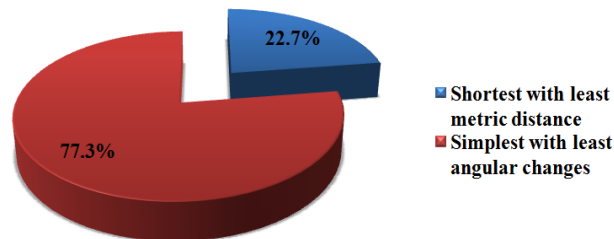

No.	Question	Yes	Partly	No	Mean	Relative index	T test	P-value	Rank
3	Do you agree with the idea of walking for 200-600 m while going on any trip?	55.9	24.7	19.4	1.64	0.78	7.995	0.000	6
4	Do you agree with the pedestrians' corridors?	69.9	20.4	9.7	2.60	0.87	15.783	0.000	4
5	Do you agree with the establishment of pedestrians' and bicyclists' lanes within streets?	82.3	14.4	3.3	2.79	0.93	28.216	0.000	2
6	Is the idea of afforesting, lighting and furnishing streets encourage you to walk to reach your destinations?	84.6	13.4	2.0	2.83	0.94	33.263	0.000	1

7	Do you agree with the idea of depending on the public transportation means after develop it and reduce costs?	72.9	24.4	2.7	2.70	0.90	23.661	0.000	3
8	Do you think that idea of encouraging the walking and using the public transport can improve the social relationships between the citizens of the neighborhood?	58.2	34.8	7.0	2.51	0.84	14.139	0.000	5
9	Do you think that the depending on public transport can contribute in solving the fuel problem, which affect on Gaza?	47.8	30.4	21.7	2.26	0.75	5.684	0.000	7
All Questions		67.4	23.2	9.4	2.58	0.86	31.956	0.000	
<i>Critical value of T at DF "298" and significance level 0.05 equal 1.97</i>									

Table (5.8); Walking and using public transportation results of the questionnaire.

Resulted notes

- 'Relative index' for the opinion of the sample about 'Walking and using the public transport' is 0.86.
- 'P-Value' = 0.000, which is less than 0.05
- 'T test' equal 31.956, which is greater than the critical value which is equal 1.97
- The results show that the sample is agreed with depending on walking and using public transport.
- Each Question can be considered as a criterion and has a degree of importance according to its rank.
- Ranking is used as inputs to both computerized tools; UCL Depthmap and ArcGIS 9.3.

D. Transportation Network, Services and Land Use, see Table (5.9)

No.	Question	Yes	Partly	No	Mean	Relative index	T test	P-value	Rank
1	Do you agree with the foreign vehicles that pass, enter and penetrate the heart of your neighborhood?	13.0	20.1	66.9	1.46	0.49	-13.024	0.000	4

2	Do you agree the idea of existing all educational, commercial, administrative, health and recreational services in your area?	49.9	16.7	3.3	2.77	0.92	26.646	0.000	1
3	Do you think that a good transportation network may increase the quality of the living conditions of the area?	76.6	20.7	2.7	2.74	0.91	25.708	0.000	2
4	Do you think that the direct connection of your area with other areas and the city center by efficient transportation system may increase the degree of satisfaction of residents?	71.6	25.8	2.7	2.69	0.90	22.982	0.000	3
All Questions		60.3	20.8	18.9	2.41	0.80	20.599	0.000	
<i>Critical value of t at DF "298" and significance level 0.05 equal 1.97</i>									

Table (5.9); Transportation Network, Services and Land Use results of the questionnaire.

Resulted notes

- 'Relative index' for the opinion of the sample about 'Walking and using the public transport' is 0.80
- 'P-Value' = 0.000, which is less than 0.05
- 'T test' equal 20.599, which is greater than the critical value which is equal 1.97
- The results show that the sample is agreed with aspects of 'Transportation network, services and the uses of the lands'
- Each Question can be considered as a criterion and has a degree of importance according to its rank.
- Ranking is used as inputs to both computerized tools; UCL Depthmap and ArcGIS 9.3

5.3.3 Resulted Indicators and Criteria

According to the community opinions, which are indicated and shown through the statistical results of the questionnaire, the criteria that have to be followed during proposing the building of smart and sustainable urban model that based on TOD are known. These criteria are weighted through the rank of each question. As a comprehensive result, the aspects and criteria that are taken in consideration are shown in Table (5.10)

Response	Indicator or criterion
The Trips and Transportation means	
(39.8%) of trips that the people do during a week are work trips.	Major work places have to treated, and the peak hours that relate to workers have to be treated.
The transportation mean that people mainly depend on to do their daily trips are public transportation means (51.6%).	Public transportation is very important element on the roads and have to be supported and enhanced physically and economically.
The time which is spent to reach workplaces is between 11-20 minutes (42.1%).	The pattern must take in consideration that the trips have be longer that this period. This factor affect on selecting velocity average and choosing the road.
The performance and efficiency of the current transpiration network and the public transport is between acceptable and weak (56.2% - 40.5%).	The model have to make significant improvements on this factor.
Walk and use the public transport	
(51.8%) of people can walk on feet to the work, home or any other trip for more than 15 minutes.	Deciding the maximum walking distance is customizable that people have no problem in this aspect.
(77.3%) of people prefer simplest path with least angular changes.	Choosing pedestrians' corridors have to be according to the most simplicity and least angular changes.
(55.9%) of people agree with the idea of walking for 200-600 m while going on any trip.	the distance for reaching public transportation and reaching the daily and local services have to be limited in this distance.
(69.9%) of people are agreeing with pedestrians' corridors.	The idea of implementing pedestrianism and bicycling corridors is agreed and can enhance the approach.
(82.3%) of people are agreeing with the establishment of pedestrians' and bicyclists' lanes within streets.	All roads classes have to involve appropriate lanes and frontages
The idea of afforesting, lighting and furnishing streets encourages (84.6%) of people to walk to reach your destinations.	Designing streetscape must include these elements.
(72.9%) are agreeing with the idea of depending on the public transportation means after develop it and reduce costs.	Public transportation must to be the focal point of planning and designing the model and they must integrate with pedestrianism. Administrative and economic support have to be implemented on this aspect.
(58.2%) of people think that idea of encouraging the walking and using the public transport can improve the social relationships between the citizens of the neighborhood.	The approach can enhance the social relations and it is very harmonious with sustainable aspects.
(47.8%) of people think that depending on	The approach can be considered as a tool to

public transport can contribute in solving the fuel problem that affect on Gaza	surmounting the political circumstances, although it contributes on reducing the emission of CO ₂
Transportation network, services and the uses of the land	
(66.9%) of people are opposed to the idea that foreign vehicles pass, enter and penetrate the heart of their neighborhoods.	The inner streets of residential areas have to be specialized just for private cars of residents and emergency services. This means that the inner streets must to have dead ends.
(49.9%) of people are agreeing with the idea of existing all educational, commercial, administrative, health and recreational services in their area	Such services have to be allocated in residential areas within acceptable walking distances.
(76.6%) of people think that a good transportation network may increase the quality of the living conditions of their area.	Improved transportation system attracts investment, business and employment, and upraises life quality.
(71.6%) of people think that direct connection between of areas with other and with city center by efficient transportation system, may increase the degree of satisfaction of residents.	Improved transportation system enhance community satisfaction and make each residential area an attractive place to live in.

Table (5.10); Resulted indicators and criteria of the questionnaire.

5.4 Semi-Structure interviews

Semi-structured interviews are used as the most useful format for gathering qualitative information, as they are called moderately scheduled. The semi-structured interviews offer topics and questions to the interviewee, but they are carefully designed to elicit the interviewee's ideas and opinions on the topic of the thesis. Interviews of this type are suited to working with small samples and are useful for studying specific situations or for supplementing and validating information derived from other sources used for making safety analysis and decision-making. In addition, since they provide access to perceptions and opinions, they are effective for gaining insight into problems that are not immediately perceptible but that nonetheless cause concern in certain areas or fields.

5.4.1 The Sample of the Semi-structure Interviews

The intended group of this tool are the professionals who work on the field of planning and development in the official and authoritative agencies on Gaza City. The interviewees are chosen according their jurisdiction and experiences in the field of planning and development. Twelve semi-structured interview are conducted, that two professionals from each authority are interviewed. The intended agencies are; Municipality of Gaza, Ministry of Local Government, Ministry of Planning, Ministry of transportation, official consultative agencies, and academians.

5.4.2 Content of the Semi-structure Interviews

The semi-structure interview is provided with a covering letter explaining the purpose of the study, the way of responding, the aim of the research and the security of the information in order to encourage a high response. The semi-structure includes close-ended questions, open-ended questions, key questions and clarifying questions. The variety in these questions aims first to meet the research objectives, and to collect all the necessary data that can support the criteria, decisions, results and recommendations in the research.

The sections in the semi-structure interview verify the aspects of planning work in Gaza City and detect the abilities of the official agencies to support the approach. The sections of this tool are organized as the following:

- A. Introduction
- B. Definition
- C. Overview about the current situation
- D. Supporting the proposed approach
- E. The importance of the new approach
- F. The impediments and challenges facing the development process and the new approach
- G. Corporation
- H. Financial issues
- I. Education and promoting awareness
- J. New ideas

5.4.3 Results and Responds of the Semi-structure Interviews

Some results are qualitative and some are quantitative that according to the question type. All answers are analyzed and summarized as the following Table (5.11):

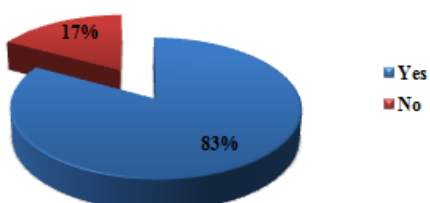
B. Definition								
3	Question	Has your agency adopted a definition or vision of developmental planning that concentrated on transportation?						
	Result	 <table border="1"> <caption>Data for Pie Chart</caption> <thead> <tr> <th>Response</th> <th>Percentage</th> </tr> </thead> <tbody> <tr> <td>Yes</td> <td>83%</td> </tr> <tr> <td>No</td> <td>17%</td> </tr> </tbody> </table>	Response	Percentage	Yes	83%	No	17%
Response	Percentage							
Yes	83%							
No	17%							
	Respond	All definitions and visions of developmental planning are taking about the spatial development, but there is no realistic adoption on transportation as a base point for developmental planning.						
4	Question	A TOD typically refers to the area within 800m of a rail station. That it is important to ensure that the 500 m TOD area around rail stations receives special planning attention so that the most appropriate development occurs. Is this approach is acceptable for you?						

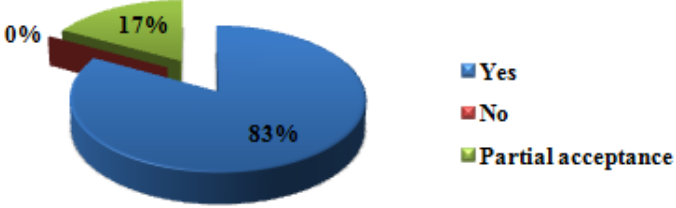
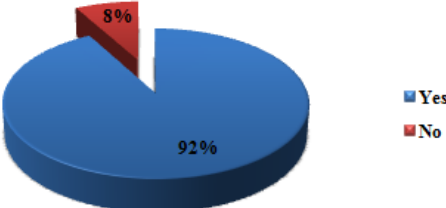
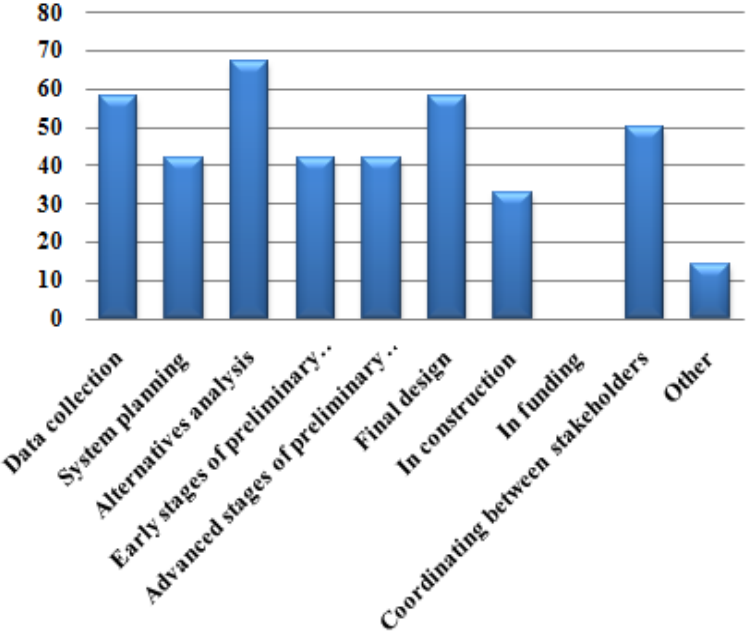
<p>Result</p>	 <p>■ Yes ■ No ■ Partial acceptance</p>																						
<p>Respond</p>	<p>It is positive that the professionals and officials support the trend. This means that the administrative and practical support can be available.</p>																						
<p>5</p>	<p>Question Can your agency support the minimum target of the approach?</p>																						
<p>Result</p>	 <p>■ Yes ■ No</p>																						
<p>Respond</p>	<p>The suggested supports are represented in preparing designs and plans, arranging the needed regulations and rules through regional and sub-regional and master plans, and facilitating the implementation.</p>																						
<p>C. Overview about the current situation</p>																							
<p>6</p>	<p>Question List the goals your agency has set for the future planning and developmental projects. Once listed, please rank them in order of importance from your agency perspective.</p>																						
<p>Respond</p>	<p>The majority of professionals set the issues of land use and housing as the most important goal, then they set transportation as a second goal, after that they set many developmental aspects such as; infrastructure, services and etc.</p>																						
<p>7</p>	<p>Question Does your agency have a fixed guideway project in planning, design or construction? What comes closest to describing your situation?</p>																						
<p>Result</p>	 <table border="1"> <caption>Guideway Project Stages</caption> <thead> <tr> <th>Stage</th> <th>Percentage</th> </tr> </thead> <tbody> <tr> <td>Data collection</td> <td>58%</td> </tr> <tr> <td>System planning</td> <td>42%</td> </tr> <tr> <td>Alternatives analysis</td> <td>68%</td> </tr> <tr> <td>Early stages of preliminary..</td> <td>42%</td> </tr> <tr> <td>Advanced stages of preliminary..</td> <td>42%</td> </tr> <tr> <td>Final design</td> <td>58%</td> </tr> <tr> <td>In construction</td> <td>32%</td> </tr> <tr> <td>In funding</td> <td>50%</td> </tr> <tr> <td>Coordinating between stakeholders</td> <td>50%</td> </tr> <tr> <td>Other</td> <td>12%</td> </tr> </tbody> </table>	Stage	Percentage	Data collection	58%	System planning	42%	Alternatives analysis	68%	Early stages of preliminary..	42%	Advanced stages of preliminary..	42%	Final design	58%	In construction	32%	In funding	50%	Coordinating between stakeholders	50%	Other	12%
Stage	Percentage																						
Data collection	58%																						
System planning	42%																						
Alternatives analysis	68%																						
Early stages of preliminary..	42%																						
Advanced stages of preliminary..	42%																						
Final design	58%																						
In construction	32%																						
In funding	50%																						
Coordinating between stakeholders	50%																						
Other	12%																						
<p>Respond</p>	<p>There is an obvious intersections between agencies. This may cause conflicts in achieving the intended goals and objectives. Also, there is no any projects or guideways that concentrate on funding, this means that all needed budgets come from donators.</p>																						

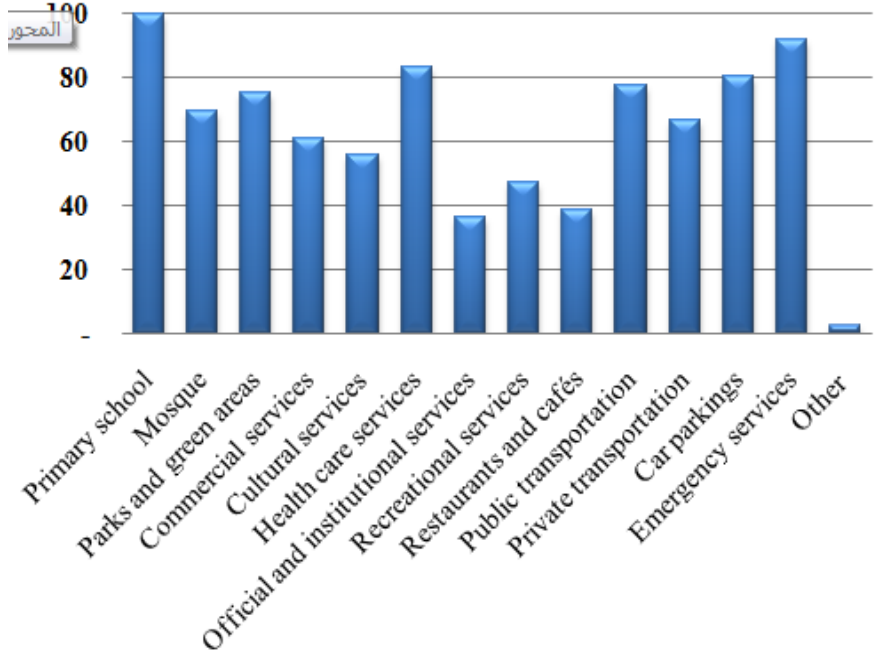
8	Question	Rate the importance of each urban service that can be considered while planning for the neighborhood scale.																														
Result	 <table border="1" data-bbox="486 280 1364 929"> <thead> <tr> <th>Service</th> <th>Importance Rating (Approximate)</th> </tr> </thead> <tbody> <tr><td>Primary school</td><td>100</td></tr> <tr><td>Mosque</td><td>70</td></tr> <tr><td>Parks and green areas</td><td>75</td></tr> <tr><td>Commercial services</td><td>60</td></tr> <tr><td>Cultural services</td><td>55</td></tr> <tr><td>Health care services</td><td>85</td></tr> <tr><td>Official and institutional services</td><td>35</td></tr> <tr><td>Recreational services</td><td>45</td></tr> <tr><td>Restaurants and cafés</td><td>35</td></tr> <tr><td>Public transportation</td><td>75</td></tr> <tr><td>Private transportation</td><td>65</td></tr> <tr><td>Car parkings</td><td>80</td></tr> <tr><td>Emergency services</td><td>90</td></tr> <tr><td>Other</td><td>5</td></tr> </tbody> </table>		Service	Importance Rating (Approximate)	Primary school	100	Mosque	70	Parks and green areas	75	Commercial services	60	Cultural services	55	Health care services	85	Official and institutional services	35	Recreational services	45	Restaurants and cafés	35	Public transportation	75	Private transportation	65	Car parkings	80	Emergency services	90	Other	5
Service	Importance Rating (Approximate)																															
Primary school	100																															
Mosque	70																															
Parks and green areas	75																															
Commercial services	60																															
Cultural services	55																															
Health care services	85																															
Official and institutional services	35																															
Recreational services	45																															
Restaurants and cafés	35																															
Public transportation	75																															
Private transportation	65																															
Car parkings	80																															
Emergency services	90																															
Other	5																															
Respond	<p>Professionals rate the primary school as the most important urban element in the neighborhoods, also they give a high rate for health and emergency services. This means that these three elements have to be facilitated with an acceptable walking distance for any residents in any neighborhood. They give a fewer rate for mosques and public transportation. This point means that there is no an official attention on the argent issues about congestion and urban sprawl.</p>																															
9	Question	What are the most perceived problems that you seek to solve and manage through developmental planning?																														
Respond	<ul style="list-style-type: none"> • Land use <ul style="list-style-type: none"> • Absence of integrated plans and regulations that control land use. • Illegal aggression from residents. • Obscureness of how to deal with some special cases, such as; housing A and C, and agricultural zones. • Unorganized horizontal urban sprawl. • Transportation <ul style="list-style-type: none"> • Hierarchy obscureness of the street and messiness of using streets. • Pavement conditions of the streets. • Environment <ul style="list-style-type: none"> • Reservation of natural and agricultural resources and areas. • Isolating industrial areas from public and residential areas. • Pollution that related to traffic density and congestion. • Inattention to the suggestion of Authority of Environment Quality. • Society <ul style="list-style-type: none"> • Weakness of society initiatives and resonances. • Local NGO's unable to intervene to reform the planning reality. • Services <ul style="list-style-type: none"> • Absence of any planning criteria that control services distribution. • Inefficient services locations and designs. • Inefficient services management. • Correlation between infrastructure and streets projects. 																															

10	Question	How does your agency address land use? Please check the statement that comes closest to describing your agency's position.																
Result	<table border="1"> <caption>Data for Question 10 Bar Chart</caption> <thead> <tr> <th>Statement</th> <th>Percentage</th> </tr> </thead> <tbody> <tr> <td>Land use is not something we are ...</td> <td>14%</td> </tr> <tr> <td>Our agency takes the lead.</td> <td>50%</td> </tr> <tr> <td>Municipality takes the lead.</td> <td>33%</td> </tr> <tr> <td>Ministry of Planning takes the lead.</td> <td>14%</td> </tr> <tr> <td>Ministry of Local Government takes...</td> <td>50%</td> </tr> <tr> <td>Provide funds to leverage land use...</td> <td>42%</td> </tr> <tr> <td>Has a formal relationship with other...</td> <td>42%</td> </tr> </tbody> </table>		Statement	Percentage	Land use is not something we are ...	14%	Our agency takes the lead.	50%	Municipality takes the lead.	33%	Ministry of Planning takes the lead.	14%	Ministry of Local Government takes...	50%	Provide funds to leverage land use...	42%	Has a formal relationship with other...	42%
Statement	Percentage																	
Land use is not something we are ...	14%																	
Our agency takes the lead.	50%																	
Municipality takes the lead.	33%																	
Ministry of Planning takes the lead.	14%																	
Ministry of Local Government takes...	50%																	
Provide funds to leverage land use...	42%																	
Has a formal relationship with other...	42%																	
Respond	It is obvious that land use planning is a common process, but MOLG has the lead in this domain.																	
11	Question	What are the planning priorities that your agency takes in consideration while planning the land use?																
Result	<table border="1"> <caption>Data for Question 11 Bar Chart</caption> <thead> <tr> <th>Priority</th> <th>Percentage</th> </tr> </thead> <tbody> <tr> <td>Financial capacity</td> <td>100%</td> </tr> <tr> <td>Available vacant land</td> <td>70%</td> </tr> <tr> <td>To be similar to the existing land uses</td> <td>78%</td> </tr> <tr> <td>To be different of the existing land...</td> <td>78%</td> </tr> <tr> <td>Solving existing urban problems</td> <td>42%</td> </tr> <tr> <td>Solving existing transportation...</td> <td>92%</td> </tr> <tr> <td>Other</td> <td>18%</td> </tr> </tbody> </table>		Priority	Percentage	Financial capacity	100%	Available vacant land	70%	To be similar to the existing land uses	78%	To be different of the existing land...	78%	Solving existing urban problems	42%	Solving existing transportation...	92%	Other	18%
Priority	Percentage																	
Financial capacity	100%																	
Available vacant land	70%																	
To be similar to the existing land uses	78%																	
To be different of the existing land...	78%																	
Solving existing urban problems	42%																	
Solving existing transportation...	92%																	
Other	18%																	
Respond	The most common priority in planning for land use is the needs of community within 15 years and this period is classified into stages every 5 years.																	
12	Question	Does your agency have staff or consultants assigned to work on land use development?																
Result	<table border="1"> <caption>Data for Question 12 Pie Chart</caption> <thead> <tr> <th>Response</th> <th>Percentage</th> </tr> </thead> <tbody> <tr> <td>Yes</td> <td>67%</td> </tr> <tr> <td>No</td> <td>33%</td> </tr> </tbody> </table>		Response	Percentage	Yes	67%	No	33%										
Response	Percentage																	
Yes	67%																	
No	33%																	
Respond	Most agencies have staff assigned to work on land use development, this provides an appropriate platform for implementing any innovative trends and proposals.																	

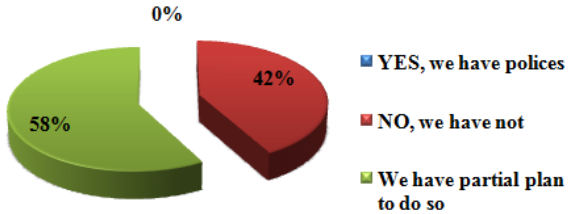
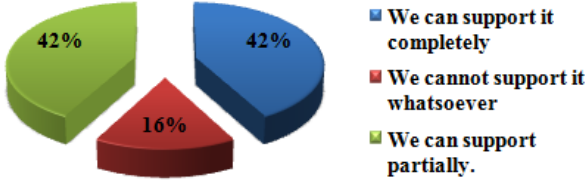
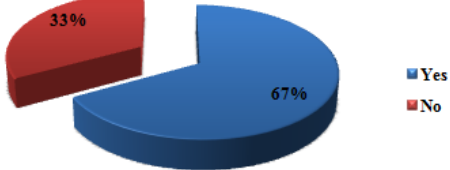
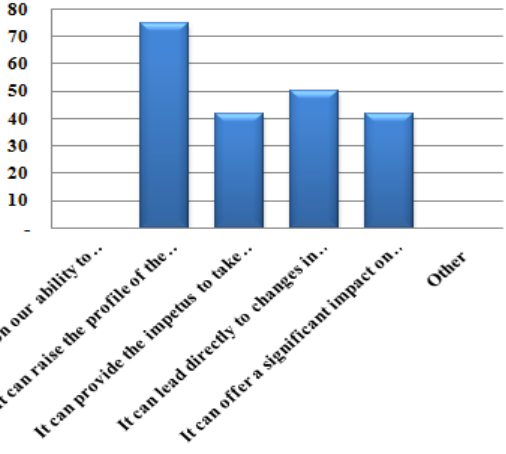
13	Question	Does your agency have a specific polices or formal program designed to encourage the usage of public transportation and walkability?
Result	 <p>0% 42% 58%</p> <ul style="list-style-type: none"> ■ YES, we have polices ■ NO, we have not ■ We have partial plan to do so 	
Respond	No specific policies or programs are designed to encourage the usage of public transportation and walkability despite the big need for this trend in movement and circulation in Gaza City.	
D. Supporting the proposed approach		
14	Question	For which extend can you support the approach of this study?
Result	 <p>42% 16% 42%</p> <ul style="list-style-type: none"> ■ We can support it completely ■ We cannot support it whatsoever ■ We can support partially. 	
Respond	Many professionals can support the approach completely or partially, this gives a support to the proposed model.	
15	Question	Are there any internal regulations, policies, or mandates within your organization that explicitly devoted to promoting and implementation Transit Oriented Development trends?
Result	 <p>33% 67%</p> <ul style="list-style-type: none"> ■ Yes ■ No 	
Respond	All internal policies that related to Transit Oriented Development is about implementing the aspects that is involved within the master plan of Gaza City. This gives a clear idea that there are innovative trends, which are not feature from 1997 until now. This situation tells about some inattention about important enclosures.	
16	Question	Can the inclusion of land use, transportation as emergent mechanical factors in the developmental processes change your agency's interest in and its capability to undertake and implement Transit Oriented Development planning in your community?
Result	 <p>80 70 60 50 40 30 20 10 -</p> <p>It had no impact on our ability to... It can raise the profile of the... It can provide the impetus to take... It can lead directly to changes in... It can offer a significant impact on... Other</p>	

Respond	The majority of professionals see that the inclusion of land use, transportation as emergent mechanical factors in the developmental processes, can raise the profile of the transit and land use connection in their agencies, local governments and the community. Also, they see that it can lead directly to changes in locally adopted land use policies and plans for the transit corridor														
17	Question Has the presence of land use as a rating criterion changed how your agency approaches land use in the development of transit projects?														
Result	<table border="1"> <caption>Data for Question 17 Result</caption> <thead> <tr> <th>Response Category</th> <th>Percentage</th> </tr> </thead> <tbody> <tr> <td>No, we have always treated land use ..</td> <td>0</td> </tr> <tr> <td>No, how we address land use as a ..</td> <td>0</td> </tr> <tr> <td>Yes, it helped to provide the impetus ..</td> <td>92</td> </tr> <tr> <td>Yes, it has opened the door to get the ..</td> <td>58</td> </tr> <tr> <td>Other</td> <td>0</td> </tr> </tbody> </table>	Response Category	Percentage	No, we have always treated land use ..	0	No, how we address land use as a ..	0	Yes, it helped to provide the impetus ..	92	Yes, it has opened the door to get the ..	58	Other	0		
Response Category	Percentage														
No, we have always treated land use ..	0														
No, how we address land use as a ..	0														
Yes, it helped to provide the impetus ..	92														
Yes, it has opened the door to get the ..	58														
Other	0														
Respond	The majority of professionals see that the presence of land use as a rating criterion in the development of transit projects help to provide the impetus to more seriously address land use issues and open the door to get the discussion going.														
18	Question On which category do you focus your attention while planning for transportation?														
Result	<table border="1"> <caption>Data for Question 18 Result</caption> <thead> <tr> <th>Response Category</th> <th>Percentage</th> </tr> </thead> <tbody> <tr> <td>Public transportation</td> <td>82</td> </tr> <tr> <td>Private transportation</td> <td>72</td> </tr> <tr> <td>Pedestrian environment</td> <td>62</td> </tr> <tr> <td>Bicycle tracks</td> <td>38</td> </tr> <tr> <td>Emergency services</td> <td>75</td> </tr> <tr> <td>Other</td> <td>8</td> </tr> </tbody> </table>	Response Category	Percentage	Public transportation	82	Private transportation	72	Pedestrian environment	62	Bicycle tracks	38	Emergency services	75	Other	8
Response Category	Percentage														
Public transportation	82														
Private transportation	72														
Pedestrian environment	62														
Bicycle tracks	38														
Emergency services	75														
Other	8														
Respond	The professionals agencies concern of public transportation and pedestrian environment while preparing for any planning approach. This situation is adjustable with the proposed trend of developmental planning.														
19	Question Which, if any, national/regional government policies does your agency currently employ to encourage														
Respond	<ul style="list-style-type: none"> • Mixed Land use <ul style="list-style-type: none"> • Lows and regulations of building and organization. • Confiscation areas within parceling projects. • Hierarchy in urban elements and patterns. 														

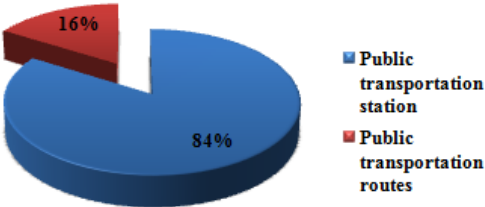
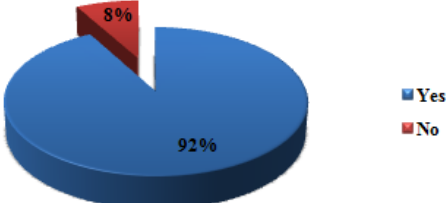
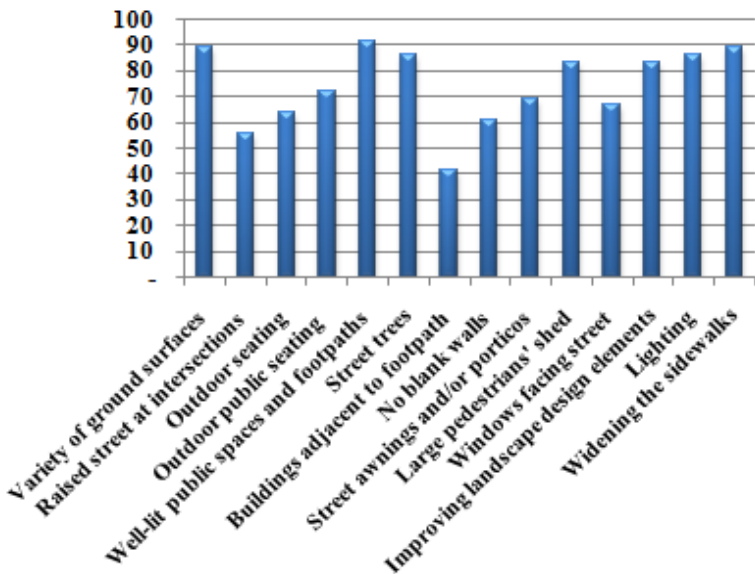
		<ul style="list-style-type: none"> • Public Transportation <ul style="list-style-type: none"> • Proposing the regional transportation station in the regional and master plans of Gaza. • Allocating of parking for each area. • Walkability <ul style="list-style-type: none"> • There is no any concerns on encouraging walkability. 																												
20	Question	Which is preferable while planning and developing for public transportation network, please explain the reason?																												
	Result	 <p>A 3D pie chart with two segments. The larger segment is blue and labeled '84%' with a legend entry 'Public transportation station'. The smaller segment is red and labeled '16%' with a legend entry 'Public transportation routes'.</p>																												
	Respond	The majority of professionals see that the core point of developing public transportation is allocating and designing public station, which can be seen as base point for any smart traffic system. However, they see that the integration between station and corridors is the ideal choice.																												
21	Question	Are there any environmental concerns while planning for land use and transportation?																												
	Result	 <p>A 3D pie chart with two segments. The larger segment is blue and labeled '92%' with a legend entry 'Yes'. The smaller segment is red and labeled '8%' with a legend entry 'No'.</p>																												
	Respond	There are number of concerns about environmental aspects while planning for land use and transportation, these concerns are represented in: <ul style="list-style-type: none"> • Preservation of natural areas and resources. • Main and long streets are perpendicular on the sea line and this allow wind to penetrate all urban areas. 																												
E. The importance of the new approach																														
22	Question	Based on your experience, how important is each design element to encourage walkability and usage of public transportation?																												
	Result	 <p>A bar chart with 14 bars representing different design elements. The y-axis is labeled from 10 to 100 in increments of 10. The x-axis labels are rotated 45 degrees. The bars show varying levels of importance, with most between 60 and 90.</p> <table border="1"> <thead> <tr> <th>Design Element</th> <th>Importance (%)</th> </tr> </thead> <tbody> <tr><td>Variety of ground surfaces</td><td>90</td></tr> <tr><td>Raised street at intersections</td><td>55</td></tr> <tr><td>Outdoor public seating</td><td>65</td></tr> <tr><td>Well-lit public spaces and footpaths</td><td>72</td></tr> <tr><td>Buildings adjacent to footpaths</td><td>92</td></tr> <tr><td>Street trees</td><td>88</td></tr> <tr><td>No blank walls</td><td>42</td></tr> <tr><td>Street awnings and/or porticos</td><td>62</td></tr> <tr><td>Large pedestrians' shed</td><td>70</td></tr> <tr><td>Windows facing street</td><td>85</td></tr> <tr><td>Improving landscape design elements</td><td>68</td></tr> <tr><td>Lighting</td><td>85</td></tr> <tr><td>Widening the sidewalks</td><td>92</td></tr> </tbody> </table>	Design Element	Importance (%)	Variety of ground surfaces	90	Raised street at intersections	55	Outdoor public seating	65	Well-lit public spaces and footpaths	72	Buildings adjacent to footpaths	92	Street trees	88	No blank walls	42	Street awnings and/or porticos	62	Large pedestrians' shed	70	Windows facing street	85	Improving landscape design elements	68	Lighting	85	Widening the sidewalks	92
Design Element	Importance (%)																													
Variety of ground surfaces	90																													
Raised street at intersections	55																													
Outdoor public seating	65																													
Well-lit public spaces and footpaths	72																													
Buildings adjacent to footpaths	92																													
Street trees	88																													
No blank walls	42																													
Street awnings and/or porticos	62																													
Large pedestrians' shed	70																													
Windows facing street	85																													
Improving landscape design elements	68																													
Lighting	85																													
Widening the sidewalks	92																													

	<p>Respond</p> <p>The professionals give high rates for most of proposed design element as factors of encouraging walkability and usage of public transportation, which means that these elements are very important to be involved within TOD approaches.</p>																												
<p>23</p>	<p>Question</p> <p>Based on your agency's experience in urban planning and growth management, how important is Transit Oriented Development towards:</p>																												
<p>Result</p>	<table border="1"> <caption>Data for Question 23 Result</caption> <thead> <tr> <th>Factor</th> <th>Percentage</th> </tr> </thead> <tbody> <tr><td>Increasing transit ridership</td><td>85</td></tr> <tr><td>Increasing political support for transit</td><td>90</td></tr> <tr><td>Relieving traffic congestion</td><td>90</td></tr> <tr><td>Reducing sprawl</td><td>85</td></tr> <tr><td>Increasing housing choices</td><td>70</td></tr> <tr><td>Improving neighborhood quality</td><td>85</td></tr> <tr><td>Spurring economic development</td><td>75</td></tr> <tr><td>Creating a diverse community</td><td>65</td></tr> <tr><td>Environmental preservation</td><td>80</td></tr> <tr><td>Oil and Gas preservation</td><td>80</td></tr> </tbody> </table>	Factor	Percentage	Increasing transit ridership	85	Increasing political support for transit	90	Relieving traffic congestion	90	Reducing sprawl	85	Increasing housing choices	70	Improving neighborhood quality	85	Spurring economic development	75	Creating a diverse community	65	Environmental preservation	80	Oil and Gas preservation	80						
Factor	Percentage																												
Increasing transit ridership	85																												
Increasing political support for transit	90																												
Relieving traffic congestion	90																												
Reducing sprawl	85																												
Increasing housing choices	70																												
Improving neighborhood quality	85																												
Spurring economic development	75																												
Creating a diverse community	65																												
Environmental preservation	80																												
Oil and Gas preservation	80																												
<p>Respond</p>	<p>The professionals are agreeing that TOD is important for solving many issues in planning, economic, social and environmental aspects.</p>																												
<p>F. The impediments and challenges facing the development process and the new approach</p>																													
<p>24</p>	<p>Question</p> <p>Based on your experience, to what degree is each one of the following an impediment to Transit Oriented Development?</p>																												
<p>Result</p>	<table border="1"> <caption>Data for Question 24 Result</caption> <thead> <tr> <th>Factor</th> <th>Percentage</th> </tr> </thead> <tbody> <tr><td>Lack of Market Demand</td><td>75</td></tr> <tr><td>Community Opposition</td><td>55</td></tr> <tr><td>Local Zoning Restrictions</td><td>60</td></tr> <tr><td>Lack of Investor Interest and Support</td><td>55</td></tr> <tr><td>Skepticism Among Local Governments</td><td>75</td></tr> <tr><td>Lack of Political Support</td><td>60</td></tr> <tr><td>Inadequate Transit Service</td><td>80</td></tr> <tr><td>Location of Transit Stations</td><td>70</td></tr> <tr><td>Predominance of Auto-Oriented Land Uses</td><td>55</td></tr> <tr><td>Lack of Local Expertise in TOD Planning or..</td><td>65</td></tr> <tr><td>Transit Agency Requirements for Replacement..</td><td>60</td></tr> <tr><td>Lack of Collaboration</td><td>55</td></tr> <tr><td>Lack of financial and legal support</td><td>35</td></tr> </tbody> </table>	Factor	Percentage	Lack of Market Demand	75	Community Opposition	55	Local Zoning Restrictions	60	Lack of Investor Interest and Support	55	Skepticism Among Local Governments	75	Lack of Political Support	60	Inadequate Transit Service	80	Location of Transit Stations	70	Predominance of Auto-Oriented Land Uses	55	Lack of Local Expertise in TOD Planning or..	65	Transit Agency Requirements for Replacement..	60	Lack of Collaboration	55	Lack of financial and legal support	35
Factor	Percentage																												
Lack of Market Demand	75																												
Community Opposition	55																												
Local Zoning Restrictions	60																												
Lack of Investor Interest and Support	55																												
Skepticism Among Local Governments	75																												
Lack of Political Support	60																												
Inadequate Transit Service	80																												
Location of Transit Stations	70																												
Predominance of Auto-Oriented Land Uses	55																												
Lack of Local Expertise in TOD Planning or..	65																												
Transit Agency Requirements for Replacement..	60																												
Lack of Collaboration	55																												
Lack of financial and legal support	35																												

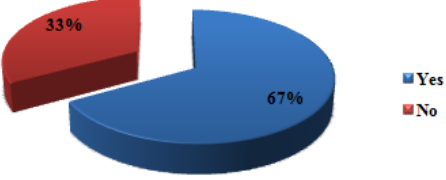
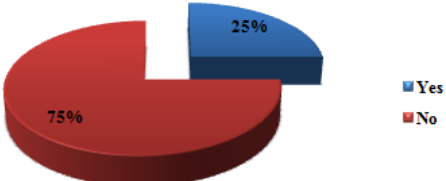
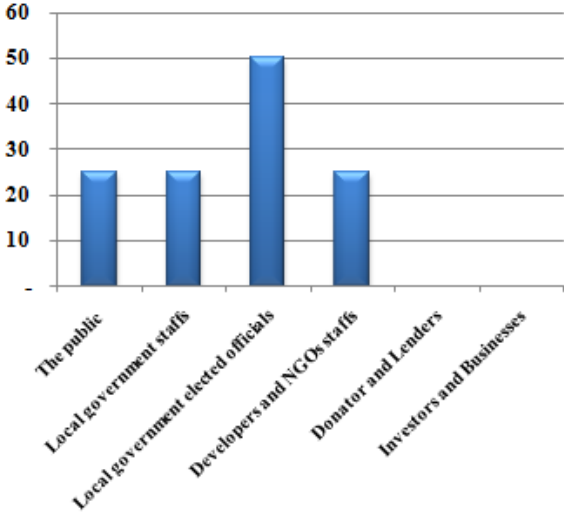
Respond	The professionals see that the most of local situation aspects can be considered as impediments to TOD. This needs a strategic plan to overcome such predicament.	
G. Corporation		
25	Question	Does your agency have cooperative agreements with any of the public agencies to promote Transit Oriented Development trends?
	Result	 <p>A 3D pie chart with a blue slice representing 'Yes' at 67% and a red slice representing 'No' at 33%. A legend to the right shows a blue square for 'Yes' and a red square for 'No'.</p>
Respond	Most of cooperative agreements are between the ministries and municipalities and some are with donors. Generally, the Central Committee of regulations has the lead in this domain.	
H. Financial issues		
26	Question	List the major sources of funding for the programs of planning and development, and divide into the following categories. Please specify whether these sources of funding are dedicated.
Respond	<ul style="list-style-type: none"> • No any funding source for administration and planning issues. • All funding sources direct their targets toward construction and implementation issues and these sources are distinguished by their seriousness. 	
I. Education and promoting awareness		
27	Question	Are there any programs involve promoting awareness and education?
	Result	 <p>A 3D pie chart with a blue slice representing 'Yes' at 25% and a red slice representing 'No' at 75%. A legend to the right shows a blue square for 'Yes' and a red square for 'No'.</p>
Respond	The majority of agencies have no educational or awareness programs and this reflects the weakness on this field.	
28	Question	Who is the primary intended audience for the program?
	Result	 <p>A bar chart with a vertical axis from 0 to 60 in increments of 10. The horizontal axis lists five categories: 'The public', 'Local government staffs', 'Local government elected officials', 'Developers and NGOs staffs', and 'Donator and Leaders'. The bars show values of approximately 25, 25, 50, 25, and 0 respectively. The 'Investors and Businesses' category is listed on the axis but has no bar.</p>
Respond	Most of audiences of educational programs are the staff of governmental agencies. This highlights the issue that there is no corresponding between stakeholders' backgrounds and goals.	

29	Question	What is the primary program strategy?												
Result	<table border="1"> <caption>Data for Question 29: Primary Program Strategy</caption> <thead> <tr> <th>Strategy</th> <th>Percentage</th> </tr> </thead> <tbody> <tr> <td>To provide outreach and education in...</td> <td>50</td> </tr> <tr> <td>To provide outreach and education on...</td> <td>75</td> </tr> <tr> <td>Other</td> <td>25</td> </tr> </tbody> </table>		Strategy	Percentage	To provide outreach and education in...	50	To provide outreach and education on...	75	Other	25				
Strategy	Percentage													
To provide outreach and education in...	50													
To provide outreach and education on...	75													
Other	25													
Respond	Discussions take place through all projects procedures.													
30	Question	What do these programs focus on?												
Result	<table border="1"> <caption>Data for Question 30: Program Focus Areas</caption> <thead> <tr> <th>Focus Area</th> <th>Percentage</th> </tr> </thead> <tbody> <tr> <td>Technical assistance with finance</td> <td>25</td> </tr> <tr> <td>Technical assistance with planning</td> <td>75</td> </tr> <tr> <td>Technical assistance with legal issues</td> <td>25</td> </tr> <tr> <td>To encourage political support</td> <td>25</td> </tr> <tr> <td>Other</td> <td>0</td> </tr> </tbody> </table>		Focus Area	Percentage	Technical assistance with finance	25	Technical assistance with planning	75	Technical assistance with legal issues	25	To encourage political support	25	Other	0
Focus Area	Percentage													
Technical assistance with finance	25													
Technical assistance with planning	75													
Technical assistance with legal issues	25													
To encourage political support	25													
Other	0													
Respond	Most discussions and promoting awareness are intended to provide technical assistance with planning and design.													
J. New ideas														
31	Question	Please share any other ideas you have on the design and practice of Transit Oriented Development.												
Respond	All professionals express their needs for integrated and comprehensive model that involves all planning issues. Also, they recommend to give details and evaluation method for such model and													

Table (5.11); Semi-structure interviews results.

5.5 Space Syntax Analysis using UCL Depthmap v.10

The term space syntax encompasses a set of theories and techniques for the analysis of spatial configurations. Originally, it is conceived as a tool to help architects and planners to simulate the likely social effects of their designs. The general idea is that spaces can be broken down into components, analyzed as networks of choices, then represented as maps and graphs that describe the relative connectivity and integration of those spaces (Teklenburg, Timmermans & Wagenberg 1993).

To apply space syntax, it is necessary to construct a graphical representation of an urban area. This typically is done by generating an axial map in order to analyze the streets network; as in Figure (5.1). The axial map contains the least set of the longest straight lines that can be drawn in the open space of streets. The axial map can be presented as a graph; the lines of the graph represent the streets and the nodes represent the intersections of the streets.

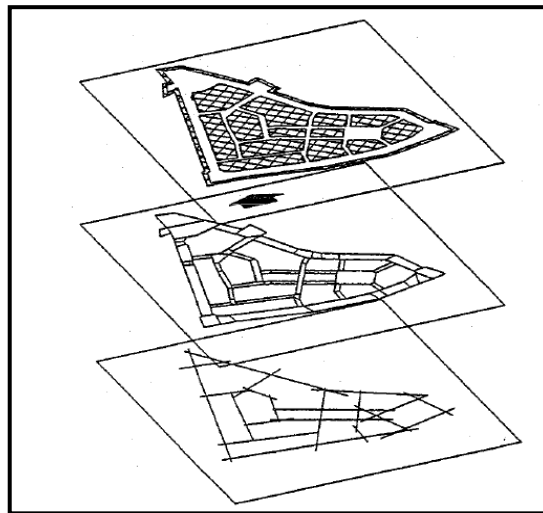

Figure (5.1); Open space, convex map and axial map of an urban area.
(Teklenburg, Timmermans & Wagenberg 1993)

5.5.1 Analytical Approaches

Two space syntax analytical approaches are done on streets network according to the theoretical criteria and resulted indicators, which appeared from the questionnaire results. Both results of the questionnaire and theoretical criteria are used as inputs on UCL Depthmap. The two analytical approaches are:

1. Integration

Integration measures how many turns one has to make from a street segment to reach all other street segments in the network, using shortest paths. Theoretically, the integration measure shows the cognitive complexity of reaching a street, and is often argued to predict the pedestrian use of a street. It means that more integration and easier reaching of a street makes it more popularly in use. While there is some evidence of this being true, the method is also biased towards long, straight streets that intersect with lots of other streets (Teklenburg, Timmermans & Wagenberg 1993).

2. Connectivity

Connectivity can be described as the depth distance measures, which is the most common analyzing methods in Space Syntax. It explains the linear distance from the center point of each street segment to the center points of all the other segments (Teklenburg, Timmermans & Wagenberg 1993). If every segment is successively chosen as a starting point, then a graph of accumulative final values is achieved. The streets with lowest depth distance values are said to be nearest to all the other streets. Again, the search radius can be limited to any distance.

5.5.2 Expected Results

- Defining the most integrated streets that can involve the major and public movement with high efficiency.
- Defining the most connective streets that one of them can accommodate the intended elements of the approach.
- The results of analysis define some places to allocate the needed elements of the proposed model. These results is used as inputs on ArcGIS.

5.6 GIS Analysis using ArcGIS v.9.3

There are three interrelated concepts of geographic information system (GIS); data, information and decision making. Geographical or spatial data are defined as undigested, unorganized and unevaluated material that can be associated with a location. Data are of little value in themselves. To be useful, they must be transformed into information. When data are organized, presented, analyzed, interpreted and considered useful for a particular decision problem, they become information; as in Figure (5.2). Accordingly, geographical information is defined as a georeferenced data that have been processed into a form that is meaningful and of real or perceived value to decision makers. Decision problems that involve geographical data are referred to a spatial decision problem (Malczewski, Jacek 1999).

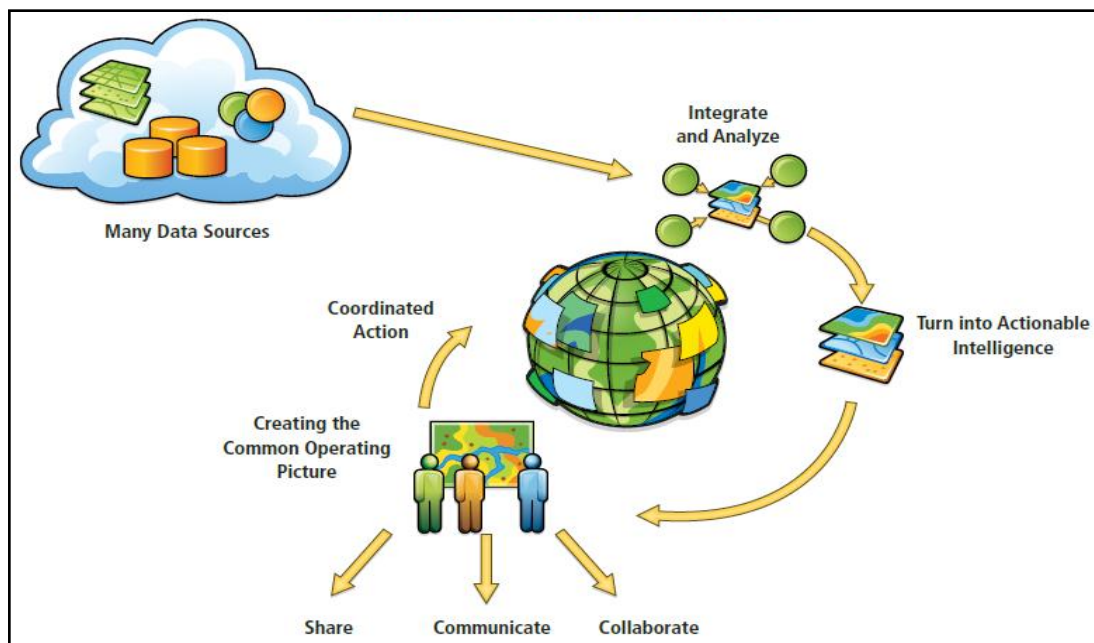

Figure (5.2); GIS applies geographic approach. (Malczewski, Jacek 1999).

The proposed approach is seeking to build a spatial pattern with specific criteria. The GIS application can offer the ability to connect all needed data , receive all criteria as inputs, make analysis, give weight for every criterion, and finally generate and define the intended query.

Network models are based on interconnecting logical components, of which the most important are:

1. 'Nodes' are defined as start, end, and intersections
2. 'Chains' are line features joining nodes
3. 'Links' joint together points making up a chain

The working on ArcGIS 9.3 is progressed within the following steps:

1. Defining Objective
2. Defining Decisions
3. Defining Criteria
4. Defining Scenarios

CHAPTER 6

MAKING (TOD) HAPPENS ..

THE IMPLEMENTATION OF A SUSTAIBANLE AND SMART URBAN DEVELOPMENT PATTERN

(Gaza City)

- 6.1** Introduction
- 6.2** Strategic Transaction
- 6.3** Spatial Movement and Transportation System
- 6.4** Stations Allocation by using ArcGIS and UCL Depthmap
- 6.5** Urban Spaces Design
- 6.6** Evaluation Tool and Measuring Success of TOD

6.1 Introduction

The space of the city is the theatre of everyday activity. The purpose of these activities is about creating trade off relations between social & economic potentialities. Also, any urban place is a trading engine, so it is a hugely valuable asset. Moreover, each space within a spatial network is affected by all other spaces in the system. Then, the spatial layout is a critical aspect of design that influences human behavior and physical impacts of urbanization.

Herein, a smart approach is necessary to be embraced. Transit Oriented Development (TOD) is chosen as a tool to reach smart and sustainable growth to regulate the process through restraining urban sprawls, promoting efficiency of land development, protecting environment resources, guiding urban development patterns, and building a highly livable environment (Chia-Nung 2003). Within this context, many strategies are gradually developed to achieve these goals.

The proposed design seeks to exploit the potential of sites by converting the pre-design potentials to design exploitation; as in Figure (6.1).



Figure (6.1); The pursued proposal.

To make sure that the proposed design is exploiting the potentials, the following aspects are taken into account: see Figure (6.2)

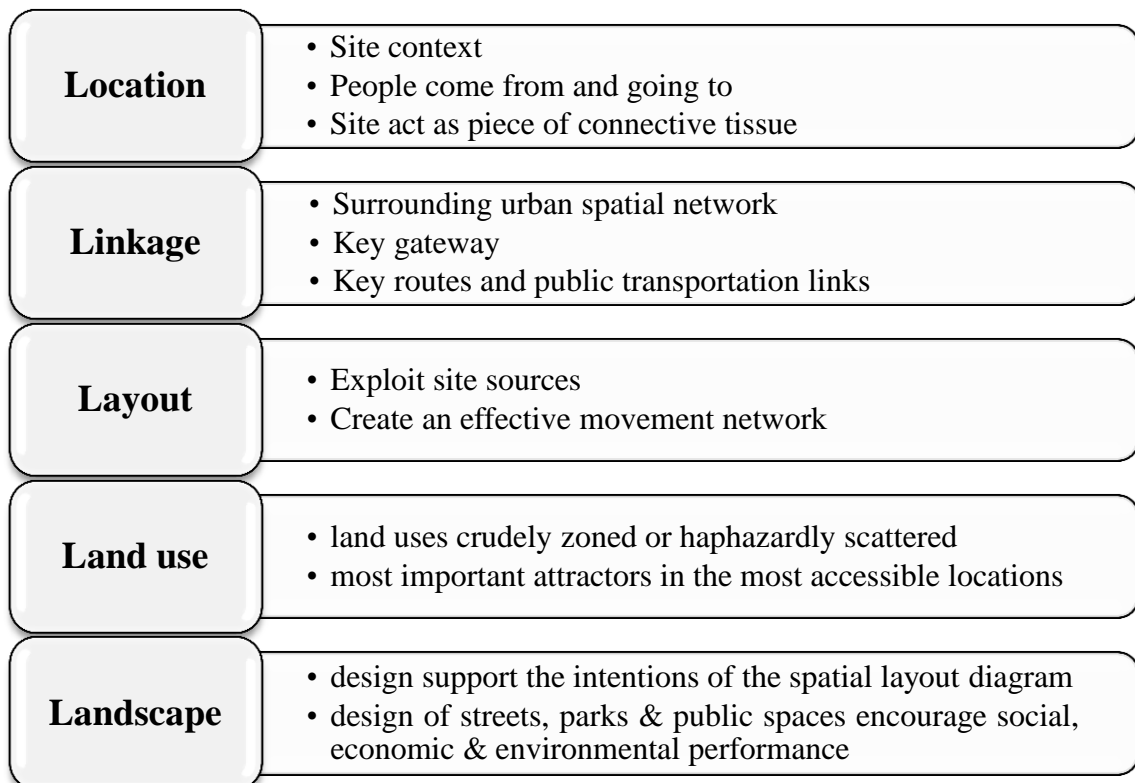

Figure (6.2); The aspects that are taken in consideration to make sure that the design is exploiting the potential. (Dittmar, & Ohland 2004)

The proposed design pattern is about making a complement and comprehensive developmental approach for Gaza City, rather than making a compete one. It is attempted to give a strategic transaction, draw a spatial movement system, allocate and design urban spaces, and then, it is condenses all aspects throughout a specific urban neighborhood.

6.2 Strategic Transaction

The main goal of the approach is to set a comprehensive and methodological framework for upraising the quality of life in the city within modeling a new pattern of sustainable and smart urban developmental planning, which based on transit oriented development (TOD). Also, the approach is considering city's transaction mechanism to handle the method of connecting people together. In order to achieve this major goal, a strategic transaction is needed to be determined.

To satisfy all aspects of developmental urban planning, four major principles are accomplished: see Figure (6.3)

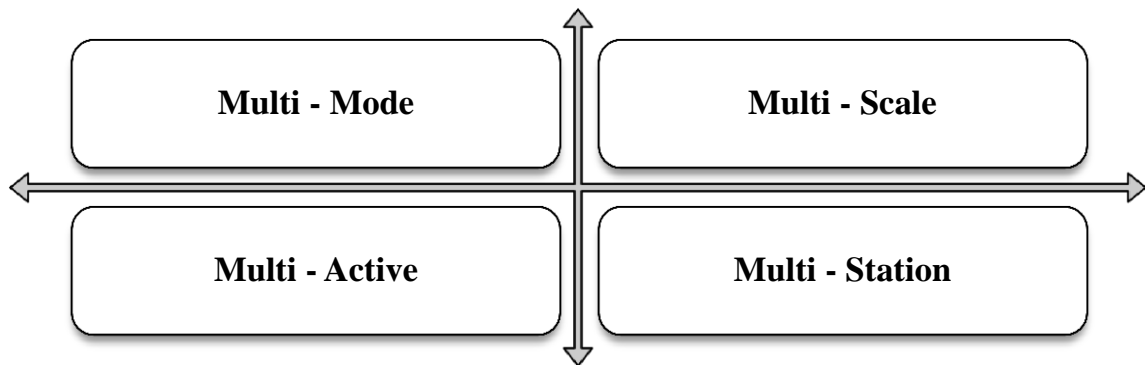

Figure (6.3); The four major principles that are accomplished through the developmental urban planning.

6.2.1 Multi – Mode Strategy

According to the results of the questionnaire about the transportation means that people mainly depend on, it is seen that it is essential to provide a variety of transportation choices. Then, three modes of travel means are proposed to satisfy the trends of community and formal agencies, with compatibility with the approach: see Figure (6.4)

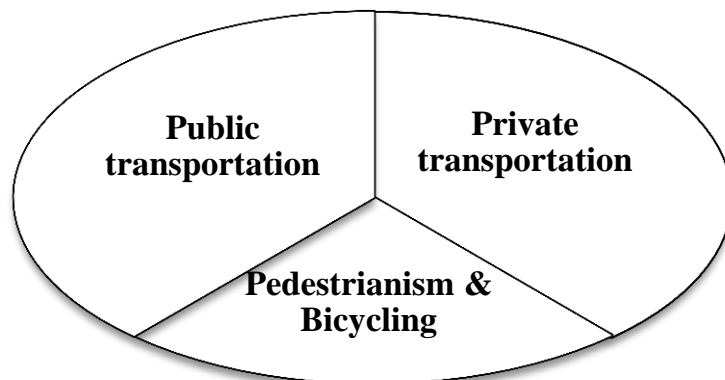

Figure (6.4); The four three modes of travel.

1. Public transportation

- It is a very efficient system, which include buses and taxis.
- The system is supported and enhanced physically by the government in order to save time and effort of travel, especially in peak hours.
- The system is supported and enhanced economically by the government, in order to minimize the prices of travel.
- It is an Eco-friendly system, that the vehicles' mechanisms able to reduce greenhouse gas emission and they may work on electricity.

2. Private transportation

- It is a critical transportation mean, which needs a very caution treatment.
- It supported physically by the government, in order to reduce congestion and greenhouse emission.
- It is not supported economically, in order to reduce the dependency on it and to make it as auxiliary transportation mean

3. Pedestrianism and Bicycling

- It is a very important idea, which needs a lot of strengthening and enhancing.
- A pleasant pedestrian environment and corridors are promoted to attract this trend by lightening, furnishing and safety.
- All destinations are close all origins and to each other, to encourage the idea. The maximum walking distance to reach and transit station or any destination is 200-600 m.
- The idea of bicycling is not acceptable for all community groups in Gaza, so; it needs promoting awareness and encouragement.

6.2.2 Multi – Scale Strategy

According to the structured interviews about the planning work in the institutes and agencies, it is seen that to ensure the ideal implementation of urban development pattern, it is essential to work across scales. The hierarchy of planning stages is promoted to achieve this aspect: see Figure (6.5)

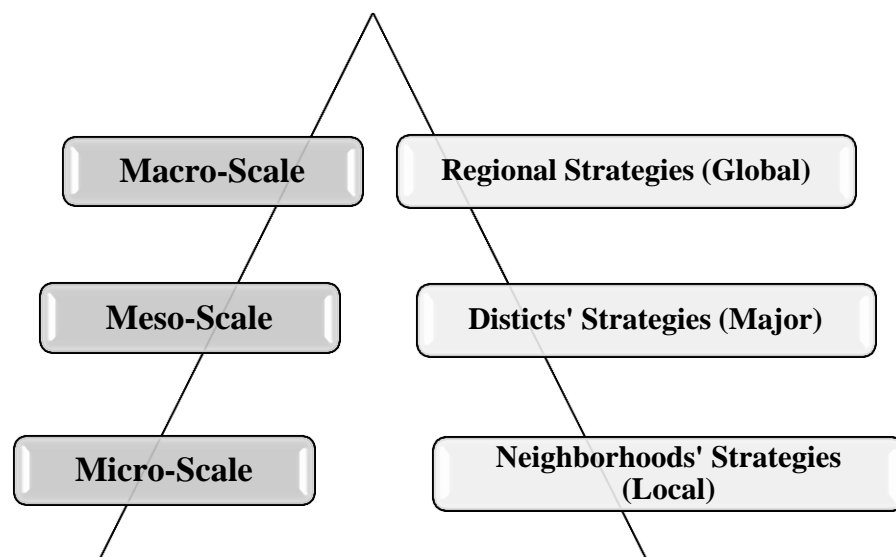

Figure (6.5); Scales of planning work.

6.2.3 Multi – Active Strategy

According to the questionnaire results about the most trips that people do during a week and the places of these trips, it is seen that the proposed model must measure the movement potentials in two ways, reflecting the fact that every trip involves two things: see Figure (6.6)



Figure (6.6); The two elements of any trip.

1. 'TO-movement' element of trip

It is about determining a destination from an origin and deciding where to go; as in Figure (6.7). This kind of movement highlights the principal urban centers of the urban area. It is also picks the key radial connections.

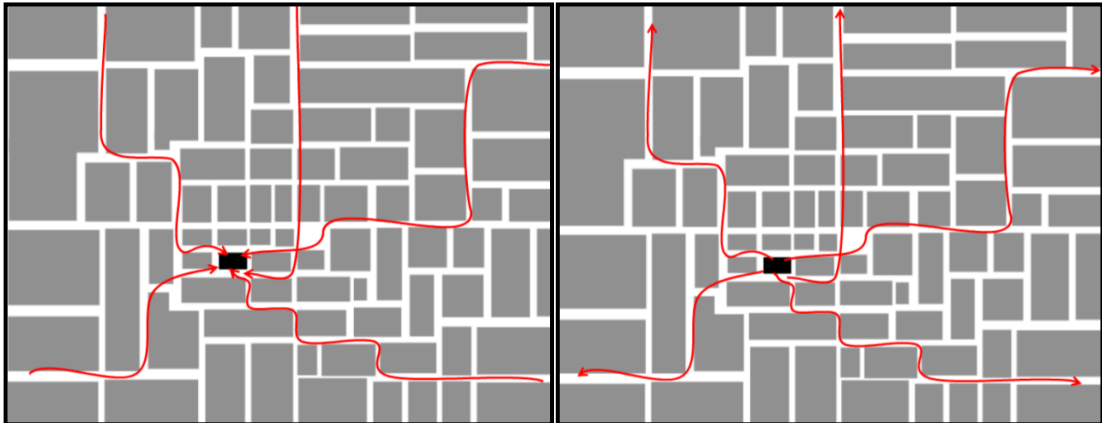

Figure (6.7); To-movement.

2. 'THROUGH-movement' element of the trip

It is about selecting the space to pass through on the way to the destination and selecting the route to get there; as in Figure (6.8). This kind of movement highlights the routes that feed the main urban centers, which are small, local centers in their own right.

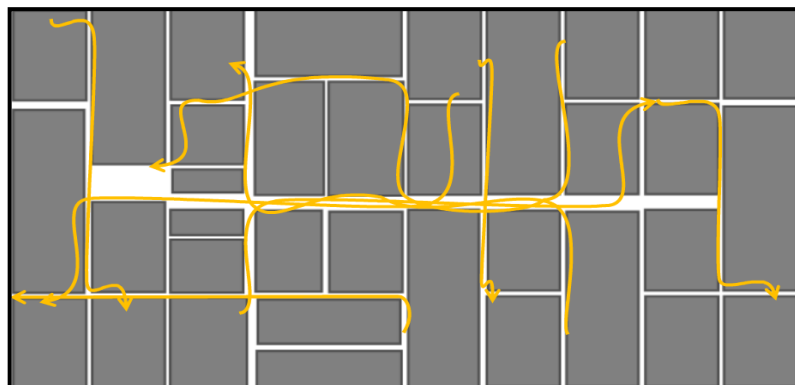

Figure (6.8); Through-movement.

Researchers showed that 60-80% of movement flows are due to the structure of the network, measured by spatial accessibility. Places that are more accessible get more movement. This does not mean that space determines individual movement, but it means that human movement follows predictable patterns. So, the proposed pattern takes into consideration the two types of movement as they are the essential tools for shaping the land use. (Teklenburg, Timmermans & Wagenberg 1993)

6.2.4 Multi – Station Strategy

There are three types of stations to be proposed to serve the complement model. These stations are allocated and determined their areas according to many criteria. The stations execute a very significant role in supporting the approach by their design and arrangement. The three types are illustrated in Figure (6.9):

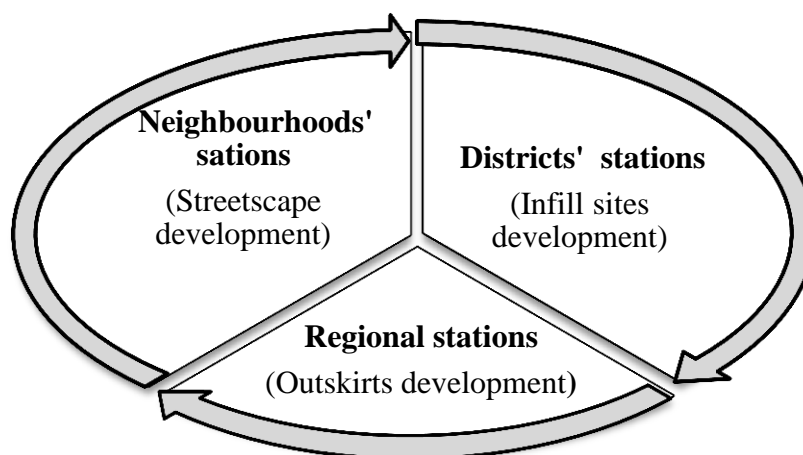

Figure (6.9); The three types of proposed stations.

1. Neighborhood' stations (Local stations)

Can be considered as local stations that serve at the scale of neighborhoods and can make a streetscape development.

2. Districts' stations (Major stations)

Can be considered as major stations that serve at the scale of all district and can make a significant development for infill sites in the district.

3. Regional stations (Global stations)

Can be considered as global stations that serve at the scale of all Gaza Strip and it can direct the future development of Gaza City throughout the outskirts of the city.

6.3 Spatial Movement and Transportation System

Transit Oriented Development (TOD) is a viable model for transportation and land use integration. TOD is a straightforward concept: concentrate a mix of moderately dense and pedestrian friendly development around transit around transit stations to promote transit riding, increase walk and other alternatives to the use of private cars.

This need a transportation general and action plan to be accomplished (Curtis, Renne & Bertolini 2009).

The questionnaire showed that most people do not see the public transportation as an ideal mean to transit with; also, most of them are agree with the idea of depending on these public means after making some essential improvements. These results represent a strong platform to establish such developmental approach.

From this point, TOD is viewed as a promising aspect for solving this complements. Also, it is a competent tool for cubing sprawl and the spawns of car dependence. By setting a new transportation system; and by channeling public development into struggling areas, some hope TOD can breathe new life and vitality into Gaza City.

A new transportation action plan is proposed. This plan is erected on classifying the spatial movement of Gaza into three-graded hierarchy, and each grade has a definitive components and an inner circulation system to connect the components. Then, a circulation system is drawn to connect each grade with the rest two ones; see Figure (6.10). These grades are:

- Between-neighborhoods circulation (inner district circulation): Local Circulation
- Between-districts circulation (inner city circulation): Major circulation
- Regional circulation: Global circulation

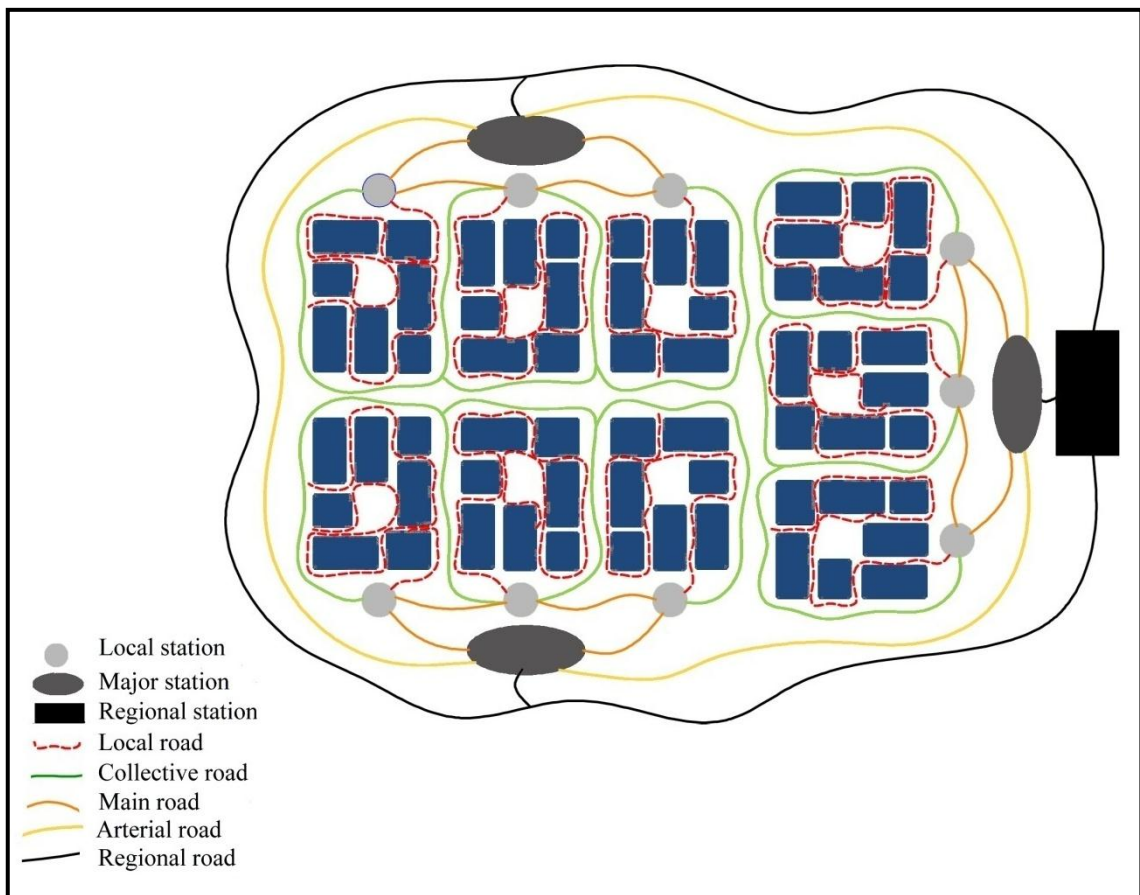

Figure (6.10); The proposed circulation system within the city.

The aspects and components of spatial movement are shown in Figure (6.11).

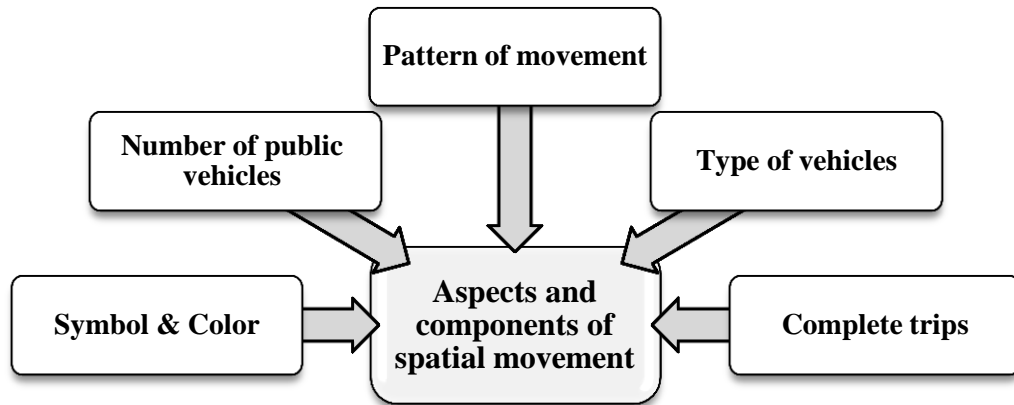

Figure (6.11); The proposed circulation system within the city.

6.3.1 Movement According Roads' Classification

According to the questionnaire and semi-structured interviews results, there is a big need for organizing the accessibility over Gaza city and across Gaza Strip, also between neighborhoods.

The continuously connected city is the largest object of human creation. So, a comprehensive modal solution is proposed. The essential step of designing the pattern is classifying the roads network into grades; and then, determining the characteristics of each grade. As what is taken place in Gaza City, the roads are classified into four grades; regional, main, collective and local streets. Each grade has a specific type of movement. These movements aiming to reduce congestion and enhance high quality live style through organizing transportation system and bending fragmented urbanism. The following is the roads classification and the movement within each grade:

- 1. Regional roads:** They involve the circulation across the strip within connecting Gaza City with the rest cities in Gaza Strip.
- 2. Main streets:** They involve the circulation over Gaza City and between districts to offer high quality accessibility and enhance public transportation system.
- 3. Collective streets:** They are used to collect and distribute traffic to and from local streets, and to ensure free accesses to the main roads.
- 4. Local streets:** They are corridors that host the local movement of pedestrians, bicyclists and emergency means.

6.3.2 Between-neighborhoods circulation and inner district circulation (Local circulation)

According to the questionnaire and semi-structured interviews results about the ability to walk for 200-600 m toward any trip, about a acceptable walking period and about the preferable environment for walking, it is seen that the people are agree with the elemental grade of TOD.

Local circulation is the first grade of circulation system and it has the smallest scale of them. It executes the connection between the dwellings and neighborhoods within one district. This grade of circulation has the following characteristics:

1. Pattern of movement: see Figure (6.12)

- Every district is divided into number if neighborhoods.
- Attractive stations are allocated on the collective streets of the district and within specific distances and criteria of distribution.
- The passenger arrive the station by walking in a very attractive local corridors, and then take a local public transportation mean to transit between the rest neighborhoods in the district.
- Determining the places and design of the stations follow specific criteria.
- Determining the transportation plan and corridors characteristics follow specific criteria.
- The public vehicles stop only on the stations according to an organizing and arrangement strategies.

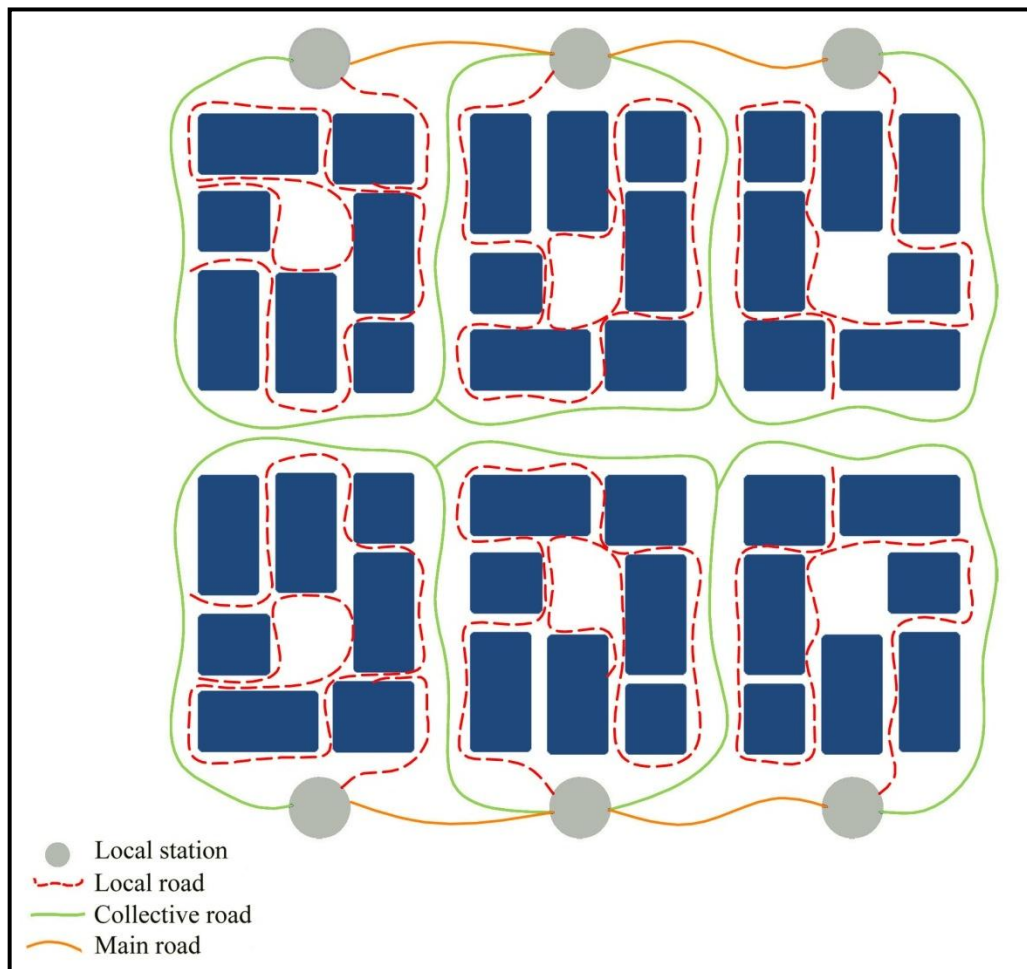

Figure (6.12); Between-neighborhoods circulation and inner district circulation (Local circulation).

2. Type of vehicles

- Using public transportation means is the main method of transit.
- Public taxis (4 seats) are one type of vehicles, that the taxi takes multi foreign passengers in one trip. The taxis stop only in the neighborhoods' stations.

- Microbuses (8 – 10 seats) are another type of vehicles, that the mini-bus takes multi foreign passengers. The mini-buses stop only in the neighborhoods' stations.
- Private vehicles are supported slightly by the approach, that they can travel over the collective streets and some (not all) local corridors.

3. Complete trips, Figure (6.13)

- Each local public vehicle has a specific complete trip. This trip begins and ends in the same station.
- The total one trip involves six stations, and the last station is a joint one between two trips. Each vehicle starts the trip from one station. Then, it ambulates through next five stations. Finally, it returns with the same method.
- The subsequent trip starts from the last station of the previous trip, and it takes place with a same method.
- The overall distance between the first and last stations can be calculated through the equation: see Figure (6.13)

$$\text{Overall distance of one trip} = \text{Distance between local stations} * X$$

$$X = \text{Total No. of stations for one trip} - 1$$

X : a variable, which can vary according to the total number of stations for one trip

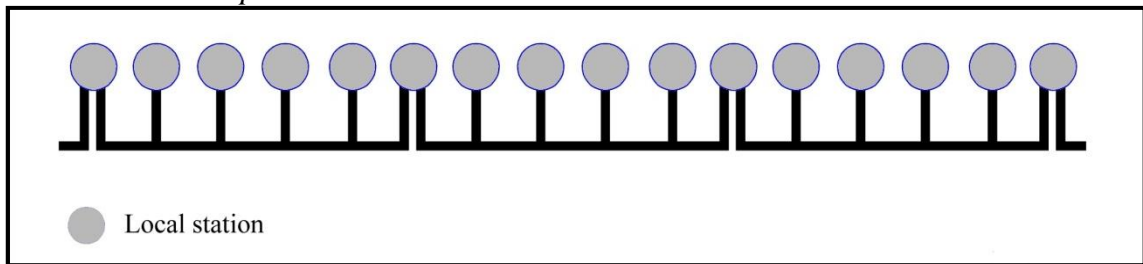

Figure (6.13); The complete trips of between-neighborhoods circulation (Local circulation).

- The overall distance of each trip is flexible, that it can be increased or decreased according to the properties of each area.
- There is another trips' type happens in the district and between neighborhoods. These trips start from a specific station and end in the district's main station.
- There is another group of vehicles, which travel between six stations and have a seventh one; the district's main station. These trips serve the transit over the city and between districts, as in Figure (6.14).

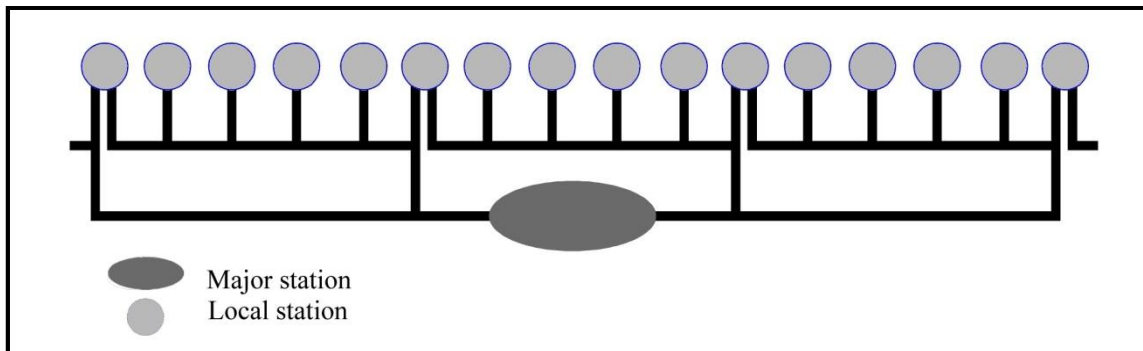

Figure (6.14); The local trips that reach the districts' station.

4. Number of public vehicles, see Figure (6.15)

- Total number of public vehicles which circulate between neighborhoods only, follow the equation:

$$\underline{\text{Total No. of vehicles between neighborhoods}} = \underline{\text{Total No. of stations}} \div X$$

$$X = \underline{\text{Total No. of stations for one trip}} - 1$$

X: a variable, which can vary according to the total number of stations for one trip

If the result is not an integer number, then:

No. of rest stations < 3, then; they are combined with the last trip's vehicle

No. of rest stations ≥ 3, then; they must have a new trip' vehicle

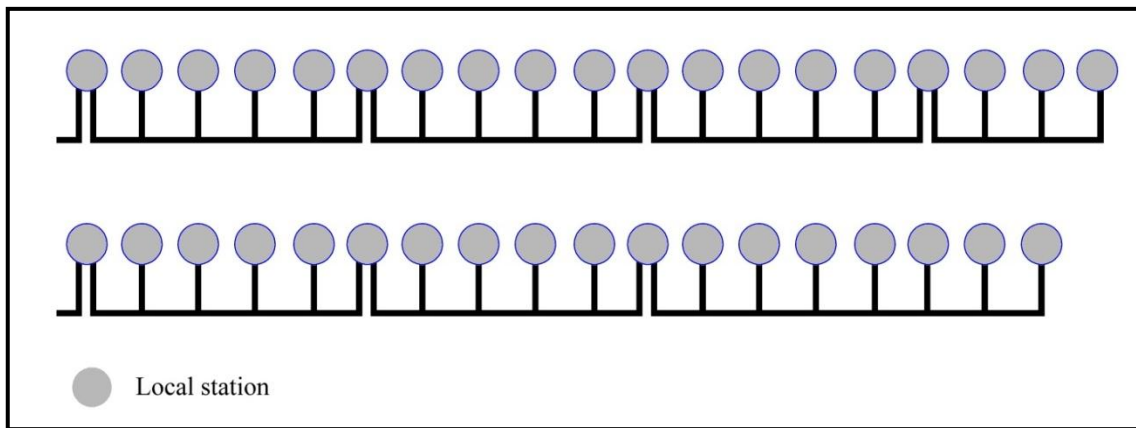

Figure (6.15); Calculating number of public vehicles of local circulations.

- Total number of vehicles in one district is the summation of:

$$\underline{\text{Total No. of vehicles between neighborhoods}} + \underline{\text{Total No. of vehicle that travel to the main district's station}}$$

5. Symbol and color, see Figure (6.16)

This scale of circulation can take the sign of (L) as it represents 'Local circulation. This sign can be put on stations, streets and vehicles. Local circulation may be colored by blue and this color can be used mainly on local vehicles and symbols. Also, the signs may involve some additional necessary information; such as, destination of the vehicle.



Figure (6.16); The proposed sign of local movement.

6.3.3 Between-districts circulation and inner city circulation (Major circulation)

According to questionnaire results about places of work and period of time resuming through trips. So, there is a big need for a competent transportation network that can connect all districts easily

This is the second grade of circulation system and it has the medium scale of them. It executes the connection between districts over the city. This grade of circulation has the following characteristics:

1. Pattern of movement, see Figure (6.17)

- Gaza City is divided into seventeen districts, which involve various activities and services.
- Attractive stations are established on infill sites that contact directly with the main streets that surround or pass through the district and within specific criteria of allocation and design.
- The passenger arrive the station through the proposed circulation pattern between neighborhoods, and then take a major public transportation mean to transit to any desired district's stations. Then, from the intended station, the passenger can take a local transportation mean to reach any specific place within any neighborhood in any district.
- Regional passenger can reach the largest scale of circulation through the districts' stations.
- Determining the places and design of the stations follow specific criteria.
- Determining the routes characteristics follow specific criteria.

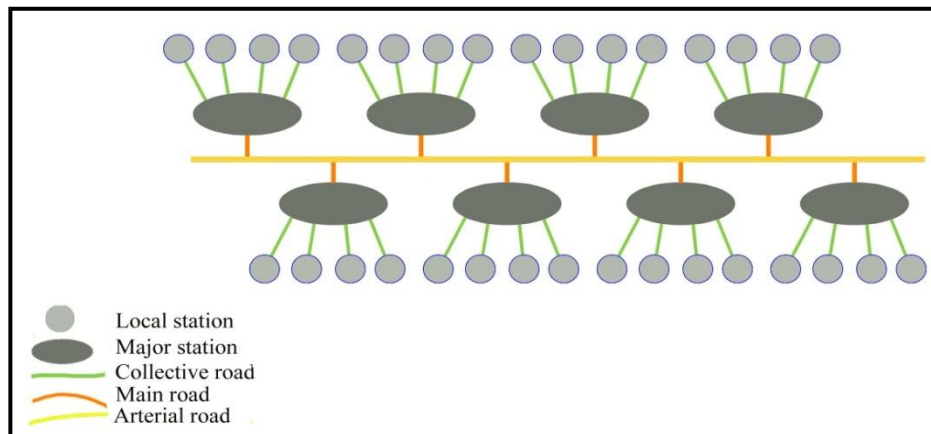

Figure (6.17); Between-districts circulation and inner city circulation (Major circulation).

2. Type of vehicles

- Using public transportation means is the main method of transit between districts and over the city.
- Public taxis (7 seats) and Microbuses (8 – 10 seats) are two types of vehicles, which distinguished by their resilience in fullness easily and they take multi foreign passengers in one trip. They stop only in the districts' stations.
- Minibuses (24 seats) are another type. They can be used between the districts that include many services especially in peak hours.
- Private vehicles are supported slightly by the approach, that they can travel over the main streets with some limitation.

3. Complete trips

- Each major public vehicle has a specific complete trip. This trip begins and ends in the same station.
- The total one trip involves two stations, that each major public vehicle has a fluctuating movement between two specific districts' stations. This pattern of movement can provide a very efficient and rapid accessibility.
- Trips for regional stations are important to be set. One trip from each district's station takes place.
- According to the total number of districts that need to be connected (17 districts) and according to the existence of regional stations (2 stations), there are nineteen total stations that relating to every district's and regional station. Then, there are eighteen trips relating to each station. These trips are considered as two-direction trips, that each trip between two major stations is relating to these two stations and there is no need to duplicate the same movement between the same major stations.

Total No. of trips for each district's station = No. of districts' station + No. of regional stations - 1

Then, Gaza City has Total No. of trips for each district's station as:
17 + 2 - 1 = 18

4. Number of public vehicles, see Figure (6.18)

- Total number of public vehicles which circulate between districts only, follow the equation:

Total No. of vehicles between districts = (Total No. of stations)*(Total No. of stations - 1) ÷ 2

Then, Gaza City needs minimum number of vehicles as:
(19 * 18) ÷ 2 = 171

- This total number can be increased according to any need for more vehicles, especially in peak hours.

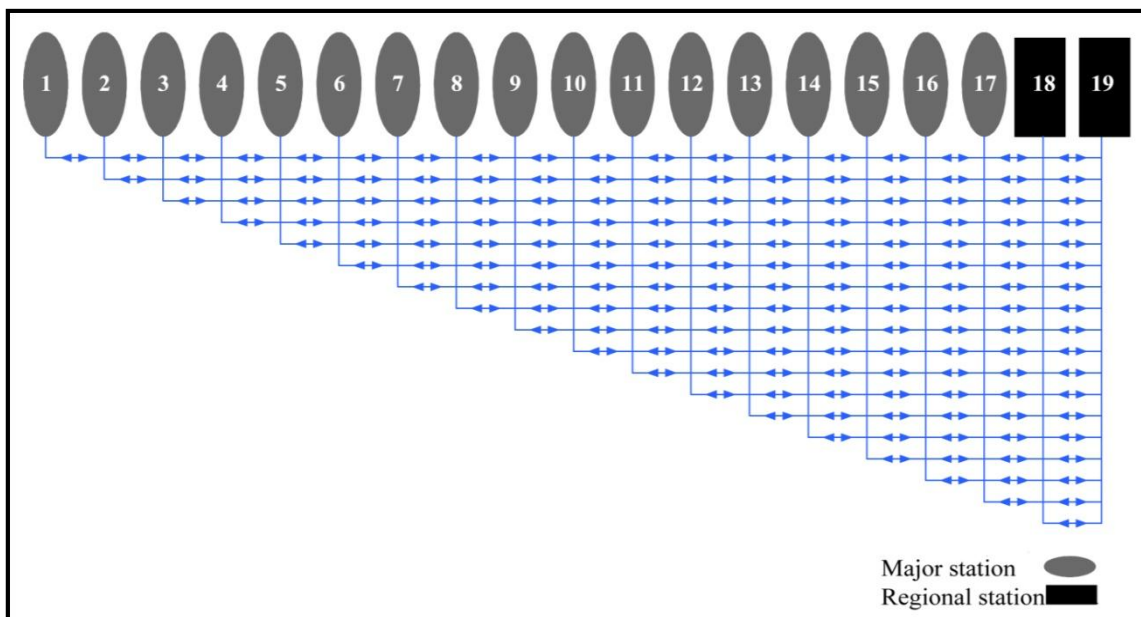

Figure (6.18); Calculating number of public vehicles of major circulations.

5. Symbol and color, see Figure (6.19)

This scale of circulation can take the sign of (M) as it represents 'Major circulation. This sign can be put on stations, streets and vehicles. Major circulation may be colored by red and this color can be used mainly on regional vehicles and symbols.



Figure (6.19); The proposed sign of major movement.

6.3.4 Regional Circulation (Global circulation)

This is the third grade of circulation system and it has the largest scale of them. It executes the connection between Gaza City and other cities, villages and refugees' camps all over Gaza Strip through the regional roads. This regional circulation and connection of Gaza City has the following characteristics:

1. Pattern of movement, see Figure (6.20)

- Gaza City is the first main urban center in Gaza Strip and there is an obvious centralization of educational, health, and administrative services in the city. This makes the city an attractive urban node. So, there is a considerable regional movement to and from the city. for passengers from all over the strip. Also, there is a considered movement from the region to all over the district. Therefore, an elaborate movement pattern is necessary to make sure that the approach can work efficiently.
- Two regional transportation stations are allocated in two sites; first is in the northern side of the city and the second is in the southern side as what admitted through the master plan and detailed plan of the area. These stations are connected with the regional roads and with the network of main roads of the city.
- The regional passenger arrive the station by regional transportation mean, which can be called global transportation mean, then take a major transportation mean according to the intended district. After that, the passenger arrive the district's station and choose a favorable mode of travel if it is local transportation mean or pedestrianism, to reach any desired neighborhood.
- The native passenger arrive the station through the proposed circulation pattern between-districts circulation (inner city circulation), and then take a global public transportation mean to transit to any desired city, village or refugee camp.
- The regional vehicles stop only on the regional station and this means that there is no any regional movement inside the city.

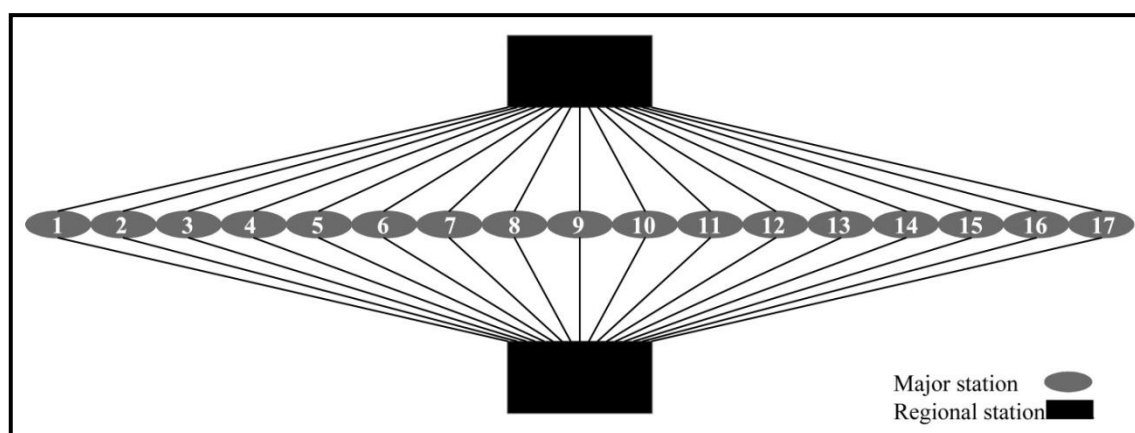

Figure (6.20); Regional Circulation (Global circulation).

2. Type of vehicles

- Using public transportation means is the main method of regional transit.
- Microbuses (8 – 10 seats) and Minibuses (24 seats) are two types of vehicles, which distinguished by their resilience in fullness easily and they take multi foreign passengers in one trip. They stop only in the regional stations.
- Buses (48 seats) are another type. They can be used between zones that include many services especially in peak hours.
- Private vehicles are supported slightly by the approach that they can travel over the regional roads with some limitation.

3. Complete trips

- Each regional public vehicle has a specific complete trip. This trip begins and ends in one of the two regional stations.
- The total one trip involves one or more regional destinations, that each regional public vehicle has a fluctuating movement between the regional station in Gaza and intended regional stations. This pattern of movement can provide a very efficient and rapid accessibility. The regional trips are classified as the following:
 1. Trip for Az-Zahra' and Al-Moghraka
 2. Trip for Jouhr Ad-Dik
 3. Trip for Al-Maghazi camp and Al-Breij camp
 4. Trip for An-Nosyrat camp
 5. Trip for Deir Al-Balah and Deir Al-Balah camp
 6. Trip for Al-Krara
 7. Trip for Khan Younis
 8. Trip for Bani Suhaila, Absan As- Sagheera, Absan Al- Kabeera and Khoza'a
 9. Trip for Rafah
 10. Trip for Jabalya
 11. Trip for Jabalya camp
 12. Trip for Beit Lahya
 13. Trip for Beit Hanon
- Every trip pass through the two main regional roads (Salah El-Din and Al Rashid Street)

4. Number of public vehicles

- Total minimum number of public regional vehicles which circulate between zones of Gaza Strip, follow the equation:

$$\underline{\text{Total min. No. of vehicles circulate between zones of Gaza Strip} = \text{total No. of regional destinations}}$$

- This total number can be increased according to any need for more vehicles to any destination, especially in peak hours.

5. Symbol and color, see Figure (6.21)

This scale of circulation can take the sign of (G) as it represents 'Global circulation. This sign can be put on stations, streets and vehicles. Regional circulation may be colored by yellow and this color can be used mainly on regional vehicles and symbols.



Figure (6.21); The proposed sign of major movement.

6.3.5 Circulation Related to the Principal Academic Institutions campuses

The cluster of universities' campuses in one area, generates a very high density movement during specific period and specially in peak hours. This movement creates tough congestion in many areas of the city. This situation is one of the hardest challenges that face the transit development. On the other hand, this can be a very important focal point for implementing Transit Oriented Development (TOD). The mode of movement has to be solved through all scales of urban planning to ensure the ideal transit system.

1. Pattern of movement

- The movement related to universities' campuses consists of local, major and global movement. Many students and workers live in the same district of universities; others live in rest districts of Gaza City and the rest live over the strip. This imposes a special situation, which need special treatment.
- The active time of the area is during the period between 7:30 am – 4:00 pm. After this period, the area becomes quite and disengaged.
- A transit station is allocated in the area of the universities. This station can be established just for the circulation of universities, or it can be the same station of the district.
- The passenger arrive the station through the proposed circulation patterns, and then take a local or major or global public transportation mean to transit to any intended area all over the strip. Then, from the intended station, the passenger can take an appropriate transportation mean to reach any specific place within

any neighborhood in any district or within any area in Gaza Strip. With inverse method, the passengers arrive the station to reach their destinations.

- The trips can serve forward the new universities' campuses in the liberated areas and Az-Zahra' City. This approach supports the daily and densely educational trips between urban areas, and universities' campuses.

2. Type of vehicles

- Using public transportation means is the main mode of educational transit to reach the cluster of universities' campuses.
- Public taxis (7 seats) and Microbuses (8 – 10 seats) are two types of vehicles, which distinguished by their resilience in fullness easily and they take multi foreign passengers in one trip. They serve the circulation within the district and between neighborhoods.
- Minibuses (24 seats) are one types of vehicles, which distinguished by their resilience in fullness easily and they take multi foreign passengers in one trip. They can be used to transit passenger during daytime and not during the peak hours. Also, it can be used for low density districts.
- Buses (48 seats) are another type. They can be used during peak hours and for regional and high-density areas.

3. Complete trips

- Each public vehicle has a specific complete trip. This trip begins and ends in the universities'.
- Four types of trips are generated in the station; between-neighborhoods trips (local trips), between-districts trips (major trips), regional trips (global trips), and educational trips.
- Between-neighborhoods trips (local trips): start from the station and go forward the local stations within the district of South Remal with the same method that is explained.
- Between-districts trips (major trips): start from the station and go forward the major station within the districts with the same method that is explained.
- The regional trips (global trips): start from the station and go forward the major station within the districts with the same method that is explained.
- Educational trips: start from the station and go forward the other universities' campuses and the new ones in the liberated areas and Az-Zahraa City.
- Every trip passes through the main and regional roads.

4. Number of public vehicles

- Calculating the total minimum number of vehicles that are needed to serve the circulation related to the university's station can be done through following the previous calculation methods.
- Between-neighborhoods (Local vehicles): depending on public taxis (4seats) and microbuses (8 – 10 seats).

$$\underline{\text{Total No. of vehicles between neighborhoods}} = \underline{\text{Total No. of stations} \div X}$$

$$X = \underline{\text{Total No. of stations for one trip} - 1}$$

X: a variable, which can vary according to the total number of stations for one trip.

If the result is not an integer number, then:

No. of rest stations ≤ 3 , then; they are combined with the last trip's vehicle

No. of rest stations > 3 , then; they must have a new trip' vehicle

- Between-districts (major vehicles): depending on minibuses (24 seats) and buses (48 seats).

Total No. of trips for each district's station = No. of districts' station + No. of regional stations

Then, Gaza City has Total No. of trips for each district's station as:

$$17 + 2 = 18$$

- Regional (global vehicles): depending on minibuses (24 seats) and buses (48 seats).

Total min. No. of vehicles circulate between zones of Gaza Strip = total No. of regional destinations

- All numbers can be increased according to any need for more vehicles to any destination, especially in high-densely areas and peak hours.

6.4 Stations Allocation by using ArcGIS and UCL Depthmap

Creating stations for each planning scale within the urban system is considered as a heart of creating a successful TOD system. The stations are the urban nodes that generate and organize the proposed circulation pattern through the all system.

As a part of implementing sustainable and smart model based on TOD, locations that are appropriate to establish stations must to be identified. This process needs obvious criteria to enhance the main principles of the approach. All aspects of determining the location stations tend toward expediting the trips and enhancing pedestrianism and public transportation.

The questionnaire showed that most people need 11-20 minutes to reach their work places. Also, the people are looking forward more improvements through the proposed approach. Then, the model seeks to connect the urban nodes with minimum distances. These distances are classified into local and major distances that each inner-city trip consists of local and major trips, or it may consists of one of them. The regional trips consist of inner-city part and regional part. Generally, the stations system is seen as a chain that concatenates the urban fabric through linear connectors. From this point, criteria are adopted to choose efficient locations for the stations. Also, each type of stations has it is own criteria of allocation.

The allocation of stations is seen as a focal point for starting a TOD project. So, this stage is proposed to be very high accurate and complementary. The allocation process consists of three steps; first is the prepared questionnaires and semi-structured interviews, and the two others are computerized applications that can held some spatial analysis depending on specific inputs. Also, each step depends on the previous ones; as follow: see Figure (6.22)

- **Firstly: Questionnaire and Semi-structured interview results analysis**
The allocation starts from the resultant records of the community and professionals.
- **Secondly: using Space Syntax UCL Depthmap version 10**
The results of questionnaire are used as inputs to apply axial and segment analysis. The application identifies the most integrated streets, then it identifies the most connective areas.
- **Thirdly: using Geographic Information System ArcGIS version 9.3**
The connective areas and some specific criteria are used as inputs on ArcGIS 9.3 to allocate a specific position for the intended station.

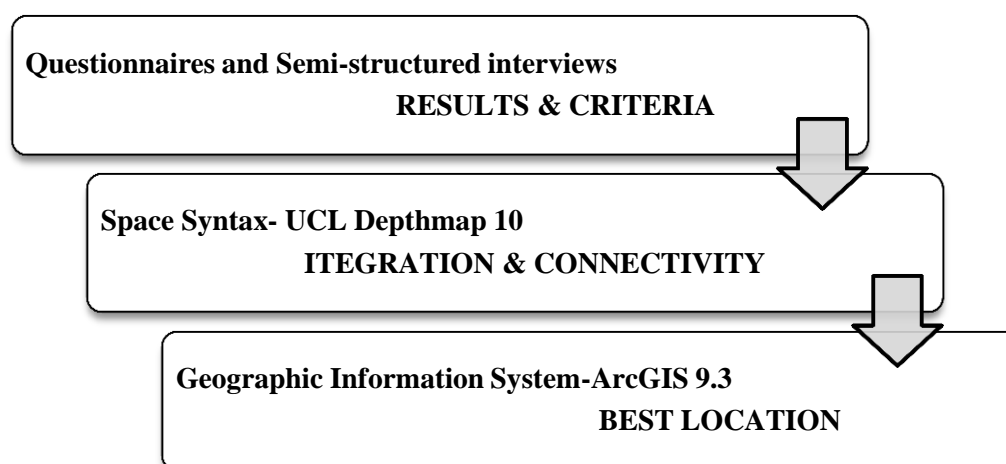

Figure (6.22); The adopted steps of stations allocation.

6.4.1 Neighborhoods' Stations (Local stations)

This is the first grade of stations system and it has the smallest scale of them. They attract all passengers as pedestrians at local movement to offer easy and fast trips to transmit them to the larger scale of urban movement. The primal mode of movement that connects the people with the major stations is the public local vehicles. The questionnaire asked about the minimum period that the people could walk toward any trip. In addition, it asked if there is any trouble in walking for 200-600 m while going on any trip. Also, the questionnaire asked if the preferred path is the shortest one with least metric distance, or the simplest one with least angular changes. From the questionnaire results, the criteria for allocation these stations are listed. Local stations have the following characteristics:

1. Spatial definition

This grade of stations involves the quick movement of vehicles and passengers that no long awaiting is expected. So, these stations are systematic surface gaps on the roads that can be considered as large and organized stop areas. The public vehicles arrive the stations and make instantaneous stop for two minutes only to load and unload passengers.

2. Allocation criteria

- Local stations are allocated on collective streets only, or on local main streets. Also, the minimum width of the street of local station is 12 m.
- It is preferable that the primal path that leads to each station to be simple and has less angular changes, than to be short and has less metric distance. See Figure (6.23) and (6.24).
- Maximum walking period from any internal parcel for the local station is 3 minutes.
- Each station has influence radius of 200-300 m that the station represents a center of buffer zone of radius of 300 m. The 300 m distance consume an average walking period of 3 minutes that;

Average speed of adults walking =

90 to 120 steps per minute = 1.0 – 1.5 m/sec. (U.S.Roads 1997)

- The distance between each two stations is 600 m to avoid overlapping in influence.
- Stations are distinguished by high accessibility for all parcels within the neighborhoods.
- Integration with the all transportation network
- Close to recreational services and mixed land uses, with maximum distance 500 m.
- All front facades of adjustment buildings are attractive for pedestrians.

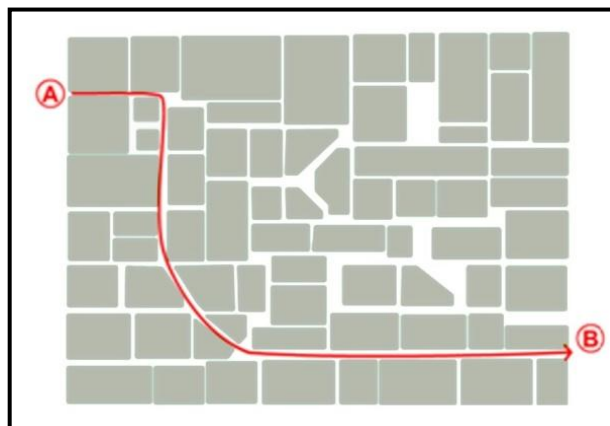

Figure (6.23); Simplest bath with less angular changes.

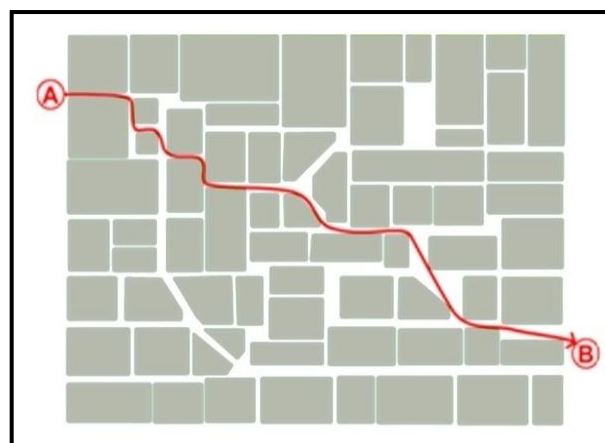

Figure (6.24); Shortest path with less metric distance.

6.4.2 Districts' Stations (Major stations)

This is the second grade of stations system and it has the medial scale of them. They gather all passengers as public or private riders to offer easy and fast public trips to transmit them to any intended district or regional station. The primal mode of movement that connects the people with the other major and global stations is the public transportation. The determination of stations location is done to ease and facilitate the major trips. The questionnaire asked about the time that is required to accomplish the main trips and from the questionnaire results, the criteria for allocation these stations are listed. Then, local stations have the following characteristics:

1. Spatial definition

The major stations are attractive places for people and business. Then, they have to be allocated with high accuracy. These stations are allocated within infill sites that appropriate to make smart development. The purpose of this effort is to demonstrate the potential for infill development to accommodate a significant portion of the development expected in the district. The districts' stations that are built within infill sites development are multi-story buildings that lodge attractive shops of retail deals, close and open recreation areas, parking and many desired services that are expected through the model. Also, they work as organizer and generator for major movement over the city. All major public vehicles have lanes and specified places to make stop to load and unload passengers.

2. Allocation criteria:

- Stations are allocated on most integrated internal local main street according to Space Syntax Depthmap Axial analysis.
- Stations are allocated on most connective area within the district according to Space Syntax Depthmap Segment analysis.
- This limitation makes each station more tempting and closer to people all over the district, even they are visitors not passengers.
- The site must be identified within Geographic Information System GIS layers provided by the Municipality as having an existing vacant or underutilized land use and identified as a potential site by city's formal agencies.
- The total area of each site has to be at least 500 m² for low-density areas, and 2000 m² for high-density areas.
- The major station serves all residents in the district, then each station has influence radius of 1700 m that the station represents a center of buffer zone of radius of 1700 m; as it is obtained from semi-structured interviews responds.
- Each major station is not far away more than 500 m from the major public services, as; community park, health and educational services, mosque, etc.
- Each major station is allocated on street with minimum width of 18 m.
- Land use designations not designated as industrial or open space.
- Major stations can be reached easily by vehicles and pedestrians.
- The site must be surrounded on three sides by existing urban development.
- Major stations are surrounded by attractive corridors that have rich frontages.
- These stations offer safe and cheap parking for private cars to encourage people to use public transportation system.
- The overlapping of influences of the stations in some areas is preferred that this situation gives people more choices and secures the large districts.

6.4.3 Regional Stations (Global stations)

This is the third grade of stations system and it has the largest scale of them. The regional stations gather all passengers as public or private riders to offer easy and fast public trips to transmit them to any intended regional destination. The primal mode of movement that connects the people with the other regional stations is the public transportation. There are two regional stations in Gaza City, one in the south area and the other is in the north area. The determination of southern regional station location is proposed through the master plan (1997) and the detailed plan of south Az-Zaitoun, which is prepared by Gaza Municipality 2012. The allocation of northern station is proposed through the model according to some criteria. These stations are established to offer an easy access to the cities, villages and refugee camps all over Gaza Strip to ease and facilitate the global trips for people and goods. Local stations have the following characteristics:

1. Spatial definition

The two regional stations are attractive large places for people and business. Also, they work as organizers and generators for regional movement over the strip that regional movement means the movement of people and goods. These stations are allocated within infill sites that appropriate to make smart regional progress and suit to the growth directions of Gaza City. The purpose of this effort is to demonstrate the potential for infill development to accommodate a significant portion of the development expected in the Gaza City for all over Gaza Strip. The regional stations are built within two infill sites on outskirts of Gaza City.

Also, they work as focal nodes for new developmental approaches for the selected areas and for city that the investment and business need strong platform to be attracted and successful. Whereat the value of any area depends basically on the overall environment, which support and integrate with the goals. Transportation systems are seen as extreme tool to attract developmental trends. In addition, transportation systems have another important factor that they have the ability to channel, direct and organize the progress through their essential function on business and housing.

Therefore, each regional station lodges the following spaces:

- Spaces for all major public vehicles, which transit people to and from all the strip, and there are lanes and specified places to make stop to load and unload passengers.
- Multi-story buildings that lodge attractive shops of retail and wholesale trade, close and open recreation areas, parking and many desired services that are expected through the model.
- Places for large shop, such as; furniture, cars, electronics.
- Places for restaurants and cafés and regional recreational services, such as; amusement park, regional gardens and nature reserves.
- Regional administrative services.
- Regional libraries.
- Places for heavy weight vehicles to load and unload goods and large stores that can distribute for all zones of the strip.

2. Allocation criteria, see Figure (6.25)

- The southern station is proposed on the master plan of Gaza City (1997) and it is allocated through the detailed plan of Az-Zaitoun district (2012). But, the northern station is allocated through the proposed model.
- Stations are connected with the regional roads to offer easy connection with the strip. Also, they are connected easily with the network of main streets because they represent joint nodes between urban scales.
- They are connected easily with the terminals and crossing points of the strip.
- They are not just physical stations, but they are new developmental areas are created by the orientation transportation model.
- Adjacent to the proposed projects that serve at the scale of the region such as Turkish hospital in the southern area of Gaza City and the new campuses.
- The northern station comprises the trips that travel to the Gaza North Governorate, and the southern station comprises the trips that travel to Middle Area, Khan Yunis and Rafah Governorate.

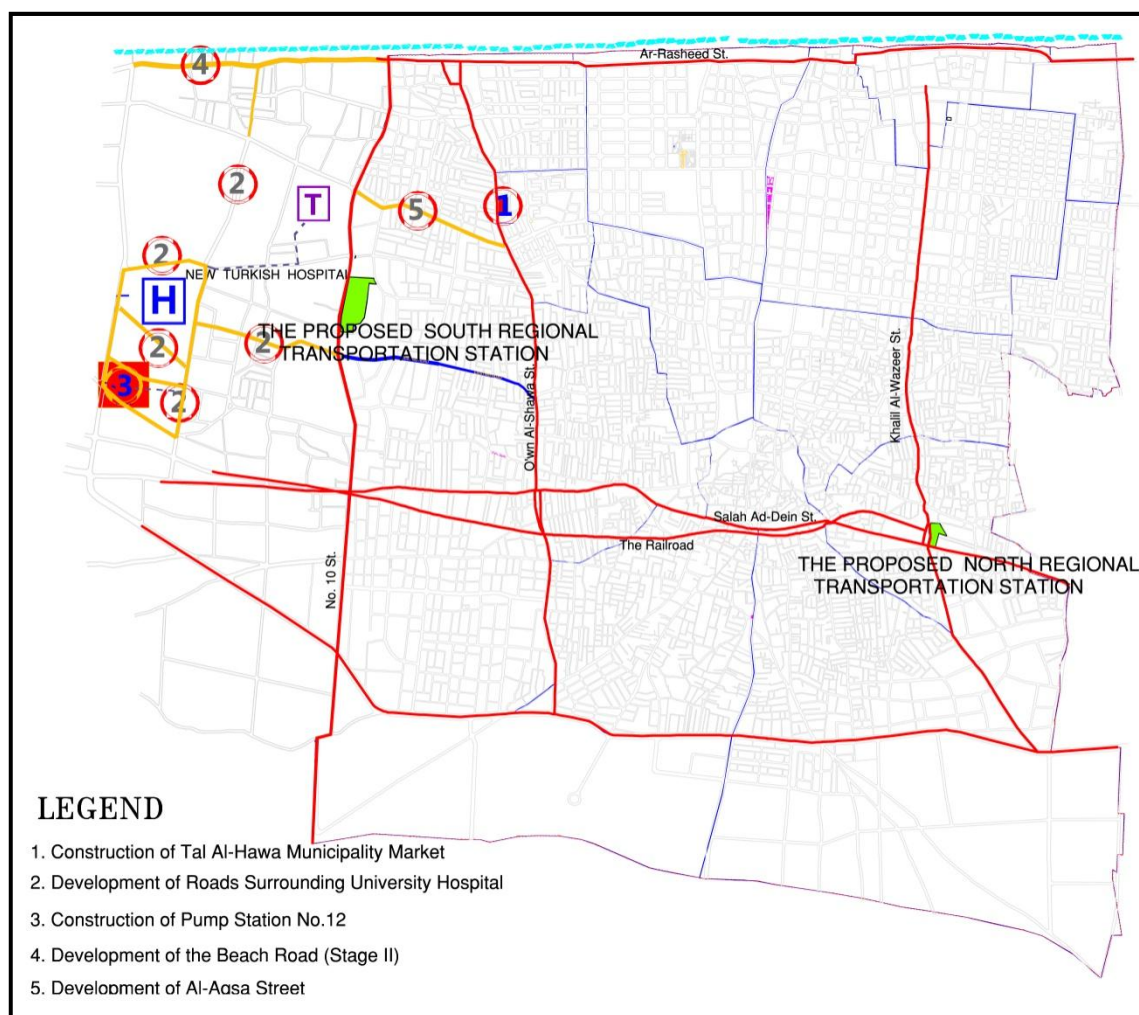

Figure (6.25); The allocation of the proposed two regional stations. (Municipality of Gaza 2009)

6.5 Urban Spaces Design

The main goal of TOD is uprising the quality of livability. This demands creating places for community life, be a key force in the revitalization of

neighborhoods, helps to create new businesses and improves access to job opportunities, and helps to make communities safer, in part by making them more comfortable and attractive.

The design of urban spaces through the proposed model considers four aspects to be taken in consideration: see Figure (6.26)

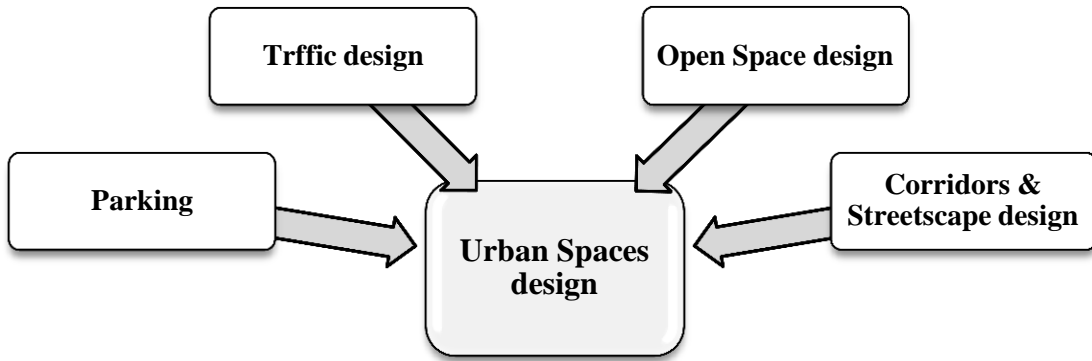

Figure (6.26); The four aspects of urban space design.

6.5.1 Traffic Design

In order to create a transit station area that encourages public transit use and TOD, the public space around stations has to be inviting and usable. Also, designing a traffic plans have to addresses the need for seamless connections between area. Stations and transit hubs is planned for upgrading the efficiency of movement and circulation by structuring and organizing an appropriate space for public vehicles to work with high efficiency. This involves the following design features:

1. Neighborhoods' stations

They include the park-and-ride activity. Therefore, they involve a traffic design that allows this mode of activity as the following Figure (6.27):

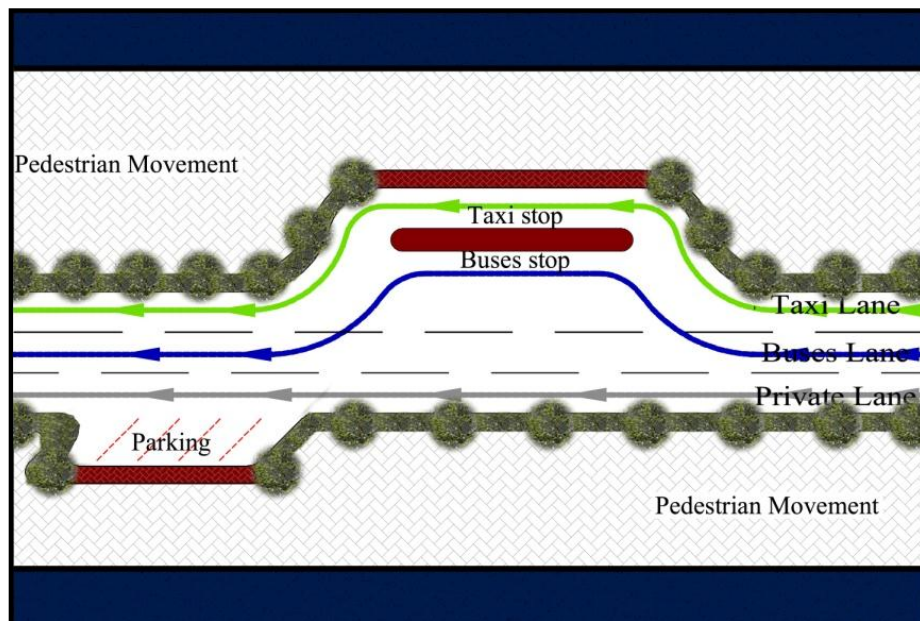

Figure (6.27); Conceptual plan of local station.

2. Districts' stations

They have to be connected with the local, major and regional scales. In addition, they have to facilitate the circulation for public, pedestrians and private modes of travel. Also, their traffic design has to host the transportation of goods as one of movement components. The traffic design of these stations can be like the following:

3. Regional stations

They are primary centers of economic, administrative and recreational activities. Also, they involve the regional-serving destinations. In addition, they have to facilitate appropriate spaces and lanes for heavy weight vehicles to satisfy the need for load and unload goods in the central stores. The movement around and in regional stations is very densely for both people and goods. Then the traffic design has to play a very important role in linking the area with the major urban structure of Gaza City and Gaza strip, and they have to attract more central activities to the proposed areas. This can direct the urban growth of Gaza City toward smart directions in order to control its urban growth. Moreover, the traffic design can effect on the value of land and investment throughout the offered accessibility and connectivity to the areas. The traffic design of these stations can be like the following:

6.5.2 Corridors and Streetscape Design

According to the result of the questionnaire and the interviews, the activities in the road are very important to encourage pedestrianism.

Then, designing the streetscape can be considered as creating the appropriate environment to practice all activities through a planned method. Also, designing the main and regional streetscape is a challenge to avoid the separation between vehicles movement and pedestrians movement, and creating the appropriate environment to practice activities. Therefore, it is essential to determine the activities in the roads carefully, in order to enhance and emphasis the new approach. The roads over the proposed approach is classified and designed as the following:

- 1. Local roads; pedestrians and bicyclists only:** see Figure (6.28)
- 2. Local roads; pedestrians, bicyclists and local private cars:** see Figure (6.29)
- 3. Collective roads:** see Figure (6.30), (6.31) and (6.32)
- 4. Local main roads:** the main roads which contain a movement for local public vehicles. see Figure (6.33)
- 5. Major main roads:** the main roads which contain a movement for major public vehicles. see Figure (6.34)
- 6. Regular regional roads:** Salah Ed-Din, Street No. 4 (Al-Karama street). see Figure (6.34)
- 7. Coastal line:** Al Rashid Street.

CHAPTER 6: Making (TOD) happens.. The implementation of a sustainable and smart urban development pattern (Gaza city)

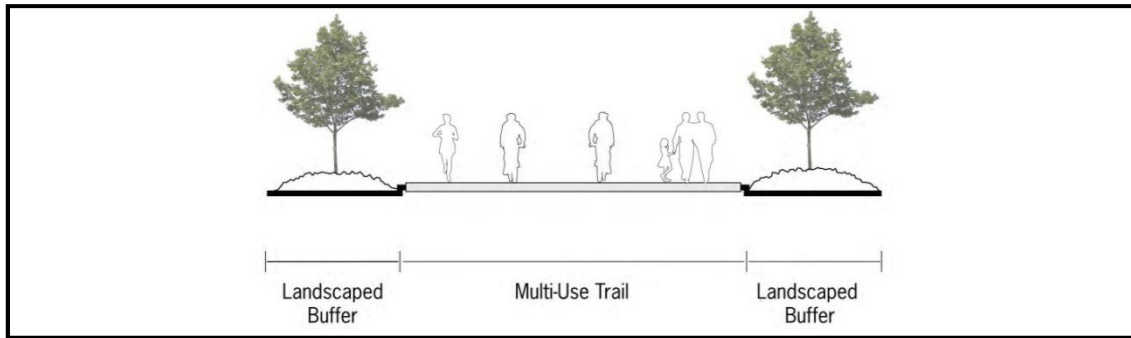

Figure (6.28); Local road; pedestrians and bicyclists only. (DC & E 2012)

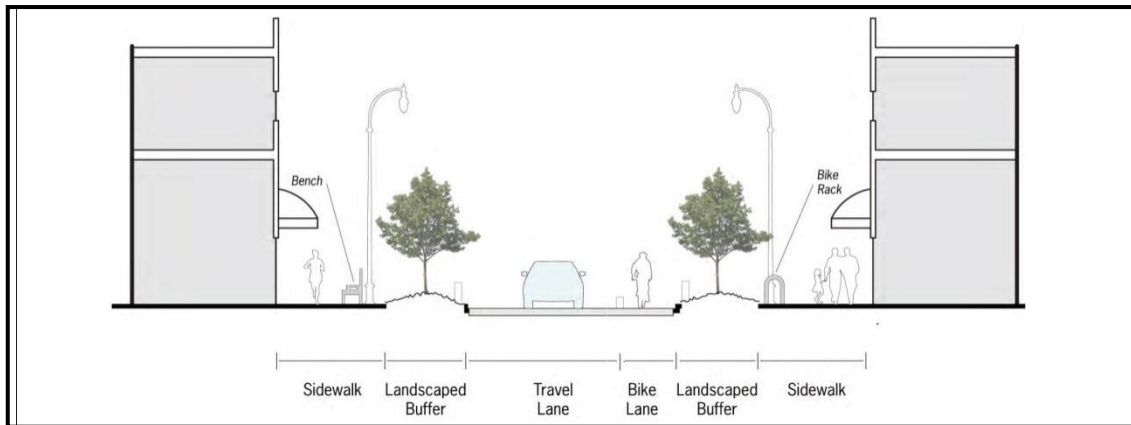

Figure (6.29); Local road; pedestrians, bicyclists and local private cars. (DC & E 2012)

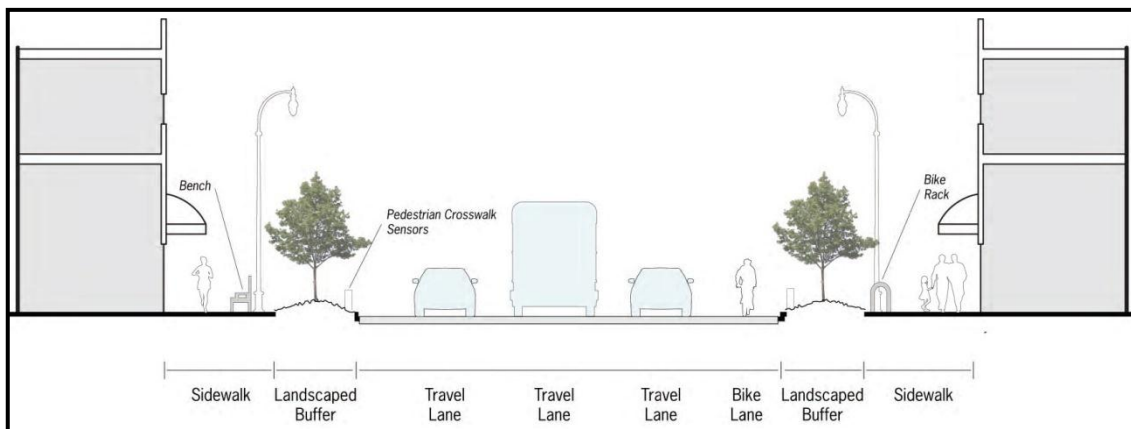

Figure (6.30); Collective one-way road. (DC & E 2012)

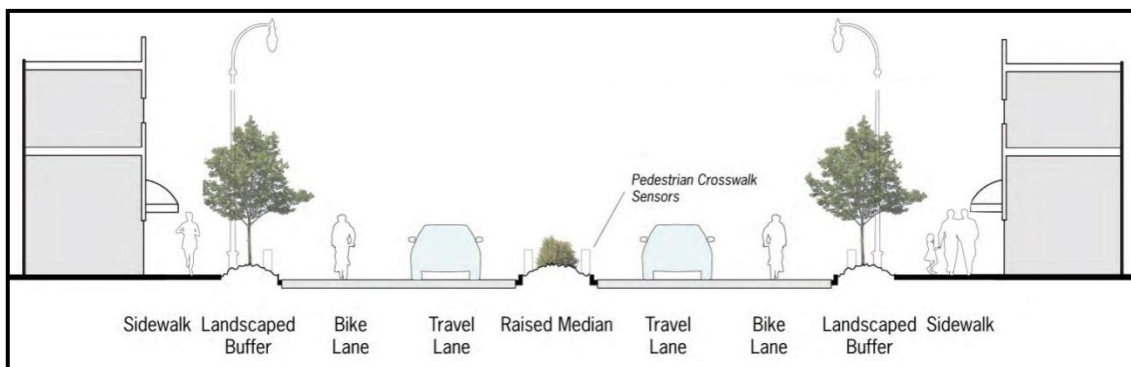

Figure (6.31); Collective two-way road. (DC & E 2012)

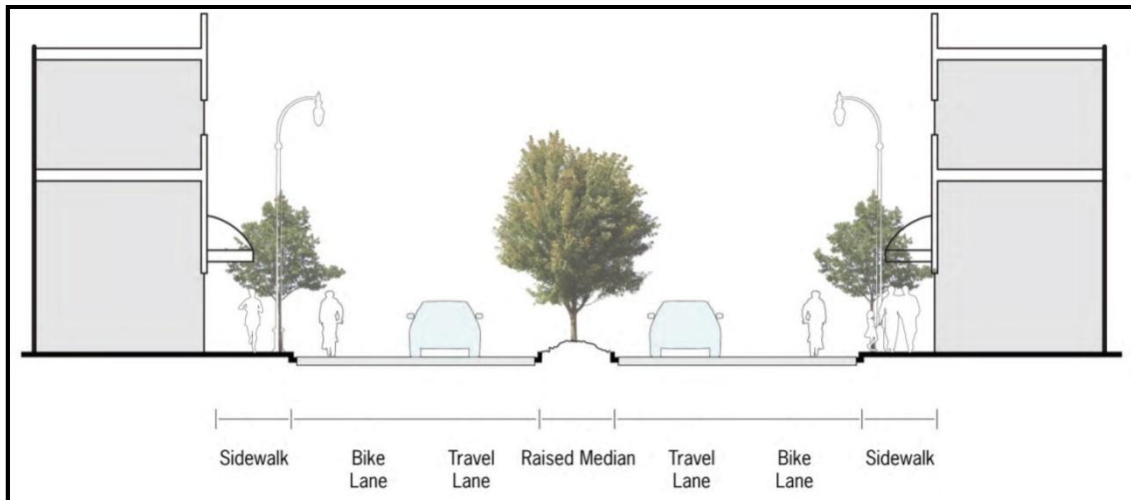

Figure (6.32); Collective two-way road 'another cross section'. (DC & E 2012)

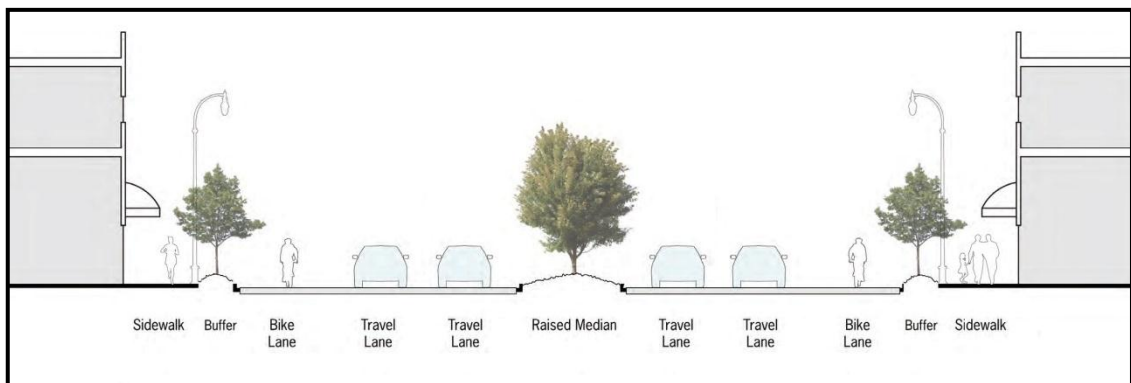

Figure (6.33); Local-main road. (DC & E 2012)

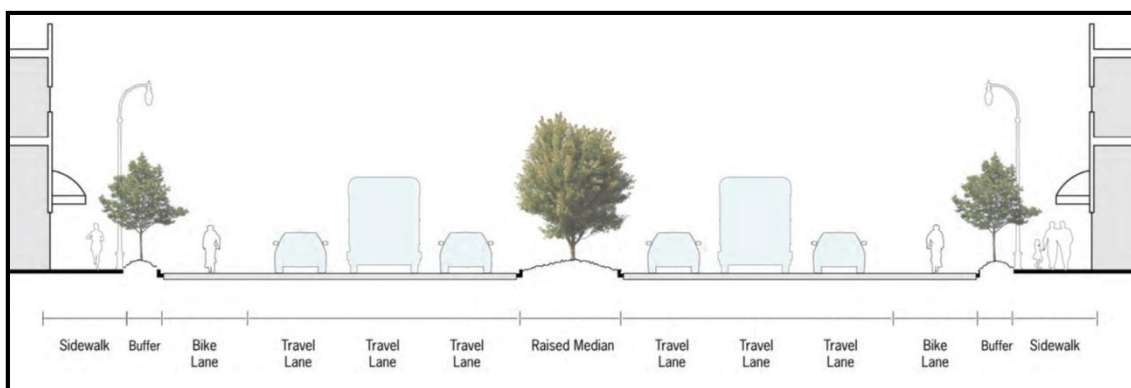

Figure (6.34); Major-main or regional road. (DC & E 2012)

6.5.3 Open Spaces Design

In addition to stations, corridors and buildings, there are different types of open spaces appropriate for TOD. The transit network should provide access to a range of different types of open spaces, from small transit plazas to large regional parks. While it is unlikely that a single station area would include a range of open space types, this typology is useful when making decisions about open spaces in station area plans. The

TOD Examples are Bay Area open spaces that are meant to illustrate the possibilities, not as examples to be replicated in every TOD location. The design of each open space should respond to site conditions, expected use patterns, and an analysis of station area open space needs. Four types of open spaces are proposed as the following:

1. Linear Transit Green Space, Figure (6.35), (6.36)

It is small and linear open space adjacent to the local station and local corridors, and it can be with defined center. It has primarily hardscape amenities for riders. It is used to support a number of station access functions and passive recreation. It can be allocated within local station areas and local corridors. (Reconnecting America 2007)



Figure (6.35); Conceptual drawing of linear transit green space. (The city of Calgary, Land Use Planning & Policies 2004b)



Figure (6.36); Conceptual drawing of linear transit green space. (Reconnecting America 2007)

2. Plaza

It is small open space usually close to station building and has primarily hardscape with some landscaped areas. It represents a destination for mix of

active to passive recreation for the residents of one district. Its area is around 400-4000 m² (Reconnecting America 2007).

3. Community park

It is medium open space usually separated from buildings by roadway. It involve mix of landscaped areas and hardscape, and mix of active and passive recreation. It represents a destination for residents from many adjutant districts. Its area is around 2000-8000 m² (Reconnecting America 2007).

4. Regional Open Space

It is large open space as part of trail system or continuous network of parks. It can involve nature reserve of the region. The regional park is primarily landscaped areas and destination for active recreation. Its area is large and unlimited with specific area (Reconnecting America 2007).

6.5.4 Parking

Parking policies in station areas should be reformed to reduce parking demand and encourage transit, walking, and bicycling. A variety of TOD supportive parking policies are exist, including transit incentive programs and TOD friendly parking design. When parking are managed poorly, they create a barrier by increasing development costs and making station access difficult. However, when they are managed well, parking can be used to create revenue for public improvements and infrastructure, as well as provide convenient access to neighborhood-serving retail and balanced access to transit stations. The proposed parking have the following forms:

- **On-Street and Surface Parking Lots**

On-street short term spaces should be provided to accommodate the local level of needed parking for residents and business. Surface parking lots should be placed to the rear of buildings with entries and windows fronting on streets and sidewalks. The size of continuous surface parking lots should be limited.

- **Shared Use and Structure Parking**

Shared parking is recommended for adjacent uses with staggered peak periods of demand. Parking structures should not be allowed to dominate the street frontage. Retail uses should be encouraged on the first floor of street fronting facades of parking structures. This type of parking can be used in the major and global stations.

- **Park-and-Ride Lots**

Park-and-Ride lots act as buffers or local stations within neighborhoods. They are adjacent mixed-use and commercial areas.

- **Landscaping**

Sufficient trees should be provided in all surface parking lots. Approximately one tree per 4 parking spaces is recommended (Anastasia, Houston, & Bromberg 2007). Landscape treatment can define the edges of parking lots and separate them from adjacent sidewalks.

6.6 Evaluation Tool and Measuring Success of TOD

Transit Oriented Development TOD as a sustainable and smart approach seeks to create an urban environment, which maximizes economic development and social equity, whilst minimizing negative externalities upon the natural environment. This section offers a strategy and calculating tool to systematically evaluate the potential success of TOD through an evaluation model. The calculator tool identifies and evaluates various indicators of the impacts of TOD, provides the results of a survey TOD indicators, and identifies evaluation model as a tool that can be used to systematically monitor and measure impacts. Moreover, it is essential to recognize this tool before starting in any TOD projects. This tool can help planners and designers to take right decisions about future outreaches. The evaluation model can be applied on the three proposed scales of TOD in any urban system.

The proposed strategy of evaluation is erected on six categories about performance criteria and TOD outcomes. Each category includes number of characters that can describe the situation. As the following Figure (6.37):

1	Travel behavior and location efficiency	<ul style="list-style-type: none"> • Transit Access • Everyday Destinations • Street Connectivity • Pedestrian and Bicycle Infrastructure • Access to Parks and Open Space • Project Location • Street Frontages • Vehicle and Bicycle Parking
2	Local income and financial return	<ul style="list-style-type: none"> • Employment Potential
3	The Natural environment	<ul style="list-style-type: none"> • Sustainable Design • Stormwater • Natural Features
4	The Built environment	<ul style="list-style-type: none"> • Mixed Land Uses • Project Density • Housing Affordability • Consistent Street Edge
5	The Social environment	<ul style="list-style-type: none"> • Housing Diversity • Community Involvement and Public Outreach • Historic Features
6	Efficient regional land use patterns and redevelopment through the policy context	<ul style="list-style-type: none"> • Universal Access

Figure (6.37); The proposed strategy of evaluation is erected on six categories about performance criteria and TOD outcomes.

CHAPTER 6: Making (TOD) happens.. The implementation of a sustainable and smart urban development pattern (Gaza city)

Each character in the aspects includes number of questions that can be asked and answered through fixed answers. The evaluation calculator model assigns a potential score to each question. Once points are assigned for each question, a scoring sheet on the evaluation model provides a weighting system that allows the user to arrive at a final number of points. This weighting reflects the priority given to the different topics. The total number of unweighted points is 59, but after the weighting is applied the total is 120. See Table (6.1)

Travel behavior and location efficiency			
A.	Transit Access		
Question 1	Is the developmental project in an area with nearby transit node that is accessible and provides regular service?		
Development Attributes		Points Available	Total Points Awarded
There is no public transit service within 300 m		0	
Most of the project is between 100–300 m of a transit corridor, station, or stop with major transit service on 30 minutes or less. Transit stops include at least one passenger amenity such as benches, passenger shelters, posted timetables, and real-time arrival information.		1	
Nearly all of the project is within 100 m of a transit corridor, or a transit stop that serves at least two different routes, with major connectivity no longer than 15 minutes on the same route. Transit stops include multiple passenger amenities.		2	
The project is immediately adjacent to a transit stop served by local and major accessibility.		3	
B.	Everyday Destination (Everyday destinations: Housing, Grocery stores, Neighborhood shopping, Restaurant, entertainment, Office, employment, Recreational, School, Health care, Mosques)		
Question 2	Is the proposed project near (300 m) existing everyday destinations?		
Development Attributes		Points Available	Total Points Awarded
The project is not near any everyday destinations.		0	
The project is near 1 or 2 everyday destinations, or it is near more than 2 everyday destinations that are between 200 and 500 m walking distance.		1	
The project is near 3 everyday destinations that are readily accessible to pedestrians and bicyclists.		2	
The project is near 4 or more everyday destinations that are readily accessible to pedestrians and bicyclists.		3	
C.	Street Connectivity		
Question 3	Is the project in an area that distinguished by high levels of street connectivity for vehicles, bicyclists, and pedestrians (within 300 m walk distance)?		
Development Attributes		Points Available	Total Points Awarded
Only one or two arterial roads connect the project to surrounding areas. Most circulation in the project area is channeled onto one or two collector roads. Many streets do not include bicycle facilities or traffic calming measures that would facilitate use by pedestrians and bicyclists.		0	
The street network in the project area has some internal connectivity. Most streets in the area are designed for vehicle speed 40 km/h or less, and every street is designed to accommodate vehicles and pedestrians.		1	
Most parts of the internal street network in the project area are a highly		2	

CHAPTER 6: Making (TOD) happens.. The implementation of a sustainable and smart urban development pattern (Gaza city)

connected grid. All streets are designed for vehicle speeds of 40km/h or less, and every street is designed to accommodate pedestrians. The project either provides or supports the inclusion of striped bicycle lanes on all streets or a separate bicycle path serving the same destinations.			
The project area has an internal street network that is a highly connected grid. Major thoroughfares are closely spaced so that each one requires fewer lanes. All streets are designed for vehicle speeds of 40 km/h or less, and every street is designed to accommodate pedestrians. The project either provides or supports the inclusion of striped bicycle lanes on all major streets or a separate bicycle path serving the same destinations.		3	
D.	Pedestrian and Bicycle Realm		
Question 4	Does the project provide adequate sidewalks, pedestrian-friendly streetscapes, bicycle facilities, and a safe environment for pedestrians and bicyclists?		
Development Attributes		Points Available	Total Points Awarded
Few or no sidewalks and no bicycle facilities are provided in the project.		0	
Every street in the project has a sidewalk on both sides, with a width of at least 1.5 m for an unobstructed through-way zone and a planted area between the through-way zone and curb on major streets. Shared or separated bicycle facilities are provided on major streets. The project improves the streetscape by providing some street trees or a landscaped center median.		1	
Every street in the project has a sidewalk on both sides, with a width of at least 2.5 m on local and major streets and a planted area between the through-way zone and curb on major streets. Shared or separated bicycle facilities are provided on all streets. Pedestrian safety is improved by providing high-visibility crosswalks with curb bulb-outs to reduce crossing distances, and sidewalks are well lightened at night. Closely spaced street trees with a broad, leafy canopy provide shade for pedestrians or in the median of most streets.		2	
Pedestrians are treated as a priority in the project. Every street in the project has a sidewalk on both sides, with a width of at least 3.5 m on major streets; or, rather than providing sidewalks, some streets are designed so that pedestrians can safely and comfortably share the entire road with slow-moving vehicle traffic. Separated bicycle facilities are provided on all local and major streets and shared facilities are provided on other streets. The through-way zone on sidewalks has a smooth surface and is free of obstructions. Sidewalks are well lightened at night. Closely spaced street trees with a broad, leafy canopy provide shade for pedestrians on all streets. Additional pedestrian safety measures are included, such as refuge islands in the street median at crosswalks. Attractive, pedestrian-oriented street furniture, such as benches and trash cans, is also provided.		3	
E.	Access to Parks and Open Space		
Question 5	Is the project in an area with nearby parks and/or private open space that is accessible and provides opportunities for outdoor recreation?		
Development Attributes		Points Available	Total Points Awarded
No active parks or plazas are located within a safe (no to physical barriers or unsafe road crossings) 500 m walking distance of the project.		0	

CHAPTER 6: Making (TOD) happens.. The implementation of a sustainable and smart urban development pattern (Gaza city)

	The project is within a safe 800 m walk of an active park or plaza	1	
	The project is within a safe 500 m walk of an active park or plaza	2	
	The project is within a safe 300 m walk of an active park or plaza	3	
F.	Project Location		
Question 6	Would the project provide infrastructure to support private development that reinforces and logically extends existing and planned development?		
Development Attributes		Points Available	Total Points Awarded
The project is adjacent to a previously undeveloped site and has developed areas on two or fewer sides.		0	
The project is adjacent to a previously undeveloped site, but there is existing development on three or more sides.		1	
The project is adjacent to a previously developed site and has developed areas on three or more sides.		2	
The project is adjacent to a previously developed site, has developed areas on three or more sides and is located within a larger scale of smart growth and TOD project.		3	
G.	Street Frontages		
Question 7	Is the project in a location where there are already visually interesting street frontages?		
Development Attributes		Points Available	Total Points Awarded
There is a blank wall on street-facing façades. Building frontages are visually monotonous and are dominated by opaque materials.		0	
The façades of large buildings with long street frontages are broken into smaller modules. Transparent window openings are provided at street level.		1	
Building façades include details and ornamentation that add visual relief and are appropriate to the building's architectural style. Durable and high-quality materials are used to enrich façades. Transparent window openings are provided at street level.		2	
Building entrances and frontages provide awnings, canopies or arcades that offer shade and weather protection for pedestrians. Durable and high-quality materials are used to enrich façades. The façades of large buildings with long street frontages are broken into smaller modules. Transparent window and door openings are provided at street level. Some ground-floor frontages are designed to allow for outdoor seating for restaurants and cafés.		3	
H.	Vehicle and Bicycle Parking		
Question 8	Does the project include parking improvements that are designed and located to maintain safe pedestrian-friendly streets and to meet the needs of bicyclists?		
Development Attributes		Points Available	Total Points Awarded
No on-street vehicle or bicycle parking is provided.		0	
On-street vehicle parking or bike lane creates a buffer between pedestrians and vehicle traffic. Limited on-street bicycle parking is available.		1	
On-street vehicle parking or bike lane creates a buffer between pedestrians and vehicle traffic. Landscaped areas or other planted areas are incorporated into the on-street parking. On-street bicycle parking is provided near most building entrances, using racks that can support the bicycle's frame at two points.		2	
On-street vehicle parking or bike lane creates a buffer between		3	

CHAPTER 6: Making (TOD) happens.. The implementation of a sustainable and smart urban development pattern (Gaza city)

pedestrians and vehicle traffic. Landscaped areas or other planted areas are incorporated into the on-street parking. An innovative strategy such as back-in angled parking is used to minimize conflicts between different modes of travel. On-street bicycle parking is provided near almost all building entrances, using racks that can support the bicycle's frame at two points.			
Local Income and Financial Return			
I.	Employment Potentiality		
Question 9	Would project construction or implementation positively impact employment opportunities within the community?		
Development Attributes		Points Available	Total Points Awarded
The project would eliminate, destabilize, or have no effect on existing employment opportunities.		0	
The project would stabilize and/or maintain existing community employment opportunities and/or provide planned and funded job relocations.		1	
The project would create permanent and/or construction jobs available to the community.		2	
The project would create permanent jobs that provide “living wages” based on local standards and are available to the community.		3	
The Natural Environment			
J.	Sustainable Design (Sustainable Design means: Construction waste reused or recycled, Landscaping that minimizes the use of water, Trees and shade structures provide shade for buildings and paved areas, Energy-efficient building design, Recycled or renewable materials, Green roof, Roof designed to reduce heat island effect, Locally-sourced materials)		
Question 10	Does the project and any private development it would support incorporate sustainable design in its construction and operation?		
Development Attributes		Points Available	Total Points Awarded
The project does not take special measures to incorporate sustainable design		0	
The project uses at least two of the measures listed above to incorporate sustainable design.		1	
The project uses at least three of the measures listed above to incorporate sustainable design.		2	
The project uses at least four of the measures listed above to incorporate sustainable design.		3	
K.	Natural Features		
Question 11	Do the project and any private development it supports respect the site's original topography and natural features?		
Development Attributes		Points Available	Total Points Awarded
New landscaping, grading or paving eliminates existing natural features, including mature trees and open space areas.		0	
The site has no significant natural features OR some existing natural features are preserved including some mature trees.		1	
Some existing natural features including most mature trees and some open space areas are preserved and highlighted as public amenities. Most of the site's finished topography retains the appearance of natural contours.		2	
The project restores natural features to the landscape - for example; by daylighting a creek or reconstructing a portion of a wetland. Nearly all		3	

CHAPTER 6: Making (TOD) happens.. The implementation of a sustainable and smart urban development pattern (Gaza city)

mature trees and some open space areas are preserved. All of the site's finished topography retains the appearance of natural contours.			
L. Stormwater			
Question 12	Does the project and any private development it would support provide innovative on-site treatment for stormwater?		
Development Attributes		Points Available	Total Points Awarded
The project complies with all applicable stormwater pollution prevention requirements.		0	
The project exceeds storm water requirements through on-site rainwater collection, pervious pavement, or other means of slowing the release of rainwater.		1	
The project exceeds stormwater requirements through on-site rainwater collection, pervious pavement, or other means of slowing the release of rainwater and reuses grey water onsite for irrigation and other uses.		2	
The project exceeds stormwater requirements through on-site rainwater collection, pervious pavement, or other means of slowing the release of rainwater and reuses grey water onsite for irrigation and other uses. Also, expands the capacity of the existing network by using constructed wetlands and other techniques to purify grey and/or black water for irrigation and other uses.		3	
The Built Environment			
M. Mixed Land Uses (Mix land uses: Single-family housing, Multi-family housing, Retail, Office/Employment, Recreation, Education/Institution)			
Question 13	Is the project in an area that provides a variety of land uses (within 500 m walk)?		
Development Attributes		Points Available	Total Points Awarded
The project area includes a single land use		0	
The project area includes two land uses		1	
The project area includes three land uses		2	
The project area includes four or more land uses		3	
N. Project Density (low, moderate, high densities is defined according to the formal institutional limitations)			
Question 14	Is the project in an area (within 300 m walk) exhibiting a smart growth pattern of development intensity?		
Development Attributes		Points Available	Total Points Awarded
The project is located in an area that is developed at a low density for 50% or more of its area.		0	
The project is located in an area that is developed at a moderate density, including at least 50% housing.		1	
The project is located in an area that is developed at a high density including at least 50% housing.		2	
The project is located in an area that is developed at a high density including at least 50% housing. It is in a core area, such as a downtown, AND is of the highest density found in the community.		3	
O. Housing Affordability			
Question 15	Would the project support new private development that includes affordable housing?		
Development Attributes		Points Available	Total Points Awarded
The project would not support significant new development, or the		0	

CHAPTER 6: Making (TOD) happens.. The implementation of a sustainable and smart urban development pattern (Gaza city)

private development includes only market			
At least 20% of the housing in the new private development would be affordable to moderate income households.		1	
At least 20% of the housing in the new private development would be affordable to low or very low income households.		2	
The housing in the new private development would be affordable to a range of household income levels, with a minimum of 20% moderate, 20% low, and 20% very low.		3	
P.	Consistent Street Edge		
Question 16	Is the project in a location where buildings already create a consistent street edge to facilitate pedestrian use?		
Development Attributes		Points Available	Total Points Awarded
Buildings are not oriented toward the street and provide no clear pedestrian connection to the street.		0	
Buildings are oriented toward the street or provide a clear pedestrian connection to the street. Most vehicle entrances, parking lots and loading docks are located behind buildings.		1	
Buildings and their main entrances are oriented toward the street and maintain or define setback/build-to lines that are close to or adjacent to the sidewalk. Vehicle entrances, parking lots and loading docks are located behind buildings.		2	
Buildings and their main entrances are oriented toward the street and maintain or define setback/build-to lines that are close to or adjacent to the sidewalk. Vehicle entrances, parking lots and loading docks are located behind buildings. Where buildings step back from the build-to line, attractive landscaping is provided. All vehicle entrances are located behind or on the sides of buildings.		3	
The Social Environment			
Q.	Housing Diversity (Single family detached, Small lot single family detached housing, Single family attached, Townhouses, Apartments, Senior housing)		
Question 17	Is the project located in an area that has a diverse array of housing types?		
Development Attributes		Points Available	Total Points Awarded
The project is in an area with no housing or a single type of housing.		0	
The project is in an area with two types of housing.		1	
The project is in an area with three types of housing.		2	
The project is in an area with four or more types of housing.		3	
R.	Community Involvement and Public Outreach		
Question 18	Has the project been designed with public input, and do any future design phases include a strategy for community involvement and public outreach?		
Development Attributes		Points Available	Total Points Awarded
Little or no community involvement strategy or public outreach efforts.		0	
Project was/will be developed through an inclusive and collaborative planning process with community stakeholders.		1	
Project was/will be developed through an inclusive and collaborative planning process with community stakeholders, and support and involvement from local agencies, transit operator(s), and/or community stakeholders, documented through support letters or public statements.		2	

CHAPTER 6: Making (TOD) happens.. The implementation of a sustainable and smart urban development pattern (Gaza city)

S.		Historic Features	
Question 19	Is the project in an area that supports the reuse and rehabilitation of historic buildings?		
Development Attributes		Points Available	Total Points Awarded
Historic and/or usable buildings have been demolished.		0	
Some existing usable buildings have been rehabilitated and reused.		1	
Most existing usable buildings have been rehabilitated and reused, and historic buildings have been at least partially restored.		2	
There is significant rehabilitation and improvement of existing buildings, extending their usable life. Historic buildings are fully restored.		3	
Efficient regional land use patterns and redevelopment through the policy context			
T.		Universal Access	
Question 20	Does the project and any private development it would support and provide access for all people, regardless of their level of mobility?		
Development Attributes		Points Available	Total Points Awarded
The project meets the requirements of mobility over a local and minimum scale of urban fabric or provides access to people with disabilities.		0	
The project exceeds some requirements for accessibility-for example; by providing separate access ramps that are wider than required.		1	
The project exceeds accessibility requirements and incorporates some elements of universal design, such as step-less paths and accessible features that are not specifically marked, but make the project accessible to all.		2	
The project fully adheres to the principles of universal design, providing access for people of all levels of mobility throughout the project and connecting to adjacent development.		3	

Table (6.1); The evaluation model of measuring TOD success.

After filling the evaluation model, the awarded points have to be weighted to calculate the total weighted points and then grant the total points awarded to the project. To calculate the project's final score, points that awarded for each category have to be listed in the first column below. If a category is scored as 'not relevant', the cell can be filled with an 'NA'. For all categories that were relevant, the row has to be completed, the points have to be multiplied to get the total weighted points. This process can be done according to the following Table (6.2):

CHAPTER 6: Making (TOD) happens.. The implementation of a sustainable and smart urban development pattern (Gaza city)

Development character		Points available	Points awarded	Weight	Total weighted points
Travel Behavior					
A.	Transit Access	3		3	
B.	Everyday destinations	3		2	
C.	Street Connectivity	3		2	
D.	Pedestrians and Bicycle Realm	3		2	
E.	Access to Parks and Open Space	3		2	
F.	Project Location	3		3	
G.	Street Frontages	3		1	
H.	Vehicle and Bicycle Parking	3		2	
Local Income and Financial Return					
I.	Employment Potential	3		1	
The Natural Environment					
J.	Sustainable Design	3		3	
K.	Natural Features	3		1	
L.	Stormwater	3		2	
The Built Environment					
M.	Mixed Land Uses	3		3	
N.	Project Density	3		3	
O.	Housing Affordability	3		3	
P.	Consistent Street Edge	3		1	
The Social Environment					
Q.	Housing Diversity	3		2	
R.	Community Involvement and Public Outreach	2		3	
S.	Historic Features	3		1	
Efficient regional land use patterns and redevelopment through the policy context					
T.	Universal Access	3		1	
SCORE					
TOD Evaluation		Total Points Available	Total Points Awarded	Weighted Points Available	Grand Total Points
		59		120	

Table (6.2); The score sheet of evaluation model.

The previous tables can be changed according to some special criteria that relate to the area and project. Also, these tables are entered and functioned on Excel format to be used in other cases and models.

The thesis produces a calculator as one of the software outputs of it. The calculator is on (*.lsx) format as Excel file that include all evaluating model and calculating models. This calculator can be used to evaluate any urban system, if it is established or proposed.

CHAPTER 7

MAKING (TOD) HAPPENS ..

THE DETAILED PRACTICE OF THE IMPLEMENTATION

(South Remal District)

- 7.1** Introduction
- 7.2** Limitation of Study Area
- 7.3** Challenges and Opportunities Facing Development
- 7.4** Methodological Framework
- 7.5** Space Syntax Analysis using UCL Depthmap v.10
- 7.6** Geographic Information System Analysis using ArcGIS v.9.3
- 7.7** Outputs and Comments

7.1 Introduction

One district of Gaza City is chosen to apply the proposed model. It represents a sample to make a smart and detailed computerized urban pattern. All theoretical background, questionnaire and semi-structure interviews results are used as inputs on two computerized applications. Scenarios are set to achieve alternatives that can be evaluated to chose the best one.

7.2 Limitation of Study Area

Southern Remal district is chosen as the study area and it is limited through the following points:

7.2.1 Boundaries, see Figure (7.1)

- Omar Al-Mokhtar Street in north.
- Al-Qahera street in south.
- Al-Jala'a and Al-Aqusa Street in east.
- Al-Rasheed Street in west.

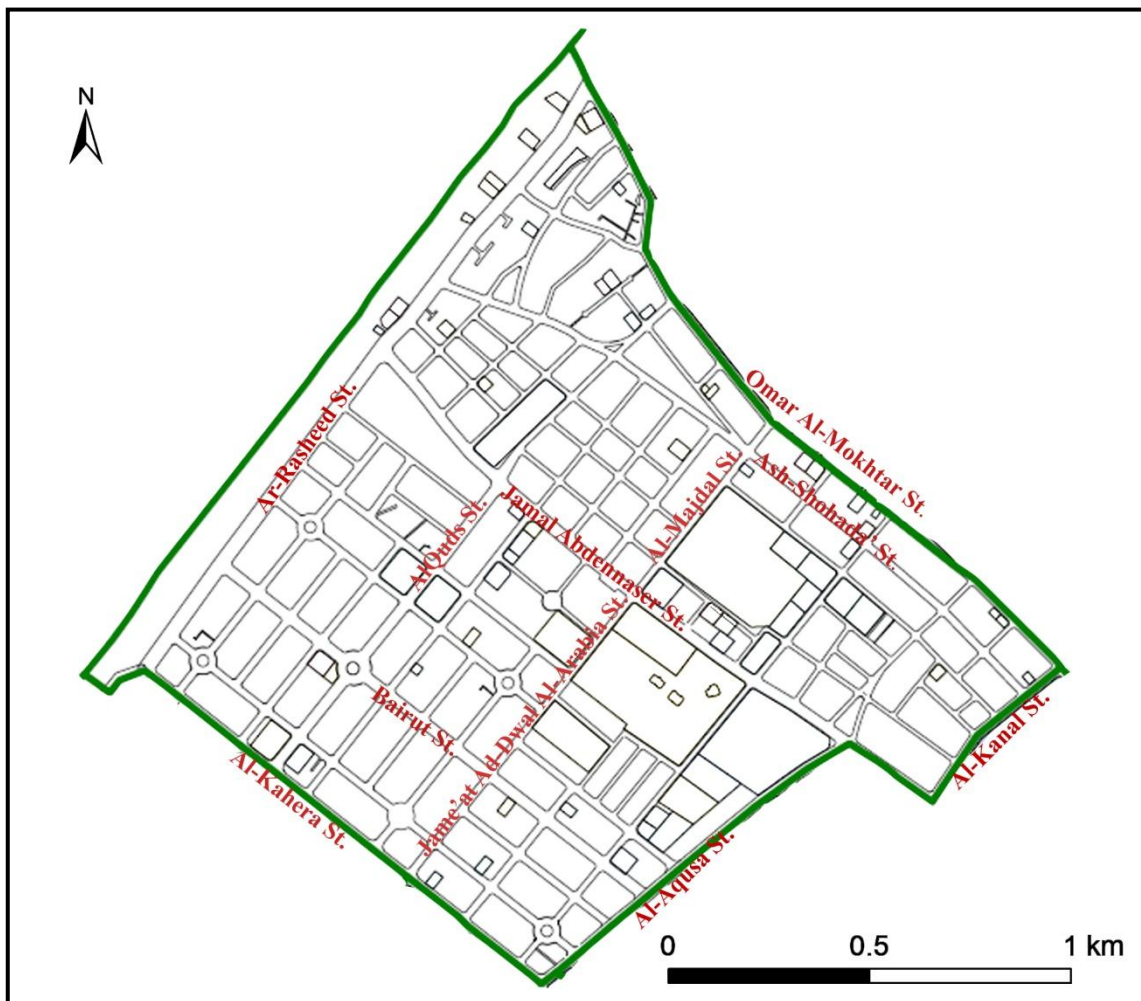

Figure (7.1); South Remal district's boundaries and its most important streets.

7.2.2 Urban Content

The area is characterized by high densely urban fabric. This situation is return to the existence of the following urban elements:

- Eleven schools serve the area, and they vary between primary and secondary schools.
- The most influential node in the area is represented by the existing of the three major universities' campuses in Gaza Strip; The Islamic University, Al-Azhar University and Al-Aqusa University.
- The United Nations headquarter and the Gaza training center are located in the area.
- Three health care service buildings are located in the area.
- High densely residential building are located in the area, such as; high rise-buildings and multi-story-buildings.
- Public administrative and official buildings are located in the area, such as; ministries, embassies, banks, General Personnel Council, and many other governmental and non-governmental administrative agencies.
- Public services and NGO's official buildings are located in the area, such as; Paltel, CHF, IHH, Al Wedad association, and many other governmental and non-governmental services agencies.
- Public cultural buildings are located in the area, such as; British council, French cultural center, Orthodox cultural center, and many other governmental and non-governmental cultural agencies.
- One petroleum station is located in the area.
- Central police and security services are located in the area, such as; Arafat political city, Al-Abbas police center.
- No any industrial buildings are located in the area, which give an advantage to urban environment.

7.2.3 Streets and Transportation Network

The area involve very influential roads that serve at the scale of Gaza City and Gaza strip, this situation can be described as the following:

- Two arterial roads pass through Southern Remal district; Al-Rasheed Street and Omar Al-Mokhtar Street.
- The area can be considered as the only entry for Tal Al-Hawa distric. The entry is through the only two roads; Al-Aqusa Street and Jameat Al-Dwal Al-Arabia Street.
- The area can be considered as a new urban area in Gaza City that it has not any of the characters of old cities.
- The streets are formed and organized on a grid system. This formation gives advantages and resilience on developing and applying and new approach.
- There is a wide variety in pavement condition index (PCI). This situation offers an indicator about local and collector streets.
- Most streets in the area are provided with lighting features and trees.

7.3 Challenges and Opportunities Facing Development

The area involves some internal characters that represent challenges or opportunities facing and developmental approaches. This situation may provide weakness or strength as the following:

7.3.1 Challenges

There are many challenges face the developmental contributions that may be implemented in the South Remal district; as the following:

- This clustering of major and regional services creates a loaded urban fabric, which conduces to a very hard charge on infrastructure and streets network, and causes a tough congestion especially during peak hours.
- There is a big load on transportation network due to existence of the major and regional services, such as; three universities campuses. Site observation shows that huge number of people enter the area every day and especially at peak hours (7:30-8:00 am) and (3:00-3:30 pm).
- The area involves the both entrances of Tal Al-Hawa, which includes more than 80 high-building with approximately 2000 apartments. Then, all residents and passengers whom related to Tal Al-Hawa have to pass through the intended area while going on any trip. This situation maximizes the load on the urban network of the area.
- The area represents the only entrance of regional trips that go towards Gaza City. These regional movements is not organized, and exaggerate the load on urban network of the area.
- The official agencies and associations that located in the area require a special treatment to the circulation and movement.

7.3.2 Opportunities

Many opportunities may help and support the developmental contributions that can be implemented in the South Remal district; as the following:

- During the war of Gaza on 2008-2009, the building of Convention of Ministries was destroyed completely. The area of the building becomes vacant and this action reduces the loaded of circulation that is related to the existence of such huge building. Also, this accident gives the planners and developers a very important and unique chance to correct a fetal mistake that is represented in establishment of these loaded urban element in this place.
- There is a serious aspiration of formal and governmental authorities to build a developmental project to serve the situation of congestion and crowd in the area.
- The grid formation of streets network offers many advantages of comprising a new developmental approaches.
- Any developmental project in the area can upraise the value of investment and can attract businesses to be found and success in the area.

7.4 Methodological Framework

The proposed pattern is a detailed system and plan that is established in the light of the mentioned comprehensive model of Gaza City, then; It can be considered as a completion stage. It comprises using all collected data as inputs to build a computerized model, then make some analysis to be done.

The fundamental stage of implementing such project is represented in allocation of stations. So, this stage has to be done accurately with high efficient method. The allocation process consists of three steps; first is the prepared questionnaires and semi-structured interviews, and the two others are computerized applications that can held some spatial analysis depending on specific inputs. Also, each step depends on the previous ones; as follow:

- **Firstly:** Questionnaire and Semi-structured interview results analysis
- **Secondly:** using Space Syntax UCL Depthmap version 10
- **Thirdly:** using Geographic Information System ArcGIS version 9.3

The allocation process has two aspects; first is the allocation major station, and second is the allocation of local stations. This core is satisfied according to many indicators and criteria. These indicators and criteria have various degrees of importance according to the special point of view. For this situation, scenarios are set to serve the target that the degree of importance varies from one point of view to another.

7.4.1 Objective of the Pattern

There is a main objective that is intended to be acquired through all methodological tools. This objective is:

- **Building a smart and sustainable urban model based on Transit Oriented Development.**

This demands a transit system that serves this approach, and demands some decisions to be made.

7.4.2 Decisions

Any transit system involves two main components; stations and corridors. The starting point to build such transit system assumes one of these components. According to the results of semi-structured interviews, 84% of the professionals see that the starting point of any transit system has to be allocation and design of transit stations. This tendency imposes decisions to be made about efficient allocation of required stations. Two decision are made:

1. **Allocation of a major transportation station:** connects the district with other districts and with regional stations
2. **Allocation of local transportation stations:** connect all neighborhoods within the district with each other and with major station.

These decisions need criteria to be defined. The decision needs to be based on efficient location for both major and local transportation stations. These locations is considered as variables that based on invariable criteria.

7.4.3 Approach's progress

The pattern is built through consecutive stages: see Figure (7.2)

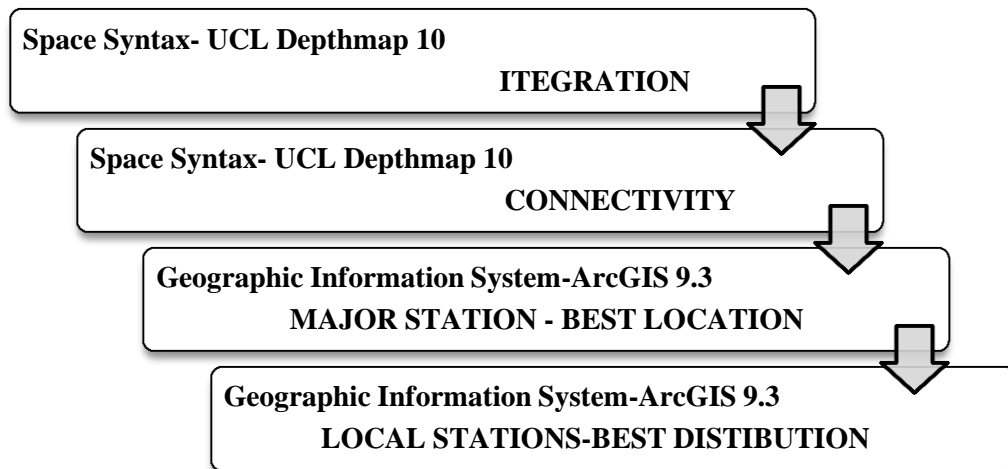

Figure (7.2); The consecutive stages of building the approach.

7.5 Space Syntax Stimulation using UCL Depthmap v.10

The purpose of using Space Syntax measures is to calculate the level of accessibility of street segments from all other street segments within the intended area as a complete spatial system. This analytical approach is done to identify two characters that distinguish each street in the internal streets network according to the axial representation of them;

- **Integrated**
- **Connectivity**

This analysis has two aspects to be taken in consideration:

- The interrelation between the streets in the internal network of the district.
- The interrelation between the internal streets and the arterial streets of the Gaza City that connect all districts with each other and connect the intended area with the regional stations.

7.5.1 Procedures of Generating an Axial Map for the Intended Area

Before starting Space syntax techniques, it is essential to generate an axial representation to the intended area. The axial map is a network of intersecting axial lines. In simple terms, the axial map is represented by the longest lines of sight that can be used to characterize every street segment; as in Figure (7.3). The axial map can be presented as a graph; the lines of the graph represent the streets and the nodes represent the intersections of the streets. To convert any map into an acceptable format on UCL Depthmap, the following procedures are done.

- The plans and maps that related to the thesis are gained from the governmental institutions as a CAD files.

- An axial map is drawn by using AutoCAD application to make the needed map ready for use in space syntax application.
- The CAD drawing is saved as AutoCAD R12/LT2DXF (*.dxf) to make it ready to be imported in space syntax application.
- A graph file is created by The CAD file is importing the CAD file in UCL Depthmap.
- An axial map is created by converting the graph into axial map to get ready to apply the analysis; as in Figure (7.4).
- A segment map created by converting axial map into segment map. The segment map is the needed formula to apply the intended analysis as in Figure (7.5).
- All numeric and descriptive data are gotten from the results of questionnaires, semi-structured interviews and theoretical background.

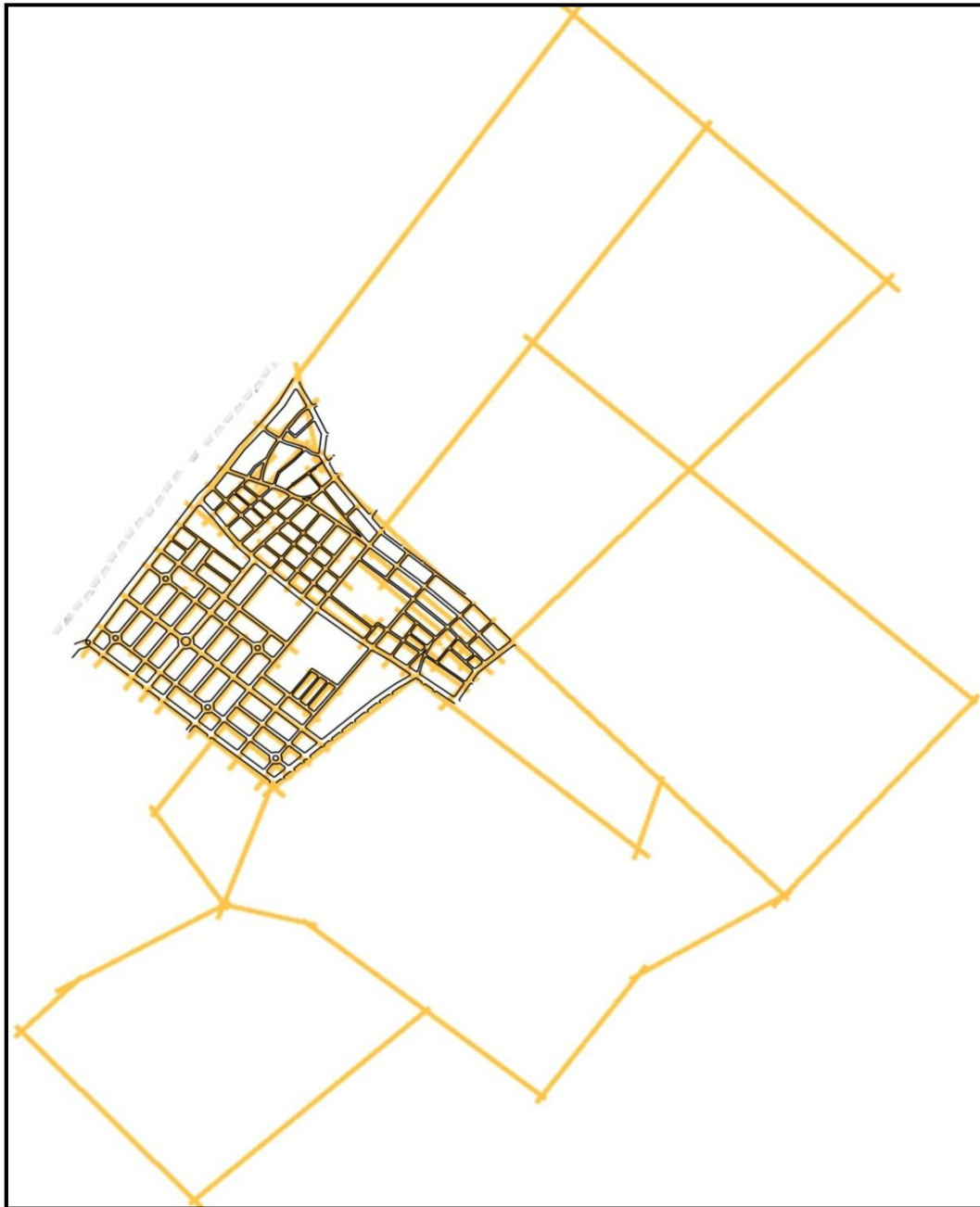

Figure (7.3); Expressing a study area CAD drawing by axial lines.

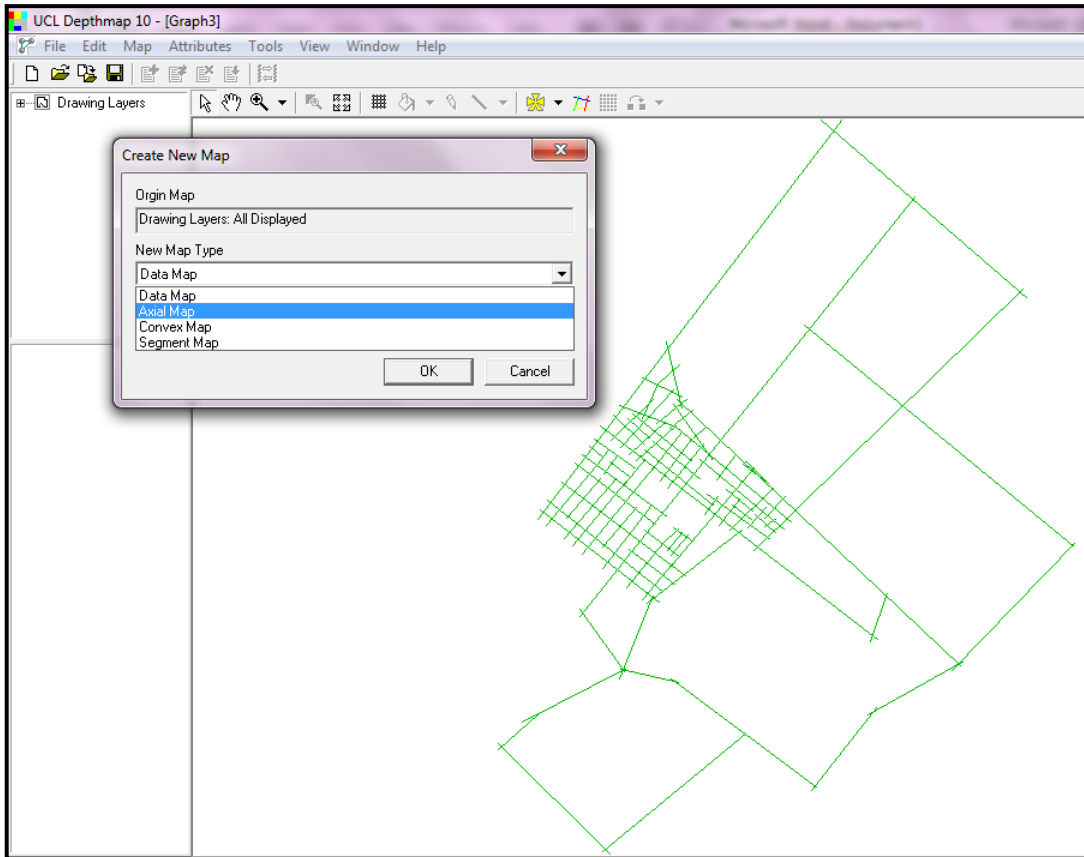

Figure (7.4); Converting graph file into axial map.

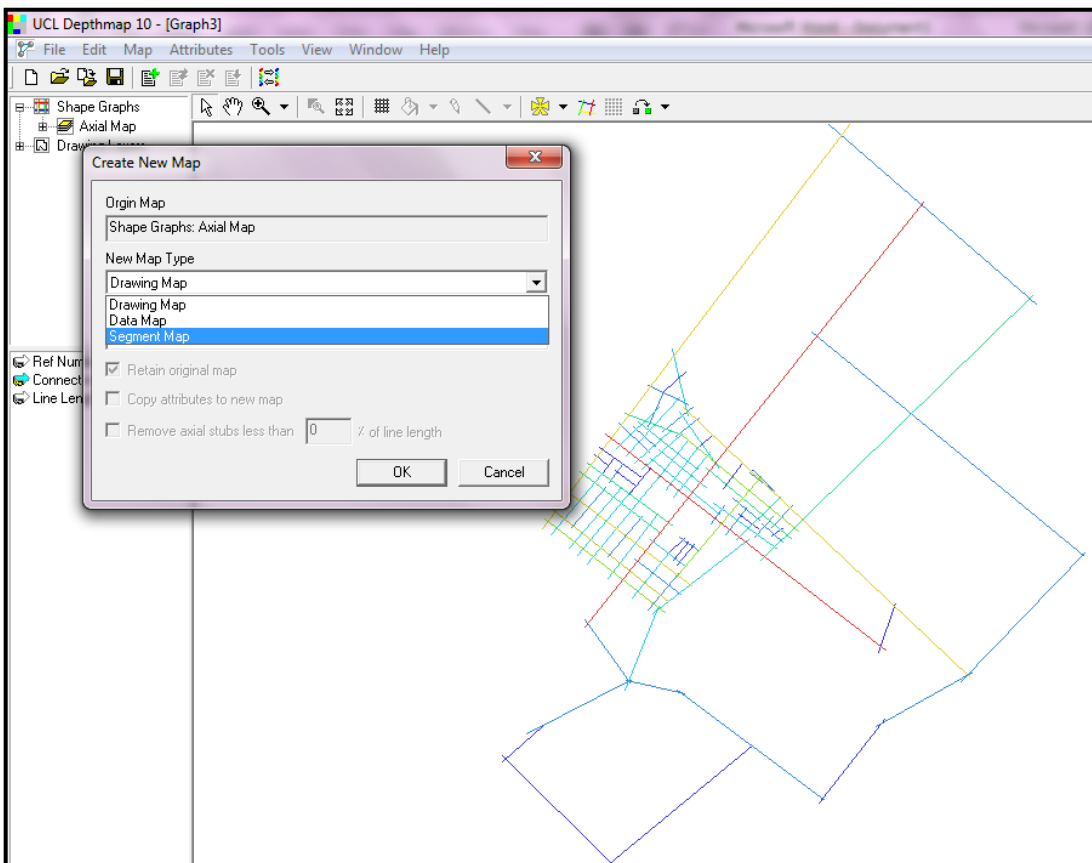

Figure (7.5); Converting axial map into segment map.

7.5.2 Integration

Integration is an indicator of how easily one can reach a specific line. Mathematically speaking, it is the average number of spaces that are needed to pass through to reach a specific line from all the axial lines in the system. In other words, these values suggest the extent to which a selected space in the system is more integrated (can be easily reached from other spaces), or more segregated (one has to travel through many spaces in order to reach that selected space). Moreover, integration measures mean how many turns one has to make from a street segment to reach all other street segments in the network, using shortest paths. The first intersecting segment requires only one turn, the second two turns and so on. The street segments that require the least amount of turns to reach all other streets are called 'most integrated' and are usually represented with hotter colors, such as red or yellow. Theoretically, the integration measure shows the cognitive complexity of reaching a street, and is often argued to predict the pedestrian use of a street. It means that more integration and easier reaching of a street makes it more popularly in use. While there is some evidence of this being true, the method is also biased towards long, straight streets that intersect with lots of other streets. However, a slightly curvy street of are typically not counted as a single line, but instead be segmented into individual straight segments, which makes curvy streets appear less integrated (Teklenburg, Timmermans & Wagenberg 1993).

- **Criteria**, see Figure (7.6)
 - Measuring integration is applied on axial map.
 - The amount of turns required for reaching all segments in the graph is analyzed, then the analysis is said to measure integration at radius 'n'.

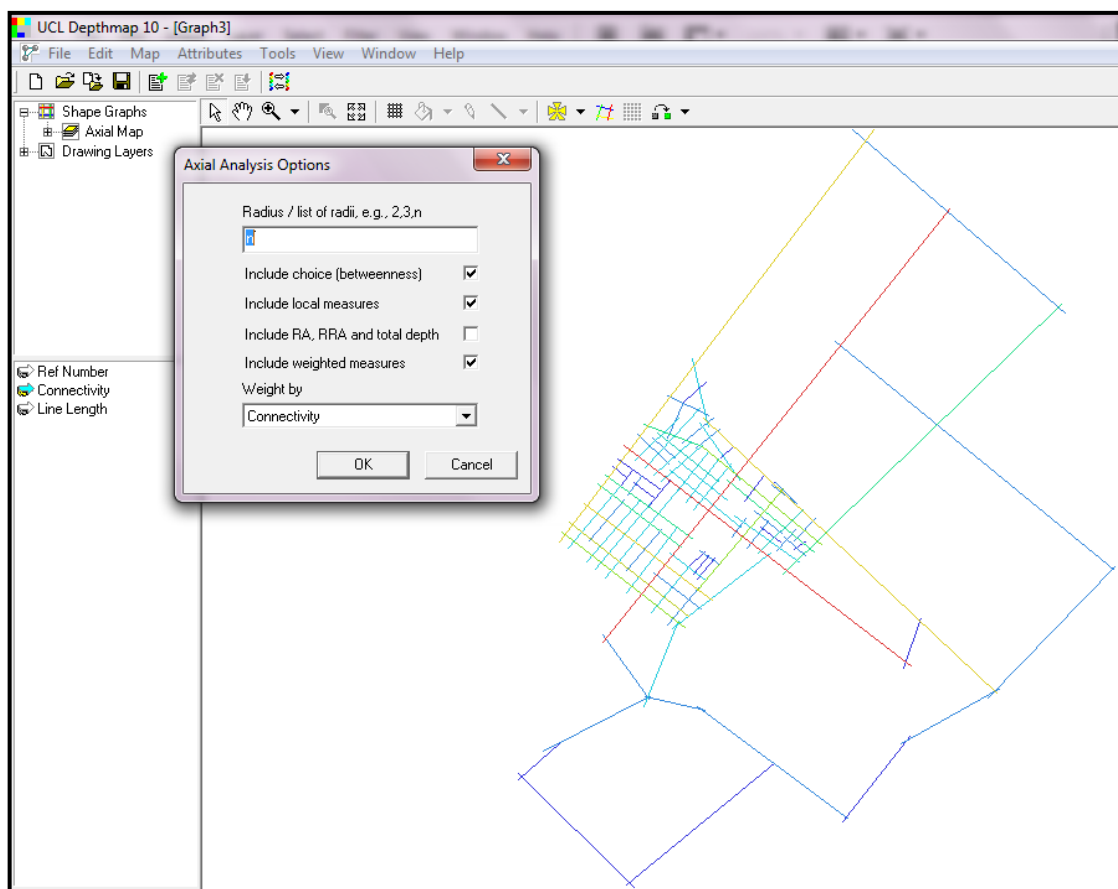

Figure (7.6); Graph analysis as axial analysis to measure integration, with radius 'n'.

- **Resulted axial map**, see Figure (7.7)
 - After making a graph analysis on the axial map, the result is as the following:

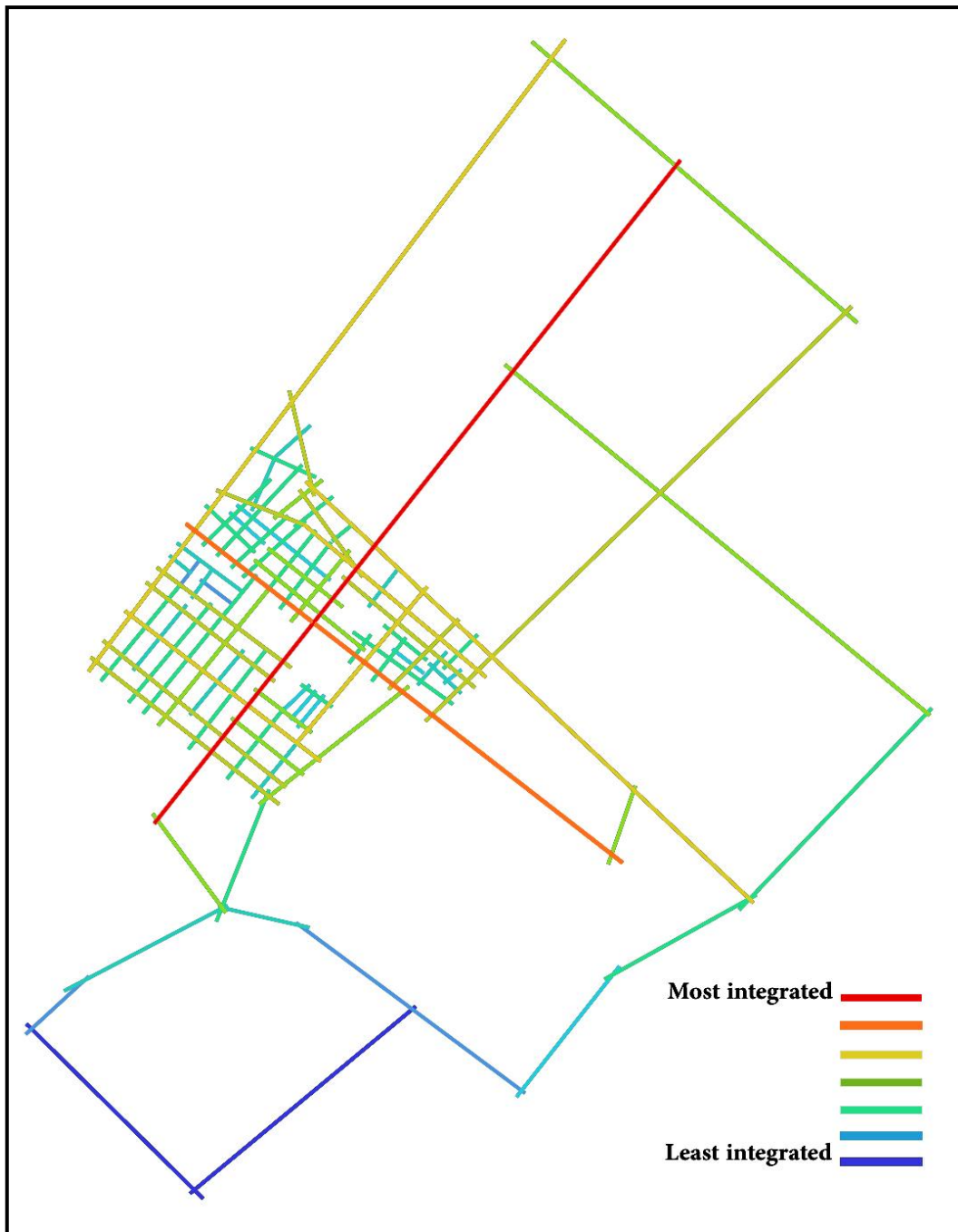

Figure (7.7); Resulted axial map that shows the integration of each axis.

- **Outputs**
 - Jameat Al-Dwal Al-Arabia Street is the most integrated one in the district, so it can host the major station of the district.
 - Most of streets that perpendicular on sea line have most integration value that streets that parallel to sea line, so they can host the local stations.

7.5.3 Connectivity

Connectivity gives the number of lines that are directly connected to a specific line. Also, connectivity indicates the number of choices that can be seen from a node space. The application counts all these choices that related to one axial line with all other lines of the spatial system that intersect with it. In space syntax, connectivity represents the number of other spaces directly accessible from it. Based on these finding, it can be suggested that connectivity measures of space syntax can be used for analyzing accessibility and way finding situation in the healthcare setting (Teklenburg, Timmermans & Wagenberg 1993).

At local scale, connectivity can be measured within a specific radius. This means that the connectivity of lines is measured within a buffer of radius 'n'. This radius depends on some criteria that are obtained from preliminary and secondary data resources.

- **Criteria**, see Figure (7.8)
 - Measuring connectivity is applied on segment map.
 - Most connective area within a buffer with radius 1700m is required to be defined to host the major station, then angular segment analysis is applied with metric radius of 1700m.

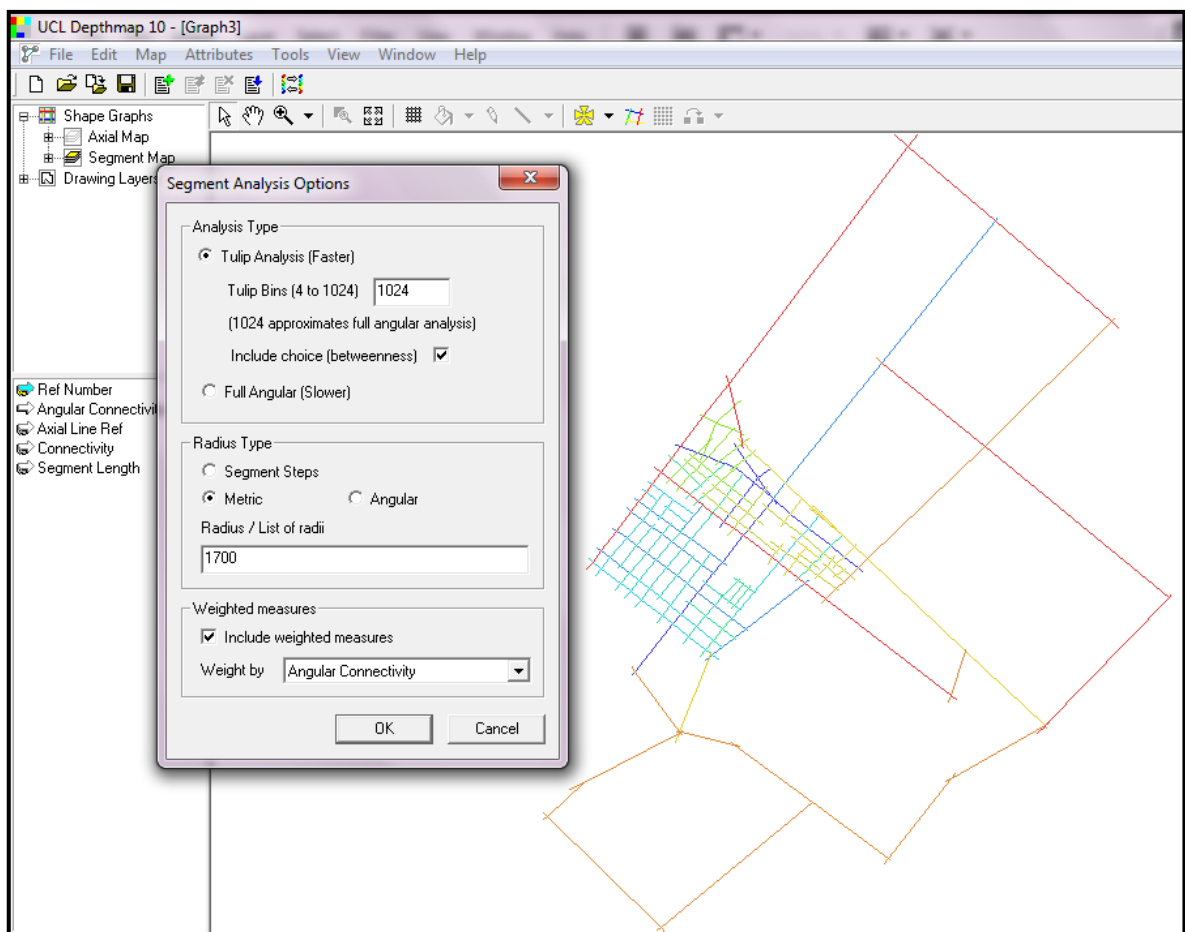

Figure (7.8); Angular segment analysis on segment map to measure identify the most connective area with radius 1700m.

- **Resulted axial map**, see Figure (7.9)
 - After making an angular segment analysis on the segment map, the result is as the following:

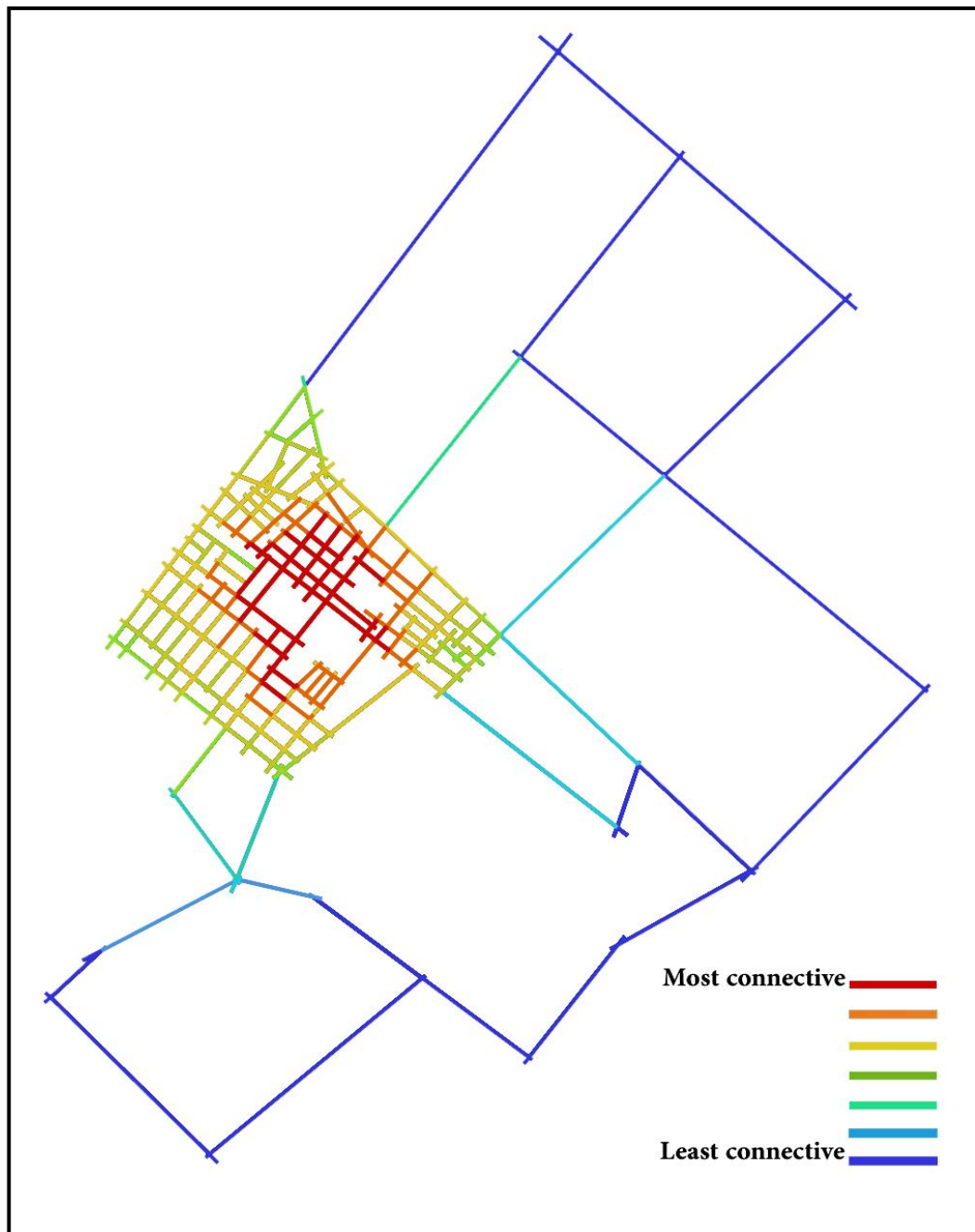

Figure (7.9); Resulted segment map that shows the most connective area within buffer with radius 1700m.

- **Outputs**
 - The most connective streets within the district are these which located in the central area.
 - The most connective area is characterized by high densely movement that related to existence of three universities campuses in this area.
 - The most connective area is very suitable to host the major station.

7.6 GIS Stimulation using ArcGIS v.9.3

The purpose of using Geographic Information System is to build a spatial model with specific criteria and through multi-scenarios. This model needs a spatial analysis to be implemented using spatial and descriptive data;

- **Spatial data (map data):** location, shape, and relationships among physical and human features.
- **Descriptive data (non-map data):** characteristics of the features (attributes).

All collected data are organized on layers that represent the reality. Then, all layers are arranged, as in Figure (7.10)

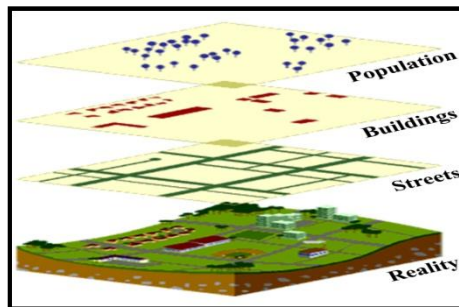

Figure (7.10); The arranged layers that represent the reality. (Malczewski, Jacek 1999)

All needed data are obtained through the governmental agencies and institutions. On the other hand, all needed criteria and inputs are obtained through the theoretical background, and results of questionnaires and semi-structure interviews and Space Syntax analysis.

Finally, vector spatial analysis is held to determine Best Location according to the conformable criteria and inputs.

7.6.1 Data Entry (Inputs)

All needed data is collected with various formats, then they are converted into shapefiles; as the following:

1. Vacant parcels

All Vacant parcels are allocated on CAD file according to the site observation and latest map on the Municipality of Gaza. One vacant parcel is needed to establish the major station. This process is done on the South Remal district and converted into shapefile; see Figure (7.11).

2. Streets integration

This data is obtained through the Space Syntax that each street takes a degree of integration; see Figure (7.12).

3. Streets connectivity

This data is obtained through the Space Syntax that each street takes a degree of connectivity. Moreover, this entry introduce the more connective area in the district; see Figure (7.13).

4. Streets width

This data is obtained through distance measure in ArcGIS 9.3. Two important widths are taken in consideration according to the needs of major and local stations; 18 m for major station and 12 m for local stations; see Figure (7.14).

5. Locations of universities campuses

The universities campuses represent heavy load on the streets network of the district during the peak hours. Then, the locations of such regional services are taken in consideration while determining the alternatives. The students and workers of these universities counts a huge number of persons in small area. So, the area has a vibrating high density that is not documented through the approved plans and data of authoritative census; see Figure (7.15).

6. Locations of the services and institutions

The area is distinguished by involving most of the public and services buildings and institutions of the city. There are 66 building located in South Remal and most of these buildings serve at the scale of all Gaza City and Gaza Strip. The locations of these buildings are obtained as CAD format from Municipality of Gaza and converted into shapefile on AcrGIS; see Figure (7.15).

7. Population density

This population of South Remal district is obtained from Municipality of Gaza that they divide the districts into number of sub-zones and then they document the number of people who lives in every sub-zone; see figure (7.16). The density is calculated by dividing the population of each sub-zone on its area. This density represents the constant density of the area; see Figure (7.17).



Figure (7.11); Vacant parcels in South Remal.



Figure (7.12); Streets integration in South Remal.



Figure (7.13); Streets connectivity in South Remal.



Figure (7.14); Streets width in South Remal.

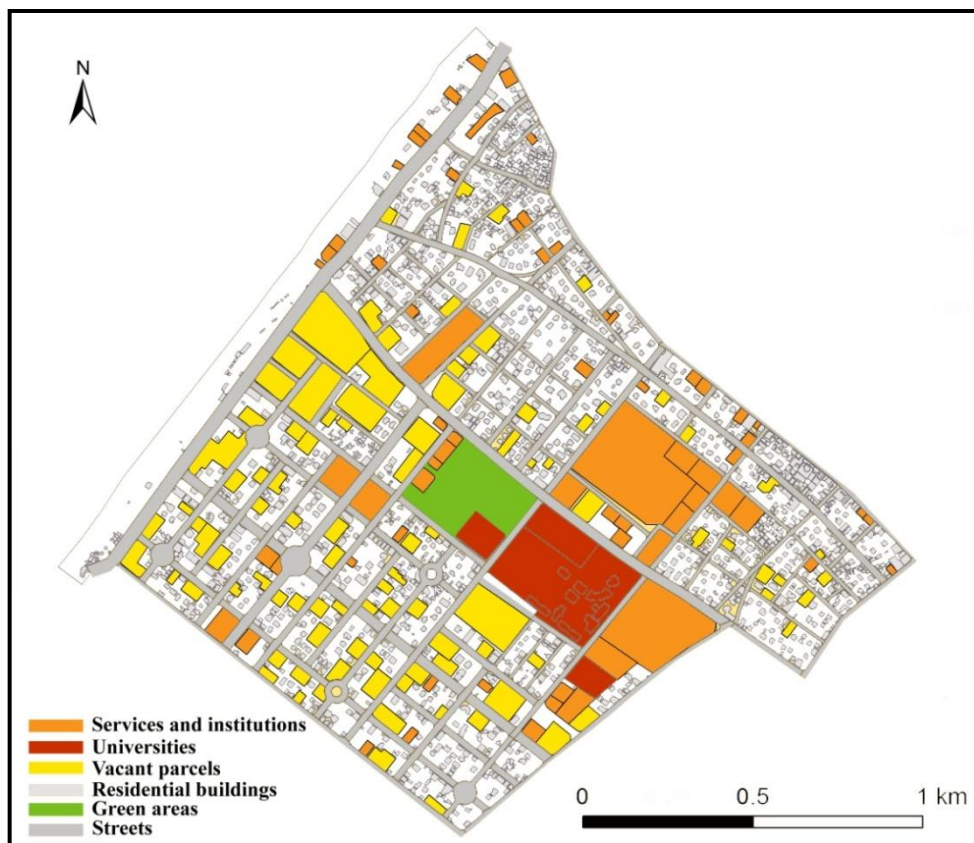

Figure (7.15); Land use in South Remal.

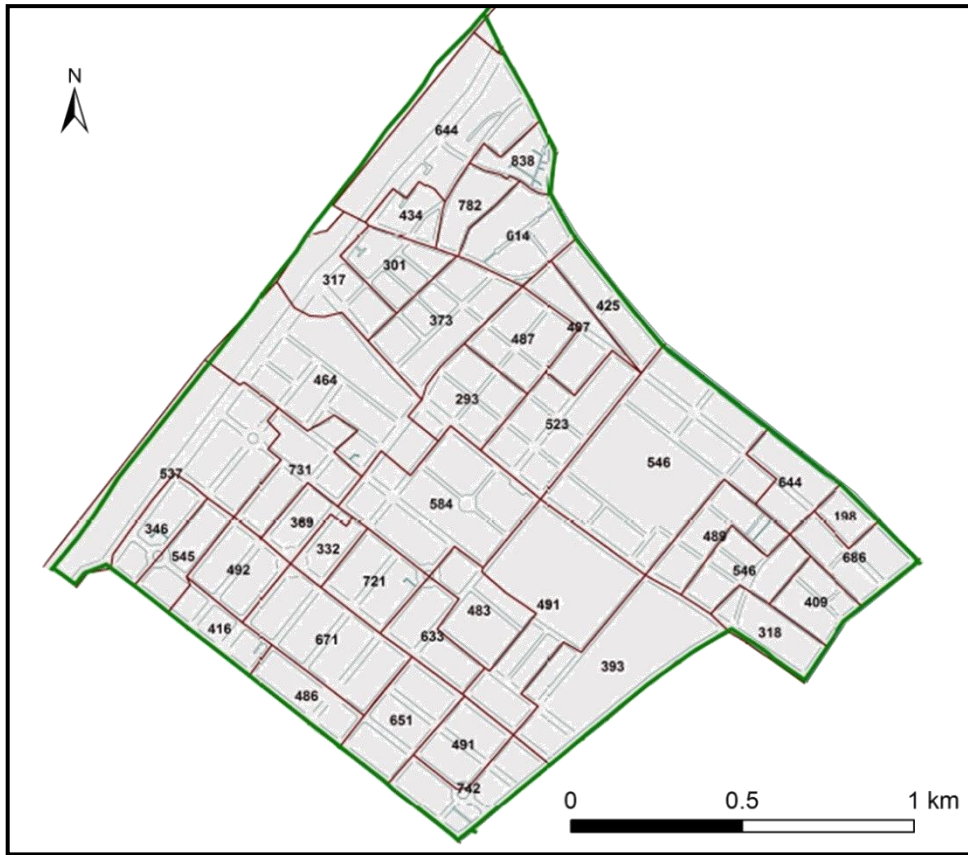

Figure (7.16); Population of sub-zones of South Remal.

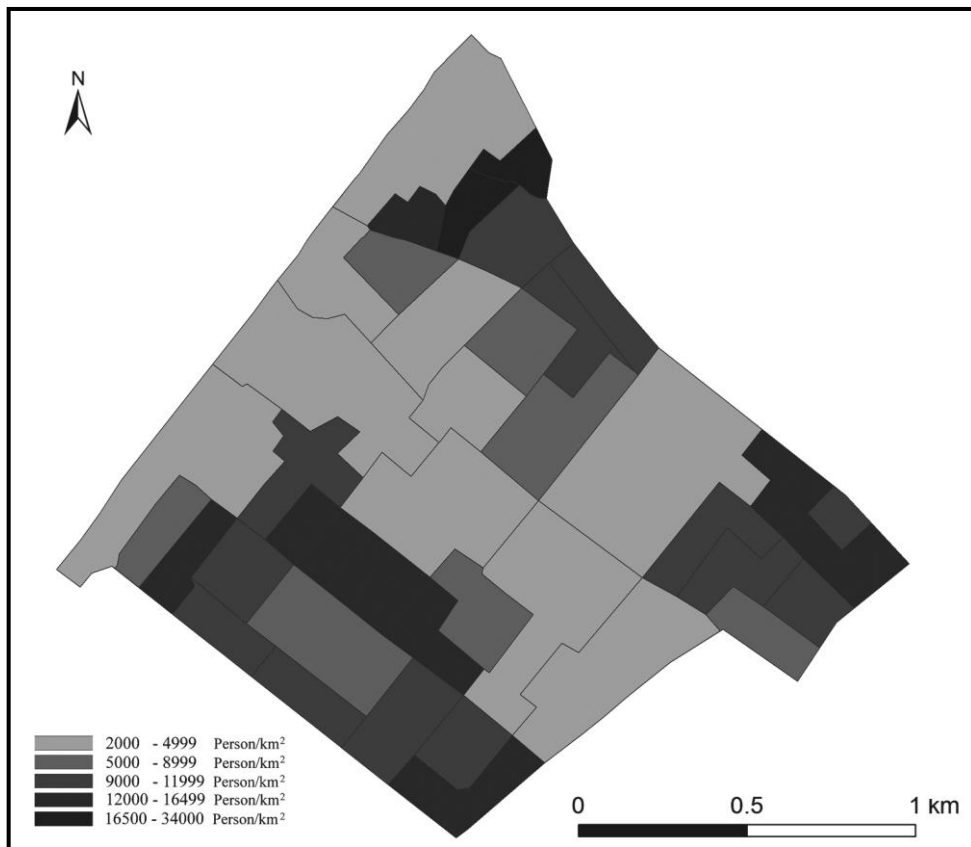

Figure (7.17); Population density of sub-zones of South Remal.

7.6.2 Major Station Allocation

Building the major station on the district can be considered as an infill site development that serves at the scale of the entire district. The allocation of this focal node has to be established on specific criteria. Also, determining the priority of each criterion may differ from one site or one case to another. So, scenarios must be drawn to offer multi alternative.

- **Criteria**, see Figure (7.18)
 1. **Vacant parcels:** According the special situation of the district, then the needed land area has not to be less than 3000m².
 2. **Streets integration:** The location must to be adjusting the most integrated streets. The streets with degrees 7, 6 and 5 are accepted for this mission.
 3. **Streets connectivity:** The site must to be located on the most integrated area in the district. The streets with degrees 7 and 6 are accepted for this mission.
 4. **Streets width:** The street has to be able to host the densely movement that related to such station. Then, the streets with width 18m or more than 18m are suitable for this mission.
 5. **Universities campuses:** A buffer with radius of 300m is created around each campus. The site may to be allocated within the buffer area.
 6. **Services building and institutions:** A buffer with radius of 300m is created around each building. The site must to be allocated within the buffer area.
 7. **Population density:** The population density of the district takes into account the constant density. The densities is categorized and distributed according to the sub-zones. The station may to be allocated in the most densely area.
 8. **Influence:** The station has an influence buffer area with radius 1700m.

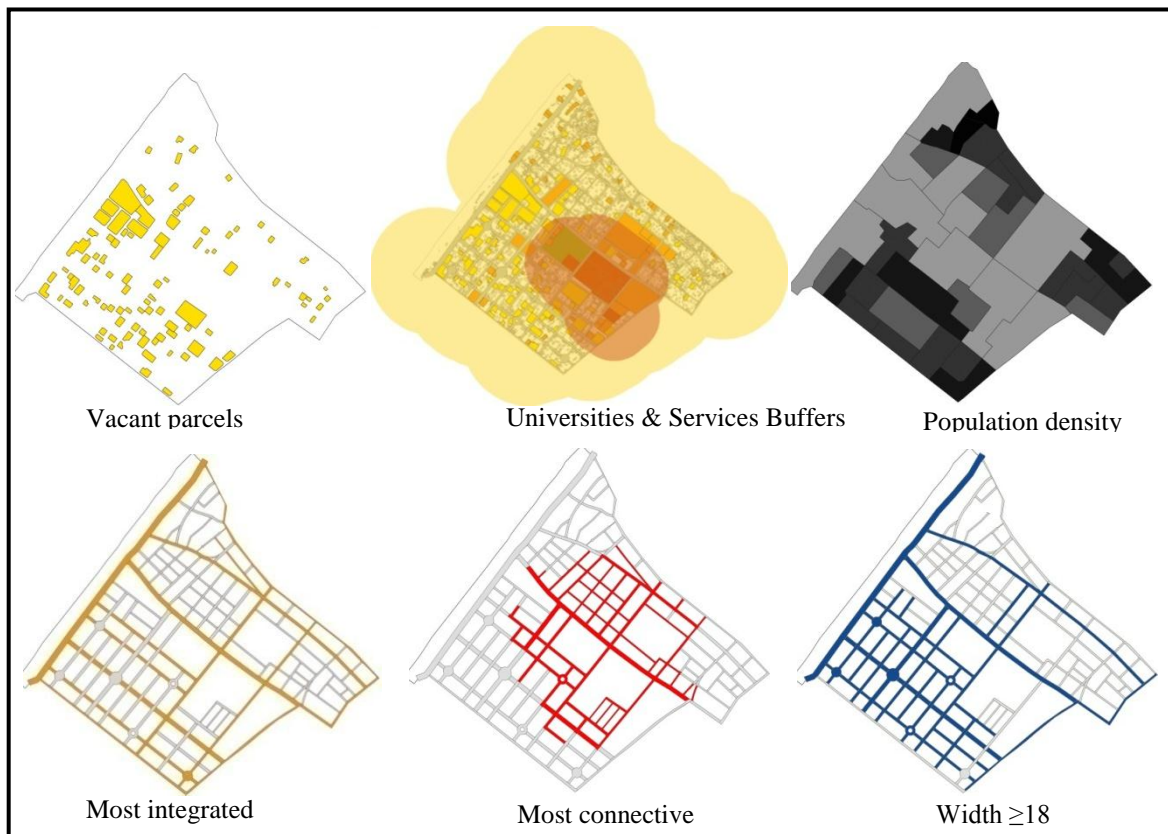

Figure (7.18); the resulted map after making queries upon the approved criteria.

- **Scenarios**

Three scenarios are drawn to give multi alternatives. The scenarios are treated by considering or ignoring some criteria. Each scenario represents a point of view and has to be evaluated in the end.

1. First Scenario: All criteria

- Considering all criteria.
- The considered population is 5000 person/km².

✓ **1st Scenario in term**

The model is searching for a vacant parcel with minimum area of 3000m². The parcel must to be located on the most connective area and must to be adjusting to one of the most integrated streets with minimum width of 18m. Also, the parcel must to be located within the buffer zone of universities campuses and services biuldings. In addition the parcel must to be located in a densely population sub-zone with minimum density of 5000 person/m². The parcel must cover the intended area with buffer with raduis of 1700m.

✓ **1st Result**

Two alternatives are resulted according to the first scenario; as in Figure (7.19).

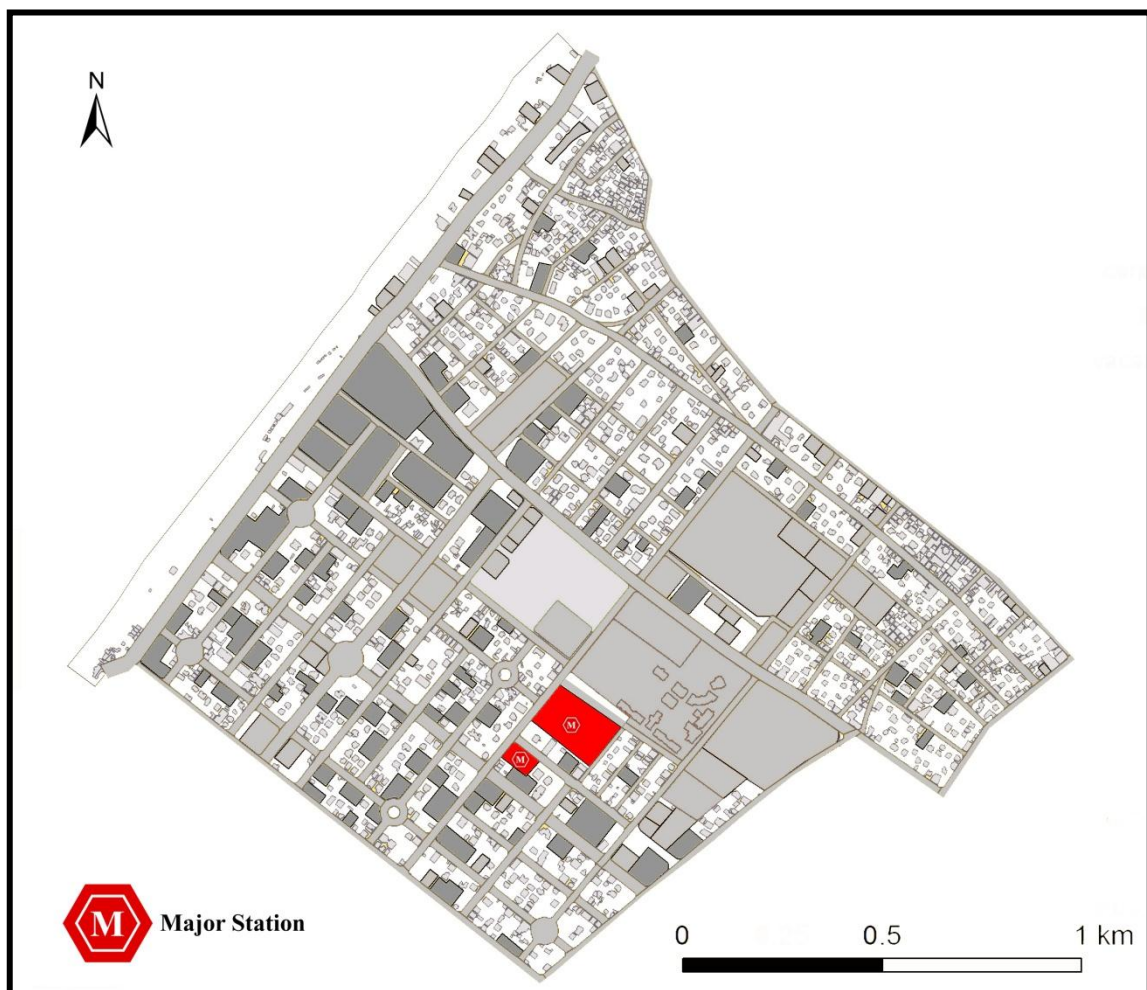

Figure (7.19); Resulted map and alternatives of the first scenario of allocating major station.

2. **Second Scenario: Constant population density (Local residents)**

- Ignoring the existence of the universities campuses as an urgent case and considering them as normal services.
- Giving more consideration for the constant population density.
- The considered population density is 12000 person/km².

✓ **2nd Scenario in term**

The model is searching for a vacant parcel with minimum area of 3000m². The parcel must to be located on the most connective area and must to be adjusting to one of the most integrated streets with minimum width of 18m. In addition the parcel must to be located in a densely population sub-zone with minimum density of 12000 person/m². The parcel must cover the intended area with buffer with raduis of 1700m.

✓ **2nd Result**

One only choice is resulted according to the second scenario; as in Figure (7.20).

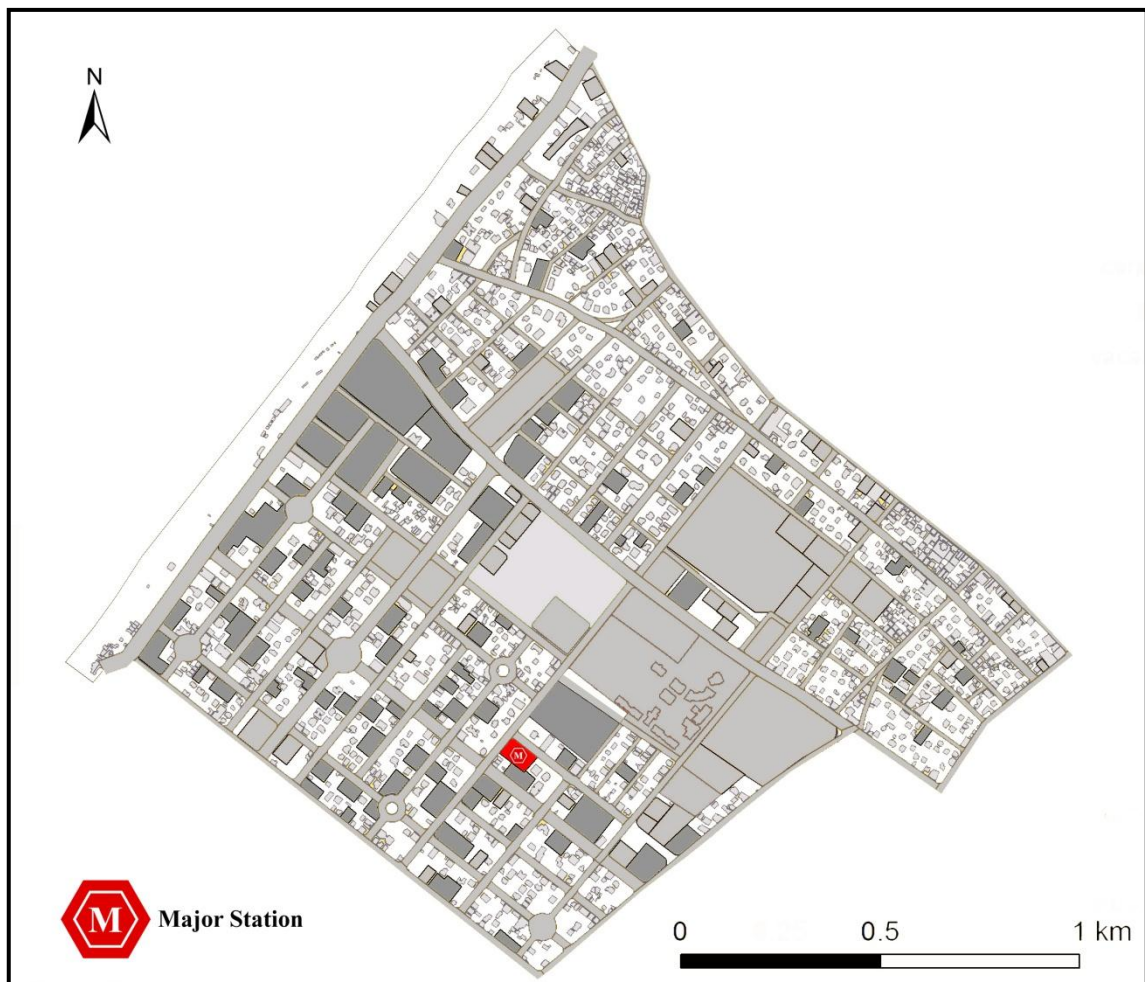

Figure (7.20); Resulted map and the one choice of the second scenario of allocating major station.

3. *Third Scenario: Peak hour movement (Vibrant population density)*

- Ignoring the constant population density.
- Giving more consideration for the existence of universities campuses as a vibrant population density.

✓ *3rd Scenario in term*

The model is searching for a vacant parcel with minimum area of 3000m². The parcel must to be located on the most connective area and must to be adjusting to one of the most integrated streets with minimum width of 18m. Also, the parcel must to be located within the buffer zone of universities campuses and services biuldings. The parcel must cover the intended area with buffer with raduis of 1700m.

✓ *3rd Result*

Four altenatives are resulted according to the second scenario; as in Figure (7.21).



Figure (7.21); Resulted map and alternatives of the third scenario of allocating major station.

7.6.3 Local Stations Allocation

The concatenation of local stations represents a chain that consists of number of transportation nodes and routes. This demands an efficient allocation of such elements of the chain. For this target, criteria are determined according to a specific scenario.

- **Criteria**

1. **Streets integration:** The local stations must be located most integrated streets. The streets with degrees 7, 6, 5 and 4 are accepted for this mission.
2. **Streets width:** The street has to be able to host a densely movement and a new lane for public vehicles. Then, the streets must to be not less than 16.
3. **Influence and walking distance:** each local station has an influence buffer area with radius 300m. This distance consumes an average walking period of 3 minutes that; *Average speed of adults walking = 90 – 120 steps per minute = 1.0 – 1.5 m/sec.* (U.S.Roads 1997)
4. **Route simplicity:** It is preferable that the primal path that leads to each station to be simple and has less angular changes.

- **Scenario**

One scenario is drawn to allocate and distribute the local stations and their routes. This scenario considers all criteria

✓ **Local station result:** as in Figure (9.22)

Chain of routs and nodes are allocated to serve the local circulation.

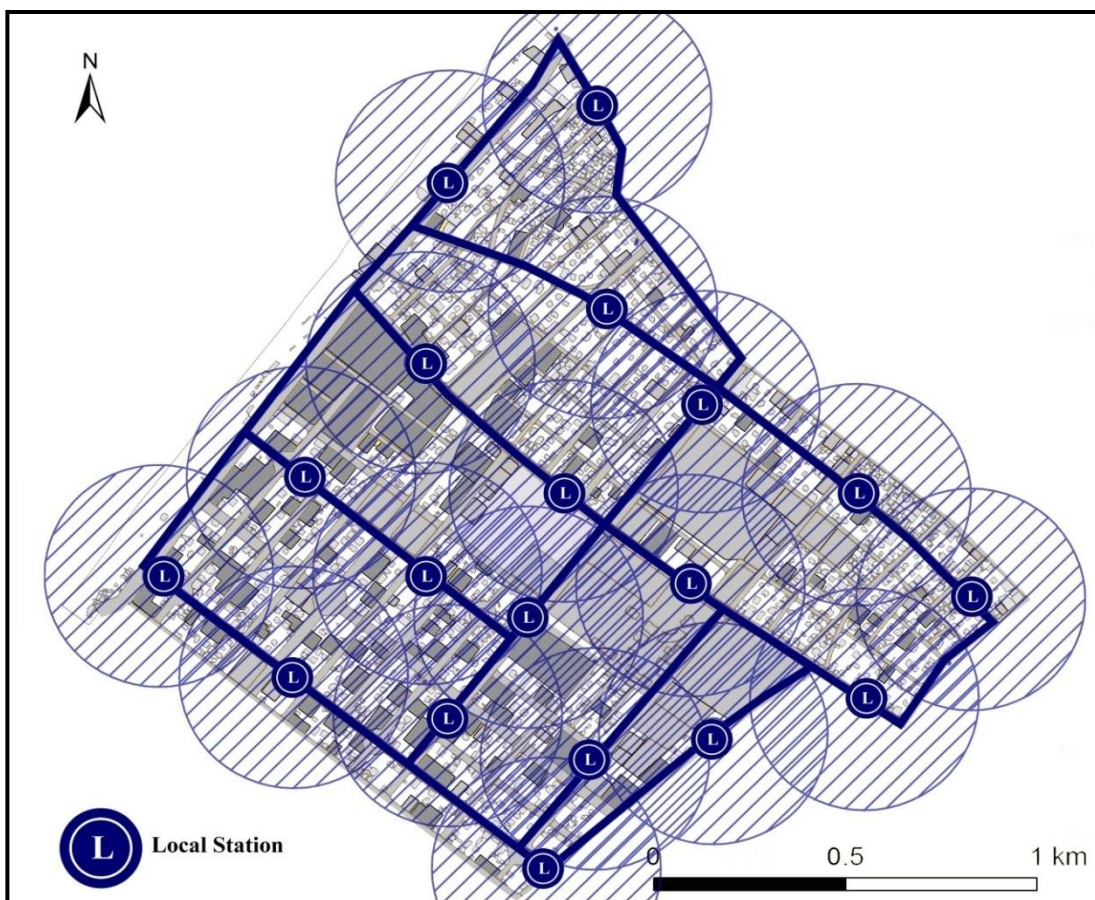

Figure (7.22); Resulted map of allocating and distributing local stations.

7.7 Outputs and Comments

There are number of outputs and comments, which can be listed as the following:

1. Computerized model

- A computerized model is created through working on the south Remal district.
- The model consists of the three scenarios of allocating the major station; and each scenario consists of the criteria that are listed above.
- The model can be considered as a tool that can be added on the toolbox menu in ArcGIS 9.3 and can be used in any other case or map with the same data types.
- The model is created as a file with (*.tbx) format.

2. Evaluation the alternatives

- Choosing the best alternative needs the evaluation tool that designed in Chapter 6 to be used.
- A computerized evaluation tool in Excel format is functioned to expedite the process.
- The proposed evaluation method awards a score for each alternative. Then, the best alternative takes the highest score.

3. The vacant land of building of Convention of Ministries

- The study validate the serious aspiration of formal and governmental authorities about establishing a transportations station in the vacant land of building of Convention of Ministries.
- Two scenarios result in that this land satisfy the approved criteria

CHAPTER 8

Thesis Outcomes ..

Conclusions, Outputs and Recommendations

- 8.1** Introduction
- 8.2** Conclusions
- 8.3** Outputs
- 8.4** Recommendations

8.1 Introduction

The thesis provides a synthesis of the major steps that are needed to create a more efficient community through the organization of transportation and circulation. Also, it provides tools for analysis, stimulation, design and evaluation. This is done through methodological framework. Conclusions, applied outputs and recommendations are achieved through all research up-growth.

8.2 Conclusions

The resulted conclusions can be classified and demonstrated as the following:

1. Controlling the urban progress needs efficient tools

Communities are looking for ways to get the most out of new development and to maximize their return from social, economic and environmental activities. Communities expect to create new neighborhoods and maintain existing ones to be more attractive, convenient, safe, and healthy. Therefore, guidelines and tools are needed to be determined.

- **Sustainable Development**

Sustainable development is very important trend because it is not about threat analysis; but, it is about system analysis. Specifically, it is about how environmental, economic, and social systems interact to their mutual advantage or disadvantage at various space-based scales of operation. Moreover, the term expounds potent expected outcome that is represented in attracting, managing and retaining infrastructure, businesses, employment, economic growth, community image, cultural diversity, accessibility, housing quality, transport system, public transport, town centers and collaborative leadership.

- **Smart Growth**

The term Smart Growth is never growth; rather, it seeks to revitalize the already-built environment to the extent necessary, and to foster efficient development at the edges of the region through the process of creating more livable communities. The importance of Smart Growth comes from the ten principles that provide a framework for how development and growth can be executed in a superior way to the status quo. These principles can be summarized in mix land uses, compact building design, range of housing choices, walkable neighborhoods, attractive communities, open space, farmland, beauty and critical environmental areas, developing existing communities, transportation choices, making development decisions fair, consistent and predictable, community and stakeholder collaboration.

2. Transit Oriented Development as a significant planning paradigm

The negative side effects of urban planning and transportation systems have become particularly apparent in the metropolitan areas. This demands an efficient planning tendency that can direct such problems to be solved. Transit Oriented Development has gained popularity as a mean of redressing number of urban problems including; automobile dependency, uncontrolled urban sprawl,

and all effects of these situations; such as traffic congestion, affordable housing shortages and air pollution. From this point, TOD has become one of the most popular tools for achieving Smart Growth and Sustainable Development principles. Also, most people make the mistake of thinking that TOD can be created through the design and development of one project, but in actuality, it usually takes multiple projects working together to create an urban fabric that seamlessly blends the ideals of trend.

TOD can be conserved as an approach that can actualize a moderate to higher density development, located within an easy walk of a major transit stop, generally with a mix of residential, employment, and shopping opportunities designed for pedestrians without excluding the auto. However, number of variables determines the success of TOD through; social and economic market demands, local government policies, strong and proactive institutions, individual political champion, supportive neighborhoods and communities, high quality transit service, availability of attractive developable land, strong real estate markets and parking management. Also, TOD needs technical and design strategies to be followed.

3. Gaza City: difficulties and constrains

Gaza City is chosen to be as a study area, but it has a special case in its urban structure that it has been surrendered to complicated geopolitical conditions, and its urban growth has been highly influenced by various colonization powers. All these circumstances impose a peculiar physical planning situation, which is represented in:

- **Institutional and administrative situation**

The urban planning in Gaza City is characterized by unstable and unorganized features. This situation returns to four main reasons; different and old laws and regulations, the absence of legal basis for national physical and spatial planning, lack of clear boundaries for local government bodies, and constraints imposed by the Israeli occupation on the development process. These institutional and administrative contradictions and gaps have led to a lot of planning and development obstructions.

- **Urban structure**

The urban structure of Gaza City is characterized by many troubles that can be summed up within; population growth, a shortage of the available land for future expansion, lack of services, deficit in infrastructures, environmental pollution especially in water (Contamination of the aquifer), traffic congestion especially in downtown, and lack of recreational areas. However, the evolution of Gaza growth with a multitude of relations and dependencies requires not only new forms of transport, but also new methods of spatial planning.

- **Trends of urban growth**

Gaza City as any metropolitan region tends to spread and coalesce into new urban regions. But, the city is restricted by many obstacles that direct the growth toward two ways only; the first is toward south horizontal direction and the second is toward vertical direction. All developmental approaches have to consider this issue.

4. Social responds with Transit Oriented Development

The study enhances the community sharing in the planning process. Then, a questionnaire is used to determine the community opinions about the practical principles of TOD. A strong social support is reached and recognized; that the people prefer to practice the main strategies of the approach. This situation gives the researchers and stakeholders a very important indication about the interaction and aspiration of the community toward sustainable approaches.

5. Authoritative and official responds with Transit Oriented Development

Semi-structured interviews are used as the most useful format for gathering qualitative information from the specialists and professionals who work on the field of planning and development in the official and authoritative agencies in Gaza City to recognize their responds with TOD. They confirm their total support to such developmental trend and they verify the importance of TOD principles on all fields of planning process; social, economic and environmental aspects. Also, they announce about the impediments and challenges facing the development process and the new approach, which are represented mostly on lack of market demand, lack of lender or investor interest and support, lack of developer interest and lack of political support. Moreover, the specialists and professionals give some criteria about the priorities of constructing developmental projects.

6. Depending on integrated methodology makes the study more reliable and trustworthy

The study is an applied research, which needs an integral approach, to study an urban phenomenon that based on the fact there is a correlation between scientific framework (theoretical trend) and practice (applied trend). For achieving an accurate and complementary results and outputs, a progressive mode is followed that every step depends on the previous ones; as follow:

- **Descriptive method:** It is used to conform a theoretical background about the main approach of the thesis.
- **SWOT analysis:** It is used to understand the current urban situation and trends of growth for the study area.
- **Questionnaire:** It is an analytical method, which is designed and distributed to gather some quantitative indicators about the problem, and to gain some criteria. All results of the questionnaires is analyzed by using SPSS application.
- **Semi-structure interview:** It is an analytical method, which is designed and distributed to gather qualitative and quantitative indicators and criteria.
- **Space Syntax analysis using UCL Depthmap v.10:** It is a computerized analytical software, which is used to make some spatial analysis by using the results of the questionnaire and the semi-structure interviews as inputs.
- **GIS analysis by using ArcGIS v. 9.3:** It is a computerized analytical software, which is used to make some spatial analysis by using the results of the space syntax analysis and by using the questionnaire and the semi-structure interviews results as inputs. This application is also used to build a model and draw scenarios for the solutions. Also, the application is used to program a tool that can be added to ArcGIS toolbox in (*.tbx) format, which can be used in other cases and areas.

7. Absence of a united Palestinian Geo-database founds many obstructionist in the development process

Palestinians formal institutions suffer from the absence of a united geo-database. Also, this situation affects researchers, developers, planners and investors to hold an innovative steps forward the urban progress.

8.3 Outputs

The thesis is considered as an applied research. Then, three technical tools are obtained through the study. These tools can be used in other projects and studies.

1. Strategic transaction

The thesis introduces a proposed design pattern, which is about making a complement and comprehensive developmental approach for any urban fabric. It is attempted to give a strategic transaction to draw a spatial movement system, allocate and design urban spaces, and then, it is condenses all aspects throughout a specific urban neighborhood. The strategic transaction considers the city's movement mechanism to handle the method of connecting people together within a smart and sustainable approach based on TOD. The proposed design pattern deals with and urban fabric through the following:

- The strategic transaction satisfies all aspects of developmental urban planning. Four major strategies are accomplished through number of secondary aspects; see Figure (8.1), that each strategy treats one aspect of urban planning.

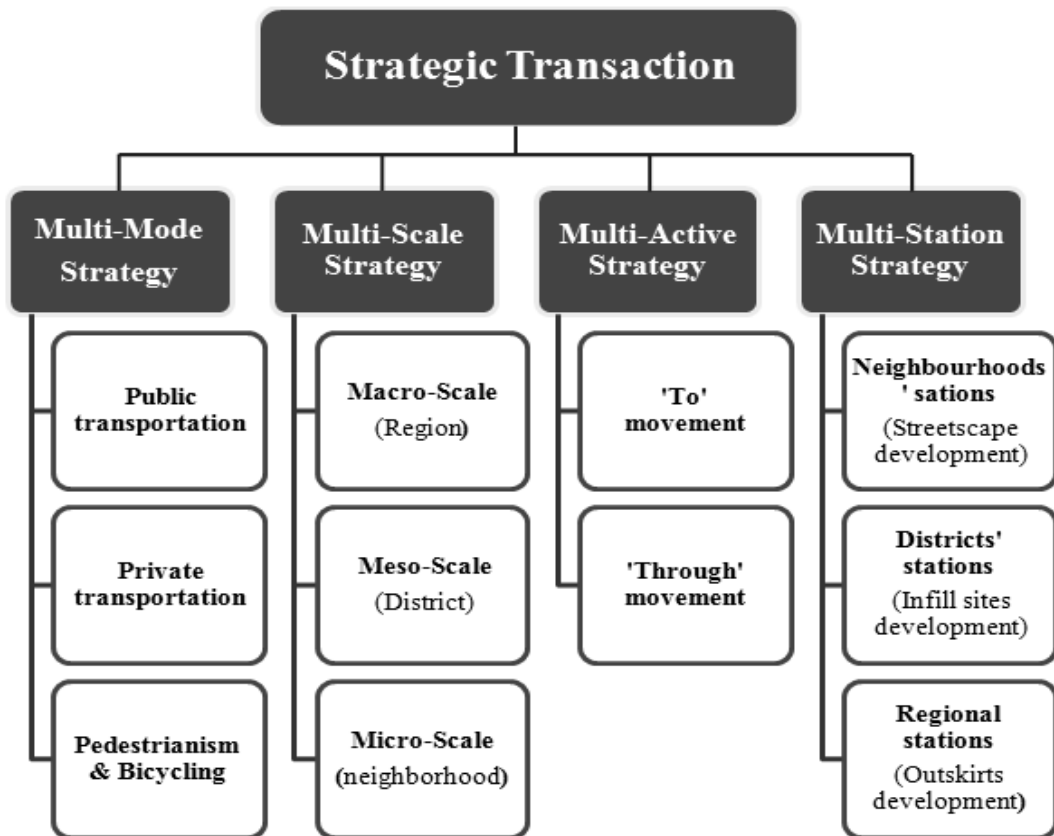

Figure (8.1); The four major strategies and the secondary aspects of the proposed strategic transaction.

- The strategic transaction gives numerical and quantitative detailed criteria about urban and detailed planning. Also, it gives criteria about identifying, classifying and designing of the suggested urban spaces.
- The strategic transaction is different from a transportation planning, that it envisions a comprehensive and complete plan as the final product of the process. The resulting product of this output is administrative tool that can be used by decision makers for identifying alternative actions, select the best alternative, and developing successful implementation pattern.

2. Evaluation calculator

- The calculator tool evaluates any urban system according to TOD major principles. It identifies and measures various aspects of the impacts of TOD, provides the results of a survey, and identifies evaluation model as a tool that can be used to systematically monitor and measure impacts. This tool can be used in established urban systems and proposed ones.
- Moreover, it is essential to recognize this tool before starting in any TOD projects. This tool can help planners and designers to take right decisions about future outreaches. The valuation model can be applied on the three proposed scales of TOD in any urban fabric.
- The calculator includes six major principles that each principle involves number of detailed aspects that related to the major principle. Each aspect includes number of questions that can be asked and answered through multi choice questions. The evaluation calculator model assigns a potential score to each question. Once points are assigned for each question, a scoring sheet on the evaluation model provides a weighting system that allows the user to arrive to a final number of points. This weighting reflects the priority given to the different topics. After filling the evaluation model, the awarded points have to be weighted to calculate the total weighted points and then grant the total points awarded to the project.
- This output is about an evaluation model which is designed and prepared in Microsoft office Excel file as (*.xls) format. Any intended group can use this calculator easily and the results can be analyzed statistically.

3. TOD-model tool on ArcGIS toolbox

- This is a computerized tool that can be added to ArcGIS toolbox on (*.tbx) format. This tool can apply all principles and criteria that is reached through the study within an application to be used in other cases and projects. Then, the tool offers TOD solutions as an applied output of the thesis.
- The main objective of this tool is to build a smart and sustainable urban model based on Transit Oriented Development. This demands a transit system that serves this approach, and demands some decisions to be made.

- Any transit system involves two main components; stations and corridors. The starting point to build such transit system assumes one of these components. According to the results of semi-structured interviews, 84% of the professionals see that the starting point of any transit system has to be allocation and design of transit stations. This tendency imposes decisions to be made about efficient allocation of required stations. Two decision are made:
 - ✓ Allocation of a major transportation station: connects the district with other districts and with regional stations
 - ✓ Allocation of local transportation stations: connect all neighborhoods within the district with each other and with major station.
- The tool needs criteria to be defined. All needed data is collected with various formats, and then they are converted into shapefiles that can be accepted on ArcGIS.
- TOD-model tool is a model of three scenarios. The scenarios are drawn to give multi alternatives and they are treated by considering or ignoring some criteria. Each scenario represents a point of view and has to be evaluated in the end. The scenarios are:
 1. Considering all criteria.
 2. Constant population density (Local residents)
 3. Peak hour movement (Vibrant population density)
- The thesis can be used as a manual to help the interests to learn how to use this tool and how to collect data and prepare files to use them within the introduced tool.

8.4 Recommendations

The thesis reaches and defines some recommendations. They are classified according to the intended groups whom may be interested in such issue.

1. Administrative level

The urban planning process in Gaza City needs upraising and developmental actions. This demands significant modifications to be implemented on the administrative level; as:

- Joining between urban planning and transportation is the key for solving the serious and essential problems
- Taking real steps forward implementation strategies not only decisions making
- Building a comprehensive regional plan based on conjunctive national plan
- Capacity building and preparing professional staffs
- Making influential improvements in the legal framework
- Enhancing the community sharing and interactions
- Building a combined and updated database
- Planning for emergency needs
- Using the innovative technological trends and tools, that can save time and effort, and give more accurate and clear results
- promoting awareness about developmental and strategic trends between all attended groups

2. Public level

The public reactions toward developmental trends have to be improved. This requires some efforts to be exerted to support the sustainable concepts; as:

- Interacting with the formal and authoritative appeals and express their opinions and needs from strategic and planning projects.
- Accepting the new trends of urban systems that seek to enhance walking and public transportation, etc.
- Thinking about the future of the humankind and the needs coming generations and their rights in natural resources

3. Researchers

This study can be considered as a starting point for such detailed studies and actual plans towards urban developmental and growth control in Gaza City and other hazy urban systems. Then, the research and development efforts have to be directed as:

- Researches and studies have to depend on such computerized tools and applications, which can give accurate, quick and up-to-date results. Space Syntax's applications are efficient and comprehensive to be used and enhanced in urban studies because of their abilities of connecting all aspects of urban planning and design. Also, GIS applications can introduce efficient tools to be used in querying, analyzing, putting alternatives and making judicious decisions.
- Evaluating the actual reality as possibilities and constrains, and giving numerical results is the essential step in making successful urban decisions. The thesis introduces an efficient calculator that can be used to evaluate the current situation and give accurate results.
- It is recommended to start working on the detailed trends of the thesis, such as; designing of urban spaces, more details about community needs, more details about traffic control and design, etc. Also, the thesis as an applied study, needs a lot of future efforts to be converted into a real implemented project.
- A managerial action plan has to be drawn. Also, an organized staff has to be formed to make sure that all implementation steps are directed toward achieving the major goals of TOD.
- Financial analytical studies have to be made to recognize and estimate all costs and risks that may face planning, designing, managing and implementing the project.
- There is a strong recommendation for researchers and academic associations to look for more integrated solutions for the problems of transportation, urban sprawl and environmental issues. These solutions have to be appropriate to Gaza City and its hard circumstances.
- Complete applications are recommended to be developed to serve the actual reality of Gaza City. The thesis introduces three technical outputs that can be assembled into one application and be easy used by all stakeholders.

4. Forward a smart and integrated transportation system

The thesis recommends setting a smart and integrated transportation system through authoritative polices that support the proposed approach. This can be done through:

- Transportation investment in vehicles and places
- Financial governmental support to reduce costs of public transportation through reducing public oil prices and expenses of public vehicles licenses
- Governmental employees paid transportations should be paid only for public transportation and not paid for private cars, this can be achieved through proposing pre-paid credit cards that are recharged monthly automatically and are used in only public vehicles
- Smart transportation pre-paid credit cards for all people, which can be bought and used in public vehicles
- Quality and comfort of public vehicles have to be observed and controlled

5. Toward a united national Geo-database

It is recommended to build a united national Geo-database that can be updated by all agencies according to their concerns. This database can be managed and controlled through a national agency and it has to be systematically updated. Also, the data and information have to be available for community, researchers, developers, investors and all interested groups.

REFERENCES

References:

- Abdelhamid, Ali 2005, '*Management of Physical Planning in the Occupied Palestinian Territories: Existing Challenges & Future Prospects*', paper presented to The Arab Meeting for Managing the Big Cities: Arab Organization for Managerial Development, League of Arab States, Alexandria, Egypt, May (22–26).
- Abdelhamid, Ali 2006, '*Urban Development and Planning in the Occupied Palestinian Territories: Impacts on Urban Form*', paper presented to The Conference on Nordic and International Urban Morphology: Distinctive and Common Themes, Stockholm, Sweden, September (3–5).
- Al-Moughani, Nihad M. 2002, 'Harmonization between the spatial and urban requirements of the children', and the reality of slums and historical areas in the cities – study area: Gaza City – Palestine, *Proceedings on the Conference of The Children And The City*, Arab Urban Development Institute, Amman, Jordan, pp. 258-279.
- Al-Moughani, Nihad M. 2006, *Orderliness of Building and Planning in Gaza City*, 1st edn, Municipality of Gaza, Palestine.
- Anastasia, Loukaitou-Sideris, Houston, Douglas & Bromberg, Ava 2007, *Gold Line Corridor Study*, Final Report, Ralph & Goldy Lewis Center for Regional Policy Studies, University of California, Los Angeles, Southern California Association of Governments.
- Berenson, Levine Krehbiel ca. 2003, *Business Statics*, 5th edn, International edition.
- Bernick, M. & Cervero, R. 1997. *Transit Villages for the 21st Century*, New York: McGraw-Hill.
- Bossard, Earl G. 2002, *Envisioning Neighborhoods with Transit-Oriented Development Potential*, MTI Technical report No. 01-15, Mineta Transportation Institute, College of Business, San José State University.
- California Department of Transportation 2001, *Statewide Transit-Oriented Development Study: Factors for Success in California*, Business, Transportation and Housing Agency, California Department Of Transportation.
- Cervero, Robert 2000, *Informal Transport in the Developing World*, HS/593/00E, ISBN 92–1–131453–4, United Nations Centre for Human Settlements (Habitat), Nairobi.
- Cervero, R., Murphy, S., Ferrell, C., Goguts, N., Tsai, Y.-H., Arrington, G. B., Borski, J., Smith-Heimer, J., Golem, R., Peninger, P., Nakajima, E., Chui, E., Dunphy, R., Myers, M., Mckay, S., and Witenstein, N. 2004. *Transit-Oriented Development in the United States: Experiences, Challenges*, Report 102, Transit Cooperative Research Program. Washington, D.C.: Transportation Research Board.

REFERENCES

- Chia-Nung, Li 2003, 'A Land Use Design Model for Metropolitan Transit-Oriented Development Planning', MSc thesis, National Taipei University, Graduate Institute of Urban Planning, Tiwan.
- Clemons, Josh (ed) ca.2007, *An Equity Agenda for Transit Oriented Development Planning for Sustainable Growth in Los Angeles Inner City*, The Mississippi-Alabama Sea Grant Legal Program,
- Cornell University 2010, *The Definition of Sprawl*, Updated 2010, Cornell University, Department of development Sociology, [Online] Available at: <http://cals.cornell.edu/cals/devsoc/outreach/cardi/programs/landuse/sprawl/definition_sprawl.cfm>, [Accessed 12th January 2012].
- Curtis, Carey, Renne, John & Bertolini, Luca (eds) 2009, *Transit Oriented Development: Making it Happen*, Ashgate publishing limited, England, USA.
- DC & E 2012, *Regional Smart Growth- Transit-Oriented Development Plan*, The Planning Center, Public Review, San Joaquin Council of Governments, Berkeley, California.
- DEP Web 2001, *What is Sustainable Development*, Updated 2001, The World Bank Group, DEP Web. [Online] Available at: <<http://www.worldbank.org/depweb/english/sd.html> >, [Accessed 9th January 2012].
- Dittmar, Hank & Ohland, Gloria (eds) 2004, *The new transit town: Best practices on transit oriented development*, Island Press, Washington DC.
- Eickmans, Luuk & Nasei, Imelda 2011, *People and Mobility Promoting non-motorised transport options and compact cities as complements to public transport*, HS Number: HS/096/11E, United Nations Human Settlements Programme (UN-HABITAT), Nairobi.
- El-Kahlout, Mohamed A. 2010, 'Traffic Conditions on Gaza Strip Roads: Problems and Recommendation', *King Saud University Magazinr, Architercture and Planning*, vol. 22, No. 1.
- English, Mary R. Peretz, Jean H. & Manderschied, Melissa 1999, *Smart Growth For Tennessee Towns And Counties: A Process Guide*, Waste Management Research and Education Institute, Energy, Environment and Resources Center, University of Tennessee, Knoxville.
- Glenn, D. 1992, *Determining Sample Size*, Fact Sheet PEOD-6, University of Florida, Florida cooperative extension services.
- Goodwill, Julie & Hendricks, Sara J. 2002, *Building Transit Oriented Development In Established Communities*, Technical report No. 473-135, National Center for Transit Research, Center for urban transportation research, University of South Florida.

REFERENCES

- Greed, Clara 1994, *Introducing Town Planning*, 2nd edn, Longman Scientific and Technical, UK.
- Hammouz, Ibrahim 2008, 'Trends in Development Planning of Nablus City in the Light of the Proposed Strategy for the City Development', MSc thesis, An-Najah National University, Faculty of Graduate Studies, Nablus, Palestine.
- Jyothi, B., Babu, G., & Krishna, I. 2008, 'Object Oriented and Multi-Scale Image Analysis: Strengths, Weaknesses, Opportunities and Threats - A Review', *Journal of Computer Science*, vol. 4, No. 9, pp. 706-712.
- Lambert, Thomas E. & Meyer, Peter B. 2006, Ex-Urban Sprawl as a factor in Traffic Facilities and EMS Response times in Southern United States, *Journal of Economic Issues*, vol. XL, No. 4, pp. 941, December.
- Lefaver, S, Buys, B, Castillo, D, Mattoon, S & Vargo, J, 2001, *Construction of Transit-Based Development*, MTI Technical report No. 01-05, Mineta Transportation Institute, College of Business, San José State University.
- Malczewski, Jacek 1999, *GIS and Multicriteria Decision Analysis*, John Wiley & Sons, Inc, Canada.
- Maryland Department of Transportation 2000, *Report to Governor Parris N. Glendening, From the Transit-Oriented Development Task Force*, Maryland Department of Transportation.
- Meyer, Michal D., Miller, Eric J. 2001, *Urban transportation planning: A decision-oriented approach*, 2nd edn, McGraw – Hill.
- Ministry of local government 1997, *The Master Project for Gaza City*, Municipality of Gaza.
- Ministry of Local Government 2010, *Physical Planning Manual: Procedures and Tools of Preparing Structural Plans for West Bank and Gaza Strip*, Final edn, Ministry of Local Government 2010, General Administration of Regulation and Urban Planning.
- Ministry of Planning 2005, *Regional Plan of Southern Governorates (2005-2020)*, Ministry of Local Government.
- Mohaisen, Amal Y. 2011, 'Sustainable Land Use Strategies for Gaza City', MSc thesis, The Islamic University of Gaza, Palestine.
- Municipality of Gaza 2009, *Project of Census and Numeration*, Department of Computer and Information.
- Nelson, Dick, Niles, John & Hibshoosh, Aharon 2001, *A New Planning Template for Transit-Oriented Development*, MTI Technical report No. 01-12, Mineta Transportation Institute, College of Business, San José State University.

REFERENCES

- New Jersey Department of Transportation; Pennsylvania Department of Transportation 2008, *Smart Transportation Guidebook, Planning and Designing Highways and Streets that Support Sustainable and Livable Communities*.
- Newman, Peter & Kenworthy, Jeffrey 2006, 'Urban design to reduce automobile dependence', *Opolis*, vol. 2, No. 1, pp. 35-52.
- Oana, P, Harutyun, S., Brendan, W. & Sheila, C. 2011, 'Scenarios and indicators supporting urban regional planning', *International Conference: Spatial Thinking and Geographic Information Sciences 2011*, Procedia Social and Behavioral Sciences, vol. 21, pp.243–252.
- Policylink National Research and Action Institute 2008, *Equitable Development Toolkit, Building Regional Equity, Transit Oriented Development*, PolicyLink National Research and Action Institute, Advancing Economic and Social Equity, New York, U.S.A.
- Poor, Aaron & Lindquist, Kathy 2009, *Sustainability and Transportation, Definitions and Relationship*, Office of Research and Library Services.
- Purvis, Charles L. 2003, *Incorporating the Effects of Smart Growth and Transit Oriented Development in San Francisco Bay Area Travel Demand Models: Current and Future Strategies*, Metropolitan Transportation Commission, planning Section, Oakland, California.
- Reconnecting America 2007, *Station Area Planning Manual*, Reconnecting America, Center For Transit Oriented Development, Metropolitan Transportation Commission.
- Renne, John L. 2008. 'Smart growth and transit - oriented development at the state level: Lessons from California, New Jersey, and Western Australia', *Journal of Public Transportation*, vol.11, No.3, pp.77-108.
- Renne, John L. 2009, 'Evaluating Transit-Oriented Development Using a Sustainability Framework: Lessons from Perth's Network City', in Tsenkova, Sasha (ed), *Planning Sustainable Communities: Diversity of Approaches and Implementation Challenges*, Calgary: University of Calgary, pp. 115-148.
- Research Results Digest 2002, *Transit-Oriented Development and Joint Development in the United States: A Literature Review*, Transit Cooperative Research Program, Sponsored by the Federal Transit Administration.
- RTD Fast Track 2006, *Strategic Plan for Transit Oriented Development*.
- Salha, Raed 1994, 'A Study On Towns Geography – Gaza City', MSc thesis, Institution of Arab Researches and Studies, League of Arab States, Arabian Organization for Education Culture And Science, Cairo University, Egypt.
- Salvesen, D. 1996, *Promoting Transit- Oriented Development*. Urban Land.

REFERENCES

- Slepian, Jenny & Stephenson, Janet, ca.2005, *Moving Forward With Transit Oriented Development In NZ*, Beca Carter Hollings & Ferner Ltd, Department Of Geography, University Of Otago, New Zealand.
- Smart Growth NetWork ca.2006, *This is Smart Growth*.
- Sprawl Guide 2001, *How Do You Define Sprawl?*, Updated 2001, Planning Commission Journal, Plannersweb, Burlington, Vermont, [Online] Available at: <<http://www.plannersweb.com/sprawl/define.html>>, [Accessed 10th January 2012].
- Still, T. 2002. *Transit-Oriented Development: Reshaping America's Metropolitan Landscape*. On Common Ground.
- Teklenburg, J., timmermans & H., Wagenberg, A. 1993, 'Space Syntax: Standardized integration measures and some simulations', *Environment and Planning B: Planning and Design*, vol. 20, p.p 347-357.
- TDM Encyclopedia 2010, *Automobile Dependency Transportation and Land Use Patterns That Cause High Levels of Automobile Use and Reduced Transport Options*, Updated 28st November, Transportation Demand Management (TDM) Encyclopedia, Victoria Transport Policy Institute. [Online] Available at: <<http://www.vtpi.org/tdm/tdm100.htm>>, [Accessed 12th October 2011].
- TDM Encyclopedia 2011a, *Smart Growth More Efficient Land Use Management*, Updated 26st December, Transportation Demand Management (TDM) Encyclopedia, Victoria Transport Policy Institute. [Online] Available at: <<http://www.vtpi.org/tdm/tdm38.htm>>, [Accessed 13th October 2011].
- TDM Encyclopedia 2011b, *Transit Oriented Development: Using Public Transit to Create More Accessible and Livable Neighborhoods*, Updated 31st August, Transportation Demand Management (TDM) Encyclopedia, Victoria Transport Policy Institute. [Online] Available at: <<http://www.vtpi.org/tdm/tdm45.htm>>, [Accessed 10th October 2011].
- The Center for Transit-Oriented Development (CTOD) 2004, *Planning for TOD at the Regional Scale, The big picture*, The Center for Transit-Oriented Development (CTOD), Federal Transit Administration, U.S.A
- The city of Calgary, Land Use Planning & Policies 2004a, *Transit Oriented Development: best practices handbook*, Calgary, AB, Canada: City of Calgary.
- The city of Calgary, Land Use Planning & Policies 2004b, *Transit Oriented Development Policy Guidelines*, Calgary, AB, Canada: City of Calgary.
- The Department of Internal Affairs, ca.2009, *Building Sustainable urban communities, A discussion document exploring place-based approaches to sustainable urban development in New Zealand*, New Zealand, Sustainable Urban Development Unit, An interagency unit hosted by the department of internal affairs.

REFERENCES

- Transportation Research Board 1991, *Transportation, urban form and the environment*, special technical report No. 231, Transportation Research Board, National Research Council, Washington DC.
- Tucker, T. Wilhelm, J. Wingate, C. Winters, J. & Wilkinson, L. 2008, *Smart Growth and Transit Oriented Development, Does it Exist in Georgia?* Growth Management Law.
- U.S.Roads 1997, 'Study Compares Older and Younger Pedestrian Walking Speeds', *Road Management and Engineering Journal*, [Online] Available at: <<http://www.usroads.com/journals/p/rej/9710/re971001.htm>>, [Accessed 28th April 2012].
- UN OCHA 2009, *Map Center*, united nations, Office For The Coordination Of Humanitarians Affairs (OCHA), Occupied Palestinian Territory . [Online] Available at: <<http://www.ochaopt.org/generalmaps.aspx?id=96>>, [Accessed 23th March 2012].
- United States Environmental Protection Agency (EPA) 2011, *Guide To Sustainable Transportation Performance Measures*.
- Waddell, Paul & Evans, Daniel J. ca.2000, *UrbanSim: Modeling Urban Development for Land Use, Transportation and Environmental Planning*, Department of Urban Design and Planning, and School of Public Affairs, University of Washington.
- Wander, Madeline 2008, *An Equity Agenda for Transit-Oriented Development, Planning for Sustainable Growth in Los Angeles' Inner City*, Urban & Environmental Policy Senior Comprehensive Project.
- Wikipedia 2011, *Smart growth*, Updated 12th December, Wikipedia, the free encyclopedia. [Online] Available at: <http://en.wikipedia.org/wiki/Smart_growth>, [Accessed 5th January 2012].

APPENDICES

- Appendix 1** Local Community Questionnaire –Gaza City
(English)
- Appendix 2** مدينة غزة - استبيان موجه لفئات المجتمع المحلي
(Arabic)
- Appendix 3** Authoritative and official Local Agencies Semi-Structured
Interview (English)
- Appendix 4** مقابلة موجهة للمختصين العاملين في المؤسسات الحكومية والرسمية المحلية
(Arabic)

The Islamic University – Gaza
Deanery of Postgraduate Studies
Faculty of Engineering
Architecture Department



Appendix 1

Local Community Questionnaire- Gaza City
Building A Sustainable and Smart Urban Development Pattern
Based On
Transit Oriented Development (TOD)

This thesis is prepared in partial fulfillment of the requirements for the degree of Master in Architectural Engineering. The researcher seeks to build a sustainable and smart pattern, that based on the term Transit Oriented Development (TOD) and Gaza city is taken as an implementation area.

The Study depends to large extend on your help and support. Therefore, the researcher would ask you to answer all questions of the following structured interview. The researcher is very sure that all of your answers will be distinguished by literalism, objectivity and accuracy. Your high quality answers will define indicators that support the approach and help to identify priorities. Finally, make sure that all answers will be used for just educational and research purposes.

THANK YOU

Researcher
Shaymaa Ali Maher\ Abu Rass

E. General Information:

A.1 Gender:

Male Female

A.2 Age:

Less than 18 19-26 27-45 46-65 more than 65

A.3 Educational degree:

Less than high-school High-school Diploma
 Bachelors degree post graduated

A.4 Job:

Employee Student Private business Housewife
 Without work Other (determine) _____

A.5 Workplace:

Inside neighborhood outside neighborhood outside city
 Other (determine) _____

F. The Trips and Transportation means:

B.1 What are the most trips that you do during a week?

Work trips Social trips Shopping trips
 Other trips (determine) _____

APPENDICES

B.2 What is the transportation mean you mainly depend on to do your daily trips?

- Private car Public transpiration Walking

B.3 How much time do you spend to arrive your workplace?

- Less than 10 min. 11-20 min. 21-30 min. more than 30 min.

B.4 What is your evaluation for the performance and efficiency of the current transpiration network and the public transport?

- Excellent Acceptable Weak

G. Walk and Using the Public Transport

C.1 How long can you walk on feet to the work, home or any other trip?

- 5 min. 10 min. 15 min. more than 15 min.

C.2 Which path is preferable for you to walk in?

- Shortest with least metric distance Simplest with least angular changes

Question No.		Yes	Partly	No
C.3	Do you agree with walking for 200-600 m while going on any trip?			
C.4	Do you agree with the pedestrians' corridors?			
C.5	Do you agree with the establishment of pedestrians' and bicyclists' lanes within streets?			
C.6	Is the idea of afforesting, lighting and furnishing streets encourage you to walk to reach your destinations?			
C.7	Do you agree with the idea of depending on the public transportation means after develop it and reduce costs?			
C.8	Do you think that idea of encouraging the walking and using the public transport can improve the social relationships between the citizens of the neighborhood?			
C.9	Do you think that depending on public transport can contribute in solving the fuel problem that affect on Gaza?			

H. Transportation Network, Services and Land Use

Question No.		Yes	Partly	No
D.1	Do you agree with the foreign vehicles that pass, enter and penetrate the heart of your neighborhood?			
D.2	Do you agree the idea of existing all educational, commercial, administrative, health and recreational services in your area?			
D.3	Do you think that a good transportation network may increase the quality of the living conditions of the area?			
D.4	Do you think that direct connection of your area with other areas and the city center by efficient transportation system may increase the degree of satisfaction of residents?			

THANK YOU



Appendix 2

استبيان موجه لفئات المجتمع المحلي - مدينة غزة

بناء نموذج عمراني تنموي ذكي ومستدام مبني على أساس التنمية القائمة على تطوير المواصلات والنقل Building A Sustainable and Smart Urban Development Model Based On Transit Oriented Development (TOD)

يتم إعداد هذه الدراسة استكمالاً لمتطلبات الحصول على درجة الماجستير في الهندسة المعمارية، حيث تسعى الباحثة لبناء نموذج عمراني تنموي ذكي ومستدام، مبني على أساس التنمية القائمة على تطوير المواصلات والنقل، وقد اختارت مدينة غزة، كحالة للدراسة والبحث والتطبيق. تعتمد هذه الدراسة إلى حد كبير على مساعدتكم ودعمكم، ولذلك فإن الباحثة ترحو منكم الإجابة على جميع الأسئلة الواردة ضمن هذا الاستبيان، كما ترحو أن تتميز إجاباتكم بالدقة والموضوعية لكي تزود البحث بمجموعة من المؤشرات التي من شأنها تحديد الأولويات... كونوا على أتم الثقة بأن إجاباتكم سوف تستخدم لأغراض علمية وبحثية خالصة.

شكراً لحسن تعاونكم

الباحثة

شيماء علي ماهر/ أبوراس

A. المعلومات العامة

1.A الجنس

ذكر أنثى

2.A العمر

أقل من 18 سنة 19 - 26 27 - 45 46 - 65 فأكثر

3.A الدرجة العلمية

أقل من الثانوية العامة الثانوية العامة دبلوم متوسط بكالوريوس دراسات عليا

4.A العمل

موظف طالب عمل خاص ربة منزل لا أعمل غير ذلك (حدد) _____

5.A مكان العمل

داخل الحي خارج الحي خارج المدينة غير ذلك (حدد) _____

B. الرحلات وأساليب التنقل

1. B ما هي أكثر الرحلات التي تقوم بها خلال الأسبوع الواحد؟

رحلات عمل رحلات اجتماعية رحلات تسوق رحلات أخرى (حدد) _____

2. B ما هي وسيلة المواصلات التي تعتمد عليها بشكل رئيسي في أداء الرحلات اليومية ؟
 سيارتك الخاصة وسائل المواصلات العامة المشي

3. B ما هي المدة التي تقتضيها للوصول إلى مكان العمل ؟
 أقل من 10 دقائق 11-20 دقيقة 21-30 دقيقة أكثر من 30 دقيقة

4. B ما تقييمك لفعالية وأداء شبكة المواصلات الحالية ووسائل النقل العامة؟
 ممتازة مقبولة رديئة

C. المشي واستخدام النقل العام

1. C ما هي المدة التي بإمكانك أن تقضيها مشياً على الأقدام باتجاه العمل أو البيت أو أي رحلة أخرى ؟
 5 دقائق 10 دقائق 15 دقيقة أكثر من 15 دقيقة

2. C أيهما تفضل المشي فيه؟
 طريق قصير ومتعرج طريق أطول قليلاً وخالي من التعرجات

رقم السؤال	نعم	إلى حد ما	لا
3. C			هل تؤيد فكرة المشي لمسافة 200-600 م عند أداء رحلاتك؟
4. C			هل تؤيد فكرة الشوارع الخاصة بالمشاة فقط؟
5. C			هل تؤيد فكرة تخصيص مسارات في الشوارع خاصة لحركة كل من المشاة والدراجات الهوائية مع فصلها عن حركة المركبات؟
6. C			تشجعك فكرة تشجير الشوارع وتزويدها بالإضاءة والمقاعد على التنقل مشياً ؟
7. C			تؤيد فكرة الاعتماد على وسائل النقل العام وذلك بعد تطويرها وتحسينها وتقليل تكاليفها؟
8. C			هل تعتقد بأن فكرة تشجيع المشي واستخدام النقل العام من شأنه أن يحسن العلاقات الاجتماعية بين سكان المنطقة الواحدة؟
9. C			هل تعتقد أن الاعتماد على وسائل النقل العام يستطيع أن يساهم في حل مشكلة الوقود التي تعاني منها غزة؟

D. شبكة المواصلات والخدمات واستخدامات الأراضي

رقم السؤال	نعم	إلى حد ما	لا
1. D			هل تؤيد فكرة دخول المركبات العابرة واختراقها لقلب المناطق السكنية؟
2. D			هل تؤيد فكرة توفر جميع الخدمات التعليمية والتجارية والإدارية والصحية والترفيهية في منطقتك ؟
3. D			هل تعتقد أن وجود شبكة مواصلات جيدة قد تزيد من جودة البيئة المعيشية للمنطقة؟
4. D			هل تعتقد بأن الارتباط المباشر لمنطقتك مع المناطق الأخرى المجاورة ومع مركز مدينة بوسائل مواصلات مناسبة قد يؤدي إلى زيادة درجة الرضا التي يشعر بها السكان ؟

شكراً لحسن تعاونكم

The Islamic University – Gaza
Deanery of Postgraduate Studies
Faculty of Engineering
Architecture Department



Appendix 3

Authoritative and official Local Agencies **Semi-Structured Interview**

Building A Sustainable And Smart Urban Development Model Based On Transit Oriented Development (TOD)

This thesis is prepared in partial fulfillment of the requirements for the degree of Master in Architectural Engineering. The researcher seeks to build a sustainable and smart pattern, that based on the term Transit Oriented Development (TOD) and Gaza city is taken as an implementation area.

The Study depends to large extend on your help and support. Therefore, the researcher would ask you to answer all questions of the following structured interview. The researcher is very sure that all of your answers will be distinguished by literalism, objectivity and accuracy. Your high quality answers will define indicators that support the approach and help to identify priorities. Finally, make sure that all answers will be used for just educational and research purposes.

THANK YOU

Researcher
Shaymaa Ali Maher\ Abu Rass

Over View:

Metropolitan areas' physical health, quality of life and environment depend on the performance of its transportation system. Not only does the transportation system provide opportunities for the mobility of people and goods, but over the long term, it influences patterns of growth and the level of activities through the accessibility it provides to land. In recent years, changes to the urban transportation systems have been treated by many officials as means of meeting an assortment of communities' objectives. Within this context, it is realized that it is needed to study how to employ the concept of Transit Oriented Development (TOD) as a new innovative trend to guide urban development patterns and to build highly livable environment.

Transit Oriented Development (TOD) refers to a form of urban design that achieves pedestrian-friendly, mixed-use, mixed-income, high-density and location efficient communities centered on public transport nodes. Hence, Transit Oriented Development (TOD) has become a popular planning response to the impacts of metropolitan growth.

(TOD) can be defined, *"Residential and Commercial Centers designed to maximize access by transit and nonmotorized transportation, and with other features to encourage transit Ridership. A typical TOD has a rail or bus station at its center, surrounded by relatively high-density development, with progressively lower-density spreading outwards one-quarter to one-half mile, which represents pedestrian scale distances"*.

APPENDICES

A. Introduction

- 1. **Agency / Jurisdiction:** _____
- 2. **Person Completing Survey:** Name: _____
Title: _____
Phone: _____
Email: _____

B. Definition

- 3. **Has your agency adopted a definition or vision of developmental planning that concentrated on transportation?**

YES NO

If YES, what is it? _____

If NO, what is your own definition? _____

- 4. **A TOD typically refers to the area within 800m of a rail station. That it is important to ensure that the 500 m TOD area around rail stations receives special planning attention so that the most appropriate development occurs. Is this approach acceptable for you?**

YES NO partial acceptance

- 5. **Can your agency support the minimum target of the approach?**

YES NO

If YES, how can you achieve this goal? _____

If NO, please list reasons _____

C. Overview about the current situation:

6. Please, briefly list the goals your agency has set for the future planning and developmental projects. Once listed, please rank them in order of importance from your agency perspective, "A" being the most important.

	Goals	Rank
A.	_____	_____
	_____	_____
	_____	_____
	_____	_____
B.	_____	_____
	_____	_____
	_____	_____
	_____	_____
C.	_____	_____
	_____	_____
	_____	_____
	_____	_____
D.	_____	_____
	_____	_____
	_____	_____
	_____	_____
E.	_____	_____
	_____	_____
	_____	_____
	_____	_____
F.	_____	_____
	_____	_____
	_____	_____
	_____	_____

7. Does your agency have a fixed guideway project in planning, design or construction? What comes closest to describing your situation?

Our projects in:

- Data collection.
- System planning.
- Alternatives analysis.
- Early stages of preliminary engineering.
- Advanced stages of preliminary engineering.
- Final design.
- In construction.
- In funding.
- Coordinating between stakeholders
- Other _____

APPENDICES

8. Please, rate the importance of each urban service that can be considered while planning for the neighborhood scale.

SERVICE	Very Important	Somewhat Important	Neutral	Not Important
Primary school				
Mosque				
Parks and green areas				
Commercial services				
Cultural services				
Health care services				
Official and institutional services				
Recreational services				
Restaurants and cafés				
Public transportation				
Private transportation				
Car parking				
Emergency services				
Other ()				

9. What are the most perceived problems that you seek to solve and manage through developmental planning?

Problems related to **Land use** _____

Problems related to **Transportation** _____

Problems related to **Environment** _____

Problems related to **Society** _____

Problems related to **Services** _____

10. How does your agency address land use? Please check the statement that comes closest to describing your agency's position.

- Land use is not something we are concerned with.
- Our agency takes the lead.
- Municipality takes the lead.
- Ministry of Planning takes the lead.
- Ministry of Local Government takes the lead.
- Provide funds to leverage land use decisions by local jurisdictions.
- Has a formal relationship with other agencies in conducting studies.
- Other _____

11. What are the planning priorities that your agency takes in consideration while planning the land use?

PRIORITY	Very Important	Somewhat Important	Neutral	Not Important
Community needs and population during specific period (____ year)				
Financial capacity				
Available vacant land				
To be similar to the existing land uses				
To be different of the existing land uses				
Solving existing urban problems				
Solving existing transportation problems				
Other (_____)				

12. Does your agency have staff or consultants assigned to work on land use development?

- YES NO

13. Does your agency have a specific polices or formal program designed to encourage the usage of public transportation and walkability?

- YES, we have polices
- NO, we have not
- We have partial plan to do so.

D. Supporting the proposed approach:

14. For which extend can you support the approach of this study?

- We can support it completely
- We cannot support it whatsoever
- We can support partially.

15. Are there any internal regulations, policies, or mandates within your organization that explicitly devoted to promoting and implementation Transit Oriented Development trends?

- YES NO

If YES, what are these arrangements? _____

16. Can the inclusion of land use, transportation as emergent mechanical factors in the developmental processes change your agency's interest in and its capability to undertake and implement Transit Oriented Development planning in your community? Please check the statement that comes closest to describing your agency's situation.

- It had no impact on our ability to undertake and implement transit-supportive planning.
 It can raise the profile of the transit and land use connection in our agency, local governments and the community.
 It can provide the impetus to take transit-supportive land use planning to the next level.
 It can lead directly to changes in locally adopted land use policies and plans for the transit corridor.
 It can offer a significant impact on moving transit-supportive land use planning and implementation forward in our community.
 Other (please explain): _____

17. Has the presence of land use as a rating criterion changed how your agency approaches land use in the development of transit projects? Please check the statement that comes closest to describing your agency's situation.

- No, we have always treated land use as a key factor; we would do it anyway.
 No, how we address land use as a local issue; while having a national criterion that control the process.
 Yes, it helped to provide the impetus to more seriously address land use issues.
 Yes, it has opened the door to get the discussion going.
 Other (please explain): _____

APPENDICES

18. On which category do you focus your attention while planning for transportation? Please give a rating.

ITEM	Very Important	Somewhat Important	Neutral	Not Important
Public transportation				
Private transportation				
Pedestrian environment				
Bicycle tracks				
Emergency services				
Other ()				

19. Which, if any, national/regional government policies does your agency currently employ to encourage:

Mixed Land use _____

Public Transportation _____

Walkability _____

20. Which is preferable while planning and developing for public transportation network, please explain the reason?

Public transportation station Public transportation routes
 Reason _____

21. Are there any environmental concerns while planning for land use and transportation?

YES NO

If YES, what are these concerns? _____

APPENDICES

If NO, please list reasons _____

E. The importance of the new approach:

22. Based on your experience, how important is each design element to encourage walkability and usage of public transportation?

ELEMENT	Very Important	Somewhat Important	Neutral	Not Important
Variety of ground surfaces				
Raised street crossings at intersections				
Outdoor seating (cafés and/or restaurants)				
Outdoor seating (public benches)				
Well-lit public spaces and footpaths				
Street trees				
Buildings adjacent to footpath (minimal or no setback on street level)				
No blank walls				
Street awnings and/or porticos				
Large pedestrians' shed (accessible street network for pedestrians)				
Windows facing street				
Improving landscape design elements				
Lighting				
Widening the sidewalks				
Other ()				

23. Based on your agency's experience in urban planning and growth management, how important is Transit Oriented Development towards:

ITEM	Very Important	Somewhat Important	Neutral	Not Important
Increasing transit ridership				
Increasing political support for transit				
Relieving traffic congestion				
Reducing sprawl				
Increasing housing choices				
Improving neighborhood quality				
Spurring economic development				
Creating a diverse community				
Other ()				

APPENDICES

F. The impediments and challenges facing the development process and the new approach:

24. Based on your experience, to what degree is each one of the following an impediment to Transit Oriented Development?

IMPEDIMENT	Major Impediment	Minor Impediment	Not Impediment
Lack of Market Demand			
Community Opposition			
Local Zoning Restrictions			
Lack of Lender / Investor Interest and Support			
Lack of Developer Interest			
Skepticism Among Local Governments			
Lack of Political Support			
Inadequate Transit Service			
Location of Transit Stations			
Predominance of Auto-Oriented Land Uses			
Lack of Local Expertise in TOD Planning or Implementation			
Transit Agency Requirements for Replacement Parking			
Lack of Collaboration Between Participating Governmental Agencies			
Legal Issues			
Lack of financial support			
Other ()			

G. Corporation

25. Does your agency have cooperative agreements with any of the public agencies to promote Transit Oriented Development trends?

YES NO

If YES, what are these agencies? _____

H. Financial issues

26. List the major sources of funding for the programs of planning and development, and divide into the following categories. Please specify whether these sources of funding are dedicated.

Sources	Administration & Planning	Construction & Implementation	Dedicated?
A.			
B.			
C.			
D.			
E.			
F.			

I. Education and promoting awareness

27. Are there any programs involve promoting awareness and education?

- YES NO

If YES, please answer the following questions:

28. Who is the primary intended audience for the program? (check one)

- The public
- Local government staffs
- Local government elected officials
- Developers and NGOs staffs
- Donator and Lenders
- Investors and Businesses
- Other: _____

29. What is the primary program strategy? (check one)

- To provide outreach and education in response to proposed developmental projects
- To provide outreach and education on an ongoing basis
- Other: _____



Appendix 4

مقابلة موجهة للمختصين العاملين في المؤسسات الحكومية والرسمية المحلية

نحو بناء نموذج عمراني تنموي ذكي ومستدام
مبني على أساس المواصلات الموجهة لعمليات التنمية

**Building A Sustainable And Smart Urban Development Pattern
Based On**

Transit Oriented Development (TOD)

يتم إعداد هذه الدراسة استكمالاً لمتطلبات الحصول على درجة الماجستير في الهندسة المعمارية، حيث تسعى الباحثة لبناء نموذج عمراني تنموي ذكي ومستدام، مبني على أساس التنمية القائمة على تطوير المواصلات والنقل، وقد اختارت مدينة غزة، كحالة للدراسة والبحث والتطبيق.

تعتمد هذه الدراسة إلى حد كبير على مساعدتكم ودعمكم، ولذلك فإن الباحثة ترحو منكم الإجابة على جميع الأسئلة الواردة ضمن هذا الاستبيان، كما ترحو أن تتميز إجاباتكم بالدقة والموضوعية لكي تزود البحث بمجموعة من المؤشرات التي من شأنها تحديد الأولويات...

كونوا على أتم الثقة بأن إجاباتكم سوف تستخدم لأغراض علمية وبحثية خالصة.

شكراً لحسن تعاونكم

الباحثة

شيماء علي ماهر/ أبوراس

❖ لمحة عامة

تعتمد كفاءة الأنظمة العمرانية في المناطق الحضرية على مدى كفاءة ونجاح أنظمة وأساليب التنقل خلال هذه التجمعات، إذا أن هذه الأنظمة لا يقتصر دورها على توفير النقل فحسب، وإنما تؤثر بشكل كبير على اتجاهات النمو العمراني ومستوى النشاطات المرتبطة به، ففي الوقت الحاضر، تتم معالجة القضايا المرتبطة بالمواصلات الحضرية عن طريق عدد من الأساليب التخطيطية والتنموية التي تتماشى مع ظروف وحيثيات كل مجتمع من المجتمعات، وفي هذا السياق تم اختيار مدينة غزة كمنقطة دراسية لبناء نموذج جديد للتنمية العمرانية المستدامة؛ يمثل ركيزة أساسية لعمليات توزيع استخدامات الأراضي وتخطيط المواصلات والتنمية البيئية، وغير ذلك من الموضوعات التي تساند عملية إدارة النمو في المدينة، وفي ظل الامتداد العمراني الواسع والتطور التكنولوجي الهائل الذي أدى إلى إعادة النظر في التخطيط الحضري ووضع بدائل جديدة قد تكون أكثر تماشياً من العصر الحالي، تم الخلوص إلى أن يبني النموذج الجديد على أساس تنموي موجه إلى إعادة هيكلة نظام المواصلات والنقل داخل المنطقة، باعتبار أن هذا الجانب هو المحرك الأساسي والفعال للخروج من الأزمة، وتطبيق مفهوم التخطيط التنموي الحضري المستدام.

وهنا لا بد من الإشارة إلى مفهوم التنمية القائمة على أساس تفعيل دور المواصلات والنقل، على أنها نموذج للتخطيط الحضري يتم من خلاله عمل مراكز سكنية وتجارية ذات كثافات سكانية عالية تشجع المشي وتشجع استخدام وسائل النقل العام بدلاً من استخدام المركبات الخاصة، وذلك من خلال عمل محطات للنقل تكون هي مراكز المجاورات السكنية، وتكون هي بؤرة الجذب التجاري والخدمات والترفيهية لكل واحدة من هذه المجاورات.

❖ تقديم

1. اسم المؤسسة أو الجهة الرسمية: _____
2. المعلومات الشخصية:
- الموقع الوظيفي _____
 - رقم الهاتف أو الجوال _____
 - البريد الإلكتروني _____

❖ التعريف والمفهوم العام

3. هل لدى مؤسستكم أية رؤية أو تعريف خاص بالتخطيط التنموي الموجه إلى التركيز على الجوانب المتعلقة بالموصلات والنقل داخل التجمع العمراني؟

نعم لا

إذا كانت الإجابة نعم، فما هو ذلك التعريف أو الرؤية؟

إذا كانت الإجابة لا، فما هو تعريفكم الخاص بالتخطيط التنموي؟

4. إن مفهوم التنمية الموجهة إلى تعزيز وتطوير الجوانب المتعلقة بالموصلات والنقل (TOD)، يشير بشكل خاص إلى المنطقة المحيطة بمحطات الموصلات الرئيسية داخل نطاق 600-800م، وهذا يتطلب أن تتلقى المنطقة المعنية تركيز تخطيطي من شأنه إحداث تغييرات تنموية في المنطقة. هل أنت تؤيد هذا التوجه التنموي؟

نعم لا أؤيد بشكل جزئي

5. هل تستطيع مؤسستكم دعم الهدف الأساسي لهذا التوجه، فيما يتعلق بنطاق عملها؟

نعم لا

إذا كانت الإجابة نعم، ففي أي المجالات تستطيع مؤسستكم تحقيق هذا الدعم؟

إذا كانت الإجابة لا، الرجاء توضيح الأسباب:

❖ لمحة عامة حول الوضع التخطيطي الحالي

6. ما هي الأهداف التي وضعتها مؤسستكم بشأن المشاريع التنموية المستقبلية، الرجاء ذكرها ومن ثم ترتيبها حسب الأولوية والأهمية من وجهة نظر مؤسستكم، ثم إعطاؤها نسبة مئوية من الأهمية.

نسبة الأهمية

الهدف

_____	_____ (1)
_____	_____
_____	_____
_____	_____
_____	_____ (2)
_____	_____
_____	_____
_____	_____
_____	_____ (3)
_____	_____
_____	_____
_____	_____
_____	_____ (4)
_____	_____
_____	_____
_____	_____
_____	_____ (5)
_____	_____
_____	_____
_____	_____
_____	_____ (6)
_____	_____
_____	_____

7. ما هي مجالات عملكم في مشاريع التخطيط أو التصميم أو التنفيذ؟ الرجاء اختيار إجابة واحدة أو أكثر تتناغم مع واقع العمل لديكم:
عملنا يخصص في:

- جمع المعلومات
 وضع خطة ونظام العمل ووضع العقود اللازمة
 دراسة وتحليل البدائل المتاحة
 المراحل الأولية والتمهيدية للمشاريع
 المراحل المتقدمة والنهائية للمشاريع
 التصميم النهائي
 مجال التنفيذ
 مجال التمويل
 التنسيق بين الجهات المعنية
 مجالات أخرى (الرجاء التوضيح):

8. اختر درجة الأهمية التي تراها مناسبة لكل واحدة من الخدمات المجتمعية التي لا بد من أخذها بعين الاعتبار أثناء عمليات التخطيط والتصميم للمشاريع التطويرية والتنموية على مستوى المجاورة السكنية:

نوع الخدمة	مهمة جداً	مهمة	محايد	غير مهمة
المدرسة الابتدائية				
المسجد				
الحدائق والمناطق الخضراء				
الخدمات التجارية				
الخدمات الثقافية				
خدمات الرعاية الصحية				
الخدمات الإدارية				
الخدمات الترفيهية				
المطاعم والاستراحات				
وسائل النقل العام				
وسائل النقل الخاص				
مواقف السيارات				
خدمات الطوارئ				
خدمات أخرى ()				

9. ما هي أهم المشكلات الحضرية التي تسعى مؤسستكم للتغلب عليها وإدارتها من خلال عمليات التخطيط التنموي؟

مشكلات تتعلق باستخدامات الأراضي

□ مشكلات تتعلق بالموصلات

□ مشكلات تتعلق بجودة البيئة

□ مشكلات تتعلق بالمجتمع المدني

□ مشكلات تتعلق بالخدمات

10. كيف تنظر مؤسستكم إلى تخطيط استخدامات الأراضي؟ الرجاء اختيار الإجابات الأكثر تناغماً مع واقع العمل لديكم:

- تخطيط استخدامات الأراضي ليس من ضمن اختصاصات عملنا.
- مؤسستنا هي المسؤولة عن تخطيط استخدامات الأراضي.
- البلدية هي المسؤولة عن تخطيط استخدامات الأراضي.
- وزارة التخطيط هي المسؤولة عن تخطيط استخدامات الأراضي.
- وزارة الحكم المحلي هي المسؤولة عن تخطيط استخدامات الأراضي.
- مؤسستنا تقدم التمويل اللازم لعمليات تخطيط استخدامات الأراضي.
- هناك علاقات رسمية وواضحة بيننا وبين مجموعة من الجهات الأخرى لإعداد دراسات حول تخطيط استخدامات الأراضي.
- أخرى (الرجاء التوضيح):

11. ما هي الأولويات التخطيطية التي يتم أخذها بعين الاعتبار عند التخطيط لاستخدامات الأراضي، الرجاء توضيح درجة الأهمية لكل منها:

الأولوية	مهمة جداً	مهمة	محايد	غير مهمة
حاجة السكان وأعدادهم خلال فترة زمنية معينة () سنة				
الإمكانات المالية المتاحة خلال فترة تنفيذ المشروع				
الأراضي المتاحة				
الاستخدامات الحالية، ومن ثم اختيار الاستخدامات الأكثر تناغماً معها				
الاستخدامات الحالية، ومن ثم اختيار الاستخدامات الأكثر اختلافاً عنها				
حلاً لمشكلات عمرانية قائمة في المنطقة				
حلاً لمشكلات مرورية قائمة في المنطقة				
أولويات أخرى ()				

12. هل يوجد لديك طاقم عمل متكامل ومستشارين وظيفتهم الأساسية هي تطوير عملية تخطيط استخدامات الأراضي؟

نعم لا

13. هل يوجد لدى مؤسستكم استراتيجيات أو برامج ثابتة ومحددة من شأنها تشجيع المشي أو استخدام وسائل النقل العام؟

- نعم، لدينا استراتيجيات وبرامج ثابتة ومحددة ومتكاملة.
 لا يوجد لدينا أي شيء من هذا القبيل.
 لدينا مجموعة من الاستراتيجيات المتفرقة لا تأخذ الطابع الرسمي أو المتكامل.

❖ الدعم والتأييد للتوجه المقترح

14. إلى أي مدى تستطيع مؤسستكم تقديم الدعم للتوجه المقترح خلال هذه الدراسة؟

- نحن نستطيع تقديم الدعم الكامل لهذه الرؤية التنموية.
 نحن لا نستطيع أن نقدم أي نوع من أنواع الدعم لهذا التوجه.
 يمكننا تقديم الدعم بشكل جزئي (الرجاء تحديد المجالات)

15. هل يوجد لدى مؤسستكم أي من التشريعات أو الاستراتيجيات التي يتم مراعاتها أو تطبيقها حالياً والتي تحاكي إلى حد بعيد أسس التنمية الموجهة إلى الاعتماد على دور المواصلات والنقل؟

نعم لا

إذا كانت الإجابة نعم، اذكر هذه الاستراتيجيات أو التشريعات

16. بعد أن أصبح من الواضح أن هناك اندماج وترباط كبير بين استخدامات الأراضي والمواصلات، كمؤثرات في عملية التخطيط، هل يمكن لهذا الاندماج أن يؤثر على توجهكم نحو تبني مفهوم التنمية القائمة على تطوير وتعزيز دور المواصلات في التخطيط الحضري؟
- هذا الاندماج لا يمكنه أن يؤثر على توجهنا في التخطيط الحضري.
- يمكن لهذا الاندماج أن يحقق نتائج مهمة في مجال تخطيط استخدامات الأراضي ومجال السيطرة على حركة المواصلات.
- يمثل حافظ مهم لإجراء عملية التخطيط لاستخدامات الأراضي التي تنطلق من السيطرة والتحكم في حركة المواصلات.
- يمكنه أن يرفع درجة الأهمية لإحداث ترباط بين استخدامات الأراضي من جهة وبين الاعتماد على النقل العام من جهة أخرى، وذلك لدى كل من مؤسستنا والجهات الرسمية والفئات المجتمعية المختلفة.
- يؤدي هذا التوجه مباشرة إلى الاهتمام بإعداد خرائط وسياسات خاصة بتهيئة الممرات والشوارع التي تتناسب مع وسائل النقل العام وتتناسب مع المشي المريح والهادئ.
- أخرى (الرجاء التوضيح)

17. هل تمثل استخدامات الأراضي عامل مهم في عمليات تخطيط المواصلات؟
- لا، يتم التعامل مع كل من استخدامات الأراضي والمواصلات بشكل منفرد عن الآخر.
- لا، حيث أن هناك عوامل قومية متفق عليها تجعل السياسات الرسمية لتخطيط استخدامات الأراضي منفصلة تماماً عن السياسات الرسمية لتخطيط المواصلات.
- نعم، حيث أن التعامل مع استخدامات الأراضي عند التخطيط للمواصلات يصعب المخططات بصيغة أكثر واقعية.
- نعم، حيث أن استخدامات الأراضي قد تطرح قضايا ملحة عند التخطيط للمواصلات.
- أخرى (الرجاء التوضيح)

18. وضّح درجة الأهمية التي توليها مؤسستكم لكل من المحددات التخطيطية التالية:

المحددات التخطيطية	مهمة جداً	مهمة	محايد	غير مهمة
وسائل النقل العام				
وسائل النقل الخاص				
توفير ممرات مهيأة للمشى				
توفير ممرات للدراجات				
خدمات الطوارئ				
أولويات أخرى ()				

19. ما هي السياسات المحلية والوطنية التي تتبناها مؤسستكم لتشجيع كل من:
 النمط المختلط لاستخدامات الأراضي

استخدام وسائل النقل العام

تشجيع المشي

20. أيهما يعتبر مفضل بشكل أكبر عند التخطيط لوسائل النقل العام وتطوير السياسات المتعلقة بها؟

إنشاء محطات للنقل العام إنشاء طرق للنقل العام

السبب

21. هل هناك أي اعتبارات بيئية تتم مراعاتها عند تخطيط استخدامات الأراضي وتخطيط المواصلات؟

نعم لا

إذا كانت الإجابة نعم، ما هي هذه الاعتبارات؟

إذا كانت الإجابة لا، الرجاء توضيح الأسباب:

❖ أهمية التوجه المقترح

22. بناء على خبرتك في مجال التخطيط الحضري، ما مدى أهمية كل من العناصر التالية لتشجيع المشي واستخدام وسائل النقل العام؟

العنصر	مهمة جداً	مهمة	محايد	غير مهمة
التنوع والتشويق في تشطيبات الشوارع				
استخدام وسائل تثبيط سرعة السيارات				
استراحات ومطاعم ذات مقاعد خارجية				
مقاعد وكراسي في الطرقات مخصصة للعامة				
ممرات مشاة مهيأة ومريحة				
شوارع مشجرة				
المباني ملاصقة تماماً لممرات المشاة				
واجهات الطوابق الأرضية مليئة بعناصر الجذب				
ممرات المشاة عبارة عن أروقة (مسقوفة وذات أعمدة)				
فصل حركة المشاة عن حركة السيارات عن طريق حواجز شجرية أو معدنية أو إسمنتية				
فتحات نوافذ المحلات وفترينات العرض ملاصقة لممرات المشاة				
تعزيز وجود الأشرطة الخضرية				
ممرات المشاة عريضة ومريحة				
وجود عناصر إضاءة				
عناصر أخرى ()				

23. بناء على خبرتك في مجال التخطيط الحضري ومجال إدارة النمو داخل التجمعات العمرانية، ما مدى أهمية تطبيق مفهوم التنمية القائمة على أساس تطوير دور المواصلات والنقل لكل من:

العنصر	مهمة جداً	مهمة	محايد	غير مهمة
زيادة الاعتماد المجتمعي على وسائل النقل العام				
زيادة الدعم الرسمي للنقل العام				
تقليل الازدحام المروري				
الحد من الامتداد العمراني الغير منظم و مدروس				
زيادة الخيارات المتعلقة بنمط الإسكان				
تعزيز جودة المجاورات السكنية				
تشجيع النمو الاقتصادي				
إنشاء مجتمعات تتميز بالتنوع				
المحافظة على جودة البيئة الطبيعية				
تقليل حدة أزمة الاعتماد على الوقود المستخدم في المركبات				
عناصر أخرى ()				

❖ المعوقات والتحديات التي تواجه عمليات التنمية ومن ثم التوجه المقترح

24. إلى أي مدى يعتبر كل عنصر مما يلي هو تحدٍ وعائق أمام تطبيق التنمية القائمة على أساس تطوير دور المواصلات؟

لا يمثل عائق	عائق متوسط التأثير	عائق رئيسي	نوع العائق
			ضعف الطلب على هذا النمط من التنمية
			المعارضة المجتمعية
			قيود رسمية محلية أو قومية على تقسيم المناطق
			ضعف المستثمرين وضعف اهتمامهم بهذا الجانب
			ضعف الاهتمام من قبل المؤسسات التنموية
			عنصر الشك وعدم الثقة لدى الجهات الرسمية والحكومية
			ضعف الدعم السياسي
			خدمات النقل الموجودة غير ملائمة لهذا النوع من التنمية
			صعوبة تحديد مواقع لإنشاء محطات للنقل العام
			نظام النقل الحالي يعتمد بشكل أساسي على النقل الخاص
			قلة عدد الخبراء في مجال التخطيط والتنفيذ للتنمية القائمة على أساس تطوير دور المواصلات
			الحاجة إلى إيجاد مساحات لتخصيصها كمواقف للمركبات
			ضعف التعاون والشراكات بين المؤسسات الرسمية المعنية
			قضايا قانونية وتشريعية
			عوائق أخرى ()

❖ الشراكات والتعاون

25. هل هناك أي من الشركات بين مؤسساتكم وبين جهات رسمية أخرى لتعزيز وتفعيل أي من توجهات التنمية القائمة على أساس تطوير دور المواصلات والنقل؟

نعم لا

إذا كانت الإجابة نعم، ما هي هذه الجهات؟

❖ القضايا المالية

26. اذكر أهم مصادر الدعم المالي المخصصة للتخطيط والتنمية لديكم، مع تصنيف هذه المصادر حسب الجهات التي تخصص لها، مع ذكر مدى جدية هذه المصادر وكفاءتها:

الترتيب	الإدارة والتخطيط	الإنشاء والتنفيذ	مدى جدية المصدر
.1			
.2			
.3			
.4			
.5			
.6			

❖ التعليم والتوعية

27. هل يوجد لديكم أي من البرامج الخاصة بالتوعية والتعليم للمشاريع الخاصة بالقضايا التنموية الحضرية؟

نعم لا

إذا كانت الإجابة نعم، الرجاء إكمال إجابة باقي الأسئلة الخاصة بهذا الجزء

28. من هي الفئات المقصودة خلال هذه البرامج؟

- فئات المجتمع المحلي.
 أفراد الطواقم العاملة في المؤسسات الرسمية والحكومية المعنية.
 الخبراء وأصحاب القرار في المؤسسات الرسمية والحكومية المعنية.
 المؤسسات التنموية والجهات الغير الحكومية العاملة في هذا المجال.
 المانحين والمقرضين.
 المستثمرين ورجال الأعمال.

29. ما هي الإستراتيجية الأساسية لهذه البرامج؟

- عرض وتعريف المشاريع التنموية المقترحة ومناقشتها، وذلك قبل البدء بها.
 التعريف بخطوات العمل في هذه المشاريع ومناقشتها، وذلك خلال المراحل المختلفة لأي منها.
 أخرى (الرجاء ذكرها)

30. على ماذا يتم التركيز خلال هذه البرامج؟

- مناقشة ودعم القضايا المالية
- مناقشة ودعم القضايا التخطيطية
- مناقشة ودعم القضايا التشريعية والقانونية
- الحصول على الدعم السياسي والرسمي
- أخرى (الرجاء ذكرها)
-
-

❖ أفكار ورؤى جديدة

31. بناء على خبرتكم، هل يمكنكم تقديم أي من الأفكار والرؤى التي يمكن لها أن تساهم في تطوير وتجويد النموذج التنموي المقترح؟
