

University of Nebraska - Lincoln

DigitalCommons@University of Nebraska - Lincoln

---

Civil Engineering Theses, Dissertations, and  
Student Research

Civil Engineering

---

5-2018

# Examination of Steel Pin and Hanger Assembly Performance – Retrofit to Replacement

Chandana Chickamagalur Balakrishna

*University of Nebraska-Lincoln*, [chandana.cb128@gmail.com](mailto:chandana.cb128@gmail.com)

Follow this and additional works at: <https://digitalcommons.unl.edu/civilengdiss>



Part of the [Structural Engineering Commons](#)

---

Chickamagalur Balakrishna, Chandana, "Examination of Steel Pin and Hanger Assembly Performance – Retrofit to Replacement" (2018). *Civil Engineering Theses, Dissertations, and Student Research*. 121.

<https://digitalcommons.unl.edu/civilengdiss/121>

This Article is brought to you for free and open access by the Civil Engineering at DigitalCommons@University of Nebraska - Lincoln. It has been accepted for inclusion in Civil Engineering Theses, Dissertations, and Student Research by an authorized administrator of DigitalCommons@University of Nebraska - Lincoln.

Examination of Steel Pin and Hanger Assembly Performance –  
Retrofit to Replacement

By

Chandana Chickamagalur Balakrishna

A THESIS

Presented to the Faculty of

The Graduate College at the University of Nebraska

In partial Fulfillment of Requirements

For the Degree of Master of Science

Major: Civil Engineering

Under the Supervision of Professor Daniel G. Linzell

Lincoln, Nebraska

May 2018

# Examination of Steel Pin and Hanger Assembly Performance – Retrofit to Replacement

Chandana Chickamagalur Balakrishna, M.S

University of Nebraska, 2018

Advisor: Daniel G. Linzell

A number of steel, multi-beam bridges exist in the United States that contain pin and hanger assemblies. Pin and hanger assemblies are fracture critical members whose failure would result in collapse of the bridge or render it unable to perform its expected functions. As these bridges continue to age, many assemblies have deteriorated to a point where retrofit or replacement has to be considered and performed to maintain intended safety and performance. States have taken various approaches to address the pin and hanger assembly retrofit and replacement options. However, there is no single document that summarizes these approaches.

This research documents steel pin and hanger assembly retrofit and replacement options via a literature review, extensive survey, and analysis that explore the performance of options that have been studied and implemented in the United States. In association with the literature review, a survey was developed in conjunction with the Bureau of Sociological Research (BOSR) at the University of Nebraska-Lincoln to assist with identifying implemented strategies and evaluate best practices. Information was solicited from 50 states and was used in conjunction with the literature review to develop flowcharts that would assist engineers with assessing various options and their consequences when pin and hanger assembly retrofit or replacement options are being considered.

The performance of prevailing retrofit and replacement options obtained from the literature review and survey was examined computationally using ABAQUS. These examinations were accomplished by creating 7 models. For the girder that was modeled and loads were applied, findings indicated that as expected the bolted splice delivers the highest level of continuity but re-evaluation of superstructure behavior and capacity needs to be considered. The link slab provides degradation protection over the pin and hanger assembly and achieves higher level of continuity at the piers as that of original pin and hanger assembly, girder capacity may need to be re-evaluated at piers and maximum positive moment location. Catcher beam system installed when pin and hanger assemblies fail to carry the design loads, and still behaves similar to the original pin and hanger assembly. The frozen pin condition has higher level of continuity as that of original pin and hanger assembly, results indicated that deterioration have continuity. Girder capacity needs to be re-evaluated at piers and maximum positive moment location.

## Table of Contents

Chapter 1 Introduction.....	1
1.1 Background .....	1
1.2 Objectives and Scope .....	3
Chapter 2 Literature Review.....	5
2.1 Introduction .....	5
2.2 Pin and Hanger Literature .....	5
2.3 State and Federal DOT Provisions .....	12
2.4 Computational Studies .....	16
2.4.1 Isolated Girder Modeling.....	16
2.4.2 Pin and Hanger Modeling.....	17
2.5 Summary .....	17
Chapter 3 U.S. State Departments of Transportation Survey.....	19
3.1 Survey Objectives .....	19
3.2 Survey History and Timeline .....	20
3.3 Findings of the Survey .....	20
3.4 Summary .....	36
Chapter 4 Flowcharts Summarizing Retrofit and/or Replacement Options.....	37
4.1 Introduction .....	37
4.2 Retrofit and/or Replacement Options Process Summaries .....	39
4.2.1 Replace with Bolted Splices.....	39
4.2.2 Link Slab.....	42
4.2.3 Catcher Beam System.....	45
4.2.4 Replace with Pin and Hanger Assembly.....	48
4.3 Summary .....	51
Chapter 5 Finite Element Modeling and Analysis.....	52
5.1 Bridge Specifications .....	52
5.2 Finite Element Model.....	54
5.2.1 Discretization, Element Selection and Interaction .....	54
5.2.2 Geometric and Material Properties.....	55
5.2.3 Boundary Conditions and Applied Loads .....	56
5.2.4 Unique Modeling Aspects.....	56

5.3 Analysis Results and Comparisons .....	63
5.3.1 Comparisons .....	63
5.3.2 Locked Condition due to deterioration .....	70
5.4 Summary .....	72
Chapter 6 Conclusions .....	73
6.1 Recommendations for Future Research .....	75
References .....	76
Appendix A .....	81
Appendix B .....	85
Response to Survey of DOTs .....	85
Additional Comments .....	89
Appendix C .....	92
List of Abbreviations .....	92
Appendix D .....	95
Table D.1 Summary .....	95
Appendix E .....	96
E.1 Dead load calculations .....	96
E.2 Largest negative moments at the pier1 .....	97

## List of Figures

Figure 2.1 Mianus River Bridge collapse (Connor et al. 2005).....	6
Figure 2.2 Link Slab detail.....	9
Figure 2.3 Catcher beam system. (Connor et al. 2005) .....	10
Figure 2.4 Link slab required reinforcement ratio design chart (Lepech & Li, 2009) .....	11
Figure 3.1 Geographic representation of states that responded to the survey. ....	21
Figure 3.2 Visual representation of responses to question 1. ....	22
Figure 3.3 Geographic representation of state responses to question 1.....	22
Figure 3.4 Visual representation of state response to question 2.....	23
Figure 3.5 Geographical representation of states responded to question 2.....	24
Figure 3.6 Visual representation of state response to question 2 (a). ....	25
Figure 3.7 Ship lap joint at bearing at joint locations (Mass DOT, 2014).....	28
Figure 3.8 Ship lap joint detail (Mass DOT, 2014) .....	29
Figure 3.9 Geographical representation of federal design Specification usage.....	30
Figure 3.10 Visual representation of state responses to question 3. ....	30
Figure 3.11 Visual representation of states response to question 4. ....	31
Figure 3.12 Geographical representation of states that have developed own criteria and procedures. ....	31
Figure 3.13 Visual representation of states response to question 5. ....	33
Figure 3.14 Geographical representation of states need or not need for further action....	34
Figure 4.1 Flowchart demonstrates decision – making process. ....	38
Figure 4.2 Bolted splice design process.....	41
Figure 4.3 Link Slab detail.....	43

Figure 4.4 Link slab design process.....	44
Figure 4.5 Catcher beam system. (Connor et al. 2005) .....	46
Figure 4.6 Catcher beam system representative detail.....	46
Figure 4.7 Catcher beam design process.....	47
Figure 4.8 New pin and hanger assembly design process. ....	50
Figure 5.1 Modeled bridge.....	53
Figure 5.2 Original girder elevation.....	53
Figure 5.3 Pin and hanger assembly .....	54
Figure 5.4 Pin and hanger assembly model .....	57
Figure 5.5 Link slab .....	58
Figure 5.6 Catcher beam system.....	60
Figure 5.7 Modeled catcher beam cases .....	61
Figure 5.8 Pin locked condition .....	62
Figure 5.9 Non-dimensionalized moment diagrams for dead loads at pier 1 .....	64
Figure 5.10 Non-dimensionalized shear diagrams for dead loads at pier 1 .....	65
Figure 5.11 Non-dimensionalized moment diagrams for dead loads at Pier 2.....	66
Figure 5.12 Non-dimensionalized shear diagrams for dead loads at Pier 2.....	67
Figure 5.13 Non-dimensionalized moment diagrams for dead loads at maximum positive moment .....	68
Figure 5.14 Non-dimensionalized moment diagrams for dead loads at pier 1 for locked condition .....	70



## **List of Tables**

Table 3.1 Implemented and programmed retrofit and/or replacement options .....	26
Table 3.2 Other implemented and programmed retrofit and/or replacement options.....	27
Table 3.3 Design Specifications .....	32
Table 3.4 Developed own criteria & procedures. ....	32
Table 3.5 Reasons for pin and hanger assembly non-action.....	35
Table 5.1 Non-dimensionalized moment ratio at pier 1 .....	65
Table 5.2 Non-dimensionalized moment ratio at pier 2 .....	67
Table 5.3 Non-dimensionalized moment ratio at maximum positive moment.....	69
Table 5.4 Non-dimensionalized moment ratio at pier 1 .....	71
Table D.1 Summary of various retrofit and replacement options pros and cons.....	95
Table E.1 Geometric dimensions .....	96
Table E.2 Non-dimensionalized moment ratio at pier 1 .....	102

## Chapter 1 Introduction

### 1.1 Background

Pin and hanger assemblies are structural components that have been used in many steel bridge systems around the United States (Mosavi et al. 2011). These assemblies are often used in steel girder systems and were traditionally implemented to reduce analysis, design, and construction complexity. The primary function of the pin and hanger assemblies is to mimic the rotational freedom provided by an idealized hinge in a continuous structural system, thereby reducing levels of indeterminacy and facilitating construction. The additional rotational degrees of freedom provided by the assemblies also help accommodate thermal movements of the bridge superstructure (Graybeal et al. 2000). As bridges continue to age, water, deicing chemicals, and debris that fall through the deck joint above the pin and hangers can accumulate on these assemblies and accelerate their degradation, possibly adversely affecting their performance and leading to a need for retrofit or replacement (Graybeal et al. 2000).

Pin and hanger assemblies are considered fracture critical members (FCMs), meaning they are non-redundant and their failure could cause partial or complete collapse. Non-redundant systems have traditionally contributed to major steel bridge collapses. The collapse of the Mianus River Bridge in Connecticut in 1983 is an example of a pin and hanger bridge that suffered a catastrophic failure (Connor et al. 2005).

The *American Association of State Highway and Transportation Officials, Load and Resistance Factor Design Specifications* (AASHTO LRFD) defines *redundancy* as “the quality of a bridge that enables it to perform its design function in a damaged state,”

and *redundant member* as “a member whose failure does not cause failure of the bridge” (AASHTO LRFD, 2014). Different ways to enhance bridge redundancy include:

- Increasing the number of main supporting elements between points of structural support;
- Providing load redistribution mechanisms or providing continuity for main elements over interior supports elements; or
- Properly detailing structural elements using built-up cross sections, which provide division of elements to restrict increasing fracture propagation across the entire cross section.

States have taken various approaches to address the pin and hanger assembly retrofit and replacement, but there is no single research work summarizing these approaches. This research work documents a literature review that explores steel pin and hanger assembly replacement and retrofit options that have been studied and implemented in the United States. In addition to the literature review, a survey was developed in conjunction with the Bureau of Sociological Research at the University of Nebraska-Lincoln (BOSR) to assist with determining implemented strategies and evaluate best practices. In this survey, information was solicited from 50 states on current engineering practices related to addressing the steel pin and hanger assembly replacement options. Of these 50 solicitations, 38 (76%) were returned. Literature review and survey information was used to design an organized decision-making tool in the form of flowcharts that would assist engineers with assessing various options and their consequences when the pin and hanger assembly replacement and retrofit are being considered. In conjunction with information obtained from the literature review and

survey, finite element analyses of the pin and hanger assembly retrofit to replacement options were carried out using finite element software (ABAQUS/CAE, 2013). These studies examined variations in the levels of continuity of the girder and were assessed by creating 7 FE models using ABAQUS for retrofit and replacement options which includes, original pin and hanger assembly, providing the catcher beam system, providing the continuous girder (bolted splice), by including the link slab in the pin and hanger assembly and by examining a from pin and hanger condition caused by corrosion and accompanying deterioration.

## 1.2 Objectives and Scope

The objectives of this research study were to review, summarize and analyze research related to pin and hanger assembly behavior, repair and replacement while also determining and summarizing retrofit and replacement options being used by states in the U.S. Computational studies were carried out for retrofit and replacement options. These objectives were accomplished via the following steps:

1. Review relevant literature related to the pin and hanger assembly replacement options that have been studied and implemented in the United States;
2. Survey U.S. State Departments of Transportation (DOTs) to investigate current practices for addressing pin and hanger assembly retrofit to replacement;
3. Develop and present flowcharts that would assist engineers with assessing various options and their consequences when the pin and hanger assembly retrofit and replacements options are being considered in the future.
4. Examine and compare the levels of continuity in the girder for different retrofit to replacement options by finite element models using ABAQUS.

5. Provide design considerations based on level of continuity in the girder for different retrofit to replacement options.

## Chapter 2 Literature Review

### 2.1 Introduction

A major element of this study consisted of an in-depth literature review. The purpose of this review was to collect and summarize information related to pin and hanger assembly retrofit and replacement options and also information related to modeling of the girder using finite element analysis. The literature review also provides information successfully implemented options in different parts of the United States and served as a resource for other portions of this study.

In this chapter, Section 2.2 *Pin and Hanger Literature*, summarizes the review of literature related to pin and hanger assembly retrofit and replacement options. Section 2.3 *State and Federal DOT Provisions*, describes available state DOT design provisions and protocols for various retrofit and replacement options, and Section 2.4 *Computational Studies*, describes previous efforts focused on developing computational models of pin and hanger assemblies and isolated girder modeling techniques.

### 2.2 Pin and Hanger Literature

In 1983, the I-95 Mianus River Bridge in Greenwich, Connecticut collapsed (Figure 2.1). The collapse was determined to occur when one of the pin and hanger assemblies fractured. This assembly was subjected to excessive corrosion due to water leaking through the deck joints and from drainage modifications (NTSB, 1984).



Figure 2.1 Mianus River Bridge collapse (Connor et al. 2005)

As a result of the Mianus River Bridge collapse, the Pennsylvania Department of Transportation (PennDOT) instructed its districts to identify and establish the current condition of pin and hanger assemblies on all bridges in Pennsylvania (Britt, 1990). A subsequent condition inspection of twin structures carrying I-80 over the Susquehanna River at Mifflinville, Pennsylvania discovered multiple fractured lower pin retainer bolts in its pin and hanger assemblies (Christie & Kulicki, 1991). Further investigation determined that the major cause of the fractures was significant build-up of corrosion on the pin and hangers. PennDOT had identified additional problems in similar bridges, such as pin cracking on the Wysox Bridge in the northeastern part of the state. As a result of this discovery and in an attempt to ensure future safety of similar bridges in the state, Modjeski and Masters (M&M) developed and proposed cost-effective methods to provide

a higher level of redundancy for these bridges. M&M proposed the following pin and hanger assembly retrofit and replacement options:

- Providing continuity by removing the pin and hanger assembly and splicing the flange and web at that location;
- Providing a secondary system under the floor beams at the pin and hanger assembly; or
- Providing a secondary system under girders at the pin and hanger assembly.

PennDOT engineers, after several major studies (Christie & Kulicki, 1991), decided that providing continuity was the most advantageous solution from both aesthetic and safety points of view. However, preliminary study shows that this approach would only be economical when re-decking was programmed. Continuity would be established by designing splices into the girders following provisions established in the *AASHTO Standard Specifications for Highway Bridges*.

In 1989, the Loma Prieta earthquake in California demonstrated that bridges designed following pre-1983 AASHTO seismic criteria were sensitive to strong earthquakes (Shirole & Malik, 1993). As a result of these findings it was determined that a considerable retrofitting program was needed to address this issue. The program included improving the strength of the existing bridges whenever practical to improve their seismic resistance and global efficiency. Pin and hanger assemblies were deemed to be seismically sensitive components and global structural efficiency would be improved via their removal, which would provide continuity and enhance the redundancy of the structure.



In response to work in California, the New York State Department of Transportation (NYSDOT) initiated part of study on seismically sensitive bridges in New York to evaluate their resiliency and to provide a cost data for various seismic retrofits (Shirole & Malik, 1993). The project included a case study of five-span, continuous, steel, multi-girder bridge having pin and hanger assemblies that produced drop-in spans. The study recommended removal of the pin and hanger assembly replacing it with top flange, bottom flange and web splices following *AASHTO Standard Specifications for Highway Bridges* guidelines. It was also recommended that cumulative dead and live load stresses be checked in the vicinity of the replaced pin and hanger assembly locations.

Another possible retrofit option, termed a “link slab”, has also been discussed in the research (Caner & Zia, 1998). In this method, expansion joints are removed at the pin and hangers, the deck is debonded from the girders for a minimum of 5 % of the span length on each side of the splice, and the joint is replaced with link slab, which renders the deck continuous while maintaining some level of rotational freedom for the girders beneath the link slab (Figure 2.2). Reducing the number of expansion joints via the placement of link slabs (Caner & Zia, 1998) would minimize or eliminate corrosion damage due to water leaking through the deck joints. Further discussion of this retrofit option can be found in *Section 4.2.2 Link Slab*.

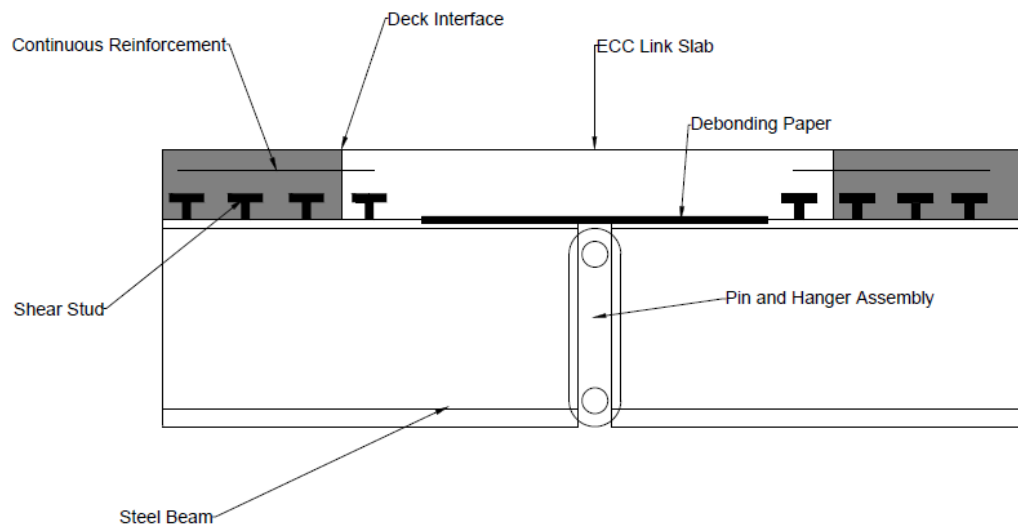

Figure 2.2 Link Slab detail

A national effort to identify and synthesize inspections and repairs appropriate for FCMs was conducted in association with the National Cooperative Highway Research Program (NCHRP). The subsequent report provided a comprehensive investigation of bridges with fracture critical details and focused on inspection and maintenance of FCMs. One of the outcomes was identifying and briefly discussing prevailing pin and hanger assembly retrofit and replacement options in the U.S. The final report summarized two common techniques for the replacement and retrofit of pin and hanger assemblies (Connor et al. 2005):

- Complete removal of the pin and hanger assembly. In this method, the pin and hanger assembly is completely removed and replaced with a new section of the girder having bolted splices. The girders are made continuous for live load and a proportion of dead load given that these splices would be placed after the large part of the deck has been cast. Continuity would be established by designing

splices into the girders following *AASHTO LRFD Bridge Design Specifications*; and

- Placement of a catcher beam system. These systems are added below the location of the pin and hanger assembly to catch the suspended girder when the existing pin and hanger assembly fails (Figure 2.3).

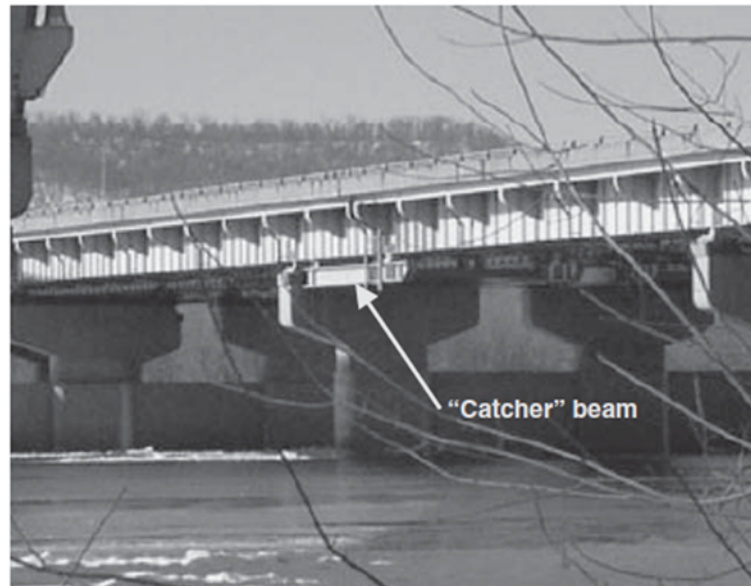

Figure 2.3 Catcher beam system. (Connor et al. 2005)

In 2009, further investigation on link slab was carried out by (Lepech & Li, 2009). In this study they have developed a chart (Figure 2.4) for required reinforcement ratio of the link slab with respect to slab thickness. Moment demand is determined based on the following equations. Specific reinforcement steel bar is selected with respect to obtained reinforcement ratio from the chart for the link slab region.

$$M_{ls} = \frac{2E_{ECC}I_{ls}0.001}{L_{dz}}\theta_{max} \quad (2.1)$$

$$I_{ts} = \frac{(1000 \text{ mm})t_s^3}{12} \quad (2.2)$$

Where  $M_{ls}$  stands for moment demand (kN-m);  $I_{ls}$  denotes uncracked moment of inertia for the link slab;  $\theta_{max}$  as maximum end rotation (radians);  $t_s$  as thickness of the bridge deck (mm);  $L_{dz}$  as length of the link slab (mm); and  $E_{ECC}$  as elastic modulus of ECC material (GPa).

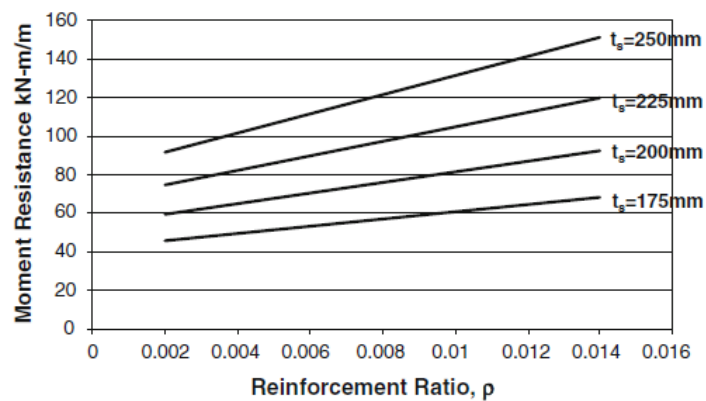

Figure 2.4 Link slab required reinforcement ratio design chart (Lepech & Li, 2009)

In 2010, PennDOT further investigated pin and hanger assembly rehabilitation via a preservation program associated with the I-579 Crosstown Boulevard Bridge in Pittsburgh (Sirianni & Tricini, 2010). The program included complete replacement of pin and hanger assemblies with new stainless pins and high strength hangers. By replacing the existing assemblies with new, more durable components, the assemblies would be strengthened and maintenance requirements for the fracture critical bridges could be reduced.

In 2014, the Manitoba Infrastructure and Transportation Department conducted a detailed structural survey of the Pinawa Bridge, a bridge that contained pin and hanger

assemblies. The study identified that steel girders near the existing pin and hanger assemblies had severe corrosion and deterioration due to deck expansion joint leakage (Banthia et al. 2014), which, subsequently, caused corrosion at the pin and hanger assembly that could possibly lead to catastrophic failure of the assembly. A number of possible failure mechanisms were identified, including:

- Reduction of pin cross section that could lead to crack initiation;
- Locking of the pin, which could produce considerable amount of torsional stresses on a reduced cross-section, stresses that, when combined with direct shear stresses, could provide an area for development and increases of cracks which leads to pin failure (Banthia et al. 2014); and
- Corrosion and packrust formation of hanger plates that could cause the pin to move out of the assembly and result in failure of the structure at the location of the assembly.

The study did not directly observe any cracks or loss in pin cross-sectional area or prevention of rotation. Despite these observations, it was recommended to replace all pin and hanger assemblies with bolted splices following guidelines provided in the *AASHTO Standard Specifications for Highway Bridges* and *Manual for Bridge Evaluation*.

### 2.3 State and Federal DOT Provisions

As this study aims for identifying other State and Federal agencies who have implemented retrofit and replacement options and developed design specifications and supporting documents. Identified DOTs and their implemented options and documentation are summarized below.

The 2002 edition of the Montana Department of Transportation's "Montana Structural Manual" provides rehabilitation alternatives for pin and hanger assemblies (MDT, 2002). It was stated that pin and hangers are sensitive to corrosion because of leaking deck joints and subsequent accumulation of debris on the assembly. This could result in the pin misplacements due to unseating of hangers and frozen pins and in initiation of fatigue cracks in the hangers. They recommended the following pin and hanger rehabilitation techniques (MDT, 2002):

- Unlocking the frozen pin and hanger assembly. Provide alternative support beam system to the suspended girder and remove the pin and hanger assembly. The elements of the assembly could be replaced or cleaned of corrosion before re-assembling the elements;
- Complete elimination of pin and hanger assembly. In this method, pin and hanger assemblies should be completely replaced with bolted splices. This approach requires a structural analysis of the continuous girder to show that revised load paths do not exceed the resistance of the superstructure. Continuity would be established by designing splices into girders following appropriate *AASHTO Standard Specifications for Highway Bridges*; and
- Providing a catcher beam system. In a catcher beam system, a supplemental support beam system is provided to catch the suspended girder ends if the pin and hanger assembly fails. Similar structural system could also be provided temporarily when frozen pin and hanger assemblies are slated to be unlocked.

PennDOT further investigated pin and hanger assembly rehabilitation in 2010 and recommended installation of a catcher beam system when pin and hanger assembly failure is a concern so that bridge integrity and safety is maintained (PennDOT, 2010). They stated that the catcher beam system should be designed to be active only if the pin and hanger fails and must accommodate anticipated thermal movements. The gap between the girder and the catcher beam system must be kept as small as possible to limit impact loading if failure occurs. They recommended use of auxiliary neoprene bearings on the catcher beam system to reduce any impact effects (PennDOT, 2010).

In 2011, the Illinois Department of Transportation published a report that recommended that steel girders with pin and hanger assemblies be examined for assembly elimination and to make the superstructure system continuous whenever feasible and economical (IDOT, 2011). Continuity would be established by designing splices into the girders following the *AASHTO Standard Specifications for Highway Bridges*.

In 2012, the Federal Highway Administration stated that pin and hanger assembly failure is caused by formation of corrosion between the hanger and the girder web due to deck expansion joint leakage. As steel corrodes, it can occupy up to 10 times its original volume and cause unwanted forces in a limited space (FHWA-BIRM , 2012), which results in packrust and possible failure of the assembly. Additional pin and hanger assembly defects that were identified in the report were corrosion, fatigue cracking and coating failures. Various retrofit and replacement options were discussed as summarized below:

- Catcher beam system. The catcher beam system is added to the structure to carry a load if the pin and hanger assembly fails. The gap between the girder and the catcher beam should be kept as small as possible to reduce impact. Auxiliary neoprene bearings on the catcher beam system could be provided to reduce impact effects should failure occur;
- Removal and replacement of pin and hanger assembly with bolted splices. This approach requires a structural analysis to determine if other members can support continuous girders instead of cantilevered and drop-in spans. Analyses should investigate both positive and negative moment regions in the superstructure; and
- Replacing the pin and hanger assembly with a structural grade stainless steel pin and hanger, which results in reduction in corrosion mitigation.

In 2014, the Minnesota Department of Transportation published a study on a rehabilitation of the Kennedy Bridge over the Red River. This study focused on rehabilitation alternatives and showed that its pin and hanger assemblies had sufficient load carrying capacity. However, failure of multiple hangers could result in failure of the structure (MnDOT, 2014). Part of this study focused on increasing reliability of a bridge containing a pin and hanger assembly. It was reported that pin and hanger assembly retrofit and replacement options can include removing existing pins and hangers, re-machining pin holes to accommodate new pins as required to remove corrosion and pitting and the installation of new, higher strength pins and reinforced hangers. It was stated that each girder must be temporarily supported while work is occurring and that temporarily supports must be able to accommodate hanger fit up.



## 2.4 Computational Studies

The number of computational studies examining steel, multi-beam, and bridge behavior is quite extensive. However, a smaller number of studies have been completed that strictly focused on the behavior of isolated girders and of girders containing pin and hangers using computational (i.e. finite element) models. These studies were completed to predict accurate analysis results with field or lab test results and studies are summarized below.

### *2.4.1 Isolated Girder Modeling*

Finite element modeling techniques for the steel bridge girder was studied by (Richardson, 2012) for predicting the cracks. Study states that providing constraints between the components is considerably important for the accurate model to obtain a detailed results. In this study, for modeling the girder, tie constraints were used and these constraints protects deformation equally between master and slave surfaces. The tie constraints were applied to prevent the sliding and intersection between the parts and provides node-to-node connection. Analysis time reduces when both slave and master surfaces were partitioned equally and master surfaces have courser mesh than the slave surface. Cracks were modeled using XFEM (Extended Finite Element Analysis).

Torsional behavior of reinforced concrete trough girder was studied by (Shang & Guo, 2012) using ABAQUS. In this study, embedded constraint were used to embed rebars into the concrete slab. In embedded constraint, the translational degrees of freedom of the node on the rebars were constrained to the respective interposition nodes of the corresponding degree of freedom of the concrete deck. Study concluded that finite

element analysis can be a better method to mimic the torsional behavior of reinforced trough girder.

#### *2.4.2 Pin and Hanger Modeling*

Computational investigation of pin and hanger assembly was studied by (Achenbach, 2008) to examine the stress analysis, thermal effects, and elastic plastic analysis by modeling elements using 8-node, reduced-integration, brick elements in ABAQUS. Contact between the pin and hanger assembly components were modeled using surface-to-surface contact between the elements in the assembly. Accurate results indicated that the design calculations are in close agreement with FEA results which confirms that the model with proper constrained and selection of the contact algorithm is very important.

### 2.5 Summary

This chapter documented the results of a literature search that focused on research related to retrofit and replacement of pin and hanger assemblies, prevailing practices and procedures used for retrofit and replacement along with a summary previous efforts used to computationally studies. These efforts indicated are summarized below.

#### *Retrofit options:*

- Bolted Splices -Provide continuity by removing the existing pin and hanger assembly and splicing the flange and web at that location following appropriate AASHTO Specifications (AASHTO Standard Specifications for Highway Bridges, and AASHTO LRFD Bridge Design Specifications) and/or relevant state specifications.

*Rehabilitation options:*

- Link Slab - Providing a link slab is a rehabilitation option that would remove expansion joints by linking two adjacent girder sections together using a continuous slab design. This approach would render the deck continuous while maintaining some level of rotational freedom for the girders.
- Catcher Beam System - A secondary catcher beam system could be added below the location of the pin and hanger assembly. This system should provide to carry loads if the existing pin and hanger fails. The use of auxiliary neoprene bearings on the catcher beam system was recommended to use, reduce any impact effects should failure occur.

*Removal and replacement option:*

- New Pin and Hanger Assembly - In this option existing pins and hangers are removed and replaced with new, higher strength pins and reinforced hangers. It was recommended to use stainless steel pins and hangers according to *AASHTO LRFD Bridge Design Specifications* (Article 6.4.7), this could result in reduction in corrosion failure.

*Finite element techniques:*

- Few methods have been reviewed and considered to develop a FE model that would be applicable for this research.

## **Chapter 3 U.S. State Departments of Transportation Survey**

### **3.1 Survey Objectives**

In December 2015 a survey was sent to 50 State Departments of Transportation (DOTs). The objective of the survey was to assemble additional information on variety of topics related to pin and hanger retrofit and replacement options. These topics included: a) types of steel bridges that contain pin and hanger assemblies; b) pin and hanger assemblies that need retrofitted and/or replacements; and c) designs, procedures, or criteria for retrofit and/or replacements. Of the 50 surveys, 38 were received as of March 2016. Results from these surveys were examined to: a) document current practices and level of success concerning pin and hanger assembly retrofit and replacement options; b) identify practical application of retrofit and replacement options documented in the literature; and c) identify new or innovative retrofit and replacement options that have not yet been recorded in the literature.

The survey was divided into three sections. Section 1 (General) collected general information related to types of steel bridges that contain pin and hanger assemblies. Section 2 (Options) intended to identify various options, criteria and procedures related to retrofit and replacement of pin and hanger assemblies in each of the states. In addition, data related to retrofit and replacement options that have been implemented and programmed for future was requested. Section 3 (Future Contact) requested that additional information related to pin and hanger assemblies be provided, information that included: to share the respective state DOTs that have developed their own criteria and procedures for retrofits and /or replacements. A copy of the survey is included in Appendix A and responses are provided in Appendix B.

### 3.2 Survey History and Timeline

The questionnaire was designed by BOSR with technical input being provided by UNL Civil Engineering personnel assigned to the project and NDOT. Prior to the initial mailing, NDOT notified and encouraged State Bridge Engineers to complete the survey. The initial mailing occurred in mid-December 2015. Non-responders were mailed survey packets a second time in early January 2016. Completed surveys were collected by BOSR through early March with findings summarized and provided to UNL Civil personnel.

### 3.3 Findings of the Survey

Surveys that were completed and returned were initially examined by BOSR, who performed data analysis, processing and filtering. BOSR's used Statistical Package for the Social Sciences (SPSS) software for processing and documenting the dataset. BOSR personnel assigned to the project, in turn, analyzed each survey question in detail and prepared a report. As stated earlier, of the 50 State Bridge Engineers who were sent the survey, 38 were completed and returned (Figure 3.1), a 76% response rate based on the American Association for Public Opinion Research's (AAPOR) standard definition for Response Rate 2 (RR2), which counts partial interviews as respondents (AAPOR, 2015). The following sections summarize survey responses to each question.

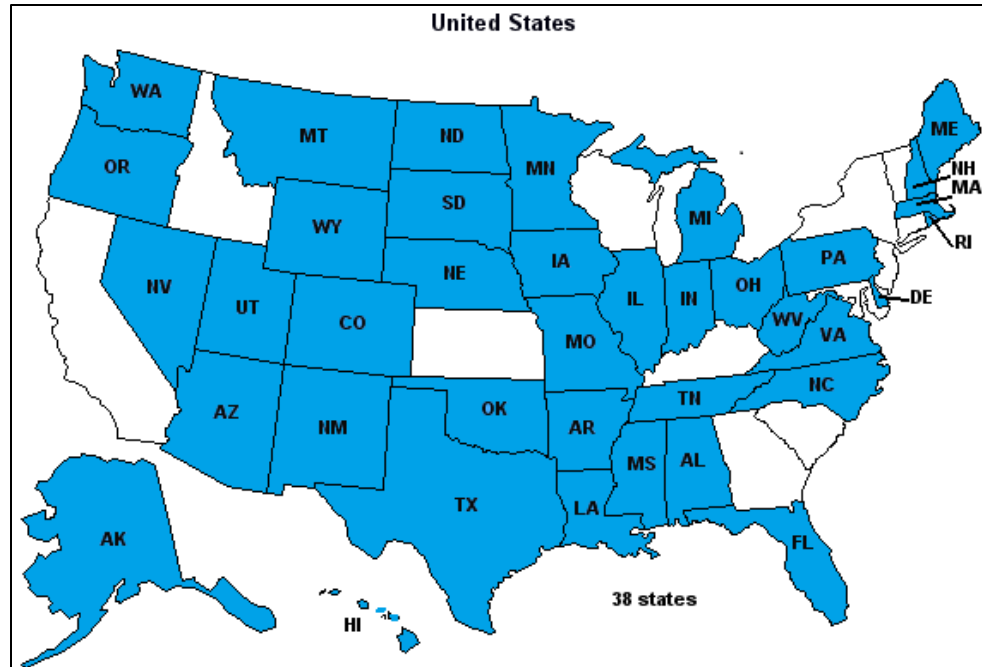

Figure 3.1 Geographic representation of states that responded to the survey

### 3.3.1 Question 1

*Do you have steel bridges that contain pin and hanger assemblies?*

Figure 3.2 and Figure 3.3 show that, of the 38 states who answered the question, 35 have steel bridges that contain pin and hanger assemblies and 3 states have steel bridges without pin and hanger assemblies.



3.3.2 Question 2

*Does your agency view the pin and hanger assemblies as components that need to be retrofitted and/or replaced?*

Figure 3.4 and Figure 3.5 shows state agencies were nearly evenly split between viewing pin and hanger assemblies as components that need to be retrofit and/or replaced and feeling that these assemblies do not need retrofitted and/or replaced. A complete list of reasons for non-action can be found in Appendix B.

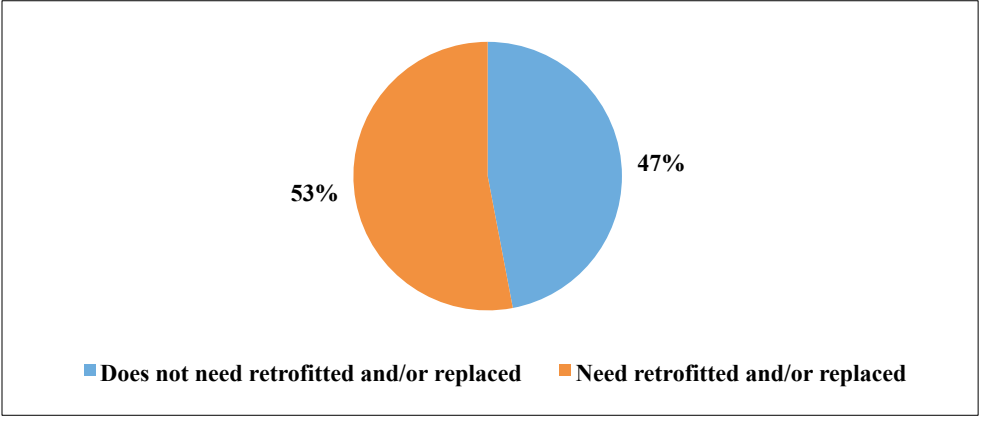

Figure 3.4 Visual representation of state response to question 2



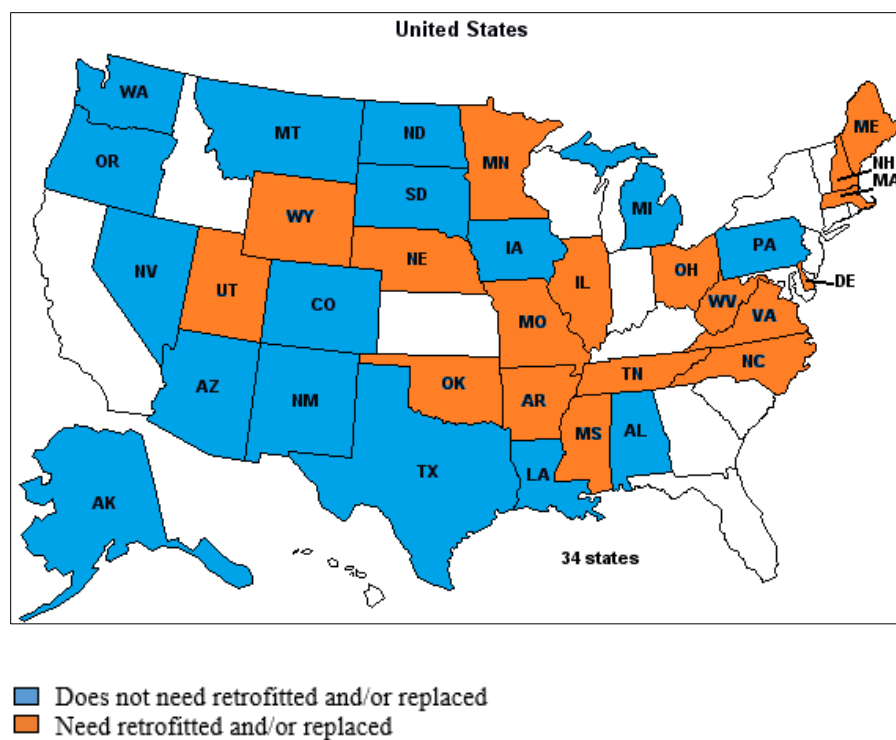

Figure 3.5 Geographical representation of states responded to question 2

*Question 2(a)*

*If yes, please provide the number of retrofit and/or replacement options that you have implemented or programmed for each category below. If you have implemented or scheduled retrofit and/or replacement options other than those listed below, please describe and provide the number for each option in the additional table rows.*

Figure 3.6 shows that, for those that view retrofitting and/or replacement as necessary, most states have implemented a secondary system, such as a catcher beam (79%). Few responses indicated that replacements had taken place using new pin and hanger assemblies (43%) or bolted splices (33%). Despite fewer states implementing replacement using new pin and hanger assemblies or bolted splices, nearly one-quarter of states who responded to the question have new pin and hanger replacement projects

planned for the future (21%), while 8% have replacements with bolted splice repairs planned. Details are found in Table 3.1.

Other retrofit and/or replacement options implemented or planned by survey respondents included: (a) replacing the bridge or entire superstructure with concrete girders; (b) supporting the assembly using an “under-running bearing beam,” which is akin to a catcher beam; and replacing the assembly with a “ship lap joint”. Complete detail on these retrofit and replacement options can be found in Table 3.2 and Appendix B.

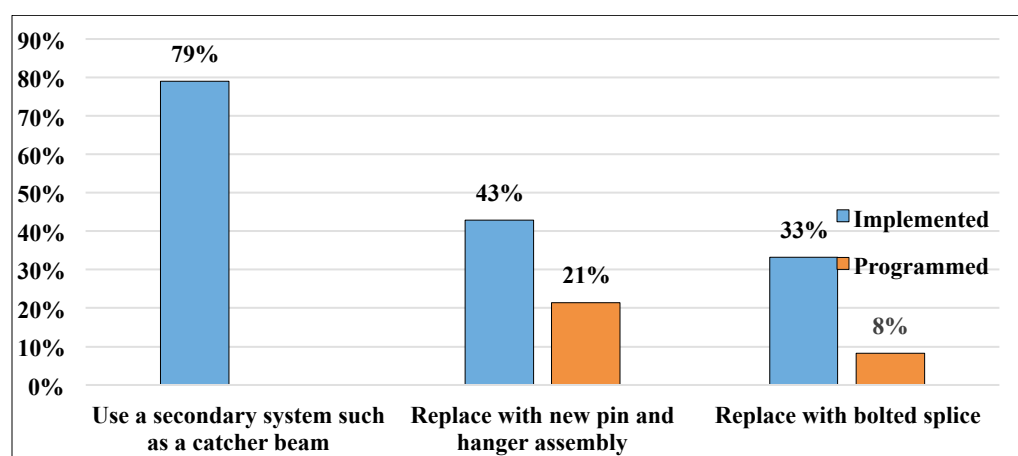

Figure 3.6 Visual representation of state response to question 2 (a)

Table 3.1 Implemented and programmed retrofit and/or replacement options

<b>Retrofit/replacement options</b>						
<b>DOTs</b>	<b>Catcher beam system</b>		<b>Replace with P &amp; H assembly</b>		<b>Replace with bolted splice</b>	
	Number implemented	Number programmed	Number implemented	Number programmed	Number implemented	Number programmed
Arkansas State Highway and Transportation Department	1					
Delaware DOT	1					
Illinois DOT	0	0	92	92	0	0
Indiana DOT	1	0	0	0	0	0
Maine DOT	4	0	0	0	1	0
Massachusetts DOT	2	0	0	0	0	0
Minnesota DOT	1	0	5	0	2	0
Mississippi DOT			1	1		
Missouri DOT	20	0	30	4	0	0
New Hampshire DOT			0		8	
North Carolina DOT	1	0	0	0	0	0
Oklahoma DOT	1	0	0	0	0	0
Tennessee DOT	1	0	0	0		
Utah DOT	0		5		2	3
West Virginia DOT	3	0	0	0	0	0
Wyoming DOT	0	0	1	0	0	0

\*Acronym definitions in Appendix C.

Table 3.2 Other implemented and programmed retrofit and/or replacement options

<b>Other, Specify</b>			
<b>DOTs</b>	<b>Other options</b>	<b>Number implemented</b>	<b>Number programmed</b>
Maine DOT	Superstructure replace	1	1
Massachusetts DOT	Ship lap joint.	0	1
	Replace P & H assembly with under running beam	1	0
Mississippi DOT	Replace bridge	1	3
Nebraska Department of Roads	Replace bridge or superstructure		50/102
North Carolina DOT	Replace with concrete girder	0	1
Virginia DOT	Replace bridge		
Wyoming YDOT	Suspension hanger/seismic	1	0

\*Acronym definitions in Appendix C.

### 3.3.2.1 Ship Lap Joint

The Massachusetts DOT has utilized a different type of pin and hanger replacement option they refer to as a “ship lap joint.” In this option, which performs in similar fashion to the original pin and hanger assembly, bearings were used to carry loads at the joint location, with girder sections being modified to act as short “cantilevers” that transfer loads across the joint in shear and bending. This detail is depicted for a specific project, the I-91 viaduct in Springfield, Massachusetts, in Figure 3.7 and Figure 3.8.



Figure 3.7 Ship lap joint at bearing at joint locations (Mass DOT, 2014)

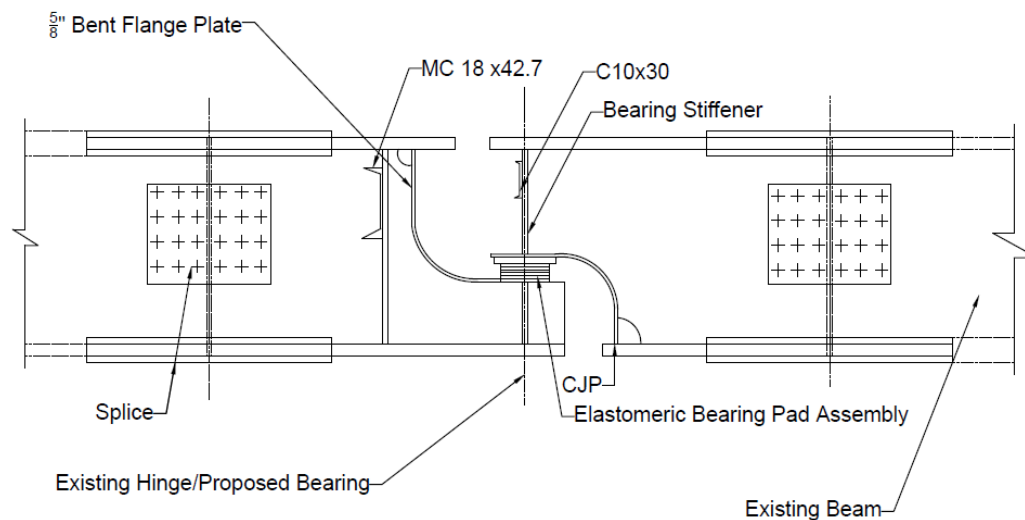
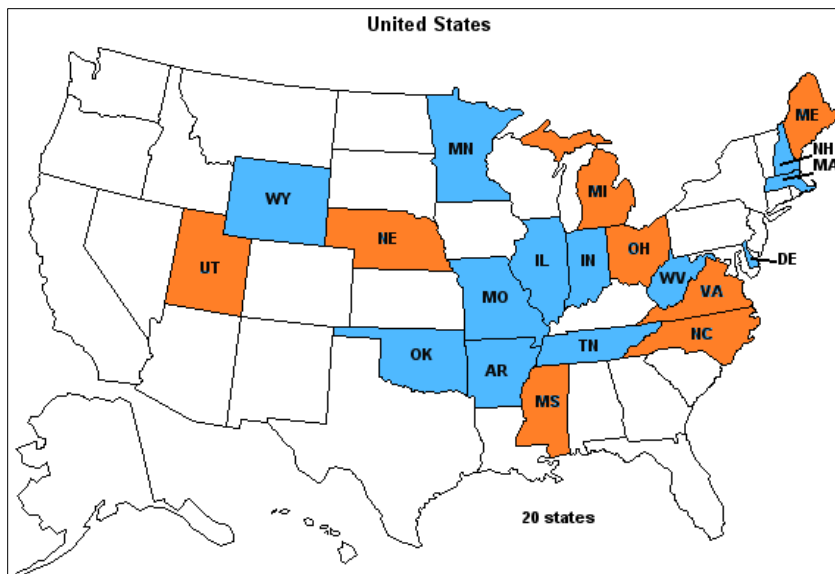

Figure 3.8 Ship lap joint detail (Mass DOT, 2014)

### 3.3.3 Question 3

*For the retrofits and /or replacements you indicated above as implemented or programmed, did you follow any of the designs, procedures, or criteria below?*

The survey indicated that multiple designs, procedures, and/or criteria are used to complete pin and hanger assembly retrofit or replacement. Nearly all state bridge engineers who answered the inventory question reported using *AASHTO Standard Specifications for Highway Bridges* criteria and procedures, while some states use *AASHTO LRFD Bridge Design Specifications* criteria and procedures as shown in Figure 3.9 and Figure 3.10. Five states reported using their own developed criteria and procedures.



- States uses AASHTO Standard Specifications for Highway Bridges
- States uses either of one design Specifications

Figure 3.9 Geographical representation of federal design Specification usage

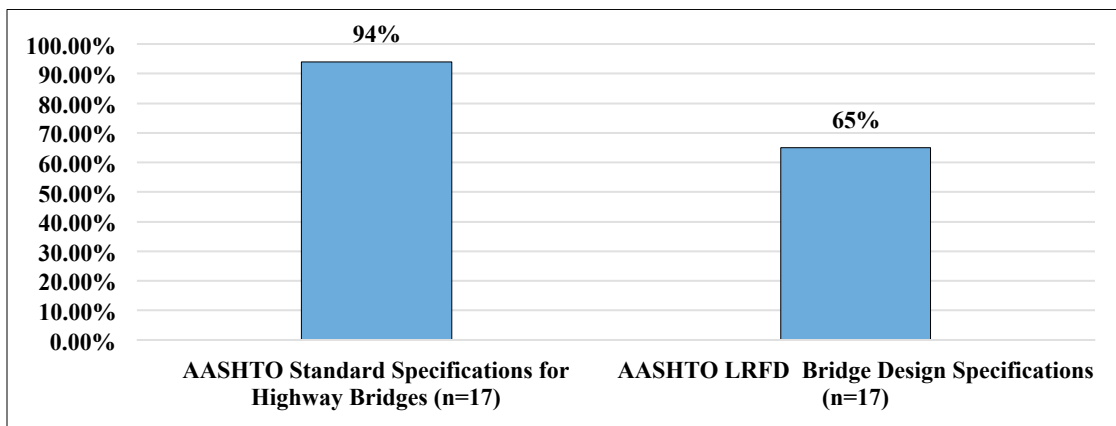

Figure 3.10 Visual representation of state responses to question 3

### 3.3.4 Question 4

*Have you developed your own criteria and procedures for retrofits and/or replacements?*

One-quarter of states in the (24%) reported developing their own criteria and procedures for retrofits and /or replacements (Figure 3.11 and Figure 3.12). More states

use their own procedures in conjunction with the *AASHTO Standard Specifications for Highway Bridges*. Additional details are found in Table 3.3, Table 3.4 and Appendix B.

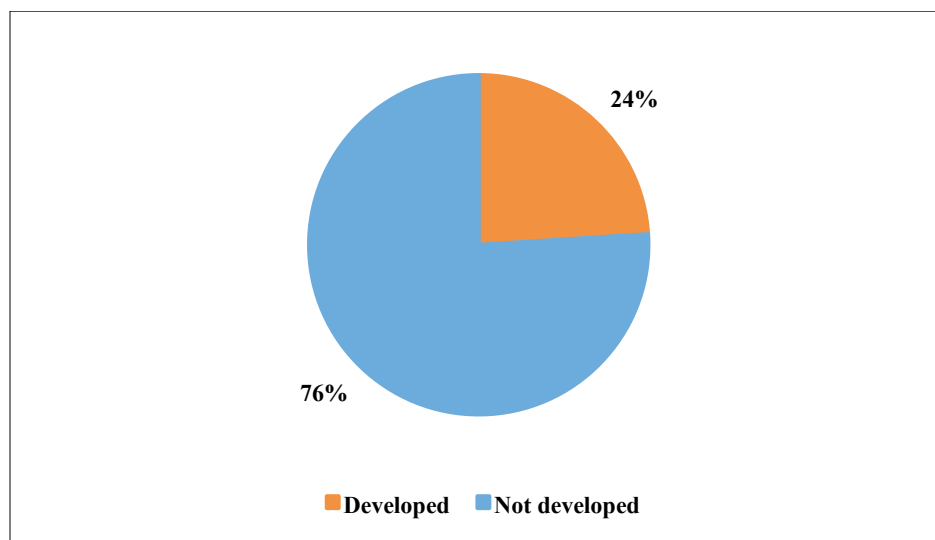

Figure 3.11 Visual representation of states response to question 4

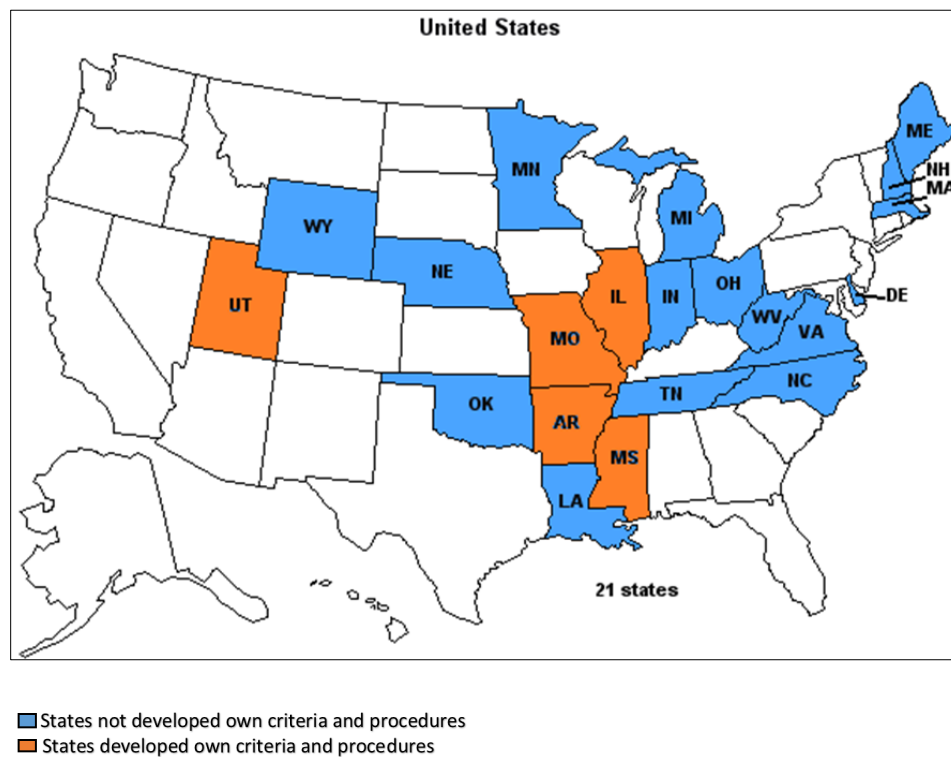

Figure 3.12 Geographical representation of states that have developed own criteria and procedures



Table 3.3 Design Specifications

<b>Design Specifications</b>	<b>Total number of States</b>
AASHTO LRFD criteria and procedures	11
AASHTO Standard Specification criteria and procedures	16
Developed own criteria and procedures	5

Table 3.4 Developed own criteria &amp; procedures.

<b>Developed own criteria &amp; procedures for retrofits/replacements</b>	
<b>DOTs</b>	<b>Comments</b>
Arkansas State Highway and Transportation Department	Internally developed.
Illinois DOT	It is part of our structural services manual. Bureau of Bridges and Structures.
Mississippi DOT	Our bridge replacement program prioritizes bridges with pins & hanger high enough to systematically replace the bridge with another (usually concrete) bridges.
Missouri DOT	No set criteria. Details are case-by-case.
Utah DOT	Is not documented.

\*Acronym definitions in Appendix C.

### 3.3.5 Question 5

*Does your agency view the pin and hanger assemblies as components that need no further action at this time?*

Of the 32 state bridge engineers who answered the question, half reported that their agency views pin and hanger assemblies as not needing further action at this time as shown in Figure 3.13 and Figure 3.14. Reasons for non-action included: a) bridges being in good condition and functioning properly; b) routine inspections and adequate maintenance; and c) a lack of concern about these assemblies. A complete list of reasons for non-action can be found in Table 3.5 and Appendix B.

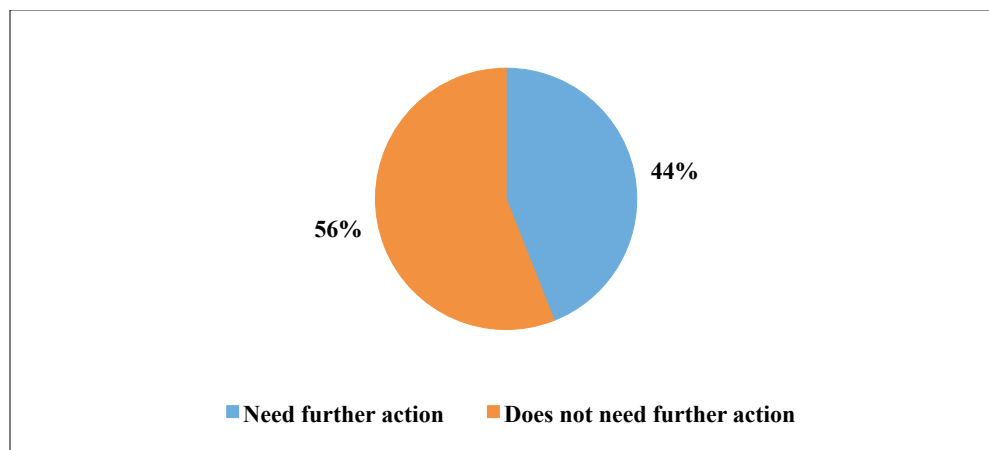

Figure 3.13 Visual representation of states response to question 5



Table 3.5 Reasons for pin and hanger assembly non-action

<b>Agency view P &amp; H assemblies that need no further action at this time</b>	
<b>DOTs</b>	<b>Comments</b>
Alaska DOT & PF	Pin & hangers are functioning properly. No pack rust present.
Colorado DOT	No section loss due to corrosion & no crack on hanger.
Delaware DOT	We are not as concerned with pin & hanger assemblies for multi-beam bridges. Pin & hanger assemblies on truss bridges are treated as a fracture critical member and are scrutinized more.
Iowa DOT	Proper inspection should identify deficiencies in time to address them without impacts to public safety.
Louisiana DOT	Bridges are in good condition.
Montana DT	Pins and hangers are usually inspected every 2 years and UT inspected every 4 years. With our relatively dry climate and large temperature swings the p & h assemblies usually stay moving as designed with little rust impact.
Minnesota DOT	We will include repairs or improvements to pin and hanger elements as conditions warrant. We have not developed projects solely on pin and hanger detail unless condition justifies.
North Carolina DOT	Inspection reports indicate the condition of the pin and hang is "good".
Nebraska Department of Transportation	All bridges are inspected by certified inspectors at least every 2 years and all bridges that this agency manages directly have redundant secondary systems should failure occur.
Nevada DOT	We haven't identified problems with the hangers, aside from minor corrosion.
Ohio DOT	We retrofit when they are deteriorated.
Oklahoma DOT	We used ultrasonic inspection on our pins. No problems were found.
Oregon DOT	We inspect & monitor p & h's and only r & r or provide supplemental support when their condition indicates a need.
Pennsylvania DOT	We have retrofitted the inventory of 2 girder and truss bridges with suspended assemblies.
South Dakota DOT	These assemblies are part of annual NBIS inspections and the pins get a periodic NDT inspection as well.
Virginia DOT	We evaluate each one individually.
Washington State DOT	Routine inspections and painting when needed.
West Virginia DOT	We monitor during routine inspections and provide action as needed

\*Acronym definitions in Appendix C.

### 3.4 Summary

The State DOT survey produced the following information:

- States who responded were roughly split between seeing such retrofits and replacements as necessary and unnecessary;
- Pin and hanger assemblies are most commonly found bridges having four and more girders (86%);
- Implementing a secondary system, such as a catcher beam (79%), is a more widely used retrofit and/or replacement option than replacing with either a new pin or hanger assembly(43%) or with bolted splices (33%), although at the time of the inventory study no future secondary system retrofits were programmed;
- Nearly all of the states utilize *AASHTO Standard Specifications for Highway Bridges* (94%),while fewer states use the *AASHTO LRFD Bridge Design Specifications* (65%),and some states developed their own criteria and procedures; and
- Additional retrofit and/or replacement options that were revealed by the survey included replacing with a “ship lap joint,” providing an “under-running bearing beam,” and, as expected, replacing the entire bridge or superstructure.

## Chapter 4 Flowcharts Summarizing Retrofit and/or Replacement Options

### 4.1 Introduction

The objective of this chapter is to provide flowcharts that describe steps associated with completing feasible options associated with addressing pin and hanger assembly retrofit and/or replacement. Approaches for which flowcharts are provided are categorized as retrofit, rehabilitation, or removal and replacement options as shown in Figure 4.1. The intention is that these flowcharts will provide an organized decision-making tool that would assist engineers with assessing options and their consequences when pin and hanger assembly retrofit and/or replacement are being considered. As appropriate, each cell in the flowcharts refers to corresponding articles in appropriate state and federal design specifications. These include the *AASHTO Standard Specifications for Highway Bridges*, the *AASHTO LRFD Bridge Design Specifications* and *NDOT's Bridge Office Policies and Procedures (BOPP) manual*.

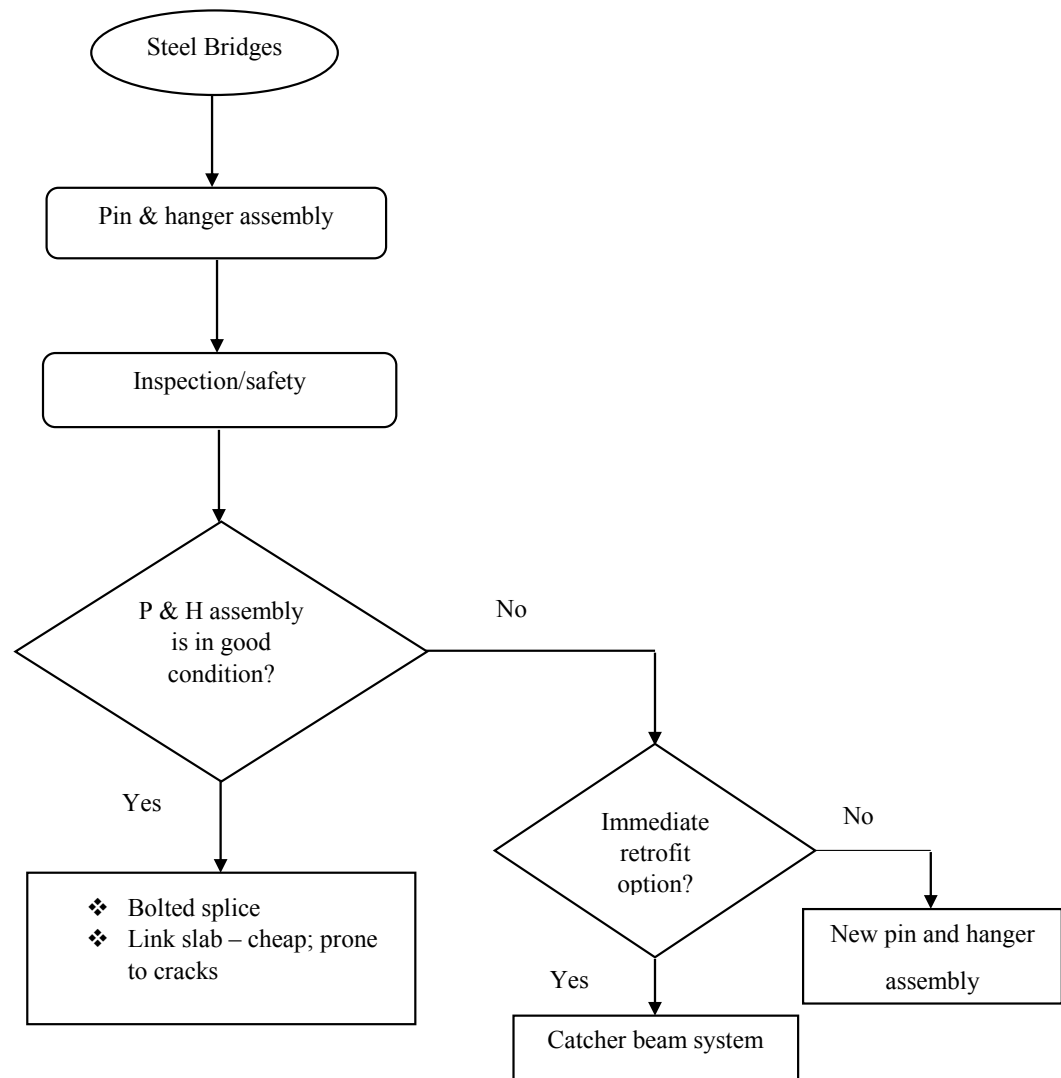

Figure 4.1 Flowchart demonstrates decision – making process

## 4.2 Retrofit and/or Replacement Options Process Summaries

This section summarizes retrofit, rehabilitation and, removal and replacement options based on the literature review and survey of DOTs and provided along with pros and cons of each respective options. Each section organized into brief summary followed by pros, cons and flowcharts with description.

### *4.2.1 Replace with Bolted Splices*

This section summarizes the option that involves removing pin and hanger assemblies and replacing them with bolted splices. Items that are discussed and presented in the corresponding flowchart incorporate relevant information from the literature search, DOT survey and appropriate federal and state specifications.

When a major retrofit of a bridge structure is programmed, pin and hanger assemblies should be examined for elimination. The pin and hanger assembly would be replaced with continuity web and flange splices and existing deck expansion joints at the hinges would be removed and replaced to make these locations continuous. By making the drop-in section spans locations to continuity support the demand of the girder changes, so demand should be recalculated. While the pin and hanger assembly is being replaced with bolted splices, the girders should be temporarily supported from below or above the deck.

The state DOT survey produced a comment related to replacing pin and hanger assemblies with bolted splices (Appendix B). For drop-in section spans, the method implemented to eliminate the assemblies completely and replace with bolted splices



involved installation of counterweights at the ends of the span. A flow-chart detailing general steps involved in the process is located in Figure 4.2.

*Pros:*

- Pin and hanger assembly is removed and continuity is provided through splices, possibly eliminating non-redundancy and making the structure more efficient; and
- Expansion joints eliminated to reduce and mitigate superstructure corrosion.

*Cons:*

- Changing the structural system from containing a drop-in span to being completely continuous necessitates a re-evaluation of superstructure behavior and capacity; and
- Higher construction cost.

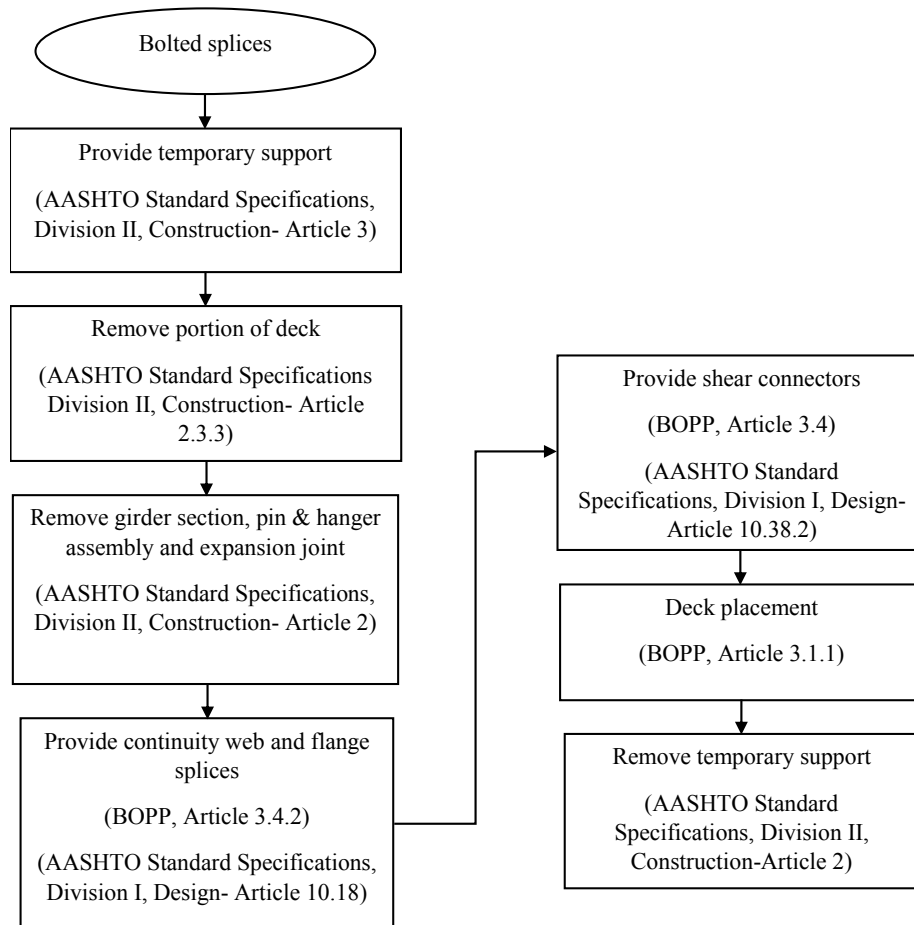

Figure 4.2 Bolted splice design process

As shown in Figure 4.2, when considering replacing the assemblies with bolted splices, the process starts with following steps. While replacing the pin and hanger assemblies with bolted splices, the girder should be supported by temporarily support beam and this support should be provided according to Standard Specifications, Division II-Construction (Article 3). The portion of the deck along the expansion joints are removed as per the design dimensions of the splices according to Standard Specifications, Division II-Construction (Article 2.3.3). The portion of the girder section near the pin and hanger location, pin and hanger assembly, and the expansion joints are removed according to Standard Specifications, Division II-Construction (Article 2). The drop-in span is completely converted into continuity support which is provided through bolted splices connection according to Standard Specifications, Division I-Design (Article 10.18) and BOPP Specifications (Article 3.4.2). Here demand of the girder changes, so demand should be recalculated. Provide shear connectors along the newly constructed girder, shear connectors are designed to provide a composite action between the slab and the girders according to Standard Specifications, Division I-Design (Article 10.38.2) and BOPP Specifications (Article 3.4). Place the deck according to BOPP Specifications (Article 3.1.1). Finally, after construction temporarily support should be removed according to Standard Specifications, Division II-Construction (Article 2).

#### *4.2.2 Link Slab*

This section summarizes the option that involves removing expansion joints and replacing them with link slab. Items that are discussed and presented in the corresponding flowchart incorporate relevant information from the literature search.

The deck expansion joint is a significant component in the functioning of bridge structures (Chang & Lee, 2002). Deck expansion joints accompany the pin and hanger assemblies. The elimination or reduction of expansion joints reduces costs. One identified option that would help eliminate deck joints is via providing “link slabs” at joint locations. Figure 4.3 referred from (Caner & Zia, 1998). A flow-chart detailing general steps involved in the process is located in Figure 4.3.

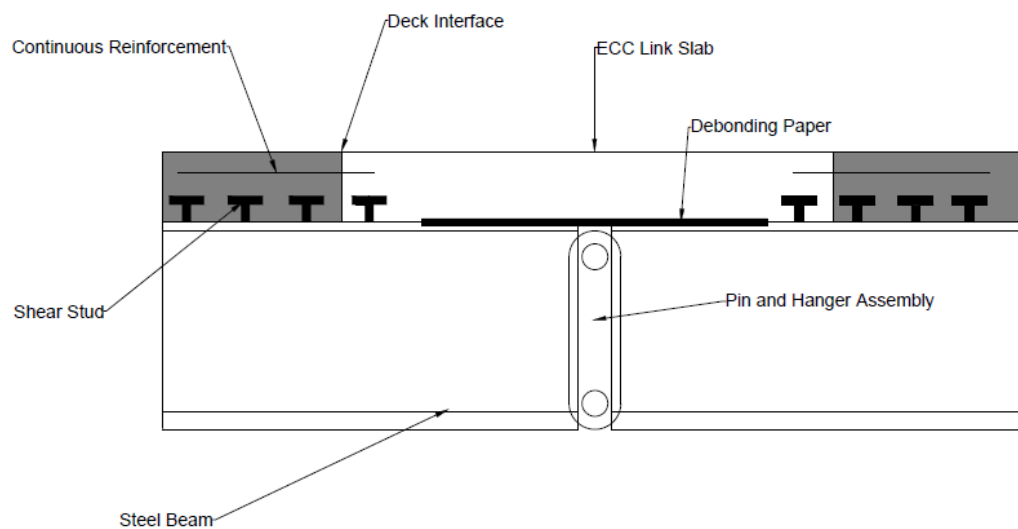

Figure 4.3 Link Slab detail

*Pros:*

- Reduced construction and maintenance of bridge via reduction of joints, moisture intrusion and subsequent corrosion control.

*Cons:*

- Continuity achieved by providing link slab influences shrinkage, creep and thermal stress which causes structural damages; and
- Continuous slab has high stresses developed due to repeated load will lead to fracture and cracking of the structures along the slab.

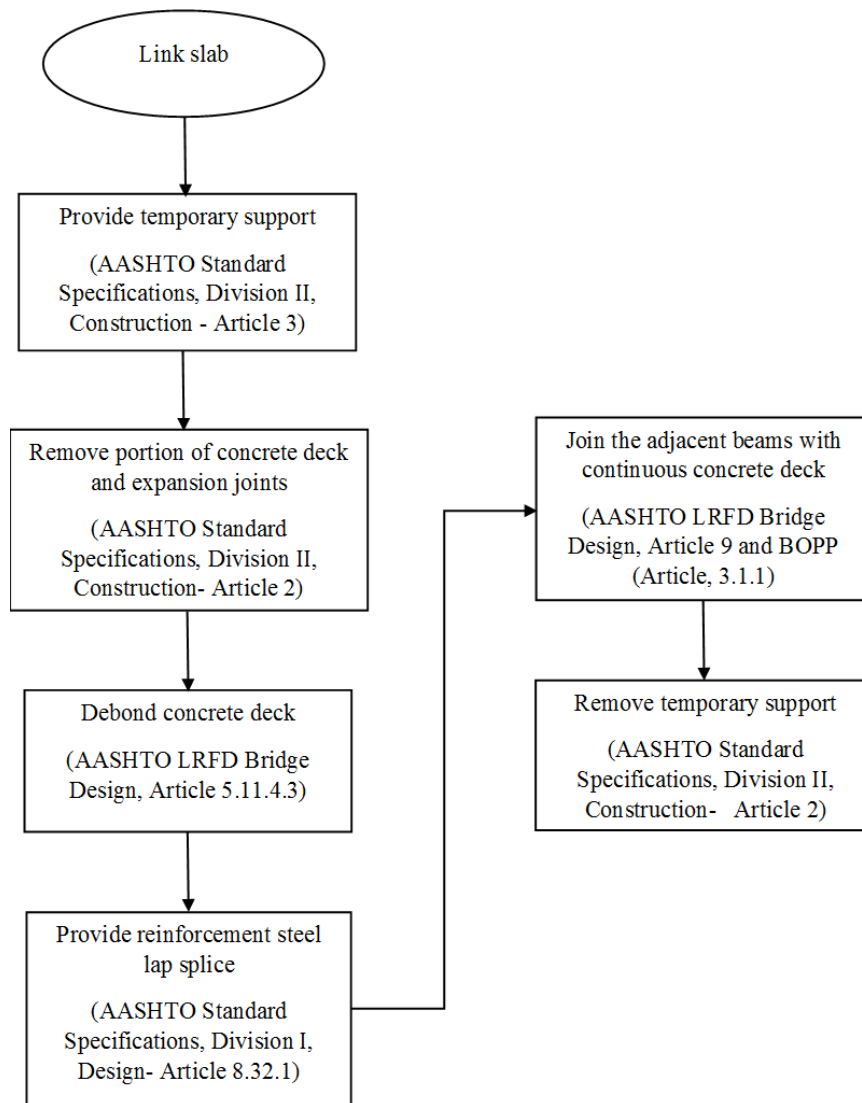

Figure 4.4 Link slab design process.

As shown in Figure 4.4, when considering rehabilitation with link slab, the process starts with following steps according to (Caner & Zia, 1998). While replacing the pin and hanger assembly with a link slab, the girder should be supported by temporarily support beam and this support should be provided according to Standard

Specifications, Division II-Construction (Article 3). Expansion joints and a portion of the concrete deck along the expansion joints are removed according to Standard Specifications, Division II-Construction (Article 2). Debond the concrete deck on each side of the beam at least 5% of the span length according to AASHTO LRFD Specifications, (Article 5.11.4.3) along the debonded region, the shear connectors are removed to prevent composite action. Further, the top flange of the girder is provided with debonding mechanism in the form of standard roofing tar paper which acts as a water proofing material. Provide reinforcement steel lap splice for continuity of deck reinforcement according to Standard Specifications, Division I-Design (Article 8.32.1). Join the adjacent beams with a continuous concrete deck according to AASHTO LRFD Specifications (Article 9) and BOPP Specifications (3.1.1). Finally, after construction temporarily support should be removed according to Standard Specifications, Division II -Construction (Article 2).

#### *4.2.3 Catcher Beam System*

This section summarizes the option that involves rehabilitation of pin and hanger assemblies with catcher beam system. Items that are discussed and presented in the corresponding flowchart incorporate relevant information from the literature search, DOT survey and appropriate federal and state specifications. A secondary catcher beam system is provided to carry loads across the expansion joint when the existing pin and hanger fails at the location of the pin and hanger assembly. The retrofit should be detailed to resist applied load and the gap between the girder and the catcher beam must be kept as small as possible to the limit impact loading. To reduce impact, the use of auxiliary

neoprene bearings on the catcher beam is also recommended (PennDOT, 2010). A flow-chart detailing general steps involved in the process is located in Figure 4.7.

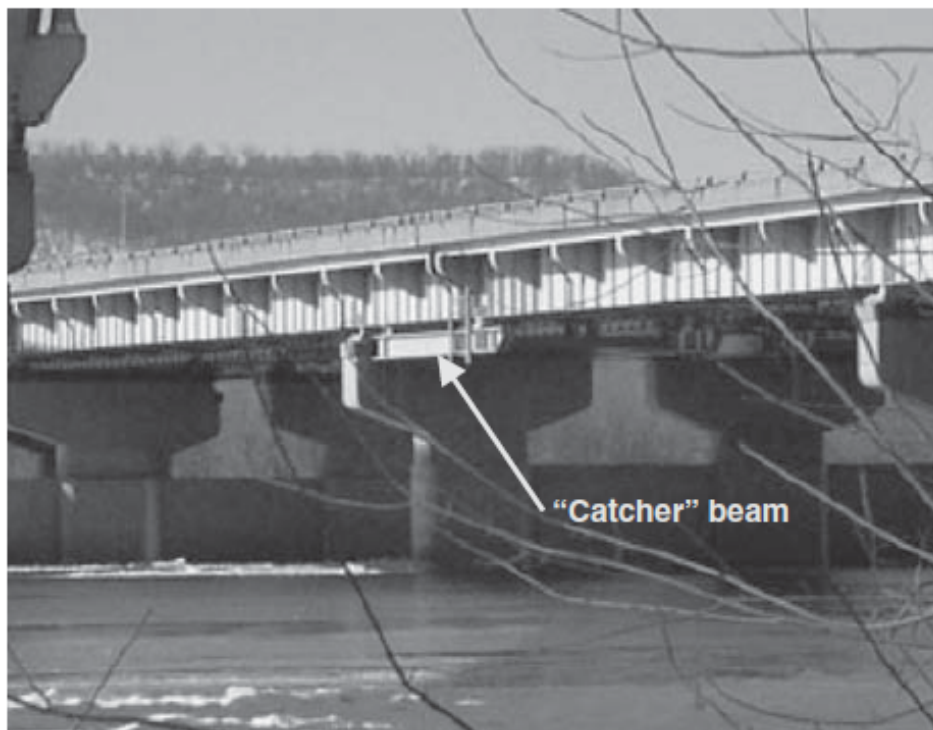

Figure 4.5 Catcher beam system. (Connor et al. 2005)

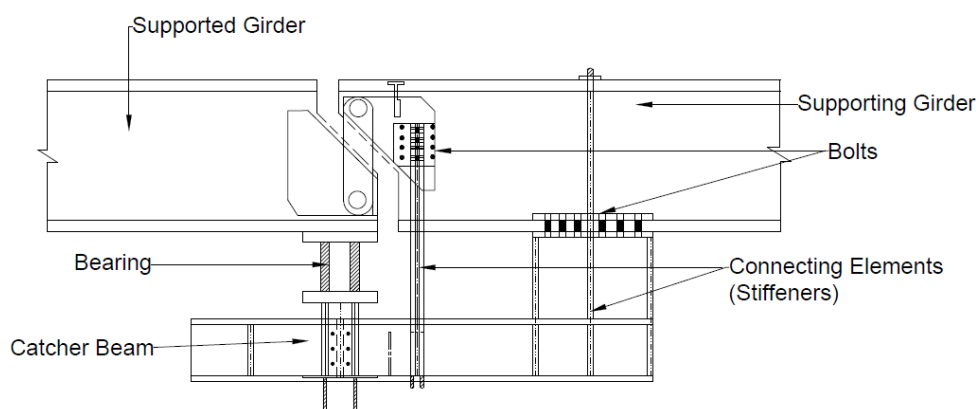

Figure 4.6 Catcher beam system representative detail

*Pros:*

- A catcher beam system provides a mechanically independent alternate load path to prevent a sudden loss of span when a pin and hanger assembly is deemed insufficiently reliable to carry required loads.

*Cons:*

- This is a temporary system, which has a shorter service life due to fatigue related problems in catcher beam system, and replacement needs to be considered.

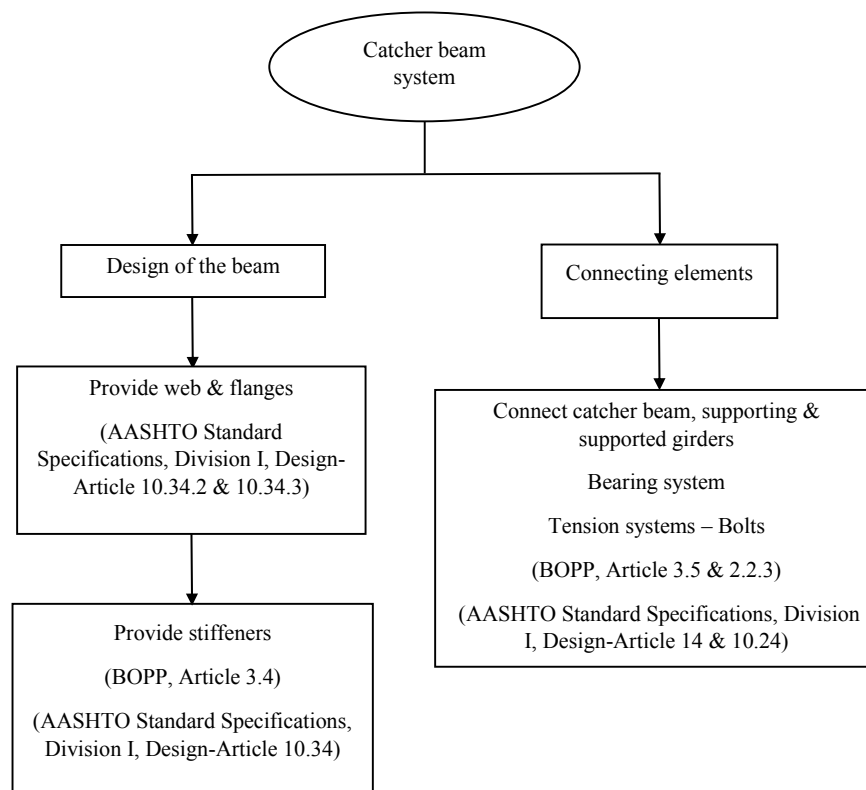

Figure 4.7 Catcher beam design process



As shown in Figure 4.7, when considering retrofit of pin and hanger assemblies with catcher beam, the design process is explained below. Catcher beam system design consists of two components: design of the beam and the connecting elements.

- Design of beam: The web and flanges of the beam is designed according to Standard Specifications, Division I-Design (Article 10.34.2 & 10.34.3). Stiffeners are designed according to Standard Specifications, Division I-Design (Article 10.34) and BOPP Specifications (Article 3.4).
- Connecting elements: For connecting the catcher beam and the supported girder, bearing systems are used and this bearing system is designed according to Standard Specifications, Division I-Design (Article 14). For connecting the catcher beam and the supporting girder, bearing systems and tension systems like bolts are designed according to Standard Specifications, Division I-Design (Article 14 & 10.24) and BOPP Specifications (Article 3.5 & 2.2.3).

#### *4.2.4 Replace with Pin and Hanger Assembly.*

This section summarizes the option that involves removing pin and hanger assemblies and replacing them with new similar pin and hanger assembly. Items that are discussed and presented in the corresponding flowchart incorporate relevant information from the literature search, DOT survey and appropriate federal and state specifications.

When pin and hanger assembly is found to be frozen, they should be considered for examination and should be replaced with new pin and hanger assembly. The hanger plates and pins should be designed according to *AASHTO Standard Specifications for Highway Bridges*. While replacing the new pin and hanger assembly, the suspended span

should be temporarily supported from below or above the deck. FHWA recommended to use new stainless steel pins and hangers according to *AASHTO LRFD Bridge Design Specifications* (Article 6.4.7), which reduces corrosion damage. Higher strength pins and larger hanger cross sections are also recommended to use so that by replacing existing assemblies with new, more durable components the assembly would be strengthened and maintenance requirements could be reduced. (Sirianni & Tricini, 2010).

From the DOTs survey, the approach of replacing new pins and hangers is programmed in more states than any other approaches. A flow-chart detailing general steps involved in the process is located in Figure 4.8.

*Pros:*

- Replacement with similar design can be cost efficient and cause minimal disruption to traffic; and
- By using stainless pins and hangers, corrosion could be controlled.

*Cons:*

- Still provides non-redundant system; and
- Pin and hanger assembly needs regular ultrasonic inspection every two years. So there is a higher inspection and maintenance cost.

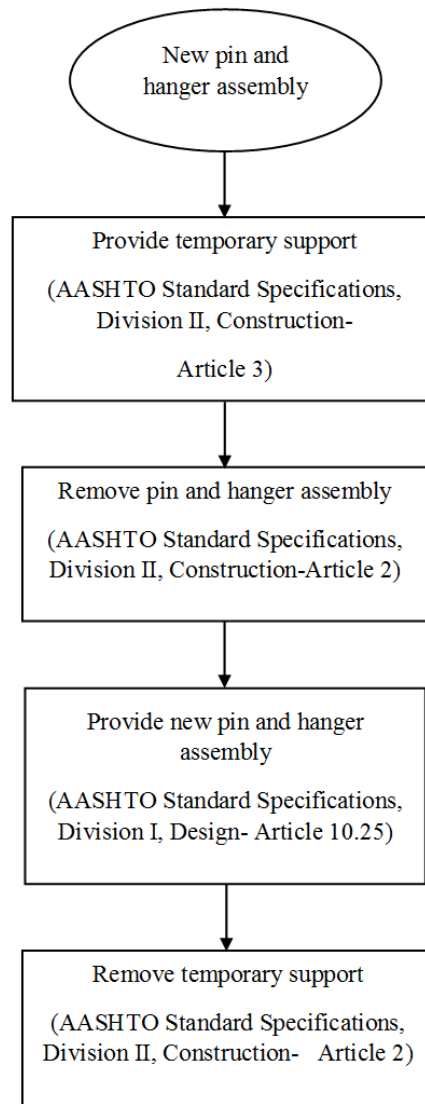

Figure 4.8 New pin and hanger assembly design process

As shown in Figure 4.8, when considering replacing the assemblies with new assemblies, the process starts with the following steps. When replacing the pin and hanger assemblies with new similar design section, the girder should be temporarily supported and this support should be provided according to Standard Specifications, Division II-Construction (Article 3). Removal of the pin and hanger assembly is carried

out according to Standard Specifications, Division II-Construction (Article 2). Then provide a new pin and new hanger according to Standard Specifications, Division I-Design (Article 10.25). Providing stainless steel pins and hangers are recommended to use and these are designed according to AASHTO LRFD Specifications (Article 6.4.7), which reduces corrosion damage. Finally, after construction, temporarily support beam should be removed according to Standard Specifications, Division II- Construction (Article 2).

### 4.3 Summary

This chapter summarized and provided flowcharts that describe steps associated with completing feasible options associated with addressing pin and hanger assembly retrofit and/or replacement. The intention was that the described flowcharts will provide an organized decision-making tool that would assist bridge engineers with assessing options and their consequences when pin and hanger assembly retrofit and/or replacement are being considered. The respective flowcharts in this chapter are designed based on the relevant information from the literature search, DOT survey and appropriate federal and state Specifications. These included the *AASHTO Standard Specifications for Highway Bridges*, the *AASHTO LRFD Bridge Design Specifications* and NDOT's *Bridge Office Policies and Procedures (BOPP) manual*.

## Chapter 5 Finite Element Modeling and Analysis

### 5.1 Bridge Specifications

Three-dimensional finite element modeling (FEM) of an in-service, single bridge girder containing pin and hanger assemblies was completed to assess the influence of selected retrofit and replacement options on the levels of continuity. Seven FEA models were created and analyzed under the influence of self-weight and superimposed dead loads from the barriers and wearing surface; and resulting moment and shear diagrams were compared. Models included the original pin and hanger detail and the following retrofit and/or replacement options:

- Bolted splice
- Link slab
- Catcher beam systems

The selected girder was taken from a 3-span, continuous, plate girder bridge having an overall length of 65.00 meters (214 feet). This bridge is located in Lincoln, Nebraska and was built in 1961. The model focused on an exterior (fascia) girder and an elevation view of the girder is shown in Figure 5.2. NDOT design drawings were used to create the models, with the original girder curved haunch shown in Figure 5.2 being replaced by a linear haunch. Figure 5.3 provides details on the pin and hanger assembly.



Figure 5.1 Modeled bridge

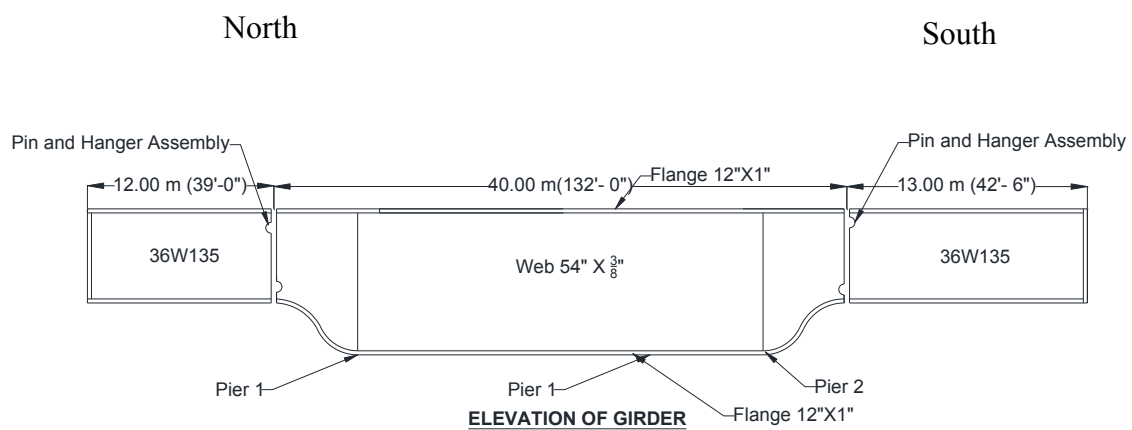

Figure 5.2 Original girder elevation

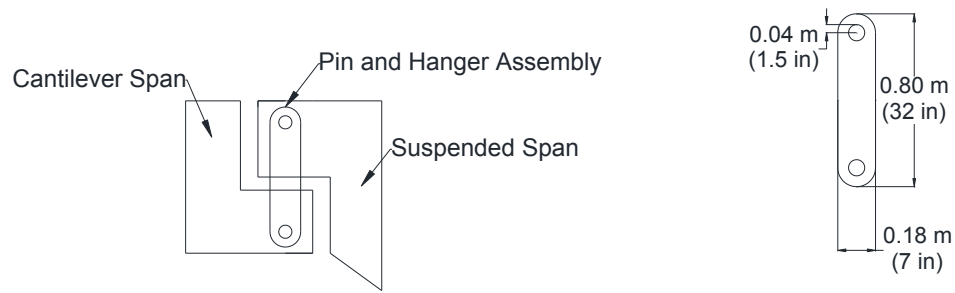

Figure 5.3 Pin and hanger assembly

## 5.2 Finite Element Model

The selected girder was modeled linear elastically (6 models) with small deformations using ABAQUS 6.13 (ABAQUS/CAE, 2013). ABAQUS was selected because it is commonly used to model steel bridge systems and, as such, has been proven to effectively model bridge girder response in the literature (Achenbach, 2008; Issa-Ei-Khoury et al. 2014). These studies were completed to predict accurate analysis results with field or lab test results. Modeling details and analysis methods are briefly discussed in the following sections.

### 5.2.1 Discretization, Element Selection and Interaction

The girder's flanges, web and stiffeners were discretized as 4-noded, reduced integration, shell elements (S4R). S4R elements are commonly used to model structural components with thin elements as they are computationally inexpensive (Bathe K.J et al. 2000; Laulusa et al. 2006). The pin and hanger assemblies, tension rods (for the catcher beam retrofit), and deck were modeled using 8-noded, reduced integration, brick elements (C3D8R). Reinforcement in the deck was modeled using 2-noded, linear, beam elements (B31) that were embedded in the deck brick elements using embedded region

constraint (Gli & Bayo, 2008). Composite action between the girder and the deck was accomplished by node-to-node coupling.

The ABAQUS TIE constraint was used to couple the pin to the hanger plates. Deck reinforcement was coupled to the deck brick elements using the embedded region constraint where nodes are directly coupled with the host element (deck).

The model was discretized using a structured meshing technique with the selected mesh density obtained from the literature it was found that for a height  $H$ , an element size should be of  $H/10$  is sufficient for the study of moment and forces of the girder response (Bapat, 2009). This resulted in 4 elements across the girder flanges, 10 elements through the web depth, and with nodal lines positioned along the length so that the element aspect ratios were close to 1:1.

### *5.2.2 Geometric and Material Properties.*

All steel was nominally assumed to be ASTM A36 (ASTM A36/A36M Standard Specification for Carbon Structural Steel) with Young's modulus being 200 GPa (29000 Ksi), a Poisson's ratio of 0.3 and a density of  $7700 \text{ kg/m}^3$  ( $0.286 \text{ lb/in}^3$ ). The deck slab was been transformed to an equivalent area of steel using a modular ratio with modulus of elasticity of concrete being 25 Gpa (3600 Ksi). Engineering stress/strain relationships from the literature were converted into true stress/strain relationships and used for ABAQUS modelling. For all retrofit to replacement options results indicated that the stresses are below the yield stress and, as a result, the ultimate stress state was not considered, as expected when subjected only to dead loads. However, for the frozen pin and hanger condition, analysis results indicated that stresses induced in the hanger from a



combination of axial and flexural stresses could be appreciably higher than yield, potentially violating linear elastic assumptions.

### *5.2.3 Boundary Conditions and Applied Loads*

Based on a review of site plans coupled with a site visit, boundary conditions for the girder model were assumed as a pinned support at the pier 1 and remaining were roller supports. For the sake of the analytical study, loads consisted of girder self-weight (AASHTO DC1) and superimposed dead loads (AASHTO DC2 and DW), which were uniformly applied along the girder (AASHTO LRFD, 2014).

### *5.2.4 Unique Modeling Aspects.*

In addition to modeling techniques described in the previous section, certain analyses required application of additional, unique modeling techniques in place of, or in addition to, the pin and hanger assembly to effectively mimic the structural behavior. These techniques are summarized below.

#### *5.2.4.1 Pin and Hanger Assembly*

The pins and hanger plates were modeled using 8-noded, reduced integration, brick elements (C3D8R) elements. Solid-to-shell coupling was used to couple these solid elements to girder shell elements (Figure 5.4). Results indicated that the stresses are below the yield stress, as expected when subjected only to dead loads.

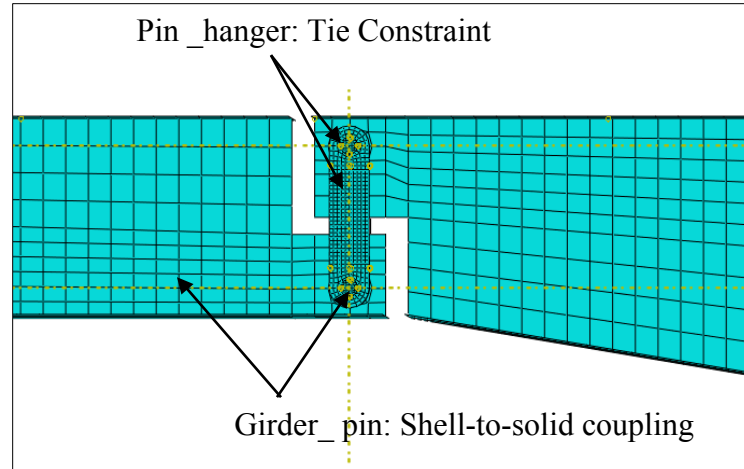

Figure 5.4 Pin and hanger assembly model

#### 5.2.4.2 Link slab

The link slab case included in the pin and hanger assembly items discussed in Chapter 2 and Chapter 4 modeled by utilizing 8-noded, reduced integration, brick elements (C3D8R) for the transformed section of concrete deck and was modeled linear elastically with small deformations. Reinforcement rebars using 2-noded, linear, beam elements (B31) for the rebar. The interactions shown in Figure 5.5 were used to render the link slab continuous over the assembly. The link slab was minimally reinforced of  $0.002\rho$  based on moment induced in the link slab due to end rotation with respect to deck thickness (Lepech & Li, 2009) Figure 2.4. Results indicated that the stresses are below the yield stress.

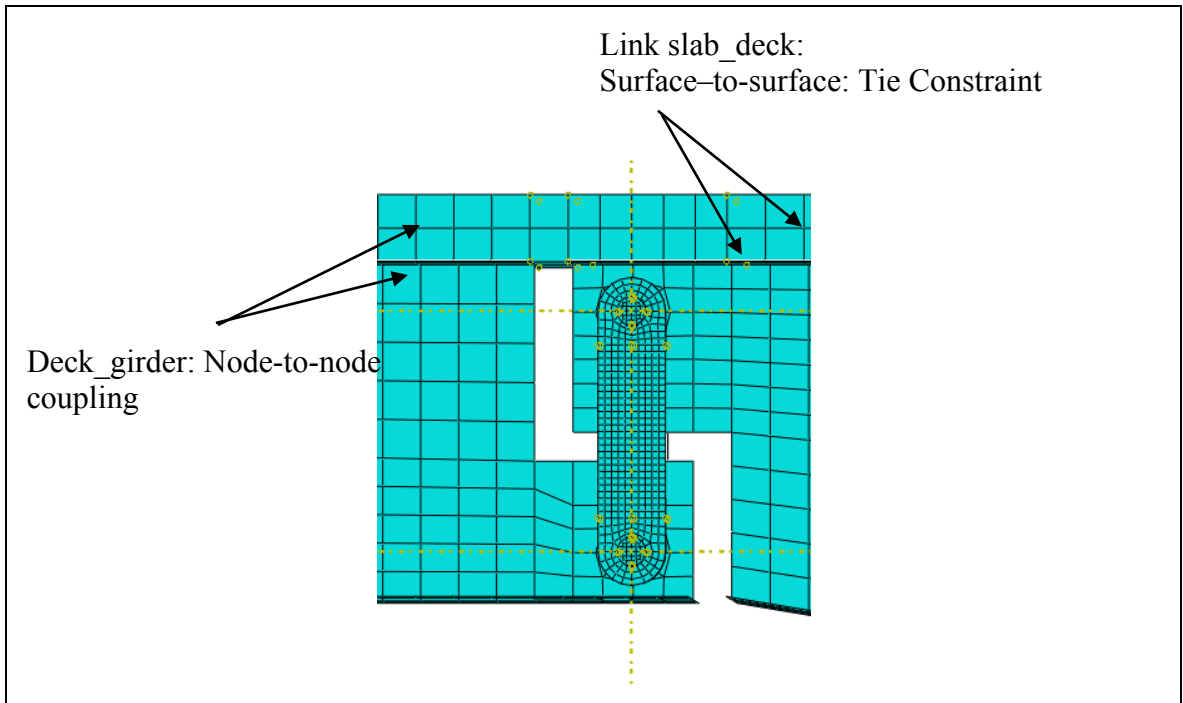
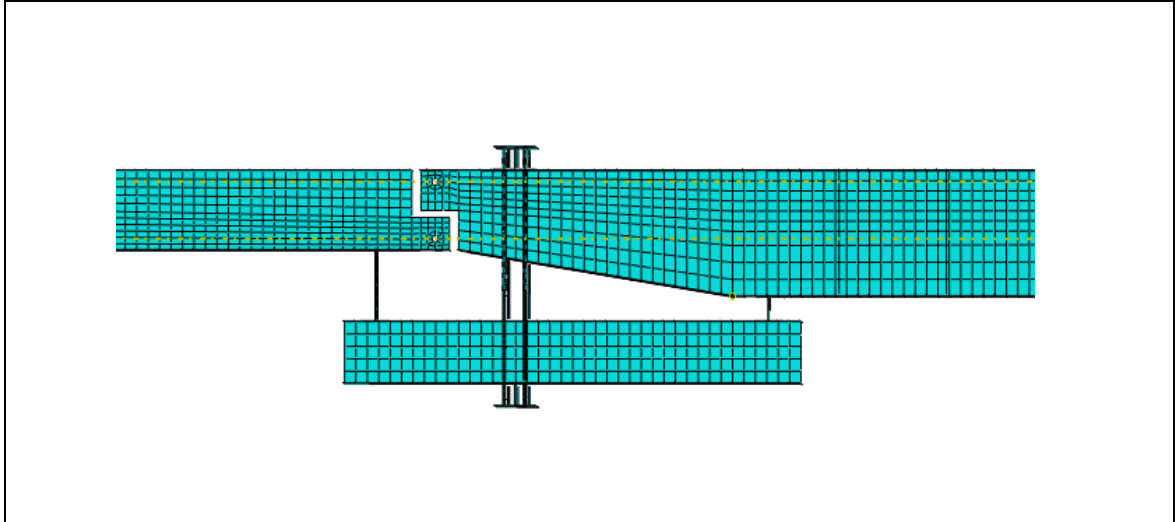

Figure 5.5 Link slab

#### 5.2.4.3 Catcher beam system

The modeled catcher beam system was based on the previous NDOT projects that utilized this retrofit. The system was modeled by utilizing 4-noded, reduced integration, shell elements (S4R) for I-beams. Tension rods were modeled using 8-noded, reduced integration, brick elements (C3D8R) as shown in



Figure

5.6

A catcher beam system provides a mechanically independent alternate load path to prevent a sudden loss of span when a pin and hanger assembly is deemed insufficiently reliable to carry required loads. Three models were generated at the two pin and hanger locations (Figure 5.7), with catcher beams provided at each location and with them simultaneously provided at both locations. Providing catcher beam at one location (north or either south) is feasible option by assuming assembly as failed at either of these locations. But, in this study separate models were generated for north and south location due to the unsymmetrical in span length. Providing catcher beam at both locations is not a feasible option because it shows that both assemblies has failed but modeled to check how it behaves having catcher beams at both locations.

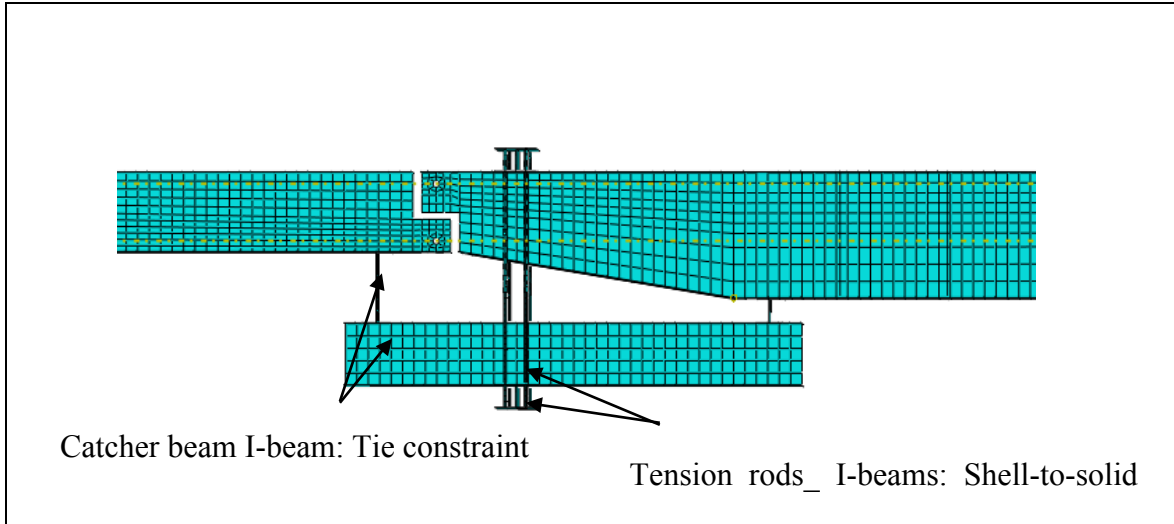

Figure 5.6 Catcher beam system

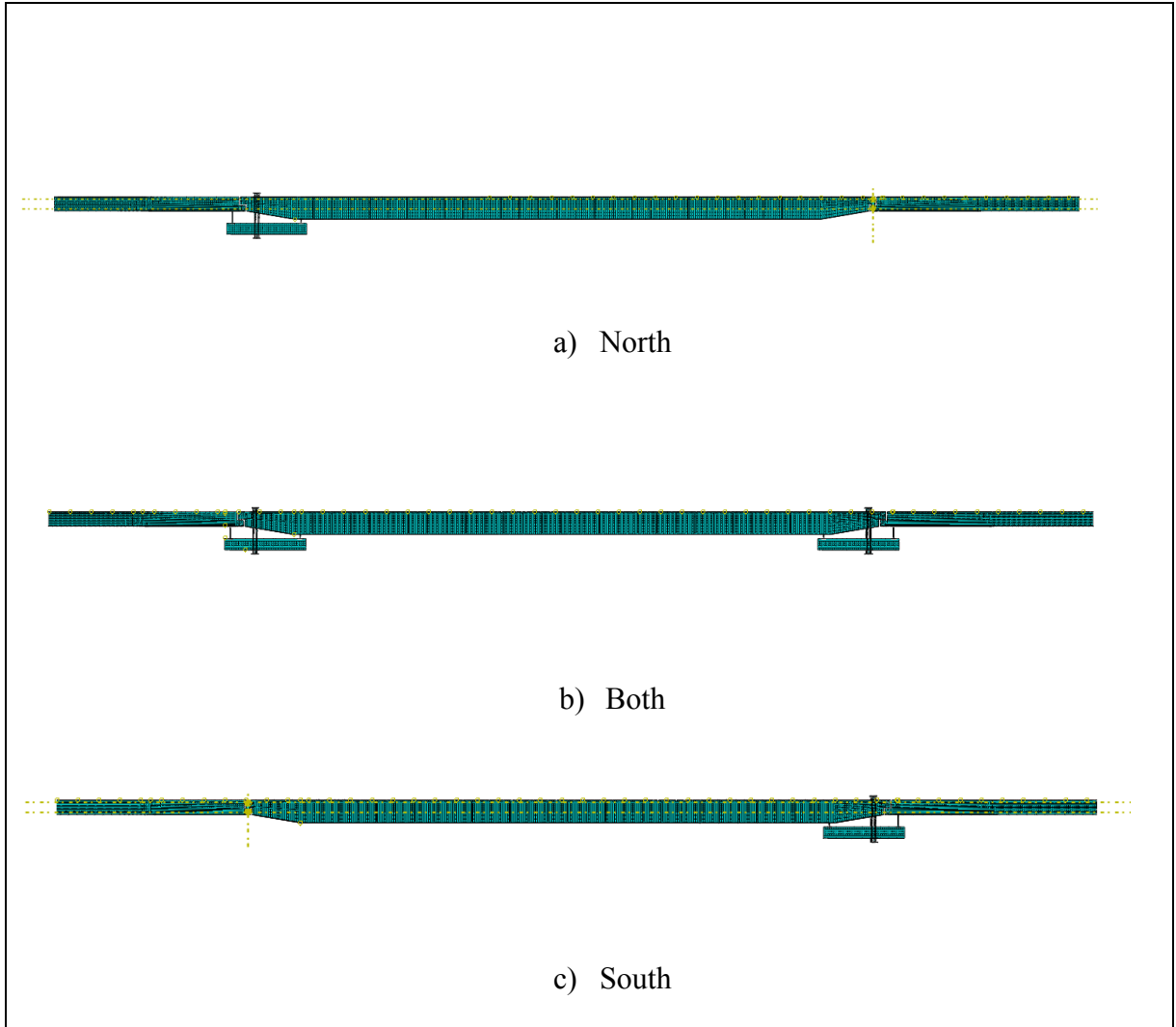

Figure 5.7 Modeled catcher beam cases

#### 5.2.4.4 Frozen Pin and Hanger

The frozen pin and hanger case, representing severe corrosion and accompanying pack rust, was included in the original pin and hanger assembly by assuming pins were nonfunctional. The hanger plates were modeled using 8-noded, reduced integration, brick elements (C3D8R). Surface-to-surface, tied constraints were used to couple the hanger

plates to the girder (Figure 5.8). The analyses performed for the previously described 6 models were all linearly elastic, an assumption confirmed upon review of the results. However, for the frozen condition, analysis results indicated that stresses induced in the hanger from a combination of axial and flexural stresses could be appreciably higher, potentially violating linear elastic assumptions. This study was limited to dead load analyses, so the findings for the locked hanger condition are preliminary and limited to examining the effect of frozen pin and hanger assemblies on continuity.

Surface-to-Surface Tie Constraint

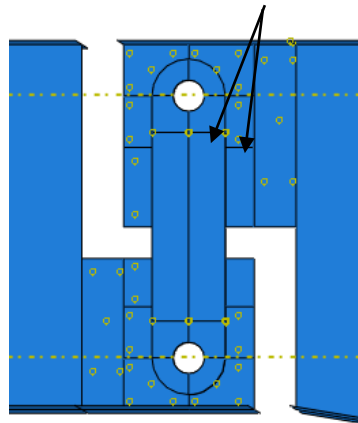

Figure 5.8 Frozen pin and hanger condition

## 5.3 Analysis Results and Comparisons

This section examines predicted behavior for modeled retrofit and replacement options and compares it against the bolted splice replacement option, which achieves complete continuity. Non-dimensionalized moments and shears were compared at the adjacent piers and at the maximum positive moment location along the girder. Results for combined dead load comparisons are shown in Figure 5.9 to Figure 5.13 and are summarized in Table 5.1, to Table 5.4. Individual dead load comparisons for DC-1, DC-2 and DW are found in Appendix E.

### 5.3.1 Comparisons

As stated earlier, behaviors of each case were discussed in Chapter 2 Literature Review and Chapter 4 Flowcharts Summarizing Retrofit and/or Replacement Options and was accomplished via FEM. Results from the comparisons of models are non-dimensionalized with respect to the bolted splices with that of the cases including the original pin and hanger, the link slab, the catcher beam systems and, the pin locked condition for the largest negative moments at adjacent piers, see Figure 5.9 to Figure 5.14. In Figure 5.13 the aforementioned comparison is performed for associated positive maximum moment.

#### 5.3.1.1 Largest negative moments at adjacent piers

##### Pier 1

As indicated in Figure 5.9, the retrofit options providing the highest level of continuity when compared against the bolted splice for each model were presented in Table 5.1.



When looking at the non-dimensionalized ratios along the girder, the ratio for dead loads at pier 1 and pier 2 are nearly the same for the pin and hanger assembly (0.31-0.32), the catcher beam system (0.31-0.35), and the link slab (0.41-0.36) (Table 5.1). Similarly, at maximum positive moment location, the original pin and hanger assembly, the catcher beam systems are 1.32 and 1.30 and the link slab is 1.12. With regard to the shear diagram, indicates that the shear force plays a very negligible role when compared with the moment. Example of non-dimensionalized equation shown in the below section.

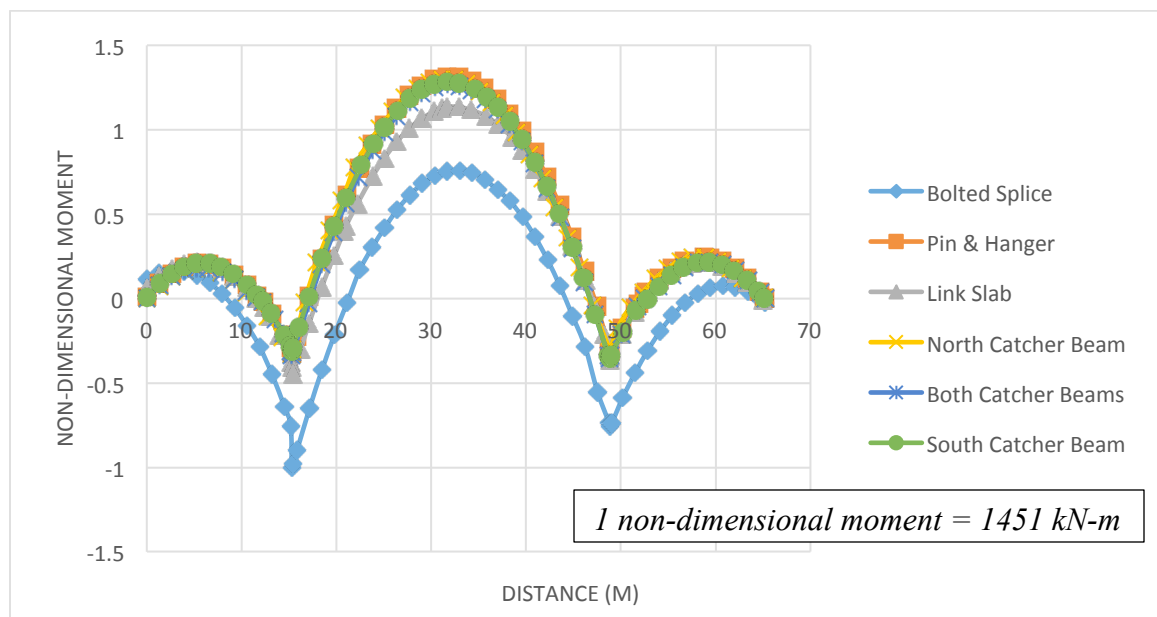

Figure 5.9 Non-dimensionalized moment diagrams for dead loads at pier 1

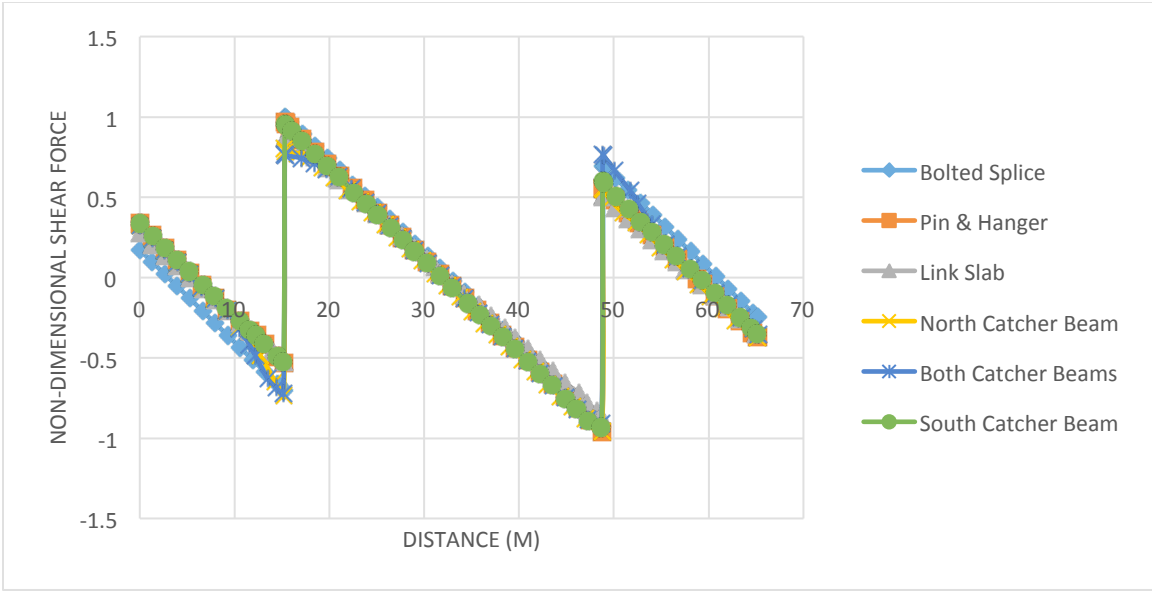

Figure 5.10 Non-dimensionalized shear diagrams for dead loads at pier 1

Table 5.1 Non-dimensionalized moment ratio at pier 1

Pier 1					
Dead Loads					
Point	Pin & Hanger	Link Slab	North Catcher Beam	Both Catcher Beams	South Catcher Beam
Pier1	0.32	0.41	0.33	0.33	0.32
Maximum moment	1.32	1.12	1.30	1.30	1.30
Pier 2	0.31	0.36	0.31	0.35	0.35

$$\text{Nondimensionalized moment (pin and hanger)} = \frac{\text{Moment (Pin and hanger)}}{\text{Moment at pier 1 (bolted splice)}} \dots \dots \dots 5.1$$

Pier 2

As indicated in Figure 5.11, the retrofit options providing the highest level of continuity when compared against the bolted splice for each model were presented in Table 5.2. When looking at the non-dimensionalized ratios along the girder, the ratio for dead loads at pier 1 and pier 2 are nearly the same for the pin and hanger assembly (0.41-0.42), the catcher beam system (0.41-0.47), and the link slab (0.54-0.50) (Table 5.2). Similarly, at maximum positive moment location, the original pin and hanger assembly, the catcher beam systems are 1.74 and 1.70 and the link slab is 1.50. From the shear diagram shown in Figure 5.12 it is implied that shear force plays a negligible role when compared with the moment. Example of non-dimensionalized equation shown in the below section.

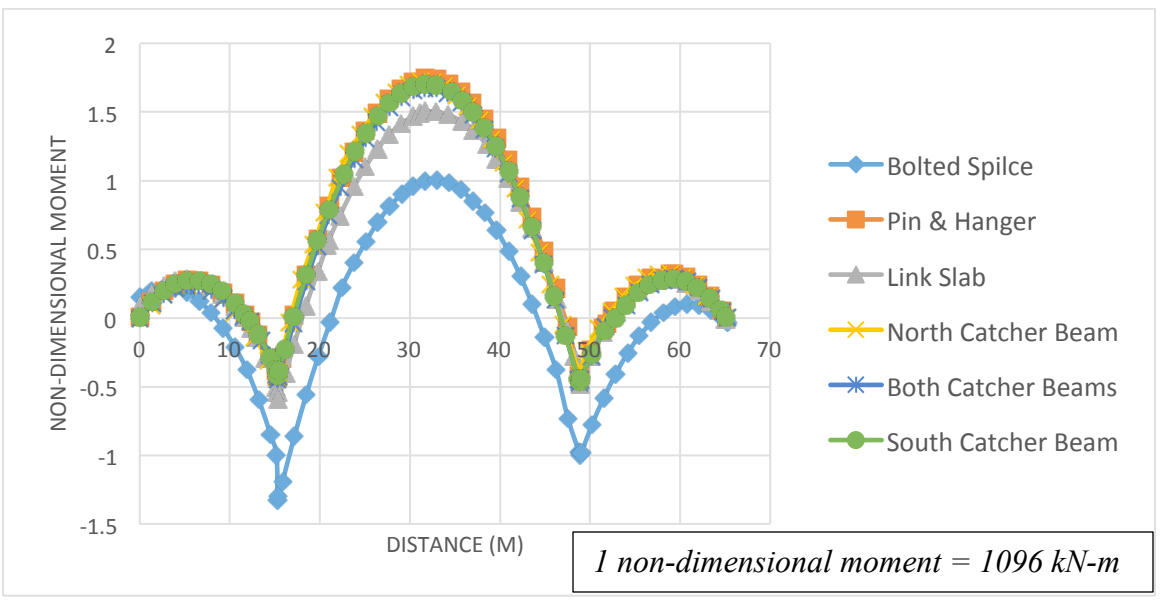

Figure 5.11 Non-dimensionalized moment diagrams for dead loads at Pier 2

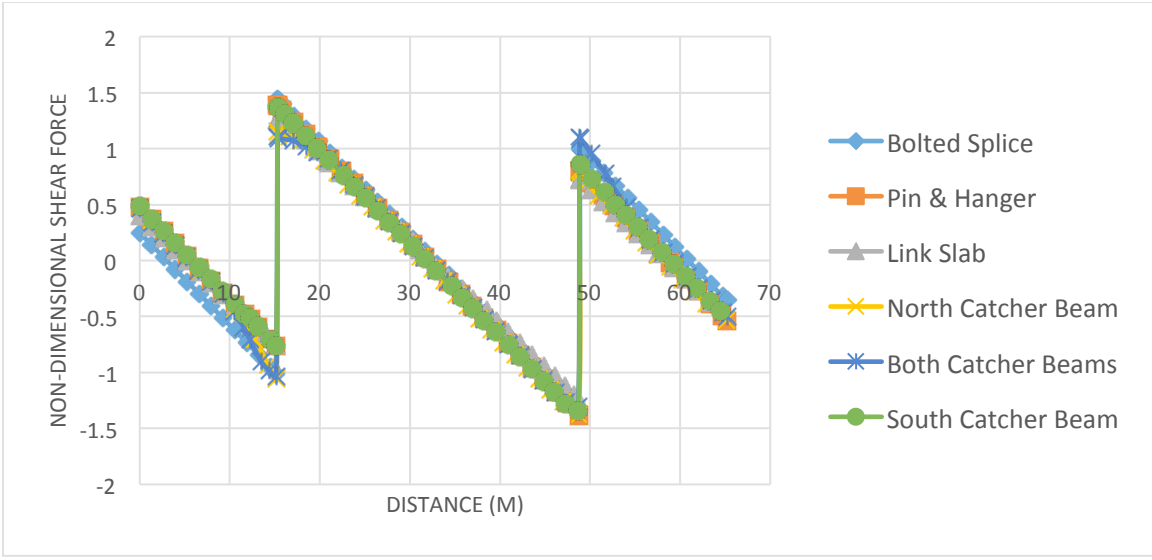

Figure 5.12 Non-dimensionalized shear diagrams for dead loads at Pier 2

Table 5.2 Non-dimensionalized moment ratio at pier 2

Pier 2					
Dead Loads					
Point	Pin & Hanger	Link Slab	North Catcher Beam	Both Catcher Beams	South Catcher Beam
Pier1	0.42	0.54	0.44	0.44	0.42
Maximum moment	1.74	1.50	1.70	1.70	1.70
Pier 2	0.41	0.50	0.41	0.47	0.47

$$\text{Nondimensionalized moment(pin and hanger)} = \frac{\text{Moment(Pin and hanger)}}{\text{Moment at pier 2 (bolted splice)}} \dots \dots \dots 5.2$$

### 5.3.1.2 Maximum positive moment

As indicated in Figure 5.13, the retrofit options providing the highest level of continuity when compared against the bolted splice for each model was presented in Table 5.3. When looking at the non-dimensionalized ratios along the girder, the ratio for dead loads at pier 1 and pier 2 are nearly the same for pin and hanger assembly (0.41-0.42), catcher beam system (0.41-0.47) and link slab is (0.54-0.50) (Table 5.3). At maximum positive moment location, original pin and hanger assembly, catcher beam systems are 1.74 and 1.70 and link slab is 1.50. Example of non-dimensionalized equation shown in the below section.

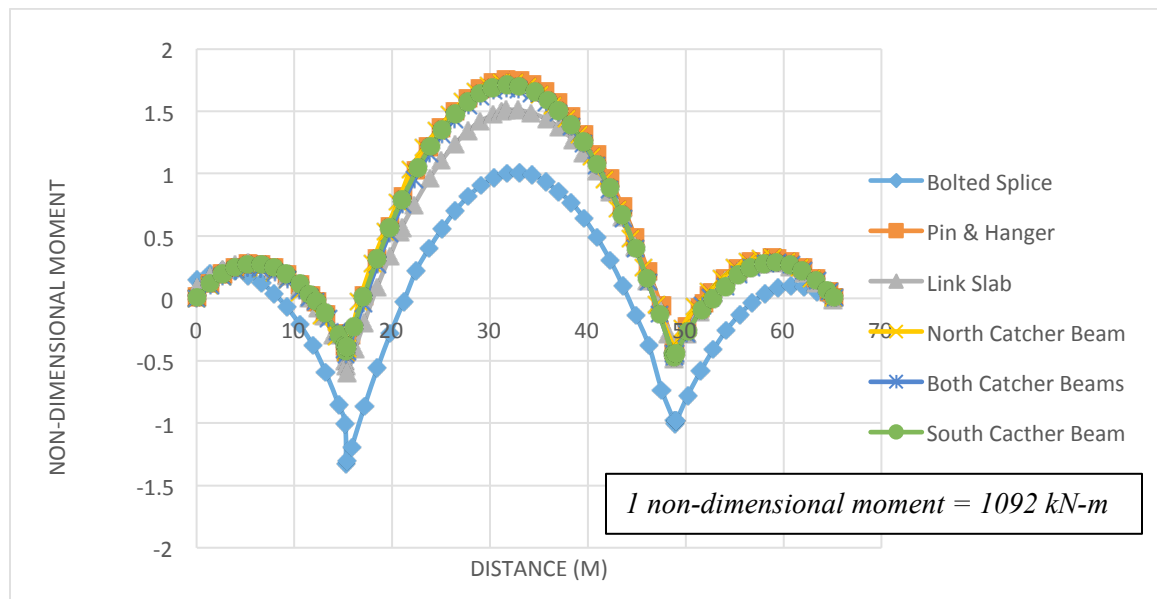

Figure 5.13 Non-dimensionalized moment diagrams for dead loads at maximum positive moment

Table 5.3 Non-dimensionalized moment ratio at maximum positive moment

Maximum Postive Moment					
Dead Loads					
Point	Pin & Hanger	Link Slab	North Catcher Beam	Both Catcher Beams	South Catcher Beam
Pier1	0.42	0.54	0.45	0.45	0.42
Maximum moment	1.74	1.50	1.70	1.70	1.70
Pier 2	0.41	0.50	0.42	0.47	0.47

$$\text{Nondimensionalized moment}(pin\ and\ hanger) = \frac{\text{Moment}(Pin\ and\ hanger)}{\text{Max positive moment (bolted splice)}} \dots \dots \dots 5.2$$

### 5.3.2 Frozen Pin and Hanger

Figure 5.14 and Table 5.4 compare levels of continuity for the bolted splice to the original pin and hanger assembly and to the frozen assembly case Table 5.1. When looking at the non-dimensionalized ratios along the girder, which indicates that the ratio for dead loads at pier 1 and pier 2 locations for the original pin and hanger assembly (0.32-0.31), and for the locked pin condition is (0.76-0.45) (Table 5.4). Similarly, at maximum positive moment location, the original pin and hanger assembly is 1.32, and the locked pin condition is 1.10. Example of non-dimensionalized equation shown in the below section.

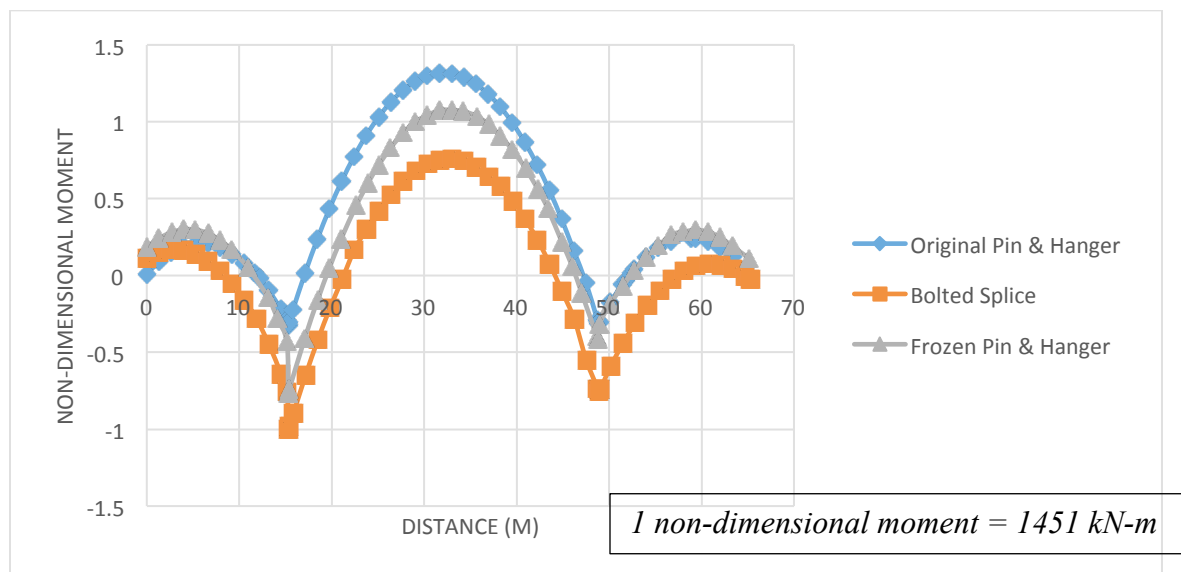

Figure 5.14 Non-dimensionalized moment diagrams for dead loads at pier 1 for locked condition

Pier 1		
Dead Loads		
Point	Pin & Hanger	Locked pins
Pier1	0.32	0.76
Maximum moment	1.32	1.10
Pier 2	0.31	0.45

Table 5.4 Non-dimensionalized moment ratio at pier 1

$$\text{Nondimensionalized moment (pin and hanger)} = \frac{\text{Moment (Pin and hanger)}}{\text{Moment at pier 1 (bolted splice)}} \dots \dots \dots .5.4$$



## 5.4 Summary

Studying models of bolted splice, original pin and hanger assembly, link slab, catcher beam systems and pin locked condition were examined and summarized results for largest negative moments at the adjacent piers and at the maximum positive moment location along the girder are discussed here below.

Non-dimensionalized ratios of bending moment along the girder, with fully bolted splices being the values taken against which the other retrofit cases were compared and examined. Results indicated that for the combined dead loads, levels of continuity were nearly the same for the original pin and hanger assemblies, the catcher beam systems and higher for link slab at pier 1 and pier 2 locations. Similarly, at maximum positive moment location, the original pin and hanger assembly features the same level of continuity with that of the catcher beam system, and is followed by the link slab.

The locked up case (representing severe pack rust) was included in the original pin and hanger assembly. To examine and compare the level of continuity along the girder when pins were locked with that of original pin and hanger assembly and the bolted splice (highest level of continuity). Non-dimensionalized ratios for the locked pin case indicated that the deterioration of pins have higher level of continuity than that of original pin and hanger assembly.

## Chapter 6 Conclusions

The focus of the initial study summarized herein was to review and summarize information related to pin and hanger assembly retrofit to replacement options and also information related to computational study of the girder. An extensive survey was conducted among U.S. State Departments of Transportation (DOTs) for investigating additional information on variety of topics related to pin and hanger retrofit to replacement options. Finally, with reference to state and federal design specifications which include the *AASHTO Standard Specifications for Highway Bridges*; the *AASHTO LRFD Bridge Design Specifications*; and NDOT's *Bridge Office Policies and Procedures (BOPP) manual*, a number of flowcharts were developed and presented that would assist engineers with assessing various options and their consequences when the pin and hanger assembly retrofit to replacements options are being considered in the future.

At the completion of initial study, prevailing retrofit and replacement options were further examined by creating 7 finite element models using ABAQUS, to examine and compare the level of continuity in the girder for different retrofit and replacement options.

Retrofit options providing the highest level of continuity when compared against the bolted splice indicated that the ratio for combined dead loads at pier 1 and pier 2 are similar for pin and hanger, catcher beam system and followed by link slab. At maximum positive moment location, the original pin and hanger and the catcher beam systems are the most similar, followed by the link slab.

Implications of these results on the design and implementation of the examined retrofit and replacement options include:

- The bolted splice delivers the highest level of continuity at the adjacent piers. However, before considering retrofit of the bridge, structural re-evaluation of the superstructure behavior is to be determined so that the member can support continuous span instead of drop-in and cantilever spans. Design should be consider for both positive and negative moments.
- The link slab provides degradation protection over the pin and hanger assembly and achieves higher level of continuity at the piers as that of original pin and hanger assembly. Girder capacity may need to be re-evaluated at piers.
- A catcher beam system provides a mechanically independent alternate load path to prevent a sudden loss of span when a pin and hanger assembly is deemed insufficiently reliable to carry required loads. Catcher beam behavior mainly depends on the stiffness of the tension rods, and the gap between the catcher beam and the main girder.

The pin locked condition (representing severe deterioration) has a highest level of continuity than that of the original pin and hanger assembly. Results indicated that girder capacity needs to be re-evaluated at piers.

## 6.1 Recommendations for Future Research

The present study focused on synthesis of various retrofit to replacement options and their computational analysis, focused on examination of the level of continuity in girder for various assembly options for the self-weight and superimposed dead loads. Future research should focus on examination of level of continuity in girder for the live loads and distortion induced fatigue cracking at the connections between the girders, one of the severe problems of steel bridges. Fatigue analysis should be carried out by computational studies also in conjunction with corrosion simulation studies, as the literature has shown that major cause of the fractures of pin and hanger assembly was significant build-up of corrosion.

## References

- A36/A36M -14 Specification for Carbon Structural Steel.* (n.d.).
- AASHTO Standard Specifications for Highway Bridges, 16th edition.* (1996). American Association of State Highway and Transportation Officials ,Washington D.C.
- AASHTO Bridge Construction Specifications, 3th edition.* (2010). American Association of State Highway and Transportation Officials,Washington D.C.
- AASHTO LRFD Bridge Design Specifications, 7th edition.* (2014). American Association of State Highway and Transportation Officials,Washington D.C.
- Achenbach, J. (2008). *Life Cycle Management of Steel Bridges Based on NDE and Failure Analysis.*
- American Association for Public Opinion Research.* (2015). "Standard Definitions", Final Dispositions of Case Codes and Outcomes Rate for Surveys.
- Banthia, V., Hengen, T., & Phillips, B. (2014). "Rehabilitation Works for Pinawa Bridge Over Winnipeg River,". *In Transportation 2014: Past, Present, Future-2014 Conference and Exhibition of Transportation of Canada//Transport 2014.*
- Bapat, A. (2009). *Influence of Bridge Parameters on Finite Element Modeling of Slab on Girder Bridges.*
- Bathe, K., Iosilevich, A., & Chapelle, D. (2000). An Evaluation of the MITC Shell Elements. *Computers & Structures*, 75 (1), 1-30.
- Bridge Condition Report Procedures and Practices.* (2011). Bureau of Bridges and Structures Division of Highways, Illinois Department of Transportation.
- Bridge Inspector's Reference Manual (BIRM).* (2012). Volume 1, Federal Highway Administration, Publication No. FHWA NHI 12- 049.

- Bridge Office Policies and Procedures (BOPP)*. (2014). Nebraska Department of Roads, Bridge Division.
- Bridge Safety Inspection Manual 2nd Edition*. (2010). Publication 238 Part IE:Evaluation Specifications, Pennsylvania Department of Transportation.
- Britt, M. F. (1990). "The Pennsylvania Department of Transportation's Auxiliary Support System Retrofit for Bridges with Non-redundant Pin and Hanger Details". *In Second Workshop on Bridge Engineering Research in Progress, Proceedings*.
- Caner, A., & Zia, P. (1998). "Behavior and Design of Link Slabs for Jointless Bridge Decks". *PCI Journal*, 43(1998):68-81.
- Chang, L. M., & Lee, Y. J. (2002). "Evaluation of Performance of Bridge Deck Expansion Joints". *Journal of Performance of Constructed Facilities*, 16(1),3-9.
- Christie, S., & Kulicki, J. M. (1991). "New Support for Pin-Hanger Bridges,". *Civil Engineering- ASCE*, 61(2).
- Chung, W., & D.Sotelino, E. (2006). Three-Dimensional Finite Element Modeling of Composite Girder Bridges. *Engineering Structures*, 28(1),63-71.
- Connor, R. J., Dexter, R., & Mahmoud, H. (2005). *"Inspection and Management of Bridges with Fracture-Critical Details"*. (No.Project 20-5(Topic 53-08)).
- Dassault Systemes "ABAQUS 6.13". (2013). Providence,RI:ABAQUS Inc.,2013.
- Eamon, C., & Nowak, A. (2002). Effect of edge - Stiffening Elements and Diaphragms on Bridge Resistance and Load Distribution. *Journal of Bridge Engineering* , 7(5),258-266.

- Gli, B., & Bayo, E. (2008). "An Alternative Design for Internal and External Semi-rigid Composite Joints. Part II: Finite Element and Analytical Study". *Engineering Structures*, 232-246.
- Graybeal, B., Walther, R., & Washer, G. (2000). "Ultrasonic Inspection of Bridge Hanger Pins". *Transportation Research Record:Journal of the Transportation Research Board*, (1697),19-23 .
- Issa-Ei-Khoury, G., Linzell, D., & Geschwinder, L. (2014). Computational Studies of Horizontally Curved, Logitudinally Stiffened, Plate girder webs in Flexure. *Journal of Constructional Steel Research*, 93,97-106.
- Kennedy Bridge Planning Study*. (2014). Technical Memorandum, Bridge Rehabilitation Alternatives, Minnesota Department of Transportation.
- Kezmane, A., Chaiaia, B., Kumpyak, O., Maksimov, V., & Placidi, L. (2017). 3D Modelling of Reinforced Concrete Slab with Yielding Supports Subject to Impact Load. *European Journal of Environmental and Civil Engineering*, 21(7-8),988-1025.
- Laulusa, A. O., Choi, J., Tan, V., & Li, L. (2006). Evaluation of Some Shear Deformable Shell Elements. *International Journal of Solids and Structures*, 43 (17),5033-5054.
- Lepech, M., & Li, V. (2009). Application of ECC for Bridge Deck Link Slabs. *Materials and Structures*, 42(9),1185.
- Liao, L. (2010). Finite Element Analysis of Cables-Truss Structures. *Structural Dynamics and Mtaerials Conference*. Orlando, Florida: AIAA.

- Montana Structures manual- Part II.* (2002). Chapter 22, Bridge Rehabilitation , Reference number:SS-10 Pin and Hanger Rehabilitation, Montana Department of Transportation.
- Mosavi, A. A., Sedarat, H., Emami-Naeini, & Lynch, J. (2011). "Finite Element Driven Damage Detection of a Skewed Highway Bridge with Pin and Hanger Assemblies".
- National Transportation Safety Board (NTSB).* (1984). "Highway Accident Report - Collapse of a Suspended Span of Interstate Route 95 Highway Bridge Over the Mianus River, Greenwich, Connecticut, June 28, 1983," Report No. NTSB/HAR-84/03, NTSB, Washington D.C.
- New York State Route 5 Buffalo Skyway management Study Report.* (2008). City of Buffalo, Erie County, New York Department of Transportation.
- Richardson, T. I. (2012). *Finite Element Modeling Techniques For Crack Prediction And Control In Steel Bridge Girders.*
- Salmon, C., & Johnson, J. (1996). *Steel Structures, Design and Behaviour, Haper Collins.* New York, NY.
- Shang, K., & Guo, Q. (2012). A Study of The Torsional Behavior of Reinforced Concrete Trough Girder Based On ABAQUS. *ASCE.*
- Shirole, A. M., & Malik, A. H. (1993). "Seismic Retrofitting of Bridges in New York State,". *In Symposium on Practical Solutions for Bridge Strengthening and Rehabilitation.*
- Sirianni, C. M., & Tricini, J. (2010). "I- 579 Crosstown Boulevard Bridge Preservation Project". *American Society of Highway Engineers.*



*Structural Services Manual*. (2015). Bureau of Bridges and Structures Division of Highways, Illinois Department of Transportation.,Springfield Illinois.

## Appendix A

### Survey

## Steel Pin and Hanger Assembly Replacement Options Inventory Survey

A number of steel beam bridges exist in the United States that contain steel pin and hanger assemblies. These assemblies were used to facilitate construction and to reduce the level of indeterminacy along a given beam line when the bridges were originally built. As the bridges continue to age, these assemblies have collected debris and moisture and, in certain instances, have deteriorated to a point where their retrofit or removal has been completed or is being considered. We are facilitating this survey on behalf of the Nebraska Department of Roads (NDOR) to explore how other agencies address pin and hanger assemblies that are aging and becoming deteriorated. Results from the survey can be provided to you upon request.

### Section 1. General

1. Do you have steel bridges that contain pin and hanger assemblies?

- Yes  
 No → Go to Question 7 on page 3

1a. If yes, please provide the number of steel bridge types for each category below that have pin and hanger assemblies. If you do not have a pin and hanger assembly for the steel bridge type, please write in '0'.

Type of bridge	Number of pin and hanger assemblies
a. Two or three girder bridges	<input type="text"/>
b. Four and more girder bridges	<input type="text"/>
c. Truss bridges	<input type="text"/>
d. Other, specify: <input type="text"/>	<input type="text"/>
e. Other, specify: <input type="text"/>	<input type="text"/>

**Section 2. Options**

2. Does your agency view the pin and hanger assemblies as components that need retrofitted and/or replaced?

- Yes
- No → Go to question 5 on page 3

2a. If yes, please provide the number of retrofit and/or replacement options that you have implemented or programmed for each category below. If you have implemented or scheduled retrofit and/or replacement options other than those listed below, please describe and provide the number for each option in the additional table rows. If you have not implemented or programmed the retrofit and/or replacement option listed, please write in '0'.

Retrofit option	Number implemented	Number programmed
a. Use a secondary system such as a "catcher beam"	<input type="text"/>	<input type="text"/>
b. Replace with new pin and hanger assembly	<input type="text"/>	<input type="text"/>
c. Replace with bolted splice	<input type="text"/>	<input type="text"/>
d. Other, specify: <input type="text"/>	<input type="text"/>	<input type="text"/>
e. Other, specify: <input type="text"/>	<input type="text"/>	<input type="text"/>

3. For the retrofits and/or replacements you indicated above as implemented or programmed, did you follow any of the designs, procedures, or criteria below?

	Yes	No
a. AASHTO LRFD criteria and procedures	<input type="radio"/>	<input type="radio"/>
b. AASHTO standard specification criteria and procedures	<input type="radio"/>	<input type="radio"/>

4. Have you developed your own criteria and procedures for retrofits and/or replacements?

- Yes
- No → Go to question 5 on page 3

4a. If yes, please provide references.

5. Does your agency view the pin and hanger assemblies as components that need no further action at this time?

- Yes  
 No → Go to Question 6

5a. If yes, please briefly explain why no action was taken.

### Section 3. Future Contact

6. If you developed your own criteria and procedures for retrofits and replacements, would you be willing to share those with us?

- Yes  
 No → Go to Question 10  
 Not applicable

6a. If yes, which format would you prefer to share those in?

- Electronically  
 Hard copy

7. Would you like to receive the results of this study?

- Yes  
 No

8. If you answered yes to Question 6 or 7, please provide your information below for us to contact you to either request your criteria and procedures, or to provide you the results of this study.

Name



*First*

*Last*

Email

@

9. Please use the space below to provide any additional comments.

**Thank you!**

That completes our questions. We greatly appreciate the time you have taken to complete this inventory survey. For your convenience, please use the postage-paid return envelope included in your survey packet to return your questionnaire to the Bureau of Sociological Research.

Questions or requests from this survey can be directed to:

Bureau of Sociological Research  
University of Nebraska-Lincoln  
PO Box 886102  
Lincoln, NE 68588-6102  
Phone: 1-800-480-4549 (toll free)  
E-mail: [bosr@unl.edu](mailto:bosr@unl.edu)

## Appendix B

### Response to Survey of DOTs

#### Question 1

Other types of steel bridges that have pin and hanger assemblies other than listed are:

- Arizona DOT: Arch Bridge (85).
- Arkansas State Highway and Transportation Department: Arch deck (2).
- Alaska Department of Transportation and Public Facilities: Box girders (1).
- Colorado DOT: Tie down.
- Illinois DOT: Truss with eye bars & pins (1).
- Iowa DOT: Secondary highway steel girders, secondary highway truss.
- Michigan DOT: All girder bridges (1099).
- Minnesota DOT: Arch (1), Suspension (1).
- Ohio DOT: Riveted steel arch (2).
- Oregon DOT: RGDG (9).
- Utah DOT: Pinned arches (7), Suspension arch (1).
- Washington State DOT: Concrete box -2 (132).
- West Virginia DOT: Tied thru arch (1), Suspension bridge (1).

#### Question 2

- Maine DOT: Superstructure replace (number implemented-1, number programmed -1).

- Massachusetts DOT: Ship lap joint (number programmed -1), replace p & h assembly with under running bearing beam (number implemented-1).
- Michigan DOT: Replace bridge (number implemented-1, number programmed - 3).
- North Carolina DOT: Replace w/ concrete girder (number programmed -1).
- Nebraska Department of Roads: replace bridge or superstructure- (of the 102 pin and hanger bridges on the state system 50 are scheduled for replacement of either the entire bridge or the entire superstructure).
- Virginia DOT: replace Bridge.
- Wyoming DOT: suspension hanger/seismic (number implemented-1).

#### **Question 4**

- Arkansas State Highway and Transportation Department: Internally developed.
- Illinois DOT: It is part of our structural services manual. Bureau of bridges and structures IDOT.
- Michigan MDOT: Our bridge replacement program prioritizes bridges with pins & hanger high enough to systematically replace the bridge with another (usually concrete) bridge.
- Missouri DOT: No set criteria. Details are case-by-case.
- Utah DOT: Is not documented.

#### **Question 5**

- Alaska Department of Transportation and Public Facilities: Pin & hangers are functioning properly. No pack rust present.
- Colorado DOT: No section loss due to corrosion & no crack on hanger.

- Delaware DOT: We are not as concerned with pin & hanger assemblies for multi-beam bridges. Pin & hanger assemblies on truss bridges are treated as a fracture critical member and are scrutinized more.
- Iowa DOT: Proper inspection should identify deficiencies in time to address them without impacts to public safety.
- Louisiana Department of Transportation and Development: Bridges are in good condition.
- Montana DOT: Pins and hangers are usually inspected every 2 years and UT inspected every 4 years. With our relatively dry climate and large temperature swings the p & h assemblies usually stay moving as designed with little rust impact.
- Minnesota DOT: We will include repairs or improvements to pin and hanger elements as conditions warrant. We have not developed projects solely on pin and hanger detail unless condition justifies.
- North Carolina DOT: Inspection reports indicate the condition of the pin and hanger is “good”.
- Nebraska Department of Roads: All bridges are inspected by certified inspectors at least every 2 years and all bridges that this agency manages directly have redundant secondary systems should failure occur.
- Nevada DOT: We haven't identified problems with the hangers, aside from minor corrosion.



- New Hampshire DOT: Framing plan varies from 10 to 7 girder lines, condition is satisfactory.
- Ohio DOT: We retrofit when they are deteriorated.
- Oklahoma DOT: We used ultrasonic inspection on our pins. No problems were found.
- Oregon DOT: We inspect & monitor p & h's and only r & r or provide supplemental support when their condition indicates a need.
- Pennsylvania DOT: We have retrofitted the inventory of 2 girder and truss bridges with suspended assemblies.
- South Dakota DOT: These assemblies are part of annual NBIS inspections and the pins get a periodic NDT inspection as well.
- Virginia DOT: We evaluate each one individually.
- Washington State DOT: Routine inspections and painting when needed.
- West Virginia DOT: We monitor during routine inspections and provide action as needed

## Additional Comments

- Arkansas State Highway and Transportation Department: We usually have 1 or 2 bridges a year that have pin/hanger issues. Our fix is normally to replace pin and hanger. Sometimes we keep the hanger and just flip it around. When we have wear we will bore and replace with bigger pins.
- Illinois DOT: As a result of a fractured pin is one of our structures in the mid 1990's the Illinois Department of Transportation developed an aggressive program for the replacement of pins and link assemblies. Between 1995 and 1997 over 90 structures on our primary system were retrofitted. Over 2000 pins and corresponding links or plate assemblies were replaced throughout the state. In general the retrofit replaced the old style “shoulder” pin (with no bushings) with a constant diameter solid pin made of a stronger material (Nitronic 60) using Teflon bushings. The intent was to provide a better pin assembly as well as one that was easier to inspect in the future.
- Iowa DOT: We have replaced bushings in pin & hanger assemblies due to corrosion/wear.
- Massachusetts DOT :For the replacement of the p & h assembly with the under running bearing beam, the detail looks just like a catcher beam except that the suspended span sits on a bearing on that beam and the p & h assembly was removed in its entirety.
- Michigan DOT: MDOT does not automatically view pin & hangers as needing replacement. We replace them on a case-by case basis based on condition and

load capacity. Although pin & hangers are not utilized on new bridges, we do not have any focused efforts to remove them from our inventory.

- Mississippi DOT: We have replace pins & links on our large scale MS River crossing bridges in Watchez, MS. It is the only bridge we intend to remain in service with these details. The replacements were very large scale. These are long span truss bridges.
- Montana DOT: Our pin and hanger assemblies tend to work well. We have replaced pins over the years due to wear and also a few assemblies when they were ruined by impacts to girders from overweight loads.
- Minnesota DOT: MnDOT stopped building bridges w/ pin and hanger details in 1960's. We have not rehabilitated that many as the bridge width is typically too narrow therefore we have done mostly bridge replacements for those vintage. It has been over 10 years since last pin and hanger rehab and that one was caused by no cotter pin on pin and there was a condition concern the hanger may come off of pin. Call w/ questions.
- Missouri DOT: We only replace or repair them after they deteriorate. We don't have a program to do so.
- New Mexico DOT: Performs ultrasonic testing on all pins every 60 months. We have found and replaced compromised/broken pins.
- Ohio DOT: Number of retrofits performed - you did not give a time frame for this work. This makes it difficult to answer. This type of work has gone on for many years. We do not track this work so there is no way to answer that question beyond the memory of current group.

- Utah DOT: Please contact me for additional details on the bridge retrofit projects we have completed or programmed. I would like a copy of the results.
- Wyoming DOT: The pin & hanger we replaced was due to damage from gunshot.

## Appendix C

### List of Abbreviations

Alabama Department of Transportation (ALDOT)

Alaska Department of Transportation and Public Facilities (Alaska DOT & PF)

American Association for Public Opinion Research (AAPOR)

American Association of State Highway and Transportation Officials, Load and Resistance Factor Design (AASHTO LRFD)

Arizona Department of Transportation (ADOT)

Arkansas State Highway and Transportation Department (AHTD)

Average Daily Truck Traffic (ADTT)

Bridge Office Policies and Procedures (BOPP)

Bureau of Sociological Research (BOSR)

Colorado Department of Transportation (CDOT)

Delaware Department of Transportation (DelDOT)

Federal Highway Administration (FHWA)

Florida Department of Transportation (FDOT)

Fracture Critical Members (FCMs)

Georgia Department of Transportation (GDOT)

Hawaii Department of Transportation (Hawaii DOT)

Illinois Department of Transportation (IDOT)

Indiana Department of Transportation (INDOT)

Iowa Department of Transportation (IOWADOT)

Louisiana Department of Transportation and Development (LADOTD)

Maine Department of Transportation (Maine DOT)

Massachusetts Department of Transportation (Mass DOT)

Michigan Department of Transportation (MDOT)

Minnesota Department of Transportation (MnDOT)

Mississippi Department of Transportation (Mississippi DOT)

Missouri Department of Transportation (MoDOT)

Montana Department of Transportation (MDT)

National Bridge Inspection Standards (NBIS)

National Cooperative Highway Research Program (NCHRP)

National Transportation Safety Board (NTSB)

Nebraska Department of Transportation (NDOT)

Nevada Department of Transportation (NDOT)

New Hampshire Department of Transportation (NHDOT)

New Mexico Department of Transportation (NMDOT)

New York State Department of Transportation (NYSDOT)

Non-destructive Testing (NDT)

North Carolina Department of Transportation (NCDOT)

North Dakota Department of Transportation (NDDOT)

Ohio Department of Transportation (ODOT)

Oklahoma Department of Transportation (OklahomaDOT)

Oregon Department of Transportation (OregonDOT)

Pennsylvania Department of Transportation (PennDOT)

Rhode Island Department of Transportation (RIDOT)

South Dakota Department of Transportation (SDDOT)

South Carolina Department of Transportation (SCDOT)

Tennessee Department of Transportation (TDOT)

Texas Department of Transportation (TxDOT)

Transportation Research Board (TRB)

Utah Department of Transportation (UDOT)

Virginia Department of Transportation, Central Office (VDOT)

Washington State Department of Transportation (WSDOT)

West Virginia Department of Transportation (WVDOT)

Wyoming Department of Transportation (WYDOT)

## Appendix D

### Table D.1 Summary

Table D.1 Summary of various retrofit and replacement options pros and cons

Retrofit/replacement options	Pros	Cons
Bolted splices	<p>Eliminates non-redundant system, make structure more efficient.</p> <p>Reduces and mitigate superstructure corrosion.</p>	<p>Need to re-evaluate superstructure behavior and capacity.</p> <p>Higher construction cost.</p>
Link slab	<p>Reduction of joints controls corrosion and moisture intrusion.</p>	<p>Structural damages-(thermal stress, shrinkage &amp; creep).</p> <p>Higher stress lead to fracture &amp; cracking along the slab.</p>
Catcher beam system	<p>Immediate option, controls sudden failure of bridge.</p>	<p>Temporarily system.</p> <p>Fatigue related problems replacement need to be considered.</p>
New pin and hanger assembly	<p>Similar design can be cost-effective and minimal traffic disruption.</p>	<p>Regular ultrasonic inspection.</p> <p>Still provides non-redundant system.</p>



## Appendix E

### *E.1 Dead load calculations*

In the following dead load calculation, the unit weight of concrete is taken as  $2400 \text{ kg/m}^3$  ( $0.087 \text{ lb. /in}^3$ ). Future wearing surface of  $1 \text{ kpa}$  ( $20 \text{ psf}$ ) consider from BOPP specifications.

Table E.1 Geometric dimensions

Components	SI units
Deck thickness	0.17 m (7 in)
Deck width	11 m (426 in)
Haunch thickness	0.05 m (2 in)
Barrier width	0.38 m (15 in)

### **Component dead load (DC1):**

- Concrete deck =  $(0.17 \times 11 \times 2400) / 100 / 5$  girder =  $9.10 \text{ kn/m/girder}$  [ $0.052 \text{ kip/in/girder}$ ]
  - Concrete deck haunches =  $(0.05 \times 0.3048 \times 2400 / 100) = 0.36 \text{ kn/m}$  = [ $0.0020 \text{ kip./in}$ ]
  - Stay- in place forms =  $5 \text{ psf} = 0.2394 \text{ KPa}$
  - Stiffeners and details =  $1.75 \text{ kn/m}$  [  $0.011 \text{ kip/in}$  ]
  - Self-weight of the girder is directly used from ABAQUS as a gravity load.
1. Component dead load (DC1)/girder =  $11.55 \text{ kn/m}$  ( $0.066 \text{ kip/in}$ ) + self-weight of the girder

2. Component dead load (DC2) =  $(0.20) (2400/100) = 4.753 \text{ kn/m/girder}$  [0.026 kip/in/girder]
3. Wearing surface load (DW) =  $[11.00 - 2 (0.381)] / 5 = 2.45 \text{ kn/m/girder}$  (0.0140 kip/in)

### *E.2 Largest negative moments at the pier1.*

Non-dimensionlized results from the comparisons of models are show against bolted splices with that of cases including the original pin and hanger, link slab and catcher beam system for the largest negative moments at pier 1 are shown below for individual dead loads conditions (DC-1, DC-2 and DW).

#### Pier 1 – DC1

As indicated in the Figure E.1, the retrofit options providing the highest level of continuity when compared against the bolted splice for each model were presented. This finding is supported when looking at the non-dimensionalized ratios show in Table E.2 , which indicate that the ratio for DC1 is identical for pin and hanger, link slab and catcher beam system at pier1 (0.32-0.33), pier2 (0.30-0.35) and, maximum positive moment (1.3-1.28). From the shear diagram Figure E.2 indicates that shear force as very negligible effect compare to moment. Example of non-dimensioned equation is presented below.

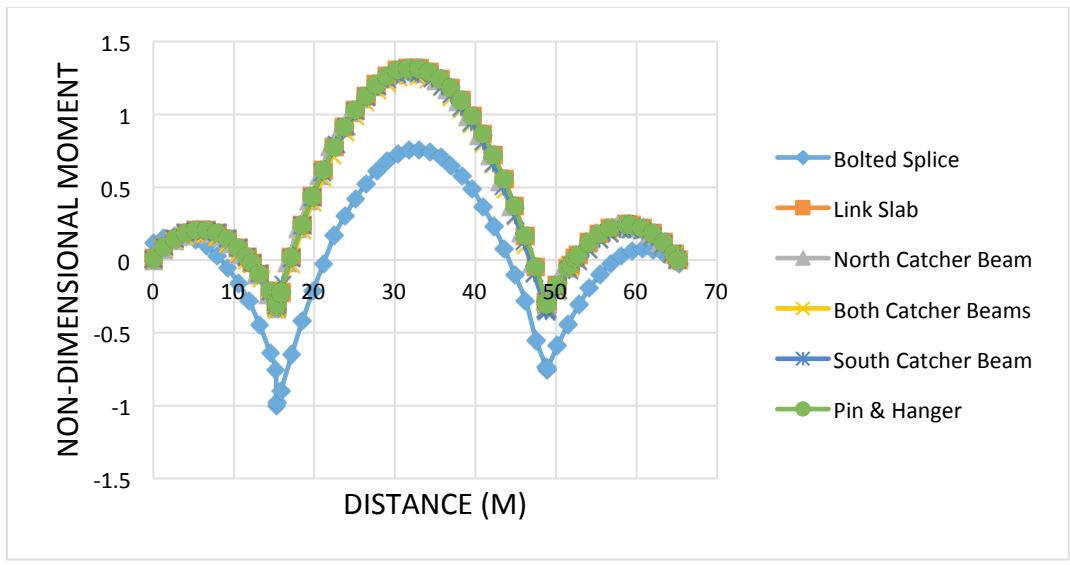

Figure E.1 Non-dimensionalized DC1 moment diagrams at pier 1

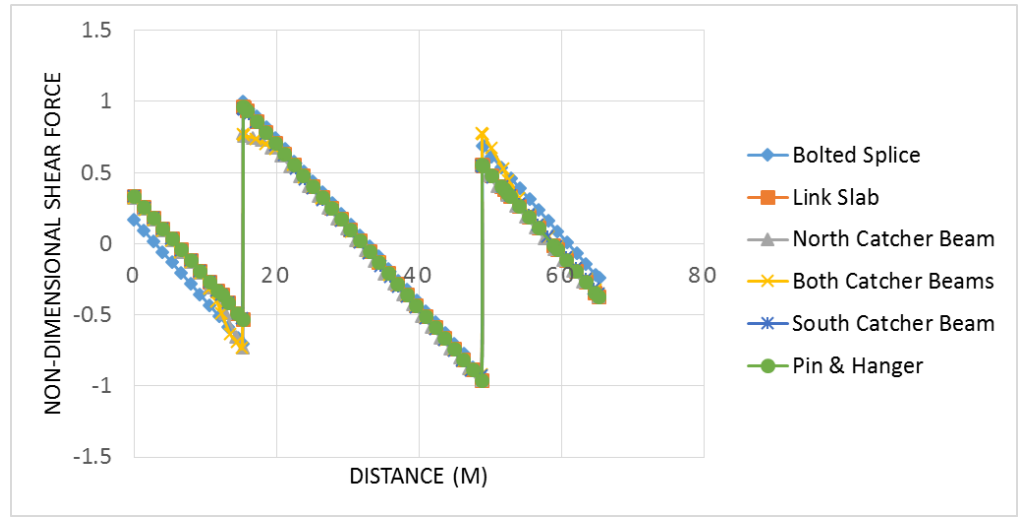

Figure E.2 Non-dimensionalized DC1 shear diagrams at pier 1

$$Nondimensionalized\ moment(pin\ and\ hanger) = \frac{Moment(Pin\ and\ hanger)}{Max\ positive\ moment\ (bolted\ splice)} \dots \dots \dots 5.2$$

### Pier 1- DC2

As indicated in the Figure E.3, the retrofit options providing the highest level of continuity when compared against the bolted splice for each model were presented. This finding is supported when looking at the non-dimensionalized ratios show in Table E.2, which indicate that for link slab as a ratio at pier1 (0.52), pier2 (0.044) and, maximum positive moment (0.9) followed by catcher beam system (3 locations) and pin and hanger assembly with ratio of pier1 (0.32-0.34), pier2 (0.301-0.35) and, maximum positive moment (1.31-1.28) level of continuity. From the shear diagram Figure E.4 indicates that shear force as very negligible effect compare to moment.

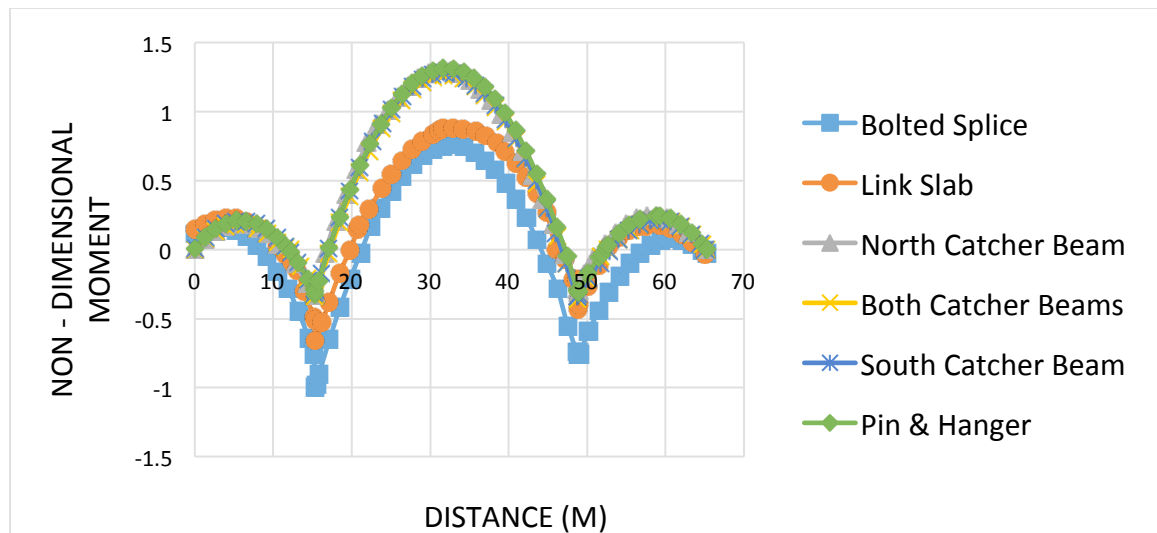

Figure E.3 Non-dimensionalized DC2 moment diagrams at pier 1

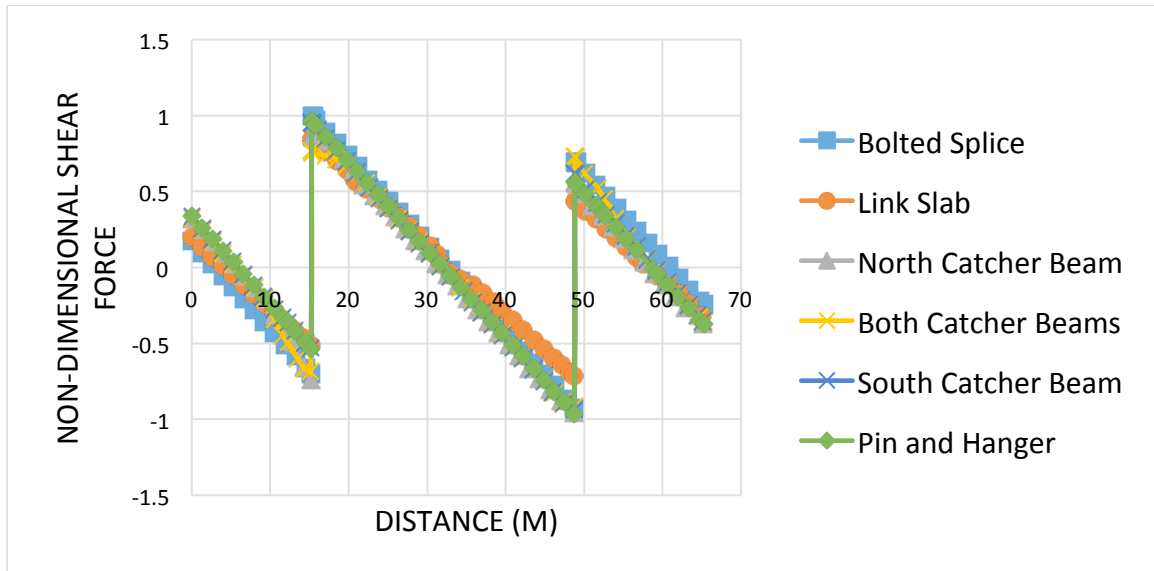

Figure E.4 Non-dimensionalized DC2 shear diagrams at pier 1

#### Pier 1- DW

As indicated in the Figure E.5, the retrofit options providing the highest level of continuity when compared against the bolted splice for each model was presented. This finding is supported when looking at the non-dimensionalized ratios show in Table E.2, which indicate that for link slab as a ratio at pier1 (0.52), pier2 (0.44) and, maximum positive moment (0.9) followed by catcher beam system (3 locations) and pin and hanger assembly with ratio of pier1 (0.32-0.34), pier2 (0.30-0.36) and, maximum positive moment (1.30-1.28) level of continuity. From the shear diagram Figure E.6 indicates that shear force as very negligible effect compare to moment.

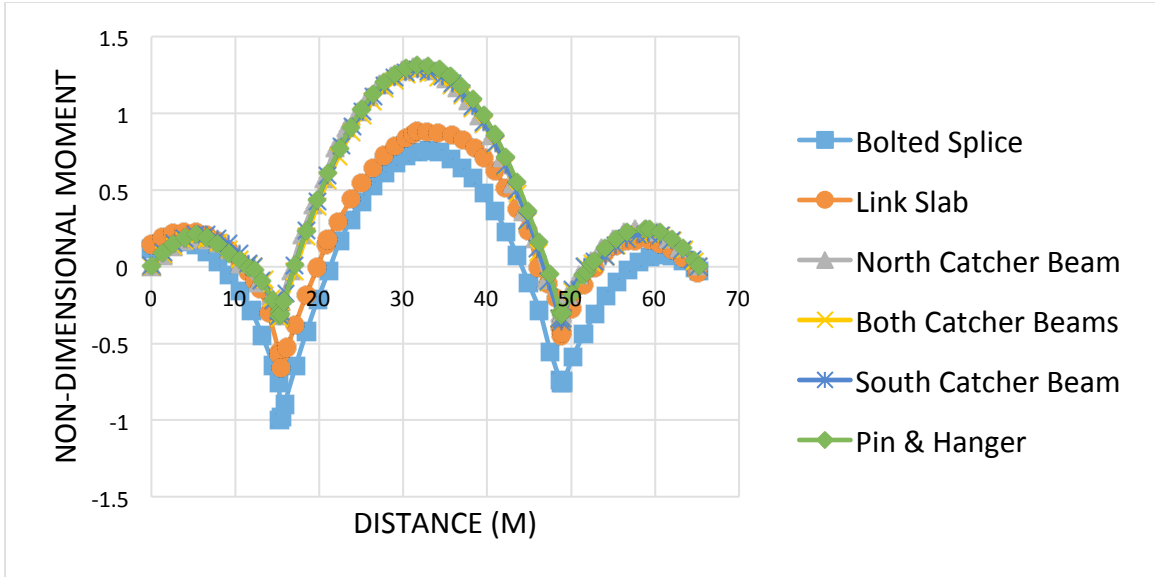

Figure E.5 Non-dimensionalized DW moment diagrams at pier 1

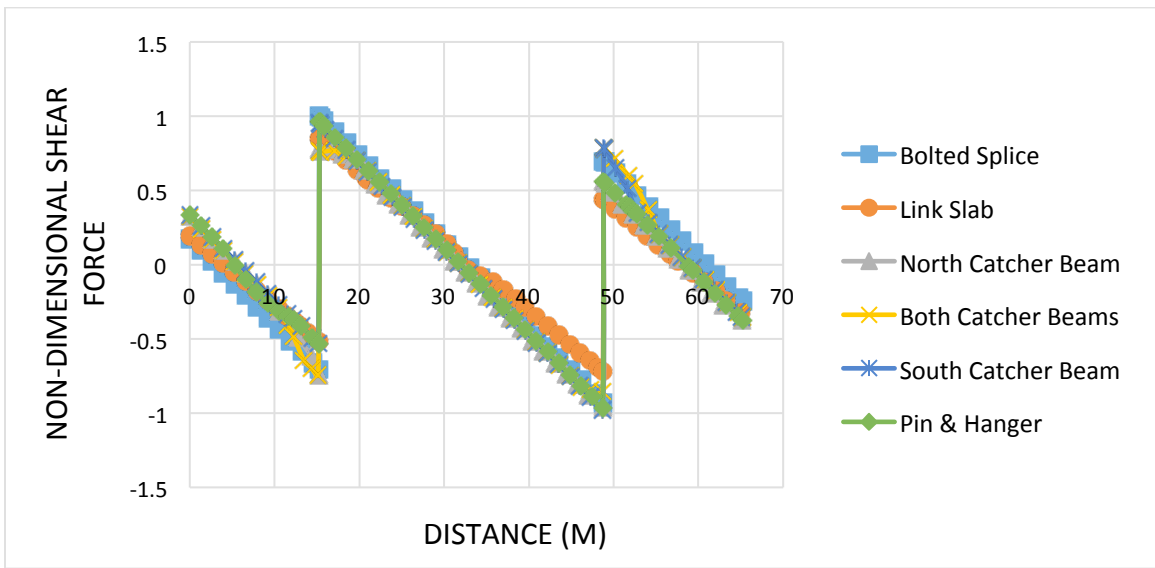

Figure E.6 Non-dimensionalized DW shear diagrams at pier 1

Table E.2 Non-dimensionalized moment ratio at pier 1

Pier 1 -Largest Negative Moment					
DC1					
Point	Pin & Hanger	Link Slab	North Catcher Beam	Both Catcher Beams	South Catcher Beam
Pier1	0.32	0.32	0.33	0.33	0.31
Maximum moment	1.31	1.32	1.30	1.28	1.28
Pier 2	0.32	0.32	0.31	0.35	0.35
DC2					
Point	Pin & Hanger	Link Slab	North Catcher Beam	Both Catcher Beams	South Catcher Beam
Pier1	0.32	0.52	0.33	0.34	0.32
Maximum moment	1.31	0.90	1.30	1.29	1.28
Pier 2	0.31	0.44	0.31	0.35	0.34
DW					
Point	Pin & Hanger	Link Slab	North Catcher Beam	Both Catcher Beams	South Catcher Beam
Pier1	0.32	0.52	0.32	0.34	0.32
Maximum moment	1.31	0.90	1.29	1.28	1.28
Pier 2	0.31	0.44	0.31	0.36	0.36