

University of Nebraska - Lincoln

DigitalCommons@University of Nebraska - Lincoln

Theses, Dissertations, and Student Research:
Department of Psychology

Psychology, Department of

5-2011

Child/Adolescent Sexual Abuse and Alcohol: Proposed Pathways to Problematic Drinking in College via PTSD Symptoms, Emotion Dysregulation, and Dissociative Tendencies

Alicia K. Klanecky

University of Nebraska-Lincoln, klanecky@huskers.unl.edu

Follow this and additional works at: <http://digitalcommons.unl.edu/psychdiss>



Part of the [Clinical Psychology Commons](#), and the [Psychiatry and Psychology Commons](#)

Klanecky, Alicia K., "Child/Adolescent Sexual Abuse and Alcohol: Proposed Pathways to Problematic Drinking in College via PTSD Symptoms, Emotion Dysregulation, and Dissociative Tendencies" (2011). *Theses, Dissertations, and Student Research: Department of Psychology*. 29.

<http://digitalcommons.unl.edu/psychdiss/29>

This Article is brought to you for free and open access by the Psychology, Department of at DigitalCommons@University of Nebraska - Lincoln. It has been accepted for inclusion in Theses, Dissertations, and Student Research: Department of Psychology by an authorized administrator of DigitalCommons@University of Nebraska - Lincoln.

CHILD/ADOLESCENT SEXUAL ABUSE AND ALCOHOL: PROPOSED
PATHWAYS TO PROBLEMATIC DRINKING IN COLLEGE VIA PTSD
SYMPTOMS, EMOTION DYSREGULATION, AND DISSOCIATIVE TENDENCIES

by

Alicia K. Klanecky

A DISSERTATION

Presented to the Faculty of
The Graduate College at the University of Nebraska
In Partial Fulfillment of Requirements
For the Degree of Doctor of Philosophy

Major: Psychology

Under the Supervision of Professor Dennis E. McChargue

Lincoln, Nebraska

May, 2011

CHILD/ADOLESCENT SEXUAL ABUSE AND ALCOHOL: PROPOSED
PATHWAYS TO PROBLEMATIC DRINKING IN COLLEGE VIA PTSD
SYMPTOMS, EMOTION DYSREGULATION, AND DISSOCIATIVE TENDENCIES

Alicia K. Klanecky, Ph.D.

University of Nebraska, 2011

Adviser: Dennis E. McChargue

Research has discussed the use of alcohol to self-medicate posttraumatic stress (PTSD) symptoms following child/adolescent sexual abuse (CASA). Less research has examined the self-medication hypothesis in college students. Further, investigation of the self-medication hypothesis generally precludes the integration of additional psychological vulnerabilities that may impact students' alcohol consumption. Supported by the "dynamic" stress-diathesis perspective, emotion regulation (ER) difficulties and insufficient dissociative tendencies existing prior to and potentially altered after CASA exposure may relate to problematic alcohol use. The current study aimed to provide an initial, cross-sectional examination of 1) the relations between CASA exposure severity and alcohol use, 2) the self-medicating role of alcohol use for PTSD symptoms, and 3) the integration of the diathesis-stress perspective such that ER difficulties and dissociative tendencies may mediate or moderate the relations among CASA exposure, PTSD symptoms, and alcohol use. Participants included 213 college students mandated to a brief alcohol intervention. After completion of a baseline assessment, results primarily indicated that the relationship between CASA severity and alcohol consumption is indirect. While CASA severity related to increased PTSD symptoms, PTSD symptoms related to greater ER difficulties and dissociative tendencies, in separate

models. After controlling for the significant effect of social desirability, ER difficulties and dissociative tendencies positively related to greater alcohol consumption. Most notably, ER difficulties moderated the relations between CASA and PTSD symptoms as well as CASA and alcohol use albeit in an unexpected direction. As CASA severity increased, PTSD symptoms and alcohol use increased at the greatest rate for individuals reporting low levels of ER difficulties. Results highlight a potential phenomenon where *perceived* superior regulatory abilities reflect reduced insight into adaptive ER including alcohol consumption as an adaptive regulatory strategy in an alcohol-laden college environment. Future research should work to replicate the current findings in a larger student sample, particularly using longitudinal research methods to allow for temporal interpretability and a more sound examination of results between genders.

ACKNOWLEDGMENTS

I would like to express my gratitude to my committee chair and adviser, Dr. Dennis McChargue, for his dedicated mentorship over the last five years. I would also like to thank each of my committee members for their involvement, assistance, and thoughtful feedback:

David DiLillo, Ph.D.

Lisa J. Crockett, Ph.D.

Les Whitbeck, Ph.D.

Thank you to undergraduate research assistants, and their contribution to the management and cleaning of the current data. Last, a special thank you to Dr. Calvin Garbin for statistical consultation and invaluable learning experiences throughout my tenure at the University of Nebraska.

TABLE OF CONTENTS

ACKNOWLEDGMENTS.....	iv
TABLE OF CONTENTS.....	v
LIST OF MULTIMEDIA OBJECTS.....	ix
INTRODUCTION.....	1
CASA and Alcohol.....	5
Theoretical Explanations Related to the Co-Occurrence of CASA and Alcohol Use.....	8
Might College Students Use Alcohol to Alleviate or Self-Medicate Symptoms of Posttraumatic Stress Following CASA.....	11
Vulnerability to Problematic Alcohol Consumption and Alcohol Use Disorders Following CASA Exposure and PTSD Symptom Development.....	17
Difficulties in Emotion Regulation.....	20
How Does Chemical Dissociation Relate to CASA, PTSD Symptoms and Alcohol Use.....	26
Summary.....	31
The Current Study.....	32
Specific Aims and Hypotheses.....	35
METHOD.....	37
Participants.....	37
Measures.....	38
Alcohol Use Disorders Identification Test.....	38

Demographic Information.....	39
Difficulties in Emotion Regulation Scale.....	39
Dissociative Experiences Scale – II.....	41
Early Trauma Inventory – Self Report – Short Form.....	42
PTSD Checklist – Civilian.....	44
Marlowe – Crowne Social Desirability Scale.....	46
Sexual Experiences Survey.....	47
Procedures.....	47
Analytic Strategy.....	49
RESULTS.....	53
Preliminary Analyses and Descriptive Characteristics.....	53
Aim 1: Examine the Relationship between Severity of CASA Exposure And Problematic Drinking.....	63
Aim 2: Examine the Potential Occurrence of the Self-Medication Model to Alcohol Use.....	64
Aim 3: Investigate the Application of the Diathesis-Stress Perspective by Examining Psychological Vulnerabilities, Specifically Emotion Regulation Difficulties and Dissociative Tendencies, to Psychopathology including Alcohol Use Following CASA Exposure.....	66
Aim 3a: Examine the Relationship between CASA Severity and PTSD Symptoms, Separately, on the Proposed Vulnerability Factor.....	66
Aim 3b: Examine the Potential for the Proposed Vulnerabilities to	

Act as Intermediary Factors in the Pathway from CASA Exposure Severity and PTSD Symptoms in Alcohol Consumption.....	72
Path Models for Emotion Regulation Difficulties as an Intermediary Factor.....	72
Path Models for Dissociative Tendencies as an Intermediary Factor.....	82
Summary of Findings for Models Examining Emotion Regulation and Dissociative Tendencies as Intermediary Factors.....	91
Aim 3c: As a Secondary Perspective, the Final Aim will Examine the Potential for the Proposed Vulnerabilities to Act as Moderating Factors in the Relation between CASA Exposure Severity and Psychopathology, including PTSD Symptoms and Alcohol Consumption.....	94
Path Models for Emotion Regulation as a Proposed Moderator.....	95
Path Models for Dissociative Tendencies as a Proposed Moderator.....	108
Summary of Findings for Models Examining Emotion Regulation and Dissociative Tendencies as Proposed Moderators.....	121
Overall Summary of Path Analysis Results Examining the	

Diathesis – Stress Perspective.....	126
DISCUSSION.....	128
Participant Characteristics.....	129
Aim 1: The Relationship between Severity of CASA Exposure and Problematic Drinking.....	132
Aim 2: The Potential Occurrence of the Self-Medication Model to Alcohol Use.....	133
Aim 3: The Application of the Diathesis-Stress Perspective by Examining Psychological Vulnerabilities, Specifically Emotion Regulation Difficulties and Dissociative Tendencies, to Psychopathology including Alcohol Use Following CASA Exposure...	135
Integrative Review and Summary of Key Findings.....	146
Clinical Implications.....	150
Study Limitations and Future Research.....	152
Conclusion.....	155
REFERENCES.....	157
APPENDICES.....	192
Appendix A.....	192
Appendix B.....	209

LIST OF MULTIMEDIA OBJECTS

TABLES

Table 1: Descriptive Statistics for Men and Women.....	55
Table 2: Frequency of Endorsement across CASA Subscale Items.....	56
Table 3: Descriptive Statistics between Students with and without CASA Exposure.....	57
Table 4: Bivariate Statistics.....	60
Table 5: Bivariate Statistics across Subscales.....	62
Table 6: Regression of Problematic Drinking on CASA Exposure.....	63
Table 7: Regression of PTSD Symptoms on CASA Exposure.....	65
Table 8: Regression of Emotion Regulation Difficulties on CASA Exposure.....	68
Table 9: Regression of Emotion Regulation Difficulties on PTSD Symptoms.....	69
Table 10: Regression of Dissociative Tendencies on CASA Exposure.....	70
Table 11: Regression of Dissociative Tendencies on PTSD Symptoms.....	71

FIGURES

Figure 1: PTSD Symptoms as a Mediating Factor between CASA and Alcohol.....	16
Figure 2: Continuum Approach to the Diathesis-Stress Perspective.....	18
Figure 3: Emotion Regulation Difficulties as an Intermediary Factor: Hypothesized Model.....	24
Figure 4: Hypothesized Emotion Regulation Difficulties Moderation Model.....	25

Figure 5: Dissociative Tendencies as an Intermediary Factor: Hypothesized Model.....30

Figure 6: Hypothesized Dissociative Tendencies Moderation Model.....31

Figure 3.1: Emotion Regulation Difficulties as an Intermediary Factor.....74

Figure 3.2: Emotion Regulation Difficulties as an Intermediary Factor: Replication with the Six-Item CASA Measure.....76

Figure 3.3: Emotion Regulation Difficulties as an Intermediary Factor: Replication with the Binary CASA Measure.....77

Figure 3.4: Emotion Regulation Difficulties as an Intermediary Factor for Men.....79

Figure 3.5: Emotion Regulation Difficulties as an Intermediary Factor for Women.....81

Figure 5.1: Dissociative Tendencies as an Intermediary Factor.....83

Figure 5.2: Dissociative Tendencies as an Intermediary Factor: Replication with the Six-Item CASA Measure.....85

Figure 5.3: Dissociative Tendencies as an Intermediary Factor: Replication with the Binary CASA Measure.....86

Figure 5.4: Dissociative Tendencies as an Intermediary Factor for Men.....88

Figure 5.5: Dissociative Tendencies as an Intermediary Factor for Women.....90

Figure 4.1: Emotion Regulation Difficulties Moderation Model.....97

 Figure 4.1.1: The Relationship between CASA Exposure and PTSD Symptoms for Different Levels of Emotion Regulation Difficulties.....99

Figure 4.1.2: The Relationship between CASA Exposure and Alcohol Consumption for Different Levels of Emotion Regulation Difficulties.....	100
Figure 4.2: Emotion Regulation Difficulties Moderation Model: Replication with the Six-Item CASA Measure.....	102
Figure 4.3: Emotion Regulation Difficulties Moderation Model: Replication with the Binary CASA Measure.....	103
Figure 4.4: Emotion Regulation Difficulties Moderation Model for Men.....	105
Figure 4.5: Emotion Regulation Difficulties Moderation Model for Women....	107
Figure 6.1: Dissociative Tendencies Moderation Model.....	109
Figure 6.2: Dissociative Tendencies Moderation Model: Replication with the Six-Item CASA Measure.....	111
Figure 6.3: Dissociative Tendencies Moderation Model: Replication with the Binary CASA Measure.....	112
Figure 6.4: Dissociative Tendencies Moderation Model for Men.....	114
Figure 6.4.1: The Relationship between CASA Exposure and Socially Desirable Reporting for Different Levels of Dissociative Tendencies for Men.....	116
Figure 6.5: Dissociative Tendencies Moderation Model for Women.....	118
Figure 6.5.1: The Relationship between CASA Exposure and PTSD Symptoms for Different Levels of Dissociative Tendencies for Women.....	120

Child/Adolescent Sexual Abuse and Alcohol: Proposed Pathways to
Problematic Drinking in College via PTSD Symptoms, Emotion Dysregulation, and
Dissociative Tendencies

Research has shown that the consequences of child/adolescent sexual abuse (CASA) are vast and include psychopathological outcomes such as personality, somatoform, anxiety, mood, and eating disorders as well as self-harm behaviors (for reviews see Hein, Cohen, & Campbell, 2005; Polusny & Follette, 1995; Trickett & Putnam, 1993; Weiss, Longhurst, & Mazure, 1999). The experience of CASA has also been associated with alcohol consumption including earlier age of alcohol onset, increased problematic alcohol intake, and risk for alcohol use disorders (Sartor, Agrawal, McCutcheon, Duncan, & Lynskey, 2008; Sartor et al., 2007; Simpson & Miller, 2002; Hamburger, Leeb, & Swan, 2007; Jarvis, Copeland, & Walton, 1998). While such associations have been identified in clinical and general populations (see review by Polusny & Follette, 1995; Goodman et al., 1999), more recent research has evidenced an increased risk for problematic alcohol consumption in CASA-exposed college students (Klanecky, Harrington, & McChargue, 2008; Rodriguez-Srednicki, 2001). Mechanisms behind the CASA exposure and alcohol use association are most clear in clinical populations and typically include (but are not limited to) symptoms of posttraumatic stress disorder (PTSD), borderline personality disorder, impulsivity and adverse familial factors (e.g., Corstorphine, Waller, Lawson, & Ganis, 2007; Simpson, 2003; Trull, Sher, Minks-Brown, Durbin, & Burr, 2000; Wall, Wekerle, & Bissonnette, 2000). However, mechanisms (potentially, similar or different) underlying this relationship in college students are less known. Understanding the factors that substantiate the CASA exposure

and alcohol use association in a college environment may provide a unique opportunity for intervention given the common use of alcohol (e.g., O'Malley & Johnston, 2002), and the relative functionality of and access to students. The importance of such work is emphasized by previous reports documenting a variety of negative consequences following CASA exposure and heavy alcohol consumption such as impaired academic functioning, sexual revictimization, and the development of co-occurring mental health disorders in adulthood (e.g., Najdowski & Ullman, 2009; Paolucci, Genuis, & Violato, 2001).

The limited amount of college-focused research has reported that symptoms of PTSD may underlie relations between CASA exposure and alcohol use at least among college women (Messman-Moore, Ward, & Brown, 2009) which is similar to findings in clinical samples (e.g., Simpson, 2003). Research working to understand the impact of underlying PTSD symptomatology on the relationship between CASA exposure and substance use primarily focuses on self-medication explanations (e.g., Messman-Moore et al., 2009). The self-medication hypothesis illustrates how alcohol use may be maintained in efforts to reduce or alleviate symptoms of PTSD following CASA exposure (Khantzian, 1997; 2003; Stewart, 1996). The majority of research supports the self-medication theory including findings that PTSD symptoms increase the risk for alcohol use, and alcohol use may reduce PTSD-related symptoms (Sher & Grekin, 2007; Simpson, 2003; Vaschillo et al., 2008; Zlotnick et al., 2006). However, the self-medication hypothesis may be limited in its assumption that symptoms of PTSD lead directly to substance use. Mechanisms to alcohol use may be more fully explained by considering additional processes or vulnerabilities that facilitate the use of alcohol for

self-medication purposes. It may be that the presence of psychological vulnerabilities catalyzes the self-medication process, and accordingly, these factors may impact the likelihood that some CASA-exposed individuals engage in problematic alcohol use for PTSD-related symptom alleviation.

Following CASA-exposure and possible PTSD symptom development, additional psychological characteristics existing prior to and potentially altered by traumatic experiences may at least partially explain one's vulnerability or resiliency to problematic alcohol consumption and subsequent risk for alcohol use disorders. This notion is consistent with more recent views of a "dynamic" diathesis-stress model, which asserts that a pre-existing diathesis (or vulnerability) *dynamically* interacts with a stressful event such that the vulnerability factor may be altered after stress to help explain relations between stress and psychopathology, in this case alcohol use disorders (Grant et al., 2005; Ingram & Luxton, 2005). The vulnerability potential of reduced coping or regulative abilities prior to CASA exposure and PTSD symptomatology, or the potential impact of CASA exposure and PTSD symptoms on coping and regulative abilities, may leave some individuals more prone to alcohol use for self-medication purposes and the development of alcohol use disorders. Applied to the two vulnerability factors of interest, low dissociative capacities or reduced emotion regulation (ER) abilities may help explain alcohol use following CASA to alleviate symptoms of PTSD. While research has yet to test these hypotheses involving ER abilities and dissociative tendencies, findings have documented the influence of CASA exposure on ER (e.g., Shipman, Zeman, Penza, & Champion, 2000) and dissociative tendencies (Ginzburg et al., 2006; Jarvis & Copeland, 1997), their mutual link to alcohol consumption (Briere & Runtz, 1987; Grayson &

Nolen-Hoeksema, 2005), and how PTSD symptoms (e.g., Cisler, Olatunji, Feldner, & Forsyth, 2010) may relate to such psychological factors.

With aims to replicate and extend previous research, the current proposal is intended to provide an initial, cross-sectional examination of the self-medication hypothesis by testing the interrelations among CASA exposure, PTSD symptoms, and problematic alcohol use in a sample of college students. The potential impact of ER difficulties and dissociative tendencies as “dynamic” vulnerability factors to alcohol use following CASA and/or PTSD symptom development will be tested meaning that ER and dissociation - existing prior to CASA as moderators - may be negatively impacted by CASA and/or PTSD and mediate the likelihood of alcohol use. Given the potential reciprocal nature of moderators and mediators as discussed by Grant and McMahon (2005), mediating hypotheses will first be tested followed by moderating models. While previous studies have focused nearly exclusively on the experience of college women, the proposed aims seek to broaden prior findings by sampling college women and men given that both women and men report CASA exposure in college populations (e.g., Ullman & Filipas, 2005). The importance of examining the current research questions in a sample of college students is emphasized in research documenting the avid use of alcohol in college men and women (O’Malley & Johnston, 2002) and the potential intervention opportunity college environments provide (e.g., Carey, Henson, Carey, & Maisto, 2007; Epler, Sher, Loomis, & O’Malley, 2009; Juarez, Walters, Daugherty, & Radi, 2006). The current study begins by first reviewing research related to CASA exposure and alcohol consumption followed by findings describing the interrelations of these constructs with PTSD symptoms. Next, research supporting the role of ER difficulties and dissociative

tendencies, separately, as psychological vulnerabilities to problematic alcohol use following CASA exposure and PTSD symptom development is reviewed.

CASA and Alcohol

While specific definitions of CASA vary in scientific literature (see reviews by DiLillo, 2001, and Moncrieff & Farmer, 1998), general components tend to include an unwanted sexual experience prior to young adulthood (age 18 or younger; e.g., Finkelhor et al., 1990; Jarvis & Copeland, 1997; Kessler & Bieschke, 1999; Zlotnick et al., 2006) with researchers commonly requiring at least one of the following: a) offenders to be older (approximately five years) than the survivor, b) the involvement of a family member, *or* c) the presence of coercion (e.g., Brown et al., 1999; Cloitre, Scarvalone, & Difede, 1997; Luterek et al., 2005; Mulder, Beautrais, Joyce, & Fergusson, 1998; Nash, Hulseley, Sexton, Harralson, & Lambert, 1993; Rosenthal et al., 2005). Rates of CASA in the general population have been reported to range from 15% to 33% in women and 13% to 16% in men (Finkelhor, Hotaling, Lewis, & Smith, 1990; Polusny & Follette, 1995; Twaite & Rodriguez-Srednicki, 2004). Individuals with a history of CASA have demonstrated an increased risk for earlier age of alcohol use initiation and problematic alcohol consumption (Sartor et al., 2008; Sartor, et al., 2007; Hamburger et al., 2007; Jarvis et al., 1998). Polusny and Follette (1995) reported that 27% to 37% of CASA survivors in clinical samples compared to 4% to 20% of non-CASA individuals experience alcohol-related problems. CASA history has been associated with a 1.9 to 3.3 greater likelihood of developing alcohol abuse or dependence by age 18 depending on severity of abuse, with results maintaining after controlling for multiple intrapersonal and familial variables (Fergusson, Horwood, & Lynskey, 1996). These findings are consistent

with reviews that have linked CASA exposure to increased risk for alcohol use disorders (Langeland & Hartgers, 1998; Moncrieff & Farmer, 1998; Simpson & Miller, 2002), and a recent methodological review which concluded that CASA exposure confers additional risk for later alcohol use beyond familial risk factors (Sartor et al., 2008).

College populations have evidenced comparable rates of CASA exposure (20 to 29%; Batten, Follette, & Aban, 2001; Filipas & Ullman, 2006; Kessler & Bieschke, 1999; Messman-Moore, Long, & Siegfried, 2000; Ullman & Filipas, 2005). Further, college women with histories of CASA are significantly more likely to drink to intoxication (Rodriguez-Srednicki, 2001) and meet alcohol use disorder criteria at age 21 than are women who had not been exposed to CASA (prevalence rates of 43.5% and 7.9%, respectively; Silverman, Reinherz, & Giaconia, 1996). With college-related implications, Zlotnick and colleagues (2006) reported that among individuals with alcohol use disorders over 50% reported CASA exposure, and 29% had completed a four-year college degree. In this sample, CASA-exposed individuals reported earlier age of alcohol use disorders (M age = 23.4) compared to non-CASA (M age = 27.2) and child physical abuse participants (M age = 25.3). Similarly, for individuals already in alcohol use treatment, retrospective reports showed that 56.3% reported CASA exposure, 16.3% reported attending some college or obtaining a college degree, and mean age for first meeting alcohol abuse/dependence was 25.3 years old (Simpson, 2003). Taken together, these findings indicate that college may coincide or come just prior to alcohol abuse/dependence for some CASA-exposed persons, suggesting that problematic drinking in college may facilitate later alcohol use disorders for individuals with CASA histories.

In addition to a heightened risk for alcohol use disorders, heavy alcohol consumption and the experience of CASA contribute to an increased risk of alcohol-related consequences including impaired academic functioning and reduced control over drinking behaviors including unplanned or unintended drinking habits, risky sexual behaviors, and alcohol-induced blackouts (Pascarella et al., 2007; Read, Beattie, Chamberlain, & Merrill, 2008; Rodriguez-Srednicki, 2001; Senn, Carey, Venable, Coury-Doniger, & Urban, 2006). In a meta-analysis, Paolucci and colleagues (2001) reported that CASA exposure substantially influenced sexual promiscuity ($d = .29$) and poor academic achievement ($d = .19$). For women, heavy alcohol consumption and the experience of CASA contribute to a heightened risk of adult sexual victimization or revictimization (Messman-Moore & Long, 2000; 2003; Testa, Hoffman, & Livingston, 2010; Testa, Livingston, Vanzile-Tamsen, & Frone, 2003; Testa & Parks, 1996). While acknowledging other factors associated with revictimization (e.g., risky sexual behavior, PTSD symptoms, risk recognition difficulties, interpersonal problems, dissociation, drug use, etc.; Classen, Paresh, & Aggarwal, 2005; Messman-Moore & Long, 2003), the study of these factors as direct mechanisms to revictimization is beyond the scope and interest of the current proposal. The current proposal aims to understand mechanisms that may directly facilitate problematic alcohol use, one of many factors that increase risk for revictimization in CASA-exposed women. For example, alcohol use moderated the relationship between history of sexual abuse and revictimization with moderate and heavy drinkers four to six times more likely to be assaulted over a two-month follow-up period (Gidycz et al., 2007). Repeated victimization and alcohol consumption heightens risk for the development of co-occurring mental health and substance use disorders

(Kimerling, Alvarez, Pavao, Kaminski, & Baumrind, 2007; Najdowski & Ullman, 2009; Sacks, McKendrick, & Banks, 2008).

In sum, previous research has demonstrated a robust link between the experience of CASA and problematic alcohol use that occurs not only in general and clinical populations, but also in college settings. Research has shown that CASA exposure confers risk for alcohol use disorders beyond familial risk factors. CASA exposure and problematic alcohol consumption have been associated with a range of adverse consequences including impaired academic achievement, alcohol-induced blackouts, added risk for revictimization and development of mental health problems. For college students, understanding the psychological factors that may help explain relations between college students' experiences of CASA-related events and heavy alcohol consumption may be particularly pertinent given that 1) CASA experiences are reported by college men and women (e.g., Ullman & Filipas, 2005), 2) college environments support heavy alcohol consumption among male and female students (O'Malley & Johnston, 2002), 3) retrospective demographic data from CASA-exposed alcohol use disorder patients identified age, education, and onset variables consistent with college-related risk (e.g., Zlotnick et al., 2006), and 4) college environments provide a unique opportunity for intervention (e.g., Carey, Carey, Maisto, & Henson, 2006; Carey et al., 2007; Epler et al., 2009; Juarez et al., 2006).

Theoretical Explanations Related to the Co-Occurrence of CASA and Alcohol Use

To date, a paucity of research has examined psychological mechanisms that may underlie the relationship between severity of CASA exposure and problematic alcohol use in college students. One recent study examined mechanisms associated with

substance use among 339 college women (Messman-Moore et al., 2009). Researchers reported that PTSD symptoms positively mediated the relationship between endorsement of CASA and a comprehensive variable measuring overall substance abuse, predicted in part, by alcohol use. Although the full model including (but not limited to) types of childhood abuse, PTSD symptoms, and substance abuse did not fit the data well, endorsement of CASA positively predicted PTSD symptoms, which predicted greater substance abuse. Limiting the generalizability of these findings, the study only sampled college women, and further, used a dichotomous (i.e., yes/no) child sexual abuse measurement. These empirical findings identify PTSD symptoms as a mediator between CASA exposure and substance abuse in college women, and accordingly, implicate theoretical approaches explaining the association between PTSD symptoms and problematic alcohol use.

Prior research has described three possible pathways explaining the co-occurrence of PTSD symptoms and substance use/abuse (Brown & Wolfe, 1994; Chilcoat & Menard, 2003; Stewart, 1996; Stewart & Conrod, 2003). First, alcohol and/or drug use may heighten one's susceptibility to experience traumatic events, and potentially, develop and maintain symptoms of PTSD (Brown & Wolfe, 1994; Stewart & Conrod, 2003). For example, alcohol use may exaggerate anxiety or arousal following the occurrence of stressful life events such as CASA, or alcohol use may be directly related to negative emotions such as guilt or shame due to consequences related to drinking. Heavy alcohol use may result in heightened physiological experiences via intoxication, chronic alcohol use, or withdrawal. This increased physiological arousal may increase the likelihood of anxiety symptoms and potential PTSD symptom development following a traumatic

event such as CASA (Stewart, 1996). Early use of alcohol may preclude the development of more adaptive coping strategies, leaving an individual more prone to managing later symptoms of trauma with alcohol (Brown & Wolfe, 1994; Stewart, 1996).

Second, alcohol use may be used to self-medicate symptoms of PTSD following the occurrence of trauma (Brown & Wolfe, 1994; Stewart, 1996; Stewart & Conrod, 2003). PTSD symptoms may facilitate the development or maintenance of alcohol use in efforts to reduce or control trauma-related symptoms. The self-medication hypothesis (Khantzian, 1985; 1997; 2003) posits that individuals use and abuse certain substances because they relieve “states of distress.” This is conceptually consistent with broader tension-reduction models of substance use that are based on reinforcement theories of learning (Conger, 1956). Importantly, the self-medication hypothesis is not limited by temporality. Temporality refers to the onset of disorders, not maintaining factors. Self-medication approaches take into account how alcohol use/abuse may be sustained in efforts to continually alleviate symptoms of PTSD (Stewart & Conrod, 2003). The third potential pathway is not direct; it posits that an alternate variable accounts for the relationship between the development and/or maintenance of PTSD symptoms and alcohol use. In other words, similar etiological factors might explain the high degree of comorbidity between the two constructs (Stewart, 1996). Some of the described mechanisms have included conduct disorder, genetics, and/or shared psychosocial or neurological deficits (Chilcoat & Menard, 2003).

Findings regarding the co-occurrence of PTSD symptoms and alcohol use have been somewhat inconsistent (e.g., Najdowski & Ullman, 2009). Of the three theoretical explanations, the majority of empirical research (i.e., cross-sectional, prospective, and

experimental) supports the self-medication pathway to alcohol use/abuse following CASA exposure and PTSD symptom development (Chilcoat & Menard, 2003; Stewart & Conrod, 2003; Stewart, 1996). While PTSD positively mediated the relationship between CASA exposure and greater substance abuse in college women (Messman-Moore et al., 2009), it is plausible that alcohol consumption is negatively reinforced by short-term alleviation or medication of PTSD symptoms in this population. Little research investigating the self-medication explanation, other than Messman-Moore and colleagues' (2009) findings, has been completed in college populations. More research exists in alternate populations including general and clinical samples. To help elucidate the self-medication pathway in CASA-exposed students, research findings detailing the relations between CASA exposure, PTSD symptoms, and alcohol use across additional populations as well as a better description of PTSD will be described.

Might College Students Use Alcohol to Alleviate or Self-Medicate Symptoms of Posttraumatic Stress Following CASA?

As defined by the American Psychiatric Association (*DSM-IV-TR*), PTSD must be pre-dated by exposure to a traumatic event where an individual 1) experienced, witnessed, or was confronted with an event that involved actual or threatened death, serious injury, or threat to the physical integrity of oneself/others, and 2) responded with intense fear, helplessness, or horror. In children, traumatic responses may be expressed by disorganized or agitated behavior. Following such trauma exposure, PTSD symptom clusters are defined by re-experiencing, avoidance, and arousal. Re-experiencing includes recurrent and distressing recollections or dreams of the event, distress or physiological reactivity following exposure to internal or external cues that resemble/symbolize an

aspect of the event, or acting/feeling as if the event were recurring. Avoidance is described by efforts to avoid aspects (thoughts, feelings, activities, or places) of the trauma, an inability to remember important components of the trauma, diminished interest in significant activities, detachment, restricted affect, or a sense of a foreshortened future. Arousal symptoms typically include hypervigilance, exaggerated startle, irritability or anger, and difficulty sleeping or concentrating. Symptoms of PTSD have been shown to impact functioning for individuals who meet full diagnostic criteria and those who experience sub-clinical symptoms of PTSD (Borsari, Read, & Campbell, 2008; Green, Krupnick, Stockton, Goodman, Corcoran, et al., 2005; Kendall-Tackett, Williams, & Finkelhor, 1993; Pietrzak, Goldstein, Malley, Johnson, & Southwick, 2009; Zlotnick, Franklin, & Zimmerman, 2002). For example, in a large community survey, individuals with partial PTSD symptoms reported intermediate impairment in school or work functioning in relation to individuals with full PTSD and non-PTSD controls. Individuals with partial PTSD symptoms reported statistically equivalent levels of functional impairment at home and in social settings compared to those meeting full PTSD criteria (Stein, Walker, Hazen, & Forde, 1997).

Exposure to CASA has long been associated with symptoms of PTSD (Freeman & Morris, 2001; Paolucci et al., 2001; Polusny & Follette, 1995; Tyler, 2002). CASA-exposed men and women in the general population reported greater PTSD symptoms compared to non-traumatized counterparts (Polusny & Follette, 1995; Twaite & Rodriguez-Srednicki, 2004). This relationship has evidenced a positive direction such that more severe CASA exposure is associated with greater PTSD symptoms (Saunders, Villeponteaux, Lipovsky, Kilpatrick, & Veronen, 1992). A meta-analysis by Paolucci and

colleagues (2001) revealed that CASA exposure yielded a substantial effect on PTSD symptoms ($d = .40$) with a 143% increase in risk for developing PTSD symptoms following CASA experiences compared to general population rates of PTSD. Last, Epstein and colleagues (1998) reported that 9% of community-dwelling women (M age = 44 years) reported a history of childhood rape in a large, structured telephone survey study. In this sample, the majority of women reported experiencing PTSD symptoms prior to alcohol abuse symptomatology, and the experience of at least one PTSD symptom fully mediated the relationship between childhood rape and substance use (Epstein, Saunders, Kilpatrick, & Resnick, 1998).

Moving from the general population to clinical samples, PTSD symptom intensity was significantly greater for CASA-exposed women compared to non-CASA controls in a sample of women seeking outpatient treatment (Rodriguez, Ryan, Vande Kemp, & Foy, 1997). For women in substance use treatment, those with a history of CASA were more likely to meet diagnostic criteria for PTSD compared to non-CASA persons (Simpson, 2003). Similarly, women with co-occurring PTSD and alcohol use disorders were more likely to report a history of CASA exposure compared to PTSD-only and no-diagnosis control women (Quimette, Wolfe, & Chrestman, 1996). Zlotnick and colleagues (2006) examined 336 individuals (72.9% men) with primary alcohol abuse/dependence, excluding those with active psychosis and/or dementia. Researchers reported that CASA experience was associated with a lifetime PTSD diagnosis, Axis I comorbidity, and earlier age of alcohol use disorder onset (Zlotnick et al., 2006).

Specific to college students, a recent review estimated that 10 to 15% of college students report symptoms of PTSD or meet criteria for PTSD (Borsari et al., 2008).

Further, CASA history (Rosenthal et al., 2005) and CASA severity have been positively associated with PTSD symptom severity ($r = .26$; Filipas & Ullman, 2006). In turn, PTSD symptoms have been related to greater rates of risk behaviors (e.g., risky sexual activities; Green et al., 2005). While rates of co-occurring PTSD and alcohol-related risk behavior in college students are currently unknown (Borsari et al., 2008), recent literature has reported that trauma symptoms mediated the relationship between child sexual abuse and overall substance abuse (Messman-Moore et al., 2009). Ullman and Filipas (2005) reported that severity of CASA exposure was associated with PTSD symptom severity ($r = .26$) as well as maladaptive coping ($r = .35$); 18.4% of college women and 8.3% of college men endorsed alcohol/drug-related coping strategies, a non-significant gender difference. PTSD symptoms predicted maladaptive coping tendencies, and the use of maladaptive coping was associated with more positive social reactions (e.g., greater support and emotional validation/belief/support) in college students (Ullman & Filipas, 2005). These findings indicate that college students may be positively reinforced for alcohol use through peer interactions and negatively reinforced through a reduction or medication of their PTSD-related symptoms. Although the positive reinforcement aspect of alcohol use is beyond the scope and interest of the current paper, empirical research has documented alcohol's ability to reduce or self-medicate symptoms related to PTSD.

Alcohol may also alleviate other aspects of PTSD-related symptoms including physiological arousal and negative emotional experiences for CASA-exposed individuals (e.g., Stewart, 1996). For example, in female volunteers with a history of CASA, individuals with greater PTSD symptom severity showed greater heart rate acceleration and reported more negative emotions while imagining their victimization compared to

CASA-exposed individuals with lower PTSD symptoms (McDonagh-Coyle et al., 2001). Further, greater PTSD symptoms were associated with increased reports of numbing, negative affect, and sustained physiological reactivity during an active, non-trauma-related arithmetic task (McDonagh-Coyle et al., 2001). In turn, reports across both survey and experimental studies have described alcohol-induced reductions in negative affect including anxiety, anger, and fear through action on gamma-aminobutyric acid (GABA) receptors primarily in the hippocampus and cortical regions (see chapter by Sher & Grekin, 2007). Alcohol use has been associated with reduced emotional arousal (Stritzke, Patrick, & Lang, 1995), and a dose-dependent reduction in startle response in control participants (Conrod & Stewart, 2003). Self-report data indicate that community (Ullman, Filipas, Townsend, & Starzynski, 2005) and college women (Miranda, Meyerson, Long, Marx & Simpson, 2002) may drink to reduce psychological distress and PTSD-related symptoms. These findings are consistent with reports that individuals with greater PTSD symptoms report elevated alcohol-related expectancies of tension reduction (Simpson, 2003). Positive PTSD-related alcohol expectancies regarding alleviation of avoidance and numbing symptoms have been positively correlated with drinks per drinking day, alcohol problems, and number of binge episodes in a sample of sexually-assaulted undergraduate women. Specifically, increased expectancies of symptom alleviation were associated with increased alcohol-related variables, such as drinks per drinking day and number of binge episodes (Vik, Islam-Zwart, & Ruge, 2008). Taken together, theoretical and empirical reports support PTSD symptoms as a mediating factor in the relationship between CASA exposure and alcohol use in college students with findings that affirm the role alcohol may play in alleviating PTSD symptoms (see Figure 1).

Figure 1. *PTSD Symptoms as a Mediating Factor between CASA and Alcohol*

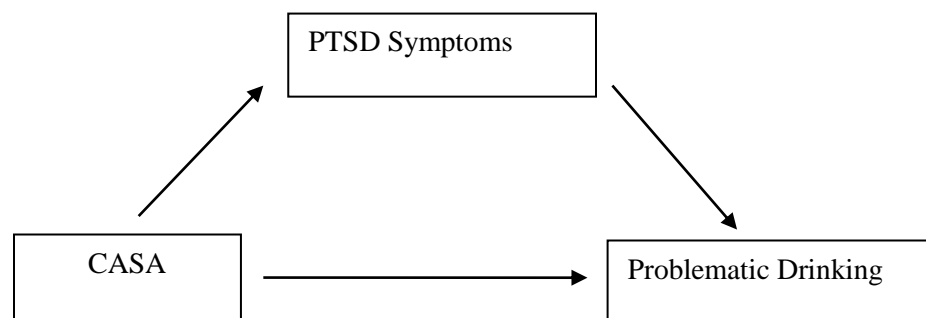

In sum, problematic alcohol consumption by college students following CASA exposure may be at least partially accounted for by efforts to alleviate PTSD-related distress. This application of the self-medication hypothesis is supported by reports that:

- 1) subsyndromal PTSD symptoms may cause impairment regardless of diagnostic status,
- 2) associations among CASA exposure, PTSD symptoms, and alcohol consumption are found across alternate populations, and
- 3) alcohol has a perceived and experienced impact on PTSD-related experiences.

While very little research exists examining the self-medication hypothesis in CASA-exposed college students, studies that have explored this hypothesis support the mediating role of PTSD symptoms in the relationship between CASA-exposure and substance abuse at least in college women. However, PTSD-related mediation findings account for only a portion of the variance in the relationship between CASA-exposure and alcohol use (Epstein et al., 1998; Messman-Moore et al., 2009), and not all studies support self-medication explanations. For example, lifetime PTSD symptoms failed to mediate the relations between child abuse and substance use severity

in alcohol use disorder participants (Zlotnick et al., 2006), and PTSD symptoms failed to predict alcohol use one year later in sample of community women (Najdowski & Ullman, 2009). Potentially limiting our ability to fully understand mechanisms of problematic drinking, the self-medication hypothesis assumes a direct relationship between psychiatric symptoms and substance use. This assumption has generally precluded the investigation of additional psychological variables that may act as intermediary factors on the relations among CASA exposure, PTSD symptoms, and problematic alcohol use. In relatively functional individuals such as those found on college campuses, certain psychological characteristics may partially explain alcohol use following the occurrence of CASA and the development of PTSD symptomatology. In other words, characteristics related to (although not overlapping with) PTSD symptoms and CASA exposure may promote resiliency, or in contrast, vulnerability to problematic alcohol use for symptom reduction and consequent risk for alcohol use disorders.

Vulnerability to Problematic Alcohol Consumption and Alcohol Use Disorders Following CASA Exposure and PTSD Symptom Development

A diathesis or vulnerability refers to a predisposition to psychopathology, which can be described in childhood/adolescence as maladaptation that results in a deviation from age-appropriate norms. In adulthood, psychopathology can be defined as psychological distress coupled with impairment in an individual's established or expected roles at a given developmental period (Ingram & Price, 2001; Price & Lento, 2001). The experience of CASA may be conceptualized as stress or an environmental event(s) that objectively threatens the health (physical or psychological) or well-being of an individual (Grant & McMahon, 2005). Individual differences in vulnerability to alcohol use

disorders have typically been conceptualized within the diathesis-stress model (for reviews, see Ingram & Luxton, 2005; Zuckerman, 1999). According to this traditional model, particularly continuum approaches (see Figure 2), a pre-existing diathesis (or vulnerability) continuum interacts with a continuum of stress to enhance the possibility of psychopathology including alcohol use disorders (Ingram & Luxton, 2005).

Figure 2. *Continuum Approach to the Diathesis-Stress Perspective*

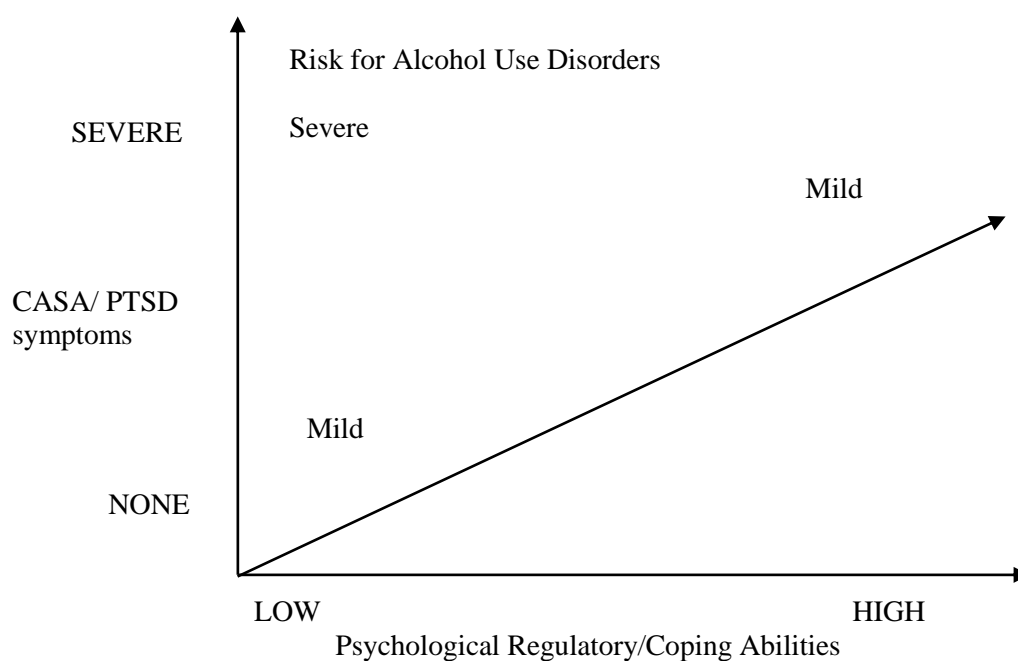

This approach advocates a moderating perspective in which varying degrees of a vulnerability factor increase the likelihood of psychopathological outcomes such as PTSD symptoms and alcohol use disorders. However, it may also be the case that following CASA, vulnerability factors are negatively impacted and mediate the relations between CASA and psychopathology. Within a diathesis-stress perspective, Grant and

colleagues (Grant et al., 2003) have proposed that the relations among stressors, moderators, mediators, and psychopathology are dynamic. “The role of specific variables within a model may vary across specific stressors and shift over time” (Grant & McMahon, 2005). While emotion regulation (ER) abilities and dissociative tendencies may initially increase the likelihood that CASA will result in psychopathological outcomes including alcohol use disorders (i.e., moderation), the experience of CASA may decrease ER abilities/increase dissociative tendencies influencing the onset and/or exacerbation of alcohol use (i.e., mediation). This theorized dynamic aspect of diathesis-stress relations has received little empirical attention; however, a) the described reciprocal potential is consistent with the interactive relations between developing individual characteristics and environmental stress posited within transactional models of psychopathology (e.g., Wills & Dishion, 2004), and b) prior research has provided evidence that ER and dissociative tendencies may be included within the traditional concept of a pre-existing vulnerability as well as altered by CASA exposure.

Traditional vulnerability factors supporting moderation are often considered trait-like, endogenous, and potentially residing in psychological domains (Ingram & Price, 2001). ER and dissociative tendencies have shown characteristics of a vulnerability factor. ER abilities have been conceptualized under the broader construct of self-regulation, and development of adaptive self-regulation includes ongoing interactions between biological and environmental aspects of a child and his/her context (Calkins & Hill, 2007). Components of ER have evidenced trait-like origins through concrete biological underpinnings regardless of trauma exposure (Posner & Rothbart, 2009; Sheese, Voelker, Posner, & Rothbart, 2009). Dissociative experiences have also been

conceptualized as trait-like qualities (Carlson & Putnam, 1993), and shown to exist in the absence of or prior to trauma exposure (Spindler & Elklit, 2003). Variations in psychological dissociation have been linked to differing levels of psychological absorption, which has been conceptualized as a trait-like characteristic and evidenced a normal distribution in the general population (Irwin, 1999; Tellegen & Atkinson, 1974). Supporting the concept of dynamic relations between moderators and mediators, prior research has also indicated that ER and dissociation may be altered after CASA, indicative of mediation. Following CASA exposure, deficits in self-regulation including ER are often reported in children and adults (e.g., Polusny & Follete, 1995; Shields & Cicchetti, 1998; Van der Kolk, 1996), and dissociative tendencies may be altered (Van der Kolk, Van der Hart, & Marmar, 1996) and relied on as a form of avoidant coping (Goodwin, Cheeves, & Connell, 1988; Irwin, 1994; Marx, Heidt, & Gold, 2005; Polusny & Follette, 1995).

Taken together, ER and dissociative capacities pre-dating CASA and/or altered following CASA may impact college students' experience of psychopathology, particularly problematic drinking and risk for alcohol use disorders. While research has yet to test this dynamic vulnerability hypothesis involving ER skills and dissociative tendencies, findings have documented the influence of CASA exposure on ER abilities and dissociative capacities, their mutual link to alcohol, and how PTSD symptoms may relate to such psychological capacities. For clarity, both proposed vulnerability factors will be reviewed separately.

Difficulties in emotion regulation

Defined as “processes by which individuals influence which emotions they have, when they have them, and how they experience and express these emotions” (Gross, 1998, p. 275), numerous studies have reported deficits in ER (i.e., emotion dysregulation; Wolfsdorf & Zlotnick, 2001) in individuals with a history of CASA exposure (Briere & Runtz, 1988; Trickett, Noll, Reiffman, & Putnam, 2001; Tyler, 2002; Van der Kolk, 1996). In a sample of maltreated boys and girls (14% with a CASA history; aged six to 12), Shields and Cicchetti (1998) reported camp counselor-rated emotion regulatory deficits in maltreated compared to non-maltreated children. Maltreated children were more likely to demonstrate emotional lability and negativity as well as less likely to evidence adaptive ER. Sexually maltreated girls aged six to 12 reported increased emotional lability and negativity compared to non-maltreated controls as well as lower emotional understanding regardless of emotion type (e.g., sadness or anger; Shipman et al., 2000). Similarly, significantly greater levels of positive and negative emotions (i.e., interest, enjoyment, surprise, sad, anger, disgust, contempt, fear, shy, and guilt) have been documented in eight to 12 year old girls with a history of CASA compared to non-abused counterparts (Carey, Kempton, & Gemmill, 1996).

ER deficits following CASA extend into college populations. Increased negative emotionality has been reported in young adult college women with CASA histories compared to controls (Rodriguez-Srednicki, 2001). Total emotion dysregulation (measured using the *Difficulties in Emotion Regulation Scale*; DERS; Gratz & Roemer, 2004) was positively correlated with child abuse, and further, was significantly predicted by child abuse for both men and women undergraduates, separately (Gratz, Paulson, Jakupcak, & Tull, 2009). Among college women with and without CASA history,

researchers used an experimental paradigm to assess emotional responding following four film clips designed to elicit feelings of amusement, joy, fear, and sadness. After controlling for baseline differences in depressive symptoms, CASA-exposed college women evidenced deficits in emotional responding including experiencing reduced positive affect, disclosing fewer negative emotion-related words during written disclosure, and showing less facial expressions compared to non-CASA individuals (Luterek, Orsillo, & Marx, 2005).

To the extent that an individual experiences emotion dysregulation following CASA, individuals may use alcohol to achieve short-term, symptom alleviation. Relief from negative affect is most clear when intoxicating doses of alcohol are consumed, and further, CASA and emotion dysregulation have been associated with increased alcohol use (Sher & Gerkin, 2007). For example, substance dependent men and women with CASA histories reported greater emotional non-acceptance (Gratz, Bornovalova, Delany-Brumsey, Nick, & Lejuez, 2007). Grayson and Nolen-Hoeksema (2005) reported that women with CASA histories in the general population were twice as likely to report alcohol-related problems and 1.5 times more likely to report being drunk in the last year compared to non-CASA counterparts. In this general population sample, both a desire to enhance positive affect and cope with negative affect mediated the relations between CASA history and alcohol consumption. Sexually abused males and females from grades six, nine, and 12 reported an increased likelihood of using alcohol, drinking to cope with painful emotions, and drinking to escape problems (Harrison, Fulkerson, & Beebe, 1997).

Only recently has research examined the interrelations between ER deficits and posttraumatic stress symptoms. In a very recent review, the integrative relationship

between ER abilities and anxiety symptoms was discussed with researchers concluding that individual differences in ER can influence anxiety symptom severity (Cisler et al., 2010). Effective ER (e.g., re-appraisal) tends to be effective in reducing negative affect and arousal, and conversely, maladaptive patterns of ER tend to characterize individuals with anxiety disorders (Cisler et al., 2010). In urban substance dependent participants (72% men with the majority frequently using alcohol), PTSD symptoms were significantly associated with three DERS subscales including difficulties controlling impulsive behavior when distressed as well as lack of emotional awareness and clarity (Bornoalova, Quimette, Crawford, & Levy, 2009). Inner-city substance dependent individuals (70.7% men) had greater ER deficits in all areas of the DERS (i.e., nonacceptance, goals, impulse, strategies, and clarity) with the exception of emotional awareness (McDermott, Tull, Gratz, Daughters, & Lejuez, 2009). Of concern, findings utilizing the DERS for ER measurement were also demonstrated in a sample of undergraduate students (Tull, Barrett, McMillan, & Roemer, 2007). Specifically, posttraumatic stress symptom severity was positively associated with lack of emotional acceptance, difficulty engaging in goal-directed behavior when upset, impulse-control difficulties, limited access to strategies, and lack of emotional clarity (r^2 's = .36 -.61). While the college study did not assess alcohol use and early sexual abuse, it provided evidence that PTSD symptoms relate to ER deficits in college students which may suggest a heightened vulnerability to engage in problematic alcohol use to achieve symptom alleviation (Tull et al., 2007).

Overall, research has shown that CASA exposure and PTSD symptoms are associated with ER deficits in undergraduate populations. While PTSD symptoms are

associated with heightened negative affect and emotional arousal which can be difficult to modulate, compounded ER deficits may account for even greater difficulty modulating experiences. Such compounded ER-related difficulty may at least partially explain problematic alcohol consumption to achieve short-term symptom alleviation. For substance dependent men, the relationship between PTSD symptoms and substance use was mediated by emotional awareness and clarity, the only two aspects of ER examined (Bornovalova et al., 2009). Given that a) Grant and McMahon (2003; 2005) describe reciprocal relations between mediating and moderating variables, b) CASA and PTSD symptoms are related to ER deficits for college students, and c) some research indicates that ER deficits may mediate the relations between CASA and alcohol use (e.g., Grayson & Nolen-Hoeksema, 2005) as well as PTSD symptoms and use (e.g., Bornovalova et al., 2009), the potential for ER to act as an intermediary factor in the relations between CASA and PTSD, and CASA and alcohol consumption will *first* be examined (see Figure 3).

Figure 3. *Emotion Regulation Difficulties as an Intermediary Factor: Hypothesized Model*

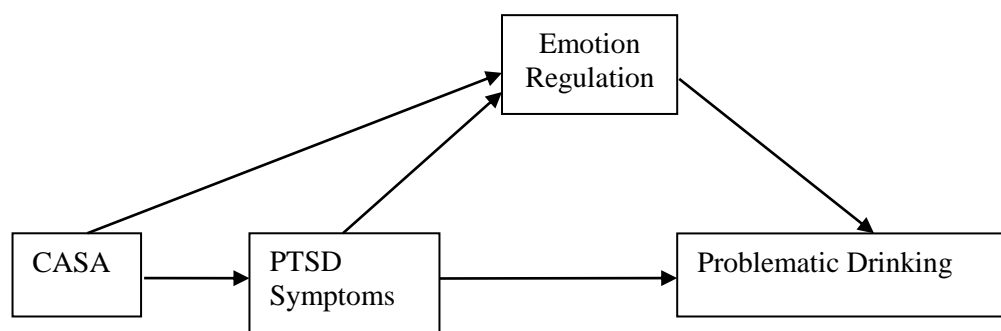

A second perspective will examine the moderating potential of ER on the relations between CASA exposure and psychopathology, including PTSD symptoms and alcohol consumption (see Figure 4). Emotion regulation as a trait-like characteristic existing prior to abuse supports the moderating perspective, and to be most thorough, the moderating potential of ER on CASA exposure and PTSD symptoms (along with alcohol consumption) will also be tested following reports that ER can influence anxiety symptom severity (Cisler et al., 2010) and that effect sizes between PTSD symptoms and ER maintained regardless of probable PTSD diagnosis (McDermott et al., 2009). Following evidence that ER abilities are treatable in CASA-related PTSD samples (Cloitre, Koenen, Cohen, & Han, 2002) and deficits in ER skills have accounted for poor response to substance use treatment for comorbid substance dependent and PTSD patients (Stewart & Conrod, 2003), working to understand the potential influence of ER on alcohol consumption in CASA-exposed college students may benefit future treatment efforts.

Figure 4. *Hypothesized Emotion Regulation Moderation Model*

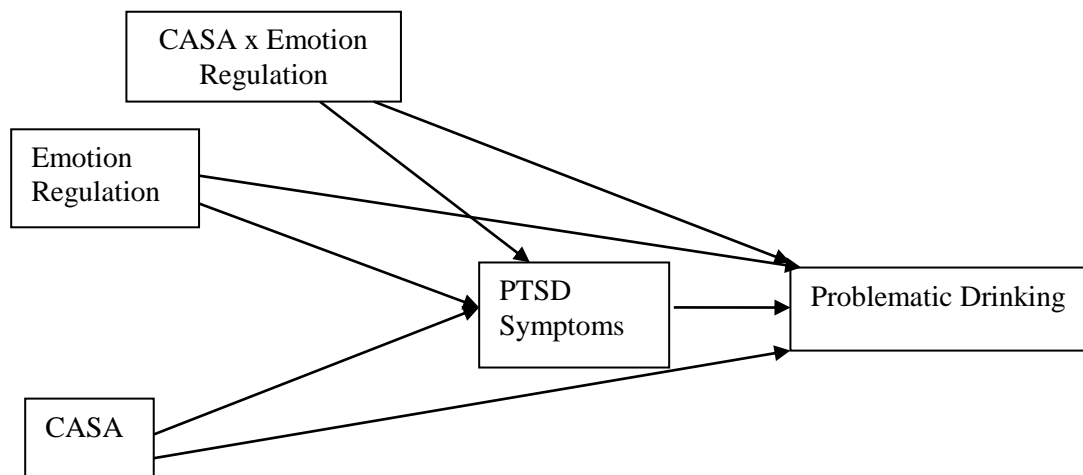

How does chemical dissociation relate to CASA, PTSD symptoms, and alcohol use?

Dissociation is a disruption in the typically integrated functions of consciousness, memory, identity, or perception of the environment; dissociation may be sudden or gradual, transient or chronic (*DSM-IV-TR*). At the time trauma is occurring, dissociation is often characterized as the inability to integrate sensory and emotional elements of an event. Further, peritraumatic dissociation is described as watching the traumatic incident from a distance while feeling as if one is not the victim of what is occurring, typically resulting in lapses of memory as well as feelings of depersonalization and derealization (Hall & Powell, 2000; Van der Kolk et al, 1996). Such occurrences have been conceptualized as efforts to avoid overwhelming experiences and emotions (Thomas, 2003; Van der Kolk et al., 1996). Given this association between dissociation and overwhelming experiences and/or emotions, it is fitting that research has reported that dissociative tendencies are often related to CASA exposure (Polusny & Follette, 1995; Van der Kolk et al., 1996). Some research has indicated that if the severity of CASA exposure is sufficient, then dissociative responses may become relied on as a means of avoidant coping or detaching from stressful experiences (Goodwin et al., 1988; Irwin, 1994; Marx et al., 2005). Empirical findings that describe positive associations between adult dissociation and severity of CASA exposure as well as adult dissociation and peritraumatic dissociation at the time of CASA support this assertion (Draijer & Langeland, 1999; Ginzburg et al., 2006; Jarvis & Copeland, 1997; Johnson, Pike, & Chard, 2001; Shields & Cicchetti, 1998).

Depending on the population targeted, patterns of dissociative tendencies following CASA are less clear. Clinical populations often report high or clinical levels of dissociative tendencies (e.g., Brown, Russell, Thornton, & Dunn, 1999; Lanius et al., 2002; Quimette et al., 1996), which are typically at least moderately related to dissociation at the time of trauma ($r = .48$; Johnson et al., 2001) and linked to co-occurring mental health disorders (Farley & Keaney, 1997; Ginzburg et al., 2006; Groth-Marnat & Michel, 2000; Johnson et al., 2001). In contrast, some researchers have reported significantly greater albeit non-clinical levels of dissociation in CASA-exposed college students compared to non-CASA students (Aydin, Atlındag, & Ozkan, 2009; Rodriguez-Srednicki, 2001). Others have reported statistically equivalent, non-clinical levels of dissociation regardless of CASA exposure in college populations (Klanecky et al., 2008; Luterek et al., 2005). Potentially explaining this variability in dissociative tendencies, researchers have theorized that individuals vary in their capacity to engage in psychological dissociation (Ross, 1996; Spindler & Elklit, 2003; Tellegen & Atkinson, 1974). Although exact mechanisms that provide dissociative capabilities are not well understood, some findings have suggested that certain individuals may lack levels of absorption, or the ability to have episodes of “total” attention, needed for psychological dissociation (Irwin, 1999; Tellegen & Atkinson, 1974). CASA-exposed individuals who are less capable of significant psychological dissociation potentially due to insufficient levels of absorption may engage in problematic alcohol use, or “chemical dissociation,” as an attempt to cope with stressful internal or external experiences (Briere & Runtz, 1987; Roesler & Dafler, 1993).

Supporting the concept of “chemical dissociation,” heavy alcohol use including alcohol-induced blackouts can mimic a dissociative-like experience (Somers, 2003; Somers & Avni, 2003). Hall and Powell (2000) reported in a qualitative assessment of dissociative experiences that women with CASA histories and substance dependence described getting and using substances as an alteration or detachment from experience. Interestingly, at least half of the women reported that during their initial use of alcohol, they experienced blackout. For CASA-exposed college students, non-clinical levels of dissociative tendencies positively predicted problematic alcohol use and rates of alcohol-related blackouts (Klonecky et al., 2008). While alcohol-related coping mediated the link between CASA exposure and alcohol problems in the general population (e.g., Grayson & Nolen-Hoeksema, 2005), dissociation has been conceptualized as a form of avoidant coping (e.g., Polusny & Follette, 1995) and has mediated relations between CASA and frequency of alcohol intoxication in college women (Rodriguez-Srednicki, 2001). These findings provide some support for chemical dissociation in college populations. Incorporating the experience of PTSD symptoms may further elucidate mechanisms relevant to college students’ possible use of chemical dissociation.

Research has shown that states of physiological arousal may be dampened by higher dissociative tendencies. For example, rape survivors with dissociative tendencies one standard deviation above the sample mean demonstrated a lower quantity of skin conductance responses, lower amplitude of skin conductance responses, and a lower heart rate compared to survivors with low dissociative levels at baseline and trauma-related phases of an experimental study (Griffin, Resick, & Mechanic, 1997). Griffin and colleagues (1997) reported that across all survivors with PTSD symptoms, high compared

to low dissociative individuals showed lower mean heart rates, which is consistent with later findings measured during a trauma-related script (Lanius et al., 2002). In adolescent delinquents, greater dissociative symptoms were negatively associated with and predicted mean heart rate (Koopman et al., 2004). These findings are consistent with cross-sectional data indicating that CASA exposure was related to greater dissociative tendencies and PTSD symptoms in a general population sample (M age = 44.8; Twaite & Rodriguez-Srednicki, 2004).

Putting it all together, dissociative tendencies may be altered after the experience of CASA and may become relied on as a means of avoidant coping or detaching from stressful experiences (Goodwin et al., 1988; Irwin, 1994; Marx et al., 2005). However, ability to dissociate varies, and degree of dissociation may help explain propensity for alcohol use after CASA exposure, and potentially, in the presence of PTSD symptoms. Chemical dissociation posits that alcohol use is explained by insufficient dissociative tendencies that are incapable of providing a substantial means of coping or escape. Supporting this assertion, previous research has reported that alcohol has been shown to lower physiological responses to stress (e.g., Vaschillo et al., 2008), and dissociation (Rodriguez-Srednicki, 2001) as well as alcohol-related coping (Grayson & Nolen-Hoeksema, 2005; Hall & Powell, 2000) mediated the relations between CASA exposure and alcohol use. Because dissociative tendencies can be altered by CASA exposure, may become relied on as a means of coping, and have been found to mediate relations between the constructs of interest, a mediating model (see Figure 5) will *first* be tested to examine the concept of chemical dissociation following CASA exposure in college students.

Figure 5. *Dissociative Tendencies as an Intermediary Factor: Hypothesized Model*

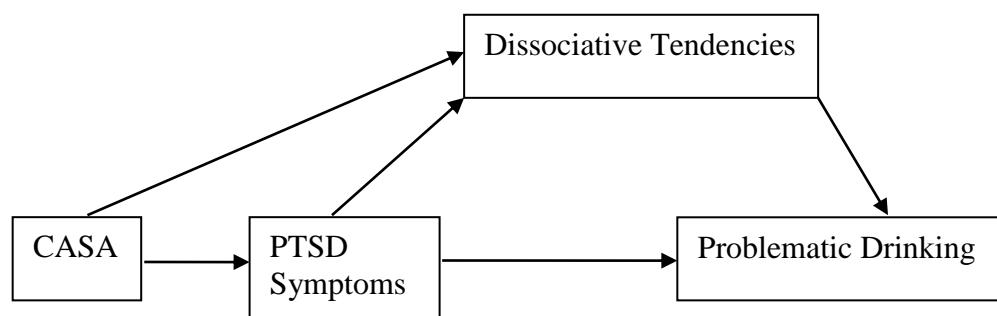

Second, a moderating model (see Figure 6) will be tested given some evidence that dissociative abilities are trait-like and exist in the absence of/prior to stress exposure (Carlson & Putnam, 1993; Spindler & Elklit, 2003), therefore making some individuals with lower dissociative tendencies vulnerable to alcohol consumption to manage stressful internal or external experiences following CASA. To be most thorough and similar to the ER models, the moderating potential of dissociative tendencies on CASA exposure severity and PTSD symptoms will also be tested. This examination is supported by the diathesis-stress model of psychopathology, and some evidence of a dissociative sub-type of PTSD and related neurological underpinnings (e.g., Lanius et al., 2010), which could imply underlying dissociative tendencies has a vulnerability to PTSD symptom development.

Figure 6. *Hypothesized Dissociative Tendencies Moderation Model*

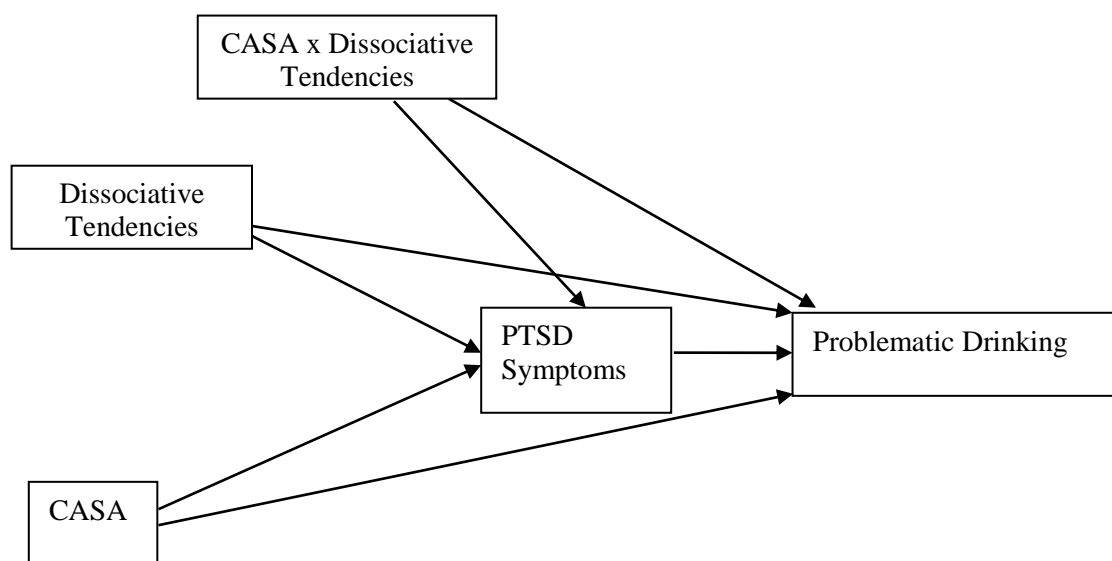

Summary

In summary, CASA exposure and problematic drinking are often associated in scientific literature. Particularly for college populations, this co-occurrence is linked to a variety of negative consequences such as impaired academic functioning, revictimization, and co-occurring mental health disorders including alcohol use disorders. Working to understand psychological mechanisms that may explain alcohol consumption following CASA exposure for some students may ultimately provide a unique opportunity to intervene and prevent life-altering consequences. Similar to clinical samples, symptoms of PTSD have mediated the relationship between CASA exposure and substance abuse in college women with the researchers suggesting substance use as an attempt to alleviate PTSD symptomatology. While very minimal research exists examining the self-medication hypothesis in college students regardless of gender, these findings along with

several others primarily support the hypothesis that alcohol is used to alleviate symptoms of PTSD following CASA, a self-medication role.

However, self-medication findings are not always consistent and only account for a portion of the variance among CASA, PTSD, and alcohol use relations. Potentially limiting our ability to fully understand mechanisms of problematic drinking and account for greater amounts of variance, the self-medication hypothesis generally precludes the investigation of additional psychological variables that may act as intermediary factors in the relations among CASA exposure, PTSD symptomatology, and alcohol use. It may be that additional psychological characteristics at least partially account for an individual's propensity to engage in problematic alcohol use for self-medication purposes following CASA exposure and PTSD symptom development. Psychological vulnerabilities such as ER difficulties and dissociative tendencies existing prior to (i.e., moderation) and altered after (i.e., mediation) CASA exposure and PTSD symptom development may explain one's propensity for problematic alcohol consumption and risk for an alcohol use disorder via unsuccessful intermediary attempts to alleviate CASA and PTSD-related experiences. Supporting this notion, prior research has evidenced links from CASA exposure and trauma-related symptomatology to ER, dissociative tendencies, and alcohol use/abuse.

The Current Study

Utilizing baseline data collected from a larger study of students completing a brief alcohol intervention, the goal of the current study is to provide an initial, cross-sectional examination (negating causal and temporal interpretability) of the relations among CASA exposure, PTSD symptoms, alcohol consumption, and psychological vulnerabilities

including ER and dissociative tendencies. First, the study will attempt to replicate the reported positive relationship between severity of CASA exposure and degree of problematic alcohol use in *Aim 1*. Next, to examine the self-medication model of substance use, the mediating influence of PTSD symptom development on the relations between CASA exposure and problematic college alcohol use will be examined in *Aim 2*. At best, prior research has demonstrated that PTSD symptoms mediate the relations between CASA exposure (i.e., measured dichotomously) and substance abuse in college women (Messman-Moore et al., 2009). The current proposal seeks to extend such findings to a sample of college men and women using a continuous measure of CASA severity. The use of a continuous measure of CASA as opposed to dichotomous measurement allows for examination of relative magnitude or severity of experience as opposed to examining the occurrence of early sexual abuse. Examining the impact of CASA severity will, therefore, provide a more heterogeneous perspective in the interplay between CASA, alcohol use, and relevant other variables discussed compared to the previous literature.

Aim 3 will examine an application of the diathesis-stress model. The notion of intermediary psychological factors, specifically ER difficulties and dissociative tendencies, to problematic alcohol use for college students following CASA exposure and the potential development of PTSD symptoms will be explored. Prior research supports the interrelations among ER difficulties and CASA exposure, PTSD symptom development, and alcohol use. ER abilities altered after CASA exposure may help account for problematic alcohol use in efforts to alleviate negative experiences including PTSD symptomatology (refer back to Figure 3); this mediation model is theoretically

supported by the concept of “dynamic” stress-diathesis relations and prior mediation findings although has yet to be examined in previous research. Similarly, research supports interrelations among dissociative tendencies and CASA exposure, PTSD symptom development, and alcohol use. However, research has yet to examine frequency of dissociative experiences as an intermediary coping strategy that may help account for the problematic use of alcohol in CASA-exposed college students experiencing PTSD symptoms (refer back to Figure 5); again, this mediation model is supported by the notion of “dynamic” stress-diathesis relations and prior mediation findings.

As a secondary perspective, which will address the more traditional application of the diathesis-stress model, the potential effect of ER difficulties and dissociative tendencies, separately, on relations between CASA severity and PTSD symptoms as well as CASA severity and alcohol consumption will be examined in moderation models. In efforts to comprehensively examine “dynamic” mediation/moderation relations and address literature describing pre-existing regulative abilities prior to CASA, ER difficulties will be tested in a moderation model (refer back to Figure 4). Similarly, while some research supports the ability for dissociative tendencies to mediate the relations among CASA exposure, PTSD symptomatology, and alcohol use (e.g., Griffin et al., 1997; Somer, 2003), other evidence describes dissociative tendencies as trait-like characteristics existing prior to or in the absence of trauma exposure. To incorporate this literature and address more traditional notions of the stress - diathesis model, a moderation model (refer back to Figure 6) will also be tested.

For clarity, the mediation models examining the diathesis-stress perspective will be completed first followed by the moderation models. Specific research aims corresponding to these goals are detailed below.

Aim 1: Examine the relationship between severity of CASA exposure and problematic alcohol use.

A. *Hypothesis:* Severity of CASA exposure will positively relate to problematic drinking in college students.

Aim 2: Examine the potential occurrence of the *self-medication model* to alcohol use.

A. *Hypothesis:* Severity of CASA exposure will positively relate to PTSD symptom severity.

B. *Hypothesis:* After fixing the severity of CASA exposure, PTSD symptom severity will mediate the relationship between CASA exposure severity and problematic alcohol use (Figure 1).

Aim 3: Investigate the application of the *diathesis-stress perspective* by examining psychological vulnerabilities, specifically, ER difficulties and dissociative tendencies, to psychopathology including alcohol use following CASA exposure.

Aim 3a: Examine the relationship between CASA severity and PTSD symptoms, separately, on the proposed vulnerability factor.

A. *Hypothesis:* In two separate models, severity of CASA exposure and PTSD symptoms, independently, will relate to ER difficulties

B. *Hypothesis:* In two separate models, severity of CASA exposure and PTSD symptoms, independently, will relate to dissociative tendencies.

Aim 3b: Examine the potential for the proposed vulnerabilities to act as intermediary factors in the pathway from CASA exposure severity and PTSD symptoms to alcohol consumption.

A. *Hypothesis*: ER difficulties as an intermediary regulative ability will mediate the pathway from severity of CASA exposure and PTSD symptoms to positively relate to severity of problematic alcohol use (Figure 3).

B. *Hypothesis*: Consistent with the concept of chemical dissociation where dissociative tendencies are unable to supply a substantial coping response, dissociative tendencies will be an intermediary factor in the pathway from severity of CASA exposure and PTSD symptoms to positively relate to severity of problematic alcohol use (Figure 5).

Aim 3c: As a secondary perspective, the final aim will examine the potential for the proposed vulnerabilities to act as moderating factors in the relation between CASA exposure severity and psychopathology, including PTSD symptoms and alcohol consumption.

A. *Hypothesis*: ER difficulties will moderate the relations between CASA exposure and PTSD symptoms as well as CASA exposure and alcohol use such that CASA exposure severity will positively relate to greater PTSD symptoms and alcohol consumption when ER difficulties are high (Figure 4).

B. *Hypothesis*: Dissociative tendencies will moderate the relations between CASA exposure and PTSD symptoms as well as CASA

exposure and alcohol use such that CASA exposure severity will positively relate to greater PTSD symptoms and alcohol consumption when dissociative abilities are high (albeit at non-clinical levels; Figure 6).

Method

Participants

Participants in the current study were 213 students who volunteered to participate in research during their completion of a brief alcohol intervention, the Alcohol Skills Training Program (ASTP). Students were mandated to ASTP following violation of the “dry campus” policy on the University of Nebraska-Lincoln campus, meaning that students were found currently intoxicated or in the presence of alcohol. While all students are required to complete the program, research participation approved by the University’s Institutional Review Board is voluntary. Exclusion criteria includes: students must be at least 19 years old, they must not be referred from Judicial Affairs due to required face-to-face treatment, and this must be their first time completing the program. On average, 271 students are referred to ASTP per year. Conservatively estimated, approximately 40% of students ($n=108$) per year consent to participate in the large research study examining vulnerabilities to problematic drinking patterns. The current sample of 213 includes students who completed the program and voluntarily consented to research from January 15, 2009, to March 1, 2011. Research participants were comprised of 63.4% men and 36.6% women with the majority being freshman (42.3%) followed by sophomores (36.2%), juniors (14.1%) and seniors (7.5%). All students endorsing marital status reported that they were single, having never married, and on average, students were 19.56

years old ($SD = 1.12$). Racial/ethnic composition indicated that 84.0% of students identified as European American, 5.6% as Hispanic, 4.2% as African American, 2.8% as Asian American, 1.4% as Native American, .5% as Pacific Islander, and 1.4% as “Other.” On average, students reported levels of drinking in the problematic range ($M = 6.88$, $SD = 4.70$). Notably, there were no differences between students who elected to consent to research and those who did not in gender composition ($p = .591$) or drinking levels ($p = .751$).

Measures

Alcohol Use Disorders Identification Test (AUDIT; Babor, Higgins-Biddle, Saunders, & Monteiro, 2001; Saunders, Aasland, Babor, de la Fuente, & Grant, 1993). The AUDIT is a brief 10-item questionnaire that was developed to measure severity of hazardous or harmful alcohol consumption. Utilizing a five point Likert scale, the measure includes questions regarding amount and frequency of drinking, symptoms of alcohol dependence, and alcohol-related problems. For example, the AUDIT includes items such as “How often do you have a drink containing alcohol?” and “How often during the last year have you been unable to remember what happened the night before because of your drinking?” All items are summed to provide a composite score of drinking (range = 0 to 40) with higher scores indicating more severe alcohol use. The AUDIT has been used in a variety of populations, and has been described as “especially useful” in college students in a publication by the National Institute of Alcohol Abuse and Alcoholism (NIAAA, 2003).

In recent reviews aggregated across 36 studies, the AUDIT has shown internal consistency across diverse samples and settings, with the median value for Cronbach’s α

greater than .80 (Reinert & Allen, 2002; 2007). Additionally, test-retest reliability among the general population has ranged from .70 to .89 (Reinhert & Allen, 2007), and among university students, the AUDIT has yielded a test-retest correlation of .92 (Reinert & Allen, 2002). The AUDIT has shown consistent criterion validity in its screening for problematic alcohol use (Reinert & Allen, 2007), with good to adequate sensitivity and specificity in college students (.78 - .87; Kokotailo et al., 2004). Although there is some debate as to the appropriate cut-off scores used to identify problem or non-problem drinkers between genders (Berner, Kriston, Bentele, & Harter, 2007; Reinert & Allen, 2007), the current study will use the AUDIT total score as a continuous measure of alcohol use severity, unrelated to cut-off guidelines.

Demographic information. Demographic data are collected via a comprehensive questionnaire asking participants to provide information on age, gender, race/ethnicity, year in school, and living arrangements. Additionally, students are asked questions related to their potential history of substance-related legal problems, family history of alcohol/drug use, and academic information (i.e., grade point average, major, and average weekly hours spent studying).

Difficulties in Emotion Regulation Scale (DERS; Gratz & Roemer, 2004). The DERS was designed to measure a comprehensive definition of ER involving “the a) awareness and understanding of emotions, b) acceptance of emotions, c) ability to control impulsive behaviors and behave in accordance with desired goals when experiencing negative emotions, and d) ability to use situationally appropriate emotion regulation strategies flexibly to modulate emotional response as desired in order to meet individual goals and situational demands” (Gratz & Roemer, 2004, p. 42). Such a comprehensive

view of ER takes into account the range of perspectives throughout adult and developmental literatures (Eisenberg, Hofer, & Vaughan, 2007; Gratz & Roemer, 2004; Gross & Thompson, 2007; Linehan, Bohus, & Lynch, 2007). With a total of 36 items, participants are asked to rate each question on a one (*almost never*) to five point (*almost always*) Likert scale. Questions include, “I pay attention to how I am feeling” and “When I’m upset, I have difficulty getting work done.” Factor structure for the DERS has indicated six individual domains (i.e., nonacceptance, goals, impulse, awareness, strategies and clarity) that may be studied independently or in aggregate, using the sum for a total score (Gratz & Roemer, 2004). Higher scores are interpreted as greater difficulties in ER.

In college student samples, high internal consistency has been reported for both the DERS total (Cronbach’s $\alpha = .93$) as well as individual subscales (Cronbach’s $\alpha > .80$) with the majority of inter-item correlations above $r = .30$. The DERS total score, in particular, has evidenced the most substantial construct validity, positively correlated with experiential avoidance ($r = .60$) as well as negatively correlated with emotional expressivity ($r = -.23$) and negative mood regulation ($r = -.69$). In regards to predictive validity, the DERS total score and behavioral outcomes of emotion dysregulation (e.g., incidence of self-harm) were positively correlated for men and women, r ’s = .26 and .20, respectively (Gratz & Roemer, 2004). The DERS has been positively correlated (r ’s = .54-.64) with borderline personality disorder symptoms in undergraduates (Glenn & Klonsky, 2009). Last, the DERS total has shown good test-retest reliability over a period of four to eight weeks (Gratz & Roemer, 2004), and psychometric stability in adolescent populations (Neumann, van Lier, Gratz, & Koot, 2010; Weinberg & Klonsky, 2009). Due

to the general findings that the DERS total performs better psychometrically compared to individual subscales (Gratz & Roemer, 2004) and all subscales have been related to PTSD symptoms and alcohol use (Bornovalova et al., 2009; McDermott et al., 2009; Tull et al., 2007), it is appropriate that the DERS total will be used in the proposed primary analysis.

Dissociative Experiences Scale – II (DES-II; Carlson & Putnam, 1993).

Conceptualized as a trait measure of dissociative tendencies, the DES-II is a self-report questionnaire comprised of 28 items and used to measure frequency of dissociative experiences. Originating from the Dissociative Experiences Scale (DES), the DES-II was modified to create an easier method of scoring (with comparable mean scores and psychometric properties; Carlson & Putnam, 1993). Specifically, the DES-II asks participants to identify how often certain dissociative experiences occur from 0% (*never*) to 100% (*always*) of the time, using 10 point increments. Questions include items such as, “Some people find that when they are watching television or a movie they become so absorbed in the story that they are unaware of other events happening around them. Circle a number to show what percentage of the time this happens to you.” Importantly, participants are asked to identify how often experiences occur when they are not under the influence of drugs or alcohol, and a cut-off of 30 has been used to identify severe levels of dissociation (Carlson & Putnam, 1993). For the current study, all items on the DES-II will be averaged in accordance with scoring guidelines, and the total will be used as a continuous measure of dissociative frequency.

The DES has been shown reliable and valid with good to excellent test-retest reliability (r 's = .79 - .96), internal reliability (split-half reliability r 's = .83-.93;

Cronbach's $\alpha = .95$), and construct validity in clinical and non-clinical populations (for review see Carlson & Putnam, 1993). Supporting Carlson and Putnam's (1993) assertion that the DES and DES-II are highly comparable, the DES-II has evidenced excellent internal reliability in non-clinical samples (split-half correlation = .82; Cronbach's $\alpha = .92 - .96$; De Maynard, 2009; Thomson, Keehn, & Gumpel, 2009; Wright & Loftus, 2000; Zingrone & Alvarado, 2002). The DES-II has shown construct validity in differentiating between eating-disordered and comparison subjects ($p = .04$; Everill, Waller, & Macdonald, 1995) as well as positive correlations with fantasy proneness/imagination ($r = .51$; Thomson et al., 2009). While factor analyses have produced somewhat mixed results in domains such as absorption, derealization, depersonalization and amnesia, findings suggest the DES-II most reliably measures one general dissociation factor (Carlson & Putnam, 1993; De Maynard, 2009; Wright & Loftus, 2000; Zingrone & Alvarado, 2002), supporting the current use of the DES-II total score. Last, the DES-II has been used successfully in randomly controlled trials targeting PTSD-related CASA (e.g., Chard, 2005).

Early Trauma Inventory – Self Report – Short Form (ETI-SR-SF; Bremner, Bolus, & Mayer, 2007). The ETI-SR-SF is a 29-item questionnaire developed as a self-report, shortened version of the semi-structured interview, the Early Trauma Inventory (ETI; Bremner, Vermetten, & Mazure, 2000), and the Early Trauma Inventory – Self Report (62 items; ETI-SR; Bremner et al., 2007). The ETI-SR-SF measures four domains of childhood/adolescent trauma including physical trauma, emotional trauma, general traumatic events, and sexual trauma. The sexual events subscale will be utilized in the proposed study as the measure of CASA. The ETI-SR-SF provides a measure of CASA

consistent with prior research (i.e., experiences prior to 18 that are coerced/forced), and to most adequately meet this definition, the one item not specifically identifying coerced or forced experiences will be removed (i.e., “Did you ever experience someone rubbing their genitals against you?”). The remaining five items will be averaged to provide the *primary*, continuous score of CASA with higher scores indicative of greater CASA exposure. However, to provide the most thorough examination of CASA, findings will be replicated using the six-item, full subscale average of CASA as well as using a binary version of CASA. The binary term will be constructed from the most conservative five items of the measure. Any student who endorses at least one item will be categorized as “yes,” and students who do not endorse any of the five items will be categorized as “no.” The remaining questions include “Were you ever forced or coerced to touch another person in an intimate or private part of their body?”, “Were you ever touched in an intimate or private part of your body (e.g., breast, thighs, genitals) in a way that surprised you or made you feel uncomfortable?”, “Did anyone ever have genital sex with you against your will?”, “Were you ever forced or coerced to perform oral sex on someone against your will?”, “Were you ever forced or coerced to kiss someone in a sexual rather than an affectionate way?”

Factor analysis has indicated that the ETI-SR-SF CASA subscale evidenced a high factor loading and correlated highly ($r = .97$) with the original ETI-SR. The ETI-SR-SF evidenced reliability with good internal consistency (Cronbach’s $\alpha = .87$) and construct validity with the Clinician Administered PTSD Scale ($r = .32, p < .001$; Bremner et al., 2007). The instrument correctly discriminated individuals with known trauma histories (i.e., PTSD, Borderline Personality Disorder, and individuals with

CASA history although no psychiatric condition) from comparison subjects (i.e., control comparisons and depressed persons; Bremner et al., 2007). The ETI-SR-SF significantly predicted suicidal ideation in a sample of medical students (Jeon et al., 2009), and has shown reliability and validity in military populations (Rademaker, Vermetten, Geuze, Mulwijk, & Kleber, 2008).

Specific to college students, the ETI-SR-SF has performed well in our own studies (Bujarski, Klanecky, & McChargue, 2010; Klanecky et al., 2008; Klanecky, Salvi, & McChargue, 2009), and lab data have allowed us to compare the ETI-SR-SF with another common survey used to measure CASA, the Childhood Trauma Questionnaire – Short Form (CTQ -SF; Bernstein et al., 2003). The ETI-SR-SF evidenced good convergent validity with the CTQ-SF ($r = .62, p < .001$). Endorsement across the five items measuring sexual abuse of the CTQ-SF ranged from 4% to 11%. In contrast, endorsement across the five coerced/forced items of the ETI-SR-SF ranged from 4% to 18%. Last, while measurement with the CTQ-SF indicated that 13.1% of students endorsed CASA of some type, the ETI-SR-SF identified 20.5% of students who endorsed experiences of coerced or forced CASA. As such, our data indicates that the ETI-SR-SF provides greater variability among individual items as well as provides overall CASA rates that are more consistent with previous research compared to the CTQ-SF (20-29%; Batten et al., 2001; Filipas & Ullman, 2006; Kessler & Bieschke, 1999; Messman-Moore et al., 2000; Ullman & Filipas, 2005).

PTSD Checklist – Civilian (PCL-C; Weathers, Litz, Herman, Huska, & Keane, 1993). The PCL-C is a brief, 17-item self-report instrument designed to measure severity of non-military-related PTSD symptoms including re-experiencing, avoidance, and

hyperarousal clusters as outlined by the *DSM-IV*. Using a five point Likert scale, respondents provide severity ratings indicative of how much they have been bothered by the item over the last month. Responses range from 1 (*not at all*) to 5 (*extremely*). Questions include “Loss of interest in activities that you used to enjoy?” and “Avoiding activities or situations because they reminded you of a stressful experience?” The total PCL-C score will be added according to scoring guidelines and used as a continuous measure of PTSD symptom severity. Higher scores are indicative of greater PTSD symptoms.

The PCL-C has evidenced sound psychometric properties. Among college students, the measure evidenced good test-retest reliability over a one week period (r 's = .87 -.88) and internal reliability (Cronbach's α = .91 -.94; Adkins, Weathers, McDevitt-Murphy, & Daniels, 2008; Ruggiero, Del Ben, Scotti, & Rabalais, 2003). The PCL-C has evidenced psychometric properties superior to alternative trauma-related self-report instruments in college populations (Adkins et al., 2008). Specifically, the PCL-C demonstrated convergent validity with interview-based measures of PTSD (i.e., Clinician Administered PTSD Scale; r = .65) as well as other self-report PTSD measures (r 's = .58-.82; Adkins et al., 2008; Ruggiero et al., 2003). Discriminant validity was present (e.g., weaker correlation with the Beck Depression Inventory compared to additional trauma measures; Adkins et al., 2008), and the PCL-C was shown to have greater diagnostic utility compared to alternate measures of PTSD symptoms (kappa coefficient = .5; Adkins et al., 2008). The PCL-C has continued to evidence internal reliability (Cronbach's α = .92) and criterion validity (76% sensitivity and 79% specificity for identifying PTSD using a cut-off of 44; Harrington & Newman, 2007) for those in

substance abuse treatment as well as construct validity (i.e., Clinician Administered PTSD Scale; $r=.93$) in traumatized adult populations (Blanchard, Jones-Alexander, Buckley, & Forneris, 1996).

Marlowe-Crowne Social Desirability Scale (MCS; Crowne & Marlowe, 1960).

The MCS is a widely-used scale to measure socially desirable reporting patterns.

Comprised of 33-items using a true/false response format, the scale includes positive and negative statements that are highly improbable and reflect one's attempt to present themselves in a desirable light (irrelevant of psychopathology; Crowne & Marlowe, 1960). Example items include "I never hesitate to go out of my way to help someone in trouble," "I have never intensely disliked anyone," and "Before voting, I thoroughly investigate the qualifications of all the candidates." Higher scores are indicative of a greater tendency to provide socially desirable responses. The initial psychometric assessment of the scale reported internal consistency at .88 among undergraduates with $r = .89$ test-retest correlation. Internal consistency in undergraduate samples has been adequate (.72 to .74; Barger, 2002; Loo & Thorpe, 2000) including in our own .76 - .78 studies (Klanecky et al., 2008, 2009). In a meta-analysis by Beretvas, Meyers, and Leite (2002), the aggregated internal consistency reliability estimate was .73, with internal consistency for men at .70 and women at .80. Test-retest reliability was variable ($r = .38$ to .86). The scale has shown concurrent validity with additional measures of socially desirable responding (Crowne & Marlowe, 1960; Paulhus, 1991) as well as positive relations with respondents less willing to report stigmatizing information (i.e., illicit drug use; Johnson & Fendrich, 2002; Reynolds, Tarter, & Kirisci, 2004) and divergent validity

with measures of psychopathology (Crowne & Marlowe, 1960) and self-deception (Paulhus, 1991).

Sexual Experiences Survey (SES; Koss & Oros, 1982; Koss & Gidycz, 1985). The SES is a 10-item instrument that has been used extensively in prior research to assess women's unwanted sexual experiences including verbal or physical, forced or coerced, attempted or completed events. Although the original SES assesses unwanted sexual experiences since age 14, instructions were modified in the present study to glean information only about experiences occurring after age 18. Example items include "Has a man used some degree of physical force (twisting your arm, holding you down) to try and make you engage in kissing and petting (fondling) when you didn't want to?" and "Has a man ever used physical force with you (twisting your arm, holding you down) in an attempt to obtain sexual intercourse but for various reasons he did not succeed?" For the current study, women who endorsed experiencing at least one or more items were classified as "yes," whereas women who denied experiencing all items were classified as "no." A significant positive correlation ($r = .73, p < .001$) was found between women's reports of victimization on the SES survey and an interviewer-administered assessment (Koss & Gidycz, 1985), with internal consistency ranging from .73 to .74 (Koss & Gidycz, 1985; Testa, VanZile-Tamsen, Livingston, & Koss, 2004) and test-retest reliability item agreement at 93% (Koss & Gidycz, 1985). Women's reports of rape or coerced penetration on the SES survey and interview responses evidenced 96.4% agreement (Testa et al., 2004).

Procedures

All data for the current study were collected at baseline prior to any intervention. Steps outlining baseline data collection first include students' referral to the brief alcohol intervention via the University's Health Education Department, following their violation of the "dry campus" policy. At the time of referral, students received a randomly generated personalized ID number, a general log-in password, and instructions to visit the ASTP program website for completion of a mandatory baseline online assessment. To log-in to the program, both the general password and personalized ID number are required. Next, students were presented with a review of the research project including the exclusion criteria and the informed consent. Regardless of students' decisions to participate in research, all students were instructed to select the baseline assessment button and complete a randomized sequence of questionnaires. Students who did not participate in research only received questionnaires pertinent to their alcohol consumption patterns including (but not limited to) quantity and frequency, expectancies, alcohol-related problems, and family history of alcohol/drug use. In contrast, students who chose to participate in research received an extended (although still randomly sequenced) questionnaire battery measuring items including participants' personality characteristics, trauma exposure and related symptoms, socially desirable responding patterns, and additional substance use. The baseline assessment takes approximately 45-60 minutes. Website pages were created using 'html' with error-checking implemented to ensure individual item completion with 'not applicable' responses available for each. The data was processed using 'asp,' transferred to a Microsoft Access database for later merging and cleaning, and last, encrypted and protected by two firewalls to ensure security as well as correct data transfer.

Analytic Strategy

Following merging data into the Statistical Package for Social Sciences (SPSS), all data were cleaned (Tabachnick & Fidell, 2001). Test and duplicate records were deleted, and syntax was completed. Preliminary analyses were conducted by completing descriptive analyses to examine demographic characteristics and response frequencies. Extreme scores were corrected using outlier analyses and Winsorizing procedures. Scores for predictor, criterion, and mediator/moderator variables were examined for skewness, and corrected (if needed) using square root data transformations given ranges of skewness that fell between .8 and 1.5. Bivariate correlations among variables were examined to determine the need for potential covariates, and all predictor variables were centered to reduce collinearity among the predictors.

The purpose of the first set of primary analyses was to establish the relationship between severity of CASA exposure and problematic alcohol use (*Aim 1*) using a simple regression model with severity of CASA exposure as the predictor variable and total problematic drinking as the criterion variable. The second set of analyses tested an application of the self-medication model to alcohol use (*Aim 2*) by examining the potential for PTSD symptoms to explain the relations between CASA severity and alcohol consumption. First, the relationship between CASA exposure and PTSD symptom severity using simple regression was examined. Next, the mediating influence of PTSD symptoms on the relationship between CASA exposure and alcohol use was tested using hierarchical regression analyses as outlined by Baron and Kenny (1986). Specifically, mediation is concluded after finding significant associations between 1) the independent variable (i.e., CASA) and the criterion (i.e., severity of problem drinking), 2)

the independent variable and the mediator (i.e., PTSD symptom severity), and 3) the mediator and the criterion variable after fixing (or controlling for) the independent variable (step 4). The Sobel (1982) test would be used to confirm significant mediation findings given some limitations to the Baron and Kenny (1986) approach (e.g., increased risk for Type I error; Mackinnon, Lockwood, Hoffman, West & Sheets, 2002; Shrout & Bolger, 2002).

The third set of analyses examined the application of the diathesis-stress model by investigating the influence of psychological vulnerabilities (i.e., ER difficulties and dissociative tendencies) on psychopathology including problematic alcohol use following CASA exposure (*Aim 3*). First, simple regression models examined the relations among CASA exposure and PTSD symptom severity on emotion regulation difficulties and dissociative tendencies, separately. Next, to test the proposed mediation and moderation models, path analyses incorporating the identified covariates were completed. Path models have evidenced a long-standing and current contribution to statistical analysis (Denis & Legerski, 2006; Wolfle, 2003; Wright, 1934; 1960). For each proposed model, the full model was first constructed to examine all possible paths using a series of multiple regression analyses. The hypothesized model was then constructed testing only the proposed pathways within the model, using a separate series of multiple regression analyses. For each multiple regression analysis, the related paths coefficients were marked by β weights and calculations of error variance [$v(1-R^2)$]. For all models, the proposed model was tested by comparing the fit of both the hypothesized and full models to the data [$R^2_{\text{model}} = 1 - p(e^2)$], examining the relative fit of the reduced model to the

full model [$Q = (1 - R^2_{\text{full}}) / (1 - R^2_{\text{reduced}})$], and a significance test to compare the fit of the two models [$W = - (N - d) * \log_e Q$].

Specific to the path models examining moderation, direct effects of the predictor (i.e., CASA exposure severity) and the proposed moderator as well as the interaction term, created by computing the product of the centered predictor and centered moderator variables, were examined (Baron & Kenny, 1986; Hoyle & Robinson, 2004). Following a significant interaction term, the pattern of moderation was interpreted by plotting the relationship between CASA exposure (as a continuous variable along the x-axis) and the outcome variable on lines representing the mean and one standard deviation above and below the mean of the moderating variable (Aiken & West, 1991). While mediating and moderating analyses were first implemented in longitudinal models, they have effectively been applied to cross-sectional models although inferences of causality and temporal ordering of variables are limited (Judd & Kenny, 1981).

Addressing the current aims using 213 students allows for adequate power for the statistical procedures (Hoyle & Robinson, 2004). Specifically, from previous research findings, correlations among CASA, PTSD symptoms, and alcohol use are anticipated to range from .19 to .37 (Bornovalova et al., 2009; Filipas & Ullman, 2006; Quimette, Wolfe, & Chrestman, 1996; Twaite & Rodriguez – Srednicki, 2004). For relations among CSA, dissociative tendencies, and emotion dysregulation, correlations have ranged from .18 to .31 (Gratz et al., 2007; Gratz et al., 2009; Twaite & Rodriguez – Srednicki, 2004), and for PTSD symptoms, alcohol, and emotion dysregulation or dissociative tendencies, correlations have ranged from .26 to .72 (Bornovalova et al. 2009; Kaplow et al. 2008; Quimette et al., 1996; Tull et al., 2007). Given the range of correlations and a primary

interest in testing CASA as a continuous variable, power calculations indicate that $N \geq 191$ individuals are needed to attain 80% power (Cohen, 1988; Friedman, 1982), indicating that $N = 213$ is sufficient for adequate power. Additionally, although *a priori* statistical power will be significantly reduced ($> 40\%$ although $< 60\%$), the current hypothesized models will be explored in men and women, separately, to allow for tentative examinations of potential gender differences.

Last, all aims were first tested with the primary CASA variable, using the most conservative, five-item subscale of the ETI-SR-SF. However, to address lower frequency rates of CASA using the more conservative five-item subscale (6.3% of the total sample), path analysis results were replicated using the less conservative definition of CASA reflected in the six-item subscale that allows for a greater endorsement of CASA exposure severity (14.5% of the total sample). To examine the potential of zero-inflatedness (i.e., the majority of responses equal to 0) in the continuous CASA variable, a binary version of CASA (i.e., yes or no) using the five-item scale was calculated, and all models were again replicated (MacCallum, Zhang, Preacher, & Rucker, 2002). Statistical power was reduced when examining the dichotomized variable (MacCallum et al., 2002); however, to complete the most thorough examination of CASA as it may relate to the key variables of interest, models will be examined using a binary CASA variable, and *post-hoc* power calculations will be noted within the results section.

Please note that for clarity purposes, the application of the diathesis-stress perspective as examined through path models are organized by type of model, rather than mediator or moderator being tested. Specifically, simple regression models testing the relations between CASA exposure severity and PTSD symptom on emotion regulation

difficulties (Aim 3a, Hypothesis A) and dissociative tendencies (Aim 3a, Hypothesis B) are grouped together. All path models testing mediation follow. The emotion regulation mediation model (Aim 3b, Hypothesis A) including the replication models and the corresponding exploratory models examining potential gender differences are first. Next, the dissociative tendencies mediation model (Aim 3b, Hypothesis B) including the replication models and the corresponding gender exploration models were completed. Last, all moderation models follow. The emotion regulation moderation model (Aim 3c, Hypothesis A) including the replication models and the corresponding gender exploration are first, followed by dissociative tendencies moderation models (Aim 3c, Hypothesis B) and the corresponding gender exploration.

Results

Preliminary Analyses and Descriptive Characteristics

For the current sample, descriptive characteristics examining all hypothesized predictor variables including the mediating/ moderating variables as well as the criterion variable (AUDIT scores) for men and women are displayed in Table 1. Using the more conservative five-item measure of CASA (most consistent with current definitions of coerced/forced experiences), rates of CASA exposure were relatively low including 3.8% of men and 10.5% of women reporting CASA experiences although increased to 14.5% in the overall sample using the less conservative, six-item scale. Women endorsed greater severity of CASA exposure compared to men across the five items of the subscale, ($F(1, 204) = 4.876, p = .028$) as well as across the six items of the full subscale ($F(1, 203) = 3.893, p = .049$). There were no differences in endorsement of CASA when examining it as a binary variable. More individuals did not endorse experiencing CASA than those

who did endorse CASA for both men and women using the five ($p = .075$) and six item totals ($p = .230$). Overall, there were no significant differences between men and women in total drinking, PTSD symptoms, emotion regulation difficulties, and dissociative tendencies (p 's = .252 to .873).

Table 1

Descriptive Statistics for Men and Women

Variable	Overall <i>M (SD)</i> or % (n)	Men (<i>n</i> = 135) <i>M (SD)</i> or % (n)	Women (<i>n</i> = 78) <i>M (SD)</i> or % (n)
CASA			
Primary 5-item scale	.11 (.66)	.05 (.31)	.21 (.70)*
Full 6-item scale	.21 (.50)	.15 (.45)	.33 (.91)*
Five-item binary variable			
Yes CASA	6.3% (13)	3.8% (5)	10.5% (8)†
No CASA	93.7% (193)	96.2% (125)	89.5% (68)
Six-item binary variable			
Yes CASA	14.5% (30)	12.2% (16)	18.4% (14)
No CASA	85.5% (177)	87.8% (115)	81.6% (62)
AUDIT	6.88 (4.70)	6.89 (4.78)	6.85 (4.58)
PCLC	21.18 (6.04)	21.82 (5.98)	22.82 (6.14)
DERS	61.00 (17.33)	60.74 (18.19)	61.45 (15.84)
DES	6.08 (5.89)	6.12 (6.11)	6.00 (5.55)

Note. AUDIT = Total problematic drinking; PCLC = Total PTSD symptoms; DERS = Total emotion regulation difficulties; DES = Total dissociative tendencies; †*p* < .10, **p* < .05

Table 2 details the frequency of endorsement across each CASA subscale item, for the overall sample as well as for men and women, separately. Notably, the columns do not add to 100% as each individual may endorse more than one experience. Items in the most conservative, five-item CASA scale are detailed in numbers one through five. Fondling was the most frequently endorsed item (Item 1) across the entire sample as well as for men and women, separately. Item six was included in the less conservative, six-item scale only.

Table 2

Frequency of Endorsement Across CASA Subscale Items

Item	Overall % (n)	Men % (n)	Women % (n)
1. Were you ever touched in an intimate or private part of your body (e.g., breast, thighs, or genitals) in a way that surprised you or made you feel uncomfortable?	61.5% (8)	60.0% (3)	62.5% (5)
2. Were you ever forced or coerced to touch another person in an intimate or private part of their body?	23.1% (3)	0.0% (0)	37.5% (3)
3. Did anyone ever have genital sex with you against your will?	23.1% (3)	20.0% (1)	25.0% (2)
4. Were you ever forced or coerced to perform oral sex on someone against your will?	38.5% (5)	20.0% (1)	50.0% (4)
5. Were you ever forced or coerced to kiss someone in a sexual rather than an affectionate way?	30.8% (4)	40.0% (2)	25.0% (2)
6. Did you ever experience someone rubbing their genitals against you? **	75.0% (21)	80.0% (12)	69.2% (9)

Note. Overall, CASA endorsement was 6.3% ($n=13$) for the 5-item scale, and 14.5% ($n=30$) for the 6-item scale. The first five questions are included in the primary, 5-scale CASA measure. The sixth item (as denoted by **) was included in the less conservative, full 6-item scale.

The primary constructs of interest were examined for students who endorsed CASA compared to those who did not endorse CASA exposure. Students with CASA exposure history endorsed significantly greater levels of alcohol consumption, PTSD symptoms, emotion regulation difficulties, and dissociative tendencies (p 's = .001 to .043) compared to students without CASA exposure, as shown in Table 3.

Table 3

Descriptive Statistics Between Students with and without CASA Exposure

Variable	No CASA Exposure <i>M (SD)</i>	CASA Exposure <i>M (SD)</i>
AUDIT	6.66 (4.58)	9.64 (6.14)*
PCLC	22.83 (5.43)	30.00 (6.67)***
DERS	60.08 (16.12)	78.62 (14.36)***
DES	5.87 (5.81)	9.40 (6.35)*

Note. AUDIT = Total problematic drinking; PCLC = Total PTSD symptoms; DERS = Total emotion regulation difficulties; DES = Total dissociative tendencies; * $p < .05$, ** $p < .01$, *** $p < .001$

Bivariate relations between predictor, mediator/moderator, and outcome variables as well as potential covariates are shown in Table 4. Preliminary results indicated that age, year in college, and Greek status were not related to any of the variables of interest, and therefore, were excluded from the correlational table. Bivariate analyses resulted in moderate to strong positive relations among PTSD symptoms, emotion regulation difficulties, and dissociative tendencies as well as a positive relationship with total problematic drinking for each variable. The most conservative five-item measure of CASA exposure was positively related to PTSD symptoms and emotion regulation although was not significantly related to dissociative tendencies (unlike the six-item CASA measure) or problematic drinking. Variance inflation factors (VIF) were calculated to examine the potential for multicollinearity among the independent variables, including the predictor variables as well as the mediating/moderating variables. Results indicated that VIFs ranged from 1.101 to 1.560, all below the conservative cut-off of 2.5 (Allison, 1999). Coupled with bivariate correlations that do not indicate multicollinearity (Tabachnick & Fidell, 2001), concerns regarding the impact of multicollinearity between variables on the current results were minimized.

Next, covariates were chosen based on their potential impact on the criterion variable, problematic drinking (Tabachnick & Fidell, 2001). After examining bivariate results, socially desirable responding patterns as measured by the *Marlowe Crowne Social Desirability Scale* (MCS; $M = 18.876$, $SD = 3.805$) and sexual victimization after the age of 18 for women as measured by the *Sexual Experiences Survey* (SES; 41% of women endorsed victimization after 18) were moderately to strongly related to problematic drinking. As such, both were controlled; however, because the SES was only

measured in women, it was only included in models comprised only of women. Covariates were also chosen based on their potential impact on CASA. Because CASA cannot be randomly assigned, controlling for group differences within the CASA variable may create a “purer” measure of the CASA – alcohol consumption relationship (Tabachnick & Fidell, 2001). Gender was selected given the significant difference between men and women in CASA exposure (as shown in Table 1) as well as the significant bivariate relations with CASA. To help control for the uniqueness of CASA as an independent variable, alternative forms of early trauma measured by the ETI-SR-SF (i.e., general, physical, and emotional) were also selected as covariates for simple regression models given significant statistical relations with CASA and/or problematic drinking. However, for the path models, entering alternative traumas simultaneously with CASA exposure created a latent variable with a one factor solution ($\lambda = 1.780$, Cumulative Variance = 44.493%), using the Eigenvalue greater than one rule (Tabachnick & Fidell, 2001). Thus, alternative traumas (i.e., general, physical, and emotional trauma) were dropped from all path models given the limitations of regression style path analysis in handling latent variables (Denis & Legerski, 2006) and the current focus on CASA exposure. All covariates were centered (i.e., alternative traumas and socially desirable responding scores) or dummy-coded (i.e., gender and sexual victimization after 18) to reduce unnecessary collinearity.

Table 4

Bivariate Statistics

Variable	1	2	3	4	5	6	7	8	9	10	11	12	13
1. Gender	---												
2. Ethnicity	-.011	---											
3. AUDIT	.012	-.049	---										
4. General trauma	-.021	.110	.083	---									
5. Physical Trauma	-.176*	-.176*	.162*	.261**	---								
6. Emotional Trauma	-.070	.202**	.044	.217**	.473**	---							
7. MCS	.010	.029	.312**	.017	-.046	-.017	---						
8. DERS	.020	.132	.306**	.104	.290**	.184**	.127	---					
9. PCLC	.081	.175*	.216**	.221**	.355**	.276**	.207**	.572**	---				
10. DES	.014	.172*	.386**	.136	.212**	-.038	.220**	.429**	.420**	---			
11. CSA5	.153*	.095	.098	.220**	.109	.252**	.136	.297**	.319**	.081	---		
12. CSA6	.137*	.127	.106	.206**	.144*	.209**	.122	.309*	.356**	.151*	.899**	---	
13. SES	.043	.246*	.443**	.213	.068	.174	.147	.257*	.196	.323**	.323**	.326**	-----

Note. CASA5 = The more conservative measure of CASA most consistent with current definitions; CASA6 = The less conservative six-item CASA measure; MCS = Marlowe Crowne Social Desirability Scale; SES = Sexual Experiences Survey; * $p < .05$, ** $p < .01$

While subscales (i.e., PTSD symptom clusters and emotion regulation subscales) were not be incorporated into the regression and path models, bivariate results for each subscale on the outcome and predictor variables are shown in Table 5 to provide a brief examination of correlations. Alcohol consumption was significantly and positively correlated with all subscales, except the DERS strategies subscale ($r = .141, p = .058$), and the PTSD re-experiencing cluster ($r = .114, p = .053$), which both showed a trend toward significance. The conservative five-item CASA measure was also significantly related to all subscales, except the DERS awareness subscale ($r = .069, p = .329$), consistent with the six-item CASA measure ($r = .086, p = .220$).

Table 5

Bivariate Statistics Across Subscales

Variable	1	2	3	4	5	6	7	8	9	10	11	12	13	14	15
1. AUDIT	---														
2. CASA6	.106	---													
3. CASA5	.098	.899**	---												
4. Non-Acceptance	.179*	.260**	.253**	---											
5. Goal-direct	.247**	.294**	.282**	.483**	---										
6. Impulse	.169*	.321**	.307**	.510**	.611**	---									
7. Awareness	.258**	.086	.069	.196**	.176*	.325**	---								
8. Strategy	.141	.287**	.271**	.595**	.671**	.844**	.247**	---							
9. Clarity	.385**	.218**	.214**	.317**	.381**	.554**	.576**	.499**	---						
10. DERS Total	.306**	.309**	.297**	.688**	.733**	.824**	.619**	.829**	.713**	---					
11. PCLC	.216**	.356**	.319**	.430**	.504**	.476**	.169*	.547*	.372**	.572**	---				

Note. CASA5 = The more conservative measure of CASA most consistent with current definitions; CASA6 = The less conservative six-item CASA measure; * $p < .05$, ** $p < .01$

Aim 1: Examine the Relationship Between Severity of CASA Exposure and Problematic Drinking

Aim 1 was developed to examine the relations between CASA exposure severity and alcohol consumption across the full sample using simple regression analyses. As shown in Table 6, CASA exposure using the conservative five-item scale did not significantly relate to problematic drinking after controlling for gender, alternative trauma exposures, and socially desirable responding, $R^2 = .104$, $F(6, 184) = 3.578$, $p = .002$. Social desirability and history of physical trauma positively related to alcohol use. Findings that CASA did not predict alcohol use were consistent when also examined in the less conservative six-item CASA measure ($\beta = .031$, $p = .681$), $R^2 = .104$, $F(6, 183) = 3.546$, $p = .002$, and the binary CASA variable ($\beta = .036$, $p = .634$), $R^2 = .105$, $F(6, 184) = 3.617$, $p = .002$.

Table 6

Regression of Problematic Drinking on CASA Exposure

Variable	<i>B</i>	<i>SE B</i>	β
Gender	.053	.125	.030
MCS	.069	.018	.268***
General Trauma	.039	.043	.067
Physical Trauma	.112	.053	.172*
Emotional Trauma	-.035	.074	-.038
CASA	.019	.131	.011

Note. Dependent variable = AUDIT; * $p < .05$, ** $p < .01$, *** $p < .001$

Aim 2: Examine the Potential Occurrence of the *Self-Medication Model* to Alcohol Use

Aim 2 was designed to examine the application of the self-medication model by investigating the mediating potential of PTSD symptoms on the relations between CASA severity and alcohol consumption. First, the relations between CASA and PTSD symptoms were tested using simple regression analyses followed by an examination of mediation as outlined by Baron and Kenny (1986). As shown in Table 7, CASA severity positively related to PTSD symptoms after controlling for gender, alternative trauma exposures, and socially desirable responding, $R^2 = .228$, $F(6, 185) = 9.089$, $p < .001$. As CASA severity increased, PTSD symptoms were expected to increase. In addition to CASA, socially desirable responding and physical trauma significantly related to PTSD symptoms. Findings that CASA positively related to PTSD symptoms were consistent when replicated with the less conservative six-item CASA measure ($\beta = .246$, $p < .001$), $R^2 = .253$, $F(6, 184) = 10,363$, $p < .001$, and the binary CASA variable ($\beta = .197$, $p = .006$), $R^2 = .227$, $F(6, 185) = 9.073$, $p < .001$.

Table 7

Regression of PTSD Symptoms on CASA Exposure

Variable	<i>B</i>	<i>SE B</i>	β
Gender	1.075	.795	.090
MCS	.297	.116	.167*
General Trauma	.278	.269	.072
Physical Trauma	1.250	.322	.290***
Emotional Trauma	.411	.473	.065
CASA	2.402	.857	.198**

Note. Dependent variable = PCLC; * $p < .05$, ** $p < .01$, *** $p < .001$

However, given the results of Aim 1, the mediating potential of PTSD symptoms on the relationship between CASA exposure and problematic drinking was not tested. According to Baron and Kenny's (1986) approach, the first step required for mediation is a significant relationship between the predictor variable and criterion (i.e., CASA exposure and alcohol use). The results of Aim 1 indicated that this requirement was not met (CASA $\beta = .011$, $p = .885$), and accordingly, mediation was not tested. To explore the potential relations between PTSD symptoms on alcohol consumption albeit not mediation, alcohol consumption was regressed on PTSD symptoms along with the control variables. PTSD symptoms did not significantly relate to alcohol consumption ($\beta = .086$, $p = .275$) when gender, socially desirable responding, and alternative trauma experiences were controlled, $R^2 = .121$, $F(6, 178) = 4.088$, $p = .001$. Consistent with Aim

1 findings, socially desirable responding patterns and physical trauma were significant contributors to the model.

Aim 3: Investigate the Application of the *Diathesis-Stress Perspective* by Examining Psychological Vulnerabilities, Specifically, Emotion Regulation Difficulties and Dissociative Tendencies, to Psychopathology Including Alcohol Use Following CASA Exposure

Aim 3 examined the application of the diathesis-stress perspective on the relations among CASA exposure severity, PTSD symptoms, and alcohol consumption by incorporating two psychological vulnerability factors (i.e., emotion regulation difficulties and dissociative tendencies) into more comprehensive path analysis models. For clarity, Aim 3 is divided into three subsections. First (Aim 3a), simple regression analyses were used to test the relations between CASA exposure severity and PTSD symptoms, individually, on each vulnerability factor. Second (Aim 3b), path analysis was used to examine the potential for emotion regulation and dissociative tendencies to each act as intermediary factors in the relations between CASA exposure severity and PTSD symptoms on alcohol consumption. Third (Aim 3c), a secondary perspective used path analysis to examine the moderating potential of each vulnerability factor on the relations between CASA severity and PTSD symptoms as well as CASA severity and alcohol consumption. Each subsection is detailed below.

Aim 3a: Examine the relationship between CASA severity and PTSD symptoms, separately, on the proposed vulnerability factor.

The first subsection of Aim 3 was developed to examine the relationship between CASA severity and PTSD symptoms on the proposed vulnerability factor. Simple

regression analyses tested the hypotheses that severity of CASA exposure and PTSD symptoms in separate models will relate to emotion regulation difficulties and dissociative tendencies, respectively. Each regression model was constructed, and shown in a table. All results were replicated with the less conservative six-item CASA measure as well as the binary CASA variable. First, CASA exposure severity was a significant, positive contributor to the model examining emotion regulation, $R^2 = .170$, $F(6, 191) = 6.498$, $p < .001$, after controlling for gender, alternative trauma exposure, and socially desirable responding. Results are shown in Table 8. As CASA exposure severity increased, emotion regulation difficulties were expected to increase. Physical trauma was also a significant contributor. These results were consistent when replicated with the less conservative six-item measure of CASA ($\beta = .274$, $p < .001$), $R^2 = .167$, $F(6, 190) = 6.346$, $p < .001$, and the binary CASA variable ($\beta = .227$, $p = .002$), $R^2 = .149$, $F(6, 191) = 5.577$, $p < .001$.

Table 8

Regression of Emotion Regulation Difficulties on CASA Exposure

Variable	<i>B</i>	<i>SE B</i>	β
Gender	.275	2.329	.008
MCS	.411	.343	.080
General Trauma	-.352	.791	-.031
Physical Trauma	3.380	.951	.271***
Emotional Trauma	-.110	1.369	-.006
CASA	9.387	2.442	.275***

Note. Dependent variable = DERS; * $p < .05$, ** $p < .01$, *** $p < .001$

Next, PTSD symptoms significantly contributed to the model examining emotion regulation, $R^2 = .334$, $F(6, 184) = 15.406$, $p < .001$, after controlling for gender, alternative trauma exposure, and socially desirable responding. Results are shown in Table 9. PTSD symptoms were the only significant variable contributing to the model. Similar to CASA severity, the significant positive contribution indicated that as PTSD symptoms increased, emotion regulation difficulties increased, after holding all other variables in the model constant. No replications were necessary as CASA was not included in the model.

Table 9

Regression of Emotion Regulation Difficulties on PTSD Symptoms

Variable	<i>B</i>	<i>SE B</i>	β
Gender	.060	2.149	.002
MCS	.028	.323	.005
General Trauma	-.395	.714	-.035
Physical Trauma	1.507	.902	.120
Emotional Trauma	-.261	1.246	-.014
PTSD Symptoms	1.566	.195	.538***

Note. Dependent variable = DERS; * $p < .05$, ** $p < .01$, *** $p < .001$

Similar to the emotion regulation simple regression models above, two separate regression models were built to examine the hypothesis that severity of CASA exposure and PTSD symptoms, independently, will relate to dissociative tendencies. Results for each regression model were outlined in a table. After controlling for gender, alternative trauma exposure, and socially desirable responding, CASA was not a significant contributor to the model examining dissociative tendencies, $R^2 = .123$, $F(6, 187) = 4.354$, $p < .001$. Results are shown in Table 10. Instead, socially desirable responding, physical trauma, and emotional trauma significantly contributed to the model. These results were consistent when replicated in the less conservative six-item CASA measure ($\beta = .100$, $p = .172$), $R^2 = .122$, $F(6, 186) = 4.326$, $p < .001$, as well as with the binary CASA variable ($\beta = .088$, $p = .239$), $R^2 = .128$, $F(6, 187) = 4.582$, $p < .001$.

Table 10

Regression of Dissociative Tendencies on CASA Exposure

Variable	<i>B</i>	<i>SE B</i>	β
Gender	.141	.188	.053
MCS	.065	.027	.164*
General Trauma	.080	.067	.087
Physical Trauma	.298	.077	.310***
Emotional Trauma	-.274	.110	-.199*
CASA	.087	.196	.033

Note. Dependent variable = DES; * $p < .05$, ** $p < .01$, *** $p < .001$

In the second model, the variable measuring PTSD symptoms significantly contributed to the model examining dissociative tendencies, $R^2 = .237$, $F(6, 181) = 9.388$, $p < .001$. Results are shown in Table 11. As PTSD symptoms increased, dissociative tendencies increased, after holding all other variables in the model constant. Physical and emotional trauma were also significant contributors.

Table 11

Regression of Dissociative Tendencies on PTSD Symptoms

Variable	<i>B</i>	<i>SE B</i>	β
Gender	.069	.178	.026
MCS	.033	.027	.083
General Trauma	.028	.062	.031
Physical Trauma	.226	.075	.236**
Emotional Trauma	-.280	.102	-.201**
PTSD Symptoms	.081	.016	.369***

Note. Dependent variable = DES; * $p < .05$, ** $p < .01$, *** $p < .001$

Aim 3b: Examine the potential for the proposed vulnerabilities to act as intermediary factors in the pathway from CASA exposure severity and PTSD symptoms to alcohol consumption.

The second subsection of Aim 3 (Aim 3b) was designed to test the potential for emotion regulation difficulties and dissociative tendencies to act as intermediary factors in the pathway from CASA exposure severity and PTSD symptoms to alcohol consumption. To address this aim, the path analysis for emotion regulation difficulties was first constructed within the full sample using the primary, five-item CASA variable. Next, results of the model in the full sample were replicated using the less conservative, six-item CASA variable and the binary CASA variable. The model using the primary CASA measure as well as each replicated model is depicted within figures. To examine potential differences between men and women, the emotion regulation difficulties model was constructed for men and women, separately. Each model exploring gender differences used the primary, five-item CASA variable and is outlined in a figure.

Models examining dissociative tendencies, the second proposed intermediary factor, follow the emotion regulation models and were constructed in the same order. First, the primary, five-item model was constructed within the full sample and shown in a figure. The model was replicated with the six-item and binary CASA measures; both are shown in a figure. Last, the model examining dissociative tendencies as an intermediary factor was constructed in men and women, separately, to explore potential gender differences. The model for each gender is described and shown in a figure.

Path models for emotion regulation difficulties as an intermediary factor

A path model was constructed to test the proposed model in Figure 3, which examined the potential for emotion regulation difficulties to act as an intermediary factor in the relations between CASA exposure and PTSD symptoms to alcohol use. The selected covariates including gender and socially desirable responding patterns were included within the model. Results indicated that the hypothesized model (Fit = .494) fit the data as well as the full model (Fit = .515), which tested all significant paths, so the null hypothesis (that the full and hypothesized models would work equally well) was supported, and the hypothesized model was retained, $Q = .958$, $W = 8.445$, $p > .05$. As shown in Figure 3.1, the model indicated that while gender was positively related to CASA, CASA significantly related to emotion regulation difficulties and PTSD symptoms. While PTSD symptoms positively related to emotion regulation difficulties, it was emotion regulation difficulties and socially desirable responding patterns that each positively related to greater alcohol use. Within the figure, each path is marked by β weights, and error variance for each predicted variable is indicated by the “e.” Error variance indicated that while emotion regulation difficulties and socially desirable responding significantly related to greater alcohol consumption, the majority of variance for alcohol consumption was not accounted for.

Figure 3.1

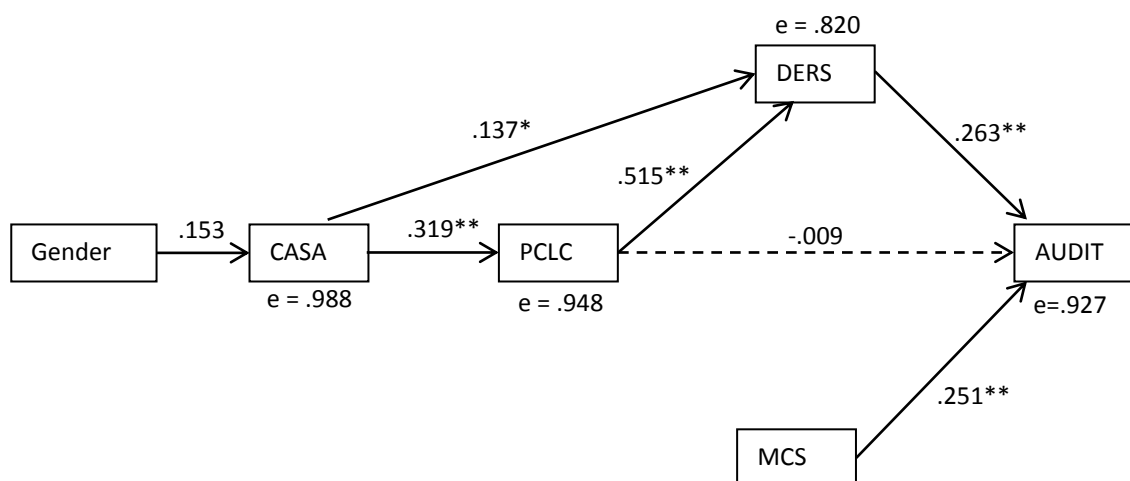
Emotion Regulation Difficulties as an Intermediary Factor

Note. Dashed lines represent non-significant paths; PCLC = PTSD symptoms; DERS = emotion regulation difficulties; AUDIT = total problematic drinking score; MCS = socially desirable responding patterns; * $p < .05$, ** $p < .01$, *** $p < .001$.

Results were replicated for the less conservative, six-item CASA variable, and the binary CASA variable. Each is shown in Figure 3.2 and 3.3, respectively. For the six-item CASA variable (Figure 3.2), the hypothesized model (Fit = .509) fit the data as well as the full model (Fit = .523), which tested all significant paths. As such, consistent with the five-item CASA variable, the null hypothesis was supported, and the hypothesized model was retained, $Q = .963$, $W = 7.596$, $p > .05$. Significant and non-significant paths were identical to the five-item CASA measure, where the path from PTSD symptoms to alcohol consumption was the only non-significant contributor to the model. The path model using the binary CASA variable is shown in Figure 3.3. Again, the hypothesized model (Fit = .491) fit the data as well as the full model (Fit = .517), so the hypothesized model was retained, $Q = .947$, $W = 10.779$, $p > .05$. The path model was primarily consistent with the prior two models with two exceptions. First, gender showed a trend toward significant relations with the binary CASA exposure variable ($p = .058$), and CASA did not significantly predict emotion regulation difficulties ($p = .112$)

Figure 3.2

Emotion Regulation Difficulties as an Intermediary Factor: Replication with the Six-Item CASA Measure

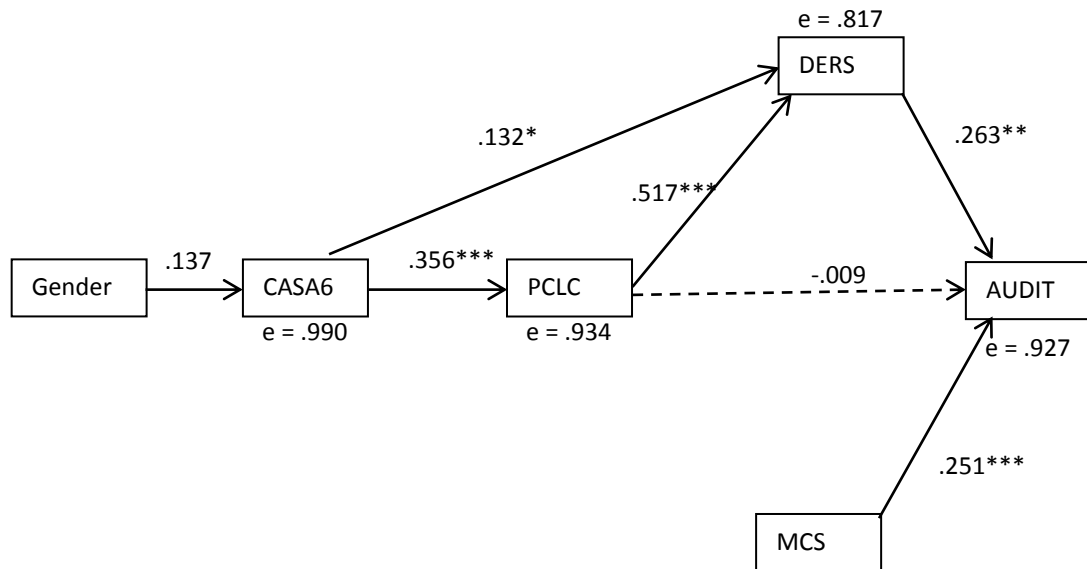

Note. Dashed lines represent non-significant paths; CASA6 = less conservative 6 item measure of CASA; PCLC = PTSD symptoms; DERS = emotion regulation difficulties; AUDIT = total problematic drinking score; MCS = socially desirable responding patterns; * $p < .05$, ** $p < .01$, *** $p < .001$.

Figure 3.3

*Emotion Regulation Difficulties as an Intermediary Factor: Replication with the Binary
CASA Measure*

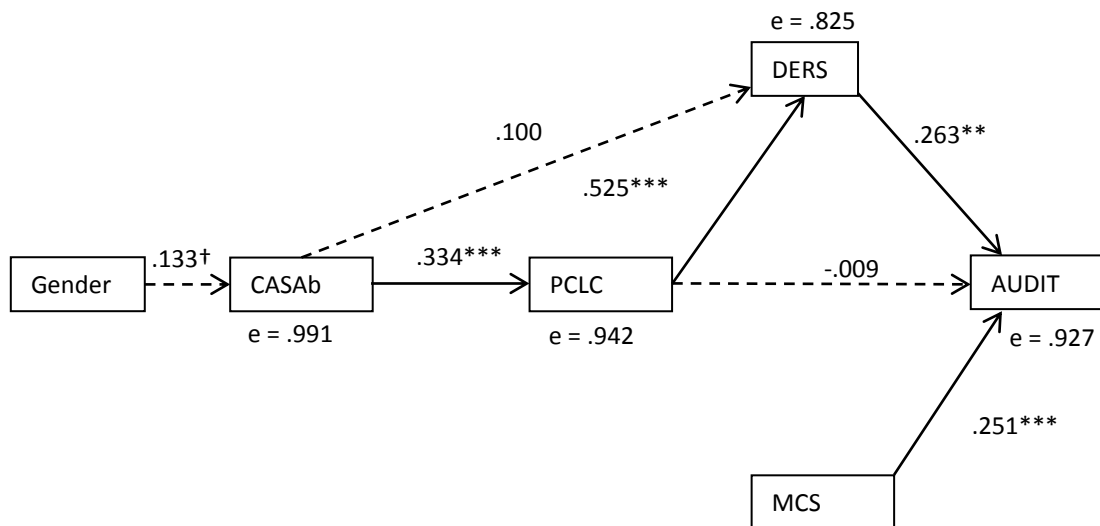

Note. Dashed lines represent non-significant paths; CASAb = binary variable; PCLC = PTSD symptoms; DERS = emotion regulation difficulties; AUDIT = total problematic drinking score; MCS = socially desirable responding patterns; [†] $p < .10$, * $p < .05$, ** $p < .01$, *** $p < .001$.

Exploratory analyses were conducted to examine potential differences in the model between men and women. Selected covariates again included socially desirable responding patterns. Gender was dropped from the model because models were being explored between genders. Additionally, sexual victimization after 18 was applied to the women's model, as it was only measured in women. While mechanisms to sexual re/victimization were beyond the scope of the current study, the variable was included as a control on the outcome variable given the significant bivariate relations with alcohol consumption ($r = .443, p < .001$; Tabachnick & Fidell, 2001).

Results for men are shown in Figure 3.4. Similar to the model constructed in the full sample (refer back to Figure 3.1), the hypothesized model (Fit = .466) fit the data as well as the full model (Fit = .491), which tested all possible paths. Therefore, the hypothesized model was retained, $Q = .953, W = 5.989, p > .05$. Consistent with the model in the full sample, CASA positively related to PTSD symptoms, which in turn, positively related to emotion regulation difficulties. Emotion regulation difficulties and socially desirable responding patterns positively related to greater alcohol consumption. PTSD symptoms were not significantly related to alcohol consumption, and CASA did not significantly relate to emotion regulation difficulties ($p = .106$).

Figure 3.4

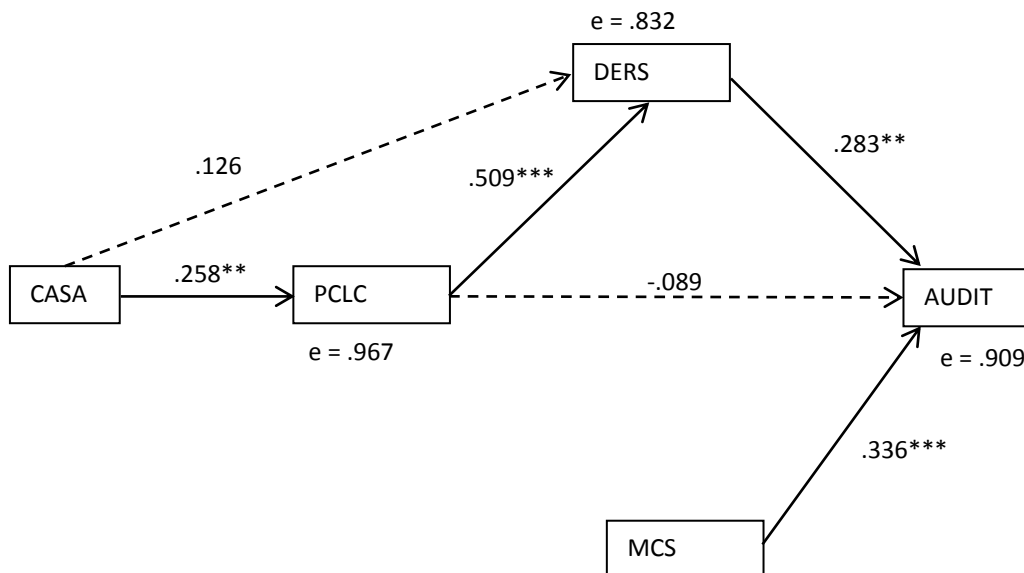
Emotion Regulation Difficulties as an Intermediary Factor for Men

Note. Dashed lines represent non-significant paths; PCLC = PTSD symptoms; DERS = emotion regulation difficulties; AUDIT = total problematic drinking score; MCS = socially desirable responding patterns; † $p < .10$, * $p < .05$, ** $p < .01$, *** $p < .001$.

The exploratory results for women are in Figure 3.5. Findings indicated that the full model (Fit = .672) fit the data significantly better than the hypothesized model (Fit = .597), so the null hypothesis was rejected, and the full model was retained, $Q = .815$, $W = 13.911$, $p < .05$. Similar to the model constructed with the full sample, CASA significantly related to PTSD symptoms, which in turn, significantly related to greater emotion regulation difficulties. Similar to the men's model, CASA did not significantly relate to emotion regulation difficulties although a trend was evident ($p = .078$). Unique to the women's model, emotion regulation difficulties did not relate to greater alcohol consumption; rather, CASA positively related to victimization after the age of 18, which in turn, related to greater alcohol consumption.

Figure 3.5

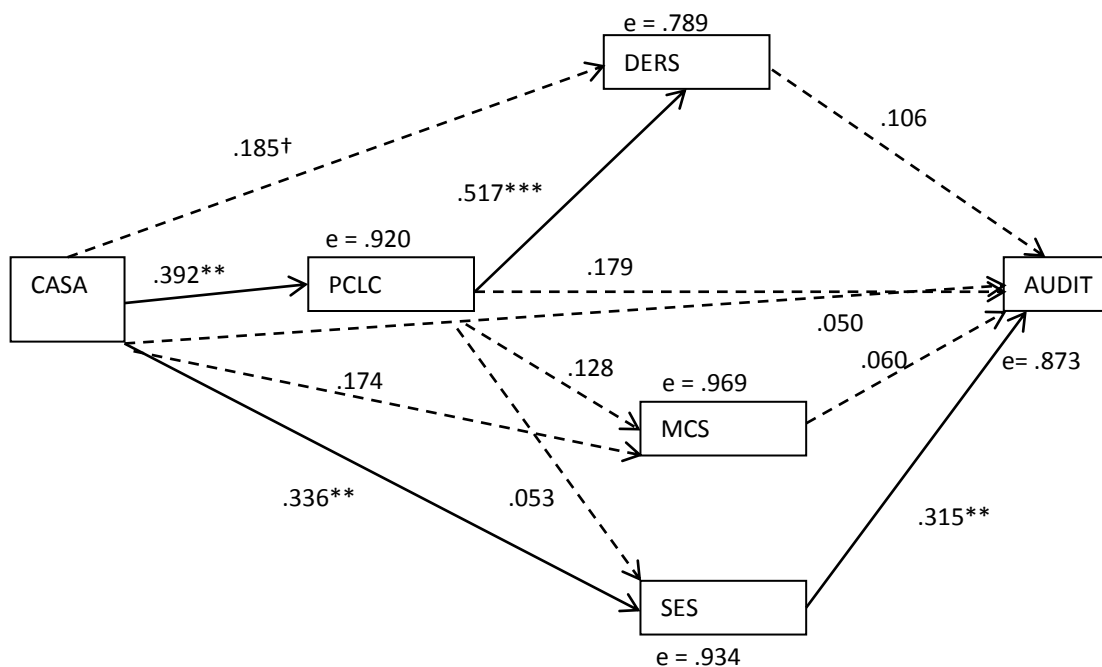
Emotion Regulation Difficulties as an Intermediary Factor for Women

Note. Dashed lines represent non-significant paths; PCLC = PTSD symptoms; DERS = emotion regulation difficulties; AUDIT = total problematic drinking score; MCS = socially desirable responding patterns; SES = sexual victimization after 18; † $p < .10$, * $p < .05$, ** $p < .01$, *** $p < .001$.

Path models for dissociative tendencies as an intermediary factor

Next, path models were constructed to test the hypotheses examining chemical dissociation, where dissociative tendencies would act as an intermediary factor in the relations between CASA exposure and PTSD symptoms to alcohol use (refer back to Figure 5). The previously selected covariates were retained. Gender and socially desirable responding patterns were included in the full sample models. While gender was dropped for the exploratory models examining men and women, separately, socially desirable responding was retained, and sexual victimization after 18 was incorporated into the women's model.

Results for the model using the full sample (and the most conservative, five-item CASA measure) are shown in Figure 5.1. The hypothesized model (Fit = .398) fit the data as well as the full model (Fit = .431), which tested all possible paths. Accordingly, the null hypothesis was supported, and the hypothesized model was retained, $Q = .945$, $W = 11.154$, $p > .05$. Significant paths indicated that gender positively related to CASA, CASA was positively related to PTSD symptoms, which in turn, were positively related to dissociative tendencies. Dissociative tendencies and socially desirable responding patterns positively related to greater alcohol consumption, although the majority of variance for alcohol consumption was not accounted for. CASA exposure was not significantly related to dissociative tendencies, and similar to models thus far, PTSD symptoms did not predict alcohol consumption.

Figure 5.1

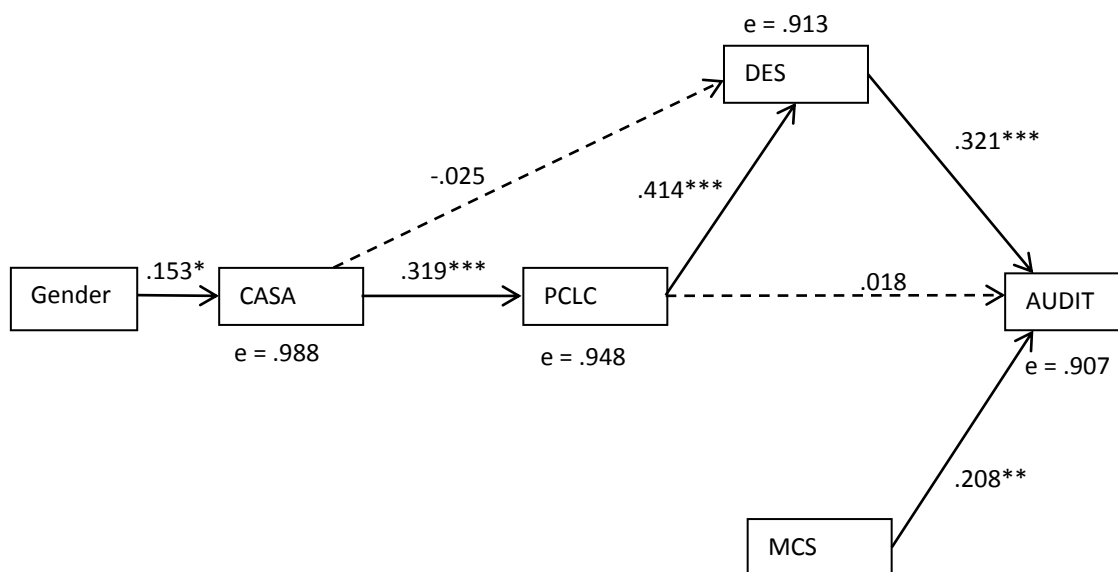
Dissociative Tendencies as an Intermediary Factor

Note. Dashed lines represent non-significant paths; PCLC = PTSD symptoms; DES = dissociative tendencies; AUDIT = total problematic drinking score; MCS = socially desirable responding patterns; † $p < .10$, * $p < .05$, ** $p < .01$, *** $p < .001$.

Results for the full sample were replicated using the less conservative, six-item CASA measure. Shown in Figure 5.2, the hypothesized model (Fit = .417) fit the data as well as the full model (Fit = .447), and accordingly, the hypothesized model was retained, $Q = .948$, $W = 10.528$, $p > .05$. The pattern of findings was consistent with the model using the primary, five-item CASA measure. Significant paths indicated that gender positively related to CASA, CASA positively related to PTSD symptoms, which in turn, was positively related to dissociative tendencies. Dissociative tendencies and socially desirable responding positively related to greater alcohol consumption. After replicating the model using the binary CASA variable, results indicated that the hypothesized model (Fit = .402) fit the data as well as the full model (Fit = .441), so the hypothesized model was retained, $Q = .935$, $W = 13.247$, $p > .05$. Results are shown in Figure 5.3. The pathway of significant contributors was consistent with the primary, five-item and six-item models, with the exception that gender showed only a trend toward significantly relating to CASA exposure ($p = .058$).

Figure 5.2

Dissociative Tendencies as an Intermediary Factor: Replication with the Six-Item CASA Measure

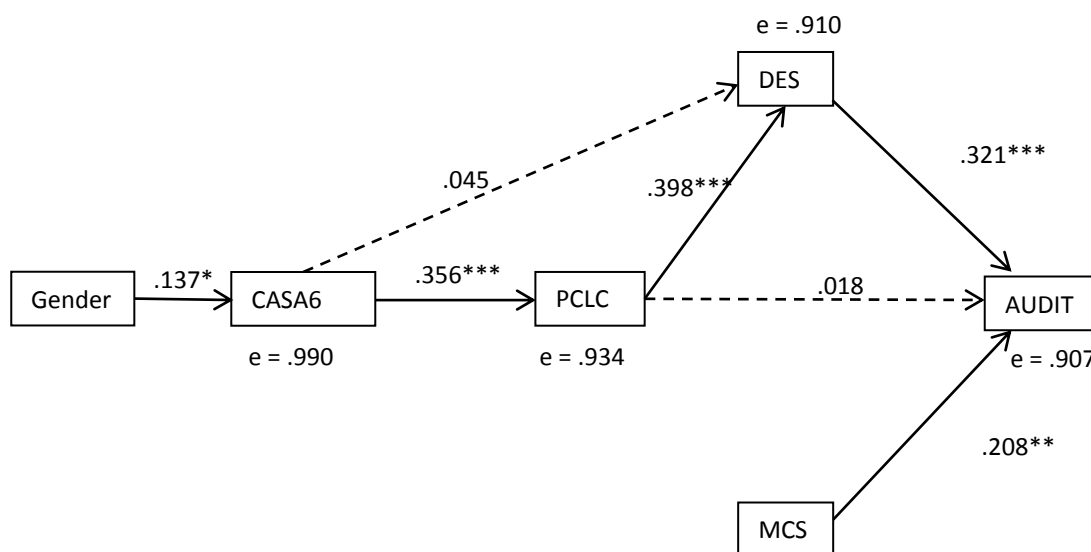

Note. Dashed lines represent non-significant paths; CASA6 = Six-item CASA variable; PCLC = PTSD symptoms; DES = dissociative tendencies; AUDIT = total problematic drinking score; MCS = socially desirable responding patterns; † $p < .10$, * $p < .05$, ** $p < .01$, *** $p < .001$.

Figure 5.3

Dissociative Tendencies as an Intermediary Factor: Replication with the Binary CASA Measure

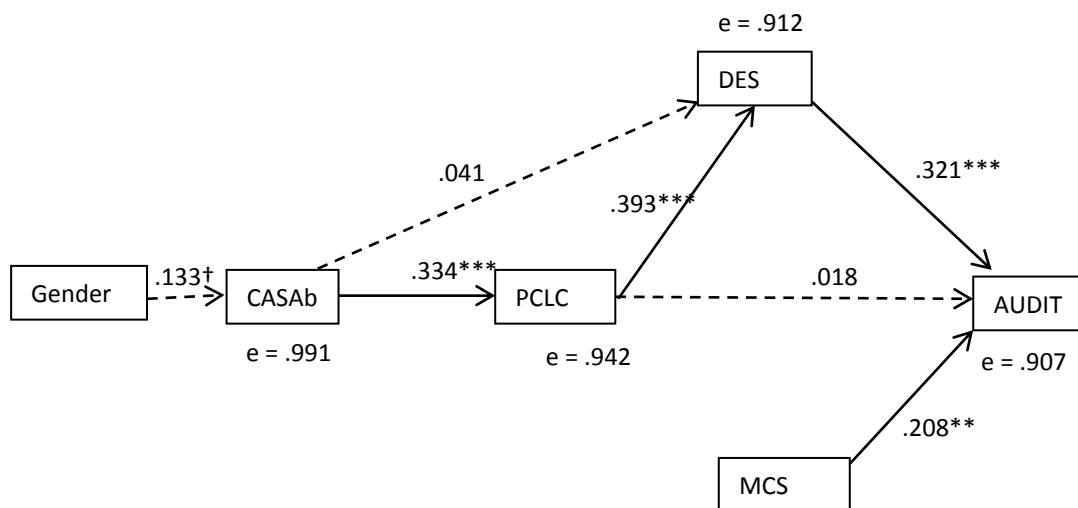

Note. Dashed lines represent non-significant paths; CASAb = binary CASA variable; PCLC = PTSD symptoms; DES = dissociative tendencies; AUDIT = total problematic drinking score; MCS = socially desirable responding patterns; † $p < .10$, * $p < .05$, ** $p < .01$, *** $p < .001$.

Next, exploratory analyses were completed by examining the model (using the most conservative, five-item CASA measure) between men and women. Consistent with the emotion regulation difficulties models, socially desirable responding was retained as a control variable, and gender was dropped. Sexual victimization after 18 was included as a control variable within the women's model. First, for the men, results indicated that the hypothesized model (Fit = .364) fit the data as well as the full model (Fit = .391), and accordingly, the hypothesized model was retained, $Q = .958$, $W = 5.378$, $p > .05$. The model is shown in Figure 5.4. The pattern of significant pathways is consistent with the model (using the five-item CASA measure) constructed within the full sample (refer back to Figure 5.1). CASA was positively related to PTSD symptoms, which in turn, was positively related to dissociative tendencies. Dissociative tendencies and socially desirable responding patterns positively related to greater alcohol consumption. CASA exposure did not significantly relate to dissociative tendencies, and PTSD symptoms were not related to alcohol consumption.

Figure 5.4

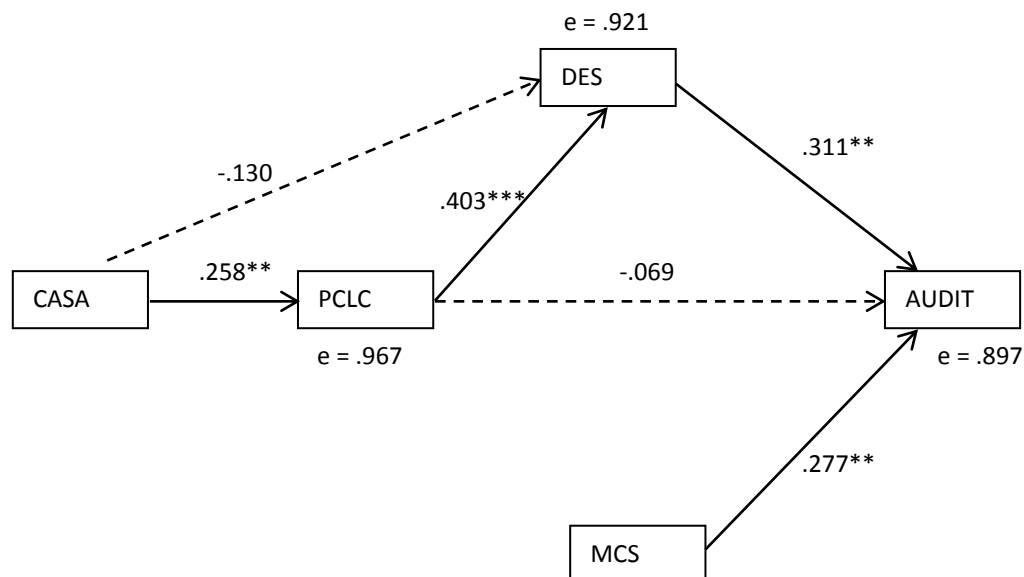
Dissociative Tendencies as an Intermediary Factor for Men

Note. Dashed lines represent non-significant paths; PCLC = PTSD symptoms; DES = dissociative tendencies; AUDIT = total problematic drinking score; MCS = socially desirable responding patterns; † $p < .10$, * $p < .05$, ** $p < .01$, *** $p < .001$.

For women, the full model (Fit = .616) fit the data significantly better than the hypothesized model (Fit = .532), so the null hypothesis was rejected, and the full model was retained, $Q = .822$, $W = 13.350$, $p < .05$. Results are shown in Figure 5.5. Similar to the model constructed with the full sample, CASA significantly related to PTSD symptoms, which in turn, significantly related to greater dissociative tendencies. Unlike the findings for women examining emotion regulation difficulties, there was a trend for dissociative tendencies to positively relate to greater alcohol consumption ($p = .070$). Although consistent with the model examining emotion regulation difficulties, CASA significantly related to victimization after the age of 18, which in turn, related to greater alcohol consumption.

Figure 5.5

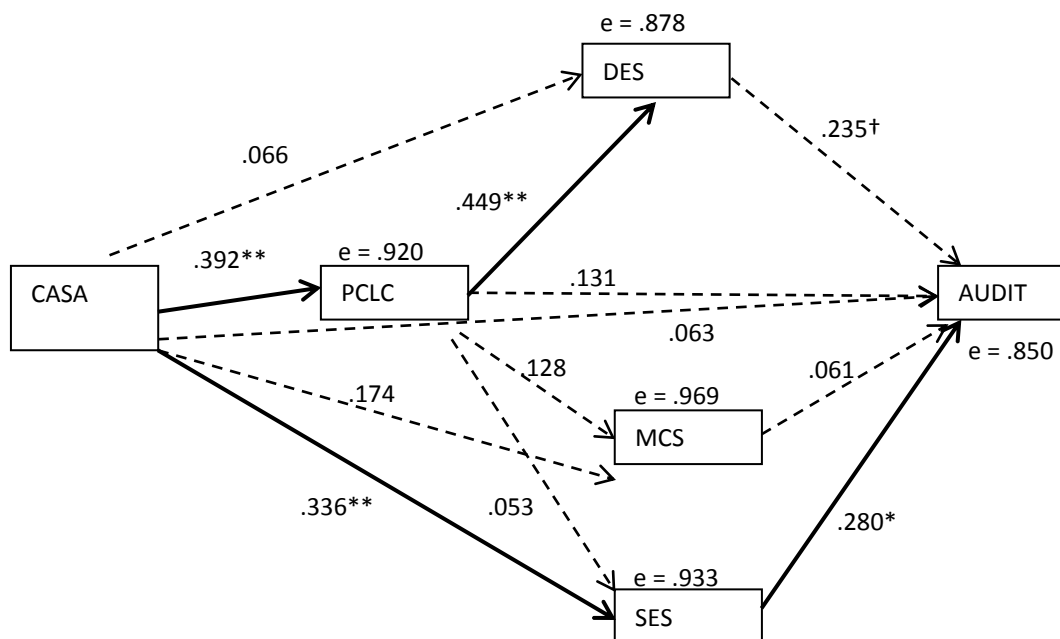
Dissociative Tendencies as an Intermediary Factor for Women

Note. Dashed lines represent non-significant paths; PCLC = PTSD symptoms; DES = dissociative tendencies; AUDIT = total problematic drinking score; MCS = socially desirable responding patterns; SES = sexual victimization after 18; $^{\dagger}p < .10$, $^{*}p < .05$, $^{**}p < .01$, $^{***}p < .001$.

Summary of findings for models examining emotion regulation and dissociative tendencies as intermediary factors

Overall, results for the mediation models in the full sample using the primary, five-item CASA measure were consistent after examining emotion regulation difficulties and dissociative tendencies, separately. In each of the full sample models, gender positively related to CASA such that women had higher mean values of CASA compared to men as CASA exposure increased. Holding gender constant, as CASA exposure increased, PTSD symptoms increased. As PTSD symptoms increased, dissociative tendencies or emotion regulation difficulties increased, and further, as dissociative tendencies or emotion regulation difficulties increased, alcohol consumption increased after controlling for the significant effect of social desirability on drinking. For both full sample models, PTSD symptoms did not significantly relate to alcohol consumption, precluding mediation by emotion regulation or dissociative tendencies. However, findings highlight a pattern that suggests emotion regulation difficulties and dissociative tendencies are intermediary variables from CASA exposure and PTSD symptoms to alcohol consumption. Unique to the emotion regulation difficulties model, as CASA exposure increased, emotion regulation difficulties increased, holding PTSD symptoms constant.

Given the somewhat low endorsement of CASA using the most conservative, five-item subscale, results were replicated with the less conservative, six-item measure. The pattern of significant pathways using the six-item scale was identical to the pattern using the five-item scale for the emotion regulation and dissociative tendencies models. To explore the potential impact of CASA exposure as a zero-inflated variable (i.e., the

majority of responses equal to 0), results were again replicated using a binary CASA variable with students' overall endorsement of CASA exposure divided into "yes" or "no" categories. The pattern of significant pathways was once again replicated for emotion regulation difficulties and dissociative tendencies with two exceptions. The binary CASA variable was not significantly related to emotion regulation difficulties ($p = .112$). Second, gender did not significantly relate to CASA exposure in either model, rather there was a positive trend such that women tended to have higher mean values of CASA compared to men as CASA exposure increased. While CASA was examined as a binary variable to explore the potential impact of zero-inflatedness when used as a continuous variable, power is limited due to the low number of individuals endorsing CASA ($n = 13$) compared to the number not endorsing CASA. For example, the effect between gender and CASA in the full sample models was $r = .135$, attaining less than 60% power and leaving a greater than 40% risk of Type II error (Cohen, 1988; Friedman, 1982).

Last, to explore potential differences between men and women, models for emotion regulation difficulties and dissociative tendencies were built for men and women, separately, using the five-item CASA measure. For men, both models were identical in their pattern of significant paths. As CASA exposure increased, PTSD symptoms increased, and in turn, as PTSD symptoms increased, emotion regulation difficulties or dissociative tendencies increased. As emotion regulation difficulties or dissociative tendencies increased, alcohol consumption was expected to increase, after accounting for the significant effect of socially desirable responding on drinking behavior. PTSD symptoms did not significantly relate to alcohol use, precluding

mediation, although again highlighting emotion regulation difficulties and dissociative tendencies as intermediary variables for men. These results are identical to the pattern of findings in the full sample with one exception. CASA exposure did not significantly relate to emotion regulation difficulties for men, unlike its significant path in the full sample model.

For women, socially desirable responding and victimization after 18 were controlled, given each variable's significant, bivariate relationship with alcohol consumption. In the emotion regulation difficulties and dissociative tendencies models, as CASA exposure increased, PTSD symptoms increased, and in turn, as PTSD symptoms increased, emotion regulation difficulties or dissociative tendencies increased. However, unlike the full sample models, neither emotion regulation difficulties nor dissociative tendencies significantly related to alcohol consumption. Dissociative tendencies and alcohol consumption showed a positive trend ($p = .070$). As dissociative tendencies increased, alcohol consumption tended to increase, after controlling for sexual victimization after 18, which was highlighted in a second pathway to alcohol use. As CASA exposure increased, sexual victimization after 18 increased, and in turn, alcohol consumption increased.

It should be emphasized that the results for the men and women's models are exploratory and tentative, given power limitations with the reduced sample size once men ($n = 135$) and women ($n = 78$) were examined individually. For example, in the women's models predicting alcohol consumption, *post-hoc* effects for the full models (which were retained given that the hypothesized models did not fit the data as well) were $r = .242$ for the emotion regulation difficulties model and $r = .267$ for the dissociative tendencies

model. With the reduced sample size ($n = 78$), power can be estimated at less than 60%, leaving a greater than 40% risk of Type II error or missing an effect (Cohen, 1988; Friedman, 1982).

Aim 3c: As a secondary perspective, the final aim will examine the potential for the proposed vulnerabilities to act as moderating factors in the relation between CASA exposure severity and psychopathology, including PTSD symptoms and alcohol consumption.

The final subsection of Aim 3 (Aim 3c) was designed to test the potential for emotion regulation difficulties and dissociative tendencies to act as moderating factors in the relation between CASA exposure severity and psychopathology, including PTSD symptoms and alcohol consumption. The organization of results is similar to the models examining the variables as mediating factors. First, the path analysis for emotion regulation difficulties was constructed within the full sample using the primary, five-item CASA variable. Next, results of the model using the full sample were replicated using the less conservative, six-item CASA variable and the binary CASA variable. All models were illustrated in figures, and interactions were graphed when appropriate. To examine potential differences between men and women, the emotion regulation difficulties model was constructed in men and women, separately. Each model exploring gender differences used the primary, five-item model and is outlined in a figure.

Models examining dissociative tendencies, the second proposed moderator, follow the emotion regulation models and were constructed in the same order. First, the primary, five-item model was constructed within the full sample and is shown in a figure. The model was replicated with the six-item and binary CASA measures, each of which is

shown in an additional figure. Last, the model examining dissociative tendencies as a proposed moderator was constructed in men and women, separately, to explore potential gender differences. The model for each gender is described and shown in a figure. Interactions were graphed when appropriate.

Path models for emotion regulation difficulties as a proposed moderator

A path model was constructed to test the proposed model in Figure 4, which examined the potential for emotion regulation difficulties to moderate the relations between CASA and PTSD symptoms as well as CASA and alcohol use such that CASA exposure severity will positively relate to greater psychopathology including problematic alcohol consumption when emotion regulation difficulties are high. The same covariates as those used in the mediation models were included in the moderation models. Gender and socially desirable responding were incorporated in the full sample models. For models that explored moderation between genders, socially desirable responding was maintained as a covariate, and sexual victimization after 18 was included in the women's model.

Results examining the moderating potential for emotion regulation difficulties using the most conservative, five-item CASA measure are shown in Figure 4.1. Findings indicated that the hypothesized model (Fit = .468) fit the data as well as the full model (Fit = .484). The null hypothesis (that the models would work equally well) was supported, and the hypothesized model was retained, $Q = .97$, $W = 6.031$, $p > .05$. Similar to the mediation models, gender significantly related to CASA severity. The direct effects of CASA exposure severity and emotion regulation difficulties were significant on PTSD symptoms and alcohol consumption, after controlling for the impact of socially desirable

responding as well as the interaction on drinking. Effects for both were positive such that as CASA exposure severity and emotion regulation difficulties increased, PTSD symptoms and alcohol consumption increased.

Figure 4.1

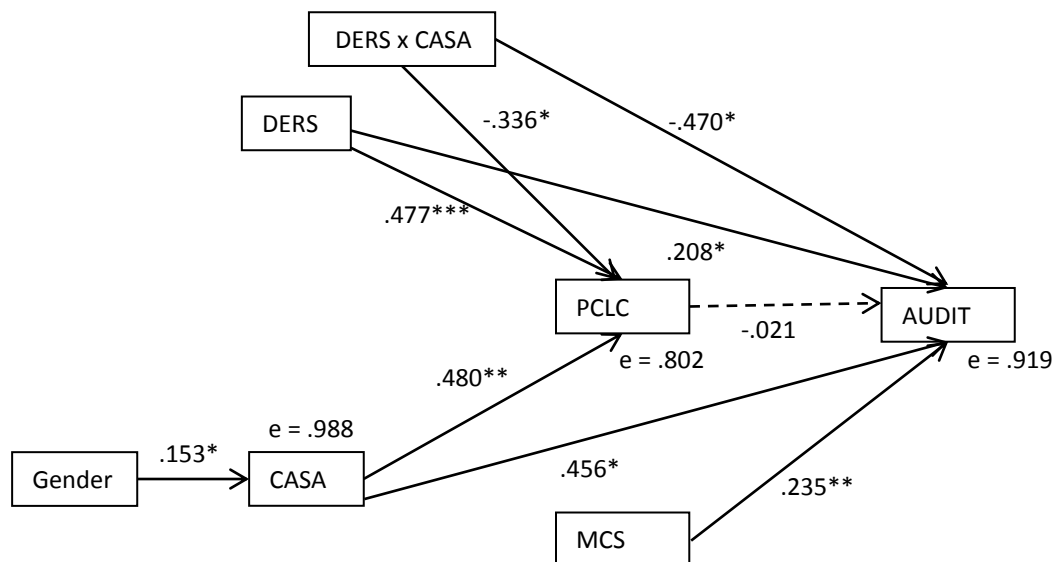
Emotion Regulation Difficulties Moderation Model

Note. Dashed lines represent non-significant paths; DERS = emotion regulation difficulties; PCLC = PTSD symptoms; AUDIT = total problematic drinking score; MCS = socially desirable responding patterns; $*p < .05$, $**p < .01$, $***p < .001$.

Additionally, the interaction term testing emotion regulation difficulties as a moderator was significant for PTSD symptoms and alcohol use although in an unexpected, negative direction. To determine the specific pattern of each interaction, the relationship between the outcome variable (i.e., PTSD symptoms or alcohol consumption) and CASA exposure (as a continuous variable along the x-axis) was plotted on lines representing the mean and one standard deviation above and below the mean of emotion regulation difficulties. Results for PTSD symptoms are shown in Figure 4.1.1. For individuals who did not endorse CASA exposure although reported greater emotion regulation difficulties, PTSD symptoms were greater compared to students who did not report CASA and endorsed average levels of emotion regulation difficulties or lower levels of emotion regulation difficulties. As severity of CASA increased, the exacerbating effect of emotion regulation difficulties lessened such that PTSD symptoms increased across all levels of emotion regulation difficulties. However, as CASA severity increased, PTSD symptoms were actually the lowest when emotion regulation difficulties were high. In contrast, as CASA severity increased, PTSD symptoms were highest for students reporting low levels of emotion regulation difficulties.

Figure 4.1.1

The Relationship between CASA Exposure and PTSD Symptoms for Different Levels of Emotion Regulation Difficulties

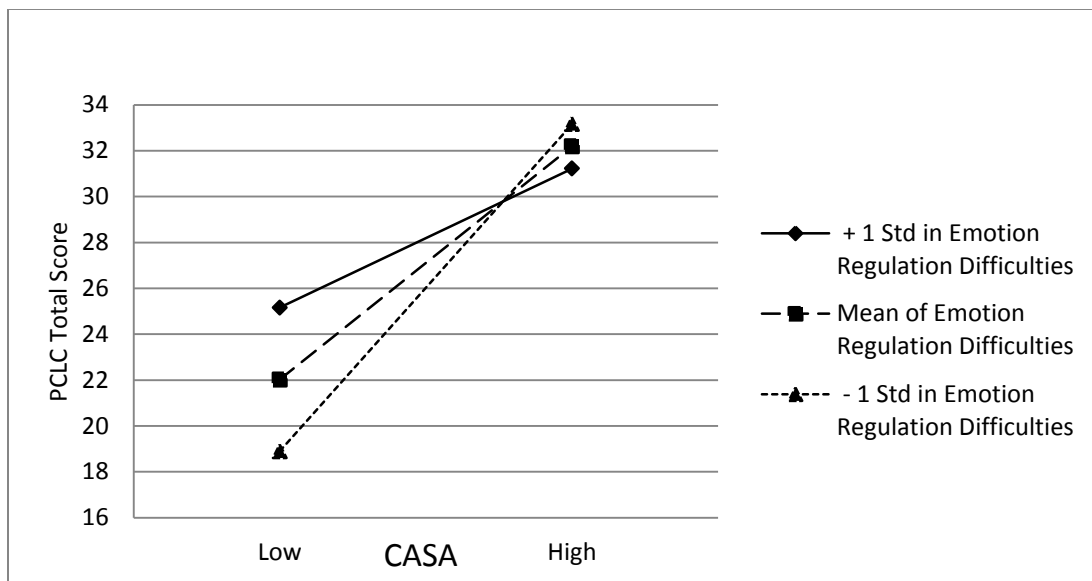

The pattern for alcohol consumption shown in Figure 4.1.2 was consistent with that of PTSD symptoms. For individuals without a history of CASA, alcohol consumption was greater for those with greater emotion regulation difficulties compared to those who endorsed average or below average levels of emotion regulation difficulties. As severity of CASA increased, the exacerbating effect of emotion regulation difficulties lessened such that alcohol consumption increased across all levels of emotion regulation difficulties. However, as CASA severity increased, alcohol consumption was actually the lowest when emotion regulation difficulties were high. In contrast, as CASA severity increased, alcohol consumption was the highest for students reporting low levels of emotion regulation difficulties.

Figure 4.1.2

The Relationship between CASA Exposure and Alcohol Consumption for Different Levels of Emotion Regulation Difficulties

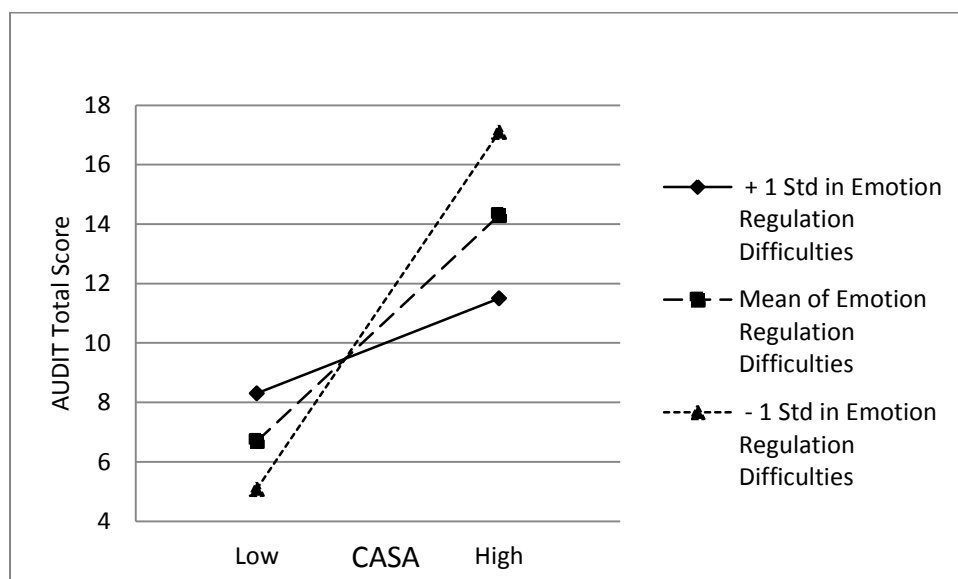

When the path analysis model was replicated using the less conservative, six-item variable, the hypothesized model (Fit = .476) fit the data as well as the full model (Fit = .487), and accordingly, the hypothesized model was retained, $Q = .978$, $W = 4.346$, $p > .05$. Results are shown in Figure 4.2. The pattern of significant paths is identical to the previous model using the five-item CASA measure with one exception. The direct effect of CASA on alcohol consumption evidenced a trend toward significance ($p = .066$).

Again, replicating the model with the binary CASA measure, the hypothesized model (Fit = .469) fit the data as well as the full model (Fit = .487). The hypothesized model was retained, $Q = .966$, $W = 6.849$, $p > .05$, and is shown in Figure 4.3. The pattern of significant pathways is consistent with the primary, five-item model and the six-item model. Similar to the six-item model, the direct effect of CASA on alcohol consumption evidenced a trend toward significance ($p = .059$), and unique to the binary model, the relations between gender and CASA also evidenced a trend toward significance ($p = .058$). All other paths including the interaction terms were consistent with the primary, five-item model. Because the patterns of the interactions for the six-item and binary CASA variables were consistent with the model using the five-item CASA measure, additional figures are not shown. Please refer back to Figures 4.1.1 and 4.1.2 for the interaction patterns.

Figure 4.2

Emotion Regulation Difficulties Moderation Model: Replication with Six-Item CASA Measure

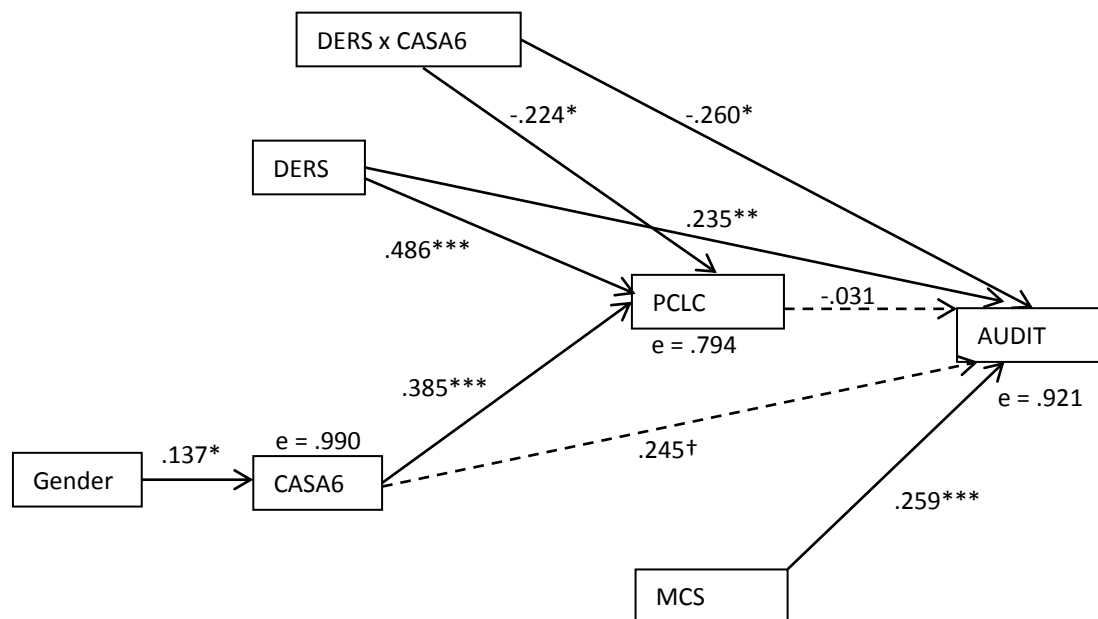

Note. Dashed lines represent non-significant paths; CASA6 = six-item CASA measure; DERS = emotion regulation difficulties; PCLC = PTSD symptoms, AUDIT = total problematic drinking score; MCS = socially desirable responding patterns; † $p < .10$, * $p < .05$, ** $p < .01$, *** $p < .001$.

Figure 4.3

Emotion Regulation Difficulties Moderation Model: Replication with the Binary CASA Measure

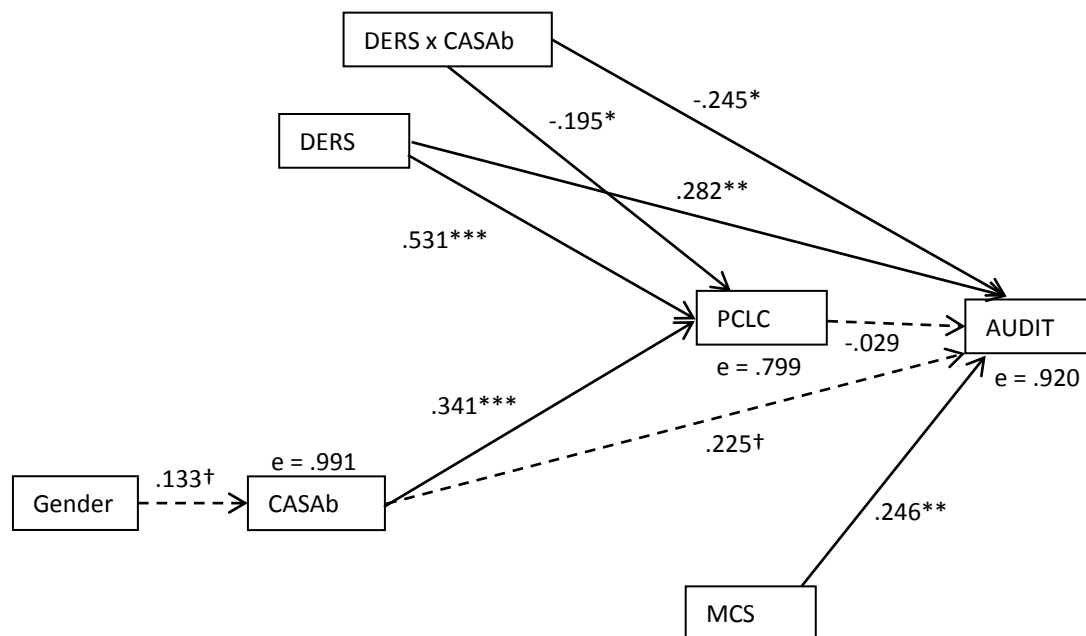

Note. Dashed lines represent non-significant paths; CASAb = binary CASA measure; DERS = emotion regulation difficulties; PCLC = PTSD symptoms; AUDIT = total problematic drinking score; MCS = socially desirable responding patterns; $^\dagger p < .10$, $*p < .05$, $**p < .01$, $***p < .001$.

Exploratory analyses were conducted to examine potential differences in the moderating effect of emotion regulation difficulties on the relations between CASA severity and PTSD symptoms as well as CASA severity and alcohol consumption in men and women, separately. The effect of socially desirable responding on alcohol consumption was controlled in both models, and the effect of sexual victimization after 18 was controlled in the women's model. First, results for the men's model are shown in Figure 4.4. The hypothesized model (Fit = .454) fit the data as well as the full model (Fit = .453), which tested all possible paths. Accordingly, the hypothesized model was retained, $Q = 1.002$, $W = .2653$, $p > .05$. Consistent with the model constructed in the full sample (refer back to Figure 4.1), there was a direct, positive effect of emotion regulation difficulties on PTSD symptoms and alcohol consumption, after controlling for the effect of socially desirable responding on drinking. Inconsistent with the original model in the full sample, the interaction between CASA and emotion regulation difficulties on PTSD symptoms was not significant. The relations between the interaction and alcohol consumption was significant at a trend level ($p = .079$) and in the same direction as the full sample model. The direct effect of CASA on PTSD symptoms was significant at a trend level ($p = .064$), and CASA was not significantly related to alcohol consumption.

Figure 4.4

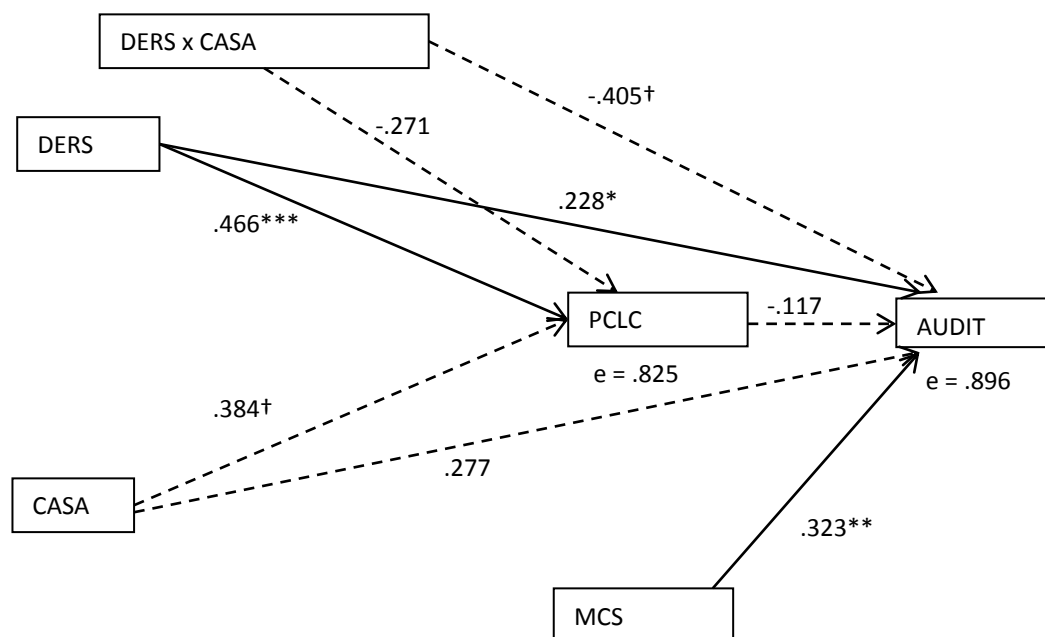
Emotion Regulation Difficulties Moderation Model for Men

Note. Dashed lines represent non-significant paths; DERS = emotion regulation difficulties; PCLC = PTSD symptoms; AUDIT = total problematic drinking score; MCS = socially desirable responding patterns; $^{\dagger}p < .10$, $^*p < .05$, $^{**}p < .01$, $^{***}p < .001$.

Results for the women's model are shown in Figure 4.5. The hypothesized model (Fit = .557) fit the data as well as full model (Fit = .624), so the hypothesized model was retained, $Q = .849$, $W = 11.002$, $p > .05$. The model, however, was comprised of primarily non-significant paths unlike the original model completed in the full sample. Within the women's model, there was a direct effect of emotion regulation difficulties and CASA exposure on PTSD symptoms. Sexual victimization after 18 significantly related to greater alcohol use. While the interaction term was significantly (and negatively) related to PTSD symptoms at a trend level ($p = .056$), the interaction term did not significantly relate to alcohol consumption. There were no direct effects for emotion regulation difficulties, PTSD symptoms, or CASA exposure on alcohol consumption.

Figure 4.5

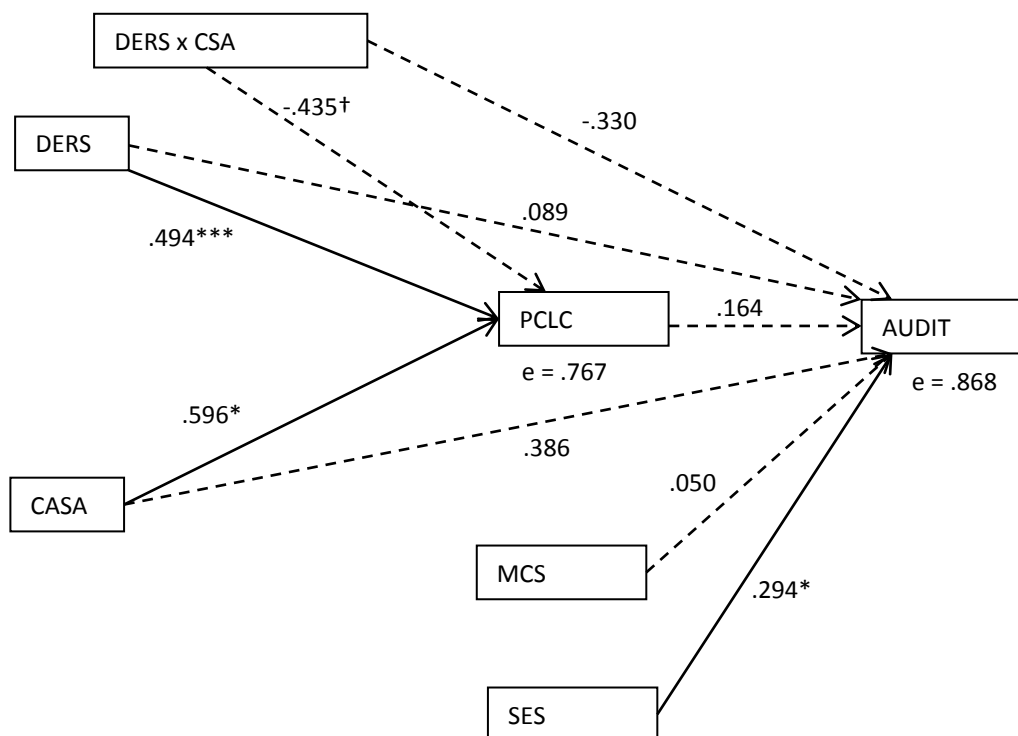
Emotion Regulation Difficulties Moderation Model for Women

Note. Dashed lines represent non-significant paths; DERS = emotion regulation difficulties; PCLC = PTSD symptoms; AUDIT = total problematic drinking score; MCS = socially desirable responding patterns; SES = sexual victimization after 18; † $p < .10$, * $p < .05$, ** $p < .01$, *** $p < .001$.

Path models for dissociative tendencies as a proposed moderator

Similar to the moderation models examining emotion regulation difficulties, path models were constructed to investigate the potential for dissociative tendencies to moderate the relations between CASA exposure severity and PTSD symptoms as well as CASA exposure severity and alcohol consumption. This secondary perspective was designed to test the hypothesis that CASA exposure severity will positively relate to greater psychopathology including alcohol consumption when dissociative abilities are high (albeit at non-clinical levels). Results for the primary model using the five-item CASA measure are shown in Figure 6.1. The hypothesized model (Fit = .445) fit the data as well as the full model (Fit = .423), which tests all possible paths. Accordingly, the null hypothesis (that the two models would be statistically equivalent) was supported, and the hypothesized model was retained, $Q = 1.024$, $W = -4.665$, $p > .05$. The pattern of significant pathways indicated that gender significantly related to CASA exposure. There was a direct effect of CASA exposure and dissociative tendencies on PTSD symptoms, and dissociative tendencies positively related to alcohol consumption, after controlling for socially desirable responding patterns. No other significant pathways emerged including the interaction term representing the moderating potential of dissociative tendencies on PTSD symptoms or alcohol consumption.

Figure 6.1

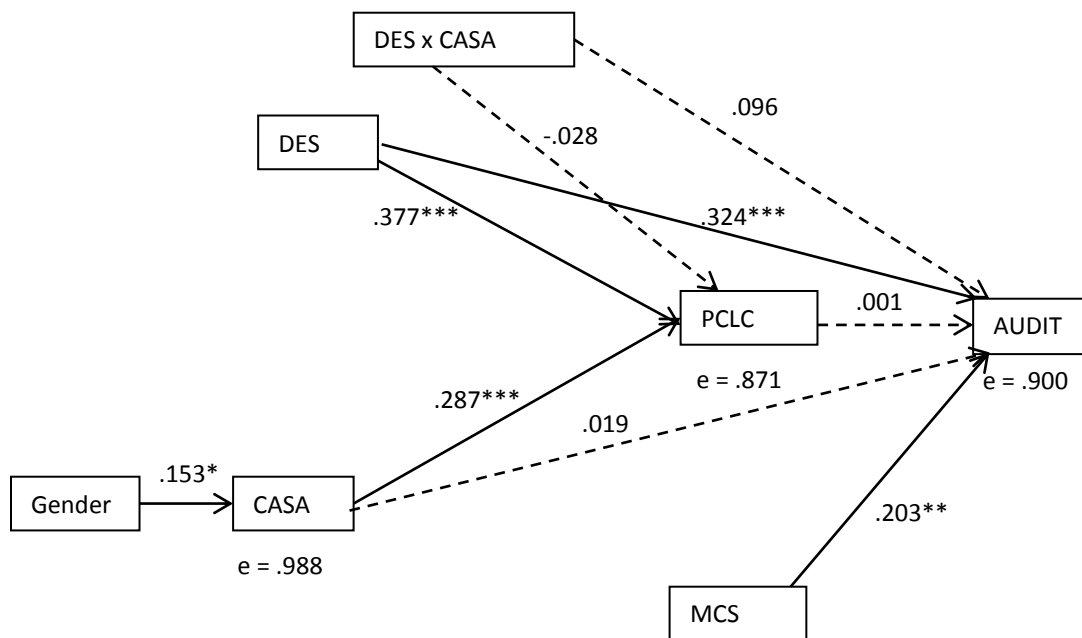
Dissociative Tendencies Moderation Model

Note. Dashed lines represent non-significant paths; DES = dissociative tendencies; PCLC = PTSD symptoms; AUDIT = total problematic drinking score; MCS = socially desirable responding patterns; * $p < .05$, ** $p < .01$, *** $p < .001$.

The replicated results using the less conservative, six-item CASA measure are shown in Figure 6.2. The hypothesized model (Fit = .400) fit the data as well as the full model (Fit = .427), and therefore, the hypothesized model was retained, $Q = .954$, $W = 9.354$, $p > .05$. The pattern of significant and non-significant pathways was identical to the model using the five-item CASA measure. The replicated results using the binary CASA variable are shown in Figure 6.3. The hypothesized model (Fit = .392) fit the data as well as the full model (Fit = .429), and so the hypothesized model was retained, $Q = .938$, $W = 12.722$, $p > .05$. The pattern of significant and non-significant pathways was identical to the five- and six-item models with one exception. The relations between gender and CASA exposure were significant at only a trend level ($p = .058$). All other pathways were consistent with the primary, five-item model.

Figure 6.2

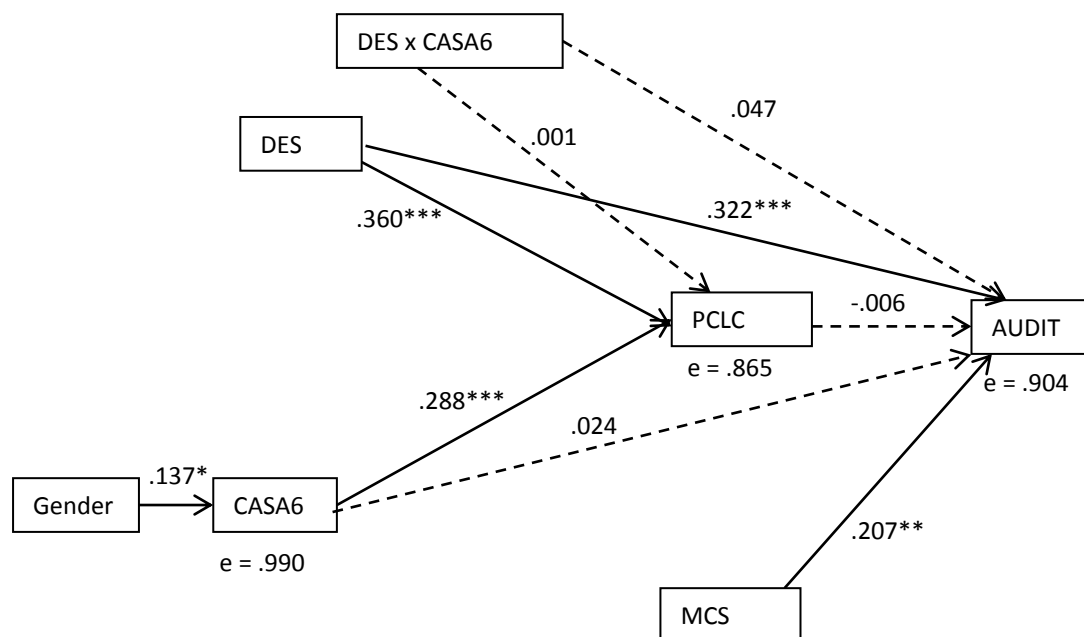
Dissociative Tendencies Moderation Model: Replication with Six-Item CASA Measure

Note. Dashed lines represent non-significant paths; CASA6 = six-item CASA measure; DES = dissociative tendencies; PCLC = PTSD symptoms; AUDIT = total problematic drinking score; MCS = socially desirable responding patterns; * $p < .05$, ** $p < .01$, *** $p < .001$.

Figure 6.3

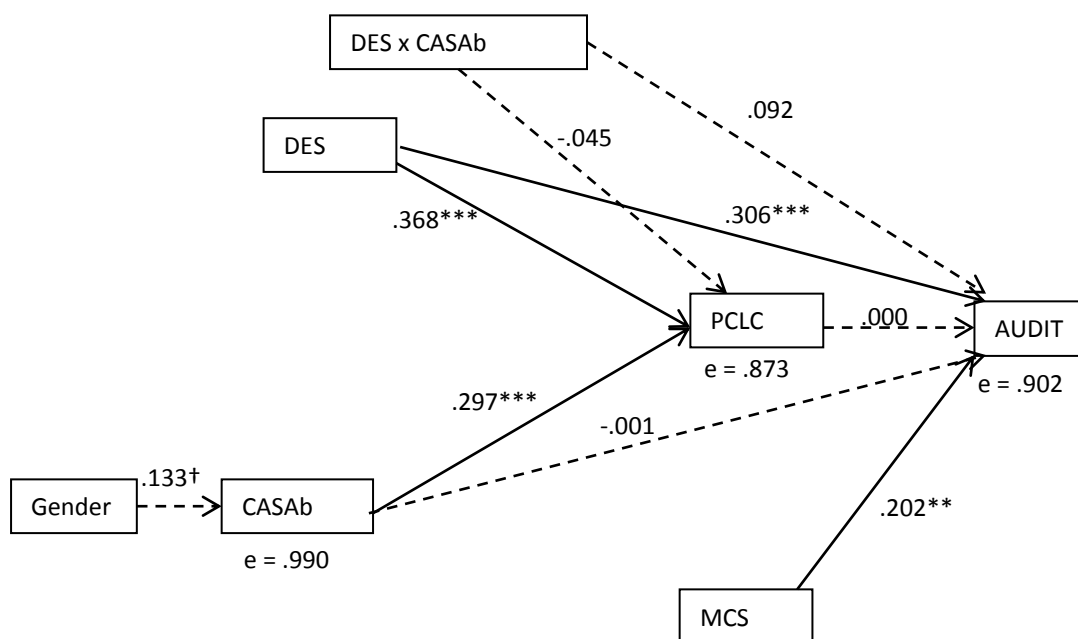
Dissociative Tendencies Moderation Model: Replication with the Binary CASA Measure

Note. Dashed lines represent non-significant paths; CASAb = binary CASA measure; DES = dissociative tendencies; PCLC = PTSD symptoms; AUDIT = total problematic drinking score; MCS = socially desirable responding patterns; $^{\dagger}p < .1$; $*p < .05$, $**p < .01$, $***p < .001$.

The model tested in the full sample examining the moderation potential of dissociative tendencies was constructed for men and women, separately, to explore potential gender differences. The effect of socially desirable responding on alcohol consumption was controlled in both models, and the effect of sexual victimization after 18 was controlled in the women's model. The model for men is shown in Figure 6.4. The hypothesized model (Fit = .365) did not fit the data as well as the full model (Fit = .426), so the null hypothesis (that the two models are statistically equivalent) was rejected, and the full model was retained, $Q = .904$, $W = 12.515$, $p < .01$. Similar to the models constructed in the full sample, CASA exposure severity and dissociative tendencies had a direct effect on PTSD symptoms, and dissociative tendencies positively related to alcohol consumption after controlling for the significant impact of socially desirable responding. Unexpectedly and unlike the full model, dissociative tendencies and CASA exposure along with their interaction term significantly related to socially desirable responding patterns.

Figure 6.4

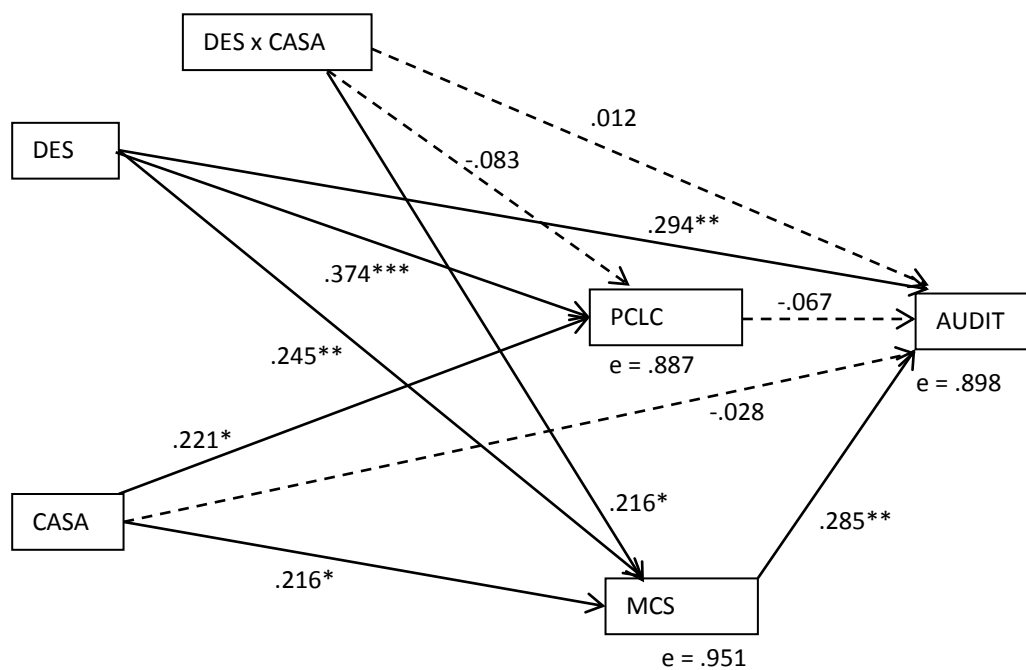
Dissociative Tendencies Moderation Model for Men

Note. Dashed lines represent non-significant paths; DES = dissociative tendencies; PCLC = PTSD symptoms; AUDIT = total problematic drinking score; MCS = socially desirable responding patterns; † $p < .10$, * $p < .05$, ** $p < .01$, *** $p < .001$.

To determine the pattern of the interaction, it was graphed and is shown in Figure 6.4.1. Results indicated that for men who did not report CASA exposure although endorsed high levels of dissociative tendencies, socially desirable responding was greater than others not endorsing CASA and reporting mean levels of dissociative tendencies. In turn, men without CASA exposure and mean levels of dissociative tendencies reported greater socially desirable responding compared to men without CASA and low levels of dissociative tendencies. As severity of CASA increased, socially desirable responding increased regardless of dissociative tendencies; however, socially desirable responding increased at a faster rate for men reporting greater CASA severity and high levels of dissociative tendencies compared to men reporting greater CASA severity and mean levels of dissociative tendencies. In turn, socially desirable responding increased at a faster rate for men reporting greater CASA severity and mean levels of dissociative tendencies compared to men reporting greater CASA severity and low levels of dissociative tendencies.

Figure 6.4.1

The Relationship between CASA Exposure and Socially Desirable Reporting for Different Levels of Dissociative Tendencies for Men

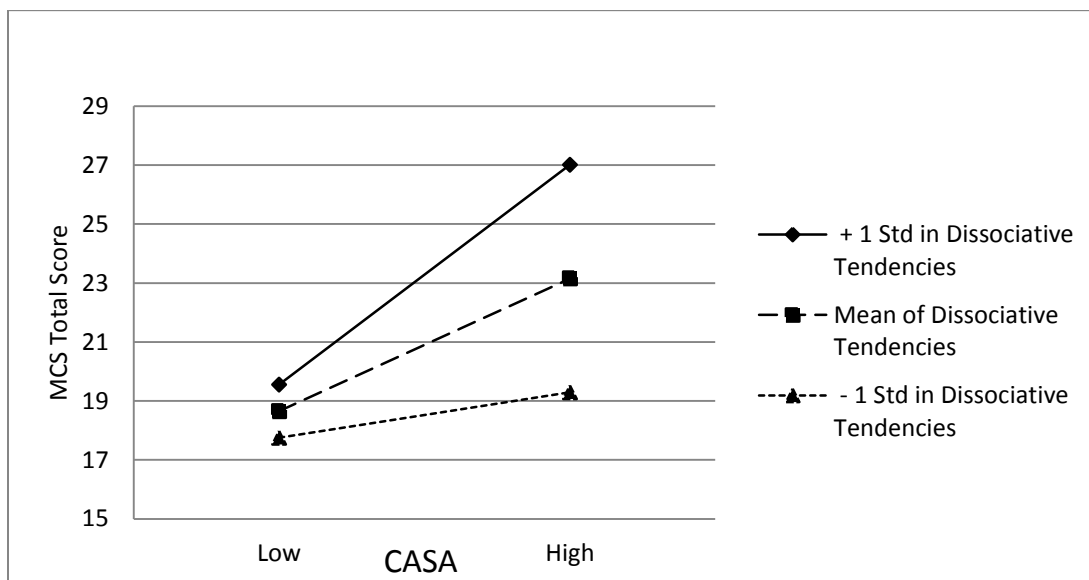

The women's results are shown in Figure 6.5. Similar to the men's model, the full model (Fit = .654) fit the data significantly better than the hypothesized model (Fit = .532), and accordingly, the null hypothesis was rejected, and the full model was retained, $Q = .739$, $W = 20.240$, $p < .01$. The pattern of significant pathways showed that there was a direct effect of dissociative tendencies on PTSD symptoms and sexual victimization after 18. While sexual victimization after 18 significantly related to greater alcohol use, there was a trend ($p = .058$) for dissociative tendencies to relate to alcohol consumption. Last, the interaction between dissociation and CASA was significantly related to PTSD symptoms.

Figure 6.5

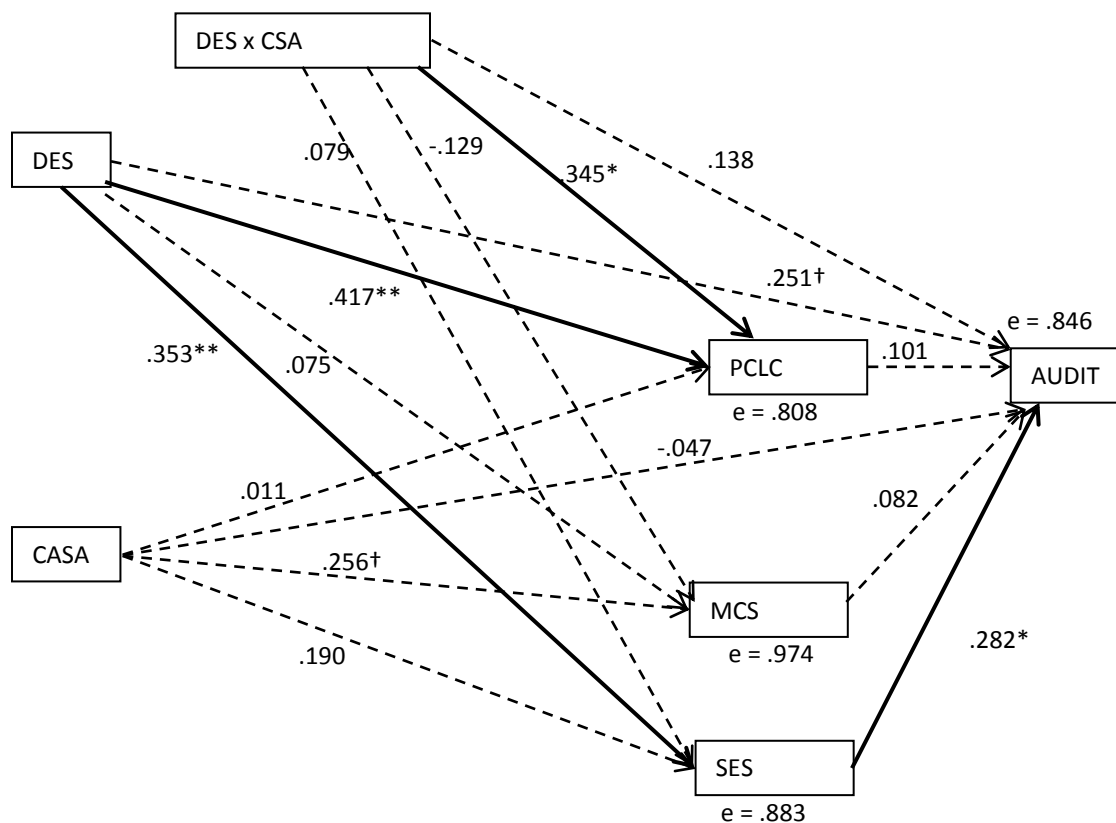
Dissociative Tendencies Moderation Model for Women

Note. Dashed lines represent non-significant paths; DES = dissociative tendencies; PCLC = PTSD symptoms; AUDIT = total problematic drinking score; MCS = socially desirable responding patterns; SES = sexual victimization after 18; † $p < .10$, * $p < .05$, ** $p < .01$, *** $p < .001$.

The pattern of the interaction is shown in Figure 6.5.1. For women not endorsing CASA exposure although with greater levels of dissociative tendencies, PTSD symptoms were greater compared to women not endorsing CASA with mean levels of dissociative tendencies. In turn, for those without CASA exposure, women with the mean level of dissociative tendencies reported greater PTSD symptoms compared to women with lower levels of dissociative tendencies. As CASA severity increased, women with low levels of dissociative tendencies reported significantly reduced PTSD symptoms. However, as CASA severity increased, women with mean levels of dissociative tendencies reported slightly increased PTSD symptoms, and women with high levels of dissociative tendencies reported the greatest increase in PTSD symptoms.

Figure 6.5.1

The Relationship between CASA Exposure and PTSD Symptoms for Different Levels of Dissociative Tendencies for Women

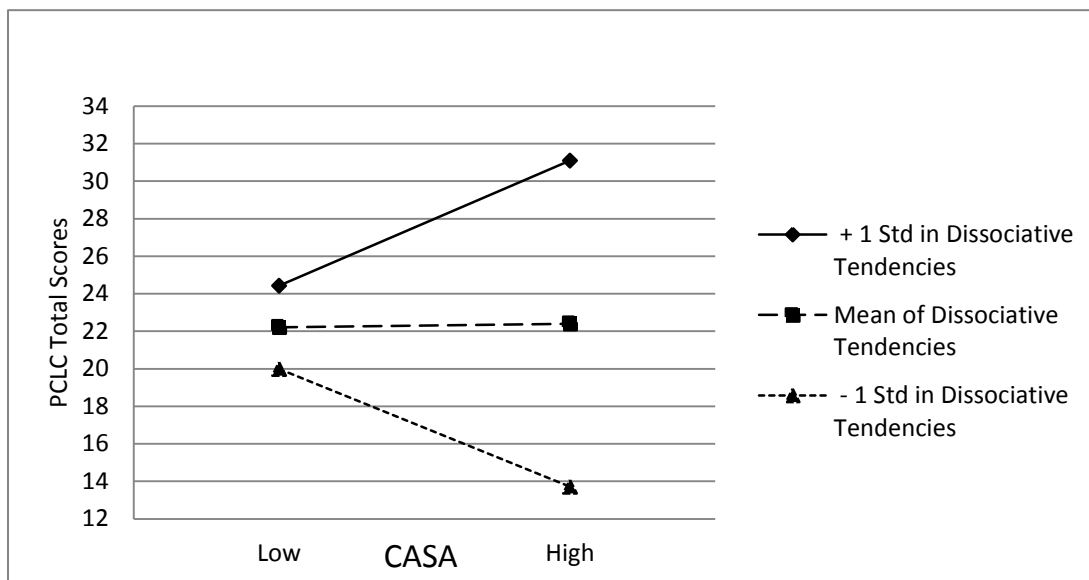

Summary of findings for models examining emotion regulation and dissociative tendencies as proposed moderators

Overall, results for the full sample using the primary, five-item CASA measure evidenced some similarities as well as some notable differences between the emotion regulation difficulties model (Figure 4.1) and the dissociative tendencies model (Figure 6.1). First, the models were similar in that gender positively related to CASA such that women had higher mean values of CASA compared to men as CASA severity increased. CASA exposure severity had a direct, positive effect on PTSD symptoms for both models. As CASA exposure severity increased, PTSD symptoms increased, holding emotion regulation difficulties constant. Similarly, as CASA exposure severity increased, PTSD symptoms increased, holding dissociative tendencies constant. Additionally, the proposed moderator variable for each model had a significant positive relationship on PTSD symptoms and alcohol consumption. As emotion regulation difficulties increased, PTSD symptoms increased, holding CASA exposure and gender constant. As emotion regulation difficulties increased, alcohol consumption increased, holding all other variables constant including the impact of socially desirable responding on drinking. Similarly, as dissociative tendencies increased, PTSD symptoms increased, holding CASA exposure and gender constant. As dissociative tendencies increased, alcohol consumption increased, holding all other variables constant including the impact of socially desirable responding on drinking. PTSD symptoms did not relate to alcohol consumption in either model. Despite these similarities between the emotion regulation difficulties and dissociative tendencies models, notable differences existed.

For the emotion regulation difficulties model, CASA exposure severity was significantly related to problematic drinking, after holding all other variables in the model constant. CASA exposure severity did not have a direct impact on problematic drinking in the dissociative tendencies model. Arguably, however, the most notable difference between models was the significant moderating effect of emotion regulation difficulties on the relations between CASA exposure and PTSD symptoms as well as CASA exposure and alcohol consumption. For both PTSD symptoms and alcohol consumption, the pattern of the interaction was consistent and contrary to the current hypotheses. Regardless of level of emotion regulation difficulties, PTSD symptoms and alcohol consumption increased as CASA exposure severity increased. However, as CASA severity increased, PTSD symptoms and alcohol consumption increased at the slowest rate for students reporting high levels of emotion regulation difficulties. In contrast, PTSD symptoms and alcohol consumption increased at the fastest rate for students reporting low levels of emotion regulation difficulties. Dissociative tendencies did not evidence a moderating effect on the relations between CASA and PTSD symptoms or CASA and alcohol consumption, as the interaction term failed to reach significance.

The replication of the emotion regulation difficulties and dissociative tendencies models using the six-item CASA variable and binary CASA variable were consistent with each proposed moderator's primary model (using the five-item CASA variable) with two exceptions. For the emotion regulation difficulties model replication, CASA exposure (using the six-item and binary variables) evidenced a trend toward significance with alcohol consumption compared to the significant relations between CASA and alcohol consumption in the five-item model. Similar to the mediation findings, gender

failed to predict the binary CASA variable for both models. Notably, it is worth reiterating that while CASA was examined as a binary variable to explore the potential impact of zero-inflatedness, power for the dichotomized term is limited due to the relatively low frequency of individuals endorsing CASA (6.5% of the overall sample). For example, the *post-hoc* effect between gender and the binary CASA variable was $r = .135$, indicating that less than 60% power was attained, leaving a greater than 40% risk of Type II error (Cohen, 1988; Friedman, 1983).

To explore the potential for gender differences, the emotion regulation difficulties and dissociative tendencies models were replicated in men and women, separately. For men, there was one, main consistency when findings were compared across the emotion regulation difficulties and dissociative tendencies models. The proposed moderator had a direct, positive effect on PTSD symptoms and alcohol consumption, after controlling for the significant effect of socially desirable responding patterns on drinking. As emotion regulation difficulties or dissociative tendencies increased, PTSD symptoms and alcohol consumption increased.

Comparing between the full sample models and men's models for emotion regulation difficulties and dissociative tendencies, the men's models were somewhat different than the full sample models. For the emotion regulation difficulties men's model, CASA exposure severity did not have a significant effect on PTSD symptoms or alcohol consumption. Instead, the relation between CASA severity and PTSD symptoms was significant at a trend level. For the men's emotion regulation difficulties model, the moderating potential of emotion regulation difficulties (indicated by the interaction term) was not significant for PTSD symptoms or alcohol consumption; rather, showed a trend

level of significance on alcohol consumption in the same direction as the full sample. In contrast, for the men's dissociative tendencies model, the model was consistent with the full sample dissociative tendencies model except for the unanticipated significant effect on socially desirable responding. There was a direct, positive relationship between CASA and social desirability as well as dissociative tendencies and social desirability.

Additionally, the interaction between dissociation and CASA was significant such that as CASA exposure severity increased, socially desirable responding increased. However, for individuals with high levels of dissociative tendencies, socially desirable responding increased at a faster rate compared to students with mean levels of dissociative tendencies. In turn, for students with mean levels of dissociative tendencies, socially desirable responding increased at a faster rate compared to those reporting low levels of dissociative tendencies.

For women, there were limited consistencies when findings were compared across the emotion regulation difficulties and dissociative tendencies models. In both models, the proposed moderating variable had a significant direct effect on PTSD symptoms such that as emotion regulation difficulties and dissociative tendencies increased, PTSD symptoms increased holding CASA exposure severity constant. In both models, sexual victimization after 18 was significantly related to greater alcohol consumption such that as alcohol consumption increased, women who endorsed sexual victimization evidenced higher mean drinking scores compared to women who did not endorse sexual victimization.

There were also few consistencies comparing between the full sample models and women's models for emotion regulation difficulties and dissociative tendencies,

respectively. First, for the emotion regulation difficulties women's model, there were a limited number of significant pathways compared to the full sample model. CASA exposure and emotion regulation difficulties each had a positive relationship with PTSD symptoms. As CASA exposure severity or emotion regulation difficulties increased, PTSD symptoms increased, holding the other variable constant. Other than the significant relations between sexual victimization after 18 and alcohol consumption, no other pathways were significant. For the dissociative tendencies model in women, dissociative tendencies had a significant positive effect on PTSD symptoms, and sexual victimization had a significant positive effect on alcohol consumption, consistent with the full sample model. Inconsistent with the full sample model, dissociative tendencies positively related to sexual victimization such that there were higher average dissociative scores for victimized compared to non-victimized women. Last, the interaction between dissociative tendencies and CASA exposure was significantly related to PTSD symptoms in women. Low dissociative tendencies buffered the relations between CASA exposure severity and PTSD symptoms such that as CASA severity increased, women with low levels of dissociative tendencies reported significantly reduced PTSD symptoms. However, as CASA severity increased, women with mean levels of dissociative tendencies reported slightly increased PTSD symptoms while women with high levels of dissociative tendencies reported a greater rate in the increase of PTSD symptoms.

Similar to the mediation models, the exploratory results for men and women should be approached with caution, given power limitations with the reduced sample size once men ($n = 135$) and women ($n = 78$) were examined individually. For the men's exploratory models, *post-hoc* effect sizes on alcohol consumption ranged from $r = .214$ to

.216 for the emotion regulation difficulties model and dissociative tendencies model, respectively. With the reduced sample size, power can be estimated at less than 60%. For women's exploratory models, *post-hoc* effect sizes on alcohol use ranged from $r = .227$ to $.249$, dropping power estimates to as low as 40% for the emotion regulation difficulties model, and increasing risk for Type II error to 60% (Cohen, 1988; Friedman, 1982).

Overall summary of path analysis results examining the diathesis-stress perspective

Several key findings were evident across mediation and moderation models examining the diathesis-stress perspective and using the primary, five-item CASA variable. Gender consistently related to CASA exposure severity such that as CASA exposure increased, women endorsed higher means of CASA exposure compared to men. At no time did PTSD symptoms significantly relate to alcohol consumption, precluding mediation. However, for mediation models completed in the full sample, CASA exposure severity positively related to greater PTSD symptoms, which in turn, related to greater emotion regulation difficulties and dissociative tendencies. Emotion regulation difficulties and dissociative tendencies, separately, related to greater alcohol consumption, after controlling for socially desirable responding patterns. For the models conducted in the full sample, findings indicated that emotion regulation difficulties and dissociative tendencies may indeed act as intermediary factors in the relations between CASA exposure, PTSD symptoms, and problematic alcohol consumption. Notably, results may be less generalizable to women. Although power limitations were present while examining each model in men and women, separately, emotion regulation difficulties were not related to greater alcohol consumption for women, and dissociative

tendencies showed only a trend toward significance. Across women's models, sexual victimization after 18 significantly related to greater alcohol consumption. For women, no other variable significantly related to alcohol consumption (other than a trend toward significance with dissociative tendencies).

In the moderation models, CASA exposure related to greater PTSD symptoms, and emotion regulation difficulties and dissociative tendencies related to greater alcohol consumption, after controlling for the effect of socially desirable responding. These patterns were consistent with mediation findings. Emotion regulation difficulties and dissociative tendencies each related significantly to greater PTSD symptoms. While the inverse was tested in the mediation models, significant reciprocal relations (*not* implying causality or temporality) speak to the interrelated nature of PTSD symptoms and emotion regulation difficulties as well as PTSD symptoms and dissociative tendencies. While dissociative tendencies acted as an intermediary factor in the relations between PTSD symptoms and alcohol use (at the trend level for women), particularly for women, low dissociative tendencies may buffer the relations between CASA exposure and PTSD symptoms. As CASA severity increased, PTSD symptoms decreased for women with low dissociative tendencies. However, as CASA severity increased, PTSD symptoms increased for women with mean levels of dissociative tendencies, and at the fastest rate for women with high dissociative tendencies.

In the full sample mediation model, emotion regulation difficulties were a significant intermediary factor in the relations from CASA severity and PTSD symptoms to alcohol consumption. Emotion regulation difficulties also significantly moderated the relations between CASA exposure and PTSD symptoms as well as CASA exposure and

alcohol consumption in the full sample moderation model. The pattern for each interaction was similar, and the direction of the moderation was contrary to the current hypotheses. Regardless of the level of emotion regulation difficulties, PTSD symptoms and alcohol consumption increased as CASA exposure severity increased. However, as CASA exposure severity increased, PTSD symptoms and alcohol consumption increased at the fastest rate for individuals reporting low (rather than high) levels of emotion regulation difficulties. In contrast, as CASA exposure increased, PTSD symptoms and alcohol consumption increased at the slowest rate for individuals reporting high (rather than low) levels of emotion regulation difficulties.

Last, there was an unanticipated effect on socially desirable responding patterns for men in the dissociative tendencies moderation model. CASA exposure severity and dissociative tendencies positively related to socially desirable responding, individually, and the interaction between dissociative tendencies and CASA positively related to socially desirable responding. The pattern of the interaction indicated that regardless of level of dissociative tendencies socially desirable responding patterns increased as CASA exposure severity increased. However, for individuals with high levels of dissociative tendencies, socially desirable responding increased at a faster rate compared to men with mean levels of dissociative tendencies. In turn, for men with mean levels of dissociative tendencies, socially desirable responding increased at a faster rate compared to those reporting low levels of dissociative tendencies.

Discussion

The current study sought to examine mechanisms that may substantiate the relations between CASA exposure severity and problematic alcohol use in college

students. The first aim examined the relationship between severity of CASA exposure and alcohol use. The second aim investigated the mediating potential of PTSD symptoms on the relationship between CASA exposure severity and alcohol use. Aim three examined psychological vulnerabilities, specifically, emotion regulation difficulties and dissociative tendencies, to problematic alcohol use following CASA exposure and potential PTSD symptom development. Aim three was comprised of three components. The first was to test the predictive utility of CASA exposure severity and PTSD symptoms on emotion regulation difficulties and dissociative tendencies, separately. Next, mediation models were tested to examine the potential for emotion regulation difficulties and dissociative tendencies, individually, to act as intermediary factors in the pathway from CASA exposure and PTSD symptoms to alcohol consumption. As a secondary perspective, moderation models were tested to examine the potential for emotion regulation difficulties and dissociative tendencies, individually, to moderate the relations between CASA exposure severity and PTSD symptoms as well as CASA exposure severity and alcohol consumption. To provide the most thorough investigation of CASA exposure, all models were first investigated using the primary, five-item CASA measure. Models were replicated with the less conservative, six-item CASA measure given relatively low overall endorsement of CASA using the five-item measure, and then replicated with a binary CASA measure to examine potential differences due to zero-inflatedness. Last, mediation and moderation models using the primary CASA measure were explored for men and women, independently.

Participant Characteristics

Demographic characteristics of the current sample were consistent with other studies sampling mandated college students, such that the majority of students were male (Carey, Henson, Carey, & Maisto, 2009; Borsari & Carey, 2005), underclassmen (including freshmen and sophomores), European American, and on average, approximately 19 years old (Carey et al., 2009; Barnett, Murphy, Colby, & Monti, 2007; Borsari & Carey, 2005). Across the full sample, rates of alcohol consumption ($M = 6.88$, $SD = 4.70$) were in the problematic range, below the traditional cut-off of eight (Saunders et al., 1993) although above the more recent discussion of six as an appropriate cut-off value (Kokotailo et al., 2004). Alcohol consumption scores were comparable to other studies examining students mandated to a brief alcohol intervention, all scores within one standard deviation of the current sample's score (Carey et al., 2009; Borsari & Carey, 2005), as well as comparable to scores in non-mandated college samples ($M = 6.37$ to 7.86 ; Goldstein, Flett, & Wekerle, 2010). Notably, while average alcohol consumption was in the hazardous range, there was wide variability in students' drinking patterns with scores ranging from 0 to 21. This is expected given that students do not have to be drinking to be mandated to the brief treatment; rather, being in the presence of alcohol warrants the violation. There were no differences in drinking rates reported between research consenters and non-consenters, men or women.

Overall, 6.3% of the full sample endorsed CASA using the primary five-item scale; 3.8% of men reported CASA exposure compared to 10.5% of women. Using the six-item scale, overall rates increased to 14.5%, including 12.2% of men and 18.4% of women endorsing CASA exposure. Using the less conservative, six-item scale, rates of CASA exposure were consistent with rates reported across additional studies examining

college men (i.e., 13.3%; Ullman & Filipas, 2005) and women (e.g., 16% to 19%; Green et al., 2005; Rosenthal et al., 2005). Rates of CASA using the more conservative five-item scale were consistent with some findings in college men (4.1%; Marx & Sloan, 2003) and women (9% to 12.8%; Marx & Sloan, 2003; Messman-Moore, Brown, & Koelsch, 2005); however, still lower than others examining CASA primarily in college women (e.g., ~ 27% to 28%; Batten et al., 2001; Ullman & Filipas, 2005). The lower rates of CASA exposure using the five-item scale may be due to the number and type of CASA questions included in the ETI-SR-SF. For example, while the primary measure of CASA was composed of five items, others have used a 14-item scale for college men and women (Filipas & Ullman, 2006; Ullman & Filipas, 2005). Additionally, the current measure of CASA did not include items measuring witnessing unwanted events (e.g., witnessing others masturbating) or items clearly acknowledging attempted (although not completed) experiences. In all, the brevity in type and number of items most likely resulted in the lower endorsement of CASA exposure severity. While all full sample models were replicated with the six-item CASA variable to address this issue, women reported more severe CASA compared to men, and there was a trend for more women to report CASA compared to men, consistent with previous research (e.g., Ullman & Filipas, 2005). Also, consistent with prior research, the most frequent item endorsed for men and women was related to fondling (Filipas & Ullman, 2006; Ullman & Filipas, 2005).

Levels of PTSD symptoms in the full sample were consistent with additional studies using the PCL-C in college students, all scores within one standard deviation of the current mean score (Adkins et al. 2008; Ruggiero et al., 2003). Symptoms of PTSD

were also consistent with studies reporting non-clinical, mild to moderate levels of PTSD symptoms in college students (Marx & Sloan, 2003; Ullman & Filipas, 2005) as well as studies showing greater levels of PTSD symptoms in CASA-exposed compared to non-CASA persons (e.g., Messman-Moore et al., 2005; Twaite & Rodriguez-Srednicki, 2004). Scores on emotion regulation difficulties were lower although still within one standard deviation of those previously reported in college students (e.g., Glenn & Klonsky, 2009). Findings that CASA-exposed students reported significantly greater levels of emotion regulation difficulties compared to non-CASA students were consistent with prior research reporting deficits in emotion regulation for students with a history of CASA (e.g., Luterek et al., 2005; Rodriguez-Srednicki, 2001). Overall dissociative tendencies scores in the college sample were low, as expected (Klanecky et al., 2008; Rodriguez-Srednicki, 2001). It should be noted that scores ranged from 0 to 22, indicating that clinically severe levels of dissociation (as evidenced by the general cut-off of 30; Carlson & Putnam, 1993) were absent in the current sample. Consistent with some research, CASA-exposed students reported significantly greater (albeit non-clinical) levels of dissociative tendencies (Aydin et al., 2009; Rodriguez-Srednicki, 2001). Lastly, rate of victimization after 18 was comparable with alternative undergraduate reports (e.g., 37% reported victimization in their first year of college; Testa et al., 2010) as were scores on socially desirable responding (e.g., $M = 17.20$, $SD = 4.98$; Barger, 2002)

Aim 1: The Relationship Between Severity of CASA Exposure and Problematic Drinking

While bivariate statistics indicated that students with CASA exposure reported consuming significantly more alcohol than students without CASA exposure, CASA

exposure severity did not significantly relate to overall alcohol consumption after controlling for gender, additional trauma exposure, and socially desirable responding patterns, contrary to the first hypothesis. As such, bivariate statistics are consistent with previous findings reporting significant differences in drinking behaviors between CASA and non-CASA individual (Fergusson et al., 1996; Sartor et al., 2007); however, regression analyses did not replicate these findings. Notably, few studies have reported a relationship between CASA and alcohol consumption in *college students* (Silverman et al., 1996) compared to studies sampling general or clinical populations. A limited number of studies (Klanecky et al., 2008; Testa, Livingston, & Hoffman, 2007) examining the direct relationship between CASA and alcohol use in young adults have controlled for additional factors aside from demographic characteristics (e.g., alternative trauma exposure). Therefore, findings may indicate that for high-functioning individuals, such as college students, the relations between CASA exposure severity and alcohol consumption are indirect. Examining a more comprehensive picture may be needed to understand the relationship between CASA severity and alcohol consumption in college students.

Aim 2: The Potential Occurrence of the Self-Medication Model to Alcohol Use

As hypothesized, CASA exposure significantly related to PTSD symptoms. The direction of findings indicated that as CASA exposure severity increased, PTSD symptoms increased after controlling for alternative traumas, gender, and socially desirable responding. Including the bivariate statistics which indicated that CASA-exposed students endorsed greater PTSD symptoms compared to non-CASA students, findings related to CASA exposure and PTSD symptoms are consistent with the majority

of previous literature in college and non-college populations (e.g., Filipas & Ullman, 2006; Paolucci et al., 2001; Saunders et al., 1992; Twaite & Rodriguez-Srednicki, 2004).

Contrary to the current hypotheses, PTSD symptoms did not mediate the relations between CASA exposure and alcohol consumption. As outlined by Baron and Kenny (1986), the first required step in mediation is a significant relationship between the predictor variable (i.e., CASA exposure severity) and the criterion variable (i.e., alcohol consumption). As discussed on the previous page, CASA did not significantly relate to overall alcohol consumption after including covariates, and accordingly, mediation was not tested. Interestingly, an exploratory analysis investigating the relations between PTSD symptoms and alcohol consumption was also not significant. For college students, very few studies have examined the relations among CASA exposure, PTSD symptoms, and alcohol consumption. While PTSD symptoms have been related to greater rates of risk behaviors (e.g., risky sexual activities; Green et al. 2005) and maladaptive coping (a composite variable of multiple strategies including alcohol/drug use; Ullman & Filipas, 2005), only one finding has reported a direct relationship between PTSD symptoms and overall substance use (Messman-Moore et al., 2009). Messman-Moore and colleagues (2009) did not report a direct relationship between CASA exposure and alcohol consumption; rather, CASA exposure was related to PTSD symptoms, which in turn, related to general substance use (a latent variable including alcohol consumption). In a prospective study by Testa and colleagues (2007), PTSD symptoms at Time 2 did not predict changes in heavy drinking at Time 3. Thus far, findings support the need to examine additional psychological variables in addition to PTSD symptoms that may help explain the relations between CASA exposure severity and alcohol consumption.

Aim 3: The Application of the *Diathesis-Stress Perspective* by Examining Psychological Vulnerabilities, Specifically, Emotion Regulation Difficulties and Dissociative Tendencies, to Psychopathology including Alcohol Use Following CASA Exposure.

The first subsection of Aim 3 (Aim 3a) was designed to test the relations between CASA severity and PTSD symptoms, separately, on each proposed moderator. First, as hypothesized, CASA severity and PTSD symptoms (in separate regression models) each positively related to emotion regulation difficulties. After controlling for the selected covariates, as CASA exposure increased, emotion regulation difficulties were expected to increase. Similarly, as PTSD symptoms increased, emotion regulation difficulties were expected to increase, after controlling for the same covariates. Positive findings related to emotion regulation are consistent with previous reports of altered regulatory abilities following CASA exposure in children and adolescents (Carey et al., 1996; Shields & Cicchetti, 1998; Shipman et al., 2000). Results are also consistent with the few studies that have examined emotion regulation difficulties in college populations using survey-based (Gratz et al., 2009; Rodriguez-Srednicki, 2001) and quasi-experimental methods (Luterek et al., 2005). While much less research has examined the relations between PTSD symptoms and emotion regulation difficulties, the current findings are consistent with theoretical reports of an integrative relationship between PTSD and emotion regulation (Cisler et al., 2010) as well as college findings reporting a positive relationship between emotion regulation difficulties (using the DERS) and PTSD symptoms (Tull et al., 2007).

Second, as hypothesized, PTSD symptoms positively related to dissociative tendencies after controlling for gender, alternative trauma exposure, and socially desirable responding. As PTSD symptoms increased, dissociative tendencies increased, holding the covariates constant. Results are consistent with previous research reporting positive relations between PTSD symptoms and dissociative tendencies (e.g., Twaite & Rodriguez-Srednicki, 2004). However, contrary to the current hypothesis, CASA exposure severity did not significantly relate to dissociative tendencies after controlling for the selected covariates. This finding adds to mixed reports on the relations between CASA exposure and dissociation, particularly in college populations. Consistent with the current bivariate results, some findings report significantly greater (albeit non-clinical) levels of dissociation in CASA compared to non-CASA students (e.g., Rodriguez-Srednicki, 2001) while others have reported non-significant differences (e.g., Luterek et al., 2005). When incorporated into regression models and after controlling for the selected covariates, the significant relations between CASA and dissociation for the current college students did not hold. Results replicate a recent finding of ours (Klanecky, McChargue, & Bruggeman, in press), and are most likely a results of more stringent statistical analysis (compared to correlations or bivariate statistics) and the relatively low, non-clinical levels of dissociation in college students.

The second subsection of Aim 3 (Aim 3b), utilized path analysis to examine the potential for the proposed vulnerabilities (i.e., emotion regulation difficulties and dissociative tendencies) to act as intermediary factors in the pathway from CASA exposure severity and PTSD symptoms to alcohol consumption. Across the full sample, findings from emotion regulation difficulties and dissociative tendencies were similar.

CASA exposure severity positively related to greater PTSD symptoms, which in turn, related to greater emotion regulation difficulties or dissociative tendencies. After controlling for socially desirable responding patterns, greater emotion regulation difficulties or dissociative tendencies positively related to greater problematic alcohol consumption. Notably, CASA also related to greater emotion regulation difficulties, consistent with the simple regression results. Results were upheld when replicated with the less conservative, six-item variable and binary CASA variable with minor differences (i.e., gender did not significantly relate to CASA) most likely a result of limited statistical power.

Although precluding mediation conclusions following the non-significant relations between PTSD and alcohol consumption, findings suggest that college students with a complex pattern of difficulties including PTSD symptoms as well as psychological vulnerabilities to alcohol use engage in greater alcohol consumption following CASA exposure. Given the relatively high functionality of college students and non-clinical levels of PTSD symptoms, the experience of distress due to PTSD symptoms (to some degree) following CASA exposure may not be enough to promote self-medication through greater alcohol consumption. Rather, the presence of additional psychological factors, specifically, greater emotion regulation difficulties or greater (albeit non-clinical) levels of dissociation, may increase the likelihood for problematic drinking following CASA exposure and PTSD symptom development. These findings are consistent with results from an outpatient addictions treatment sample where CASA exposure (rather than alternative trauma exposure) was associated with an increased risk for PTSD +

complex PTSD including symptoms of emotion dysregulation and dissociation rather than PTSD alone, irrespective of gender (Ford & Smith, 2008).

Specific to the dissociative tendencies model, findings examining the chemical dissociation perspective in college students have consistently reported a positive relationship between dissociation and alcohol consumption (Klanecky et al., 2008; Rodriguez-Srednicki, 2001). Greater, although non-clinical, levels of dissociation related to greater alcohol consumption. Given that the range of dissociative tendencies (0 to 22) did not exceed the clinical cut-off of 30, it may be that students who experience greater dissociative tendencies still do not have sufficient abilities to experience psychological dissociation to a degree that alleviates external or internal stress (Griffin et al., 1997; Lanius et al., 2002). Engaging in alcohol consumption may provide the alleviation from stress that insufficient dissociative tendencies do not, consistent with theories on chemical dissociation (Briere & Runtz, 1987; Roesler & Dafler, 1993).

To explore potential gender differences, the full sample models for emotion regulation difficulties and dissociative tendencies were constructed in men and women, separately. For men, results for emotion regulation as well as dissociative tendencies were nearly identical to the full sample models with one exception. Unlike the full sample model constructed for emotion regulation difficulties, CASA exposure severity did not significantly relate to emotion regulation difficulties for men ($p = .106$). Much less research has examined the relationship between CASA exposure and emotion regulation abilities in college men (rather child abuse in general; Gratz et al., 2009). Tentatively, it may be that for men the relationship between CASA and emotion

regulation is less salient. However, limited statistical power after reducing the total sample to only men prevents the drawing of any firm conclusions.

For women, results were less consistent with the full sample models; however, findings are confounded by reduced statistical power (~ less than 60%), and therefore, a discussion of results pertinent to only women is limited. Consistent with the full sample models, greater CASA severity positively related to greater PTSD symptoms, which in turn, related to greater emotion regulation difficulties or greater (although non-clinical) dissociative tendencies. While greater emotion regulation difficulties did not relate to greater alcohol consumption, there was a trend for greater dissociative tendencies to positively relate to greater alcohol consumption. Very tentatively, women may be more likely to engage in greater alcohol use to alleviate stress in the absence of sufficient psychological dissociation, seemingly consistent with previous findings that dissociation predicted alcohol use for college women (Rodriguez-Srednicki, 2001). However, again, reduced statistical power prevents any firm conclusions from being drawn.

It should be noted that the relationship between socially desirable responding patterns and alcohol consumption was less salient for women compared to the full sample and the men's models. Rather, CASA severity predicted re/victimization after 18, which in turn, predicted greater alcohol consumption in both the emotion regulation and dissociative tendencies models. While the mechanisms related to revictimization for CASA-exposed women were beyond the scope of the current study, the association between CASA and later victimization is consistent with previous literature (e.g., see review by Classen et al., 2005; Messman-Moore & Long, 2000). The positive relations between young adult victimization and alcohol use are consistent with previous findings

(e.g., Messman-Moore et al., 2008, 2009) although temporal conclusions are prevented due to the current methodology. Results most likely reflect a more complex picture related to early sexual victimization, the development of related psychopathology such as PTSD symptoms, an overlay of psychological vulnerabilities, substance use particularly in college women, and repeated sexual victimization (e.g., Messman-Moore et al., 2009; Testa et al., 2007; Testa & Livingston, 2009).

The final subsection of Aim 3 (Aim 3c) examined a secondary perspective. The potential for emotion regulation difficulties and dissociative tendencies to act as moderators in the relations between CASA exposure severity and PTSD symptoms as well as CASA exposure severity and alcohol consumption was investigated using path analysis. First, for the emotion regulation model, CASA severity and emotion regulation difficulties had direct, positive effects on PTSD symptoms and alcohol consumption, after controlling for socially desirable responding patterns. Seemingly consistent with the current hypothesis, emotion regulation difficulties moderated the relationship between CASA severity and PTSD symptoms as well as CASA severity and alcohol consumption. However, contrary to the current hypothesis, the moderating effect was in a negative direction across the primary, full sample model as well as the replicated models using the less conservative and binary CASA variables. Regardless of emotion regulation difficulties as CASA exposure severity increased, PTSD symptoms and alcohol consumption increased, respectively. However, contrary to the hypothesis, as CASA severity increased, PTSD symptoms and alcohol consumption increased at the fastest rate for individuals with low levels of emotion regulation difficulties. In fact, as CASA

severity increased, PTSD symptoms and alcohol consumption increased at the slowest rate for individuals with high levels of emotion regulation difficulties.

These findings were unexpected, and appeared counterintuitive given the positive relations (consistent with previous research) among emotion regulation difficulties and CASA exposure, PTSD symptoms, and alcohol consumption in the simple regression and previous path models. For college students, as CASA severity increased, PTSD symptoms and alcohol consumption increased at the fastest rate for individuals with low emotion regulation difficulties. In examining responses on the emotion regulation scale, scores ranged from 36 to 98 with the mean ($M = 61.00$, $SD = 17.33$) lower although within one standard deviation of others using the DERS instrument in college students (e.g., Glenn & Klonsky, 2009). While other studies using the DERS in college students have not reported the range of scores, studies utilizing the DERS in *clinical* populations have reported means ranging from 108.8 (compared to healthy controls who reported $M = 67.95$; Harrison, Sullivan, Tchanturia, & Treasure, 2009) to 118.0 (Axelrod, Perepletchikova, Holtzman, & Sinha, 2011). Comparing the current mean and range of scores to those reported in clinical populations suggests that emotion regulation difficulties are much less extreme in the current college sample and most likely do not identify severe dysregulation.

In contrast, low scores on the DERS are discussed much less, and conceptually, indicate superior regulatory abilities (Gratz & Roemer, 2004). However, rather than measuring superior regulatory abilities, low scores more accurately measure *perceived* superior regulatory abilities. Specific regulation skills and strategies are not delineated in the DERS, rather “subjective appraisal” of regulation effectiveness is assessed “with the

hope that this would take into account the contextually dependent nature of *adaptive* regulation strategies” (Gratz & Roemer, 2004). Alcohol use may be perceived as adaptive particularly in a college context. Approximately 70% of college students reported drinking in the past 30 days, and approximately 40% of students engaged in “heavy” drinking (i.e., five drinks per occasion) in the past two weeks, patterns of alcohol consumption that are generally greater than non-college peers (O’Malley & Johnson, 2002). Alcohol is used to help cope with negative affect or enhance positive affect for college students *with* (Goldstein et al. 2010) *and without* (Hufford, 2001) a history of childhood abuse. Further, for CASA-exposed students, the result of maladaptive coping may be emotional support or validation from peers (Ullman & Filipas, 2005). Given that the DERS measures perceived regulatory abilities and alcohol consumption may be perceived as adaptive in a college context, the interaction between CASA severity and emotion regulation abilities may be conceptualized in the following manner: As CASA severity increases, PTSD symptoms and alcohol consumption increase. Although, for college students with particularly superior *perceived* emotion regulation abilities and increased CASA exposure severity, it may be that reduced insight into their perceived regulatory abilities leads to increased PTSD symptoms. Particularly low levels of perceived emotion regulation abilities may translate into increased alcohol use as a regulatory strategy perceived as adaptive in an alcohol-laden college environment.

The significant interaction between emotion regulation difficulties and CASA severity did not hold in the models for men and women, separately. Overall, the separate models were comprised of non-significant paths. Significant pathways included direct, positive effects for emotion regulation difficulties on PTSD symptoms and alcohol

consumption for men. For women, greater emotion regulation difficulties and greater CASA severity each related to greater PTSD symptoms; sexual victimization after 18 was related to greater alcohol consumption. Importantly, models for men and women were subject to reduced statistical power (~ 40% to 60%), and so, it is difficult to draw firm conclusions.

Notable differences were apparent in the models examining dissociative tendencies as the proposed moderator. For the full sample model, dissociative tendencies did not moderate the relations between CASA severity and PTSD symptoms, or CASA severity and alcohol consumption. The interaction term failed to reach significance across all full sample models (i.e., the five-item, six-item, and binary CASA measures). For the full sample, CASA severity and dissociative tendencies each demonstrated positive relations with PTSD symptoms, after holding the other constant. As CASA severity or dissociative tendencies increased, PTSD symptoms increased. Dissociative tendencies were positively related to alcohol consumption after controlling for the effect of socially desirable responding patterns. Results are consistent with previous research reporting positive relations between CASA and PTSD symptoms (e.g., Filipas & Ullman, 2006) as well as positive relations between dissociative tendencies and PTSD symptoms (Twaite & Rodriguez-Srednicki, 2004) and alcohol consumption (Klanecky et al., 2008; Rodriguez-Srednicki, 2001).

When dissociative tendencies as the proposed moderator were examined in men and women, separately, three primary findings emerged. First, for men, there was an unexpected effect on socially desirable responding. As CASA severity increased, socially desirable responding increased for men. However, greater dissociative tendencies

enhanced the relationship between CASA severity and socially desirable responding such that as CASA severity increased, socially desirable responding increased at the fastest rate for men with higher dissociative tendencies compared to men with mean or lower levels of dissociation. Research examining CASA, dissociation, and socially desirable responding is limited, and most research examining social desirability in men primarily focuses on perpetrators of abuse or sexual offenses (e.g., Bates & Metcalf, 2007; Henning, Jones, & Holdford, 2005; Porter & Critelli, 1992; Stith, Crossman, & Bischof, 1991). However, for men, as their experience of early sexual abuse and dissociative symptoms increase, they may attempt to present themselves in what they perceive as a more culturally acceptable or traditional manner compared to men with less CASA exposure or less dissociative symptomatology.

This view is supported by findings that college men's endorsement of depressive symptoms is impacted by socially desirable responding patterns with depressive symptoms negatively predicted by traditional masculine roles (Sigmon et al., 2005). As value in traditional masculine roles increased, depressive symptoms decreased. Further, young men (age 18 to 26) who valued traditionally masculine sex roles (i.e., high expectations of being powerful, dominant, physically and sexually adequate) reported higher scores on the MCS compared to men who placed lower value on traditionally masculine sex roles (Allaman, Joyce, & Crandall, 1972). It may be that for men who experience CASA and related symptomatology, increases in socially desirable responses are attempts to present themselves in line with what they perceive as traditionally or culturally accepted for men. This may be an attempt to counter their individual experiences, which potentially violate what they perceive as traditionally or culturally,

appropriate or acceptable. Notably, as Crowne & Marlowe (1960) discussed, socially desirable responding does not involve minimization of pathology, which is consistent with the current non-significant bivariate relations between CASA severity and the MCS scale ($r = .136$), and a small to moderate correlation ($r = .220$) between dissociative tendencies and the MCS.

The second noteworthy finding that emerged after exploring the moderating potential of dissociative tendencies was in the women's model. Dissociative tendencies positively moderated the relationship between CASA severity and PTSD symptoms. As CASA severity increased, low dissociative tendencies buffered students' reports of PTSD symptoms. However, for women with mean levels of dissociation, PTSD symptoms slightly increased as CASA severity increased. For women with high levels of dissociation, there was the largest increase in PTSD symptoms as CASA severity increased. Results may lend some support to the potential for dissociative tendencies to act as a trait-like characteristic (Carlson & Putnam, 1993; Spindler & Elklit, 2003) capable of buffering the development of psychopathology, particularly PTSD symptoms, following stress. This finding is consistent with the diathesis-stress perspective (Ingram & Luxton, 2005); however, how the finding may relate to alcohol consumption is still somewhat unclear. Results for women indicated that as CASA severity increased, PTSD symptoms increased for those with higher levels of dissociation, and higher dissociation was (at the trend level) related to greater alcohol consumption. Longitudinal research is needed to examine how varying levels of PTSD symptoms and dissociative tendencies are related to alcohol consumption, and potential chemical dissociation, among CASA-exposed women.

Third, for women, there was an unexpected pathway to greater alcohol consumption through dissociative tendencies, which related to victimization after 18. Victimization after 18 related to greater drinking. While findings are consistent with some reports that dissociative tendencies may be related to an increased risk for sexual victimization (Cloitre et al., 1997), the positive relationship between victimization after 18 and alcohol consumption has been a consistent finding in the current study and some previous research (e.g., Messman-Moore et al., 2008, 2009; Testa et al., 2007).

Integrative Review and Summary of Key Findings

Across the current results, noteworthy findings may be summarized in five key points. First, the pathway to increased alcohol consumption for college students seemed to be represented by a complex pattern of symptomatology and psychological vulnerability, consistent with theories of self-medication and diathesis-stress as well as some clinical findings (Ford & Smith, 1998). Although students with CASA reported significantly greater alcohol use compared to non-CASA students, more rigorous analyses indicated that the relations between CASA and alcohol were mostly indirect (with one exception noted in the emotion regulation moderation full sample model). Across models testing the intermediary effects of psychological vulnerabilities, CASA was related to alcohol use through PTSD symptoms and greater emotion regulation difficulties or greater (although non-clinical) dissociative symptoms. Models examining proposed moderation evidenced similar direct effects. The associative relations between PTSD symptoms and greater emotion regulation as well as PTSD symptoms and greater dissociative tendencies capture the interrelated nature of these constructs. With a more rigorous longitudinal design, temporal sequencing of constructs may be better inferred.

Further, not only did dissociative tendencies play an intermediary role between PTSD symptoms and alcohol consumption (such that PTSD symptoms related to greater dissociative tendencies, which in turn, related to greater alcohol consumption), dissociative tendencies also moderated the relations between CASA severity and PTSD symptoms for women. As CASA severity increased, low dissociative tendencies buffered reports of PTSD symptom development. Results provide some support for the perspective by Grant and McMahon (2003; 2005) that a vulnerability factor may moderate or mediate relations between stress and psychopathology across time. Dissociative tendencies may exist as a trait-like characteristic prior to stress, which to some extent may buffer the development of psychopathology. Additionally, while dissociation did not mediate the pathway to alcohol use, dissociative tendencies did act as an intermediary factor between the development of psychopathology (i.e., PTSD symptoms) and further pathology, namely problematic alcohol consumption suggesting probable self-medication.

Second, and potentially the most noteworthy finding, was the moderating effect of emotion regulation on CASA severity and PTSD symptoms as well as CASA severity and alcohol consumption. The current study's results prior to testing moderation indicated that as CASA severity and PTSD symptoms increased, emotion regulation difficulties increased, which in turn, increased alcohol consumption. However, when examining the interaction of CASA severity and emotion regulation difficulties, significant moderation findings were in an unexpected direction. For individuals with high emotion regulation difficulties, as CASA severity increased, PTSD and alcohol increased to a lesser degree compared to individuals with mean emotion regulation scores. In fact, students who endorsed low emotion regulation difficulties reported the

greatest increase in PTSD symptoms and alcohol consumption as CASA severity increased. These findings call into question CASA-exposed students' abilities to accurately perceive adaptive emotion regulation skills in a college context where alcohol use is the norm, given that the DERS relies on subjective appraisals of one's regulatory skills. Reduced insight particularly for CASA-exposed college students may be a larger problem in terms of PTSD symptoms and alcohol consumption compared to CASA-exposed students who report high although seemingly non-clinical levels of emotion regulation difficulties. Additional findings that report drinking motives related to regulating emotional experiences in college students with (Goldstein et al., 2010) and without (Hufford, 2001) histories of abuse as well as positive relations between maladaptive coping for CASA-exposed students (e.g., alcohol use) and positive social reactions (e.g., emotional validation) from college peers (Ullman & Filipas, 2005) support this interpretation.

Third, dissociative tendencies moderated the relations between CASA severity and socially desirable responding for men. Unexpected and interesting, as CASA severity increased, social desirability increased at the fastest rate for men reporting high (compared to mean or low levels) of dissociative tendencies. This finding may highlight an attempt for men to counter experiences (i.e., CASA exposure and dissociative tendencies), which they perceive as less culturally or traditionally acceptable, with responses that best embrace cultural acceptance or traditionally masculine views. This interpretation is supported by previous research that has reported an increased social desirability bias for young men who hold traditionally masculine sex roles (Allaman et

al., 1972), particularly in the reporting of psychiatric symptoms such as depression (Sigmon et al., 2005).

Fourth, exploring the models in women resulted in significantly reduced statistical power, which makes conclusions difficult to draw. Findings indicated that emotion regulation difficulties did not relate to alcohol consumption for women, and dissociative tendencies related to alcohol use at the trend level. As such, caution should be used when generalizing the results of the full sample models to women only. However, it is noteworthy that CASA severity and dissociative tendencies, separately, related to the experience of sexual victimization after 18. Sexual victimization after 18 also consistently related to greater alcohol consumption across all women's models. Several findings have reported that a history of CASA increases risk for later sexual victimization (e.g., Kessler & Bieschke, 1999; Sandberg, Matorin, & Lynn, 1999; Testa et al., 2010). This relationship is most likely facilitated by risk behaviors such as heavy alcohol use, which increases risk for college sexual victimization (Testa et al., 2010); however, alcohol use may act not only act as a risk factor for repeated victimization, but may also be a consequence of sexual victimization (see review by Classen et al., 2005; Kilpatrick et al., 1997). For example, Testa and colleagues (2007) reported that rape at Time 2 significantly contributed to heavy alcohol consumption at Time 3. However, of the 29 women who experienced rape at Time 2, 31% increased their maximum drinks per occasion, 38% decreased their drinks per occasion, and 31% reported stable amounts of drinking (Testa et al., 2007). Researchers concluded that while changes in alcohol-related behaviors following victimization are variable, drinking was relatively stable across time

(Testa et al., 2007), a risk factor for repeated sexual victimization in college women, and accordingly, a target for research and treatment (Testa & Livingston, 2009).

Last, it should be noted that despite the relatively low endorsement of CASA using the most conservative, five-item scale, there were virtually no differences in findings across the primary five-item variable, the less conservative six-item variable, and the binary CASA variable created from the five-item scale. The very few differences between models (e.g., the relationship between gender and the binary CASA variable) typically included relationships that fell to a trend level of significance, which is most likely a reflection of limited statistical power. The very few differences among models suggest that the influence of zero-inflatedness and relatively low CASA endorsement had a minimal impact on findings.

Clinical Implications

Brief alcohol treatments for college students are generally effective in reducing alcohol-related behaviors for mandated (Carey et al., 2009; Mun, White, & Morgan, 2009; White et al., 2007) and non-mandated (Butler & Correia, 2009; Carey, Carey, Maisto, & Henson, 2006; Larimer et al., 2007; Walters, Vader, Field, Harris, & Jouriles, 2009) students when aspects of personalized feedback as well as brief motivational interviewing are incorporated. Personalized feedback generally includes education on blood alcohol concentration, normative comparisons, reviews of consumption rates, alcohol-related problems and alcohol-related expectancies/motives (Carey, Scott-Sheldon, Carey, & DeMartini, 2007). Less research has examined brief treatment in at-risk college sub-populations. Geisner, Neighbors, Lee and Larimer (2007) reported that for students with moderate depressive symptoms, personalized feedback effectively

reduced perceived drinking norms, which was associated with reduced alcohol consumption and alcohol-related problems across time. Mun and colleagues (2009) reported that students requiring medical or legal attention at the time of sanction benefited from combined brief motivational intervention with personalized feedback. Smith and Tran (2007) showed that students (50% women) with greater depression and anxiety symptoms reported higher readiness to change scores for alcohol-related behaviors compared to students with lower symptomatology.

Treatment findings indicate that, potentially, college students with somewhat elevated levels of psychopathology may be more ready to change problematic alcohol behaviors compared to their healthy peers. Modified brief alcohol treatments for college students with a history of CASA may be effective in reducing alcohol consumption. For example, in providing alcohol-related personalized feedback to students with elevated depressive symptoms, Geisner and colleagues (2007) incorporated psychoeducation regarding the etiology and maintenance of depression and depression-related coping strategies into the feedback form. For CASA-exposed college students who are more likely to drink heavily due to symptoms of PTSD and related emotion regulation deficits or dissociative tendencies, incorporating relevant mental health and psychoeducational material into alcohol-related personalized feedback (and brief motivational sessions) may improve student insight into their own behaviors and reduce alcohol consumption.

For example, risk rates related to heavy alcohol use and sexual revictimization for CASA-exposed students may be included in the feedback. Additionally, clinical treatments designed to address co-occurring trauma and substance use may provide some initial ideas on what to incorporate into brief alcohol treatments for CASA-exposed

students. For example, *Seeking Safety* (Najavits, 2002) discusses multiple topics related to trauma, PTSD symptoms, and problematic substance use. Cloitre and colleagues (2002, 2010) incorporate emotion regulation discussions and skills in their adult treatment for child abuse, potentially relevant for CASA-exposed students who may be experiencing reduced insight into their ability to adaptively manage emotions.

Addressing co-occurring mental health symptoms and experiences simultaneously with brief alcohol treatments may reduce problematic alcohol consumption and related consequences (e.g., sexual revictimization and academic problems) for CASA-exposed students.

Study Limitations and Future Research

While the current study shed light on factors which may substantiate the relations between CASA exposure severity and problematic alcohol consumption in college students, caution should be given to the current findings given relevant study limitations. First, the methodology of the study relied on a cross-sectional examination of students' self-reported information. The non-experimental, cross-sectional design restricts internal validity including causal and temporal interpretability. Although studies examining college students' alcohol consumption and related factors (e.g., CASA history) often use cross-sectional methods (see reviews by Marx et al., 2005, and Messman-Moore & Long, 2003), caution is emphasized when interpreting and discussing the current findings given that all information was provided at only one time point. It is recommended that results be replicated using more rigorous longitudinal research methods to better assess experience of symptoms and vulnerabilities across time. Similarly, the use of the ETI-SR-SF did not differentiate childhood and adolescent experiences, and may be subject to

difficulties with recall or socially desirable responding patterns (Widom & Morris, 1997). To attempt to address issues of social desirability bias particularly on students' alcohol use, socially desirable responding patterns were statistically controlled. However, again, longitudinal data collection may assist in minimizing recall difficulties due to the current retrospective nature of CASA reporting, and future research should replicate findings examining childhood and adolescent sexual abuse, independently, as patterns of symptomatology may differ depending on age of abuse (McCutcheon et al., 2010).

Second, as would be expected in a sample of college students, the majority of students did not endorse CASA exposure. Further, fondling was the most frequent CASA experience reported indicating that CASA exposure severity was relatively low. To most thoroughly examine the statistical associations between CASA and other constructs of interest, results were completed using the most conservative CASA measure (five-items), the less conservative measure (six-items), and a binary CASA variable to examine potential differences due to zero-inflatedness. Although minimal differences were noted among models, results should be replicated using a larger sample, particularly of CASA survivors, to improve statistical variance and predictive abilities. Relatedly, a larger sample of college students with a larger subset of CASA-related experience would improve statistical power, particularly when examining potential gender differences and examining moderating effects in non-experimental designs (McClelland & Judd, 1993). As discussed previously, exploring potential gender differences by constructing each model in men and women, separately, reduced statistical power and increased risk of Type II error. Replicating findings with a larger sample of men and women, particularly

CASA-exposed men and women, would provide more firm conclusions, particularly related to differences between genders.

Third, findings in the current mandated sample of college students may not generalize to alternative populations of young adults including non-mandated students or non-college peers. The current mandated sample was comparable to prior studies sampling mandated students in demographic and drinking characteristics. While alcohol consumption, CASA exposure, PTSD symptom severity, and levels of dissociation and emotion regulation were consistent with non-mandated students, the current sample did include substantially more men than women. Although gender was controlled statistically throughout the study, findings should be replicated in alternative populations comprised of relatively equal numbers of men and women.

Last, caution should be given to findings examining the relations between CASA exposure severity and PTSD symptoms in particular. Students were not oriented to a specific traumatic experience such as history of CASA exposure while completing the *PTSD Checklist - Civilian* (PCLC). Accordingly, it is not possible to determine if their endorsement of PTSD symptoms was directly linked to history of CASA exposure. This approach to examining PTSD symptomatology following CASA exposure is common in studies using survey (Messman-Moore et al., 2009; Rosenthal et al., 2005; Twaite & Rodriguez, 2004) as well as interviewer-administered assessments (Epstein et al., 1998; Simpson, 2003; Zlotnick et al., 2006). While alternative trauma exposure was controlled in the simple regression models to assist in examining the uniqueness of CASA exposure on PTSD symptoms, alternative traumas were not controlled in path models due to statistical limitations of regression-style path analysis and the presence of latent variables.

Future research should work to verify the current findings, particularly of the path models, using research methods that instruct participants to complete PTSD items as they directly relate to their CASA experience(s).

Conclusion

The current study sought to examine the self-medication and diathesis-stress perspectives in college students mandated to a brief alcohol intervention to shed light on factors which may help explain the relationship between problematic alcohol use and CASA severity. This was the first study to examine the role of psychological vulnerabilities, specifically, emotion regulation difficulties and dissociative tendencies, as they may relate to alcohol-related self-medicating behaviors following CASA exposure and potential PTSD symptom development. Path models examining mediating effects indicated that greater CASA severity is related to greater PTSD symptoms. PTSD symptoms are also related to greater emotion regulation difficulties and dissociative tendencies, which in turn, related to greater alcohol consumption. Although mediation was precluded because PTSD symptoms did not significantly relate to alcohol consumption, the directions of these findings were consistent with current hypotheses, and highlight psychological vulnerabilities as intermediary factors in the relations from CASA and PTSD symptoms to alcohol consumption. Contrary to the current hypotheses, however, moderating effects indicated that as CASA severity increased, PTSD symptoms and alcohol consumption reached the highest level for students with low levels of perceived emotion regulation difficulties (or superior emotion regulation) compared to students with mean or high levels of perceived regulatory difficulties. In addition to addressing the current study limitations, future research should work to better understand

this potential phenomenon, where reduced insight into regulatory abilities for CASA-exposed students may lead to the perceived adaptive use of alcohol consumption in college environments.

References

- Adkins, J. W., Weathers, F. W., McDevitt-Murphy, M., & Daniels, J. B. (2008). Psychometric properties of seven self-report measures of posttraumatic stress disorder in college students with mixed civilian trauma exposure. *Journal of Anxiety Disorders, 22*, 1393-1402. doi:10.1016/j.janxdis.2008.02.002
- Aiken, L. S., & West, S. G. (1991). *Multiple Regression: Testing and Interpreting Interactions*. Newbury Park, London: Sage.
- Allaman, J. D., Joyce, C. S., & Crandall, V. C. (1972). The antecedents of social desirability response tendencies of children and young adults. *Child development, 43*(4), 1135-1160. doi:10.2307/1127504
- Allison, P. D. (1999). *Multiple Regression, A Primer*, Thousand Oaks, CA: Pine Forge Press.
- American Psychiatric Association. (2000). *Diagnostic and statistical manual of mental disorders* (Revised 4th ed.). Washington, DC: Author.
- Axelrod, S. R., Perepletchikova, F., Holtzman, K., & Sinha, R. (2011). Emotion regulation and substance use frequency in women with substance dependence and borderline personality disorder receiving dialectical behavior therapy. *American Journal of Drug & Alcohol Abuse, 37*(1), 37-42. doi:10.3109/00952990.2010.535582
- Aydin, Y. E., Atlindag, A., & Ozkan, M. (2009). Childhood traumatic events and dissociation in university students. *International Journal of Psychiatry in Clinical Practice, 13*(1), 25-30. doi:10.1080/13651500802331540

- Babor, T. F., Higgins-Biddle, J. C., Saunders, J. B., & Monteiro, M. G. (2001). *The Alcohol Use Disorders Identification Test: Guidelines for use in primary care* (2nd ed.). Geneva, Switzerland: World Health Organization.
- Barger, S. D. (2002). The Marlowe-Crowne affair: Short forms, psychometric structure, and social desirability. *Journal of Personality Assessment*, 79(2), 286-305.
doi:10.1207/S15327752JPA7902_11
- Barnett, N. P., Murphy, J. G., Colby, S. M., & Monti, P. M. (2007). Efficacy of counselor vs. computer-delivered intervention with mandated college students. *Addictive Behaviors*, 32, 2529-2548. doi:10.1016/j.addbeh.2007.06.017
- Baron, R. M., & Kenny, D. A. (1986). The moderator-mediator variable distinction in social psychological research: Conceptual, strategic and statistical considerations. *Journal of Personality and Social Psychology*, 51, 1173-1182. doi:10.1037/0022-3514.51.6.1173
- Bates, A., & Metcalf, C. (2007). A psychometric comparison of internet and non-internet sex offender from a community treatment sample. *Journal of Sexual Aggression*, 13(1), 11-20. doi:10.1080/13552600701365654
- Batten, S. V., Follette, V. M., & Aban, I. B. (2001). Experiential avoidance and high-risk sexual behavior in survivors of child sexual abuse. *Journal of Child Sexual Abuse*, 10(2), 101-120. doi:10.1300/J070v10n02_06
- Beretvas, S. N., Meyers, J. L., & Leite, W. L. (2002). A reliability generalization study of the Marlowe-Crowne Social Desirability Scale. *Educational and Psychological Measurement*, 62(4), 570-589. doi: 10.1177/0013164402062004003

- Berner, M. M., Kriston, L., Bentele, M., & Harter, M. (2007). The Alcohol Use Disorders Identification Test for detecting at-risk drinking: A systematic review and meta-analysis. *Journal of Studies on Alcohol and Drugs, 68*, 461-473.
- Bernstein, D. P., Stein, J. A., Newcomb, M. D., Walker, E., Pogge, D., Ahluvalia, T.,...Zule, W. (2003). Development and validation of a brief screening version of the Childhood Trauma Questionnaire. *Child Abuse & Neglect, 27*, 167-190.
doi:10.1016/S0145-2134(02)00541-0
- Blanchard, E. B., Jones-Alexander, J., Buckley, T. C., & Forneris, C. A. (1996). Psychometric properties of the PTSD Checklist (PCL). *Behaviour Research and Therapy, 34*, 669-673. doi:10.1016/0005-7967(96)00033-2
- Bornovalova, M. A., Quimette, P., Crawford, A. V., & Levy, R. (2009). Testing gender effects on the mechanisms explaining the association between post-traumatic stress symptoms and substance use frequency. *Addictive Behaviors, 34*, 685-692.
doi:10.1016/j.addbeh.2009.04.005
- Borsari, B., & Carey, K. B. (2005). Two brief alcohol interventions for mandated college students. *Psychology of Addictive Behaviors, 19*(3), 296-302. doi:10.1037/0893-164X.19.3.296
- Borsari, B., Read, R. J., & Campbell, J. F. (2008). Posttraumatic stress disorder and substance use disorders in college students. *Journal of College Student Psychotherapy, 22*(3), 61-85. doi:10.1080/87568220801960720
- Bremner, J. D., Bolus, R., & Mayer, E. A. (2007). Psychometric properties of the Early Trauma Inventory Self-Report. *Journal of Nervous and Mental Disease, 195*(3), 211-218. doi:10.1097/01.nmd.0000243824.84651.6c

- Bremner, J. D., Vermetten, E., & Mazure, C. M. (2000). Development and preliminary psychometric properties of an instrument for the measurement of childhood trauma: The Early Trauma Inventory. *Depression and Anxiety, 12*, 1-12.
doi:10.1002/1520-6394(2000)12:1<1::AID-DA1>3.0.CO;2-W
- Briere, J., & Runtz, M. (1987). Post sexual abuse trauma: Data and implications for clinical practice. *Journal of Interpersonal Violence, 2*, 367-379.
doi:10.1177/088626058700200403
- Briere, J., & Runtz, M. (1988). Post sexual abuse trauma: Data and implication for clinical practice. *Journal of Interpersonal Violence, 2*(4), 367-379.
doi:10.1177/088626058700200403
- Brown, L., Russell, J., Thornton, C., & Dunn, S. (1999). Dissociation, abuse and the eating disorders: Evidence from an Australian population. *Australian and New Zealand Journal of Psychiatry, 33*, 521-528.
- Brown, P. J., & Wolfe, J. (1994). Substance abuse and post-traumatic stress disorder comorbidity. *Drug and Alcohol Dependence, 35*, 51-59. doi:10.1016/0376-8716(94)90110-4
- Browne, A., & Finkelhor, D. (1986). Impact of child sexual abuse: A review of the research. *Psychological Bulletin, 99*(1), 66-77. doi:10.1037/0033-2909.99.1.66
- Bujarski, S., Klanecky, A. K., & McChargue, D. E. (2010). The relationship between alexithymia and alcohol-related risk perceptions: The moderating effect of general trauma in a college population. *Addictive Behaviors, 35*, 363-366.
doi:10.1016/j.addbeh.2009.10.023

- Butler, L. H., & Correia, C. J. (2009). Brief alcohol intervention with college student drinkers: Face-to-face versus computerized feedback. *Psychology of Addictive Behaviors, 23*(1), 163-167. doi:10.1037/a0014892
- Calkins, S. D., & Hill, A. (2007). Caregiver influences on emerging emotion regulation: Biological and environmental transactions in early development. In J. J. Gross (Ed). *Handbook of emotion regulation* (pp. 229-248). New York: Guilford Press.
- Carey, K. B., Carey, M. P., Maisto, S. A., & Henson, J. M. (2006). Brief motivational interventions for heavy college drinkers: A randomized controlled trial. *Journal of Consulting and Clinical Psychology, 74*, 943-954. doi:10.1037/0022-006X.74.5.943
- Carey, K. B., Henson, J. M., Carey, M. P., & Maisto, S. A. (2007). Which heavy drinking college students benefit from a brief motivational intervention? *Journal of Consulting and Clinical Psychology, 75*(4), 663-669. doi:10.1037/0022-006X.75.4.663
- Carey, K. B., Henson, J. M., Carey, M. P., & Maisto, S. A. (2009). Computer versus in-person intervention for students violating campus alcohol policy. *Journal of Consulting and Clinical Psychology, 77*(1), 74-87. doi:10.1037/a0014281
- Carey, T. C., Kempton, T. L., & Gemmill, W. D. (1996). The significance of emotions in the affective presentation of sexually abused girls. *Child Psychiatry & Human Development, 27*(2), 155-124. doi:10.1007/BF02353805
- Carey, K. B., Scott-Sheldon, L., Carey, M. P., & DeMartini, K. S. (2007). Individual-level interventions to reduce college student drinking: A meta-analytic review. *Addictive Behaviors, 32*, 2469-2494. doi:10.1016/j.addbeh.2007.05.004

- Carlson, E. B., & Putnam, F. W. (1993). An update on the Dissociative Experiences Scale. *Dissociation*, 6, 16-27. Retrieved from <https://scholarsbank.uoregon.edu/xmlui/handle/1794/1539>
- Chard, K. M. (2005). An evaluation of cognitive processing therapy for the treatment of posttraumatic stress disorder related to childhood sexual abuse. *Journal of Consulting and Clinical Psychology*, 73, 965-971. doi:10.1037/0022-006X.73.5.965
- Chilcoat, H. D., & Menard, C. (2003). Epidemiological investigations: Comorbidity of posttraumatic stress disorder and substance use disorder. In P. Quimette & P. J. Brown (Eds.), *Trauma and substance abuse: Causes, consequences, and treatment of comorbid disorders* (pp. 9-28). Washington, DC: American Psychological Association. doi:10.1037/10460-001
- Cisler, J. M., Olatunji, B. O., Feldner, M. T., & Forsyth, J. P. (2010). Emotion regulation and the anxiety disorders: An integrative review. *Journal of Psychopathology and Behavioral Assessment*, 32, 68-82. doi:10.1007/s10862-009-9161-1
- Classen, C. C., Palesh, O. G., & Aggarwal, R. (2005). Sexual revictimization: A review of the empirical literature. *Trauma, Violence, & Abuse*, 6, 103-129. doi:10.1177/1524838005275087
- Cloitre, M., Koenen, K. C., Cohen, L. R., & Han, H. (2002). Skills training in affective and interpersonal regulation followed by exposure: A phase-based treatment for PTSD related to childhood abuse. *Journal of Consulting and Clinical Psychology*, 70(5), 1067-1074. doi:10.1037/0022-006X.70.5.1067

- Cloitre, M., Scarvalone, P., & Difede, J. (1997). Posttraumatic stress disorder, self- and interpersonal dysfunction among sexually retraumatized women. *Journal of Traumatic Stress, 10*, 437-452. doi:10.1002/jts.2490100309
- Cloitre, M., Stovall-McClough, K. C., Noonan, K., Zorbas, P., Cherry, S., Jackson, C. L.,...Petkova, E. (2010). Treatment for PTSD related to childhood abuse: A randomized controlled trial. *American Journal of Psychiatry, 167*, 915-924. doi:10.1176/appi.ajp.2010.09081247
- Cohen, J. (1988). *Statistical power analysis for the behavioral sciences* (2nd ed.). Hillsdale, NJ: Erlbaum.
- Conger, J. J. (1956). Reinforcement theory and the dynamics of alcoholism. *Quarterly Journal of Studies on Alcohol, 17*, 296-305.
- Conrod, P. J., & Stewart, S. H. (2003). Experimental studies exploring functional relations between posttraumatic stress disorder and substance use disorder. In P. Quimette & P. J. Brown (Eds.), *Trauma and substance abuse: Causes, consequences, and treatment of comorbid disorders* (pp. 57-71). Washington, DC: American Psychological Association.
- Corstorphine, E., Waller, G., Lawson, R., & Ganis, C. (2007). Trauma and multi-impulsivity in the eating disorders. *Eating Behaviors, 8*, 23-30. doi:10.1016/j.eatbeh.2004.08.009
- Crowne, D. P., & Marlowe, D. (1960). A new scale of social desirability independent of psychopathology. *Journal of Consulting Psychology, 24*(4) 349-354. doi:10.1037/h0047358

- De Maynard, V. A. (2009). Dissociation in black or black-British people of African and African-Caribbean descent in the United Kingdom. *International Journal of Mental Health, 38*, 37-73. doi:10.2753/IMH0020-7411380203
- Denis, D., & Legerski, J. (2006). Causal modeling and the origins of path analysis. *Theory & Science, 7*, Retrieved from <http://theoryandscience.icaap.org/content/vol7.1/denis.html>
- DiLillo, D. (2001). Interpersonal functioning among women reporting a history of childhood sexual abuse: Empirical findings and methodological issues. *Clinical Psychology Review, 21*, 553-576. doi:10.1016/S0272-7358(99)00072-0
- Draijer, N., Langeland, W. (1999). Childhood trauma and perceived parental dysfunction in the etiology of dissociative symptoms in psychiatric inpatients. *American Journal of Psychiatry, 156*, 379-385. Retrieved from <http://ajp.psychiatryonline.org/cgi/content/abstract/156/3/379>
- Eisenberg, N., Hofer, C., & Vaughan, J. (2007). Effortful control and its socioemotional consequences. In J. J. Gross (Ed). *Handbook of emotion regulation* (pp. 287-306). New York: Guilford Press.
- Epler, A. J., Sher, K. J., Loomis, T. B., & O'Malley, S. S. (2009). College student receptiveness to various alcohol treatment options. *Journal of American College Health, 58*(1), 26-32. doi:10.3200/JACH.58.1.26-32
- Epstein, J. N., Saunders, B. E., Kilpatrick, D. G., & Resnick, H. S. (1998). PTSD as a mediator between childhood rape and alcohol use in adult women. *Child Abuse & Neglect, 22*, 223-234. doi:10.1016/S0145-2134(97)00133-6

- Everill, J., Waller, G., & Macdonald, W. (1995). Dissociation in bulimic and non-eating-disordered women. *International Journal of Eating Disorders, 17*(2), 127-134. doi:10.1002/1098-108X(199503)17:2<127::AID-EAT2260170204>3.0.CO;2-B
- Farley, M., & Keaney, J. C. (1997). Physical symptoms, somatization, and dissociation in women survivors of childhood sexual assault. *Women & Health, 25*, 33-45. doi:10.1300/J013v25n03_03
- Fergusson, D. M., Horwood, J., & Lynskey, M. T. (1996). Childhood sexual abuse and psychiatric disorder in young adulthood: II. Psychiatric outcomes of childhood sexual abuse. *Journal of the American Academy of Child and Adolescent Psychiatry, 35*, 1365-1374. doi:10.1097/00004583-199610000-00024
- Filipas, H. H., & Ullman, S. E. (2006). Child sexual abuse, coping responses, self-blame, posttraumatic stress disorder, and adult sexual revictimization. *Journal of Interpersonal Violence, 21*, 652-672. doi:10.1177/0886260506286879
- Finkelhor, D., Hotaling, G., Lewis, I. A., & Smith, C. (1990). Sexual abuse in a national survey of adult men and women: Prevalence, characteristics, and risk factors. *Child Abuse and Neglect, 14*, 19-28. doi: 10.1016/0145-2134(90)90077-7
- Ford, J. D., & Smith, S. F. (2008). Complex posttraumatic stress disorder in trauma-exposed adults receiving public sector outpatient substance abuse disorder treatment. *Addiction Research & Theory, 16*(2), 193-203. doi: 10.1080/16066350701615078
- Frazier, P. A., Tix, A. P., & Barron, K. E. (2004). Testing moderator and mediator effects in counseling psychology research. *Journal of Counseling Psychology, 51*, 115-134. doi:10.1037/0022-0167.51.1.115

- Freeman, K. A., & Morris, T. L. (2001). A review of the conceptual models explaining the effects of child sexual abuse. *Aggression and Violent Behavior, 6*, 357-373. doi:10.1016/S1359-1789(99)00008-7
- Friedman, H. (1982). Simplified determinations of statistical power, magnitude of effect and research sample sizes. *Educational and Psychological Measurement, 42*(20), 521-526. doi: 10.1177/001316448204200214
- Geisner, I. M., Neighbors, C., Lee, C. M., & Larimer, M. E. (2007). Evaluating personal alcohol feedback as a selective prevention for college students with depressed mood. *Addictive Behaviors, 32*(12), 2776-2787. doi:10.1016/j.addbeh.2007.04.014
- Gidycz, C. A., Loh, C., Lobo, T., Rich, C., Lynn, S. J., & Pashdag, J. (2007). Reciprocal relationships among alcohol use, risk perception, and sexual victimization: A prospective analysis. *Journal of American College Health, 56*(1), 5-14. doi:10.3200/JACH.56.1.5-14
- Ginzburg, K., Koopman, C., Butler, L. D., Palesh, O., Kraemer, H. C., Classen, C. C., & Spiegel, D. (2006). Evidence for a dissociative subtype of post-traumatic stress disorder among help-seeking childhood sexual abuse survivors. *Journal of Trauma and Dissociation, 7*(2), 7-27. doi:10.1300/J229v07n02_02
- Glenn, C. R., & Klonsky, E. D. (2009). Emotion regulation difficulties as a core feature of borderline personality disorder. *Journal of Personality Disorders, 23*, 20-28. doi:10.1521/pedi.2009.23.1.20
- Goldstein, A. L., Flett, G. L., & Wekerle, C. (2010). Child maltreatment, alcohol use and drinking consequences among male and female college students: An examination

of drinking motives as mediators. *Addictive Behaviors*, 35(6), 636-639.

doi:10.1016/j.addbeh.2010.02.002

- Goodman, L. A., Thompson, K. M., Weinfurt, K., Corl, S., Acker, P., Mueser, K. T., & Rosenberg, S. D. (1999). Reliability of reports of violent victimization and posttraumatic stress disorder among men and women with serious mental illness. *Journal of Traumatic Stress*, 12(4), 587-599. doi:10.1023/A:1024708916143
- Goodwin, J., Cheeves, K., & Connell, V. (1988). Defining a syndrome of severe symptoms in survivors of severe incestuous abuse. *Dissociation*, 1(4), 11-16. Retrieved from <https://scholarsbank.uoregon.edu/xmlui/handle/1794/1390>
- Grant, K. E., Compas, B. E., Stuhlmacher, A. F., Thurm, A. E., McMahon, S. D., & Halpert, J. A. (2003). Stressors and child and adolescent psychopathology: Moving from markers to mechanisms of risk. *Psychological Bulletin*, 129(3), 447-466. doi:10.1037/0033-2909.129.3.447
- Grant, K. E., & McMahon, S. D. (2005). Conceptualizing the role of stressors in the development of psychopathology. In B. L. Hankin & J. R. Z. Abela, (Eds). *Development of psychopathology: A vulnerability-stress perspective* (pp. 3-31). Thousand Oaks, CA: Sage Publications.
- Gratz, K. L., Bornovalova, M. A., Delany-Brumsey, A., Nick, B., & Lejuez, C. W. (2007). A laboratory-based study of the relationship between childhood abuse and experiential avoidance among inner-city substance users: The role of emotional nonacceptance. *Behavior Therapy*, 38, 256-268. doi:10.1016/j.beth.2006.08.006
- Gratz, K. L., Paulson, A., Jakupcak, M., & Tull, M. T. (2009). Exploring the relationship between childhood maltreatment and intimate partner abuse: Gender differences

in the mediating role of emotion regulation difficulties. *Violence and Victims*, 24(1), 68-82. doi:10.1891/0886-6708.24.1.68

Gratz, K. L., & Roemer, L. (2004). Multidimensional assessment of emotion regulation and regulation difficulties: Development, factor structure, and initial validation of the difficulties in emotion regulation scale. *Journal of Psychopathology and Behavioral Assessment*, 26(1), 41-54.

doi:10.1023/B:JOBA.0000007455.08539.94

Grayson, C. E., & Nolen-Hoeksema, S. (2005). Motives to drink as mediators between childhood sexual assault and alcohol problems in adult women. *Journal of Traumatic Stress*, 18(2), 137-145. doi:10.1002/jts.20021

Green, B. L., Krupnick, J. L., Stockton, P., Goodman, L., Corcoran, C., & Petty, R. (2005). Effects of adolescent trauma exposure on risky behavior in college women. *Psychiatry*, 68(4), 363-378. doi:10.1521/psyc.2005.68.4.363

Griffin, M. G., Resick, P. A., & Mechanic, M. B. (1997). Objective assessment of peritraumatic dissociation: Psychophysiological indicators. *American Journal of Psychiatry*, 154, 1081-1088. Retrieved from

<http://ajp.psychiatryonline.org/cgi/reprint/154/8/1081.pdf>

Gross, J. J. (1998). The emerging field of emotion regulation: An integrative review. *Review of General Psychology*, 2, 271-299. doi:10.1037/1089-2680.2.3.271

Gross, J. J., & Thompson, R. A. (2007). Emotion regulation: Conceptual foundations. In J. J. Gross (Ed). *Handbook of emotion regulation* (pp. 3-24). New York: Guilford Press.

- Groth-Marnat, G., & Michel, N. (2000). Dissociation, comorbidity of dissociative disorders, and childhood abuse in a community sample of women with current and past bulimia. *Social Behavior and Personality*, 28(3), 279-292.
doi:10.2224/sbp.2000.28.3.279
- Hall, J. M., & Powell, J. (2000). Dissociative experiences described by women survivors of childhood abuse. *Journal of Interpersonal Violence*, 15,184-204.
doi:10.1177/088626000015002005
- Hamburger, M. E., Leeb, R. T., & Swan, M. H. (2007). Childhood maltreatment and early alcohol use among high-risk adolescents. *Journal of Studies on Alcohol & Drugs*, 69, 291-295.
- Harrington, T., & Newman, E. (2007). The psychometric utility of two self-report measures of PTSD among women substance users. *Addictive Behaviors*, 32, 2788-2798. doi:10.1016/j.addbeh.2007.04.016
- Harrison, A., Sullivan, S., Tchanturia, K., & Treasure, J. (2009). Emotion recognition and regulation in anorexia nervosa. *Clinical Psychology and Psychotherapy*, 16(4), 348-356. doi:10.1002/cpp.628
- Harrison, P. A., Fulkerson, J. A., & Beebe, T. J., (1997). Multiple substance use among adolescent physical and sexual abuse victims. *Child Abuse and Neglect*, 21(6), 529-539. doi:10.1016/S0145-2134(97)00013-6
- Hein, D., Cohen, L., & Campbell, A. (2005). Is traumatic stress a vulnerability factor for women with substance use disorders? *Clinical Psychology Review*, 25, 813-823.
doi:10.1016/j.cpr.2005.05.006

- Henning, K., Jones, A., & Holdford, R. (2005). "I didn't do it, but if I did I had a good reason": Minimization, denial, and attributions of blame among male and female domestic violence offenders. *Journal of Family Violence, 20*(3), 131-139.
doi:10.1007/s10896-005-3647-8
- Holmbeck, G. N. (2002). Post-hoc probing of significant moderational and mediational effects in studies of pediatric population. *Journal of Pediatric Psychology, 27*, 87-96. doi:10.1093/jpepsy/27.1.87
- Hoyle, R. H., & Robinson, J. C. (2004). Mediated and moderated effects in social psychological research: Measurement, design, and analysis issues. In C. Sansone, C. C. Morf, & A. T. Panter (Eds.), *The Sage handbook of methods in social psychology* (pp. 213-233). Thousand Oaks, CA: Sage Publications.
- Hufford, M. R. (2001). An examination of mood effects on positive alcohol expectancies among undergraduate drinkers. *Cognition & Emotion, 15*(5), 593-613. doi: 10.1080/02699930126252
- Ingram, R. E., & Luxton, D. D. (2005). Vulnerability-stress models. In B. L. Hankin, & J. R. Abela (Eds.), *Development of psychopathology: A vulnerability-stress perspective* (32-46). Thousand Oaks, CA: Sage Publications.
- Irwin, H. J. (1994). Proneness to dissociation and traumatic childhood events. *Journal of Nervous and Mental Disease, 182*, 456-460. doi:10.1097/00005053-199408000-00006
- Irwin, H. J. (1999). Pathological and nonpathological dissociation: The relevance of childhood trauma. *Journal of Psychology, 133*(2), 157-164.
doi:10.1080/00223989909599730

- Jarvis, T. J., & Copeland, J. (1997). Child sexual abuse as a predictor of psychiatric co-morbidity and its implications for drug and alcohol treatment. *Drug and Alcohol Dependence, 49*, 61-69. doi:10.1016/S0376-8716(97)00139-7
- Jarvis, T. J., Copeland, J., & Walton, L. (1998). Exploring the nature of the relationship between child sexual abuse and substance use among women. *Addiction, 93*(6), 865-875. doi:10.1046/j.1360-0443.1998.9368658.x
- Jeon, H. J., Roh, M., Kim, K., Lee, J., Lee, D., Yoon, S. C., & Hahm, B. (2009). Early trauma and lifetime suicidal behavior in a nationwide sample of Korean medical students. *Journal of Affective Disorders, 119*, 210-214.
doi:10.1016/j.jad.2009.03.002
- Johnson, D. M., Pike, J. L., & Chard, K. M. (2001). Factors predicting PTSD, depression, and dissociative severity in female treatment-seeking childhood sexual abuse survivors. *Child Abuse & Neglect, 25*, 179-198. doi:10.1016/S0145-2134(00)00225-8
- Johnson, T. P., & Fendrich, M. (2002). A validation of the Crowne-Marlowe Social Desirability Scale. National Institute on Drug Abuse. RO1DA12425. p. 1661 – 1666.
- Juarez, P., Walters, S. T., Daugherty, M., & Radi, C. (2006). A randomized trial of motivational interviewing and feedback with heavy drinking college students. *Journal of Drug Education, 36*(3), 233-246. doi:10.2190/753N-8242-727T-G63L
- Judd, C. M., & Kenny, D. A. (1981). Process analysis: Estimating mediation in treatment evaluations. *Evaluation Review, 5*, 602-619. doi:10.1177/0193841X8100500502

- Kaplow, J. B., Hall, E., Koenen, K. C., Dodge, K. A., & Amaya-Jackson, L. (2008). Dissociation predicts later attention problems in sexually abused children. *Child Abuse & Neglect, 32*, 261-275. doi:10.1016/j.chiabu.2007.07.005
- Kendall-Tackett, K. A., Williams, L. M., & Finkelhor, D. (1993). Impact of sexual abuse on children: A review and synthesis of recent empirical studies. *Psychological Bulletin, 113*, 164-180. doi:10.1037/0033-2909.113.1.164
- Kessler, B. L., & Bieschke, K. J. (1999). A retrospective analysis of shame, dissociation, and adult victimization in survivors of childhood sexual abuse. *Journal of Consulting Psychology, 46*(3), 335-341.
- Khantzian, E. J. (1985). The self-medication hypothesis of addictive disorders: Focus on heroin and cocaine dependence. *American Journal of Psychiatry, 142*, 1259-1264.
- Khantzian, E. J. (1997). The self-medication hypothesis of substance use disorders: A reconsideration and recent applications. *Harvard Review of Psychiatry, 4*(5), 231-244. doi:10.3109/10673229709030550
- Khantzian, E. J. (2003). The self-medication hypothesis revisited: The dually diagnosed patient. *Primary Psychiatry, 10*(9), 47-54.
- Kilpatrick, D. G., Acierno, R., Resnick, H. S., Saunders, B. E., & Best, C. L. (1997). A two year longitudinal analysis of the relationship between violent assault and alcohol and drug use in women. *Journal of Consulting and Clinical Psychology, 65*(5), 834-847. doi:10.1037/0022-006X.65.5.834
- Kimerling, R., Alvarez, J., Pavao, J., Kaminski, A., & Baumrind, N. (2007). Epidemiology and consequences of women's revictimization. *Women's Health Issues, 17*, 101-106. doi:10.1016/j.whi.2006.12.002

- Klanecky, A. K., Harrington, J., & McChargue, D. E. (2008). Child sexual abuse, dissociation, and alcohol: Implications of chemical dissociation via blackouts among college women. *American Journal of Drug and Alcohol Abuse, 34*, 277-284. doi:10.1080/00952990802013441
- Klanecky, A. K., McChargue, D. E., & Bruggeman, L. (In press). Desire to dissociate: Implications for problematic drinking in college students with childhood or adolescent sexual abuse exposure. *American Journal on Addictions*.
- Klanecky, A. K., Salvi, S., & McChargue, D. E. (2009). Childhood sexual trauma severity exposure moderates the association between cigarette smoking initiation and college drug use. *American Journal on Addictions, 18*(5), 363-366.
- Kokotailo, P. K., Egan, J., Gangnon, R., Brown, D., Mundt, M., & Fleming, M. (2004). Validity of the Alcohol Use Disorders Identification Test in college students. *Alcoholism: Clinical and Experimental Research, 28*(6), 914-920.
- Koopman, C., Carrion, V., Butler, L. D., Sudhakar, S., Palmer, L., & Steiner, H. (2004). Relationships of dissociation and childhood abuse and neglect with heart rate in delinquent adolescents. *Journal of Traumatic Stress, 17*, 47-54.
doi:10.1023/B:JOTS.0000014676.83722.35
- Koss, M. P., & Gidycz, C. A. (1985). Sexual Experiences Survey: Reliability and validity. *Journal of Consulting and Clinical Psychology, 53*(3), 422-423.
doi:10.1037/0022-006X.53.3.422
- Koss, M. P., & Oros, C. J. (1982). Sexual Experiences Survey: A research instrument investigating sexual aggression and victimization. *Journal of Consulting and Clinical Psychology, 50*(3), 455-457. doi:10.1037/0022-006X.50.3.455

- Langeland, W., & Hartgers, C. (1998). Child sexual and physical abuse and alcoholism: A review. *Journal of Studies on Alcohol*, *59*, 336-348. Retrieved from http://www.jsad.com/jsad/article/Child_Sexual_and_Physical_Abuse_and_Alcoholism_A_Review/522.html
- Lanius, R. A., Vermetten, E., Loewenstein, R. J., Brand, B., Schmahl, C., Bremner, J. D., & Spiegel, D. (2010). Emotion modulation in PTSD: Clinical and neurobiological evidence for a dissociative subtype. *The American Journal of Psychiatry*, *167*(6), 640-647. doi: 10.1176/appi.ajp.2009.09081168
- Lanius, R. A., Williamson, P. C., Boksman, K., Densmore, M., Gupta, M., Neufeld, R.,...Menon, R. S. (2002). Brain activation during script-driven imagery induced dissociative responses in PTSD: A functional magnetic resonance imaging investigation. *Biological Psychiatry*, *52*, 305-311. doi:10.1016/S0006-3223(02)01367-7
- Larimer, M. E., Lee, C. M., Kilmer, J. R., Fabiano, P. M., Stark, C. B., Griesner, I. M...Neighbors, C. (2007). Personalized mailed feedback for college drinking prevention: A randomized clinical trial. *Journal of Consulting and Clinical Psychology*, *75*(2), 285-293. doi:10.1037/0022-006X.75.2.285
- Linehan, M. M., Bohus, M., & Lynch, T. R. (2007). Dialectical behavior therapy for pervasive emotion regulation difficulties: Theoretical and practical underpinnings. *Handbook of emotion regulation* (pp. 581-605). New York: Guilford Press.

- Loo, R., & Thorpe, K. (2000). Confirmatory factor analyses of the full and short versions of the Marlowe-Crowne Social Desirability Scale. *Journal of Social Psychology, 140*(5), 628-635. doi:10.1080/00224540009600503
- Luterek, J. A., Orsillo, S. M., & Marx, B. P. (2005). An experimental examination of emotional experience, expression, and disclosure in women reporting a history of childhood sexual abuse. *Journal of Traumatic Stress, 18*, 237-244. doi:10.1002/jts.20027
- MacCallum, R. C., Zhang, S., Preacher, K. J., & Rucker, D. D. (2002). On the practice of dichotomization of quantitative variables. *Psychological Methods, 7*, 19-40. doi:10.1037/1082-989X.7.1.19
- MacKinnon, D. P., Lockwood, C. M., Hoffman, J. M., West, S. G., & Sheets, V. (2002). A comparison of methods to test the significance of the mediated effect. *Psychological Methods, 7*, 83-104. doi:10.1037/1082-989X.7.1.83
- Marx, B. P., Heidt, J. M., & Gold, S. D. (2005). Perceived uncontrollability and unpredictability, self-regulation, and sexual revictimization. *Review of General Psychology, 9*, 67-90. doi:10.1037/1089-2680.9.1.67
- Marx, B. P., & Sloan, D. M. (2003). The effects of trauma history, gender, and race on alcohol use and posttraumatic stress symptoms in a college student sample. *Addictive Behaviors, 28*, 1631-1647. doi:10.1016/j.addbeh.2003.08.039
- McClelland, G. H., & Judd, C. M. (1993). Statistical difficulties of detecting interactions and moderator effects. *Psychological Bulletin, 114*, 376-390. doi:10.1037/0033-2909.114.2.376

- McCutcheon, V. V., Sartor, C. E., Pommer, N. E., Bucholz, K. K., Nelson, E. C., Madden, P., & Heath, A. C. (2010). Age of trauma exposure and PTSD risk in young adult women. *Journal of Traumatic Stress, 23*(6), 811-814.
DOI: 10.1002/jts.20577
- McDermott, M. J., Tull, M. T., Gratz, K. L., Daughters, S. B., & Lejuez, C. W. (2009). The role of anxiety sensitivity and difficulties in emotion regulation in posttraumatic stress disorder among crack/cocaine dependent patients in residential substance abuse treatment. *Journal of Anxiety Disorders, 23*, 591-599.
doi:10.1016/j.janxdis.2009.01.006
- McDonagh-Coyle, A., McHugo, G. J., Friedman, M. J., Schnurr, P. P., Zayfert, C., & Descamps, M. (2001). Psychophysiological reactivity in female sexual abuse survivors. *Journal of Traumatic Stress, 14*(4), 667-683.
doi:10.1023/A:1013081803429
- Messman-Moore, T. L., Brown, A. L., & Koelsch, L. E. (2005). Posttraumatic symptoms and self-dysfunction as consequences and predictors of sexual revictimization. *Journal of Traumatic Stress, 18*(3), 253-261. doi:10.1002/jts.20023
- Messman-Moore, T. L., Coates, A. A., Gaffey, K. J., & Johnson, C. F. (2008). Sexuality, substance use, and susceptibility to victimization: Risk for rape and sexual coercion in a prospective study of college women. *Journal of Interpersonal Violence, 23*(12), 1730-1746. doi: 10.1177/0886260508314336
- Messman-Moore, T. L., & Long, P. J. (2000). Child sexual abuse and revictimization in the form of adult sexual abuse, adult physical abuses, and adult psychological

maltreatment. *Journal of Interpersonal Violence*, 15, 489-502.

doi:10.1177/088626000015005003

Messman-Moore, T. L., & Long, P. J. (2003). The role of childhood sexual abuse sequelae in the sexual revictimization of women: An empirical review and theoretical reformulation. *Clinical Psychology Review*, 23, 537-571.

doi:10.1016/S0272-7358(02)00203-9

Messman-Moore, T. L., Long, P. J., & Siegfried, N. J. (2000). The revictimization of child sexual abuse survivors: An examination of the adjustment of college women with child sexual abuse, adult sexual assault, and adult physical abuse. *Child Maltreatment*, 5, 18-27. doi:10.1177/1077559500005001003

Messman-Moore, T., Ward, R. M., & Brown, A. L. (2009). Substance use and PTSD symptoms impact the likelihood of rape and revictimization in college women. *Journal of Interpersonal Violence*, 24, 499-521. doi:10.1177/0886260508317199

Miranda, R., Meyerson, L. A., Long, P. J., Marx, B. P., & Simpson, S. M. (2002). Sexual assault and alcohol use: Exploring the self-medication hypothesis. *Violence and Victims*, 17, 205-217. doi:10.1891/vivi.17.2.205.33650

Moncrieff, J., Farmer, R. (1998). Sexual abuse and the subsequent development of alcohol problems. *Alcohol and Alcoholism*, 33, 592-601.

doi:10.1093/alcalc/33.6.592

Mulder, R. T., Beautrais, A. L., Joyce, P. R., & Fergusson, D. M. (1998). Relationship between dissociation, childhood sexual abuse, childhood physical abuse, and mental illness in a general population sample. *American Journal of Psychiatry*, 155, 806-811.

- Mun, E. Y., White, H. R., & Morgan, T. J. (2009). Individual and situational factors that influence the efficacy of personalized feedback substance use interventions for mandated college students. *Journal of Consulting and Clinical Psychology, 77*(1), 88-102. doi:10.1037/a0014679
- Najavits, L. M. (2002). *Seeking Safety: A Treatment Manual for PTSD and Substance Abuse*. New York, NY: Guilford Press.
- Najdowski, C. J., & Ullman, S. E. (2009). Prospective effects of sexual victimization on PTSD and problem drinking. *Addictive Behaviors, 34*(11), 965-968. doi:10.1016/j.addbeh.2009.05.004
- Nash, M. R., Hulseley, T. L., Sexton, M. C., Harralson, T. L., & Lambert, W. (1993). Long-term sequelae of childhood sexual abuse: Perceived family environment, psychopathology, and dissociation. *Journal of Consulting and Clinical Psychology, 61*, 276-283. doi:10.1037/0022-006X.61.2.276
- National Institute of Alcohol Abuse and Alcoholism, National Institute of Health, U.S. Department of Health and Human Services. (2003). *Assessing alcohol problems: A guide for clinicians and researchers* (2nd ed.). Retrieved from <http://pubs.niaaa.nih.gov/publications/Assesing%20Alcohol/>
- Neumann, A., van Lier, P., Gratz, K. L., & Koot, H. M. (2010). Multidimensional assessment of emotion regulation difficulties in adolescents using the Difficulties in Emotion Regulation Scale. *Assessment, 17*, 138-149. doi:10.1177/1073191109349579
- O'Malley, P. M., & Johnston, L. D. (2002). Epidemiology of alcohol and other drug use among American college students. *Journal of Studies on Alcohol, 14*, 23-39.

- Paolucci, E. O., Genuis, M. L., & Violato, C. (2001). A meta-analysis of the published research on the effects of child sexual abuse. *Journal of Psychology, 135*(1), 17-36. doi:10.1080/00223980109603677
- Pascarella, E. T., Goodman, K. M., Seifert, T. A., Tagliapietra-Nicoli, G., Park, S., & Whitt, E. J. (2007). College student binge drinking and academic achievement: A longitudinal replication and extension. *Journal of College Student Development, 48*(6), 715-727. doi:10.1353/csd.2007.0060
- Paulhus, D. L. (1991). Measurement and control of response bias. In J. P. Robinson, P. R. Shaver, & L. S. Wrightsman (Eds.), *Measures of personality and social psychological attitudes*. San Diego, CA: Academic Press.
- Pietrzak, R. H., Goldstein, M. B., Malley, J. C., Johnson, D. C., & Southwick, S. M. (2009). Subsyndromal posttraumatic stress disorder is associated with health and psychosocial difficulties in veterans of operations enduring freedom and Iraqi freedom. *Depression and Anxiety, 26*, 739-744. doi:10.1002/da.20574
- Polusny, M. A., & Follette, V. M. (1995). Long-term correlates of child sexual abuse: Theory and review of the empirical literature. *Applied & Preventive Psychology, 4*, 143-166. doi:10.1016/S0962-1849(05)80055-1
- Porter, J. F., & Critelli, J. W. (1992). Measurement of sexual aggression in college men: A methodological analysis. *Archives of Sexual Behavior, 21*(6), 525-542. doi:10.1007/BF01542254
- Posner, M. I., & Rothbart, M. K. (2009). Toward a physical basis of attention and self-regulation. *Physics of Life Reviews, 6*, 103-120. doi:10.1016/j.plprev.2009.02.001

- Price, J. M., & Lento, J. (2001). The nature of child and adolescent vulnerability: History and definitions. In R. E. Ingram & J. M. Price (Eds.), *Vulnerability to psychopathology: Risk across the Lifespan* (pp. 20-38). New York: Guilford Press.
- Quimette, P. C., Wolfe, J., & Chrestman, K. R. (1996). Characteristics of posttraumatic stress disorder-alcohol abuse comorbidity in women. *Journal of Substance Abuse*, 8(3), 335-346. doi:10.1016/S0899-3289(96)90188-1
- Rademaker, A. R., Vermetten, E., Geuze, E., Mulwijk, A., & Kleber, R. J. (2008). Self-reported early trauma as a predictor of adult personality: A study in a military sample. *Journal of Clinical Psychology*, 64(7), 863-875. doi:10.1002/jclp.20495
- Read, J. P., Beattie, M., Chamberlain, R., & Merrill, J. E. (2008). Beyond the 'binge' threshold: Heavy drinking patterns and their association with alcohol involvement indices in college students. *Addictive Behaviors*, 33(2), 225-234. doi:10.1016/j.addbeh.2007.09.001
- Reinert, D. F., & Allen, J. P. (2002). The Alcohol Use Disorders Identification Test (AUDIT): A review of recent research. *Alcoholism: Clinical and Experimental Research*, 26(2), 272-279.
- Reinert, D. F., & Allen, J. P. (2007). The Alcohol Use Disorders Identification Test: An update of research findings. *Alcoholism: Clinical and Experimental Research*, 31(2), 185-199. doi:10.1111/j.1530-0277.2006.00295.x
- Reynolds, M. D., Tarter, R. E., & Kirisci, L. (2004). Characteristics of men with substance use disorder consequent to illicit drug use: Comparison of a random

sample and volunteers. *Drug and Alcohol Dependence*, 75, 241-251.

doi:10.1016/j.drugalcdep.2004.03.009

Rodriguez, N., Ryan, S. W., Vande Kemp, H., & Foy, D. W. (1997). Posttraumatic stress disorder in adult female survivors of childhood sexual abuse: A comparison study. *Journal of Consulting and Clinical Psychology*, 65, 53-59.

doi:10.1037/0022-006X.65.1.53

Rodriguez-Srednicki, O. (2001). Childhood sexual abuse, dissociation, and adult self-destructive behavior. *Journal of Child Sexual Abuse*, 10(3), 75-90.

doi:10.1300/J070v10n03_05

Roesler, T. A., & Dafler, C. E. (1993). Chemical dissociation in adults sexually victimized as children: Alcohol and drug use in adult survivors. *Journal of Substance Abuse Treatment*, 10, 537-543. doi:10.1016/0740-5472(93)90057-9

Rosenthal, M. Z., Rasmussen Hall, M. L., Palm, K. M., Batten, S. V., & Follette, V. M. (2005). Chronic avoidance helps explain the relationship between severity of childhood sexual abuse and psychological distress in adulthood. *Journal of Child Sexual Abuse*, 14(4), 25-41. doi:10.1300/J070v14n04_02

Ross, C. (1996). History, phenomenology and epidemiology of dissociation. In L. K. Michelson & W. J. Ray (Eds.), *Handbook of dissociation: Theoretical, empirical and clinical perspectives* (pp. 3-240). New York, NY: Plenum Press.

Ruggiero, K. J., Del Ben, K., Scotti, J. R., & Rabalais, A. E. (2003). Psychometric properties of the PTSD Checklist-Civilian Version. *Journal of Traumatic Stress*, 16, 495-502. doi:10.1023/A:1025714729117

- Sacks, J. Y., McKendrick, K., & Banks, S. (2008). The impact of early trauma and abuse on residential substance abuse treatment outcomes for women. *Journal of Substance Abuse Treatment, 34*(1), 30-100. doi:10.1016/j.jsat.2007.01.010
- Sandberg, D. A., Matorin, A. I., & Lynn, S. J. (1999). Dissociation, posttraumatic symptomatology, and sexual revictimization: A prospective examination of mediator and moderator effects. *Journal of Traumatic Stress, 12*(1), 127-138. doi:10.1023/A:1024702501224
- Sartor, C. E., Agrawal, A., McCutcheon, V. V., Duncan, A. E., & Lynskey, M. T. (2008). Disentangling the complex association between childhood sexual abuse and alcohol-related problems: A review of methodological issues and approaches. *Journal of Studies on Alcohol & Drugs, 69*, 718-727.
- Sartor, C. E., Lynskey, M. T., Bucholz, K. K., McCutcheon, V. V., Nelson, E. C., Waldron, M., & Heath, A. C. (2007). Childhood sexual abuse and the course of alcohol dependence development. Findings from a female twin sample. *Drug & Alcohol Dependence, 89* (2/3), 139-144. doi:10.1016/j.drugalcdep.2006.12.022
- Saunders, B. E., Villepontaux, L. A., Lipovsky, J. A., Kilpatrick, D. G., & Veronen, L. J. (1992). Child sexual assault as a risk factor for mental health disorders among women: A community survey. *Journal of Interpersonal Violence, 7*, 189-204. doi:10.1177/088626092007002005
- Saunders, J. B., Aasland, O. G., Babor, T. F., de la Fuente, J. R., & Grant, M. (1993). Development of the Alcohol Use Disorders Screening Test (AUDIT): WHO collaborative project on early detection of persons with harmful alcohol

consumption. II. *Addiction*, 88, 791-804. doi:10.1111/j.1360-0443.1993.tb02093.x

Senn, T. E., Carey, M. P., Vanable, P. A., Coury-Doniger, P., & Urban, M. A. (2006).

Childhood sexual abuse and sexual risk behavior among men and women attending a sexually transmitted disease clinic. *Journal of Consulting and Clinical Psychology*, 74(4), 720-731. doi:10.1037/0022-006X.74.4.720

Sheese, B. E., Voelker, P., Posner, M. I., & Rothbart, M. K. (2009). Genetic variation

influences on the early development of reactive emotions and their regulation by attention. *Cognitive Neuropsychiatry*, 14, 332-355.

doi:10.1080/13546800902844064

Sher, K. J., & Grekin, E. R. (2007). Alcohol and affect regulation. In J. J. Gross (Ed.),

Handbook of emotion regulation (pp. 560-580). New York: Guilford Press.

Shields, A., & Cicchetti, D. (1998). Reactive aggression among maltreated children: The

contributions of attention and emotion regulation difficulties. *Journal of Clinical Child Psychology*, 27(4), 381-395. doi:10.1207/s15374424jccp2704_2

Shipman, K., Zeman, J., Penza, S., & Champion, K. (2000). Emotion management skills

in sexually maltreated and nonmaltreated girls: A developmental psychopathology perspective. *Development and Psychopathology*, 12, 47-62.

doi:10.1017/S0954579400001036

Shrout, P. E., & Bolger, N. (2002). Mediation in experimental and nonexperimental

studies: New procedures and recommendations. *Psychological Methods*, 7, 422-445. doi:10.1037/1082-989X.7.4.422

- Sigmon, S. T., Pells, J. J., Boulard, N. E., Whitcomb-Smith, S., Edenfield, T. M., Hermann, B. A.,...Kubik, E. (2005). Gender differences in self-reports of depression: The response bias hypothesis revisited. *Sex Roles, 53*(5-6), 401-411. doi:10.1007/s11199-005-6762-3
- Silverman, A. B., Reinherz, H. Z., & Giaconia, R. M. (1996). The long-term sequelae of child and adolescent abuse: A longitudinal community study. *Child Abuse & Neglect, 20*(8), 709-723. doi:10.1016/0145-2134(96)00059-2
- Simpson, T. L. (2003). Childhood sexual abuse, PTSD, and the functional roles of alcohol use among women drinkers. *Substance Use & Misuse, 38*, 249-270. doi:10.1081/JA-120017248
- Simpson, T. L., & Miller, W. R. (2002). Concomitance between childhood sexual and physical abuse and substance use problems: A review. *Clinical Psychology Review, 22*, 27-77. doi:10.1016/S0272-7358(00)00088-X
- Smith, J. P., & Tran, G. Q. (2007). Does negative affect increase change readiness among college hazardous drinkers? *Addictive Behaviors, 32*, 2281-2285. doi:10.1016/j.addbeh.2007.01.019
- Sobel, M. E. (1982). Asymptotic confidence intervals for indirect effects in structural equation models. In S. Leinhardt (Ed.), *Sociological Methodology 1982* (pp. 290-312). Washington DC: American Sociological Association.
- Somer, E. (2003). Prediction of abstinence from heroin addiction by childhood trauma, dissociation, and extent of psychosocial treatment. *Addiction Research and Theory, 11*, 339-348. doi:10.1080/1606635031000141102

- Somer, E., & Avni, R. (2003). Dissociative phenomena among recovering heroin users and their relationship to duration of abstinence. *Journal of Social Work Practice, 3*(1), 25-38. doi:10.1300/J160v03n01_03
- Spindler, H., Elklit, A. (2003). Dissociation, psychiatric symptoms, and personality traits in a non-clinical population. *Journal of Trauma and Dissociation, 4*(2), 89-107. doi:10.1300/J229v04n02_06
- Stein, M. B., Walker, J. R., Hazen, A. L., & Forde, D. R. (1997). Full and partial posttraumatic stress disorder: Findings from a community survey. *American Journal of Psychiatry, 154*, 1114-1119.
- Stewart, S. H. (1996). Alcohol abuse in individuals exposed to trauma: A critical review. *Psychological Bulletin, 120*(1), 83-112. doi:10.1037/0033-2909.120.1.83
- Stewart, S. H., & Conrod, P. J. (2003). Psychosocial models of functional associations between posttraumatic stress disorder and substance disorder. In P. Quimette & P. J. Brown (Eds.), *Trauma and substance abuse: Causes, consequences, and treatment of comorbid disorders* (pp. 29-55). Washington, DC: American Psychological Association. doi:10.1037/10460-002
- Stith, S. M., Crossman, R. K., & Bischof, G. P. (1991). Alcoholism and marital violence: A comparative study of men in alcohol treatment programs and batterer treatment programs. *Alcoholism Treatment Quarterly, 8*(2), 3-20. doi:10.1300/J020V08N02_02
- Stritzke, W. G., Patrick, C. J., & Lang, A. R. (1995). Alcohol and human emotion: A multidimensional analysis incorporating startle-probe methodology. *Journal of Abnormal Psychology, 104*, 114-122. doi:10.1037/0021-843X.104.1.114

- Tabachnick, B. G., & Fidell, L. S. (2001). *Using Multivariate Statistics* (4th ed.). Needham Heights, MA: Allyn & Bacon.
- Tellegen, A., & Atkinson, G. (1974). Openness to absorbing and self-altering experiences (“absorption”), a trait related to hypnotic susceptibility. *Journal of Abnormal Psychology, 83*(3), 268-277. doi:10.1037/h0036681
- Testa, M., Hoffman, J. H., & Livingston, J. A. (2010). Alcohol and sexual risk behaviors as mediators of the sexual victimization-revictimization relationship. *Journal of Consulting and Clinical Psychology, 78*(2), 249-259. doi:10.1037/a0018914
- Testa, M., & Livingston, J. A. (2009). Alcohol consumption and women’s vulnerability to sexual victimization: Can reducing women’s drinking prevent rape? *Substance Use & Misuse, 44*, 1349-1376. doi:10.1080/10826080902961468
- Testa, M., Livingston, J. A., & Hoffman, J. H. (2007). Does sexual victimization predict subsequent alcohol consumption? A prospective study among a community sample of women. *Addictive Behaviors, 32*, 2926-2939. doi:10.1016/j.addbeh.2007.05.017
- Testa, M., Livingston, J. A., Vanzile-Tamsen, C., & Frone, M. R. (2003). The role of women’s substance use in vulnerability to forcible and incapacitated rape. *Journal of Studies on Alcohol, 64*(6), 756-764.
- Testa, M., & Parks, K. A. (1996). The role of women’s alcohol consumption in sexual victimization. *Aggression & Violent Behavior, 1*(3), 217-234. doi:10.1016/1359-1789(95)00017-8
- Testa, M., VanZile-Tamsen, C., Livingston, J. A., & Koss, M. P. (2004). Assessing women’s experiences of sexual aggression using the Sexual Experiences Survey:

- Evidence for validity and implications for research. *Psychology of Women Quarterly*, 28, (256-265). doi:10.1111/j.1471-6402.2004.00143.x
- Thomas, P. M. (2003). Protection, dissociation, and internal roles: Modeling and treating the effects of child abuse. *Review of General Psychology*, 7(4), 364-380.
doi:10.1037/1089-2680.7.4.364
- Thomson, P., Keehn, E. B., & Gumpel, T. P. (2009). Generators and interpreters in a performing arts population: Dissociation, trauma, fantasy proneness, and affective states. *Creativity Research Journal*, 21(1), 72-91.
doi:10.1080/10400410802633533
- Trickett, P. K., Noll, N. G., Reiffman, A., & Putnam, F. W. (2001). Variants of intrafamilial sexual abuse experience: Implications for short- and long-term development. *Development and Psychopathology*, 13, 1001-1019.
- Trickett, P. K., & Putnam, F. W. (1993). Impact of child sexual abuse on females: Toward a developmental psychobiological integration. *Psychological Science*, 4(2), 81-87. doi:10.1111/j.1467-9280.1993.tb00465.x
- Trull, T. J., Sher, K. J., Minks-Brown, C., Durbin, J., & Burr, R. (2000). Borderline personality disorder and substance use disorders: A review and integration. *Clinical Psychology Review*, 20, 235-253. doi:10.1016/S0272-7358(99)00028-8
- Tull, M. T., Barrett, H. M., McMillan, E. S. & Roemer, L. (2007). A preliminary investigation of the relationship between emotion regulation difficulties and posttraumatic stress symptoms. *Behavior Therapy*, 38, 303-313.
doi:10.1016/j.beth.2006.10.001

- Twaite, J. A., & Rodriguez-Srednicki, O. (2004). Childhood sexual and physical abuse and adult vulnerability to PTSD: The mediating effects of attachment and dissociation. *Journal of Child Sexual Abuse, 13*(1), 17-38.
doi:10.1300/J070v13n01_02
- Tyler, K. A. (2002). Social and emotional outcomes of childhood sexual abuse: A review of recent research. *Aggression and Violent Behavior, 7*, 567-589.
doi:10.1016/S1359-1789(01)00047-7
- Ullman, S. E., & Filipas, H. H. (2005). Gender differences in social reactions to abuse disclosures, post-abuse coping, and PTSD of child sexual abuse survivors. *Child Abuse & Neglect, 29*, 767-782.
- Ullman, S. E., Filipas, H. H., Townsend, S. M., & Starzynski, L. L. (2005). Trauma exposure, posttraumatic stress disorder and problem drinking in sexual assault survivors. *Journal of Studies on Alcohol, 66*, 610-619.
- Van der Kolk, B. A. (1996). The complexity of adaptation to trauma: Self-regulation, stimulus, discrimination, and characterological development. In B. A. Van der Kolk, A. C. McFarlane, & L. Weisaeth (Eds.), *Traumatic stress: The effects of overwhelming experience on mind, body and society* (pp. 182-213). New York: Guilford Press.
- Van der Kolk, B. A., Van der Hart, O., & Marmar, C. R. (1996). Dissociation and information processing in posttraumatic stress disorder. In B. A. Van der Kolk, A. C. McFarlane, & L. Weisaeth (Eds.), *Traumatic stress: The effects of overwhelming experience on mind, body, and society* (pp. 303-327). New York, NY: Guilford Press.

- Vaschillo, E. G., Bates, M. E., Vaschillo, B., Lehrer, P., Udo, T., Mun, E. Y., & Ray, S. (2008). Heart rate variability response to alcohol, placebo, and emotional picture cue challenges: Effects of 0.1-Hz stimulation. *Psychophysiology*, *45*, 847-858. doi:10.1111/j.1469-8986.2008.00673.x
- Vik, P. W., Islam-Zwart, K. A., & Ruge, L. N. (2008). Application of the PTSD-alcohol expectancy questionnaire (P-AEQ) to sexually assaulted college women. *Addiction Research and Theory*, *16*, 585-594. doi:10.1080/16066350701867273
- Wall, A., Wekerle, C., & Bissonnette, M. (2000). Childhood maltreatment, parental alcoholism, and beliefs about alcohol: Subgroup variation among alcohol-dependent adults. *Alcoholism Treatment Quarterly*, *18*(3), 49-60. doi:10.1300/J020v18n03_05
- Walters, S. T., Vader, A. M., Harris, T. R., Field, C. A., & Jouriles, E. N. (2009). Dismantling motivational interviewing and feedback for college drinkers: A randomized clinical trial. *Journal of Consulting and Clinical Psychology*, *77*(1), 64-73. doi:10.1037/a0014472
- Weathers, F.W., Litz, B.T., Herman, D.S., Huska, J.A., & Keane, T.M. (1993, October). *The PTSD Checklist: Reliability, validity and diagnostic utility*. Paper presented at the annual meeting of the International Society for Traumatic Stress Studies, San Antonio, TX.
- Weinberg, A., & Klonsky, E. D. (2009). Measurement of emotion regulation difficulties in adolescents. *Psychological Assessment*, *21*, 616-621. doi:10.1037/a0016669

- Weiss, E. L., Longhurst, J. G., & Mazure, C. M. (1999). Childhood sexual abuse as a risk factor for depression in women: Psychosocial and neurobiological correlates. *American Journal of Psychiatry, 156*, 816-828.
- White, H. R., Mun, E. Y., Pugh, L., & Morgan, T. J. (2007). Long-term effects of brief substance use intervention for mandated college students: Sleeper effects of an in-person personal feedback intervention. *Alcoholism: Clinical and Experimental Research, 31*(8), 1380-1391. doi:10.1111/j.1530-0277.2007.00435.x
- Widom, C. S., & Morris, S. (1997). Accuracy of adult recollections of childhood victimization: Part 2. Childhood sexual abuse. *Psychological Assessment, 9*, 34-46. doi:10.1037/1040-3590.9.1.34
- Wolfe, L. M. (2003). The introduction of path analysis to the social sciences, and some emergent themes: An annotated bibliography. *Structural Equation Modeling, 10*(1), 1-34. doi:10.1207/S15328007SEM1001_1
- Wolfsdorf, B. A., & Zlotnick, C. (2001). Affect management in group therapy for women with posttraumatic stress disorder and histories of childhood sexual abuse. *Journal of Clinical Psychology, 57*(2), 169-181. doi:10.1002/1097-4679(200102)57:2<169::AID-JCLP4>3.0.CO;2-0
- Wright, D. B., & Loftus, E. F. (2000). Measuring dissociation: Comparison of alternative forms of the Dissociative Experiences Scale. *Australian Journal of Clinical and Experimental Hypnosis, 28*(2), 103-126.
- Wright, S. (1934). The method of path coefficients. *Annals of Mathematical Statistics, 5*(3), 161-215. doi:10.1214/aoms/1177732676

- Wright, S. (1960). Path coefficients and path regressions: Alternative or complementary concepts. *Biometrics*, *16*(2), 189-202. doi:10.2307/2527551
- Zingrone, N. L., & Alvarado, C. S. (2002). The Dissociative Experiences Scale-II: Descriptive statistics, factor analysis, and frequency of experiences. *Imagination, Cognition, and Personality*, *21*(2), 145-157. doi:10.2190/K48D-XAW3-B2KC-UBB7
- Zlotnick, C., Franklin, C. L., & Zimmerman, M. (2002). Does 'subthreshold' posttraumatic stress disorder have any clinical relevance? *Comprehensive Psychiatry*, *43*(6), 413-419. doi:10.1053/comp.2002.35900
- Zlotnick, C., Johnson, D. M., Stout, R. L., Zywiak, W. H., Johnson, J. E., & Schneider, R. J. (2006). Childhood abuse and intake severity in alcohol disorder patients. *Journal of Traumatic Stress*, *19*(6), 949-959. doi:10.1002/jts.20177
- Zuckerman, M. (1999). Diathesis-stress models. In M. Zuckerman (Ed.), *Vulnerability to psychopathology: A biosocial model* (pp. 3-23). Washington, DC: American Psychological Association. doi:10.1037/10316-001

Appendix A
STUDY MEASURES

AUDIT

Id Number _____

For the following set of questions, please mark the answer that is correct for you during the past year by placing an 'X' in the appropriate box.

1. How often do you have a drink containing alcohol?

_____	_____	_____	_____	_____
Never	Monthly or less	2-4 times a month	2-3 times a week	4 or more times a week

2. How many drinks containing alcohol do you have on a typical day when you drink?

_____	_____	_____	_____	_____	_____	_____	_____	_____
1-2	3-4	5-6	7-9	10-12	13-15	16-19	20 or more	Not applicable

3. If male, how often do you have six or more drinks on one occasion? If female, how often do you have four or more drinks on one occasion?

_____	_____	_____	_____	_____
Never	Less than monthly	Monthly	Weekly	Daily or almost daily

4. How often during the last year have you found that you were not able to stop drinking once you had started?

_____	_____	_____	_____	_____
Never	Less than monthly	Monthly	Weekly	Daily or almost daily

5. How often during the last year have you failed to do what normally expected from you because of drinking?

_____	_____	_____	_____	_____
Never	Less than monthly	Monthly	Weekly	Daily or almost daily

6. How often during the last year have you needed a first drink in the morning to get yourself going after a heavy drinking session?

_____	_____	_____	_____	_____
Never	Less than monthly	Monthly	Weekly	Daily or almost daily

7. How often during the last year have you had a feeling of guilt or remorse after drinking?

_____	_____	_____	_____	_____
Never	Less than monthly	Monthly	Weekly	Daily or almost daily

8. How often during the last year have you been unable to remember what happened the night before because you had been drinking?

_____	_____	_____	_____	_____
Never	Less than monthly	Monthly	Weekly	Daily or almost daily

9. Have you or someone else been injured as a result of your drinking?

_____	_____	_____
No	Yes, but not in the last year	Yes, during the last year

10. Has a relative or friend, or a doctor or other health worker been concerned about your drinking or suggested you cut down?

_____	_____	_____
No	Yes, but not in the last year	Yes, during the last year

DERS

Id Number _____

Response categories:

- 1 Almost never (0-10%)
- 2 Sometimes (11-35%)
- 3 About half the time (36-65%)
- 4 Most of the time (66 – 90%)
- 5 Almost always (91-100%)

1. I am clear about my feelings. _____
2. I pay attention to how I feel. _____
3. I experience my emotions as overwhelming and out of control. _____
4. I have no idea how I am feeling. _____
5. I have difficulty making sense out of my feelings. _____
6. I am attentive to my feelings. _____
7. I know exactly how I am feeling. _____
8. I care about what I am feeling. _____
9. I am confused about how I feel. _____
10. When I'm upset, I acknowledge my emotions. _____
11. When I'm upset, I become angry with myself for feeling that way. _____
12. When I'm upset, I become embarrassed for feeling that way. _____
13. When I'm upset, I have difficulty getting work done. _____
14. When I'm upset, I become out of control. _____
15. When I'm upset, I believe that I will remain that way for a long time. _____
16. When I'm upset, I believe that I'll end up feeling very depressed. _____
17. When I'm upset, I believe that my feelings are valid and important. _____
18. When I'm upset, I have difficulty focusing on other things. _____
19. When I'm upset, I feel out of control. _____
20. When I'm upset, I can still get things done. _____
21. When I'm upset, I feel ashamed with myself for feeling that way. _____
22. When I'm upset, I know that I can find a way to eventually feel better. _____
23. When I'm upset, I feel like I am weak. _____
24. When I'm upset, I feel like I can remain in control of my behaviors. _____
25. When I'm upset, I feel guilty for feeling that way. _____
26. When I'm upset, I have difficulty concentrating. _____
27. When I'm upset, I have difficulty controlling my behaviors. _____
28. When I'm upset, I believe there is nothing I can do to make myself feel better. _____
29. When I'm upset, I become irritated with myself for feeling that way. _____
30. When I'm upset, I start to feel very bad about myself. _____
31. When I'm upset, I believe that wallowing in it is all I can do. _____
32. When I'm upset, I lose control over my behaviors. _____
33. When I'm upset, I have difficulty thinking about anything else. _____
34. When I'm upset, I take time to figure out what I'm really feeling. _____
35. When I'm upset, it takes me a long time to feel better. _____
36. When I'm upset, my emotions feel overwhelming. _____

DES

Id Number _____

This questionnaire consists of 28 questions about experiences that you may have in your daily life. We are interested in how often you have these experiences. It is important, however, that your answers show how often these experiences happen to you when you ARE NOT under the influence of alcohol or drugs. To answer the questions, please determine to what degree the experience described in the question applies to you and place an 'X' in the box that corresponds with what percentage of the time you have the experience.

1. Some people have the experience of driving a car and suddenly realizing that they don't remember what has happened during all or part of the trip. Select an answer to show what percentage of the time this happens to you.

0%	10%	20%	30%	40%	50%	60%	70%	80%	90%	100%	NA
NEVER											ALWAYS

2. Some people find that sometimes they are listening to someone talk and they suddenly realize that they did not hear all or part of what was said. Select an answer to show what percentage of the time this happens to you.

0%	10%	20%	30%	40%	50%	60%	70%	80%	90%	100%	NA
NEVER											ALWAYS

3. Some people have the experience of finding themselves in a place and having no idea how they got there. Select an answer to show what percentage of the time this happens to you.

0%	10%	20%	30%	40%	50%	60%	70%	80%	90%	100%	NA
NEVER											ALWAYS

4. Some people have the experience of finding themselves dressed in clothes that they don't remember putting on. Select an answer to show what percentage of the time this happens to you.

0%	10%	20%	30%	40%	50%	60%	70%	80%	90%	100%	NA
NEVER											ALWAYS

5. Some people have the experience of finding new things among their belongings that they do not remember buying. Select an answer to show what percentage of the time this happens to you.

0%	10%	20%	30%	40%	50%	60%	70%	80%	90%	100%	NA
NEVER											ALWAYS

6. Some people sometimes find that they are approached by people that they do not know who call them by name or insist that they have met them before. Select an answer to show what percentage of the time this happens to you.

0%	10%	20%	30%	40%	50%	60%	70%	80%	90%	100%	NA
NEVER											ALWAYS

7. Some people sometimes have the experience of feeling as though they are standing next to themselves or something as if they were looking at another person. Select an answer to show what percentage of the time this happens to you.

<input type="checkbox"/>	<input type="checkbox"/>	<input type="checkbox"/>	<input type="checkbox"/>	<input type="checkbox"/>	<input type="checkbox"/>	<input type="checkbox"/>	<input type="checkbox"/>	<input type="checkbox"/>	<input type="checkbox"/>	<input type="checkbox"/>	<input type="checkbox"/>
0%	10%	20%	30%	40%	50%	60%	70%	80%	90%	100%	NA

NEVER ALWAYS

8. Some people are told that they sometimes do not recognize friends or family members. Select an answer to show what percentage of the time this happens to you.

<input type="checkbox"/>	<input type="checkbox"/>	<input type="checkbox"/>	<input type="checkbox"/>	<input type="checkbox"/>	<input type="checkbox"/>	<input type="checkbox"/>	<input type="checkbox"/>	<input type="checkbox"/>	<input type="checkbox"/>	<input type="checkbox"/>	<input type="checkbox"/>
0%	10%	20%	30%	40%	50%	60%	70%	80%	90%	100%	NA

NEVER ALWAYS

9. Some people find that they have no memory for important events in their lives (for example, a wedding or graduation). Select an answer to show what percentage of the time this happens to you.

<input type="checkbox"/>	<input type="checkbox"/>	<input type="checkbox"/>	<input type="checkbox"/>	<input type="checkbox"/>	<input type="checkbox"/>	<input type="checkbox"/>	<input type="checkbox"/>	<input type="checkbox"/>	<input type="checkbox"/>	<input type="checkbox"/>	<input type="checkbox"/>
0%	10%	20%	30%	40%	50%	60%	70%	80%	90%	100%	NA

NEVER ALWAYS

10. Some people have the experience of being accused of lying when they do not think that they have lied. Select an answer to show what percentage of the time this happens to you.

<input type="checkbox"/>	<input type="checkbox"/>	<input type="checkbox"/>	<input type="checkbox"/>	<input type="checkbox"/>	<input type="checkbox"/>	<input type="checkbox"/>	<input type="checkbox"/>	<input type="checkbox"/>	<input type="checkbox"/>	<input type="checkbox"/>	<input type="checkbox"/>
0%	10%	20%	30%	40%	50%	60%	70%	80%	90%	100%	NA

NEVER ALWAYS

11. Some people have the experience of looking in a mirror and not recognizing themselves. Select an answer to show what percentage of the time this happens to you.

<input type="checkbox"/>	<input type="checkbox"/>	<input type="checkbox"/>	<input type="checkbox"/>	<input type="checkbox"/>	<input type="checkbox"/>	<input type="checkbox"/>	<input type="checkbox"/>	<input type="checkbox"/>	<input type="checkbox"/>	<input type="checkbox"/>	<input type="checkbox"/>
0%	10%	20%	30%	40%	50%	60%	70%	80%	90%	100%	NA

NEVER ALWAYS

12. Some people sometimes have the experience of feeling that other people, objects, and the world around them are not real. Select an answer to show what percentage of the time this happens to you.

<input type="checkbox"/>	<input type="checkbox"/>	<input type="checkbox"/>	<input type="checkbox"/>	<input type="checkbox"/>	<input type="checkbox"/>	<input type="checkbox"/>	<input type="checkbox"/>	<input type="checkbox"/>	<input type="checkbox"/>	<input type="checkbox"/>	<input type="checkbox"/>
0%	10%	20%	30%	40%	50%	60%	70%	80%	90%	100%	NA

NEVER ALWAYS

13. Some people sometimes have the experience of feeling that their body does not belong to them. Select an answer to show what percentage of the time this happens to you.

<input type="checkbox"/>	<input type="checkbox"/>	<input type="checkbox"/>	<input type="checkbox"/>	<input type="checkbox"/>	<input type="checkbox"/>	<input type="checkbox"/>	<input type="checkbox"/>	<input type="checkbox"/>	<input type="checkbox"/>	<input type="checkbox"/>	<input type="checkbox"/>
0%	10%	20%	30%	40%	50%	60%	70%	80%	90%	100%	NA

NEVER ALWAYS

14. Some people have the experience of sometimes remembering a past event so vividly that they feel as if they were reliving that event. Select an answer to show what percentage of the time this happens to you.

<input type="checkbox"/>	<input type="checkbox"/>	<input type="checkbox"/>	<input type="checkbox"/>	<input type="checkbox"/>	<input type="checkbox"/>	<input type="checkbox"/>	<input type="checkbox"/>	<input type="checkbox"/>	<input type="checkbox"/>	<input type="checkbox"/>	<input type="checkbox"/>
0%	10%	20%	30%	40%	50%	60%	70%	80%	90%	100%	NA

NEVER ALWAYS

15. Some people have the experience of not being sure whether things that they remember happening really did happen or whether they just dreamed them. Select an answer to show what percentage of the time this happens to you.

<input type="checkbox"/>	<input type="checkbox"/>	<input type="checkbox"/>	<input type="checkbox"/>	<input type="checkbox"/>	<input type="checkbox"/>	<input type="checkbox"/>	<input type="checkbox"/>	<input type="checkbox"/>	<input type="checkbox"/>	<input type="checkbox"/>	<input type="checkbox"/>
0%	10%	20%	30%	40%	50%	60%	70%	80%	90%	100%	NA

NEVER ALWAYS

16. Some people have the experience of being in a familiar place but find it strange and unfamiliar. Select an answer to show what percentage of the time this happens to you.

<input type="checkbox"/>	<input type="checkbox"/>	<input type="checkbox"/>	<input type="checkbox"/>	<input type="checkbox"/>	<input type="checkbox"/>	<input type="checkbox"/>	<input type="checkbox"/>	<input type="checkbox"/>	<input type="checkbox"/>	<input type="checkbox"/>	<input type="checkbox"/>
0%	10%	20%	30%	40%	50%	60%	70%	80%	90%	100%	NA

NEVER ALWAYS

17. Some people find that when they are watching television or a movie they become so absorbed in the story that they are unaware of other events happening around them. Select an answer to show what percentage of the time this happens to you.

<input type="checkbox"/>	<input type="checkbox"/>	<input type="checkbox"/>	<input type="checkbox"/>	<input type="checkbox"/>	<input type="checkbox"/>	<input type="checkbox"/>	<input type="checkbox"/>	<input type="checkbox"/>	<input type="checkbox"/>	<input type="checkbox"/>	<input type="checkbox"/>
0%	10%	20%	30%	40%	50%	60%	70%	80%	90%	100%	NA

NEVER ALWAYS

18. Some people sometimes find that they become so involved in a fantasy or daydream that it feels as though it were really happening to them. Select an answer to show what percentage of the time this happens to you.

<input type="checkbox"/>	<input type="checkbox"/>	<input type="checkbox"/>	<input type="checkbox"/>	<input type="checkbox"/>	<input type="checkbox"/>	<input type="checkbox"/>	<input type="checkbox"/>	<input type="checkbox"/>	<input type="checkbox"/>	<input type="checkbox"/>	<input type="checkbox"/>
0%	10%	20%	30%	40%	50%	60%	70%	80%	90%	100%	NA

NEVER ALWAYS

19. Some people find that they are sometimes able to ignore pain. Select an answer to show what percentage of the time this happens to you.

<input type="checkbox"/>	<input type="checkbox"/>	<input type="checkbox"/>	<input type="checkbox"/>	<input type="checkbox"/>	<input type="checkbox"/>	<input type="checkbox"/>	<input type="checkbox"/>	<input type="checkbox"/>	<input type="checkbox"/>	<input type="checkbox"/>	<input type="checkbox"/>
0%	10%	20%	30%	40%	50%	60%	70%	80%	90%	100%	NA

NEVER ALWAYS

20. Some people find that they sometimes sit staring off into space, thinking of nothing, and are not aware of the passage of time. Select an answer to show what percentage of the time this happens to you.

<input type="checkbox"/>	<input type="checkbox"/>	<input type="checkbox"/>	<input type="checkbox"/>	<input type="checkbox"/>	<input type="checkbox"/>	<input type="checkbox"/>	<input type="checkbox"/>	<input type="checkbox"/>	<input type="checkbox"/>	<input type="checkbox"/>	<input type="checkbox"/>
0%	10%	20%	30%	40%	50%	60%	70%	80%	90%	100%	NA

NEVER ALWAYS

21. Some people sometimes find that when they are alone they talk out loud to themselves. Select an answer to show what percentage of the time this happens to you.

<input type="checkbox"/>	<input type="checkbox"/>	<input type="checkbox"/>	<input type="checkbox"/>	<input type="checkbox"/>	<input type="checkbox"/>	<input type="checkbox"/>	<input type="checkbox"/>	<input type="checkbox"/>	<input type="checkbox"/>	<input type="checkbox"/>	<input type="checkbox"/>
0%	10%	20%	30%	40%	50%	60%	70%	80%	90%	100%	NA

NEVER ALWAYS

22. Some people find that in one situation they may act so differently compared with another situation that they feel almost as if they were different people. Select an answer to show what percentage of the time this happens to you.

<input type="checkbox"/>	<input type="checkbox"/>	<input type="checkbox"/>	<input type="checkbox"/>	<input type="checkbox"/>	<input type="checkbox"/>	<input type="checkbox"/>	<input type="checkbox"/>	<input type="checkbox"/>	<input type="checkbox"/>	<input type="checkbox"/>	<input type="checkbox"/>
0%	10%	20%	30%	40%	50%	60%	70%	80%	90%	100%	NA

NEVER ALWAYS

23. Some people sometimes find that in certain situations they are able to do things with amazing ease and spontaneity that would usually be difficult for them (for example, sports, work, social situations, etc.) Select an answer to show what percentage of the time this happens to you.

<input type="checkbox"/>	<input type="checkbox"/>	<input type="checkbox"/>	<input type="checkbox"/>	<input type="checkbox"/>	<input type="checkbox"/>	<input type="checkbox"/>	<input type="checkbox"/>	<input type="checkbox"/>	<input type="checkbox"/>	<input type="checkbox"/>	<input type="checkbox"/>
0%	10%	20%	30%	40%	50%	60%	70%	80%	90%	100%	NA

NEVER ALWAYS

24. Some people sometimes find that they cannot remember whether they have done something or have just thought about doing that thing (for example, not knowing whether they have just mailed a letter or have just thought about mailing it). Select an answer to show what percentage of the time this happens to you.

<input type="checkbox"/>	<input type="checkbox"/>	<input type="checkbox"/>	<input type="checkbox"/>	<input type="checkbox"/>	<input type="checkbox"/>	<input type="checkbox"/>	<input type="checkbox"/>	<input type="checkbox"/>	<input type="checkbox"/>	<input type="checkbox"/>	<input type="checkbox"/>
0%	10%	20%	30%	40%	50%	60%	70%	80%	90%	100%	NA

NEVER ALWAYS

25. Some people find evidence that they have done things that they do not remember doing. Select an answer to show what percentage of the time this happens to you.

<input type="checkbox"/>	<input type="checkbox"/>	<input type="checkbox"/>	<input type="checkbox"/>	<input type="checkbox"/>	<input type="checkbox"/>	<input type="checkbox"/>	<input type="checkbox"/>	<input type="checkbox"/>	<input type="checkbox"/>	<input type="checkbox"/>	<input type="checkbox"/>
0%	10%	20%	30%	40%	50%	60%	70%	80%	90%	100%	NA

NEVER ALWAYS

26. Some people sometimes find writings, drawings, or notes among their belongings that they must have done but cannot remember doing. Select an answer to show what percentage of the time this happens to you.

<input type="checkbox"/>	<input type="checkbox"/>	<input type="checkbox"/>	<input type="checkbox"/>	<input type="checkbox"/>	<input type="checkbox"/>	<input type="checkbox"/>	<input type="checkbox"/>	<input type="checkbox"/>	<input type="checkbox"/>	<input type="checkbox"/>	<input type="checkbox"/>
0%	10%	20%	30%	40%	50%	60%	70%	80%	90%	100%	NA

NEVER ALWAYS

27. Some people find that they sometimes hear voices inside their head that tell them to do things or comment on things that they are doing. Select an answer to show what percentage of the time this happens to you.

<input type="checkbox"/>	<input type="checkbox"/>	<input type="checkbox"/>	<input type="checkbox"/>	<input type="checkbox"/>	<input type="checkbox"/>	<input type="checkbox"/>	<input type="checkbox"/>	<input type="checkbox"/>	<input type="checkbox"/>	<input type="checkbox"/>	<input type="checkbox"/>
0%	10%	20%	30%	40%	50%	60%	70%	80%	90%	100%	NA

NEVER ALWAYS

28. Some people sometimes feel as if they are looking at the world through a fog so that people or objects appear far away or unclear. Select an answer to show what percentage of the time this happens to you.

0%	10%	20%	30%	40%	50%	60%	70%	80%	90%	100%	NA
----	-----	-----	-----	-----	-----	-----	-----	-----	-----	------	----

NEVER

ALWAYS

ETI-SR-SF

Id Number _____

Part 1: General traumas **before** the age of 18

1. Were you ever exposed to a life-threatening natural disaster?
 Yes No
2. Were you ever involved in a serious accident?
 Yes No
3. Did you ever suffer a serious personal injury or illness?
 Yes No
4. Did you ever experience the death or serious illness of a parent or primary caretaker?
 Yes No
5. Did you experience the divorce or separation of your parents?
 Yes No
6. Did you experience the death or serious injury of a sibling?
 Yes No
7. Did you ever experience the death or serious injury of a friend?
 Yes No
8. Did you ever witness violence towards others, including family members?
 Yes No
9. Did anyone in your family ever suffer from a mental or psychiatric illness or have a "breakdown"?
 Yes No
10. Did your parents or primary caretaker have a problem with alcoholism or drug abuse?
 Yes No
11. Did you ever see someone murdered?
 Yes No

Part 2: Physical punishment **before** the age of 18

1. Were you ever exposed slapped in the face with an open hand?
 Yes No
2. Were you ever burned with hot water, a cigarette or something else?
 Yes No
3. Were you ever punched or kicked?
 Yes No
4. Were you ever hit with an object that was thrown at you?
 Yes No
5. Were you ever pushed or shoved?
 Yes No

Part 3: Emotional abuse **before** the age of 18

1. Were you often put down or ridiculed?
 Yes No
2. Were you often ignored or made to feel that you didn't count?
 Yes No
3. Were you often told you were no good?
 Yes No
4. Most of the time were you treated in a cold, uncaring way or made to feel like you were not loved?
 Yes No
5. Did your parents or caretakers often fail to understand you or your needs?
 Yes No

Part 4: Sexual events **before** the age of 18

1. Were you ever touched in an intimate or private part of your body (e.g., breast, thigh, genitals) in a way that surprised you or made you feel uncomfortable?
 Yes No
2. Did you ever experience someone rubbing their genitals against you?
 Yes No
3. Were you ever forced or coerced to touch another person in an intimate or private part of their body?
 Yes No
4. Did anyone ever have genital sex with you against your will?
 Yes No
5. Were you ever forced or coerced to perform oral sex on someone against your will?
 Yes No
6. Were you ever forced or coerced to kiss someone in a sexual rather than affectionate way?
 Yes No

If you responded 'Yes' to any of the above events, answer the following for the one that had the greatest impact on your life. In answering consider how you felt at the time of the event.

1. Did you experience emotions of fear, horror, or helplessness?
 Yes No
2. Did you experience an out-of-body dream like sensation?
 Yes No

PCLC

Id Number _____

Instructions: Below is a list of problems and complaints that people sometimes have in response to stressful experiences. Please read each one carefully, circle the word that indicates how much you have been bothered by that problem in the past month.

1. Repeated, disturbing memories, thoughts, or images of a stressful experience?
1. Not at all 2. A little bit 3. Moderately 4. Quite a bit 5. Extremely 6. Not applicable
2. Repeated, disturbing dreams of a stressful experience?
1. Not at all 2. A little bit 3. Moderately 4. Quite a bit 5. Extremely 6. Not applicable
3. Suddenly acting or feeling as if a stressful experience were happening again (as if you were reliving it)?
1. Not at all 2. A little bit 3. Moderately 4. Quite a bit 5. Extremely 6. Not applicable
4. Feeling very upset when something reminded you of a stressful experience?
1. Not at all 2. A little bit 3. Moderately 4. Quite a bit 5. Extremely 6. Not applicable
5. Having physical reactions (e.g., heart pounding, trouble breathing, sweating) when something reminded you of a stressful experience?
1. Not at all 2. A little bit 3. Moderately 4. Quite a bit 5. Extremely 6. Not applicable
6. Avoiding thinking about or talking about a stressful experience or avoiding having feelings related to it?
1. Not at all 2. A little bit 3. Moderately 4. Quite a bit 5. Extremely 6. Not applicable
7. Avoiding activities or situations because they reminded you of a stressful experience?
1. Not at all 2. A little bit 3. Moderately 4. Quite a bit 5. Extremely 6. Not applicable
8. Trouble remembering important parts of a stressful experience?
1. Not at all 2. A little bit 3. Moderately 4. Quite a bit 5. Extremely 6. Not applicable
9. Loss of interest in activities that you used to enjoy?
1. Not at all 2. A little bit 3. Moderately 4. Quite a bit 5. Extremely 6. Not applicable
10. Feeling distant or cut off from other people?
1. Not at all 2. A little bit 3. Moderately 4. Quite a bit 5. Extremely 6. Not applicable

11. Feeling emotionally numb or being unable to have loving feelings for those close to you?

1. Not at all 2. A little bit 3. Moderately 4. Quite a bit 5. Extremely 6. Not applicable

12. Feeling as if your future will somehow be cut short?

1. Not at all 2. A little bit 3. Moderately 4. Quite a bit 5. Extremely 6. Not applicable

13. Trouble falling or staying asleep?

1. Not at all 2. A little bit 3. Moderately 4. Quite a bit 5. Extremely 6. Not applicable

14. Feeling irritable or having angry outbursts?

1. Not at all 2. A little bit 3. Moderately 4. Quite a bit 5. Extremely 6. Not applicable

15. Having difficulty concentrating?

1. Not at all 2. A little bit 3. Moderately 4. Quite a bit 5. Extremely 6. Not applicable

16. Being "super-alert" or watchful or on guard?

1. Not at all 2. A little bit 3. Moderately 4. Quite a bit 5. Extremely 6. Not applicable

17. Feeling jumpy or easily startled?

1. Not at all 2. A little bit 3. Moderately 4. Quite a bit 5. Extremely 6. Not applicable

MCS

Id Number _____

Listed below are a number of statements concerning personal attitudes and traits. Read each item and decide whether the statement is TRUE or FALSE as it pertains to you personally. Place an 'X' in the appropriate box.

1. Before voting, I thoroughly investigate the qualifications of all the candidates.

_____ True	_____ False	_____ Not applicable
---------------	----------------	-------------------------

2. I never hesitate to go out of my way to help someone in trouble.

_____ True	_____ False	_____ Not applicable
---------------	----------------	-------------------------

3. It is sometimes hard for me to go on with my work if I am not encouraged.

_____ True	_____ False	_____ Not applicable
---------------	----------------	-------------------------

4. I have never intensely dislike someone.

_____ True	_____ False	_____ Not applicable
---------------	----------------	-------------------------

5. On occasion, I have had doubts about my ability to succeed in life.

_____ True	_____ False	_____ Not applicable
---------------	----------------	-------------------------

6. I sometimes feel resentful when I don't get my way.

_____ True	_____ False	_____ Not applicable
---------------	----------------	-------------------------

7. I am always careful about my manner of dress.

_____ True	_____ False	_____ Not applicable
---------------	----------------	-------------------------

8. My table manners at home are as good as when I eat out in a restaurant.

_____ True	_____ False	_____ Not applicable
---------------	----------------	-------------------------

9. If I could get into a movie without paying and be sure I was not seen, I would probably do it.

_____ True	_____ False	_____ Not applicable
---------------	----------------	-------------------------

10. On a few occasions, I have given up doing something because I thought too little of my ability.

_____ True	_____ False	_____ Not applicable
---------------	----------------	-------------------------

11. I like to gossip at times.

_____	_____	_____
True	False	Not applicable

12. There have been times when I like rebelling against people in authority even though I knew they were right.

_____	_____	_____
True	False	Not applicable

13. No matter whom I'm talking to, I'm always a good listener.

_____	_____	_____
True	False	Not applicable

14. I can remember "playing sick" to get out of something.

_____	_____	_____
True	False	Not applicable

15. There have been occasions when I took advantage of someone.

_____	_____	_____
True	False	Not applicable

16. I'm always willing to admit it when I made a mistake.

_____	_____	_____
True	False	Not applicable

17. I always try to practice what I preach.

_____	_____	_____
True	False	Not applicable

18. I don't find it particularly difficult to get along with loud-mouthed, obnoxious people.

_____	_____	_____
True	False	Not applicable

19. I sometimes try to get even rather than forgive and forget.

_____	_____	_____
True	False	Not applicable

20. When I don't know something I don't at all mind admitting it.

_____	_____	_____
True	False	Not applicable

21. I am always courteous, even to people who are disagreeable.

_____	_____	_____
True	False	Not applicable

22. At times I have really insisted on having things my own way.

_____	_____	_____
True	False	Not applicable

23. There have been occasions when I felt like smashing things.

<input type="checkbox"/>	<input type="checkbox"/>	<input type="checkbox"/>
True	False	Not applicable

24. I would never think of letting someone else be punished for my wrong doings.

<input type="checkbox"/>	<input type="checkbox"/>	<input type="checkbox"/>
True	False	Not applicable

25. I never resent being asked to return a favor.

<input type="checkbox"/>	<input type="checkbox"/>	<input type="checkbox"/>
True	False	Not applicable

26. I have never been irked when people expressed ideas very different from my own.

<input type="checkbox"/>	<input type="checkbox"/>	<input type="checkbox"/>
True	False	Not applicable

27. I never make a long trip without checking the safety of my car.

<input type="checkbox"/>	<input type="checkbox"/>	<input type="checkbox"/>
True	False	Not applicable

28. There have been times when I was quite jealous of the good fortune of others.

<input type="checkbox"/>	<input type="checkbox"/>	<input type="checkbox"/>
True	False	Not applicable

29. I have almost never felt that I was punished without cause.

<input type="checkbox"/>	<input type="checkbox"/>	<input type="checkbox"/>
True	False	Not applicable

30. I am sometimes irritated by people who ask favors of me.

<input type="checkbox"/>	<input type="checkbox"/>	<input type="checkbox"/>
True	False	Not applicable

31. I have never felt that I was punished without cause.

<input type="checkbox"/>	<input type="checkbox"/>	<input type="checkbox"/>
True	False	Not applicable

32. I sometimes think when people have a misfortune they only got what they deserved.

<input type="checkbox"/>	<input type="checkbox"/>	<input type="checkbox"/>
True	False	Not applicable

33. I have never deliberately said something to hurt someone's feelings.

<input type="checkbox"/>	<input type="checkbox"/>	<input type="checkbox"/>
True	False	Not applicable

SES-F

Id Number _____

Instructions: Please answer the following questions **IF YOU ARE A FEMALE** by indicating the frequency with which these things happened on the blank line.

1	2	3	4	5	6
Never		Occasionally		Often	Not applicable

1. Have you ever had unwanted sex because you were too drunk to resist? _____
2. Have you ever had sex with a man when you didn't really want to because he threatened to end the relationship? _____
3. Has a man ever obtained sex with you by saying things that he really didn't mean? _____
4. Have you ever had unwanted sexual intercourse with a man because he pressured you with continual arguments? _____
5. Has a man used some degree of physical force with you to try and make you engage in kissing and petting (fondling) when you didn't want to? _____
6. Has a man ever threatened to use physical force with you (twisting your arm, holding you down), in an attempt to obtain sexual intercourse but for various reasons he did not succeed? _____
7. Has a man ever used physical force with you (twisting your arm, holding you down), in an attempt to obtain sexual intercourse but for various reasons he did not succeed? _____
8. Have you ever had oral or anal sex with a man when you did not want to because he threatened to use physical force if you did not cooperate? _____
9. Have you ever had sexual intercourse with a man when you did not want to because he threatened to use physical force if you did not cooperate? _____
10. Have you ever been raped? _____

Appendix B

UNIVERSITY OF NEBRASKA – LINCOLN

INSTITUTIONAL REVIEW BOARD APPROVAL LETTERS



HUMAN RESEARCH PROTECTIONS
Institutional Review Board

September 21, 2006

Dr. Dennis McChargue
Alicia Klanecky
Psychology
238 BURN
(0308)

IRB # 2006-08-520 FB

TITLE OF PROJECT: **Alcohol Skills Training Program Project**

Dear Dr. McChargue:

This letter is to officially notify you of the approval of your project by the Institutional Review Board (IRB) for the Protection of Human Subjects. It is the Board's opinion that you have provided adequate safeguards for the rights and welfare of the participants in this study. Your proposal seems to be in compliance with this institution's Federal Wide Assurance 00002258 and the DHHS Regulations for the Protection of Human Subjects (45 CFR 46).

Date of FB Review: **08/16/06**.

You are authorized to implement this study as of the Date of Final Approval: 09/19/06. This approval is Valid Until: 08/15/07.

1. Enclosed is the IRB approved Consent form for this project. Please use this form when making copies to distribute to your participants. If it is necessary to create a new informed consent form, please send us your original so that we may approve and stamp it before it is distributed to participants.

We wish to remind you that the principal investigator is responsible for reporting to this Board any of the following events within 48 hours of the event:

- Any serious event (including on-site and off-site adverse events, injuries, side effects, deaths, or other problems) which in the opinion of the local investigator was unanticipated, involved risk to subjects or others, and was possibly related to the research procedures;
- Any serious accidental or unintentional change to the IRB-approved protocol that involves risk or has the potential to recur;
- Any publication in the literature, safety monitoring report, interim result or other finding that indicates an unexpected change to the risk/benefit ratio of the research;
- Any breach in confidentiality or compromise in data privacy related to the subject or others; or
- Any complaint of a subject that indicates an unanticipated risk or that cannot be resolved by the research staff.

For projects which continue beyond one year from the starting date, the IRB will request continuing review and update of the research project. Your study will be due for continuing review as indicated above. The investigator must also advise the Board when this study is finished or discontinued by completing the enclosed Protocol Final Report form and returning it to the Institutional Review Board.

If you have any questions, please contact Shirley Horstman, IRB Administrator, at 472-9417 or email shorstman1@unl.edu.

Sincerely,

Dan R. Hoyt, Chair
for the IRB

Shirley Horstman
IRB Administrator

August 8, 2007

Dr. Dennis McChargue
 Alicia Klanecky
 Psychology
 238 BURN
 (0308)

IRB# 2006-08-520 FB

TITLE OF PROJECT: **Alcohol Skills Training Program Project**

Dear Dr. McChargue:

This is to officially notify you of the approval of your project's Continuing Review by the Institutional Review Board for the Protection of Human Subjects. It is the committee's opinion that you have provided adequate safeguards for the rights and welfare of the subjects in this study. Your proposal seems to be in compliance with DHHS Regulations for the Protection of Human Subjects (45 CFR 46).

1. Enclosed is the IRB approved Informed Consent form for this project. Please use this form when making copies to distribute to your participants. If it is necessary to create a new informed consent form, please send us your original so that we may approve and stamp it before it is distributed to participants.

We wish to remind you that the principal investigator is responsible for reporting to this Board any of the following events within 48 hours of the event:

- Any serious event (including on-site and off-site adverse events, injuries, side effects, deaths, or other problems) which in the opinion of the local investigator was unanticipated, involved risk to subjects or others, and was possibly related to the research procedures;
- Any serious accidental or unintentional change to the IRB-approved protocol that involves risk or has the potential to recur;
- Any publication in the literature, safety monitoring report, interim result or other finding that indicates an unexpected change to the risk/benefit ratio of the research;
- Any breach in confidentiality or compromise in data privacy related to the subject or others; or
- Any complaint of a subject that indicates an unanticipated risk or that cannot be resolved by the research staff.

It is the responsibility of the principal investigator to provide the Board with a review and update of the research project each year the project is in effect. This approval is valid until **August 15, 2008**.

If you have any questions, please contact Shirley Horstman, IRB Administrator, at 472-9417 or email at shorstman1@unl.edu.

Sincerely,

 Dan R. Hoyt, Chair
 For the IRB

 Shirley Horstman
 IRB Administrator



August 4, 2008

Dennis McChargue
Department of Psychology
238 BURN UNL 68588-0308

Alicia Klanecky
Department of Psychology
511 Lakeside Dr #305 Lincoln, NE 68528

IRB Number: 2006-08-520 FB
Project ID: 7537
Project Title: Alcohol Skills Training Program Project

Dear Dennis:

This is to officially notify you of the approval of your project's Continuing Review by the Institutional Review Board for the Protection of Human Subjects. It is the committee's opinion that you have provided adequate safeguards for the rights and welfare of the subjects in this study based on the information provided. Your proposal is in compliance with DHHS Regulations for the Protection of Human Subjects (45 CFR 46).

Date of EP Review: 08/04/2008

1. Enclosed is the IRB approved Informed Consent form for this project. Please use this form when making copies to distribute to your participants. If it is necessary to create a new informed consent form, please send us your original so that we may approve and stamp it before it is distributed to participants.

We wish to remind you that the principal investigator is responsible for reporting to this Board any of the following events within 48 hours of the event:

- Any serious event (including on-site and off-site adverse events, injuries, side effects, deaths, or other problems) which in the opinion of the local investigator was unanticipated, involved risk to subjects or others, and was possibly related to the research procedures;
- Any serious accidental or unintentional change to the IRB-approved protocol that involves risk or has the potential to recur;
- Any publication in the literature, safety monitoring report, interim result or other finding that indicates an unexpected change to the risk/benefit ratio of the research;
- Any breach in confidentiality or compromise in data privacy related to the subject or others; or
- Any complaint of a subject that indicates an unanticipated risk or that cannot be resolved by the research staff.

It is the responsibility of the principal investigator to provide the Board with a review and update of the research project each year the project is in effect. This approval is valid until 08/15/2009.

If you have any questions, please contact the IRB office at 472-6965.

Sincerely,
Mario Scalora, Ph.D.
Chair for the IRB





October 22, 2008

Dennis McChargue
Department of Psychology
238 BURN UNL 68588-0308

Alicia Klanecky
Department of Psychology
511 Lakeside Dr #305 Lincoln, NE 68528

IRB Number: 2006-08-520 FB
Project ID: 7537
Project Title: Alcohol Skills Training Program Project

Dear Dennis:

The Institutional Review Board for the Protection of Human Subjects has completed its review of the Request for Change in Protocol submitted to the IRB.

Date of FB Review: October 22, 2008

The approved and labeled informed consent form has been uploaded into NUgrant. Please use this document to distribute to participants. If you need to make changes to the informed consent form, please submit the revised form to the IRB for review and approval prior to using it.

It has been approved to include the addition of scales designed to assess emotion regulation abilities, trauma symptoms, and sexual victimization among college students engaging in binge drinking. Changes were made in the website format that will allow participants who do not consent to research to bypass research-specific questionnaires. Also, added clarification to specify research-only components of ASTP from required components of the program including time involvement, question content, participation of minors, and ASTP group treatment. To reduce the burden of the additional requested questionnaires, four measures in the current study were removed to allow four new measures to be added. The expanded introduction will state in two places that refusal to participate in research will in no way influence their status, completion, and/or placement in group versus online intervention. Modifications to the consent form further describe research questionnaires participants will receive should they consent to research.

We wish to remind you that the principal investigator is responsible for reporting to this Board any of the following events within 48 hours of the event:

- Any serious event (including on-site and off-site adverse events, injuries, side effects, deaths, or other problems) which in the opinion of the local investigator was unanticipated, involved risk to subjects or others, and was possibly related to the research procedures;
- Any serious accidental or unintentional change to the IRB-approved protocol that involves risk or has the potential to recur;
- Any publication in the literature, safety monitoring report, interim result or other finding that

indicates an unexpected change to the risk/benefit ratio of the research;

- Any breach in confidentiality or compromise in data privacy related to the subject or others; or
- Any complaint of a subject that indicates an unanticipated risk or that cannot be resolved by the research staff.

This letter constitutes official notification of the approval of the protocol change. You are therefore authorized to implement this change accordingly.

If you have any questions, please contact the IRB office at 472-6965.

Sincerely,
Mario Scalora, Ph.D.
Chair for the IRB





July 23, 2009

Dennis McChargue
Department of Psychology
238 BURN UNL 68588-0308

Alicia Klanecky
Department of Psychology
511 Lakeside Dr #305 Lincoln, NE 68528

IRB Number:
Project ID: 7537
Project Title: Alcohol Skills Training Program Project

Dear Dennis:

This is to officially notify you of the approval of your project's Continuing Review by the Institutional Review Board for the Protection of Human Subjects. It is the committee's opinion that you have provided adequate safeguards for the rights and welfare of the subjects in this study based on the information provided. Your proposal is in compliance with DHHS Regulations for the Protection of Human Subjects (45 CFR 46).

Date of FB Review:

1. Enclosed is the IRB approved Informed Consent form for this project. Please use this form when making copies to distribute to your participants. If it is necessary to create a new informed consent form, please send us your original so that we may approve and stamp it before it is distributed to participants.

We wish to remind you that the principal investigator is responsible for reporting to this Board any of the following events within 48 hours of the event:

- Any serious event (including on-site and off-site adverse events, injuries, side effects, deaths, or other problems) which in the opinion of the local investigator was unanticipated, involved risk to subjects or others, and was possibly related to the research procedures;
- Any serious accidental or unintentional change to the IRB-approved protocol that involves risk or has the potential to recur;
- Any publication in the literature, safety monitoring report, interim result or other finding that indicates an unexpected change to the risk/benefit ratio of the research;
- Any breach in confidentiality or compromise in data privacy related to the subject or others; or
- Any complaint of a subject that indicates an unanticipated risk or that cannot be resolved by the research staff.

It is the responsibility of the principal investigator to provide the Board with a review and update of the research project each year the project is in effect. This approval is valid until 08/14/2010.

If you have any questions, please contact the IRB office at 472-6965.

Sincerely,

A handwritten signature in black ink, appearing to read "Mario Scalora". The signature is fluid and cursive, with the first name "Mario" being the most prominent.

Mario Scalora, Ph.D.
Chair for the IRB





August 20, 2010

Dennis McChargue
Department of Psychology
238 BURN, UNL, 68588-0308

Alicia Klanecky
Department of Psychology
511 Lakeside Dr #305 Lincoln, NE 68528

IRB Number: 200608520FB
Project ID: 7537
Project Title: Alcohol Skills Training Program Project

Dear Dennis:

This is to officially notify you of the approval of your project's Continuing Review by the Institutional Review Board for the Protection of Human Subjects. It is the committee's opinion that you have provided adequate safeguards for the rights and welfare of the subjects in this study based on the information provided. Your proposal is in compliance with DHHS Regulations for the Protection of Human Subjects (45 CFR 46).

1. Enclosed is the IRB approved Informed Consent form for this project. Please use this form when making copies to distribute to your participants. If it is necessary to create a new informed consent form, please send us your original so that we may approve and stamp it before it is distributed to participants.

We wish to remind you that the principal investigator is responsible for reporting to this Board any of the following events within 48 hours of the event:

- * Any serious event (including on-site and off-site adverse events, injuries, side effects, deaths, or other problems) which in the opinion of the local investigator was unanticipated, involved risk to subjects or others, and was possibly related to the research procedures;
- * Any serious accidental or unintentional change to the IRB-approved protocol that involves risk or has the potential to recur;
- * Any publication in the literature, safety monitoring report, interim result or other finding that indicates an unexpected change to the risk/benefit ratio of the research;
- * Any breach in confidentiality or compromise in data privacy related to the subject or others; or
- * Any complaint of a subject that indicates an unanticipated risk or that cannot be resolved by the research staff.

It is the responsibility of the principal investigator to provide the Board with a review and update of the research project each year the project is in effect. This approval is valid until 08/13/2011.

If you have any questions, please contact the IRB office at 472-6965.

Sincerely,

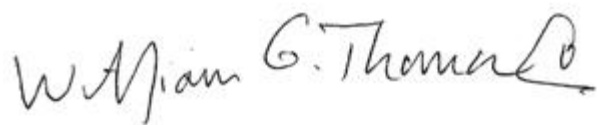
A handwritten signature in black ink that reads "William G. Thomas". The signature is written in a cursive style with a long horizontal stroke at the end.

William Thomas, Ph.D.
Chair for the IRB

