

January 2012

Fermentation and Supercritical Extraction Studies of Açai Berry

Rosanna Iris Ayala

University of South Florida, roiray@gmail.com

Follow this and additional works at: <http://scholarcommons.usf.edu/etd>



Part of the [American Studies Commons](#), and the [Chemical Engineering Commons](#)

Scholar Commons Citation

Ayala, Rosanna Iris, "Fermentation and Supercritical Extraction Studies of Açai Berry" (2012). *Graduate Theses and Dissertations*.
<http://scholarcommons.usf.edu/etd/3961>

This Thesis is brought to you for free and open access by the Graduate School at Scholar Commons. It has been accepted for inclusion in Graduate Theses and Dissertations by an authorized administrator of Scholar Commons. For more information, please contact scholarcommons@usf.edu.

Fermentation and Supercritical Extraction Studies of Açai Berry

by

Rosanna I. Ayala

A thesis submitted in partial fulfillment
of the requirements for the degree of
Master of Science in Chemical Engineering
Department of Chemical and Biomedical Engineering
College of Engineering
University of South Florida

Major Professor: Aydin Sunol, Ph.D.
Scott Campbell, Ph.D.
John N. Kuhn, Ph.D.

Date of Approval:
April 26, 2012

Keywords: Soxhlet, FTIR, Anthocyanins,
Euterpe Oleracea, Freeze Dried Powder

Copyright © 2012, Rosanna I. Ayala

Dedication

I dedicate this thesis to my son, Devin, who has supported me emotionally and been there for me through the rollercoaster of the last few years. Throughout the long hours I'm away at school and work he has shown continuous understanding. I have such a wonderful little boy. I couldn't have done it without you there to motivate me with your love and compassion!

I would like to thank my parents for always being there to reassure me that I was on the right path and for being a positive support. I would also like to thank my Rob, for the constant push for success and keeping me balanced. You are all fantastic and I couldn't have done it without you!

Acknowledgments

I would like to acknowledge and offer my sincere gratitude to Dr. Aydin Sunol for the opportunity to work on this research, for his continuous guidance, and moral support. I would also like thank Brandon Smeltzer and Haitao (Eddie) Li for answering any and all of my questions. Brandon gave me a great deal of positive feedback and advice to help me improve my work. Eddie shared the equipment and took the time to teach me how to use it properly so I could be safe. Special thanks to Sandy for help getting FTIR analysis. I wouldn't have been able to finish without all your support.

Table of Contents

List of Tables	iii
List of Figures	iv
Abstract	vi
Chapter 1: Introduction	1
Chapter 2: Background	5
2.1 Natural Products and Antioxidants	5
2.1.1 Açaí Berry and Nutrient Information	8
2.2 Extraction Methods	15
2.2.1 Supercritical Extraction	16
2.2.2 Subcritical Water Extraction	19
2.3 Berry Wine	21
2.3.1 Fermentation Process	22
2.3.2 Yeasts and Enzymes	25
2.4 Methods of Analysis	27
Chapter 3: Modeling	31
3.1 Gas Extraction Model	31
3.2 Fermentation Kinetic Model	36
Chapter 4: Experiments	44
4.1 List of Experiments	44
4.2 Soxhlet Extraction Procedure	46
4.2.1 Cleaning Procedure	48
4.3 High Pressure Extraction Procedure	49
4.3.1 Supercritical Carbon Dioxide	53
4.3.2 Subcritical Water	55
4.4 Fermentation Equipment and Materials	57
4.4.1 Fermentation Cleaning Procedure	59
4.4.2 Merlot Kit Procedure	60
4.4.3 Açaí Berry Procedure	63
4.5 Wine Judging	65
Chapter 5: Results and Discussion	67
5.1 Açaí Extraction and Evaluation	67
5.2 Fermentation Studies	75
5.3 Wine Judging Analysis	79

Chapter 6: Conclusions and Future Directions	83
References	86
Appendices	95
Appendix A: Nomenclature	96
Appendix B: MSDS	98
Appendix C: Equipment List	123
Appendix D: Operating Procedures	126
Appendix E: Sample Calculations	131
Appendix F: Wine Tasting Survey Materials	134

List of Tables

Table 1: Composition of Primary Constituents of Açaí Berry	14
Table 2: Example Yeast Strains	26
Table 3: Fermentation Model Data	41
Table 4: Soxhlet Extraction Results	68
Table 5: Açaí Berry Supercritical Extraction	70
Table 6: Specific Group Frequencies	72
Table 7: The Age and Experience of the Tasters	80

List of Figures

Figure 1: Cyanidin-DNA Interaction Mechanism	8
Figure 2: Açaí Life Cycle	11
Figure 3: Chemical Structures of Primary Anthocyanins	12
Figure 4: Chemical Structures of Primary Fatty Acids	13
Figure 5: Chemical Structure of Vitamin A	13
Figure 6: Chemical Structure of Primary Sugars	15
Figure 7: Phase Behavior of Carbon Dioxide-Ethanol	19
Figure 8: Dielectric Constant of Water and Varying Temperatures	20
Figure 9: Fermentation Diagram	23
Figure 10: Yeast Fermentation Mechanisms	27
Figure 11: Concentration of Extract in Solvent Curve	32
Figure 12: Extraction Curve with Multiple Components	32
Figure 13: Extraction Curve	33
Figure 14: Sugars Consumption	42
Figure 15: Ethanol and Yeast Production	43
Figure 16: Fermentation Temperature	43
Figure 17: Structure of the Experimental Program	45
Figure 18: Soxhlet Extraction Setup	47
Figure 19: Supercritical Extraction Process Diagram	51
Figure 20: Subcritical Water Extraction Process Diagram	52

Figure 21: Fermentation Airlock	59
Figure 22: Grape Wine Flow Diagram	62
Figure 23: Açaí Wine Flow Diagram	64
Figure 24: Extract Color Variations	68
Figure 25: Supercritical Extraction of Açaí Berry	69
Figure 26: Supercritical Carbon Dioxide at 600 bar Açaí Extract	71
Figure 27: Carbon Dioxide-Ethanol at 127 bar Açaí Extract	71
Figure 28: Carbon Dioxide-Ethanol at 140 bar Açaí Extract	71
Figure 29: Spectrum of Açaí Extract Obtained by Soxhlet Extraction	73
Figure 30: Spectrum of Extract Obtained by Supercritical Extraction	74
Figure 31: Spectrum of Extract from SCCO ₂ Extraction at 600 bar	74
Figure 32: Grape Fermentation and Grape Wine	76
Figure 33: Post Primary Fermentation without pH Modification	77
Figure 34: Hydrated and Filtered Freeze-Dried Açaí and Açaí after Supercritical Extraction	78
Figure 35: Rate of Fermentation by Density	79
Figure 36: Açaí Wine Comparison	79
Figure 37: Overall Wine Averages	81
Figure 38: Wine Characteristics	82

Abstract

The açai berry has grown in popularity for dieters and the health conscious. The berry contains high levels of antioxidants. The main anthocyanins are cyanidin-3-rutinoside and cyanidin-3-glucoside. The berries also contain vitamins and nutrients that help boost energy and alertness, and fatty acids that help maintain normal cholesterol levels. As a result of the health benefits of the constituents, the berries are chosen for obtaining the active ingredients by extraction.

The solids left over after extraction still contain nutrients and useful components. There is a possibility of fermenting this residual and creating an açai berry wine. Açai berry wine is another new product on the market. The extracts and the wine are analyzed using Fourier transform infrared spectroscopy (FTIR). In an effort to utilize every part of the berry, the residual from the extract is also successfully fermented.

Pilot plant studies are conducted utilizing supercritical carbon dioxide, an ethanol entrainer to increase its solubility, and subcritical water to extract components from freeze dried açai berry. There is much potential and flexibility in the process, which effectively extracted lipids from the berry leaving behind anthocyanins without solvent residue.

Chapter 1

Introduction

People have become more health conscious as the population has been aging. The proliferation of scientific knowledge has given way for a new level of understanding about weight control and cardiovascular health. The standards in nutrition have increased which has led to a growing demand in products in the nutraceutical world. There is an expected increase of 7.5 percent a year of shipments of nutraceutical ingredients coming from Central and South America; in 2015, an estimated demand worth 830 million dollars compared to 567 million dollars in 2010.¹

The açai berry is an attractive functional food ingredient, because it is plentiful in antioxidant polyphenols and its increased popularity in markets worldwide. Açai products, from 2004 to 2005, experienced a “year-over-year growth of nearly 770%”² and it continues to remain one of the top superfood categories.³ Polyphenols, specifically the anthocyanins found in açai, have been associated with anti-inflammatory effects, a means of combating cardiovascular disease by way of vascular protection, and cancer prevention.⁴ Anthocyanins are beneficial to individuals to improving health before developing serious medical conditions.

Açai berries are only grown on the palm trees in the Amazon rainforest. Shipping for use in the United States requires concentrated açai

juice or açai pulps undergo extensive processing before it is frozen or bottled to prevent spoilage.⁵ Due to the processing methods, the heat labile compounds degrade and the product loses much of its antioxidant activity.⁶ Conversely, lyophilization results in a powder still high in antioxidants that is easily shipped. The processing and shipping means the açai berries are not inexpensive when purchased in the United States. Therefore, this author proposes to use the açai powder for achieving more than one product while extracting the most valuable compounds. Currently, freeze dried açai berry is used in nutritional supplements and beverages, added into smoothies and yogurts, jelly, natural juices and desserts, and cereals.⁷ It is also used as an antioxidant rich extract for cosmetics.⁸

Nutraceutical extractions result in a product as well as residues that still contain viable nutrients. Extraction methods using a solvent are the most common. This includes soxhlet extractions, pressurized fluid extraction, ultrasound-assisted extraction, and microwave-assisted extraction. The yield and extracts are dependent on the solvent and how much is used and the temperature and pressure of the system. It is desirable to improve the quality of the extraction by leaving behind no extra residue. The temperature must also be below 70 degrees Celsius to keep the anthocyanins from rapidly degrading.⁹ Extractions using pressurized fluids were chosen for this study because it satisfies these requirements. Supercritical carbon dioxide can be used and the result is a very pure extract without solvent residue.

Another focus of this study is the fermentation of açai berry juice. Açai wine is a product that did not exist commercially until early 2011.¹⁰ As a

wine, the health benefits of açai antioxidants can reach a wider audience and offer an alternative method of consuming antioxidants. It also provides alternative methods of utilizing the entire açai berry prior or post extraction. Currently, the açai wine is manufactured from frozen açai pulp. In this study, the freeze dried açai is used for the fermentation and extraction processes. This was chosen because, as a dried solid, the açai berry is ready for extraction before rehydrating and the remaining soluble material fermented into wine. The benefit in recycling the material is that it also allows more control over the antioxidants put in the wine.

The following chapters will explain in more detail the background of this study, the theory to the experiments and the methods. The various experiments will be listed as well as each experimental set-up and procedure. Lastly, the results will be discussed followed by future directions for this research.

Chapter 2 will discuss the background of natural products and antioxidants, and nutritional information of the açai berry. There are also details on the component solubility in supercritical carbon dioxide and subcritical water. A discussion of extraction methods and berry fermentation will also be presented. Some insight will be given into wine and its flavor. The methods of analysis utilized in this study will be discussed.

Chapter 3 will include modeling of gas extraction and the kinetics of wine fermentation. The model utilized to obtain approximate fermentation time and estimate percent alcohol will be presented.

Chapter 4 will explain the experiments that were conducted as well as their set-up and experimental methods.

Chapter 5 will delve into the results from the analysis and a presentation of the data will be in the form of graphs and tables. The experiments will then be discussed.

Chapter 6 provides suggestions that can be used to improve on the results obtained. The chapter also outlines possible techniques that can be used in future works to further analyze the samples.

Chapter 2

Background

This chapter will discuss natural products, specifically antioxidants and açai berry. The extraction methods that were conducted will also be explained as well as give some background on fermentation. Finally, the possible methods of analysis will be explored.

2.1 Natural Products and Antioxidants

Functional foods not only provide nutritive value but also provide additional physiological benefit.¹¹ The natural products, compounds and substances, which are found in these foods, are increasingly popular as a way of improving health without harmful side effects. Increasing the ease of intake of these products is desirable. This can be done by extracting the compounds from their plant derivatives. These nutraceuticals can then be used as supplements or added in other foods. Science is backing this practice by providing evidence of which specific compounds can treat and prevent disease.¹²

One unlikely candidate as a nutraceutical is ethanol or simply alcohol. It is both soluble in water and in lipids and can therefore cross membranes like the blood brain barrier. As such, it is better known as a psychoactive drug and for causing birth defects and cirrhosis. However, "a considerable body of evidence associates moderate alcohol intake with a lower incidence

of, and mortality, from coronary heart disease."¹³ The risk of the negative effects of alcohol outweighs the benefits when consumed in large amounts or in binge drinking. Keeping to moderate doses of 20 to 30 grams per day¹⁴ which is no more than two drinks per day, does increase high-density lipoprotein (good cholesterol) by about 12 percent.¹⁵ Coupled with antioxidants, such as those found in red wine, and coronary heart disease can be reduced by 40 percent.¹⁴

Oxidant by-products of metabolism, a result of natural aging, are a contributing factor of diseases "such as cancer, cardiovascular disease, immune-system decline, brain dysfunction, and cataracts."¹⁶ Free radicals, which also enter the body in the form of "rouge molecular fragments produced whenever we inhale oxygen,"¹⁷ contribute to disease when they react with essential biomolecules such as proteins or nucleic acids.¹⁷ Antioxidants, primarily found in fruits and vegetables, defend against these diseases. Plant polyphenols are one category of compounds with potent antioxidant properties. More than 8,000 phenolic structures, compounds that contain one or more aromatic rings with one or more hydroxyl groups, are currently known.⁹ Tannins, phenolic acids, and flavonoids are all common groups of polyphenols. Flavonoids specifically are abundant in berries and wine. They have been found to "possess anti-inflammatory, antiallergic, antiviral, and anticarcinogenic properties."¹⁸

The French Paradox is an example of the effects of flavonoids. In red wine, anthocyanin and flavanol subgroups of flavonoids have been found to contribute in different ways. Anthocyanins absorb oxygen radicals to protect

against lipoprotein oxidation.¹⁹ This prevents a part of the early development of atherosclerosis. Catechins, a flavonol compound, inhibit the platelet-derived growth factor receptor which also play a critical role in the atherogenic process.²⁰

Moreover, the most noted for health benefits are anthocyanins. Positive results have been found for treatment of microcirculation diseases from capillary fragility, fibrocystic disease, and diabetic retinopathy to name a few.¹⁹ Several chemical studies²¹ and analysis on the biological activities²² of anthocyanins have been done to better understand the effects of pH, stability with antioxidant activity, and free radical scavenging ability based on chemical structure. These compounds are visible plant pigments easily affected by pH and temperature. "The structure of an anthocyanin is strongly dependent on the solution pH, and as a consequence so is its color stability."²³ They produce the red to blue color on dark skinned fruit. The most common anthocyanins found in nature are cyanidin-based compounds.²³ They have been found to interact with DNA preventing oxidative damage.²² Figure 1 shows the mechanism of how anthocyanins help stabilize DNA by forming a cyanidin-DNA copigmentation complex.

Greater than other flavanoids, the daily intake of anthocyanins is approximately 180-215 mg/day in the United States alone.¹⁹ Further research is directed at discovering the foods, specifically berry fruits, with the highest antioxidant capacity to measure their impact on human health.^{24,25} This led to the popularity of exotic superfoods like the açai palm berry.

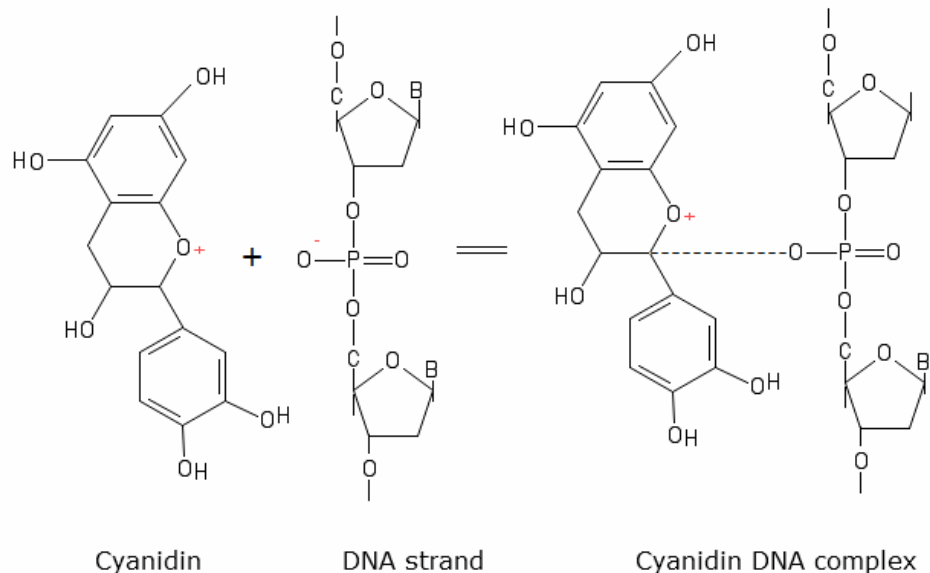

Figure 1: Cyanidin-DNA Interaction Mechanism

2.1.1 Açáí Berry and Nutrient Information

The açáí berry or *Euterpe oleracea* is found in central and south America and originate from the Amazon River basin. It grows as the fruit of the açáí palm trees. This berry was made popular in the United States by Oprah on the Oprah Winfrey Show when she had a guest, Dr. Oz, feature its products and it became the new super food. (They have stated, however, that they do not endorse the products.)²⁶ Some internet advertisements suggest it may even be able to assist in weight loss. A study has shown a daily intake of açáí has a positive impact on metabolic parameters, but weight loss has not be proven.²⁷ This berry is not just for consumption but it also has many functional ingredients. This berry is mainly composed of lipids but it is popular for the high amounts of antioxidant polyphenolics it contains. It also has very low sugar content. But because of the berry's high nutritional value, it has been a main food source for natives of the Brazilian rainforests.

The berries have a variety of applications. It can be used in smoothies or as a paste. The flavor has been described as a combination of blueberry and chocolate.

Unfortunately, the decomposition rate of this berry is very high and untreated berry lasts no longer than 24 hours. There are many ways to bring this berry to other parts of the world. It can be dried or chemical agents added to help resist decomposition and degradation. The pulp and juice can also be pasteurized and frozen. However, most of these methods destroy the antioxidant activity found and the best parts of the berry would be rendered useless. Conversely, freeze drying the berries after harvesting helps preserve the polyphenol activity. This is due to the fact that high temperatures and chemicals are not needed in the process. The freeze dry process results in a dark purple powder that can last an extended period of time, though the cost for freeze drying and shipping is expensive.

The life cycle of the açai berry is depicted in Figure 2. After harvesting the açai berry pulp needs to be separated from the seeds. The seeds, which make up 80 percent of the berry volume,⁵ can be used as beads in jewelry or crushed to be used as animal feed stock or fertilizer.²⁸ The berries are treated differently depending on the desired product and can go through extensive processing. Broadly speaking, making juice requires the berries to first be soaked in water before adding to a rotating machine to separate the seeds. The water can range in temperatures: ambient temperature, a warm 40 to 60 degrees Celsius, or a cold 10 degrees Celsius before it's heated to 60 degrees. Citric acid may also be added to the juice to reduce the pH.⁵ The

resulting juice is pasteurized, and then frozen for transport if needed, or used fresh in food and drinks. The methods which require keeping the juice cold result in higher quality for juice with more antioxidants. This juice can be filtered again to separate the pulp from the solids. The solids are further extracted for nutrients and the juice can be used for wine making.

Besides juice, drying methods preserve the açai pulp into a powder to be used as a nutrition supplement or food and beverage additive. Depending on the extraction method there are different uses for the açai berry extract. When not used for consumption, the extracts become additives for some cosmetics.⁸ The highlighted green boxes, starting with purchased organic açai berry leading to extracted nutrients and açai wine, are featured in this study.

Açai berry is high in proteins, fatty acids, vitamins and antioxidants. There have been studies to observe the in vivo effects of the antioxidants from açai. The anthocyanins are found to be bioavailable upon consumption which holds much potential in demonstrating the health benefits.^{4,29} Extracts have potential for use in combating cardiovascular disease.³⁰ A study also found leukemia cancer cells were reduced by the polyphenolics in açai.³¹ The berry was found to have many flavonoids, but the two main antioxidants are cyanidin-3-glucoside and cyanidin-3-rutinoside;³² their molecular structure is shown in Figure 3. (Molecular structures and others in this work are from the ChemSpider database.³³) Although cyanidin-3-glucoside is more stable, both anthocyanins are degraded in acidic solutions of 1-4 pH and at 100 degrees Celsius.²³ The stability of anthocyanins is also affected by negatively by

extended exposure to oxygen and to light, and positively with concentration.³⁴

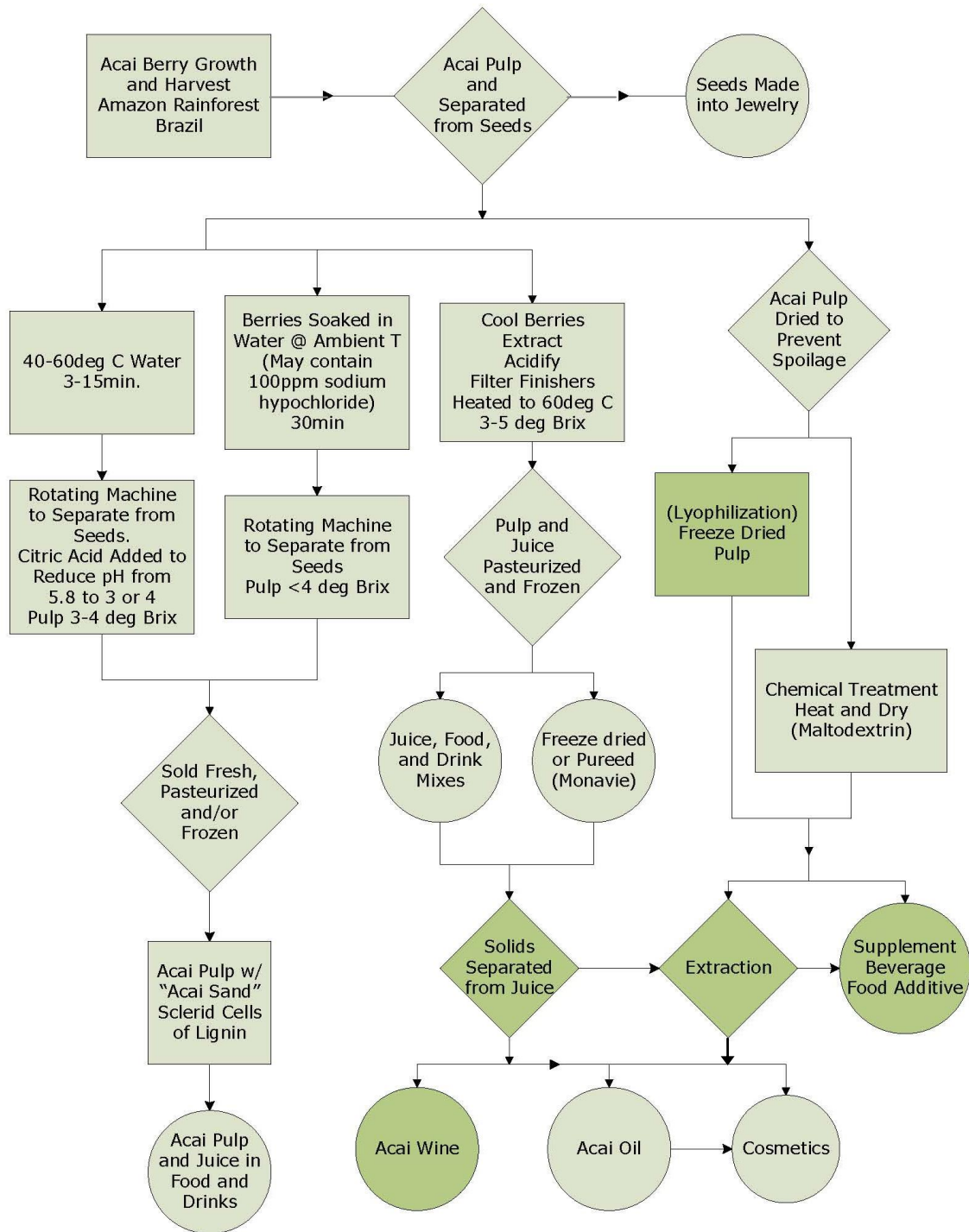

Figure 2: Açaí Life Cycle

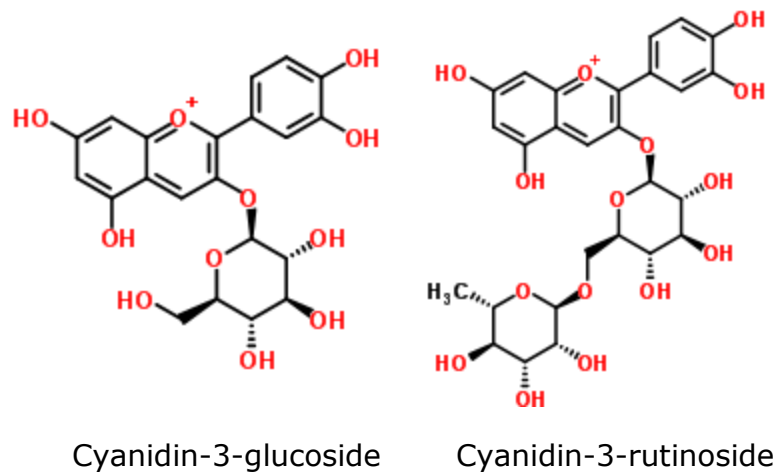

Figure 3: Chemical Structures of Primary Anthocyanins

The phytochemistry of açai berry does vary slightly, as with any fruit, based on the time, location, season of harvest²⁸, species, and method of processing. Table 1 includes the most prominent of each type of compound found in açai by Schauss et al. when they investigated the photochemical and nutrient components in freeze dried açai.³⁵ More than half of the fatty acids are monounsaturated; oleic acid making up 56.2% of the total fat content. Saturated fatty acids, mainly palmitic acid, are also predominant, which are then followed by polyunsaturated fatty acids, nearly all linoleic acid. The molecular structure of the predominant fatty acids found in açai berry is presented in Figure 4. The figures shows linoleic acid is an Omega-6 essential fatty acid. Oleic acid is an Omega-9, which are the same fat found in olives. Though it is not an essential fatty acid, it has been used to treat human breast cancer cells.¹⁷ The açai berry was also found to contain at least 19 amino acids. Though proteins are not within the scope of this study, it is worth mentioning because many amino acids are important for overall wellness and may contribute to the positive impact açai berries have on

health. An additional contributing factor to health is the several vitamins and nutrients açai berry contains. This includes vitamin A, calcium, and sodium. Vitamin A, depicted in Figure 5, is an antioxidant commonly known to benefit cell growth, vision, and support a healthy immune system.

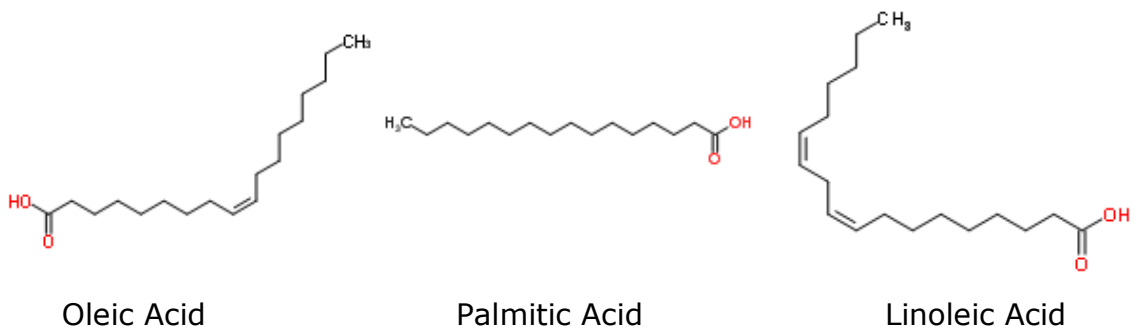

Figure 4: Chemical Structures of Primary Fatty Acids

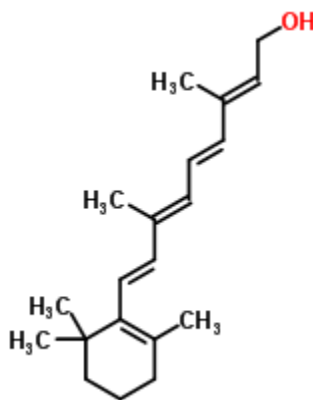

Figure 5: Chemical Structure of Vitamin A

Provided that the freeze dried açai will be used in fermentation, another group of important constituents are sugars. As açai are not sweet berries, a sugar profile found that less than 1.5% of the freeze dried powder contained sugar. The majority of which was glucose, 0.8 grams per 100 grams of dry açai, followed by fructose and maltose, 0.4 grams and 0.1 grams per 100 grams of dry açai respectively.³⁵ As a result of the low sugar

content, the addition of sugar will be required to assist in a fermentation process.

Table 1: Composition of Primary Constituents of Açaí Berry

Type	Compound	Formula	MW (g/mol)	Water Solubility (mg/L)	Content
Anthocyanins					(mg/g ^{DW})
	Cyanidin-3				
	-rutinoside	C ₂₇ H ₃₁ O ₁₅ Cl	631	Highly	1.17
	-glucoside	C ₂₁ H ₂₁ O ₁₁ Cl	484.8	Highly	1.93
Fatty Acids (total fat = 0.325 g/g ^{DW})					(%)
	Palmitic	16:0	256.42	Insoluble	24.1
	Oleic	18:1C	282.461	Insoluble	56.2
	Linoleic	18:2	280.45	0.139	12.5
Nutrients					(unit/g ^{DW})
	Vitamin A	C ₂₀ H ₃₀ O	286.452		1002 IU
	Calcium	Ca	40.078		2.6 Mg
	Sodium	Na	22.99		0.304 Mg
Sugars					(g/100g ^{DW})
	Glucose	C ₆ H ₁₂ O ₆	180.16	9.1 E5	0.8
	Fructose	C ₆ H ₁₂ O ₆	180.16	Highly	0.4
	Maltose	C ₁₂ H ₂₂ O ₁₁	342.3	1.08 E6	0.1

Note: Content data from Schauss et al.³⁵ Chemical data from Haynes and Lide³⁶
^{DW}dry weight

The many nutritious constituents in açaí berries make it an ideal candidate for nutraceutical extraction and wine fermentation. Even the oldest person ever to live, Madame Jeanne Calment (1875-1997), “attributed her longevity to port wine and olive oil.”¹⁷ Perhaps açaí wine and oil can help more people become supercentenarians.

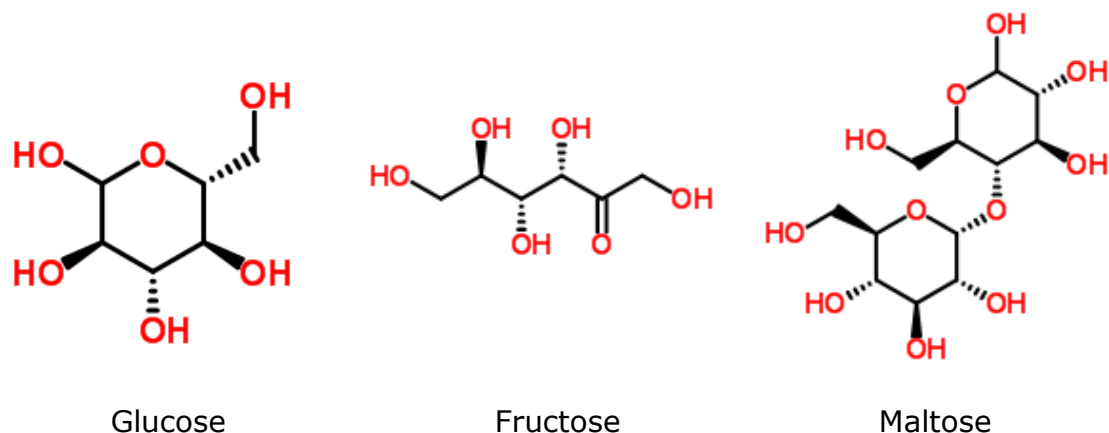

Figure 6: Chemical Structure of Primary Sugars

2.2 Extraction Methods

There are many methods for isolating nutraceuticals from fruit. The polar compounds in açai berry are currently extracted via water from the fiber. The cell wall of the plant material has to be permeated or broken down for the solvent to reach the extracts.³⁷ Many extraction methods for polyphenolics involve the use of large quantities of solvent and high temperatures including solid-liquid extractions and microwave-assisted extractions.³⁸ In microwave-assisted extraction, the system is repeatedly heated and cooled to speed up extraction. Hydrodistillation has been used to obtain essential oils, which are then dried over anhydrous sodium sulfate.³⁹ Membrane separation, or ultrafiltration, is also an option to removing extracts from a liquid based on molecular size. Effective methods of extracting from solids involve solvents which then have to be separated from the extracts. The separation can be done by evaporating the solvent by heating, air drying, or use of a drying agent. In any case “polyphenol denaturation is most serious effect of the [heat] drying process.”³⁸ Existing

solvents used in polyphenolic plant extraction include, hexane-methanol, ethanol-benzene, water-ethanol, and water-methanol to name a few.³⁸ The processing to separate the solvents would ultimately still leave behind some trace residue in solid and extract.⁴⁰ High pressure methods, such as supercritical fluid extraction, are an alternate method of using solvents which relies on pressure rather than temperature to speed up extraction. Pressure control is also used to fractionate several components from the extract. The use of carbon dioxide as a solvent can avoid many issues due to the fact that is a gas at atmospheric conditions. The pure extracts are left behind without the need for further processing. Entrainers can be of use when targeting polar compounds. Extraction of phenolic antioxidants can then be further optimized by adjusting the solid to liquid solvent ratio.⁴¹

Soxhlet extraction was used as a way of determining how much would be expected to be removed in an extraction via a mass balance and measure which constituents would be extracted. The technique has been long used as “the main reference for evaluating the performance of other solid-liquid extraction (or leaching) methods.”⁴² Although anthocyanins are more soluble in ethanol, this method uses high temperatures that decompose the labile compounds, and more so the longer they are exposed to elevated temperatures.^{43,44}

2.2.1 Supercritical Extraction

The decision to extract the freeze dried açai berry using supercritical methods was made to avoid high temperatures without contaminating the product. This was the best way to control the solubility of the solvent and

keep the product pure. Another benefit of this process is that it is a green method for it does not create any hazardous byproducts. The possible entrainers would also have to be environmentally safe and non-toxic. This is why ethanol was chosen. The main solvents of carbon dioxide or water are also green. Carbon dioxide is not created only purchased and used for the purposes of this study.

There is a vast amount of information as supercritical extraction accounts for work that has been done in the past 40 years or so. Supercritical fluids are applied to polymer materials, natural materials extraction, waste water extraction, and petrochemicals to name a few. The characteristics of these supercritical systems are attractive for more than increased solubility at lower temperatures. There are also improved mass transfer rates and the selectivity of the solubility offers a great deal of control and optimization of the process. The basis of these favorable characteristics is the variation in the solvent properties within the critical region. "As the critical point of a substance is approached, its isothermal compressibility tends to infinity, thus its molar volume or density changes dramatically."⁴⁵ The density is more like that of a liquid with the diffusivity of a gas. The solvent capacity can also be controlled with varying pressures because this changes the fluid density; the higher the pressure, the greater the solubility power of the solvent.

An entrainer or co-solvent would alter the separation if there is a substance that has a low solubility in the main solvent. Entrainers also provide selectivity to composition and temperature.⁴⁰ Supercritical solvents

are not only effective in separation processes, but also in crystallization, reactions, extrusion, and sorption applications. Reviews such as Application of Supercritical Fluid Extraction in Biotechnology^{6, 9, 46} and text such as the Handbook of Solvents^{40,38, 47,48,45} provide the reader an extend treatise of the subject matter.

The choice of carbon dioxide as a solvent for supercritical extraction was not uncommon. Supercritical CO₂ is popular for use with natural products because it can be used without leaving behind chemical residual. It is not a toxic or volatile organic chemical, so it is also safe for many drug and food applications. CO₂ is relatively inexpensive because it leaves the system as a gas, which can then be easily recycled. Its critical pressure and temperature is also relatively low at 73.8 bar and 31.1 degrees Celsius. The low critical temperature and natural non reactivity makes it ideal for labile compounds.

The entrainer of choice needed to be able to solubilize the target extracts as well as be soluble in the supercritical CO₂. Ethanol was chosen because it is safe in food and it is polar like anthocyanins. The solubility of ethanol was found in a study by Chany-Yih Day et al.⁴⁹ regarding the phase equilibrium of ethanol and CO₂. The phase behavior of the system with two temperatures above the critical temperature of CO₂ is shown in Figure 7. Various compositions are shown from 9 bar to 80 bar. This shows that ethanol is soluble at many conditions and compositions in supercritical CO₂.

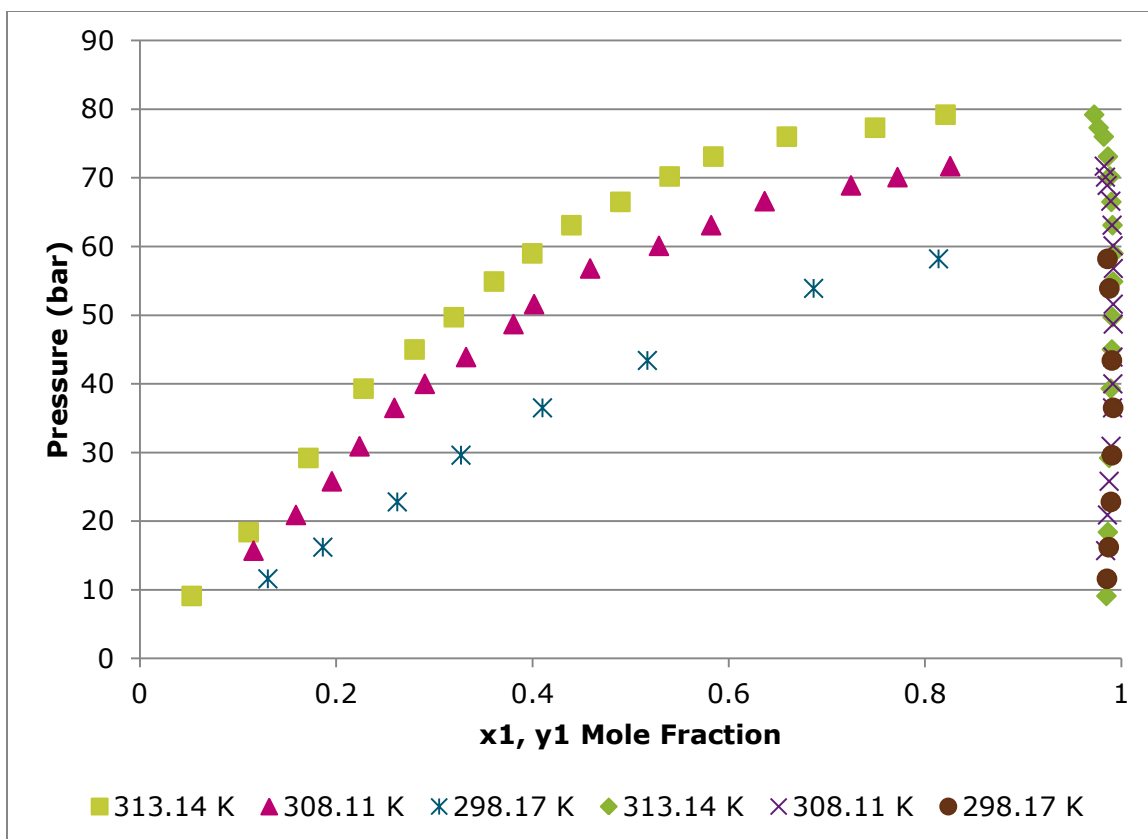

Figure 7: Phase Behavior of Carbon Dioxide-Ethanol⁴⁹

2.2.2 Subcritical Water Extraction

Water is another solvent that can be used in extraction under high pressure. Non-polar to moderately polar solutes can be extracted with supercritical CO₂, while subcritical water extraction (SWE) is for polar solutes and reactants. In order to reach the solvation properties of organic solvents like methanol, the water has to be heated. Figure 8 shows how the dielectric constant of water decreases with temperature at saturated liquid pressure. The corresponding organic solvents are also shown at their dielectric constant at room temperature. Typically, SWE is done at temperatures above 100 degrees Celsius but less than the critical temperature of 374 degrees Celsius. In doing so, the dielectric constant changes to allow water absorption of

compounds that are non-polar.⁵⁰ In other words, “the intermolecular hydrogen bonds of water break down, causing water polarity to decrease.”⁵¹

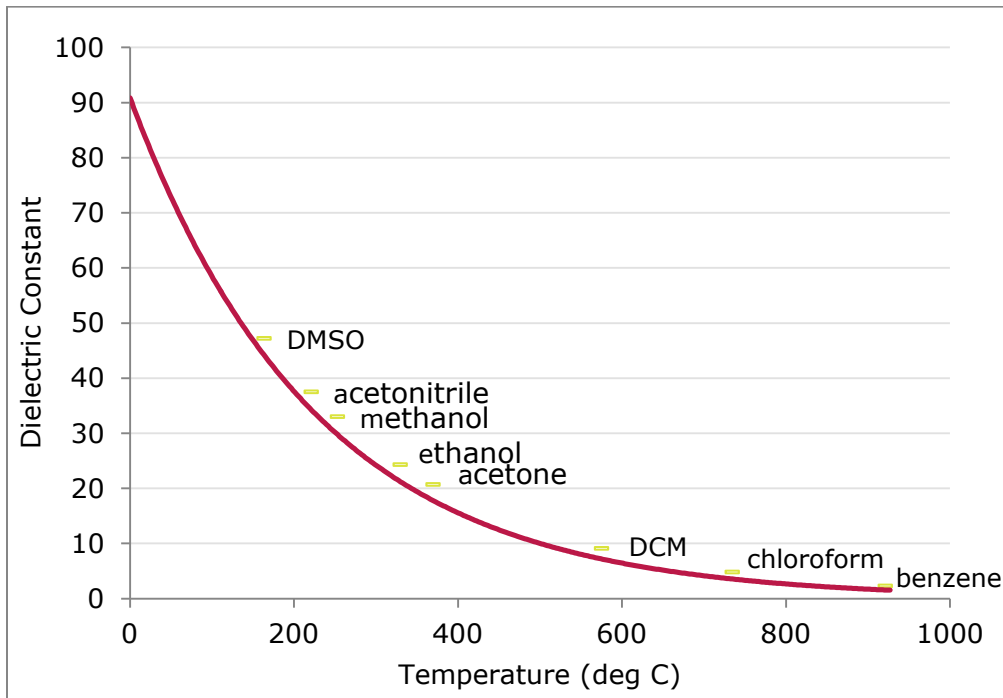

Figure 8: Dielectric Constant of Water and Varying Temperatures^{52,53,54}

Current SWE processes are used in obtaining phenolic compounds from herbs like oregano⁵⁰ where the water is evaporated under vacuum or by lyophilization. Fractionation is also possible with lipids like citrus oil.⁵⁵ Proanthocyanins are extracted from grape processing wastes batch continuous SWE.⁵⁶ There is also industrial use of subcritical water in multiple unit processing, as was presented by King and Srinivas.⁵⁶ Supercritical CO₂ is used in conjunction with subcritical water to obtain multiple products. Subcritical water can also be used in processes involving fat splitting and hydrogenation.⁵⁶ The tendency for the solutes to degrade at the selected extraction environment can prevent the use of SWE even if the physical properties are ideal. Although degradation of anthocyanins can be minimized

by reducing exposure time to hot pressurized water, it would be preferable if there was better control over such side reactions. Hence, there may still be benefits in extractions done at relatively lower temperatures and even higher pressures.

2.3 Berry Wine

Wine making is considered both an art and a science. Not expanded upon here, are a great many books that discuss chemicals which affect the taste and the process of wine making.⁵⁷ The most common fruit used are grapes, but almost any fruit can be made into wine. In the case of fruits that are not as juicy or sweet, water and sugar can be added. The total ratio of water or sugar added, excluding what is required for fermentation, is all about the desired flavor. The primary fermentation is the time where most of the sugar is converted into ethanol and carbon dioxide by the yeast. After racking, removing sediment and excess yeast, grape wine undergoes a secondary fermentation. The fermentation is much slower and is part of the flavor developing process of the wine.

A large variety of phenols and flavones are present in fruits. This translates to the wine as complexities of flavor. It also adds to the healthy aspects of wine. Red wine has become popular for combating heart disease⁵⁸ due to its polyphenolic constituents such as resveratrol and anthocyanins. Heinonen et al. found that grape wines typically have more than double the phenolic content and antioxidant activity than fruit and berry wines. Although the processes as a whole are similar, the extraction time and fermentation times may vary. Much also depends on the wine-making process and the raw

materials. Furthermore, the antioxidant activity as compared to the total phenolic content does not correlate and can vary greatly. Only black current wine was found to have higher phenolic content than red grape wine. The antioxidant activity was at most 4% greater in mixed berries than the red grape wine.⁵⁹ While apple and strawberry wines may not reach the antioxidant benefits of red wine, it is promising that other richly colored berries can meet or surpass typical wine antioxidant concentrations.

2.3.1 Fermentation Process

There have been various studies on the antioxidant power of grape wine.⁶⁰ It contains amounts of resveratrol and other antioxidants that appear to have a medicinal advantage when alcohol is not consumed in large quantities due to the lifespan of populations that drink wine on a daily basis. It is also well known that grapes are not the only wines available on the market. Other fruit wines such as blueberry or strawberry wine are popular. It can also be made from different forms of fruit. Some manufacturers use fruit concentrate and others use the whole fruit, which holds the same for grape wine manufacturing.

The ethanol content, or alcohol content, of the wine is largely dependent on the concentration of sugar in a must and partially dependent upon the strain of yeast utilized. In 1815, Gay-Lussac showed the dependence on sugar as seen in the reaction below.⁶¹

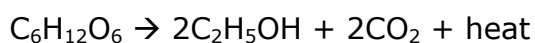

In order to reach high levels of alcohol concentration, high concentrations of sugar are necessary. The better part of the reaction is used

to calculate the amount of sugar needed for a desired percentage of alcohol. Any sugar that can break down into glucose can take part in this reaction. The enzymes will convert glucose into different products in the presence of oxygen, but fermentation into CO₂ and ethanol takes place in an anaerobic environment. Figure 9 shows the overview of the fermentation process. Ripened grapes meet all the requirements for sugar, nutrients, and pH that yeast need to thrive. When other fruits are used, additives may be used to produce a favorable wine.

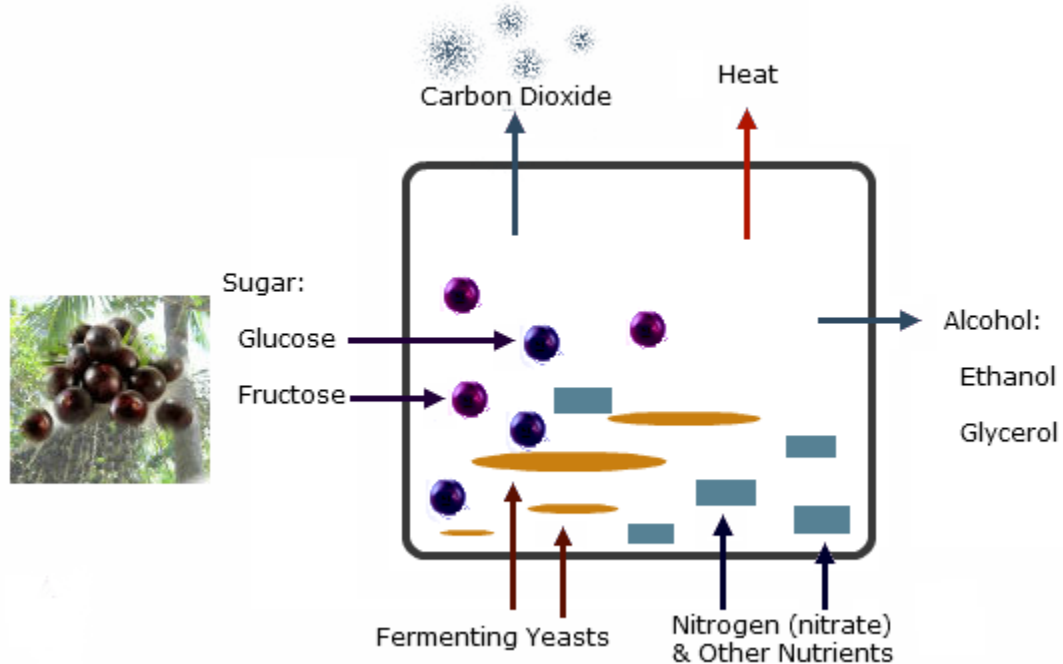

Figure 9: Fermentation Diagram

The primary sugars in grapes are dextrose (d-glucose) and levulose (d-fructose).⁶² Therefore, sweeteners added to a must would be similar in composition. The concentration, typically in degrees Brix where one degree is 1 gram sugar per 100 grams solution, can be measured with a refractometer or a hydrometer. Table sugar, sucrose, is preferred because it does not alter

flavor. Sucrose is hydrolyzed into glucose and fructose before it is consumed by the yeast. Other sweeteners include honey, molasses, brown sugar, and corn syrup. Corn syrup is mostly glucose and water; however, there may be other sugars, such as maltose, and preservatives that could negatively affect the fermentation process.

The pH of the must is important to prevent undesirable microorganism growth and produce a wine that is not flat in taste. Grapes contain tartaric and malic acid with a pH from 3.0 to 3.6.⁶² When the pH of a must needs to be lowered, acid blends and/or individual acids, for better control over flavor, can be added. Acid blends contain tartaric, malic, and citric acid. Malic acid has an apple flavor and tartaric acid adds tartness but also has an odor.⁶¹ Citric acid buffers to a low pH without the odor, but too much will result in a citrus flavor.

Grapes can have a variety of strains of yeast and molds, as do fruits and berries. In order to reduce the chance for off flavors, a specific strain of yeast is desired for fermentation. Detailed explanation on yeasts will be discussed in the next section. Potassium metabisulfite or sodium metabisulfite, campden tablets, is added to juice in very small amounts to kill wild organisms. The sulfur dioxide (SO₂) amounts to less than 70 ppm and it kills the microbe by "disrupting the activity of the enzymes and proteins of the cell."⁶³ Desirable yeasts are not killed, because the concentration levels of molecular SO₂ effect various species differently.

Many other additives can be used prior and post fermentation: pectic enzyme to enhance the clarification process, yeast nutrient to provide the

yeast with the nitrogen it needs for fermentation, and potassium sorbate for wine stabilizing and preventing re-fermentation in sweet wines to name a few. The decision to use particular additives is not only dependent on what is necessary for the fermentation process, but also on the winemaker's desired taste of the completed wine. Studying the fermentation process gives the winemaker more control when mass producing the finished product.

2.3.2 Yeasts and Enzymes

Yeast is the organism responsible for the fermentation of wine. Majority of commercial wines use the yeast strain *Saccharomyces cerevisiae*. The yeast is bred to tolerate varying conditions: temperatures, alcohol concentrations, sugar concentrations, and sulfur concentrations. A chart to show examples of strains that thrive in different temperature ranges and varying levels of maximum alcohol tolerance in percent alcohol by volume (ABV) is included as Table 2.

Different yeast release different enzymes which contribute to reactions that change the content of the wine. Biochemical reactions are complex and result in higher alcohols, esters, and sulfur compounds. Therefore, the flavor profiles are not limited and can be altered. Malolactic fermentation is an example of this. Lactic acid is produced from malic acid. A fuller feeling in the taste of the wine is a result and can have a buttery flavor, but too much produces disagreeable aromas. There are many volatile compounds that contribute to the flavor and aroma of wine. Francis and Newton conducted a study to identify several of these aroma producing compounds.⁶⁵

Table 2: Example Yeast Strains⁶⁴

Company	Yeast Name	Strain #	Temp Range (°F)	Alc Tol (%ABV)	Sugg. Wine Styles
Lalvin	71-B	1022-02	59-86	14	Young Reds, Blush, Juice from Concentrates, Whites
Lalvin	EC-1118	1018-02	45-95	18	Dry Meads, Champagne, Secondary-Stuck
Red Star	Montrachet	Davis#522	59-86	13	Merlot, Syrah, Chardonnay
Red Star	Pasteur Red	Davis#904	64-86	16	Cherry Wine, Merlot, Pinot, Syrah
Vinter's Harvest	Saccharomyces Cerevisiae	CR51	72-86	13.5	Merlot, Syrah
Vinter's Harvest	Saccharomyces Cerevisiae	MA33	64-80	14	Fruity Whites, Fruit Wine, Blush

Before fermentation, hydrolysis breaks down disaccharides that are in the must. Then the yeast metabolizes the sugars. The general mechanism for *Saccharomyces cerevisiae* is shown in Figure 10. Glycolysis starts the process when glucose molecules are broken down into two pyruvate molecules. Pyruvate synthesis will proceed differently depending on the enzymes of the yeast strain. Less than 5% of the yeast production results in the compounds that contribute to the flavor. Ethanol is mainly produced from the acetaldehyde production of pyruvate synthesis. Acetyl coenzyme A (CoA) and fatty acid CoA will produce fatty acids. They can also combine with higher

alcohols produced from amino and keto acids to produce esters. Esters are the “one of the largest and most important groups of compounds affecting flavor.”⁶⁶ It is the yeast that helps produce the fruit and fresh aromas in wine. Swiegers and Pretorius provide a detailed description of the impact of yeast on other wine flavor compounds.⁶⁶

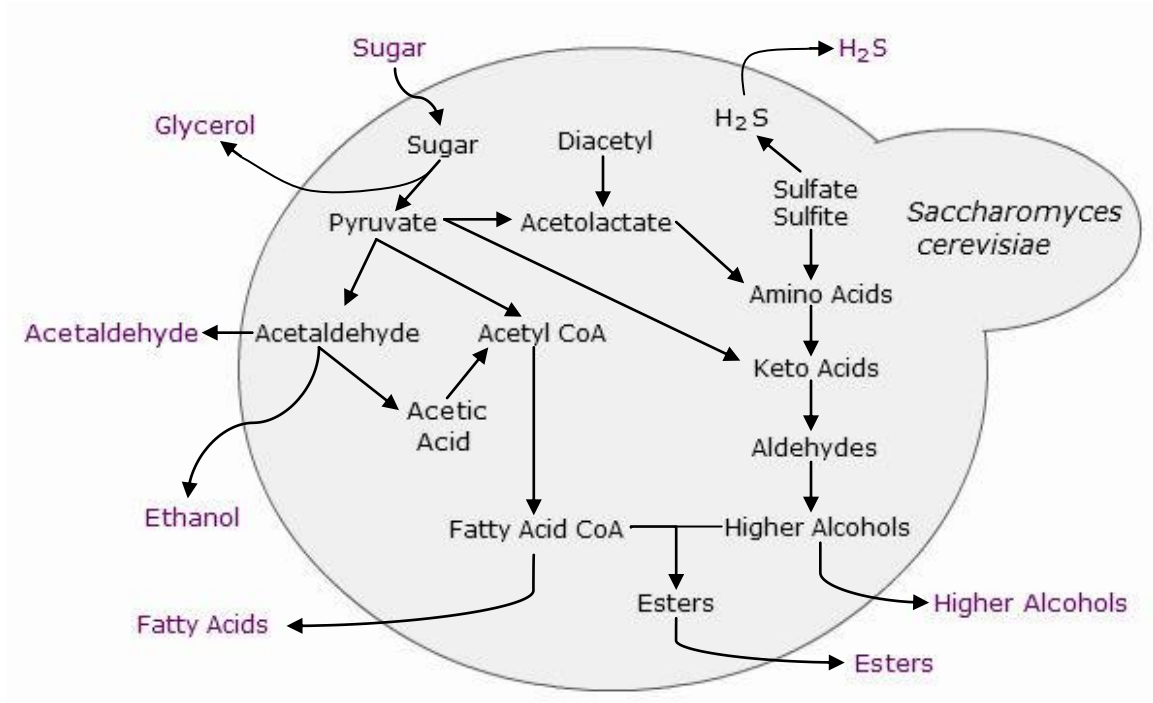

Figure 10: Yeast Fermentation Mechanisms⁶⁶⁻⁶⁷

The reader now has a general understanding of why different strains of yeast would be chosen. The metabolism of the yeast and the by-products of its processes strongly impact flavors of the finished wine.

2.4 Methods of Analysis

There are a variety of ways to analyze the extracts and wine content. Some methods only aim to obtain qualitative data, while others are more

detailed and can provide qualitative as well as quantitative results. Only an overview of current methods of analysis will be included here.

The concentration of alcohol in wine can be estimated when the initial density prior to fermentation is known. Solids that have not yet settled can skew the density resulting in error in calculations. It is then desirable to measure alcohol percentage without knowing the initial density. A vinometer is the method of choice for wine makers; however, the sugar in the wine can create an error in the percentage. For instance, the higher the percent sugar, the higher alcohol percent seemed to be for the wine. The percent volume measurements on the vinometer are based off of capillary action of pure water and alcohol. The change in surface tension with increase alcohol concentration is measured. Sugar and other impurities will also change the surface tension. Alternatively, chromatography can determine the amount of ethanol in wine without the need for distillation or chemical reaction. Gas-liquid chromatography provides quantitative analysis of "ethanol separately from other wine components that interfere in other methods."⁶⁸ The GC can also be used to determine what other alcohols are in the wine.

Chromatography is also useful in identifying polyphenolic constituents as well. After measuring the total phenolic content with spectroscopy, GC-MS can identify specific volatile constituents.⁶⁹ UV region spectrophotometry has been used in measuring anthocyanin content and capillary GC-FID for volatile oils.³⁹ As long as the compound is highly volatile, a GC can be used. However, due to the nature of the components and the size of the molecules this was not always the best method of analysis. When molecules are large,

there is a low volatility and a high solubility, and the molecules are very polar a LC or HPLC is preferred to lessen sample preparation time. Polyphenolic constituents have been measured employing HPLC-DAD-UV-Vis and HPLC-MS.³² Large molecules such as proanthocyanins can be observed by using gel permeation chromatography.³⁸ Turbulent-flow chromatography coupled to LC-MS has been used to determine flavonoids and resveratrol in wines.⁷⁰ If the specific compound is unimportant, the total anthocyanin content can be measured using pH differential method, which utilizes the different absorbance spectra that result from changes in the pH.⁴⁴

High polyphenolic content does not mean there is a high amount of active antioxidants. There are several ways of measuring antioxidant capacity including free radical scavenging capacity using assay of reduction of 1,1-diphenyl-2-picrylhydrazyl (DPPH), oxygen radical absorbance capacity (ORAC), ferric reducing antioxidant capacity assay (FRAP), and trolox equivalent antioxidant capacity (TEAC).⁷¹ The aforementioned are all in vitro chemical tests and will result in different antioxidant capacities. The antioxidant capacity of select anthocyanins can be determined by first measuring spectrophotometrically at a known wavelength, such as 520 nm for cyanidin-3-glucoside, using reverse HPLC-MS to identify the specific compound and then using ORAC.⁴³ ORAC is the most common method for measuring antioxidant capacity but there is not yet physiological proof to its validity. This method measures a fluorescent molecule after oxidative degradation. Modifications of ORAC have been made to simulate species that exist in the body.⁷² Lichtenthaler et al. found the total oxidant scavenging

capacity (TOSC) of açai fruits, using HPLC-MS to identify and HPLC-Vis to quantify individual compounds, anthocyanins included.⁷³ Non chemical methods have also been used in attempt to measure antioxidant capacities in vitro but in conditions to better simulate the body. Two cell based methods include cell-based antioxidant protection of erythrocytes (CAP-e) assay and inhibition of reactive oxygen species formation by polymorphonuclear cells (ROS PMN) assay. Unlike chemical methods, CAP-e and ROS PMN methods provide insight on behaviors in living cells exposed to antioxidants.⁷⁴

Chapter 3

Modeling

The focus of this chapter is to give insight to the behavior of the extraction and fermentation systems discussed within this work. In addition to the equations, detailed descriptions of the model to explain the behaviors are also presented. Understanding the systems through models assists in prediction and improved controls of the systems.

3.1 Gas Extraction Model

Extraction of natural plants involves principles of mass transfer. In the case of supercritical fluids, whether or not the system behaves more like a gas or liquid depends on the thermodynamic properties. The process of extraction with supercritical solvent flowing continuously is not a steady state system. The gas extraction model can become more complex by considering more phases or by modeling different extracts individually.

The rate of the extraction will vary depending on the constituent extracted, its concentration, and its solubility in the solvent. Figure 11 shows how the largest amount of extract dissolved in the supercritical carbon dioxide will be obtained at the beginning of the extraction. After this time, it is no longer beneficial to continue with the extraction. The 'ideal' path assumes the rate of the extraction in the beginning follows a linear path. After some time, given by the total quantity of extract, a limit is reached.

Figure 12 shows the percent extracted from the total amount of extract available with respect to time. Figure 11 and Figure 12 also show how extracts with varying initial concentration or solubility can affect the extraction process, thereby making it important to utilize the model to adjust the thermodynamic conditions and time best suited for the target extract.

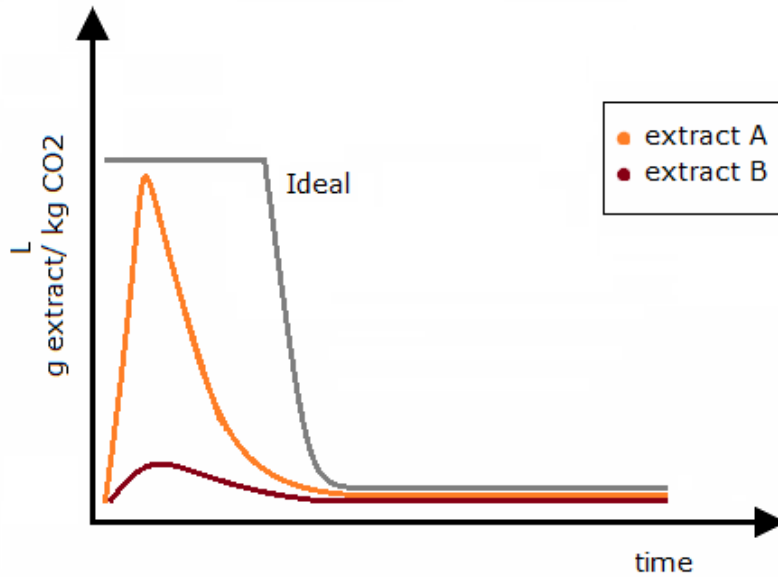

Figure 11: Concentration of Extract in Solvent Curve

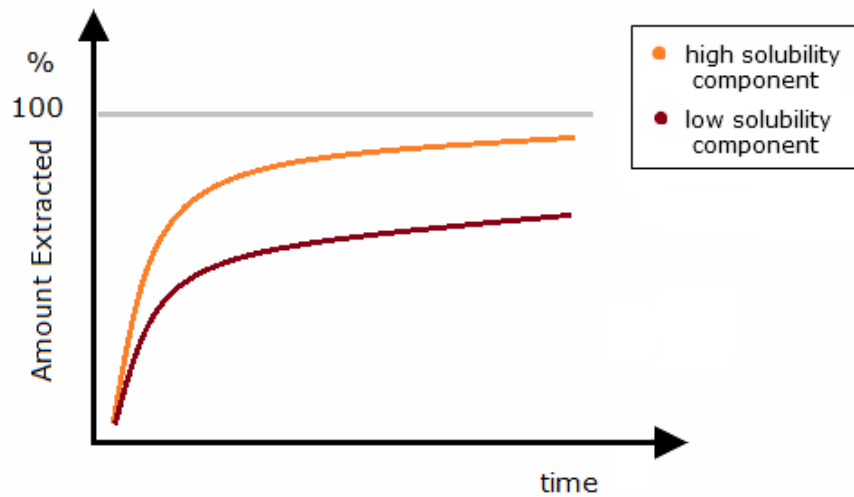

Figure 12: Extraction Curve with Multiple Components

The model here, assumes gas extraction properties. The solid substrate forms a "fixed bed, through which the supercritical gas flows and extracts the product component until the substrate is depleted."⁷⁵ The amount of solvent and the process parameters will affect the rate of diffusion of the extracts from the solid.

The extraction time of solids is reasonably slow, taking minutes to hours, while solvent residence time is few minutes at most. Therefore, the semi-continuous process can be assumed to operate at quasi-steady state.⁷⁵ The total amount of extract against the amount of solvent used with time can be seen in Figure 13. Zone one is solubility limited where amount of solvent used is increased total extract amount linearly increases. The second zone is limited by amount of extract left in the porous solid matrix.

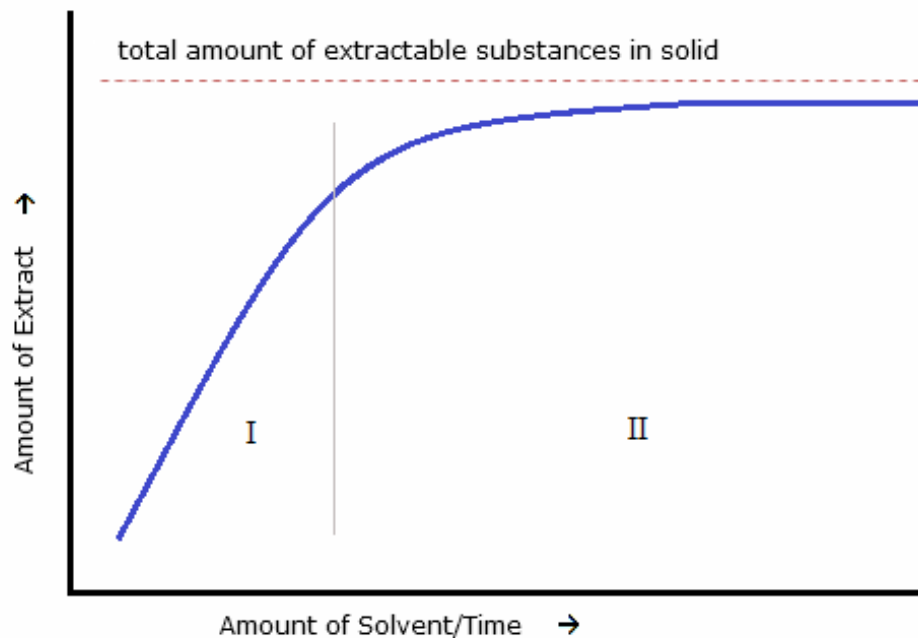

Figure 13: Extraction Curve

Modeling the process is useful in obtaining some quantitative values and parameters to represent the system. The following equations were derived by Brunner for a steady state approximation of solid extraction.⁷⁵ The mass of the extract components, m , extracted per unit time t can be deduced using known mass of the solid substrate, m_s , and the mean concentration of components in the solid that are extractable, c_m . The relationship is shown in equation 1.

$$\dot{m} = \frac{dm}{dt} = - m_s \frac{dc_m}{dt} \quad (1)$$

The amount of substances extracted per unit time, \dot{m} , is related to the mass transfer coefficient in the solid phase and fluid phase, β_s and β_f respectively. Equation 2 represents the transport of the extract from the solid to the interface, where A is the mass transfer area and c_0 is the initial concentration of components in the solid that are extractable. Equation 3 is the transport of the extract from the interface to the bulk of the fluid. The bulk fluid concentration of the extract is c_b .

$$\dot{m} = \beta_s A (c_m - c_0) \quad (2)$$

$$\dot{m} = \beta_f A (c_0 - c_b) \quad (3)$$

The total mass transfer coefficient, k , can be determined using the phase mass transfer coefficients as seen in equation 4. This equation for the total mass transfer resistance assumes no other transport resistances and no phase change at the interface of the solid and the fluid.

$$\frac{1}{k} = \frac{1}{\beta_s} + \frac{1}{\beta_f} \quad (4)$$

The long term model of the process is represented in the model which is similar to the non-linear section of Figure 13. Equation 5, mean concentration of the extracts in the solid, is the integration of equation when k is assumed constant. β_s is approximately equal to k if the mass transport resistance is dominant in the solid and the not fluid.

$$\frac{c_m - c_b}{c_0 - c_b} \approx \exp\left(-\frac{k A}{m_s c_0} t\right) \quad (5)$$

The mass transfer in the linear section of the extraction will have a constant rate of extraction. Correlations for a fixed bed, in the form of dimensionless numbers, can then be used to calculate the first part of the extraction which is important for the total extraction. The correlations below were determined using experimental data by Wakao and Kaguei.⁷⁶

$$Re = \frac{u d}{\nu} \quad (6)$$

$$Sh = 2 + 1.1 Re^{0.6} Sc^{0.33} \quad \text{for} \quad 3 < Re < 3000 \quad (7)$$

$$Sc = \frac{\nu}{Dg} \quad (8)$$

$$Sh = \frac{\beta_f d}{Dg} \quad (9)$$

Reynolds number, Re , is first calculated using the linear flow velocity of the fluid, u , the fluid viscosity, ν , and the diameter of volume equivalent sphere, d , as shown in equation 6. If the Reynolds number is between 3 and

3000, equation 7 applies to solve for Sherwood number utilizing the Reynolds number and the Schmidt number, Sc , relationship. The self diffusion coefficient of the fluid, D_g , is a factor in both the Schmidt number and the Sherwood number in equation 8 and equation 9. This self diffusivity for supercritical carbon dioxide varies greatly for a large range of temperatures and pressures, but compared to the diffusivity of solutes in liquids is one to two orders of magnitude higher.⁴⁵

The model that was presented may be simplistic, but it would be beneficial approximating total extraction time as well as determining initial parameters for the system. Collecting experimental data of the amount of extract obtained as an extraction progresses would be necessary to model the extraction of individual extracts as they relate to each other at various thermodynamic settings.

3.2 Fermentation Kinetic Model

Wine is a fermented beverage generally made from fruit juice. The initial characteristics of the fruit juice and the choice of yeast, contributes to the unique taste of the wine. This is due to metabolic regulation of the yeast producing various side reactions and by-products in the conversion of the sugars to alcohol. In order to predict the resulting concentrations in the wine, it would be beneficial to incorporate the mechanism of sugar uptake and the kinetic behavior of the fermentation into the model.⁷⁷ There have been various models developed to take into account nitrogen and oxygen limitations as well as temperature extremes and the effects of different sugars on the kinetic performance of the yeast throughout

fermentation.^{67,78,79,80,81,77} However, there is still much to be investigated to obtain parameters for these models to combine them to obtain full understanding and control of the process. Therefore, a simplistic model is used to offer a visual representation of the dynamics of batch fermentation.

The kinetic model was generated in Matlab after modifying equations from an existing model of beer fermentation.⁸² The difference in wine versus beer fermentation, and fermentation of other alcoholic beverages for that matter, is that the yeast has to tolerate high levels of ethanol, unusually low pH, and the presence of bisulfite ions.⁸³ High levels of various sugars in the media lead to competitive inhibition as well as decreasing the growth rate of the yeast.⁸³ The model assumes sugars to be the limiting nutrients in an ideally mixed batch reactor. In the açai wine fermentation, sucrose is added to the juice to increase the sugar concentration to reach the desired potential percent of the alcohol by volume. Through hydrolysis, sucrose is broken into glucose and fructose. There is naturally a small amount of maltose, about 0.1 gram per 100 grams of dry açai powder, also present.³⁵ The medium in the fermentation model can be altered to take into account the presence of various sugars. The presented model includes glucose and maltose.

The mathematical model begins with a material balance, equation 10, which incorporates the growth of microorganisms. There are one of these for each sugar, i . S is the sugar concentration in gram moles per cubic meter. X is the yeast concentration in gram moles per cubic meter and t is time in hours.

$$\frac{dS_i}{dt} = \mu_i X \quad (10)$$

The consumption of the sugars is related to the rates of ethanol produced and the change in yeast concentration over time. The relationships are expressed in equations 11 and 12. R_{Ei} and R_{Xi} are the stoichiometric yield per mole of sugar reacted of ethanol and yeast respectively, where the subscripts 1 and 2 are glucose and maltose respectively and subscript 3 can be another sugar if desired.

$$\frac{dE}{dt} = -R_{E1} \frac{dS_1}{dt} - R_{E2} \frac{dS_2}{dt} - R_{E3} \frac{dS_3}{dt} \quad (11)$$

$$\frac{dX}{dt} = -R_{X1} \frac{dS_1}{dt} - R_{X2} \frac{dS_2}{dt} - R_{X3} \frac{dS_3}{dt} \quad (12)$$

The Monod equation, founded by Jacques Monod, relates microbial growth rates in an aqueous environment to the concentration of a limiting nutrient. It is an empirical model similar to the theoretical Michaelis-Menten equation. The specific reaction rates for the consumption of sugar i are expressed in the parameters μ_i . The yeast concentration is from first-order reactions which reflect the conversion of sugar into alcohol within the yeast cells in catalyzed enzymatic reactions.⁸² Equation 13 presents the Monod expression for glucose with equations 14 and 15 being the Monod forms accounting for inhibition of each consequent sugar. The reaction rate constants are as follows: V_i is maximum reaction velocity in hr^{-1} , K_i is the Michaelis constant in gram moles per cubic meter, and K_i^i is the inhibition constant in gram moles per cubic meter.

$$\mu_1 = \frac{V_1 S_1}{K_1 + S_1} \quad (13)$$

$$\mu_2 = \frac{V_2 S_2}{K_2 + S_2} \cdot \frac{K'_1}{K'_1 + S_1} \quad (14)$$

$$\mu_3 = \frac{V_3 S_3}{K_3 + S_3} \cdot \frac{K'_1}{K'_1 + S_1} \cdot \frac{K'_2}{K'_2 + S_2} \quad (15)$$

Knowing the effects of environmental factors on the fermentation process would be helpful. Instead of hoping to get the desired results in an estimated amount of time, having knowledge of the effect on some key variables helps control the fermentation process. While the amount of ethanol produced in wine fermentation reaction relies strongly on the initial sugar concentration and the active yeast concentration, temperature is also an important factor. Combining many variables that relate to temperature, as was presented by Coleman et al.⁷⁸, would create a model that more accurately shows the effects of temperature on wine the fermentation. More simply in this model, only the reaction rate constants are temperature dependent. Seen in equation 16, equation 17, and equation 18, the temperature dependency of the rate constants follow the Arrhenius equation.

$$V_i = v_{i0} \exp\left(\frac{-E_{V_i}}{R(T+273)}\right) \quad (16)$$

$$K_i = k_{i0} \exp\left(\frac{-E_{K_i}}{R(T+273)}\right) \quad (17)$$

$$K'_i = k'_{i0} \exp\left(\frac{-E_{K'_i}}{R(T+273)}\right) \quad (18)$$

An energy balance, equation 19, around the reactor is a way to monitor the temperature as the reaction progresses. The heat of fermentation of sugar, ΔH_{Fi} , is in Joules per mole. Temperature, T, and

environment temperature, T_e , are in degrees Celsius. The size of the batch reactor has some affect on the heat transfer rate to the environment, where A is the heat-transfer area in square meters and V is the volume of the fermenting mixture in cubic meters.

$$\frac{dT}{dt} = \frac{1}{\rho \cdot Cp} \left[\Delta H_{F1} \frac{dS_1}{dt} + \Delta H_{F2} \frac{dS_2}{dt} + \Delta H_{F3} \frac{dS_3}{dt} - \frac{U \cdot A}{V} (T - T_e) \right] \quad (19)$$

The overall heat-transfer coefficient, U (J/hr·m²·°C), will change depending on where the fermentation vessel is stored.⁸⁴ As presented by Colombié et al.⁸⁴, forced convection can be assumed for outdoor storage and natural convection is sufficient for indoor storage; indoor storage is assumed for this model. Density, ρ (kg/m³), and heat capacity of the mixture, Cp (J/kg·°C), will change as the reaction progresses and the sugars are consumed, but this model assumes the values at the initial conditions. The data given in Table 3 were used to perform the numerical simulation.

Runge Kutta was the decided numerical method of choice used to solve the ordinary differential equations. There are functions built into MATLAB that incorporate the Runge Kutta method; the function used was ode45. The following figures are the result of the model. Figure 14 shows the sugar consumption as time progresses. Since the yeast favor glucose, it is consumed first. Maltose is consumed after but at a much slower rate.

Ethanol is generated in the fermentation as seen in Figure 15. There is also an increase in the concentration of the yeast they reproduce throughout the fermentation. The generation of ethanol by the yeast is exothermic.

Figure 16 illustrates the production of heat with the increase in temperature.

When the sugars are no longer consumed, the temperature would no longer increase.

Table 3: Fermentation Model Data

Physical Parameters			
Sugar	R_{Ei}	R_{Xi}	ΔH_{Fi} (J/gmol)
Glucose (S_1)	1.92	0.134	- 91.3 x 10 ³
Maltose (S_2)	3.84	0.268	-226.3 x 10 ³
Initial Conditions*			
S_1 (t_0)	563.30 gmol/m ³	$T(t_0)$	20°C
S_2 (t_0)	0.42 gmol/m ³	T_e	23°C
C_p	4016 J/kg°C	ρ	1096 kg/m ³
$X(t_0)$	2.65 gmol/m ³		
Equipment Parameters			
A (heat transfer area) = 0.188 m ²		$V = 0.1$ m ³	
Arrhenius Constants			
Parameter	Frequency Factor ln (x)	Activation Energy (cal/g mol)	
V_1	35.77	22.6 x 10 ³	
V_2	16.40	11.3 x 10 ³	
K_1	-121.30	-68.6 x 10 ³	
K_2	-19.15	-14.4 x 10 ³	
K'_1	23.33	10.2 x 10 ³	

Note: Data from Ramirez⁸² unless otherwise noted.

*From açai fermentation experiment, calculations are shown in Appendix E.

Although the model developed was simplistic, it is possible to improve accuracy by incorporating more parameters that contribute to the reaction. Once the parameters fit experimental data, the initial conditions can be varied to see the type of reaction: sluggish, normal, or stuck. The optimal

condition would be when the most amount of sugar was reacted to form ethanol in least amount of time. Knowing only this optimal point is not as beneficial as seeing the different possibilities. The wine maker will be able to use the different types of reactions to perhaps create different wines, for example dry versus sweet wine.

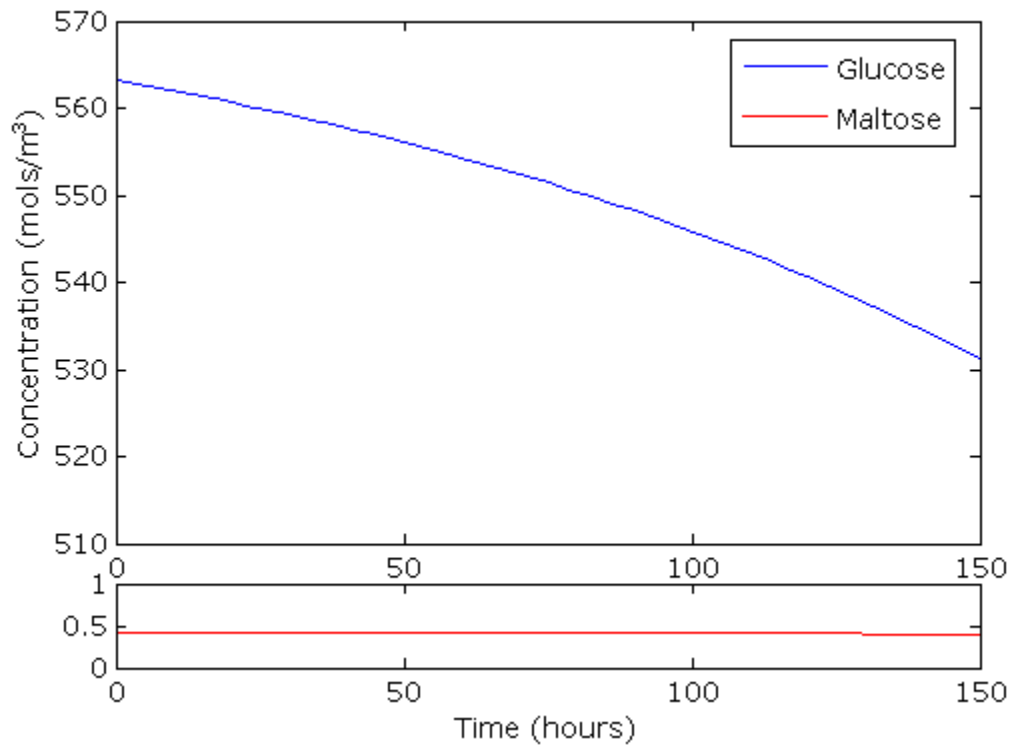

Figure 14: Sugars Consumption

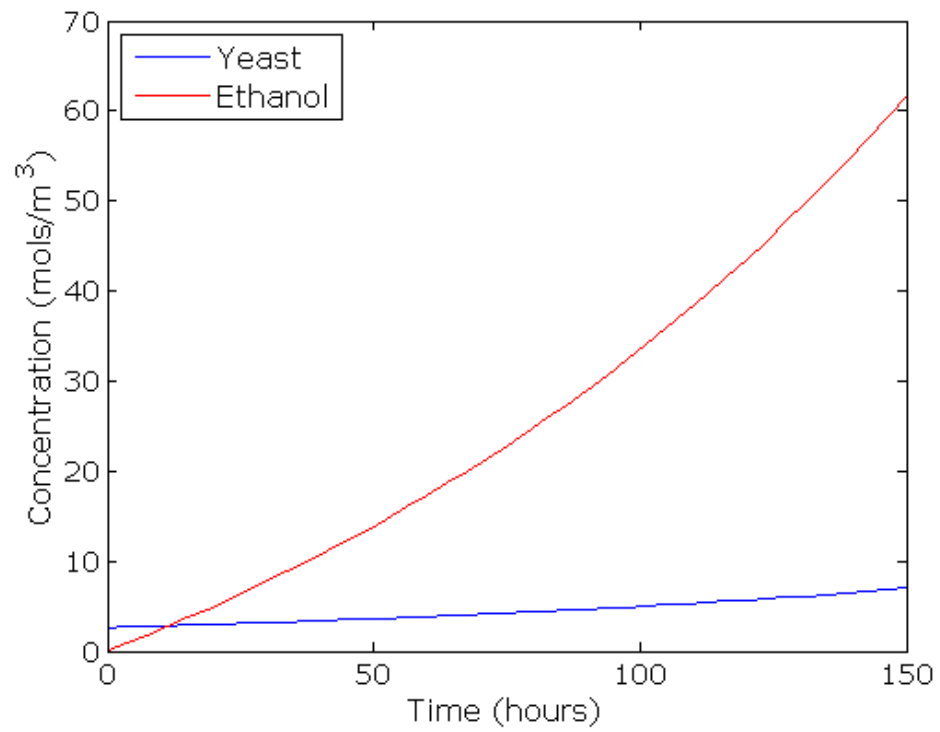

Figure 15: Ethanol and Yeast Production

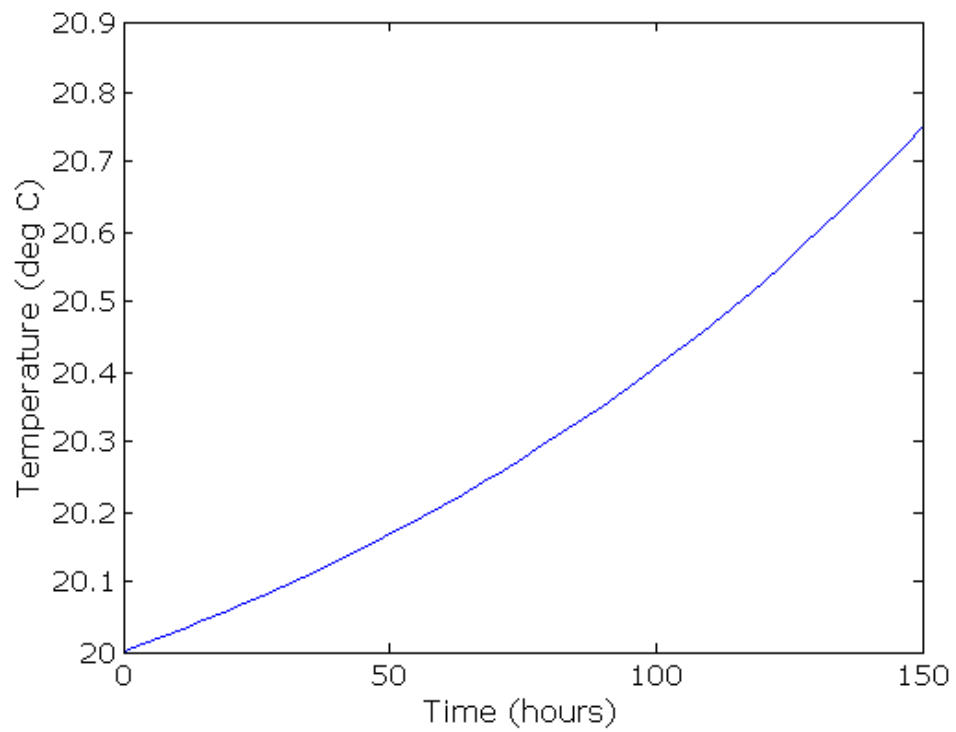

Figure 16: Fermentation Temperature

Chapter 4

Experiments

The experimental set-up and procedure for extracting the active components of the freeze dried açai berry are described in detail here. The fermentation set-ups and procedures will also be discussed as well any equipment and materials used throughout the study.

4.1 List of Experiments

This is a compilation of the various experiments completed in order to obtain a comprehensive study of the fermentation and supercritical extraction of açai berry. Figure 17 is a block flow diagram of the experiments that are involved in this study.

Soxhlet extraction is prepared with açai berry and an ethanol solvent to determine approximate possible yield of extract. Extractions of açai berry and açai berry with ethanol entrainer via supercritical carbon dioxide are then conducted. For pressures above that feasible on a small laboratory scale, the extraction was done at Valensa Nutraceuticals' pilot plant.

Grape juice from Merlot wine kit, açai berry pre-extraction, and açai berry solids after extraction are fermented to make table wine.

A wine testing of Merlot, Merlot of less than 1% by volume of alcohol, sweet and dry açai wines, and blueberry wine are given to tasters for

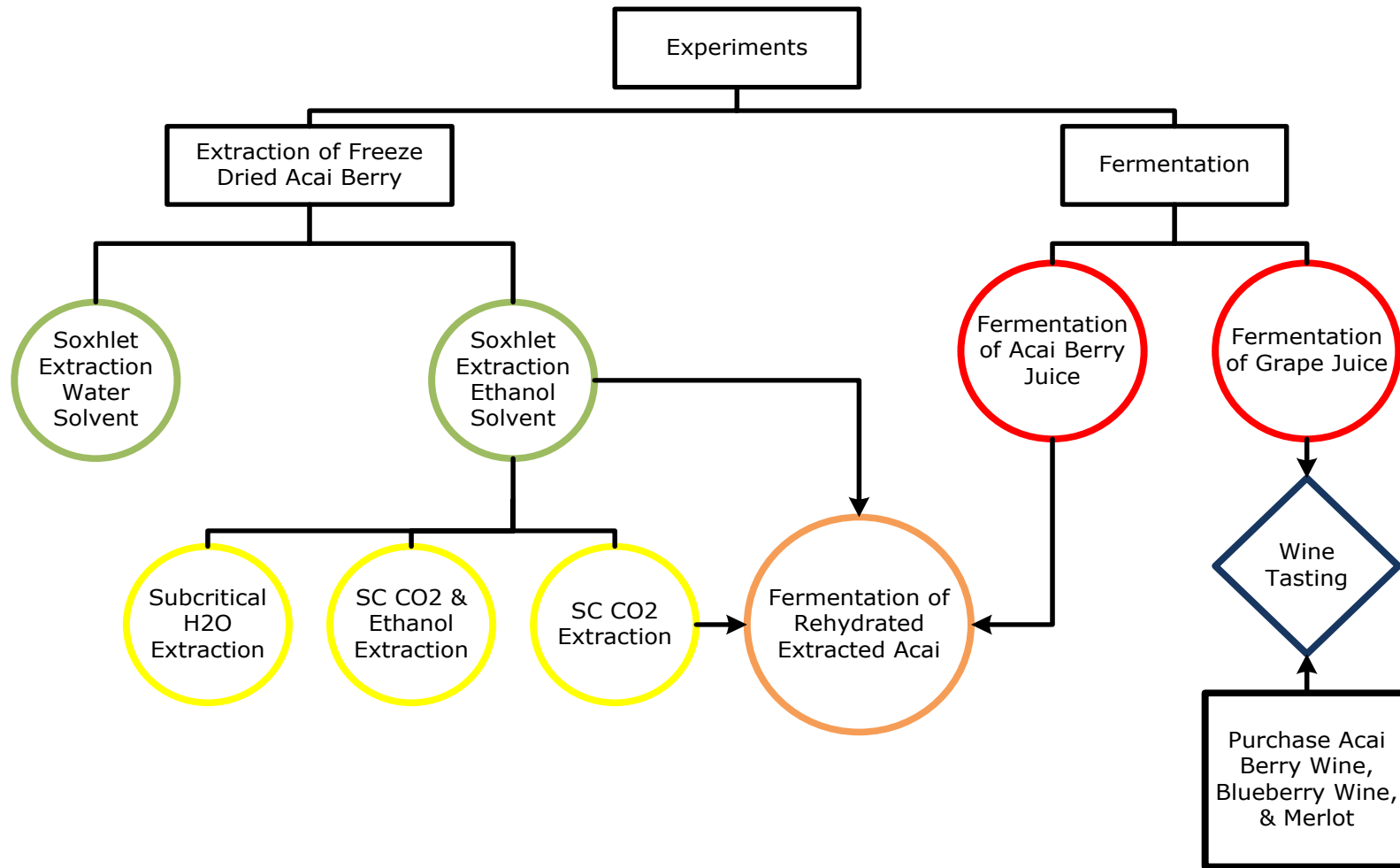

Figure 17: Structure of the Experimental Program

analysis. The basis of the scale for analysis was developed by Tromp and Conradie⁸⁵ to evaluate the overall wine and obtain information on the characteristics of the wine.

4.2 Soxhlet Extraction Procedure

A soxhlet extraction with açai berry is performed to obtain preliminary estimates of yields and constituents of extract with ethanol and water solvents. The clean and dry glassware is gathered and assembled on a stand over a hotplate as seen in Figure 18. The cooling water will flow continuously to condense the solvent onto the material in the thimble. The solvent vapor comes from the round bottom flask and travels through the side arm. When it condenses it fills the extraction chamber. When it fills above the siphon arm, it refluxes and is essentially flushed back down into the boiling flask. This process is repeated for the duration of the experiment.

The thimble is a semi-permeable vessel used to keep the solids separate from the solvent in the boiling flask. It can either be ceramic or disposable cellulose. The heating medium, ethylene glycol, is placed in the container so that the round bottom flask is not in direct contact with the heat source. In order to tare the final samples, the weights of the round bottom flask and thimble are recorded first. Then the desired amount of freeze dried açai powder, about 8 grams, is placed in the thimble and weight recorded. The thimble is carefully placed in the extractor. 200 milliliters of solvent is measured with a graduated cylinder. It is added to the round bottom flask and weight recorded.

The apparatus is assembled, condenser on top followed by extractor then round bottom flask, so that the flask is placed in the ethylene glycol bath over a hot plate. The flow of water at the condenser is turned on and then hot plate. Aluminum foil is wrapped around the extractor and flask to assist with the temperature control. The thermometer should be pushed down enough that the tip is in the solvent the entire run to monitor that the temperature stays at the boiling point of the solvent. The extraction operates for 24 hours.

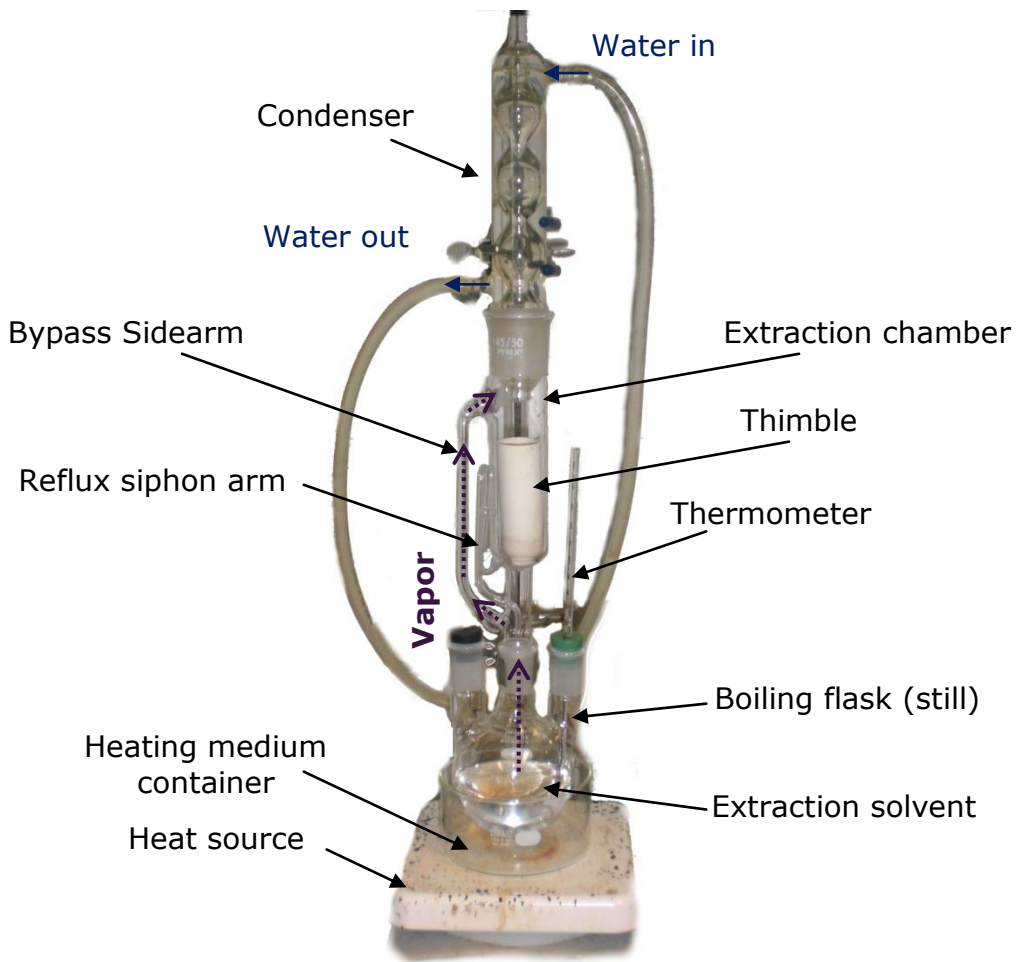

Figure 18: Soxhlet Extraction Setup

At the end of the experiment, the hot plate is turned off and the apparatus is left to cool. The thimble containing wet açai powder is carefully removed from the extractor. Any remaining liquid in the extractor is poured into the round bottom flask. The wet thimble is weighed and then placed in the vacuum oven at 2.5 mmHg and 34°C to dry. Once dry the amount of açai that was extracted can be found after determining its weight. The amount of solvent and extract left in the round bottom flask is also measured by weight and volume.

4.2.1 Cleaning Procedure

When the experimental run is complete and sample weights recorded, the apparatus can be disassembled for cleaning. The remaining ethylene glycol is poured in a storage container for future use. Then the heating medium container can be washed. The condenser is removed and rinsed several times in warm water to remove any residue. The extractor and round bottom flask are scrubbed out with soap and water. If the material is difficult to remove, the glassware is soaked in soapy water with vinegar for a few hours. Then it is rinsed out several times and scrubbed again. After a final rinsing with deionized water, the glassware is left to air dry entirely before another experiment is performed.

If a ceramic thimble is used, the left over material is scrubbed out with hot water and soap. It is rinsed and allowed to air dry. The thimble is then placed in the furnace and heated to 450°C until the material trapped in the pores is burned off. Cellulose thimbles are simply discarded.

4.3 High Pressure Extraction Procedure

There are two types of high pressure experiment setups. The first, seen in Figure 19, is for supercritical extractions. Carbon dioxide (CO_2) is the main solvent and there is an option to use an entrainer. The second, seen in Figure 20, is for subcritical water extractions. In both cases, there is one pump for CO_2 and another pump used for liquid solvents. The chiller is used to decrease the temperature at the syringe pump to ensure the CO_2 is in its liquid state. The HPLC pump forces the liquid solvent, either ethanol or water, into the system. The pressure at the extractor is set at the back pressure regulator (BPR), which is wrapped in electric heating tape to prevent freezing during depressurization. A nitrogen (N_2) tank's regulator maintains the pressure for the BPR. The air activated BPR is located before the separator such that the lines after the BPR are at atmospheric pressure. The temperature of the system is verified by checking the pressure at the controllers of the pumps. The experiment is enclosed so that it operates in a controlled temperature environment. The set point of the heater is approximately 20°C higher than the desired set point temperature of the system. A fan is used to circulate the air to create a uniform temperature environment. The specifications for the equipment are in Appendix C.

In supercritical extraction, if co-solvent is desired, the CO_2 and ethanol come together at the in-line mixer. The fluid then travels through the pre-heater coil to ensure it reaches the desired temperature before passing up through the extractor. The temperature is verified with a thermocouple on the exit side of the extractor. Once it reaches the separator, the change in

pressure allows for the extracts to precipitate out. CO₂ exits as a gas into the water of the reservoir. As the gas escapes, the total CO₂ used in the experiment is measured with the flow meter.

The subcritical water extraction as a continuous flow system is not used. A check valve is placed before the extractor to prevent water and extracts from flowing back to the pumps. The water flows from the top of the extractor down. There is a bypass line connected to an outlet valve after the extractor to allow for depressurization after the experiment and draining prior to removal of the extractor. CO₂ is used to pressurize the system. Then warm water is pumped to the extractor and the lines filled. The lines are known to be full when it starts dripping from the separator into the collection vessel. The flow of water is then stopped to allow for a static extraction. After the desired extraction time has passed, the flow of water is initiated. The extract is collected into the collection vessel. Most CO₂ will escape from the top of the separator and out the reservoir.

The system has to be prepared the day before each run because it takes several hours for the air temperature of the system to reach 40 - 45°C. First the extractor vessel is removed and loaded with 10 grams of the freeze dried açai berry. The vessel is constricted at the top and bottom by two filters with five micron diameter pores. This prevents solids from being transferred out of the collection cell. The extractor covers are hand tightened. Then it is placed on the apparatus where the fittings are tightened. A low pressure leak check is performed as explained in the next section. The flow meter is checked to ensure the reservoir has adequate

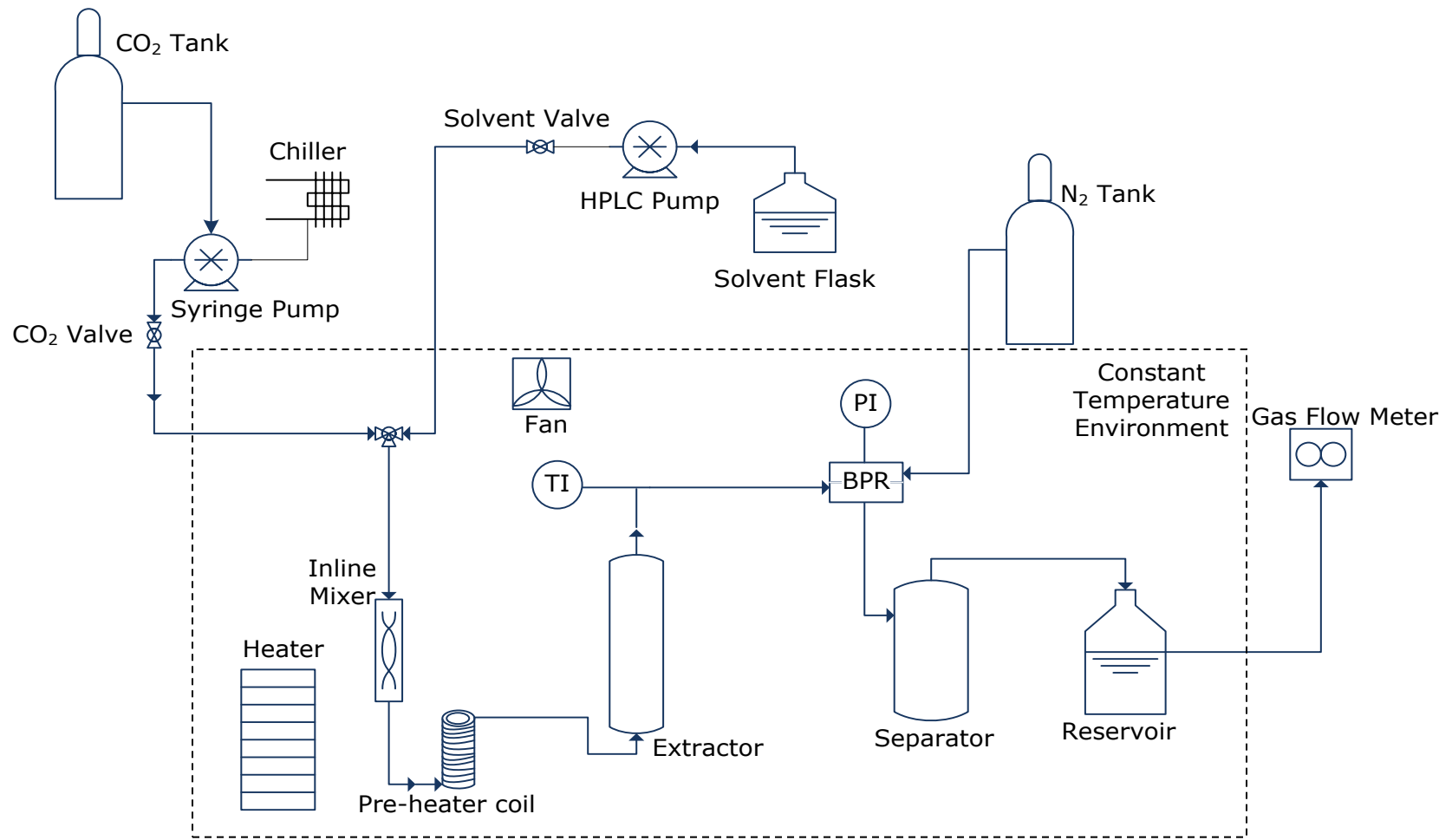

Figure 19: Supercritical Extraction Process Diagram

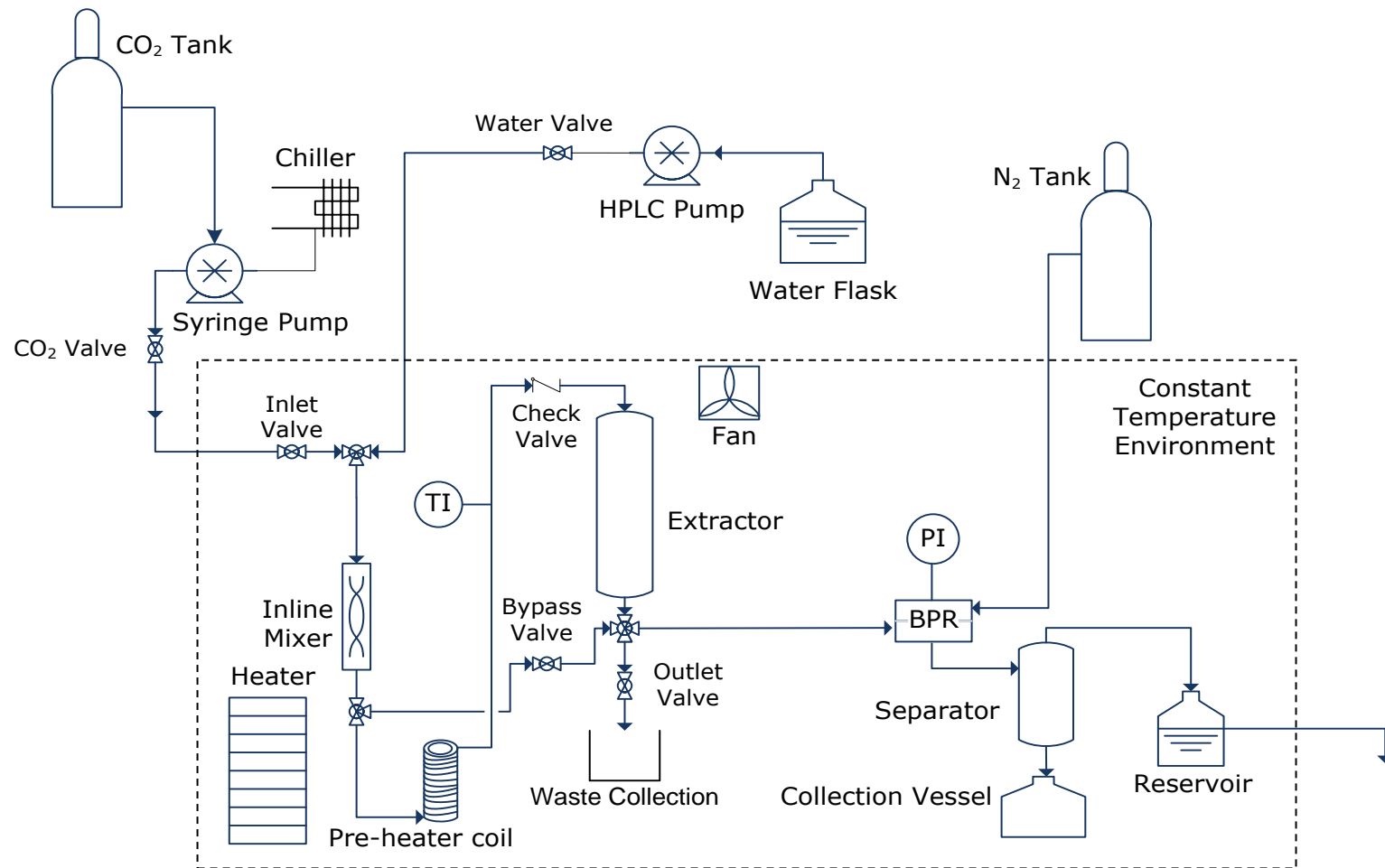

Figure 20: Subcritical Water Extraction Process Diagram

amount of deionized water; more is added if needed. Then the fan is plugged in and the insulation box is closed. The timer is set for the heater to turn on at least three hours prior to running the experiment. Finally, the day of the experiment the chiller is turned on fifteen to thirty minutes prior to starting the pump.

4.3.1 Supercritical Carbon Dioxide

An environmentally friendly and biologically safe solvent, carbon dioxide, is put under pressure to place it in a supercritical state to facilitate in extraction of nutraceuticals of açai berry. Prior to any pressurized run, a lower pressure leak check is done to ensure all fittings are properly tightened. A high pressure leak check is performed when the system is first set up. Except for the pressure, the procedure for both is the same. Lower pressure is around 52 bar while high pressure as considered around 100 bar.

The pressure at the N₂ regulator is set to the desired pressure. The CO₂ valve is opened. If pressure is not high enough, the chiller has to be turned on to cool the pump heads. When the temperature on the chiller reads 0°C the pump can be turned on and a flow rate set. 5 – 10 grams per minute is generally enough to the desired pressure. Once desired pressure is reached, the flow is stopped and the fittings can be checked for leaks.

The system and chiller should be at the proper temperatures before beginning. The syringe pump and flow meter are turned on. If it is desired to use an entrainer, the HPLC pump is turned on and ethanol added to the solvent flask as needed. The pumps do the automatic self-checks. Meanwhile, the system temperature of the box is verified and recorded. Confirm the

connections at the N₂ tank, used for depressurizing, are tightened. Then the N₂ tank is opened and the pressure is set using the regulator. The BPR is verified to be at about the same pressure. The electrical heating tape is turned on to prevent plugs from forming. The next step is to pressurize the system which starts the experimental run.

The CO₂ tank and valve are opened. The valve at the syringe pump is opened and the flow rate is set to 15 g/min. This is left to increase system to desired pressure and then reduced to 8 g/min. While pressure is rising, open the solvent valve and set the HPLC pump to 10 ml/min. After a few seconds the ethanol will fill the lines and pressure will build. The HPLC pump rate is then reduced to 0.5 ml/min. The final pressure of the CO₂ at the syringe pump is recorded. The temperature and pressure is recorded every 30 minutes to ensure there are no large fluctuations to the system. The proper flow of the co-solvent is observed in verifying the pump pressure at the HPLC pump is similar to the CO₂ pump. The gas flow meter's starting gas volume and the start time of the experimental run is recorded.

After the desired time has passed the pumps are stopped by setting the flow rates to zero. The CO₂ and N₂ tanks are closed, and the chiller and the cooler are turned off. Very slowly, the depressurizing connection on the N₂ tank is loosened. The pressure has to be released gradually so it may take an hour or more to depressurize to zero. The heating tape can be turned off and left to cool once the pressure reaches zero. It is important to ensure the pressure at the pumps and the BPR read zero before proceeding further. The

pumps are then turned off and connections at the extractor and separator can be loosened.

The extract from the collection vessel is put in a vial and weighed. It is immediately capped, labeled, and wrapped with aluminum foil and refrigerated to ensure minimal degradation to the compounds. The starting material is taken out of the extraction vessel and the weight is recorded as well. If ethanol was used, the material is dried in a vacuum oven for three days and it is weighed again.

The equipment is cleaned after each experimental run. The filters are removed from the vessels and placed in a beaker after rinsing with water. The beaker is filled with ethanol or isopropanol to cover the filters and allow them to soak. Any solid particles will loosen when stirred until the filters are cleaned. The vessels are cleaned with soap and immersed in water. After rinsing with water, to ensure cleanliness, it is rinsed with ethanol. All the equipment is air dried completely before reassembling. The extractor and separator are attached to the system to clean the lines. CO₂ and ethanol are pumped through the lines at 100 bars for at least one hour.

4.3.2 Subcritical Water

An alternative to a supercritical system is one that is subcritical. The setup involving water provides for easier collection of extract. The outlet valve and bypass valves should be in the closed position. There should be waste collection beaker at the outlet line under the extractor and a clean and dry collection flask under the opened separator. While the system is reaching the proper temperature, a 500 milliliter flask is filled with deionized water

and warmed to 45 to 50°C on a hot plate. The flask is wrapped with aluminum foil and cotton cloth to keep warm longer. The HPLC pump solvent B line is placed in this flask. The water will be used for the extraction. By now, the target system and chiller temperature has been reached. The syringe pump and the HPLC pump are turned on. The pumps do the automatic self-checks. Meanwhile, the system temperature of the box is verified and recorded. Confirm the connections at the N₂ tank, used for depressurizing, are tightened. Then open the N₂ tank and set the pressure using the regulator. Verify that the BPR is at about the same pressure. Then the electrical heating tape is turned on to prevent plugs from forming. The next step is to pressurize the system.

The CO₂ tank and valve are opened. The valve at the syringe pump is opened and the flow rate is set to 15 g/min. This is left to increase system to desired pressure and then is reduced to zero and the CO₂ valve and inlet valve closed. The inlet valve has to be closed quickly as to not lose heat in the insulation box. The water valve is opened and then the flow rate at HPLC pump set to 10 ml/min, 100% line B. After about 15 minutes, the water will drip from the separator. When this occurs, the flow rate is set to zero and the water valve closed. The system is left for thirty minutes.

When the thirty minutes are up, the water valve is opened and the flow rate set to 5 ml/min for another thirty minutes. Higher flow rates will cause the pressure to build up behind the extractor as the water cannot flow out faster due to the compressed açai solid inside the extractor. When the extract is done being replaced with fresh water, it will lighten. At this point

the flow is returned to zero and the extract is taken from the collection vessel. The amount of extract recovered is measured in a graduated cylinder and stored in foil wrapped and labeled bottle which is refrigerated.

The system is now depressurized. Before starting, an empty beaker is placed after separator to catch any excess water. The heating tape is turned on and the CO₂ tank closed. Then very slowly, the depressurizing connection on the N₂ tank is loosened. The pressure has to be released gradually so it may take an hour or more to depressurize to zero. Once the BPR reaches zero the lines after the extractor are also zero. The lines before the extractor have to be depressurized next. To do this while simultaneously removing the water from the lines, the outlet valve is slowly opened. Then the inlet and CO₂ valve are opened. If water and gas are no longer escaping, the bypass line can be slowly opened. Once opened and any extra gas is removed, the pressure at the syringe pump and the HPLC pump should be back to zero.

The HPLC pump can now be turned off and the water valve closed. Removing water in the line requires opening the CO₂ tank a little at a time, with the bypass valve open, until water is no longer left. The CO₂ tank and valves are closed. The syringe pump turned off. The extractor and the separator can now be removed for cleaning. The left over material in the extractor is weighed and if possible dried and weighed again.

4.4 Fermentation Equipment and Materials

In order to ferment fruit without introducing bacteria which can result in spoilage and control oxidation, the proper equipment and cleaning solutions must be utilized. The fermentation vessels used are glass or plastic

with an opening that can be sealed with an airlock sealed on with a rubber stopper. The airlock, shown in Figure 21, is filled with water or sanitation solution during use.

The airlock allows carbon dioxide generated from the fermentation reaction to escape, while microbes and oxygen are kept from entering. Size of vessel is based on by preference; however, the Merlot wine kit was designed for a 5 gallon carboy set-up. The açai wines are created using 1000 milliliter down to 250 milliliter flasks and up to a one gallon carboy. The amount of solid material available for the fermentation set the scale of the experiment. A 7 gallon plastic bucket is used as a primary fermentation vessel for the Merlot wine. This allows for the expansion of the liquid due to gases created during fermentation. The bucket has a lid with a rubber stopper and airlock. The carboys each have their own rubber stopper and airlock. The airlock is filled with StarSan diluted solution to prevent microbes from entering. After the primary fermentation the wine is siphoned to the secondary vessel using plastic tubing and an automatic siphon tube.

The William's Brewing California Merlot kit comes with concentrated grape juice, Lalvin 71B-1122 strain yeast, and oak chips. The grape juice concentrate is 100% Central Valley varietal wine grapes and comes in two 96 ounce cans. It is at 68 Brix, has sulfites already added, and makes 5 gallons as indicated on the packaging. The addition of water and combining the ingredients is all that is needed to start the fermentation.

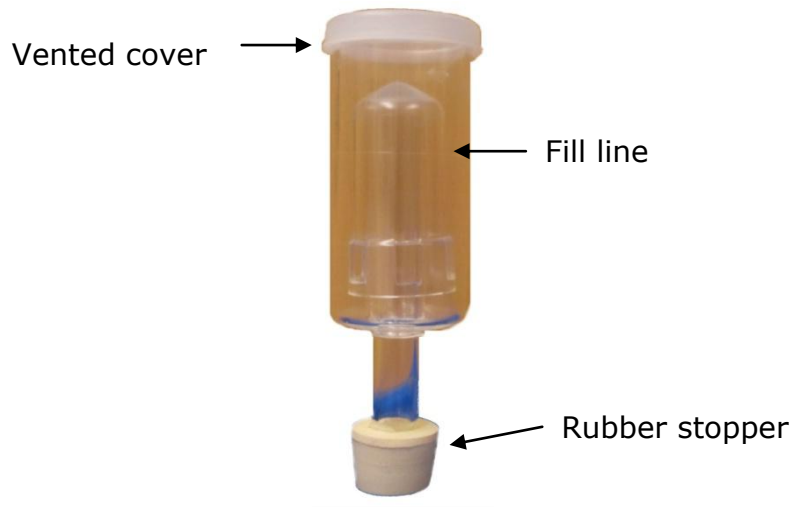

Figure 21: Fermentation Airlock

The açai wine recipe had to be created. The açai used for all the experiments is organic freeze dried and are all purchased from the same location. A pH meter is used to determine the amount of citric acid should be added so the pH is less than four and greater than three. If a temperature reading needs to be taken, a temperature gun is used to measure the temperature while the wine is still in the vessel or a sanitized thermometer. A sample of wine is filtered prior to measuring the density to approximate the amount of alcohol. A hydrometer which is also marked for Brix and potential alcohol is also utilized. After fermentation a glass vinometer can measure the finished percent alcohol if the wine is fermented to dryness (no more sugar).

4.4.1 Fermentation Cleaning Procedure

In order to prevent introduction of foreign microbes which can potentially spoil the wine, any equipment in contact with the must and wine needs to be cleaned and sterilized properly. After fermentation the

equipment should be cleaned thoroughly so that it does not dry hard and make washing exceedingly difficult later.

The first step in the cleaning process is to wash any solid debris from the equipment using soap and water. Bottle and carboy brushes are used to get to the hard to reach areas. The equipment is then rinsed thoroughly with tap water before rinsing again with diluted Star San solution. Star San is a no-rinse sanitizing solution made by Five Star Chemicals specifically for dairy and food-use surface sanitation. It comes concentrated, so it needs to be diluted with water before use.

Star San comes with directions for use. One ounce of Star San is added to every five gallons of water. The solution has to remain on the surface of the equipment for at least one minute wet and allowed to air dry.

4.4.2 Merlot Kit Procedure

Merlot is a varietal grape used in for the wine. In order to understand the basis of traditional fermentation, William's California wine kit was used, and the process is illustrated in Figure 22. The grape juice concentrate is poured into the seven gallon bucket. The bucket has already been marked for the five gallons, so cold water can simply be added until it makes up to the five gallons. The package of toasted oak is then stirred into the juice. This is now the must.

The yeast that comes with the wine kit has its own instructions for active yeast rehydration. The packet has a net weight of 5 grams, which is added to 50 milliliters of water between 40 and 43 degrees Celsius. After

letting stand in the container for 15 minutes, it is added to the must. This is called pitching.

The must is stirred and the specific gravity is found using a hydrometer. Then the lid is placed on top along with the airlock to create an airtight seal. The must stays in this primary fermentation vessel for 14 days. After which the wine is racked by siphoning into a glass five gallon carboy. In doing so the sediment is not to be disturbed to avoid transfer into the carboy. This sediment, containing mostly of oak chips, yeast, and grape sediment can now be discarded. The carboy serves as a secondary fermentation vessel. It is sealed with another airlock. After 12 weeks or when it reaches the 13% alcohol, the wine can be bottled for aging.

Every couple of weeks a sample is taken from the carboy to determine the specific gravity. This was first done by measuring the amount of liquid in milliliters and finding the mass on a scale. The specific gravity (SG) was calculated. Once the SG stopped changing, a vinometer was used to get the approximate percent alcohol.

The bottling was done using the same siphoning equipment, after cleaning, as with the racking. The wine is transferred to a 7 gallon plastic bucket with a spigot first. The spigot is then open and closed to add the wine to cleaned bottles while the wine is siphoned to the bucket. This way the automatic siphon can continue transferring wine between bottles. Each bottle is sealed with a synthetic T-cork before storage.

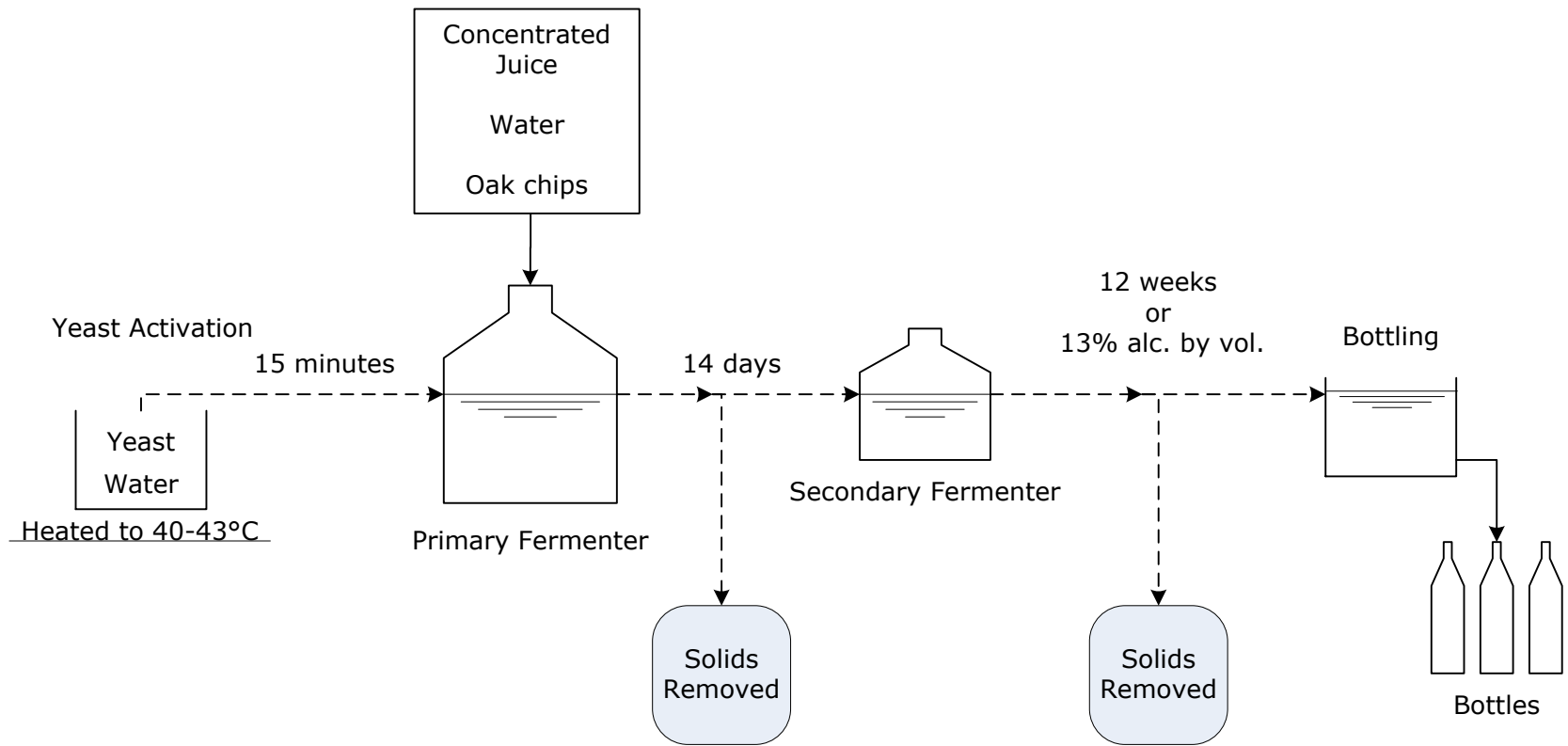

Figure 22: Grape Wine Flow Diagram

4.4.3 Açaí Berry Procedure

Wine made directly from açaí juice is currently available. The method presented here starts with açaí berry powder which is rehydrated. All equipment is sanitized and dried first. Then the materials can be set up for fermentation as depicted in Figure 23. Freeze dried açaí berry powder, or the açaí power residue from an extraction, is added to a one gallon glass carboy. For every 14 grams of açaí, 86 grams of water is added. This was determined to be the amount of water needed to reconstitute freeze dried açaí berry into pulp.⁷ After settling, the hydrometer reads about 1.000 SG. Then sugar is added so that the potential alcohol was at about 12 percent. This was calculated using the stoichiometry from the fermentation reaction. An example of these calculations can be found in Appendix E.

Sulfites are now added to kill molds, yeast and bacteria that are naturally in the açaí powder. One tablet of potassium metabisulfate is added per gallon of must (0.5 grams/3785 milliliters). The pH is measured followed by the addition of citric acid to lower the pH. The yeast can be pitched after 24 hours. This allows time for the sulfur dioxide to bind with other compounds and not kill off good yeast.

The density of the liquid is measured daily for about two weeks. At this point there is little to no change in density and the fermentation is assumed complete. Using a vacuum filter, the solids are separated from the wine. Settling of the solids is not as beneficial to clearing the wine due to the very fine particles of the solids. The fermentation is also done in small volumes

which make it difficult to siphon. After filtering the sample can then be bottled.

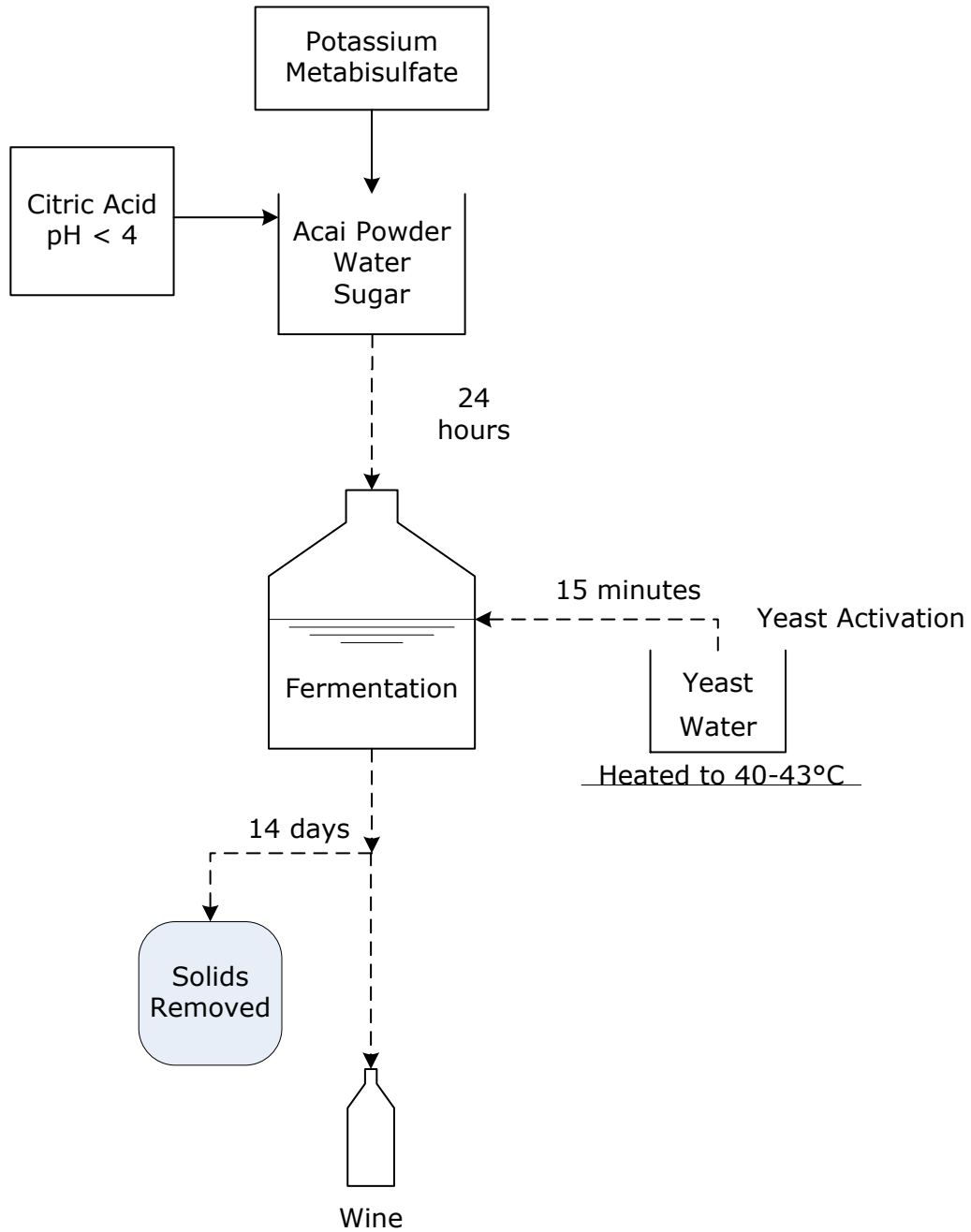

Figure 23: Açaí Wine Flow Diagram

4.5 Wine Judging

New fruit wines perceived taste as compared to other similar commercial wines is important factor to consider. The ranking of various wine characteristics would allow the winemaker to make changes in the fermentation process that would result in a more readily accepted fruit wine commercially. Judges used in the wine tasting have a minimum of two years wine tasting experience. Prior to the tasting they fill out a survey which includes their assigned judge number. They provide their age, years of experience, ethnicity, gender, and any notes on their wine experience or background.

The tasting for all the wines is done in one day, but at the judges' leisure. The labels on the wine bottles are covered so that it is impossible to know the origin of the wine. The wine is poured in front of them into clear glasses. Water and bread are offered to cleanse their palate between samples. They are given one survey with two categories for each wine sampled. Any duplicates are done at random. A copy of the survey materials used can be found in the Appendix F.

The first section is overall wine quality. It is rated on a nine-category scale from unacceptable to superior. The categories are assigned numerical values which are averaged to obtain a final rating for the wine. The lowest rank is worth 20 and each category 10 more than the last so that the highest rating is worth 100.

The second section is characteristics for the wine. Five characteristics, including overall impression, are on a five-category scale from unacceptable

to outstanding. These characteristics are for visual clarity and color, maturation bouquet, and flavor on the palate. Four characteristics are on a three-category scale from unacceptable to good. Judges evaluate the characteristics in purity of aroma, and acidity, fullness, and astringency on the palate. For astringency and acidity, they are also asked to select too much or too little for their rationale behind the ranking.

Chapter 5

Results and Discussion

The experimental results are presented within this chapter. The first section discusses the varying extractions performed as well as provides the experimental conditions. The second section focuses on the fermentation aspect of this study. There is also a comparison between wines produced as a result of this work and commercial wines.

5.1 Açaí Extraction and Evaluation

Prior to high pressure experiments, it was desired to obtain an estimate yield to be extracted from the freeze dried açaí powder and find out if ethanol and water would be viable solvents. This was done using soxhlet extraction. Table 4 is a summary of the results obtained when using ethanol as a solvent. The target temperature range was the boiling point of the solvent at one atmosphere. The results varied due to difficulties keeping the temperature constant. The highest yields were obtained when there was a steady reflux every 10 to 15 minutes during the course of the 24 hour run. Although water was a good solvent, there were experimental problems due to having to keep the boiling point at 100 degrees Celsius. As a result the yield was very low.

Color variations were seen in the extract during reflux and the final extract removed from the still. This can be seen in below when comparing

the images in Figure 24. During ethanol extraction the reflux is dark purple, seen on the left. As there are no more extractable components, the reflux is pink, seen in the center. Afterwards, the concentrated solution has darkened to brown yellow, seen on the right. When the extract was stored in the refrigerator, a solid material precipitated from the solution. The final color was also slightly different in hue for the various experiments; conversely, upon comparison using FTIR, the spectrums were similar. This indicates the degradation of anthocyanins and varying concentrations rather than obtaining different extracts. It is also agrees with findings that the anthocyanins denatured as result of the high temperatures.

Table 4: Soxhlet Extraction Results

Ethanol Solvent Soxhlet Conditions			
Experiment #	Temperature (°C)	Yield	Concentration (mg/mL)
1	78.9	53%	31
2	78.9	48%	22
3	78.9	44%	21



Figure 24: Extract Color Variations

A variety of high pressure extraction experiments were performed to determine what extracts and yields could be obtained utilizing supercritical

extraction. The temperature was maintained between 40 and 45 degrees Celsius. The laboratory setup could not achieve pressures above 145 bars. Experiment 3 was therefore conducted at the pilot plant at Valensa Nutraceuticals with the supervision of Dr. Uy Nguyen. A chart comparing the extractions at varying pressures using supercritical carbon dioxide with and without an ethanol entrainer can be seen in Figure 25. In all cases, the ratio of the mass flow rate of carbon dioxide to the mass of the açai in extractor is 8 to 10. The y-axis on the left shows the different yields with respect to pressure. The y-axis on the right corresponds with the orange bars to show time with respect to pressure. This information is then tabulated in Table 5.

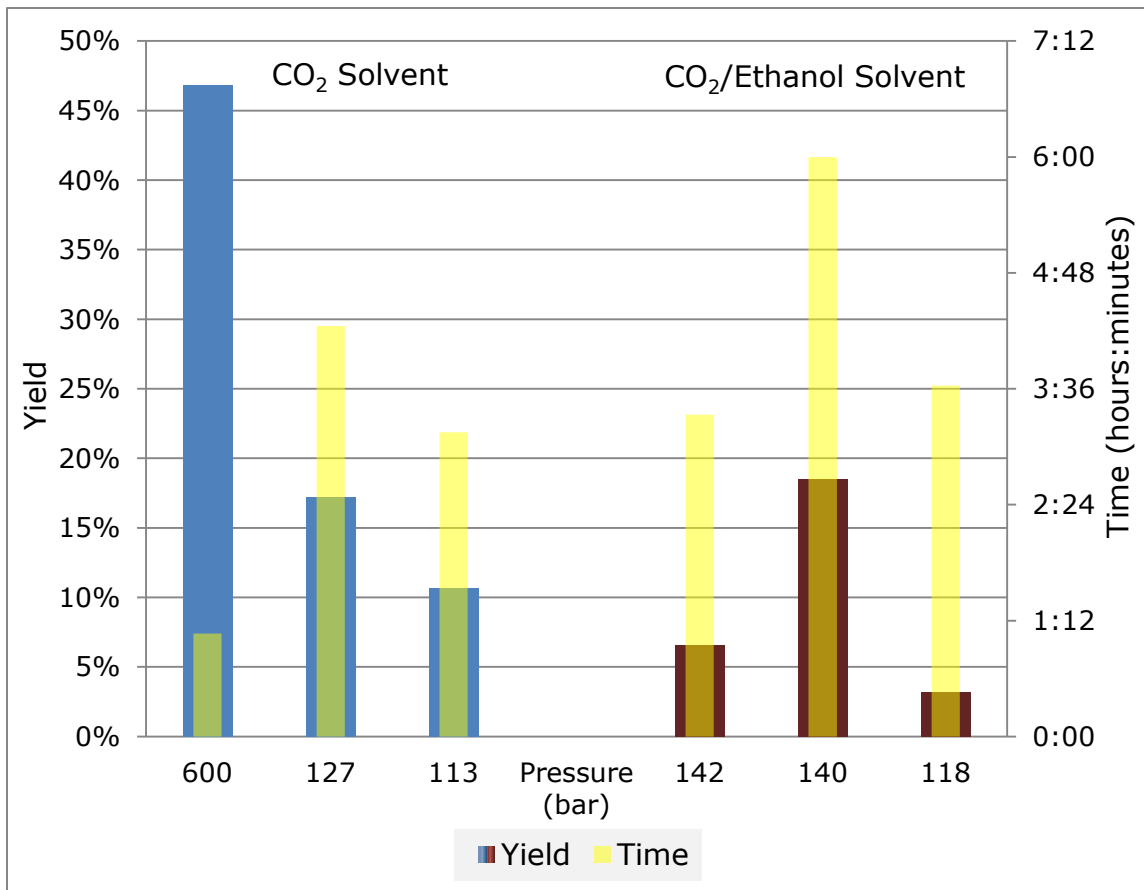

Figure 25: Supercritical Extraction of Açai Berry

It can be seen that an increase of pressure drastically increases the mass transfer rate of the extract. There is also something to be said for the use of the ethanol entrainer. Although the experiments using ethanol as a co-solvent were conducted at a pressure at about 20 bars higher than the low pressure carbon dioxide solvent experiments, the yield was not positively affected. Comparing experiments two and six, the increase of time by nearly half the original and pressure only increases the yield by one percent.

Table 5: Açai Berry Supercritical Extraction

Experiment #	Solvent	Pressure (bar)	Total CO ₂ kg	Time (hr:min)	Yield %
1	CO ₂	113	1.5	3:09	11%
2	CO ₂	127	2.0	4:15	17%
3	CO ₂	600	24.3	1:04	46.8%
4	CO ₂ /EtOH	118	1.7	3:38	3%
5	CO ₂ /EtOH	142	1.6	3:20	7%
6	CO ₂ /EtOH	140	2.9	6:00	18%

Upon observations of the color of the extract, the desired anthocyanins were most likely not extracted due to the non polar nature of carbon dioxide. The extract obtained for pressures greater than 130 bars was a clear oily green substance as seen in Figure 26. The picture on the left is the extract exiting the separator, full of carbon dioxide. Moving to the right, carbon dioxide escapes until only the oil is remaining. The extract obtained at lower pressures was oily as well, but not green in color. This is most likely due to the selectivity of the supercritical carbon dioxide of different pressures, which allows for the solubility of specific components. The higher pressures allow

for more components to be extracted. The oil extracted is most likely made up of oleic acid, which is the main fatty acid in the açai berry; However, further analysis can determine what other components were also extracted.



Figure 26: Supercritical Carbon Dioxide at 600 bar Açai Extract

The extract obtained when using ethanol as an entrainer is visually similar to the extract discussed previously. The extraction of experiment 2, seen in Figure 27, has a faint color compared to the extract from experiment 6, seen in Figure 28. Unlike only using the carbon dioxide solvent, there also ethanol left behind to mix with the extract. This can be seen in the layers due to the difference in densities and was apparent in the smell.



Figure 27: Carbon Dioxide-Ethanol at 127 bar Açai Extract

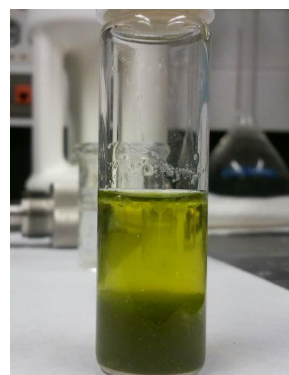

Figure 28: Carbon Dioxide-Ethanol at 140 bar Açai Extract

The FTIR spectrum reveals similar components were extracted in the soxhlet and supercritical methods. Through comparison with an ethanol

standard, as seen in Figure 29, there were four noticeably different peaks. These peaks belong to the açai extract. From the wavenumbers, it is determined that the extract has at least one carboxyl group, an ether linkage, and -C-H-Alkane groups. Table 6 is a list of the frequency, or wave number, and the various corresponding functional groups. Also included is the peak intensity to assist in distinguishing the functional groups.

Table 6: Specific Group Frequencies

Functional Group	Wavenumber	Intensity
Carboxyl	2928, 2852, 1746	M, M, S
Ether linkage	1150	W
-C-H-Alkane	2928, 2852	S

Note: S= strong, M= medium, W= weak
References with more detailed information on interpretation of infrared spectra are cited.^{86, 87}

These same peaks from the soxhlet extraction were found later when reading the spectrum of the açai extract from the supercritical methods. These peaks are in bold in Figure 30. The spectrum also reveals that there is indeed ethanol in the extract when it is used as a co-solvent. The extract from the pure carbon dioxide extraction reveals a few more functional groups that were hidden by the ethanol peaks. When the extract obtained from supercritical CO₂ extraction at 600 bars was analyzed, the results of the IR spectrum was very similar. The peaks were located at about the same wavelength, suggesting it is the same compound. Since the extract looked like oil, the spectrum was compared to the three main fatty acids found in açai: oleic acid, linoleic acid, and palmitic acid. The IR spectrums for the fatty

acids were found from NIST.⁸⁸ Upon comparison, all the fatty acids had peaks at 2920, 2850, and 1745. Palmitic acid was ruled out to because the peak at about 1745 was visually half the absorbance compared to the other two peaks as corresponding peak of the extract. There is a small peak to the left of peak 2920. Both oleic acid and linoleic acid have similar peak, however, oleic acid's peak is much less prominent as is the peak on the extract. Therefore, the main extract obtained by supercritical CO₂ extraction was oleic acid. This does not say that no palmitic acid or linoleic acid is present.

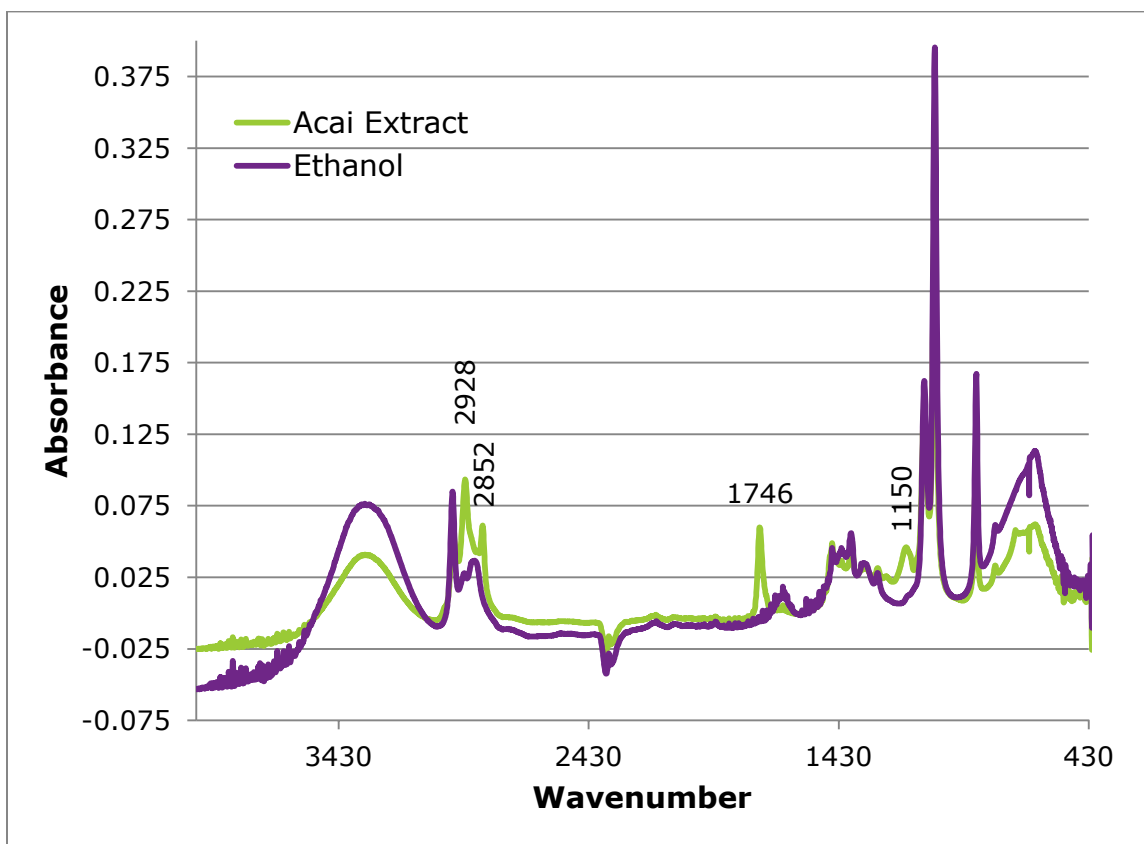

Figure 29: Spectrum of Açai Extract Obtained by Soxhlet Extraction
Subcritical water extractions were conducted. Unfortunately, the results were inconclusive due to inability to close mass balance. The IR spectrum was also blocked by the large water peaks.

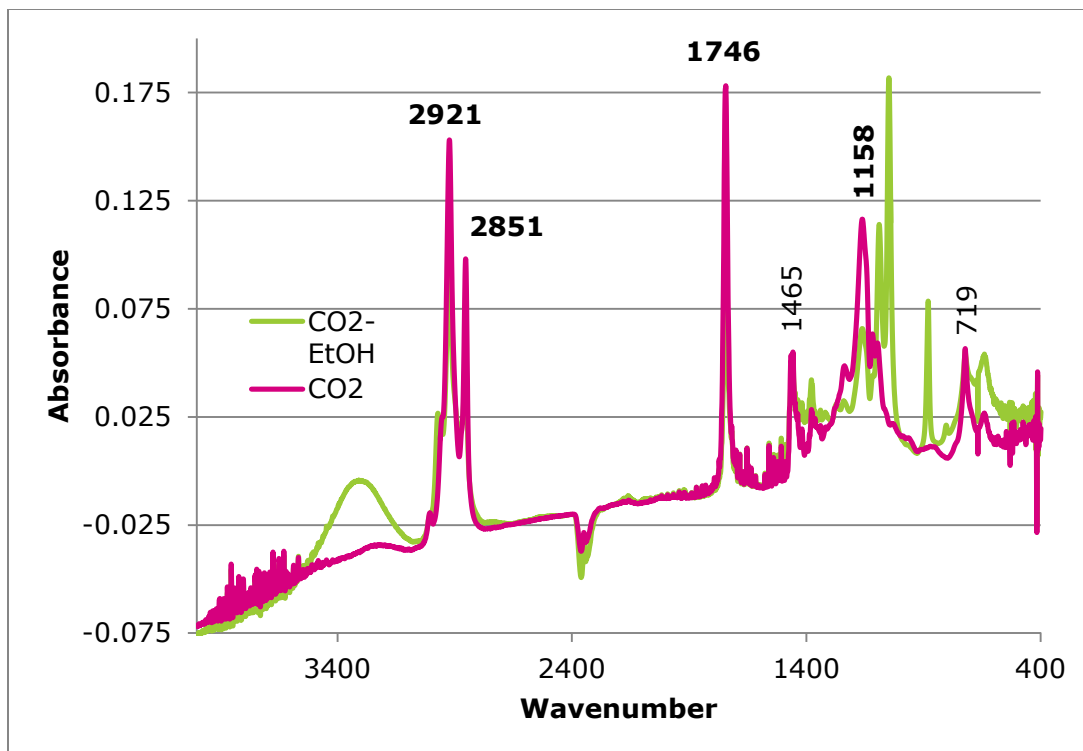

Figure 30: Spectrum of Extract Obtained by Supercritical Extraction

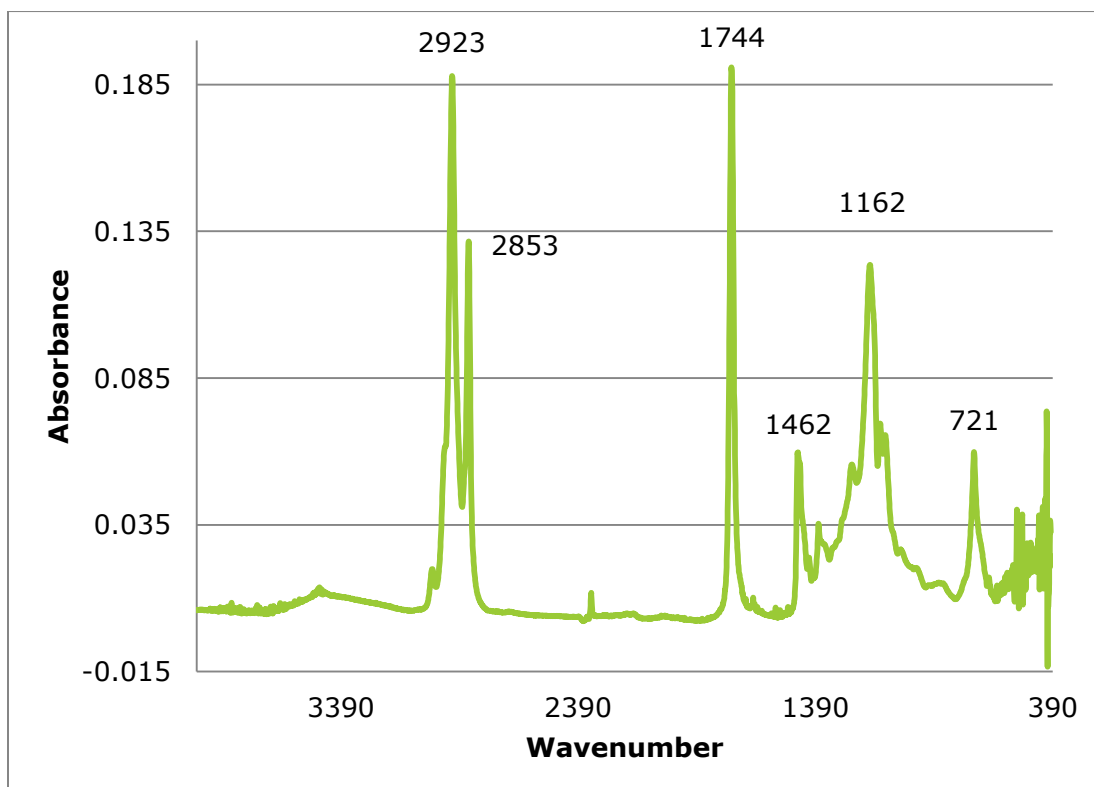

Figure 31: Spectrum of Extract from SCCO₂ Extraction at 600 bar

5.2 Fermentation Studies

There were four main fermentation experiments. The first was a grape wine. This was used as a basis of comparison for the açai wine. The rest involved fermentation of the freeze dried açai done prior to extraction and after both, soxhlet and supercritical, extraction methods. The equipment used for the açai fermentations were not all food safe. Therefore, no tastings of the açai wine were permitted.

The yeast used in the açai fermentations was the Red Star Montrachet brand, Davis#522 strain. This species of yeast is *Saccharomyces cerevisiae* was chosen because it tolerates up to 13% alcohol by volume, temperatures between 59 and 86 degrees Fahrenheit (15-30 degC), and is good for intense-color red wines. The grape wine was from a Californian merlot wine kit. It required only the addition of water to bring the juice concentrate up to five gallons with a Brix of 23%. This was for a potential alcohol of about 11% alcohol by volume. Oak chips were also included in the kit for flavor purposes. The yeast that came with the kit was also *Saccharomyces cerevisiae*, but a different strain. This strain, 71B-1122, can tolerate up to 18% alcohol.

The grape wine began with a very dark purple color. The specific gravity was recorded at the start of the primary and secondary fermentation. After the secondary fermentation the sediment free wine was bottled. The wine was in the primary fermentation vessel for 16 days. Then it was left in the secondary fermentation vessel for two months. The grape wine at the end of the primary fermentation is seen in Figure 32 on the left; on the right

is the final product. There is a difference in the color of the final wine and the grape juice. Though some commercial merlots have a more red pigment, this is typically the case as the wine ages. The color is associated with the phenolic compounds. As the wine ages anthocyanin-tannin reactions within the wine are the cause of the change in color and taste.⁸⁹ The pH also contributes to these reaction mechanisms to affect color.⁹⁰



Figure 32: Grape Fermentation and Grape Wine

The açai fermentations were done on a much smaller scale due to the amount of açai that could be extracted with the given time. The hydrated freeze-dried açai berry also had to be treated before the fermentation could take place. If untreated, molds and yeasts found naturally in the berry could cause undesirable reactions. One method of treatment is the addition of potassium metabisulfite. It is added 24 hours prior to yeast addition at 0.5 grams per 3.785 liters. The pH also had to be less than four to prevent microbial spoilage. Negative effects of not adjusting the pH are seen below. This was later prevented by adding citric acid until the pH of the must was between three and four.



Figure 33: Post Primary Fermentation without pH Modification

The addition of sugar is needed because açai berries are relatively low in sugar naturally. Based on the final volume of the wine and obtaining an alcohol percent by volume of 13, the estimated amount of sugar was calculated. A sample of these calculations is found in Appendix E. The amount of water added was consistent with the ratio of 14 grams açai and 86 grams of water (approximately 1:7) to reconstitute the dried açai into the natural açai pulp.⁷ The resulting pulp is about 14 percent solid by mass.⁷ The same ratio of solid to water was used on the supercritically extracted açai, but the pulp was much thicker. The density of the açai pulp⁹¹ and supercritically extracted açai pulp at 20 degrees Celsius is 1.02 g/mL and 1.03 g/mL respectively. The insoluble solids are removed by vacuum filtration. As seen in Figure 34, there is a distinct deepness in color between natural açai juice and the liquid that is obtained from the açai after supercritical extraction. This is because the concentration of anthocyanins is higher.

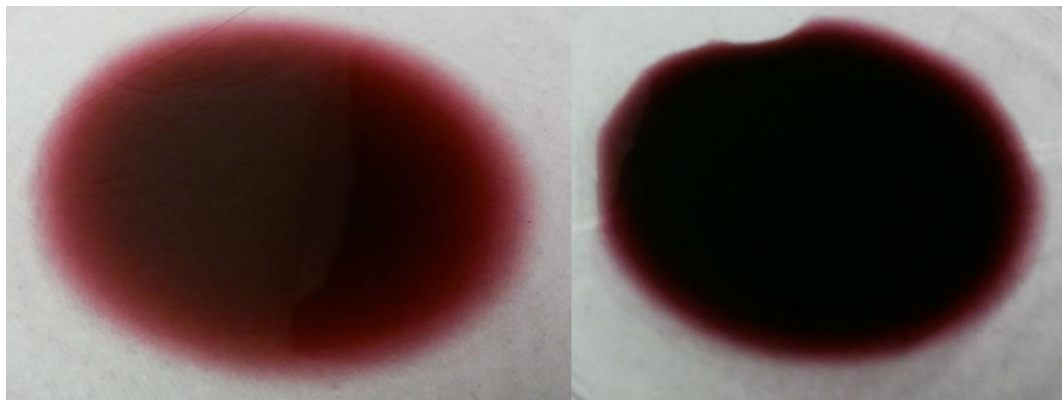

Figure 34: Hydrated and Filtered Freeze-Dried Açai and Açai after Supercritical Extraction

The density of the fermenting juice was observed. A drop in density indicates the production of ethanol and the consumption of sugar. Figure 35 shows the trend of change in density with respect to time. This is also a method of tracking the rate of reaction. Due to the similar slopes, the rate appears to be nearly the same for all the reactions. However, there were problems with obtaining good density data. The fermentations that were conducted without filtration in small batches, less than 150 mL, had solids would create error in density. This can be seen for wine from the supercritical extracted solid. The initial density after sugar addition was 1.19 g/mL. After filtering the same must, the density was 1.01 g/mL.

A visual comparison of the açai wines is in Figure 36. The Soxhlet extraction did yield some anthocyanins; therefore, the solid residue had less resulting in a more diluted looking wine. The photo on the left is the natural açai. Oils in the berry were released and float on the surface. This undesirable trait in wine is not seen in the wines where the solids were first extracted. Another noticeable trait in the wines was the smell. The açai and soxhlet extracted açai exhibited berry notes, similar to that of blueberry

wine. The supercritically extracted açai wine had a much stronger smell not unlike cough syrup, but upon dilution became more like the other two wines.

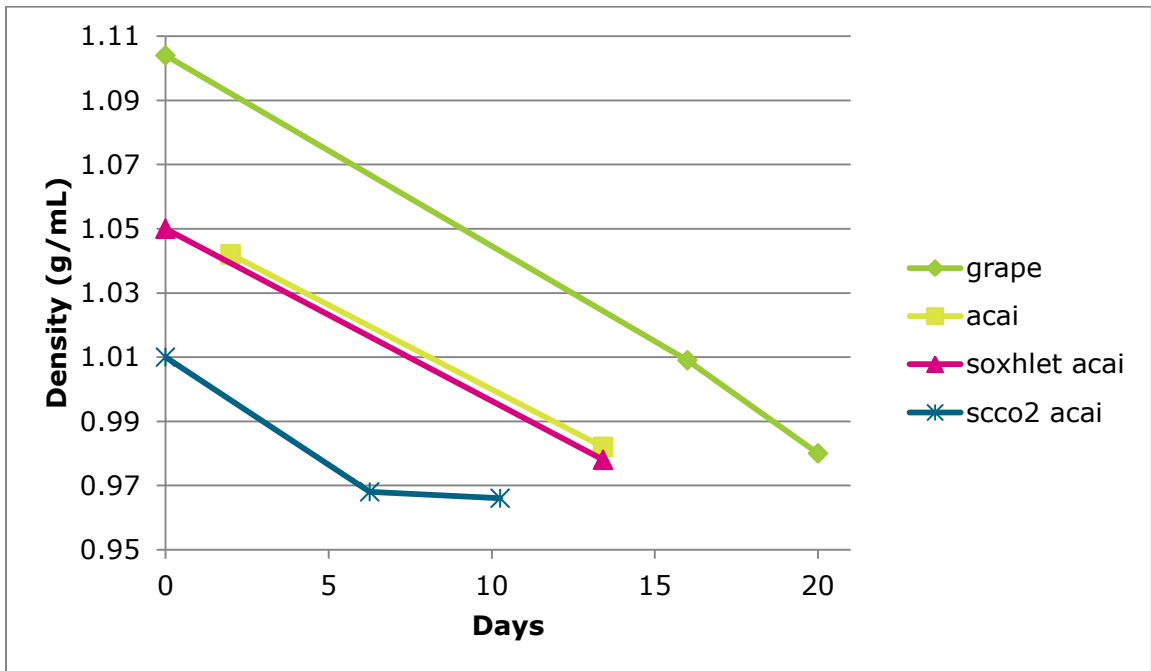

Figure 35: Rate of Fermentation by Density



Figure 36: Açai Wine Comparison

5.3 Wine Judging Analysis

There were six wines judged by a total of 12 judges. Their wine tasting experience ranged from 2 years to 60 years. There were 8 males and 4 females.

Table 7: The Age and Experience of the Tasters

Judge #	Age	Total Years of Experience	Gender
i	68	45	male
ii	58	35	male
iii	52	34	male
iv	49	34	male
v	58	20	female
vi	36	4	male
vii	25	4	female
viii	39	22	female
ix	27	2	male
x	65	60	male
xi	25	2	female
xii	24	3	male

The averages of the results for the overall wine are displayed in Figure 37. The judges evaluated six wines. The wines that received the highest scores were found to be the sweet açaí and the Merlot purchased from the store. The lab made Merlot and the alcohol removed wine received the lowest scores. There is wide range of deviation which correlates with the small sample population and bias of dry versus sweet wines. However, those who commented on preferring dry wines still had tendency to present higher score to the sweet açaí rather than the dry açaí.

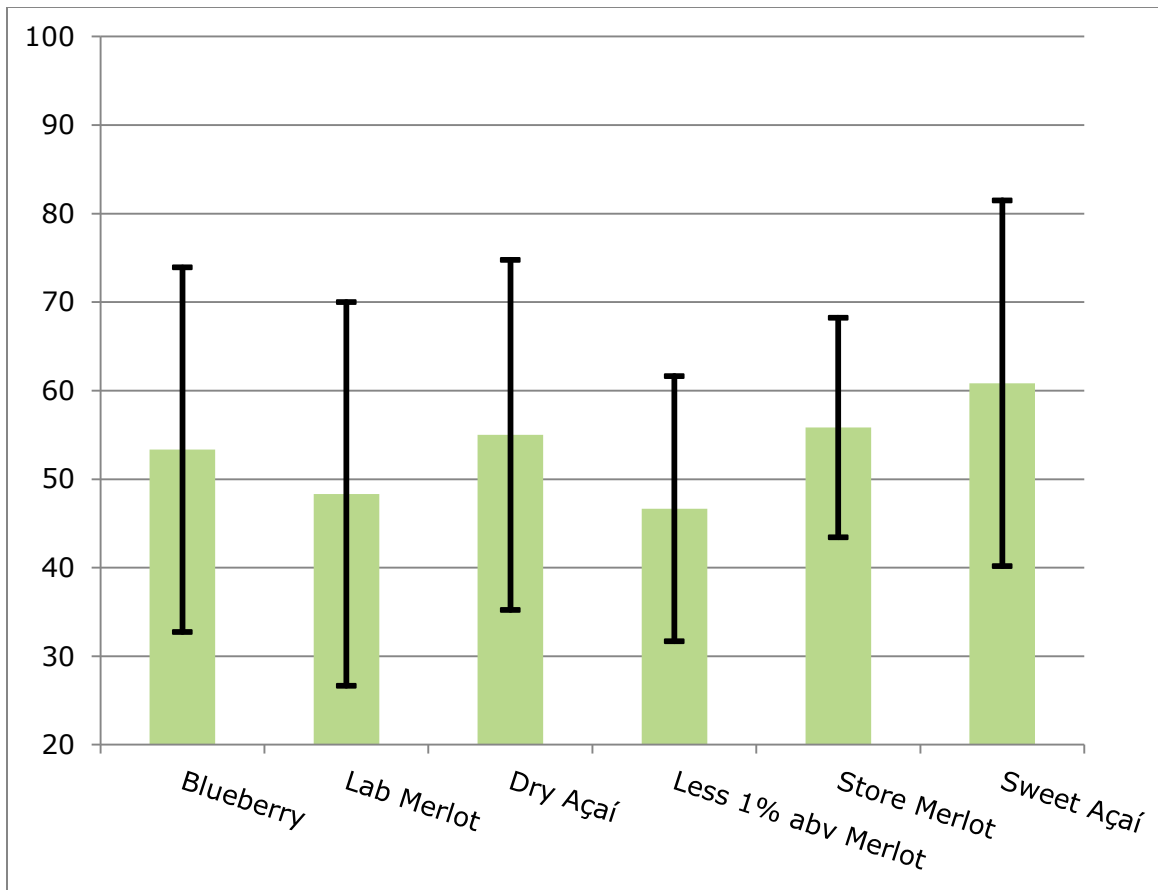

Figure 37: Overall Wine Averages

The characteristics of the wines were also judged to see which factors had more influence on the overall score. Figure 38 displays the average scores of the nine characteristics for each wine as well as the overall average. The clarity and the color were least important. These visual aspects were scored significantly lower or higher than the overall average score of the wine. Characteristics of the palate, such as bitterness and flavor, were the most important factors on the judges' overall evaluation of the wines.

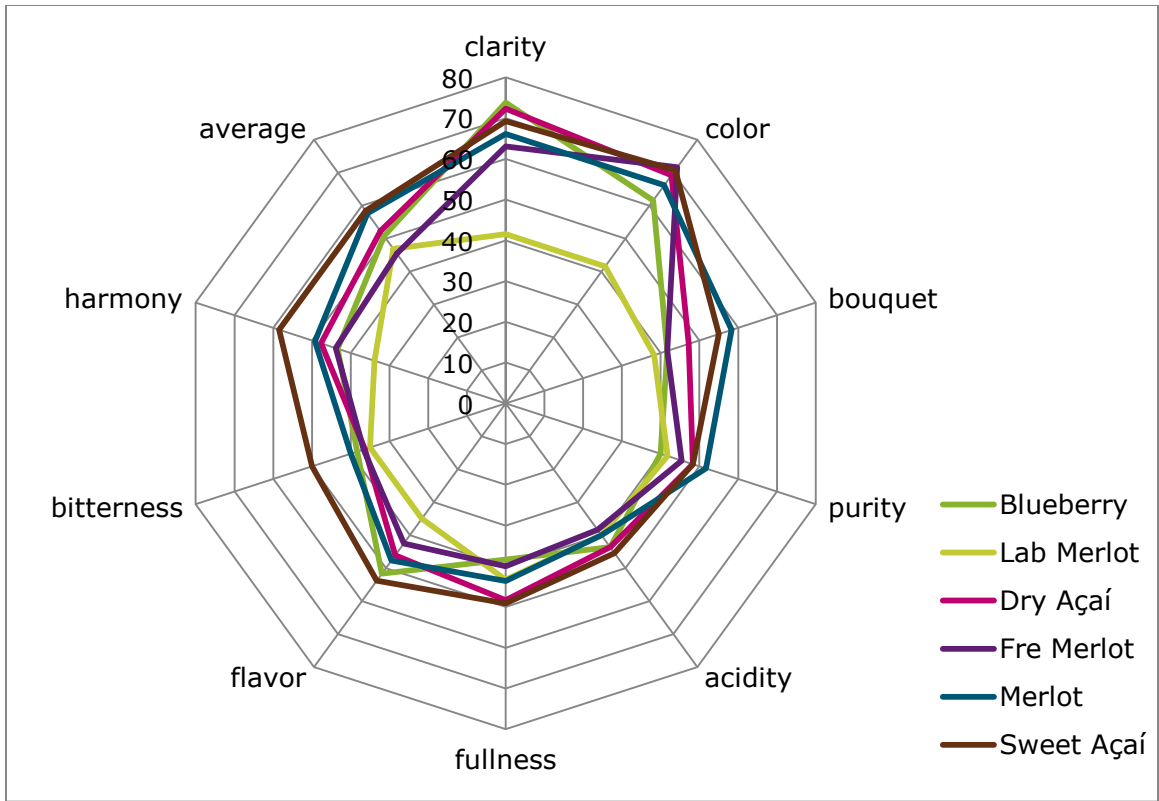

Figure 38: Wine Characteristics

Chapter 6

Conclusions and Future Directions

The supercritical carbon dioxide extraction is successful in removing the lipids from the açai berry while leaving behind the anthocyanins in the solids untainted by solvent. Very high pressures allow for the temperatures to remain low and are beneficial for faster extraction time. It would be necessary to do further analysis, such as mass spectroscopy, to determine what specific antioxidants and lipids were separated from solid. Based on the color, polar molecules, such as the anthocyanins, were not able to be extracted with supercritical carbon dioxide even at very high pressures. Utilizing ethanol as a co-solvent decreases the rate of mass transfer of the non polar components. Further analysis would determine if there are additional components or polyphenols extracted from the berry when using a co-solvent. Furthermore, experiments could also be done to measure the amount extracted at progressing time intervals to obtain a model of the rate of mass transfer.

The açai wine would contain some antioxidant properties similar to wine, but it does not include resveratrol as this is not found in the açai berry. It is beneficial to extract the oils from the açai berry prior to fermentation to result in a clearer wine. However, it was undetermined if the extraction would significantly alter the wine's flavor. The concentrated solids had the

ability to ferment with the addition of sugar. More experiments would need to be done to obtain the optimum amount of antioxidants the wine would need for better flavor and color.

Subcritical water extraction is another possible extraction method that could be looked into as a way of targeting the anthocyanins. Anthocyanins are highly temperature labile, the subcritical water extractions would be done at higher pressures rather than higher temperatures. If this was successful, the anthocyanins could be separated and only the supplement of what is needed would be added to the wine.

The kinetics of the fermentation reaction was difficult to monitor due to the solids in the starting material affecting the density. The açai fermentations were done in small volumes, so there was more room for experimental error when taking samples of the wine at different stages of the fermentation process. Future works would include filtering the juice prior to fermentation and batches in large volumes.

FTIR analysis was not helpful in determining differences in the wines. Other methods, such as HPLC-MS, would need to be done to make a comparison of the antioxidants in grape wine versus açai wine. The amount of active antioxidants could also be compared such as measuring the ORAC value. The FTIR form of analysis was able to conclude that similar components were extracted during soxhlet extraction versus supercritical extraction. Oleic acid was also identified as the main extract from supercritical extraction; however, it would be beneficial to use MS to identify other constituents that may have been extracted.

The wine tasting survey results were positive, suggesting that sweet açai wine would be a good direction to take as an açai product. A study with a larger population is warranted for testing future açai wines.

References

1. Winter, J., Ingredient production rising 7.5% a year in Central, South America. *Functional Ingredients* 2012, p 14.
2. Rourke, K. Acai Sales Show Wild Growth.
http://www.spins.com/news/newsletters/insidespins_q106.php.
3. Functional Ingredients: Fuel Consumer Self Care Trend.
http://www.spins.com/news/11.23.09_FI_Overview.php.
4. Mertens-Talcott, S. U.; Rios, J.; Jilma-Stohlawetz, P.; Pacheco-Palencia, L. A.; Meibohm, B.; Talcott, S. T.; Derendorf, H., Pharmacokinetics of anthocyanins and antioxidant effects after the consumption of anthocyanin-rich acai juice and pulp (*Euterpe oleracea* Mart.) in human healthy volunteers. *J Agric Food Chem* **2008**, 56 (17), 7796-802.
5. Dragt, S. R.; Souza, S. T. A. Method for Making Juice. US 7,906,165 B1, 15 March, 2011.
6. Rawson, A.; Patras, A.; Tiwari, B. K.; Noci, F.; Koutchma, T.; Brunton, N., Effect of thermal and non thermal processing technologies on the bioactive content of exotic fruits and their products: Review of recent advances. *Food Research International* **2011**, 44 (7), 1875-1887.
7. Cury, F. Technical Data Sheets: Acai Freeze Dried Powder.
www.earthfruits.com/docs/EF_Freeze-dried_acai_powder-Amazon_Line.doc.
8. Gan, D.; Hines, M.; Aravena, J.; Jones, B. Compositions Comprising Kakadu Plum Extract or Acai Berry Extract. 11 March, 2010.
9. Dai, J.; Mumper, R. J., Plant Phenolics: Extraction, Analysis and Their Antioxidant and Anticancer Properties. *Molecules* **2010**, 15 (10), 1420-3049.
10. Kane, R., Sniffing and Swirling: It's the 1st Premium Acai Wine. In *Vintage Texas Blog*, 2011; Vol. 2012.

11. Hasler, C. M., Functional foods: their role in disease prevention and health promotion. *Food Technology* **1998**, 52 (2), 57-62.
12. Kris-Etherton, P. M.; Hecker, K. D.; Bonanome, A.; Coval, S. M.; Binkoski, A. E.; Hilpert, K. F.; Griel, A. E.; Etherton, T. D., Bioactive compounds in foods: their role in the prevention of cardiovascular disease and cancer. *The American Journal of Medicine* **2002**, 113 (9, Supplement 2), 71-88.
13. Eskin, N. A. M.; Tamir, S., *Dictionary of Nutraceuticals and Functional Foods*. Taylor & Francis Group/CRC Press: 2006; p 523p.
14. Renaud, S.; de Lorgeril, M., Wine, alcohol, platelets, and the French paradox for coronary heart disease. *The Lancet* **1992**, 339 (8808), 1523-1526.
15. Szmitko, P. E.; Verma, S., Red Wine and Your Heart. *Circulation* **2005**, 111, e10-e11.
16. Ames, B. N.; Shigenaga, M. K.; Hagen, T. M., Oxidants, antioxidants, and the degenerative diseases of aging. *Proceedings of the National Academy of Sciences* **1993**, 90 (17), 7915-7922.
17. Schwarcz, J. A.; Schwarcz, J., *An apple a day: the myths, misconceptions, and truths about the foods we eat*. Other Press: 2009.
18. Nijveldt, R. J.; van Nood, E.; van Hoorn, D. E. C.; Boelens, P. G.; van Norren, K.; van Leeuwen, P. A. M., Flavonoids: a review of probable mechanisms of action and potential applications. *Am. J. Clin. Nutr.* **2001**, 74, 418-425.
19. Wang, H.; Cao, G.; Prior, R. L., Oxygen Radical Absorbing Capacity of Anthocyanins. *Journal of Agricultural and Food Chemistry* **1997**, 45 (2), 304-309.
20. Rosenkranz, S.; Knirel, D.; Dietrich, H.; Flesch, M.; Erdmann, E.; Bohm, M., Inhibition of the PDGF receptor by red wine flavonoids provides a molecular explanation for the "French paradox". *The FASEB Journal* **2002**, 16 (14), 1958-1960.
21. Araceli, C.-O.; Ma. de Lourdes, P.-H.; Ma. Elena, P.-H.; José, A. R.; Carlos Andrés, G.-V., Chemical studies of anthocyanins: A review. *Food Chemistry* **2009**, 113, 859-871.

22. Kong, J.-M.; Chia, L.-S.; Goh, N.-K.; Chia, T.-F.; Brouillard, R., Analysis and biological activities of anthocyanins. *Phytochemistry* **2003**, *64* (5), 923-933.
23. Adriana, M., Anthocyanins in Foods. In *Food Colorants*, CRC Press: 2007; pp 195-299.
24. Seeram, N. P., Berry fruits: compositional elements, biochemical activities, and the impact of their intake on human health, performance, and disease. *J Agric Food Chem* **2008**, *56* (3), 627-9.
25. Schauss, A. G.; Wu, X.; Prior, R. L.; Ou, B.; Huang, D.; Owens, J.; Agarwal, A.; Jensen, G. S.; Hart, A. N.; Shanbrom, E., Antioxidant capacity and other bioactivities of the freeze-dried Amazonian palm berry, *Euterpe oleracea* mart. (acai). *J Agric Food Chem* **2006**, *54* (22), 8604-10.
26. Heinrich, M.; Dhanji, T.; Casselman, I., Acai (*Euterpe oleracea* Mart.)—A phytochemical and pharmacological assessment of the species' health claims. *Phytochemistry Letters* **2010**.
27. Udani, J.; Singh, B.; Singh, V.; Barrett, M., Effects of Acai (*Euterpe oleracea* Mart.) berry preparation on metabolic parameters in a healthy overweight population: A pilot study. *Nutrition Journal* **2011**, *10* (1), 45.
28. Rodrigues, R. B.; Lichtenthaler, R.; Zimmermann, B. F.; Papagiannopoulos, M.; Fabricius, H.; Marx, F.; Maia, J. G.; Almeida, O., Total oxidant scavenging capacity of *Euterpe oleracea* Mart. (açai) seeds and identification of their polyphenolic compounds. *J Agric Food Chem* **2006**, *54* (12), 4162-7.
29. Pacheco-Palencia, L. A.; Talcott, S. T.; Safe, S.; Mertens-Talcott, S., Absorption and biological activity of phytochemical-rich extracts from açai (*Euterpe oleracea* Mart.) pulp and oil in vitro. *J Agric Food Chem* **2008**, *56* (10), 3593-600.
30. Rocha, A. P. M.; Carvalho, L. C. R. M.; Sousa, M. A. V.; Madeira, S. V. F.; Sousa, P. J. C.; Tano, T.; Schini-Kerth, V. B.; Resende, A. C.; Soares de Moura, R., Endothelium-dependent vasodilator effect of *Euterpe oleracea* Mart. (Açai) extracts in mesenteric vascular bed of the rat. *Vascular Pharmacology* **2007**, *46* (2), 97-104.

31. Del Pozo-Insfran, D.; Percival, S. S.; Talcott, S. T., Açai (*Euterpe oleracea* Mart.) polyphenolics in their glycoside and aglycone forms induce apoptosis of HL-60 leukemia cells. *J Agric Food Chem* **2006**, *54* (4), 1222-9.
32. Gallori, S.; Bilia, A. R.; Bergonzi, M. C.; Barbosa, W. L. R.; Vincieri, F. F., Polyphenolic Constituents of Fruit Pulp of *Euterpe oleracea* Mart. (Açai palm). *Chromatographia* **2004**, *59* (11), 739-743.
33. RSC ChemSpider The free chemical database.
<http://cssp.chemspider.com/> (accessed April).
34. Cavalcanti, R. N.; Santos, D. T.; Meireles, M. A. A., Non-thermal stabilization mechanisms of anthocyanins in model and food systems—An overview. *Food Research International* **2011**, *44* (2), 499-509.
35. Schauss, A. G.; Wu, X.; Prior, R. L.; Ou, B.; Patel, D.; Huang, D.; Kababick, J. P., Phytochemical and nutrient composition of the freeze-dried amazonian palm berry, *Euterpe oleracea* mart. (acai). *J Agric Food Chem* **2006**, *54* (22), 8598-603.
36. Haynes, W. M.; Lide, D. R., *CRC handbook of chemistry and physics : a ready-reference book of chemical and physical data*. 92 ed.; CRC Press: Boca Raton, FL, 2011.
37. Nafisi-Movaghar, K.; Svanoe, T. T.; Seroy, W. A. Method for Extraction of Proanthocyanidins from Plant Material. 5,912,363, 15 June, 1999.
38. Shi, J.; Nawaz, H.; Pohorly, J.; Mittal, G.; Kakuda, Y.; Jiang, Y., Extraction of Polyphenolics from Plant Material for Functional Foods—Engineering and Technology. *Food Reviews International* **2005**, *21* (1), 139-166.
39. Andrade, J. M. M.; Apel, M. A.; Ramirez, M. R.; Raseira, M. d. C. B.; Pereira, J. F. M.; Henriques, A. T., Anthocyanins Content and Chemical Composition of the Essential Oil of Three Blackberry Cultivars from Southern Brazil. *Latin American Journal of Pharmacy* **2010**, *29* (4), 622-625.
40. Wypych, G., *Handbook of solvents*. Toronto ; New York ; ChemTec, 2001.: 2001.

41. Pompeu, D. R.; Silva, E. M.; Rogez, H., Optimisation of the solvent extraction of phenolic antioxidants from fruits of *Euterpe oleracea* using Response Surface Methodology. *Bioresource Technology* **2009**, *100*, 6076-6082.
42. Wang, L.; Weller, C. L., Recent advances in extraction of nutraceuticals from plants. *Trends in Food Science & Technology* **2006**, *17* (6), 300-312.
43. Pacheco-Palencia, L. A.; Duncan, C. E.; Talcott, S. T., Phytochemical composition and thermal stability of two commercial açai species, *Euterpe oleracea* and *Euterpe precatoria*. *Food Chemistry* **2009**, *115* (4), 1199-1205.
44. Kechinski, C. P.; Guimarães, P. V. R.; Noreña, C. P. Z.; Tessaro, I. C.; Marczak, L. D. F., Degradation Kinetics of Anthocyanin in Blueberry Juice during Thermal Treatment. *Journal of Food Science* **2010**, *75* (2), C173-C176.
45. McHugh, M. A.; Kurkonis, V. J., *Supercritical fluid extraction : principles and practice*. Boston : Butterworths, c1986.: 1986.
46. Khosravi-Darani, K.; Vasheghani-Farahani, E., Application of Supercritical Fluid Extraction in Biotechnology. *Critical Reviews in Biotechnology* **2005**, *25* (4), 231-242.
47. Rizvi, S. S. H., *Supercritical fluid processing of food and biomaterials*. London ; New York : Blackie Academic & Professional, 1994.: 1994.
48. Martinez, J. L., *Supercritical fluid extraction of nutraceuticals and bioactive compounds*. CRC Press: Boca Raton, FL, 2008.
49. Day, C.-Y.; Chang, C. J.; Chen, C.-Y., Phase Equilibrium of Ethanol + CO₂ and Acetone + CO₂ at Elevated Pressures. *Journal of Chemical & Engineering Data* **1999**, *44* (2), 365-365.
50. Rodríguez-Meizoso, I.; Marin, F. R.; Herrero, M.; Señorans, F. J.; Reglero, G.; Cifuentes, A.; Ibáñez, E., Subcritical water extraction of nutraceuticals with antioxidant activity from oregano. Chemical and functional characterization. *Journal of Pharmaceutical and Biomedical Analysis* **2006**, *41* (5), 1560-1565.

51. Thitiporn, A.; Motonobu, G.; Mitsuru, S.; Prasert, P.; Artiwan, S.,
Extraction of anti-cancer damnacanthal from roots of *Morinda citrifolia*
by subcritical water. *Separation and Purification Technology* **2007**, *55*,
343-349.
52. Carr, A. G.; Mammucari, R.; Foster, N. R., A review of subcritical water
as a solvent and its utilisation for the processing of hydrophobic
organic compounds. *Chemical Engineering Journal* **2011**, *172* (1), 1-
17.
53. Uematsu, M.; Frank, E. U., Static Dielectric Constant of Water and
Steam. *Journal of Physical and Chemical Reference Data* **1980**, *9* (4),
1291-1306.
54. Pitzer, K. S., Dielectric Constant of Water at Very High Temperature and
Pressure. *Proceedings of the National Academy of Sciences of the
United States of America* **1983**, *80* (14), 4575-4576.
55. King, J. W., Critical fluid technology for the processing of lipid-related
natural products. *Comptes Rendus Chimie* **2004**, *7* (6/7), 647-659.
56. Jerry, W. K.; Keerthi, S., Multiple unit processing using sub- and
supercritical fluids. *The Journal of Supercritical Fluids* **2009**, *47*, 598-
610.
57. Wilkes, E. Wine Chemical Dictionary.
<http://www.erictheviking.com/Chemistry/Wine%20Chemical%20Dictionary.pdf>.
58. Micallef, M.; Lexis, L.; Lewandowski, P., Red wine consumption increases
antioxidant status and decreases oxidative stress in the circulation of
both young and old humans. *Nutrition Journal* **2007**, *6* (1), 27.
59. Heinonen, I. M.; Lehtonen, P. J.; Hopia, A. I., Antioxidant Activity of
Berry and Fruit Wines and Liquors. *Journal of Agricultural and Food
Chemistry* **1998**, *46*, 25-31.
60. Basha, S. M.; Musingo, M.; Colova, V. S., Compositional differences in
the phenolics compounds of muscadine and bunch grape wines.
African Journal of Biotechnology **2004**, *3* (10), 523-528.
61. SonomaCountyWineriesAssociation, Wine and Wine Making. In
Encyclopedia of chemical processing and design, McKetta, J. J.;
Cunningham, W. A., Eds. Marcel Dekker, Inc.: New York 1999; Vol.
67, pp 220-227.

62. Amerine, M. A., Wine. In *Encyclopedia of food science and technology*, 6th ed. ed.; Hui, Y. H., Ed. Wiley: New York, 1992; Vol. 4, pp 2855-2867.
63. Henderson, P., Sulfur Dioxide: Science behind this anti-microbial, anti-oxidant, wine additive. *Practical Winery & Vineyard Journal* **2009**.
64. Yeast Strains Chart. <http://winemakermag.com/guide/yeast> (accessed March).
65. Francis, I. L.; Newton, J. L., Determining wine aroma from compositional data. *Australian Journal of Grape and Wine Research* **2005**, *11*, 114-126.
66. Swiegers, J. H.; Pretorius, I. S., Yeast Modulation of Wine Flavor. *Advances in Applied Microbiology* **2005**, *57*, 131-175.
67. Charnomordic, B.; David, R.; Dochain, D.; Hilgert, N.; Mouret, J. R.; Sablayrolles, J. M.; Vande Wouwer, A., Two modelling approaches of winemaking: first principle and metabolic engineering. *Mathematical & Computer Modelling of Dynamical Systems* **2010**, *16* (6), 535-553.
68. Stackler, B.; Christensen, E. N., Quantitative Determination of Ethanol in Wine by Gas chromatography. *American Journal of Enology and Viticulture* **1974**, *25* (4), 202-207.
69. Shelly, H.; Hyun, C.; Lei, Z.; Jianrong, L.; Yongwoo, L.; Yumin, D.; Kequan, Z., Antiproliferative and antioxidant properties of anthocyanin-rich extract from açai. *Food Chemistry* **2010**, *118*, 208-214.
70. Presta, M. A.; Bruyneel, B.; Zanella, R.; Kool, J.; Krabbe, J. G.; Lingeman, H., Determination of Flavonoids and Resveratrol in Wine by Turbulent-Flow Chromatography-LC-MS. *Chromatographia* **2009**, *69* (Suppl 2), 167-173.
71. Seeram, N. P.; Aviram, M.; Zhang, Y.; Henning, S. M.; Feng, L.; Dreher, M.; Heber, D., Comparison of Antioxidant Potency of Commonly Consumed Polyphenol-Rich Beverages in the United States. *Journal of Agricultural and Food Chemistry* **2008**, *56*, 1415-1422.

72. Nemzer, B.; Rodriguez, L.; Hammond, L.; DiSilvestro, R.; Hunter, J.; Pietrzkowski, Z., Acute reduction of serum 8-iso-PGF₂-alpha and advanced oxidation protein products in vivo by a polyphenol-rich beverage; a pilot clinical study with phytochemical and in vitro antioxidant characterization. *Nutrition Journal* **2011**, *10* (1), 67.
73. Lichtenthäler, R.; Rodrigues, R. B.; Maia, J. G. S.; Papagiannopoulos, M.; Fabricius, H.; Marx, F., Total oxidant scavenging capacities of Euterpe oleracea Mart. (Açaí) fruits. *International Journal of Food Sciences and Nutrition* **2005**, *56* (1), 53-64.
74. Kang, J.; Li, Z.; Wu, T.; Jensen, G. S.; Schauss, A. G.; Wu, X., Antioxidant capacities of flavonoid compounds isolated from acai pulp (Euterpe oleracea Mart.). *Food Chemistry* **2010**, *122* (3), 610-617.
75. Brunner, G., *Gas extraction: an introduction to fundamentals of supercritical fluids and the application to separation processes*. Steinkopff: 1994.
76. Wakao, N.; Kagei, S., *Heat and mass transfer in packed beds*. New York : Gordon and Breach Science Publishers, c1982.: 1982; Vol. 1.
77. Wang, D.; Xu, Y.; Hu, J.; Zhao, G., Fermentation Kinetics of Different Sugars by Apple Wine Yeast *Saccharomyces cerevisiae*. *J. Inst. Brew.* **2004**, *110* (4), 340-346.
78. Coleman, M. C.; Fish, R.; Block, D. E., Temperature-Dependent Kinetic Model for Nitrogen-Limited Wine Fermentations. *Applied and Environmental Microbiology* **2007**, *73*, 5875-5884.
79. Cramer, A. C.; Vlassides, S.; Block, D. E., Kinetic model for nitrogen-limited wine fermentations. *Biotechnology and Bioengineering* **2002**, *77* (1), 49-60.
80. Phisalaphong, M.; Srirattana, N.; Tanthapanichakoon, W., Mathematical modeling to investigate temperature effect on kinetic parameters of ethanol fermentation. *Biochemical Engineering Journal* **2006**, *28* (1), 36-43.
81. Sener, A.; Canbas, A.; Unal, M. U., The Effect of Fermentation Temperature on the Growth Kinetics of Wine Yeast Species. *Turk. J. Agric. For.* **2007**, *31*, 349-354.
82. Ramirez, W. F., *Computational methods for process simulation*. Butterworth Publishers: Stoneham, Ma, 1989.

83. Boulton, R., The Prediction of Fermentation Behavior by a Kinetic Model. *American Journal of Enology and Viticulture* **1980**, 31 (1), 40-45.
84. Colombié, S.; Malherbe, S.; Sablayrolles, J. M., Modeling of heat transfer in tanks during wine-making fermentation. *Food control* **2007**, 18 (8), 953.
85. Tromp, A.; Conradie, W. J., An Effective Scoring System for Sensory Evaluation of Experimental Wines. *Am. J. Enol. Vitic.* **1979**, 30 (4), 278-283.
86. Silverstein, R. M.; Bassler, G. C.; Morrill, T. C., *Spectrometric Identification of Organic Compounds*. 4th ed.; John Wiley and Sons: New York, 1981.
87. Gunzler, H.; Gremlich, H.-U., *IR Spectroscopy: An Introduction*. Wiley VCH: 2002.
88. Stein, S. E. "Infrared Spectra". <http://webbook.nist.gov> (accessed 20 March).
89. Cheynier, V.; Dueñas-Paton, M.; Salas, E.; Maury, C.; Souquet, J.-M.; Sarni-Manchado, P.; Fulcrand, H., Structure and Properties of Wine Pigments and Tannins. *American Journal of Enology and Viticulture* **2006**, 57 (3), 298-305.
90. Fulcrand, H.; Dueñas, M.; Salas, E.; Cheynier, V., Phenolic Reactions during Winemaking and Aging. *American Journal of Enology and Viticulture* **2006**, 57 (3), 289-297.
91. Silva, L. H. M.; Reis, H. H. M. B.; Amazonas, L. A.; Costa, T. S., Temperature Effect on the Physical and Thermophysical Properties of Amazonian Fruit Pulps and Their Derivates Products. *Enpromer* **2005**.

Appendices

Appendix A: Nomenclature

S	sugar concentration (gmol m^{-3})
X	biomass [yeast] concentration (gmol m^{-3})
t	time (hours)
μ	sugar uptake specific reaction rate
i	sugar: 1=glucose 2=maltose 3=other
V_i	maximum reaction velocity for i^{th} sugar (hr^{-1})
K_i	Michaelis-Menten constant for i^{th} sugar (gmol m^{-3})
K_i'	inhibition constant for i^{th} sugar (gmol m^{-3})
E	activation energy
v_{i0}	frequency factor for maximum reaction velocity for i^{th} sugar
k_{i0}	frequency factor for Michaelis-Menten constant for i^{th} sugar
k_{i0}'	frequency factor for inhibition constant for i^{th} sugar
g	gravity constant (m s^{-2})
ρ	density (kg m^{-3})
R	universal gas constant
R_{Ei}	stoichiometric yield per mole of i^{th} sugar of ethanol
R_{Xi}	stoichiometric yield per mole of i^{th} sugar of yeast
ΔH_{fi}	heat of fermentation of i^{th} sugar (J mol^{-1})
U	overall heat transfer coefficient ($\text{J hr}^{-1} \text{m}^{-2} \text{ }^\circ\text{C}^{-1}$)
V	volume of fermenting mixture (m^3)
T_e	coolant or environment temperature ($^\circ\text{C}$)
C_p	heat capacity of the mixture ($\text{J kg}^{-1} \text{ }^\circ\text{C}^{-1}$)
T	temperature ($^\circ\text{C}$)

Appendix A (Continued)

A	transfer area (m^2)
\dot{m}	amount of substances extracted per unit time
m	mass of extracts
m_s	mass of solid substrate
c_m	mean concentration of extracts
c_0	initial concentration
c_b	concentration in the bulk fluid
β_s	mass transfer coefficient of solid phase
β_f	mass transfer coefficient of fluid phase
k	total mass transfer coefficient
u	linear flow velocity
ν	fluid viscosity
d	diameter of volume equivalent sphere
Dg	self diffusion coefficient of fluid
Sc	Schmidt number
Re	Reynolds number
Sh	Sherwood number

Appendix B: MSDS

Experiments in this work used the following chemical MSDS.

B.1 Star San HB MSDS

Manufactured By:
Five Star Chemical Company
Phone: 303-287-0186
6731 E. 50th Ave.
Commerce City, CO 80022

MSDS Date: 12-15-10
Replaces: 01/01/08

IDENTIFICATION

PRODUCT NAME: STAR SAN HB

COMPOSITION: Solution of Phosphoric Acid and Dodecylbenzene sulfonic acid.

HAZARDOUS INGREDIENTS: % ACGIH TLV OSHA/PEL
Phosphoric Acid (75%) (CAS# 7664-38-2) 50.0 1 mg/ m 1 mg/M3(TWA)
Dodecylbenzene Sulfonic Acid (CAS# 27176-87-0) 15.0 N/A
(Other compositional information is considered a trade secret).

PHYSICAL DATA

APPEARANCE: Dark, amber liquid
SOLUBILITY IN WATER: Complete
ODOR: Slight
SPECIFIC GRAVITY: 1.36
pH OF CONCENTRATE: 1
FLASH POINT: TCC 121 deg F
EVAPORATION RATE: .9 (water=1)

FIRE AND EXPLOSION DATA

FLAMMABILITY: TCC-121 deg F
EXTINGUISHING MEDIA: Water, Carbon Dioxide, Foam
UNUSUAL FIRE AND EXPLOSION HAZARDS: Contact with metals may evolve flammable hydrogen gas. Containers may explode when heated. Contact with chlorine will evolve chlorine gas.
NFPA HAZARD RATING: Health 3; Flammability 0; Reactivity 1

HEALTH HAZARD DATA

- EYE CONTACT: Corrosive to the eyes may cause severe damage.
- INHALATION: Irritating to the nose , throat, and respiratory tract.
- INGESTION: Harmful if swallowed. Swallowing product can cause sever burns to lining of throat and stomach

Appendix B (Continued)

- SKIN CONTACT: Substance is corrosive. Causes severe skin burns.
- SIGNS AND SYMPTOMS OF EXPOSURE: Destruction to skin and eye tissue
- SUPPLEMENTAL HEALTH INFORMATION: NOTE TO PHYSICIAN: Probable mucosal damage may contraindicate the use of gastric lavage. Measures against circulatory shock, reparatory depression and convulsions may be needed.

EMERGENCY & FIRST AID PROCEDURES

EYE CONTACT: Flush with cool running water for at least 15 minutes. For eye exposure irrigate with saline solution Get medical attention as soon as possible.

SKIN CONTACT: Flush with cool running water. If irritation develops get medical attention.

INGESTION: If conscious, give several glasses of milk, water, egg whites or gelatin solution. Get medical attention immediately. DO NOT induce vomiting.

INHALATION: Move victim to fresh air. Call emergency medical care. Apply artificial respiration if victim is not breathing.

SPECIAL PROTECTION INFORMATION

RESPIRATORY PROTECTION: Atmospheric levels should be maintained below the exposure limits

Listed in Hazardous Ingredients by using engineering controls. If not feasible, Use approved full face piece air-purifying respirator.

VENTILATION SYSTEM: Provide general and/or local exhaust ventilation to maintain airborne levels below the exposure limits in Hazardous Ingredients. Refer to "Industrial Ventilation" by ACGIH for a manual of recommended practices.

SKIN PROTECTION: If skin or contamination of clothing is likely, protective clothing should be worn.

EYE PROTECTION: Chemical goggles are required.

PROTECTIVE GLOVES: Wear chemical resistant gloves.

REACTIVITY DATA

INCOMPATIBLE MATERIALS: Alkalis, chlorinated products, and soft metals.

STABILITY: Product is stable.

POLYMERIZATION: Will not occur.

DECOMPOSITION PRODUCTS: May give off phosphorous oxide at high heat (fire conditions).

SPILL OR LEAK PROCEDURES

SPILL: See Emergency First Aid Procedures and Special Protection Information for hazards and exposure controls. Dike with sand or earth to contain spill. Avoid ignition sources.

Absorb with sand to other non-flammable material and transfer to approve DOT drum for recovery or disposal.

Appendix B (Continued)

DISPOSAL: Dispose of in accordance with local, state and federal regulations.
GENERAL: CERCLA/SARA requires notification to the appropriate Federal state and local authorities of releases of hazardous or extremely hazardous quantities equal to or greater than the Reportable Quantities (RQs) in 50 CFR 302.4 and 40 CFR 355.

SARA Title 313 requires submissions of annual reports of releases of toxic chemicals that appear in 40 CFR 372. Components present in this product at a level which could require reporting under statute are listed under identification.

TRANSPORTATION

DOT HAZARD CLASSIFICATION: Corrosive Liquid N.O.S.
(Contains Phosphoric Acid and Dodecylbenzensulfonic Acid)
8, UN1760, PG III

US DOT LABEL: Corrosive Liquid, UN 1760, Class 8

LABEL REQUIRED: Corrosive Liquid, Class 8 Label as required by OSHA Hazard Communication Standard, and any applicable state and local regulations.

EMERGENCY TELEPHONE: INFOTRAC 800-535-5053

B.2 Carbon Dioxide MSDS

CARBONIC INDUSTRIES -- CARBON DIOXIDE - CO₂
MATERIAL SAFETY DATA SHEET
NSN: 6830011002215
Manufacturer's CAGE: 63140
Part No. Indicator: A
Part Number/Trade Name: CARBON DIOXIDE - CO₂

General Information

Company's Name: CARBONIC INDUSTRIES CORP
Company's Street: 3340 ROSEBUD RD
Company's City: LOGANVILLE
Company's State: GA
Company's Country: US
Company's Zip Code: 30249
Company's Emerg Ph #: 404-979-0250, CHEMTREC 800-424-9300
Company's Info Ph #: 404-979-0250
Record No. For Safety Entry: 006
Tot Safety Entries This Stk#: 006
Status: SE
Date MSDS Prepared: 18JUN90
Safety Data Review Date: 13OCT92
MSDS Serial Number: BPHRR

Appendix B (Continued)

Hazard Characteristic Code: NK
Unit Of Issue: EA

Ingredients/Identity Information

Proprietary: NO
Ingredient: CARBON DIOXIDE
Ingredient Sequence Number: 01
Percent: >99.5
NIOSH (RTECS) Number: FF6400000
CAS Number: 124-38-9
OSHA PEL: 5000 PPM ACGIH TLV: 5000PPM/30000STEL;93
Other Recommended Limit: NOT KNOWN

Physical/Chemical Characteristics

Appearance And Odor: COLORLESS AND ODORLESS GAS OR LIQUID.
Boiling Point: -109F,-78C
Melting Point: N/A
Vapor Pressure (MM Hg/70 F): 838 PSIG
Vapor Density (Air=1): SEE SUP
Specific Gravity: 1.5240(SEE SUP)
Decomposition Temperature: UNKNOWN
Evaporation Rate And Ref: N/A
Solubility In Water: V/V @ 60F & 0 PSIG
Corrosion Rate (IPY): UNKNOWN

Fire and Explosion Hazard Data

Flash Point: N/A
Lower Explosive Limit: N/A
Upper Explosive Limit: N/A
Extinguishing Media: INERT AND NONFLAMMABLE.
Special Fire Fighting Proc: N/A
Unusual Fire And Expl Hazrds: CONFINEMENT OF CARBON DIOXIDE IN
VESSELS OR CONTAINERS OF IMPROPER DESIGN CAN RESULT IN
EXPLOSION OR RUPTURE FROM OVERPRESSURIZATION.

Reactivity Data

Stability: YES
Cond To Avoid (Stability): NOT APPLICABLE
Materials To Avoid: CAUSES VIOLENT POLYMERIZATION OF
ACRYLALDEHYDE OR ETHYLENEIMINE.
Hazardous Decomp Products: HEATING ABOVE 1700C CAUSES
DECOMPOSITION TO CARBON MONOXIDE AND OXYGEN.

Appendix B (Continued)

Hazardous Poly Occur: NO
Conditions To Avoid (Poly): NOT APPLICABLE

Health Hazard Data

LD50-LC50 Mixture: NOT KNOWN
Route Of Entry - Inhalation: YES
Route Of Entry - Skin: YES
Route Of Entry - Ingestion: YES
Health Haz Acute And Chronic: INHALATION:SIMPLE
ASPHYXIANT.HIGH CONCENTRATIONS IN AIR CAN REDUCE OXYGEN
NECESSARY TO SUPPORT LIFE.EYES/SKIN:CONTACT WITH SOLID OR LIQUID
CAUSES FROSTBITE.

Carcinogenicity - NTP: NO
Carcinogenicity - IARC: NO
Carcinogenicity - OSHA: NO
Explanation Carcinogenicity: NONE

Signs/Symptoms Of Overexp: INHALATION:SHORTNESS OF
BREATH,HEADACHE, DIZZINESS,RINGING IN EAR.ASPHYXIANT IN HIGH
CONCENTRATION.EYES/SKIN:CONTACT WITH SOLID OR LIQUID PRODUCES
BURNING SENSATION AND FROSTBITE OCCURS WITHIN SEVERAL
SECONDS.

Med Cond Aggravated By Exp: ANY CONDITION THAT WOULD BE
AGGRAVATED BY A REDUCED QUANTITY OF NORMAL QUALITY
BREATHING AIR.

Emergency/First Aid Proc: EYES: FLUSH WITH LARGE AMOUNTS OF
WATER FOR AT LEAST 15 MIN (FP A).INHALATION:DO NOT ATTEMPT TO
REMOVE INDIVIDUAL FROM SCENE OF OVEREXPOSURE WITHOUT UTILIZING
PROPER RESCUE EQUIPMENT.PROVIDE VICTIM WITH PLENTY OF FRESH AIR
WHILE KEEPING THE PERSON WARM,DRY,AND QUIET.IF BREATHING HAS
STOPPED,GIVE ARTIFICIAL RESPIRATION.GET MEDICAL ATTENTION.

Precautions for Safe Handling and Use

Steps If Matl Released/Spill: EVACUATE AREA OF SPILL OR
RELEASE,EMPLOY EMERGENCY FIRST AID PROCEDURES,PROVIDE PLENTY OF
FRESH AIR. REMOVE DRY ICE RESIDUAL AND ALLOW TO SUBLIME IN
SECURED, WELL-VENTILATED AREA AND CONTACT THE MANUFACTURER'S
SAFETY DEPARTMENT.

Waste Disposal Method: ALLOW CARBON DIOXIDE TO
RELEASE,SUBLIME OR DISSIPATE IN THE OPEN AIR.AVOID RELEASING IN
COURTYARDS OR INDOORS OR ANY AREAS WHERE HEAVY CARBON
DIOXIDE VAPORS CAN ACCUMULATE.

Precautions-Handling/Storing: LIQUID/VAPOR STORAGE CONTAINERS
ARE UNDER HIGH PRESSURE.DO NOT MISHANDLE OR ABUSE THEM.USE
ONLY CONTAINERS AND EQUIPMENT DESIGNED FOR CARBON DIOXIDE.

Appendix B (Continued)

Other Precautions: AVOID DIRECT SKIN CONTACT WITH DRY ICE OR VENTING CO*2 LIQUID OR VAPOR. USE PROTECTIVE EQUIPMENT AND CLOTHING AND GET PROPER TRAINING BEFORE HANDLING CARBON DIOXIDE.

Respiratory Protection: SELF-CONTAINED BREATHING APPARATUS, USE IN STRICT ACCORDANCE WITH THE MANUFACTURER'S RECOMMENDATIONS

Ventilation: PASSIVE SYSTEM: FLOOR LEVEL, OPENINGS TO OUTDOORS. ELECTRICAL FANS: REMOVE CO*2 FROM FLOOR/LOW AREAS, EXHAUST OUTDOORS.

Protective Gloves: HEAVY TERRY CLOTH TYPE.

Eye Protection: CHEMICAL SAFETY GOGGLES (FP A)

Other Protective Equipment: HARD HATS & EAR PROTECTION SHOULD BE WORN WHEN WORKING WITH PRESSURIZED CARBON DIOXIDE.

Work Hygienic Practices: PERSONS HANDLING CARBON DIOXIDE SHOULD BE FULLY TRAINED IN ADVANCE.

Suppl. Safety & Health Data: VAPOR DENSITY: 0.1234 LB/FT³ @ 32F & 1 ATM.

SPECIFIC GRAVITY: @ 32F & 1 ATM IN GAS PHASE.

Transportation Data

Trans Data Review Date: 93053

DOT PSN Code: CVK

DOT Proper Shipping Name: CARBON DIOXIDE, REFRIGERATED LIQUID

DOT Class: 2.2

DOT ID Number: UN2187

DOT Label: NONFLAMMABLE GAS

IMO PSN Code: DOJ

IMO Proper Shipping Name: CARBON DIOXIDE, REFRIGERATED LIQUID

IMO Regulations Page Number: 2111

IMO UN Number: 2187

IMO UN Class: 2(2.2)

IMO Subsidiary Risk Label: -

IATA PSN Code: FHM

IATA UN ID Number: 2187

IATA Proper Shipping Name: CARBON DIOXIDE, REFRIGERATED LIQUID

IATA UN Class: 2.2

IATA Label: NON-FLAMMABLE GAS

AFI PSN Code: FHM

AFI Prop. Shipping Name: CARBON DIOXIDE, REFRIGERATED LIQUID

AFI Class: 2.2

AFI ID Number: UN2187

AFI Basic Pac Ref: 6-6,6-15

Appendix B (Continued)

Additional Trans Data: USE ONLY CONTAINERS AND EQUIPMENT SPECIFICALLY DESIGNATED FOR CARBON DIOXIDE. LIQUID AND VAPOR STORAGE CONTAINERS ARE UNDER HIGH PRESSURE. DO NOT MIS-HANDLE OR ABUSE CONTAINERS.

Label Data

Label Required: YES

Technical Review Date: 15OCT92

Label Date: 15OCT92

Label Status: G

Common Name: CARBON DIOXIDE - CO₂

Chronic Hazard: NO

Signal Word: CAUTION!

Acute Health Hazard-Slight: X

Contact Hazard-Slight: X

Fire Hazard-None: X

Reactivity Hazard-None: X

Special Hazard Precautions: ACUTE:EYES AND SKIN:CONTACT WITH SOLID OR LIQUID MAY CAUSE FROSTBITE.INHALATION:HIGH CONCENTRATION OF CARBON DIOXIDE CAN REDUCE THE OXYGEN CONTENT NECESSARY TO SUPPORT LIFE.INHALATION MAY CAUSE HEADACHE,DIZZINESS,AND SHORTNESS OF BREATH.CHRONIC:DELAYED HAZARD NOT DETERMINED.

FIRST AID:EYES:FLUSH WITH LARGE AMOUNTS OF WATER FOR AT LEAST 15 MIN (FP A). INHALATION:REMOVE PATIENT TO FRESH AIR.IF BREATHING HAS STOPPED,GIVE ARTIFICIAL RESPIRATION,GET MEDICAL ATTENTION. LIQUID AND GAS STORAGE CONTAINERS ARE UNDER HIGH PRESSURE.

USE ONLY CONTAINERS AND EQUIPMENT SPECIFICALLY DESIGNED FOR CARBON DIOXIDE.

Protect Eye: Y

Protect Skin: Y

Protect Respiratory: Y

Label Name: CARBONIC INDUSTRIES CORP

Label Street: 3340 ROSEBUD RD

Label City: LOGANVILLE

Label State: GA

Label Zip Code: 30249

Label Country: US

Label Emergency Number: 404-979-0250

B.3 Ethyl Alcohol MSDS

Material Safety Data Sheet

Ethyl Alcohol

ACC# 91791

Appendix B (Continued)

Section 1 - Chemical Product and Company Identification

MSDS Name: Ethyl Alcohol

Catalog Numbers: S75119, S75120, S556CA4

Synonyms: Ethyl Alcohol; Ethyl Hydrate; Ethyl Hydroxide;

Fermentation Alcohol; Grain

Alcohol; Methylcarbinol;

Molasses Alcohol; Spirits of Wine.

Company Identification:

Fisher Scientific

1 Reagent Lane

Fair Lawn, NJ 07410

For information, call: 201-796-7100

Emergency Number: 201-796-7100

For CHEMTREC assistance, call: 800-424-9300

For International CHEMTREC assistance, call: 703-527-3887

Section 2 - Composition, Information on Ingredients

CAS#

Chemical Name

Percent

EINECS/ELINCS

64-17-5

Ethyl alcohol

70

200-578-6

7732-18-5

Water

30

231-791-2

Hazard Symbols: F

Risk Phrases: 11

Section 3 - Hazards Identification

EMERGENCY OVERVIEW

Appearance: colorless clear liquid. Flash Point: 16.6 deg C.

Flammable liquid and vapor.

May cause central nervous system depression.

Causes severe eye irritation.

Causes respiratory tract irritation.

Causes moderate skin irritation.

This substance has caused adverse reproductive and fetal effects in humans.

Warning!

May cause liver, kidney and heart damage.

Target Organs: Kidneys, heart, central nervous system, liver.

Appendix B (Continued)

Eye: Causes severe eye irritation. May cause painful sensitization to light. May cause chemical conjunctivitis and corneal damage.

Skin: Causes moderate skin irritation. May cause cyanosis of the extremities.

Ingestion: May cause gastrointestinal irritation with nausea, vomiting and diarrhea. May cause systemic toxicity with acidosis. May cause central nervous system depression, characterized by excitement, followed by headache, dizziness, drowsiness, and nausea. Advanced stages may cause collapse, unconsciousness, coma and possible death due to respiratory failure.

Inhalation: Inhalation of high concentrations may cause central nervous system effects characterized by nausea, headache, dizziness, unconsciousness and coma. Causes respiratory tract irritation. May cause narcotic effects in high concentration. Vapors may cause dizziness or suffocation.

Chronic: May cause reproductive and fetal effects. Laboratory experiments have resulted in mutagenic effects. Animal studies have reported the development of tumors. Prolonged exposure may cause liver, kidney, and heart damage.

Section 4 - First Aid Measures

Eyes: Immediately flush eyes with plenty of water for at least 15 minutes, occasionally lifting the upper and lower eyelids. Get medical aid. Gently lift eyelids and flush continuously with water.

Skin: Get medical aid. Flush skin with plenty of water for at least 15 minutes while removing contaminated clothing and shoes. Wash clothing before reuse. Flush skin with plenty of soap and water.

Ingestion: Do NOT induce vomiting. If victim is conscious and alert, give 2-4 cupfuls of milk or water. Never give anything by mouth to an unconscious person. Get medical aid.

Inhalation: Remove from exposure and move to fresh air immediately. If not breathing, give artificial respiration. If breathing is difficult, give oxygen. Get medical aid. Do NOT use mouth-to-mouth resuscitation.

Notes to Physician: Treat symptomatically and supportively. Persons with skin or eye disorders or liver, kidney, chronic respiratory diseases, or central and peripheral nervous system diseases may be at increased risk from exposure to this substance.

Antidote: Replace fluid and electrolytes.

Section 5 - Fire Fighting Measures

General Information: Containers can build up pressure if exposed to heat and/or fire. As in any fire, wear a self-contained breathing apparatus in pressure-demand, MSHA/NIOSH (approved or equivalent), and full protective gear. Vapors may form an explosive mixture with air. Vapors can travel to a source of ignition and flash back. Will burn if involved in a fire.

Appendix B (Continued)

Flammable Liquid. Can release vapors that form explosive mixtures at temperatures above the flashpoint. Use water spray to keep fire-exposed containers cool. Containers may explode in the heat of a fire.

Extinguishing Media: For small fires, use dry chemical, carbon dioxide, water spray or alcohol-resistant foam.

For large fires, use water spray, fog, or alcohol-resistant foam. Use water spray to cool fire-exposed containers. Water may be ineffective. Do NOT use straight streams of water.

Flash Point: 16.6 deg C (61.88 deg F)

Autoignition Temperature: 363 deg C (685.40 deg F)

Explosion Limits, Lower:3.3 vol %

Upper: 19.0 vol %

NFPA Rating: (estimated) Health: 2; Flammability: 3; Instability: 0

Section 6 - Accidental Release Measures

General Information: Use proper personal protective equipment as indicated in Section 8.

Spills/Leaks: Absorb spill with inert material (e.g. vermiculite, sand or earth), then place in suitable container. Remove all sources of ignition. Use a spark-proof tool. Provide ventilation. A vapor suppressing foam may be used to reduce vapors.

Section 7 - Handling and Storage

Handling: Wash thoroughly after handling. Use only in a well-ventilated area. Ground and bond containers when transferring material. Use spark-proof tools and explosion proof equipment. Avoid contact with eyes, skin, and clothing. Empty containers retain product residue, (liquid and/or vapor), and can be dangerous. Keep container tightly closed. Avoid contact with heat, sparks and flame. Avoid ingestion and inhalation. Do not pressurize, cut, weld, braze, solder, drill, grind, or expose empty containers to heat, sparks or open flames.

Storage: Keep away from heat, sparks, and flame. Keep away from sources of ignition. Store in a tightly closed container. Keep from contact with oxidizing materials. Store in a cool, dry, well-ventilated area away from incompatible substances.

Flammables-area. Do not store near perchlorates, peroxides, chromic acid or nitric acid.

Section 8 - Exposure Controls, Personal Protection

Engineering Controls:Use explosion-proof ventilation equipment. Facilities storing or utilizing this material should be equipped with an eyewash facility and a safety shower.

Use adequate general or local exhaust ventilation to keep airborne concentrations below the permissible exposure limits.

Exposure Limits

Chemical Name

Appendix B (Continued)

ACGIH

NIOSH

OSHA - Final PELs

Ethyl alcohol

1000 ppm TWA

1000 ppm TWA; 1900 mg/m³ TWA 3300 ppm IDLH

1000 ppm TWA; 1900 mg/m³ TWA Water

OSHA Vacated PELs: Ethyl alcohol: 1000 ppm TWA; 1900 mg/m³ TWA

Water: No

OSHA Vacated PELs are listed for this chemical.

Personal Protective Equipment

Eyes: Wear appropriate protective eyeglasses or chemical safety goggles as described by OSHA's eye and face protection regulations in 29 CFR 1910.133 or European Standard EN166.

Skin: Wear appropriate protective gloves to prevent skin exposure.

Clothing: Wear appropriate protective clothing to prevent skin exposure.

Respirators: A respiratory protection program that meets OSHA's 29 CFR 1910.134 and ANSI Z88.2 requirements or European Standard EN 149 must be followed whenever workplace conditions warrant a respirator's use.

Section 9 - Physical and Chemical Properties

Physical State: Clear liquid

Appearance: colorless

Odor: Mild, rather pleasant, like wine or whis

pH: Not available.

Vapor Pressure: 59.3 mm Hg @ 20 deg C

Vapor Density: 1.59

Evaporation Rate: Not available.

Viscosity: 1.200 cP @ 20 deg C

Boiling Point: 78 deg C

Freezing/Melting Point: -114.1 deg C

Decomposition Temperature: Not available.

Solubility: Miscible.

Specific Gravity/Density: 0.790 @ 20°C

Molecular Formula: C₂H₅OH

Molecular Weight: 46.0414

Section 10 - Stability and Reactivity

Chemical Stability: Stable under normal temperatures and pressures.

Conditions to Avoid: Incompatible materials, ignition sources, excess heat, oxidizers.

Incompatibilities with Other Materials: Strong oxidizing agents, acids, alkali metals, ammonia, hydrazine, peroxides, sodium, acid anhydrides, calcium hypochlorite, chromyl chloride, nitrosyl perchlorate, bromine

Appendix B (Continued)

pentafluoride, perchloric acid, silver nitrate, mercuric nitrate, potassium-tert-butoxide,

magnesium perchlorate, acid chlorides, platinum, uranium hexafluoride, silver oxide, iodine heptafluoride, acetyl bromide, disulfuryl difluoride, tetrachlorosilane + water, acetyl chloride, permanganic acid, ruthenium (VIII) oxide, uranyl perchlorate, potassium dioxide.

Hazardous Decomposition Products: Carbon monoxide, irritating and toxic fumes and gases, carbon dioxide.

Hazardous Polymerization: Will not occur.

Section 11 - Toxicological Information

RTECS#:

CAS# 64-17-5: KQ6300000

CAS# 7732-18-5: ZC0110000

LD50/LC50:

CAS# 64-17-5:

Draize test, rabbit, eye: 500 mg Severe;

Draize test, rabbit, eye: 500 mg/24H Mild;

Draize test, rabbit, skin: 20 mg/24H Moderate;

Inhalation, mouse: LC50 = 39 gm/m³/4H;

Inhalation, rat: LC50 = 20000 ppm/10H;

Oral, mouse: LD50 = 3450 mg/kg;

Oral, rabbit: LD50 = 6300 mg/kg;

Oral, rat: LD50 = 9000 mg/kg;

Oral, rat: LD50 = 7060 mg/kg;

CAS# 7732-18-5:

Oral, rat: LD50 = >90 mL/kg;

Carcinogenicity:

CAS# 64-17-5:

ACGIH: A4 - Not Classifiable as a Human Carcinogen CAS# 7732-18-5: Not listed by

ACGIH, IARC, NIOSH, NTP, or

OSHA.

Epidemiology: Ethanol has been shown to produce fetotoxicity in the embryo or fetus of laboratory animals. Prenatal exposure to ethanol is associated with a distinct pattern of congenital malformations that have collectively been termed the "fetal alcohol syndrome".

Teratogenicity: Oral, Human - woman: TDLo = 41 gm/kg (female 41 week(s) after conception) Effects on Newborn - Apgar score (human only) and Effects on Newborn - other neonatal measures or effects and Effects on Newborn - drug dependence.

Reproductive Effects: Intrauterine, Human - woman: TDLo = 200 mg/kg (female 5 day(s) pre-mating) Fertility - female fertility index (e.g. # females pregnant per # sperm positive females; # females pregnant per # females mated).

Neurotoxicity: No information available.

Appendix B (Continued)

Mutagenicity: DNA Inhibition: Human, Lymphocyte = 220 mmol/L.;
Cytogenetic

Analysis: Human, Lymphocyte = 1160 gm/L.; Cytogenetic Analysis:
Human, Fibroblast = 12000 ppm.; Cytogenetic Analysis: Human, Leukocyte
= 1 pph/72H gm/L.; Cytogenetic Analysis: Human, Fibroblast = 12000 ppm.;
Cytogenetic Analysis: Human, Leukocyte = 1 pph/72H (Continuous).; Sister
Chromatid Exchange: Human, Lymphocyte = 500 ppm/72H (Continuous).

Other Studies: Standard Draize Test (Skin, rabbit) = 20 mg/24H
(Moderate) Standard

Draize Test: Administration into the eye (rabbit) = 500 mg (Severe).

Section 12 - Ecological Information

Ecotoxicity: Fish: Rainbow trout: LC50 = 12900-15300 mg/L; 96 Hr;
Flow-through @ 24-24.3°C Rainbow trout: LC50 = 11200 mg/L; 24 Hr;
Fingerling (Unspecified) ria:

Phytobacterium phosphoreum: EC50 = 34900 mg/L; 5-30 min;

Microtox test When spilled on land it is apt to volatilize, biodegrade,
and leach into the ground water, but no data on the rates of these processes
could be found. Its fate in ground water is unknown. When released into
water it will volatilize and probably biodegrade. It would not be expected to
adsorb to sediment or bioconcentrate in fish.

Environmental: When released to the atmosphere it will photodegrade
in hours (polluted urban atmosphere) to an estimated range of 4 to 6 days in
less polluted areas. Rainout should be significant.

Physical: No information available.

Other: No information available.

Section 13 - Disposal Considerations

Chemical waste generators must determine whether a discarded
chemical is classified as a hazardous waste. US EPA guidelines for the
classification determination are listed in 40 CFR Parts 261.3.

Additionally, waste generators must consult state and local hazardous
waste regulations to ensure complete and accurate classification.

RCRA P-Series: None listed.

RCRA U-Series: None listed.

Section 14 - Transport Information

US DOT

IATA

RID/ADR

IMO

Canada TDG

Shipping Name:

Ethanol

No information available.

Hazard Class:3

Appendix B (Continued)

UN Number: UN1170

Packing Group:II

Section 15 - Regulatory Information

US FEDERAL TSCA

CAS# 64-17-5 is listed on the TSCA inventory.

CAS# 7732-18-5 is listed on the TSCA inventory.

Health & Safety Reporting List

None of the chemicals are on the Health & Safety Reporting List.

Chemical Test Rules

None of the chemicals in this product are under a Chemical Test Rule.

Section 12b

None of the chemicals are listed under TSCA Section 12b.

TSCA Significant New Use Rule

None of the chemicals in this material have a SNUR under TSCA.

SARA

CERCLA Hazardous Substances and corresponding RQs

None of the chemicals in this material have an RQ.

SARA Section 302 Extremely Hazardous Substances

None of the chemicals in this product have a TPQ.

SARA Codes

CAS # 64-17-5: acute, chronic, flammable.

Section 313

No chemicals are reportable under Section 313.

Clean Air Act:

This material does not contain any hazardous air pollutants. This material does not contain any Class 1 Ozone depletors.

This material does not contain any Class 2 Ozone depletors.

Clean Water Act:

None of the chemicals in this product are listed as Hazardous Substances under the CWA. None of the chemicals in this product are listed as Priority Pollutants under the CWA. None of the chemicals in this product are listed as Toxic Pollutants under the CWA.

OSHA: None of the chemicals in this product are considered highly hazardous by OSHA.

STATE CAS# 64-17-5 can be found on the following state right to know lists: California, New Jersey, Pennsylvania, Minnesota, Massachusetts.

CAS# 7732-18-5 is not present on state lists from CA, PA, MN, MA, FL, or NJ.

WARNING: This product contains Ethyl alcohol, a chemical known to the state of California to cause birth defects or other reproductive harm.

California No Significant Risk Level: None of the chemicals in this product are listed.

European/International Regulations

European Labeling in Accordance with EC Directives

Hazard Symbols:F

Risk Phrases:

Appendix B (Continued)

R 11 Highly flammable.

Safety Phrases:

S 16 Keep away from sources of ignition - No smoking.

S 33 Take precautionary measures against static discharges.

S 7 Keep container tightly closed.

S 9 Keep container in a well-ventilated place.

WGK (Water Danger/Protection)

CAS# 64-17-5: 0

CAS# 7732-18-5: No information available.

Canada - DSL/NDSL

CAS# 64-17-5 is listed on Canada's DSL List.

CAS# 7732-18-5 is listed on Canada's DSL List.

Canada - WHMIS

This product has a WHMIS classification of B2, D2A, D2B.

Canadian Ingredient Disclosure List

CAS# 64-17-5 is listed on the Canadian Ingredient Disclosure List.

Exposure Limits

CAS# 64-17-5: OEL-AUSTRALIA:TWA 1000 ppm (1900 mg/m³)

OEL-BELGIUM:TWA 1000 ppm (1880 mg/m³)

OEL-CZECHOSLOVAKIA:TWA 1000 mg/m³; STEL 5000 mg/m³

OEL-DENMARK:TWA 1000 ppm (1900 mg/m³)

OEL-FINLAND:TWA 1000 ppm(1900 mg/m³);STEL 1250 ppm (2400 mg/m³)

OEL-FRANCE:TWA 1000 ppm (1900 mg/m³);STEL 5000 pp

OEL-GERMANY:TWA 1000 ppm (1900 mg/m³)

OEL-HUNGARY:TWA 1000 mg/m³;STEL 3000 mg/m³

OEL-THE NETHERLANDS:TWA 1000 ppm (1900 mg/m³)

OEL-THE PHILIPPINES:TWA 1000 ppm (1900 mg/m³)

OEL-POLAND:TWA 1000 mg/m³

OEL-RUSSIA:STEL 1000 mg/m³

OEL-SWEDEN:TWA 1000 ppm (1900 mg/m³)

OEL-SWITZERLAND:TWA 1000 ppm (1900 mg/m³)

OEL-THAILAND:TWA 1000 ppm (1900 mg/m³)

OELTURKEY:TWA 1000 ppm (1900 mg/m³)

OEL-UNITED KINGDOM:TWA 1000 ppm (1900 mg/m³) JAN9

OEL IN BULGARIA, COLOMBIA, JORDAN, KOREA check ACGIH TLV

OEL IN NEW ZEALAND, SINGAPORE, VIETNAM check ACGI TLV

Section 16 - Additional Information

MSDS Creation Date:4/17/2001

Revision #1 Date: 4/17/2001

B.4 Sucrose MSDS

Material Safety Data Sheet

D(+)-Sucrose

Appendix B (Continued)

ACC# 22174

Section 1 - Chemical Product and Company Identification

MSDS Name: D(+)-Sucrose

Catalog Numbers: BP220-1, BP220-10, BP220-212, S3-12, S3-212, S3-500, S5-3, S5-500, S512, S71203, S71204

Synonyms: Beet sugar; cane sugar; saccharose; table sugar.

Company Identification:

Fisher Scientific

1 Reagent Lane

Fair Lawn, NJ 07410

For information, call: 201-796-7100

Emergency Number: 201-796-7100

For CHEMTREC assistance, call: 800-424-9300

For International CHEMTREC assistance, call: 703-527-3887

Section 2 - Composition, Information on Ingredients

CAS#	Chemical Name	Percent	EINECS/ELINCS
57-50-1	Sucrose	100	200-334-9

Hazard Symbols: None listed.

Risk Phrases: None listed.

Section 3 - Hazards Identification

EMERGENCY OVERVIEW

Appearance: white. Caution! May cause eye and skin irritation. This is expected to be a low hazard for usual industrial handling. May cause respiratory tract irritation.

Target Organs: Lungs.

Potential Health Effects

Eye: Dust may cause mechanical irritation.

Skin: May cause skin irritation. Low hazard for usual industrial handling.

Ingestion: Not available. Hydrolysis of sucrose yields invert sugar composed of equal parts fructose and glucose. Sugar is an important source of metabolic energy in foods and its formation in plants is an essential factor in the life process.

Inhalation: Excessive inhalation may cause minor respiratory irritation.

Chronic: Chronic inhalation of fine dusts may cause lung damage.

Section 4 - First Aid Measures

Appendix B (Continued)

Eyes: Flush eyes with plenty of water for at least 15 minutes, occasionally lifting the upper and lower eyelids. Get medical aid.

Skin: Get medical aid if irritation develops or persists. Flush skin with plenty of soap and water.

Ingestion: Do NOT induce vomiting. If victim is conscious and alert, give 2-4 cupfuls of milk or water. Get medical aid if irritation or symptoms occur.

Inhalation: Remove from exposure to fresh air immediately. If not breathing, give artificial respiration. If breathing is difficult, give oxygen. Get medical aid if cough or other symptoms appear.

Notes to Physician: Treat symptomatically and supportively.

Section 5 - Fire Fighting Measures

General Information: Wear appropriate protective clothing to prevent contact with skin and eyes. Wear a self-contained breathing apparatus (SCBA) to prevent contact with thermal decomposition products. This material in sufficient quantity and reduced particle size is capable of creating a dust explosion.

Extinguishing Media: Use extinguishing media most appropriate for the surrounding fire.

Section 6 - Accidental Release Measures

General Information: Use proper personal protective equipment as indicated in Section 8.

Spills/Leaks: Vacuum or sweep up material and place into a suitable disposal container. Clean up spills immediately, observing precautions in the Protective Equipment section. Avoid generating dusty conditions. Provide ventilation.

Section 7 - Handling and Storage

Handling: Use with adequate ventilation. Minimize dust generation and accumulation.

Storage: Store in a cool, dry, well-ventilated area away from incompatible substances.

Section 8 - Exposure Controls, Personal Protection

Engineering Controls: Use adequate ventilation to keep airborne concentrations low.

Exposure Limits

Chemical Name	ACGIH	NIOSH	OSHA - Final PELs
---------------	-------	-------	-------------------

Appendix B (Continued)

Sucrose 10 mg/m³ TWA total: 10 mg/m³ TWA; respirable dust: 5 mg/m³ TWA 15 mg/m³ TWA (total dust); 5 mg/m³ TWA (respirable fraction)

OSHA Vacated PELs: Sucrose: total dust: 15 mg/m³ TWA; respirable fraction: 5 mg/m³ TWA

Personal Protective Equipment

Eyes: Wear appropriate protective eyeglasses or chemical safety goggles as described by OSHA's eye and face protection regulations in 29 CFR 1910.133 or European Standard EN166.

Skin: Wear appropriate gloves to prevent skin exposure.

Clothing: Wear appropriate protective clothing to minimize contact with skin.

Respirators: Follow the OSHA respirator regulations found in 29CFR 1910.134 or European Standard EN 149. Always use a NIOSH or European Standard EN 149 approved respirator when necessary.

Section 9 - Physical and Chemical Properties

Physical State: Solid

Appearance: white

Odor: odorless

pH: Not available.

Vapor Pressure: Not available.

Vapor Density: Not available.

Evaporation Rate: Not available.

Viscosity: Not available.

Boiling Point: Not available.

Freezing/Melting Point: 190-192 deg C (dec)

Autoignition Temperature: Not applicable.

Flash Point: Not applicable.

Decomposition Temperature: 190-192 deg C

NFPA Rating: (estimated) Health: 1; Flammability: 1; Reactivity: 0

Explosion Limits, Lower: Not available.

Upper: Not available.

Solubility: 1970 G/L WATER (15°C)

Specific Gravity/Density: Not available.

Molecular Formula: C₁₂H₂₂O₁₁

Molecular Weight: 342.29

Section 10 - Stability and Reactivity

Chemical Stability: Stable.

Conditions to Avoid: Dust generation, excess heat.

Incompatibilities with Other Materials: Strong oxidizers.

Appendix B (Continued)

Hazardous Decomposition Products: Carbon monoxide, carbon dioxide.
Hazardous Polymerization: Has not been reported.

Section 11 - Toxicological Information

RTECS#:

CAS# 57-50-1: WN6500000

LD50/LC50:

CAS# 57-50-1:

Oral, rat: LD50 = 29700 mg/kg;

Carcinogenicity:

CAS# 57-50-1:

ACGIH: A4 - Not Classifiable as a Human Carcinogen

Epidemiology: No information available.

Teratogenicity: No information available.

Reproductive Effects: No information available.

Neurotoxicity: No information available.

Mutagenicity: No information available.

Other Studies: See actual entry in RTECS for complete information.

Section 12 - Ecological Information

Ecotoxicity: No data available. No information available.

Environmental: Dissolves completely in water.

Physical: No information available.

Other: No information available.

Section 13 - Disposal Considerations

Chemical waste generators must determine whether a discarded chemical is classified as a hazardous waste. US EPA guidelines for the classification determination are listed in 40 CFR Parts 261.3. Additionally, waste generators must consult state and local hazardous waste regulations to ensure complete and accurate classification.

RCRA P-Series: None listed.

RCRA U-Series: None listed.

Section 14 - Transport Information

	US DOT	IATA	RID/ADR	IMO	Canada	TDG
Shipping Name:						
information available.			No information available.			No
Hazard Class:						
UN Number:						
Packing Group:						

Section 15 - Regulatory Information

Appendix B (Continued)

US FEDERAL

TSCA

CAS# 57-50-1 is listed on the TSCA inventory.

Health & Safety Reporting List

None of the chemicals are on the Health & Safety Reporting List.

Chemical Test Rules

None of the chemicals in this product are under a Chemical Test Rule.

Section 12b

None of the chemicals are listed under TSCA Section 12b.

TSCA Significant New Use Rule

None of the chemicals in this material have a SNUR under TSCA.

SARA

Section 302 (RQ)

None of the chemicals in this material have an RQ.

Section 302 (TPQ)

None of the chemicals in this product have a TPQ.

SARA Codes

CAS # 57-50-1: acute, flammable.

Section 313

No chemicals are reportable under Section 313.

Clean Air Act:

This material does not contain any hazardous air pollutants. This material does not contain any Class 1 Ozone depletors. This material does not contain any Class 2 Ozone depletors.

Clean Water Act:

None of the chemicals in this product are listed as Hazardous Substances under the CWA. None of the chemicals in this product are listed as Priority Pollutants under the CWA. None of the chemicals in this product are listed as Toxic Pollutants under the CWA.

OSHA:

None of the chemicals in this product are considered highly hazardous by OSHA.

STATE

CAS# 57-50-1 can be found on the following state right to know lists: Pennsylvania, Minnesota, Massachusetts.

California No Significant Risk Level: None of the chemicals in this product are listed. European/International Regulations

European Labeling in Accordance with EC Directives

Hazard Symbols:

Not available.

Risk Phrases:

Safety Phrases:

Appendix B (Continued)

WGK (Water Danger/Protection)

CAS# 57-50-1: 0

Canada

CAS# 57-50-1 is listed on Canada's DSL List. CAS# 57-50-1 is listed on Canada's DSL List.

This product has a WHMIS classification of Not controlled.

CAS# 57-50-1 is not listed on Canada's Ingredient Disclosure List.

Exposure Limits

CAS# 57-50-1: OEL-AUSTRALIA:TWA 10 mg/m³ OEL-BELGIUM:TWA 10 mg/m³

OEL-FRANCE:TWA 10 mg/m³ OEL-UNITED KINGDOM:TWA 10 mg/m³ OEL IN BULGA

RIA, COLOMBIA, JORDAN, KOREA check ACGIH TLV OEL IN NEW ZEALAND, SING

APORE, VIETNAM check ACGI TLV

Section 16 - Additional Information

MSDS Creation Date: 3/05/1999

Revision #2 Date: 10/29/2001

The information above is believed to be accurate and represents the best information currently available to us. However, we make no warranty of merchantability or any other warranty, express or implied, with respect to such information, and we assume no liability resulting from its use. Users should make their own investigations to determine the suitability of the information for their particular purposes. In no event shall Fisher be liable for any claims, losses, or damages of any third party or for lost profits or any special, indirect, incidental, consequential or exemplary damages, howsoever arising, even if Fisher has been advised of the possibility of such damages.

B.5 Montrachet Yeast MSDS

WADY (Revised 2008.07)

Lallemand MATERIAL SAFETY DATA SHEET

SECTION I - PRODUCT & COMPANY IDENTIFICATION

Product name: Active Dry Yeast, powder

Reference name: *Saccharomyces cerevisiae*

Description: Yeast culture in powder form.

Product use: Alcohol fermentation

Manufacturer's name: Lallemand inc.

Information telephone: + 1- 514 522-2133

Emergency telephone (direct): + 1- 514 858-4612

Appendix B (Continued)

Date of MSDS preparation: 23th January 2007

Party responsible for MSDS preparation:
Quality management technician, +49 176 22 12 62 89

SECTION II - DATA ON COMPONENTS

Product composition: Proprietary.

Microbial concentration: > 15 billion viable yeast cells/gram.

Hazardous ingredients:

None. There are no WHMIS Controlled Products present at greater than 1.0% of the composition. There are no known embryo toxins, carcinogens, reproductive toxins, respiratory tract sensitizers or mutagens (as per sections 53 to 57 of the Canadian Controlled Products Regulations) present at greater than 0.1%. There are no ingredients present which are listed on the WHMIS Ingredient Disclosure List at, or above, the minimum concentration specified on the List.

Information on yeast components, as follows:

Name: *Saccharomyces cerevisiae*

CAS # 68876-77

% by Wt: 100%

LD50 & LC50: Not established

OSHA PEL: Not established

ACGIH TLV: Not established

SECTION III – HEALTH HAZARD IDENTIFICATION

Signs and symptoms of overexposure to bacterial powder through primary routes of exposure:

Skin contact: May cause irritation on prolonged contact.

Eye contact: May cause eye irritation upon direct contact.

Inhalation: In some cases, repeated exposure may lead to allergic sensitization based on the exposure level, duration and susceptibility of the individual. Subsequent chronic or acute exposure in sensitized persons may cause a respiratory allergic reaction in minutes or delayed, or a mixture of both. Typical symptoms are respiratory irritation, breathlessness, coughing, chest tightness and difficulty breathing.

Ingestion: Excessive ingestion of highly concentrated yeast powder could lead to intestinal discomfort (e.g. diarrhea, bloating, cramping, etc.).

SECTION IV – FIRST AID MEASURES (If any symptoms persist, seek medical attention)

If accidental overexposure is suspected:

Eye contact: Flush eyes for at least 15 minutes.

Skin contact: Wash affected area with soap and water.

Inhalation: Immediately remove person to fresh air.

Ingestion: Drink plenty of water.

Note to physician: No special precautions to report.

Appendix B (Continued)

Medical conditions likely to be aggravated by exposure: None

SECTION V – FIRE FIGHTING MEASURES

Conditions of flammability: Unknown.

Extinguishing media: Water, foam, carbon dioxide, dry powder.

Flash point and method of determination: Solid.

Flammable limits: Not applicable.

Auto ignition temperature: No data available.

Hazardous combustion products: None.

Explosion – sensitivity to mechanical impact: None.

Explosion – sensitivity to static discharge: None.

Firefighting procedures: Use self-contained breathing apparatus (SCBA) when exposed to confined or enclosed fires. Material becomes slippery when wet.

SECTION VI – ACCIDENTAL RELEASE MEASURES

In case material released or spilled, vacuum spill or dilute with water before removal. Collect waste in suitable container and wash surface with water. Avoid high pressure rinsing. Maintain good housekeeping practices. Bio-degradable may be discharged into sewer. No special disposal method required, except that it be in accordance with current local, state/provincial and federal regulations.

SECTION VII – HANDLING & STORAGE

Handling: Avoid breathing dust. Avoid contact with eyes, skin and clothing. Wear protective equipment described in Section VIII if exposure conditions warrant. Wash thoroughly after handling. Launder contaminated clothing before reuse.

Storage: Store in original container or in clean, covered container. Keep containers sealed and dry. Store in cool, dry, well-ventilated area. Avoid storage at elevated temperatures for prolonged periods of time. Bags should be kept sealed and dry.

SECTION VIII – EXPOSURE CONTROLS / PERSONAL PROTECTION

Respiratory protection: Protective mask should be worn in conditions of excessive dusting.

Eye contact: Protective glasses should be worn in conditions of excessive dusting. If eye contact occurs, rinse with water.

Clothing: Suitable protective clothing. Follow current Good Manufacturing Practices when handling food ingredients and materials.

Specific engineering controls: None.

SECTION IX – PHYSICAL & CHEMICAL PROPERTIES

Microbial concentration: > 15 billion viable yeast cells/gram

Physical state: Solid (powder)

Appendix B (Continued)

Appearance: Light tan powder.
Odour: Toasty.
Odour threshold: Not applicable.
Specific gravity: No data available.
Vapour pressure: Not applicable.
Vapour density: Not applicable.
Evaporation rate: Not applicable.
Boiling point: Not applicable.
Freezing point: Not applicable.
Melting point: Not applicable.
pH: No data available.
Partition coefficient: Not applicable.
Viscosity: Not applicable.
Solubility in water: Partially soluble.

SECTION X – STABILITY AND REACTIVITY

Stability: Stable under normal conditions of use.
Incompatibility: No hazardous incompatibilities. Moisture and high temperatures are detrimental to the viable yeast concentration of product.
Conditions to avoid: Avoid storage at elevated temperatures for prolonged periods. Avoid high humidity.
Hazardous decomposition products: None.
Hazardous polymerization: None.

SECTION XI – TOXICOLOGICAL INFORMATION

Product recognized as safe.
Effects of short-term exposure: None.
Effects of long-term exposure: None.
Irritancy: Unknown.
Sensitization: Possible allergic sensitization (see Section III).
Allergy: Yeast product.
Carcinogenicity: None.
Reproductive toxicity: None.
Teratogenicity: None.
Mutagenicity: None.
Toxicologically synergistic products: None.

SECTION XII – ECOLOGICAL INFORMATION

No environmental effect.

SECTION XIII – DISPOSAL CONSIDERATIONS

Product can be removed and disposed of in regular trash or waste. No special disposal method required, except that it be in accordance with current local authority regulations.

Appendix B (Continued)

SECTION XIV – TRANSPORT INFORMATION

Shipping classification: Not hazardous.

SECTION XV – REGULATORY INFORMATION

WHMIS classification for product: Not a WHMIS regulated product. Product is classified as WHO Risk Group I and is not considered to fall within the Canadian Controlled Products Regulations criteria for biohazardous infectious materials.

This product does not meet the definition of a hazardous material given in the U.S. Occupational Safety and Health Administration's Hazard Communication Standard.

This MSDS has been prepared to meet the requirements of the Canadian Controlled Products Regulations.

SECTION XVI – OTHER INFORMATION

The information herein is based on current available data and is believed to be correct. No warranty, express or implied, is made regarding data accuracy, merchantability or hazards associated with product use. The user is responsible for determining product suitability, conditions of use and all associated hazards. Values listed in this document are not product specifications.

Appendix C: Equipment List

The following is a comprehensive list of the equipment used in this work for the high pressure extractions and fermentations.

C.1 High Pressure Extraction Equipment

- Extraction cell: Thar Designs, 26526-44
100 mL, 10000 psi max
- Collection vessel: Thar Designs, 26880-5
25 mL Cyclone, 1500 psi max
- Heater and Chiller: Lauda, EcoLine chiller
Temperature range: -30°C to 90°C
- Multi-solvent pump: Waters, 6PLEPE730
Waters 600E, Multi-solvent Delivery System
System Controller and Fluid Unit
- High pressure pump: Thar Technologies, 1813-5
Model P200B
- Wet test meter: Precision, 63135
Pressure range: 0.3 to 0.6 in H₂O
Accuracy: ±0.5%)

C.2 Merlot Fermentation Equipment

- 7 gallon bucket
- Lid with bung hole
- 5 gallon carboy
- 7 gallon bucket with spigot

Appendix C (Continued)

- 1/2 inch plastic tubing
- Automatic siphon starter
- Airlock x2
- Rubber stopper for airlock that fits lid
- Rubber stopper for airlock that fits carboy
- Hydrometer
- Cylinder to float hydrometer
- Glass thermometer
- Temperature gun
- 250 mL flask for yeast
- Wine bottles
- Synthetic T-corks
- Wine thief
- Bottle brush
- Carboy brush

C.3 Açaí Fermentation Equipment

- 1 gallon carboy
- 250 mL flask
- 1000 mL flask
- Rubber stoppers to fit
- Airlock
- 2 mL disposable pipets
- Glass thermometer

Appendix C (Continued)

- 250 mL flask for yeast
- Buchner funnel
- Filter paper
- Filter flask
- Tubing for vacuum filter

Appendix D: Operating Procedures

The operating procedures are provided step by step. This includes cleaning methods and shut down as well as the experimental procedure for the high pressure set-up.

D.1 Supercritical Start-Up Procedure

1. Perform the leak check procedure
2. If needed perform the cleaning procedure
3. Weigh açai berries
4. Load berries into the Extraction cell (up to 10 mL)
5. Tighten all connections
6. Make sure there is some water in the beaker that catches the exit gas and the rubber stopper is set tight on glass.
7. Set heater to desired Temperature (60 deg C)
8. Have timer set to start: fan and heater (2-3 hours before starting flow)
9. Turn on Temperature indicator
10. Leave containment area closed until environment reaches desired temperature (2-3 hrs)
11. Make sure Flow meter is ON and plastic tubing is PROPERLY connected
12. Turn on chiller (0 deg C) to cool CO₂ pump heads
13. Plug in electrical heating tape and set Variac to 20% 120V
14. Open N₂ tank valve (Back Pressure Regulator)
15. Use tank left regulator knob to set desired pressure
16. Open valve for CO₂ line and turn on pump, set flow rate (g/min)
17. Write down time pump is started

Appendix D (Continued)

18. Once system is full of CO₂, open solvent valve at HPLC pump
19. Turn on ethanol HPLC pump to 5mL/min faster than desired rate
20. Once ethanol line is full of ethanol, reduce rate to the desired flow rate
21. While running make sure there is enough ethanol

D.2 Leak Check Procedure

1. Make sure to tighten all fittings
2. Open valve and turn on CO₂ pump
3. Open CO₂ tank valve all the way
4. After system has pressurized check for bubbles using soapy solution or Snoop® liquid leak detector on joints.
5. Close CO₂ tank valve
6. Depressurize system
7. Tighten or reconnect joints that had leaks
8. Repeat steps 2-7 until there are no more leaks in the line. Continue to steps 9-14 to perform a high pressure leak check.
9. Open N₂ tank and set regulator to 1400 psi
10. Open CO₂ tank valve all the way
11. Set flow rate of the CO₂ pump to 20 g/min
12. After system has pressurized stop flow at the pump.
13. Check for bubbles at the fittings using soapy solution or Snoop® liquid leak detector
14. Close CO₂ tank valve and N₂ tank valve

Appendix D (Continued)

15. Slowly depressurize by opening and closing line at the N₂ tank
16. Tighten or reconnect joints that had leaks
17. Repeat steps 9-14 until there are no more leaks in the line.

D.3 Running Procedure

1. Write down and keep track of flow meter reading for total gas usage
2. Check that the system is at desired pressure using the Pressure indicator above the back pressure regulator.
3. The pressure is then verified by checking the pressure at the pump.
4. The pressure can be lowered Nitrogen tank.
5. Check that the temperature is as desired internally as well as the surrounding temperature.
6. Adjust the heater temperature set point to increase or decrease the system temperature as desired.
7. Check the flow rate of the CO₂ is correct.
8. Write down temperature and pressure every 30 minutes throughout the entire run.

D.4 Shut Down Procedure

1. Write down stop time
2. Turn off ethanol flow at the HPLC pump
3. Turn off the flow at the CO₂ pump
4. Turn off chiller
5. Shut off the N₂ valve

Appendix D (Continued)

6. Turn off the fan
7. Turn off the heater
8. Slowly depressurize by opening N₂ line and closing repeatedly
9. Slowly open the fittings of the extraction chamber
10. Open the collection chamber
11. Collect extract solution quickly into a pre weighed vial.
12. Record the weight, wrap with aluminum foil, and store in fridge.
13. Collect residue and put into pre weighed plastic container.
14. Record weight; dry in vacuum oven (1.5 mmHg, 40 deg C)
15. Record dry weight; close and store in dark place

D.5 Cleaning Procedure

1. Perform a leak check
2. Follow startup procedure steps 6-21
3. Allow to run for 3 hours with 2 mL/min of ethanol
4. Turn off ethanol flow at the HPLC pump
5. Run for at least 1 hour at 5 g/min of CO₂.
6. Follow shutdown procedure steps 3-10

D.6 Precautions

- Tighten fitting that opens N₂ line to depressurize prior to opening N₂ valve and starting a run.
- Prior to starting pumps, the valves must be open and the fittings are tightened.

Appendix D (Continued)

- The lines can clog from freezing during depressurizing. This must be done slowly, releasing nitrogen to decrease the pressure by no more than a few psi at a time. It is best to open the line a quarter of a turn and closing promptly. Wait until the CO₂ gas escapes before repeating.
- Always check pressure at both pumps is at zero before opening any fittings.
- The outlet valve, part of the subcritical water experiment, must be closed for the duration of the experiment and not opened until after depressurizing.
- Precaution should be taken when removing the extractor vessel. It is possible for some pressurized gas to still remain.

Appendix E: Sample Calculations

The following are sample calculations of analysis found in this work.

E.1 Values for Fermentation Model

Find the initial density at 20°C.

SG	Density (g/mL)	Brix
1.08479	1.08287	20
1.10747	1.10551	25

Interpolating:

$$(23-20)/(25-20) = (\rho-1.08287)/(1.10551-1.08287)$$

$$\rho = 1096.454 \text{ at 23 Brix}$$

Find the biomass (yeast) concentration.

Approximate MW biomass = 99.56 g/mol

1 g yeast/ gal

$$1/99.56 = 0.010044 \text{ mol yeast/gal}$$

$$1 \text{ gal} = 3785 \text{ mL} \quad 1 \text{ m}^3 = 1000000 \text{ mL}$$

$$0.010044 / 3785 * 1000000 = 2.65368 \text{ mol yeast/m}^3$$

Find the concentration of maltose.

$$\rho \text{ solution} = 1.023 \text{ g/mL} = 1023000 \text{ g/m}^3$$

$$0.1 \text{ g maltose}/100 \text{ g dry açai} * 14 \text{ g dry açai}/100 \text{ g solution} =$$

$$0.00014 \text{ g maltose/ g solution} * \rho \text{ solution} = 143.22 \text{ g maltose/m}^3 \text{ solution}$$

$$\text{MW maltose} = 342.3 \text{ g/mol}$$

$$143.22/342.3 = 0.418 \text{ mol maltose/ m}^3$$

Find the concentration of glucose.

Using glucose amount of dry açai and adding to the amount of sugar added to the must which is calculated in the next section.

Appendix E (Continued)

$0.8 \text{ g glucose}/100 \text{ g dry açai} * 14 \text{ g dry açai}/100 \text{ g solution} =$
 $0.00112 \text{ g glucose}/ \text{g solution} * \rho \text{ solution} = 1145.76 \text{ g glucose}/\text{m}^3 \text{ solution}$
MW glucose = 180.16 g/mol
 $1145.76/180.16 = 6.36 \text{ mol glucose}/ \text{m}^3$
 $4.216 \text{ mol sugar}/3785 \text{ mL solution} * 1000000\text{mL}/\text{m}^3 = 1113.87 \text{ mol sugar}/\text{m}^3$
Sugar sucrose is $\frac{1}{2}$ glucose => $1113.87/2 = 556.93 \text{ mol glucose}/\text{m}^3$
 $556.93 \text{ mol glucose}/\text{m}^3 + 6.36 \text{ mol glucose}/\text{m}^3 = 563.30 \text{ mol glucose}/\text{m}^3$

E.2 Amount of Sugar to Add Based On Desired Alcohol Concentration

1 gal = 128 fluid oz = 3785.4 mL

1 lb = 453.59 g

This is the estimated makeup of water calculation for the Merlot.

5gal - 192 oz = water

640oz -192 oz = 448 oz water = 3.5 gal water

This is to determine estimated sugar concentration to get 13% alcohol by volume. The sugar used in the fermentation reaction calculations has the molecular formula $\text{C}_6\text{H}_{12}\text{O}_6$ which is the same for glucose and fructose.

1 gallon must \rightarrow 1 gallon wine

$\rho \text{ sugar} = 1.54 \text{ g/mL}$ $\rho \text{ ethanol (EtOH)} = 0.789 \text{ g/mL}$

MW sugar = 180 g/mol MW EtOH = 46.04 g/mol

3785 mL wine at 13% vol. alc. = 498.05 mL EtOH

498.05 mL (0.789 g/mL) = 388.227 g EtOH

388.227 g (1 mol / 46.04 g) = 8.432 mol EtOH

Appendix E (Continued)

Now to find out how much is needed to make that amount the fermentation reaction for sugar to alcohol is taken into account. Since one mole of sugar results in two moles of ethanol:

$$8.432 \text{ mol EtOH (1 mol glucose / 2 mol EtOH)} = 4.216 \text{ mol sugar}$$

$$4.216 \text{ mol (180 g/mol)} = 758.88 \text{ g sugar} = 1.67 \text{ lbs sugar}$$

Sucrose, table sugar, is actually used in the experiment. This can be done because the addition of water converts sucrose to glucose and fructose by way of hydrolysis.

$$\text{density sucrose} = 1.587 \text{ g/mL} \qquad \text{density water at } 23^{\circ}\text{C} = 0.998 \text{ g/mL}$$

$$1 \text{ Brix} = 1 \text{ g sucrose/ } 100 \text{ g solution}$$

$$758.88 \text{ g (1 mL/1.587 g)} = 478.19 \text{ mL}$$

$$X \text{ mL water} + 478.19 \text{ mL sugar} = 3785 \text{ mL total}$$

$$X = 3306.81 \text{ mL water} = 0.87 \text{ gal water}$$

$$3306.81 \text{ mL (0.998 g/mL)} = 3300.20 \text{ g water}$$

$$758.88 \text{ g sucrose} / 3300.20 \text{ g water} * 100 \text{ g water} = 23 \text{ Brix}$$

Appendix F: Wine Tasting Survey Materials

These are the forms used by the judges during the survey.

F.1 Background Survey

Judge #
Name
Age
Years of experience
Ethnicity
Gender
Experience/ Background Notes:

Appendix F (Continued)

F.2 Wine Analysis Survey Section A

Wine
No.

Judge #

Date

Information: First complete Section A and then Section B

Section A

Mark the appropriate space.

Unacceptable	
Average quality with some defects	
Average quality	
Above average quality with some superior qualities	
Superior	

Appendix F (Continued)

F.3 Wine Analysis Survey Section B

Section B

Mark the appropriate space and motivation.

		Outstanding	Very Good	Good	Acceptable	Unacceptable	Rationale
Visual	clarity						
	color						
Aroma	maturaton bouquet						
	purity						
Palate	acidity						too much / too little
	fullness						
	flavor						
	astringency/ bitterness						too much / too little
Overall Impression	harmony						

Additional Comments: