

University of Nebraska - Lincoln

DigitalCommons@University of Nebraska - Lincoln

Civil Engineering Theses, Dissertations, and
Student Research

Civil Engineering

8-2010

Impact of Bottom Flange Confinement Reinforcement on Performance of Prestressed Concrete Bridge Girders

Quinton Patzlaff

University of Nebraska at Lincoln, qpatzlaff@yahoo.com

Follow this and additional works at: <http://digitalcommons.unl.edu/civilengdiss>



Part of the [Civil Engineering Commons](#)

Patzlaff, Quinton, "Impact of Bottom Flange Confinement Reinforcement on Performance of Prestressed Concrete Bridge Girders" (2010). *Civil Engineering Theses, Dissertations, and Student Research*. 7.

<http://digitalcommons.unl.edu/civilengdiss/7>

This Article is brought to you for free and open access by the Civil Engineering at DigitalCommons@University of Nebraska - Lincoln. It has been accepted for inclusion in Civil Engineering Theses, Dissertations, and Student Research by an authorized administrator of DigitalCommons@University of Nebraska - Lincoln.

IMPACT OF BOTTOM FLANGE CONFINEMENT REINFORCEMENT ON
PERFORMANCE OF PRESTRESSED CONCRETE BRIDGE GIRDERS

by

Quinton G Patzlaff

A THESIS

Presented to the Faculty of
The Graduate College at the University of Nebraska
In Partial Fulfillment of Requirements
For the Degree of Master of Science

Major: Civil Engineering

Under the Supervision of Professor Maher Tadros

Lincoln, Nebraska

August, 2010

IMPACT OF BOTTOM FLANGE CONFINEMENT REINFORCEMENT ON
PERFORMANCE OF PRESTRESSED CONCRETE BRIDGE GIRDERS

Quinton G Patzlaff, M.S.

University of Nebraska, 2010

Advisor: Maher K. Tadros

For many years AASHTO provided no recommendation to state DOT's on bottom flange confinement reinforcement for their bridge superstructures. The 1996 edition of AASHTO Standard Specification for Highway Bridges stated that nominal reinforcement be placed to enclose the prestressing steel from the end of the girder for at least a distance equal to the girder's height. A few years later the 2004 AASHTO LRFD Bridge Design Specification changed the distance over which the confinement was to be distributed from $1.0h$ to $1.5h$, and gave minimum requirements for the amount of steel to be used, No.3 bars, and their maximum spacing, not to exceed 6".

Research was undertaken to study what impact, if any, confinement reinforcement has on the performance of prestressed concrete bridge girders. Of particular interest was the effect confinement had on the transfer length, development length, and vertical shear capacity of the fore mentioned members. First, an analytical investigation was performed on the subject, and then an experimental investigation followed which consisted of designing, fabricating, and testing eight tee-girders and three NU1100 girders with particular attention paid to the amount and distribution of confinement reinforcement placed at the end of each girder.

The results of the study show: 1) neither the amount or distribution of confinement reinforcement had a significant effect on the initial or final transfer length of the prestress strands; 2) at the AASHTO calculated development length, no significant impact from confinement was found on either the nominal flexural capacity of bridge girders or bond capacity of the prestressing steel; 3) the effects from varied confinement reinforcement on the shear resistance of girders tested was negligible, however, distribution of confinement did show to have an impact on the prestressed strands' bond capacity; 4) confinement distribution across the entire girder did increase ductility and reduced cracking under extreme loading conditions.

ACKNOWLEDEMENTS

I would like to express my appreciation to my advisor Dr. Maher Tadros for his continued support throughout my education going into my young professional career. I will be forever grateful for the opportunities provided to me while working under his supervision. I also would like to thank my co-advisor Dr. George Morcoucous for his guidance and support through all of my research and coursework during my graduate studies. I need to thank Dr. Christopher Tuan for being a part of my advisory committee, and Dr. Kromel Hanna for his educational and personal encouragement.

To my fellow current and past graduate assistant colleagues, your assistance in the structural lab and comradeship was greatly appreciated. I need to thank Kelvin Lein, manager of the PKI structural laboratory, Jeff Svatora, undergraduate laboratory assistant, and Mike Rezac, manager of the mechanical laboratory, for all of their help with specimen fabrication and test setup. I also want to acknowledge the office staff at the Peter Kiewit Institute, whose guidance made the process towards receiving my degree effortless and enjoyable.

Lastly, I need to acknowledge my family and friends, especially my wife Stacey and parents, for all of their infinite support throughout my entire secondary education. The process was long and at times overwhelming. Their never ending encouragement, along with an excess of caffeine, are what drove me through many all-night sessions. I will never forget the sacrifices you made while I was completing my education.

TABLE OF CONTENTS

TABLE OF FIGURES v

TABLE OF TABLES ix

NOTATIONS..... x

ACRONYMS xii

1 INTRODUCTION 1

 1.1 Overview 1

 1.2 Objectives 4

 1.3 Tasks 5

 1.3.1 Analytical Investigation of NU I-Girders 5

 1.3.2 Full Scale Testing of 24 inch Tee-girders (T24)..... 5

 1.3.3 Full Scale Testing of NU1100 Bridge Girders 6

 1.4 Organization 7

2 LITERATURE REVIEW 7

 2.1 Transfer Length Overview 7

 2.1.1 Definition of Transfer Length..... 8

 2.1.2 Methods of Calculating Transfer Length 8

 2.1.2.1 2004 AASHTO LRFD 8

 2.1.3 Previous Transfer Length Research 9

 2.1.3.1 Russell and Burns (1996) 9

 2.1.3.2 Maguire (2009)..... 13

 2.2 Development Length Overview 16

2.2.1	Definition of Development Length	17
2.2.2	Methods of Calculating Development Length	17
2.2.2.1	2004 AASHTO LRFD	17
2.2.3	Previous Development Length Research	18
2.2.3.1	FHWA (1994)	19
2.2.3.2	Shahawy (2001).....	20
2.3	Vertical Shear Overview	23
2.3.1	Definition of Vertical Shear	24
2.3.2	Methods of Calculating Vertical Shear Capacity.....	24
2.3.2.1	2004 AASHTO LRFD	24
2.3.3	Previous Vertical Shear Research	25
2.3.3.1	Csagoly (1991)	25
2.3.3.2	Shahawy, Robinson, and deV. Batchelor (1993)	29
2.3.3.3	Ross (2010)	34
3	ANALYTICAL & EXPERIMENTAL INVESTIGATION	39
3.1	Analytical Investigation.....	39
3.1.1	Concrete Strength.....	39
3.1.2	Transfer & Development Length	44
3.2	Experimental Investigation.....	46
3.2.1	Girder Design, Fabrication, and Test Setup.....	46
3.2.1.1	T24 Girder Design.....	46
3.2.1.2	T24 Girder Fabrication.....	49
3.2.1.3	T24 Girder Test Setup.....	53

3.2.1.3.1	Transfer Length.....	53
3.2.1.3.2	Development Length.....	55
3.2.1.3.3	Vertical Shear	57
3.2.1.4	NU1100 Girder Design	59
3.2.1.5	NU1100 Girder Fabrication	63
3.2.1.6	NU1100 Girder Test Setup.....	67
3.2.1.6.1	Development Length.....	67
3.2.1.6.2	Vertical Shear	70
3.2.2	Test Results.....	72
3.2.2.1	T24 Girders	72
3.2.2.1.1	Transfer Length.....	73
3.2.2.1.2	Development Length.....	76
3.2.2.1.3	Vertical Shear	85
3.2.2.2	NU1100 Girders	92
3.2.2.2.1	Development Length.....	92
3.2.2.2.2	Vertical Shear	101
4	SUMMARY, CONCLUSIONS, & RECOMMENDATIONS	107
4.1	Summary.....	107
4.2	Conclusions	109
4.2.1	Transfer Length.....	109
4.2.2	Development Length.....	110
4.2.3	Vertical Shear.....	111
4.3	Recommendations	112

4.3.1 Future Research 112

4.3.2 DOT Girder Detailing 113

REFERENCES 115

APPENDIX A – T24 Girder Design Calculations..... 117

APPENDIX B – NU1100 Girder Design Calculations 123

TABLE OF FIGURES

Figure 1.1 Concrete Stress-Strain Relationship (Braga, Gigliotti and Laterza 2006)	1
Figure 2.1 AASHTO Idealized Steel Stress vs. Distance from Member End	9
Figure 2.2 Transfer Prism Reinforcement (Maguire 2009)	14
Figure 2.3 Initial and Final Transfer Lengths from Transfer Prisms (Maguire 2009).....	15
Figure 2.4 Transfer Length vs. Confinement Reinforcement (Maguire 2009).....	16
Figure 2.5 AASHTO Idealized Steel Stress vs. Distance from Member End	18
Figure 2.6 Section Details of Type C Test Girders (M. Shahawy 2001).....	20
Figure 2.7 Effects of Shear Span to Depth Ratio on Strand Slip (M. Shahawy 2001).....	22
Figure 2.8 Splitting Force in Bearing Area (Csagoly 1991).....	28
Figure 2.9 AASHTO Beam Cross Section (Shahawy et al. 1993)	31
Figure 2.10 Shear Comparison (Shahawy et al. 1993)	33
Figure 2.11 Specimen Details (Ross 2010).....	35
Figure 2.12 Specimen Fabrication and Test Setup (Ross 2010).....	36
Figure 2.13 Specimen Reinforcement and Confinement (Ross 2010)	36
Figure 2.14 Shear vs. Displacement (Ross 2010).....	37
Figure 2.15 Shear vs. Strand Slip (Ross 2010)	38
Figure 3.1 Proposed Stress-Strain Relationship (Saatcioglu and Razvi 1992).....	39
Figure 3.2 Computation of Lateral Pressure from Hoop Tension (Saatcioglu and Razvi 1992)	41
Figure 3.3 Distribution of Lateral Pressures (Saatcioglu and Razvi 1992)	42
Figure 3.4 Cross Section of T24 Girder.....	48

Figure 3.5 T24 Confinement Reinforcement Distribution.....	49
Figure 3.6 T24 End Confinement	50
Figure 3.7 T24 Forming.....	51
Figure 3.8 T24 Concrete Spread	52
Figure 3.9 T24 Finishing.....	53
Figure 3.10 T24 Transfer Length Test Setup.....	54
Figure 3.11 Measuring Strain in Concrete for Transfer Length Estimation	55
Figure 3.12 T24 Development Length Test Setup (CAD).....	56
Figure 3.13 Development Length Testing Setup	56
Figure 3.14 Potentiometers Attached to the Bottom Row of Strands.....	57
Figure 3.15 T24 Vertical Shear Test Setup (CAD).....	57
Figure 3.16 T24 Vertical Shear Test Setup.....	58
Figure 3.17 Vertical Shear Test Strand Instrumentation	59
Figure 3.18 Cross Section of NU1100 Girder and Deck	61
Figure 3.19 NU1100 Confinement Reinforcement Detail.....	62
Figure 3.20 NU1100 Reinforcement.....	64
Figure 3.21 NU1100 Confinement Reinforcement.....	64
Figure 3.22 NU1100 Pouring.....	65
Figure 3.23 NU1100 at Release	66
Figure 3.24 NU1100 Deck Forming.....	66
Figure 3.25 NU1100 Deck Pouring	67
Figure 3.26 NU1100 Development Length Test Setup (CAD)	68
Figure 3.27 NU1100 Development Length Test Setup	69

Figure 3.28 Development Length Test Strand Instrumentation.....	70
Figure 3.29 NU1100 Vertical Shear Test Setup (CAD)	71
Figure 3.30 NU1100 Vertical Shear Test Setup	71
Figure 3.31 Vertical Shear Test Strand Instrumentation	72
Figure 3.32 T-4-1.0h-B North End, West Side Surface Strain Measurements with Modified 95% AMS Method	73
Figure 3.33 T24 Transfer Length Comparison	75
Figure 3.34 T24 Load v. Deflection Comparison	78
Figure 3.35 T24 Post Development Testing	79
Figure 3.36 T24 Development Test Strand Designation	80
Figure 3.37 T-6-1.5h-A Development Length Test Strand Slippage.....	80
Figure 3.38 T-6-0.51-A Development Length Test Strand Slippage	81
Figure 3.39 T-6-1.5h-B Development Length Test Strand Slippage.....	81
Figure 3.40 T-4-1.0h-B Development Length Test Strand Slippage.....	82
Figure 3.41 T-6-1.5h-C Development Length Test Strand Slippage.....	82
Figure 3.42 T-4-1.0h-C Development Length Test Strand Slippage.....	83
Figure 3.43 T-12-0.51-D Development Length Test Strand Slippage	83
Figure 3.44 T-4/6-1/1.5h-D Development Length Test Strand Slippage	84
Figure 3.45 T24 Load v. Deflection Comparison	86
Figure 3.46 T-12-0.51-D Development Length Test Slippage	87
Figure 3.47 T-4/6-1/1.5h-D Development Length Test Slippage.....	88
Figure 3.48 T24 T-4-1.0h-D Post Shear Test	89
Figure 3.49 T24 Load v. Avg. Strand Slip Comparison	90

Figure 3.50 T24 Load v. Max. Strand Slip Comparison.....	90
Figure 3.51 NU1100 Load v. Deflection Comparison.....	94
Figure 3.52 NU1100 Girder 2 Post Development Testing	95
Figure 3.53 NU1100 Development Test Strand Designation	96
Figure 3.54 NU1100 Girder 1 Strand Slip.....	97
Figure 3.55 NU1100 Girder 2 Strand Slip.....	97
Figure 3.56 NU1100 Girder 3 Strand Slip.....	98
Figure 3.57 NU1100 Girder 3 Post Development Test.....	99
Figure 3.58 NU1100 Load v. Max. Strand Slip Comparison	100
Figure 3.59 NU1100 Load v. Deflection Comparison.....	102
Figure 3.60 NU1100 Girder 2 Post Shear Test.....	103
Figure 3.61 NU1100 Shear Test Strand Designation.....	103
Figure 3.62 NU1100 Girder 1 Strand Slip.....	104
Figure 3.63 NU1100 Girder 2 Strand Slip.....	105
Figure 3.64 NU1100 Girder 3 Strand Slip.....	105
Figure 3.65 NU1100 Load v. Max. Strand Slip Comparison	106
Figure 4.1 Collision Impact on Exterior Girder.....	114

TABLE OF TABLES

Table 2.1 Effects of Confining Reinforcement on Measured Transfer Lengths.....	12
Table 3.1 Confined Concrete Strength.....	43
Table 3.2 Transfer Length and Development Length Equations.....	45
Table 3.3 T24 Girder Designation and Confinement Reinforcement.....	49
Table 3.4 NU1100 End Confinement	62
Table 3.5 T24 Girder Transfer Length Summary	74
Table 3.6 T24 Girder Transfer Length Comparison	76
Table 3.7 T24 Girder Flexural Capacity	77
Table 3.8 T24 Girder Shear Capacity	86
Table 3.9 NU1100 Girder Flexural Capacity.....	93
Table 3.10 NU1100 Girder Shear Capacity	101

NOTATIONS

A_s	Area of confinement steel
A_v	Area of shear reinforcement
b_c	Distance of confinement steel
b_v	Effective web width; minimum width within d_v
d_b	Diameter of strand or reinforcing bar
d_v	Effective shear depth
f'_c	Final (design) concrete strength
f'_{cc}	Final confined concrete strength
f'_{ci}	Initial concrete strength at time of release of prestress force
f'_{co}	Unconfined initial concrete strength
f_{le}	Lateral uniform confining pressure
f_{pe}	Effective stress after losses
f_{ps}	Stress at nominal resistance
f_{yt}	Yield stress of confinement steel in tension
h	Height of girder
K_{tr}	Transverse reinforcement coefficient
k	Modification factor (1.6 for bridge girders greater than 24" deep)
k_1	Variation coefficient
k_2	Variation coefficient
l_d	Development length

l_t	Transfer length
M_n	Nominal moment capacity
n	Number of longitudinal bars to develop
s	Spacing of confinement reinforcement
s_l	Spacing of lateral reinforcement
V_c	Concrete contribution to shear resistance
V_n	Nominal shear capacity
V_p	Prestress force contribution to shear resistance
V_s	Steel contribution to shear resistance
β	Factor indicating ability of diagonally cracked concrete to transmit tension (AASHTO Article 5.8.3.4)
ϕ	Resistance design factor
θ	Angle of inclination of diagonal compressive stresses
α	Angle of inclination of transverse reinforcement to longitudinal axis

ACRONYMS

AASHTO	American Association of State Highway and Transportation Officials
ACI	American Concrete Institute
AMS	Average Maximum Strain
BOPP	Bridge Operations, Policy, and Procedure
CAD	Computer Aided Drawing
DEMEC	Detachable Mechanical (gauges)
DOT	Department of Transportation
FDOT	Florida Department of Transportation
FHWA	Federal Highway Administration
LRFD	Load and Resistance Factor Design
LVDT	Linear Voltage Differential Transducers
NCHRP	National Cooperative Highway Research Program
NDOR	Nebraska Department of Roads
NU	Nebraska University
PCA	Portland Cement Association
PKI	Peter Kiewit Institute
WWR	Welded Wire Reinforcement

1 INTRODUCTION

1.1 Overview

The definition of confine is to enclose an area with bounds. The effects from confinement are known and utilized in numerous applications throughout engineering. A confining volume, or vessel, changes the reaction, for all three states of matter, when outside stimulates are added. Confined concrete for example, behaves quite differently than a similarly unconfined specimen when an axial stress is induced. Figure 1.1 shows a stress-strain relationship for both unconfined and confined concrete.

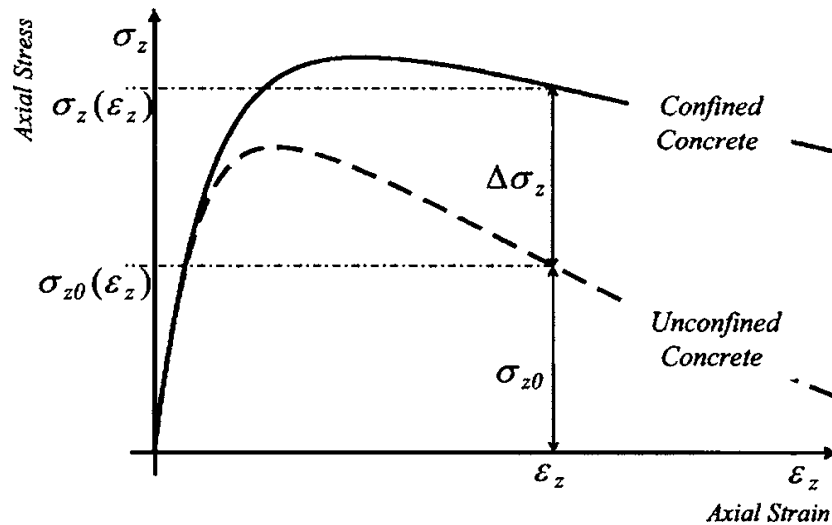

Figure 1.1 Concrete Stress-Strain Relationship (Braga, Gigliotti and Laterza 2006)

This phenomenon has led to increased research on the subject to study the consequences of confining a particular material with another.

Reinforced and prestressed concrete incorporates confinement for strength and stability, and to enhance the overall product. In particular, prestressed concrete bridge girders designed today require confinement reinforcement to be located at their ends, around the prestressing steel in the bottom flange. There are many reasons for adding the reinforcement around the strands, one of which is to reduce cracking in the bottom flange from the force transferred into the girder by the prestressed steel. But recent research has provided code officials with information on other benefits related to confinement.

For many years AASHTO Standard Specifications provided no guidance to state DOT's on confinement reinforcement for bridge superstructures. Variety existed from every state bridge department and practicing engineer on the amount of reinforcement and the length of its distribution. In 1996 the AASHTO Standard Specification for Highway Bridges included a specification, Section 9.22.2, which included and mandated confinement reinforcement. Section 9.22.2 simply stated:

“For at least the distance d from the end of the girder, [where d is the depth of the girder] nominal reinforcement shall be placed to enclose the prestressing steel in the bottom flange” (AASHTO 1996).

While the 1996 specification did now require confinement reinforcement in newly designed bridge girders, it did not specify either a size of reinforcement to be used or suggest adequate spacing of the bottom flange reinforcement over the distance d .

Therefore, bridge engineers and departments of transportation were still left to interpret the new specification, and girder details from state to state remained inconsistent. For example, several bridge girders designed and developed in Nebraska during the mid 1990's, such as NU I-girders, were detailed conservatively using welded wire reinforcement D4@4" spacing, equivalent to #3 @ 12", along the full length of the girder regardless of the girder depth.

A few years later AASHTO reviewed their specification on confinement reinforcement and unveiled a modified version in the 2004 AASHTO LRFD Bridge Design Specification. Section 5.10.10.2 of the 2004 specification states that,

“For the distance of $1.5d$ from the end of the girders other than box girders, [where d is the depth of the girder] reinforcement shall be placed to confine the prestressing steel in the bottom flange. The reinforcement shall not be less than No. 3 deformed bars, with spacing not exceeding 6.0 in. and shaped to enclose the strands” (AASHTO 2004).

Although the 2004 AASHTO Section 5.10.10.2 does not refer to the origin of this provision, it is believed that it was based on the research sponsored by the Florida Department of Transportation (FDOT) in the late 1980's which investigated the effect of confinement reinforcement on the shear capacity of prestressed/precast bridge girders (Shahawy, Robinson and Batchelor 1993) & (Csagoly 1991).

This newly developed requirement, in 2004 by AASHTO, now gave bridge girder designers some guidance as to an adequate amount and proper distribution of the bottom flange confining steel, while invoking a level of variability. It was still up to the individual states to detail their girder confinement reinforcement in a matter which could satisfy the above mentioned spec.

Very little is known on what effects confinement reinforcement has on the structural integrity of prestressed concrete members. For this reason, researchers set out to study the variables which could impact the capacity of bridge girders designed by current and previous specification.

1.2 Objectives

The main objective of this study was to determine what impact, if any, confinement reinforcement has on the performance of prestressed concrete bridge girders. Of particular interest was the effect confinement had on the transfer length, development length, and vertical shear capacity of the fore mentioned members. A secondary objective of the study was with regards to 0.7” diameter prestressing strand. This newly developed product provides for higher prestress force transfer than the currently used 0.5” and 0.6” diameter strands. Attention was paid to the effective transfer length and development length from the larger diameter strand relative to current specifications and design codes and its impact on implementation into future bridge girder design. The

results from this study are from a most extreme prestress case, 0.7” strand, and will be applicable to girders which were produced with either 0.5” or 0.6” diameter strands.

1.3 Tasks

The following sections present the tasks set forth by the researchers to complete the aforementioned objectives of the study.

1.3.1 Analytical Investigation of NU I-Girders

An analytical investigation was performed by the university for the Nebraska Department of Roads (NDOR). The proposed theoretical investigation was towards the effect of confinement reinforcement between the current NDOR bottom flange standard detail and that required by AASHTO LRFD specifications on the structural performance of NU I-girders. The 2004 AASHTO specified confinement reinforcement was significantly higher than NDOR’s standard bottom flange reinforcement specified in the Bridge Operations, Policies, and Procedures (BOPP) manual. Although NDOR adopted AASHTO LRFD specifications for superstructure design since 2004, the bottom flange reinforcement detail developed in the mid 1990’s was not updated to satisfy the latest AASHTO LRFD specifications.

1.3.2 Full Scale Testing of 24 inch Tee-girders (T24)

A total of eight tee-girders, with six 0.7” diameter strands, were cast and tested at university facilities to investigate the impact confinement reinforcement has on a

members transfer length, development length and shear capacity. Tee-shaped girders were chosen because of their simplicity for forming, pouring, and stripping. The transfer lengths were determined through concrete surface strain readings at the centroid of the prestressing force. A total of fourteen girder ends were tested for characterization and determination of transfer length in the specimens. In addition, eight mid-span flexural tests, for development, and four vertical shear tests were performed on all eight and two girders respectively. Attention was paid to the amount and distribution of the confinement reinforcement at the end of each girder.

1.3.3 Full Scale Testing of NU1100 Bridge Girders

A total of three beams, incorporating thirty-four 0.7” diameter strands at 2” by 2” spacing, were cast with the aid of a local precaster. NU I-girders are the predominant girder series specified during design and for construction of bridges in the state by the NDOR. The NU1100 girder selection was based on the handling and testing capacity of the university’s structural laboratory. All three specimens had different levels of end confinement for comparison purposes. The length of the specimen along with the executed test setup allowed for each girder to be subjected to two tests. A flexural test, at the American Association of State Highway Officials, Load Resistance Factor Design (AASHTO LRFD) predicted development length, was performed on each girder; after which, a vertical shear test was performed on one end of all three NU I-girders.

1.4 Organization

This thesis is divided into four chapters. Chapter 1 has provided an overview on the proposed topic as well as the objectives of the research and tasks performed to complete the study. Chapter 2 presents a thorough and comprehensive literature review with regards to the transfer length and development length of prestressing strand, along with a pretensioned members design vertical shear capacity. Chapter 3 provides results from analytical and experimental investigations, performed at the University of Nebraska, on the impact of confinement reinforcement on the transfer length, development length, and vertical shear capacity of concrete girders. Finally, Chapter 4 presents a summary and conclusions from the research, as well as provides recommendations for designers and for future research.

2 LITERATURE REVIEW

2.1 Transfer Length Overview

The transfer length of prestressing strand is an important calculation with regards to the shear design and release stresses at the girder ends. An over-estimated transfer length results in conservative shear design and higher top and bottom stresses at release. An under-estimated transfer length results in inadequate shear design and lower top and bottom stresses at release. The transferred force along the transfer length is assumed to increase linearly from zero at the free end of the strand to the effective prestress, f_{pe} , at the end of the transfer length, l_t .

The purpose of the research was to validate current AASHTO LRFD specifications with respect to different levels and distributions of confinement with the use of 0.7” diameter strands, not to study or propose a different equation when calculating the transfer length of the larger strand. Therefore, the current AASHTO transfer length equation from section 5.11.4.1 will be the basis for justification of all results from testing.

2.1.1 Definition of Transfer Length

Transfer length is defined as the distance required, along the length of a prestressed member, for the fully effective prestress, f_{pe} , to be transferred to the beam.

2.1.2 Methods of Calculating Transfer Length

2.1.2.1 2004 AASHTO LRFD

According to the 2004 AASHTO LRFD Bridge Design Specifications Section 5.11.4.1, a fully bonded prestress strands’ transfer length, l_t , is equal to:

$$l_t = 60d_b \qquad \text{Equation 1 (AASHTO 5.11.4.1)}$$

Figure 2.1 shows a strands stress distribution from the free end of the member. The shaded portion represents the part of the figure designated to and required for proper transfer of the effective stresses to the concrete.

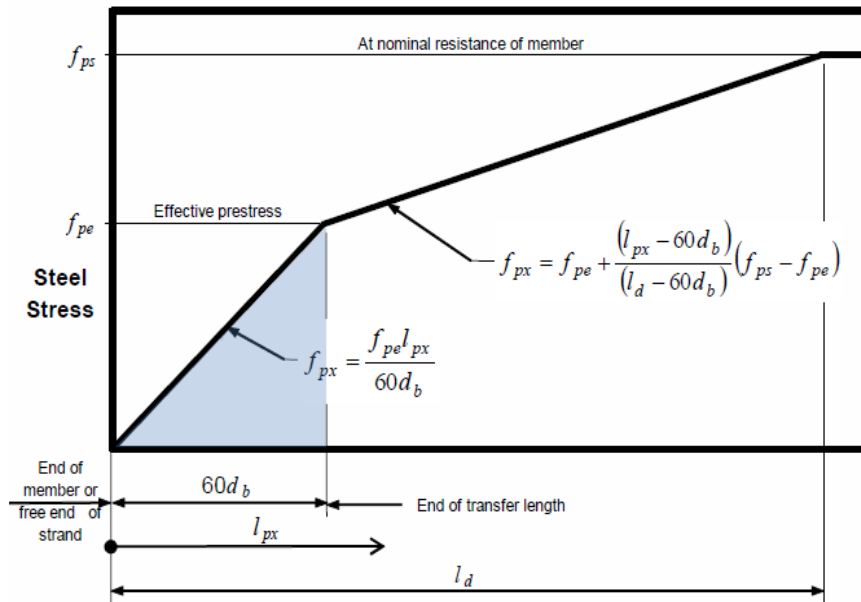

Figure 2.1 AASHTO Idealized Steel Stress vs. Distance from Member End
(AASHTO LRFD 2005)

2.1.3 Previous Transfer Length Research

The following reports present past research with respect to confinement reinforcement and its effect on the transfer length of prestress to concrete. Although abundant, no other research on the basis of prestress transfer will be presented in this section, as it does not assist the researchers or provide any reference to comparable data for the subject being studied.

2.1.3.1 Russell and Burns (1996)

For this study, transfer lengths were measured on a wide variety of variables and on different sizes and types of cross sections. The variables included number of strands, size

of strand (0.5 and 0.6), debonding, confinement reinforcement, and size and shape of the cross section.

The number of specimens and the variables included in the testing represent one of the largest bodies of transfer length data taken from a single research project. Altogether, transfer lengths were measured on each end of 44 specimens. Of these specimens, 32 were constructed with concentric prestressing in rectangular transfer length prisms. The remaining 12 specimens were built as scale model AASHTO type beams with four, five, or eight strands.

Primarily, transfer lengths were determined by measuring concrete surface strains along the length of each specimen. By measuring the concrete strains and plotting the strains with respect to length, transfer length can be determined from the resulting strain profile. The strain profiles taken were then plotted versus the length of the specimen. The method used, which was conceived by personnel from the research project, was labeled the “95 Percent Average Maximum Strain” method. The method gives a transfer length value that is free from arbitrary interpretation because the “Average Maximum Strain” will not change significantly if one or two data points are either included or excluded from the average. Its “inherent objectivity” is the major advantage derived by using the “95% AMS” method.

The results show that for both 0.5” and 0.6” strands, the transfer lengths for AASHTO type beams were remarkably shorter than the transfer lengths of the other test specimens. The data indicated that test specimens with larger cross sections and multiple strands possess significantly shorter transfer lengths. Those results indicate that transfer lengths measured on relatively small, single strand specimens may not simulate transfer lengths of real pretensioned concrete members. Typical pretensioned beams, with larger cross sections and multiple strands, could be expected to register shorter transfer lengths when compared to many of the typical research specimens.

Confining reinforcement is analogous to hoop ties in a column. Presumably, confining reinforcement surrounding the concrete and pretensioned strand would improve strand anchorage and shorten the transfer length. However, the data from this study did not support this theory. Transfer length measurements on specimens containing confining reinforcement are presented in Table 2.1.

Table 2.1 Effects of Confining Reinforcement on Measured Transfer Lengths
(Russell and Burns 1996)

Specimen	Measured transfer length (in.)			
	0.5 in. strands		0.6 in. strands	
	North end	South end	North end	South end
FCT350-3	30.5	30.0	—	—
FCT350-4	29.0	32.0	—	—
FCT550-2	36.0	39.5	—	—
FCT360-3	—	—	39.5	45.5
FCT360-4	—	—	50.5	42.0
FCT362-12	—	—	44.0	42.0
FCT560-2	—	—	48.0	51.5
Average transfer lengths: Strands confined by hoops	32.8 (Standard deviation = 4.1 in.)		45.4 (Standard deviation = 4.3 in.)	
Average transfer lengths: All test specimens	29.5 (Standard deviation = 6.9 in.)		40.0 (Standard deviation = 6.8 in.)	

Note: 1 in. = 25.4 mm.

The average transfer lengths for specimens made with confining reinforcement are 32.8” for 0.5” strands and 45.4” for 0.6” strands. In comparison, specimens containing confining reinforcement possessed about 12% longer transfer lengths than those with the confinement reinforcing omitted.

It is postulated that the confining reinforcement remained largely ineffective because the concrete remained relatively free from cracking throughout the transfer zone. Even though confining reinforcement necessarily must increase each member’s elastic stiffness in the circumferential direction, the effect is apparently small compared to the elastic stiffness of concrete. Fundamental mechanics prove that small radial cracking must

occur locally at the interface of strand and concrete. However, these cracks do not usually become large enough to activate confining forces in the reinforcement hoops.

Therefore, the confining reinforcement exerts little or no influence on the prestress transfer. Conversely, for the general design case, pretensioned concrete members must be detailed to prevent propagation of splitting cracks that can occur at transfer and transverse reinforcement should not be eliminated from standard detailing.

In the early and mid 1980's, many testing programs focused on developing reliable design guidelines for the shear design of pretensioned concrete. Tests performed in those research programs consistently demonstrated a direct interaction between shear failures and bond failures. The failure modes from the research were difficult to distinguish and failures were labeled shear/bond failures. Of significance, those shear/bond failures were sudden, violent and would represent catastrophic failures in real structures. From the development length testing, it is imperative to recognize that the transfer length can adversely affect the strength and ductility of a pretensioned member. Those failures highlight the need for the industry to collectively acknowledge the importance of transfer length in the safe design of pretensioned beams.

2.1.3.2 Maguire (2009)

The main subject of this report was to study the impact of 0.7" diameter prestressing strands in bridge girders. Most of the study involved fabricating and testing bridge

girders with the larger diameter strand for its inclusion into AASHTO and acceptance by state DOT's. Included in the research is one test performed on four transfer prisms which took into account and modified the confinement reinforcement placed thorough them. The specimen were seven inches square and eight feet long with a single 0.7" diameter strand stressed to $0.75f_{pu}$ (59.5 kips) placed longitudinally down the center. The confinement ties consisted of five inch square #3 Grade 60 hoops placed at three, six, nine, and twelve inch centers. Figure 2.2 presents the confinement layout for the subjects tested by Maguire.

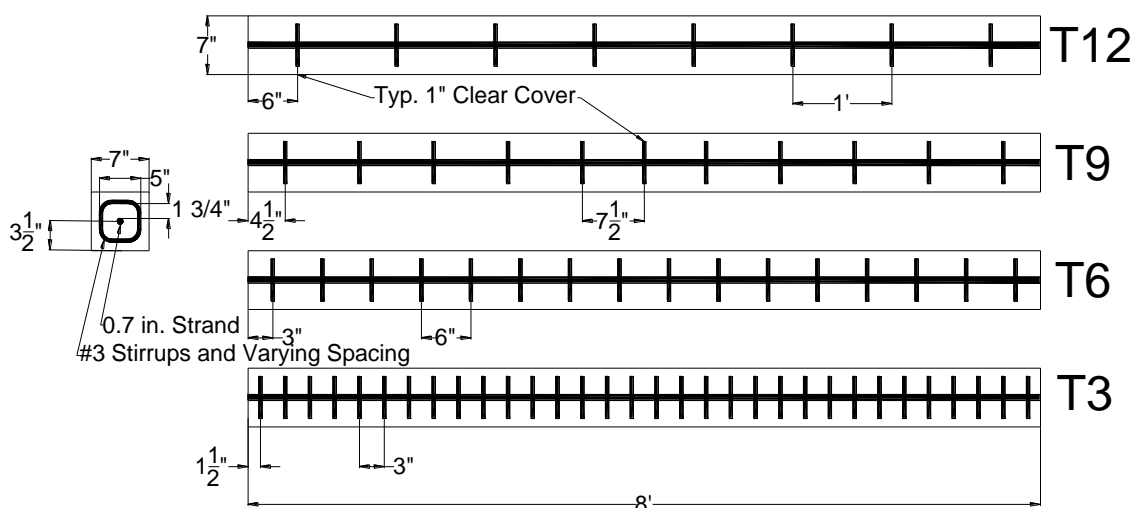

Figure 2.2 Transfer Prism Reinforcement (Maguire 2009)

The transfer length testing was performed by the use of DEMEC disks glued to both ends and both sides of each prism. Surface strain measurements were taken prior to release of the prestressing force, just after release, and fourteen days after release. The 95% AMS method was performed for all transfer regions, accounting for sixteen initial and sixteen

final transfer results. The results for each prism ends initial and final transfer length testing is provided by Figure 2.3. Figure 2.4 is a plot of the prism's transfer length versus the amount of confinement reinforcement.

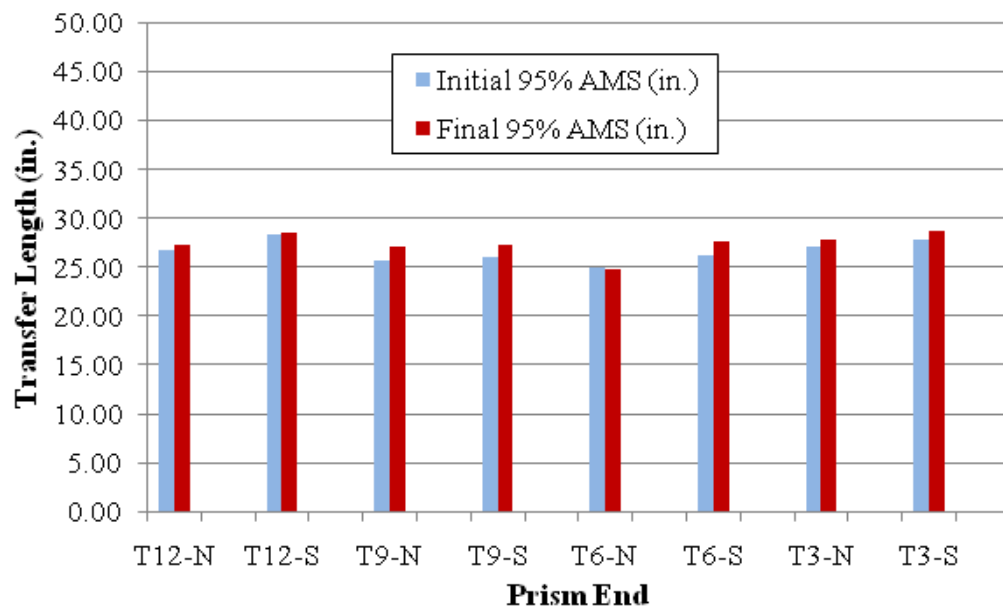

Figure 2.3 Initial and Final Transfer Lengths from Transfer Prisms (Maguire 2009)

While there was a slight increase between the initial and final transfer lengths, the increase was not significant. All measured transfer lengths were under both ACI and AASHTO predictions. There was no discernable correlation between the transfer length and the amount of confinement reinforcement, implying no effect on the transfer length.

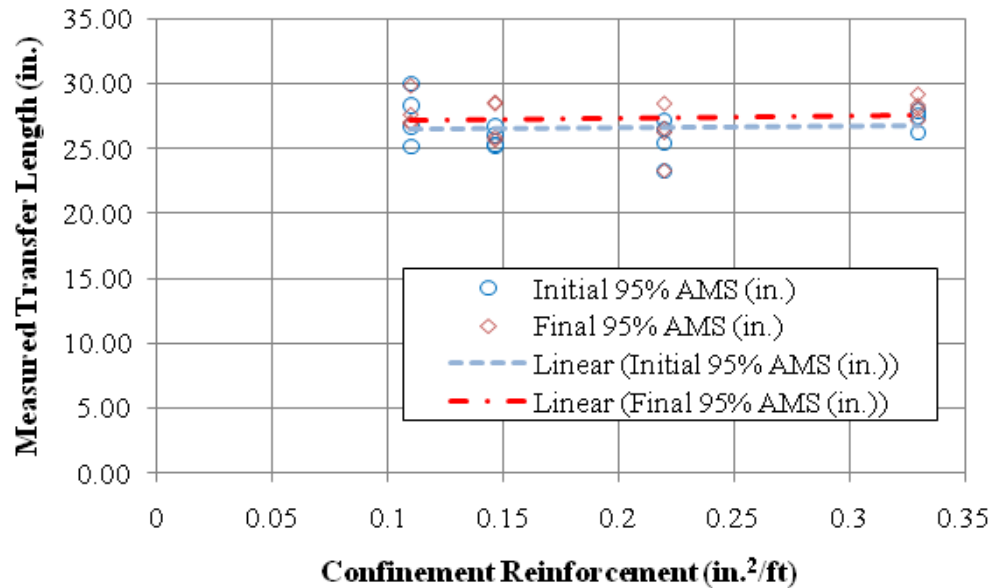

Figure 2.4 Transfer Length vs. Confinement Reinforcement (Maguire 2009)

2.2 Development Length Overview

The relationship of development length is necessary for identifying the critical sections in flexure and shear and calculating the capacities of the girder. An accurate estimate of the development length is important for the flexure design of girders. While an underestimated development length might result in a lower girder capacity at the sections within the development length, an over-estimated development length result in an uneconomical design with unnecessarily excessive reinforcement.

The purpose of the research is to validate current AASHTO LRFD specifications with differing levels and distributions of confinement with the use of 0.7" diameter strands, not to study or propose a different equation when calculating the development length of

the larger strand. Therefore, the current AASHTO development equation 5.11.4.2-1 will be the basis for justification of all results from testing.

2.2.1 Definition of Development Length

The development length of a prestress strand is the required distance along the length of a prestressed member, starting from the free end of the strand, for the ultimate design stress of the strand to be achieved.

2.2.2 Methods of Calculating Development Length

2.2.2.1 2004 AASHTO LRFD

According to the 2004 AASHTO LRFD Bridge Design Specifications Section 5.11.4.2, a fully bonded prestress strands' development length, l_d , is greater than or equal to:

$$l_d \geq k \left[f_{ps} - \frac{2}{3} f_{pe} \right] d_b \quad \text{Equation 2 (AASHTO 5.11.4.2-1)}$$

Figure 2.5 shows a strands stress distribution from the free end of the member. The shaded portion represents the part of the figure designated to and required for proper development of the effective stresses to the concrete.

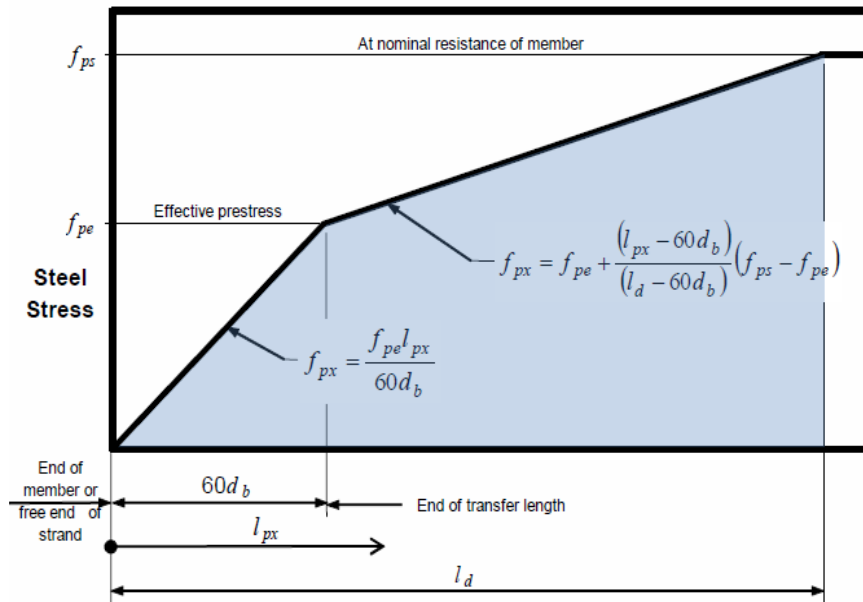

Figure 2.5 AASHTO Idealized Steel Stress vs. Distance from Member End
(AASHTO 2004)

Similar to a strands' transfer length, the development length required is a result of the individual strands' bond length. If there is not enough bond length from the end of the girder, or end of debonding, to develop the stress in the strand to the match the ultimate stress from external forces, a bond failure is likely to occur resulting in the strand slipping relative to the concrete. This will in turn reduce the section capacity of the girder over a longer distance required to establish full development of the prestress force.

2.2.3 Previous Development Length Research

The following report presents past research with respect to confinement reinforcement and its effect on the development length of prestress strand. Many papers present research on, or propose new development length equations, but no other current research

was found to be done with respect to the proposed study. No general papers on development length will be presented in this section, as they do not assist the researchers or provide any reference to comparable data for the subject being studied.

2.2.3.1 FHWA (1994)

In 1988 the FHWA issued a memorandum, restricting the use of seven-wire strands for pretensioned members in bridge applications. In an attempt to reconcile some of the differences in the design recommendations, the FHWA requested an independent review of the recently conducted research on transfer and development lengths of pretensioned strands. The author, Dale Buckner, fulfills the administration's objectives by reporting findings and presenting recommendations and equations for determining strand transfer and development lengths.

The author reviews the research performed with respect to confinement steel and commented. Intuitively the effect of closed hoops or spirals around prestressing strands should constrict lateral expansion of concrete, therefore improving frictional resistance and improving the transfer length. However, experimental evidence, performed at the University of Texas-Austin, shows the effects from confinement reinforcement to be negligible for members which do not split at release.

With regards to a prestress strands development length, the author mentions the testing done previously by the FDOT. The tests performed indicated the effectiveness of the

steel against longitudinal splitting in the bottom flanges of end bearing members. The report also mentions that the steel is beneficial in maintaining the integrity of girders that develop splitting cracks at transfer.

2.2.3.2 Shahawy (2001)

Part of the overall study presented by Shahawy in 2001 involved testing twelve forty-one foot long AASHTO Type II girders designed in accordance by the AASHTO 1991 Interim Specification with approximately the same ultimate flexural strength (2100 k-ft) for their individual development lengths. Figure 2.6 presents a cross-section of one type of girder tested.

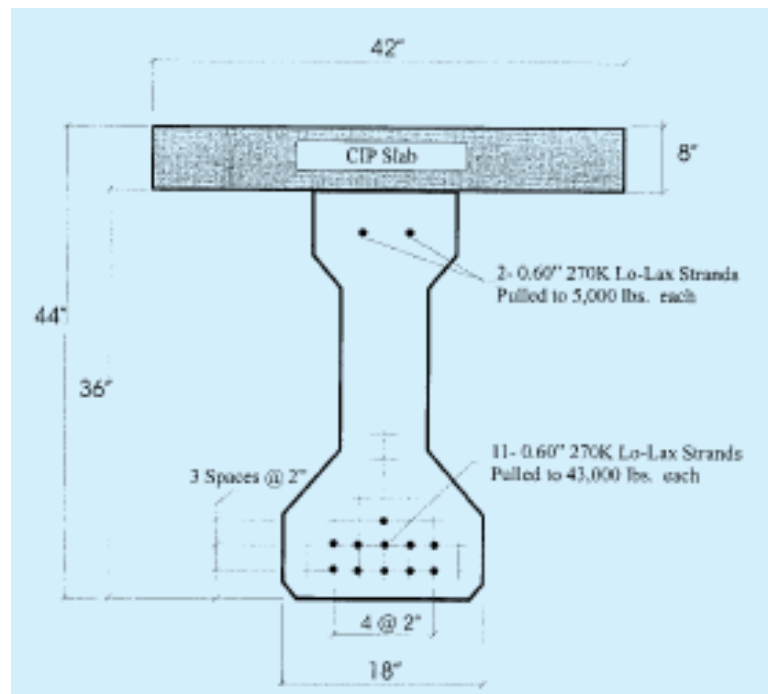

Figure 2.6 Section Details of Type C Test Girders (M. Shahawy 2001)

Three different size 270 ksi, LRS prestressing strands were used in the investigation; namely, 1/2", 1/2" Special, and 0.6". The main variables in the test program were the nominal strand diameter, available embedment length as a result of varying the distance of the applied loading, and the presence of confinement reinforcement in the tension flange. After the precast beams were produced a top flange, 42 inches wide and 8 inches thick, was cast on all the specimens as shown in Figure 2.6.

The effects of confinement steel were seen by comparing the results for those girders provided with confinement steel, beams A0-00R, A1-00R, C0-00R, and C1-00R, against those not provided with such reinforcement, beams A0-00RD, A1-00RD, C0-00RD, and C1-00RD. Each girder end was tested using a single concentrated load. The location of the load varied and the test span was shortened after the first end of the girder was tested to eliminate the opposite failed zone. According to AASHTO, the presence or lack of confinement steel does not affect the predicted development length. In all sixteen tests were performed by Shahawy for comparison with regard to confinement reinforcement.

During testing all of the strands were continuously monitored by linear voltage differential transducers (LVDT). The strains and deflections were also monitored. An important observation for Shahawy was the value of the applied moment at which initial strand slippage occurred. The author reports that although the initial strand slippage occurred shortly after the appearance of the first shear crack, all of the girders continued to carry increasing load until complete bond slip of all strands occurred.

Figure 2.7 presents the results of development testing the AASHTO girders. The green circles encompass the eight points on the graph which represent the tests done on the four girders without any confinement steel. The other points are tests performed on specimen with confinement reinforcement consisting of No. 3 D-bars placed six inches apart for a distance of $1.0h$. The lines presented on Figure 2.7 represent a best fit approximation of the data for reference purposes only. The circles and lines were not a part of the original figure; they were placed by the researchers for visual assistance and understanding to the reader.

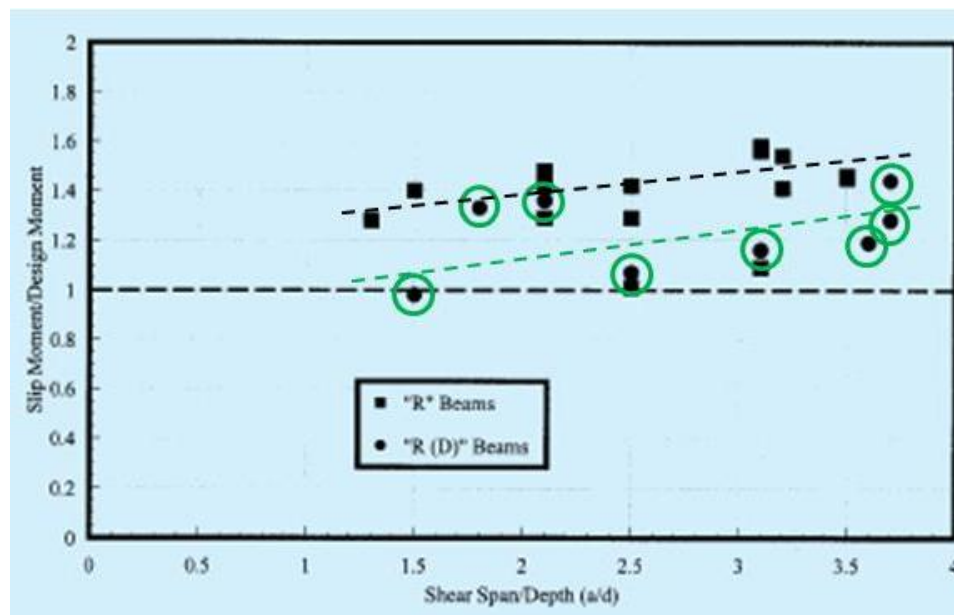

Figure 2.7 Effects of Shear Span to Depth Ratio on Strand Slip (M. Shahawy 2001)

From Figure 2.7 the effects of confinement, as the loading gets closer to the end of the girder, are more pronounced. Intuitively this makes sense. As the bond length of the strand increases, the contribution from confinement reinforcement proportionally

decreases. The author concludes, with respect to the effect of confinement, it was determined that higher strength and higher ductility can be expected with the use of confinement reinforcement in the tension flange. The strength ratios, $M_{\text{applied}}/M_{\text{nominal}}$, were also compared for girders with and girders without confinement. There was high variability in the strength ratio results, but seven of the eight cases showed that the presence of confinement increased the capacity of the tested girders. Overall, on average the actual capacity of girders with confinement steel increased by 23%.

2.3 Vertical Shear Overview

One critical check involved with bridge girder design is the vertical shear capacity of the section with respect to the expected ultimate shear seen by the member over its design life. A shear failure is brittle by nature with little fore warning to the occupants of the structure. Due to its sudden occurrence, shear design equations generally have lower resistance factors applied to them. Although generally not controlling the overall design of bridge girders, due to their long spans, the shear capacity check must be performed on the girders in the pre-composite state for construction loading as well as post-composite, with the decking, for the applied live load from lane loading.

The purpose of the research was to validate current AASHTO LRFD specifications for calculating a bridge girders vertical shear capacity with specific attention to differing levels and distributions of confinement along with the use of 0.7” diameter prestressing strand. The study was not intended to propose a modified AASHTO equation for

calculating the nominal shear resistance of bridge girders. Therefore, the current AASHTO shear resistance equations from Sections 5.8.3 and 5.8.4 will be the basis for justification of all results from testing.

2.3.1 Definition of Vertical Shear

The vertical shear force is defined as the resultant of the stresses acting, and distributed on a given cross section. The resistance of the load by the girder must be provided by the combined contribution from the concrete and vertical shear reinforcement.

2.3.2 Methods of Calculating Vertical Shear Capacity

2.3.2.1 2004 AASHTO LRFD

According to the 2004 AASHTO LRFD Bridge Design Specifications Section 5.8.3.3, the nominal shear resistance of a prestressed concrete section, V_n , is equal to the lesser of:

$$V_n = V_c + V_s + V_p \quad \text{Equation 3 (AASHTO 5.8.3.3-1)}$$

$$V_n = 0.25f'_c b_v d_v + V_p \quad \text{Equation 4 (AASHTO 5.8.3.3-2)}$$

Where:

$$V_c = 0.0316\beta\sqrt{f'_c} b_v d_v \quad \text{Equation 5 (AASHTO 5.8.3.3-3)}$$

$$V_s = \frac{A_v f_y d_v (\cot\theta + \cot\alpha) \sin\alpha}{s} \quad \text{Equation 6 (AASHTO 5.8.3.3-4)}$$

V_p = Effective prestressing force; positive if resisting the applied shear

AASHTO Section 5.8.3.3, from which the previous equations were taken, is a simplified approach for calculating the nominal shear resistance of a prestressed concrete section. Article 5.8.3.1 explains methods for calculating the shear stresses of a section by a more complex detailed section analysis. Shear calculations, performed by the researchers for design and validation of the research specimen, were done by means of the detailed method.

2.3.3 Previous Vertical Shear Research

The following reports present past or current research with respect to confinement reinforcement and its effect on the vertical shear capacity of different bridge girder sections. Many papers present research with regard to anticipating a member's shear capacity, however, no papers on shear without reference to confinement and prestressing will be presented in this section, as they do not assist the researchers or provide any reference of comparable data for the subject being studied.

2.3.3.1 Csagoly (1991)

In excess of 1,300 AASHTO IV beams were prefabricated for the approaches of the Florida Sunshine Skyway Bridge over the Tampa Bay entrance. The end zones of some of these prestressed concrete beams showed honey-combing and cracking, indicating the possibility of reduced shear resistance. Pilot tests which were carried out on two such beams confirmed that possibility. Under the aegis of the Florida Department of Transportation (FDOT), the author performed 16 shear tests on eight AASHTO IV

beams, specially fabricated, in order to determine the cause(s) of the substandard performance observed. The three independent variables involved for review in this study were, a) 50% shielding or no shielding of the strands, b) confinement or no confinement cage in the end zone, and c) coated or uncoated web steel.

The shear span for all 16 tests was 75 inches, or about 1.21 times the structural height of the specimen, including the 54 inch AASHTO beam with an 8 inch deep concrete slab. Regardless of the combination of variables, the failure pattern was observed to be remarkably identical and in all cases, several diagonal web cracks developed, one of which - not necessarily the first or last that had appeared - dilated out-of proportion to the others. That crack, was referred to as the “significant” or "S" crack, completely separated the bottom chord, the web, and bottom part of the top chord (the slab) and was confined by what appeared to be a compression zone.

The "S" crack invariably intercepted the development length, even at times the transfer length of the AASHTO beams. The failure was always precipitated by the slip of strands, after which a considerable resistance had been retained, but the peak value was never regained. An earlier study performed by Maruyama and Rizkalla at the University of Manitoba, also brought attention to the significance of the "S" crack intercepting the strands within the development length.

Where the “S” crack intercepts the development length of the prestressing strands, the bonded or anchored strength of the strands should be calculated on the basis of bond stress distribution between the crack and the end of the beam. Both the 1996 AASHTO Standard Specifications for Highway Bridges and the 2004 AASHTO LRFD Bridge Design Specifications provide only for the transfer and development lengths, and therefore cannot directly be used in conjunction with a mechanical shear model.

Over the years several jurisdictions abandoned the confinement steel, as well as the end block, in order to reduce cost of pre-cast, pre-stressed concrete beams. This change was supported by several tests, either carried out or sponsored by the Portland Cement Association (PCA). The majority of these tests, both static and dynamic, included third-point loading, in which the environment leading to serious inelastic straining of and subsequent shear failure in the end zone may not easily be attained, as the beam tends to fail in flexure.

In an appropriate shear test, the shear span should not normally exceed 2.0 to 2.5 times the structural height (h) of the beam. The Florida DOT tests with a shear span of $1.21h$ were therefore valid shear tests as all beams exhibited pronounced longitudinal cracking at the level of strand rows, as well as at the center line of the bottom of the lower flange. Obviously the cracks observed at the level of strands must have been caused by the wedging or Hoyer effect of the strands.

The author concludes that a plausible explanation for the crack in the bottom is exhibited in Figure 2.8, a strut-and-tie model which can be drawn to approximate the magnitude of the transverse splitting force (T), resulting from the spreading of the reaction force (R) above the bearing.

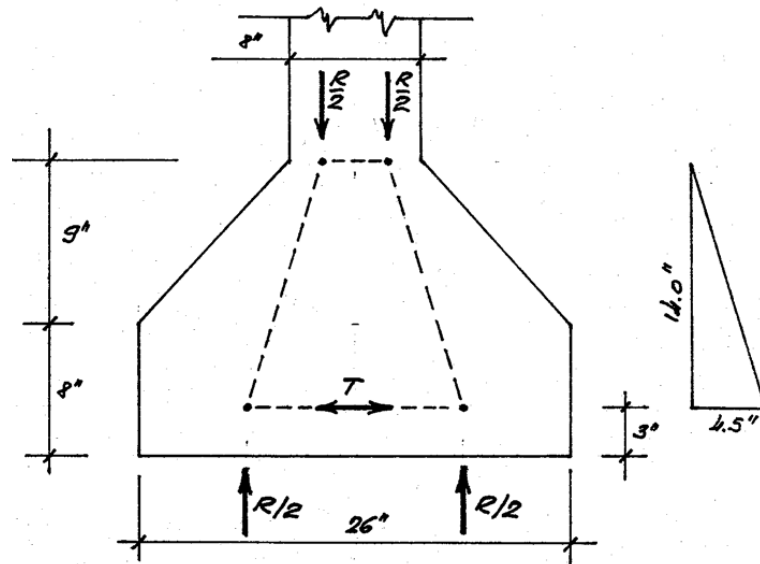

Figure 2.8 Splitting Force in Bearing Area (Csagoly 1991)

By this calculation an AASHTO IV beam would experience a splitting force of $T = 0.161 R$, which translates to 56.3k for a 350k reaction force. This T-force, depending on other factors such as the lateral bearing resistance, resistance by the horizontal stirrup legs and the longitudinal distribution of the T-force, may conceivably cause cracking. If the significant crack penetrates the end zone, where confinement steel is present, such steel is incorporated in the calculated force V_s . Unfortunately; there is no way by which the

enhancement of bond due to confinement may be assessed with complete confidence. Consequently only the direct shear effect of this steel was considered by the author.

Testing found that on average the beams with confinement steel possessed 13.2% more shear resistance than those without any confinement. It is of interest to note that neither the ACI nor AASHTO directly incorporates the effects of confinement steel in the shear design of prestressed concrete beams.

It is often difficult to determine whether failure is precipitated by shear or by the slip of strands. The model assumes that all active strands slip simultaneously. In reality the slip is gradual, one or two strands at a time, always starting at the top row. As the shear resistance depends to a large degree on the compression force, which in turn is being limited by the anchored strand force, a gradual deterioration by slip may lead to what appears to be a genuine shear failure. It is therefore quite conceivable that the two modes do closely interact.

2.3.3.2 Shahawy, Robinson, and deV. Batchelor (1993)

The main objectives of this study was to determine experimentally the actual values of transfer and development lengths of prestressing strands, effect of strand shielding (debonding) on development length, shear and fatigue behavior, and the shear strength as it compares to existing and proposed code provisions. This shear capacity study was particularly significant in light of the then proposed changes to the AASHTO code for the

design of members subject to shear and torsion. This report presented and compared the test results with predictions based on the 1989 AASHTO Standard Specifications for Design of Highway Bridges, the 1990 and 1991(current) Interim Specifications of that code, and the proposed revisions of the code based on the Modified Compression Field Theory (MCFT).

The test program consisted of thirty-three (33) 41 feet long AASHTO Type II prestressed concrete girders, designed in accordance by the AASHTO 1991 Interim Specification with approximately the same ultimate flexural strength (2100 k-ft). Three different size 270 ksi, LRS prestressing strands were used in the investigation; namely, 1/2", 1/2" Special, and 0.6". In addition, the amount of shear reinforcement was varied by changing the area and spacing of stirrups. Shear reinforcement ranged from the minimum (M) steel permitted by AASHTO, to three times (3R) the amount required for the design dead and live loads.

The main variables in the test program were the percentage of shielded strands (25 and 50%), the web shear reinforcement ratio and beam end details, and the size of the prestressing strands. After the precast beams were produced a top flange, 42 inches wide and 8 inches thick, was cast on all the specimens as shown in Figure 2.9.

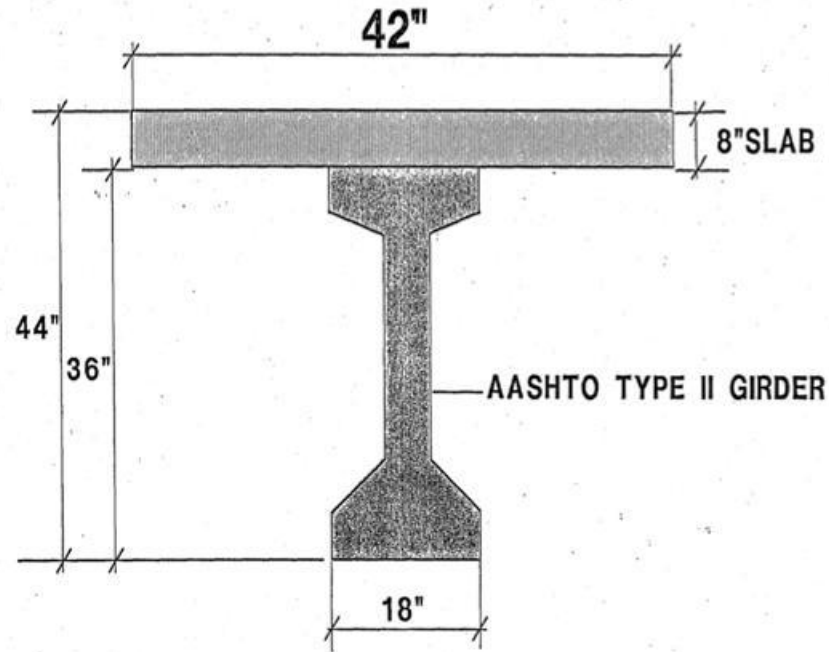

Figure 2.9 AASHTO Beam Cross Section (Shahawy et al. 1993)

The effects of confinement steel were seen by comparing the results for those girders provided with confinement steel against those not provided with such reinforcement. According to AASHTO, the presence or lack of confinement steel does not affect the predicted shear capacities. However, the test results clearly show that test shear strength was reduced when confinement steel was not present.

Ten beams were designed, fabricated, and tested for comparison as beams A0-00R, A1-00R, A2-003R, C0-00R, and C1-00R included confinement, while the corresponding beams A0-00RD, A1-00RD, A2-003RD, C0-00RD, and C1-00RD did not contain any confinement.

The values for the tests shears at both ends of A0-00-R were much greater than the predicted capacities, the ratio of the test values to the AASHTO Code values being 1.41 and 1.25 for the TEST NORTH and TEST SOUTH values, respectively. Comparatively the test shears of beam A0-00-RD were greatly reduced in comparison to A0-00-R. The test shears in the former specimen are approximately equal to the current AASHTO predicted values, the ratios of test capacity to current AASHTO capacity being 1.06 and 1.03 for TEST NORTH and TEST SOUTH, respectively.

The results for specimens A1-00-R and A1-00-RD also show a similar reduction in shear capacity when confinement steel is not present. The shear capacity for A1-00-R with confinement steel is greater than the capacity predicted by the current AASHTO Code, the test to AASHTO ratios being 1.09 and 1.31 for the TEST NORTH and TEST SOUTH, respectively. However, the shear capacity is reduced in beam A1-00-RD, for which, the ratios of the test capacity to AASHTO capacities were 0.93 and 1.19, respectively for the TEST NORTH and TEST SOUTH values. For girders A2-00-3R and A2-00-3RD, as well as C0-00R and C1-00R, the failure mode was that of flexure, and therefore was not able to be compared in shear. Figure 2.10 graphically presents the results from testing of the A-series girders.

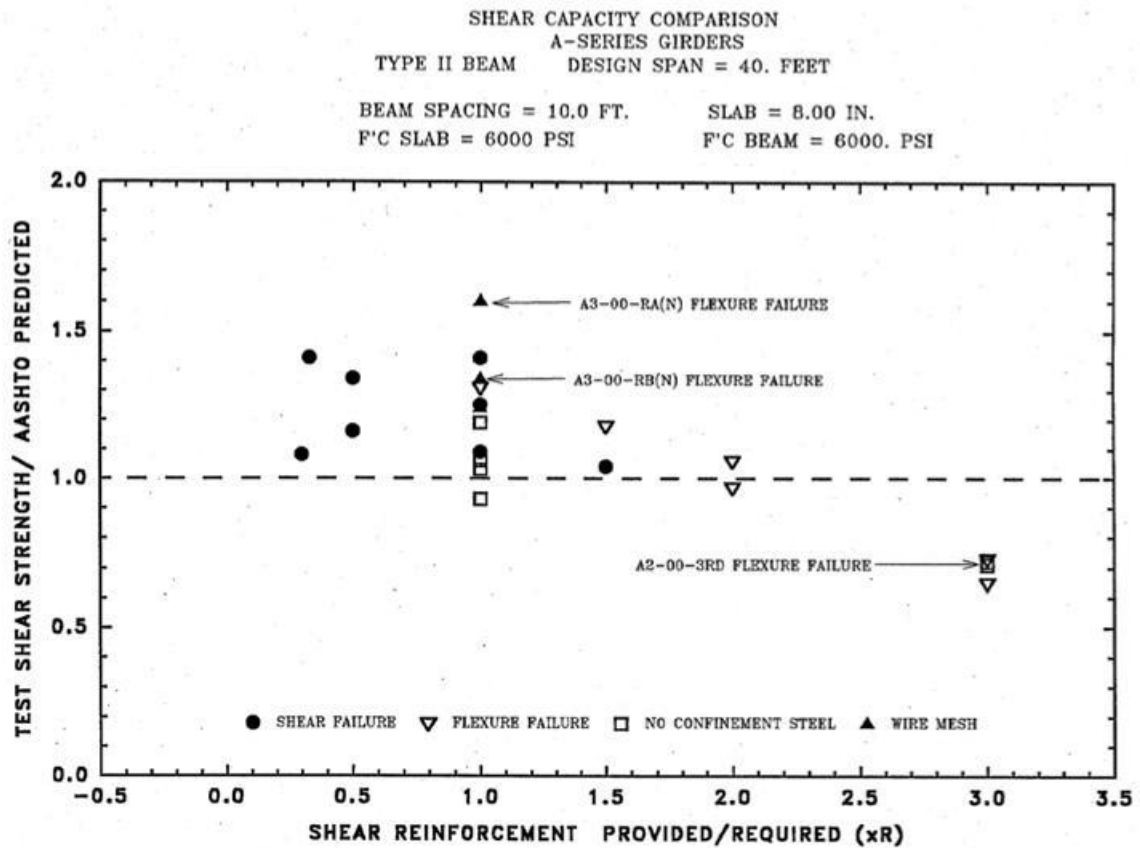

Figure 2.10 Shear Comparison (Shahawy et al. 1993)

From testing, the presence of confinement steel increased the shear capacity for the TEST SOUTH values by 10% from 189k to 208k. Similarly, for the TEST NORTH values, the presence of confinement steel increased the shear capacity by 17% from 179k to 210k.

Another test of note in the study involved girder B1-00-0R, which contained no shear reinforcement. The predicted shear capacities for this beam were 90k for TEST NORTH and 88k TEST SOUTH while the actual shear capacities found for this beam were 166k for TEST NORTH and 155k TEST SOUTH. These figures indicate that the codes

greatly under-predict the shear contribution of the concrete, V_c , to the overall shear strength. The then current AASHTO code gave its best approximation, but even that value was an average of only 54% of the test value.

Notable conclusions from this report were, 1) the provision of confinement steel for the prestressing strands at the end regions of a girder increases their shear capacity, 2) the 1991 AASHTO code predicts shear capacities which are adequate for girders with or without confinement steel, 3) both the current AASHTO code and the proposed code greatly under-estimate the shear strength provided by concrete with the current AASHTO code the less conservative of the two. This study demonstrated the beneficial effect of confinement steel in delaying bond failure of prestressing strands, and in enhancing shear capacity.

2.3.3.3 Ross (2010)

Work has begun at the University of Florida to experimentally evaluate confinement reinforcement in pretensioned concrete girders. The test program is performing full-scale tests on specimen with variable 0.5 and 0.6 in. strand patterns with and without confinement. Figure 2.11 presents the test specimen.

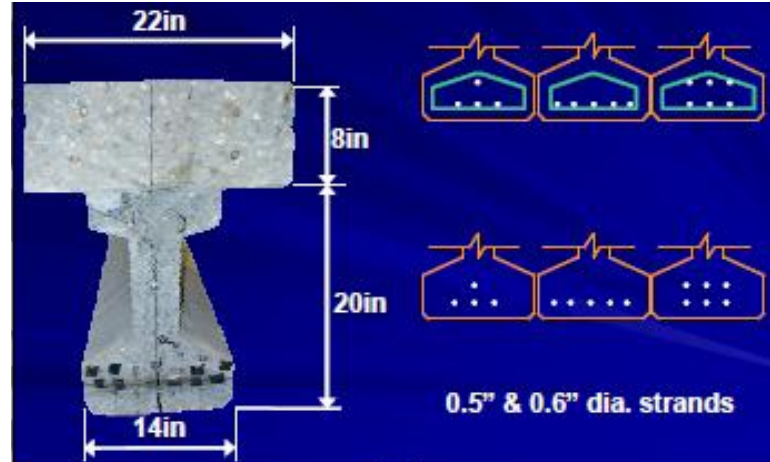

Figure 2.11 Specimen Details (Ross 2010)

In order to test an unconfined section versus confined the end of a pretensioned bridge girder was removed as shown in Figure 2.12 and both ends were tested independently from each other. The supports were placed at 5.5 inches from one end and 11 feet 2 inches from the end support. A single point load was placed at a distance of 2 feet 10 inches from the end of the girder, 2 feet 4.5 inches from the support, for a tested shear span of almost exactly 1.0h.

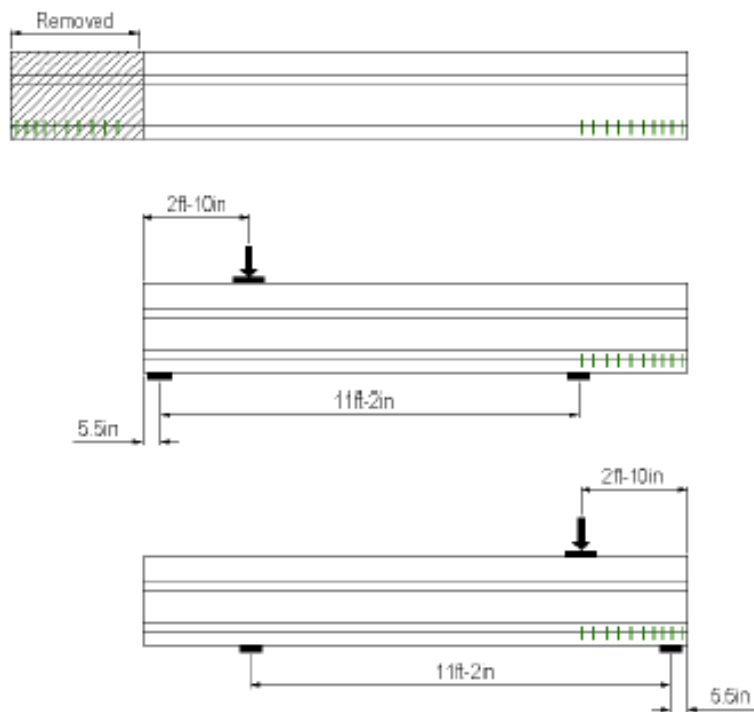

Figure 2.12 Specimen Fabrication and Test Setup (Ross 2010)

Figure 2.13 shows the typical reinforcing and confinement details of test specimens.

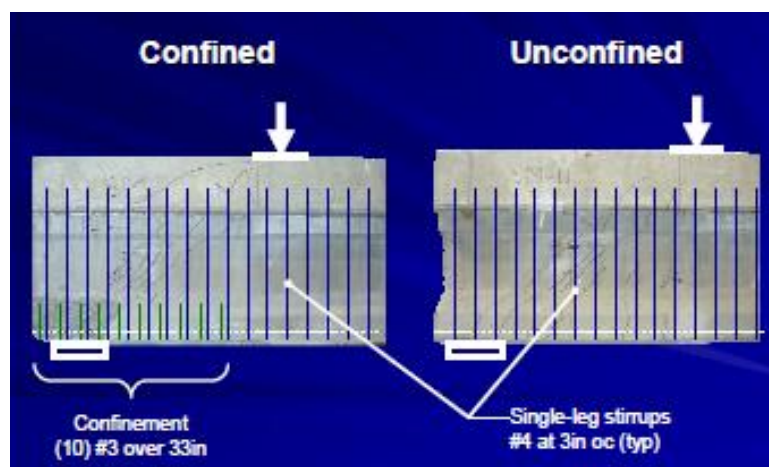

Figure 2.13 Specimen Reinforcement and Confinement (Ross 2010)

The results from testing are presented in Figure 2.14 and Figure 2.15. One preliminary conclusion was that the addition of confinement has negligible effect on the elastic behavior of the test girders. Another conclusion was that the confinement reinforcement has negligible effect on the initial strand slip, but does aid in maintaining the strand capacity after the initial slippage.

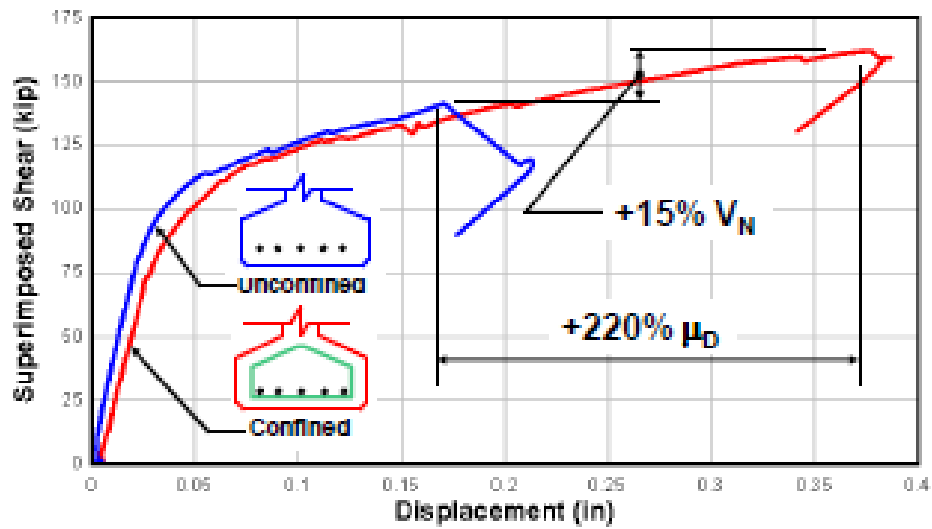

Figure 2.14 Shear vs. Displacement (Ross 2010)

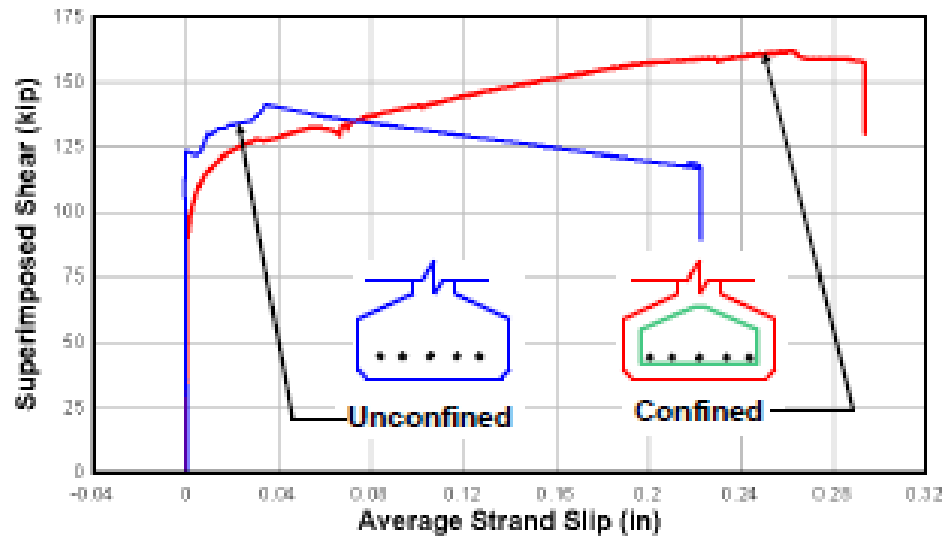

Figure 2.15 Shear vs. Strand Slip (Ross 2010)

Two notable conclusions from the initial test results at the University of Florida are: 1) the incorporation of confinement steel as prescribed by AASHTO LRFD Section 5.10.10.2 increases the shear capacity of the given girder by approximately 15% and 2) the overall ductility of the structure significantly increases, with the confined beam experiencing a deflection of 200% to that of the unconfined.

Future work at the university will include full-scale testing of more girders as well as an analytical investigation incorporating finite element modeling for comparison and justification of the test data.

3 ANALYTICAL & EXPERIMENTAL INVESTIGATION

3.1 Analytical Investigation

3.1.1 Concrete Strength

The effects of confinement on the compressive strength of concrete has been observed and documented by many researchers. It makes logical sense that if you confine Material A with another stronger material, Material B, and then measure the axial force required to yield Material A, that force should be higher than the same test performed on Material A without the benefit of any confinement. By resisting the lateral displacement of the confined material, an increase in its overall strength can be achieved. Figure 3.1 presents a stress-strain diagram for confined and unconfined concrete.

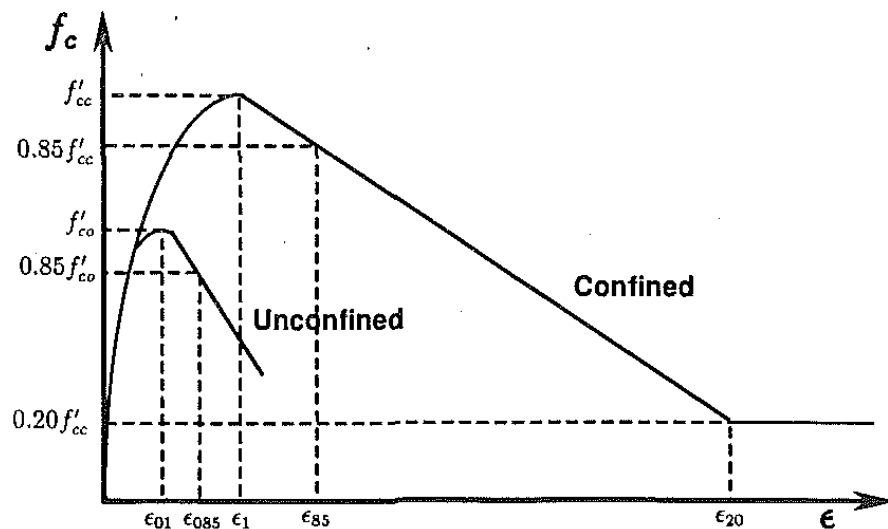

Figure 3.1 Proposed Stress-Strain Relationship (Saatcioglu and Razvi 1992)

Research was done in the early 1990's by Saatcioglu and Razvi on the subject of concrete confinement and its effects on the overall compressive strength of concrete. They tested ninety-seven specimens, with varying cross-sections, and derived an equation to calculate the concrete strength of a confined specimen. Their research found the general equation for confined concrete to be:

$$f'_{cc} = f'_{co} + k_1 f_{le} \quad \text{Equation 7}$$

The term f'_{co} is taken as:

$$f'_{co} = f'_c MF \quad \text{Equation 8}$$

The unconfined concrete strength may be different than that obtained from standard cylinder testing. A modification factor, MF, may need to be applied to adjust the cylinder results to a better approximation of f'_{co} . Modification factors from 0.85 to 1.00 have been documented in literature. All sample calculations for the research will use an MF of 1.00, therefore standard cylinder test results can be used directly.

Where the coefficient k_1 was calculated as:

$$k_1 = 6.7(f_{le})^{-0.17} \quad \text{Equation 9}$$

The term f_{le} , which represents the uniform confining pressure, for a square section is:

$$f_{le} = \frac{\sum A_s f_{yt} \sin \alpha}{s b_c} k_2 \quad \text{Equation 10}$$

Whereas for a rectangular section, the f_{le} term is calculated as:

$$f_{le} = \frac{f_{lex}b_{cx} + f_{ley}b_{cy}}{b_{cx} + b_{cy}} k_2 \quad \text{Equation 11}$$

The k_2 term is used to reduce the average lateral pressure for concrete which has large spacing between lateral reinforcement. For cases with closely spaced lateral reinforcement k_2 is equal to 1.0. For our calculations the strands, which are spaced at two inches horizontally and vertically, will be considered the longitudinal reinforcement and k_2 will be set at 1.0, which is the most conservative case. Figure 3.2 presents the distribution of lateral pressure from the confined concrete to the reinforcement. It also explains the calculation of f_l for the steel.

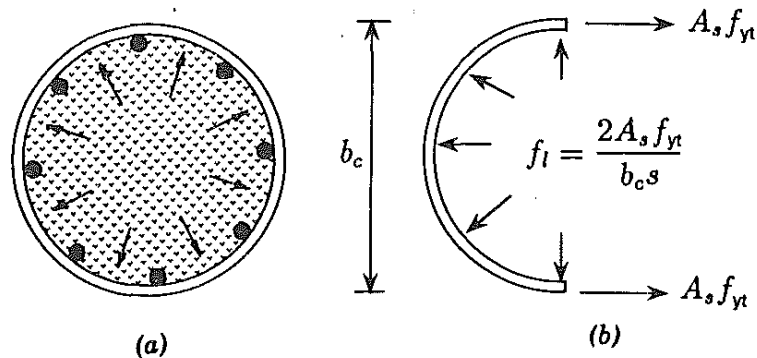

Figure 3.2 Computation of Lateral Pressure from Hoop Tension (Saatcioglu and Razvi 1992)

Figure 3.3 presents the lateral distribution between the ties of a rectangular member. From the figure, it can be seen that the pressure is dependent on the longitudinal

reinforcement. This is where the k_2 term becomes relevant. The actual calculation of k_2 is:

$$k_2 = 0.26 \sqrt{\frac{b_c b_c}{s s_1} \frac{1}{f_l}} \quad \text{Equation 12}$$

In the k_2 equation, s_1 is the spacing between the lateral reinforcement. As the lateral spacing increases, the term k_2 decreases.

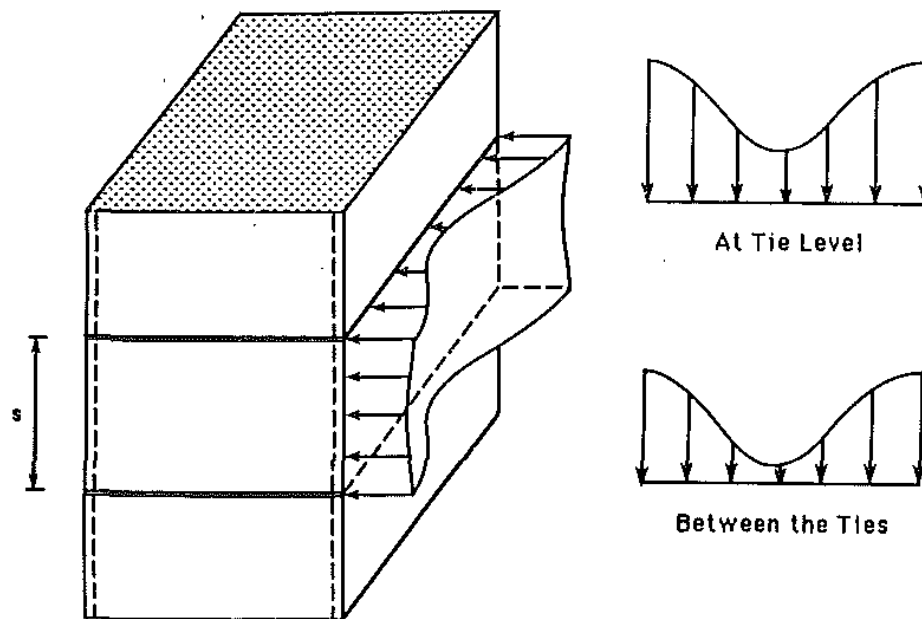

Figure 3.3 Distribution of Lateral Pressures (Saatcioglu and Razvi 1992)

Knowing of the phenomena introduced by confinement, the researchers looked into what effect the bottom flange confinement reinforcement had on the actual strength of the concrete surrounding the prestressing steel of bridge girders. The two types of girders that were looked at were the shapes to be utilized for the experimental work. The first is

a tee girder and the second is an NU I-girder. Figure 3.4 and Figure 3.18 present those two cross-sections. Using the equations derived by Saatcioglu and Razvi along with confinement specifications prescribed in AASHTO 5.10.10.2, Table 3.1 presents the results from confinement on both girder sections.

Table 3.1 Confined Concrete Strength

T24			NU1100		
f'_{co}	8,000	psi	f'_{co}	10,000	psi
k_1	2.12		k_1	2.84	
k_2	1.00		k_2	1.00	
f_1	880	psi	f_{lex}	157	psi
A_s	0.22	in ²	A_s	0.22	in ²
f_{yt}	60,000	psi	f_{yt}	75,000	psi
b_c	5.00	in	b_{cx}	35.00	in
s	6.0	in	s	6.0	in
			f_{ley}	917	psi
			A_s	0.22	in ²
			f_{yt}	75,000	psi
			b_{cy}	6.00	in
			s	6.0	in
			f_{le}	268	psi
f'_{cc}	9,862	psi	f'_{cc}	10,446	psi
f'_{cc} / f'_{co}	1.23		f'_{cc} / f'_{co}	1.04	

The T24 concrete strength was calculated using confinement for a square section, while the NU1100 was calculated with a rectangular section. There is quite a difference in the effects from confinement on the two different sections. Initially the effects from confinement on the T24 section look good, but the final ratio presents a maximum case, which may never exist in the life of the girder as it takes into account three assumptions. The first assumption for both girders is that the confinement reinforcement has reached

yielding. The second assumption is that the k_2 factor is indeed 1.0. The third is that the MF factor for f'_{co} is 1.0. With all three assumptions, then the concrete strength could possibly reach a confined strength presented in Table 3.1.

Also, the overall effects from confinement are drastically reduced for larger I-girder or box cross-sections. Taking into account the assumptions and standard deviation between specimens, the equations presented show there is no significant increase in the confined concrete strength of those members. From these results, the researchers concluded that there is no conclusive evidence supporting a significant effect from confinement on the concrete strength around the prestressing strands. This is mainly due to the relatively small amount of confinement around a very large area, without the presence of any longitudinal reinforcement.

3.1.2 Transfer & Development Length

Through the years quite a little research has been done on the subject of prestress transfer and the development length of prestressing strands. Many new equations for both transfer and development lengths have been derived and proposed. Neither the current AASHTO equations, nor any proposed equations for transfer or development, take into account any effect from confinement reinforcement. Interestingly enough, the ACI-318-08 specification does include a variable, K_{tr} , which does account for transverse reinforcement in the development of longitudinal reinforcing bars.

$$K_{tr} = \frac{40A_{tr}}{s n} \quad \text{Equation 13 (ACI 318-08 12-2)}$$

$$l_d = \left(\frac{3}{40} \frac{f_y}{\lambda \sqrt{f'_c}} \frac{\Psi_t \Psi_e \Psi_s}{\left(\frac{c_b + K_{tr}}{d_b} \right)} \right) d_b \quad \text{Equation 14 (ACI 318-08 12-1)}$$

Table 3.2 presents some of the more recently developed equations for transfer length and development length. None of the selected equations proposed by Ramirez and Russell, Kose and Burkett, Lane, or Mitchell include a term for confinement, but all do include either an initial concrete strength, f'_{ci} , or a final concrete strength, f'_c .

Table 3.2 Transfer Length and Development Length Equations

AASHTO Standard	$L_t = 50d_b$	$L_d = \frac{f_{se}}{3} d_b + (f_{ps} - f_{se}) d_b$
AASHTO LRFD	$L_t = 60d_b$	$L_d = 1.6 \left(f_{ps} - \frac{2}{3} f_{se} \right) d_b$
Ramirez and Russell (2007)	$L_t = \left(\frac{120d_b}{\sqrt{f'_{ci}}} \right) \geq 40d_b$	$L_d = \left(\frac{120}{\sqrt{f'_{ci}}} + \frac{225}{\sqrt{f'_{ci}}} \right) d_b \geq 100d_b$
Kose and Burkett (2005)	$L_t = 95 \frac{f_{pt}(1-d_b)^2}{\sqrt{f'_c}}$	$L_t = \left[95 \frac{f_{pt}(1-d_b)^2}{\sqrt{f'_c}} \right] + \left[8 + 400 \frac{(f_{pt} - f_{se})(1-d_b)^2}{\sqrt{f'_c}} \right]$
Susan Lane (1998)	$L_t = \left(\frac{4 \cdot f_{pt} d_b}{f'_c} - 5 \right)$	$L_d = \left(\frac{4 \cdot f_{pt} d_b}{f'_c} - 5 \right) + \left(\frac{6.4(f'_c - f_{se})}{f'_c} + 15 \right)$
Mitchell et al (1993)	$L_t = 0.33 f_{pt} d_b \sqrt{\frac{3}{f'_{ci}}}$	$L_t = 0.33 f_{si} d_b \sqrt{\frac{3}{f'_{ci}}} + (f_{ps} - f_{se}) d_b \sqrt{\frac{4.5}{f'_c}}$

Although some of the recent research proposing new equations for the AASHTO development and transfer lengths do include a term for the strength of the concrete, it is the opinion of these researchers that the confinement reinforcement in the bottom flange of bridge girders has an insignificant effect on either the current AASHTO LRFD transfer or development equations due to the minimal impact on the concrete strength around the strands, as explained in the previous section.

3.2 Experimental Investigation

This section presents the tested specimen and corresponding results from the PKI structures lab in Omaha, Nebraska.

3.2.1 Girder Design, Fabrication, and Test Setup

3.2.1.1 T24 Girder Design

Eight twenty-eight foot long tee-girders were designed for testing the effects of confinement reinforcement on the transfer length, development length, and shear capacity using different confinement patterns with different concrete strengths. Each girder was pretensioned with six 0.7" diameter Grade 270 low-relaxation strands, stressed to 75% f_{pu} (59.5 kips), distributed in two rows (3 strands each) with 2" horizontal and vertical spacing as shown in Figure 3.4. The overall depth of each girder was 24"; each had an 8" wide web and a 32" wide top flange. The overall length of the T24 girders was chosen with respect to satisfaction of AASHTO LRFD Equation 5.11.4.2-1. Using a strain compatibility analysis of the section to determine the stress in the girders strands, found

Appendix A, and then incorporating those values into the mentioned equation, the length required to fully develop the 0.7" diameter strands was:

$$1.6 \left[265 - \frac{2}{3} 170 \right] 0.7 = 170" = 14.1' \quad \text{Equation 15}$$

Therefore, satisfaction of the strands full development could be achieved if the specimen were twenty-eight feet in length, tested at their mid-span, and the section reached its nominal flexural capacity.

An 8 ksi self consolidating concrete (SCC) mix was specified for design and fabrication while four 0.6" diameter strands, stressed to 7.5% f_{pu} (3.2 kips), were used in the top flange to control cracking at release. Shear reinforcement of two WWR sheets of D20@12", Grade 75, was calculated and incorporated in the design to ensure that the girders reached their ultimate flexural capacity prior to their shear capacity. End zone reinforcement of two 0.5" coil rods were welded to the 0.5" bearing plate at each girder end to control cracking due to bursting force. Transverse top flange reinforcement consisted of #3 Grade 60 bars placed at twelve inch intervals. Figure 3.4 shows the typical dimensions and reinforcing details of the T24 girder test specimens.

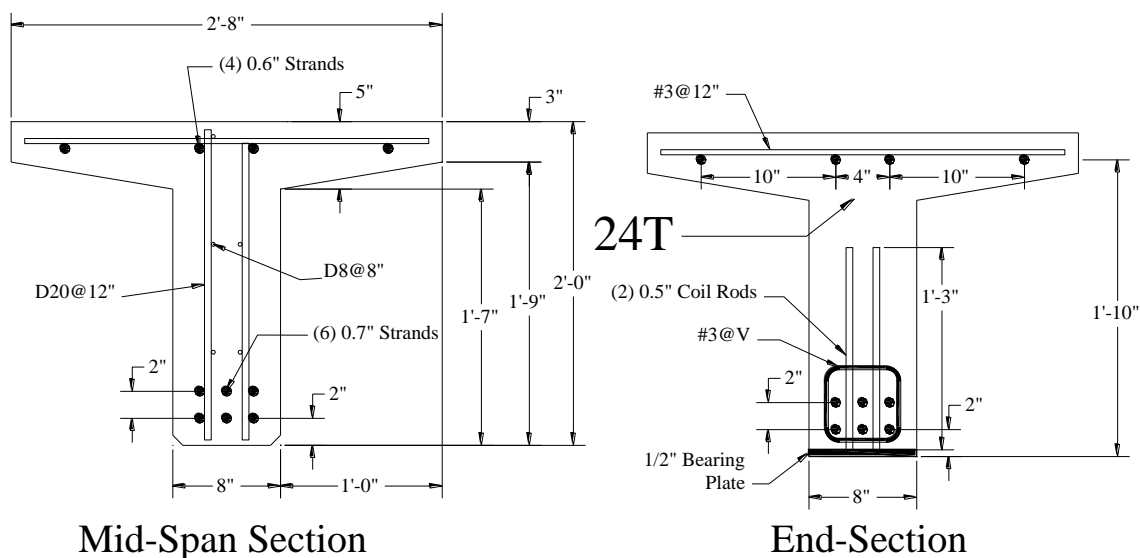

Figure 3.4 Cross Section of T24 Girder

To evaluate the effect of confinement reinforcement, No. 3, Grade 60, 5" x 5" square confinement ties were used in all specimens at variable spacing (V) along a distance (L). Figure 3.5 shows these parameters on the side view of the T24 specimen, while Table 3.3 lists the values of these parameters in the eight specimens. It should be noted that the 2004 AASHTO LRFD confinement reinforcement was used as the base confinement in all comparisons. Table 3.3 also presents the girder designation used for comparison, which was set up as follows: Girder Shape - Confinement Spacing - Confinement Distribution Distance - Concrete Strength Designation (A for 13,500 psi, B for 11,900 psi, C for 9,000 psi, and D for 11,200 psi).

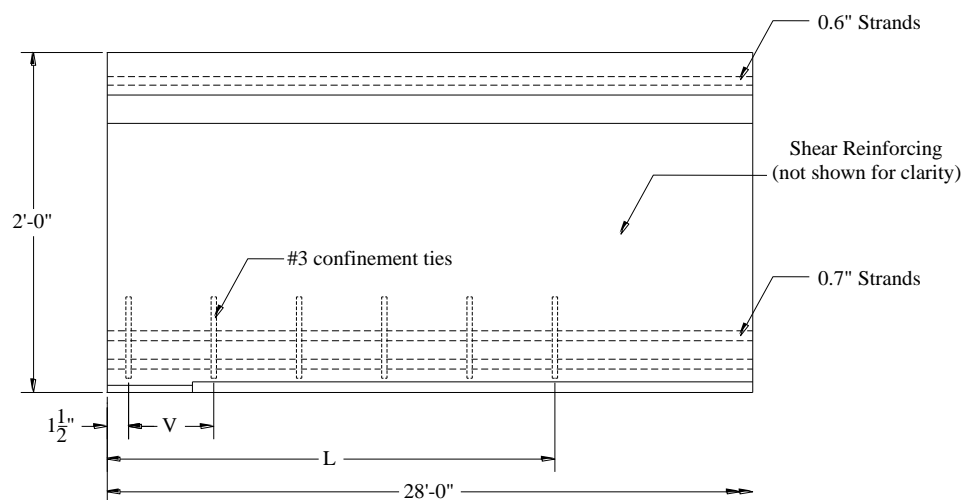

Figure 3.5 T24 Confinement Reinforcement Distribution

Table 3.3 T24 Girder Designation and Confinement Reinforcement

Test		Confinement			
Number	Girder Designation	Size	No. per end	Spacing-V (in)	Distribution-L (in)
1	T-6-1.5h-A	#3	6	6.0	36.0
2	T-6-0.5l-A	#3	28	6.0	168.0
3	T-6-1.5h-B	#3	6	6.0	36.0
4	T-4-1.0h-B	#3	6	4.0	24.0
5	T-6-1.5h-C	#3	6	6.0	36.0
6	T-4-1.0h-C	#3	6	4.0	24.0
7	T-12-0.5l-D	#3	14	12.0	168.0
8	T-4/6-1/1.5h-D	#3	6	4.0 / 6.0	24.0 / 36.0

3.2.1.2 T24 Girder Fabrication

The eight T24 girders were fabricated and cast in the prestressing bed at the PKI structural laboratory on the University of Nebraska-Omaha campus. Expanded Polystyrene (EPS) forms were used to form the eight girders because of their ease of

setup, stripping, mobility, and light weight. A layer of plastic sheeting was used to cover the prestress bed floor and the EPS forms so they could be used for multiple pours.



Figure 3.6 T24 End Confinement

The fabrication sequence for the T24 girders proceeded as listed:

- 1) Plastic sheeting was placed on the floor of the prestressing bed.
- 2) Chamfer was stapled to the bed to secure the plastic and provide adequate spacing for the forms.
- 3) Six 0.7" diameter strands were threaded the length of the prestress bed, through the end plates and confinement loops.
- 4) Each strand was chucked at both ends and tensioned to 75% f_{pu} .
- 5) The confinement was tied to the six now stressed bottom strands.
- 6) Four 0.6" diameter strands were threaded for location in the top flange.
- 7) Vertical shear reinforcement was then tied to the bottom and top strands.

- 8) Transverse flange reinforcement was placed and tied to the top of the top strands.
- 9) The EPS formwork was placed under the extended plastic and secured with bracing.
- 10) The plastic was smoothed and attached to the foam. All joints were secured from leaking.

Figure 3.6 shows an end of a T24 girder with the confinement and shear reinforcement tied in, prior to the EPS forms being secured. Figure 3.7 shows the final setup of the EPS forms prior to placement of the concrete.

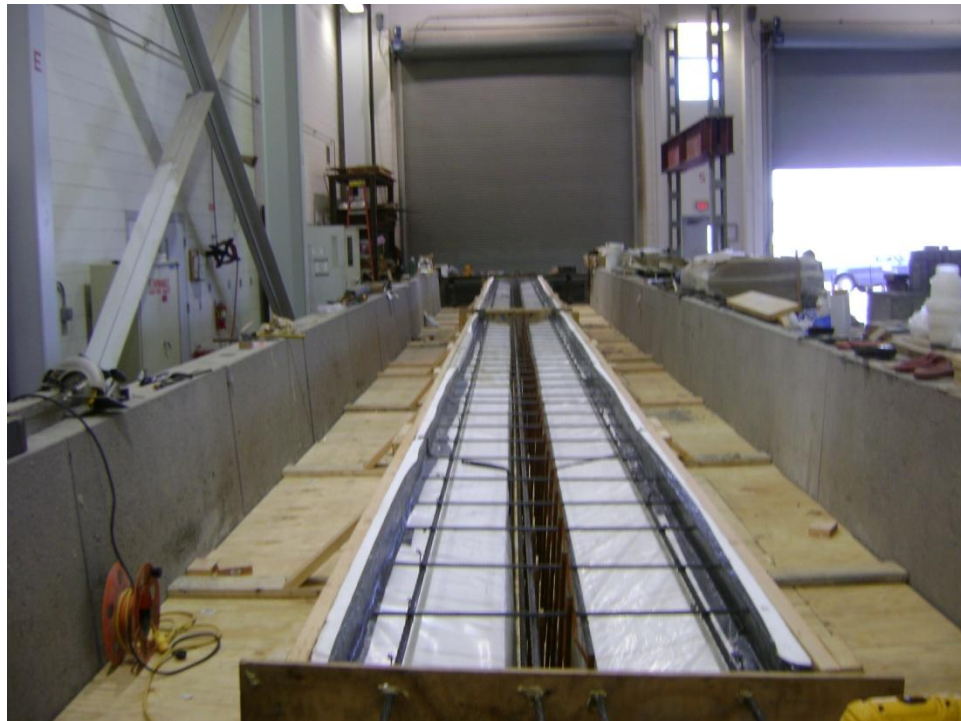

Figure 3.7 T24 Forming

The concrete was delivered to the structures lab at PKI and upon arrival a spread diameter test was performed. A high range water reducer was added to the batch at the lab in order to provide a minimum 24” spread of the mix to increase flowability as seen in Figure 3.8.



Figure 3.8 T24 Concrete Spread

This step was added to ensure an unvoided concrete girder could be produced with little finish work and no vibration. Figure 3.9 shows finishing of one of the T24 girders in the structures lab at PKI. Four inch cylinder specimens were taken from each batch for testing of the concrete strength at release and on the day of testing. Burlap was placed over the forms after finishing off the tee girders and was kept moist during curing for a minimum of two day. After three days the concrete reached the desired initial strength,

f'_{ci} , and the prestress force was gradually released from the prestress bed and the strands were cut.



Figure 3.9 T24 Finishing

3.2.1.3 T24 Girder Test Setup

The following sections discuss the setup and procedure followed with regards to testing the T24 girders.

3.2.1.3.1 Transfer Length

To measure the transfer length from the prestressing strands in the T24 girders, a series of Detachable Mechanical gauges (DEMEC gauges) were placed starting 1" from each

girder end at an elevation equal to the centroid of the prestressing force. The DEMEC gauges were spaced at approximately 2 inches, over a distance of 44 inches, at which time the spacing changed to approximately 4 inches for another 32 inches. Those measurements were based on the expected AASHTO LFRD transfer length of 42 inches, from Section 5.11.4.1, and a maximum possible transfer length of $100d_b$ or 70 inches. Figure 3.10 provides a drawing of the DEMEC gauge layout.

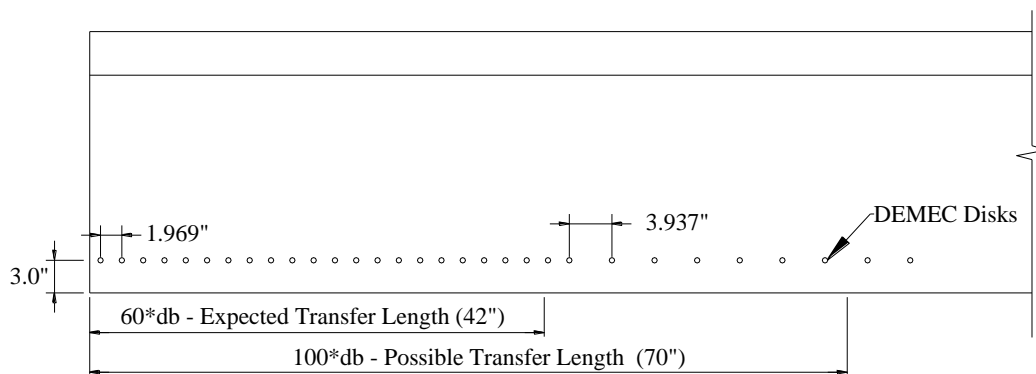

Figure 3.10 T24 Transfer Length Test Setup

DEMEC readings were taken before release of the prestress force, immediately after release (1-day), three days after release, and 14 days after release using a W.H. Mayes & Son caliper gauge as shown in Figure 3.11. The change in the measured distance between DEMEC gauges was used to calculate the surface strain of the concrete at the girders' different age.



Figure 3.11 Measuring Strain in Concrete for Transfer Length Estimation

The 95% AMS Method was then utilized, with the measured data, to calculate the transfer length of the prestress force into the girder.

3.2.1.3.2 Development Length

To determine the effects from confinement on the development length of the T24 specimen, a single point load was applied to the top flange at mid-span of the fabricated girders as shown in Figure 3.12 and Figure 3.13. The bearing rollers were located at a distance of three inches in from the end of the girder, creating an overall unsupported span of 27'-6". The loading location was chosen to satisfy current AASHTO specifications for required length to fully develop prestress strand, as described in previous Section 3.2.1.1. The applied load and corresponding mid-span vertical deflection were monitored and recorded as the load increased up to failure.

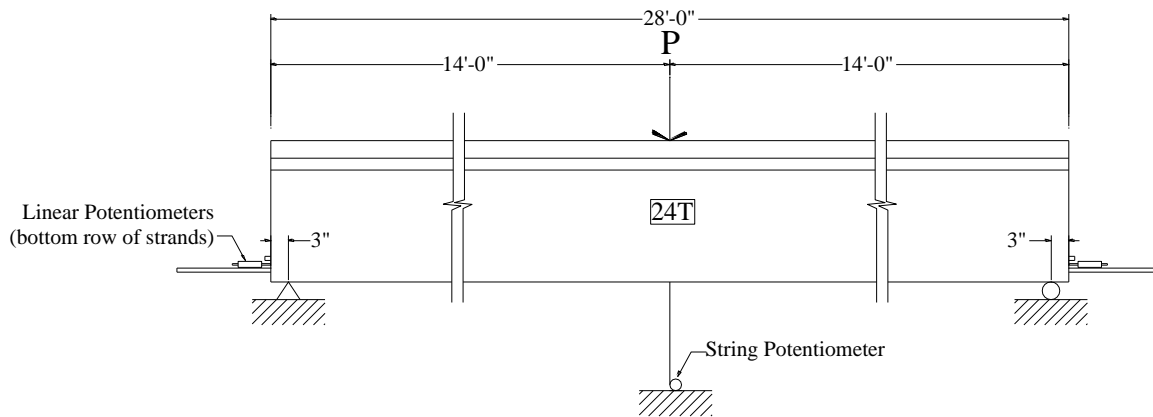

Figure 3.12 T24 Development Length Test Setup (CAD)

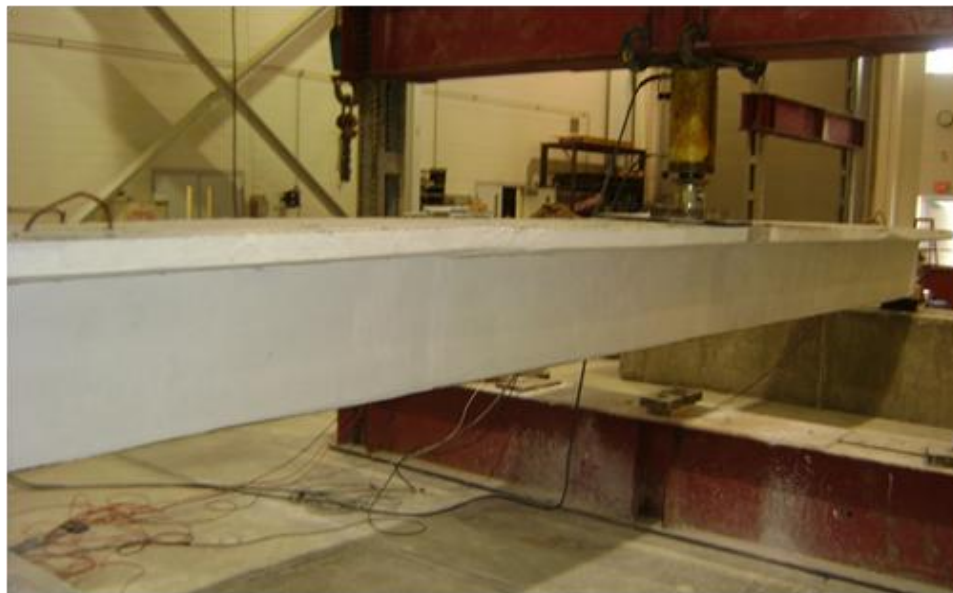

Figure 3.13 Development Length Testing Setup

While testing, each girder was visually inspected and cracks were periodically marked to identify the failure mode. Also, bottom strand slippage was monitored using six potentiometers (three at each girder end), as shown in Figure 3.14.



Figure 3.14 Potentiometers Attached to the Bottom Row of Strands

3.2.1.3.3 Vertical Shear

Four tests were performed on two of the eight T24 girders. The girders were loaded at a distance of $2.08h$ from the end support. This distance, for loading, was chosen based on previous shear testing research and reporting on appropriate shear spans. (Csagoly 1991)

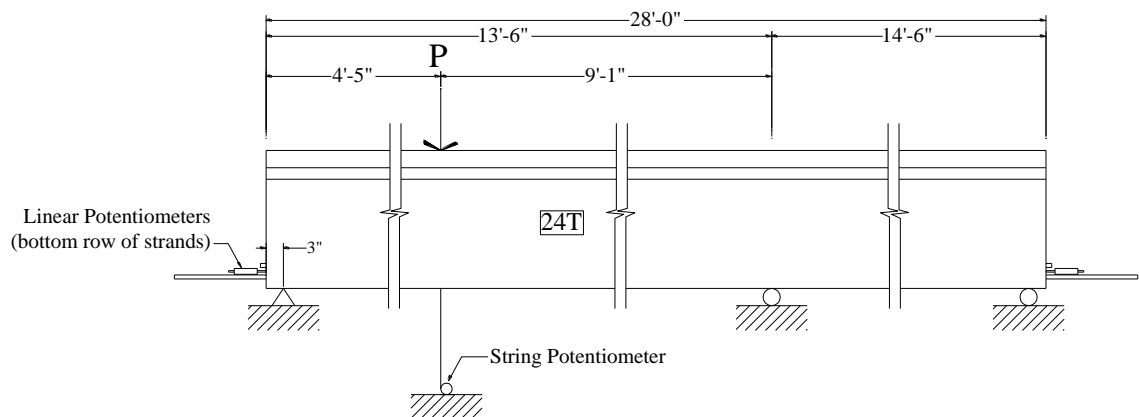

Figure 3.15 T24 Vertical Shear Test Setup (CAD)

Figure 3.15 presents the CAD drawing for setup of the tests, while Figure 3.16 presents an image of the setup prior to one of the tests. The overall span of the girders for the shear tests was reduced to 13'-6". This was done in order to perform two tests, one on each end, of the two T24 girders. Also, these girders were first tested for development; consequently the mid section of the tee girders was damaged from the previous test. By moving the support near the mid-span of the girder, the damaged portion at the new support location would see no moment and roughly one third of the shear from the applied loading.



Figure 3.16 T24 Vertical Shear Test Setup

While testing, each girder was visually inspected and cracks were periodically marked to identify the failure mode. Also, bottom strand slippage was monitored using three potentiometers on the tested end as shown in Figure 3.17.

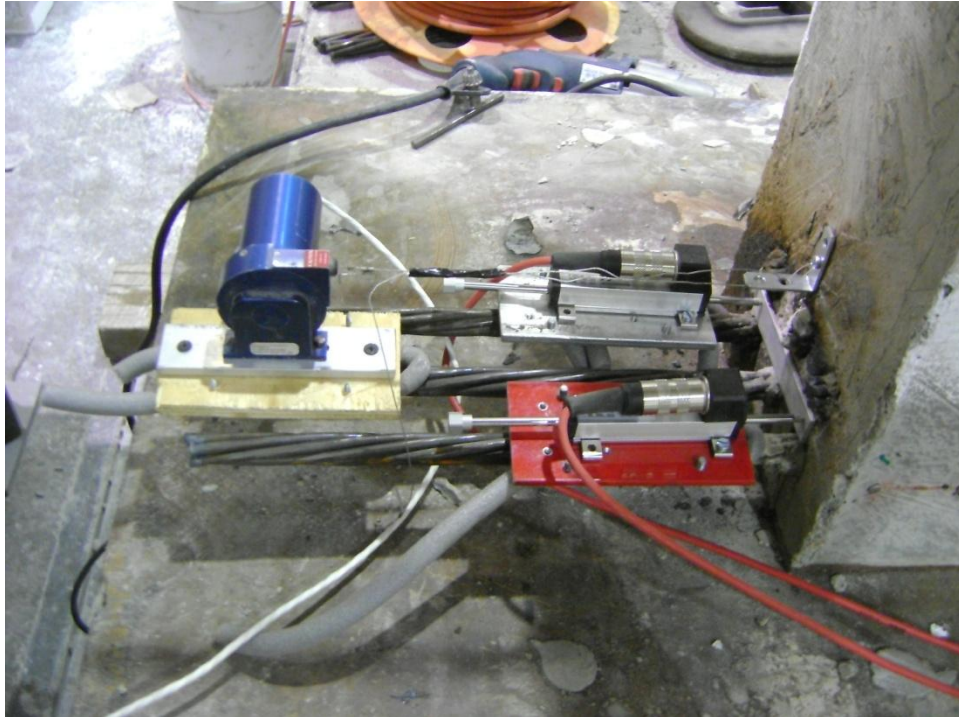

Figure 3.17 Vertical Shear Test Strand Instrumentation

3.2.1.4 NU1100 Girder Design

Three forty foot long NU1100 girders were designed by the researchers for testing the effects of confinement reinforcement on the transfer length, development length, and shear capacity of commonly specified bridge girders in the state of Nebraska. The depth of the NU1100 girder is 43.3"; they have a 5.9" wide web, a 38.4" wide bottom flange and a 48.2" wide top flange.

Each girder was pretensioned with thirty-four 0.7" diameter Grade 270 low-relaxation strands, stressed to 75% f_{pu} (59.5 kips), distributed in three rows with eighteen in the bottom, fourteen in the middle, and two strands in the top row at 2" horizontal and vertical spacing as shown in Figure 3.18. Four 0.5" diameter strands were placed and fully stressed to 75% f_{pu} (30.9 kips), in the top flange of the girders to control cracking upon release of the prestress force. As designed for all three NU specimens, one end of the girders had eight strands debonded. The end designated with the debonded strands was to be used during the shear testing of the girders. This criterion was implemented as it is common practice for bridge girders designed in the state of Nebraska to have debonded strands on each end, in lieu of draping them. There were four debonded strands in the bottom row for a distance of 3.5 feet, and four strands debonded in the middle row for a distance of 7 feet. Figure 3.18 designates the specified debonded strands with a box.

Each girder was designed with a 0.5" by 36" by 18" bearing plate at each end. Eight 0.5" diameter by 5" steel studs were welded to the bearing plates, along with four 0.75" by 46" coil rods with nuts which extended through the top flange into the decking. The shear reinforcement was consistent for all three girders. Two layers of Grade 75 welded wire mesh D20@2" were placed throughout the web with 1.125" clearance to the edge. Additional WWM reinforcing steel, Grade 75, placed in the top flange of the NU1100's consisted of D20@12" transverse and D20@6" longitudinal to reduce concrete stresses and cracking upon release.

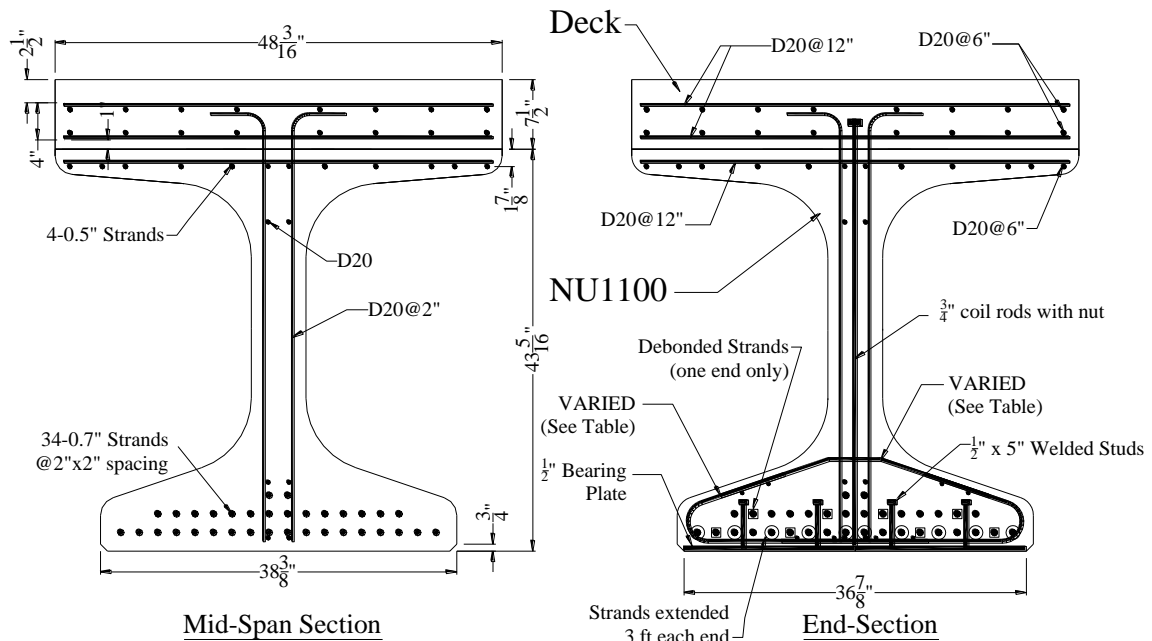

Figure 3.18 Cross Section of NU1100 Girder and Deck

The overall length of the NU1100 girders, forty feet, was chosen as to successfully perform a development length test on one end and a shear test on the opposite. It was necessary for the girders to be long enough to test one end while not yielding any of the elements in the opposite end. Limits imposed on the researchers by the structural lab equipment also contributed to the specification of the girder section and overall length.

Figure 3.19 provides the detail used by the researchers for comparison on the project. The bottom pieces of the confinement were made up of either D4 or D11 Grade 75 mesh, while the cap bar always consisted of a #3 Grade 60 bent bar. One detail provided to the fabricator for incorporation into the girders was specified by the 2008 NDOR BOPP, one

came from AASHTO LRFD Section 5.10.10.2, and the third was a combination of the first two.

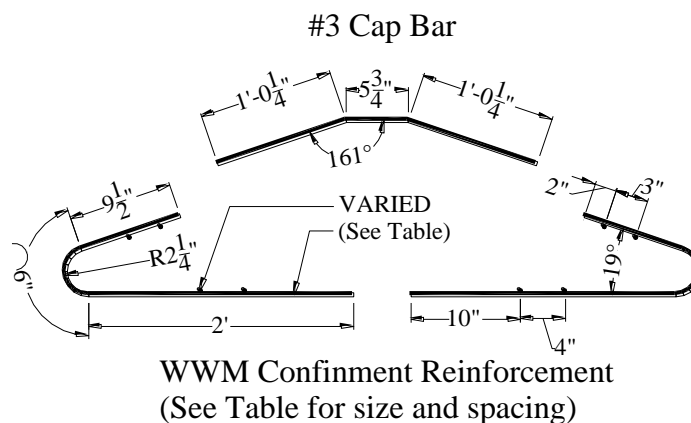

Figure 3.19 NU1100 Confinement Reinforcement Detail

Although both ends of each girder were provided the same confinement reinforcement detail, to evaluate the effect of confinement reinforcement each NU1100 was designed with a different amount and distribution of confinement. Table 3.4 presents the confinement reinforcement and cap bar placement specific to each girder.

Table 3.4 NU1100 End Confinement

Girder Designation	Specified Confinement	Confinement Reinforcement	
		WWM	Cap Bar
1	2008 NDOR BOPP	D4 @ 4" entire length	#3 @ 12" entire length
2	2004 AASHTO LRFD	D11 @ 6" for 72" each end	#3 @ 6" for 72" each end
3	AASHTO + NDOR	D11 @ 6" for 72" each end D4 @ 4" middle	#3 @ 6" for 72" each end #3 @ 12" middle

The concrete specified for girder design and fabrication was a SCC mix with a minimum strength at release of 7.8 ksi, and an f'_c at twenty-eight days of 10 ksi.

The design of the NU1100 specimen incorporated the addition of a concrete deck to be placed prior to any testing. The deck was designed to be 7.5" thick, the full width of the girders' top flange. The deck concrete was specified to have a final strength of 8 ksi, which was done to simulate a 7.5" deck comprised of 4 ksi concrete for a girder with eight foot spacing. Welded wire mesh was used for reinforcing the deck as two rows of D20@12" transverse and D20@6" longitudinal steel sheets were placed the length of the girder.

3.2.1.5 NU1100 Girder Fabrication

Three NU1100 girders topped with 7.5" of decking were fabricated at Coreslab Structures in Bellevue, Nebraska. The details of the three girders were provided to the prestress company by the researchers in preparation of ordering materials and scheduling manufacture. The placement of the reinforcing steel, as well as the casting process was monitored by researchers at the university. Figure 3.20 presents the girders after the shear and confinement reinforcement was set, prior to placement of the forms' sides. Figure 3.21 shows the confinement reinforcement placed for girder three, which is a combination of AASHTO requirement for the first six feet and the NDOR detail in the middle.



Figure 3.20 NU1100 Reinforcement



Figure 3.21 NU1100 Confinement Reinforcement

Figure 3.22 is of pouring the three NU1100 girders at the precast plant and Figure 3.23 presents the girders after removal of the forms, prior to release of the prestress force by means of flame cutting the strands.



Figure 3.22 NU1100 Pouring

Upon release and after removal of the girders from the precast bed, forming for placement of the deck began. Figure 3.24 shows the girders post deck forming and placement of the reinforcing steel. Figure 3.25 an image of the workers placing the decking on top of the NU1100 girders. Four inch cylinders were taken at the time of concrete placement for the girders and decking and strengths were checked at release at the plant and at the structures lab on the day of testing the each girder.



Figure 3.23 NU1100 at Release



Figure 3.24 NU1100 Deck Forming

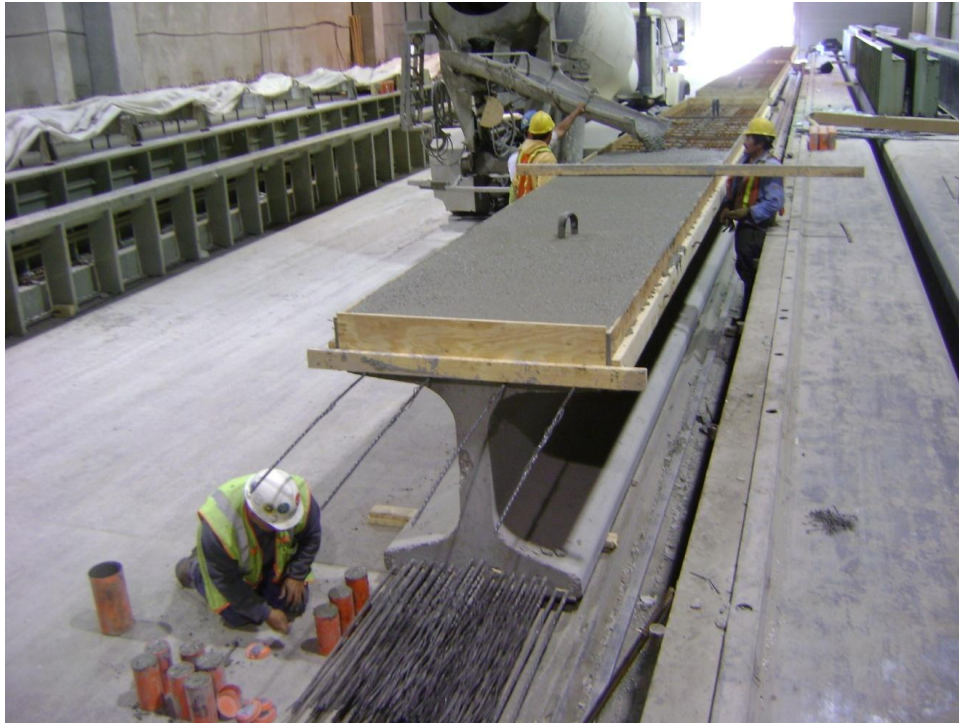

Figure 3.25 NU1100 Deck Pouring

3.2.1.6 NU1100 Girder Test Setup

The following sections discuss the setup and procedure followed with regards to testing the NU1100 girders.

3.2.1.6.1 Development Length

To determine the effects from confinement on the development length of the NU1100 specimen, a point load was applied to the deck at a distance of fourteen feet as shown in Figure 3.26 and Figure 3.27. Bearing was located six inches in from each end producing an overall unsupported span of the girder for the development test of thirty-nine feet. The loading location for testing was chosen to satisfy current AASHTO specifications for

required length to fully develop prestress strand. Using a strain compatibility analysis of the section to determine the stress in the girders strands, found Appendix B, and then incorporating those values into the mentioned equation, the length required to fully develop the 0.7" diameter strands was:

$$1.6 \left[260 - \frac{2}{3} 160 \right] 0.7 = 172" = 14.3' \quad \text{Equation 16}$$

The applied load and corresponding vertical deflection was monitored and recorded as the load increased up to the calculated nominal flexural capacity of the section. The load was stopped just above the calculated value in order to validate the strands full development and corresponding girders capacity, while preserving the structural integrity of the girder for moving and future testing.

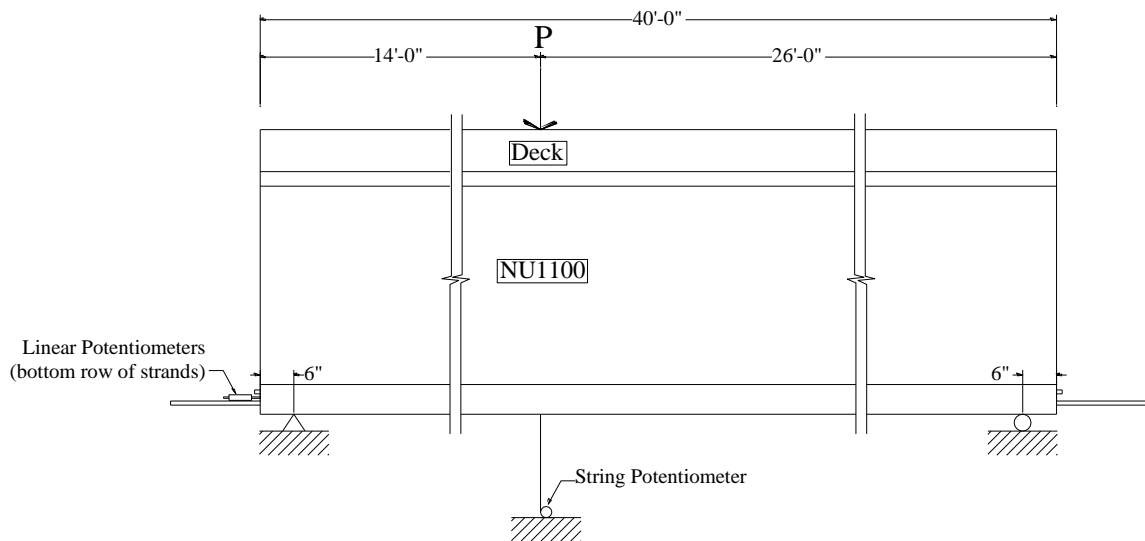

Figure 3.26 NU1100 Development Length Test Setup (CAD)



Figure 3.27 NU1100 Development Length Test Setup

While testing, each girder was visually inspected and cracks were periodically marked to identify the failure mode. Bottom strand slippage was monitored using ten potentiometers as shown in Figure 3.28, while the two top strands were monitored via a mechanical gauge and a string potentiometer.



Figure 3.28 Development Length Test Strand Instrumentation

3.2.1.6.2 Vertical Shear

A shear test was performed on one end of each of the three NU1100 girders. The girders were loaded at a distance of $1.77h$ from the end support, eight feet from the end of the girder. The overall span for the test was thirty-nine feet with each end bearing located in six inches from the end of the girder. Figure 3.29 and Figure 3.30 present the setup utilized for testing the NU1100 girders in shear.

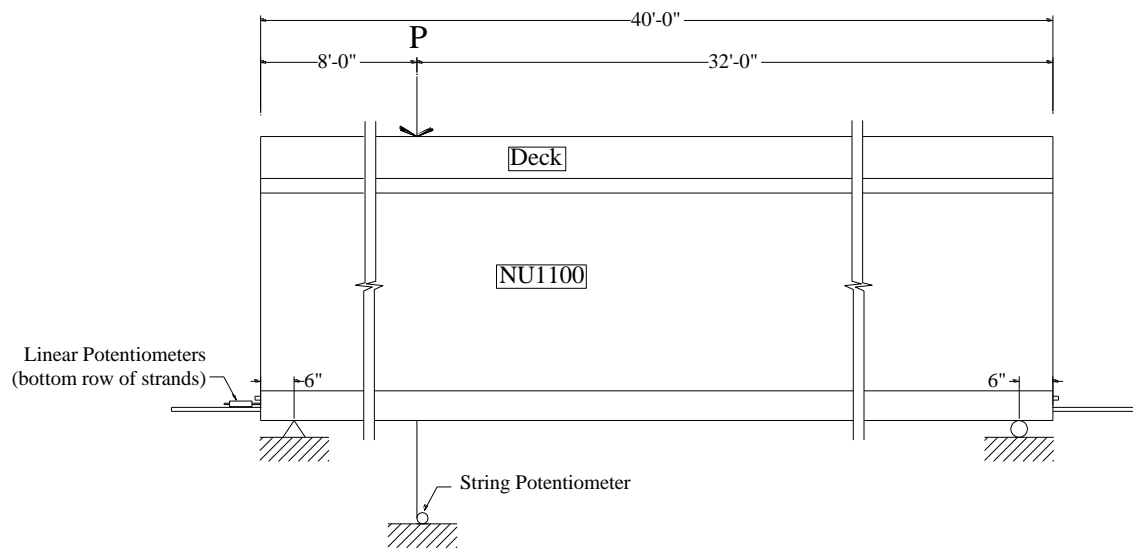

Figure 3.29 NU1100 Vertical Shear Test Setup (CAD)



Figure 3.30 NU1100 Vertical Shear Test Setup

While testing, each girder was visually inspected and cracks were periodically marked to identify the failure mode. Bottom strand slippage was monitored using ten potentiometers as shown in Figure 3.31, while the two top strands were monitored via a mechanical gauge and a string potentiometer.

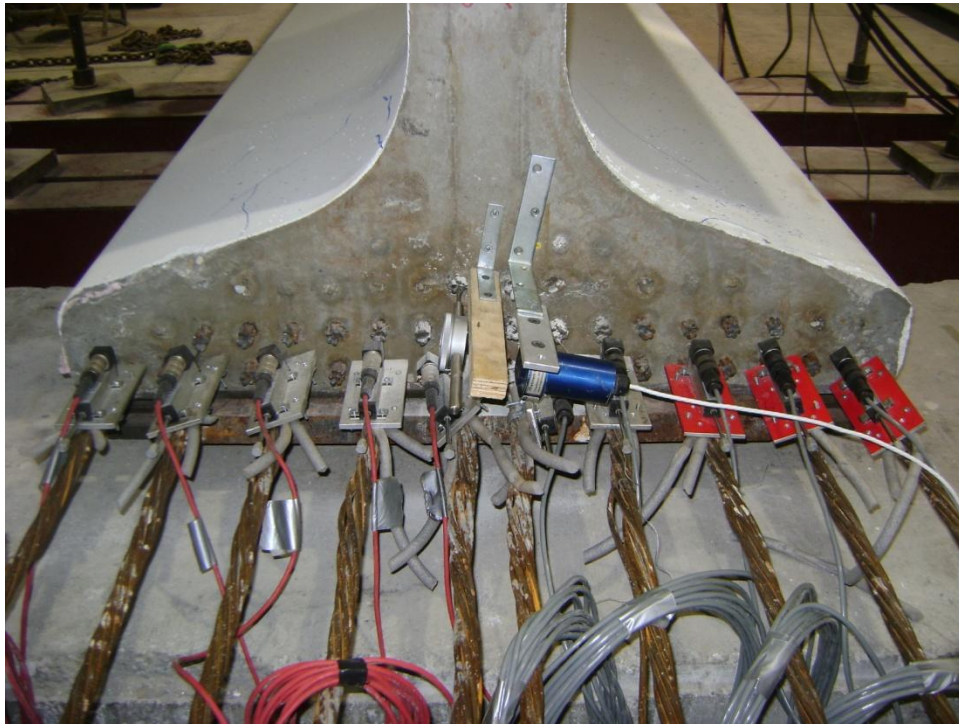

Figure 3.31 Vertical Shear Test Strand Instrumentation

3.2.2 Test Results

3.2.2.1 T24 Girders

The following three sections present the results from transfer length, development length, and shear testing performed by the researchers on the T24 girders.

3.2.2.1.1 Transfer Length

The transfer length was tested on six of the T24 girders fabricated at the university. The initial readings taken just after release, as well as the final transfer readings, taken at fourteen days after release, were measured as described in Section 3.2.1.3.1 of this report. The surface strain on each side and each end of the girders was calculated using the 95% AMS Method outlined by Russell and Burns in Section 2.1.3.1. A sample of the surface strain plot set up for initial and final 95% AMS transfer length determination is presented by Figure 3.32.

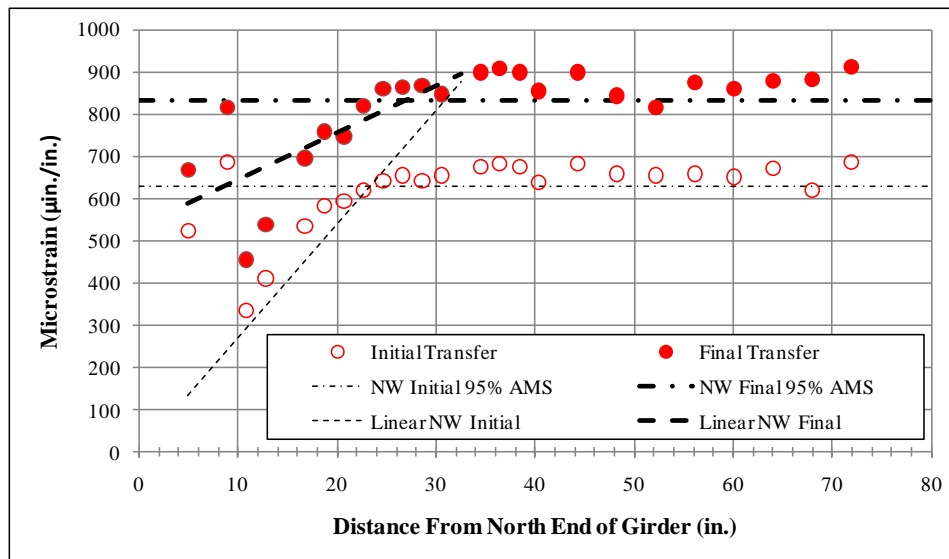

Figure 3.32 T-4-1.0h-B North End, West Side Surface Strain Measurements with Modified 95% AMS Method

Table 3.5 presents the overall results from all of the 95% AMS transfer length plots. AASHTO LRFD section 5.11.4.1 estimates the transfer length of a 0.7" diameter strand to be 42 inches. As can be seen with Table 3.5, all specimens saw prestress transfer at a

much lower value than that predicted by AASHTO specifications. This result was expected by the researchers as the code on this subject is generally conservative, not taking into account many aspects believed to aid in reducing the length of prestress transfer from the strand to the concrete, as noted by (Maguire 2009) and others.

Table 3.5 T24 Girder Transfer Length Summary

Girder Designation	End-Side	Initial Measurements (in.)			Final Measurements (in.)					
		95% AMS	Girder End	Girder	95% AMS	Girder End	Girder			
T-6-1.5h-A	N-W	21.6	25.0	23.0	22.0	25.5	23.5			
	N-E	28.4			29.1					
	S-W	22.5	21.0		22.8	21.5				
	S-E	19.6			20.1					
T-6-0.5l-A	N-W	22.6	22.3	24.8	24.1	22.8	25.5			
	N-E	21.9			21.5					
	S-W	26.0	27.3		26.3	28.2				
	S-E	28.5			30.1					
T-6-1.5h-B	N-W	24.3	22.6	20.5	25.4	16.0	20.9			
	N-E	21.0			6.5					
	S-W	20.6	18.4		25.8	25.9				
	S-E	16.3			25.9					
T-4-1.0h-B	N-W	23.3	19.4	18.3	26.8	22.5	21.3			
	N-E	15.5			18.1					
	S-W	18.3	17.1		21.1	20.2				
	S-E	15.9			19.3					
T-6-1.5h-C	N-W	20.8	19.3	19.1	N/A					
	N-E	17.8								
	S-W	19.8	18.9							
	S-E	18.0								
T-4-1.0h-C	N-W	25.9	19.6	18.8				N/A		
	N-E	13.2								
	S-W	20.5	18.0							
	S-E	15.5								

Figure 3.33 graphically presents the results from the transfer length testing on the T24 girders. Again, it should be noted the relative proportion from actual specimen measurements to the length specified by AASHTO for design.

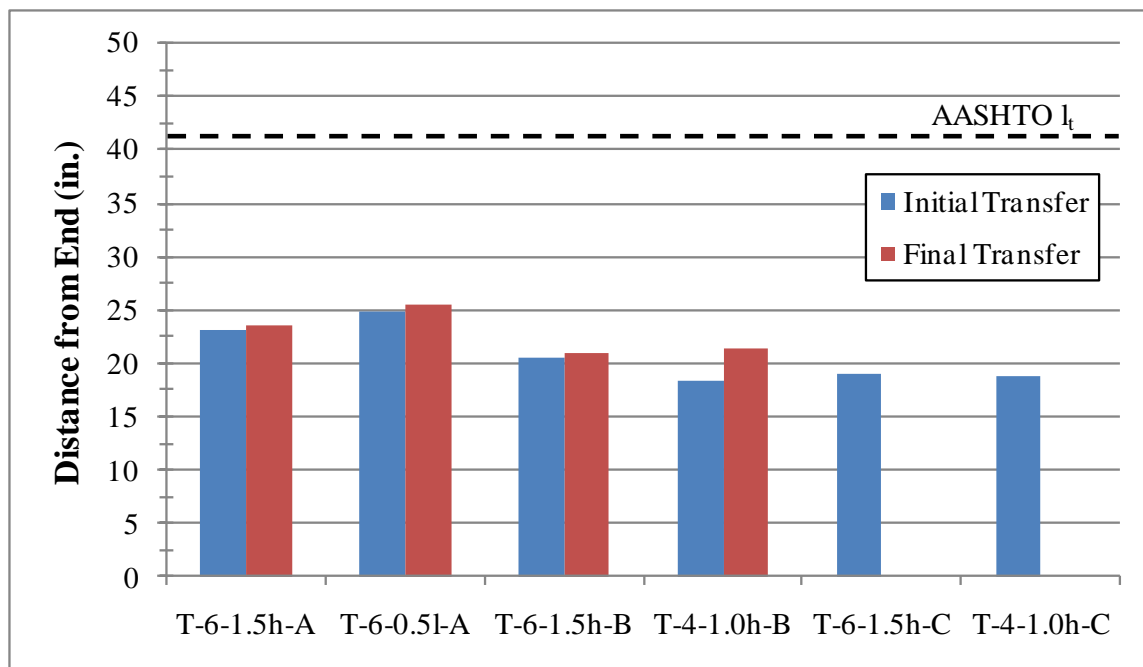

Figure 3.33 T24 Transfer Length Comparison

Table 3.6 is for comparing what effects, if any, come from changing either the amount or distribution of confinement throughout a girder. To compare the effects from the amount of confinement, girders T-6-1.5h-A/B/C were analyzed against girder T-6-0.5l-A. The results show no added benefit on prestress transfer from all the extra confinement steel. This result was of no surprise as previous research by (Russell and Burns 1996) produced similar results.

To compare the effects from distribution of the same amount of confinement, girders T-6-1.5h-A/B/C were measured against those of girders T-4-1.0h-C. Again, there was little to no effect from the distribution of the confinement reinforcement. Overall the longer distribution, 1.5h, seemed to increase the transfer length slightly at initial and final readings; however, when comparing girders with like concrete strength individually, class B or C, the values became even closer. This may show that the strength of the concrete around the prestress strand plays a larger role on transfer than the presence, or lack of confinement reinforcement.

Table 3.6 T24 Girder Transfer Length Comparison

Confinement Spacing (in)	Distribution (L)	Initial Measurements (in.)		Final Measurements (in.)		Change (%)
		24T Girders	Transfer	24T Girders	Transfer	
6.0	1.5h	23.0	20.9	23.5	22.2	6.3
		20.5		20.9		
		19.1		-		
	0.5l	24.8	25.5	3.0		
4.0	1.0h	18.3	18.5	21.3	-	15.2
		18.8		-		

3.2.2.1.2 Development Length

The development length of the prestress strand was tested on all eight of the fabricated T24 girders. The testing was performed as previously described in Section 3.2.1.3.2. Table 3.7 presents the results from the flexural tests performed on the specimen. The calculated column presents the section values with the actual material properties inserted in the design calculations. The tested column in Table 3.7 is data from the actual test performed on the T24 girders.

Table 3.7 T24 Girder Flexural Capacity

Nominal Flexural Capacity [M_n]			
Girder No.	Calculated	Tested	Tested/Calculated
	(kip-ft)	(kip-ft)	(%)
T-6-1.5h-A	809	948	117.2
T-6-0.5l-A	809	948	117.2
T-6-1.5h-B	805	830	103.1
T-4-1.0h-B	805	829	103.0
T-6-1.5h-C	787	824	104.7
T-4-1.0h-C	787	879	111.7
T-12-0.5l-D	803	827	103.0
T-4/6-1/1.5h-D	803	814	101.4

Figure 3.34 provides a graphical presentation of the girders behavior while testing. The line indicating AASHTO M_n represents the required applied load, at the designated test distance which corresponds to the nominal capacity of the section incorporating the specified materials properties and with a resistance factor, ϕ , of 1.0. All T24 girders tested met and exceeded the nominal flexural capacity for the specified materials, as well as the modified values from actual material properties.

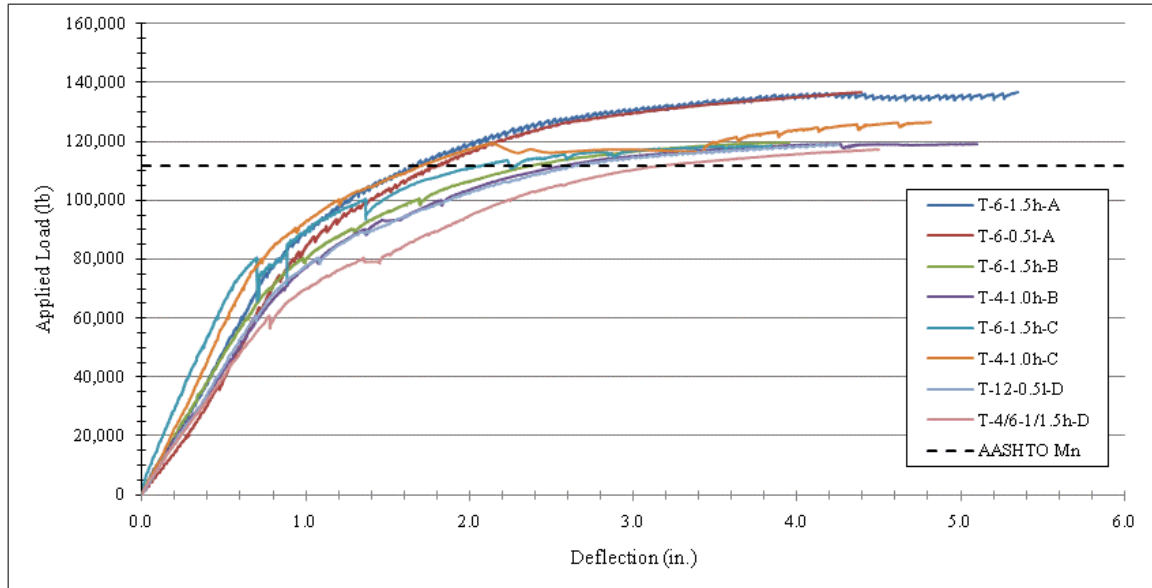

Figure 3.34 T24 Load v. Deflection Comparison

Figure 3.35 presents one of the T24 girders post the flexural test. The failure shown was typical for all eight specimens. One notable outcome from the test was with regards to the cracking and spalling of the concrete from the bottom of the tee girders. The two girders with confinement throughout the entire length of them, T-6-0.5l-A and T-12-0.5l-D experienced less cracking at the bottom of the web and little spalling of concrete upon reaching the ultimate load. It can also be seen that those two girders experienced more deflection than their designed counterparts. This could be attributed to the added confinement around the strands protecting the concrete, holding it together, and in return increasing the overall ductility of the section.

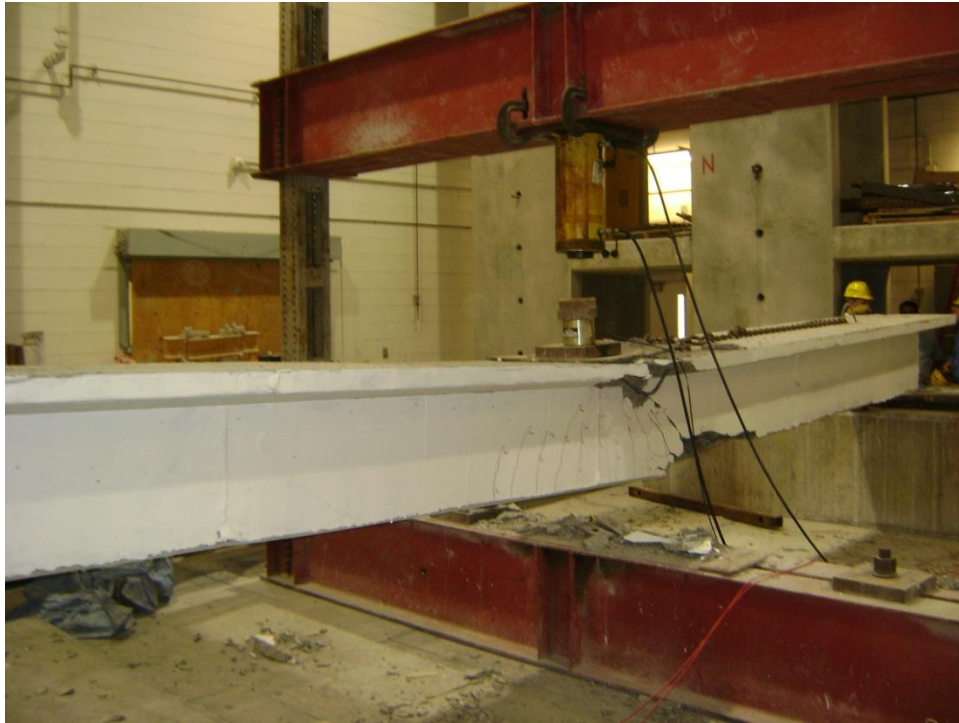

Figure 3.35 T24 Post Development Testing

While testing the T24 girders' flexural capacity, the bottom row of strands was monitored for any relative movement which would indicate a bond failure within the calculated AASHTO development length of the specimen. Figure 3.36 provides a drawing of the strand layout and designation for monitoring and reporting purposes. Consequently, Figure 3.37 through Figure 3.44 presents the data from the potentiometers during each girders test. Again the line indicating AASHTO M_n represents the required applied load, at the designated test distance which corresponds to the nominal capacity of the section incorporating the specified materials properties and with a resistance factor, ϕ , of 1.0

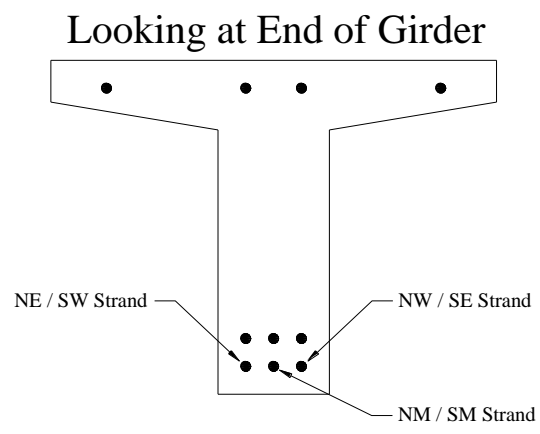

Figure 3.36 T24 Development Test Strand Designation

Also of note are the lines at ± 0.01 " on the subsequent figures. These lines represent the permitted slippage allowed by ASTM A416 with regard to maintaining bond between the strand and surrounding concrete.

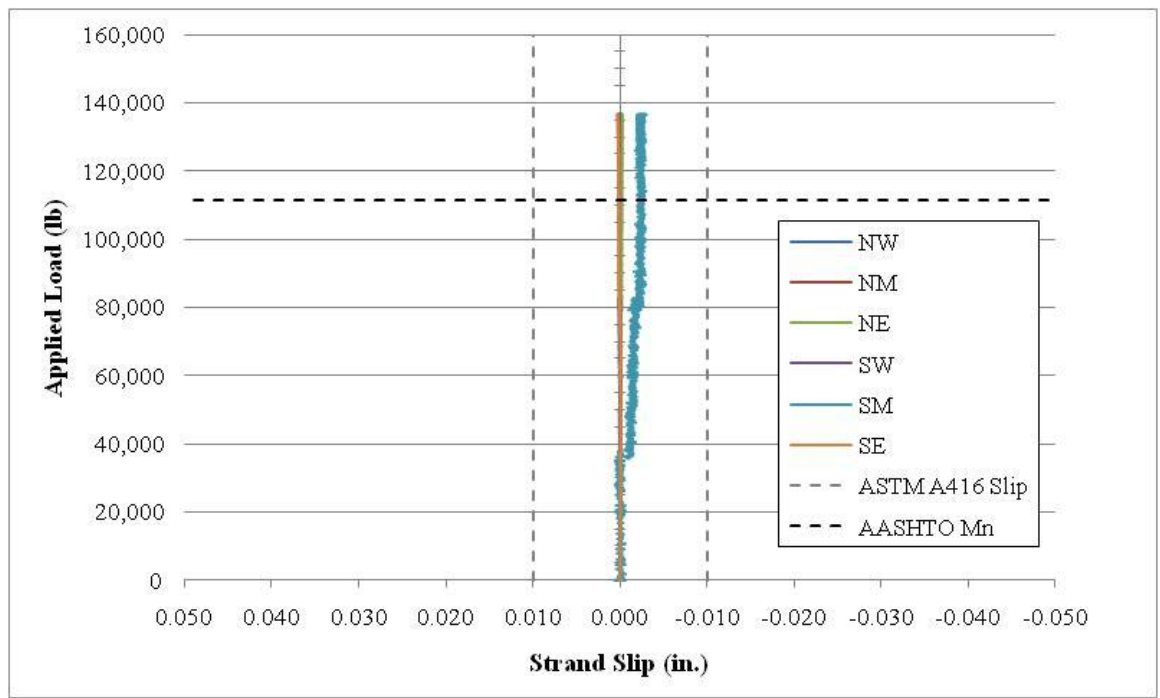

Figure 3.37 T-6-1.5h-A Development Length Test Strand Slippage

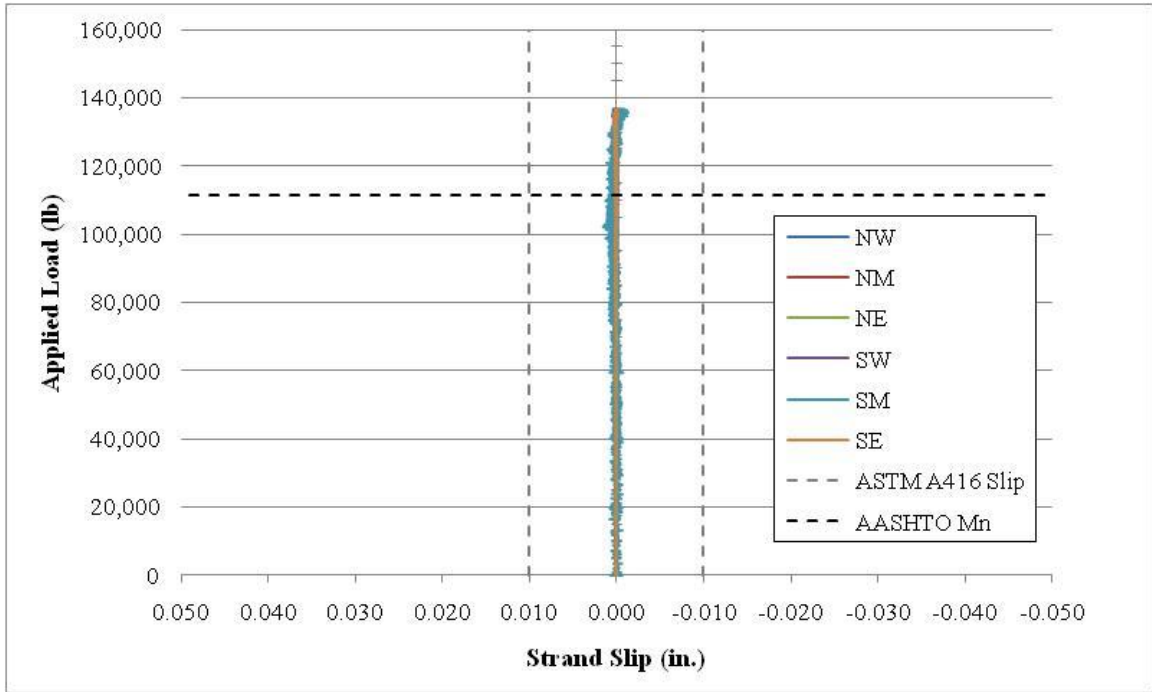

Figure 3.38 T-6-0.5l-A Development Length Test Strand Slippage

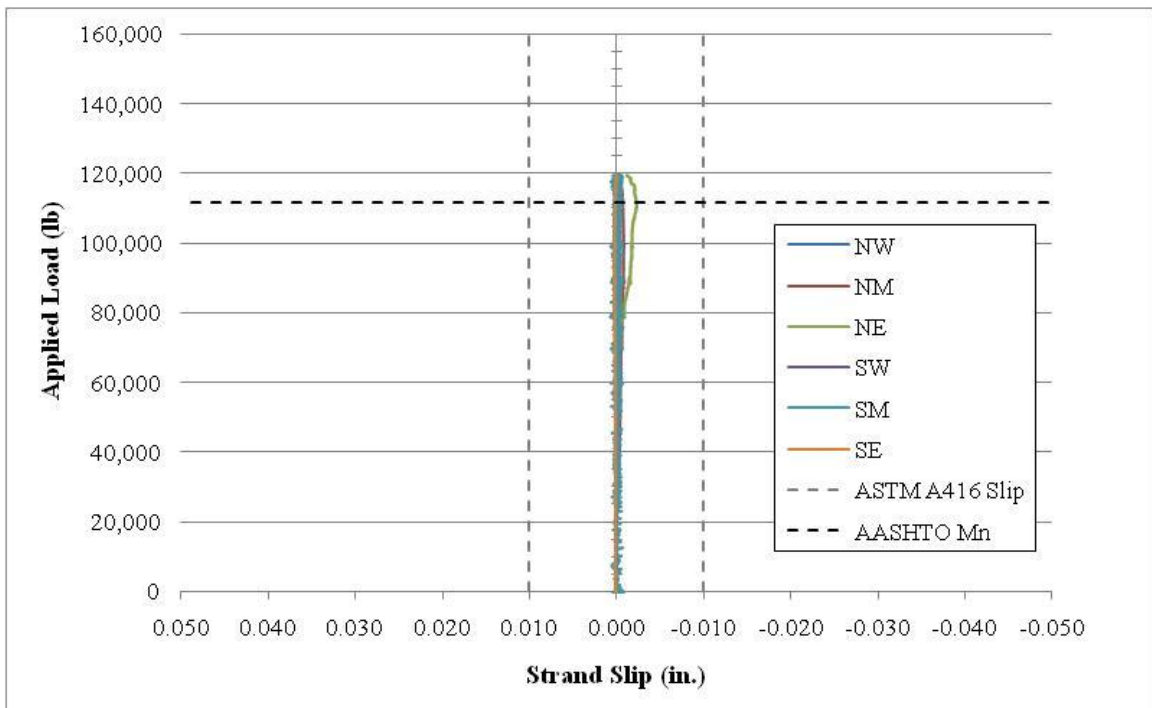

Figure 3.39 T-6-1.5h-B Development Length Test Strand Slippage

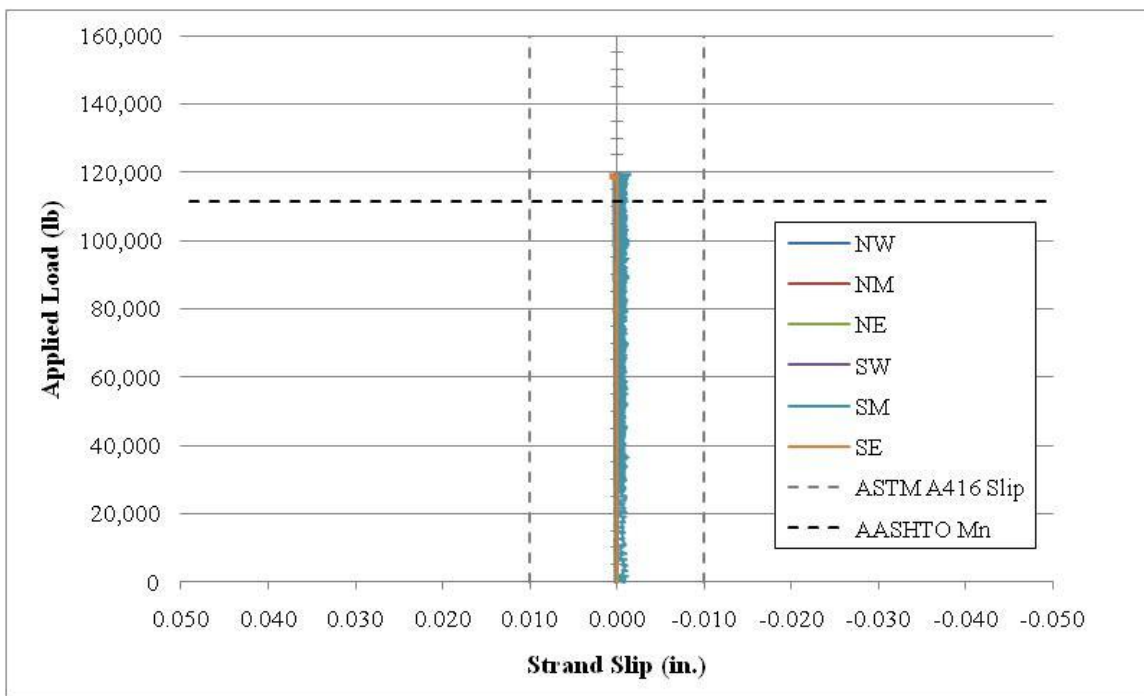

Figure 3.40 T-4-1.0h-B Development Length Test Strand Slippage

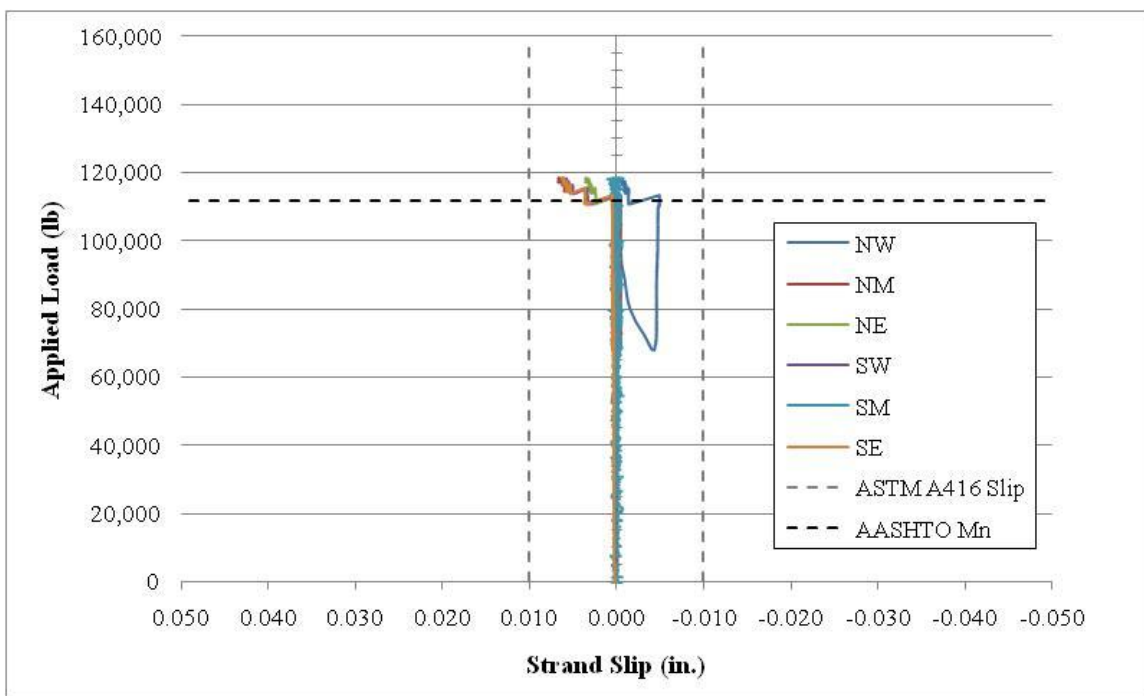

Figure 3.41 T-6-1.5h-C Development Length Test Strand Slippage

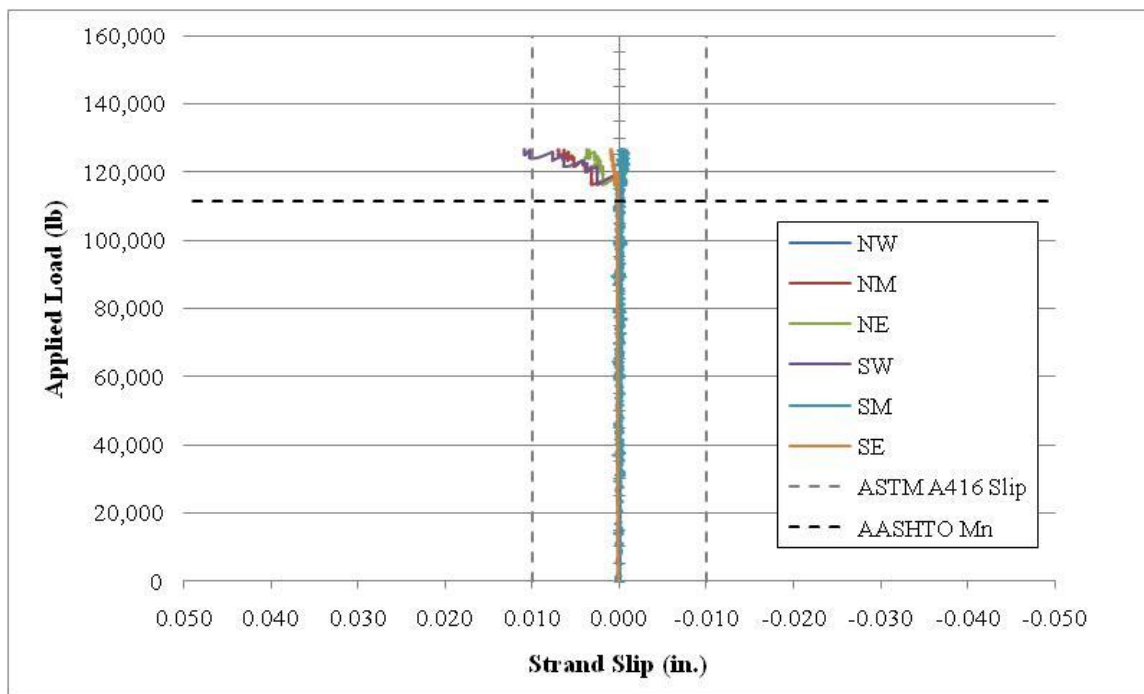

Figure 3.42 T-4-1.0h-C Development Length Test Strand Slippage

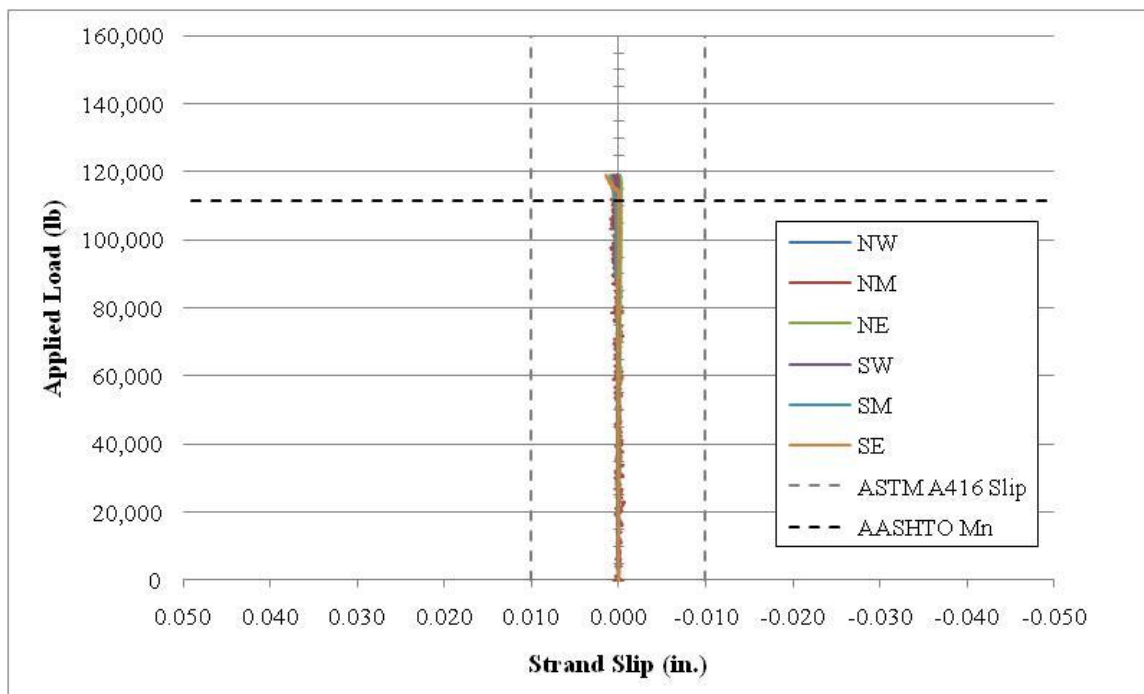

Figure 3.43 T-12-0.5l-D Development Length Test Strand Slippage

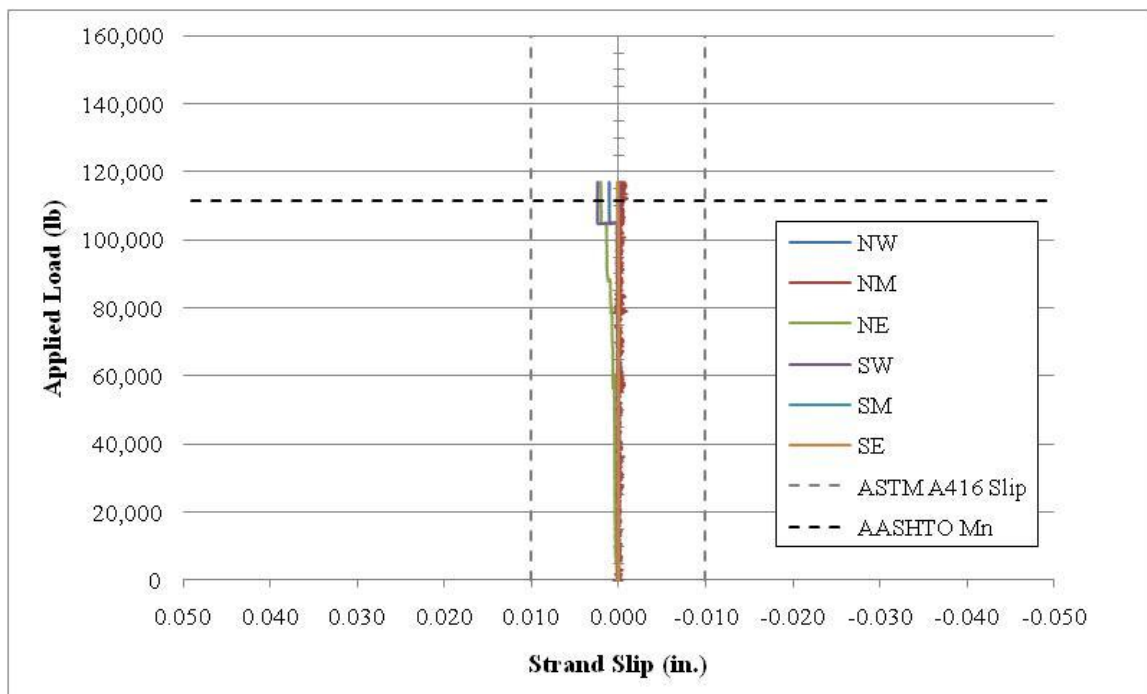

Figure 3.44 T-4/6-1/1.5h-D Development Length Test Strand Slippage

Figure 3.44 presents the slip data from girder T-4/6-1/1.5h-D. This girder was designed with a confinement spacing of four inches at one end and six inch spacing at the opposite. When monitoring the girders' strands for the development test the north set of strands designated NW, NM, and NE were confined with the four inch spaced hoops. As the previous eight figures show, none of the girders experienced a premature failure due to inadequate bond of the larger strand at the AASHTO specified development length. Only two girders, the class C series with lower concrete strength, show any noticeable movement of any monitored strands. This may support the notion that the strength of the concrete surrounding the prestress strands contributes to fully develop the strands.

In order to study the effects from the amount of confinement placed in the girder, the results of testing the two specimens T-6-1.5h-A and T-6-0.5l-A can be compared. Table 3.7 along with Figure 3.34 shows the load and deflection for the development length testing of the two girders. These relationships were almost identical, which indicates that increasing the amount of confinement reinforcement above the specified AASHTO minimum does not significantly increase the flexural capacity of the girder. Designing with the AASHTO specified development length and confinement reinforcement resulted in fully developed strands up to the failure load.

When analyzing the effects from the distribution of confinement reinforcement the results from testing the two specimens T-6-1.5h-B and T-6-1.5h-C are compared versus those of specimens T-4-1.0h-B and T-4-1.0h-C. The relationships of the girders with the same concrete strength were almost identical, which indicates that increasing the intensity of confinement reinforcement above the AASHTO specification has negligible effect on the flexural capacity of the girders. Once again, designing by the AASHTO specified development length and confinement reinforcement resulted in fully developed strands up to the failure load.

3.2.2.1.3 Vertical Shear

Two of the T24 girders, T-4/6-1/1.5h-D and T-12-0.5l-D, were subjected to shear testing at both ends post their development testing. Table 3.8 provides the test data from the four shear tests on the T24 girders.

Table 3.8 T24 Girder Shear Capacity

Nominal Shear Capacity [V_n]			
Girder No.	Calculated	Tested	Tested/Calculated
	(lb)	(lb)	(%)
T-6-1.5h-D	82,000	109,000	132.9
T-4-1.0h-D	82,000	102,000	124.4
T-12-0.5l-D	82,000	102,000	124.4
T-12-0.5l-D	82,000	62,000	-

The calculated column presents the section values with the actual material properties inserted in the design calculations. The tested column of Table 3.8 is obtained data from the actual test performed on the two T24 girders.

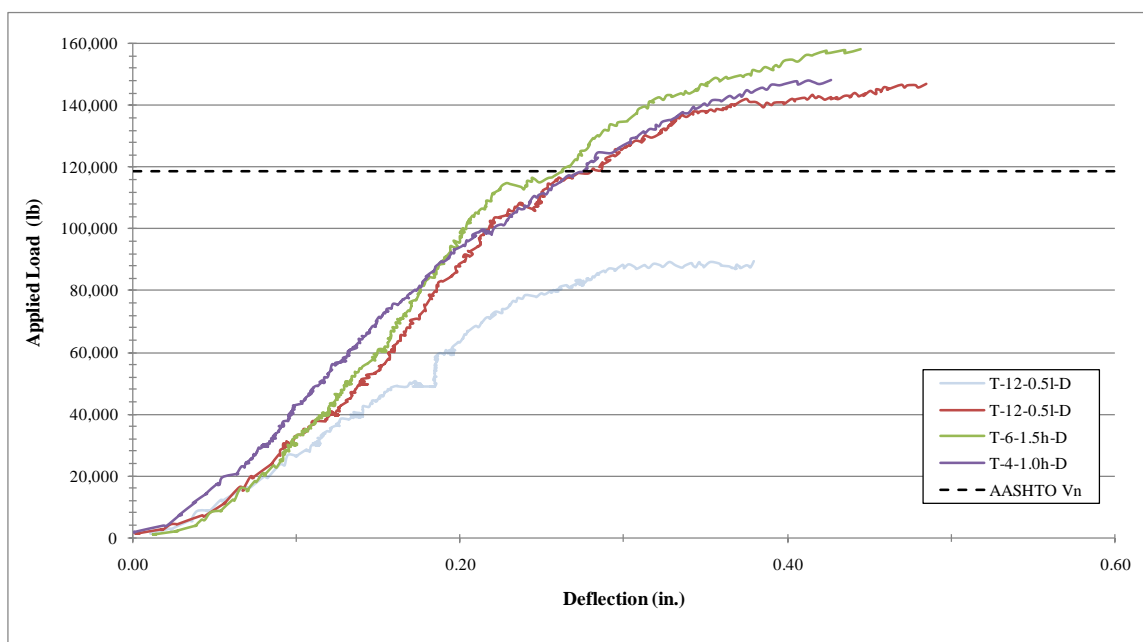

Figure 3.45 T24 Load v. Deflection Comparison

Figure 3.45 graphically presents the applied load versus girder deflection for the tests performed. The line indicating AASHTO V_n represents the required applied load, at the designated test distance which corresponds to the nominal shear resistance of the section incorporating the actual materials properties and with a resistance factor, ϕ , of 1.0.

Upon completion of shear testing the T24 girders one result was drastically different from the other three. One end of the T-12-0.5l-D reached an actual shear capacity of 109,000 pounds, similar to the T-4/6-1/1.5h-D results, while the opposite end only obtained an ultimate capacity of 62,000 pounds. Further investigation of previously recorded data revealed the cause of the premature failure at one end of the girder.

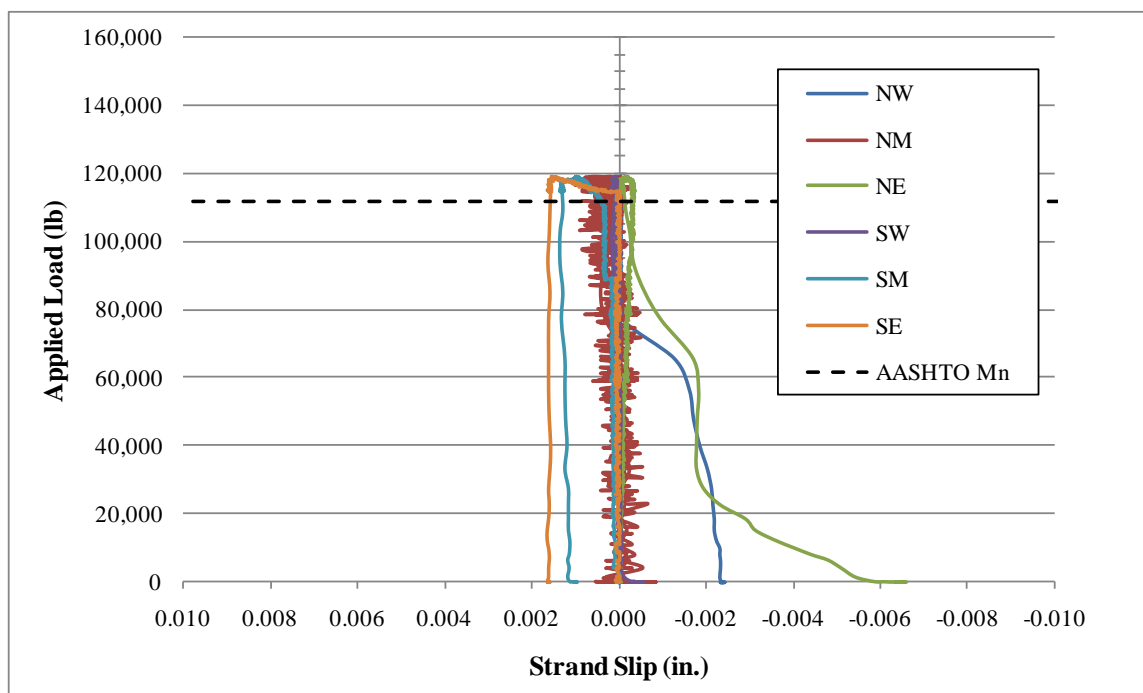

Figure 3.46 T-12-0.5l-D Development Length Test Slippage

Figure 3.46 presents the strand slip data from the development test for the T-12-0.51-D girder. Figure 3.47 shows the same strand slip data for the T-4/6-1/1.5h-D from development testing; the north strands are confined with four inch spaced hoops. Of note is the action from the strands upon completion of the prior test. For three of the girder ends the strands saw a permanent movement at or around 0.002". But one end, the north end, of girder T-12-0.51-D had an outer strand with permanent slip above 0.006". This strand movement confirms that the bond of that outer strand was compromised in the previous test which could have led to a greatly reduced capacity of the tee section on that end. For this reason, the data obtained from the low shear test is only provided for information. The results from that test will not be included in the researchers' evaluation on the shear performance of the T24 girders.

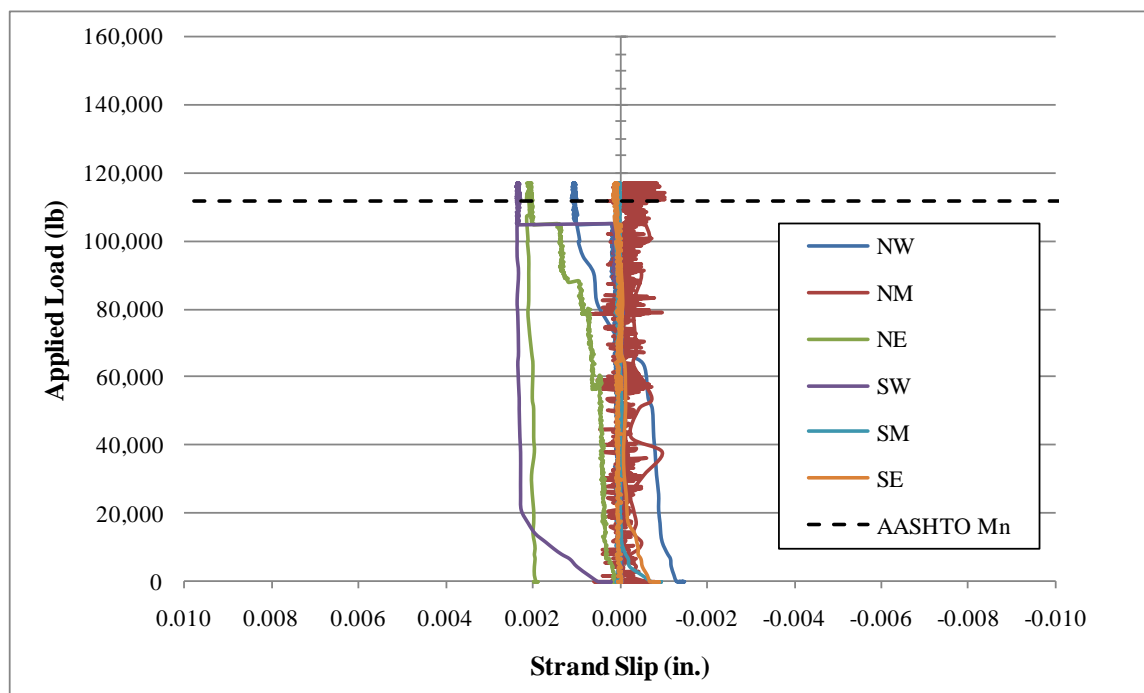

Figure 3.47 T-4/6-1/1.5h-D Development Length Test Slippage

Figure 3.48 provides an image of the T-4-1.0h-D girder after completion of the shear test. The failure mode shown was typical for all four shear tests performed at the structures lab.



Figure 3.48 T24 T-4-1.0h-D Post Shear Test

Once the shear tests were completed on the girders, data was obtained and analyzed in reference to the performance of the strands during ultimate loading. Figure 3.49 graphically presents the applied load versus the average strand slippage during testing. The average slippage was calculated incorporating movement from all three monitored bottom strands.

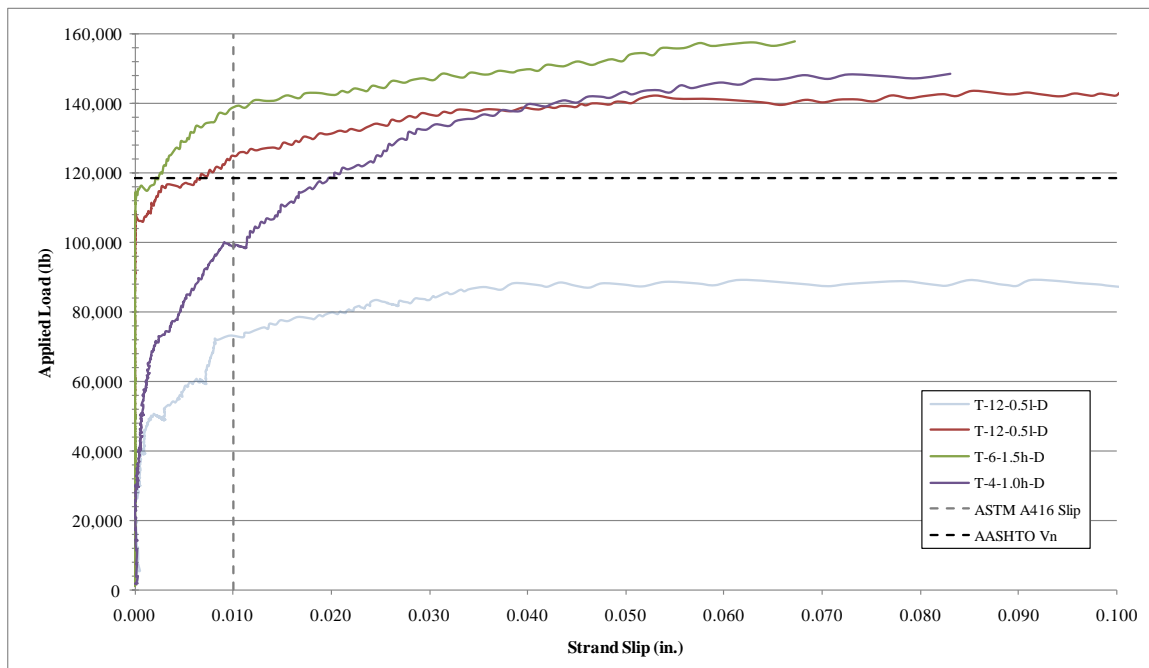

Figure 3.49 T24 Load v. Avg. Strand Slip Comparison

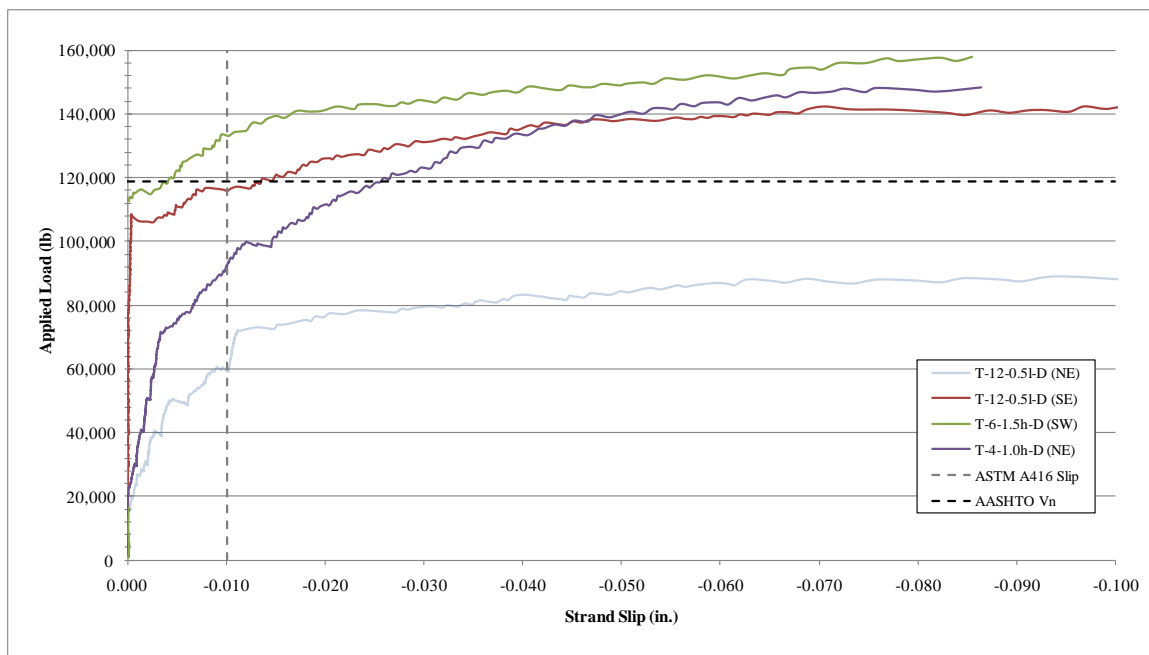

Figure 3.50 T24 Load v. Max. Strand Slip Comparison

Figure 3.50 provides the applied load versus the maximum strand slippage for each shear test. The maximum strand slippage plot is of the one strand which saw the greatest amount of relative movement throughout the shear testing. In all cases it was an outer strand which saw the most slippage during testing. This would make sense as there is bound to be an eccentricity not only from some derivation of the load from the exact center of the top flange but also from a lateral shift, or displacement of the strands from the designed location due to fabrication tolerances and methods. These factors would produce a small torque on the girder which would result in a higher stress in one of the outer strands, causing a bond failure or slippage in that overstressed strand.

In both the average strand slip case and the maximum strand slip case, the end with the confinement spaced at four inches for a distance equal to the height of the girder saw bond failure before the section reached its nominal capacity. This was not the case for either of the other two comparable cases. This may be connected to the location of the shear cracking through the transfer region of the girders' web. For the T-4-1.0h-D all of the confinement was located within the first 1.0h, twenty-four inches. The transfer length previously found on similar specimen was between twenty and twenty-five inches, and the shear cracking is clearly within the transfer region of the tested T24 girders. For this test setup, the distribution of confinement presented an effect on the bond capacity of the strands. However, even though the strands did slip on the T-4-1.0h-D section beyond the ASTM A416 limit of 0.01", the ultimate shear capacity of the section was not compromised.

Overall the T24 girders shear tests provide negligible results with regard to the effects from the amount of confinement reinforcement on the capacity of the section. In both the AASHTO specified amount, T-4/6-1/1.5h-D, and for above the minimum amount, T-12-0.51-D, the overall capacity was shown to be around 24% above the calculated values. Something of note again with the shear test; the girder with the confinement dispersed throughout its entire length saw slightly more deflection during loading. This result was previously seen during the development length testing of the T24 girders. The data seems to show that one benefit to providing confinement throughout a girders' entire length is in an increase in ductility of that member.

3.2.2.2 NU1100 Girders

The following two sections present the results from development length and shear testing performed by the researchers on the NU1100 girders.

3.2.2.2.1 Development Length

The development length of the prestress strand was tested on one end of all three NU1100 girders. The testing was performed as previously described in Section 3.2.1.6.1. Table 3.9 presents the results from the flexural tests performed on the specimen. The calculated column presents the section values with the actual material properties inserted in the design calculations. The tested column in Table 3.9 is data from the actual test performed on the NU1100 girders.

Table 3.9 NU1100 Girder Flexural Capacity

Nominal Flexural Capacity [M_n]			
Girder No.	Calculated	Tested	Tested/Calculated
	(kip-ft)	(kip-ft)	(%)
1	9697	9649	99.5
2	9634	9648	100.1
3	9653	9647	99.9

Figure 3.51 provides a graphical presentation of the girders behavior while testing. The line indicating AASHTO M_n represents the required applied load, at the designated test distance which corresponds to the nominal capacity of the section incorporating the specified materials properties and with a resistance factor, ϕ , of 1.0. All three NU1100 girders were tested to approximately their calculated nominal flexural capacity in order to validate the strands full development and corresponding girders capacity and yet preserve the structural integrity of the girder for subsequent shear testing.

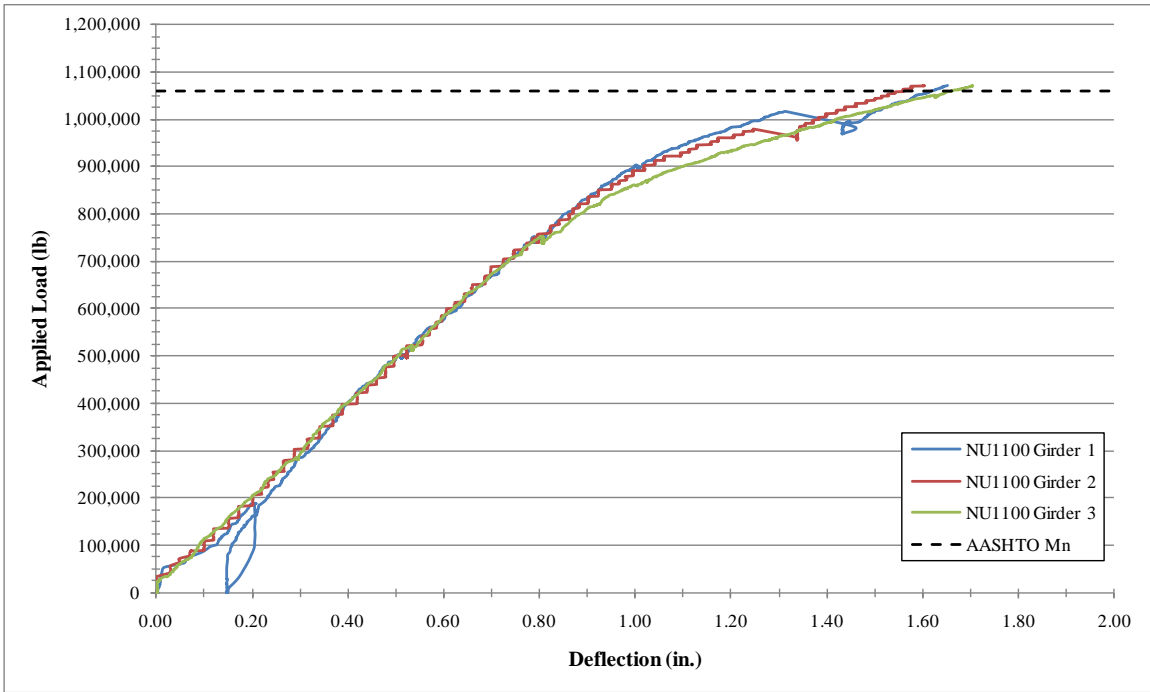

Figure 3.51 NU1100 Load v. Deflection Comparison

Figure 3.52 presents NU1100 Girder 2 post the flexural test. The resulting cracks and pattern shown was typical for all three specimens. The black marks occurred before or at 500,000 pounds, the cracks marked in red were present under an applied load of 750,000 pounds, and the green cracks were created up to the final loading of the section, around 1,070,000 pounds.

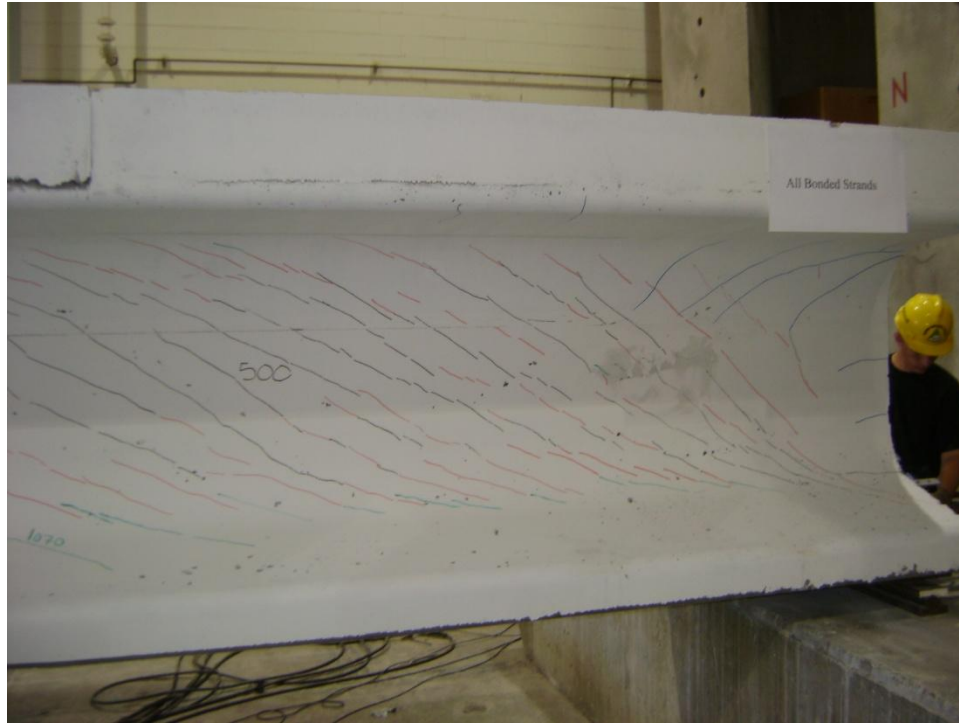

Figure 3.52 NU1100 Girder 2 Post Development Testing

While testing the NU1100 girders' flexural capacity, ten strands in the bottom row as well as the top two strands were monitored for any relative movement which would indicate a bond failure within the calculated AASHTO development length of the specimen. Figure 3.53 provides a drawing of the strand layout and designation for monitoring and reporting purposes. Figure 3.54, Figure 3.55, and Figure 3.56 present the data from the potentiometers during each girders test. Again the line indicating AASHTO M_n represents the required applied load, at the designated test distance which corresponds to the nominal capacity of the section incorporating the specified materials properties and with a resistance factor, ϕ , of 1.0.

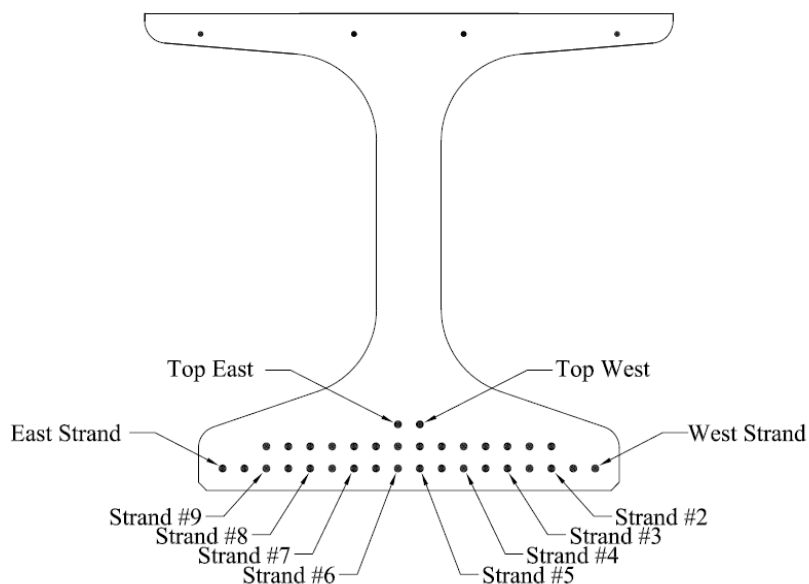

Figure 3.53 NU1100 Development Test Strand Designation

Also of note are the lines at $-0.01''$ on the subsequent figures. These lines represent the permitted slippage allowed by ASTM A416 with regard to maintaining bond between the strand and the surrounding concrete.

Monitoring of the two top strands during the development tests was done with both a mechanical gauge and a rotary potentiometer as described in Section 3.2.1.6.1. In none of the three tests, for either of the top strands, was any slippage detected by either means of observation and documentation.

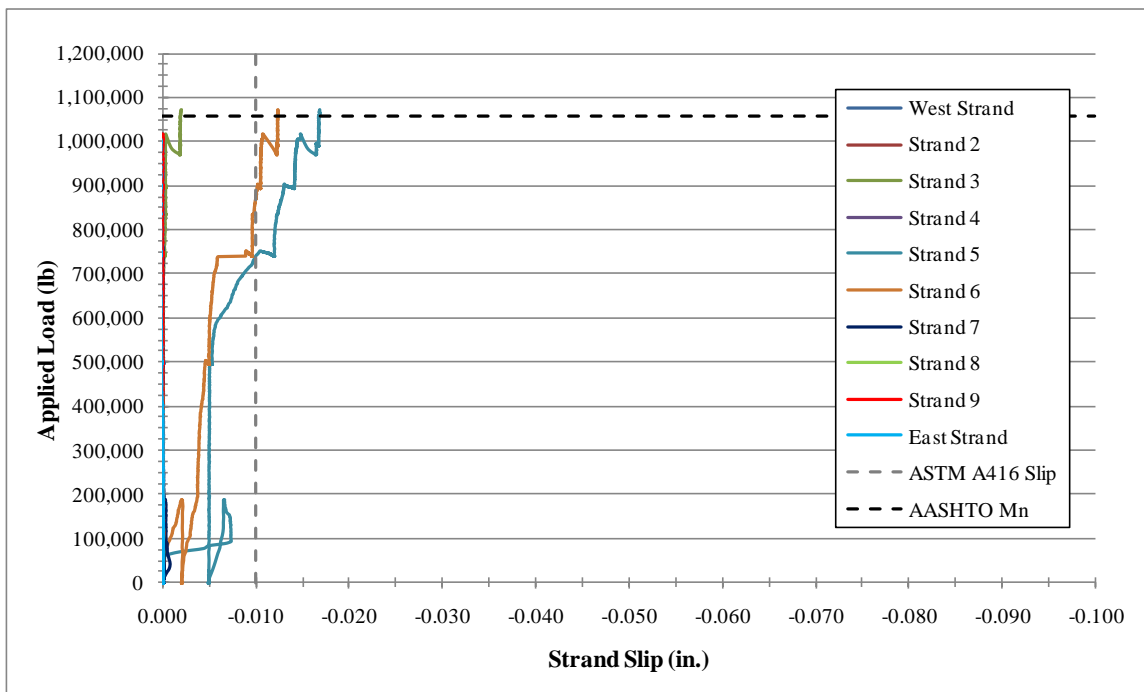

Figure 3.54 NU1100 Girder 1 Strand Slip

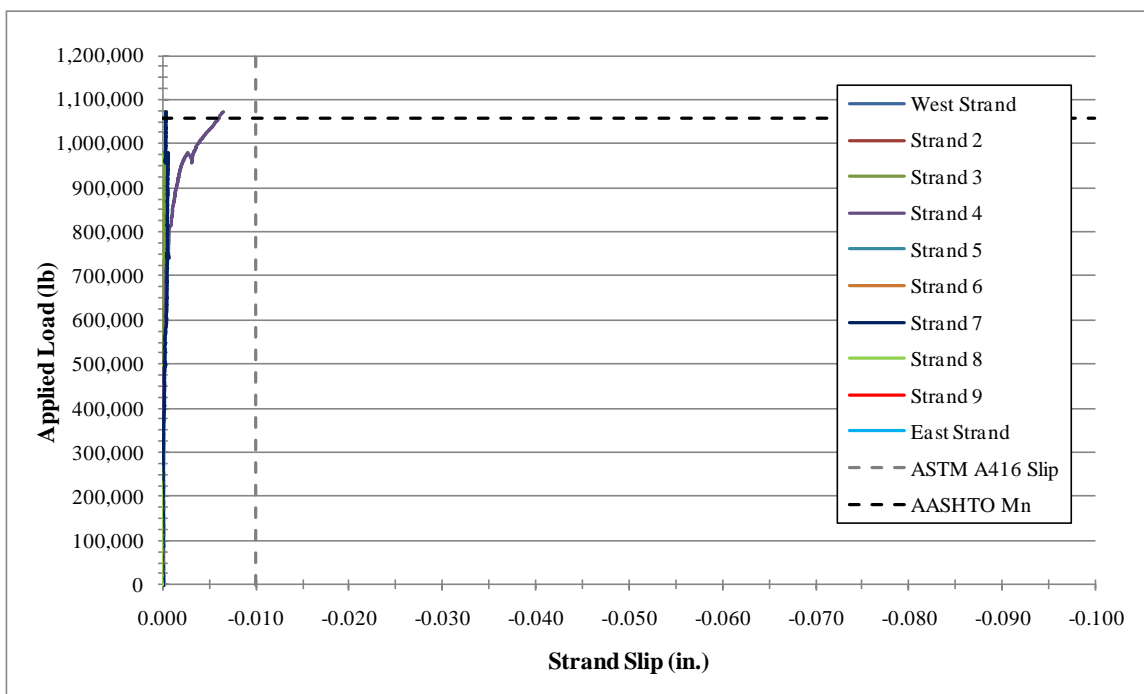

Figure 3.55 NU1100 Girder 2 Strand Slip

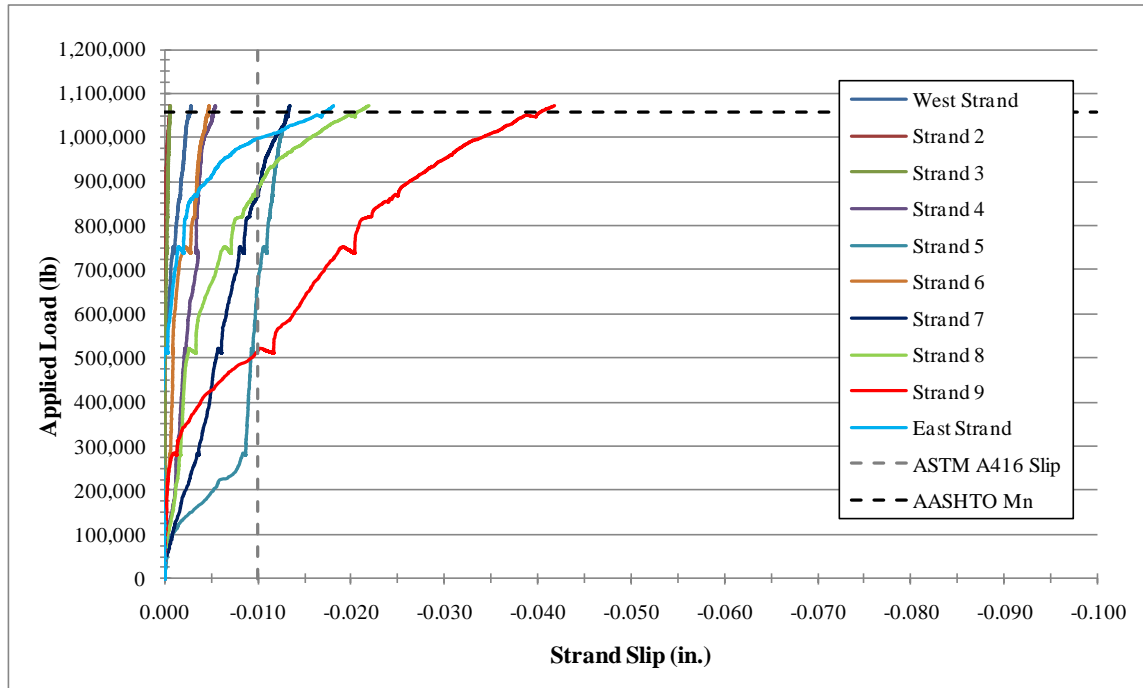

Figure 3.56 NU1100 Girder 3 Strand Slip

The first NU1100 girder tested for development was Girder 3. Although the girder reached its nominal capacity, when the strand slippage data was analyzed it was found that half of the monitored bottom strands had enough reduction of their bond capacity to cause defined slippage. One strand in particular, Strand 9, lost bond at only around one third of its estimated capacity and had a total movement of over 0.040" during the development test.

Figure 3.57 presents what was deemed the cause of the early failure for multiple strands. While testing, the bearing width at the tested end of the girder was only three inches. That condition caused a stress concentration at the bearing location, inducing cracks through the bottom flange of the girder in the transfer zone of the prestressed strands.

This detail was changed prior to development tests on Girders 1 and 2 as a twelve inch by thirty inch plate was placed above the roller to increase the overall bearing area, better representing actual conditions experienced by bridge girders in the field.

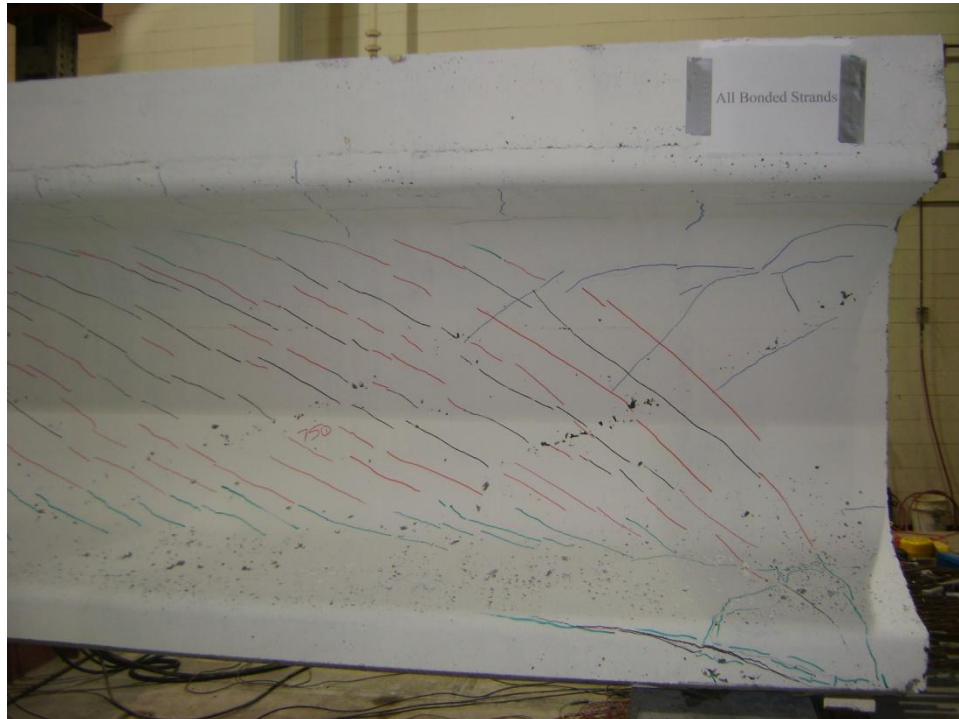

Figure 3.57 NU1100 Girder 3 Post Development Test

Figure 3.58 provides the applied load versus the maximum strand slippage for each development test. The maximum strand slippage plot is of the one strand which saw the greatest amount of relative movement throughout the development testing. Girder 1 saw Strand 5 experience the most movement, for Girder 2 it was Strand 4, and for Girder 3 it was Strand 9.

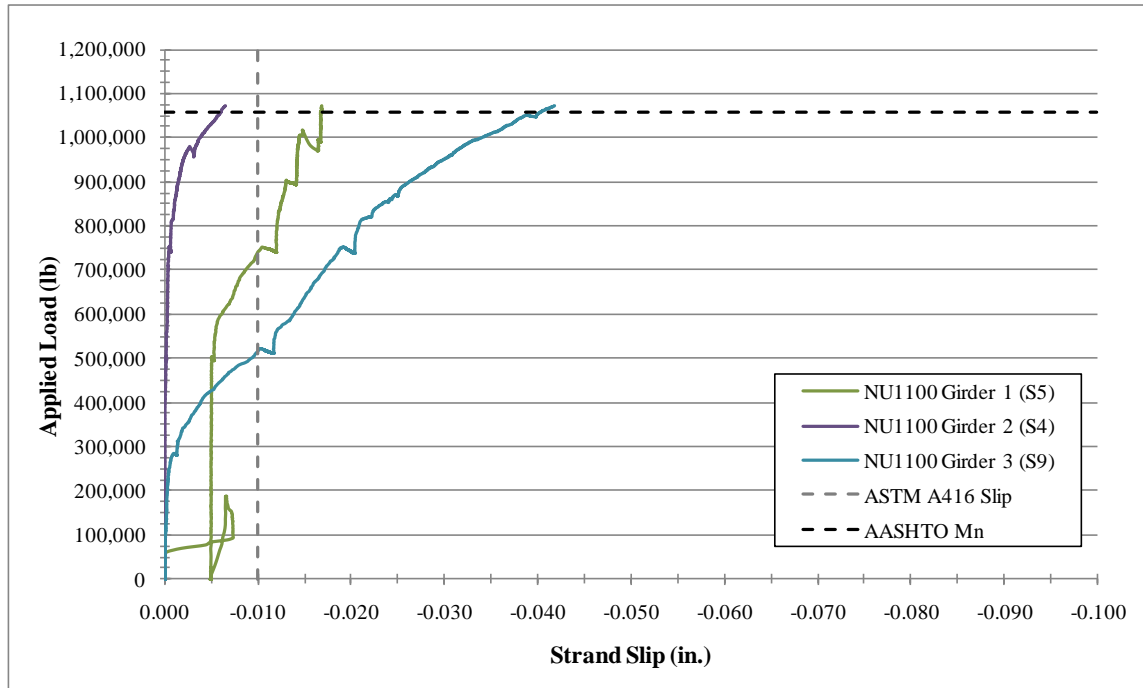

Figure 3.58 NU1100 Load v. Max. Strand Slip Comparison

Table 3.9 along with Figure 3.51 shows the calculated load and observed deflection for the development length testing on the NU1100 girders. The relationships between all three girders were almost identical, indicating that an increase in the amount of confinement reinforcement above the specified AASHTO minimum, Girders 1 and 3 versus Girder 2, does not significantly increase the flexural capacity of the girder. Comparing Girder 1 with Girder 2, a decrease in the intensity of confinement over a distance equal to $1.5h$, but with an overall increase in total confinement again provides no significant increase in a girders' flexural capacity. Excluding the strand data from Girder 3, due to the unfavorable bearing condition, no significant impact was found on the strands bond as a result from decreasing the intensity of confinement over the initial $1.5h$ of the girder end.

Note, one minor result noticed with the NU1100 girder development data. When comparing Girders 1 and 3 versus Girder 2, again, a slight increase was detected in the girders deflection with the confinement reinforcement distributed throughout the entire girder while experiencing equivalent loading.

3.2.2.2.2 Vertical Shear

After the development length testing was performed on the NU1100 girders, the opposite end was subjected to shear testing. Table 3.10 provides the test data from the three shear tests on the NU1100 girders. The calculated column presents the section values with the actual material properties inserted in the design calculations. The tested column in Table 3.10 is data from the actual test performed.

Table 3.10 NU1100 Girder Shear Capacity

Nominal Shear Capacity [V_n]			
Girder No.	Calculated	Tested	Tested/Calculated
	(lb)	(lb)	(%)
1	659,000	795,000	120.6
2	659,000	796,000	120.8
3	659,000	766,000	116.2

Figure 3.59 presents the behavior of the three girders while testing. The line indicating AASHTO V_n represents the required applied load, at the designated test distance which corresponds to the nominal shear resistance of the section incorporating the actual materials properties and with a resistance factor, ϕ , of 1.0.

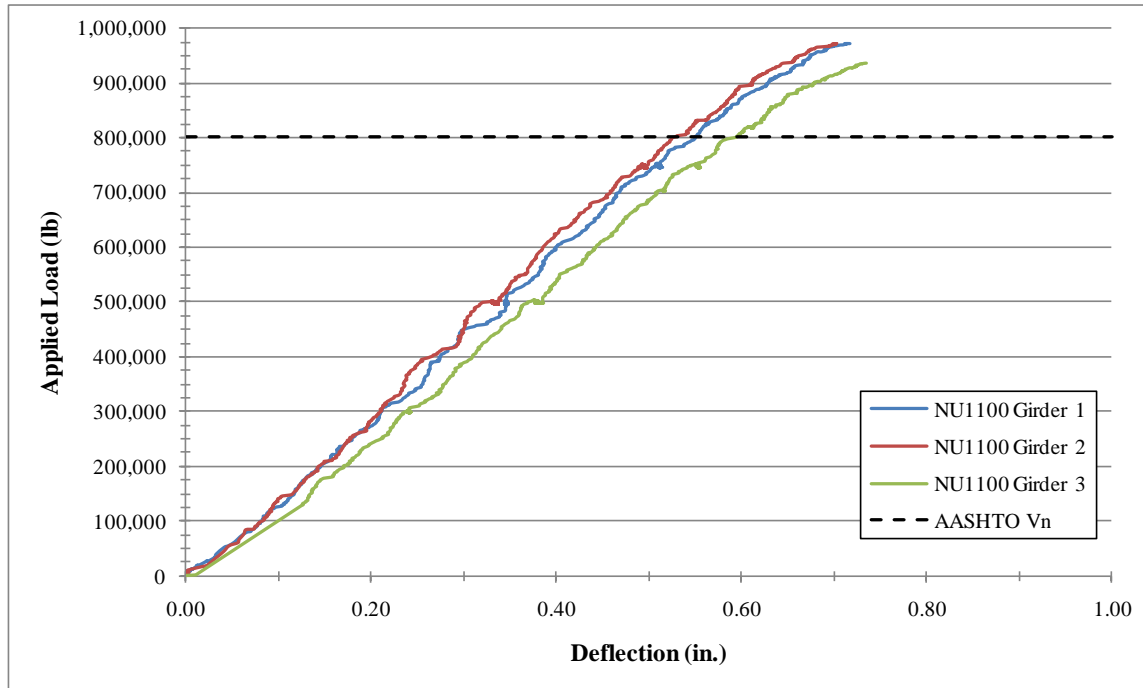

Figure 3.59 NU1100 Load v. Deflection Comparison

Figure 3.60 provides an image of Girder 2 after completion of the shear test. The failure mode shown was typical for all three shear tests performed at the structures lab. While testing the NU1100 girders' shear capacity, ten strands in the bottom row as well as the top two strands were monitored for any relative movement which would indicate a bond failure within the calculated AASHTO development length of the specimen. Figure 3.61 provides a drawing of the strand layout and designation for monitoring and reporting purposes.

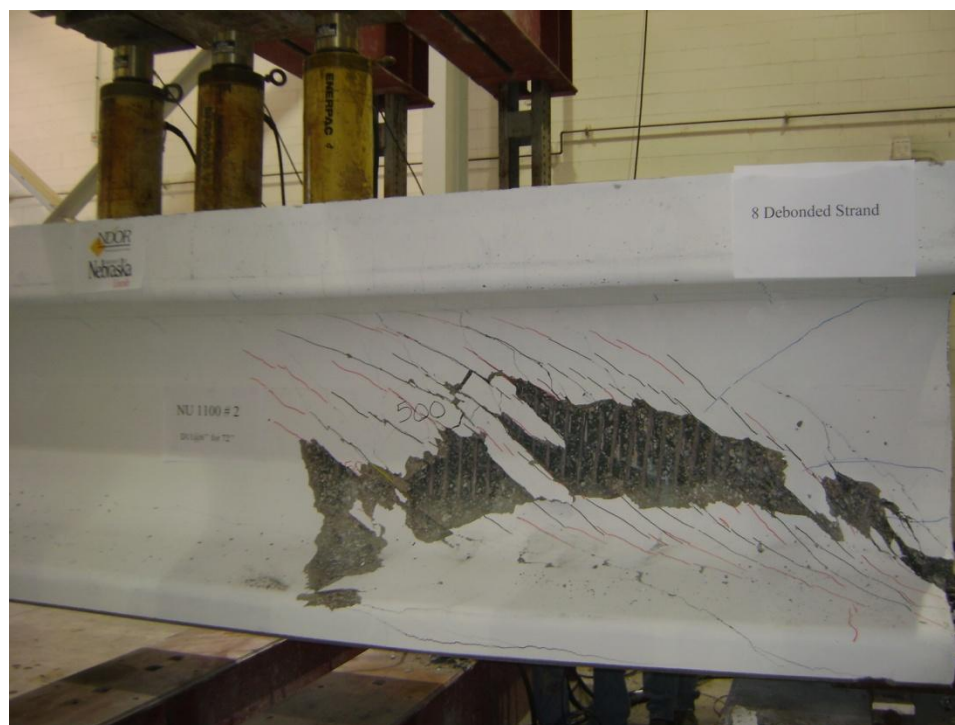

Figure 3.60 NU1100 Girder 2 Post Shear Test

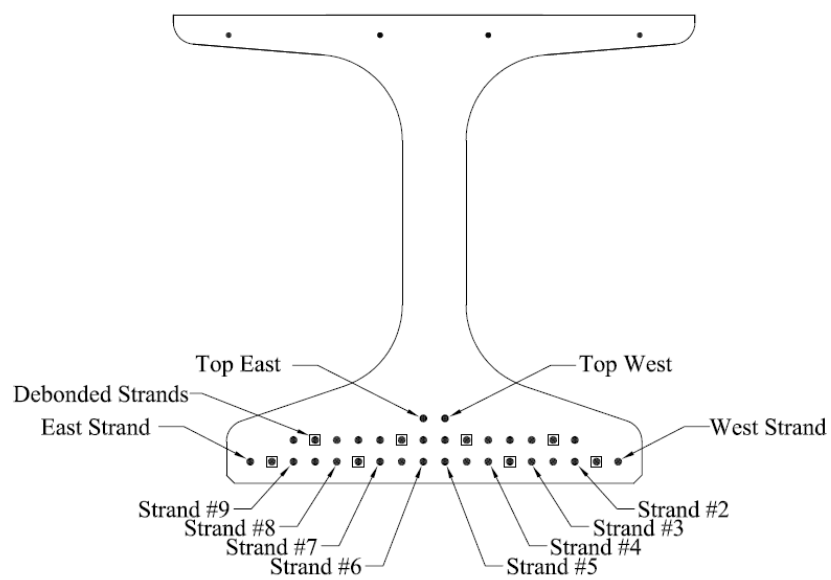

Figure 3.61 NU1100 Shear Test Strand Designation

Figure 3.62, Figure 3.63, and Figure 3.64 present the data from the potentiometers during each girder's test. Again the line indicating AASHTO V_n represents the required applied load, at the designated test distance which corresponds to the nominal capacity of the section incorporating the actual materials properties and with a resistance factor, ϕ , of 1.0. Also, the lines at -0.01" on the subsequent figures represent the permitted slippage allowed by ASTM A416 with regard to maintaining bond between the strand and the surrounding concrete.

Monitoring of the two top strands during the shear tests was done with both a mechanical gauge and a rotary potentiometer as described in Section 3.2.1.6.2. In none of the three tests, for either of the top strands, was any slippage detected by either means of observation and documentation.

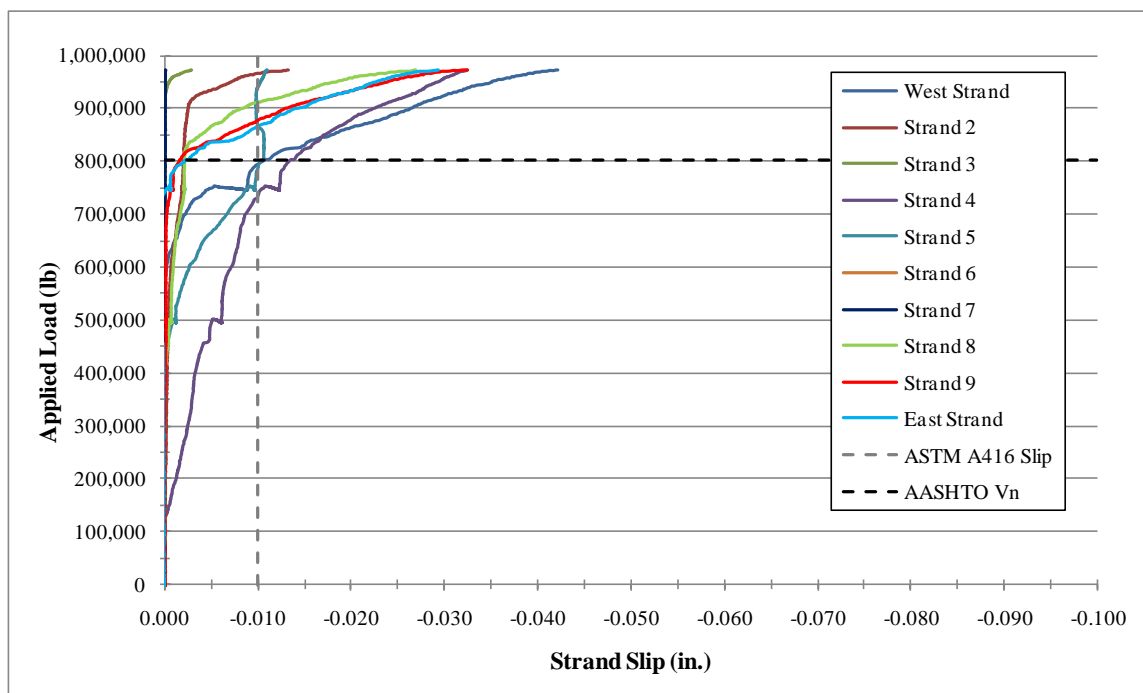

Figure 3.62 NU1100 Girder 1 Strand Slip

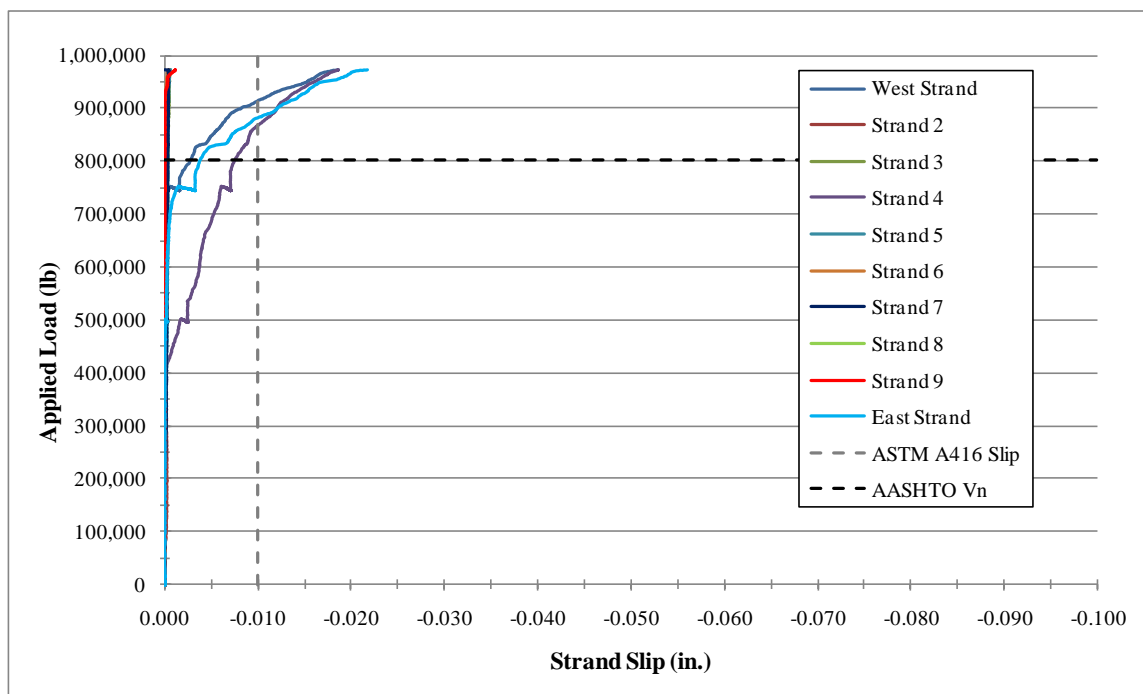

Figure 3.63 NU1100 Girder 2 Strand Slip

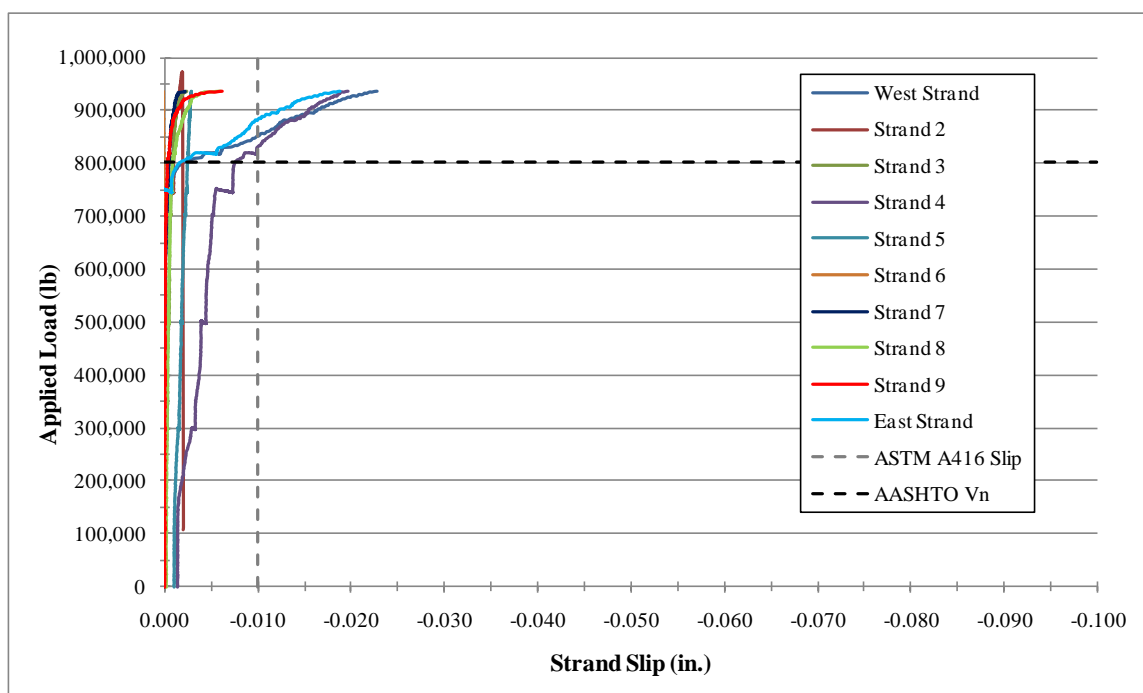

Figure 3.64 NU1100 Girder 3 Strand Slip

Figure 3.65 provides the applied load versus the maximum strand slippage for each shear test. The maximum strand slippage plot is of the one strand which saw the greatest amount of relative movement throughout the shear testing. For all three NU girders Strand 4 experienced the most relative movement during testing but only Girder 1 had any strands which reached the ASTM defined level of slippage prior to meeting the nominal shear resistance of the section.

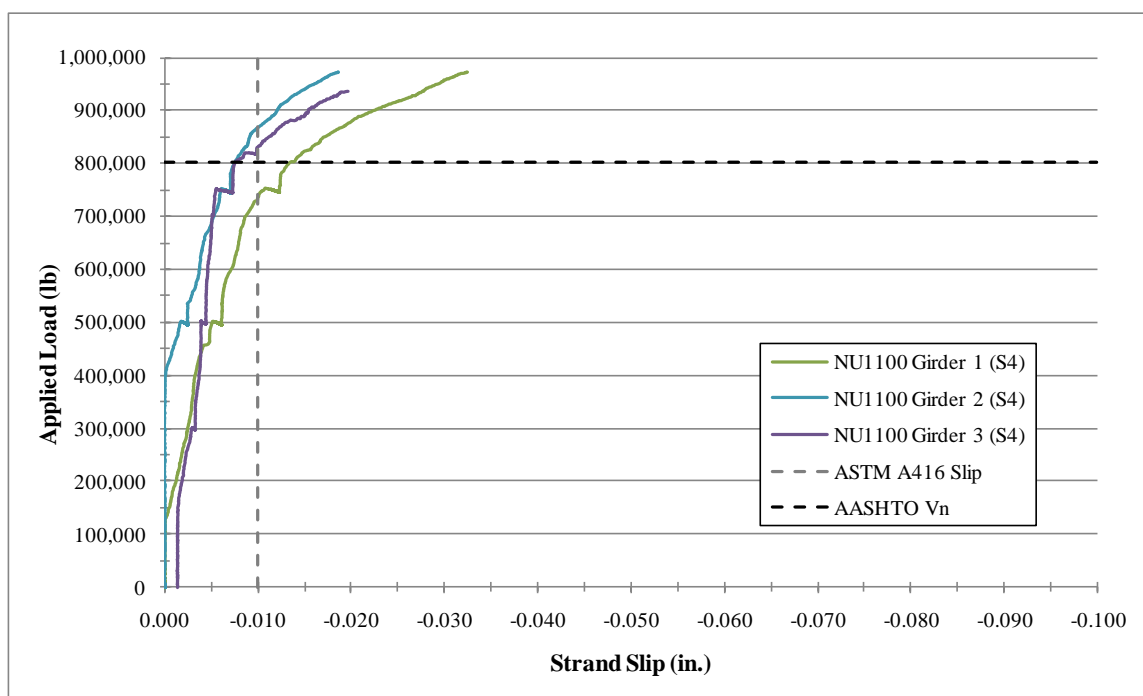

Figure 3.65 NU1100 Load v. Max. Strand Slip Comparison

The slippage results from shear testing provided some noticeable information. Girder 1, with a reduced amount of confinement at the end of the girder saw more strands slip and with greater intensity than the other two girders with the AASHTO specified end

confinement. An association may be made that the intensity of confinement at the end of the girder does aid the strand-concrete bond with respect to a shear loading condition.

The overall load-deflection results show no conclusive evidence which favors one confinement condition over another. The results shown in Figure 3.59 between Girders 1 and 2 are indistinguishable and Table 3.10 provides results which associate the actual nominal shear capacity of the three NU1100 girders between sixteen and twenty percent higher than their calculated values. The reason for Girder 3 providing slightly lower values is unknown by the researchers. There are a number of factors which can skew test results, beginning with fabrication of the specimen, proper handling, or minor difference in the testing setup. In any case, the results were still positive and within four percent of the values seen from the other two girders.

4 SUMMARY, CONCLUSIONS, & RECOMMENDATIONS

4.1 Summary

The main objective of this study was to determine what impact, if any, confinement reinforcement has on the performance of prestressed concrete bridge girders. Of particular interest was the effect confinement had on the transfer length, development length, and vertical shear capacity of the fore mentioned members. This was accomplished through extensive analytical and experimental investigations performed on first a twenty-four inch tee girder section (T24) and later a NU1100 girder section.

The T24 girders designed, fabricated, and tested by the researchers were subjected to transfer length tests, flexural tests for development length, and shear testing. The NU1100 girders were designed and tested by the researchers, but fabrication was provided by a local precaster. The specimens were later shipped to the PKI structures lab for testing in flexure (one end), and finally shear (opposite end).

Transfer length data was obtained by means of the concrete surface strain and calculated using the 95% AMS Method outlined by Russell and Burns. DEMEC readings were taken just prior to release of the prestressing force to the girder and immediately after to establish the initial transfer. After a period of fourteen days the readings were again taken and compared to the pre-release data to constitute the final transfer data.

Development length testing for both sets of specimen was performed by placing an applied load to the top of the section at a distance equal to the 2004 AASHTO specified development length, which for both sections was approximately fourteen feet. The ultimate capacity of the sections were then calculated and used to gauge the performance of each specimen. An actual ultimate capacity greater than that calculated by AASHTO specifications provided evidence that the section was fully developed and met AASHTO design criteria.

Shear tests were also performed on a number of specimens. A load was applied to the top of the section at a specified distance of approximately two times the height of the section.

The nominal resistance was then calculated and used to gauge the performance of each specimen. The ultimate capacity data recorded from each test, for each section, was then compared to one another.

At the conclusion of the experimental investigation all data was thoroughly analyzed and presumptions were made, in this report, with regard to the results.

4.2 Conclusions

The following sections present conclusions made, from the study, with respect to the impact of confinement reinforcement on performance of prestressed concrete bridge girders.

4.2.1 Transfer Length

- 1) The amount of confinement reinforcement had an insignificant effect on the initial or final prestress strand transfer length.

- 2) The distribution of confinement reinforcement had an insignificant effect on the initial or final prestress strand transfer length.

The aforementioned conclusions occur because confinement reinforcement remains inactive until concrete cracks, which does not usually occur at time of prestress transfer.

This result is in agreement with conclusions made by others studying 0.5” and 0.6” diameter strands.

4.2.2 Development Length

At the 2004 AASHTO LRFD calculated development length; the following conclusions can be made.

1) The amount of confinement reinforcement:

- a) Had insignificant effect on the flexural capacity of the tested girders.
- b) Produced insignificant evidence that it effects bond capacity or prevents premature slippage of the prestressed strands.
- c) Provided a slight increase in the girders’ overall ductility when placed across its entire length.

2) The distribution of confinement reinforcement:

- a) Had insignificant effect on the flexural capacity of the tested girders.
- b) Produced insignificant evidence that it effects bond capacity or prevents premature slippage of the prestressed strands.
- c) Reduced cracking and spalling of concrete from around the strands at ultimate loading.

Overall, the impact of varied confinement reinforcement on the ultimate flexural capacity of bridge girders at their development length was negligible. This determination is viewed as a product of a conservative AASHTO LRFD development length equation by incorporating a k factor of 1.6. In all tested cases, regardless of confinement variability, the sections' nominal moment capacity was reached or exceeded. The tests performed show that current AASHTO LRFD specifications pertaining to nominal moment values of bridge girder sections, as well as, strand development length are adequate.

4.2.3 Vertical Shear

From testing, the following results can be made for girders which include some amount of bottom flange confinement reinforcement.

1) The amount of confinement reinforcement:

- a) Had an insignificant effect on the shear resistance of the tested girders.
- b) Provided a slight increase in the girders' overall ductility when placed across its entire length.

2) The distribution of confinement reinforcement:

- a) Had an insignificant effect on the shear resistance of the tested girders.
- b) Produced conclusive evidence that it improves bond capacity or prevents premature slippage of the prestressed strands.

Overall, the impact of varied confinement reinforcement on the shear resistance of bridge girders was negligible. In all tested cases, regardless of confinement variability, the ultimate shear capacity was found to be 17% - 25% greater than the AASHTO LRFD calculated nominal resistance for each section.

4.3 Recommendations

Section 4.3 provides recommendations from the researchers based on results from the analytical and experimental investigations presented herein.

4.3.1 Future Research

One area with little research is the effect confinement reinforcement has on the development length of prestress strand. This particular project only looked to validate current AASHTO LRFD specified codes, not to challenge or provide alternate means and methods of calculating the development length of prestress strand. Theoretically the effects of confinement should assist in developing a strand, but to what extent? Should the AASHTO LRFD development length equation incorporate a variable for confinement? As the material properties of future prestressing strand increase, (grade, diameter, etc.) the current AASHTO development length equation will need to be reviewed and opportunities to link research for the newly developed strand with modifying the existing development length equation will become present.

4.3.2 DOT Girder Detailing

The data suggests some recommendations applicable to state DOT engineers and bridge girder detailers. The first is to incorporate AASHTO LRFD Specification 5.10.10.2 as their typical end confinement. No benefit was exposed to altering the amount or distribution of the confinement at the end of the tested girders. The current AASHTO LRFD detail seems to be efficient and adequate.

Another recommendation to state DOT's is actually an extension of the first. It is in the best interest of bridge girder details to include some level of confinement between the end regions defined as $1.5h$. One benefit from the extra confinement is reduced cracking and spalling concrete from aged and overstressed girders. Another is a slightly more ductile behavior of the girder above its nominal capacity. The third and strongest argument for the extra steel is for protection and support of the prestress strands in the event of impact on the girders from over height vehicles. Figure 4.1 presents damage done to bridge girders in the state of Washington from an over height vehicle. The additional confinement reinforcement adds very little expense to the overall cost of a bridge girder, and the benefits provided by that steel seems worth its presence.



Figure 4.1 Collision Impact on Exterior Girder

The last suggestion is to extend at least a portion of the strands from the fabricated bridge girders and bend them into a poured diaphragm. This detail will reduce, if not eliminate, the strand bond failure seen from testing. Although the ultimate capacities for all girders met and exceeded their nominal values, strand slippage was present in a number of specimens. The addition of this step will further decrease the development length of the embedded strands thereby reducing the length of girder which is under developed. This suggestion too provides exceptional benefits versus the cost and inconvenience involved.

REFERENCES

- AASHTO. "AASHTO LRFD Bridge Design Specifications." 3rd Edition, Washington D.C., 2004.
- AASHTO. "AASHTO Standard Specification for Highway Bridges." 16th Edition, Washinton D.C., 1996.
- ACI Committee 318. "Building Code Requirements for Structural Concrete (ACI 318-08)." American Concrete Institute, 2008.
- American Society for Testing and Materials. *ASTM A416 Standard Specifications for Steel Strand, Uncoated Seven-Wire for Prestressed Concrete*. ASTM Annual Book of Standards, 2006.
- Braga, Franco, Rosario Gigliotti, and Michelangelo Laterza. "Analytical Stress-Strain Relationship by Steel Stirrups and/or FRP Jackets." *Journal of Structural Engineering - ASCE*, 2006: 1402-1416.
- Csagoly. *A Shear Moment Model for Prestressed Concrete Beams*. FDOT, 1991.
- Federal Highway Administration. "An Analysis of Transfer and Development Lengths for Pretensioned Concrete Structures." 1994.
- Kose, Mehmet, and William Burkett. "Formulation of New Development Length Equation for 0.6 in. Prestressing Strand." *PCI Journal*, 2005: 96-105.
- Lane, S. *A New Development Length Equation for Pretensioned Strands in Bridge Beams and Piles*. Research Report, Federal Highway Administration, 1998.
- Maguire, Marc. "Impact of 0.7 Inch Diameter Prestressing Strands in Bridge Girders." MS Thesis, Lincoln, NE, 2009.

- Mitchell, D, W. Cook, A. Khan, and T. Tham. "Influence of High Strength Concrete on Transfer and Development Length of Pretensioning Strand." *PCI Journal*, 1993: 52-66.
- Nebraska Department of Roads. "Bridge Operations, Policies, and Procedures." Lincoln, Nebraska, 2008.
- Patzlaff, Quinton, George Morcoux, Kromel Hanna, and Maher Tadros. "Bottom Flange Reinforcement of Precast-Prestressed." PCA Conference, 2010.
- Ramirez, J., and B. Russell. *Transfer, Development, and Splice Length for Strand/Reinforcement in High-Strength Concrete*. NCHRP, 2007.
- Ross. "Experimental Evaluation of Confinement Reinforcement in Pretensioned Concrete Girders." *ACI Convention*. Chicago, 2010.
- Russell, and Burns. "Measured Transfer Lengths of 0.5 and 0.6 inch Strands in Pretentioned Concrete." *PCI Journal*, 1996.
- Saatcioglu, Murat, and Salim Razvi. "Strength and Ductility of Confined Concrete." *Journal of Structural Engineering*, June 1992: 1590-1607.
- Shahawy, Mohsen. "A Critical Evaluation of the AASHTO Provisions for Strand Development Length of Prestressed Concrete Members." *PCI Journal*, 2001: 94-117.
- Shahawy, Robinson, and deV Batchelor. *An Investigation of Shear Strength of Prestressed Concrete AASHTO Type II Girders*. FDOT, 1993.

APPENDIX A – T24 Girder Design Calculations

Table A.1 T24 Properties

Specimen Properties					
Girder	H (in)	A (in ²)	I _x (in ⁴)	y _b (in)	W (lb/ft)
T24	24.0	288	15744	15.32	300

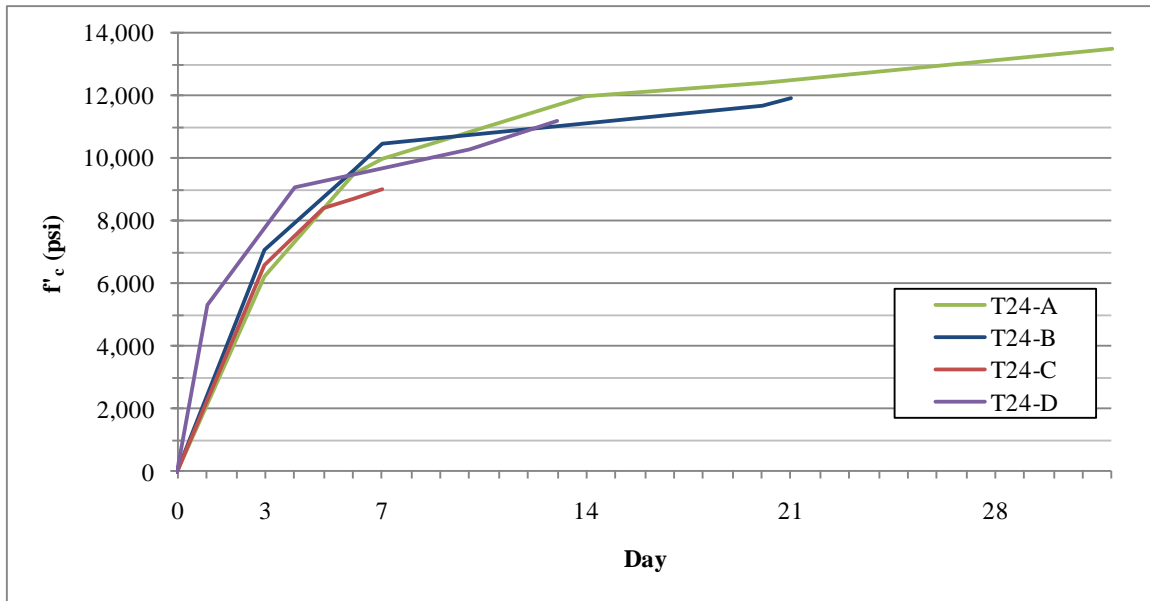

Figure A.1 T24 Concrete Strength

Flexural Strength															
	f_c	Width, W	Effective Prest.	Depth d_{tr}	E_s	Q	R	K	ϵ_{sp}	Area A_s	Total ϵ_s	Stress	Force	Moment	Modified stress
Units in Kips and Inches															
Concrete Layers															
	1	13.500	32.000	4.000	1.500	29000	0	1.096	0.0000	0.0000	-0.0008	-23.63	0.00	-42.833	0.00
	2	13.500	8.000	20.000	3.875	29000	0	1.096	0.0000	0.0000	0.0026	60.00	0.00	0.000	0.00
	3				6.500	29000	0	1.096	0.0000	0.0000	0.0065	60.00	0.00	0.000	0.00
	4				9.125	29000	0	1.096	0.0000	0.0000	0.0103	60.00	0.00	0.000	0.00
	5				11.750	29000	0	1.096	0.0000	0.0000	0.0141	60.00	0.00	0.000	0.00
	6				14.375	29000	0	1.096	0.0000	0.0000	0.0179	60.00	0.00	0.000	0.00
	7				17.000	29000	0	1.096	0.0000	0.0000	0.0218	60.00	0.00	0.000	0.00
	8				19.625	29000	0	1.096	0.0000	0.0000	0.0256	60.00	0.00	0.000	0.00
	9				22.250	29000	0	1.096	0.0000	0.0000	0.0294	60.00	0.00	0.000	0.00
	10				24.875	29000	0	1.096	0.0000	0.0000	0.0332	60.00	0.00	0.000	0.00
	11				27.500	29000	0	1.096	0.0000	0.0000	0.0371	60.00	0.00	0.000	0.00
	12				30.125	29000	0	1.096	0.0000	0.0000	0.0409	60.00	0.00	0.000	0.00
	13				32.750	29000	0	1.06	0.0000	0.0000	-0.0030	-70.00	0.00	0.000	0.00
Grade 70 Plate	1				0.000	29000	0	1.01	0.0000	0.0000	0.0045	80.34	0.00	0.000	0.00
Gr. 120 Rods	1				5.125	29000	0.0217	4.224	1.01	0.0000	0.0045	80.34	0.00	0.000	0.00
Gr. 150 Rods	1				5.125	29000	0.0217	4.224	1.01	0.0000	0.0045	80.34	0.00	0.000	0.00
Gr 270	1	0.882	270	170	22.000	28500	0.031	7.36	1.043	0.0060	0.0291	270.00	238.14	5239.08	270.00
Gr 270	2	0.882	270	170	20.000	28500	0.031	7.36	1.043	0.0060	0.0291	270.00	238.14	4762.80	270.00
Gr 270	3	0.868	270	20	2.000	28500	0.031	7.36	1.043	0.0007	-0.0001	17.54	15.22	30.45	17.54
Gr 270	4				2.000	28500	0.031	7.36	1.043	0.0056	0.0055	156.92	0.00	0.000	156.92
Gr 270	5				12.333	28500	0.031	7.36	1.043	0.0056	0.0206	263.71	0.00	0.000	263.71
Gr 270	6				14.867	28500	0.031	7.36	1.043	0.0056	0.0240	266.76	0.00	0.000	266.76
Gr 270	7				17.000	28500	0.031	7.36	1.043	0.0056	0.0274	269.77	0.00	0.000	269.77
Gr 270	8				19.333	28500	0.031	7.36	1.043	0.0056	0.0308	270.00	0.00	0.000	270.00
Gr 270	9				21.667	28500	0.031	7.36	1.043	0.0056	0.0342	270.00	0.00	0.000	270.00
Gr 270	10				24.000	28500	0.031	7.36	1.043	0.0056	0.0376	270.00	0.00	0.000	270.00
Gr 270	11				26.333	28500	0.031	7.36	1.043	0.0056	0.0410	270.00	0.00	0.000	270.00
Gr 270	12				28.667	28500	0.031	7.36	1.043	0.0056	0.0444	270.00	0.00	0.000	270.00
Gr 270	13				31.000	28500	0.031	7.36	1.043	0.0056	0.0478	270.00	0.00	0.000	270.00
Sum of M								MAXIMUM	$A_s :$	0.0291	Moment (I	0.00	9703.38	kip in	808.62

Figure A.2 T24-A Flexural Capacity

Flexural Strength

	fc	Width, W	Thick., T	Units in kips and inches		E _s	Q	R	K	ε _{so}	A _s	Total ε _s	Stress	Force	Moment	Modified stress	
				Depth, d _c	β ₁												Revised T
Concrete Layers																	
1	11,900	32,000	4,000	0.748	0.650	29,000	0	100	1.096	0.0000	0.0000	-0.0010	-30.27	0.00	-361.79	11.90	
2	11,900	8,000	20,000	4,000	0.650	29,000	0	60	1.096	0.0000	0.0000	0.0021	59.56	0.00	0.00	11.90	
3				24,000	0.850	29,000	0	100	1.096	0.0000	0.0000	0.0055	60.00	0.00	0.00	60.00	
4				24,000	0.850	29,000	0	60	1.096	0.0000	0.0000	0.0089	60.00	0.00	0.00	60.00	
5				24,000	0.850	29,000	0	100	1.096	0.0000	0.0000	0.0123	60.00	0.00	0.00	60.00	
6				24,000	0.850	29,000	0	60	1.096	0.0000	0.0000	0.0157	60.00	0.00	0.00	60.00	
7				24,000	0.850	29,000	0	100	1.096	0.0000	0.0000	0.0226	60.00	0.00	0.00	60.00	
8				24,000	0.850	29,000	0	60	1.096	0.0000	0.0000	0.0294	60.00	0.00	0.00	60.00	
9				24,000	0.850	29,000	0	100	1.096	0.0000	0.0000	0.0329	60.00	0.00	0.00	60.00	
10				24,000	0.850	29,000	0	60	1.096	0.0000	0.0000	0.0363	60.00	0.00	0.00	60.00	
11				24,000	0.850	29,000	0	100	1.06	0.0000	0.0000	-0.0030	-70.00	0.00	0.00	60.00	
12				24,000	0.850	29,000	0	70	1.01	0.0000	0.0000	0.0037	77.21	0.00	0.00	11.90	
Grade 70 Plate																	
Gr. 120 Rods	1	150	0	5,125	29,000	29,000	0.0217	4,224	1.01	0.0000	0.0000	0.0037	96.01	0.00	0.00	96.01	
Gr. 150 Rods	1	170	0	5,125	29,000	29,000	0.0217	4,224	1.01	0.0000	0.0000	0.0037	96.01	0.00	0.00	96.01	
Gr. 270	1	270	170	22,000	28,500	28,500	0.031	243	1.043	0.0060	0.0257	0.0317	270.00	238.14	5239.08	270.00	
Gr. 270	2	270	170	20,000	28,500	28,500	0.031	243	1.043	0.0060	0.0251	0.0290	270.00	238.14	4762.80	270.00	
Gr. 270	3	270	20	2,000	28,500	28,500	0.031	243	1.043	0.0007	-0.0004	0.0003	8.84	7.67	15.35	8.84	
Gr. 270	4	270	160	2,000	28,500	28,500	0.031	243	1.043	0.0056	0.0000	0.0052	148.45	0.00	0.00	148.45	
Gr. 270	5	270	160	12,333	28,500	28,500	0.031	243	1.043	0.0056	0.0000	0.0187	261.97	0.00	0.00	261.97	
Gr. 270	6	270	160	14,867	28,500	28,500	0.031	243	1.043	0.0056	0.0000	0.0217	264.76	0.00	0.00	264.76	
Gr. 270	7	270	160	17,000	28,500	28,500	0.031	243	1.043	0.0056	0.0000	0.0248	267.47	0.00	0.00	267.47	
Gr. 270	8	270	160	19,333	28,500	28,500	0.031	243	1.043	0.0056	0.0000	0.0278	270.00	0.00	0.00	270.00	
Gr. 270	9	270	160	21,667	28,500	28,500	0.031	243	1.043	0.0056	0.0000	0.0309	270.00	0.00	0.00	270.00	
Gr. 270	10	270	160	24,000	28,500	28,500	0.031	243	1.043	0.0056	0.0000	0.0339	270.00	0.00	0.00	270.00	
Gr. 270	11	270	160	26,333	28,500	28,500	0.031	243	1.043	0.0056	0.0000	0.0370	270.00	0.00	0.00	270.00	
Gr. 270	12	270	160	28,667	28,500	28,500	0.031	243	1.043	0.0056	0.0000	0.0400	270.00	0.00	0.00	270.00	
Gr. 270	13	270	160	31,000	28,500	28,500	0.031	243	1.043	0.0056	0.0000	0.0430	270.00	0.00	0.00	270.00	
Sum of M								7.36	MAXIMUM	0.0056	0.0257	0.0430	Moment (l)	0.00	9655.43	kip-in	804.62

Figure A.3 T24-B Flexural Capacity

Flexural Strength																	
Units in kips and inches																	
Concrete Layers	fc	Width, W	Thick., T	Depth, dc	β_1	T_{upper}	T_{lower}	Revised T	Beta calculation	ϵ_{so}	As	Total ϵ_s	Stress	Force	Moment	Modified stress	fc
1	9.000	32.000	4.000	1.500	0.850	0.000	4.000	1.901	355.8115434	547.402374	60.822	-0.0015	-42.37	0.00	-465.29	-34.72	9.00
2	9.000	8.000	20.000	3.875	29000	0	60	100	1.096	0.000	0.0000	0.0010	28.29	0.00	0.00	28.29	9.00
3				6.500	29000	0	60	100	1.096	0.000	0.0000	0.0037	60.00	0.00	0.00	60.00	9.00
4				9.125	29000	0	60	100	1.096	0.000	0.0000	0.0064	60.00	0.00	0.00	60.00	9.00
5				11.750	29000	0	60	100	1.096	0.000	0.0000	0.0091	60.00	0.00	0.00	60.00	9.00
6				14.375	29000	0	60	100	1.096	0.000	0.0000	0.0117	60.00	0.00	0.00	60.00	9.00
7				17.000	29000	0	60	100	1.096	0.000	0.0000	0.0144	60.00	0.00	0.00	60.00	9.00
8				19.625	29000	0	60	100	1.096	0.000	0.0000	0.0171	60.00	0.00	0.00	60.00	9.00
9				22.250	29000	0	60	100	1.096	0.000	0.0000	0.0198	60.00	0.00	0.00	60.00	9.00
10				24.875	29000	0	60	100	1.096	0.000	0.0000	0.0225	60.00	0.00	0.00	60.00	9.00
11				27.500	29000	0	60	100	1.096	0.000	0.0000	0.0252	60.00	0.00	0.00	60.00	9.00
12				30.125	29000	0	60	100	1.096	0.000	0.0000	0.0279	60.00	0.00	0.00	60.00	9.00
13				32.750	29000	0	60	100	1.096	0.000	0.0000	0.0306	60.00	0.00	0.00	60.00	9.00
Grade 70 Plate				0.000	29000	0	70	100	1.06	0.000	0.0000	-0.0030	-70.00	0.00	0.00	0.00	60.67
Gr. 120 Rods				5.125	29000	0.0217	81.00	4.224	1.01	0.000	0.0000	0.0023	60.67	0.00	0.00	64.40	9.00
Gr. 150 Rods				5.125	29000	0.0217	120.00	4.224	1.01	0.000	0.0000	0.0023	64.40	0.00	0.00	64.40	9.00
Gr 270	0.882	270	170	22.000	28500	0.031	243	7.36	1.043	0.0660	0.0196	0.0255	268.14	236.50	5202.96	268.14	9.00
Gr 270	0.882	270	170	20.000	28500	0.031	243	7.36	1.043	0.0660	0.0175	0.0235	266.31	234.89	4697.77	266.31	9.00
Gr 270	0.868	270	20	2.000	28500	0.031	243	7.36	1.043	0.0656	-0.0009	-0.0002	-7.02	-6.09	-12.19	-7.02	9.00
Gr 270				2.000	28500	0.031	243	7.36	1.043	0.0656	0.0000	0.0047	132.83	0.00	0.00	132.83	9.00
Gr 270				12.333	28500	0.031	243	7.36	1.043	0.0656	0.0000	0.0153	258.46	0.00	0.00	258.46	9.00
Gr 270				14.867	28500	0.031	243	7.36	1.043	0.0656	0.0000	0.0177	260.98	0.00	0.00	260.98	9.00
Gr 270				17.000	28500	0.031	243	7.36	1.043	0.0656	0.0000	0.0201	263.23	0.00	0.00	263.23	9.00
Gr 270				19.333	28500	0.031	243	7.36	1.043	0.0656	0.0000	0.0224	265.39	0.00	0.00	265.39	9.00
Gr 270				21.667	28500	0.031	243	7.36	1.043	0.0656	0.0000	0.0248	267.52	0.00	0.00	267.52	9.00
Gr 270				24.000	28500	0.031	243	7.36	1.043	0.0656	0.0000	0.0272	269.65	0.00	0.00	269.65	9.00
Gr 270				26.333	28500	0.031	243	7.36	1.043	0.0656	0.0000	0.0296	270.00	0.00	0.00	270.00	9.00
Gr 270				28.667	28500	0.031	243	7.36	1.043	0.0656	0.0000	0.0320	270.00	0.00	0.00	270.00	9.00
Gr 270				31.000	28500	0.031	243	7.36	1.043	0.0656	0.0000	0.0344	270.00	0.00	0.00	270.00	9.00
Sum of M									MAXIMUM	As :	0.0196		Moment (l	0.00	9446.35 kip-in	787.20 kip-ft	

Figure A.4 T24-C Flexural Capacity

Flexural Strength

Concrete Layers												
fc	Width, W	Thick., T	Depth, d _c	β ₁	Units in kips and inches		Revised T		β ₁	Beta calculation		
1	11,200	32,000	4,000	0.850	T _{upper}	T _{lower}	4,000	1,578	0.000	367.5047943	565.391991	565.391991
2	11,200	8,000	20,000	0.850	4,000	4,000	24,000	0.000	0	0	0	0
3				0.850	24,000	24,000	24,000	0.000	0	0	0	0
4				0.850	24,000	24,000	24,000	0.000	0	0	0	0
5				0.850	24,000	24,000	24,000	0.000	0	0	0	0
6				0.850	24,000	24,000	24,000	0.000	0	0	0	0
7				0.850	24,000	24,000	24,000	0.000	0	0	0	0

Steel Layers														
Area A _{st}	Grade	Effective Prest.	Depth d _{st}	E _s	Q	R	K	ε _{sp}	A _s	Total ε _s	Stress	Force	Moment	Modified stress
1	0.882	270	170	29000	0.031	243	7.36	1.043	0.0060	0.0242	270.00	238.14	5239.08	270.00
2	0.882	270	170	29000	0.031	243	7.36	1.043	0.0060	0.0217	270.00	238.14	4762.80	270.00
3	0.868	270	20	29000	0.031	243	7.36	1.043	0.0007	-0.0005	4.96	4.30	8.61	4.96
4				29000	0.031	243	7.36	1.043	0.0056	0.0000	144.65	0.00	0.00	144.65
5				29000	0.031	243	7.36	1.043	0.0056	0.0000	261.17	0.00	0.00	261.17
6				29000	0.031	243	7.36	1.043	0.0056	0.0000	263.85	0.00	0.00	263.85
7				29000	0.031	243	7.36	1.043	0.0056	0.0000	266.44	0.00	0.00	266.44
8				29000	0.031	243	7.36	1.043	0.0056	0.0000	269.00	0.00	0.00	269.00
9				29000	0.031	243	7.36	1.043	0.0056	0.0000	271.00	0.00	0.00	271.00
10				29000	0.031	243	7.36	1.043	0.0056	0.0000	273.00	0.00	0.00	273.00
11				29000	0.031	243	7.36	1.043	0.0056	0.0000	275.00	0.00	0.00	275.00
12				29000	0.031	243	7.36	1.043	0.0056	0.0000	277.00	0.00	0.00	277.00
13				29000	0.031	243	7.36	1.043	0.0056	0.0000	279.00	0.00	0.00	279.00
Sum of M								MAXIMUM	A _s	0.0242	Moment (l)	0.00	9631.42	802.62

Figure A.5 T24-D Flexural Capacity

Parameter	Symbol	Value	Unit		
Total Section Depth	h	24.00	in		
C.G. of Bottom Strands	y_{ps}	3.00	in		
Effective Depth	d_e	21.00	in		
Shear Depth	d_v	18.90	in		
Web Width	b_v	5.0	in		
Shear Reduction Factor	ϕ	0.9	N/A		
Section Distance From Support	x	4.42	ft	Applied Load	119.5
Ultimate Shear	V_u	82	kip		
Ultimate Moment	M_u	341	kip.ft		
Ultimate Axial Force	N_u	0	kip		
Locked in Stresses	f_{po}	189	ksi		
Development Length	l_d	14	ft		
Area of Strands in Tension Side	A_{ps}	1.76	in ²		
Transfer Length	l_t	3.5	ft		
Prestressing Shear Force	V_p	0.0	kip		
Strands Modulus	E_{ps}	28,500	ksi		
Area of Steel	A_s	0	in ²		
Steel Modulus	E_s	29,000	ksi		
Concrete Strength	f'_c	11.2	ksi		
Stirrup Yield Strength	f_y	75.0	ksi	Modified A_{ps}	1.281
Strain	ϵ_x	0.0015	N/A	$0 \leq \epsilon_x \leq 0.006$	
Maximum Aggregate Size	a_g	0.75	in		
Maximum Spacing bet. Skin Rft Layer	S_x	18.90	in		
Crack Spacing Parameter	S_{xe}	18.90	in	$12 \leq S_{xe} \leq 80$	
Shear Stress in Concrete / f'_c	v/f'_c	0.086	N/A	≤ 0.25	
Section Contains at Least Min. Transverse Rft.		Yes	N/A		
Calculated shear Angle	θ	34.42	degree		
Concrete Shear Factor	β	2.22	N/A		
Concrete Shear Force	V_c	22.2	kip	Use at least A_{vmin}	
Steel Shear Force	V_s	68.8	kip		
Maximum Spacing	S_{max}	15.1	in		
Minimum Steel Shear Force	A_{vmin}	0.085	in ² /ft		
Required Area of Steel	A_v	0.40	in ² /ft		

Figure A.6 T24-D Vertical Shear Capacity by Detailed Method

APPENDIX B – NU1100 Girder Design Calculations

Table B.1 NU1100 Properties

Specimen Properties					
Girder	H (in)	A (in ²)	I _x (in ⁴)	y _b (in)	W (lb/ft)
NU1100	43.3	694.6	182,279	19.60	724
NU1100+Deck	50.8	1,056.1	363,187	29.00	1,100

Table B.2 Specimen Concrete Strength @ Testing

NU1100 Concrete Strength		
	Girder	Deck
	f _c (psi)	f _c (psi)
1	14770	9790
2	14710	9250
3	14760	9410

L (ft)	40	a (ft)	13.5	b (ft)	25.5	WD.L (k-ft)	1.1	MD.L (k-ft)	189.3	MP (k-ft)	9508.1	P (k)	1077	V (kip)	704				
<div style="display: flex; justify-content: space-around; align-items: center;"> <div style="text-align: center;"> <p>Flexural Strength</p> </div> <div style="border: 1px solid black; padding: 5px; text-align: center;"> <p>Calculate</p> </div> </div>																			
				ϵ_{su}	0.003					$c=\frac{M_u}{A_s f_y}$	9.825								
				a	6.386					Sum of forces	0.00								
				Design	PIC AASHTO					ANSWER:	1.00								
				ϕ	116.889					Area	0.650								
				ϕM_u kip-in	9697.4					Force	0.00								
				ϕM_u kip-ft	9697.4					Moment	0.00								
				Concrete Layers	f_c		Width, W		Thick., T		Units in kips and inches	Revised T	Beta calculation	Area	Force	Moment	Modified stress	fc	
1	1.6	48,200	0	2,560	0.000	0.850	0.000	0.000	0.000	0.000	0.000	0.000	0.000	0.000	0.000	0.000	0.000	0.000	
2	1.6	48,200	0	2,560	3.193	0.650	0.000	7.500	6.386	1958.738599	7.500	6.386	3013.444	307.808	-2561.43	-8178.72	-49.90	9.79	
3	1.6	48,200	0	2,560	7.500	0.650	0.000	10.060	7.500	0.000	10.060	0.000	0.000	0.000	0.000	0.000	0.000	0.000	0.000
4	1.6	48,200	0	2,560	11.830	0.650	0.000	14.375	11.830	0.000	14.375	0.000	0.000	0.000	0.000	0.000	0.000	0.000	0.000
5	1.6	48,200	0	2,560	15.700	0.650	0.000	19.625	15.700	0.000	19.625	0.000	0.000	0.000	0.000	0.000	0.000	0.000	0.000
6	1.6	48,200	0	2,560	19.625	0.650	0.000	24.975	19.625	0.000	24.975	0.000	0.000	0.000	0.000	0.000	0.000	0.000	0.000
7	1.6	48,200	0	2,560	24.975	0.650	0.000	30.125	24.975	0.000	30.125	0.000	0.000	0.000	0.000	0.000	0.000	0.000	0.000
8	1.6	48,200	0	2,560	30.125	0.650	0.000	35.275	30.125	0.000	35.275	0.000	0.000	0.000	0.000	0.000	0.000	0.000	0.000
9	1.6	48,200	0	2,560	35.275	0.650	0.000	40.425	35.275	0.000	40.425	0.000	0.000	0.000	0.000	0.000	0.000	0.000	0.000
10	1.6	48,200	0	2,560	40.425	0.650	0.000	45.575	40.425	0.000	45.575	0.000	0.000	0.000	0.000	0.000	0.000	0.000	0.000
11	1.6	48,200	0	2,560	45.575	0.650	0.000	50.725	45.575	0.000	50.725	0.000	0.000	0.000	0.000	0.000	0.000	0.000	0.000
12	1.6	48,200	0	2,560	50.725	0.650	0.000	55.875	50.725	0.000	55.875	0.000	0.000	0.000	0.000	0.000	0.000	0.000	0.000
13	1.6	48,200	0	2,560	55.875	0.650	0.000	61.025	55.875	0.000	61.025	0.000	0.000	0.000	0.000	0.000	0.000	0.000	0.000
Grade 70 Plate																			
1	120	0	0	0.000	29000	0.000	0.000	0.000	0.000	0.000	0.000	0.000	0.000	0.000	0.000	0.000	0.000	0.000	0.000
1	150	0	0	5.125	29000	0.0217	120.00	4.224	1.01	1.01	1.01	1.01	1.01	1.01	1.01	1.01	1.01	1.01	1.01
1	270	28	28	1.500	28500	0.031	243	7.36	1.043	1.043	1.043	1.043	1.043	1.043	1.043	1.043	1.043	1.043	1.043
1	270	160	160	9.000	28500	0.031	243	7.36	1.043	1.043	1.043	1.043	1.043	1.043	1.043	1.043	1.043	1.043	1.043
3	5.292	270	160	48.800	28500	0.031	243	7.36	1.043	1.043	1.043	1.043	1.043	1.043	1.043	1.043	1.043	1.043	1.043
4	4.116	270	160	46.800	28500	0.031	243	7.36	1.043	1.043	1.043	1.043	1.043	1.043	1.043	1.043	1.043	1.043	1.043
5	0.588	270	160	44.800	28500	0.031	243	7.36	1.043	1.043	1.043	1.043	1.043	1.043	1.043	1.043	1.043	1.043	1.043
6		270	160	42.800	28500	0.031	243	7.36	1.043	1.043	1.043	1.043	1.043	1.043	1.043	1.043	1.043	1.043	1.043
7		270	160	40.800	28500	0.031	243	7.36	1.043	1.043	1.043	1.043	1.043	1.043	1.043	1.043	1.043	1.043	1.043
8		270	160	38.800	28500	0.031	243	7.36	1.043	1.043	1.043	1.043	1.043	1.043	1.043	1.043	1.043	1.043	1.043
9		270	160	36.800	28500	0.031	243	7.36	1.043	1.043	1.043	1.043	1.043	1.043	1.043	1.043	1.043	1.043	1.043
10		270	160	34.800	28500	0.031	243	7.36	1.043	1.043	1.043	1.043	1.043	1.043	1.043	1.043	1.043	1.043	1.043
11		270	160	32.800	28500	0.031	243	7.36	1.043	1.043	1.043	1.043	1.043	1.043	1.043	1.043	1.043	1.043	1.043
12		270	160	30.800	28500	0.031	243	7.36	1.043	1.043	1.043	1.043	1.043	1.043	1.043	1.043	1.043	1.043	1.043
13		270	160	28.800	28500	0.031	243	7.36	1.043	1.043	1.043	1.043	1.043	1.043	1.043	1.043	1.043	1.043	1.043
Sum of M										MAXIMUM			MAXIMUM						

Figure B.1 NU1100-1 Flexural Capacity

L (ft)	40											ε _{sp}	0.003						
a (ft)	13.5											C=	10.307						
b (ft)	25.5											a	6.689	Calculate					
WD.L (k-ft)	1.1											Sum of forces	0.00						
MD.L (k-ft)	188.3											Design	P/C AASHTO						
MP (k-ft)	9444.3											ANSWER:	1.00						
P (k)	1070											9	115604	Av. β ₁ :					
V (kip)	700											kip-ft	9633.6	0.650					
Flexural Strength																			
Units in kips and inches																			
Concrete Layers	f _c	Width, W	Thick., T	Depth, d _c	β ₁	T _{upper}	T _{lower}	Revised T	Beta calculation	R	K	ε _{so}	A _s	Total ε _s	Stress	Force	Moment	Modified stress	f _c
1	9,250	48,200	7,500	0,000	0,850	0,000	0,000	0,000	1941.519193	100	1.096	0,000	-0,0021	-59,57	-268,86	-8504,66	51,70	9,25	
2	14,710	48,200	2,560	3,350	0,650	0,000	7,500	6,689	1941.519193	100	1.096	0,000	-0,0013	-38,46	-48,96	-281,54	30,60	9,25	
3	14,710	27,050	1,770	10,060	0,650	7,500	10,060	0,000	1941.519193	100	1.096	0,000	-0,0004	-11,03	-17,65	-158,85	-11,03	14,71	
4	14,710	5,900	28,170	11,830	0,650	11,830	40,000	0,000	1941.519193	100	1.096	0,000	0,0000	0,0000	0,0000	0,0000	0,0000	0,0000	
5	14,710	22,150	5,300	40,000	0,650	40,000	45,300	0,000	1941.519193	100	1.096	0,000	0,0000	0,0000	0,0000	0,0000	0,0000	0,0000	
6	14,710	38,400	5,500	45,300	0,650	45,300	50,800	0,000	1941.519193	100	1.096	0,000	0,0000	0,0000	0,0000	0,0000	0,0000	0,0000	
7			50,800																
Steel Layers	Area A _{s1}	Grade	Effective Prest.	Depth d _{s1}	E _s	Q	f _{fy}	R	K	ε _{so}	A _s	Total ε _s	Stress	Force	Moment	Modified stress	f _c		
Grade 60 Bars	1	1.6	0	3,250	29000	0,031	243	7,36	1.043	0,056	0,106	0,162	259,54	1068,27	48995,25	259,54	14,71		
	2	1.6	0	5,750	29000	0,031	243	7,36	1.043	0,056	0,100	0,157	258,91	152,24	6820,23	258,91	14,71		
	3	1.6	0	9,000	29000	0,031	243	7,36	1.043	0,056	0,000	0,0151	258,23	0,00	0,00	258,23	14,71		
	4	1.6	0	9,125	29000	0,031	243	7,36	1.043	0,056	0,000	0,0145	257,49	0,00	0,00	257,49	14,71		
	5	1.6	0	11,750	29000	0,031	243	7,36	1.043	0,056	0,000	0,0139	256,66	0,00	0,00	256,66	14,71		
	6	1.6	0	14,375	29000	0,031	243	7,36	1.043	0,056	0,000	0,0133	255,71	0,00	0,00	255,71	14,71		
	7	1.6	0	17,000	29000	0,031	243	7,36	1.043	0,056	0,000	0,0098	239,48	0,00	0,00	239,48	14,71		
	8	1.6	0	19,625	29000	0,031	243	7,36	1.043	0,056	0,000	0,0056	148,77	0,00	0,00	148,77	14,71		
	9	1.6	0	22,250	29000	0,031	243	7,36	1.043	0,056	0,000	0,0016	251,59	0,00	0,00	251,59	14,71		
	10	1.6	0	24,875	29000	0,031	243	7,36	1.043	0,056	0,000	0,0042	60,00	0,00	0,00	60,00	14,71		
	11	1.6	0	27,500	29000	0,031	243	7,36	1.096	0,000	0,000	0,0056	60,00	0,00	0,00	60,00	14,71		
	12	1.6	0	30,125	29000	0,031	243	7,36	1.096	0,000	0,000	0,0065	60,00	0,00	0,00	60,00	14,71		
	13	1.6	0	32,750	29000	0,031	243	7,36	1.096	0,000	0,000	0,0050	60,00	0,00	0,00	60,00	14,71		
Grade 70 Plate	1	70	0	0,000	29000	0,0217	81,00	4,224	1.01	0,000	0,000	-0,0030	-70,00	0,00	0,00	-62,14	9,25		
Gr. 120 Rods	1	120	0	5,125	29000	0,0217	120,00	4,224	1.01	0,000	0,000	-0,0015	-43,60	0,00	0,00	-35,19	9,25		
Gr. 150 Rods	1	150	0	5,125	29000	0,031	243	7,36	1.043	0,000	0,000	-0,0016	-45,06	0,00	0,00	-37,19	9,25		
Gr 270	1	0.612	270	1,500	28500	0,031	243	7,36	1.043	0,056	-0,0004	0,0052	148,77	91,05	819,41	148,77	14,71		
Gr 270	2	5,292	270	160	48,800	28500	0,031	243	7,36	1.043	0,056	0,0112	0,168	260,15	1376,69	67182,58	260,15	14,71	
Gr 270	4	4,116	270	160	46,800	28500	0,031	243	7,36	1.043	0,056	0,106	0,162	259,54	1068,27	48995,25	259,54	14,71	
Gr 270	5	0,588	270	160	44,800	28500	0,031	243	7,36	1.043	0,056	0,100	0,157	258,91	152,24	6820,23	258,91	14,71	
	6		270	160	42,800	28500	0,031	243	7,36	1.043	0,056	0,000	0,0151	258,23	0,00	0,00	258,23	14,71	
	7		270	160	40,800	28500	0,031	243	7,36	1.043	0,056	0,000	0,0145	257,49	0,00	0,00	257,49	14,71	
	8		270	160	38,800	28500	0,031	243	7,36	1.043	0,056	0,000	0,0139	256,66	0,00	0,00	256,66	14,71	
	9		270	160	36,800	28500	0,031	243	7,36	1.043	0,056	0,000	0,0133	255,71	0,00	0,00	255,71	14,71	
	10		270	160	34,800	28500	0,031	243	7,36	1.043	0,056	0,000	0,0098	239,48	0,00	0,00	239,48	14,71	
	11		270	160	32,800	28500	0,031	243	7,36	1.043	0,056	0,000	0,0056	148,77	0,00	0,00	148,77	14,71	
	12		270	160	28,667	28500	0,031	243	7,36	1.043	0,056	0,000	0,0016	251,59	0,00	0,00	251,59	14,71	
	13		270	160	31,000	28500	0,031	243	7,36	1.043	0,056	0,000	0,0012	60,00	0,00	0,00	60,00	14,71	
Sum of M									MAXIMUM				A _s :	0,0112	Moment (115603.56	kip-in	9633.63	kip-ft

Figure B.2 NU1100-2 Flexural Capacity

Flexural Strength																																																																																																																																																																																																																																																																																																																																																																																																																																																																																																																																																																																																																																											
L (ft)	a (ft)	b (ft)	WD.L (k-ft)	MD.L (k-ft)	MP (k-ft)	P (k)	V (kip)	ϵ_{su}	$c=\frac{a}{b}$	a	Sum of forces	Design	ANSWER:	ϕ	ϕM_n kip-ft	Av. β_1	Area	Force	Moment	Modified stress	f_c																																																																																																																																																																																																																																																																																																																																																																																																																																																																																																																																																																																																																						
40	13.5	25.5	188.3	9463.7	1072	701		0.003	10.158	6.603	0.00	PIC AASHTO	1.00	115656	0.650	0.000	0.000	0.000	0.000	0.000	0.000	9.41																																																																																																																																																																																																																																																																																																																																																																																																																																																																																																																																																																																																																					
										<p>Units in kips and inches</p> <table border="1"> <thead> <tr> <th>Concrete Layers</th> <th>f_c</th> <th>Area A_{ci}</th> <th>Width, W</th> <th>Thick., T</th> <th>Effective Prest. d_{si}</th> <th>E_s</th> <th>Q</th> <th>R</th> <th>K</th> <th>ϵ_{so}</th> <th>As</th> <th>Total ϵ_s</th> <th>Stress</th> <th>Force</th> <th>Moment</th> <th>Modified stress</th> <th>f_c</th> </tr> </thead> <tbody> <tr> <td>1</td> <td>1.6</td> <td>4.116</td> <td>48.200</td> <td>7.500</td> <td>3.250</td> <td>29000</td> <td>0</td> <td>100</td> <td>1.096</td> <td>0.0000</td> <td>-0.0020</td> <td>-0.0020</td> <td>-59.17</td> <td>-81.87</td> <td>-266.07</td> <td>-51.17</td> <td>9.41</td> </tr> <tr> <td>2</td> <td>1.6</td> <td>4.116</td> <td>48.200</td> <td>2.560</td> <td>5.750</td> <td>29000</td> <td>0</td> <td>100</td> <td>1.096</td> <td>0.0000</td> <td>-0.0013</td> <td>-0.0013</td> <td>-37.76</td> <td>-47.61</td> <td>-273.76</td> <td>-29.76</td> <td>9.41</td> </tr> <tr> <td>3</td> <td>1.6</td> <td>4.116</td> <td>48.200</td> <td>1.770</td> <td>10.060</td> <td>29000</td> <td>0</td> <td>100</td> <td>1.096</td> <td>0.0000</td> <td>-0.0003</td> <td>-0.0003</td> <td>-9.92</td> <td>-15.87</td> <td>-142.87</td> <td>-9.92</td> <td>9.41</td> </tr> <tr> <td>4</td> <td>1.6</td> <td>4.116</td> <td>48.200</td> <td>1.170</td> <td>14.375</td> <td>29000</td> <td>0</td> <td>100</td> <td>1.096</td> <td>0.0000</td> <td>0.0000</td> <td>0.0000</td> <td>0.00</td> <td>0.00</td> <td>0.00</td> <td>0.00</td> <td>9.41</td> </tr> <tr> <td>5</td> <td>1.6</td> <td>4.116</td> <td>48.200</td> <td>0.5300</td> <td>18.625</td> <td>29000</td> <td>0</td> <td>100</td> <td>1.096</td> <td>0.0000</td> <td>0.0000</td> <td>0.0000</td> <td>0.00</td> <td>0.00</td> <td>0.00</td> <td>0.00</td> <td>9.41</td> </tr> <tr> <td>6</td> <td>1.6</td> <td>4.116</td> <td>48.200</td> <td>0.0000</td> <td>22.875</td> <td>29000</td> <td>0</td> <td>100</td> <td>1.096</td> <td>0.0000</td> <td>0.0000</td> <td>0.0000</td> <td>0.00</td> <td>0.00</td> <td>0.00</td> <td>0.00</td> <td>9.41</td> </tr> <tr> <td>7</td> <td>1.6</td> <td>4.116</td> <td>48.200</td> <td>0.0000</td> <td>27.500</td> <td>29000</td> <td>0</td> <td>100</td> <td>1.096</td> <td>0.0000</td> <td>0.0000</td> <td>0.0000</td> <td>0.00</td> <td>0.00</td> <td>0.00</td> <td>0.00</td> <td>9.41</td> </tr> <tr> <td>8</td> <td>1.6</td> <td>4.116</td> <td>48.200</td> <td>0.0000</td> <td>30.125</td> <td>29000</td> <td>0</td> <td>100</td> <td>1.096</td> <td>0.0000</td> <td>0.0000</td> <td>0.0000</td> <td>0.00</td> <td>0.00</td> <td>0.00</td> <td>0.00</td> <td>9.41</td> </tr> <tr> <td>9</td> <td>1.6</td> <td>4.116</td> <td>48.200</td> <td>0.0000</td> <td>32.150</td> <td>29000</td> <td>0</td> <td>100</td> <td>1.096</td> <td>0.0000</td> <td>0.0000</td> <td>0.0000</td> <td>0.00</td> <td>0.00</td> <td>0.00</td> <td>0.00</td> <td>9.41</td> </tr> <tr> <td>10</td> <td>1.6</td> <td>4.116</td> <td>48.200</td> <td>0.0000</td> <td>34.175</td> <td>29000</td> <td>0</td> <td>100</td> <td>1.096</td> <td>0.0000</td> <td>0.0000</td> <td>0.0000</td> <td>0.00</td> <td>0.00</td> <td>0.00</td> <td>0.00</td> <td>9.41</td> </tr> <tr> <td>11</td> <td>1.6</td> <td>4.116</td> <td>48.200</td> <td>0.0000</td> <td>35.125</td> <td>29000</td> <td>0</td> <td>100</td> <td>1.096</td> <td>0.0000</td> <td>0.0000</td> <td>0.0000</td> <td>0.00</td> <td>0.00</td> <td>0.00</td> <td>0.00</td> <td>9.41</td> </tr> <tr> <td>12</td> <td>1.6</td> <td>4.116</td> <td>48.200</td> <td>0.0000</td> <td>35.125</td> <td>29000</td> <td>0</td> <td>100</td> <td>1.096</td> <td>0.0000</td> <td>0.0000</td> <td>0.0000</td> <td>0.00</td> <td>0.00</td> <td>0.00</td> <td>0.00</td> <td>9.41</td> </tr> <tr> <td>13</td> <td>1.6</td> <td>4.116</td> <td>48.200</td> <td>0.0000</td> <td>35.125</td> <td>29000</td> <td>0</td> <td>100</td> <td>1.096</td> <td>0.0000</td> <td>0.0000</td> <td>0.0000</td> <td>0.00</td> <td>0.00</td> <td>0.00</td> <td>0.00</td> <td>9.41</td> </tr> <tr> <td>Grade 70 Plate</td> <td></td> <td></td> <td></td> <td></td> <td></td> <td></td> <td></td> <td></td> <td></td> <td></td> <td></td> <td></td> <td></td> <td></td> <td></td> <td></td> <td></td> <td></td> <td></td> <td></td> <td></td> </tr> <tr> <td>Gr. 120 Rods</td> <td></td> <td></td> <td></td> <td></td> <td></td> <td></td> <td></td> <td></td> <td></td> <td></td> <td></td> <td></td> <td></td> <td></td> <td></td> <td></td> <td></td> <td></td> <td></td> <td></td> <td></td> <td></td> </tr> <tr> <td>Gr. 150 Rods</td> <td></td> <td></td> <td></td> <td></td> <td></td> <td></td> <td></td> <td></td> <td></td> <td></td> <td></td> <td></td> <td></td> <td></td> <td></td> <td></td> <td></td> <td></td> <td></td> <td></td> <td></td> <td></td> </tr> <tr> <td>Gr 270</td> <td>1</td> <td>0.612</td> <td>270</td> <td>160</td> <td>180</td> <td>28500</td> <td>0.031</td> <td>243</td> <td>1.043</td> <td>0.0056</td> <td>-0.0003</td> <td>0.0053</td> <td>149.83</td> <td>91.70</td> <td>825.28</td> <td>148.83</td> <td>9.41</td> </tr> <tr> <td>Gr 270</td> <td>2</td> <td>0.612</td> <td>270</td> <td>160</td> <td>180</td> <td>28500</td> <td>0.031</td> <td>243</td> <td>1.043</td> <td>0.0056</td> <td>-0.0003</td> <td>0.0053</td> <td>149.83</td> <td>91.70</td> <td>825.28</td> <td>148.83</td> <td>9.41</td> </tr> <tr> <td>Gr 270</td> <td>3</td> <td>5.292</td> <td>270</td> <td>160</td> <td>48.800</td> <td>28500</td> <td>0.031</td> <td>243</td> <td>7.36</td> <td>0.0114</td> <td>0.0170</td> <td>0.0170</td> <td>260.36</td> <td>1377.80</td> <td>67236.68</td> <td>260.36</td> <td>14.76</td> </tr> <tr> <td>Gr 270</td> <td>4</td> <td>4.116</td> <td>270</td> <td>160</td> <td>46.800</td> <td>28500</td> <td>0.031</td> <td>243</td> <td>7.36</td> <td>0.0056</td> <td>0.0164</td> <td>0.0164</td> <td>259.75</td> <td>1069.14</td> <td>50035.59</td> <td>259.75</td> <td>14.76</td> </tr> <tr> <td>Gr 270</td> <td>5</td> <td>0.588</td> <td>270</td> <td>160</td> <td>44.800</td> <td>28500</td> <td>0.031</td> <td>243</td> <td>7.36</td> <td>0.0056</td> <td>0.0102</td> <td>0.0158</td> <td>259.12</td> <td>152.36</td> <td>6825.81</td> <td>259.12</td> <td>14.76</td> </tr> <tr> <td>Gr 270</td> <td>6</td> <td>0.588</td> <td>270</td> <td>160</td> <td>42.800</td> <td>28500</td> <td>0.031</td> <td>243</td> <td>7.36</td> <td>0.0056</td> <td>0.0000</td> <td>0.0153</td> <td>258.45</td> <td>0.00</td> <td>258.45</td> <td>258.45</td> <td>14.76</td> </tr> <tr> <td>Gr 270</td> <td>7</td> <td>0.588</td> <td>270</td> <td>160</td> <td>40.800</td> <td>28500</td> <td>0.031</td> <td>243</td> <td>7.36</td> <td>0.0056</td> <td>0.0000</td> <td>0.0147</td> <td>257.72</td> <td>0.00</td> <td>257.72</td> <td>257.72</td> <td>14.76</td> </tr> <tr> <td>Gr 270</td> <td>8</td> <td>0.588</td> <td>270</td> <td>160</td> <td>38.800</td> <td>28500</td> <td>0.031</td> <td>243</td> <td>7.36</td> <td>0.0056</td> <td>0.0000</td> <td>0.0141</td> <td>256.91</td> <td>0.00</td> <td>256.91</td> <td>256.91</td> <td>14.76</td> </tr> <tr> <td>Gr 270</td> <td>9</td> <td>0.588</td> <td>270</td> <td>160</td> <td>36.800</td> <td>28500</td> <td>0.031</td> <td>243</td> <td>7.36</td> <td>0.0056</td> <td>0.0000</td> <td>0.0135</td> <td>255.98</td> <td>0.00</td> <td>255.98</td> <td>255.98</td> <td>14.76</td> </tr> <tr> <td>Gr 270</td> <td>10</td> <td>0.588</td> <td>270</td> <td>160</td> <td>34.800</td> <td>28500</td> <td>0.031</td> <td>243</td> <td>7.36</td> <td>0.0056</td> <td>0.0000</td> <td>0.0097</td> <td>240.44</td> <td>0.00</td> <td>240.44</td> <td>240.44</td> <td>14.76</td> </tr> <tr> <td>Gr 270</td> <td>11</td> <td>0.588</td> <td>270</td> <td>160</td> <td>32.800</td> <td>28500</td> <td>0.031</td> <td>243</td> <td>7.36</td> <td>0.0056</td> <td>0.0000</td> <td>0.0065</td> <td>149.83</td> <td>0.00</td> <td>149.83</td> <td>149.83</td> <td>14.76</td> </tr> <tr> <td>Gr 270</td> <td>12</td> <td>0.588</td> <td>270</td> <td>160</td> <td>30.800</td> <td>28500</td> <td>0.031</td> <td>243</td> <td>7.36</td> <td>0.0056</td> <td>0.0000</td> <td>0.0111</td> <td>249.42</td> <td>0.00</td> <td>249.42</td> <td>249.42</td> <td>14.76</td> </tr> <tr> <td>Gr 270</td> <td>13</td> <td>0.588</td> <td>270</td> <td>160</td> <td>28.800</td> <td>28500</td> <td>0.031</td> <td>243</td> <td>7.36</td> <td>0.0056</td> <td>0.0000</td> <td>0.0118</td> <td>252.03</td> <td>0.00</td> <td>252.03</td> <td>252.03</td> <td>14.76</td> </tr> <tr> <td>Sum of M</td> <td></td> <td></td> <td></td> <td></td> <td></td> <td></td> <td></td> <td></td> <td></td> <td></td> <td></td> <td></td> <td></td> <td></td> <td></td> <td></td> <td></td> <td></td> <td></td> <td></td> <td></td> <td></td> </tr> <tr> <td></td> <td></td> <td></td> <td></td> <td></td> <td></td> <td></td> <td></td> <td></td> <td></td> <td></td> <td></td> <td></td> <td></td> <td></td> <td></td> <td></td> <td></td> <td></td> <td></td> <td></td> <td></td> <td></td> </tr> </tbody> </table>										Concrete Layers	f_c	Area A_{ci}	Width, W	Thick., T	Effective Prest. d_{si}	E_s	Q	R	K	ϵ_{so}	As	Total ϵ_s	Stress	Force	Moment	Modified stress	f_c	1	1.6	4.116	48.200	7.500	3.250	29000	0	100	1.096	0.0000	-0.0020	-0.0020	-59.17	-81.87	-266.07	-51.17	9.41	2	1.6	4.116	48.200	2.560	5.750	29000	0	100	1.096	0.0000	-0.0013	-0.0013	-37.76	-47.61	-273.76	-29.76	9.41	3	1.6	4.116	48.200	1.770	10.060	29000	0	100	1.096	0.0000	-0.0003	-0.0003	-9.92	-15.87	-142.87	-9.92	9.41	4	1.6	4.116	48.200	1.170	14.375	29000	0	100	1.096	0.0000	0.0000	0.0000	0.00	0.00	0.00	0.00	9.41	5	1.6	4.116	48.200	0.5300	18.625	29000	0	100	1.096	0.0000	0.0000	0.0000	0.00	0.00	0.00	0.00	9.41	6	1.6	4.116	48.200	0.0000	22.875	29000	0	100	1.096	0.0000	0.0000	0.0000	0.00	0.00	0.00	0.00	9.41	7	1.6	4.116	48.200	0.0000	27.500	29000	0	100	1.096	0.0000	0.0000	0.0000	0.00	0.00	0.00	0.00	9.41	8	1.6	4.116	48.200	0.0000	30.125	29000	0	100	1.096	0.0000	0.0000	0.0000	0.00	0.00	0.00	0.00	9.41	9	1.6	4.116	48.200	0.0000	32.150	29000	0	100	1.096	0.0000	0.0000	0.0000	0.00	0.00	0.00	0.00	9.41	10	1.6	4.116	48.200	0.0000	34.175	29000	0	100	1.096	0.0000	0.0000	0.0000	0.00	0.00	0.00	0.00	9.41	11	1.6	4.116	48.200	0.0000	35.125	29000	0	100	1.096	0.0000	0.0000	0.0000	0.00	0.00	0.00	0.00	9.41	12	1.6	4.116	48.200	0.0000	35.125	29000	0	100	1.096	0.0000	0.0000	0.0000	0.00	0.00	0.00	0.00	9.41	13	1.6	4.116	48.200	0.0000	35.125	29000	0	100	1.096	0.0000	0.0000	0.0000	0.00	0.00	0.00	0.00	9.41	Grade 70 Plate																						Gr. 120 Rods																							Gr. 150 Rods																							Gr 270	1	0.612	270	160	180	28500	0.031	243	1.043	0.0056	-0.0003	0.0053	149.83	91.70	825.28	148.83	9.41	Gr 270	2	0.612	270	160	180	28500	0.031	243	1.043	0.0056	-0.0003	0.0053	149.83	91.70	825.28	148.83	9.41	Gr 270	3	5.292	270	160	48.800	28500	0.031	243	7.36	0.0114	0.0170	0.0170	260.36	1377.80	67236.68	260.36	14.76	Gr 270	4	4.116	270	160	46.800	28500	0.031	243	7.36	0.0056	0.0164	0.0164	259.75	1069.14	50035.59	259.75	14.76	Gr 270	5	0.588	270	160	44.800	28500	0.031	243	7.36	0.0056	0.0102	0.0158	259.12	152.36	6825.81	259.12	14.76	Gr 270	6	0.588	270	160	42.800	28500	0.031	243	7.36	0.0056	0.0000	0.0153	258.45	0.00	258.45	258.45	14.76	Gr 270	7	0.588	270	160	40.800	28500	0.031	243	7.36	0.0056	0.0000	0.0147	257.72	0.00	257.72	257.72	14.76	Gr 270	8	0.588	270	160	38.800	28500	0.031	243	7.36	0.0056	0.0000	0.0141	256.91	0.00	256.91	256.91	14.76	Gr 270	9	0.588	270	160	36.800	28500	0.031	243	7.36	0.0056	0.0000	0.0135	255.98	0.00	255.98	255.98	14.76	Gr 270	10	0.588	270	160	34.800	28500	0.031	243	7.36	0.0056	0.0000	0.0097	240.44	0.00	240.44	240.44	14.76	Gr 270	11	0.588	270	160	32.800	28500	0.031	243	7.36	0.0056	0.0000	0.0065	149.83	0.00	149.83	149.83	14.76	Gr 270	12	0.588	270	160	30.800	28500	0.031	243	7.36	0.0056	0.0000	0.0111	249.42	0.00	249.42	249.42	14.76	Gr 270	13	0.588	270	160	28.800	28500	0.031	243	7.36	0.0056	0.0000	0.0118	252.03	0.00	252.03	252.03	14.76	Sum of M																																													
Concrete Layers	f_c	Area A_{ci}	Width, W	Thick., T	Effective Prest. d_{si}	E_s	Q	R	K	ϵ_{so}	As	Total ϵ_s	Stress	Force	Moment	Modified stress	f_c																																																																																																																																																																																																																																																																																																																																																																																																																																																																																																																																																																																																																										
1	1.6	4.116	48.200	7.500	3.250	29000	0	100	1.096	0.0000	-0.0020	-0.0020	-59.17	-81.87	-266.07	-51.17	9.41																																																																																																																																																																																																																																																																																																																																																																																																																																																																																																																																																																																																																										
2	1.6	4.116	48.200	2.560	5.750	29000	0	100	1.096	0.0000	-0.0013	-0.0013	-37.76	-47.61	-273.76	-29.76	9.41																																																																																																																																																																																																																																																																																																																																																																																																																																																																																																																																																																																																																										
3	1.6	4.116	48.200	1.770	10.060	29000	0	100	1.096	0.0000	-0.0003	-0.0003	-9.92	-15.87	-142.87	-9.92	9.41																																																																																																																																																																																																																																																																																																																																																																																																																																																																																																																																																																																																																										
4	1.6	4.116	48.200	1.170	14.375	29000	0	100	1.096	0.0000	0.0000	0.0000	0.00	0.00	0.00	0.00	9.41																																																																																																																																																																																																																																																																																																																																																																																																																																																																																																																																																																																																																										
5	1.6	4.116	48.200	0.5300	18.625	29000	0	100	1.096	0.0000	0.0000	0.0000	0.00	0.00	0.00	0.00	9.41																																																																																																																																																																																																																																																																																																																																																																																																																																																																																																																																																																																																																										
6	1.6	4.116	48.200	0.0000	22.875	29000	0	100	1.096	0.0000	0.0000	0.0000	0.00	0.00	0.00	0.00	9.41																																																																																																																																																																																																																																																																																																																																																																																																																																																																																																																																																																																																																										
7	1.6	4.116	48.200	0.0000	27.500	29000	0	100	1.096	0.0000	0.0000	0.0000	0.00	0.00	0.00	0.00	9.41																																																																																																																																																																																																																																																																																																																																																																																																																																																																																																																																																																																																																										
8	1.6	4.116	48.200	0.0000	30.125	29000	0	100	1.096	0.0000	0.0000	0.0000	0.00	0.00	0.00	0.00	9.41																																																																																																																																																																																																																																																																																																																																																																																																																																																																																																																																																																																																																										
9	1.6	4.116	48.200	0.0000	32.150	29000	0	100	1.096	0.0000	0.0000	0.0000	0.00	0.00	0.00	0.00	9.41																																																																																																																																																																																																																																																																																																																																																																																																																																																																																																																																																																																																																										
10	1.6	4.116	48.200	0.0000	34.175	29000	0	100	1.096	0.0000	0.0000	0.0000	0.00	0.00	0.00	0.00	9.41																																																																																																																																																																																																																																																																																																																																																																																																																																																																																																																																																																																																																										
11	1.6	4.116	48.200	0.0000	35.125	29000	0	100	1.096	0.0000	0.0000	0.0000	0.00	0.00	0.00	0.00	9.41																																																																																																																																																																																																																																																																																																																																																																																																																																																																																																																																																																																																																										
12	1.6	4.116	48.200	0.0000	35.125	29000	0	100	1.096	0.0000	0.0000	0.0000	0.00	0.00	0.00	0.00	9.41																																																																																																																																																																																																																																																																																																																																																																																																																																																																																																																																																																																																																										
13	1.6	4.116	48.200	0.0000	35.125	29000	0	100	1.096	0.0000	0.0000	0.0000	0.00	0.00	0.00	0.00	9.41																																																																																																																																																																																																																																																																																																																																																																																																																																																																																																																																																																																																																										
Grade 70 Plate																																																																																																																																																																																																																																																																																																																																																																																																																																																																																																																																																																																																																																											
Gr. 120 Rods																																																																																																																																																																																																																																																																																																																																																																																																																																																																																																																																																																																																																																											
Gr. 150 Rods																																																																																																																																																																																																																																																																																																																																																																																																																																																																																																																																																																																																																																											
Gr 270	1	0.612	270	160	180	28500	0.031	243	1.043	0.0056	-0.0003	0.0053	149.83	91.70	825.28	148.83	9.41																																																																																																																																																																																																																																																																																																																																																																																																																																																																																																																																																																																																																										
Gr 270	2	0.612	270	160	180	28500	0.031	243	1.043	0.0056	-0.0003	0.0053	149.83	91.70	825.28	148.83	9.41																																																																																																																																																																																																																																																																																																																																																																																																																																																																																																																																																																																																																										
Gr 270	3	5.292	270	160	48.800	28500	0.031	243	7.36	0.0114	0.0170	0.0170	260.36	1377.80	67236.68	260.36	14.76																																																																																																																																																																																																																																																																																																																																																																																																																																																																																																																																																																																																																										
Gr 270	4	4.116	270	160	46.800	28500	0.031	243	7.36	0.0056	0.0164	0.0164	259.75	1069.14	50035.59	259.75	14.76																																																																																																																																																																																																																																																																																																																																																																																																																																																																																																																																																																																																																										
Gr 270	5	0.588	270	160	44.800	28500	0.031	243	7.36	0.0056	0.0102	0.0158	259.12	152.36	6825.81	259.12	14.76																																																																																																																																																																																																																																																																																																																																																																																																																																																																																																																																																																																																																										
Gr 270	6	0.588	270	160	42.800	28500	0.031	243	7.36	0.0056	0.0000	0.0153	258.45	0.00	258.45	258.45	14.76																																																																																																																																																																																																																																																																																																																																																																																																																																																																																																																																																																																																																										
Gr 270	7	0.588	270	160	40.800	28500	0.031	243	7.36	0.0056	0.0000	0.0147	257.72	0.00	257.72	257.72	14.76																																																																																																																																																																																																																																																																																																																																																																																																																																																																																																																																																																																																																										
Gr 270	8	0.588	270	160	38.800	28500	0.031	243	7.36	0.0056	0.0000	0.0141	256.91	0.00	256.91	256.91	14.76																																																																																																																																																																																																																																																																																																																																																																																																																																																																																																																																																																																																																										
Gr 270	9	0.588	270	160	36.800	28500	0.031	243	7.36	0.0056	0.0000	0.0135	255.98	0.00	255.98	255.98	14.76																																																																																																																																																																																																																																																																																																																																																																																																																																																																																																																																																																																																																										
Gr 270	10	0.588	270	160	34.800	28500	0.031	243	7.36	0.0056	0.0000	0.0097	240.44	0.00	240.44	240.44	14.76																																																																																																																																																																																																																																																																																																																																																																																																																																																																																																																																																																																																																										
Gr 270	11	0.588	270	160	32.800	28500	0.031	243	7.36	0.0056	0.0000	0.0065	149.83	0.00	149.83	149.83	14.76																																																																																																																																																																																																																																																																																																																																																																																																																																																																																																																																																																																																																										
Gr 270	12	0.588	270	160	30.800	28500	0.031	243	7.36	0.0056	0.0000	0.0111	249.42	0.00	249.42	249.42	14.76																																																																																																																																																																																																																																																																																																																																																																																																																																																																																																																																																																																																																										
Gr 270	13	0.588	270	160	28.800	28500	0.031	243	7.36	0.0056	0.0000	0.0118	252.03	0.00	252.03	252.03	14.76																																																																																																																																																																																																																																																																																																																																																																																																																																																																																																																																																																																																																										
Sum of M																																																																																																																																																																																																																																																																																																																																																																																																																																																																																																																																																																																																																																											

Figure B.3 NU1100-3 Flexural Capacity

Parameter	Symbol	Value	Unit		
Total Section Depth	h	50.80	in		
C.G. of Bottom Strands	y_{ps}	3.06	in		
Effective Depth	d_e	47.74	in		
Shear Depth	d_v	42.97	in		
Web Width	b_v	5.9	in		
Shear Reduction Factor	ϕ	1.0	N/A		
Span	L	39.0	ft		
Section Distance From Support	x	7.50	ft		
Applied Load	P	802	kip		
Ultimate Shear	V_u	659	kip		
Ultimate Moment	M_u	4988	kip.ft		
Ultimate Axial Force	N_u	0	kip		
Locked in Stresses	f_{po}	189	ksi		
Development Length	l_d	13.5	ft		
Area of Strands in Tension Side	A_{ps}	7.64	in ²		
Transfer Length	l_t	3.5	ft		
Prestressing Shear Force	V_p	0.0	kip		
Strands Modulus	E_{ps}	28,500	ksi		
Area of Steel	A_s	0	in ²		
Steel Modulus	E_s	29,000	ksi		
Concrete Strength	f'_c	14.75	ksi		
Stirrup Yield Strength	f_y	75.0	ksi	Modified A_{ps}	6.268
Strain	ϵ_x	0.0049	N/A	$0 \leq \epsilon_x \leq 0.006$	
Maximum Aggregate Size	a_g	0.50	in		
Maximum Spacing bet. Skin Rft Layer	S_x	42.97	in		
Crack Spacing Parameter	S_{xe}	52.47	in	$12 \leq S_{xe} \leq 80$	
Shear Stress in Concrete / f'_c	v/f'_c	0.176	N/A	≤ 0.25	
Section Contains at Least Min. Transverse Rft.		Yes	N/A		
Calculated shear Angle	θ	45.99	degree		
Concrete Shear Factor	β	1.03	N/A		
Concrete Shear Force	V_c	31.8	kip	Use at least A_{vmin}	
Steel Shear Force	V_s	626.7	kip		
Maximum Spacing	S_{max}	12.0	in		
Minimum Steel Shear Force	A_{vmin}	0.115	in ² /ft		
Required Area of Steel	A_v	2.42	in ² /ft		

Figure B.4 NU1100 Vertical Shear Capacity by Detailed Method