



2011

# CORRELATION BETWEEN ALTERNANS OF EARLY AND LATE PHASES OF VENTRICULAR ACTION POTENTIAL

Sonam Chourasia

*University of Kentucky*, [sonam.chourasia@gmail.com](mailto:sonam.chourasia@gmail.com)

---

## Recommended Citation

Chourasia, Sonam, "CORRELATION BETWEEN ALTERNANS OF EARLY AND LATE PHASES OF VENTRICULAR ACTION POTENTIAL" (2011). *Theses and Dissertations--Biomedical Engineering*. 1.  
[http://uknowledge.uky.edu/cbme\\_etds/1](http://uknowledge.uky.edu/cbme_etds/1)

This Master's Thesis is brought to you for free and open access by the Biomedical Engineering at UKnowledge. It has been accepted for inclusion in Theses and Dissertations--Biomedical Engineering by an authorized administrator of UKnowledge. For more information, please contact [UKnowledge@lsv.uky.edu](mailto:UKnowledge@lsv.uky.edu).

**STUDENT AGREEMENT:**

I represent that my thesis or dissertation and abstract are my original work. Proper attribution has been given to all outside sources. I understand that I am solely responsible for obtaining any needed copyright permissions. I have obtained and attached hereto needed written permission statements(s) from the owner(s) of each third-party copyrighted matter to be included in my work, allowing electronic distribution (if such use is not permitted by the fair use doctrine).

I hereby grant to The University of Kentucky and its agents the non-exclusive license to archive and make accessible my work in whole or in part in all forms of media, now or hereafter known. I agree that the document mentioned above may be made available immediately for worldwide access unless a preapproved embargo applies.

I retain all other ownership rights to the copyright of my work. I also retain the right to use in future works (such as articles or books) all or part of my work. I understand that I am free to register the copyright to my work.

**REVIEW, APPROVAL AND ACCEPTANCE**

The document mentioned above has been reviewed and accepted by the student's advisor, on behalf of the advisory committee, and by the Director of Graduate Studies (DGS), on behalf of the program; we verify that this is the final, approved version of the student's dissertation including all changes required by the advisory committee. The undersigned agree to abide by the statements above.

Sonam Chourasia, Student

Dr. Abhijit Patwardhan, Major Professor

Dr. Abhijit Patwardhan, Director of Graduate Studies

---

CORRELATION BETWEEN ALTERNANS OF EARLY AND LATE PHASES OF  
VENTRICULAR ACTION POTENTIAL

---

THESIS

---

A thesis submitted in partial fulfillment of the  
requirements for the degree of Master of Science in Biomedical Engineering in the  
College of Engineering at the University of Kentucky

By

SonamChourasia

Lexington, Kentucky

Director: Dr. AbhijitPatwardhan, Professor of Biomedical Engineering

Lexington, Kentucky

2011

Copyright © SonamChourasia 2011

## ABSTRACT OF THESIS

### CORRELATION BETWEEN ALTERNANS OF EARLY AND LATE PHASES OF VENTRICULAR ACTION POTENTIAL

Several studies suggest that action potential duration (APD) alternans play an important role in initiation of arrhythmias, while less is known about the alternans of early phases of action potential (AP) and phase relation between the two. Transmembrane potentials recorded from swine and canine ventricles were analyzed to determine the correlation and phase relation between alternans of early and late phases of an AP. In both species, for activation intervals  $\leq 400$  ms, action potential amplitude (APA) alternans occurred  $\geq 50\%$  of times when APD alternans occurred and vice versa, both were mostly in phase. Also, alternans of APA and APD were mostly in phase with alternans of maximal rate of depolarization. The correlation between alternans in early and later parts of AP, however, was variable between species; APD<sub>10</sub> and APD<sub>90</sub> alternans were out of phase 81 % versus 34 % in canines and swines. These observations suggest that ionic mechanisms underlying alternans of depolarization and early repolarization phases may be distinct from those underlying later phases of repolarization. Simulations conducted to see the spatiotemporal effect of phase behavior between these alternans show that out of phase behavior suppresses oscillations in wavelength and minimizes the chances of spatial discordance.

**KEYWORDS:** Alternans of depolarization, alternans of repolarization, maximum rate of depolarization, arrhythmia, alternans

SonamChourasia

December 2011

CORRELATION BETWEEN ALTERNANS OF EARLY AND LATE PHASES OF  
VENTRICULAR ACTION POTENTIAL

By

SonamChourasia

Dr. AbhijitPatwardhan  
Director of Thesis

Dr. AbhijitPatwardhan  
Director of Graduate Studies

December 01, 2011

## ACKNOWLEDGEMENTS

I would like to specially thank my mentor Dr. Abhijit Patwardhan for guiding me throughout the course of my graduate studies. It has been an honor and a privilege to be his student. It would not have been possible for me to successfully complete my thesis without his guidance and expertise. I appreciate all his contributions of time, ideas, and funding to make my MS experience productive and stimulating. I am thankful for the excellent example he has provided as successful scientist and professor.

I gratefully acknowledge the funding sources that made my MS possible. My work was supported by the American Heart Association and the National Science Foundation.

I would like to acknowledge few people who hold a very special place in my life: - Pratik, Siddharth, Rutooj and Parag. I am blessed to have around such wonderful people and wish to thank them for everything they do. My time at UK was made unforgettable in large due to formation of our musical group “KOSHISH” that eventually became part of life. In addition, I would like to thank all my friends for being so encouraging and supportive and making my MS journey joyous and beautiful.

“Other things may change me, but I start and end with my family”

Last and foremost, I would thank my parents, grandparents, uncle, aunty, Akansha, Mohit, Nimisha for their selfless love and encouragement. This MS would not have been possible without them. And most of all I thank God who has been showering his blessings on me. Thank you!

## CONTENTS

ACKNOWLEDGEMENTS .....	iii
LIST OF TABLES .....	vi
LIST OF FIGURES .....	vii
1.1 CONCORDANT AND DISCORDANT ALTERNANS .....	1
1.2 CONDUCTION .....	1
CHAPTER 2: OBJECTIVE .....	3
CHAPTER 3: BACKGROUND .....	4
3.1 ELECTRICAL ACTIVITY OF HEART .....	4
3.2 PHASES OF ACTION POTENTIAL MORPHOLOGY .....	4
3.3 IRREGULAR CARDIAC RHYTHMS .....	5
3.4 ALTERNANS OF REPOLARIZATION AND DEPOLARIZATION .....	6
CHAPTER 4: METHODS .....	8
4.1 DATA ACQUISITION .....	8
4.1.1 Swine.....	8
4.1.2 Canine .....	10
4.2 DATA ANALYSIS .....	10
4.3 SIMULATIONS.....	12
4.3.1 Simulation Protocols.....	13
CHAPTER 5: RESULTS .....	14

5.1 EXPERIMENTAL STUDY .....	14
5.1.1 Occurrence and phase relation in swine.....	14
5.1.1a Alternans of APD <sub>90</sub> and APA .....	14
5.1.1b APD <sub>10-80</sub> and APD <sub>90</sub> .....	16
5.1.1c Alternans of $ dv/dt _{\max}$ .....	18
5.1.2 Occurrence and Phase Relation in Canine.....	19
5.1.2a Alternans of APD <sub>90</sub> and APA .....	19
5.1.2b APD <sub>10-80</sub> and APD <sub>90</sub> .....	20
5.1.2c Alternans of $ dv/dt _{\max}$ .....	22
5.2 SIMULATION STUDY .....	25
CHAPTER 6: DISCUSSION.....	29
6.1 ALTERNANS OF DEPOLARIZATION PHASE AND THEIR CORRELATION WITH APD ALTERNANS.....	29
6.2 MECHANISM UNDERLYING CORRELATION OF EARLY AND LATE PHASE ALTERNANS .....	30
6.3 SIMULATION OF PHASE BEHAVIOR .....	32
CHAPTER 7: LIMITATIONS .....	34
REFERENCES .....	35



## LIST OF TABLES

Table 1: Percentage occurrence of APD and APA alternans with each other along with the out of phase alternans present in swine. The percentage out of phase (when long-short-long APDs were associated with tall-short-tall APAs) and in phase were calculated as a part of total percentage of occurrence of alternans. ....	16
Table 2: Summary showing percentage occurrence of alternans of APD <sub>80</sub> to APD <sub>10</sub> alternans along with their in or out of phase behavior with respect to APD <sub>90</sub> alternans in swine. The percentage in and out of phase shown were calculated out of total percentage of occurrence of alternans. ....	17
Table 3: Percentage occurrence of $ dv/dt _{\max}$ alternans is shown when computed along with APD and APA alternans (occurring alone or together) in swine . Percentage occurrence was calculated with respect to total number of alternating beats of APD or APA in respective cases. ....	19
Table 4: Percentage occurrence of APD and APA alternans with each other along with the out of phase alternans present in canines. The percentage in and out of phase shown were calculated as a part of total percentage of occurrence of alternans. ....	20
Table 5: Summary showing percentage occurrence of alternans of APD <sub>80</sub> to APD <sub>10</sub> alternans along with their in or out of phase behavior with respect to APD <sub>90</sub> alternans in swine. The percentage in and out of phase shown were calculated out of total percentage of occurrence of alternans. ....	21
Table 6: Percentage occurrence of $ dv/dt _{\max}$ alternans is shown when computed along with APD and APA alternans (occurring alone or together) in swine. Percentage occurrence was calculated with respect to total number of alternating beats of APD or APA in respective cases. ....	25

**LIST OF FIGURES**

Figure 1: Schematic diagram showing experimental set used for Data recording and acquisition from swines. .... 9

Figure 2: Example of AP recorded from swine. Figure shows the start and end points of an AP along with measurement of APA and APD<sub>10-90</sub>. .... 11

Figure 3: The figure shows examples of action potential recordings from swines. a) Alternans of APD occurring along with alternans of APA. Thick and thin lines represent long and short APDs. Tall APAs are represented by an asterisk. b) APA alternans occurring without APD alternans. Tall APAs are marked by an asterisk. c) APD alternans occurring without APA alternans. Thick and thin lines represent long and short APDs. d) Discord between APA and APD alternans which shows that short APDs are associated with tall APAs as opposed to the more frequent phenomenon shown in figure 3a. Thick lines represent long APDs and asterisks denote tall APAs. .... 15

Figure 4: a) Percent occurrence of alternans at each level of repolarization (APD<sub>80</sub> to APD<sub>10</sub>) when APD<sub>90</sub> alternans occurs in the swines (N=8). b) Percent out of phase of alternans at each level of repolarization with respect to APD<sub>90</sub>, also in swine, as a part of total occurrence of alternans. c) Percent occurrence of alternans at each level of repolarization (APD<sub>80</sub> to APD<sub>10</sub>) when APD<sub>90</sub> alternans occurs in the canines (N=3). d) Percent out of phase of alternans at each level of repolarization with respect to APD<sub>90</sub>, also in swine, as a part of total occurrence of alternans. .... 17

Figure 5: Examples of TMP recordings from canines. a) An example of in phase alternans is shown with respect to APD<sub>90</sub> alternans. In this figure only APD<sub>10</sub>, APD<sub>20</sub>, APD<sub>30</sub> are shown although in phase behavior occurs at all levels of AP i.e. from APD<sub>10</sub> to APD<sub>80</sub>. Thick lines represent long APDs and thin lines represent short APDs. b) An example of out of phase alternans is shown with respect to APD<sub>90</sub> alternans. Similar to the figure 5a only APD<sub>10</sub>, APD<sub>20</sub>, APD<sub>30</sub> are shown although out of phase behavior also occurs at other levels of AP i.e. from APD<sub>40</sub> to APD<sub>60</sub>. .... 22

Figure 6: Examples of data from a trial in canines. a) Relationship between |dv/dt|<sub>max</sub> (mV/ms) and APD (ms). The figure shows for each pair of alternating APDs, AP associated with slower maximum rate of depolarization had shorter duration (APD) while those having faster maximum rate of depolarization had longer duration. b) Relationship between |dv/dt|<sub>max</sub> (mV/ms) and APA (mV). Figure shows that short APA was associated with slower rate of depolarization while tall APA was associated with faster rate of depolarization for those trials where APD and |dv/dt|<sub>max</sub> were in phase. c) The figure shows that APs associated with slower rate of depolarization had longer APDs while those having faster rate of depolarization had shorter APDs. d) Out of phase behavior between APA and |dv/dt|<sub>max</sub> alternans for the trials when alternans of APD were out of phase with alternans of |dv/dt|<sub>max</sub>. e) In phase behavior between APA alternans and alternans of |dv/dt|<sub>max</sub> when they occurred independent of APD alternans. .... 24

Figure 7. Time-space plots of the simulation results from co-author to study effects of phase relationship between APD alternans and alternans of  $|dv/dt|_{max}$  in linear strand of 1000 cells. a) Shows in phase simulation between alternans of APD and  $|dv/dt|_{max}$  and also shows the transition between concordant and discordant alternans occurring several times. The vertical white lines (solid and dashed) show wavelengths (long and short, respectively) at different time instances. b) Shows out of phase relationship between alternans of APD and  $|dv/dt|_{max}$  and also shows that concordant alternans persisted along the tissue length with minimized oscillation of wavelength as compared to figure 7a. The TMP traces below each time space plot are those recorded from first cell in each case. The pairs of lines on the right are drawn for comparison of respective wavelengths..... 26

Figure 8i.) Figure shows the time-space plot for the simulation study conducted on linear strand of 1000 cells where cells 400 to 500 were induced with out of phase behavior for 20 beats preceded and followed by 30 beats of 200 ms cycle length a.) Shows the plot of first 11th to 30th beats b.) Shows plot from 31st to 50th beat c.) Shows plot of 41st to 60th beats for entire tissue length. .... 27

Figure 8 ii.) Figure shows the time-space plot for the simulation study conducted on linear strand of 1000 cells where cell number 1 to 100 were induced with out of phase behavior for the 20 beats preceded and followed by 30 beats of 200 ms cycle length respectively. a.) Shows the plot of first 11th to 30th beats b.) Shows plot from 31st to 50th beat c.) Shows plot of 41st to 60th beats for entire tissue length. .... 28

Figure 9: An example of average of 5 consecutive long and short APs from a single trial. a) The figure shows an example of APD10 alternans being in phase with APD90 alternans in swine. b) The figure shows an example of APD10 alternans being out of phase with APD90 alternans in a canine..... 31

## CHAPTER 1: INTRODUCTION

Sudden Cardiac Death (SCD) is the leading cause of death in the United States with the death rate of 600,000 per year [1]. Ventricular tachycardia (VT), when electric impulse becomes faster, or ventricular fibrillation (VF), when impulse becomes chaotic, leads to cardiac arrest [1], has been reported as the major cause of SCD. Beat to beat changes in myocyte excitability such as variation in action potential duration (APD) and action potential amplitude (APA) is often correlated and is thought to cause electrical instability, an important precursor to VF. The oscillation in APD or APA is termed as alternans and the behavior is also known as period doubling bifurcation. Alternans of repolarization has been established as an important factor in genesis of ventricular fibrillation (VF) [2-4] however not many studies have focused on alternans of depolarization phase.

### 1.1 CONCORDANT AND DISCORDANT ALTERNANS

Alternans of APD are also known to exhibit spatial patterns. When alternans occur in long-short-long or short-long-short pattern for the entire region of tissue it signifies that they are spatially concordant. However, sometimes alternans may show different patterns in different regions which is the case when the long-short-long pattern in APDs in one area is accompanied by short-long-short pattern in another known as discordant alternans. Spatial variation in conduction governs transition of concordant to discordant alternans [5]. The non-homogenous conduction which leads to discord in alternans of APD is a possible mechanism that can cause VF [6].

### 1.2 CONDUCTION

Conduction, regulated by autonomic nerve activity, depends on initial rate of depolarization of action potential. Sympathetic nerve activity increases rate of depolarization of action potential and thus increases the conduction through the heart.

Hormone regulation and drugs are the other extrinsic factors affecting conduction. The slope of the phase 0 (depolarization phase) of action potential defines the rate of depolarization and is an important intrinsic factor governing conduction. Availability of fast sodium channels describes the nature of AP in the depolarization phase. The rate of depolarization increases when more sodium channels are open allowing rapid depolarization of a cell and leading to higher conduction velocity [7].

## **CHAPTER 2: OBJECTIVE**

It is believed that spatial discordance in alternans is a precursor to reentrant arrhythmia [8], where transition to discord is to a greater extent dependent on conduction and thus influenced by changes in depolarization phase of an action potential. There are few studies on alternans of APA which suggests their role in prediction of ventricular fibrillation [9, 10]. Our purpose was to study alternans of early phase of depolarization and find whether they are correlated with alternans of repolarization in early and late phase. This was done to see if the mechanism underlying alternans of different phases is distinct or not. We proposed that if the mechanism was the same, then any factor modifying repolarization alternans would also affect alternans in depolarization phase and conduction which in turn can affect discord and dispersion of repolarization. However, if the mechanisms were distinct then the two phenomena could occur independent of other and any alteration in one may not affect the other. A secondary, and minor, objective was to provide evidence that alternans of repolarization are observed in the swine. Since swine happens to be a widely used model to study repolarization dynamics and its link to arrhythmogenesis.

## CHAPTER 3: BACKGROUND

As it is known, the mechanical and electrical events in harmony govern the functioning of the heart. The mechanical event causing the heart to pump blood is divided into two phases systole (when myocardium contracts) and diastole (when myocardium relaxes). The atrial systole causes blood to enter ventricles (ventricle diastole) followed by ventricular systole, when the blood is pumped to all parts of body.

### 3.1 ELECTRICAL ACTIVITY OF HEART

The electrical event governs the mechanical event periodically causing heart to continuously pump blood. It begins at sino atrial (SA) node and spreads through both atria there after a brief delay at atrio ventricular (AV) node travels through bundle of His to Purkinje fibers and stimulates the two ventricles. Electrocardiogram (ECG) measures this electrical activity of heart as P wave representing atrial depolarization (contraction), QRS complex representing depolarization of ventricles and T wave showing repolarization (relaxation) of ventricles.

### 3.2 PHASES OF ACTION POTENTIAL MORPHOLOGY

At cellular level this phenomenon occurs periodically in the form of Action Potential (AP). The depolarization occurs when the cell is excited by an electrical signal triggering rapid upstroke of transmembrane potential followed by repolarization of AP back to its resting potential. Generation of AP occurs due to inward and outward flux of positive and negative ions. The morphological changes of an AP can be described in the following phases:

Phase 4 or the electrical diastolic interval (DI) is defined as the state when the inside of the cell becomes negative with respect to outside, also known as resting potential of the cell, and the potential gradient across the cell approximates 90 mV [11] .

The resting potential depends upon the conductance and concentration of potassium ions and is determined by equilibrium potential of potassium.

Phase 0 refers to depolarization of AP when the cell encounters a stimulus from nearby cell causing a transmembrane potential change, from around  $-90$  mV, of an amplitude of near 120 mV (APA) [12]. A rapid depolarization occurs due to the transient opening of fast sodium channel which results in an inward sodium current ( $I_{Na}$ ) and trans membrane potential (TMP) reaches a value near equilibrium potential of sodium.

Phase 1 occurs due to closing of fast sodium channels. The transient opening of hyperpolarizing potassium channels results in outward flow of potassium current,  $I_{to1}$  and movement of  $Cl^-$  ions ( $I_{to2}$ ) inside the cell.

Phase 2 occurs due to the balance between inward L-type calcium current and outward potassium current also known as slow delayed rectifier potassium current ( $I_{Ks}$ ). Phase 2 happens for longer duration in contracting myocytes due to calcium current regulation. Other currents active during this phase are sodium-calcium exchanger current ( $I_{NaCa}$ ) and sodium potassium pump current ( $I_{NaK}$ ).

In phase 3 the calcium channels start closing while slow rectifier component of potassium channels remain open resulting in opening of other potassium channels known as rapid delayed rectifier current ( $I_{Kr}$ ) and inward rectifier current ( $I_{K1}$ ). In the later part of phase 3  $I_{Kr}$  channels close while  $I_{K1}$  remain open till phase 4.

### 3.3 IRREGULAR CARDIAC RHYTHMS

Irregular rhythms also known as arrhythmia occur due to disturbances in the normal rhythm. Tachycardia is the state when heart rate accelerates over 100 beats/minute while bradycardia is the state with heart rate less than 60 beats/minute.



However, tachycardia is not always irregular, it can be due to stress or exercise in normal conditions. Irregular tachycardia can occur commonly due to formation of reentry circuits [13-15] or due to ectopic beats [16, 17] , which can occur when myocytes other than nodal cells fire impulses by themselves. In few cases ectopic beats can also result in lethal re-entry [18].

Mechanisms possibly governing reentry are the occurrence of a premature beat [19][20] or conduction block, event when two wavefronts interact [14, 21]. Reentry mostly occurs due to the presence of unidirectional block in which case APs are blocked in one direction while conducted in other direction. Depending upon whether those cells in the blocked tissue segment are in excitable state or not and the conduction velocity of AP wavefront, AP can also travel in the retrograde direction and return back through previous pathway. The reentry circuit may repeat itself and result in arrhythmias.

### 3.4 ALTERNANS OF REPOLARIZATION AND DEPolarIZATION

Alternans of both repolarization and depolarization are purported to predict VF [22]. A study in 1988 [23] found strong correlation between alternans of QRS wave and ST segment alternans during electrical instability. Later, studies showed alternans of T wave as an important precursor in genesis of arrhythmia [24]. Many studies also hypothesized restitution of AP, a function defining dependence of APD on previous DI [2, 25], and cardiac memory, dependence of APD on previous APDs or DIs for several seconds [26], as important factors in predicting VF.

Moreover, it has been investigated that at higher pacing rates, alternans of APD form discord in space, the situation when long-short-long pattern alternates adjacent to short-long-short pattern [27], resulting in wave breaks and reentrant circuits. Conduction velocity largely determines whether wave breaks can result in reentry, since propagation through nearby cell can occur only when it is not in its refractory period [25]. Conduction velocity is the rate at which AP travels from one cell to other thus depends on how quick depolarization occurs.

In performing data analysis for one of our previous studies we also found alternans of APA significantly occurring at shorter cycle length. The purpose of our study therefore was also to identify the mechanisms that underlie alternans of early phases of AP and are responsible for the phase relations (in or out of phase) with alternans of APD as observed in our study. We further investigated the consequences of this behavior on spatial dynamics of conduction by performing simulation study.

## CHAPTER 4: METHODS

This study is based on experiments and simulations we performed. The experimental study includes: data recording, data acquisition and data analysis of the signals obtained from single cell of the swine and canine ventricular tissue. Data was acquired from swines for further analysis. However, data acquired previously from a canine study was used for similar analysis [28].

### 4.1 DATA ACQUISITION

#### 4.1.1 Swine

The experiments conducted were approved by Institutional Animal Care and Use Committee (IACUC) at the University of Kentucky. Eight farm pigs (susscrofa) weighing 18- 20 kg were sedated with a telazol/ketamine/xylazine mixture (4–8 mg/kg, 2–4 mg/kg, 2–4 mg/kg) and were anesthetized with thiopental sodium (10–30 mg/kg, IV). After anesthesia, the heart was excised and kept in chilled Tyrode's solution. Small strip of ventricular tissue from endocardium of right ventricle, endocardium or epicardium of left ventricle was cut with an approximate size of 20×10×5 mm and placed in the Plexiglass chamber. Experimental setup used for data recording and acquisition is shown in figure 1. The tissue strips were superfused continuously with the Tyrode's solution bubbled with a mixture of 95% oxygen and 5% carbon dioxide. Composition of the Tyrode's solution was (in mmol/L): 0.5 MgCl<sub>2</sub>, 0.9 NaH<sub>2</sub>PO<sub>4</sub>, 2.0 CaCl<sub>2</sub>, 137.0 NaCl, 4.0 KCl and 5.5 glucose. To this solution, NaHCO<sub>3</sub> (in mmol/L) was added until the pH was obtained to be between 7.3±0.05. The temperature of the circulating solution was maintained at 36 ±1°C. Initially the tissue sample was paced at 500 ms cycle length for the

duration of 60 minutes. The pacing stimulus was bipolar with 3 ms width and delivered using platinum-iridium electrodes. Stimulus intensities were 3 to 4 times the diastolic threshold.

Figure 1: Schematic diagram showing experimental set used for Data recording and acquisition from swines.

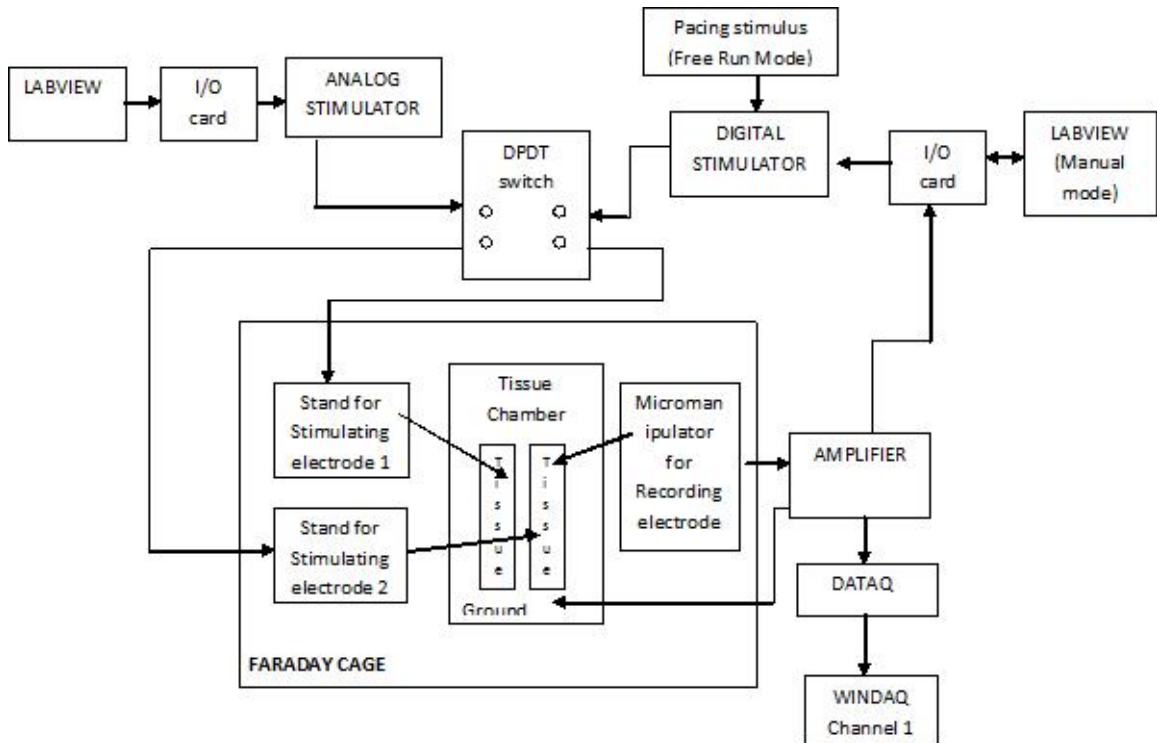

Stimulation in real time was done using a feedback based controlled DI (diastolic interval) or CL (cycle length) protocol discussed previously [28]. Machine pulled glass micropipette electrodes, filled with 3M KCl solution, were used to record TMPs.

Also, the data collected in the similar way by my co-authors for one of our previous swine studies was also analyzed for the purpose of this study [29].

#### 4.1.2 Canine

Experimental procedure similar to swine study was followed to acquire data from canines where dogs (beagles) weighing 10-25 kgs were used [28]. All canine studies were approved by IACUC at University of Kentucky. The tissue samples were similarly superfused, and were paced at the CL of 500 ms for 60 minutes at the beginning before engaging any protocols. The TMPs were recorded using glass microelectrodes similar to swine study, however, recordings were taken only from right ventricular endocardial site. Additionally, the recordings that were analyzed for the purpose of this study were not all used in the previous study.

In both swines and canines the TMPs recorded were digitized at the sample rate of 10000 samples per second using a commercial data acquisition system. In order to record signals free from external noise i.e. disturbances due to the presence of electromagnetic fields, we used Faraday's cage made of copper wire mesh.

#### 4.2 DATA ANALYSIS

The TMPs obtained were analyzed offline using custom developed code in Matlab (Mathworks, Natick MA). TMPs obtained from both animal models were either stimulated with controlled CL or DI, however in this study control of DI is not necessary.

The TMPs were filtered using low pass filter at a cut off frequency 1000 Hz for computing APD and amplitude alternans. The durations were computed at all repolarization levels from 10-90% in step of 10% for each filtered action potential as shown in figure 2.

Figure 2: Example of AP recorded from swine. Figure shows the start and end points of an AP along with measurement of APA and  $APD_{10-90}$ .

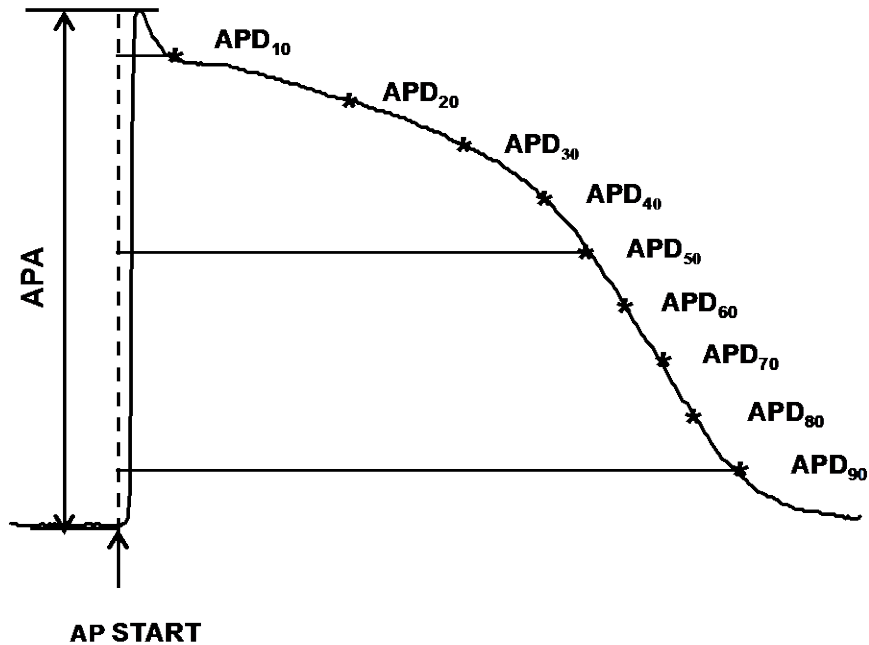

These computed durations were reported as  $APD_{10-90}$  where subscript signifies respective repolarization level. For example,  $APD_{10}$  was calculated as the duration from the beginning of an AP to the time instant when the TMP had repolarized back to 10 % the total amplitude of action potential. Change in  $APD_{90}$  in either long-short-long or short-long-short pattern with difference between each successive APD of  $\geq 4$  ms was considered as alternans of  $APD_{90}$  or APD when they occurred for a minimum of 10 successive beats. The threshold of 4 ms change is consistent with that used previously by others [28, 30]. The alternans of  $APD_{10}$  to  $APD_{80}$  were computed when alternans of  $APD_{90}$  occurred and analysis of their occurrence was done with respect to  $APD_{90}$  alternans.

Alternans of  $APD_{10-80}$  were considered to occur when alternation in duration as long-short-long or short-long-short pattern were observed for a minimum of 3 beats irrespective of the magnitude of alternation.

The amplitude of each TMP was computed as the difference between beginning of the upstroke of the AP to the maximum value it reaches before repolarization (peak of the AP). The alternans of APA was quantified as change in the amplitude  $\geq 2\%$  for sequential beats computed as the average value of each pair of tall and short APA. Since our goal in the present study was to quantify frequency of occurrence of APA independently or with APD alternans two different criteria were formulated for these cases. To find whether APA alternans occurred independent of APD alternans the criteria was to look for at least 10 consecutive beats of APA alternans (short-long-short or long-short-long) in each trial. However, when computing the occurrence of APA alternans along with APD alternans the criteria was to look for at least 3 consecutive beats of APA alternans.

The alternans of  $|dv/dt|_{\max}$  was also computed when alternans of APA or APD occurred either independently or together. We considered alternans of  $|dv/dt|_{\max}$  to occur when alternation in rate of depolarization as fast-slow-fast or slow-fast-slow were seen for at least 3 consecutive beats irrespective of the magnitude of change of alternans.

#### 4.3 SIMULATIONS

To interpret the effect of phase relation between alternans of APD and  $|dv/dt|_{\max}$  on conduction my colleague, Linyuan Jing, performed simulations for both in and out of phase behavior. Canine Ventricular Model (CVM), developed by Fox et al [31], implemented, in house, in Fortran was used for this simulation study where the ionic currents were computed individually for each cell and the cells were coupled using a diffusion equation[32].

Linear strand of 1000 cells was simulated with no flux boundary conditions [33, 34]. The strand was paced from one end with a CL of 200 ms for 60 beats to obtain steady state results for the simulations.

#### 4.3.1 Simulation Protocols

To further confirm and analyze the results computed from the above simulation study, we used following protocols with CVM model and previously defined parameters.

1) The model was paced at 200 ms cycle length for 30 beats to achieve a steady state. Once steady state was reached the phase for cell number 400 to 500 were induced with out of phase behavior (as discussed in the following part) for the next 20 beats and then changed to in phase (default) for the next 30 beats. Thus the total simulation duration was 80 beats.

2) As above, after pacing the strand at 200 ms CL for 30 beats, out of phase behavior was induced only for cell 1 to 100, in this protocol, for 20 beats, and then changed to in phase (default) for the next 30 beats.

The out of phase behavior was simulated in consistence with previously done simulation study, however, sodium current was changed only for particular beats and cells discussed above. Before changing sodium current for a beat two previous APs were used to predict whether the upcoming AP was relatively long or short, ‘one step ahead’ prediction. Depending upon which behavior to be simulated sodium current was decreased for long or short beat. In phase behavior in previous simulation was induced by reducing sodium current for shorter beats by 30 % (this way rate of depolarization slows down for shorter beats) while for out of phase behavior current was reduced by 30 % for longer beats. The reduction in sodium current of this magnitude was chosen to match the magnitude of change in  $|dv/dt|_{\max}$  alternans obtained from experimental results in our study. The APD and  $|dv/dt|_{\max}$  obtained from simulations were computed in similar way as per the procedure used for experimentally obtained data.



## CHAPTER 5: RESULTS

### 5.1 EXPERIMENTAL STUDY

#### 5.1.1 Occurrence and phase relation in swine

##### 5.1.1a Alternans of APD<sub>90</sub> and APA

For all action potentials recorded (51 trials, N=8) with cycle lengths  $\leq 400$  ms we found that occurrence of APD alternans was 33 % and of APA was 28 %. To further look into the correlation between APA and APD alternans we obtained the occurrence of each with respect to the other. It was found that for all those beats when APD alternans occurred they were accompanied with alternans of APA 74 % times of which 98 % were in phase. Figure 3a shows an example of the trial where alternans of APD occur along with alternans of APA and were in phase. The rare case where APD alternans occur independent of APA alternans is shown in figure 3c.

To find whether occurrence of APA alternans is always dependent on APD alternans or if APA can occur independently we calculated percentage occurrence of APD alternans for all those beats when APA alternans occurred. It was found that when APA alternans occurred, APD alternans occurred 86 % times and 96 % of them were in phase. For these APs taller APAs occurred along with longer APDs. Figure 3b shows one of the recordings when APA alternans occurred independent of APD alternans. Figure 3a also exemplifies in phase occurrence of APA and APD. Those APs where APA alternans occur out of phase with APD alternans are shown in figure 3d. These data showing the occurrence and phase relation of alternans of APD and APA as a fraction of total number of APs (with cycle length  $\leq 400$  ms) are summarized in table 1.

Figure 3: The figure shows examples of action potential recordings from swines. a) Alternans of APD occurring along with alternans of APA. Thick and thin lines represent long and short APDs. Tall APAs are represented by an asterisk. b) APA alternans occurring without APD alternans. Tall APAs are marked by an asterisk. c) APD alternans occurring without APA alternans. Thick and thin lines represent long and short APDs. d) Discord between APA and APD alternans which shows that short APDs are associated with tall APAs as opposed to the more frequent phenomenon shown in figure 3a. Thick lines represent long APDs and asterisks denote tall APAs.

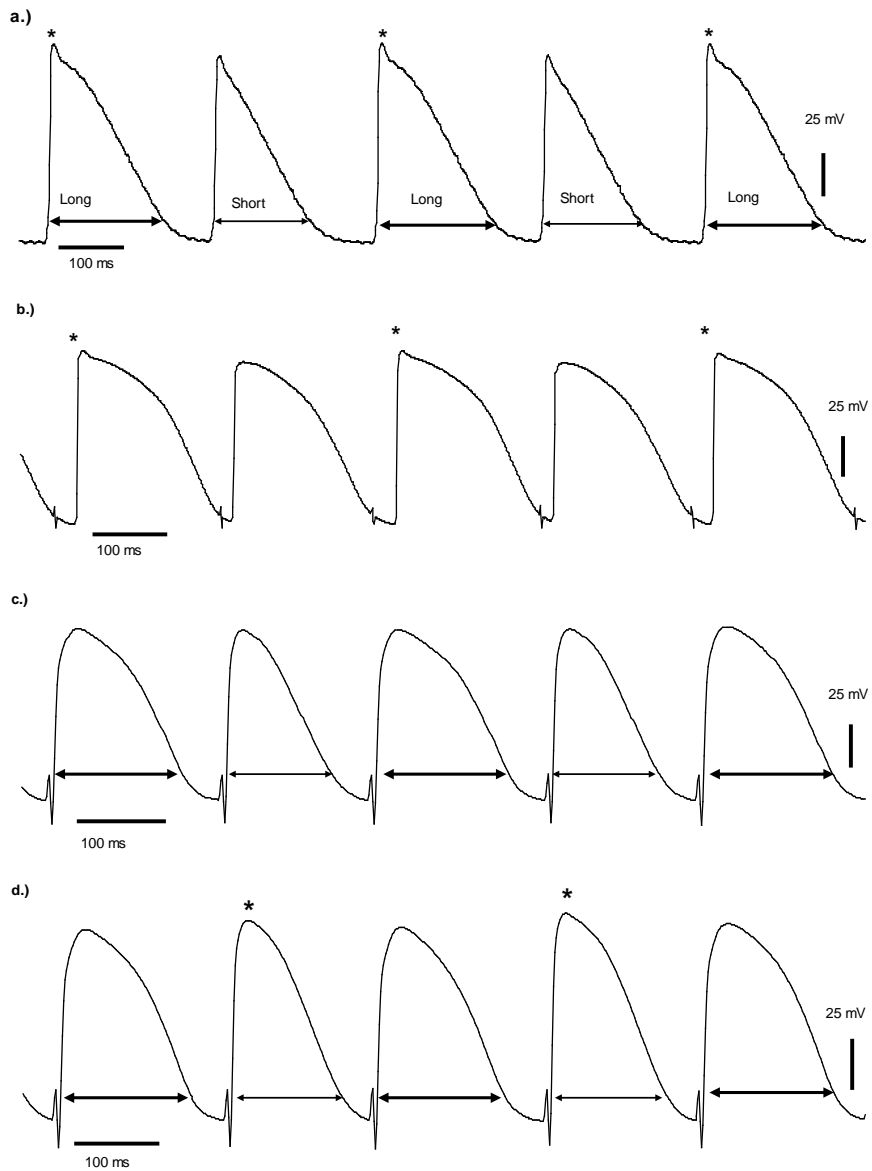

Table 1: Percentage occurrence of APD and APA alternans with each other along with the out of phase alternans present in swine. The percentage out of phase (when long-short-long APDs were associated with tall-short-tall APAs) and in phase were calculated as a part of total percentage of occurrence of alternans.

	% Occurrence	% Out of phase Alternans	% In phase Alternans
APA alternans when APD alternates	74%	2%	98%
APD alternans when APA alternates	86%	4%	96%

#### 5.1.1b APD<sub>10-80</sub> and APD<sub>90</sub>

The relative occurrence and phase relation of alternans of early phase and of phase 2 and phase 3 were also computed with alternans of APD<sub>90</sub>. The computations were done to explore potential mechanisms other than widely known calcium regulation, responsible for alternans of AP in its earlier phases at fast pacing rates. It was observed that in the swine APD<sub>90</sub> alternans was accompanied with alternans at all repolarization levels. Their respective occurrences were APD<sub>80</sub> – 100 %, APD<sub>70</sub> ~100 %, APD<sub>60</sub> ~100 %, APD<sub>50</sub> ~100 %, APD<sub>40</sub> ~100 %, APD<sub>30</sub> - 94%, APD<sub>20</sub> - 83% and APD<sub>10</sub> - 92% as shown by the bar graph in figure 4a,b. Results showing relative occurrence and phase relations are summarized in table 2.

Figure 4: a) Percent occurrence of alternans at each level of repolarization (APD<sub>80</sub> to APD<sub>10</sub>) when APD<sub>90</sub> alternans occurs in the swines (N=8). b) Percent out of phase of alternans at each level of repolarization with respect to APD<sub>90</sub>, also in swine, as a part of total occurrence of alternans. c) Percent occurrence of alternans at each level of repolarization (APD<sub>80</sub> to APD<sub>10</sub>) when APD<sub>90</sub> alternans occurs in the canines (N=3). d) Percent out of phase of alternans at each level of repolarization with respect to APD<sub>90</sub>, also in swine, as a part of total occurrence of alternans.

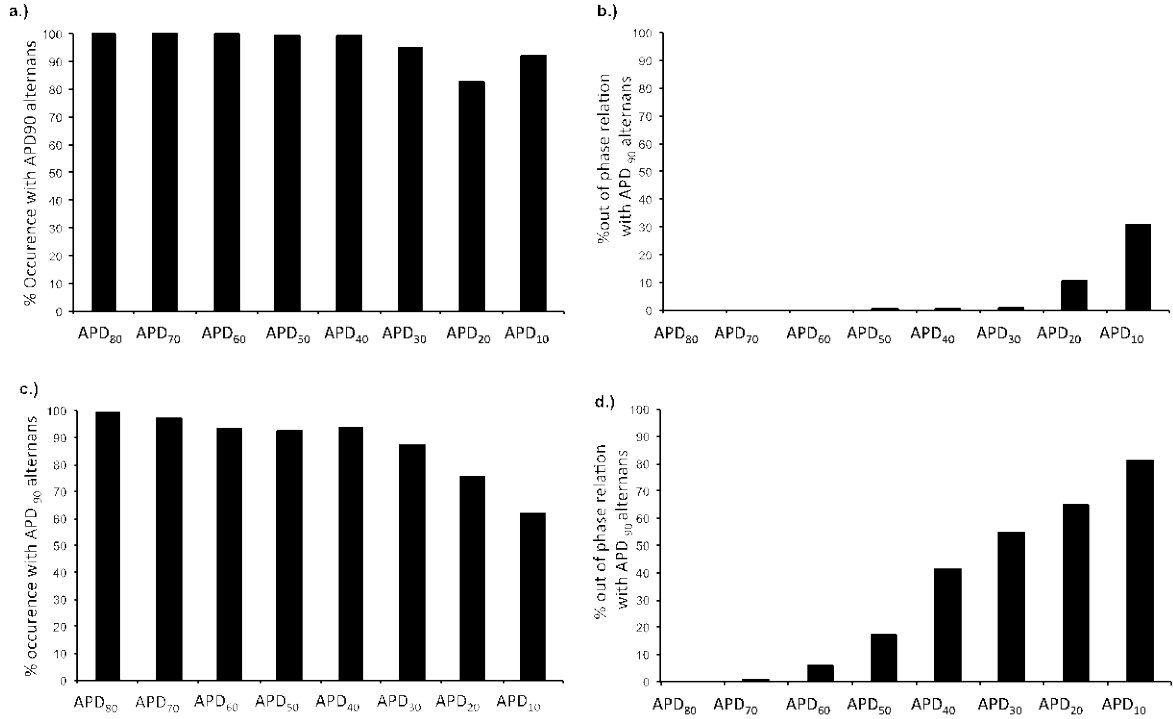

Table 2: Summary showing percentage occurrence of alternans of APD<sub>80</sub> to APD<sub>10</sub> alternans along with their in or out of phase behavior with respect to APD<sub>90</sub> alternans in swine. The percentage in and out of phase shown were calculated out of total percentage of occurrence of alternans.

	APD <sub>80</sub>	APD <sub>70</sub>	APD <sub>60</sub>	APD <sub>50</sub>	APD <sub>40</sub>	APD <sub>30</sub>	APD <sub>20</sub>	APD <sub>10</sub>
% occurrence of alternans	100%	100%	100%	99%	99%	94%	83%	92%
% of out of phase alternans	<1%	<1%	<1%	<1%	1%	1%	13%	34%
% of in phase alternans	100%	100%	100%	100%	99%	99%	87%	66%

One of the interesting results seen in figure 4b is that one-third (34 %) of the alternating APD<sub>10</sub> was out of phase with APD<sub>90</sub> alternans and only rest of the two-third was in phase with APD<sub>90</sub> alternans. Similarly APD<sub>20</sub> alternans was out of phase with APD<sub>90</sub> alternans few times (13 %) and was in phase for rest of the 87 % times. APD<sub>40</sub> and APD<sub>30</sub> alternans were rarely out of phase (1 %) while APD<sub>80</sub>, APD<sub>70</sub>, APD<sub>60</sub> and APD<sub>50</sub> were never out of phase. Table 2 represents the summary of the results discussed above. We also verified whether the phase relation is consistent within a trial, for example APD<sub>10</sub> when alternates along with APD<sub>90</sub> is in phase/ out of phase throughout the trial or not. It was found that there were only 8 trials exhibiting both in phase and out of phase APD<sub>10</sub> alternans and 3 trials for APD<sub>20</sub> alternans. Moreover, there were 2 trials where APD<sub>30</sub> to APD<sub>60</sub> were out of phase and as discussed earlier APD<sub>70</sub> and APD<sub>80</sub> were always in phase with APD<sub>90</sub> alternans.

#### 5.1.1c Alternans of $|dv/dt|_{\max}$

Rate of depolarization illustrates how fast an AP is travelling across the cell and is governed by sodium regulation. Since the results show occurrence of alternans at all morphological levels in an AP, we computed alternans of  $|dv/dt|_{\max}$  for the trials when APD, APA or both alternans occurred.

It was found that when APD<sub>90</sub> alternans occurred along with APA alternans,  $|dv/dt|_{\max}$  alternans occurred 90 % times. Out of these 90 % occurred at faster rate for longer APDs and slower rate for shorter APDs implying that  $|dv/dt|_{\max}$  and APD alternans were in phase most of the times. For the rest 10 % beats  $|dv/dt|_{\max}$  and APD alternans were out of phase. When APD alternans occurred independent of APA alternans  $|dv/dt|_{\max}$  occurred 86 % times of which 83 % were in phase and were out of phase for rest 17 % alternating beats.

These results are summarized in table 3. Moreover when APA alternans occurred alone, the rate of depolarization occurred 75 % times and they were never out of phase. The average amplitude of alternans of  $|dv/dt|_{\max}$  was 9 %.

Table 3: Percentage occurrence of  $|dv/dt|_{\max}$  alternans is shown when computed along with APD and APA alternans (occurring alone or together) in swine . Percentage occurrence was calculated with respect to total number of alternating beats of APD or APA in respective cases.

	% Occurrence	% Out of phase Alternans	% In phase Alternans
Alternans of APA and APD occurring together	90%	10%	90%
APD alternans occurring alone	86%	17%	83%
APA alternans occurring alone	75%	< 1%	100%

### 5.1.2 Occurrence and Phase Relation in Canine

Data collected from previous canine study (52 trials, n=3) were analyzed for the purpose of this study [28]. Procedure for calculating occurrence of alternans and their phase relations is similar to that used for the swine study.

#### 5.1.2a Alternans of APD<sub>90</sub> and APA

For all the APs recorded with cycle lengths  $\leq 400$  ms, occurrence of APD alternans was found to be 73% while that of APA alternans was 65%. When APD alternans occurred it was associated with APA alternans for 50% times and was 66 % times in phase. Moreover, when APA alternans occurred it was associated with APD alternans for 96% times and was in phase 68 % times. Table 4 includes the summary of results discussed above.

Table 4: Percentage occurrence of APD and APA alternans with each other along with the out of phase alternans present in canines. The percentage in and out of phase shown were calculated as a part of total percentage of occurrence of alternans.

	% Occurrence	% Out of phase Alternans	% In phase Alternans
APA alternans when APD alternates	50%	44%	66%
APD alternans when APA alternates	96%	32%	68%

#### 5.1.2b APD<sub>10-80</sub> and APD<sub>90</sub>

Similar to swine study, alternans at repolarization levels from 10 % to 80 % were computed for the alternans of APD<sub>90</sub> and their relative occurrence as a fraction of total number of APs (with cycle lengths  $\leq 400$  ms) was calculated.

It was observed that almost always APD<sub>90</sub> alternans occurred along with APD<sub>80</sub> alternans (99% times), APD<sub>70</sub> alternans (97% times), APD<sub>60</sub> (93%), APD<sub>50</sub> (83%), APD<sub>40</sub> (93%) and APD<sub>30</sub> (87 %). Also quite frequently APD<sub>20</sub> (75%) alternans was seen and more than half of the times APD<sub>10</sub> (62%) alternans was seen to occur along with APD<sub>90</sub> alternans. The results are also represented by the bar graphs in figure 4c, d and summarized in table 5.

Table 5: Summary showing percentage occurrence of alternans of APD<sub>80</sub> to APD<sub>10</sub> alternans along with their in or out of phase behavior with respect to APD<sub>90</sub> alternans in swine. The percentage in and out of phase shown were calculated out of total percentage of occurrence of alternans.

	APD <sub>80</sub>	APD <sub>70</sub>	APD <sub>60</sub>	APD <sub>50</sub>	APD <sub>40</sub>	APD <sub>30</sub>	APD <sub>20</sub>	APD <sub>10</sub>
% occurrence of alternans	99%	97%	93%	83%	93%	87%	75%	62%
% out of phase alternans	<1%	<1%	6%	17%	41%	55%	65%	81%
% of in phase alternans	100%	100%	94%	83%	59%	45%	35%	19%

In contrast to the phase relation obtained in swine study, interestingly, it was found that most of the times APD<sub>10</sub> alternans was out of phase with APD<sub>90</sub> alternans i.e. for the relative occurrence of 62% (with respect to APD<sub>90</sub> alternans), 81 % times it had alternans in opposite phase (long APD<sub>90</sub> associated short APD<sub>10</sub>) and only for rest of the 19 % times it was in phase (long APD<sub>90</sub> associated long APD<sub>10</sub>). Similarly APD<sub>20</sub>, APD<sub>30</sub> and APD<sub>40</sub> alternans were mostly out of phase with APD<sub>90</sub> alternans (65 %, 55 % and 41 % times) and were in phase only for rest of the 35 %, 45 % and 59 % times when their relative occurrence was 75 %, 87 % and 93 % respectively. APD<sub>60</sub> and APD<sub>50</sub> out of phase behavior were low i.e. 6% (out of 93% relative occurrence) and 17% times (out of 93% relative occurrence) respectively. In agreement with the swine study APD<sub>80</sub> and APD<sub>70</sub> alternans were never out of phase. The TMPs in Figure 5a show an example of in phase behavior between APD<sub>10-30</sub> and APD<sub>90</sub> alternans while those in 5b show an example of out of phase behavior between these alternans. Also Table 5 includes the summary of these results. Moreover, similar to that in the swine, the trials which had both in phase and out of phase alternans were few, 8 trials for APD<sub>10</sub>, 11 trials for APD<sub>20</sub>, 7 trials for APD<sub>30</sub>, 5 trials for APD<sub>40</sub>, 9 trials for APD<sub>50</sub>, 7 trials for APD<sub>60</sub> and none for APD<sub>70</sub> and APD<sub>80</sub>.



Figure 5: Examples of TMP recordings from canines. a) An example of in phase alternans is shown with respect to APD<sub>90</sub> alternans. In this figure only APD<sub>10</sub>, APD<sub>20</sub>, APD<sub>30</sub> are shown although in phase behavior occurs at all levels of AP i.e. from APD<sub>10</sub> to APD<sub>80</sub>. Thick lines represent long APDs and thin lines represent short APDs. b) An example of out of phase alternans is shown with respect to APD<sub>90</sub> alternans. Similar to the figure 5a only APD<sub>10</sub>, APD<sub>20</sub>, APD<sub>30</sub> are shown although out of phase behavior also occurs at other levels of AP i.e. from APD<sub>40</sub> to APD<sub>60</sub>.

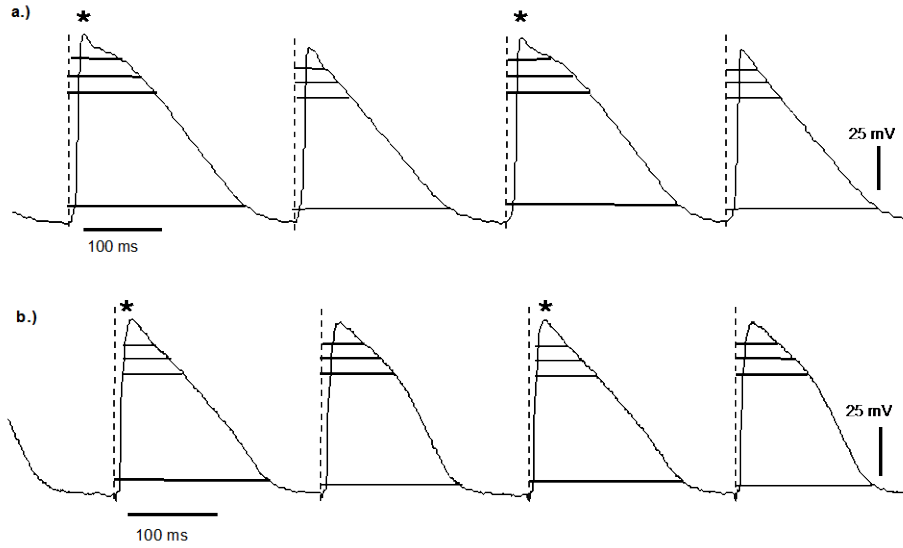

### 5.1.2c Alternans of $|dv/dt|_{\max}$

The trials in which APD alternans occurred along with APA alternans, the incidence of  $|dv/dt|_{\max}$  alternans was 79 %, out of these, 80 % was in phase that is long APD associated with faster rate of depolarization and short APD associated with slower rate of depolarization and for rest 20 % times it was out of phase with APD alternans. Figure 6a and figure 6b represent an example from one of the trials where APD and APA alternans were in phase with  $|dv/dt|_{\max}$ . Figures 6c and 6d show examples, from one trial, of the relationship between  $|dv/dt|_{\max}$  and APD or APA when APD<sub>90</sub> or APA alternans were out of phase with  $|dv/dt|_{\max}$  alternans. Furthermore, when APA alternans occurred independent of APD alternans,  $|dv/dt|_{\max}$  alternated 84% times and was always (100 %) in phase, as shown by an example in figure 6e.

For those cases when  $APD_{90}$  alternans occurred independent of APA alternans incidence of alternans of  $|dv/dt|_{\max}$  was 81 % and was in phase for 88 % times. The average amplitude of alternans of  $|dv/dt|_{\max}$  was 7 %. Table 6 summarizes the results.

Figure 6: Examples of data from a trial in canines. a) Relationship between  $|dv/dt|_{max}$  (mV/ms) and APD (ms). The figure shows for each pair of alternating APDs, AP associated with slower maximum rate of depolarization had shorter duration (APD) while those having faster maximum rate of depolarization had longer duration. b) Relationship between  $|dv/dt|_{max}$  (mV/ms) and APA (mV). Figure shows that short APA was associated with slower rate of depolarization while tall APA was associated with faster rate of depolarization for those trials where APD and  $|dv/dt|_{max}$  were in phase. c) The figure shows that APs associated with slower rate of depolarization had longer APDs while those having faster rate of depolarization had shorter APDs. d) Out of phase behavior between APA and  $|dv/dt|_{max}$  alternans for the trials when alternans of APD were out of phase with alternans of  $|dv/dt|_{max}$ . e) In phase behavior between APA alternans and alternans of  $|dv/dt|_{max}$  when they occurred independent of APD alternans.

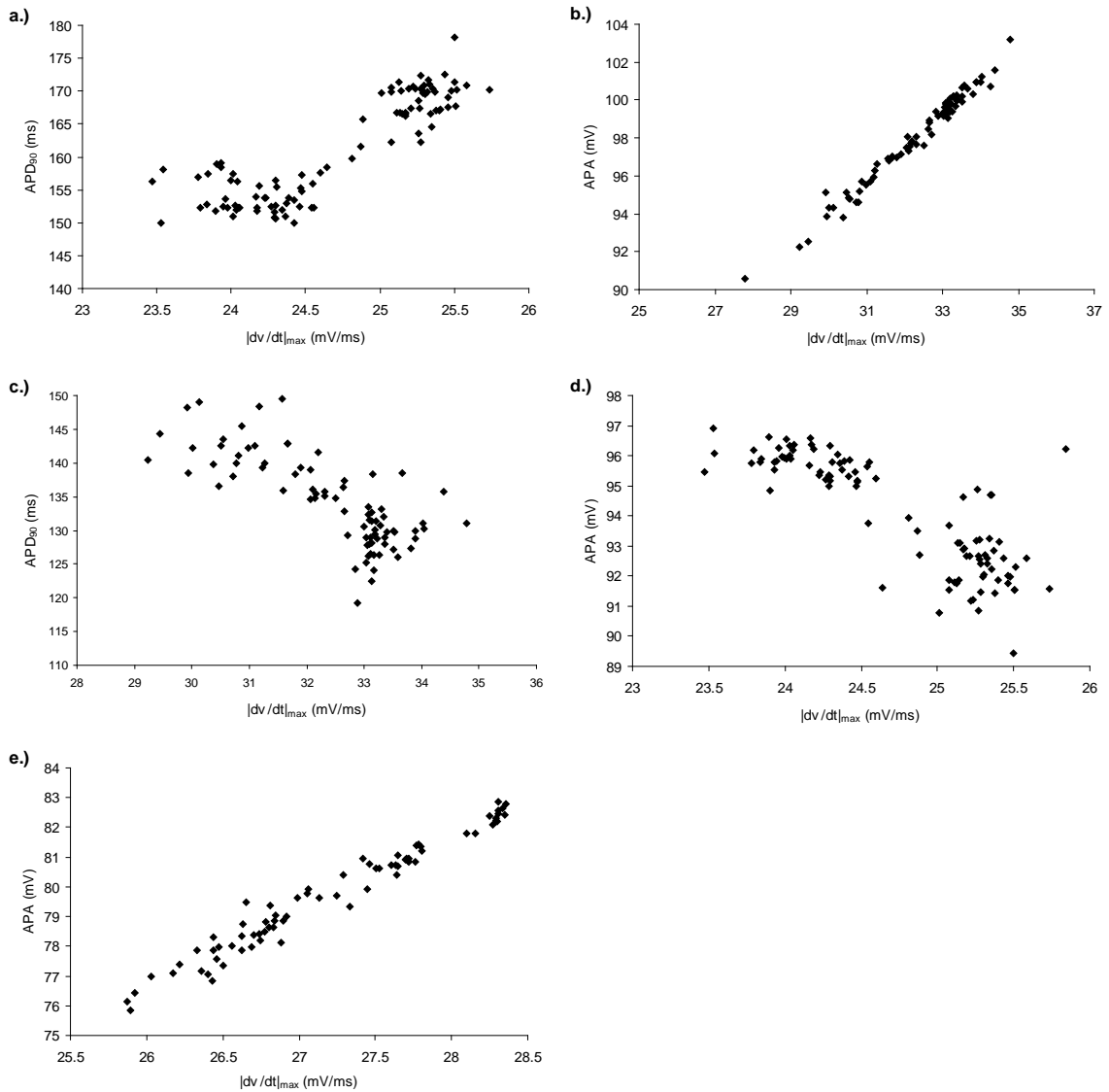

Table 6: Percentage occurrence of  $|dv/dt|_{\max}$  alternans is shown when computed along with APD and APA alternans (occurring alone or together) in canine. Percentage occurrence was calculated with respect to total number of alternating beats of APD or APA in respective cases.

	% Occurrence	% Out of phase Alternans	% In phase Alternans
Alternans of APA and APD occurring together	79%	20%	80%
APD alternans occurring alone	81%	12%	88%
APA alternans occurring alone	84%	< 1%	100%

## 5.2 SIMULATION STUDY

The simulation results were consistent with those done by my colleague, shown in figure 7, to study the phase behavior in a linear strand of tissue. Figure 8i. and ii. show skewed oscillations of wavelength (which is product of APD and conduction velocity) during out of phase simulation in a patch of linear strand of 1000 cells, when longer APDs were forced to occur along with slower rate of depolarization ( $|dv/dt|_{\max}$ ). Moreover the oscillations of wavelength were not observed in the cells following those with out of phase behavior.

Figure 7. Time-space plots of the simulation results from co-author to study effects of phase relationship between APD alternans and alternans of  $|dv/dt|_{max}$  in linear strand of 1000 cells. a) Shows in phase simulation between alternans of APD and  $|dv/dt|_{max}$  and also shows the transition between concordant and discordant alternans occurring several times. The vertical white lines (solid and dashed) show wavelengths (long and short, respectively) at different time instances. b) Shows out of phase relationship between alternans of APD and  $|dv/dt|_{max}$  and also shows that concordant alternans persisted along the tissue length with minimized oscillation of wavelength as compared to figure 7a. The TMP traces below each time space plot are those recorded from first cell in each case. The pairs of lines on the right are drawn for comparison of respective wavelengths.

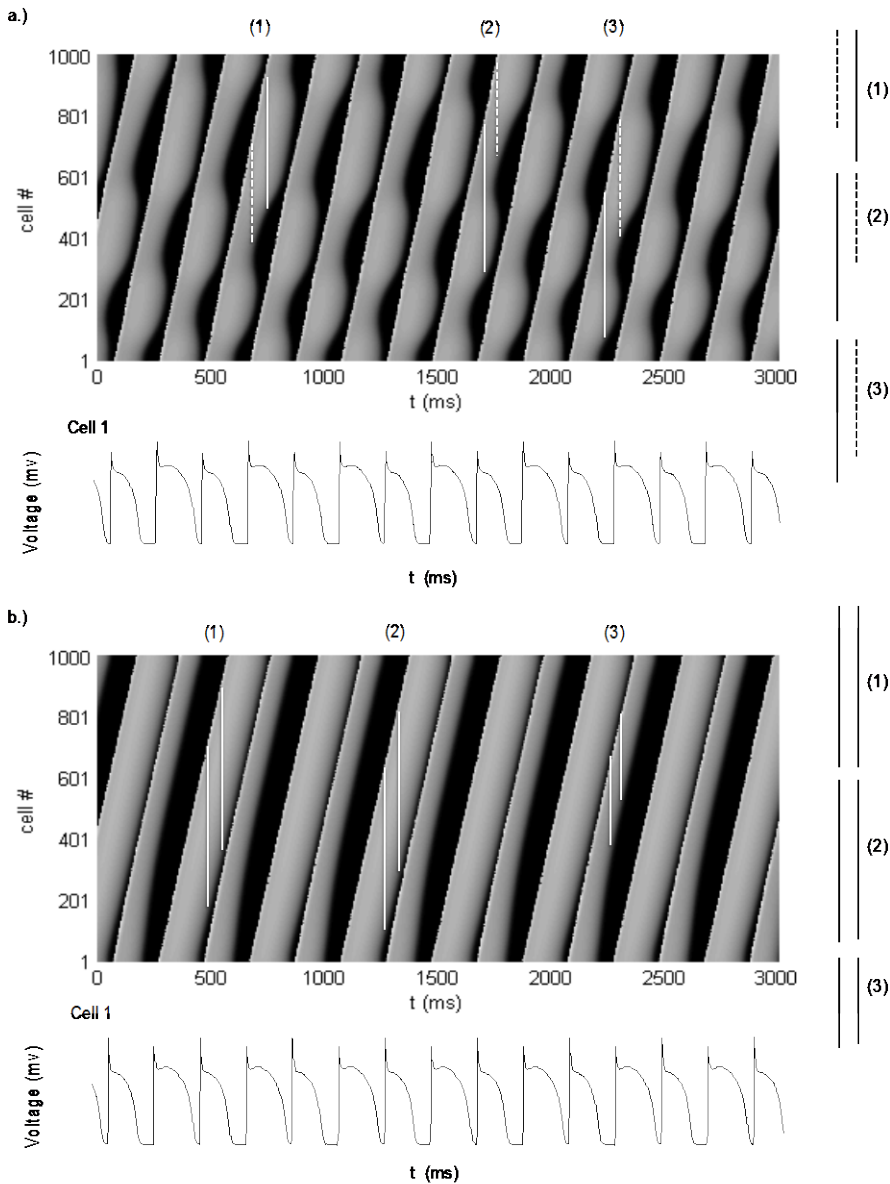

Figure 8i.) Figure shows the time-space plot for the simulation study conducted on linear strand of 1000 cells where cells 400 to 500 were induced with out of phase behavior for 20 beats preceded and followed by 30 beats of 200 ms cycle length a.) Shows the plot of first 11th to 30th beats b.) Shows plot from 31st to 50th beat c.) Shows plot of 41st to 60th beats for entire tissue length.

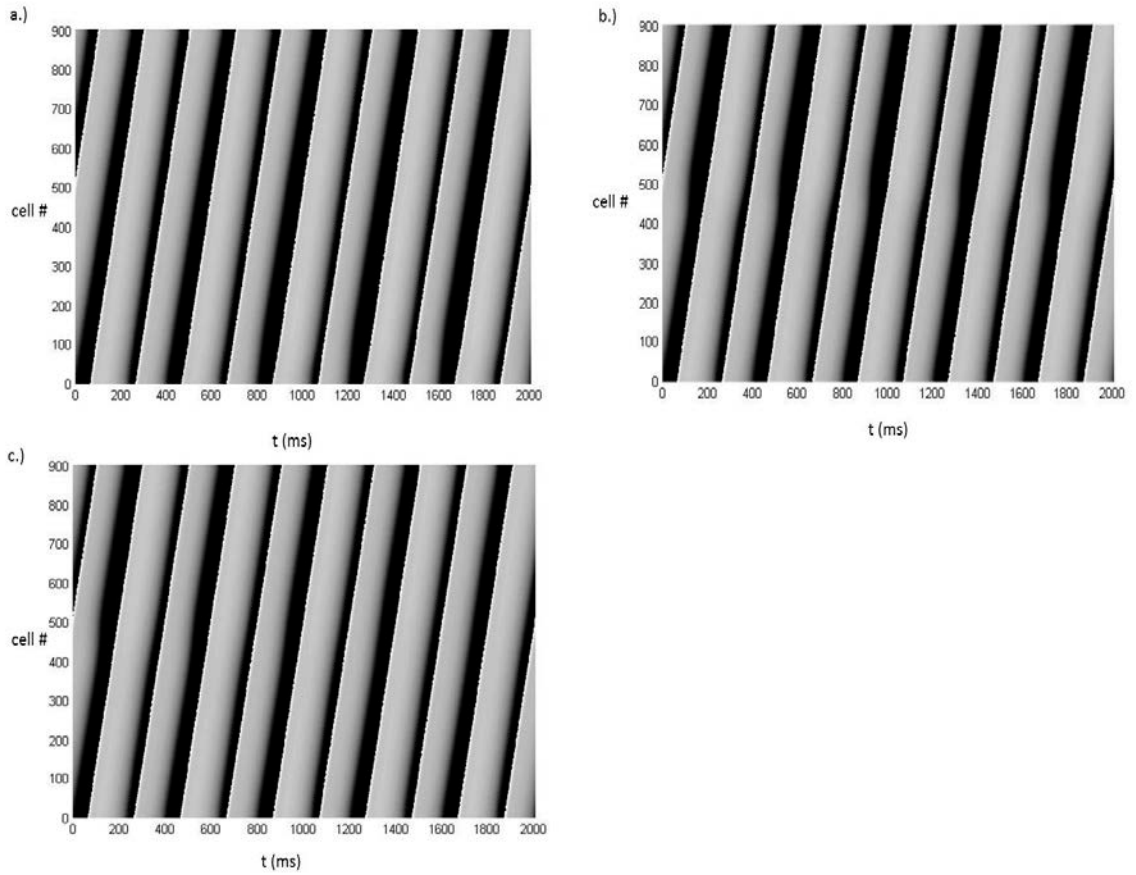
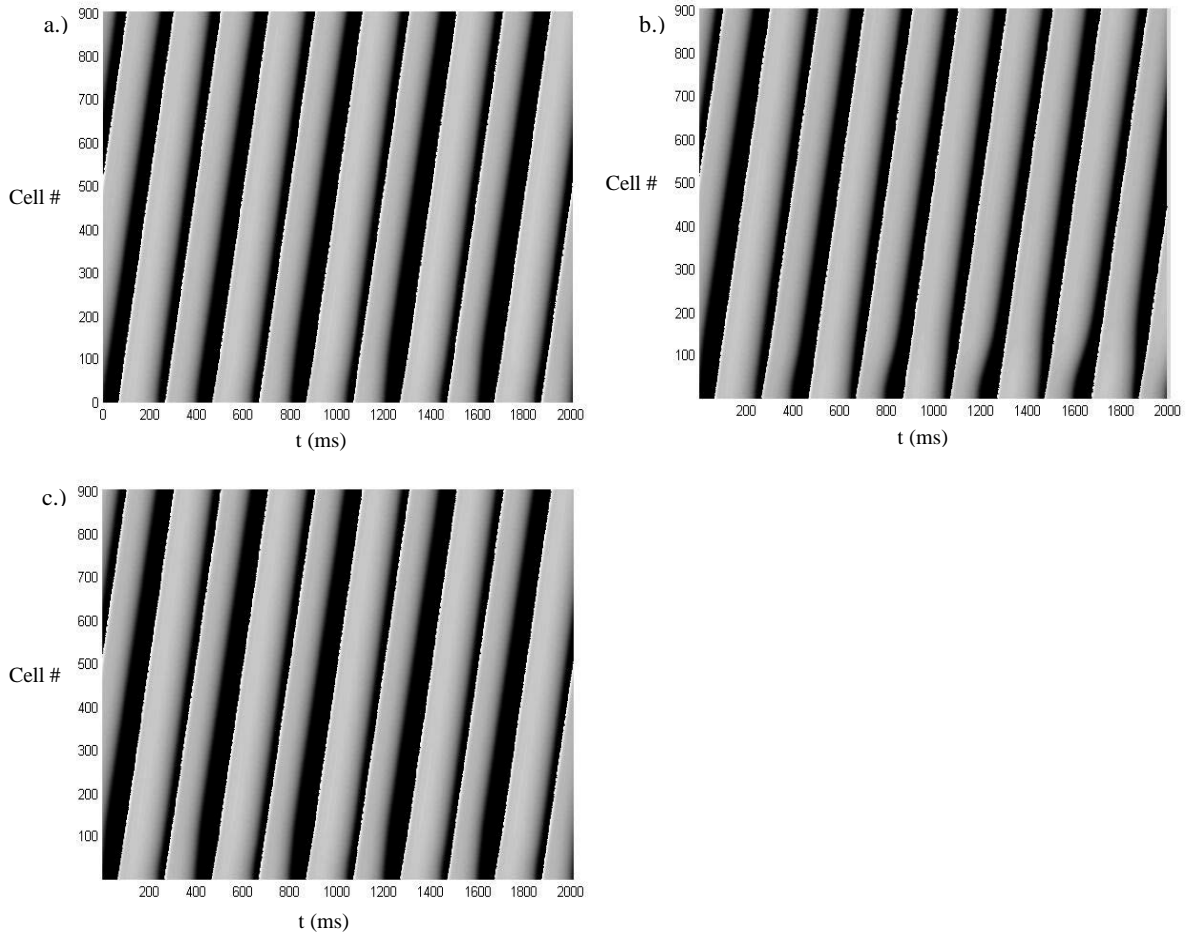

Figure 8 ii.) Figure shows the time-space plot for the simulation study conducted on linear strand of 1000 cells where cell number 1 to 100 were induced with out of phase behavior for the 20 beats preceded and followed by 30 beats of 200 ms cycle length respectively. a.) Shows the plot of first 11th to 30th beats b.) Shows plot from 31st to 50th beat c.) Shows plot of 41st to 60th beats for entire tissue length.



## CHAPTER 6: DISCUSSION

The primary objective was to find the correlation between alternans of morphology of early and late phase of AP. We focused on finding the frequency of occurrence of alternans of  $APD_{10-80}$ ,  $|dv/dt|_{max}$ , APA and  $APD_{90}$  and their phase relation with APD ( $APD_{90}$ ) or APA alternans. Our results show that the phase relation among these alternans can change and the correlation is not invariant. Secondary purpose of this study, though not unimportant, was also to show that the APD alternans are seen quite frequently in a swine model. Although it is less widely known that occurrence of APD alternans in swine model is not rare, the results of our study suggest that for cycle lengths  $\leq 400$  ms, APD alternans occur 33% times when calculated as a fraction of total number of APs recoded in 51 trials (n=8).

### 6.1 ALTERNANS OF DEPOLARIZATION PHASE AND THEIR CORRELATION WITH APD ALTERNANS

It is widely known that alternans of repolarization, also known as T wave alternans is the most important factor in determining the risk of VF [24, 35]. Increase in the magnitude of oscillation of APD alternans is theorized to cause unidirectional block and result in reentrant arrhythmias which is a precursor to VF [36, 37]. Moreover few studies focusing on mechanisms of arrhythmia show very little or no evidence of alternations of amplitude of AP [38, 39]. Our results indicate significant occurrence of APA alternans along with APD alternans. In addition, we found that, though infrequent, at a few shorter cycle lengths APA alternans occur independent of APD alternans as seen in both swine and canine model. Also, the alternans of APA when occurring independently were mostly seen to occur along with alternans of  $|dv/dt|_{max}$ .



In the present study a high positive correlation between APD and APA alternans was seen i.e. they mostly occurred together and longer APD was associated with taller APA.

Similar to these results, study by Gordon et al [22] in ischemic canine model established importance of depolarization alternans along with repolarization alternans in prediction of VF, they found restitution of conduction velocity as the possible factor governing the correlation between these alternans. Also, in our study the APD and APA alternans, when occurring together or fewer times independent of each other, were mostly accompanied with  $|dv/dt|_{\max}$  alternans. Consistent with the results of the study conducted by Huang et al. we observed a positive correlation between  $|dv/dt|_{\max}$  and APD and  $|dv/dt|_{\max}$  and APA most of the times [40]. The study by Huang et al [40] found  $|dv/dt|_{\max}$  as a governing predictor of APD and focused on determining correlations between  $|dv/dt|_{\max}$  and APD during VF, however their findings were restricted to VF settings and not during or before arrhythmogenesis. The study also did not investigate the relationship between occurrence of APA and APD alternans. The frequent occurrence of APA and  $|dv/dt|_{\max}$  alternans and observed correlation between APA, APD and  $|dv/dt|_{\max}$  alternans, in our study, suggests that depolarization phase may play an important role in causing electrical instability along with the repolarization phase.

## 6.2 MECHANISM UNDERLYING CORRELATION OF EARLY AND LATE PHASE ALTERNANS

We further computed the alternans at each level of AP to investigate the mechanisms that correlate APD and APA alternans and possibly underlie arrhythmogenesis. APA and  $|dv/dt|_{\max}$  alternans were computed as the indexes of depolarization phase while  $APD_{10-90}$  were computed as indexes of early and late repolarization of AP.

Interestingly our analysis show alternans of AP at all levels of repolarization including those at 10% and 20% repolarization which occur during early repolarization phase just before phase 2 of

AP as also shown in figure 9. Also significant alternation in APA and  $|dv/dt|_{\max}$  along with APD alternans and times even without APD alternans were observed.

Figure 9: An example of average of 5 consecutive long and short APs from a single trial. a) The figure shows an example of APD10 alternans being in phase with APD90 alternans in swine. b) The figure shows an example of APD10 alternans being out of phase with APD90 alternans in a canine.

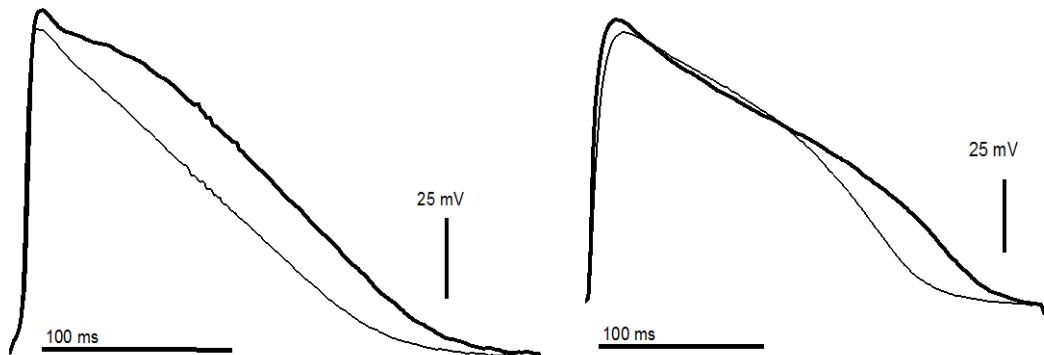

The magnitude of sodium current entering a cell dictates the amplitude of phase 0 of AP, indexed as APA, and governs the speed of conduction of AP reflected in rate of depolarization of AP or  $|dv/dt|_{\max}$ [40]. The influx and rapid efflux of potassium current occurs during initial rapid repolarization phase via  $I_{to}$ , where the AP repolarizes to about 20% of its peak value. The strength of this current can modulate refractoriness and thus the duration of AP [41, 42]. Existence of alternans in early phases, where sodium and potassium current majorly operate, followed by the alternans in later phases and their correlation suggests the contribution of mechanisms other than conventional calcium current in causing electrical instability. In support of this hypothesis, a study conducted by Sah et al. [43] suggests that  $I_{to}$  governs the morphology of early repolarization phase and regulates  $I_{Ca,L}$  and  $I_{NaCa}$ , thus effecting magnitude and duration of calcium current in the cell. It also advocates that there is difference in distribution of  $I_{to}$  magnitude through different regions of heart, which is greatly reduced under diseased heart state

and result in shortening of duration of AP at 90 % repolarization by slowing the rate of repolarization. This mechanistic approach also explains the presence of out of phase behavior between  $APD_{10}$  and  $APD_{90}$  in canine study most of the times and also more than one third times in swine study. Consistent with the results of our study Hopfenfeld et al. [44] reported that the decrease in the  $I_{Na}$  strength decreases the maximum rate of depolarization and leads to reduced  $I_{to}$ . This explains the reason behind slower rate of depolarization, driven by  $I_{Na}$ , leading to shorter APA while longer  $APD_{10}$  due to decreased  $I_{to}$  in our study most of the times. The mechanism responsible for in phase behavior between  $APD_{10}$  and  $APD_{90}$  however, is still ambiguous. While there was a correlation between alternans in morphology of early and late phases of an AP, there were differences between the two, even within a species and also between the two species in terms of the frequency of out of phase between  $APD_{10}$  and  $APD_{90}$  alternans. This difference, as shown by some studies, can be attributed to difference in  $I_{to}$  regulation in the two species which is shown to be absent in pigs [45] while prominent in dogs [46] at higher pacing rates.

In summary, the above results show that alternans of early and late phases of AP are correlated, however, the nature of this correlation is variant. These observations also suggest that, at higher activation rates, mechanisms that govern the morphology of early part of an AP may also contribute to electrical instability and that the mechanisms affecting early and later parts of repolarization may work independent of each other.

### 6.3 SIMULATION OF PHASE BEHAVIOR

The experimental study led us to determine the phase relation between alternans of early and late phase of action potentials at pacing rate faster than the normal heart rhythm. However, as discussed earlier, other indexes of AP morphology such as  $|dv/dt|_{max}$  and APA also govern conduction velocity and thus change in these parameter leads to variation in conduction of AP spatially, further influencing transformation from concordant to discordant alternans in heart [5, 47]. Simulations were thus performed in a linear strand of tissue of around 10 cm (1000 cells) in

length to see what effects does in (out of) phase behavior between these two parameters has on spatiotemporal gradient of conduction.

Results from colleague's simulation study show that there were alternans of wavelength with greater amplitude during in phase alternans of  $|dv/dt|_{\max}$  and APD as compared to out of phase behavior, which lowered the wavelength oscillations as seen in figure 7a, b. Wavelength oscillations, determined as product of APD and conduction velocity [48] harbingers wave break [47, 49]. The in phase behavior, seen quite frequently in experimental study, where faster rate of depolarization of TMP resulted in longer repolarization duration also led to faster conduction and thus smaller DI for next beat. The functional dependence of APD on previous DI, APD restitution [50, 51], thus results in a smaller APD and slower depolarization rate following smaller DI. The in phase alternans thus spatially results in alternation of wavelength. The out of phase behavior, in contrast, negates the effect diminishing the oscillations of wavelength and thus lessening the probability of formation of discordant alternans and wavebreak.

We further simulated out of phase behavior in a defined patch of cells for a certain time interval and not for the entire duration of trial, to see whether the change in phase has any effect on the dynamics of AP propagation. Figure 8i.) and ii.) show the results obtained from the above simulations. Similar to previous simulation result we observed minimized oscillations of wavelength during out of phase behavior. Also there was no impact of induced out of phase behavior on following beats in the simulated patch of cells or in the cells adjacent to that patch and they acquired regular AP conduction with no signs of oscillation of wavelength. This further led to an indication that out of phase alternans of  $|dv/dt|_{\max}$  and APD as compared to in phase is less susceptible to forming discordant alternans.

## CHAPTER 7: LIMITATIONS

For data from swine, we included TMPs collected from the right and the left ventricles, while in the canines all TMPs were obtained only from the right ventricle. While the main objective of our study was to investigate the relationship between alternans of the early and the late phases of an AP in a global sense, we acknowledge that the differences in spatial expression of ionic currents may affect the subtle changes in relationship between these alternans. However, the degree to which there were differences within the swine and canines was less compared to the degree to which there were differences between swines and canines, suggesting that at the global level, spatial variation may have affected our observations in swine to a lesser extent. The effect of this difference, nevertheless, is possible. Our results suggest that elucidation of these may require a much larger sample size.

## REFERENCES

1. American Heart Association, *I. Sudden Cardiac Death*. . 2009.
2. Koller, M.L., M.L. Riccio, and R.F. Gilmour, *Dynamic restitution of action potential duration during electrical alternans and ventricular fibrillation*. American Journal of Physiology-Heart and Circulatory Physiology, 1998. **44**(5): p. H1635-H1642.
3. Fox, J.J., J.L. McHarg, and R.F. Gilmour, *Ionic mechanism of electrical alternans*. American Journal of Physiology-Heart and Circulatory Physiology, 2002. **282**(2): p. H516-H530.
4. Banville, I., N. Chattipakorn, and R.A. Gray, *Restitution dynamics during pacing and arrhythmias in isolated pig hearts*. Journal of Cardiovascular Electrophysiology, 2004. **15**(4): p. 455-463.
5. Qu, Z., et al., *Mechanisms of discordant alternans and induction of reentry in simulated cardiac tissue*. Circulation, 2000. **102**(14): p. 1664-70.
6. S. Bertil Olsson, J.P.A., Shiwen Yuan, *Dispersion of ventricular repolarization: state of the art*2000.
7. Klabunde, R.E., *Cardiovascular Physiology Concepts*2005: Lippincott Williams & Wilkins. 235.
8. Myles, R.C., et al., *The link between repolarisation alternans and ventricular arrhythmia: Does the cellular phenomenon extend to the clinical problem?* Journal of Molecular and Cellular Cardiology, 2008. **45**(1): p. 1-10.

9. Karagueuzian, H.S., et al., *Action-Potential Alternans and Irregular Dynamics in Quinidine-Intoxicated Ventricular Muscle-Cells - Implications for Ventricular Proarrhythmia*. *Circulation*, 1993. **87**(5): p. 1661-1672.
10. Lalani, G.G., et al., *Action potential dynamics explain arrhythmic susceptibility in systolic heart failure*. *Journal of Cardiac Failure*, 2008. **14**(6): p. S8-S8.
11. Brian Francis Hoffman, P.F.C., *Electrophysiology of the Heart* 1960, New York: McGraw-Hill. 323.
12. Douglas P. Zipes, J.C.B., Victor Elharrar, *The Slow inward current and cardiac arrhythmias* 1980, Neiterlands: Martinus Nijhoff. 521.
13. Garrey, W.E., *Auricular fibrillation*. *Physiological Reviews*, 1924. **4**(2): p. 215-250.
14. Gray, R.A., A.M. Pertsov, and J. Jalife, *Spatial and temporal organization during cardiac fibrillation (vol 392, pg 75, 1998)*. *Nature*, 1998. **393**(6681): p. 191-191.
15. Witkowski, F.X., et al., *Spatiotemporal evolution of ventricular fibrillation*. *Nature*, 1998. **392**(6671): p. 78-82.
16. Kotler, M.N., et al., *Prognostic Significance of Ventricular Ectopic Beats with Respect to Sudden Death in Late Postinfarction Period*. *Circulation*, 1973. **47**(5): p. 959-966.
17. Harrison, D.C., J.W. Fitzgerald, and R.A. Winkle, *Ambulatory Electrocardiography for Diagnosis and Treatment of Cardiac-Arrhythmias*. *New England Journal of Medicine*, 1976. **294**(7): p. 373-380.
18. Moe, G.K. and C. Mendez, *Physiologic Basis of Premature Beats and Sustained Tachycardias*. *New England Journal of Medicine*, 1973. **288**(5): p. 250-254.

19. Marban, E., S.W. Robinson, and W.G. Wier, *Mechanisms of Arrhythmogenic Delayed and Early Afterdepolarizations in Ferret Ventricular Muscle*. Journal of Clinical Investigation, 1986. **78**(5): p. 1185-1192.
20. Rosen, M.R., H. Gelband, and B.F. Hoffman, *Correlation between Effects of Ouabain on Canine Electrocardiogram and Transmembrane Potentials of Isolated Purkinje Fibers*. Circulation, 1973. **47**(1): p. 65-72.
21. Gray, R.A., et al., *Mechanisms of Cardiac Fibrillation*. Science, 1995. **270**(5239): p. 1222-1223.
22. Gordon, D., et al., *High-resolution electrical mapping of depolarization and repolarization alternans in an ischemic dog model*. American Journal of Physiology-Heart and Circulatory Physiology, 2010. **298**(2): p. H352-H359.
23. Smith, J.M., et al., *Electrical Alternans and Cardiac Electrical Instability*. Circulation, 1988. **77**(1): p. 110-121.
24. Rosenbaum, D.S., et al., *Electrical Alternans and Vulnerability to Ventricular Arrhythmias*. New England Journal of Medicine, 1994. **330**(4): p. 235-241.
25. Qu, Z.L., et al., *Mechanisms of discordant alternans and induction of reentry in simulated cardiac tissue*. Circulation, 2000. **102**(14): p. 1664-1670.
26. Gilmour, R.F., N.F. Otani, and M.A. Watanabe, *Memory and complex dynamics in cardiac Purkinje fibers*. American Journal of Physiology-Heart and Circulatory Physiology, 1997. **41**(4): p. H1826-H1832.
27. Pastore, J.M., et al., *Mechanism linking T-wave alternans to the genesis of cardiac fibrillation*. Circulation, 1999. **99**(10): p. 1385-1394.



28. Wu, R. and A. Patwardhan, *Mechanism of repolarization alternans has restitution of action potential duration dependent and independent components*. J Cardiovasc Electrophysiol, 2006. **17**(1): p. 87-93.
29. Jing, L., S. Chourasia, and A. Patwardhan, *Heterogeneous memory in restitution of action potential duration in pig ventricles*. Journal of Electrocardiology, 2010. **43**(5): p. 425-432.
30. Pruvot, E.J., et al., *Role of calcium cycling versus restitution in the mechanism of repolarization alternans*. Circulation Research, 2004. **94**(8): p. 1083-90.
31. Fox, J.J., J.L. McHarg, and R.F. Gilmour, Jr., *Ionic mechanism of electrical alternans*. Am J Physiol Heart Circ Physiol, 2002. **282**(2): p. H516-30.
32. Qu, Z., et al., *Scroll wave dynamics in a three-dimensional cardiac tissue model: roles of restitution, thickness, and fiber rotation*. Biophys J, 2000. **78**(6): p. 2761-75.
33. Fenton, F. and A. Karma, *Vortex dynamics in three-dimensional continuous myocardium with fiber rotation: Filament instability and fibrillation*. Chaos, 1998. **8**(1): p. 20-47.
34. Berenfeld, O. and A.M. Pertsov, *Dynamics of intramural scroll waves in three-dimensional continuous myocardium with rotational anisotropy*. J Theor Biol, 1999. **199**(4): p. 383-94.
35. Dilly, S.G. and M.J. Lab, *Electrophysiological Alternans and Restitution during Acute Regional Ischemia in Myocardium of Anesthetized Pig*. Journal of Physiology-London, 1988. **402**: p. 315-333.

36. Riccio, M.L., M.L. Koller, and R.F. Gilmour, *Electrical restitution and spatiotemporal organization during ventricular fibrillation*. Circulation Research, 1999. **84**(8): p. 955-963.
37. Garfinkel, A., et al., *Preventing ventricular fibrillation by flattening cardiac restitution*. Proceedings of the National Academy of Sciences of the United States of America, 2000. **97**(11): p. 6061-6066.
38. Clusin, W.T., *Mechanisms of calcium transient and action potential alternans in cardiac cells and tissues*. American Journal of Physiology-Heart and Circulatory Physiology, 2008. **294**(1): p. H1-H10.
39. Qian, Y.W., et al., *Spatial heterogeneity of action potential alternans during global ischemia in the rabbit heart*. American Journal of Physiology-Heart and Circulatory Physiology, 2003. **285**(6): p. H2722-H2733.
40. Huang, J., et al., *Role of maximum rate of depolarization in predicting action potential duration during ventricular fibrillation*. American Journal of Physiology-Heart and Circulatory Physiology, 2007. **293**(4): p. H2530-H2536.
41. Dangman, K.H. and D.S. Miura, *Electrophysiology and pharmacology of the heart: a clinical guide*. 1991, New York: Marcel Dekker Inc.
42. Saksena, S.A. and J. Camm, *Electrophysiological disorders of the heart* 1995, Philadelphia: Elsevier.
43. Sah, R., et al., *Regulation of cardiac excitation-contraction coupling by action potential repolarization: role of the transient outward potassium current ( $I_{to}$ )*. J Physiol, 2003. **546**(Pt 1): p. 5-18.

44. Hopenfeld, B., *Mechanism for action potential alternans: The interplay between L-type calcium current and transient outward current*. Heart Rhythm, 2006. **3**(3): p. 345-352.
45. Callewaert, G., et al., *Intracellular Citrate Induces Regenerative Calcium-Release from Sarcoplasmic-Reticulum in Guinea-Pig Atrial Myocytes*. Pflugers Archiv-European Journal of Physiology, 1995. **429**(6): p. 797-804.
46. Hiraoka, M. and S. Kawano, *Calcium-Sensitive and Insensitive Transient Outward Current in Rabbit Ventricular Myocytes*. Journal of Physiology-London, 1989. **410**: p. 187-212.
47. Weiss, J.N., et al., *Ventricular fibrillation: how do we stop the waves from breaking?* Circulation Research, 2000. **87**(12): p. 1103-7.
48. Weiss, J.N., et al., *Electrical restitution and cardiac fibrillation*. J Cardiovasc Electrophysiol, 2002. **13**(3): p. 292-5.
49. Karma, A., *Electrical alternans and spiral wave breakup in cardiac tissue*. Chaos, 1994. **4**(3): p. 461-472.
50. Huang, J., et al., *Restitution properties during ventricular fibrillation in the in situ swine heart*. Circulation, 2004. **110**(20): p. 3161-7.
51. Garfinkel, A., et al., *Preventing ventricular fibrillation by flattening cardiac restitution*. Proc Natl Acad Sci U S A, 2000. **97**(11): p. 6061-6.

## VITA

Date of Birth: 30 May, 1987

Place of Birth: Indore, India

### **Education**

Bachelor of Engineering in Biomedical Engineering, S.G.S.I.T.S, Indore, India 2008