

University of Nebraska - Lincoln

DigitalCommons@University of Nebraska - Lincoln

Architectural Engineering -- Dissertations and
Student Research

Architectural Engineering

Spring 4-20-2012

A Composite Structural Steel and Prestressed Concrete Beam for Building Floor Systems

Nathan deWit

University of Nebraska-Lincoln, ndewit@mail.unomaha.edu

Follow this and additional works at: <http://digitalcommons.unl.edu/archengdiss>

 Part of the [Architectural Engineering Commons](#), [Construction Engineering Commons](#), and the [Other Engineering Commons](#)

deWit, Nathan, "A Composite Structural Steel and Prestressed Concrete Beam for Building Floor Systems" (2012). *Architectural Engineering -- Dissertations and Student Research*. 19.

<http://digitalcommons.unl.edu/archengdiss/19>

This Article is brought to you for free and open access by the Architectural Engineering at DigitalCommons@University of Nebraska - Lincoln. It has been accepted for inclusion in Architectural Engineering -- Dissertations and Student Research by an authorized administrator of DigitalCommons@University of Nebraska - Lincoln.

A COMPOSITE STRUCTURAL STEEL AND PRESTRESSED
CONCRETE BEAM FOR BUILDING FLOOR SYSTEMS

by

Nathan J. deWit

A THESIS

Presented to the Faculty of

The Graduate College at the University of Nebraska

In Partial Fulfillment of Requirements

For the Degree of Master of Science

Major: Architectural Engineering

Under the Supervision of Professor George Morcous

Lincoln, Nebraska

May, 2012

A COMPOSITE STRUCTURAL STEEL AND PRESTRESSED CONCRETE BEAM
FOR BUILDING FLOOR SYSTEMS

Nathan Jon deWit, M.S.
University of Nebraska, 2012

Adviser: George Morcous

Precast prestressed concrete beams, such as rectangular and inverted tee beam, currently used in residential and commercial buildings are deep, heavy, and limited to span-to-depth ratios of 15. The research proposes a composite structural steel and prestressed concrete beam that is shallow, light, easy to produce and erect, and able to achieve a span-to-depth ratio of 24. The proposed beam is designed to be used with precast columns, hollow-core planks, and a cast-in-place topping to create a moment-resisting floor system that minimizes the need for shear walls. The goal of this system is to eliminate as many of the limitations of precast concrete buildings as possible while remaining economically competitive. The developed beams consists of one half of a standard steel W-section, embedded into the top of a shallow rectangular prestressed concrete bottom flange, to create a composite section that supports hollow-core planks. Cast-in-place concrete is then used to fill the voids between the hollow-cores and composite beam and provide a leveled topping. A typical commercial building was analyzed and designed using the proposed beam under normal loading conditions. This design example indicated that the proposed system is economical, shallower, lighter, and more resistant to lateral loads than conventional precast concrete floor systems.

Table of Contents

Chapter 1 - Introduction.....	1
1.1 - Problem Statement	1
1.2 - Objectives	2
1.3 - Scope	3
Chapter 2 – Literature Review	4
2.1 – Cast-in-place systems	4
2.2 – Structural Steel Systems	5
2.3 – Precast Systems	6
2.4 – Proprietary & Emerging Systems	7
2.4.1 – Delta Beam®	8
2.4.2 – Girder-slab	9
2.4.3 – Versa: T Beam®	10
2.4.4 – Shallow Hollow-Core Floor System	11
2.4.5 – Patented Systems	11
Chapter 3 – System Overview	15
3.1 – System Development	15
3.2 – System Description	17
3.2.1 – Structural System Overview	17
3.2.2 - Production.....	21
3.2.3 – Erection & Construction	25
3.2.4 – Service.....	31
Chapter 4 – System Analysis & Design.....	34
4.1 - Design Criteria	34
4.2 – Gravity Loads	37
4.2.1 – Hollow-Core Design	37
4.2.2 - T-RECS Beam Design.....	39
4.2.3 – Precast Column Design.....	60
4.2.4 – Precast L-Beam Design.....	61
4.3 – Lateral Analysis	63
4.4 – Deflections	71
4.5 – Connection Design.....	74
4.5.1 – Moment Embed Connection Design	74
4.5.2 – Torsion Connection Design	75
Chapter 5 – Cost Estimate and Design Aids.....	77
5.1 – Design Aids	77
5.2 – Cost Estimate.....	84
Chapter 6 – Conclusions	87
Bibliography	89
Appendix.....	90
A – Section Properties	90
B – Pre-Composite Shear Design	90
C – WF Beam Analysis during CIP Topping Pour.....	93

D – Composite Shear Design.....	96
E – Flexural Strength (Positive Moment).....	98
F – Flexural Strength (Negative Moment at Support).....	99
G – ASCE7 – 05 – MWFRS Wind Profile Calculation.....	100
H – Structure Weight for Seismic Design.....	101
I – ASCE7-05 – Seismic Load Story Shear Calculation.....	102
J – Beam Deflections.....	104

List of Figures

Figure 2.1 – Construction of Deltabeam Floor System with Shoring (Peikko Group, 2012)	1
Figure 2.2 – Typical Girder-Slab Floor System (Girder-Slab Technologies, 2008)	1
Figure 2.3 – Diversakore Floor System (Diversakore, 2012)	1
Figure 2.4 – Shallow Hollow-Core Floor System (Tadros and Morcous, 2011)	1
Figure 2.5 – Column Capital System (Hanlon, 1990)	1
Figure 2.6 – T Shaped Steel Cutting (Kim, 2011)	1
Figure 2.7 – Composite beam with T-Type Steel (Kim, 2011)	1
Figure 2.8 – Composite Beam with T-Steel (Kim, 2011)	1
Figure 3.1 – Effects of Increasing Compression Steel Area ($A_{ps} = 1.53 \text{ in}^2$)	1
Figure 3.2 – Effects of Increasing Compression Steel Area ($A_{ps} = 2.448 \text{ in}^2$)	1
Figure 3.3 – Effects of Increasing Compression Steel Area ($A_{ps} = 2.604 \text{ in}^2$)	1
Figure 3.4 – Effects of Increasing Compression Steel Area ($A_{ps} = 3.472 \text{ in}^2$)	1
Figure 3.5 – Typical Beam Elevation	1
Figure 3.6 – Wide Flange Beam Manufacturing Process	1
Figure 3.7 – Typical Cross Section at A	1
Figure 3.8 – Typical Cross Section at B	1
Figure 3.9 – Column Embed Detail	1
Figure 3.10 – Typ. Column Connection	1
Figure 3.11 – Typical Column Connection	1
Figure 3.12 – Erect precast columns cast with corbels and embed plates	1
Figure 3.13 – Erect T-RECS beams and L spandrels	1
Figure 3.14 – Make connection to precast column and install torsion restraints	1
Figure 3.15 – Place hollow-core on one half of beam & feed rebar into hollow-core	1
Figure 3.16 – Place second bay of hollow-core & reposition rebar	1
Figure 3.17 – Position topping reinforcement over beams & around columns	1
Figure 3.18 – Pour CIP topping	1
Figure 4.1 – Typical Floor Plan	1
Figure 4.2 – Typical Building Section	1
Figure 4.3 – Composite Hollow-Core Section	1
Figure 4.7 – Stage 3 Loads at Service Life	1
Figure 4.4 – Stage 1 Loads at Release	1
Figure 4.5 – Stage 2 Loads During Erection	1
Figure 4.6 – Stage 2 Loads During CIP Pour	1
Figure 4.8 – Cross Section at A	1
Figure 4.9 – Cross Section at B	1
Figure 4.10 – T-RECS Beam Elevation with Reinforcement	1
Figure 4.11 – WF Beam Manufacturing Detail	1
Figure 4.12 – Stage 2 – Uniform Dead Load	1
Figure 4.13 – Stage 2 – Shear Diagram	1
Figure 4.14 – Stage 2 – Moment Diagram	1
Figure 4.15 – Stage 2 – Factored Load Diagram (Pre-Composite)	1

Figure 4.16 – Stage 2 –Factored Shear Diagram (Pre-Composite)	1
Figure 4.17 – Stage 2 –Factored Moment Diagram (Pre-Composite).....	1
Figure 4.18 – Stage 3 –Factored Load Diagram (Post-Composite).....	1
Figure 4.19 – Stage 3 –Factored Shear Diagram (Post-Composite).....	1
Figure 4.20 – Stage 3 –Factored Moment Diagram (Post-Composite)	1
Figure 4.21 – Fully Composite Cross Section	1
Figure 4.22– Full Composite Cross Section at Web Opening.....	1
Figure 4.23–Typical Connection at Column Section.....	1
Figure 4.24– Typical Connection at Interior Column.....	1
Figure 4.25– Stage 3 Service Loads	1
Figure 4.26– Stage 3 Service Load Shear Diagram.....	1
Figure 4.27– Stage 3 Service Load Moment Diagram	1
Figure 4.28–Stress Diagrams for Transformed Cross Section (8 ksi)	1
Figure 4.29– Strain Diagrams for Transformed Cross Section (8 ksi)	1
Figure 4.30– Interaction Diagram for Prestressed Concrete Column.....	1
Figure 4.31 – Interaction Diagram for Reinforced Concrete Column.....	1
Figure 4.32– Service Level Story Forces for Each Moment Frame Due to Wind Loading	1
Figure 4.33– Service Level Story Forces for Each Moment Frame Due to Seismic Loading	1
Figure 4.34– Ultimate Factored Loads for Each Moment Frame Due to Seismic Loading	1
Figure 4.35– Ultimate Factored Moment Diagrams for Beams	1
Figure 4.36– Ultimate Factored Moment Diagrams for Columns.....	1
Figure 4.37– Deflections at Release	1
Figure 4.38 – Deflections During Construction.....	1
Figure 4.39 – Deflections for Service Loads	1
Figure 4.40 – Total Deflections	1
Figure 5.1 – 14TR24-S12 Load Table	1
Figure 5.2 – 18TR24-S14 Load Table	1
Figure 5.3 – 18TR28-S18 Load Table	1
Figure 5.4 – 20TR32-S22 Load Table	1

List of Tables

Table 4.1 - Summary of Section Properties	39
Table 4.2 - Stress Check at Release	42
Table 4.3 - Flexure Analysis of Steel Beam	50
Table 4.4 - Stress Check at Erection	50
Table 4.5 - Strength Design of T-RECS Beam.....	56
Table 4.6 - Stress Check at Service Life.....	57
Table 4.7 - Interstory Drift.....	73
Table 5.1 - T-RECS Section Properties	79
Table 5.2 – Cost Analysis of Comparable Steel System	1
Table 5.3 – Cost Analysis of Proposed System	1

Chapter 1 - Introduction

1.1 - Problem Statement

Many options are available to designers when developing the structural system of a building. The most common approaches are precast concrete, cast-in-place (CIP) concrete, or structural steel, each with its own distinct advantages and disadvantages. Typical drawbacks of a standard precast system include low span-to-depth ratios of floors as well as the need for shear walls to resist lateral loads. This means increased costs in the façade, mechanical electrical and plumbing (M/E/P) systems, and greater energy consumption for heating and cooling, due to increased floor-to-floor heights as well as a decrease in the versatility of the space. Prestressing can be utilized to improve the span-to-depth ratios of precast but it still underperforms when compared to steel. Steel systems will often utilize bar joists to support the floor structure; however, they too have rather low span-to-depth ratios. One of the major deficiencies of steel structures is that they have low fire-resistance characteristics and require the use of special partitions or fireproofing methods. Steel structures typically will employ frames to resist the applied lateral loads, which allow the architect much more flexibility over a shear wall system when designing the layout and functionality of the building. Additionally, steel is much lighter than concrete and this saves on erection costs. One of the primary concerns of cast-in-place systems is they usually require the use of formwork and shoring while curing, which results in increases in construction cost and duration over typical precast construction. Post-tensioning of CIP concrete allows for some of the shallowest floor systems but they are rather complex systems to construct. The ideal structural system

would eliminate the drawbacks of each of these traditional systems while retaining as many of the advantages of each as possible.

1.2 - Objectives

The primary objective of this project is to develop a shallow composite structural steel and prestressed concrete beam for residential and commercial construction. The beam being developed is designed to have the following features to address the shortcomings of existing floor beams:

- All exposed surfaces should be concrete to take advantage of its fire-resistance characteristics.
- Utilize both steel and prestressing strand to achieve a span-to-depth ratio of 24 or better which will help decrease the floor-to-floor heights as well as decrease the erection weight over standard precast components.
- Detail member connections as full moment resistant connections to reduce the positive moments, and resist lateral loads, while maintaining simplicity of the connection for construction.
- Use precast concrete components for as much of the building as possible to take advantage of its greater production quality, improved construction and erection time, and eliminate the need for formwork and shoring.
- Produce all structural components with standard materials and in a minimally complex manner so that the system can be commercially viable in as many markets as possible.

1.3 - Scope

The scope of this project is constrained purely to the development and theoretical evaluation of the proposed system. An analysis is conducted on all structural components for resisting both the gravity and lateral loads of a typical six-story office building in zones with low seismic activity. This evaluation includes the analysis, design, production methodology, construction sequencing, and detailing of all typical members and member connections. Full-scale testing should be done in the future to verify the assumptions and performance of the structural system presented.

Chapter 2 – Literature Review

The literature review for this report focuses on current structural systems commonly available to designers for residential and commercial buildings, which is the target application for the proposed system. Currently, the most common systems are cast-in-place, structural steel with steel joist or wide flange beams, precast concrete, as well as several proprietary systems. The scope of the proprietary systems for this literature review is limited to composite structural systems. The remainder of this chapter briefly describes the attributes of each of these systems.

2.1 – Cast-in-place systems

CIP systems have many inherent advantages. It is an extremely versatile material because its shape is directed by formwork erected on site. The formwork can be configured into almost any shape or dimension desired. Another advantage of CIP concrete is the continuity of the system, which allows for the implementation of frames as the lateral load resisting system. This gives the architect significant versatility in the floor plan of the space by allowing for greater flexibility in placement of walls. Columns, beams, and floors are cast monolithically and therefore; do not require connections between members as most other structural systems do. The natural properties of concrete make it a very durable material, allowing it to withstand extreme weather and last a long time. It also has significant advantages over steel when it comes to fire protection, thermal performance, and acoustic characteristics. A typical span-to-depth ratio of a CIP beam is typically around 15 to ensure that the beam conform to the

requirements for live load deflections. For the slab, a conservative estimate is around 30 but this can vary greatly based on the floor being a one or two-way system and whether or not it is constructed as a continuous floor over the beam supports. For a 30' x 30' bay this translates to beams with a depth of 24" and an approximate slab depth of 10"-12". These values can be significantly improved by implementing post-tensioning. However; this means added cost due to the need for specialty contractors to perform the post-tensioning, as the systems can be rather complex and have very strict construction tolerances. The main drawback of CIP systems is the cost and time required for formwork construction, as this is very labor intensive. The formwork may also require shoring to reach longer span lengths, thereby adding additional cost to the project. The subject of quality control is more of a concern with CIP concrete systems too, with issues such as material testing for strength and slump needing to be conducted on site. Weather also poses challenges to CIP systems; common concretes require certain temperatures for curing and typically cannot be poured during rain.

2.2 – Structural Steel Systems

Structural steel is a very common solution to many commercial applications as well. Steel is an attractive option due to the material's high strength and relatively lower weight compared to concrete. Similar to CIP structures, steel allows for great versatility to the floor plan due to its ability to utilize beam-column frames to resist the lateral loads. Steel joists can also attain very large span lengths. Typically, steel structures will utilize a 2" steel deck with an additional 2" CIP floor. The floor can be either composite or

non-composite with the joists. Steel joist, spaced at approximately 6' on center, support the floor and these are usually supported by either wide flange beams or steel joists spanning between columns. A 30' x 30' bay typically requires steel joist girders around 30" deep. Accounting for the 5" depth of the floor joist's bearing height and an additional 4" for the floor, the total depth is around 39". However, the joists allow mechanical chases to run between the webs in the joists, which enables finish ceiling to come up near the bottom of the joists. A standard wide flange (WF) section for this type of system would be a WF18x106. The drawbacks of steel include high material costs, a lead-time on the ordering of materials, and decreased fire and corrosion resistance compared to concrete, unless treated and maintained with fireproofing materials.

2.3 – Precast Systems

Precast concrete is another attractive solution to builders for a variety of reasons. It allows for much greater production quality and consistency of concrete over its CIP counterpart. Precast concrete also does not have the weather concerns that a CIP system is susceptible to because it is typically produced indoors away from the elements.

Precast concrete also provides significant benefits in the schedule and cost of a project due to its fast erection time and the repetitious nature of the components. It does not require the setting up of formwork, pouring concrete, and then curing of the concrete to achieve an acceptable level of strength. To maximize these benefits, many precast elements have been standardized by the industry; these include solid slabs, hollow-core slabs, double tees, inverted tees, and L-beams. The cost effectiveness of precast is lost, however, if unusual sizes and shapes must be utilized and sometimes production

capabilities of the plant will not allow for these types of pieces to be produced. Most precast structures will typically consist of hollow-core slabs supported by inverted tee (IT) beams that are then supported by precast columns with corbels. Precast can also be effectively used in conjunction with other structural elements such as steel beams and CIP toppings. The topping can be either non-structural or composite with the precast to give additional strength and continuity to the system. Prestressing also helps to improve the performance of precast concrete. A typical precast prestressed concrete system with 30' spans will have 6" hollow-core planks with a 2" topping supported by 28" IT beams for a total depth of around 30". However, unlike joists, mechanical equipment cannot pass through the IT beams so additional depth is needed for drop ceilings to allow the mechanical equipment to pass below the IT beams. Precast concrete typically requires more planning in the preliminary design because pieces are produced off-site. Issues such as connections and penetrations must be coordinated with other trades prior to production. Precast concrete must be transported to the job site, and any cost savings can be lost if transporting pieces long distances. Concrete is significantly heavier than steel and this creates a need for cranes and/or lifting equipment with higher lifting capacities. Once constructed, however, the concrete provides great fire protection, durability, deflection performance, and vibration characteristics.

2.4 – Proprietary & Emerging Systems

There are a variety of systems available that could be considered 'non-standard' types of structural systems. The scope here will be limited to systems that are currently available, for residential and commercial applications, and are composite in nature.

2.4.1 – Delta Beam®

The Delta Beam® system is a rapidly emerging shallow floor system produced by Peikko Group which implements a composite beam composed of a hollow steel member formed with steel plates into a trapezoidal shape. This steel beam supports a hollow-core, thin shell slabs, or CIP floor system. The beam is then integrated with a CIP topping which fills all of the voids in the steel beam. This system can span approximately 30' at a depth of around 18" with a 2" topping for a total depth of approximately 20 inches. This is shallower than precast concrete systems; however, the Delta Beam® requires shoring of each span and this adds costs in time and material to the system. Materials must be purchased for the shoring and floor-to-floor construction times are slowed while waiting for the CIP concrete to obtain adequate strength. The construction of a project using this system is shown in Figure 2.1.



Figure 2.1 – Construction of Deltabeam Floor System with Shoring (Peikko Group, 2012)

Peikko's web site claims the system has a fire rating of R120 which is a two-hour fire rating. Higher ratings can be achieved with the delta beam but additional fireproofing steps must be taken. Another drawback of this system is that both the columns and beams cannot be continuous simultaneously which creates discontinuities for moment transfer in either the beams or columns.

2.4.2 – Girder-slab

Girder-Slab Technologies has developed the Girder-Slab® System which is a steel and precast composite structural system. It utilizes precast slabs with an integral steel beam to form a composite beam. Extended bottom flanges of the steel beam support the precast planks. Figure 2.2 shows what the typical floor system looks like.



Figure 2.2 – Typical Girder-Slab Floor System (Girder-Slab Technologies, 2008)

The system is only 8-10” deep, dependent on if a 2” topping is utilized, and provides a flat soffit which allows for mechanical equipment to be easily run without adding more depth to plenum space of the system. An effective bay size for this type of system is a 20’ x 28’ with the girders spanning the 20’ dimension. This is lower than would typically

be expected for office applications and limits the space as well as increases the number of columns required. Due to its shorter span lengths, this product is marketed primarily for residential applications.

2.4.3 – Versa: T Beam®

Diversakore has developed a system similar to the Delta Beam® with a different take on the steel shape utilized to create the composite girder. The steel is formed into a channel with studs anchored to the bottom to help the concrete achieve composite action with the steel. The assembly is reinforced with longitudinal bars and stirrups. The Versa: T Beam® can be used in conjunction with 8” hollow-core planks, hollow-core with a CIP topping (as shown in Figure 2.3), or a steel deck. This method gives it an advantage over traditional CIP systems because the floor system and steel beam act as the formwork for the CIP concrete. The primary disadvantage of this system is again the need to shore the steel members during construction. This system also only has a two-hour fire rating and additional measures must be taken if greater fire-resistance is required.

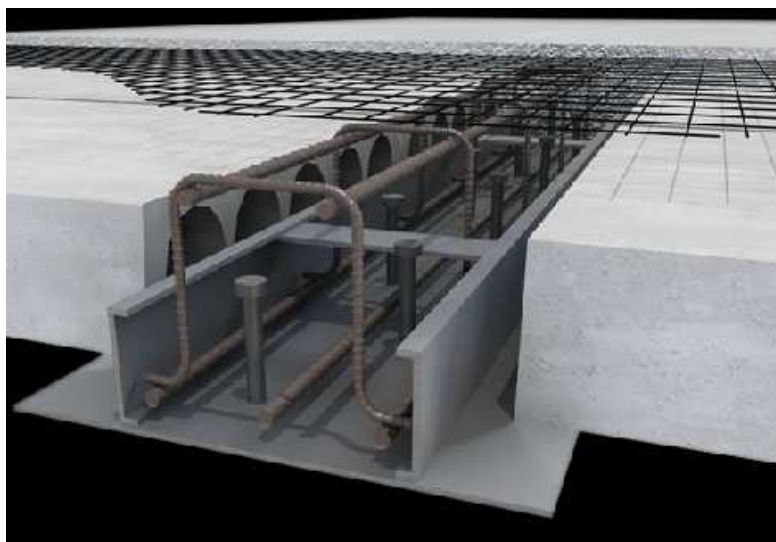

Figure 2.3 – Diversakore Floor System (Diversakore, 2012)

2.4.4 – Shallow Hollow-Core Floor System

Tested and developed by the University of Nebraska, the Shallow Hollow-Core Floor System is a prestressed concrete system that utilizes precast prestressed IT beams with hollow-core and a CIP topping. This system achieves a better span-to-depth ratio by making the IT beam wider instead of deeper and making all the components continuous throughout the structure. A cross section of the beam can be seen in Figure 2.4. The system achieves continuity through the column by having a key-way for CIP concrete and moment reinforcing. For bay sizes of 32' x 34', the system was able to have a beam depth of 16". Because the system is completely composed of concrete, it can easily achieve at least a two-hour fire rating, but it also causes the members to be much heavier than steel members. This creates the need for larger cranes with greater capacities.



Figure 2.4 – Shallow Hollow-Core Floor System (Tadros and Morcous, 2011)

2.4.5 – Patented Systems

Many patents exist for a wide variety of composite beams and slab systems. Hanlon developed a precast system (US patent 2008/0060293) where columns are cast integrally with large 'capitals' at the floor level. The largest system described allows for spans up

to 50' with a capital depth of 24" and width of 12' x 12'. The capitals support precast planks which span from capital to capital through the use of bearing connections across the precast joint. All components are preferably prestressed and reinforced with additional mild steel. Figure 2.5 shows a diagram of the systems.

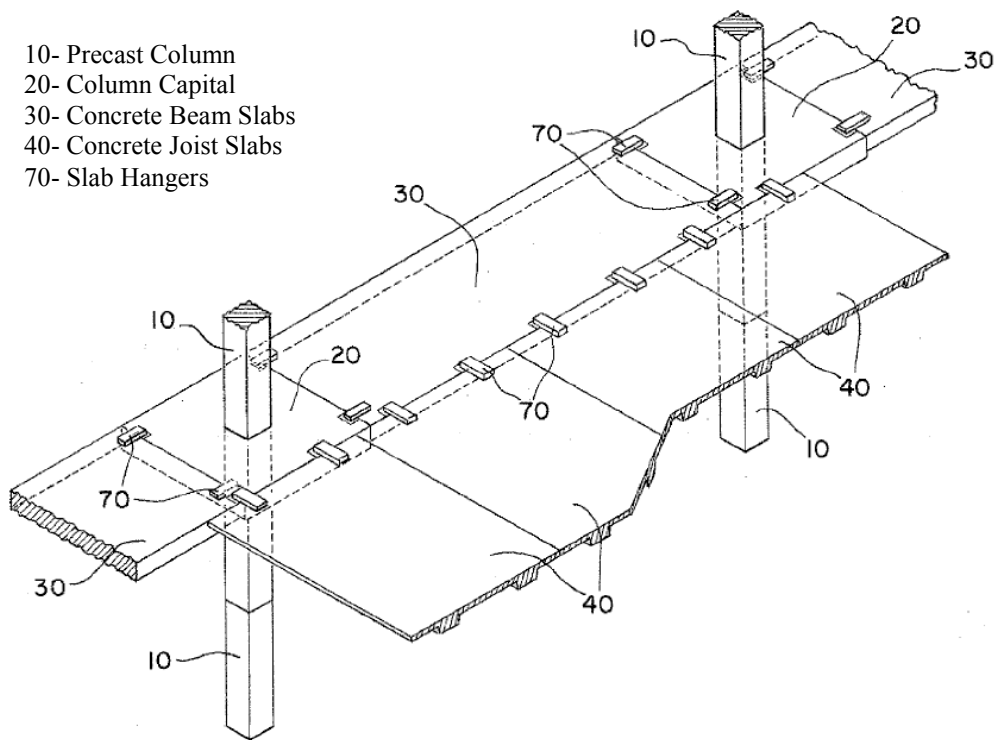

Figure 2.5 – Column Capital System (Hanlon,1990)

Kim et al. recently developed a system which was published and patented late in 2011 (US 2011/0265422) after this project had been undertaken. It utilizes some of the same concepts to be presented in this project. The girder is composed of a steel WF beam cut in half with a saw tooth type pattern as shown in Figure 2.6. Each T-shaped portion of the steel beam can then be embedded into a prestressed precast concrete beam. A steel

deck with a non-composite CIP topping then creates the floor. The voids in the T-shaped beam are intended to allow mechanical equipment to pass through as can be seen in figure 2.7. A diagram of the girder with cross sections is given in Figure 2.8. Limited technical information is known about the geometry and performance of this system from the patent, however, several key differences exist between this system and the one presented. These differences are addressed in more detail later in Chapter 3 of this document.

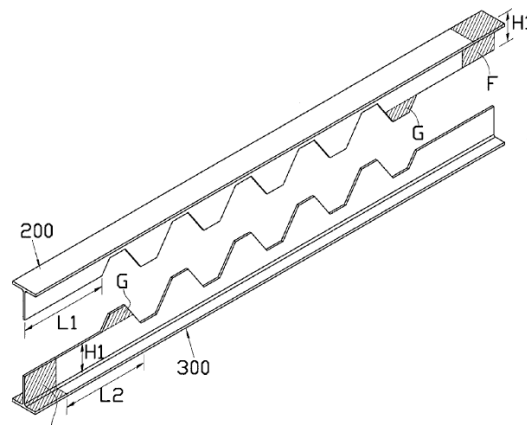

Figure 2.6 – T Shaped Steel Cutting (Kim, 2011)

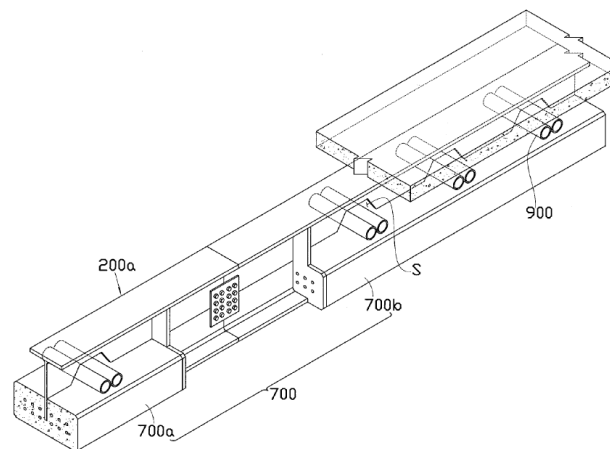

Figure 2.7 – Composite beam with T-Type Steel (Kim, 2011)

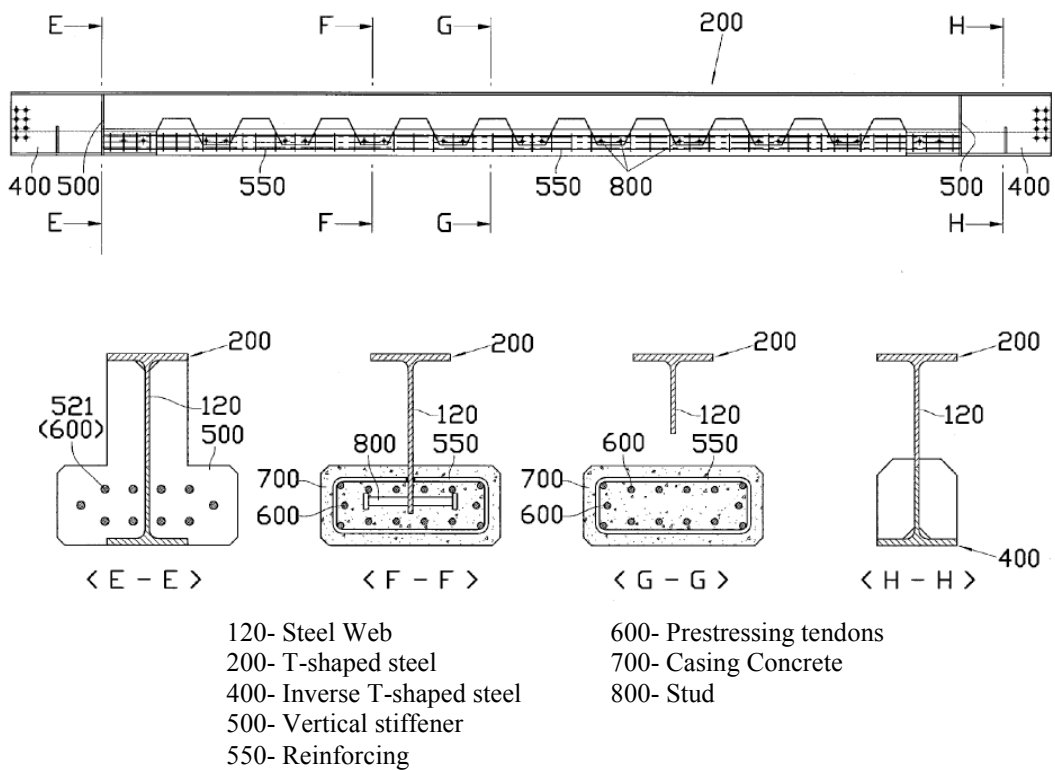

Figure 2.8 – Composite Beam with T-Steel (Kim, 2011)

Chapter 3 – System Overview

3.1 – System Development

The concept for the design of this system revolves around improving the performance of standard precast prestressed concrete structural systems. The proposed system incorporates as many of the advantages as possible from both steel and concrete systems previously described. The span-to-depth ratio of standard precast prestressed IT beams is poor relative to the other systems. Improving on this will be one of the goals of the proposed system. Making the beams wider and adding additional strand can reduce the depth of the precast IT beams, however, the section then becomes much larger and heavier. Also, when using more prestressing strands to increase the moment capacity it becomes difficult for concrete alone to counteract the large tension force generated. This results in the compression block of concrete moving much deeper into the cross section. As the compression block moves deeper, it begins to reduce the effectiveness of the prestressing strand because the strand is not being strained enough to reach its yield stress, and this causes the section to become compression controlled and significantly reduces the moment capacity. The solution to the problem for this proposed system was to introduce a large area of steel in the compression. The steel acts as the primary element utilized for carrying the compressive force during flexure instead of the concrete.

Steel is more expensive than concrete so determining the most effective manner to utilize the steel is extremely important in order to develop an economical solution. Figures 3.1

through 3.4 show the general effect that increasing the area of compression steel has on the moment capacity of a member, divided by the depth (d) of that member. The data shown is for a standard 28IT28 prestressed IT beam made with common 5 ksi and 7 ksi concrete. Several different conditions with varying amounts of prestressing strand were evaluated using strain compatibility to establish when it becomes more effective to employ steel as the compression element instead of concrete. Several determinations can be established from these figures: 1) With lower areas of prestressing strand (Figure 3.1), the compressive capacity of the concrete can match the tension force of the strand by itself and compression steel has little to no value. 2) Increasing the area of compression steel is effective only to a certain extent. Eventually, the prestressing strand becomes fully utilized and additional compression steel no longer increases the section's moment capacity. 3) For cases where a large area of prestressing is being used, the effects of additional compression steel reinforcement yield the greatest results. In cases like this, the concrete cannot effectively generate an adequate compressive capacity to equal the full tension force of the strand, and the moment capacity is greatly reduced due to the prestressing strand being underutilized. Increasing the amount of steel allows for the complete utilization of the strand's strength and greater moment capacities.

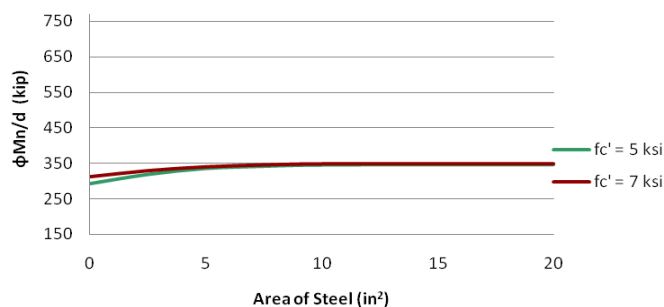

Figure 3.1 – Effects of Increasing Compression Steel Area ($A_{ps} = 1.53 \text{ in}^2$)

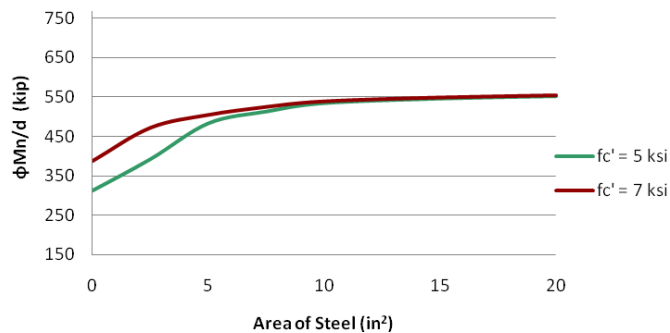

Figure 3.2 – Effects of Increasing Compression Steel Area ($A_{ps} = 2.448 \text{ in}^2$)

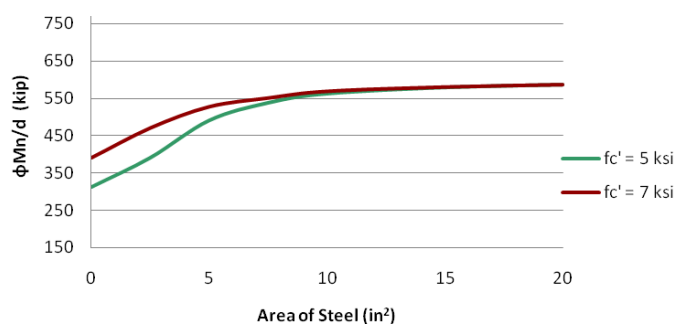

Figure 3.3 – Effects of Increasing Compression Steel Area ($A_{ps} = 2.604 \text{ in}^2$)

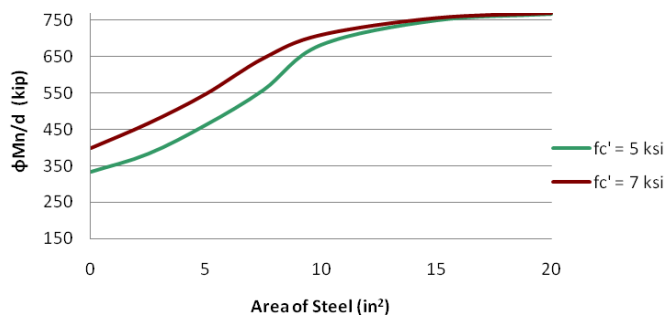

Figure 3.4 – Effects of Increasing Compression Steel Area ($A_{ps} = 3.472 \text{ in}^2$)

3.2 – System Description

3.2.1 – Structural System Overview

The proposed system is designed to be similar to a precast prestressed concrete structure in its construction, behavior, and performance characteristics. The columns will be

continuous through the beam connections at each floor level and each column can stretch roughly 35' or approximately three and a half stories for a typical office building. This would result in two precast column pieces at each grid line for a six-story building. The columns need to carry the gravity loads from the floors above as well as be able to resist significant moments from lateral loads. This is due to two different load cases: 1) They are part of the frame for the lateral load resisting system and 2) They must to be able to resist the negative moments from the continuous floor beams.

A composite steel and prestressed concrete beam, referred to as the T-RECS beam (The Real Easy Composite System), is the primary members used to support the floor system. An elevation of the beam can be seen in Figure 3.5. The T-RECS beam has three primary components:

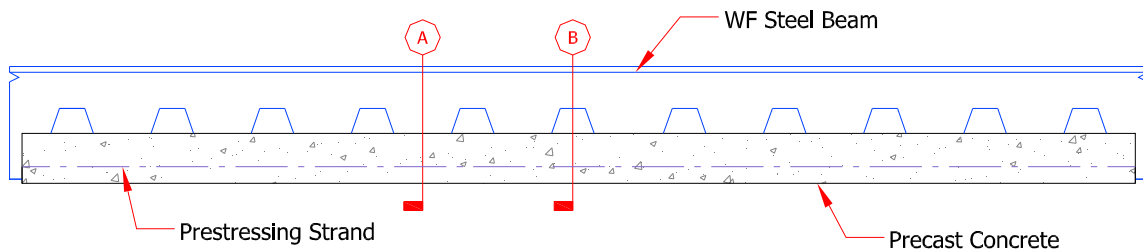

Figure 3.5 – Typical Beam Elevation

- 1) Multiple low-lax prestressing strand (270 ksi)
- 2) A rectangular precast beam
- 3) One half of a 50 ksi WF steel beam cut into a form similar to Figure 3.6.

The steel beam is cast directly into the top of the prestressed concrete rectangular section and becomes a singular unit with the precast concrete once it has hardened. The T-RECS beams bears on corbels cast into the columns at each story elevation.

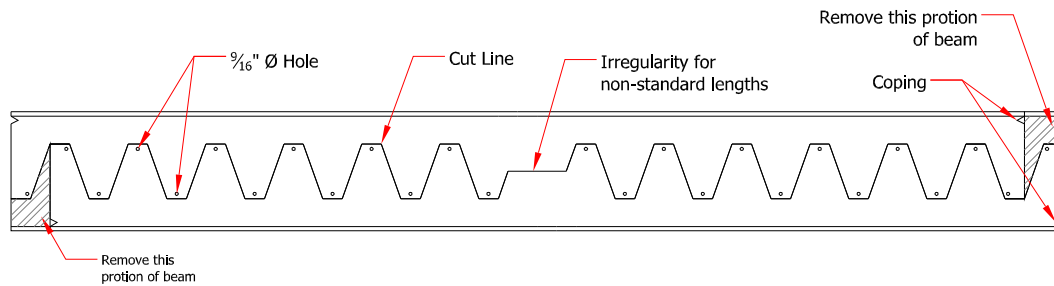

Figure 3.6 – Wide Flange Beam Manufacturing Process

Precast hollow-core slabs span from beam to beam and make up the floor system. They bear on the ledge between the edge of the steel flange and the edge of the precast concrete. A structural CIP topping is added once all the components have been put in place. Typical cross sections at 'A' and 'B' from Figure 3.5 are shown in Figures 3.7 and 3.8 at the final stage of construction which includes the hollow-core planks and CIP topping.

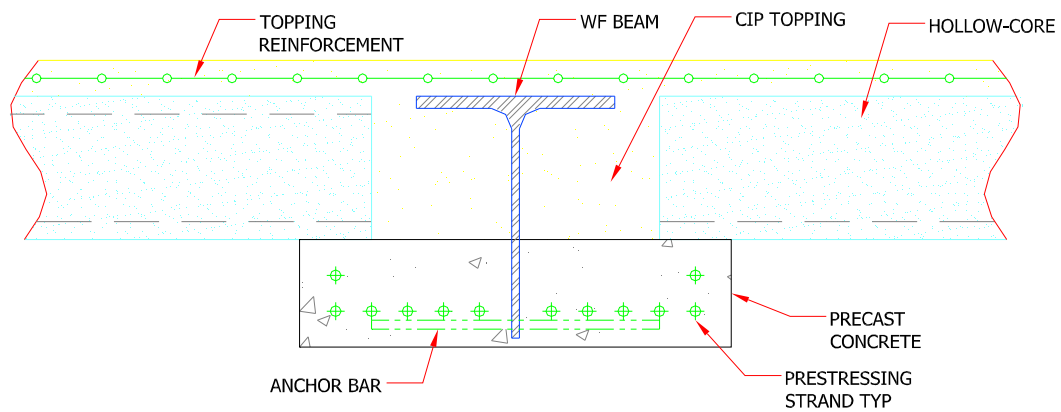

Figure 3.7 – Typical Cross Section at A

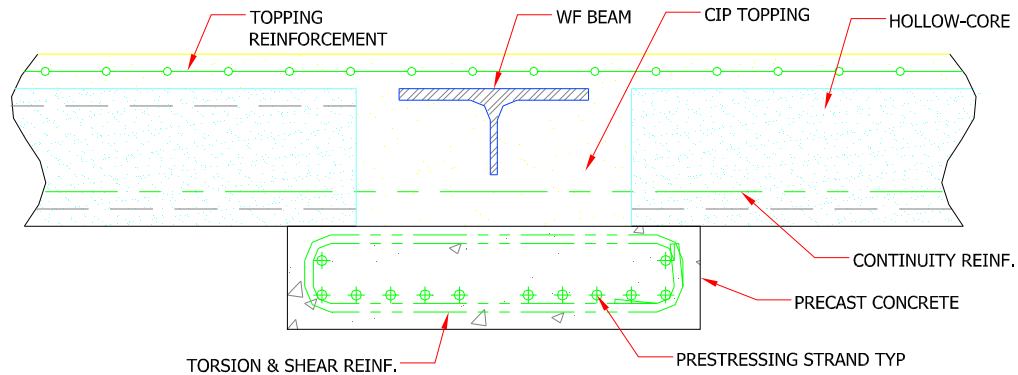

Figure 3.8 – Typical Cross Section at B

The T-RECS beam is not used at the perimeter of the structure because it is not well suited for cases where high torsion loads are present. Instead, precast prestressed L-beams are utilized where only one side of the beam is being loaded. The L-beams will likely need to be deeper than the T-RECS beams to resist the torsion loads, but it should have little effect on the span-to-depth ratio of the system because the L-beams can be integrated into the walls. Using L-beams at the perimeter also helps when pouring the CIP topping. It creates a projection above the floor level that acts as the sidewalls of the formwork for the CIP topping. Without this projection, construction of formwork would have been necessary around the perimeter.

The structural system can easily be tailored to accommodate any building façade the architect desires, and it is ideally suited for the use of insulated architectural prestressed wall panels. Insulated wall panels can easily be connected to columns and/or perimeter

beams of the structure. They provide excellent durability, thermal insulation, fire protection, and are economical to produce.

3.2.2 - Production

All structural components in the system, with the exception of the CIP place topping, are manufactured or assembled in a precast plant. The columns are cast with any corbels and embed plates required to make the connections. They are then shipped to the job site for erection. There are a total of five embed plates

needed at each floor level for a typical column connection. Four of the embed plates are used as torsion anchor restraints and the other is a plate assembly used to connect the T-RECS beam to the

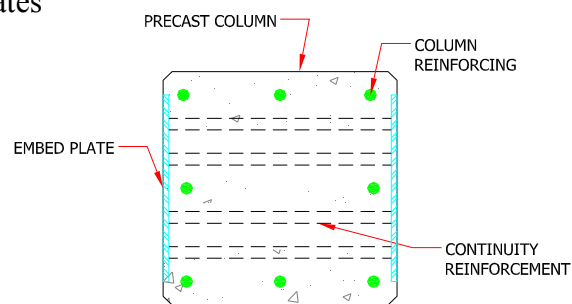

Figure 3.9 – Column Embed Detail

column. The plate assembly is shown in Figure 3.9 and consists of two flat plates held together by rows of rebar. The spacing of these bars can be altered to allow for the column reinforcement to pass through them.

The steel beam, which is to be embedded in the precast concrete, is a WF steel beam that has effectively been cut in half. The beam is cut the entire length of the web in the general form shown in Figure 3.6. The beam is being cut in this fashion for four primary reasons: 1) It allows for fully composite behavior between the steel and concrete during flexure and the transfer of horizontal shear. 2) The voids created between the precast concrete and the steel where it has been cut back above the top of the precast allows for

reinforcement to be passed through. This will allow for greater continuity of the hollow-core, thereby improving its capacity. 3) It allows for the easy placement of the CIP topping as the concrete can easily flow from one side of the beam to the other. 4) It makes it possible to use less steel in terms of total weight because it uses a shallower section than would be possible if the beam were to be cut directly in half. Exact dimensions for the cut will vary slightly based on the required WF beam size determined by the design criteria of each building. Each end of the beam needs to be coped to allow for the placement of the backing bar to make the weld between the beam and column. Holes that are $9/16'' \text{ } \varnothing$ are drilled in each 'tooth' of the cut beam to allow a #4 bar to be eventually placed through it during production.

When preparing the precast bed to pour the concrete, the necessary size and quantity of stirrups should be threaded onto the $0.6'' \text{ } \varnothing$ strand prior to tensioning. Once the stirrups are placed on the strand, the strand can be tensioned to the appropriate stress and the stirrups spaced as required by design.

The manufactured steel beam should be placed in the bed from above, prior to pouring the concrete and positioned so the top of the flange corresponds to the same elevation as the top of the hollow-core once erected. For example, if 8'' hollow-core is required for the design, this means that the top of the steel should be located 8'' above the top of the precast concrete. Positioning it this way will allow for a smooth transition from the hollow-core on one side of the beam, to the steel, and then over to the hollow-core on the

other side. Similarly, if 10" hollow-core was to be used, the steel section should be positioned so that the top of the steel is 10" above the top of precast. To assist in positioning of the beam, the holes should be drilled at the proper elevation so that when the #4 bar is threaded through them, it can be tied to the underside of the strand and the steel beam is held in the proper location. The #4 bars also act to interlock the steel beam with the precast concrete and prevent it from pulling out of the precast. Once all of the steel is properly positioned, the concrete can be poured. When the concrete is cured to the appropriate strength the strands can be cut, thereby shifting the tension force of the prestressing strand into a compressive force acting on the concrete and steel beam. The assumption that the steel also carries the compressive force from the prestressing strand is an important one that greatly affects the effective area, centroid, and moment of inertia of the cross section at release. This is an assumption that will be made throughout the design of the beam; however, it is unknown exactly how much of the prestressing force will actually be transferred to the steel.

While the beam at this stage shows a resemblance to the patented system described previously in Chapter 2, several processes and aspects of the beam are different. Figure 2.6 shows the intended manufacturing process for the patented system. The beam is cut longitudinally from the mid-height of each end of the steel beam for a length of L_1 before the saw tooth pattern begins. The intent is to then cut off pieces 'F' and 'G'. These two pieces should be of equal length so that once removed, length L_2 will be equal to the length L_1 at each end of the two beams thus making them identical. Compare this to

Figure 3.6, where the cut does not begin at the mid-height and travels horizontally; instead, the saw tooth pattern begins immediately. A second difference is the method for tolerating variance in the beam length. The proposed system addresses it through an irregularity in the pattern at the mid span of the beam while the patented beam allows for the adjustment to take place by varying the length of the first horizontal cut.

Additionally, the proposed system requires that only one additional cut needs to be made at each end, instead of two, to make the halves identical.

The means of anchoring the steel beam into the precast concrete is different as well. The proposed system relies on bars fed through pre-drilled holes in the steel which interlocks with the prestressing stands; whereas the other system uses headed studs (800 in Figure 2.8) welded to each tooth of the steel beam.

The ends of the beam have differences as well. A separate T shaped section (400 in Figure 2.8) must be attached to the bottom half of the beam to recreate an I shape cross section at each end. This is not required by the proposed system. Stiffeners are also being added along the web, as seen in section H – H, which are not required by the proposed system.

When setting up the formwork to pour concrete, the proposed system utilizes a void form at each end of a standard prestressing bed to create an offset from the end to the steel to the end of the concrete. Section E – E in Figure 2.8 shows that steel plates are welded to

the beam a certain distance from the end. These plates are intended to allow the strand to pass through them as well as act as the end-caps for the formwork. The proposed system uses the standard techniques that would be utilized for any typical prestressed beam.

3.2.3 – Erection & Construction

The T-RECS structural system is one that is extremely easy and straightforward to construct. Once the columns are erected, beams can be put into place on bearing pads on the column corbels. When the beam is properly positioned, loose angles are welded to the torsion embed plates in the column previously described. These angles act to prevent the beam from overturning during erection of the hollow-core and they ensure the entire torsion load is resisted by only the precast portion of the T-RECS beam.

There are three distinct loading situations that the T-RECS beam must be designed for during construction of the building. The first load case to be considered occurs when all of the hollow-core for one bay has been put in place. This results in an unbalanced load where one side of the beam is loaded with the dead weight of the hollow-core, and the other is not. This creates a torsion load that the T-RECS beam and the connections must be designed to resist. Next, rebar should be fed through the openings in the steel web and into the voids in the hollow-core. This rebar will be used to help create greater continuity of the structural system. After the rebar has been put in place, the hollow-core for the other bay can be erected. Once all of the precast components have been put in place, the connection of the steel beam to the precast embed can be made, as shown in a column section in Figure 3.10, and as a section through the beam in Figure 3.11. The connection

to the column is made by placing a backing bar in the coped portion of the steel beam near the flange and then making a plug-fillet weld over the full length of the joint. This whole process can then be repeated for each level of the structure.

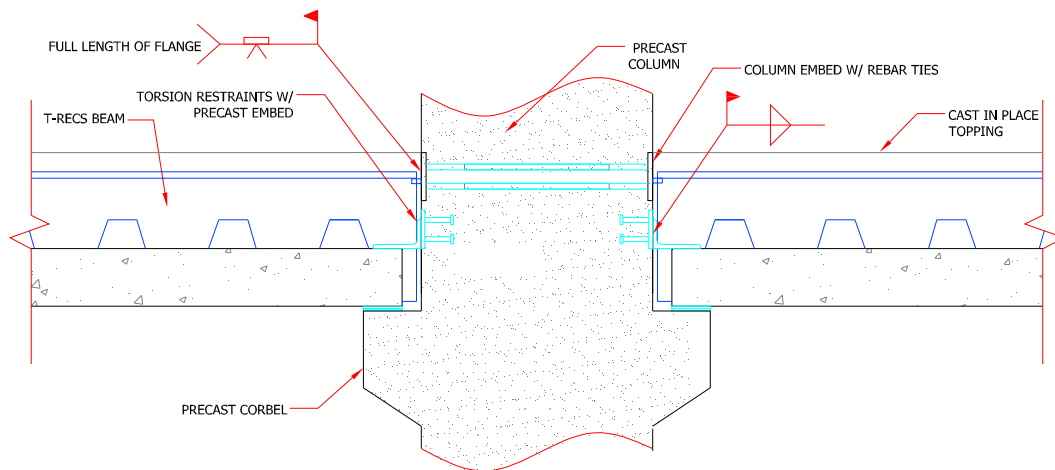

Figure 3.10 – Typ. Column Connection

Loads that the beam must resist during the second load case include the beam's self weight, the weight of the hollow core, and a construction live load. This load case is present until placement of the CIP topping. The non-composite beam's ability to resist these loads gives the erector the choice and flexibility of when to pour the topping at each floor level or to continue the erection of precast components for the story above. This type of flexibility is major advantage over traditional CIP which requires waiting for the concrete to gain adequate strength before continuing to the next floor. The third load case occurs when pouring the CIP topping. The loads at this stage consist of the beam's self weight, the weight of the hollow-core and the weight of the CIP topping. Under all of these load cases the beam behaves as a simple span with only the cross section of the non-composite T-RECS beam resisting the loads. A minimal amount of formwork is required to be constructed alongside the edge of the T-RECS beam and column to contain

the concrete that flows into the gap between the precast beam and the face of the column. The formwork can be anchored into the column and removed once the concrete has hardened.

Figures 3.12 - 3.18 on the following pages detail in 3D representations the construction of the proposed system.

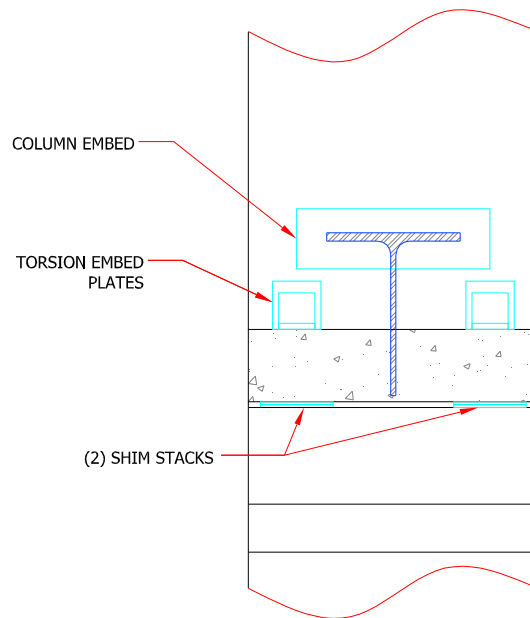

Figure 3.11 – Typical Column Connection

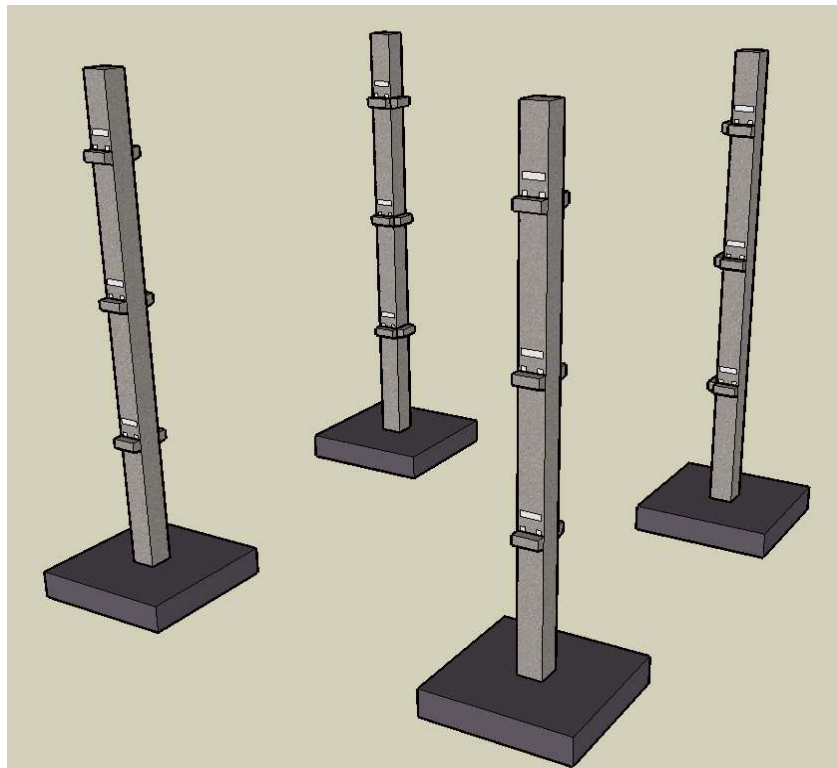

Figure 3.12 – Erect precast columns cast with corbels and embed plates

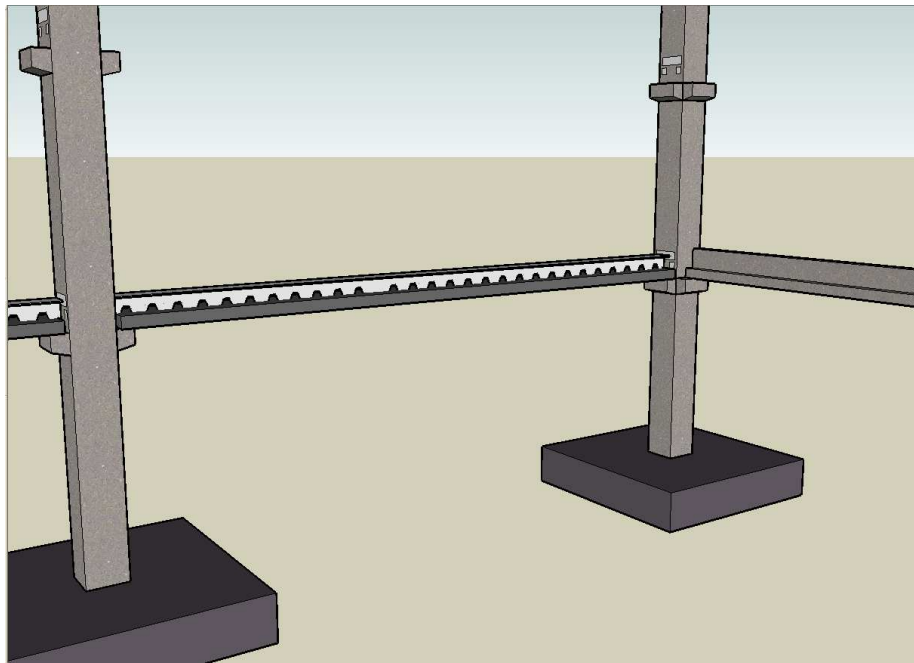

Figure 3.13 – Erect T-RECS beams and L spandrels

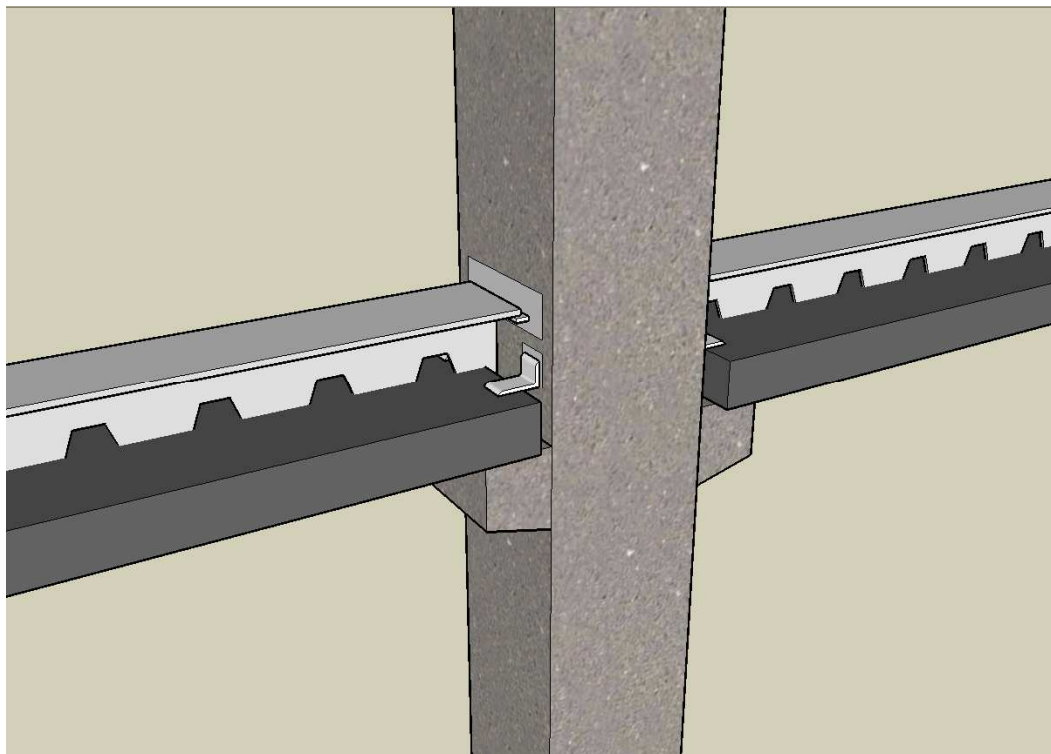

Figure 3.14 – Make connection to precast column and install torsion restraints

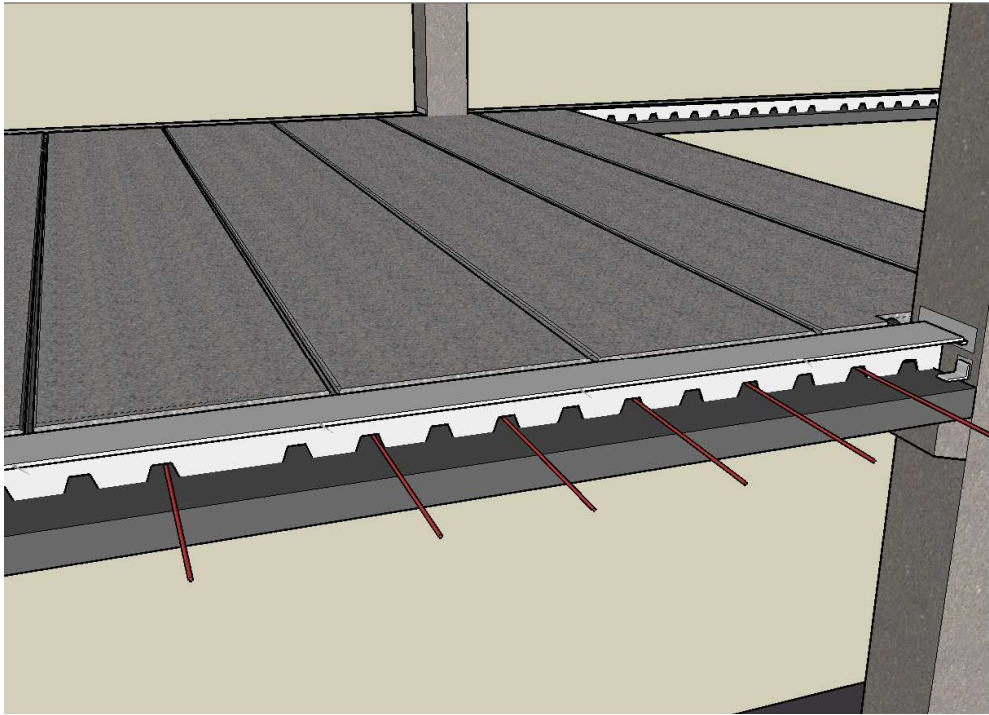

Figure 3.15 – Place hollow-core on one half of beam & feed rebar into hollow-core

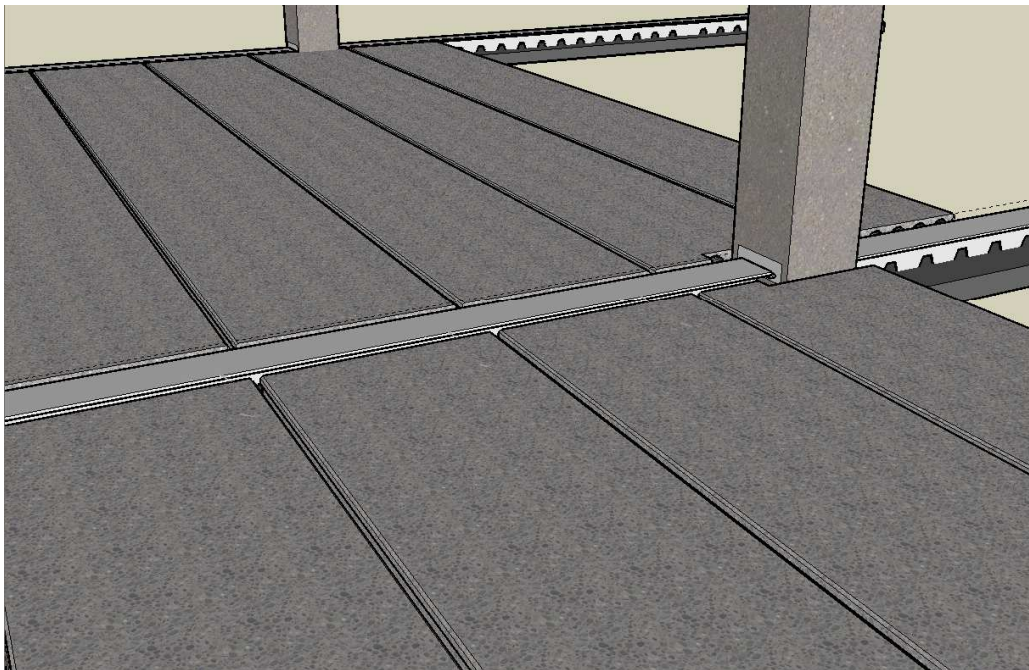

Figure 3.16 – Place second bay of hollow-core & reposition rebar

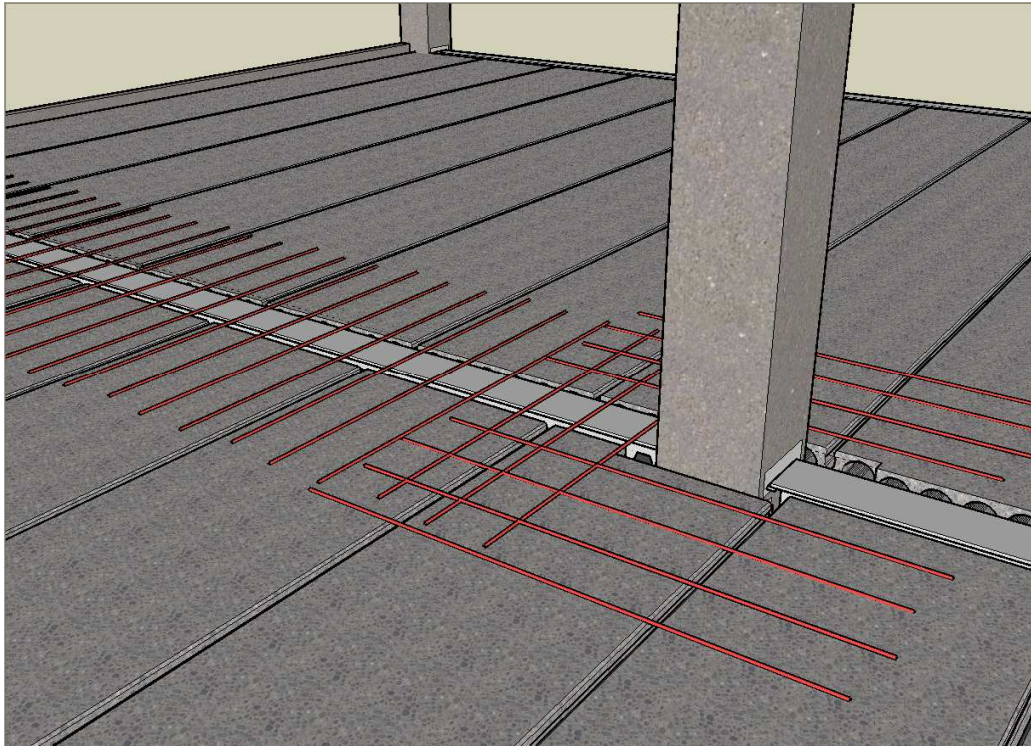

Figure 3.17 – Position topping reinforcement over beams & around columns



Figure 3.18 – Pour CIP topping

Additional differences between the proposed system and the patented system from the literature review lie in the member connections. Figure 2.7 shows a typical bolted connection for the patented system which allows for continuous beams. These beams can also be connected to the columns using a standard bolted connection. The structural system is intended to be used in conjunction with a metal deck and CIP slab. This is also different than the hollow-core floor of the proposed system, and there is no intent to allow for the splicing together of two beams as is possible in the patented system.

3.2.4 – Service

Once the CIP topping hardens, it becomes a fully composite cross section with the T-RECS beam. The hardening of the CIP topping creates a moment connection between the beams and columns so that the structure now behaves as a moment frame with continuous beams. Due to the continuous beam loading, significant negative moments are generated at the face of the column. This moment must be resolved into the precast connections. The weld between the steel beam and precast column embed carries the tension force generated by these negative moments. Similarly, the compression force from the negative moment is carried by the hardened CIP topping between the precast column and the precast concrete of the T-RECS beam.

At this point, any superimposed dead loads such as the mechanical, electrical, plumbing, flooring, drop ceilings, and partitions can now be installed. These loads as well as the live loads applied to the system are resisted by the fully composite cross section which

now includes the CIP concrete for the in-fill between hollow-core planks and the effective width of the CIP topping flange as prescribed in the ACI 318 (2008).

There are also distinctions in the design intent between the patented system and the proposed one. The patented system is intended to be predominately a steel structure instead of concrete as evidenced by the connections and exposed steel web and top flange of the beam. It can be seen in Figure 2.7 that the designer wants to allow for M/E/P equipment to be able to pass through the voids in the steel web of the beam. This is quite different than the proposed system where reinforcing is passed through these openings, filled with concrete, and M/E/P systems must pass under the beam. The proposed system also does not have any exposed steel surfaces after pouring to the topping which is different than the patented system where the flange and web remain exposed.

There are many advantages to the proposed system discussed in this chapter:

- All exposed surfaces are concrete. This gives the system superior fire performance characteristics over steel.
- The system utilizes moment connections at the columns. This allows for moment frames to be formed with the columns thereby eliminating the need for shear walls in the direction of the frame. Moment connections also make it possible for reductions in the moment demand due to continuous beam loading.
- The proposed system is able to achieve beam continuity while using continuous columns.

- Cutting the steel beam in half in the manner proposed allows for a large reduction in the amount of steel required.
- The system uses all precast components with the exception of a CIP structural topping, which may be poured at any point prior to the installation of any superimposed dead loads.
- Having all precast components greatly increases the quality and allows for an expedited construction schedule.
- Perimeter L-beams act as formwork for the CIP topping thereby eliminating this costly and time-consuming process for typical CIP structures.
- The system is able to achieve span-to-depth ratios of over 20, which is an improvement over standard precast products.
- Field connections are simple, requiring only three welds at each column connection.
- Beams are able to resist construction loads and do not require the use of shoring during the construction process.

Chapter 4 – System Analysis & Design

4.1 - Design Criteria

The structural system developed in this paper is tailored toward applications such as residential and commercial buildings. The design criteria for these types of structures generally call for an approximate column-to-column spacing of 30' in each direction. The floor plan and a typical building section for the structure being designed for are shown in Figures 4.1 and 4.2 respectively. The overall plan dimensions for the structure are 124' x 120'. Each story has a height of 10', and the building is six stories tall for a total height of 60'. Span lengths for the beams are 30' at the exterior and 32' at the interior. In the opposite direction, the spans lengths for the hollow-core are 30'. Span lengths at the exterior have been shortened to account for the larger moments that are present at the end spans of continuous beams.

In addition to the self weight of the beams, the hollow-core, and CIP topping, a superimposed dead load (SIDL) of 15 psf is applied over the entire floor. This is to account for any M/E/P, additional flooring, drop ceiling loads, or partitions that may be required for typical office applications. ASCE 07 (2005) Table 4.1 requires that offices be designed for a minimum uniformly distributed live load of 50 psf at each floor level. The hollow-core and beams are design to meet the deflection limit of $L/360$ for applied live loads according to ACI 318 (2008) Table 9.5(b). For a 30' span, this requires that the service live loads do not cause deflections of more than 1". An occupancy Category

of II has been assumed for the building. The chosen location for the building is in the western portion of the state of Iowa.

Non-standard manufacturing techniques or special materials would greatly add to the cost of producing the system and would limit the proposed system's commercial viability. To address this, an additional restriction imposed on the design is to limit the materials to standard materials that can be economically procured by, or produced at, typical prestressing plants. With this in mind, the following is a list of materials used for the design:

- Precast concrete: compressive release strength = $f_{ci}' = 6500$ psi
 28-day compressive strength = $f_c' = 8000$ psi
- Prestressing strand: ASTM A416, 0.6 \emptyset 270 ksi low-relaxation strand
- Reinforcing bars: ASTM A615, Grade 60 ($F_y = 60$ ksi)
- Structural steel: ASTM A992, $F_y = 50$ ksi, $F_u = 65$ ksi
- Cast-in-place concrete: 28-day compressive strength = $f_c' = 4000$ psi
- Welding electrodes: conform to AWS D1.4 with E70XX or E80EXX electrodes
- Plates, angles, channels, all-thread rod and other misc. shapes shall be ASTM A36 steel ($F_y = 36$ ksi, $F_u = 58$ ksi), UNO.
- Columns: 28-day compressive strength = $f_c' = 5000$ psi
- Hollow-Core: 28-day compressive strength = $f_c' = 5000$ psi

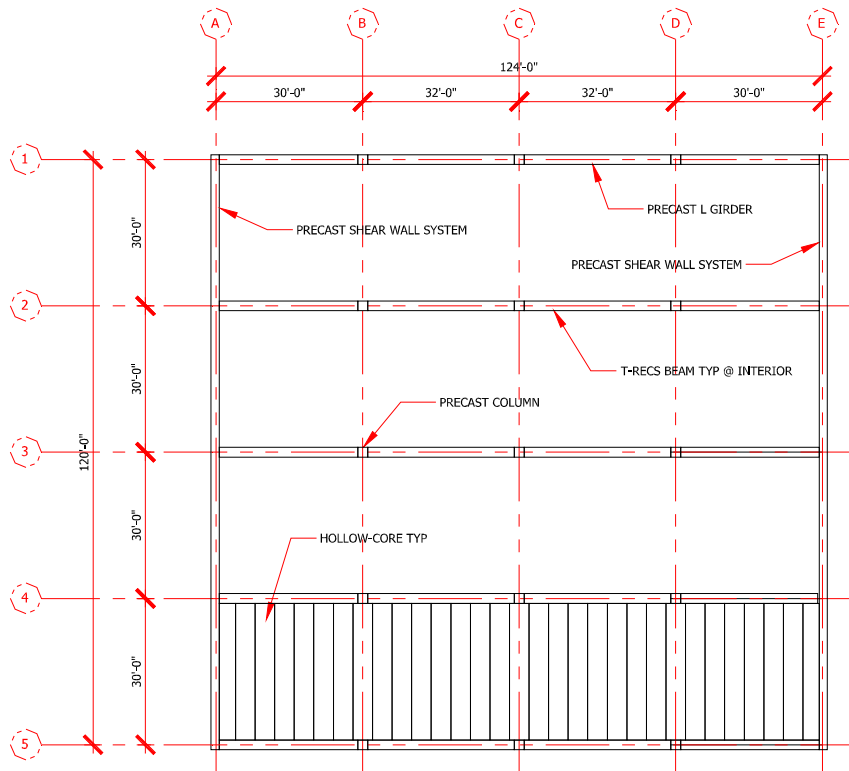

Figure 4.1 – Typical Floor Plan

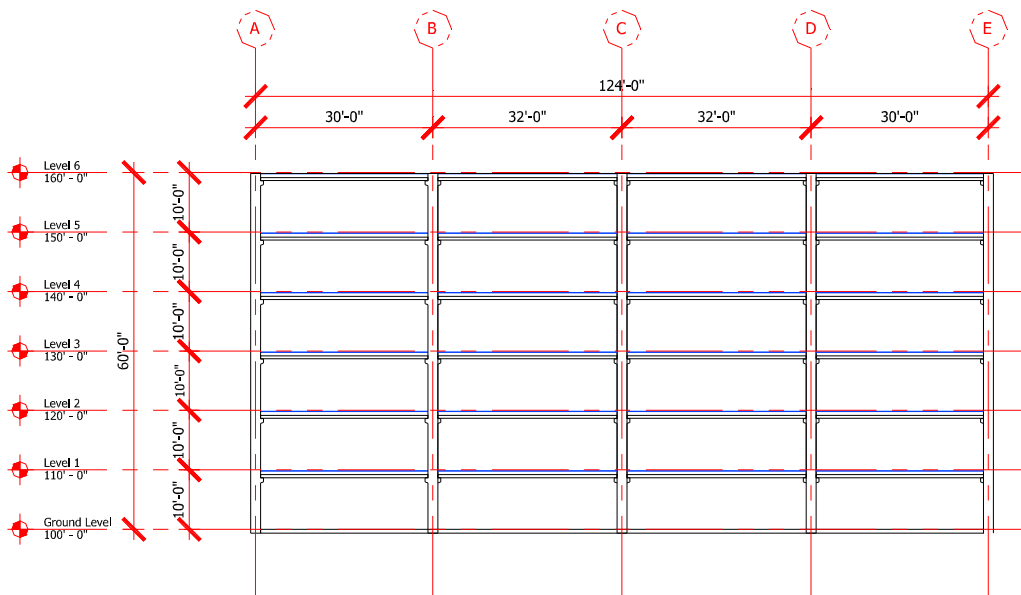

Figure 4.2 – Typical Building Section

Design procedures were conducted in accordance with the following design codes and manuals:

- Precast/Prestressed Concrete Institute (PCI) “PCI Design Handbook”, 6th Edition, 2004
- American Institute of Steel Construction (AISC) “Steel Construction Manual”, 13th Edition, June 2008
- American Society of Civil Engineers “ASCE 7-05 Minimum Design Loads for Buildings and Other Structures”, 2005
- American Concrete Institute (ACI) “Building Code Requirements for Structural Concrete (ACI318-08) and Commentary”, 2008

4.2 – Gravity Loads

The criteria previously described are used in designing the members for the gravity loads on the system at three separate stages: Stage 1 - production, Stage 2 - erection/ construction, and Stage 3 - service. The member designs are detailed in the following sections.

4.2.1 – Hollow-Core Design

Hollow-core is an economical, easy to produce, and easily erected product. The hollow-core for the proposed system is similar to any conventional floor system. It comes in standard depths of 8”, 10”, and 12”, with a standard width of 4’. Design tables are available from precast manufacturers and can be used to determine the appropriate size needed for the applied loads and span length of the member. The hollow-core is designed as simply supported for gravity loads applied prior to pouring of the topping. Once the

CIP topping is poured, the continuity reinforcement previously described helps to make the hollow core continuous over the beam supports for the superimposed dead and live loads. This helps to give the hollow-core additional capacity. Stain compatibility was used to ensure adequate negative moment capacity at these supports for the continuous live loads. The following table is taken from the PCI Handbook (2004).

3.6 Hollow-Core Load Tables (cont.)

Strand Pattern Designation
76-S

Section Properties
No Topping 2 in. topping

A = 215 in. ²	-
I = 1666 in. ⁴	3071 in. ⁴
y _s = 4.00 in.	5.29 in.
y _i = 4.00 in.	4.71 in.
S _s = 417 in. ³	581 in. ³
S _i = 417 in. ³	652 in. ³
wt = 224 lb/ft	324 lb/ft
DL = 56 lb/ft ²	81 lb/ft ²
V/S = 1.92 in.	

f'_c = 5000 psi
f'_{pu} = 270,000 psi

Key
385- Safe superimposed service load, lb/ft²
0.1 - Estimated camber at erection, in.
0.2 - Estimated long-time camber, in.

Safe loads shown include dead load of 10 lb/ft² for untopped members and 15 lb/ft² for topped members. Remainder is live load. Long-time cambers include superimposed dead load but do not include live load.
Capacity of sections of other configurations are similar. For precise values, see local hollow-core manufacturer.

4HC8

Table of safe superimposed service load, lb/ft², and cambers, in. No Topping

Strand designation code	Span, ft																																					
	11	12	13	14	15	16	17	18	19	20	21	22	23	24	25	26	27	28	29	30	31	32	33	34	35	36	37	38	39	40								
66-S	385	345	313	283	260	240	223	204	179	158	140	124	110	98	87	77	69	61	54	48	43	38	33	29														
76-S	449	407	367	334	309	285	263	242	213	188	167	149	133	119	106	95	86	77	69	62	55	50	44	39	35	31	26											
58-S	422	380	346	316	290	267	247	231	216	202	190	179	169	160	144	130	118	107	97	88	80	72	66	60	54	48	42	37	32	28								
68-S	476	430	393	361	332	309	286	269	253	235	223	209	200	180	165	153	142	132	121	110	101	92	84	77	70	63	56	51	45	40								
78-S	488	442	402	370	341	318	295	275	259	241	229	215	203	195	180	168	157	144	135	126	118	110	101	92	84	77	70	64	58	52								

4HC8 + 2

Table of safe superimposed service load, lb/ft², and cambers, in. 2 in. Normalweight Topping

Strand designation code	Span, ft																																						
	13	14	15	16	17	18	19	20	21	22	23	24	25	26	27	28	29	30	31	32	33	34	35	36	37	38	39	40											
66-S	400	365	333	308	282	256	224	197	173	153	135	119	105	93	82	68	56	45	36	26																			
76-S	474	435	396	366	340	304	267	235	208	184	164	148	130	116	103	98	74	62	51	41	31																		
58-S	445	405	374	342	318	298	275	260	243	228	217	196	177	159	143	126	111	95	2	70	59	49	40	32															
68-S	463	426	393	366	342	319	299	282	267	251	239	216	195	177	158	141	124	110	97	84	73	62	53	44	36	28													
78-S	472	435	402	375	348	325	305	288	273	257	245	232	220	207	186	167	149	133	119	106	94	83	73	64	55	46	38												

Strength is based on strain compatibility; bottom tension is limited to 7.5√f'_c; see pages 3-8 through 3-11 for explanation. See item 3, note 4, Section 3.3.2 for explanation of vertical line.

The boxed region in the table indicates the appropriate hollow-core strand configuration for a 30' span with a superimposed service load of 85 psf. A 4HC8+2 with a strand designation code 58-S satisfies the design requirements. This describes an 8" deep hollow-core plank with a 2" CIP structural topping and containing 5 - ½" \varnothing strands. The typical cross section for the hollow-core is shown in Figure 4.3.

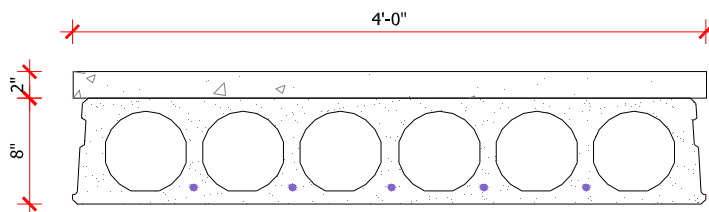

Figure 4.3 – Composite Hollow-Core Section

4.2.2 - T-RECS Beam Design

The T-RECS beam is a prestressed member, and because of this, both stress design and ultimate strength design must be considered. The concrete should be designed to remain uncracked throughout the various stages of loading. PCI Handbook (2004), Chapter 4 details the design requirements that must be met. The stress limits used are $0.7 f_c'$ for compression and $12\sqrt{f_c'}$ for tension. Service loads for the various design stages can be seen in Figures 4.4 through 4.7. A summary of the section properties for each stage is provided in table 4.1. Refer to the appendix for detailed calculations of these properties.

	A (in ²)	I (in ⁴)	y _t (in)	y _b (in)	S _t (in ³)	S _b (in ³)
Stage 1	189	4,298	8.48	5.52	507	779
Stage 2	160	3,783	8.33	5.67	454	667
Stage 3	327	9,207	7.68	8.32	1,199	1,106

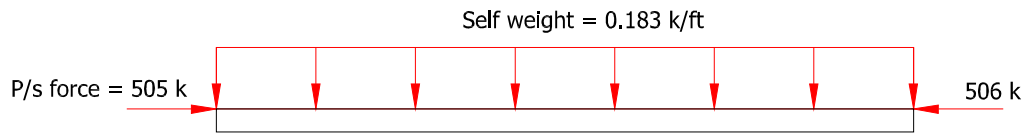

Figure 4.4 – Stage 1 Loads at Release

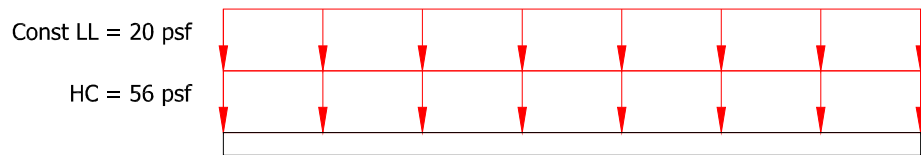

Figure 4.5 – Stage 2 Loads During Erection

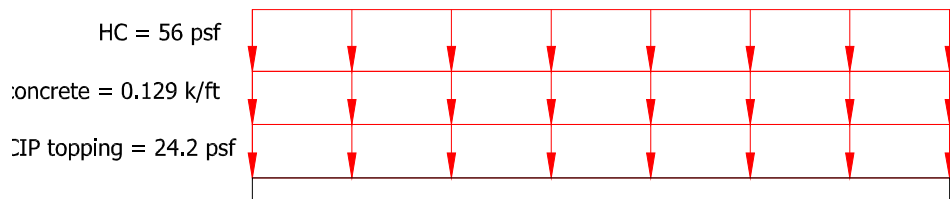

Figure 4.6 – Stage 2 Loads During CIP Pour

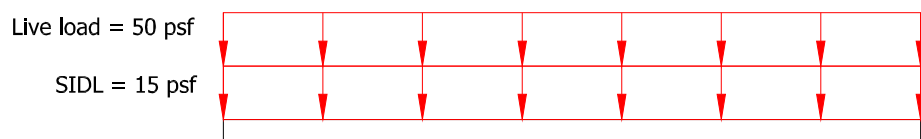

Figure 4.7 – Stage 3 Loads at Service Life

4.2.2.1 - Stage 1 – Production

The precast member must be designed for the first stage, which is at release of the prestressing strand. At this stage the member is analyzed as a simple span member. It is unknown exactly how much of the prestressing force is transferred to the steel beam once the prestressing force is released. The assumption made for this analysis is that the steel member is fully composite with the precast concrete; therefore, the section properties include the transformed area of the steel based on the modular ratio. Cross-sections detailing the T-RECS beam used for the design can be seen in Figures 4.8 and 4.9. Reference the elevation view in Figure 4.10 for locations of section cuts.

A W18x76 was the steel section selected for the design. Figure 4.11 details the dimensions for how the steel beam should be cut to allow for proper production. 12 – 0.6” \varnothing strands, tensioned to $0.78 f_{pu}$, are used to achieve the appropriate precompressive force in the concrete for stress design and moment capacity the strength design. The stress design for the beam is detailed in Table 4.2. A final concrete strength of 8 ksi with a release strength of 6.5 ksi are required to meet the stress limits for the design. Only the transformed area of the steel flange is used in the analysis, due to the uncertainty of how the cut portion of the web would behave when subjected to the prestressing force. This is a conservative assumption and should not result in an overestimation of the member’s capacity. Initial stress losses in the prestressing strand due to anchorage seating and elastic shortening of the concrete were assumed to be approximately 7%. Analysis initially shows that stresses at the ends of the member are above the acceptable stress

limits for the concrete at release. To address this, the two strands in the top row are debonded at each end for 5' which reduces the stress at the ends of the member to acceptable limits.

Table 4.2 - Stress Check at Release				
	Mid-Span		Transfer Length	
	Steel Top (ksi)	Conc. Bot. (ksi)	Steel Top (ksi)	Conc. Bot. (ksi)
P/A	16.504	2.644	16.504	2.644
Pe/S	-19.085	2.048	-19.085	2.048
M/S	2.905	-0.312	2.179	-0.234
Σ	0.324	4.380	-0.402	4.458
Limit	50.000	4.550	50.000	4.550
Check	OK	OK	OK	OK

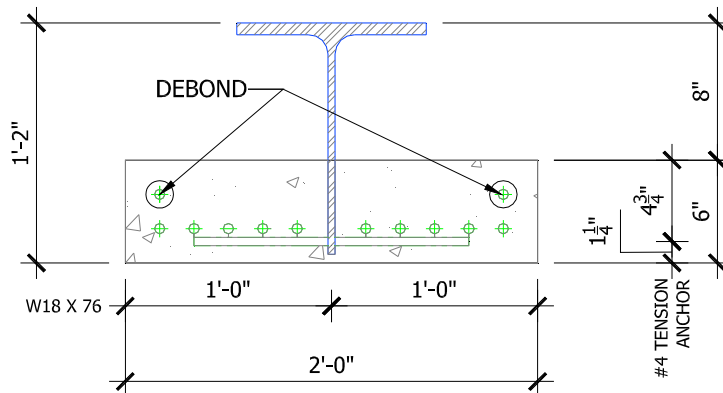

Figure 4.8 – Cross Section at A

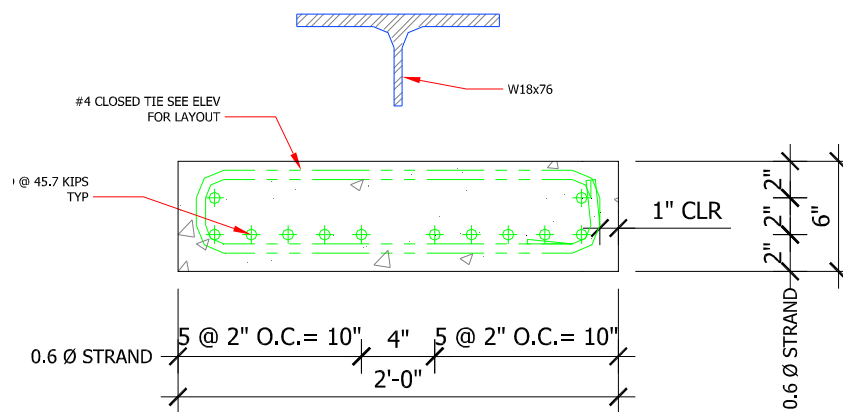

Figure 4.9 – Cross Section at B

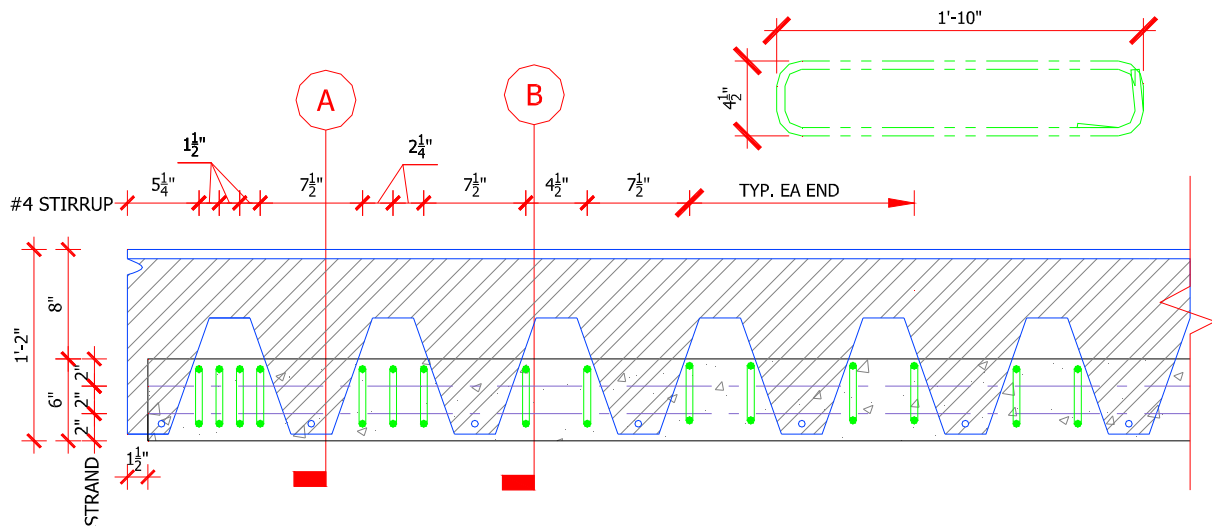

Figure 4.10 – T-RECS Beam Elevation with Reinforcement

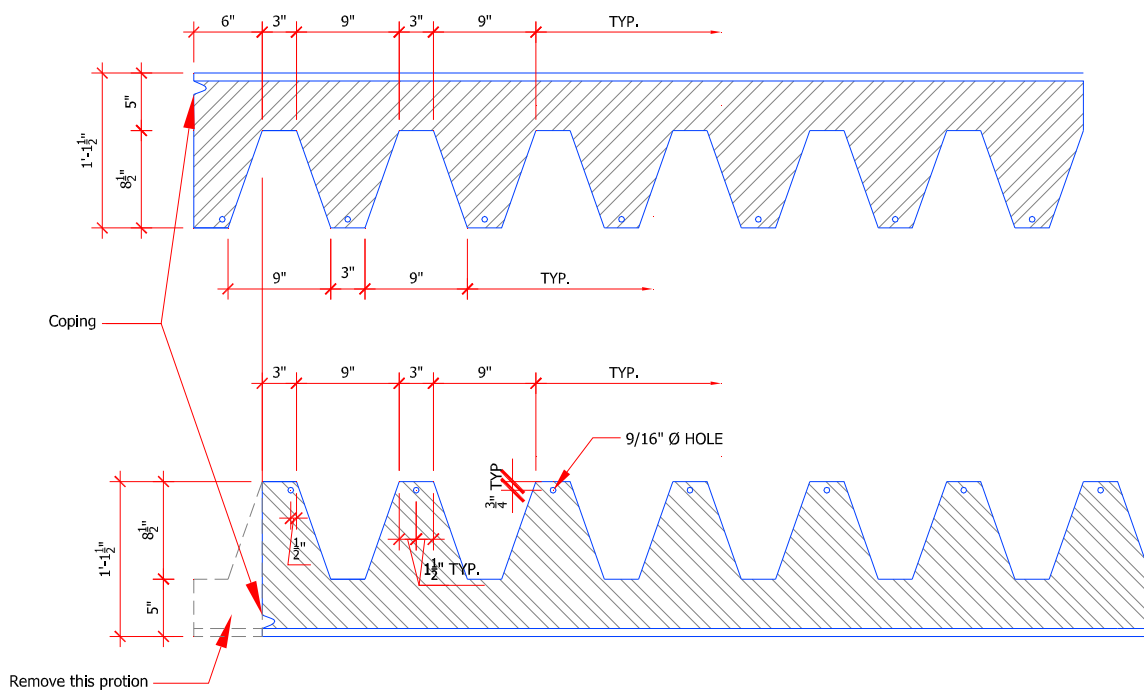

Figure 4.11 – WF Beam Manufacturing Detail

4.2.2.2 - Stage 2 – Erection

During the erection of the precast, three loading cases need to be analyzed. All loads during the erection of the precast are temporary load cases, and therefore a load factor of 1.0 is applied.

The first case occurs when one half of the beam is loaded with the weight of the hollow-core. This unbalanced load results in torsion being applied to the beam and the precast must be designed to resist this load. When analyzing the beam for torsion, strength of the steel beam was neglected because the torsional strength of the rectangular precast is much greater relative to the T-shaped steel section embedded in the top of the concrete. The torsion angles previously described are provided to ensure that the entire torsion force is resisted by the precast concrete and that the beam is restrained from overturning. Torsion loads were analyzed using the PCI Handbook (2004) recommended method developed by Zia and McGee. The detailed calculation of the torsion analysis is presented here and the design of the torsion restraints is detailed in the connection design section of this report. Results from the analysis require the use of $1.28 \text{ in}^2/\text{ft}$ not spaced at greater than 10" O.C. Stirrup placement can be seen by referencing back to Figure 4.10. Stirrups are #4 bars spaced at $1\frac{1}{2}$ " on center which equals $1.6 \text{ in}^2/\text{ft}$ for the first segment of the beam where torsion is the greatest. The number of stirrups can be reduced closer the midspan where the torsion is theoretically equal to zero. The torsion design is conducted as follow:

Torsion Design

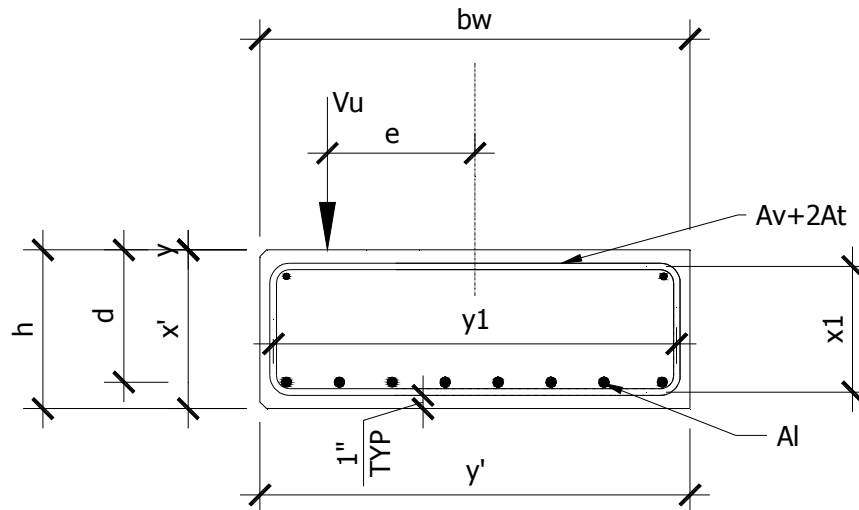

Note: Uses simplified PCI method which assumes $f_{se} > 40\% f_{pu}$

Beam Geometry

*Width of stem	$b_w = 24$ in
*Beam height	$h = 6.0$ in
*Depth to prestressing reinforcement	$d = 4.0$ in
*Moment of Area	$\Sigma x^2y = 864$ in ³
*Short side of closed tie	$x_1 = 5$ in
*Long side of close tie	$y_1 = 20$ in

Material properties

*Compressive strength of concrete	$f'_c = 8$ ksi
*Yield strength of reinforcement	$f_y = 60$ ksi
*Concrete density modifier	$\lambda = 1.0$
*Strand transfer length	$l_t = 30$ in
*Area of prestressing strand	$A_{ps} = 2.604$ in ²
Ultimate tensile strength of strand	$f_{pu} = 270$ ksi
*Stress @ centroid of concrete after p/s losses	$f_{pc} = 1.75$ ksi

Design load data

*Factored vertical load at critical section	$V_u = 12.3$ kips
*Factored moment at critical section	$M_u = 92.4$ kip_in
*Factored Torsional moment	$T_u = 130$ kip_in
*Section under investigation	$l = 3$ in
*Strength reduction factor	$\phi = 0.75$

Preliminary Torsion Check

Prestressing factor
Torsion neglecting limit
 $\text{lbs/in}^2 \times \Sigma x^2 y \times \gamma = 51.74 \text{ kip_in}$

$$\gamma = \sqrt{(1+10 \times (f_{pc}/f_c))} = 1.79$$

$$T_{\text{umin}} = \phi \times (0.5 \times \lambda \times \sqrt{f_c} \times 1$$

NG - Member must be analyzed for torsion

Check Shear & Torsional Limits

Torsion factor
Geometric torsion factor
Maximum torsional limit
 $(1 \times C_t \times T_u)^2 = 404 \text{ kip_in}$
Maximum shear limit
 $/(K_t \times V_u)^2 = 38 \text{ kip}$
Ultimate combined torsion strength
Ultimate combined shear strength

$$K_t = \gamma \times (12 - 10 \times f_{pc}/f_c) = 17.52$$

$$C_t = 1 \text{ in} \times b_w \times d / \Sigma x^2 y = 0.111$$

$$T_{\text{nmax}} = (1/3) \times K_t \times \lambda \times \sqrt{f_c} \times 1 \text{ lbs/in}^2 \times \Sigma x^2 y / \sqrt{(1 + (K_t \times V_u / (30 \text{ in}^{-1} \times C_t \times T_u))^2)}$$

$$V_{\text{nmax}} = 10 \times \lambda \times \sqrt{f_c} \times 1 \text{ lbs/in}^2 \times b_w \times d / \sqrt{(1 + (30 \text{ in}^{-1} \times C_t \times T_u / (K_t \times V_u))^2)}$$

$$\phi T_n = \phi \times T_{\text{nmax}} = 303.06 \text{ kip_in}$$

$$\phi V_n = \phi \times V_{\text{nmax}} = 28.67 \text{ kip}$$

$\phi T_n \geq T_u$ - Analysis may continue
 $\phi V_n \geq V_u$ - Analysis may continue

Concrete Shear & Torsion Design

Shear Strengths

Nominal shear strength
 $\min(1, V_u \times d / M_u) \times b_w \times d = 40.93 \text{ kip}$
Maximum shear strength limit
Minimum shear strength limit
Support shear strength
Transition zone strength at 'x'
kip

$$V_c = (0.6 \times \lambda \times \sqrt{f_c} \times 1 \text{ lbs/in}^2) + (700 \text{ lbs/in}^2 \times b_w \times d)$$

$$V_{\text{cw max}} = 5 \times \lambda \times \sqrt{f_c} \times 1 \text{ lbs/in}^2 \times b_w \times d = 42.93 \text{ kip}$$

$$V_{\text{cw min}} = 2 \times \lambda \times \sqrt{f_c} \times 1 \text{ lbs/in}^2 \times b_w \times d = 17.17 \text{ kip}$$

$$V_{\text{cw sup}} = 3.5 \times \lambda \times \sqrt{f_c} \times 1 \text{ lbs/in}^2 \times b_w \times d = 30.05 \text{ kip}$$

$$V_{\text{cx}} = V_{\text{cw sup}} + (V_{\text{cw max}} - V_{\text{cw sup}}) \times \min(l, l_t) / l_t = 31.34$$

Controlling value

Nominal shear strength

$$V_{\text{nx}} = 31.34 \text{ kip}$$

$$V'_c = V_{\text{nx}} = 31.34 \text{ kip}$$

Torsional Strength

Nominal torsion strength
 $\text{lbs/in}^2 \times \Sigma x^2 y \times (2.5 \times \gamma - 1.5) = 183.21 \text{ kip_in}$

$$T'_c = 0.8 \times \lambda \times \sqrt{f_c} \times 1$$

Shear-Torsion Interaction

Combined concrete torsional moment strength
160.32 kip_in
Combined concrete shear strength
kip

$$T_c = T'_c / (\sqrt{(1 + (T'_c \times V_u / (T_u \times V'_c))^2)}) =$$

$$V_c = V'_c / (\sqrt{(1 + (V'_c \times T_u / (V_u \times T'_c))^2)}) = 15.17$$

Reinforcement Design

Closed stirrup design

Spacing requirements
*Spacing provided

$$s = \min(x_1 + y_1 / 4, 12 \text{ in}) = 10 \text{ in}$$

$$s_{\text{prov}} = 4 \text{ in}$$

Pass - Spacing provided is adequate

Torsion reinforcement per leg in ²	$\alpha_t = \min((0.66 + 0.33 \times y_1/x_1), 1.5) = 1.5$
Area of shear steel required	$A_t = (T_u/\phi - T_c) \times s_{prov} / (\alpha_t \times x_1 \times y_1 \times f_y) = 0.01$
Minimum area of shear steel required = 0.06 in²	$A_{vreq} = (V_u/\phi - V_c) \times s_{prov} / (f_y \times d) = 0.02 \text{ in}^2$
Controlling area of shear steel	$A_{vmin} = A_{ps} \times f_{pu} \times s_{prov} / (80 \times f_y \times d) \times (\sqrt{d/b_w})$
Total area of stirrup reinforcing required	$A_v = \max(A_{vreq}, A_{vmin}) = 0.06 \text{ in}^2$
	$A_s = \max(A_v + 2 \times A_t, 50 \text{ lbs/in}^2 \times b_w \times s_{prov} / f_y \times \gamma^2, 200 \text{ lbs/in}^2 \times b_w \times s_{prov} / f_y) = 0.32 \text{ in}^2$

***Shear reinforcement (user input)**

Diameter of stirrup bars	$D_{stir} = 0.5 \text{ in}$
Area of horizontal reinforcement provided	$A_{s_prov} = 2 \times \pi \times D_{stir}^2 / 4 = 0.393 \text{ in}^2$
	Pass - Torsion reinforcing is adequate

Longitudinal reinforcement design

Required longitudinal reinforcement	$A_{l1} = 2 \times A_t \times (x_1 + y_1) / s_{prov} = 0.07 \text{ in}^2$
$L = \max(2 \times A_t / s_{prov}, \min(200 \text{ lbs/in}^2 \times b_w / f_y, 50$	
$\text{lbs/in}^2 \times b_w / f_y \times (1 + 12 \times f_{pc} / f_c))) = 0.072 \text{ in}$	
$= 1.303 \text{ in}^2$	$A_{l2} = (400 \text{ lbs/in}^2 \times b_w / f_y \times (T_u / (T_u + V_u / (3 \text{ in}^{-1} \times C_t))) - L) \times (x_1 + y_1)$
Controlling longitudinal steel area	$A_l = \max(A_{l1}, A_{l2}) = 1.3 \text{ in}^2$

***Longitudinal reinforcement (user input)**

Area of prestressing strand	$A_{ps} = 0.217 \text{ in}^2$
Number of longitudinal bars	$n_l = 12$
Area of longitudinal reinforcement provided	$A_{l_prov} = n_l \times A_{ps} = 2.604 \text{ in}^2$
	Pass - Torsion reinforcing is adequate

Design Summary

- ~Beam height of 6.00" by 24.0" wide with 8000 psi concrete
- ~Section under investigation is located at 0.25 ft from support
- ~Reinforcement at section under investigation consists of 0.50 in dia vertical stirrups spaced at 4 in O.C.
- ~Longitudinal reinforcement consists of 12-0.60 in dia strand.

Once all of the hollow-core has been erected, two additional load cases must be checked.

These loads are detailed in Figures 4.5 and 4.6 and the controlling load is shown in

Figure 4.12. In this design example, the load case during the pouring of the CIP topping

is the critical load case. Shear and moment diagrams for this load case are given in Figures 4.13 and 4.14 respectively. The clear span distance is 30' for the interior spans and 28' at the exterior spans.

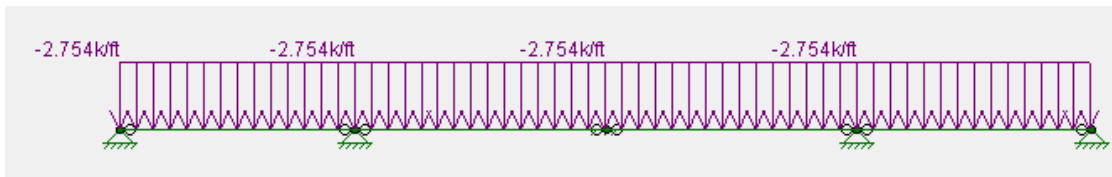

Figure 4.12 – Stage 2 – Uniform Dead Load

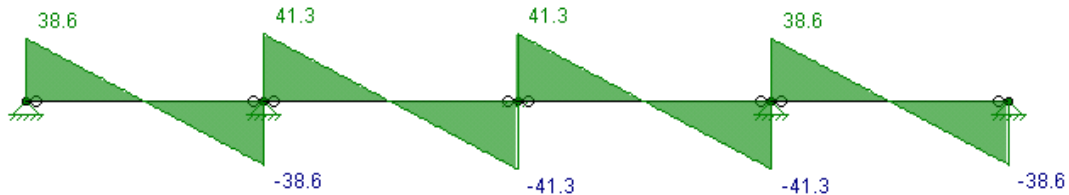

Figure 4.13 – Stage 2 – Shear Diagram

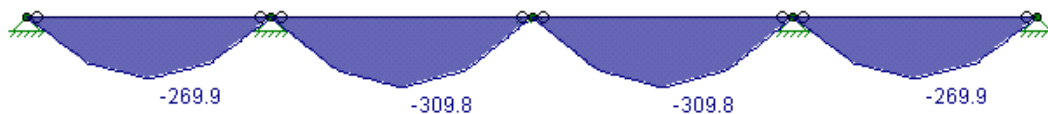

Figure 4.14 – Stage 2 – Moment Diagram

At this stage, the entire shear force must be resisted by the precast concrete alone. This is because the loads are applied directly to the precast and the steel beam is not subjected to any shear until the CIP topping has hardened. Design of the precast is done in accordance with the PCI Design Handbook (2004). For a detailed calculation of the shear design, see the Appendix. The design requires $0.72 \text{ in}^2/\text{ft}$. Reinforcement that was utilized to resist the torsion loads that are no longer present can now be considered as

reinforcement for the shear strength of the member. The amount of reinforcement required for torsion was $1.6 \text{ in}^2/\text{ft}$, which exceeds the $0.72 \text{ in}^2/\text{ft}$ required here for shear.

When analyzing the moment strength of the T-RECS beam during construction, the moment strength of the prestressing strand is not a concern because it is designed for higher factored loads during the service life of the member. However, the strength of the steel beam during this stage must be checked. The steel beam acts as the compression flange during flexure until the CIP topping has hardened. Because the steel beam is anchored in concrete at its base and has portions of the web removed, it is uncertain exactly how the steel behaves under loading. To help simplify this analysis, the steel beam is analyzed similar to any typical steel beam. This is likely a conservative assumption because a beam during flexure often undergoes lateral torsion buckling before achieving the full plastic strength of the beam. Lateral torsional buckling is a phenomenon where failure of a beam takes place normal to the plane of bending while also twisting about its shear center. This is not likely with the T-RECS beam due to the significant differences in the cross section and material properties. For instance, the moment of inertia in the weak axis for the T-RECS beam is significantly larger than a standard steel section and therefore global buckling of the beam in a lateral direction is extremely unlikely. It is possible, however, that this could occur locally in the compression flange in some similar manner. However, to be conservative the steel beam is still analyzed as if it were a W18x76 steel section unbraced for its entire length. The

results for this design are shown in table 4.3 and the detailed analysis can be seen in the Appendix.

Table 4.3 - Flexure Analysis of Steel Beam		
Moment capacity	ϕM_n	374 k-ft
Moment demand	M_u	306 k-ft

Stress levels in the prestressed concrete are also checked at this stage even though it is fairly safe to assume that stress levels will be adequate because much higher loads are present during the service life. The results of the stress analysis for an interior span are shown in table 4.4. Section properties used in the calculations are based on those for Stage 2 in table 4.1. The section properties vary slightly from stage 1 due to changes in the concrete strength from 6.5 ksi at release to 8 ksi at final strength.

Table 4.4 - Stress Check at Erection		
	Mid-Span	
	Steel Top (ksi)	Conc. Bot (ksi)
P/A	18.145	3.224
Pe/S	-20.870	2.604
M/S	43.957	-5.484
Σ	41.232	0.344
Limit	50.000	5.600
Check	OK	OK

4.2.2.2 - Stage 3 – Service Life

The third and final stage, which must be analyzed, is during the service life of the structure. At this stage, the CIP topping has hardened and is fully composite with the T-RECS beams. Any superimposed dead and live loads now act on the fully composite section. The structure now behaves as a moment frame with continuous beams and

columns, producing negative moments at the column connections. Refer to Figure 4.7 for the service loads applied at this stage for the example building.

First, the beam is analyzed for ultimate strength design. Figures 4.15 through 4.17 show the uniform factored loads applied prior to Stage 3 and the shear and moment diagrams for those loads. The factored loads, shear, and moment diagrams for State 3 are shown in Figures 4.18 through 4.20. By using superposition, the loads previously applied are combined with the post-composite loads of Stage 3 shown in Figure 4.18 to get the total factored load applied to the beams. The final shear and moment diagrams for the design can similarly be obtained by superposition of the shear and moment diagrams for Stages 2 and 3.

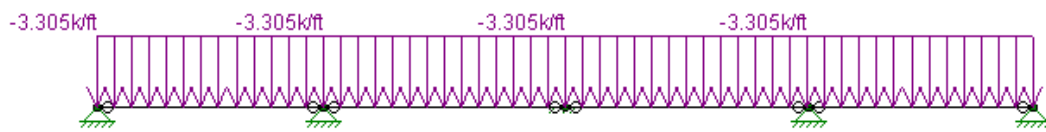

Figure 4.15 – Stage 2 – Factored Load Diagram (Pre-Composite)

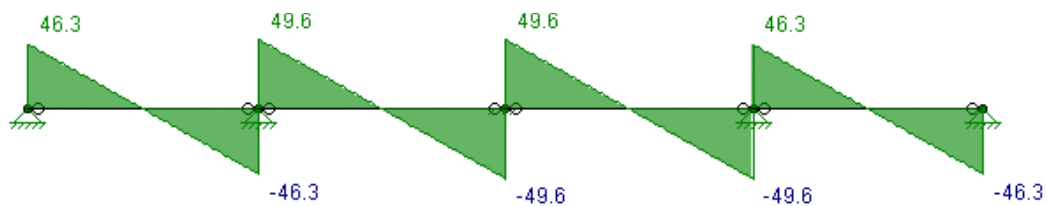

Figure 4.16 – Stage 2 – Factored Shear Diagram (Pre-Composite)

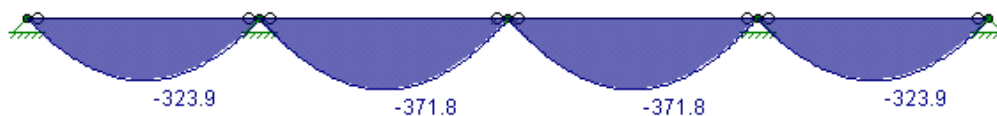

Figure 4.17 – Stage 2 – Factored Moment Diagram (Pre-Composite)

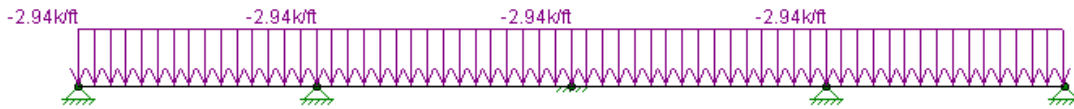

Figure 4.18 – Stage 3 –Factored Load Diagram (Post-Composite)

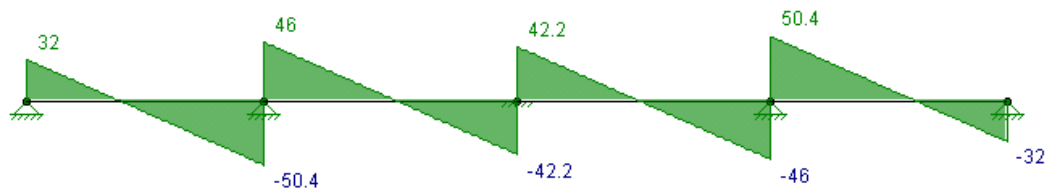

Figure 4.19 – Stage 3 –Factored Shear Diagram (Post-Composite)

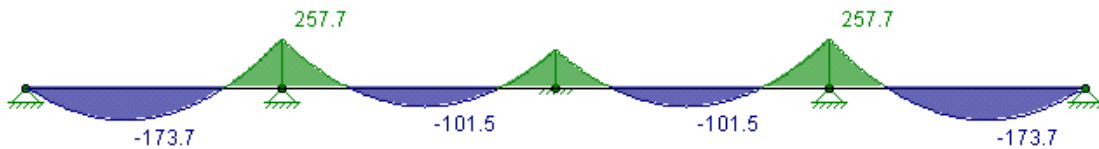

Figure 4.20 – Stage 3 –Factored Moment Diagram (Post-Composite)

The assumed load case for the design at this point is $1.2D + 1.6L$. The controlling load case will be verified upon completion of the lateral analysis conducted in subsequent sections. The final, fully composite cross section of the T-RECS beam is shown in Figures 4.21 and 4.22. This section is analyzed for its shear capacity, moment capacity, and a deflection performance. Details of the column connection with component sizes are provided in Figures 4.23 and 4.24.

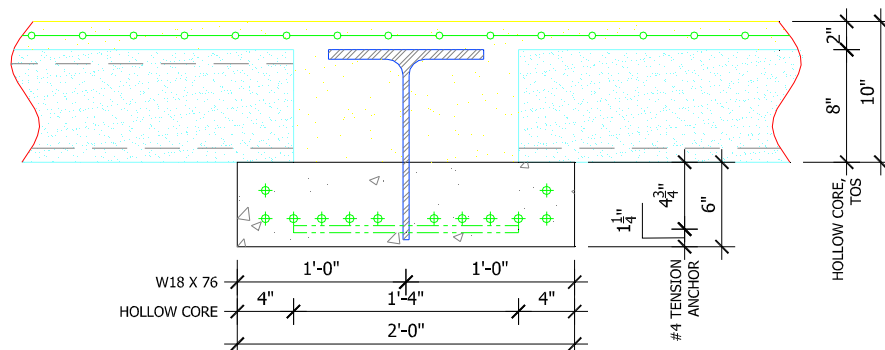

Figure 4.21 – Fully Composite Cross Section

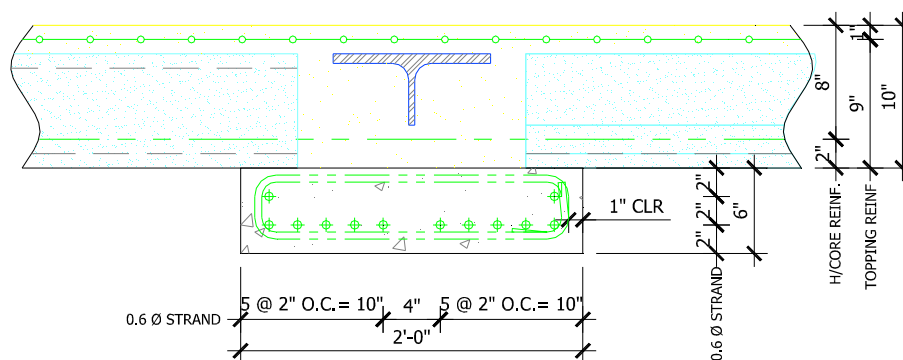

Figure 4.22– Full Composite Cross Section at Web Opening

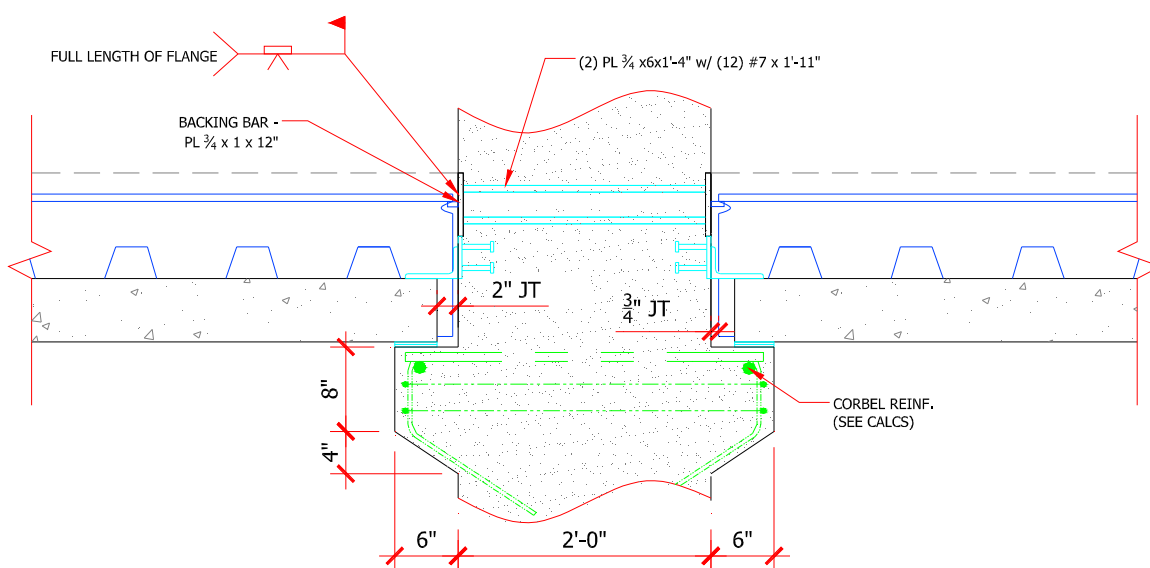

Figure 4.23–Typical Connection at Column Section

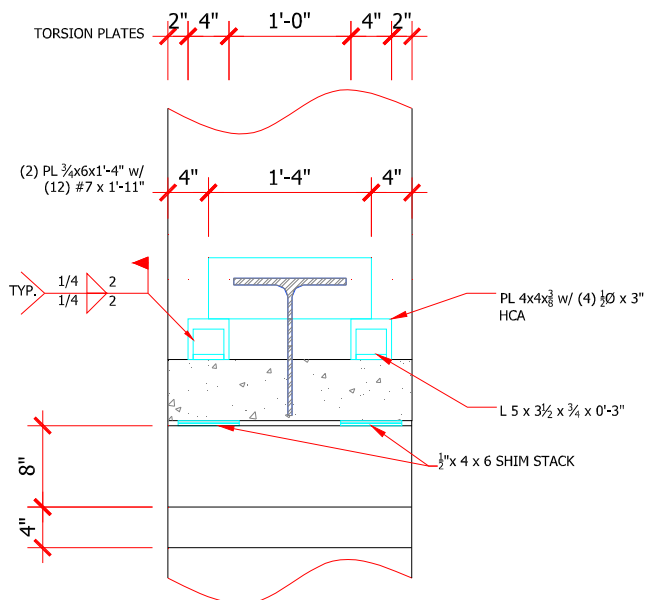

Figure 4.24– Typical Connection at Interior Column

Some simplifying assumptions have been made to make calculating the shear capacity for the cross section easier because the member is a combination of prestressed concrete, reinforced concrete, and a steel beam and current design manuals to not provide specific guidelines to analyze a beam of this

nature. To perform the analysis, the beam is assumed to be a prestressed concrete beam with a concrete strength equal to the topping strength because the majority of the depth of the member is the CIP topping. Also, there are too many irregularities in the steel beam to assume consistent performance for analysis as a steel member. These are conservative both fairly conservative assumptions. Completely ignoring the shear capacity of the steel is a too conservative approach so a methodology for incorporating the additional shear capacity of the T-shaped steel section must be considered as well. The assumption made is that each longer tooth of the steel beam is the equivalent of a stirrup with an area of steel equal to the cross sectional area of the stem. For this example, the stem has a minimum width of 3” with a thickness of 0.425” for a total area of 1.275 in². Each tooth is located at 12” O.C. which results in an area 1.275 in²/ft. This is likely a conservative assumption as well because shear stress is a maximum near the neutral axis and the 3”

width used is located near the bottom of the beam. A detailed calculation for the shear design can be found in the Appendix.

Due to the continuous loads applied to the floor, the section must be analyzed for both positive and negative flexure. Flexural analysis of the beam for strength design is again done using strain compatibility. For the positive moment design, the area of the T-shaped flange is considered to act as longitudinal compression reinforcement. For the cross section shown, this area is equal to 7.23 in^2 . An additional area of steel at the transition from the flange to the web is also included in the calculation. The effective width of the 2" CIP topping also acts as a compression element. This width is calculated according to ACI 318-08, (2008) and is equal to 52" wide. The two layers of strand, as detailed in the cross section, are the tension elements during flexure.

The negative moment at the face of the column relies on the steel flange to act as tension reinforcement. This tension force is then transferred into the column through the weld to the precast embed plate. The area of the rebar in the precast embed plate must be able to carry this force to ensure that the steel flange can be fully developed. The capacity of this connection is calculated in Section 4.5.1. Concrete from the CIP topping fills in the void between the precast beam and the column, and this concrete acts as the compression element for the negative moment. Both the negative and positive moment capacities are calculated in detail in the Appendix. The results of the design for an interior span are

tabulated in Table 4.5. The governing value for the negative moment is found after completion of the lateral analysis.

Table 4.5 - Strength Design of T-RECS Beam		
Shear capacity - ϕV_n	110 kips	
Shear demand - V_u	96 kips	1.2D + 1.6L
Moment capacity - $\phi M_n (+)$	595 k-ft	
Moment demand - $M_u (+)$	468 k-ft	1.2D + 1.6L
Moment capacity - $\phi M_n (-)$	307 k-ft	
Moment demand - $M_u (-)$	271 k-ft	1.2D + 1.0E + L

Stresses in the precast are analyzed at this stage as well. Service level load, shear, and moment diagrams applied during Stage 3 for the stress design are shown in Figures 4.25 through 4.27. The total loads for stress design are obtained by superposition of loads from Stage 2, (Figures 4.12 – 4.14) with those shown below.

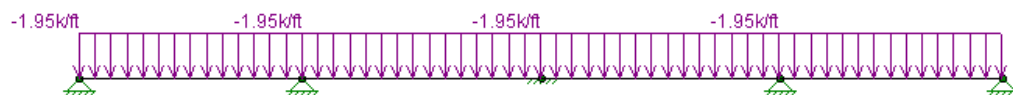

Figure 4.25– Stage 3 Service Loads

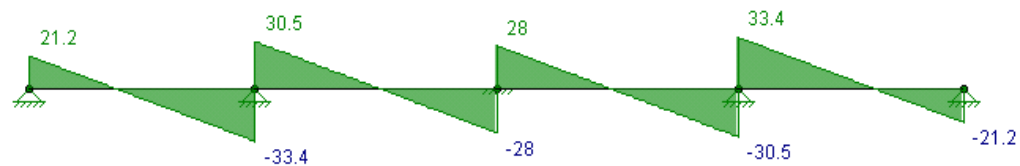

Figure 4.26– Stage 3 Service Load Shear Diagram

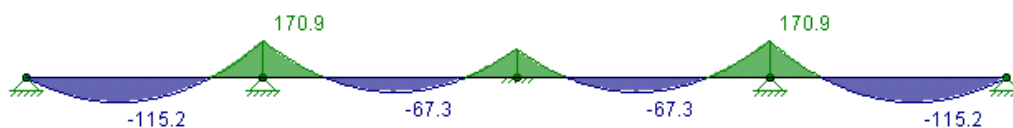

Figure 4.27– Stage 3 Service Load Moment Diagram

The final stress analysis assumes 15% losses in the prestressing strand stress due to additional relaxation of the strand, creep of the concrete, and shrinkage of the concrete. Checks are performed under the total and sustained loads. For the tensile stresses at the bottom of the precast section, the limit is $12\sqrt{f_c'}$. This value is the limit of the transition zone between cracked and uncracked concrete, and using this limit allows for the gross moment of inertia of be used at all stages of design. If the stresses were not limited so that the concrete remains uncracked, the changes in the moment of inertia due to cracking would need to be accounted for in the design. The limit for the compressive stress on the CIP topping is $0.7f_c'$. All dead loads prior to achieving the fully composite section are resisted by the construction stage cross section (re: Table 4.1) and the superimposed dead and live loads are resisted by the composite stage section properties. Table 4.6 summarizes the results from the service life analysis. Figures 4.28 and 4.29 summarize the stresses and strain values for the composite transformed cross section relative to 8 ksi concrete for each stage.

Table 4.6 - Stress Check at Service Life				
Mid-Span (+)				
	Service		Sustained	
	Conc. Topping	Conc. Bot	Conc. Topping	Conc. Bot
P/A	0.000	2.947 ksi	0.000	2.947 ksi
P _e /S	0.000	2.380 ksi	0.000	2.380 ksi
M _{DL} /S	0.000	-5.484 ksi	0.000	-5.484 ksi
M _{SIDL} /S ^a	0.143	-0.164 ksi	0.143	-0.164 ksi
M _{LL} /S ^a	0.477	-0.549 ksi	0.000	0.000 ksi
Σ	0.620	-0.871 ksi	0.143	-0.322 ksi
Limit	2.800	-1.073 ksi	1.800	-1.073 ksi
Check	OK	OK	OK	OK

a. uses composite section modulus

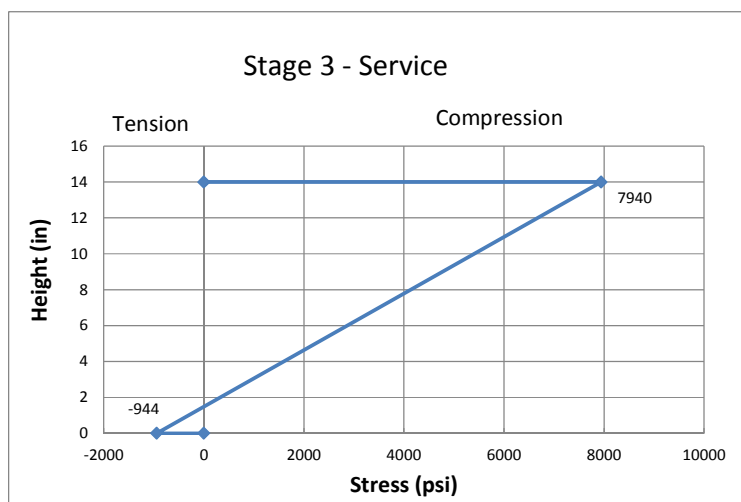
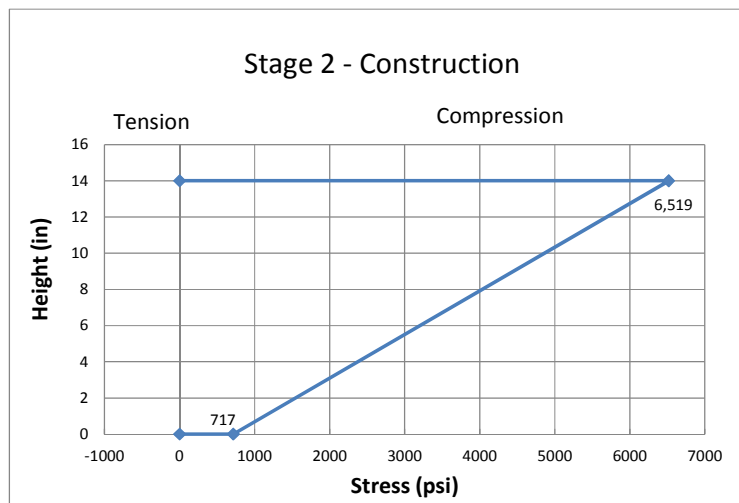
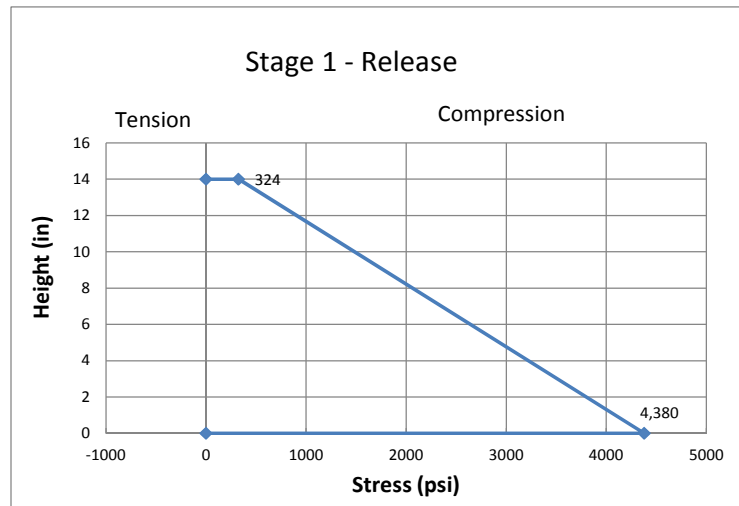

Figure 4.28–Stress Diagrams for Transformed Cross Section (8 ksi)

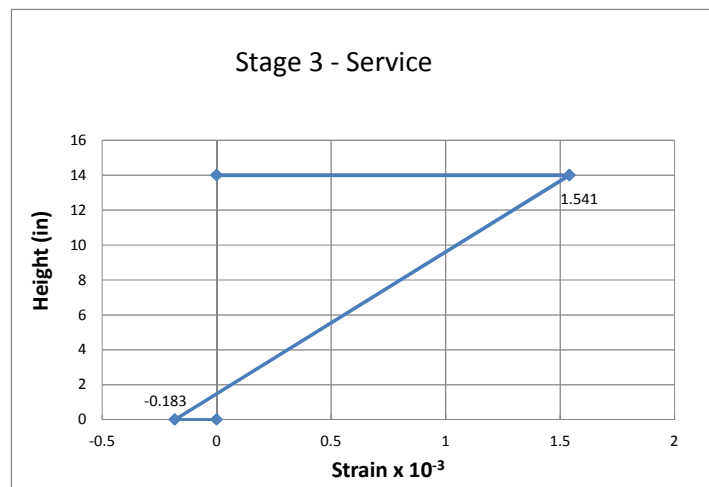
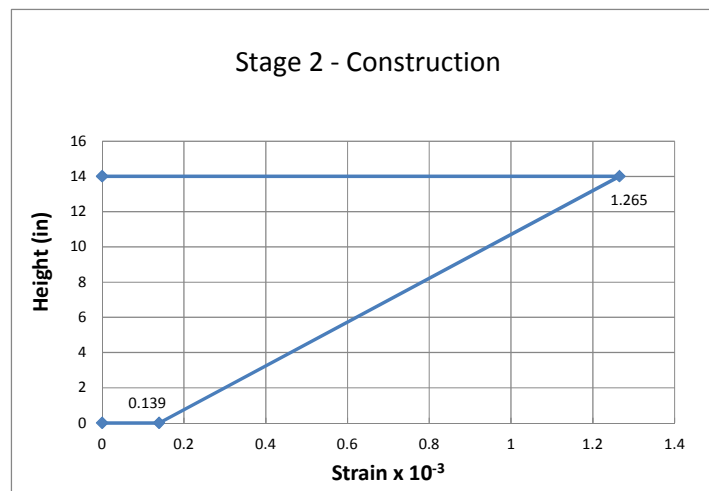
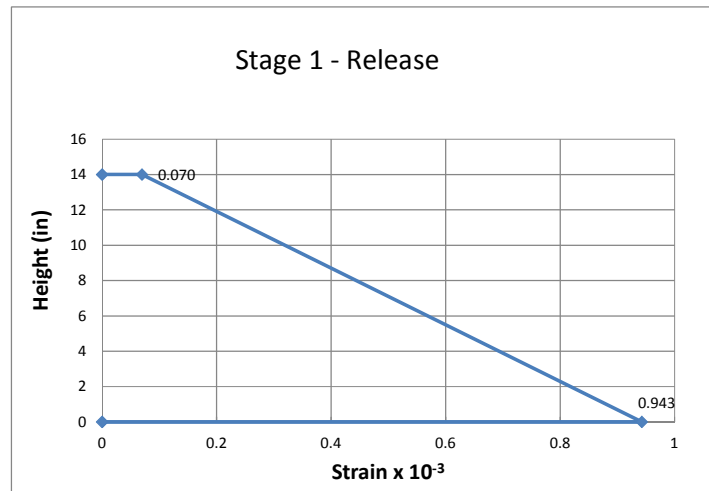

Figure 4.29– Strain Diagrams for Transformed Cross Section (8 ksi)

4.2.3 – Precast Column Design

Similar to the hollow-core, the precast columns can be designed according to manufacturer's load tables. A square column was chosen to maximize the efficiency of production and to make the column-to-column connections as easy as possible to construct. The design should conform to ACI 318 (2008) Chapter 10. Columns are cast with integral corbels to support the structural beams. The columns for this design are 24" x 24" column. Moments applied to the columns are due to the columns acting as part of the frame for the lateral load resisting system. These loads are detailed later in the lateral analysis portion. A factored axial load of 901 kips and bending moment of 271 k-ft are the design loads for the column at the first floor. The following interaction load tables (Figures 4.28 and 4.29) were taken from the PCI design handbook (2004).

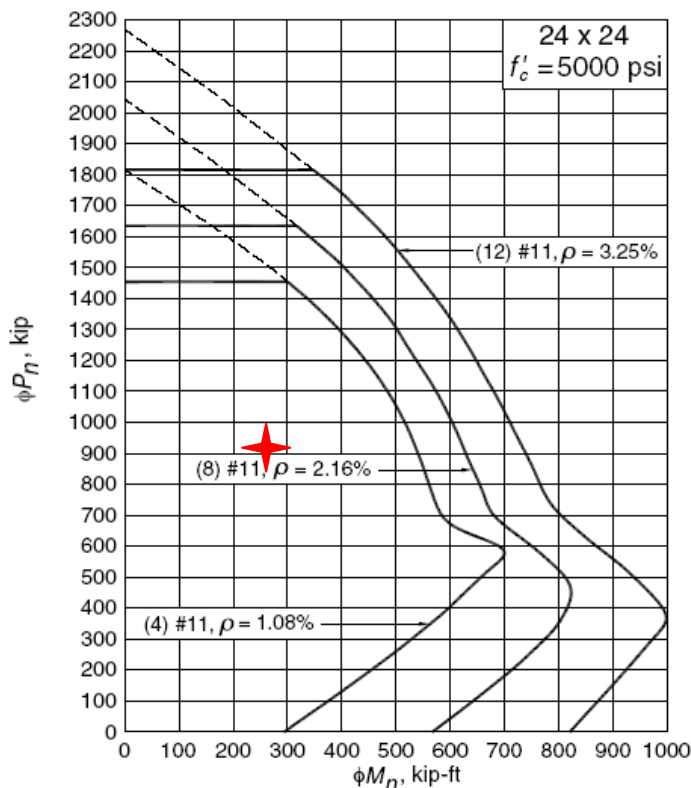

Figure 4.30– Interaction Diagram for Prestressed Concrete Column

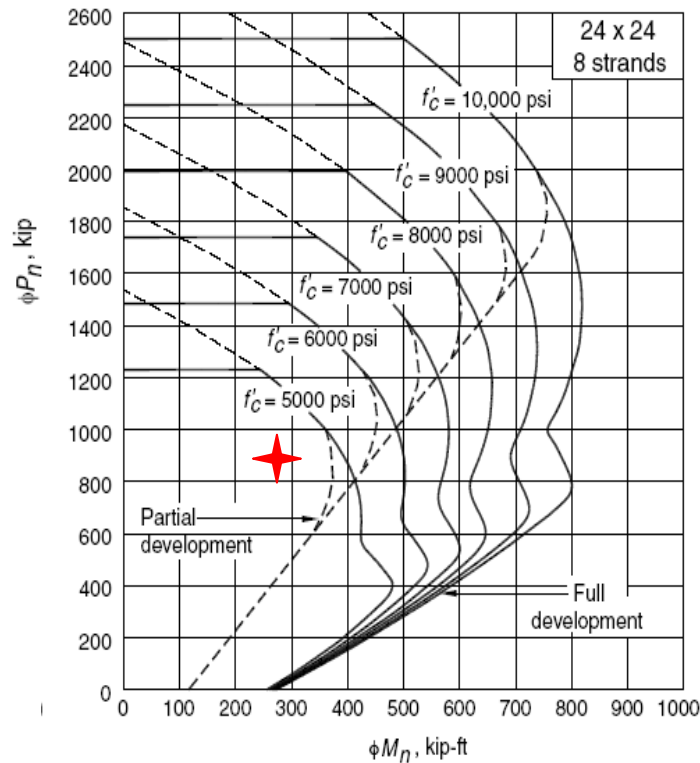

Figure 4.31 – Interaction Diagram for Reinforced Concrete Column

One is for 24"x24" reinforced concrete columns and the other is for 24" x 24" prestressed columns. Reduced column sizes are possible based on the interaction diagrams, however, maintaining the 24" x 24" size allows for easier connections to the T-RECS beams, simple placement of formwork alongside both the beam and column, and a greater moment capacity at the face of the support. Therefore, the size has been selected to match the dimensions of the precast beam.

4.2.4 – Precast L-Beam Design

Precast L-Beams at the perimeter of the building can be designed using load tables as well. The L-beams will be designed as simple span members subject to the same loads

but with half the tributary width. This results in a uniform superimposed service load of 2,349 plf. The table shown below is taken from the PCI design handbook (2004) and for a 30' clear span, calls for a 20LB24.

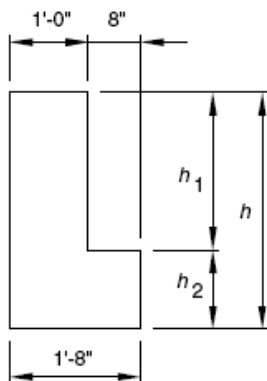

$f'_c = 5000$ psi
 $f_{pu} = 270,000$ psi
 1/2-in.-diameter,
 low-relaxation strand

Normalweight Concrete

Section Properties								
Designation	h in.	h ₁ /h ₂ in.	A in. ²	I in. ⁴	y _b in.	S _b in. ³	S _t in. ³	Wt lb/ft
20LB20	20	12/8	304	10,160	8.74	1163	902	317
20LB24	24	12/12	384	17,568	10.50	1673	1301	400
20LB28	28	16/12	432	27,883	12.22	2282	1767	450
20LB32	32	20/12	480	41,600	14.00	2971	2311	500
20LB36	36	24/12	528	59,119	15.82	3737	2930	550
20LB40	40	24/16	608	81,282	17.47	4653	3608	633
20LB44	44	28/16	656	108,107	19.27	5610	4372	683
20LB48	48	32/16	704	140,133	21.09	6645	5208	733
20LB52	52	36/16	752	177,752	22.94	7749	6117	783
20LB56	56	40/16	800	221,355	24.80	8926	7095	833
20LB60	60	44/16	848	271,332	26.68	10,170	8143	883

1. Check local area for availability of other sizes.
2. Safe loads shown include 50% superimposed dead load and 50% live load. 900 psi top tension has been allowed, therefore, additional top reinforcement is required.
3. Safe loads can be significantly increased by use of structural composite topping.

Key
 6560 – Safe superimposed service load, lb/ft
 0.3 – Estimated camber at erection, in.
 0.1 – Estimated long-time camber, in.

Table of safe superimposed service load, lb/ft, and cambers, in.

Designation	Number strand	y _s in.	Span, ft																		
			16	18	20	22	24	26	28	30	32	34	36	38	40	42	44	46	48	50	
20LB20	9	2.44	6560	5130	4100	3340	2760	2310	1960	1670	1430	1240	1070								
			0.3	0.4	0.5	0.6	0.7	0.8	0.9	1.0	1.0	1.1	1.2								
			0.1	0.2	0.2	0.2	0.2	0.2	0.3	0.3	0.3	0.3	0.2								
20LB24	10	2.80	9570	7490	6000	4900	4060	3410	2890	2470	2130	1850	1610	1410	1240	1090	969				
			0.3	0.3	0.4	0.5	0.5	0.6	0.7	0.8	0.9	0.9	1.0	1.0	1.1	1.1	1.2				
			0.1	0.1	0.1	0.1	0.1	0.2	0.2	0.2	0.2	0.2	0.2	0.1	0.1	0.1	0.0	0.0			

4.3 – Lateral Analysis

A first-order linear elastic lateral analysis is conducted for the building. The intent of this analysis is to ensure that the moment frames are reasonably capable of achieving the required capacities from lateral loads, and not to perform a complete and detailed lateral analysis. Under this pretense, the second-order P- Δ effects and moment magnification procedures of an elastic second-order analysis have been omitted. There are five separate beam lines referenced at grids 1 through 5 in Figure 4.1. This allows for a possible total of five moment frames which could be used in the lateral load resisting system. Only the interior frames are used, however, for a total of three frames. This is done because the exterior beams are L-beams. Using these beams as part of a frame would require special detailing to create moment connections at the column supports and would add additional complexity to the system. In the orthogonal direction to the moment frames, the lateral load resisting system is a typical precast shear wall system.

The lateral analysis is conducted according to ASCE 7 (2005) which contains provisions for wind and seismic design of structures in Chapters 6 and 11 respectively. As stated in the design criteria, the building is assigned an Occupancy Category of II and is located in western Iowa. For the lateral analysis due to wind loading, the location dictates an average wind speed of 90 mph. The structure is 60' tall and therefore conforms to the definition of a low-rise building, and it is also assumed to be fully enclosed.

Additionally, it is assumed that the building is located in an urban or suburban area not

near hills, ridges, or escarpments and therefore the exposure category is B. The design wind pressure is calculated according to the provisions for the Main Wind-Force Resisting System (MWFRS) of a low rise building. A detailed calculation showing the wind pressure profile can be found in the Appendix. This wind pressure profile is applied to the surface of the building and then the story forces are calculated. Each story force is divided among the three moment frames and these forces are shown in Figure 4.30.

For a seismic analysis the weight assigned to each floor level, needs to be determined. In addition to the weights of the floors, beams, and column, a 6" precast wall panel is assumed to be the exterior envelope of the building. Summing the weight of all these components results in a weight of approximately 1,865 kips for a typical floor. This weight gets reduced to 1,717 kips at the top story due to the square footage of the precast wall panels being cut in half. A detailed breakdown of the component weights is shown in the Appendix.

ASCE 7 (2005) stipulates that when soil properties are unknown, the site class shall be assumed as D. The seismic design category based upon the short and one second period response acceleration parameters is category B. Selecting the appropriate response modification coefficient 'R' is highly subjective for this system because the ductility of members and behavior of the connection during a seismic event is unknown.

Experimental testing is likely required in order to assign an appropriate value. A conservative assumption is made here that the structure is an 'ordinary reinforced

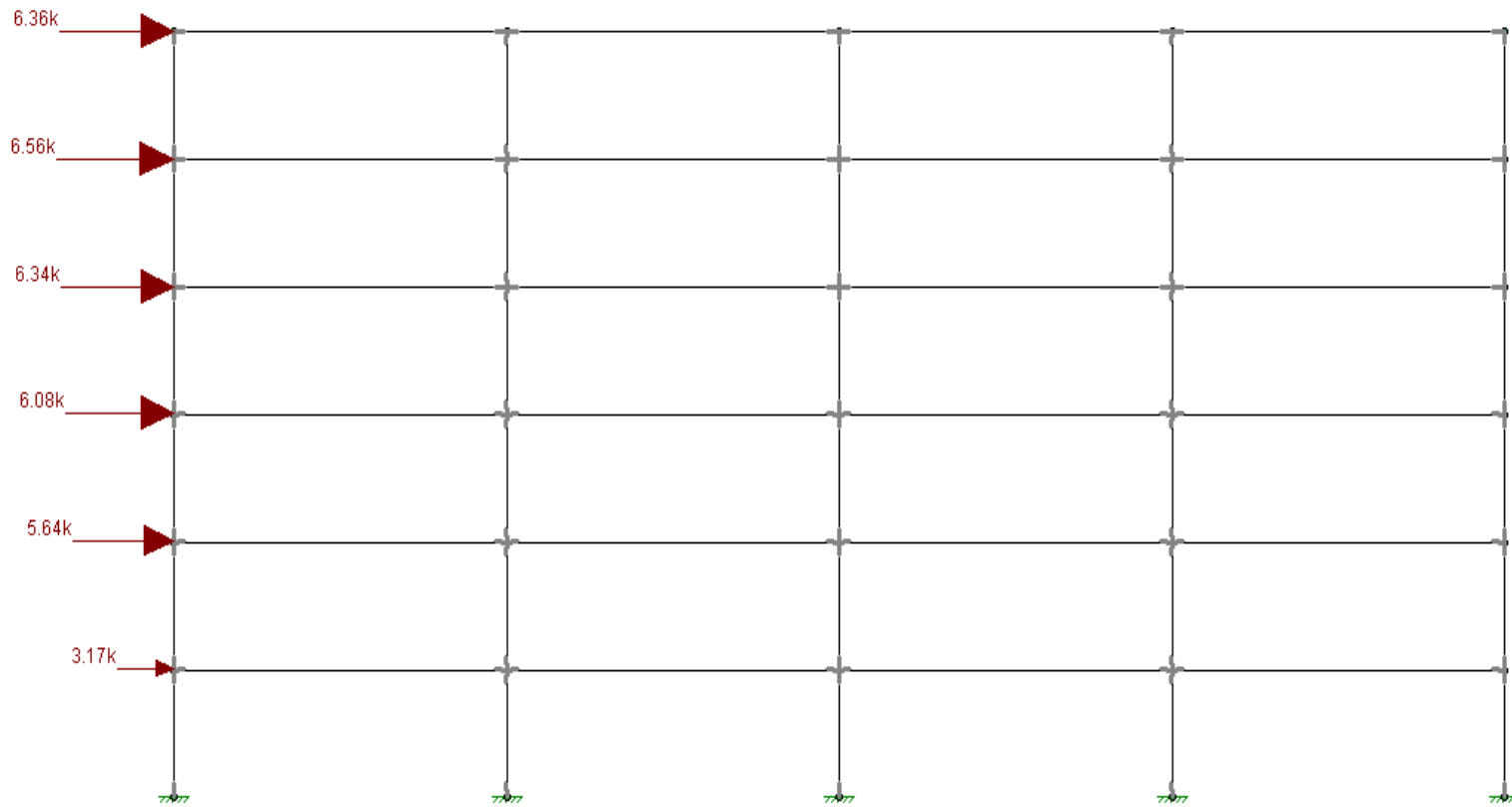

Figure 4.32– Service Level Story Forces for Each Moment Frame Due to Wind Loading

concrete moment frame'. This designation assigns an R value of 3 and a system overstrength factor, Ω_0 , of 3. The overstrength factor is applied to the connections to ensure that the connection can hold up to the full force of the seismic event without failing. Total base shear for the design is 315 kips. Detailed calculations showing the analysis and the distribution of the base shear to each story is shown in the Appendix. Story forces distributed to each of the three moment frames are shown in Figure 4.31.

RISA 3-D software is used to perform the lateral analysis. Columns are modeled as 24"x24" concrete columns with 5000 psi concrete, and the T-RECS beams are modeled as a generic section with a moment of inertia and modulus of elasticity equal to that of the final fully composite cross section. Nodes are modeled as full moment connections. Vertical offsets have been added at each node in all directions to resemble the thicknesses of the column and beams. This will help produce more accurate deflection results. The load case producing the greatest moments from the lateral analysis is 1.2D + 1.0E + L. This loading condition is shown in Figure 4.32. Beam and column moments generated by these loads are shown in Figures 4.33 and 4.34 respectively. The greatest negative moment produced by the lateral loads for the beam design is 95.5 k-ft.

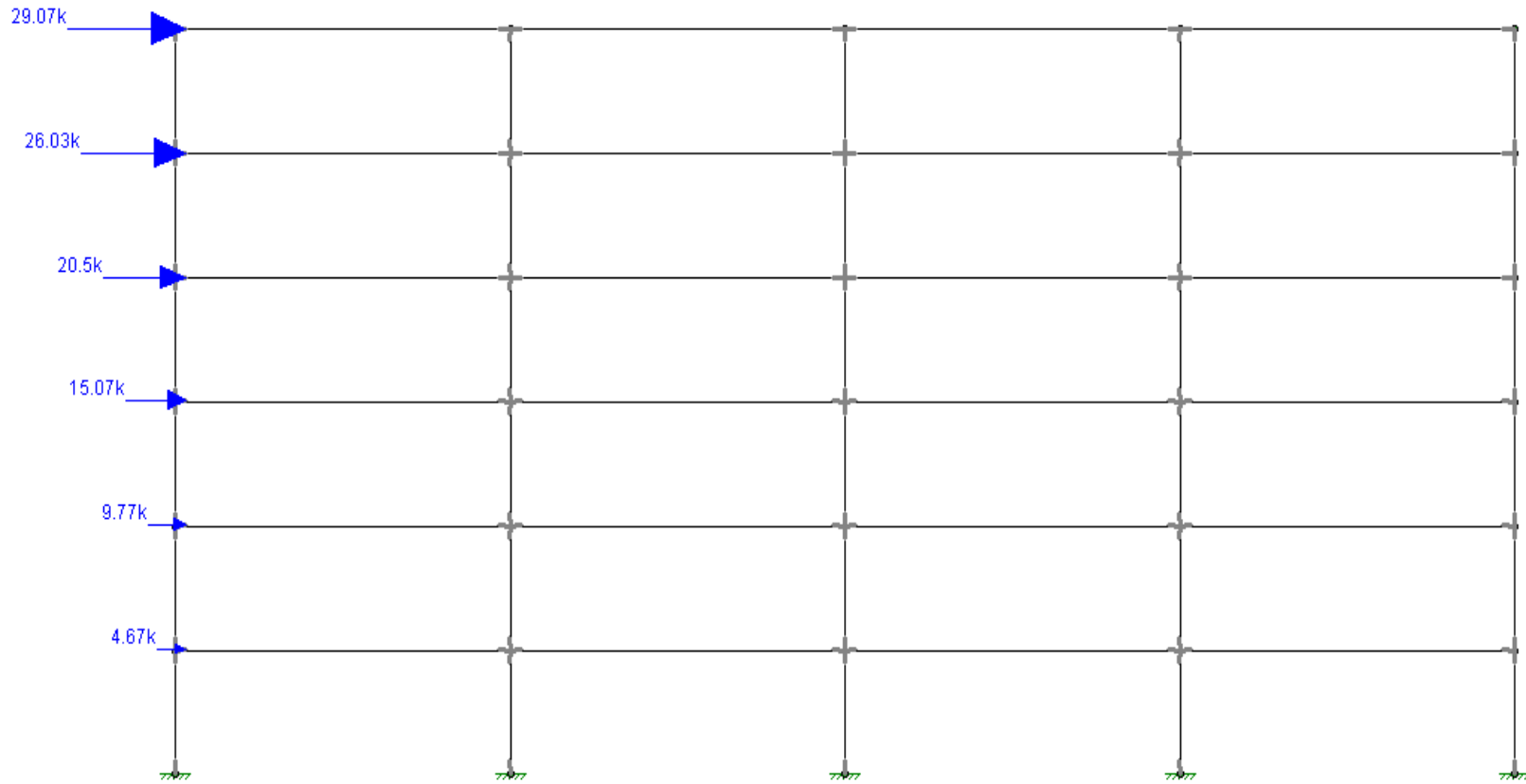

Figure 4.33– Service Level Story Forces for Each Moment Frame Due to Seismic Loading

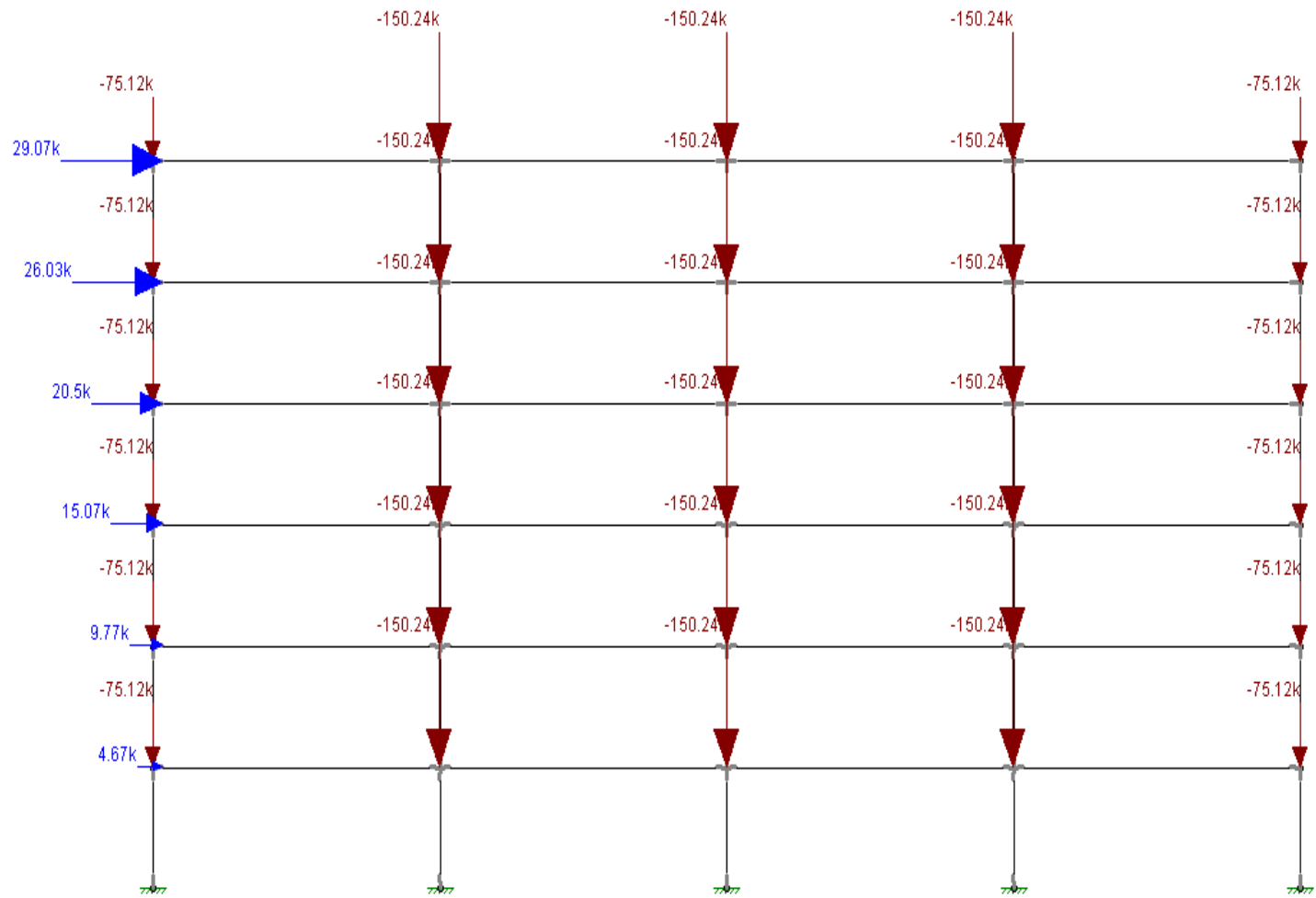

Figure 4.34– Ultimate Factored Loads for Each Moment Frame Due to Seismic Loading

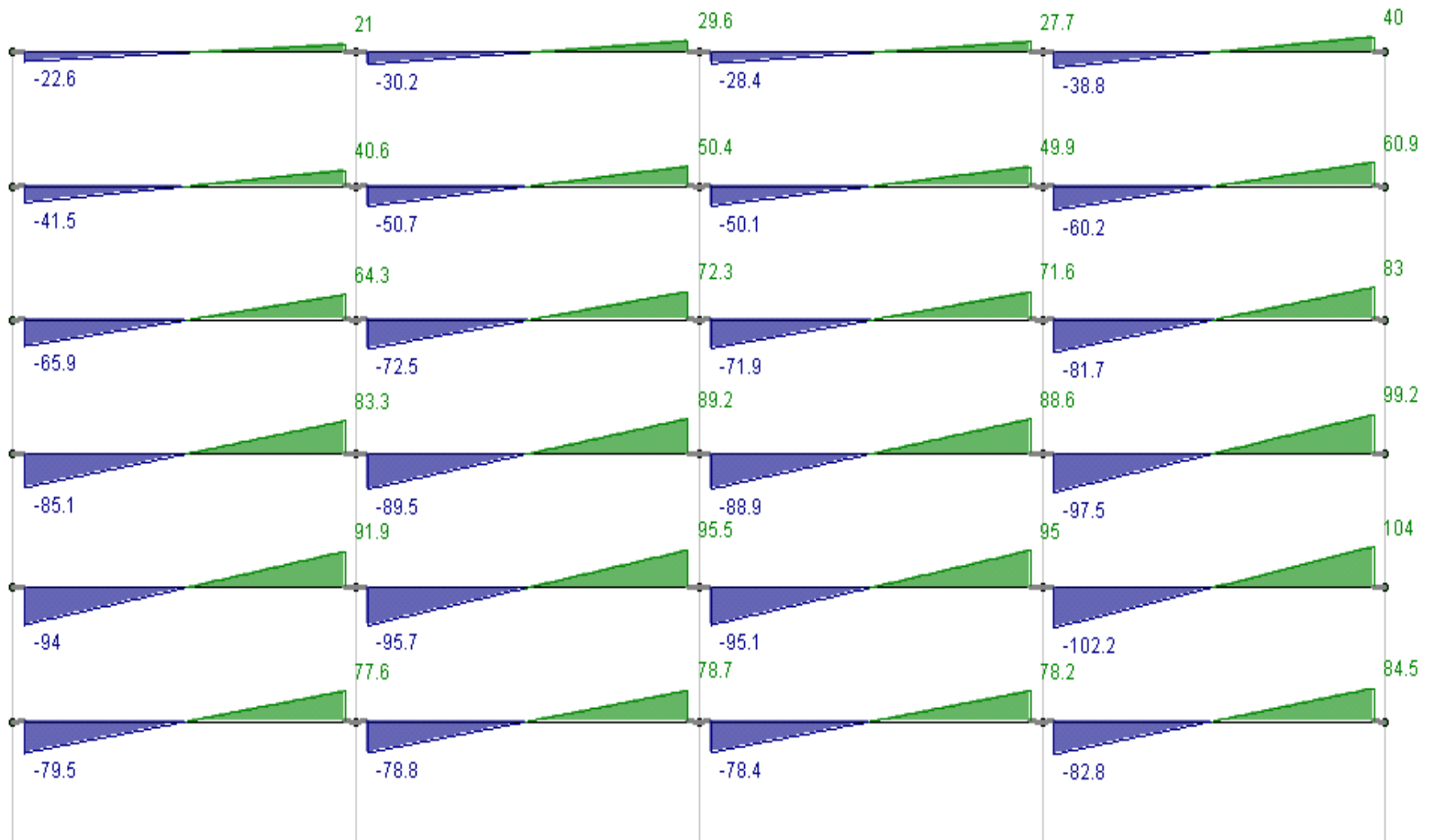

Figure 4.35– Ultimate Factored Moment Diagrams for Beams

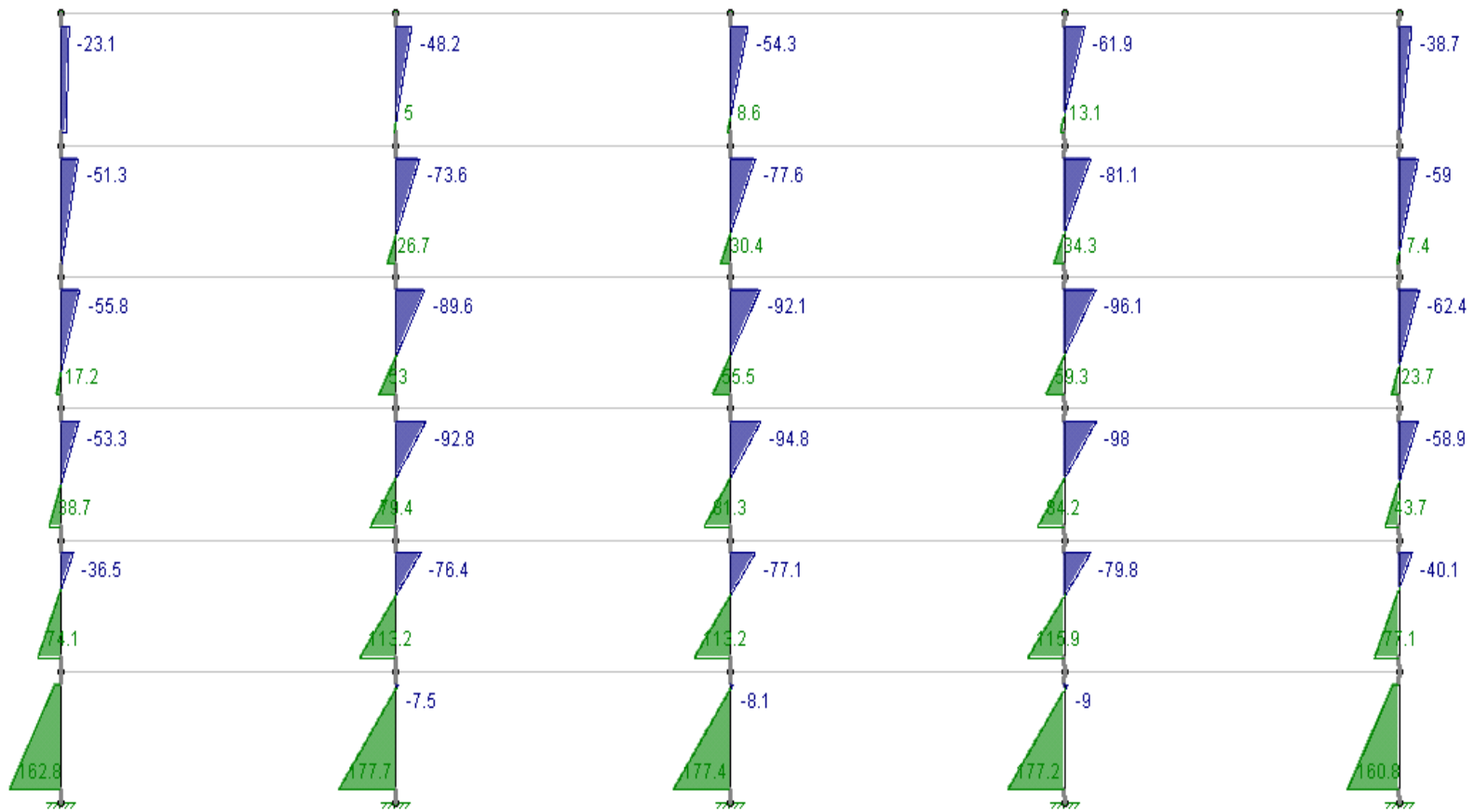

Figure 4.36– Ultimate Factored Moment Diagrams for Columns

4.4 – Deflections

Deflection limits for the design also need to be satisfied. There are two deflections limits that are checked in the design. The first is beam deflections due to live load and the second is the inter-story drift from lateral loads.

ACI 318 (2008) sets limits for live load deflections of floors not supporting or attached to nonstructural elements likely to be damaged by large deflections at $L/360$. Figure 4.35 shows the expected deflections at release of prestressing strand based on the PCI Design handbook (2004). Deflections due to loads during construction are shown in Figure 4.36. Deflections of the fully composite section due to SIDL and live loads are shown in Figure 4.37 and the final total deflection experienced by the beam is shown in Figure 4.38. All deflection values shown are for an interior span.

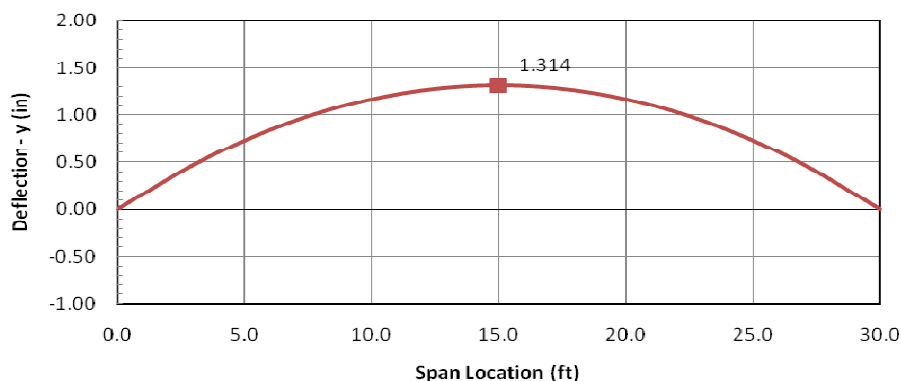

Figure 4.37– Deflections at Release

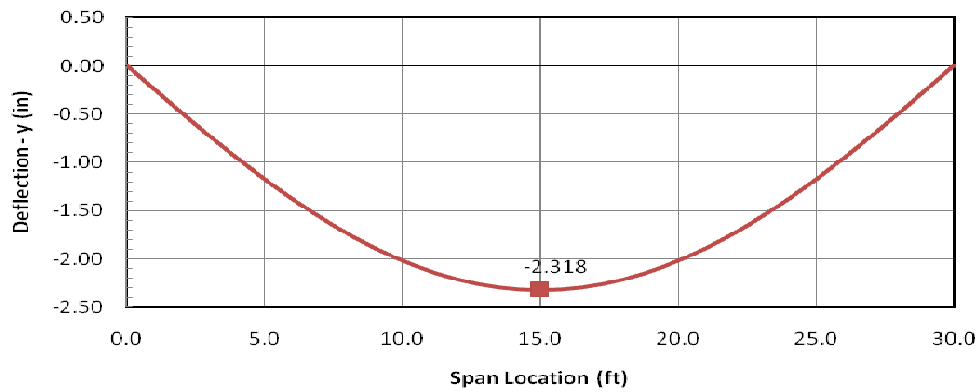

Figure 4.38 – Deflections During Construction

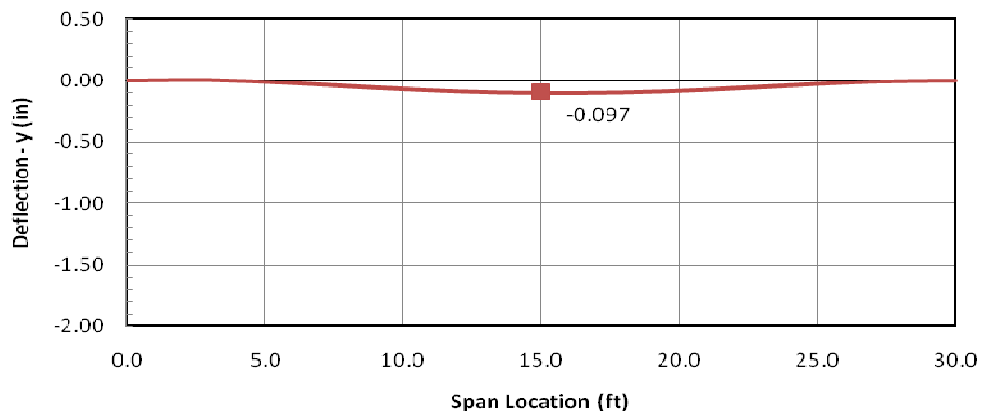

Figure 4.39 – Deflections for Service Loads

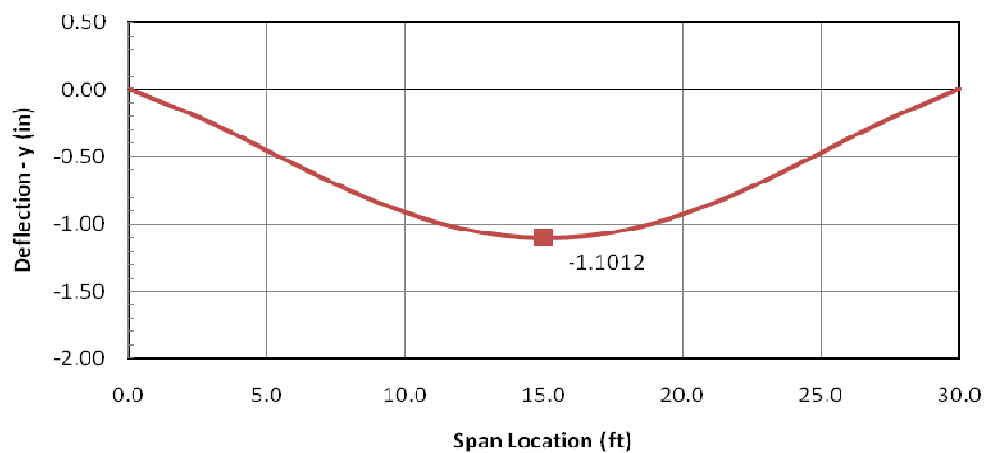

Figure 4.40 – Total Deflections

A detailed breakdown of the deflections caused by each load can be found in the Appendix along with the deflection equation used to determine the deflection at each portion of the beam. The total deflection value is obtained by adding the previous three stages together. The primary value of concern is the live load deflections. These must not exceed 1". With live load deflections of only 0.1", the limit is easily satisfied.

Limits on inter-story drift are prescribed by the ASCE 7 (2005). The table in Chapter 12 calls for the inter-story drift to be limited to $0.020h_{sx}$ based on an occupancy category of II. h_{sx} is the story height below level 'x'. This calls for a limit of 2.4" between stories. Deflections for inter-story drift are taken from the RISA model constructed for the lateral analysis, and the results are shown in Table 4.7. This shows that the inter-story drift is acceptable.

Level	Displacement (in)	Relative Displacement (in)
0	0	0
1	0.079	0.079
2	0.231	0.152
3	0.39	0.159
4	0.527	0.137
5	0.632	0.105
6	0.698	0.066

4.5 – Connection Design

This section details the calculations for ensuring adequate strength of connecting materials for the system. The connections designed in this section are the torsion restraints and the moment connection at the column support.

4.5.1 – Moment Embed Connection Design

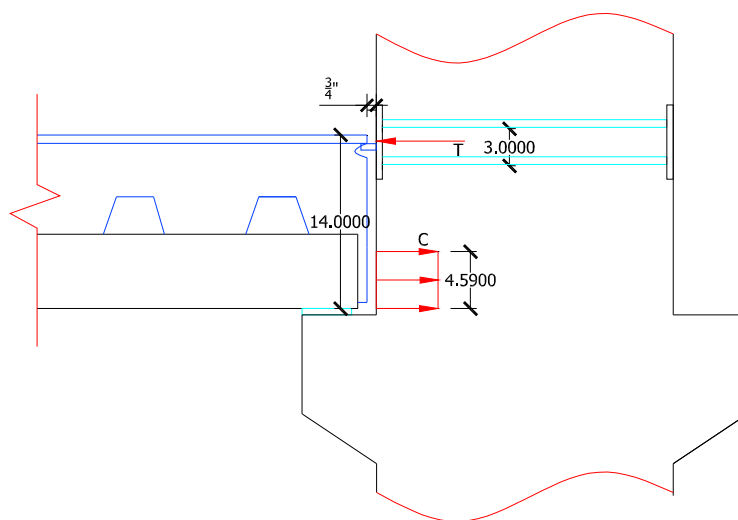

Design Loads

Negative Moment at Column; $M_u = 271 \text{ kip_ft}$;

Given;
 $a = 4.59 \text{ in}$; $d = 14 \text{ in}$;

$$T_u = M_u / (d - a/2) = \mathbf{277.83 \text{ kip}}$$

Weld Design

Given:

$$\phi = 0.75;; \quad F_{\text{exx}} = 80 \text{ ksi};$$

$$\phi T_n = f \times 0.6 \times F_{\text{exx}} \times t_w \times l_w;$$

$$\phi T_n = 297.95 \text{ kips};$$

$$t_w = 0.75 \text{ in}; \quad l_w = 11.035 \text{ in};$$

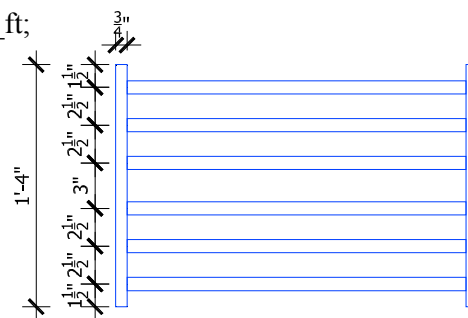

*see Figure 4.23 for weld

Embed Plate design

Given:

$$\phi = 0.9; \quad n = 12; \quad A_s = n \times 0.6 \text{ in}^2 = \mathbf{7.2 \text{ in}^2}; \quad t_{pl} = 0.75 \text{ in}; \quad b_{pl} = 16 \text{ in};$$

$$f_y = 60 \text{ ksi}; \quad z_{pl} = b_{pl} \times t_{pl}^2 / 4 = \mathbf{2.25 \text{ in}^3}; \quad s = 3 \text{ in};$$

Rebar Tension Capacity;

$$\phi T_n = \phi \times A_s \times f_y = \mathbf{388.8 \text{ kip}};$$

*use 12 #7 bars

Plate Bending Capacity;

- Assume plate behaves as a fixed-fixed condition between the rebar

$$\phi M_n \leq f \times z_{pl} \times f_y; \quad \phi T_n \leq T_u \times s / 8;$$

Therefore;

$$\phi T_n = 8 \times (f \times z_{pl} \times f_y) / s;$$

$$\phi T_n = 324 \text{ kips};$$

*use a 3/4" thick embed plate

4.5.2 – Torsion Connection Design

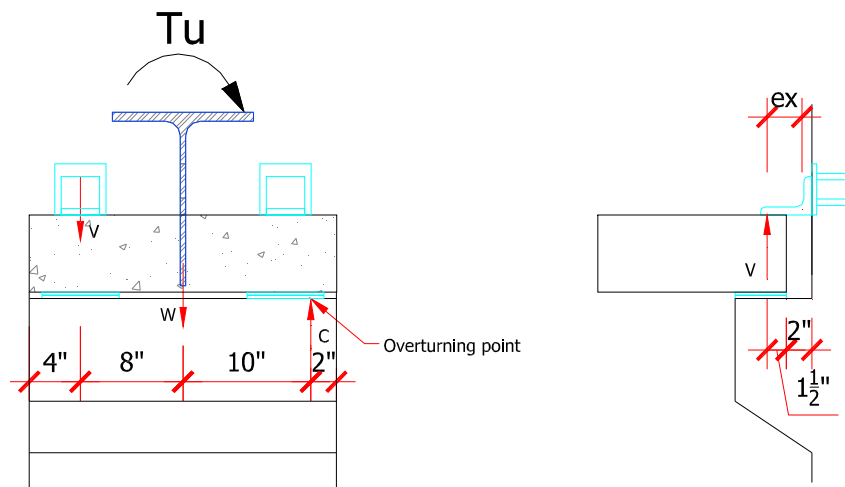

Design Loads

$$T_u = 130 \text{ kip_in}; \quad d = 18 \text{ in}; \quad x = 10 \text{ in}; \quad W_{\text{beam}} = 0.183 \text{ klf} \times 30 \text{ ft} = \mathbf{5.49 \text{ kip}};$$

$$V_u = (T_u - W_{\text{beam}} \times x) / d = \mathbf{4.17 \text{ kip}};$$

Loose angle bending

Given:

$$t_{pl} = 0.75 \text{ in}; \quad b_{pl} = 3 \text{ in}; \quad k_{ang} = 1.1875 \text{ in};$$

$$f_y = 36 \text{ ksi}; \quad z_{pl} = b_{pl} \times t_{pl}^2 / 4 = \mathbf{0.42 \text{ in}^3};$$

- Assume the angle behaves as a fixed cantilever

$$e_x = 3.5 \text{ in} - k_{ang} = \mathbf{2.31 \text{ in}};$$

$$\phi M_n \text{ "="} \phi \times z \times F_y; \text{ "}\geq\text{" } M_u \text{ "="} V \times e_y;$$

Therefore,

$$\phi V_n = (\phi \times z_{pl} \times f_y) / e_x = \mathbf{5.91 \text{ kip}}$$

*use a 3½ x 5 x ¾" x 0'-3" angle

Weld to Loose Angle

In-Plane Vertical Load

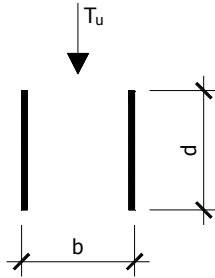

Given:

$$\phi = 0.75; F_{exx} = 70 \text{ ksi};$$

$$b = 3 \text{ in}; \quad d = 2 \text{ in};$$

$$a = 0.25 \text{ in};$$

$$t_w = a / \sqrt{2} = \mathbf{0.18 \text{ in}};$$

Weld Capacity:

$$A_w = t_w \times (d) \times 2 = \mathbf{0.71 \text{ in}^2};$$

$$\text{"} \phi f_n = f \times (0.6 \times F_{exx}) \text{"};$$

$$\text{"} f_u = T_u / A_w \text{"};$$

$$\text{"} f \times (0.6 \times F_{exx}) > T_u / A_w \text{"}$$

$$\phi V_n = \phi \times 0.6 \times F_{exx} \times A_w$$

$$\phi V_n = \mathbf{22.27 \text{ kips}};$$

*see Figure 4.24 for weld

Chapter 5 – Cost Estimate and Design Aids

5.1 – Design Aids

The following tables and charts have been developed based on the detailed methodology previously presented in this document. Load tables for four possible standardized T-RECS beams are presented in Figures 5.1 through 5.4. The hollow-core weight and capacities for generating these tables are taken from Concrete Industries, Inc., for 8", 10", and 12" hollow-core planks. These load tables are provided for reference below. In generating the tables, the span length of the hollow-core is constrained to the span length allowing for a maximum load of 100 psf. For example, an 8" hollow-core can achieve a span length of 30' under a service load of 100 psf according to the load table below. The span length of the T-RECS beam is then allowed to vary.

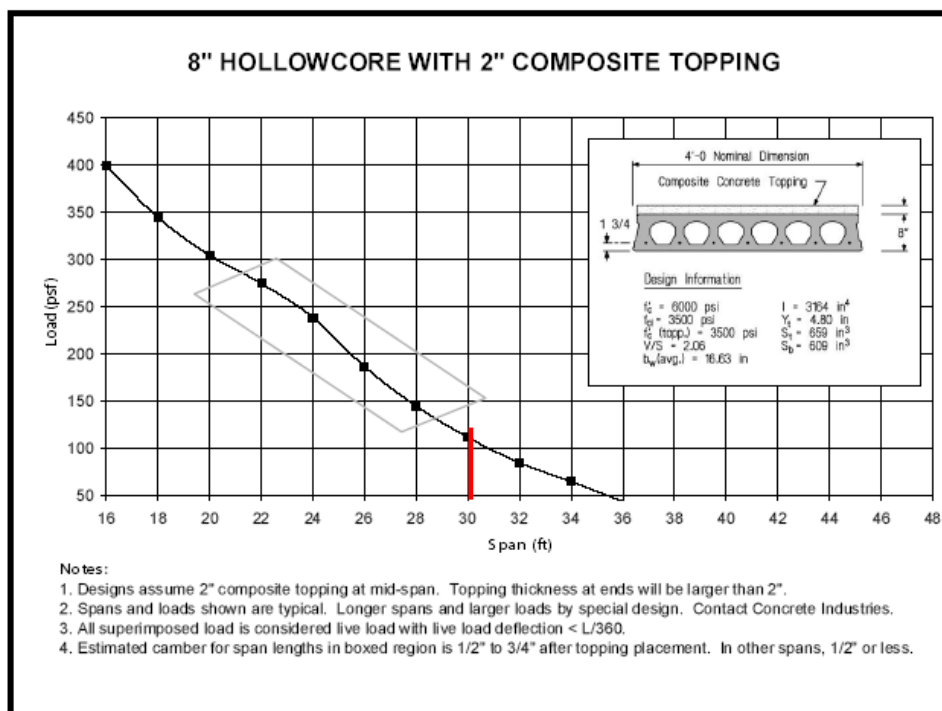

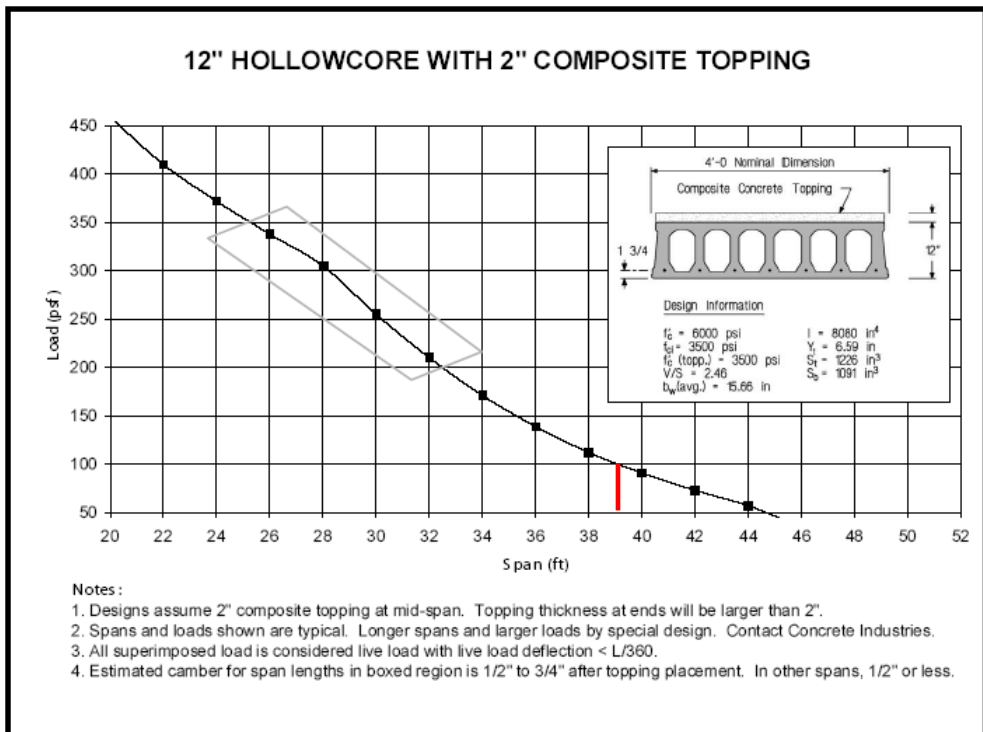
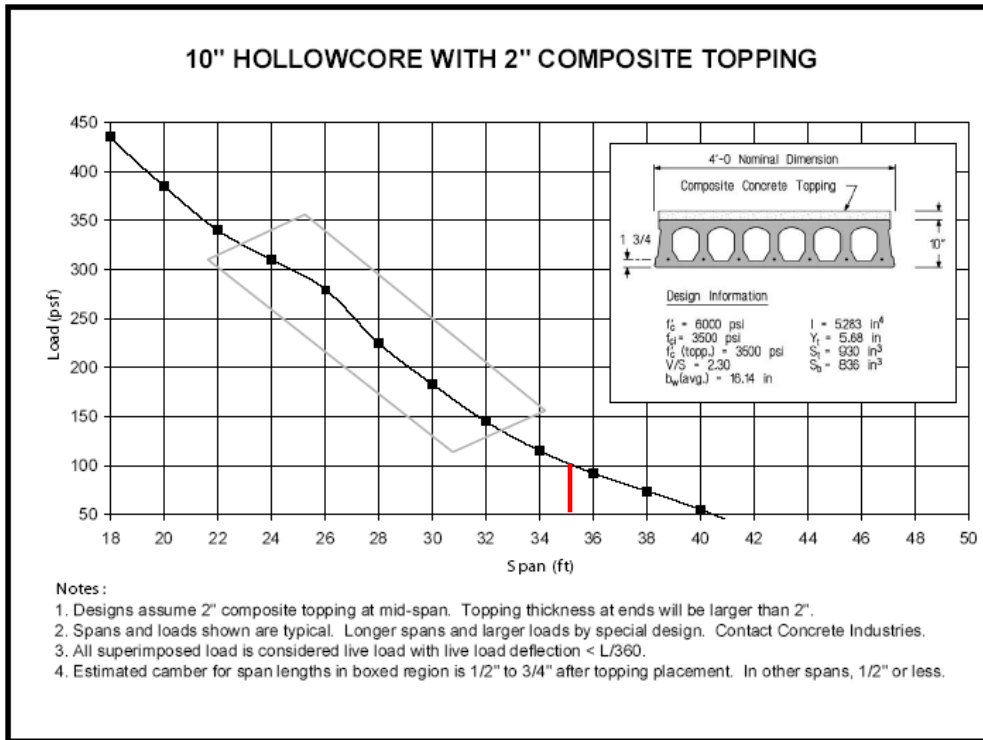

The naming convention proposed incorporates the total depth of the beam, the width of the precast concrete, and the number of strands in the precast. For example, a beam with a height of 14", a width of 24", and 12 – 0.6"Ø strand is named 14TR24-S12. Using this naming convention, the four beams presented in this chapter are: 14TR42-S12, 18TR24-S14, 18TR28-S18, and 20TR32-S22. Composite section properties for each of the proposed standardized beams are presented in Table 5.1. Each of the Figures, 5.1 through 5.4, contain the cross section of the beam and a chart demonstrating the safe allowable superimposed service loads for a given span length in pounds per square foot. The load tables are intended to be approximate loads used for preliminary sizing of the beam. More detailed analysis should be conducted in each case to ensure adequate strength and stress design.

Table 5.1 - T-RECS Section Properties				
	14TR24-S12	18TR24-S14	18TR28-S18	20TR32-S22
A (in ²)	329	424	568	576
I (in ⁴)	9,267	18,571	34,123	30,561
y _t (in)	7.64	9.51	10.47	10.84
y _b (in)	8.36	10.49	12.53	11.16
S _t (in ³)	1,212	1,952	3,259	2,818
S _b (in ³)	1,109	1,771	2,723	2,740
y _{ps} (in)	2.40	2.57	2.67	2.72
wt (plf)	183	251	284	331
A _{ps} (in ²)	2.604	3.038	3.906	4.447

14TR24-S12

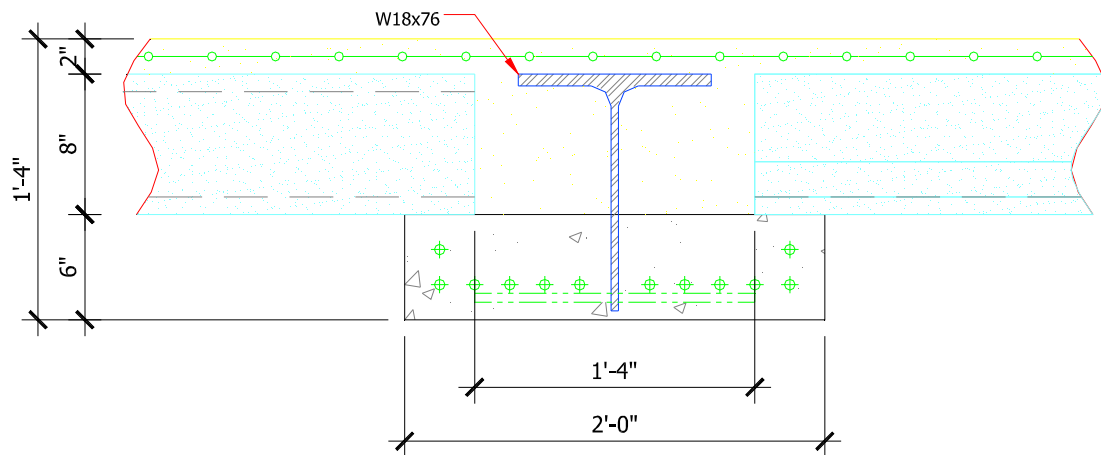

8" HC x 30' span		12 - 0.6" strand				
Span length (ft)	25	26	27	28	29	30
14TR24-S12 load (psf)	100	100	96	76	56	38

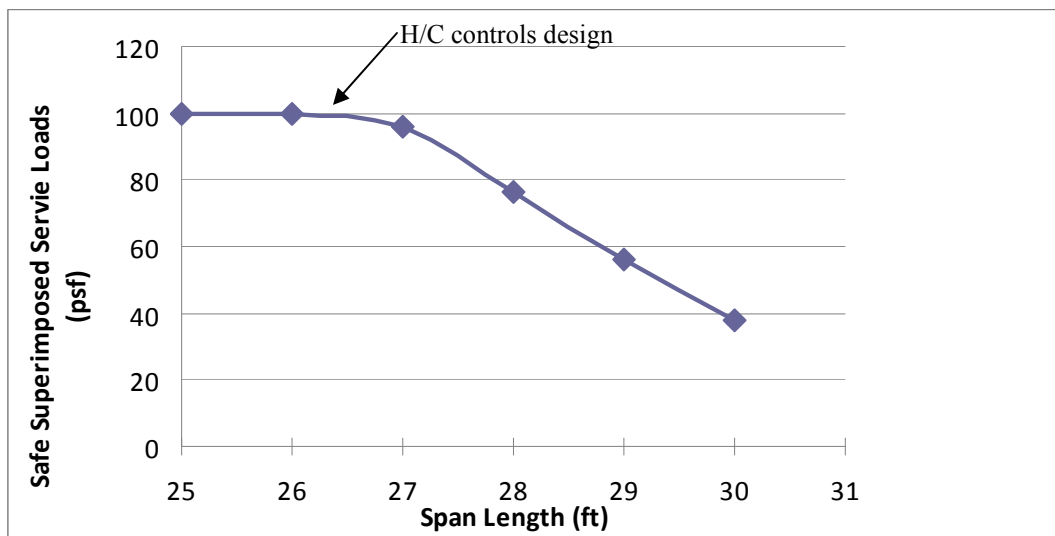
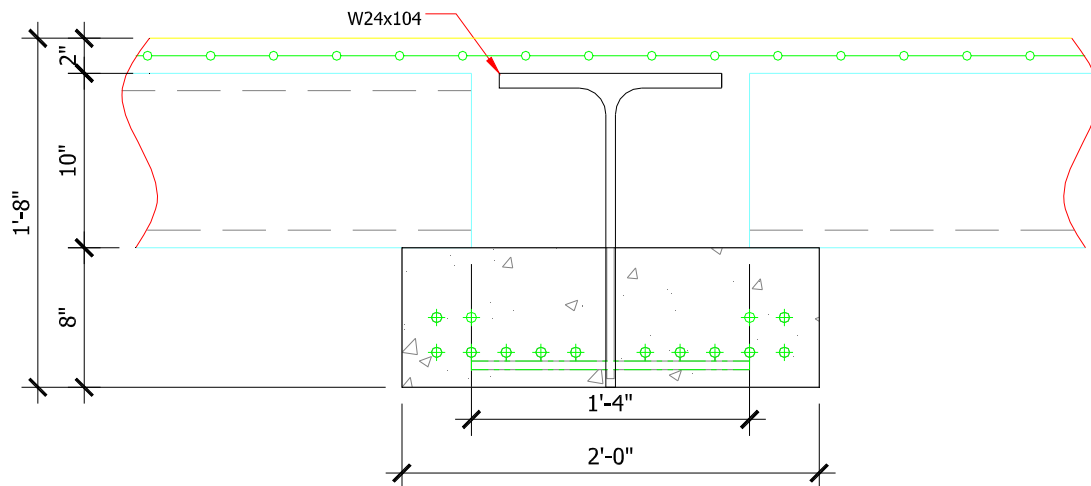

Figure 5.1 – 14TR24-S12 Load Table

18TR24-S14



10" HC x 35' span		14 - 0.6 " strand				
Span length (ft)	29	30	31	32	33	34
18TR24-S14 load (psf)	100	100	82	62	44	28

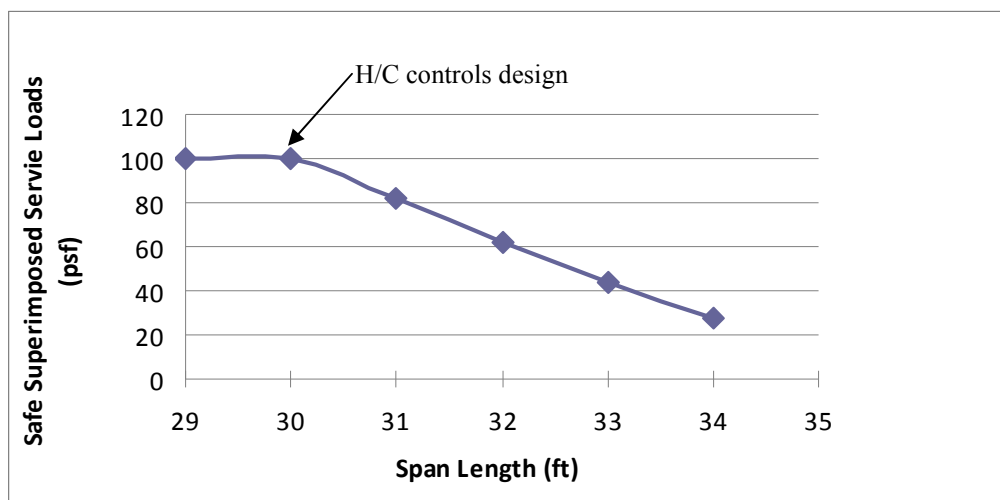
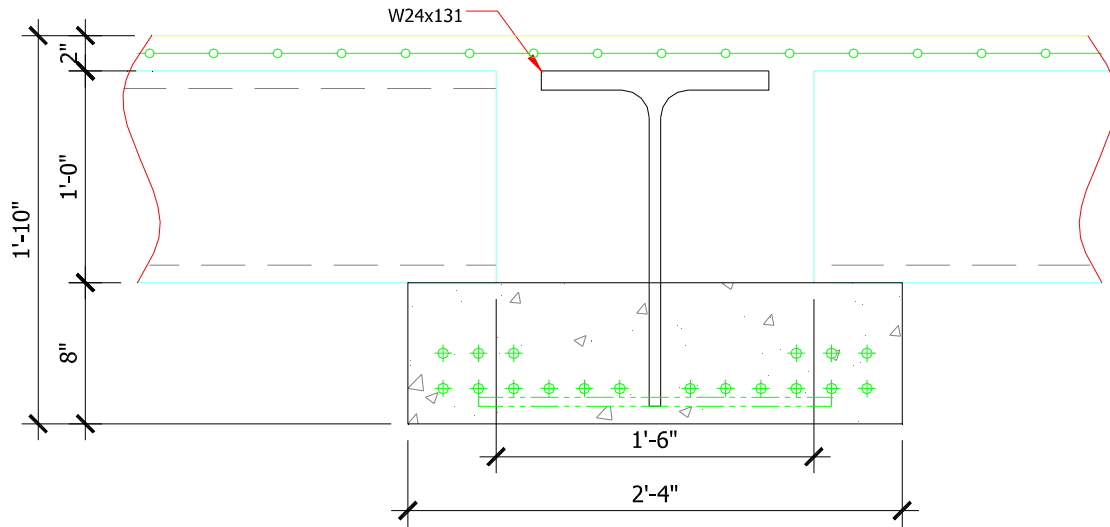

Figure 5.2 – 18TR24-S14 Load Table

18TR28-S18



12" HC x 39' span		18 - 0.6 " strand				
Span length (ft)		32	33	34	35	36
18TR28-S18 load (psf)		100	100	91	66	44

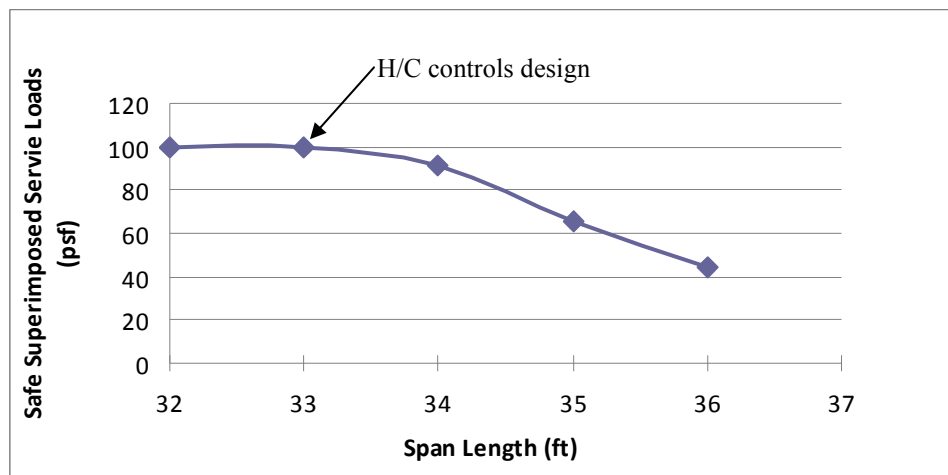
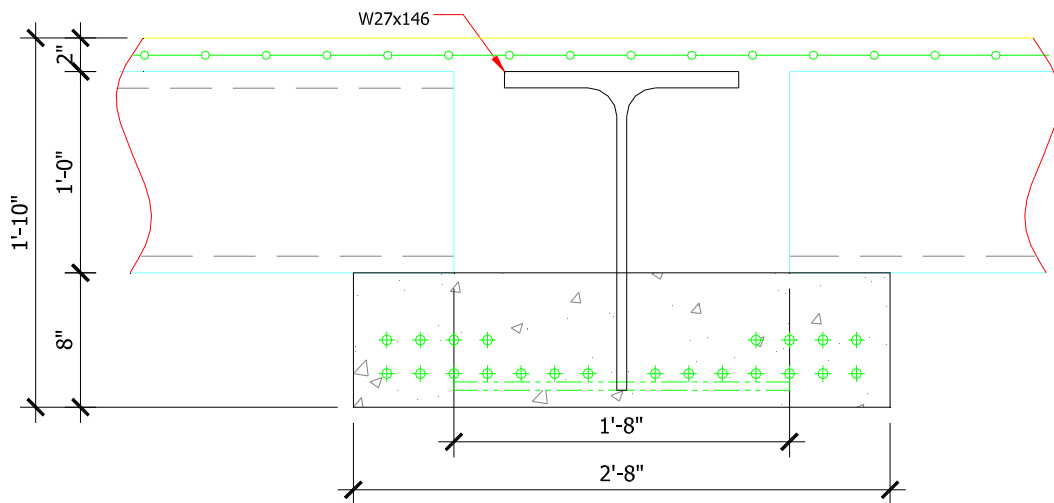

Figure 5.3 – 18TR28-S18 Load Table

20TR32-S22



12" HC x 39' span	22 - 0.6 " strand					
Span length (ft)	34	36	37	38	39	40
20TR32-S22 load (psf)	100	100	94	73	53	35

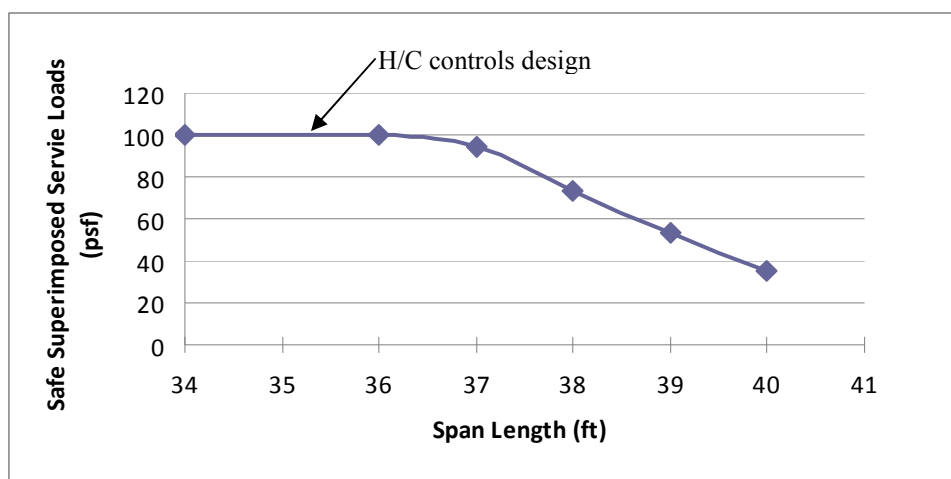

Figure 5.4 – 20TR32-S22 Load Table

5.2 – Cost Estimate

A cost estimate is presented in this section to provide an approximation of how the T-RECS beam's cost compares to that of a steel-framed building. It is not the intent of this estimate to provide an exhaustive detailed cost breakdown of all components required for the construction of a building including labor, transportation, and time cost-savings. Rather, the intent is to establish that the proposed system is not significantly more expensive and therefore commercially unviable when compared to a structural steel system. The estimate will focus on the raw material costs to establish this approximation. Material costs are taken from the RSMeans Building Construction Cost Data (2012). The structure for the comparison uses WF beams for all structural framing elements and the floor system is an 8" hollow-core plank system. All loads and span distances are similar to those described in section 4.1. Tables 5.2 and 5.3 provide a breakdown of this cost estimate. Results from this analysis show an estimate material cost of \$24/sq ft for a steel system and around \$18/sq ft for the proposed system. This shows that it is reasonable to expect that the proposed system should not be significantly more expensive and therefore can be a commercially viable option for designers in the future.

Table 5.2 – Cost Analysis of Comparable Steel System					
Structural Steel System					
Description	units	Material	Qty	Total	Comments
30' Interior Beams					
W18 x 106	lf	146	360	\$ 52,560	
Floor System					
8" Hollow-core	s.f.	7.15	900	\$ 6,435	30'x30' bays
2" Topping	c.y	103	5.56	\$ 573	30'x30' bays
Topping reinf.	lb	0.49	194	\$ 95	10' long @ 1' O.C.; 0.668 #/ft
Material cost per sq. ft. of floor		\$ 7.89	14400	\$ 113,642	
Columns					
W12 x 79	lf	109	1200	\$ 130,800	
Perimeter Beams					
W12 x 72	lf	99	480	\$ 47,520	
Structure Cost					
Material cost per floor				\$ 344,522	
Material cost per sq foot				\$ 24	

Table 5.3 – Cost Analysis of Proposed System					
T-RECS Structural System					
Description	units	Mat. Cost	Qty	Total	Comments
30' T-RECS Beam					
Precut W18x76	lf	89.25	30	\$ 2,678	1/2 of W18x76 + 75% increase for cutting
#4 Stirrups	lb	0.49	64	\$ 31	3 lf per stirrup @ 2 stirrups per foot; 0.668 #/ft
0.6" dia strand	lb	0.49	266.4	\$ 131	12 - 0.6" strand @ 0.74 #/ft
Concrete 8ksi NW	c.y.	202	1.07	\$ 216	1 ft ³ per ft
high early strength	%	10%		\$ 22	concrete additive; 10% concrete increase
Total cost per lf of beam		\$ 106.11	360	\$ 38,199	total qty per floor
Floor System for 30'x30' bays					
8" Hollow-core	s.f.	7.15	900	\$ 6,435	30'x30' bays
2" Topping 4 ksi	c.y.	103	5.56	\$ 573	30'x30' bays
#5 Continuity reinf.	lb	0.49	302	\$ 148	10' long @ 1' O.C.; 1.043 #/ft
Topping reinf.	lb	0.49	194	\$ 95	10' long @ 1' O.C.; 0.668 #/ft
Material cost per sq. ft. of floor		\$ 8.06	14400	\$ 116,013	total qty per floor
35' Columns					
Concrete 6 ksi NW	c.y.	124	5.19	\$ 644	24"x24"
#8 rebar	lb	0.49	748	\$ 367	35' long @ 8 per column; 2.67 #/ft
#5 Strriups	lb	0.49	219	\$ 107	6 lf per stirrup @ 1 stirrup per ft; 1.043 #/ft
Corbels	ea	50	6	\$ 300	
Material Cost per lf of column		\$ 40.50	1200	\$ 48,596	total qty per floor
30' Precast L-Beam					
12"x36"	ea	\$ 3,300	1	\$ 3,300	
Material Cost per lf of beam		\$ 110	480	\$ 52,800	total qty per floor
Structure Cost					
Material cost per floor				\$ 255,608	
Material cost per sq foot				\$ 18	

Chapter 6 – Conclusions

This research has proposed, developed, and designed a complete structural system for residential and commercial buildings. This system achieves significant improvements over typical structural systems such as steel, precast concrete, and CIP concrete. It is able to blend together, in an economical manner, nearly all of the advantages of each individual system into one composite steel and prestressed concrete system. These advantages are:

- All exposed surfaces are concrete. This gives the system superior fire performance characteristics over steel.
- The proposed system uses all precast structural members, which allows for greater quality and erection speed over CIP methods.
- The lateral load resisting system consists of moment frames, thereby eliminating the need for shear walls in the direction of the frame. This is an advantage over standard precast concrete systems.
- The proposed system is able to achieve span-to-depth ratios of over 24, which is an improvement over standard precast concrete systems.
- The proposed system does not require the CIP topping for construction loads. This gives the system incredible flexibility in its construction and greatly reduces floor-to-floor construction durations.

- The proposed system requires minimal formwork and no shoring or temporary bracing during construction. These are significant advantages over CIP concrete and other composite structural systems available to designers today.
- The proposed system is able to reduce the amount of steel used in the structural beams by nearly 30%, which results in significant cost savings.
- The proposed system achieves significant reductions in beam weights when compared to precast concrete.
- The proposed system is able to effectively resist the typical loads experienced by a six-story commercial building.

	Precast	Proposed	Achieved	
Span-to-depth ratio (\$)	15	> 20	24	✓
Fire Resistance (\$)	Good	Maintain	Maintained	✓
Construction Speed (\$)	Good	Maintain	Maintained	✓
Production Quality	Good	Maintain	Maintained	✓
Shoring (\$)	No	Maintain	Maintained	✓
Material Price (\$)	Low	Maintain	Possible increase	--
Weight	Heavy	Reduce	Approx 50% or greater reduction	✓
Floor Plan	Restricted	Improve	Moment frames allow for greater flexibility	✓

Bibliography

- American Concrete Institute. (2008). Building code requirements for structural concrete (ACI 318-08) and commentary. Farmington Hills, MI: American Concrete Institute.
- American Society of Civil Engineers. (2006). Minimum design loads for buildings and other structures. Reston, VA: American Society of Civil Engineers.
- Girder-Slab Technologies. (2008). Composite steel and precast system: Design guide v1.4. Retrieved from <http://www.girder-slab.com/downloads/GSDGv1.4.pdf>
- Hanlon, J. W. (2008). *U.S. Patent No. 4,903,448*. Washington, DC: U.S. Patent and Trademark Office.
- Henin, E., Morcoux, G., & Tadros, M. (2011). *Flat soffit shallow precast floor system* (Technical Report). Retrieved from University of Nebraska-Lincoln.
- Kim, J. H., Cho, Y. S., Jeong, E. H., & Lee, K. H. (2011). *U.S. Patent Application No. 20110265422*. Washington, DC: U.S. Patent and Trademark Office.
- Martin, L. D., & Perry, C. J. (Eds.). (2004). PCI design handbook: Precast and prestressed concrete (6th ed.). Chicago, IL: Precast/Prestressed Concrete Institute.
- Metal Dek Group & Diversakore. (2010). Versa-floor PG. Retrieved from <http://www.diversakore.com/documents/VFPG-VDC35LS-v052110DRAFT3.pdf>
- Peikko Group. (2007). Deltabeam composite beam. Retrieved from <http://materials.crasman.fi/materials/extloader/?fid=3962&org=2&chk=1b9c49ab>
- Tadros, M., & Morcoux, G. (2011). *Shallow hollow-core floor system* (Design Procedure Document). Retrieved from University of Nebraska-Lincoln.
- Tadros, M., & Morcoux, G. (2011). *Shallow hollow-core floor system* (Final Report). Retrieved from University of Nebraska-Lincoln.
- Waier, P. R. (Ed.). (2011). RSMMeans building construction cost data (70th ed.). Norwell, MA: Reed Construction Data.

Appendix

A – Section Properties

Modulus of Elasticity

E_s	29000	ksi
E_{ci}	4645.4	ksi
E_c	5153.6	ksi
E_{cip}	3644.1	ksi

At Release

h'	6	in
b	24	in
T_f	0.68	in
b_f	11.035	in
f_y	50	ksi
f_{ci}	6.5	ksi
h_i	14	in
n_{si}	6.2	

Trans. Dim.

68.89 in

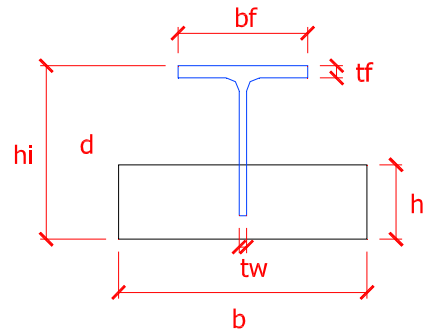

	Area	\hat{y}	$A\hat{y}$	I'	Ad^2	$I'+Ad^2$
Flange	46.84	13.66	639.9	1.8	3030.7	3032.5
Precast	144.00	3.00	432.0	432.0	985.9	1417.9
Σ	190.84	5.62			$I_{tr} =$	4450.4

At Construction

h'	6	in
b	20	in
T_f	0.68	in
b_f	11.035	in
f_y	50	ksi
f_c	8	ksi
h_i	14	in
n_s	5.6	

62.10 in

	Area	\hat{y}	$A\hat{y}$	I'	Ad^2	$I'+Ad^2$
Flange	42.22	13.66	576.8	1.6	2731.8	2733.4
Precast	120.00	3.00	360.0	360.0	821.6	1181.6
Σ	162.22	5.77			$I_{tr} =$	3915.0

At Service

h'	6	in
b	24	in
T_f	0.68	in
b_f	11.035	in
h	16	in
a	8	in
b_t	16	in
t_{ef}	2	in
b_e	48	in
f_y	50	ksi
f_c	8	ksi
f_{et}	4	ksi
n_s	5.6	
n_{cip}	0.71	

Trans. Dim.

51.06 in (n-1)

11.31 in

33.94 in

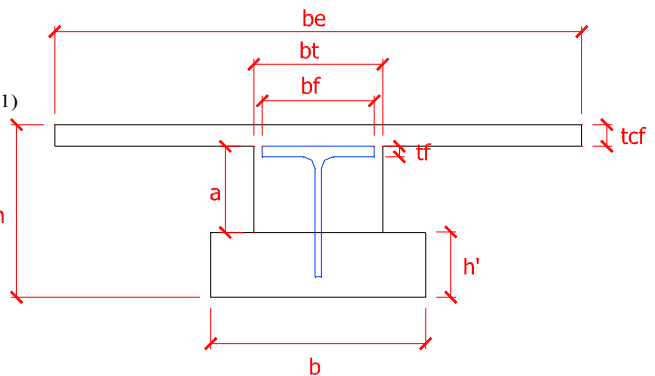

	Area	\hat{y}	$A\hat{y}$	I'	Ad^2	$I'+Ad^2$
Flange	34.72	13.66	474.3	1.3	976.7	978.1
Precast	144.00	3.00	432.0	432.0	4131.2	4563.2
CIP Top.	67.88	15.00	1018.2	22.6	2996.4	3019.0
CIP Web	82.82	10.00	828.2	482.7	223.8	706.5
Σ	329.42	8.36			$I_{tr} =$	9266.7

B – Pre-Composite Shear Design

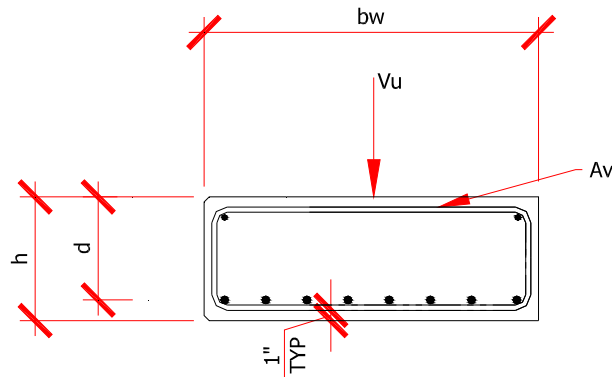

Note: Uses simplified PCI method which assumes $f_{se} > 40\% f_{pu}$

CONCRETE SHEAR STRENGTH

Beam Geometry

*Width of stem	$b_w = 24$ in
*Beam height	$h = 6$ in
*Depth to prestressing reinforcement	$d = 4.8$ in ($\geq 0.8h$)

Material properties

*Compressive strength of concrete	$f'_c = 8$ ksi
*Yield strength of reinforcement	$f_y = 60$ ksi
*Concrete density modifier	$\lambda = 1.0$
*Strand transfer length	$l_t = 26$ in
*Area of prestressing strand	$A_{ps} = 2.604$ in ²
Ultimate tensile strength of strand	$f_{pu} = 270$ ksi

Design load data

*Factored vertical load at critical section	$V_u = 41.3$ kips
*Factored moment at critical section	$M_u = 116$ kip_in
*Section under investigation	$x = 10$ in
(critical section typically located at $h/2 = 3$ in unless not loaded on a ledge – refer ACI 318-08 §11.1.3)	
*Strength reduction factor	$\phi = 0.75$

Shear Strengths

Nominal shear strength	$V_c = (0.6 \times \lambda \times \sqrt{f'_c \times 1 \text{ lbs/in}^2}) + (700 \text{ lbs/in}^2 \times$
$\min(1, V_u \times d / M_u) \times b_w \times d = 86.82$ kip	
Maximum shear strength limit	$V_{cw \text{ max}} = 5 \times \lambda \times \sqrt{f'_c \times 1 \text{ lbs/in}^2} \times b_w \times d = 51.52$ kip
Minimum shear strength limit	$V_{cw \text{ min}} = 2 \times \lambda \times \sqrt{f'_c \times 1 \text{ lbs/in}^2} \times b_w \times d = 20.61$ kip
Support shear strength	$V_{cw \text{ sup}} = 3.5 \times \lambda \times \sqrt{f'_c \times 1 \text{ lbs/in}^2} \times b_w \times d = 36.06$ kip

Transition zone strength at 'x'
kip

$$V_{cx} = V_{cw\ sup} + (V_{cw\ max} - V_{cw\ sup}) \times \min(x, l_t) / l_t = \mathbf{42.01}$$

Controlling value

Nominal shear strength
Ultimate shear strength

$$V_{nx} = \mathbf{42.01\ kip}$$

$$\phi V_c = \phi \times V_{nx} = \mathbf{31.51\ kip}$$

Fail - Concrete shear strength $\phi V_c/2 < V_u$ - Provide shear reinforcing detailed below

User note: (if $\phi V_c/2 > V_u$ – stop here, do not continue to shear reinforcement design)

SHEAR REINFORCEMENT DESIGN

Nominal steel shear strength required
Maximum allowable steel shear strength
 $b_w \times d = \mathbf{82.43\ kip}$

$$V_s = (V_u - \phi V_c) / \phi = \mathbf{13.06\ kip}$$

$$V_{smax} = 8 \times \lambda \times \sqrt{f'_c} \times 1\ \text{lbs/in}^2 \times$$

OK- $V_s < V_{smax}$ - Section is Adequate

Stirrup Spacing

Stirrup center to center spacing
Reduced stirrup spacing (if applicable)
*Spacing Provided

$$s = \min(0.75 \times h, 24\ \text{in}) = \mathbf{4.5\ in}$$

$$s_{max} = \mathbf{4.5\ in}$$

$$s_{prov} = 4\ \text{in}$$

Pass - Spacing is adequate

Shear reinforcement check

Area of steel required
Minimum area of steel required
 $/(80 \times f_y \times d) \times (\sqrt{d/b_w}) = \mathbf{0.05\ in}^2$
Controlling area of steel

$$A_{vreq} = V_s \times s_{prov} / (f_y \times d) = \mathbf{0.18\ in}^2$$

$$A_{vmin} = A_{ps} \times f_{pu} \times s_{prov}$$

$$A_v = \max(A_{vreq}, A_{vmin}) = \mathbf{0.18\ in}^2$$

*Shear reinforcement (user input)

Diameter of stirrup bars
Area of horizontal reinforcement provided
Steel shear strength

$$D_{stir} = 0.5\ \text{in}$$

$$A_{v_prov} = 2 \times \pi \times D_{stir}^2 / 4 = \mathbf{0.393\ in}^2$$

$$\phi V_s = \phi \times A_{v_prov} \times f_y \times d / s_{prov} = \mathbf{21.21\ kip}$$

Pass - Shear reinforcing is adequate

Design strength

$$\phi V_n = \phi V_c + \phi V_s = \mathbf{52.71\ kip}$$

Design Summary

- ~Member has a cross section of 24.0" wide by 6.0" deep with 8000 psi concrete
- ~Location of section under investigation is at 0.83 ft from support
- ~Required reinforcement at section under investigation consists of 0.50 in dia vertical stirrups spaced at 4 in O.C.

C – WF Beam Analysis during CIP Topping Pour

Steel beam analysis & design (AISC360-05)

In accordance with AISC360 13th Edition published 2005 using the LRFD method

Tedds calculation version 3.0.03

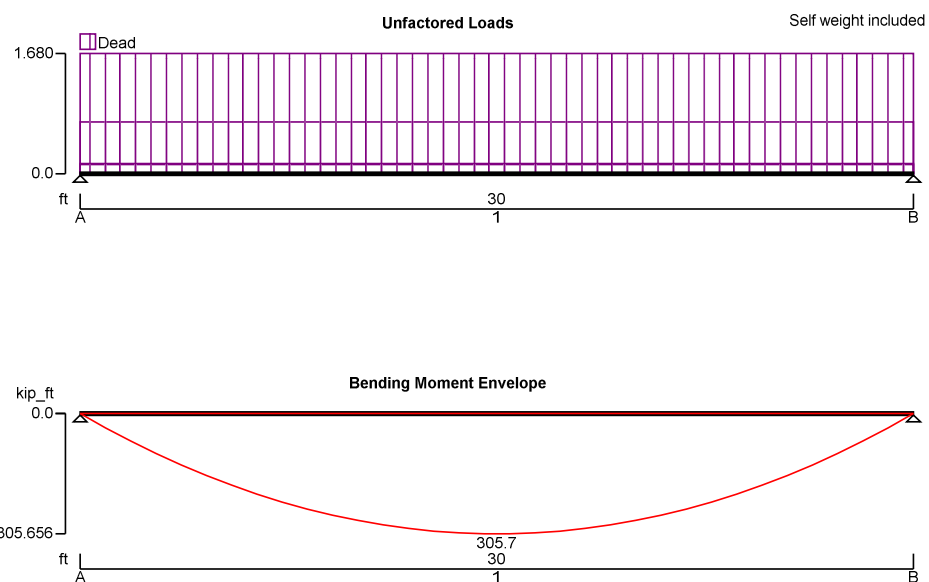

Support conditions

Support A	Vertically restrained Rotationally free
Support B	Vertically restrained Rotationally free

Applied loading

Beam loads	CIP Beam - Dead full UDL 0.129 kips/ft CIP Top - Dead full UDL 0.725 kips/ft H/C - Dead full UDL 1.68 kips/ft Precast - Dead full UDL 0.145 kips/ft Dead self weight of beam \times 0.5
------------	---

Load combinations

Load combination 1	Support A	Dead \times 1.00
	Span 1	Dead \times 1.00

	Support B	Dead × 1.00
Analysis results		
Maximum moment; kips_ft	$M_{\max} = 305.7$ kips_ft;	$M_{\min} = 0$
Maximum reaction at support A; kips	$R_{A_{\max}} = 40.8$ kips;	$R_{A_{\min}} = 40.8$
Unfactored dead load reaction at support A;	$R_{A_{\text{Dead}}} = 40.8$ kips	
Maximum reaction at support B; kips	$R_{B_{\max}} = 40.8$ kips;	$R_{B_{\min}} = 40.8$
Unfactored dead load reaction at support B;	$R_{B_{\text{Dead}}} = 40.8$ kips	
Section details		
Section type;	W 18x76 (AISC 13th Edn 2005)	
ASTM steel designation;	A992	
Steel yield stress;	$F_y = 50$ ksi	
Steel tensile stress;	$F_u = 65$ ksi	
Modulus of elasticity;	$E = 29000$ ksi	

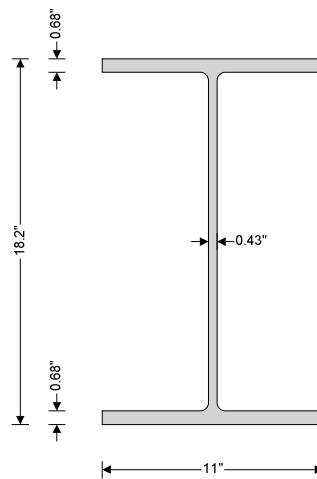
**Resistance factors**

Resistance factor for tensile yielding;	$\phi_{ty} = 0.90$
Resistance factor for compression;	$\phi_c = 0.90$
Resistance factor for flexure;	$\phi_b = 0.90$

Lateral bracing

Span 1 has lateral bracing at supports only

Classification of sections for local bending - Section B4**Classification of flanges in flexure - Table B4.1 (case 1)**

Width to thickness ratio;	$b_f / (2 \times t_f) = 8.09$	
Limiting ratio for compact section;	$\lambda_{pff} = 0.38 \times \sqrt{[E / F_y]} = 9.15$	
Limiting ratio for non-compact section;	$\lambda_{rff} = 1.0 \times \sqrt{[E / F_y]} = 24.08$;	Compact

Classification of web in flexure - Table B4.1 (case 9)

Width to thickness ratio;	$(d - 2 \times k) / t_w = 37.74$
Limiting ratio for compact section;	$\lambda_{pwf} = 3.76 \times \sqrt{[E / F_y]} = 90.55$

Limiting ratio for non-compact section; $\lambda_{rnf} = 5.70 \times \sqrt{[E / F_y]} = \mathbf{137.27}$; Compact
Section is compact in flexure

Design of members for flexure in the major axis - Chapter F

Required flexural strength; $M_r = \max(\text{abs}(M_{s1_max}), \text{abs}(M_{s1_min})) =$
305.656 kips_ft

Yielding - Section F2.1

Nominal flexural strength for yielding - eq F2-1; $M_{nyld} = M_p = F_y \times Z_x = \mathbf{679.167}$ kips_ft

Lateral-torsional buckling - Section F2.2

Unbraced length; $L_b = L_{s1} = \mathbf{360}$ in
 Limiting unbraced length for yielding - eq F2-5; $L_p = 1.76 \times r_y$
 $\times \sqrt{[E / F_y]} = \mathbf{110.629}$ in

Distance between flange centroids; $h_o = d - t_f = \mathbf{17.52}$ in
 $c = \mathbf{1}$
 $r_{ts} = \sqrt{[(I_y \times C_w) / S_x]} = \mathbf{3.022}$ in

Limiting unbraced length for inelastic LTB - eq F2-6

$L_r = 1.95 \times r_{ts} \times E / (0.7 \times F_y) \times \sqrt{[J \times c / (S_x \times h_o)]} \times \sqrt{[1 + \sqrt{(1 + 6.76 \times (0.7 \times F_y \times S_x \times h_o) / (E \times J \times c))}]}$ = **325.144** in

Cross-section mono-symmetry parameter; $R_m = \mathbf{1.000}$
 Moment at quarter point of segment; $M_A = \mathbf{229.242}$ kips_ft
 Moment at center-line of segment; $M_B = \mathbf{305.656}$ kips_ft
 Moment at three quarter point of segment; $M_C = \mathbf{229.242}$ kips_ft
 Maximum moment in segment; $M_{abs} = \mathbf{305.656}$ kips_ft

Lateral torsional buckling modification factor - eq F1-1; $C_b = \min(3, 12.5 \times M_{abs} \times R_m / [2.5 \times M_{abs} + 3$
 $\times M_A + 4 \times M_B + 3 \times M_C]) = \mathbf{1.136}$

Critical flexural stress - eq F2-4; $F_{cr} = C_b \times \pi^2 \times E / (L_b / r_{ts})^2 \times \sqrt{[1 + 0.078 \times J \times c /$
 $(S_x \times h_o) \times (L_b / r_{ts})^2]} = \mathbf{34.189}$ ksi

Nominal flexural strength for lateral torsional buckling - eq F2-2; $M_{ntlb} = F_{cr} \times S_x = \mathbf{415.962}$ kips_ft

Nominal flexural strength; $M_n = \min(M_{nyld}, M_{ntlb}) = \mathbf{415.962}$ kips_ft

Design flexural strength; $M_c = \phi_b \times M_n = \mathbf{374.366}$ kips_ft

PASS - Design flexural strength exceeds required flexural strength

D – Composite Shear Design

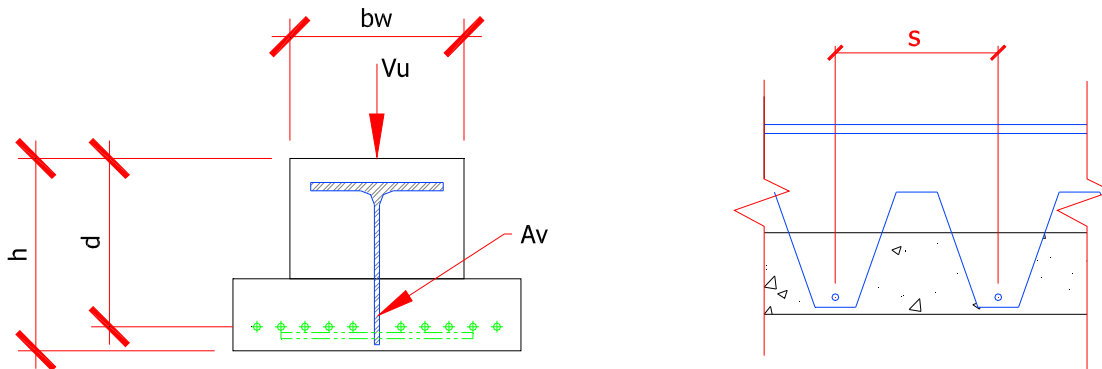

Note: Uses simplified PCI method which assumes $f_{se} > 40\% f_{pu}$

CONCRETE SHEAR STRENGTH

Beam Geometry

*Width of stem	$b_w = 16$ in
*Beam height	$h = 16$ in
*Depth to prestressing reinforcement	$d = 14$ in ($\geq 0.8h$)

Material properties

*Compressive strength of concrete	$f'_c = 4$ ksi
*Yield strength of reinforcement	$f_y = 60$ ksi
*Concrete density modifier	$\lambda = 1.0$
*Strand transfer length	$l_t = 26$ in
*Area of prestressing strand	$A_{ps} = 2.604$ in ²
Ultimate tensile strength of strand	$f_{pu} = 270$ ksi

Design load data

*Factored vertical load at critical section	$V_u = 96$ kips
*Factored moment at critical section	$M_u = 10$ kip_in
*Section under investigation	$x = 10$ in
*Strength reduction factor	$\phi = 0.75$

Shear Strengths

Nominal shear strength	$V_c = (0.6 \times \lambda \times \sqrt{f'_c \times 1 \text{ lbs/in}^2}) + (700 \text{ lbs/in}^2) \times$
$\min(1, V_u \times d / M_u) \times b_w \times d = 165.3$ kip	
Maximum shear strength limit	$V_{cw \text{ max}} = 5 \times \lambda \times \sqrt{f'_c \times 1 \text{ lbs/in}^2} \times b_w \times d = 70.84$ kip
Minimum shear strength limit	$V_{cw \text{ min}} = 2 \times \lambda \times \sqrt{f'_c \times 1 \text{ lbs/in}^2} \times b_w \times d = 28.33$ kip
Support shear strength	$V_{cw \text{ sup}} = 3.5 \times \lambda \times \sqrt{f'_c \times 1 \text{ lbs/in}^2} \times b_w \times d = 49.58$ kip

Transition zone strength at 'x'
kip

$$V_{cx} = V_{cw\ sup} + (V_{cw\ max} - V_{cw\ sup}) \times \min(x, l_t) / l_t = \mathbf{57.76}$$

Controlling value

Nominal shear strength
Ultimate shear strength

$$V_{nx} = \mathbf{57.76\ kip}$$

$$\phi V_c = \phi \times V_{nx} = \mathbf{43.32\ kip}$$

Fail - Concrete shear strength $\phi V_c/2 < V_u$ - Provide shear reinforcing detailed below

User note: (if $\phi V_c/2 > V_u$ – stop here, do not continue to shear reinforcement design)

SHEAR REINFORCEMENT DESIGN

Nominal steel shear strength required
Maximum allowable steel shear strength
 $b_w \times d = \mathbf{113.34\ kip}$

$$V_s = (V_u - \phi V_c) / \phi = \mathbf{70.24\ kip}$$

$$V_{smax} = 8 \times \lambda \times \sqrt{f'_c} \times 1\ \text{lbs/in}^2 \times$$

OK- $V_s < V_{smax}$ - Section is Adequate

Stirrup Spacing

Stirrup center to center spacing
Reduced stirrup spacing (if applicable)
Spacing decreased by 1/2
*Spacing Provided

$$s = \min(0.75 \times h, 24\ \text{in}) = \mathbf{12\ in}$$

$$s_{max} = \mathbf{6\ in} \quad \mathbf{4\lambda \sqrt{f'_c} b_w d < V_s -}$$

$$s_{prov} = 12\ \text{in}$$

Fail - Spacing must be reduced

Shear reinforcement check

Area of steel required
Minimum area of steel required
 $/(80 \times f_y \times d) \times (\sqrt{d/b_w}) = \mathbf{0.12\ in}^2$
Controlling area of steel

$$A_{vreq} = V_s \times s_{prov} / (f_y \times d) = \mathbf{1\ in}^2$$

$$A_{vmin} = A_{ps} \times f_{pu} \times s_{prov}$$

$$A_v = \max(A_{vreq}, A_{vmin}) = \mathbf{1\ in}^2$$

*Shear reinforcement (user input)

Area of horizontal reinforcement provided
Steel shear strength

$$A_{v_prov} = 3\ \text{in} \times 0.425\ \text{in} = \mathbf{1.27\ in}^2$$

$$\phi V_s = \phi \times A_{v_prov} \times f_y \times d / s_{prov} = \mathbf{66.94\ kip}$$

Pass - Shear reinforcing is adequate

Design strength

$$\phi V_n = \phi V_c + \phi V_s = \mathbf{110.26\ kip}$$

Design Summary

- ~Member has a cross section of 16.0" wide by 16.0" deep with 4000 psi concrete
- ~Location of section under investigation is at 0.83 ft from support
- ~Reinforcement at section under investigation consists an area of steel equal to 1.27 in² spaced at 12 in O.C.

W18x76

Flexural Strength

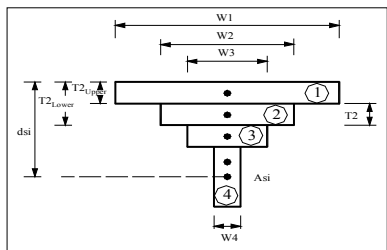

ϵ_{cu} 0.003
 c 4.084
 a 3.472
 Sum of forces 0.00
 Design R/C & P/C ACI
 ANSWER:
 ϕM_n kip-in 7142
 kip/ft 595.2

Av. β_1 : 0.850

Units in kips and inches																	
Concrete Layers	f'c	Width, W	Thick., T	Depth, d _c	β_1	T _{upper}	T _{lower}	Revised T	Beta calculation	Area	Force	M _n k-in.					
1	4.000	48.000	2.000	1.000	0.850	0.000	2.000	2.000	326.4	384	96.000	-326.40	-326.40				
2	4.000	16.000	8.000	2.736	0.850	2.000	10.000	1.472	80.06247705	94.1911495	23.548	-80.06	-219.04				
3	8.000	24.000	6.000	10.000	0.650	10.000	16.000	0.000	0	0	0.000	0.00	0.00				
4				16.000	0.850	16.000	16.000	0.000	0	0	0.000	0.00	0.00				
5				16.000	0.850	16.000	16.000	0.000	0	0	0.000	0.00	0.00				
6				16.000	0.850	16.000	16.000	0.000	0	0	0.000	0.00	0.00				
7				16.000	0.850	16.000	16.000	0.000	0	0	0.000	0.00	0.00				
										406.462477	478.191149						
Steel Layers	Area A _{si}	Grade	Effective Prest.	Depth d _{si}	E _s	Q	f _{py}	R	K	ϵ_{so}	$\Delta\epsilon$	Total ϵ_s	Stress	Force	Moment	Modified stress	corresp. f'c
Grade 50 steel																	
1	7.504	50	0	2.360	29000	0	50	100	1.096	0.0000	-0.0013	-0.0013	-36.73	-250.11	-590.27	-33.33	4.00
2	1.245	50	0	3.720	29000	0	50	100	1.096	0.0000	-0.0003	-0.0003	-7.76	-9.66	-35.95	-7.76	4.00
3		50	0		29000	0	60	100	1.096	0.0000	0.0000	-0.0030	-50.00	0.00	0.00	-46.60	4.00
4		50	0		29000	0	60	100	1.096	0.0000	0.0000	-0.0030	-50.00	0.00	0.00	-46.60	4.00
5		50	0		29000	0	60	100	1.096	0.0000	0.0000	-0.0030	-50.00	0.00	0.00	-46.60	4.00
6		50	0		29000	0	60	100	1.096	0.0000	0.0000	-0.0030	-50.00	0.00	0.00	-46.60	4.00
7		50	0		29000	0	60	100	1.096	0.0000	0.0000	-0.0030	-50.00	0.00	0.00	-46.60	4.00
8		50	0		29000	0	60	100	1.096	0.0000	0.0000	-0.0030	-50.00	0.00	0.00	-46.60	4.00
Rebar in Topping																	
9		60	0		29000	0	60	100	1.096	0.0000	0.0000	-0.0030	-60.00	0.00	0.00	-56.60	4.00
10		60	0		29000	0	60	100	1.096	0.0000	0.0000	-0.0030	-60.00	0.00	0.00	-56.60	4.00
11		60	0		29000	0	60	100	1.096	0.0000	0.0000	-0.0030	-60.00	0.00	0.00	-56.60	4.00
12		60	0		29000	0	60	100	1.096	0.0000	0.0000	-0.0030	-60.00	0.00	0.00	-56.60	4.00
13		60	0		29000	0	60	100	1.096	0.0000	0.0000	-0.0030	-60.00	0.00	0.00	-56.60	4.00
Grade 70 Plate																	
1		70	0		29000	0	70	100	1.06	0.0000	0.0000	-0.0030	-70.00	0.00	0.00	-66.60	4.00
Gr. 120 Rods																	
1		120	0		29000	0.0217	81.00	4.224	1.01	0.0000	0.0000	-0.0030	-71.79	0.00	0.00	-68.39	4.00
Gr. 150 Rods																	
1		150	0		29000	0.0217	120.00	4.224	1.01	0.0000	0.0000	-0.0030	-82.67	0.00	0.00	-79.27	4.00
Gr 270																	
1		270	28		28500	0.031	243	7.36	1.043	0.0010	0.0000	-0.0020	-57.50	0.00	0.00	-54.10	4.00
2		270	28		28500	0.031	243	7.36	1.043	0.0010	0.0000	-0.0020	-57.50	0.00	0.00	-54.10	4.00
3		270	130		28500	0.031	243	7.36	1.043	0.0046	0.0000	0.0016	44.50	0.00	0.00	47.90	4.00
Gr 270																	
4		270	130		28500	0.031	243	7.36	1.043	0.0046	0.0000	0.0016	44.50	0.00	0.00	47.90	4.00
5	0.434	270	183	12.000	28500	0.031	243	7.36	1.043	0.0064	0.0058	0.0122	253.38	109.97	1319.58	253.38	8.00
6	2.17	270	183	14.000	28500	0.031	243	7.36	1.043	0.0064	0.0073	0.0137	256.35	556.27	7787.84	256.35	8.00
7		270	180		28500	0.031	243	7.36	1.043	0.0063	0.0000	0.0033	94.49	0.00	0.00	97.89	4.00
8		270	180		28500	0.031	243	7.36	1.043	0.0063	0.0000	0.0033	94.49	0.00	0.00	97.89	4.00
9		270	180		28500	0.031	243	7.36	1.043	0.0063	0.0000	0.0033	94.49	0.00	0.00	97.89	4.00
10		270	180		28500	0.031	243	7.36	1.043	0.0063	0.0000	0.0033	94.49	0.00	0.00	97.89	4.00
11		270	180		28500	0.031	243	7.36	1.043	0.0063	0.0000	0.0033	94.49	0.00	0.00	97.89	4.00
12		270	180		28500	0.031	243	7.36	1.043	0.0063	0.0000	0.0033	94.49	0.00	0.00	97.89	4.00
13		270	180		28500	0.031	243	7.36	1.043	0.0063	0.0000	0.0033	94.49	0.00	0.00	97.89	4.00
Sum of M											MAXIMUM	$\Delta\epsilon$:	0.0073	Moment (k)	0.00	7935.76 kip/in	661.31 kip/ft

E - Flexural Strength (Positive Moment)

W18x67
Neg. Moment

Flexural Strength

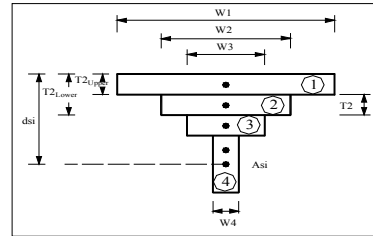

ϵ_{cu} 0.003
 c 5.409
 a 4.598
Sum of forces 0.00
Design R/C & P/C ACI
ANSWER:
 ϕ 0.86
 M_n , kip-in 3686
kip*ft 307.1

Av. β_1 : 0.850

Concrete Layers														Units in kips and inches				
	f_c	Width, W	Thick., T	Depth, d_c	β_1	T_{upper}	T_{lower}	Revised T	Beta1calculation			Area	Force	M_n , k-in.				
1	4.000	24.000	16.000	2.299	0.850	0.000	16.000	4.598	375.2	441.411765		110.353	-375.20	-862.59				
2				16.000	0.850	16.000	16.000	0.000	0	0		0.000	0.00	0.00				
3				16.000	0.850	16.000	16.000	0.000	0	0		0.000	0.00	0.00				
4				16.000	0.850	16.000	16.000	0.000	0	0		0.000	0.00	0.00				
5				16.000	0.850	16.000	16.000	0.000	0	0		0.000	0.00	0.00				
6				16.000	0.850	16.000	16.000	0.000	0	0		0.000	0.00	0.00				
7				16.000	0.850	16.000	16.000	0.000	0	0		0.000	0.00	0.00				
										375.2	441.411765							
Steel Layers																		
	Area A_{st}	Grade	Effective Prest.	Depth d_{st}	E_s	Q	f_{py}	R	K	ϵ_{su}	A_e	Total ϵ_s	Stress	Force	Moment	Modified stress	corresp. f_c	
Grade 50 steel	7.504	50	0	13.660	29000	0	50	100	1.096	0.0000	0.0046	0.0046	50.00	375.20	5125.23	50.00	4.00	
1					29000	0	50	100	1.096	0.0000	0.0000	-0.0030	-50.00	0.00	0.00	-46.60	4.00	
2					29000	0	60	100	1.096	0.0000	0.0000	-0.0030	-50.00	0.00	0.00	-46.60	4.00	
3					29000	0	60	100	1.096	0.0000	0.0000	-0.0030	-50.00	0.00	0.00	-46.60	4.00	
4					29000	0	60	100	1.096	0.0000	0.0000	-0.0030	-50.00	0.00	0.00	-46.60	4.00	
5					29000	0	60	100	1.096	0.0000	0.0000	-0.0030	-50.00	0.00	0.00	-46.60	4.00	
6					29000	0	60	100	1.096	0.0000	0.0000	-0.0030	-50.00	0.00	0.00	-46.60	4.00	
7					29000	0	60	100	1.096	0.0000	0.0000	-0.0030	-50.00	0.00	0.00	-46.60	4.00	
8					29000	0	60	100	1.096	0.0000	0.0000	-0.0030	-50.00	0.00	0.00	-46.60	4.00	
9					29000	0	60	100	1.096	0.0000	0.0000	-0.0030	-60.00	0.00	0.00	-56.60	4.00	
10					29000	0	60	100	1.096	0.0000	0.0000	-0.0030	-60.00	0.00	0.00	-56.60	4.00	
11					29000	0	60	100	1.096	0.0000	0.0000	-0.0030	-60.00	0.00	0.00	-56.60	4.00	
12					29000	0	60	100	1.096	0.0000	0.0000	-0.0030	-60.00	0.00	0.00	-56.60	4.00	
13					29000	0	60	100	1.096	0.0000	0.0000	-0.0030	-60.00	0.00	0.00	-56.60	4.00	
Topping Bars					29000	0	70	100	1.06	0.0000	0.0000	-0.0030	-70.00	0.00	0.00	-66.60	4.00	
6-#4					29000	0.0217	81.00	4.224	1.01	0.0000	0.0000	-0.0030	-71.79	0.00	0.00	-68.39	4.00	
Grade 70 Plate					29000	0.0217	120.00	4.224	1.01	0.0000	0.0000	-0.0030	-82.67	0.00	0.00	-79.27	4.00	
Gr. 120 Rods					28500	0.031	243	7.36	1.043	0.0010	0.0000	-0.0020	-57.50	0.00	0.00	-54.10	4.00	
Gr. 270					28500	0.031	243	7.36	1.043	0.0010	0.0000	-0.0020	-57.50	0.00	0.00	-54.10	4.00	
Gr. 270					28500	0.031	243	7.36	1.043	0.0056	0.0000	0.0026	74.50	0.00	0.00	77.90	4.00	
Gr. 270					28500	0.031	243	7.36	1.043	0.0056	0.0000	0.0026	74.50	0.00	0.00	77.90	4.00	
4					28500	0.031	243	7.36	1.043	0.0056	0.0000	0.0026	74.50	0.00	0.00	77.90	4.00	
5					28500	0.031	243	7.36	1.043	0.0056	0.0000	0.0026	74.50	0.00	0.00	77.90	4.00	
6					28500	0.031	243	7.36	1.043	0.0056	0.0000	0.0026	74.50	0.00	0.00	77.90	4.00	
7					28500	0.031	243	7.36	1.043	0.0056	0.0000	0.0026	74.50	0.00	0.00	77.90	4.00	
8					28500	0.031	243	7.36	1.043	0.0056	0.0000	0.0026	74.50	0.00	0.00	77.90	4.00	
9					28500	0.031	243	7.36	1.043	0.0056	0.0000	0.0026	74.50	0.00	0.00	77.90	4.00	
10					28500	0.031	243	7.36	1.043	0.0056	0.0000	0.0026	74.50	0.00	0.00	77.90	4.00	
11					28500	0.031	243	7.36	1.043	0.0056	0.0000	0.0026	74.50	0.00	0.00	77.90	4.00	
12					28500	0.031	243	7.36	1.043	0.0056	0.0000	0.0026	74.50	0.00	0.00	77.90	4.00	
13					28500	0.031	243	7.36	1.043	0.0056	0.0000	0.0026	74.50	0.00	0.00	77.90	4.00	
Sum of M											MAXIMUM	A_e :	0.0046	Moment (k)	0.00	4262.64 kip-in		
																	355.22 kip-ft	

F – Flexural Strength (Negative Moment at Support)

G – ASCE7 – 05 – MWFRS Wind Profile Calculation

ASCE7-05

Wind speed	90	mph	figure 6-1 (ASCE 7-05)
Occupancy Cat.	2		
Import. factor (I)	1		table 6-1 (ASCE 7-05)
GC _{pi} =	0.18		figure 6-5 ASCE 7-05
G =	0.85		assumed
C _{pw} =	0.8		figure 6-6 ASCE 7-05
C _{pi} =	-0.5		figure 6-6 ASCE 7-05
exposure cat.	B		assumed
wall height	60	feet	q _z * K _z 17.626 (must still be multiplied by I)
L/B	1		qh = 15.158
topo factor(Kzt)	1.0		assumed
enclosure type	enclosed		
direct. Factor (Kd)	0.85		table 6-4 (ASCE 7-05)

Height (ft)	K _z (table 6-3)	Q _z	Case 1 (+GCpi)			Case 2 (-GCpi)		
			P _{windward}	P _{leeward}	P _{total}	P _{windward}	P _{leeward}	P _{total}
0	0.57	10.047	4.10	-9.17	13.27	9.56	-3.71	13.27
15	0.57	10.047	4.10	-9.17	13.27	9.56	-3.71	13.27
20	0.62	10.928	4.70	-9.17	13.87	10.16	-3.71	13.87
25	0.66	11.633	5.18	-9.17	14.35	10.64	-3.71	14.35
30	0.7	12.338	5.66	-9.17	14.83	11.12	-3.71	14.83
40	0.76	13.395	6.38	-9.17	15.55	11.84	-3.71	15.55
50	0.81	14.277	6.98	-9.17	16.15	12.44	-3.71	16.15
60	0.85	14.982	7.46	-9.17	16.63	12.92	-3.71	16.63
parapet	62	0.86	15.16			22.74	15.158	37.90

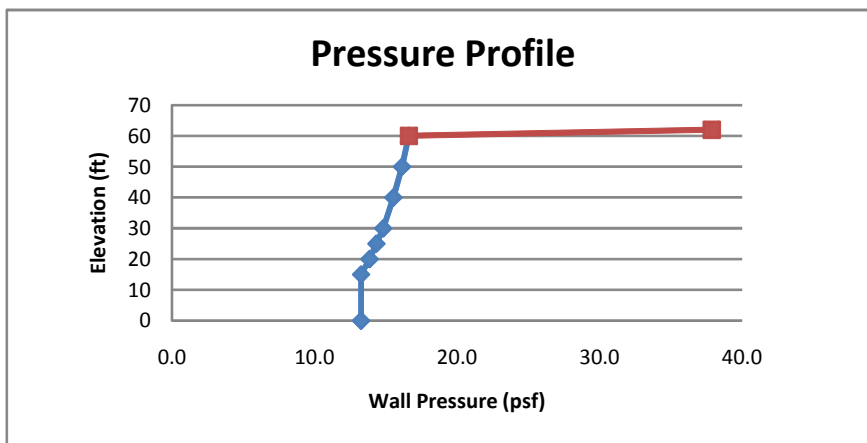

H – Structure Weight for Seismic Design

Weight for Seismic Design

Floor to floor height

	10.0	ft		
Weight (k) for a typical floor	units	qty	weight	
(15)24x24 Columns	lf	150.0	87	kip
8" Hollow-core	sq ft	14880	833	kip
Precast beams	lf	372	54	kip
Precast L-Beams	lf	248	96	kip
2" CIP Topping	sf	14880	360	kip
CIP Beam in-fill	lf	372	48	kip
Steel beam	lf	372	14	kip
6" P/c wall panels	sf	4480	325	kip
			1,817	kips/floor

Weight (k) for half story

	units	qty	weight	
(15)24x24 Columns	lf	150.0	87	kip
8" Hollow-core	sq ft	14880	833	kip
Precast beams	lf	372	54	kip
Precast L-Beams	lf	248	96	kip
2" CIP Topping	sf	14880	360	kip
CIP Beam in-fill	lf	372	48	kip
Steel beam	lf	372	14	kip
6" P/c wall panels	sf	2440	177	kip
			1,669	kips/floor

I – ASCE7-05 – Seismic Load Story Shear Calculation

Tedds calculation version 3.0.01

Site parameters

Site class; D
 Mapped acceleration parameters (Section 11.4.1)
 at short period; $S_S = 0.075$
 at 1 sec period; $S_1 = 0.043$
 Site coefficient at short period (Table 11.4-1); $F_a = 1.6$
 at 1 sec period (Table 11.4-2); $F_v = 2.4$

Spectral response acceleration parameters

at short period (Eq. 11.4-1); $S_{MS} = F_a \times S_S = 0.120$
 at 1 sec period (Eq. 11.4-2); $S_{M1} = F_v \times S_1 = 0.103$

Design spectral acceleration parameters (Sect 11.4.4)

at short period (Eq. 11.4-3); $S_{DS} = 2 / 3 \times S_{MS} = 0.080$
 at 1 sec period (Eq. 11.4-4); $S_{D1} = 2 / 3 \times S_{M1} = 0.069$

Seismic design category

Occupancy category (Table 1-1); II

 Seismic design category based on short period response acceleration (Table 11.6-1)
 A
 Seismic design category based on 1 sec period response acceleration (Table 11.6-2)
 B
 Seismic design category; B

Approximate fundamental period

Height above base to highest level of building; $h_n = 60$ ft

From Table 12.8-2:
 Structure type; Reinforce concrete moment frame
 Building period parameter C_t ; $C_t = 0.016$
 Building period parameter x ; $x = 0.90$

Approximate fundamental period (Eq 12.8-7); $T_a = C_t \times (h_n)^x$
 $\times 1 \text{ sec} / (1 \text{ ft})^x = 0.637$ sec
 Building fundamental period (Sect 12.8.2); $T = T_a = 0.637$ sec
 Long-period transition period; $T_L = 12$ sec

Seismic response coefficient

Seismic force-resisting system (Table 12.14-1);
 C_MOMENT_RESISTING_FRAME_SYSTEM
 S
 7. Ordinary reinforced concrete moment
 frames
 Response modification factor (Table 12.14-1); $R = 3$
 Seismic importance factor (Table 11.5-2); $I_e = 1.000$
 Seismic response coefficient (Sect 12.8.1.1)
 Calculated (Eq 12.8-2); $C_{s_calc} = S_{DS} / (R / I_e) = 0.027$
 Maximum (Eq 12.8-3); $C_{s_max} = S_{D1} / (T \times (R / I_e)) = 0.036$

Minimum (Eq 12.8-5, Supp. No. 2);
Seismic response coefficient;

$$C_{s,min} = \max(0.044 \times S_{DS} \times I_e, 0.01) = \mathbf{0.010}$$

$$C_s = \mathbf{0.027}$$

Seismic base shear (Sect 12.8.1)

Effective seismic weight of the structure;
Seismic response coefficient;
Seismic base shear (Eq 12.8-1);

$$W = \mathbf{11826.0 \text{ kips}}$$

$$C_s = \mathbf{0.027}$$

$$V = C_s \times W = \mathbf{315.4 \text{ kips}}$$

Vertical distribution of seismic forces (Sect 12.8.3)

Vertical distribution factor (Eq 12.8-12);

$$C_{vx} = w_x \times h_x^k / \Sigma(w_i \times h_i^k)$$

Lateral force induced at level i (Eq 12.8-11); $F_x = C_{vx} \times V$

Vertical force distribution table

Level	Height from base to Level i (ft), h_x	Portion of effective seismic weight assigned to Level i (kips), w_x	Distribution exponent related to building period, k	Vertical distribution factor, C_{vx}	Lateral force induced at Level i (kips), F_x
1	0.0;	1000.0;	1.07;	0.000;	0.0;
2	10.0;	1829.0;	1.07;	0.044;	14.0;
3	20.0;	1829.0;	1.07;	0.093;	29.3;
4	30.0;	1829.0;	1.07;	0.143;	45.2;
5	40.0;	1829.0;	1.07;	0.195;	61.5;
6	50.0;	1829.0;	1.07;	0.248;	78.1;
7	60.0;	1681.0;	1.07;	0.277;	87.2;

J – Beam Deflections

At Release

		Deflection										
Location (in)		0	36	72	108	144	180	216	252	288	324	360
P/S End Mom 1	$M/(6EI)(3x^2-x^3-2lx)$	0.0000	0.2899	0.4883	0.6053	0.6511	0.6358	0.5697	0.4629	0.3256	0.1679	0.0000
P/S End Mom 2	$M/(6EI)(3x^2-x^3-2lx)$	0.0000	0.1679	0.3256	0.4629	0.5697	0.6358	0.6511	0.6053	0.4883	0.2899	0.0000
Beam weight	$5wl^4/384EI$	0.0000	-0.0015	-0.0029	-0.0039	-0.0046	-0.0048	-0.0046	-0.0039	-0.0029	-0.0015	0.0000
Net at release		0.000	0.456	0.811	1.064	1.216	1.267	1.216	1.064	0.811	0.456	0.000

At Construction

		Deflection										
Location (in)		0	36	72	108	144	180	216	252	288	324	360
Hollow core	$\omega x/(24EI)(l^3-2lx^2+x^3)$	0.0000	-0.4764	-0.9013	-1.2339	-1.4452	-1.5175	-1.4452	-1.2339	-0.9013	-0.4764	0.0000
CIP beam	$\omega x/(24EI)(l^3-2lx^2+x^3)$	0.0000	-0.0365	-0.0691	-0.0947	-0.1109	-0.1164	-0.1109	-0.0947	-0.0691	-0.0365	0.0000
CIP topping	$\omega x/(24EI)(l^3-2lx^2+x^3)$	0.0000	-0.2056	-0.3889	-0.5325	-0.6237	-0.6549	-0.6237	-0.5325	-0.3889	-0.2056	0.0000
Net during construction		0.000	-0.719	-1.359	-1.861	-2.180	-2.289	-2.180	-1.861	-1.359	-0.719	0.000

At Service

		Deflection										
Location (in)		0	36	72	108	144	180	216	252	288	324	360
SIDL simple span	$\omega x/(24EI)(l^3-2lx^2+x^3)$	0.0000	-0.0539	-0.1020	-0.1396	-0.1635	-0.1717	-0.1635	-0.1396	-0.1020	-0.0539	0.0000
SIDL End Mom 1	$M/(6EI)(3x^2-x^3-2lx)$	0.0000	0.0376	0.0633	0.0785	0.0844	0.0824	0.0739	0.0600	0.0422	0.0218	0.0000
SIDL End Mom 2	$M/(6EI)(3x^2-x^3-2lx)$	0.0000	0.0174	0.0338	0.0480	0.0591	0.0659	0.0675	0.0628	0.0506	0.0301	0.0000
Total SIDL		0.0000	0.0011	-0.0049	-0.0132	-0.0200	-0.0234	-0.0222	-0.0168	-0.0091	-0.0021	0.0000
LL simple span	$\omega x/(24EI)(l^3-2lx^2+x^3)$	0.0000	-0.1797	-0.3400	-0.4655	-0.5451	-0.5724	-0.5451	-0.4655	-0.3400	-0.1797	0.0000
LL End Mom 1	$M/(6EI)(3x^2-x^3-2lx)$	0.0000	0.1253	0.2110	0.2616	0.2814	0.2748	0.2462	0.2000	0.1407	0.0725	0.0000
LL End Mom 2	$M/(6EI)(3x^2-x^3-2lx)$	0.0000	0.0580	0.1125	0.1600	0.1970	0.2198	0.2251	0.2093	0.1688	0.1002	0.0000
Total LL		0.0000	0.0036	-0.0164	-0.0439	-0.0668	-0.0779	-0.0739	-0.0562	-0.0305	-0.0069	0.0000
Net during service		0.000	0.005	-0.021	-0.057	-0.087	-0.101	-0.096	-0.073	-0.040	-0.009	0.000

Total Deflections

		Deflection										
Location (in)		0	36	72	108	144	180	216	252	288	324	360
Total Deflection (in)		0.0000	-0.2575	-0.5697	-0.8538	-1.0504	-1.1232	-1.0595	-0.8698	-0.5880	-0.2712	0.0000