

2011

# Developing strategies for sustainable residential building design: Kathmandu Metropolitan City, Nepal

Gaurav Kumar Tuladhar  
*Iowa State University*

Follow this and additional works at: <http://lib.dr.iastate.edu/etd>

 Part of the [Architecture Commons](#)

---

## Recommended Citation

Tuladhar, Gaurav Kumar, "Developing strategies for sustainable residential building design: Kathmandu Metropolitan City, Nepal" (2011). *Graduate Theses and Dissertations*. 11985.  
<http://lib.dr.iastate.edu/etd/11985>

This Thesis is brought to you for free and open access by the Graduate College at Iowa State University Digital Repository. It has been accepted for inclusion in Graduate Theses and Dissertations by an authorized administrator of Iowa State University Digital Repository. For more information, please contact [digirep@iastate.edu](mailto:digirep@iastate.edu).

**Developing strategies for sustainable residential building design:  
Kathmandu Metropolitan City, Nepal**

by

**Gaurav Kumar Tuladhar**

A thesis submitted to the graduate faculty  
in partial fulfillment of the requirements for the degree of  
**MASTER OF ARCHITECTURE**

Major: Architecture

Program of Study Committee:

Ulrike Passe, Major Professor

Clare Cardinal-Pett

Ron M. Nelson

Iowa State University

Ames, Iowa

2011

Copyright © Gaurav Kumar Tuladhar, 2011. All rights reserved.

<b>TABLE OF CONTENTS</b>	<b>PAGE</b>
<b>LIST OF FIGURES</b> .....	v
<b>LIST OF TABLES</b> .....	viii
<b>LIST OF ABBREVIATION</b> .....	ix
<b>ACKNOWLEDGEMENT</b> .....	x
<b>ABSTRACT</b> .....	xi
<b>CHAPTER 1: INTRODUCTION</b> .....	1
1.1 Introduction.....	1
1.2 Goal.....	4
1.3 Organization of Thesis.....	5
1.4 Research Methodology.....	6
<b>CHAPTER 2: LITERATURE REVIEW</b> .....	9
2.1 Sustainability.....	9
2.2 Dimensions of Sustainability .....	11
2.3 Sustainable Building Design .....	12
2.4 Elements of Sustainable Design .....	13
2.5 Principles of Sustainable Design.....	14
2.6 Sustainable Building Design Guidelines Practices .....	17
2.6.1 Leadership in Energy and Environmental Design (LEED)) .....	18
2.6.2 Building Research Establishment’s Environmental Assessment Method.....	21
2.6.3 Green Rating for Integrated Habitat Assessment .....	22
2.6.4 Comparisons of Sustainable Building Guidelines .....	24
<b>CHAPTER 3: THE RESEARCH REGION- KATHMANDU</b> .....	29
3.1 Kathmandu .....	29
3.2 Brief History of Kathmandu .....	31
3.3 Sustainability Issues in Kathmandu.....	32
3.4 Residential Status in Kathmandu .....	36
3.5 Climate of Kathmandu .....	39
3.5.1 Humidity and Precipitation.....	40
3.5.2 Wind.....	41
<b>CHAPTER 4: GLOBAL ENERGY AND ENERGY ISSUES IN KATHMANDU</b> .....	43
4.1 Introduction.....	43

4.2 Passive Solar Design / Architecture .....	44
4.3 Energy Situation in Kathmandu.....	45
4.4 Traditional Newari Architecture of Kathmandu .....	48
4.4.1 Spatial Configuration of Traditional Settlement.....	50
4.4.2 Building Layout.....	51
4.4.3 Building Materials and Construction Technology .....	53
4.4.4 Development of Traditional Building and Daylight Improvement.....	55
4.4.5 Building Envelope and Materials .....	56
4.5 Case Study of Bidani House, Delhi, India.....	58
4.6 Summary .....	61
<b>CHAPTER 5: GLOBAL WATER AND SCENARIO IN KATHMANDU .....</b>	<b>63</b>
5.1 Introduction.....	63
5.2 Water Conservation .....	65
5.3 Kathmandu and Water Supply .....	69
5.4 Water Supply Analysis for Kathmandu.....	71
5.5 Alternatives to Municipal Supply Dhunge Dharas.....	73
5.5.1 Groundwater .....	73
5.5.2 Water Vendors .....	75
5.5.3 Rainwater Harvesting.....	76
5.6 Rainwater Harvesting Potential in Kathmandu .....	76
5.7 Case Study of The Autonomous House .....	78
5.8 Summary .....	80
<b>CHAPTER 6: WASTE MANAGEMENT AND SCENARIO IN KATHMANDU.....</b>	<b>82</b>
6.1 Introduction .....	82
6.2 Waste Water and Solid Waste Treatment in Kathmandu .....	83
6.2.1 Issues of Waste.....	84
6.2.2 Municipal Solid Waste .....	85
6.3 Municipal Wastewater.....	88
6.4 Case Study of Eco-Home, Kathmandu, Nepal .....	90
6.5 Summary .....	94
<b>CHAPTER 7: CLIMATE STUDY FOR KATHMANDU.....</b>	<b>96</b>
7.1 Climate of Kathmandu .....	96
7.2 Climatic Analysis for Design Strategies.....	96
7.2.1 Analysis Based on Mahoney Table .....	96

7.2.2 Comfort Index: Plotting in The Bioclimatic Chart.....	100
7.2.3 Psychrometric Chart.....	102
7.3 Summary .....	103
<b>CHAPTER 8: DISCUSSION AND RECOMMENDATIONS .....</b>	<b>105</b>
8.1 Discussion .....	105
8.2 Design Guidelines.....	107
8.2.1 Climate Responsive Design .....	108
8.2.2 Water Efficiency .....	111
8.2.3 Waste Water Management.....	113
8.2.4 Energy Efficiency .....	113
<b>CHAPTER 9: DESIGN PROCESS AND OUTCOME .....</b>	<b>115</b>
9.1 Site Analysis .....	115
9.2 Design Process.....	120
9.2.1 Concept.....	120
9.2.2 Form Exploration.....	121
9.2.3 Functional Organization .....	123
9.3 Design Limitation .....	125
9.4 Design Strategies .....	126
9.4.1 Passive Solar Design / Climate Responsive Design.....	126
9.4.2 Sustainable Design Features .....	130
9.5 Ecotect Results.....	139
9.6 Construction Cost.....	142
<b>CHAPTER 10: CONCLUSION.....</b>	<b>146</b>
10.1 Conclusion.....	146
<b>BIBLIOGRAPHY.....</b>	<b>148</b>
<b>APPENDIX A: CLIMATIC DATA OF KATHMANDU AIRPORT, KATHMANDU .....</b>	<b>153</b>
<b>APPENDIX B: LITERATURE REVIEW.....</b>	<b>156</b>
<b>APPENDIX C: DESIGN OPTIONS.....</b>	<b>168</b>
<b>APPENDIX D: ECOTECT TEST .....</b>	<b>171</b>
<b>APPENDIX E: PRELIMINARY SKETCHES.....</b>	<b>173</b>
<b>APPENDIX F: DRAWINGS (NOT TO SCALE) .....</b>	<b>174</b>

## LIST OF FIGURES

Figure 1.1- Research Methodology Flowchart .....	8
Figure 2.1- Dimensions of sustainability for human well being.....	11
Figure 2.2- Conceptual framework for sustainable design and pollution prevention in architecture .....	13
Figure 2.3- Principles of sustainable design .....	15
Figure 3.1- Map of Nepal.....	29
Figure 3.2- Kathmandu Metropolitan City, Kathmandu valley, Nepal .....	30
Figure 3.3- Water shortage has caused untreated use of ground water from wells.....	33
Figure 3.4- Waste collected by roadside before being disposed.....	34
Figure 3.5- Pollution of rivers due to untreated industrial effluent and domestic sewerages	35
Figure 3.6- Traditional residence in Kathmandu, Nepal .....	37
Figure 3.7- Main market place at Ason, Kathmandu .....	37
Figure 3.8- A typical housing colony developed by private developers in Kathmandu .....	38
Figure 3.9- Interior of living room in a modern housing development.....	39
Figure 3.10- Sun path diagram for Kathmandu.....	40
Figure 3.11- Graphical representation of climate summary.....	42
Figure 4.1 - Energy consumption by section in 2005 .....	46
Figure 4.2- Energy demand for next 15 years in Nepal.....	47
Figure 4.3- A typical Gurung house .....	49
Figure 4.4- A typical Sherpa house .....	49
Figure 4.5- A typical Tharu house .....	49
Figure 4.6- Wide and narrow street allowing solar radiation from ground floor and first floor respectively .....	52
Figure 4.7- Number of storey development in the traditional building in Kathmandu.....	54

Figure 4.8- Size of opening becomes bigger in traditional residential building over time.....	55
Figure 4.9- Traditional wall and roof construction details .....	57
Figure 4.10- Plan of <i>Bidani House</i> , Faridabadh .....	59
Figure 4.11- Analysis of courtyard and louvers being used for internal comfort zone in living spaces .....	60
Figure 5.1- Global distribution of World's water .....	63
Figure 5.2- Hydro cycle .....	64
Figure 5.3- Stone water spout (dhunge dhara) .....	69
Figure 5.4- Ground water use through tube well.....	74
Figure 5.5- Private water vendor .....	75
Figure 6.1- Door to door collection of household waste .....	87
Figure 6.2- Agencies involved in storm water and sewer management in Kathmandu.....	88
Figure 6.3- Waste collection center at Teku, Kathmandu.....	89
Figure 6.4- Greywater treatment system used in <i>Eco-Home</i> .....	92
Figure 6.5- Constructed wetland on site.....	93
Figure 6.6- Bin composting.....	94
Figure 7.1- Bioclimatic chart for Kathmandu (1997-2008) .....	101
Figure 7.2- Psychrometric chart for Kathmandu .....	103
Figure 8.1- Building orientation options for optimized solar gain.....	108
Figure 8.2- South facing building with solar gain and open space between buildings good for air circulation.....	109
Figure 8.3- Enhancing living space according to room orientation .....	109
Figure 8.4- Service cores acting as buffer zone.....	110
Figure 8.5- Relationship of floor height and horizontal shading .....	111
Figure 8.6- Section of a building showing rainwater harvesting system .....	112

Figure 8.7- Schematic diagram of grey water recycling system .....	113
Figure 9.1- Aerial view of Kathmandu .....	117
Figure 9.2- Location of site, Thapathali, Kathmandu, Nepal .....	118
Figure 9.3- Solar path and wind direction .....	118
Figure 9.4- Site analysis .....	119
Figure 9.5- Site surrounding .....	120
Figure 9.6- Concept 3 variation in courtyard.....	122
Figure 9.7- Third floor plan of proposed building (not to scale).....	124
Figure 9.8- Functional zoning of spaces in the proposed building.....	125
Figure 9.9- Plan of double height living room of 4 bedroom apartment.....	127
Figure 9.10- Double height of living space of 4-bedroom apartment.....	128
Figure 9.11 - Solar access in various living spaces during varied seasons.....	128
Figure 9.12- Climatic control through ventilation during summer in proposed building.....	129
Figure 9.13- Climatic control during winter season in proposed building.....	130
Figure 9.14- Section of rainwater tank on ninth floor (scale - 1:30).....	133
Figure 9.15 - Solar water heating system .....	134
Figure 9.16- Section of vertical flow reed bed system incorporated in proposed building (scale - 1:20).....	136
Figure 9.17- Cross section of grey water recycling system at ground floor (scale - 1:30)...	136
Figure 9.18- Water conservation and reuse system.....	137
Figure 9.19- Section of green roof (16" thick) proposed for residential building .....	138
Figure 9.20- Solar path study .....	140
Figure 9.21- Optimum building orientation.....	141
Figure 9.22- Discomfort degree hours .....	141



**LIST OF TABLES**

Table 2.1- Categories in LEED Home .....	19
Table 2.2- Categories in EcoHome.....	21
Table 2.3- Categories in GRIHA.....	23
Table 2.4- Energy Efficiency Comparison Table.....	25
Table 2.5- Water Efficiency Comparison Table.....	26
Table 2.6- Waste Management Comparison Table .....	26
Table 2.7- Indoor Environment Comparison Table .....	27
Table 3.1 - Highlights of History of Nepal .....	31
Table 5.1- Water Use in Urban Households .....	72
Table 5.2 - Domestic Water Consumption for Kathmandu Valley in Past Studies .....	72
Table 5.3 - Water Consumption Comparison.....	81
Table 6.1- Solid Waste Generation in Kathmandu ( in % of waste by weight).....	86
Table 6.2- Monthly Water Demand and Clean Water Requirement at Eco-Home.....	91
Table 7.1- Mahoney Table for Kathmandu .....	98
Table 9.1- Discomfort Degree Hours (see 9.5 Ecotect) .....	142
Table 9.2 - Traditional Construction Estimate.....	145
Table 9.3 - Green Construction Estimate.....	145

## LIST OF ABBREVIATION

ADB	Asian Development Bank
BREEAM	Building Research Establishment's Environmental Assessment Method
CBS	Central Bureau of Statistics
CBO	Community Based Organization
DHM	Department of Hydrology and Meteorology
GRIHA	Green Rating and Integrated Habitat Assessment
HMGN	His Majesty Government of Nepal
ICIMOD	International Center for Integrated Mountain Development
KMC	Kathmandu Metropolitan City
KUKL	Kathmandu Upatyaka Khanepani Limited (Kathmandu Water Agency)
LEED	Leadership in Environment and Energy Design
MLD	Millions Liters per Day
M/S	Meter per Second
NEA	Nepal Electricity Authority
NWSC	Nepal Water Supply Corporation
NGO	Non-Governmental Organization
PV	Photovoltaic
RH	Relative Humidity
SUD	Sustainable Urban Drainage
SWERA	Solar and Wind Energy Resource Assessment
UNEP	United Nations Environment Program
WBSCD	World Business Council for Sustainable Development
WHO	World Health Organization
USGBC	United States Green Building Council

## **ACKNOWLEDGMENT**

My sincere gratitude goes to all the people who helped and guided me to complete this thesis. I take this opportunity to express my appreciation to my supervisor Assistant Professor Ulrike Passe (Major) for her supervision, support and encouragement. Her guidance was integral and helpful throughout my studies at Iowa State University.

I would like to thank Associate Professor Clare Cardinal -Pett and Professor Ron Nelson for their willingness to serve on my committee and their valuable comments and guidance.

My special thanks go to Ar. Shritu Shrestha, Ar. Prabina Shrestha, Ar. Bhagawat Khokhali and Ar. Amit Bajracharya for their invaluable support. Special thanks go to Mr. Sanjil Tamrakar for lending his hand and great support.

Lastly, I want to thank my parents and my brothers for their never-ending support, love and encouragement to prepare this thesis.

## **ABSTRACT**

Sustainable building design has gained rapid interest to achieve lesser environmental impacts through man-made structures. Guidelines have been set up by the leading developed nations to balance the environment and human needs with sustainable building design guidelines. This is even more necessary for under developed nations like Nepal, with its burgeoning capital city, Kathmandu. In this thesis, the environmental issues in Kathmandu ranging from water, energy, waste management to land management have been studied widely and especially relating to the residential buildings. After the analysis of facts and hard issues faced by the people of Kathmandu and a study of climatic conditions in the city, residential sustainable design guidelines have been proposed. Finally, the design recommendations have been developed in this thesis and applied to multilevel multi-family sustainable residential building in a site in Kathmandu.

## **CHAPTER 1: INTRODUCTION**

### **1.1 INTRODUCTION**

Nepal is one of the least developed countries in the world located between two emerging economic giants of the present world - India and China. It is a nation with rich and vibrant history and blessed by nature in its diverse topographical features from the high mountain ranges of the Himalayas to the low-lying flat lands of Terai. It is a nation formed by an amalgamation of multitude of ethnic groups each with their own culture, language and social customs. In the last fifteen years, the nation has undergone a huge paradigm shift in terms of its socio-cultural and political orientation. The year 2006 was momentous for it saw the end of 240 years of monarchy and a dawn of a republic Nepal. After a decade long insurgency war, the rebel Maoist declared peace and joined the mainstream political movement. The tumultuous period, especially since 1950, have left a deep-scarred legacy in the collective psyche of the nation from which it is still trying to emerge. These constant upheavals have often resulted in the government, policy makers and leaders focusing on the short-term fire fighting solutions rather than to focus on long-term sustainable plans and policy. A small example is the lack of the government's policy and interest in the sustainable development of Kathmandu Metropolitan City, which is not only the capital of the nation but also its social, cultural and economic hub.

Kathmandu is a historic city, a home to seven of the World Heritage Sites. It is expanding at unprecedented rate putting enormous pressure on its primitive and overwhelmed infrastructures and services. The city has seen an exponential population growth primarily due to the large influx of migrants from other parts of the country. Lack of economic opportunities in rural areas, search for a better life and flight from political persecution during the insurgency period are some of the primary reasons for the population

growth. The situation warrants immediate attention, otherwise it will turn into a national crisis very soon. The city's infrastructural systems and services can no longer support the rising population and burgeoning residential buildings. The need of the hour is to mitigate the issues at its origin itself with incorporation of sustainable principles during the design of the residential building. Therefore, the objective of this study is to prescribe the guidelines regarding the strategies that can be implemented in a sustainable residential building and in turn minimize the load on infrastructural systems of the city and devise necessary improvements.

The industrial revolution has accelerated the modernization and growth of technology in the developed world and developing world. It has brought about the need to house humans for their sustenance and desire to expand their comfort to a new level. With the increase in economic development and economic status of people in developing countries, demands for architectural resources like land, buildings or building products, energy, and other resources augments too (Kim and Rigdon 1998). This in turn increases the combined impact of architecture on the global ecosystem, which is made up of inorganic elements, living organisms, and humans. The issues of climate change have come to the forefront and have become topic of hot debate among scientist, researchers, policy makers and governments. Therefore, the need to maintain the fundamental ecological balance between nature and man-made environment, and sustainable building practice is emerging.

Sustainable building design approach for mitigating the problems caused by the extensive use of toxic and environmentally unsustainable materials have resulted in finding newer approaches to design and construction of buildings.

Sustainable building design encompasses broad fields, which include environmental, economic, social and cultural aspects. Countries like Britain, United States of America, Canada and Japan have devised a system of rating buildings that are subjected to certify

their sustainability. Rating systems are checklists of various sustainability parameters ranging from energy, water, waste, indoor air quality, health, atmosphere and site planning factors that are involved in functioning of building. The rating systems for sustainability emphasize environmental and technical aspects. In the book 'Ten Shades of Green', Peter Buchanan, stresses the need not only to focus on environmental sustainability but also on economic, social, and cultural aspects (Buchanan 2005).

This thesis seeks to address environmental sustainability issues particularly on energy, water, waste management and health and well being related to buildings in Kathmandu. The emphasis of this thesis is on sustainability in residential building design in the Kathmandu Metropolitan City (KMC), herein after referred to as Kathmandu. This thesis will develop sustainability guidelines for Kathmandu, which will act as reference to the policy makers, planners and urban development professionals working for the development and management of sustainable buildings in the city and the researcher further hopes will be applicable to comparable other cities with similar climatic conditions in developing countries.

Given that Kathmandu Valley's environmental quality is deteriorating at an unprecedented rate,(Adhikari 2008) ensuring the sustainability of the environment is of paramount importance. The buildings are exposed to various environmental and health hazards like unmanaged construction sites, lack of proper guidance on using protective gears and use of harmful chemicals during their construction.

The approach to mitigate environmental issues and to seek sustainable building design in the developed world has been brought about through the introduction of guidelines and tools developed by various independent organizations and agencies. This thesis studies the following sustainable and green design guidelines, Leadership in Environment and Energy Design (LEED); Green Rating and Integrated Habitat Assessment (GRIHA) and Building Research Establishment's Environmental Assessment Method (BREEAM) that are

practiced in countries like the United States, United Kingdom and India. The research delineates the main areas such as energy, water and waste management that are highlighted as focus areas by the sustainable building design guidelines in the aforementioned countries, and environmental problems of the city that has impact on a sustainable residential building design. The initial set of parameters for setting the design of environmentally sustainable building are mainly in energy conservation, water conservation and waste management. The aforementioned parameters are applied to a model of a multi level multi-unit residential building in Kathmandu. The precedents for the design of environmentally sustainable buildings is studied through *The Autonomous House* located at Southwell, United Kingdom for the parameter on water conservation; *Eco-Home* located at Kathmandu for parameters on rainwater harvesting; and a case study of *Bidani House* located at Faridabad, India for parameters on climate responsive design.

Thus, the aim is to devise an approach for sustainability guidelines for Kathmandu with a model of a sustainable residential design that emphasizes on energy, water and waste management.

## **1.2 GOAL**

Owing to the problems of managing utility and services that are necessary for a residential building, the principal goal of the research is to develop guidelines for environmentally sustainable residential building design in Kathmandu. The guidelines developed are applied to designing a residential building that is environmentally sustainable. The design addresses on energy, water and waste management.



### 1.3 ORGANIZATION OF THESIS

The thesis report is classified into ten chapters under four main levels. It starts with the overview about the research in Chapter 1 (Introduction) which gives a general background on sustainable design and its importance globally. Brief information on issues and problems faced by the people of Kathmandu is discussed. Sustainable building guidelines and countries that have adopted their own guidelines are discussed in brief. The research objectives and organization of the thesis are also described. Finally, research methodology and the overall outlook for the report are presented. The report continues with Chapter 2 (Literature review) with review of concepts on sustainability, its principle, aspects, definition of sustainable, sustainable design, sustainable design guidelines adopted by developed countries and a comparison among few selected guidelines is studied.

The study of the research region - Kathmandu is covered in Chapter 3, 4, 5 and 6 respectively. The chapters discuss the general background of the city with respect to topography, history of settlement, social and economic context, and current residential situation. It describes the climate of the city, which is one of the main factors for climate responsive design. In depth, study of energy situation in the city, brief background on energy situation in world scenario, traditional Newari architecture and its development over time are studied and in the end precedent study of *Bidani House* in Delhi, India is presented. Chapter 5 deals with water situation in the city and the potential of rainwater harvesting system with precedent study of *Eco-Home* in Kathmandu. Chapter 6 deals with waste management issues of the city and viable means to manage the organic and greywater waste.

The analysis of climate of Kathmandu is done in Chapter 7 with the help of tools like Mahoney Table, Bioclimatic Chart and Psychrometric Chart. This gave design recommendation to be useful for newer buildings in the city. Chapter 8 (Discussion and recommendation) highlight the summary of the thesis so far and some recommendation on

the design strategies put forward. Chapter 9 (Design Process and outcome) deals with a proposed site in Kathmandu for designing a multilevel residential building where the design guidelines are incorporated and tested with Ecotect for orientation and thermal analysis.

Finally, Chapter 10 deals with the conclusion and the Appendixes followed with climatic data, background study of day lighting, shading design; site planning and building planning. Some options for design are presented along with final architectural drawings at the end.

#### **1.4 RESEARCH METHODOLOGY**

The research strategy for this thesis is comprised of three phases: literature review, analysis and design strategies as a result. In the first phase, the research evaluates three sustainable design assessment tools among many prevalent tools. For the literature review, the research takes environmental, social, and economic issues related to Kathmandu from sustainability point and potential areas of development and implementation of design strategy for sustainable residential building design. With the sustainable building design tools that have been used by the researched countries in this thesis, a basis has been drawn with regard to energy conservation, water conservation and waste management. The climate study of the city is carried out and design guidelines for sustainable residential building in the city are developed. The design strategies are then incorporated into a design of sustainable residential building in the city as a prototype.

In particular, the first phase generated a theoretical assessment based on the analysis and discussion of three sustainable design assessment tools: LEED and in particular LEED for homes, BREEAM and GRIHA. These three sustainability tools were selected due to their innovation as being one of its kinds to be developed and implemented. GRIHA is the closest tool that is very similar to the climate and design aspect in relation to

the city. The analytical process seeks to bring out close issues that can be related to the city's prevailing sustainability issues for designing a sustainable residential building.

The second phase studies the city from social, cultural, environmental and economic standpoint. The sustainable issues are studied extensively in environmental aspect with emphasis on energy, water and waste management. The techniques and approaches to enhance these features in the sustainable residential building for the climate of the city are delineated under the guidelines.

The third analytical phase brings about an assessment between the common issues of sustainable building design practice from the theoretical viewpoint and from the literature review and sustainability issues of the city. The guidelines thus derived have emphasis in energy, water and waste management as indicated with environmental issues of the city. A prototype for a sustainable residential building in Kathmandu is designed based on above-mentioned environmental features. The growing trend of housing development in the city has emphasized on multilevel residential building.

The precedent study from *The Autonomous House* focuses on water conservation while *Bidani House* focuses on the use of thermal mass and site orientation. The literature review from *Eco-Home* dwells on waste management especially greywater recycling, organic waste management and rainwater harvesting system. Traditional residential building study in Kathmandu is studied for vernacular architecture of the city.

Finally, the results are presented for sustainable building design strategies based on the synthesis and evaluation of the theoretical studies, precedent studies, climatic analysis and literature study of the city.

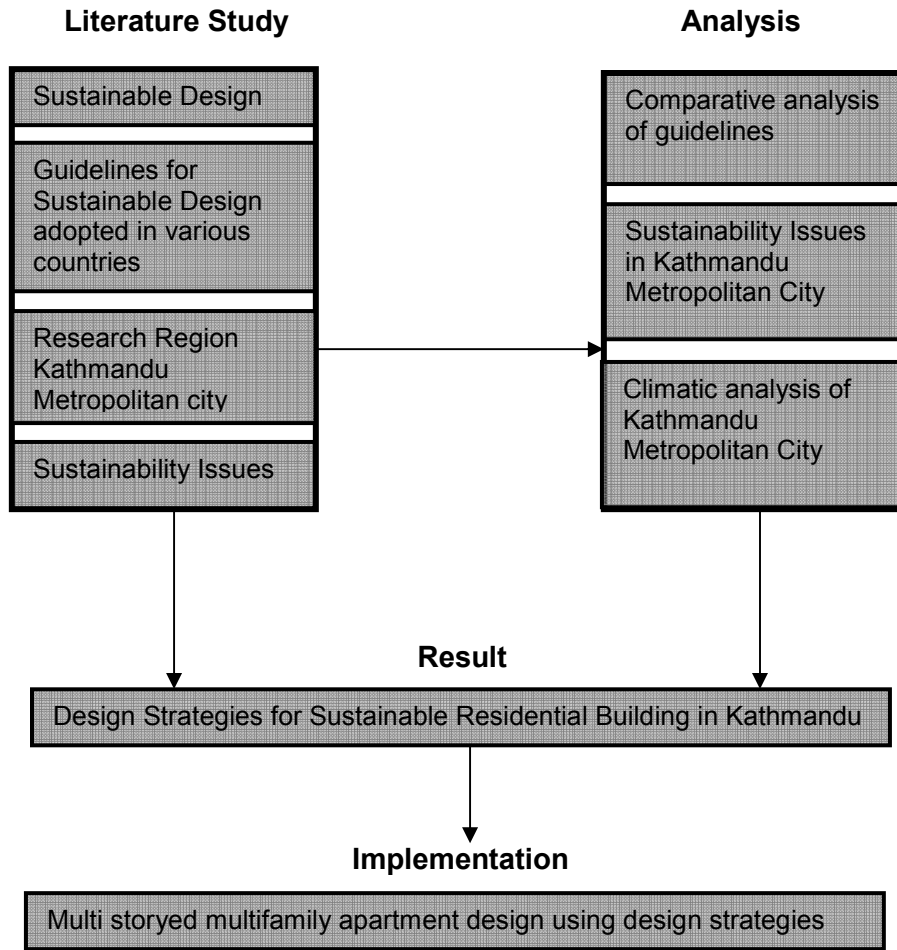

Figure 1.1- Research methodology flowchart

## CHAPTER 2: LITERATURE REVIEW

This chapter deals with the literature review of the research topic. The researcher collated the information for the research through the literature review of various books, reports, articles, academic research works, other secondary documents and drawing from personal experience. The literature study was done with regards to sustainability, and overview of the guidelines pertaining to sustainable design that have been practiced in countries like United States, United Kingdom and India and comparison among them in areas pertaining to environmental sustainability.

### 2.1 SUSTAINABILITY

In its report 'Our Common Future', published in 1987, World Commission on Environment and Development (WCED) first used the term 'Sustainable Development'. Since then this term has been widely used and has been defined as 'meeting the needs of the present without compromising the ability of future generations to meet their own needs.' A specialized and a comprehensive definition of sustainable development pertaining to various organizations and writers have been defined. These definitions attempt to entail range of groups to ensure sustainability of a system. One definition, particularly, related to architecture was developed by Royal Institute of British Architects (RIBA) which states:

'Sustainable Development is that which raises the quality of life and serves the goal of achieving global equity in the distribution of the Earth's resource whilst conserving the natural capital and achieving significant and sustained reductions in all forms of pollution, especially emissions of greenhouse gases.'

- ((RIBA) 2000)

Sustainability means long-term viability. In its simplistic terms, Oxford Dictionary defines sustain as "maintain", "support" or "endure". In the definition itself elements of

environment has been embedded and emphasized. In order to accomplish the mission of sustainable and continuous development; it is imperative to recognize the relationship between society's needs and environmental limitations. The human needs comprise of the basic amenities such as food, clothing, and housing, and the prospect to have a higher standard of living over and above the basic needs. The word "design" in this context encompasses a building's life from preconstruction, construction, occupancy, and finally decommissioning. According to Environmental Protection Agency (EPA) (United States Environmental Protection Agency, 2000):

- 42% of energy, 30% of raw materials, and 25% of water consumption can be attributed to buildings.
- 40% of air pollution, 25% of solid waste, and 20% of wastewater are building-related.

The fact demonstrates the significant impact buildings have on the environment. The building sector of the economy includes the acquisition of raw materials and the production of building materials, as well as the transportation, construction, and the day-to-day operation and maintenance of buildings. These activities are the prime sources of environmental pollution and impact. Hence, buildings in general, present a significant opportunity to reduce the associated environmental impact and to contribute to the overall sustainable development of society (Samuels, 1994). Most cultures build to fulfill a set of needs and desires that reach well beyond simple shelter and basic sustenance. However, in the process of fulfilling these needs, the introduction of sustainable design concepts proposes to include environmental considerations to the design equation of cost and performance (United States Environmental Protection Agency, 2002).

After nearly two decades, sustainable design as a global issue continues to garner attention and gain wider acceptance. Interest in sustainable design has impelled actions by

industry, along with numerous studies, articles, and reports by a wide range of organizations from state and local groups in multiple countries of the United Nations.

## 2.2 DIMENSIONS OF SUSTAINABILITY

The success of sustainable design in developing and developed countries in terms of enhanced awareness, relevance, and application relies heavily on the economic, environmental, and social dimensions. These three dimensions affect the way people perceive and pursue sustainability in their environment (figure 2.1). Human well-being is highly correlated on the relationships of environmental sustainability, economic sustainability, and social sustainability

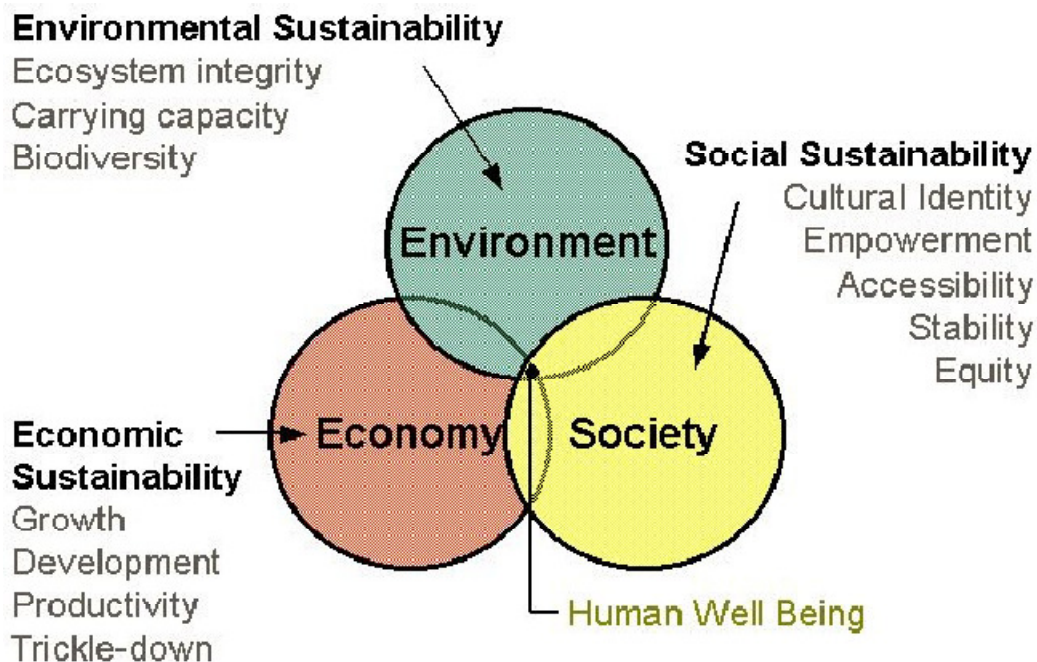

Figure 2.1- Dimensions of sustainability for human well being Source: (SABD 1996)

As explained by Samuel Mock Bee of Auburn University (2002), Sustainable Design involves a combination of values: aesthetic, environmental, social, political, and moral. The

smart designer must think rationally about a combination of issues including sustainability, economic constraints, durability, longevity, appropriateness of materials, and creation of a sense of place. The challenge is finding the balance among these issues within the context of sustainable cultural norms and value systems.

### **2.3 SUSTAINABLE BUILDING DESIGN**

The sustainable building design has its origin in the cradle-to-cradle concept that is prevalent in the field of sustainability. Walter R. Stahel first coined the term 'cradle to cradle' in 1970 and in 1990's Michael Braungart took it up with the term 'lifecycle development.' The buildings, their assembly, use and disposal, have a considerable impact on the natural environment and social fabric of our society. Since the impact is of great concern for the environment and human beings, the question remains on how to design buildings that addresses such critical issues, achieve economically strong, socially inclusive, stable communities while minimizing the impact on the environment? In the book, 'Strategies for sustainable architecture' by Paola Sassi (Sassi 2006), she points out there are two aims for sustainable architectural design

"First, sustainable buildings should be metaphorically 'tread lightly on the Earth' by minimizing the environmental impacts associated with their construction, their life in use and at the end of their life. Sustainable buildings should have small ecological footprints.

Second, buildings should make a positive and appropriate contribution to the social environment they inhabit, by addressing people's practical needs while enhancing their surrounding environment and their psychological and physical well being."

- (Sassi 2006)



Jong-Jin Kim, an assistant professor at The University of Michigan, has proposed a framework for sustainable architectural design. He forwards three principles for sustainable architectural design that are economy of resources, life cycle design and humane design (Kim and Rigdon 1998) (figure 2.2). The framework here aims to assist designers seeking sustainable design to find 'solution rather than giving them a set of solutions.' (Kim and Rigdon 1998)

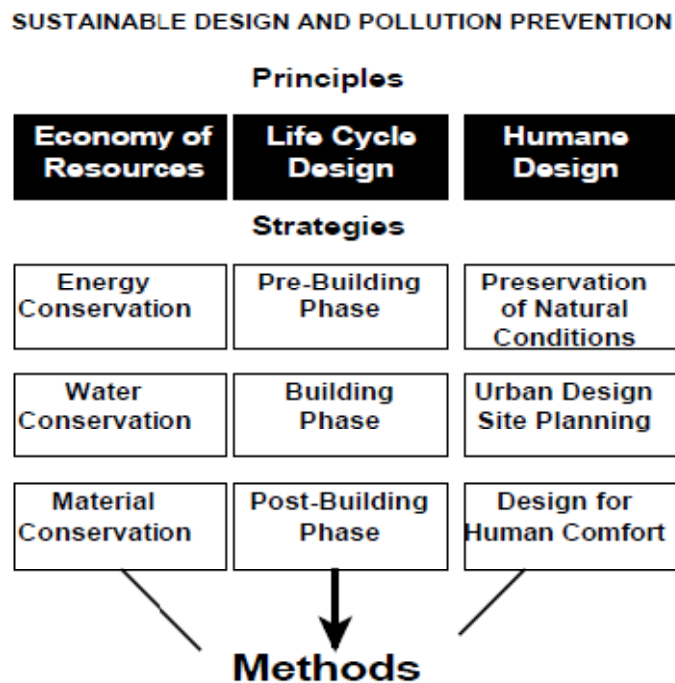

Figure 2.2- Conceptual framework for sustainable design and pollution prevention in architecture  
Source: (Kim and Rigdon 1998)

## 2.4 ELEMENTS OF SUSTAINABLE DESIGN

Sustainable design is the harmonious integration of architecture, landscape and interior design along with electrical, mechanical, and structural engineering components. The Rocky Mountain Institute delineates five essential elements for sustainable design:(SABD 1996)

- Planning and design should be thorough because early decisions have the greatest impact on energy efficiency, passive solar design, day lighting, and natural cooling.
- Sustainable design is more of a philosophy of building rather than a regulatory building style.
- Sustainable buildings should neither be mostly inexpensive, nor be more complicated, than traditional construction.
- Integrated design, with each element considered part of a greater whole, is critical to successful sustainable design.
- Encouraging human health, energy conservation, and ecological systems features, the design of the building envelope, and protection of users' health and well-being through interior design, as well as mechanical, electrical, and plumbing systems, are the key elements.

## **2.5 PRINCIPLES OF SUSTAINABLE DESIGN**

Sustainably designed buildings aim to lessen their impact on the environment through energy and resource efficiency. It is imperative to understand the governing principles of sustainable design before analyzing its relevance and perception in different parts of the world (SABD 1996) :

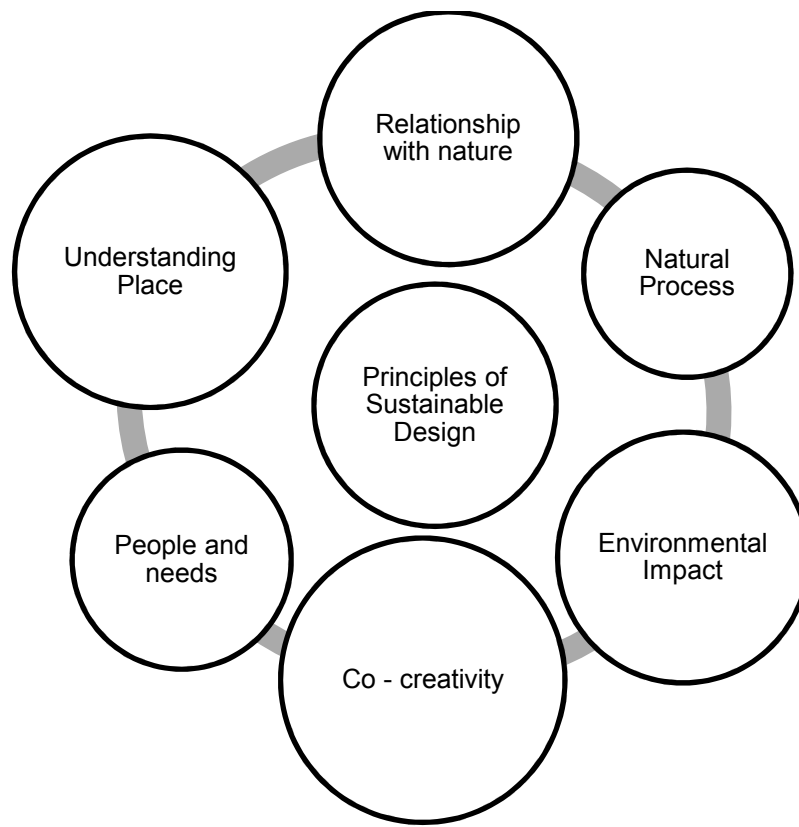

Figure 2.3- Principles of sustainable design

- Understanding place: Sustainable design begins with an intimate understanding and recognition of the nuances of place. The place helps determine various design practices such as solar orientation of a building on the site, preservation of the natural environment, access to public transportation, and specification of local materials for finishing and furnishings.
- Understanding the relationship with nature: The relationship of the building and the natural environment, such as urban/rural setting and connection of interior and exterior, helps to create effective design.
- Understanding natural processes: In nature, there is no waste, and the by-product of one organism becomes the food for another. Replicating natural cycles, processes, and making them visible can bring the designed environment to life.

- Understanding environmental impact: Understanding of the environmental impact by evaluating the site, the embodied energy and toxicity of the materials, and the energy efficiency of design, materials, and construction techniques is very significant to alleviate the negative effects of construction.
- Understanding co-creativity: Collaboration of systems consultants, engineers, and other experts, as well as listening to the voices of local communities, generates a synergy in designing buildings.
- Understanding people: Sustainable design must take into consideration a wide range of cultures, races, religions, and habits of the people who are going to be using and inhabiting the built environment. This requires sensitivity and empathy to the needs of the people and the community.

The aforementioned principles can be applied universally. However, it is the responsibility of the respective governments to create the appropriate codes and regulations for their respective societies to protect the health, safety, and welfare of the populace on the micro level (i.e. environmentally sustainable design) and the environment on the macro-level (i.e. sustainable development).

The proposal forwarded by Jong-Jin Kim is apt and addresses the environmental sector of sustainability. The life cycle design principle is the added tool for addressing economic factor for building design solutions. The approach is good enough for seeking solutions for environmentally sustainable building that highlights economical and conservative use of resources. Paola Sassi adheres to the ideas of Jong-Jin Kim, by treating the Earth's ecosystem delicately and in life cycle design of buildings. Human comfort design is one of the top priorities in designing buildings and the occupants should be able to feel healthy and well during their stay. It is imperative to maintain environmental balance with nature so that buildings that have minimal impact to the Earth's environment.

## **2.6 SUSTAINABLE BUILDING DESIGN GUIDELINES PRACTICES**

The effort on development of building design guides, improving energy codes, the using and developing low environmental impact building materials, renewable energy and resources and the concept of analyzing the effects of design choices over the complete life cycle of a building have been of great concern for designers, planners and building industry for over two decade. After the first Green Building assessment tool Building Research Establishment Environmental Assessment Method (BREEAM) was developed in 1990 by the Building Research Establishment (BRE) in the United Kingdom, more than 14 countries have established their own assessment tools (Bay 2006). Leadership in Energy and Environmental Design (LEED) in United States, Green Building Tool in Canada, Guideline for Sustainable Building in Germany, Green Calc in Netherlands have come out with their own assessment tools for sustainable building design. Asian countries like Japan, Taiwan and South Korea have already established their own assessment tools namely Comprehensive Assessment System for Building Environmental Efficiency (CASBEE) and Ecology, Energy, Water and Health Systems (EEWH), Green Building Rating System (GBRS) respectively. Moreover, most of the South Asian countries like Malaysia, Singapore, Philippines, India, and China have began making guidelines for sustainable building design practices.

The main guidelines of LEED (United States) and BREEAM (Great Britain) for sustainable building design are studied in detail. In addition, Green Rating for Integrated Habitat Assessment (GRIHA) is examined for sustainable building guidelines from India. The guidelines thus studied highlight the similarities that can be incorporated and address the environmental problems in case of Kathmandu and ascertain common grounds for developing the environmental sustainability indicators.

## **2.6.1 LEADERSHIP IN ENERGY AND ENVIRONMENTAL DESIGN (LEED)**

(USGBC, 2009)

LEED was developed and piloted in the U.S. in 1998 as a consensus-based building rating system based on the use of existing building technology. LEED was developed through the U.S. Green Building Council member committees. The rating system addresses specific environmental building related impact using a whole building environmental performance approach. In addition to LEED-NC (for new construction and major renovations), there are versions for existing buildings, commercial interiors, core and shell, homes, and neighborhood development. There are also application guides that can be used to increase the applicability and flexibility of LEED (e.g., multiple buildings and campuses, schools, health care, laboratories, lodging, and retail (pilot)). The new LEED Version 3.0 has been developed since April 2009.

### **2.6.1.1 LEED FOR HOMES ((USGBC) 2009)**

It is a program of U.S. Green Building Council (USGBC), launched officially in 2008. LEED Home is a voluntary system that promotes the design and construction of green homes. Similar to LEED, it also has varied sections ranging from energy, water conservation, site planning to name a few, under which the parameters for sustainable design are measured. The following are the main criteria under which homes are certified for its sustainability:

Table 2.1- Categories in LEED Home

LEED Home	Issues in Home Pilot Project Checklist
<b>Location and Linkage</b>	<ul style="list-style-type: none"> <li>• LEED-ND Neighborhood</li> <li>• Site Selection (Edge development, Infill, Previously developed infrastructure)</li> <li>• Community Resources (Basic, Extensive, Outstanding)</li> <li>• Compact Development</li> </ul>
<b>Sustainable Sites</b>	<ul style="list-style-type: none"> <li>• Site Stewardship ( Erosion, Minimize disturbed area of site)</li> <li>• Landscaping-(No invasive plant, Basic landscape design, Limit conventional turf, Drought tolerant plants, Reduce overall irrigation demand -at least 20%)</li> <li>• Shading of Hardscapes</li> <li>• Surface Water Management</li> <li>• Non-Toxic Pest Control</li> </ul>
<b>Water Efficiency</b>	<ul style="list-style-type: none"> <li>• Water Reuse (Rainwater harvesting system, Gray-water reuse system, Use of municipal recycled water system)</li> <li>• Irrigation System (High efficiency irrigation system, Third party inspection, Reduce overall irrigation demand (at least 45%))</li> <li>• Indoor Water use (High and Very high efficiency fixtures and fittings)</li> </ul>
<b>Indoor Environmental Quality</b>	<ul style="list-style-type: none"> <li>• ENERGY STAR with IAP</li> <li>• Combustion Venting (Basic and enhanced combustion venting measures)</li> <li>• Humidity Control</li> <li>• Outdoor Air Ventilation (Basic and enhanced outdoor air ventilation, Third party performance testing)</li> <li>• Local Exhaust (Basic and enhanced local exhaust, Third party performance testing)</li> <li>• Supply Air Distribution (Room by room calculations, Return air flow/ room by room controls, Third party performance test/ multiple zones)</li> <li>• Supply Air Filtering (Good filters, Better filters, Best filters)</li> <li>• Containment Control (Indoor contaminant control during construction, Indoor contaminant control, Preoccupancy flush)</li> <li>• Radon Protection (Radon resistance construction in high – risk areas and moderate – risk areas)</li> <li>• Vehicle Emission Protection</li> </ul>

Table 2.1 Contd...	
<b>Materials and Resources</b>	<ul style="list-style-type: none"> <li>• Home Size</li> <li>• Material Efficient Framing (Framing order waste factor limit, Detailed framing documents, Detailed cut list and lumber order, Framing efficiencies, off-site fabrication)</li> <li>• Local Sources</li> <li>• Durability Plan</li> <li>• Environmentally Preferable Products</li> <li>• Waste Management (Construction Waste Management Planning, Construction Waste Reduction)</li> </ul>
<b>Energy and Atmosphere</b>	<ul style="list-style-type: none"> <li>• ENERGY STAR Home</li> <li>• Insulation</li> <li>• Air Infiltration</li> <li>• Windows</li> <li>• Duct Tightness</li> <li>• Space Heating and Cooling</li> <li>• Water Heating (Efficient Hot Water Distribution, Pipe Insulation)</li> <li>• Lighting</li> <li>• Appliances</li> <li>• Renewable Energy</li> <li>• Refrigerant Management</li> </ul>
<b>Innovation Design Process</b>	<ul style="list-style-type: none"> <li>• Innovative Regional Design</li> <li>• Integrated Project Planning (Preliminary rating, Integrated project team, Professional credential with respect to LEED for Home, Building orientation for solar design)</li> <li>• Durability Management Process (Durability Planning, Durability Management and Third Party Durability Management Verification)</li> </ul>
<b>Homeowner Awareness</b>	<ul style="list-style-type: none"> <li>• Homeowner Education</li> </ul>



## 2.6.2 BUILDING RESEARCH ESTABLISHMENT'S ENVIRONMENTAL ASSESSMENT METHOD (BREEAM) (BREEAM 2002, 2003)

In 1990, BREEAM was developed in the United Kingdom. It is the building environmental assessment method with the longest track record. BREEAM covers a range of building types including: offices, homes, industrial units, retail units, and schools. Other building types can be assessed using Bespoke BREEAM (“bespoke”- another word for custom-made). After assessing the building, points are awarded for each criterion and total score is computed with addition of the points. The overall building performance is awarded a “Pass”, “Good”, “Very Good” or “Excellent” rating based on the score.

BREEAM has launched its EcoHome in 2006 for rating residences that has following major categories:

Table 2.2- Categories in EcoHome

<b>BREEAM/ EcoHome</b>	<b>Issues in EcoHome</b>
<b>Energy</b>	<ul style="list-style-type: none"> <li>• Dwelling Emission Rate – CO<sub>2</sub></li> <li>• Building Envelope Performance</li> <li>• Drying Space</li> <li>• Eco-labelled white goods</li> <li>• External Lighting</li> <li>• Internal Lighting</li> </ul>
<b>Transport</b>	<ul style="list-style-type: none"> <li>• Public Transport</li> <li>• Cycle Storage</li> <li>• Local Amenities</li> <li>• Home Office</li> </ul>

Table 2.2 Contd...	
<b>Water</b>	<ul style="list-style-type: none"> <li>• Internal Potable Water</li> <li>• External Potable Water</li> </ul>
<b>Pollution</b>	<ul style="list-style-type: none"> <li>• Insulation ODP and GWP</li> <li>• NO<sub>2</sub> Emission</li> <li>• Reduction of Surface Runoff</li> <li>• Renewable and Low Emission Energy Source</li> <li>• Flood Risk Mitigation</li> </ul>
<b>Materials</b>	<ul style="list-style-type: none"> <li>• Environmental Impact of Materials</li> <li>• Responsible sourcing of Materials Basic Building Elements</li> <li>• Responsible sourcing of Materials Finishing Elements</li> <li>• Recycling Facilities</li> </ul>
<b>Land Use and Ecology</b>	<ul style="list-style-type: none"> <li>• Ecological value of site</li> <li>• Change of Ecological value of site</li> <li>• Building footprint</li> <li>• Ecological enhancement</li> <li>• Protection of Ecological features</li> </ul>
<b>Health and Well Being</b>	<ul style="list-style-type: none"> <li>• Daylighting</li> <li>• Sound Insulation</li> <li>• Private Space</li> </ul>
<b>Management</b>	<ul style="list-style-type: none"> <li>• Home user guide</li> <li>• Considerate Contractors</li> <li>• Construction Site Impacts</li> <li>• Security</li> </ul>

### 2.6.3 GREEN RATING FOR INTEGRATED HABITAT ASSESSMENT (GRIHA

2010)

GRIHA is the National Rating System of India. It was conceived by The Energy and Resource Institute (TERI) and was developed jointly with the Ministry of New and

Renewable Energy, Government of India. It is a green building 'Design evaluation system', and is suitable for all kinds of buildings in different climatic zones of the country. It evaluates the environmental performance of a building holistically over its entire life cycle, thereby providing a definitive standard for what constitutes a 'green building'. The rating system, based on accepted energy and environmental principles, will seek to strike a balance between the established practices and emerging concepts, both nationally and internationally. There are four broad categories for evaluation of green building design. GRIHA's major categories are as follows:

Table 2.3- Categories in GRIHA

<b>TERI GRIHA</b>	<b>Issues in GRIHA</b>
<b>Site Selection and Planning</b>	<ul style="list-style-type: none"> <li>• Site Selection</li> <li>• Preserve and protect the landscape during construction/compensatory depository forestation</li> <li>• Soil conservation (till post-construction)</li> <li>• Design to include existing site features</li> <li>• Reduce hard paving on-site and /or provide shaded hard - paved surfaces</li> <li>• Enhance outdoor lighting system efficiency</li> <li>• Plan utilities efficiently and optimize on-site circulation efficiency</li> <li>• Provide at least, the minimum level of sanitation/safety facilities for construction workers</li> <li>• Reduce air pollution during construction</li> </ul>
Building Operation and Maintenance	<ul style="list-style-type: none"> <li>• Internal Energy audit and validation</li> <li>• Building operation and maintenance</li> <li>• </li> </ul>
<b>Innovation</b>	<ul style="list-style-type: none"> <li>• Innovative Design</li> </ul>

Table 2.3 Cont...

<p>Building Planning and Construction Stage</p>	<ul style="list-style-type: none"> <li>• Water: Reduce landscape water requirement, Reduce building water use, Efficient water use during construction</li> <li>• Energy: Optimize building design to reduce the conventional energy demand, Optimize the energy performance of the building within specified comfort limits;</li> <li>• Embodied Energy and construction: use flyash, Reduce volume, weight, and time of construction by adopting an efficient technology (e.g. pre-cast systems, ready-mix concrete, etc.), use low energy material in the interiors</li> <li>• Renewable Energy: Renewable energy utilization, Renewable energy - based hot- water system</li> <li>• Recycle, Recharge, and Reuse of water: Wastewater treatment, Water recycle and reuse (including rainwater)</li> <li>• Waste management: Reduction in waste during construction, Storage and disposal of waste, Resource recovery from waste</li> <li>• Health and well being during post –construction occupation: Use of low-VOC (volatile organic compounds) paints/ adhesives / sealants, Minimize ozone – depleting substances, Ensure water quality, acceptable outdoor and indoor noise levels, Tobacco and smoke control, Provide the minimum level of accessibility for persons with disabilities</li> </ul>
---	--

**2.6.4 COMPARISONS OF SUSTAINABLE BUILDING GUIDELINES**

The comparison tables are tabulated for the aforementioned sustainability tools for setting the indicators of Sustainable Building Design. The comparisons are done broadly in energy efficiency, water efficiency, indoor environment and waste management. With the initial environmental issues of Kathmandu and the factors that affected residential building design, the following comparisons from the three guidelines of sustainable building design are:

Table 2.4- Energy Efficiency Comparison Table

Design Area	LEED Home	EcoHomes /BREEAM	GRIHA	Common Issues Addressed
Energy Efficiency	ENERGY STAR Home	Building envelope performance	Optimize building design to reduce conventional energy demand	Fabric Insulation – High U-value
	Appliances	Drying space	Optimize energy performance	Ecological friendly Appliances
	Lighting	External Lighting Internal Lighting	Renewable Energy utilization	Lighting – Design and appliances
	Water Heating / Renewable Energy		Renewable energy based hot-water system	Renewable and low-emission energy source
	Duct Tightness			
	Space Heating and Cooling			
	Windows			
	Air Infiltration / Insulation			
	Refrigerant Management			
			Eco-Labelled white goods	

Table 2.5- Water Efficiency Comparison Table

<b>Design Area</b>	<b>LEED Home</b>	<b>Eco-Home /BREEAM</b>	<b>GRIHA</b>	<b>Common Issues Addressed</b>
<b>Water Efficiency</b>	Water Reuse	Internal Potable Water Use	Reduce landscape and buildings water use	Indoor water Reuse
	Irrigation System	External Potable Water Use	Recycle, recharge and reuse water	Outdoor Irrigation System
	Indoor Water Reuse		Efficient water use during construction	Water Reuse – Rainwater and Grey Water
				Surface water management

Table 2.6- Waste Management Comparison Table

<b>Design Area</b>	<b>LEED Home</b>	<b>Eco-Home /BREEAM</b>	<b>GRIHA</b>	<b>Common Issues Addressed</b>
<b>Waste Management</b>	Waste Management	Recycling Facility	Waste reduction during construction	Waste Management and Recycle
	Material Efficient Framing			
			Resource recovery	
			Storage and disposal	

Table 2.7- Indoor Environment Comparison Table

Design Area	LEED Home	Eco-Home /BREEAM	GRIHA	Common Issues Addressed
Indoor Environment	ENERGY STAR with IAP	Day lighting	Health and well being	Refrigerant Management
	Combustion Venting	Sound Insulation	Use of low Volatile Organic Compounds	Windows – Natural Lighting and Insulation
	Humidity Control	Private Space		
	Outdoor Air Ventilation		Outdoor and indoor noise level	
	Local Exhaust		Tobacco and smoke control	
	Supply Air Distribution			
	Supply Air Filtering			
	Contaminant Control			
	Radon Protection			
	Vehicle Emission Protection			
				Accessibility for persons with disabilities
				Minimize Ozone-depleting substance

The aforementioned evaluation criteria under various types of climate and sustainable design guidelines can be summarized into following broad category. With the considerations of the problems faced by Kathmandu and reviews of literature on the sustainable design practices, following primitive categories has been formulated for development of guidelines in Kathmandu and features to be incorporated into sustainable building design:

- Energy Conservation
- Water Conservation
- Waste Management



## CHAPTER 3: THE RESEARCH REGION- KATHMANDU

### 3.1 KATHMANDU

Nepal is a small, land locked mountainous country extending 500 miles from east to west and some 150 miles north to south, bordered between China to the north and India to the South, East and West (Shrestha 1972). Nepal has diversified landforms that range from the high Himalayas towards the north to the tropical zones (Tarai) of the Indo-Gangetic basin, close to sea level, towards the south. Kathmandu, the capital and main political and economic centre of Nepal, lies in the bowl-shaped Kathmandu valley, a natural region, which contains some of the oldest human settlements in the central Himalayas. The valley includes four main cities, Kathmandu Metropolitan City (figure 3.1), Lalitpur Sub-Metropolitan City, Kritipur Municipality and Bhaktapur Municipality. The valley covers an area of 900 square kilometers (347 square miles) (ICIMOD 2007).



Figure 3.1- Map of Nepal (Source: CIA, 2007)

Kathmandu Metropolitan City (KMC) is positioned with the geographic coordinates of

27°43'00" North latitudes and 85°16'5" East longitudes (figure 3.2). The city lies at an average altitude of 1,350 meters above sea level. The city covers an area of 50.67 square kilometers (19.56 square miles) (KMC 2010). The climate is sub-tropical cool temperate. Normally, the annual maximum and minimum temperatures are between 29°C in June and 1°C in January. The annual rainfall records for Kathmandu from 1995 to 2003 show fluctuations between 1,171 to 1,868 millimeters (mm) (ICIMOD 2007).

The valley is experiencing an extraordinary rate of population growth, mostly in Kathmandu. An indication of this accelerated growth can be seen by the rate of growth of Kathmandu district, which is estimated to 4.71 percent per year (ICIMOD 2007). The population of the city was 671,846 (CBS 2003) while the projected population is expected to be 1,011,105 for the year 2011 (CBS 2003)

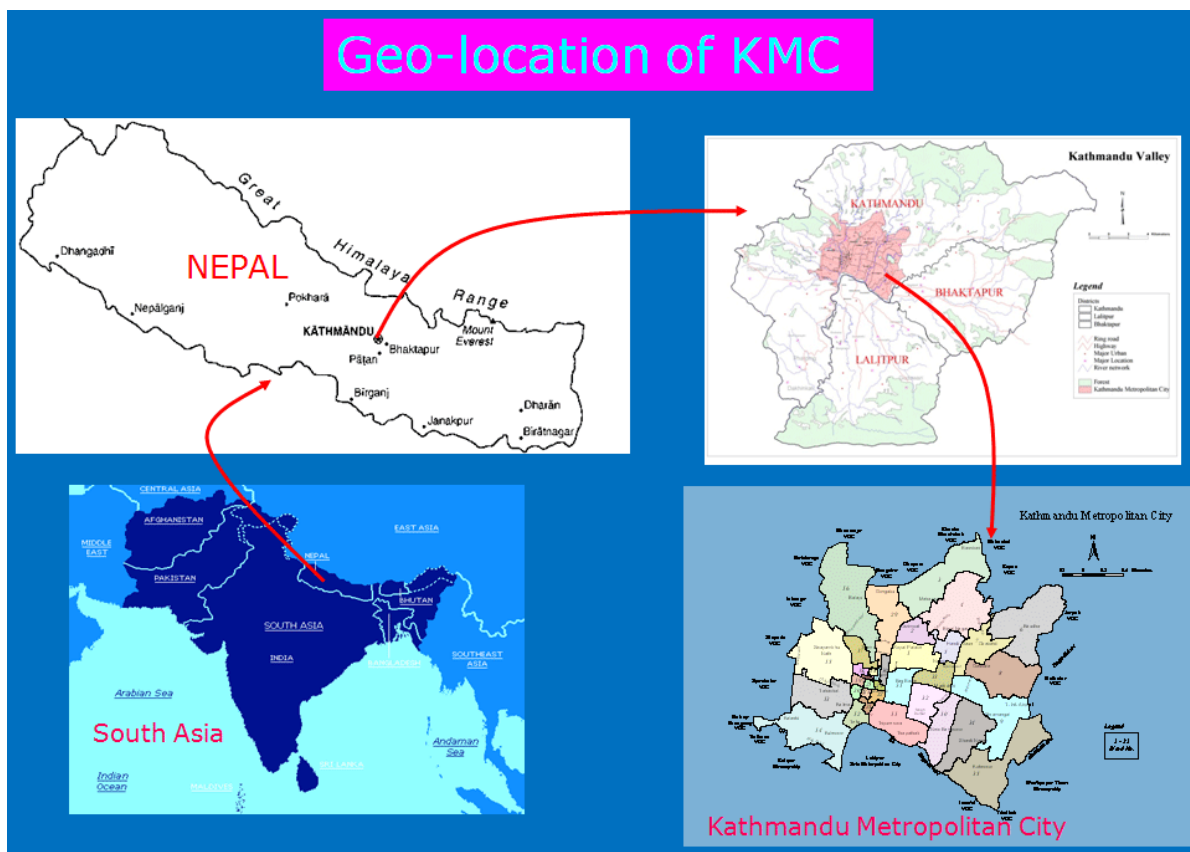

Figure 3.2- Kathmandu Metropolitan City, Kathmandu Valley, Nepal (Source: KMC 2010)

### 3.2 BRIEF HISTORY OF KATHMANDU

Kathmandu city was made capital of Nepal after unification of the nation in 1769 AD. It was already dominant and flourishing urban center then. The history of the city, which is inseparable from that of the Kathmandu valley, dates back to ancient times. Archaeological explorations indicate that the city and the two other sister towns in the valley were the oldest towns in the region and its origin can be traced to the period between 167 BC and 1 AD. According to legends, Kathmandu valley was a huge lake and was drained by Manjushree Bodhisatva, a Buddhist saint, by cutting open an outlet in the southern rim of the valley. Thus, the valley that formed was fertile and people started cultivating here and building their homes here. According to an inscription found while excavating, the history of the valley dates back to 185 AD thus providing vital information of the rulers of the city thereafter. The first settlers were cowherds belonging to Abhir dynasty that included eight rulers followed by the Kirat dynasty, which was ruled by twenty-nine rulers until Lichhavi dynasty took over in 400 A.D.

Table 3.1 - Highlights of History of Nepal

Period	Highlights
<b>Lichhavi dynasty (400 - 750)</b> Mana Deva I ruled from 464 and credited for his works in art and architecture	Introduction of the Pagoda roofed architecture, erected exquisite sculptures and built the temples of Changunarayan, Vishabhjynarayan, Sikhomanarayan and Ichabgunarayan.
<b>Dark Age (750 -1200)</b>	Little is known of this period as it was called transitional period with war and demise of Lichhavi dynasty
<b>Malla dynasty (1200- 1768)</b>	Golden period, development of city all round, traditional Newari architecture developed and flourished, palaces were built among those three major palaces namely Kathmandu Durbar, Patan Durbar (present Museum) and Bhaktapur Durbar are still intact till today

<p><b>Shah dynasty (1769 - 1845)</b> Prithivi Narayan Shah - unification of petty states into Kingdom of Nepal</p>	<p>Continuation of Malla architecture with modification to style and imported new art and architecture. Nepal's boundary expanded in East, West and South.</p>
<p><b>Rana rule (1846 - 1950)</b> Ranas were Prime Ministers who overtook from Shah King and became only figurative head of nation while all activities were performed by Rana Prime Ministers</p>	<p>Mostly developments were noticeable with more than 40 palaces of Victorian style were made over this period out of which 4-5 still exists in the Kathmandu valley, rise of modern style building seen at latter stages</p>
<p><b>Modern Period ( 1950 - present)</b> Regain of Shah King as main ruler and Democracy was established with peoples' effort and King who threw 104 Rana rule. Currently, there is no King and 250 year old history of Monarchy was eliminated in 2006</p>	<p>The valley opened itself to international and national arena and overall development was seen, various planning document of Kathmandu valley proposed but nothing sufficed, modern materials of construction began replacing old building construction techniques and newer contemporary design began taking over.</p>

### 3.3 SUSTAINABILITY ISSUES IN KATHMANDU

Kathmandu valley was a sustainable place from environmental and ecological point of view until the modern era. It was agriculturally self sufficient and socially harmonious, bounded in a social hierarchy for a long period of time throughout the history that remained intact (Adhikari 2008). The society is very much diversified with various ethnic groups and social hierarchy based on caste still lingers within Kathmandu valley. In the traditional Newari residential architecture, the social spaces and private spaces were segregated such as kitchen space was at top level of the residence as a part of cultural norms. But, nowadays residences have kitchen space at ground floor going by contemporary trends. These segregated social structures and its desirable normative issues in time need a critical review by the standards of today's democratic and pluralistic norms in Nepal (Adhikari 2008). The sociological, cultural and heritage in many ways played a bigger role in sustainable lifestyle. In due time, with advancement of urbanization in the city, various development projects in infrastructure, economics and societal benefits brought about

change in lifestyle. The switch from agro based work and industry to service and business oriented work brought about change in lifestyle. Being a native of Kathmandu and drawing from my experience, the problems of urban management in the city is at a critical juncture as there is no proper monitoring and evaluation of the systems working in the city.



Figure 3.3- Water shortage has caused untreated use of ground water from wells  
(Source: Ghimire 2008)

One of the issues is the current population growth that is clearly unsustainable if apt infrastructure, housing, water supply and other urban amenities cannot keep up with the rate of growth. Improper solid waste management, poor service and non-existent recycling of sewerage and industrial waste are a visible sight. Inadequate processing and improper handling of solid waste is posing a risk to the public health (Devkota and Watanabe 2006). Sewerage systems on the other hand are often combined with storm water drainage systems. Although it exists in some places in the city but their coverage is inadequate and they are in a poor maintenance condition. The sewage treatment plants in the city are not

functioning and the untreated sewage has to be discharged directly into the rivers.

Groundwater in the city is also contaminated due to seepage from pits and septic tanks, and open defecation (Thapa, Murayama et al. 2008).

Conflicting land use, unplanned and haphazard construction, inadequate road network, and inefficient transport management are creating severe traffic congestion during peak commuting periods in the city. Emission of dust due to old and smoky motor vehicles and construction works, and the release of particulate matters (PM) by small-scale industries such as brick kilns are major sources of air pollution (Dhakal, 2006). A major infrastructural insufficiency in the city is the shortage of potable water. Although there are available supplies of potable water, it is insufficient in quantity and quality for the city's demands.



Figure 3.4- Waste collected by roadside before being disposed  
(Source: Ghimire 2008)

Piped water supply covers only a small portion of urban residents, and the supply is usually intermittent. Some of the major issues pertaining to water supply in the city are inadequate quantity, chronic drinking water shortage, and a high rate of water loss, due to leakage and illegal connections (ADB 2006).

## BRIEF ENERGY ISSUES IN KATHMANDU

Owing to the energy problems, the current demand of energy is not meet even to its minimum level. The loadshedding (temporary shutdown of electricity supply in phased timing in different areas of the city) faced by the city people for a long period confirm to the fact that energy supply are inadequate. Furthermore, accessibility of energy and use of locally produced energy will also determine how vulnerable Kathmandu is for its energy needs. The use of solar water heating, photovoltaic panels and biogas in the valley are in rise, which are helpful indicators of sustainable energy use. But, the extensive use of individual electricity generators, even though perceived as in part self-sufficiency to individual home owners and business, exhibit as bad indicators of sustainability in the long run. As my own experience living in Kathmandu, the generators consume petrol, need a regular supply of spare parts, and do not enjoy an economy of scale for energy production.



Figure 3.5- Pollution of rivers due to untreated industrial effluent and domestic sewerages  
(Source: (Ghimire 2008))

Thus, the environmental quality of the city is on a speedy decline with high levels of air pollution, water pollution and land pollution in the urban areas. (Adhikari 2008) The accelerated levels of pollution have been widely studied by experts, international agencies (International Center for Integrated Mountain Development, Asian Development Bank, World Bank) and Nepal government agencies (Ministry of Physical Planning and Works, Ministry of Energy). With my experience, the whole process of meeting the demands of a building from construction to water supply, material and resources, indoor air quality and energy is not met adequately with aforementioned infrastructural and environmental problems in the city.

### **3.4 RESIDENTIAL STATUS IN KATHMANDU**

With the kind of housing development booming in the last decade, the residential buildings in the housing sector are vulnerable from environment and its construction point of view. The regulations and building standards that safeguard the buildings' construction have a weak monitoring mechanism and enforcement of building standards. The land area is quite sustainable with respect to close neighborhood and its potential and accessibility of other urban amenities. The buildings do follow certain norms of climate responsiveness but it is limited to maximize the solar heat gain primarily, for the city has been viewed as climate with cold temperatures in winter and warm climate in summer.

Traditionally, the residences of the city were vernacular that used local resources for the construction to attain maximum climatic comfort. The local resources were cheaper, environmentally and ecologically sound and aesthetically pleasing. The modern trend of residence design began with overall development of Kathmandu and with international connection. Building construction methods have changed greatly in the last two or three decades in the city (Upadhyay, Yoshida et al. 2006). The rise of standardized international style of building ((Upadhyay, Yoshida et al. 2006) have led to residential building design



being more structurally sound and safe.



Figure 3.6- Traditional residence in Kathmandu, Nepal  
(Source: ICIMOD 2007)



Figure 3.7- Main market place at Ason, Kathmandu  
Source (<http://www.flickr.com/photos/wonderlane/2046772588/in/pool-1411592@N25>)

The modern residence designs are highly influenced by the western designs. Five years ago, people had reservation to modern western designs and the result was rise of conflict during construction of the building with numerous modifications in the original design. Over the years with change in mindset due to modernization of lifestyle, popularity of design magazines and economic viability, people have been able to afford a dwelling of their own and incorporate own ideas into the building design, particularly residence design. The building design needs some serious changes with respect to environment in spite of building codes and construction norms to follow but those are not adhered in totality. Building codes related to building area, structural norms, lighting needs among others have been violated.



Figure 3.8- A typical housing colony developed by private developers in Kathmandu  
Source: Comfort Housing Pvt. Ltd. 2006

With Kathmandu facing problems in relation to sanitary, sewerage, water supply, energy demands, noise and air pollution, the need to modify standards that meet environment conscious building is critical.



Figure 3.9- Interior of Living room in a modern housing development  
(Source: Civil Homes Pvt. Ltd 2007)

### 3.5 CLIMATE OF KATHMANDU

Climate of a place depends on several geographic factors but it is mainly attributed to topography and altitude. Nepal experiences extremities of hot and cold climate in flat plains in *Terai* and in the Himalayas respectively. Based on altitude, Kathmandu falls under Warm Temperate Zone where the climate is pleasant. However, the study of climatic data collected from the Meteorological Department for Kathmandu airport point out that the climate of Kathmandu is sub-tropical temperate, characterized by slightly hot summer and cold winters. Kathmandu lies at an altitude of 1350 meters and experiences all the four seasons: summer, autumn, winter and spring.

The climatic data of Kathmandu has been collected for the climatic analysis and the data range from years 1997 to 2008 (see Appendix A) have been computed for climate summary. The calculations of degree hours and wind speed have been done in Ecotect analysis 2011 as shown in figure 3.11. The average of the maximum and minimum monthly

mean temperature is found to be 29.3 °C during the month of June while 2.4 °C during the month of January respectively. The average hour of sunshine is about 6.3 hours and it varies between 3.3 hours to 8.4 hours. The sun path diagram, figure 3.10, shows the solar altitude angle and azimuth angle for different time of a day for any month of a year. The sun's angle at noon during equinox (March 21 and September 22) is 62.3°, summer solstice (June 22) is 85.8° and winter solstice (December 22) is 38.8°.

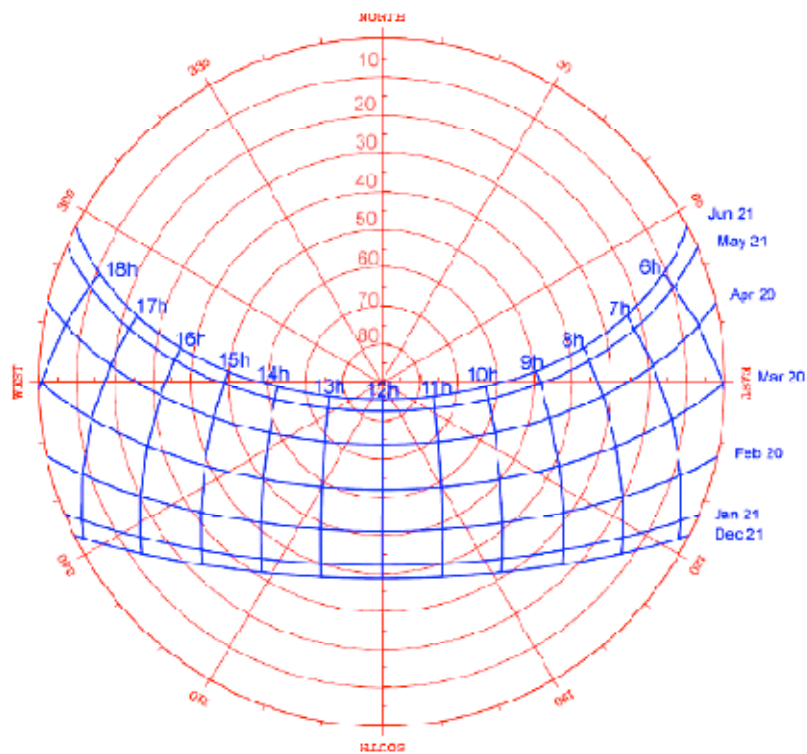

Figure 3.10- Sun path diagram for Kathmandu Source: www.giasma.com

### 3.5.1 HUMIDITY AND PRECIPITATION

Heavy concentration of precipitation is notable during the months from June to August due to southeast monsoon winds (HMGN, 1969). The maximum annual rainfall recorded during the years studied (1997 to 2008) is found to be 1871 millimeters (mm) in the year 2002. The average annual humidity in Kathmandu normally remains approximately

75%. If the amount of precipitation is high, relative humidity is also high, which means the amount of water content in the air is high that makes people uncomfortable. Therefore, measures to protect buildings from high precipitation have to be considered while designing buildings in Kathmandu.

### **3.5.2 WIND**

The average wind speed is 1.88 m/s and wind direction is usually from south and southwest. But, the major wind appears throughout the year on west, northwest and southwest direction. While designing openings, these wind direction and velocity are necessary to control or allow it inside the buildings according to the requirement.

In general, the climate data for Kathmandu shows that there is the requirement of heating, cooling and rain protection. Since the humidity is high during monsoon season, provision to protect from rainfall needs to be prepared. The wind direction data can be used to provide natural ventilation in summer and protect against cold in winter.

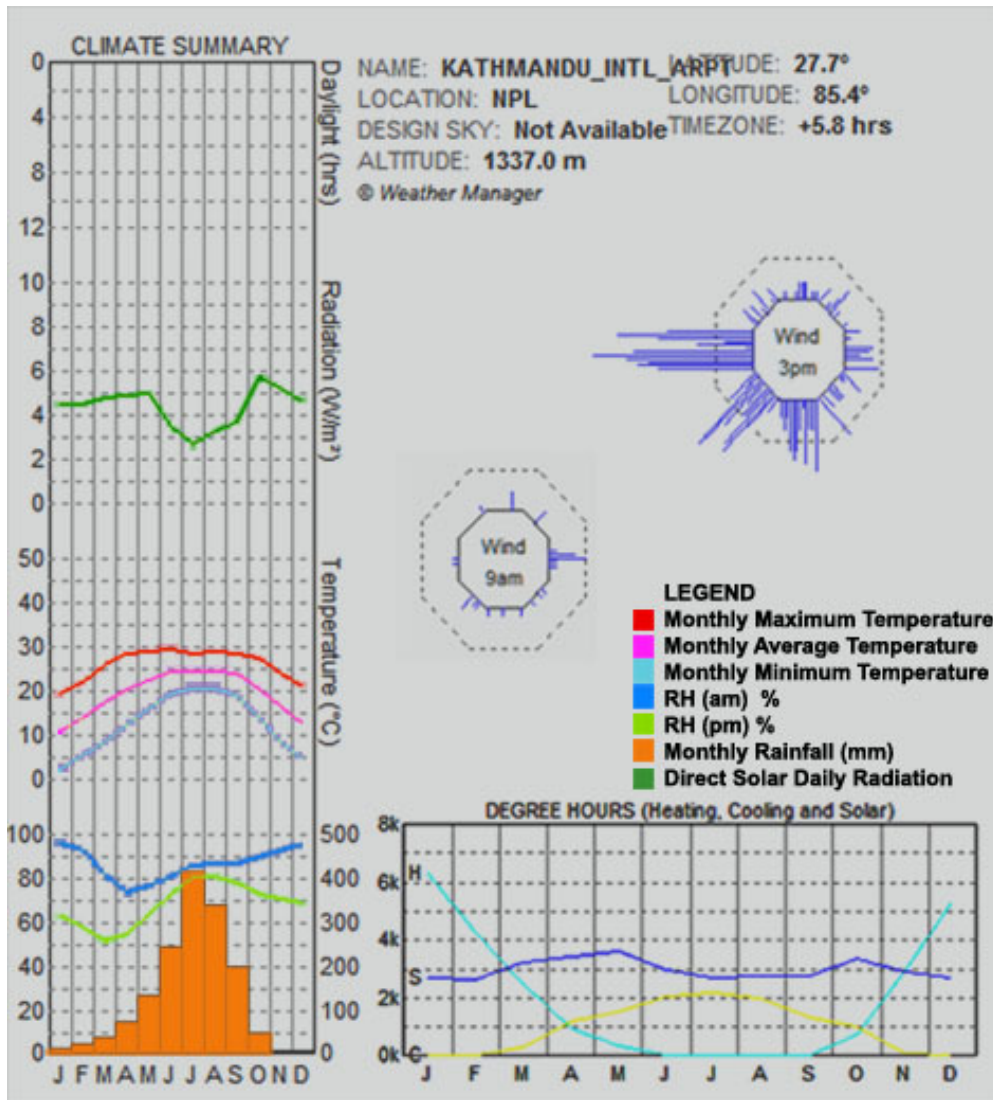

Figure 3.11- Graphical representation of climate summary

(Source: Ecotect Analysis 2011)

## **CHAPTER 4: GLOBAL ENERGY AND ENERGY ISSUES IN KATHMANDU**

### **4.1 INTRODUCTION**

Energy consumption has increased tremendously in the last few hundred years, particularly after the industrial revolution. After the oil crisis of 1970s, there has been global concern about energy use, shifting from non-renewable energy to renewable energy use. Energy is consumed in various areas such as transportation, industries, and buildings and alarmingly utilization is increasing everyday at unprecedented rate. Human beings are consuming energy from non renewable resources in the form of fossil fuel combustion, at a rate two million times faster than their formation process. This situation of energy utilization and environmental degradation is getting worse day-by-day. The major threats from these to our environment are global warming, ozone depletion and depleting resources.

The industrial revolution and technological advancement in the last fifty years have dramatically changed human life and lifestyle. In addition, industries and the built environment are producing greenhouse gases such as methane, nitrous oxide, water vapor etc. These greenhouse gases trap infrared radiation emitted by the sun and prevent re-radiation from the surface of the earth, resulting in the rise of the temperature of the atmosphere. This increase in temperature, known as 'Climate change', has wide impact on the environment such as rising of sea levels, receding coastlines, violent storms, melting glaciers, intensity of precipitation, agriculture, forestry, and wild life. The consequences of such environmental destruction and ecological imbalance created by climate change could cause dislocation of people, occurrence of more and severe natural disasters, impact on food supplies, reduction of bio-diversity, and degradation of the average quality of life.

Among the greenhouse gases, carbon dioxide is a key contributor to the greenhouse

effect. One of the approaches to reduce greenhouse effect is to reduce excessive consumption of fossil fuel to achieve a higher efficiency in the transformation and utilization of energy. Additionally, to switch from fossil fuel consumption to renewable and emission free energy resources, such as solar energy, geothermal energy, wind energy, hydroelectric energy etc. (Daniels 1997)

Buildings account for about 40% of the total energy consumed worldwide (Eicker 2009). Among the buildings, residential sector consume considerable portion of the energy used. In the current context of energy consumption of buildings, the main source of energy for residential sector is electricity, fossil fuel consumption, and burning of biomass. Reducing energy consumption in residential buildings can drastically reduce the global energy consumption. This can be achieved with the climate responsive design of residences and use of appropriate energy technology. Using such approaches not only benefit in lowering energy consumption by the buildings but also considerably reducing environmental impact using natural techniques.

Awareness in conserving energy in planning and designing energy efficient buildings has been in the limelight for over the last two decades. Energy is required in buildings for heating and cooling, ventilation of interior and running electrical and mechanical appliances. Climatic factors such as temperature, humidity, solar radiation, precipitation, wind speed, wind direction and rainfall has multiple effects on human comfort level. To adjust within given climatic conditions, human have been using different technologies to heat, cool, light, ventilate their built environment, and make their living conditions suit their physical comfort.

## **4.2 PASSIVE SOLAR DESIGN / ARCHITECTURE**

Passive solar design means the use of the sun's energy for the heating of living spaces within building. It is the architecture design/space, which minimizes the adverse



impact caused by the climatic influences, both in summer and winter in a natural way exclusive of mechanical control systems. The word 'Passive' accentuates the importance of solar energy in the control of the flow of thermal energy through natural means to attain comfort level as against the use of mechanical means like fans, pumps, air condition etc, often termed as 'active' systems and consumes external fuel for running them. The fundamental natural processes used in passive solar energy are the thermal energy flows linked with conduction, natural convection and radiation. The optimum utilization of solar energy, which is a renewable source of energy, is an essential facet of an energy efficient design for comfortable built environment. The passive design relies heavily on energy conservation along with economic use of available natural resources and design according to the comfort needs of the occupants with respect to the environment. Since, the buildings designed are with regard to taking maximum solar energy through effective use of shape, location and orientation of the site, which saves unnecessary energy, used in the building and makes the buildings energy efficient.

### **4.3 ENERGY SITUATION IN KATHMANDU**

More than 87% of Nepal's total energy demand is currently met by traditional energy sources such as fuel wood, agricultural residues and animal waste. (WECS, 2006) Likewise, about 90% of total energy is consumed in households (figure 4.1). Commercially viable fossil fuel reserve is absent in Nepal thus, all petroleum products are imported, so is coal to some extent. In spite of having impending renewable energy resources, the country is largely dependent on its forest resources for the energy supply. But, the forest resources are utilized in an unsustainable manner and with no proper management. Though Nepal has a huge potential of hydropower generation, its exploitation is minimal. Various studies show that the feasible potential is about 83 Giga-watt (GW), of which about 42 GW is considered

as technically and economically viable (Shrestha, 1966). The actual generation capacity of hydropower is limited to only 0.64 GW (NEA, 2008), due to the lack of necessary investment. Besides hydropower, there is a thermal generation of electricity capacity of about 53 Mega-watt (MW), which is not in regular operation (NEA, 2008). Nepal Electricity Authority (NEA) is the government owned electricity supply in Nepal.

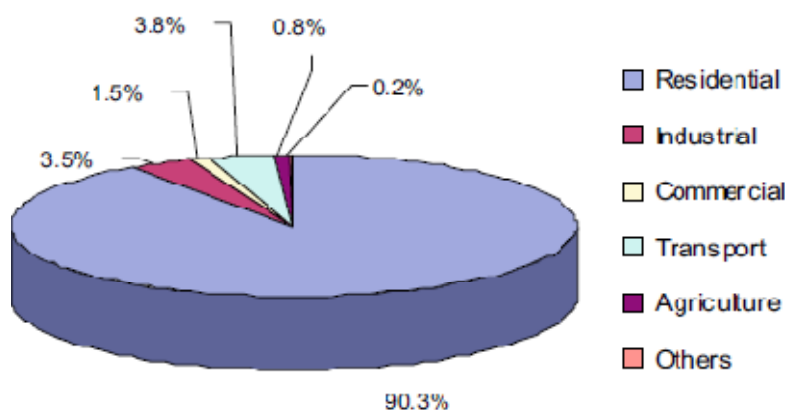

Figure 4.1 - Energy consumption by section in 2005  
Source:(Bhandari and Stadler 2011)

According to Nepal Electricity Authority or NEA (2008), 95.66% of its customers belonged to the domestic group. And with the rise in population and basic need, power and energy demand went up by 11.31% and 10.76% respectively in 2008, and it could mount up in coming years too (figure 4.2). The lopsided gap between supply and demand of electricity could not be filled despite utmost available operation resources including power import from Indian short-term market. Hence, Nepalese were compelled to suffer from long hours of load shedding during winter seasons mainly and in summer season too. NEA, a sole government utility responsible for national electrification (generation, transmission and distribution) had imposed a 16 hours a day of load shedding during the winter of 2008-2009 (NEA 2009). This is primarily due to the increase in demand and lack of hydro power plants and nature of existing hydro power plant usually operated by runoff river water. The hydro

power plants takes 4-5 years for completion thus there is no respite from black out in near future. Therefore, there is an immediate need of economically feasible energy alternatives based on renewable energy sources.

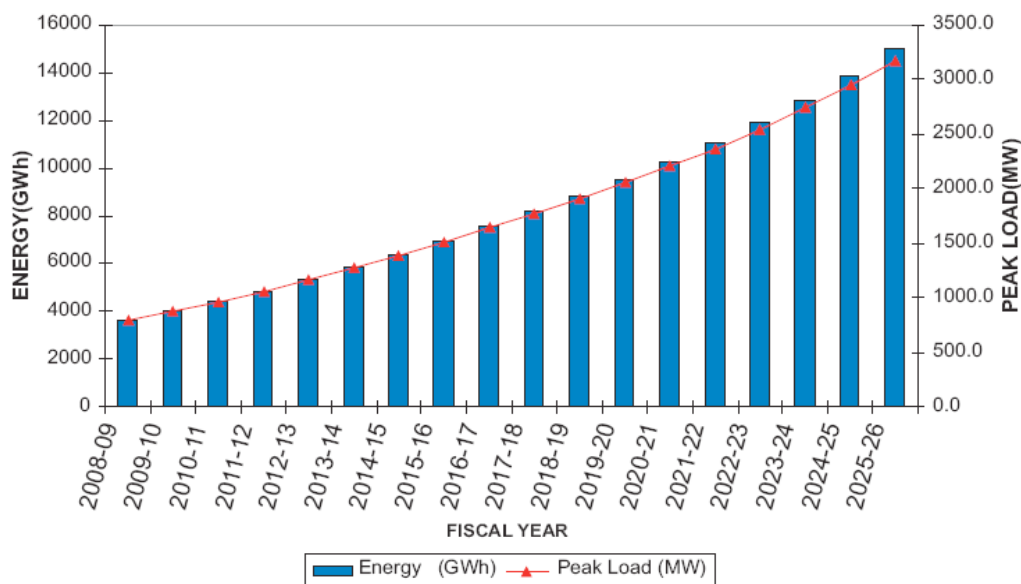

Figure 4.2- Energy demand for next 15 years in Nepal (Source: NEA 2009)

Most of the residential buildings in the urban areas and Kathmandu use electricity primarily for heating, cooling and lighting. According to the survey, it reveals that most of the residence use electrical appliances to have comfortable indoor environment in summer and winter (Shrestha 2009). During summer, most of the buildings use electric fans and in winter, most of the buildings use electric heaters or gas heaters. With growing trends of using air-condition incorporated into building spaces, there is a rise in energy consumption. Although the use of air-condition system in residential buildings is far more less than in other buildings, there is a possibility of use of the system in future that shall hamper the energy demands.

In the city, biomass (fuel wood made out of organic waste) and wind energy are not viable means of renewable energy as both are not feasible enough to produce energy in the

urban context according to various research works carried out by Center for Energy Studies, Institute of Engineering (IOE), Laltipur, Nepal. Photovoltaic (PV) system of solar energy would be another option to generate energy in local level with available technology. But this technology is expensive and has to depend on foreign donor agencies for the necessary equipment to be imported and sell at a subsidized price. In the end, this system might not be feasible as far as maintenance and operation of the system is concerned. Hydropower would be the best option because of abundant water resources available in Nepal. Small-scale hydropower has been setup in rural areas for the energy demand. Although it has higher initial investment, transportation difficulties and cost, with proper maintenance and operation management, this system of energy generation would be sustainable in the end.

Currently, most of the residential houses use solar energy for water heating. The best option to meet the increasing demand of energy is using the solar energy and passive approaches to building for the reduction of demand in conserving energy and meeting partial energy needs.

#### **4.4 TRADITIONAL NEWARI ARCHITECTURE OF KATHMANDU**

Nepal has a diverse cultural heritage, art and architecture due to castes, creed and ethnic group, each having their own culture, religion and built structures. People live in various climatic zones ranging from high altitudes with snow-capped mountains to plain land in *Terai* (local name for plain region of Nepal). With such diversification of climatic regions, uniquely designed forms according to their lifestyle and local climatic condition typify their architecture. Among various ethnic groups in Nepal such as Newar, Gurung, Sherpa, Limbu, Magar, Tamang, Rai, Thakali to name a few, have their residence of unique quality and vernacular aspect in design. More importantly, the Kathmandu valley (includes Kathmandu) has its own architectural history that is still inspirational and that fact can be attested by the

fact that some sites in the valley are enlisted in World Heritage Sites. Predominantly Newars, one of the ethnic groups, and the natives to the valley have been the majority since the beginning of the settlements in the valley although now there has been influx of people from all other caste and creeds.



Figure 4.3- A typical Gurung house  
Source: By Gaurav Tuladhar

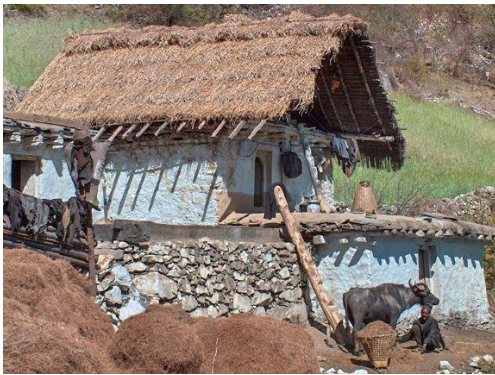

Figure 4.4- A typical Sherpa house  
Source: <http://www.rara-lake.com/nepali-house.html>



Figure 4.5- A typical Tharu house Source:  
<http://www.flickr.com/photos/bluetiger/4068573637/>

The traditional buildings of Kathmandu are an excellent example of strong architectural style that emerged from socio cultural values, economic standards and climatic factors. The traditional buildings of Kathmandu share a harmonious relationship with nature that is reflected in the proper use of local building materials, the orientation of the individual dwellings and the entire settlement as a response to seasonal and daily variation in climatic factors (see figures 4.3 - 4.5). Therefore, these buildings present as excellent models for energy efficient design and good examples of the use of natural, local building materials and these buildings are being used with great satisfaction, even today.

#### **4.4.1 SPATIAL CONFIGURATION OF TRADITIONAL SETTLEMENT**

The settlement pattern of the Kathmandu valley is highly influenced by the Newari culture and the response to the natural environment and prevailing climatic conditions. Most of the prominent settlement of the Kathmandu valley (include Kathmandu) dates back to the beginning of the Malla period (13<sup>th</sup>-18<sup>th</sup> Century) and have remained intact in the compact form. Generally, the traditional towns of Kathmandu valley have two forms of settlement patterns: houses on either sides of the narrow streets and group of building units around an open space called 'courtyard'. Not only does the distinct, open-to-sky courtyards of the housing unit present climatically comfortable spaces for the occupants but also space for miscellaneous activities like social gathering, domestic works such as cleaning and washing, drying of foods and other communal purposes. The need for separate open space for individual housing unit is completely saved by the courtyard since it served as a common open space for the surrounding plots (Mathema, 1999). The traditional settlement of the Kathmandu valley are mostly found on highlands plains between or along rivers and is characterized by grid pattern with narrow streets, alleys and small courtyards. Most of the streets, alleys and courtyards of the settlements are brick paved and used as social, cultural

spaces depending on the festivities and activities. The form of these settlements is changing rapidly and seems to have lost their originality due to pressures of modernization and urban growth. Modern designs and materials seem to interrupt the smooth silhouette of the settlements and their brick and wood colours (Korn, 1976).

The settlements on uplands or hillocks enjoy maximum benefit with respect to easy access for ventilation as well as for solar radiation and as for those settlements near rivers, they have a strong thermal value as water bodies bodes well for maintaining the air conditions in and around the buildings. By and large, the average temperature of the valley remains within the comfortable range for most of the period of the year with only few cold months. Thus, from energy saving and the thermal perspective, the compact settlement pattern suits well to trap the maximum solar radiation during daytime and emit it during cool night period.

#### **4.4.2 BUILDING LAYOUT**

A simple rectangular building plan with sloped *jhingati* tiled roof is a typical building form of the traditional Newari residences. The length generally ranges from a minimum of 5 meters up to 15 meters, yet 4-8 meters is the standard norm (Korn, 1976). The compact form of vertically stacked living spaces i.e. vertical arrangement of rooms (regardless of the building size) is one of the distinct characteristic features of the traditional design that is primarily aimed at security concern along with saving of precious agricultural land. Symmetry is highlighted in most of the façade designs with common materials like burnt brick and timber standing out as exterior features for facade in a typical traditional Newari architecture.

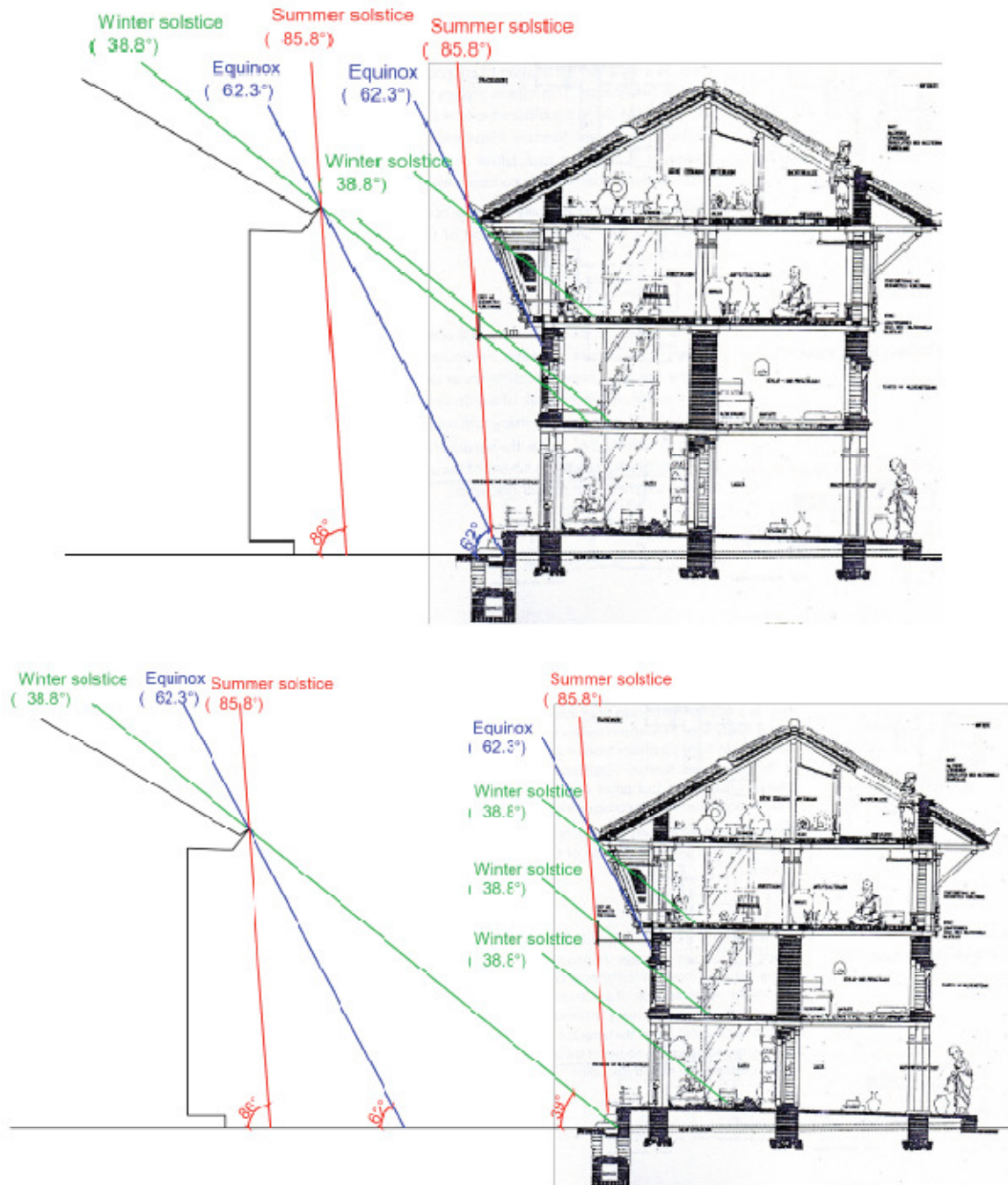

Figure 4.6- Wide and narrow street allowing solar radiation from ground floor and first floor respectively  
Source: (Korn 1998)

The 6 meters house depth dictates the spine wall, parallel to the front wall, divides each floor into two rooms, which on top floor is replaced by the timber columns to provide a large open living space (Korn, 1998). Generally, the central wall divides the ground floor into two narrow rooms, front of which is used for shop or workshop and back one is used as



storage rooms or opening into courtyard. Due to the problems of damp floors caused by use of clay filling or brick tile, the ground floor is not used for living purpose but generally for storing grains and or small kiosks. A narrow wooden staircase (single flight) provides an access to the upper floors.

The living spaces occupy the first floors. In most houses, the first floor is used as bedrooms where small sized wooden latticed windows are preferred for privacy reasons. The second floor, is usually an open hall, is the main living and family area, and has a huge ornately carved window called '*Sajhya*' (slanting bay window projecting from second floor generally) that facilitates interaction and communication with people walking or passing by on the street. Further, this window provides ample light and ventilation in summer and winter days. The top floor is the attic, just below the pitched roof, and is used as kitchen cum dining and puja (worship) room that is featured by a family shrine. In the attic, especially designed tiles and dormer window fulfills the lighting and ventilation needs. The large overhangs of roofs provide the sufficient protection from rain as well as from sun during hot summer days.

#### **4.4.3 BUILDING MATERIALS AND CONSTRUCTION TECHNOLOGY**

The construction of traditional building during the Malla era was done with locally available materials. The availability of good soil and abundance of forest resources in the valley gave the Nepalese builders the two basic materials of construction: mud and wood that characterize the Nepalese architecture (Tiwari, 2001). Mud is used for manufacturing of brick, the main building material for wall constructions and tiles along with use of mud as mortar. Thick load-bearing walls are made of mainly green or unfired bricks held together with mud mortar that ensures low heat transfer to render houses with coolness in summer and warmth in winter. The timber used is mainly hard wood for beams, posts, joists, rafters, struts, doors, windows, staircases, and purlins. The floors of the houses are plastered with

mud supported by wooden planks while *Telia* tiles are found to be used in terrace. The construction technology used in the traditional Newari residential buildings shows the innovation and excellent mastery in artistry in use of the building materials that summarize the development of the architecture overtime. In his book, 'The Ancient Settlements of Kathmandu Valley, Tiwari mentions , “The great technological achievements in brickwork, such as manufacturing technique of 'Telia brick' and its fungi based glazing compound, the wedged brick to cut contact of water with mud mortar, the sealant mortar and similar progress in classification of timber for exposed and unexposed as well as structural and decorative members and their joinery and carvings, all go to show that the Nepalese builder had amassed a wealth of know-how to deal with the elements of nature.” (Tiwari, 2001)

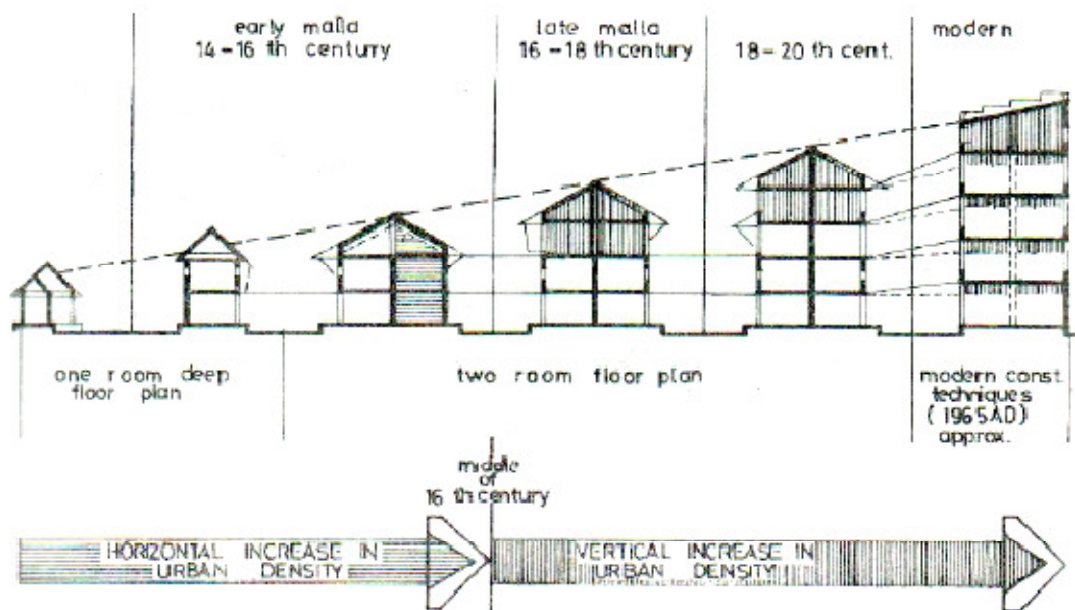

Figure 4.7- Number of storey development in the traditional building in Kathmandu  
Source:Parajuli 1986

#### 4.4.4 DEVELOPMENT OF TRADITIONAL BUILDING AND DAYLIGHT IMPROVEMENT

Malla period saw the rise of traditional Newari architecture but due to earthquake, most of the buildings were damaged and due to war and invasion by Gorkha King - Prithivi Narayan Shah. After the fall of Malla period, new development of buildings emerged during Shah Period (1756 - 1856) with addition of floors that made buildings to increase the height (see figure 4.7). Although the building materials were the same but a significant development with opening size was seen that was made simple and enlarged in size maintaining little or no woodwork. Later during Rana period, more simplification of windows is seen where the wooden frames on the openings were made thinner with iron railings and shutters. Thus, more sunlight penetrated into the rooms and lighting was improved than previously that facilitated with ventilation.

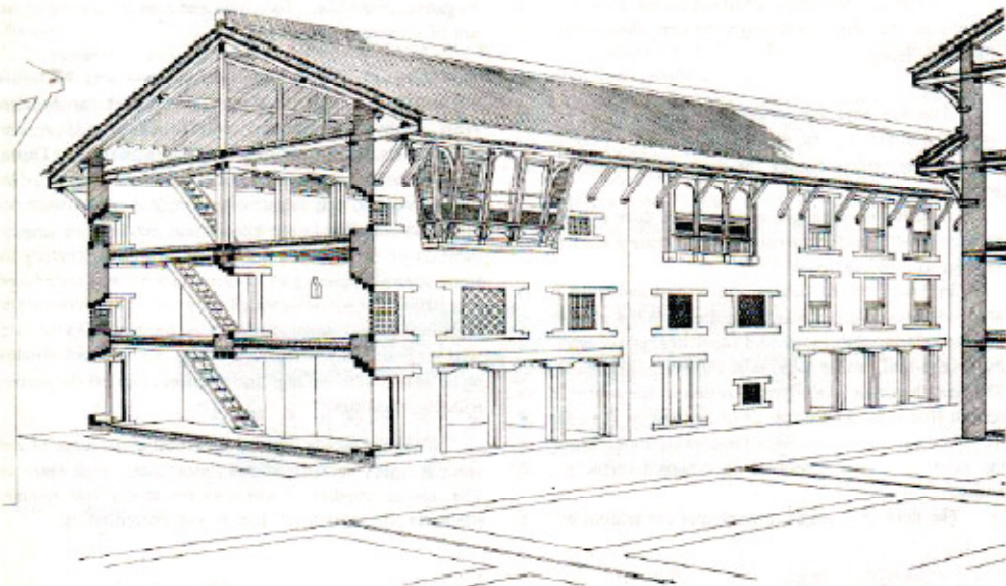

Figure 4.8- Size of opening becomes bigger in traditional residential building over time  
Source:(Korn 1998)

#### **4.4.5 BUILDING ENVELOPE AND MATERIALS**

Building envelope includes outer skin or shell of building and protects it from fire, access the heat flow and check on overall building exchanges of energy. These outer and internal exchanges of heat and other environmental factors take places through external skin of building. The elements of the building that are involved in building envelope are external wall and windows, roof, external doors, underground slab and foundation. The main issue in building envelope is thermal properties of the materials used in the exterior area of the building. Other factor comprises air tightness, color and reflectance of exterior surface, wind direction, orientation, shading and type. The traditional residential buildings used bricks, clay and timber as chief construction materials. Since there was abundance of timber and clay within the Kathmandu valley, these materials were easily affordable and economical. Bricks and tiles of various kinds were made of grey and black clay while distinctive yellow clay as mortar was used for plastering of joints and joining trapezoidal cut bricks for external face.

##### **4.4.5.1 WALL**

Depending upon the size and height of the building, the width of the external walls varied from half a meter to a meter. The external walls had double leaves of brick walls, where external leaf of walls were constructed with burnt bricks while the internal leaf of wall were sun dried bricks (figure 4.9). The gaps between the two leaves were filled with broken pieces of bricks and clay. The walls thus had high time lag with low U-value. The thermal resistance is provided by sun-dried bricks since they have lower density than burnt bricks. In addition, sun-dried bricks absorbed 10 to 20 times more moisture than burnt bricks making indoor environment more comfortable. The U-value for traditional buildings' external wall of 505mm thick with mud plaster is  $1.014\text{W/m}^2\text{C}$  with time lag of 12.5 hours and indoor

surface temperature of 17.63°C. (Shrestha 2009)

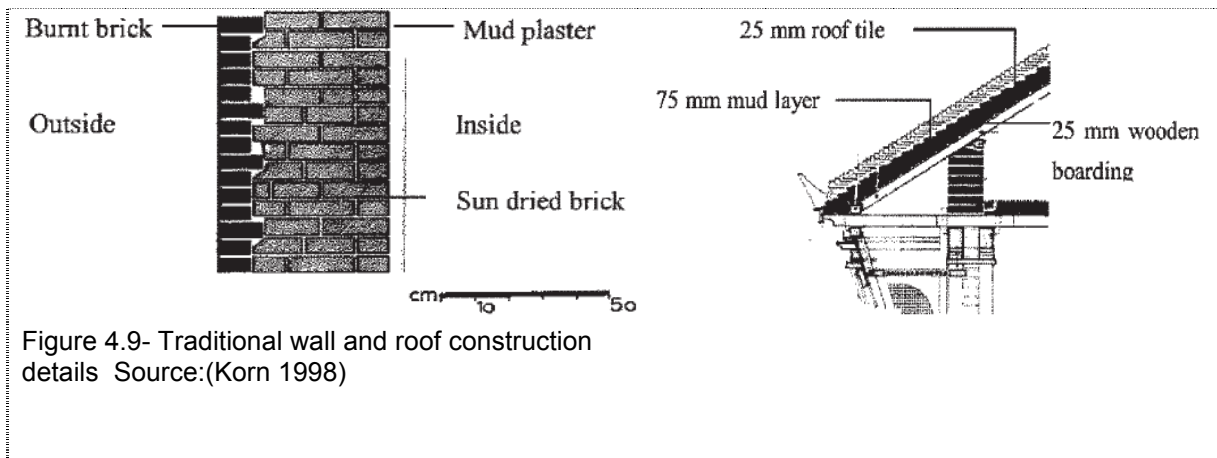

Figure 4.9- Traditional wall and roof construction details Source:(Korn 1998)

#### 4.4.5.2 ROOF

Roofs are constructed with wooden rafters and wooden board. Clay tiles are fixed with mud over the wooden board for roofing. Since the horizontal projection of roof is about one meter, the traditional buildings are protected from severe rainfall and from external exposure to sun (Korn 1976). The U-value for a roof with 143 mm thick without rafter is 1.30 W/m<sup>2</sup>°C and a time lag of 4.86 hours and indoor surface temperature of 17.6°C(Shrestha 2009). The attic space act as a buffer space to living space even though overall U-value of the roof is higher than that of the walls.

#### 4.4.5.3 OPENINGS

The openings of traditional Newari building is small and area of the opening is about 10 percent of the total floor area (Upadhyay, Yoshida et al. 2006). Much of this is attributed to activities being carried out in open spaces like courtyard and streets and alleys, thus, large openings were not necessary for the rooms during the day. But, over time, the opening size and type changed from wooden latticework to metal screen and glass panels. The

U-value of  $5 \text{ W/m}^2\text{C}$  is calculated if traditional openings consisted of single pane glass of 6mm thickness and with 20% wooden frame (Szokolay 2008).

#### **4.5 CASE STUDY OF BIDANI HOUSE, DELHI, INDIA**

The *Bidani House* was chosen for the case study purpose with regard to architectural planning, site planning and due to climate responsive design. The site is located in Delhi, India that has similar climate to Kathmandu with building size and site area having similar characteristics to that of typical Kathmandu houses. The seasonal difference seen in both the place is due to altitude and in contrast similar except summer season where Delhi is hotter than Kathmandu. The building also used local materials and local construction technology.

The house is situated in the 'composite climate' zone near Delhi. The climate is hot and dry during summer that lasts for two and a half months and is characterized by high temperature with dry bulb temperature of up to  $45^\circ\text{C}$ . The hot dry period is followed by hot humid- monsoon period where dry bulb temperature reaches  $38^\circ\text{C}$  along with 90% relative humidity. The cold season is for short period where minimum dry bulb temperature may reach as low as  $3^\circ\text{C}$ . This climatic situation is very similar to Kathmandu. The hot temperatures do not reach as high as  $45^\circ\text{C}$  but relatively reaches as high as  $34^\circ\text{C}$ . This temperature is enough to keep summer days hot and dry. The period of monsoon is similar to hot and humid condition. Thus, in many aspects the climate of Delhi is similar to Kathmandu. The house has an area of  $295 \text{ m}^2$  with site area of  $1000 \text{ m}^2$ . Primarily, the house has been designed to tackle extreme weather conditions by eliminating heat gain during summer, increasing ventilation monsoon and maximize heat gain during winter. The orientation of the house has been chosen with regard to climate by facing in southeast direction and a courtyard in the northeast direction that act as heat sink. Most of the living

spaces where people spent most of the time in the house have been built around the courtyard. The living space has double height, with high volume of space, is placed near courtyard that allows good ventilation and thermal control that is essential for the hot humid period.

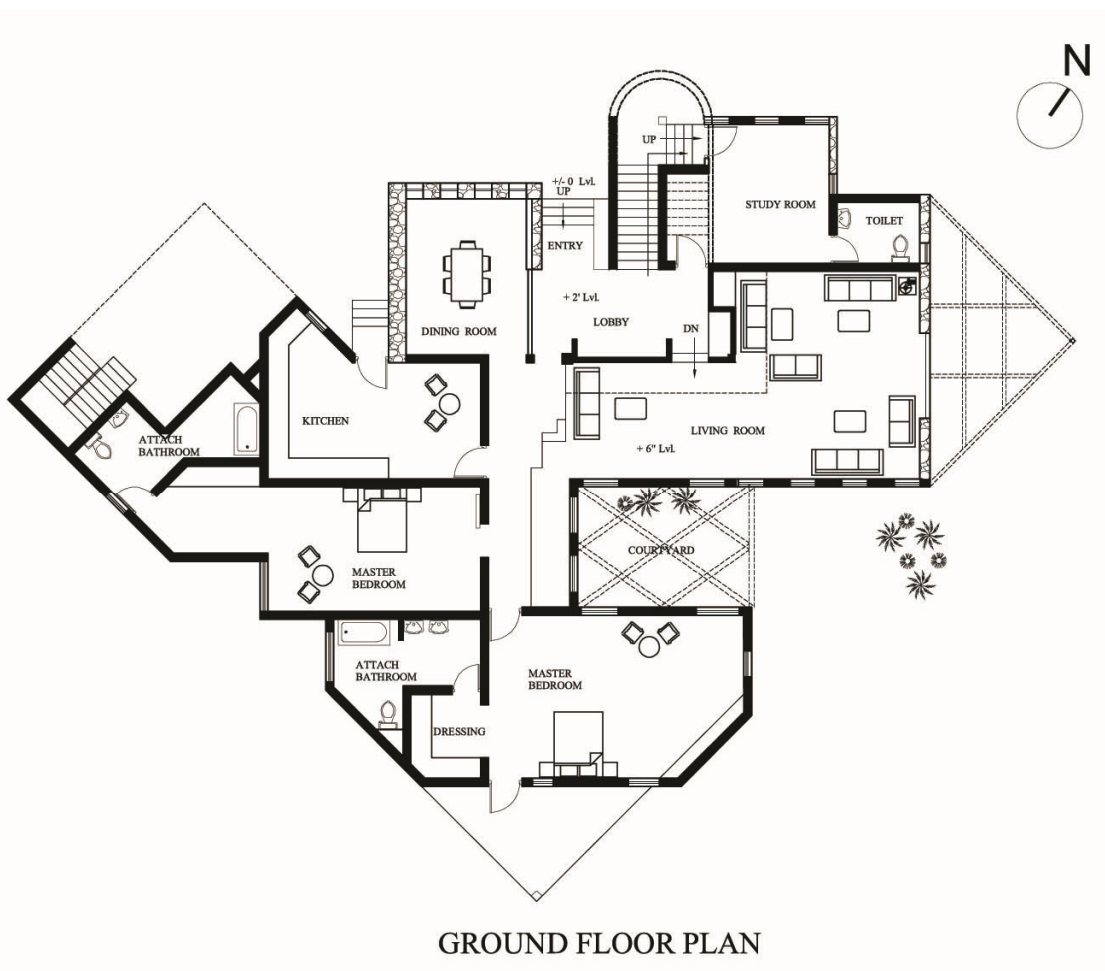

Figure 4.10- Plan of *Bidani House*, Faridabadh  
Source: After (Majumdar, Tata Energy Research Institute. et al. 2001)

The locally available materials with low embodied energy have been used in internal walls and floors. Some of the noted users' feedbacks are as follows:

- Despite no formal monitoring of the building, the occupants have been satisfied with thermal conditions prevailing inside the house.

- With courtyard as heat sink and large volume spaces, the occupants have been feeling comfortable in all living spaces.

The occupants had installed 'room type' air conditioning units in bedrooms but they were of no use as the "air-conditioning system were tripping off all the time."(Majumdar, Tata Energy Research Institute. et al. 2001)

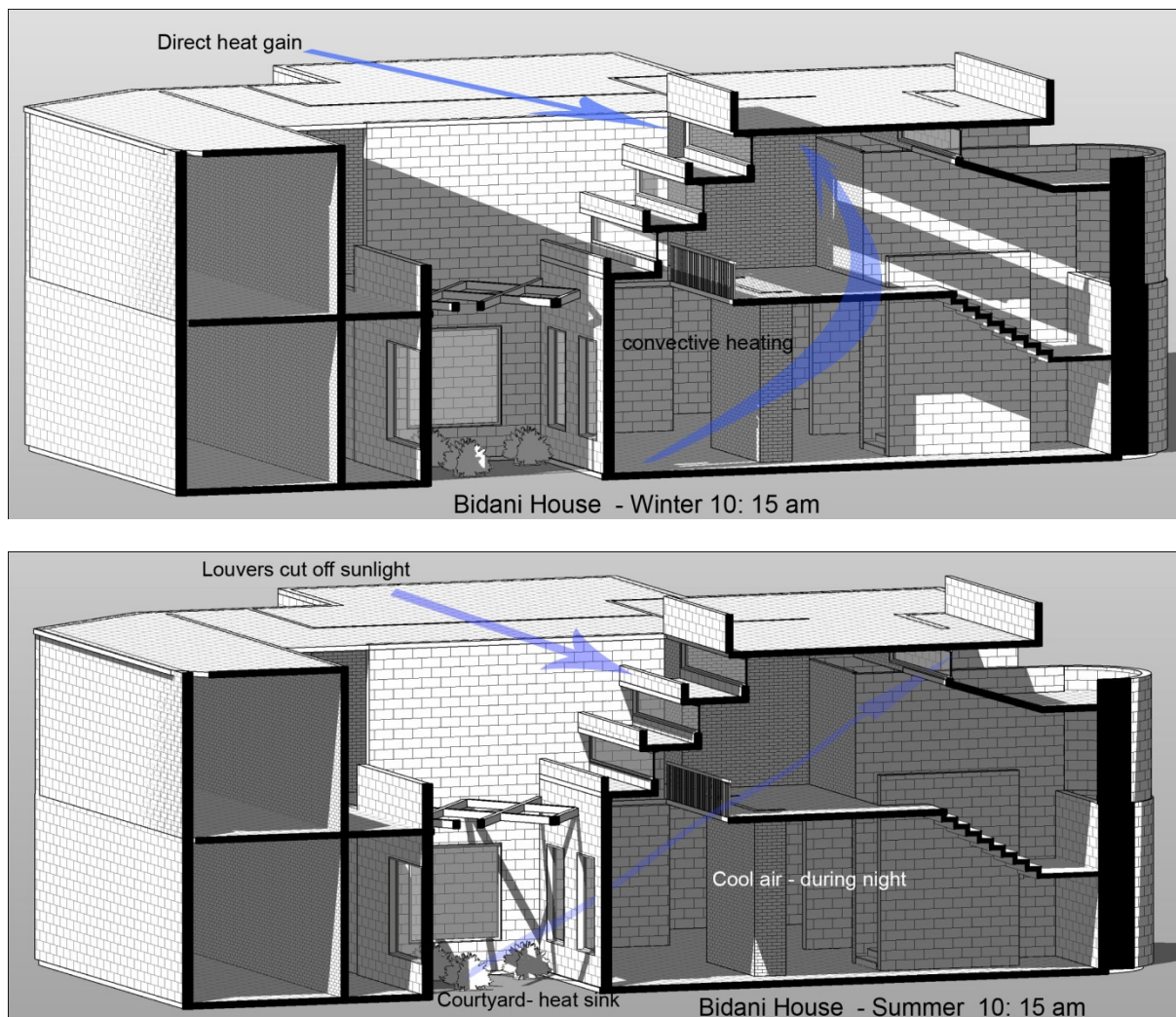

Figure 4.11- Analysis of courtyard and louvers being used for internal comfort zone in living spaces  
Source: Author (After Drawings (Majumdar, Tata Energy Research Institute. et al. 2001)

The energy efficient approach used in this building, range from site planning, orientation of building according to the local climate and architectural planning of living



spaces. To check the validity of planning and concept used in this house, analysis was conducted with study of sunlight with replicating the plan and drawings and building was modeled. The sunlight penetrated the living areas through the side lighting over living room during winter months with November 10, 2010 used as solar study day. Similarly, solar study was carried out for June 1, 2010 as a random day during summer month and sunlight was cut off due to use of louvers. The buffer spaces like toilets and stores are located on the overheated southwestern exposure to eliminate heat gain in summers. The building envelope use local material like stone as thermal mass in external and internal wall has proved to be beneficial for maintaining comfortable indoor thermal condition. Since the design has been focused in mitigating the extreme conditions of seasons encountered, it is learnt that design of any building should be done for extreme cases and keeping in view with future patterns of climatic variations. The courtyard design in architectural planning is effective for composite climate in regulating site condition and building envelope.

#### **4.6 SUMMARY**

Energy conservation and renewable energy technology have been seen as two main broad approaches to address the higher energy consumption pattern in the building sector. In buildings, variation in internal environment is constant according to the external environment and conditions where it is situated. Thus, local climate affects the building and its internal environment to house the occupants for comfortable thermal conditions. In seeking appropriate comfortable indoor conditions, people resort to various heating, cooling, ventilation and lighting active systems depending on climatic variation.

Energy efficient design mainly addresses key aspects of building design regarding site and climate, efficient architectural planning and design. The study of traditional

architecture of Kathmandu gives insight on the use of local materials, construction technology and use of spaces according to the climate, social and influence of local cultural heritage. In this case, Kathmandu saw development in houses planned in courtyard system and traditional Newari architecture, which has been highly recognized until today. The study of *Bidani House* and traditional Newari architecture helps us to understand the climate responsive design pertaining to the local climate. The passive design incorporated in the design of traditional building eliminates the need for any external or active system for heating of living spaces. Thus, the key to designing energy efficient building is to respond with care with immediate surroundings and use of local technology and materials available.

Through the case study of *Bidani House*, Delhi, we could draw parallel comparisons since the climatic condition is similar to Kathmandu. The climatic study has paved way for efficient building orientation for intended indoor climatic condition. Not only that, the use of courtyard as 'heat sink' and planning of architectural features in site has made appropriate use of local design techniques in mitigating similar condition. The use of locally available construction technology and materials further emphasizes the building envelope approach in seeking energy efficient design. The passive technology applications such as use of high volume of spaces, planning of living spaces, use of thermal walls in indoor spaces, courtyard for use of cross ventilation all address the composite climate faced by the building.

In all, the basic aspect of passive solar design technology and appropriate architectural planning of site and living spaces has made *Bidani House* a sustainable building.

## CHAPTER 5: GLOBAL WATER AND SCENARIO IN KATHMANDU

### 5.1 INTRODUCTION

Water is an indispensable part of human life. It has a profound effect at every level, from global climate patterns to ecosystems to the process within living cells. Over ninety-seven percent of world's water is undrinkable or salty while next two percent is locked as ice caps and glaciers and remaining one percent is fit for agricultural, residential, manufacturing, community and personal needs as well as other freshwater-dependent species (Lohan 2008). In the world's water cycle, we all are downstream from someone else due to our lifestyle and livelihood and we are completely dependent on freshwater. The technological innovation made delivery of water possible to wherever it is sought and this has been one of the important factors in the development of civilization and cities. But over time, our technological innovation caused deleterious effect to social and environmental aspect of human environment. The depleting water sources from wetlands, aquifers, rivers due to use of mechanical means, construction of dams, and construction of hard landscapes have all affected the environment directly or indirectly altering the natural environment. The unhealthy practice of disposing industrial waste into rivers and land have been causing greater health

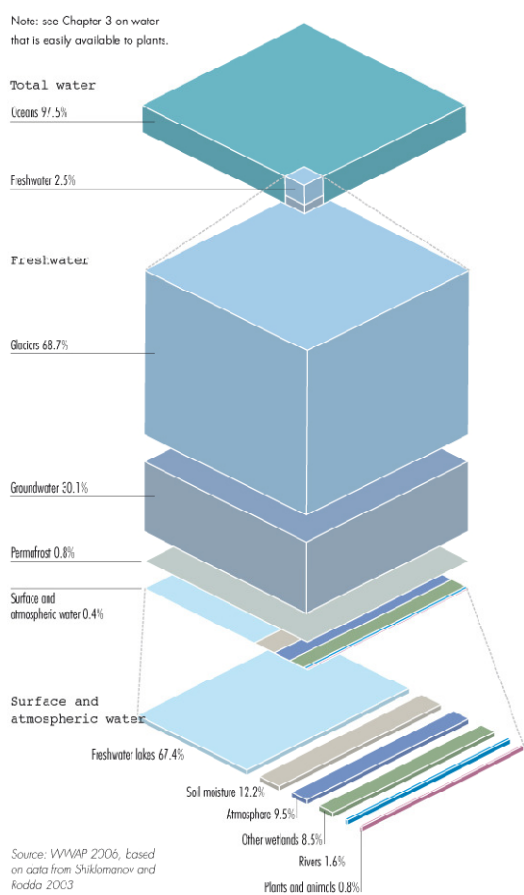

Figure 5.1- Global Distribution of World's Water  
Source: <http://www.myconfinedspace.com/2008/05/29/global-distribution-of-water/>

risks to human society and environment in developing and under developed countries. Since water is a fundamental right of every people, having easy access of it is also an inherent right of every people (Lohan 2008). But, this is not the case with world scenario.

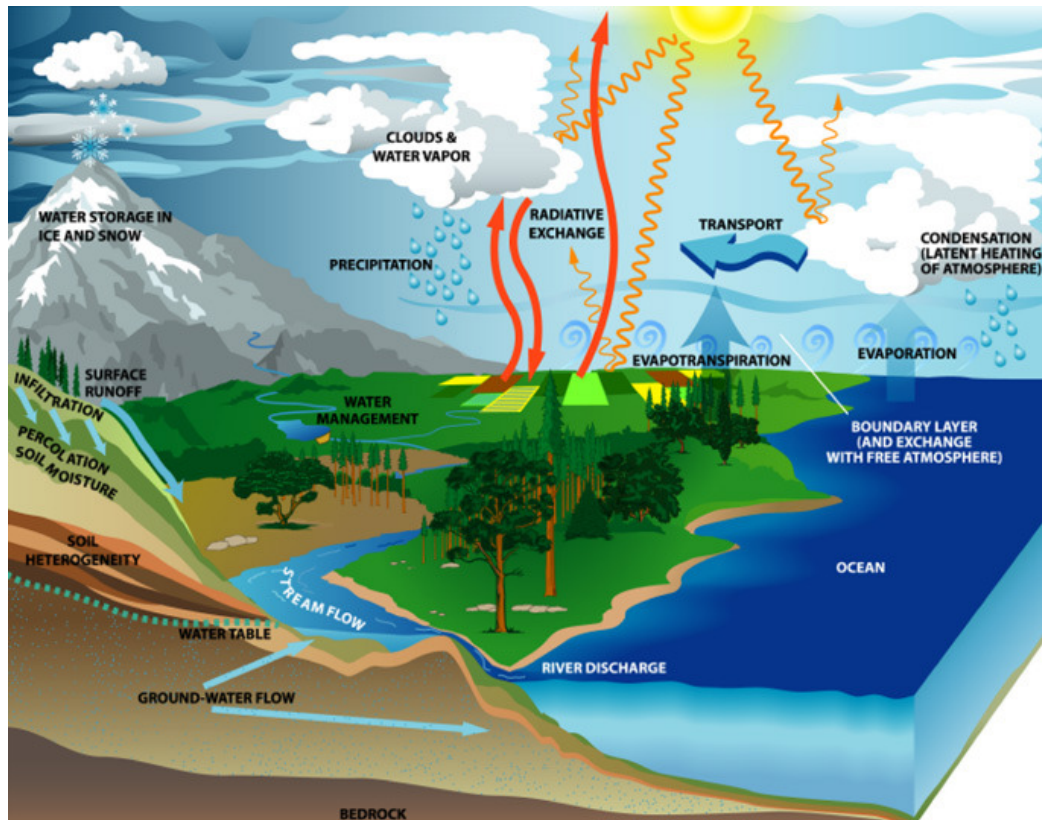

Figure 5.2- Hydro Cycle Source:(Oram 2010)

The value of water has been undermined and now scenario of water crisis is looming largely all over the world. In 2006, the new findings released by the Comprehensive Assessment of Water Management in Agriculture at World Water Week concluded that one in three people are enduring one form or another of water scarcity (CGIAR 2006). According to a report released by the International Water Management Institute (IWMI) at the Stockholm World Water Conference in 2006, a third of world's population (roughly 2 billion people) are facing water scarcity now (CGIAR 2006). The findings suggested that the water scarcity would hit worse by the year 2050. But these alarming findings totally overrun predictions that

this situation would happen in 2025. The world's water resource is in crisis. The World Business Council for Sustainable Development (WBCSD) concisely puts in: *It is cheap, scarce and wasted.* (WBCSD 2004) Thus, the triple paradox of water is highlighted. The water crisis has been exacerbated by number of factors such as climate change altering the precipitation pattern and affecting freshwater sources. Moreover, pollution of surface waters, deforestation, over-mining of ground water, and hard surfaces paved over natural landscape caused water logging causing flooding and decreased ground water recharge. (Lohan 2008)

Today, 83 percent of the global population drinks water from improved water sources, leaving 1.1 billion people without access to safe drinking water. Of this 1.1 billion without access, two thirds live in Asia (WHO/UNICEF 2004). In the aggregate, in order to meet the Millennium Development Goals (MDG) of reducing by one-half the numbers of people without access to safe drinking water, 1.5 billion people will need to be served over the next decade (WHO/UNICEF 2004). At this hour, it is imperative to use water as efficiently as possible and find ways for water conservation.

## **5.2 WATER CONSERVATION**

There is no concrete definition of water conservation. As defined by Cambridge Advance Learner's Dictionary (Cambridge Dictionary 2010), conservation means - carefully using valuable natural substances that exist in limited amounts in order to make certain that they will be available for as long a time as possible. Water conservation simply be defined as - the minimization of loss or waste, care and protection of water resources and the efficient and effective use of water such that it will be available for longer time as much as possible. (Wikipedia 2010) Water conservation is the overall principle that involves the effective management and protection of water resources. A water conservation assessment is an act, behavioral change, device, technology, or improved design or process

implemented to reduce water loss, waste, or use. Water efficiency is a tool of water conservation that results in more efficient water use and thus reduces water demand. The significance and cost-effectiveness of a water efficiency measure must be assessed in relation to its effects on the use and cost of other natural resources.

The objectives of water conservation efforts include: (Wikipedia 2010)

- Sustainability: to ensure availability for future generations, the extraction of fresh water from an ecosystem should not surpass its natural replacement rate. Energy conservation: water pumping, delivery and wastewater treatment facilities consume a significant amount of energy
- Habitat conservation: minimizing human water use facilitates to preserve fresh water habitats for local wildlife and migrating waterfowl, as well as reducing the need to build new dams and other water diversion infrastructure.

In her book, *Strategies for Sustainable Architecture*, Paola Sassi put forwards three main approaches for conservation of water that are appropriate to building design and water-related issues. Firstly, the freshwater consumption should be reduced and introduction of efficient use of freshwater in the buildings. Secondly, rainwater and greywater should be recycled and effectively used where it is possible. Lastly, consideration should be on effective disposal of grey, black and rainwater. Water in a house is used for drinking, cleaning, washing, cooking, landscaping and other household works. For the home, there are some key points to be addressed for sustainable water use and wastewater disposal. They are as follows: (Sassi 2006)

#### Minimizing the need for water

- Using composting toilets
- Selecting plants with low watering requirements
- Awareness and encouraging the use of showers instead of using bathtub

#### Efficient use of Water

- Installing water-saving spray or automatic taps on basins and showers, installing dual or low flush water closets.
- Retrofitting and maintaining existing appliances, taps upgrade, installing water meters
- Educating and awareness among people for water- consciousness

#### Recycling used water

- Installing greywater collection systems to flush water closets or water gardens.

#### Recycle rainwater

- Installing a rainwater recycling system
- Installing catchment for collection of rainwater for gardening

#### Reducing the use of mains drains

- Installing on-site waste water treatment systems
- Installing a sustainable urban drainage system (SUD)

The consumption of water in the building can be reduced through installation of water-efficient equipment. In toilets, dual flush water closets, low flush water closets, water less toilets such as composting toilets with or without electrical drying, use no or minimal water. These composting toilets can save up to 40 percent of domestic water use.(Sassi 2006) Similarly in urinals too, person detector can used to activate water flush, waterless

urinals with a barrier and seal foul smell can save lot of water. For basins and showers, a mix of water with air provides a normal water volume while non-aerated taps uses more water volume. Thus, aerated taps save water a lot of water as aerated showerhead can use 9 liters instead of the usual 20 liters per minute. (Sassi 2006) In addition, use of flow regulators and automatic basin taps with infrared sensors limit the use of water as required. More importantly, the use of laundry and dishwashing equipments should be water efficient as approximately 50 liters per wash is saved compared to older inefficient models of those equipments. In landscaping, use of region specific plants, grouping of plants according to their water needs saves a lot of water.

Rainwater harvesting and greywater treatment systems are fast being explored in every other type of building be it residential, commercial, institutional, or public. Alternative water sources from rainwater and greywater treatment can be used for non-potable uses and if treated properly, rainwater can be used for drinking. Utilizing alternative sources of water collected on the site diminishes the need for the extraction, treatment and distribution of fresh main water, thus reducing pressure on freshwater sources and energy use. In addition, reducing the use of main storm drains and the sewers by providing on-site systems to clean and drain or reuse rainwater, greywater and blackwater can assist in minimizing sewage and storm-water pollution; reduce contamination of water resources during discharge of treated sewage effluent; replenish groundwater recharge and reduce energy required to treat and transfer wastewater. Using sustainable urban drainage (SUD) helps in reducing hard landscapes and integrating water absorbing surface and planted areas to suite the local environment. Similarly, retaining and filtering storm-water on site through underground retention tank, deep paving and creating water catchment areas like ponds, swales are largely used in large-scale projects for proper drain management.

Buildings that apply aforementioned approaches to minimize the use of freshwater



and adhere to *reduce, reuse and recycle* concept for water shall be water autonomous.

Thus, the aim of modern residential buildings should be water autonomous with the ongoing water crisis in the world and looming scarcity of fresh water.

### 5.3 KATHMANDU AND WATER SUPPLY

Water is a very important issue and without solving the problems of water, it would be difficult to address the issue of sustainability that happens to be one of the prime agendas of Millennium Development Goals (MDG). Until 1891, city residents of Kathmandu had to depend on springs, rivers and shallow dug wells for water needs. Stone spouts locally known as *dhunge dhara* were common in serving the three cities Kathmandu, Bhaktapur and Lalitpur. After the introduction of piped water system in Kathmandu in 1891, water was supplied at public stand-posts and to Rana palaces (see chapter 3, 3.2).



Figure 5.3- Stone water spout (dhunge dhara)

Source:<http://praveenkm2.blogspot.com/2009/05/day-72-may-18-kathmandu-local-tour-with.html>

Today, Nepal Water Supply Corporation (NWSC) is responsible for administrating drinking water service to various districts of Nepal. Kathmandu Upatyaka Khanepani Limited (KUKL) uses both surface water and groundwater sources to provide water for the population in Kathmandu and Kathmandu Valley. The catchment of the Bagmati River is the main source for surface water. It also produces water from groundwater sources at a treatment facility and treated water is distributed for public use. Most of the traditional sources of water have dried up and ceased producing, thus water scarcity is on the rise.

The population of the city was 671,846 (CBS 2003) while the projected population is expected to be 1,011,105 for the year 2011 (CBS 2003). On one side, the increasing population is polluting the fresh water resources while on the other side; rivers and streams are diverted to meet the drinking and other household needs by the government, which is looked up by Nepal Water Supply Co-operation (NWSC) and non-governmental agencies such as local private companies. (Dixit 2009) According to Kathmandu Metropolitan City (KMC), daily water demand in the city is 140 million liters per day (mld) (Wet Season - Surface Water 88.3%, ground 11.7%) but the daily water supply is only 105.3 mid (Dry Season - 70.8 mld - Surface 65%, ground 35%). (KMC, 2010) The government has been investing in a major scheme 'the Melamchi Project' (a large scale project funded by Asian Development Bank (ADB), Norway Agency for International Cooperation (NORD), Swedish International Development Cooperation Agency (Sida), Organization of Petroleum Exporting Countries (OPEC) Fund, the Nordic Development Fund (NDF) and Japan Bank of International Cooperation (JICA)), to divert water from a stream outside the valley and deliver it to the city through a 26.5 kilometer long water transmission tunnel (Dixit 2009). The project was started in 1998 and yet to be completed due to several technical problems and the Maoist Insurgency (during 1990s a radical outfit-group Maoist group was formed under the influence of communist ideology that made Nepal go into ten

years of in the civil unrest until 2006, thus hampered the overall development of Nepal) decade long civil turmoil impeded the project and progress was not moving forward as expected and the cost of construction rocketed every year. Hence, it can be said that water supply to Kathmandu valley through the project is yet uncertain, as the project is still ongoing. One study conducted by Nepal Water Conservation Foundation shows that if we do not find alternative source of water, by 2015 (even if the Melamchi comes) Kathmandu valley (includes Kathmandu) will continue to have water scarcity. (Dixit 2009)

#### **5.4 WATER SUPPLY ANALYSIS FOR KATHMANDU**

The table 5.1 below depicts the minimum water requirements for different household activities in an urban area. However, due to the intermittent water supply and limited water accessibility the distribution of water is not uniform in most places as some places receives plenty of water where as others do not receive any water at all. The table 5.1 below shows that most of the water in an urban area is spent in cleaning and washing, where as only three liters is needed for an individual for a day. Even though, the supply is very limited, many household in Kathmandu usually use a toilet flush of 12-15 liters capacity, which normally uses fresh water from the municipal supply or groundwater, extracted with centrifugal pump. (Dixit 2009) If the harvested rainwater can supply this much water, around 70-80 liters of fresh water can be saved per day in a house of five family members. In addition, cost of electricity to run pump can be saved. If the water collected is clean, it can be used for other household purposes besides flushing toilet and water supplied from municipal supply can be used for drinking purposes only.

Table 5.1- Water Use in Urban Households  
Source: Dixit 2002

Use	Amount (liters)
Washing hands/person	0.6
Brushing teeth/person	2.0
Toilet flush (one time)	15.0
Bucket bath/person	20.0
Shower bath/person	25.0
Tub bath/person	80.0
Washing machine/person	100.0
Drinking/person	3.0

The reality is that the government has been unable to provide even the minimum drinking water to its residents in most part of the city; whereas the lifestyle of people is changing thus affecting their water consumption habit. The water demand of an individual household is increasing while water supplied is decreasing. In parallel, the population is on increase and the questions looms when the city will have sufficient drinking water or else find an alternative water source.

Table 5.2 - Domestic Water Consumption for Kathmandu Valley in Past Studies  
(Source: After (Joshi 2003) )

Study	Year	Average Domestic Water Consumption (lpcd)		
Binnie & Partners	1988	145 (full plumbing)	92 lcd (yard taps)	45 lcd (standpipe users)
Nippon Koei	1999	55 (average)	43 (Kathmandu Municipality)	98 (Lalitpur Municipality)
SILT & DRTC	1999	70 (municipal areas)	65 (rural areas)	
RTI	2001		56 (for poor HH)	330 (for non poor HH)
Jha. K. K.	2002	46.5 (Poor), 57.5 (Lower Middle Income Group)	64.9 (Middle Income Group), 71 (Upper Middle Income Group)	59.7 lpcd (Overall average domestic water consumption)
Joshi et. al.	2003	149 (Economic Class I)	109 (Economic Class II); 55 (Economic Class III)	31 (Economic Class IV)

## 5.5 ALTERNATIVES TO MUNICIPAL SUPPLY DHUNGE DHARAS

Stone spouts often called *dhunge dharas* are a popular source of water. The water collected is used for washing clothes, drinking, bathing and for other household purposes. Few conduits are believed to have healing powers against certain diseases like arthritis, goiter catarrh (commonly called pinash). (Gyawali 2001) Most of these *dhunge dharas* were built during Lichhavi and Malla era (1201-1768 Century). Albeit the supply system of such spouts were systematic and efficient, the population explosion and uncontrolled urbanization is creating stress on these structures often polluting and damaging the recharging channels causing them to dry out. The surface pollution is the main cause of groundwater and stone spout pollution; many of such *dharas* are still used for cooking and drinking in the city. People normally boil and filter the water received from spouts.

### 5.5.1 GROUNDWATER

The shortage of the municipal supply creates environment of water scarcity and for the development and use of an alternative water sources. The most probable ones are underground water, water vendors or develop coping strategies. In this context, the scarcity of surface water sources to provide water to homes, led the Nepal Government to the mining of groundwater resources during the Sixties. By the end of 1989, the estimated groundwater abstraction from 60 tube wells both private and public was 14 million m<sup>3</sup>. Of the 60 wells, 28 belong to the government (public) that was looked after by Nepal Water Supply Cooperation (NWSC) - the sole government water provider (Dixit 2009). Besides NWSC, private hotels, domestic households, government institutes, factories and industries have exploited the groundwater resources extensively. At present, the total extraction of groundwater in the Kathmandu Valley has been estimated at 46.86 (mld) (Dixit 2009).



Figure 5.4- Ground water use through tube well

Source: [http://3.bp.blogspot.com/\\_iYu4kbbxQjM/S3srm0O-oRI/AAAAAAAAACd4/gJx4a8-HfNI/s1600-h/2009+NEPAL+KATHMANDU+womann+kids+taking+water+096.JPG](http://3.bp.blogspot.com/_iYu4kbbxQjM/S3srm0O-oRI/AAAAAAAAACd4/gJx4a8-HfNI/s1600-h/2009+NEPAL+KATHMANDU+womann+kids+taking+water+096.JPG)

The widespread use of deep unpolluted aquifers under the Kathmandu Valley is suffering from overdraft. This is not only the case of Kathmandu valley, as groundwater depletion has become a major problem all over the world. For example, a study conducted by IWMI in Sri Lanka's dry zone where groundwater use for farming is greatest; highlighted a significant rise in number of water pumps and wells. Estimated numbers of wells are close to 50,000 while numbers of pumps are around 100,000 in the dry zone according to the researchers. Thus due to excessive use of pumps and wells, acute shortage of water in aquifers have been noted and people are deprived of water at the end of farming period for household needs. (Williams 2005)

### 5.5.2 WATER VENDORS

For the past few years, the private water markets have emerged as an alternative source. On one hand, bottled waters are gaining popularity while on the other hand; private tanks have become major water vendors in the urban areas of Kathmandu where municipal supply have failed. Both of these markets are completely unregulated, leaving the price to be determined by the competitive market and water quality discretion of the individual company. (Moench 2003) In another words, there is monopoly of vendors on price and quality. There are scores of private tankers that supply water to urban areas of the city that are run by local people as a business.



Figure 5.5- Private water vendor

Source:[http://www.ekantipur.com/tkp/news/showimage.php?news\\_id=211760&image\\_id=3398](http://www.ekantipur.com/tkp/news/showimage.php?news_id=211760&image_id=3398)

### **5.5.3 RAINWATER HARVESTING**

Current scenario shows that the only water available in Kathmandu Valley beside polluted river water is in the form of underground water that is extracted by all sectors, which include individuals, hotels, commercials, and government. In order to supply water in a sustainable way these resources need to be recharged gradually. With the current trend of migration, the only probable recharging area - in the northern part of Kathmandu - is under heavy urbanization. The heavy engineering structures that are increasing every day - are preventing the water to percolate thorough this permeable soil (Dixit 2009). Similarly, the rising population is causing surface and groundwater pollution - in most cases, it is undrinkable. In contrast, with the groundwater level decreasing (increasing cost of pumping); monopolizing water prices by water vendors; and the intermittent supply of Kathmandu Upatyaka Khanepani Limited (KUKL), (responsible for water supply in Kathmandu valley similar to water supply agency) there is no other option for the residents other than to harvest rainwater. This method is very cost effective and guarantees relief. It is clear that no viable water sources are around the city that could be tapped and supplied; besides Melamchi, whose fate is in doubt. Hence, the only feasible way to fulfill water needs of the Kathmanduties is by installing rainwater harvesting systems. Rainwater harvesting systems can be built in individual houses, government offices, commercial buildings or public places.

### **5.6 RAINWATER HARVESTING POTENTIAL IN KATHMANDU**

Until 6-7 years back, people were unaware that water could be collected and used for drinking purposes as well. With the growing need to conserve the country's groundwater resources, rainwater harvesting is the next best option to meet our water needs. Rainwater is free, so why not make use of it. Rainwater harvesting and artificial recharge into shallow



and deep aquifers presents a promising approach for reversing the trend of water resource exploitation and groundwater depletion. The average annual rainfall in the city is around 1500 millimeters (Gyawali 2001). Most of the rainfall is recorded from May to September, which is called 'Monsoon'; primarily due to seasonal monsoon winds.

Dr Roshan Raj Shrestha, Chief Technical Advisor to UN-Habitat's Water for Asian Cities Programme, which is popularizing environment-friendly technologies in Nepal like rainwater harvesting, says that collecting rain that falls on a roof or a sealed surface is a "simple concept that brings a lot of benefits." (Amatya 2009) He further says, "Rainwater-harvesting is very affordable. Everybody is capable of using the technology. We just need to re-popularize it." (Amatya 2009)

Gyawali in his book *Water in Nepal* presents an optimistic view of rainwater harvesting potential in Kathmandu valley (includes Kathmandu). With a catchment area of 656 kilometers of the Kathmandu valley, he assumes that if only half of the available rain either evaporates and percolates in ground, about 500 million m<sup>3</sup> of rain will still be available for capturing. He adds on that if only six percent of the 500 million m<sup>3</sup> were harvested, the city could meet much of its water needs by allocating less than 1.5 % of its area for tanks, and other water harvesting structures with an average depth of only two meters. With this assumption, it can be said that if the individual households could collect rainwater it will be enough to meet their domestic needs. Rightly, so, nowadays people are more aware of rainwater harvesting system due to awareness programs by various Non-Government Organization (NGO) and International Non-Governmental Organization (INGO) and Government of Nepal. Enactment of rainwater harvesting system in large-scale buildings should be done in order to manage water efficiently and make necessary steps for water conservation.

History of water in Nepal and particularly in the city shows that people never had any piped water system in their homes. They primarily developed a self-sustaining water system -

stone- water sprout, a water conduit system that was dependent on rainwater that recharged ground water. It is only through the introduction of piped water system; that these indigenous systems were malfunctioned and went out of service. It is now high time, the usefulness of rainwater be reintroduced with modern technology to harvest its potential and mitigate the problems of water scarcity in the city. The government has recently considered rainwater collection as a complement to the city water supply.

The culture of rainwater harvesting should be “re-appreciated.”(Amatya 2009) Our older generations valued rainwater for good reasons and if they practiced it for centuries, why can't we? The formulation and incorporation of rainwater on national policy should be executed if re-integration of rainwater is introduced. Experts say if the government succeeds in re-popularizing the indigenous technology of rainwater harvesting, it could save as much as US \$ 38,888,888 (Nepalese Rs. 2.8 billion) annually in Kathmandu valley (includes Kathmandu) alone besides its environmental benefits. (Amatya 2009) It is believed that water in the city will be more expensive than currently, even if Melamchi Water supply comes into effect.

There is no doubt that the reintroduction and mainstreaming of rainwater harvesting at both local and national levels, through regulations and a national law, could well address the city's growing water needs. With favorable conditions of climate and an economical viability of implementing in household and other commercial activities, rainwater harvesting is truly a sustainable approach to mitigate water woes the people of Kathmandu is facing.

## **5.7 CASE STUDY OF THE AUTONOMOUS HOUSE,** Southwell, Nottinghamshire, United Kingdom

Located in a small town of Southwell in Nottinghamshire, UK, *The Autonomous House* was designed to exhibit that a house completely autonomous from main power, water

and sewerage was feasible. It also further demonstrates the use of local traditional building methods and skills through traditional builders. The building adheres to the local architectural language and urban fabric that has an area of 255 meters including 66 meters of uninhabitable basement, a 28m<sup>2</sup> conservatory and a 7m<sup>2</sup> porch and the building minimizes energy and water use. This case study was chosen specifically for its water autonomous aspect.

Most of the water requirements including drinking water, are covered by rainwater harvesting and waterless composting toilets that were installed for saving water needs; thus preventing production of blackwater. The greywater thus produced is filtered and drained in the garden. One of the important points to be noted while collecting rainwater is that, the collection surface should be as clean as possible so that less contaminant are trapped and can be washed off with rainwater. The rainwater is collected from the clay tile and glass roof into a copper gutter. Here copper was chosen for its slightly disinfectant effect. The collection chamber was in recycled orange juice tanks located in the basement. The collected water is then pumped through a sand filter and then into another tank that stores clean water. The stored clean water is fed to overhead tank and through gravity flow down to the kitchen and bathroom where filter was used for drinking purposes according to the required law in the United Kingdom. The rainwater harvesting system has proved very effective as no problems were noted while three different tenants resided in the building with a problem-free operation of the water system (Sassi 2006). Moreover, during 1996 drought, the water level in the tanks dropped by just 30 percent.

The minimization of water need reuse and recycle of rainwater and greywater have been core approaches to water conservation. Architects Brenda and Robert Vale have been innovative in designing *The Autonomous House* for being energy and water autonomous. It is noted that use of recycled juice tanks for storage of water also proves that not only in

design but also by locally available materials and/or reusable items can also be benefit in design of sustainable building.

## **5.8 SUMMARY**

Water is a vital aspect of human life and only a few percent of useable water is present in the Earth although over ninety-seven percent is water. The looming water crisis all over the world due to technical advancement, land and water pollution, population swelling, climate changes have made water scarce and unhealthy to drink. With proper water management, corrective measures and water conservation techniques, this crisis can be solved and mitigated. Building sector use water extensively where humans dwell for most of their life. Thus, for day-to-day activities water is used and wasted and by products are released in the form of greywater and blackwater.

Kathmandu is facing water crisis since mid 1990s and with increasing population, growth and infrastructure development over the years have exacerbated the problem. The boom in construction industry saw many new buildings and need for water grew over time. With limited source of water and finding alternative ways of water brought about the water extraction from underground and rivers through water vendors. Although these measures are temporary and give a sustaining solution to the aggravated problem in the long run, these do pose an environmental problem. The wastewater from industries and residential building are dumped into the nearby rivers and rivulets with no proper environmental measures. All these activities have marred the water quality and water problem to great extent.

The climate of Kathmandu is relatively temperate with monsoon season bringing a lot of rainfall for half the year. Rainwater harvesting potential is seen as most viable and feasible system to mitigate the water scare problem in the city. Although, awareness programs on this system have picked up pace and people are being aware, the inclusion of this in most of the

buildings are still not ventured. Through the case study of *The Autonomous House*, it is clear that we can have a fully functional self-sustaining water system through rainwater harvesting. This attests to the fact that we can depend on rainwater without any external source of water in worst-case scenario if we can minimize our water needs with careful planning of water needs.

Table 5.3 - Water Consumption Comparison  
Source: Vale 2001

<b>Category</b>	<b>UK house (l/ head/ day)</b>	<b>Autonomous House (l/ head/ day)</b>	<b>% reduction</b>
Personal Hygiene	45	21	53%
Laundry	15	06	60%
Dishes	15	2	87%
Drinking and cooking	5	5	0%
Garden and car	10	0	100%
Losses	20	0	100%
Flushing Toilet	50	0	100%
<b>Total</b>	<b>160 l / head / day</b>	<b>34 l / head / day</b>	<b>79%</b>
<b>Five household</b>	<b>800 l / head / day</b>	<b>170 l / day</b>	

## **CHAPTER 6: WASTE MANAGEMENT AND SCENARIO IN KATHMANDU**

### **6.1 INTRODUCTION**

The assortment, transportation, processing, recycling or discarding, and monitoring of waste materials generated by human activity is called waste management. The waste is necessary to manage, to reduce the harmful effect on health, the environment or aesthetics. It may involve solid, liquid, gaseous or radioactive substances, or combination of those mentioned with many methods and fields of expertise for each. (Wikipedia, 2010) In the context of sustainability too, there is waste generated at various level of building construction, demolition of building, after its lifespan and at operational levels. Large amount of waste are accrued once the building construction gets started and by the end of building construction, these waste need to be disposed or recycled or reused. Once the building gets into operational phase, the occupants use the building and services that are incorporated to facilitate comfort to the occupants. Both organic and inorganic waste needs to be managed in every phase of building life cycle for a building to be sustainable.

The construction and demolition waste generated are solid and inorganic and not covered in this thesis but is more focused in organic waste generated by humans or activities involving organic substances as by product during the operational phase. More specifically, wastewater and solid waste management is focused in this study.

Greywater treatment systems are fast being popular and alternative water sources like greywater treatment can be used for non-potable uses; and when treated properly, rainwater can be used for drinking purposes. Utilizing alternative sources of water collected on the site diminishes the need for the extraction, treatment and distribution of fresh main water, thus reducing pressure on freshwater sources and energy use. In addition, reducing

the use of main storm drains and the sewers by providing on-site systems to clean and drain or reuse rainwater, greywater and blackwater can assist in minimizing sewage and storm water pollution; reduce contamination of water resources during discharge of treated sewage effluent; replenishing groundwater recharge and reduce energy required to treat and transfer waste water. Using sustainable urban drainage (SUD) helps in integrating water absorbing surface and planted areas to suite the local environment; thus eliminating hard paved landscape.

## **6.2 WASTE WATER AND SOLID WASTE TREATMENT IN KATHMANDU**

The two most evident environmental nuisances and main causes of pollution in the urban areas of Kathmandu Valley (includes Kathmandu) with ramifications beyond the urban limits are solid waste and wastewater. In Kathmandu, supervising solid waste and wastewater has become an overwhelming task as urban areas have grown haphazardly without provisions or plans for suitable infrastructure management and services. Typically, the trend is that first housing is built that leads to settlements and then urban areas spread out without any plan and then infrastructure and services are demanded. In theory, the process should be the reverse. Urban growth should follow plans and provision of infrastructure. The consequences of unplanned and disorganized urban growth are that providing infrastructure and services turn out to be complex and difficult; infrastructure and services provided become incompetent and unproductive; and pressure on the existing infrastructure systems and services augments beyond their capacity as they were designed for certain conditions/limits.

Until the modern development, solid waste and wastewater produced in Kathmandu valley's urban areas were re-used/ re-circulated in agricultural activities in nearby rural areas (ICIMOD 2007). Most of waste was organic and surrounding areas of urban settlements

were agricultural fields, thus the reuse of waste was possible. Previously, the population of the city was limited to inner core and surrounding areas of the city. In addition, people were largely involved in agricultural occupation and most of them were in fringe area of the city boundary. But, this is not the case anymore and this waste is polluting the environment.

### **6.2.1 ISSUES OF WASTE**

The rapid urban growth in the city over the years has been attributed to centralization. Most of the administrative, health and services such as educational, health facilities, infrastructure systems and international linkages have been concentrated in the city. Thus, people from all over the country are attracted towards the power centered urban area in Kathmandu. Over the years, urban growth rate has risen from 40% in 1980 to 60% in urban areas of Nepal. More importantly, in Kathmandu population growth has been five fold since 1950 (ICIMOD 2007). With increased population, waste generated has also increased for both solid waste and wastewater.

Kathmandu continues to grow haphazardly and without appropriate planning and infrastructure such as water supply and sewerage systems, solid waste management facilities, and services even though various plans were prepared for urban development of the Kathmandu valley (includes Kathmandu). Properly planned urbanization can play a positive role in promoting economic activities, as well as in promoting conservation of resources to reduce pressure on land resources. The change in consumption habit of people of Kathmandu over the years have attributed to producing more waste and change in composition of waste such as plastics in solid waste and chemicals in waste water. The city experienced significantly higher commercial and business activities than any part of the country. About 80% of the industries are scattered throughout the valley that have the potential to affect land, water, and the environment. (ICIMOD 2007) Businesses, commerce,



services, and industries generate waste, and this is quite different from domestic waste.

## **6.2.2 MUNICIPAL SOLID WASTE**

According to a survey in 2005, nearly 450 tons of solid waste is generated each day in the Kathmandu valley. (ICIMOD 2007) The waste generation in Kathmandu in 2004 was 308.4 tons/day with collection of 250 tons/day while forecasted waste generation in 2015 is estimated at 547.9 tons/day. (ICIMOD 2007) The solid wastes generated in the valley are of three main types: household waste, industrial waste and hospital waste. The household wastes are both recyclable and non-degradable. The industrial waste contains mainly metal scraps and some hazardous materials. Health care units generate infectious waste.

The composition of municipal waste has changed over time as consumption patterns altered. Waste generation during a study carried out in 1976, suggested that it used to be mainly organic and degradable. However, since the urban growth and increase in population from mid 1990s, the volume of non-degradable waste has increased considerably. From less than 1% in 1976, the volume of plastic in waste increased to 16% by 2004 and paper by 6-9 % approximately (UNEP 2001). Electronic waste such as parts of mobile phones, computers, televisions, and so on are new constituents of solid waste in the Kathmandu Valley.

The Municipalities are the main responsible bodies at the operational levels for the management of the solid waste on a daily basis. Besides, various non-governmental organizations, community based organizations (CBOs) and the private party are involved in solid waste management activities in Kathmandu. The volume (weight) of materials collected for recycling is less than one-fourth of the total waste generated in the Kathmandu valley, which is about 450 tons and most of which end up in the landfill site at Sisdol.

Table 6.1- Solid Waste Generation in Kathmandu by Type of Waste ( in % of waste by weight)  
After (ICIMOD 2007)

Description	Kathmandu		
	2002	2003	2004
Organic	69	69	66.00
Paper	9	9	10.40
Rubber	1	1	0.24
Leather	NA	NA	0.24
Wood	1	1	-
Plastic	9	9	16.30
Textile	3	3	3.58
Ferrous Metals	1	1	0.84
Glass	3	3	1.38
Others	4	4	0.04
Inert	-	-	1.01
<b>Total</b>	<b>100</b>	<b>100</b>	<b>100</b>
Average Collection %			65.20

Current practices of municipal solid waste management in urban areas are summarized below.

### **Street and Door-to-Door Collection**

Municipalities employ sweepers to collect the waste from the streets and at public places. However, they perform their duties mainly in the core city areas and at the places with religious interests. After the 1990s, a different trend started in the valley.

The concept of door-to-door collection appeared as the most suitable way of collecting household waste. Due to the limited number of households and lack of social understanding

at the community level, it was found to be economically unfeasible in the newly developed areas. Thus, the new concept remained limited to the old settlement. Waste collected from the streets, as well as from households that happen to be roadsides in most cases is picked up and transported to open spaces. Waste containers are found in core urban areas, but are unavailable in the rest of the areas of the valley due to unavailability of both containers and appropriate place to position them. Finally, municipal trucks or tractors pick up the collected waste and disposes of it either in Teku, which is the main collection centre in the heart of Kathmandu, or directly to the landfill site at Sisdol, 25 kilometers away from the city center. There are few more waste collection centers in the valley, but others are not as big and organized as the one in Teku, Kathmandu.



Figure 6.1- Door to Door collection of household waste

Source:(Ghimire 2008)

### **Disposal and Landfill Site**

A major issue for the local government since the 1990s has been in finding a suitable landfill site. The issue to finding landfill site has been plagued by the community and governments friction on using the area as waste dumping and environmental concerns. With

no alternative, the municipalities were forced to dump the waste along the river corridors. This act was very much inappropriate but there was no other designated place to dump the waste or manage it properly. Sadly, this practice continues today in municipalities that do not have suitable landfill sites. The problem of a landfill was settled in 2005 when the local residents of Sisdol, a small village in the northwest side from the valley, allowed the use of the riverbank and surrounding agricultural land as landfill site. Since June 2005, major portion of the solid waste from the valley is being transported to the Sisdol landfill site, which is 25 kilometers from the valley. Originally estimated to run for three years, it is still under operation. This landfill site is operated by the office of the Kathmandu Metropolitan City.

### 6.3 MUNICIPAL WASTEWATER

In Kathmandu, there is overlapping in zoning of residential and commercial areas; thus making it difficult to estimate the volume of wastewater generated from those sources. According to a study conducted during 2000 in Kathmandu, the potential domestic wastewater generation was found out to be 124 million liters per day (mld) , out of which only about 47 mld (about 38%) was collected through the sewerage system(ICIMOD 2007). The agencies that are involved in the storm water and sewer management in the city are shown in figure 6.2 and their work is haphazard and inept.

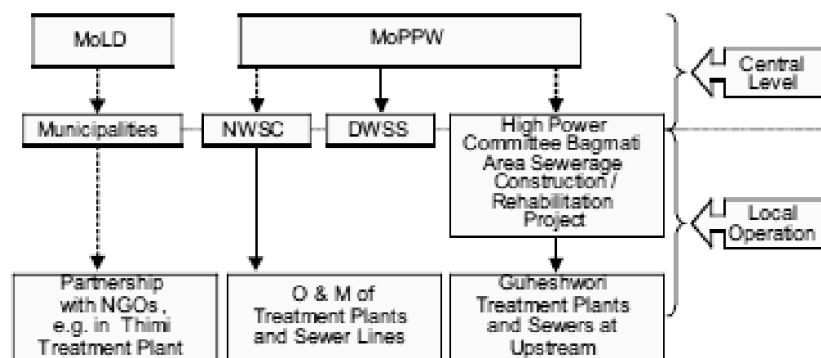

Figure 6.2- Agencies involved in storm water and sewer management in Kathmandu  
Source:(ICIMOD 2007)



Figure 6.3- Waste collection center at Teku, Kathmandu

Source: (ICIMOD 2007)

Although the construction of sewerage system has increased significantly but actual data on those constructions are difficult to obtain, planning of those system lacks design consideration and no treatment aspects. It is also noted that during peak monsoon season, the existing sewers and drains cannot bear the load as they have to cope with storm water. Scenes of overflowing of sewers, drains, and manholes are recurrent in rainy season. Due to lack of control mechanism and coordination of the municipalities and communities, there is no differentiation between sanitary sewer and storm drains. Moreover, outlets from households are connected to the Department of Road (DoR)-constructed road drains and the DoR connects road drains to sewers. Currently, only about 70% of the solid waste is collected and disposed of.

Notably residential wastewater contains discharge from the toilets (containing urine, feces, soap, detergents, etc) and; from the kitchen (containing foodstuff, fats, oils, etc) and variation in the composition from this source are almost similar. Septic tanks are the most

common method of managing domestic wastewater in those parts of municipal areas where there is no sewer line. Effluent from the septic tank is discharged either into a soak pit where the effluent percolates inside the ground or into a drain. The number of septic tanks in the city is estimated to be 33,000.(ICIMOD 2007) Although various agencies, including the private sector and the municipalities, provide facilities for suctioning and cleaning them, septic tanks are not cleaned as frequently as required. The tanks, therefore, do not function efficiently; consequently, septage has a higher pollution load than normally expected. When cleaned, the septage collected is generally dumped into the river or into a sewer/ drain, which is connected to the river. There is no septage treatment facility (constructed wetland developed by KMC is not functional at present).

#### **6.4 CASE STUDY OF *ECO HOME*, KATHMANDU, NEPAL**

The house is situated at the heart of the Kathmandu with a land area of 135 m<sup>2</sup> and it was built in 2003. The owner of the building is Mr. Roshan Raj Shrestha who has been working as Chief Technical Advisor at UN HABITAT - Water for Asian Cities Program Nepal. The building has been noteworthy for its adoption of sustainable water management. This *Eco-Home* has rainwater harvesting system, greywater recycling, urine and feces diversion dry toilet (Ecological Sanitation - ECOSAN Toilet), household composting, simple method on drinking water treatment. There is no connection with city water supply network with all the aforementioned system placed in and building can rely on rainwater and water from shallow well throughout the year. Similarly, it does not have connection to sewer network. The water requirements of the *Eco-Home* is given below (Shrestha 2007):

Table 6.2- Monthly Water Demand and Clean Water Requirement at *Eco-Home*

<b>Type of water use and requirement</b>	<b>Liters/month</b>	<b>%</b>
Drinking & cooking	900	7
Dishwashing, bathing, showering, &	7500	55
Toilet flushing, cleaning vehicle &	5250	38
<b>Total Water Demand</b>	<b>13650</b>	<b>100</b>
Reuse of Treated Greywater	5250	38
Water Requirement	8400	62

In a typical household of Kathmandu, about 5 % of the total water consumption is used for drinking and cooking, 52 % for hygienic purpose like bathing, laundry and dishwashing and remaining 43% is used for toilet flushing, gardening and cleaning (NGO Forum for Urban Water and Sanitation, 2003). Approximately 40% of clean drinking water is used for non-drinking purposes where low quality water is adequate. Thus, wastewater generated from bathing, laundry and kitchen can be recycled for use for household activities like washing, cleaning, and toilet flushing purposes. Greywater generally contains much less nutrients (nitrogen and phosphorus) and pathogens since greywater is not contaminated directly by human excrement. Therefore, it can be treated and reused that saves more than 40% of water.

A separate plumbing system has been fixed to separate greywater and blackwater in the *Eco-Home* that produces about 250 liters/day of greywater. The greywater is collected in two-chambered settling tanks (500 liters) for sedimentation of larger particles. From here, water passes to a 200 liters feeding tank from where a siphon device feeds water intermittently into the vertical subsurface flow bed of the constructed wetland for further treatment. The treated water is collected into an underground tank of 2,000 liters

(figure 6.4). Even though the monthly water demand is about 13650 liters, it needs only 8,400 liters of clean drinking water due to installation of grey water treatment unit and dry toilet. Treated greywater is being used for toilet flushing (*Eco-Home* has one flush toilet beside dry toilet), cleaning vehicles and gardening.

Since 2003, the system is in operation and has no major problem. For the maintenance of the system, following actions were taken:

- Sludge removal from the settlement once in two years
- Regular inspection of dosing chamber for proper siphonic action as vertical bed needs intermittent feeding of greywater.
- Plant cutting once a year
- Regular inspection of pipes and fittings of settling tank to observe clogging problem due to accumulation of oil and grease.

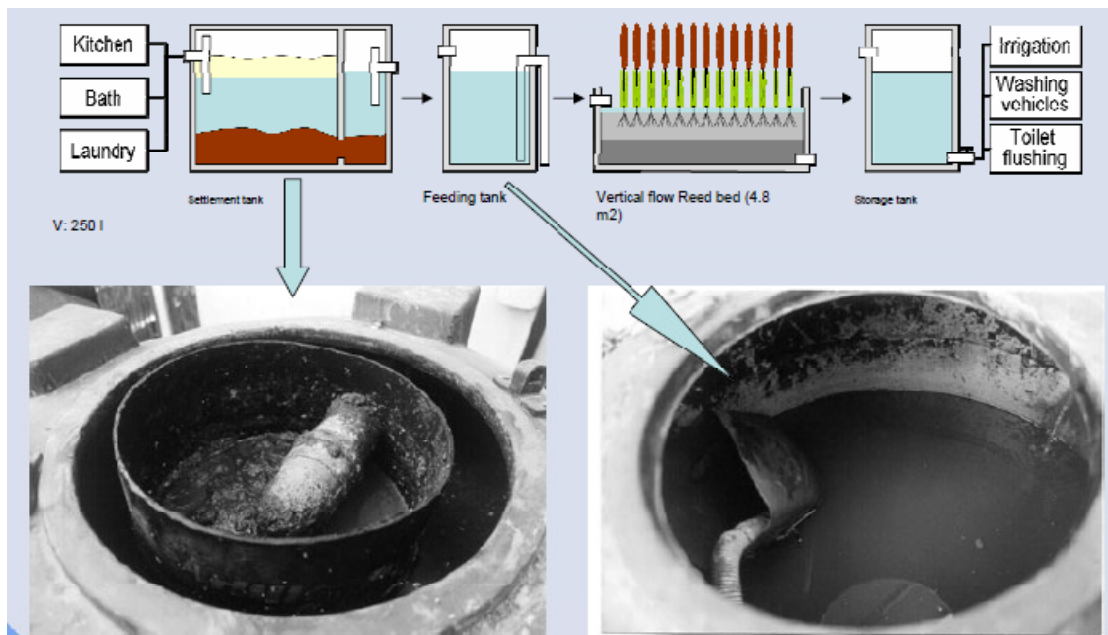

Figure 6.4- Greywater treatment system used in Eco-Home

Source: (Shrestha 2007)



The greywater recycling system used was vertical subsurface flow bed of the Reed Bed Treatment System (RBTS). It is a type of constructed wetland that consisted of a rectangular bed (4.8 m<sup>2</sup>) filled with 20 centimeters of gravel (20 to 40 mm) at the bottom, 10 centimeters of small gravel (10 mm) in the middle and 60 centimeters of coarse sand on the top. The bed is planted with *Phragmites karka* (Reed) and water is distributed 1 to 2 times a day through a 50 millimeters diameter perforated pipe that is fixed above the surface level of the bed and connected to the feeding tank (figure 6.4).

As the wastewater flows through the bed, it is treated through natural processes by mechanical filtration, chemical transformation, and biological consumption of potential pollutants in the wastewater stream. The plants grown in the wetland bed not only offer a root mass for filtration, but also provide oxygen and carbon for water treatment. Plants act like biological pumps, converting sunlight into chemical energy and carrying oxygen from their leaves to their roots. Pollutant digesting microbes colonize in the oxidized zone surrounding the root surface where it consumes the available oxygen in the process of breaking down pollutants. The plants themselves also take up pollutants. (Shrestha 2007)



Figure 6.5- Constructed wetland on site Source: (Shrestha 2007)

## 6.5 SUMMARY

Inefficient management of collection, disposition and proper treatment aggravates solid waste treatment in Kathmandu. Since lifestyle of people in the city has changed over time, new waste products that are non-biodegradable are amassed in waste. But, in spite of all these, organic waste still account for most of the waste produced by households in the city. Since organic waste is biodegradable, it can be composted for organic manure to be used in agriculture. The composting facility at Teku, Kathmandu (capacity 15 tons/day) has been closed since 1990. The private sector has shown an interest in setting up a compost plant; this, however, has not progressed because no site is available and low priority is given to this approach. The Sisdol landfill site has been plagued by numerous objections from local and environmentalist in degrading the environment of the area. Thus, use of composting bins at household level and vermi-composting should be introduced. In *the Eco-Home*, the composting bins have been used for composting organic waste. In vermi-composting, composting is done by using special worms (*Eisenia foetida*). Both of these techniques are appropriate for composting of organic waste at the household scale. These simple techniques help to reduce the waste load at source thereby reducing at municipal level. This can help manage small volume of waste produced at home.



Figure 6.6- Bin composting  
Source: <http://www.mld.gov.np/swm/images/Galary/Large/18.jpg>

The wastewater in case of Kathmandu has had adverse effect to the river sources. Significant volume of wastewater ends up in nearby rivers or rivulets thus, hampering the local environment. Mostly attributed to the mismanagement of sewerage system, storm water lines and drainage system, the clogging of main drains during monsoon speak volumes of ineffectiveness of these systems. Thus, to reduce the load of these systems, wastewater treatment at household level can be carried out using reed bed system. As mentioned about its benefits and usage, it is economical and feasible in the context of Kathmandu. The demonstration of using vertical reed bed system has significantly helped to sustain the building without any city water lines and applying principles of reduce, reuse and recycle of water. Thus, for the treatment of greywater and blackwater, this system should be applied. Since most of the components are organic, this system can handle both grey and black water.

Thus, it is imperative to add the treatment of solid waste and wastewater treatment in every household for a sustainable living. The people of Kathmandu need to reintroduce the traditionally used mechanism of composting organic waste in agriculture field, which at that time was the most viable option. With agricultural lands, being converted to build structure, a system that can recycle the organic waste on-site is required. Thus, reed bed treatment for wastewater is the most feasible option in the context of Kathmandu.

## **CHAPTER 7: CLIMATE STUDY FOR KATHMANDU**

### **7.1 CLIMATE OF KATHMANDU**

The climate of Kathmandu is discussed in the last Chapter 3 under Climate of Kathmandu (see 3.5). Based on those climatic data, climatic analysis for potential buildings in developing guidelines is completed using various tools that are developed by researchers such as Victor Olgay, Carl Mahoney. Design strategies have been developed in the following sections from the climatic analysis.

### **7.2 CLIMATIC ANALYSIS FOR DESIGN STRATEGIES**

Climate sensitive design is one of the major factors of sustainable design as buildings are designed in response to climate in order to make indoor environment physically comfortable. Human comfort depends upon physiological, psychological, environmental and cultural factors. There is a wide range of factors such as prevailing climatic conditions, available resources, construction materials, technologies, housing requirements, lifestyle etc. that needs to be considered while applying design strategies for sustainable building. To draw comfort requirements for different climate, researchers like Victor Olgay, Carl Mahoney, and John Martin Evans have developed various tools. These tools give recommendations that are useful in designing climate responsive buildings in any specific climate. Some of those tools that are used in this research are Bioclimatic Chart, Psychrometric Chart and Mahoney Table. These are discussed as below:

#### **7.2.1 ANALYSIS BASED ON MAHONEY TABLE**

The Mahoney tables, named after architect Carl Mahoney who worked with Otto. H. Koenigsberger and John Martin Evans, developed in 1970, are a series of tables developed

to address the design requirements for composite climates (Koenigsberger et al., 1973). Mahoney Table provide more detailed design recommendations based on the analysis of temperature, humidity, wind, precipitation and comfort conditions for a given location.

Monthly mean maximum temperature, monthly mean minimum temperature, monthly mean maximum and minimum humidity, and air velocity were entered in the respective tables as demanded by the Mahoney Table. The Mahoney Table has been developed for Kathmandu for years from 1997 to 2008 for this research (see Table 7.1). The averages of temperature, precipitation and humidity for years from 1997 to 2008 were taken into account. (see Appendix A) The Mahoney Table itself provides results and suggestions. The wind direction has been opted out from the analysis due to lack of data on it.

The analysis suggests design recommendations for 8 different parts which are summarized as follows:

- a. Orientation of the house should be along North and South (long axis on East-West)
- b. Open space should be created for wind breeze but with the protection from hot and cold wind
- c. Rooms should be single banked with permanent provision for air movement
- d. Openings should be 25-40% of floor area
- e. Window should be on windward side walls and at body height
- f. Light walls with low thermal capacity and short time lag
- g. Roof should be light and insulated
- h. Protection from heavy rain for windows and walls

Table 7.1- Mahoney Table for Kathmandu

Mahoney Tables

Data

Location	KATHMANDU AIRPORT											
Longitude	85°											
Latitude	27°											
Altitude	1337 m											

*You have to fill out temperature, humidity and rainfall data for all months before you can make the evaluation!*

Air temperature °C	Jan	Feb	Mar	Apr	May	Jun	Jul	Aug	Sep	Oct	Nov	Dec	High	AMT
	(annual mean temp)													
Monthly mean max.	19.6	22.1	25.7	28.4	28.8	29.3	28.6	28.9	28.5	27.2	24.1	20.7	29.3	24.8
Monthly mean min.	2.4	5.2	8.6	12.4	16.1	19.3	20.3	20.2	18.8	13.8	8.6	4.2	20.3	####
Monthly mean range	17.2	16.9	17.1	16	12.7	10	8.3	8.7	9.7	13.4	15.5	16.5	Low	AMR
	(annual mean range)													

Relative humidity %	Jan	Feb	Mar	Apr	May	Jun	Jul	Aug	Sep	Oct	Nov	Dec
	Monthly mean max am	97	93	82	75	78	81	87	88	88	90	94
Monthly mean min pm	63	58	53	55	65	73	82	81	79	73	71	69
Average	80	75.5	67.5	65	71.5	77	84.5	84.5	83.5	81.5	82.5	83
Humidity group	4	4	3	3	4	4	4	4	4	4	4	4

1 <30%  
2 30-50%  
3 50-70%  
4 >70%

Rain and wind	Jan	Feb	Mar	Apr	May	Jun	Jul	Aug	Sep	Oct	Nov	Dec	Total
Rainfall mm	14	20	40	72	134	241	412	339	200	48	7	10	1537

Wind, prevailing	W												
Wind, secondary													

N, NE, E, SE,  
S, SW, W, NW

Diagnosis °C	Jan	Feb	Mar	Apr	May	Jun	Jul	Aug	Sep	Oct	Nov	Dec	AMT
Monthly mean max	19.6	22.1	25.7	28.4	28.8	29.3	28.6	28.9	28.5	27.2	24.1	20.7	24.8
Day comfort, upper	27	27	29	29	27	27	27	27	27	27	27	27	
Day comfort, lower	22	22	23	23	22	22	22	22	22	22	22	22	
Thermal stress, day	C	O	O	O	H	H	H	H	H	H	O	C	
Monthly mean min	2.4	5.2	8.6	12.4	16.1	19.3	20.3	20.2	18.8	13.8	8.6	4.2	
Night comfort, upper	21	21	23	23	21	21	21	21	21	21	21	21	
Night comfort, lower	17	17	17	17	17	17	17	17	17	17	17	17	
Thermal stress, night	C	C	C	C	C	O	O	O	O	C	C	C	

H = Hot  
O = Comfort  
C = Cold

Comfort limits	AMT >20°C				AMT 15-20°C				AMT <15°C				For AMT = 24.8			
	Day		Night		Day		Night		Day		Night					
	Lower	Upper	Lower	Upper	Lower	Upper	Lower	Upper	Lower	Upper	Lower	Upper				
Humidity group 1	26	34	17	25	23	32	14	23	21	30	12	21	26	34	17	25
Humidity group 2	25	31	17	24	22	30	14	22	20	27	12	20	25	31	17	24
Humidity group 3	23	29	17	23	21	28	14	21	19	26	12	19	23	29	17	23
Humidity group 4	22	27	17	21	20	25	14	20	18	24	12	18	22	27	17	21

Meaning	Indicator	Thermal stress		Rainfall	Humidity group	Monthly mean range
		Day	Night			
Air movement essential	H1	H			4	
Air movement desirable	H2	H			2-3	<10°C
Rain protection necessary	H3	O		>200mm	4	
Thermal capacity necessary	A1				1-3	>10°C
Outdoor sleeping desirable	A2		H		1-2	
Protection from cold	A3	H	O		1-2	>10°C
			C			

Indicators	Jan	Feb	Mar	Apr	May	Jun	Jul	Aug	Sep	Oct	Nov	Dec	Total
H1					1	1	1	1	1	1			6
H2		1									1		2
H3						1	1	1					3
A1			1	1									2
A2													0
A3	1											1	2

*You have to fill out temperature, humidity and rainfall data for all months before you can make the evaluation!*

Indicator totals from data sheet					
H1	H2	H3	A1	A2	A3
6	2	3	2	0	2

**KATHMANDU AIRPORT**  
Latitude 27°N

Layout					
			0-10		
			11-12	5-12	X Orientation north and south (long axis east-west)
				0-4	Compact courtyard planning
Spacing					
11-12					Open spacing for breeze penetration
2-10					X As above, but protection from hot and cold wind
0-1					Compact layout of estates
Air movement					
3-12					X Rooms single banked, permanent provision for air movement
1-2			0-5		Rooms double banked, temporary provision for air movement
			6-12		
0	2-12				No air movement requirement
	0-1				
Openings					
			0-1	0	Large openings, 40-80%
			11-12	0-1	Very small openings, 10-20%
Any other conditions					
					X Medium openings, 20-40%
Walls					
			0-2		X Light walls, short time-lag
			3-12		Heavy external and internal walls
Roofs					
			0-5		X Light, insulated roofs
			6-12		Heavy roofs, over 8h time-lag
Outdoor sleeping					
				2-12	Space for outdoor sleeping required
Rain protection					
			3-12		X Protection from heavy rain necessary
Size of opening					
			0-1	0	Large openings, 40-80%
				1-12	X Medium openings, 25-40%
			2-5		Small openings, 15-25%
			6-10		
				0-3	Very small openings, 10-20%
			11-12	4-12	Medium openings, 25-40%
Position of openings					
3-12					X In north and south walls at body height on windward side
1-2			0-5		
			6-12		As above, openings also in internal walls
0	2-12				
Protection of openings					
				0-2	X Exclude direct sunlight
			2-12		X Provide protection from rain
Walls and floors					
			0-2		X Light, low thermal capacity
			3-12		Heavy, over 8h time-lag
Roofs					
10-12			0-2		Light, reflective surface, cavity
			3-12		X Light, well insulated
			0-5		
0-9			6-12		Heavy, over 8h time-lag
External features					
				1-12	Space for outdoor sleeping
			1-12		X Adequate rainwater drainage

## **7.2.2 COMFORT INDEX: PLOTTING IN THE BIOCLIMATIC CHART**

Victor Olgyay, in 1962, developed a chart, known as Bioclimatic Chart, in which comfort zone is identified in terms of dry bulb temperature and relative humidity (Olgyay, 1962). This chart shows how the comfort zone is affected by the wind, radiation and shading. This graph can be used to evaluate comfort conditions and propose some design strategies. The "comfort zone" lies at the center with winter and summer ranges indicated separately. The chart also recommends the "radiation needed" zone, "wind needed" zone and "shading needed" zone to make the environment balanced and comfort as shown in figure 7.1. On the basis of mean monthly maximum temperature, mean monthly minimum temperature and their respective humidity, plotting for different months was done in Bioclimatic Chart. The reference data was taken from years 1997 to 2008.

The maximum solar radiation suggested by the corrective measure of the Bioclimatic Chart corresponds to the combination of minimum temperature and minimum humidity when the cooling condition is the worst. The maximum wind velocity suggested by the corrective measure of the Bioclimatic Chart corresponds to the combination of the maximum temperature and the maximum humidity when the heating condition is the worst.

The "comfort zone" suggests that no corrective measures regarding wind velocity and solar radiation is required.

### **7.2.2.1 CONCLUSION FROM BIOCLIMATIC CHART**

The major periods that demand radiation is during December, January and February. The radiation demand goes to as high as 800 watts/square meter during December and January. Half of the month of March and November; and one-third of the month of April and October too demand certain level of radiation.

High wind movement is demanded during the months of May, June, July, August,



September and October. Air velocity demand reaches up to 3.5m/s, the upper limit as suggested by the Bioclimatic Chart. One-third of the period of April and October too demand wind movement up to 1.5 m/s (meters per second).

The periods that are above the corrective measures (one-tenth of the period of June, July and August) are all over-heated conditions. Half period of March, one-third period of November and few periods in April and October are under comfortable zone.

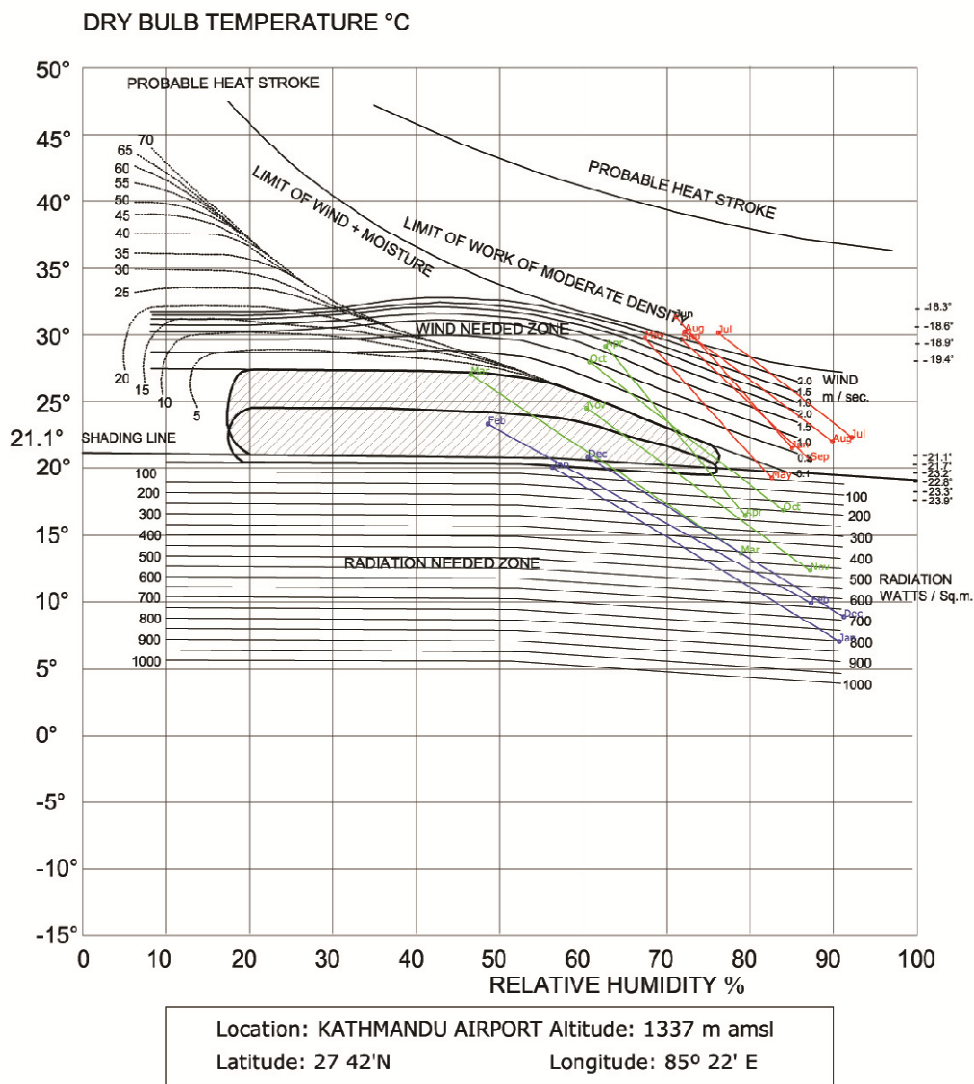

BIO CLIMATIC CHART FOR (1997-2008)  
 Figure 7.1- BioClimatic Chart for Kathmandu (1997-2008) Source: By Author

### 7.2.3 PSYCHROMETRIC CHART

Psychrometric chart is a graph used to find temperatures, relative humidity and used to design and analysis of air conditioning systems, heating, cooling system. It can depict human comfort in relation to temperature and humidity. The chart ascertains a process whereby a designer can match solutions to climatic conditions when climatic data of a given site is plotted on the chart. Based upon monthly average temperature and humidity, different zones are plotted to indicate design requirements for a given place. The Psychrometric chart for Kathmandu is shown in figure 7.2.

The plot demonstrates (see figure 7.2) that for most of the months, passive solar heating strategies should be implemented. December through February requires conventional heating in addition to passive solar designs. October, April and May need passive solar design for most of the period but seemingly fall under "comfort zone" as during daytime temperature is comfortable while nights are still slightly cold. Similarly, June to September is slightly off the "comfort zone" where provisions for air movement, internal gains and shading are highly demanded.

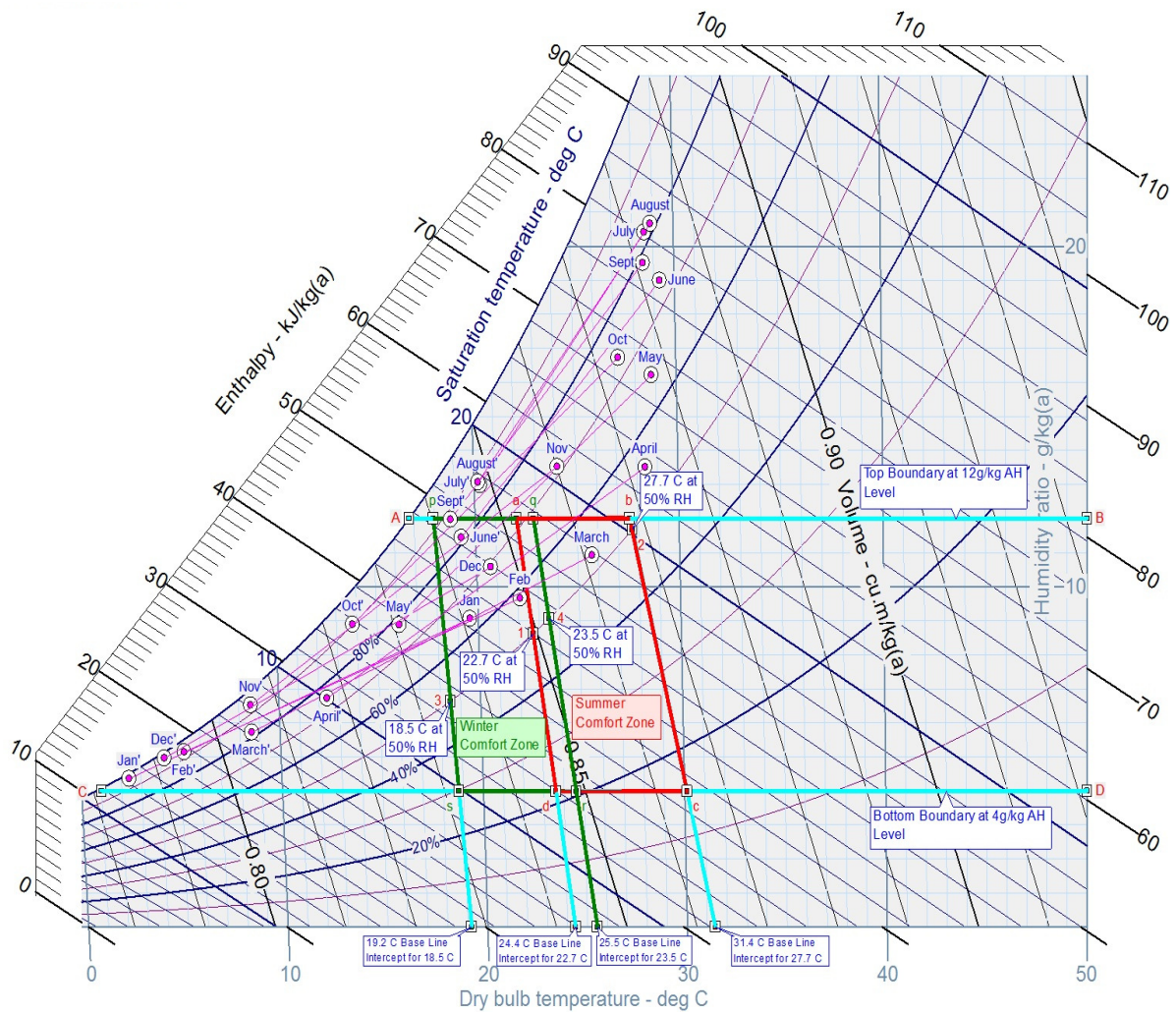

Figure 7.2- Psychrometric Chart for Kathmandu Source: By Author developed using CYT Soft Psychrometric Chart

### 7.3 SUMMARY

Kathmandu has a mix of subtropical humid and temperate climate with four distinct seasons: autumn, winter, spring and summer. The winter temperature reaches low to about 32°F (0°C) and summer temperature reaches on an average up to about 86°F (30°C). The summer period features heavy monsoon rain whereas winter is dry. Passive solar design has a huge potential in these climate as they can be integrated in residence design.

The thermal comfort range for temperature in Kathmandu is from 64.4°F - 80.4°F (18°C to 27°C) (see appendix A). The study of temperature shows there is a rise in upper

temperature and a fall of lower temperature thus, experiencing hot days during summer and cold days in winter. The layout of streets and courtyards from Malla era suggests that the climate of Kathmandu have been colder but the trend in recent years have altered and people have been facing with slightly higher temperatures. Moreover, the materials used have contributed to the heat gain and this has impacted the internal thermal comfort temperature.

The following tools developed by researchers like Carl Mahoney, Victor Olgyay, have been used to analyze the climate. Mahoney Table is produced based on the monthly temperatures, humidity, wind and precipitation. This table recommends the orientation, openings, and air movement, type of walls and roofs and protection from rain for a building. These recommendations can be useful to passive solar design.

Bioclimatic Chart is another tool for climatic analysis, which is plotted with monthly data of relative humidity and dry bulb temperature. This chart depicts that most of the days during March and October are in comfort zone. Likewise, May, June, July, August and September are "wind needed" zone and shadings in the openings during daytime whereas December to February requires radiation during daytime.

In the same way, Psychrometric Chart depicts human comfort in relation to temperature and humidity. According to this chart, the only months that fall within "comfort zone" are April, May and October during daytime. All other months during daytime requires heating or cooling depending upon season. Similarly, winter months require internal heat gain and conventional heating during nighttime.

## **CHAPTER 8: DISCUSSION AND RECOMMENDATIONS**

### **8.1 DISCUSSION**

This study gathered information regarding sustainability and its implications to principle from literature review has provided basis for identifying terms. The discussion was focused on major aspects of sustainability - economic, environmental and society, which have affected to every human and manmade structure at local and global level. The fact that every other field have defined and addressed the need to adopt sustainability issues in their field has heightened its significance in today's world.

The field of building design and construction seems no exception in regard to adopt sustainable strategies to the buildings. Researches like mainly Paula Sassi and Jong-Jin-Kim and academic institutions working for best possible solutions to the environmental sustainability have been foremost in talking and discussing environmental aspect of sustainable building design. Over the last two decades, developed countries and developing countries have started to address this prominent issue by setting up sustainable building design parameters and guidelines. BREEAM was the first to adopt such guideline that was developed by United Kingdom to address the environmental sustainability. LEED that was developed by the United States has been gaining popularity in developing world as a basis to form their own guidelines according to their own need. The environmental sustainability, one of the dimensions of sustainability, highlights energy, water, waste management, health and well-being at its core.

As discussed in Chapter 3, the research showed that Kathmandu has grown in the past two decade with rapid and haphazard development. The influx of people from countryside to the capital has seen sea change in the development of Kathmandu with rise in; need for housing, employment, infrastructure development and basic supplies.

The augmenting problems faced by the people of Kathmandu ranging from waste management, water need, solid waste management, air pollution, land pollution has brought the environment of the city in deep crisis. Energy demands are growing day-by-day but temporary black out of electricity urged users to venture out into alternative sources of energy. Currently, electricity is generated by hydropower that uses river water for generation, but these rivers run dry during dry winter season. Similarly, potable water supply is in huge crisis. The traditional source of water has run dry and ground water table is decreasing day by day with hazardous substances contaminating the water taken out from underground water. Solid waste management has been mismanaged and problems with overall system have developed from time to time. Thus, to mitigate these problems, sustainable building techniques should be adopted to reduce the generation at its source. Since residential building generates most of the problems, solving the issue at source shall reduce the problems at larger context. Moreover, the lifestyle of people needs to change from global perspective of climate change and environmental sustainability.

The climate of Kathmandu is favorable for passive solar design. The climate is temperate with warm summer and dry winter conditions. Precipitation is high enough for half a year and wind speed is good enough for cooling in summer time. The table below summarizes the climatic analysis (see Table 8.1).

Overall, with all the insights of problems of the city and growing trend of sustainable design at global level, it is imperative in devising design strategies at local level to meet the needs and demands and address the problems at specific micro level. Thus, the final step is to propose design guidelines that could be regulated in Kathmandu and has been recommended in the following section.

Table 8.1- Summary of climatic study for Kathmandu

	Summer				Winter				Remarks
	Sun Shading		Rain Protection	Courtyard	Opening		Thermal Mass	Passive Heating	
	Natural Vegetation	Overhang			Air Movement	Solar gain and South Orientation			
Bioclimatic Chart	-	-	-	-	■	■	■	■	Consider internal comfort
Mahoney Table	■	■	■	■	■	■	■	■	Consider external and internal comfort
Psychrometric Chart	■	■	-	-	■	■	■	■	Consider internal comfort
Climatic data	■	■	■	■	■	■	■	■	Consider internal and external comfort

Note: ■ Issues addressed  
 - Issues not addressed

## 8.2 DESIGN GUIDELINES

This design guideline recommends applying design strategies for sustainable design using passive controls such as sun, wind and other climatic data, using rainwater harvesting system instead of Municipal water pipe system for meeting water demands, using grey water recycling treatment systems for solid waste treatment and composting technology for organic waste produced by a residential building.

## 8.2.1 CLIMATE RESPONSIVE DESIGN

### ORIENTATION

From the analysis of Ecotect, the best orientation for buildings to harness solar gain during winter is to tilt the building 15° East or West of South. The long axis facing South means more solar radiation and thus, benefit from it.

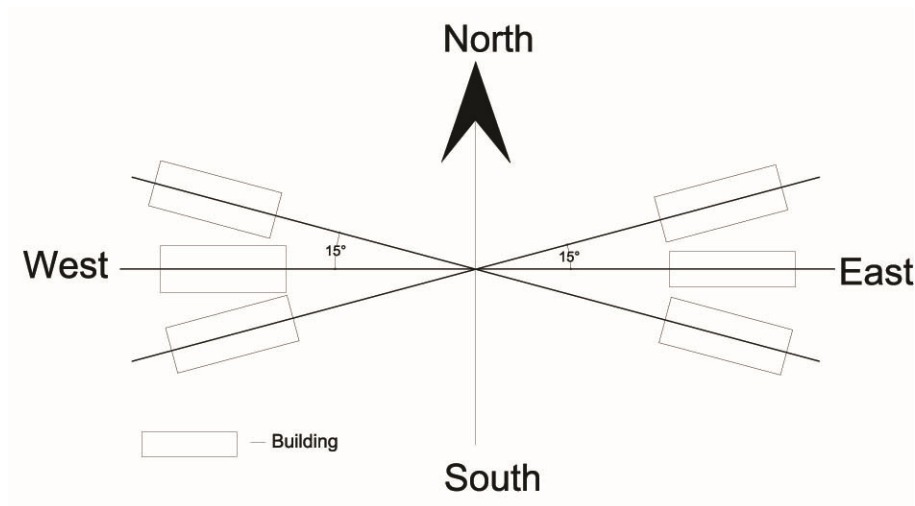

Figure 8.1- Building orientation options for optimized solar gain

### SITE SELECTION

Sites that face South direction are beneficial for avoiding overshadowing.

As far as possible, adjacent building should be wide apart for westerly wind in order to gain from westerly winds.



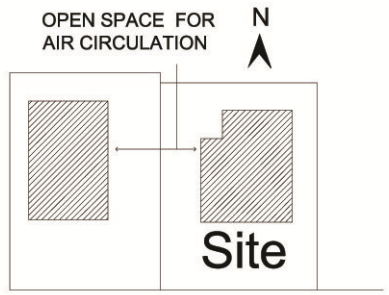

South Facing site best orientation

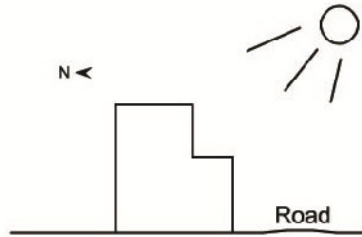
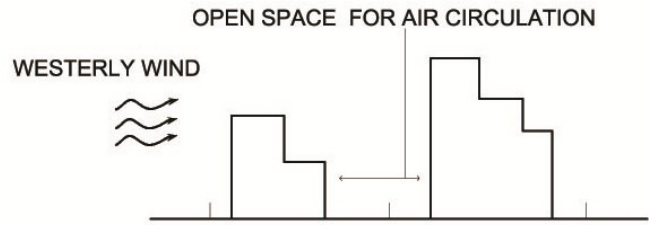

South Facing site best orientation

Figure 8.2- South facing building with solar gain and open space between buildings good for air circulation

### BUILDING LAYOUT

Most used spaces such as living room; bedroom should be oriented to South, South East and South West. But room oriented towards West should have large volume of space and or adequate ventilation.

Height of living space for large volume of space - longest side of the living space

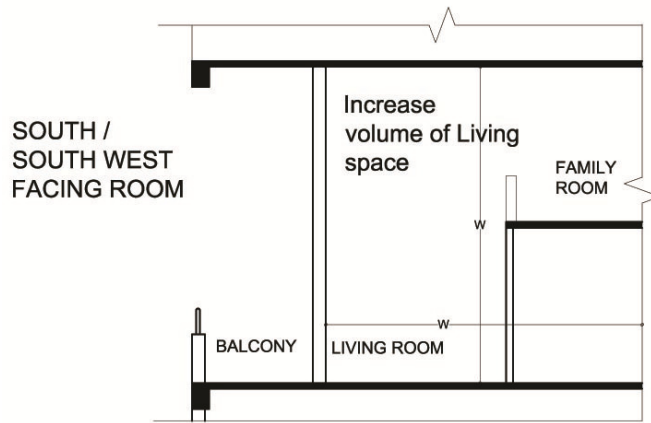

Figure 8.3- Enhancing living space according to room orientation

Service cores should be as far as possible in West side of the site in order to achieve good ventilation and as buffer zone.

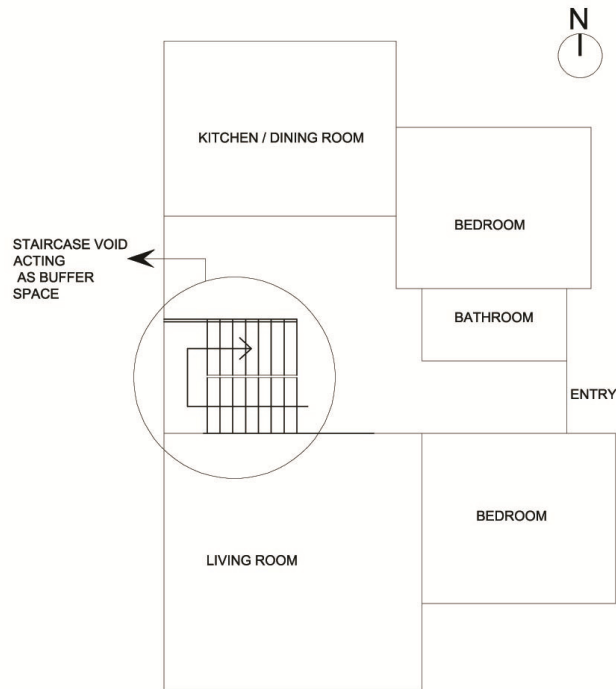

Figure 8.4- Service cores acting as buffer zone

## SHADING DEVICE

Protection from direct sunlight and rain to windows and walls should be provided according to the floor-to-floor height and surface facing sun.

Horizontal Shading Projection =  $0.215 H$ , where H- floor height of the room

Provision of vegetative elements over the shading device shall reduce solar heat gain during summer.

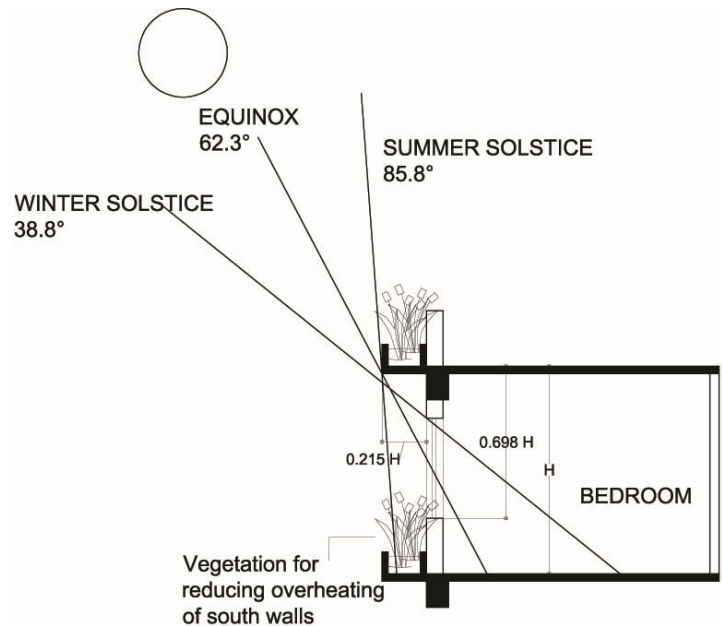

Figure 8.5- Relationship of floor height and horizontal shading

## 8.2.2 WATER EFFICIENCY

### RAINWATER HARVESTING SYSTEM

Owing to the problems of water supply system in Kathmandu, it is necessary to implement rainwater harvesting system in every household. A simple schematic diagram as shown below (figure 8.6) shall provided fundamental basis for instituting this system in a residential building. The sizing of water collection tank can be followed as below:

Water demand per capita-  $62 \text{ l / p / d}$

Total water demand for a household of 5 people -  $310 \text{ l/d}$

Total water demand for a household of 5 people in a year -  $113,150 \text{ ltrs.}$

Annual Rainfall -  $1.60 \text{ m (1600mm)}$  (Department of Hydrology and Meteorology,  
Kathmandu)

Assuming for dry rainfall for a year,

Designed Annual Rainfall -  $2/3 \text{ of Annual Rainfall} = 1.07 \text{ m}$

Since the rainfall is negligible from October to February during dry rainfall year,

expected dry days - 150 days

Capacity of water tank = 310 l/d x 150 days = 46,500 liters

Volume of water tank = 46.5 m<sup>3</sup>

Size of water tank = (4.5 x 6.9 x 1.5) m = (12'6" x 18'9" x 5')

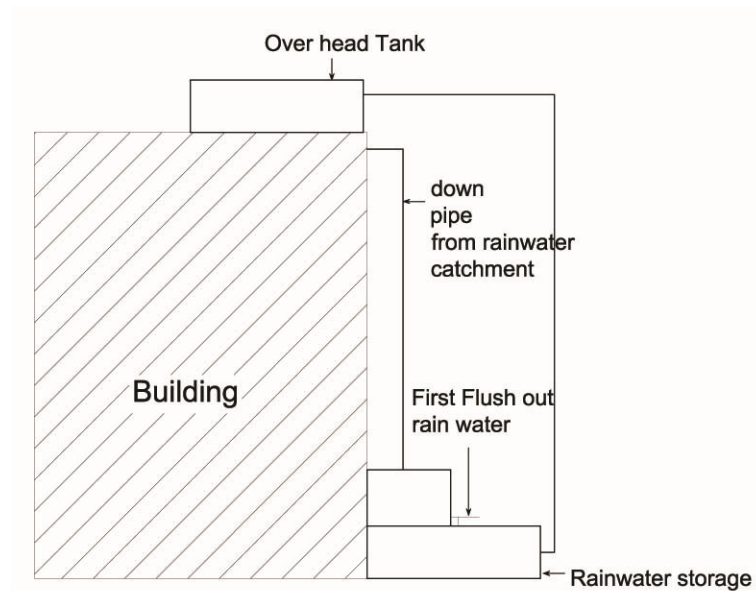

Figure 8.6- Section of a building showing rainwater harvesting system (schematic diagram)

## USE OF EFFICIENT WATER FIXTURES

- Use of composting toilets
- Installing water-saving spray or automatic taps on basins and showers
- Installing dual or low flush water closets.
- Retrofitting and maintain existing appliances, taps upgrade.
- Installing water meters
- Sustainable urban drainage (SUD) assist in reducing hard landscapes and integrating water absorbing surface and planted areas to suite local environment.

## 8.2.3 WASTE WATER MANAGEMENT

### GREYWATER RECYCLING SYSTEM

A separate greywater recycling system is to be included for treating greywater from kitchen sinks, wash basin, showers, cleaning and washing clothes. Reed bed system is efficient, cost effective system for Kathmandu besides other mechanical system where water pump is used extensively for extracting water from Municipal water taps and ground water.

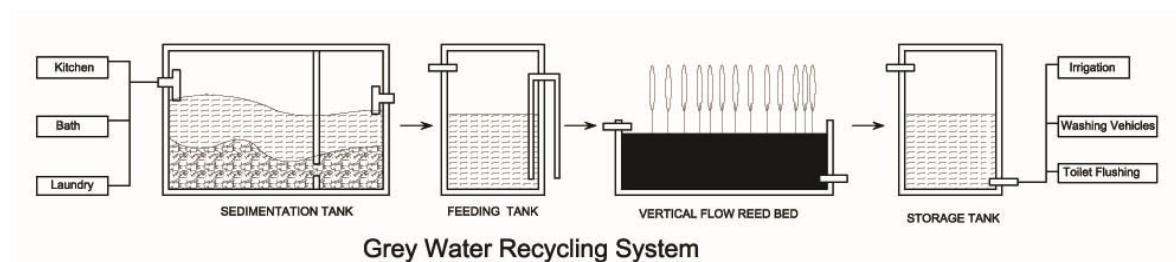

Figure 8.7- Schematic diagram of grey water recycling system

## 8.2.4 ENERGY EFFICIENCY

### SOLAR HEATER SYSTEM

To minimize the heating load, solar thermal panels should be installed for warm water supply in the building. Most of this water is used for bathing purposes during winter period that lasts for about four months from November to February. During summer, the water in roof top water tank is warm and gets heated due to direct solar radiation. The water tank mostly is made of plastic materials thus; it is easier to get heated up.

### PHOTOVOLTAIC PANELS

As an alternative to electricity for running appliances in the building, photovoltaic (PV) panels have been initiated. The cost of purchasing and installing these panels are far fetching for public unless some mechanisms to introduce at subsidized price is beyond the scope of use. In recent years, PV panels in the valley have been used and available in commercial

market but a lot of study and regulations to implement commercial needs to be studied. The introduction of these PV panels means different electrical setup for installing in homes and there are no governmental regulations on these issues. The legal and technical issues must be thoroughly studied before its full implementation.

## **CHAPTER 9: DESIGN PROCESS AND OUTCOME**

This chapter discusses the process of transforming analytical outcome gained from literature review, precedent studies and incorporating sustainable design approaches into multilevel residential building model. It has four stages namely - site analysis, design process, design limitation and design outcome.

### **9.1 SITE ANALYSIS**

The site selected for the project is situated at Thapathali, Kathmandu, Nepal. The location is a busy and prominent place for mixed used residential area. The site area is 5494.67 square feet. The main access road is 17 feet wide on the west side but the main road is on South side with 24feet wide. The site falls under residential mix zone with institution like Hospital, school, bank and commercial activities related to hospital such as pharmacy, kiosks, food restaurant are prominent. The major transportation is public transport mainly micro-van, bus, which is five minutes away. The Bagmati River flows on southern side and this divides the city from other city (Patan) as two bridges run over the river.

The site is oblong in North-South direction. The site is flat with few types of vegetation around it. The surrounding buildings are mostly residential with two- three storyed in height.

### **SUSTAINABLE SITE ANALYSIS**

The site analysis is considered with regard to the points mentioned in the LEED Home checklist for sustainability. Similarly, an analysis for the proposed site was conducted

within the topics raised in the sustainable site and location linkage headings from LEED Home.

**Site Selection** - The site selected is not environmentally sensitive and not used as farmland. The site is in urban context thus does not pose any threat to the environment around.

**Infrastructure**- The site is within half a kilometer of existing water, sewer and road system. Moreover, the proposed building is independent of Municipal water system and partially dependent on sewer system.

**Community Resources**- The site is easily accessible for public transportation mostly micro-van, bus and three wheelers- names locally 'tempo'. The site boasts high school at a walking distance and three major educational institutes at a walking distance. Maternity hospital and a private hospital are right next to the site. Government office such as Department of Tax and Road, National Bank (Nepal Rastry Bank) are at close proximity.

**Compact Development**- The site is in residential mixed zone with institutional zone. Over the past decade, the area has been developed into residential zone with many residential buildings around the site.

**Landscaping**- The site is devoid of hard landscape and barren land with few vegetations that can be removed with no significance to environment. The proposed site has vegetation on its boundary and mix of soft and hard landscape at ground floor.



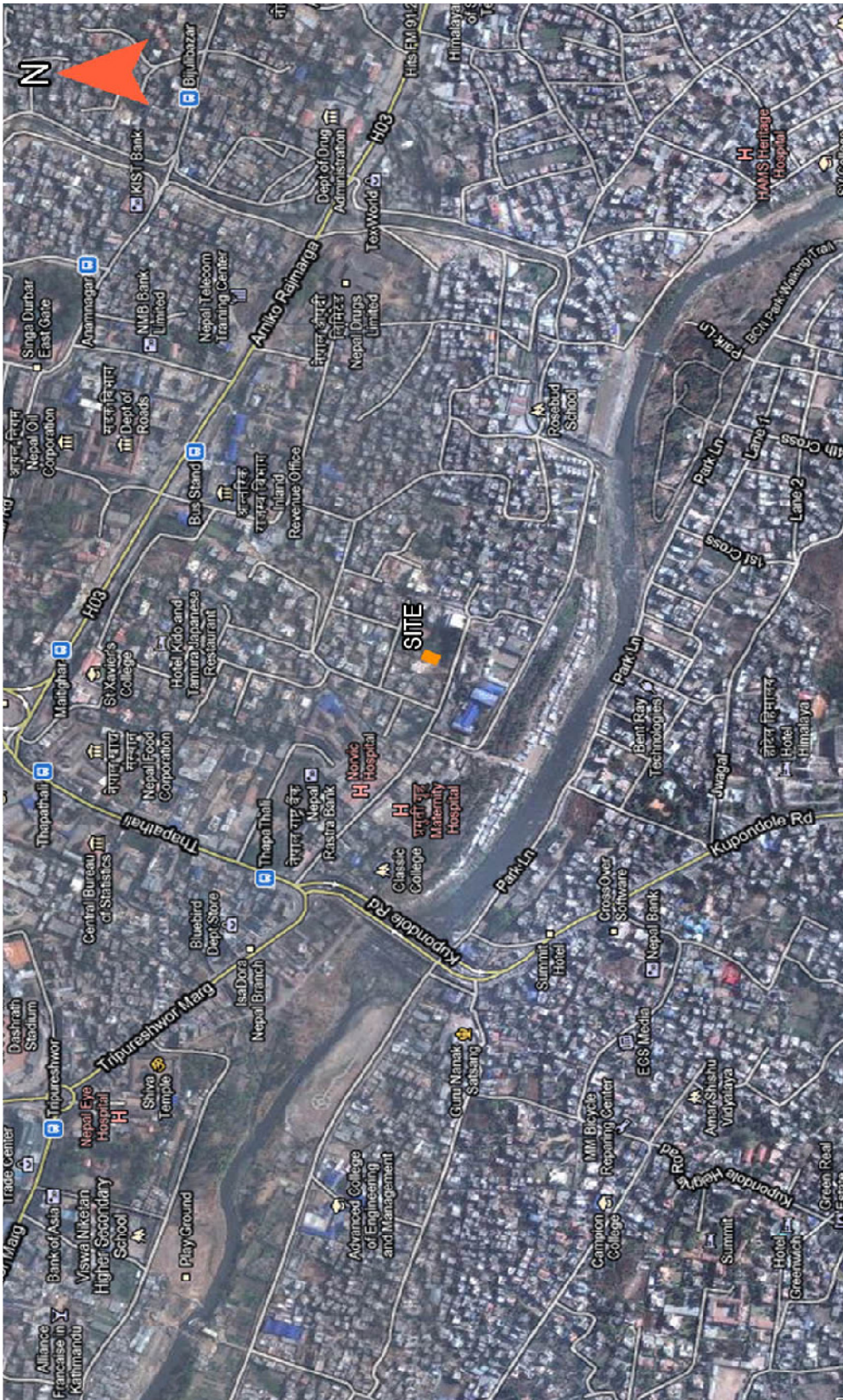

Figure 9.1- Aerial View of Kathmandu (Source: Google Map 2011)



Figure 9.2- Location of Site, Thapathali, Kathmandu, Nepal



Figure 9.3- Solar path and wind direction

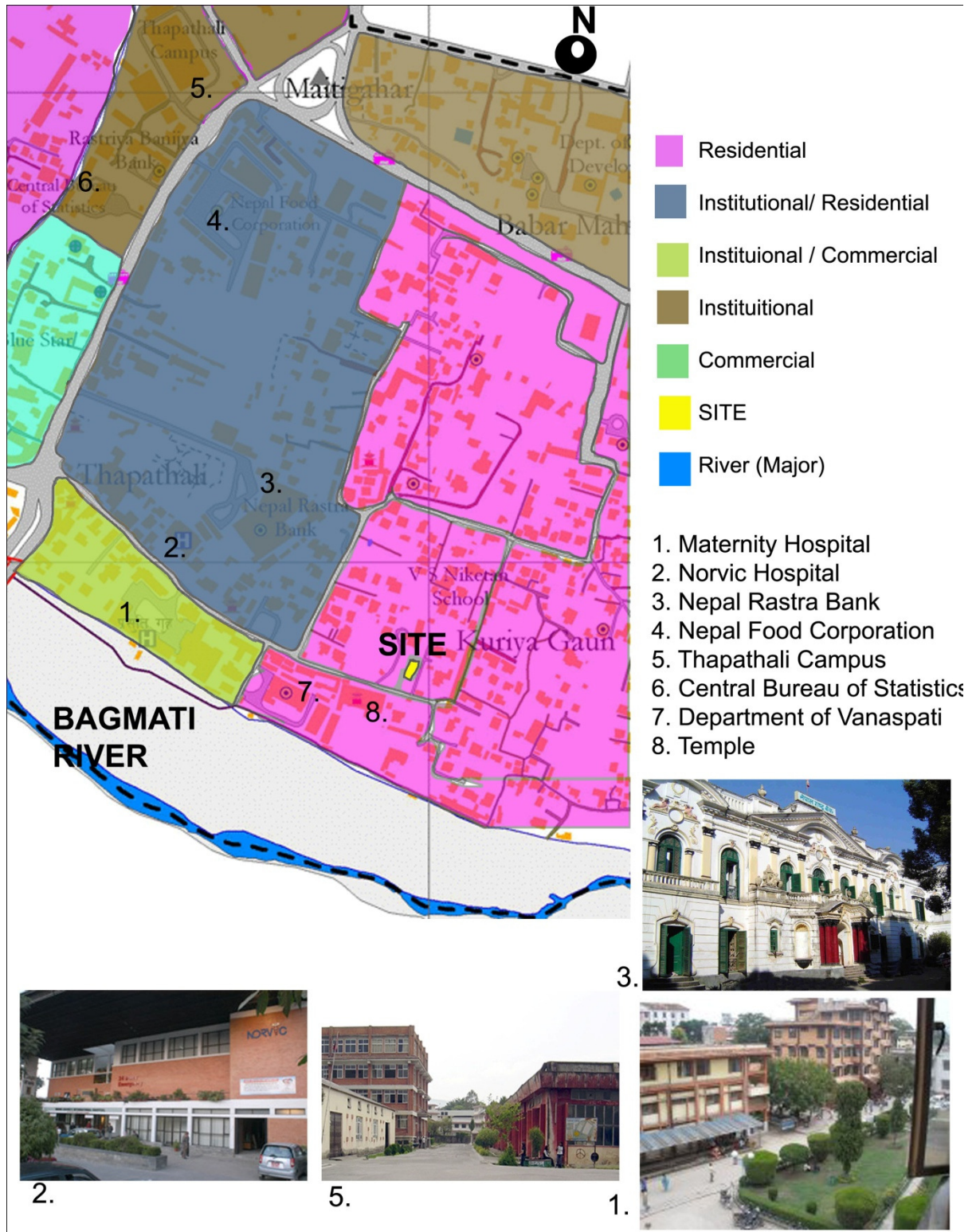

Figure 9.4- Site Analysis



Main road on the way to the site (Source: Manjari Shakya, 2011)



Department of Vanaspati near the site (source: Manjari Shakya, 2011)



Site on left side viewed from neighboring residence (source: Manjari Shakya, 2011)



Old Temple in front of site across the road (source: Manjari Shakya, 2011)

Figure 9.5- Site Surrounding

## 9.2 DESIGN PROCESS

### 9.2.1 CONCEPT

The research and study related to issues of Kathmandu has brought about the need to address the problems chiefly in water management, waste management and meet energy

demands in residential buildings. As discussed in Chapter 3, most of the buildings in Kathmandu have no adequate water supply, mismanagement of waste generation from the buildings; power outage problems to run the appliances to name a few are most of the critical problems faced by the people. In all, there is no sustainable building to mitigate the problems. The proposed design presents the design guidelines that are recommended in Chapter 8 to implement it in a multilevel residential building.

The design is conceptualized with climate responsive design along with sustainable design approaches for the multilevel residential building. The study of sustainable design strategies and issues concerning in the city depict augmenting problems in infrastructure planning especially in wastewater management, solid waste management, water supply and energy. More importantly, construction industry in residential sector has been impaired with aforementioned problems. Thus, the design focuses to address the problem at source itself with incorporation of greywater recycling system, rainwater harvesting and climate responsive design in the existing scenario with future explorations.

Incorporation of green roof in the design is to mitigate the rise in hard landscape and bring elements of agriculture related activities into the building. The courtyard, one of the features of traditional Newari architecture, is designed as a light well and for maintaining indoor temperature with ventilation purposes. The interplay of facades generates private green balconies, summer shading and assist in capturing the energy and providing shading from rainwater.

### **9.2.2 FORM EXPLORATION**

The climatic study showed that Kathmandu has temperate climate with need for ventilation during monsoon period from June to August and in summer to regulate the indoor air. The optimum solar gain was sought during winter with orientation of living spaces

directed towards South and West. Although there is a possibility of overheating during summer in west side, this has been negated with service core on west side and use of deep recessed open spaces. Thus, using southern sun and channelizing wind from the west into the building highlights the general form of the building.

The forms that were explored and options viewed are attached in Appendix C section of this thesis and the preferred option was as follows:

The choice of the preferred option is mainly due to climatic response in utilizing solar gain and channelizing wind into the building for cooling and ventilation purposes. Some of the advantages and disadvantages are as follows:

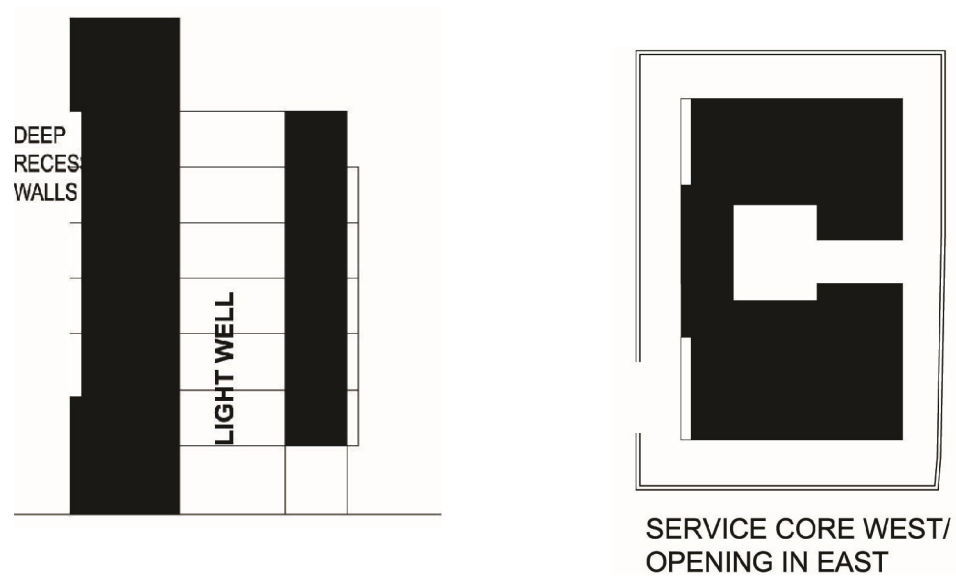

Figure 9.6- Concept 3 variation in courtyard

#### Advantages:

- The form is a rectangle with courtyard and acts as divider between two sections of apartments.
- The form managed natural lighting in all living spaces and so did the courtyard plan.
- The interplay of facade is developed through mass and void and thus, regulating sunlight.

Disadvantages:

- The form is generated with respect to site and it does pose restriction on form.
- Since the shorter side is facing south, so most of the surface area is devoid of significant solar gain.

### **9.2.3 FUNCTIONAL ORGANIZATION**

The apartments are on North and South side that is divided by service space and courtyard. The service core is on west side and courtyard is at center and along the same axis is the outdoor space for individual apartment (see figure 9.7). Thus, these space acts as a barrier between two apartments. The facilities like rainwater harvesting, greywater recycling, and green space have been incorporated at top level of the building while ground floor is used for parking of vehicles (see figure 9.8). The apartments and green/outdoor spaces start from first floor until the top floor. Basement level houses mechanical system, underground water tank and storage of recycled grey water.

The apartments are of three types - two-bedroom, three-bedroom and four-bedroom, which are intended for large family. In the lower floors -first and second floors, the combination of two- bedroom and three-bedroom apartment type bring about a five-bedroom apartment. There are only two four- bedroom apartments on third and fifth floor and those are multilevel. The three-bedroom apartments are all on the north side.

Individually, the layout of apartment is with respect to the occupant's frequent use of space. The living room is the most used space, with bedroom being second most used space, thus, these spaces have been targeted as major preference (see figure 9.7). These spaces along with service rooms as restrooms and bathrooms have access to external light and ventilation that are on outer wall as these are requirements set by the building laws.

Moreover, the fact that the region boasts ample sunlight and higher solar radiation, ensue climatic responses to these layouts.

The outdoor space is on east side and access is through Kitchen. The roof garden, water tank and communal space are at top level. The use of roof garden is for agriculture purpose so that the occupants can grow vegetables. The use of communal space is for physical fitness.

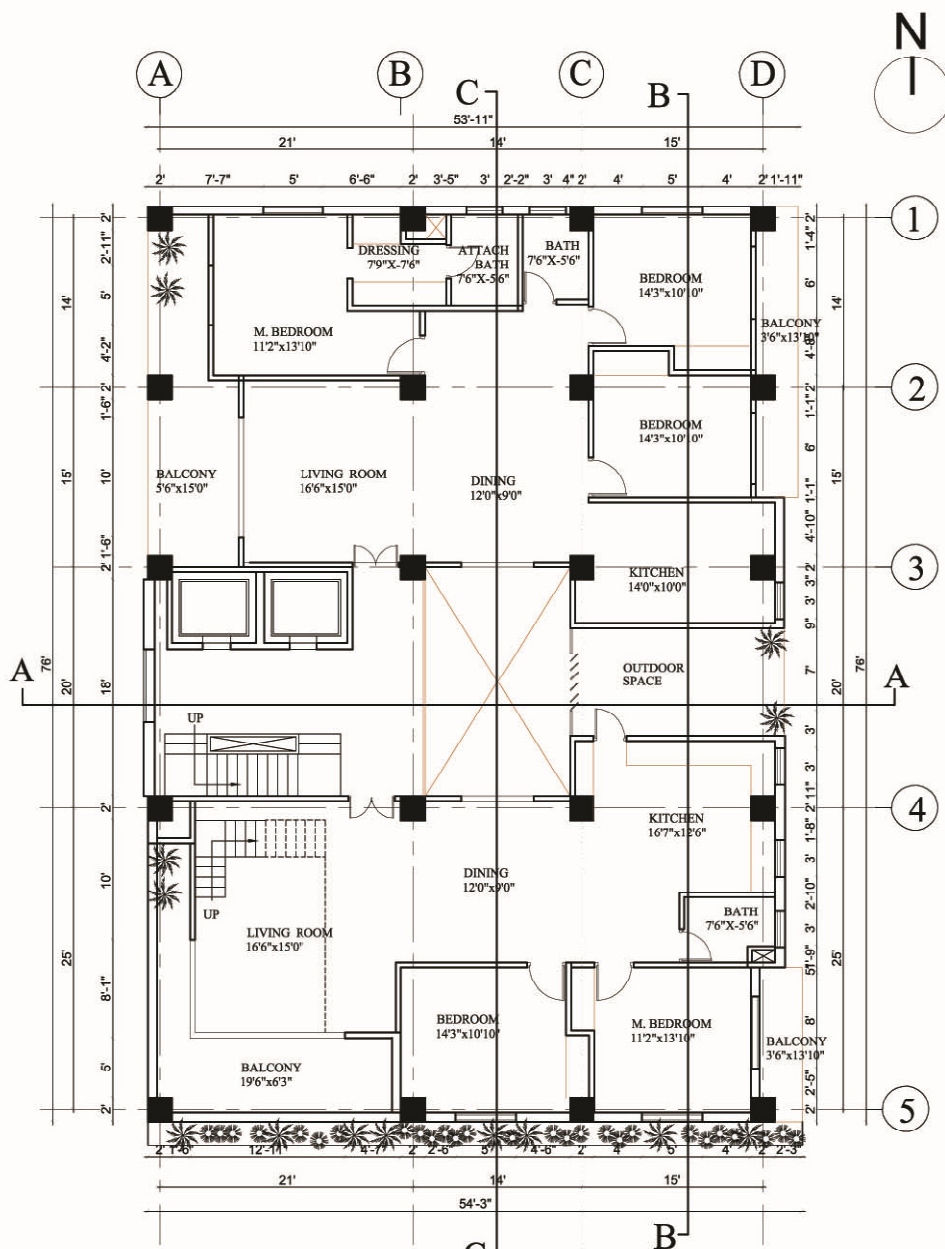

Figure 9.7- Third floor plan of proposed building (not to scale)



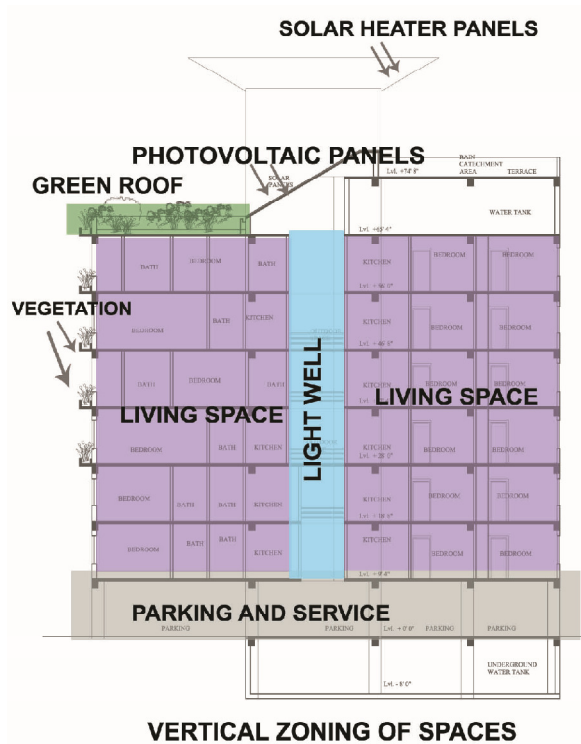

Figure 9.8- Functional zoning of spaces in the proposed building

### 9.3 DESIGN LIMITATION

The discussion on design limitations is as follows:

**Constructability** - The design dissertation considers a conventional understanding for the constructability of the building and assumes certain rules of thumb that are prevalent in Kathmandu. The general construction technology adopted is reinforced concrete column post and reinforced concrete beam structure with grid planning. These reinforced concrete frame structures are moment-resisting structures with masonry infill walls. The width of the grids ranges from 12 feet to 25 feet while the size of column is 2 feet by 2 feet. The cost of construction is opted out due to lack of insufficient and varied data on construction materials.

**Details**- The detailing of the proposed design will submit architectural details with general details of specific strategies used for greywater recycling system, rainwater

harvesting, biosand filter used in water filtration, green roofs/ vegetations.

**Demonstration** - The proposed numbers for area and sizes of apartments have been taken into consideration of ongoing trends in apartment design in Kathmandu but no full detail study and research was done. Thus, all area requirements are purely rough estimates.

## 9.4 DESIGN STRATEGIES

### 9.4.1 PASSIVE SOLAR DESIGN / CLIMATE RESPONSIVE DESIGN

The analysis of traditional Newari architecture and climate responsive design of *Bidani House* in literature review brought about two main strategies, which applies to the context of Kathmandu. The use of courtyards as 'heat-sink' in regulating air temperature and incorporating passive design techniques for heating and cooling in the building.

The central courtyard acts as a light well and in regulating heating and cooling system and ventilation. Since the ground floor is devoid of enclosed space, the air from west side mainly drifts upwards through the courtyard and control of opening is by lattice system. The transfer of air to inner living spaces is mainly in dining areas of the apartment and hot air flows out of the building through the opening at top floor during summer (see figure 9.12). During winter, the lattice system closes the opening at first floor level and the opening at top floor level is closed, thus, the air inside the light well gets heated up due to solar gain (see figure 9.13). This in-turn will heat the adjacent spaces.

The passive strategies incorporated are in planning of living spaces. The living rooms and Master bedroom on south side benefit from solar gain (figure 9.11). The deep recessed spaces created in west side to protect from excessive heat gains and overheating conditions during summer. In winter, these spaces act as sunspace and bring light into the living spaces due to lower solar angles. The southern side has a band of vegetation running

around that cut off sunlight during summer conditions and provides cooler space around the window area due to vegetation (figure 9.12). Moreover, they act as overhung and cut off rain splashing on the walls and windows. Similarly, the winter sun in living spaces benefit from solar gain (figure 9.13). The design of eastern walls of bedroom is recessed walls and balcony act as sunspace during winter and in cutting off rain splashing the walls. The four-bedroom apartment has a double height living room at entry (see figure 9.9 and figure 9.10). The glazed south and west walls and deep recessed walls help cut off summer sun and with double interior space makes it comfortable indoors. In winter, the sun can penetrate and with convective process, the indoor living room gets heated.

Volume of double height -  $W$  where  $W$  - longest side of the living room

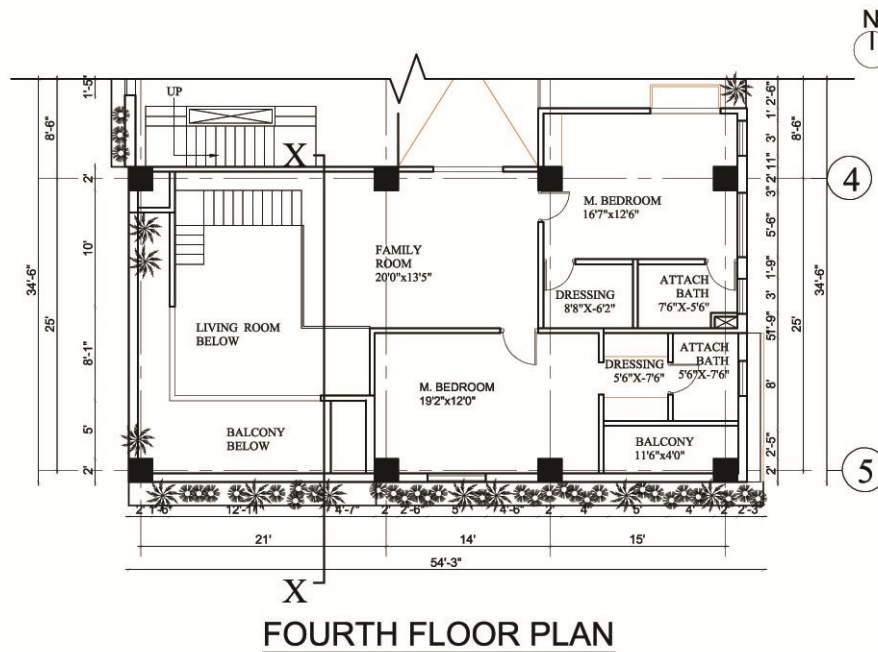

Figure 9.9- Plan of double height living room of 4-bedroom apartment

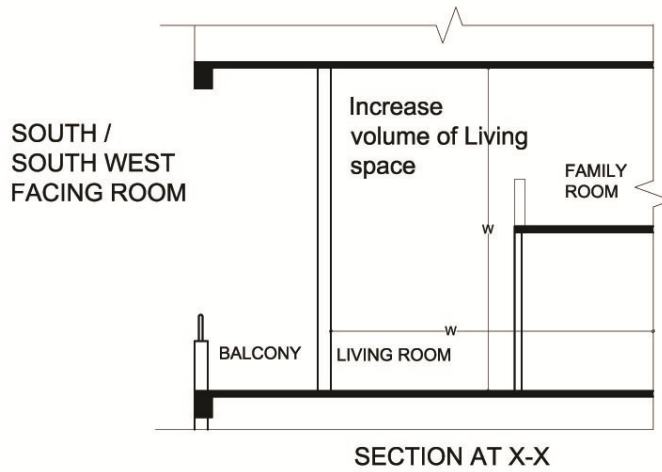

Figure 9.10- Double height of living space of 4-bedroom apartment

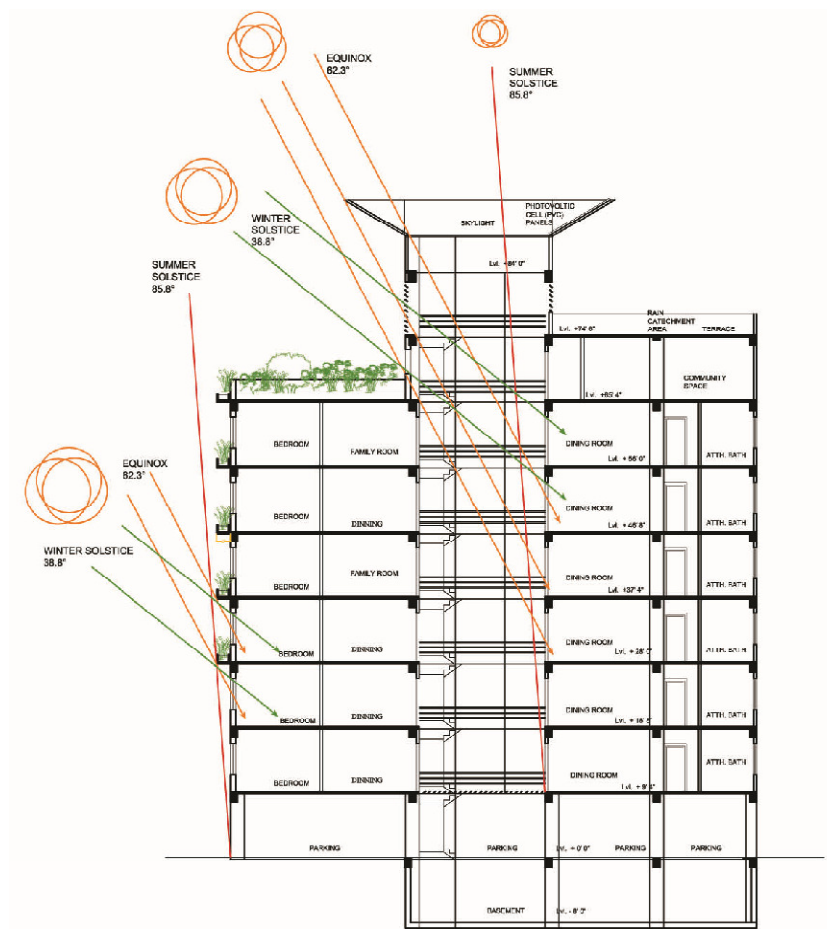

Figure 9.11 - Solar access in various living spaces during varied seasons  
Source: By Author

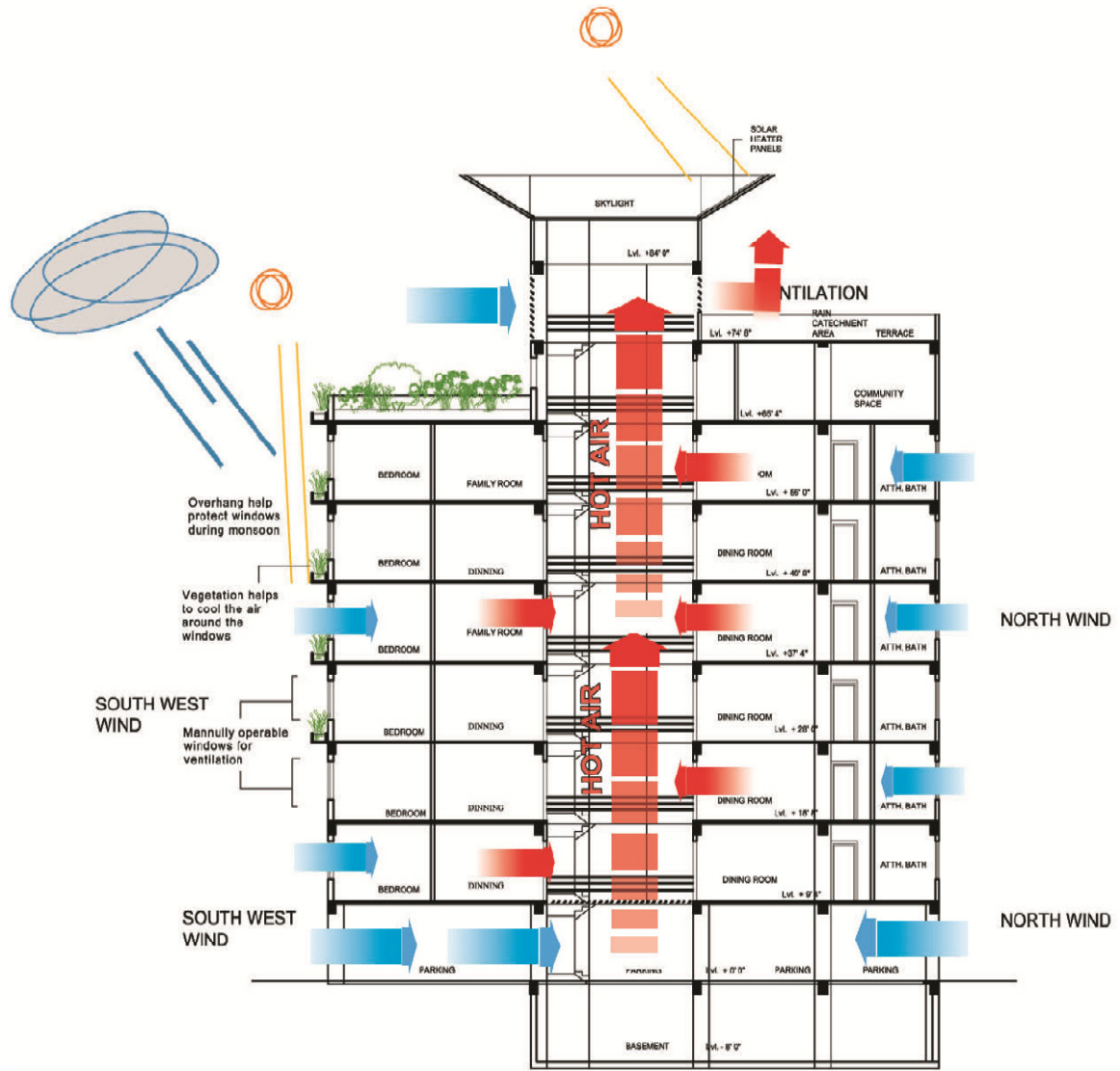

Figure 9.12- Climatic control through ventilation during summer in proposed residential building  
Source: by author

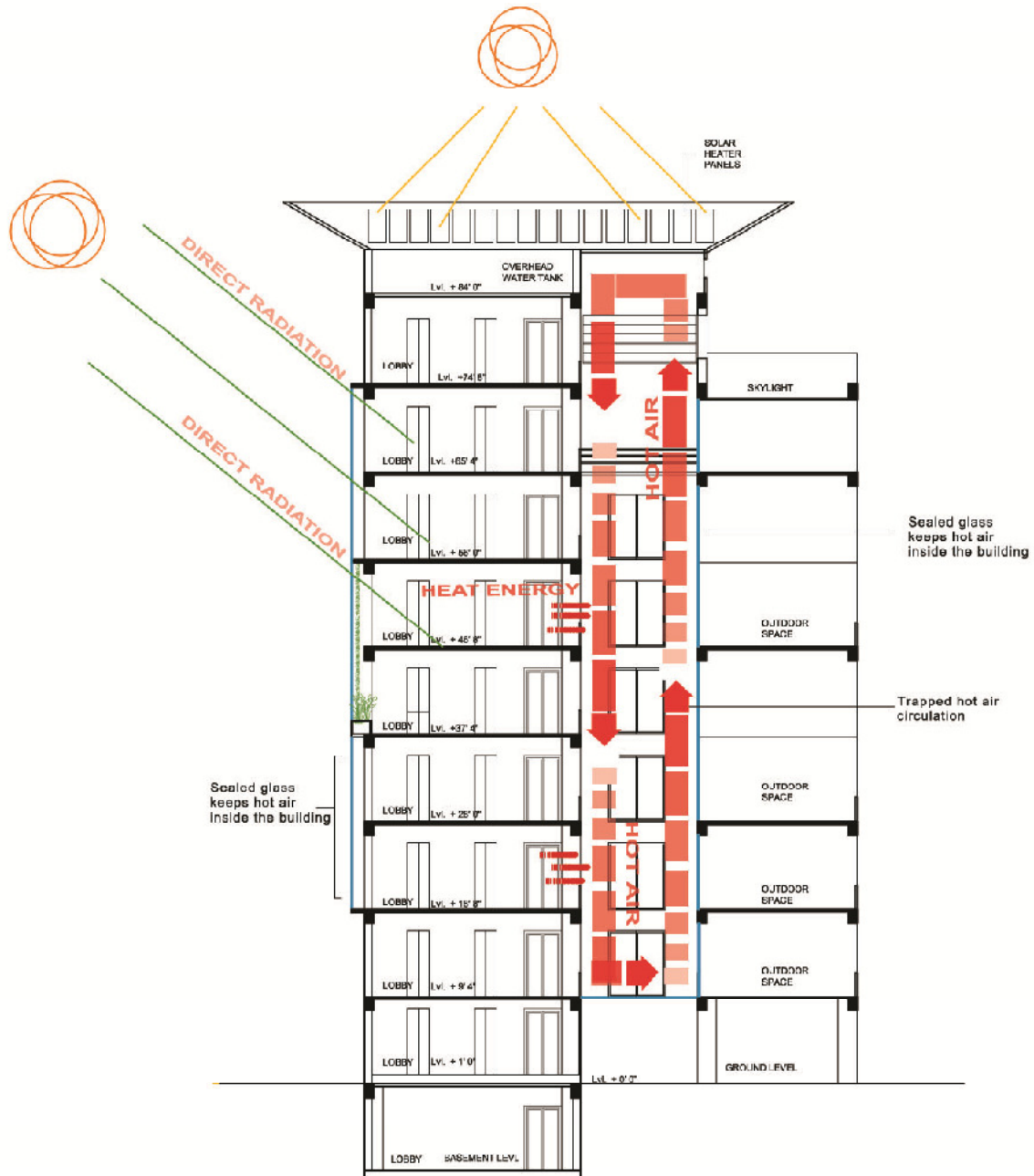

Figure 9.13- Climatic control during winter season in proposed building  
 Source: by author

## 9.4.2 SUSTAINABLE DESIGN FEATURES

The traditional architecture proved apt to the climate of Kathmandu and research showed planning was according to the climate, culture and social norms in the Malla era.

However, today the climate of Kathmandu has changed drastically with increase in temperature, environmental problems such as land, air and water pollution. Thus, venturing into the concept of sustainable design, this project incorporates three broad aspects of it- energy, water and waste management.

#### **9.4.2.1 ENERGY**

The key focus in this section has been to keep balanced temperature inside the living spaces in the building. Drawing similar concepts from passive design and climate responsive design, the overall balance of energy has been maintained with respect to heating and cooling techniques and explained in the previous heading under passive solar design /Climate responsive design (see chapter 4, 4.2). Furthermore, provision of photovoltaic (PV) panels located at rooftop help in future exploration into energy needs to run the building. The PV panels of 65 watt each and a size of 4 feet x 8 feet has been proposed. This module is currently available in market for commercial purposes. Each panel generates 0.27 Kilowatt hour per day, thus total number of PV panel is estimated at 30 units for the purposed building. Although provision of these technology is quite gaining popular but it is expensive in the context of Kathmandu. Nevertheless, this option seems the only choice we have at present besides any other alternative for current hydro- electric energy.

#### **9.4.2.2 WATER**

The calculation of volume of water need per capita per day was based on study of water requirements with case study of *Eco-home* in Kathmandu and a survey carried out in 2003 titled "Household water use survey and research in urban Kathmandu valley" done by Center for Integrated Urban Development (Joshi 2003). The survey highlighted domestic water requirement according to economic class, with Class I needing 149 liters per capita

per day (lpcd). The average of Class I's domestic water consumption and water consumption from Eco-home was taken into account for the calculation of water need for per person per day. The water consumption from Eco-home totaled 55 lpcd while economic class I totaled 149 lpcd. Thus, 102 lpcd was used as forecasted daily water consumption needed by an individual of this apartment. This was further broken down into water needed for various purposes, which are as follows:

Table 9.1- Distribution of water requirements for a household in Kathmandu

<b>Purpose</b>	<b>Amount required (lpcd)</b>
Drinking	5
Cooking	7
Dishwashing	5
Bathing	25
Showering	10
Laundry	10
<b>Total</b>	<b>62</b>

The above water requirement 62 lpcd is fulfilled by rainwater harvesting while the rest of water requirement 40 lpcd was separated for car washing, gardening and flushing purposes and the requirement was fulfilled by greywater recycling method. The water systems have been devoid of Municipal water system and the building is entirely based on rainwater harvesting system. The total maximum capacity of the occupants in the apartments is 60 and water requirements have been calculated for maximum occupancy.

Rainwater is collected in a main gutter situated at rooftop and run down to the top level in the North side. The water collected is sent down the pipe to the water tank situated at seventh floor where some amount of the first water collected is flushed out as a norm for



rainwater harvesting process (figure 9.14). The rainwater is sent to the filtration tank where biosand filter process has been setup for purification of rainwater and collected at water tank with a capacity of 68,415 liters. The strategic placement of water tank at top is to conserve energy by utilizing gravity flow of water rather than using mechanical water pump. The overflow water is collected at basement where the underground water tank has a capacity of 108,000 liters. The underground water is pumped to the overhead tank for distribution to apartment from rooftop.

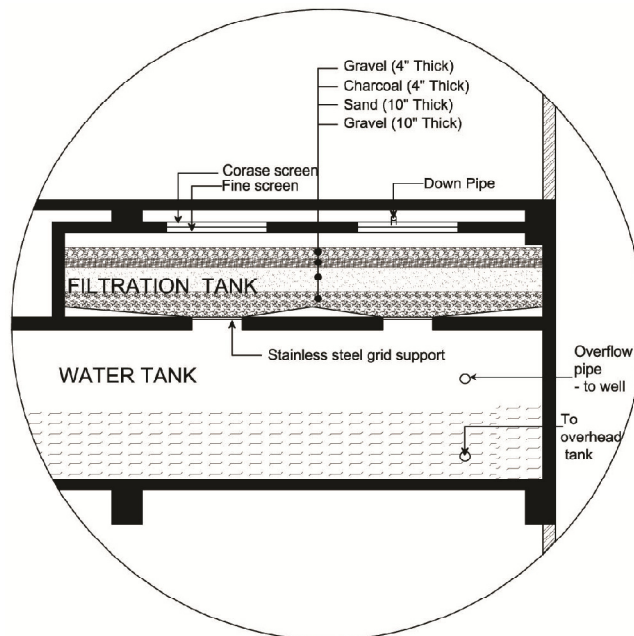

Figure 9.14- Section of rainwater tank on ninth floor (scale - 1:30)

Calculation of Rainwater harvesting potential:

Primary Catchment Area: terrace area

Annual Rainfall: 1.60 m (1600mm)

Catchment Area: 1421 sq. ft. = 335.02 m<sup>2</sup>

Run off Coefficient: 0.8

Annual Harvesting Potential:  $335.02 \times 1.60 \times 0.8 = 428.8256 \text{ m}^3 = 428,825.6 \text{ liters}$

Size of Tank: 16' 3" x 28' 3" x 5' 10"

Size of Underground Water tank (at basement for dry season and year round) = 16' 3" x 28' 3" x 8' 10"



Figure 9.15 - Solar water heating system

The solar water heaters installed at rooftop provide the hot water to the apartments (figure 9.15). These have been popular and been very successful keeping in view of energy demand that needs to heat the water using electric power. Mostly, these are used during

winter season that lasts for four months and less often during other season. The solar radiation is high and this is apposite to practice sustainable design feature. The construction of roof structure with extension at angle is for collection of rainwater and placing solar heaters.

### **9.4.2.3 WASTE MANAGEMENT**

The waste here is made up of solid waste such as organic waste from kitchen and liquid waste such as greywater generated from showers, wash basin and kitchen sink. The handling of organic waste from kitchen is by the vermicomposting method. The collected organic waste is in a container with perforated holes and disintegration of waste takes place inside these boxes and later used as compost in vegetation as manure.

The greywater is collected from waste generated from kitchen sink, wash basin, shower and collected at ground floor in sedimentation tank. As the waste settles in, the greywater is sent to feeding tank from where, the greywater is transported to the Vertical Flow Reed Bed System comprising of gravels, sand and reed to filter the toxic waste and settlement of other waste products (see figure 9.16). The filtered water is then stored in greywater storage tank located at basement where biosand filters further purifies the water. The recycled greywater is used for flushing, car washing and for irrigation purposes. A different set of plumbing system is used for this system. The greywater is fed into the reed bed system slowly and the reed system is designed along the west side of the site. The system of reed bed system is shown in figure 9.17.

#### **Calculations of Tank Capacity for Grey Water recycling system**

Total number of occupants: 60

Water per person: 40 liters / capita/ day (lpcd)

Size of Sedimentation Tank:  $60 \times 40 (V1) = 2400$  liters

Size of Feeding Tank:  $\frac{2}{3}$  of V1 (V2) = 1600 liters

Size of Vertical Flow reed bed Area =  $2 \text{ m}^2$  per  $1 \text{ m}^3$  of Sedimentation  
 =  $4.8 \text{ m}^2 = 51.02 \text{ sq.ft.}$

Size of Storage Tank:  $\frac{2}{3}$  of V1 (V3) = 1600 liters

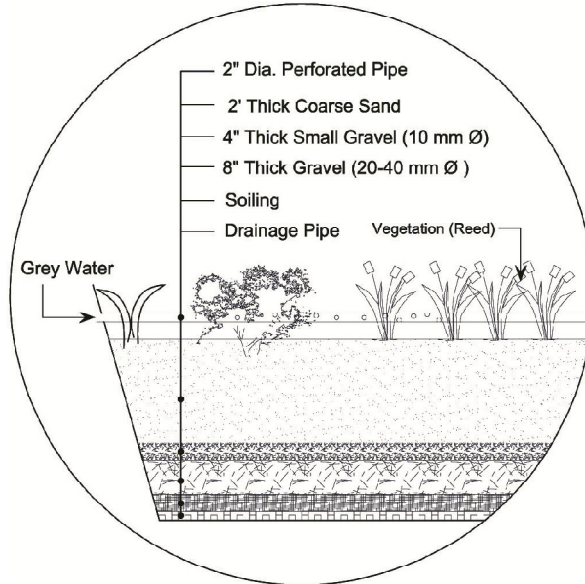

Figure 9.16- Section of Vertical Flow Reed Bed System incorporated in proposed building (scale - 1:20)

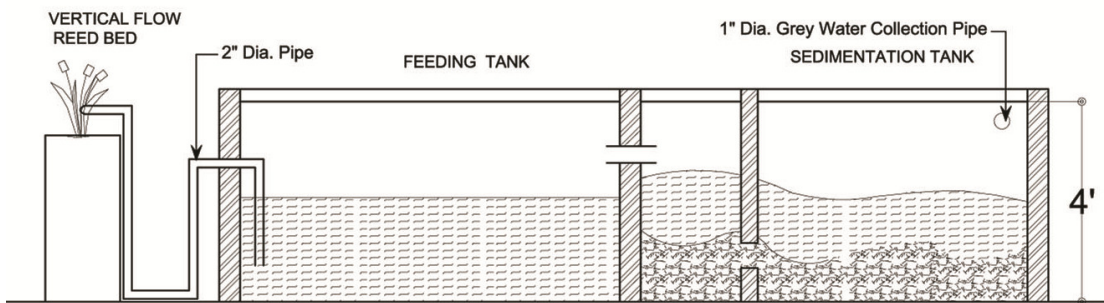

Figure 9.17- Cross section of grey water recycling system at ground floor (scale - 1:30)

The grey water recycling system is a sustainable approach and hence proved beneficial (see chapter 6). The system uses water conservation technique, which is depicted in figure 9.18.

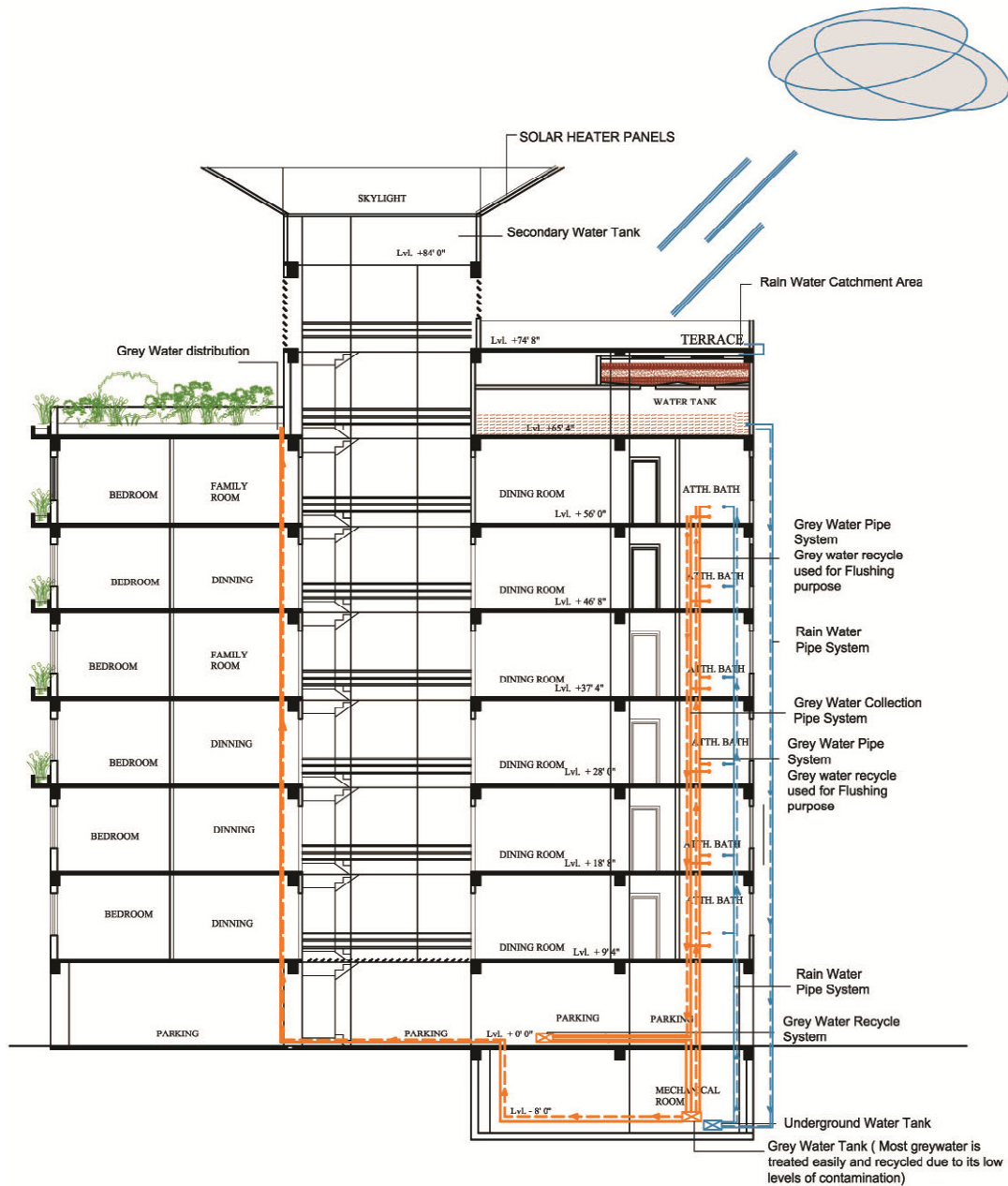

Figure 9.18- Water conservation and reuse system

#### 9.4.2.4 GREEN ROOF / VERTICAL FARMING

The green roof is located at rooftop and using it as farming for growing various foods. The Kathmandu valley predominantly is best suited for agriculture occupation that has been

marred by growing urban population and development. In Nepal, most of the people are engaged in agriculture occupation. The rural and village area is predominantly agriculture driven occupation while urban cities are secondary and tertiary consumers where urban population need to buy food. Thus, such integration into building shall provide a social and communal activities and interaction. Recycled greywater is used to irrigate for vegetation. The cross section is shown in figure 9.19.

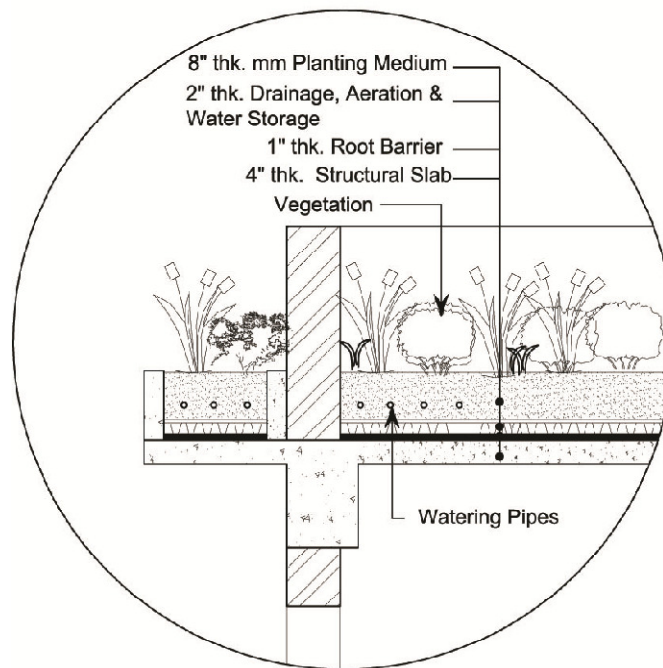

Figure 9.19- Section of green roof (16" thick) proposed for residential building (scale- 1:20)

The design proposes passive solar design taking into account of climate and incorporating sustainable design features - rainwater harvesting, greywater recycling system, green roof, and solar heating and energy conscious design. The water autonomous residential building has been able to demonstrate that problems owing to Kathmandu can be curbed at source and have fewer loads over water and waste management system.

## 9.5 ECOTECT RESULTS

Autodesk Ecotect is a software program that helps in comprehensive building design and environmental analysis tool that does more than just energy analysis. It assists in design process early on for making sustainable design decisions through weather data input and getting vital information upon analysis. The program performs full range of simulation and analyzes functions that allow to fully understanding how a building design will operate and perform in different setting and situations. Engineers, local authorities, environmental consultants, building designers, owner-builders and environmental enthusiasts use it for analysis and studies of building modeling.

The Ecotect model was created to check the results from thermal analysis and see how the building responded to the application and recommendations from climatic analysis. The selection of this program was for the interior conditions analysis for the individual spaces. Ecotect allows the user to load the weather data for the selected site and conducts the analysis based on the local conditions. This provides an excellent alternative for on-site measurements under the time constraints of the research. The assumptions made for thermal analysis was as realistic as possible.

Since the building was considered to be in naturally ventilated condition, the analysis calculated the discomfort degree hours. The following parameters were considered and subsequent number was chosen for comfort (see table 9.2)

Comfort temperature band - 18 °C - 24 °C

Internal design condition

Lighting level - 400 lux for living and bedroom

200 lux for Dining / kitchen

150 lux for Bathroom / Dressing

Occupancy - 5 - living room

3 - Bedroom / Dining / Kitchen

1 - Bathroom

The Ecotect's study for optimum building orientation showed that building need to be tilted 5° East from South for better solar gain (figure 9.20). The calculation for monthly space discomfort was performed for whole building including lobby and balcony spaces that resulted in months from May to September with higher heat gain thus needing cooling requirements and remaining November to February with less heat gain thus needing heating requirements.

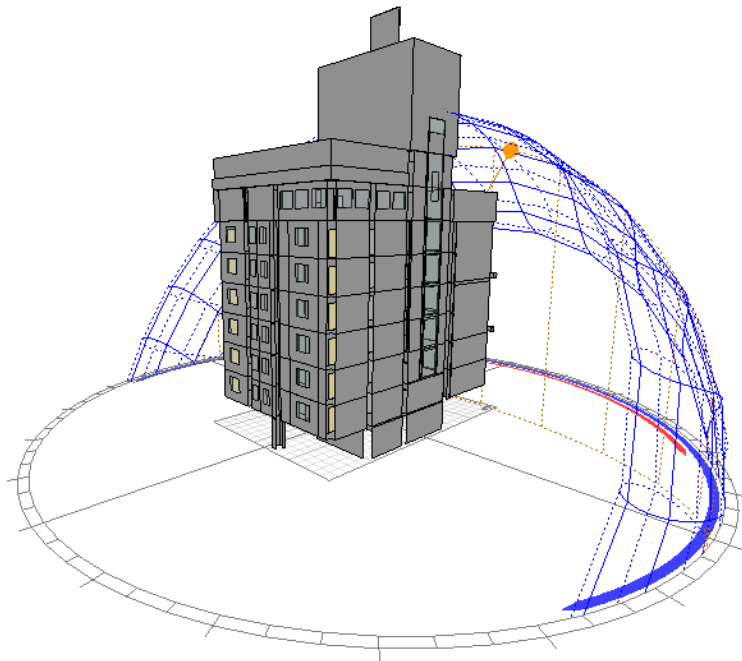

Figure 9.20- Solar path study



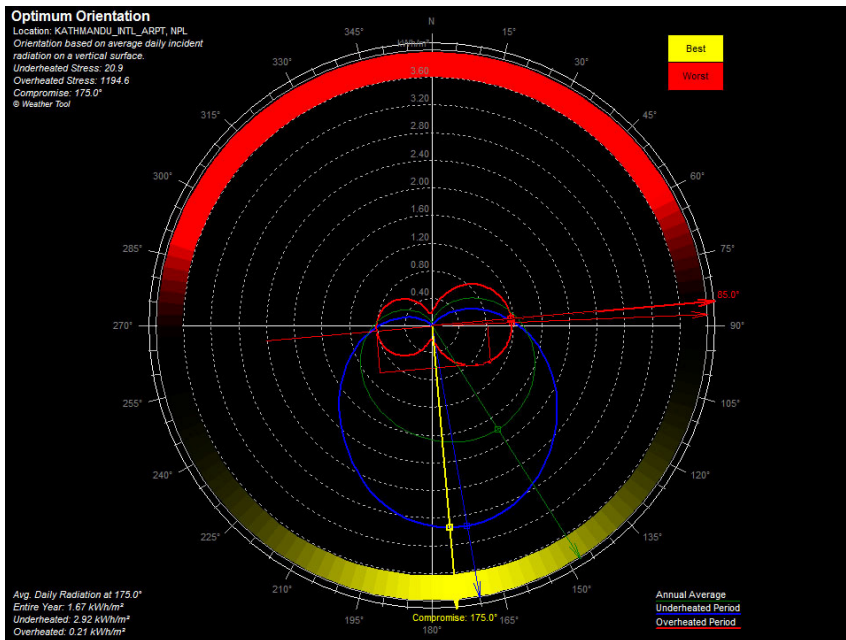

Figure 9.21- Optimum building orientation

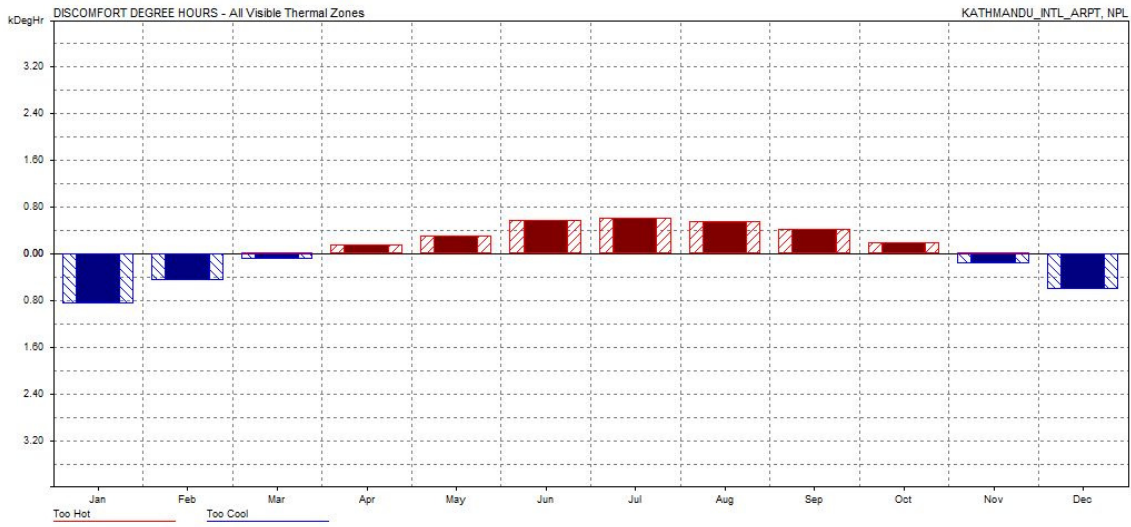

Figure 9.22- Discomfort degree hours

Table 9.1- Discomfort Degree Hours (see 9.5 Ecotect)

<b>DISCOMFORT DEGREE HOURS</b>			
All Visible Thermal Zones			
Comfort: Zonal Bands			
	<b>TOO HOT</b>	<b>TOO COOL</b>	<b>TOTAL</b>
<b>MONTH</b>	<b>(DegHrs)</b>	<b>(DegHrs)</b>	<b>(DegHrs)</b>
Jan	0	863	863
Feb	1	452	453
Mar	17	101	118
Apr	149	5	155
May	300	2	301
Jun	578	0	578
Jul	617	0	617
Aug	562	0	562
Sep	416	0	416
Oct	185	5	191
Nov	10	179	189
Dec	0	617	617
<b>TOTAL</b>	<b>2835.4</b>	<b>2224.5</b>	<b>5059.8</b>

## 9.6 CONSTRUCTION COST

A cost estimate was developed for the whole building with sustainable features. The cost provides a simple comparison between the traditional high-rise residential building and a building with incorporated sustainable design features.

The construction cost estimation determines the approximate costs of the structure itself including material and labor. The construction of the structure is according to the norm of the prevailing construction techniques, mostly reinforced concrete framed structure and infill brick walls in exterior and interiors. The rough estimate of this type of construction is used here to develop a basic understanding of the construction cost in order to evaluate the economic impact of sustainable design features. The major interior finish on floors will be

marble tiles, parquet and plain cement concrete.

The total estimated cost of construction for a fully finished high-rise residential building ranges from US \$ 55.55 - US \$ 111.11 (NRs.4000 - 8000) per square feet in Nepal. (Sunuwar, 2010) The total cost of the construction i.e. civil works is the base cost. The total floor area of the apartment is 13,516 sq. ft. For the cost of construction per sq. feet, the rate has been computed by taking the average of the aforementioned range. The base cost of the whole building is estimated at US\$ 1,126,333.50 (NRs.81, 096,000). Thus from this base cost other works such as sanitary, electrical, landscape works is computed. The estimated cost for sanitary, electrical, landscape is at 5% of base cost of the construction. The total estimated cost for sanitary, electrical and landscape work is US\$ 56316.6 (NRs. 4,054,800) for each one of the works.

The estimated overall cost of construction of the traditional whole building is at US \$ 1,295,283 (see Table 9.2).

A similar approach was used to determine the construction cost estimate for the sustainable high-rise residential building. The cost of sustainable features in the building is a rough estimate as data is very primitive.

The cost analysis for rainwater harvesting and greywater recycling system is based on the 3% of the base cost of the construction. Since the costing of these systems is new to the construction industry, the costing of the technologies is in primitive stage. The projected cost of these technologies is at US \$ 33,790 (NRs. 2,432,880). Based on the data collected regarding the civil construction work rate related to building construction (Department of Urban Development and Building Construction under Ministry of Physical Planning and Works, 2010), a rough estimate was calculated for the aforementioned works for rainwater and greywater recycling system.

The cost analysis for installing solar panels is based on the data from Gham Power

(one of the dealers who sell photovoltaic panels in Kathmandu). (Gham Power, 2011) The currently available model of solar panel is SP series Solar Module Model SP 185. This model of panel has capacity to produce 1.6-kilowatt hour/day of energy with maximum capacity of 500 watt power. Thus, using this solar panel model for the whole building, 30 solar panels have been calculated as necessary units. Since the apartment has three different sizes of individual units, the need for the power differs and thus number of panels. Accordingly, the number of solar panel for each type of apartment has been computed. The 2-bedroom unit has been provided with 2 solar panels while 3-bedroom units has been provided with 3 solar panels and 4-bedroom unit has been provided with 4 solar panels. The cost of the solar panels per unit is US\$ 1530 (NRs. 110,000) on average. (Gham Power, 2011) The total cost for solar panels is US\$ 45,833.33 (NRs. 3,300,000).

The cost of solar water heater prevailing in Kathmandu for a volume of 200 liters with two panel of solar water heater is US \$ 1370 (NRs. 100,000) (Rai, 2001). The estimated total solar water heater panels are 30 units with 3000 liters capacity and the estimated cost amounts to US\$ 20,550. Hence, the total estimated cost of the whole building to build is US \$1,429,530 (see Table 9.3).

The cost comparison indicates that the sustainable construction costs would sum up to approximately US \$134,247 more than traditional construction cost, which would be about 11% more than traditional construction cost. Although, here the costs of water and electricity is not presented due to lack of rough data, but discussion of perceived benefits is noteworthy. In traditional construction, buying water from water agency and problems of intermittent water supply make both economic and mental pressure. The cost of buying water from private water vendor is saved and is far better in building with sustainable design feature like greywater recycling and rainwater harvesting system. The benefit of using solar panels in Kathmandu is profound as the city is facing electricity blackouts for number of

hours. The benefit of storing the solar energy into electric energy for future purpose is a huge advantage as they can be used as a backup energy to run the building. All the calculations are rough estimate of present construction cost. A detail estimate for accurate cost of construction and finding differences is necessary. These entire factors make a building with sustainable design features worth developing and have a better environment.

Table 9.2 - Traditional Construction Estimate

<b>Traditional Construction Cost Estimate</b>					Estimated Cost
<b>Base Cost</b>					Nepalese Rs (NRs.)
	For 13516sq. ft.			6000 per sq. ft.	81,096,000
<b>Additional Costs</b>		Quantity	Calculations		
	Electrical Works		5% of Base Cost		4,054,800
	Landscaping Works		5% of Base Cost		4,054,800
	Sanitary Works		5% of Base Cost		4,054,800
<b>Total Cost</b>					NRs. <b>93,260,400</b> US \$ <b>1,295,283</b>

Table 9.3 - Green Construction Estimate

<b>Green Construction Cost Estimate</b>					Estimated Cost
<b>Base Cost</b>					Nepalese Rs (NRs.)
	Total Floor Area	13516 sq. ft.		6000 per sq. ft.	81,096,000
<b>Additional Costs</b>		Quantity	Calculations		
	Rain water harvesting		3% of Base Cost		2,432,880
	Waste Water management		3% of Base Cost		2,432,880
	Electrical Works		5% of Base Cost		4,054,800
	Landscaping Works		5% of Base Cost		4,054,800
	Solar Panel	30 units		110,000	3,300,000
	Solar Water Heating	30 units	30 *100000/ 2	100,000	1,500,000
	Sanitary Works		5% of Base Cost		4,054,800
<b>Total Cost</b>					NRs. <b>102,926,160</b> US \$ <b>1,429,530</b>

## CHAPTER 10: CONCLUSION

### 10.1 CONCLUSION

The residential buildings in Kathmandu shows that current modern residential buildings lack water demand, waste management problems and climate responsive design according to the various literature study and reviews. From the study of climate, the buildings in the city require a climate responsive design and sustainable approach to meet the comfort and household needs respectively. In spite of cooling need, the energy consumption for electricity is higher during winter and the energy supply system of the city is critical at that season. This is what currently people are facing with daily 14hours of power outage and me having experienced it.

Therefore, to mitigate the problem, the concepts of passive designs are used for heating, cooling, ventilating and daylighting based on the comfort limit of the occupants in the city. Moreover, the analysis from Mahoney Table, Bioclimatic chart and Psychrometric chart provide useful design techniques such as building orientation, wall materials with low thermal properties, protection to walls and windows during rainy period, ventilation requirement during summer, radiation needs during winter period to be applied. The infrastructure problems chiefly water supply, waste management and solid waste management needed to be resolved at source. Thus, a design model was proposed incorporating sustainable design features applicable to a multilevel residential building.

As a result, the design guidelines are recommended for the sustainable residential buildings in Kathmandu with focus in climate responsive design, rainwater harvesting system, greywater recycling system, green roof, organic decomposition of kitchen waste and solar water heater system. The guidelines thus developed initiate the process of dealing with sustainability issues at micro level and be localized rather than generic. The guidelines

should therefore be location and climate specific that responds to bring about change in building design and lifestyle largely.

## BIBLIOGRAPHY

- Adams, W. M. (2006). *The Future of Sustainability : Rethinking Environment and Development in the Twenty-first Century*. Report of the IUCN Renowed Thinkers Meeting IUCN The World Conservation Union
- ADB (Asian Development Bank) (2006) *Nepal: Preparing the Kathmandu Valley Water Distribution, Sewerage, and Urban Development Project*. Technical Assistance Report, Project no: 34304 in Thapa, R. B., Y. Murayama, et al. (2008). "Kathmandu." Cities 25(1): 45-57.
- Adhikari, A. P. (2008). *Towards Developing Indicators of Environmental Sustainability for Kathmandu, Nepal*.
- Amatya, P. (2009). *Rainwater Harvesting*. MYREPUBLICA, Nepal Republic Meida Pvt. Ltd
- Bay, J.-H. O., Boon Lay (2006). Tropical Sustainable Architecture - soical and environmental dimensions Elsevier Ltd.
- Buchanan, P. (2005). Ten Shades of Green: Architecture and the Natural World. New York, The Architectural League of New York.
- Building Research Establishment Ltd. (BREEAM). (2002). Document Refernce General Overview DJB, Garston, U.K. in Kimberly, R. B., P. H. Gregor, et al. (2006). "Survey of Sustainable Building Design Practices in North America, Europe, and Asia." Journal of Architectural Engineering 12(1): 33-62.
- Building Research Establishment Ltd. (BREEAM). (2003). Document Refernce General Overview DJB, Garston, U.K. in Kimberly, R. B., P. H. Gregor, et al. (2006). "Survey of Sustainable Building Design Practices in North America, Europe, and Asia." Journal of Architectural Engineering 12(1): 33-62.
- CGIAR, C. G. o. I. A. R. (2006). *A Third of the World Population Faces Water Scarcity Today*. Stockholm, Consultative Group on International Agricultural Research.
- Daniels, K. (1997). The technology of ecological building : basic principles and measures, examples and ideas. Basel; Boston, Birkhäuser Verlag.



Department of Urban Development and Building Construction under Ministry of Physical Planning and Works (2010). "Civil Rate Analysis 2067-68." Babarmahal, Kathmandu, Nepal.

Devkota, D. C. and K. Watanabe (2006). "Need Of Community Based Sustainable Approach For Solid Waste Management In Kathmandu." Doboku Gakkai Ronbunshuu D 62(4): 519-525.

Dhakal, S (2006) Urban Transportation and the Environment in Kathmandu Valley, Nepal. Institute for Global Environmental Strategies, Japan

Dixit, K. M. (2009). Rainwater Harvesting in Kathmandu Valley. Kathmandu, Nepal WaterConservation Foundation.

Eicker, U. (2009). Low energy cooling for sustainable buildings. Chichester, West Sussex, U.K., Wiley.

F. Sabina. (2008) Design Strategies for Environmentally Sustainable Residential Skyscrapers. CTBUH 8<sup>th</sup> World Congress.

FBR (2010). Greywater Recycling and Reuse, Association for rainwater Harvesting and Water Utilization 12.

Ghimire , H. (2008). An Assessment of the Environmental Problems in the Kathmandu Valley of Nepal Institute of Environmental Sciences Oxford, Ohio, Miami University. Master in Environmental Sciences.

Gham Power. (2011). Retrieved 02-25-2011, from <http://www.ghampower.com>

Goulding, J. R., Lewis, J. O. and Steemers, T. C., 1996. *Energiebewusstes Entwerfen: Ein Leitfadens für Architekten in Europa*. Luxemburg: Kommission der Europäischen Gemeinschaften, Wissenschaftlichen- und technische Kommunikationseinheit in Shritu Shrestha (2009). An Approach to Energy Efficient Residential Buildings in the Kathmandu Valley, Nepal. Institute for Technology and Resource Management in the Tropics and Subtropics. Klon, Germany, Cologne University of Applied Sciences Master in Technology and Resource Management in the Tropics and Subtropics.

GRIHA. (2010). Retrieved 04-09-2010, from <http://www.grihaindia.org/>.

Gyawali, D. (2001). Water in Nepal. Kathmandu Himal Books and Panos South Asia with Nepal Water Conservation Foundation

ICIMOD, I. C. f. I. M. D. (2007). Kathmandu Valley Environment Outlook. Kathmandu, Nepal, International Center for Integrated Mountain Development

ICIMOD (International Center for Integrated Mountain Development), UNEP and Government of Nepal (2007), Kathmandu Environment Outlook, Hillside Press, Kathmandu, Nepal.

ICEVIOD (International Center for Integrated Mountain Development), UNEP and Government of Nepal (2007), Kathmandu Environment Outlook, Hillside Press, Kathmandu, Nepal

Joshi, P. S. S., Kabita Bade; Shrestha, Puskar Lal (2003). Household Water Use Survey and Research in Urban Kathmandu Valley - To Support SAPI II Study for Melamchi Water Supply Project. Kathmandu, Center for Integrated Urban Development.

Kim, J.-J. and B. Rigdon (1998) "Introduction to Sustainable Design." Volume, 28

KMC (Kathmandu Metropolitan City). (2010). Retrieved on 4-12-2010 , from [http://www.kathmandu.gov.np/index.php?cid=2&pr\\_id=2](http://www.kathmandu.gov.np/index.php?cid=2&pr_id=2)

Korn, W. (1998). The traditional architecture of the Kathmandu Valley. Kathmandu :, Ratna Pustak Bhandar.

Majumdar, M., Tata Energy Research Institute., et al. (2001). Energy-efficient buildings in India. New Delhi, Tata Energy Research Institute and Ministry of Non-Coventional Energy Sources.

Moench, M., Dixit, A., Janakarajan, S., Rathore, M. S. and Mudrakartha (2003). The Fluid Mosaic: Water Governance in the Context of Variability, Unvertainty and Change. Kathmandu and Boulder Nepal Water Conservation Foundation and Institute for Social and Environmental Transition-International.

Nepal Water Conservation Foundation Lohan, T. (2008). Water consciousness : how we all have to change to protect our most critical resource. San Francisco, CA Healdsburg, CA, AlterNet Books ; Watershed Media.

Oram, B. (2010). Drinking water testing, water quality and pathogenic disease laboratories. Wilkes University Center for Environmental Quality Environmental Engineering and Earth Sciences, Wilkes University Center for Environmental Quality Environmental Engineering and Earth Sciences.

(RIBA), R. I. o. B. A. (2000). RIBA Environmental Manifesto. London.

Rai, Hemlata. (2000). Hot showers. Retrieved 03-24-2011, from <http://www.nepalitimes.com/issue/2000/12/29/Nation/8045>. Nepali Times. Issue no. 23. 2000

SABD, S. A. a. B. D. (1996, 08/22/2002). "Sustainable Architecture." Retrieved 06/04/2010, 2010, from <http://www.arch.hku.hk/research/BEER/sustain.htm>.

Sassi, P. (2006). Strategies for sustainable architecture. London ; New York, Taylor & Francis.

Shrestha, R. R. (2007). Eco Home for Sustainable Water Management: A case study in Kathmandu, Nepal. International Conference on Sustainable Sanitation: "Food and Water Security for Latin America". Fortaleza, Brazil.

Shrestha, S. (2009). An Approach to Energy Efficient Residential Buildings in the Kathmandu Valley, Nepal. Institute for Technology and Resource Management in the Tropics and Subtropics. Klon, Germany, Cologne University of Applied Sciences Master in Technology and Resource Management in the Tropics and Subtropics.

Sunuwar, Krishna. (2010). "Real Estate in Nepal and NRB Cap." Retrieved 03/24/2011, from <http://www.krishnasunuwar.com.np/category/emba/page/3/>

Thapa, R. B., Y. Murayama, et al. (2008). "Kathmandu." Cities 25(1): 45-57.

Tiwari, S. R. (2001). The Ancient Settlements of the Kathmandu Valley Kathmandu Center for Nepal and Asian Studies

Upadhyay, A. K., H. Yoshida, et al. (2006). "Climate Responsive Building Design in the Kathmandu Valley." Journal of Asian Architecture and Building Engineering 5(1): 169-176.

- USGBC), U. S. G. B. C. (2009). LEED for Homes Rating System. Washignton, D.C., United States Green Building Council.
- WBCSD, W. B. C. f S. D. (2004). "Water and Sustainable Development - a Business Perspective." Retrieved 08/20/2010,2010, from [www.wbcSD.org/includes/getTarget.asp?type=d&id=MTYxOTU](http://www.wbcSD.org/includes/getTarget.asp?type=d&id=MTYxOTU).
- WHO/UNICEF. (2004). "Meeting the MDG drinking water and sanitation target: a mid-term assessment of progress." Retrieved 08-15, 2010, from [http://www.who.int/water sanitation health/monitoring/jmp04.pdf](http://www.who.int/water_sanitation_health/monitoring/jmp04.pdf).
- Wikipedia. (2010). "Water Conservation." Retrieved 08/16, 2010, from [http://en.wikipedia.org/wiki/Water\\_conservation](http://en.wikipedia.org/wiki/Water_conservation).
- Williams, S. (2005). Planning Groundwater Use for Sustainable Rural Development. Water Policy Briefing. Colombo, International Water Management Institute. 14
- Upadhyay, A. K., H. Yoshida, et al. (2006). "Climate Responsive Building Design in the Kathmandu Valley." Journal of Asian Architecture and Building Engineering 5(1): 169-176.

## APPENDIX A: CLIMATIC DATA OF KATHMANDU AIRPORT, KATHMANDU

Table 1- Average Monthly Maximum and Minimum Temperature (1997-2008) Source: Department of Hydrology and Meteorology, Kathmandu, Nepal

Monthly Maximum and Minimum Temperature (1997 - 2008)													
Location : Kathmandu Airport		Latitude : 27° 42' N											
Index No. : 1030		Longitude : 85° 22' E											
District : Kathmandu		Elevation : 1337 m.											
<u>For Average Tmax in ° C</u>													
Months/Yrs	1997	1998	1999	2000	2001	2002	2003	2004	2005	2006	2007	2008	Average
January	18.0	19.2	21.0	20.7	20.7	19.0	19.2	18.2	17.9	22.3	19.1	19.4	19.6
February	19.5	21.6	25.7	21.1	24.6	22.7	20.7	22.0	22.0	25.2	19.1	21.3	22.1
March	25.0	23.4	28.3	25.4	26.7	25.2	24.5	27.3	25.8	26.3	24.7	26.0	25.7
April	24.6	27.0	32.0	29.0	29.6	27.1	28.6	27.7	28.6	27.8	29.1	29.3	28.4
May	28.5	28.6	29.3	28.7	28.2	27.3	29.7	28.6	29.4	28.4	29.8	29.0	28.8
June	29.4	30.2	28.9	29.0	28.6	29.3	28.8	28.8	30.5	29.5	29.6	29.3	29.3
July	28.6	27.8	28.0	29.0	28.9	28.5	28.7	27.7	29.1	29.5	28.4	29.3	28.6
August	28.6	28.3	27.8	29.1	29.0	29.0	29.1	29.1	29.0	29.6	29.2	29.5	28.9
Sept.	28.0	29.2	28.6	28.1	28.5	28.1	28.5	28.1	29.5	28.3	28.1	29.4	28.5
October	25.2	29.0	26.5	27.9	27.7	26.7	27.6	26.0	26.4	27.2	28.0	28.4	27.2
November	22.9	25.4	24.0	24.5	25.2	23.8	23.6	22.7	23.3	23.8	24.7	25.3	24.1
December	18.5	22.2	21.4	21.1	20.6	19.8	19.6	20.6	21.0	20.2	20.9	22.2	20.7
<u>For Average Tmin in ° C</u>													
Months/Yrs	1997	1998	1999	2000	2001	2002	2003	2004	2005	2006	2007	2008	Average
January	1.7	1.6	1.3	2.4	2.1	2.7	2.0	3.1	4.3	2.0	2.9	3.0	2.4
February	3.0	4.5	6.0	3.0	4.8	5.4	5.4	5.2	5.9	9.1	6.5	3.3	5.2
March	7.6	7.4	7.5	6.8	7.4	9.3	9.0	10.7	10.1	8.6	9.3	9.5	8.6
April	10.6	11.4	13.9	12.1	11.2	12.8	13.3	13.2	11.6	12.4	13.8	12.5	12.4
May	13.8	17.0	17.1	17.2	16.4	16.7	14.5	16.5	14.9	17.3	16.8	15.4	16.1
June	18.0	20.0	18.8	19.8	19.2	19.6	19.1	19.1	19.2	19.4	19.5	19.6	19.3
July	20.2	20.2	20.0	20.1	20.1	20.2	20.3	20.2	20.6	20.9	20.6	20.3	20.3
August	19.9	20.2	19.8	20.0	19.9	19.8	20.5	20.6	20.6	20.3	20.5	20.1	20.2
Sept.	18.2	18.8	19.0	18.1	18.5	18.2	19.4	19.3	19.5	18.9	19.2	18.7	18.8
October	10.6	15.3	14.5	13.5	14.3	13.5	14.8	13.1	14.0	13.7	15.3	13.5	13.8
November	7.1	9.2	8.5	9.4	8.5	8.4	9.3	7.5	8.4	9.2	8.9	8.7	8.6
December	3.8	3.3	5.3	3.4	3.7	4.0	4.4	4.5	3.5	5.1	3.8	6.0	4.2

Table 2- Average Relative Humidity (RH) for Kathmandu Airport (1997-2008) Source: Department of Hydrology and Meteorology, Kathmandu Airport, Nepal

<b><u>FOR RH (%) at 8:45</u></b>													
Months/Yr:	1997	1998	1999	2000	2001	2002	2003	2004	2005	2006	2007	2008	Average
January	96.7	96.0	97.6	95.9	99.2	99.7	98.0	96.5	94.9	91.7	98.4	95.2	96.65
February	93.8	92.5	94.2	92.5	96.5	96.7	95.6	92.7	91.2	92.1	94.2	90.3	93.5
March	77.9	80.7	74.3	79.3	85.8	91.9	86.5	82.5	83.8	76.1	86.2	82.7	82.3
April	76.5	73.1	65.5	72.8	76.9	84.7	78.7	79.3	71.7	75.0	74.5	69.8	74.9
May	71.7	79.4	79.5	80.5	83.1	83.9	74.2	78.8	74.0	79.6	73.5	73.0	77.6
June	76.3	76.5	81.0	84.3	84.5	86.2	84.2	86.9	76.7	79.1	79.7	80.9	81.4
July	83.3	88.4	88.3	86.6	89.2	91.2	86.7	91.2	84.7	82.6	84.2	83.2	86.6
August	88.6	89.9	89.4	88.7	90.9	90.7	86.8	85.9	87.3	84.0	86.1	84.0	87.7
Sept.	85.7	86.0	85.6	88.5	91.3	91.7	89.0	88.6	86.0	87.7	88.5	85.4	87.8
October	91.4	88.2	91.8	93.9	92.5	90.6	91.1	89.7	87.9	89.4	89.9	84.4	90.1
November	92.8	91.2	96.7	95.8	96.3	95.3	93.6	94.1	91.7	92.5	92.6	91.3	93.7
December	97.3	97.7	97.1	98.6	99.1	97.0	96.3	95.8	94.1	96.5	96.7	95.7	96.8
<b><u>FOR RH (%) at 17:45</u></b>													
Months/Yr:	1997	1998	1999	2000	2001	2002	2003	2004	2005	2006	2007	2008	Average
January	67.6	62.9	51.3	59.0	61.1	57.5	73.4	75.8	68.2	53.6	71.6	59.8	63.5
February	72.6	57.6	45.6	54.1	48.8	49.6	68.8	62.4	54.5	59.9	71.6	51.0	58.0
March	52.6	58.3	38.8	47.5	42.4	54.2	63.0	56.3	54.4	50.2	59.9	54.3	52.7
April	63.9	53.6	43.6	48.8	45.2	59.8	60.0	65.7	53.6	54.8	59.8	55.4	55.4
May	54.0	70.8	64.9	67.1	69.6	69.6	60.9	70.0	59.1	71.4	60.5	58.2	64.7
June	64.3	68.2	75.6	77.8	78.2	72.8	77.9	80.5	65.0	71.8	72.4	75.2	73.3
July	82.3	80.8	84.8	77.7	82.1	79.7	82.5	89.3	80.7	81.1	80.5	79.5	81.8
August	81.1	85.3	85.1	80.0	78.9	80.7	82.8	81.1	81.6	79.9	80.5	79.5	81.4
Sept.	77.4	80.6	81.4	76.5	78.3	75.1	83.7	79.9	78.5	80.4	79.7	74.6	78.8
October	72.2	78.4	72.3	65.9	67.2	74.8	76.2	73.5	76.1	74.9	73.9	72.8	73.2
November	68.7	73.7	69.9	66.2	65.6	76.6	79.5	70.9	75.0	73.3	67.3	70.7	71.5
December	73.8	59.0	67.4	63.3	62.4	78.0	78.4	69.0	67.8	72.7	65.2	72.1	69.1

Table 3- Average Annual Rain Fall (1997-2008), Kathmandu Airport, Nepal  
Hydrology and Meteorology, Kathmandu, Nepal

Source: Department of

ANNUAL RAIN FALL (mm)													
Months/Yr	1997	1998	1999	2000	2001	2002	2003	2004	2005	2006	2007	2008	Average
January	16.4	0.1	4.2	1.3	6.8	33.8	19.5	26.9	55.1	0.0	0.0	4.9	14.08
February	5.5	28.2	4.2	5.3	15.7	29.9	68.4	0.0	17.0	0.0	72.8	0.0	20.58
March	13.9	70.6	0.0	20.9	8.4	93.0	85.9	32.3	50.1	30.9	36.3	35.9	39.85
April	100.1	75.9	6.0	61.9	34.6	93.9	38.0	164.1	34.8	133	77.9	43.7	71.98
May	90.3	282.0	106.5	209.9	179.9	159	37.7	168.8	40.6	146	90.7	99.9	134.22
June	245.4	248	315.6	266.5	250.4	227	222.3	183.0	222.9	216	263.0	237.7	241.51
July	511.0	440	485.2	336.3	498.8	545	591.5	459.5	253.5	337.0	227.3	255.4	411.71
August	370.5	376	393.5	384.7	460.3	500	347.0	219.4	309.3	248	223.7	240.8	339.48
Sept.	70.9	194	266.9	119.4	145.5	148.0	293.4	199.1	126.5	218	332.5	291.3	200.38
October	12.0	44.2	152.2	0.6	20.5	15.0	17.7	120.5	126.1	43.9	18.5	10.3	48.458
November	4.9	12.0	0.0	0.0	0.0	26.5	0.0	36.0	0.0	1.5	3.2	0.0	7.0083
December	87.4	0.0	1.2	0.2	0.0	0.0	18.6	0.0	0.0	17.5	0.0	0.0	10.41
<b>Total</b>	1528.3	1771	1735.5	1407	1620.9	1871	1740	1610	1236	1391	1346	1220	1539.67

Table 4- Average Wind Speed (1997-2008), Kathmandu Airport, Nepal Source: Department of  
Hydrology and Meteorology, Kathmandu, Nepal

Location	: Kathmandu Airport				Latitude				: 27° 42' N					
Index No.	: 1030		Wind Speed (Km/hr)				Longitude				: 85° 22' E			
District	: Kathmandu				Elevation				: 1337 m.					
Months/Yr	1998	1999	2000	2001	2002	2003	2004	2005	2006	2007	2008			
January	1.0	1.1	i	0.9	0.9	0.8	0.6	0.7	0.8	0.6	0.7			
February	1.5	1.2	1.2	1.2	1.2	1.1	1.0	1.1	1.0	0.8	1.3			
March	1.9	i	1.8	1.5	1.6	1.5	1.3	1.2	1.2	1.2	1.4			
April	1.5	1.8	1.7	1.5	1.5	1.5	1.4	1.3	1.2	1.2	1.6			
May	1.3	1.5	1.2	1.3	1.1	1.5	1.1	1.3	0.9	0.9	1.2			
June	1.2	1.2	0.7	0.9	1.1	0.9	0.7	1.0	0.8	0.6	0.9			
July	0.7	0.8	0.7	0.7	0.7	0.7	0.5	0.6	0.6	0.5	0.8			
August	0.6	0.6	0.7	0.7	0.7	0.6	0.6	0.4	0.5	0.4	0.7			
Sept.	0.8	0.8	0.8	0.7	0.7	0.6	0.6	0.6	0.5	0.4	0.7			
October	0.8	0.5	0.9	0.8	0.8	0.6	0.6	0.6	0.5	0.6	0.7			
November	0.8	0.6	0.7	0.7	0.7	0.7	0.5	0.5	0.5	0.5	0.6			
December	0.7	0.7	0.7	0.7	0.7	0.6	0.6	0.5	l	0.5	0.5			
<b>Total</b>	1.1	1.0	1.0	1.0	1.0	0.9	0.8	0.8	0.8	0.7	0.9			

## **APPENDIX B: LITERATURE REVIEW**

The literature review has been done for the common features found for the passive design techniques, daylighting, and ventilation and shading study. These have been compiled here with reference to primary and secondary resources.

### **ENERGY EFFICIENT DESIGN APPROACHES**

The foremost aspect of energy in sustainable building design is to enable human comfort to the occupants with possibilities of improving lifestyle along with lower carbon-dioxide emissions. The human comfort comprise of air temperature, relative humidity, activity level of the occupants, type of clothes worn by the occupants and air movement in contact with the occupants. Building envelope has direct relation with the varying outdoor conditions such as air temperature, solar radiation, humidity, precipitation, wind velocity and direction and clarity of the sky that affect internal environment within buildings (Sodha *et al.* 1986). These environmental conditions have great influence on human comfort. Therefore, human seeks for heating, cooling, ventilating and lighting active systems in the buildings to adjust the unfavorable conditions depending upon climatic necessity. However, for their operation, they require a lot of energy. Hence, efficient use of passive controls incorporated with the environmental condition can save unnecessary energy and makes the buildings efficient.

### **CLIMATE AND SITE**

The climate of the local area is very important with data related to wind direction, solar orientation, temperature and humidity. The site should be well studied for understanding, identifying and controlling climatic influences. The techniques of passive approaches henceforth depend on careful judgment of climate and site study.



## **SITTING AND ARCHITECTURAL PLANNING**

The sitting of building in appropriate location within the site with proper site study harness the optimal site condition and avoid the unfavorable site area. The energy efficient site design factor includes topography of the site such as valley or hills or slopes; vegetation, built form and water bodies. These factors should be utilized where possible to locate the building within the site. Local wind patterns and stack effect helps to protect building against wind and shelter against unwanted winds, cool breeze in summer is desirable that minimizes use of energy for operating air condition, and use of water-land interface to promote airflow also aid in siting of building. Since most of early design decision affects the overall building, these siting and planning is indispensable.

## **BUILDING ENVELOPE**

Building envelope includes outer skin or shell of building and helps protect from fire, filters air and light, access the heat flow and checks on overall building exchanges of energy. These outer and internal exchanges of heat and other environmental factors take places through external skin of building. The elements of the building that are involved in building envelope are external wall and windows, roof, external doors, underground slab and foundation. The main issue in building envelope is thermal properties of the materials used in the exterior area of the building. Other factors comprise of air tightness, color and reflectance of exterior surface, wind direction, orientation, shading and type.

## **PASSIVE DESIGN STRATEGIES**

All life processes depend on solar energy that is a source of radiant heat and basis of natural process. Passive solar design generally means the use of the sun's energy for the heating and cooling of living spaces within building. In this method, the building or some of

its component is exposed to the sun to take advantage of its natural energy characteristics. The fundamental natural processes that are used in passive solar energy are the thermal energy flows linked with conduction, natural convection and radiation. When sunlight strikes a building, the building materials used in the exterior surface can reflect, transmit, or absorb the solar radiation. Moreover, the heat generated by the sun evokes air movement that can be predictable in designed spaces. These basic responses to solar heat lead to design elements, material choices and placements that can provide heating and cooling effects in a home. Some of the heating, cooling, ventilation and daylighting strategies that can be applied in passive solar design are as follows:

## **HEATING STRATEGY**

During winter period, buildings can be heated passively by the use of solar energy. The transmittance of heat in the buildings by conduction, convection, radiation and evaporation (or condensation) and during its mode of transfer can change the energy form. According to Goulding *et al.* (1996), the buildings can be heated through three simple steps of collection of solar energy, storing the heat and lastly distributing the stored heat to internal space. Some of the heating strategies for buildings are discussed below.

### **Collection of solar energy**

As discussed above on the siting and architectural planning, the building should be properly oriented for the provision of collection of solar energy. The collection of solar energy can be improved by using glazing materials for transmitting more solar energy and through opaque materials by collecting within the material for future dissipation.

### **Orientation and tilt**

Equator facing orientation is considered as the major collector of solar energy. West or South orientation is beneficial if heat demand is more or essential in the afternoon than in

the morning. During summer, solar energy is more on eastern, western, south eastern and southwestern vertical surfaces. Similarly, tilt or reduction of the slope of vertical equator facing surface can result in a greater quantity of solar energy during heating season but it can give over heating problems in the building especially in summer and give less probability for the application of horizontal sunshades. Thus, while tilting the buildings to collect solar energy a cautionary approach is necessary.

The materials used for collection of solar energy can be glazing or opaque. Glazing materials have low thermal resistance but if used in combination can be useful such as in case of trombe wall or water wall. The masonry walls of exterior are opaque materials that have high thermal capacity than glazing. Insulation materials can be used in combination for greater thermal capacity.

### **Storage of heat**

Thermal storage saves energy by storing the surplus energy for later use. During the climate with high diurnal temperature difference (i.e. hot days and cold nights), it may be favorable to store daytime heat to discharge later at night when the temperature falls. For this, exposed surface can be of thick layer of heavyweight material with a high thermal capacity and longer thermal lag (Autodesk 2008). The storage of energy depends on the thermal properties and the thickness of material in direct heat storage, except the means whereby solar heat is charged and released by the storage in indirect heat storage (Achard 1986). Heat or thermal energy can be stored in the form of sensible heat i.e. by changing the temperature of inert materials such as water, brick, gravel and others, and latent heat i.e. by changing the state in reversible chemical and physical-chemical reactions.

### **Heat distribution**

The heat stored can be disseminated in the space by the exchange of heat between the walls (radiation) and from the walls to the air (convection). A good distribution of heat is

when the heat enters the room evenly over the entire floor surface. It is better to have door height extended up to ceiling level in order to enhance air circulation from one room to other and to avoid heavy pockets of hot air near the ceiling (Achard 1986).

## COOLING STRATEGY

Cooling strategies entails cooling the buildings in warm period passively by excluding unnecessary heat gain and generate cooling potential in the buildings as per the requirement (Autodesk 2008). Some of the cooling strategies by the control of external and internal gain of heat are discussed below.

### Control external heat gain

It is required to deal with controlling of external heat gain while there is excessive solar radiation into the buildings. Solar radiation can enter in a space and superfluous heat is accumulated directly through a window or indirectly through opaque elements of the building materials. It is required to prevent it from reaching the building surfaces (Autodesk 2008) through shading with respect to the openings such as external and internal shading devices, shading through neighboring structures and vegetation, using insulation, using special glazing material and considering surface texture and coloring.

### Shading with respect to the openings

Shading controls the quantity of direct incident radiation and modifies not only heat flow to the interior but also indoor temperature. External shading devices can be vertical, horizontal and combination of both (egg-crate) while internal shading devices can be venetian blinds, roller blinds, curtains and others (Givoni 1976).

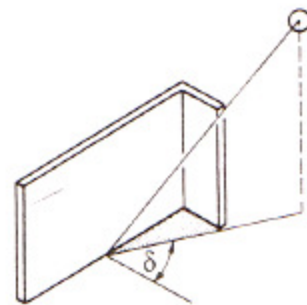

Figure 1: Vertical shading device  
(source:(Koenigsberger 1975))

The external vertical shading devices, oriented towards east and west sides, have to shield openings fully from sun at low angle during mornings and afternoons. However, they have to allow winter sun and control summer sun. To calculate its fixed projection, the horizontal shadow angle ( $\delta$ ) determines a vertical shading device which is the difference between the solar azimuth and wall azimuth and is the horizontal component for the angle of incidence (see figure 1). The vertical shading devices perpendicular or angular to the wall on the openings can be broadens only up to its top or extend throughout the whole height of the building to control heat gain.

The external horizontal shading devices, oriented towards equator facing side, have to protect openings fully from sun during summer to reduce overheating, but to permit direct sun as much as possible in winter. The sun's position in summer and winter should be understood prior to designing them. During summer, the sun appears more overhead (summer solstice) and in winter it appears much lower in the sky (winter solstice). Thus the length of the shading devices have to react on both the seasons. Horizontal shading can extend not only above the window but also along whole façade to control heating the surface. In order to calculate its fixed projection, the vertical shadow angle ( $\varepsilon$ ) determines the horizontal shading device and measured on a vertical plane normal to the elevation considered (see

figure 2).

$\gamma$ = Solar altitude angle

$\varepsilon$ = Vertical shadow angle

$\delta$ = horizontal shadow angle

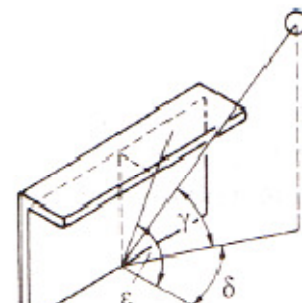

Figure 2: Horizontal shading device  
(source: (Koenigsberger 1975))

Internal shading devices such as internal blinds and curtains stop passage of radiation since they absorb the solar heat and can reach high temperature. Some part of

absorbed heat will be convected to the indoor air and some reradiated (Koenigsberger 1975) Then, external devices are much more efficient than internal devices. The difference in efficiency between external and internal devices depends on the color of the shades. For external devices, the efficiency raises as the color is darker but for internal devices, the efficiency increases, as the color is lighter. With efficient shading, such as external shutters, it is possible to eliminate more than 90% of the heating effect of solar radiation. But with inept shading, such as dark colored internal devices, about 75-80% of the solar radiation on the openings may enter the buildings (Givoni 1976) (see table 5).

Table 5: Comparison of different shading devices (source:(Kukreja 1978)

Type of Control	Percentage reduction in total heat gain	Percentage efficiency to ensure cross ventilation	Percentage of natural light resulting from control	Approx. Average efficiency as means of control
Curtains	10-20	5-25	30-50	35
Metal venetian blinds	20-30	5-90	50-75	64
Heat resisting glass (coloured)	60	70 (presumed)	40	57
Roof or corridor overhang	75-80	80-100	40	69
Concrete hood and fins	70-80	80-100	45	70
Louvered hood	85	80-100	77	84
Vertical louvres	70-80	10-50	45-65	54
Horizontal louvres	70-80	15-50	45-70	53
Suspended louvres	80-85	80-100	70-80	82

## SHADING THROUGH NEIGHBORING STRUCTURES, TOPOGRAPHY AND VEGETATION

Shading through neighboring structures depends upon the shadow length of the structures. The shadow lengths depend on 'the time of the day, time of the year, slope of the land, and the height of the structure/ vegetation' (Shrestha 2009). Shadow length on flat land can be calculated as:

$$\text{Shadow length} = \text{Height of the structure} / \tan(\text{Altitude angle of the sun})$$

Shading through neighboring buildings in courtyard creates cooler air, cooler surfaces and the earth that will draw heat from the surrounding areas and reemitting it to the open sky during night (Koenigsberger 1975). In consideration to the topography of the site with slopes, slope that face towards equator cast lower shadow length than those facing pole. Moreover, in order to minimize heat gain, ground should be soft and preferably green. Planted area can lower the temperature as much as 5.6 – 8.3 °C (Brown and DeKay 2000). Heat island effect through hard and dark surfaces should be minimized because they absorb and reradiate the heat later. Solar radiation can be minimized between 73% and 93% through vegetation (Bodach 2008). Plantation of deciduous trees proves helpful in providing shade in summer and allows enough radiation in winter.

### **CONTROL INTERNAL GAIN OF HEAT**

Internal heat gain of heat needs to be controlled in areas where there is maximum use of equipments in those areas because the equipments themselves are emitting additional heat. In order to control internal heat gain, it is better to minimize the use of equipments from the space. Energy efficient lights should be used as the heat from incandescent lamps is produced more than fluorescent lamps. With a careful design of openings that maximizes daylight saves electrical energy and reduce internal gains. Proper planning and spatial selection can separate high gain space from low gain, so that ventilation and other strategies can be applied as per the requirement to minimize heat generated by internal gains (Autodesk 2008).

### **VENTILATION**

Ventilation in buildings allows fresh air and convective cooling with movement of air. During warm period, this movement of air passing the skin surface speeds up heat dissipation by increasing convective heat loss and by accelerating evaporation. This gives the effect of physiological cooling (Koenigsberger 1975).

## **Physical mechanisms of ventilation**

The air movement in buildings is the cause of pressure gradients across it. This is either by thermal gradient effect or by wind effect (Givoni 1976).

### **Temperature gradient effect**

Temperature gradient effect or stack effect is due to the density difference between indoor and outdoor air. It occurs through openings when warmer and lighter indoor air flows out at the top; and cooler and denser air from outside flows in from the bottom (see figure 3). The air movement is higher with the increase in height of shaft (Koenigsberger. 1975). It works better at night when the outdoor temperature is cool and indoor temperature is warm due to the heat stored in the building envelopes. The passage of cooler air from outside and movement of warmer air at the top creates light and comfortable air movement inside. During the day, the passage of cool air is higher when the openings or exterior areas are shaded.

### **Wind pressure effect**

Ventilation through wind pressure effect on buildings depends on the direction and speed of wind, and also the form of the buildings (Krishan 2001). When wind blows against the buildings, it creates a high pressure zone of increased velocity on the windward side of them, and a low pressure zone of lower velocity on the leeward side of them (Brown and DeKay 2001). Air movement inside the rooms is created by the passage of wind from the windward side where air is subject to pressure and moving out from the leeward side where suction zone is created (see figure 3).



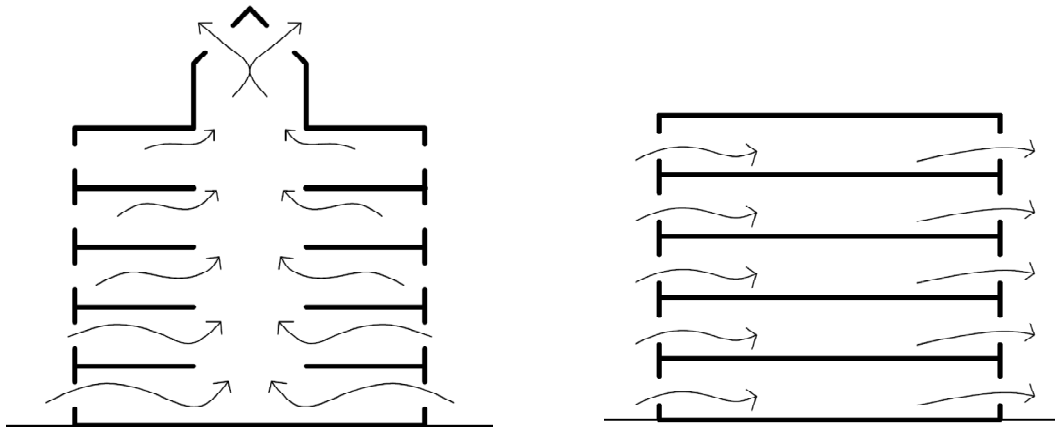

Figure 3 Temperature gradient effect of ventilation (source: Krishan *et al.* 2001)

### Orientation with respect to wind

Wind direction is required before taking into account orientation for proper ventilation. When the wind direction is perpendicular to the buildings, only frontal side is in pressure and other three sides are under suction. However, when the wind direction is oblique, two upwind sides are in pressure and the others are under suction. This creates more air movement inside the buildings (Givoni 1976.)

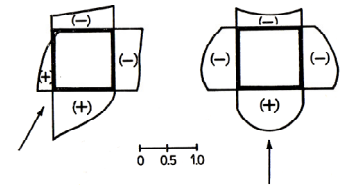

Figure 4 Distribution of pressure around a building (source: Givoni 1976)

### Opening size and position, and cross ventilation

. The position openings on adjacent walls proves better air movement than on opposite walls. Moreover, while positioning openings on the vertical wall, air movement should be emphasized in the living zone, which is up to 2m high. If the inlet opening is at the high level, regardless of outlet opening position, the air will flow near the ceiling and not in the living zone (Koenigsberger 1975) (see figure 5).

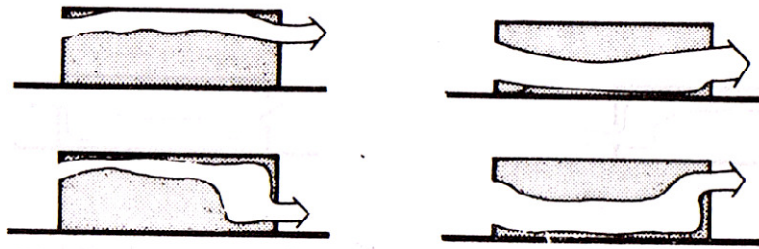

Figure 5- Effect of opening positions for ventilation (source: (Koenigsberger *et al.* 1975))

## DAY LIGHTING

### Daylight distribution

Daylight distribution depends on size, shape and position of the openings. The height of the window determines the depth of daylight penetration and the width affects the sideways spread of daylight (Szokolay 2008) that eventually affects the distribution of light. Higher the position of the window in a room, deeper gets the balanced light inside the room.

Daylight can be distributed through windows, skylights, saw tooth skylights, roof monitor and atrium according to the function and requirement in a room (Autodesk 2008) (see figure 6).

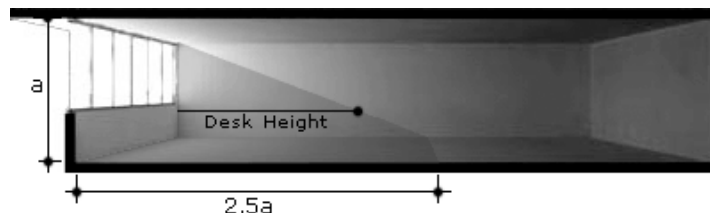

1. Daylight penetration through vertical window in which light will generally reach 2.5 times the height of the top of the window



2. Lighting distribution with windows on two sides



3. Skylights



4. Saw tooth roof lighting system

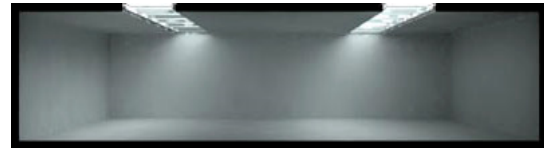

5. Raised roof monitor

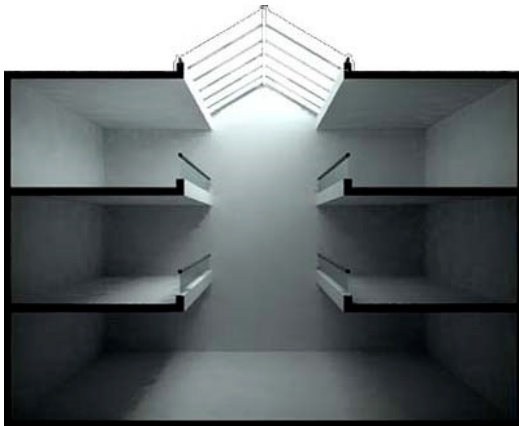

6. Atrium

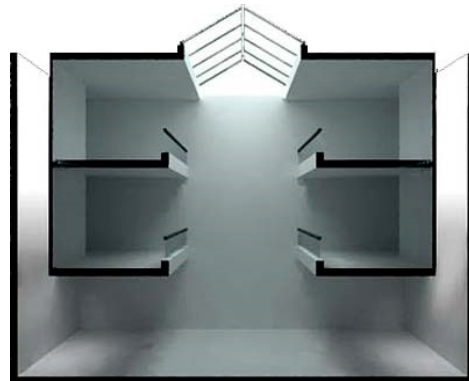

7. Addition of light wells down each side of atrium building

Figure 6- Various ways of daylight distribution (source: Autodesk 2008)

## APPENDIX C: DESIGN OPTIONS

### OPTION 1

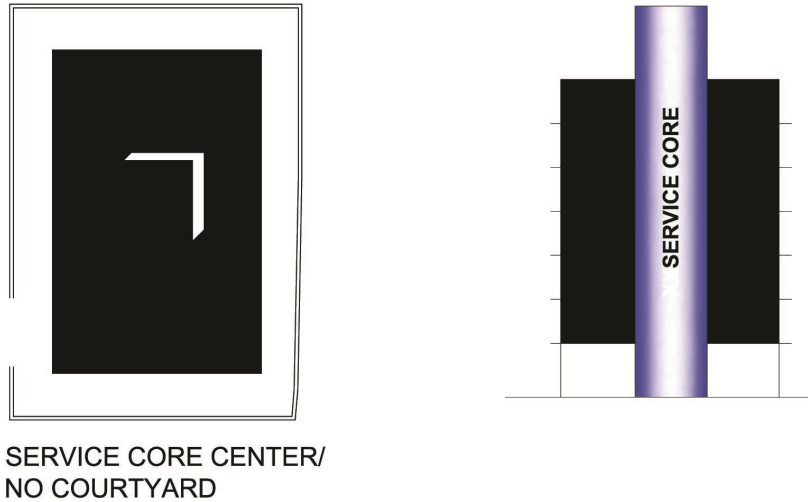

Figure 7- Typical high rise layout plan

#### Concept:

The concept approached is for high rise building where service core is centered center and easy access to living spaces around it.

#### Function:

The plan is simple with either side of service core living spaces are housed and no green spaces, light wells that act as courtyard. Balconies are extended part of the floor and do not have rain cover. Not a good plan for accessing parking in ground floor.

#### Energy and Green Spaces:

The main drawback is the inner facing living spaces are not well ventilated and no access to daylight. The outer living spaces have well access to daylight.

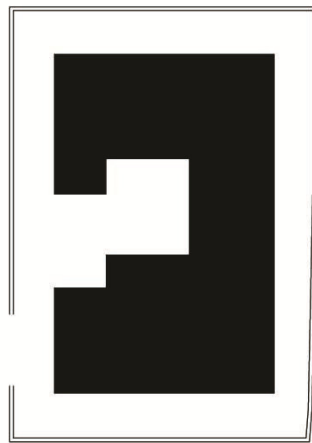
**OPTION 2**

SERVICE CORE EAST/  
OPENING IN WEST

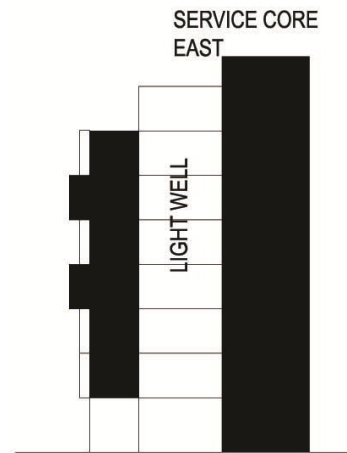

Figure 8- Interior courtyard variation

**Concept:**

The concept was to use the westerly wind into the court and living spaces. From energy point of view it was unsuitable with leeward wind created in the courtyard.

**Function:**

The planning dealt with use of deep balconies in west side and ward off west sun. The service core is located on East side thus; parking in ground floor was a problem. Moreover, light well did not serve well as it was intended for.

**Energy and Green Spaces:**

It allowed good daylight but the east section is used for service core that could be well used as living spaces such as Kitchen.

**OPTION 3 - CHOSEN ONE**

Figure 9- Interior courtyard variation

The preferred option was chosen mainly due to climatic response in utilizing solar gain and channelizing wind into the building for cooling and ventilation purposes. Some of the advantages and disadvantages are as follows:

**Advantages:**

- The form is a rectangle with courtyard and acts as divider between two sections of apartments.
- The form managed natural lighting in all living spaces and so did the courtyard plan.
- The interplay of facade developed mass and void and thus regulating sunlight.

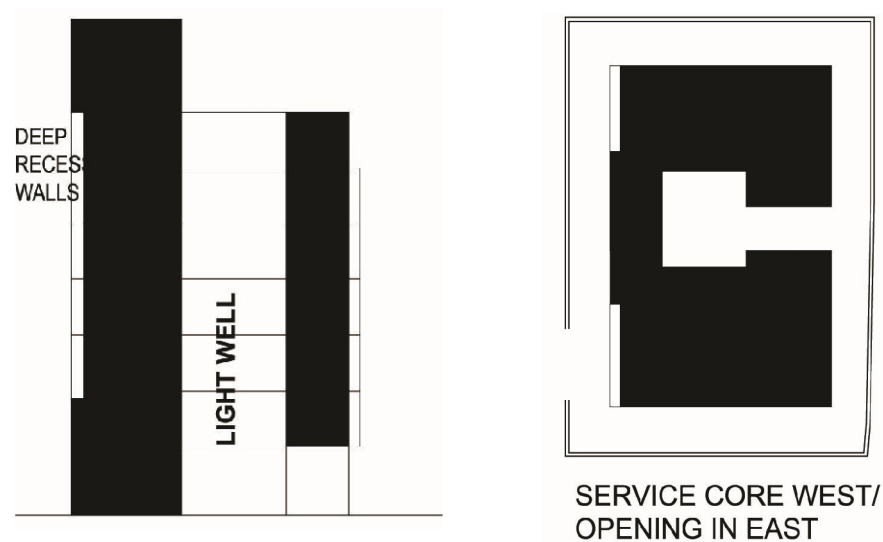
**Disadvantages:**

- The form is generated with respect to site and it does pose restriction on form.
- Since the shorter side is facing south, so most of the surface area is devoid of solar gain.

## APPENDIX D: ECOTECT TEST

### Daylight Analysis

Daylight Factor  
Value Range: 14.0 - 74.0 %  
© ECOTECT 16

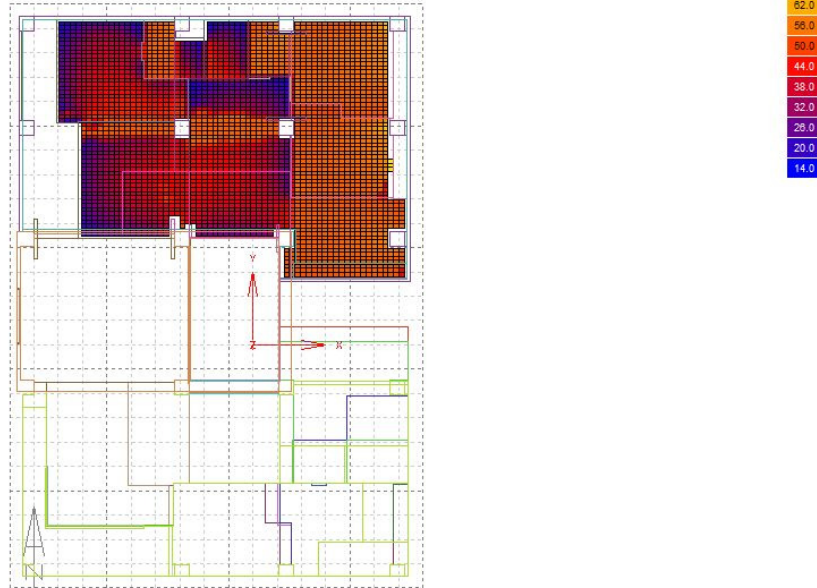

Figure 10- Daylight Factor Analysis for 3-bedroom apartment at fifth floor  
Source: Ecotect 2010

Table 6 - Discomfort Degree Hours for Living and dining room at 5th floor of type 3- bedroom

DISCOMFORT DEGREE HOURS				DISCOMFORT DEGREE HOURS			
Zone: 75 3-5-Living Room				Zone: 76 3-5-Dining			
Zone is not air-conditioned.				Zone is not air-conditioned.			
Occupancy: Weekdays 19-23, Weekends 07-13.				Occupancy: Weekdays 19-23, Weekends 07-13.			
Comfort: Band = 18.0 - 24.0 C				Comfort: Band = 18.0 - 24.0 C			
MONTH	TOO HOT (DegHrs)	TOO COOL (DegHrs)	TOTAL (DegHrs)	MONTH	TOO HOT (DegHrs)	TOO COOL (DegHrs)	TOTAL (DegHrs)
Jan	0	924	924	Jan	0	949	949
Feb	6	611	617	Feb	6	638	643
Mar	114	397	511	Mar	98	427	525
Apr	318	109	426	Apr	288	132	420
May	337	43	380	May	306	56	362
Jun	422	0	422	Jun	394	0	394
Jul	439	0	439	Jul	409	0	409
Aug	337	0	337	Aug	316	0	316
Sep	403	0	403	Sep	375	0	375
Oct	223	104	327	Oct	206	114	320
Nov	40	446	486	Nov	37	463	500
Dec	0	722	722	Dec	0	744	744
<b>TOTAL</b>	<b>2638.9</b>	<b>3355.1</b>	<b>5994</b>	<b>TOTAL</b>	<b>2434.9</b>	<b>3523.5</b>	<b>5958.4</b>

Table 7 - Discomfort Degree Hours for two bedroom at 5th floor for type 3-bedroom

DISCOMFORT DEGREE HOURS				DISCOMFORT DEGREE HOURS			
Zone: 77 3-5-M BedRoom				Zone: 82 3-5-BedRoom2			
Zone is not air-conditioned.				Zone is not air-conditioned.			
Occupancy: Weekdays 19-08, Weekends 18-10.				Occupancy: Weekdays 19-08, Weekends 18-10.			
Comfort: Band = 18.0 - 24.0 C				Comfort: Band = 18.0 - 24.0 C			
MONTH	TOO HOT (DegHrs)	TOO COOL (DegHrs)	TOTAL (DegHrs)	MONTH	TOO HOT (DegHrs)	TOO COOL (DegHrs)	TOTAL (DegHrs)
Jan	0	2634	2634	Jan	0	1630	1630
Feb	0	1496	1496	Feb	0	616	616
Mar	4	343	347	Mar	6	0	6
Apr	97	1	98	Apr	387	0	387
May	336	0	336	May	966	0	966
Jun	860	0	860	Jun	1850	0	1850
Jul	904	0	904	Jul	1922	0	1922
Aug	806	0	806	Aug	1798	0	1798
Sep	391	0	391	Sep	1332	0	1332
Oct	133	1	134	Oct	522	0	522
Nov	1	627	628	Nov	0	77	77
Dec	0	2028	2028	Dec	0	1049	1049
<b>TOTAL</b>	<b>3531.4</b>	<b>7130.2</b>	<b>10661.6</b>	<b>TOTAL</b>	<b>8782.9</b>	<b>3371.5</b>	<b>12154.4</b>



### APPENDIX E: PRELIMINARY SKETCHES

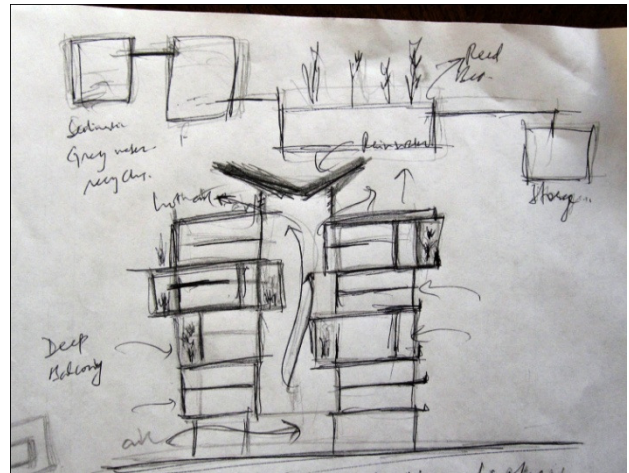
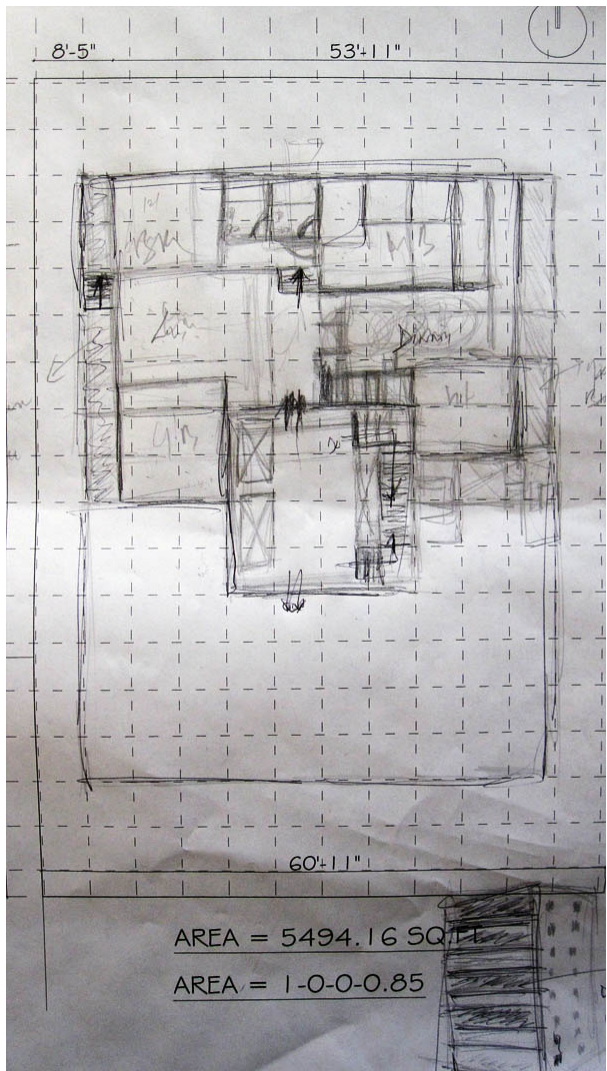
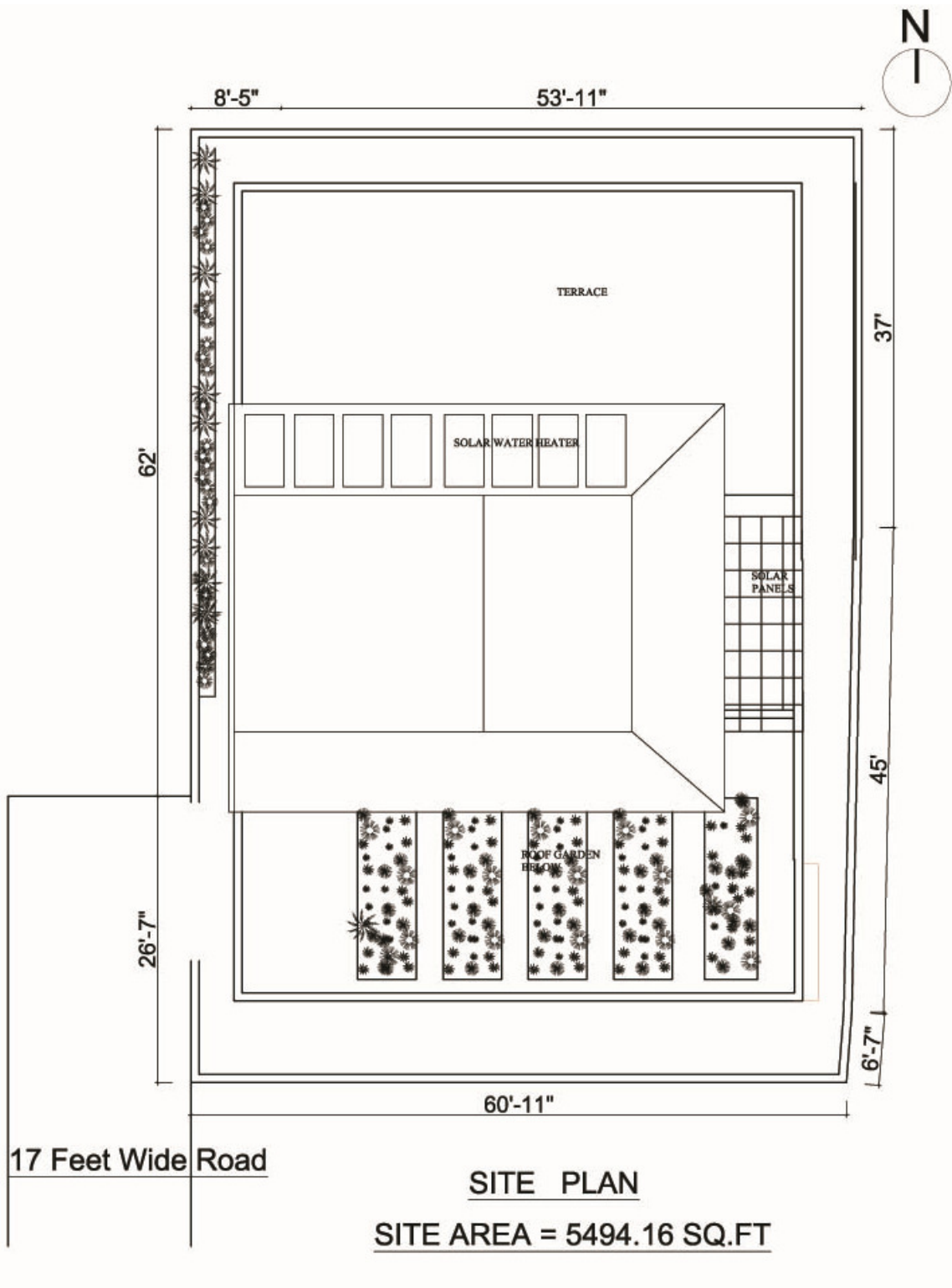
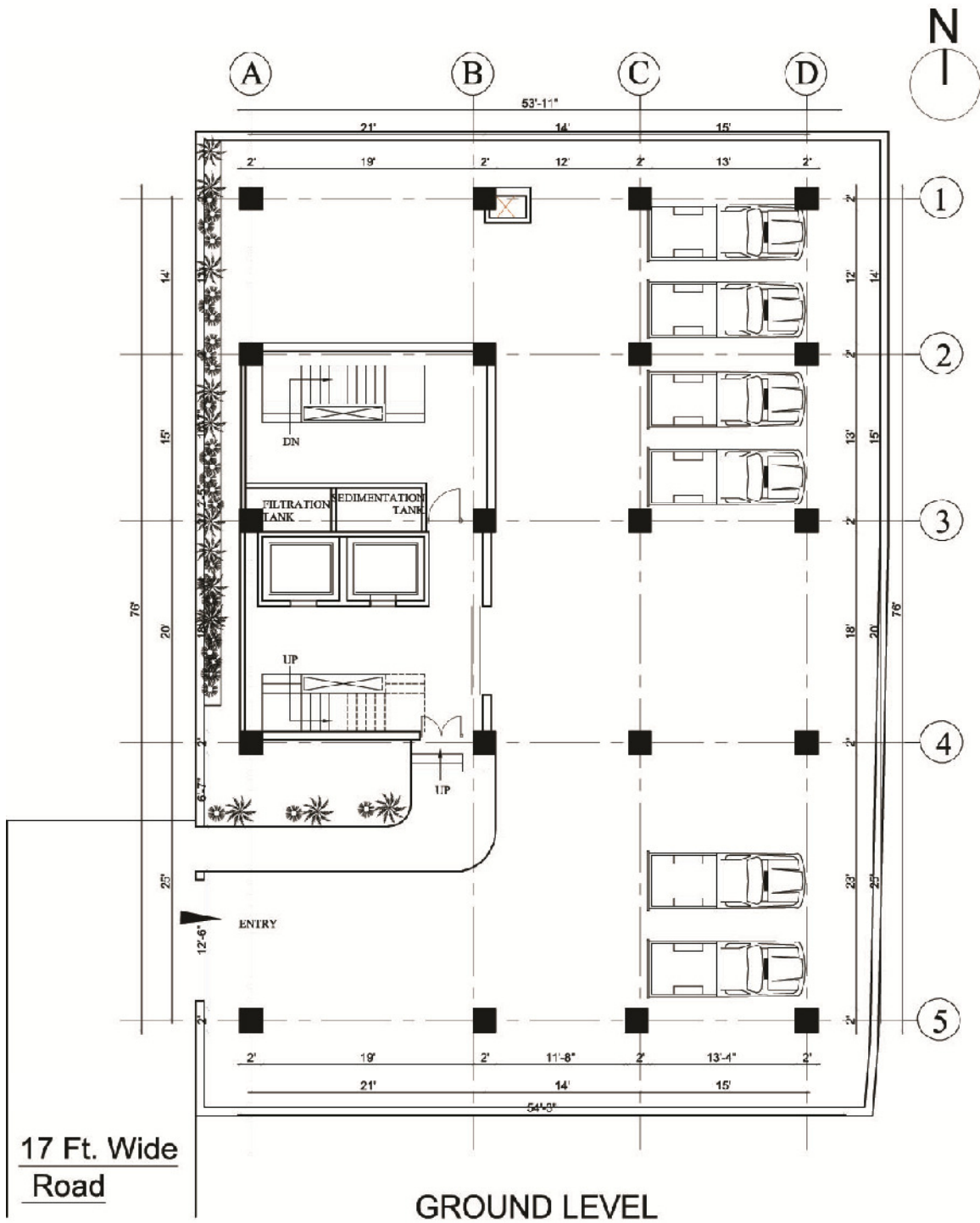
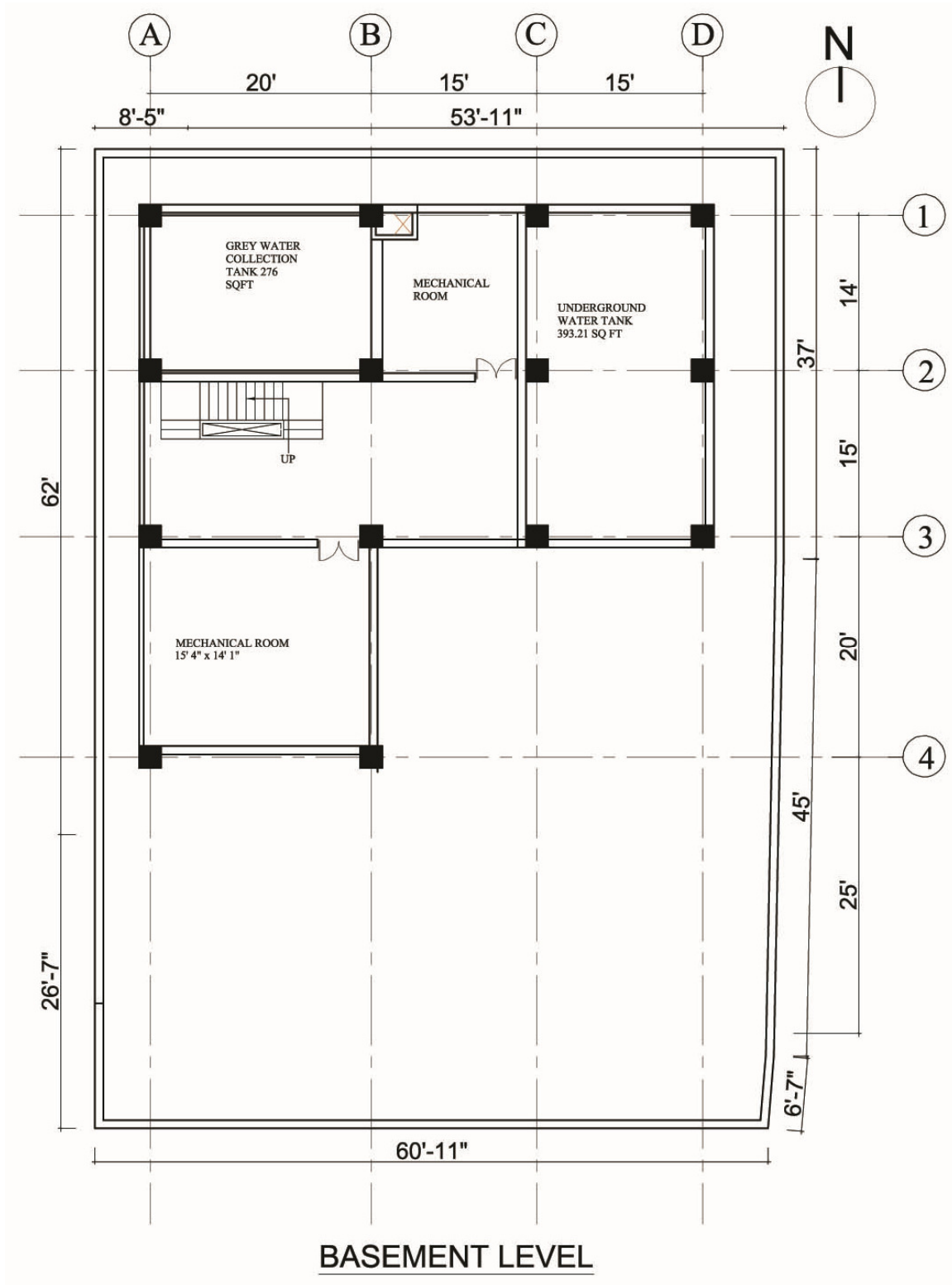

Figure 11 - Preliminary layout and section

**APPENDIX F : DRAWINGS (NOT TO SCALE)**







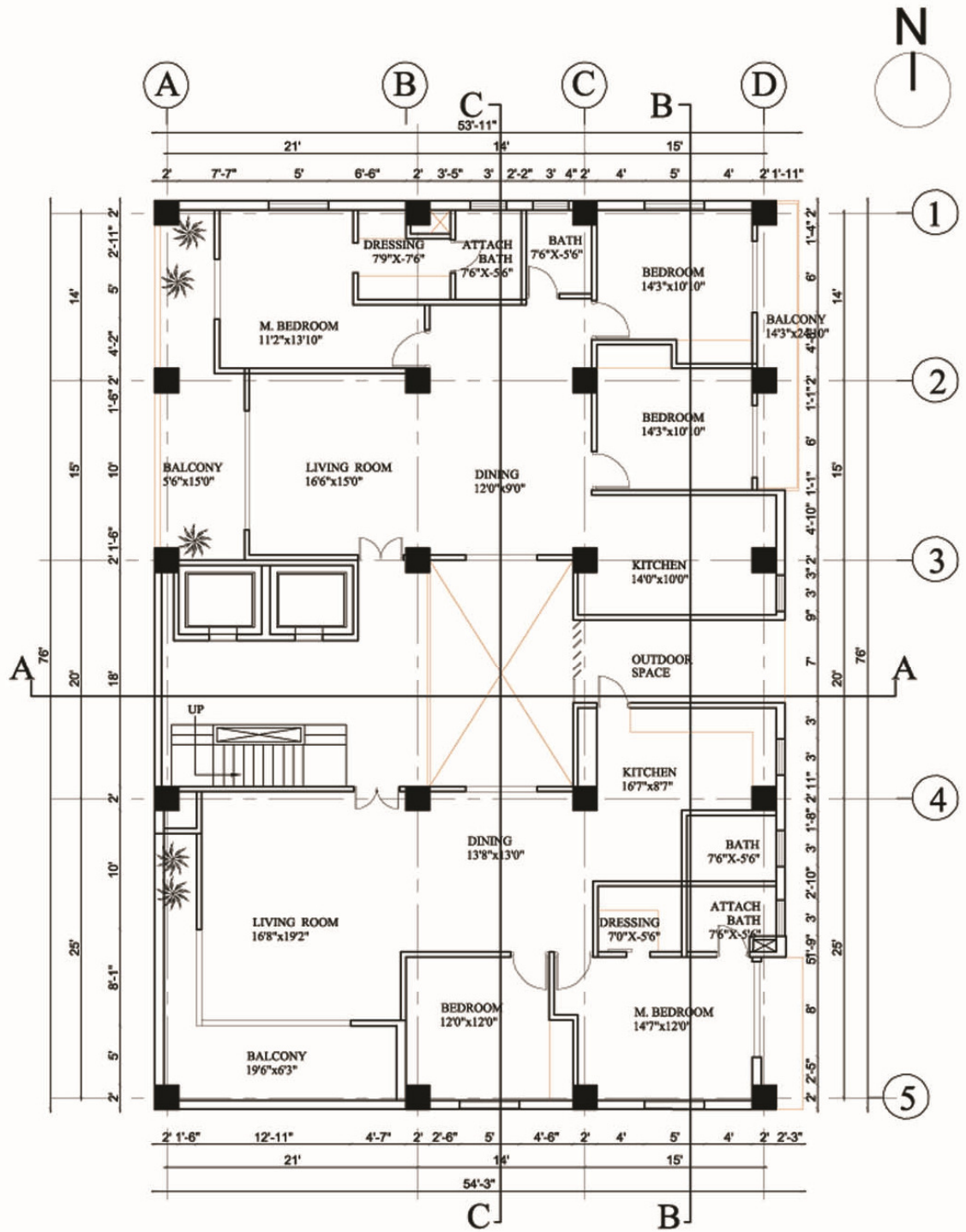

**FIRST AND SECOND FLOOR PLAN**  
 Area: 2993 sq .ft.

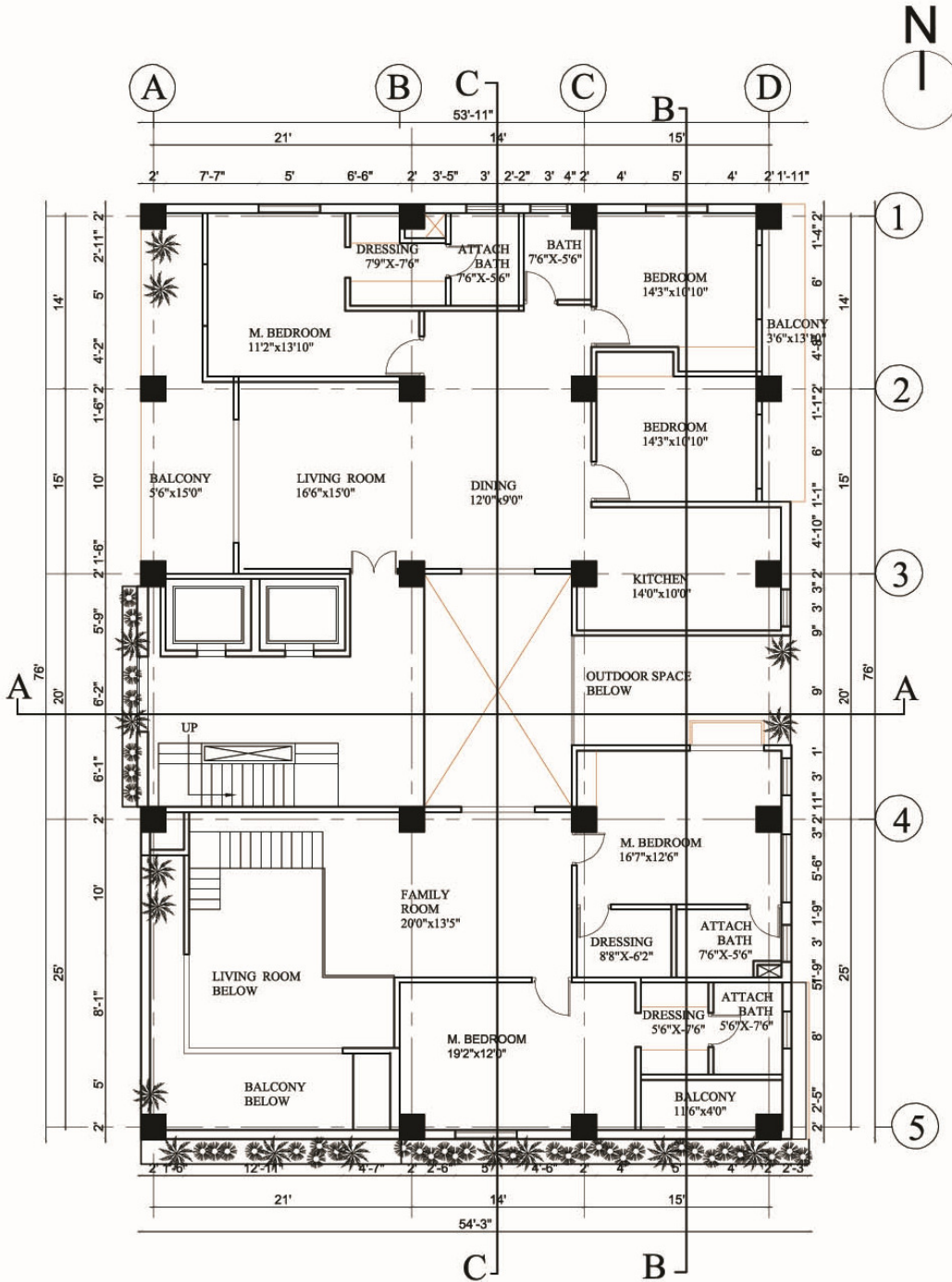

**FOURTH, SIXTH, EIGHTH FLOOR PLAN**

Area: 2719 sq. ft.

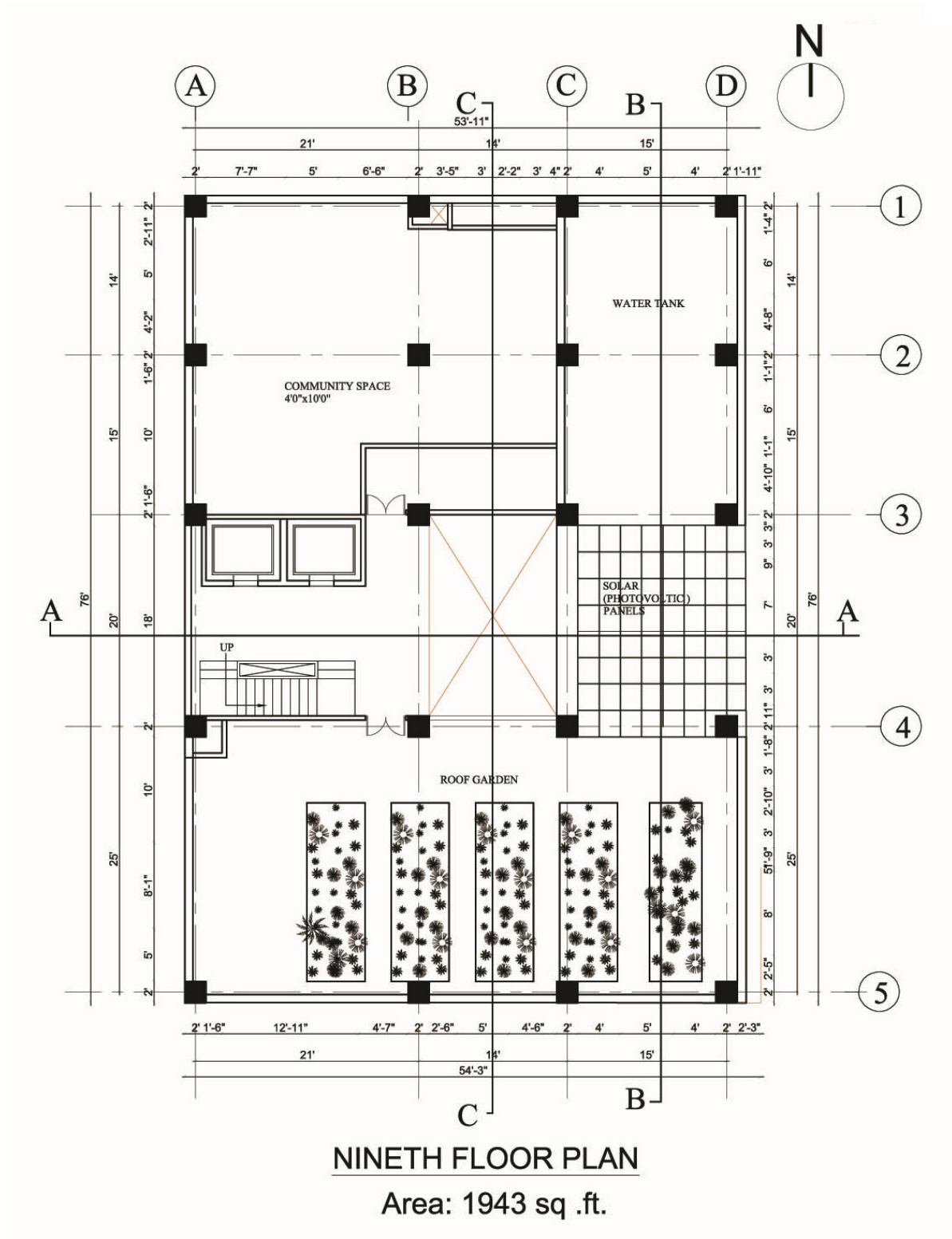

**NINETH FLOOR PLAN**

Area: 1943 sq .ft.



SOUTH ELEVATION

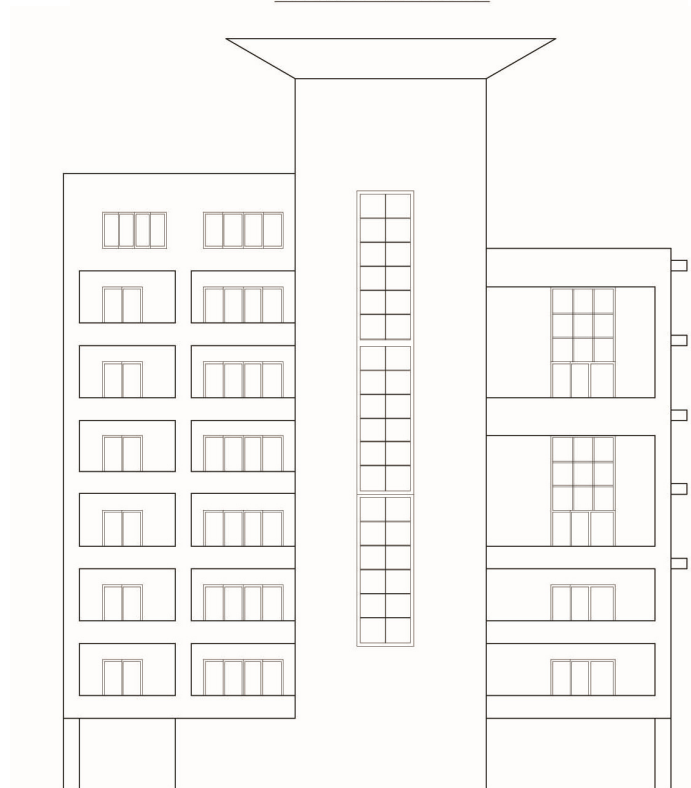

WEST ELEVATION



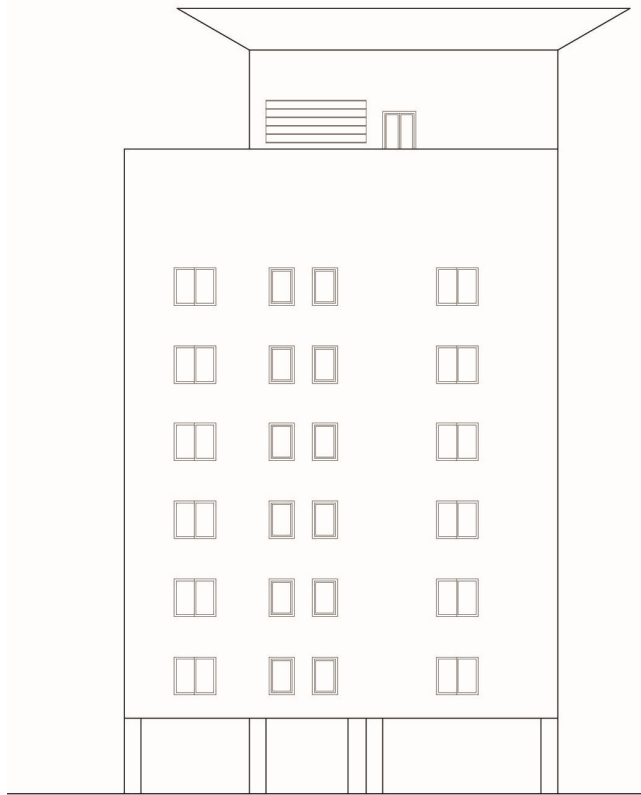

NORTH ELEVATION



EAST ELEVATION

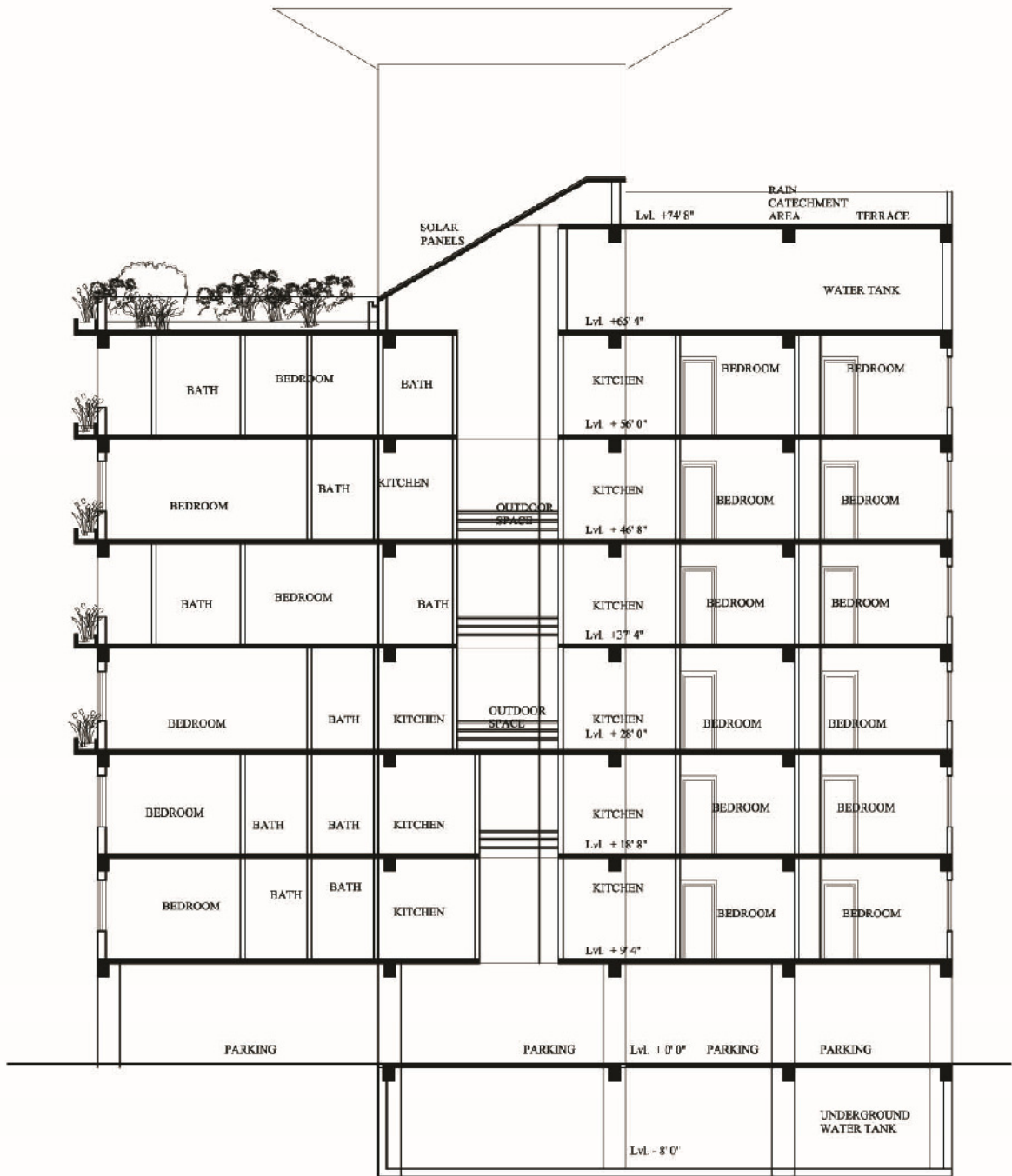

**SECTION B-B**

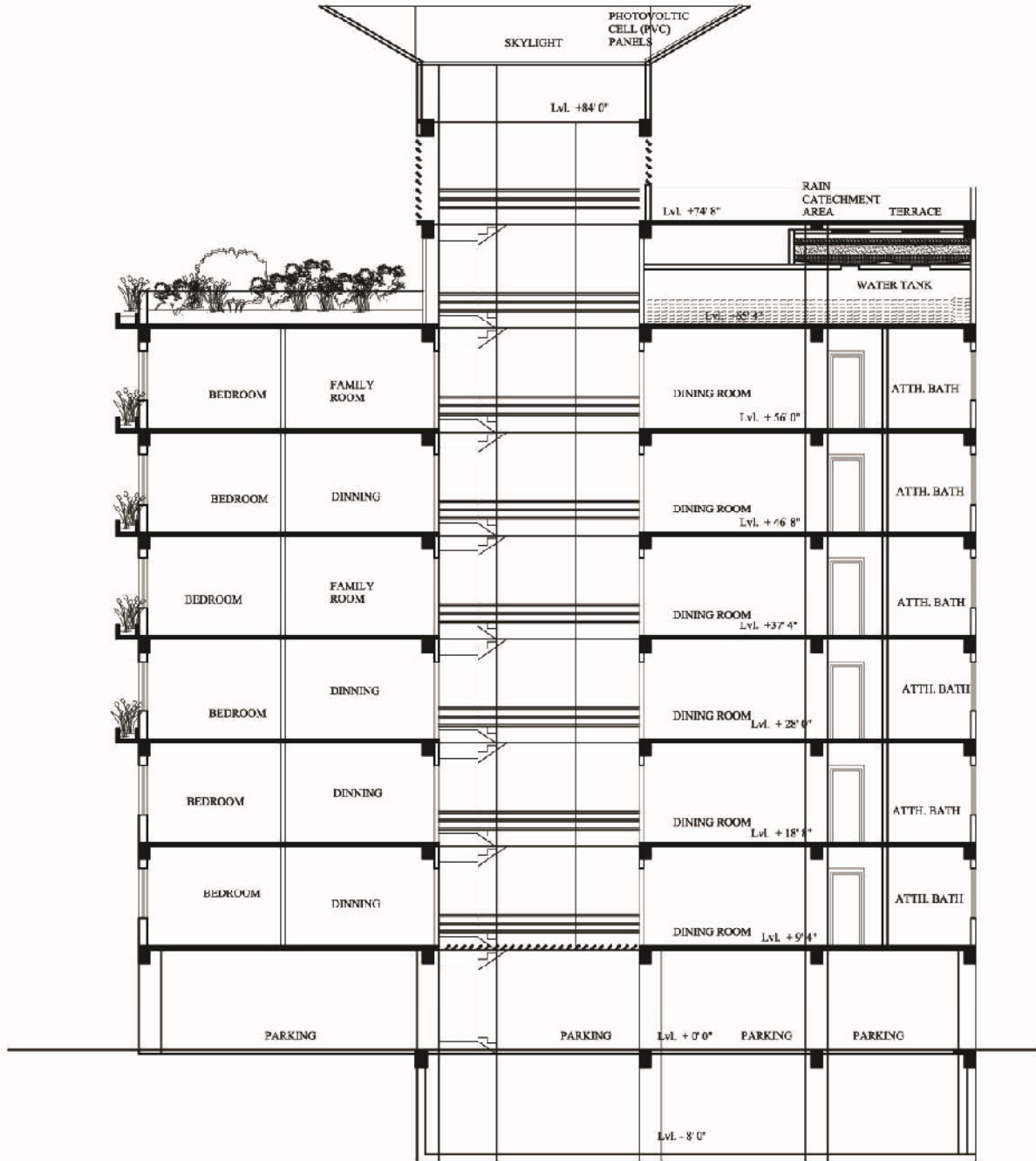

SECTION C-C

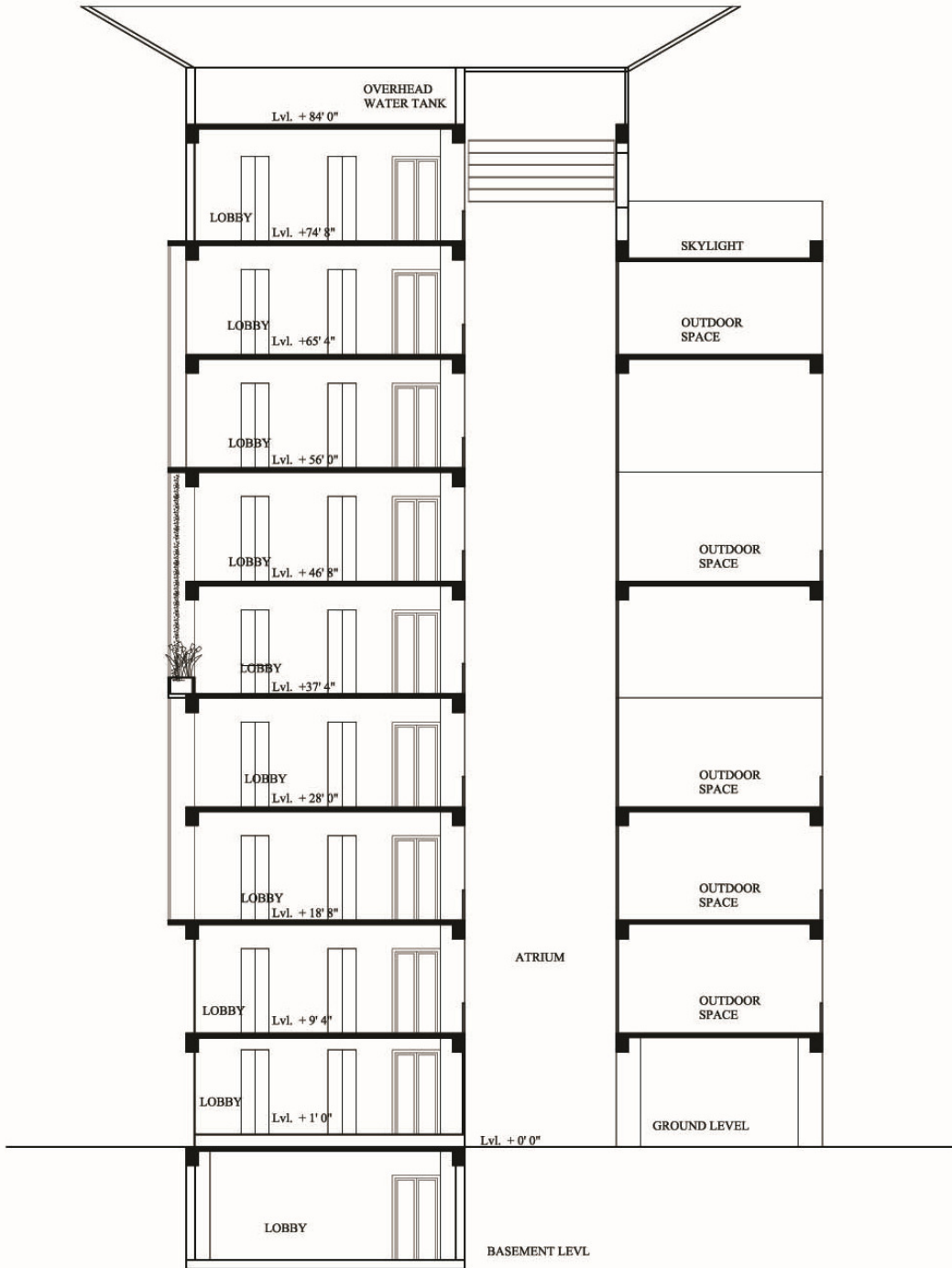

SECTION A-A