

University of Nebraska - Lincoln

DigitalCommons@University of Nebraska - Lincoln

---

Architectural Engineering -- Dissertations and  
Student Research

Architectural Engineering

---

5-2011

# Investigations of the relationships between unoccupied classroom acoustical conditions and elementary student achievement

Lauren M. Ronsse

*University of Nebraska - Lincoln*, ronsse.lauren@gmail.com

Follow this and additional works at: <http://digitalcommons.unl.edu/archengdiss>



Part of the [Architectural Engineering Commons](#)

---

Ronsse, Lauren M., "Investigations of the relationships between unoccupied classroom acoustical conditions and elementary student achievement" (2011). *Architectural Engineering -- Dissertations and Student Research*. 8.

<http://digitalcommons.unl.edu/archengdiss/8>

This Article is brought to you for free and open access by the Architectural Engineering at DigitalCommons@University of Nebraska - Lincoln. It has been accepted for inclusion in Architectural Engineering -- Dissertations and Student Research by an authorized administrator of DigitalCommons@University of Nebraska - Lincoln.

INVESTIGATIONS OF THE RELATIONSHIPS BETWEEN  
UNOCCUPIED CLASSROOM ACOUSTICAL CONDITIONS AND  
ELEMENTARY STUDENT ACHIEVEMENT

by

Lauren M. Ronsse

A DISSERTATION

Presented to the Faculty of  
The Graduate College at the University of Nebraska  
In Partial Fulfillment of Requirements  
For the Degree of Doctor of Philosophy

Major: Interdepartmental Area of Engineering (Architectural Engineering)

Under the Supervision of Professor Lily M. Wang

Lincoln, Nebraska

May, 2011

INVESTIGATIONS OF THE RELATIONSHIPS BETWEEN  
UNOCCUPIED CLASSROOM ACOUSTICAL CONDITIONS AND  
ELEMENTARY STUDENT ACHIEVEMENT

Lauren Michelle Ronsse, Ph.D.

University of Nebraska, 2011

Advisor: Lily M. Wang

Current building standards recommend specific unoccupied background noise levels and reverberation times for classroom spaces. While clear communication in elementary school classrooms may be critical for successful learning environments, the existing research does not show a consistent connection between the classroom acoustics parameters specified in building standards and student achievement. This research seeks to determine what acoustical conditions should be attained in elementary school classrooms to optimize student achievement.

In this dissertation, acoustical studies in two midwestern United States public school systems are described. Unoccupied background noise level (BNL) and reverberation time (RT) measurements were gathered in a range of elementary school classrooms (125 total). Additionally, detailed binaural room impulse response (BRIR) measurements were gathered in 24 of these classrooms. For the BRIR measurements, a source loudspeaker with a directivity pattern similar to that of a human talker was used. The loudspeaker was placed at the front of each room at varying rotation angles to simulate a teacher facing different directions while

speaking to the class. Multiple receiver positions at typical student locations were used in each classroom. The metrics calculated from the BRIR measurements include perception-based parameters, such as speech transmission index (STI), distortion of frequency-smoothed magnitude (DFSM), interaural cross-correlation (IACC), and interaural level difference (ILD).

The results from this research suggest that elementary student reading and language subject areas may be negatively impacted by higher unoccupied BNLs. Also, classrooms with lower DFSMs generally had students with higher language achievement scores. However, the classrooms included in the study had a limited range of RTs. Therefore, further investigations are needed in classrooms with longer RTs to fully assess the relationships between classroom acoustical conditions and student achievement.

# Copyright

Copyright 2011, Lauren M. Ronsse

## Acknowledgements

First and foremost, I would like to thank my advisor, *Dr. Lily Wang*. Throughout my graduate career, Lily has supported both my professional and research endeavors. Her constant enthusiasm and selflessness helped create an environment in which I could thrive as an architectural engineering acoustician in Omaha, Nebraska. I would also like to thank my undergraduate advisor and continual advocator, *Prof. Bob Coffeen*. Bob's love of acoustics and positive outlook, perceiving every challenge as a new "unsolved opportunity," provided an excellent role model for success. I will be forever indebted to Lily and Bob drawing me to acoustics and supporting me both personally and professionally.

Special thanks to my dissertation committee, including *Dr. Mahmoud Alahmad*, *Dr. Steve From*, *Dr. Siu-Kit Lau*, and *Dr. Peggy Nelson*, for their review and feedback on this research. I would also like to thank *Dr. Barbara Shinn-Cunningham* and *Dr. Ralph Muehleisen* for discussing the project and providing invaluable comments during the development of the research.

I would like to recognize the undergraduate and graduate students at the University of Nebraska who assisted with various portions of this research, including *Christopher Ainley*, *Michael Crabb*, *Hyun Hong*, *Dakota Kelley*, *Eric Powell*, and *Paul Sim*. The many hours they spent helping with measurements and data compilation were essential for the success of this project.

Thanks to *Dr. Daniel Valente* and *Dr. Walt Jesteadt* at Boys Town National Research Hospital in Omaha, NE, for allowing use of their KEMAR for measurements and testing. Special thanks to the Council Bluffs Community School District, especially *Dr. Marty Shudak* for providing access to the classrooms and student achievement data. Thanks also to the Papillion-La Vista Public School District, especially *Dave Harrill* for providing assistance with the classroom mechanical system controls and *Dr. Melanie Mueller* for coordinating access to detailed student achievement data.

Finally, I am grateful for all of my friends and family who provided encouragement throughout my graduate student career: notably, *Dr. Jonathan Rathsam*, *Dr. Michelle Vigeant*, and *Alicia Wagner* for their friendship; my *parents* for their love and support; my brother and sister-in-law, *Luke* and *Erin*, for guiding me toward graduate school; and most especially my sister, *Brittany*, for lending a patient ear along every step of the way.

## **Grant Information**

- American Society of Heating, Refrigerating, and Air-Conditioning Engineers  
Graduate Student Grant-in-Aid
- National Science Foundation Graduate Research Fellowship
- University of Nebraska Presidential Graduate Fellowship
- 3M Acoustic, Thermal, and Shock Solutions Scholarship



## Table of Contents

List of Figures.....	xii
List of Tables .....	xxi
Glossary of Terms.....	xxiv
Chapter 1: Introduction .....	1
1.1 Background .....	1
1.2 Dissertation Outline.....	3
Chapter 2: Previous Research: Acoustical Metrics.....	5
2.1 Introduction .....	5
2.2 Background Noise Level.....	6
2.3 Reverberation Time.....	8
2.4 Speech Transmission Index.....	10
2.5 Distortion of Frequency-Smoothed Magnitude.....	12
2.6 Frequency-to-Frequency Fluctuations.....	15
2.7 Interaural Cross-Correlations .....	16
2.8 Interaural Level Difference .....	19
2.9 Conclusions .....	20
Chapter 3: Effects of Room Form and Finishes, Receiver Location, and Source Rotation on Perception-based Acoustical Metrics.....	21
3.1 Introduction .....	21
3.2 Previous Research .....	21
3.3 Methods.....	22
3.3.1 Space Descriptions .....	23
3.3.2 Measurement Procedures.....	27
3.4 Results and Discussion.....	30
3.4.1 Distortion of Frequency-Smoothed Magnitude.....	30
3.4.2 Interaural Level Difference .....	39
3.5 Conclusions .....	45

Chapter 4: Statistical Methods .....	47
4.1 Introduction .....	47
4.2 Parametric Tests .....	47
4.3 Correlations .....	48
4.4 Analysis of Variance .....	50
4.5 Regressions.....	52
4.6 Conclusions .....	55
Chapter 5: Acoustical Study of Classrooms in an Iowa Public School District .....	56
5.1 Introduction .....	56
5.2 Methods .....	56
5.2.1 Site Visit Procedures .....	57
5.2.2 Classroom Descriptions.....	57
5.2.3 Background Noise Level Measurement Procedures.....	58
5.2.4 Reverberation Time Measurement Procedures .....	59
5.2.5 Binaural Room Impulse Response Measurement Procedures.....	59
5.2.6 Standardized Achievement Tests .....	64
5.3 Results .....	65
5.3.1 Background Noise Level .....	65
5.3.2 Reverberation Time .....	68
5.3.3 Speech Transmission Index.....	70
5.3.4 Distortion of Frequency-Smoothed Magnitude.....	73
5.3.5 Interaural Cross-Correlation.....	80
5.3.6 Interaural Level Difference .....	84
5.3.7 Student Achievement Tests and Poverty Rates .....	87
5.4 Data Analyses and Discussion .....	89
5.4.1 Background Noise Level and Reverberation Time vs. Student Achievement .....	89
5.4.1.1 Background Noise Level.....	90
5.4.1.2 Reverberation Time .....	95
5.4.1.3 Discussion.....	96

5.4.2 Binaural Room Impulse Response Acoustical Metrics vs. Student Achievement.....	97
5.4.2.1 Speech Transmission Index .....	98
5.4.2.2 Distortion of Frequency-Smoothed Magnitude .....	98
5.4.2.3 Interaural Cross-Correlation .....	100
5.4.2.4 Interaural Level Difference.....	102
5.4.2.5 Discussion.....	103
5.5 Conclusions .....	103
Chapter 6: Acoustical Study of Classrooms in a Nebraska Public School District ...	105
6.1 Introduction .....	105
6.2 Methods.....	105
6.2.1 Site Visit Procedures .....	106
6.2.2 Classroom Descriptions.....	106
6.2.3 Background Noise Level Measurement Procedures.....	109
6.2.4 Reverberation Time Measurement Procedures .....	110
6.2.5 Binaural Room Impulse Response Measurement Procedures.....	110
6.2.6 Standardized Achievement Tests .....	111
6.3 Results .....	111
6.3.1 Background Noise Level .....	112
6.3.2 Reverberation Time .....	119
6.3.3 Speech Transmission Index.....	121
6.3.4 Distortion of Frequency-Smoothed Magnitude.....	125
6.3.5 Interaural Cross-Correlation.....	131
6.3.6 Interaural Level Difference .....	140
6.3.7 Student Achievement Tests and Demographic Data .....	148
6.4 Data Analyses and Discussion .....	151
6.4.1 Background Noise Level and Reverberation Time vs. Student Achievement .....	151
6.4.1.1 Background Noise Level.....	154
6.4.1.2 Reverberation Time .....	166
6.4.1.3 Discussion.....	168

6.4.2 Binaural Room Impulse Response Acoustical Metrics vs. Student Achievement.....	170
6.4.2.1 Speech Transmission Index .....	173
6.4.2.2 Distortion of Frequency-Smoothed Magnitude .....	176
6.4.2.3 Interaural Cross-Correlation .....	182
6.4.2.4 Interaural Level Difference.....	186
6.4.2.5 Discussion.....	189
6.5 Conclusions .....	191
Chapter 7: Summary and Conclusions.....	193
7.1 Summary of Background Research and Preliminary Investigations.....	193
7.2 Classroom Acoustics Research Summary and Results .....	194
7.2.1 Acoustical Study of Classrooms in an Iowa Public School District .....	195
7.2.2 Acoustical Study of Classrooms in a Nebraska Public School District ....	196
7.3 Conclusions and Recommendations.....	197
References.....	200
Appendix I: Binaural Room Impulse Response Metrics: Dummy Head Receiver vs. Human Head Receiver .....	205
Appendix II: Binaural Room Impulse Response Metrics: Comparison of Human Head Receivers.....	215

## List of Figures

Figure 2.1:	Reverberant impulse response. ....	13
Figure 2.2:	Pseudo-anechoic impulse response.....	13
Figure 2.3:	Reverberant and pseudo-anechoic frequency responses.....	14
Figure 3.1:	View of conference room space tested. ....	23
Figure 3.2:	Views of classroom room space tested. ....	24
Figure 3.3:	Views of theater space tested.....	25
Figure 3.4:	Views of concert hall space tested. ....	26
Figure 3.5:	Octave band reverberation time ( $T_{20}$ ) values for the four spaces tested. .....	27
Figure 3.6:	Plan view of source rotations and receiver positions used in each space (not to scale).....	29
Figure 3.7:	View of measurement configuration for back receiver position, $0^\circ$ source rotation in theater space.....	30
Figure 3.8:	Distortion of frequency-smoothed magnitude for center receiver position, $0^\circ$ source rotation. Error bars for theater space show the range about the average value from the three sets of repeated measurements.....	31
Figure 3.9:	Distortion of frequency-smoothed magnitude for side receiver position, $0^\circ$ source rotation. Error bars for theater space show the range about the average value from the three sets of repeated measurements.....	32
Figure 3.10:	Distortion of frequency-smoothed magnitude for back receiver position, $0^\circ$ source rotation. Error bars for theater space show the range about the average value from the three sets of repeated measurements.....	33
Figure 3.11:	Distortion of frequency-smoothed magnitude for back receiver position, $90^\circ$ source rotation. Error bars for theater space show the range about the average value from the three sets of repeated measurements.....	34

Figure 3.12:	Distortion of frequency-smoothed magnitude measured at the left ear in the conference room.....	35
Figure 3.13:	Distortion of frequency-smoothed magnitude measured at the left ear in the theater. Error bars show the range about the average value from the three sets of repeated measurements.....	36
Figure 3.14:	Distortion of frequency-smoothed magnitude measured at the right ear in the theater. Error bars show the range about the average value from the three sets of repeated measurements.....	37
Figure 3.15:	Distortion of frequency-smoothed magnitude measured at the left ear in the concert hall.....	38
Figure 3.16:	Interaural level differences for center receiver position, 0° source rotation. Error bars for theater space show the range about the average value from the three sets of repeated measurements. ....	40
Figure 3.17:	Interaural level differences for side receiver position, 0° source rotation. Error bars for theater space show the range about the average value from the three sets of repeated measurements. ....	41
Figure 3.18:	Interaural level differences for side receiver position, 45° source rotation. Error bars for theater space show the range about the average value from the three sets of repeated measurements. ....	42
Figure 3.19:	Interaural level differences for center receiver position, 90° source rotation. Error bars for theater space show the range about the average value from the three sets of repeated measurements. ....	43
Figure 3.20:	Interaural level differences for side receiver position, 90° source rotation. Error bars for theater space show the range about the average value from the three sets of repeated measurements. ....	44
Figure 5.1:	Views of a typical classroom tested.....	58
Figure 5.2:	Plan view of source rotations and receiver positions used for BRIR measurements in four classrooms (not to scale). ....	61
Figure 5.3:	Response curves for JBL LSR6325P-1 loudspeaker. Source: JBL Professional LSR6325P-1 specification sheet.....	62
Figure 5.4:	On-axis amplitude and phase response of JBL LSR6325P-1 loudspeaker. Source: JBL Professional LSR6325P-1 specification sheet.....	62
Figure 5.5:	Polar plots for the JBL LSR25P loudspeaker in the 2000 Hz third-octave band. The red line shows the horizontal polar plot, and the blue	

	line shows the vertical polar plot. Source: Enhanced Acoustic Simulator for Engineers (EASE) software speaker database, version 4.0.....	63
Figure 5.6:	Polar plots in the 2000 Hz third-octave band for a female human, talking in a normal voice. The red line shows the horizontal polar plot, and the blue line shows the vertical polar plot. Source: Enhanced Acoustic Simulator for Engineers (EASE) software speaker database, version 4.0.....	63
Figure 5.7:	A-weighted equivalent sound levels for all of the classrooms measured. This includes spaces with the BNL measured with central mechanical system activated (50 classrooms), with the central mechanical system deactivated (2 classrooms), and with the window air-conditioning units activated when present (6 classrooms).....	66
Figure 5.8:	A-weighted equivalent sound levels for 11 of the schools, all with consistent mechanical system conditions for the BNL measurements (BNL measured with central mechanical system activated). The bars show the range in BNL about the average value for all classrooms at each grade level in each school.....	67
Figure 5.9:	RT average in the 500 and 1000 Hz octave bands for all of the classrooms measured. ....	69
Figure 5.10:	Octave band reverberation time ( $T_{20}$ ) values averaged between the right and left ears for the four classrooms in which BRIR measurements were conducted. ....	70
Figure 5.11:	Speech transmission index values for the center receiver position, $0^\circ$ source rotation. Error bars for Classroom C show the range about the average value from the three sets of repeated measurements. ....	71
Figure 5.12:	Speech transmission index values for the side receiver position, $45^\circ$ source rotation. Error bars for Classroom C show the range about the average value from the three sets of repeated measurements. ....	72
Figure 5.13:	Speech transmission index values measured at the left ear in Classroom B.....	73
Figure 5.14:	Distortion of frequency-smoothed magnitude values for the center receiver position, $0^\circ$ source rotation. Error bars for Classroom C show the range about the average value from the three sets of repeated measurements.....	74

Figure 5.15:	Distortion of frequency-smoothed magnitude values for the side receiver position, 45° source rotation. Error bars for Classroom C show the range about the average value from the three sets of repeated measurements.....	75
Figure 5.16:	Distortion of frequency-smoothed magnitude values for the back receiver position, 90° source rotation. Error bars for Classroom C show the range about the average value from the three sets of repeated measurements.....	76
Figure 5.17:	Distortion of frequency-smoothed magnitude values measured at the right ear in Classroom A.....	77
Figure 5.18:	Distortion of frequency-smoothed magnitude values measured at the right ear in Classroom B.....	78
Figure 5.19:	Distortion of frequency-smoothed magnitude values measured at the right ear in Classroom D.....	79
Figure 5.20:	Interaural cross-correlation (early) values for the center receiver position, 0° source rotation. Error bars for Classroom C show the range about the average value from the three sets of repeated measurements.....	81
Figure 5.21:	Interaural cross-correlation (early) values for the side receiver position, 45° source rotation. Error bars for Classroom C show the range about the average value from the three sets of repeated measurements.....	82
Figure 5.22:	Interaural cross-correlation (early) values for the center receiver position, 180° source rotation. Error bars for Classroom C show the range about the average value from the three sets of repeated measurements.....	83
Figure 5.23:	Interaural cross-correlation (early) values for Classroom A.....	84
Figure 5.24:	Interaural level differences for the center receiver position, 0° source rotation. Error bars for Classroom C show the range about the average value from the three sets of repeated measurements.....	85
Figure 5.25:	Interaural level differences for the center receiver position, 45° source rotation. Error bars for Classroom C show the range about the average value from the three sets of repeated measurements.....	86
Figure 5.26:	Interaural level differences for Classroom D.....	87
Figure 5.27:	Scatter plot and linear regression lines between unoccupied BNL and reading comprehension scores.....	93



Figure 5.28:	Scatter plot between left ear distortion of frequency-smoothed magnitude values and reading comprehension scores from all four classrooms.....	99
Figure 5.29:	Scatter plot between distortion of frequency-smoothed magnitude values (difference between left and right ear) and reading comprehension scores from all four classrooms.....	100
Figure 5.30:	Scatter plot between interaural cross-correlation (early) and reading comprehension scores from all four classrooms.....	101
Figure 5.31:	Scatter plot between interaural level differences and reading comprehension scores from all four classrooms.....	102
Figure 6.1:	A-weighted equivalent sound levels for all of the third-grade classrooms.....	114
Figure 6.2:	A-weighted equivalent sound levels for all of the fifth-grade classrooms.....	115
Figure 6.3:	A-weighted and C-weighted equivalent sound levels for all of the third-grade classrooms.....	117
Figure 6.4:	A-weighted and C-weighted equivalent sound levels for all of the fifth-grade classrooms.....	118
Figure 6.5:	RT average in the 500 and 1000 Hz octave bands for the third-grade classrooms.....	119
Figure 6.6:	RT average in the 500 and 1000 Hz octave bands for the fifth-grade classrooms.....	120
Figure 6.7:	Speech transmission index values for the center receiver position, 0° source rotation. Error bars show the range about the average value from the three sets of repeated measurements.....	122
Figure 6.8:	Speech transmission index values for the back receiver position, 90° source rotation. Error bars show the range about the average value from the three sets of repeated measurements.....	123
Figure 6.9:	Speech transmission index values measured at the left ear in Classroom 12B. Error bars show the range about the average value from the three sets of repeated measurements.....	124
Figure 6.10:	Speech transmission index values measured at the left ear in Classroom 11A. Error bars show the range about the average value from the three sets of repeated measurements.....	124

Figure 6.11:	Speech transmission index values measured at the left ear in Classroom 3B. Error bars show the range about the average value from the three sets of repeated measurements..	125
Figure 6.12:	Distortion of frequency-smoothed magnitude values for the center receiver position, 0° source rotation for the third-grade classrooms. Error bars show the range about the average value from the three sets of repeated measurements.....	126
Figure 6.13:	Distortion of frequency-smoothed magnitude values for the center receiver position, 0° source rotation for the fifth-grade classrooms. Error bars show the range about the average value from the three sets of repeated measurements.....	127
Figure 6.14:	Distortion of frequency-smoothed magnitude values for the back receiver position, 90° source rotation for the third-grade classrooms. Error bars show the range about the average value from the three sets of repeated measurements.....	128
Figure 6.15:	Distortion of frequency-smoothed magnitude values for the back receiver position, 90° source rotation for the fifth-grade classrooms. Error bars show the range about the average value from the three sets of repeated measurements.....	129
Figure 6.16:	Distortion of frequency-smoothed magnitude values measured at the left ear in Classroom 12B. Error bars show the range about the average value from the three sets of repeated measurements.....	130
Figure 6.17:	Distortion of frequency-smoothed magnitude values measured at the left ear in Classroom 11A. Error bars show the range about the average value from the three sets of repeated measurements.....	130
Figure 6.18:	Distortion of frequency-smoothed magnitude values measured at the left ear in Classroom 3B. Error bars show the range about the average value from the three sets of repeated measurements..	131
Figure 6.19:	Interaural cross-correlation (early) values for the 1000 Hz octave band in the center receiver position, 0° source rotation. Error bars show the range about the average value from the three sets of repeated measurements.....	132
Figure 6.20:	Interaural cross-correlation (early) values for the 1000 Hz octave band in the back receiver position, 90° source rotation. Error bars show the range about the average value from the three sets of repeated measurements.....	133

Figure 6.21:	Interaural cross-correlation (early) values for the 0° source rotation in Classroom 12B. Error bars show the range about the average value from the three sets of repeated measurements.....	134
Figure 6.22:	Interaural cross-correlation (early) values for the 90° source rotation in Classroom 12B. Error bars show the range about the average value from the three sets of repeated measurements.....	135
Figure 6.23:	Interaural cross-correlation (early) values for the 0° source rotation in Classroom 11A. Error bars show the range about the average value from the three sets of repeated measurements.....	136
Figure 6.24:	Interaural cross-correlation (early) values for the 90° source rotation in Classroom 11A. Error bars show the range about the average value from the three sets of repeated measurements.....	137
Figure 6.25:	Interaural cross-correlation (early) values for the 0° source rotation in Classroom 3B. Error bars show the range about the average value from the three sets of repeated measurements.....	138
Figure 6.26:	Interaural cross-correlation (early) values for the 90° source rotation in Classroom 3B. Error bars show the range about the average value from the three sets of repeated measurements.....	139
Figure 6.27:	Interaural level difference magnitudes for the 1000 Hz octave band in the center receiver position, 0° source rotation. Error bars show the range about the average value from the three sets of repeated measurements.....	140
Figure 6.28:	Interaural level difference magnitudes for the 1000 Hz octave band in the back receiver position, 90° source rotation. Error bars show the range about the average value from the three sets of repeated measurements.....	141
Figure 6.29:	Interaural level differences for the 0° source rotation in Classroom 12B. Error bars show the range about the average value from the three sets of repeated measurements.....	142
Figure 6.30:	Interaural level differences for the 90° source rotation in Classroom 12B. Error bars show the range about the average value from the three sets of repeated measurements.....	143
Figure 6.31:	Interaural level differences for the 0° source rotation in Classroom 11A. Error bars show the range about the average value from the three sets of repeated measurements.....	144

Figure 6.32:	Interaural level differences for the 90° source rotation in Classroom 11A. Error bars show the range about the average value from the three sets of repeated measurements.....	145
Figure 6.33:	Interaural level differences for the 0° source rotation in Classroom 3B. Error bars show the range about the average value from the three sets of repeated measurements.....	146
Figure 6.34:	Interaural level differences for the 90° source rotation in Classroom 3B. Error bars show the range about the average value from the three sets of repeated measurements.....	147
Figure 6.35:	Scatter plot and linear regression line between cooling mode BNL and Terra Nova language test scores for closed-plan fifth-grade classrooms with consistent HVAC conditions..	160
Figure 6.36:	Scatter plot and linear regression line between temperature-weighted average BNL from August to November 2009 and Terra Nova language test scores for closed-plan fifth-grade classrooms with consistent HVAC conditions.....	161
Figure 6.37:	Scatter plot and linear regression line between cooling mode BNL and Terra Nova reading test scores for closed-plan fifth-grade classrooms with consistent HVAC conditions..	163
Figure 6.38:	Scatter plot and linear regression line between cooling mode BNL and State Accountability reading test scores for closed-plan fifth-grade classrooms with consistent HVAC conditions.....	164
Figure 6.39:	Scatter plot between left ear distortion of frequency-smoothed magnitude values and Terra Nova language test scores..	180
Figure 6.40:	Scatter plot between right ear distortion of frequency-smoothed magnitude values and Terra Nova language test scores..	181
Figure 6.41:	Scatter plot between distortion of frequency-smoothed magnitude values (difference between left and right ear) and Terra Nova language test scores.....	182
Figure 6.42:	Scatter plot between interaural cross-correlation (early) values and Terra Nova language test scores..	185
Figure 6.43:	Scatter plot between interaural cross-correlation (early) values and State Accountability reading test scores..	186
Figure 6.44:	Scatter plot between interaural level difference magnitudes and Terra Nova language test scores.....	189

Figure A2.1: Left ear speech transmission index values.....	216
Figure A2.2: Right ear speech transmission index values.....	216
Figure A2.3: Left ear distortion of frequency-smoothed magnitude values. ....	217
Figure A2.4: Right ear distortion of frequency-smoothed magnitude values. ....	217
Figure A2.5: Interaural cross-correlation (early) values for the 0° source rotation. .....	218
Figure A2.6: Interaural cross-correlation (early) values for the 45° source rotation. .....	219
Figure A2.7: Interaural cross-correlation (early) values for the 90° source rotation. .....	220
Figure A2.8: Interaural cross-correlation (early) values for the 180° source rotation. .....	221
Figure A2.9: Interaural level difference values for the 0° source rotation.....	222
Figure A2.10: Interaural level difference values for the 45° source rotation.....	223
Figure A2.11: Interaural level difference values for the 90° source rotation.....	224
Figure A2.12: Interaural level difference values for the 180° source rotation.....	225

## List of Tables

Table 5.1:	A-weighted and C-weighted equivalent sound levels for the four classrooms in which BRIR measurements were conducted. ....	68
Table 5.2:	Standardized student achievement scores and poverty rates for all 14 elementary schools tested. Schools A through K had consistent mechanical system conditions for BNL measurements. ....	88
Table 5.3:	Correlations between BNL and student achievement scores (** p < 0.01). ....	91
Table 5.4:	Regression results predicting reading comprehension scores (** p < 0.01). ....	94
Table 5.5:	Regression results predicting reading comprehension scores (* p < 0.05). ....	95
Table 5.6:	Correlations between RT and student achievement scores (* p < 0.05). ....	96
Table 6.1:	Floor plan types and construction dates for third-grade classrooms..	107
Table 6.2:	Floor plan types and construction dates for fifth-grade classrooms. .	108
Table 6.3:	Standardized achievement scores and demographic data for students in the third-grade classrooms. ....	149
Table 6.4:	Standardized achievement scores and demographic data for students in the fifth-grade classrooms. ....	150
Table 6.5:	Nebraska State Accountability reading test scores and target student performance levels. ....	151
Table 6.6:	Correlations between third-grade student achievement scores and percentage of students receiving free or reduced-price lunches (** p < 0.01). ....	153
Table 6.7:	Correlations between fifth-grade student achievement scores and percentage of students receiving free or reduced-price lunches (** p < 0.01). ....	154
Table 6.8:	Correlations between BNL and third-grade student achievement scores for the closed-plan classrooms with consistent HVAC conditions (** p < 0.01). ....	157

Table 6.9:	Correlations between BNL and fifth-grade student achievement scores for the closed-plan classrooms with consistent HVAC conditions (* $p < 0.05$ ; ** $p < 0.01$ ).....	158
Table 6.10:	Regression results predicting Terra Nova language scores for the closed-plan fifth-grade classrooms with consistent HVAC conditions (* $p < 0.05$ ; ** $p < 0.01$ ). .....	162
Table 6.11:	Regression results predicting Terra Nova reading scores for the closed-plan fifth-grade classrooms with consistent HVAC conditions (* $p < 0.05$ ). .....	163
Table 6.12:	Regression results predicting State Accountability reading scores for the closed-plan fifth-grade classrooms with consistent HVAC conditions (* $p < 0.05$ ). .....	165
Table 6.13:	Cooling BNLs corresponding to fifth-grade Nebraska State Accountability reading test scores and student performance levels predicted by equation* from regression model calculated with closed-plan classrooms with consistent HVAC conditions.....	165
Table 6.14:	Regression results predicting State Accountability reading scores for the closed-plan fifth-grade classrooms with consistent HVAC conditions (** $p < 0.01$ ). .....	166
Table 6.15:	Correlations between RT and student achievement scores for all third-grade classrooms surveyed (** $p < 0.01$ ). .....	167
Table 6.16:	Correlations between RT and student achievement scores for all fifth-grade classrooms surveyed (** $p < 0.01$ ). .....	168
Table 6.17:	Correlations between acoustical metrics for classrooms in which BRIR measurements were conducted (* $p < 0.05$ ; ** $p < 0.01$ ). .....	172
Table 6.18:	Correlations between RT, BNL, and STI for 12 of the third and fifth-grade classrooms (* $p < 0.05$ ; ** $p < 0.01$ ).....	174
Table 6.19:	Correlations between STI and student achievement scores for 12 of the third and fifth-grade classrooms (* $p < 0.05$ ; ** $p < 0.01$ ). .....	175
Table 6.20:	Correlations between RT, BNL, and DFSM for 20 of the third and fifth-grade classrooms (* $p < 0.05$ ; ** $p < 0.01$ ). .....	177
Table 6.21:	Correlations between DFSM and student achievement scores for 20 of the third and fifth-grade classrooms (** $p < 0.01$ ).....	179
Table 6.22:	Correlations between RT, BNL, and $IACC_E$ for 20 of the third and fifth-grade classrooms (** $p < 0.01$ ).....	183

Table 6.23:	Correlations between $IACC_E$ and student achievement scores for 20 of the third and fifth-grade classrooms (* $p < 0.05$ ; ** $p < 0.01$ ). .....	184
Table 6.24:	Correlations between RT, BNL, and ILD for 20 of the third and fifth-grade classrooms (** $p < 0.01$ ). .....	187
Table 6.25:	Correlations between ILD and student achievement scores for 20 of the third and fifth-grade classrooms (* $p < 0.05$ ; ** $p < 0.01$ ). .....	188
Table A1.1:	Dummy head receiver speech transmission index values. ....	206
Table A1.2:	Human head receiver speech transmission index values. ....	206
Table A1.3:	Difference between dummy head receiver and human head receiver speech transmission index values. ....	207
Table A1.4:	Dummy head receiver distortion of frequency-smoothed magnitude values. ....	207
Table A1.5:	Human head receiver distortion of frequency-smoothed magnitude values. ....	208
Table A1.6:	Difference between dummy head receiver and human head receiver distortion of frequency-smoothed magnitude values. ....	208
Table A1.7:	Dummy head receiver interaural cross-correlation (early) values. ....	209
Table A1.8:	Human head receiver interaural cross-correlation (early) values. ....	210
Table A1.9:	Difference between dummy head receiver and human head receiver interaural cross-correlation (early) values. ....	211
Table A1.10:	Dummy head receiver interaural level difference values. ....	212
Table A1.11:	Human head receiver interaural level difference values. ....	213
Table A1.12:	Difference between dummy head and human head receiver ILDs. ...	214



## Glossary of Terms

**Background Noise Level (BNL):** Noise level in furnished, unoccupied space. BNL is typically measured in decibels (dB) with reference to 20  $\mu$ Pa.

**Distortion of Frequency-Smoothed Magnitude (DFSM):** Mean absolute difference between the reverberant frequency response and the pseudo-anechoic frequency response, measured in dB.

**Interaural Cross-Correlation (IACC):** Metric quantifying the similarity of the sound arriving at the two ears. Values range from 0 to 1, with high values relating to more highly correlated signals.

**Interaural Level Difference (ILD):** Difference in signal level between the two ears, measured in dB.

**Reverberation Time (RT):** The time it takes for sound to decay 60 dB, typically measured in seconds (s).

**Speech Transmission Index (STI):** Measure of speech intelligibility, which incorporates the negative effects of high background noise on intelligibility. Values range from 0 to 1, with high values indicating good speech intelligibility.

# Chapter 1

## Introduction

### 1.1 Background

Though the importance of enhancing education for school children is widely recognized, the elements of classroom learning environments necessary for optimizing student achievement are not clearly defined. While many aspects may impact elementary student learning, research has shown the physical characteristics of classrooms are a contributing factor (Lanham III 1999). Particularly, good indoor environmental quality is important for the comfort and learning of school children (Mendell and Heath 2005). Other research indicates that student achievement and performance may be negatively impacted by high levels of occupied background noise (Dockrell and Shield 2006; Shield and Dockrell 2008), and there is some evidence that higher unoccupied noise levels lead to higher occupied noise levels in classrooms (Sato and Bradley 2008). Since mechanical systems are often used to create high-quality indoor environments, the impacts of the noise levels generated by these systems on student learning should be further investigated.

It has been shown that speech intelligibility is dramatically reduced by high levels of background noise, particularly for young listeners (Elliott 1979; Bradley and Sato 2008). Yet, high background noise levels have been documented in several existing elementary schools (Knecht et al. 2002; Shield and Dockrell 2004; Choi and McPherson 2005). Similarly, long room reverberation times can degrade speech

intelligibility for young school children (Yang and Bradley 2009). Currently, the ANSI S12.60 Standard on classroom acoustics specifies a maximum unoccupied background noise level of 35 dBA and reverberation time of 0.6 s in each octave band from 500 to 2000 Hz for classrooms with volumes less than 283 m<sup>3</sup> based on requirements for appropriate speech intelligibility (ANSI/ASA 2010). However, research is lacking that indicates if meeting this standard translates into measurable student achievement gains. As such, more work is necessary to determine the effects of unoccupied background noise and reverberation time on student achievement and learning, since these unoccupied acoustical parameters are typically specified in the design and construction phases of buildings.

Furthermore, other acoustical metrics have been developed that focus on quantifying the perception of sound by the human ear. Previous research has compared how different room acoustics metrics, such as the speech transmission index, the useful-to-detrimental ratio, and the percent articulation loss of consonants, relate to speech intelligibility (Bradley 1998). Another investigation examined perception-based monaural and binaural metrics in a typical classroom (Shinn-Cunningham et al. 2005). The metrics examined by Shinn-Cunningham et al. (2005) include frequency-to-frequency fluctuations, distortion of frequency-smoothed magnitude, interaural level differences, interaural time differences, and cross-correlations. Research considering relationships between these additional perception-based metrics and student achievement is needed.

The goal of this dissertation is to determine what unoccupied classroom acoustical conditions impact student learning by assessing the relationships between

measured classroom acoustical parameters and standardized student achievement scores. This research was conducted in 28 elementary schools in two midwestern United States public school systems. Acoustical measurements were made in second, third, fourth, and fifth-grade classrooms in these schools and correlated to the standardized student achievement test results from students in the surveyed classrooms.

## **1.2 Dissertation Outline**

Chapter 2 of this dissertation provides a review of research pertaining to the following acoustical metrics: background noise level (BNL), reverberation time (RT), speech transmission index (STI), distortion of frequency-smoothed magnitude (DFSM), frequency-to-frequency fluctuations, interaural cross-correlation (IACC), and interaural level difference (ILD). Descriptions of previous investigations relating BNL to student achievement are included. The chapter discusses how BNL, RT, and STI convey speech intelligibility. The impacts of DFSM, frequency-to-frequency fluctuations, IACC, and ILD on source localization are also expressed.

An investigation of the effects of room form and finishes, receiver location, and source rotation on acoustical metrics including DFSM and ILD is described in Chapter 3. The four spaces selected for this research had a wide range of shapes and RTs. The results indicate how DFSM and ILD are impacted by these factors, as well as source rotation and receiver location with respect to hard, reflective room surfaces.

Chapter 4 explains the statistical methods used for data analyses relating classroom acoustical metrics to standardized student achievement scores, as performed on data contained in Chapters 5 and 6. Chapter 5 details an acoustical

study conducted in elementary school classrooms in an Iowa public school district. Methods and results from unoccupied BNL, RT, and binaural room impulse response (BRIR) measurements are presented. The BNL measurements were conducted with the mechanical systems operating in either the heating or cooling mode. Chapter 6 describes methods and results from a similar study conducted in a Nebraska public school district. In this school district, BNL measurements were acquired with the mechanical systems operating in both the heating and cooling modes, and BRIRs were gathered in a greater number of classrooms.

A summary of this dissertation and main conclusions are conveyed in Chapter 7. Recommendations for classroom design based on the research outcomes are presented. Areas requiring further investigation are also referenced.

## Chapter 2

### Previous Research: Acoustical Metrics

#### 2.1 Introduction

Reverberation time (RT) is one of the earliest acoustical metrics developed to quantify room effects on speech intelligibility. This metric was investigated by Wallace Clement Sabine from 1895 to 1900 based on experiments in a lecture hall (Thompson 2002), and it is still used today to characterize room acoustics. Another common metric for quantifying the acoustical condition of classrooms is background noise level (BNL). Both of these metrics may be measured by using one microphone for the receiver, which corresponds to the signal a person would perceive at one ear. This type of metric is referred to as a monaural metric.

Because the human auditory system processes sound in a complex way, more sophisticated acoustical metrics have also been developed that quantify how sound is perceived by human listeners. Some of these metrics, such as the speech transmission index (STI), distortion of frequency-smoothed magnitude (DFSM), and frequency-to-frequency fluctuations, were introduced as monaural metrics (Houtgast and Steeneken 1985; Shinn-Cunningham et al. 2005). However, the auditory system uses the information it receives in both ears to fully process and understand incoming signals (Moore 2004). Therefore, acoustical metrics have been developed to quantify the signal as it is perceived by both ears. These are referred to as binaural metrics and are

calculated from impulse response measurements made with two microphones placed at the entrances to the ear canals on a human-shaped head. These binaural metrics include interaural cross-correlations (IACC) and interaural level differences (ILD). Also, differences between the left and right ear monaural perception-based metrics quantify any differences occurring in the signal between the two ears, which may relate to how the overall signal is processed by the brain.

This chapter describes all of these metrics in greater detail and provides a summary of previous research related to these metrics.

## **2.2 Background Noise Level**

Background noise level (BNL) directly impacts speech intelligibility due to its relationship to the signal-to-noise ratio (SNR). Bradley and Sato (2008) conducted speech recognition tests in 41 elementary school classrooms containing students ranging from 6 to 11 years old. The researchers found that a minimum SNR of approximately +20 dB is required for the youngest students to achieve 95% speech intelligibility or better. For typical teacher voice levels of approximately 60 dBA (Sato and Bradley 2008), the occupied BNL should be a maximum of 40 dBA to obtain a SNR required for good speech intelligibility for young students (Bradley and Sato 2008). Measurements in classrooms indicate occupied noise levels are on average 5 dBA greater than unoccupied BNLs, and occupied noise levels tend to increase with higher levels of ambient noise from building systems and other sources (Sato and Bradley 2008).

Noise levels exceeding 40 dBA have been measured in numerous elementary school classrooms. Picard and Bradley (2001) provide a summary of published noise level data in classrooms. This summary reports ambient noise levels with students engaged in normal quiet activity ranging from 52 to 75 dBA in elementary school classrooms. Unoccupied BNLs ranging from 34 to 66 dBA were measured in 32 elementary classrooms in central Ohio, USA (Knecht et al. 2002). In this investigation, all of the measurements of noise levels below 50 dBA were acquired with the heating, ventilating, and air-conditioning (HVAC) systems off.

Shield and Dockrell (2004) conducted noise level measurements in 30 unoccupied classrooms in primary schools in the UK. This study reports an average equivalent noise level ( $L_{Aeq}$ ) of 47 dBA and an average level exceeded 90% of the time ( $L_{A90}$ ) of 37 dBA. For these measurements, the heating system was operating in only seven of the 30 classrooms. Acoustical measurements were conducted in 47 primary school classrooms in Hong Kong with quiet students present (Choi and McPherson 2005). The average noise level among all of the classrooms was 61 dBA, with a range from 54 to 68 dBA. The research documents high BNLs in existing elementary and primary school classrooms.

While high noise levels can negatively impact speech intelligibility, the effect of BNL on student learning and achievement is another area of concern. Shield and Dockrell (2008) explored relationships between both occupied and unoccupied noise levels in primary schools and student performance on achievement tests. The researchers found a significant negative correlation between occupied noise levels in



classrooms and achievement test results. The English test scores for the older students (approximately 11 years old) were significantly correlated to occupied noise levels. Also, government targets for literacy and numeracy were not met in classrooms with occupied  $L_{A90}$  values above 50 dBA. Another study examined the effects of aircraft noise on reading performance via tests administered to school children ranging from 8 to 11 years old in Germany (Hygge et al. 2002). A new airport was constructed near one school, and an old airport was shut-down near another. The children's reading scores were negatively impacted when the new airport opened, and the reading scores improved for the children near the airport that was shut-down.

The current ANSI S12.60 Standard on classroom acoustics recommends a maximum BNL of 35 dBA and 55 dBC for classrooms with single mode HVAC systems (ANSI/ASA 2010). For classrooms containing multiple mode HVAC systems, a maximum BNL of 37 dBA and 57 dBC is specified in this standard. However, it is unclear if the unoccupied BNL requirements in this standard are linked to student achievement. More research is necessary to quantify this relationship.

### **2.3 Reverberation Time**

The reverberation time (RT) of a room is quantified as the amount of time it takes for an impulsive sound to decay 60 dB. Excessive reverberation may smear speech sources, adversely affecting speech intelligibility (Bistafa and Bradley 2000). However, some reverberation is beneficial in rooms, particularly for early reflections that reinforce the direct sound. This may increase the level of the direct sound,

improving speech intelligibility in the space (Bradley et al. 2003). Hodgson and Nosal (2002) emphasize the importance of considering the interaction of BNL on the resulting RT for optimal speech intelligibility. Their research suggests that longer RTs may be desired in spaces with higher BNLs for adequate speech intelligibility.

Reverberation times have been documented in numerous existing classrooms. Bradley (1986) measured RTs ranging from 0.39 to 1.20 s in the 1000 Hz octave band in ten occupied classrooms in Ottawa, Canada. The RTs in 32 unoccupied classrooms in Ohio, USA, were found to range from about 0.32 to 1.27 s (Knecht et al. 2002). Both occupied and unoccupied RT measurements were conducted in eight secondary school classrooms in Italy (Astolfi and Pellerey 2008). The occupied RT values averaged across the 500, 1000, and 2000 Hz octave bands ranged from 0.6 to 1.4 s, and the unoccupied RT values averaged across the 500, 1000, and 2000 Hz octave bands ranged from 0.9 to 2.6 s.

Yang and Bradley (2009) performed listening tests on school children with headphones under simulated classroom conditions with varying reverberation times. Their results suggest that elementary school classrooms should have reverberation times ranging from 0.3 to 0.9 s to create an acoustical environment necessary for adequate speech intelligibility.

The ANSI S12.60 Standard specifies that core learning spaces with volumes less than 283 m<sup>3</sup> should have a maximum reverberation time of 0.6 s in each octave band from 500 to 2000 Hz (ANSI/ASA 2010). However, research comparing unoccupied RTs in existing classrooms to student learning is needed.

## 2.4 Speech Transmission Index

Another metric developed to quantify the intelligibility of speech in rooms is the speech transmission index (STI) (Houtgast and Steeneken 1985). This metric incorporates the modulation transfer function (MTF) (Houtgast and Steeneken 1973) to calculate a one-number rating ranging from zero to one, which is the STI. The mathematical steps to calculate STI are shown in Equations 2.1 to 2.4 (Long 2006).

$$m(f_m) = \frac{1}{\sqrt{1 + \left[2\pi f_m \frac{T_{60}}{13.8}\right]^2}} \times \frac{1}{1 + 10^{(-0.1L_{SN})}} \quad (\text{Eq. 2.1})$$

Where:

$m(f_m)$  = modulation reduction factor

$L_{SN}$  = signal to noise level (dB)

$f_m$  = modulation frequency (Hz), ranges from 0.63 to 12.5 Hz in one-third octave intervals

$T_{60}$  = room reverberation time (s)

$$L_{SNapp} = 10 \log \frac{m}{1-m} \quad (\text{Eq. 2.2})$$

Where:

$L_{SNapp}$  = apparent signal to noise ratio (dB)

$m$  = modulation reduction factor

$$\overline{L_{SNapp}} = \sum_{i=1}^7 w_i (L_{SNapp})_i \quad (\text{Eq. 2.3})$$

Where:

$\overline{L_{SNapp}}$  = average apparent signal-to-noise ratio

$W_i$  = weighting for octave bands from 125 to 8000 Hz (0.13, 0.14, 0.11, 0.12, 0.19, 0.17, and 0.14)

$$STI = \frac{[\overline{L_{SNapp}} + 15]}{30} \quad (\text{Eq. 2.4})$$

This metric includes the negative effects of high background noise on speech intelligibility and gives more weight to the SNR occurring in octave bands more important for understanding speech. Speech intelligibility tests have shown that low STI values indicate poor speech intelligibility, and high values indicate good speech intelligibility (Houtgast and Steeneken 1985; Bradley 1986; Sato et al. 2008).

It has also been shown that STI predictions of speech intelligibility are similar to those predicted by the speech intelligibility index (Larm and Hongisto 2006). Another study found that STI, useful-to-detrimental ratios, and articulation loss of consonants are all accurate predictors of speech intelligibility (Bradley et al. 1999). STI values measured in 30 classrooms at the University of British Columbia ranged from 0.34 to 0.71 (Kennedy et al. 2006). Research in eight secondary school classrooms in Italy documented STI values ranging from 0.55 to 0.74 (Astolfi and Pellerey 2008).

Another version of STI has been developed, which uses the highest value of the MTF between the left and right ears in certain octave bands to calculate a binaural STI (van Wijngaarden and Drullman 2008). However, other research suggests that the auditory system is not able to select and integrate optimal information between ears to separate speech from interfering speech sources (Edmonds and Culling 2006).

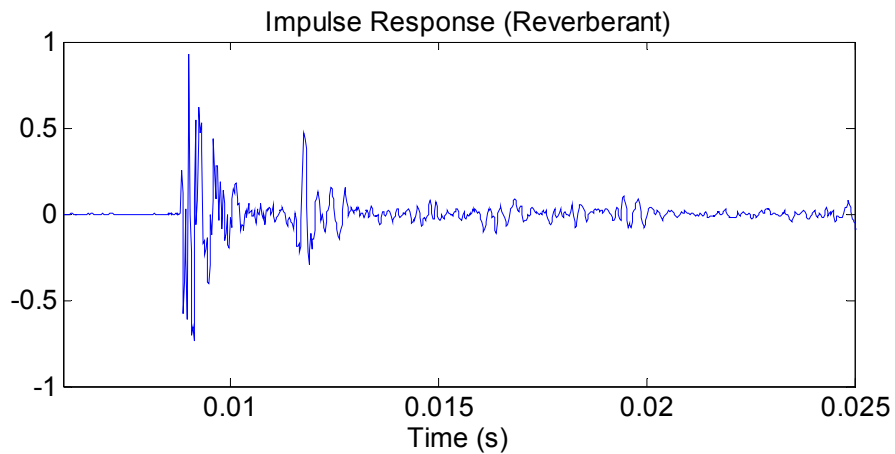
Rather, their results show that only the information arriving at the better-ear is used for this task. A rigorously validated model of binaural STI that may be readily implemented has not yet been finalized. Therefore, this research examines the magnitude of the difference in STI values between the left and right ears to quantify the similarity of the speech intelligibility information received between the two ears. By relating the left-to-right ear STI differences to student achievement in classrooms, an indication of listener ability to understand speech in cases where the two ears are receiving dissimilar intelligibility information may be provided.

## **2.5 Distortion of Frequency-Smoothed Magnitude**

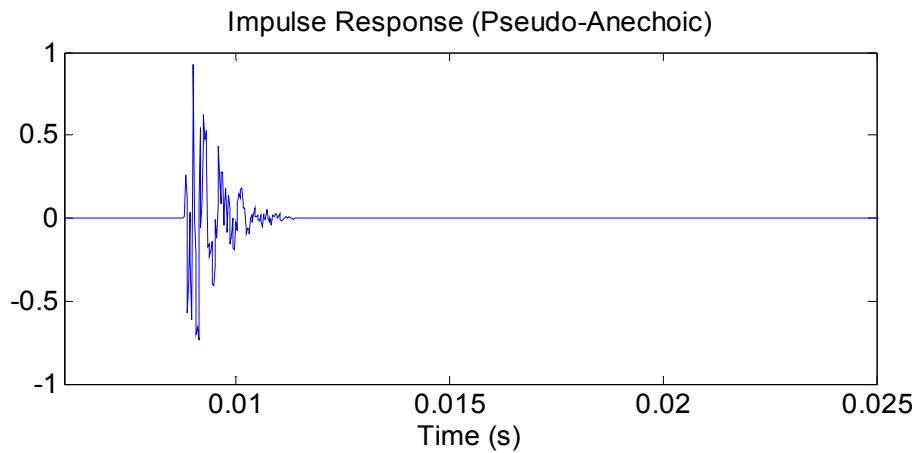
The distortion of the frequency-smoothed magnitude (DFSM) metric was developed by Shinn-Cunningham et al. (2005) to quantify how reverberant energy distorts the spectral content of the incoming signal. This metric is calculated from the frequency response of a room. The frequency-smoothed reverberant frequency response is compared to a corresponding frequency-smoothed ‘pseudo-anechoic’ frequency response. The pseudo-anechoic frequency response is calculated from the time-windowed impulse response to eliminate all reflections occurring after the direct sound.

An example of a reverberant impulse response measured in a classroom with a JBL LSR6325P-1 loudspeaker as the source is shown in Figure 2.1. The corresponding time-windowed impulse response that eliminates the reflections from surfaces in the room occurring after the direct sound is shown in Figure 2.2. As shown in Figure 2.2, small fluctuations occur in the pseudo-anechoic impulse

response immediately following the direct sound. These fluctuations may be resulting from the impulse response of the loudspeaker, since they occur too close in time to the direct sound to be reflections from room surfaces.

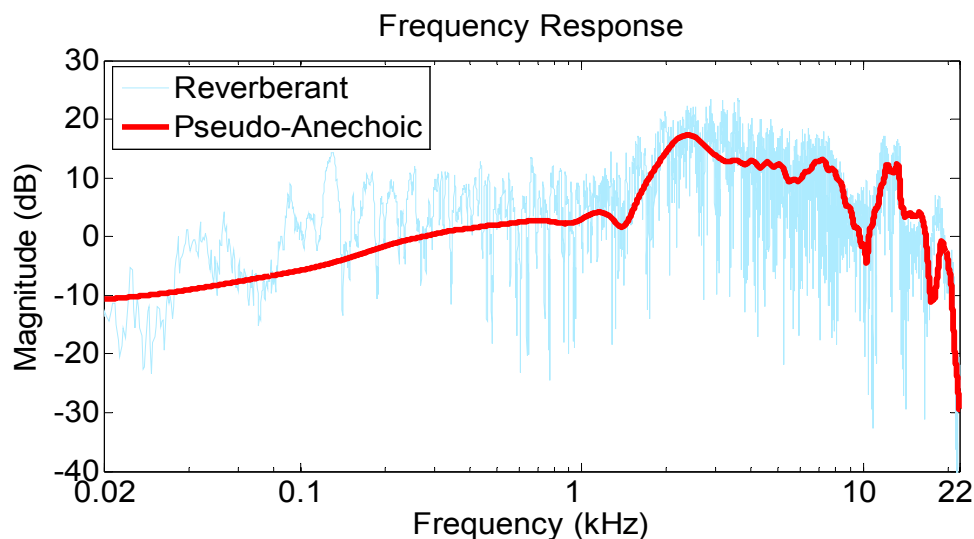


**Figure 2.1:** Reverberant impulse response.



**Figure 2.2:** Pseudo-anechoic impulse response.

Figure 2.3 presents an overlay of the frequency-smoothed reverberant and pseudo-anechoic frequency responses calculated from the impulse responses shown in Figures 2.1 and 2.2. The spectral level of the pseudo-anechoic frequency response is subtracted from the level of the reverberant frequency response. The absolute value of this difference is computed in each one-third octave band and averaged across frequency. This mean absolute difference between the frequency-smoothed reverberant and pseudo-anechoic impulse responses is the DFSM. Because the frequency response of the loudspeaker is included in both the reverberant and pseudo-anechoic frequency responses, this does not impact the mean absolute difference calculated.



**Figure 2.3:** Reverberant and pseudo-anechoic frequency responses.

More details on the DFSM calculation procedure may also be found in Shinn-Cunningham et al. (2005). Localization bias, wherein the listener perceives an

incorrect source location, may result if more spectral distortion occurs (Shinn-Cunningham et al. 2005). This condition corresponds to higher DFSM values.

Research investigating the impact of monaural and interaural spectral cues on source localization has been conducted (Jin et al. 2004). Their results show that reliable interaural spectral cues are not sufficient for localization when the two ears are receiving signals with very different spectral content. Also, their outcomes indicate that a listener cannot use monaural spectral cues to correctly locate the source if interaural spectral cues do not exist.

Shinn-Cunningham et al. (2005) performed binaural room impulse response measurements in a typical classroom for varying receiver positions and nearby source distances, up to 1 meter away from the source. The mean absolute difference between the reverberant and pseudo-anechoic measurements reported in this study range from approximately 0 to 10 dB (re: Anechoic). Differences between the left and right ear DFSM may be calculated to quantify the similarity of the distortion of the spectral content perceived between the two ears. The present research will relate differences between the left and right ear DFSM to standardized student achievement scores, which may indicate how differences in DFSM between the two ears impact the listener's ability to determine the correct source location.

## **2.6 Frequency-to-Frequency Fluctuations**

The frequency-to-frequency fluctuation metric was introduced by Shinn-Cunningham et al. (2005) to quantify the across-time fluctuations caused by reverberant energy in rooms. If more fluctuations occur in the signal received by the



ears, then the listener may have greater difficulty judging the correct source location (Shinn-Cunningham et al. 2005). This metric is defined as the average difference in level occurring between two adjacent frequencies. It is calculated in dB/Hz by taking the average of the absolute value of the derivative of a room frequency response. The full calculation procedures are detailed in Shinn-Cunningham et al. (2005). The magnitude of the difference in frequency-to-frequency fluctuations occurring between the two ears may also be calculated to quantify differences in localization cues occurring between the left and right ears.

Shinn-Cunningham et al. (2005) reported frequency-to-frequency fluctuation values for a typical classroom ranging from 0 to 1.5 dB/Hz. In their investigation, the frequency-to-frequency fluctuations were found to be significantly inversely correlated to the clarity index ( $C_{80}$ ). Higher frequency-to-frequency fluctuation values occur for lower values of clarity.

## **2.7 Interaural Cross-Correlation**

The interaural cross-correlation (IACC) metric was developed to quantify the subjective diffuseness or spatial impression in rooms (Ando 1977; Ando and Kurihara 1986). IACC values range from zero to one, with lower values indicating low levels of signal correlation between the two ears, which corresponds to a subjective impression of increased diffuseness. High IACC values indicate high levels of signal correlation between the two ears, which corresponds to lower spatial impression. The IACC is calculated from the interaural cross-correlation fraction (IACF), detailed in Equations 2.5 and Eq. 2.6 (Long 2006).

$$IACF_t(\tau) = \frac{\int_{t_1}^{t_2} p_L(t)p_R(t+\tau)dt}{\sqrt{\int_{t_1}^{t_2} p_L^2(t) \int_{t_1}^{t_2} p_R^2(t)dt}} \quad (\text{Eq. 2.5})$$

Where:

$p_L$  = sound pressure at the entrance of the left ear canal

$p_R$  = sound pressure at the entrance of the right ear canal

$t_1$  = arrival time of direct sound at one ear

$t_2$  = end of time interval selected for evaluation

$\tau$  = range from -1 to +1 ms from the arrival time of the direct sound

$$IACC_t = |IACC_t(\tau)|_{max} \quad \text{for } -1 < \tau < +1 \quad (\text{Eq. 2.6})$$

$IACC_{E3}$  (IACC averaged across the 500, 1000, and 2000 Hz octave bands for the first 80 ms of the impulse response) values relate to subjective preferences of the acoustical quality of concert halls (Hidaka et al. 1995). In general, concert halls with lower IACC values were given higher ratings for subjective impression of symphonic performances.

Other studies have related IACC to image shift (Okano 2000) and apparent source width (Okano et al. 1998). Okano (2000) found that if the IACC values are too small, an image shift may occur, wherein the listener perceives the source to be in different location than its actual location. The results indicate  $IACC_{E3}$  values should be above 0.15 to reduce the occurrence of image shift in concert halls. The relation of IACC to apparent source width was investigated by Okano et al. (1998). Apparent source width is the subjective impression of the auditory width of the source. Okano

et al. (1998) found that the apparent source width increases and  $IACC_{E3}$  decreases until the number of early lateral reflections reaches approximately ten.

The just noticeable difference (JND) of IACC values has been investigated for a musical source signal (Okano 2002). This study found the JND of  $[1 - IACC_{E3}]$  to be  $0.065 \pm 0.015$  for  $[1 - IACC_{E3}]$  values ranging from 0.4 to 0.8. Other research has quantified the difference between IACC values measured with microphones located at the ear canal entrances on human heads versus a dummy head (Nakajima et al. 1993). Seven different human heads and a Brüel and Kjaer type 5390 dummy head were used for this experiment. The results show that IACC values measured on human heads are similar to IACC values measured on dummy heads.

Much of the research to develop the IACC metric and its relation to subjective impression has focused on musical sources in large concert halls. However, Shinn-Cunningham et al. (2005) applied this type of metric to measurements within a typical classroom space to quantify the systematic changes to interaural time delay caused by reverberation in the room. Cross-correlation values were computed from binaural impulse response measurements, using a calculation procedure similar to that used to calculate IACC. The cross-correlation values were lower in the reverberant room than in the corresponding pseudo-anechoic condition. Also, the lowest cross-correlation values occurred for the  $90^\circ$  source azimuth relative to the receiver for both the reverberant and pseudo-anechoic conditions.

## 2.8 Interaural Level Difference

Interaural level differences (ILD) are calculated by taking the difference in signal level between the left and right ears. Jeffress and McFadden (1971) found that ILDs are one cue that listeners use for source detection and lateralization. Yost (1991) evaluated the effect of varying ILDs on the listener's ability to segregate a narrow-band from a broadband stimulus. The results suggest the ear is most sensitive to ILDs presented at 500 Hz, and ILDs are more effective at segregating noise from the source as the bandwidth of the noise increases. Another study examined the usefulness of ILDs in determining the apparent lateral angle of the source (Macpherson and Sabin 2007). One outcome indicates that ILD is the primary cue for determining the lateral angle of high-pass stimuli presented from 4000 to 16,000 Hz.

The JND of ILD has been investigated with uncorrelated one-third octave band noise sources (Francart and Wouters 2007). The JND of ILD for sources with the same frequency content presented to the two ears was found to be 2.6, 2.6, 2.5, and 1.4 dB for 250, 500, 1000, and 4000 Hz respectively. Shinn-Cunningham et al. (2005) reported ILDs in a typical classroom for nearby sound sources. The magnitude of the ILDs measured in one-third octave bands ranged from approximately 0 to 45 dB. The greatest ILDs occurred at higher frequencies with the source located at a 90° azimuth relative to the receiver.

## **2.9 Conclusions**

This chapter has provided a description of the acoustical metrics that are presented in Chapters 5 and 6 of this dissertation from measurements in elementary school classrooms. The monaural metrics include BNL, RT, STI, DFSM, and frequency-to-frequency fluctuations. The binaural metrics include IACC, ILD, and differences between the left and right ear STI, DFSM, and frequency-to-frequency fluctuations. More research is needed to determine which of these metrics may relate to student achievement.

## **Chapter 3**

# **Effects of Room Form and Finishes, Receiver Location, and Source Rotation on Perception-based Acoustical Metrics**

### **3.1 Introduction**

This chapter describes the effects of room shape, reverberation, source rotation, and receiver position on perception-based acoustical metrics, such as distortion of frequency-smoothed magnitude (DFSM) and interaural level differences (ILD), calculated from measured binaural room impulse responses (BRIR). Previous research examining perception-based binaural metrics in a typical classroom is presented. Conclusions from this previous research are related to findings from measured BRIRs in spaces with varying shapes and reverberation times (RT). The DFSM and ILD metrics presented in this chapter are included in the classroom studies described in Chapters 5 and 6 of this dissertation.

### **3.2 Previous Research**

Previous research has investigated the effects of receiver and source positions on measured BRIRs for nearby sources within a typical classroom (Shinn-Cunningham et al. 2005). The broadband RT of the rectangular room tested was approximately 0.6 s. The receiver was placed in three locations: near the center of the room, near a side wall, and near the corner of the room for the measurements. The source was located 0.15, 0.40, and 1 m away from the receiver at each position to

simulate typical conversation distances. The source was placed at different azimuths around the receiver, varying from directly in front of the receiver ( $0^\circ$  source azimuth) to the right side of the receiver ( $90^\circ$  source azimuth). The right ear tended to receive more direct sound than the left ear as the source azimuth increased from  $0^\circ$  to  $90^\circ$ .

BRIR measurements were conducted using a Knowles Electronics Manikin for Acoustic Research (KEMAR) at the receiver position for each of these different configurations.

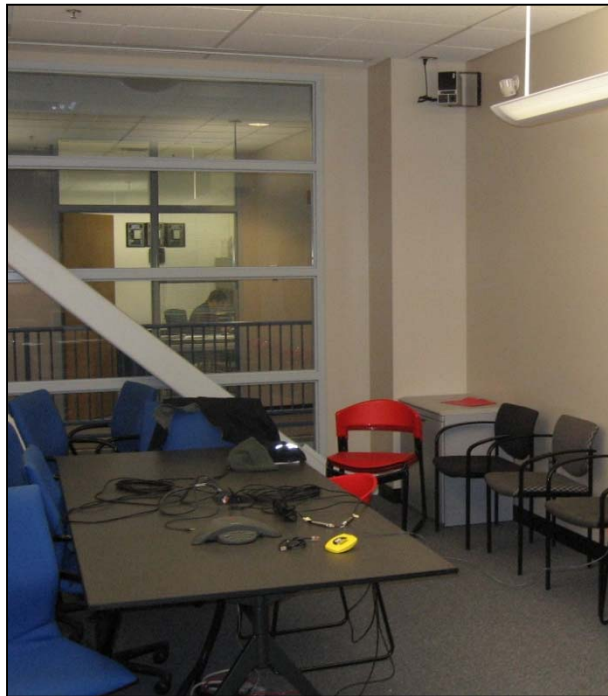
Shinn-Cunningham et al. (2005) calculated perception-based acoustics metrics from the measured BRIRs, including DFSM and ILD. The DFSM metric is most impacted by the presence of energy from early strong reflections relative to the energy from the direct sound, so its magnitude is greater and increases more dramatically with source azimuth in conditions with early reflections. The ILD magnitude tends to be smallest for conditions with more reverberant energy, increasing with higher frequencies.

### **3.3 Methods**

Previously, Shinn-Cunningham et al. (2005) measured BRIRs for various receiver and source positions within a single space. To determine if the results from their study are applicable to spaces with varying shapes and RTs, BRIR measurements were conducted in four different spaces. The spaces investigated and measurement procedures are described in this section.

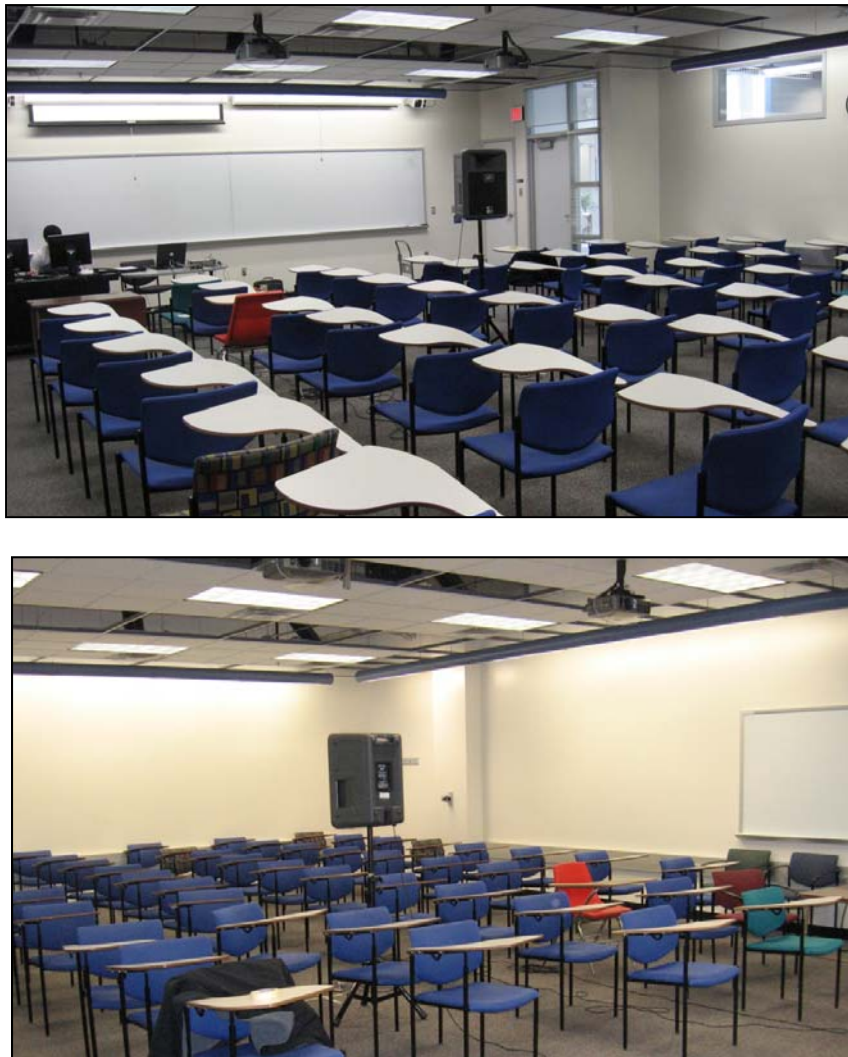
### 3.3.1 *Space Descriptions*

The spaces tested include a conference room, classroom, theater, and concert hall. Both the conference room and classroom have primarily rectangular shapes, with thin carpet on the floor, gypsum board walls, and acoustical ceiling tile. The conference room was furnished with a large table surrounded by upholstered chairs. See Figure 3.1 for a view of this space. The classroom contained several student desks attached to upholstered chairs and a large desk at the front of the space. Figure 3.2 presents views of this classroom. Both the conference room and the classroom are located in the Peter Kiewit Institute at the University of Nebraska in Omaha, NE.



**Figure 3.1:** View of conference room space tested.





**Figure 3.2:** Views of classroom space tested.

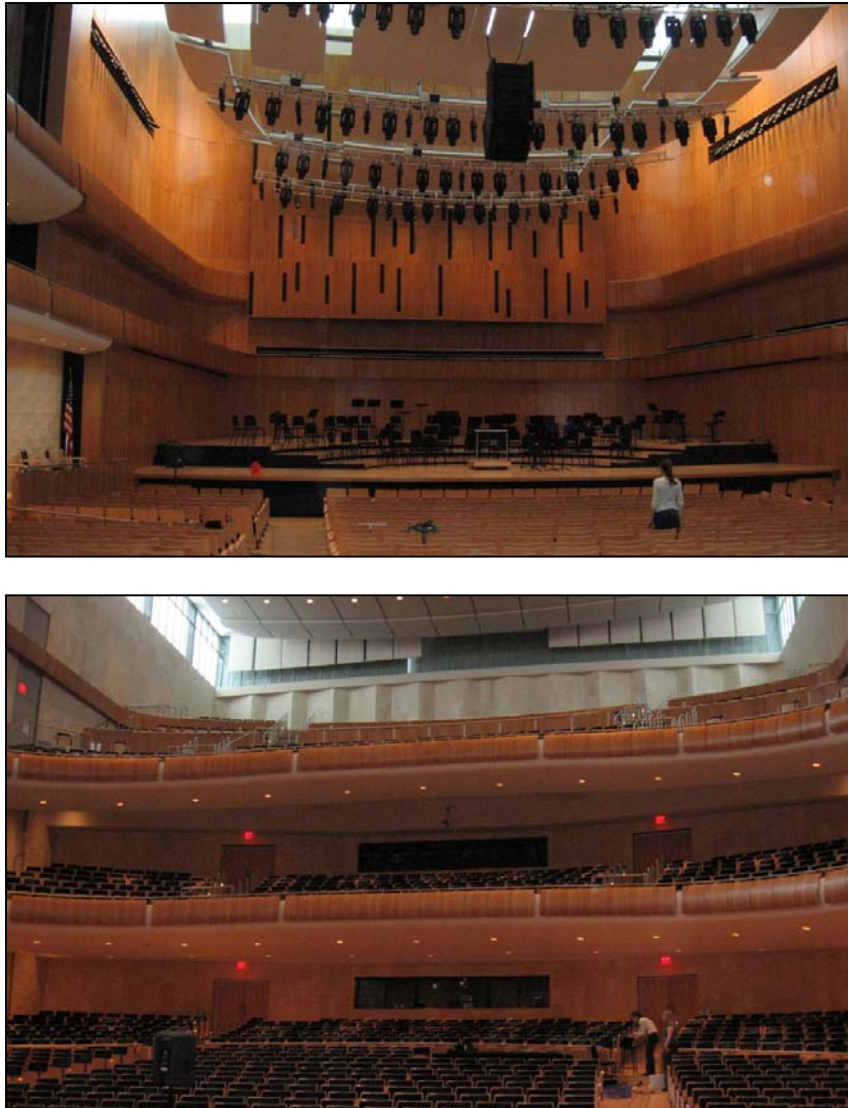
The theater is the main stage theater in the Lied Education Center for the Arts at Creighton University in Omaha, NE. This space may be viewed in Figure 3.3. The theater has a fan-shaped seating area, shallow balcony along the rear and side walls, and a stage house. The surface materials include concrete walls, wood ceiling, thin carpet on the floor aisles, and upholstered seating.



**Figure 3.3:** Views of theater space tested.

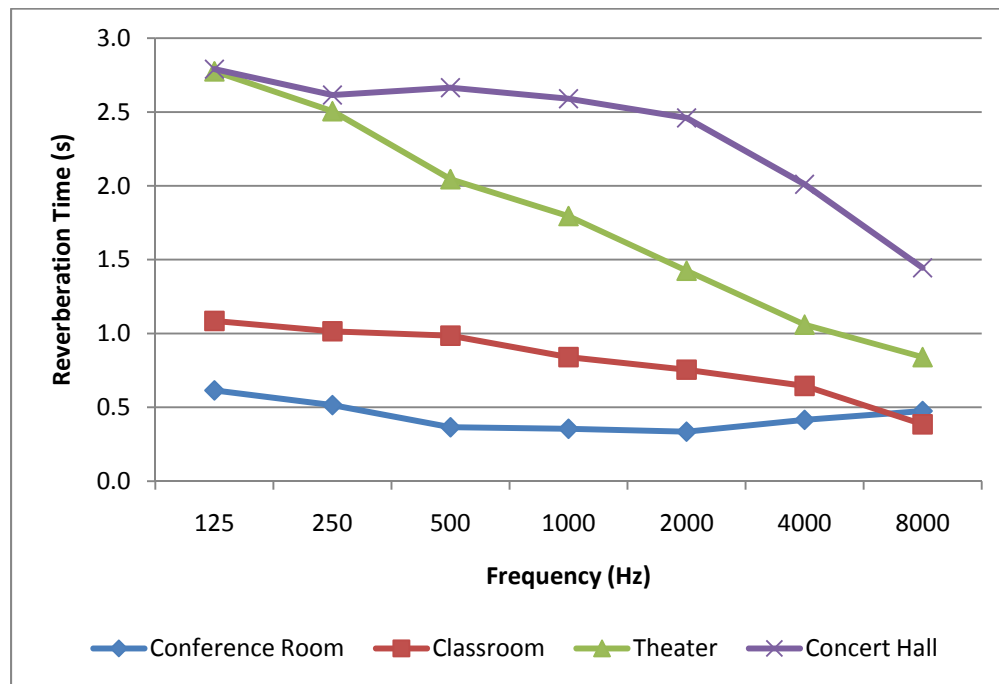
The concert hall is the Peter Kiewit Concert Hall in the Holland Performing Arts Center in Omaha, NE. This is the largest space examined, with two stacked balconies along the back wall and two stacked shallow balconies along the side walls. The stage is open to the seating area, with a floating reflector panel above. The room

finishes include upholstered seating with hard wood and concrete floor surfaces. The walls are comprised of hard surfaces with shallow indentations to provide diffusion, partially covered by absorptive panels. The ceiling is a hard, convex surface. Figure 3.4 contains views of the hall configuration when the measurements were conducted.



**Figure 3.4:** Views of concert hall space tested.

The RTs of the conference room, classroom, theater, and concert hall are shown in Figure 3.5, with mid-frequency averages across 500 and 1000 Hz ranging from 0.4 to 2.6 s. The RTs shown in this figure are the  $T_{20}$  values in each octave band from 125 to 8000 Hz, measured as detailed in Section 3.3.2. The RTs increase from the conference room to the classroom to the theater to the concert hall.



**Figure 3.5:** Octave band reverberation time ( $T_{20}$ ) values for the four spaces tested.

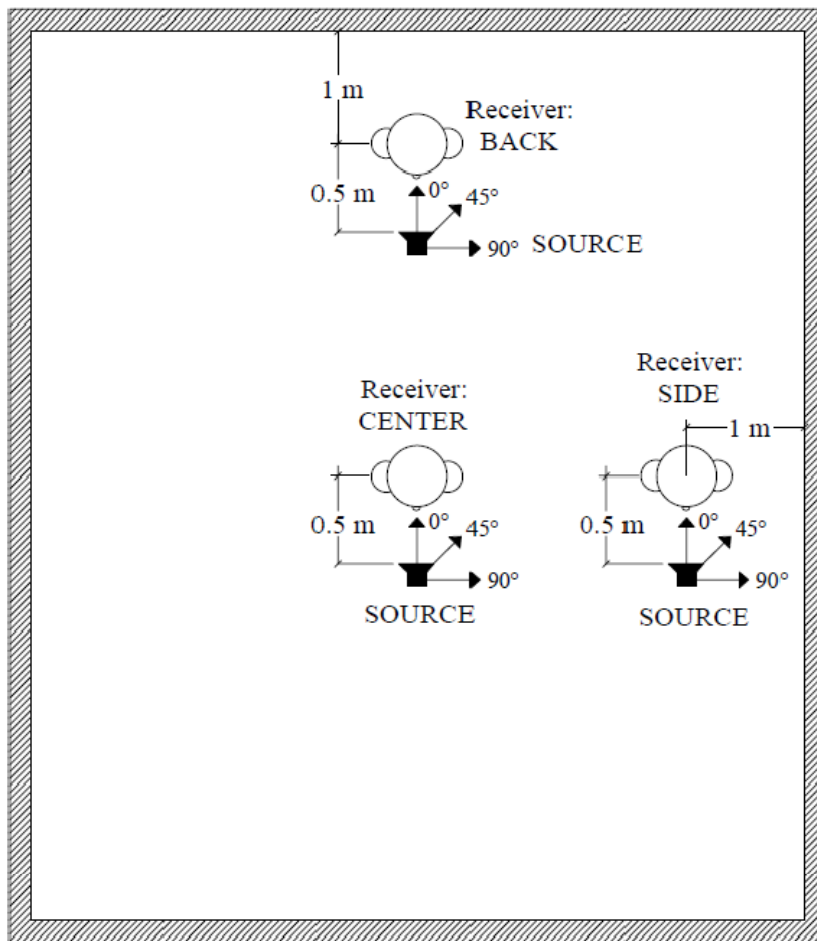
### 3.3.2 Measurement Procedures

The BRIRs were generated and recorded using the Electronic and Acoustic System Evaluation and Response Analysis (EASERA) room acoustics analysis software, operating on a notebook computer. The notebook computer was connected

to an EASERA Gateway, which served as the soundcard for the measurements. A pink-weighted logarithmic sweep with two presents and four averages was used to excite each space. The signals were generated by a directional Peavey PR 12 loudspeaker and recorded via a Brüel and Kjaer Type 4104 binaural microphone headset, placed on an adult female human head. The Peavey PR 12 loudspeaker has a frequency range (-10 dB, half space) from 54 Hz to 21 kHz, with a nominal coverage pattern of 90° by 40°, according to specifications provided by the manufacturer. The level of the signal was standardized among spaces by setting the level of pink noise generated to 70 dBA (re: 20  $\mu$ Pa), recorded one meter away from the source.

For all of the measurements, the source was placed approximately 0.5 m in front of the receiver, simulating a typical conversation distance. The distance between the floor and the receiver microphones was approximately 1.57 m, which was the distance from the ear level of the standing adult female to the floor. The middle of the source loudspeaker was approximately 1.52 m above the floor, so that the loudspeaker was at a height similar to the receiver microphone height. In each space, the receiver was located near the center, one meter away from a side wall, and one meter away from the back wall for the measurements. In each location, measurements were made for three different source rotations: 0 degrees, 45 degrees, and 90 degrees from the receiver. The receiver was facing directly toward the source in each condition. See Figure 3.6 for schematic plan view of the different source rotations and receiver positions tested. A view of the back receiver position, 0° source rotation measurement configuration in the theater space is shown in Figure

3.7. In the theater space, the measurements were repeated three times in each location for each source rotation to quantify the measurement repeatability.



**Figure 3.6:** Plan view of source rotations and receiver positions used in each space (not to scale).



**Figure 3.7:** View of measurement configuration for back receiver position,  $0^\circ$  source rotation in theater space.

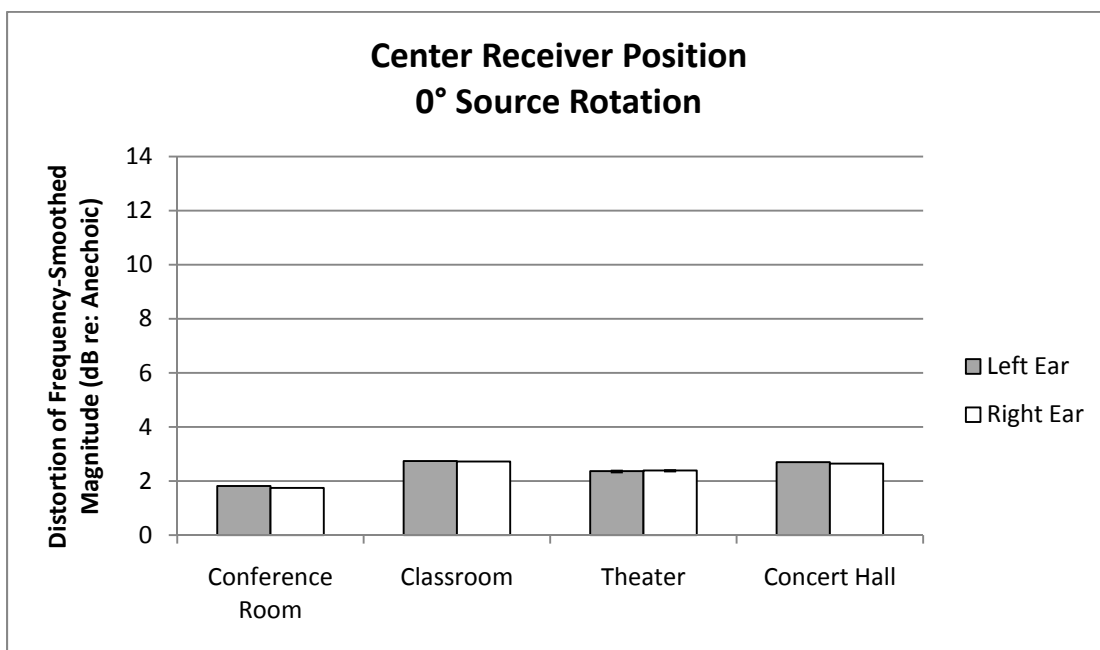
### 3.4 Results and Discussion

The acoustical metrics calculated from the measured BRIRs include DFSM and ILD.

#### *3.4.1 Distortion of Frequency-Smoothed Magnitude*

The DFSM metric is calculated as the mean absolute difference between the frequency-smoothed reverberant and pseudo-anechoic measurements. Full details on this calculation procedure may be found in Chapter 2 of this dissertation and in Shinn-Cunningham et al. (2005).

Comparisons of the DFSM among the four spaces are shown in Figures 3.8, 3.9, 3.10, and 3.11. These figures show the values measured at both the left (gray bars) and right ears (white bars). The error bars depict the range about the average value from the three sets of repeated measurements conducted in the theater space. Figure 3.8 shows the DFSM for the center receiver position with the source directly facing the receiver ( $0^\circ$  source rotation). For this configuration, the DFSM values are approximately equivalent between the two ears and among the four spaces.

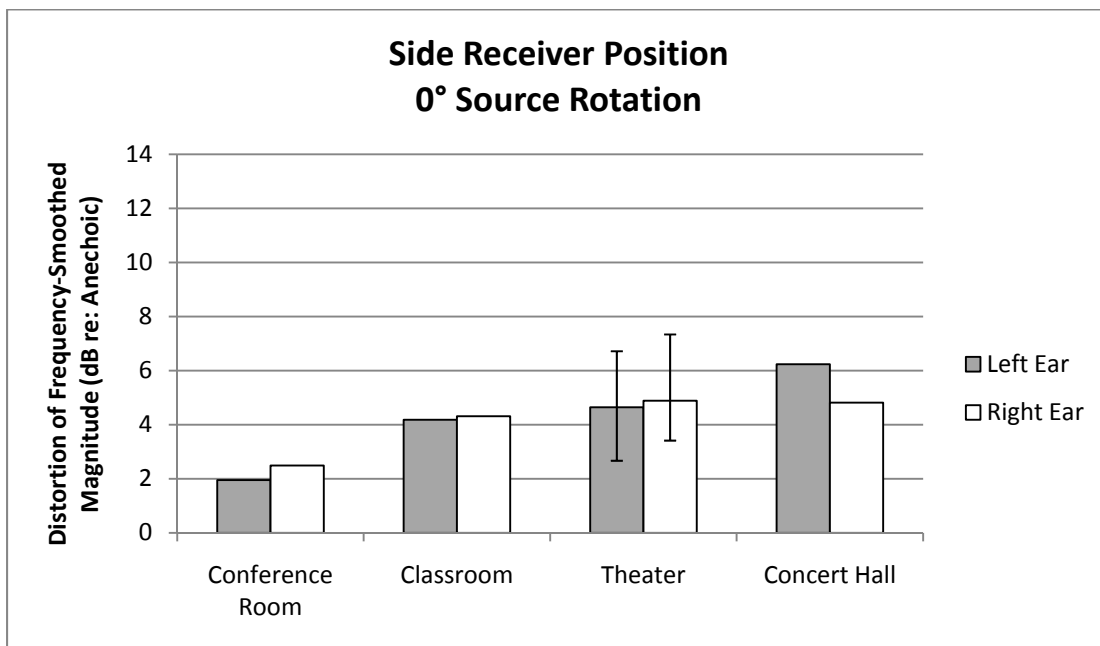


**Figure 3.8:** Distortion of frequency-smoothed magnitude for center receiver position,  $0^\circ$  source rotation. Error bars for theater space show the range about the average value from the three sets of repeated measurements.

Figure 3.9 displays the DFSM values for the side receiver position,  $0^\circ$  source rotation. For this condition, a strong reflection from the side wall is present, which is

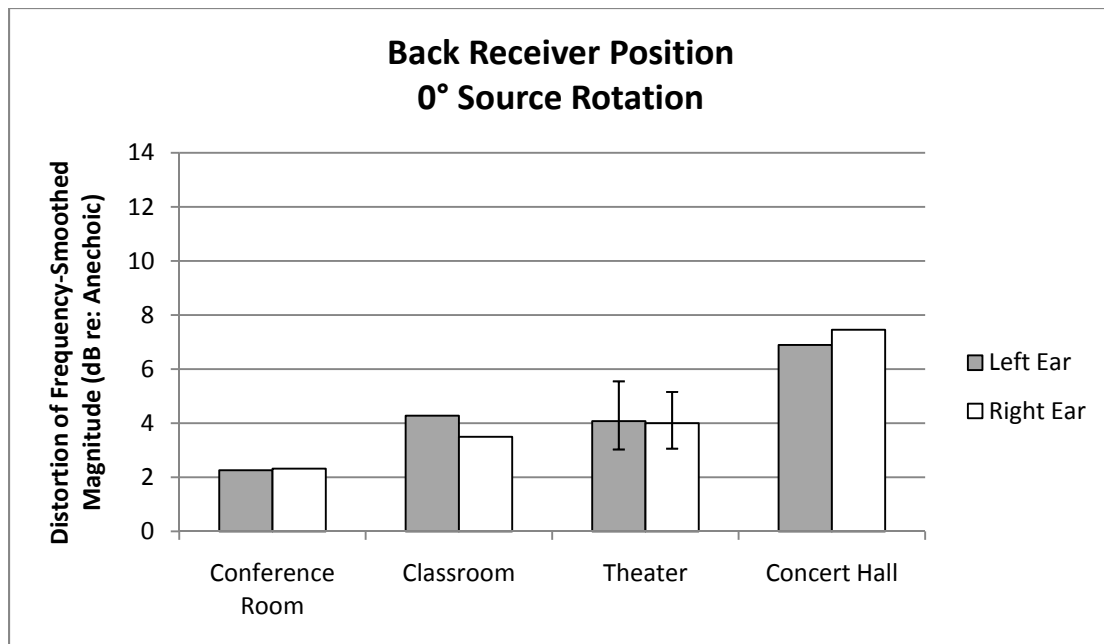


closest to the left ear. In this configuration, the DFSM values tend to increase with increasing room reverberation time, and the DFSM value is greater in the left ear than the right ear for the space with the longest reverberation time (concert hall).



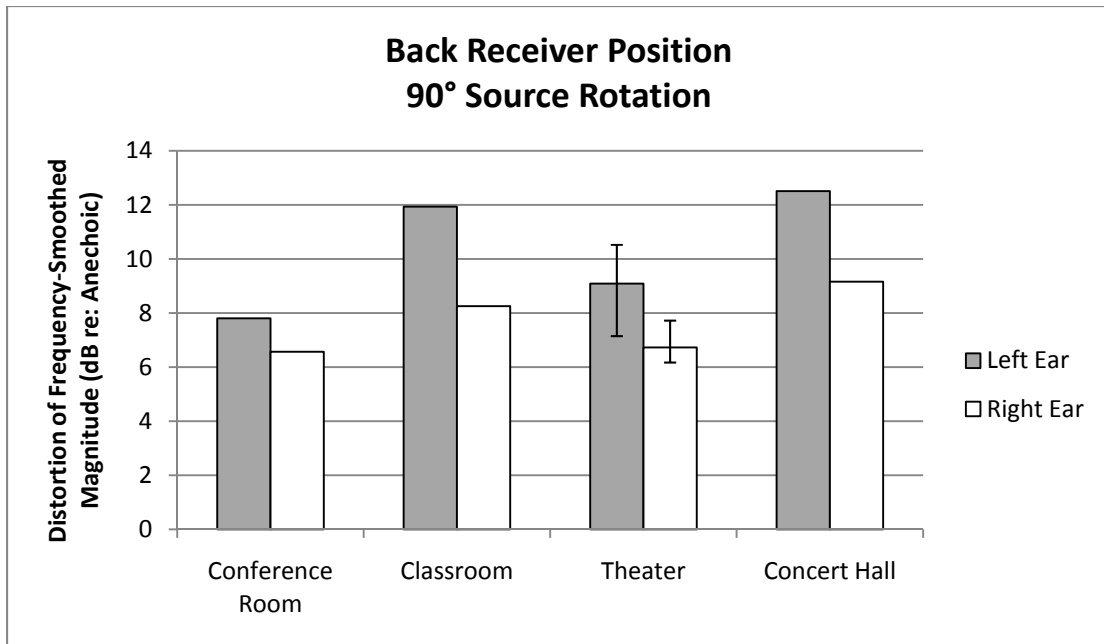
**Figure 3.9:** Distortion of frequency-smoothed magnitude for side receiver position, 0° source rotation. Error bars for theater space show the range about the average value from the three sets of repeated measurements.

The DFSM values for the back receiver position, 0° source rotation are shown in Figure 3.10. In this position, the conference room has the lowest DFSM values, the classroom and theater have similar and slightly higher DFSM values than the conference room, and the concert hall has the highest DFSM values. The DFSM values between the left and right ears are similar.



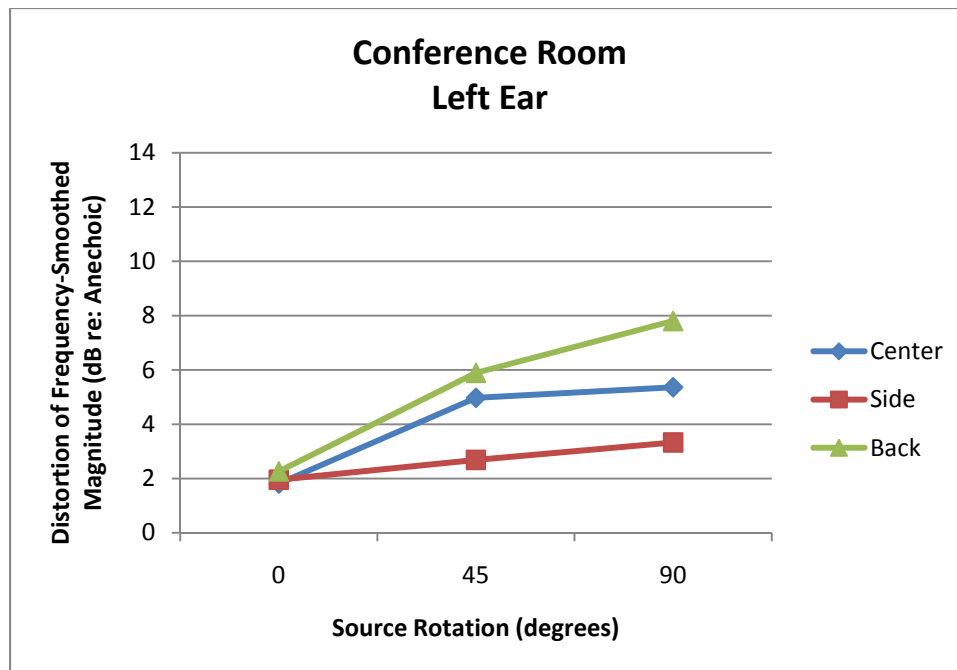
**Figure 3.10:** Distortion of frequency-smoothed magnitude for back receiver position,  $0^\circ$  source rotation. Error bars for theater space show the range about the average value from the three sets of repeated measurements.

Figure 3.11 shows the DFSM values for the back receiver position,  $90^\circ$  source rotation. The back wall provides a strong reflection to both the left and right ears in this condition; however, the left ear is receiving more direct sound energy than the right ear due to the rotation of the source. In this configuration, the left ear DFSM is greater than the right ear DFSM in each space, and the DFSM values are highest in the classroom and concert hall.



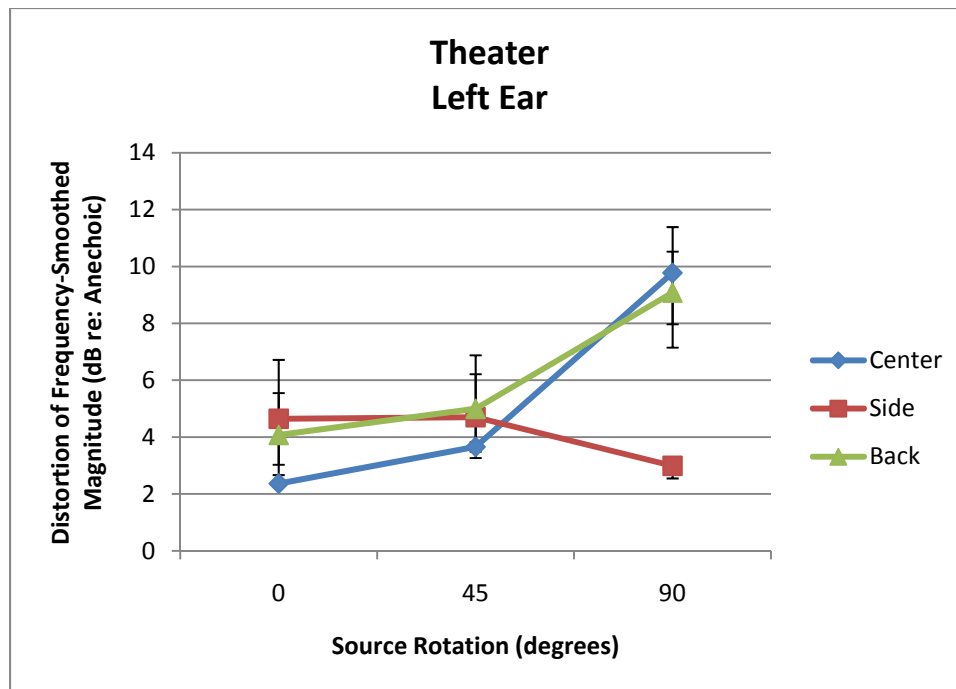
**Figure 3.11:** Distortion of frequency-smoothed magnitude for back receiver position, 90° source rotation. Error bars for theater space show the range about the average value from the three sets of repeated measurements.

Next, an assessment of how DFSMs are impacted by source rotation and receiver location is provided. The DFSM values measured in the left ear for the different receiver positions and source rotations for the conference room, theater, and the concert hall are shown in Figures 3.12, 3.13, and 3.15 respectively. In the conference room, the DFSM values increase for the 45° and 90° source rotations as the receiver moves from the side to the center to the back of the room. The DFSM values also increase as the source rotates from 0° to 45° to 90°. Similar trends occur for the right ear DFSM values in the conference room, but the magnitude of the values is generally smaller.

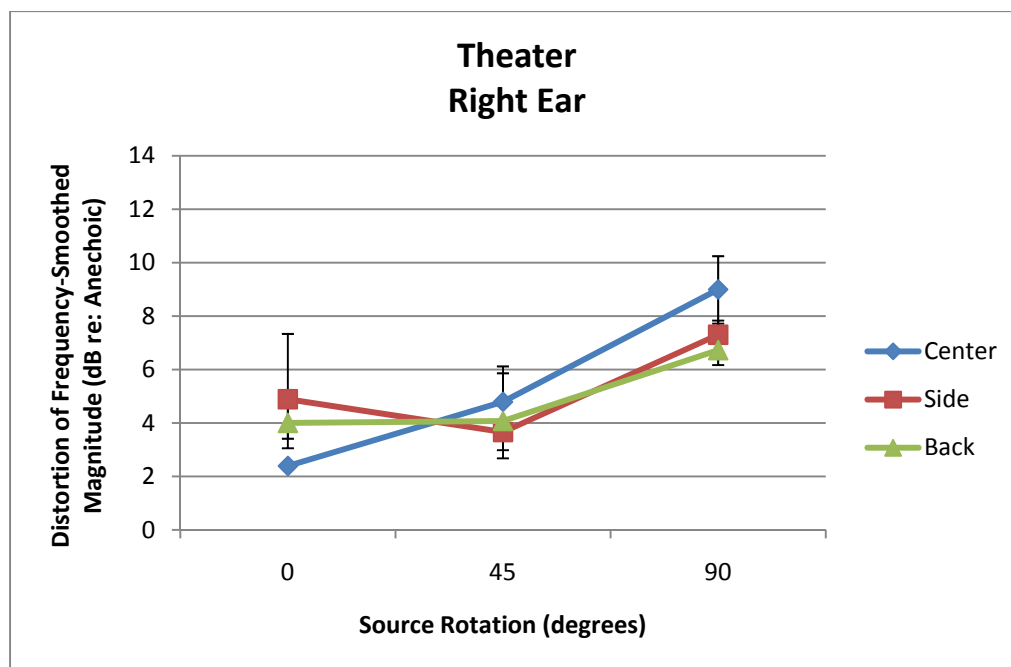


**Figure 3.12:** Distortion of frequency-smoothed magnitude measured at the left ear in the conference room.

In the theater the DFSM values, shown in Figure 3.13, increase as the source rotates from  $0^\circ$  to  $45^\circ$  to  $90^\circ$  for the center and back positions. For the side position, the DFSM left ear values decrease as the source rotates from  $45^\circ$  to  $90^\circ$ . The right ear DFSM values for the theater are shown in Figure 3.14. For the right ear in the side position, the DFSM values increase as the source rotates from  $45^\circ$  to  $90^\circ$ . Trends similar to those measured in the theater for the left and right ear DFSM values occur in the classroom.

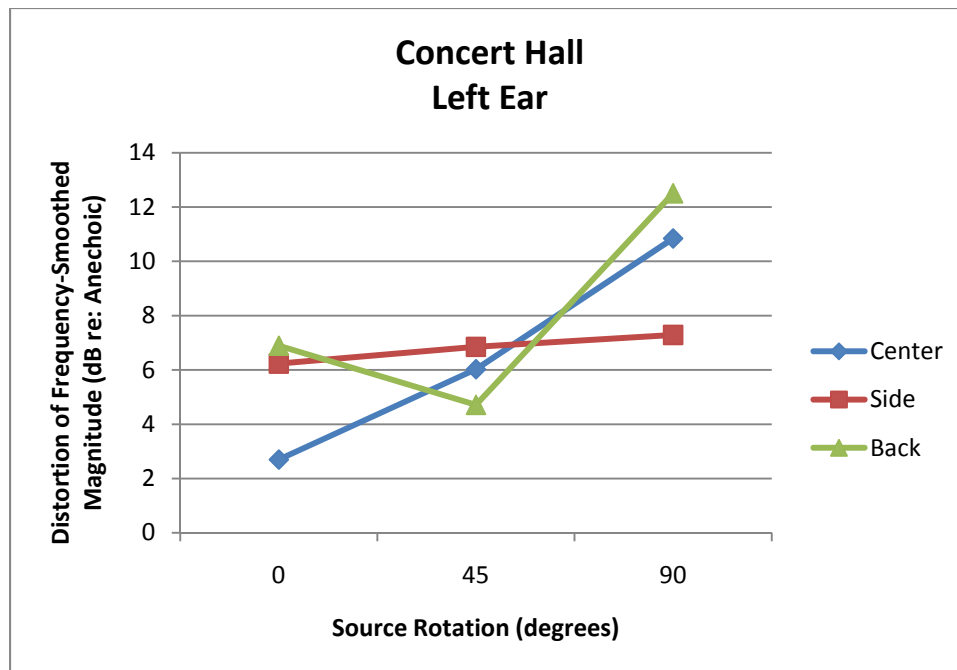


**Figure 3.13:** Distortion of frequency-smoothed magnitude measured at the left ear in the theater. Error bars show the range about the average value from the three sets of repeated measurements.



**Figure 3.14:** Distortion of frequency-smoothed magnitude measured at the right ear in the theater. Error bars show the range about the average value from the three sets of repeated measurements.

The concert hall DFSM values, shown in Figure 3.15, have a wider range among the different conditions. The DFSM values in the center position increase as the source rotation changes from  $0^\circ$  to  $45^\circ$  to  $90^\circ$ , as they do in the conference room. However, the DFSM value in the back location is lower for the  $45^\circ$  source rotation than for the  $0^\circ$  and  $90^\circ$  source rotations. The DFSM values in the side location are similar among the varying source rotations. The right ear DFSM trends are similar to those measured in the left ear, with a reduced magnitude.



**Figure 3.15:** Distortion of frequency-smoothed magnitude measured at the left ear in the concert hall.

To summarize these results, the DFSM values do not change systematically with varying room reverberation times. This metric is more sensitive to the room geometry and measurement configuration, which impacts the amount and level of early sound energy received. Similar DFSM values between the left and right ears occur for the 0° source rotation as expected, since the two ears are receiving similar amounts of direct and early energy. The left ear DFSM values are typically slightly higher than or equal to the right ear DFSM values for the 45° source rotation. The DFSM values tend to be greater in the left ear than in the right ear for the 90° source rotation in the center position in the classroom and in the back position in all spaces. For the 90° source rotation, the left ear receives more early sound energy than the

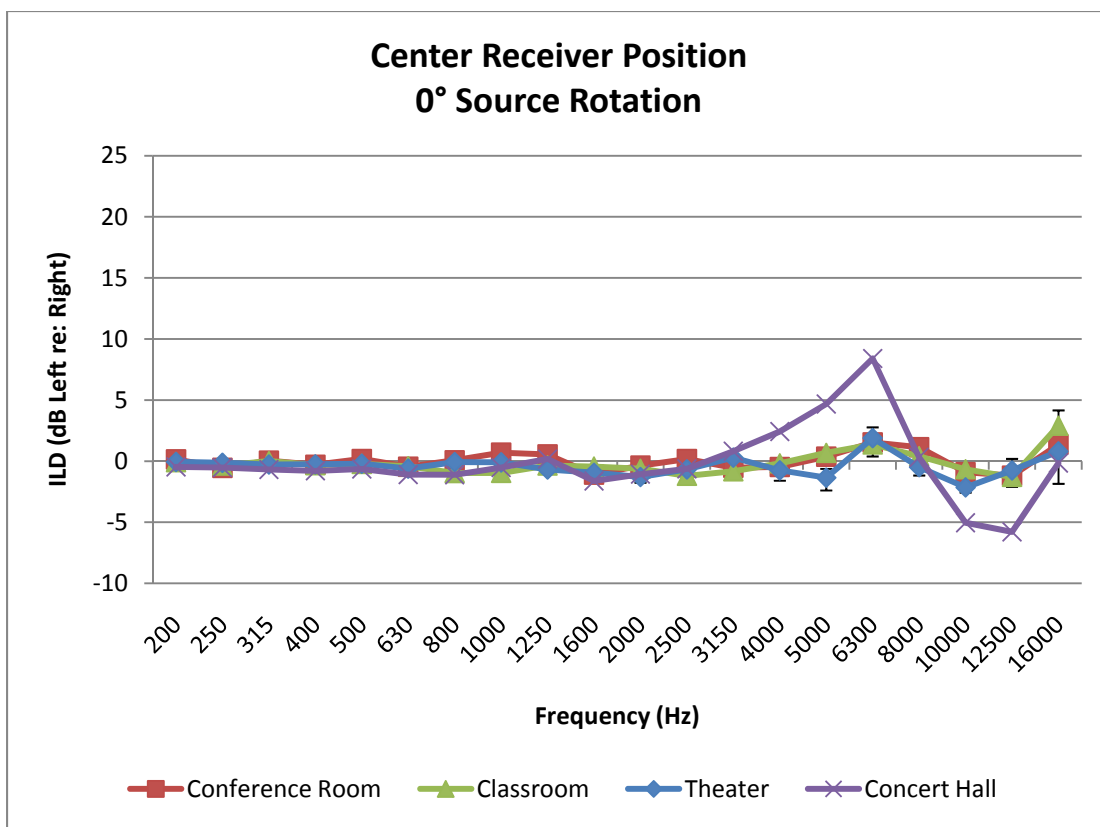
right ear. These results are similar to those reported by Shinn-Cunningham et al. (2005), wherein configurations with strong early reflections have higher DFSM values.

### ***3.4.2 Interaural Level Difference***

ILDs are calculated by taking the difference in signal level between the left and right ears. The ILDs presented in this chapter are the level differences occurring in one-third octave bands from 200 to 16,000 Hz. The ILDs are reported as a dB value, with the level in the left ear calculated with reference to the level in the right ear (dB Left re: Right).

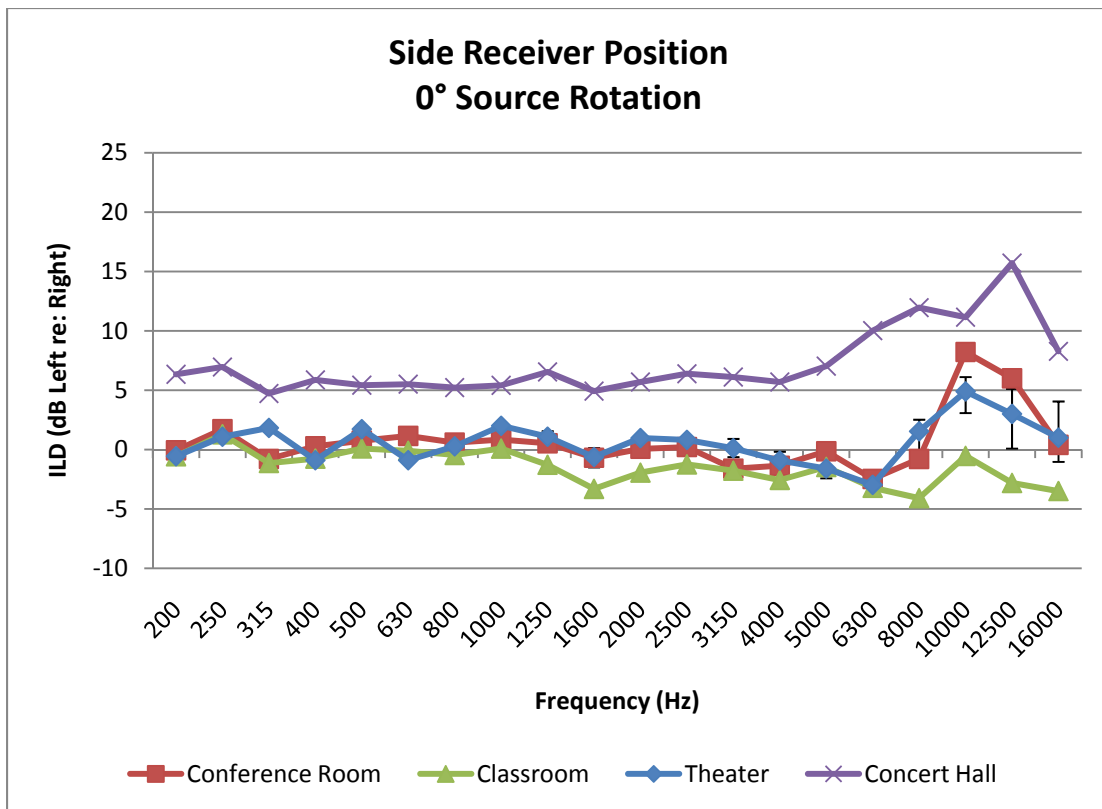
The ILD values for the four different spaces are shown for various source rotations and receiver positions in Figures 3.16, 3.17, 3.18, 3.19, and 3.20. Figure 3.16 shows the ILDs for the center receiver position, 0° source rotation. For this condition, the ILDs are similar among the conference room, classroom, and theater spaces. The ILDs for the concert hall are slightly greater in magnitude than the ILDs for the other spaces at higher frequencies. These trends are similar to those occurring for the ILD values measured in the back receiver position, 0° source rotation.





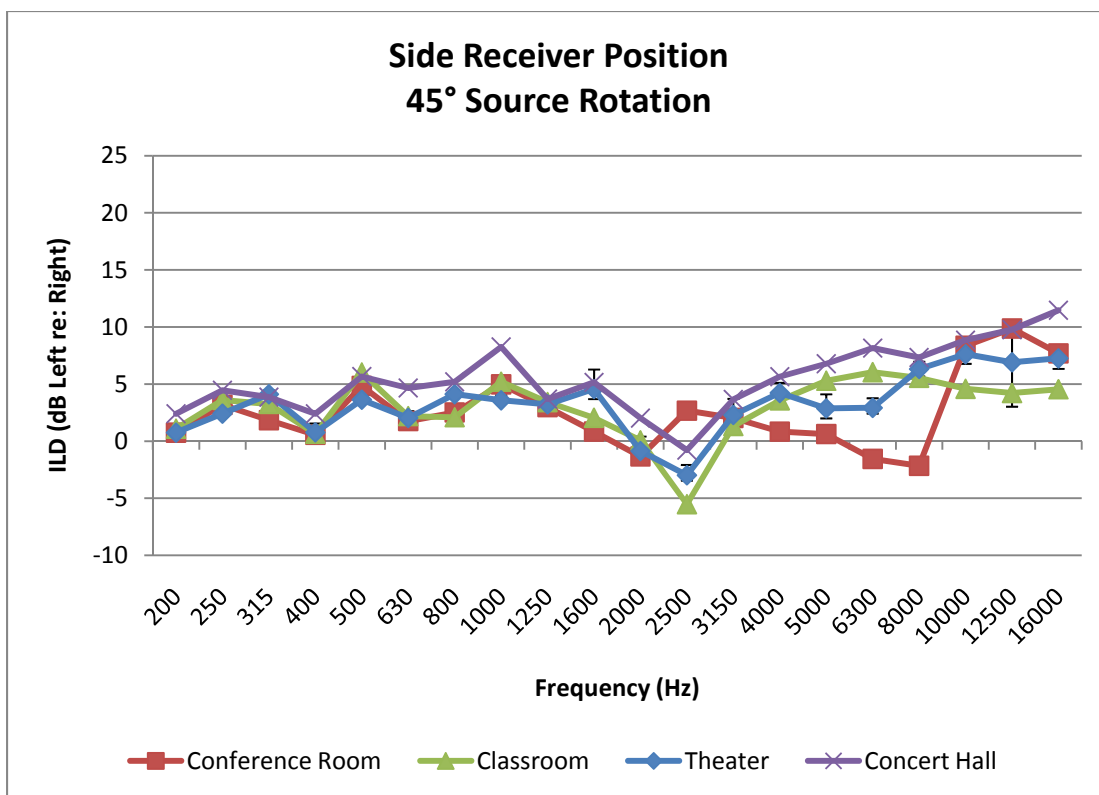
**Figure 3.16:** Interaural level differences for center receiver position, 0° source rotation. Error bars for theater space show the range about the average value from the three sets of repeated measurements.

The ILDs for the side receiver position, 0° source rotation are shown in Figure 3.17. By comparing Figure 3.16 to Figure 3.17, the impact of receiver position on the ILDs may be observed. With the receiver in the side position, the ILD values are greater in the concert hall space than the rest of the spaces across all frequencies. Also, the magnitude of the ILD values in the side position for the conference room, theater, and concert hall is greatest at higher frequencies.



**Figure 3.17:** Interaural level differences for side receiver position, 0° source rotation. Error bars for theater space show the range about the average value from the three sets of repeated measurements.

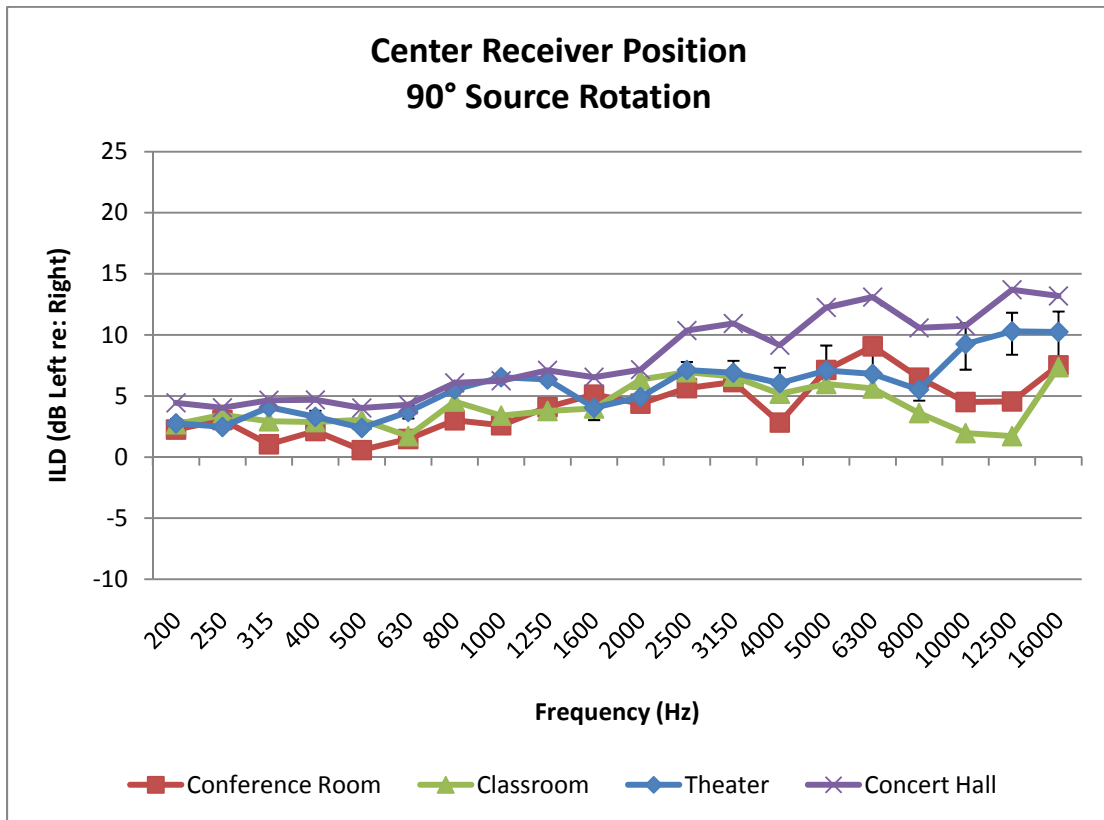
Figure 3.18 contains the ILDs for the side receiver position, 45° source rotation. In this condition, the ILD magnitude is similar among the four spaces, and is typically greater at higher frequencies. These trends are similar to those occurring in the side and back receiver positions for the 45° source rotation. The only deviation from these trends occurs in the classroom for the back receiver position. In the classroom in the back receiver position, 45° source rotation, the ILD magnitude is significantly greater from 3,150 to 16,000 Hz than at the other frequencies.



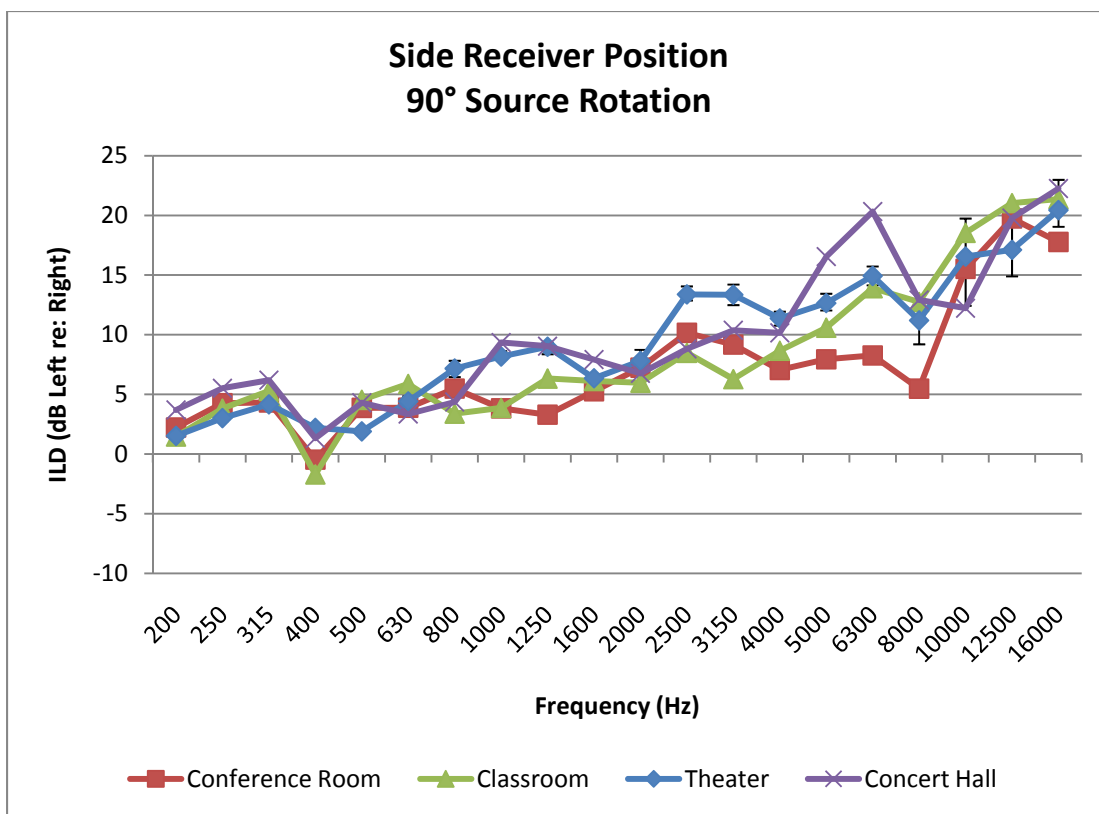
**Figure 3.18:** Interaural level differences for side receiver position, 45° source rotation. Error bars for theater space show the range about the average value from the three sets of repeated measurements.

The ILDs for the 90° source rotation for the center and side receiver positions are shown in Figures 3.19 and 3.20, respectively. For both the center and side receiver positions at the 90° source rotation, the ILD magnitude tends to increase for all spaces as the frequency increases. This trend also occurs for the back receiver position, 90° source rotation condition. The magnitude of this increase in ILD values is greater for the side receiver position than the center and back receiver positions.

With the receiver in the side condition, the magnitude of the ILD values ranges from 0 to 22 dB (Left re: Right) for the 90° source rotation.



**Figure 3.19:** Interaural level differences for center receiver position, 90° source rotation. Error bars for theater space show the range about the average value from the three sets of repeated measurements.



**Figure 3.20:** Interaural level differences for side receiver position, 90° source rotation. Error bars for theater space show the range about the average value from the three sets of repeated measurements.

Since positive ILD values typically occur for the 45° and 90° source rotations and in the side receiver positions, this indicates that the level in the left ear is greater than the level in the right ear as expected for these conditions. The ILDs are typically greater at higher frequencies as observed in previous research (Shinn-Cunningham et al. 2005). However, the ILDs are not consistently reduced in spaces with longer reverberation times as expected from results reported by Shinn-Cunningham et al. (2005). A reason for this may be the variation in room geometry among the spaces

tested. The specific room shapes and surface materials may have a larger impact on ILDs than room RT. Rooms with similar shapes and surfaces should be tested to quantify the effects of reverberation alone on ILDs.

### **3.5 Conclusions**

This investigation has documented acoustics metrics reported by Shinn-Cunningham et al. (2005) for a typical classroom in spaces with varying shapes and reverberation times. This study indicates that DFSM values are not systematically altered by rooms with varying reverberation times. The location of nearby reflective surfaces and measurement configurations in which the source faces away from the receiver tend to increase the DFSM, as this will increase the amount of early sound energy received relative to the direct sound energy. This suggests that localization bias may occur in these conditions (Shinn-Cunningham et al. 2005). These results are similar to those documented by Shinn-Cunningham et al. (2005).

The ILD values measured in this investigation typically increase with frequency as expected. This effect is most drastic for the side receiver position, 90° source rotation. This may be due to the pronounced asymmetry between the two ears that occurs in this condition. This trend agrees with results from Shinn-Cunningham et al. (2005). However, the ILDs are not systematically reduced in spaces with longer reverberation times. This may be due to the differences in room furnishings and shapes among the spaces, in addition to the varying RTs. To isolate the effect of reverberation on ILD, measurements in more spaces with similar geometries and finishes should be conducted.

This investigation has provided insight on how these newer metrics may be impacted by room characteristics. One additional area of interest is to determine if DFSM and ILD can be used to provide a more detailed characterization of classrooms than traditional room acoustics metrics. The outcomes of this study indicate that both DFSM and ILD are more impacted by source orientation relative to the receiver than room RT. Also, the DFSM values are influenced more consistently by the location of nearby reflective surfaces than varying room reverberation. Therefore, these metrics may be able to quantify differences in classroom acoustical environments with similar RTs. This analysis has been conducted as part of the research on elementary school classrooms in Council Bluffs, Iowa, and Papillion-La Vista, Nebraska. These results are presented in Chapters 5 and 6 of this dissertation.

## **Chapter 4**

### **Statistical Methods**

#### **4.1 Introduction**

This chapter describes the statistical methods used to evaluate the data presented in Chapters 5 and 6 of this dissertation. These methods include parametric tests, correlations, analysis of variance (ANOVA), and regressions. The assumptions and necessary conditions for the data to perform these statistical procedures are also described.

#### **4.2 Parametric Tests**

Many statistical tests are developed on the condition that the data set under investigation is parametric. The following assumptions must be met for the data to be parametric: normally distributed data, homogeneity of variance, interval data, and independence (Field 2000).

To test if a data set has a normal distribution, the Kolmogorov-Smirnov test may be used. This test compares the sample data set to a normal data set with the same mean and standard deviation as the sample data. If the test is non-significant, then the sample is not significantly different from a normal distribution, and the assumption of normality is satisfied (Field 2000).

The assumption of homogeneity of variance may be tested using Levene's test. The hypothesis for this test is that the two data sets being compared have equal



variances. If the test is non-significant, it may be assumed that the variances of the two samples are approximately equivalent, and the assumption of homogeneity of variance is met (Field and Hole 2003).

The interval data assumption is satisfied if the distance between data points has equal meaning for the entire range of data (Field 2000). For example, the difference between 35 and 36 dBA must be the same as the difference between 50 and 51 dBA. The assumption of independence is met if the data for one sample point is not dependent on another sample point (Field 2000). For example, the achievement scores in one classroom must not depend on the achievement scores within another classroom.

### 4.3 Correlations

Correlations quantify what relationship exists, if any, between two variables. A correlation indicates the strength and nature (positive, negative, or non-existent) of the linear relationship between variables (Field 2000). One method to determine the correlation between two variables is to calculate the Pearson product-moment correlation coefficient,  $r$ . This correlation coefficient between variable  $x$  and variable  $y$  is calculated as shown in Equation 4.1 (Field 2000).

$$r_{xy} = \frac{\sum(x_i - \bar{x})(y_i - \bar{y})}{(N-1)s_x s_y} \quad (\text{Eq. 4.1})$$

Where:

$x_i$  = data point in sample  $x$

$\bar{x}$  = mean of sample  $x$

$y_i$  = data point in sample  $y$

$\bar{y}$  = mean of sample y

N = number of data points in sample

$s_x$  = standard deviation of sample x

$s_y$  = standard deviation of sample y

The Pearson product-moment correlation coefficient ranges from -1 to +1. Negative coefficients indicate that there is an inverse or negative correlation between the variables. Low values for one of the variables occur for high values in the other variable. A coefficient value of zero indicates that there is no relationship between the two variables. For this case, changes in one variable occur, though the other variable does not change. Positive coefficients occur for direct or positive correlations between the two variables. High values for one variable occur for high values of the other variable, and low values for one variable occur for low values of the other variable. To perform the Pearson correlation coefficient test, the data must be parametric (Field 2000).

The significance of the correlation is quantified by determining what the probability is that the correlation would have occurred due to chance alone. This is generally reported as a p-value. Typically, the p-value is compared to an alpha ( $\alpha$ ) value of either 0.01 or 0.05 to determine if it is significant. If the p-value is less than  $\alpha$ , then the correlation may be reported as being statistically significant. For example, if the p-value is less than 0.01, then the probability that the correlation coefficient occurred for the sample due to chance is less than 0.01. This indicates that the relationship found in the sample data set is likely to occur in the general population (Field and Hole 2003). The sample size impacts the ability of a statistical test to

determine if the effect is meaningful, or the effect size. Larger samples are typically necessary to detect smaller effect sizes (Field and Hole 2003).

To determine the correlation between two variables while controlling for the effect of a third variable on one of the variables, semi-partial (also called part) correlations are conducted (Field 2000). For example, this type of analysis may be used to determine the correlation between classroom noise levels and student achievement with the effects of poverty on student achievement removed. The semi-partial correlation is calculated as shown in Equation 4.2 (adapted from Pedhazur 1997).

$$r_{x(y.z)} = \frac{r_{xy} - r_{xz}r_{yz}}{\sqrt{1 - r_{yz}^2}} \quad (\text{Eq. 4.2})$$

Where:

$r_{xy}$  = correlation coefficient between variable x and variable y

$r_{xz}$  = correlation coefficient between variable x and variable z

$r_{yz}$  = correlation coefficient between variable y and variable z

In Equation 4.2, the correlation between the variable x and the variable y is determined with the effect of the variable z partialled out of the variable y.

#### 4.4 Analysis of Variance

ANOVA is a statistical test method that is commonly used to compare means across several groups of independent variables. The parametric data assumptions should be met to perform this test (Field 2000). However, if the assumption of homogeneity of variance is not met, the results of an ANOVA test may be reported

along with the results from Levene's test (Field and Hole 2003). The null hypothesis in ANOVA is that the means of three or more groups of an independent variable are approximately equal. To quantify if the null hypothesis is met, an F-ratio test statistic is evaluated. The F-ratio is the ratio of systematic variance (or variance explained by the model) to unsystematic variance (difference between the model and the actual data) (Field 2000; Field and Hole 2003).

Independent ANOVAs should be used when different participants are used in the groups. If two independent variables are compared, a two-way ANOVA is performed. For example, a two-way independent ANOVA may be used to analyze achievement data collected from different students at various grade levels in classrooms with a range of background noise conditions. In this case, student grade level and classroom background noise would be the independent variables with student achievement as the dependent variable. The outcome of a two-way independent ANOVA will indicate the significance of the effect of each independent variable on the dependent variable. This is referred to as a main effect (Field and Hole 2003). If the F-ratio is significant ( $p < \alpha$ ) for one of the independent variables, then the main effect of the independent variable on the dependent variable is significant. The combined effect of the two independent variables on the dependent variable is an interaction effect (Field and Hole 2003). If the interaction effect is non-significant, then the effects of one independent variable on the dependent variable are not impacted by the other independent variable.

In a two-way independent ANOVA, the F-ratio value is reported along with the degrees of freedom in the model ( $df_M$ ) and the degrees of freedom for the residuals or error ( $df_R$ ) (Field and Hole 2003). For a main effect, the degree of freedom for the model is one less than the number of groups being compared. The results from the ANOVA are typically reported as follows:  $F(df_M, df_R) = F\text{-value}, p < \alpha$  or  $p > \alpha$ .

When evaluating the significance of ANOVA results, the number of tests being conducted should be considered. This may impact the possible occurrence of Type I error. Type I error has occurred when an effect has been found to be statistically significant in the sample under evaluation, but in the general population this effect does not exist (Field and Hole 2003). This may be evaluated using the Bonferroni correction, which is a conservative way to control for error. For this test,  $\alpha$  is divided by the total number of tests conducted. The resulting value should be used as the upper limit for assessing statistical significance (Field and Hole 2003).

#### **4.5 Regressions**

Regressions quantify the amount of variance that is accounted for in one variable due to the variance in one or more other variables. A simple linear regression determines the linear relationship between a dependent variable and one independent or predictor variable. If two or more predictor variables are used, then the regression is referred to as a multiple regression (Pedhazur 1997). The difference between the value of the dependent variable accounted for by the predictor variables and the actual value of the dependent variable for the predictor variables is the

residual term (Field 2000). A multiple regression model has the form shown in Equation 4.3 (Field 2000).

$$Y = \beta_0 + \beta_1 X_1 + \beta_2 X_2 + \dots + \beta_n X_n + \varepsilon_i \quad (\text{Eq. 4.3})$$

Where:

$Y$  = dependent or outcome variable

$\beta_0$  = intercept

$\beta_1$  = coefficient of predictor variable,  $X_1$

$\beta_2$  = coefficient of predictor variable,  $X_2$

$\beta_n$  = coefficient of  $n^{\text{th}}$  predictor variable,  $X_n$

$\varepsilon_i$  = residual term

To determine how much variance in the dependent variable is accounted for by the predictor variables, an  $R^2$  value is calculated.  $R^2$  is the ratio of the amount of variance in the dependent variable accounted for by the predictor variables to the total amount of variance in the dependent variable (Field 2000). If the  $R^2$  value is multiplied by 100, it is the percentage of variance accounted for in the dependent variable by the model or predictor variables. If the p-value associated with  $R^2$  is less than  $\alpha$ , then there is a very small chance that the percentage of variance accounted for by the model is due to chance alone. In regression, the same F-value that is calculated in an ANOVA is often reported. This indicates the improvement achieved by using the regression model over using the mean of the independent variable as a predictor of what the independent variable will be (Field 2000).

To determine the significance of individual predictor variables in regression, a t-test is calculated. The t-statistic is the ratio of  $\beta$  to the standard error of  $\beta$  (Field

2000). The null hypothesis for this test is the  $\beta$ -value for the predictor variable is zero. If this t-test is significant, with an associated p-value less than  $\alpha$ , then it may be assumed that the  $\beta$  is significantly different than zero (Field 2000). If this occurs, the predictor variable associated with the  $\beta$ -value under consideration has a significant contribution to the regression model.

Several assumptions must be met for regression models to be valid (Field 2000). These assumptions include the following:

- Sample points for the independent variable are from different subjects.
- All predictor variables must have some variance.
- Predictor variables must not be significantly correlated (no multicollinearity).
- All variances of the residual terms should be the same for each level of the predictor variable (homoscedasticity).
- Residual terms should not be correlated for two observations (independent errors).
- Most differences between the model and actual data are typically zero (normally distributed errors).
- The relationship under investigation is linear (linearity).

Many of these assumptions may be checked by examining plots of the residual values (Field 2000). The assumption of linearity may be investigated by examining plots between each predictor variable and the dependent variable. If linear relationships are apparent, then linearity may be assumed. Also, if the points are spaced

approximately evenly around the regression line for each plot, it indicates that homoscedasticity has been achieved (Field 2000).

#### **4.6 Conclusions**

The statistical methods and tests that are used to evaluate the data presented in this dissertation have been described. By examining the significance of each statistical test, it is possible to determine the likelihood that relationships present in the sample data are applicable to the general population.



## **Chapter 5**

### **Acoustical Study of Classrooms in an Iowa Public School District**

#### **5.1 Introduction**

This chapter describes an acoustical study of second and fourth-grade classrooms in the Council Bluffs Community School District in Iowa, USA. Classrooms in all 14 of the elementary schools in the district were tested. Acoustical measurements, including background noise level (BNL), reverberation time (RT), and binaural room impulse responses (BRIR), were made in unoccupied second and fourth-grade classrooms in these schools and correlated to the student achievement test results. This work is important because it is one of the first studies to relate unoccupied classroom acoustical conditions to student achievement rather than speech intelligibility.

#### **5.2 Methods**

Site visits were conducted in 58 total second and fourth-grade classrooms in the public school system in Council Bluffs, Iowa, USA, from April – June 2009. This encompassed all of the second and fourth-grade classrooms, typically containing 7 to 8 and 9 to 10 year-old students, respectively, in the school system during the 2008 – 2009 academic year.

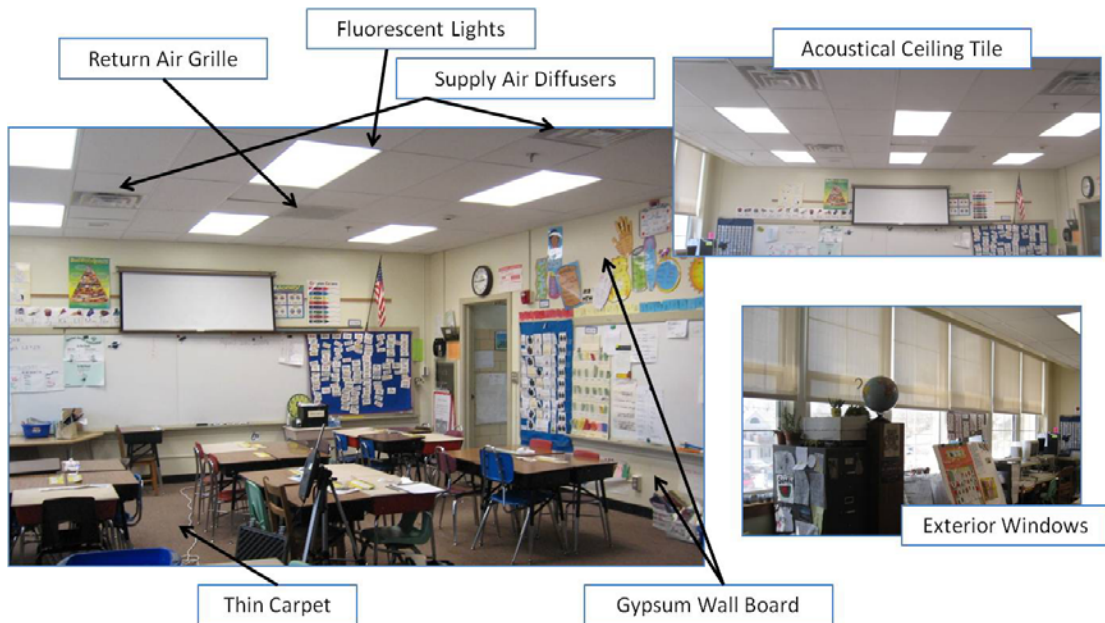
### **5.2.1 Site Visit Procedures**

During each site visit, detailed notes and photographs were taken to record the room dimensions, building materials, room furnishings, and noise sources. BNL and RT measurements were gathered in each unoccupied classroom. Binaural room impulse response measurements were gathered in four of the unoccupied classrooms. Prior to the start of each acoustical measurement, the windows and doors to exterior and adjacent spaces were closed.

### **5.2.2 Classroom Descriptions**

All of the classrooms had a traditional, closed floor plan design. Typical room materials included a thin carpet on the floor, acoustical ceiling tile, and either gypsum board or concrete masonry unit walls. Many of the classrooms had several large windows facing the exterior. The rooms were furnished with desks, shelves, and cabinets, with tack-boards and chalkboards lining the walls. Views of a typical classroom surveyed are shown in Figure 5.1.

Most of the rooms were temperature controlled by central mechanical systems, with regularly spaced overhead diffusers supplying the air for cooling. The return air grille was often located near the classroom entrance. The temperature was set in each room by a wall-mounted control unit, which typically had set-points ranging from 21 - 24° C (70 - 76° F). However, six of the classrooms had window air-conditioning units supplying the cool air, instead of a central cooling system. In these classrooms, the air-conditioning units were activated by the teachers as needed for cooling the space.



**Figure 5.1:** Views of a typical classroom tested.

### ***5.2.3 Background Noise Level Measurement Procedures***

Prior to the start of each BNL measurement, the mechanical systems were activated in the cooling mode whenever possible. BNL measurements were not obtained with the mechanical systems operating in the heating mode. The BNL was recorded at the center of each space using a Larson Davis 824 sound level meter, with reference to 20  $\mu\text{Pa}$ . The meter was mounted on a tripod, with the microphone located approximately 1.1 m above the ground. The BNL was recorded in additional locations when the background noise in the space was not approximately uniform, as subjectively determined by the measurement personnel. When additional BNL measurements were taken, the energy average of the BNL in each position was used

to characterize the background noise of the space. The BNL was recorded over a five minute continuous time period. The content and duration of atypical noise sources occurring during the BNL measurement time were noted.

#### ***5.2.4 Reverberation Time Measurement Procedures***

The RT of each space was measured using a balloon pop impulse response method. The balloons were inflated to the same size, about 0.76 m circumference, for each measurement to improve the impulse repeatability. The Larson Davis 824 sound level meter was used to record the decay from the balloon pop impulse in each center measurement position. The resulting  $T_{20}$  was estimated from the impulse decay time by Larson Davis 824 - Utility software. The  $T_{20}$  values are reported since the balloon pop impulses did not generate enough energy at the low frequencies to calculate accurate  $T_{30}$  values. RT values were calculated in each octave band from 125 to 8000 Hz.

#### ***5.2.5 Binaural Room Impulse Response Measurement Procedures***

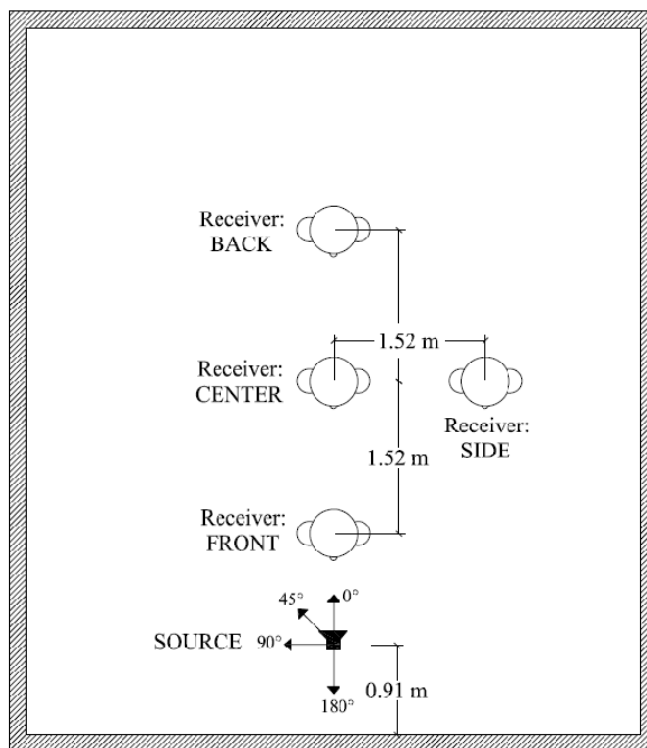
BRIR measurements were gathered in four of the classrooms tested. These classrooms were selected because they were located in schools with only one classroom at both the second and fourth-grade level. The designations used for these classrooms are as follows:

- Classroom A: Second-grade classroom in School B
- Classroom B: Second-grade classroom in School G
- Classroom C: Fourth-grade classroom in School B

- Classroom D: Fourth-grade classroom in School G

Sixteen BRIR measurements were gathered in each of the four classrooms with source rotations and receiver positions as shown in Figure 5.2. For each measurement, the source was located at the front of the classroom, approximately 0.91 m from the wall and 1.68 m above the floor. The four source rotations included 0° from center, 45° from center, 90° from center, and 180° from center to simulate a teacher facing various directions while speaking. The receiver was directly facing the front of the room for each measurement, located in four different positions throughout the room. For the center position, the receiver was located at the approximate center of the room. The receiver was located 1.52 m to the front, side, and back of the center position for the three other positions. Therefore, the receiver was closer to the source for all of the measurement configurations in classrooms with a shorter distance from the front to the back of the room.

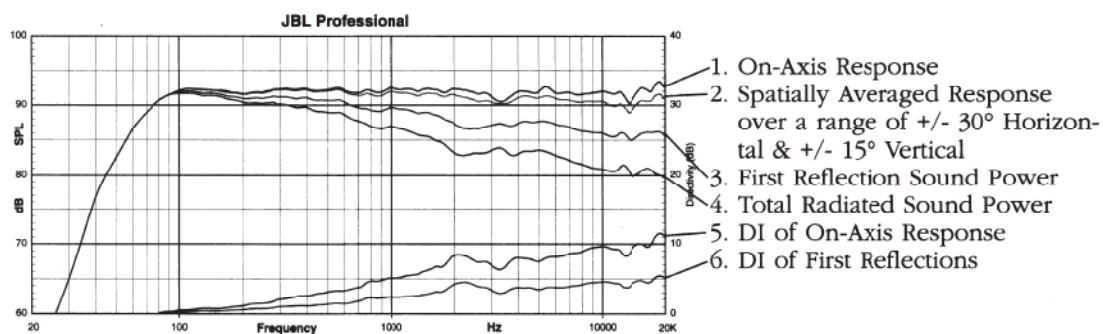
A small JBL LSR6325P-1 loudspeaker was used for the source. The level of the loudspeaker while generating pink noise was set to 65 dBA (re: 20  $\mu$ Pa) at a distance of 1 m directly in front of the speaker. The signal used for each BRIR measurement was a pink-weighted logarithmic sweep with two presents and four averages generated and recorded by the Electronic and Acoustic System Evaluation and Response Analysis (EASERA) computer software program.



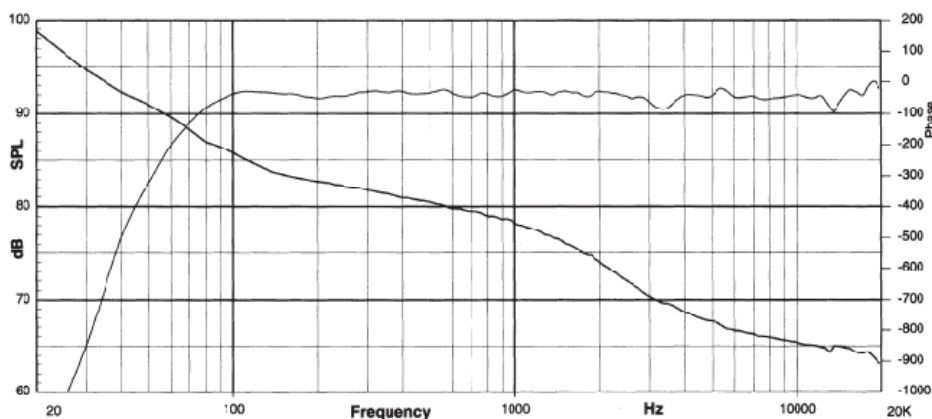
**Figure 5.2:** Plan view of source rotations and receiver positions used for BRIR measurements in four classrooms (not to scale).

The frequency response and on-axis amplitude and phase response of the JBL LSR6325P-1 loudspeaker are shown in Figures 5.3 and 5.4, respectively. These figures are from the loudspeaker specifications reported by the manufacturer. The loudspeaker frequency response (+1 to -2 dB) ranges from 70 Hz to 20 kHz. This loudspeaker was selected because its directivity characteristics are similar to those of a human talker. Chu and Warnock (2002) report the directivity patterns for human talkers. Although polar plots were not available for the JBL LSR6325P-1 loudspeaker, the components and verbiage of this model are similar to those of the

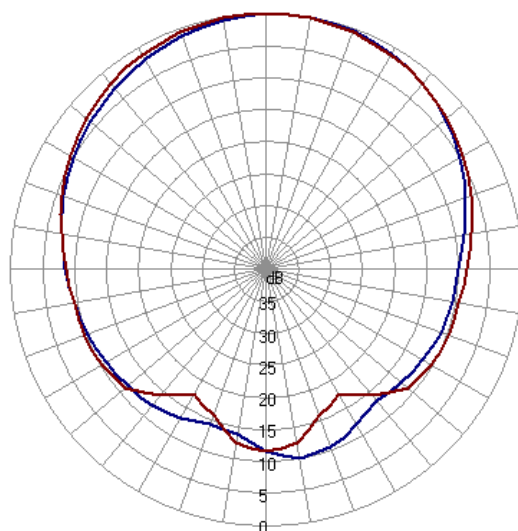
JBL LSR25P loudspeaker. The polar plots in the horizontal and vertical planes for the JBL LSR25P loudspeaker in the 2000 Hz third-octave band are shown in Figure 5.5. Figure 5.6 shows the polar plots in the horizontal and vertical planes in the 2000 Hz third-octave band for a female speaking in a normal voice. The directivity characteristics of the JBL loudspeaker are similar to those of a female talker, as seen by comparing Figure 5.5 to Figure 5.6.



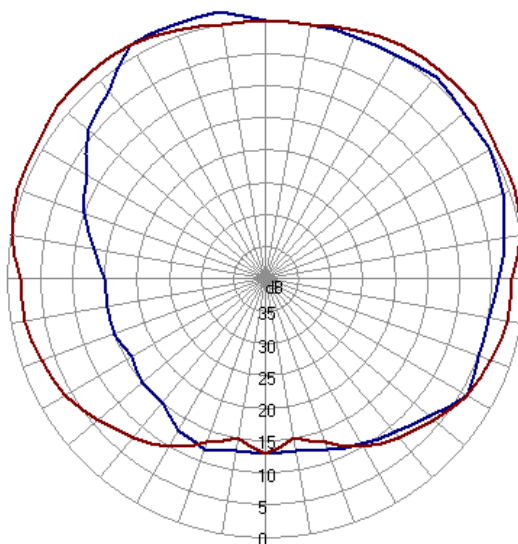
**Figure 5.3:** Response curves for JBL LSR6325P-1 loudspeaker. Source: JBL Professional LSR6325P-1 specification sheet.



**Figure 5.4:** On-axis amplitude and phase response of JBL LSR6325P-1 loudspeaker. Source: JBL Professional LSR6325P-1 specification sheet.



**Figure 5.5:** Polar plots for the JBL LSR25P loudspeaker in the 2000 Hz third-octave band. The red line shows the horizontal polar plot, and the blue line shows the vertical polar plot. Source: Enhanced Acoustic Simulator for Engineers (EASE) software speaker database, version 4.0.



**Figure 5.6:** Polar plots in the 2000 Hz third-octave band for a female human, talking in a normal voice. The red line shows the horizontal polar plot, and the blue line shows the vertical polar plot. Source: Enhanced Acoustic Simulator for Engineers (EASE) software speaker database, version 4.0.



For the receiver, a Brüel and Kjaer Type 4104 binaural microphone headset was placed on the head of an adult female seated in a student chair in each classroom. The same head was used for all of the measurements. In Appendix I, metrics from BRIR measurements gathered with this receiver are compared to those from measurements with a G.R.A.S. Sound and Vibration KEMAR Manikin Type 45BA receiver. On average, small differences were found between the two receivers for the metrics analyzed, with the largest differences occurring for ILD and DFSM. BRIR measurements with the receiver in the center position were also gathered with the microphone headset placed on the head of another adult female in one of the classrooms (Classroom D) to study the effect of using a different head. The effect of using different human heads on the measured BRIRs was found to be minimal for most of the metrics investigated. The results of this analysis are shown in Appendix II.

In another classroom (Classroom C), the BRIR measurements were repeated three times to quantify their repeatability, changing both the source rotation and receiver position between each set of measurements.

#### ***5.2.6 Standardized Achievement Tests***

Results from the Iowa Test of Basic Skills administered to the students during the 2008 – 2009 academic year were gathered. Available scores from the reading comprehension subject area and math subject area, which included concepts, estimation, problem solving, and data analysis, were compiled. The scores were reported as a pass rate, which is the percentage of proficient students, averaged per

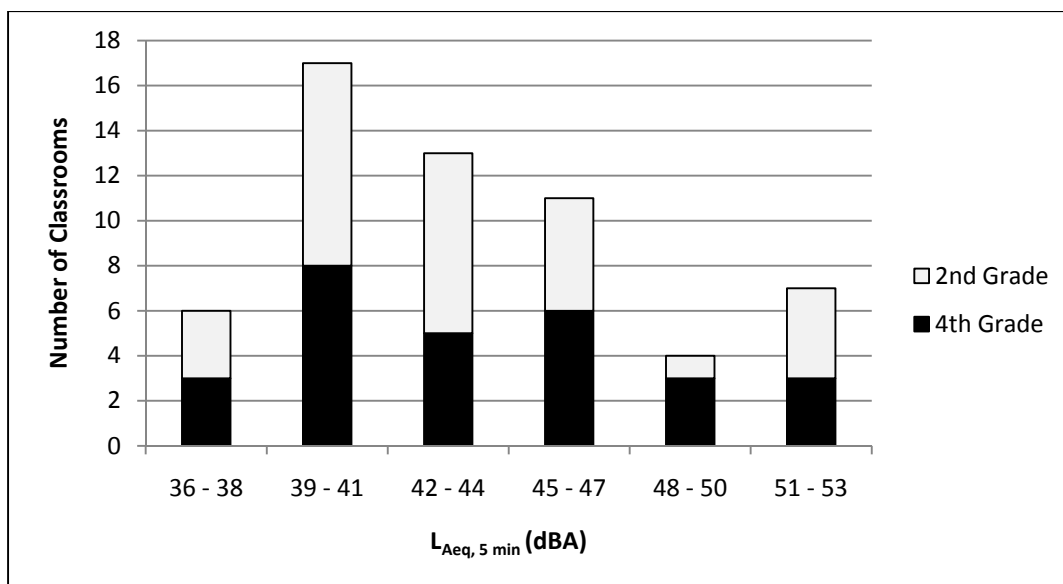
grade level per school. The percent of proficient students is determined by the state of Iowa for each school year, and was set to be the percent of students scoring above the 41<sup>st</sup> percentile for the 2008 – 2009 academic year. Poverty rates for each school were used as a demographic variable to control for some of the socio-economic differences between schools. This was reported as the percent of students who lived in households below a certain income level, averaged per school.

### **5.3 Results**

This section contains results from the acoustical measurements, student achievement tests, and poverty rates. The acoustical metrics include BNL, RT, speech transmission index (STI), distortion of frequency-smoothed magnitude (DFSM), interaural cross-correlation (IACC), and interaural level difference (ILD).

#### ***5.3.1 Background Noise Level***

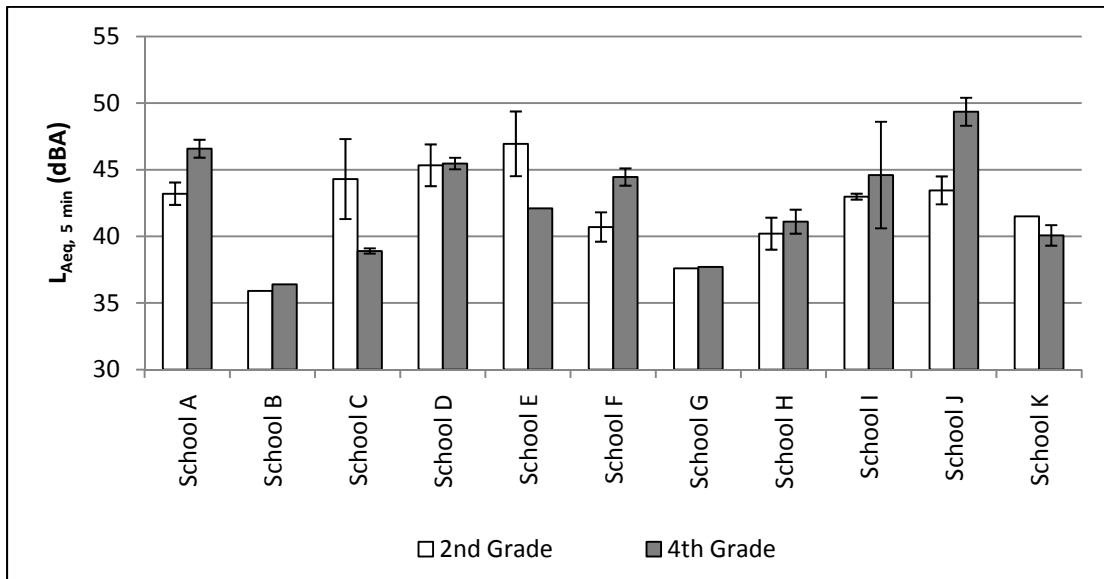
The results from the BNL measurements for each classroom are shown in Figure 5.7. This figure shows the A-weighted equivalent sound level ( $L_{Aeq}$ ) over the five minute measurement time period for all of the classrooms.



**Figure 5.7:** A-weighted equivalent sound levels for all of the classrooms measured. This includes spaces with the BNL measured with central mechanical system activated (50 classrooms), with the central mechanical system deactivated (2 classrooms), and with the window air-conditioning units activated when present (6 classrooms).

The results from the BNL measurements averaged per grade level per school are shown in Figure 5.8. This figure shows the  $L_{Aeq}$  over the five minute measurement time period for 11 of the 14 schools included in the study. Results from three of the schools have been omitted, since these included classrooms with window air-conditioning units that were activated or central mechanical systems that were deactivated for the measurements. The bars show the range in BNL about the average value for all of the classrooms at each grade level in each school. As shown in Figure 5.8, the unoccupied BNLs in the analyzed classrooms range from 36 to 50

dBA, none of which meets the maximum level of 35 dBA recommended in the ANSI S12.60 Standard for single mode HVAC systems (ANSI/ASA 2010).



**Figure 5.8:** A-weighted equivalent sound levels for 11 of the schools, all with consistent mechanical system conditions for the BNL measurements (BNL measured with central mechanical system activated). The bars show the range in BNL about the average value for all classrooms at each grade level in each school.

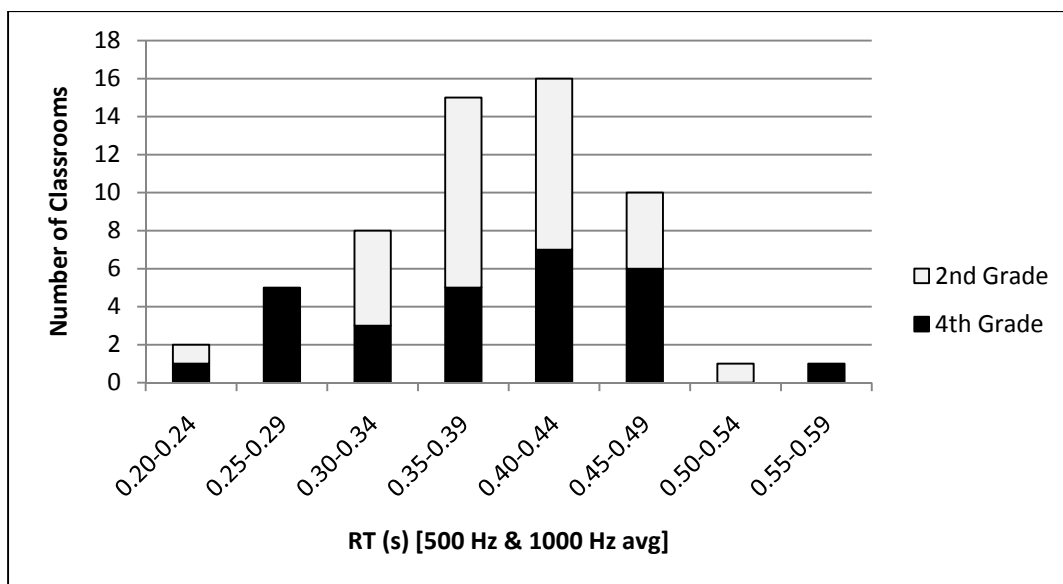
The A-weighted and C-weighted equivalent sound levels over the five minute measurement time period,  $L_{Aeq}$  and  $L_{Ceq}$  respectively, for the four classrooms selected for the BRIR measurements are shown in Table 5.1.

**Table 5.1:** A-weighted and C-weighted equivalent sound levels for the four classrooms in which BRIR measurements were conducted.

	$L_{Aeq, 5 \text{ min}} \text{ (dBA)}$	$L_{Ceq, 5 \text{ min}} \text{ (dBC)}$
<b>Classroom A (2<sup>nd</sup> Grade)</b>	36	54
<b>Classroom B (2<sup>nd</sup> Grade)</b>	38	59
<b>Classroom C (4<sup>th</sup> Grade)</b>	36	52
<b>Classroom D (4<sup>th</sup> Grade)</b>	38	57

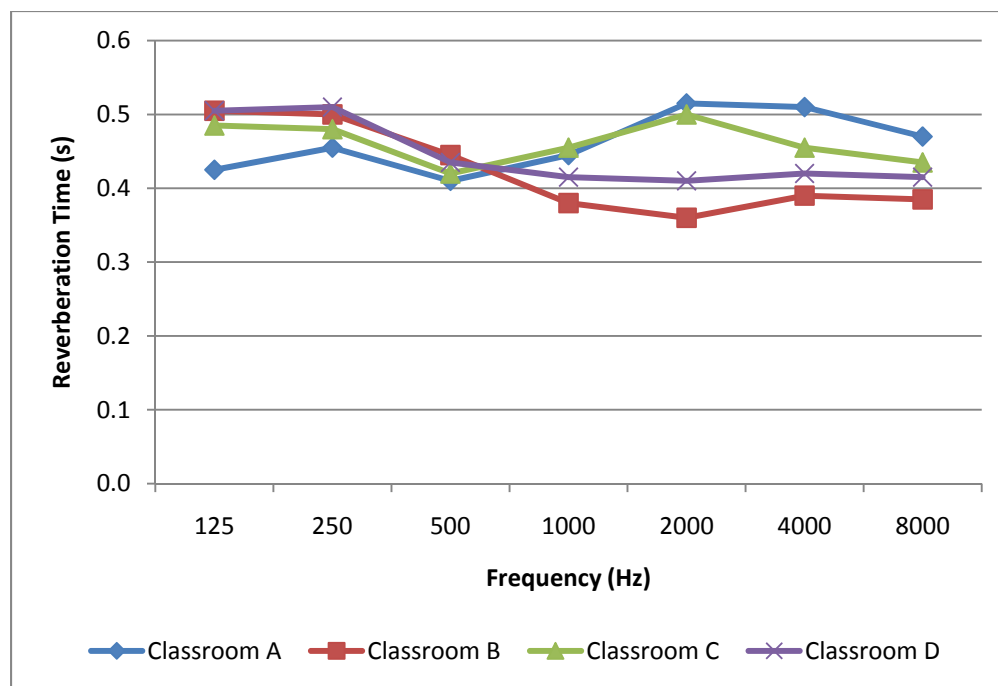
### 5.3.2 Reverberation Time

The RT measured in each unoccupied classroom from the balloon pop impulse response measurement is shown in Figure 5.9. This figure shows the average RT in each classroom in the 500 and 1000 Hz octave bands. The RT shown is the estimated  $T_{20}$  value from the balloon pop impulse response measurements. As shown in Figure 5.9, the mid-frequency RTs range from 0.2 to 0.6 seconds, which are all less than the maximum RT of 0.6 seconds recommended in the ANSI S12.60 building standard (ANSI/ASA 2010).



**Figure 5.9:** RT average in the 500 and 1000 Hz octave bands for all of the classrooms measured.

The RT values calculated from the BRIR measurements conducted in four of the classrooms are shown in Figure 5.10. This figure shows the average  $T_{20}$  values from the left and right ears in each octave band from 125 to 8000 Hz.



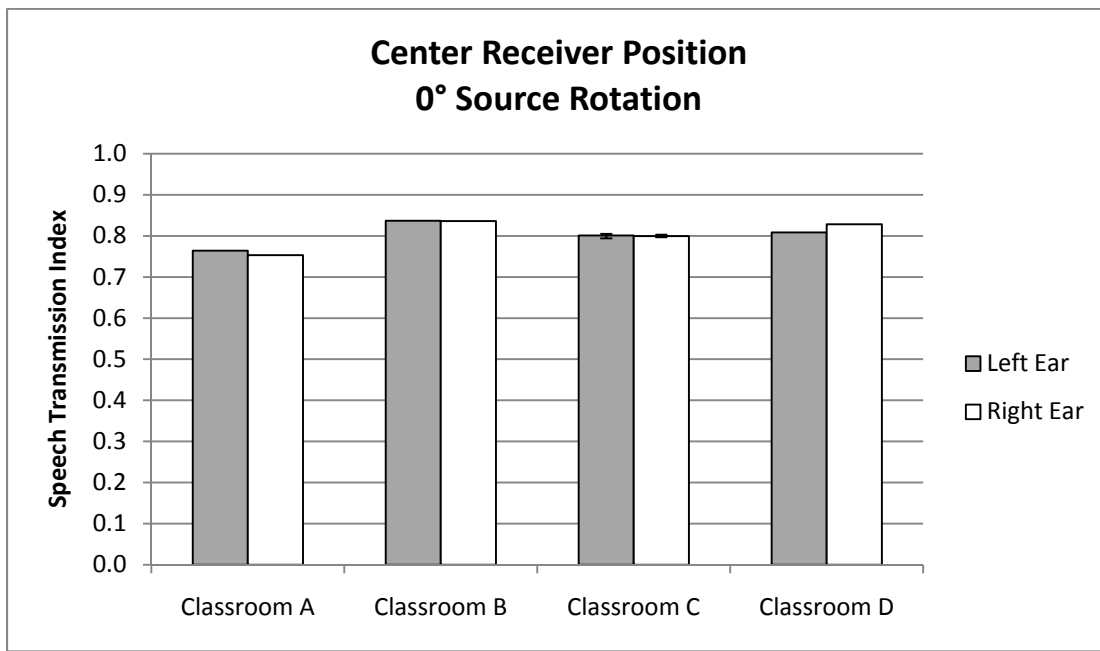
**Figure 5.10:** Octave band reverberation time ( $T_{20}$ ) values averaged between the right and left ears for the four classrooms in which BRIR measurements were conducted.

### 5.3.3 *Speech Transmission Index*

The STI values were calculated from the BRIR measurements conducted in four of the classrooms. More details on the STI calculation procedure are in Chapter 2 of this dissertation.

Comparisons of the STI values among the four spaces tested are shown in Figures 5.11 and 5.12. Figure 5.11 shows the STI values for the center receiver position,  $0^\circ$  source rotation. As expected for this measurement configuration, similar STI values occur between the left and right ears. Also, similar STI values occur

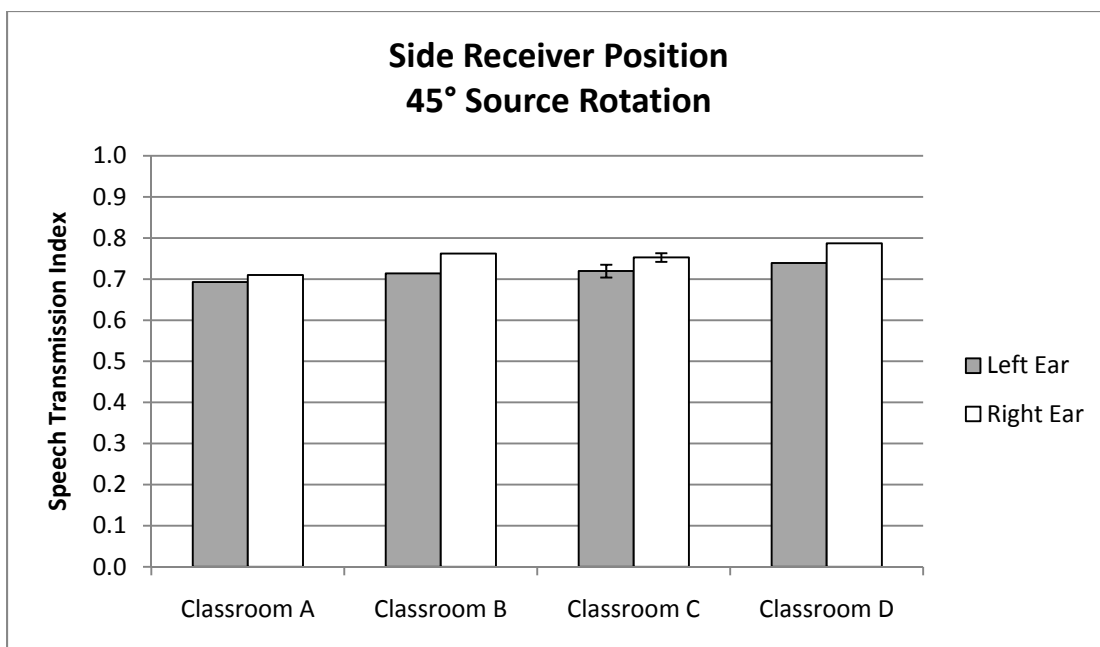
among the four different classrooms, which may be partially attributed to the similar background noise levels in the four spaces.



**Figure 5.11:** Speech transmission index values for the center receiver position, 0° source rotation. Error bars for Classroom C show the range about the average value from the three sets of repeated measurements.

Figure 5.12 contains the STI values for the side receiver position, 45° source rotation. As expected, the right ear STI values are slightly greater than the left ear STI values in this configuration, since the right ear is receiving more direct sound energy than the left ear. The STI values among classrooms are similar for this configuration as well.

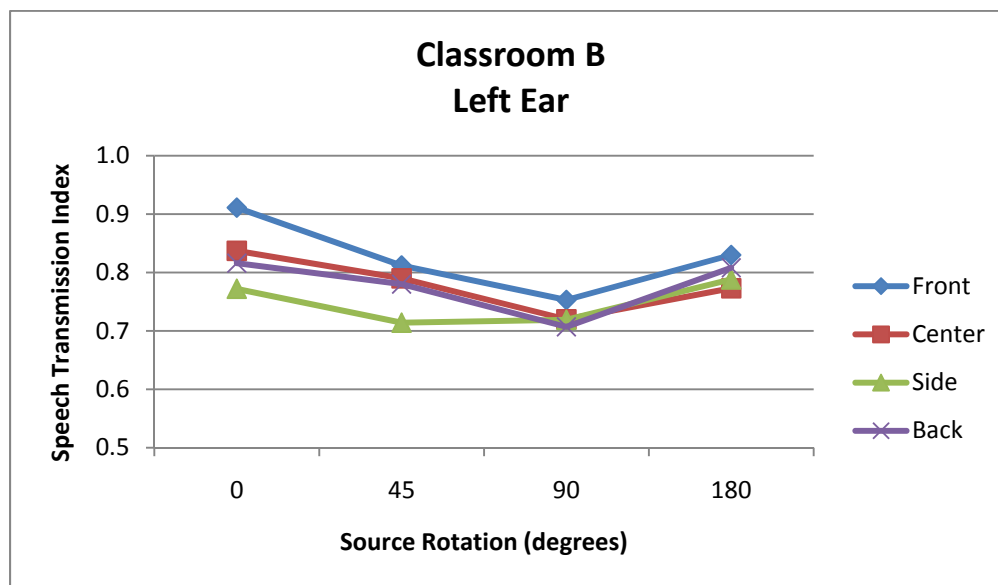




**Figure 5.12:** Speech transmission index values for the side receiver position, 45° source rotation. Error bars for Classroom C show the range about the average value from the three sets of repeated measurements.

The variation in STI among the other measurement configurations is similar among the four classrooms. Figure 5.13 shows the STI values measured at the left ear for all of the measurement configurations within Classroom B. The STI trends shown in this figure are similar to the STI trends occurring for both the left and right ears in all of the classrooms. Typically, the STI is highest in the front receiver position and lowest in the side or back receiver position. As expected, the STI tends to decrease as the source rotates from 0° to 45° to 90°, since the direct sound incrementally decreases among these source rotations. The increase in STI occurring

for the 180° source rotation may be due to the integration of the reflections off of the hard front wall surface with the early sound energy.



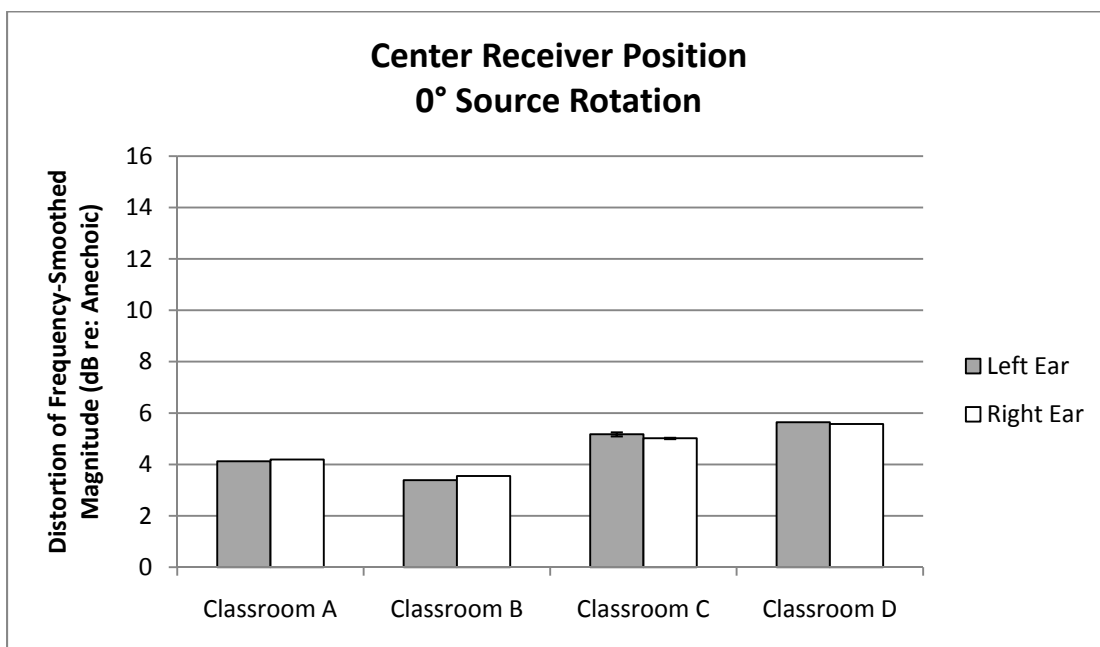
**Figure 5.13:** Speech transmission index values measured at the left ear in Classroom B.

#### 5.3.4 Distortion of Frequency-Smoothed Magnitude

The DFSM metric was calculated from the measured BRIRs as described in Chapter 2 of this dissertation and in Shinn-Cunningham et al. (2005). It is the mean absolute difference between the pseudo-anechoic and reverberant frequency response for each space.

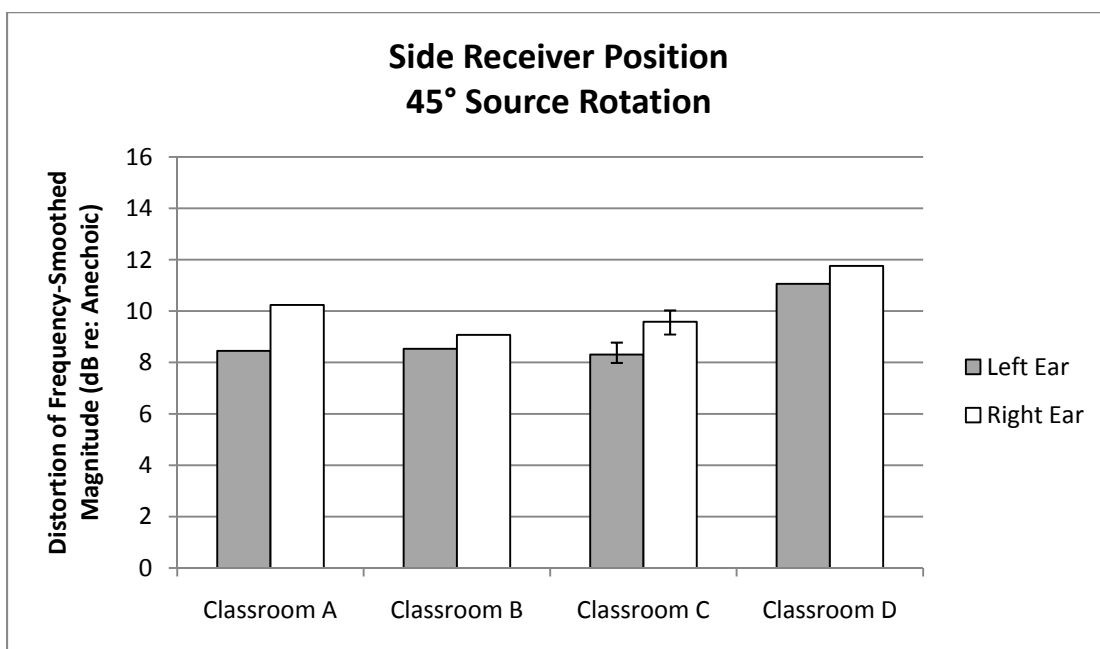
Figures 5.14, 5.15, and 5.16 contain comparisons of the DFSM values among the four classrooms. The DFSM values for the center receiver position, 0° source

rotation are shown in Figure 5.14. In this measurement configuration, the left and right ear DFSM values are approximately equivalent as expected. Slight differences in DFSM values occur among the classrooms, with the lowest DFSM values occurring in Classroom B and the highest DFSM values occurring in Classroom D. Classroom D had the largest distance from the front to the back of the room, and Classroom B had the shortest distance from the front to the back of the room. Therefore, the differences in DFSM values among classrooms may be explained by the differences in source to receiver distances among classrooms.



**Figure 5.14:** Distortion of frequency-smoothed magnitude values for the center receiver position,  $0^\circ$  source rotation. Error bars for Classroom C show the range about the average value from the three sets of repeated measurements.

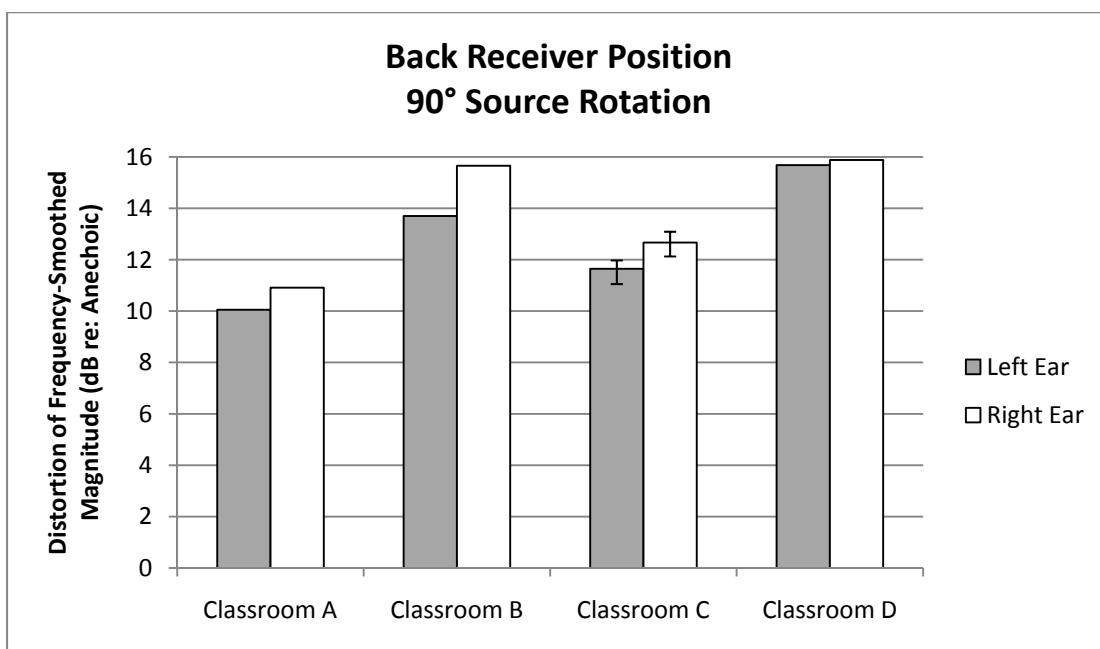
Figure 5.15 contains the DFSM values for the side receiver position,  $45^\circ$  source rotation. In this configuration, the right ear DFSM values tend to be higher than the left ear DFSM values. As in the center receiver position,  $0^\circ$  source rotation, the DFSM values in Classroom D are higher than the DFSM values in the other classrooms in this condition. As previously noted, Classroom D also had the longest distance from the source to the receiver for all measurement configurations.



**Figure 5.15:** Distortion of frequency-smoothed magnitude values for the side receiver position,  $45^\circ$  source rotation. Error bars for Classroom C show the range about the average value from the three sets of repeated measurements.

The DFSM values among the classrooms for the back receiver position,  $90^\circ$  source rotation are shown in Figure 5.16. All of the right ear DFSM values are higher than the left ear DFSM values for this condition. In this condition, the DFSM values

in Classrooms B and D are higher than the DFSM values in Classrooms A and C. These differences may be partially attributed to the varying furniture arrangements near the front corners of the classrooms that the source was facing for the 90° rotations. Both Classrooms B and D had more stacked furniture and shelves in this corner than Classrooms A and C, which may have created more variations in the signal spectra.

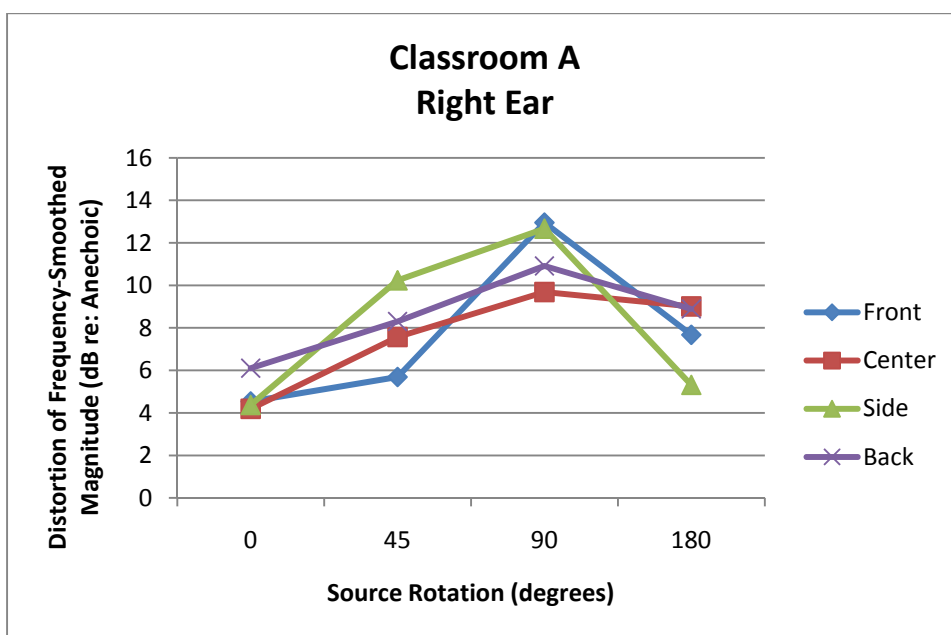


**Figure 5.16:** Distortion of frequency-smoothed magnitude values for the back receiver position, 90° source rotation. Error bars for Classroom C show the range about the average value from the three sets of repeated measurements.

Figures 5.17, 5.18, and 5.19 display the DFSM values for the different measurement conditions within three of the classrooms. The left and right ear trends among the different measurement configurations are similar, though the magnitude of

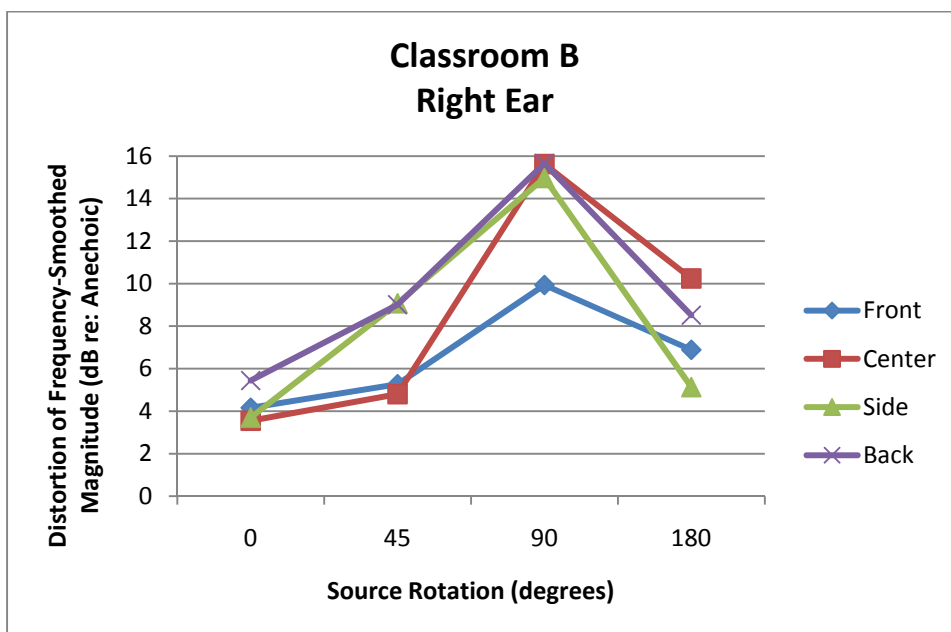
the left ear DFSM values is typically equal to or less than the magnitude of the right ear DFSM values.

The DFSM values measured at the right ear in Classroom A are shown in Figure 5.17. In this classroom, the DFSM values tend to increase as the source rotates from 0° to 45° to 90°, and decrease for the 180° source rotation. The change in DFSM values among the different measurement conditions in Classroom A is similar to the change occurring in Classroom C. Classrooms A and C also have similar distances from the source to the receiver for all measurement configurations.



**Figure 5.17:** Distortion of frequency-smoothed magnitude values measured at the right ear in Classroom A.

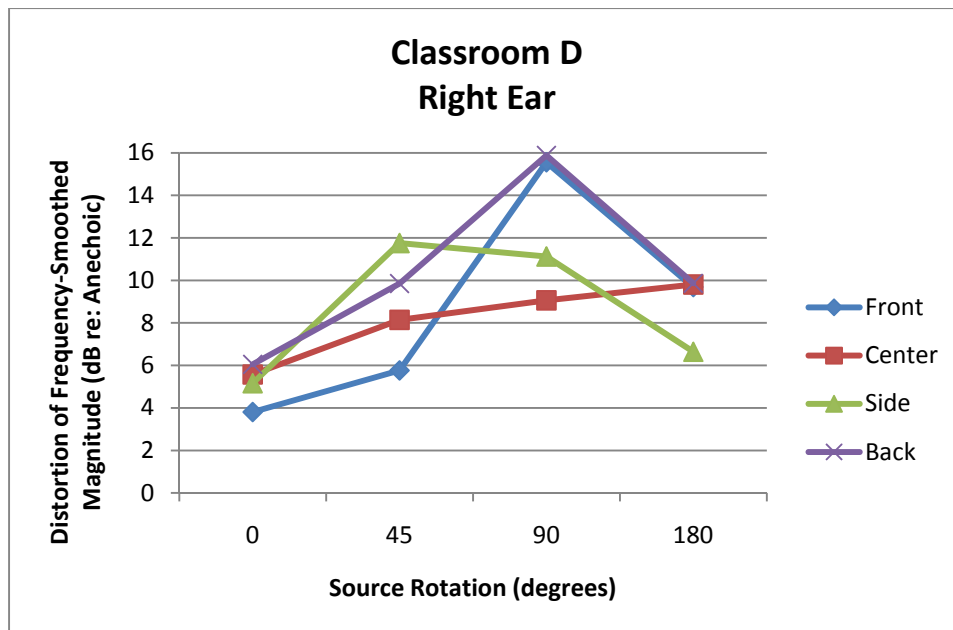
Figure 5.18 contains the DFSM values measured at the right ear in Classroom B. The DFSM values in this classroom follow the same trends with varying source rotations as in Classrooms A and C, though the effect is more pronounced. Classroom B had a counter with a cabinet directly behind the source which may have caused this. Also, in Classroom B, the front receiver position DFSM value is considerably smaller than the DFSM values in the other receiver positions for the 90° source rotation, which may be attributed to the short distance from the source to the receiver in the front position in Classroom B.



**Figure 5.18:** Distortion of frequency-smoothed magnitude values measured at the right ear in Classroom B.

The DFSM values for the right ear in Classroom D are shown in Figure 5.19. In this classroom, the trends for the side receiver position DFSM values differ from

the other receiver positions. In the side receiver position, the DFSM values are highest for the 45° source rotation, rather than the 90° source rotation. The reason for this is unknown, though it may be due to the particular furniture arrangement in that classroom.



**Figure 5.19:** Distortion of frequency-smoothed magnitude values measured at the right ear in Classroom D.

A wide range of DFSM values occurs among all of the different measurement configurations within the classrooms, from 3 to 16 dB (re: Anechoic). The differences in DFSM values within classrooms may be due to the varying distances from the source to the receiver and the impacts of different reflective or diffusing surfaces in the path from the source to the receiver. Generally, classrooms or measurement configurations with longer distances from the source to the receiver

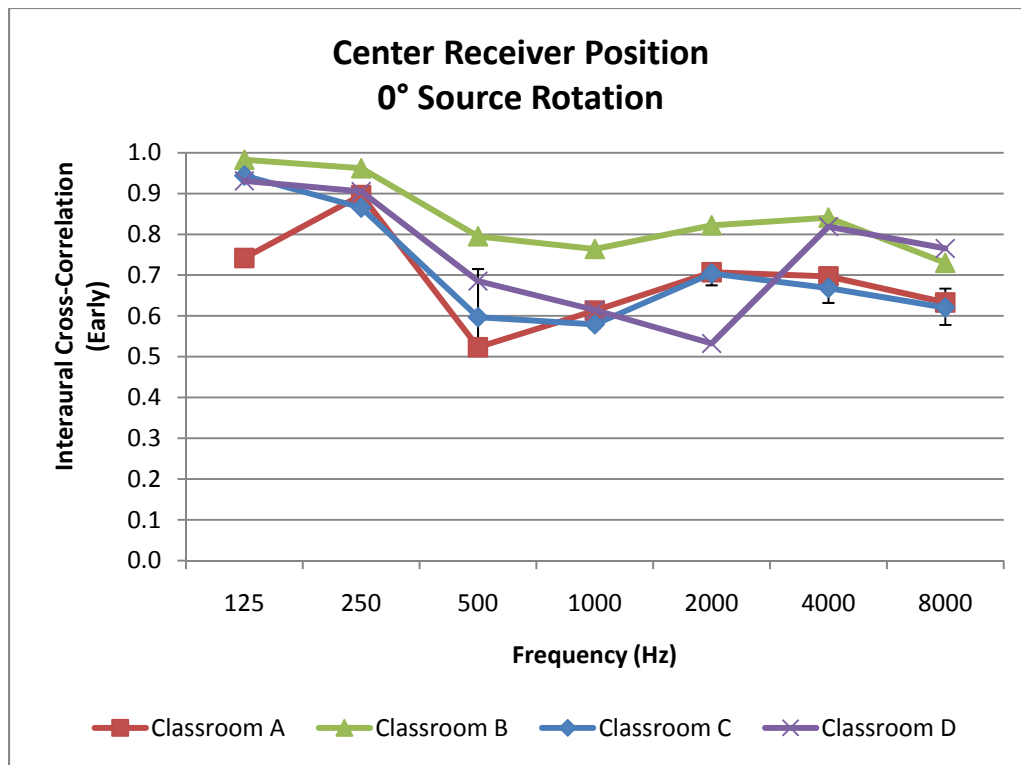


have higher DFSM values. Also, classrooms with more surfaces along the reflection path typically have higher DFSMs.

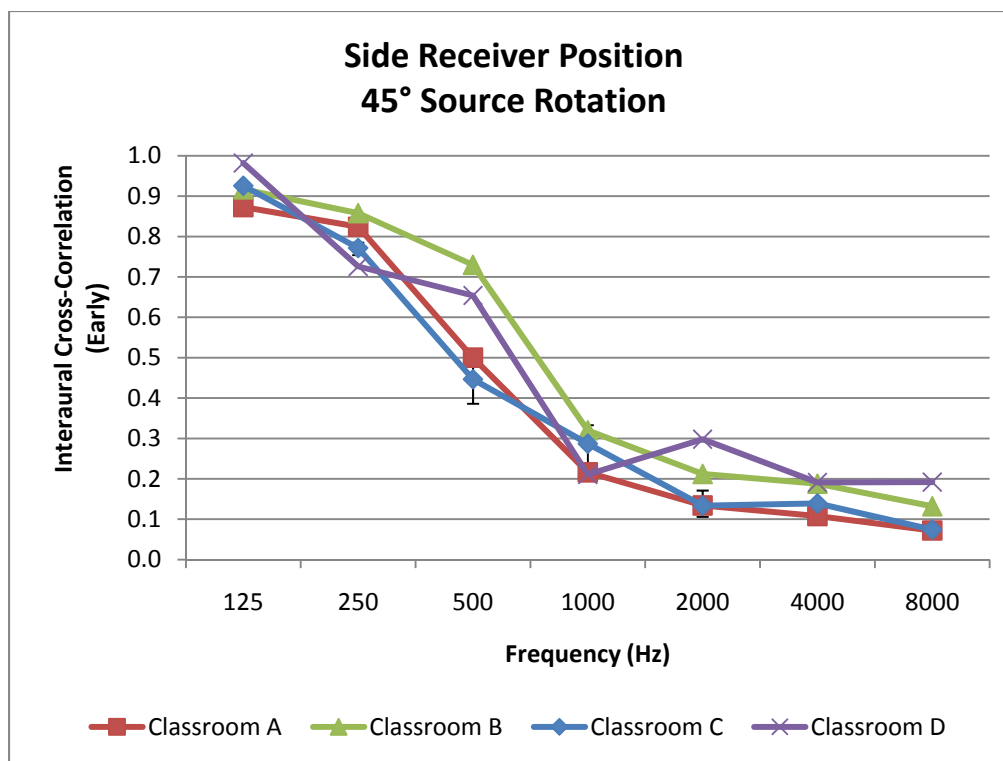
### **5.3.5 Interaural Cross-Correlation**

The IACC quantifies how similar the content of the signal is between the left and right ears. IACC values range from zero to one, with values closer to one corresponding to a more highly correlated signal between the two ears. More details on the calculation procedure for IACC may be found in Chapter 2 of this dissertation. The  $IACC_E$  or IACC (early) designation denotes IACC values calculated from the first 80 ms of the impulse response. The  $IACC_E$  values calculated from the BRIRs in octave bands from 125 to 8000 Hz are presented in this chapter.

Comparisons of the  $IACC_E$  values among the four classrooms are shown in Figures 5.20 and 5.21 for the center receiver position,  $0^\circ$  source rotation and the side receiver position,  $45^\circ$  source rotation, respectively. In general, the  $IACC_E$  values tend to decrease with frequency as expected. This decrease is most pronounced for measurement configurations in which the two ears are receiving unequal amounts of direct sound energy.



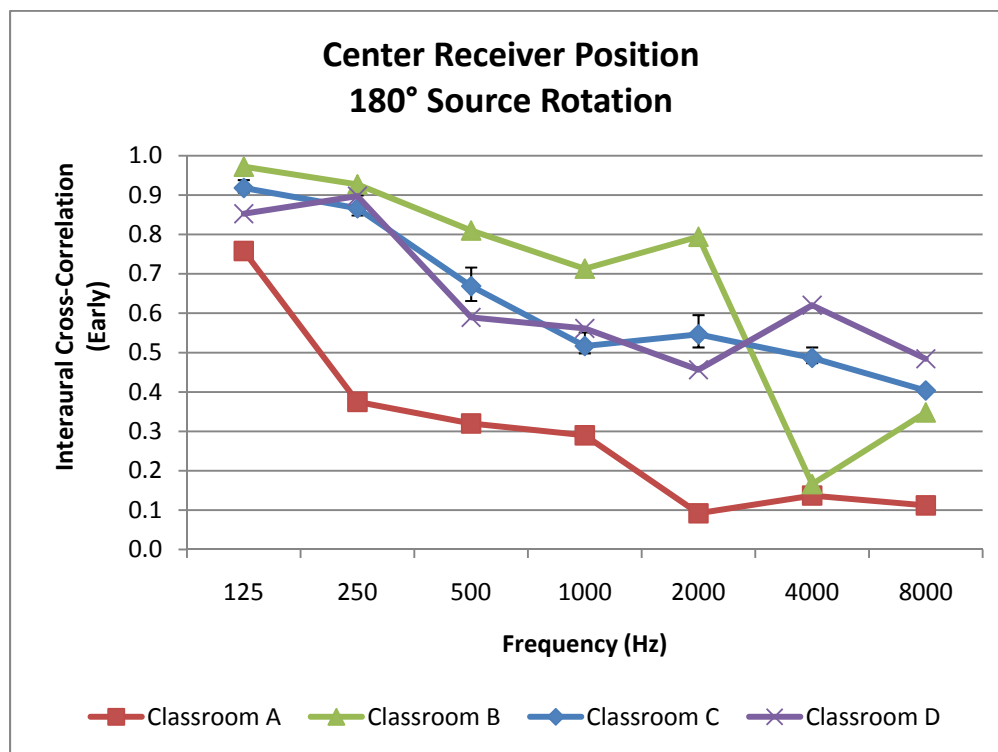
**Figure 5.20:** Interaural cross-correlation (early) values for the center receiver position, 0° source rotation. Error bars for Classroom C show the range about the average value from the three sets of repeated measurements.



**Figure 5.21:** Interaural cross-correlation (early) values for the side receiver position, 45° source rotation. Error bars for Classroom C show the range about the average value from the three sets of repeated measurements.

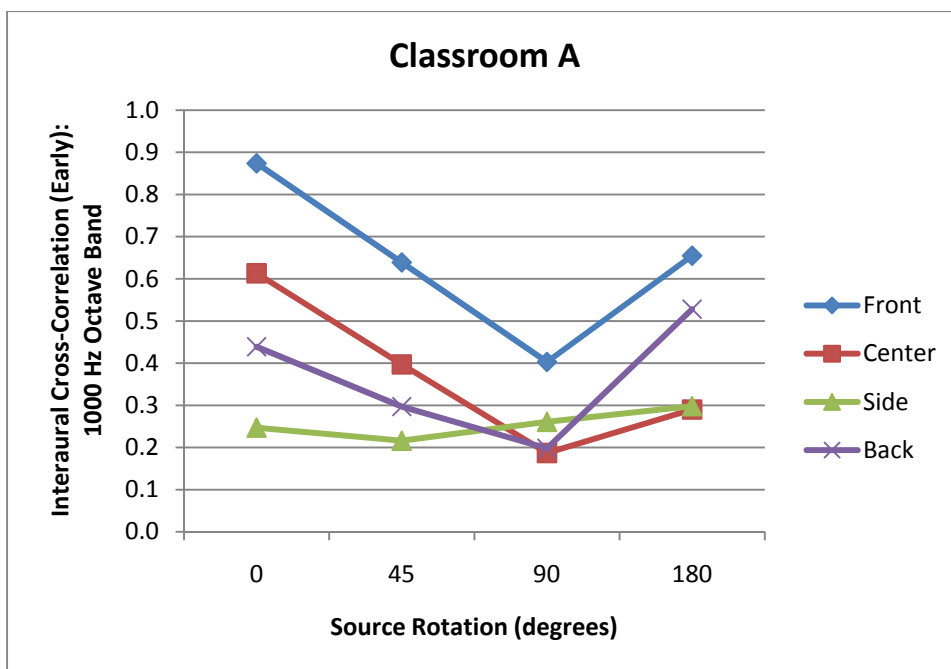
Differences among classrooms are most pronounced for the center receiver position, 180° source rotation, shown in Figure 5.22. In this condition, Classroom A has the lowest  $IACC_E$  value for all frequencies. This may be due to the student desk arrangement in this classroom. Classroom A was the only classroom with a traditional, linear arrangement of student desks facing the front of the room when the measurements were conducted. Classrooms B, C, and D had open areas or grouped desks near the receiver locations when the measurements were conducted. For all

other measurement conditions, the IACC values are more similar among classrooms, with most differences occurring from 1000 to 8000 Hz.



**Figure 5.22:** Interaural cross-correlation (early) values for the center receiver position, 180° source rotation. Error bars for Classroom C show the range about the average value from the three sets of repeated measurements.

The  $IACC_E$  variations within a typical classroom (Classroom A) are shown in Figure 5.23. As expected, the  $IACC_E$  values tend to decrease as the receiver moves from the front to the center to the back to the side position. The  $IACC_E$  values also tend to decrease as the source rotates from 0° to 45° to 90°, and increase for the 180° source rotation.

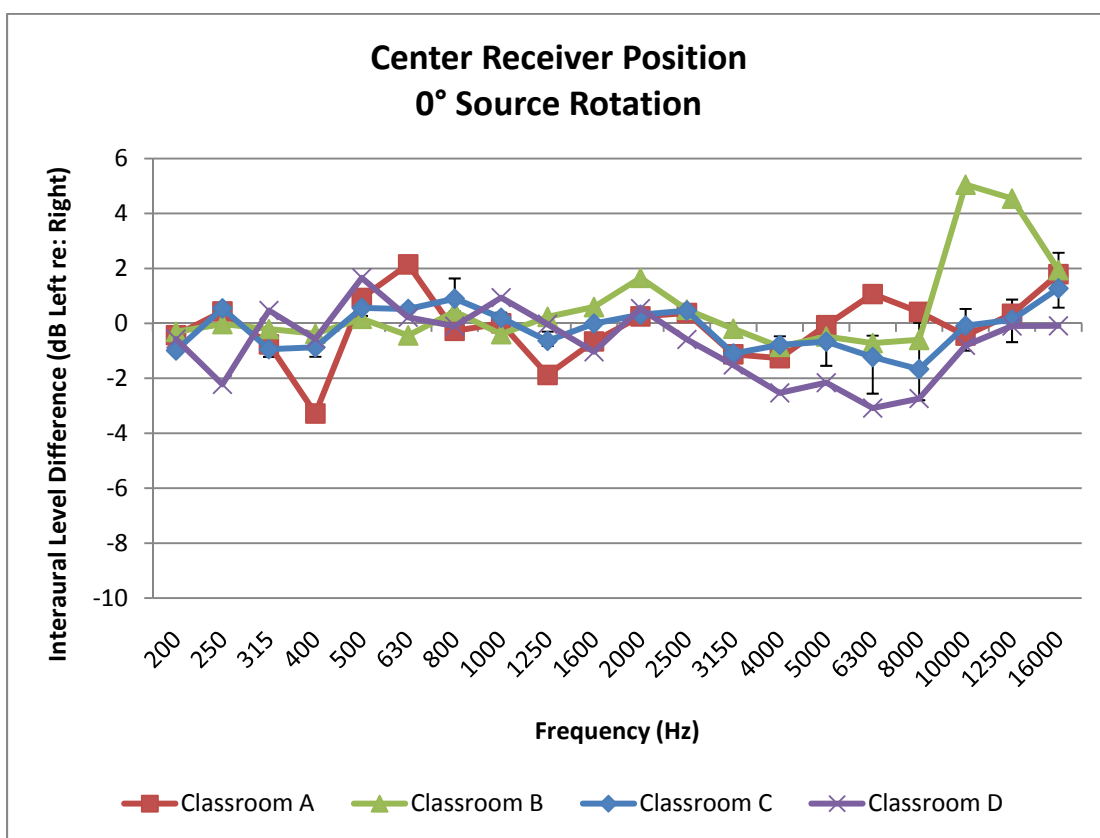


**Figure 5.23:** Interaural cross-correlation (early) values for Classroom A.

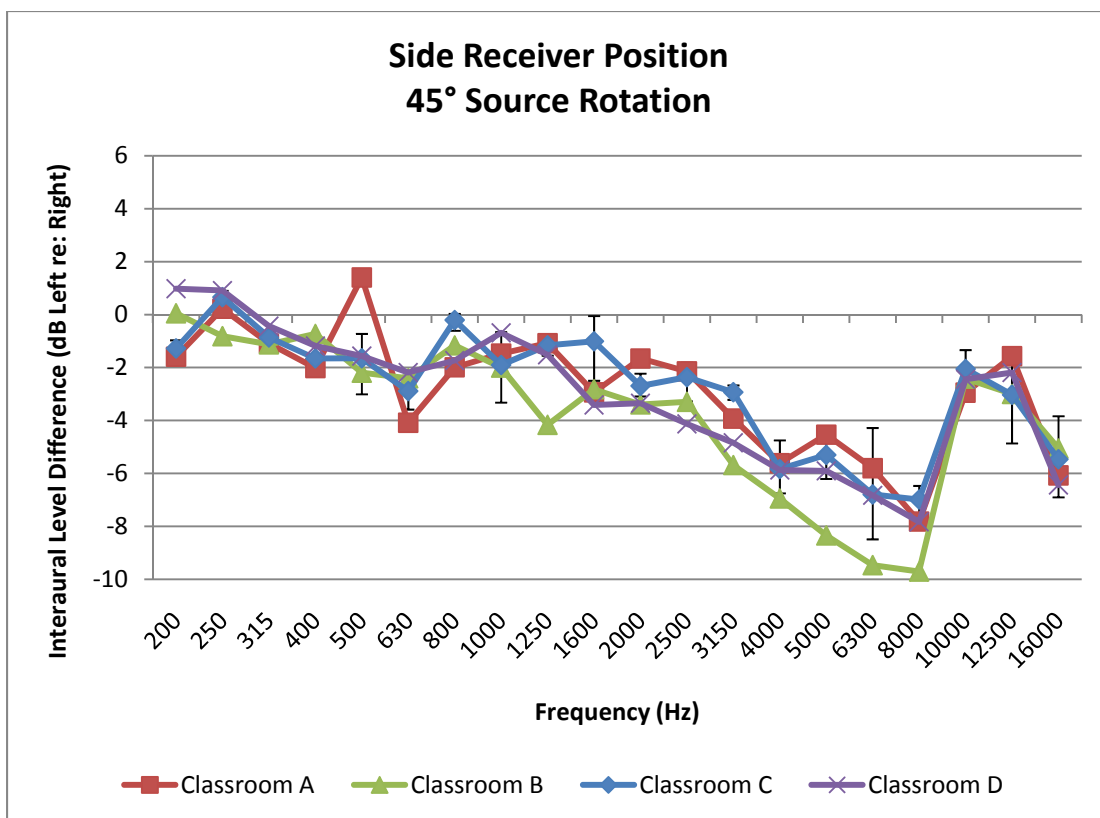
### 5.3.6 Interaural Level Difference

The ILD is the level difference occurring between the left and right ears. The ILDs presented in this chapter are calculated in one-third octave bands from 200 to 16,000 Hz from the measured BRIRs, with the level in the left ear calculated with reference to the level in the right ear. Therefore, positive ILD values correspond to conditions where the level in the left ear is greater than the level in the right ear, and negative ILD values correspond to conditions where the level in the right ear is greater than the level in the left ear.

In general, similar ILDs occur among classrooms for any given condition. Figures 5.24 and 5.25 show ILD values for all four classrooms for two measurement configurations. Figure 5.24 contains the ILDs for the center receiver position, 0° source rotation. The ILDs for the side receiver position, 45° source rotation are displayed in Figure 5.25. In general, the magnitude of the ILDs increases with frequency, particularly for measurement configurations in which the right ear is receiving more direct sound energy than the left ear.

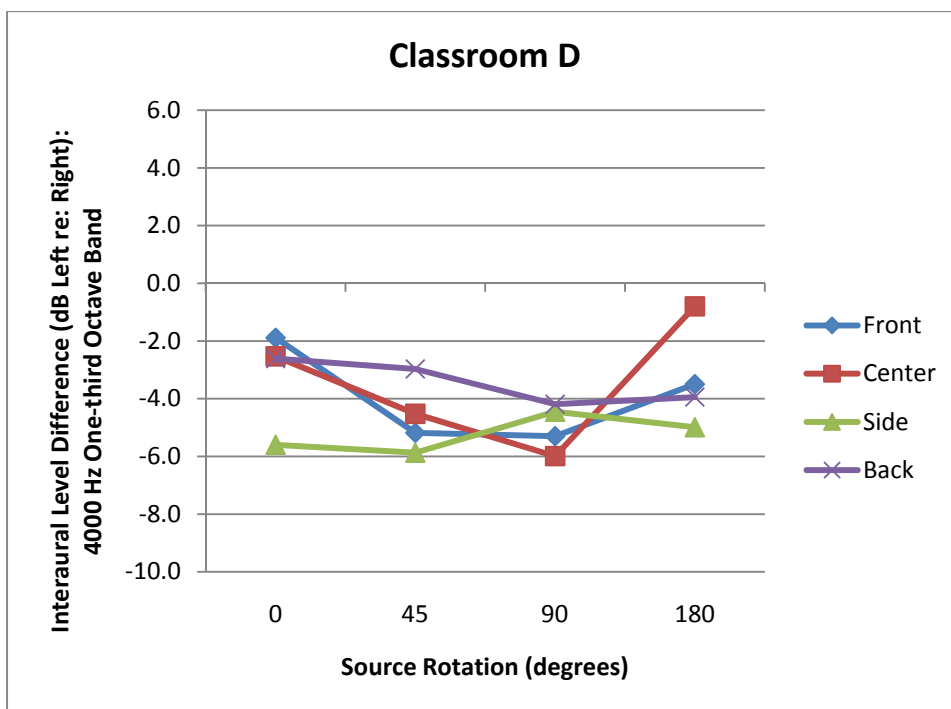


**Figure 5.24:** Interaural level differences for the center receiver position, 0° source rotation. Error bars for Classroom C show the range about the average value from the three sets of repeated measurements.



**Figure 5.25:** Interaural level differences for the center receiver position, 45° source rotation. Error bars for Classroom C show the range about the average value from the three sets of repeated measurements.

ILD values in the 4000 Hz one-third octave band for different measurement configurations within a typical classroom (Classroom D) are shown in Figure 5.26. The ILD magnitude tends to be greater for the side measurement configuration and the 45° and 90° source rotations. In these conditions, the two ears are receiving unequal amounts of direct sound energy.



**Figure 5.26:** Interaural level differences for Classroom D.

### 5.3.7 Student Achievement Tests and Poverty Rates

The results from the standardized student achievement tests, reported as the percentage of students at each grade level in each school scoring above the 41<sup>st</sup> percentile are shown in Table 5.2. The average poverty rates for each school are also provided in Table 5.2. The poverty rates among schools range from 33% to 78%, and are used as a control variable in some of the statistical analyses. Schools A through K in Table 5.2 are the same schools shown in Figure 5.8, which had consistent mechanical system conditions for all of the BNL measurements. The state of Iowa sets the minimum percentage of proficient students who should meet the state



achievement trajectory at the fourth-grade level for each academic year. For 2008 – 2009, the fourth-grade state trajectory for reading comprehension was 76% proficient and the state trajectory for math was 74.7% proficient.

**Table 5.2:** Standardized student achievement scores and poverty rates for all 14 elementary schools tested. Schools A through K had consistent mechanical system conditions for BNL measurements.

<b>Standardized Student Achievement Scores (% Proficient)</b>					
	<b>2nd Grade</b>		<b>4th Grade</b>		<b>Poverty Rates</b>
	<b>Reading Comprehension</b>	<b>Math</b>	<b>Reading Comprehension</b>	<b>Math</b>	
<b>School A</b>	62	42	72	72	77
<b>School B</b>	75	75	100	73	34
<b>School C</b>	73	71	71	73	81
<b>School D</b>	66	59	66	71	63
<b>School E</b>	62	62	84	74	49
<b>School F</b>	59	51	72	84	64
<b>School G</b>	92	62	69	77	72
<b>School H</b>	69	49	78	69	78
<b>School I</b>	78	83	76	76	64
<b>School J</b>	68	66	58	70	75
<b>School K</b>	70	65	66	66	84
<b>School L</b>	81	73	73	76	68
<b>School M</b>	81	65	83	91	33
<b>School N</b>	75	64	87	87	42

## 5.4 Data Analyses and Discussion

Statistical analyses were performed on the data to evaluate relationships between the classroom acoustical conditions and the student achievement scores. All of the statistical tests used are described in Chapter 4 of this dissertation. The classroom BNL and RT are the acoustical metrics included in the statistical analyses. Since the STI, DFSM, IACC, and ILD metrics were only gathered in four of the classrooms, statistical tests were not performed on these variables. Rather, scatter plots relating these acoustical variables to the achievement scores are discussed.

### 5.4.1 *Background Noise Level and Reverberation Time vs. Student Achievement*

Since the standardized achievement test results were not available on a per classroom basis, the average BNL and RT conditions per grade level per school were compared to the average reading comprehension and math standardized achievement scores per grade level per school. Only the schools (11 total) with the central mechanical system operating during the measurements were included in the BNL statistical analyses.

To determine if parametric statistical tests should be used, the distributions of all of the data sets were tested for normality. The Kolmogorov-Smirnov tests for normality indicated that none of the data distributions are significantly different from normal distributions: BNL ( $D(22) = 0.092, p > 0.05$ ), RT ( $D(28) = 0.162, p > 0.05$ ), reading comprehension ( $D(28) = 0.102, p > 0.05$ ), and math ( $D(28) = 0.109, p > 0.05$ ). Consequently, parametric statistical tests including Pearson correlations, semi-partial correlations controlling for poverty rates, analysis of variance (ANOVA), and

regressions may be utilized to assess the relationships between the BNL and the standardized student achievement scores. More information on these statistical methods may be found in Chapter 4 of this dissertation, Field (2000), and Field and Hole (2003).

#### *5.4.1.1 Background Noise Level*

The zero-order Pearson correlations relating the BNL shown in Figure 5.8 to the standardized achievement scores were calculated, with the only significant relationship occurring between BNL and the reading comprehension student achievement scores ( $r = -0.55, p < 0.01$ ), indicating that students' reading comprehension learning ability is negatively impacted by higher unoccupied BNL. The zero-order Pearson correlations relating BNL to the standardized achievement scores are shown in Table 5.3. When controlling for the effects of poverty rates on the reading comprehension scores, the semi-partial correlation value of -0.49 between BNL and reading comprehension is also significant ( $t(19) = -2.55, p < 0.05$ ).

**Table 5.3:** Correlations between BNL and student achievement scores (\*\*  $p < 0.01$ ).

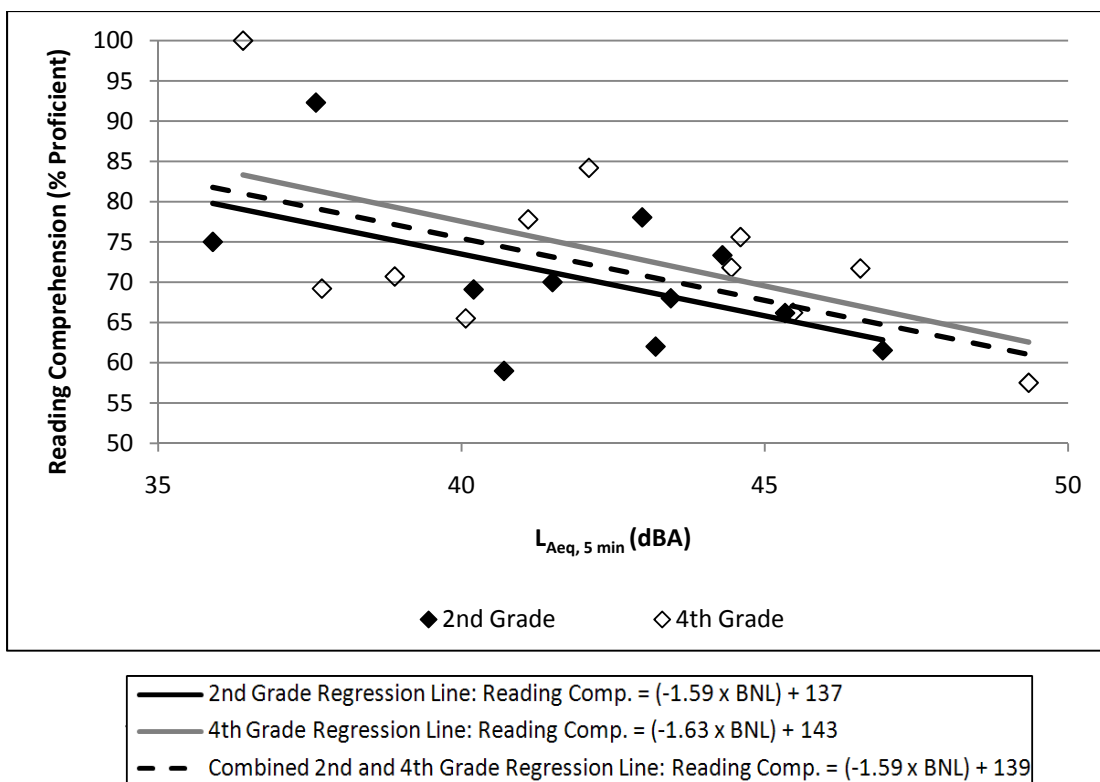
Variable	1	2	3
<b>1. BNL</b>	-	-0.55**	-0.01
<b>2. Reading Comprehension</b>	-	-	0.37
<b>3. Math</b>	-	-	-

---

*Note.* The sample size for all of the pairs of correlations is 22.

A two-way independent ANOVA, with grade level and BNL as the independent variables and reading comprehension scores as the dependent variable, was conducted to further assess the relationship between BNL and reading comprehension. For the ANOVA, the BNLs were grouped in 3 dBA ranges. The results show that the main effect of grade level on the reading comprehension scores is non-significant ( $F(1, 13) = 2.04, p > 0.05$ ), whereas the main effect of BNL on the reading comprehension scores is significant ( $F(4, 13) = 3.38, p < 0.05$ ). The interaction effect between grade level and BNL is not significant ( $F(3, 13) < 1, p > 0.05$ ), indicating the second and fourth-grade students' reading comprehension scores were impacted similarly by varying BNL. For the ANOVA, Levene's test indicated that the assumption of homogeneity of variance has been violated, ( $F(8, 13) = 5.82, p < 0.01$ ), thus the F-tests reported should be interpreted with caution.

A scatter plot between BNL and reading comprehension student achievement scores is shown in Figure 5.27, along with regression lines plotted from models that were calculated to quantify the negative relationship of high BNL on reading comprehension scores for the data sets containing (a) the second-grade classrooms only, (b) the fourth-grade classrooms only, and (c) the combined second and fourth-grade classrooms. The full results from the regression analysis are shown in Table 5.4. The model using the combined second and fourth-grade data set is significant at the 0.01 level ( $F(1,20) = 8.56, p < 0.01$ ), with BNL accounting for 30% of the variance in the reading comprehension scores ( $R^2 = 0.30, p < 0.01$ ). The results suggest that in order to meet the minimum state trajectory of having 76% of the fourth-grade students exhibiting proficiency in reading comprehension, the highest acceptable unoccupied BNL predicted by the regression model for the fourth-grade classrooms only is 41 dBA; note that the reading comprehension scores continue to improve as the unoccupied BNL is decreased below 41 dBA, though.



**Figure 5.27:** Scatter plot and linear regression lines between unoccupied BNL and reading comprehension scores.

As shown in Figure 5.27, the intercept for the second-grade regression line is lower than the intercept for the fourth-grade regression line. This indicates that lower BNLs would be required for the younger students to attain the same reading comprehension scores as the older students.

**Table 5.4:** Regression results predicting reading comprehension scores (\*\*  $p < 0.01$ ).

Predictor Variables	<b>b</b>	$\beta$	<i>t</i>	$R^2$	<i>F</i>
<b>Second-Grade (N = 11)</b>					
<b>Intercept</b>	137.04				
<b>BNL</b>	-1.59	-0.53	-1.88	0.28	3.54
<b>Fourth-Grade (N = 11)</b>					
<b>Intercept</b>	142.87				
<b>BNL</b>	-1.63	-0.59	-2.17	0.32	4.72
<b>Combined Second and Fourth-Grade (N = 22)</b>					
<b>Intercept</b>	138.95				
<b>BNL</b>	-1.59	-0.55	-2.93**	0.30	8.56**

The regression results with both BNL and poverty rates as predictors for the reading comprehension scores for the combined second and fourth-grade data set are shown in Table 5.5. This model is significant at the 0.05 level ( $F(2,19) = 5.78, p < 0.05$ ), with the predictor variables accounting for 38% of the variance in the reading comprehension scores ( $R^2 = 0.38, p < 0.05$ ). The significant predictor variable in this model is BNL ( $t(19) = -2.55, p < 0.05$ ).

**Table 5.5:** Regression results predicting reading comprehension scores (\*  $p < 0.05$ ).

Predictor Variables	<b>b</b>	<b><math>\beta</math></b>	<b><i>t</i></b>	<b><math>R^2</math></b>	<b><i>F</i></b>
<b>Combined Second and Fourth-Grade (N = 22)</b>					
<b>Intercept</b>	143.72				
<b>BNL</b>	-1.38	-0.48	-2.55*		
<b>Poverty Rates</b>	-0.20	-0.29	-1.55		
				0.38	5.78*

#### 5.4.1.2 Reverberation Time

The zero-order Pearson correlations relating the mid-frequency RT shown in Figure 5.9 to the standardized student achievement scores are shown in Table 5.6.

The unoccupied RT is not significantly correlated to either the reading comprehension or math student achievement scores. Therefore, results from further statistical analyses for RT are not shown.



**Table 5.6:** Correlations between RT and student achievement scores (\*  $p < 0.05$ ).

Variable	1	2	3
1. RT	-	0.24	0.03
2. Reading Comprehension	-	-	0.45*
3. Math	-	-	-

---

*Note.* The sample size for all of the pairs of correlations is 28.

#### 5.4.1.3 Discussion

The measured acoustical data from second and fourth-grade classrooms in the public school system in Council Bluffs, Iowa, have been compared with the standardized student achievement scores from the Iowa Test of Basic Skills. The results indicate that the unoccupied BNLs are not significantly correlated to the math student achievement scores, but they are significantly correlated to the reading comprehension student achievement scores even when controlling for poverty rates. In general, higher unoccupied background noise levels are related to lower reading comprehension student achievement scores. The learning processes for math may be more visual, problem-solving based, rather than verbal, which may explain why the reading comprehension scores are detrimentally impacted by higher BNL, whereas the math scores are not. The significant relationship between unoccupied BNLs and

reading comprehension student achievement scores supports previous research, which found that occupied noise levels are impacted by unoccupied noise levels (Sato and Bradley 2008).

Since the central mechanical systems were activated and comprising the majority of the background noise content during the measurements, this indicates that mechanical systems should be designed with lower background noise levels in elementary school classrooms to optimize student learning and achievement. This study shows that the highest allowable unoccupied BNL to meet the minimum acceptable fourth-grade reading comprehension student achievement in Iowa is 41 dBA. However, more research is necessary to determine the exact unoccupied background noise levels that should be specified in building standards. Chapter 6 reports on further research in this area that includes measurements in additional classrooms with the mechanical systems operating in various modes.

The statistical analyses show the classroom RTs are not significantly correlated to either the reading comprehension or math student achievement scores. However, nearly all of the classrooms tested have RTs that meet the ANSI S12.60 building standard (ANSI/ASA 2010). Measurements in classrooms with higher RTs are needed to fully assess the impact of RT on student learning.

#### ***5.4.2 Binaural Room Impulse Response Acoustical Metrics vs. Student Achievement***

As shown in Table 5.1 and Figure 5.10, the unoccupied BNLs and RTs are similar for the four classrooms in which BRIR measurements were conducted.

However, a wide range occurs among the student reading comprehension achievement scores in the four rooms. Therefore, the acoustical metrics from the BRIRs are further related to the reading comprehension scores. The standardized achievement scores shown in Table 5.2 are reported as an average value per classroom. Thus, for direct comparison, the acoustical metrics were averaged among the four receiver positions in each classroom as well.

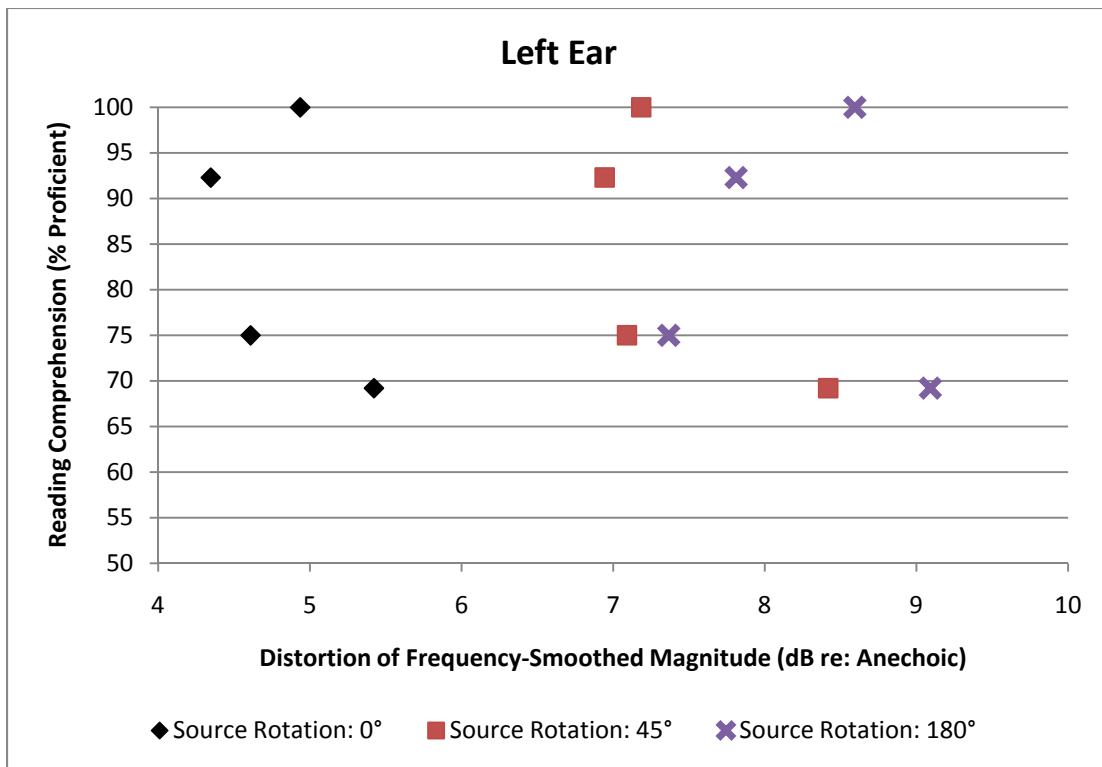
#### *5.4.2.1 Speech Transmission Index*

When averaged among all receiver positions in each room, the range in right ear STI among rooms is 0.79 to 0.85 for the 0° source rotation, 0.76 to 0.82 for the 45° source rotation, 0.75 to 0.80 for the 90° source rotation, and 0.73 to 0.81 for the 180° source rotation. The average difference in STI between the left and right ears for all source azimuth rotations ranges only from 0 to 0.05 among the four rooms. Due to the limited range in STI among the spaces investigated, relationships between the STI and the standardized student achievement scores are not presented.

#### *5.4.2.2 Distortion of Frequency-Smoothed Magnitude*

A wider range in DFSM values occurs among the four classrooms, even when averaged across receiver position. A scatter plot of the average left ear DFSM values versus the reading comprehension scores for the 0°, 45°, and 180° source rotations is shown in Figure 5.28. For all source rotations, the classrooms with the lowest (Classroom C) and highest (Classroom D) reading comprehension scores have the highest average DFSM values. The classroom with the lowest reading

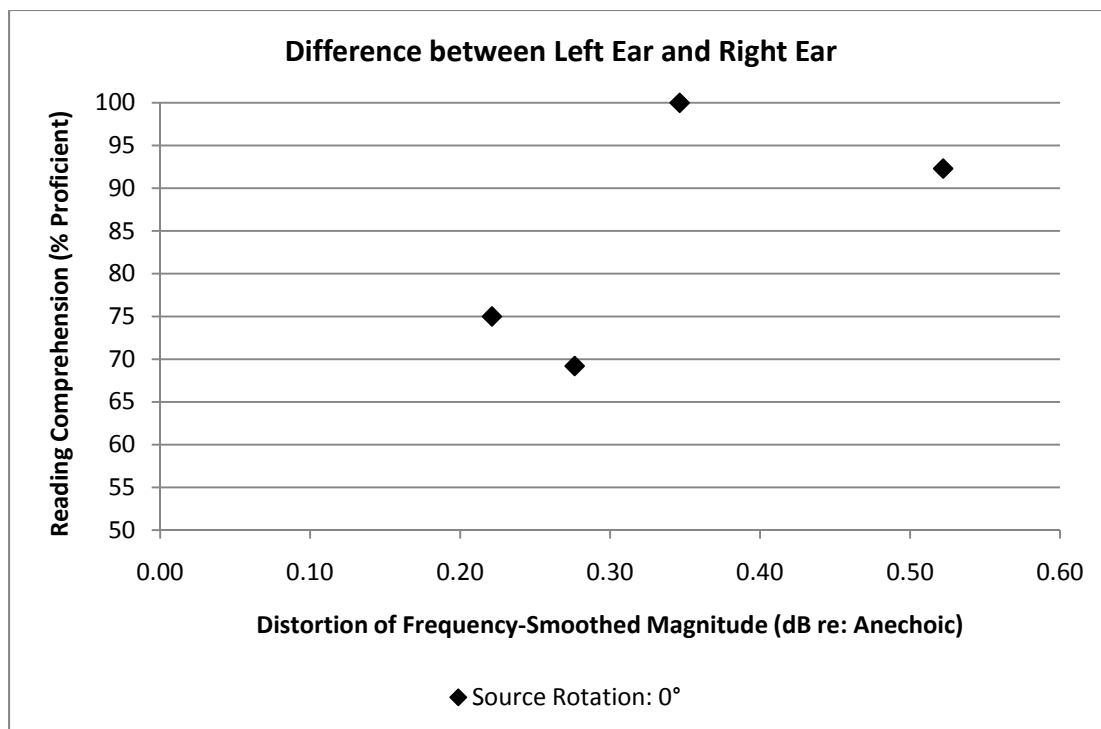
comprehension score should have the highest DFSM value, since it is theoretically harder for listeners to accurately locate the source in rooms with high DFSMs, which could explain the results in Classroom C. However, this does not account for the relationship between DFSM and reading comprehension occurring in Classroom D.



**Figure 5.28:** Scatter plot between left ear distortion of frequency-smoothed magnitude values and reading comprehension scores from all four classrooms.

To evaluate the similarity of the signal between the two ears, differences between the left and right ear DFSM values are also examined. The average difference in DFSM values between the left and right ears for the 0° source rotation versus the reading comprehension scores are shown in Figure 5.29. The two

classrooms with the highest reading comprehension scores (Classroom B and Classroom C) also have the greatest DFSM differences between the two ears. This indicates that the brain may use differences in the frequency information received between the two ears to help localize to the source.

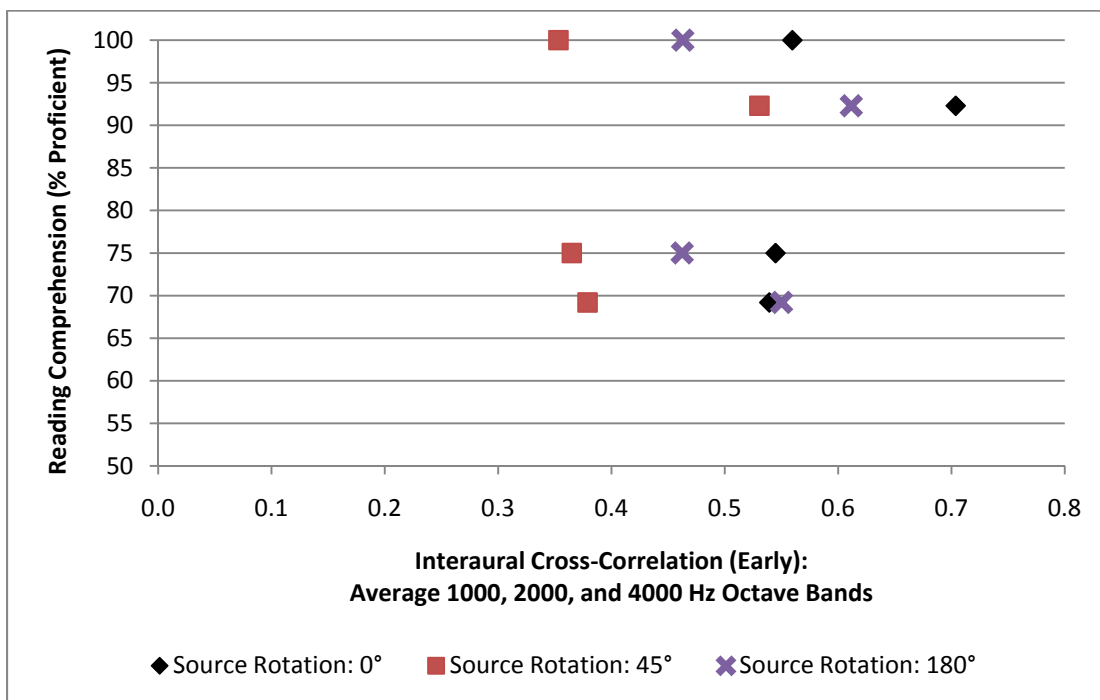


**Figure 5.29:** Scatter plot between distortion of frequency-smoothed magnitude values (difference between left and right ear) and reading comprehension scores from all four classrooms.

#### 5.4.2.3 Interaural Cross-Correlation

Sato et al. (2008) found that listening difficulty is more strongly impacted by reverberation occurring from 1 to 4 kHz than in the other octave bands. Therefore,

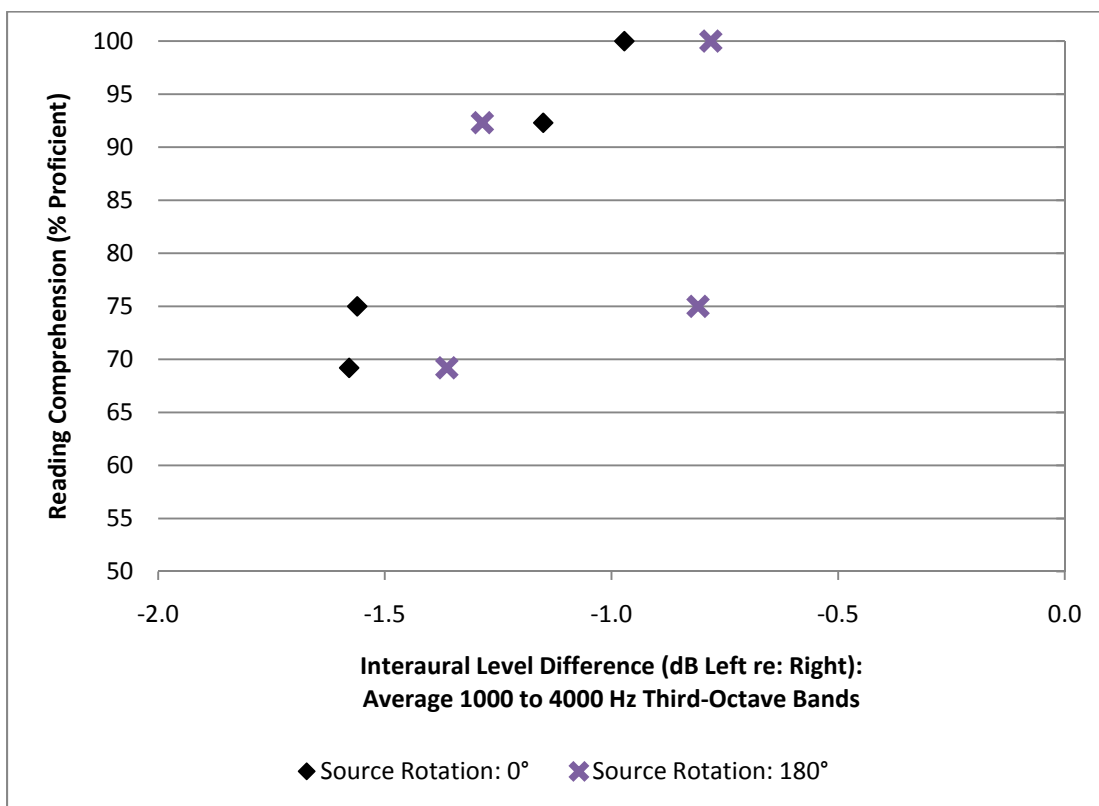
the average  $IACC_E$  value across the 1000, 2000, and 4000 Hz octave bands is compared to standardized student achievement scores. These average  $IACC_E$  values among all receiver positions in each classroom for the  $0^\circ$ ,  $45^\circ$ , and  $180^\circ$  source rotations versus the reading comprehension scores are shown in Figure 5.30. Though the  $IACC_E$  values are similar for three of the classrooms, the  $IACC_E$  for Classroom B (92.3% proficient reading comprehension score) is higher than the  $IACC_E$  value in the three other rooms for the  $0^\circ$ ,  $45^\circ$ , and  $180^\circ$  source rotations. Since the classroom with a high reading comprehension score also has the highest average  $IACC_E$  values, this indicates that high signal correlation between the two ears may aid in attaining reading comprehension learning skills.



**Figure 5.30:** Scatter plot between interaural cross-correlation (early) and reading comprehension scores from all four classrooms.

#### 5.4.2.4 Interaural Level Difference

The average ILD from 1 to 4 kHz for the 0° and 180° source rotations in each classroom is also related to the reading comprehension scores. This relationship is shown in Figure 5.31. As shown in this figure, the magnitude of the ILDs is generally lower for higher reading comprehension scores. This trend suggests that conditions with similar signal levels between the two ears may be better for reading comprehension.



**Figure 5.31:** Scatter plot between interaural level differences and reading comprehension scores from all four classrooms.

#### *5.4.2.5 Discussion*

The analyses of the BRIR measurements has shown certain binaural metrics, including interaural cross-correlations, interaural level differences, and differences in distortion of frequency-smoothed magnitude between the left and right ears, may relate to student reading comprehension. However, further analysis of these metrics using larger samples of classrooms is needed before definite conclusions may be drawn.

### **5.5 Conclusions**

This chapter presents results from an acoustical study in second and fourth-grade classrooms in Council Bluffs, Iowa. The unoccupied background noise levels in the classrooms with the central mechanical systems activated is found to be significantly related to the reading comprehension achievement scores from students in the surveyed classrooms. The results indicate that the unoccupied BNL should be at least less than 41 dBA to meet the state target for fourth-grade student performance in reading comprehension. Lower BNLs may be required for the second-grade students to attain the same reading comprehension scores as the fourth-grade students.

Binaural metrics, including interaural cross-correlations, interaural level differences, and differences in distortion of frequency-smoothed magnitude between the left and right ears, were measured in four of the classrooms that showed similar BNLs and RTs. Differences in those metrics among the four classrooms are noted, and relationships between these binaural metrics and the student reading comprehension scores are presented. In general, lower ILDs occurred in classrooms



with higher achieving students in the reading comprehension subject area. BRIR measurements in additional classrooms are needed, though, to determine if student achievement is significantly related to these metrics.

## **Chapter 6**

# **Acoustical Study of Classrooms in a Nebraska Public School District**

### **6.1 Introduction**

This chapter describes an acoustical study conducted in third and fifth-grade classrooms in the Papillion-La Vista Public School District, located in north-eastern Nebraska, USA. All of the third and fifth-grade classrooms in the 14 elementary schools during the 2009 – 2010 academic year were included in the study. For the research described in Chapter 5, background noise levels were gathered with the mechanical systems operating in only one mode. Also, acoustical data and student achievement scores were averaged per grade level per school. In the present study, noise levels were recorded with the mechanical systems operating in both the heating and cooling modes. Additionally, student achievement scores were available per classroom rather than averaged per school. This chapter presents results from the acoustical measurements in the Nebraska school district. Comparisons of these acoustical metrics to the standardized student achievement scores from students in the surveyed classrooms are also shown.

### **6.2 Methods**

An acoustical survey of the third and fifth-grade classrooms in the Papillion-La Vista School District was conducted from January through May 2010. The third-

grade students are typically 8 to 9 years-old, and the fifth-grade students are typically 10 to 11 years-old. Sixty-seven classrooms were included in the study.

### **6.2.1 *Site Visit Procedures***

As in the Council Bluffs classrooms, detailed notes and photographs were taken in each space to document the room architectural features, furnishings, and prominent noise sources. Unoccupied background noise level (BNL) and reverberation time (RT) measurements were gathered in each classroom. Unoccupied binaural room impulse response (BRIR) measurements were also gathered in 20 of the classrooms, including ten classrooms at each grade level. All perimeter windows and doors were closed before the start of each acoustical measurement.

### **6.2.2 *Classroom Descriptions***

Most of the classrooms had a traditional, closed floor plan design. However, some of the classrooms had an open floor plan design, wherein wall or door openings were present to adjacent spaces. Also, one of the classrooms was a portable unit, separate from the rest of the school building. The floor plan types and school construction dates are shown in Tables 6.1 and 6.2 for the third and fifth-grade classrooms, respectively. In these tables, classrooms with the same number designation were located in the same school building. The room finishes typically included acoustical ceiling tile, hard wall surfaces of gypsum wall board or concrete masonry unit, and thin carpet on the floor. The classrooms were usually furnished with desks, chairs, whiteboards, tack-boards, cabinets, and shelves.

**Table 6.1:** Floor plan types and construction dates for third-grade classrooms.

<b>Classroom</b>	<b>Floor Plan Type</b>	<b>Original School Construction Date</b>	<b>Most Recent School Addition Date</b>
1A	Open	1985	2000
2A*	Closed	2009	N/A
2B*	Closed		
3A	Closed	1969	1995
3B*	Closed		
3C	Closed		
4A	Closed	1963	1995
4B	Closed		
5A*	Open	1976	1995
5B*	Open		
6A	Closed with open door	1985	2008
6B	Closed with open door		
7A	Closed	1963	2001
7B	Closed		
8A	Closed	1968	2000
8B	Closed		
8C	Closed		
9A	Closed	2008	N/A
9B*	Closed		
10A	Closed	2003	2005
10B	Closed		
10C	Closed		
10D	Closed		
11A*	Closed	1995	2007
11B	Closed		
11C*	Closed		
12A	Portable	1960	1994
12B*	Closed		
12C	Closed with open door		
13A	Closed	1960	2006
13B	Closed		
13C	Closed		
14A	Closed	2000	2006
14B*	Closed		

\* Classrooms selected for BRIR measurements

**Table 6.2:** Floor plan types and construction dates for fifth-grade classrooms.

<b>Classroom</b>	<b>Floor Plan Type</b>	<b>Original School Construction Date</b>	<b>Most Recent School Addition Date</b>
<b>1B</b>	Closed	1985	2000
<b>1C*</b>	Closed		
<b>2C</b>	Closed	2009	N/A
<b>2D</b>	Closed		
<b>3D</b>	Closed	1969	1995
<b>3E</b>	Closed		
<b>3F</b>	Closed		
<b>4C</b>	Closed	1963	1995
<b>4D</b>	Closed		
<b>4E</b>	Closed		
<b>5C</b>	Open	1976	1995
<b>5D*</b>	Open		
<b>6C</b>	Closed with open door	1985	2008
<b>6D</b>	Closed with open door		
<b>7C*</b>	Closed	1963	2001
<b>7D*</b>	Closed		
<b>8D</b>	Closed	1968	2000
<b>8E</b>	Closed		
<b>8F</b>	Closed		
<b>9C*</b>	Closed	2008	N/A
<b>9D</b>	Closed		
<b>10E</b>	Closed	2003	2005
<b>10F</b>	Closed		
<b>11D</b>	Closed	1995	2007
<b>11E*</b>	Closed		
<b>11F</b>	Closed		
<b>12D*</b>	Closed with open door	1960	1994
<b>12E*</b>	Closed with open door		
<b>13D*</b>	Closed	1960	2006
<b>13E*</b>	Closed		
<b>13F</b>	Closed with open door		
<b>14C</b>	Closed	2000	2006
<b>14D</b>	Closed		

\* Classrooms selected for BRIR measurements

Most of the rooms were both heated and cooled by central mechanical systems. The temperature set points were controlled remotely. Cooling in five of the classrooms (4A, 4B, 4C, 4D, and 4E) was provided by window air-conditioning units. These units automatically turned on and off as necessary to meet the temperature set point. All of the mechanical systems were set to operate in the cooling mode if the outdoor air temperature was above 12.8° C (55° F). If the outdoor air temperature was below 12.8° C (55° F), the mechanical systems should have been operating in the heating mode.

### ***6.2.3 Background Noise Level Measurement Procedures***

BNL measurements were conducted in each classroom with the mechanical systems operating in both the heating and cooling modes. The BNL measurement procedures are the same as those used in the Council Bluffs School District, described in Section 5.2.3 of this dissertation. To quantify the number of days the mechanical systems were operating in each mode throughout the school year, from August 2009 to May 2010, weather data from two nearby weather stations were collected. If the average outdoor air temperature for the day was above 12.8° C (55° F), it was assumed the mechanical systems were operating in the cooling mode for that day. Otherwise, the mechanical systems were assumed to be operating in the heating mode for the day. The mechanical system operating conditions were used to quantify the cumulative BNLs in the classrooms throughout the school year as described in Section 6.3.1.

#### ***6.2.4 Reverberation Time Measurement Procedures***

The unoccupied RT was gathered in all of the classrooms as described in Section 5.2.4 of this dissertation.

#### ***6.2.5 Binaural Room Impulse Response Measurement Procedures***

BRIR measurements were gathered in 20 of the classrooms. These classrooms were selected due to their wide range in BNL and RT, relative to the sample of surveyed classrooms. Also, classrooms with mechanical systems that generated similar noise levels in the heating and cooling modes were chosen. The classrooms selected for the BRIR measurements are noted in Tables 6.1 and 6.2. The measurement configurations, source loudspeaker, and computer software used are the same as those described in Section 5.2.5 of this dissertation. A G.R.A.S. Sound and Vibration KEMAR Manikin Type 45BA was used for the receiver, rather than a binaural microphone headset. The manikin ear height was 1.0 m above the ground for all of the measurements.

The measurements were repeated three times in 19 classrooms for each configuration to quantify the measurement repeatability. The BRIRs could only be gathered two times for each measurement configuration in one of the classrooms (9C) due to time constraints. The source rotation and receiver manikin were moved between each set of repeated measurements.

### **6.2.6 *Standardized Achievement Tests***

Students in the surveyed classrooms completed four different standardized achievement tests during the 2009 – 2010 academic year. The students typically completed the achievement tests in the classroom spaces surveyed. The test scores were available for students in each individual classroom, rather than averaged per grade level as in Chapter 5.

Terra Nova tests in the math, language, and reading subject areas were administered to the third and fifth-grade students in November 2009. Terra-Nova assessment tests are available to schools nation-wide. The math and reading subject scores were reported as normal curve equivalent (NCE) scores, and the language subject scores were reported as percentile rank scores. Another set of tests in the reading subject area developed by the state of Nebraska, called Nebraska State Accountability tests, were administered to the students in March 2010. These results were reported as scale scores.

The percentage of students in each classroom who received free or reduced-price school lunches was also gathered. This demographic variable was used to control for socio-economic differences among the students in some of the data analyses.

## **6.3 Results**

Results from the acoustical measurements, standardized student achievement tests, and student demographic data are presented in this section. The acoustical



metrics presented include BNL, RT, speech transmission index (STI), distortion of frequency-smoothed magnitude (DFSM), interaural cross-correlation (IACC) and interaural level difference (ILD).

Although the STI, DFSM, IACC, and ILD values were calculated at 16 source-receiver conditions in each classroom, with the receiver in four different locations and the source in four different rotations, only a typical measurement configuration (center receiver position, 0° source rotation) and one additional measurement configuration (back receiver position, 90° source rotation) are shown for all classrooms. These metrics are also compared across three classrooms with a range of mid-frequency RTs.

### ***6.3.1 Background Noise Level***

The A-weighted equivalent sound levels ( $L_{Aeq}$ ) over the five minute measurement period for both the heating and cooling mechanical system modes in each classroom are shown in Figures 6.1 and 6.2 for the third and fifth-grade classrooms, respectively. The temperature-weighted average  $L_{Aeq}$  values from August through November 2009 (8/09 – 11/09) and August 2009 through March 2010 (8/09 – 3/10) are also shown in these figures. These averages were calculated from the percentage of days the mechanical systems were assumed to be operating in the cooling and heating modes based on local weather data while school was in session during these time periods, as shown in Equation 6.1.

$$BNL_{TWA} = BNL_C \left( \frac{N_C}{N_T} \right) + BNL_H \left( \frac{N_H}{N_T} \right) \quad (\text{Eq. 6.1})$$

Where:

$BNL_{TWA}$  = Temperature-weighted average BNL over a given time period

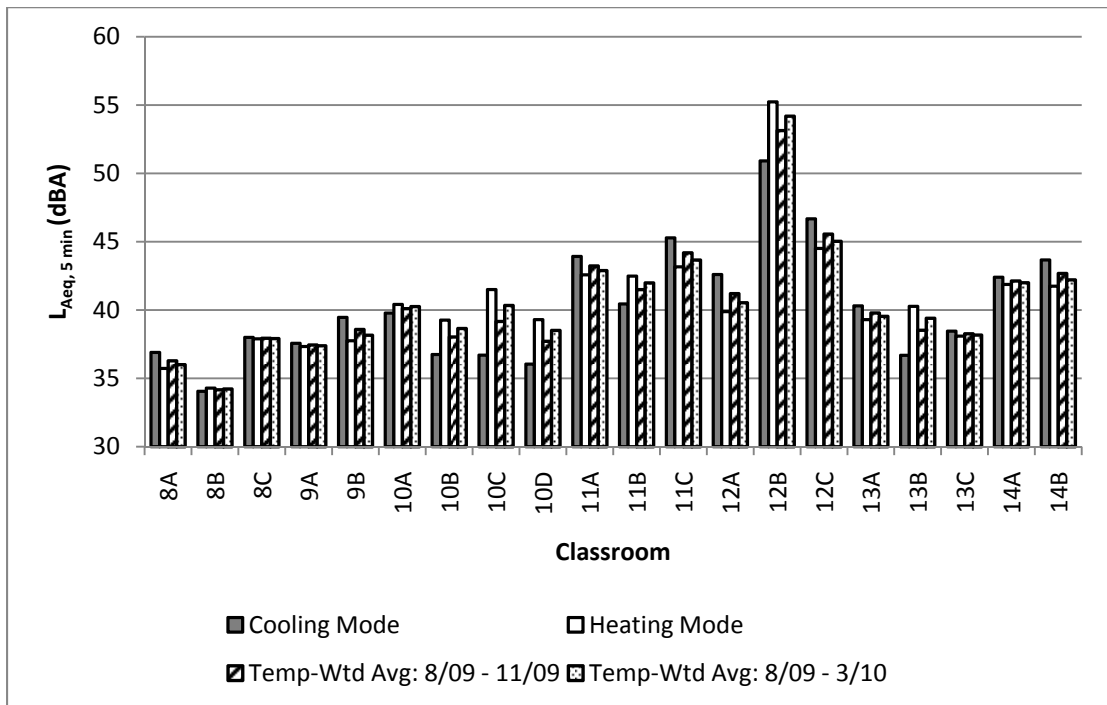
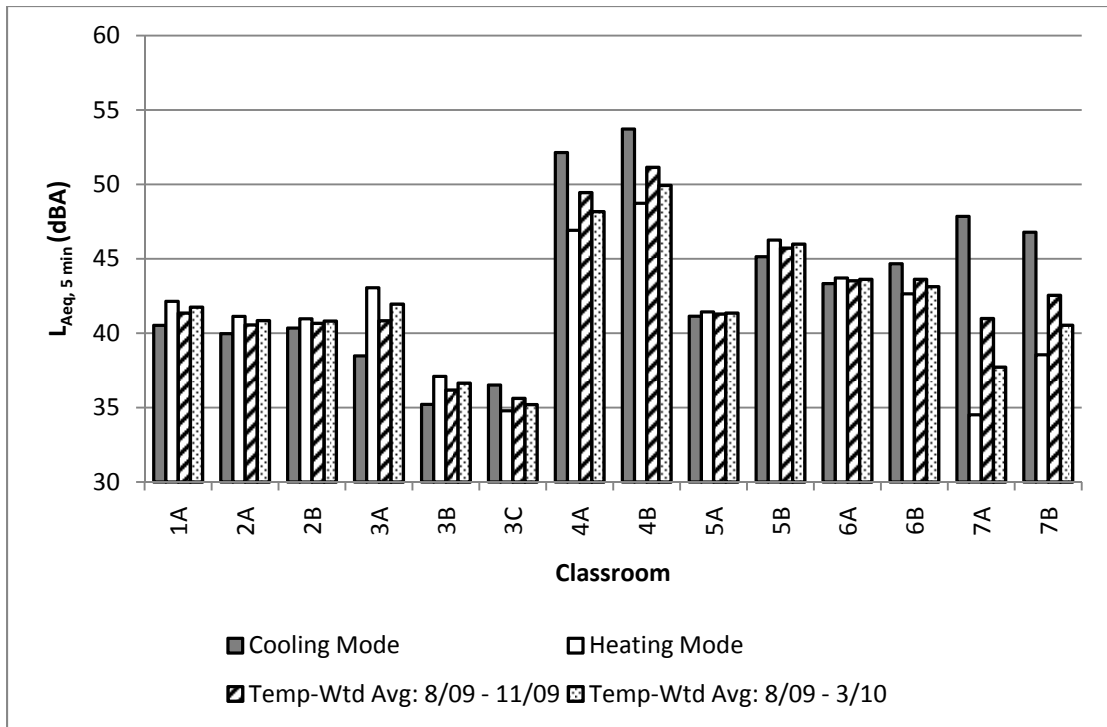
$BNL_C$  = BNL with classroom mechanical system operating in the cooling mode

$BNL_H$  = BNL with classroom mechanical system operating in the heating mode

$N_C$  = Number of days classroom mechanical system is operating in the cooling mode while school is in session over a given time period

$N_H$  = Number of days classroom mechanical system is operating in the heating mode while school is in session over a given time period

$N_T$  = Total number of days school is in session over a given time period



**Figure 6.1:** A-weighted equivalent sound levels for all of the third-grade classrooms.

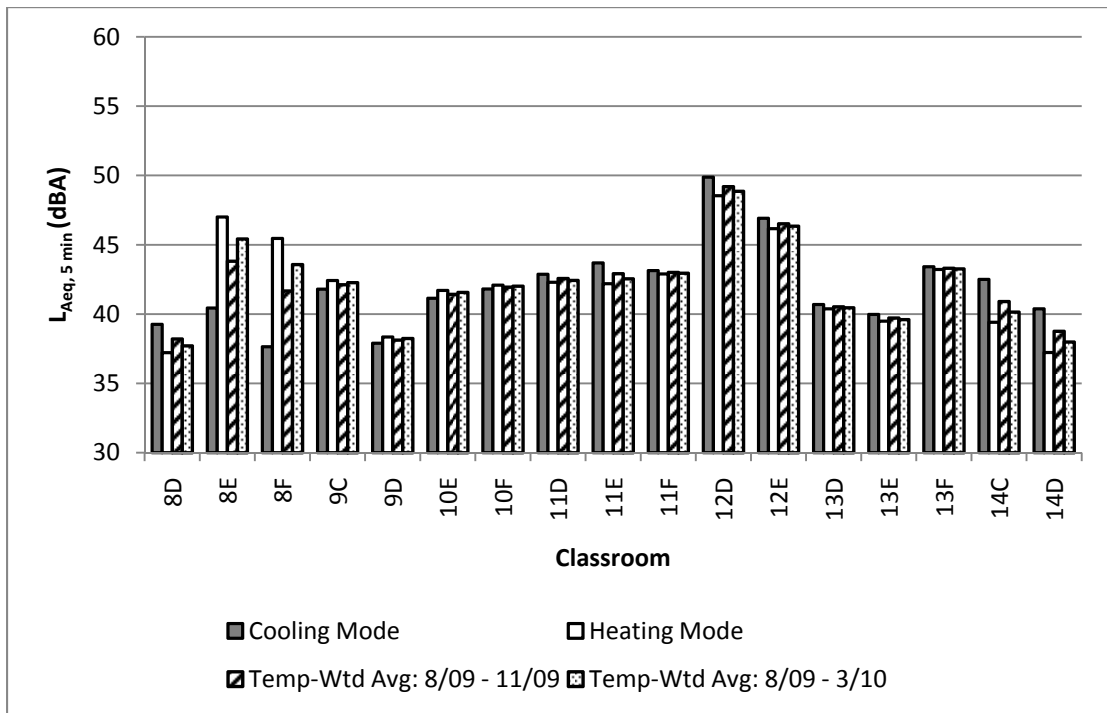
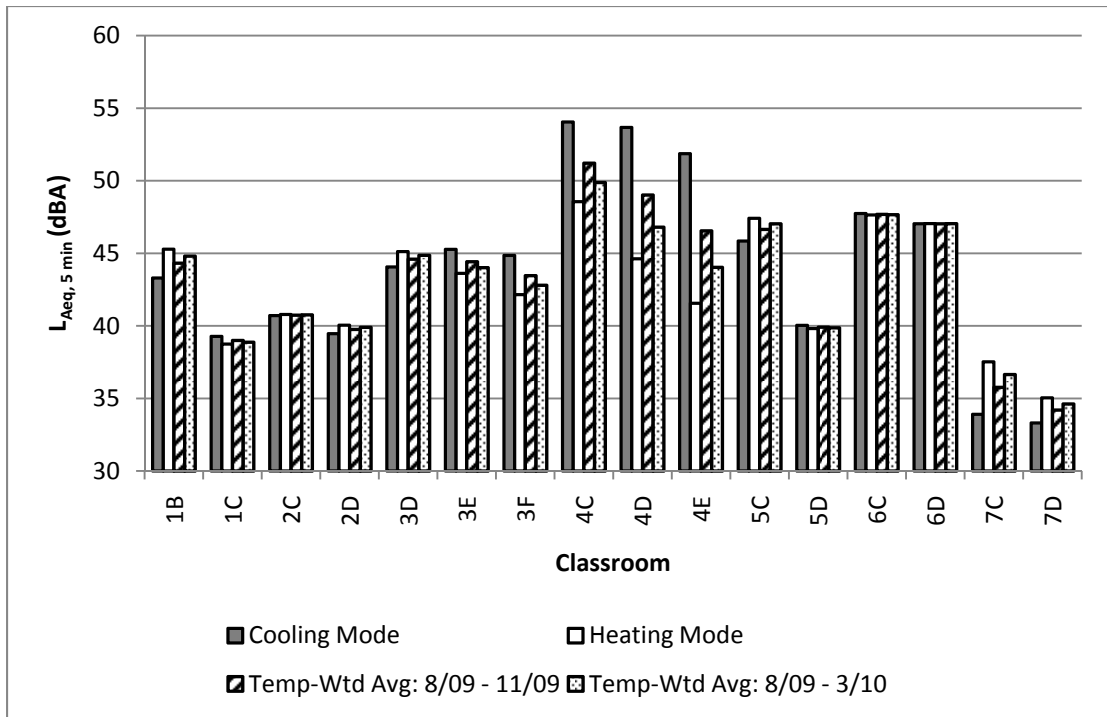
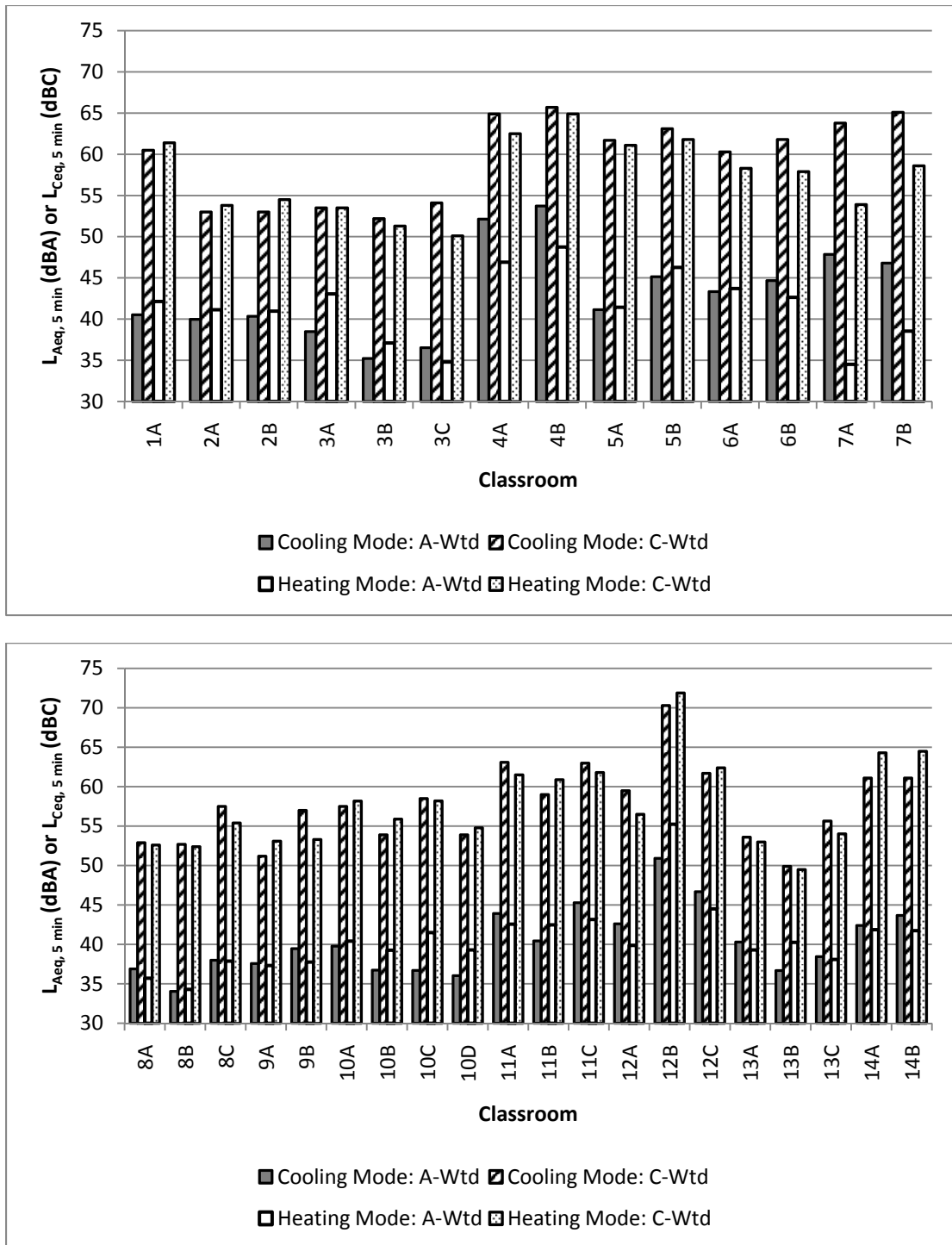


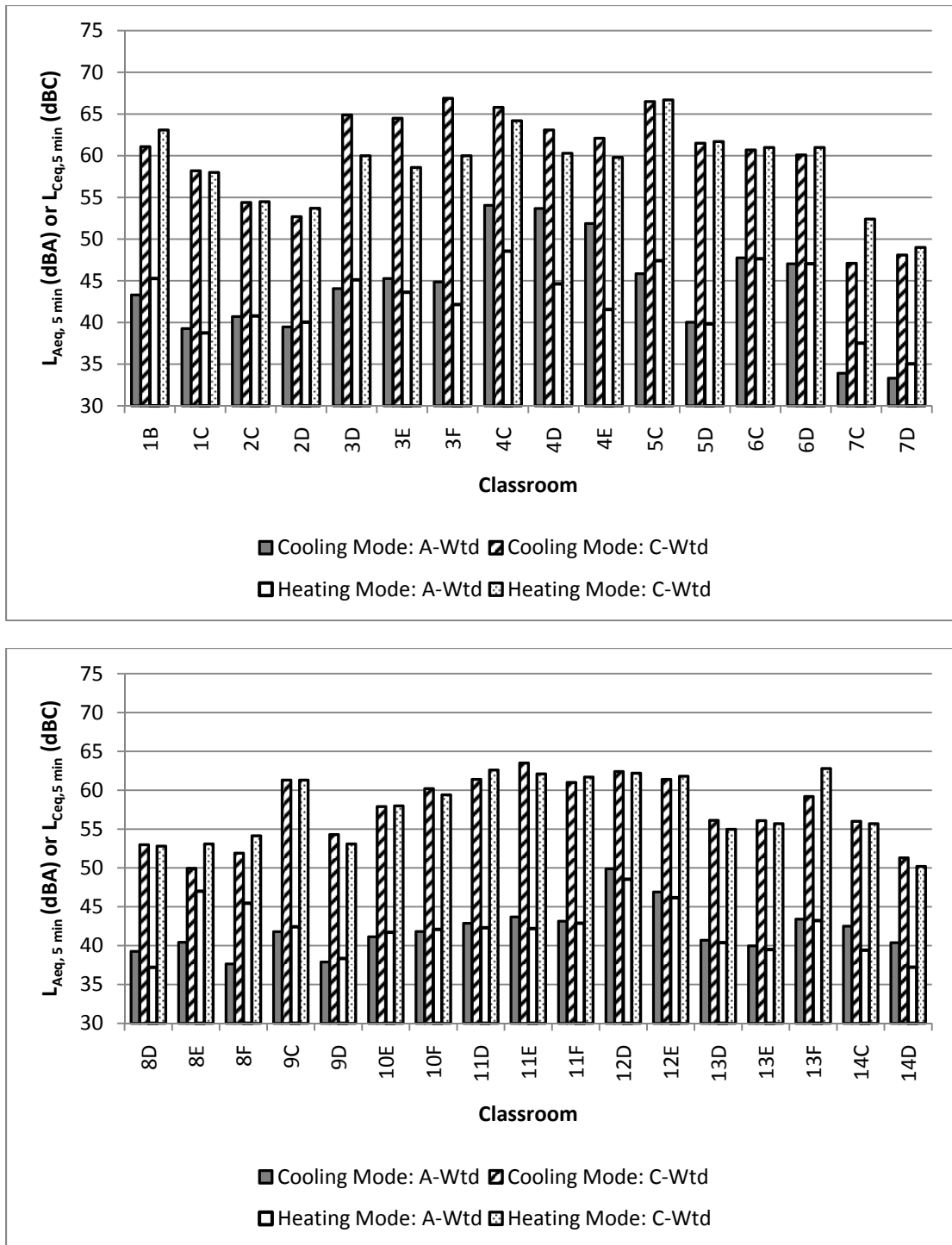
Figure 6.2: A-weighted equivalent sound levels for all of the fifth-grade classrooms.

In most classrooms, the BNL in the heating and cooling mode is similar, though large differences occur in some of the spaces. Based on the outdoor air temperatures, the mechanical systems should have been operating in the cooling mode for 33 out of the 68 days school was in session from August to November 2009, and operating in the heating mode for the rest of the days. The mechanical systems should have been operating in the cooling mode for 33 out of the 137 days school was in session from August 2009 to March 2010, and operating in the heating mode for the other 104 days. Since the mechanical systems were operating in the heating mode for most of the school days from August 2009 to March 2010, these temperature-weighted BNL averages are more similar to the heating BNLs.

As shown in Figures 6.1 and 6.2, the  $L_{Aeq}$  values range from 33 to 54 dBA, most of which exceed the BNL recommendations in the ANSI S12.60 Standard (ANSI/ASA 2010). The C-weighted equivalent sound levels ( $L_{Ceq}$ ) over the five minute measurement period for both the heating and cooling mechanical system modes are compared to the  $L_{Aeq}$  values in Figures 6.3 and 6.4 for the third and fifth-grade classrooms, respectively. The  $L_{Ceq}$  values range from 47 to 72 dBC, which generally exceed the recommendations in the ANSI S12.60 Standard (ANSI/ASA 2010). However the differences between the  $L_{Aeq}$  and the  $L_{Ceq}$  values are only greater than 20 dB in six of the classrooms, and the largest difference observed is 23 dB. This indicates that the low-frequency noise is not excessively dominant in most of the classrooms. The unoccupied BNLs referenced in the remainder of the chapter are the  $L_{Aeq}$  values.



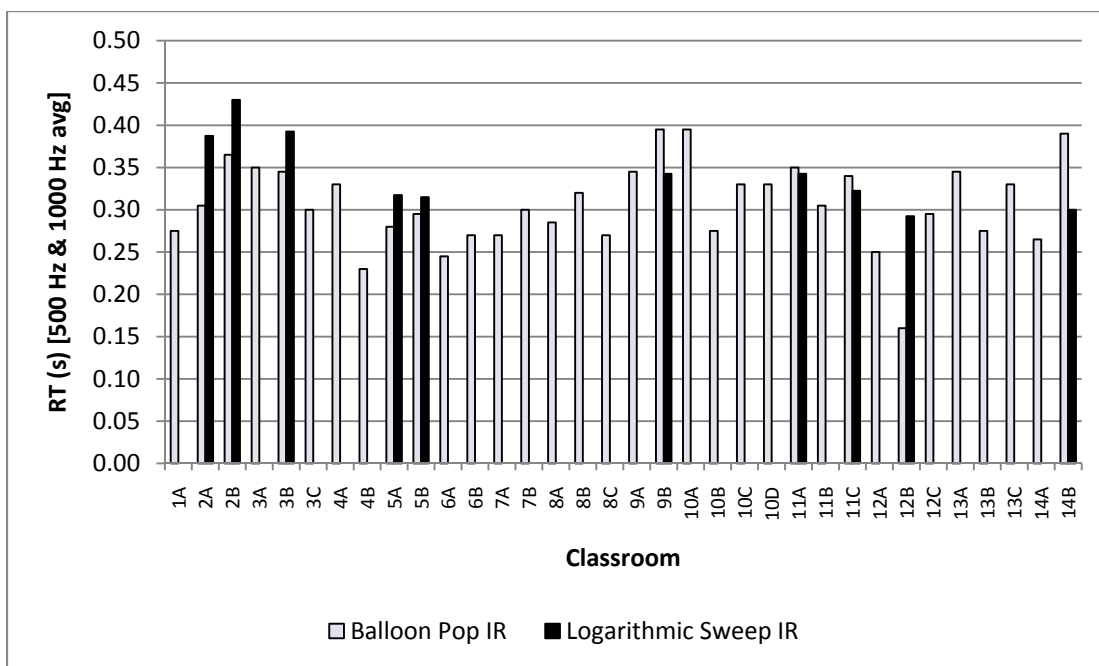
**Figure 6.3:** A-weighted and C-weighted equivalent sound levels for all of the third-grade classrooms.



**Figure 6.4:** A-weighted and C-weighted equivalent sound levels for all of the fifth-grade classrooms.

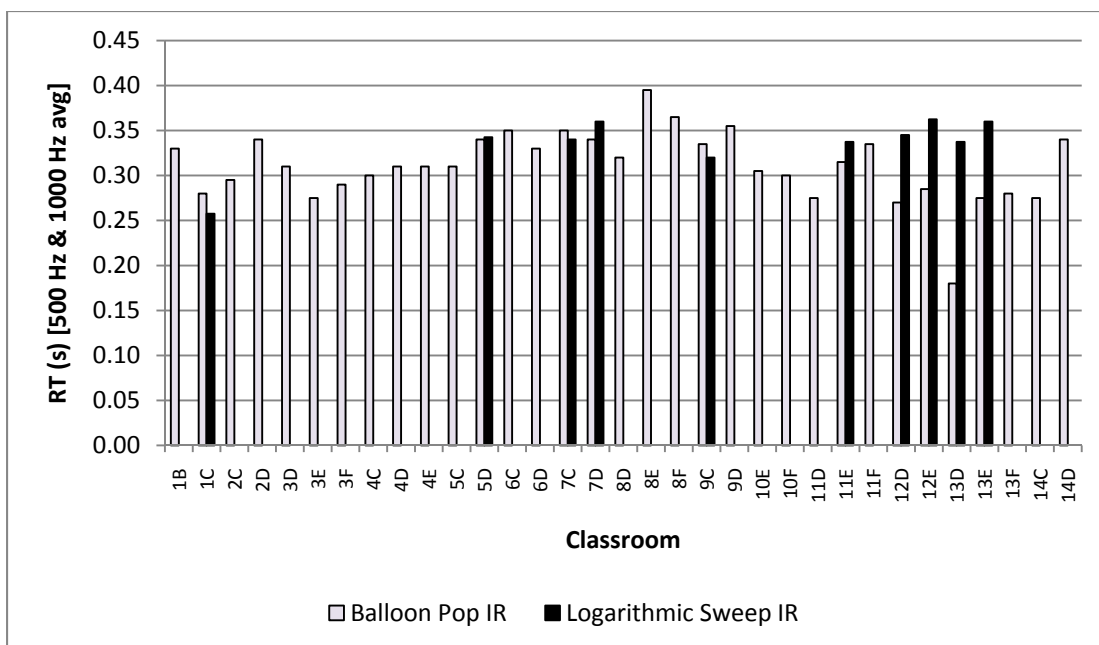
### 6.3.2 Reverberation Time

The unoccupied RTs averaged across the 500 and 1000 Hz octave bands are shown in Figures 6.5 and 6.6 for the third and fifth-grade classrooms, respectively. The RT shown for all of the classrooms is the estimated  $T_{20}$  value from the balloon pop impulse response (IR) measurements. These figures also show the  $T_{20}$  values averaged for the left and right ears from the logarithmic sweep IR measurements for 20 of the classrooms. The mid-frequency RT is below 0.6 s for all of the classrooms, as specified in the ANSI S12.60 Standard (ANSI/ASA 2010).



**Figure 6.5:** RT average in the 500 and 1000 Hz octave bands for the third-grade classrooms.





**Figure 6.6:** RT average in the 500 and 1000 Hz octave bands for the fifth-grade classrooms.

The RTs calculated from the logarithmic sweep IR measurements are typically within 0.1 s of the RT values estimated from the balloon pop IR measurements. However, larger differences occur for Classrooms 12B and 13D. In these classrooms, the RT calculated from the logarithmic sweep IR measurements is 0.13 s higher than the RT estimated from the balloon pop IR measurement for Classroom 12B and 0.16 s higher for Classroom 13D. A logarithmic sweep is a sine signal with continuously increasing frequency, wherein the frequency doubles per time interval. See Stan et al. (2002) for more details on this measurement procedure. However for a balloon pop IR measurement, the balloon pop generates the signal. Pätynen et al. (2011) reported that impulses measured from balloon pops typically do not meet directivity

requirements in measurement standards (ISO 2009) for impulse sources. This may have impacted the IR measured from the balloon pops in some of the classrooms, providing a possible explanation for the differences between the logarithmic sweep and balloon pop RTs calculated.

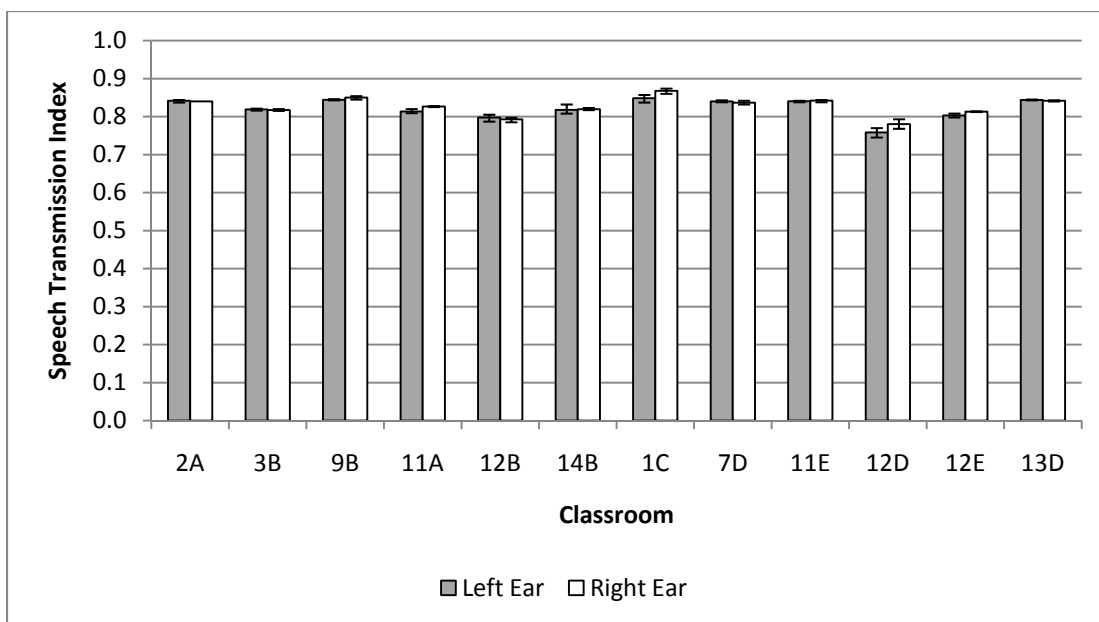
Classrooms with typical mid-frequency RTs calculated from the logarithmic sweep IRs in the low, middle, and high range of measured RTs are as follows:

- Classroom 12B:  $RT_{500 \text{ Hz} \& 1000 \text{ Hz Avg}} = 0.29 \text{ s}$
- Classroom 11A:  $RT_{500 \text{ Hz} \& 1000 \text{ Hz Avg}} = 0.34 \text{ s}$
- Classroom 3B:  $RT_{500 \text{ Hz} \& 1000 \text{ Hz Avg}} = 0.39 \text{ s}$

Note that the range of RTs across these classrooms is still quite narrow, and the values are below the upper RT limit specified in the ANSI S12.60 Standard (ANSI/ASA 2010).

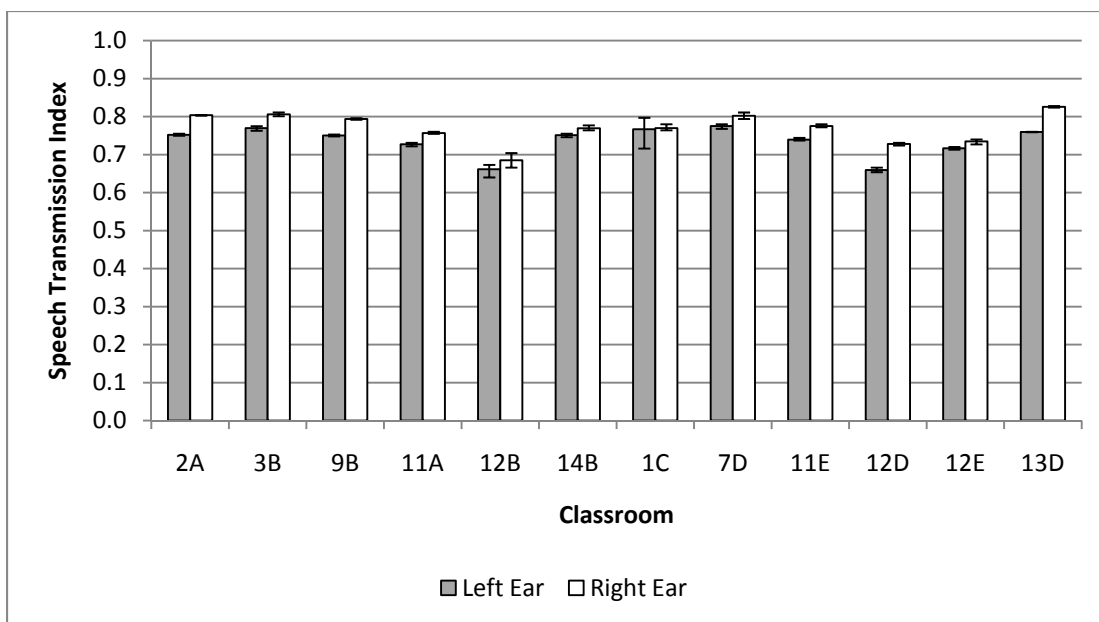
### ***6.3.3 Speech Transmission Index***

The STIs for the center receiver position,  $0^\circ$  source rotation for 12 of the classrooms are shown in Figure 6.7. As expected for this configuration, the STI values between the left and right ears are similar in all of the classrooms. There is also a limited range in STIs among classrooms for this condition.



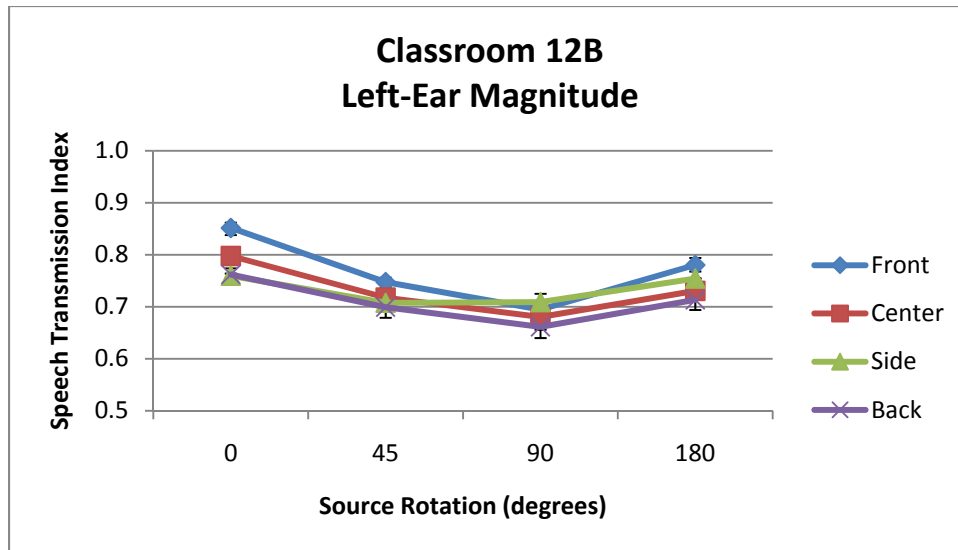
**Figure 6.7:** Speech transmission index values for the center receiver position,  $0^\circ$  source rotation. Error bars show the range about the average value from the three sets of repeated measurements.

The STIs for the back receiver position,  $90^\circ$  source rotation for the same 12 classrooms are shown in Figure 6.8. In all classrooms shown, the right ear STI is slightly higher than the left ear STI, since the right ear is receiving more direct sound energy than the left ear in this condition. However the differences between the two ears are still small in this configuration, with the greatest difference of 0.07 occurring in Classrooms 12D and 13D. The magnitudes of the STI values in this condition are generally lower than for the center receiver position,  $0^\circ$  source rotation. This is expected, since there is a greater distance from the source to the receiver for the condition shown in Figure 6.8, and the source is facing away from the receiver.

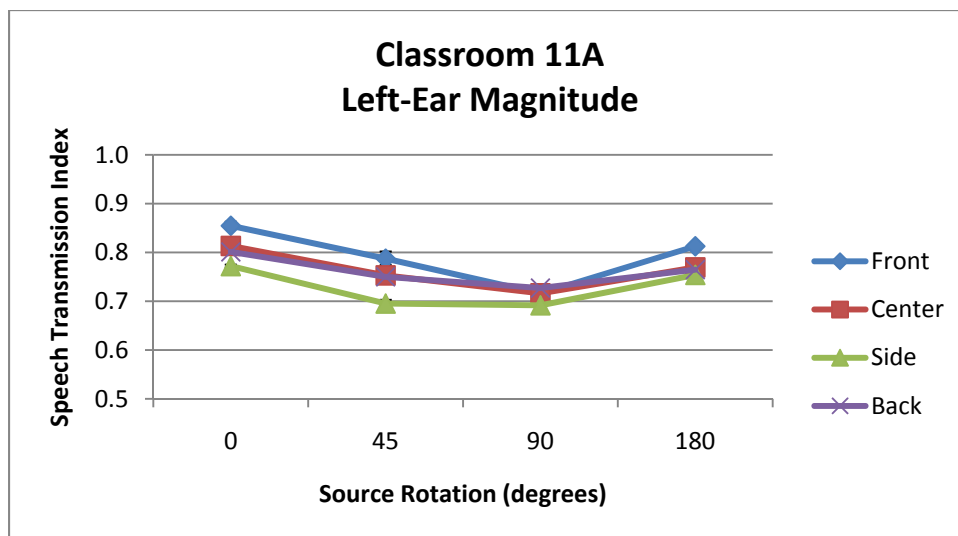


**Figure 6.8:** Speech transmission index values for the back receiver position,  $90^\circ$  source rotation. Error bars show the range about the average value from the three sets of repeated measurements.

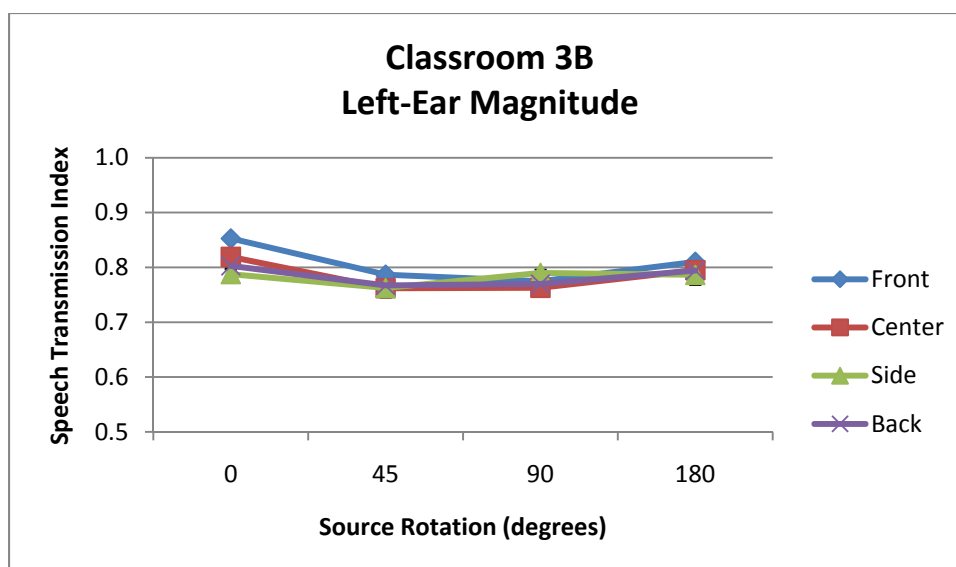
The STIs measured at the left ear within typical classrooms are shown in Figures 6.9, 6.10, and 6.11 for Classrooms 12B, 11A, and 3B, respectively. For all three classrooms, the STIs tend to decrease as the source rotates from  $0^\circ$  to  $45^\circ$  to  $90^\circ$ , then increase as the source rotates from  $90^\circ$  to  $180^\circ$ . Also, the STIs tend to decrease as the receiver moves from the front to the back of the room. The right ear STI trends in these classrooms are similar to those occurring at the left ear, but the magnitudes of the right ear STI values are slightly higher than those at the left ear. The magnitude of the change in STI among the different source rotations and receiver positions is smallest for Classroom 3B, which has the highest mid-frequency RT.



**Figure 6.9:** Speech transmission index values measured at the left ear in Classroom 12B. Error bars show the range about the average value from the three sets of repeated measurements.



**Figure 6.10:** Speech transmission index values measured at the left ear in Classroom 11A. Error bars show the range about the average value from the three sets of repeated measurements.



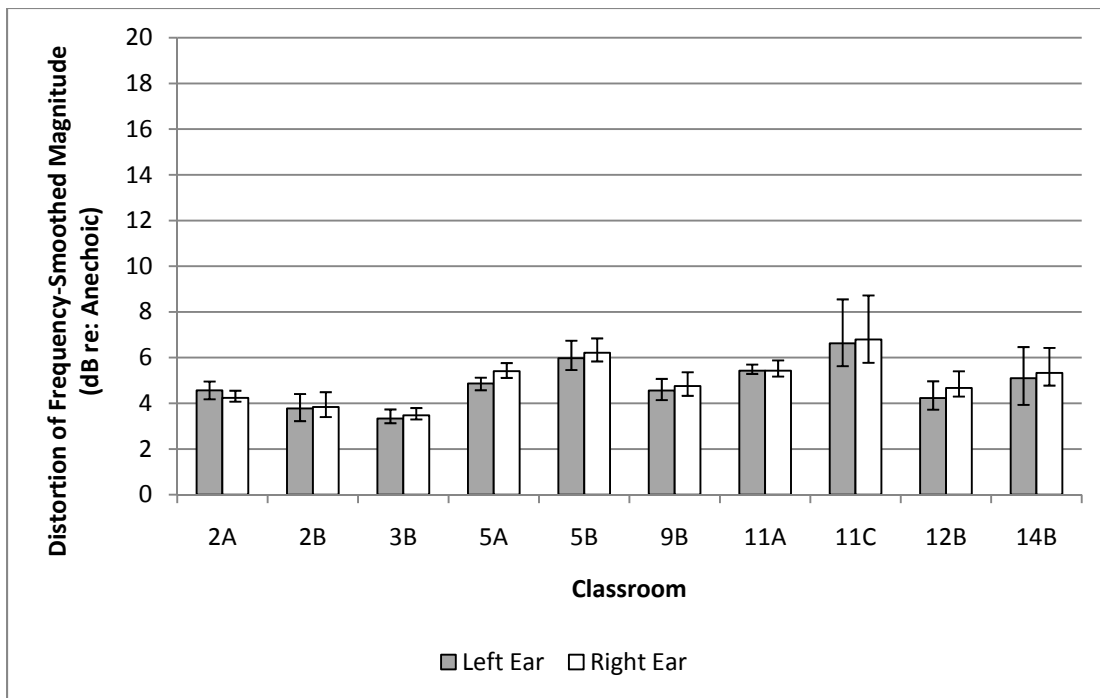
**Figure 6.11:** Speech transmission index values measured at the left ear in Classroom 3B. Error bars show the range about the average value from the three sets of repeated measurements.

These results are similar to those reported in Section 5.3.3 from measurements in the Council Bluffs classrooms, with similar STIs occurring between the left and right ears. Also, the magnitude of the STI values decreases for source rotations that are not facing the receiver and receiver positions that are further away from the source.

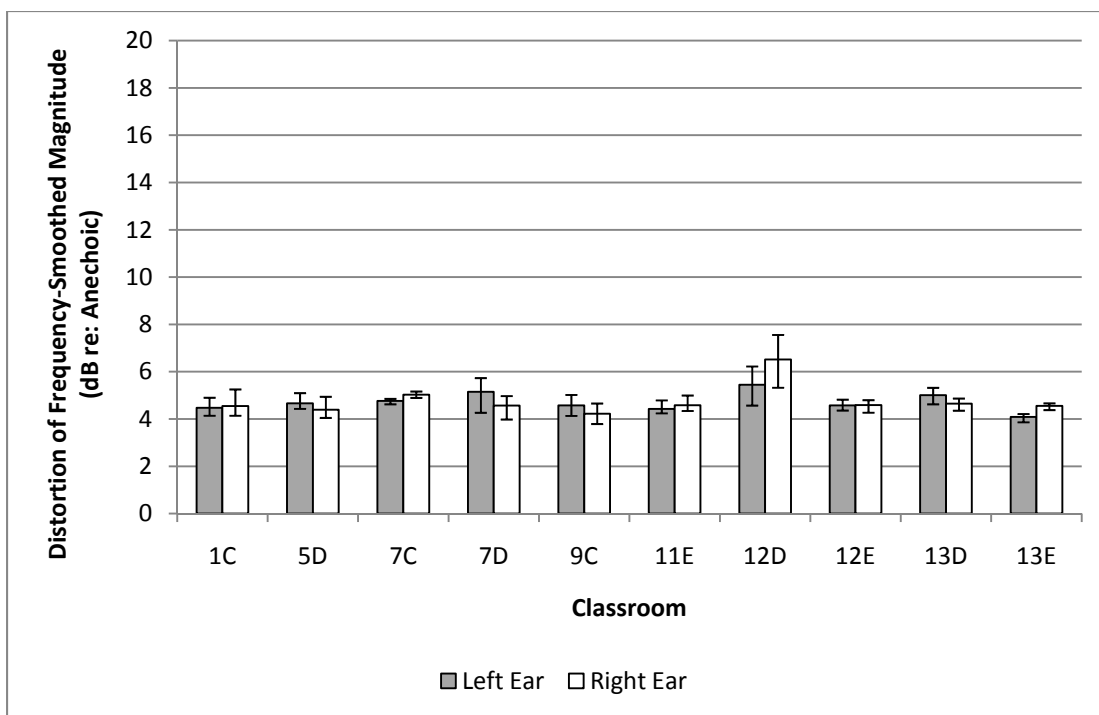
#### **6.3.4 Distortion of Frequency-Smoothed Magnitude**

Figures 6.12 and 6.13 show the left and right ear DFSM values for the center receiver position,  $0^\circ$  source rotation for 10 of the third and fifth-grade classrooms, respectively. The DFSM values among classrooms in this condition range from 3 to 7 dB (re: Anechoic), and the DFSM values measured in the left and right ear are

similar within each classroom. The DFSM values measured in this condition are similar to the DFSMs for this condition measured in the Council Bluffs classrooms, reported in Section 5.3.4. Similar DFSM values between the left and right ears occur for this condition for classrooms in both school districts.



**Figure 6.12:** Distortion of frequency-smoothed magnitude values for the center receiver position,  $0^\circ$  source rotation for the third-grade classrooms. Error bars show the range about the average value from the three sets of repeated measurements.

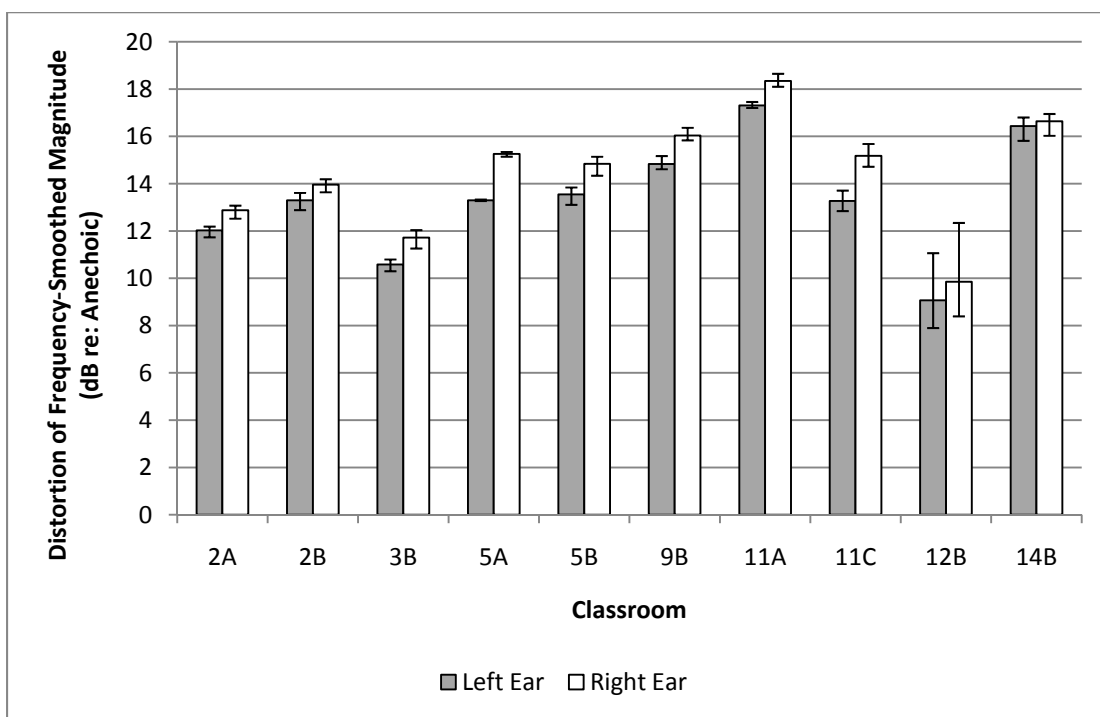


**Figure 6.13:** Distortion of frequency-smoothed magnitude values for the center receiver position, 0° source rotation for the fifth-grade classrooms. Error bars show the range about the average value from the three sets of repeated measurements.

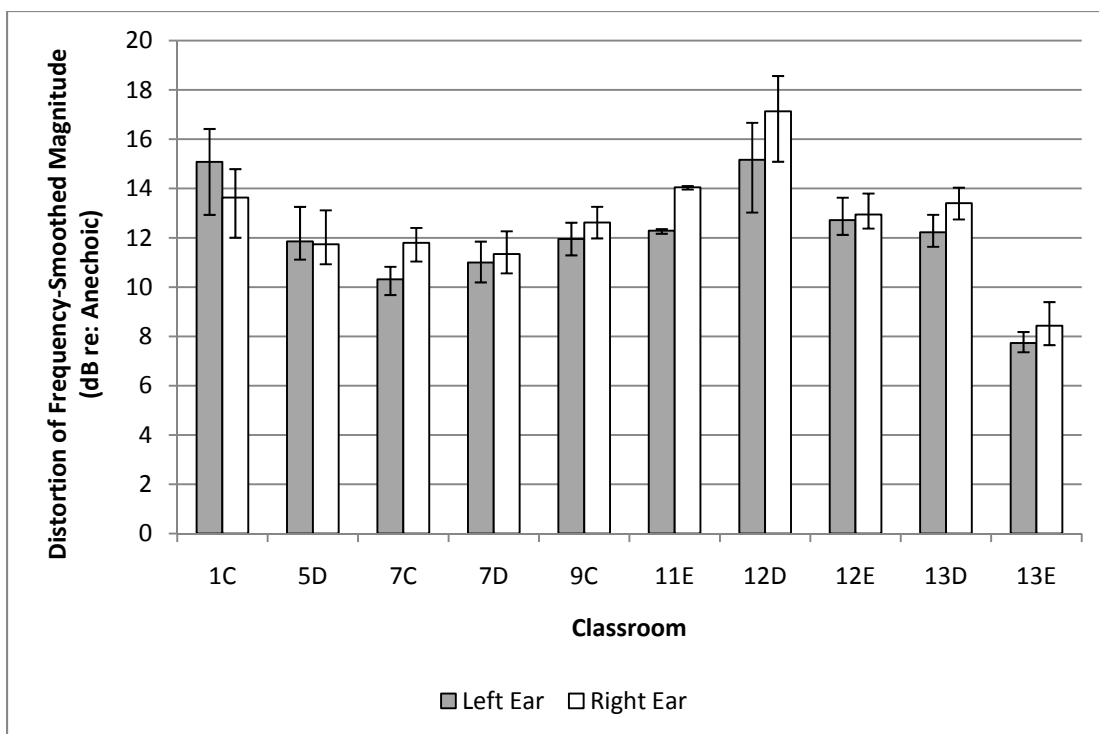
The left and right ear DFSM values for the back receiver position, 90° source rotation are shown in Figures 6.14 and 6.15 for the third and fifth-grade classrooms, respectively. A wider range of DFSM values occurs for this condition, ranging from 8 to 18 dB (re: Anechoic). A wider range among the DFSM values in this condition was also observed in the Council Bluffs classrooms, reported in Section 5.3.4. The right ear DFSM values are typically greater than the left ear DFSM values in this measurement configuration, as they are for the Council Bluffs classrooms. The lowest DFSM values occur in Classrooms 12B and 13E, which have mid-frequency



reverberation times of 0.30 s and 0.36 s, respectively. Classroom 3B is the only space with a shorter distance from the source to the receiver for all conditions than Classrooms 12B and 13E. Therefore, these findings are similar to those from the Council Bluffs classrooms, for which spaces with shorter distances from the source to the receiver also have lower DFSMs. The right ear DFSMs tend to be larger than the left ear DFSMs for this condition in Council Bluffs as well.

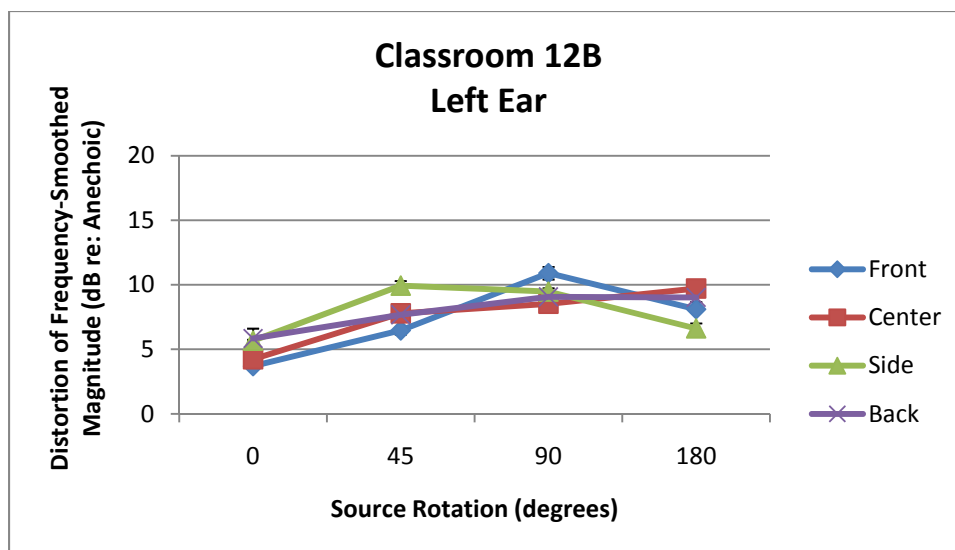


**Figure 6.14:** Distortion of frequency-smoothed magnitude values for the back receiver position, 90° source rotation for the third-grade classrooms. Error bars show the range about the average value from the three sets of repeated measurements.

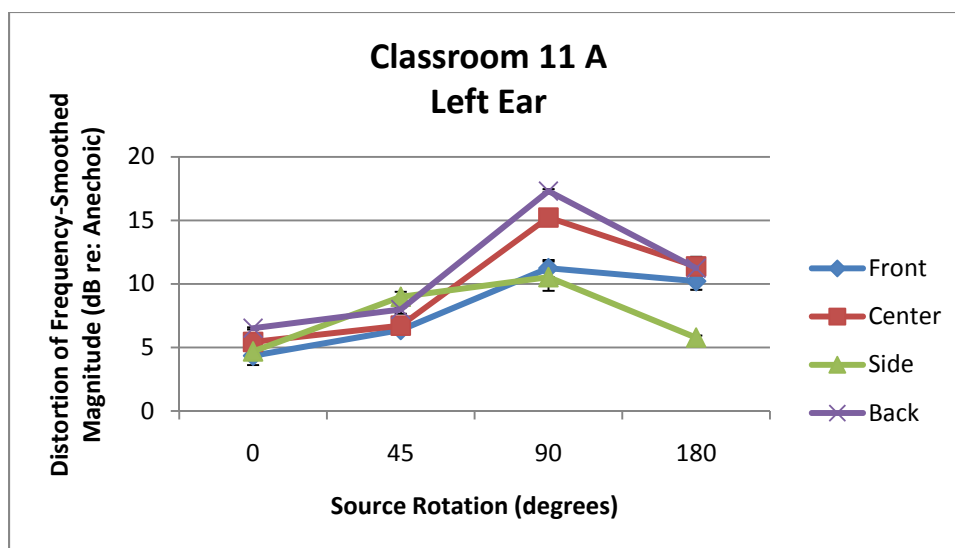


**Figure 6.15:** Distortion of frequency-smoothed magnitude values for the back receiver position, 90° source rotation for the fifth-grade classrooms. Error bars show the range about the average value from the three sets of repeated measurements.

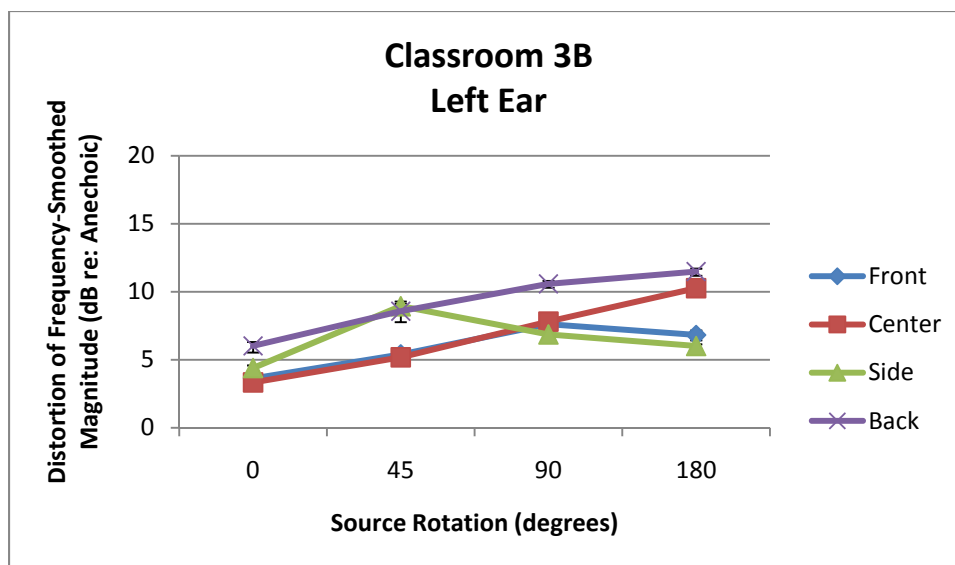
The DFSM values measured at the left ear for the three typical classrooms are shown in Figures 6.16, 6.17, and 6.18. For all three classrooms, the DFSM values generally tend to increase as the receiver moves from the front to the center to the side to the back position, though this varies with source rotation. The DFSM values are typically smallest for the 0° source rotation and largest for the 90° source rotation. Classroom 11A has the largest DFSM values, which occur in the 90° source rotation. The DFSM trends occurring for the right ear are similar to those occurring for the left ear, though the magnitude of the values is generally slightly higher.



**Figure 6.16:** Distortion of frequency-smoothed magnitude values measured at the left ear in Classroom 12B. Error bars show the range about the average value from the three sets of repeated measurements.



**Figure 6.17:** Distortion of frequency-smoothed magnitude values measured at the left ear in Classroom 11A. Error bars show the range about the average value from the three sets of repeated measurements.



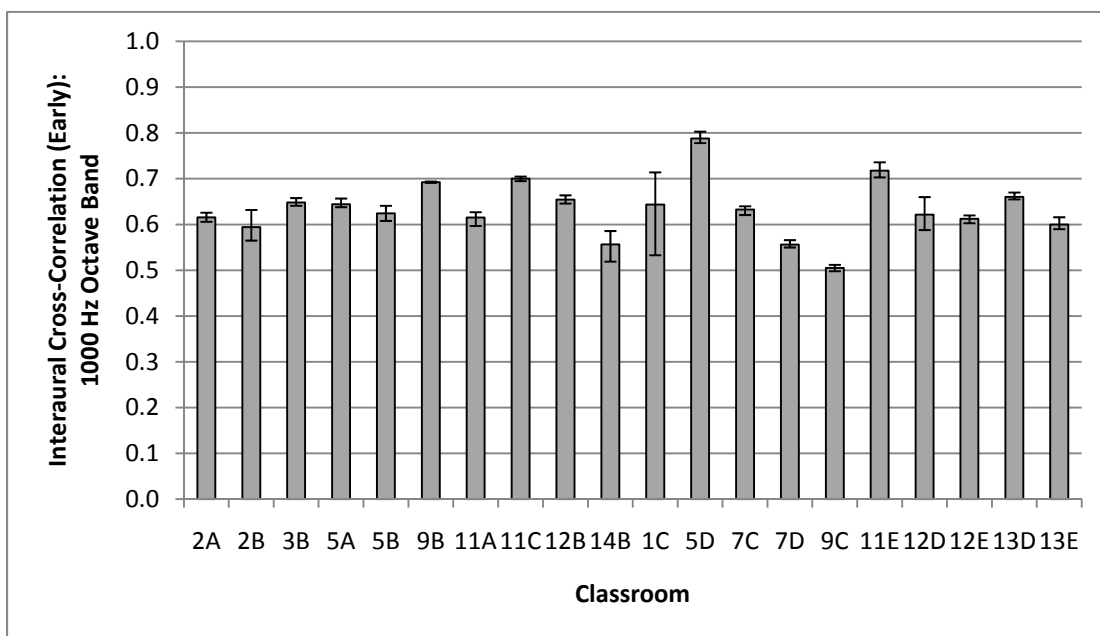
**Figure 6.18:** Distortion of frequency-smoothed magnitude values measured at the left ear in Classroom 3B. Error bars show the range about the average value from the three sets of repeated measurements.

In general, the DFSM trends observed in the Papillion-La Vista classrooms are similar to those from measurements in the Council Bluffs classrooms. These results support the theory that classrooms or measurement configurations with shorter paths from the source to the receiver will have lower DFSM values.

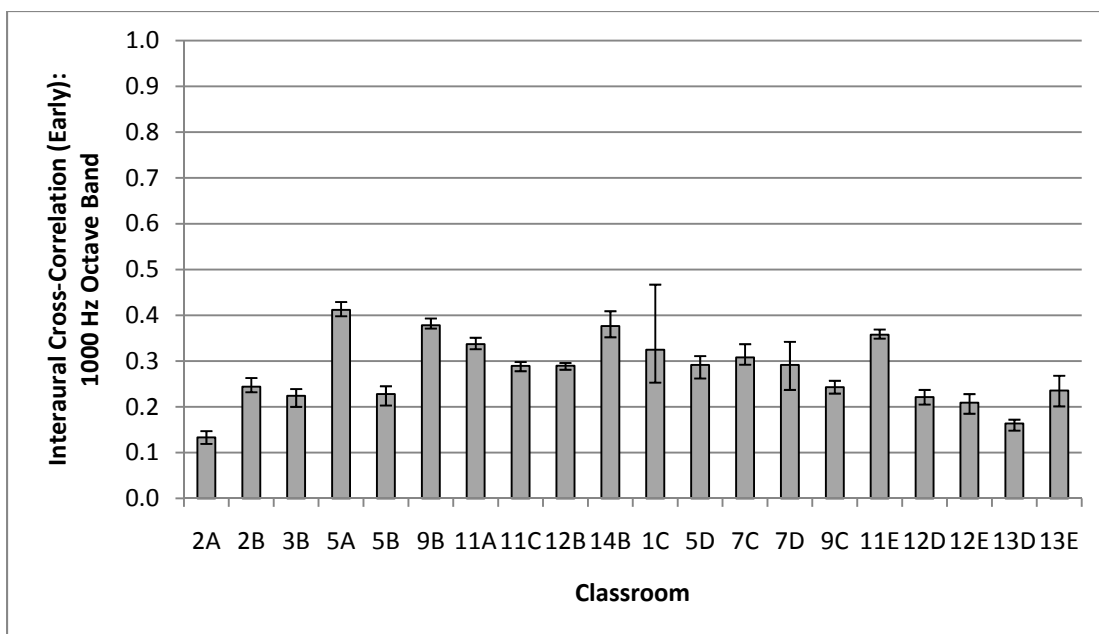
### 6.3.5 Interaural Cross-Correlation

For direct comparison, the  $IACC_E$  values in the 1000 Hz octave band are shown for all 20 of the classrooms in which BRIR measurements were conducted. The  $IACC_E$  values for the center receiver position,  $0^\circ$  source rotation and the back receiver position,  $90^\circ$  source rotation are shown in Figures 6.19 and 6.20, respectively. The  $IACC_E$  values in the 1000 Hz octave band range from 0.5 to 0.8

among classrooms for the center receiver position,  $0^\circ$  source rotation. This is similar to the range in  $IACC_E$  values occurring in the Council Bluffs classrooms for this condition, as reported in Section 5.3.5. The  $IACC_E$  values in the 1000 Hz octave band are lower for the back receiver position,  $90^\circ$  source rotation, ranging from 0.1 to 0.4. A decrease in  $IACC_E$  values also occurs for this condition in the Council Bluffs classrooms. This is expected, since the two ears are receiving unequal amounts of direct sound energy in the back receiver position,  $90^\circ$  source rotation.



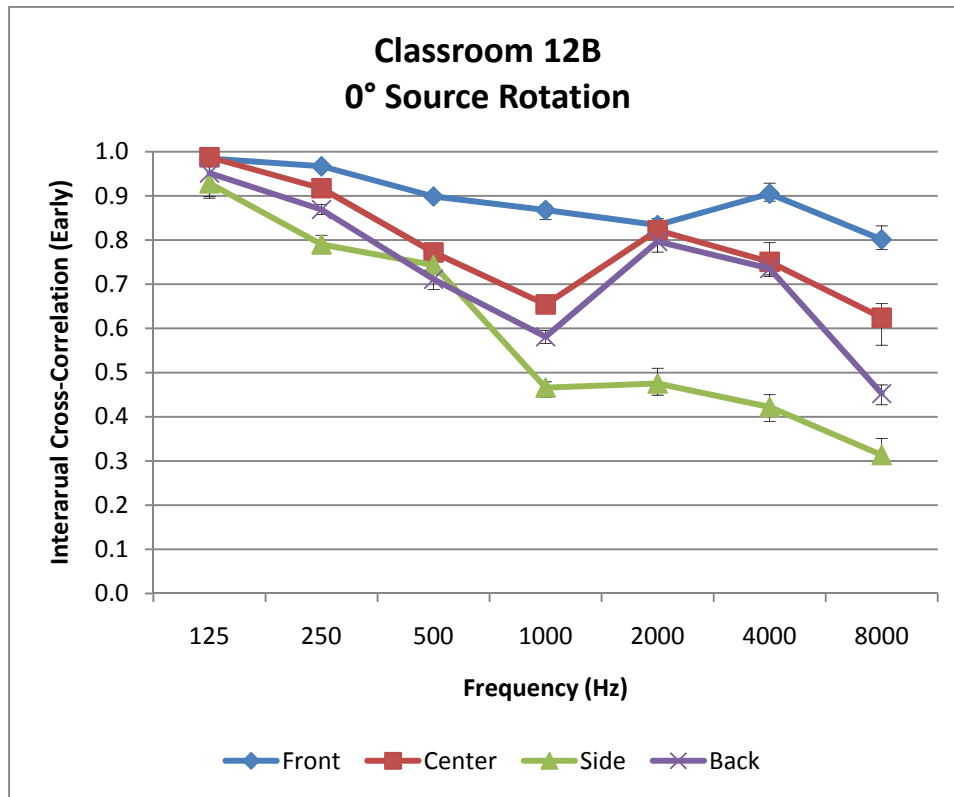
**Figure 6.19:** Interaural cross-correlation (early) values for the 1000 Hz octave band in the center receiver position,  $0^\circ$  source rotation. Error bars show the range about the average value from the three sets of repeated measurements.



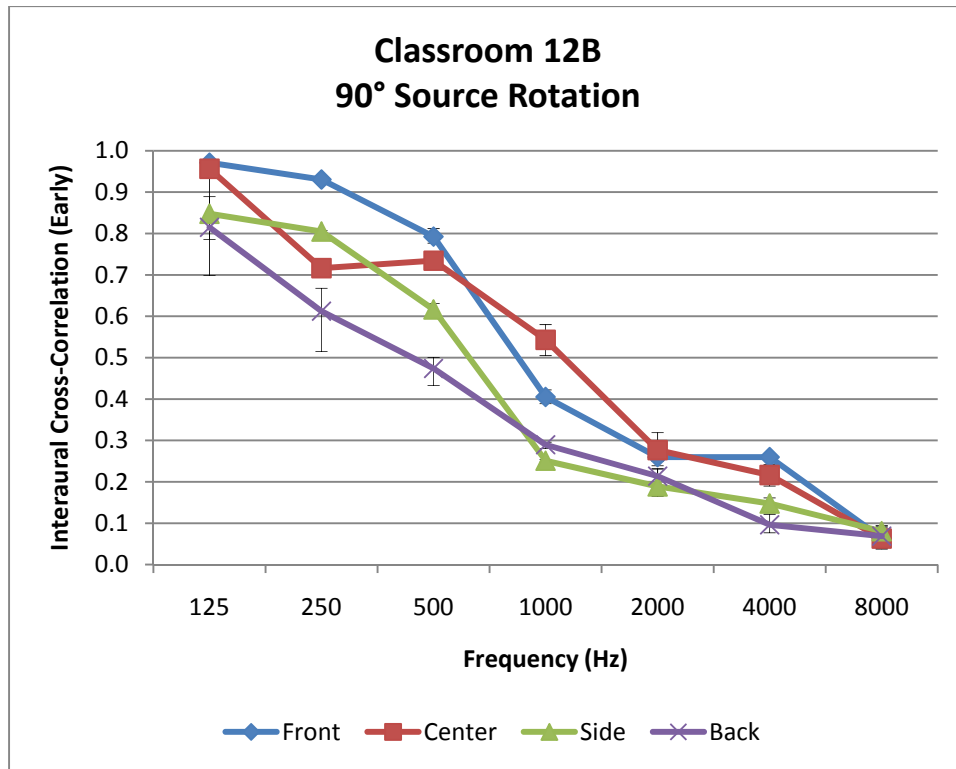
**Figure 6.20:** Interaural cross-correlation (early) values for the 1000 Hz octave band in the back receiver position, 90° source rotation. Error bars show the range about the average value from the three sets of repeated measurements.

The  $IACC_E$  values in each octave band from 125 to 8000 Hz are shown for Classroom 12B in Figures 6.21 and 6.22 for the 0° and 90° source rotations, respectively. The  $IACC_E$  values for Classrooms 11A and 3B for the 0° and 90° source rotations are shown in Figures 6.23, 6.24, 6.25, and 6.26. For all three classrooms, a significant decrease in  $IACC_E$  values occurs with increasing frequency for the 90° source rotation for all receiver positions. However, the effect of frequency is less pronounced for the 0° source rotation, particularly for the front receiver position. For the 0° source rotation, the  $IACC_E$  values typically decrease as the

receiver position moves from front to center to back to side. The effects of frequency on the  $IACC_E$  values are similar to those occurring in the Council Bluffs classrooms.

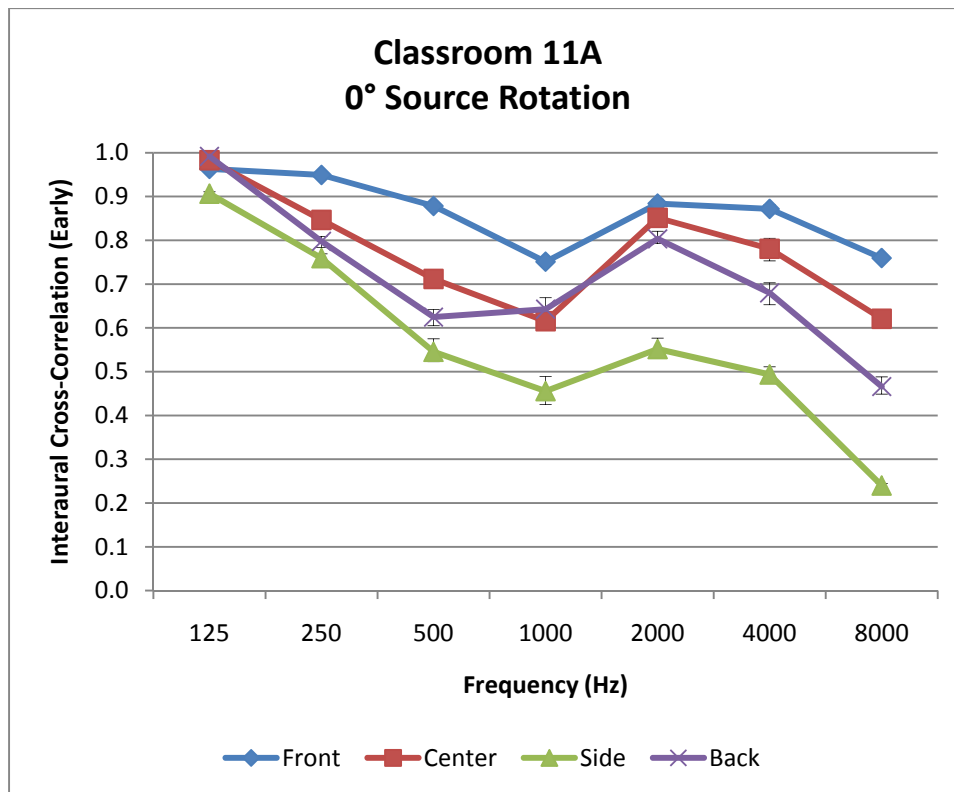


**Figure 6.21:** Interaural cross-correlation (early) values for the 0° source rotation in Classroom 12B. Error bars show the range about the average value from the three sets of repeated measurements.

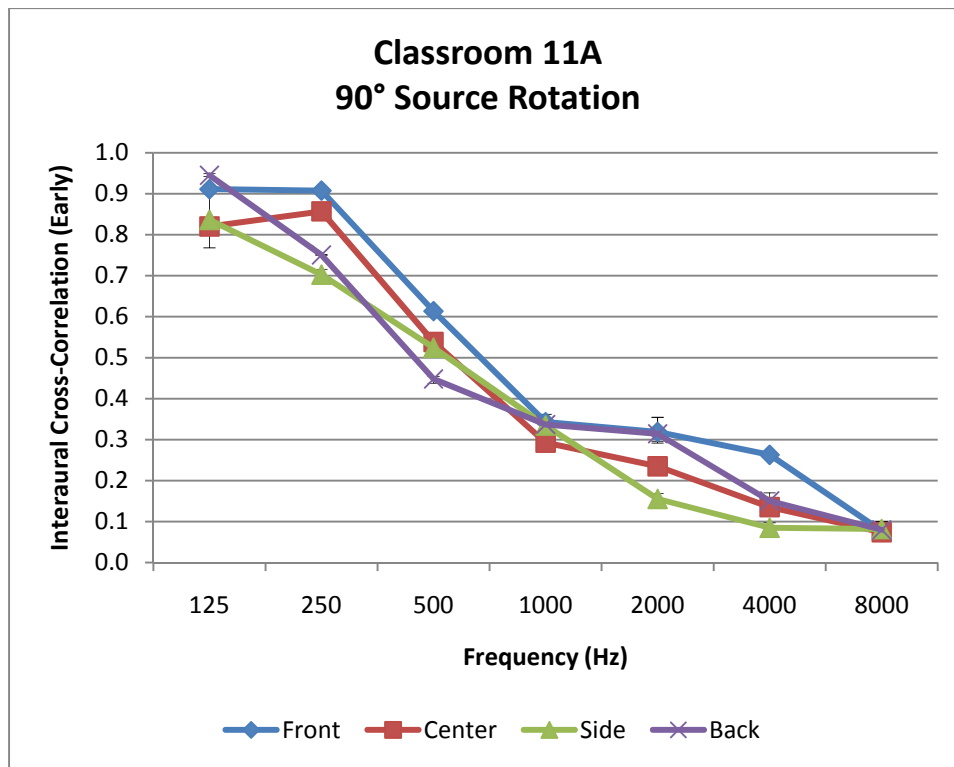


**Figure 6.22:** Interaural cross-correlation (early) values for the 90° source rotation in Classroom 12B. Error bars show the range about the average value from the three sets of repeated measurements.

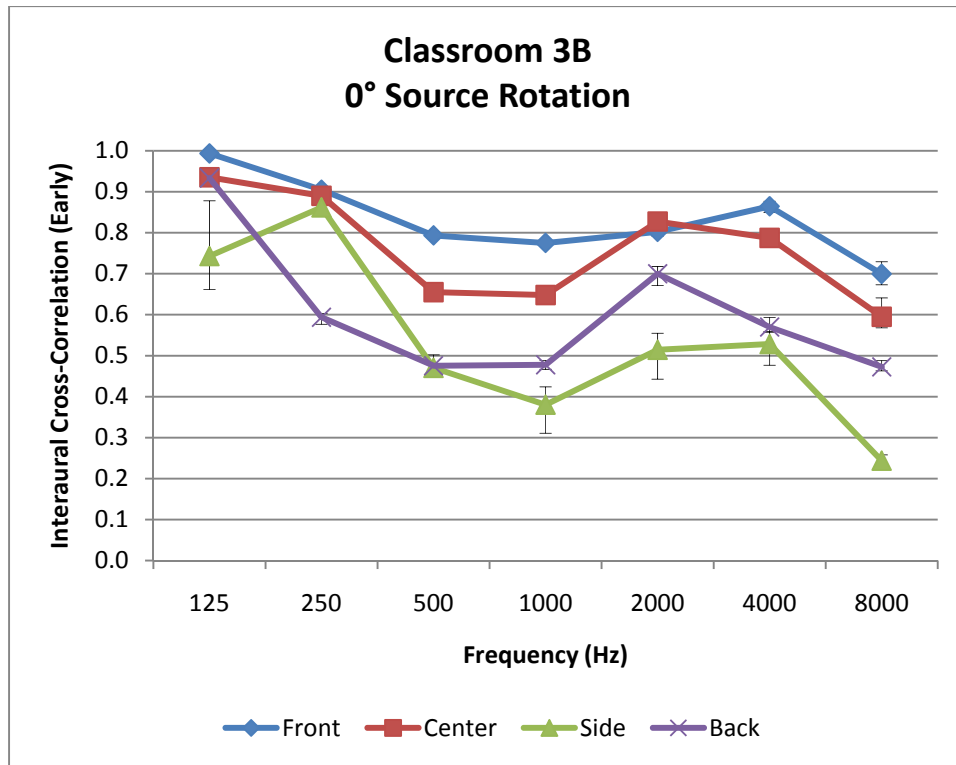




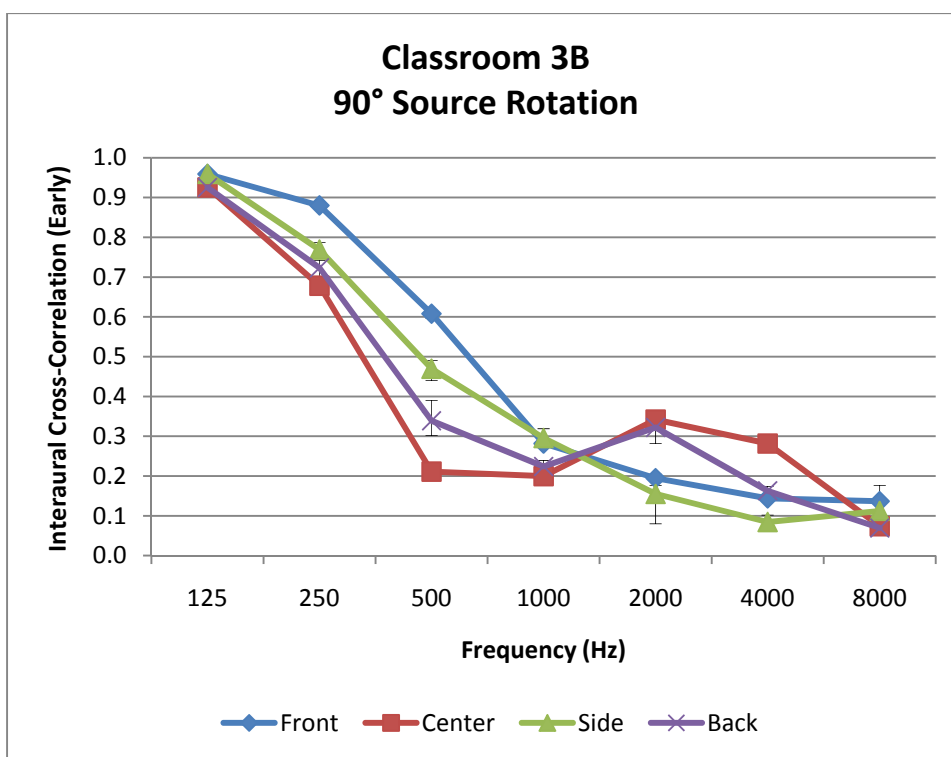
**Figure 6.23:** Interaural cross-correlation (early) values for the 0° source rotation in Classroom 11A. Error bars show the range about the average value from the three sets of repeated measurements.



**Figure 6.24:** Interaural cross-correlation (early) values for the 90° source rotation in Classroom 11A. Error bars show the range about the average value from the three sets of repeated measurements.



**Figure 6.25:** Interaural cross-correlation (early) values for the 0° source rotation in Classroom 3B. Error bars show the range about the average value from the three sets of repeated measurements.

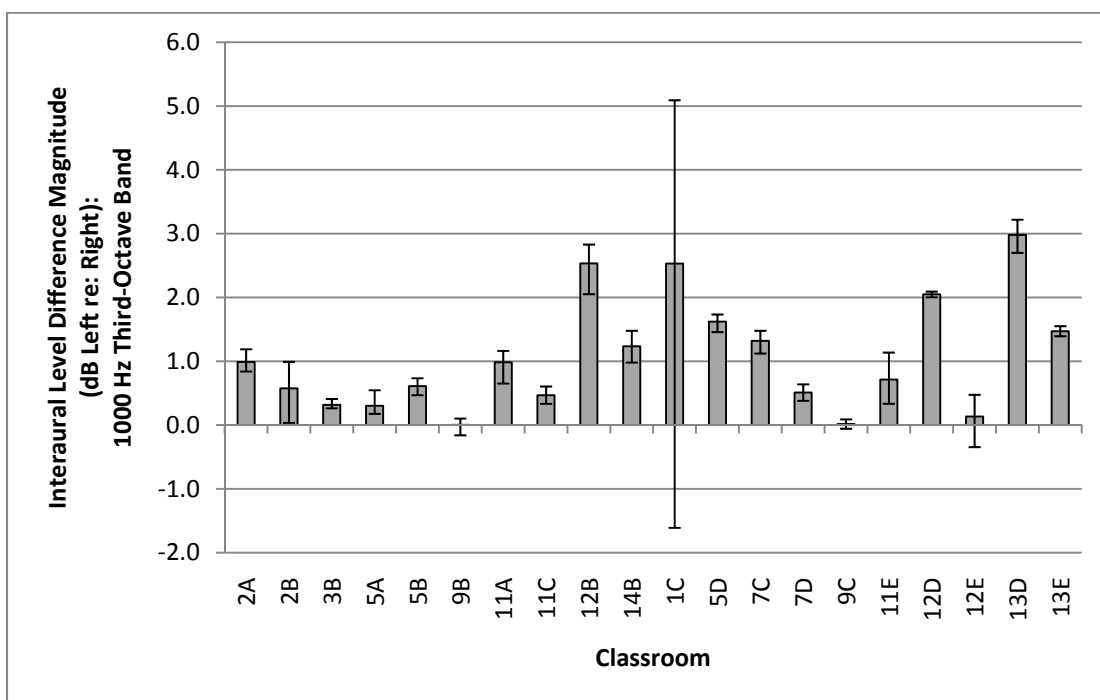


**Figure 6.26:** Interaural cross-correlation (early) values for the 90° source rotation in Classroom 3B. Error bars show the range about the average value from the three sets of repeated measurements.

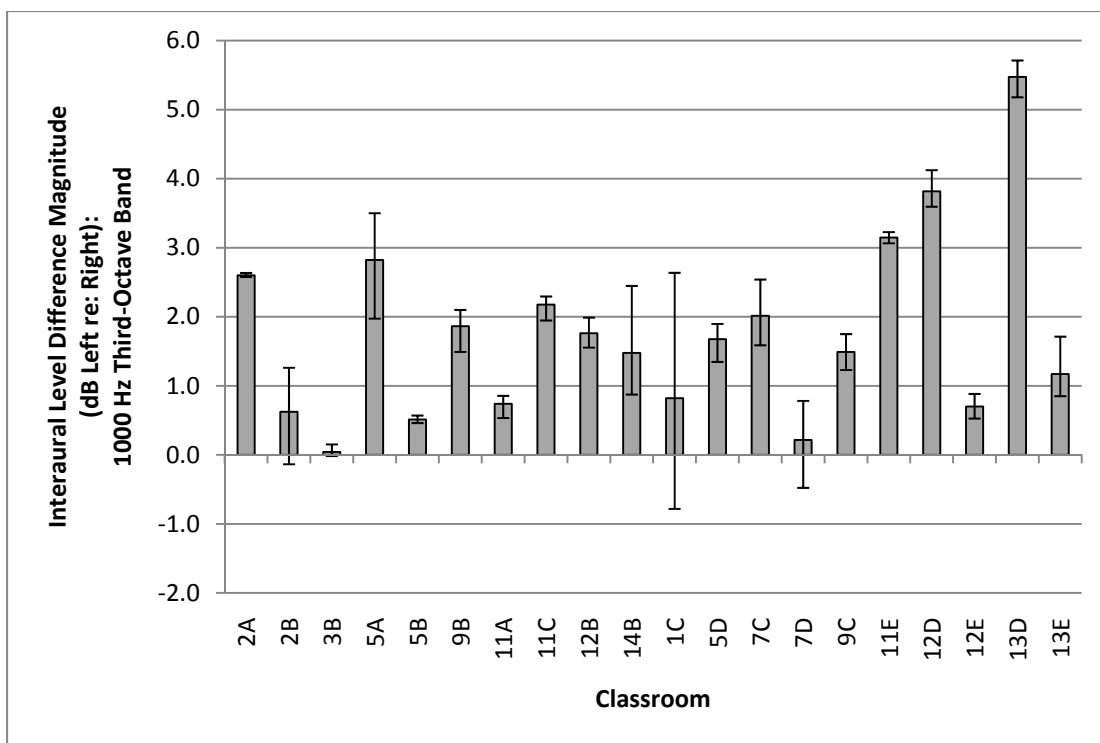
While some changes do occur in the  $IACC_E$  values among classrooms, the  $IACC_E$  values do not vary systematically with BNL or RT. The differences may possibly be attributed to varying furniture arrangements among the classrooms, as was hypothesized for the Council Bluffs classrooms. Larger changes in  $IACC_E$  values occur within classrooms across the various measurement configurations tested. This indicates that the student location and teacher orientation may have a significant impact on the acoustical conditions perceived by individual students.

### 6.3.6 Interaural Level Difference

Comparisons of the ILD magnitudes in the 1000 Hz third-octave band across the 20 classrooms for the center receiver position,  $0^\circ$  source rotation are shown in Figure 6.27. These comparisons for the back receiver position,  $90^\circ$  source rotation are shown in Figure 6.28. The range in ILD magnitude is greater for the back receiver position,  $90^\circ$  source rotation than for the center receiver position,  $0^\circ$  source rotation as expected. Classroom 13D has the highest ILD value in the 1000 Hz third-octave band for both of the conditions shown. The mid-frequency reverberation time in this classroom is 0.34 s.



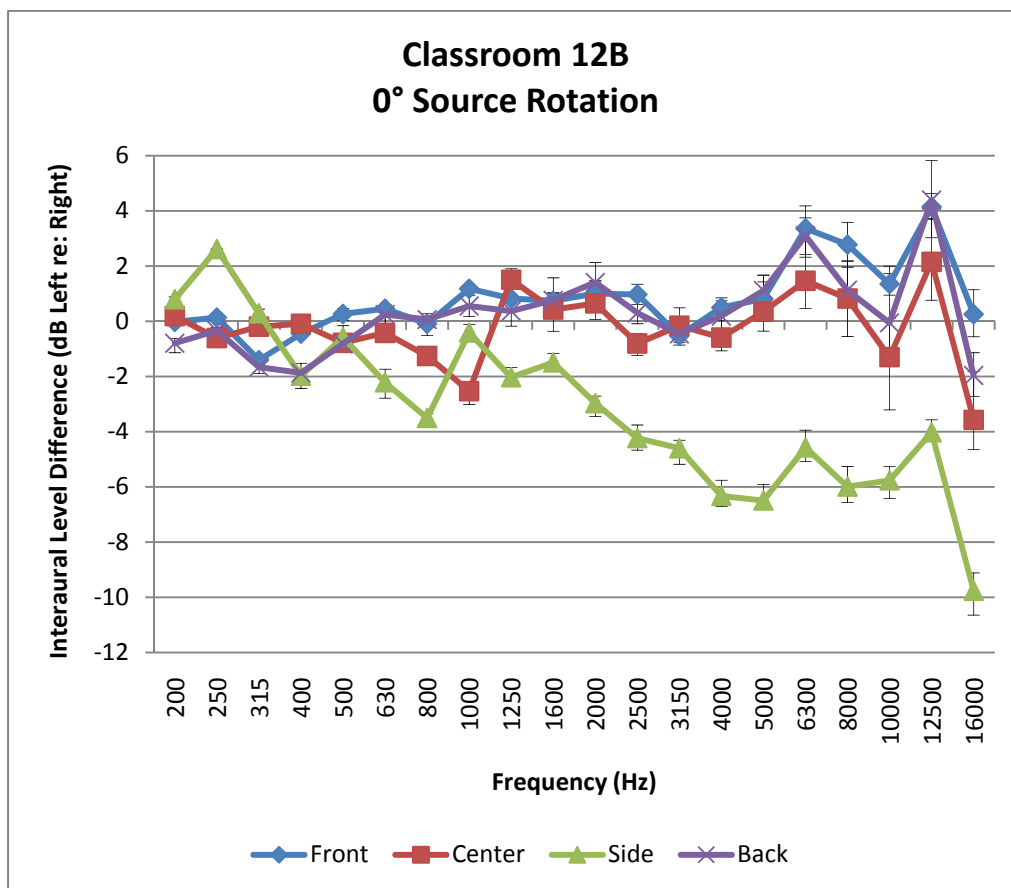
**Figure 6.27:** Interaural level difference magnitudes for the 1000 Hz octave band in the center receiver position,  $0^\circ$  source rotation. Error bars show the range about the average value from the three sets of repeated measurements.



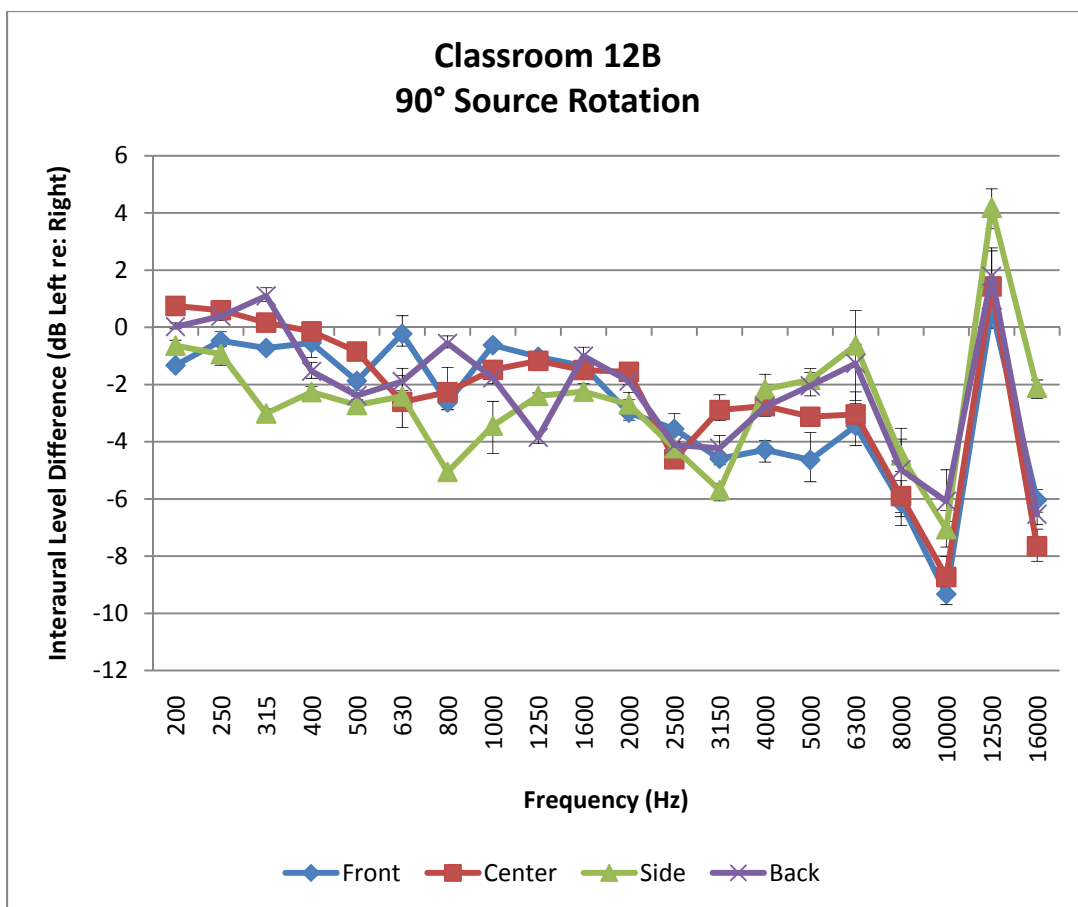
**Figure 6.28:** Interaural level difference magnitudes for the 1000 Hz octave band in the back receiver position, 90° source rotation. Error bars show the range about the average value from the three sets of repeated measurements.

The ILDs in one-third octave bands from 200 to 16,000 Hz for the 0° and 90° source rotations in Classrooms 12B, 11A, and 3B are shown in Figures 6.29, 6.30, 6.31, 6.32, 6.33, and 6.34. For all 0° source rotations, the ILD magnitudes are similar for the front, center, and back receiver positions. However for the side receiver position, the ILD magnitude increases at higher frequencies. This also occurs in the Council Bluffs classrooms, as reported in Section 5.3.6, and may be attributed to the unequal amounts of direct sound energy received by the two ears in the side condition. For the 90° source rotation, the ILD magnitude increases with increasing

frequency for all receiver positions, with the level typically larger for the right ear than the left ear.

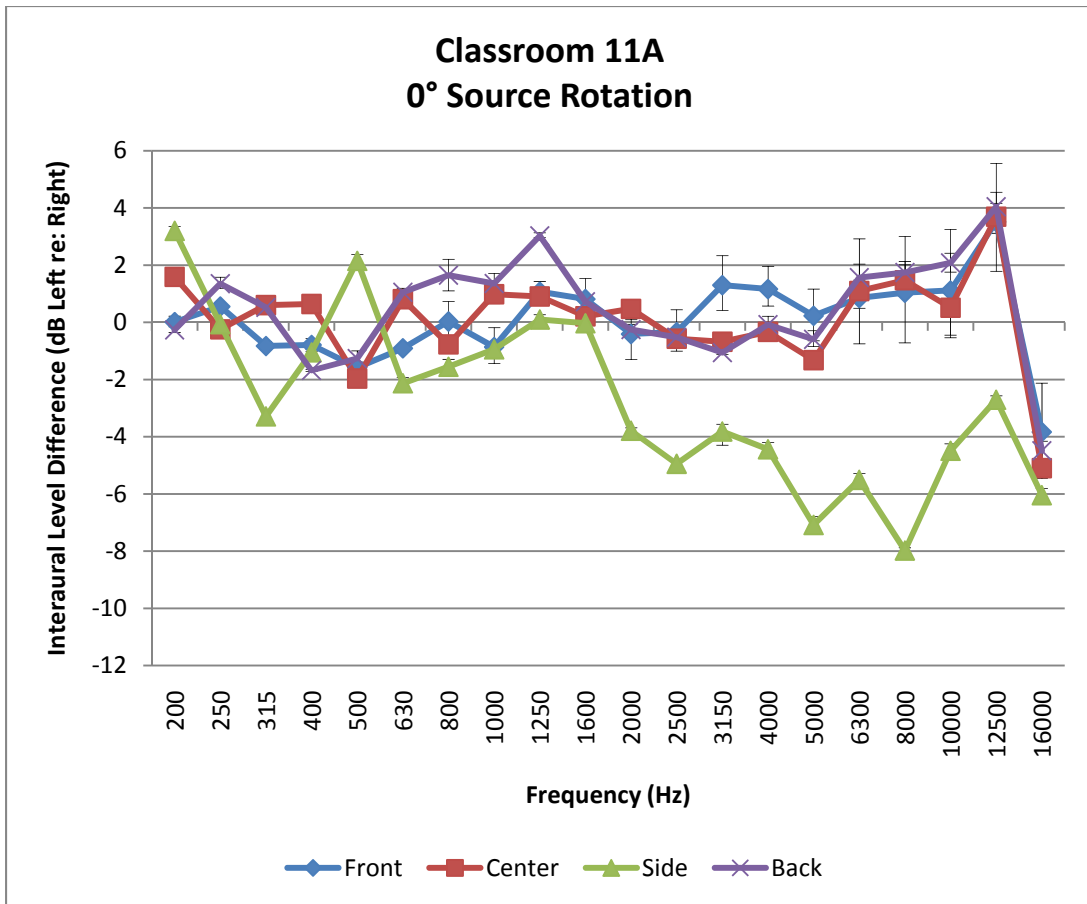


**Figure 6.29:** Interaural level differences for the 0° source rotation in Classroom 12B. Error bars show the range about the average value from the three sets of repeated measurements.

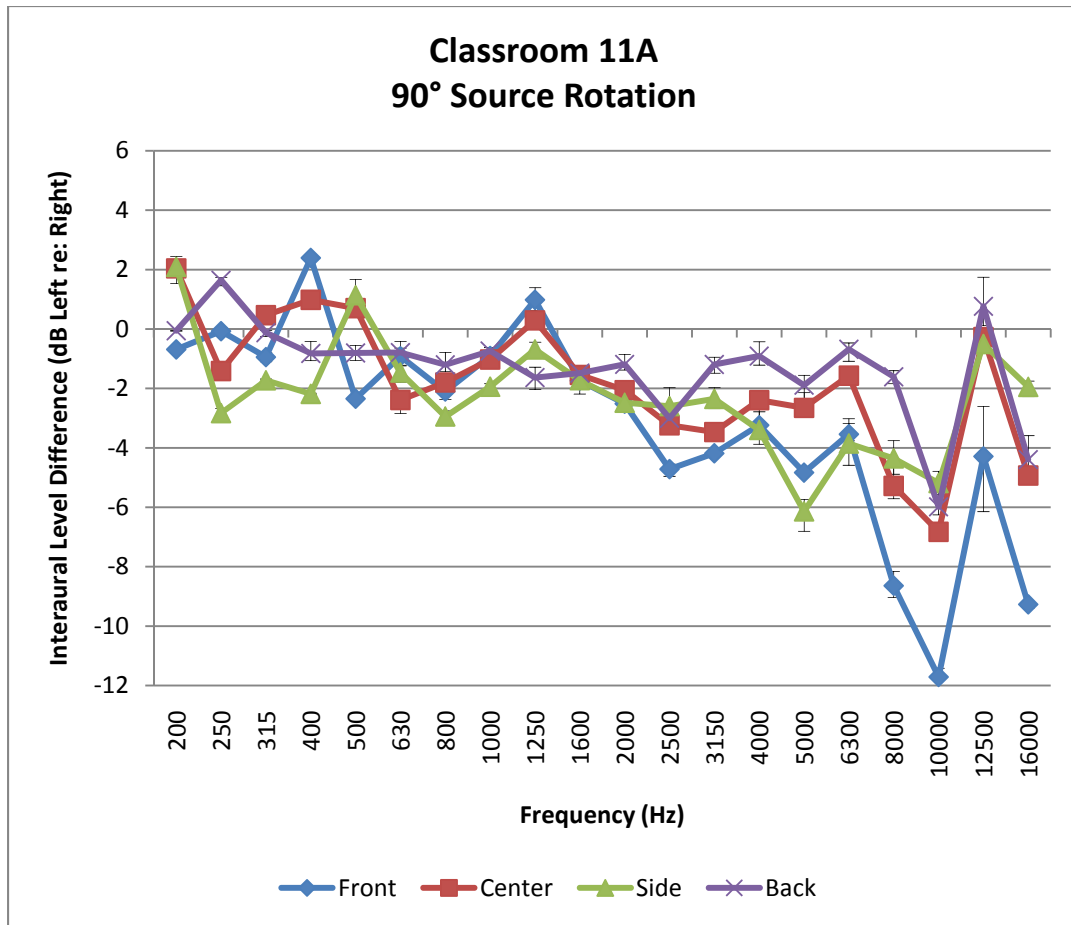


**Figure 6.30:** Interaural level differences for the 90° source rotation in Classroom 12B. Error bars show the range about the average value from the three sets of repeated measurements.

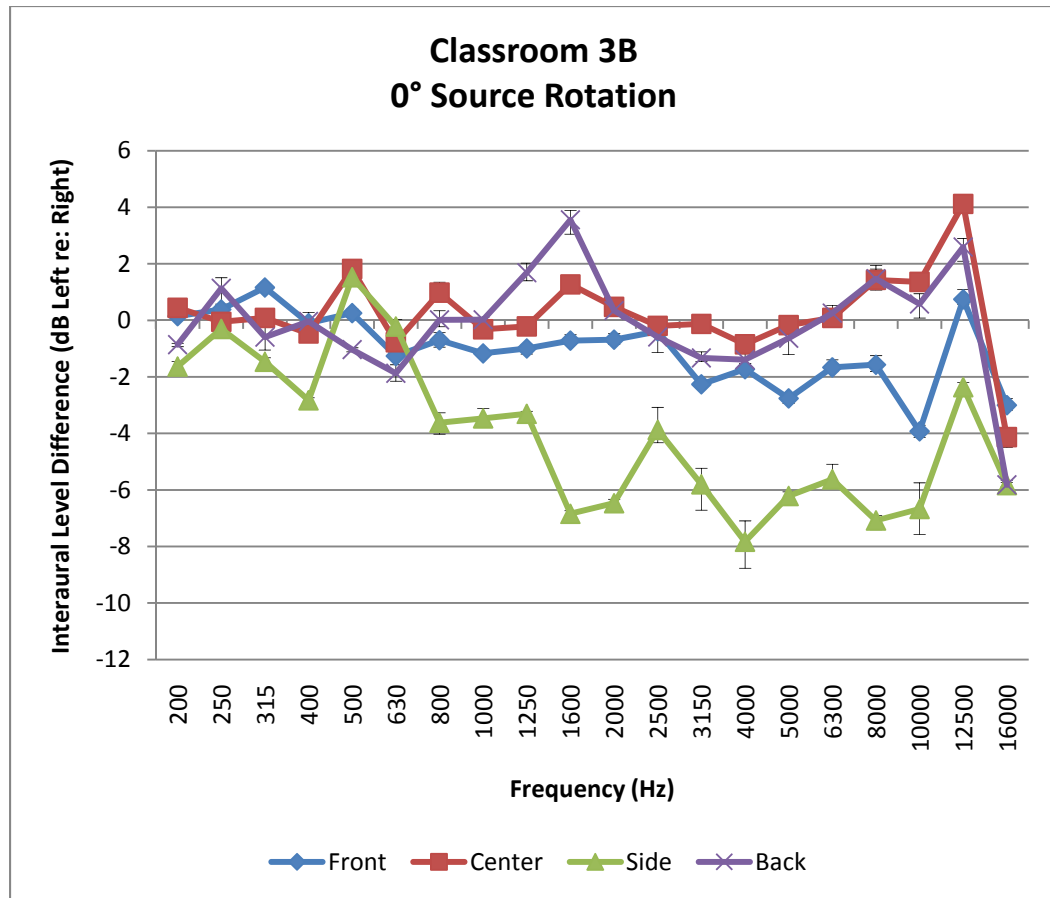




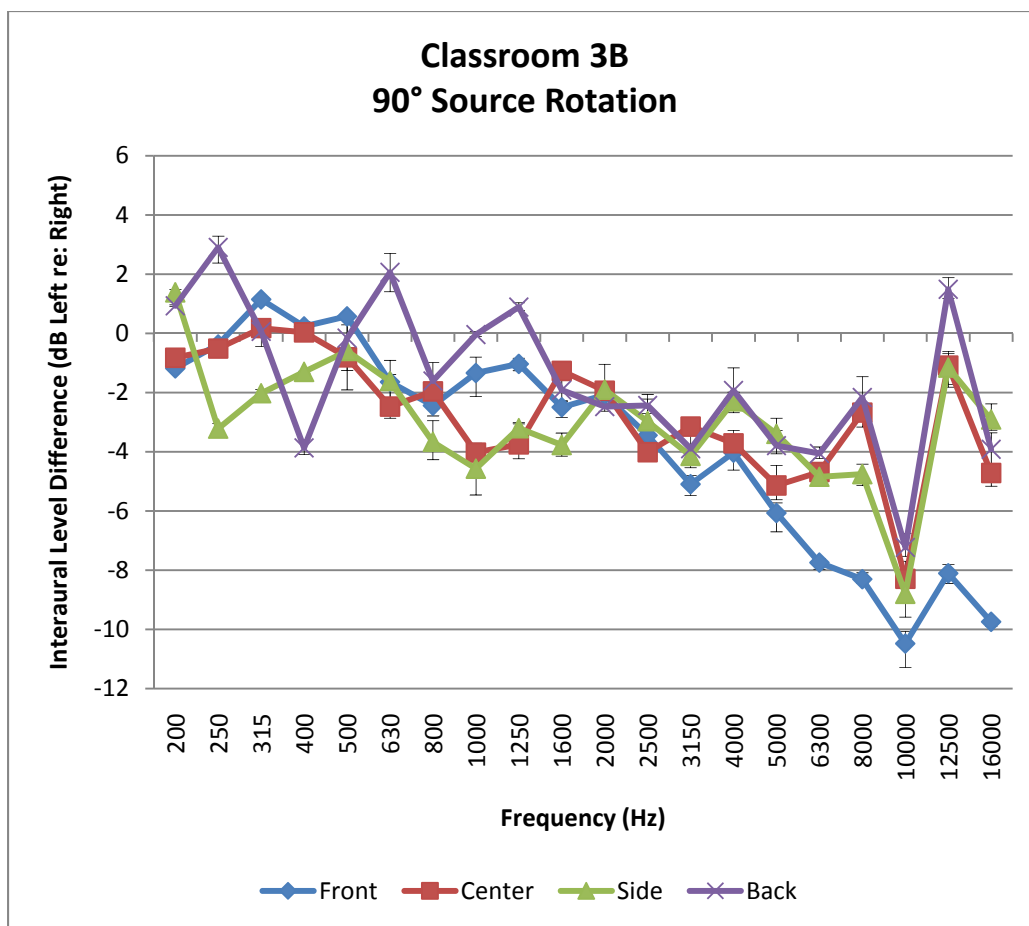
**Figure 6.31:** Interaural level differences for the 0° source rotation in Classroom 11A. Error bars show the range about the average value from the three sets of repeated measurements.



**Figure 6.32:** Interaural level differences for the 90° source rotation in Classroom 11A. Error bars show the range about the average value from the three sets of repeated measurements.



**Figure 6.33:** Interaural level differences for the 0° source rotation in Classroom 3B. Error bars show the range about the average value from the three sets of repeated measurements.



**Figure 6.34:** Interaural level differences for the 90° source rotation in Classroom 3B. Error bars show the range about the average value from the three sets of repeated measurements.

As for the  $IACC_E$  metric, larger differences in ILD occur within classrooms depending on the measurement configuration than among classrooms for the same source-receiver condition. This was also observed in the Council Bluffs classrooms. The ILD metric is most impacted by the relative amount of direct sound energy occurring between the two ears. The ILDs tend to be larger if the source is facing perpendicular to the receiver or if the receiver is not aligned with the source.

### ***6.3.7 Student Achievement Tests and Demographic Data***

The results from the standardized achievement tests and the free and reduced-price lunches are shown in Tables 6.3 and 6.4 for the third and fifth-grade classrooms, respectively. The state of Nebraska also reported the relationship between the Nebraska State Accountability reading test scores and the target performance level for the third and fifth-grade students for the 2009 – 2010 academic year. This relationship is shown in Table 6.5.

**Table 6.3:** Standardized achievement scores and demographic data for students in the third-grade classrooms.

Room	Terra Nova Achievement Scores			State Accountability Reading Scores (Scale Score)	Free or Reduced- Price Lunches (%)
	Math (NCE)	Language (Percentile Rank)	Reading (NCE)		
1A	63	55	65	116	4
2A	52	46	51	89	7
2B	64	73	67	113	12
3A	47	35	50	86	47
3B	55	50	59	103	42
3C	50	41	52	88	31
4A	52	46	62	100	64
4B	49	44	59	108	50
5A	63	58	60	117	29
5B	55	48	64	103	31
6A	58	60	59	102	17
6B	64	59	59	121	24
7A	45	33	46	80	68
7B	45	44	57	99	48
8A	47	42	49	86	44
8B	58	48	59	96	50
8C	53	49	54	91	35
9A	65	64	74	124	4
9B	66	66	68	124	12
10A	61	61	64	101	6
10B	60	61	64	100	0
10C	64	61	70	125	10
10D	57	51	58	102	6
11A	60	47	59	117	11
11B	65	55	63	121	5
11C	50	43	56	105	0
12A	53	58	59	92	27
12B	55	54	63	105	38
12C	67	73	70	131	17
13A	48	49	55	101	22
13B	72	59	68	110	16
13C	66	59	64	105	21
14A	67	61	63	122	25
14B	52	44	54	108	24

**Table 6.4:** Standardized achievement scores and demographic data for students in the fifth-grade classrooms.

Room	Terra Nova Achievement Scores			State Accountability Reading Scores (Scale Score)	Free or Reduced- Price Lunches (%)
	Math (NCE)	Language (Percentile Rank)	Reading (NCE)		
1B	68	76	68	131	0
1C	53	59	51	93	29
2C	51	61	57	115	13
2D	65	73	69	129	0
3D	50	47	52	84	29
3E	62	69	61	119	24
3F	49	57	51	101	32
4C	58	53	57	109	29
4D	51	41	51	95	53
4E	38	46	47	87	44
5C	52	50	51	86	47
5D	49	60	56	112	39
6C	59	76	61	111	9
6D	57	75	61	121	9
7C	47	47	53	93	64
7D	46	47	50	78	40
8D	50	71	60	121	24
8E	51	63	56	97	29
8F	55	65	60	116	25
9C	63	70	62	125	0
9D	64	64	56	119	4
10E	70	77	64	127	3
10F	64	69	63	115	3
11D	62	71	60	108	0
11E	65	65	60	117	13
11F	57	69	55	106	16
12D	49	55	51	90	35
12E	59	63	57	124	15
13D	61	61	58	114	28
13E	64	65	64	125	17
13F	54	53	54	100	6
14C	52	54	54	102	11
14D	61	64	62	126	5

**Table 6.5:** Nebraska State Accountability reading test scores and target student performance levels.

<b>Grade Level</b>	<b>Scale Score</b>	<b>Performance Level</b>
Third	<b>135 – 200</b>	Exceeds Target
	<b>85 – 127</b>	Meets Target
	<b>1 – 81</b>	Below Target
Fifth	<b>141 – 200</b>	Exceeds Target
	<b>85 – 133</b>	Meets Target
	<b>1 – 80</b>	Below Target

#### **6.4 Data Analyses and Discussion**

Statistical analyses relating the classroom acoustical metrics to the standardized achievement scores have been conducted for the surveyed classrooms. The statistical analyses indicate which metrics are most highly correlated to student achievement. Explanations of the statistical tests described are provided in Chapter 4 of this dissertation.

##### ***6.4.1 Background Noise Level and Reverberation Time vs. Student Achievement***

The BNL and RT conditions in each classroom were compared to the average student achievement scores per classroom. To determine if parametric statistical tests should be used, the distributions of the achievement score data sets from all of the classrooms surveyed were tested for normality. Results from the Kolmogorov-Smirnov tests for normality indicate that none of the achievement score distributions significantly deviate from normal distributions.

Zero-order Pearson correlations between the student achievement scores and percent of students receiving free or reduced-price lunches in each classroom were



conducted. These correlations are shown in Tables 6.6 and 6.7 for the third and fifth-grade classrooms, respectively. Significant negative correlations occur between all of the achievement test scores and the percentage of students receiving free or reduced-price lunches ( $p < 0.01$ ). This indicates that classrooms containing a larger percentage of students receiving free or reduced-price lunches also had students with lower achievement scores. Because a significant relationship occurs between achievement scores and free or reduced-price lunches, this demographic variable was used as a control variable for some of the statistical analyses.

**Table 6.6:** Correlations between third-grade student achievement scores and percentage of students receiving free or reduced-price lunches (\*\*  $p < 0.01$ ).

Variable	1	2	3	4	5
<b>1. Terra Nova Math</b>	-	0.84**	0.81**	0.78**	-0.58**
<b>2. Terra Nova Language</b>	-	-	0.83**	0.71**	-0.58**
<b>3. Terra Nova Reading</b>	-	-	-	0.80**	-0.50**
<b>4. State Reading</b>	-	-	-	-	-0.51**
<b>5. Free or Reduced-price Lunches</b>	-	-	-	-	-

*Note.* The sample size for all of the pairs of correlations is 34.

**Table 6.7:** Correlations between fifth-grade student achievement scores and percentage of students receiving free or reduced-price lunches (\*\*  $p < 0.01$ ).

Variable	1	2	3	4	5
<b>1. Terra Nova Math</b>	-	0.74**	0.83**	0.79**	-0.75**
<b>2. Terra Nova Language</b>	-	-	0.86**	0.81**	-0.77**
<b>3. Terra Nova Reading</b>	-	-	-	0.89**	-0.74**
<b>4. State Reading</b>	-	-	-	-	-0.71**
<b>5. Free or Reduced-price Lunches</b>	-	-	-	-	-

*Note.* The sample size for all of the pairs of correlations is 33.

#### 6.4.1.1 Background Noise Level

In one of the schools the mechanical system fan motor was not activated during the BNL measurements. This motor would typically be running while the classrooms were occupied, generating different noise levels than those measured with the fan deactivated. Therefore, the classrooms in this school (Classrooms 7A, 7B,

7C, and 7D) were omitted from the BNL analyses. The distributions of the achievement score data sets with these classrooms removed were tested for normality to determine if parametric statistical tests may be used. These data distributions are not significantly different from normal distributions.

Intrusive noise causes higher occupied noise levels in open-plan classrooms than closed-plan classrooms, due to the lack of isolation from noise in the hallways and adjacent rooms for open-plan classrooms (Shield et al. 2010). Therefore, data analyses were conducted with the open plan, open door, and portable classrooms removed from the data sets. None of the distributions of the achievement scores from the reduced set of classrooms significantly differ from normality. Therefore, parametric statistical tests were used for all of the statistical analyses.

The zero-order Pearson correlations relating BNL to the achievement scores were calculated for the third-grade and fifth-grade classrooms. The correlations between BNL and the third-grade student achievement scores for the classrooms with closed-plans and consistent HVAC conditions are shown in Table 6.8. The BNL variables shown are the  $L_{Aeq}$  values measured with the mechanical system operating in the cooling mode (BNL: Cooling), in the heating mode (BNL: Heating), and the average noise levels calculated based on weather data from August to November 2009 (BNL: TW (8/09 – 11/09)) and from August 2009 to March 2010 (BNL: TW (8/09 – 3/10)). The correlation coefficients between the BNL variables (1 – 4) and the achievement test score variables (5 – 8) reflect the relationships between BNL and

student achievement. As shown in this table, all correlations between BNL and the achievement scores for the third-grade classrooms are non-significant.

The zero-order Pearson correlations between BNL and the achievement test scores for the closed-plan fifth-grade classrooms with consistent HVAC conditions are shown in Table 6.9. The cooling BNL is significantly negatively correlated to the following achievement test scores: Terra Nova language ( $r = -0.64, p < 0.01$ ), Terra Nova reading ( $r = -0.47, p < 0.05$ ), and State Accountability reading ( $r = -0.46, p < 0.05$ ). Also, a significant negative correlation exists between the Terra Nova language test score and the temperature-weighted average BNL from August 2009 to November 2009 ( $r = -0.51, p < 0.05$ ). Since the students completed the Terra Nova tests in November 2009, this BNL average should reflect the cumulative noise levels the students experienced prior to taking this test.

The State Accountability reading test score is significantly negatively correlated to the temperature-weighted average BNL from August 2009 to November 2009 ( $r = -0.44, p < 0.05$ ), but it is not significantly correlated to the temperature-weighted BNL average from August 2009 to March 2010. The relationship between the State Accountability reading test score and the temperature-weighted average BNL from August 2009 to November 2009 will not be further investigated, since the students took the State Accountability reading test in March 2010.

**Table 6.8:** Correlations between BNL and third-grade student achievement scores for the closed-plan classrooms with consistent HVAC conditions (\*\* p < 0.01).

<b>Variable</b>	<b>1</b>	<b>2</b>	<b>3</b>	<b>4</b>	<b>5</b>	<b>6</b>	<b>7</b>	<b>8</b>
<b>1. BNL: Cooling</b>	-	0.87**	0.97**	0.92**	-0.28	-0.20	0.01	0.14
<b>2. BNL: Heating</b>	-	-	0.97**	0.99**	-0.15	-0.10	0.08	0.17
<b>3. BNL: TW (8/09 – 11/09)</b>	-	-	-	0.99**	-0.21	-0.14	0.05	0.17
<b>4. BNL: TW (8/09 – 3/10)</b>	-	-	-	-	-0.17	-0.11	0.08	0.18
<b>5. Terra Nova Math</b>	-	-	-	-	-	0.84**	0.84**	0.73**
<b>6. Terra Nova Language</b>	-	-	-	-	-	-	0.86**	0.66**
<b>7. Terra Nova Reading</b>	-	-	-	-	-	-	-	0.81**
<b>8. State Reading</b>	-	-	-	-	-	-	-	-

*Note.* The sample size for all of the pairs of correlations is 25.

**Table 6.9:** Correlations between BNL and fifth-grade student achievement scores for the closed-plan classrooms with consistent HVAC conditions (\*  $p < 0.05$ ; \*\*  $p < 0.01$ ).

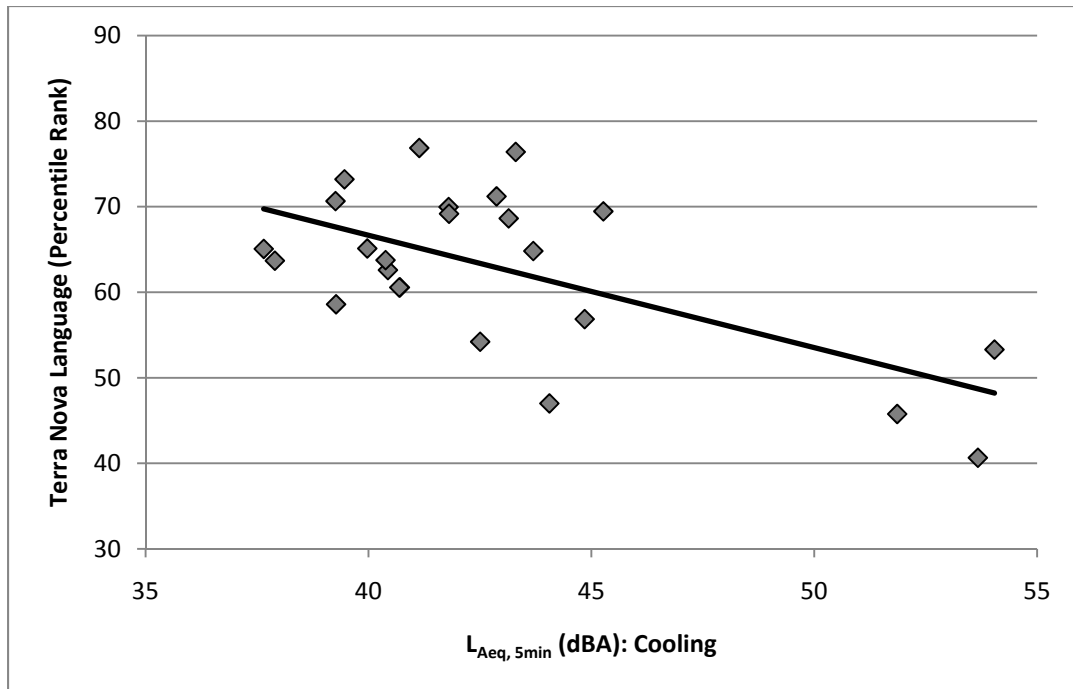
<b>Variable</b>	<b>1</b>	<b>2</b>	<b>3</b>	<b>4</b>	<b>5</b>	<b>6</b>	<b>7</b>	<b>8</b>
<b>1. BNL: Cooling</b>	-	0.55**	0.91**	0.75**	-0.37	-0.64**	-0.47*	-0.46*
<b>2. BNL: Heating</b>	-	-	0.85**	0.96**	-0.09	-0.22	-0.14	-0.30
<b>3. BNL: TW (8/09 – 11/09)</b>	-	-	-	0.96**	-0.27	-0.51*	-0.36	-0.44*
<b>4. BNL: TW (8/09 – 3/10)</b>	-	-	-	-	-0.18	-0.37	-0.25	-0.37
<b>5. Terra Nova Math</b>	-	-	-	-	-	0.73**	0.83**	0.79**
<b>6. Terra Nova Language</b>	-	-	-	-	-	-	0.85**	0.80**
<b>7. Terra Nova Reading</b>	-	-	-	-	-	-	-	0.91**
<b>8. State Reading</b>	-	-	-	-	-	-	-	-

*Note.* The sample size for all of the pairs of correlations is 24.

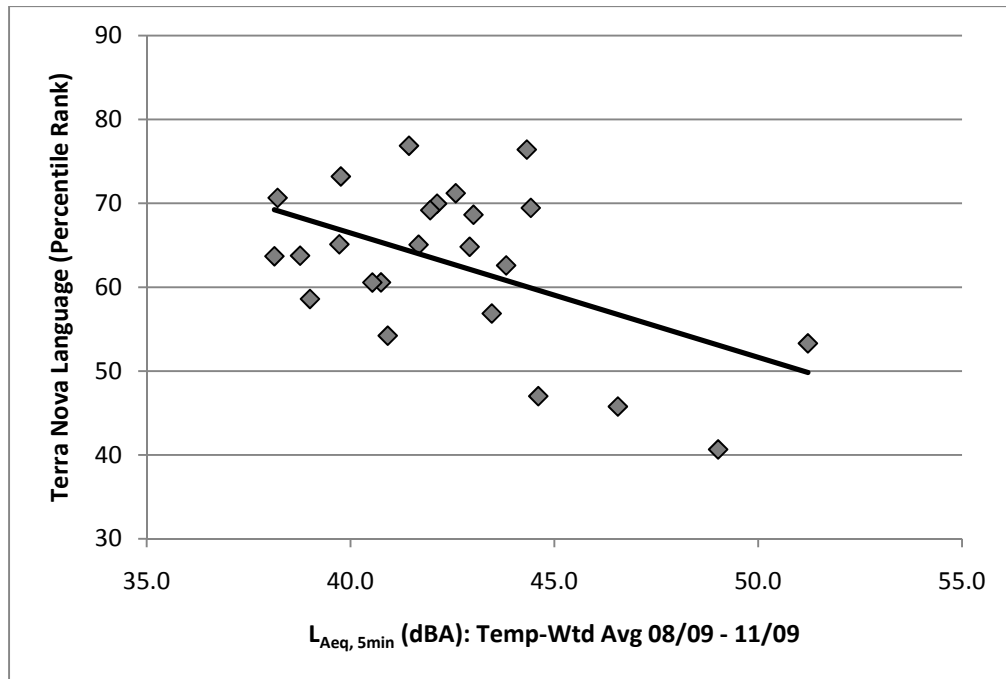
When controlling for the effects of free or reduced-price lunches on achievement, though, none of the semi-partial correlations between BNL and the achievement test scores are statistically significant. This means that when the effects of free or reduced-price lunches are factored out of the achievement scores, the amount of new variance in achievement accounted for by BNL is non-significant (Field 2000).

The scatter plots between BNL and the achievement test scores with significant zero-order correlations are shown in Figures 6.35, 6.36, 6.37, and 6.38. Figure 6.35 contains the scatter plot between the cooling BNL and the Terra Nova language test scores. The scatter plot between the temperature-weighted average BNL from August 2009 to November 2009 and the Terra Nova language test scores is shown in Figure 6.36. The regression models for the linear regression equations plotted in these figures are shown in Table 6.10. The model with the cooling BNL as the predictor variable is significant at the 0.01 level ( $F(1,22) = 14.92, p < 0.01$ ), with BNL accounting for 40% of the variance in the Terra Nova language scores ( $R^2 = 0.40, p < 0.01$ ). The regression model with the temperature-weighted average BNL as the predictor variable is significant at the 0.05 level ( $F(1,22) = 7.57, p < 0.05$ ), with BNL accounting for 26% of the variance in the Terra Nova language scores ( $R^2 = 0.26, p < 0.05$ ).





**Figure 6.35:** Scatter plot and linear regression line between cooling mode BNL and Terra Nova language test scores for closed-plan fifth-grade classrooms with consistent HVAC conditions.

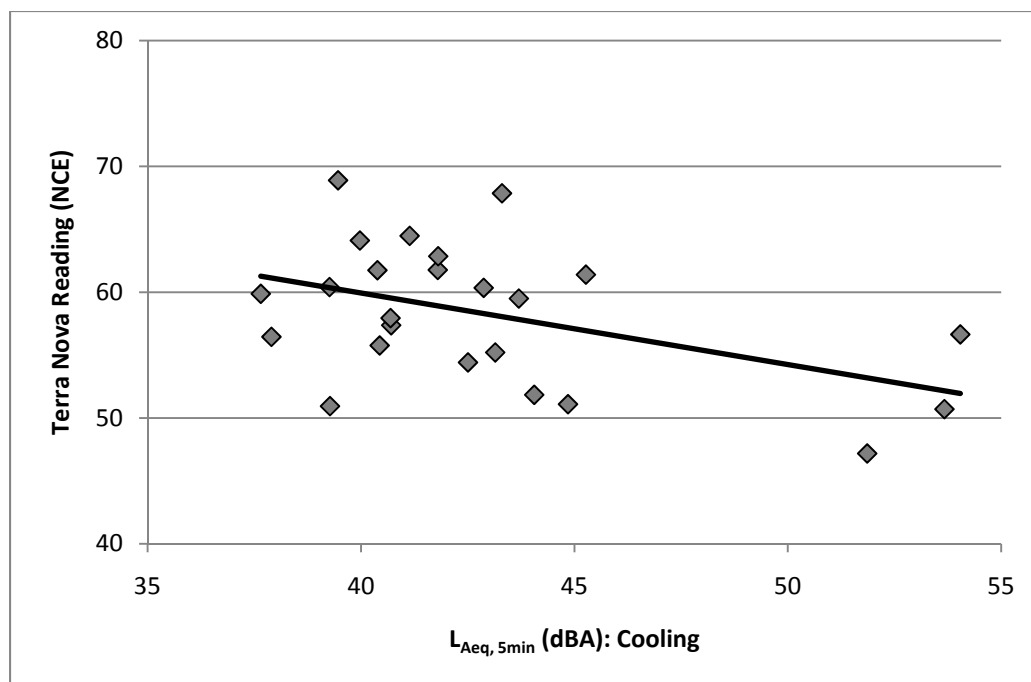


**Figure 6.36:** Scatter plot and linear regression line between temperature-weighted average BNL from August to November 2009 and Terra Nova language test scores for closed-plan fifth-grade classrooms with consistent HVAC conditions.

**Table 6.10:** Regression results predicting Terra Nova language scores for the closed-plan fifth-grade classrooms with consistent HVAC conditions (\*  $p < 0.05$ ; \*\*  $p < 0.01$ ).

Predictor Variables	<b>b</b>	$\beta$	<i>t</i>	$R^2$	<i>F</i>
<b>Fifth-Grade (N = 24)</b>					
<b>Intercept</b>	125.89				
<b>BNL: TW (8/09 – 11/09)</b>	-1.49	-0.51	-2.75*	0.26	7.57*
<b>Fifth-Grade (N = 24)</b>					
<b>Intercept</b>	119.98				
<b>BNL: Cooling</b>	-1.33	-0.64	-3.86**	0.40	14.92**

The scatter plot between the cooling BNL and the Terra Nova reading test scores is shown in Figure 6.37. The regression line relating these variables is calculated from the model shown in Table 6.11. The regression model with the cooling BNL as a predictor variable for the Terra Nova reading test scores is significant ( $F(1,22) = 6.34, p < 0.05$ ), with 22% of the variance in the Terra Nova reading scores accounted for by BNL ( $R^2 = 0.22, p < 0.05$ ).

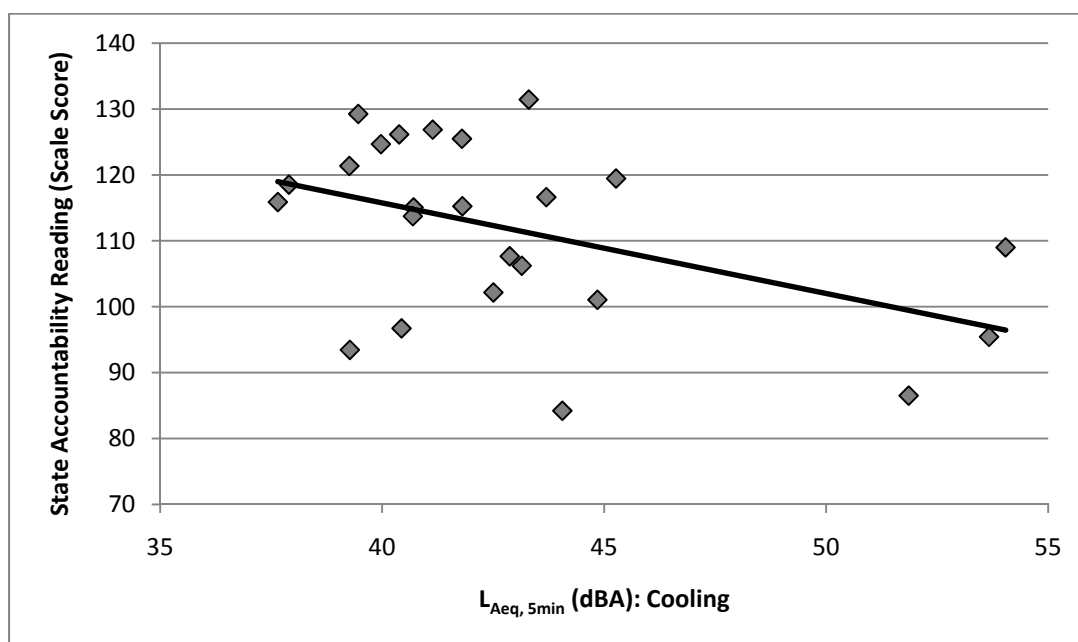


**Figure 6.37:** Scatter plot and linear regression line between cooling mode BNL and Terra Nova reading test scores for closed-plan fifth-grade classrooms with consistent HVAC conditions.

**Table 6.11:** Regression results predicting Terra Nova reading scores for the closed-plan fifth-grade classrooms with consistent HVAC conditions (\*  $p < 0.05$ ).

Predictor Variables	<b>b</b>	$\beta$	<i>t</i>	$R^2$	<i>F</i>
<b>Fifth-Grade (N = 24)</b>					
<b>Intercept</b>	83.23				
<b>BNL: Cooling</b>	-0.58	-0.47	-2.52*	0.22	6.34*

Figure 6.38 contains the scatter plot between the cooling BNL and the State Accountability reading scores. The model for the regression line plotted in this figure is shown in Table 6.12. This model is significant at the 0.05 level ( $F(1,22) = 5.91, p < 0.05$ ), with the cooling BNL accounting for 21% of the variance in the State Accountability reading scores ( $R^2 = 0.21, p < 0.05$ ). The unoccupied cooling BNLs corresponding to the State Accountability reading scores for different student performance levels predicted by this regression model are shown in Table 6.13. As shown in this table, a cooling BNL of 45 dBA corresponds to the average State Accountability reading score that meets the target performance level. However, the cooling BNL decreases to 22 dBA for a reading score that exceeds the target level.



**Figure 6.38:** Scatter plot and linear regression line between cooling mode BNL and State Accountability reading test scores for closed-plan fifth-grade classrooms with consistent HVAC conditions.

**Table 6.12:** Regression results predicting State Accountability reading scores for the closed-plan fifth-grade classrooms with consistent HVAC conditions (\*  $p < 0.05$ ).

Predictor Variables	<b>b</b>	<b><math>\beta</math></b>	<b><i>t</i></b>	<b><math>R^2</math></b>	<b><i>F</i></b>
<b>Fifth-Grade (N = 24)</b>					
<b>Intercept</b>	170.95				
<b>BNL: Cooling</b>	-1.38	-0.46	-2.43*	0.21	5.91*

**Table 6.13:** Cooling BNLs corresponding to fifth-grade Nebraska State Accountability reading test scores and student performance levels predicted by equation\* from regression model calculated with closed-plan classrooms with consistent HVAC conditions.

Student Performance Level	State Accountability Reading Test (Scale Score)	$L_{Aeq, 5min}$ (dBA): Cooling
Below Target	80	66
Meets Target	85	62
Meets Target	109	45
Meets Target	133	28
Exceeds Target	141	22

\*Note. State Accountability Reading Score =  $-1.38 * (\text{Cooling BNL}) + 170.95$

The regression model with both the cooling BNL and the percent of students receiving free or reduced-price lunches as predictor variables for the State Accountability reading scores is shown in Table 6.14. This model is significant at the 0.01 level ( $F(2,21) = 11.40, p < 0.01$ ), with 52% of the variance in the reading scores accounted for by the predictor variables ( $R^2 = 0.52, p < 0.01$ ). However, the

significant predictor variable is free or reduced-price lunches ( $t(21) = -3.68, p < 0.01$ ), rather than the cooling BNL ( $t(21) = -0.36, p > 0.05$ ).

**Table 6.14:** Regression results predicting State Accountability reading scores for the closed-plan fifth-grade classrooms with consistent HVAC conditions (\*\*  $p < 0.01$ ).

Predictor Variables	b	$\beta$	$t$	$R^2$	$F$
<b>Fifth-Grade (N = 24)</b>					
<b>Intercept</b>	131.51				
<b>BNL: Cooling</b>	-0.20	-0.07	-0.36		
<b>Free/Reduced Lunches</b>	-0.63	-0.68	-3.68**		
				0.52	11.40**

#### 6.4.1.2 Reverberation Time

The average RT in the 500 Hz and 1000 Hz octave from the balloon pop impulse response measurements shown in Figures 6.5 and 6.6 in all of the classrooms was compared to the student achievement test scores. The zero-order Pearson correlations relating the mid-frequency RT to the achievement scores for all of the third and fifth-grade classrooms are shown in Tables 6.15 and 6.16, respectively. None of the correlations between RT and achievement are significant at the 0.05 level. Therefore, no further analysis between RT and achievement is presented.

**Table 6.15:** Correlations between RT and student achievement scores for all third-grade classrooms surveyed (\*\*  $p < 0.01$ ).

<b>Variable</b>	<b>1</b>	<b>2</b>	<b>3</b>	<b>4</b>	<b>5</b>
<b>1. RT</b>	-	0.10	0.07	0.10	0.14
<b>2. Terra Nova Math</b>	-	-	0.84**	0.81**	0.78**
<b>3. Terra Nova Language</b>	-	-	-	0.83**	0.71**
<b>4. Terra Nova Reading</b>	-	-	-	-	0.80**
<b>5. State Reading</b>	-	-	-	-	-

*Note.* The sample size for all of the pairs of correlations is 34.



**Table 6.16:** Correlations between RT and student achievement scores for all fifth-grade classrooms surveyed (\*\*  $p < 0.01$ ).

<b>Variable</b>	<b>1</b>	<b>2</b>	<b>3</b>	<b>4</b>	<b>5</b>
<b>1. RT</b>	-	-0.08	0.15	0.12	0.05
<b>2. Terra Nova Math</b>	-	-	0.74**	0.83**	0.79**
<b>3. Terra Nova Language</b>	-	-	-	0.86**	0.81**
<b>4. Terra Nova Reading</b>	-	-	-	-	0.89**
<b>5. State Reading</b>	-	-	-	-	-

*Note.* The sample size for all of the pairs of correlations is 33.

#### 6.4.1.3 Discussion

The unoccupied RT and BNL in the third and fifth-grade classrooms have been compared to student scores on the Terra Nova math, language, and reading and Nebraska State Accountability reading tests. None of the BNL conditions are significantly correlated to the third-grade student achievement scores. Additionally, BNL is not significantly correlated to the fifth-grade Terra Nova math test scores. However, significant negative correlations occur between the cooling BNL and the language and reading scores for the closed-plan fifth-grade classrooms with

consistent HVAC conditions. Also, a significant negative correlation exists between the temperature-weighted BNL average from August 2009 to November 2009 and the fifth-grade Terra Nova language test scores. These results indicate that high unoccupied BNLs negatively impact learning processes for the language and reading subject areas for fifth-grade students, but not for the third-grade students.

The differences between how the younger and older students were impacted by BNL may be attributed to possible differences in instructional styles used between the two grade levels. It is possible that more interactive, visual teaching methods were used for the third-graders, causing their learning to be less impacted by noise distractions. However, an examination of teaching styles was not included in the scope of this research. Therefore, this theory was not confirmed.

The BNLs measured with the HVAC systems operating in the heating mode are not significantly correlated to any of the achievement test results. The mechanical systems may have been generating noise similar to the cooling mode conditions more often than the heating mode conditions. However, the systems were set to operate in the heating mode if the outdoor air temperature was below 12.8° C (55° F), as it was for the majority of the academic year.

The results from the regression analyses indicate that the allowable unoccupied cooling mode BNL to meet the Nebraska state target levels for reading performance ranges from 28 to 62 dBA. Though this is a wide range of possible acceptable BNLs, the State Accountability reading scores were predicted to improve as the unoccupied BNL was reduced.

The measured mid-frequency RTs are not significantly correlated to any of the student achievement test results. As with the study conducted in the Council Bluffs School District, all of the RTs measured in the Papillion-La Vista School District meet the requirements specified in the ANSI S12.60 Standard (ANSI/ASA 2010). To determine the relationship between RT and achievement, measurements in classrooms with a wider range of RT are needed.

#### ***6.4.2 Binaural Room Impulse Response Acoustical Metrics vs. Student Achievement***

All of the metrics from the BRIR measurements, including STI, DFSM, IACC, and ILD, are compared to the RT, BNL, and achievement scores. These comparisons are shown for the 20 classrooms in which BRIR measurements were conducted. The mid-frequency RTs analyzed in this section are calculated from the logarithmic sweep impulse responses, as described in Section 6.3.2 and shown in Figures 6.5 and 6.6. Because the achievement test results are averaged among all of the students in each classroom, the BRIR metrics are averaged among all of the receiver positions in each classroom as well. The results from the 0° source rotation measurement configuration are reported. The IACC<sub>E</sub> and ILD magnitude values are averaged from 1 to 4 kHz, since excessive reverberation occurring in this range of frequencies has the strongest effect on listening difficulty (Sato et al. 2008).

The distributions of the achievement test scores for the combined third and fifth-grade data set were tested for normality. The Kolmogorov-Smirnov tests for normality indicate that none of the data distributions significantly differ from

normality: Terra Nova math ( $D(20) = 0.12, p > 0.05$ ), Terra Nova language ( $D(20) = 0.17, p > 0.05$ ), Terra Nova reading ( $D(20) = 0.10, p > 0.05$ ), and State Accountability reading ( $D(20) = 0.12, p > 0.05$ ). Therefore, parametric statistical tests may be used.

The zero-order Pearson correlations between all of the acoustical metrics calculated from the BRIR measurements are shown in Table 6.17. Significant positive correlations exist between the left and right ear STI values ( $r = 0.93, p < 0.01$ ) and the left and right ear DFSM values ( $r = 0.85, p < 0.01$ ). A significant negative relationship occurs between the left ear STI and the difference between the left and right ear STI ( $r = -0.69, p < 0.05$ ). Significant negative relationships also exist between the left ear DFSM and both the left ear STI ( $r = -0.67, p < 0.05$ ) and the right ear STI ( $r = -0.65, p < 0.05$ ). This indicates that higher DFSM values occur for lower STI values. This is expected, since both STI and DFSM values are impacted by any smearing of the signal that occurs before reaching the listener.

**Table 6.17:** Correlations between acoustical metrics for classrooms in which BRIR measurements were conducted (\*  $p < 0.05$ ; \*\*  $p < 0.01$ ).

Variable	1	2	3	4	5	6	7	8
<b>1. STI: Left Ear</b>	-	0.93**	-0.69*	-0.55	-0.67*	-0.28	0.49	-0.14
<b>2. STI: Right Ear</b>	-	-	-0.37	-0.53	-0.65*	-0.10	0.42	0.04
<b>3. STI: Left/Right Ear Difference</b>	-	-	-	0.35	0.42	0.50	-0.42	0.41
<b>4. DFSM: Left Ear</b>	-	-	-	-	0.85**	0.16	0.04	-0.19
<b>5. DFSM: Right Ear</b>	-	-	-	-	-	0.02	0.09	-0.33
<b>6. DFSM: Left/Right Ear Difference</b>	-	-	-	-	-	-	0.02	0.26
<b>7. IACC<sub>E</sub></b>	-	-	-	-	-	-	-	-0.03
<b>8. ILD Magnitude</b>	-	-	-	-	-	-	-	-

*Note.* The sample size for the pairs of correlations including STI is 12. The sample size for all other pairs of correlations is 20.

#### *6.4.2.1 Speech Transmission Index*

When averaged across receiver position for the 0° source rotation, the STI values within 12 of the classrooms range from 0.76 to 0.86 for the left ear and from 0.80 to 0.86 for the right ear. The difference in STIs between the left and right ears ranges only from 0 to 0.04.

The average STI values within 12 of the classrooms for the 0° source rotation are compared to the mid-frequency RT, cooling BNL, and heating BNL. The zero-order Pearson correlations for these comparisons are shown in Table 6.18. Significant negative correlations exist between both the cooling and heating BNLs and the left and right ear STI values. This is expected, since the STI metric includes the negative effects of high background noise on intelligibility. The zero-order Pearson correlations relating STI to the student achievement test scores are shown in Table 6.19. As shown in this table, none of the achievement scores are significantly correlated to the STIs.

Due to the limited range in STI values across classrooms and the non-significant correlations between STI and achievement, further analysis of the STIs is not presented.

**Table 6.18:** Correlations between RT, BNL, and STI for 12 of the third and fifth-grade classrooms (\*  $p < 0.05$ ; \*\*  $p < 0.01$ ).

<b>Variable</b>	<b>1</b>	<b>2</b>	<b>3</b>	<b>4</b>	<b>5</b>	<b>6</b>
<b>1. RT</b>	-	-0.31	-0.30	-0.12	0.12	0.53
<b>2. BNL: Cooling</b>	-	-	0.94**	-0.69*	-0.84**	0.09
<b>3. BNL: Heating</b>	-	-	-	-0.70**	-0.87**	0.06
<b>4. STI: Left Ear</b>	-	-	-	-	0.93**	-0.69*
<b>5. STI: Right Ear</b>	-	-	-	-	-	-0.37
<b>6. STI: Difference between Left Ear and Right Ear</b>	-	-	-	-	-	-

*Note.* The sample size for all of the pairs of correlations is 12.

**Table 6.19:** Correlations between STI and student achievement scores for 12 of the third and fifth-grade classrooms (\*  $p < 0.05$ ; \*\*  $p < 0.01$ ).

Variable	1	2	3	4	5	6	7
<b>1. STI: Left Ear</b>	-	0.93**	-0.69*	0.22	0.10	-0.05	-0.01
<b>2. STI: Right Ear</b>	-	-	-0.37	0.18	0.12	-0.10	-0.10
<b>3. STI: Left/Right Ear Difference</b>	-	-	-	-0.19	-0.02	-0.06	-0.18
<b>4. Terra Nova Math</b>	-	-	-	-	0.69**	0.81**	0.90**
<b>5. Terra Nova Language</b>	-	-	-	-	-	0.50	0.56
<b>6. Terra Nova Reading</b>	-	-	-	-	-	-	0.77**
<b>7. State Reading</b>	-	-	-	-	-	-	-

*Note.* The sample size for all of the pairs of correlations is 12.



#### 6.4.2.2 Distortion of Frequency-Smoothed Magnitude

A wider range in DFSM values occurs among classrooms for the 0° source rotation when averaged across receiver positions. The DFSM values among 20 of the classrooms range from 4.0 to 6.1 dB (re: Anechoic) for the left ear and from 3.9 to 6.4 dB (re: Anechoic) for the right ear. The difference between the left ear and right ear DFSM values ranges from 0 to 0.8 (dB re: Anechoic) among the 20 classrooms.

The zero-order Pearson correlations between the DFSM values, mid-frequency RT, and BNLs are shown in Table 6.20. A significant positive correlation exists between the DFSM right ear values and the cooling BNL ( $r = 0.52, p < 0.05$ ). Significant negative correlations exist between the mid-frequency RT and the DFSM left ear values ( $r = -0.50, p < 0.05$ ) and right ear values ( $r = -0.47, p < 0.05$ ). Therefore lower DFSM values are occurring in rooms with longer RTs.

**Table 6.20:** Correlations between RT, BNL, and DFSM for 20 of the third and fifth-grade classrooms (\*  $p < 0.05$ ; \*\*  $p < 0.01$ ).

Variable	1	2	3	4	5	6
<b>1. RT</b>	-	-0.31	-0.29	-0.50*	-0.47*	0.08
<b>2. BNL: Cooling</b>	-	-	0.94**	0.41	0.52*	0.02
<b>3. BNL: Heating</b>	-	-	-	0.29	0.41	-0.03
<b>4. DFSM: Left Ear</b>	-	-	-	-	0.85**	0.16
<b>5. DFSM: Right Ear</b>	-	-	-	-	-	0.02
<b>6. DFSM: Difference between Left Ear and Right Ear</b>	-	-	-	-	-	-

*Note.* The sample size for all of the pairs of correlations is 20.

Zero-order Pearson correlations between the DFSM values and the achievement scores were also calculated. These results are shown in Table 6.21. A significant negative correlation exists between the left ear DFSM and the Terra Nova language test scores ( $r = -0.48, p < 0.05$ ). The relationship between the left ear DFSM and Terra Nova language scores is also significant when controlling for the

effects of free or reduced-price lunches on the language scores with a semi-partial correlation value of  $-0.51$  ( $t(17) = -2.45, p < 0.05$ ). Though the zero-order correlation between the right ear DFSM and Terra Nova language scores is not significant, these variables are significantly correlated when controlling for the effects of free or reduced-price lunches on the language scores. The semi-partial correlation value for this relationship is  $-0.46$  ( $t(17) = -2.15, p < 0.05$ ).

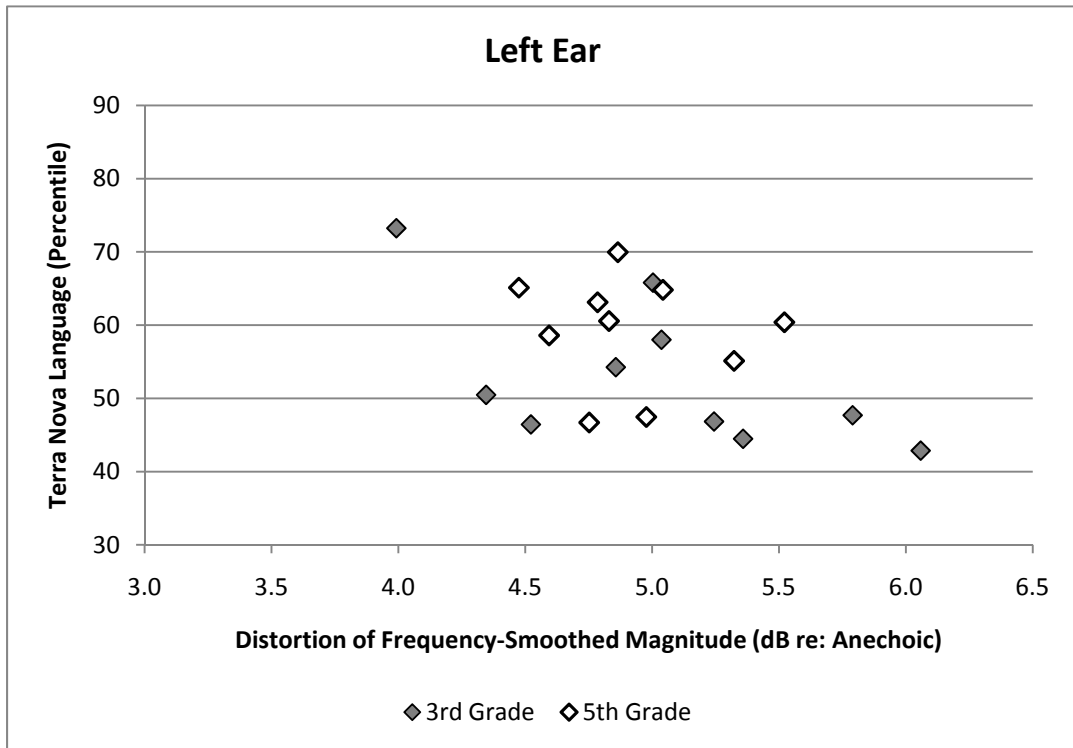
The scatter plots between the Terra Nova language scores and the left and right ear DFSM values are shown in Figures 6.39 and 6.40, respectively. As shown in these figures, lower language test scores tend to occur for higher DFSM values. Because DFSM is significantly negatively correlated to RT, it is possible that excessive room reverberation has some impact on the language scores. Alternatively, this may support the theory discussed in Shinn-Cunningham et al. (2005) that localization bias may be occurring in room conditions with higher DFSM values. Localization ability may be particularly advantageous for developing language aptitude in group learning environments, wherein accurate source localization may help the listener focus attention on the teacher in the presence of competing noise sources.

A scatter plot between the Terra Nova language scores and the difference between the left and right ear DFSM values is shown in Figure 6.41. A clear relationship between this variable and achievement is not evident for the classrooms analyzed.

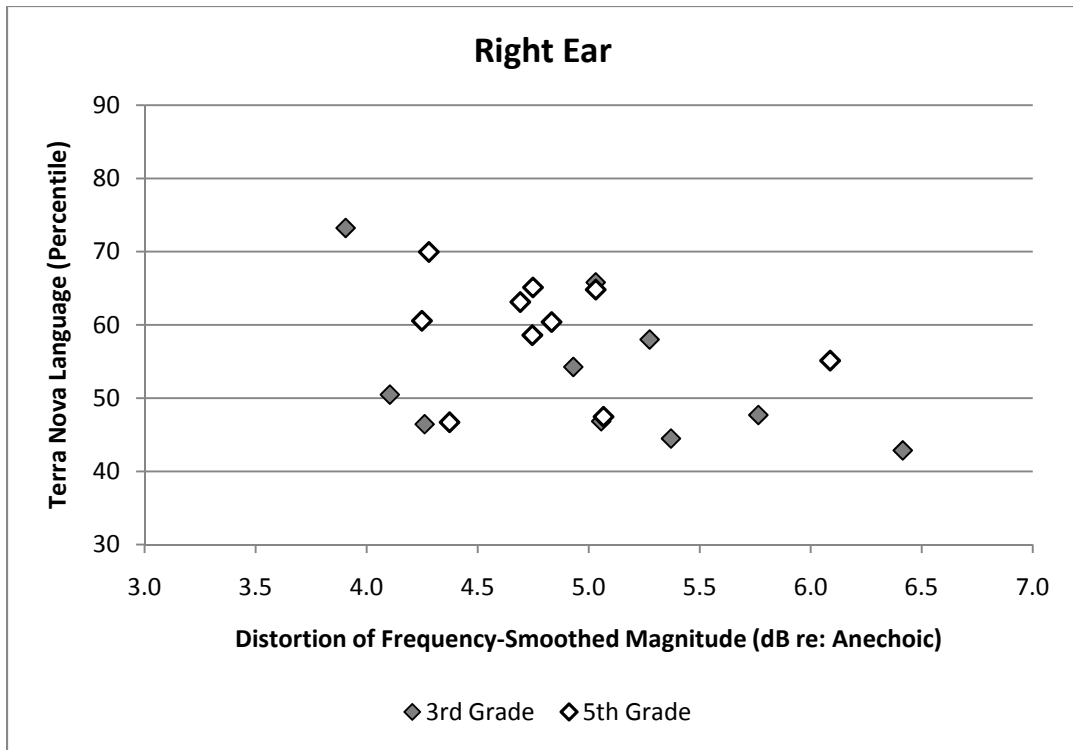
**Table 6.21:** Correlations between DFSM and student achievement scores for 20 of the third and fifth-grade classrooms (\*\*  $p < 0.01$ ).

Variable	1	2	3	4	5	6	7
<b>1. DFSM: Left Ear</b>	-	0.85**	0.16	-0.36	-0.48*	-0.11	-0.02
<b>2. DFSM: Right Ear</b>	-	-	0.02	-0.32	-0.44	-0.11	-0.10
<b>3. DFSM: Left/Right Ear Difference</b>	-	-	-	-0.27	0.09	-0.32	-0.14
<b>4. Terra Nova Math</b>	-	-	-	-	0.73**	0.77**	0.83**
<b>5. Terra Nova Language</b>	-	-	-	-	-	0.55*	0.63**
<b>6. Terra Nova Reading</b>	-	-	-	-	-	-	0.73**
<b>7. State Reading</b>	-	-	-	-	-	-	-

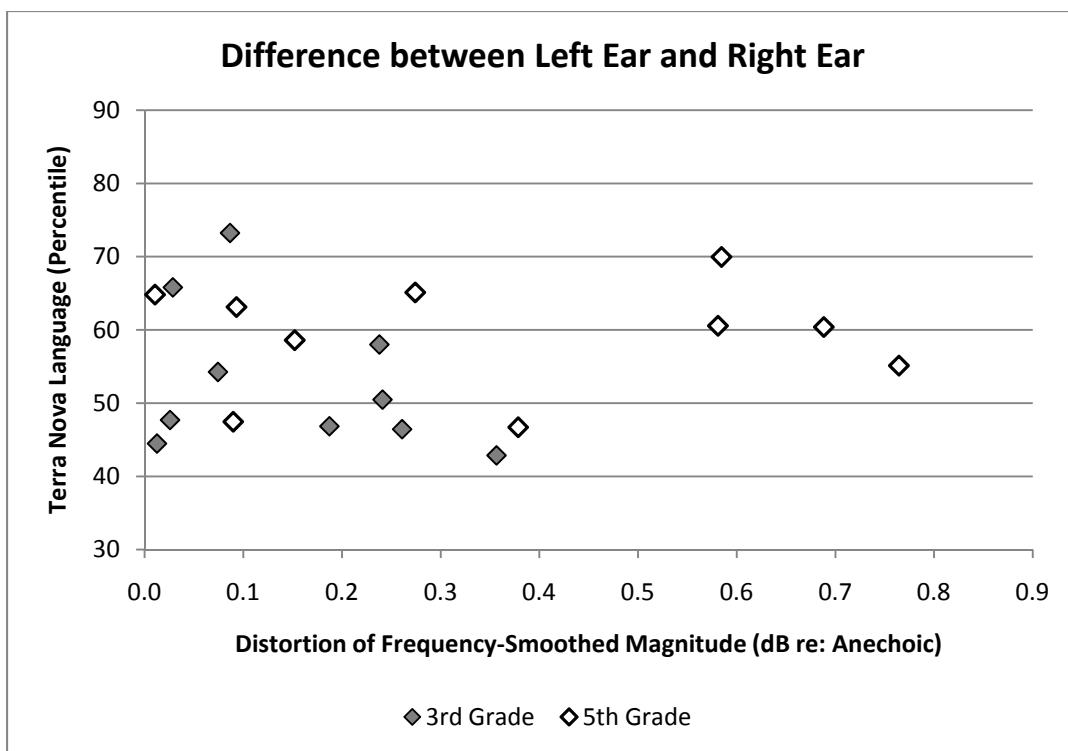
*Note.* The sample size for all of the pairs of correlations is 20.



**Figure 6.39:** Scatter plot between left ear distortion of frequency-smoothed magnitude values and Terra Nova language test scores.



**Figure 6.40:** Scatter plot between right ear distortion of frequency-smoothed magnitude values and Terra Nova language test scores.



**Figure 6.41:** Scatter plot between distortion of frequency-smoothed magnitude values (difference between left and right ear) and Terra Nova language test scores.

#### 6.4.2.3 Interaural Cross-Correlation

The  $IACC_E$  values averaged across receiver position and frequency from 1 to 4 kHz for the  $0^\circ$  source rotation range from 0.66 to 0.78 among classrooms. The zero-order Pearson correlations relating these  $IACC_E$  values to mid-frequency RT and BNL are shown in Table 6.22. As shown in this table,  $IACC_E$  is not significantly correlated to RT or BNL.

**Table 6.22:** Correlations between RT, BNL, and IACC<sub>E</sub> for 20 of the third and fifth-grade classrooms (\*\* p < 0.01).

Variable	1	2	3	4
<b>1. RT</b>	-	-0.31	-0.29	-0.10
<b>2. BNL: Cooling</b>	-	-	0.94**	0.06
<b>3. BNL: Heating</b>	-	-	-	-0.03
<b>4. IACC<sub>E</sub></b>	-	-	-	-

*Note.* The sample size for all of the pairs of correlations is 20.

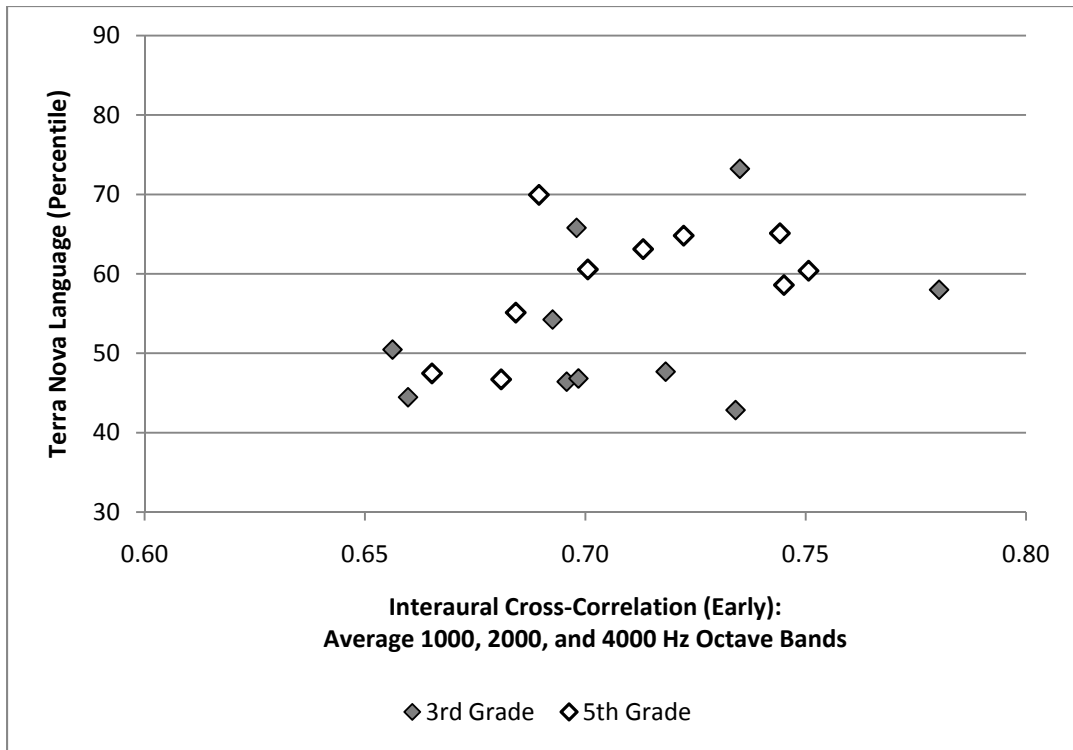
Comparisons between the IACC<sub>E</sub> values and student achievement were also conducted. These zero-order Pearson correlations are shown in Table 6.23. Positive correlation values occur between IACC<sub>E</sub> and all of the student achievement scores, though none of the relationships are statistically significant at the 0.05 level. The scatter plots between IACC<sub>E</sub> and the Terra Nova language and State Accountability reading test scores are shown in Figures 6.42 and 6.43, respectively. As shown in these figures, higher IACC<sub>E</sub> values only occur for higher language and reading test scores within some of the classrooms.



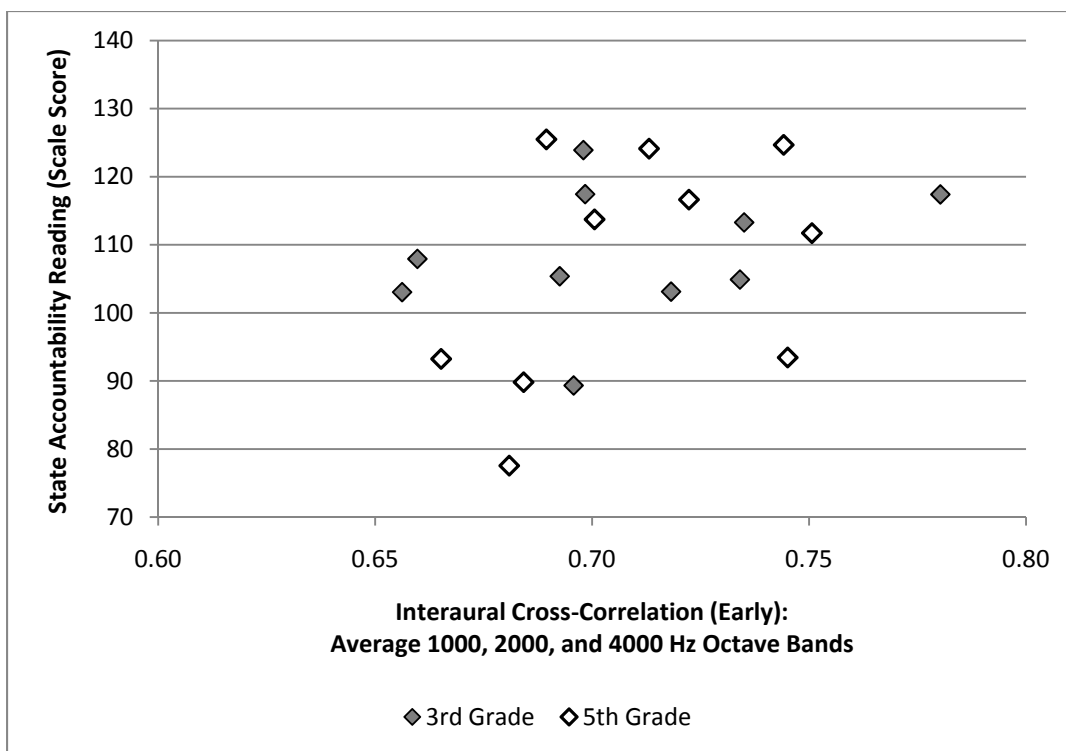
**Table 6.23:** Correlations between IACC<sub>E</sub> and student achievement scores for 20 of the third and fifth-grade classrooms (\*  $p < 0.05$ ; \*\*  $p < 0.01$ ).

<b>Variable</b>	<b>1</b>	<b>2</b>	<b>3</b>	<b>4</b>	<b>5</b>
<b>1. IACC<sub>E</sub></b>	-	0.35	0.40	0.26	0.33
<b>2. Terra Nova Math</b>	-	-	0.73**	0.77**	0.83**
<b>3. Terra Nova Language</b>	-	-	-	0.55*	0.63**
<b>4. Terra Nova Reading</b>	-	-	-	-	0.72**
<b>5. State Reading</b>	-	-	-	-	-

*Note.* The sample size for all of the pairs of correlations is 20.



**Figure 6.42:** Scatter plot between interaural cross-correlation (early) values and Terra Nova language test scores.



**Figure 6.43:** Scatter plot between interaural cross-correlation (early) values and State Accountability reading test scores.

#### 6.4.2.4 Interaural Level Difference

The magnitude of the ILDs averaged across receiver positions and from 1 to 4 kHz range from 0 to 1.9 dB (Left re: Right) among classrooms for the 0° source rotation. To quantify the relationship between ILD, RT, and BNL, the zero-order Pearson correlations between these variable are shown in Table 6.24. A significant positive correlation exists between the ILD magnitudes and RT ( $r = 0.59, p < 0.01$ ). This indicates that higher ILDs occur in rooms with longer RTs.

**Table 6.24:** Correlations between RT, BNL, and ILD for 20 of the third and fifth-grade classrooms (\*\*  $p < 0.01$ ).

Variable	1	2	3	4
<b>1. RT</b>	-	-0.31	-0.29	0.59**
<b>2. BNL: Cooling</b>	-	-	0.94**	-0.28
<b>3. BNL: Heating</b>	-	-	-	-0.26
<b>4. ILD</b>	-	-	-	-

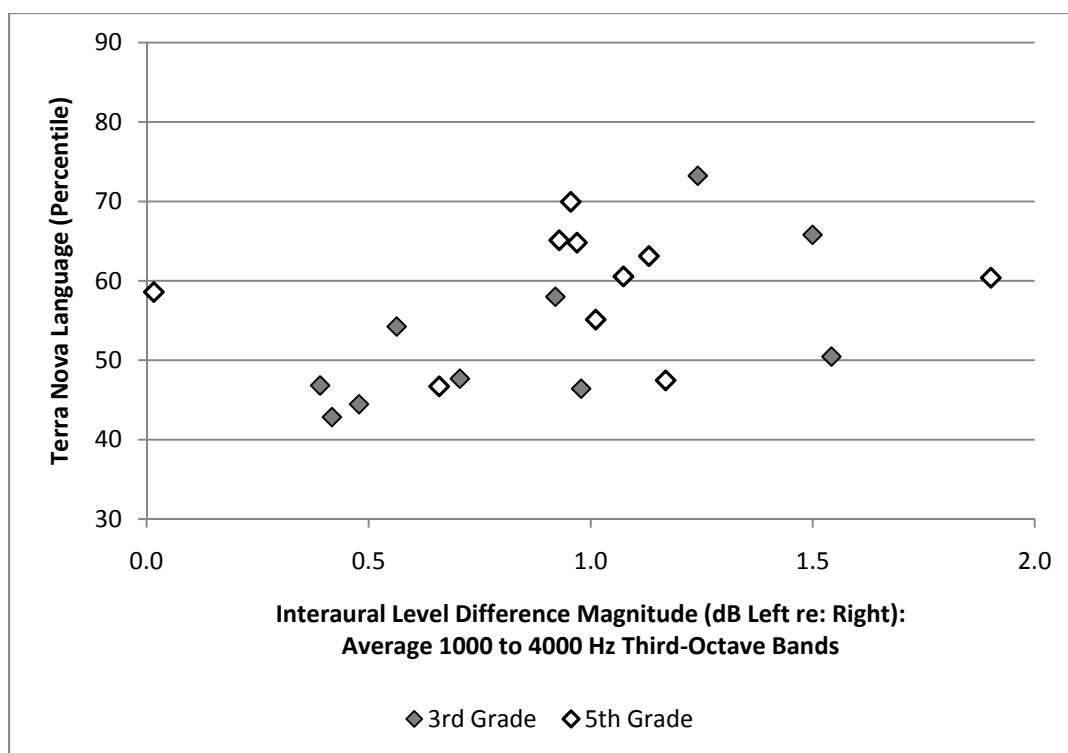
*Note.* The sample size for all of the pairs of correlations is 20.

The relationship between ILD magnitude and the student achievement scores was also investigated. The zero-order Pearson correlations between these variables are shown in Table 6.25. As for the  $IACC_E$  correlations, positive correlations occur between ILD and all of the student achievement scores, though they are non-significant. The scatter plot between the ILD magnitudes and the Terra Nova language scores is shown in Figure 6.44. Higher Terra Nova language scores tend to occur for higher ILD magnitudes, though the relationship is not statistically significant.

**Table 6.25:** Correlations between ILD and student achievement scores for 20 of the third and fifth-grade classrooms (\*  $p < 0.05$ ; \*\*  $p < 0.01$ ).

<b>Variable</b>	<b>1</b>	<b>2</b>	<b>3</b>	<b>4</b>	<b>5</b>
<b>1. ILD</b>	-	0.17	0.41	0.27	0.26
<b>2. Terra Nova Math</b>	-	-	0.73**	0.77**	0.83**
<b>3. Terra Nova Language</b>	-	-	-	0.55*	0.63**
<b>4. Terra Nova Reading</b>	-	-	-	-	0.72**
<b>5. State Reading</b>	-	-	-	-	-

*Note.* The sample size for all of the pairs of correlations is 20.



**Figure 6.44:** Scatter plot between interaural level difference magnitudes and Terra Nova language test scores.

#### 6.4.2.5 Discussion

The STI, DFSM,  $IACC_E$ , and ILD magnitude metrics have been compared to each other, BNL, RT, and student achievement scores. A significant negative correlation exists between STI and DFSM. This indicates that classroom conditions which cause lower STI values indicating reduced speech intelligibility also yield high DFSM values. High DFSM values may create localization bias, which can impact intelligibility (Shinn-Cunningham et al. 2005). STI is significantly negatively correlated to BNL, whereas DFSM is significantly positively correlated to mid-

frequency RT. The ILD magnitude averaged from 1 to 4 kHz is also significantly positively correlated to mid-frequency RT.

The only significant correlations between the BRIR metrics investigated and achievement occur between DFSM and the Terra Nova language scores. A significant negative correlation exists between these variables. This indicates that classrooms with high DFSM values may also have reduced speech intelligibility. For the Council Bluffs study, one classroom with a high reading comprehension score had the lowest left ear DFSM value for the 0° source rotation. For the present study in the Papillion-La Vista classrooms, the difference between the left and right ear DFSM values and the achievement scores were not significantly related. For the Council Bluffs classrooms, the classroom with a high reading comprehension score had the highest left to right ear DFSM difference.

Positive trends occur between both  $IACC_E$  and ILD magnitude averaged from 1 to 4 kHz and Terra Nova language achievement scores within the Papillion-La Vista classrooms, though the relationships are not statistically significant. For the Council Bluffs study one classroom with a high reading comprehension score had the highest  $IACC_E$  values. However, smaller ILD magnitudes were measured in classrooms with higher reading comprehension scores in the Council Bluffs classrooms.

## 6.5 Conclusions

Results from an acoustical study in third and fifth-grade classroom in Papillion-La Vista, Nebraska have been presented in this chapter. The unoccupied BNLs with the mechanical systems operating in the cooling mode are significantly negatively correlated to language and reading subject area achievement scores for the fifth-grade students. This is similar to results from the study in the Council Bluffs School District, in which high unoccupied BNLs occurred in elementary school classrooms with low reading comprehension achievement test scores. In the Council Bluffs School District, the negative correlations between BNL and reading comprehension were significant when controlling for the effects of poverty rates on achievement. However, in the Papillion-La Vista School District, the correlations between BNL and achievement are not significant when controlling for the percent of students in each classroom receiving free or reduced-price lunches on achievement.

Differences in how the achievement scores were reported between the two school districts may account for some of the differences in the results between the studies. In the Council Bluffs School District, the achievement scores were reported as pass rates, whereas the achievement scores in the Papillion-La Vista School District were reported as normal curve equivalent, percentile rank, or scale scores. This may explain why stronger correlations were typically found between BNL and achievement in the Council Bluffs School District than in the Papillion-La Vista School District.



A significant negative correlation also occurred between the DFSM metric and the language achievement test scores in the Papillion-La Vista study. This supports the finding from the Council Bluffs study, wherein the classroom with the lowest DFSM value had a high reading comprehension score. However, further investigations of binaural metrics, including IACC, ILD, and differences between the left and right ear STI and DFSM, are needed in classrooms with a wider range of RTs so that optimal values for these metrics may be determined.

## Chapter 7

### Summary and Conclusions

#### 7.1 Summary of Background Research and Preliminary Investigations

Chapter 2 provides a summary of previous research related to the acoustical metrics investigated in this study. These metrics include background noise level (BNL), reverberation time (RT), speech transmission index (STI), distortion of frequency-smoothed magnitude (DFSM), interaural cross-correlation (IACC), and interaural level difference (ILD). BNL, RT, and STI have traditionally been used as indicators of speech intelligibility in spaces, whereas DFSM and IACC have been linked to source localization. IACC has also been shown to relate to spatial impression and apparent source width. Previous research has revealed that listeners use ILDs for source detection and lateralization.

Methodology and results from an investigation of DFSM and ILD in four spaces with a range of finishes, shapes, and sizes are presented in Chapter 3. This study was an extension of previous research on these metrics, which was conducted in a single classroom space (Shinn-Cunningham et al. 2005). Binaural room impulse response (BRIR) measurements were conducted in a conference room, classroom, theater, and concert hall. For all of the measurements, the receiver was located approximately 0.5 m in front of the source to simulate a typical conversation distance. Three different receiver positions and three different source rotations were tested. This study found that neither DFSM nor ILD vary systematically with RT. Rather,

both DFSM and ILD were more impacted by nearby reflective surfaces and source orientation relative to the receiver. Since the spaces tested had different finishes, shapes, and sizes in addition to varying RTs, the effects of RT alone on these metrics could not be assessed. To isolate the effect of reverberation on DFSM and ILD, measurements in more spaces with similar geometries should be conducted. However, the results of this study did show that DFSM and ILD may be able to quantify differences in classroom acoustical environments with similar RTs. Therefore, these metrics were included in the acoustical studies of elementary school classrooms in Iowa and Nebraska.

Chapter 4 introduces the statistical methods used to assess the data from the classroom studies, presented in Chapters 5 and 6. Parametric tests, correlations, analysis of variance, and regressions are explained. Relevant examples of these tests are included. The data assumptions and essential conditions to perform these statistical procedures are also described.

## **7.2 Classroom Acoustics Research Summary and Results**

Investigations of classroom acoustical conditions were conducted in two different midwestern public school districts. Elementary school classrooms in the Council Bluffs Community School District in Iowa and the Papillion-La Vista Public School District in Nebraska were included in the studies. Acoustical metrics in these classrooms, including unoccupied BNL, RT, STI, DFSM,  $IACC_E$ , and ILD, were related to standardized student achievement test results. The BNLs that were compared to the student achievement scores were A-weighted equivalent sound levels ( $L_{Aeq}$ ) recorded over a five minute time period. The STI, DFSM,  $IACC_E$ , and ILD

metrics were calculated from BRIR measurements with the source placed near the front of the classrooms facing various directions and the receiver in four typical student locations throughout the classrooms.

### ***7.2.1 Acoustical Study of Classrooms in an Iowa Public School District***

The acoustical study of second and fourth-grade classrooms in the Council Bluffs Community School District in Iowa is described in Chapter 5. All classrooms had a closed floor plan design. The BNL measurements in this school district were conducted with the mechanical systems operating in a single mode. Achievement scores in the math and reading comprehension subject areas were available as average results per grade level per school. For example, if there were three sections of fourth-graders in a particular school, one average test score from fourth-grade students across all three classrooms was provided for the school. Therefore, the classroom acoustical conditions were averaged per grade level per school for direct comparison to the achievement scores. Four classrooms were selected for the BRIR measurements. These classrooms were located in schools that had only one section per grade level per school.

This research found that the unoccupied RT was not significantly correlated to the student achievement scores. However, nearly all of the classrooms tested had RTs that were below the maximum values specified in the current ANSI classroom standard (ANSI/ASA 2010). The BNLs were significantly negatively correlated to the student reading comprehension scores. These correlations were significant even when controlling for the effects of poverty rates on achievement. The results from

the regression analyses indicated that the unoccupied BNL should be at least less than 41 dBA to meet the state target for reading comprehension student performance.

Relationships between certain binaural metrics, including DFSM left-to-right ear differences,  $IACC_E$ , and ILD, and reading comprehension were noted. However, BRIR measurements in a wider range of classrooms were needed to assess the significance of these relationships. Further measurements and analyses of these metrics were included in the Nebraska school district research described in Chapter 6.

### ***7.2.2 Acoustical Study of Classrooms in a Nebraska Public School District***

The acoustical measurements conducted in third and fifth-grade classrooms in the Papillion-La Vista Public School District in Nebraska are presented in Chapter 6. The classrooms with closed floor plan designs were included in the BNL data analyses presented. The BNL measurements conducted in this school district were obtained with the mechanical systems operating in both the heating and cooling modes. Because the mechanical systems were set to operate in either the heating or cooling mode depending on the outdoor air temperature, an average BNL occurring in the classrooms throughout the school year was computed based on local weather data. Also, student achievement data were available in the math, language, and reading subject areas for the students in each individual classroom. Therefore, the acoustical metrics averaged per classroom were related to the achievement test results. The 20 classrooms selected for the BRIR measurements had a wide range of BNL and RT, relative to the range of the sample. They were chosen because the mechanical systems in each classroom generated similar noise levels in the heating and cooling modes.

Significant correlations did not occur between the classroom RTs and the student achievement scores. As in the Council Bluffs School District, all of the RTs measured were below the upper limit specified in the ANSI Standard S12.60 on classroom acoustics (ANSI/ASA 2010). Also, the third-grade student achievement scores were not significantly correlated to the BNL or RT. However, significant negative correlations were noted between the unoccupied BNLs with the mechanical systems operating in the cooling mode and the fifth-grade language and reading student achievement scores. However, these correlations were not significant when controlling for the effects of student demographics on achievement. The results from the regression analyses with cooling BNL as a predictor variable for reading indicate that the classroom BNLs may range from 28 to 62 dBA to meet the Nebraska state targets for reading performance. Though this is a wide range of possible acceptable BNLs, the student reading scores were predicted to exceed the target levels for reading performance as the BNL was reduced beyond 28 dBA.

A negative correlation also occurred between DFSM and achievement in the language subject area. This correlation was significant, even when controlling for the effects of student demographics on achievement. Positive relationships were also noted between  $IACC_E$  and ILD magnitude averaged from 1 to 4 kHz and the language achievement scores. However, these relationships were not statistically significant.

### **7.3 Conclusions and Recommendations**

This research indicates that elementary school classrooms should be designed with lower unoccupied BNLs to optimize student performance in the reading and language subject areas. Also, it has been found that the distortion of frequency-

smoothed magnitude, a metric for quantifying source localization ability, is related to language achievement test scores. Classrooms with lower DFSMs typically had higher achieving students in the language subject area.

In these studies, the correlations between BNL and achievement were significant when controlling for the effects of poverty rates on achievement in one of the school districts tested. However, these relationships were not significant when controlling for poverty effects on achievement for the other school district. Further research should examine if different acoustical recommendations should be made for schools constructed in areas with different levels of poverty.

One limitation of this study is the relatively narrow range of reverberation times across all of the classrooms tested. The average mid-frequency RT across the 500 and 1000 Hz octave bands ranged only from 0.2 to 0.6 s across all of the classrooms surveyed. To quantify the impact of RT on student achievement, investigations are needed in classrooms with longer reverberation times. Also, measurements of binaural metrics, including IACC, ILD, and left-to-right ear STI and DFSM differences, are needed in classrooms with a wider range of RTs to fully assess their impact on achievement.

Continuing research should also consider the effects of unoccupied classroom acoustical conditions on the occupied classroom acoustical environments. BNL, RT, and BRIR measurements should be conducted in occupied classrooms and compared to the unoccupied conditions. The change in BNLs throughout the school day should also be monitored to quantify the effects of fluctuating BNLs on student achievement.

Another area requiring further investigation is the effect of the classroom architectural features and furnishings on the BRIR metrics. This study shows that these metrics are highly impacted by the source orientation relative to the receiver and the distance from the source to the receiver. It also suggests that DFSM and ILD are affected by the presence of reflective and diffusive surfaces altering the path from the source to the receiver. However, more research is needed to determine the suggested placement of reflective surfaces and room furnishings for optimal student achievement.



## References

- Ando, Y. 1977. Subjective preference in relation to objective parameters of music sound fields with a single echo. *J. Acoust. Soc. Am.*, 62 (6): 1436 - 1441.
- Ando, Y. and Kurihara, Y. 1986. Nonlinear response in evaluating the subjective diffuseness of sound fields. *J. Acoust. Soc. Am.*, 80 (3): 833 - 836.
- ANSI/ASA S12.60-2010/Part 1. 2010. Acoustical Performance Criteria, Design Requirements, and Guidelines for Schools, Part 1: Permanent Schools. New York: American National Standards Institute.
- Astolfi, A. and Pellerrey, F. 2008. Subjective and objective assessment of acoustical and overall environmental quality in secondary school classrooms. *J. Acoust. Soc. Am.*, 123 (1): 163 - 173.
- Bistafa, S.R. and Bradley, J.S. 2000. Reverberation time and maximum background noise level for classrooms from a comparative study of speech intelligibility metrics. *J. Acoust. Soc. Am.*, 107 (2): 861 - 875.
- Bradley, J.S. 1986. Predictors of speech intelligibility in rooms. *J. Acoust. Soc. Am.*, 80 (3): 837 - 845.
- Bradley, J.S. 1998. Relationships among measures of speech intelligibility in rooms. *J. Audio Eng. Soc.*, 46 (5): 396 - 404.
- Bradley, J.S. 1986. Speech intelligibility studies in classrooms. *J. Acoust. Soc. Am.*, 80 (3): 846 - 854.
- Bradley, J.S., Reich, R.D., and Norcross, S.G. 1999. On the combined effects of signal-to-noise ratio and room acoustics on speech intelligibility. *J. Acoust. Soc. Am.*, 106 (4): 1820 - 1828.
- Bradley, J.S. and Sato, H. 2008. The intelligibility of speech in elementary school classrooms. *J. Acoust. Soc. Am.*, 123 (4): 2078 - 2086.
- Bradley, J.S., Sato, H., and Picard, M. 2003. On the importance of early reflections for speech in rooms. *J. Acoust. Soc. Am.*, 113 (6): 3233 - 3244.
- Choi, C.Y. and McPherson, B. 2005. Noise levels in Hong Kong primary schools: Implications for classroom listening. *International Journal of Disability, Development and Education*, 52 (4): 345 - 360.

- Chu, W.T and Warnock, A.C.C. 2002. Detailed directivity of sound fields around human talkers. National Research Council Canada, IRC-RR-104.
- Dockrell, J.E. and Shield, B.M. 2006. Acoustical barriers in classrooms: The impact of noise on performance in the classroom. *British Educational Research Journal*, 32 (3): 509 – 525.
- Edmonds, B.A. and Culling, J.F. 2006. The spatial unmasking of speech: Evidence for better-ear listening. *J. Acoust. Soc. Am.*, 120 (3): 1539 – 1545.
- Elliott, L.L. 1979. Performance of children aged 9 to 17 years on a test of speech intelligibility in noise using sentence material with controlled word predictability. *J. Acoust. Soc. Am.*, 66 (3): 651 – 653.
- Field, A. 2000. *Discovering Statistics Using SPSS for Windows*. London: Sage Publications, Ltd.
- Field, A. and Hole, G. 2003. *How to Design and Report Experiments*. London: Sage Publications, Ltd.
- Francart, T. and Wouters, J. 2007. Perception of across-frequency interaural level differences. *J. Acoust. Soc. Am.*, 125 (5): 2826 - 2831.
- Hidaka, T., Beranek, L.L., and Okano, T. 1995. Interaural cross-correlation, lateral fraction, and low- and high-frequency sound levels as measures of acoustical quality in concert halls. *J. Acoust. Soc. Am.*, 98 (2): 988 - 1007.
- Hodgson, M. and Nosal, E.-M. 2002. Effect of noise and occupancy on optimal reverberation times for speech intelligibility in classrooms. *J. Acoust. Soc. Am.*, 111 (2): 931 - 939.
- Houtgast, T. and Steeneken, H.J.M. 1985. A review of the MTF concept in room acoustics and its use for estimating speech intelligibility in auditoria. *J. Acoust. Soc. Am.*, 77 (3): 1069 – 1077.
- Houtgast, T. and Steeneken, H.J.M. 1973. The modulation transfer function in room acoustics as a predictor of speech intelligibility. *Acustica*, 28: 66 - 73.
- Hygge, S., Evans, G.W., and Bullinger, M. 2002. A prospective study of some effects of aircraft noise on cognitive performance in school children. *Psychological Science*, 13 (5): 469 – 474.
- ISO Standard 3382-1. 2009. *Acoustics – Measurement of Room Acoustic Parameters – Part I: Performance Spaces*. International Standards Organization.

- Jeffress, L.A. and McFadden, D. 1970. Differences of interaural phase and level in detection and lateralization. *J. Acoust. Soc. Am.*, 49 (4): 1169 - 1179.
- Jin, C., Corderoy, A., and van Schaik, A. 2004. Contrasting monaural and interaural spectral cues for human sound localization. *J. Acoust. Soc. Am.*, 115 (6): 3124 - 3141.
- Kennedy, S.M., Hodgson, M., Edgett, L.D., Lamb, N., and Rempel, R. 2006. Subjective assessment of listening environments in university classrooms: Perception of students. *J. Acoust. Soc. Am.*, 119 (1): 299 - 309.
- Knecht, H.A., Nelson, P.B., Whitelaw, G.M., and Feth, L.L. 2002. Background noise levels and reverberation times in unoccupied classrooms: Predictions and measurements. *American Journal of Audiology*, 11: 65 - 71.
- Lanham III, J.W. 1999. Relating building and classroom conditions to student achievement in Virginia's elementary schools. Ph. D. thesis, Virginia Polytechnic Institute and State University.
- Larm, P. and Hongisto, V. 2006. Experimental comparison between speech transmission index, rapid speech transmission index, and speech intelligibility index. *J. Acoust. Soc. Am.*, 119 (2): 1106 - 1117.
- Long, M. 2006. *Architectural Acoustics*. Boston: Elsevier, Inc.
- Macpherson, E.A. and Sabin, A.T. 2007. Binaural weighting of monaural spectral cues for sound localization. *J. Acoust. Soc. Am.*, 121 (6): 3677 - 3688.
- Mendell, M.J. and Heath, G. A. 2005. Do indoor pollutants and thermal conditions in schools influence student performance? A critical review of the literature. *Indoor Air Journal*, 15: 27 - 32.
- Moore, B.C.J. 2004. *An Introduction to the Psychology of Hearing*. San Diego: Elsevier, Ltd.
- Nakajima, T., Yoshida, J., and Ando, Y. 1993. A simple method of calculating the interaural cross-correlation function for a sound field. *J. Acoust. Soc. Am.*, 93 (2): 885 - 891.
- Okano, T. 2000. Image shift caused by strong lateral reflections, and its relation to inter-aural cross correlation. *J. Acoust. Soc. Am.*, 108 (5): 2219 - 2230.

Okano, T. 2002. Judgments of noticeable differences in sound fields of concert halls caused by intensity variations in early reflections. *J. Acoust. Soc. Am.*, 111 (1): 217 - 229.

Okano, T., Beranek, L.L., and Hidaka, T. 1998. Relations among interaural cross-correlation coefficient ( $IACC_E$ ), lateral fraction ( $LF_E$ ), and apparent source width (ASW) in concert halls. *J. Acoust. Soc. Am.*, 104 (1): 255 - 265.

Pätynen, J., Katz, B.F.G., and Lokki, T. 2011. Investigations on the balloon as an impulse source. *J. Acoust. Soc. Am. EL*, 129 (1): 27 - 33.

Pedhazur, E.J. 1997. *Multiple Regression in Behavioral Research: Explanation and Prediction*. United States: Wadsworth, Thompson Learning, Inc.

Picard, P. and Bradley, J.S. 2001. Revisiting speech interference in classrooms. *Audiology*, 40 (5): 221 – 244.

Sato, H. and Bradley, J.S. 2008. Evaluation of acoustical conditions for speech communication in working elementary school classrooms. *J. Acoust. Soc. Am.*, 123 (4): 2064 – 2077.

Sato, H., Morimoto, M., Sato, H., and Wada, M. 2008. Relationship between listening difficulty and acoustical objective measures in reverberant sound fields. *J. Acoust. Soc. Am.*, 123 (4): 2087 - 2093.

Shield, B.M. and Dockrell, J.E. 2004. External and internal noise surveys of London primary schools. *J. Acoust. Soc. Am.*, 115 (2): 730 – 738.

Shield, B.M. and Dockrell, J.E. 2008. The effects of environmental and classroom noise on the academic attainments of primary school children. *J. Acoust. Soc. Am.*, 123 (1): 133 – 144.

Shield, B., Greenland, E., and Dockrell, J. 2010. Noise in open plan classrooms in primary schools: A review. *Noise & Health*, 12 (49): 225 – 234.

Shinn-Cunningham, B.G., Kopco, N., and Martin, T.J. 2005. Localizing nearby sound sources in a classroom: Binaural room impulse responses. *J. Acoust. Soc. Am.*, 117 (5): 3100 – 3115.

Stan, G., Embrechts, J., and Archambeau, D. 2002. Comparison of different impulse response measurement techniques. *J. Audio Eng. Soc.*, 50 (4): 249 - 262.

Thompson, E. 2002. *The Soundscape of Modernity*. Cambridge: The MIT Press.

van Wijngaarden, S.J. and Drullman, R. 2008. Binaural intelligibility prediction based on the speech transmission index. *J. Acoust. Soc. Am.*, 123 (6): 4514 - 4523.

Yang, W. and Bradley, J.S. 2009. Effects of room acoustics on the intelligibility of speech in classrooms for young children. *J. Acoust. Soc. Am.*, 125 (2): 922 - 933.

Yost, W.A. 1991. Thresholds for segregating a narrow-band from a broadband noise based on interaural phase and level differences. *J. Acoust. Soc. Am.*, 89 (2): 838 - 844.

## Appendix I

### **Binaural Room Impulse Response Metrics: Dummy Head Receiver vs. Human Head Receiver**

This appendix contains data from binaural room impulse response (BRIR) measurements gathered in a typical classroom space. Metrics are presented for BRIR measurements comparing two different receivers: 1) dummy head (G.R.A.S. Sound and Vibration KEMAR Manikin Type 45 BA) and 2) human head (Brüel and Kjaer Type 4101 binaural microphone headset placed on the head of an adult female). The classroom had a background noise level (BNL) of 40 dBA and a reverberation time (RT) of 0.87 s averaged across the 500 and 1000 Hz octave bands.

On average, small differences were found between the two receivers for the metrics analyzed. However, the largest differences occurring between the two receivers for the different metrics were as follows: 0.02 for the speech transmission index (STI), 5 dB (re: Anechoic) for the distortion of frequency-smoothed magnitude (DFSM), 0.30 for the interaural cross-correlation (early) (IACC<sub>E</sub>), and 6.8 dB (Left re: Right) for the interaural level difference (ILD).

**Table A1.1:** Dummy head receiver speech transmission index values.

STI: Dummy Head Receiver					
		Source Rotation (Degrees)			
Ear	Receiver Position	0	45	90	180
Left	Front	0.73	0.66	0.69	0.69
	Center	0.71	0.67	0.67	0.67
	Side	0.67	0.66	0.66	0.68
	Back	0.71	0.67	0.66	0.67
Right	Front	0.75	0.74	0.73	0.70
	Center	0.71	0.72	0.70	0.68
	Side	0.71	0.69	0.67	0.70
	Back	0.71	0.69	0.65	0.67

**Table A1.2:** Human head receiver speech transmission index values.

STI: Human Head Receiver					
		Source Rotation (Degrees)			
Ear	Receiver Position	0	45	90	180
Left	Front	0.74	0.66	0.68	0.67
	Center	0.70	0.65	0.66	0.67
	Side	0.66	0.66	0.65	0.68
	Back	0.70	0.68	0.66	0.68
Right	Front	0.76	0.75	0.72	0.70
	Center	0.70	0.70	0.68	0.69
	Side	0.70	0.68	0.65	0.69
	Back	0.70	0.68	0.66	0.68

**Table A1.3:** Difference between dummy head receiver and human head receiver speech transmission index values.

STI Difference: Dummy Head Receiver – Human Head Receiver					
		Source Rotation (Degrees)			
Ear	Receiver Position	0	45	90	180
Left	Front	-0.01	0.00	0.01	0.01
	Center	0.01	0.02	0.01	0.00
	Side	0.01	0.00	0.00	0.00
	Back	0.01	0.00	0.00	-0.01
Right	Front	-0.01	-0.01	0.01	0.00
	Center	0.01	0.02	0.02	-0.01
	Side	0.01	0.00	0.02	0.00
	Back	0.01	0.01	0.00	-0.01

**Table A1.4:** Dummy head receiver distortion of frequency-smoothed magnitude values.

DFSM (dB re: Anechoic): Dummy Head Receiver					
		Source Rotation (Degrees)			
Ear	Receiver Position	0	45	90	180
Left	Front	4	4	6	11
	Center	4	5	5	8
	Side	4	5	6	5
	Back	5	5	8	9
Right	Front	4	4	6	10
	Center	4	5	5	8
	Side	4	6	6	5
	Back	5	5	8	8



**Table A1.5:** Human head receiver distortion of frequency-smoothed magnitude values.

DFSM (dB re: Anechoic): Human Head Receiver					
		Source Rotation (Degrees)			
Ear	Receiver Position	0	45	90	180
Left	Front	5	7	9	10
	Center	6	8	10	10
	Side	4	8	9	9
	Back	8	9	12	12
Right	Front	5	7	10	10
	Center	6	8	10	10
	Side	4	9	9	9
	Back	8	8	12	11

**Table A1.6:** Difference between dummy head receiver and human head receiver distortion of frequency-smoothed magnitude values.

DFSM Difference (dB re: Anechoic): Dummy Head Receiver – Human Head Receiver					
		Source Rotation (Degrees)			
Ear	Receiver Position	0	45	90	180
Left	Front	-2	-3	-3	0
	Center	-2	-3	-4	-2
	Side	-1	-3	-3	-4
	Back	-3	-3	-4	-3
Right	Front	-1	-3	-3	0
	Center	-2	-3	-5	-2
	Side	0	-3	-3	-4
	Back	-3	-3	-5	-3

**Table A1.7:** Dummy head receiver interaural cross-correlation (early) values.

IACC <sub>E</sub> : Dummy Head Receiver								
		Octave Band Center Frequency (Hz)						
Receiver Position	Source Rotation (Degrees)	125	250	500	1000	2000	4000	8000
Front	0	0.96	0.90	0.57	0.53	0.70	0.78	0.80
Front	45	0.98	0.84	0.45	0.29	0.31	0.53	0.40
Front	90	0.84	0.75	0.52	0.28	0.12	0.11	0.05
Front	180	0.95	0.80	0.43	0.34	0.36	0.28	0.29
Center	0	0.98	0.89	0.37	0.36	0.63	0.49	0.55
Center	45	0.97	0.76	0.24	0.23	0.43	0.23	0.11
Center	90	0.97	0.74	0.50	0.23	0.18	0.16	0.09
Center	180	0.77	0.83	0.55	0.40	0.37	0.26	0.17
Side	0	0.89	0.63	0.21	0.21	0.42	0.31	0.23
Side	45	0.94	0.64	0.37	0.26	0.19	0.14	0.05
Side	90	0.90	0.58	0.22	0.24	0.12	0.14	0.08
Side	180	0.82	0.62	0.22	0.26	0.51	0.32	0.21
Back	0	0.98	0.86	0.75	0.38	0.45	0.36	0.26
Back	45	0.90	0.65	0.20	0.19	0.33	0.26	0.13
Back	90	0.98	0.74	0.28	0.23	0.16	0.14	0.08
Back	180	0.94	0.78	0.45	0.29	0.42	0.29	0.30

**Table A1.8:** Human head receiver interaural cross-correlation (early) values.

IACC <sub>E</sub> : Human Head Receiver								
		Octave Band Center Frequency (Hz)						
Receiver Position	Source Rotation (Degrees)	125	250	500	1000	2000	4000	8000
Front	0	0.97	0.93	0.61	0.54	0.80	0.81	0.80
Front	45	0.98	0.83	0.52	0.35	0.45	0.42	0.42
Front	90	0.97	0.76	0.37	0.28	0.12	0.08	0.08
Front	180	0.87	0.85	0.40	0.29	0.45	0.33	0.42
Center	0	0.97	0.86	0.33	0.34	0.59	0.60	0.64
Center	45	0.96	0.69	0.10	0.21	0.37	0.27	0.26
Center	90	0.96	0.73	0.51	0.17	0.13	0.10	0.09
Center	180	0.66	0.70	0.61	0.18	0.30	0.38	0.42
Side	0	0.88	0.81	0.36	0.35	0.54	0.52	0.54
Side	45	0.93	0.66	0.30	0.24	0.19	0.12	0.07
Side	90	0.93	0.69	0.36	0.20	0.12	0.10	0.08
Side	180	0.87	0.60	0.21	0.19	0.47	0.29	0.29
Back	0	0.98	0.90	0.74	0.21	0.44	0.41	0.52
Back	45	0.86	0.69	0.37	0.18	0.24	0.13	0.15
Back	90	0.86	0.62	0.36	0.27	0.17	0.13	0.10
Back	180	0.95	0.82	0.58	0.45	0.16	0.33	0.24

**Table A1.9:** Difference between dummy head receiver and human head receiver interaural cross-correlation (early) values.

IACC <sub>E</sub> Difference: Dummy Head Receiver – Human Head Receiver								
		Octave Band Center Frequency (Hz)						
Receiver Position	Source Rotation (Degrees)	125	250	500	1000	2000	4000	8000
Front	0	-0.01	-0.03	-0.03	0.00	-0.10	-0.02	0.00
Front	45	0.00	0.01	-0.07	-0.06	-0.14	0.11	-0.02
Front	90	-0.14	-0.01	0.14	0.00	0.00	0.03	-0.02
Front	180	0.09	-0.04	0.03	0.05	-0.10	-0.05	-0.13
Center	0	0.01	0.03	0.04	0.01	0.04	-0.12	-0.09
Center	45	0.01	0.07	0.14	0.02	0.06	-0.04	-0.15
Center	90	0.01	0.01	-0.02	0.06	0.05	0.06	-0.01
Center	180	0.11	0.13	-0.06	0.22	0.06	-0.11	-0.25
Side	0	0.00	-0.18	-0.16	-0.14	-0.12	-0.20	-0.30
Side	45	0.02	-0.03	0.07	0.02	0.00	0.02	-0.02
Side	90	-0.02	-0.11	-0.14	0.04	0.00	0.04	0.00
Side	180	-0.05	0.02	0.01	0.07	0.04	0.03	-0.08
Back	0	0.00	-0.05	0.00	0.17	0.00	-0.05	-0.26
Back	45	0.04	-0.04	-0.17	0.02	0.09	0.13	-0.02
Back	90	0.12	0.12	-0.08	-0.04	-0.01	0.01	-0.02
Back	180	-0.01	-0.04	-0.13	-0.16	0.26	-0.03	0.06

**Table A1.10:** Dummy head receiver interaural level difference values.

ILD (dB Left re: Right): Dummy Head Receiver											
		One-third Octave Band Center Frequency (Hz)									
Rec. Pos.	Source Rot. (Degrees)	200	250	315	400	500	630	800	1000	1250	1600
Front	0	-1.0	-0.2	-0.7	1.0	-1.0	0.5	2.3	-0.1	-1.4	0.5
Front	45	-1.6	-0.4	-0.7	0.5	-0.6	-1.9	-1.6	-3.2	-3.3	-2.5
Front	90	-1.1	0.1	1.8	-1.6	-0.7	-0.8	-1.2	0.0	-2.4	-2.7
Front	180	0.0	-0.4	0.3	-1.4	-0.2	-0.1	-1.5	-1.4	1.1	1.0
Center	0	-0.8	-0.2	0.4	-1.1	0.6	-0.2	-0.7	-2.1	-0.6	-0.1
Center	45	-0.5	2.1	-0.6	0.8	-1.6	-2.3	-1.9	-1.9	-1.5	-0.4
Center	90	0.2	-0.1	2.0	-0.3	-0.3	0.3	-2.1	-0.8	-2.5	-0.7
Center	180	-0.1	-0.3	1.2	0.8	-1.6	0.1	0.2	-1.0	0.2	-0.3
Side	0	-0.4	-1.1	0.5	-0.8	0.7	0.1	-1.1	0.1	0.6	-0.8
Side	45	-1.4	-0.4	-0.1	-3.4	-0.8	-1.5	-3.2	-0.4	-0.8	-0.5
Side	90	-1.8	-0.5	1.7	-1.9	0.4	-2.6	-2.1	-0.5	0.3	-0.4
Side	180	2.3	-2.6	1.4	-1.5	0.0	-0.9	-1.7	-0.5	-0.9	0.2
Back	0	-0.3	-0.7	-0.9	-0.5	0.8	1.4	0.9	1.1	1.9	0.1
Back	45	-0.1	2.5	0.1	3.0	0.0	-1.4	-2.5	-1.2	-1.3	-1.7
Back	90	-0.7	3.5	1.8	-0.5	-1.5	-0.6	-0.4	0.0	-0.8	-0.6
Back	180	-0.5	-1.9	0.4	-0.1	-0.5	-0.3	0.8	-1.0	1.3	1.5
		One-third Octave Band Center Frequency (Hz)									
Rec. Pos.	Source Rot. (Degrees)	2000	2500	3150	4000	5000	6300	8000	10000	12500	16000
Front	0	-0.8	-1.1	-0.6	-0.3	-0.7	-1.7	-2.8	1.5	-1.1	-2.6
Front	45	-2.6	-3.4	-1.8	-2.5	-2.8	-4.8	-7.2	-4.1	-5.3	-8.5
Front	90	-0.6	-2.0	-2.8	-3.3	-2.5	-2.8	-7.0	-6.2	-3.8	-5.3
Front	180	0.0	-0.2	-0.8	0.7	0.4	-0.4	-3.0	1.9	-1.5	-2.9
Center	0	1.4	0.2	-0.8	2.0	0.4	1.0	-0.3	4.3	2.0	-0.6
Center	45	-1.0	-2.9	-4.3	-1.2	-3.2	-2.1	-4.8	-2.3	-2.0	-5.5
Center	90	-0.5	-1.8	-4.5	-3.2	-1.7	-1.5	-3.7	-2.3	-2.8	-4.6
Center	180	-0.7	1.1	-0.8	-0.2	1.2	0.0	0.0	2.7	1.8	-1.0
Side	0	-2.4	-2.9	-1.6	-1.2	-2.3	-1.2	-5.1	-1.8	-5.5	-7.6
Side	45	-1.5	-2.1	-2.4	-2.0	-0.4	0.0	-3.5	-2.9	-4.9	-5.1
Side	90	-0.6	-1.2	-2.2	-1.5	-0.2	-0.7	-2.8	-1.7	-0.5	-0.3
Side	180	-1.3	-2.6	-1.6	-0.2	-1.0	-1.8	-4.2	0.8	-1.7	-5.3
Back	0	-0.6	-0.5	-2.5	0.6	1.3	1.2	-1.4	3.5	1.8	-1.2
Back	45	-1.4	-2.9	-2.8	-1.3	-1.6	-1.3	-3.5	-1.5	-0.9	-4.6
Back	90	-1.6	-0.4	-2.2	-2.9	-1.0	-0.6	-2.2	-0.6	-0.1	-2.6
Back	180	0.2	0.4	0.9	0.3	2.0	1.3	-0.2	2.7	1.7	-0.7

**Table A1.11:** Human head receiver interaural level difference values.

ILD (dB Left re: Right): Human Head Receiver											
		One-third Octave Band Center Frequency (Hz)									
Rec. Pos.	Source Rot. (Degrees)	200	250	315	400	500	630	800	1000	1250	1600
Front	0	-0.8	-0.1	-1.1	0.1	-0.7	-0.3	-0.2	-1.1	-2.1	-1.6
Front	45	-1.5	-0.2	-2.9	1.0	-1.0	-1.1	-0.5	-2.9	-2.6	-2.3
Front	90	-1.5	-0.3	0.9	-2.0	-1.6	-1.3	-0.2	-2.5	-1.9	-1.6
Front	180	-0.8	0.4	0.1	-0.8	-3.1	0.3	-1.7	-2.0	-0.2	-0.7
Center	0	-0.7	1.4	-0.5	-0.2	2.7	-2.0	-0.5	-2.1	-1.8	-1.0
Center	45	-0.2	1.7	-1.0	-2.0	-2.1	0.4	-1.2	-1.0	-2.4	-1.9
Center	90	0.5	-1.5	0.6	0.4	-1.2	-0.7	-0.6	-0.7	-3.6	-2.3
Center	180	1.1	0.2	-0.5	1.2	-0.9	1.2	-0.9	-0.8	-2.0	-2.7
Side	0	0.4	-0.8	0.2	-0.4	0.6	-1.3	-0.9	-1.8	-1.8	-2.6
Side	45	-1.5	-0.3	-0.9	-1.8	-2.3	-0.8	-1.4	0.0	-0.3	-1.3
Side	90	-2.6	-1.3	0.0	-1.5	0.7	-1.7	-2.1	0.0	-2.8	0.4
Side	180	1.9	-2.3	-0.3	-2.8	-0.1	-1.8	-2.1	-1.5	-2.0	-1.2
Back	0	0.0	0.3	-0.5	-1.2	0.5	-0.4	2.3	0.4	-2.1	-1.4
Back	45	0.8	1.8	1.6	2.2	1.0	-1.9	0.0	-0.6	-1.9	-2.2
Back	90	0.0	2.9	-0.4	-3.2	-2.6	-1.8	0.4	-1.8	-2.7	-0.2
Back	180	-1.0	-2.4	-0.7	0.6	0.8	0.6	0.5	-0.6	-0.3	-1.0
		One-third Octave Band Center Frequency (Hz)									
Rec. Pos.	Source Rot. (Degrees)	2000	2500	3150	4000	5000	6300	8000	10000	12500	16000
Front	0	-0.6	-1.3	-0.8	-0.7	0.2	1.0	-1.5	0.8	0.7	-1.8
Front	45	-2.3	-4.5	-3.5	-3.4	-3.0	-2.6	-5.8	-4.5	-5.4	-5.8
Front	90	-1.4	-2.8	-2.4	-3.8	-2.5	-2.6	-5.0	-1.1	-3.5	-6.5
Front	180	-0.7	-0.2	-1.3	-2.0	0.1	-1.1	-0.2	-0.5	-3.7	-2.5
Center	0	-1.0	-0.6	-0.9	0.3	1.3	1.0	0.5	1.6	-0.1	-2.4
Center	45	-1.0	-3.4	-2.7	-2.9	-1.5	-3.8	-4.1	-1.4	-3.5	-5.5
Center	90	-2.2	-2.7	-2.4	-3.4	-0.8	-1.7	-3.3	2.8	-0.9	-4.7
Center	180	-1.3	-0.5	-2.3	-2.0	-0.1	-1.0	-1.9	-1.2	-2.4	-3.7
Side	0	-3.1	-2.2	-2.2	-1.4	-2.3	-1.3	-2.8	-1.8	-5.1	-7.0
Side	45	-2.4	-1.7	-1.5	-2.3	-1.0	-0.6	-2.1	1.2	-2.9	-5.8
Side	90	-1.0	-2.1	-1.2	-2.5	-0.1	0.1	-0.8	5.1	1.5	-0.8
Side	180	-1.4	-0.4	-1.2	-1.0	2.5	-0.4	-1.7	-2.9	-5.3	-5.7
Back	0	-0.8	-0.3	-0.6	-0.3	0.1	-0.5	-1.1	0.4	-0.5	-2.4
Back	45	-2.4	-2.3	-1.9	-2.4	-0.8	-0.4	-2.6	-2.1	-4.0	-6.5
Back	90	-2.6	-1.6	-3.0	-3.0	-1.6	0.3	-1.8	2.4	-1.1	-4.9
Back	180	-1.0	0.5	-1.2	-0.8	0.7	1.5	0.9	2.8	-1.5	-1.4

**Table A1.12:** Difference between dummy head and human head receiver ILDs.

ILD Difference (dB Left re: Right): Dummy Head Receiver - Human Head Receiver											
		One-third Octave Band Center Frequency (Hz)									
Rec. Pos.	Source Rot. (Degrees)	200	250	315	400	500	630	800	1000	1250	1600
Front	0	-0.2	-0.1	0.4	0.8	-0.3	0.8	2.5	1.0	0.6	2.1
Front	45	-0.1	-0.2	2.2	-0.5	0.4	-0.9	-1.1	-0.3	-0.7	-0.2
Front	90	0.4	0.4	0.9	0.4	0.9	0.5	-1.0	2.5	-0.4	-1.1
Front	180	0.8	-0.8	0.2	-0.6	2.9	-0.4	0.2	0.6	1.3	1.6
Center	0	-0.1	-1.6	1.0	-0.9	-2.1	1.8	-0.2	0.0	1.2	0.9
Center	45	-0.3	0.3	0.4	2.8	0.5	-2.7	-0.7	-0.9	0.9	1.5
Center	90	-0.3	1.4	1.4	-0.7	0.9	1.0	-1.5	0.0	1.1	1.5
Center	180	-1.2	-0.5	1.7	-0.4	-0.7	-1.1	1.1	-0.2	2.2	2.4
Side	0	-0.8	-0.3	0.3	-0.4	0.1	1.4	-0.3	1.9	2.4	1.8
Side	45	0.2	-0.2	0.7	-1.6	1.5	-0.8	-1.8	-0.3	-0.6	0.8
Side	90	0.8	0.8	1.7	-0.4	-0.4	-0.9	-0.1	-0.5	3.1	-0.8
Side	180	0.3	-0.3	1.7	1.3	0.0	0.8	0.4	1.1	1.0	1.4
Back	0	-0.3	-1.0	-0.4	0.8	0.3	1.8	-1.4	0.7	4.0	1.5
Back	45	-0.9	0.8	-1.6	0.8	-1.0	0.5	-2.5	-0.5	0.6	0.5
Back	90	-0.7	0.6	2.2	2.7	1.1	1.2	-0.8	1.8	1.9	-0.4
Back	180	0.5	0.4	1.0	-0.7	-1.3	-0.9	0.3	-0.4	1.6	2.5
		One-third Octave Band Center Frequency (Hz)									
Rec. Pos.	Source Rot. (Degrees)	2000	2500	3150	4000	5000	6300	8000	10000	12500	16000
Front	0	-0.2	0.2	0.3	0.3	-0.9	-2.6	-1.4	0.7	-1.7	-0.8
Front	45	-0.4	1.1	1.7	0.9	0.2	-2.2	-1.4	0.5	0.1	-2.6
Front	90	0.8	0.8	-0.5	0.5	0.0	-0.2	-2.1	-5.1	-0.4	1.2
Front	180	0.7	0.0	0.4	2.7	0.4	0.7	-2.8	2.4	2.2	-0.4
Center	0	2.4	0.7	0.1	1.7	-0.9	0.0	-0.8	2.8	2.1	1.7
Center	45	0.0	0.5	-1.5	1.7	-1.7	1.6	-0.7	-0.8	1.5	0.1
Center	90	1.7	0.9	-2.1	0.2	-0.9	0.2	-0.3	-5.1	-1.9	0.2
Center	180	0.6	1.6	1.5	1.9	1.2	1.0	1.9	3.8	4.2	2.7
Side	0	0.7	-0.7	0.5	0.2	0.1	0.2	-2.4	-0.1	-0.4	-0.6
Side	45	0.9	-0.4	-0.8	0.3	0.6	0.6	-1.4	-4.2	-2.0	0.7
Side	90	0.3	0.9	-1.0	1.0	-0.1	-0.8	-1.9	-6.8	-2.0	0.5
Side	180	0.1	-2.2	-0.5	0.7	-3.5	-1.5	-2.5	3.7	3.5	0.3
Back	0	0.3	-0.2	-2.0	1.0	1.2	1.7	-0.3	3.1	2.3	1.3
Back	45	1.1	-0.6	-0.9	1.1	-0.8	-0.9	-0.8	0.6	3.1	1.9
Back	90	1.0	1.1	0.8	0.0	0.7	-0.9	-0.4	-3.1	1.0	2.4
Back	180	1.2	-0.1	2.2	1.1	1.3	-0.2	-1.1	-0.1	3.2	0.6

## Appendix II

### **Binaural Room Impulse Response Metrics: Comparison of Human Head Receivers**

This appendix contains data from binaural room impulse response (BRIR) measurements gathered in Classroom D in the Iowa Public School District. Metrics are presented for BRIR measurements comparing two different adult female human head receivers. A Brüel and Kjaer Type 4101 binaural microphone headset was placed on the heads of the two adults for the measurements. In general, minimal differences were found between the two heads for the metrics investigated, including speech transmission index (STI), distortion of frequency-smoothed magnitude (DFSM), interaural cross-correlation (early) ( $IACC_E$ ), and interaural level difference (ILD).



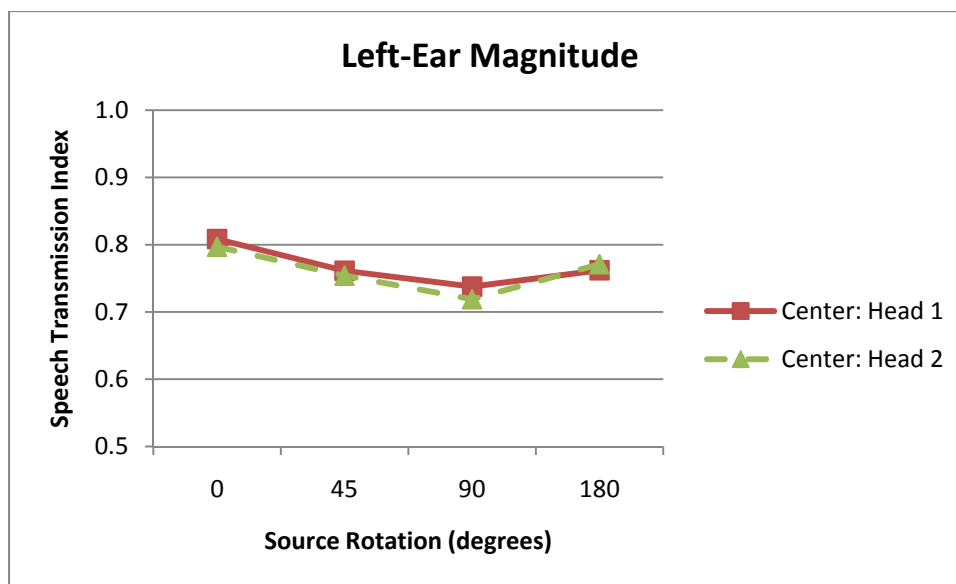


Figure A2.1: Left ear speech transmission index values.

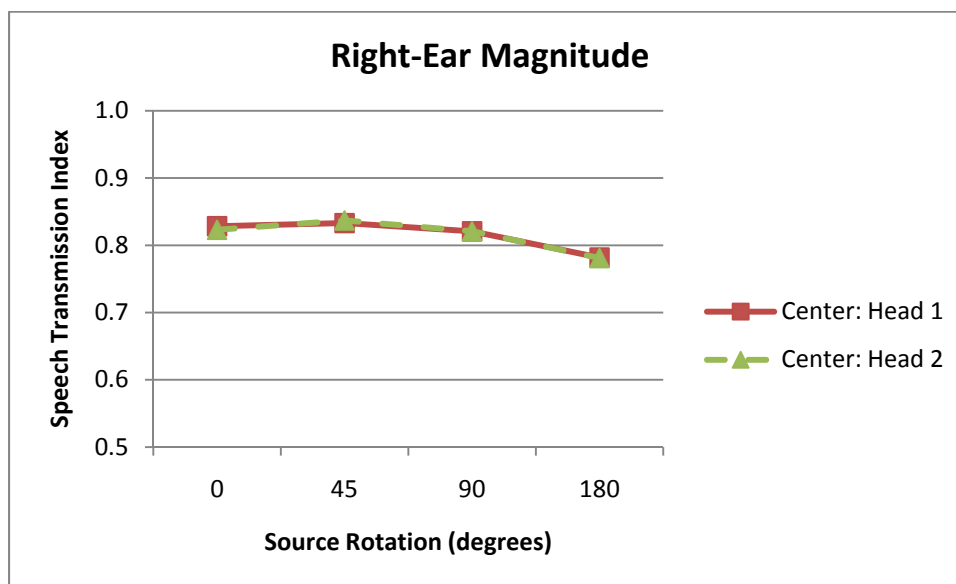
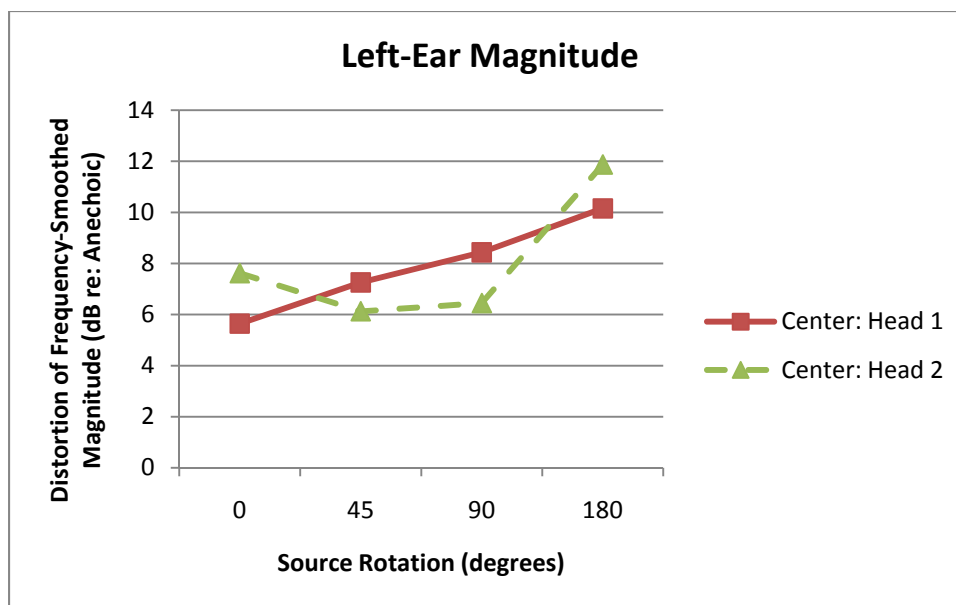
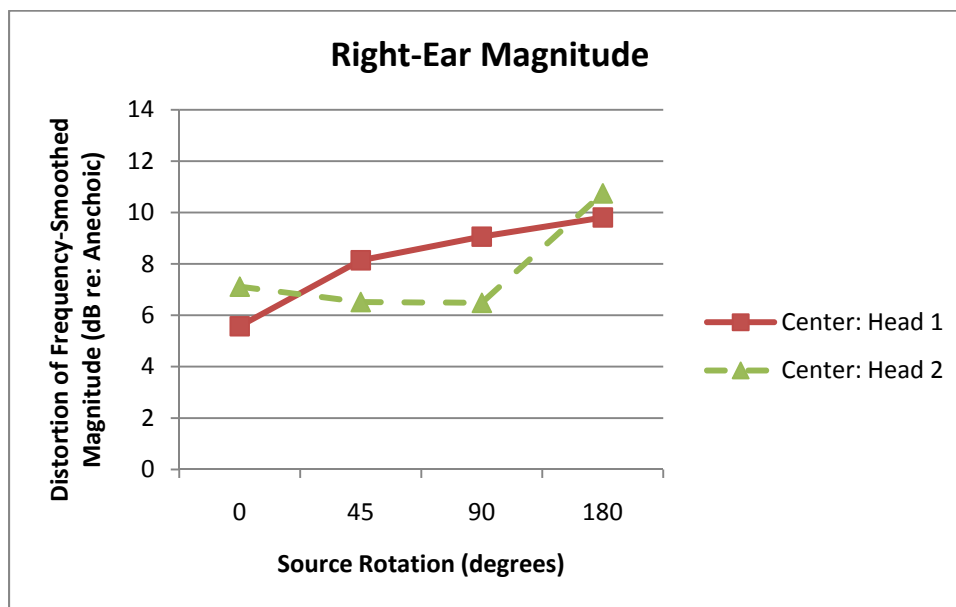


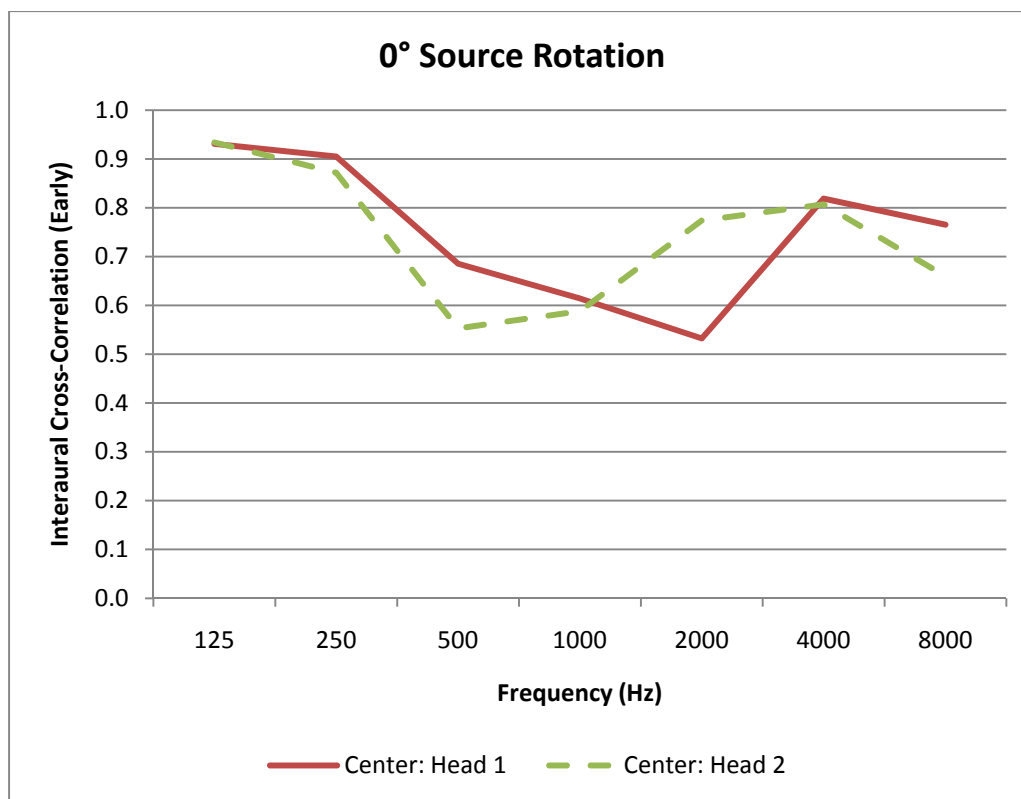
Figure A2.2: Right ear speech transmission index values.



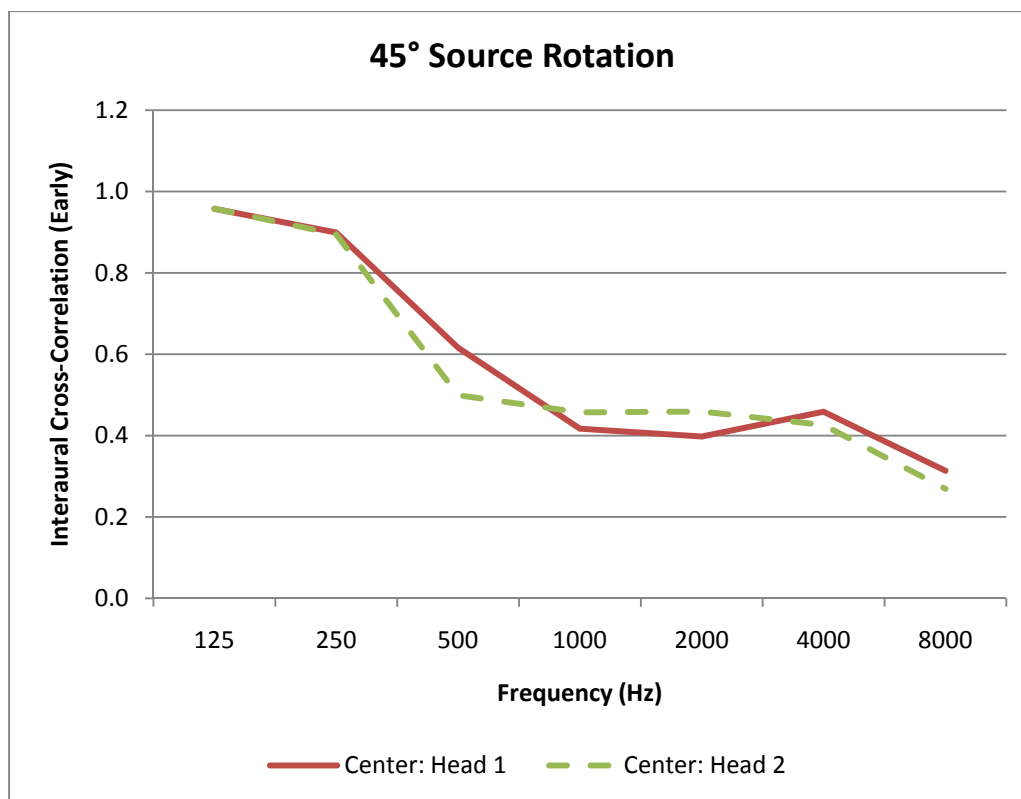
**Figure A2.3:** Left ear distortion of frequency-smoothed magnitude values.



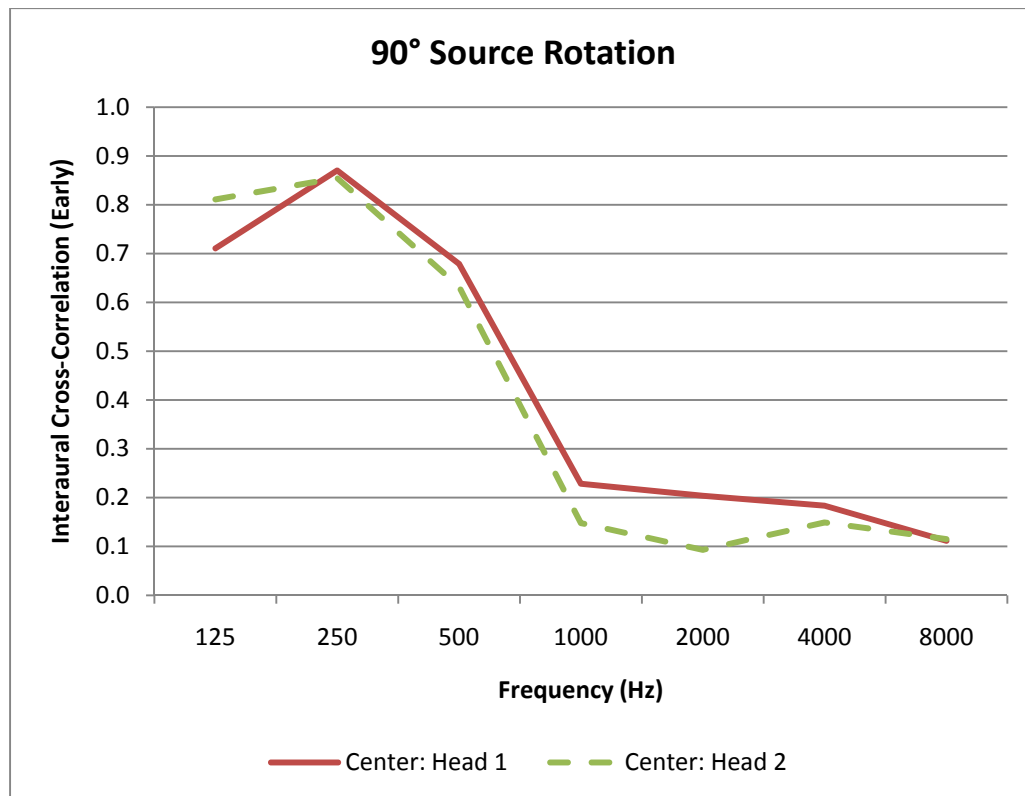
**Figure A2.4:** Right ear distortion of frequency-smoothed magnitude values.



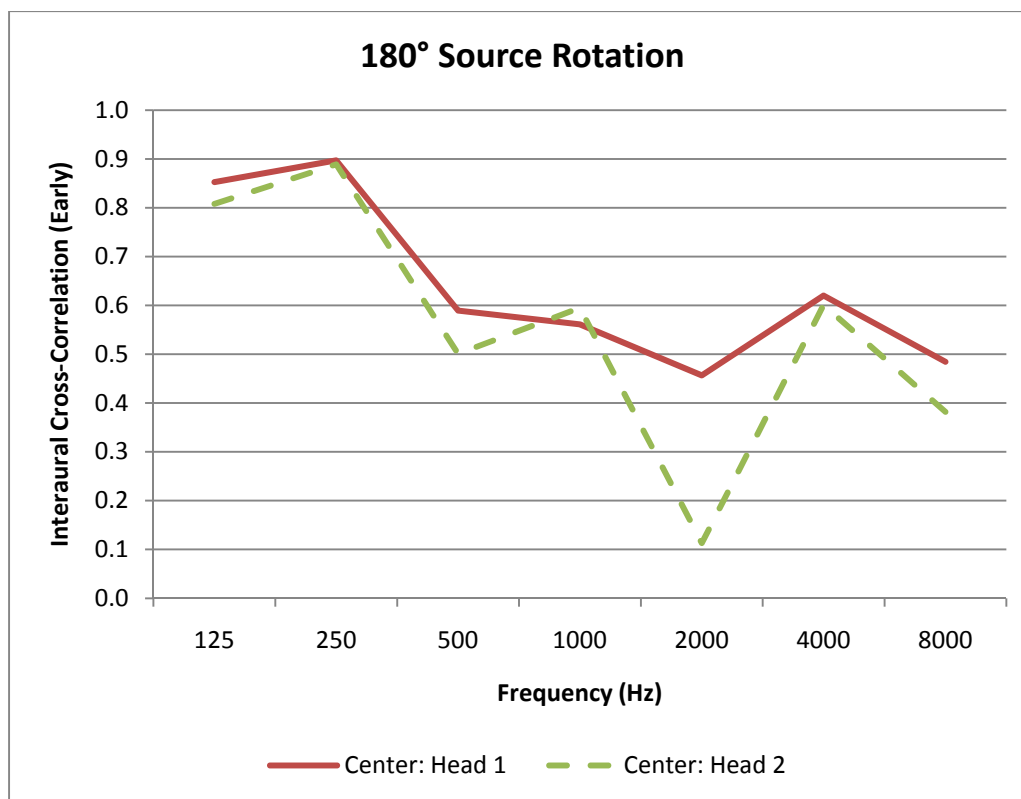
**Figure A2.5:** Interaural cross-correlation (early) values for the 0° source rotation.



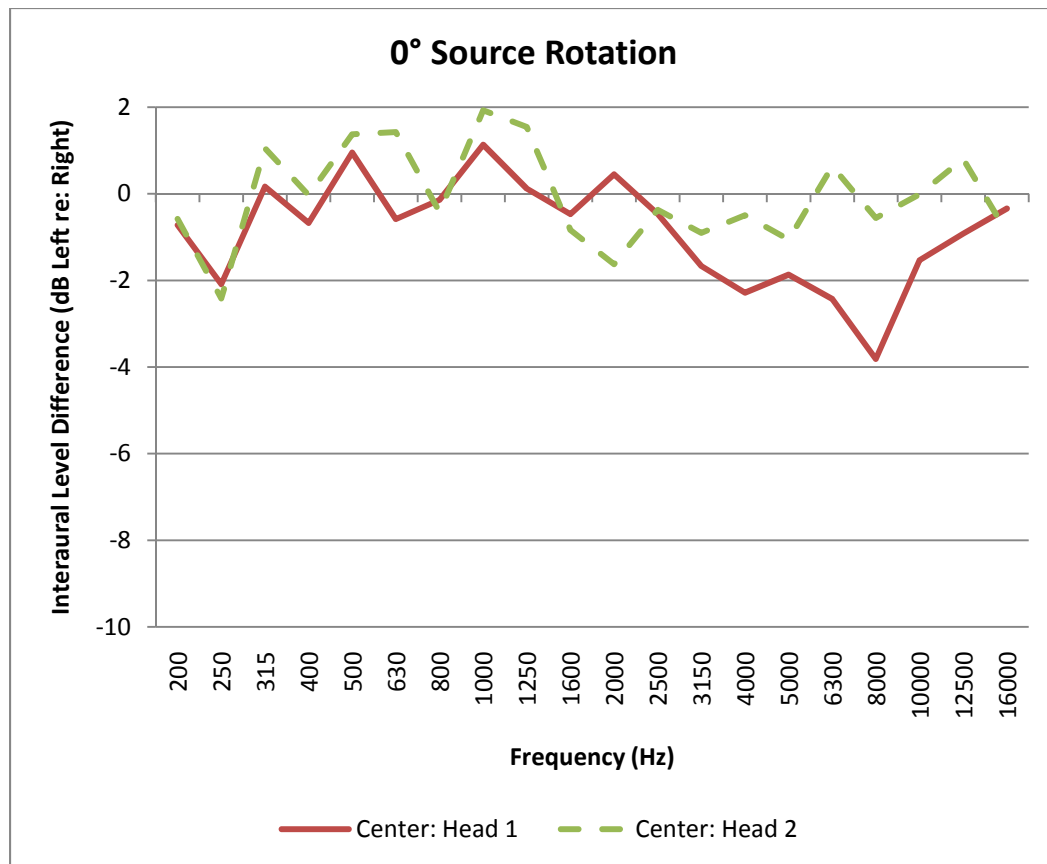
**Figure A2.6:** Interaural cross-correlation (early) values for the 45° source rotation.



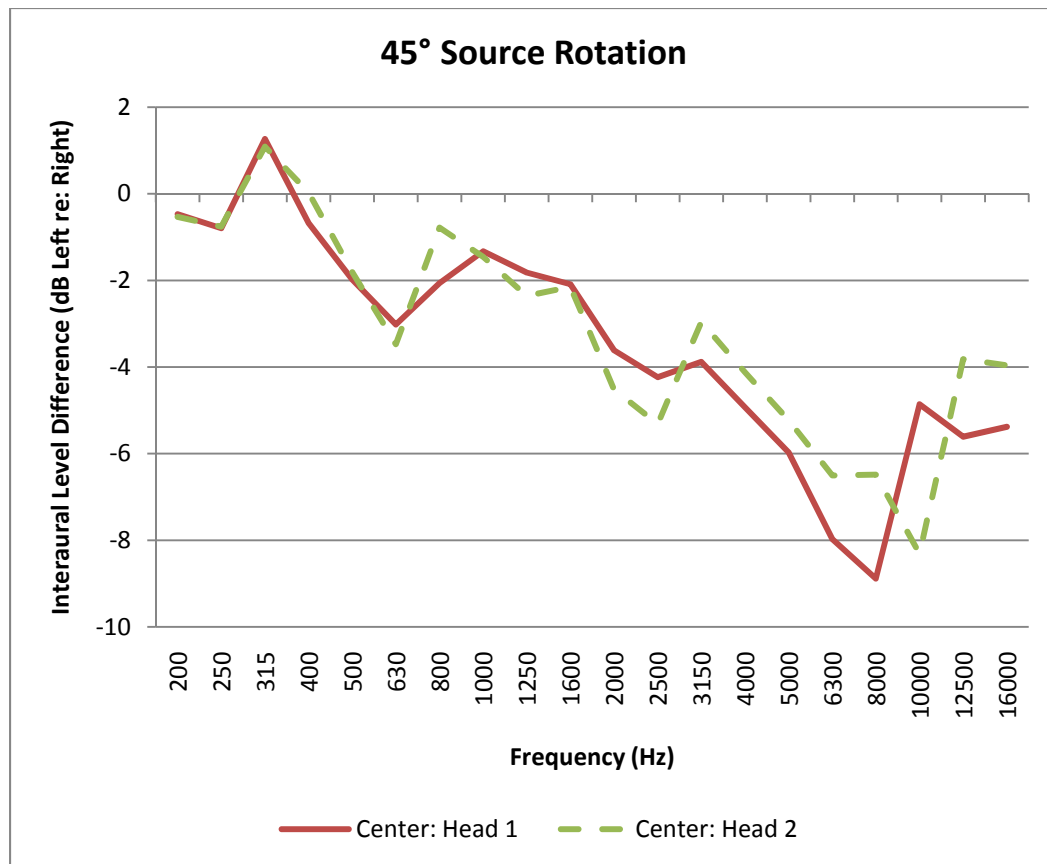
**Figure A2.7:** Interaural cross-correlation (early) values for the 90° source rotation.



**Figure A2.8:** Interaural cross-correlation (early) values for the 180° source rotation.

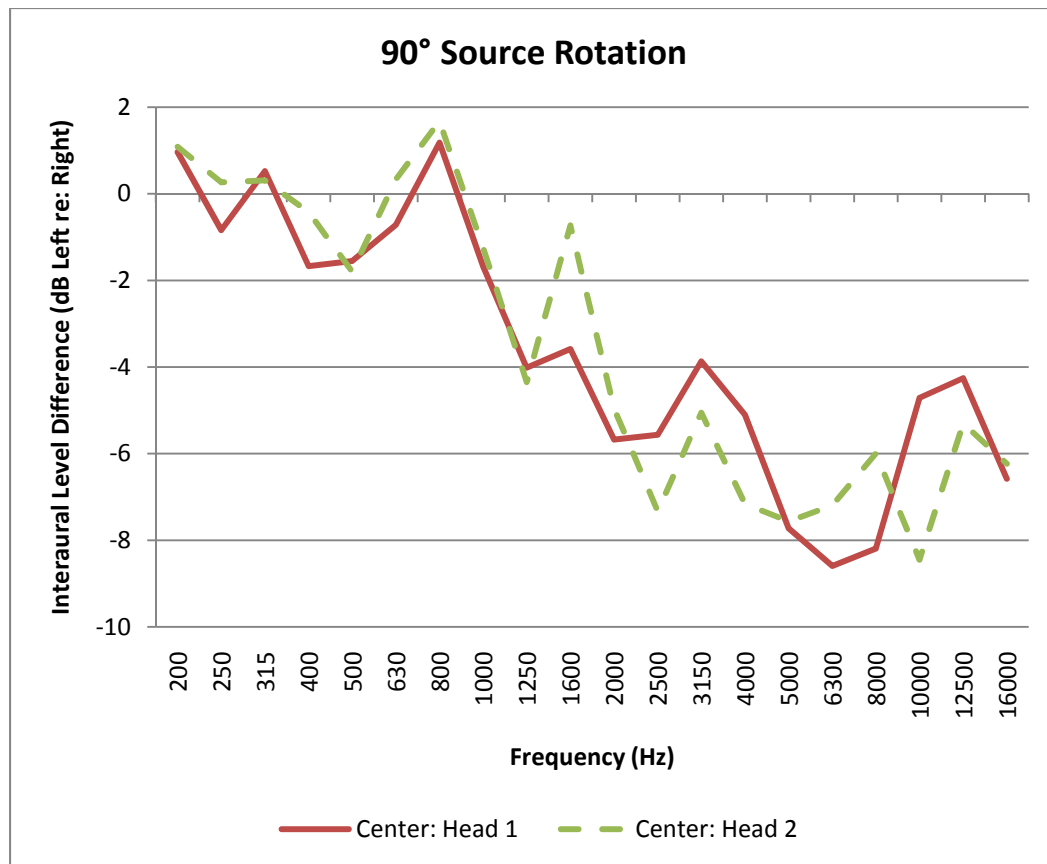


**Figure A2.9:** Interaural level difference values for the 0° source rotation.

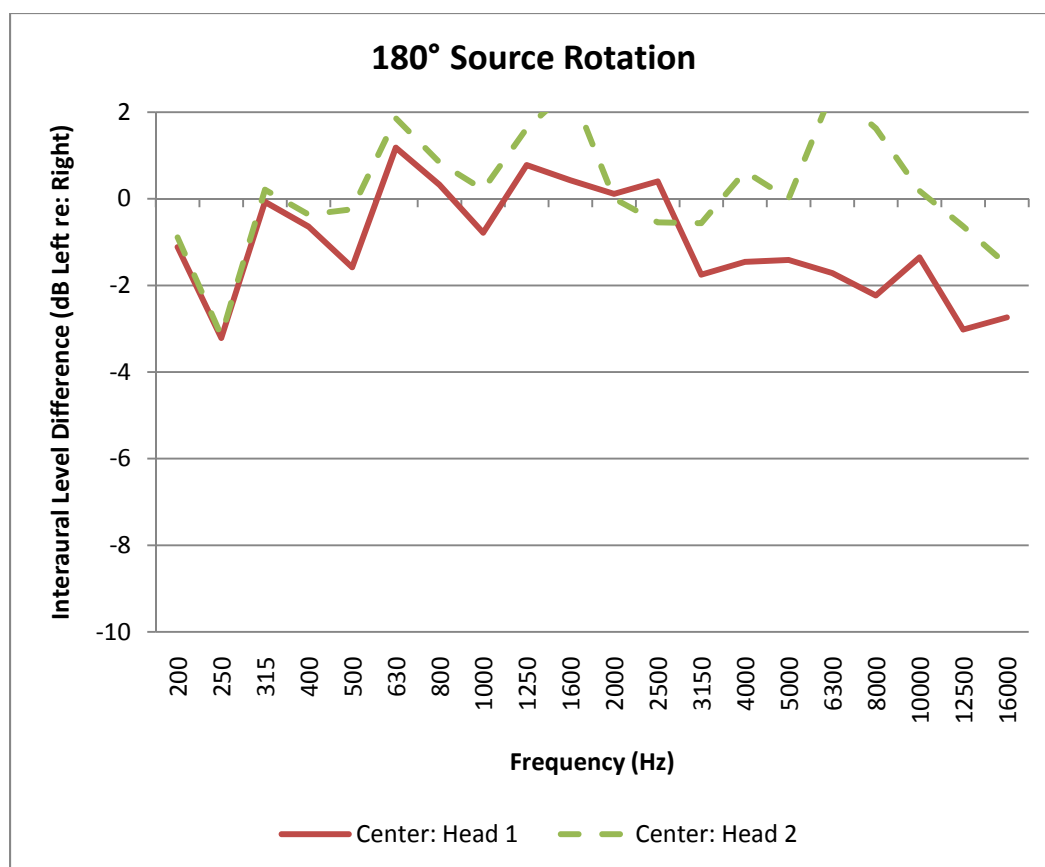


**Figure A2.10:** Interaural level difference values for the 45° source rotation.





**Figure A2.11:** Interaural level difference values for the 90° source rotation.



**Figure A2.12:** Interaural level difference values for the 180° source rotation.