

5-2013

# Stormwater Pollution Treatment BMP Discharge Structures

Miles F. Simmons

*University of Nebraska-Lincoln*, [miles2@huskers.unl.edu](mailto:miles2@huskers.unl.edu)

Follow this and additional works at: <http://digitalcommons.unl.edu/civilengdiss>



Part of the [Civil Engineering Commons](#), and the [Environmental Engineering Commons](#)

---

Simmons, Miles F, "Stormwater Pollution Treatment BMP Discharge Structures" (2013). *Civil Engineering Theses, Dissertations, and Student Research*. 60.

<http://digitalcommons.unl.edu/civilengdiss/60>

This Article is brought to you for free and open access by the Civil Engineering at DigitalCommons@University of Nebraska - Lincoln. It has been accepted for inclusion in Civil Engineering Theses, Dissertations, and Student Research by an authorized administrator of DigitalCommons@University of Nebraska - Lincoln.

# **Stormwater Pollution Treatment BMP Discharge Structures**

By

Miles Ford Simmons

A THESIS

Presented to the Faculty of  
The Graduate College at the University of Nebraska  
In Partial Fulfillment of Requirements  
For the Degree of Master of Science

Major: Civil Engineering

Under the Supervision of Professor David M. Admiraal  
Lincoln, Nebraska  
May, 2013

# **Stormwater Pollution Treatment BMP Discharge Structures**

Miles Ford Simmons, M.S.  
University of Nebraska, 2013

Advisor: David M. Admiraal

Structural best management practices (BMPs) are used to capture and treat stormwater runoff. Most structural BMPs provide treatment by filtering runoff through a filter media or collecting it in a detention basin and slowly discharging it over an extended period of time to allow suspended solids and associated contaminants to settle out. The purpose of this study is to design an effective outlet structure that provides adequate filtration or slows discharge to 40 hours.

A model detention basin was constructed in the Civil Engineering Hydraulics Laboratory at the University of Nebraska-Lincoln (UNL) and two full scale outlet structures were tested in it. The first outlet device was an orifice controlled perforated riser. Discharge from the device was measured at many head levels and the results correlated well with discharge given by the orifice equation. The orifice controlled perforated riser adequately provided a 40 hour drain time and can be sized for various detention basin sizes using the orifice equation. At low heads, however, it was observed that perforations in the riser pipe could also control flow rates, depending on the size, elevation, and number of the lowest perforations.

The second outlet structure tested was a filtered perforated riser. An 18" diameter barrel was placed around the perforated riser and filled with coarse ( $D_{50}=0.11$  in) sand. Fifteen tests were run where sediment laden water was cycled through the filtered riser.

The device provided good filtration but showed significant clogging. The filter media, in series with the orifice, impacted flow rates and was modeled using an unconfined aquifer equation. The unconfined aquifer equation was used to estimate changes in hydraulic conductivity as the filter began to clog with sediment. However, clogging of the filter screen was also observed and was modeled as a minor loss. Estimation of the minor loss coefficient provided a better fit to the data than the hydraulic conductivity. Therefore, it was concluded that the clogging of the filter screen was the significant driver of the head loss. Both methods of estimating clogging showed a dramatic initial increase in head loss, followed by much smaller increases. When designing the filtered riser these changes in head loss should be considered and the filtered riser should be sized based on flow rates after initial clogging.



## Acknowledgements

I could not have finished this thesis on my own. There have been many people that have provided me with support, encouragement, and wisdom during my two years as a grad student. I would like to thank:

My lovely and beautiful wife, Ashley

For putting up with being poor for two more years and all of the love and support you have given me.

My advisor and an Admiral of the Great Navy of Nebraska, David Admiraal

For his seemingly infinite wisdom, his great contributions to my work, and for inviting me to go sailing again even after I flipped over his boat in cold November waters.

My friend and coworker, Clark Kephart

For saying yes so many times to the question, “Can you come help me quick, it will only be 15 minutes” and all the good times both at and outside the office.

My other coworker, Alex Evans

For never providing a dull moment.

My office mate, Mohamed Jalloh

For showing me what a thirst for knowledge looks like and for advising me to not wake up in a roadside ditch.

My parents and family

For instilling a hard work ethic in me, always supporting me in all my endeavors, and for pretending to find my research interesting.

## Table of Contents

Acknowledgements.....	iii
Table of Contents.....	iv
List of Tables .....	vii
List of Figures.....	viii
Chapter 1. Introduction.....	1
1.1 Introduction .....	1
1.2 Objectives.....	2
1.3 Thesis Overview.....	3
Chapter 2. Literature Review.....	4
2.1 Introduction .....	4
2.2 Passive Outlet Structures.....	4
2.2.1 Rock Dam Outlets.....	4
2.2.2 Perforated Risers.....	6
2.2.3 Floating Skimmers .....	12
2.2.4 Basin Modifications .....	14
2.2.5 Comparisons and Conclusions.....	16
2.3 Infiltration Devices.....	18
2.3.1 Sand Filters .....	18
2.3.2 Bioretention Basins.....	27
2.3.3 Wetlands .....	29
2.3.4 Comparison and Conclusions .....	32
2.4 Mechanical Outlets.....	33
2.4.1 Electro-Mechanical Skimmer .....	33
2.4.2 Perforated Riser with Valve Control.....	37
2.4.3 Comparisons and Conclusions.....	41
2.5 Summary of Outlet Devices.....	42
2.6 Influent Sediment Characteristics .....	45
2.6.1 Sediment Concentrations .....	45
2.6.2 Particle Size Distributions in Highway Runoff .....	46
2.6.3 Conclusions.....	50

2.7	Clogging.....	51
2.7.1	Column Tests .....	51
2.7.2	Column Tests Conclusions .....	55
2.8	Stormwater Specifications.....	55
Chapter 3. Initial BMP Design Considerations .....		58
3.1	Watershed Size.....	58
3.2	Design Storm/Hydrograph .....	59
3.3	Basin Size.....	60
3.4	Basin Routing.....	61
3.5	Conclusion.....	64
Chapter 4. Outlet Device Hydraulic Characterization.....		65
4.1	Introduction .....	65
4.2	Experimental Setup .....	66
4.2.1	V-notch Weir Calibration .....	69
4.3	Orifice Plate.....	72
4.4	Perforated Riser and Orifice Combination.....	74
4.4.1	Head Discharge Curve .....	75
4.4.2	Flow Regimes for Perforated Riser.....	76
4.5	Riser Pipe with Sand Filter .....	79
4.5.1	Flow Regimes for the Filtered Riser.....	83
4.5.2	Discussion of Flow Regime 2: Flow through only the Filter and Orifice ...	84
Chapter 5. Filtered Riser Performance Testing .....		87
5.1	Steady State Experimental Procedure .....	87
5.1.1	Test Sediment.....	88
5.1.2	TSS Measurements .....	90
5.1.3	Silica Sand Test – Filtered Riser with 1.5625 inch Orifice .....	91
5.1.4	Initial Silica Flour Tests – Filtered Riser with 1.5625 inch Orifice.....	92
5.1.5	Silica Flour Tests 3-10 – Filtered Riser with 1.5625 inch Orifice.....	93
5.1.6	Silica Flour Tests – Filtered Riser with 4 inch Outlet and No Orifice .....	97
5.2	Post-Loading Drain Tests.....	99
5.2.1	Post Loading Drain Tests – Initial Observations .....	100
5.2.2	Impact of Clogging on Hydraulic Conductivity .....	102
5.2.3	Modeling Screen Head Losses.....	106

5.2.4	Comparison of Prediction Results – Minor Loss vs Filter Conductivity...	108
Chapter 6.	Conclusions.....	110
6.1	Thesis Summary.....	110
6.2	Future Work.....	112
References	.....	114

## List of Tables

Table 2.1 Parameters of the Fit for Discharge Coefficient (Prohaska, 2010).....	10
Table 2.2 Sediment Retention for Three Outlet Structures (Fennessey and Jarrett 1997; Line and White 2001; McCaleb and McLaughlin 2008).....	17
Table 2.3 Design Percent Removal Rates of TSS by Basins Upstream of a Media Filter (Urbonas 1999) .....	23
Table 2.4 Removal Rates for Infiltration Devices (Urbonas 1999; Barrett 2003; Roseen et al. 2010; Hunt 2008; Mungasavalli 2006; Yu et al. 1998).....	32
Table 2.5 Results from Delay Time Treatments (Bidelsphach et al. 2004).....	36
Table 2.6 Basin Performance for Various Constituents (Middleton and Barrett 2008) ...	40
Table 2.7 Comparison of Mechanical Outlets for a 12 hour Delay Time (Bidelsphach et al. 2004; Middleton and Barrett 2008).....	41
Table 2.8 Summary of Passive Outlet Structures .....	43
Table 2.9 Summary of Infiltration Devices .....	44
Table 2.10 Summary of Mechanical Outlets .....	45
Table 2.11 Summary of Particle Diameters (Jartun 2008) .....	47
Table 3.1 Detention Basin Parameters.....	63
Table 5.1 Hydraulic Conductivity of Filtered Riser before and after Testing .....	105

## List of Figures

Figure 2-1 Rock Dam Sediment Trap (McCaleb and McLaughlin 2008) .....	5
Figure 2-2 Sedimentation Basin with Perforated Riser (Jarrett 1993).....	7
Figure 2-3 Perforated Riser Design Space (Jarrett 1993).....	8
Figure 2-4 Stage-Storage Relationships (Jarrett 1993).....	9
Figure 2-5 Outflow Hydrographs (Fennessey and Jarrett 1997) .....	11
Figure 2-6 Faircloth Skimmer (Millen et al. 1997).....	13
Figure 2-7 Overgrown Vegetation Restricting Movement of Skimmer (Faircloth 2010) 14	
Figure 2-8 Baffle Configuration (Millen et al. 1997) .....	15
Figure 2-9 Plan and Profile View of an Austin Sand Filter (Barrett 2003) .....	19
Figure 2-10 Three Settling and Infiltration Basin Arrangements (Urbonas 1999).....	21
Figure 2-11 Flow-through Rate of a Sand Filter as a Function of TSS Removed (Urbonas 1999) .....	23
Figure 2-12 Maintenance Activities at Sand Filter Sites over a Three Year Period (Barrett 2003) .....	26
Figure 2-13 Cross Section of Bioretention Pond (Roseen et al. 2010).....	27
Figure 2-14 Cross Section of a Subsurface Gravel Wetland (Roseen et al. 2010).....	30
Figure 2-15 Electro-Mechanical Skimmer (Bidelspach et al. 2004) .....	34
Figure 2-16 Schematic of (a) Locations of the Skimmer and Control Device Components and (b) Control Device's Electro-mechanical Components (Bidelspach and Jarrett 2004) .....	35
Figure 2-17 Valve, Actuator, and Controller (Middleton and Barrett 2008).....	39
Figure 2-18 Grain Size Distributions for a Fine, Average, and Coarse Grained Sample (Jartun 2008) .....	47
Figure 2-19 Particle Number Fraction of all Events (Li et al. 2006).....	49
Figure 2-20 Comparison of Particle Sizes on Urban Street Surfaces and in Runoff (Kim and Sansalone 2008) .....	50
Figure 2-21 Average Treatment Seepage Rate Over Time (Bright 2010).....	52
Figure 2-22 Gravel Filter Media Column (Siriwardene 2007a) .....	54
Figure 3-1 Bridge Deck Areas .....	59
Figure 3-2 NRCS Synthetic Storm Runoff Hydrograph.....	60
Figure 3-3 Required Orifice Size to Maintain 40-hr Drain Time for (a) a Given Watershed Area and (b) a Corresponding 4-ft deep Basin Size .....	62
Figure 3-4 Real Hydrograph Inflow and Basin Outflow .....	63

Figure 4-1 Diagram of the Experimental Test Facility .....	67
Figure 4-2 Experimental Test Facility .....	68
Figure 4-3 Free Flow Outlet from Model Basin .....	69
Figure 4-4 Measured Weir Discharge for Two Tests .....	71
Figure 4-5 Calibrated Weir Discharge .....	72
Figure 4-6 Discharge Calculations using Weir, Tank Volume Conservation, and Orifice Equation Methods .....	74
Figure 4-7 Perforated Riser Pipe Detail .....	75
Figure 4-8 Orifice-Controlled Perforated Riser Discharge in Model Basin .....	76
Figure 4-9 Measured and Calculated Discharge using the Orifice and Perforation Equations .....	79
Figure 4-10 Sand Filter Chamber: (a) Top View and (b) Side View .....	81
Figure 4-11 Filter Sand Sieve Analysis Size Distribution .....	82
Figure 4-12 Head-Discharge Curves for Filtered and Perforated Risers .....	83
Figure 4-13 Flow Regimes through Filtered Riser .....	84
Figure 4-14 Schematic of Flow through Filtered Riser .....	85
Figure 4-15 Estimation of Hydraulic Conductivity of Filtered Riser .....	86
Figure 5-1 Grab Sample Locations .....	88
Figure 5-2 Silica Sand #140-270 Sieve Analysis .....	89
Figure 5-3 Silica Flour Sieve Analysis .....	90
Figure 5-4 Silica Sand TSS Concentrations .....	91
Figure 5-5 Influent and Effluent Silica Flour TSS Concentrations for Test 1 and 2 .....	93
Figure 5-6 Influent TSS Concentrations (inside Basin) for Silica Flour Tests .....	95
Figure 5-7 Effluent TSS Concentrations (below Weir) for Silica Flour Tests .....	96
Figure 5-8 Ratio of Influent and Effluent TSS Concentration for Silica Flour Tests .....	97
Figure 5-9 Influent TSS Concentrations (inside Model Basin) .....	98
Figure 5-10 Effluent TSS Concentrations (below Weir) .....	99
Figure 5-11 Drain Times for Filtered Riser .....	100
Figure 5-12 Drain Times for Filtered Riser Before and After Testing .....	102
Figure 5-13 Estimation of K Values for Filtered Riser and Orifice Combination .....	103
Figure 5-14 Estimation of K Values for Filtered Riser with No Orifice .....	104
Figure 5-15 Filter Screen (a) after the Suspended Sediment Tests and (b) after Silica has been Wiped from the Screen .....	107

Figure 5-16 Estimation of  $K_m$  Values for Filtered Riser and Orifice Combination..... 108



## Chapter 1. **Introduction**

### **1.1 Introduction**

According to the new National Pollutant Discharge Elimination System (NPDES) Phase II stormwater regulations, small to medium municipal separate storm sewer systems (MS4s) must treat their stormwater discharges. Any governmental entity that collects and discharges stormwater, including highway departments, is considered an MS4. NPDES permits require treatment of stormwater, but do not state allowable concentrations for specific pollutants, nor do they list acceptable best management practices (BMPs). BMPs can take on a variety of forms, from structural (e.g., detention ponds and infiltration basins) to nonstructural (e.g., public programs and regulations), that reduce pollutants in stormwater runoff.

Under these regulations, Nebraska Department of Roads (NDOR) projects and right of ways within municipalities are subject to the same permitting rules by which the municipalities must abide. This includes improving runoff water quality through implementation of BMPs. One of the primary concerns of NDOR is runoff from bridges. In most cases, runoff from bridges discharges directly into a stream or water body; whereas along roads runoff typically flows through grass-lined ditches before reaching a water body. Consequently, it is more important to capture and treat bridge runoff. Only the ‘first flush’ of the design rainfall event is captured since building a detention basin large enough to capture all runoff from storm events is infeasible. The ‘first flush’ is typically only the first 0.5 inches of rainfall runoff, but it carries the majority of the

pollutants washed off during a storm. Due to the characteristics of NDOR sites, structural BMPs that capture and treat runoff are the most likely to succeed.

Most structural BMPs provide treatment by filtering the runoff through a filter media or collecting it in a detention structure and discharging it over an extended time period, allowing suspended solids to settle out. Drainage from detention basins should be slow but complete so there is no standing water. Slow discharge from the basin allows time for the suspended solids to settle out and reduces the amount of pollutant from the 'first flush' that is transmitted downstream. Detention basins should drain completely to prevent problems with mosquitos and other biological concerns associated with standing water, and in the case of NDORs applications, complete emptying of the detention basins eliminates hazards associated with standing water adjacent to roads.

## **1.2 Objectives**

The goal of this project is to identify an effective outlet structure design for stormwater treatment detention basins. To provide treatment, the outlet structure must be designed to cause the basin to hold stormwater runoff and slow the discharge over an extended period. Such a structure should also be reliable and easily maintained. The objectives to be filled were to:

1. Provide an extensive review of literature on detention based BMPs and BMP outlet structures, including design and operation information. This information will be helpful for evaluating the efficacy of new BMP design projects.
2. Perform laboratory testing of outlet structures that are not sufficiently documented but hold promise for being effective. The effectiveness for each structure tested

will be assessed based on efficiency for removing suspended solids, long term reliability, susceptibility to clogging, and long term maintenance requirements.

3. Determine methods to accurately size outlet structures for a specific dewatering time and multiple basin sizes.
4. Establish a laboratory testing procedure that can be used to test additional structures so that the results can be accurately compared with previous and future tests.

### **1.3 Thesis Overview**

This thesis is the product of research conducted by the UNL Civil Engineering Department in collaboration with NDOR. The research project focuses on the study of stormwater BMP outlet structures. The thesis consists of six chapters. Chapter 1 is an introduction to the research. A literature review pertaining to the research project is provided in Chapter 2. Chapter 3 outlines the design parameters for BMP structures. Chapter 4 describes methods used to test outlet structures. Chapter 5 presents results of the outlet structure tests. A summary of conclusions from the research project and recommendations for future work are included in Chapter 6. Finally, a bibliography is provided at the end of the thesis.

## Chapter 2. Literature Review

### 2.1 Introduction

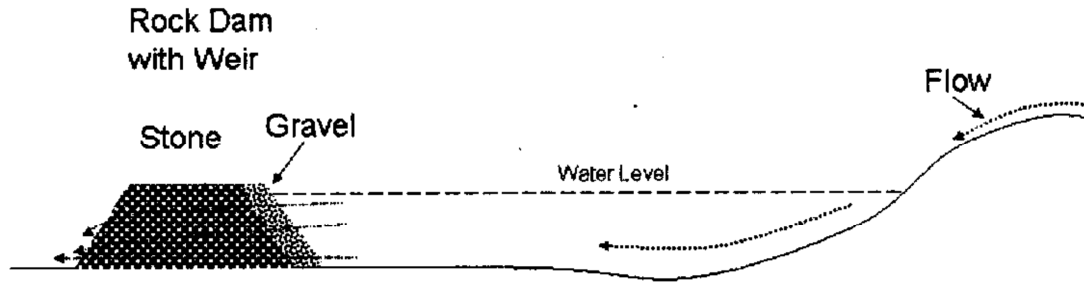
This report focuses on structural BMPs designed to detain and treat stormwater runoff and, in particular, the outlet structures associated with these BMPs. There are three main types of outlet structures: passive, filtration, and mechanical. The BMPs with these outlet structures provide treatment by filtration, sedimentation, or both. The following sections discuss the outlet structure categories and the different devices within them in greater detail, including information on pollutant retention efficiencies, construction costs, and maintenance issues.

### 2.2 Passive Outlet Structures

Passive outlet structures capture the stormwater and release it over an extended period of time, allowing the suspended solids time to settle out. Examples of passive outlet structures include rock dams, perforated risers, and floating skimmers as discussed subsequently.

#### 2.2.1 Rock Dam Outlets

Rock dam outlets are 5 to 8 ft. (1.5 to 2.5 m) wide rock weirs, usually designed to pass a 10-year, 24-hour storm for the catchment area draining into the detention basin (McLaughlin et al. 2009). The rock weir is comprised of stone with a layer of washed gravel on the upstream face of the dam to reduce flow (McCaleb and McLaughlin 2008). Figure 2-1 shows a cross section of the rock dam sediment trap.



*Figure 2-1 Rock Dam Sediment Trap* (McCaleb and McLaughlin 2008)

Basins with rock outlets typically have vertical walls and no inlet protection; however, basin modifications, such as silt fence baffles and addition of a permanent pool, have been shown to improve sediment retention (McCaleb and McLaughlin 2008; McLaughlin et al. 2009). Types of basin modifications, as well as their effects, are discussed in a later section.

### **Performance**

Several studies have been done on sediment traps with gravel dam outlets, showing various results for effluent quality and sediment retention. A field study by Line and White (2001) of three traps with rock outlets found overall sediment trapping efficiencies ranging from 59% to 69%. The traps were earthen basins with vertical walls and no inlet protection, designed for a 10-year storm event. McCaleb and McLaughlin (2008) found that a standard rock outlet basin with the same design as one studied by Line and White (2001) only retained 35% of incoming sediment. Differences in the findings of the two studies can be attributed to soil type and storm characteristics, as well as to construction activities inside the catchment area.

The main characteristic of soil type that influences retention is soil particle size. Sediment traps retain an average of 80%, 58%, and 30% of the sand, silt, and clay

particles entering the trap, respectively (Line and White 2001). As expected, the larger particles are retained more effectively due to their higher settling velocities.

No strong correlation between effluent quality and rainfall amount or intensity has been reported for these systems. In a study by McCaleb (2008), one event accounted for 81% of the total sediment discharged by a standard basin, even though there were four other events with more rainfall but much less sediment. The study suggested that the unusually high sediment levels were due either to activities in the watershed or to erosion of the unprotected inlet. McLaughlin (2008) suggests variability in water quality from the same treatment system is a result of complex interactions between site conditions and storm characteristics, with earth moving activities being a dominant variable in system performance.

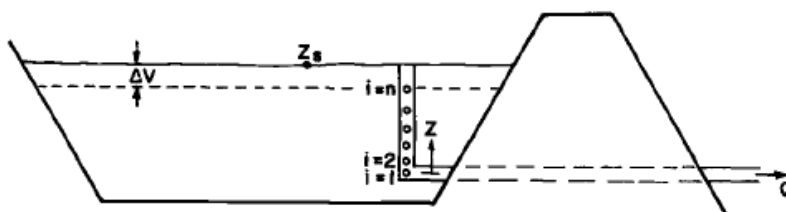
## **Maintenance**

Maintenance requirements for rock dam outlets are low. In the study by Line and White (2001), all three basins were dredged to remove accumulated sediment but only one of the basins became clogged by sediment, resulting in a 1 ft (30 cm) deep permanent pool. The partial clogging of this basin occurred after a hurricane released over 12 inches (300 mm) of rain on the site. The ensuing runoff filled the basin with sediment and the sediment that remained after dredging partially clogged the rock dam.

### **2.2.2 Perforated Risers**

Perforated riser spillways are passive structures that draw water throughout the height of the riser. Risers consist of one or more columns of holes drilled into a vertical pipe or a plywood box, designed to control the dewatering time of a sedimentation basin (Millen et al. 1997). Figure 2-2 shows a typical sedimentation basin with a perforated

riser spillway. According to Jarrett (1993), many perforated risers are overdesigned, providing higher flow rates than required, and thus result in rapid dewatering and poor sediment removal. Furthermore, non-uniform criterion for perforations such as: diameters, spacing, and locations have made performance comparisons difficult (Fennessey and Jarrett 1997).



**Figure 2-2 Sedimentation Basin with Perforated Riser** (Jarrett 1993)

### Design

Several studies have developed procedures for accurate design of perforated risers. Jarrett (1993) developed a design and analysis procedure for the two stage dewatering process of perforated risers. In the first stage when water is below the second perforation, the perforation referred to in Figure 2-2 as  $i=2$ , discharge only occurs through the bottom perforation. During the second stage, the water elevation is above the second perforation and water discharges from multiple perforations. These two stages are expressed by two different formulas that are combined in Equation 2.1 to predict the overall basin dewatering rate.

$$t_1 = \frac{4.63}{T a_t x} [z_2^{-0.38} - 0.57 z_s^{-0.38}] \quad (2.1)$$

Where,  $t_1$  = total dewatering time in days

$T = 86,400$  s/day

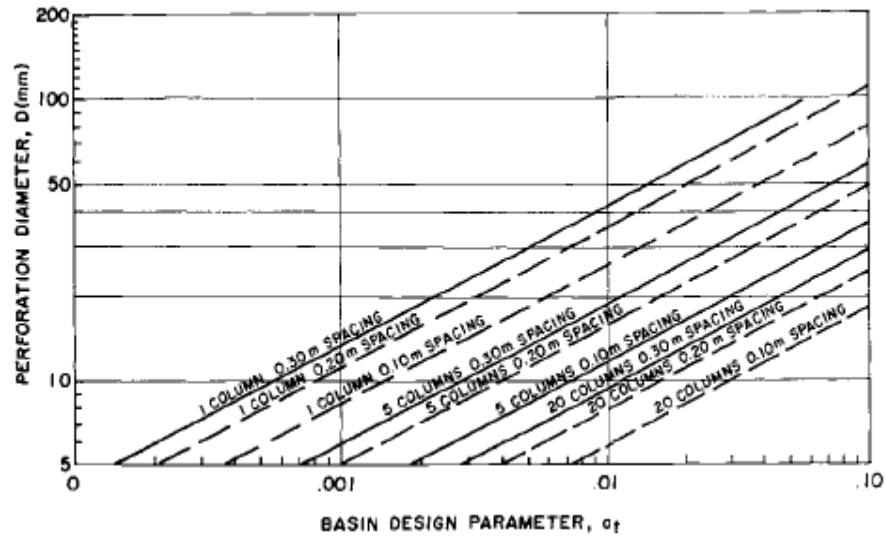
$a_t$  = design parameter

$x$  = slope of stage-storage relationship for basin

$z_s$  = full basin depth in meters

$z_2$  = elevation of second perforation in meters

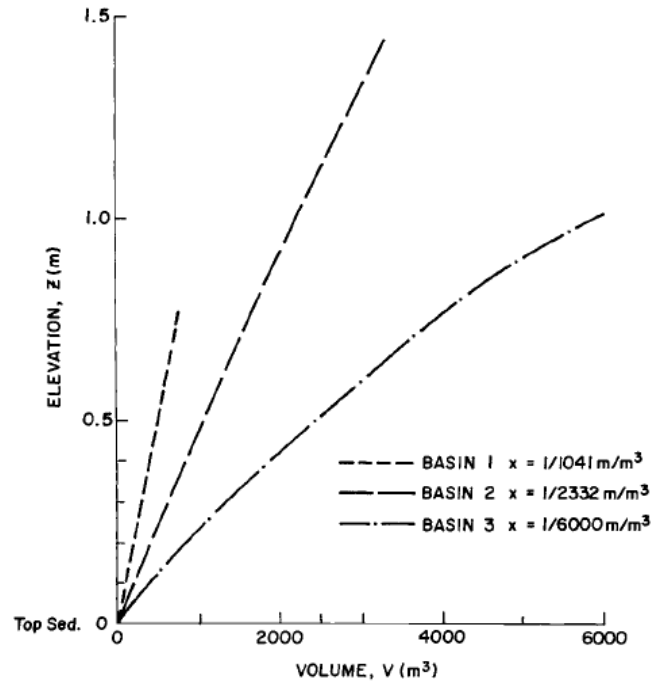
In a design situation, the dewatering time is known and Equation 2.1 can be solved for  $a_t$ . Then, perforation diameter, spacing, and columns can be determined using Figure 2-3.



**Figure 2-3 Perforated Riser Design Space** (Jarrett 1993)

The analysis procedure for the two stage dewatering process was applied to three different basins with varying degrees of nonlinearity in their stage-storage relationships. Many sedimentation basins with uniformly constructed side slopes have linear or nearly linear stage-storage relationships, correlating the depth to the storage volume in the water storage zone. The stage-storage curves of the three basins are shown in Figure 2-4. Actual dewatering times were the same as the design times, except for the severely nonlinear basin, for which actual dewatering was 11% faster than the design time.





**Figure 2-4 Stage-Storage Relationships** (Jarrett 1993)

Another study by Prohaska (2010) investigated the flow through a circular orifice cut into the side of a vertical riser pipe. The study examined the variation of the discharge coefficient with the ratio of the orifice diameter to pipe diameter, the head over the orifice, and location of the orifice above the bed. The study developed an expression, Equation 2.2, which determines the discharge coefficient for any circular orifice in any riser pipe.

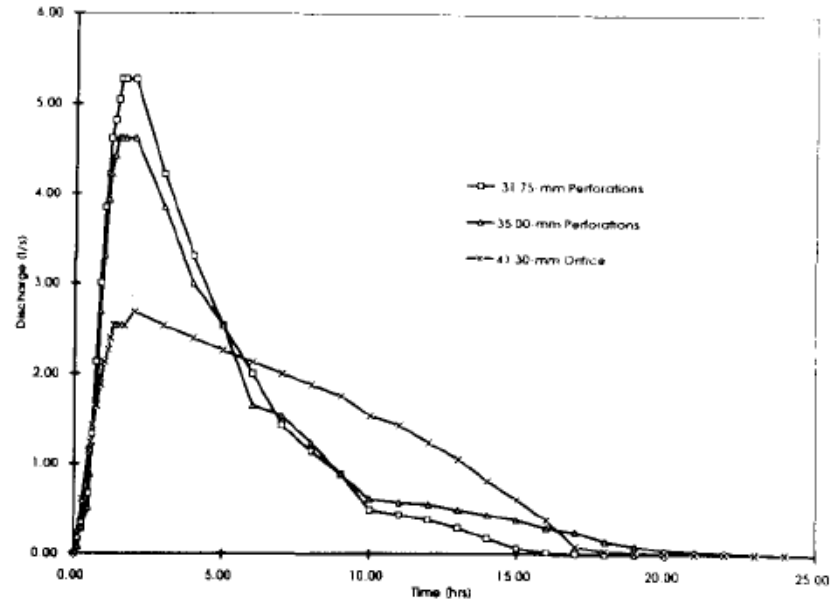
$$C_D = a + \frac{b}{\left(\frac{h_o}{d}\right)^{0.2}} + \frac{c}{\left(\frac{h_b}{d}\right)^{0.5}} \quad (2.2)$$

The discharge coefficient was found to be a function of the head above the orifice ( $h_o/d$ ), the location of the orifice above the tank floor ( $h_b/d$ ), and the ratio of the orifice diameter to the riser pipe diameter ( $d/D$ ). The values of parameters  $a$ ,  $b$ , and  $c$  for different  $d/D$  ratios along with the corresponding coefficient of determination are given in Table 2.1.

**Table 2.1 Parameters of the Fit for Discharge Coefficient (Prohaska, 2010)**

Riser pipe size (cm)	$d/D$	$a$	$b$	$c$	$R^2$
15.2	0.167	0.120	0.682	0.241	0.79
	0.250	0.025	0.676	0.259	0.92
	0.333	0.074	0.415	0.383	0.78
	0.500	0.075	0.420	0.170	0.93
30.5	0.083	0.148	0.547	0.402	0.88
	0.167	0.124	0.503	0.228	0.81
	0.250	0.058	0.462	0.204	0.83
	0.417	0.085	0.346	0.131	0.80

Even with well-designed risers, dewatering is very rapid during the initial 25% of the dewatering time. Subsequently, more than 80% of the influent is discharged from the basin after being exposed to gravitational settling for less than 25% of the design dewatering time (Jarrett 1993). Consequently, a modification that restricts flow from the perforated riser could potentially increase sediment retention. A study by Fennessey and Jarrett (1997) showed that a perforated riser spillway had a peak discharge twice as high as a single orifice spillway for the same basin and dewatering time. The outlet hydrographs are shown in Figure 2-5. Therefore, a perforated riser with outflow controlled by a single orifice would reduce peak flow while drawing water from the entire water column. Our review did not find any publications discussing perforated risers with orifice control.



**Figure 2-5 Outflow Hydrographs** (Fennessey and Jarrett 1997)

### Performance

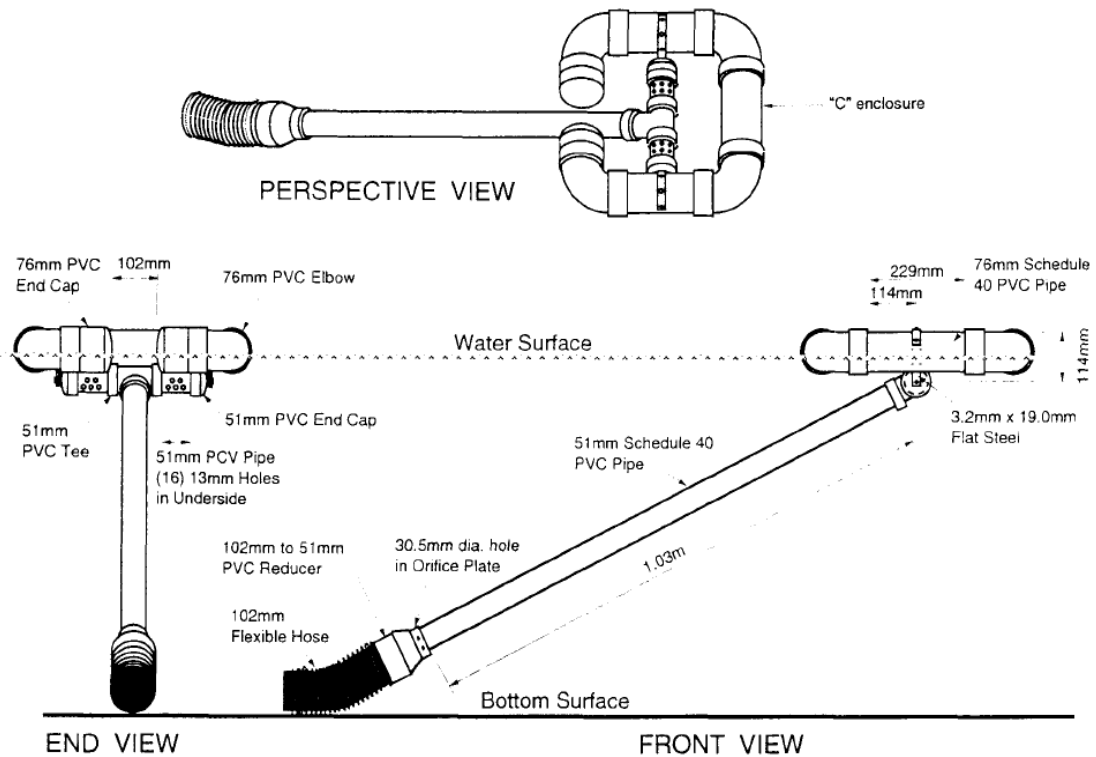
According to Millen (1997), a typical sedimentation basin with a perforated riser spillway had an overall retention efficiency (the percentage of incoming sediment captured by the basin) of 94.2% for a 24 hour dewatering time. A later study by Rauhofer (2001), which replicated the testing procedures with the exception of a smaller basin that did not completely impound the simulated runoff event, found that the smaller basins lost 20% more sediment.

To improve sediment removal efficiencies, filters can be placed around perforated risers. Engle and Jarrett (1995) tested filter envelopes of polystyrene chips (EPS) and gravel for 1.5 and 3 hour dewatering times against a control perforated riser with no filter. The average sediment retention for 3-hr dewatering was 71%, 85.6%, and 89.4%, for the no filter, gravel, and EPS treatments respectively. These efficiencies are significantly lower than those found by Millen (1997); however, the dewatering time is considerably faster. Gravel and EPS envelopes increased sediment retention by 23% and

25%, respectively, while neither filter measurably increased the design dewatering time. Using the same filter for more than one dewatering event may reduce its ability to capture suspended sediment. Further investigation is needed to evaluate long term performance and required maintenance.

### **2.2.3 Floating Skimmers**

A floating skimmer is a riser that removes the water from the top layer of the basin where higher quality effluent is expected. Also, drawing water from the surface allows water at greater depths to remain still and prevents some of the resuspension associated with mixing (Millen et al. 1997). A Faircloth Skimmer ® (Faircloth Skimmers, Hillsborough, N.C.) consists of a buoyant “C” structure that floats on the surface, which raises a pipe that connects to a flexible hose, as shown in Figure 2-6, below.



**Figure 2-6 Faircloth Skimmer** (Millen et al. 1997)

### Performance

Numerous studies have researched the effectiveness of floating skimmers as principal spillways. Millen (1997) and Bidelspach and Jarrett (2004) found that for a 24 hr dewatering time the skimmer had a retention efficiency of 96.8%. Similarly, 99% efficiency was recorded by McCaleb (2008) until the skimmer became mired in sediment at the bottom of the basin, reducing the efficiency to 76%.

### Cost and Maintenance

The only maintenance requirement is insuring the skimmer is able to freely rise and fall with the water elevation. A frame or block is needed to keep the skimmer off the bottom of the basin so it does not get stuck in the mud. Normal maintenance including removal of accumulated sediment and overgrown vegetation around the skimmer will

prevent movement problems (McCaleb, 2008). Figure 2-7 illustrates the problem. The impact of floating debris on skimmer effectiveness requires further investigation.



**Figure 2-7 Overgrown Vegetation Restricting Movement of Skimmer** (Faircloth 2010)

The Faircloth Skimmer ® ranges in price from \$450 to over \$4,000 depending on basin size and dewatering time. At the lower end of the price range, the 1-1/2" skimmer drains approximately 1728 cu. ft (49 m<sup>3</sup>) in 24 hrs. At the high end, the 8" skimmer drains approximately 97,978 cu. ft (2775 m<sup>3</sup>) in 24 hrs (Faircloth 2010).

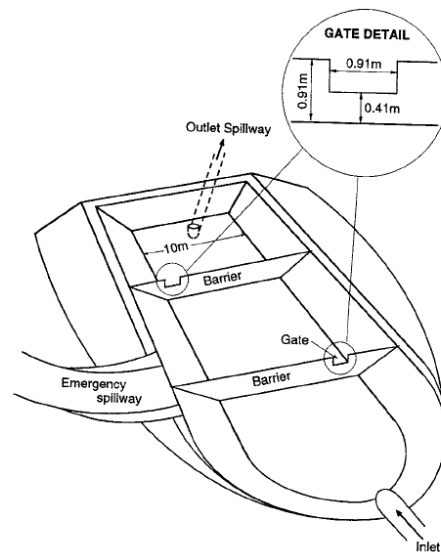
#### **2.2.4 Basin Modifications**

The principal spillway structure is only one of several physical factors that influence the sediment retention of a basin. Other factors include basin geometry, inlet configuration, and the use of silt fence baffles. These factors have a significant impact on dead storage volume, short-circuiting, and turbulence in a sedimentation basin.

Dead storage volume is often used to collectively account for short circuiting, turbulence, stagnation and any other non-ideal behavior (Griffin 1985). Dead storage is the stagnant portion of a pond that does not contribute to the mean flow of the pond. As a result, the detention time of the pond is shortened because of the smaller effective volume, thus reducing the total trap efficiency of the pond (Griffin 1985). Griffin (1985)

found that dead storage depended heavily on the length to width (l/w) ratio of the basin. Dead storage values for l/w ratios of 3:1 and 2:1 fell within the same range - 12% to 17% of the total pond volume, while values for l/w ratios of 1:1 and ½:1 ranged between 23% and 27%. A minimum l/w ratio of 2:1 for sediment basins is recommended by Barfield (1983).

Silt fence baffles can improve sediment retention by diverting flow through opposing weirs, as shown in Figure 2-8, lengthening the flow path and residence time (Millen et al. 1997). The use of baffles in combination with a perforated riser increased sediment retention from 94.2%, using the perforated riser alone, to 95.5%. This difference appears to be insignificant and is most likely not repeatable. In a standard trap with a rock weir outlet, efficiency increased from 35% to 45% with the use of silt fence baffles (McCaleb and McLaughlin 2008).



**Figure 2-8 Baffle Configuration** (Millen et al. 1997)

Thaxton and McLaughlin (2005) suggested that optimal baffle permeability (the open space fraction of baffle surface area) is in the range of 0.05 to 0.1, to allow for maximum sediment capture effectiveness. Higher baffle permeabilities may lead to less

effective flow rate and turbulence reduction, while lower baffle permeabilities encounter problems with overtopping and baffle structure failure.

Another modification that improves efficiency is the addition of a permanent pool. A permanent pool is created by excavating the basin up to 3.3 ft (1 m) below the basin outlet. Unlike dead storage, the water in the permanent pool is flushed out and replaced by incoming flow. Fennessey and Jarrett (1997) found that for a basin with a perforated riser sediment retention increased from 94.7% to 97% when the permanent pool depth was increased from 0.5 ft to 1.5 ft (0.15 m to 0.46 m). McCaleb (2008) tested two standard basins with rock outlets: one without a permanent pool and the other with a 3.3 ft (1m) deep permanent pool; both basins had average retentions of 35%. The data shows that for the permanent pool basin case, one storm event accounted for 81% of the total sediments discharged. If this storm event was excluded from the analysis, the retention of the permanent pool basin would have improved to 73%. This suggests that, for most storm events, having a permanent pool would increase the retention efficiency of the system.

### **2.2.5 Comparisons and Conclusions**

Three passive outlet structures are commonly used to control dewatering of a sedimentation basin: rock dam weirs, perforated risers, and floating skimmers. Rock dam weirs are the least effective at retaining sediment, while floating skimmers are the most effective. Table 2.2 summarizes sediment retention efficiencies for the three outlet structures. The results in Table 2.2 are not directly comparable as most of the studies were not performed under the same conditions.



**Table 2.2 Sediment Retention for Three Outlet Structures (Fennessey and Jarrett 1997; Line and White 2001; McCaleb and McLaughlin 2008)**

<b>Outlet Structures</b>	<b>Sediment Retention Percentage</b>	
	Range	24-hr Dewatering
Rock Dam Weirs	35 - 69%	40%
Perforated Risers	71 - 97%	94.2%
Floating Skimmers	76 - 99%	96.8%

The wide range of efficiencies can be attributed to site characteristics and basin modifications as well as maintenance issues. For example, the low end of the range for the floating skimmer occurred when the skimmer became mired in sediment and drew water from the bottom of the basin. All other efficiencies reported for the skimmer were greater than 90%.

The second column, based on findings by McCaleb (2008) and Millen (1997), provides a better comparison of the outlet structures. The studies used similar basins designed for a 10-year storm event with no modifications and each outlet was designed to dewater the basin in 24 hours.

Rock dam weirs are inexpensive and simple to construct but provide the least amount of sediment retention. Also, rock dams do not provide consistent dewatering times. Sediment retention can be improved up to 69% with basin modifications such as adding a permanent pool and using silt fence baffles.

Perforated risers dewater the basin from the entire water column, which improves sediment capture. Perforated risers can be accurately designed to dewater a basin in a given time period, but the initial 25% of dewatering is very rapid. Efficiency can be improved with a filtered envelope, but the long term performance and maintenance requirements for these filters need further investigation.

Floating skimmers provide the highest sediment trapping by removing water from the top of the water column, where sediment concentrations are typically lowest. Furthermore, floating skimmers provide a constant discharge rate to the outlet, whereas other head driven passive devices generally have much higher discharges earlier in the detention period; this leads to longer detention times for a larger percentage of the initial volume. Efficiency is greatly reduced if the skimmer is stuck to the bottom, so routine maintenance is needed to insure the skimmer is not mired in sediment or hindered by vegetation. The price of a skimmer depends on basin size and dewatering time but the skimmer is the most expensive of the three passive outlet structures.

### **2.3 Infiltration Devices**

Infiltration devices remove pollutants through sedimentation and filtration. One main concern of all infiltration devices is clogging of the filter media.

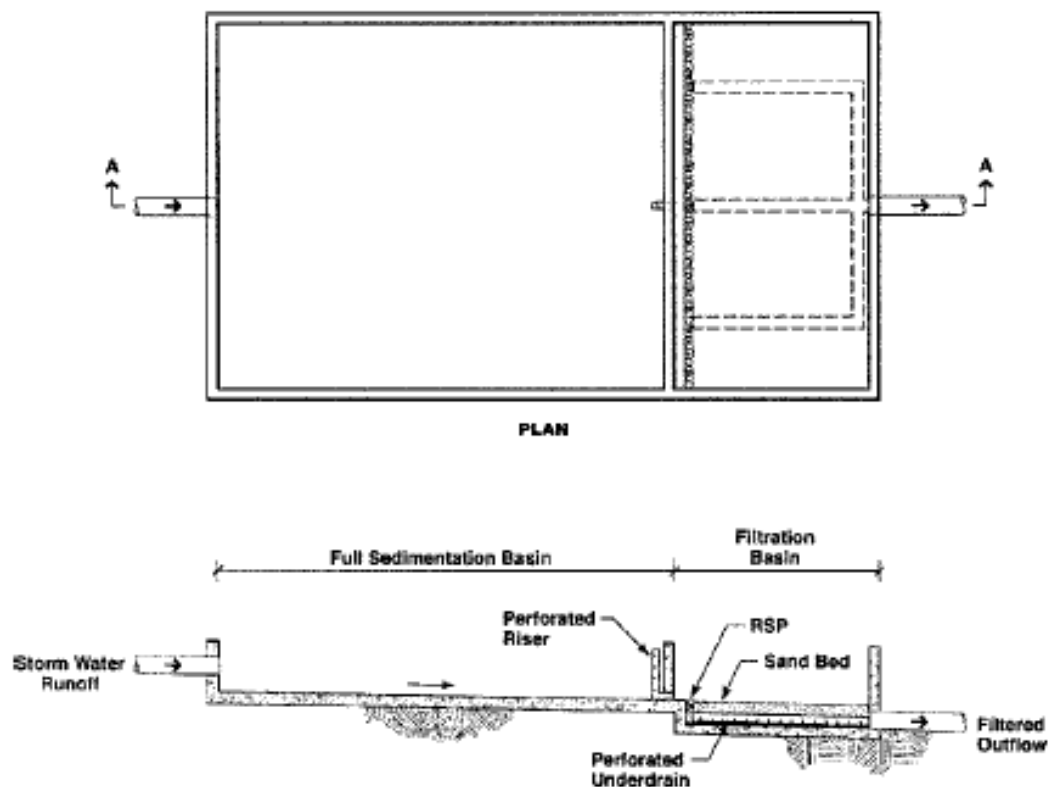
#### **2.3.1 Sand Filters**

Sand filters and other filter media remove pollutants by filtering particulates from water. The type of media and its grain size determines how small of a particle can be removed (Urbonas 1999). The hydraulic conductivity of a sand filter is governed by the hydraulic conductivity of the media and of the accumulated solids on the filter surface. Sand specified for concrete (ASTM C-33 mix) has been shown to provide a good balance between filtering efficiency and hydraulic flow through rates (City of Austin, 1990; Neufeld, 1996; U.S. EPA, 1983; and Veenhuis et al., 1989).

Infiltration systems typically consist of two basins: a settling basin and an infiltration basin (Dechesne et al. 2005). Figure 2-9 shows a typical plan and profile view of an Austin sand filter. In this design, the settling and infiltration basins are connected

by a perforated riser and the water is collected and discharged by perforated underdrains. The sand media depth is a minimum of 18” (46 cm) and typically ranges between 18 and 36 inches (46 – 91cm).

Three case arrangements for settling and infiltration basins are shown in Figure 2-10. Case 1 represents an arrangement where the detention basin completely drains into the infiltration basin through an orifice that controls the flow rate. Similarly, Case 2 controls flow between the basins with a perforated riser, while in Case 3 the outlet between the detention and infiltration basin is oversized and the effluent outflow rate is governed by the flow through rate of the filter.

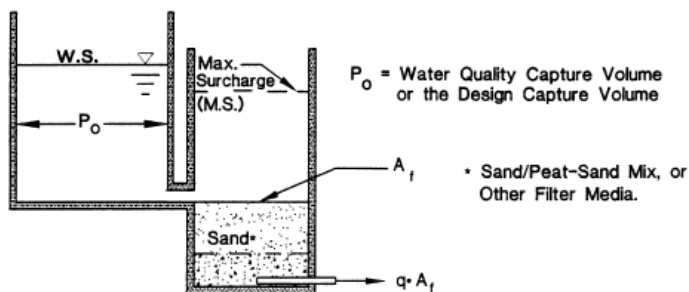


**Figure 2-9 Plan and Profile View of an Austin Sand Filter** (Barrett 2003)

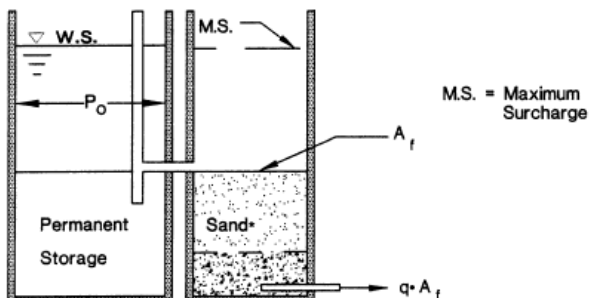
Discharge from the settling basin to the infiltration basin can be either controlled or uncontrolled. An orifice or a passive structure, like those mentioned in the previous section, can be used to regulate flow between the settling and infiltration basins. Using a

control device to decrease the flow rate into the infiltration basin reduces the rate that the hydraulic conductivity of the accumulated sediment layer decreases due to sedimentation in the basin, thus improving hydraulic performance of the basin (Lassabatere et al. 2010).

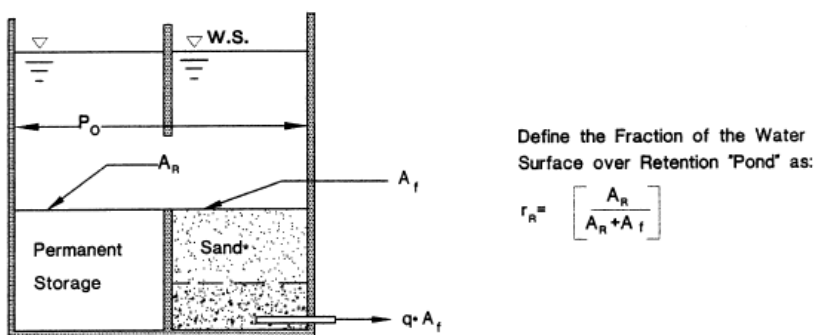
Another benefit of the two basin arrangement is that the sedimentation basin reduces the pollutant loading to the infiltration basin, which helps to prevent clogging. Premature clogging of the filter media, caused by excessive amounts of sediment, is the biggest threat to the long-term successful operation of the filter (Barrett 2003).



Case 1: Detention Basin with Controlled Release Followed by a Filter Media



Case 2: Retention Pond with Controlled Surcharge Release, followed by a Media Filter



Case 3: Combination Retention Pond &amp; Media Filter Without Controlled Release to Filter

**Figure 2-10 Three Settling and Infiltration Basin Arrangements** (Urbonas 1999)

Sand filters provide high pollutant removal efficiencies; according to Urbonas (1999) removal of TSS is in the range of 80-96%. Barrett (2003) found that effluent concentrations of sand filters are generally independent of influent concentrations and proposed that effluent quality is a better comparative measure of sand filter performance than percent removal. It was found in a three year study of five different sites that the TSS concentration in treated runoff was  $7.8 \text{ mg/L} \pm 1.2 \text{ mg/L}$ . This very consistent effluent quality demonstrates that percent reduction is a secondary characteristic of the

device and depends primarily on the influent concentration. Urbonas (1999) found a mean TSS effluent concentration of 16 mg/L based on findings of filters tested at four cities in the U.S.; Alexandria, VA; Austin, TX; Anchorage, AK; and Lakewood, CO. Differences in effluent quality are likely due to variations of accumulated sediment on the sand filter surface; accumulated sediment on the filter surface improves TSS removal efficiency but reduces hydraulic flow through rates (Barrett 2003).

Sand filters also provide nutrient removal. For an average filter basin size of 495 ft<sup>2</sup> (46 m<sup>2</sup>), Barrett (2003) found average removal rates of 22% for total nitrogen (TN) and 39% for total phosphorus (TP). A study by Urbonas (1999) recorded 50-75% removal of TP and 30-50% removal of TN at five field sites. Removal rates depend highly on the sand media used and the surrounding soil characteristics.

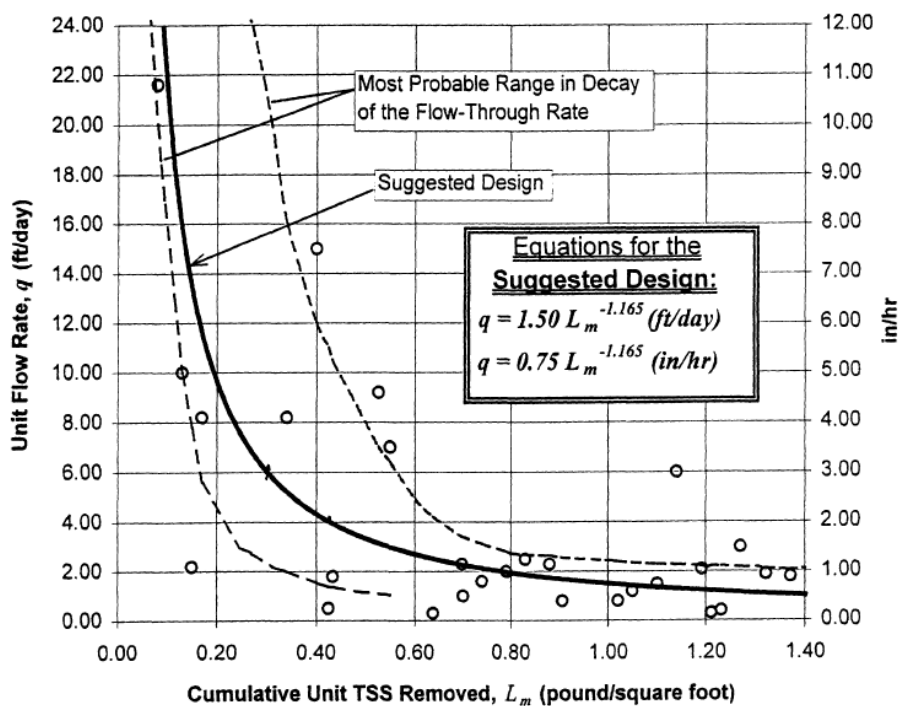
### **Design**

Accumulation of sediment on the filter plays a large role in the design of sand filters. Urbonas (1999) developed a design procedure based primarily on solids loading and removal rates of the filter. The first step in the procedure is to define the target storm water runoff volumes and their average annual TSS loads. Afterwards, an estimate of the TSS removal efficiency of the upstream sedimentation basin allows estimation of the TSS loading to the filter. Table 2.3 shows suggested percent removal rates for sedimentation basins based on design dewatering times and basin types. Detention basins are basins that drain completely while retention basins have a permanent pool.

**Table 2.3 Design Percent Removal Rates of TSS by Basins Upstream of a Media Filter (Urbonas 1999)**

Detention volume drain time (hrs)	Suggested percent removal	
	Detention	Retention
48	60	90
24	55	85
12	50	80
6	40	75
3	30	70
1	20	50

The TSS removal efficiency of the filter depends on the hydraulic flow through rate of the filter. The flow through rate is a function of the total sediment accumulated on the surface of the filter. Figure 2-11 graphically illustrates a correlation between the cumulative retained TSS and the flow through rate.



**Figure 2-11 Flow-through Rate of a Sand Filter as a Function of TSS Removed (Urbonas 1999)**

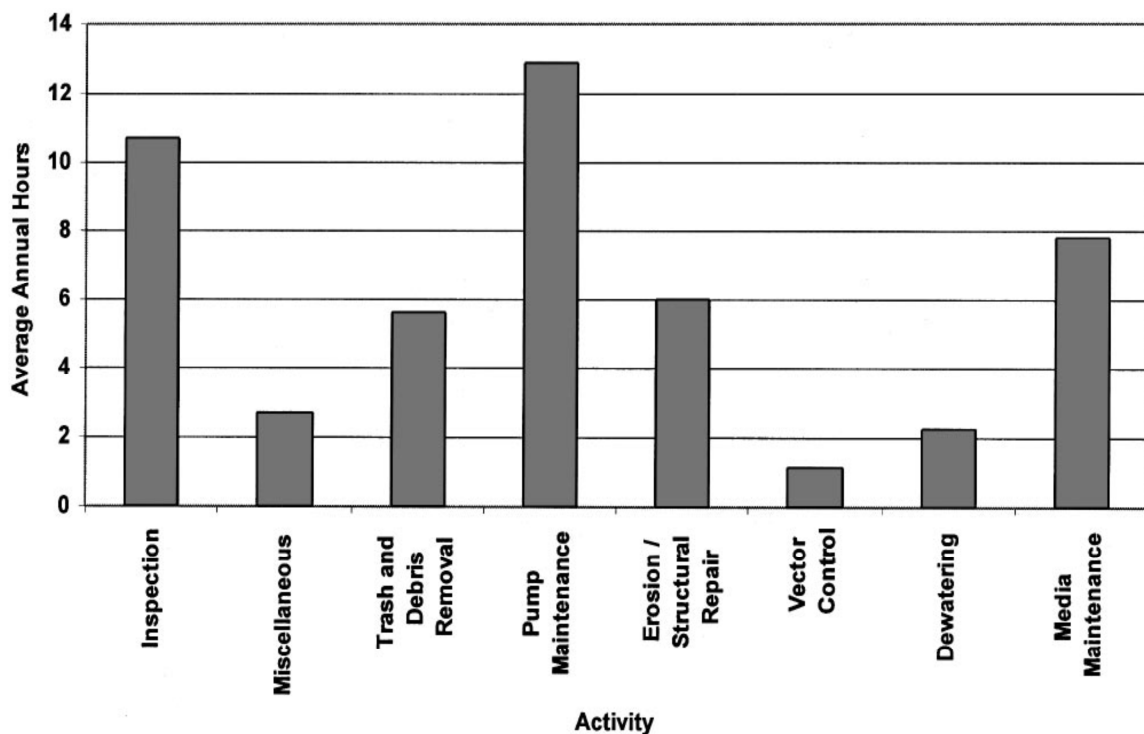
The solids accumulation depends on the frequency of maintenance cycles and accordingly should be taken into account when the filter area is sized. The sand media used should have a median particle size diameter ( $D_{50}$ ) of about 0.5mm with a coefficient of uniformity ( $C_u$ ) of about 2, which is comparable to ASTM C-33 concrete sand.  $C_u$  is a measure of the particle size distribution of a sand media.  $C_u$  is the ratio of  $D_{60}$  to  $D_{10}$ . Based on a coefficient of uniformity value of 2, the sand is uniformly graded or most of the particles are about the same size. After the filter is sized, a procedure is provided by Urbonas (1999) for estimating the pollutant load removals from stormwater runoff.

### **Maintenance and Cost**

Maintenance is an integral part of the operation of sand filters. A typical maintenance cycle begins with dredging and replacing the surface layer, which leads to regaining some of the hydraulic capacity lost due to TSS retained from previous storm events (Urbonas 1999). Surface layer dredging, however, only helps for a few cycles, after which deeper contaminated layers must be removed and replaced with new media. This is usually necessary after 5 to 10 times of surface cleanings. Barrett (2003), however, found that only a small portion of the filter bed surface area was actually used for infiltration during most storm events. Stormwater collected in the lower portions of the filter bed and infiltrated quickly enough so that the water level was never high enough to cover the entire filter surface. As a result, parts of the surface of the filter bed remained in their initial condition after 3 years of operation. Smaller filter areas may be adequate for infiltration but reducing the size of the filter area will increase maintenance frequency.



Sand filters are generally considered high maintenance BMPs. In a three year study, Barrett (2003) stated that about 49 hours per year were required for maintenance activities. Figure 2-12 shows a typical distribution of required maintenance hours at the sand filter sites. Pump repair was the single largest maintenance activity. Pumps were required when there was insufficient hydraulic head at the filter sites to allow for gravity drainage. Dewatering was required to remove standing water from the level spreader, which also provided a breeding site for vectors (e.g., mosquitoes, bacteria, etc.). The level spreader is a weir at the inlet of the infiltration basin designed to distribute water evenly in the infiltration basin. The level spreader was ineffective (runoff tended to collect in the lowest part of the filter bed despite the spreader) and could be replaced by a pad of riprap. Maintenance requirements could be reduced to about 28 h/year by eliminating the level spreader as no vector control or dewatering will be required and thus reducing the necessary inspection frequency. Installing infiltration basins at locations with sufficient hydraulic head to allow gravity drainage of the basins will eliminate pump maintenance activities.

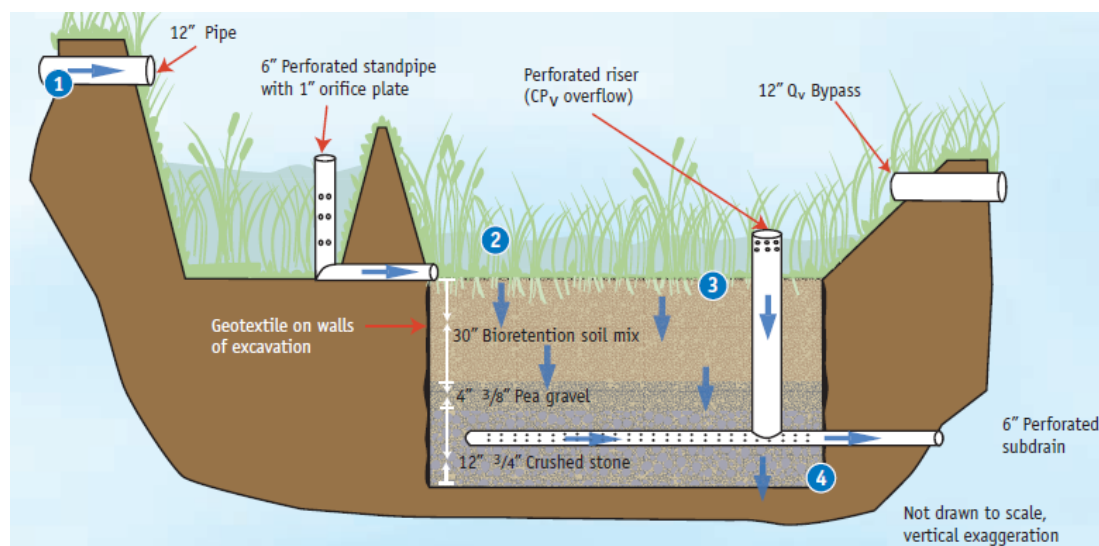


*Figure 2-12 Maintenance Activities at Sand Filter Sites over a Three Year Period*  
(Barrett 2003)

A retrofit project in California resulted in high construction costs, about \$81,000 per acre (\$200,000/ha) of runoff (Barrett 2003). These basins required deep excavations to intercept existing storm drain systems and required pumps since there was not sufficient head to allow for gravity operation, both of which contributed to the increase in costs. The basins were constructed of concrete, and Barrett (2003) estimated that an earthen basin of the same size and configuration would reduce the cost to about \$60,700/acre (\$150,000/ha). Furthermore, lower costs would be expected if the sand filter installation was part of a larger construction project and not a retrofit of an existing system.

### 2.3.2 Bioretention Basins

Bioretention ponds are very similar in design to sand filters, except for the media which is different than that used in infiltration basins. An engineered soil mix is used that will sustain vegetation while providing sufficient hydraulic flow through rates (Roseen et al. 2010). Bioretention systems usually consist of a forebay followed by an infiltration basin. The infiltration basin has sub drains enveloped by a gravel layer placed below 2 to 3 ft (0.6 – 0.9 m) of fill soil media (Hunt 2006). Plants and mulch are added to the surface of the bioretention pond. A cross section of a bioretention pond is shown in Figure 2-13. Bioretention ponds are essentially aesthetically pleasing vegetated sand filters.



**Figure 2-13 Cross Section of Bioretention Pond** (Roseen et al. 2010)

Bioretention ponds provide water quality improvement as well as peak flow mitigation. Hunt (2008) found that for a bioretention pond designed to drain in 24 to 36 hours, outflow peaks were reduced by at least 96% for events ranging in size from 0.07 to 1.57 in (2 to 39.9mm). The bioretention cell had a surface area of 2,480 ft<sup>2</sup> (230 m<sup>2</sup>) with a watershed of 0.92 acres (0.36 ha) Bioretention basins also reduce outflow volumes

through infiltration and evapo-transpiration. Roseen et al. (2010) found during a one year study that outflow volumes were 79% lower than runoff volumes for a 272 ft<sup>2</sup> (25.3 m<sup>2</sup>) basin with a 1 acre (0.4 ha) catchment. This reduction in outflow volume shows that bioretention basins have the potential to reduce flooding and recharge groundwater.

Nutrient removal of total nitrogen is consistently around 32% for bioretention basins (Roseen et al. 2010; Hunt 2006; Hunt 2008). The reduction of total phosphorus (TP) varies greatly from 65% removal to 240% increase (Hunt 2006). This increase is probably short term since over time the basin will likely absorb phosphorus. The large range is the result of the phosphorus index (P-index) of the soil media used in the filter. A P-index of 86 to 100 is indicative that the soil is saturated with phosphorus and has a high risk of delivering it to nearby waterbodies. The method for determining the P-index includes several factors and is outlined in the USDA-NRCS Field Office Technical Note 25 (U.S. Department of Agriculture – Natural Resources Conservation Service 2004)). Accordingly, a high P-index soil will contribute to an increase in TP effluent concentration. Therefore, a lower P-index soil has the potential to enhance the adsorption of phosphorus and should be used in phosphorus sensitive watersheds.

Bioretention cells provide excellent removal of heavy metals. Davis (2003) recorded removal efficiencies above 95% for zinc, copper, and lead. A study by Hunt (2006) of three bioretention ponds recorded 98, 99, and 81% removal for zinc, copper, and lead, respectively. One concern of these high removal rates is the accumulation of heavy metals in the bioretention soil over many years of operation. Using mass balance calculations, Davis (2003) determined that after 15-20 years metals may accumulate to

levels that may present a health risk. Further investigations are necessary to confirm this estimate and to propose appropriate management strategies.

Reports of TSS removal varied significantly for bioretention ponds. (Hunt 2008) found that effluent concentrations were 60% lower than those of the influent. On the other hand, removal efficiency was found to be greater than 95% by Roseen et al. (2006) and an annual removal efficiency of 86% was reported by Roseen et al. (2009). Differences in removal rates are likely the result of differences in the soil media, soil volume, and detention time. More media (depth and area) increases basin efficiency, mainly by producing longer contact time in the media (Li 2009). Also, higher silt, clay, and organic matter content in the bioretention media provides better pollutant filtration.

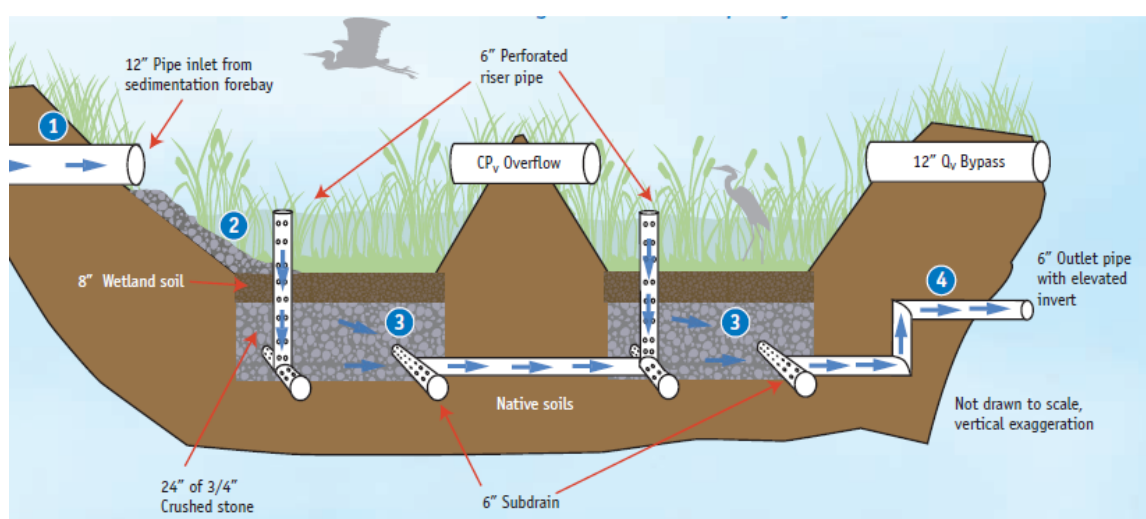
Maintenance requirements are highest during the first three to four months as vegetation grows and the system stabilizes (Roseen et al. 2010). Once vegetation is established maintenance becomes similar to that required for standard landscaping, such as seasonal mowing, raking, and pruning of vegetation. Clogging occurs mainly on the surface, so removal and replacement of only the top layer of mulch or soil is occasionally needed.

The construction cost of a bioretention system was \$14,000 per acre (\$34,500/ha) of watershed drainage area according to Roseen et al. (2010). Labor and installation were calculated to be \$8,500 per acre (\$21,000/ha) and the materials and planting costs were \$5,500 per acre (\$13,500/ha).

### **2.3.3 Wetlands**

There are two main types of constructed wetlands used for stormwater treatment: surface flow (SF) and subsurface flow (SSF) wetlands. SF wetlands are similar to a

natural wetland with slow and shallow flow of water and the presence of emergent vegetation (Mungasavalli 2006). SF wetlands have a free water surface and a gravel, crushed rock, or peat bed. SSF wetlands are a horizontal-flow system as shown in Figure 2-14. Water flows almost exclusively through the vegetation mat and the underlying layer of gravel. The wetland basin is usually filled with 2 feet (0.6 m) of gravel topped by 8 inches (20.3 cm) of wetland soil (Roseen et al. 2010). The outlet pipe has an elevated invert so that the wetland soil remains saturated.



**Figure 2-14 Cross Section of a Subsurface Gravel Wetland** (Roseen et al. 2010)

On average, constructed wetlands remove about 80% of TSS and 60% of nutrients from stormwater runoff (Mungasavalli 2006). Wetlands also attenuate peak flows by greater than 50% (Schaad 2008). Roseen et al. (2010) found peak flow reduction of 87% for SSF wetlands.

SSF wetlands are more efficient than SF wetlands in removing pollutants, providing removal efficiencies of 99% for TSS and 60% for TP (Roseen et al. 2010). SSF wetlands show little seasonal variation in removal efficiencies and frozen filter media does not reduce performance (Roseen et al. 2009). However, clogging of the media of subsurface systems can result in a reduced efficiency (Mungasavalli 2006).

SF wetlands are simpler to construct and maintain. Some SF wetlands are designed specifically for water quality improvement, while others are designed to mitigate the loss of multifunctional natural wetlands (Yu et al. 1998). Well designed and maintained mitigated wetlands can perform adequately as stormwater BMPs without jeopardizing their desired wetland functions.

Yu et al. (1998) evaluated two mitigated wetlands not designed for stormwater treatment that received stormwater runoff as their primary water source. The study found peak flow reductions of 90% and average removal rates of 90% for TSS and 70% for TP. Both sites supported healthy and diverse vegetation and provided habitat for a variety of wildlife.

On average, constructed wetlands remove 80% of TSS and 60% of nutrients from stormwater runoff (Mungasavalli 2006). Wetlands also attenuate peak flows. A wetland with 5.3 acre-ft (6,561 m<sup>3</sup>) of storage and a 675 acre (273 ha) watershed, reduced peak flows for a 25 year storm by greater than 50% (Schaad 2008). Roseen et al. (2010) found an annual average peak flow reduction of 87% for a 5,450 sq. ft. (506 m<sup>2</sup>) SSF wetland with a 1 acre (0.4 ha) watershed.

Maintenance for wetlands may include adjusting plantings, grass cutting, weed control, and trash removal (Mungasavalli 2006). Installing a forebay allows for periodic cleanout of accumulated sediments without disturbing vegetation (Carleton 2000). A forebay prevents clogging of the wetland system, reducing maintenance requirements and extending the lifetime of the wetlands.

### 2.3.4 Comparison and Conclusions

There are three main infiltration devices used to treat stormwater runoff: sand filters, bioretention, and constructed wetlands. All three devices effectively remove pollutants and reduce peak flows. Table 2.4 shows TSS and nutrient removal rates for the three infiltration devices.

**Table 2.4 Removal Rates for Infiltration Devices (Urbonas 1999; Barrett 2003; Roseen et al. 2010; Hunt 2008; Mungasavalli 2006; Yu et al. 1998)**

Filter Device	TSS Removal	Nutrient Removal	
		Total Phosphorus	Total Nitrogen
Sand Filter	80-96%	40-75%	15-50%
Bioretention	60-95%	0-65%	20-40%
Wetlands	80-99%	60-70%	50-60%

Comparisons of infiltration devices are difficult because of variability in filter media, climatic conditions, design parameters, and soil conditions. Nutrient removal, for example, is highly dependent on the type of filter media used. Improper filter media can result in negligible removal or even export of nutrients.

Sand filters provide high removal efficiencies with a relatively small footprint but they have a high construction cost. Sand filters do require significant maintenance, consisting of surface cleanings and replacement of the sand media. However, no upkeep of vegetation is required.

Bioretention provides high removal efficiencies for solids, nutrients, and metals. Bioretention ponds require maintenance similar to standard landscaping with the addition of cleaning the topsoil layer if clogging occurs. Bioretention areas are aesthetically pleasing and can meet both water quality and landscape objectives.

Constructed wetlands can have low construction costs but require large land areas. There are two main types of wetlands: surface (SF) and subsurface (SSF) wetlands. SSF



wetlands provide better pollutant removal but SF wetlands are simpler to construct and maintain. Constructed wetlands can also serve a dual purpose: mitigation of wetland losses and improving stormwater quality.

All three filtration devices have a forebay or sedimentation basin upstream of the filter to prevent clogging and extend the life of the filter. One major concern of filter devices is the potential for soil and groundwater contamination. Current estimates predict 15-20 years of operation before pollutant accumulation reaches levels that pose a health risk. Further investigation is needed to determine the long term effects of infiltration devices.

## **2.4 Mechanical Outlets**

Mechanical outlets improve sediment retention by creating a delay between the inflow and outflow hydrographs, allowing more time for solids to settle out.

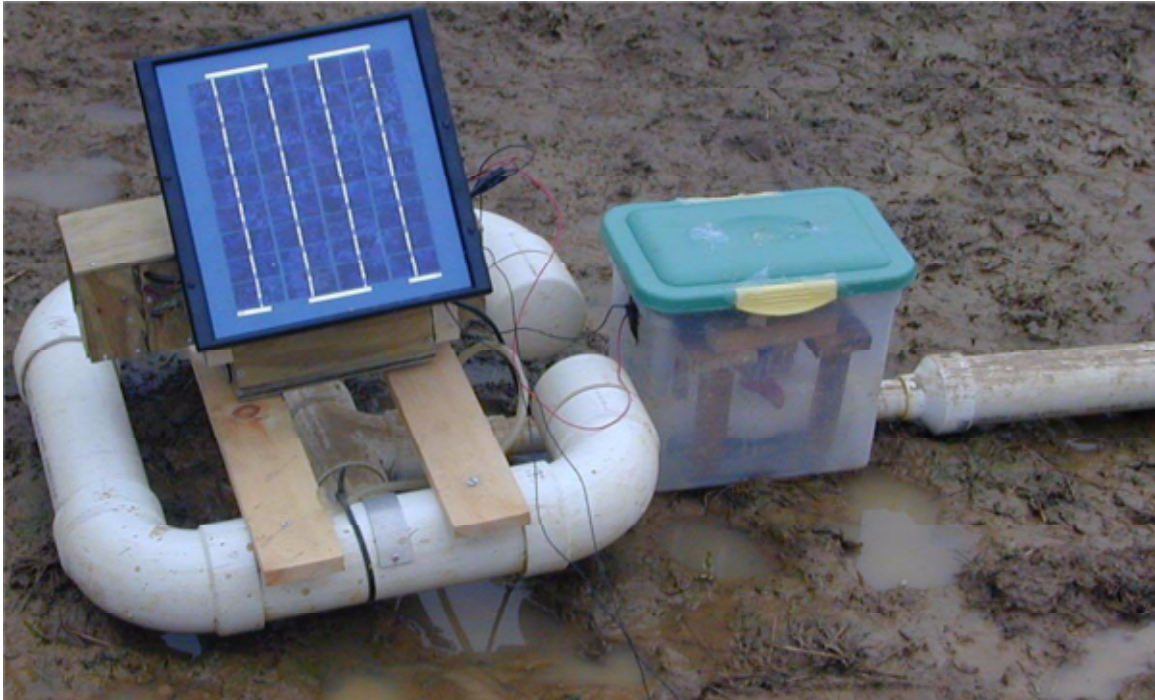
### **2.4.1 Electro-Mechanical Skimmer**

An electro-mechanical skimmer is a modified Faircloth Skimmer mounted with a solar-powered outlet control device (Bidelspach and Jarrett 2004). This device is logically controlled and can create a delay between the basin's inflow and outflow hydrographs by opening and closing a valve in the skimmer arm. Figure 2-15 shows the control device attached to the modified skimmer.

#### **Design**

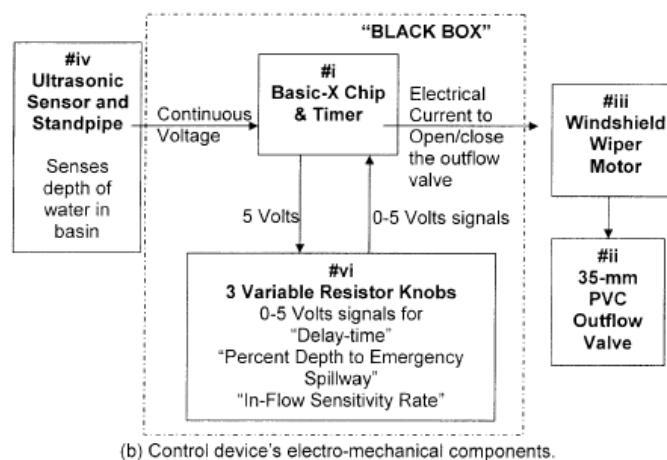
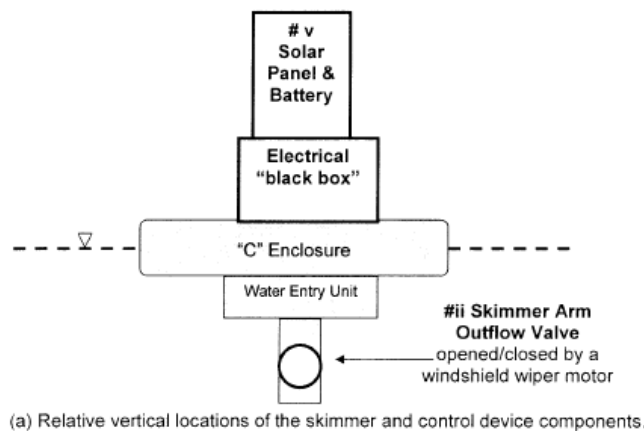
The delay time control device consists of a solar panel, battery, "black box", motor, and outflow valve. Figure 2-15 shows the locations of control device components. A PVC ball valve was installed on the skimmer arm to control outflow from the basin. A

windshield wiper motor was used to both open and close the outflow valve. An ultrasonic sensor with 0.14 in (3.5mm) resolution was used to measure the water depth in the basin.



***Figure 2-15 Electro-Mechanical Skimmer*** (Bidelsphach et al. 2004)

The main components of the “black box” were a Basic-X micro-controller with built-in timer clock and three variable resistors, as shown in Figure 2-16. The Basic-X chip was programmed with five functions to implement the delay-time control. The first function closed the outlet valve when the water level in the basin rose above a preset elevation, typically the top of the sediment storage depth. The second function caused the outflow valve to remain shut as long as the inflow rate was greater than a preset inflow rate. The preset inflow rate was the change in water depth divided by the time interval between readings multiplied by the slope of the basin’s stage-storage relationship.



**Figure 2-16 Schematic of (a) Locations of the Skimmer and Control Device Components and (b) Control Device's Electro-mechanical Components** (Bidelspach and Jarrett 2004)

The third function started a timer when the depth of the water was greater than the sediment storage depth and the inflow rate was less than the user-specified inflow sensitivity rate. The timer was user-adjustable and controlled the duration of the period between the end of the inflow event and the start of dewatering. The fourth function opened the valve after the delay-time elapsed. The fifth function automatically opened the valve when the water depth in the basin was within a user-set percentage of the depth of the auxiliary spillway. In other words, if the inflow volume was larger than the basin,

this function opened the outflow valve on the skimmer before the water level reached the auxiliary spillway.

### Performance

Bidelsphach et al. (2004) used the electro-mechanical skimmer in an experiment consisting of four treatments based on introducing the delay time between the inflow and outflow hydrographs. Treatment 1 was the control and was designated the no delay treatment; water was discharged as soon as it reached the outlet. Treatments 2, 3, and 4 were created by opening the skimmer valve 0h, 12h, and 168h, respectively, after the inflow hydrograph finished entering the basin. The earthen basin had a length to width ratio of 2:1, with an overall length of approximately 60 ft (18.3m). The basin contained 500 ft<sup>3</sup> (14 m<sup>3</sup>) of sediment storage and 5000 ft<sup>3</sup> (142 m<sup>3</sup>) of water storage capacity. Table 2.5 shows the results from the different delay time treatments.

**Table 2.5 Results from Delay Time Treatments (Bidelsphach et al. 2004)**

Result	Delay Time			
	No delay	0 h	12 h	168 h
Cumulative sediment loss (kg)	14.7	13.3	9.4	3.1
Water volume exiting through the principal spillway (m <sup>3</sup> )	87.0	84.5	74.5	9.9
Peak outflow rate (L/s)	0.96	1.23	1.18	0.78
Peak outflow rate for no infiltration evaluation (L/s)	0.96	1.20	1.20	1.20
Peak outflow sediment concentration (g/L)	0.68	0.42	0.22	0.11
Median outflow sediment concentration (g/L)	0.35	0.14	0.11	0.032
Sediment retention efficiency based on all injected particles (%)	96.8	97.1	97.9	99.3
Sediment retention efficiency based on particles <45 μm (%)	90.5	91.4	93.9	98.0

The differences in water volume exiting through the principal spillway show that significant infiltration occurred during the delay period. As expected, the no delay

treatment had the lowest retention efficiency based on all injected particles (96.8%), and efficiency increased with the delay time. For the 12h delay time, the mean effluent concentration was 11 mg/L, which corresponded to 97.9% retention efficiency.

### **Cost and Maintenance**

The components of the delay time control device, not including the Faircloth skimmer, were purchased for about \$1550. The most expensive components were the ultrasonic water depth sensor, \$750, and the solar panel, \$268.

Reliability is the issue of most concern for this device. One reliability issue was the ability of motor to open the outlet valve. Because of the valve's excessive friction, the motor on some occasions was unable to open the valve, overloading the motor. This issue was not corrected and in future designs a larger motor or a different valve are needed to increase reliability. Another problem was that the sealant on the top of the motor case leaked, causing it to flood, and resulting in failure of the unit. To fix this problem, the skimmer had to be modified and enlarged to increase buoyancy of the skimmer. Also, since the entire device floated on the water, water damage to electrical components was of constant concern.

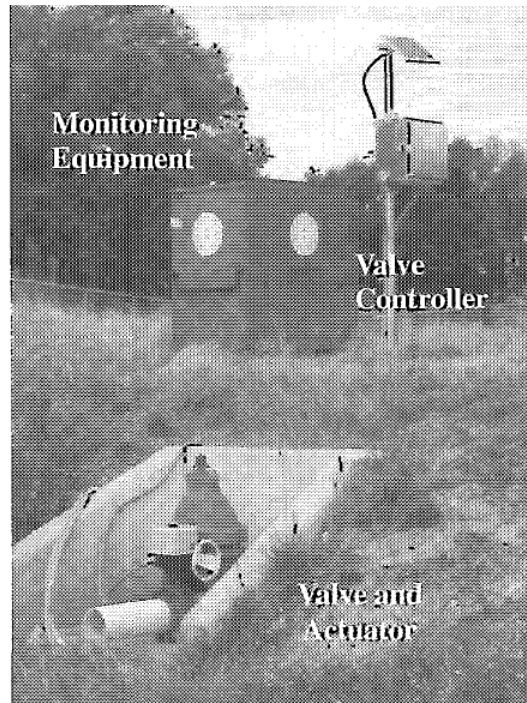
#### **2.4.2 Perforated Riser with Valve Control**

Middleton and Barrett (2008) performed a study on a structural BMP - a detention basin followed by a sand filter that was not functioning properly. It was found that the design and construction issues were associated with the filter portion of the system, so an alternative outlet configuration was needed. An automated valve and controller were installed on the outlet of the detention basin. The detention basin was lined and contained 52,000 ft<sup>3</sup> (1472 m<sup>3</sup>) of water storage.

The original outlet structure for the detention basin was a perforated riser pipe. A perforated riser begins to discharge runoff at the instant the runoff reaches the outlet. As a result, the first flush, which typically contains the highest pollutant concentrations, has the shortest residence time and receives the least amount of treatment. To increase residence time, an automated valve with a controller was added to the existing outlet structure.

### **Design**

A butterfly valve with an actuator, installed in the outlet pipe below the perforated riser, was used to control the outflow. The controller was housed in a lockable enclosure for security and safety purposes. The enclosure and solar panel were mounted on a metal pole near the outlet. The system was designed to supply power for 5 consecutive storm cycles without recharging. A level sensor float switch was used to detect the water level in the basin. Figure 2-17 shows the valve/actuator and controller installed at the site.



*Figure 2-17 Valve, Actuator, and Controller (Middleton and Barrett 2008)*

The delay time function was provided by an IDEC FL1C programmable logic controller. The controller was programmed so that the default valve position is closed. The detention timer starts when the float switch is activated by runoff filling the basin. After a preset time period elapses, the valve opens, and dewatering of the basin begins. When the float switch detects that the basin has emptied, the controller waits an additional 2 hours before closing the valve, to ensure the basin has drained completely.

### **Performance**

The effluent TSS concentration for a 12 hour delay time was 7 mg/L for all monitored storm events. This resulted in a percent reduction of 91%, which exceeds conventional detention basins.

**Table 2.6 Basin Performance for Various Constituents (Middleton and Barrett 2008)**

summarizes sampling results and performance of the modified outlet structure for various constituents.

**Table 2.6 Basin Performance for Various Constituents (Middleton and Barrett 2008)**

Constituent	Influent EMC (range)	Effluent EMC (range)	Reduction %	p-value
Total copper (µg/L)	8.6 (4.40 to 12.10)	3.9 (2.10 to 8.41)	55	>0.001
Total lead (µg/L)	3.2 (1.51 to 5.74)	<1.00 <1.00 to <1.00	69	>0.001
Total zinc (µg/L)	42.37 (21.10 to 76.10)	15.89 (7.36 to 29.8)	62	>0.001
Dissolved copper (µg/L)	3.03 (1.88 to 5.63)	3.35 (1.83 to 7.01)	-11	0.225
Dissolved lead (µg/L)	<1.02 <1.02 to <1.02	<1.02 <1.02 to <1.02	Not applicable	Not applicable
Dissolved zinc (µg/L)	16.41 (4.35 to 25.20)	12.54 (4.82 to 17.70)	-13	0.251
COD (mg/L)	51 (34 to 74)	33 (16 to 62)	34	>0.001
Nitrogen, nitrate + nitrite (mg/L)	0.44 (0.28 to 0.80)	0.19 (<0.02 to 0.65)	58	0.005
Dissolved phosphorus (mg/L)	0.10 (<.020 to 0.70)	0.09 (<0.020 to 0.28)	7	0.040
Total phosphorus (mg/L)	0.28 (0.06 to 0.74)	0.14 (0.03 to 0.33)	52	0.004
Total Kjeldahl nitrogen (mg/L)	1.27 (0.74 to 3.91)	0.83 (0.40 to 2.69)	35	0.007
TSS (mg/L)	72 (27 to 134)	7 (1 to 10)	91	>0.001

Adding a delay between the inflow and outflow hydrographs improves the retention efficiency of the perforated riser. Also, the outlet concentrations for TSS and other constituents are similar to or lower than sand infiltration basins.

### Cost and Maintenance

The entire valve, actuator, and controller system cost was about \$1,550. The footprint of the modified detention basin is 15% smaller than an equivalent sand filter basin, which reduces the cost of the BMP. Also, this modified outlet structure can be used where available head is limited but the performance of a sand filter is desired. The valve operation of the outlet structure allows it to be operated as a hazardous material trap.

The design is relatively simple and uses readily available components. Reliability is addressed by minimizing the number of electronic and mechanical parts and making field replacement of parts as easy as possible. This study reported no mechanical or



electrical problems; however, long-term evaluation of performance and reliability is needed.

### 2.4.3 Comparisons and Conclusions

The perforated riser with valve control and the electro-mechanical skimmer have many similarities. Both mechanical outlets are modifications of passive outlet structures. The mechanical outlets create a delay between the inlet and outlet hydrographs, which captures first flush and improves retention efficiencies. The two devices are solar powered, logically controlled, and programmable. Also, the components of each device cost about \$1,550.

Both devices provided good retention efficiencies. Table 2.7 shows the comparative performance when a 12 hour delay time between the inflow and outflow hydrographs was used.

**Table 2.7 Comparison of Mechanical Outlets for a 12 hour Delay Time (Bidelsphach et al. 2004; Middleton and Barrett 2008)**

Outlet Type	12 hour Delay	
	Effluent (mg/L)	Retention Efficiency (%)
Electro-Mechanical Skimmer	11	98
Perforated Riser w/Valve Control	7	91

The electro-mechanical skimmer provides high retention efficiency and many programmable options. The electro-mechanical device adds reliability concerns. Also, the addition of the device requires modification to a standard floating skimmer to increase buoyancy and to properly balance the device.

The perforated riser with valve control provides excellent effluent water quality and allows the basin to be used as a hazardous material trap. There are fewer reliability

concerns with this mechanical device as the electronic and mechanical parts can be housed in a protective case that is mounted on dry land. Both devices need further investigation of long term performance and maintenance.

## **2.5 Summary of Outlet Devices**

Three types of outlet devices were reviewed in the literature: passive outlet structures, infiltration devices, and mechanical outlets. Table 2.8 gives a summary of different sizing and performance characteristics for the three passive outlet structures. Rock dams provided the least sediment retention, while floating skimmers provided the most. However, perforated risers also had sediment removal greater than 90%. Rock dams are inexpensive and simple to construct but do not provide consistent dewatering times. Perforated risers provide adequate dewatering times but the initial 25% of dewatering is very rapid. Floating skimmers provide the highest sediment trapping but are the most expensive and most likely to experience maintenance issues.

**Table 2.8 Summary of Passive Outlet Structures**

<i>Device</i>	<i>Study</i>	<i>Watershed (ha, acre)</i>	<i>Basin Volume (m<sup>3</sup>, yd<sup>3</sup>)</i>	<i>Design Storm (yr)</i>	<i>Dewatering Time (hr)</i>	<i>Retention Efficiency (%)</i>
<b><i>Rock Dams</i></b>						
	(Line and White 2001)	2, 4.94	59, 77	10	-	69%
	(Line and White 2001)	4, 9.88	200, 262	10	-	59%
	(Line and White 2001)	4, 9.88	200, 262	10	-	58%
	(McCaleb and McLaughlin 2008)	1, 2.47	128, 167	10	-	35%
	(McCaleb and McLaughlin 2008)	0.8, 1.97	75, 98	10	-	73%
	(McCaleb and McLaughlin 2008)	0.6, 1.48	242, 317	10	-	45%
<b><i>Perforated Risers</i></b>						
	(Rauhofer et al. 2001)	0.4, 1	51, 67	2	24	91.7%
	(Fennessey and Jarrett 1997)	0.4, 1	140, 183	2	24	94.2%
	(Fennessey and Jarrett 1997)	0.4, 1	140, 183	2	24	95.5%
<b><i>Floating Skimmers</i></b>						
	(Rauhofer et al. 2001)	0.4, 1	51, 67	2	24	94.2%
	(McCaleb and McLaughlin 2008)	1.4, 3.5	882, 1154	25	-	99.6%
	(Fennessey and Jarrett 1997)	0.4, 1	140, 183	2	24	96.8%
	(Fennessey and Jarrett 1997)	0.4, 1	140, 183	2	24	96.5%

A summary of infiltration device characteristics is shown in Table 2.9. Sand filters, bioretention, and constructed wetlands effectively remove pollutants and reduce peak flows. Sand filters have a relatively small footprint but have a high construction cost. Maintenance consists of surface cleanings and replacement of the sand media but no upkeep of vegetation is required. Bioretention can meet both water quality and landscape objectives. Maintenance is similar to standard landscaping with the addition of cleaning the top soil layer. Constructed wetlands typically have low construction costs but require large land areas.

Table 2.9 Summary of Infiltration Devices

Device	Study	Watershed (ha, acres)	Sediment Basin Size (m <sup>2</sup> , ft <sup>2</sup> )	Filter Basin Size (m <sup>2</sup> , ft <sup>2</sup> )	Design Storm (yr)	Dewatering Time (hr)	Retention Efficiency (%)	Peak Flow Reduction (%)
<b><i>Sand Filters</i></b>								
	(Barrett 2003)	0.7, 1.7	102, 1098	40, 431	10	24	85%	
	(Barrett 2003)	1.1, 2.7	114, 1227	57, 614	10	24	82%	
	(Barrett 2003)	1.1, 2.7	180, 1938	72, 775	10	24	70%	
	(Barrett 2003)	0.3, .75	56, 603	32, 345	10	24	92%	
<b><i>Bioretention</i></b>								
	(Hunt 2008)	0.37, .91	-	229, 2465	10	24	60%	96%
	(Li 2009)	0.28, .69	-	181, 1948	10	24	96%	-
	(Li 2009)	0.45, 1.1	-	102, 1098	10	24	99%	-
	(Roseen et al. 2006)	0.4, 1	303, 3261	218, 2345	10	24	95%	85%
	(Roseen et al. 2010)	0.4, 1	10.4, 112	25.3, 272	2	24	86%	79%
<b><i>Wetlands</i></b>								
	(Mungasavalli 2006)	5-10, 12-24	-	-	10	24	80%	-
	(Schaad 2008)	64.3, 159	76, 818	10,500, 113,020	25	24	45%	50%
	(Carleton 2000)	2.9, 7.2	9, 97	125, 1345	10	24	65%	
	(Hatt 2007)	2.0, 4.94	-	5,000, 53,820	10	24	55%	40%
	(Hatt 2007)	2.8, 6.9	-	4,000, 43,055	10	24	90%	46%
	(Roseen et al. 2010)	0.4, 1	30, 323	45, 484	2	24	99%	87%

Table 2.10 summarizes the characteristics of the mechanical outlets found in the literature. Both the electro-mechanical skimmer and the perforated riser with valve control are modifications of passive outlet devices. Both devices provided excellent effluent water quality but add more reliability concerns because of the electronic and mechanical parts.

**Table 2.10 Summary of Mechanical Outlets**

Device	Study	Watershed (ha)	Basin Volume (m <sup>3</sup> , yd <sup>3</sup> )	Design Storm (yr)	Delay Time (hr)	Retention Efficiency (%)	Sediment Concentration (mg/L)
<i>Electro-Mechanical Skimmer</i>							
	(Bidelsphach et al. 2004)	0.4, 1	155, 203	2	No Delay	96.8%	35
		0.4, 1	155, 203	2	0	97.1%	14
		0.4, 1	155, 203	2	12	97.9%	11
		0.4, 1	155, 203	2	168	99.3%	3
<i>Perforated Risers with Valve Control</i>							
	(Middleton and Barrett 2008)	10.5, 26	1480, 1936	2	12	91%	7

Two of the passive outlet devices, the perforated riser and floating skimmer, provided similar sediment removal rates as the infiltration and mechanical outlets. Additionally, the perforated riser and floating skimmer have fewer maintenance requirements and reliability concerns compared to the other outlet device types.

## 2.6 Influent Sediment Characteristics

Influent sediment concentrations and particle size distributions in runoff are very important in designing BMPs. These characteristics affect sizing and removal efficiency of basins.

### 2.6.1 Sediment Concentrations

The influent TSS concentrations are often used to size basins and design the outlet. In studies found in the literature, TSS concentrations in stormwater runoff varied from about 40 to 800 mg/L. TSS concentrations vary widely depending on storm events, rainfall intensity, event frequency, site characteristics, and soil types.

In California, for small impervious watersheds the average TSS influent concentration was 90 mg/L (Barrett 2003). In a study by Middleton and Barrett (2008) of highway runoff, the average TSS concentration was 72 mg/L with a range of 27-134 mg/L. In another study of highway runoff in Texas, Li and Barrett (2008) found mean influent concentrations at 6 sites varied from 116 to 173 mg/L. Hunt (2008) found an average TSS concentration of 283 mg/L in a study in urban Charlotte, N.C.

Two watersheds in Lincoln, NE were monitored for three years in a study by Fisher (2011). The watersheds were mainly residential, with about 40% impervious cover. For the Colonial Hills watershed, TSS concentrations during storm events ranged from 43-762 mg/L, with an average of 180 mg/L. At the other site, Taylor Park, concentrations ranged from 40-464 mg/L, with an average of 210 mg/L. Samples at both sites were taken with an auto-sampler and grab samples.

## **2.6.2 Particle Size Distributions in Highway Runoff**

Particle size of sediment affects removal efficiencies both in settling and filtration processes. Also, particle size affects transportation of contaminants. Fine grained particles transport more pollutants because of their large surface area and good adsorption properties. Fine sediment particles, up to about 250  $\mu\text{m}$ , are easily transported in suspension (Jartun 2008).

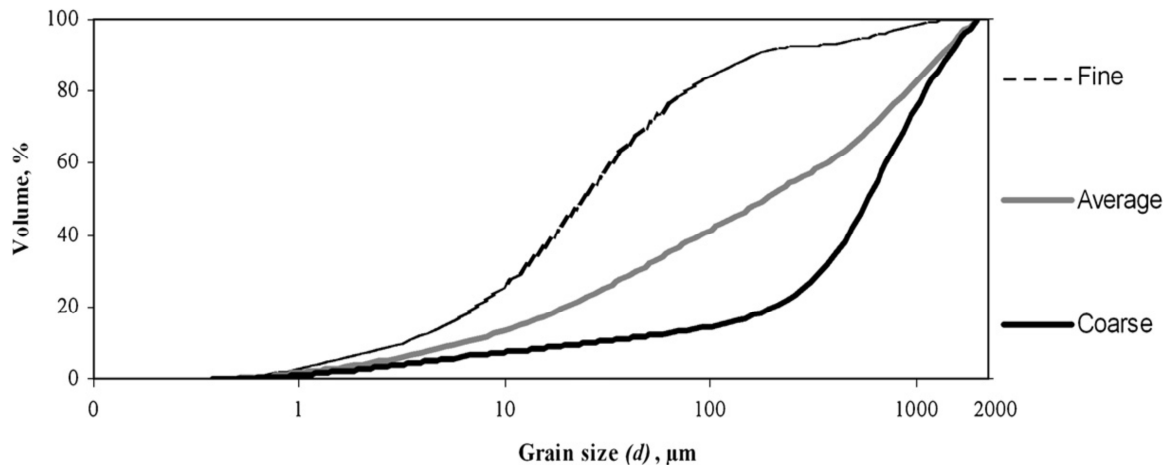
Particle size distributions vary greatly by area and by storm. In a study by Jartun (2008), samples were taken from 68 small stormwater traps in the city of Bergen, Norway. Grain size distributions were done on 21 samples. A summary of these distributions is shown in Table 2.11.

**Table 2.11 Summary of Particle Diameters (Jartun 2008)**

Sample ID	d at 10% vol.	d at median vol.	d at 90% vol.	Sample ID	d at 10% vol.	d at median vol.	d at 90% vol.
1	14.83	438.6	1604	40	16.54	511.7	1453
6	9.140	550.0	1712	45	29.30	599.3	1583
8	26.66	586.2	1435	47	4.917	275.9	1157
12	12.89	164.0	1303	51	8.448	256.3	918.8
13	18.75	171.0	1129	53	2.074	23.18	139.4
17	3.540	48.70	614.6	56	8.045	341.5	1569
21	3.119	23.92	160.4	61	13.17	337.5	1321
22	9.161	285.5	1333	65	5.315	99.52	1376
23	32.50	231.7	1297	67	1.956	19.77	215.7
37	22.95	646.7	1608	68	5.051	69.70	857.1
38	6.132	226.3	1295				

Particle diameter in  $\mu\text{m}$  at 10%, 50% (median) and 90% of sample volume.

The samples had a wide range of particle sizes from 0.4 to 2000  $\mu\text{m}$ . The median grain size ranged from 23 to 646  $\mu\text{m}$ . However, the samples had a wide variety of grain size distributions, some samples were mostly clay and silt, while others had a main fraction of coarse sand. Figure 2-18 shows grain size distributions for a fine-grained, average, and coarse-grained sample.

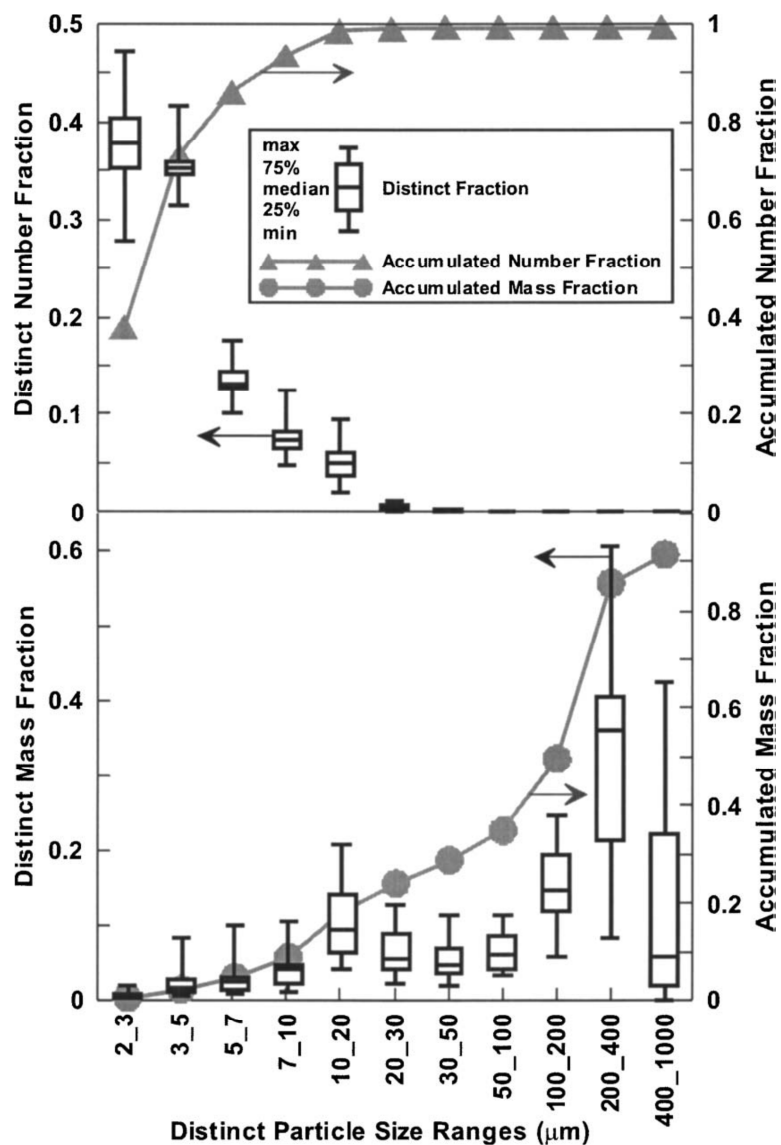


**Figure 2-18 Grain Size Distributions for a Fine, Average, and Coarse Grained Sample (Jartun 2008)**

Seven rainfall events at three highway sites in west Los Angeles were monitored for particle size distributions in a study by Li et al. (2006). The study found that more than 90% of the particles in number were less than 10  $\mu\text{m}$  and most were less than 30

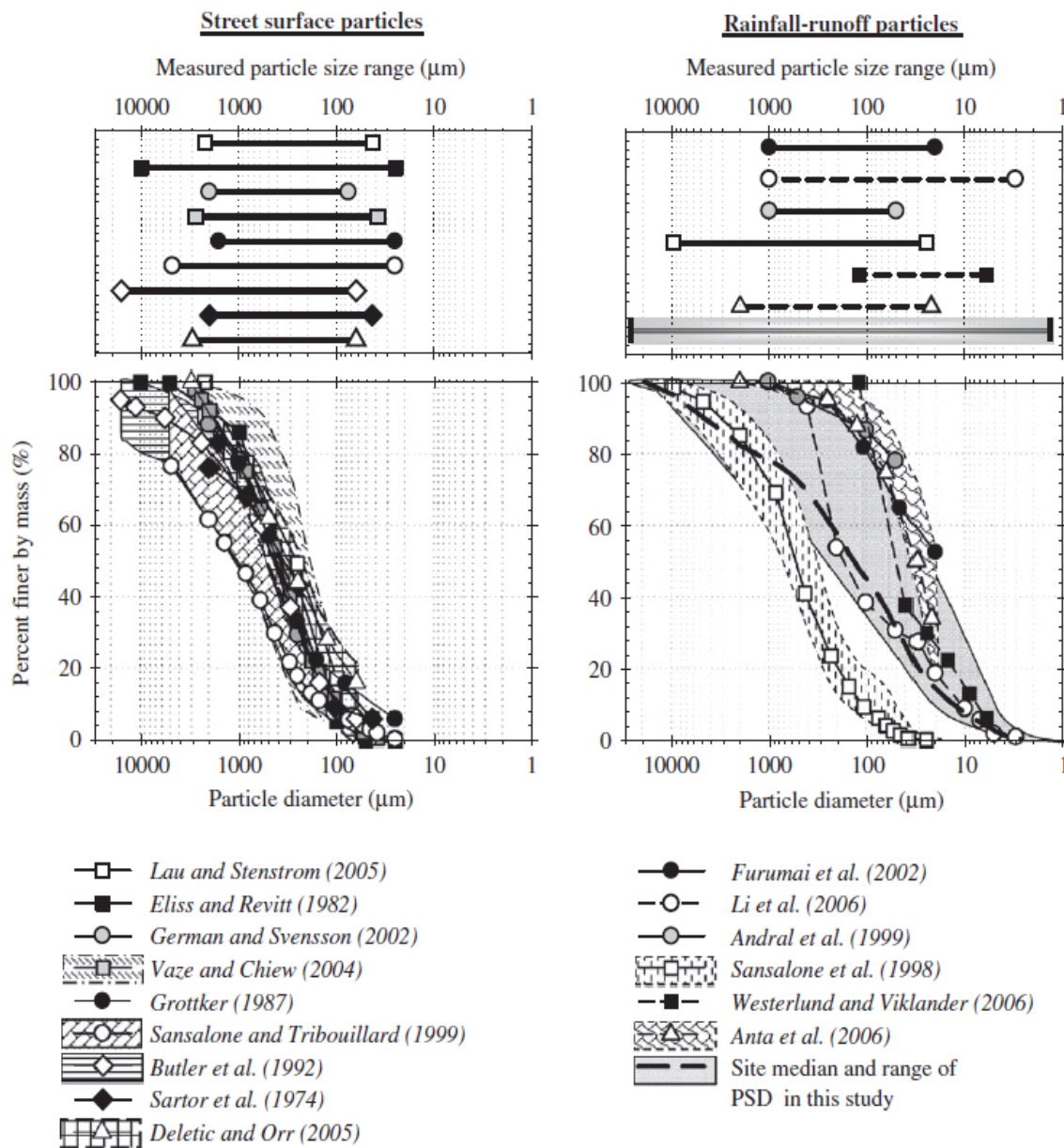
$\mu\text{m}$ . The median particle diameter, based on counted particles, ranged from 2.72 to 7.15  $\mu\text{m}$ . Figure 2-19 shows the number fraction and mass fraction of particles in different size ranges. Figure 2-19 shows that small particles are large in number but have a small contribution to mass. Particles less than 10  $\mu\text{m}$  contribute less than 10% of the mass even though they are greater than 90% of the particles in number. Sixty percent of the mass comes from particles larger than 100  $\mu\text{m}$ . The study also demonstrated first flush, showing a sharp falloff in particle concentration after the beginning of the storm. Other studies referenced by Li et al. (2006) state that particles less than 50  $\mu\text{m}$  in diameter were 70-80% of the TSS load carried by runoff by weight and particles less than 20  $\mu\text{m}$  accounted for more than 50% of the particulate mass for runoff samples with TSS concentrations less than 100 mg/L.





*Figure 2-19 Particle Number Fraction of all Events* (Li et al. 2006)

Kim and Sansalone (2008) studied particle size distributions from bridge deck runoff in Baton Rouge, LA. The study found that fine particles, less than 75  $\mu\text{m}$ , accounted for 25 to 80% of the gradation on a mass basis; gravel sized particles, greater than 2000  $\mu\text{m}$ , accounted for 0.5 to 30%. The mean  $D_{50}$  for all events was 136  $\mu\text{m}$ . Figure 2-20 shows a comparison of particle size from street surface and runoff from published articles.



**Figure 2-20 Comparison of Particle Sizes on Urban Street Surfaces and in Runoff**  
(Kim and Sansalone 2008)

### 2.6.3 Conclusions

Particle size distributions in stormwater runoff vary greatly depending on storm events and watersheds. Particle sizes in runoff typically fall in the range of 0.4 to 2000  $\mu\text{m}$ . The median particle size, or  $D_{50}$ , is usually between 25 to 250  $\mu\text{m}$ . The particles of

most concern are fine sediment particles, up to about 250  $\mu\text{m}$ , because they carry the most pollutants and are easily suspended.

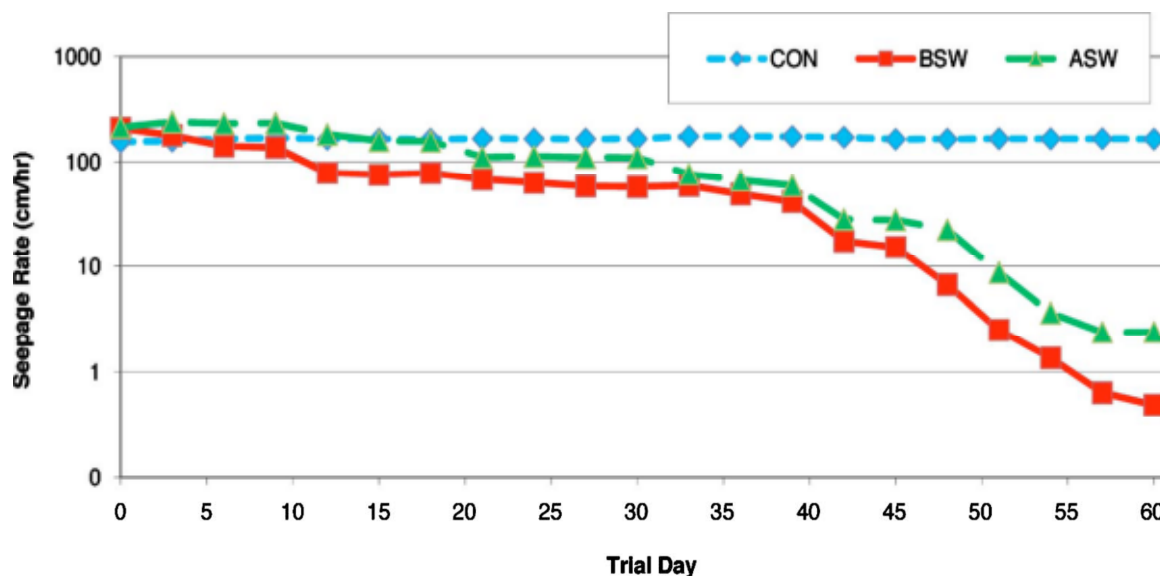
## **2.7 Clogging**

The major disadvantage of any infiltration or filtered outlet device is the high likelihood of failure due to clogging. Clogging of filters is studied extensively in many areas of water resources, such as potable water filters. However, there are major differences in potable water filters and stormwater filtration BMPs. Sand filters have steady inflow rates and ponding heads, whereas BMPs have variability in incoming runoff and experience unsaturated media during dry weather periods (Li 2008). Also, stormwater has much higher solids concentrations than water used for potable water treatment (Siriwardene 2007b). Recent studies have begun to investigate clogging for stormwater filtration, focusing on when infiltration will be reduced to unacceptable levels.

### **2.7.1 Column Tests**

Bright (2010) performed sand column experiments to determine infiltration rates over time and bacteria removal by sand columns. The experiments were used to determine the effectiveness of two Dune Infiltration Systems (DIS) to reduce stormwater pollution at Kure Beach, N.C. The sand used in the experiments was Newhan Fine sand and was sieved through a 0.19 in (0.48 cm) opening to remove clay aggregates. Nine columns were studied using three treatments: loading with DI water (CON), loading with autoclaved stormwater runoff (ASW), and loading with bacteria spiked stormwater runoff (BSW). Trials were run every third day for 60 days to simulate the median number of days between precipitation events in North Carolina. The seepage rate over time is shown

in Figure 2-21. After the 18<sup>th</sup> trial (Day 54) the seepage rate in the ASW column was similar to the infiltration rate of silty soil, which is the type of the local soil.



**Figure 2-21 Average Treatment Seepage Rate Over Time** (Bright 2010)

Based on the findings of this study, bimonthly maintenance is recommended because that is when the seepage rate reaches 1.3 cm/h, which is also the rainfall intensity used to design the DIS. Over-sizing the DIS would reduce the maintenance frequency.

Fine media was studied by Hatt (2008) using column experiments. Fine sand, sandy loam, and a mixture of sand and compost were tested. The filter columns were dosed with semi-synthetic stormwater which had 150 mg/L of TSS and other nutrients and heavy metals. The fine sand media had the lowest initial seepage rate,  $7.23 \times 10^{-5}$  m/s, but only lost 4% of its infiltration capacity after 9 months of testing. The other media lost between 14-68% of original seepage rate. The sand media also had the least recovery of seepage rate following a dry period. Pollutant accumulation and clogging was concentrated in the top 10 centimeters of all media types. Therefore, scraping off the top 2-5 cm of the filter media every two years is recommended. This maintenance will likely

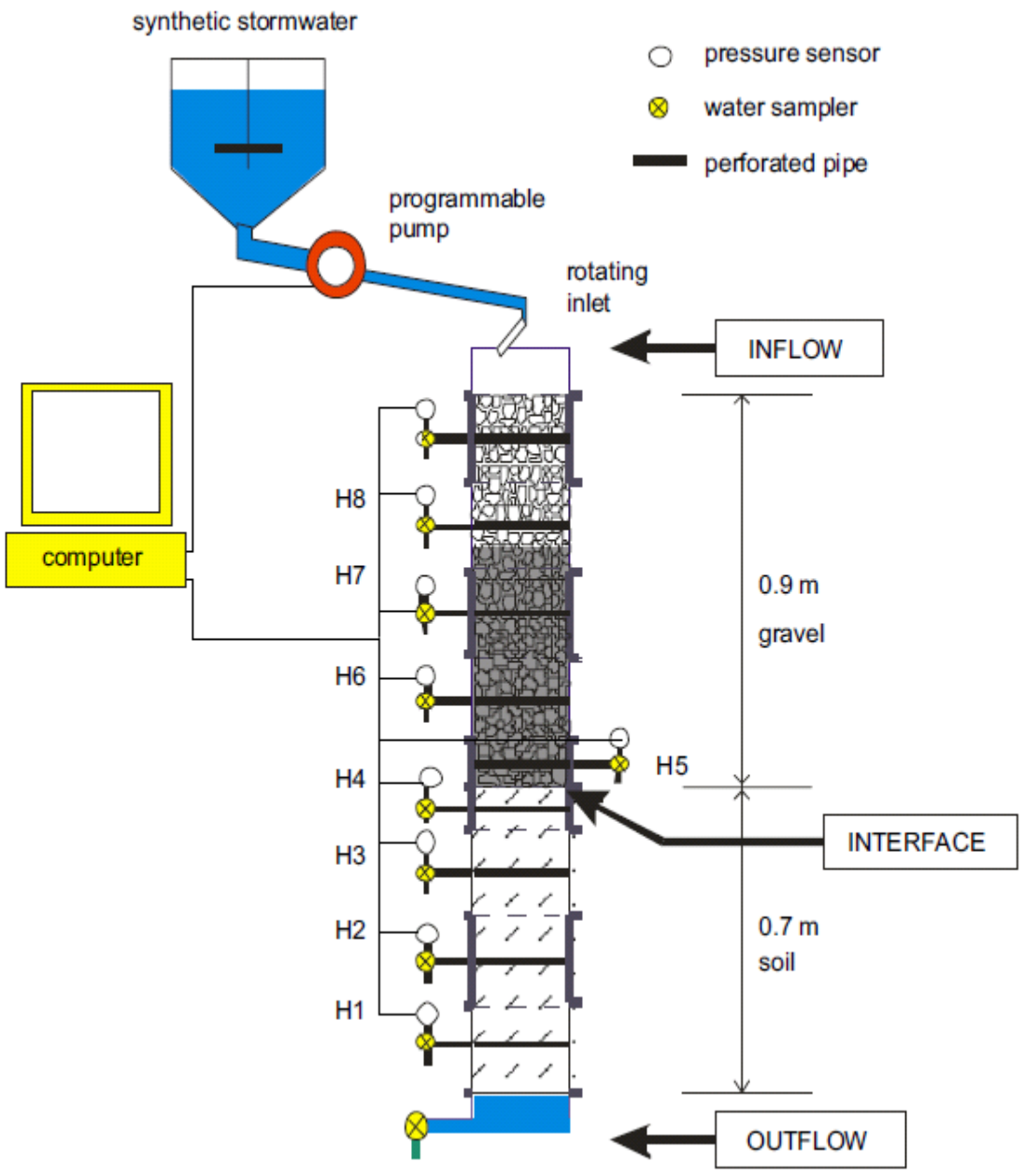
remove most of the heavy metals deposited in the media, reducing the likelihood that metal concentrations will reach soil contamination limits.

Two bioretention soil media samples were column tested by Li (2008). Both soil mixes were classified as sandy soils. Continuous and intermittent column tests were run, adding synthetic stormwater with a TSS concentration of about 150 mg/L. The hydraulic conductivity of the media columns was reduced by 80-95% after each test. The study also found that the primary filtration mechanism is surface straining and cake layer formation. Most of the suspended solids were deposited in the top 5 cm of the media layer and clay sized particles were the main component of clogging.

In the same study, Li (2008) performed a hydraulic conductivity restoration test, by removing and replacing the top 3, 5, and 7 cm of media. The media had an initial clean bed hydraulic conductivity of 72 cm/h, which fell to 6.8 cm/h after loading. The hydraulic conductivity was restored to 36, 39, and 43 cm/h after replacing the top 3, 5, and 7 cm, respectively. The study concluded that the recommended media depth for a bioretention cell is 5-20 cm for particulate pollutant capture. This depth is also suggested for media replacement, which should be performed every 1-2 years depending on pollutant loading characteristics.

(Siriwardene 2007b) studied clogging in gravel infiltration systems using column tests. The column was filled with 90 cm of gravel filter media over 70 cm of soil, shown in Figure 2-22. The gravel had a median particle size ( $D_{50}$ ) of 10.5 mm. Semi-synthetic stormwater with concentrations between 80 and 300 mg/L were used in two types of experiments: constant water level (kept at either 5, 45, or 75 cm above the filter/soil

interface) and fluctuating water level (filling to 75 cm and draining to 5 cm above the interface repeatedly).



**Figure 2-22 Gravel Filter Media Column** (Siriwardene 2007a)

Clogging occurred more rapidly during the fluctuating water level tests and the clogging layer formed at the media/soil interface. Clogging formation slowed dramatically when the water level was kept at 45 cm above the interface and even further

at 75 cm. The sediment mainly accumulates near the minimum water level, slowing the development of the clogging layer at the interface. The study also found that particles less than 6 microns in diameter are the main driver in the development of the clogging layer.

### **2.7.2 Column Tests Conclusions**

Several conclusions from column tests have implications in BMP design and maintenance. First, clogging occurs on the surface of the filter media, except for coarse media like gravel infiltration where clogging occurs at the minimum water level or the filter/soil interface. Clogging at the surface indicates that removing or replacing the top 2-10 cm of the filter media will recover some of the infiltration capacity of the filter. Second, replacing the top layer of the filter media is required every 1-2 years depending on inflow characteristics and basin size. Lastly, clogging is mainly caused by clay sized particles. (Siriwardene 2007b; Siriwardene 2007a)

## **2.8 Stormwater Specifications**

Sizing of detention based BMPs is typically driven by local or state standards. The required size of detention basins can be based on watershed size or design storms. The dewatering time for detention basins is also based on local or state standards. Several examples are provided in this section to provide justification for detention basin sizing methods used later in the thesis.

Pennsylvania requires sedimentation basins for all earth moving activities on sites larger than 5 acres. PA-DEP standards require 500 ft<sup>3</sup> (15 m<sup>3</sup>) of sediment storage and 5000 ft<sup>3</sup> (140 m<sup>3</sup>) of water storage capacity per acre of disturbed watershed. They also require that basins dewater in 2 to 7 days after inflow of runoff from a 1.4-in., 2-yr, 24-h

storm. There have been studies that used detention basins that are half the required size and have found only 10 to 15% reductions in TSS removal (Millen et al. 1997).

North Carolina typically uses a 5-in, 10-yr, 24-h storm to design basins. North Carolina only requires 1800 ft<sup>3</sup> (51 m<sup>3</sup>) of water storage per acre of drainage (McCaleb and McLaughlin 2008). The specifications of Pennsylvania and North Carolina are both for sedimentation basins on construction sites, not for detention basins for existing infrastructure.

According to the Iowa Stormwater Drainage Manual, the appropriate size of a detention basin is based on the water quality control volume (WQCV). The WQCV is the amount of stormwater runoff from a given storm that should be captured and treated in order to remove a majority of storm water pollutants on an average annual basis. The WQCV is calculated using the following equation:

$$WQCV = \frac{PR_vA}{12} * 43,560 \frac{ft^2}{acre} \quad (2.3)$$

Where

*WQCV* = water quality control volume, ft<sup>3</sup>

*P* = design rainfall depth, in

*A* = drainage area, acres

*R<sub>v</sub>* = runoff coefficient = 0.05 + 0.009(*I*)

*I* = impervious area, %

The design rainfall depth applied in Iowa is 1.25 inches, which is the 90% cumulative frequency depth or in other words, 90% of rainfall events had a depth of 1.25 inches or less. More detailed methods can also be used to calculate the runoff coefficient.

The Urban Drainage and Flood Control District Manual, which governs the Denver metro area, require a WQCV equal to 85% of the runoff volume from a 2-yr storm.



The City of Lincoln Drainage Criteria Manual and the Omaha Regional Stormwater Design Manual have identical standards for stormwater BMPs. The minimum WQCV is the first 0.5 inches of runoff from the drainage area. The WQCV must be detained for at least 24 hours and the recommended drain time for a dry detention basin is 40 hours.

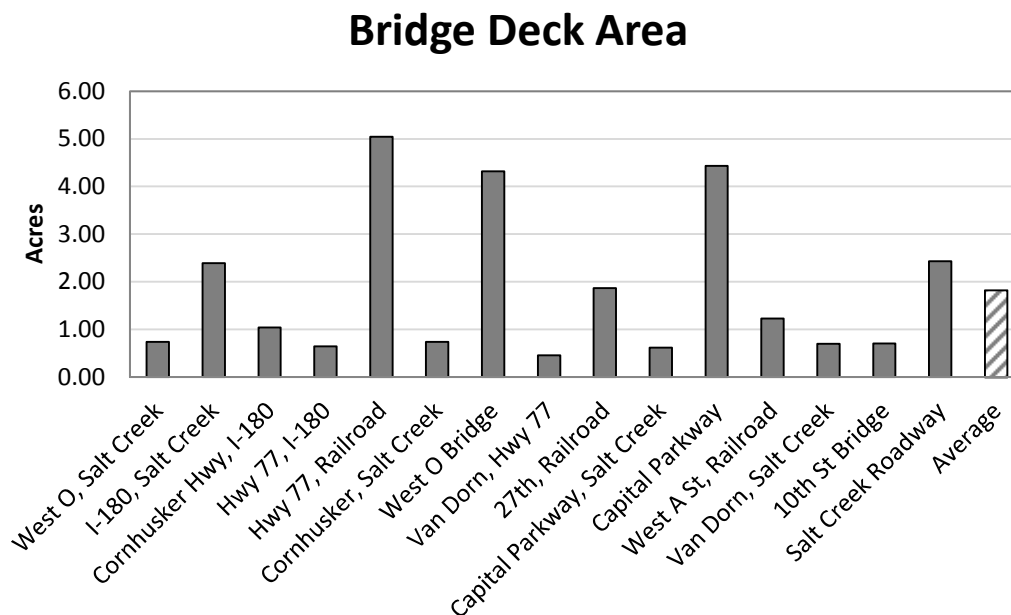
## Chapter 3. **Initial BMP Design Considerations**

In order to design and test outlet structures, a typical basin must be selected that is representative of the basins that will be constructed in the field. The design of a typical basin depends on the design criteria, watershed size, and design storm. Once the typical basin is designed and sized, the outlet structures and model basin can be designed.

### **3.1 Watershed Size**

In a meeting with NDOR on October 14, 2010, NDOR indicated the initial primary treatment is for runoff from bridges. Other locations that may require treatment of runoff are at the middle and ends of storm sewers and curb breaks, or drops into ditches. NDOR expects five to ten acre watersheds for the treatment facilities.

Using ArcGIS, fifteen large bridges in Lincoln were delineated and measured. Figure 3-1 below shows the areas calculated for the bridges. The average size of a bridge is 1.82 acres. The largest bridge was on Hwy 77 over the BNSF rail yard at 5.04 acres followed by the Capital Parkway Bridge and West O Bridge at 4.44 and 4.32 acres, respectively.

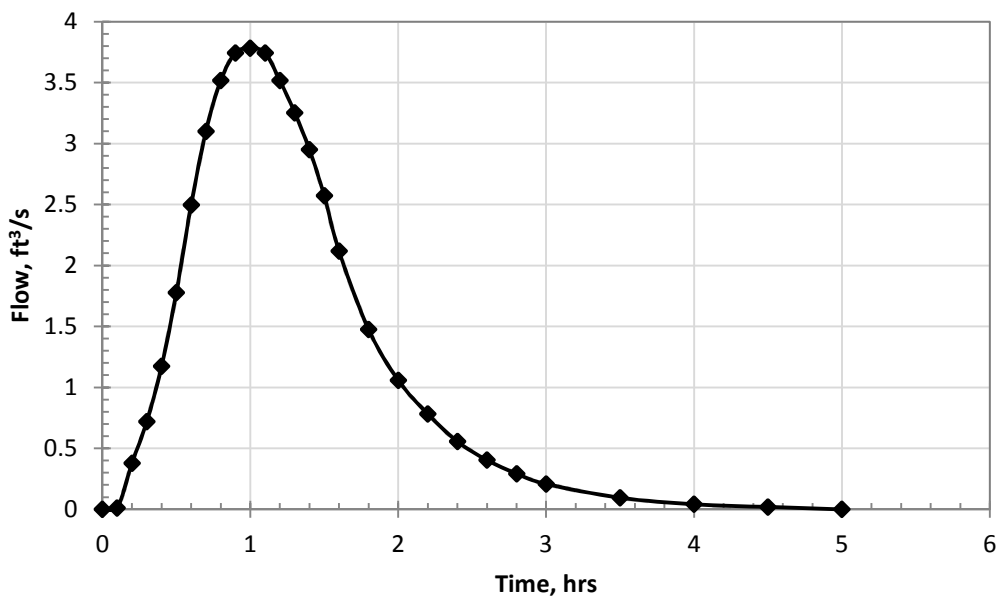


**Figure 3-1 Bridge Deck Areas**

The approximate drainage area of two major interchanges was also calculated using ArcGIS. Based on Flow Accumulation Tool, the drainage area from the I-80 and I-180 interchange was 8.95 acres and the drainage area for the Cornhusker Hwy and I-180 interchange was 6.5 acres.

### 3.2 Design Storm/Hydrograph

In Lincoln, the rainfall depths for 2-yr and 10-yr storms are 3 inches and 4.7 inches, respectively. A synthetic runoff hydrograph was calculated using the NRCS dimensionless unit hydrograph. A 1 hour storm duration and a drainage area of 5 acres were used in the equation  $Q_p = \frac{484A}{P_r}$ .  $Q_p$  was then multiplied by the Hydrograph Discharge Ratios to get the synthetic hydrograph, as shown in Figure 3-2.



*Figure 3-2 NRCS Synthetic Storm Runoff Hydrograph*

### 3.3 Basin Size

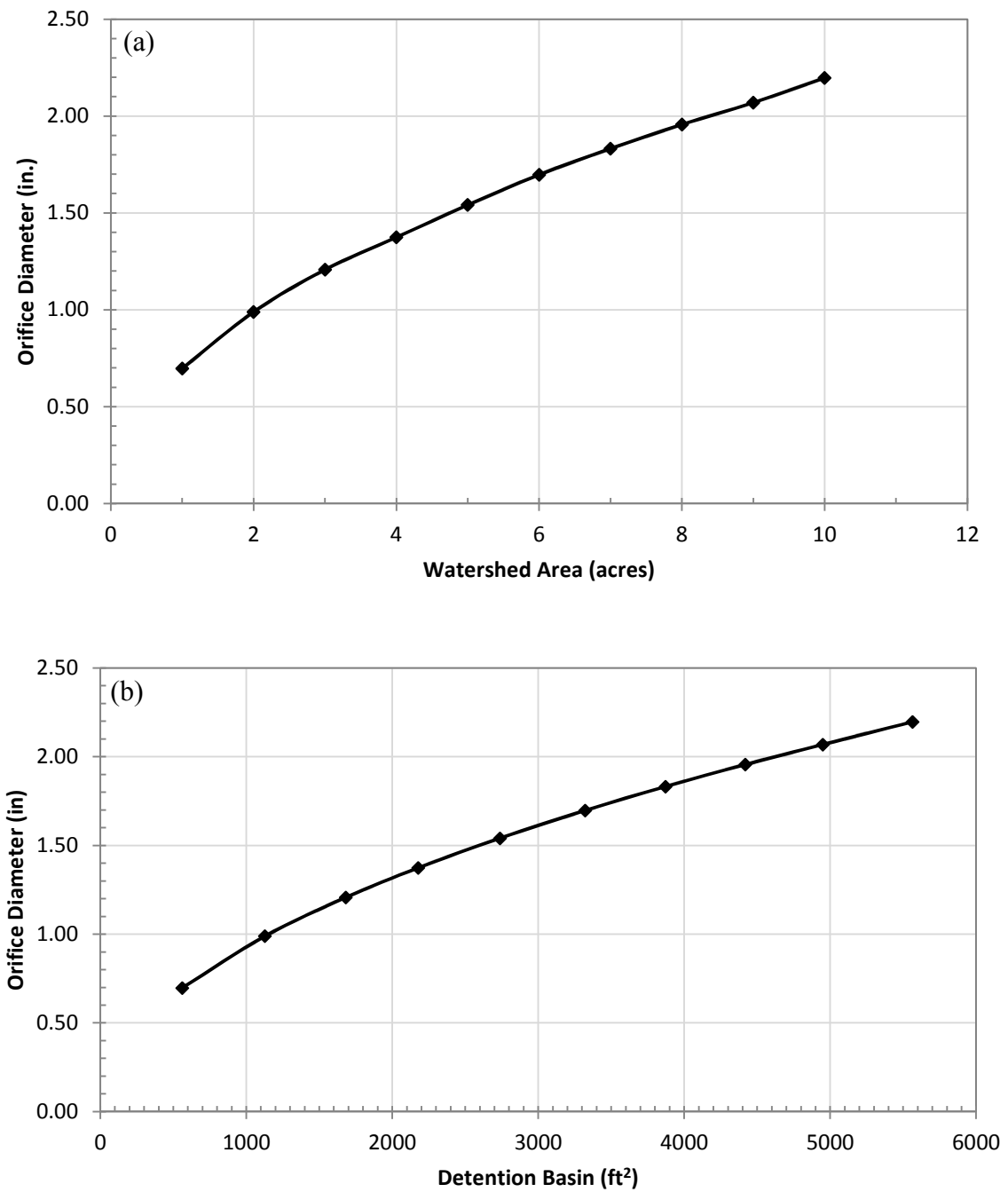
Basin size can be based on rainfall depth, runoff, percentage of runoff, or a first flush depth of 0.5 inches. Distributing any of these depths over the watershed area generates the WQCV and thus the required size of the basin. Based on discussions with NDOR, NDOR expects typical bridge and interchange site designs to have 5 to 10 acre watersheds; calculations of representative interchange areas fall within that range, and bridge decks are at the lower end of that range. Therefore 5 acres was selected as a representative design watershed area.

Using the first flush depth over a 5 acre watershed, the WQCV is equal to 9,075 ft<sup>3</sup>. According to the Lincoln Drainage Criteria Manual (City of Lincoln 2004) manual for dry detention basins, an additional 20% of the WQCV is needed for sediment storage, resulting in 10,890 ft<sup>3</sup>. The Drainage Manual also gives a typical depth of 2-5 feet, a

maximum side slope of 4:1 and minimum length to width ratio of 2:1. Using these parameters, a 37ft x 74ft x 4ft basin would be required.

### **3.4 Basin Routing**

After sizing the basin, the inflow hydrograph was routed through the basin. Outflow from the basin was designed to be controlled by an orifice, so outflow was calculated using  $Q = C_D A \sqrt{2gH}$ . Using  $C_D = 0.61$  (Finnemore and Franzine, 2002), a 1.5625 in diameter orifice was required to drain the basin over a 40 hour time period. Forty hours is a standard holding time for detention basins that is required by many municipalities (e.g., Lincoln Drainage Criteria Manual (City of Lincoln, 2004)) to allow sufficient time for suspended sediment to settle from detained storm water runoff. Routing was also done for different watershed areas. The watershed area was used to calculate a new inflow hydrograph and basin size. The required orifice diameter to maintain a 40-hr drain time for other watershed sizes and corresponding four foot deep basin areas is shown below in Figure 3-3 (a) and (b).



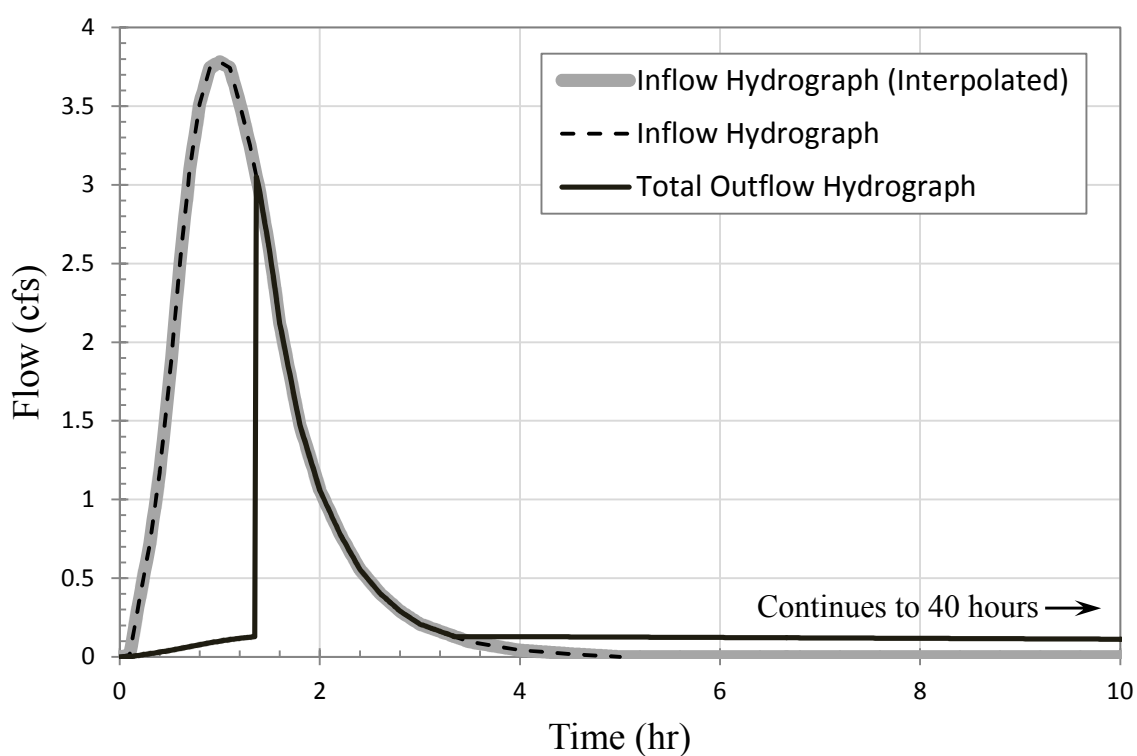
**Figure 3-3 Required Orifice Size to Maintain 40-hr Drain Time for (a) a Given Watershed Area and (b) a Corresponding 4-ft deep Basin Size**

For a 5-acre watershed, the detention basin parameters in Table 3.1 were used to route the inflow hydrograph through the basin. The inflow hydrograph was routed through the basin using a 1 minute time step. The inflow and outflow hydrographs for the

basin are shown in Figure 3-4. The outflow hydrograph is the total outflow, combining the discharge from the primary outlet structure and the overflow spillway.

**Table 3.1 Detention Basin Parameters**

Depth:	4	ft	Orifice Diameter:	1.5625	in.
Width:	37	ft	Orifice Area:	0.02633	ft <sup>2</sup>
Length:	74	ft	Discharge Coefficient:	0.61	
Side Slope:	0.25				
Volume:	11,401	ft <sup>3</sup>			



**Figure 3-4 Real Hydrograph Inflow and Basin Outflow**

The jump in the outflow hydrograph signifies that the stage in the basin has reached 4 feet and flow is discharging through the overflow spillway. The outflow remains equal to the inflow until the basin drops below 4 feet and water only discharges through the perforated riser. Then, the basin slowly discharges over a 40 hour period (only the first 10 hours is shown in the figure).

### **3.5 Conclusion**

In this chapter, the representative size of a detention basin for NDOR bridge projects was determined based on fifteen typical bridge decks in the Lincoln area. For the bridges that were considered, the average bridge area was calculated and was used along with an estimate of the first flush depth to assess the necessary detention basin size. The detention basin size was then used to calculate the required size of an orifice that would dewater the basin over a 40 hour period. The required orifice size was used to design and construct full size outlet structures that were tested. The resulting outlet structures and testing methods are discussed in the following chapters.



## Chapter 4. Outlet Device Hydraulic Characterization

### 4.1 Introduction

From the literature review, two BMP outlet devices were identified that showed promise for being effective but were insufficiently documented in the literature. The first outlet device, a perforated riser with single orifice control, was not found in the literature, but one study did find that a single orifice outlet had half the peak discharge of a perforated riser (Fennessey and Jarrett 1997). The benefits of an orifice controlled perforated riser include reducing the peak discharge, drawing water from the entire water column, and providing a way to accurately size the device to produce a consistent 40-hr dewatering time.

The second outlet device, a filtered perforated riser, showed excellent sediment removal but was not well documented in the literature. Specifically, the literature did not provide any estimation for clogging or longevity of the filter and little discussion was found on designing a filtered perforated riser for a required drainage period. The major advantage of filtering the perforated riser is that the filter can prevent large debris from blocking holes in the perforated riser or the orifice itself.

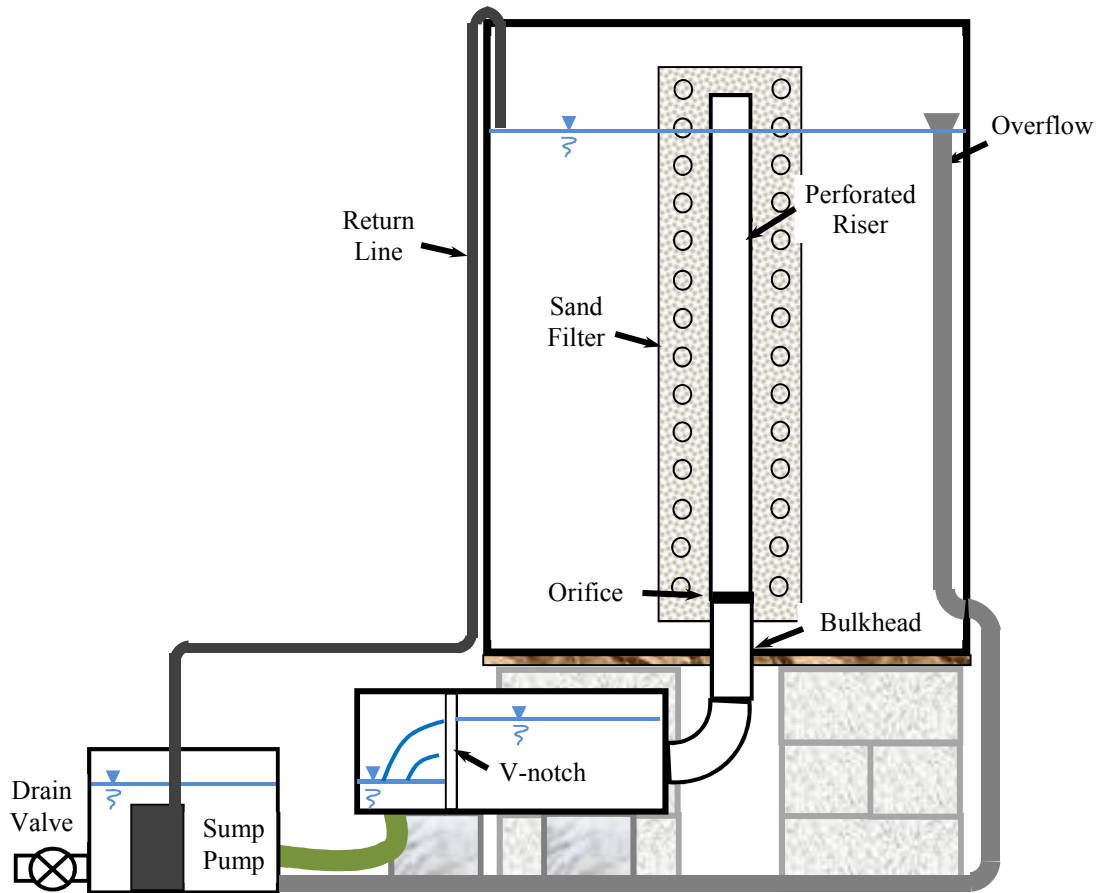
The two structures that were tested in the experimental basin were tested (1) to determine how well the rating curves of the devices could be predicted and (2) to better understand the impact that high sediment loads might have on device performance. In this way, NDOR could use the results to design appropriate outlet structures for their detention basins.

## 4.2 Experimental Setup

To test BMP outlet devices, a model basin was built. A schematic of the basin is shown in Figure 4.1. The model basin was a 7.5-ft diameter plastic tank with an overall depth of 5.5 ft. A four inch pipe (not shown in Figure 4.1), routed over the side of the basin, was attached to a water supply and was used to fill the model basin. The model basin was not scaled in height, but the width and length were scaled down and were much smaller than an actual detention basin. The basin was large enough so that different full size outlet structures could be installed in the basin and tested. Outlet structures that were tested to varying degrees inside the basin included an unobstructed orifice, a perforated riser with an orifice, and sand filter/perforated riser/orifice combination. The filter/perforated riser/orifice combination is shown in Figure 4.1.

A point gage was mounted inside the basin and adjusted so that the orifice elevation was the datum for the point gage. Thus, all depth measurements inside the tank were relative to the elevation of the orifice. During testing, outlet structures were connected to a v-notch weir box on the outside of the tank through a bulkhead connector. The v-notch weir was for measuring flow rate through the outlet structure. A point gage inside the weir box measured the height of the water above the weir.

Flow from the v-notch weir led to an aluminum diversion tank and could be recirculated with a submersible pump during steady flow tests or drained from the system during drain tests. A ½ HP submersible pump with a float switch was mounted in the diversion tank and attached to a 2” hose that returned flow to the test basin, as shown in Figure 4-2. During recirculation tests, the discharge from the pump was controlled by a valve to keep the head in the experimental tank constant.



**Figure 4-1 Diagram of the Experimental Test Facility**

Initially, a two-inch bulkhead connector was installed in the bottom of the test tank, connecting each outlet structure that was tested to the weir box. Later, it was determined that the two-inch bulkhead connector restricted flow from the orifice, making it impossible to determine orifice head losses. Consequently, the two inch bulkhead connector was replaced with a four inch bulkhead connector in order to ensure that the connector had no effect on outflow from the test basin. In addition, as shown in Figure 4.3, the four inch connector drained downward directly into an unsealed 6 inch reducer. In this way, atmospheric pressure was maintained on the downstream side of the orifice, and all measured head losses could be attributed to the outlet structure being tested and not to the pipe network that leads from the test basin to the v-notch weir box.



*Figure 4-2 Experimental Test Facility*



**Figure 4-3 Free Flow Outlet from Model Basin**

An overflow line installed in the test basin prevents the basin from overflowing during filling and during steady flow tests. Finally, after initial flow testing, a Minn Kota trolling motor was mounted on the side of the basin to provide mixing prior to sediment tests.

#### **4.2.1 V-notch Weir Calibration**

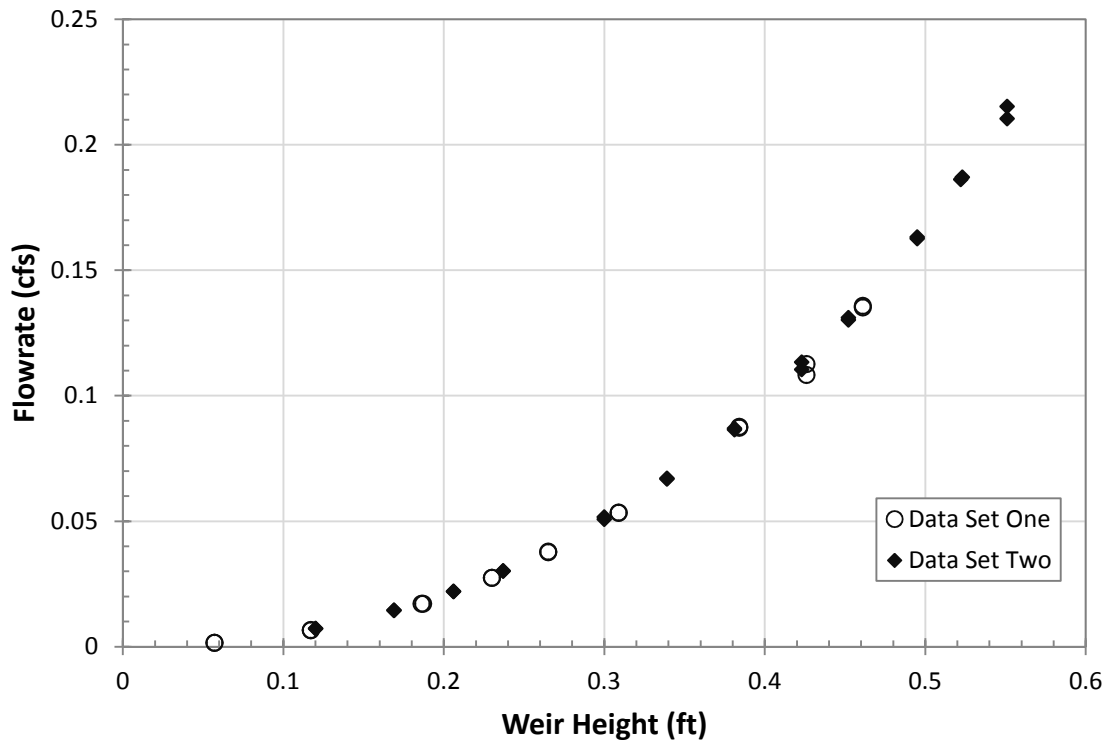
The weir used to measure outflow is a 30 degree v-notch weir. The height, in feet, of the water above the weir is converted into discharge, in cfs, using Equation 4.1. (Finnemore and Franzini, 2002)

$$Q = C_w \frac{8}{15} \sqrt{2g} \tan\left(\frac{\theta}{2}\right) H_w^{\frac{5}{2}} \quad (4.1)$$

Where,  $C_w$  = coefficient of discharge  
 $g$  = acceleration of gravity (32.2 ft/s<sup>2</sup>)  
 $\theta$  = vertex angle of v-notch weir

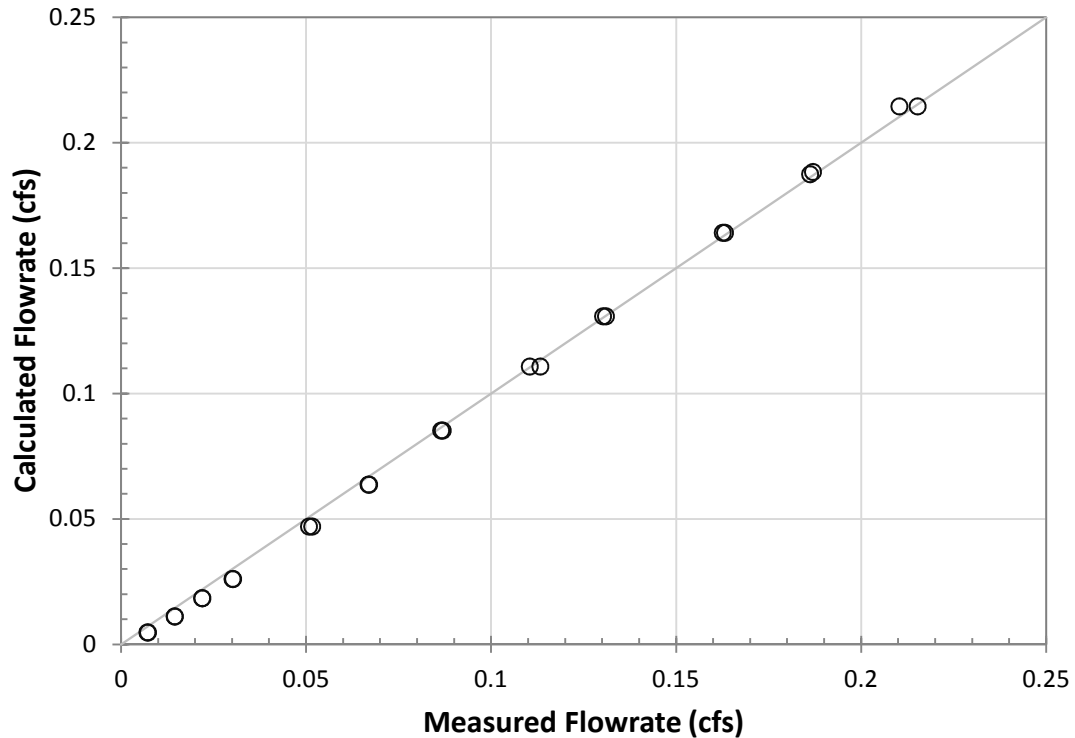
$H_w$  = height of the water surface above crest of weir (ft)

The weir was calibrated to determine the coefficient of discharge. To perform the calibration, the inlet to the tank was connected to a water source that was controlled by a valve. The valve was opened and water was allowed to run through the tank until the water level above the weir stabilized. Then the water level was measured and recorded. The discharge from the weir box was then diverted into a weigh tank and a timer was started. When the weigh tank was nearly full, the flow was redirected away from the weigh tank and the timer was stopped. The water level in the weir tank was remeasured to confirm that the flow was in equilibrium. Using the time and the initial and final weights of the weigh tank the flow rate was calculated. This procedure was repeated for different flow rates and head levels in the weir tank. The weir height versus the measured discharge is shown in Figure 4-4. The calibration was done on two separate days. For data set one the water temperature was 56.4° F and for data set two it was 55.2° F.



*Figure 4-4 Measured Weir Discharge for Two Tests*

Using the data from Figure 4-4, the  $C_w$  value from Equation 4.1 was adjusted to obtain the best fit for the data. The best fit was found using a  $C_w$  value of 0.83. The measured and calculated data are shown in Figure 4-5.



*Figure 4-5 Calibrated Weir Discharge*

### 4.3 Orifice Plate

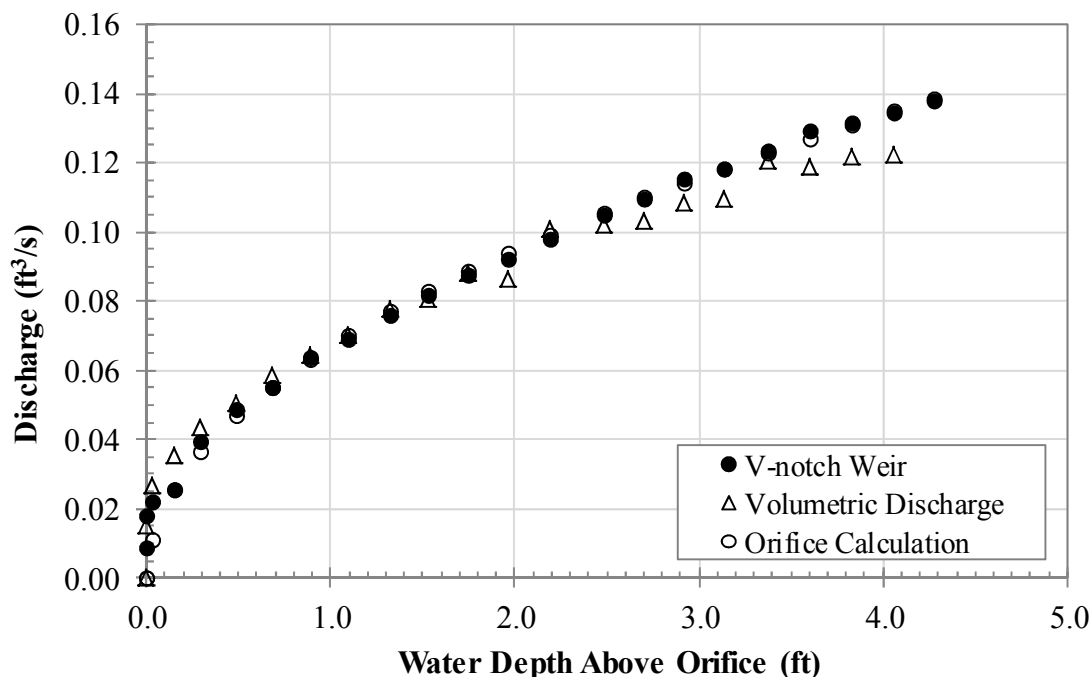
The reason for using an orifice as a component of the outlet structure was to control flow as accurately as possible. Orifice plates are widely used for controlling and measuring flow. The orifice that was implemented for the work reported herein was constructed from 0.125 inch aluminum plate. The orifice had an outer diameter of 4 inches so that it would fit inside a standard 4 inch diameter PVC pipe, and it had an internal diameter of 1.5625 inches, as discussed in the previous chapter. The orifice was installed in the four inch outflow pipe directly above the bulkhead connector and was tested without any other outlet structure components installed. The widely accepted equation for flow through an orifice is given by Equation 4.2. (Finnemore and Franzini, 2002)



$$Q = C_d * \left(\frac{\pi}{4} D^2\right) * \sqrt{2gh} \quad (3.2)$$

Where,            Q = discharge through the orifice (ft<sup>3</sup>/s)  
                       C<sub>d</sub> = coefficient of discharge  
                       g = acceleration of gravity (ft/s<sup>2</sup>)  
                       D = diameter of the orifice (ft)  
                       h = depth of water above the orifice (ft)

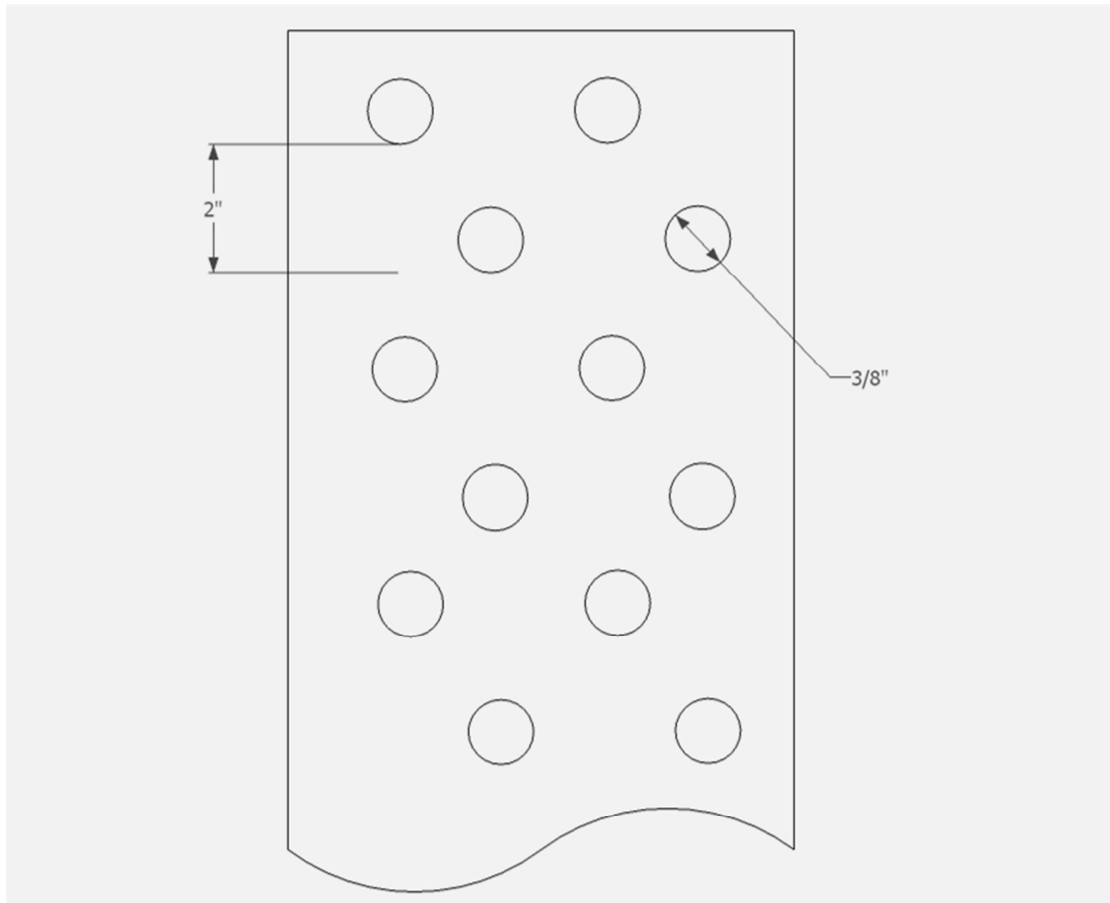
In order to establish the best coefficient of discharge for the orifice, a test was done with only the orifice in place. During a drainage cycle of the test basin, the depth of water above the orifice in the tank, the head above the crest of the v-notch weir in the weir box, and the time were recorded. The volume flow rate from the tank could then be calculated by three independent methods: (1) based on change in volume of water in the test basin over time, (2) based on the calibrated v-notch weir measurement, and (3) based on the orifice equation. The discharges based on weir flow measurements, the orifice equation, and the tank volume conservation measurements are shown in Figure 4-6. The coefficient of discharge for the orifice was determined by a least squares fit between the weir data and the orifice data and was found to be 0.63. This coefficient of discharge is within the accepted range of 0.60 to 0.68 identified by Gupta (2001).



*Figure 4-6 Discharge Calculations using Weir, Tank Volume Conservation, and Orifice Equation Methods*

#### 4.4 Perforated Riser and Orifice Combination

The second outlet device tested was a 54 inch high, 4 inch diameter perforated PVC riser pipe in series with the 1.5625 in orifice. The purpose of the orifice was to control the flow, while the riser pipe was intended to prevent large debris from plugging the orifice. Twenty five rows of 3/8 inch diameter holes, vertically spaced 2 inches apart, were drilled into the riser pipe. Each row consisted of 8 columns of holes spaced evenly around the pipe. The size and spacing, depicted in Figure 4-7, of the holes in the riser pipe was selected so that flow through the outlet structure would be primarily controlled by the orifice. The orifice was mounted inside the riser pipe at a distance of 1.5 inches above the bottom of the pipe. The first row of perforations in the riser pipe was 2.5 inches above the orifice. Following construction, the riser pipe and orifice assembly was mounted in the test facility.

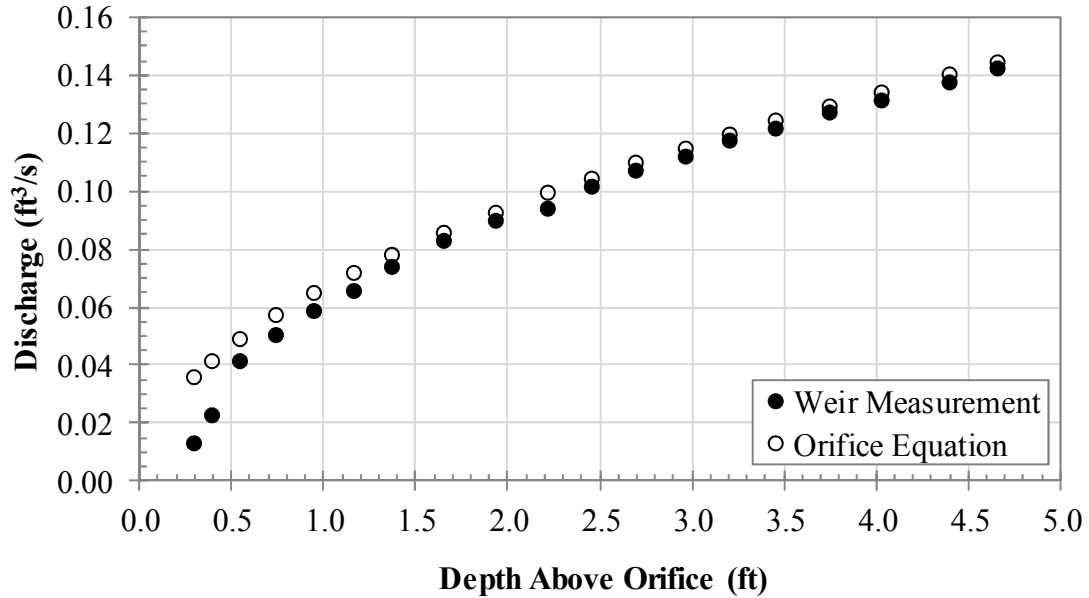


***Figure 4-7 Perforated Riser Pipe Detail***

#### **4.4.1 Head Discharge Curve**

The perforated riser pipe was installed and steady state tests were performed to verify that the orifice was controlling the flow by comparing the calculated discharge using the orifice equation to the discharge measured using the outlet weir.

A large number of tests were run to produce the Head-Discharge curve. As seen in Figure 4-8, the weir measured discharge corresponds fairly well to the orifice equation discharge with the exception of very low heads. So the discharge is controlled by the orifice except at low heads. At low heads, only a few of the holes in the perforated riser convey flow, resulting in a greater head loss than that due to the orifice.



*Figure 4-8 Orifice-Controlled Perforated Riser Discharge in Model Basin*

#### 4.4.2 Flow Regimes for Perforated Riser

There are two flow regimes for the perforated riser: the first is at low heads where both the perforations and the orifice limit the flow and the second is at higher heads where the orifice controls the flow and the effect of the perforations becomes negligible. These two regimes occur because as the depth in the basin increases, more and more perforations convey flow. In the first flow regime, the head losses from the perforations are not negligible but in the second flow regime the head loss across the orifice becomes dominant. In order to account for the perforations, Equation 4.3 was developed to estimate discharge through the perforations.

$$Q = C_p * A * \sqrt{2g} * \sum \sqrt{\text{MIN}(H - h, H - h_r)} \quad (4.3)$$

Where,

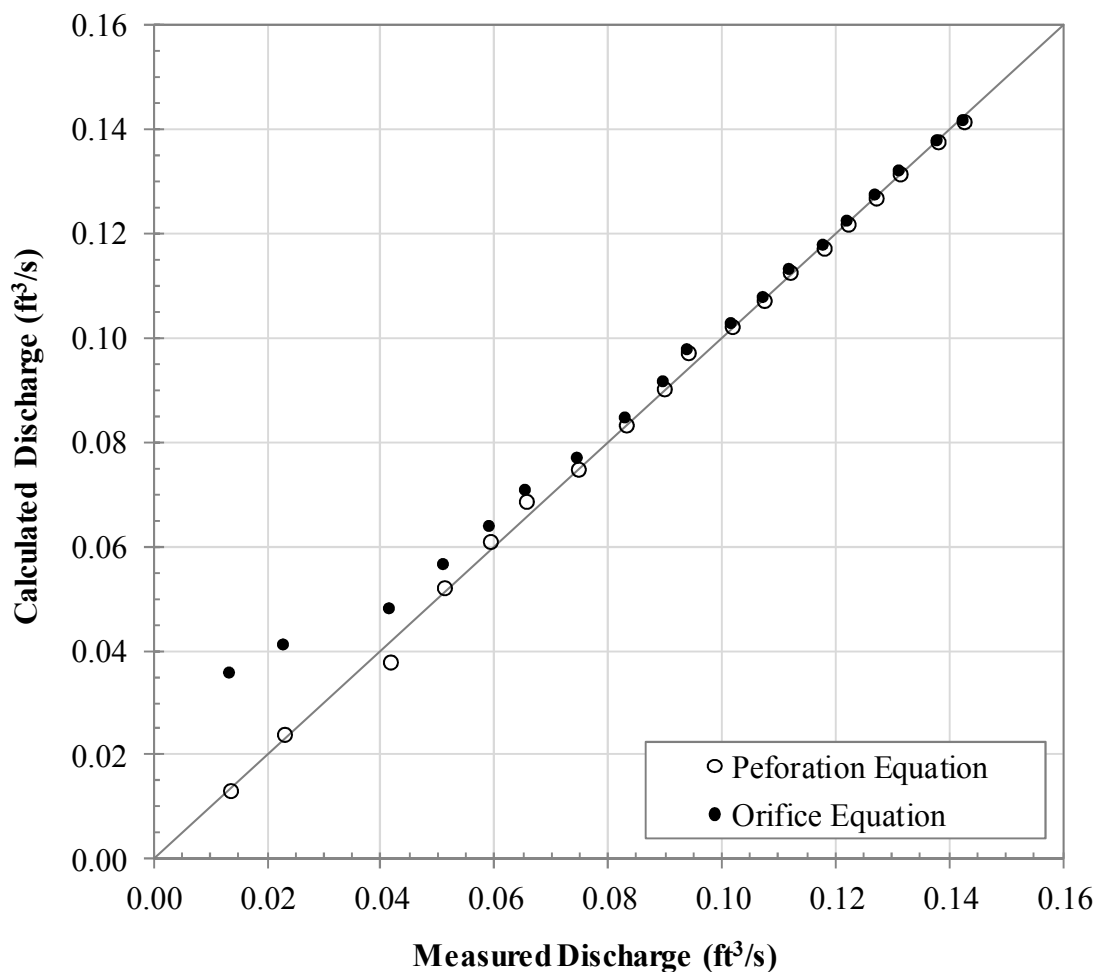
- $C_p$  = coefficient of discharge of a perforation
- $g$  = acceleration of gravity ( $\text{ft/s}^2$ )
- $A$  = area of all perforations in one row ( $\text{ft}^2$ )
- $H$  = water height in the test basin above the orifice (ft)
- $h_r$  = height of the row of perforations above the orifice (ft)
- $h$  = water height inside the perforated riser above the orifice (ft)

The summation in Equation 4.3 is calculated for all rows of perforations that are below the elevation of the water surface in the test basin. The equation differentiates between perforations that are above and below the water surface elevation in the riser pipe. The head differential for holes above the water line in the riser is the difference between the elevation of the water in the tank and the elevation of the holes; whereas the head differential for holes below the water line in the riser is the difference between the elevation of the water in the tank and the elevation of the water in the riser. Thus, the MIN (minimum) function is used to choose the appropriate differential for each row. To estimate  $C_p$ , the measured heads and discharges from the test results given in Figure 4.8 were used.

First, the coefficient of discharge of the orifice,  $C_d$ , was re-optimized for the orifice inside the perforated riser using only flows above 0.10 cfs. The cutoff of 0.10 cfs was chosen because the effect of the perforations was negligible above this flow rate, as can be seen in Figure 4-9. The new estimate of  $C_d$  was 0.62, slightly lower than what was estimated with the orifice alone. A change in  $C_d$  was expected since the orifice was now inside a pipe, changing approach conditions upstream of the orifice. Additional head losses may be what caused  $C_d$  to decrease slightly.

If the new  $C_d$  value is assumed to be correct for all heads inside the riser, and the measured values of the head in the test basin ( $H$ ) are used, Equations 4.2 and 4.3 form two equations and three unknowns, where the unknowns are  $Q$ ,  $h$ , and  $C_p$ . Thus, using Equations 4.2 and 4.3 and the measured values of  $H$ ,  $C_p$  was optimized to minimize the sum of the squares of the differences in estimated and measured discharges of the data shown in Figure 4.8. The optimum value of  $C_p$  was found to be 0.91 for the 3/8 inch

diameter perforation holes cut in the 0.25 inch thick PVC riser. Figure 4-9 shows the resulting calculated discharge versus the measured discharge. By taking head loss from the perforations into account, the estimated discharge is more accurate, especially at low heads. However, at higher heads the orifice equation alone is sufficient to accurately predict flow. Furthermore, it is possible to add perforations near the base of the riser to reduce perforation head losses at low heads. Doing this would give the orifice control over the entire flow range, but would also draw more water from the lower depths of the basin.



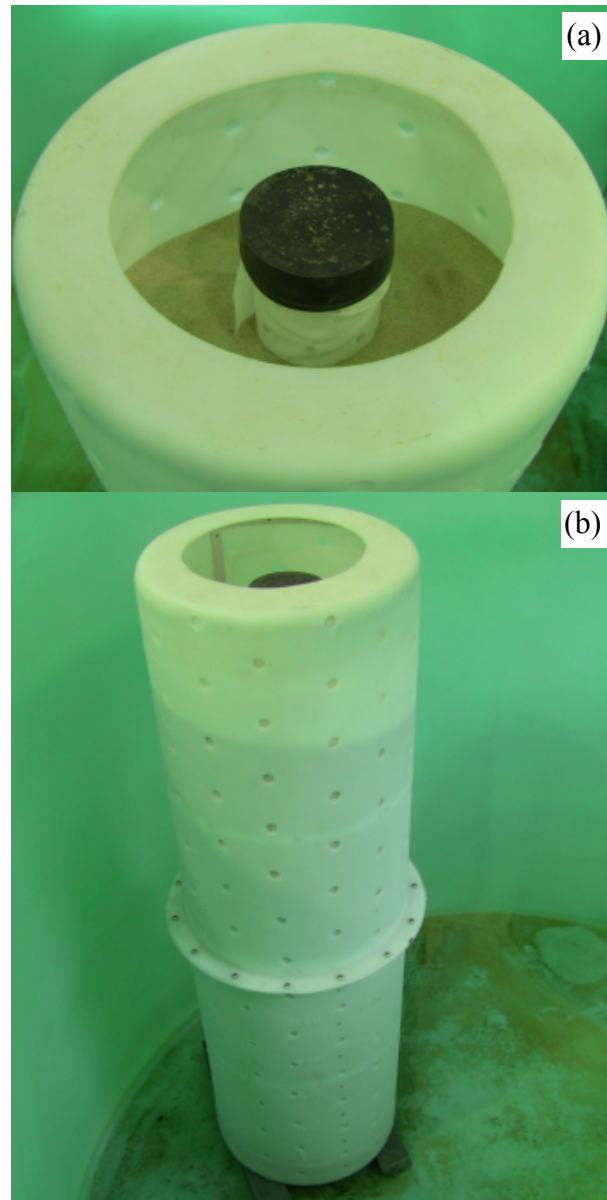
**Figure 4-9 Measured and Calculated Discharge using the Orifice and Perforation Equations**

#### 4.5 Riser Pipe with Sand Filter

The third outlet device that was tested was a modification of the riser pipe. An 18 inch diameter perforated HDPE cylindrical casing was installed around the riser pipe. The casing had 28 rows of 0.75 inch diameter holes drilled in it. Rows 1, 3, 5, 7, 9, 11, 13, 16, 18, 20, 22, 24, 26, and 28 had eight holes each. Rows 2, 4, 6, 8, 10, 12, 14, 15, 17, 19, 21, 23, 25, and 27 had seven holes each. The rows of holes were for the most part vertically spaced at 2 inches, starting at one inch below the orifice datum. The exception is that between rows 14 and 15 there was a 4 inch vertical spacing between the rows

because of a horizontal split in the filter casing. The split in the casing was not perfectly sealed and likely behaved like a row of holes, though the exact area of the split is difficult to ascertain. The space between the casing and the riser was filled with sand, as shown in Figure 4-10. In order to prevent filter sand from escaping through holes in the riser pipe or the casing, a woven plastic mesh screen was placed around the outside of the riser pipe and the inside of the casing. The mesh screen had an opening size of 0.0165 in (0.42 mm). The fine mesh size was chosen so that different filter sand sizes could be tried.

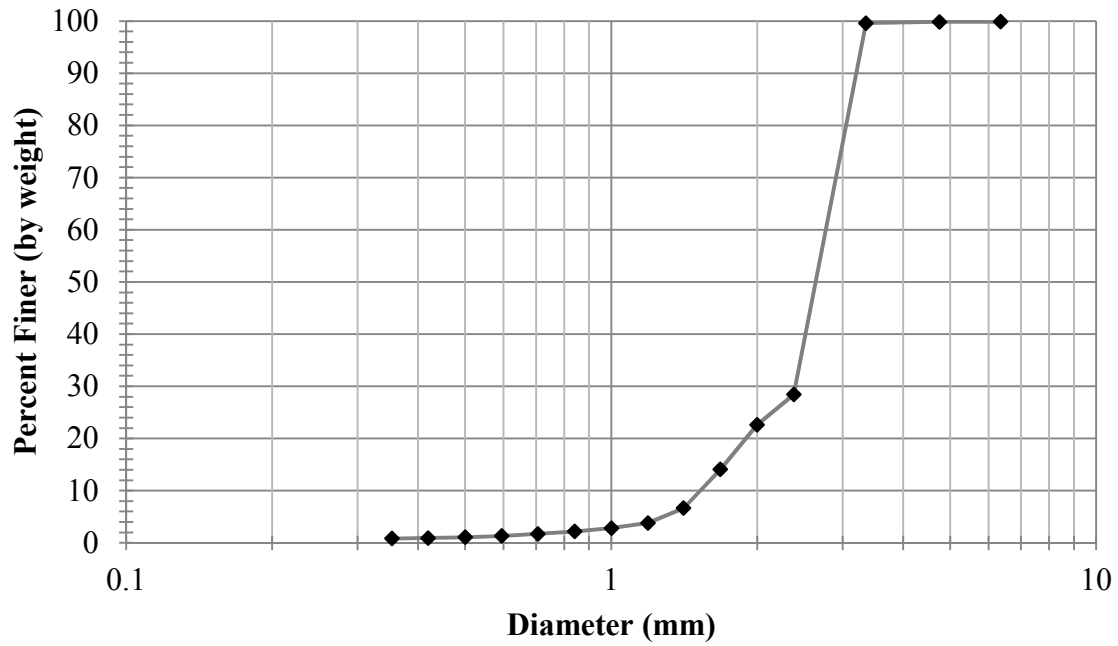




***Figure 4-10 Sand Filter Chamber: (a) Top View and (b) Side View***

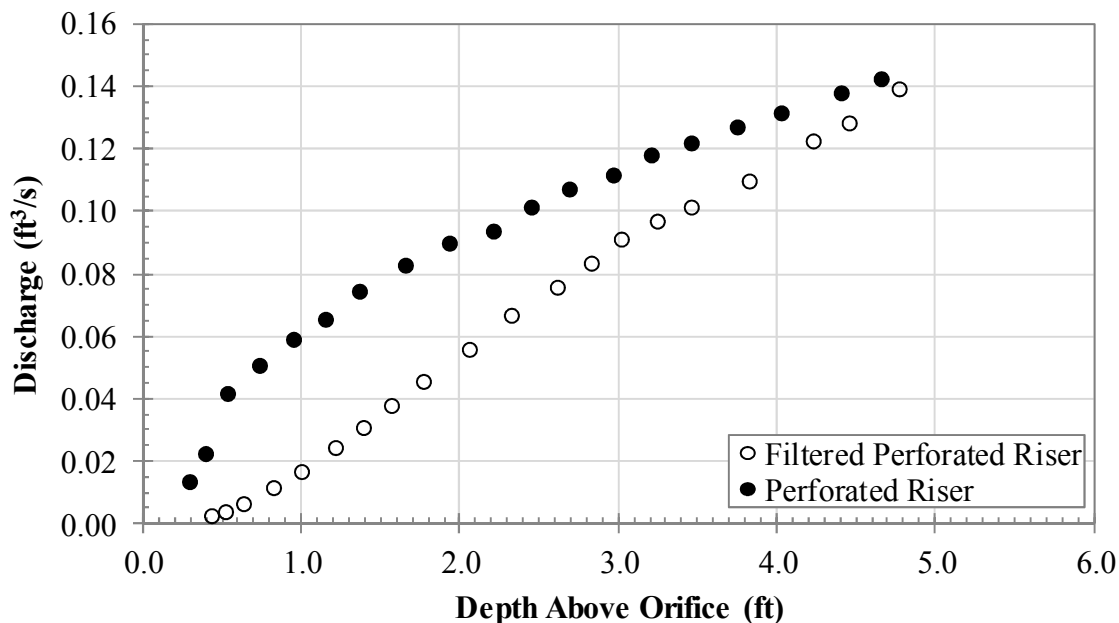
Two sand sizes were tried in the filter, 0.5 mm  $D_{50}$  and 2.8 mm  $D_{50}$ . The median grain size,  $D_{50}$ , is the grain diameter for which half the sample by weight is finer. Initial testing showed that the 0.5 mm sand did not provide adequate flow through rates, so the 2.8 mm sand was used in all subsequent tests. The sand was sieved through a #12 mesh (1.68 mm) to make it more uniform. A sieve analysis, following the ASTM C136-06 Standard Test Method for Sieve Analysis of Fine and Coarse Aggregates, was performed

on the sand, and results of the analysis are shown in Figure 4-11. The  $D_{50}$  was 2.8 mm and the coefficient of uniformity,  $C_u$ , was 2. The filter material is thus very coarse sand to very fine gravel based on the USDA soil classification system (Soil Survey Staff 1999).



*Figure 4-11 Filter Sand Sieve Analysis Size Distribution*

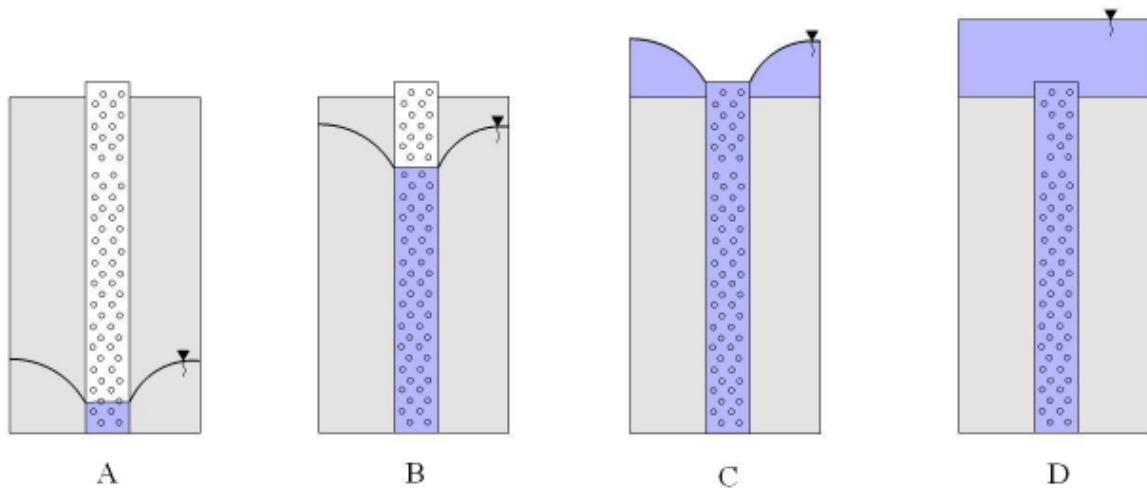
Steady state tests were completed to develop Head-Discharge curves. Figure 4-12 compares the discharge of the filter/perforated riser combination to the perforated riser without the filter. The discharge from the filtered riser pipe is much lower than the discharge from the riser pipe alone due to the head drop across the sand filter.



*Figure 4-12 Head-Discharge Curves for Filtered and Perforated Risers*

#### 4.5.1 Flow Regimes for the Filtered Riser

There are four different flow regimes that can occur for the filtered riser, as illustrated in Figure 4-13. The first flow regime is at low heads where the flow is controlled primarily by the lowest perforations of the riser. The perforations of the casing are not expected to limit the flow because there are more of them, they are larger, and the first row of perforations in the casing starts at a lower elevation than the first row of perforations in the riser. The second flow regime occurs most often, where only the filter media and the orifice have an effect on the flow. The third regime occurs at high water heads with flow over the top of the riser pipe (which causes the riser to act like a weir), in parallel to flow through the filter media. The fourth and final flow regime is when the filtered riser is completely submerged; in this case the flow is only restricted by the orifice. The first three flow regimes were observed during testing of the filtered riser, but the first and second regimes are the ones of primary design concern because they will be the regimes that control the flow over the 40-hour drawdown period.



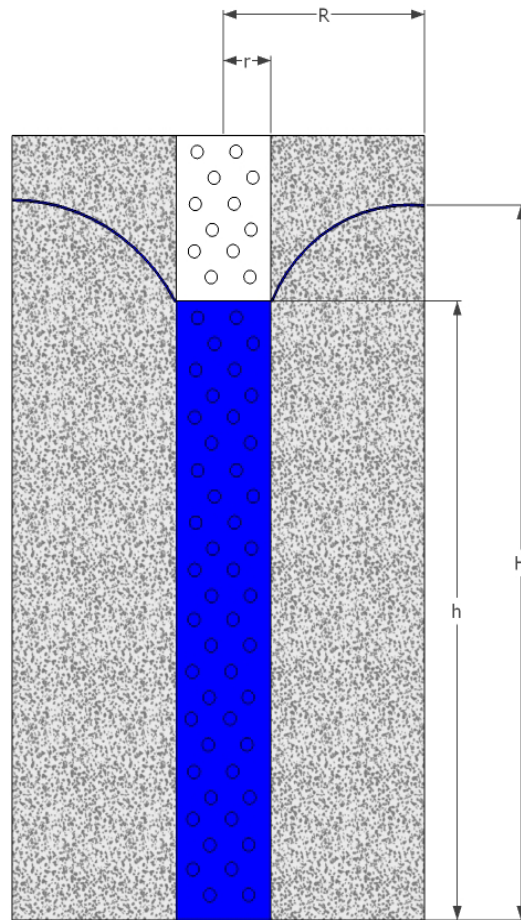
**Figure 4-13 Flow Regimes through Filtered Riser**

#### 4.5.2 Discussion of Flow Regime 2: Flow through only the Filter and Orifice

Flow through the filtered riser is similar to flow in an unconfined aquifer (radial flow in porous media), so the equation for flow through an unconfined aquifer was used to estimate the flow through the filtered riser. The unconfined aquifer equation is:

$$H^2 - h^2 = \frac{Q}{\pi K} * \ln \frac{R}{r} \quad (4.4)$$

For the filtered riser, H, is the height of the water above the orifice inside the test basin; h, is the water height above the orifice inside the perforated riser; R, is the inner radius of the filter casing; r, is the outer radius of the perforated riser; Q, is the discharge; and K, is the hydraulic conductivity of the media. A schematic of unconfined flow through a filtered riser is shown in Figure 4-14.

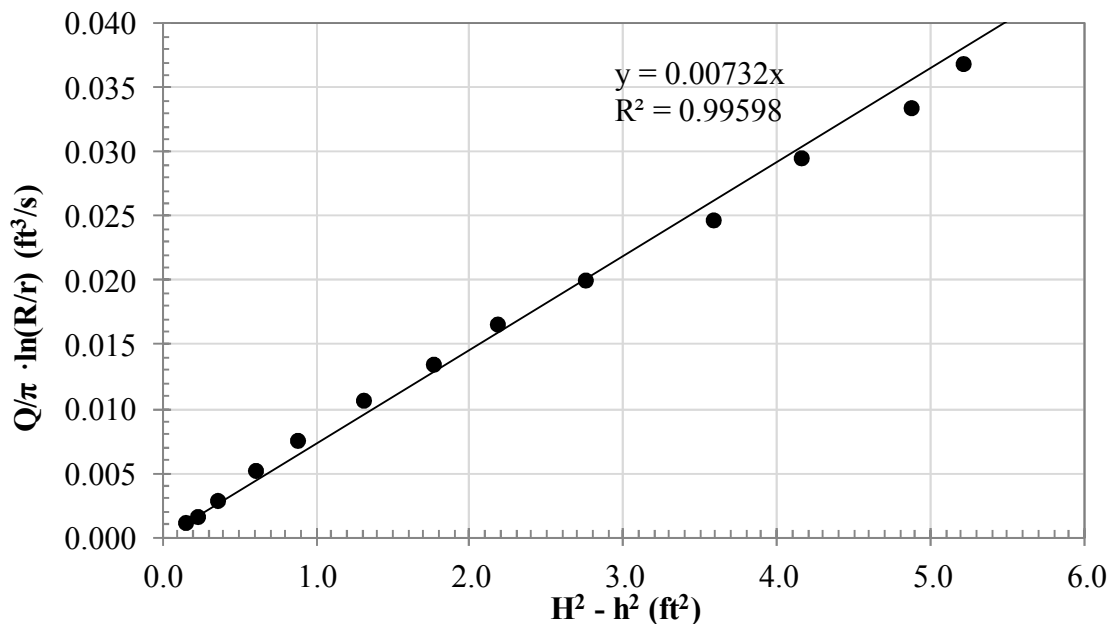


***Figure 4-14 Schematic of Flow through Filtered Riser***

$R$  and  $r$  are constants;  $Q$  and  $H$  were measured during tests, which leaves  $h$  and  $K$  as unknowns. Assuming that the equation used to calculate flow through the orifice is still valid; Equation 4.2 can be solved for  $h$  as shown in Equation 4.5. The value of  $h$  is then equal to the height of the water above the orifice inside the perforated riser and can be calculated using the measured discharge from the tests. Head losses from the perforations can be added to the estimate of  $h$  to provide more accurate results at low heads, as discussed in Section 4.4.2.

$$h = \left(\frac{Q}{c_d A}\right)^2 * \frac{1}{2g} \quad (4.5)$$

Equation 4.4 can now be linearized to estimate K, the only unknown. If  $\frac{Q}{\pi} * \ln \frac{R}{r}$  is plotted against  $H^2 - h^2$  and the y-intercept is set to 0, K can be determined from the slope of a least squares fit to the data. Equation 4.4 is only valid for the second flow regime, when the effects of perforations are negligible and when no water is bypassing the filter media by flowing over the top of the riser pipe, so only higher head data that did not have any flow over the top of the riser were used to estimate K. The linearization for the filtered riser is shown below in Figure 4-15. The initial hydraulic conductivity of the filtered riser is estimated to be 0.0073 ft/s. For comparison, Gupta (2001) gives hydraulic conductivities of 0.0017 ft/s and 0.017 ft/s for coarse sand and fine gravel, respectively.

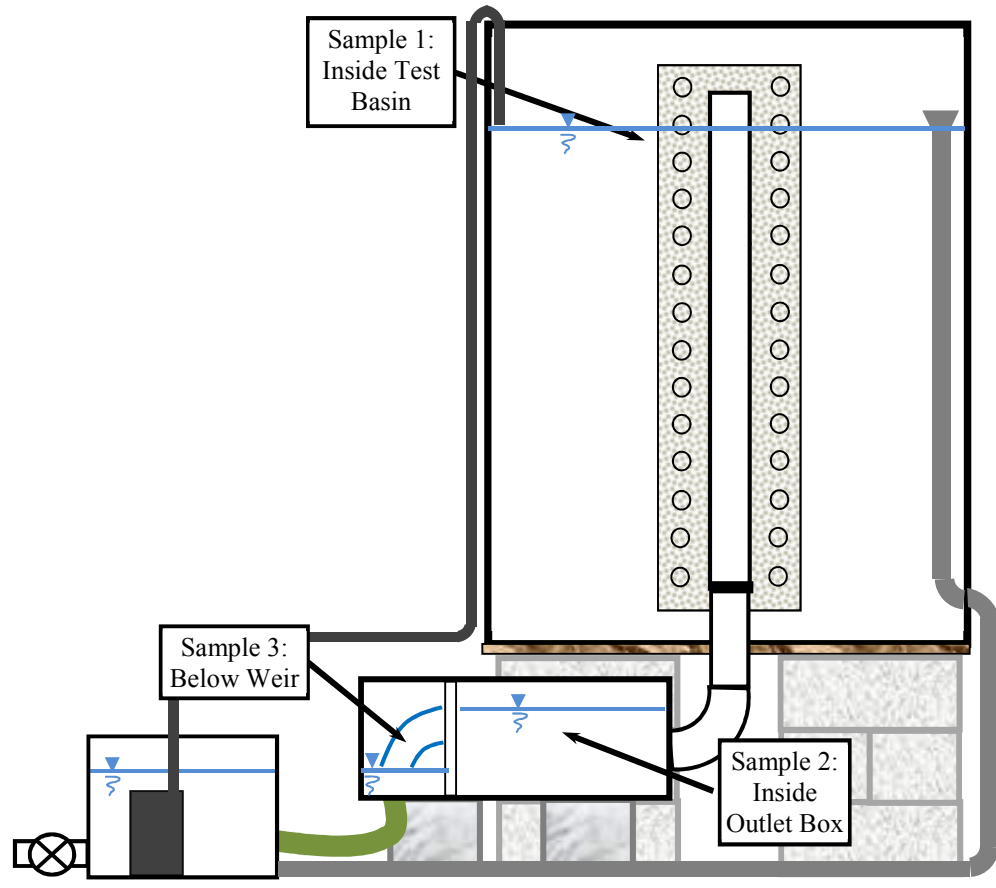


**Figure 4-15 Estimation of Hydraulic Conductivity of Filtered Riser**

## Chapter 5. Filtered Riser Performance Testing

### 5.1 Steady State Experimental Procedure

Only the filtered riser was tested because much larger debris (having a major axis greater than ½”) would be necessary to plug the orifice or the perforated riser. Choosing a representative sample of natural, large debris is difficult; such debris can come in many shapes and sizes, and it would be very difficult to characterize. Furthermore, results of tests with large debris would likely be anecdotal and difficult to apply. To test the filtering capability and clogging potential of the filtered riser outlet structure, sediment was added to the water in the test basin. For steady state experiments, the test basin outlet was closed and the model basin was filled to 4.5 ft above the orifice. Then sediment was added to the model tank while the water inside the tank was continuously stirred. Once all of the sediment was added to the tank, and thoroughly mixed, the mixer was turned off, the outlet was opened and a timer was started. A 125 mL grab sample was taken inside of the test basin (approximately 3” below the surface near the center of the tank) and below the measurement weir at the beginning of each test. A third sample was taken inside the outlet box to determine if any settling occurred in the outlet box. The three locations where the grab samples were taken are shown in Figure 5-1. Grab samples were taken at 15, 30, 45, 60, and 90 minutes, and then at 2, 3, and 4 hours after the start of each experiment. Water from the outlet box was recirculated back into the model basin to keep the water level at 4.5 ft. After the test was run, the basin was allowed to drain completely. Additional tests were repeated in the same manner. The test basin was not cleaned between tests to simulate how the basin might perform over time during multiple events.

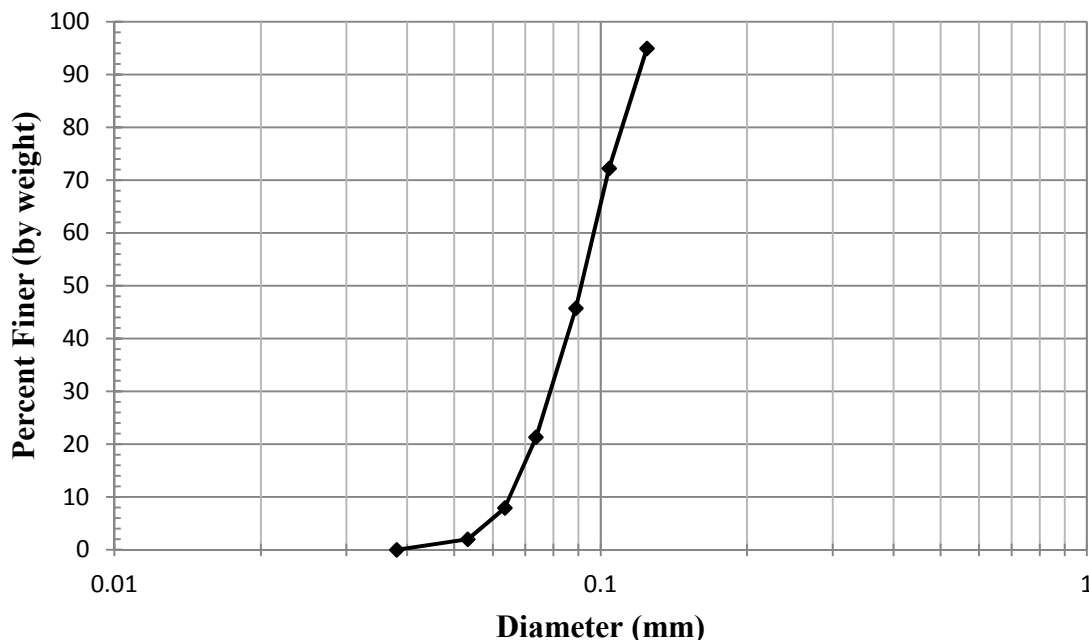


*Figure 5-1 Grab Sample Locations*

**5.1.1 Test Sediment**

Silica sand #140-270 purchased from AGSCO Corporation was used in the first steady state experiment. The silica sand was chosen as it covered a large range of particle sizes typically found in urban stormwater runoff, as discussed in section 2.6.2. The sieve analysis for the silica sand is shown below in Figure 5-2. Based on the sieve analysis, the silica sand has a mean diameter of 0.09 mm.





**Figure 5-2 Silica Sand #140-270 Sieve Analysis**

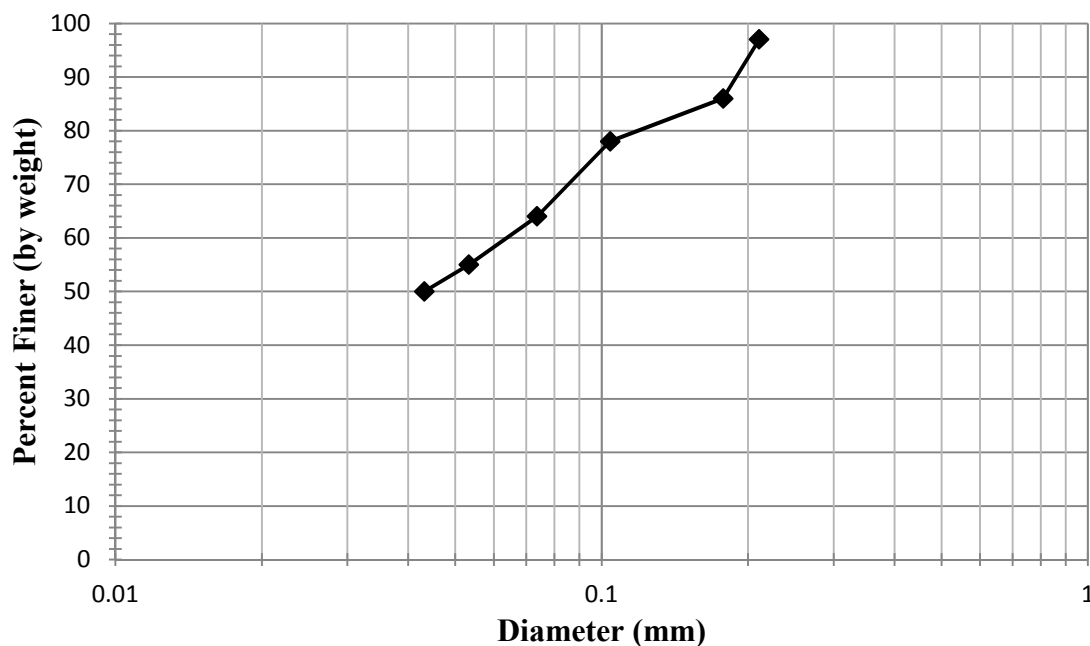
Based on the literature discussed in section 2.6.1, a concentration of 200 mg/L was chosen, which was in the middle range of sediment concentrations reported and was close to median concentrations of suspended sediment measured at two sites in Lincoln. In order to create a concentration of 200 mg/L, 1.064 kg of sediment was added to the water in the model basin. The calculation for this conversion is shown below.

$$\text{Test Basin Volume} = \frac{\pi}{4} (7.29 \text{ ft})^2 * 4.5 \text{ ft} = 188 \text{ ft}^3$$

$$200 \frac{\text{mg}}{\text{L}} * 188 \text{ ft}^3 * 28.3 \frac{\text{L}}{1 \text{ ft}^3} * \frac{\text{kg}}{10^6 \text{ mg}} = 1.064 \text{ kg}$$

After the first experiment, the data showed that the silica sand clearly settled out too quickly to allow for analysis of outlet device performance. Thus, it was decided that in subsequent tests finer silica flour purchased from AGSCO Corporation would be used. The sieve analysis for the silica flour is shown in Figure 5-3. Fifty percent of the silica flour is finer than the #325 sieve or 0.0017 in (.044 mm). Note that the median sediment

size is about one tenth of the openings in the screen used to contain the filter sand (0.42 mm). The sieve analysis shows that individual grains of the sediment should easily fit through the screen, but groups of particles can still clog the filter and/or the filter screen.



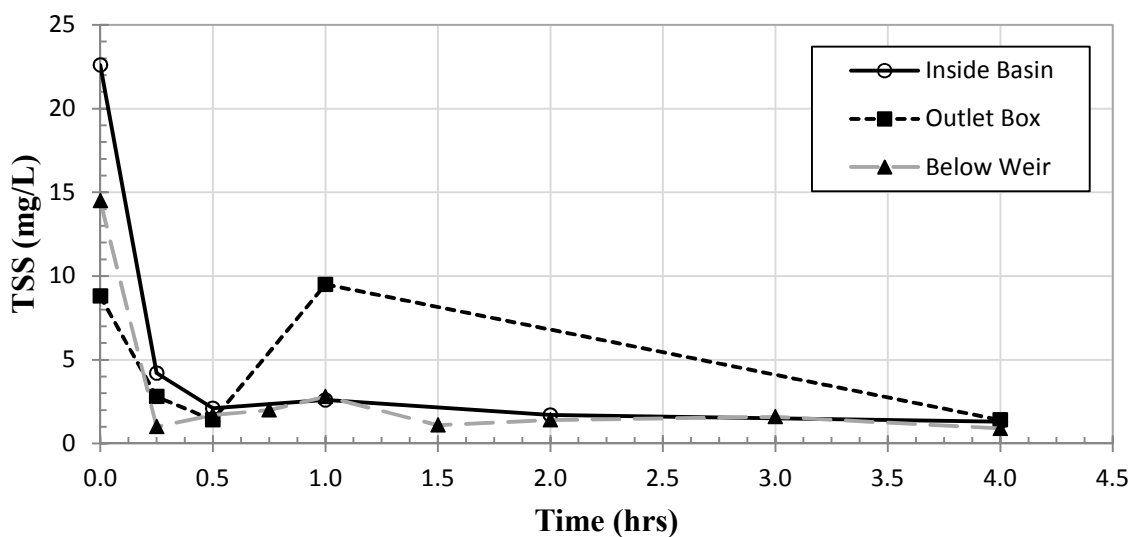
*Figure 5-3 Silica Flour Sieve Analysis*

### 5.1.2 TSS Measurements

Total suspended solids (TSS) were analyzed for the grab samples taken during the steady state tests. The grab samples for each test were collected inside the test basin (approximately 3" below the surface near the center of the basin), in the outlet box downstream of the outlet structure, and immediately below the measurement weir. The samples were analyzed in the CIVE environmental laboratory the day after the tests were run. Standard Method 2540D was followed for the TSS testing procedure using a vacuum filtration apparatus and 105 degree Celsius drying oven.

### 5.1.3 Silica Sand Test – Filtered Riser with 1.5625 inch Orifice

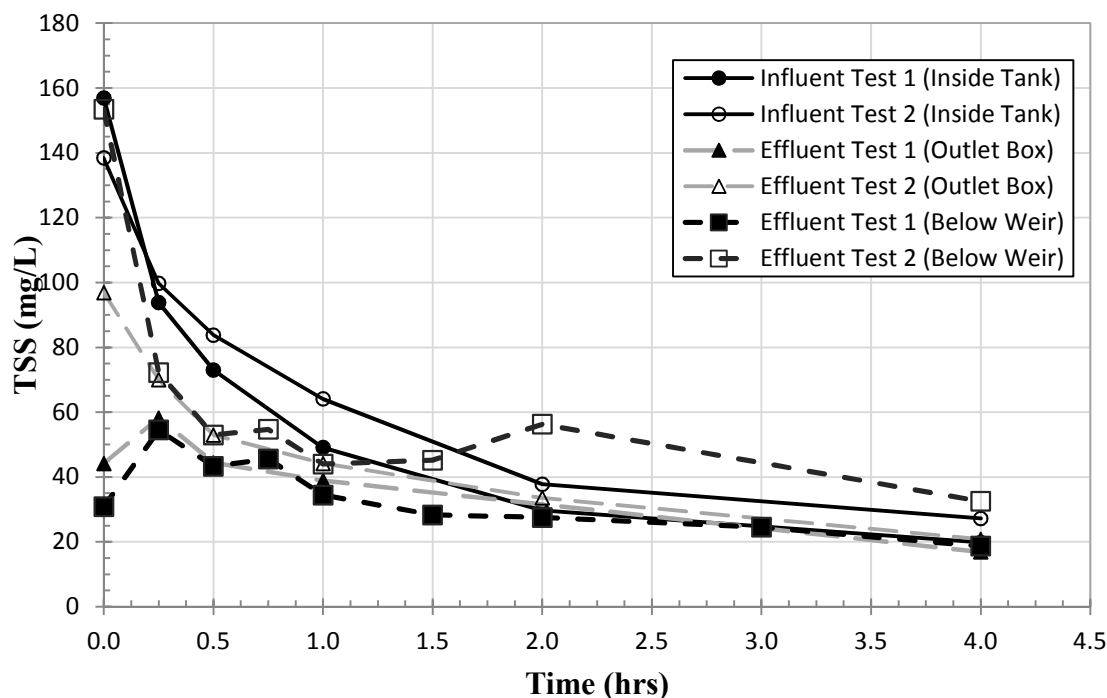
As stated previously, the first steady state test was done with AGSCO #140-270 silica sand. TSS concentrations from grab samples taken inside the test basin, in the outlet box, and below the measurement weir are shown in Figure 5-4. The figure shows that at the beginning of the test, concentrations are an order of magnitude lower than the initial 200 mg/L added to the test basin. Furthermore, with the exception of one measurement in the outlet box, sediment concentrations drop below 5 mg/L within 30 minutes of the beginning of the test. Most of the concentrations measured in the outlet box and below the weir are similar, though it cannot be conclusively determined from the data whether settling in the outlet box is negligible or significant. However, there was no visible deposition of particles in the outlet box during the tests. No conclusions were drawn from this test about the effectiveness or longevity of the filtered perforated riser because of the rapid settling of the silica sand. The TSS sampled in the outlet box at a time of one hour is much higher than similar measurements and appears to be an outlier.



*Figure 5-4 Silica Sand TSS Concentrations*

#### **5.1.4 Initial Silica Flour Tests – Filtered Riser with 1.5625 inch Orifice**

The AGSCO silica flour was used for the remainder of the filtered riser performance tests. The silica flour remained suspended for much longer periods of time than the silica sand, as shown in Figure 5-5, allowing for better observation of filter behavior. The TSS concentration inside the basin was 157 mg/L at the beginning of the first test and declined to 20 mg/L after 4 hours. The concentrations in the outlet box and below the weir correlated well, suggesting no settling in the outlet box. Furthermore, no settling was observed in the outlet box during the tests. This was expected due to the constant high velocities in the box. The filtered riser pipe provides some filtering capacity as evidenced by the large drops in concentration between the test basin and the outlet during the first hour. Incidentally, this means that some clogging of the filter may be occurring. After 2 hours, concentrations were nearly identical in the basin and at the outlet, and they declined very slowly. This is likely due to the recirculation of water through the system, which generates enough turbulence to keep the smallest particles in suspension. Also, the particles that don't settle out are probably small enough to pass through the filter, so the concentrations in the basin and the outlet are the same.



**Figure 5-5 Influent and Effluent Silica Flour TSS Concentrations for Test 1 and 2**

The TSS concentrations in Test 2 were in general slightly higher than in Test 1. It is assumed that this is because of resuspension of particles that settled out in Test 1. The test basin was not cleaned between runs because resuspension of particles also occurs in real basins. Note, however, that resuspension can be minimized in a well-designed basin. At the beginning of the test the concentration was higher below the weir than inside the basin, which may have been caused by initial flushing of particles that settled in the outlet box or the filter during low flows at the end of the previous test.

### 5.1.5 Silica Flour Tests 3-10 – Filtered Riser with 1.5625 inch Orifice

Seven additional silica flour tests were done to analyze how the filter performed over time. Figure 5-6 shows the TSS concentrations inside the test basin for all ten tests. The data clearly show a steady increase in TSS concentration in the water from test to test

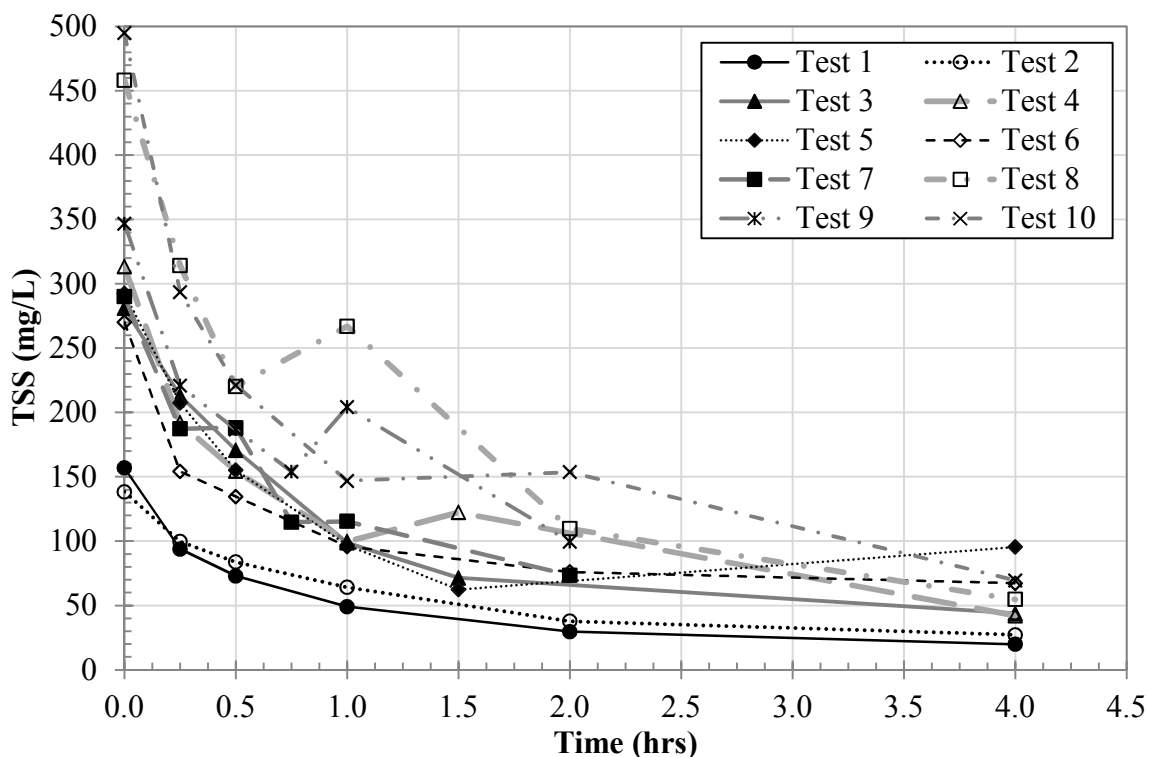
despite the fact that the same amount of sediment was added to the flow prior to each test. The additional sediment is due to resuspension of sediment accumulated in the test basin.

Concentrations downstream of the outlet also increased steadily over the course of the tests as shown in Figure 5-7, but the increases in concentration were much more dramatic at the start of the test than after the 15-minute test sample. Note that Figure 5.7 was plotted on a semi-log scale so that the high concentrations at the beginning of the test could be shown without sacrificing resolution of concentration measurements later in the test. When comparing Figures 5.6 and 5.7, the difference in scales should be acknowledged. At the beginning of the test, concentrations increased from 30.8 mg/L to 1423 mg/L between Tests 1 and 10, but after 15 minutes, concentrations only increased from 54.5 mg/L to 193.7 mg/L between Tests 1 and 10. At the end of each test, concentrations were similar to those in the test basin and only ranged from 19 to 77 mg/L. The general increase of concentrations during subsequent tests is the resuspension of sediment settled out during previous tests. This resuspension increases the initial concentration in the basin for each test.

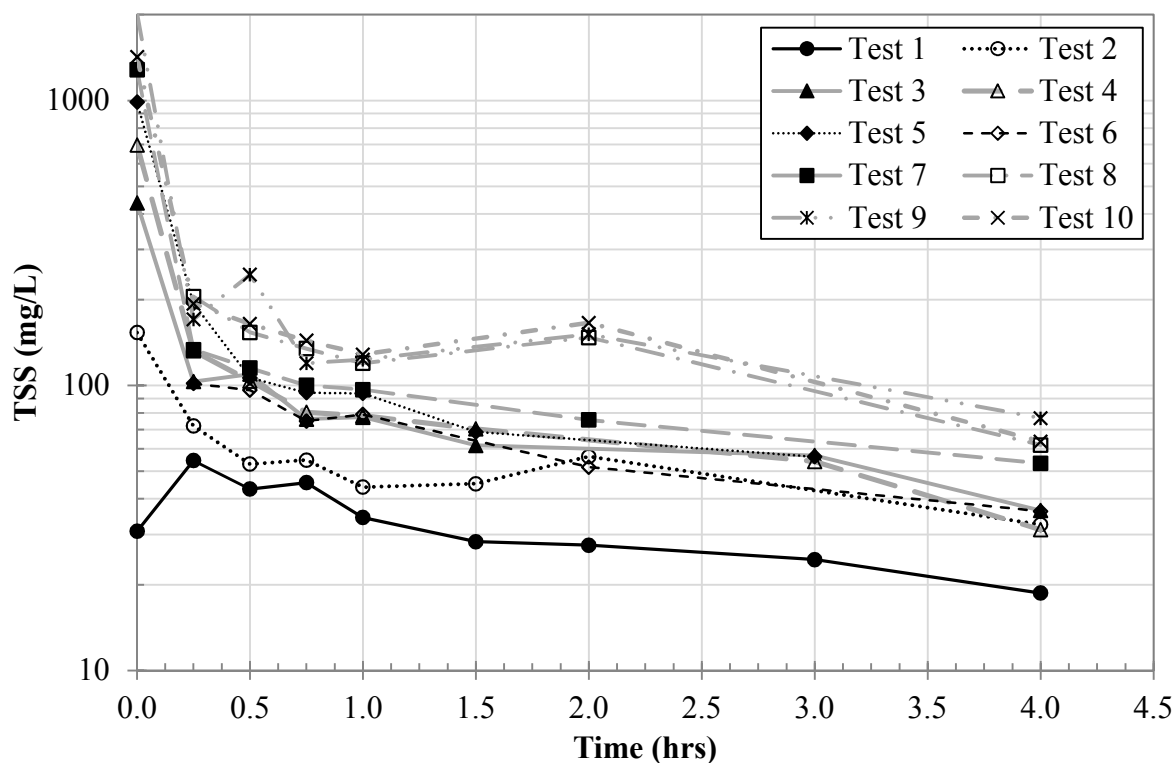
The initial burst of concentration that occurs at the start of each test could be associated with silica that has been trapped by the filter since the burst shows concentrations that are higher at the outlet than in the basin itself. It is quite possible that the emptying and filling of the test basin between tests releases the trapped sediment at the beginning of the next test. Furthermore, the test basin sample is collected from near the top of the basin, whereas the filter draws flow from the entire water column. Initially, when coarse sediment is still in suspension, water near the bottom of the test basin probably has a higher concentration than water near the surface. In addition, at the

beginning of the test, the head and thus pore velocities are higher, which could flush particles out of the filter.

It is also interesting to note that after less than half an hour, concentrations of sediment in the basin and below the weir (following the filtered riser), become very similar. The conclusion that can be drawn is that any sediment which cannot make it through the filter is either quickly filtered out of the water by the filter (so that it does not recirculate to the test basin) or settles in the test basin.



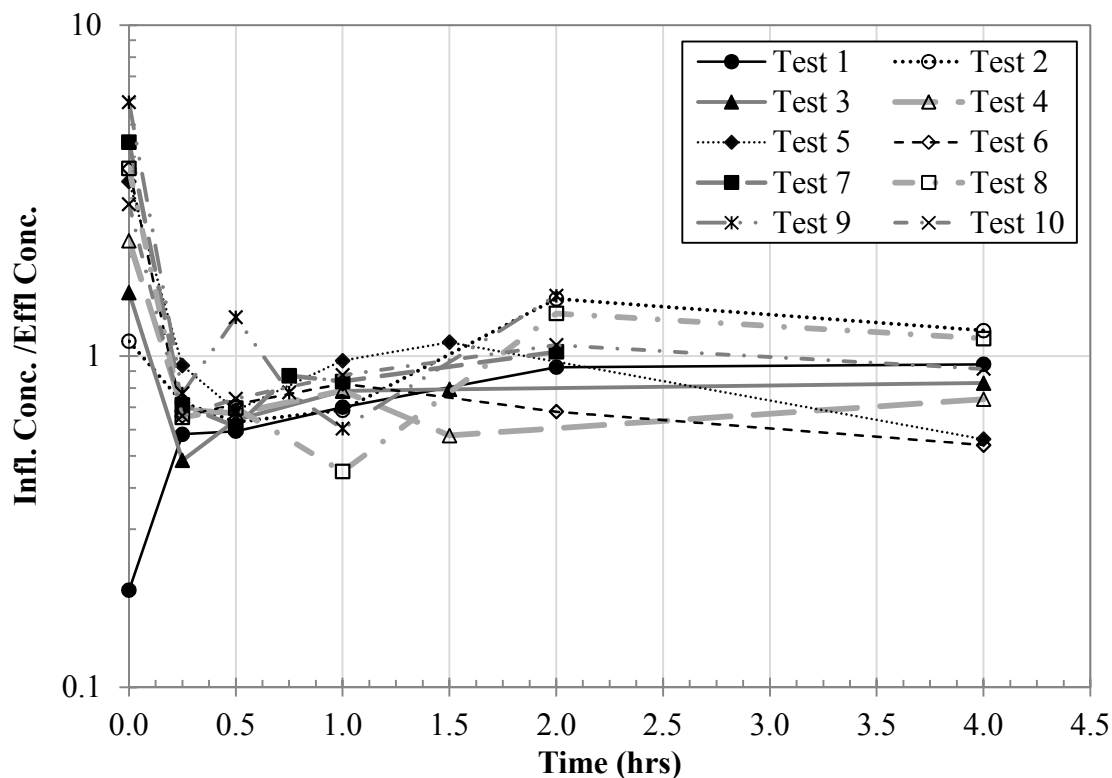
**Figure 5-6 Influent TSS Concentrations (inside Basin) for Silica Flour Tests**



**Figure 5-7 Effluent TSS Concentrations (below Weir) for Silica Flour Tests**

The ratio of influent to effluent of the filtered perforated riser was calculated for the silica flour tests. The results are shown in Figure 5-8. Excluding the initial burst of effluent concentration, most of the ratios were less than 1 meaning that the filter was removing particles. This removal is much lower than most outlet structures found in the literature. However, in the literature, the majority of sediment removal is from settling in the detention basin which occurs before the water reaches the outlet. Due to the small size of the model detention basin, the calculated removal rates are not representative of performance in a full size detention basin. In addition, based on observations during testing, mixing in the model basin caused most if not all of previously settled sediment to be resuspended. Resuspension of this magnitude will not occur in an actual detention basin.





**Figure 5-8 Ratio of Influent and Effluent TSS Concentration for Silica Flour Tests**

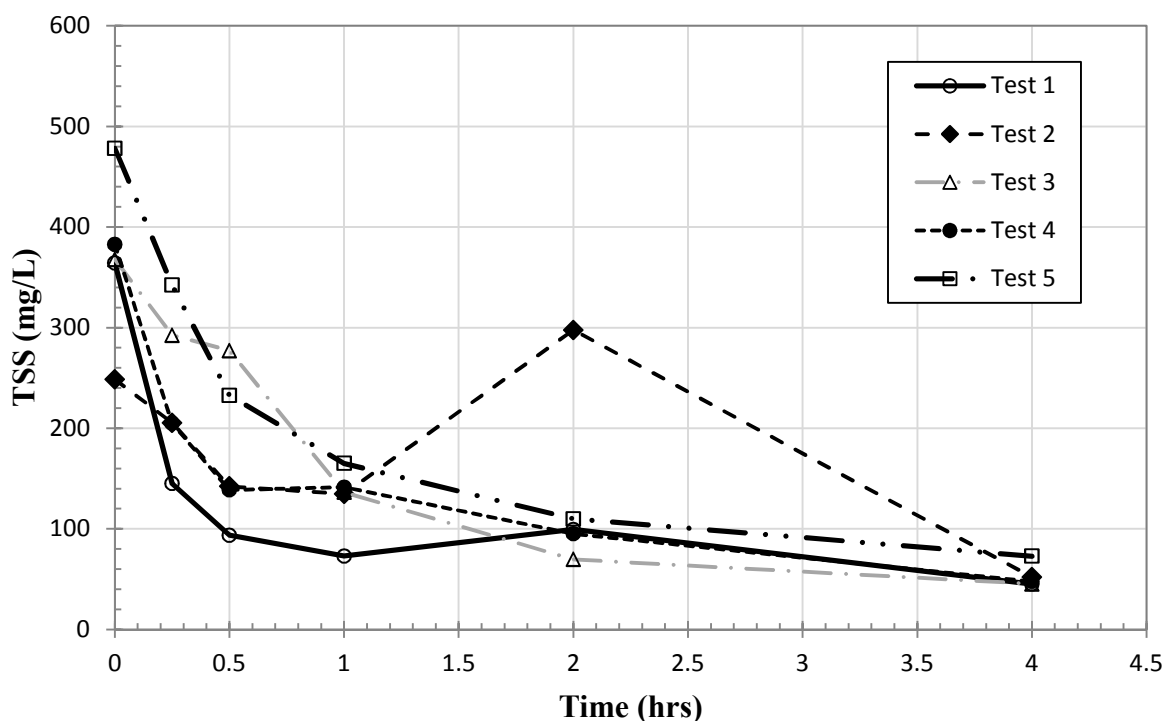
The main purpose of filtered perforated riser is not to provide the majority of the sediment removal, but to prevent clogging of the perforated riser and orifice. Relying on the filtered riser to provide most of the sediment removal would result in a short life span of the filter and susceptibility to failure. The goal of the filtered riser is to provide sufficient drain times for settling, reduce clogging potential, and secondarily provide some filtration for removal of large debris that might otherwise clog the orifice or the perforated riser. It is best if the filtered riser does not remove fine sediment from the flow because trapped sediment would reduce the conveyance of the riser.

#### 5.1.6 Silica Flour Tests – Filtered Riser with 4 inch Outlet and No Orifice

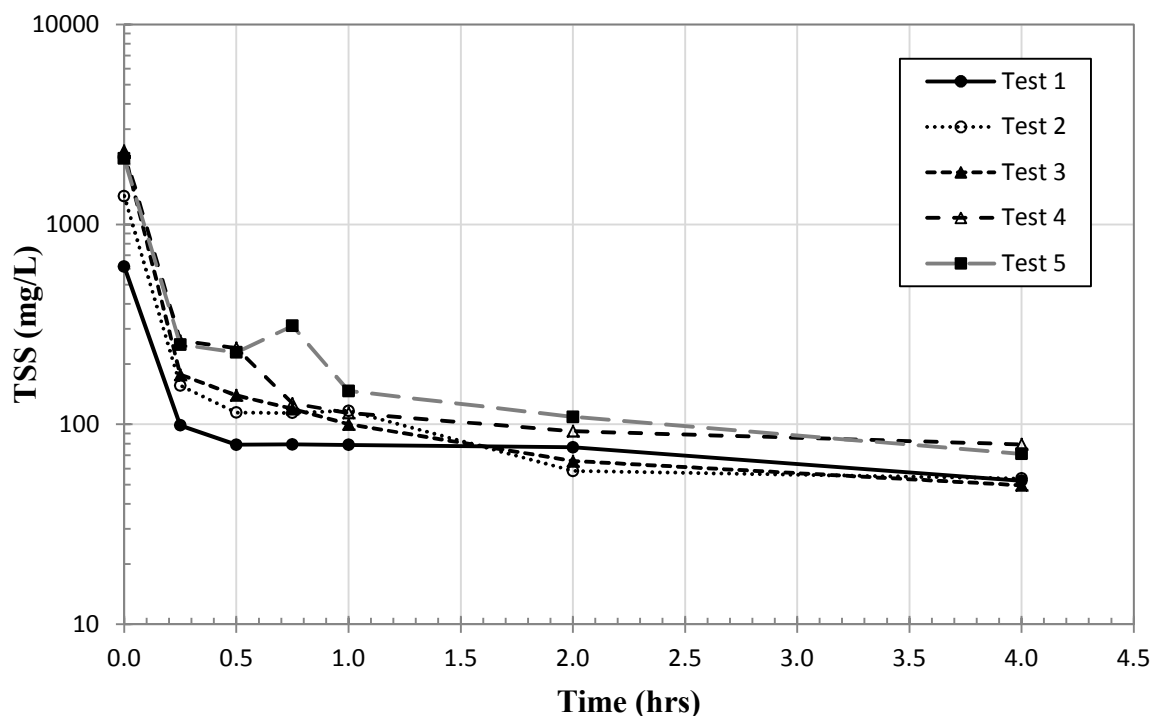
Observations made during the previous tests indicated that after even one sediment test, the drain time for the filtered riser was much longer than the recommended

drain time. After additional tests, drain times increased. Changes in drain times will be discussed in a later section, but in order to better understand the filtering process, the filter media was removed from the riser, the orifice was removed, and the media was replaced. Then drain tests and sediment tests were performed to analyze the system without the orifice in place (i.e. just the sand filter and the perforated riser).

Five silica flour tests were performed using the same procedure as before for the modified filtered riser. The results of these tests are summarized in Figure 5-9 and Figure 5-10. The initial concentrations, both inside the basin and below the weir, were much higher than the first five tests of the previous set, possibly because of residual silica from the previous tests. The ending concentrations, however, were very similar to the first set, ranging from 45 to 80 mg/L. This shows that the orifice does not have a significant impact on the sediment concentrations.



*Figure 5-9 Influent TSS Concentrations (inside Model Basin)*



*Figure 5-10 Effluent TSS Concentrations (below Weir)*

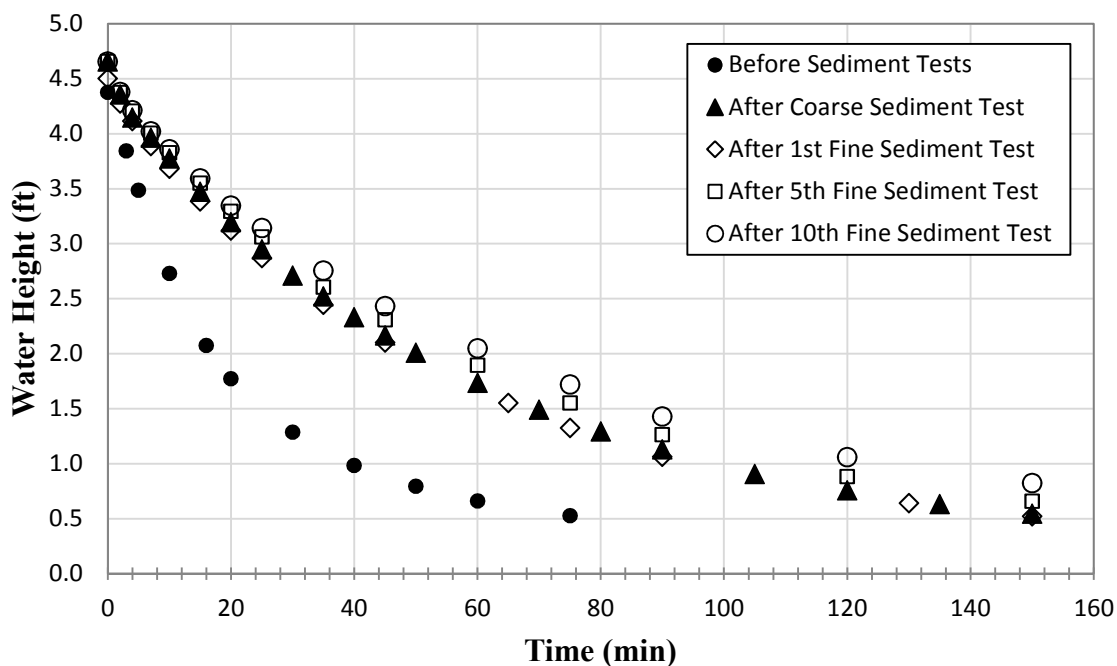
## 5.2 Post-Loading Drain Tests

Drain tests were performed to determine how clogging affected filter velocities and flow rates for the filtered riser structure after the filter had been loaded with sediment. The post-loading tests were done before and after experimental loading tests to assess how clogging progressed over time.

The drain tests involved filling the test basin to capacity with clear water and then allowing it to drain freely. The head in the tank and the weir-based discharge at the outlet of the structure were measured over the drainage period, providing information about changes in the conveyance of the outlet structure.

### 5.2.1 Post Loading Drain Tests – Initial Observations

Drain tests were performed for the filtered riser and 1.5625” orifice combination before any sediment loading, after a coarse sediment test, and after the first, fifth, and tenth silica flour tests. The ‘Before Sediment Tests’ drain test was conducted when the outlet still had a 2” bulkhead connector. However, the drain test data was compared to a steady state test after the 4” bulkhead connector and the estimated hydraulic conductivities (discussed in Section 5.2.2) were very similar, 0.00705 and 0.00732, respectively. Therefore, the drain test is assumed to be representative of the pre-loading drain time. The head above the orifice in the test basin is shown for each of the tests as a function of time in Figure 5-11.

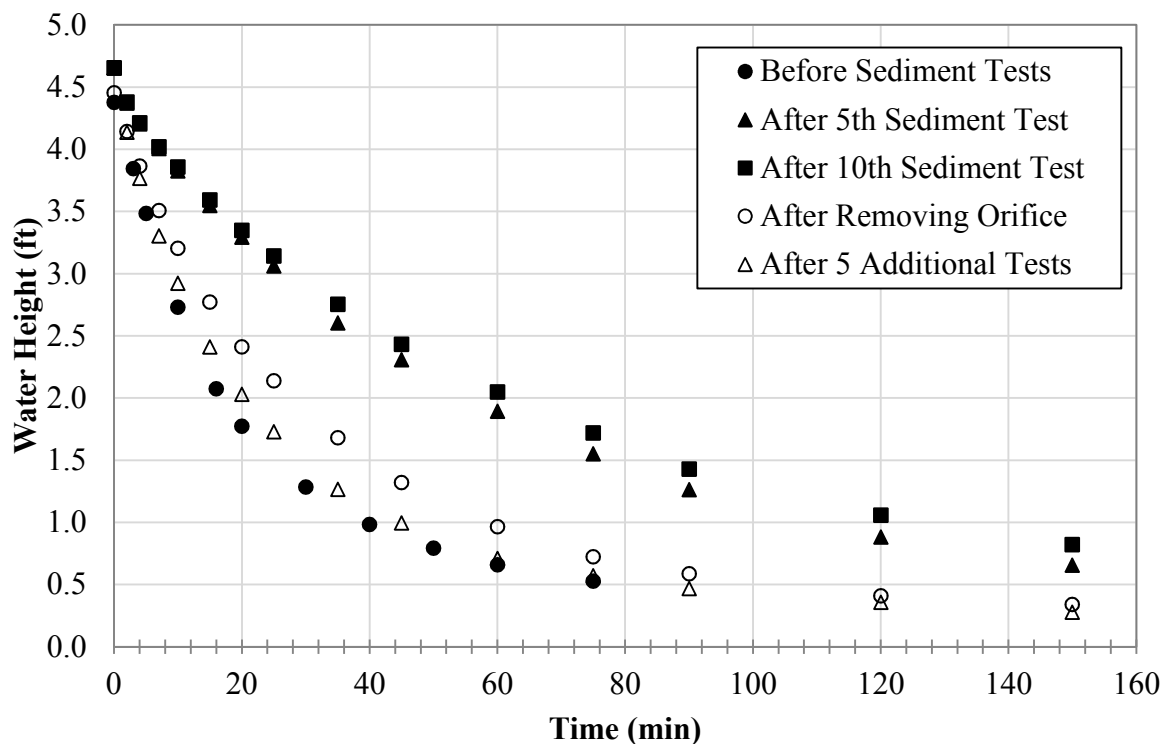


*Figure 5-11 Drain Times for Filtered Riser*

After the 1<sup>st</sup> sediment test, it took about 95 minutes for the water level in the test basin to drain down to 1 ft. After the 5<sup>th</sup> sediment test, the drain time down to 1 ft

increased to approximately 110 minutes and then to 120 minutes after the 10<sup>th</sup> sediment test. The increase in drain time suggests clogging of the filter.

After the filtered riser with orifice tests, the orifice was removed to allow free flow in the riser pipe. Additional drain tests were done before and after the sediment tests that were done without the orifice in place. Figure 5-12 shows the drain times after removing the orifice as well as the drain times from the previous set of testing. As shown in the figure, there was an increase in drainage capacity after the orifice was removed and an even greater increase in capacity after 5 additional sediment tests. Removing the orifice creates a significantly larger head drop across the sand filter; the perforated riser and the filter are essentially the sole causes of head loss when there is no orifice plate inside the riser. It appears that the additional head may have flushed particles out of the filter media rather than depositing additional particles. Essentially, the higher flow rates and head differentials appear to have helped flush out the filter during the five tests, resulting in reduced head losses.



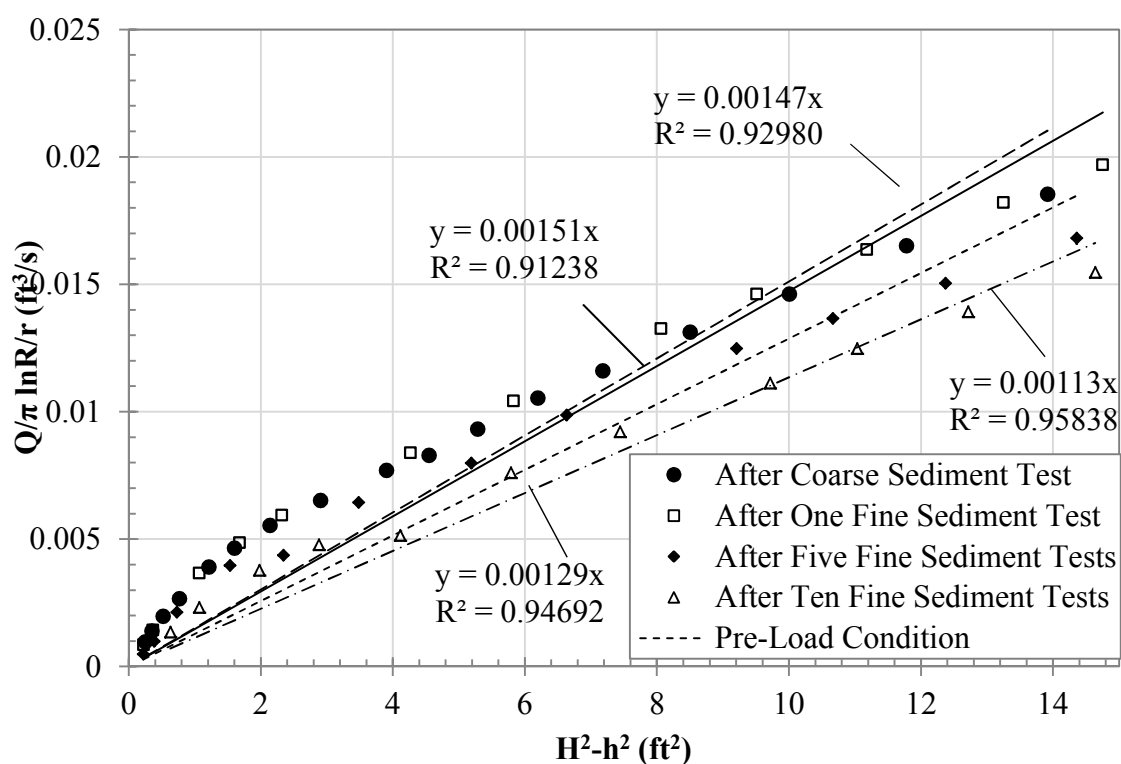
*Figure 5-12 Drain Times for Filtered Riser Before and After Testing*

### 5.2.2 Impact of Clogging on Hydraulic Conductivity

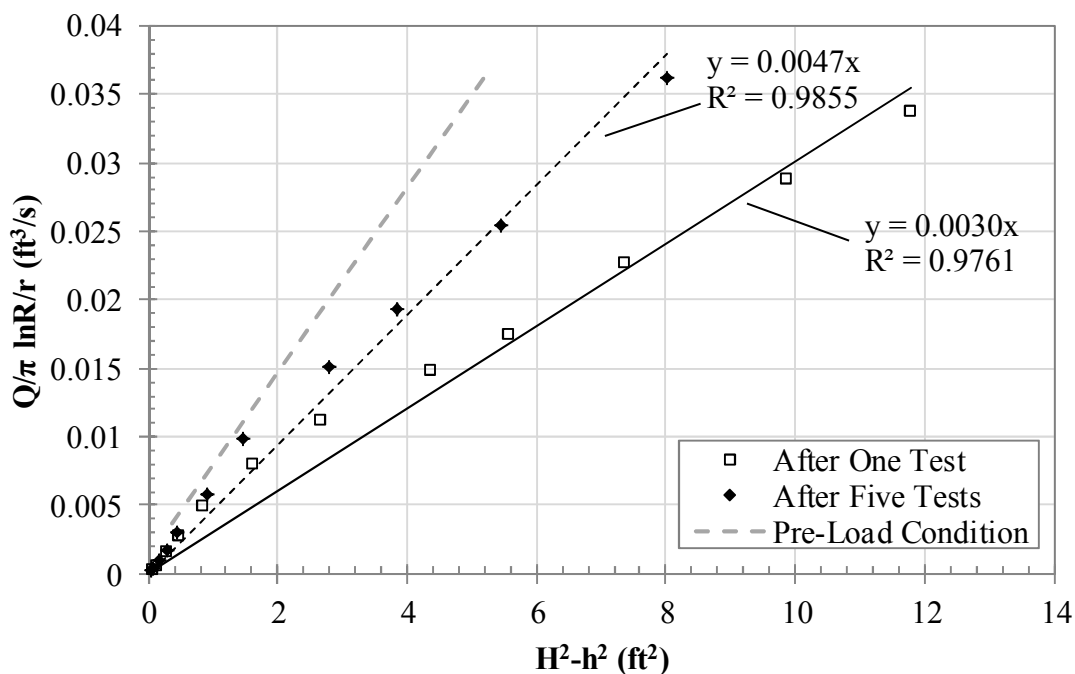
Sediment loading can affect the performance of the filtered riser in two ways: (1) the hydraulic conductivity of the sediment filter can decrease over time, and (2) The screen that holds the sand in place can become clogged. The perforations in the riser and the orifice are too large to become clogged with the fine sediment used in the tests. Furthermore, in the case of the filtered riser, particles that are large enough to plug riser perforations or the orifice cannot make it through the sand filter. Thus, it was first assumed that the sediment from the sediment tests is deposited in the sand filter and reduces the hydraulic conductivity of the sand in the filter.

The same method discussed in Section 4.5.2 to calculate hydraulic conductivity ( $K$ ) was used to estimate  $K$  after sediment testing. The measured discharge is used to calculate the head loss across the orifice and the perforated riser so that the head at the

inside radius of the sand filter is known. The head in the test basin and the head at the inside radius of the filter are then used to compute the left side of Equation 4.4. Plotting  $\frac{Q}{\pi} * \ln \frac{R}{r}$  against  $H^2 - h^2$ , and forcing a least squares fit of the data to pass through the origin, the slope of the resulting line is the hydraulic conductivity of the sand filter. The resulting curve fits are shown in Figure 5-13 and Figure 5-14. The datum used for the tests without an orifice (Figure 5.13) is the same datum as for the tests with an orifice.



**Figure 5-13 Estimation of K Values for Filtered Riser and Orifice Combination**



**Figure 5-14 Estimation of K Values for Filtered Riser with No Orifice**

It should be noted that in order to compute the results shown in Figure 5.13, it was necessary to make an assumption about head losses associated with the outlet of the structure when the orifice was removed. The assumption that was made for tests done after the orifice plate was removed was that the outlet section of the pipe behaved like a four inch diameter orifice with the same discharge coefficient as the 1.5625 inch orifice. When the 1.5625 inch orifice was in place, it created a substantial head loss and backed water up in the riser, but when removed, most of the orifice head loss was also removed for the observed tests. While this assumption cannot be verified, the resulting head losses calculated at the outlet have a negligible impact on the results given in Figure 5.13. Assuming there is a four inch orifice at the bulkhead produces the same results as assuming that outlet head losses are negligible and that discharge through the perforations into the riser is the same as discharge into the atmosphere (free jet flow).



For the runs with an orifice in place, much of the clogging of the filtered riser occurs during the first loading test. However, additional reduction in hydraulic conductivity occurs after five loading tests and again after ten loading tests.

Table 5.1 shows the estimated hydraulic conductivities before and after sediment testing. As expected, the hydraulic conductivity of the filter media declined as more tests were run, showing that the sediment was clogging the filter. The reduction in hydraulic conductivity was much less pronounced after the initial test. This suggests that the hydraulic conductivity may be approaching an asymptotic value where additional sediment loading will not have an effect. This hypothesis was also found in a column study by Bright (2010) that showed the hydraulic conductivity of the filter media approached the hydraulic conductivity of the silt that was being used to load the filter.

**Table 5.1 Hydraulic Conductivity of Filtered Riser before and after Testing**

<b>Test</b>	<b>Hydraulic Conductivity K (ft/s)</b>	<b>R<sup>2</sup></b>
Pre-Load	0.00732	0.996
After Coarse Test	0.00151	0.912
After One Fine Test	0.00147	0.930
After Five Fine Tests	0.00129	0.947
After Ten Fine Tests	0.00113	0.958
After One Test - No Orifice	0.0030	0.976
After Five Tests – No Orifice	0.0047	0.986

The hydraulic conductivity did not respond as anticipated during the second set of tests, after the orifice was removed from the filtered riser. First of all, when the orifice plate was removed, all of the sand had to be removed from the filter; this should have freed much of the silica flour that was trapped in the sand. The expected hydraulic conductivity would then be something that was similar to the original conductivity of the sand. However, the conductivity that was measured after the sand was replaced was less

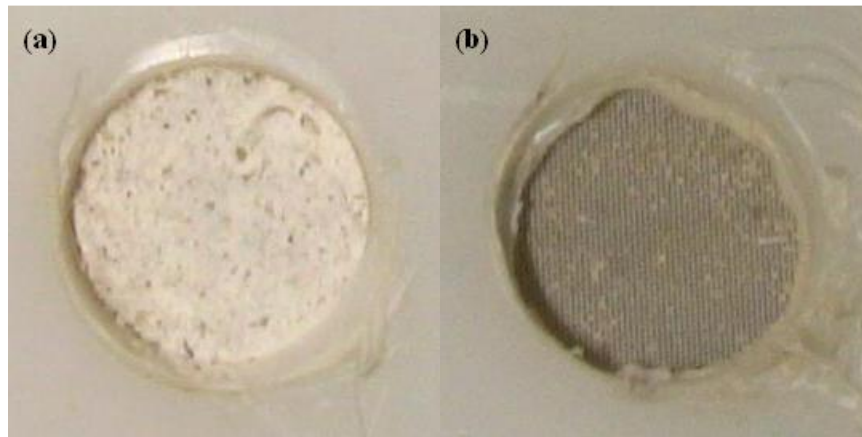
than half of the original conductivity. Moreover, it was expected that after loading with sediment that the conductivity of the filter would drop just as it had when the orifice plate was in place, but what was observed was an increase in conductivity over the loading period.

One explanation is that much of the reduction in conductivity is not due to the sand, but due to head losses across the screen that held the sand in place. When the sand was removed and replaced, the filter screen was not cleaned, and it is possible that remnant silica flour on the screen prevented the filter conductivity from returning to its original value in subsequent tests. This issue could be remedied by increasing the filter screen mesh size. Second, without an orifice in place, the head drop across the filter and filter screen would have been much greater. The augmented head drops led to higher screen and pore velocities and may have flushed out silica sediment deposited in the filter or on the screen, resulting in a recovery in hydraulic conductivity or a reduction in screen head losses. Another potential method to recover hydraulic conductivity is to backwash the filtered riser, a common practice in drinking water treatment to restore filter flow rates. Additional pipe would be added to the outlet pipe to allow water to be pumped back up through the filter. Unfortunately, this would be an additional maintenance requirement for the system.

### 5.2.3 Modeling Screen Head Losses

The data shown in Figure 5.12 do not show a linear relation between  $\frac{Q}{\pi} * \ln \frac{R}{r}$  and  $H^2 - h^2$ , especially for low heads in the experimental tank and in the perforated riser. In addition, performance of the sand filter appeared to degrade rapidly, even after the coarse sand tests were completed. One potential reason for this is that it may not be the filter

that is clogging, but the screen that holds the filter sand in place. Under the assumption that this might be the case, the outside screen of the sand filter was inspected and was found to be coated with sediment particles. Figure 5.14a shows the filter screen after all suspended sediment tests after the sediment has dried. Figure 5.14b shows the screen after it has been partially cleaned by rubbing the dry particles off the screen. It is clear that the fine particles coat the screen, plugging holes in the screen.



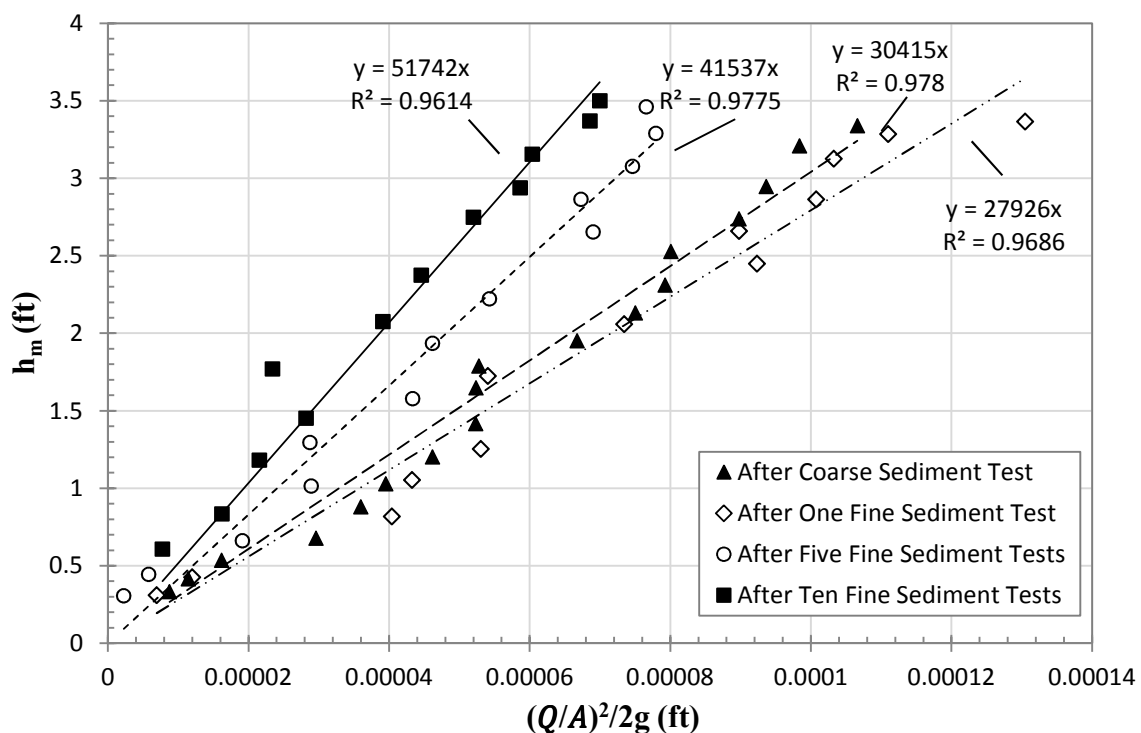
**Figure 5-15 Filter Screen (a) after the Suspended Sediment Tests and (b) after Silica has been Wiped from the Screen.**

A possible model of the clogging screen is to treat the screen as a minor loss, using the equation:

$$h_m = \frac{K_m}{2g} \left( \frac{Q}{A} \right)^2 \quad (5.1)$$

The same method discussed in Section 5.2.2 to estimate hydraulic conductivity was used to estimate the minor loss coefficient ( $K_m$ ). The measured discharge is used to calculate the head loss across the orifice and the perforated riser so that the head at the inside radius of the sand filter is known. The head in the test basin and the head at the inside radius of the filter are then used to compute the left side of Equation 5.1. Plotting

$\frac{1}{2g} \left(\frac{Q}{A}\right)^2$  against  $h_m$ , and forcing a least squares fit of the data to pass through the origin, the slope of the resulting line is the minor loss coefficient. This method assumes that the head loss through the screen is dominant and that there is no additional head loss from the filter media. The resulting curve fits are shown in Figure 5-16.



**Figure 5-16 Estimation of  $K_m$  Values for Filtered Riser and Orifice Combination**

For the filtered riser with orifice, the minor loss coefficient increased significantly following the first sediment tests. There was a slight decrease in  $K_m$  after one silica flour test, but then the minor loss increased after five and ten fine sediment tests.

#### 5.2.4 Comparison of Prediction Results – Minor Loss vs Filter Conductivity

Modeling the screen loss as a minor loss provides a good fit for the data and a more linear fit than hydraulic conductivity. Furthermore, the large initial increase in head

loss from the filtered riser, with subsequent smaller increases is better explained by clogging of the outer screen than of the filter media.

## Chapter 6. Conclusions

### 6.1 Thesis Summary

An extensive literature review of detention based BMP outlet structures was completed. Three main types of outlets were investigated: passive structures, infiltration devices, and mechanical outlets. A few key conclusions from the literature review are summarized below.

1. Rock dams are inexpensive and simple to construct but do not provide consistent dewatering times or sediment retention rates.
2. Infiltration devices generally provided excellent sediment retention rates, in some cases greater than 95%, but require the most extensive maintenance requirements and can require large land areas.
3. The mechanical outlets investigated only provided small increases in sediment retention efficiency compared to the perforated riser and floating skimmer. The mechanical outlets also have more maintenance requirements and reliability concerns compared to the other outlet device types.

Based on the literature review, two stormwater BMP outlet structures were designed and tested in the hydraulics laboratory. The first outlet structure was an orifice controlled perforated riser, which was not found in the literature review. This structure was chosen because it combined the benefits of a perforated riser, drawing water from the entire water column and reduced clogging, with the benefits of a single orifice outlet, mainly a lower peak outflow and better flow control. The second structure was a filtered perforated riser, chosen due to its potential to reduce clogging from larger debris, and

because there is a lack of data on its design and longevity. The conclusions from laboratory testing of these two structures are presented below.

1. The orifice controlled perforated riser adequately controlled flow rates to produce a 40-hour drain time. Also, designing the perforated riser for different basin sizes is very straight forward because the flow rates correlate very well with those predicted by the orifice discharge equation.
2. For the perforated riser with orifice, the orifice plate controls the flow until low heads where the perforations limit the flow. The effect of the perforations can be accurately modeled, but alternatively, there are two methods to eliminate their effects. One method is to increase the amount of perforations at the bottom of the riser pipe; however, this would also increase the amount of water drawn from the bottom of the basin. The other method is to drop the riser pipe and orifice below the bottom of the basin; this would also fix the problem of the asymptotic nature of the drain times.
3. Flow through the filtered riser is similar to flow in an unconfined aquifer and can be modeled using the unconfined aquifer equation. However, clogging of the filter screen controls the flow of the filtered perforated riser. By increasing the screen mesh size, the filter media would be the limiting factor for the flow.
4. The screen head loss of the filtered riser increased dramatically after the first sediment test; subsequent tests produce a much smaller increase in screen losses. In order to design the filtered riser to a specific drain time, this initial clogging should be taken into account.

5. Very high initial concentrations below the outlet suggest that at high flows some particles previously captured in the filter media or the filter screen are flushed out. Another source of the high concentration is resuspension of particles that settled out inside the model basin.

A laboratory testing procedure was established to test the outlet structures and can be used to test future outlet structure designs. The testing procedure produced useful results but also had deficiencies. A few observations about the testing procedure are presented below:

1. The testing procedure can easily be reproduced and provided consistent results. The testing procedure is only moderately time intensive and preparation for testing is quick and simple.
2. Flow rates were accurately measured for a variety of heads. This allows for accurate sizing of outlet structures which can be installed and tested.
3. Resuspension of particles settled out in previous tests made it difficult to infer conclusions about the sediment removal qualities of the filtered riser. In the future, it may be beneficial to start with the same initial concentration for each test, if possible.

## **6.2 Future Work**

Through the findings of this research project, several areas have been identified that would benefit from further research. Recommendations for future work are listed below.



1. Install the orifice controlled perforated riser in an actual detention basin to determine if it provides the same sediment capture rates as those found in the literature. This would also help determine if a 40 hour drain time is sufficient to achieve the desired level of pollutant removal.
2. Measure the water head inside of the filtered perforated riser during sediment testing in order to determine if using the orifice equation is a good estimation of  $h$ .
3. Use a larger screen mesh size to contain the sand in the filtered perforated riser to see how this affects head loss and flow. A fine mesh was used in the experiments described in this thesis because two different filter grain sizes were tested and one was very fine. A coarse mesh can be used with coarse filter sediment, and this will reduce the tendency of the filter screen to become clogged.
4. Different media sizes could be tested to find the size that provides flow rates sufficient to drain a basin in 40 hours while still providing filtration.

## References

- Barrett, M. E. (2003). "Performance, cost, and maintenance requirements of Austin sand filters." *J. Water Resour. Plann. Manage.*, 129(3), 234-242; 242.
- Bidelspach, D. A., and Jarrett, A. R. (2004). "Electro-mechanical outlet flow control device delays sediment basin dewatering." *Appl. Eng. Agric.*, 20(6), 759-763; 763.
- Bidelspach, D. A., Jarrett, A. R., and Vaughan, B. T. (2004). "Influence of Increasing the Delay Time Between the Inflow and Outflow Hydrographs of Sediment Basin." *Trans. ASAE*, 47(2), 439.
- Bright, T. M. (2010). "Impact of Storm-Water Runoff on Clogging and Fecal Bacteria Reduction in Sand Columns." *J ENVIRON ENG-ASCE*, 136(12), 1435; 1435-1441; 1441.
- Carleton, J. (2000). "Performance of a constructed wetlands in treating urban stormwater runoff." *Water Environ. Res.*, 72(article), 295-304; 304.
- City of Lincoln (2004). "Lincoln Drainage Criteria Manual."  
<<http://www.lincoln.ne.gov/city/pworks/watrshed/require/drainage/>> (April 18, 2013)
- Davis, A. P. (2003). "Water quality improvement through bioretention: Lead, copper, and zinc removal." *Water Environ. Res.*, 75(1), 73-82; 82.
- Dechesne, M., Barraud, S., and Bardin, J. (2005). "Experimental assessment of stormwater infiltration basin evolution." *J. Environ. Eng.*, 131(7), 1090-1098; 1098.
- J. W. Faircloth. (2010). "Faircloth Skimmer." <<http://www.fairclothskimmer.com/>> (Aug. 2, 2010).
- Fennessey, L. A. J., and Jarrett, A. R. (1997). "Influence of Principal Spillway Geometry and Permanent Pool Depth on Sediment Retention of Sedimentation Basins." *Transactions of the ASAE*, 40(1), 53-59.
- Finnemore, E. John. and Franzini, Joseph B. (2002) "Fluid Mechanics with Engineering Applications, 10<sup>th</sup> Ed.", *New York: Mcgraw Hill*, 790 pp.

- Fisher, J. (2011). "Water Quality Models for Stormwater Runoff in Two Lincoln, Nebraska Urban Watersheds." M.S. thesis, Univ. of Nebraska, Lincoln, NE.
- Griffin, M. L. (1985). "Laboratory Studies of Dead Storage in Sediment Ponds." *Transactions of the American Society of Agricultural Engineers*, 28(3), 799-804; 804.
- Gupta, R. S. (2001). Hydrology and Hydraulic Systems, 2<sup>nd</sup> Edition. Waveland Press, Inc., Prospect Heights, IL, 867 pp.
- Hatt, B. (2007). "Treatment performance of gravel filter media: Implications for design and application of stormwater infiltration systems." *Water Res.*, 41(article), 2513-2524; 2524.
- Hatt, B. E. (2008). "Hydraulic and pollutant removal performance of fine media stormwater filtration systems." *Environ.Sci.Technol.*, 42(7), 2535; 2535-2541; 2541.
- Hunt, W. (2008). "Pollutant Removal and Peak Flow Mitigation by a Bioretention Cell in Urban Charlotte, N.C." *J.Environ.Eng.*, 134(5), 403.
- Hunt, W. (2006). "Evaluating Bioretention Hydrology and Nutrient Removal at Three Field Sites in North Carolina." *Journal of Irrigation & Drainage Engineering*, 132(6), 600.
- Jarrett, A. R. (1993). "Design of perforated risers to control dewatering of sedimentation basins." *Appl.Eng.Agric.*, 9(1), 37-42; 42.
- Jartun, M. (2008). "Runoff of particle bound pollutants from urban impervious surfaces studied by analysis of sediments from stormwater traps." *Sci.Total Environ.*, 396(2-3), 147; 147-163; 163.
- Kim, J., and Sansalone, J. J. (2008). "Event-based size distributions of particulate matter transported during urban rainfall-runoff events." *Water Res.*, 42(10-11), 2756; 2756-2768; 2768.
- Lassabatere, L., Angulo-Jaramillo, R., Goutaland, D., Letellier, L., Gaudet, J. P., Winiarski, T., and Delolme, C. (2010). "Effect of the settlement of sediments on water infiltration in two urban infiltration basins." *Geoderma*, 156(3), 316-325; 325.
- Li, H. (2009). "Water quality improvement through reductions of pollutant loads using bioretention." *J.Environ.Eng.*, 135(8), 567-576; 576.

- Li, H. (2008). "Urban particle capture in bioretention media. I: Laboratory and field studies." *J ENVIRON ENG-ASCE*, 134(6), 409; 409-418; 418.
- Li, M., and Barrett, M. (2008). "Documenting stormwater quality on Texas highways and adjacent vegetated roadsides." *J. Environ. Eng.*, 134(1), 48-59; 59.
- Li, Y., Lau, S., Kayhanian, M., and Stenstrom, M. K. (2006). "Dynamic characteristics of particle size distribution in highway runoff: Implications for settling tank design RID A-3177-2008." *J. Environ. Eng.-ASCE*, 132(8), 852-861.
- Line, D. E., and White, N. M. (2001). "Efficiencies of temporary sediment traps on two North Carolina construction sites." *Transactions of the American Society of Agricultural Engineers*, 44(5), 1207-1215; 1215.
- McCaleb, M. S., and McLaughlin, R. A. (2008). "Sediment Trapping by Five Different Sediment Detention Devices on Construction Sites." *Transactions of the ASABE*, 51(5), 1613.
- McLaughlin, R. A., Hayes, S. A., Clinton, D. L., McCaleb, M. S., and Jennings, G. D. (2009). "Water Quality Improvements using Modified Sediment Control Systems on Construction Sites." *Transactions of the ASABE*, 52(6), 1859.
- Middleton, J. R., and Barrett, M. E. (2008). "Water Quality Performance of a Batch-Type Stormwater Detention Basin." *Water Environ. Res.*, 80(2), 172-178.
- Millen, J. A., Jarrett, A. R., and Faircloth, J. W. (1997). "Experimental Evaluation of Sedimentation Basin Performance for Alternative Dewatering Systems." *Transactions of the ASAE*, 40(4), 1087-1095.
- Mungasavalli, D. (2006). "Constructed wetlands for stormwater management: A review." *Fresenius Environ. Bull.*, 15(article), 1363-1372; 1372.
- Rauhofer, J., Jarrett, A. R., and Shannon, R. D. (2001). "Effectiveness of Sedimentation Basins that do not Totally Impound a Runoff Event." *Transactions of the ASAE*, 44(4), 813-818.
- Roseen, R. M., Ballesterro, T., and Houle, J. (2010). "University of New Hampshire Stormwater Center 2009 Biannual Report." UNH Stormwater Center, .
- Roseen, R. M., Thomas P. Ballesterro, , James J. Houle, Pedro Avellaneda, Joshua Briggs, George Fowler, and and Robert Wildey. (2009). "Seasonal performance variations for storm-water management systems in cold climate conditions." *J. Environ. Eng.*, 135(3), 128-137; 137.

- Roseen, R., Ballestero, T., Houle, J., Avelleneda, P., Wildey, R., and Briggs, J. (2006). "Storm Water Low-Impact Development, Conventional Structural, and Manufactured Treatment Strategies for Parking Lot Runoff: Performance Evaluations Under Varied Mass Loading Conditions." *Transportation Research Record: Journal of the Transportation Research Board*, 1984(-1), 135-147.
- Schaad, D. (2008). "Design and performance of multipurpose constructed wetland and flow equalization basin." *JOURNAL OF ENVIRONMENTAL ENGINEERING-ASCE*, 134(article), 118-125; 125.
- School of Natural Resources, UNL. (2012). "Lincoln Weather and Climate Data." <http://snr.unl.edu/lincolnweather/data/> 2012).
- Siriwardene, N. (2007a). "Clogging of stormwater gravel infiltration systems and filters: Insights from a laboratory study." *Water Res.*, 41(article), 1433-1440; 1440.
- Siriwardene, N. R. (2007b). "Clogging of stormwater gravel infiltration systems and filters: Insights from a laboratory study." *Water Res.*, 41(7), 1433; 1433-1440; 1440.
- Soil Survey Staff. (1999). "Soil taxonomy: A basic system of soil classification for making and interpreting soil surveys." *Natural Resources Conservation Service. U.S. Department of Agriculture Handbook 436*. 2nd edition.
- Urbonas, B. R. (1999). "Design of a sand filter for stormwater quality enhancement." *Water Environ.Res.*, 71(1), 102-113; 113.
- U.S. Department of Agriculture – Natural Resources Conservation Service (2004). "Technical Note No. 25. The Iowa Phosphorus Index." Des Moines, IA. <<http://www.ia.nrcs.usda.gov/technical/Phosphorus/phosphorusstandard.html>.> (April 4, 2013)
- Yu, S., Earles, T., and Fitch, G. (1998). "Aspects of Functional Analysis of Mitigated Wetlands Receiving Highway Runoff." *Transportation Research Record: Journal of the Transportation Research Board*, 1626(-1), 21-30.