

University of Nebraska - Lincoln

DigitalCommons@University of Nebraska - Lincoln

Civil Engineering Theses, Dissertations, and
Student Research

Civil Engineering

12-2013

Development of a Field Test for Total Suspended Solids Analysis

Jessica Branigan

University of Nebraska, jabranigan@unomaha.edu

Follow this and additional works at: <http://digitalcommons.unl.edu/civilengdiss>



Part of the [Civil Engineering Commons](#), and the [Environmental Engineering Commons](#)

Branigan, Jessica, "Development of a Field Test for Total Suspended Solids Analysis" (2013). *Civil Engineering Theses, Dissertations, and Student Research*. 68.

<http://digitalcommons.unl.edu/civilengdiss/68>

This Article is brought to you for free and open access by the Civil Engineering at DigitalCommons@University of Nebraska - Lincoln. It has been accepted for inclusion in Civil Engineering Theses, Dissertations, and Student Research by an authorized administrator of DigitalCommons@University of Nebraska - Lincoln.

DEVELOPMENT OF A FIELD TEST METHOD FOR TOTAL
SUSPENDED SOLIDS ANALYSIS

by

Jessica A. Branigan

A THESIS

Presented to the Faculty of
The Graduate College at the University of Nebraska
In Partial Fulfillment of Requirements
For the Degree of Master of Science

Major: Civil Engineering

Under the Supervision of Professor John Stansbury

Lincoln, Nebraska

December 2013

DEVELOPMENT OF A FIELD TEST METHOD FOR
TOTAL SUSPENDED SOLIDS ANALYSIS

Jessica A. Branigan, M.S.

University of Nebraska, 2013

Adviser: John Stansbury

Total suspended solids (TSS) are all particles in water that will not pass through a glass fiber filter with a pore size less than 2 μm , including sediments, algae, nutrients, and metals. TSS is an important water quality parameter because of its adverse effects on aquatic species and wildlife. The EPA has proposed a regulation for turbidity, a related water quality parameter, which has been stayed pending further testing. TSS is regulated through the EPA via the NPDES in many states. Since there are no accepted field tests for TSS, projects with TSS regulations must send samples to a laboratory for analysis, which can delay projects for days. The goal of this research was to develop a rapid, cost-effective, and consistent method for direct measurement of TSS in the field.

Theoretical analyses of three initial designs (centrifugation, rapid heating, and rapid filtration using vacuum assist) showed that in order to obtain sufficient suspended material to measure in the field, too much water would be needed for each sample to be feasible for centrifugation and rapid heating. A new prototype rapid filtration system design was developed for evaluation. Subsequent testing showed this system to be inaccurate. A second system was modified the method was modified to for rapid

filtration with no vacuum. Testing of this system also showed results were not precise enough to be a feasible field test.

It was concluded that none of the described methods were currently feasible, and that the laboratory test could also have inaccuracies in measuring water samples tested to meet regulation standards.

ACKNOWLEDGMENTS

The author expresses thanks to all who assisted with the completion of this project. My appreciation is especially extended to my adviser Dr. John Stansbury for his motivation and support through the steps of this project. The author would also like to thank Dr. Tian Zhang and Dr. John Rohde for their guidance throughout the process of completing this project. Special appreciation goes to the sponsor of this project, Mid-America Transportation Center (MATC).

Special thanks go to Robbie Jones, manager of the University of Nebraska at Omaha (UNO) Theatre Scene Shop, for allowing the use of the space and tools for the construction of an apparatus, as well as Dan Jones, a research assistant at UNO, for aid in the design of an apparatus. Thanks are also extended to Midwest Plastics, Inc., for the expert construction of the final apparatus design.

A special thank you goes to Dr. Steve From and Dr. Andrew Swift, professors in the UNO Math Department, who provided great insight into time-dependent statistical analysis at the initial stages of this project.

Lastly, I would like to thank my family and friends as well as Luke Batterman for their support and contributions throughout the project.

TABLE OF CONTENTS

ABSTRACT.....	ii
ACKNOWLEDGEMENTS.....	iv
TABLE OF CONTENTS.....	v
LIST OF FIGURES	ix
LIST OF TABLES.....	xiii
SECTION 1: INTRODUCTION	1
SECTION 2: OBJECTIVES AND SCOPE.....	3
2.1 Objectives	3
2.2 Scope.....	3
SECTION 3: LITERATURE REVIEW	6
3.1 Regulatory Definition of Total Suspended Solids	6
3.2 Sources of Suspended Solids	6
3.3 Factors Affecting TSS Concentrations in Water Bodies	7
3.4 Effects of Total Suspended Solids on Water Quality	9
3.4.1 Water Clarity.....	9
3.4.2 Water Temperature	9
3.4.3 Dissolved Oxygen.....	10
3.4.4 Sedimentation	10
3.4.5 Nutrient and Chemical Loading in Water Bodies.....	11
3.4.6 Impacts to Wildlife and Aquatic Species.....	12
3.5 Regulation of Total Suspended Solids.....	13
3.5.1 History of Total Suspended Solids Regulation.....	13
3.5.2 Current Total Suspended Solids Regulation.....	13

3.6 Existing Testing Methods for Total Suspended Solids.....	14
3.6.1 Representative Sampling	14
3.6.2 Common Laboratory Total Suspended Solids Testing Methods	18
3.6.3 Comparison of Laboratory Methods.....	19
3.6.4 Total Suspended Solids Sensors and Probes.....	20
3.7 Total Suspended Solids and Turbidity.....	24
3.7.1 Turbidity	24
3.7.2 Turbidity Regulation.....	25
3.7.3 Correlations between Total Suspended Solids and Turbidity.....	26
3.8 Control and Treatment of Total Suspended Solids	26
SECTION 4: METHODS AND MATERIALS.....	29
4.1 Soil Sample Production.....	29
4.1.1 Soil Analysis	29
4.1.2 Soil Types Used in Experiments.....	36
4.2 Laboratory Technique Used for Total Suspended Solids Testing	36
4.3 Proposed Field Techniques for Total Suspended Solids	38
4.3.1 Development of a Homogenous Mixing System	38
4.3.2 Theoretically-Analyzed Methods.....	39
4.3.3 Experimentally-Tested Methods.....	44
4.3.4 TSS Portable Sensor Calibration	57
4.4 Statistical Methods.....	58
4.4.1 Determination of Statistical Analyses to be Completed	58
4.4.2 Average and Standard Deviation	59
4.4.3 T-Test Analysis.....	59

SECTION 5: RESULTS	61
5.1 Soil Analyses	61
5.1.1 Specific Gravity Determination	61
5.1.2 Hydrometer Test	62
5.1.3 Liquid Limit, Plastic Limit, and Plasticity Indices	66
5.1.4 Classification of Soils	67
5.2 Laboratory Method Accuracy and Precision	68
5.2.1 Precision of Standard Method Laboratory Test	68
5.2.2 Effect of Total Dissolved Solids on Sample TSS Results	69
5.3 Vacuum-Assisted Rapid Filtration.....	70
5.3.1 Vacuum-Assisted Filtration with Top Chamber Full of Air.....	70
5.3.2 Vacuum-Assisted Filtration with Top Chamber Full of Water	71
5.3.3 Vacuum-Assisted Filtration with Top Chamber Full of Water, Testing Different TSS Concentrations.....	72
5.3.4 Vacuum-Assisted Filtration Testing at Similar TSS Concentrations and Pressures.....	74
5.3.5 Vacuum-Assisted Filtration at Similar TSS Concentrations and Pressures	76
5.3.6 Vacuum-Assisted Filtration, Comparing Two TSS Concentrations at a Consistent Pressure	77
5.3.7 Vacuum-Assisted Filtration Using a Standard Glass Fiber Filter.....	81
5.3.8 Data Analysis of Vacuum-Assisted Results	83
5.4 Rapid Filtration Without Vacuum Assistance	85
5.4.1 Filtration with No Vacuum, Comparing Two TSS Concentrations.....	87
5.4.2 Total Dissolved Solids Testing	89
5.4.3 Filtration with No Vacuum using Large Volumes.....	90

5.4.4 Filtration with No Vacuum Using Consistent Laboratory Practices at Different Manufactured TSS Concentrations	91
5.4.5 Filtration with No Vacuum at Different TSS Concentration Targets	96
5.4.6 Filtration with No Vacuum Using Grade GF/F Filter Paper.....	99
5.4.7 Effects of Standard Laboratory Method Imprecision on Variability of Rapid Filtration with no Vacuum Assistance	100
5.5 TSS Sensor Analysis.....	101
SECTION 6: CONCLUSIONS.....	104
SECTION 7: RECOMMENDATIONS.....	106
SECTION 8: BIBLIOGRAPHY.....	107
APPENDIX A.....	114
A.1 EPA Method 160.2 Residue, Non-Filterable	114
A.2. Standard Method 2540 D Total Suspended Solids Dried at 103 – 105°C	118
A.3 ASTM D5907 – 09 Filterable and Nonfilterable Matter in Water.....	119
A.4 ASTM D854 – 10 Specific Gravity of Soil Solids by Water Pycnometer.....	125
A.5 ASTM D422 – 63 Particle-Size Analysis of Soils.....	132
A.6 ASTM D4318 – 10 Liquid Limit, Plastic Limit, and Plasticity Index of Soils	140
A.7 ASTM D2487 – 10 Classification of Soils for Engineering Purposes.....	152
APPENDIX B	161

LIST OF FIGURES

Figure 3.1: Proposed LED Absorption Instrument as Tested by Lim et al. (2011).....	24
Figure 4.1: Bilge Pump Mixing Apparatus Used for Keeping Particles in Suspension	39
Figure 4.2: Initial Design of Rapid Filtration Apparatus	46
Figure 4.3: Final Design of Rapid Filtration Apparatus	48
Figure 4.4: Apparatus Used in Vacuum-Assisted Experiments.....	51
Figure 4.5: Closed System Filtration Apparatus with Mixer and Vacuum Pump	52
Figure 4.6: Filtration System with No Vacuum.....	55
Figure 5.1: Hydrometer Test Results for Soil #1	65
Figure 5.2: Hydrometer Test Results for Soil #2.....	66
Figure 5.3: Hydrometer Test Results for Soil #3.....	66
Figure 5.4: Soil #3 with Top Chamber of the Filtration Apparatus Mostly Filled with Air, Using Grade 3 Filter Paper and a TSS Concentration of 100 mg/L.....	71
Figure 5.5: Soil #3 with Top Chamber of Filtration Apparatus Full of Water, Using Grade 3 Filter Paper and a TSS Concentration of 100 mg/L.....	72
Figure 5.6: Soil #2 with Top Chamber of Filtration Apparatus Filled with Water, Using Grade 3 Filter Paper and TSS Concentrations of 100 mg/L and 110 mg/L.....	73
Figure 5.7: Soil #3 with Top Chamber of Filtration Apparatus Filled with Water, Using Grade 3 Filter Paper and TSS Concentrations of 90 mg/L, 100 mg/L, and 110 mg/L.....	74
Figure 5.8: Soil #1 Using Grade 3 Filter Paper with Three Replicates of a TSS Concentration at 100 mg/L and Similar Pressures.....	75
Figure 5.9: Soil #1 Using Grade 5 Filter Paper with Two Replicates of a TSS Concentration of 100 mg/L and Similar Pressures	75
Figure 5.10: Soil #1 Using Grade 5 Filter Paper with Five Replicates of a TSS Concentration of 100 mg/L and a Consistent Pressure of 575 mmHg	78

Figure 5.11: Soil #1 Using Grade 5 Filter Paper with Three Replicates of a TSS Concentration of 85 mg/L and a Consistent Pressure of 575 mmHg78

Figure 5.12: Soil #1 Using Grade 5 Filter Paper at a Pressure of 575 mmHg, Comparing TSS Concentrations of 85 mg/L and 100 mg/L.....79

Figure 5.13: Soil #1 Using Grade 5 Filter Paper after Mixing Apparatus Modification, with Three Replicates of a TSS Concentration of 100 mg/L and a Consistent Pressure of 575 mmHg.....80

Figure 5.14: Soil #1 Using Grade 5 Filter Paper after Mixing Apparatus Modification, with Two Replicates of a TSS Concentration of 85 mg/L and a Consistent Pressure of 575 mmHg.....80

Figure 5.15: Soil #1 Using Grade 5 Filter Paper after Mixing Apparatus Modification at a Pressure of 575 mmHg, Comparing TSS Concentrations of 85 mg/L and 100 mg/L81

Figure 5.16: Soil #1 Using 934-AH Filter Paper, with Three Replicates of a TSS Concentration of 100 mg/L and a Consistent Pressure of 575 mmHg82

Figure 5.17: Soil #1 Using 934-AH Filter Paper, with Three Replicates of a TSS Concentration of 85 mg/L and a Consistent Pressure of 575 mmHg82

Figure 5.18: Soil #1 Using 934-AH Filter Paper at a Pressure of 575 mmHg, Comparing TSS Concentrations of 85 mg/L and 100 mg/L.....83

Figure 5.19: Soil #1 Using 934-AH Filter Paper, Comparing Effective Permeability Over Time between Concentrations of 100 mg/L and 85 mg/L84

Figure 5.20: Soil #1 Dilution Test Using 934-AH Filter Paper and no Vacuum, with Estimated Concentrations of 100 mg/L, 50 mg/L and 20 mg/L86

Figure 5.21: Soil #1 with No Vacuum Using 934-AH Filter Paper, with Eight Replicates at a Manufactured TSS Concentration of 115 mg/L87

Figure 5.22: Soil #1 with No Vacuum Using 934-AH Filter Paper, with Eight Replicates at a Manufactured TSS Concentration of 100 mg/L88

Figure 5.23: Soil #1 with No Vacuum Using 934-AH Filter Paper, Comparison of Four Replicates of Manufactured TSS Concentrations of 115 mg/L and 100 mg/L, Using Large Volumes.....90

Figure 5.24: Soil #1 with No Vacuum Using 934-AH Filter Papers, with Five Replicates at a Manufactured TSS Concentration of 170 mg/L and Consistent Volumes	91
Figure 5.25: Soil #1 with No Vacuum Using 934-AH Filter Papers, with Fifteen Replicates at a Manufactured TSS Concentration of 160 mg/L and Consistent Volumes	91
Figure 5.26: Soil #1 with No Vacuum Using 934-AH Filter Papers, with Ten Replicates at a Manufactured TSS Concentration of 140 mg/L and Consistent Volumes	92
Figure 5.27: Soil #1 with No Vacuum Using 934-AH Filter Papers, with Five Replicates at a Manufactured TSS Concentration of 135 mg/L and Consistent Volumes	92
Figure 5.28: Soil #1 with No Vacuum Using 934-AH Filter Papers, with Five Replicates at a Manufactured TSS Concentration of 130 mg/L and Consistent Volumes	93
Figure 5.29: Soil #1 with No Vacuum Using 934-AH Filter Papers, with Five Replicates at a Manufactured TSS Concentration of 120 mg/L and Consistent Volumes	93
Figure 5.30: Soil #1 with No Vacuum Using 934-AH Filter Papers, with Five Replicates at a Manufactured TSS Concentration of 115 mg/L and Consistent Volumes	94
Figure 5.31: Soil #1 with No Vacuum Pressure Using 934-AH Filter Papers, with Seven Replicates at a Manufactured TSS Concentration of 100 mg/L and Consistent Volumes	94
Figure 5.32: Soil #1 with No Vacuum Pressure Using 934-AH Filter Papers, with Fourteen Replicates at a Manufactured TSS Concentration of 75 mg/L and Consistent Volumes	95
Figure 5.33: Soil #1 with No Vacuum Using 934-AH Filter Papers, Nine Replicates at a Target TSS Concentration of 130 mg/L.....	96
Figure 5.34: Soil #1 with No Vacuum Using 934-AH Filter Papers, Eight Replicates at a Target TSS Concentration of 115 mg/L.....	96

Figure 5.35: Soil #1 with No Vacuum Using 934-AH Filter Papers, Ten Replicates at a Target TSS Concentration of 100 mg/L.....	97
Figure 5.36: Soil #1 with No Vacuum Using 934-AH Filter Papers, Eleven Replicates at a Target TSS Concentration of 85 mg/L	97
Figure 5.37: Soil #1 with No Vacuum Using 934-AH Filter Papers, Eight Replicates at a Target TSS Concentration of 70 mg/L.....	98
Figure 5.38: Soil #1 with No Vacuum Using Grade GF/F Filter Paper, Two Replicates of Manufactured TSS Concentrations of 160 mg/L, 140 mg/L and 120 mg/L.....	99
Figure B.1: Liquid Limit Test Results for Soil #1	161
Figure B.2: Liquid Limit Test Results for Soil #2	161
Figure B.3: Liquid Limit Test Results for Soil #3.....	162
Figure B.4: Plasticity Chart with Data Overlay for Soil #1, #2, and #3	162

LIST OF TABLES

Table 3.1: State-Specific TSS Regulations for Construction Site Dewatering Activities	14
Table 3.2: Existing TSS Sensors and Probes	21
Table 4.1: Precision and Accuracy of the Standard Method TSS Laboratory Test Using 4 Sets of 10 Determinations Each (APHA et al. 2012)	37
Table 4.2: Soil Column Height at Different TSS Concentrations	43
Table 5.1: Specific Gravity Ranges for Different Soil Types (Toledo Laboratory)	61
Table 5.2: Pycnometer Calibration Data	61
Table 5.3: Data for Completion of Specific Gravity Lab Analysis	62
Table 5.4: Hygroscopic Moisture Correction Factors	63
Table 5.5: Soil #1 Hydrometer Analysis Data	64
Table 5.6: Soil #2 Hydrometer Analysis Data	64
Table 5.7: Soil #3 Hydrometer Analysis Data	64
Table 5.8: Liquid Limit, Plastic Limit, and Plasticity Index of Analyzed Soils	67
Table 5.9: Precision and Accuracy of the Standard Method TSS Laboratory Test Using Results from 5 to 15 Runs Each	69
Table 5.10: Average Soil Loss due to Dissolved Particles for Different Total Suspended Solids Concentrations	70
Table 5.11: TDS Analysis Results	89
Table 5.12: Comparison between Standard Laboratory Analysis Results and the Sensor-Reported Values of Two Sets of Manufactured TSS Concentrations, 75 mg/L and 150 mg/L	101
Table 5.13: Comparison of the Average, Standard Deviation, and Variability between Laboratory-Analyzed and Sensor-Reported Results for Two Manufactured TSS Concentrations, 75 mg/L and 150 mg/L	102

Table B.1: Variability and Average Loss Due to Dissolved Particles of Standard Laboratory Analysis at Different Manufactured.....	163
Table B.2: Tabulation of Figure 5.4 – Soil #3 with Top Chamber of the Filtration Apparatus Mostly Filled with Air, Using Grade 3 Filter Paper and a TSS Concentration of 100 mg/L.....	164
Table B.3: Tabulation of Figure 5.5 – Soil #3 with Top Chamber of Filtration Apparatus Full of Water, Using Grade 3 Filter Paper and a TSS Concentration of 100 mg/L.....	165
Table B.4: Tabulation of Figure 5.6 – Soil #2 with Top Chamber of Filtration Apparatus Filled with Water, Using Grade 3 Filter Paper and TSS Concentrations of 100 mg/L and 110 mg/L.....	167
Table B.5: Tabulation of Figure 5.7 – Soil #3 with Top Chamber of Filtration Apparatus Filled with Water, Using Grade 3 Filter Paper and TSS Concentrations of 90 mg/L, 100 mg/L, and 110 mg/L.....	168
Table B.6: Tabulation of Figure 5.8 – Soil #1 Using Grade 3 Filter Paper with Three Replicates of a TSS Concentration at 100 mg/L and Similar Pressures.....	170
Table B.7: Tabulation of Figure 5.9 – Soil #1 Using Grade 5 Filter Paper with Two Replicates of a TSS Concentration of 100 mg/L and Similar Pressures.....	172
Table B.8: Tabulation of Figure 5.10 – Soil #1 Using Grade 5 Filter Paper with Five Replicates of a TSS Concentration of 100 mg/L and a Consistent Pressure of 575 mmHg.....	173
Table B.9: Tabulation of Figure 5.11 – Soil #1 Using Grade 5 Filter Paper with Three Replicates of a TSS Concentration of 85 mg/L and a Consistent Pressure of 575 mmHg.....	175
Table B.10: Tabulation of Figure 5.12 – Soil #1 Using Grade 5 Filter Paper at a Pressure of 575 mmHg, Comparing TSS Concentrations of 85 mg/L and 100 mg/L.....	176
Table B.11: Tabulation of Figure 5.13 – Soil #1 Using Grade 5 Filter Paper after Mixing Apparatus Modification, with Three Replicates of a TSS Concentration of 100 mg/L and a Consistent Pressure of 575 mmHg.....	178

Table B.12: Tabulation of Figure 5.14 – Soil #1 Using Grade 5 Filter Paper after Mixing Apparatus Modification, with Two Replicates of a TSS Concentration of 85 mg/L and a Consistent Pressure of 575 mmHg	180
Table B.13: Tabulation of Figure 5.15 – Soil #1 Using Grade 5 Filter Paper after Mixing Apparatus Modification at a Pressure of 575 mmHg, Comparing TSS Concentrations of 85 mg/L and 100 mg/L.....	181
Table B.14: Tabulation of Figure 5.16 – Soil #1 Using 934-AH Filter Paper, with Three Replicates of a TSS Concentration of 100 mg/L and a Consistent Pressure of 575 mmHg	183
Table B.15: Tabulation of Figure 5.17 – Soil #1 Using 934-AH Filter Paper, with Three Replicates of a TSS Concentration of 85 mg/L and a Consistent Pressure of 575 mmHg	184
Table B.16: Tabulation of Figure 5.18 – Soil #1 Using 934-AH Filter Paper at a Pressure of 575 mmHg, Comparing TSS Concentrations of 85 mg/L and 100 mg/L.....	185
Table B.17: Tabulation of Figure 5.19 – Soil #1 Dilution Test Using 934-AH Filter Paper and no Vacuum, with Estimated Concentrations of 100 mg/L, 50 mg/L and 20 mg/L	187
Table B.18: Tabulation of Figure 5.21 – Soil #1 with No Vacuum Using 934-AH Filter Paper, with Eight Replicates at a Manufactured TSS Concentration of 115 mg/L.....	188
Table B.19: Tabulation of Figure 5.22 – Soil #1 with No Vacuum Using 934-AH Filter Paper, with Eight Replicates at a Manufactured TSS Concentration of 100 mg/L.....	190
Table B.20: Tabulation of Figure 5.23 – Soil #1 with No Vacuum Using 934-AH Filter Paper, Comparison of Four Replicates of Manufactured TSS Concentrations of 115 mg/L and 100 mg/L, Using Large Volumes.....	192
Table B.21: Tabulation of Figure 5.24 – Soil #1 with No Vacuum Using 934-AH Filter Papers, with Five Replicates at a Manufactured TSS Concentration of 170 mg/L and Consistent Volumes.....	197
Table B.22: Tabulation of Figure 5.25 – Soil #1 with No Vacuum Using 934-AH Filter Papers, with Fifteen Replicates at a Manufactured TSS Concentration of 160 mg/L and Consistent Volumes.....	199

Table B.23: Tabulation of Figure 5.26 – Soil #1 with No Vacuum Using 934-AH Filter Papers, with Ten Replicates at a Manufactured TSS Concentration of 140 mg/L and Consistent Volumes.....	203
Table B.24: Tabulation of Figure 5.27 – Soil #1 with No Vacuum Using 934-AH Filter Papers, with Five Replicates at a Manufactured TSS Concentration of 135 mg/L and Consistent Volumes.....	206
Table B.25: Tabulation of Figure 5.28 – Soil #1 with No Vacuum Using 934-AH Filter Papers, with Five Replicates at a Manufactured TSS Concentration of 130 mg/L and Consistent Volumes.....	208
Table B.26: Tabulation of Figure 5.29 – Soil #1 with No Vacuum Using 934-AH Filter Papers, with Five Replicates at a Manufactured TSS Concentration of 120 mg/L and Consistent Volumes.....	210
Table B.27: Tabulation of Figure 5.30 – Soil #1 with No Vacuum Using 934-AH Filter Papers, with Five Replicates at a Manufactured TSS Concentration of 115 mg/L and Consistent Volumes.....	212
Table B.28: Tabulation of Figure 5.31 – Soil #1 with No Vacuum Pressure Using 934-AH Filter Papers, with Seven Replicates at a Manufactured TSS Concentration of 100 mg/L and Consistent Volumes.....	214
Table B.29: Tabulation of Figure 5.32 – Soil #1 with No Vacuum Pressure Using 934-AH Filter Papers, with Fourteen Replicates at a Manufactured TSS Concentration of 75 mg/L and Consistent Volumes.....	216
Table B.30: Variability of Rapid Filtration without Vacuum Assist When Categorized into Target TSS Concentrations	220
Table B.31: Tabulation of Figure 5.33 – Soil #1 with No Vacuum Using 934-AH Filter Papers, Nine Replicates at a Target TSS Concentration of 130 mg/L	221
Table B.32: Tabulation of Figure 5.34 – Soil #1 with No Vacuum Using 934-AH Filter Papers, Eight Replicates at a Target TSS Concentration of 115 mg/L	224
Table B.33: Tabulation of Figure 5.35 – Soil #1 with No Vacuum Using 934-AH Filter Papers, Ten Replicates at a Target TSS Concentration of 100 mg/L.....	226
Table B.34: Tabulation of Figure 5.36 – Soil #1 with No Vacuum Using 934-AH Filter Papers, Eleven Replicates at a Target TSS Concentration of 85 mg/L.....	229

Table B.35: Tabulation of Figure 5.37 – Soil #1 with No Vacuum Using 934-AH Filter Papers, Eight Replicates at a Target TSS Concentration of 70 mg/L	232
Table B.36: Tabulation of Figure 5.38 – Soil #1 with No Vacuum Using Grade GF/F Filter Paper, Two Replicates of Manufactured TSS Concentrations of 160 mg/L, 140 mg/L and 120 mg/L.....	234

SECTION 1: INTRODUCTION

Water discharges from construction sites, utility pits, and other dewatering activities can be highly turbid with large amounts of total suspended solids (TSS). Suspended solids are organic and inorganic materials with a grain size larger than 2 μm suspended in the water. These particles can include sediment, algae, and nutrients or metals that have attached to the particles in the water (Kerr 1995).

It is important to monitor and regulate suspended solids in runoff and discharges because high TSS can adversely affect water quality in receiving water bodies. For example, high suspended solids concentrations can result in lower water clarity, which in turn reduces the amount of sunlight able to reach aquatic species. This ultimately results in a reduction of dissolved oxygen (Berg 1970). The increased amount of solids in the water can also lead to clogged fish gills, and can prevent egg/larvae development (O'Connor et al. 1977).

Turbidity is relatively easy to measure and has been proposed as a surrogate measure of TSS. However, turbidity measurements are not always an accurate measurement of suspended solids. Turbidity is not only affected by the amount of solids suspended in the water sample, but also by the size, shape, and color of the particles (APHA 2012). Because of this, it is more accurate to use the measurement of TSS for calculating mass quantities of suspended solids in or entering a water body. Though correlations between turbidity and TSS can be made, these correlations are site specific. In a research study conducted in the Puget Lowlands in Washington, samples were taken in thirteen streams to determine the feasibility of using turbidity to estimate TSS. The

results of the study showed that a strong positive correlation between turbidity and TSS exists, but that this correlation is dependent on the materials and conditions of each site (Packman et al. 1999).

Quick and easy field tests already exist to measure turbidity. However, the existing TSS testing method is a time-consuming laboratory test that cannot currently be completed in the field. It would, therefore, be very useful to design a rapid, cost-effective, and consistent method for direct measurement of TSS in the field. The goal of this research was to evaluate potential methods for measuring TSS in the field.

SECTION 2: OBJECTIVES AND SCOPE

2.1 Objectives

The goal of this research was to develop an accurate, rapid, cost-effective method for testing total suspended solids (TSS) in the field. This method would allow for testing of discharges and stormwater runoff from construction sites, utility pits, and other dewatering activities.

Several potential methods were identified. Three methods were theoretically analyzed to determine feasibility, and two others were constructed and tested using water samples with various TSS concentrations. If a method showed promise, it would be tested with different soil types to simulate actual field conditions. This ensured that results would be applicable and reliable across all likely field conditions.

2.2 Scope

The three theoretically-analyzed potential field-testing methods for TSS were identified as:

- Rapid evaporation of water from sample using high temperatures,
- Measurement of TSS by separation of solids from liquids using a centrifuge, and
- Rapid TSS measurement using a repeating pipette comparing volume and TSS concentration.

The two experimentally-tested methods for TSS analysis were identified as:

- Rapid filtration of water using vacuum and designed apparatus, and
- Filtration of water samples using the laboratory apparatus without vacuum.

Promising designs would be tested using artificial stormwater runoff with various suspended load characteristics to ensure consistency across different field conditions.

The rapid evaporation method consists of rapidly evaporating a known volume of water at high temperatures and then weighing the remaining solids in the field. This method is a conservative approach because it will be a measure of total solids rather than just the total suspended solids. If the total solids concentration is less than the TSS discharge limit, the TSS concentration in the sample is acceptable for discharge.

The centrifugal separation method uses a centrifuge to separate the suspended solids from the water in a small sample. Theoretically, the sample would be separated into distinct layers, and a correlation could be made between the volume of the solids layers and the concentration of TSS. This relationship requires that the bulk density of the settled solids be known for all types of soils. Alternatively, the TSS concentration could be determined from the mass of the solids and the volume of the water that was centrifuged.

The vacuum filtration system uses an electronic repeating pipette and compatible glass fiber filled tip to filter the sample. Calibration curves would be developed relating the TSS concentration and the rate of the volume of water passing through the filter in the pipette if the method is determined to be feasible.

Lastly, the experimentally-tested rapid filtration methods filter a sample through a filter system. The vacuum-assisted filtration system was tested using a vacuum pump to allow for large volumes of water to be run through the filtration apparatus. The filtration system without vacuum-assist would gravity-feed a smaller water sample through the

filtration apparatus. In both cases, a correlation would be made between the TSS concentration and the volume of water passing through the samples in a designated amount of time.

SECTION 3: LITERATURE REVIEW

3.1 Regulatory Definition of Total Suspended Solids

Total suspended solids (TSS) can be defined as all particles in water that will not pass through a glass fiber filter without an organic binder (USEPA 1971). This includes all organic and inorganic matter such as sediments, algae, and nutrients or metals that have attached to the particles. Total solids concentration is the total suspended solids in a water sample plus the total dissolved solids (TDS) in that sample. TDS particles are less than 2 μm , while all particles greater than 2 μm are considered TSS. The standard pore size of the glass fiber filter to be used for TSS experiments cannot be absolutely defined because of the physical nature of glass fiber filters. However, pore sizes of 2 μm or smaller should be used for TSS testing so that TDS does not highly skew test results (USEPA 2012b). For the laboratory tests conducted during this research, a glass fiber filter with a nominal 1.5 μm pore size was utilized.

3.2 Sources of Suspended Solids

Suspended solids are a natural part of the environment. Natural processes such as erosion, flooding, forest fires, wind, wave action, storms, and ice break-up can cause an increase in TSS concentrations in nearby water bodies (Waters 1995). The geology of each watershed affects the amount of runoff and the amount of suspended solids entering the respective water body. Particles that already exist in the water body such as algae, zooplankton, bacteria, detritus, and phytoplankton can be suspended solids, and bottom feeders can stir up sediments while removing vegetation from the stream or lake bed (Waters 1995).

Human activities such as construction and agriculture can increase the amount of erosion, leading to increased TSS concentrations (USEPA 1990). Dams and reservoirs can decrease TSS concentrations immediately downstream of the dam since more settling occurs in the created reservoir. The sediment-hungry waters that flow downstream of the dam can increase stream bank sloughing and erosion (Kerr 1995). Dredging of rivers and ponds for navigation or recreation can resuspend previously settled solids. Logging activities, mining, road construction and runoff from roads, and recreational boating and navigation can increase TSS concentrations. Urban development increases the amount of runoff, thus increasing the amount of suspended solids in receiving waters. Finally, treatment processes such as wastewater treatment often increases suspended solids in receiving water bodies (Waters 1995). Not all water discharges are monitored for TSS, but state permits involving TSS regulations can be issued for activities such as dewatering processes from construction sites.

3.3 Factors Affecting TSS Concentrations in Water Bodies

The concentration of TSS in a water body not only depends on the sources of suspended solids, but also on physical, biological, and chemical processes active in the water body that can affect the amount of solids suspended in the water column. Concentrations of TSS tend to fluctuate daily due to these processes, complicating control and regulation of the parameter in water bodies (Chapman 1996).

Sediment transport mechanisms are important physical processes which affect TSS concentrations. The concentration of particles in a water body is affected by settling velocities, water flow, and water depth (Beschta and Jackson 1979). Biological processes

that affect TSS concentrations include stabilization of the streambed by aquatic organisms or removal of suspended particles by filter-feeders (Appleby and Scarratt 1989). Algal growth can increase TSS concentrations in a water body. Natural coagulants such as *Moringa oleifera* and other water-soluble materials from plants or animals, which are specific to the location of the water bodies, use the common chemical process of coagulation to decrease suspended solid concentrations (Ali et al. 2009).

Storm events, high winds, and tidal fluctuations also are a cause of variation in suspended solids concentrations. Resuspension of bottom sediments increases TSS concentrations during these events (Waters 1995). In an analysis completed on data taken from streams across America between 1970 and 1983, it was found that TSS measurements ranged from negligible amounts to 10,000 mg/L (Dodds 2004). The analysis further evaluated possible correlations between land use and TSS measurements, and found that suspended sediments in streams are highly variable and dependent on not only land use and character, but also weather and the type of ecosystem around the stream. Results of the study found TSS concentrations are negatively correlated to the percentage of forest cover and percentage of urban area in a watershed, and positively correlated to the percentage of rangeland and cropland cover in a watershed. The lowest concentrations of TSS were found in the Northern Forests region of North America, while the highest concentrations of TSS were found in the North American Deserts (Dodds 2004).

In the 2004 Water Quality Report to Congress, it was found that sedimentation is one of the top ten causes of impairment of streams, rivers, and lakes in the U.S. (USEPA 2009). Sixteen percent of the country's rivers and streams were assessed, and 44% were

considered impaired. Thirty-nine percent of the country's lakes, ponds, and reservoirs were assessed, and 64% were considered impaired.

3.4 Effects of Total Suspended Solids on Water Quality

3.4.1 Water Clarity

As TSS concentrations increase, the overall water quality of a water body decreases (Michigan DEQ 2001). Higher concentrations of suspended solids decrease water clarity. This adversely affects aesthetics and recreation in surface water bodies. The reduction in water clarity can hide obstacles that may be dangerous to people boating or swimming. In addition to its adverse effects on recreation, reduction in water clarity also has biological effects. Sight distance for aquatic species is reduced, which can reduce feeding efficiency (Appleby and Scarratt 1989). The amount of sunlight able to reach aquatic life in the water body, particularly near the bottom, is decreased as water clarity decreases. This slows the rate of photosynthesis and reduces plant growth, which decreases dissolved oxygen (DO) levels. DO levels are also decreased by the adsorption of oxygen molecules onto resuspended silt particles or uptake of oxygen by organic acids (Appleby and Scarratt 1989). Many species of fish are highly dependent on specific DO levels for growth and development and can be adversely affected by large changes of DO in a water body (O'Connor et al. 1977).

3.4.2 Water Temperature

As suspended solids concentrations increase and water clarity decreases, more heat can be absorbed into the water (Marcus et al. 1990). Since the saturation concentration for oxygen decreases as temperatures increase, higher water temperatures

ultimately result in a decrease of dissolved oxygen (Missouri DNR). When water temperatures rise seasonally in water bodies, it causes fish to become less tolerant of suspended solids in the water column. Since fish are already stressed from the condition of higher water temperatures, heightened concentrations of TSS during these times can produce greater lethal or sublethal effects (Appleby and Scarratt 1989).

3.4.3 Dissolved Oxygen

Dissolved oxygen is a primary parameter for determining water quality in a water body. High concentrations of suspended solids ultimately reduce dissolved oxygen concentrations in the water body, as described above. Some species are very sensitive to changes in dissolved oxygen, and if the dissolved oxygen concentration drops too low it will result in death for many species (O'Connor et al. 1977).

3.4.4 Sedimentation

Increased suspended solids concentrations can increase sedimentation in a water body. High levels of suspended solids leads to more settling, and sediment can cover the water bed. This can lead to sedimentation of spawning beds. Sediment that settles on spawning beds can prevent successful incubation and hatching of certain fish species' eggs (Ventling-Schwank and Livingstone 1994). Particles can also clog the interstitial spaces in gravel beds, thus reducing water flow and the amount of oxygen that can reach the eggs. If enough sediment settles on the bed, suffocation of the eggs may occur (Ventling-Schwank and Livingstone 1994). Sedimentation can also adversely affect bottom algae, fish habitat, and other benthic species. Studies have found that fish tend to

leave water bodies that no longer provide interstitial spaces for winter refuge on the bottoms due to sedimentation (Bjornn et al. 1977).

3.4.5 Nutrient and Chemical Loading in Water Bodies

Nutrient loading in a water body refers to the total amount of nutrients entering that water body in a given time. The two nutrients that most affect water quality are nitrogen and phosphorus (Minnesota PCA 2008). Phosphorus is especially related to TSS because phosphorus molecules tend to attach to particles such as eroded soil and are transported into water bodies with those particles (Sharpley and Tunney 2000). Nitrogen is more soluble than phosphorus and is usually in a dissolved form, making it more difficult to pinpoint the source of the increased loading, but is usually agriculturally related as well (Carpenter et al. 1998). Nutrients in the water support aquatic plant growth, particularly algae, which is a benefit in small amounts, but increased nutrients in the water can lead to algal blooms. Large amounts of algae growing near the surface in a water body can block sunlight to deeper aquatic plants, thus limiting their growth and DO production at depth (McDowell et al. 2004). In addition, as the algal blooms die and decompose dissolved oxygen is consumed, which lowers the DO concentration in the water body (McDowell et al. 2004).

Suspended sediments are a major carrier of metals and other chemicals as well as nutrients. Chemicals that attach to sediment particles much the same way as phosphorus molecules can be carried into a water body with the sediment particles. These contaminants can be retained in sediments for years after the source of contamination has been eliminated, and the resuspension of these sediments can adversely affect the water

quality and aquatic life in that water body (USEPA 1990). Some common chemical contaminants that are likely to adsorb to and be transported with particulates include PCBs, mercury, copper, and lead (USEPA 1990).

3.4.6 Impacts to Wildlife and Aquatic Species

In addition to the impacts mentioned above, high suspended solids concentrations can adversely affect the ecosystem of the water body. Suspended sediments in the water can greatly influence the benthic species composition of a water body (Brusven and Prather 1974). In 1973, a study determined that higher concentrations of suspended sediments in the water decreased insect diversity and density (Nuttall and Bielby 1973). In addition to reduced insect diversity and density, high suspended sediment concentrations lead to reduced fish production and diversity (Berkman and Rabeni 1987). Sensitive fish species can be lost to an area if TSS concentrations increase dramatically, and the fish community as a whole could shift toward species which are more tolerant to suspended sediments. Sensitive fish populations that could decline include sunfish, bass, chub, and catfish (Schueler 1997). This reduced diversity affects the food chain of the ecosystem.

Suspended sediments can scour or suffocate periphyton as well as large aquatic plants (Schueler 1977). Fish gills can also be abraded and damaged. These abrasions on the gill surfaces increase the risk of infection and disease (Schueler 1997). Especially in lakes and estuaries, the filtering efficiency of zooplankton can be reduced. High concentrations can disrupt the respiration process in all aquatic species; for example, the respiratory capacity of the gill surfaces of fishes can be reduced (Waters 1995). Fish also

have a loss of vision and decreased feeding efficiency as suspended solids concentrations increase. Fish eggs or fry may be suffocated or coated with particles, which reduces reproductive success. Migrating fish populations tend to avoid streams with high suspended solids, thus disrupting the migratory pattern of fish (Waters 1995).

3.5 Regulation of Total Suspended Solids

3.5.1 History of Total Suspended Solids Regulation

The National Pollutant Discharge Elimination System (NPDES) permit program was developed by the EPA to authorize states to regulate pollutants in point source discharges (USEPA 2013). The regulations put forth by the state permits must be at least as stringent as those specified by the EPA. One of the pollutants regulated under the NPDES program is TSS. Almost any source which will discharge directly to surface waters requires an NPDES permit. This includes construction activities which need to dewater into surface waters of the state (USEPA 2012a). The laboratory test used to determine whether requirements are met is time-consuming, however, which causes difficulty in testing requirements in the field.

3.5.2 Current Total Suspended Solids Regulation

Though the EPA does not regulate total suspended solids nationwide, currently many states have their own regulations in place for certain TSS via the NPDES permit program. Authorized states provide TSS discharge limits that are equal to or more stringent than a numerical value the EPA provides. There are different limits for different types of discharges, such as between discharge from utility pits and discharges from dewatering activities at construction sites. Table 3.1 lists some state regulations for

dewatering activities at construction sites. These regulations specify a maximum TSS concentration or percent removal for any dewatering activity that requires discharging to waters of the state. Some of these regulations are numerical limits, and some are narrative limits. Narrative limits do not specify a concentration, but are applied to each site based on its particular parameters.

Table 3.1: State-Specific TSS Regulations for Construction Site Dewatering Activities

STATE	TSS REGULATION	REFERENCE
EPA	100 mg/L daily maximum concentration	USEPA 2012a
Michigan	"...waters of the state shall not have any of the following unnatural physical properties in quantities which are or may become injurious to any designated use...suspended solids..."	Michigan DEQ 2001
Nebraska	90 mg/L daily maximum concentration	Nebraska DEQ 2011
Minnesota	80% Removal	Minnesota PCA 2008
South Carolina	100 mg/L daily maximum concentration	SCDHEC 2006
Montana	Turbidity Limit $X = C_r + [(Q_s/Q_d) * (C_r - C_s)]$	Montana DEQ 2010
South Dakota	90 mg/L maximum concentration for all waters except coldwater permanent fish life propagation waters 53 mg/L maximum concentration for coldwater permanent fish life propagation waters	SD DENR 2011

X = Turbidity Limit (NTU)

C_r = Downstream concentration (NTU)

Q_s = Background stream flow (mgd or cfs)

Q_d = Maximum discharge flow rate (same units as Q_s)

C_s = Background concentration (NTU)

3.6 Existing Testing Methods for Total Suspended Solids

3.6.1 Representative Sampling

In stormwater runoff water quality analyses, total suspended solids is often the primary parameter available for estimation of sediment loads; therefore, it is important to have a reliable test for TSS. An alternative way to calculate the concentration of

suspended solids is by the suspended solids concentration (SSC) test (Guo 2006). There are only minor differences between the TSS test and the SSC test, the most significant being in the sample preparation. The TSS test uses a sub-sample taken from the whole sample container. The test for SSC uses the whole sample collected (Guo 2006). This can affect results because quickly settling particles (such as sands) could be in the water sample. Using the entire volume of water in the sample for the SSC test ensures the capture of even the most non-filterable matter as long as the entire sample remains completely mixed. However, standard-of-practice and current suspended solids regulations dictate that TSS is the parameter that should be tested, since the regulated parameter is TSS (EPA 2012a).

In an evaluation of TSS and SSC data completed by the USGS, it was found that the variation in TSS results was significantly larger than that for the SSC analytical results (Kayhanian 2008). This research evaluated the sub-sampling methods for TSS in order to find the most consistent results. These issues are discussed below.

In addition to ensuring that a representative sub-sample is collected, collection of the initial sample must be representative of the water body being tested. For testing of stormwater discharges from construction sites and utility pits, the sample should be collected at the end of the pipe for a sample that most closely matches the discharge that will be entering the water body (Kayhanian 2008).

Two of the most common methods for testing total suspended solids are the EPA Method 160.2 (USEPA 1971) and Standard Method (SM) 2540-D (APHA et al. 1997). Studies have shown that duplicate samples sent to different labs to analyze for TSS came back with very different results (Kayhanian 2008). This could be due to the

representativeness of the sub-samples taken, insufficient sample mixing, or individual lab procedures. The Kayhanian (2008) study evaluated the best method of testing for TSS to give consistent results when testing stormwater runoff. It was found that a major reason for variance in TSS experiments is due to taking a sub-sample that is not representative of the whole sample volume. The study found that specified methods of sub-sampling can be as simple as dipping a beaker in the larger sample or as complicated as stirring at a specified speed and dipping in the beaker midway between the vortex created and the edge of the sample.

3.6.1.1 Recommended Mixing Methods

For TSS testing, a representative sample must be taken while the larger sample is being adequately stirred to prevent settling. Some methods of mixing for TSS include inversion, mechanical stirring, stirring using a churn splitter (a machine that composites and splits water samples), or combining the churn splitter and mechanical stirring. Both the EPA Method 160.2 and SM 2540-D state a “well-mixed sample” should be used, but do not further define how the sample should be mixed. For this reason, Kayhanian (2008) tested different mixing methods to find which gave the most consistent and accurate results. Each sub-sample was taken from the same initial water sample. It was found that combining a churn splitter and mechanical stirring gave the best results.

3.6.1.2 Recommended Mixing Speed

A practical question brought up by the discussion of mixing methods is how fast one should be stirring the original sample. No literature on this is cited in the current standard methods, so Kayhanian (2008) tested speeds between 60 and 700 rpm for

consistency. It was found that the speeds that had the lowest variation between experiments were 600 rpm to 700 rpm, and the optimum speed within this range was 700 rpm.

3.6.1.3 Sub-Sampling Depth

Three depths were tested in the Kayhanian (2008) study: upper third, middle, and lower third of the original sample. The sub-samples were taken from a whole sample with a known TSS concentration, so accuracy of the results as well as consistency could be determined. When mixing, the surface of the original sample will have the lowest concentration, and the bottom will have the highest due to settling of the larger particles that are not held in suspension by the stirring. Even if all the particles are held in suspension, the largest will be near the bottom and the finest towards the surface, so the middle would give the best representation of the particle distribution of the sample. According to the results of the study, a sample collected at mid-depth was the most accurate and gave the most consistent results.

3.6.1.4 Sub-Sampling Lateral Distance from the Center

A lateral concentration gradient occurs when the sample is being mixed, so the sub-sample should be collected midway between the wall and the vortex of the sample (Kayhanian 2008). This will also ensure a representative particle size in the sub-sample, since higher concentrations and larger particles tend to be near the wall, while lower concentrations and fine particles tend to be near the center of the vortex. Using a similar method as described above, sub-samples were taken from a whole sample with known TSS concentration, and the results showed that the sub-sample should be collected

midway between the wall and the vortex of the sample for consistent results (Kayhanian 2008).

3.6.2 Common Laboratory Total Suspended Solids Testing Methods

3.6.2.1 EPA Method 160.2 Summary

Wash glass fiber filter paper with three 20 mL successive washes using vacuum pressure. Dry filter for one hour at 103 to 105°C, then cool to room temperature in a desiccator and weigh. Shake sample vigorously, then transfer 100 mL of sample to a graduated cylinder. Pass sample through the filtration apparatus, using more sample volume if needed so that at least 1 mg of residue is retained. Wash filter with three 10 mL successive washes. Dry filter for one hour at 103 to 105°C, then cool in a desiccator and weigh. The weight retained on the filter paper divided by the volume of sample filtered is the total suspended solids concentration. The full method can be found in Appendix A.1.

3.6.2.2 Standard Method 2540-D Summary

Wash glass fiber filter paper with three 20 mL successive washes using vacuum pressure. Dry filter for one hour at 103 to 105°C, then cool to room temperature in a desiccator and weigh. Stir sample with a magnetic stirrer, and pipet a measured volume into the filtration apparatus. The total volume of sample filtered should leave at least 2.5 mg of residue on the filter paper, but no more than 200 mg residue. Wash filter with three 10 mL successive washes. Dry filter for one hour at 103 to 105°C, then cool in a desiccator and weigh. The weight retained on the filter paper divided by the volume of

sample filtered is the total suspended solids concentration. The actual method can be found in Appendix A.2.

3.6.2.3 ASTM Method D5907 Summary

Wash glass fiber filter paper with three 30 mL successive washes using vacuum pressure. Dry filter for one hour at 103 to 105°C, then cool to room temperature in a desiccator and weigh. Transfer 100 mL of the well-mixed sample to a graduated cylinder and pass the sample through the filtration apparatus. If less than 2.5 mg of residue is left on the filter paper, filter enough volume of sample to leave between 2.5 and 200 mg of residue on the filter. No more than one liter of water should be used. Wash filter with three 20 mL successive washes. Dry filter for one hour at 103 to 105°C, then cool in a desiccator and weigh. The weight retained on the filter paper divided by the volume of sample filtered is the total suspended solids concentration. The actual method can be found in Appendix A.3.

3.6.3 Comparison of Laboratory Methods

These three methods for testing the concentration of total suspended solids are very similar. All require the use of a glass microfiber filter that is prewashed, and all describe the procedure as filtering a volume of water through the filter and rinsing the filter with distilled water. The filter paper is then removed and dried for at least one hour at 103 to 105 degrees Celsius. The weight of the residue left on the filter paper divided by the volume of sample filtered is the total suspended solids concentration.

The ASTM method requires a prewash using three successive 30 mL washes, while the EPA and Standard Method (SM) require a prewash using three successive 20

mL washes. The ASTM method also requires a post-wash using three successive 20 mL washes, while the EPA and SM require a post-wash using three successive 10 mL washes. The ASTM and SM require at least 2.5 mg of matter on the filter but no more than 200 mg of residue to provide an accurate test, while the EPA method requires only 1.0 mg of matter on the filter. The EPA method specifies mixing the sample by shaking it vigorously before transferring to a graduated cylinder. The ASTM method does not specify a mixing process, only that the sample should be well-mixed before transfer to a graduated cylinder. The SM specifies mixing the sample with a magnetic stirrer then pipetting the required volume to the filtration apparatus.

3.6.4 Total Suspended Solids Sensors and Probes

Many different total suspended solids sensors and probes have been developed for rapid TSS measurement. Most of these probes have been developed for wastewater treatment processes, and are good for testing TSS in mixed liquor suspended solids (MLSS), return activated sludge (RAS), and waste activated sludge (WAS). Some probes were additionally developed with the chemical and pharmaceutical sectors in mind, and are developed for testing suspended solids concentrations in different chemical or medical processes. While these probes were not initially developed for field tests in places like construction sites, the technology can be applied to these situations. Table 3.2 below shows some existing TSS probes and sensors, the method of measurement for TSS used by those sensors, the range and resolution of the results, and a price estimate for each unit.

Table 3.2. Existing TSS Sensors and Probes

Product	Method of Measurement	Range (mg/L)	Accuracy	Repeatability	Price
Paab SS Probe ¹	90° Scattering/ Light Absorption	0 – 30,000	± 3% of reading	98%	\$2,300
Galvanic Monitek Acoustic SS Probe ²	Ultrasonic Reflection	0 – 10,000	± 5% of reading	± 4% of reading	\$15,000
Hach TSS Sensor ³	Modified Absorption Measurement	1 – 500,000	Based on Sampling Technique	< 4% of reading	\$5,233
Insite IG Portable SS Analyzer ⁴	Single Gap Optical	0 – 30,000	± 3% of reading or ± 20 mg/L	± 0.5% of reading	\$1,555
Insite IG SS Analyzer ⁵	Single Gap Optical	0 – 30,000	± 3% of reading	± 0.5% of reading	\$2,510
Royce Water Process Analyzer + Sensor ⁶	Single Gap Optical	10 – 80,000	± 5% of reading or ± 5 mg/L	± 1% of reading or ± 2 mg/L	\$4,038
Royce TSS Analyzer + Sensor ⁷	Single Gap Optical	10 – 80,000	± 5% of reading or ± 5 mg/L	± 1% of reading or ± 2 mg/L	\$4,038
Royce Portable TSS Analyzer ⁸	Single Gap Optical	10 – 10,000	± 5% of reading or ± 100 mg/L	± 1% of reading or ± 20 mg/L	\$1,826

¹(Paab 2013) Model No. S461/S

²(Galvanic 2013) Model No. AS3

³(Hach 2012) Model No. LXV323.99.10002

⁴(Insite IG 2013a) Model No. 3150

⁵(Insite IG 2013b) Model No. 1500

⁶(Royce 2013) Model No. 7110/7120 + 72A

⁷(Royce 2013) Model No. 7011A + 72A

⁸(Royce 2013) Model No. 711

The Paab suspended solids probe uses a 90° scattering method for absorption.

This method is based on the Beer-Lambert Law, which relates light absorption to the concentration of the compound in solution. A common way to express the Beer-Lambert Law is as follows:

$$A = e * b * c$$

where:

A = absorbance (unitless)

e = wavelength-dependent molar absorptivity (L/mol-cm)

b = path length of the sample (cm)

c = concentration of the compound in solution or suspension (mol/L)

The Paab probe specifications show that the probe uses optical infrared technology to pass light at a wavelength of 880 nanometers through the sample. Using this information, the molar absorptivity can be found, and the path length of the sample is a constant. The absorbance is the log-10 of the ratio of the initial radiant power before passing through the sample over the radiant power after passing through the sample. The above equation can then be manipulated to find the concentration of the compound in solution or of suspended solids in liquid.

The Galvanic sensor uses ultrasonic reflection technology to measure TSS concentrations. The principle of ultrasonic reflection is to beam ultrasonic pulses through a sample. These pulses are reflected by the particles in the water as echoes. The intensity and quantity of the echoes are then measured and evaluated to find a concentration of suspended solids in that sample (ChemTronic 2013). This method of measurement can detect particles such as minerals, metals, and organic matter as well as gas bubbles and free oil in water. Advantages to using an acoustical method are that the method can still be used when measurements are needed in extreme colored or opaque liquids, and that results are not affected by ambient light (Gartner 2004).

A second acoustical technology that can be used for measuring suspended solids is an acoustic Doppler current profiler (ADCP), which is currently used in water velocity measurements (Gartner 2004). An ADCP was used to measure backscatter intensity of water, and results were compared to an optical sensor which also measured backscatter intensity. Gartner (2004) reported that results of suspended solids concentrations were “found to agree within about 8-10%” accuracy of the total range of concentrations tested. However, there are some limitations to this method of measurement. One limitation is

that it is a single-frequency instrument, so changes in particle size distribution can cause the ADCP to output a difference in suspended solids concentrations even if the mass concentration does not change. Quantifying this error depends both on the type of instrument and how much the particle size distribution changes (Gartner 2004). A second limitation is the relationship between particle size and acoustic frequency. As Gartner (2004) describes, the Rayleigh scattering model that is used by the ADCP contains a condition that the wave number multiplied by the particle radius must be less than one. When the particle sizes of the suspended solids cause the wave number multiplied by the particle radius to approach one, errors in readings increase.

The Hach sensor uses a modified absorption measurement with eight-channel multiple-angle measurement at a wavelength of 860 nanometers (Hach 2012). Combining the multiple beams with light pulses allows for greater accuracy in measurements. The scattered light is measured at multiple angles and evaluated to give a TSS concentration.

The two Insite IG sensors and the Royce sensors use single gap optical technology to make measurements. The sensors use an infrared emitter, which minimizes color effects, and measures the initial source brightness to account for changes in temperature that may affect the emitter (Insite IG 2013a). The wavelength of light used is 880 nanometers (Insite IG 2013b).

The method used by the Paab probe is similar to a light-emitting diode (LED) technology that is a proposed optical system for testing TSS (Lim et al. 2011). This system analyzed two different methods of testing: one where the detecting photodiode was 180° from the LED, and one where the photodiode was 90° from the LED. A

diagram of the experiment conducted can be found in Figure 3.1. The results of the experimentation showed reliable and accurate results for TSS concentrations between 0 and 500 mg/L. For the first experiment with 180° between the LED and the photodiode, the optical algorithm developed for the sensor showed a strong correlation between laboratory-analyzed results and sensor results with an R^2 value of 0.9918. For the second experiment with a 90° angle between the photodiode and the LED, the R^2 was again very high with a value of 0.9524 (Lim et al. 2011). This sensor system has not been manufactured for use, but shows promising results for a less expensive technology that might be used in the future.

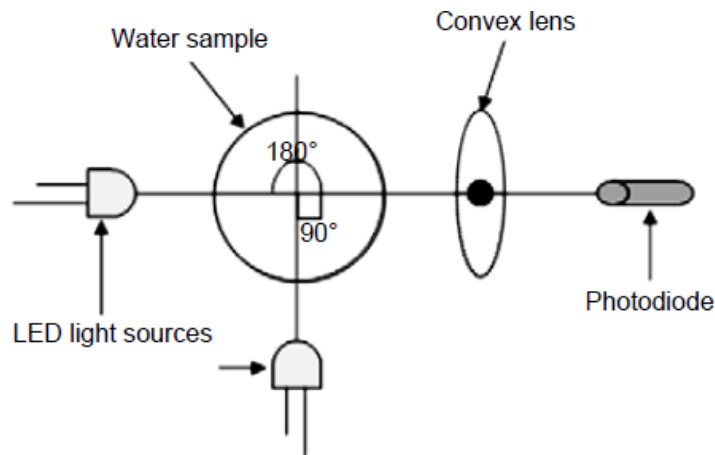

Figure 3.1: Proposed LED Absorption Instrument as Tested by Lim et al. (2011)

3.7 Total Suspended Solids and Turbidity

3.7.1 Turbidity

Turbidity is a measure of water clarity. A Secchi disc or transparency tube is used to measure how much the suspended material in a water body decreases the passage of light through the water (APHA 2012). While turbidity is a commonly measured water

quality parameter and can be used as an indicator of the amount of materials in the water, it is not an accurate measure of the suspended solids concentration. Turbidity is a measure of the amount of light that is scattered by materials in the water, and it can be affected by color and shape of the particles in addition to the amount of suspended solids (APHA 2012).

3.7.2 Turbidity Regulation

In 2009, the National Pollutant Discharge Elimination System (NPDES) effluent guideline rules proposed a numeric turbidity limit of 280 NTU, or Nephelometric Turbidity Units, for certain construction sites (74 FR 2009). All sites were subject to non-numeric turbidity limitations which were also added to the final rule to prevent pollutants from entering surface waters. Examples of these non-numeric regulations include erosion and sediment controls, soil stabilization methods, managing dewatering activities, prohibition of certain discharges, and utilizing surface outlets for discharges from basins and impoundments.

In November 2010, because of an error in the EPA's interpretation of the data used to establish the numeric limitation, the EPA submitted a proposed rule to revise the proposed numeric turbidity limit of 280 NTU. In January, 2011 the Agency stayed the limit of 280 NTU until further testing provides data that can correct the controversial turbidity limit published in the 2009 Construction and Development Effluent Limitation Guidelines (77 FR 2012). However, the non-numeric pollution controls are still in effect and incorporated into NPDES permits. Currently, no EPA regulation exists with a

numeric turbidity limit for stormwater discharges from construction sites. However, many states regulate turbidity as well as total suspended solids.

3.7.3 Correlations between Total Suspended Solids and Turbidity

Because turbidity and total suspended solids are related measurements, correlations can sometimes be developed between the two. Using simultaneous measurements of turbidity and TSS, regression analysis can be used to correlate the two measurements. However, this correlation is site-specific (Packman et al. 1999). While turbidity is affected by factors such as coloring chemicals and materials that have different light-scattering properties, TSS is just a measurement of the amount of suspended particles. For example, a stream with a certain concentration of clay particles in the water will give a different turbidity reading than a stream with that same concentration of silt particles because clay and silt particles have different light-scattering properties. Therefore, on-site testing must be completed at each site before turbidity can be used to estimate TSS. For these reasons, using turbidity measurements, though they are quick and easy, to estimate TSS is generally not feasible for each temporary construction site.

3.8 Control and Treatment of Total Suspended Solids

There are many methods to control suspended solids loading into surface waters. Waters (1995) put these methods into three phases: prevention, interdiction, and restoration. Prevention focuses on stopping sediment from leaving its origin, interdiction reduces sediment loading between the origin and the water body, and restoration removes sediment which is already in the water body. Best management practices (BMPs) for

non-point source runoff, such as stormwater, can include general public education and keeping areas where runoff occurs as clean as possible (USEPA 2012c). According to the EPA, stormwater BMPs are controls which are used to improve the quality of stormwater runoff (2013b).

Prevention can be achieved by taking measures to reduce erosion. In urban areas, constructing detention basins, adding runoff control mechanisms to bridges, and other erosion control structures on construction sites around the area such as sediment barriers could greatly reduce runoff and subsequent erosion. Modifying road ditch design and road design can reduce runoff and erosion from banks as well (USEPA 2005). Contour planting reduces erosion, and leaving crop residues reduces erosion and filters sediment in surface runoff (USEPA 2003). Erosion control BMPs can include slope stabilization as well as simply scheduling construction activities to minimize active construction area during the rainy season, and preserving the existing vegetation where possible (Waters 1995).

Interdiction captures sediment in transport between its origin and the potential receiving water body. Two common methods of accomplishing this are to plant vegetation, and construct settling basins of some type, for example either as a temporary basin during construction or something permanent for an urban development area (Waters 1995). Planting vegetation filters sediments during transport, and helps control erosion by retaining sediments. Settling basins of any type (detention, retention, dams, etc.) can control suspended sediments because they are designed with a large enough retention time to settle out a majority of solids before water is released from the basin. Sediment control BMPs include silt fences, sedimentation basins, fiber rolls, and

installing gravel bags where needed (Waters 1995). Keeping the streets clean and protecting the storm drain inlets from receiving too much of the sediment and sand generated by the construction also will help prevent sediments from reaching the water body. Simple lagoons, terraces, sediment basins, or fences can also greatly reduce sediment transport.

Restoration of streams with unnaturally high suspended sediment concentrations can be completed in a variety of ways. With the construction of dams on many rivers, temporary “flushes” can be used to wash and scour the downstream channel. Instream devices can be built to locally increase current velocities to restore fish habitat, or some sort of removal process such as gravel washing or a filtering process to remove sediment (Waters 1995). Lake restoration techniques include alum treatment and dredging (Singh 1982).

After the BMPs have been implemented, general inspections of the controls placed on the site during and after storms will ensure that the controls placed are working properly. Maintenance should be completed on BMPs as needed. Those employed and working on the site should be educated to know if something needs maintenance or if more controls need to be placed (EPA 2012c).

SECTION 4: METHODS AND MATERIALS

4.1 Soil Sample Production

4.1.1 Soil Analysis

Soil analysis was completed on three different soils to ensure different soil types would be used in the development of a field experiment for total suspended solids. The classification of these soils can be found in Section 4.1.2. ASTM standard tests were completed to classify each soil. Before soil analysis it is usually necessary to complete a dry preparation of soil samples for particle-size analysis and determination of soil constants, unless soil types are very consistent in grain size. This procedure uses the standard method ASTM D421-85. The purpose of this method is to separate the soil samples by particle size, since further analysis requires soil samples to only contain small particles. This soil sample preparation test was not completed on the three soils tested because all of the three soils had consistent particle sizes which passed the No. 40 sieve.

4.1.1.1 Specific Gravity Determination

The first analysis run for each soil type was “Standard Test Methods for Specific Gravity of Soil Solids by Water Pycnometer” (ASTM D854-10). The full method can be found in Appendix A.4, and a summary follows. The pycnometer, a piece of glassware that helps determine the density of a liquid, was first calibrated before use in determining the specific gravity. This calibration was completed by verifying the mass of a clean and dry pycnometer with five mass measurements that gives a standard deviation less than or equal to 0.02 g. The pycnometer was then filled with deaired water to above the calibration mark and allowed to come to thermal equilibrium with a bottle of deaired

water to room temperature. The equilibrated deaired water was added or removed from the pycnometer to ensure the meniscus was at the calibration mark. The pycnometer and water was weighed, and the temperature of the water taken. After the first measurement of the filled pycnometer, the water was removed, the pycnometer was refilled to slightly above the calibration mark, and the apparatus was again given time to reach thermal equilibrium. This process was completed until five measurements were taken, and those measurements were used to find the calibrated volume of the pycnometer. The calibrated volume, V_p , is calculated using the equation below:

$$V_p = \frac{(M_{pw,c} - M_p)}{\rho_{w,c}}$$

where:

V_p = calibrated volume of the pycnometer (mL)

M_p = average calibrated mass of the dry pycnometer (g)

$M_{pw,c}$ = mass of the pycnometer and water at the calibration temperature (g)

$\rho_{w,c}$ = mass density of water at the calibration temperature (g/mL) (see Table 2 in ASTM D854-10 in the Appendix A.4)

The standard deviations of these five calibrated volumes must be less than or equal to 0.05 mL to yield accurate specific gravity determinations

After calibrating the pycnometer, “Method B – Procedure for Oven-Dried Specimens” was used (ASTM D854-10). The mass of the dry pycnometer was verified to be within 0.06 grams of the average calibrated dry pycnometer mass. Dry soil was then added to the pycnometer, and water was then added to form a soil slurry. The slurry was de-aired, and then the pycnometer was filled with water. After the apparatus had reached thermal equilibrium with room temperature, the mass of the pycnometer, soil,

and water was determined, and the temperature of the soil slurry was taken. The soil slurry was then transferred to a pan to be dried and weighed to find the mass of the dry soil. The calculation to find the mass of the pycnometer and water at the test temperature of each of the three soils is:

$$M_{pw,t} = M_p + (V_p * \rho_{w,t})$$

where:

$M_{pw,t}$ = mass of the pycnometer and water at the test temperature (g)

V_p = average calibrated volume of the pycnometer (mL)

$\rho_{w,t}$ = density of water at the test temperature (g/mL) (see Table 2 in ASTM D854-10 in the Appendix A.4)

This calculated mass was then used to find the specific gravity, G_t , of the soil solids at the test temperature:

$$G_t = \frac{\rho_s}{\rho_{w,t}} = \frac{M_s}{(M_{pw,t} - (M_{pws,t} - M_s))}$$

where:

ρ_s = density of soil solids (mg/m³ or g/cm³)

$\rho_{w,t}$ = density of water at the test temperature (g/mL or g/cm³) (see Table 2 in ASTM D854-10 in the Appendix A.4)

M_s = mass of the oven-dried soil solids (g)

$M_{pws,t}$ = mass of pycnometer, water, and soil solids at the test temperature (g)

In order to find the specific gravity of these soils at 20 °C, the following equation is used:

$$G_{20^\circ C} = K * G_t$$

where:

K = temperature coefficient (see Table 2 in ASTM D854-10 in Appendix A.4)

4.1.1.2 Hydrometer Test

The second standard method test used for analysis on the three unknown soils was the ASTM Method “Standard Test Method for Particle-Size Analysis of Soils” (ASTM D422-63). The full method procedure can be found in Appendix A.5. Two types of hydrometers could be used to run this test: hydrometer 151H or hydrometer 152H. Hydrometer 152H was used in this test. Since hydrometers are calibrated at 20°C (ASTM D422-63), a composite correction must be determined to apply to the readings taken during the test at different temperatures. The composite correction for hydrometer 152H (Gilson SA-2), which was the hydrometer type used for this test, was the difference between zero and the hydrometer reading taken.

Before completing the hydrometer test, hygroscopic moisture was determined for the three soils. The hygroscopic moisture is a correction factor that is equal to the ratio between the mass of an oven-dried sample and an air-dry sample. Unless there is no hygroscopic moisture, this number is a value less than one. Hygroscopic moisture was determined by weighing out a small portion of the soil sample and drying to a constant mass in an oven. The dispersion of the soil sample was tested. The soil was mixed with a sodium hexametaphosphate solution and stirring the mixture in a special dispersion cup (stirring apparatus A in the ASTM method was used for this experiment). After the solution was thoroughly dispersed, the soil-water slurry was transferred to a glass sedimentation cylinder, and distilled water was added until the total volume was 1000 mL. This was mixed to complete the agitation of the slurry before beginning to take readings at 2, 5, 15, 30, 60, 250, and 1440 minutes. The hygroscopic moisture correction factor, or the ratio between the mass of the oven-dried sample and the air-dry mass, was

used to calculate the oven-dry mass of soil used in the hydrometer analysis. This is found by multiplying the air-dry mass by the hygroscopic moisture correction factor. That value, the oven-dry mass of soil, is converted as follows:

$$W = \frac{\text{oven dry mass}}{\% \text{ passing No. 10 sieve}} * 100$$

where:

W = the oven-dry mass of soil represented by mass of soil dispersed (g)

For hydrometer 152H, the percentage of soil remaining in suspension at the level at which the hydrometer is measuring the density of the suspension is shown below:

$$P = (R * a/W) * 100$$

where:

a = correction faction applied to the reading of hydrometer 152H (see Table 1 in ASTM D422-63 in Appendix A.5)

R = hydrometer reading with composite correction applied

The diameter of the particles which correspond to the percentage shown by a hydrometer reading was calculated using Stoke's Law, which can be condensed to:

$$D = K\sqrt{L/T}$$

where:

D = diameter of the particle (mm)

K = constant depending on temperature of the suspension and specific gravity of soil particles (see Table 3 in ASTM D422-63 in Appendix A.5)

L = distance from the surface of the suspension to the level at which the density of the suspension is being measured (cm) (see Table 2 in ASTM D422-63 in Appendix A.5)

T = interval of time from the beginning of sedimentation to the taking of the reading (min)

4.1.1.3 Determining Liquid Limit, Plastic Limit, and Plasticity Index

The last standard procedure completed on the three soils for analysis before classification was the ASTM method for determining liquid limit (LL), plastic limit (PL) and plasticity index (PI) of soils (ASTM D4318-10). The full method procedure can be found in Appendix A.6. The wet preparation method was used to prepare the test specimens for the experiments.

A sample of each soil was mixed with distilled water thoroughly in a mixing dish with a spatula. Method A – Multipoint Liquid Limit was used to determine LL, so water content was adjusted to bring it to a consistency that would require about 25 to 35 blows of the LL device to close the groove. The mixed soil was set aside to cure overnight before analysis. The soil sample was remixed and its water content readjusted before beginning the LL test for analysis after curing. A portion of soil large enough to sit in the brass cup of the LL device was placed at the base, and squeezed down and spread apart to eliminate air bubbles and have a maximum depth of 10 mm. A groove was formed using the grooving tool in the middle of the soil pat, then the crank was turned, and the number of drops, N , required to close the groove was recorded. The first successful trial should take 25 to 35 drops to close the groove, then each successive trial should have a small amount of distilled water added to lower the numbers of blows to between 20 and 30 and between 15 and 25 blows. The soil used for each of the three trials was saved, and the water content of those soil samples determined.

The LL was determined by plotting the relationship between the water content and the number of drops on a semilogarithmic graph and drawing a best-fit straight line

through the plotted points. The water content rounded to the nearest whole number which corresponds with the 25-drop line is the liquid limit.

From the soil samples used to calculate the LL, a portion of each soil type was taken and dried by blotting with paper and mixing continuously in a mixing dish. These soil portions were used to calculate the plastic limit (PL). A 1.5 to 2.0 gram portion of the dried soil was then rolled into a cylindrical shape by hand to a diameter of 3.2 mm. If the soil mass could be rolled to a smaller diameter then it needed to be dried more and the rolling process started again. Once the soil mass could not be rolled to a diameter of less than 3.2 mm without crumbling, the soil was placed into a container to be tested for moisture content. Once two containers held approximately 6 grams of rolled soil, the moisture content was tested for each and averaged to one number. This value is the plastic limit of the soil.

The plasticity index (PI) uses the LL and PL in the following equation:

$$PI = LL - PL$$

In most cases the liquid limit will be larger than the plastic limit of a soil. If the liquid limit is smaller than or equal to the plastic limit, the soil is reported as nonplastic (NP).

4.1.1.4 Classification of Soils

The sieve test was not necessary to run before classifying the soil types analyzed because soil particles were all fine enough to pass through the No. 200 (75 μ m) sieve. Using this knowledge and the data collected from the aforementioned experiments, the soils were classified following the ASTM method for classification of soils for

engineering purposes (ASTM D2487-10). The full classification procedure can be found in Appendix A.7.

4.1.2 Soil Types Used in Experiments

The results of the described soil analyses can be found in Section 5.1.4. The three soils analyzed were very similar, and all were generally classified as clay. Though the soils were similar, they could be classified as a lean clay, a fat clay, and a silty clay. Because all of these soils are very similar, the impact different clay properties may have on filtration techniques are not fully tested. Variation in clay properties, such as a high amount of clay colloids, could settle and “clog” the filter very differently (Kovalsky et al. 2007). Consolidation on the filter paper usually transforms from a high porosity, high permeability state to a low porosity, low permeability state, but in some cases high porosity might be maintained (Kovalsky et al. 2007). These differences can highly affect the performance of the filtration apparatus and would need further study.

4.2 Laboratory Technique Used for Total Suspended Solids Testing

The Standard Method technique SM 2540-D was used for analysis of total suspended solids (TSS) concentrations (APHA et al. 2012). The full method can be found in Appendix A.2. This method entails prewashing a standard glass-fiber filter with three successive 20-mL portions of distilled water. After all traces of water have been removed, the filter paper is dried for one hour in an oven at 103 to 105°C. The filter paper is cooled in a desiccator after being oven-dried, and weighed to a constant weight. After weighing the filter paper, it is placed in the filtering apparatus and wet with a small volume of distilled water to seal the paper to the apparatus. A measured volume of well-

mixed sample is filtered through the apparatus, and then washed with three successive 10-mL volumes of distilled water. After all traces of water have been removed, the filter paper is again oven-dried for one hour at 103 to 105°C, then cooled in a desiccator. The filter paper can then be weighed a second time to a constant weight. The calculation to determine TSS concentration is shown below:

$$\frac{mg\ TSS}{L} = \frac{(A - B) * 1000}{sample\ volume,\ mL}$$

where

A = weight of filter + dried residue (mg)

B = weight of filter (mg).

The precision and accuracy of the laboratory test is important to note, since comparisons between different testing methods and the standard method laboratory analysis for TSS are dependent on that accuracy. The standard method (APHA et al. 2012) reports that studies by two analysts of four sets of ten determinations each gave the following results in Table 4.1. These results are assumed to be averages of the standard deviations calculated by each analyst for each experiment completed.

Table 4.1: Precision and Accuracy of the Standard Method TSS Laboratory Test Using 4 Sets of 10 Determinations Each (APHA et al. 2012)

TSS Concentration	Standard Deviation	Coefficient of Variation
15 mg/L	5.2 mg/L	33%
242 mg/L	24 mg/L	10%
1707 mg/L	13 mg/L	0.76%

This table shows that the standard deviation of the samples at the 100 mg/L EPA limit for discharge from construction sites could be between 5.2 and 24 mg/L. Linear interpolation between the two numbers results in 12 mg/L standard deviation at a 100

mg/L TSS concentration, that is, 100 ± 12 mg/L is the accuracy of the laboratory method of testing TSS concentrations around that limit. This gives a variability of 12% in sample analysis.

A second way to use the data given in Table 4.1 to find what the standard deviation would be at a TSS concentration of 100 mg/L is to use a simple average of the three standard deviations given. This average comes out to be 14 mg/L, standard deviation at a 100 mg/L TSS concentration, or 100 ± 14 mg/L. Therefore, the standard method laboratory TSS analysis cannot reliably determine whether samples of 90 and 110 mg/L are above or below the EPA threshold of 100 mg/L.

4.3 Proposed Field Techniques for Total Suspended Solids

Five techniques were analyzed for feasibility as a field test for total suspended solids. Three methods were found to be infeasible based on theoretical analysis. Two of the five methods were constructed and tested under simulated field conditions.

4.3.1 Development of a Homogenous Mixing System

Before a TSS field apparatus could be tested, a system had to be developed to maintain consistent and continuous mixing of the laboratory-made samples to be tested. Initially, it was thought that a large quantity of water would be needed to complete the testing of a field apparatus. A 55-gallon drum was used as the basin, and a wood structure built to hold a mixer that would be operated by a drill. Testing of the field apparatus found that a smaller quantity of water needed to be used in order for the experiment to be run in a timely manner. Thus, a 5-gallon bucket was used for a basin.

A wooden paint stirrer was initially used to mix the muddy water sample, but was found to be inconsistent between tests. A variety of paint stirrers operated by a drill were then tested, and it was found that in order to mix the soil homogenously throughout the bucket no vortex could be created. The final design for the mixing apparatus was a bilge pump with tubing attached. The tubing had small holes drilled into it, so that water flowed in all directions through the bucket and eliminated vortices and pockets of stagnant water. An image of this mixing apparatus can be found in Figure 4.1.



Figure 4.1: Bilge Pump Mixing Apparatus Used for Keeping Particles in Suspension

4.3.2 Theoretically-Analyzed Methods

4.3.2.1 Rapid Evaporation

Theoretical Method

The rapid evaporation method procedure would use a heat source (such as a propane torch) to rapidly heat the system to evaporate the water portion from a known volume of sample. A crucible and watch glass would be used to contain the sample and

prevent loss of soil particles during heating. This crucible and watch glass system would be weighed before filling with the sample. The crucible and watch glass would then be weighed after the water was evaporated and after cooling to air temperature in a desiccator. A field scale would be used to weigh the crucible and watch glass system to calculate the TSS concentration, similar to the laboratory test method, using the following equation:

$$\frac{mg\ TSS}{L} = \frac{(A - B) * 1000}{sample\ volume, mL}$$

where:

- A = weight of crucible/watch glass + residue
- B = weight of crucible/watch glass

Analysis of Method

This test would not only capture TSS, but would also capture total dissolved solids (TDS), making it a total solids test. However, this test could be used as a conservative estimate of TSS such that if the total solids concentration is less than the criteria for total suspended solids, the TSS concentration of the water would be acceptable for discharge. Conversely, organic matter in the sample may be volatilized and lost during heating.

Field scales are commonly precise to 10-100 mg (Hach Model No. 2946801 is accurate to 10 ± 10 mg, and Test Mark Industries SC-0192 is accurate to 100 ± 0 mg). In order to show a significant difference between the initial weighing and the weighing after heating, a small sample could not be used. Assuming a TSS concentration near 100 mg/L

(a common TSS limit on construction sites (USEPA 2012a)), sample of 100 mL would be needed to produce 0.01 grams (10 mg) of TSS and show a difference of 0.01 grams on the scale. Assuming the evaporation apparatus (crucible and watch glass) might weigh 200 g, 10 mg of total solids produced from a TSS concentration of 100 mg/L would only account for 0.005% of the total weight. This could not likely be reliably measured on a field balance. Accordingly, a 100 L sample at 100 mg/L would be needed to produce enough total solids (10 g) to represent 5% of the total weight and, therefore, be detectable by the field scale. The sample size becomes impractical to “rapidly evaporate” because of the time it would take to evaporate that amount of water from a sample.

The sample may need to be repeated to ensure a certain confidence, and the overall test could take a very long time to complete. The conclusion drawn from this analysis is that this method is not feasible as a field test method for total suspended solids.

4.3.2.2 Centrifugal Separation

Theoretical Method

Because of the different densities between soil particles and water, centrifuging should separate the water and the soil particles. The soil particles may also be separated between the clay, silt, and sand particles, but the overall measured length of the soil particles in the tube could be correlated to a TSS concentration. These correlations could be developed using the laboratory TSS testing method and comparing the results of the lab test on a sub-sample of the same water sample that was run in the centrifuge.

Analysis of Method

The first step to determining the feasibility of this method was to find whether the length of the soil in the centrifugation tube at common concentrations is measurable. Common test tube sizes range from 6 to 25 mm in outer diameter (OD). The smallest test tubes have volume capacities of 0.5 to 1.5 mL, which would likely be too small a sample to ensure that sample is representative. Therefore, a vessel that can hold a substantial volume (such as 100 mL) of sample and that tapers to a small diameter to create a measureable length of settled solids is needed. A sample size of 100 mL and a TSS concentration of 100 mg/L (a common discharge criterion limit) centrifuged into a tube with an inner diameter (ID) of 5 mm were assumed for the initial analysis. The bulk density of soils can change based on particle size and compaction, but an average bulk density of 1.33 g/cm³ was used for this calculation based on a medium textured soil (USDA NRCS 2008).

Using the mass of soil in the sample (10 mg soil for a 100 mL sample with 100 mg/L TSS) and the bulk density of 1.33 g/cm³, the volume of settled soil is found to be 0.00752 cm³ ($10 \text{ mg} * \frac{\text{cm}^3}{1.33 \text{ g}}$). Solving the cylindrical volume equation for height and using the assumed radius (0.25 mm) and volume, the height of the settled soil column in the micro tube would be 0.38 mm. The height of the settled soil column starting with a TSS concentration of 90 mg/L (a concentration that would be acceptable to discharge) and using the same other assumptions for bulk density and sample size would be 0.34 mm. This is an immeasurably small height difference between the acceptable and unacceptable concentrations of TSS.

Though centrifuging a vessel with 1000 mL of sample is problematic, a 1000 mL sample size was then used to see if a larger sample size would make centrifugation feasible. Using the same bulk density (1.33 g/cm^3) and calculation process described above, Table 4.2 shows the height of the settled soil column in a 5-mm ID tube for a 1000 mL sample size at different initial TSS concentrations.

Table 4.2: Soil Column Height at Different TSS Concentrations

TSS Concentration	Height of Soil Column
70 mg/L	2.6 mm
80 mg/L	3.0 mm
90 mg/L	3.4 mm
100 mg/L	3.8 mm
110 mg/L	4.2 mm
120 mg/L	4.6 mm
130 mg/L	5.0 mm

As can be seen from these results, it would require a difference of about 30 mg/L in total suspended solids concentration in order to find a measurable difference of a little over one millimeter in the height. This is very difficult sample size to centrifuge, and the imprecision of the test results shows that centrifugation is not feasible for determining regulatory concentrations. In addition, the ability of the particles to adequately settle in such a small diameter tube has not been tested and is likely problematic.

4.3.2.3 Repeatable Pipette

Theoretical Method

The procedure for this method would be to use a repeatable pipette to draw water from samples with different TSS concentrations through a glass fiber filter by applying the same vacuum to each sample. The differences in the rate of water drawn into the pipette at different total suspended solids concentrations would be correlated to measured TSS concentrations. Pipette tips would be filled with glass fibers made with a consistency that is comparable to the filter papers used in the standard laboratory method.

Analysis of Method

The feasibility of this method was assessed while evaluating the “vacuum-assisted rapid filtration” method as discussed below in Section 4.3.3.1. The vacuum-assisted rapid filtration method is essentially a larger version of the “repeatable pipette” method (i.e., both methods measure the time to draw a volume of TSS-laden water through a filter). Therefore, if the vacuum-assisted rapid filtration method is feasible, the smaller repeatable pipette method is potentially feasible. However, since the vacuum-pressured rapid filtration method was not feasible, the repeatable pipette method, which would use a smaller sample volume and have a lower precision, was also shown to be infeasible.

4.3.3 Experimentally-Tested Methods

4.3.3.1 Vacuum-Assisted Rapid Filtration

Development of Apparatus

An initial design of an apparatus which could filter large amounts of water is shown in Figure 4.2. This design consisted of acrylic tubing cut into sections with acrylic plates attached to both ends. These plates hold O-rings and filter papers between them. Once the plates are screwed together, the system is water-tight and air-tight, and the filter papers are visible for inspection during each experiment. This first design had three sections for filter papers, where filter papers of different pore sizes could be placed. This would help separate sediment by particle size, so that a rough analysis could be done on the particle size distribution. A vacuum pump attaches to this system to pull high volumes of water through in reasonable amounts of time. This apparatus would be developed with a way to measure pressure differences between each chamber that holds water during the experiment. Theoretically, the time it takes to “plug” the system (where the pressure at the highest chamber approaches zero) can be correlated to the concentration of TSS in the water. Different correlations would be made for soils with differing particle size distributions.

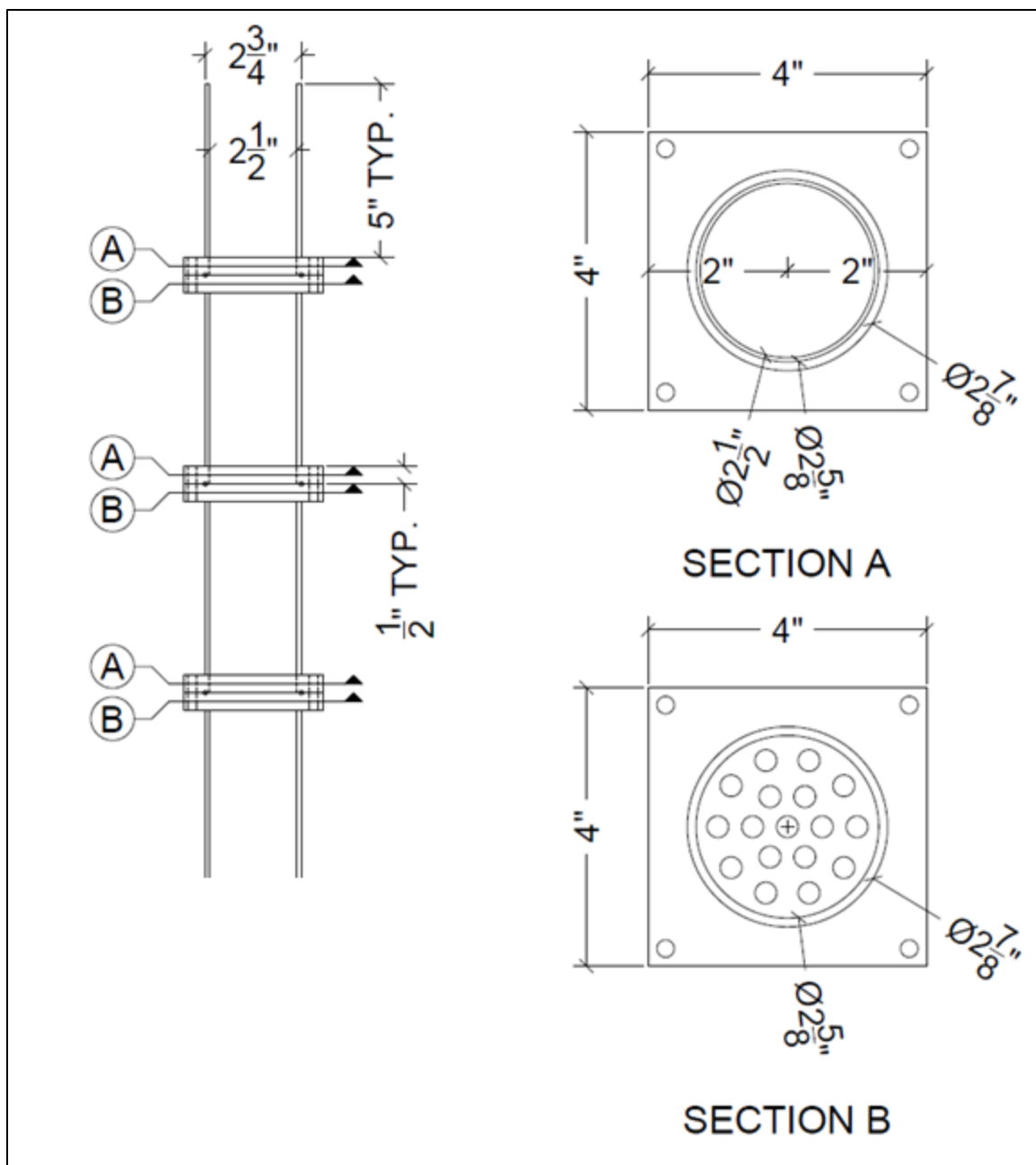

Figure 4.2: Initial Design of Rapid Filtration Apparatus

Further analysis of this system determined that with the small concentrations of TSS that were being tested, the system would never “plug” as intended. It would take a very large volume of water and a very long time to run the pressure at the lowest chamber

down to zero. It also wasn't feasible to put pressure sensors on each chamber. Pressure sensors that could handle water running through them would be needed, and it would create openings for a significant amount of soil to be lost. Therefore, it was decided to design the apparatus without pressure sensors, and to develop a correlation between the volume of water passed through in a given amount of time and the TSS concentration. Soil analyses of the three types of soil that were planned to be used in this experiment found a small range of soil particle sizes. This range was small enough that it was more practical to use only two filter paper sizes to separate the larger particles from the fines. The final design that would be constructed is shown in Figure 4.3.

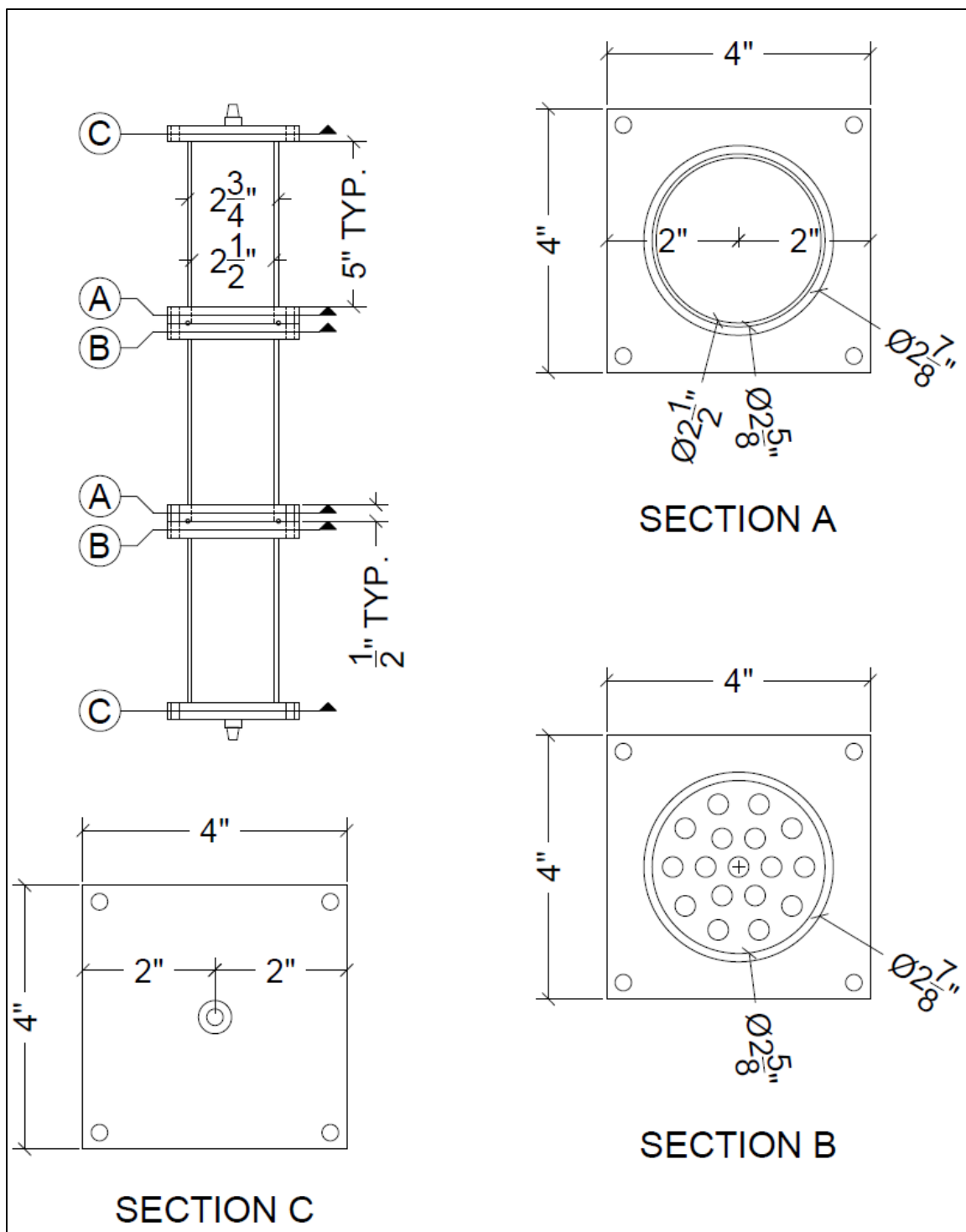

Figure 4.3: Final Design of Rapid Filtration Apparatus

The top plates (Section A in Figure 4.3) for this system were designed with a large open circle cut through the center of the plate. This allows water to come in contact directly with the filter paper with minimal soil particle loss. The bottom plates (Section B in Figure 4.3) had 5/16 inch holes drilled into the center to allow water through to the next chamber while the plate could support the filter paper. A test of this design showed that with pressure, the filter paper tended to tear above those holes. The holes under the filter paper also caused soil particles to settle in an inconsistent manner, so a screen was cut to fit on the bottom plate. The filter paper would sit on the screen, which spread the vacuum pressure evenly across the filter paper and allowed for more consistent settling. Section C in Figure 4.3 depicts an acrylic plate with a nozzle attached that would allow for tubing to run between the apparatus and the water. This allowed for a completely closed system that would be run by a vacuum pump.

Further testing of the apparatus showed that the velocity of the water pouring onto a glass fiber filter of larger pore size would rip fibers from the top of the filter and make it inconsistent across the surface of the filter. Using filter papers with a smaller pore size eliminated that problem, so only one filter paper was used in the apparatus. Many different types of filter papers were tested. Cellulose filter papers were initially used because they were more durable. Grade 3 cellulose filters were initially used with a pore size of 6.0 μm . Testing found that this large of a pore size allowed too many soil particles through the system, so Grade 5 cellulose filter papers with a pore size of 2.5 μm were then tested. Inconsistent results led to a hypothesis that glass fiber filters should be used in order to match the laboratory method as closely as possible, so Grade GF/D glass fiber filter papers with a pore size of 2.7 μm were tested. The pore size was chosen to

match the smaller Grade 5 filters, but results remained inconsistent. Since suspended solids are defined as solids with a diameter of 2 μm or larger, Grade 934-AH filter papers with a pore size of 1.5 μm were tested so that all suspended solids would be captured on the filter paper.

Once this design was developed, experiments were run, and it was found that the soil particles in the water were still not consistently settling over the filter paper. The uneven settling on the filter paper was apparently caused by turbulence above the filter which pushed soil particles to the edges of the filter paper and left a clear space in the middle for water to run through without slowing. To completely fill the upper chamber of the apparatus with water and thus reduce the turbulence, the air had to be allowed to escape the chamber. This was accomplished by drilling a hole in the top plate of the upper chamber, and once the chamber filled with water a rubber stopper was placed in the hole to plug it. A photo of the apparatus used in the experiments is shown in Figure 4.4. An image showing the apparatus along with the vacuum pump and the rest of the system is shown in Figure 4.5.

As shown in Figure 4.5, a 5-gallon bucket with the water sample sits directly above the acrylic apparatus, and tubing connects the apparatus to a second 5-gallon vessel that sits on a scale. The vacuum pump is attached to the system, and the change in weight is recorded from the scale over time. The weight of the water that gets to the vessel on the scale can be converted to a volume, so that the end volume can be measured after a given amount of time. This conversion is as follows: 1,000 g = 1,000 mL of water.



Figure 4.4: Apparatus Used in Vacuum-Assisted Experiments



Figure 4.5: Closed System Filtration Apparatus with Mixer and Vacuum Pump

Experimental Procedure

The experimental procedure for this method is simply running water through the apparatus and measuring the volume that flows through the filter in a given amount of time. The tests that were run were timed between fifteen and thirty minutes, with readings taken of the weight of the water that had passed through the system every thirty seconds.

Analysis of Method

Once the pressure and filter problems were resolved, results were expected to be consistent, with significant differences in the volume of water passed through at a given amount of time for runs with different TSS concentrations. However, experimental results did not show statistically significant differences between filtering times for samples with different total suspended solids concentrations. Analysis also showed very inconsistent results when multiple experiments were run at the same TSS concentration. The reason for the inconsistent results was hypothesized to be that the vacuum pressure was too high. For this reason, a fifth method was developed to the filtration system with zero vacuum pressure.

4.3.3.2 Filtration Without Vacuum Assist

Development of Apparatus

The experimental apparatus for these tests was developed by modifying the equipment used in the laboratory method. A standard glass fiber filter paper was placed on the porous plate used by the lab test, but instead of sealing it to a Büchner flask to

create an airtight system, the device was placed above a 250-mL graduated cylinder that could be read to the nearest mL. Glass fiber filters of pore size 1.5 μm were initially used, then the pore size was decreased to 0.7 μm to try to minimize the variability of the test.

To test the system, a 3-gallon sample of water was made at 100 mg/L TSS, and a 250-mL sub-sample was batch-loaded into the Büchner funnel while simultaneously starting a timer. The volume of water passed through at different time intervals was recorded. A second sub-sample was taken and diluted to 50 mg/L TSS and tested as well as a third sub-sample diluted to 20 mg/L TSS. Experimental results found a significant difference between sample concentrations and the difference in TSS concentrations, so it was decided to move forward with further testing of the system.

One noticeable problem was found during this initial dilution test, where the sample time series created by volume versus time tended to merge near the end of the experiment as the volume of water left in the Büchner funnel became very small (i.e., the filtration rate for all samples, regardless of TSS concentration, approached zero as the head above the filter approached zero). In order to keep the time series at different concentrations apart for the entire experiment duration, 300 mL sub-samples would be used while readings would only be taken up to 250 mL of sample passed through the filter, thus maintaining a significant head above the filter through the end of the run. An image of this filtration system can be found in Figure 4.6.



Figure 4.6: Filtration System with No Vacuum

Apparent variability encountered during testing led to use of glass fiber filter of smaller pore size ($0.7 \mu\text{m}$) to see if pore size affected the variability of this test.

Experimental Procedure

Once the filtration system was set up, water samples were batch-loaded into the funnel while simultaneously starting a timer. The time was recorded for every 10 mL of water that passed through the funnel. Initially the entire time series were compared with each other, but since differences in batch loading can affect the beginning of each experiment, it was decided to compare the volume of water that had passed through the system in four minutes.

Analysis of Method

Testing of this method found that the results were extremely variable and could not distinguish between samples with 80 mg/L and those with 100 mg/L TSS. No significant difference in volume passed through could be found between runs with different TSS concentrations. In order to test whether running the experiment for a longer period of time would provide more difference in the results, the apparatus used for the rapid filtration system was used without vacuum pressure to run water through a standard filter for fifteen minutes. Results again found no significant difference, so it was determined that the variability did not exist because of the small volumes of water being used. Switching to a filter paper with a smaller pore size of 0.7 μm was then tried to minimize variability. Results were as variable as with the 1.5 μm filter paper. The high variability of this field test method, however, could have been partially due to the variability in the standard method laboratory analysis. Section 5.4.7 discusses the effect of the standard method inaccuracy on the variability of the field test in detail.

4.3.4 TSS Portable Sensor Calibration

As discussed in Section 3.6.4, there are many existing suspended solids sensors or probes that have been developed for onsite testing of TSS. However, many of these sensors were developed particularly for mixed liquor suspended solids (MLSS) and return activated sludge (RAS) processes in wastewater treatment plants. An Insite IG Portable Suspended Solids Analyzer Model 3150 was purchased for testing to determine whether the accuracy of the probe was comparable to the standard laboratory method.

In Table 3.2 the specifications of the Insite IG Portable SS Analyzer are described. Before using the sensor to take readings of samples, the sensor was calibrated according to the manufacturer's specifications. The first step was to submerge the probe into clean distilled water for fifteen minutes, zero the reading for a baseline. The second step of calibration was to take an actual reading, called a "Snapshot" reading, which the sensor saves into the calibration menu to later be calibrated to the results of the laboratory analysis of that sample. Once that sample was analyzed using the standard method for TSS analysis, the snapshot reading was changed to the actual concentration.

After the sensor was calibrated, readings were taken by submerging the probe into a water sample. Once the reading shown on the screen stabilized, the value could be stored in the sensor. Taking a reading using the portable sensor purchased took about fifteen seconds per water sample.

4.4 Statistical Methods

4.4.1 Determination of Statistical Analyses to be Completed

The initial idea was to compare the entire time series of water passing the filter for samples with different TSS concentrations to see if significant differences could be found. The first statistical method researched was the Wilcoxon Signed-Rank test. This test compares two related samples with the assumptions that the data are paired and come from the same population, each pair is chosen randomly and is independent, and the data have a normal distribution (Lowry 1998). The null hypothesis, H_0 , would be that the mean difference in the pairs is equal to zero. This analysis was completed on some of the results, but further research found that a Chow test would be a better representation of the actual data. The Chow analysis tests for the equality of two time series that tend to increase linearly with time (Gould 2013).

While the Chow test seemed to be the most accurate test for determining whether two time series are equal, the goal of the experiment was changed to compare the total volumes of water that passed through a filter in a given period of time. Statistical analyses of these data would have to be conducted on those total volumes, not on the complete time series. For this reason, the average and standard deviation of final volumes was used for statistical analysis.

Though the average and standard deviation was sufficient to analyze the field test results from the filtration methods, a t-test was necessary to determine whether a significant difference existed between laboratory and field test values during the TSS sensor analysis. These statistical methods are described in Sections 4.4.2 and 4.4.3.

4.4.2 Average and Standard Deviation

The arithmetic mean, or average, of a set of numbers is a measure of central tendency for that set of numbers. The equation for calculating the average, \bar{x} , is:

$$\bar{x} = \frac{1}{n} \sum_{i=1}^n a_i$$

where:

n = size of the sample
 a_i = each observed value of the sample

The standard deviation of a set of numbers shows the average variation from the arithmetic mean. The standard deviation, s^2 , can be calculated using the following equation:

$$s^2 = \frac{1}{n-1} \sum_{i=1}^n (x_i - \bar{x})^2$$

where:

n = size of the sample
 x_i = each observed value of the sample
 \bar{x} = arithmetic mean of the sample

4.4.3 T-Test Analysis

To analyze the TSS sensor data and compare the results to the laboratory-analyzed data, a two-sided t-test assuming unequal variances was used. This test has a null hypothesis that the two means of the populations are equal, $\mu_1 = \mu_2$, and an alternative hypothesis that the two means of the populations are not equal, $\mu_1 \neq \mu_2$.

The average and standard deviations of the lab-analyzed and sensor-reported data were used to determine the degrees of freedom, v , and calculate the test statistic, t . If the absolute value of the computed test statistic was greater than the critical t-value found using the degrees of freedom, the null hypothesis would be rejected and there would be a significant difference between the two means of the laboratory-analyzed and sensor-reported data. A confidence level of 95% was used for these calculations. The degrees of freedom is calculated using the following equation:

$$v = \frac{\left(\frac{s_1^2}{n_1} + \frac{s_2^2}{n_2}\right)}{\frac{\left(\frac{s_1^2}{n_1}\right)}{n_1 - 1} + \frac{\left(\frac{s_2^2}{n_2}\right)}{n_2 - 1}}$$

where:

- v = degrees of freedom of the sample
- n = size of the sample
- s^2 = standard deviation of the sample

The test statistic is calculated by:

$$t = \frac{\bar{X}_1 - \bar{X}_2}{\sqrt{\frac{s_1^2}{n_1} + \frac{s_2^2}{n_2}}}$$

where:

- t = test statistic
- \bar{X} = arithmetic mean of the sample
- n = size of the sample
- s^2 = standard deviation of the sample

SECTION 5: RESULTS

5.1 Soil Analyses

5.1.1 Specific Gravity Determination

Specific gravity of a soil is a measure of the ratio between the density of the soil and the density of water. Different soil types have different ranges of specific gravities, as shown in Table 5.1.

Table 5.1: Specific Gravity Ranges for Different Soil Types (Toledo Laboratory 2013)

Soil Type	Average S_G Range
Sand	2.63 – 2.67
Silty Sand	2.67 – 2.70
Silt	2.65 – 2.70
Silty Clay	2.67 – 2.80
Clay	2.70 – 2.80
Organic Soil	< 2.60

5.1.1.1 Pycnometer Calibration for Specific Gravity Tests

The specific gravity was determined for Soil #1, #2, and #3 using ASTM D854-10. A 100 mL pycnometer was used to complete this test. The pycnometer calibration data, obtained by the procedure described in Section 4.1.1.1 are shown below:

Table 5.2: Pycnometer Calibration Data

M_p (g)	$M_{pw,c}$ (g)	Temperature (°C)	V_p (mL)
22.08	122.10	21.9	100.24
22.09	122.13	22.0	100.26
22.09	122.16	22.0	100.29
22.07	122.09	22.1	100.25
22.08	122.13	22.0	100.27
Ave = 22.08 St. Dev = $0.008 \leq 0.02$	Ave = 112.12 St. Dev = 0.028	Between 15 and 30 °C	Ave = 100.26 St. Dev = $0.019 \leq 0.05$

As can be seen in Table 5.2, the standard deviations and temperatures met the necessary requirements stated in the ASTM method, which can be found in Appendix A.4.

Explanations of the pycnometer calibration data shown in Table 5.2 can be found in Section 4.1.1.1. The pycnometer calibration results found that the calibration procedure had a variability small enough to use the average volume as the calibrated volume of the pycnometer. The results of the calibration found that the value that would be used in further calculations for the determination of the specific gravity of the three soils was 100.26 mL for the 100 mL pycnometer.

5.1.1.2 Results of Specific Gravity Determination for the Three Test Soils

The specific gravity determination was conducted on three soils. Table 5.3 shows the results from the intermediate steps and final specific gravity results of the procedure. The specific gravity of Soil 1 was 2.64, for Soil 2 it was 2.66, and for Soil 3 it was 2.69.

Table 5.3: Data for Completion of Specific Gravity Lab Analysis

	Soil #1	Soil #2	Soil #3
$M_{pws,t}$	132.52 g	132.48 g	138.09 g
Slurry Temp.	22.1 °C	22.1 °C	22.1 °C
$\rho_{w,t}$	0.99775 g/mL	0.99775 g/mL	0.99775 g/mL
M_s	16.76 g	16.62 g	25.44 g
G_t	2.64	2.66	2.69
$G_{20^\circ\text{C}}$	2.64	2.66	2.69

5.1.2 Hydrometer Test

5.1.2.1 Composite Correction and Hygroscopic Moisture

Since hydrometers are calibrated at 20°C (ASTM D422-63), a composite correction must be determined to apply to the readings taken during the test at different temperatures. Dispersing agent was placed in distilled water, and when the temperature of the solution became constant the hydrometer was inserted and a reading taken. The

composite correction for hydrometer 152H (Gilson SA-2), which was the hydrometer type used for this test, was the difference between zero and the hydrometer reading taken, which had a value of 0.40 g/L at the temperature of 22.0°C. The temperature stayed constant at 22.0°C for the entirety of the hydrometer test for each soil.

Before completing the hydrometer test, hygroscopic moisture was determined for the three soils. The hygroscopic moisture is a correction factor that is equal to the ratio between the mass of an oven-dried sample and an air-dry sample. Unless there is no hygroscopic moisture, this number is a value less than one. The hygroscopic moisture correction factors for the three soils are shown below:

Table 5.4: Hygroscopic Moisture Correction Factors

Soil #1	Soil #2	Soil #3
0.9676	0.8827	0.9656

5.1.2.2 Hydrometer Analysis Results

The hygroscopic correction factors shown in Table 5.4 are applied to the air-dry mass of the soil sample used in the hydrometer analysis to give the oven-dry mass. The full procedure can be found in Appendix A.5, and a description of this procedure with explanation can be found in Section 4.1.1.2. Since all three samples consisted of particles smaller than the No. 10 sieve, the oven-dry mass did not need to be corrected after being initially calculated. Tables 5.5 through 5.7 show the data taken and calculated during the hydrometer analysis for each soil type. Section 4.1.1.2 contains definitions of the variables and how to calculate them in the following tables. The four variables (R , P , L , and D) use the constants W , a , and K for their calculation.

Table 5.5: Soil #1 Hydrometer Analysis Data

T (min)	Time	Hydrometer Reading (g/L)	R (g/L)	P (%)	L (cm)	D (mm)
2	9:10 a.m.	37.5	37.1	81.04	10.2	0.0301
5	9:13 a.m.	33.0	32.6	71.21	10.9	0.0197
15	9:23 a.m.	26.1	25.7	56.14	12.0	0.0120
30	9:38 a.m.	24.0	23.6	51.55	12.4	0.0086
60	10:08 a.m.	21.9	21.5	46.96	12.7	0.0061
250	1:18 p.m.	19.1	18.7	40.85	13.1	0.0031
1440	9:08 a.m.	16.8	16.4	35.82	13.5	0.0013

$$W = 45.78 \text{ g}$$

$$a = 1.00$$

$$K = 0.13362$$

Table 5.6: Soil #2 Hydrometer Analysis Data

T (min)	Time	Hydrometer Reading (g/L)	R (g/L)	P (%)	L (cm)	D (mm)
2	9:21 a.m.	17.5	17.1	37.25	13.4	0.0344
5	9:24 a.m.	15.0	14.6	31.81	13.8	0.0221
15	9:34 a.m.	13.7	13.3	28.98	14.1	0.0129
30	9:49 a.m.	12.9	12.5	27.23	14.2	0.0091
60	10:19 a.m.	11.2	10.8	23.53	14.4	0.0065
250	1:29 p.m.	10.0	9.6	20.92	14.6	0.0032
1440	9:19 a.m.	9.3	8.9	19.39	14.8	0.0013

$$W = 45.90 \text{ g}$$

$$a = 1.00$$

$$K = 0.13280$$

Table 5.7: Soil #3 Hydrometer Analysis Data

T (min)	Time	Hydrometer Reading (g/L)	R (g/L)	P (%)	L (cm)	D (mm)
2	9:30 a.m.	45.9	45.5	93.67	8.8	0.0276
5	9:33 a.m.	33.2	32.8	67.52	10.9	0.0194
15	9:43 a.m.	30.5	30.1	61.97	11.2	0.0114
30	9:58 a.m.	28.1	27.7	57.02	11.7	0.0082
60	10:28 a.m.	26.2	25.8	53.11	12.0	0.0059
250	1:38 p.m.	23.0	22.6	46.53	12.5	0.0029
1440	9:28 a.m.	20.2	19.8	40.76	13.0	0.0013

$$W = 48.09 \text{ g}$$

$$a = 0.99$$

$$K = 0.13160$$

The above information can be used to create a plot of the percent of soil in suspension based on particle size. The plots for the three test soils can be found in Figures 5.1 through 5.3. All three of the soils are generally classified as clays because the particle sizes are small enough to pass through the No. 200 (75 μm) sieve, which can be seen in the plots.

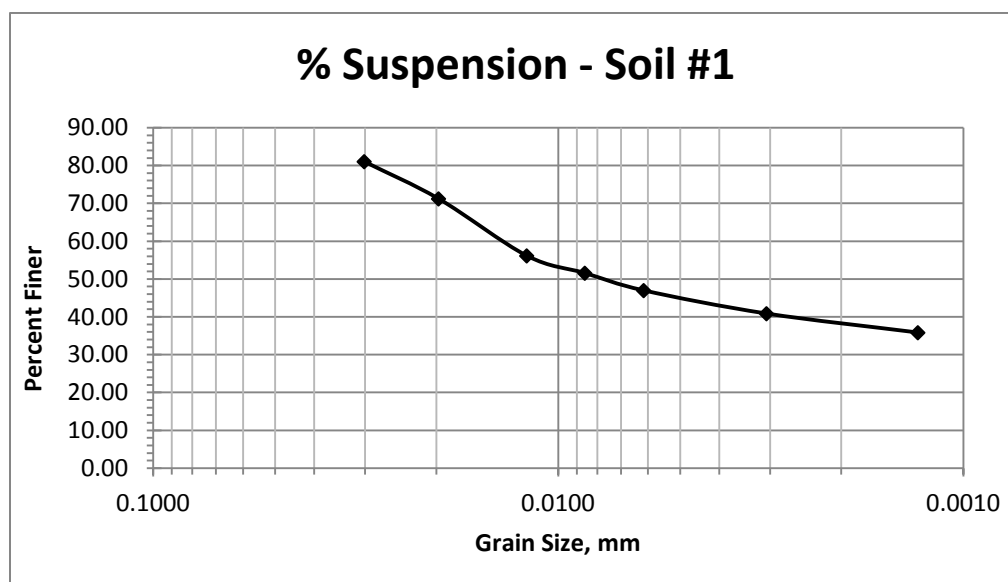

Figure 5.1: Hydrometer Test Results for Soil #1

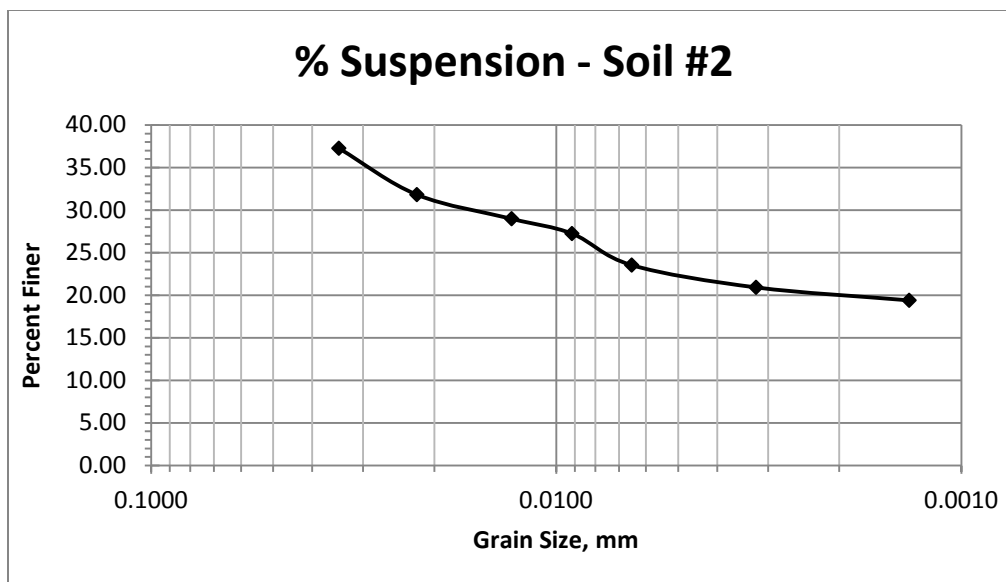

Figure 5.2: Hydrometer Test Results for Soil #2

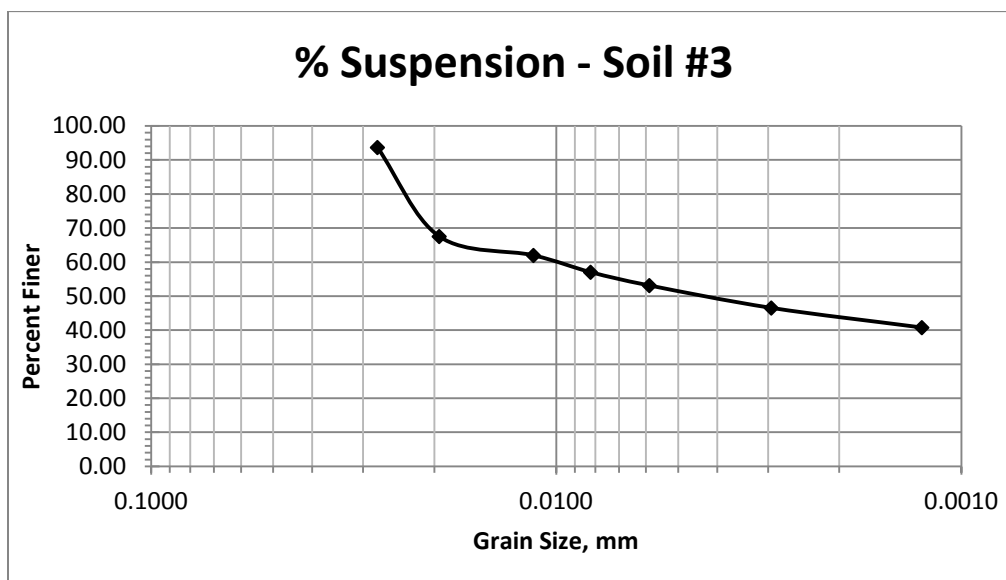

Figure 5.3: Hydrometer Test Results for Soil #3

5.1.3 Liquid Limit, Plastic Limit, and Plasticity Indices

The liquid limit was determined by plotting the moisture content and blow count of three samples and plotting a linear trendline with the data points. The moisture content

corresponding to 25 blows on the best fit line is the liquid limit. Plots for the liquid limits of each of the three soils are shown in Figures B.1 through B.3 in Appendix B.

The plastic limit was determined by finding the moisture content of at least 6 grams of soil that can be rolled to a diameter of 3.2 mm and no farther for each type of soil. This experiment was repeated to give two moisture content values for each soil type, the average of which was the plastic limit.

The plasticity index was found by subtracting the plastic limit from the liquid limit. Table 5.8 shows the liquid limit, plastic limit, and plasticity index of each soil.

Table 5.8: Liquid Limit, Plastic Limit, and Plasticity Index of the Analyzed Soils

	Soil #1	Soil #2	Soil #3
Liquid Limit, LL	35.6	29.6	48.6
Plastic Limit, PL	20.8	22.5	25.8
Plasticity Index, PI	14.9*	7.1	22.8

*NOTE: These values are rounded to the nearest 0.0 after calculations

5.1.4 Classification of Soils

The results of the soil analyses showed that each of the three soils analyzed was classified generally as clay. A plasticity chart is commonly used to classify fine-grained soils. This chart plots the plasticity index against the liquid limit. An overlay of this plasticity chart and the data points from the three soil analysis results can be found in Figure B.4 in Appendix B.

Each of the three soils falls into the “lean clay” category on the chart. Soil #1 is centered in the *CL* (lean clay) portion of the graph, while Soil #2 is on the border of the *CL-ML* (silty clay) portion and Soil #3 is close to the border of the *CH* (fat clay) portion of the chart. While all three soil types are clays, more specifically the three soil types can be described as a lean clay, a silty clay, and a fat clay. More diverse soil types would

have been tested and used in the developed TSS field test method if results showed promise with the existing soil types. Since the existing soil types were fairly easy to keep in suspension, it was determined that these soils would be consistently the most completely mixed for field testing. If a field test method was found that had good accuracy and precision, other soil types would have been used as well to ensure it worked with every soil type.

5.2 Laboratory Method Accuracy and Precision

5.2.1 Precision of Standard Method Laboratory Test

The laboratory method for analyzing TSS using Standard Method 2540 D can be found in Appendix A.2, and is summarized in Section 3.6.2.2. The precision of the standard method laboratory test for total suspended solids (TSS) is described in Section 4.2 under Table 4.1. For this research project, many samples at different TSS concentrations were manufactured, and most of those samples were analyzed using the standard laboratory method. The precision and accuracy of that method (SM 2540 D) were computed and compared to the published values. Initial TSS concentrations in test soil samples were created by placing a weighed mass of soil into a known volume of water. The final TSS concentration in the sample was reduced by the mass of original solids that dissolved in the water. Since the mass of solids that would dissolve was unknown, the final TSS concentration was determined with the standard method laboratory analysis. Nine different initial concentrations were manufactured and analyzed using the standard laboratory method, the results of which are shown in Table B.1 in Appendix B and in Table 5.9. On average, the precision of the standard laboratory

method in the experiments performed during this project was higher than that reported in the laboratory method.

Table 5.9: Precision and Accuracy of the Standard Method TSS Laboratory Test Using Results from 5 to 15 Runs Each

Manufactured Sample TSS Concentrations	Average TSS Concentration	Standard Deviation	Coefficient of Variation	Number of Replicates
75 mg/L	66 mg/L	5.7 mg/L	8.6%	14
100 mg/L	91 mg/L	9.5 mg/L	10.5%	8
115 mg/L	92.5 mg/L	8.8 mg/L	9.5%	5
120 mg/L	81 mg/L	12.2 mg/L	15%	5
130 mg/L	88 mg/L	4.0 mg/L	4.6%	5
135 mg/L	94 mg/L	4.1 mg/L	4.3%	5
140 mg/L	103 mg/L	5.8 mg/L	5.6%	10
160 mg/L	122 mg/L	4.5 mg/L	3.7%	15
170 mg/L	128 mg/L	4.6 mg/L	3.6%	5

5.2.2 Effect of Total Dissolved Solids on Sample TSS Results

The average TSS concentration of the manufactured samples described above in Table 5.9 showed a significant soil loss due to dissolving particles. Table 5.10 shows the concentration at which the samples were made, the average TSS concentration, and the average soil loss. The reported standard deviations in the standard laboratory method (shown in Table 4.1) showed higher precision at lower concentrations. This trend can also be seen in the statistics for the laboratory analyses conducted in this project in Table 5.9.

Table 5.10: Average Soil Loss due to Dissolved Particles for Different Total Suspended Solids Concentrations

Manufactured Sample TSS Concentrations	Lab-Analyzed Average TSS Concentration	Average Soil Mass Dissolved	Number of Replicates
75 mg/L	66 mg/L	9 mg/L	14
100 mg/L	91 mg/L	9 mg/L	8
115 mg/L	92.5 mg/L	22 mg/L	5
120 mg/L	81 mg/L	39 mg/L	5
130 mg/L	88 mg/L	42 mg/L	5
135 mg/L	94 mg/L	41 mg/L	5
140 mg/L	103 mg/L	37 mg/L	10
160 mg/L	122 mg/L	38 mg/L	15
170 mg/L	128 mg/L	42 mg/L	5

5.3 Vacuum-Assisted Rapid Filtration

5.3.1 Vacuum-Assisted Filtration with Top Chamber Full of Air

The first full experiment was conducted using one filter paper with the top chamber of the filtration apparatus full of air. See Figure 4.4 for a visual of the filtration apparatus. The tabular data for the graph shown in this section can be found in Table B.2 in Appendix B. The initial experiments were conducted using a Grade 3 cellulose filter paper with a pore size of 6 μm . Testing of the apparatus showed that since the chamber above the filter was not full of water, turbulence caused the particles retained on the filter paper to be pushed to the sides of the filter. Therefore, the filter paper never ‘plugged’ while the top chamber remained full of air. The result of the lack of plugging can be seen in Figure 5.4, where the flow rate through the filter never approaches zero. The y-axis depicts the volume of water that had gone through the filter paper in mL, and the x-axis represents time.

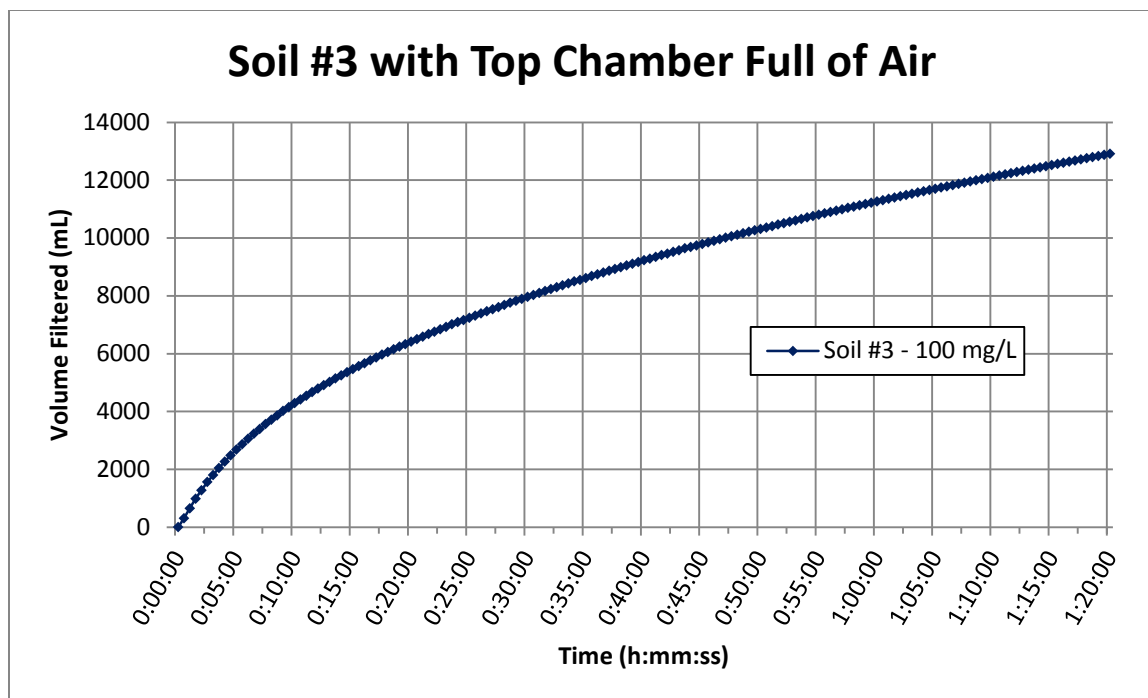

Figure 5.4: Soil #3 with Top Chamber of the Filtration Apparatus Mostly Filled with Air, Using Grade 3 Filter Paper and a TSS Concentration of 100 mg/L

The results of this experiment showed that the filter would not plug in a reasonable amount of time while the top chamber of the filtration apparatus allowed high levels of turbulence to push the particles from the middle of the filter paper. As a result, the filtration apparatus was modified to allow the upper chamber to fill with water and reduce the turbulence of the water above the filter.

5.3.2 Vacuum-Assisted Filtration with Top Chamber Full of Water

The following experiments were conducted using the same experimental setup as described above with the only difference being the top chamber of the filtration apparatus was full of water. The tabular data for the graph shown in this section can be found in Table B.3 in Appendix B. During this set of experiments it was noticed that there were pressure differences on the vacuum pump gauge from one experiment to another.

Multiple experiments were run to see whether the pressure differences significantly affected the consistency of the results. Figure 5.5 shows three experiments run using Soil #3 at a TSS concentration of 100 mg/L with different vacuum pressures. As can be seen, the results differed significantly as the pressure changed, with higher vacuum pressure resulting in higher flow-through rates.

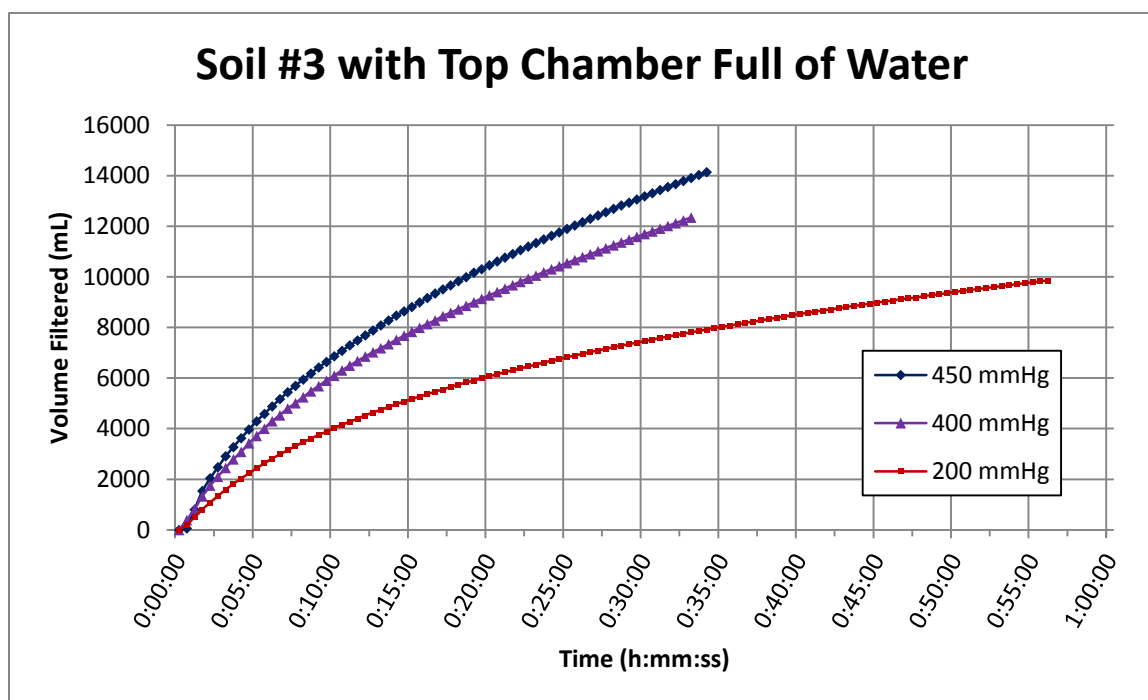

Figure 5.5: Soil #3 with Top Chamber of Filtration Apparatus Full of Water, Using Grade 3 Filter Paper and a TSS Concentration of 100 mg/L

5.3.3 Vacuum-Assisted Filtration with Top Chamber Full of Water, Testing Different TSS Concentrations

A second set of experiments was run using different TSS concentrations for all three soil types. The tabular data for the graphs shown in this section can be found in Tables B.4 and B.5 in Appendix B. Figures 5.6 and 5.7 show results from Soil #2 and

Soil #3 at different concentrations and recording the pressure shown on the vacuum pump gauge. Soil #1 was not tested in this set of experiments.

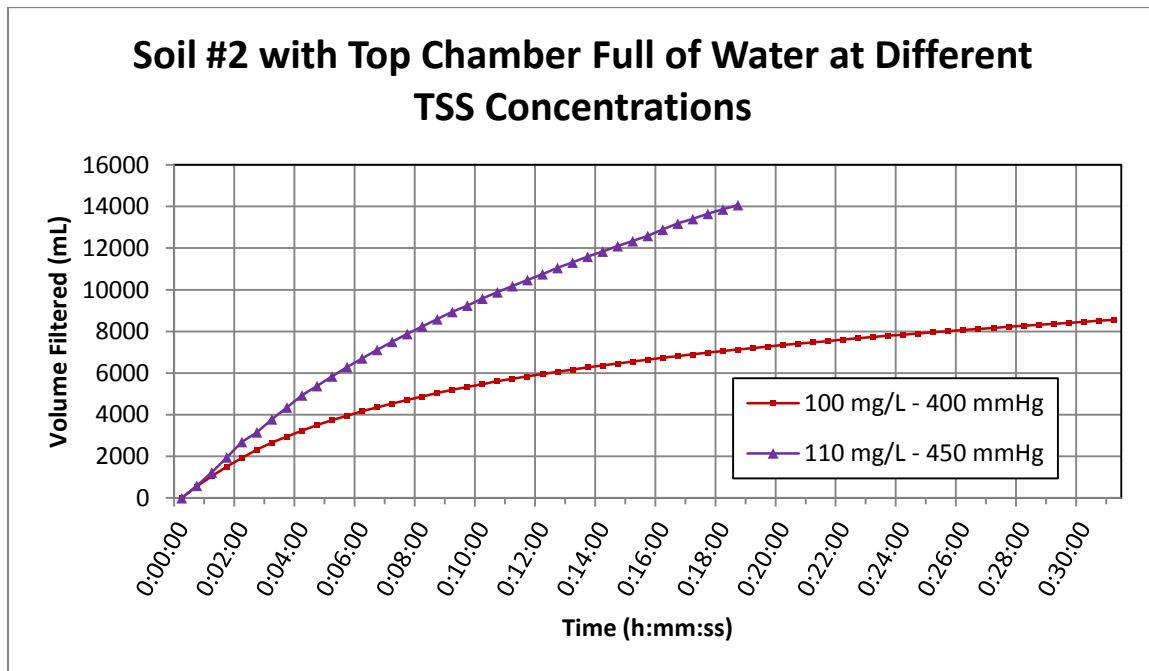

Figure 5.6: Soil #2 with Top Chamber of Filtration Apparatus Filled with Water, Using Grade 3 Filter Paper and TSS Concentrations of 100 mg/L and 110 mg/L

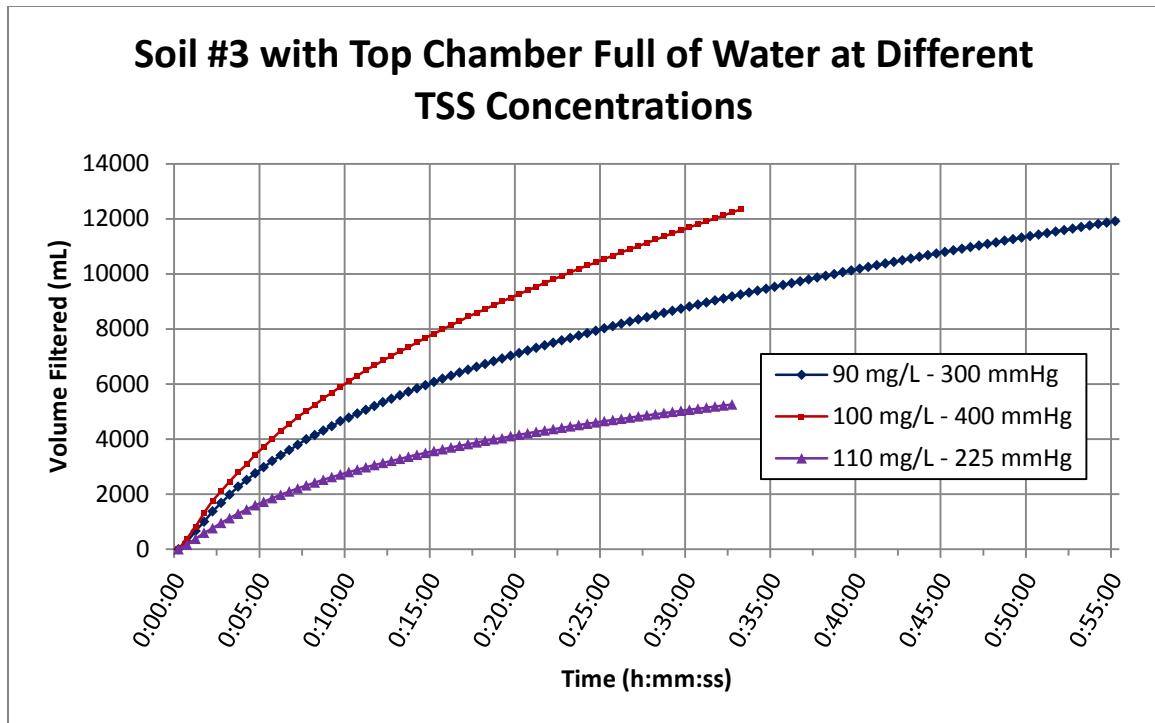

Figure 5.7: Soil #3 with Top Chamber of Filtration Apparatus Filled with Water, Using Grade 3 Filter Paper and TSS Concentrations of 90 mg/L, 100 mg/L, and 110 mg/L

5.3.4 Vacuum-Assisted Filtration Testing at Similar TSS Concentrations and Pressures

In an effort to determine whether the concentration or pressure changes were causing the most significant difference, a third set of experiments was run using Soil #1 at the same TSS concentrations and similar vacuum pressures, found by repetition. The tabular data for the graph shown in this section can be found in Table B.6 in Appendix B. The results of these experiments are shown in Figure 5.8. As can be seen, inconsistency was still present between the data sets.

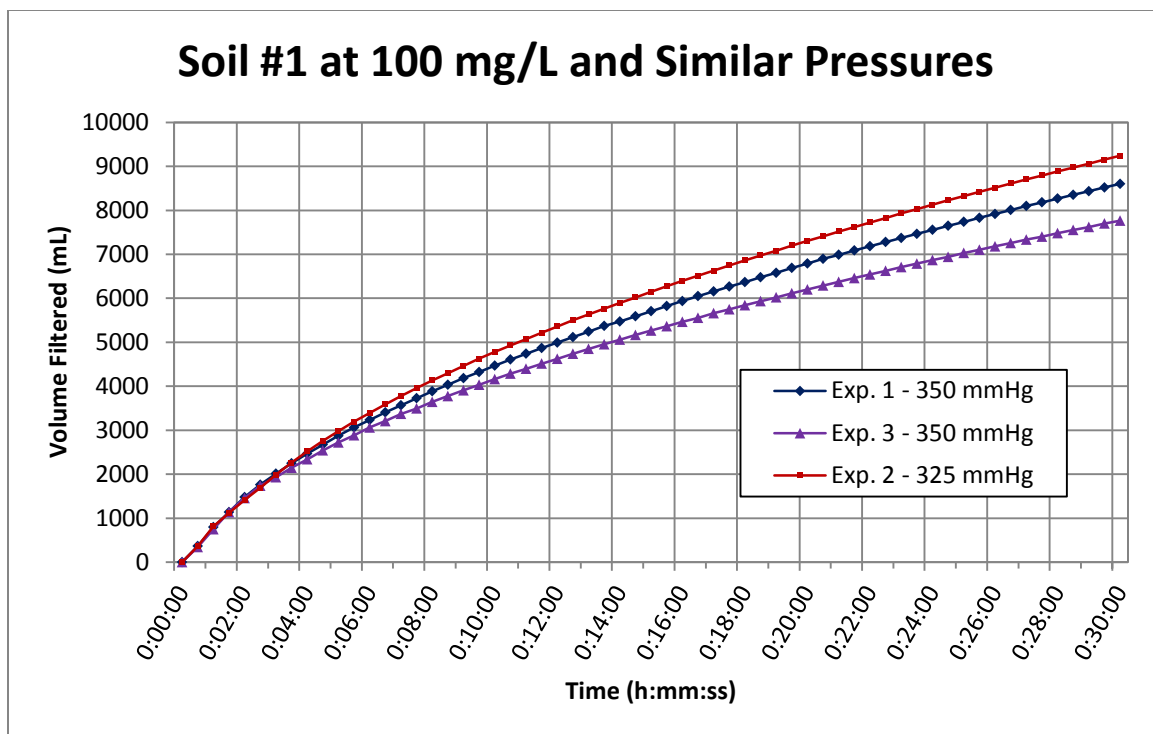

Figure 5.8: Soil #1 Using Grade 3 Filter Paper with Three Replicates of a TSS Concentration at 100 mg/L and Similar Pressures

Figure 5.8 showed that at the same pressure and concentration data sets are more consistent, but still not consistent enough to be able to differentiate between different TSS concentrations accurately. For example, at 30 minutes of filtration, the two runs at a 350 mmHg vacuum differed by almost 10%. With this level of uncertainty, one would not be able to distinguish between TSS concentrations of 90 mg/L (an acceptable TSS concentration value for construction dewatering activity discharge under the EPA regulations) and 100 mg/L (an unacceptable TSS concentration value under EPA guidelines). Another inconsistency shown in the above figure is that a lower vacuum pressure of 325 mmHg produced a higher filtration rate. This indicates that the uncertainty is actually greater than the 10% indicated by the two runs at the 350 mmHg vacuum pressure.

5.3.5 Vacuum-Assisted Filtration at Similar TSS Concentrations and Pressures

The 6 μm pore size of the Grade 3 filter being used was a much larger pore size than that used for the laboratory test. For this reason, more experiments were run using Soil #1 at the same concentration and pressure with a smaller filter pore size (Grade 5, 2.5 μm). The tabular data for the graph shown in this section can be found in Table B.7 in Appendix B. The results of two data sets that were run at nearly equal pressures are shown in Figure 5.9.

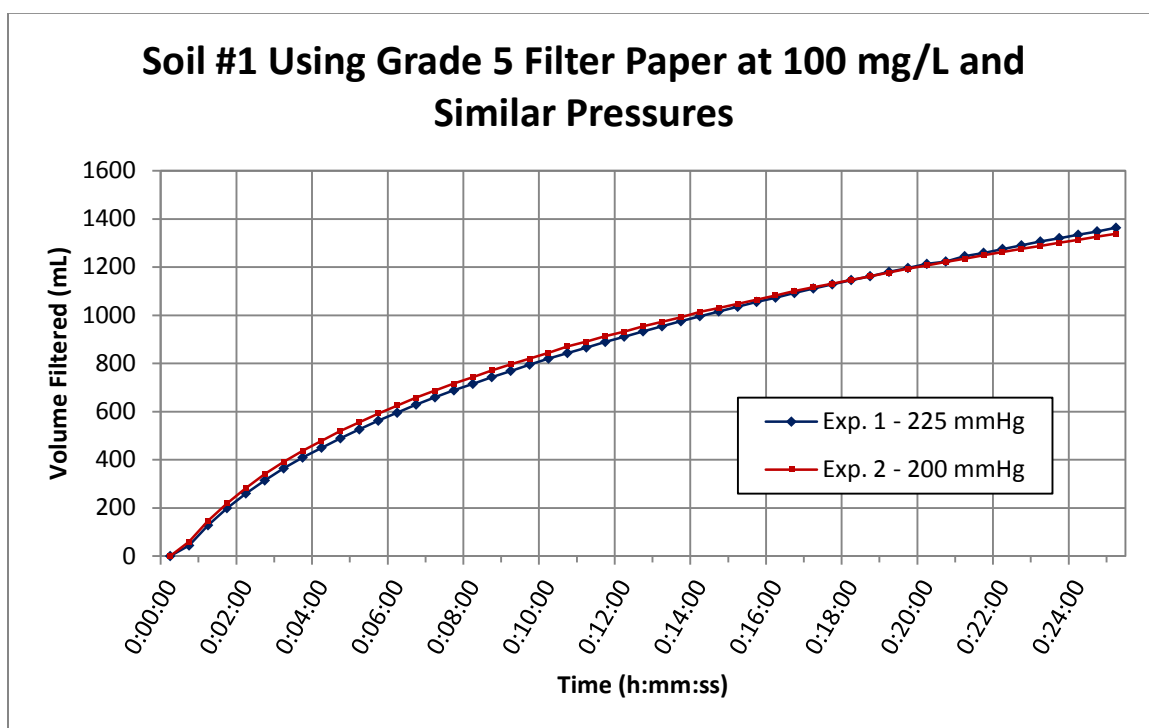

Figure 5.9: Soil #1 Using Grade 5 Filter Paper with Two Replicates of a TSS Concentration of 100 mg/L and Similar Pressures

These results were much more consistent and looked very promising for being able to differentiate between TSS concentrations. Before moving on with more experimentation, the problem of inconsistent pressure was analyzed and solved. A description of this problem and the solution found is discussed in Section 4.3.3. The

slight design modification of the filtration apparatus allowed the pressure to be at a consistent 575 mmHg vacuum for all the remaining experiments.

5.3.6 Vacuum-Assisted Filtration, Comparing Two TSS Concentrations at a Consistent Pressure

It was determined that experiments should be completed using just one soil type until the method is found to be consistent, so Soil #1 was used for the following experiments. The Grade 5 filter paper with a smaller pore size of 2.5 μm was also used for these experiments. The tabular data for the graphs shown in this section can be found in Tables B.8 through B.13 in Appendix B. Figure 5.10 shows several data sets using Soil #1 at a TSS concentration of 100 mg/L and a consistent pressure of 575 mmHg. Figure 5.11 shows three experiments run using the same parameters as in Figure 5.10, but with a TSS concentration of 85 mg/L. The results of these experiments at the two different TSS concentrations are plotted together in Figure 5.12.

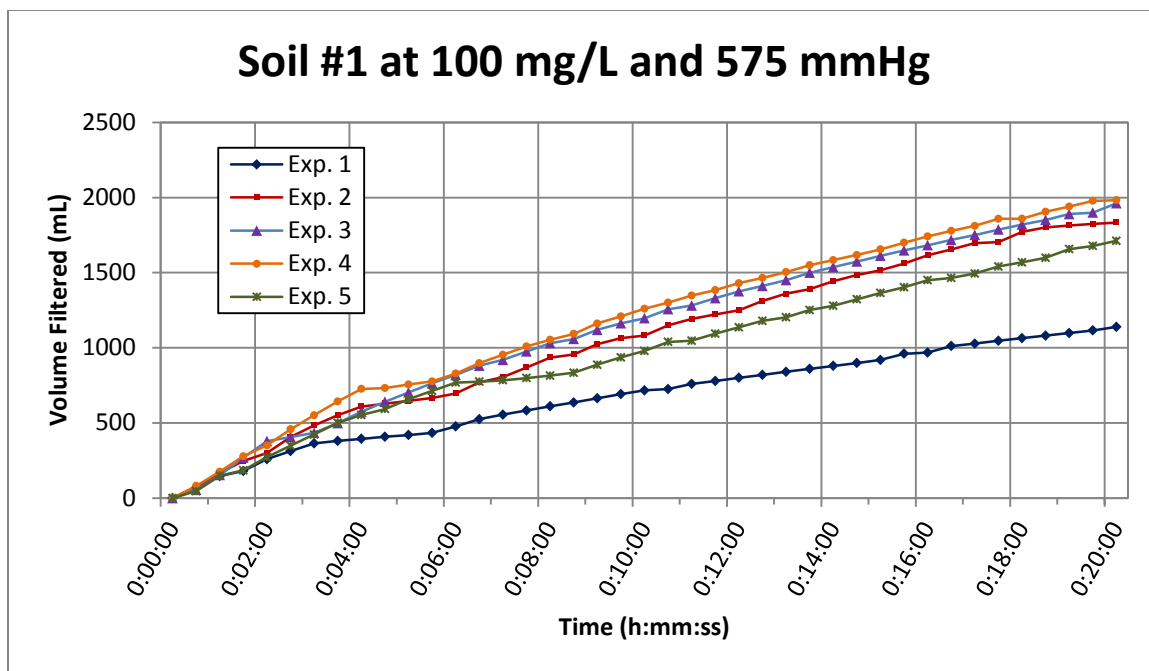

Figure 5.10: Soil #1 Using Grade 5 Filter Paper with Five Replicates of a TSS Concentration of 100 mg/L and a Consistent Pressure of 575 mmHg

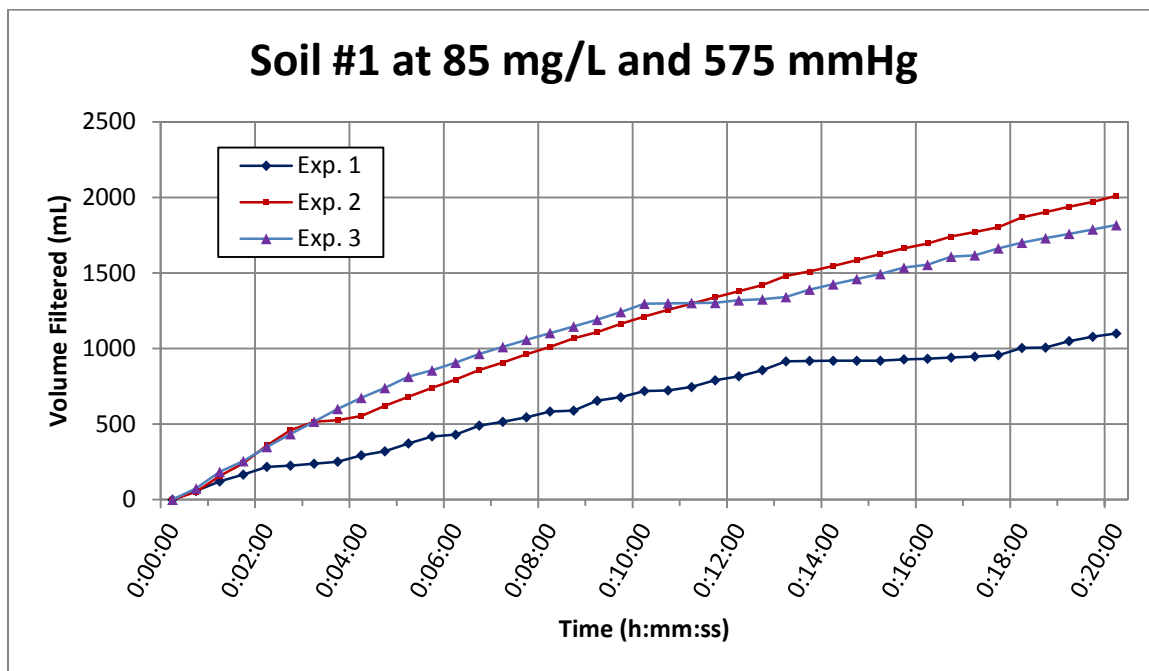

Figure 5.11: Soil #1 Using Grade 5 Filter Paper with Three Replicates of a TSS Concentration of 85 mg/L and a Consistent Pressure of 575 mmHg

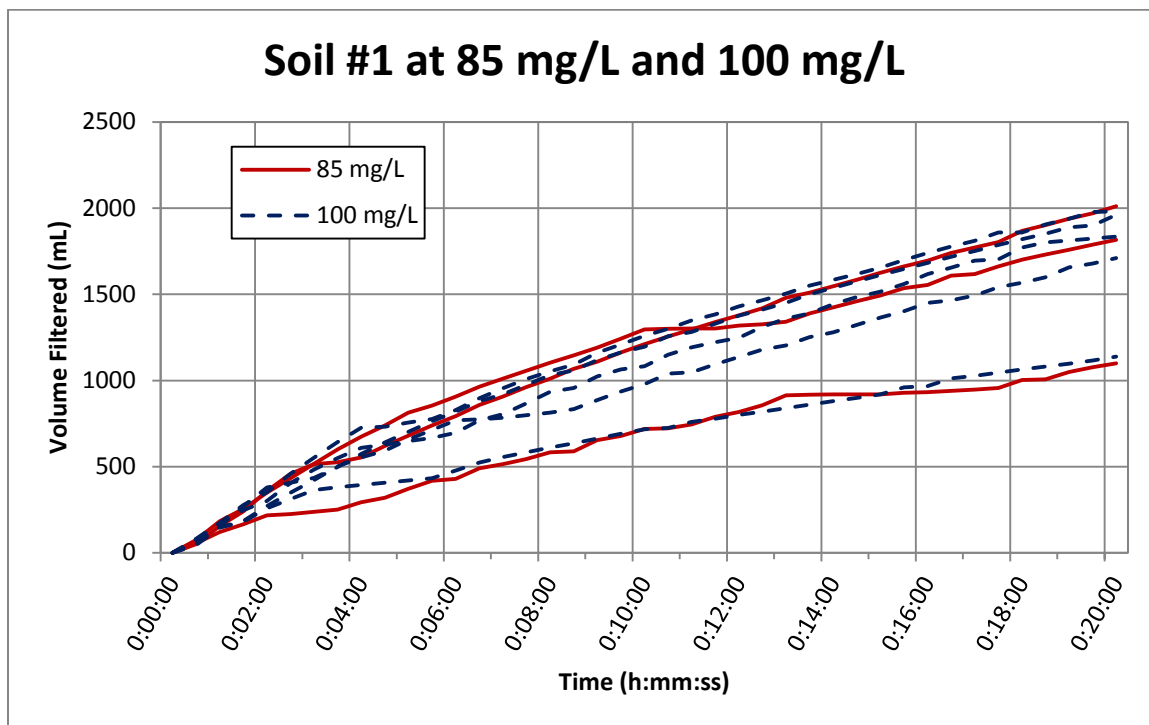

Figure 5.12: Soil #1 Using Grade 5 Filter Paper at a Pressure of 575 mmHg, Comparing TSS Concentrations of 85 mg/L and 100 mg/L

The results show overlap between concentrations that should be differentiated for this field test. Laboratory analysis of multiple sub-samples taken from a large mixture found that the mixing apparatus was not consistently mixing the soil particles. Soil particles could be seen settling within the mixture, which showed there were “dead spots” of poor mixing in the bucket. The mixing apparatus was modified and tested to ensure the system was completely mixing the samples before further testing. The tests discussed in Figures 5.10 through 5.12 were repeated ensure the highest consistency possible. The results are shown in Figures 5.13 through 5.15.

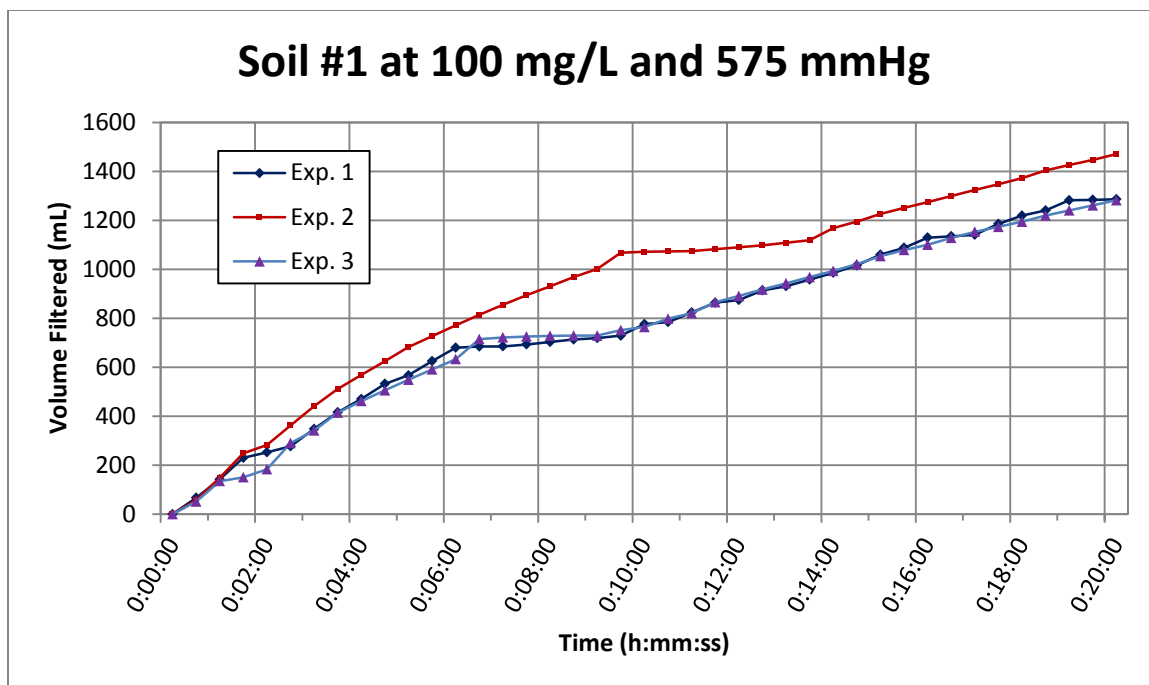

Figure 5.13: Soil #1 Using Grade 5 Filter Paper after Mixing Apparatus Modification, with Three Replicates of a TSS Concentration of 100 mg/L and a Consistent Pressure of 575 mmHg

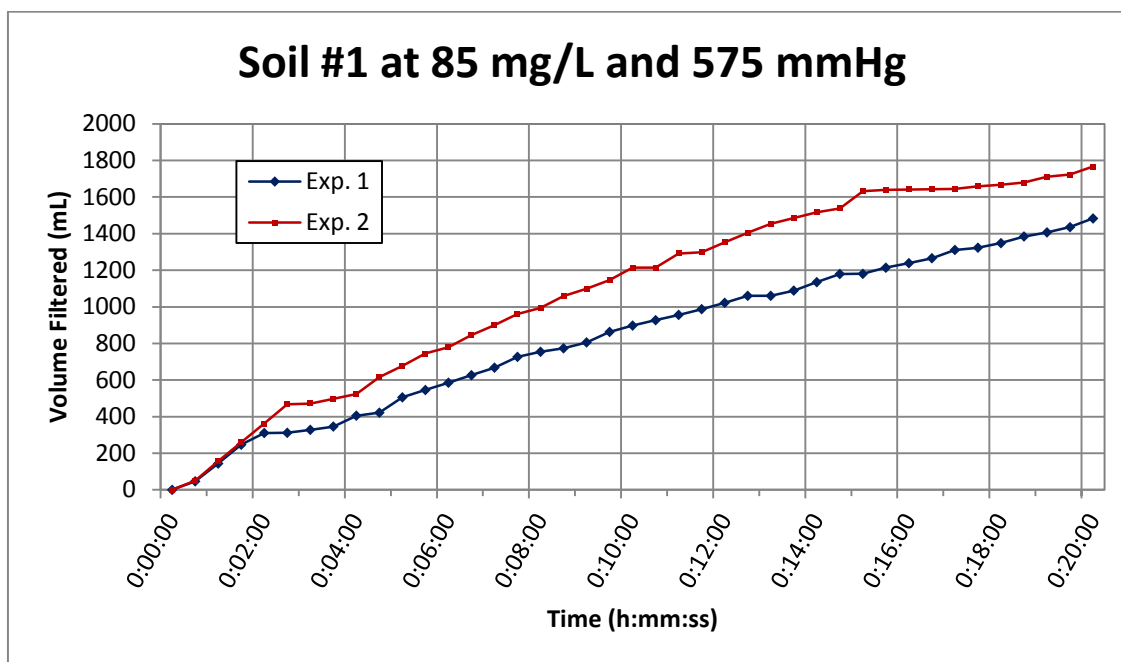

Figure 5.14: Soil #1 Using Grade 5 Filter Paper after Mixing Apparatus Modification, with Two Replicates of a TSS Concentration of 85 mg/L and a Consistent Pressure of 575 mmHg

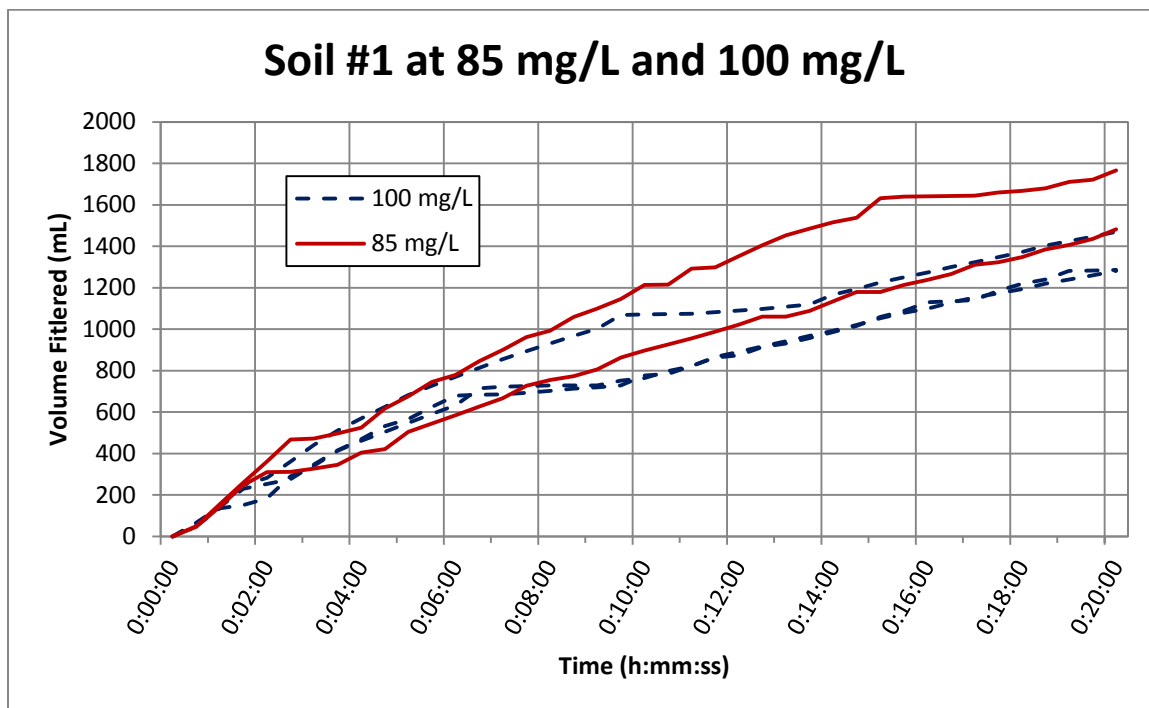

Figure 5.15: Soil #1 Using Grade 5 Filter Paper after Mixing Apparatus Modification at a Pressure of 575 mmHg, Comparing TSS Concentrations of 85 mg/L and 100 mg/L

Figures 5.13 through 5.15 show that even with improved mixing, the filtration results for TSS concentrations of 85 mg/L and 100 mg/L were completely overlapping. Therefore, this method using a filter paper of a 2.5 μm pore size was shown to not be adequate to distinguish between acceptable and unacceptable TSS concentrations.

5.3.7 Vacuum-Assisted Filtration Using a Standard Glass Fiber Filter

Since filtration with a 2.5 μm pore sized filter paper did not provide acceptable results, the experiments were rerun using glass fiber filter paper with the same pore size as used in the laboratory analyses (934-AH filter papers with a pore size of 1.5 μm). The tabular data for the graphs shown in this section can be found in Tables B.14 through B.16 in Appendix B. The results are shown in Figures 5.16 through 5.18.

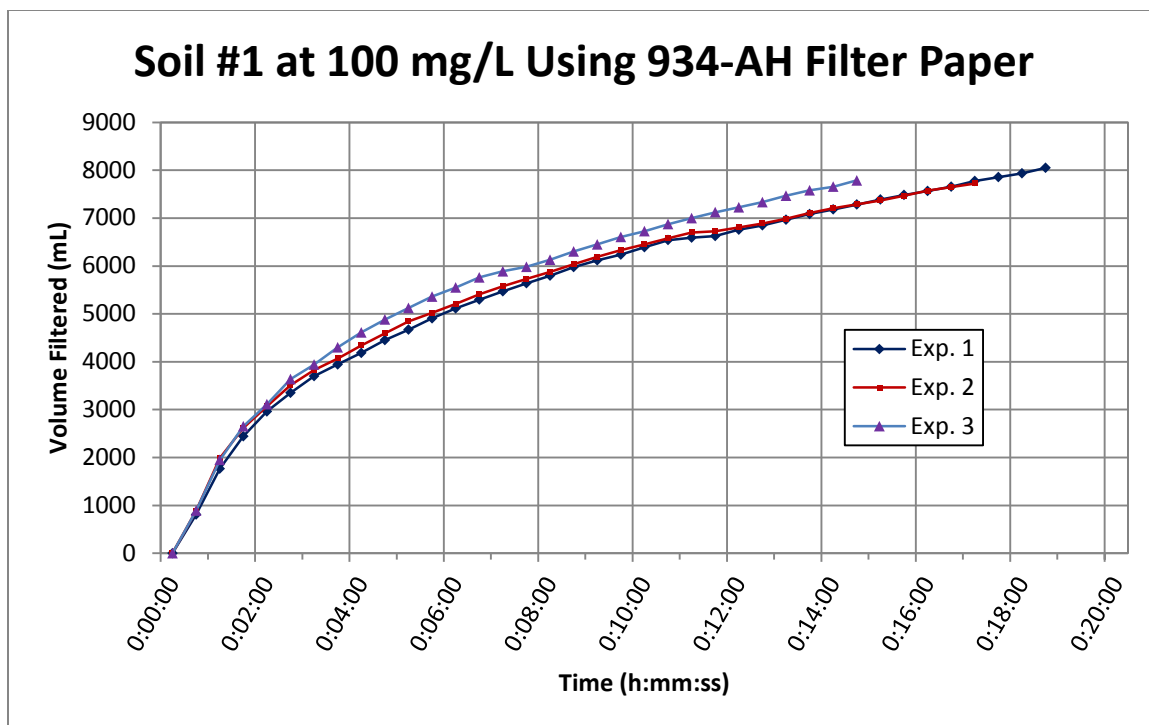

Figure 5.16: Soil #1 Using 934-AH Filter Paper, with Three Replicates of a TSS Concentration of 100 mg/L and a Consistent Pressure of 575 mmHg

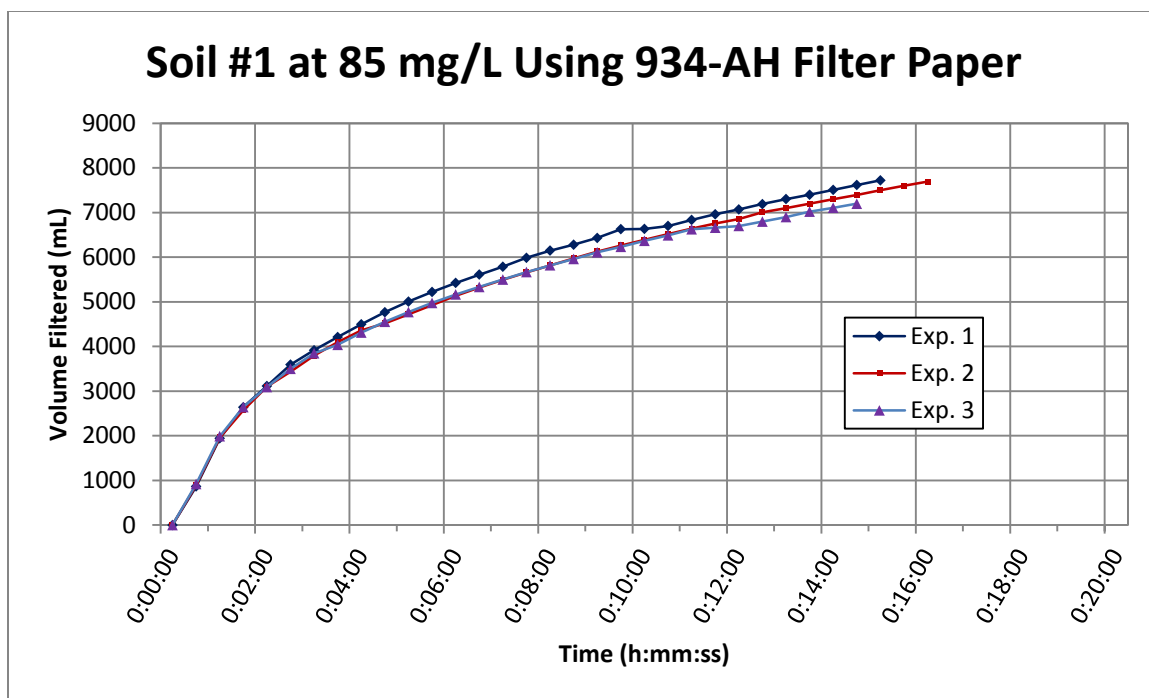

Figure 5.17: Soil #1 Using 934-AH Filter Paper, with Three Replicates of a TSS Concentration of 85 mg/L and a Consistent Pressure of 575 mmHg

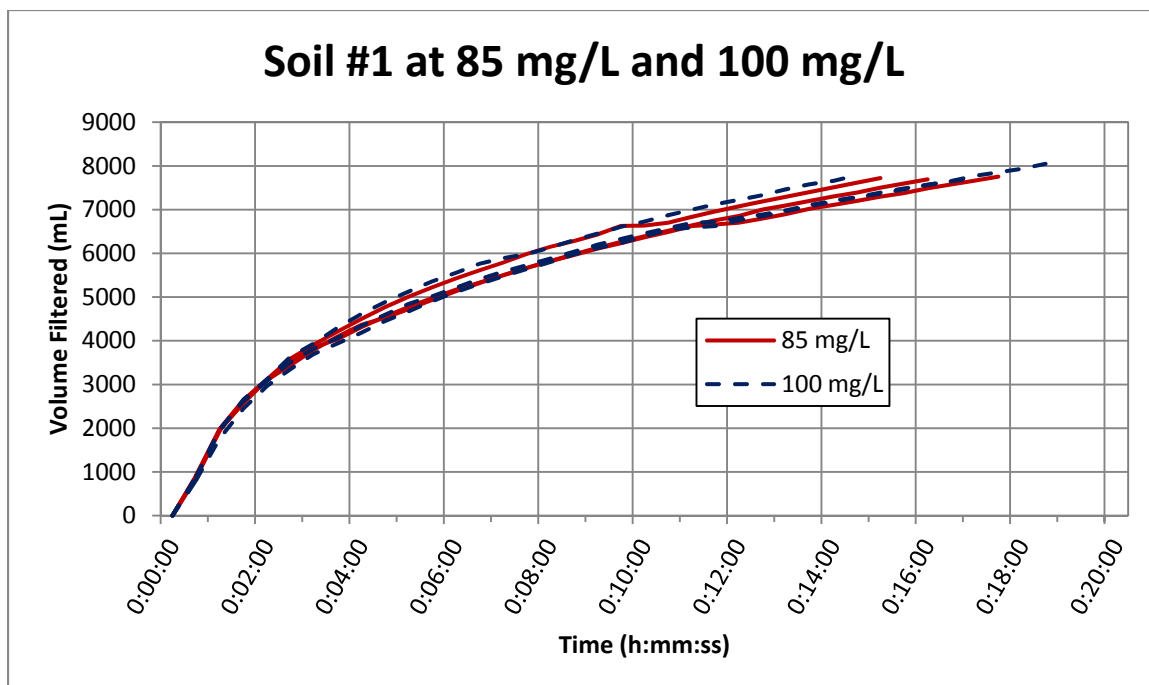

Figure 5.18: Soil #1 Using 934-AH Filter Paper at a Pressure of 575 mmHg, Comparing TSS Concentrations of 85 mg/L and 100 mg/L

While these results are more consistent, the 85 mg/L and 100 mg/L concentrations still show complete overlap.

5.3.8 Data Analysis of Vacuum-Assisted Results

The data discussed in Section 5.3 can be further analyzed by using Darcy's Law to find how the effective permeability of the filter paper changes over time. Darcy's Law is relevant for this test due to the large volumes of water being filtered through the apparatus. The significant mass of soil collected on the filter paper allows for the system to be analyzed using porous media flow. Darcy's Law can be defined as follows:

$$Q = KiA$$

where:

- Q = flow of water through the substance (cms)
 K = permeability coefficient (m/s)
 i = the hydraulic gradient, calculated by the change in head, Δh , over the length of the soil pack, L (m/m)
 A = cross-sectional area of flow (m^2)

An “effective permeability” was calculated rather than simply finding the permeability because the length of the soil pack changes through time. The final equation used to find the effective permeability is:

$$\frac{K}{L} = \frac{Q}{\Delta h * A}$$

A comparison of the data sets in Figure 5.18 was analyzed to determine whether a relationship between the changes in permeability over time could be found. This data is shown in Figure 5.19.

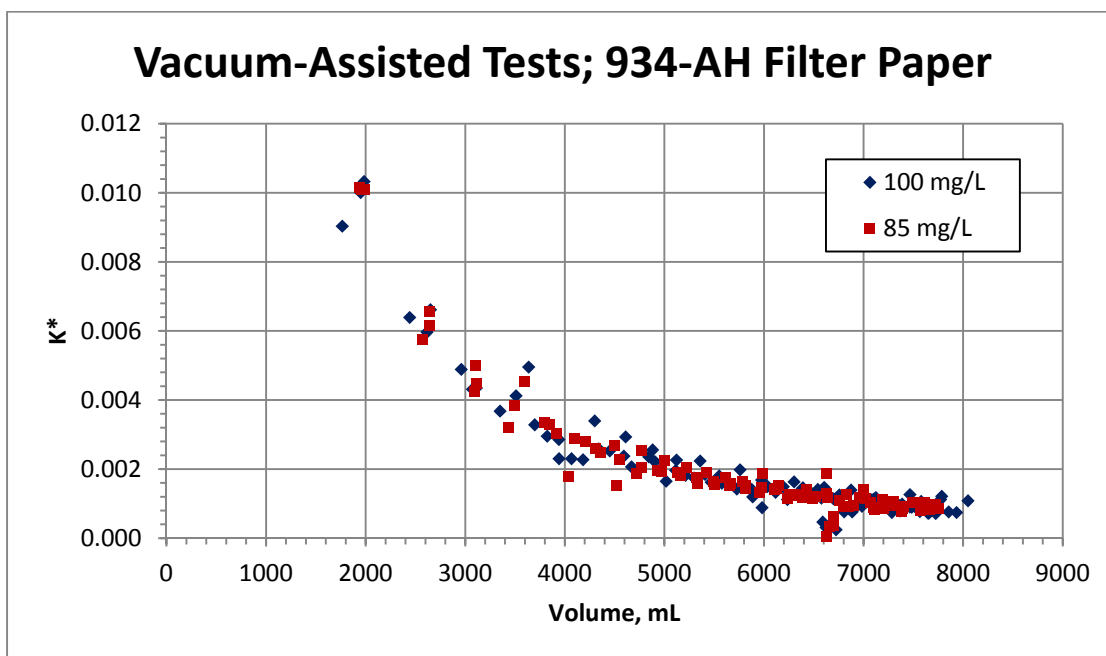

Figure 5.19: Soil #1 Using 934-AH Filter Paper, Comparing Effective Permeability Over Time between Concentrations of 100 mg/L and 85 mg/L

As shown in Figure 5.19, a relationship cannot be calculated between these data at TSS concentrations differing by 15 mg/L. It was concluded that this system was not able to distinguish between samples with concentrations of 85 mg/L and 100 mg/L TSS.

5.4 Rapid Filtration Without Vacuum Assistance

While the filtration apparatus with vacuum assistance did not show consistent enough results to be feasible, it was thought the inconsistency may be caused by the vacuum pressure being too high. Thus a dilution experiment was run to determine whether using no vacuum pressure would allow the filtration method to distinguish between samples with different TSS concentrations. A concentration of 100 mg/L was initially manufactured, and then subsamples were taken from that sample to create samples with TSS concentrations of 50 mg/L and 20 mg/L. The results of the dilution test are shown in Figure 5.20. It is important to note that these three data sets were not analyzed using the laboratory analysis to find the actual concentrations of total suspended solids; the concentrations are estimates based on mass of soil placed in the water. The tabular data for the graphs shown in this section can be found in Tables B.17 through B.29 and B.31 through B.36 in Appendix B.

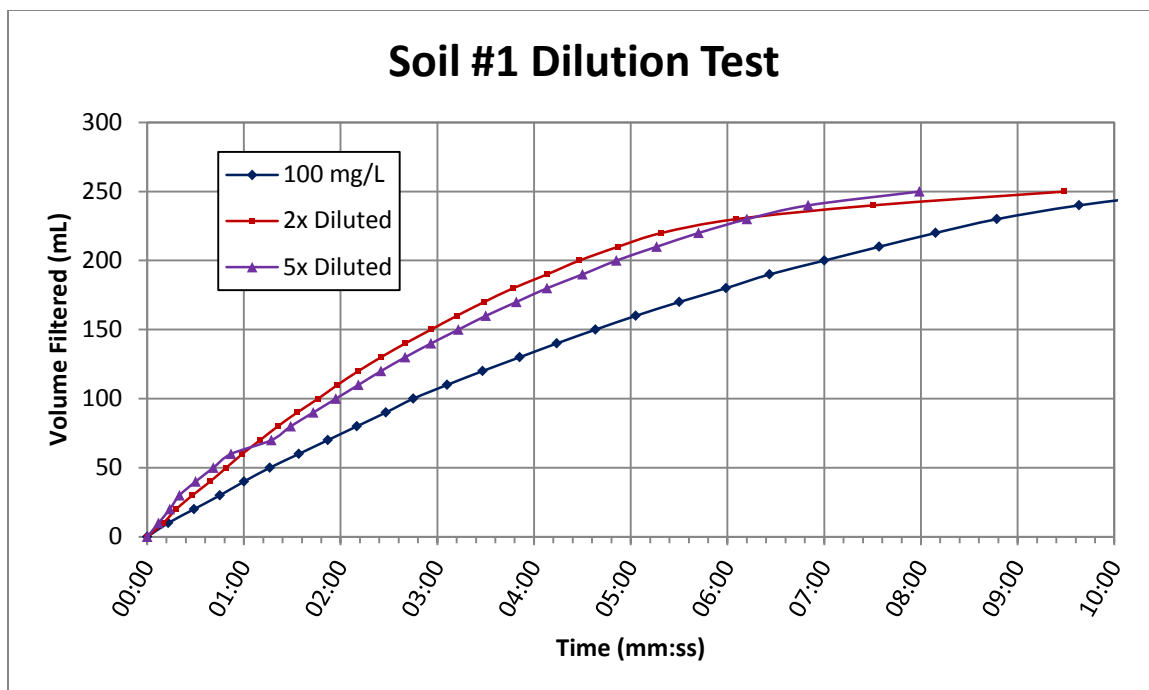

Figure 5.20: Soil #1 Dilution Test Using 934-AH Filter Paper and no Vacuum, with Estimated Concentrations of 100 mg/L, 50 mg/L and 20 mg/L

The results of the dilution experiment are shown in Figure 5.20. Figure 5.20 shows that there was significant separation between the 100 mg/L data series and the more dilute samples (50 mg/L and 20 mg/L). However, the dilute samples still show considerable overlap. The limited sample size caused an apparent merging of the plots as the head over the filter approached zero near the end of each test. For the dilution test, samples of 250 mL were used. To eliminate the merging of the plots, samples of approximately 300 mL were used for the following experiments so that a substantial head would still be present over the filter paper through the end of the test.

To analyze the data, the volume passed through the filter at a given time for each data set was measured. The average and standard deviation of these values were then calculated to quantify the overlap of data sets and to determine whether different

concentrations of TSS allowed significantly different volumes of water to pass through. If this test yielded promising results, the data could be further analyzed. A time value of four minutes was selected to perform these calculations.

5.4.1 Filtration with No Vacuum, Comparing Two TSS Concentrations

A series of experiments was run using eight samples each of two different manufactured TSS concentrations of 100 mg/L and 115 mg/L. A small subsample of each experimental volume was taken and analyzed using the standard laboratory method to find the actual TSS concentration after some particles had dissolved. The results can be seen in Figures 5.21 and 5.22.

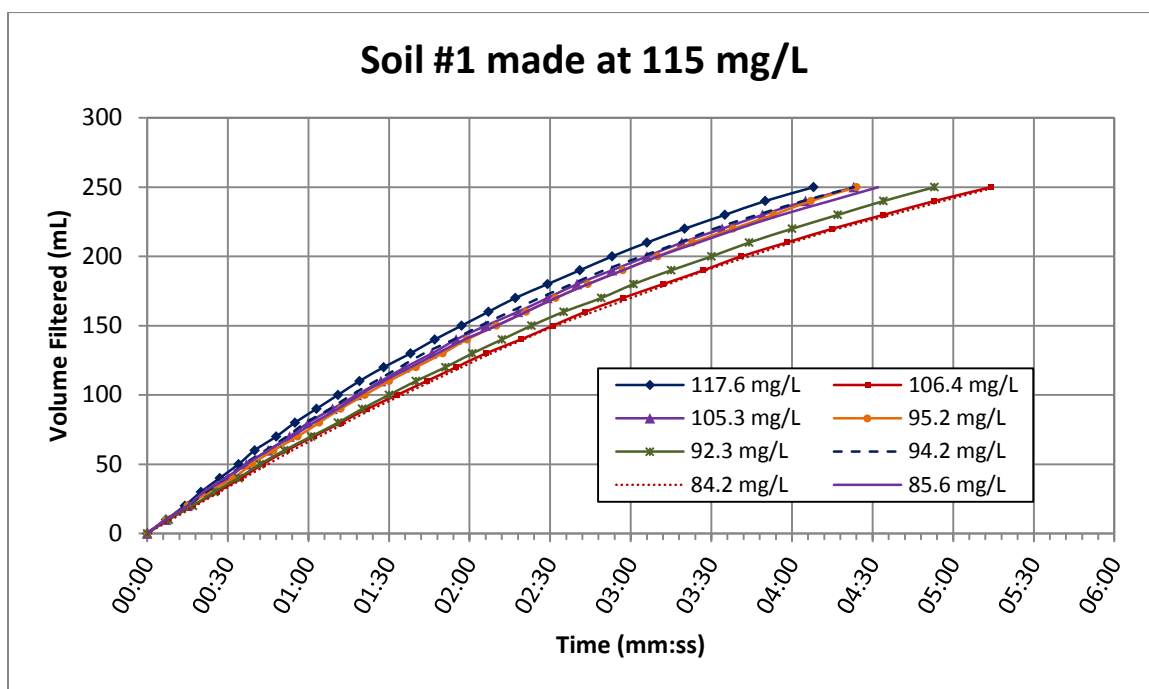

Figure 5.21: Soil #1 with No Vacuum Using 934-AH Filter Paper, with Eight Replicates at a Manufactured TSS Concentration of 115 mg/L

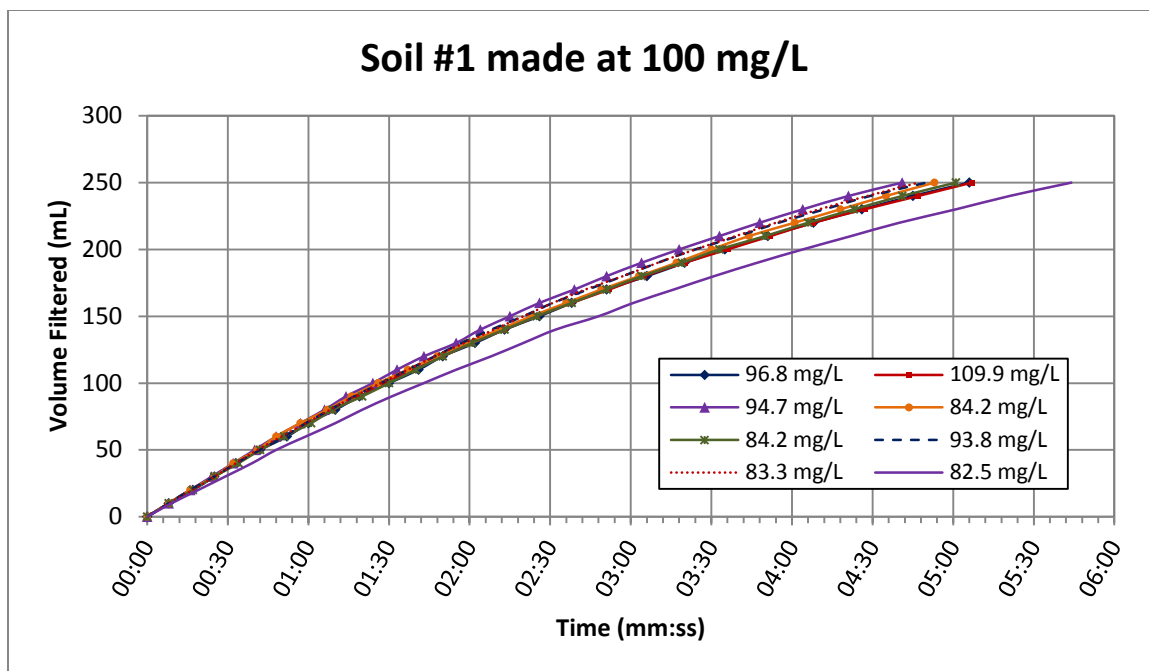

Figure 5.22: Soil #1 with No Vacuum Using 934-AH Filter Paper, with Eight Replicates at a Manufactured TSS Concentration of 100 mg/L

In both Figure 5.21 and Figure 5.22, one laboratory TSS analysis came out to be above the manufactured TSS concentration. This is hypothesized to be due to a weighing error during the test, and did not happen in further testing.

5.4.2 Total Dissolved Solids Testing

The inconsistency of the laboratory analysis results and the data sets shown above led to a hypothesis that different concentrations of soil might be dissolving in each batch. A laboratory analysis of total dissolved solids and total suspended solids was run on four samples to determine whether TDS was different with samples. Since the samples were made with tap water, four tests were also run on tap water to ensure that the TDS in the tap water did not vary significantly. The TDS tests run on tap water used water from the same tap used to manufacture the TSS samples, but did not come from the same tap water

used to make each sample. If the values of TDS in tap water did not vary significantly, the average value of TDS in the tap water could be subtracted from the average TDS value of the sample experiments to determine the average loss of particles due to dissolving. The results of these experiments are shown in Table 5.11 below.

Table 5.11: TDS Analysis Results

	Sample TDS (100 mg/L made)	Tap Water TDS
Exp. 1	471.6 mg/L	441.3 mg/L
Exp. 2	464.5 mg/L	456.5 mg/L
Exp. 3	467.0 mg/L	454.2 mg/L
Exp. 4	461.9 mg/L	433.8 mg/L
Average	466.3 mg/L	446.5 mg/L

The variability of the sample TDS tests was just 2%, and the variability of the tap water TDS tests was only 5%. Once it was determined that TDS was consistent between samples, it was concluded that the inconsistency of the laboratory analyses was due to the variability of the standard method TSS laboratory test, which is discussed in Section 4.2. An analysis of the variability of the laboratory analyses conducted during this experimentation was also completed, which is described in Section 5.2.

5.4.3 Filtration with No Vacuum using Large Volumes

A hypothesis for lack of differentiation between filtration rates for samples with different TSS concentrations was that the volume of water being filtered was too small to yield significantly different results. To test this hypothesis, the filtration apparatus shown in Figure B.4 in Appendix B was used as an open system without a vacuum to run a much larger volume of water through. The results of these experiments are shown in Figure 5.23.

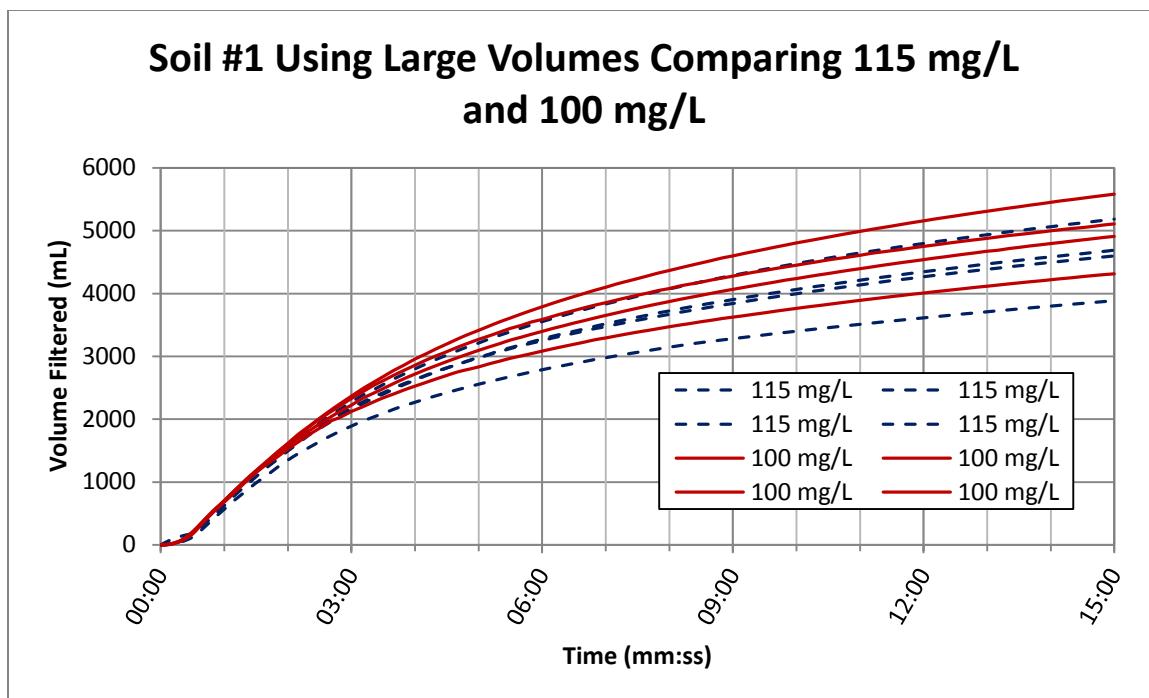

Figure 5.23: Soil #1 with No Vacuum Using 934-AH Filter Paper, Comparison of Four Replicates of Manufactured TSS Concentrations of 115 mg/L and 100 mg/L, Using Large Volumes

Figure 5.23 shows complete overlap between the two TSS concentrations, so it was concluded that a larger volume of water did not improve consistency of this test.

5.4.4 Filtration with No Vacuum Using Consistent Laboratory Practices at Different Manufactured TSS Concentrations

Another reason for the inconsistency of the data sets using the smaller volumes of water could have been due to the inconsistent volumes being filtered in the initial experiments. The volume of sample in the following experiments was carefully measured to be exactly 300 mL, and was batch loaded the same way each time. Though this allowed greater consistency, there is still overlap between the experiments, shown below in Figures 5.24 through 5.32.

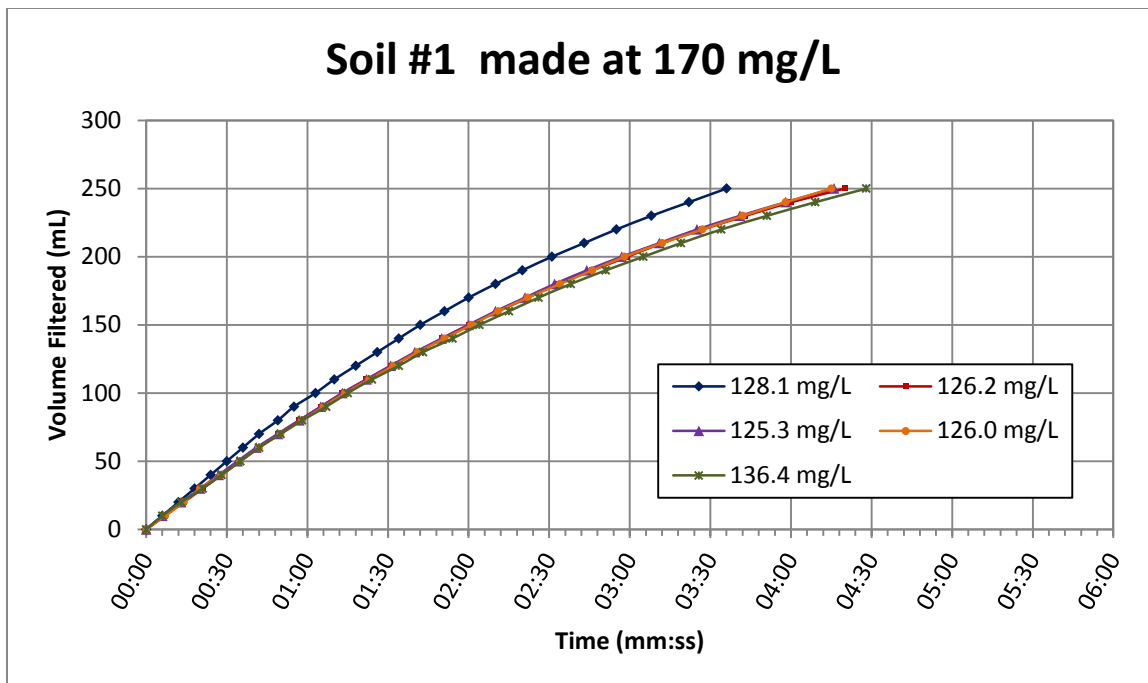

Figure 5.24: Soil #1 with No Vacuum Using 934-AH Filter Papers, with Five Replicates at a Manufactured TSS Concentration of 170 mg/L and Consistent Volumes

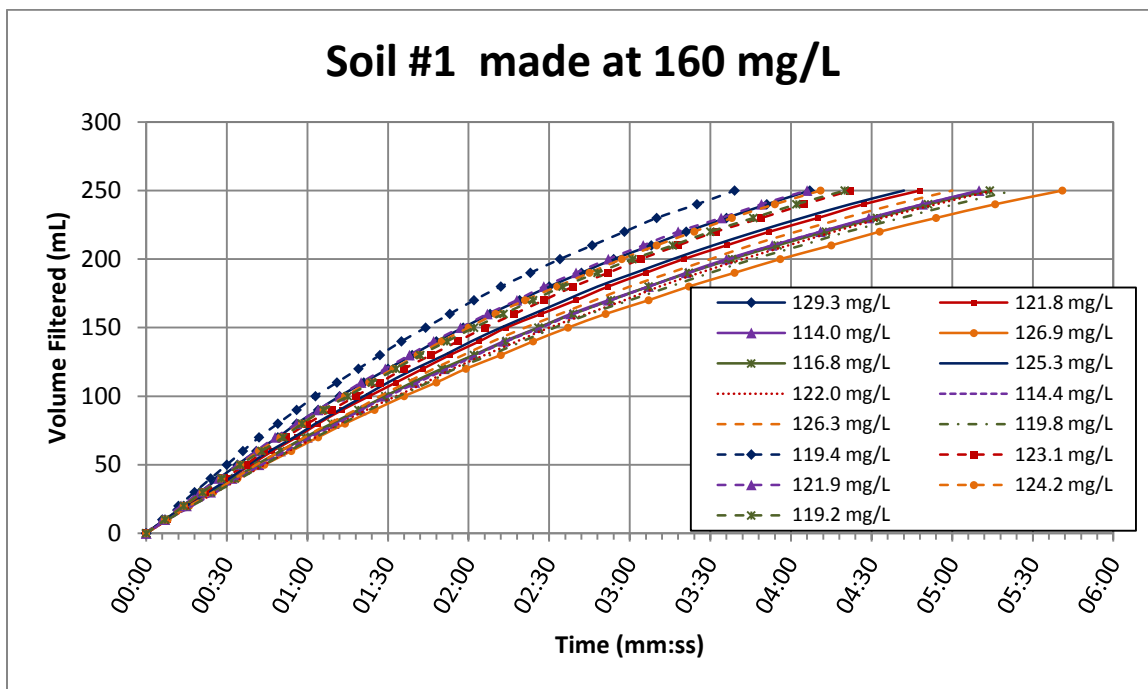

Figure 5.25: Soil #1 with No Vacuum Using 934-AH Filter Papers, with Fifteen Replicates at a Manufactured TSS Concentration of 160 mg/L and Consistent Volumes

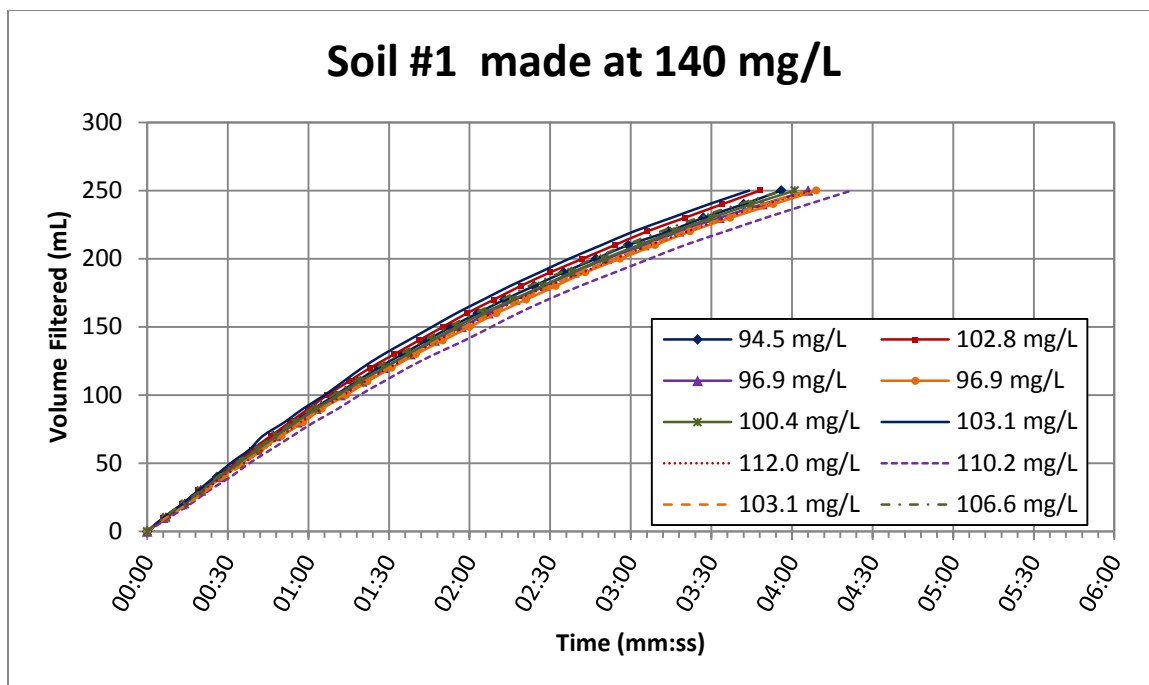

Figure 5.26: Soil #1 with No Vacuum Using 934-AH Filter Papers, with Ten Replicates at a Manufactured TSS Concentration of 140 mg/L and Consistent Volumes

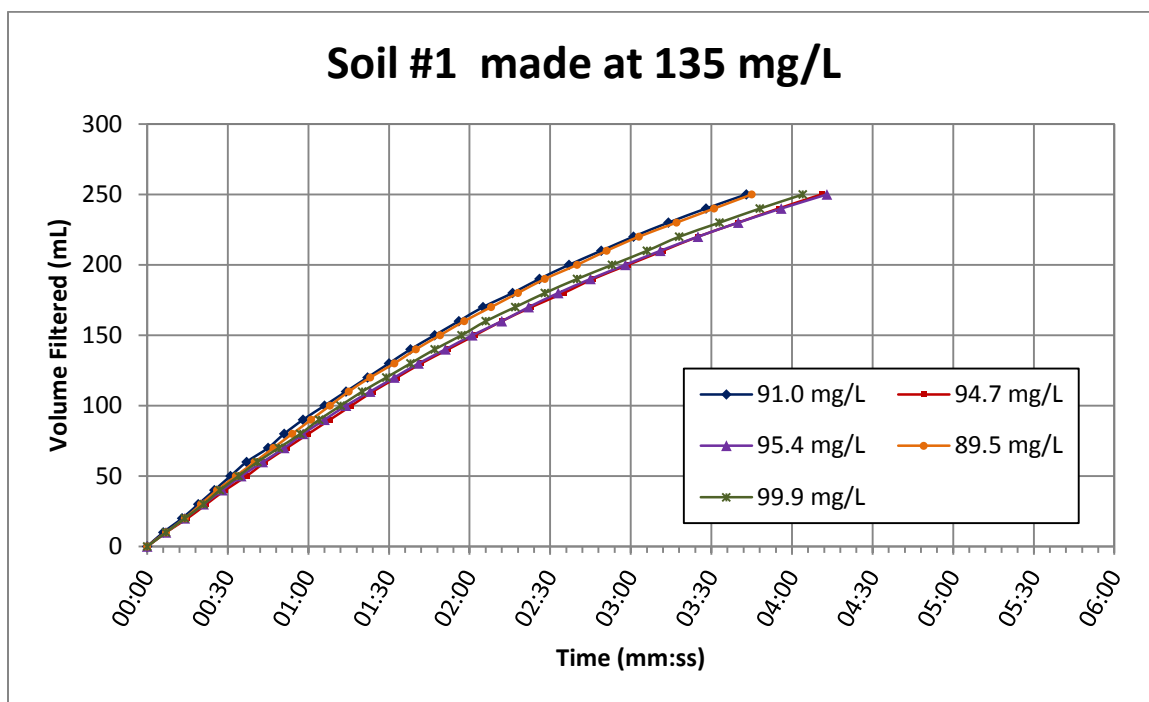

Figure 5.27: Soil #1 with No Vacuum Using 934-AH Filter Papers, with Five Replicates at a Manufactured TSS Concentration of 135 mg/L and Consistent Volumes

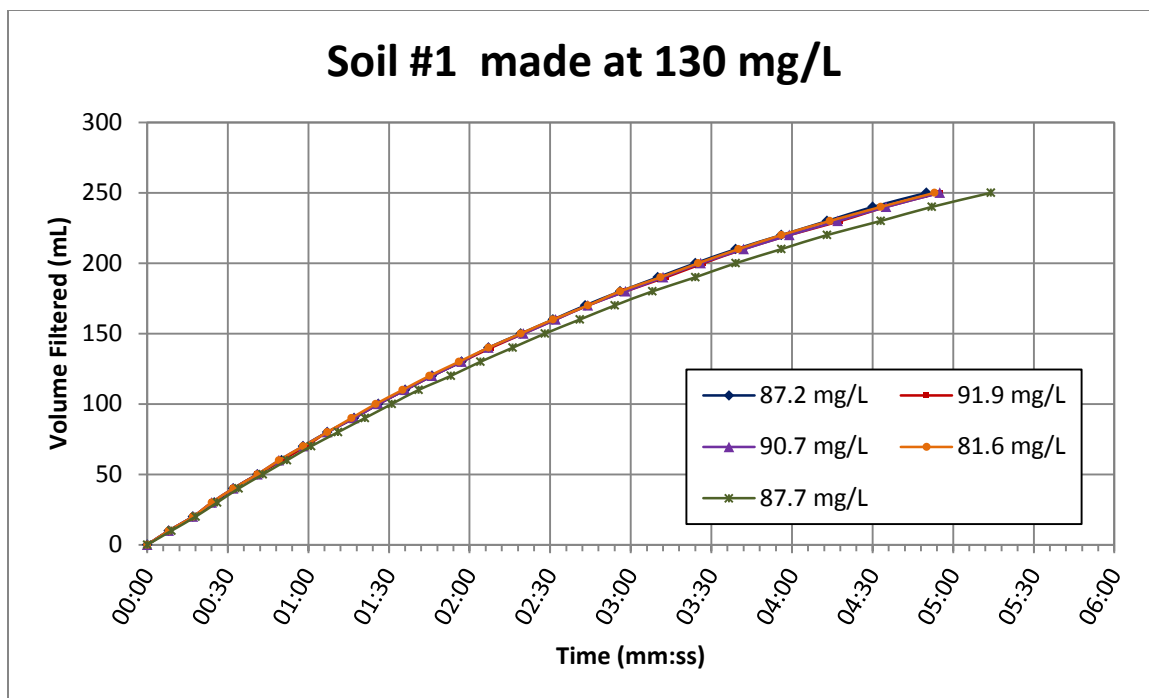

Figure 5.28: Soil #1 with No Vacuum Using 934-AH Filter Papers, with Five Replicates at a Manufactured TSS Concentration of 130 mg/L and Consistent Volumes

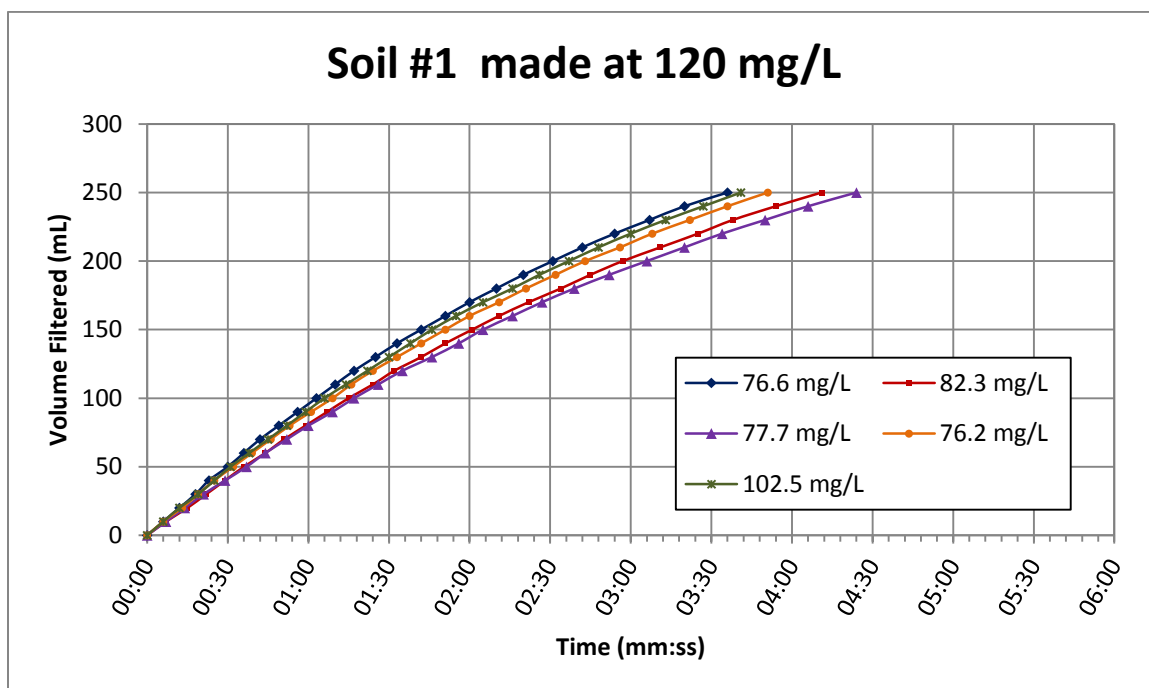

Figure 5.29: Soil #1 with No Vacuum Using 934-AH Filter Papers, with Five Replicates at a Manufactured TSS Concentration of 120 mg/L and Consistent Volumes

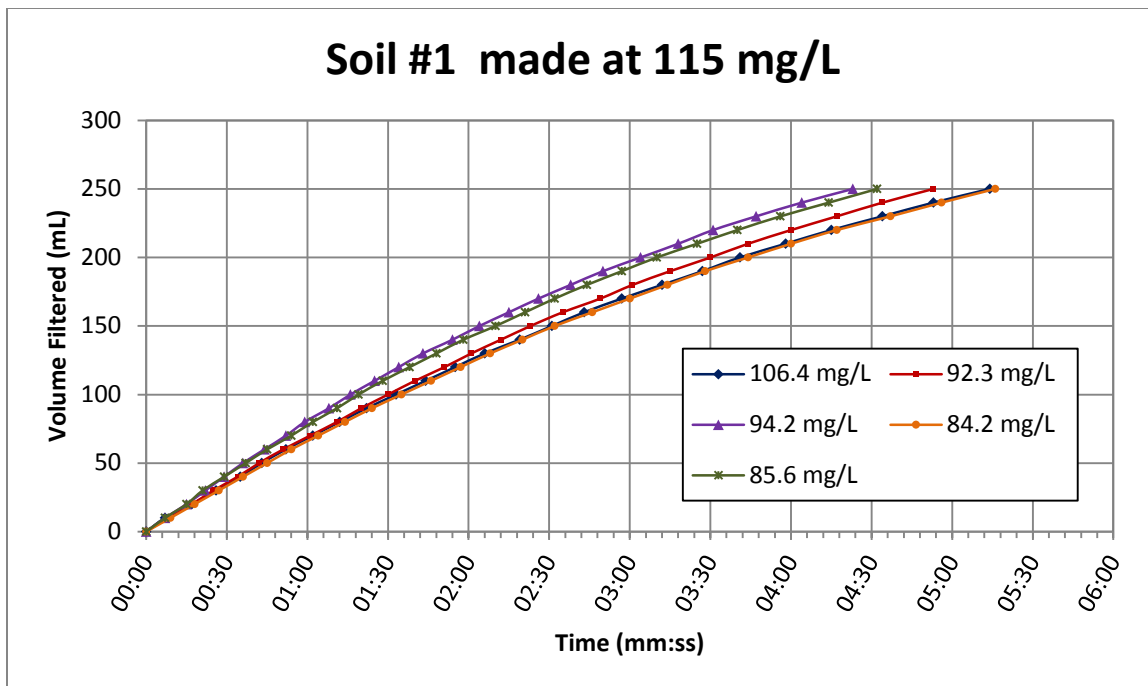

Figure 5.30: Soil #1 with No Vacuum Using 934-AH Filter Papers, with Five Replicates at a Manufactured TSS Concentration of 115 mg/L and Consistent Volumes

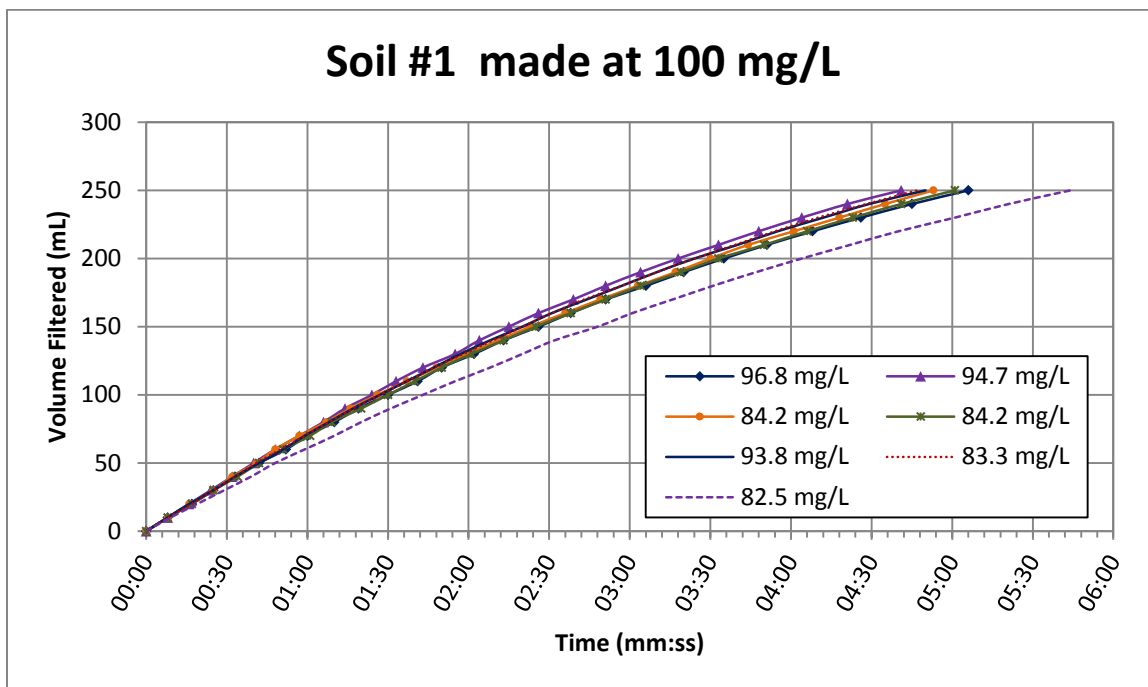

Figure 5.31: Soil #1 with No Vacuum Pressure Using 934-AH Filter Papers, with Seven Replicates at a Manufactured TSS Concentration of 100 mg/L and Consistent Volumes

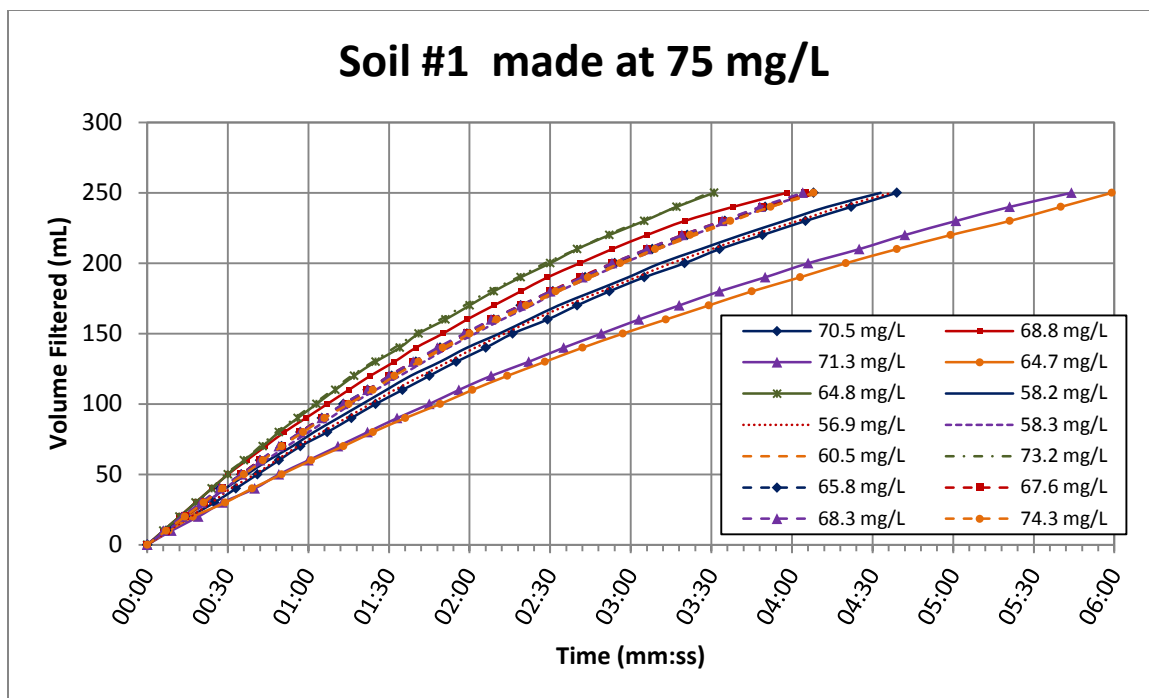

Figure 5.32: Soil #1 with No Vacuum Pressure Using 934-AH Filter Papers, with Fourteen Replicates at a Manufactured TSS Concentration of 75 mg/L and Consistent Volumes

The previous figures show that samples made at similar concentrations had high inconsistency and overlap with samples at different manufactured TSS concentrations. The imprecision of the laboratory analysis made it difficult to analyze data sets sorted by manufactured TSS concentrations, so target concentrations were developed and results categorized into those targets.

5.4.5 Filtration with No Vacuum at Different TSS Concentration Targets

A tabulation of this data can be found in Table B.30 in Appendix B. Figures 5.33 through 5.37 depict a graphical representation of all the data sets in each target.

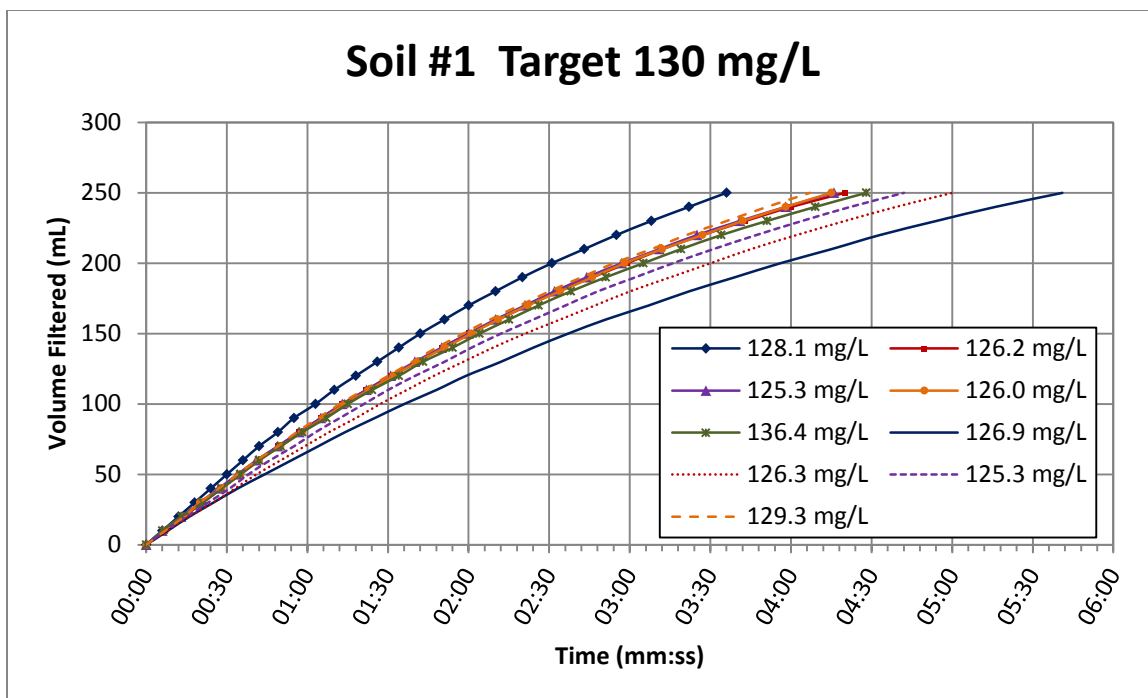

Figure 5.33: Soil #1 with No Vacuum Using 934-AH Filter Papers, Nine Replicates at a Target TSS Concentration of 130 mg/L

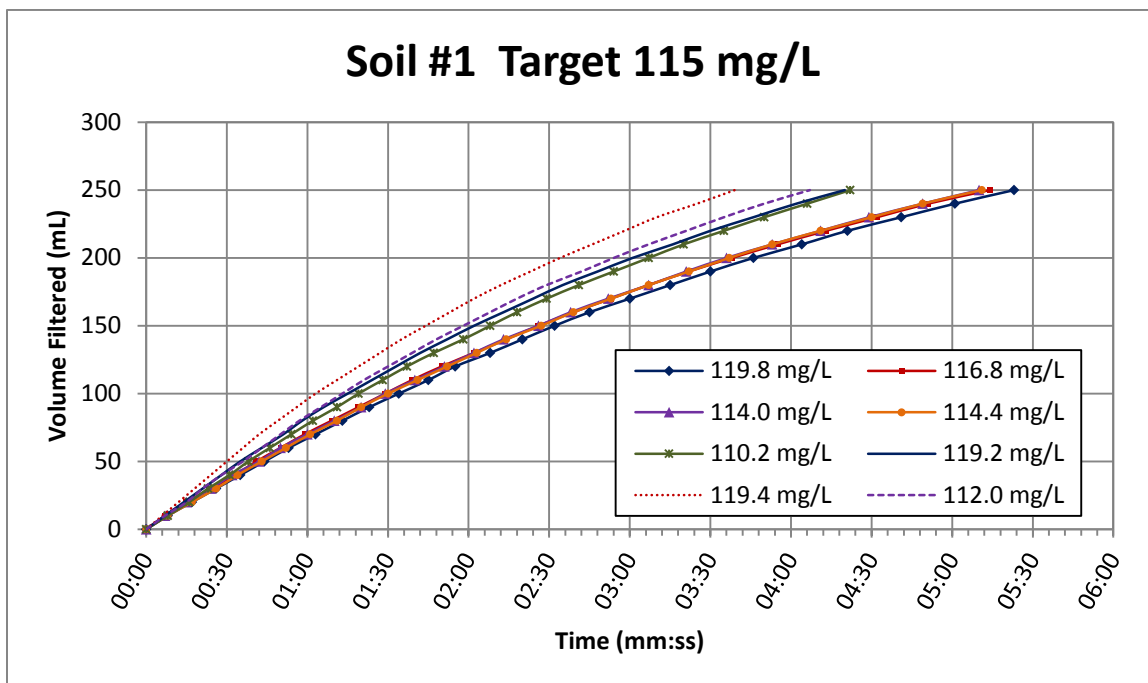

Figure 5.34: Soil #1 with No Vacuum Using 934-AH Filter Papers, Eight Replicates at a Target TSS Concentration of 115 mg/L

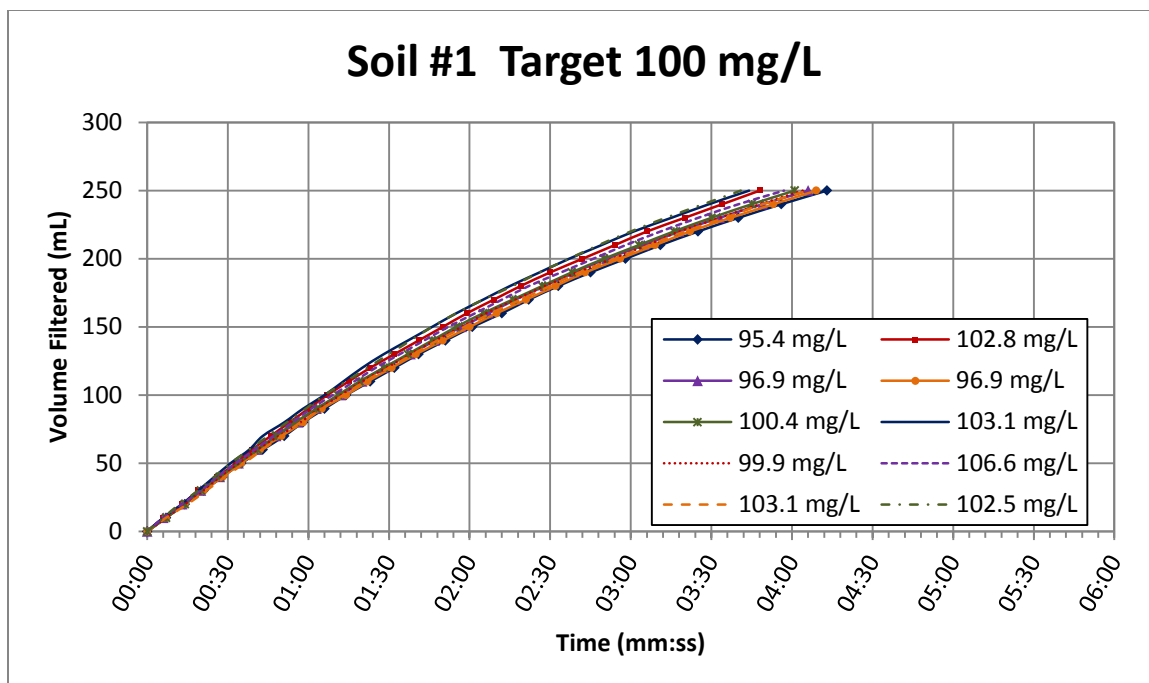

Figure 5.35: Soil #1 with No Vacuum Using 934-AH Filter Papers, Ten Replicates at a Target TSS Concentration of 100 mg/L

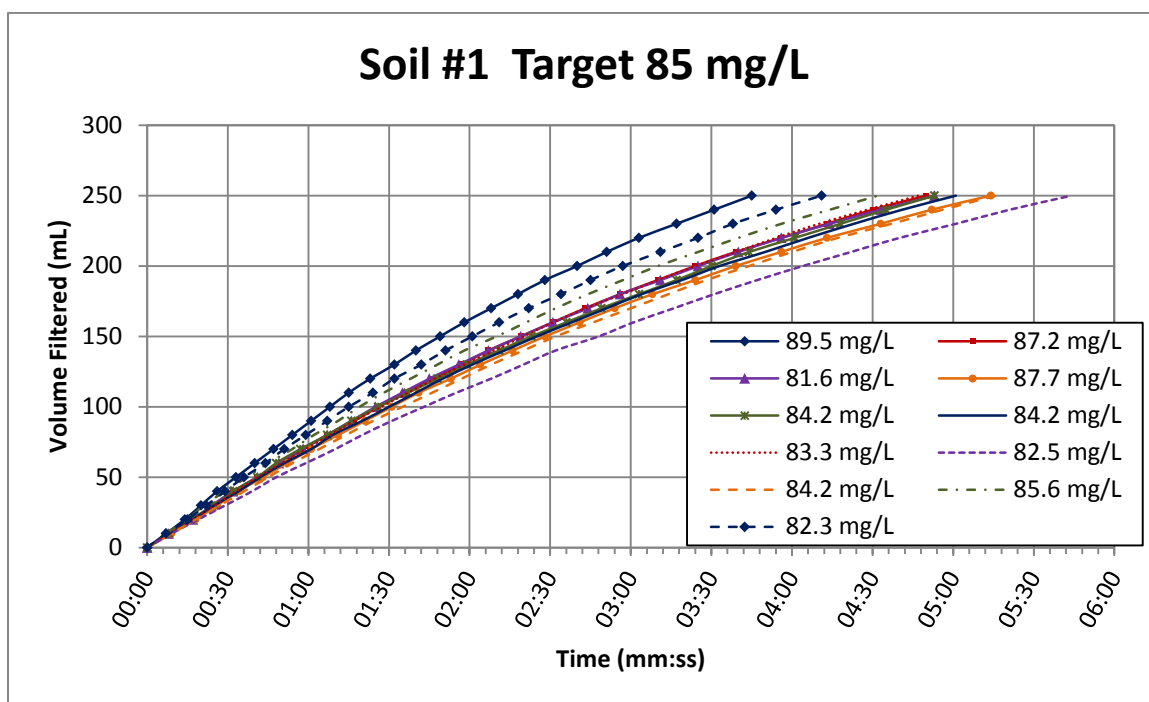

Figure 5.36: Soil #1 with No Vacuum Using 934-AH Filter Papers, Eleven Replicates at a Target TSS Concentration of 85 mg/L

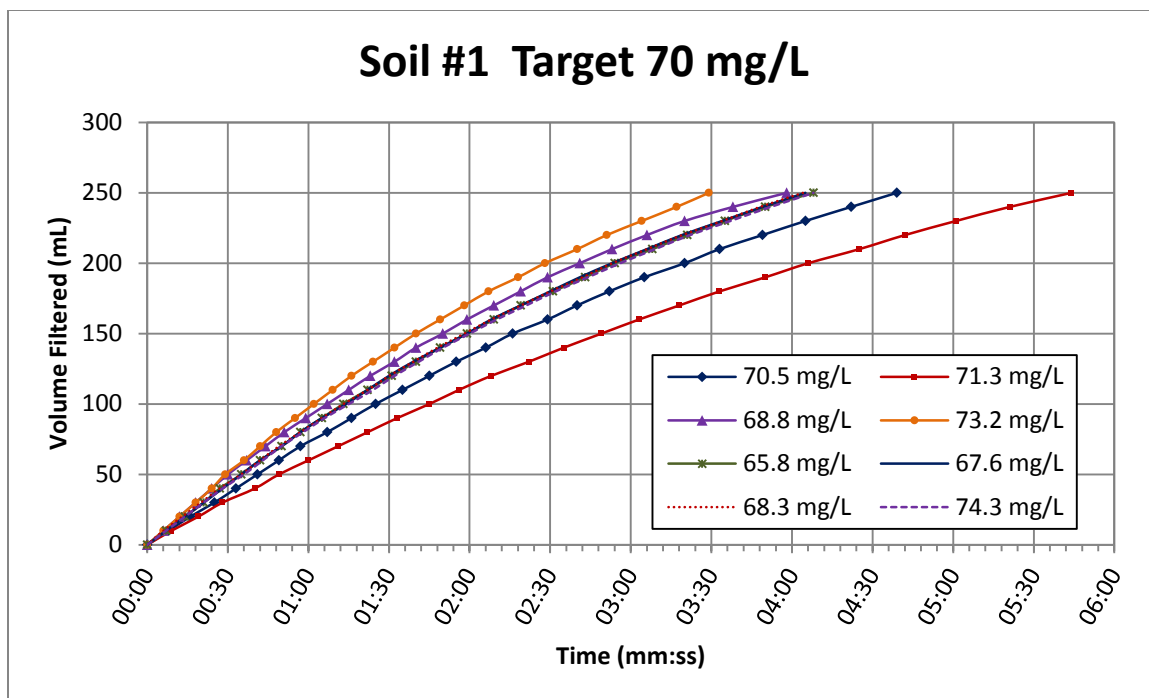

Figure 5.37: Soil #1 with No Vacuum Using 934-AH Filter Papers, Eight Replicates at a Target TSS Concentration of 70 mg/L

These target concentrations allowed for a tight range of laboratory-analyzed TSS concentrations to be compared to each other. However, the inconsistencies and overlap of these experiments show that this experimental method is inadequate to distinguish between different TSS concentrations.

5.4.6 Filtration with No Vacuum Using Grade GF/F Filter Paper

To try to make the test more consistent and precise, a glass fiber filter Grade GF/F with a pore size of $0.7 \mu\text{m}$ was used. The hypothesis was that a smaller pore size may result in more consistent settling of individual particles on the filter paper. The results of those experiments are shown below in Figure 5.38.

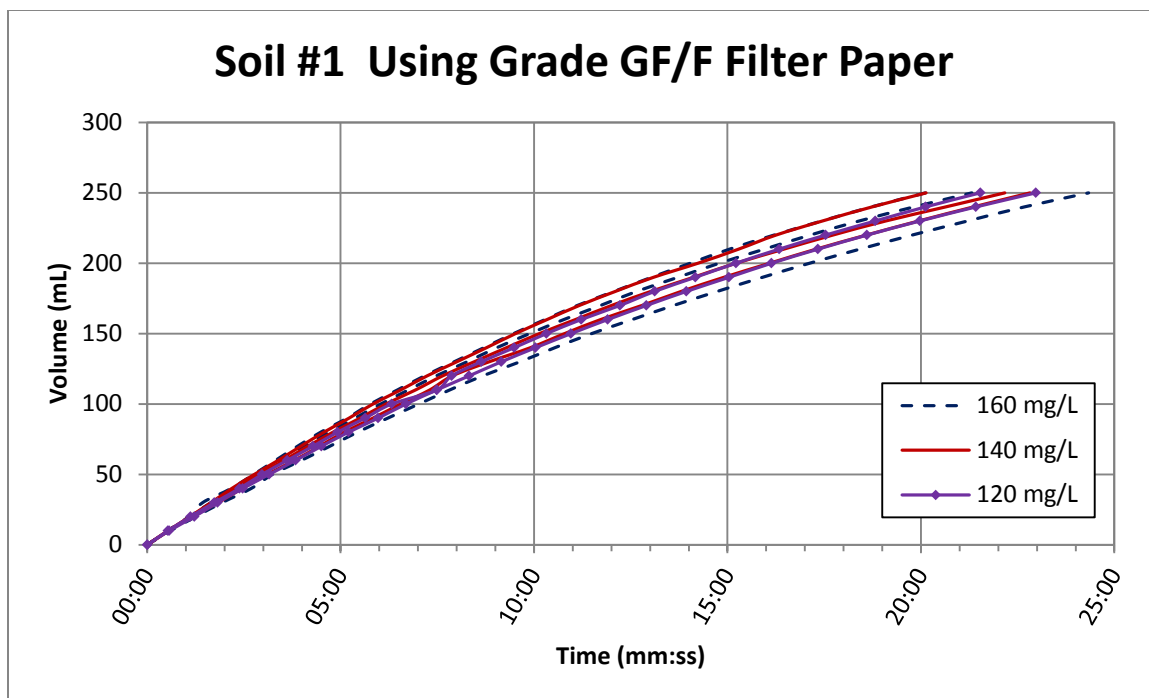

Figure 5.38: Soil #1 with No Vacuum Using Grade GF/F Filter Paper, Two Replicates of Manufactured TSS Concentrations of 160 mg/L, 140 mg/L and 120 mg/L

Figure 5.38 clearly shows complete overlap between experiments at different TSS concentrations even with a smaller pore-sized filter being used. None of the experiment modifications gave results that would differentiate between samples with TSS concentrations ranging from 120 – 160 mg/L. It was concluded that there is too much variability for this method to be feasible.

5.4.7 Effects of Standard Laboratory Method Imprecision on Variability of Rapid Filtration with no Vacuum Assistance

The high variability of the filtration test with no vacuum assist was the reason the experiment was concluded to be infeasible. However, the imprecision of the standard method laboratory test affected the apparent variability of the field test. The imprecision and variability of the standard laboratory method is described in Table 4.1. Linear

interpolations between the data given in the Standard Method 2540-D showed variability of over 10% at the concentrations being tested. This variability means that some of the results of the laboratory analysis could have been off from the actual TSS concentration by over 10%, which would have placed some of the experiments into different target groups (see Figure B.30 in Appendix B). This could have been a cause of the apparent inconsistencies seen in the experiment results discussed above. However, since the laboratory test method is the most accurate analysis currently available for testing total suspended solids, the impact that variability may have had on the field tests cannot be quantified. Therefore, while this field test method was concluded to be infeasible, perhaps with the availability of a more precise TSS analysis the variability of the field test could be reduced to the current variability of the standard method laboratory analysis.

5.5 TSS Sensor Analysis

Once calibration of the TSS sensor was completed, eleven samples were measured using the Insite IG Model 3150 sensor and then analyzed using the standard laboratory method to compare results. Five of these samples were approximately 65 mg/L, and six were approximately 110 mg/L to cover the range of acceptable TSS concentrations. Table 5.12 shows the laboratory-analyzed results and the sensor-reported results of these tests.

Table 5.12: Comparison between Standard Laboratory Analysis Results and the Sensor-Reported Values of Two Sets of Manufactured TSS Concentrations, 75 mg/L and 150 mg/L

Manufactured TSS Concentration of 75 mg/L					
Lab-Analyzed TSS Conc. (mg/L)	58.9	62.5	62.8	64.8	70.1
Sensor-Reported TSS Conc. (mg/L)	71	69	76	72	67
Difference (mg/L) =	+12	+7	+13	+7	-3
Ave Diff (mg/L) =	8				

Manufactured TSS Concentration of 150 mg/L						
Lab-Analyzed TSS Conc (mg/L)	109.4	110.3	110.5	112.5	113.0	113.9
Sensor-Reported TSS Conc (mg/L)	99	99	98	100	97	100
Difference (mg/L) =	-10	-11	-13	-13	-16	-14
Ave Diff (mg/L) =	13					

These results show that the average difference between sensor-reported and laboratory-analyzed TSS concentrations range from 8 mg/L at approximately 65 mgTSS/L to 13 mg/L at approximately 110 mgTSS/L. One interesting detail of these results is that the sensor-reported concentrations of the first set of samples is consistently above the average laboratory-analyzed concentration, while the sensor reported concentrations of the second set of samples is consistently below the average laboratory-analyzed concentration.

Table 5.13 compares the average, standard deviation, and variability of the laboratory-analyzed concentrations and the sensor-reported concentrations of the two sets of experiments.

Table 5.13: Comparison of the Average, Standard Deviation, and Variability between Laboratory-Analyzed and Sensor-Reported Results for Two Manufactured TSS Concentrations, 75 mg/L and 150 mg/L

Manufactured TSS Conc. 75 mg/L		Average (mg/L)	St. Dev. (mg/L)	C.V.
	Lab-Analyzed TSS Conc (mg/L)	63.8	4.1	6.4%
	Sensor-Reported TSS Conc (mg/L)	71	3	5%
Manufactured TSS Conc. 150 mg/L		Average (mg/L)	St. Dev. (mg/L)	C.V.
	Lab-Analyzed TSS Conc (mg/L)	111.6	1.8	1.6%
	Sensor-Reported TSS Conc (mg/L)	99	1	1%

The results in Table 5.13 show very similar standard deviations and variability coefficients between the laboratory-analyzed and sensor-reported TSS concentrations. In fact, the precision between the values reported by the sensor were higher in both sets of experiments, and the variability was lower in the sensor-reported values. A t-test was completed on these results to determine whether the means of the two samples were equal, and it was determined that in both cases the average value of the laboratory-analyzed data were significantly different than the average value of the sensor-reported data. However, the variability in the standard method laboratory analysis has a variability of over 10% at these concentrations, which may contribute to an inaccurate value for the laboratory-analyzed average value. Further testing may be needed to confirm the results of the t-test because of the minimal amount of data used in this analysis.

In conclusion, this sensor would be appropriate to use onsite for testing construction site runoff for TSS and using the values reported. However, it would be

beneficial to complete a series of experiments and compare the laboratory-analyzed results to those reported by the sensor so that the average difference could be recorded.

SECTION 6: CONCLUSIONS

Six methods for conducting a field test for total suspended solids (TSS) were evaluated. First, a rapid evaporation method was analyzed, and it was found that the sample sizes would need to be too large for this method to be feasible. The imprecision of field balances make it necessary to have an appreciable mass of suspended particles in the sample, which would make the sample size too large to rapidly evaporate.

Second, a centrifugation method was developed and analyzed. Theoretically, the volume of suspended particles left in the bottom of a centrifuge tube (measured by knowing the inner diameter and length of the mass) could be correlated to the concentration of suspended particles in the water. The analysis found that large volumes of sample would need to be centrifuged into very small-diameter tubes. The analysis concluded that the volumes would need to be too large and the tubes too narrow to be feasible.

Third, a repeatable pipette method was evaluated. This method would pipette very small volumes at a consistent vacuum pressure, and the time it takes to pipette a given volume would theoretically differ between different concentrations. In order to more easily analyze the feasibility of this method, a larger apparatus was designed to handle increased volumes of water so that time differences would be large between concentrations.

A vacuum-assisted filtration apparatus was initially tested using Grade 3 cellulose filter papers with a pore size of 6.0 μm . Problems with pressure loss and inconsistency

led to design modifications, but the precision of this test method was never high enough to show a significant difference between samples with different TSS concentrations.

As an attempt to make a rapid filtration system that showed significantly different results for different concentrations, an apparatus was developed to filter the samples with no vacuum. The apparatus was tested and the experimental method was modified to find the most consistent results between experiments. The precision of the test was not adequate to distinguish between samples with different TSS concentrations, and it was concluded that this method was infeasible.

Lastly, a portable TSS sensor was purchased and tested to determine whether its accuracy was high enough to be a feasible field test for TSS. The precision of the sensor was comparable to the standard method laboratory test, the accuracy showed a significant difference between the average values of the laboratory-analyzed and sensor-reported results. This data must be taken into consideration when being used as a field test for TSS analysis.

Since none of the developed methods proved feasible for field testing after analysis, a TSS sensor was purchased and tested to determine whether it could be used for this application as well as the MLSS and RAS applications for which it was developed. The sensor showed precision comparable to the standard laboratory method, though it was not as accurate. Its accuracy did fall within the accuracy of the standard laboratory method, however, so it may be able to be used as an initial testing of runoff before determining whether samples need to be sent on for laboratory analysis.

SECTION 7: RECOMMENDATIONS

The goal of this project was to develop a field test that could measure TSS concentrations with accuracy close to that of the laboratory analysis. In order to be feasible, not only should this test be accurate, but also be operable in the field. The only method researched during this project that was found to be accurate and precise enough was the commercial probe or sensor. Table 3.2 in Section 3.6.4 shows a short list of existing TSS probes, their specifications, and their initial costs. These probes have a tested accuracy and precision that is very close to that of the laboratory test. Despite the higher initial cost, these probes and sensors can provide a way to test for total suspended solids in the field.

SECTION 8: BIBLIOGRAPHY

- Ali, E. N., S. A. Muyibi, H. M. Salleh, M. Z. Alam, and M. R. Salleh (2009). "Production of Natural Coagulant from Moringa Oleifera Seed for Application in Treatment of Low Turbidity Water." *Journal of Water Resource and Protection*, Vol. 2: 259-266.
- American Public Health Association (APHA), American Water Works Association (AWWA), Water Environment Federation (WEF) (2012). *Standard Methods for the Examination of Water and Wastewater*, 22nd Ed., Washington, D.C.
- American Society for Testing and Materials (ASTM) (2010). "Standard Test Method for Filterable and Non-filterable Matter in Water." ASTM 5907-09.
- ASTM (2010). "Standard Practice for Classification of Soils for Engineering Purposes (Unified Soil Classification System)." ASTM D2487-10.
- ASTM (2010). "Standard Test Method for Particle-Size Analysis of Soils." ASTM D422-63.
- ASTM (2010). "Standard Test Methods for Liquid Limit, Plastic Limit, and Plasticity Index of Soils." ASTM D4318-10.
- ASTM (2010). "Standard Test Methods for Specific Gravity of Soil Solids by Water Pycnometer." ASTM D854-10.
- Appleby, J.P. and J. Scarratt (1989). "Physical Effects of Suspended Solids on Marine and Estuarine Fish and Shellfish with Special Reference to Ocean Dumping: A Literature Review." *Canadian Technical Report of Fisheries and Aquatic Sciences*, No. 1681.
- Berg, R.H. (1970). "The Oxygen Uptake Demand of Resuspended Bottom Sediments." *Water Pollutant Control Research Series 16070-DCD-09/70*, USEPA, Washington, D.C.
- Berkman, H. E. and C. F. Rabeni (1987). "Effect of Siltation on Stream Fish Communities." *Environmental Biology of Fishes*, 18(4): 285-294.

- Beschta, R.L. and W.L. Jackson (1979). "The intrusion of fine sediments into a stable gravel bed." *Journal of Fisheries Research Board of Canada*, 36(2): 204-210.
- Bjornn, T.C., M.A. Brusven, M.P. Molnau, J.H. Milligan, R.A. Klamt, E. Chacho, and C. Schaye (1977). "Transport of Granitic Sediment in Streams and its Effects on Insects and Fish." University of Idaho, Idaho Cooperative Fishery Research Unit, Moscow, Idaho, Completion Report Project B-036-IDA, Bulletin 17.
- Brusven, M.A. and K.V. Prather (1974). "Influence of Stream Sediments on Distribution of Macrobenthos." *Journal of the Entomological Society of British Columbia*, 71: 25-32.
- Carpenter, S.R., N.F. Caraco, D.L. Correll, R.W. Howarth, A.N. Sharpley, and V.H. Smith (1998). "Nonpoint Pollution of Surface Waters with Phosphorus and Nitrogen." *Ecological Applications*, 8: 559-568.
- Chapman, D.V. (1996). "Water Quality Assessments: A Guide to the Use of Biota, Sediments, and Water in Environmental Monitoring." London: E & FN Spon.
- ChemTronic (2013). "Optical or Acoustic Process Measurement of Liquids." <http://www.chemtronic-gmbh.de/images/chemtronic/PDFe/Prospect%20AS3_AT3.pdf> (October 9, 2013).
- Dodds, W.K. and M. R. Whiles (2004). "Quality and Quantity of Suspended Particles in Rivers: Continent-scale patterns in the United States." *Environmental Management*, 33(3): 355-367.
- Federal Register (FR) 74:229 (2009). "Effluent Limitations Guidelines and Standards for the Construction and Development Point Source Category, Final Rule." 62996-63058.
- FR 77:1 (2012). "Effluent Limitations Guidelines and Standards for the Construction and Development Point Source Category, Final Rule." 112-123.
- Galvanic Applied Sciences, Inc. (Galvanic) (2013). "Acoustical Suspended Solids Probe – Monitek Acoustic Suspended Solids Probe Specification Sheet." <http://www.chemtronic-gmbh.de/images/chemtronic/PDFe/Prospect%20AS3_AT3.pdf> (October 9, 2013).

- Gartner, J. W. (2004). "Estimating Suspended Solids Concentrations from Backscatter Intensity Measured by Acoustic Doppler Current Profiler in San Francisco Bay, California." *Marine Geology*, 211 (3-4): 169-187.
- Gilson Company, Inc (Gilson) (2013). "SA-2 ASTM Soils Hydrometer 152H, Range -5 to 60 g/L (SG)." Gilson Company, Inc. <<http://www.globalgilson.com/productdisplay.asp?model=SA-2>> (October 20, 2013).
- Gould, W. (2013). "Computing the Chow Statistic." *STATA Data Analysis and Statistical Software*. <<http://www.stata.com/support/faqs/statistics/computing-chow-statistic>> (July 15, 2013).
- Guo, Q. G. (2006). "Correlation of Total Suspended Solids (TSS) and Suspended Sediment Concentration (SSC) Test Methods." State University of New Jersey.
- Hach Company (Hach) (2012). "TSS User Manual." Hach TSS Probe User Manual. Edition 2. <<http://www.hach.com/tss-sc-suspended-solids-insitu-sensor/product-downloads?id=7640163555>> (October 9, 2013).
- Hach (2013). "Field Balance, 200 x 0.1g Capacity." Hach Company Products. <<http://www.hach.com/field-balance-200-x-0-1g-capacity/product?id=7640243080>> (September 30, 2013).
- Insite Instrumentation Group, Inc. (Insite IG) (2013a). "Model 3150 Data Sheet." InsiteIG Suspended Solids Analyzer Data Sheet. <<http://www.insiteig.com/pdfs/MODEL%203150%20PORTABLE%20SS%20DATA%20SHEET.PDF>> (October 9, 2013).
- Insite IG (2013b). "Model 1500 Suspended Solids Analyzer Specifications." InsiteIG Suspended Solids Analyzer Data Sheet. <<http://www.insiteig.com/pdfs/SPECS%20FOR%20MODEL%201500%20WITH%20MODEL%2015%20SERIES%20SENSORS.PDF>> (October 9, 2013).
- Kayhanian M, E. Rasa, A. Vichare, and J. Leatherbarrow. (2008). "Utility of Suspended Solid Measurements for Storm-Water Runoff Treatment." *Journal of Environmental Engineering*, 134(9): 712-721.

- Kerr, S.J. (1995). "Silt, Turbidity and Suspended Sediments in the Aquatic Environment: An Annotated Bibliography and Literature Review." Technical Report TR-008. Ontario Ministry of Natural Resources, Southern Region Science and Technology Transfer Unit.
- Kovalsky, P., M. Gedrat, G. Bushell, and T.D. Waite (2007). "Compressible Cake Characterization from Steady-State Filtration Analysis." *Aiche Journal*, 53: 1483-1495.
- Lim, H.S., M.Z.M. Jafri, K. Abdullah, and S.G. Daraigan (2011). "A Sensitive Suspended Sediment Sensor for the Detection of Total Suspended Solids (TSS)". *Optica Applicata*, 41: 631-638.
- Lowry, R. (1998). "Concepts and Applications of Inferential Statistics." VassarStats Online Library. Vassar College, Poughkeepsie, NY.
<<http://vassarstats.net/textbook/>> (September 1, 2013).
- Marcus, M.D., M.K. Young, L.E. Noel, and B.A. Mullan (1990). "Salmonid Habitat Relationships in the Western United States: A Review and Indexed Bibliography: Impacts of Fine Sediments." U.S. Department of Agriculture, Forest Service, Fort Collins, Colorado, RM-GTR-188.
- McDowell, R.W., B.F. Biggs, A.N. Sharpley, and L.L. Nguyen (2004). "Connecting Phosphorus Loss from Agricultural Landscapes to Surface Water Quality." *Chemistry and Ecology*, 20(1): 1-40.
- Michigan Department of Environmental Quality (DEQ) (2001). "DEQ – Water Quality Parameters – Total Suspended Solids." Michigan DEQ.
- Minnesota Pollution Control Agency (PCA) (2008). "General Permit – Authorization to Discharge Stormwater Associated with Construction Activity under the NPDES." Minnesota PCA Permit No. MN R100001.
- Minnesota PCA (2008). "Nutrients: Phosphorus, Nitrogen Sources, Impact on Water Quality." Minnesota PCA. Water Quality/Impaired Waters #3.22.
- Missouri Department of Natural Resources (DNR) (2013). "Maximum Dissolved Oxygen Concentration Saturation Table." Missouri DNR, Environmental Services Program.

- Montana DEQ (2010). "General Permit for Construction Dewatering." Montana DEQ Permit No. MTG070000.
- Nebraska DEQ (2011). "General NPDES Authorizing Dewatering Discharges Fact Sheet – Entire State of Nebraska." Nebraska DEQ Wastewater Section.
- Nuttall, P.M. and G.H. Bielby (1973). "The Effects of China Clay on Stream Invertebrates." *Environmental Pollution*, 5: 77-86.
- O'Connor, J.M., D.A. Neumann, and J.A. Sherk, Jr. (1977). "Sublethal Effects of Suspended Sediments on Estuarine Fish." US Army Corps of Engineers, Technical Paper #77-3.
- Paab Tekno Trading (Paab) (2013). "Measurement and Control: 4263 Turbidity and Suspended Solids." TSS Sensor Specifications, <
http://www.paab.com/dokument/bibliotek/Vatskeanalys/PTT_Turbidity_probe_holder_with_debubbler_for_S461.pdf> (October 9, 2013).
- Packman, J.J., K.J. Comings, and D.B. Booth (1999). "Using Turbidity to Determine Total Suspended Solids in Urbanizing Streams in the Puget Lowlands." *Confronting Uncertainty: Managing Change in Water Resources and the Environment*, Canadian Water Resources Association Annual Meeting, Vancouver, British Columbia, 158-165.
- Royce Technologies (Royce) (2013). "Royce Total Suspended Solids Systems." TSS Probe and Sensor Specifications. <
http://www.roycetechnologies.com/refdocs/Royce_711Portable.pdf> (October 9, 2013).
- Schueler, T. (1997). "Comparison of Forest, Urban, and Agricultural Streams in North Carolina." *Watershed Project*, Tech. 2(4): 503-506.
- Sharpley, A. and H. Tunney (2000). "Phosphorus Research Strategies to Meet Agricultural and Environmental Challenges of the 21st Century." *Journal of Environmental Quality*, 29(1): 176-181.

- Singh, K.P. (1982). "Lake Restoration Methods and Feasibility of Water Quality Management in Lake of the Woods." Illinois Department of Energy and Natural Resources, State Water Survey Contract Report 301.
- South Carolina Department of Health and Environmental Control (SCDHEC) (2006). "NPDES General Permit for Storm Water Discharges from Large and Small Construction Activities." SCDHEC Permit No. SCR 100000.
- South Dakota Department of Environment and Natural Resources (DENR) (2011). "Authorization to Discharge under the Surface Water Discharge System." SD DENR Permit No. SDG0700000.
- Test Mark Industries (2013). "Portable Precision Balance 1000 g x 0.01 g." Scales: SC0190 Series Portable Precision Balance. < <http://www.testmark.net/c-8-p-57.html>> (September 30, 2013).
- University of Toledo Soil Mechanics Laboratory (Toledo Laboratory) (2013). "Specific Gravity of Soil Solids." ASTM D854 – 92.
- US Department of Agriculture Natural Resources Conservation Service (USDA NRCS) (2008). "Soil Quality Indicators – Bulk Density." USDA NRCS.
- US Environmental Protection Agency (USEPA) (1971). "Residue, Non-filterable (Gravimetric, Dried at 103-105 DegC)." USEPA Method 160.2.
- USEPA (1990). "The Quality of Our Nation's Water: A Summary of the 1988 National Water Quality Inventory." USEPA Office of Water, EPA Report 440/4-90-005, Washington, D.C.
- USEPA (2003). "National Management Measures to Control Nonpoint Source Pollution from Agriculture." USEPA 841-B-03-004.
- USEPA (2005). "National Management Measures to Control Nonpoint Source Pollution from Urban Areas." USEPA 841-B-05-004.
- USEPA (2009). "National Water Quality Inventory: Report to Congress – 2004 Reporting Cycle." USEPA Office of Water. EPA 841-R-08-001, Washington, D.C.

- USEPA (2012a). “Construction General Permit – NPDES General Permit for Discharges from Construction Activities.” USEPA NPDES Publications.
- USEPA (2012b). “Total Solids – What are Total Solids and Why Are They Important?” USEPA Water: Monitoring and Assessment.
- USEPA (2012c). “Stormwater BMPS.” National Menu of Stormwater Best Management Practices, < <http://cfpub.epa.gov/npdes/stormwater/menuofbmps/>> (September 12, 2013).
- USEPA (2013a). “Clean Water Act Requirements: EPA NPDES Permit Program.” USEPA Design for the Environment – Alternatives Assessments.
- USEPA (2013b). “Best Management Practices – Stormwater.” USEPA Stormwater BMPs. < <http://www.epa.gov/nrmrl/wswrd/wq/stormwater/bmp.html>> (September 12, 2013).
- Ventling-Schwank, A.R. and D.M. Livingstone (1994). “Transport and Burial as a Cause of Whitefish (*Coregonus* sp.) Egg Mortality in a Eutrophic Lake.” *Canadian Journal of Fisheries and Aquatic Sciences*, 51(9): 1908-1919.
- Waters, T.F. (1995). “Sediment in Streams: Sources, Biological Effects, and Control.” *American Fisheries Society Monograph no. 7*, American Fisheries Society, Bethesda, MD.

APPENDIX A

A.1 EPA Method 160.2 Residue, Non-Filterable

METHOD #: 160.2	Approved for NPDES (Issued 1971)
TITLE:	Residue, Non-Filterable (Gravimetric, Dried at 103-105°C)
ANALYTE:	Residue, Non-Filterable
INSTRUMENTATION:	Drying Oven
STORET No.	00530

1.0 Scope and Application

- 1.1 This method is applicable to drinking, surface, and saline waters, domestic and industrial wastes.
- 1.2 The practical range of the determination is 4 mg/L to 20,000 mg/L.

2.0 Summary of Method

- 2.1 A well-mixed sample is filtered through a glass fiber filter, and the residue retained on the filter is dried to constant weight at 103-105°C.
- 2.2 The filtrate from this method may be used for Residue, Filterable.

3.0 Definitions

- 3.1 Residue, non-filterable, is defined as those solids which are retained by a glass fiber filter and dried to constant weight at 103-105°C.

4.0 Sample Handling and Preservation

- 4.1 Non-representative particulates such as leaves, sticks, fish, and lumps of fecal matter should be excluded from the sample if it is determined that their inclusion is not desired in the final result.
- 4.2 Preservation of the sample is not practical; analysis should begin as soon as possible. Refrigeration or icing to 4°C, to minimize microbiological decomposition of solids, is recommended.

5.0 Interferences

- 5.1 Filtration apparatus, filter material, pre-washing, post-washing, and drying temperature are specified because these variables have been shown to affect the results.
- 5.2 Samples high in Filterable Residue (dissolved solids), such as saline waters, brines and some wastes, may be subject to a positive interference. Care must be taken in selecting the filtering apparatus so that washing of the filter and any dissolved solids in the filter (7.5) minimizes this potential interference.

6.0 Apparatus

- 6.1 Glass fiber filter discs, without organic binder, such as Millipore AP-40, Reeves Angel 934-AH, Gelman type A/E, or equivalent.
NOTE: Because of the physical nature of glass fiber filters, the absolute pore size cannot be controlled or measured. Terms such as "pore size", collection efficiencies and effective retention are used to define this property in glass fiber filters. Values for these parameters vary for the filters listed above.
- 6.2 Filter support: filtering apparatus with reservoir and a coarse (40-60 microns) fritted disc as a filter support.
NOTE: Many funnel designs are available in glass or porcelain. Some of the most common are Hirsch or Buchner funnels, membrane filter holders and Gooch crucibles. All are available with coarse fritted disc.
- 6.3 Suction flask.
- 6.4 Drying oven, 103-105°C.
- 6.5 Desiccator.
- 6.6 Analytical balance, capable of weighing to 0.1 mg.

7.0 Procedure

- 7.1 Preparation of glass fiber filter disc: Place the glass fiber filter on the membrane filter apparatus or insert into bottom of a suitable Gooch crucible with wrinkled surface up. While vacuum is applied, wash the disc with three successive 20 mL volumes of distilled water. Remove all traces of water by continuing to apply vacuum after water has passed through. Remove filter from membrane filter apparatus or both crucible and filter if Gooch crucible is used, and dry in an oven at 103-105°C for one hour. Remove to desiccator and store until needed. Repeat the drying cycle until a constant weight is obtained (weight loss is less than 0.5 mg). Weigh immediately before use. After weighing, handle the filter or crucible/filter with forceps or tongs only.

7.2 Selection of Sample Volume

For a 4.7 cm diameter filter, filter 100 mL of sample. If weight of captured residue is less than 1.0 mg, the sample volume must be increased to provide at least 1.0 mg of residue. If other filter diameters are used, start with a sample volume equal to 7 mL/cm² of filter area and collect at least a weight of residue proportional to the 1.0 mg stated above.

NOTE: If during filtration of this initial volume the filtration rate drops rapidly, or if filtration time exceeds 5 to 10 minutes, the following scheme is recommended: Use an unweighed glass fiber filter of choice affixed in the filter assembly. Add a known volume of sample to the filter funnel and record the time elapsed after selected volumes have passed through the filter. Twenty-five mL increments for timing are suggested. Continue to record the time and volume increments until filtration rate drops rapidly. Add additional sample if the filter funnel volume is inadequate to reach a reduced rate. Plot the observed time versus volume filtered. Select the proper filtration volume as that just short of the time a significant change in filtration rate occurred.

7.3 Assemble the filtering apparatus and begin suction. Wet the filter with a small volume of distilled water to seat it against the fritted support.

7.4 Shake the sample vigorously and quantitatively transfer the predetermined sample volume selected in 7.2 to the filter using a graduated cylinder. Remove all traces of water by continuing to apply vacuum after sample has passed through.

7.5 With suction on, wash the graduated cylinder, filter, non-filterable residue and filter funnel wall with three portions of distilled water allowing complete drainage between washing. Remove all traces of water by continuing to apply vacuum after water has passed through.

NOTE: Total volume of wash water used should equal approximately 2 mL per cm². For a 4.7 cm filter the total volume is 30 mL.

7.6 Carefully remove the filter from the filter support. Alternatively, remove crucible and filter from crucible adapter. Dry at least one hour at 103-105°C. Cool in a desiccator and weigh. Repeat the drying cycle until a constant weight is obtained (weight loss is less than 0.5 mg).

8.0 Calculations

8.1 Calculate non-filterable residue as follows:

$$\text{Non-filterable residue, } \frac{\text{mg}}{\text{L}} = \frac{(A - B) * 1000}{C}$$

where:

A = weight of filter (or filter and crucible) + residue in mg

B = weight of filter (or filter and crucible) in mg

C = mL of sample filtered

9.0 Precision and Accuracy

9.1 Precision data are not available at this time.

9.2 Accuracy data on actual samples cannot be obtained.

A.2. Standard Method 2540 D Total Suspended Solids Dried at 103 – 105°C

1. General Discussion

a. Principle: A well-mixed sample is filtered through a weighed standard glass-fiber filter and the residue retained on the filter is dried to a constant weight at 103 to 105°C. The increase in weight of the filter represents the total suspended solids. If the suspended material clogs the filter and prolongs filtration, it may be necessary to increase the diameter of the filter or decrease the sample volume. To obtain an estimate of total suspended solids, calculate the difference between total dissolved solids and total solids.

b. Interferences: See 2540A.2 and 2540B.1. Exclude large floating particles or submerged agglomerates of nonhomogeneous materials from the sample if it is determined that their inclusion is not representative. Because excessive residue on the filter may form a water-entrapping crust, limit the sample size to that yielding no more than 200 mg residue. For samples high in dissolved solids thoroughly wash the filter to ensure removal of dissolved material. Prolonged filtration times resulting from filter clogging may produce high results owing to increased colloidal materials captured on the clogged filter.

2. Apparatus

Apparatus listed in Sections 2540B.2 and 2540C.2 is required, except for evaporating dishes, steam bath, and 180°C drying oven. In addition:

Aluminum weighing dishes.

3. Procedure

a. Preparation of glass-fiber filter disk: If pre-prepared glass fiber filter disks are used, eliminate this step. Insert disk with wrinkled side up in filtration apparatus. Apply vacuum and wash disk with three successive 20-mL portions of reagent-grade water. Continue suction to remove all traces of water, turn vacuum off, and discard washings. Remove filter from filtration apparatus and transfer to an inert aluminum weighing dish. If a Gooch crucible is used, remove crucible and filter combination. Dry in an oven at 103 to 105°C for 1 h. If volatile solids are to be measured, ignite at 550°C for 15 min in a muffle furnace. Cool in desiccator to balance temperature and weigh. Repeat cycle of drying or igniting, cooling, desiccating, and weighing until a constant weight is obtained or until weight change is less than 4% of the previous weighing or 0.5 mg, whichever is less. Store in desiccator until needed.

b. Selection of filter and sample sizes: Choose sample volume to yield between 2.5 and 200 mg dried residue. If volume filtered fails to meet minimum yield, increase sample volume up to 1 L. If complete

filtration takes more than 10 min, increase filter diameter or decrease sample volume.

c. Sample analysis: Assemble filtering apparatus and filter and begin suction. Wet filter with a small volume of reagent-grade water to seat it. Stir sample with a magnetic stirrer at a speed to shear larger particles, if practical, to obtain a more uniform (preferably homogeneous) particle size. Centrifugal force may separate particles by size and density, resulting in poor precision when point of sample withdrawal is varied. While stirring, pipet a measured volume onto the seated glass-fiber filter. For homogeneous samples, pipet from the approximate midpoint of container but not in vortex. Choose a point both middepth and midway between wall and vortex. Wash filter with three successive 10-mL volumes of reagent-grade water, allowing complete drainage between washings, and continue suction for about 3 min after filtration is complete. Samples with high dissolved solids may require additional washings. Carefully remove filter from filtration apparatus and transfer to an aluminum weighing dish as a support. Alternatively, remove the crucible and filter combination from the crucible adapter if a Gooch crucible is used. Dry for at least 1 h at 103 to 105°C in an oven, cool in a desiccator to balance temperature, and weigh. Repeat the cycle of drying, cooling, desiccating, and weighing until a constant weight is obtained or until the weight change is less than 4% of the previous weight or 0.5 mg, whichever is less. Analyze at least 10% of all samples in duplicate. Duplicate determinations should agree within 5% of their average weight. If volatile solids are to be determined, treat the residue according to 2540E.

4. Calculation

$$\text{mg total suspended solids/L} = \frac{(A - B) * 1000}{\text{sample volume, mL}}$$

where:

A = weight of filter + dried residue, mg, and

B = weight of filter, mg.

5. Precision

The standard deviation was 5.2 mg/L (coefficient of variation 33%) at 15 mg/L, 24 mg/L (10%) at 242 mg/L, and 13 mg/L (0.76%) at 1707 mg/L in studies by two analysts of four sets of 10 determinations each. Single-laboratory duplicate analyses of 50 samples of water and wastewater were made with a standard deviation of differences of 2.8 mg/L.

A.3 ASTM D5907 – 09 Filterable and Nonfilterable Matter in Water

1. Scope

1.1 This test method covers the determination of filterable and nonfilterable matter in drinking, surface, and saline waters, domestic and industrial wastes. The practical range of the determination of nonfilterable particulate matter is 4 to 20 000 mg/L. The practical range of the determination of filterable matter is 10 to 20 000 mg/L.

1.2 Since the results measured by this test are operationally defined, careful attention must be paid to following the procedure as specified.

1.3 This method for the determination of nonfilterable matter (TSS) must not be used when water samples were collected from open channel flow. For the determination of matter collected in open channel flow use Test Methods D3977.

1.4 The values stated in SI units are to be regarded as standard. No other units of measurement are included in this standard.

1.5 *This standard does not purport to address all of the safety concerns, if any, associated with its use. It is the responsibility of the user of this standard to establish appropriate safety and health practices and determine the application of regulatory limitations prior to use.* For a specific hazard statement, see Section 9.

2. Referenced Documents

2.1 ASTM Standards²

- D596 Guide for Reporting Results of Analysis of Water
- D1129 Terminology Relating to Water
- D1193 Specification of Reagent Water
- D2777 Practice for Determination of Precision and Bias of Applicable Test Methods of Committee D19 on Water
- D3370 Practices for Sampling Water from Closed Conduits
- D3856 Guide for Good Laboratory Practices in Laboratories Engaged in Sampling and Analysis of Water
- D3977 Test Methods for Determining Sediment Concentration in Water Samples
- D4411 Guide for Sampling Fluvial Sediment in Motion
- D5847 Practice for Water Quality Control Specifications for Standard Test Methods for Water Analysis
- E319 Practice for the Evaluation of Single-Pan Mechanical Balances
- D898 Test Method of Testing Top-Loading, Direct-Reading Laboratory Scales and Balances

3. Terminology

3.1 *Definitions:* For definitions of other terms used in this test method, refer to Terminology D1129.

3.2 Definitions of Terms Specific to This Standard:

3.2.1 *filterable matter* – also commonly referred to as total dissolved solids. It is that dissolved matter that is capable of passing through a glass fiber filter and dried to a constant weight at 180°C, as determined by following the procedures outlined in this test method.

3.2.2 *nonfilterable matter* – also commonly known as total suspended solids. It is that particulate matter that is retained on a glass fiber filter and dried to a constant weight at 103 to 105°C, as determined by following the procedures outlined in this test method.

4. Summary of Test Method

4.1 A well-mixed sample is filtered through a weighed standard glass fiber filter. The suspended solids are retained on the filter, which is dried at 105°C and weighed. The increased mass on the filter represents the nonfilterable matter.

4.2 The filtrate from 4.1 may be used to determine the filterable matter. The filtered sample (liquid phase) is evaporated to dryness and heated to 180°C in a tared vessel to a constant weight.

5. Significance and Use

5.1 Solids, both as filterable and nonfilterable matter, are important in the treating of raw water and wastewater, and in the monitoring of streams.

5.2 Waste solids impose a suspended and settleable residue in receiving waters. Suspended and soluble materials provide a matrix for some biological slime and, in sufficient quantity, impair respiration of organisms. These solids may create nuisance slime beds and odors while imposing a long-term biological oxidation load over limited receiving water areas.

5.3 Knowledge of suspended solids and soluble materials is important in treating raw water supplies. Knowledge of solids loading can aid in determining the type or amount of treatment, or both, necessary to make the water acceptable for use. Such information may also be used to determine acceptability of water after treatment. Too little treatment may not be desirable and excess treatment costs money.

5.4 Stream monitoring is important for environmental reasons. Stream improvements, water pollution monitoring, mass wasting, algal studies, and sediment loads are but a few of the many reasons streams are monitored.

6. Interferences

6.1 For some samples, chemical reactions may cause some materials to change from one phase to another. For example, in some groundwaters, ferrous ions may form insoluble ferric hydroxides. Softened water high in carbonates may precipitate calcium carbonate. In such cases, holding time may have a

critical impact upon both the filterable and nonfilterable matter. Such samples may have to be filtered in the field.

6.2 This test method is not meant to include nonrepresentative particulates such as leaves, sticks, insects, fish, etc. These should be removed before analysis.

6.3 Certain materials may be measured poorly, or not at all. Some materials may decompose or volatilize at the required temperature. Other substances, such as glycerin or sulfuric acid, will remain liquid at the required temperature, giving variable results. Oils and greases may present similar problems and can end up in either the filterable or nonfilterable portion.

6.4 Suspended solids samples high in dissolved matter, such as saline waters, brines, and some wastes, may be subject to a positive interference by the retention of dissolved matter, such as salts and sugars, on the filter. Care must be taken in the final rinsing of the filter so as to minimize this potential interferent. Additional washing must be necessary.

6.5 Clogging of the filter with too fine or too much material will prolong the filtering time and retain smaller particles that would normally pass through the filter, thus giving elevated values to nonfilterable matter and low values to the filterable matter. Biological material, such as algae, may also prolong filtration time or plug the filter.

6.6 Some samples may be hygroscopic, requiring prolonged drying, extra careful desiccation, and rapid weighing. For filterable matter, samples highly mineralized or high in bicarbonate may require careful and possibly prolonged drying. For the bicarbonate, the extended drying may be needed to ensure complete conversion to carbonate.

6.7 Too much material retained on the filter may entrap water, and may also require extended drying time for the suspended solids. For filterable matter, excessive residue in the dish may cause the formation of a water-trapping crust, giving elevated values.

6.8 For some users, certain biological materials, such as algae, slimes, insects, or other small crustaceans, may be considered positive interferences for nonfilterable matter. Modifications or adjustments may be needed to generate a better value. An example is determining chlorophyll content to estimate the amount of algae present. Such modifications may be beyond the scope of this test method.

7. Apparatus

7.1 *Glass Fiber Filters*, without organic binder.³

NOTE 1 – Although there is no organic binder in these filters, they may contain a wet strength resin that is partially soluble. It is therefore important to adequately prewash the filters as described.

7.2 *Membrane Filter Assembly* – A borosilicate glass, stainless steel, or plastic funnel with a flat, fritted, or grid base so as to provide uniform support and filterable surface. The top section of the funnel shall fit over the edge of the filter to provide a seal.

The top should be removable to allow easy access for removing the filter. A Gooch crucible with a fritted bottom may be used in lieu of the funnel.

7.3 *Planchet or Pan*, made of aluminum or stainless steel, capable of supporting the filter when it is not on the filter assembly.

7.4 *Drying Oven*, capable of maintaining a temperature between 103 and 105°C for nonfilterable matter and between 178 and 182°C for filterable matter.

NOTE 2 – To prevent dust and sample from being blown around, it is preferred that the oven for the particulate matter be of a gravity convection type. If this is not possible, samples should be shielded from the forced air of mechanical convection ovens.

7.5 *Analytical Balance*, capable of measuring to the nearest 0.1 mg.⁴

7.6 *Vacuum Source*.

8. Reagents and Materials

8.1 *Purity of Water* – Unless otherwise indicated, references to water shall be understood to mean reagent water conforming to Type I or II of Specification D1193. Type III or IV may be used if they effect no measurable change in the blank or sample.

9. Hazards

9.1 Care must be taken to ensure filter funnels and filtering flasks are in a sound state. Any tiny nick, scratch, or weakness in glass flasks or other apparatus can create a potential for an implosion standard. Wrapping a flask is not adequate protection in case of an implosion. It is recommended that a solid shield, such as a plexiglass cage, be placed around any filtering flask.

10. Sampling

10.1 Collect the sample in accordance with the applicable ASTM Practices D3370.

10.2 If sampling is required from an open channel flow, use Guide D4411 to collect the sample and Test Methods D3977 to analyze a separate sample bottle to determine the suspended sediment concentrations instead of the TSS.

11. Procedure

11.1 Prepare the glass fiber filters before use.

11.1.1 Place the glass fiber filter on the membrane filter assembly, or insert into the bottom of a suitable Gooch crucible, with the wrinkled surface up. While a vacuum is applied, wash the disc with three successive volumes of water. Each volume of water should be equal to 3 mL for each square centimeter of filterable surface area. For standard 47 mm filter holders with 35 mm diameter funnels, this would be 30 mL for each wash for a total of 90 mL. Continue the vacuum until the free water has been removed. Discard the washings.

NOTE 3 – Proper washing is important for removing loose fiber and wet strength resins. One 90-mL wash is not as effective as three 30-mL washes.

NOTE 4 – On some filters it may be difficult to tell which is the wrinkled side. Usually the opposite side has faint markings of the wire mesh used to manufacture the filter mat.

11.1.2 Skip 11.1.3 and 11.1.4 if only filterable matter is being determined.

11.1.3 Release the vacuum and carefully remove the filter with forceps. Place the filter on a planchet, and dry in an oven at 103 to 105°C for 1 h. Gooch crucibles with filter may be handled without the planchet.

11.1.4 Remove from the oven and place in a desiccator until cool. If the desiccation time exceeds 12 h, reheat and desiccate again. Where the filter plus planchet to the nearest 0.1 mg just before using. After oven drying, the filter shall be handled only with forceps, and the planchet or crucible shall be handled only with forceps, tongs, or lint-free gloves.

11.2 Preparation of the Evaporating Dish:

11.2.1 If filterable matter is to be determined, heat a clean dish to 178 to 182°C in an oven for 1 h. After removing from the oven, treat as in 11.1.3.

NOTE 5 – The dish should be as small as practical to contain the volume of the sample plus the rinses. The relative mass of the dish needs to be kept at a minimum in order to be able to measure small mass differences with any accuracy. This is because of the inherent difficulties of trying to control temperature and moisture on a large mass within the requirements of the test. For larger volumes, it may be more practical to evaporate smaller increments, refilling the dish when dry until all the sample is transferred.

NOTE 6 – The dish should be made of a material that is inert to the sample. Materials such as aluminum will oxidize when heated with many liquids, increasing the mass of the pan. Glass or light weight ceramic material is generally preferred.

11.3 Determine the proper sample volume.

11.3.1 Sample volume determination for nonfilterable matter.

11.3.1.1 Start with a volume of sample equal to about 10 mL/cm² of filterable surface area. For the standard 47 mm filter holders with 35 mm diameter funnels, this would be about 100 mL. If this fails to yield at least 2.5 mg of dry solids on the filter, increase the sample volume until that mass is attained, a volume of 1 L is reached, or the “break point” in 11.3.1.3 is reached. Do not exceed 200 mg on the filter.

11.3.1.2 For other filter sizes, maintain at least 1 mg of dry solids per 4 cm² of filterable surface area, with a minimum of 2.5 mg.

11.3.1.3 If the filtration time exceeds 5 min, develop a “break-point” curve (see 11.3.3). This process needs to be done only when the character of a sample is unfamiliar or changes.

11.3.2 Sample volume determination for filterable matter.

11.3.2.1 Choose a sample volume to yield between 2.5 mg and 200 mg. If more than 5 min is needed for the filtration, perform the “break-point” determination as per 11.3.3

NOTE 7 – If the solids are expected to be high, a known *proportion* of the total material, sample plus wash solution, that passed through the filter may be used for the determination. For example, if 200 mL of sample was filtered and only 190 mL of liquid passed through the filter (with all free filterable liquid passing through, leaving 10 mL of nonfilterable solids retained on the filter), the total volume of filtrate would be 250 mL, including the wash water. If a 100-mL portion of the filtrate could be used for the filterable solids test, the final mass of dried solids weighed would have to be divided by 0.4 to account for the 40% proportion of the sample used.

11.3.3 Break-Point Determination:

11.3.3.1 Place filter in the filtering apparatus. For this procedure, the filter needs no preparation. Add a small, known volume of sample that will filter rapidly and time how long it takes to filter.

11.3.3.2 Repeat 11.3.3.1, increasing the volume until it can be determined at what point the filtration rate drops off rapidly.

11.3.3.3 Plot the time versus the volume filtered. Select the proper volume as that just short of the time that a significant change in a filtration rate occurs. An example of a break point curve is shown in Appendix XI.

NOTE 8 – If at least 2.5 mg of material cannot be retained on the filter because of plugging, a larger diameter filtration system is suggested. Fritted membrane style filter holders range in sizes up to 9 cm in diameter.

11.3.4 Analyze sample volumes of less than 20 mL by diluting 100 mL to 1 L and running the diluted sample. This is to assure that a representative sample is obtained. Pipetting is generally discouraged since the pipet tip can act as a filter.

11.4 Assemble the filter apparatus with the prepared filter (see 11.1) and start the suction. If the filter is not sealed around the edges by the funnel, such as in the case with a Gooch crucible, wet the filter with a small volume of water to seat it to the base or support. If filterable matter is to be determined, be sure the suction flask is clean.

NOTE 9 – If the sample size is small, it may be convenient to place a smaller container, such as a large test tube, into the vacuum flask in order to catch the sample and rinses for filterable matter.

11.5 Mix the sample thoroughly, and quickly transfer a volume of sample as determined in 11.2 into a “to contain,” or TC, graduated cylinder. Pour this measured sample onto the filter and continue to apply the section until all traces of water have passed through.

NOTE 10 – Because of the nature of TSS, it is important to thoroughly mix each sample immediately before every aliquot is taken. Many suspended solids settle rapidly, giving a distorted sample if not carefully mixed and quickly sampled.

11.6 With the suction still on, wash the graduated cylinder, the filter, and particulate matter, and the funnel wall with three portions of water, allowing complete drainage between washing. Each portion of wash water should be about 2 mL/cm² of filterable surface. For a 47 mm filter with a 35 mm diameter funnel, the volume of each portion should be 20 mL

for a total of 60 mL. If filterable matter is being run, save the wash water with the sample. Table 1
NOTE 11 – For nonfilterable matter samples with high dissolved solids contents, such as seawater and brine solutions, small increments of extra wash water may be required. Tests such as conductivity, chloride, dissolved solids, etc. can be used to determine when there are no significant dissolved solids in the wash water. For filterable matter, this generally is not a significant problem.

11.7 After the filter has been sucked dry, release the vacuum and carefully remove the filter from the filtering apparatus and place on the planchet, or remove the Gooch crucible from the crucible holder.

11.8 If filterable matter is being determined, carefully transfer the contents from the filtering flask into the evaporating dish (see 11.2). Rinse the filtering flask three times with a small portion of water and add the rinse to the evaporating dish.

11.9 If nonfilterable matter is being determined, dry the filter at least 1 h at 103 to 105°C. The drying time should be long enough to ensure a constant weight. Place in a desiccator, cool, and weigh to the nearest 0.1 mg as in 11.1.3.

NOTE 12 – The drying time should be checked on new types of samples and periodically on familiar samples to be sure that it is sufficient for the mass to be constant; that is, the difference is less than 0.5 mg, or 4% of the previous weighing, whichever is greater.

11.10 Evaporate the liquid for the filterable matter on a steam bath or in an oven at 103 to 105°C. After the liquid is gone, dry the evaporating dish at 178 to 182°C for at least 1 h. The drying time should be long enough to ensure a constant weight. Place in a desiccator, cool, and weigh to the nearest 0.1 mg as in 11.1.3.

NOTE 13 – The drying time should be checked on new types of samples and periodically on familiar samples to be sure that it is sufficient for the mass to be constant; that is, the difference is less than 0.5 mg, or 4% of the previous weighing, whichever is greater.

11.11 With each batch of samples that are run, a blank shall be run. The blank shall be taken through the process without the addition of a sample in 11.4. If a blank filter shows any increase in mass or a loss of greater than 0.4 mg, rerun the samples associated with it. If the mass of a blank evaporating dish varies by more than ± 0.5 mg from the initial mass, rerun the samples associated with it. The blank result is not subtracted from the sample.

NOTE 14 – A blank filter carried through the process generally loses a mass of about 0.2 mg. So, blank requirements represent the range of -0.2 ± 0.2 mg.

12. Calculation

12.1 Calculate the amount of nonfilterable matter as follows:

total nonfilterable matter, in mg/L

$$= \frac{(mg \text{ of residue} + filter) - mg \text{ of filter}}{mL \text{ of sample filtered}} * 1000$$

12.2 Calculate the amount of filterable matter as follows:

total filterable matter, in mg/L

$$= \frac{(mg \text{ of residue} + dish) - mg \text{ of dish}}{mL \text{ of sample filtered}} * 1000$$

13. Report

13.1 Do not report results smaller than the nearest milligram per litre. The precision and bias data from the round-robin suggest the method is good to two significant figures at most. There should be supporting data available in the laboratory before reporting more significant figures.

14. Precision and Bias

14.1 The single-operator precision and overall precision and bias of this test method are given in Table 1 for nonfilterable matter and Table 2 for filterable matter. The material tested was a purchased commercial suspended solids material in an unspecified mixture of salt.⁵ The material is only available at the maximum concentration tested. Other concentrations were created for testing by diluting the original solution. The precision and bias statement reflects only the results for this specified matrix and may not reflect other matrices. The material tested was the only material known to the committee to be available in a liquid form that can test all aspects of the test method. The limit of available known material in a form that can test all aspects of this test method prohibits testing the full range of the method.

14.2 Six independent laboratories and operators successfully completed the round robin study for filterable matter. Six to eleven independent laboratories successfully completed the round robin study for nonfilterable matter. The precision and bias evaluation for this test method was conducted using a Youden pair design and conforms to Practice D2777-86. Under allowances made in 1.4 of D2777-98, these precision and bias data do not meet existing requirements for interlaboratory studies of Committee D19 test methods. Information on low-level results from laboratories that survived the ranking tests, but not meeting full requirements of the test method, is given in Appendix X2.

14.3 A duplicate and know control sample should be run each day that a sample is analyzed. The duplicate and control sample shall meet satisfactory limits as established by the control chart before an analysis is considered satisfactory.

14.4 Until such time as other quality assurance/quality control (QA/QC) procedures are established, it is recommended that the user use Guide D3856 as a guide for establishing QA/QC.

14.5 Before this test method is applied to the analysis of samples, the analyst shall establish his/her

own precision and bias data.

TABLE 1 Nonfilterable Matter (TSS)^A

Number of Laboratories	Expected Amount in mg/L	Measured Amount in mg/L	S_T in mg/L	S_O in mg/L	Bias, in mg/L	Bias, %	Statistically Significant
6	5	4.75	0.23	NA	-0.25	-5	yes
11	10	9.4	0.69	0.94	-0.6	-6	yes
11	15	14.8	1.41	0.94	-0.2	-1	no
11	30	28.9	1.50	0.56	-1.1	-4	yes
10	36	34.6	0.98	0.56	-1.4	-4	yes
11	50	49.2	2.05	1.79	-0.8	-2	no
11	67.4	65.3	2.53	1.79	-2.1	-3	yes
11	70	68.7	2.82	1.63	-1.3	-2	no
10	80	78.7	2.97	1.63	-1.3	-2	no

^A NA = not available. There is no acceptable Youden pair for this sample set.

TABLE 2 Filterable Matter (TDS)

Number of Laboratories	Expected Amount in mg/L	Measured Amount in mg/L	S_T in mg/L	S_O in mg/L	Bias, in mg/L	Bias, %	Statistically Significant
6	37.5	36.7	2.8	2.1	-0.8	-2	no
6	56.2	54.8	3.1	2.1	-1.4	-2	no
6	112	101	12	15	-11	-10	no
6	135	126	21	15	-11	-8	no
6	188	173	16	9.3	-15	-8	no
6	253	228	11	9.3	-25	-10	yes
6	262	243	18	2.9	-19	-7	no
6	300	279	21	2.9	-21	-7	no

15. Quality Control (QC)

15.1 In order to be certain that analytical values obtained using these test methods are valid and accurate within the confidence limits of the test, the following QC procedures must be followed when analyzing filterable and nonfilterable matter.

15.2 Calibration and Calibration Verification

15.2.1 The balance used should be calibrated internally or with known weights prior to use.

15.2.2 Verify balance contribution with weights prior to use.

15.3 Initial Demonstration of Laboratory Capability

15.3.1 If a laboratory has not performed the test before, or if there has been a major change in the measurement system, for example, new analyst, new instrument, etc., a precision and bias study must be performed to demonstrate laboratory capability.

15.3.2 Analyze seven replicates of a standard solution prepared from an Independent Reference Material containing a mid-range concentration of filterable or nonfilterable matter. The matrix and chemistry of the solution used should be equivalent to the solution used in the collaborative study. Each replicate must be taken through the complete analytical test method. The replicates may be interspersed with samples.

15.3.3 Calculate the mean and standard deviation of the seven values and compare to the acceptable ranges of bias in Table 1 for nonfilterable or Table 2 for filterable matter. This study should be repeated until the recoveries are within the limits given in Table 1 for nonfilterable or Table 2 for filterable matter. If a concentration other than the recommended concentration is used, refer to Practice D5847 for information on applying the F test and t test in

evaluating the acceptability of the mean and standard deviation.

15.4 Laboratory Control Sample (LCS)

15.4.1 To ensure that this test method is in control, analyze a LCS containing a mid-range concentration of filterable or nonfilterable matter with each batch or ten samples. If large numbers of samples are analyzed in the batch, analyze the LCS after every ten samples. The LCS must be taken through all of the steps of the analytical method including sample preservation and pretreatment. The result obtained for the LCS shall fall within $\pm 15\%$ of the known concentration.

15.5 Method Blank

15.5.1 Perform a blank as stipulated in 11.11. If those results cannot be attained, halt analysis of samples until the cause can be determined and eliminated. Either all the samples in the batch must be reanalyzed or the results must be qualified with an indication that they do not fall within the performance criteria of the test method.

15.6 Matrix Spike (MS)

15.6.1 Filterable and nonfilterable matter cannot be feasibly spiked into samples.

15.7 Duplicate

15.7.1 To check the precision of sample analyses, analyze a sample in duplicate for each batch. The value obtained must fall within the control limits established by the laboratory.

15.7.2 Calculate the standard deviation of the duplicate values and compare to the precision determined by the laboratory or in the collaborative study using an F test. Refer to 6.4.4 of Practice D5847 for information on applying the F test.

15.7.3 If the result exceeds the precision limit, the batch must be reanalyzed or the results must be

qualified with an indication that they do not fall within the performance criteria of the test method.

15.8 *Independent Reference Material (IRM)*

15.8.1 In order to verify the quantitative value produced by the test method, analyze an Independent Reference Material (IRM) submitted on a regular sample (if practical) to the laboratory at least once per quarter. The concentration of the IRM should be in the

concentration mid-range for the method chosen. The value obtained must fall within the control limits established by the laboratory.

16. Keywords

16.1 dissolved matter; dissolved solids; filterable matter; nonfilterable matter; suspended matter; suspended solids

A.4 ASTM D854 – 10 Specific Gravity of Soil Solids by Water Pycnometer

1. Scope

1.1 These test methods cover the determination of the specific gravity of soil solids that pass the 4.75-mm (No. 4) sieve, by means of a water pycnometer. When the soil contains particles larger than the 4.75-mm sieve, Test Method C127 shall be used for the soil solids retained on the 4.75-mm sieve and these test methods shall be used for the soil solids passing the 4.75-mm sieve.

1.1.1 Soil solids for these test methods do not include solids which can be altered by these methods, contaminated with a substance that prohibits the use of these methods, or are highly organic soil solids, such as fibrous matter which floats in water.

NOTE 1—The use of Test Method D5550 may be used to determine the specific gravity of soil solids having solids which readily dissolve in water or float in water, or where it is impracticable to use water.

1.2 Two methods for performing the specific gravity are provided. The method to be used shall be specified by the requesting authority, except when testing the types of soils listed in 1.2.1

1.2.1 *Method A*—Procedure for Moist Specimens, described in 9.2. This procedure is the preferred method. For organic soils; highly plastic, fine grained soils; tropical soils; and soils containing halloysite, Method A shall be used.

1.2.2 *Method B*—Procedure for Oven-Dry Specimens, described in 9.3.

1.3 All observed and calculated values shall conform to the guidelines for significant digits and rounding established in Practice D6026.

1.3.1 The procedures used to specify how data are collected/recorded and calculated in this standard are regarded as the industry standard. In addition, they are representative of the significant digits that generally should be retained. The procedures used do not consider material variation, purpose for obtaining the data, special purpose studies, or any considerations for the user's objectives; and it is common practice to increase or reduce significant digits of reported data to be commensurate with these considerations. It is beyond the scope of these test methods to consider significant digits used in analysis methods for engineering design.

1.4 The values stated in SI units are to be regarded as standard. The inch-pound units given in parentheses are mathematical conversions which are provided for information purposes only and are not considered standard.

1.5 *This standard does not purport to address all of the safety concerns, if any, associated with its use. It is the responsibility of the user of this standard to establish appropriate safety and health practices and determine the applicability of regulatory limitations prior to use.*

2. Referenced Documents

2.1 ASTM Standards:²

- C127 Test Method for Density, Relative Density (Specific Gravity), and Absorption of Coarse Aggregate
- D653 Terminology Relating to Soil, Rock, and Contained Fluids
- D2216 Test Methods for Laboratory Determination of Water (Moisture) Content of Soil and Rock by Mass
- D2487 Practice for Classification of Soils for Engineering Purposes (Unified Soil Classification System)
- D3740 Practice for Minimum Requirements for Agencies Engaged in Testing and/or Inspection of Soil and Rock as Used in Engineering Design and Construction
- D4753 Guide for Evaluating, Selecting, and Specifying Balances and Standard Masses for Use in Soil, Rock, and Construction Materials Testing
- D5550 Test Method for Specific Gravity of Soil Solids by Gas Pycnometer
- D6026 Practice for Using Significant Digits in Geotechnical Data
- E11 Specification for Woven Wire Test Sieve Cloth and Test Sieves
- E177 Practice for Use of the Terms Precision and Bias in ASTM Test Methods
- E691 Practice for Conducting an Interlaboratory Study to Determine the Precision of a Test Method

3. Terminology

3.1 *Definitions*—For definitions of technical terms used in these test methods, refer to Terminology D653.

3.2 *Definitions of Terms Specific to This Standard:*

3.2.1 *specific gravity of soil solids, G_s , n* —the ratio of the mass of a unit volume of a soil solids to the mass of the same volume of gas-free distilled water at 20°C.

4. Significance and Use

4.1 The specific gravity of a soil solids is used in calculating the phase relationships of soils, such as void ratio and degree of saturation.

4.1.1 The specific gravity of soil solids is used to calculate the density of the soil solids. This is done by multiplying its specific gravity by the density of water (at proper temperature).

4.2 The term soil solids is typically assumed to mean naturally occurring mineral particles or soil like particles that are not readily soluble in water. Therefore, the specific gravity of soil solids containing extraneous matter, such as cement, lime, and the like, water-soluble matter, such as sodium chloride, and soils containing matter with a specific gravity less than

one, typically require special treatment (see Note 1) or a qualified definition of their specific gravity.

4.3 The balances, pycnometer sizes, and specimen masses are established to obtain test results with three significant digits.

NOTE 2—The quality of the result produced by these test methods is dependent on the competence of the personnel performing it, and the suitability of the equipment and facilities used. Agencies that meet the criteria of Practice D3740 are generally considered capable of competent and objective testing/sampling/inspection/etc. Users of these test methods are cautioned that compliance with Practice D3740 does not in itself assure reliable results. Reliable results depend on many factors; Practice D3740 provides a means of evaluating some of those factors.

5. Apparatus

5.1 *Pycnometer*—The water pycnometer shall be either a stoppered flask, stoppered iodine flask, or volumetric flask with a minimum capacity of 250 mL. The volume of the pycnometer must be 2 to 3 times greater than the volume of the soil-water mixture used during the deairing portion of the test.

5.1.1 The stoppered flask mechanically sets the volume. The stoppered iodine flask has a flared collar that allows the stopper to be placed at an angle during thermal equilibration and prevents water from spilling down the sides of the flask when the stopper is installed. The wetting the outside of the flask is undesirable because it creates changes in the thermal equilibrium. When using a stopper flask, make sure that the stopper is properly labeled to correspond to the flask.

5.2 *Balance*—A balance meeting the requirements of Guide D4753 for a balance of 0.01 g readability. When using the 250-mL pycnometers, the balance capacity shall be at least 500 g and when using the 500-mL pycnometers, the balance capacity shall be at least 1000 g.

5.3 *Drying Oven*—Thermostatically controlled oven, capable of maintaining a uniform temperature of $110 \pm 5^\circ\text{C}$ throughout the drying chamber. These requirements usually require the use of a forced-draft oven.

5.4 *Thermometric Device*, capable of measuring the temperature range within which the test is being performed, having a readability of 0.1°C and a maximum permissible error of 0.5°C . The device must be capable of being immersed in the sample and calibration solutions to a depth ranging between 25 and 80 mm. Full immersion thermometers shall not be used. To ensure the accuracy of the thermometric device, the thermometric device shall be standardized by comparison to a NIST traceable thermometric device. The standardization shall include at least one temperature reading within the range of testing. The thermometric device shall be standardized at least once every twelve months.

5.5 *Desiccator*—A desiccator cabinet or large desiccator jar of suitable size containing silica gel or anhydrous calcium sulfate.

NOTE 3—It is preferable to use a desiccant that changes color to indicate when it needs reconstitution.

5.6 *Entrapped Air Removal Apparatus*—To remove entrapped air (deairing process), use one of the following:

5.6.1 *Hot Plate or Bunsen Burner*, capable of maintaining a temperature adequate to boil water.

5.6.2 *Vacuum System*, a vacuum pump or water aspirator, capable of producing a partial vacuum of 100 mm of mercury (Hg) or less absolute pressure.

Warning—Mercury has been designated by EPA and many state agencies as a hazardous material that can cause central nervous system, kidney and liver damage. Mercury, or its vapor, may be hazardous to health and corrosive to materials. Caution should be taken when handling mercury and mercury containing products. See the applicable product Material Safety Data Sheet (MSDS) for details and EPA's website – <http://www.epa.gov/mercury/faq.htm> - for additional information. Users should be aware that selling mercury and/or mercury containing products into your state may be prohibited by state law.

NOTE 4—A partial vacuum of 100 mm Hg absolute pressure is approximately equivalent to a 660 mm (26 in.) Hg reading on vacuum gauge at sea level.

5.7 *Insulated Container*—A Styrofoam cooler and cover or equivalent container that can hold between three and six pycnometers plus a beaker (or bottle) of deaired water, and a thermometer. This is required to maintain a controlled temperature environment where changes will be uniform and gradual.

5.8 *Funnel*—A non-corrosive smooth surface funnel with a stem that extends past the calibration mark on the volumetric flask or stoppered seal on the stoppered flasks. The diameter of the stem of the funnel must be large enough that soil solids will easily pass through.

5.9 *Pycnometer Filling Tube with Lateral Vents (optional)*—A device to assist in adding deaired water to the pycnometer without disturbing the soil-water mixture. The device may be fabricated as follows. Plug a 6 to 10-mm ($\frac{1}{4}$ to $\frac{3}{8}$ in.) diameter plastic tube at one end and cut two small vents (notches) just above the plug. The vents should be perpendicular to the axis of the tube and diametrically opposed. Connect a valve to the other end of the tube and run a line to the valve from a supply of deaired water.

5.10 *Sieve*— 4.75 mm (No. 4) conforming to the requirements of Specification E11.

5.11 *Blender (optional)*—A blender with mixing blades built into the base of the mixing container.

5.12 *Miscellaneous Equipment*, such as a computer or calculator (optional), specimen dishes, and insulated gloves.

6. Reagents

6.1 *Purity of Water*—Distilled water is used in this test method. This water may be purchased and is readily available at most grocery stores; hereafter, distilled water will be referred to as water.

7. Test Specimen

7.1 The test specimen may be moist or oven-dry soil and shall be representative of the soil solids that pass the 4.75-mm (No. 4) sieve in the total sample. Table 1 gives guidelines on recommended dry soil mass versus soil type and pycnometer size.

7.1.1 Two important factors concerning the amount of soil solids being tested are as follows. First, the mass of the soil solids divided by its specific gravity will yield four-significant digits. Secondly, the mixture of soil solids and water is a slurry not a highly viscous fluid (thick paint) during the deairing process.

TABLE 1 Recommended Mass for Test Specimen

Soil Type	Specimen Dry Mass (g) When Using 250 mL Pycnometer	Specimen Dry Mass (g) When Using 500 mL Pycnometer
	SP, SP-SM	60 ± 10
SP-SC, SM, SC	45 ± 10	75 ± 10
Silt or Clay	35 ± 5	50 ± 10

8. Calibration of Pycnometer

8.1 Determine the mass of the clean and dry pycnometer to the nearest 0.01 g (typically five significant digits). Repeat this determination five times. One balance should be used for all of the mass measurements. Determine and record the average and standard deviation. The standard deviation shall be less than or equal to 0.02 g. If it is greater, attempt additional measurements or use a more stable or precise balance.

8.2 Fill the pycnometer with deaired water to above or below the calibration mark depending on the type of pycnometer and laboratory preference to add or remove water.

8.2.1 It is recommended that water be removed to bring the water level to the calibration mark. The removal method reduces the chances of altering the thermal equilibrium by reducing the number of times the insulated container is opened.

8.2.2 The water must be deaired to ensure that there are no air bubbles in the water. The water may be deaired using either boiling, vacuum, combination of vacuum and heat, or a deairing device. This deaired water should not be used until it has equilibrated to room temperature. Also, this water shall be added to the pycnometer following the guidance given in 9.6.

8.3 Up to six pycnometers can be calibrated concurrently in each insulated container. Put the pycnometer(s) into a covered insulated container along with the thermometric device (or the temperature sensing portion of the thermometric device), a beaker (or bottle) of deaired water, stopper(s) (if a stoppered pycnometer is being used), and either an eyedropper

or pipette. Let the pycnometer(s) come to thermal equilibrium (for at least 3 h). The equilibrium temperature should be within 4°C of room temperature and between 15 and 30°C.

8.4 Move the insulated container near the balance or vice versa. Open the container and remove one pycnometer. Only the rim of the pycnometer shall be touched as to prevent the heat from handling changing the thermal equilibrium. Either work in the container or place the pycnometer on an insulated block (Styrofoam) while making water level adjustments.

8.4.1 If using a volumetric flask as a pycnometer, adjust the water to the calibration mark, with the bottom of the meniscus level with the mark. If water has to be added, use the thermally equilibrated water from the insulated container. If water has to be removed, use a small suction tube or paper towel. Check for and remove any water beads on the pycnometer stem or on the exterior of the flask. Measure and record the mass of pycnometer and water to the nearest 0.01 g.

8.4.2 If a stoppered flask is used, adjust the water to prevent entrapment of any air bubbles below the stopper during its placement. If water has to be added, use the thermally equilibrated water from the insulated container. Then, place the stopper in the bottle. If water has to be removed, before or after inserting the stopper, use an eyedropper. Dry the rim using a paper towel. Be sure the entire exterior of the flask is dry. Measure and record the mass of pycnometer and water to the nearest 0.01 g.

8.5 Measure and record the temperature of the water to the nearest 0.1°C using the thermometric device that has been thermally equilibrated in the insulated container. Insert the thermometric device (or the temperature sensing portion of the thermometric device) to the appropriate depth of immersion (see 5.4). Return the pycnometer to the insulated container. Repeat the measurements for all pycnometers in the container.

8.6 Readjust the water level in each pycnometer to above or below the calibration line or empty the pycnometer and fill to the above or below the calibration line. Allow the pycnometers to thermally equilibrate (for at least 3 h) in the covered insulated container. Adjust the water level to the calibration line by removing water from the pycnometer or by filling the pycnometer to the calibration mark with the thermally equilibrated deaired water from the insulated container. Measure and record the mass and temperature of the filled pycnometer.

8.6.1 Repeat the procedure in 8.6 until a total of five independent measurements of the mass of the filled pycnometer and temperature readings are obtained. The temperatures do not need to bracket any particular temperature range.

8.7 Using each of these five data points, compute the calibrated volume of each pycnometer, V_p , using the following equation:

$$V_p = (M_{pw,c} - M_p) / \rho_{w,c}$$

where:

$M_{pw,c}$ = the mass of the pycnometer and water at the calibration temperature, g,

M_p = the average mass of the dry pycnometer at calibration, g, and

$\rho_{w,c}$ = the mass density of water at the calibration temperature g/mL, (Table 2).

8.8 Calculate the average and the standard deviation of the five volume determinations. The standard deviation shall be less than or equal to 0.05 mL (rounded to two decimal places). If the standard deviation is greater than 0.05 mL, the calibration procedure has too much variability and will not yield accurate specific gravity determinations. Evaluate areas of possible refinement (adjusting the volume to the calibration mark, achieving temperature equilibrium, measuring temperature,

deairing method or changing to the stoppered flasks) and revise the procedure until the standard deviation is less than or equal to 0.05 mL.

9. Procedure

9.1 *Pycnometer Mass*—Using the same balance used to calibrate the pycnometer, verify that the mass of the pycnometer is within 0.06 g of the average calibrated mass. If it is not, re-calibrate the dry mass of the pycnometer.

9.2 *Method A—Procedure for Moist Specimens:*

9.2.1 Determine the water content of a portion of the sample in accordance with Test Method D2216. Using this water content, calculate the range of wet masses for the specific gravity specimen in accordance with 7.1. From the sample, obtain a specimen within this range. Do not sample to obtain an exact predetermined mass.

TABLE 2 Density of Water and Temperature Coefficient (K) for Various Temperatures^{A,B}

Temperature (°C)	Density (g/mL) ^C	Temperature Coefficient (K)	Temperature (°C)	Density (g/mL) ^C	Temperature Coefficient (K)	Temperature (°C)	Density (g/mL) ^C	Temperature Coefficient (K)	Temperature (°C)	Density (g/mL) ^C	Temperature Coefficient (K)
15.0	0.99910	1.00090	16.0	0.99895	1.00074	17.0	0.99878	1.00057	18.0	0.99860	1.00039
.1	0.99909	1.00088	.1	0.99893	1.00072	.1	0.99876	1.00055	.1	0.99858	1.00037
.2	0.99907	1.00087	.2	0.99891	1.00071	.2	0.99874	1.00054	.2	0.99856	1.00035
.3	0.99906	1.00085	.3	0.99890	1.00069	.3	0.99872	1.00052	.3	0.99854	1.00034
.4	0.99904	1.00084	.4	0.99888	1.00067	.4	0.99871	1.00050	.4	0.99852	1.00032
.5	0.99902	1.00082	.5	0.99886	1.00066	.5	0.99869	1.00048	.5	0.99850	1.00030
.6	0.99901	1.00080	.6	0.99885	1.00064	.6	0.99867	1.00047	.6	0.99848	1.00028
.7	0.99899	1.00079	.7	0.99883	1.00062	.7	0.99865	1.00045	.7	0.99847	1.00026
.8	0.99898	1.00077	.8	0.99881	1.00061	.8	0.99863	1.00043	.8	0.99845	1.00024
.9	0.99896	1.00076	.9	0.99879	1.00059	.9	0.99862	1.00041	.9	0.99843	1.00022
19.0	0.99841	1.00020	20.0	0.99821	1.00000	21.0	0.99799	0.99979	22.0	0.99777	0.99957
.1	0.99839	1.00018	.1	0.99819	0.99998	.1	0.99797	0.99977	.1	0.99775	0.99954
.2	0.99837	1.00016	.2	0.99816	0.99996	.2	0.99795	0.99974	.2	0.99773	0.99952
.3	0.99835	1.00014	.3	0.99814	0.99994	.3	0.99793	0.99972	.3	0.99771	0.99950
.4	0.99833	1.00012	.4	0.99812	0.99992	.4	0.99791	0.99970	.4	0.99768	0.99947
.5	0.99831	1.00010	.5	0.99810	0.99990	.5	0.99789	0.99968	.5	0.99766	0.99945
.6	0.99829	1.00008	.6	0.99808	0.99987	.6	0.99786	0.99966	.6	0.99764	0.99943
.7	0.99827	1.00006	.7	0.99806	0.99985	.7	0.99784	0.99963	.7	0.99761	0.99940
.8	0.99825	1.00004	.8	0.99804	0.99983	.8	0.99782	0.99961	.8	0.99759	0.99938
.9	0.99823	1.00002	.9	0.99802	0.99981	.9	0.99780	0.99959	.9	0.99756	0.99936
23.0	0.99754	0.99933	24.0	0.99730	0.99909	25.0	0.99705	0.99884	26.0	0.99679	0.99858
.1	0.99752	0.99931	.1	0.99727	0.99907	.1	0.99702	0.99881	.1	0.99676	0.99855
.2	0.99749	0.99929	.2	0.99725	0.99904	.2	0.99700	0.99879	.2	0.99673	0.99852
.3	0.99747	0.99926	.3	0.99723	0.99902	.3	0.99697	0.99876	.3	0.99671	0.99850
.4	0.99745	0.99924	.4	0.99720	0.99899	.4	0.99694	0.99874	.4	0.99668	0.99847
.5	0.99742	0.99921	.5	0.99717	0.99897	.5	0.99692	0.99871	.5	0.99665	0.99844
.6	0.99740	0.99919	.6	0.99715	0.99894	.6	0.99689	0.99868	.6	0.99663	0.99842
.7	0.99737	0.99917	.7	0.99712	0.99892	.7	0.99687	0.99866	.7	0.99660	0.99839
.8	0.99735	0.99914	.8	0.99710	0.99889	.8	0.99684	0.99863	.8	0.99657	0.99836
.9	0.99732	0.99912	.9	0.99707	0.99887	.9	0.99681	0.99860	.9	0.99654	0.99833
27.0	0.99652	0.99831	28.0	0.99624	0.99803	29.0	0.99595	0.99774	30.0	0.99565	0.99744
.1	0.99649	0.99828	.1	0.99621	0.99800	.1	0.99592	0.99771	.1	0.99562	0.99741
.2	0.99646	0.99825	.2	0.99618	0.99797	.2	0.99589	0.99768	.2	0.99559	0.99738
.3	0.99643	0.99822	.3	0.99615	0.99794	.3	0.99586	0.99765	.3	0.99556	0.99735
.4	0.99641	0.99820	.4	0.99612	0.99791	.4	0.99583	0.99762	.4	0.99553	0.99732
.5	0.99638	0.99817	.5	0.99609	0.99788	.5	0.99580	0.99759	.5	0.99550	0.99729
.6	0.99635	0.99814	.6	0.99607	0.99785	.6	0.99577	0.99756	.6	0.99547	0.99726
.7	0.99632	0.99811	.7	0.99604	0.99783	.7	0.99574	0.99753	.7	0.99544	0.99723
.8	0.99629	0.99808	.8	0.99601	0.99780	.8	0.99571	0.99750	.8	0.99541	0.99720
.9	0.99627	0.99806	.9	0.99598	0.99777	.9	0.99568	0.99747	.9	0.99538	0.99716

^A Reference: CRC Handbook of Chemistry and Physics, David R. Lide, Editor-in-Chief, 74th Edition, 1993–1994.

^B

$$\rho_w = 1.00034038 - (7.77 \times 10^{-6}) \times T - (4.95 \times 10^{-6}) \times T^2$$

where:

ρ_w = Density of water in g/mL,

T = the test temperature in °C, and

K = ^{°C}(1.0002003)

^C mL = cm³.

9.2.2 To disperse the soil put about 100 mL of water into the mixing container of a blender or equivalent device. Add the soil and blend. The minimum volume of slurry that can be prepared by this equipment will typically require using a 500-mL pycnometer.

9.2.3 Using the funnel, pour the slurry into the pycnometer. Rinse any soil particles remaining on the funnel into the pycnometer using a wash/spray squirt bottle.

9.2.4 Proceed as described in 9.4.

9.3 *Method B—Procedure for Oven-Dried Specimens:*

9.3.1 Dry the specimen to a constant mass in an oven maintained at 110 ± 5°C. Break up any clods of soil using a mortar and pestle. If the soil will not easily disperse after drying or has changed composition, use Test Method A. Refer to 1.2.1 for soils that require use of Test Method A.

9.3.2 Place the funnel into the pycnometer. The stem of the funnel must extend past the calibration mark or stopper seal. Spoon the soil solids directly into the funnel. Rinse any soil particles remaining on the funnel into the pycnometer using a wash/spray squirt bottle.

9.4 *Preparing the Soil Slurry*—Add water until the water level is between $\frac{1}{3}$ and $\frac{1}{2}$ of the depth of the main body of the pycnometer. Agitate the water until slurry is formed. Rinse any soil adhering to the pycnometer into the slurry.

9.4.1 If slurry is not formed, but a viscous paste, use a pycnometer having a larger volume. See 7.1.1. NOTE 5—For some soils containing a significant fraction of organic matter, kerosene is a better wetting agent than water and may be used in place of distilled water for oven-dried specimens. If kerosene is used, the entrapped air should only be removed by use of an aspirator. Kerosene is a flammable liquid that must be used with extreme caution.

9.5 *Deairing the Soil Slurry*—Entrapped air in the soil slurry can be removed using either heat (boiling), vacuum or combining heat and vacuum.

9.5.1 When using the heat-only method (boiling), use a duration of at least 2 h after the soil-water mixture comes to a full boil. Use only enough heat to keep the slurry boiling. Agitate the slurry as necessary to prevent any soil from sticking to or drying onto the glass above the slurry surface.

9.5.2 If only a vacuum is used, the pycnometer must be continually agitated under vacuum for at least 2 h. Continually agitated means the silt/clay soil solids will remain in suspension, and the slurry is in constant motion. The vacuum must remain relatively constant and be sufficient to cause bubbling at the beginning of the deairing process.

9.5.3 If a combination of heat and vacuum are used, the pycnometers can be placed in a warm water bath (not more than 40°C) while applying the vacuum. The water level in the bath should be slightly below the water level in the pycnometer, if the pycnometer

glass becomes hot, the soil will typically stick to or dry onto the glass. The duration of vacuum and heat must be at least 1 h after the initiation of boiling. During the process, the slurry should be agitated as necessary to maintain boiling and prevent soil from drying onto the pycnometer.

9.6 *Filling the Pycnometer with Water*—Fill the pycnometer with deaired water (see 8.2.2) by introducing the water through a piece of small-diameter flexible tubing with its outlet end kept just below the surface of the slurry in the pycnometer or by using the pycnometer filling tube. If the pycnometer filling tube is used, fill the tube with water, and close the valve. Place the tube such that the drainage holes are just at the surface of the slurry. Open the valve slightly to allow the water to flow over the top of the slurry. As the clear water layer develops, raise the tube and increase the flow rate. If the added water becomes cloudy, do not add water above the calibration mark or into the stopper seal area. Add the remaining water the next day.

9.6.1 If using the stoppered iodine flask, fill the flask, such that the base of the stopper will be submerged in water. Then rest the stopper at an angle on the flared neck to prevent air entrapment under the stopper. If using a volumetric or stoppered flask, fill the flask to above or below the calibration mark depending on preference.

9.7 If heat has been used, allow the specimen to cool to approximately room temperature.

9.8 *Thermal Equilibrium*—Put the pycnometer(s) into a covered insulated container along with the thermometric device (or the temperature sensing portion of the thermometric device), a beaker (or bottle) of deaired water, stopper(s) (if a stoppered pycnometer is being used), and either an eyedropper or pipette. Keep these items in the closed container overnight to achieve thermal equilibrium.

9.9 *Pycnometer Mass Determination*—If the insulated container is not positioned near a balance, move the insulated container near the balance or vice versa. Open the container and remove the pycnometer. Only touch the rim of the pycnometer because the heat from hands can change the thermal equilibrium. Place the pycnometer on an insulated block (Styrofoam or equivalent).

9.9.1 If using a volumetric flask, adjust the water to the calibration mark following the procedure in 8.4.1.

9.9.2 If a stoppered flask is used, adjust the water to prevent entrapment of any air bubbles below the stopper during its placement. If water has to be added, use the thermally equilibrated water from the insulated container. Then, place the stopper in the bottle. If water has to be removed, before or after inserting the stopper, use an eyedropper. Dry the rim using a paper towel. Be sure the entire exterior of the flask is dry.

9.10 Measure and record the mass of pycnometer, soil, and water to the nearest 0.01 g using the same balance used for pycnometer calibration.

9.11 *Pycnometer Temperature Determination*—Measure and record the temperature of the slurry/soil-water mixture to the nearest 0.1°C using the thermometric device and method used during calibration in 8.5. This is the test temperature, T .

9.12 *Mass of Dry Soil*—Determine the mass of a tare or pan to the nearest 0.01 g. Transfer the soil slurry to the tare or pan. It is imperative that all of the soil be transferred. Water can be added. Dry the specimen to a constant mass in an oven maintained at 110 ± 5°C and cool it in a desiccator. If the tare can be sealed so that the soil cannot absorb moisture during cooling, a desiccator is not required. Measure the dry mass of soil solids plus tare to the nearest 0.01 g using the designated balance. Calculate and record the mass of dry soil solids to the nearest 0.01 g.

NOTE 6—This method has been proven to provide more consistent, repeatable results than determining the dry mass prior to testing. This is most probably due to the loss of soil solids during the de-airing phase of testing.

10. Calculation

10.1 Calculate the mass of the pycnometer and water at the test temperature as follows:

$$M_{pw,t} = M_p + (V_p * \rho_{w,t})$$

where:

$M_{pw,t}$ = mass of the pycnometer and water at the test temperature (T), g,

M_p = the average calibrated mass of the dry pycnometer, g,

V_p = the average calibrated volume of the pycnometer, mL, and

$\rho_{w,t}$ = the density of water at the test temperature (T), g/mL from Table 2.

10.2 Calculate the specific gravity at soil solids the test temperature, G_t as follows:

$$G_t = \frac{\rho_s}{\rho_{w,t}} = \frac{M_s}{(M_{pw,t} - (M_{pws,t} - M_s))}$$

where:

ρ_s = the density of the soil solids Mg/m³ or g/cm³,

$\rho_{w,t}$ = the density of water at the test temperature (T), from Table 2, g/mL or g/cm³.

M_s = the mass of the oven dry soil solids (g), and

$M_{pws,t}$ = the mass of pycnometer, water, and soil solids at the test temperature, (T), g.

10.3 Calculate the specific gravity of soil solids at 20°C as follows:

$$G_{20^\circ C} = K * G_t$$

where:

K = the temperature coefficient given in Table 2.

10.4 For soil solids containing particles greater than the 4.75-mm (No. 4) sieve for which Test Method C127 was used to determine the specific gravity of these particles, calculate an average specific gravity. Test Method C127 requires the test be performed at 23 ± 1.7°C and does not require the specific gravity data to be corrected to 20°C. Use 10.3 to correct this measurement to 20°C. Use the following equation to calculate the average specific gravity:

$$G_{avg@20^\circ C} = \frac{1}{\frac{R}{100 * G_{1@20^\circ C}} + \frac{P}{100 * G_{2@20^\circ C}}}$$

where:

R = the percent of soil retained on the 4.75-mm sieve,

P = the percent of soil passing the 4.75-mm sieve, $G_{1@20^\circ C}$ = the apparent specific gravity of soils retained on the 4.75-mm sieve as determined by Test Method C127, corrected to 20°C

$G_{2@20^\circ C}$ = the specific gravity of soil solids passing the 4.75-mm sieve as determined by these test methods (Equation 4).

11. Report: Test Data Sheets(s)/Form(s)

11.1 The method used to specify how data are recorded on the test data sheets or forms, as given below, is the industry standard, and are representative of the significant digits that should be retained. These requirements do not consider in situ material variation, use of the data, special purpose studies, or any considerations for the user's objectives. It is common practice to increase or reduce significant digits of reported data commensurate with these considerations. It is beyond the scope of the standard to consider significant digits used in analysis methods for engineering design.

11.2 Record as a minimum the following information (data):

11.2.1 Identification of the soil (material) being tested, such as boring number, sample number, depth, and test number.

11.2.2 Visual classification of the soil being tested (group name and symbol in accordance with Practice D2487).

11.2.3 Percent of soil particles passing the 4.75-mm (No. 4) sieve.

11.2.4 If any soil or material was excluded from the test specimen, describe the excluded material.

11.2.5 Method used (Method A or Method B).

11.2.6 All mass measurements (to the nearest 0.01 g).

11.2.7 Test temperature (to the nearest 0.1°C).

11.2.8 Specific gravity at 20°C (G , G_s , $G_{20^\circ C}$) to the nearest 0.01. If desired, values to the nearest 0.001 may be recorded.

11.2.9 Average specific gravity at 20°C (G_{ave} or $G_{avg@20^\circ C}$) to the nearest 0.01, if applicable. (See 10.4).

12. Precision and Bias

12.1 *Precision*—Criteria for judging the acceptability of test results obtained by these test methods on a range of soil types using Method A (except the soil was air dried) is given in Tables 3 and 4. These estimates of precision are based on the results of the interlaboratory program conducted by the ASTM Reference Soils and Testing Program.³ In this program, some laboratories performed three replicate tests per soil type (triplicate test laboratory), while other laboratories performed a single test per soil type (single test laboratory). A description of the soils tested is given in 12.1.4. The precision estimates may vary with soil type and method used (Method A or B). Judgement is required when applying these estimates to another soil or method.

12.1.1 The data in Table 3 are based on three replicate tests performed by each triplicate test laboratory on each soil type. The single operator and multilaboratory standard deviation shown in Table 3, Column 4 were obtained in accordance with Practice E691, which recommends each testing laboratory perform a minimum of three replicate tests. Results of two properly conducted tests performed by the same operator on the same material, using the same equipment, and in the shortest practical period of time should not differ by more than the single-operator d_2s limits shown in Table 3, Column 5. For definition of d_2s see Footnote C in Table 3. Results of two properly conducted tests performed by different operators and on different days should not differ by more than the multilaboratory d_2s limits shown in Table 3, Column 5.

TABLE 3 Summary of Test Results from Triplicate Test Laboratories (Specific Gravity)

(1) Soil Type	(2) Number of Triplicate Test Labs	(3) Average Value ^A	(4) Standard Deviation ^B	(5) Acceptable Range of Two Results ^C
<i>Single-Operator Results (Within-Laboratory Repeatability):</i>				
CH	14	2.717	0.009	0.03
CL	13	2.670	0.006	0.02
ML	14	2.725	0.006	0.02
SP	14	2.658	0.006	0.02
<i>Multilaboratory Results (Between-Laboratory Reproducibility):</i>				
CH	14	2.717	0.028	0.08
CL	13	2.670	0.022	0.06
ML	14	2.725	0.022	0.06
SP	14	2.658	0.008	0.02

^A The number of significant digits and decimal places presented are representative of the input data. In accordance with Practice D6026, the standard deviation and acceptable range of results cannot have more decimal places than the input data.

^B Standard deviation is calculated in accordance with Practice E691 and is referred to as the $1s$ limit.

^C Acceptable range of two results is referred to as the d_2s limit. It is calculated as $1.960\sqrt{2}$ $1s$, as defined by Practice E177. The difference between two properly conducted tests should not exceed this limit. The number of significant digits/decimal places presented is equal to that prescribed by these test methods or Practice D6026. In addition, the value presented can have the same number of decimal places as the standard deviation, even if that result has more significant digits than the standard deviation.

TABLE 4 Summary of Single Test Result from Each Laboratory (Specific Gravity)^A

(1) Soil Type	(2) Number of Test Laboratories	(3) Average Value	(4) Standard Deviation	(5) Acceptable Range of Two Results
<i>Multilaboratory Results (Single-Test Performed by Each Laboratory):</i>				
CH	18	2.715	0.027	0.08
CL	18	2.673	0.018	0.05
ML	18	2.726	0.022	0.06
SP	18	2.660	0.007	0.02

^A See footnotes in Table 3.

12.1.2 In the ASTM Reference Soils and Testing Program, many of the laboratories performed only a single test. This is common practice in the design and construction industry. The data in Table 4 are based upon the first test result from the triplicate test laboratories and the single test results from the other laboratories. Results of two properly conducted tests performed by two different laboratories with different operators using different equipment and on different days should not vary by more than the d_2s limits shown in Table 4, Column 5. The results in Tables 3 and 4 are dissimilar because the data sets are different.

12.1.3 Table 3 presents a rigorous interpretation of triplicate test data in accordance with Practice E691 from prequalified laboratories. Table 4 is derived from test data that represents common practice.

12.1.4 *Soil Type*—Based on the multilaboratory test results, the soil used in the program is described below in accordance with Practice D2487. In addition, the local name of the soil is given.

CH—Fat clay, CH, 99 % fines, LL=60, PI=39, grayish brown, soil had been air dried and pulverized. Local name—Vicksburg Buckshot Clay

CL—Lean clay, CL, 89 % fines, LL=33, PI=13, gray, soil had been air dried and pulverized. Local name—Annapolis Clay

ML—Silt, ML, 99 % fines, LL=27, PI=4, light brown, soil had been air dried and pulverized. Local name—Vicksburg Silt

SP—Poorly graded sand; SP, 20 % coarse sand, 48 % medium sand, 30 % fine sand, 2 % fines, yellowish brown. Local name—Frederick sand

12.2 *Bias*—There is no acceptable reference value for this test method, therefore, bias cannot be determined.

A.5 ASTM D422 – 63 Particle-Size Analysis of Soils

1. Scope

1.1 This test method covers the quantitative determination of the distribution of particle sizes in soils. The distribution of particle sizes larger than 75 μm (retained on the No. 200 sieve) is determined by sieving, while the distribution of particle sizes smaller than 75 μm is determined by a sedimentation process, using a hydrometer to secure the necessary data (Note 1 and Note 2).

NOTE 1—Separation may be made on the No. 4 (4.75-mm), No. 40 (425- μm), or No. 200 (75- μm) sieve instead of the No. 10. For whatever sieve used, the size shall be indicated in the report.

NOTE 2—Two types of dispersion devices are provided: (1) a highspeed mechanical stirrer, and (2) air dispersion. Extensive investigations indicate that air-dispersion devices produce a more positive dispersion of plastic soils below the 20- μm size and appreciably less degradation on all sizes when used with sandy soils. Because of the definite advantages favoring air dispersion, its use is recommended. The results from the two types of devices differ in magnitude, depending upon soil type, leading to marked differences in particle size distribution, especially for sizes finer than 20 μm .

2. Referenced Documents

2.1 ASTM Standards:²

D421 Practice for Dry Preparation of Soil Samples for Particle-Size Analysis and Determination of Soil Constants

E11 Specification for Woven Wire Test Sieve Cloth and Test Sieves

E100 Specification for ASTM Hydrometers

2.2 ASTM Adjuncts:³

Air-Jet Dispersion Cup for Grain-Size Analysis of Soils³

3. Apparatus

3.1 *Balances*—A balance sensitive to 0.01 g for weighing the material passing a No. 10 (2.00-mm)

sieve, and a balance sensitive to 0.1 % of the mass of the sample to be weighed for weighing the material retained on a No. 10 sieve.

3.2 *Stirring Apparatus*—Either apparatus A or B may be used.

3.2.1 Apparatus A shall consist of a mechanically operated stirring device in which a suitably mounted electric motor turns a vertical shaft at a speed of not less than 10 000 rpm without load. The shaft shall be equipped with a replaceable stirring paddle made of metal, plastic, or hard rubber, as shown in Fig. 1.

The shaft shall be of such length that the stirring paddle will operate not less than $\frac{1}{4}$ in. (19.0 mm) nor more than $1\frac{1}{2}$ in. (38.1 mm) above the bottom of the dispersion cup. A special dispersion cup conforming to either of the designs shown in Fig. 2 shall be provided to hold the sample while it is being dispersed.

3.2.2 Apparatus B shall consist of an air-jet dispersion cup (See drawing 2.2₃) (Note 3) conforming to the general details shown in Fig. 3 (Note 4 and Note 5).

NOTE 3—The amount of air required by an air-jet dispersion cup is of the order of 2 ft³/min; some small air compressors are not capable of supplying sufficient air to operate a cup.

NOTE 4—Another air-type dispersion device, known as a dispersion tube, developed by Chu and Davidson at Iowa State College, has been shown to give results equivalent to those secured by the air-jet dispersion cups. When it is used, soaking of the sample can be done in the sedimentation cylinder, thus eliminating the need for transferring the slurry. When the air-dispersion tube is used, it shall be so indicated in the report.

NOTE 5—Water may condense in air lines when not in use. This water must be removed, either by using a water trap on the air line, or by blowing the water out of the line before using any of the air for dispersion purposes.

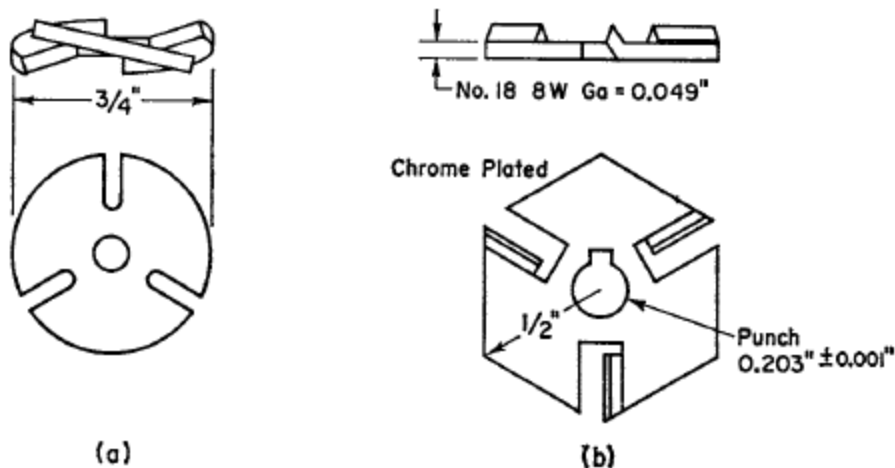

Metric Equivalents					
in.	0.001	0.049	0.203	1/2	3/4
mm	0.03	1.24	5.16	12.7	19.0

FIG. 1 Detail of Stirring Paddles

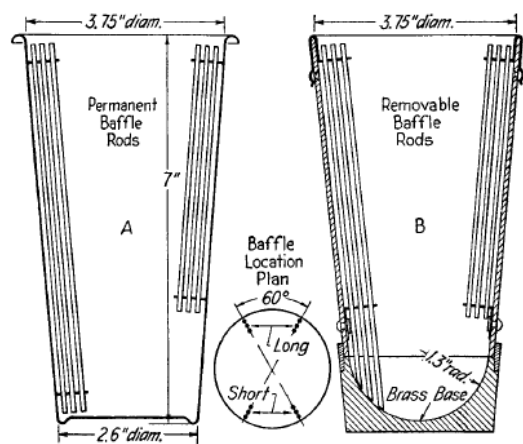

Metric Equivalents			
in.	1.3	2.6	3.75
mm	33	66	95.2

FIG. 2 Dispersion Cups of Apparatus

3.3 *Hydrometer*—An ASTM hydrometer, graduated to read in either specific gravity of the suspension or grams per litre of suspension, and conforming to the requirements for hydrometers 151H or 152H in Specifications E100. Dimensions of both hydrometers are the same, the scale being the only item of difference.

3.4 *Sedimentation Cylinder*—A glass cylinder essentially 18 in. (457 mm) in height and 2 1/2 in. (63.5 mm) in diameter, and marked for a volume of 1000

mL. The inside diameter shall be such that the 1000-mL mark is 36 6 2 cm from the bottom on the inside.

3.5 *Thermometer*—A thermometer accurate to 1°F (0.5°C). 3.6 *Sieves*—A series of sieves, of square-mesh woven-wire cloth, conforming to the requirements of Specification E11. A full set of sieves includes the following (Note 6):

- 3-in. (75-mm) No. 10 (2.00-mm)
- 2-in. (50-mm) No. 20 (850-µm)
- 1 1/2-in. (37.5-mm) No. 40 (425-µm)
- 1-in. (25.0-mm) No. 60 (250-µm)
- 3/4-in. (19.0-mm) No. 140 (106-µm)
- 5/8-in. (9.5-mm) No. 200 (75-µm)
- No. 4 (4.75-mm)

NOTE 6—A set of sieves giving uniform spacing of points for the graph, as required in Section 17, may be used if desired. This set consists of the following sieves:

- 3-in. (75-mm) No. 16 (1.18-mm)
- 1 1/2-in. (37.5-mm) No. 30 (600-µm)
- 3/4-in. (19.0-mm) No. 50 (300-µm)
- 5/8-in. (9.5-mm) No. 100 (150-µm)
- No. 4 (4.75-mm) No. 200 (75-µm)
- No. 8 (2.36-mm)

3.7 *Water Bath or Constant-Temperature Room*—A water bath or constant-temperature room for maintaining the soil suspension at a constant temperature during the hydrometer analysis. A satisfactory water tank is an insulated tank that maintains the temperature of the suspension at a convenient constant temperature at or near 68°F (20°C). Such a device is illustrated in Fig. 4. In cases where the work is performed in a room at an automatically controlled constant temperature, the water bath is not necessary.

3.8 *Beaker*—A beaker of 250-mL capacity.

3.9 *Timing Device*—A watch or clock with a second hand.

4. Dispersing Agent

4.1 A solution of sodium hexametaphosphate (sometimes called sodium metaphosphate) shall be used in distilled or demineralized water, at the rate of

40 g of sodium hexametaphosphate/litre of solution (Note 7).

NOTE 7—Solutions of this salt, if acidic, slowly revert or hydrolyze back to the orthophosphate form with a resultant decrease in dispersive action. Solutions should be prepared frequently (at least once a month) or adjusted to pH of 8 or 9 by means of sodium carbonate. Bottles containing solutions should have the date of preparation marked on them.

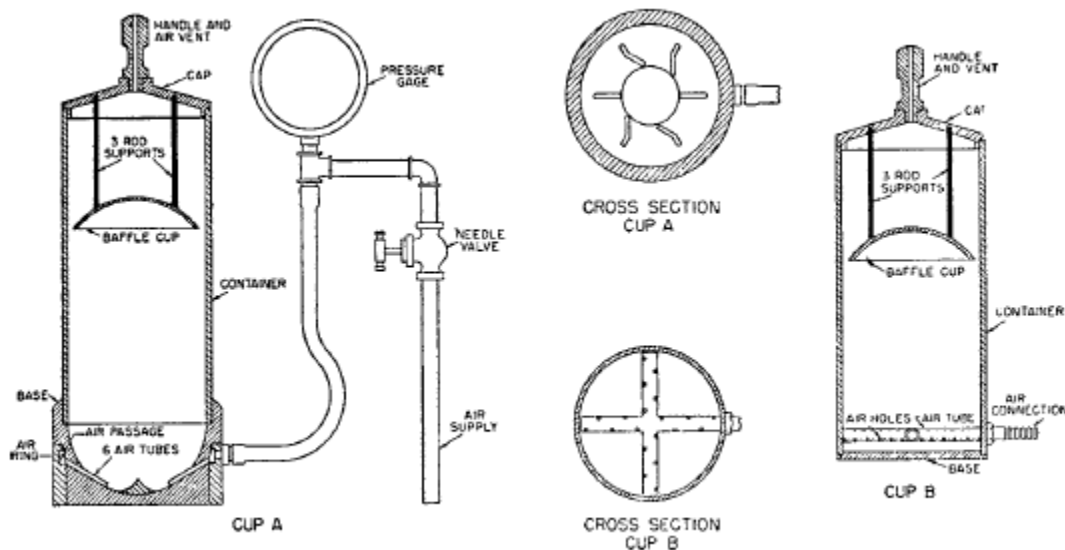
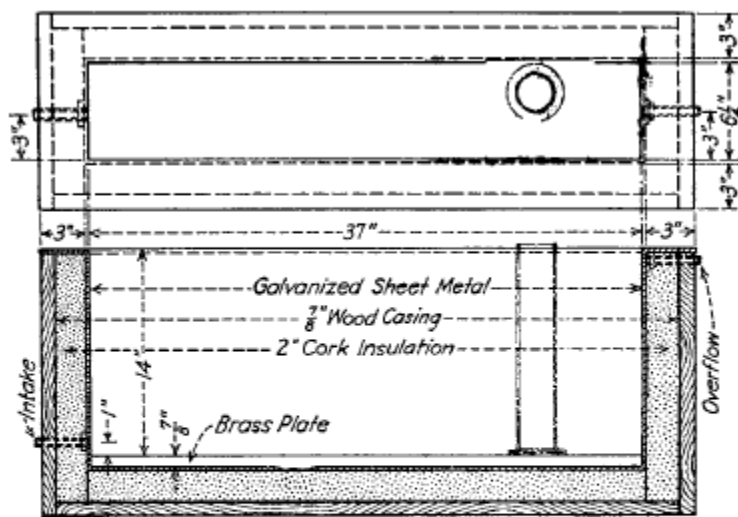

FIG. 3 Air-Jet Dispersion Cups of Apparatus B



Metric Equivalents

in.	7/8	1	3	6 1/4	14	37
mm	22.2	25.4	76.2	158.2	356	940

FIG. 4 Insulated Water Bath

4.2 All water used shall be either distilled or demineralized water. The water for a hydrometer test shall be brought to the temperature that is expected to prevail during the hydrometer test. For example, if the sedimentation cylinder is to be placed in the water bath, the distilled or demineralized water to be used shall be brought to the temperature of the controlled water bath; or, if the sedimentation cylinder is used in a room with controlled temperature, the water for the test shall be at the temperature of the room. The basic temperature for the hydrometer test is 68°F (20°C). Small variations of temperature do not introduce differences that are of practical significance and do not prevent the use of corrections derived as prescribed.

5. Test Sample

5.1 Prepare the test sample for mechanical analysis as outlined in Practice D421. During the preparation procedure the sample is divided into two portions. One portion contains only particles retained on the No. 10 (2.00-mm) sieve while the other portion contains only particles passing the No. 10 sieve. The mass of air-dried soil selected for purpose of tests, as prescribed in Practice D421, shall be sufficient to yield quantities for mechanical analysis as follows:

5.1.1 The size of the portion retained on the No. 10 sieve shall depend on the maximum size of particle, according to the following schedule:

Nominal Diameter of Largest Particles, in. (mm)	Approximate Minimum Mass of Portion, g
3/8 (9.5)	500
1/4 (19.0)	1000
1 (25.4)	2000
1 1/2 (38.1)	3000
2 (50.8)	4000
3 (76.2)	5000

5.1.2 The size of the portion passing the No. 10 sieve shall be approximately 115 g for sandy soils and approximately 65 g for silt and clay soils.

5.2 Provision is made in Section 5 of Practice D421 for weighing of the air-dry soil selected for purpose of tests, the separation of the soil on the No. 10 sieve by dry-sieving and washing, and the weighing of the washed and dried fraction retained on the No. 10 sieve. From these two masses the percentages retained and passing the No. 10 sieve can be calculated in accordance with 12.1.

NOTE 8—A check on the mass values and the thoroughness of pulverization of the clods may be secured by weighing the portion passing the No. 10 sieve and adding this value to the mass of the washed and oven-dried portion retained on the No. 10 sieve.

SIEVE ANALYSIS OF PORTION RETAINED ON NO. 10 (2.00-mm) SIEVE

6. Procedure

6.1 Separate the portion retained on the No. 10 (2.00-mm) sieve into a series of fractions using the 3-in. (75-mm), 2-in. (50-mm), 1 1/2-in. (37.5-mm), 1-in. (25.0-mm), 3/4-in. (19.0-mm), 3/8-in. (9.5-mm), No. 4 (4.75-mm), and No. 10 sieves, or as many as may be needed depending on the sample, or upon the specifications for the material under test.

6.2 Conduct the sieving operation by means of a lateral and vertical motion of the sieve, accompanied by a jarring action in order to keep the sample moving continuously over the surface of the sieve. In no case turn or manipulate fragments in the sample through the sieve by hand. Continue sieving until not more than 1 mass % of the residue on a sieve passes that sieve during 1 min of sieving. When mechanical sieving is used, test the thoroughness of sieving by using the hand method of sieving as described above.

6.3 Determine the mass of each fraction on a balance conforming to the requirements of 3.1. At the end of weighing, the sum of the masses retained on all the sieves used should equal closely the original mass of the quantity sieved.

HYDROMETER AND SIEVE ANALYSIS OF PORTION PASSING THE NO. 10 (2.00-mm) SIEVE

7. Determination of Composite Correction for Hydrometer Reading

7.1 Equations for percentages of soil remaining in suspension, as given in 14.3, are based on the use of distilled or demineralized water. A dispersing agent is used in the water, however, and the specific gravity of the resulting liquid is appreciably greater than that of distilled or demineralized water.

7.1.1 Both soil hydrometers are calibrated at 68°F (20°C), and variations in temperature from this standard temperature produce inaccuracies in the actual hydrometer readings. The amount of the inaccuracy increases as the variation from the standard temperature increases.

7.1.2 Hydrometers are graduated by the manufacturer to be read at the bottom of the meniscus formed by the liquid on the stem. Since it is not possible to secure readings of soil suspensions at the bottom of the meniscus, readings must be taken at the top and a correction applied.

7.1.3 The net amount of the corrections for the three items enumerated is designated as the composite correction, and may be determined experimentally.

7.2 For convenience, a graph or table of composite corrections for a series of 1° temperature differences for the range of expected test temperatures may be prepared and used as needed. Measurement of the composite corrections may be made at two temperatures spanning the range of expected test

temperatures, and corrections for the intermediate temperatures calculated assuming a straight-line relationship between the two observed values.

7.3 Prepare 1000 mL of liquid composed of distilled or demineralized water and dispersing agent in the same proportion as will prevail in the sedimentation (hydrometer) test. Place the liquid in a sedimentation cylinder and the cylinder in the constant-temperature water bath, set for one of the two temperatures to be used. When the temperature of the liquid becomes constant, insert the hydrometer, and, after a short interval to permit the hydrometer to come to the temperature of the liquid, read the hydrometer at the top of the meniscus formed on the stem. For hydrometer 151H the composite correction is the difference between this reading and one; for hydrometer 152H it is the difference between the reading and zero. Bring the liquid and the hydrometer to the other temperature to be used, and secure the composite correction as before.

8. Hygroscopic Moisture

8.1 When the sample is weighed for the hydrometer test, weigh out an auxiliary portion of from 10 to 15 g in a small metal or glass container, dry the sample to a constant mass in an oven at 230 ± 5°F (110 ± 5°C), and weigh again. Record the masses.

9. Dispersion of Soil Sample

9.1 When the soil is mostly of the clay and silt sizes, weigh out a sample of air-dry soil of approximately 50 g. When the soil is mostly sand the sample should be approximately 100 g.

9.2 Place the sample in the 250-mL beaker and cover with 125 mL of sodium hexametaphosphate solution (40 g/L). Stir until the soil is thoroughly wetted. Allow to soak for at least 16 h.

9.3 At the end of the soaking period, disperse the sample further, using either stirring apparatus A or B. If stirring apparatus A is used, transfer the soil-water slurry from the beaker into the special dispersion cup shown in Fig. 2, washing any residue from the beaker into the cup with distilled or demineralized water (Note 9). Add distilled or demineralized water, if necessary, so that the cup is more than half full. Stir for a period of 1 min.

NOTE 9—A large size syringe is a convenient device for handling the water in the washing operation. Other devices include the wash-water bottle and a hose with nozzle connected to a pressurized distilled water tank.

9.4 If stirring apparatus B (Fig. 3) is used, remove the cover cap and connect the cup to a compressed air supply by means of a rubber hose. A air gage must be on the line between the cup and the control valve. Open the control valve so that the gage indicates 1 psi (7 kPa) pressure (Note 10). Transfer the soil-water slurry from the beaker to the air-jet dispersion cup by washing with distilled or demineralized water. Add distilled or demineralized water, if necessary, so that the total volume in the cup is 250 mL, but no more.

NOTE 10—The initial air pressure of 1 psi is required to prevent the soil-water mixture from entering the air-jet chamber when the mixture is transferred to the dispersion cup.

9.5 Place the cover cap on the cup and open the air control valve until the gage pressure is 20 psi (140 kPa). Disperse the soil according to the following schedule:

Plasticity Index; Dispersion Period, min
Under 5; 5
6 to 20; 10
Over 20; 15

Soils containing large percentages of mica need be dispersed for only 1 min. After the dispersion period, reduce the gage pressure to 1 psi preparatory to transfer of soil-water slurry to the sedimentation cylinder.

10. Hydrometer Test

10.1 Immediately after dispersion, transfer the soil-water slurry to the glass sedimentation cylinder, and add distilled or demineralized water until the total volume is 1000 mL.

10.2 Using the palm of the hand over the open end of the cylinder (or a rubber stopper in the open end), turn the cylinder upside down and back for a period of 1 min to complete the agitation of the slurry (Note 11). At the end of 1 min set the cylinder in a convenient location and take hydrometer readings at the following intervals of time (measured from the beginning of sedimentation), or as many as may be needed, depending on the sample or the specification for the material under test: 2, 5, 15, 30, 60, 250, and 1440 min. If the controlled water bath is used, the sedimentation cylinder should be placed in the bath between the 2- and 5-min readings.

NOTE 11—The number of turns during this minute should be approximately 60, counting the turn upside down and back as two turns. Any soil remaining in the bottom of the cylinder during the first few turns should be loosened by vigorous shaking of the cylinder while it is in the inverted position.

10.3 When it is desired to take a hydrometer reading, carefully insert the hydrometer about 20 to 25 s before the reading is due to approximately the depth it will have when the reading is taken. As soon as the reading is taken, carefully remove the hydrometer and place it with a spinning motion in a graduate of clean distilled or demineralized water.

NOTE 12—It is important to remove the hydrometer immediately after each reading. Readings shall be taken at the top of the meniscus formed by the suspension around the stem, since it is not possible to secure readings at the bottom of the meniscus.

10.4 After each reading, take the temperature of the suspension by inserting the thermometer into the suspension.

11. Sieve Analysis

11.1 After taking the final hydrometer reading, transfer the suspension to a No. 200 (75- μ m) sieve and wash with tap water until the wash water is clear. Transfer the material on the No. 200 sieve to a suitable container, dry in an oven at $230 \pm 9^\circ\text{F}$ ($110 \pm 5^\circ\text{C}$) and make a sieve analysis of the portion retained, using as many sieves as desired, or required for the material, or upon the specification of the material under test.

CALCULATIONS AND REPORT

12. Sieve Analysis Values for the Portion Coarser than the No. 10 (2.00-mm) Sieve

12.1 Calculate the percentage passing the No. 10 sieve by dividing the mass passing the No. 10 sieve by the mass of soil originally split on the No. 10 sieve, and multiplying the result by 100. To obtain the mass passing the No. 10 sieve, subtract the mass retained on the No. 10 sieve from the original mass.

12.2 To secure the total mass of soil passing the No. 4 (4.75-mm) sieve, add to the mass of the material passing the No. 10 sieve the mass of the fraction passing the No. 4 sieve and retained on the No. 10 sieve. To secure the total mass of soil passing the $\frac{3}{8}$ -in. (9.5-mm) sieve, add to the total mass of soil passing the No. 4 sieve, the mass of the fraction passing the $\frac{3}{8}$ -in. sieve and retained on the No. 4 sieve. For the remaining sieves, continue the calculations in the same manner.

12.3 To determine the total percentage passing for each sieve, divide the total mass passing (see 12.2) by the total mass of sample and multiply the result by 100.

13. Hygroscopic Moisture Correction Factor

13.1 The hygroscopic moisture correction factor is the ratio between the mass of the oven-dried sample and the air-dry mass before drying. It is a number less than one, except when there is no hygroscopic moisture.

14. Percentages of Soil in Suspension

14.1 Calculate the oven-dry mass of soil used in the hydrometer analysis by multiplying the air-dry mass by the hygroscopic moisture correction factor.

14.2 Calculate the mass of a total sample represented by the mass of soil used in the hydrometer test, by dividing the oven-dry mass used by the percentage passing the No. 10 (2.00-mm) sieve, and multiplying the result by 100. This value is the weight W in the equation for percentage remaining in suspension.

14.3 The percentage of soil remaining in suspension at the level at which the hydrometer is measuring the density of the suspension may be calculated as follows (Note 13): For hydrometer 151H:

$$P = [(100000/W) * G / (G - G_1)](R - G_1)$$

NOTE 13—The bracketed portion of the equation for hydrometer 151H is constant for a series of readings and may be calculated first and then multiplied by the portion in the parentheses.

For hydrometer 152H:

$$P = (R * a/W) * 100$$

where:

a = correction fraction to be applied to the reading of hydrometer 152H. (Values shown on the scale are computed using a specific gravity of 2.65. Correction factors are given in Table 1),

P = percentage of soil remaining in suspension at the level at which the hydrometer measures the density of the suspension,

R = hydrometer reading with composite correction applied (Section 7),

W = oven-dry mass of soil in a total test sample represented by mass of soil dispersed (see 14.2), g,

G = specific gravity of the soil particles, and

G_1 = specific gravity of the liquid in which soil particles are suspended. Use numerical value of one in both instances in the equation. In the first instance any possible variation produces no significant effect, and in the second instance, the composite correction for R is based on a value of one for G_1 .

TABLE 1 Values of Correction Factor, α , for Different Specific Gravities of Soil Particles^A

Specific Gravity	Correction Factor ^A
2.95	0.94
2.90	0.95
2.85	0.96
2.80	0.97
2.75	0.98
2.70	0.99
2.65	1.00
2.60	1.01
2.55	1.02
2.50	1.03
2.45	1.05

^A For use in equation for percentage of soil remaining in suspension when using Hydrometer 152H.

15. Diameter of Soil Particles

15.1 The diameter of a particle corresponding to the percentage indicated by a given hydrometer reading shall be calculated according to Stokes' law (Note 14), on the basis that a particle of this diameter was at the surface of the suspension at the beginning of sedimentation and had settled to the level at which the hydrometer is measuring the density of the suspension. According to Stokes' law: see Table 2

$$D = \sqrt{[30 * n / 980 * (G - G_1)] * L / T}$$

where:

D = diameter of particle, mm,

n = coefficient of viscosity of the suspending medium (in this case water) in poises (varies with changes in temperature of the suspending medium),

L = distance from the surface of the suspension to the level at which the density of the suspension is being measured, cm. (For a given hydrometer and sedimentation cylinder, values vary according to the hydrometer readings. This distance is known as effective depth (see Table 2)),

T = interval of time from beginning of sedimentation to the taking of the reading, min,

G = specific gravity of soil particles, and

G_l = specific gravity (relative density) of suspending medium (value may be used as 1.000 for all practical purposes).

NOTE 14—Since Stokes' law considers the terminal velocity of a single sphere falling in an infinity of liquid, the sizes calculated represent the diameter of spheres that would fall at the same rate as the soil particles.

TABLE 2 Values of Effective Depth Based on Hydrometer and Sedimentation Cylinder of Specified Sizes^A

Hydrometer 151H		Hydrometer 152H			
Actual Hydrometer Reading	Effective Depth, L, cm	Actual Hydrometer Reading	Effective Depth, L, cm	Actual Hydrometer Reading	Effective Depth, L, cm
1.000	16.3	0	16.3	31	11.2
1.001	16.0	1	16.1	32	11.1
1.002	15.8	2	16.0	33	10.9
1.003	15.5	3	15.8	34	10.7
1.004	15.2	4	15.6	35	10.6
1.005	15.0	5	15.5		
1.006	14.7	6	15.3	36	10.4
1.007	14.4	7	15.2	37	10.2
1.008	14.2	8	15.0	38	10.1
1.009	13.9	9	14.8	39	9.9
1.010	13.7	10	14.7	40	9.7
1.011	13.4	11	14.5	41	9.6
1.012	13.1	12	14.3	42	9.4
1.013	12.9	13	14.2	43	9.2
1.014	12.6	14	14.0	44	9.1
1.015	12.3	15	13.8	45	8.9
1.016	12.1	16	13.7	46	8.8
1.017	11.8	17	13.5	47	8.6
1.018	11.5	18	13.3	48	8.4
1.019	11.3	19	13.2	49	8.3
1.020	11.0	20	13.0	50	8.1
1.021	10.7	21	12.9	51	7.9
1.022	10.5	22	12.7	52	7.8
1.023	10.2	23	12.5	53	7.6
1.024	10.0	24	12.4	54	7.4
1.025	9.7	25	12.2	55	7.3
1.026	9.4	26	12.0	56	7.1
1.027	9.2	27	11.9	57	7.0
1.028	8.9	28	11.7	58	6.8
1.029	8.6	29	11.5	59	6.6
1.030	8.4	30	11.4	60	6.5
1.031	8.1				
1.032	7.8				
1.033	7.6				
1.034	7.3				
1.035	7.0				
1.036	6.8				
1.037	6.5				
1.038	6.2				

^A Values of effective depth are calculated from the equation:

$$L = L_1 + 1/2 [L_2 - (V_B/A)] \quad (5)$$

where:

L = effective depth, cm,

L_1 = distance along the stem of the hydrometer from the top of the bulb to the mark for a hydrometer reading, cm,

L_2 = overall length of the hydrometer bulb, cm,

V_B = volume of hydrometer bulb, cm³, and

A = cross-sectional area of sedimentation cylinder, cm²

Values used in calculating the values in Table 2 are as follows:

For both hydrometers, 151H and 152H:

L_2 = 14.0 cm

V_B = 67.0 cm³

A = 27.8 cm²

For hydrometer 151H:

L_1 = 10.5 cm for a reading of 1.000
= 2.3 cm for a reading of 1.031

For hydrometer 152H:

L_1 = 10.5 cm for a reading of 0 g/litre
= 2.3 cm for a reading of 50 g/litre

15.2 For convenience in calculations the above equation may be written as follows: see Table 3

$$D = K\sqrt{L/T}$$

where:

K = constant depending on the temperature of the suspension and the specific gravity of the soil particles. Values of K for a range of temperatures and specific gravities are given in Table 3. The value of K does not change for a series of readings constituting a test, while values of L and T do vary.

15.3 Values of D may be computed with sufficient accuracy, using an ordinary 10-in. slide rule.

NOTE 15—The value of L is divided by T using the A - and B -scales, the square root being indicated on the D -scale. Without ascertaining the value of the square root it may be multiplied by K , using either the C - or CI -scale.

16. Sieve Analysis Values for Portion Finer than No. 10 (2.00-mm) Sieve

16.1 Calculation of percentages passing the various sieves used in sieving the portion of the sample from the hydrometer test involves several steps. The first step is to calculate the mass of the fraction that would have been retained on the No. 10 sieve had it not been removed. This mass is equal to the total percentage retained on the No. 10 sieve (100 minus total percentage passing) times the mass of the total sample represented by the mass of soil used (as calculated in 14.2), and the result divided by 100.

16.2 Calculate next the total mass passing the No. 200 sieve. Add together the fractional masses retained on all the sieves, including the No. 10 sieve, and subtract this sum from the mass of the total sample (as calculated in 14.2).

16.3 Calculate next the total masses passing each of the other sieves, in a manner similar to that given in 12.2.

16.4 Calculate last the total percentages passing by dividing the total mass passing (as calculated in 16.3) by the total mass of sample (as calculated in 14.2), and multiply the result by 100.

TABLE 3 Values of K for Use in Equation for Computing Diameter of Particle in Hydrometer Analysis

Temperature,° C	Specific Gravity of Soil Particles								
	2.45	2.50	2.55	2.60	2.65	2.70	2.75	2.80	2.85
16	0.01530	0.01505	0.01481	0.01457	0.01435	0.01414	0.01394	0.01374	0.01356
17	0.01511	0.01486	0.01462	0.01439	0.01417	0.01396	0.01376	0.01356	0.01338
18	0.01492	0.01467	0.01443	0.01421	0.01399	0.01378	0.01359	0.01339	0.01321
19	0.01474	0.01449	0.01425	0.01403	0.01382	0.01361	0.01342	0.1323	0.01305
20	0.01456	0.01431	0.01408	0.01386	0.01365	0.01344	0.01325	0.01307	0.01289
21	0.01438	0.01414	0.01391	0.01369	0.01348	0.01328	0.01309	0.01291	0.01273
22	0.01421	0.01397	0.01374	0.01353	0.01332	0.01312	0.01294	0.01276	0.01258
23	0.01404	0.01381	0.01358	0.01337	0.01317	0.01297	0.01279	0.01261	0.01243
24	0.01388	0.01365	0.01342	0.01321	0.01301	0.01282	0.01264	0.01246	0.01229
25	0.01372	0.01349	0.01327	0.01306	0.01286	0.01267	0.01249	0.01232	0.01215
26	0.01357	0.01334	0.01312	0.01291	0.01272	0.01253	0.01235	0.01218	0.01201
27	0.01342	0.01319	0.01297	0.01277	0.01258	0.01239	0.01221	0.01204	0.01188
28	0.01327	0.01304	0.01283	0.01264	0.01244	0.01225	0.01208	0.01191	0.01175
29	0.01312	0.01290	0.01269	0.01249	0.01230	0.01212	0.01195	0.01178	0.01162
30	0.01298	0.01276	0.01256	0.01236	0.01217	0.01199	0.01182	0.01165	0.01149

17. Graph

17.1 When the hydrometer analysis is performed, a graph of the test results shall be made, plotting the diameters of the particles on a logarithmic scale as the abscissa and the percentages smaller than the corresponding diameters to an arithmetic scale as the ordinate. When the hydrometer analysis is not made on a portion of the soil, the preparation of the graph is optional, since values may be secured directly from tabulated data.

- (1) Gravel, passing 3-in. and retained on No. 4 sieve %
- (2) Sand, passing No. 4 sieve and retained on No. 200 sieve %
- (a) Coarse sand, passing No. 4 sieve and retained on No. 10 sieve %
- (b) Medium sand, passing No. 10 sieve and retained on No. 40 sieve %
- (c) Fine sand, passing No. 40 sieve and retained on No. 200 sieve %
- (3) Silt size, 0.074 to 0.005 mm %
- (4) Clay size, smaller than 0.005 mm %
- Colloids, smaller than 0.001 mm %

18. Report

18.1 The report shall include the following:

- 18.1.1 Maximum size of particles,
- 18.1.2 Percentage passing (or retained on) each sieve, which may be tabulated or presented by plotting on a graph (Note 16),
- 18.1.3 Description of sand and gravel particles:
 - 18.1.3.1 Shape—rounded or angular,
 - 18.1.3.2 Hardness—hard and durable, soft, or weathered and friable,
- 18.1.4 Specific gravity, if unusually high or low,
- 18.1.5 Any difficulty in dispersing the fraction passing the No. 10 (2.00-mm) sieve, indicating any change in type and amount of dispersing agent, and
- 18.1.6 The dispersion device used and the length of the dispersion period.

NOTE 16—This tabulation of graph represents the gradation of the sample tested. If particles larger than those contained in the sample were removed before testing, the report shall so state giving the amount and maximum size.

18.2 For materials tested for compliance with definite specifications, the fractions called for in such specifications shall be reported. The fractions smaller than the No. 10 sieve shall be read from the graph.

18.3 For materials for which compliance with definite specifications is not indicated and when the soil is composed almost entirely of particles passing the No. 4 (4.75-mm) sieve, the results read from the graph may be reported as follows:

18.4 For materials for which compliance with definite specifications is not indicated and when the soil contains material retained on the No. 4 sieve sufficient to require a sieve analysis on that portion, the results may be reported as follows (Note 17):

SIEVE ANALYSIS	
Sieve Size	Percentage Passing
3-in.
2-in.
1½-in.
1-in.
¾-in.
½-in.
No. 4 (4.75-mm)
No. 10 (2.00-mm)
No. 40 (425-µm)
No. 200 (75-µm)
HYDROMETER ANALYSIS	
0.074 mm
0.005 mm
0.001 mm

NOTE 17—No. 8 (2.36-mm) and No. 50 (300-µm) sieves may be substituted for No. 10 and No. 40 sieves.

19. Keywords

19.1 grain-size; hydrometer analysis; hygroscopic moisture; particle-size; sieve analysis

A.6 ASTM D4318 – 10 Liquid Limit, Plastic Limit, and Plasticity Index of Soils

1. Scope

1.1 These test methods cover the determination of the liquid limit, plastic limit, and the plasticity index of soils as defined in Section 3 on Terminology.

1.2 Two methods for preparing test specimens are provided as follows: *Wet preparation method*, as described in 10.1. *Dry preparation method*, as described in 10.2. The method to be used shall be specified by the requesting authority. If no method is specified, use the wet preparation method.

1.2.1 The liquid and plastic limits of many soils that have been allowed to dry before testing may be considerably different from values obtained on non-dried samples. If the liquid and plastic limits of soils are used to correlate or estimate the engineering behavior of soils in their natural moist state, samples should not be permitted to dry before testing unless data on dried samples are specifically desired.

1.3 Two methods for determining the liquid limit are provided as follows: *Method A*, Multipoint test as described in Sections 11 and 12. *Method B*, One-point test as described in Sections 13 and 14. The method to be used shall be specified by the requesting authority. If no method is specified, use Method A.

1.3.1 The multipoint liquid limit method is generally more precise than the one-point method. It is recommended that the multipoint method be used in cases where test results may be subject to dispute, or where greater precision is required.

1.3.2 Because the one-point method requires the operator to judge when the test specimen is approximately at its liquid limit, it is particularly not recommended for use by inexperienced operators.

1.3.3 The correlation on which the calculations of the one-point method are based may not be valid for certain soils, such as organic soils or soils from a marine environment. It is strongly recommended that the liquid limit of these soils be determined by the multipoint method.

1.4 The plastic limit test is performed on material prepared for the liquid limit test.

1.5 The liquid limit and plastic limit of soils (along with the shrinkage limit) are often collectively referred to as the Atterberg limits. These limits distinguished the boundaries of the several consistency states of plastic soils.

1.6 The composition and concentration of soluble salts in a soil affect the values of the liquid and plastic limits as well as the water content values of soils (see Method D4542). Special consideration should therefore be given to soils from a marine environment or other sources where high soluble salt concentrations may be present. The degree to which the salts present

in these soils are diluted or concentrated must be given careful consideration.

1.7 The methods described herein are performed only on that portion of a soil that passes the 425- μm (No. 40) sieve. Therefore, the relative contribution of this portion of the soil to the properties of the sample as a whole must be considered when using these tests to evaluate properties of a soil.

1.8 The values stated in SI units are to be regarded as the standard, except as noted below. The values given in parentheses are for information only.

1.8.1 The standard units for the resilience tester covered in Annex A1 are inch-pound, not SI. The SI values given are for information only.

1.9 All observed and calculated values shall conform to the guidelines for significant digits and rounding established in Practice D6026.

1.9.1 For purposes of comparing a measured or calculated value(s) with specified limits, the measured or calculated value(s) shall be rounded to the nearest decimal or significant digits in the specified limits.

1.9.2 The procedures used to specify how data are collected/ recorded or calculated, in this standard are regarded as the industry standard. In addition, they are representative of the significant digits that generally should be retained. The procedures do not consider material variation, purpose for obtaining the data, special purpose studies, or any considerations for the user's objectives; and it is common practice to increase or reduce significant digits of reported data to be commensurate with these considerations. It is beyond the scope of this standard to consider significant digits used in analysis methods for engineering design.

1.10 *This standard does not purport to address all of the safety concerns, if any, associated with its use. It is the responsibility of the user of this standard to establish appropriate safety and health practices and determine the applicability of regulatory limitations prior to use.*

2. Referenced Documents

2.1 ASTM Standards:²

C702 Practice for Reducing Samples of Aggregate to Testing Size

D75 Practice for Sampling Aggregates

D420 Guide to Site Characterization for Engineering Design and Construction Purposes

D653 Terminology Relating to Soil, Rock, and Contained Fluids

D1241 Specification for Materials for Soil-Aggregate Subbase, Base, and Surface Courses

D2216 Test Methods for Laboratory Determination of Water (Moisture) Content of Soil and Rock by Mass

D2487 Practice for Classification of Soils for Engineering Purposes (Unified Soil Classification System)
 D3282 Practice for Classification of Soils and Soil-Aggregate Mixtures for Highway Construction Purposes
 D3740 Practice for Minimum Requirements for Agencies Engaged in Testing and/or Inspection of Soil and Rock as Used in Engineering Design and Construction
 D4542 Test Method for Pore Water Extraction and Determination of the Soluble Salt Content of Soils by Refractometer
 D4753 Guide for Evaluating, Selecting, and Specifying Balances and Standard Masses for Use in Soil, Rock, and Construction Materials Testing
 D6026 Practice for Using Significant Digits in Geotechnical Data
 E11 Specification for Woven Wire Test Sieve Cloth and Test Sieves
 E177 Practice for Use of the Terms Precision and Bias in ASTM Test Methods
 E691 Practice for Conducting an Interlaboratory Study to Determine the Precision of a Test Method

3. Terminology

3.1 Definitions:

- 3.1.1 For common definitions of terms in this standard, refer to Terminology D653.
- 3.1.2 *Atterberg Limits*—Originally, six “limits of consistency” of fine-grained soils were defined by Albert Atterberg: the upper limit of viscous flow, the liquid limit, the sticky limit, the cohesion limit, the plastic limit, and the shrinkage limit. In current engineering usage, the term usually refers only to the liquid limit, plastic limit, and in some references, the shrinkage limit.
- 3.1.3 *consistency*—the relative ease with which a soil can be deformed.
- 3.1.4 *liquid limit (LL, w_L)*—the water content, in percent, of a soil at the arbitrarily defined boundary between the semiliquid and plastic states.
- 3.1.4.1 *Discussion*—The undrained shear strength of soil at the liquid limit is considered to be approximately 2 kPa (0.28 psi).
- 3.1.5 *plastic limit (PL, w_p)*—the water content, in percent, of a soil at the boundary between the plastic and semi-solid states.
- 3.1.6 *plastic soil*—a soil which has a range of water content over which it exhibits plasticity and which will retain its shape on drying.
- 3.1.7 *plasticity index (PI)*—the range of water content over which a soil behaves plastically. Numerically, it is the difference between the liquid limit and the plastic limit.
- 3.1.8 *liquidity index*—the ratio, expressed as a percentage of (1) the water content of a soil minus its plastic limit, to (2) its plasticity index.

3.1.9 *activity number (A)*—the ratio of (1) the plasticity index of a soil to (2) the percent by mass of particles having an equivalent diameter smaller than 2 μm .

4. Summary of Test Method

4.1 The specimen is processed to remove any material retained on a 425- μm (No. 40) sieve. The liquid limit is determined by performing trials in which a portion of the specimen is spread in a brass cup, divided in two by a grooving tool, and then allowed to flow together from the shocks caused by repeatedly dropping the cup in a standard mechanical device. The multipoint liquid limit, Method A, requires three or more trials over a range of water contents to be performed and the data from the trials plotted or calculated to make a relationship from which the liquid limit is determined. The one-point liquid limit, Method B, uses the data from two trials at one water content multiplied by a correction factor to determine the liquid limit.

4.2 The plastic limit is determined by alternately pressing together and rolling into a 3.2-mm ($1/8$ -in.) diameter thread a small portion of plastic soil until its water content is reduced to a point at which the thread crumbles and can no longer be pressed together and re-rolled. The water content of the soil at this point is reported as the plastic limit.

4.3 The plasticity index is calculated as the difference between the liquid limit and the plastic limit.

5. Significance and Use

5.1 These test methods are used as an integral part of several engineering classification systems to characterize the finegrained fractions of soils (see Practices D2487 and D3282) and to specify the fine-grained fraction of construction materials (see Specification D1241). The liquid limit, plastic limit, and plasticity index of soils are also used extensively, either individually or together, with other soil properties to correlate with engineering behavior such as compressibility, hydraulic conductivity (permeability), compactibility, shrink-swell, and shear strength.

5.2 The liquid and plastic limits of a soil and its water content can be used to express its relative consistency or liquidity index. In addition, the plasticity index and the percentage finer than 2- μm particle size can be used to determine its activity number.

5.3 These methods are sometimes used to evaluate the weathering characteristics of clay-shale materials. When subjected to repeated wetting and drying cycles, the liquid limits of these materials tend to increase. The amount of increase is considered to be a measure of a shale's susceptibility to weathering.

5.4 The liquid limit of a soil containing substantial amounts of organic matter decreases dramatically when the soil is oven-dried before testing. Comparison

of the liquid limit of a sample before and after oven-drying can therefore be used as a qualitative measure of organic matter content of a soil (see Practice D2487).

NOTE 1—The quality of the result produced by this standard is dependent on the competence of the personnel performing it and the suitability of the equipment and facilities used. Agencies that meet the criteria of Practice D3740, generally, are considered capable of competent and objective testing/sampling/inspection/etc. Users of this standard are cautioned that compliance with Practice D3740 does not in itself assure reliable results. Reliable results depend on many factors; Practice D3740 provides a means of evaluating some of those factors.

6. Apparatus

6.1 *Liquid Limit Device*—A mechanical device consisting of a brass cup suspended from a carriage designed to control its drop onto the surface of a block of resilient material that serves as the base of the device. Fig. 1 shows the essential features and critical dimensions of the device. The device may be operated by either a hand crank or electric motor.

6.1.1 *Base*—A block of material having a resilience rebound of at least 77 % but no more than

90 %. Conduct resilience tests on the finished base with the feet attached. Details for measuring the resilience of the base are given in Annex A1.

6.1.2 *Rubber Feet*, supporting the base, designed to provide dynamic isolation of the base from the work surface.

6.1.3 *Cup*, brass, with a mass, including cup hanger, of 185 to 215 g.

6.1.4 *Cam*—Designed to raise the cup smoothly and continuously to its maximum height, over a distance of at least 180° of cam rotation, without developing an upward or downward velocity of the cup when the cam follower leaves the cam. (The preferred cam motion is a uniformly accelerated lift curve.)

NOTE 2—The cam and follower design in Fig. 1 is for uniformly accelerated (parabolic) motion after contact and assures that the cup has no velocity at drop off. Other cam designs also provide this feature and may be used. However, if the cam-follower lift pattern is not known, zero velocity at drop off can be assured by carefully filing or machining the cam and follower so that the cup height remains constant over the last 20 to 45° of cam rotation.

DIMENSIONS

LETTER	A ^Δ	B ^Δ	C ^Δ	E ^Δ	F	G	H	J ^Δ	K ^Δ	L ^Δ	M ^Δ
MM	54 ± 0.5	2 ± 0.1	27 ± 0.5	56 ± 2.0	32	10	16	60 ± 1.0	50 ± 2.0	150 ± 2.0	125 ± 2.0
LETTER	N	P	R	T	U ^Δ	V	W	Z			
MM	24	28	24	45	47 ± 1.0	3.8	13	6.5			

^Δ ESSENTIAL DIMENSIONS

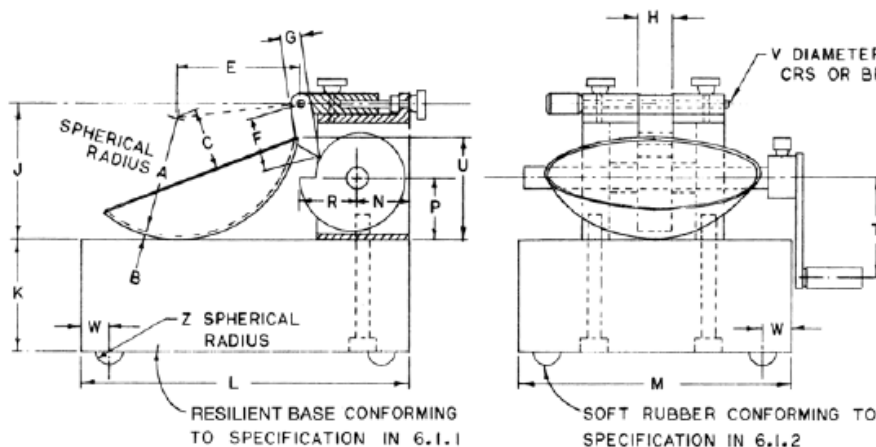

CAM ANGLE DEGREES	CAM RADIUS
0	0.742 R
30	0.753 R
60	0.764 R
90	0.773 R
120	0.784 R
150	0.796 R
180	0.818 R
210	0.854 R
240	0.901 R
270	0.945 R
300	0.974 R
330	0.995 R
360	1.000 R

FIG. 1 Hand-Operated Liquid Limit Device

6.1.5 *Carriage*, constructed in a way that allows convenient but secure adjustment of the height-of-drop of the cup to 10 mm (0.394 in.), and designed such that the cup and cup hanger assembly is only attached to the carriage by means of a removable pin. See Fig. 2 for definition and determination of the height-of-drop of the cup.

6.1.6 *Motor Drive (Optional)*—As an alternative to the hand crank shown in Fig. 1, the device may be equipped with a motor to turn the cam. Such a motor must turn the cam at 2 ± 0.1 revolutions per second and must be isolated from the rest of the device by rubber mounts or in some other way that prevents

vibration from the motor being transmitted to the rest of the apparatus. It must be equipped with an ON-OFF switch and a means of conveniently positioning the cam for height-of-drop adjustments. The results obtained using a motor-driven device must not differ from those obtained using a manually operated device.

6.2 *Flat Grooving Tool*—A tool made of plastic or noncorroding-metal having the dimensions shown in Fig. 3. The design of the tool may vary as long as the essential dimensions are maintained. The tool may, but need not, incorporate the gauge for adjusting the height-of-drop of the liquid limit device.

NOTE 3—Prior to the adoption of this test method, a curved grooving tool was specified as part of the apparatus for performing the liquid limit test. The curved tool is not considered to be as accurate as the flat tool described in 6.2 since it does not control the depth of the soil in the liquid limit cup. However, there are some data which indicate that typically the liquid limit is slightly increased when the flat tool is used instead of the curved tool.

6.3 *Gauge*—A metal gauge block for adjusting the height-of-drop of the cup, having the dimensions shown in Fig. 4. The design of the tool may vary provided the gauge will rest securely on the base without being susceptible to rocking, and the edge which contacts the cup during adjustment is straight, at least 10 mm ($\frac{3}{8}$ in.) wide, and without bevel or radius.

6.4 *Water Content Containers*—Small corrosion-resistant containers with snug-fitting lids for water content specimens. Aluminum or stainless steel cans 2.5 cm (1 in.) high by 5 cm (2 in.) in diameter are appropriate.

6.5 *Balance*, conforming to Specification D4753, Class GP1 (readability of 0.01 g).

6.6 *Mixing and Storage Container*—A container to mix the soil specimen (material) and store the prepared material. During mixing and storage, the container shall not contaminate the material in any way, and prevent moisture loss during storage. A porcelain, glass, or plastic dish about 11.4 cm ($4\frac{1}{2}$ in.) in diameter and a plastic bag large enough to enclose the dish and be folded over is adequate.

6.7 *Plastic Limit*:

6.7.1 *Ground Glass Plate*—A ground glass plate of sufficient size for rolling plastic limit threads.

6.7.2 *Plastic Limit-Rolling Device (optional)*—A device made of acrylic conforming to the dimensions shown in Fig. 5.3.4 The type of unglazed paper attached to the top and bottom plate (see 16.2.2) shall be such that it does not add foreign matter (fibers, paper fragments, etc.) to the soil during the rolling process.

6.8 *Spatula*—A spatula or pill knife having a blade about 2 cm ($\frac{3}{4}$ in.) wide, and about 10 to 13 cm (3 to 4 in.) long.

6.9 *Sieve(s)*—A 200-mm (8-in.) diameter, 425- μ m (No. 40) sieve conforming to the requirements of Specification E11 and having a rim at least 5 cm (2 in.) above the mesh. A 2.00-mm (No. 10) sieve meeting the same requirements may also be needed.

6.10 *Wash Bottle*, or similar container for adding controlled amounts of water to soil and washing fines from coarse particles.

6.11 *Drying Oven*, thermostatically controlled, preferably of the forced-draft type, capable of continuously maintaining a temperature of $110 \pm 5^\circ\text{C}$ ($230 \pm 9^\circ\text{F}$) throughout the drying chamber.

6.12 *Washing Pan*, round, flat-bottomed, at least 7.6 cm (3 in.) deep, and slightly larger at the bottom than a 20.3-cm (8-in.) diameter sieve.

7. Reagents and Materials

7.1 *Purity of Water*—Where distilled water is referred to in this test method, either distilled or demineralized water may be used. See Note 7 covering the use of tap water.

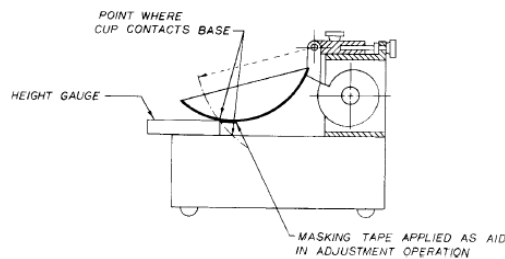

FIG. 2 Calibration for Height-of-Drop

DIMENSIONS

LETTER	A ^Δ	B ^Δ	C ^Δ	D ^Δ	E ^Δ	F ^Δ
MM	2 ± 0.1	11 ± 0.2	40 ± 0.5	8 ± 0.1	50 ± 0.5	2 ± 0.1
LETTER	G	H	J	K [□]	L ^Δ	N
MM	10 MINIMUM	13	60	10 ± 0.05	60 DEG ± 1 DEG	20

^Δ ESSENTIAL DIMENSIONS

[□] BACK AT LEAST 15 MM FROM TIP

NOTE : DIMENSION A SHOULD BE 1.9-2.0 AND DIMENSION D SHOULD BE 8.0-8.1 WHEN NEW TO ALLOW FOR ADEQUATE SERVICE LIFE

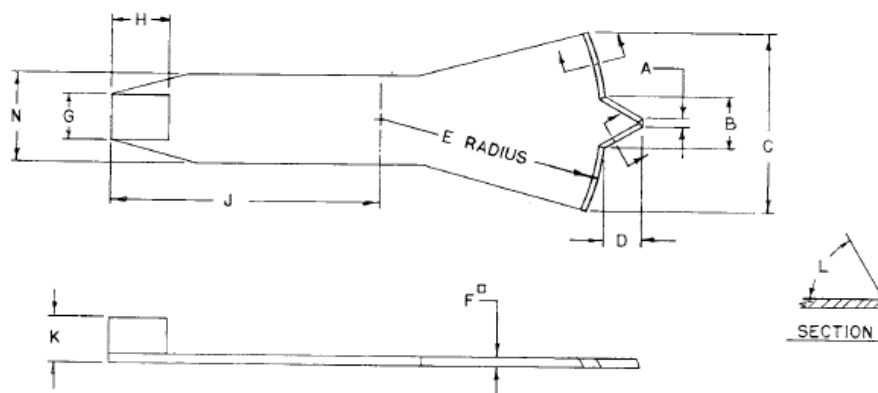
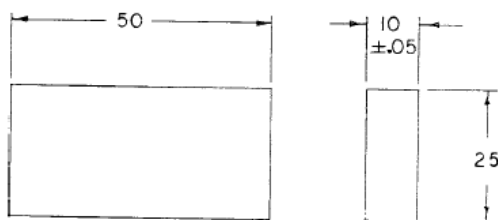

FIG. 3 Grooving Tool (Optional Height-of-Drop Gauge Attached)



DIMENSIONS IN MILLIMETRES
FIG. 4 Height-of-Drop Gauge

8. Sampling and Specimen

8.1 Samples may be taken from any location that satisfies testing needs. However, Practices C702, D75, and D420 should be used as guides for selecting and preserving samples from various types of sampling operations. Samples in which specimens will be prepared using the wet-preparation method (10.1) must be kept at their as-sampled water content prior to preparation.

8.1.1 Where sampling operations have preserved the natural stratification of a sample, the various strata must be kept separated and tests performed on the particular stratum of interest with as little contamination as possible from other strata. Where a mixture of materials will be used in construction, combine the various components in such proportions

that the resultant sample represents the actual construction case.

8.1.2 Where data from these test methods are to be used for correlation with other laboratory or field test data, use the same material as used for those tests where possible.

8.2 *Specimen*—Obtain a representative portion from the total sample sufficient to provide 150 to 200 g of material passing the 425- μ m (No. 40) sieve. Free flowing samples (materials) may be reduced by the methods of quartering or splitting. Non-free flowing or cohesive materials shall be mixed thoroughly in a pan with a spatula or scoop and a representative portion scooped from the total mass by making one or more sweeps with a scoop through the mixed mass.

9. Calibration of Apparatus

9.1 Inspection of Wear:

9.1.1 *Liquid Limit Device*—Determine that the liquid limit device is clean and in good working order. Check the following specific points.

9.1.1.1 *Wear of Base*—The spot on the base where the cup makes contact should be worn no greater than 10 mm ($\frac{3}{8}$ in.) in diameter. If the wear spot is greater than this, the base can be machined to remove the worn spot provided the resurfacing does not make the base thinner than specified in 6.1 and the other dimensional relationships are maintained.

Dimensions:

IW—100 mm (4 in.), more or less

L—200 mm (8 in.), more or less

T-top—10 to 15 mm (3/8 to 1/2 in.) or thicker, see Note B

T-bottom—5 mm (1/4 in.) or thicker

H—is the height of the slide rails. It shall equal 3.2 mm (1/8 in.) plus the total thickness of the unglazed paper that is not in contact with the top or bottom surface of the slide rails. The tolerance on this height is $\pm 1/4$ mm ($\pm 1/100$ in.), see Note C.

W—See Note A.

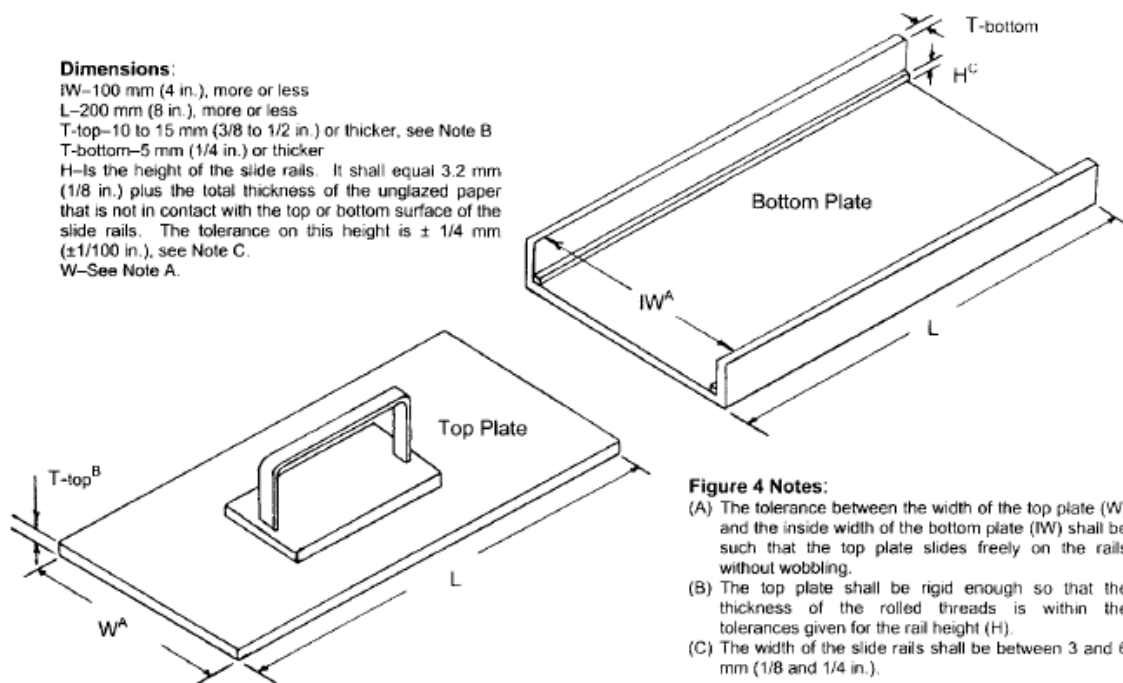
**Figure 4 Notes:**

- (A) The tolerance between the width of the top plate (W) and the inside width of the bottom plate (IW) shall be such that the top plate slides freely on the rails without wobbling.
- (B) The top plate shall be rigid enough so that the thickness of the rolled threads is within the tolerances given for the rail height (H).
- (C) The width of the slide rails shall be between 3 and 6 mm (1/8 and 1/4 in.).

FIG. 5 Plastic Limit-Rolling Device

9.1.1.2 *Wear of Cup*—Replace the cup when the grooving tool has worn a depression in the cup 0.1 mm (0.004 in.) deep or when the rim of the cup has been reduced to half its original thickness. Verify that the cup is firmly attached to the cup hanger.

9.1.1.3 *Wear of Cup Hanger*—Verify that the cup hanger pivot does not bind and is not worn to an extent that allows more than 3 mm ($\sqrt{8}$ in.) side-to-side movement of the lowest point on the rim.

9.1.1.4 *Wear of Cam*—The cam shall not be worn to an extent that the cup drops before the cup hanger (cam follower) loses contact with the cam.

9.1.1.5 *Rubber Feet*—The feet should prevent the base from bouncing or sliding on the work surface. Replace rubber feet that become hard, cracked, or brittle from age.

9.1.2 *Grooving Tools*—Inspect grooving tools for wear on a frequent and regular basis. The rapidity of wear depends on the material from which the tool is made, and the types of soils being tested. Soils containing a large proportion of fine sand particles may cause rapid wear of grooving tools; therefore, when testing these materials, tools should be inspected more frequently than for other soils.

NOTE 4—The width of the tip of grooving tools is conveniently checked using a pocket-sized measuring magnifier equipped with a millimeter scale. Magnifiers of this type are available from most laboratory supply companies. The depth of the tip of grooving tools can be checked using the depth-measuring feature of vernier calipers.

9.2 *Adjustment of Height-of-Drop*—Adjust the height-of-drop of the cup so that the point on the cup that comes in contact with the base rises to a height of

10 \pm 0.2 mm. See Fig. 2 for proper location of the gauge relative to the cup during adjustment.

NOTE 5—A convenient procedure for adjusting the height-of-drop is as follows: place a piece of masking tape across the outside bottom of the cup parallel with the axis of the cup hanger pivot. The edge of the tape away from the cup hanger should bisect the spot on the cup that contacts the base. For new cups, placing a piece of carbon paper on the base and allowing the cup to drop several times will mark the contact spot. Attach the cup to the device and turn the crank until the cup is raised to its maximum height. Slide the height gauge under the cup from the front, and observe whether the gauge contacts the cup or the tape. (See Fig. 2.) If the tape and cup are both simultaneously contacted, the height-of-drop is ready to be checked. If not, adjust the cup until simultaneous contact is made. Check adjustment by turning the crank at 2 revolutions per second while holding the gauge in position against the tape and cup. If a faint ringing or clicking sound is heard without the cup rising from the gauge, the adjustment is correct. If no ringing is heard or if the cup rises from the gauge, readjust the height-of-drop. If the cup rocks on the gauge during this checking operation, the cam follower pivot is excessively worn and the worn parts should be replaced. Always remove tape after completion of adjustment operation.

10. Preparation of Test Specimen

10.1 *Wet Preparation Method*—Except where the dry method of specimen preparation is specified (10.2), prepare the specimen for testing as described in the following sections.

10.1.1 *Material Passes the 425- μ m (No. 40) Sieve:*

10.1.1.1 Determine by visual and manual methods that the specimen from 8.2 has little or no material retained on a 425- μm (No. 40) sieve. If this is the case, prepare 150 to 200 g of material by mixing thoroughly with distilled or demineralized water on the glass plate or mixing dish using the spatula. If desired, soak the material in a mixing/storage dish with a small amount of water to soften the material before the start of mixing. If using Method A, adjust the water content of the material to bring it to a consistency that would require about 25 to 35 blows of the liquid limit device to close the groove (Note 6). For Method B, the number of blows should be between about 20 and 30 blows.

10.1.1.2 If, during mixing, a small percentage of material is encountered that would be retained on a 425- μm (No. 40) sieve, remove these particles by hand (if possible). If it is impractical to remove the coarser material by hand, remove small percentages (less than about 15 %) of coarser material by working the material (having the above consistency) through a 425- μm sieve. During this procedure, use a piece of rubber sheeting, rubber stopper, or other convenient device provided the procedure does not distort the sieve or degrade material that would be retained if the washing method described in 10.1.2 were used. If larger percentages of coarse material are encountered during mixing, or it is considered impractical to remove the coarser material by the procedures just described, wash the sample as described in 10.1.2. When the coarse particles found during mixing are concretions, shells, or other fragile particles, do not crush these particles to make them pass a 425- μm sieve, but remove by hand or by washing.

10.1.1.3 Place the prepared material in the mixing/storage dish, check its consistency (adjust if required), cover to prevent loss of moisture, and allow to stand (cure) for at least 16 h (overnight). After the standing period and immediately before starting the test, thoroughly remix the soil.

NOTE 6—The time taken to adequately mix a soil will vary greatly, depending on the plasticity and initial water content. Initial mixing times of more than 30 min may be needed for stiff, fat clays.

10.1.2 Material Containing Particles Retained on a 425- μm (No. 40) Sieve:

10.1.2.1 Place the specimen (see 8.2) in a pan or dish and add sufficient water to cover the material. Allow the material to soak until all lumps have softened and the fines no longer adhere to the surfaces of the coarse particles (Note 7).

NOTE 7—In some cases, the cations of salts present in tap water will exchange with the natural cations in the soil and significantly alter the test results if tap water is used in the soaking and washing operations. Unless it is known that such cations are not present in the tap water, distilled or demineralized water should be used. As a general rule, water containing more than 100 mg/L of dissolved solids should not be used for either the soaking or washing operations.

10.1.2.2 When the material contains a large percentage of particles retained on the 425- μm (No. 40) sieve, perform the following washing operation in increments, washing no more than 0.5 kg (1 lb) of material at one time. Place the 425- μm sieve in the bottom of the clean pan. Transfer, without any loss of material, the soil-water mixture onto the sieve. If gravel or coarse sand particles are present, rinse as many of these as possible with small quantities of water from a wash bottle, and discard. Alternatively, transfer the soil-water mixture over a 2.00-mm (No. 10) sieve nested atop the 425- μm sieve, rinse the fine material through and remove the 2.00-mm sieve. After washing and removing as much of the coarser material as possible, add sufficient water to the pan to bring the level to about 13 mm ($\frac{1}{2}$ in.) above the surface of the 425- μm sieve. Agitate the slurry by stirring with the fingers while raising and lowering the sieve in the pan and swirling the suspension so that fine material is washed from the coarser particles. Disaggregate fine soil lumps that have not slaked by gently rubbing them over the sieve with the fingertips. Complete the washing operation by raising the sieve above the water surface and rinsing the material retained with a small amount of clean water. Discard material retained on the 425- μm sieve.

10.1.2.3 Reduce the water content of the material passing the 425- μm (No. 40) sieve until it approaches the liquid limit. Reduction of water content may be accomplished by one or a combination of the following methods: (a) exposing to air currents at room temperature, (b) exposing to warm air currents from a source such as an electric hair dryer, (c) decanting clear water from surface of the suspension, (d) filtering in a Büchner funnel or using filter candles, or (e) draining in a colander or plaster of Paris dish lined with high retentivity, high wetstrength filter paper. If a plaster of Paris dish is used, take care that the dish never becomes sufficiently saturated that it fails to absorb water into its surface. Thoroughly dry dish between uses. During evaporation and cooling, stir the material often enough to prevent over-drying of the fringes and soil pinnacles on the surface of the mixture. For materials containing soluble salts, use a method of water reduction (a or b) that will not eliminate the soluble salts from the test specimen.

10.1.2.4 If applicable, remove the material retained on the filter paper. Thoroughly mix this material or the above material on the glass plate or in the mixing dish using the spatula. Adjust the water content of the mixture, if necessary, by adding small increments of distilled or demineralized water or by allowing the mixture to dry at room temperature while mixing on the glass plate. If using Method A, the material should be at a water content that would require about 25 to 35 blows of the liquid limit device to close the groove. For Method B, the number of blows should be between about 20 and 30. Put, if necessary, the mixed material in the storage dish, cover to prevent loss of moisture, and allow to stand (cure) for at least 16 h.

After the standing period and immediately before starting the test, thoroughly remix the specimen.

10.2 Dry Preparation Method:

10.2.1 Dry the specimen from 8.2 at room temperature or in an oven at a temperature not exceeding 60°C until the soil clods will pulverize readily. Disaggregation is expedited if the material is not allowed to completely dry. However, the material should have a dry appearance when pulverized.

10.2.2 Pulverize the material in a mortar with a rubber-tipped pestle or in some other way that does not cause breakdown of individual particles. When the coarse particles found during pulverization are concretions, shells, or other fragile particles, do not crush these particles to make them pass a 425- μm (No. 40) sieve, but remove by hand or other suitable means, such as washing. If a washing procedure is used, follow 10.1.2.1-10.1.2.4.

10.2.3 Separate the material on a 425- μm (No. 40) sieve, shaking the sieve by hand to assure thorough separation of the finer fraction. Return the material retained on the 425- μm sieve to the pulverizing apparatus and repeat the pulverizing and sieving operations. Stop this procedure when most of the fine material has been disaggregated and material retained on the 425- μm sieve consists of individual particles.

10.2.4 Place material retained on the 425- μm (No. 40) sieve after the final pulverizing operations in a dish and soak in a small amount of water. Stir this mixture and transfer it to a 425- μm sieve, catching the water and any suspended fines in the washing pan. Pour this suspension into a dish containing the dry soil previously sieved through the 425- μm sieve. Discard material retained on the 425- μm sieve.

10.2.5 Proceed as described in 10.1.2.3 and 10.1.2.4.

MULTIPOINT LIQUID LIMIT—METHOD A

11. Procedure

11.1 Thoroughly remix the specimen (soil) in its mixing dish, and, if necessary, adjust its water content until the consistency requires about 25 to 35 blows of the liquid limit device to close the groove. Using a spatula, place a portion(s) of the prepared soil in the cup of the liquid limit device at the point where the cup rests on the base, squeeze it down, and spread it into the cup to a depth of about 10 mm at its deepest point, tapering to form an approximately horizontal surface. Take care to eliminate air bubbles from the soil pat, but form the pat with as few strokes as possible. Keep the unused soil in the mixing/storage dish. Cover the dish with a wet towel (or use other means) to retain the moisture in the soil.

11.2 Form a groove in the soil pat by drawing the tool, beveled edge forward, through the soil on a line joining the highest point to the lowest point on the rim of the cup. When cutting the groove, hold the grooving tool against the surface of the cup and draw in an arc, maintaining the tool perpendicular to the

surface of the cup throughout its movement. See Fig. 6. In soils where a groove cannot be made in one stroke without tearing the soil, cut the groove with several strokes of the grooving tool. Alternatively, cut the groove to slightly less than required dimensions with a spatula and use the grooving tool to bring the groove to final dimensions. Exercise extreme care to prevent sliding the soil pat relative to the surface of the cup.

11.3 Verify that no crumbs of soil are present on the base or the underside of the cup. Lift and drop the cup by turning the crank at a rate of 1.9 to 2.1 drops per second until the two halves of the soil pat come in contact at the bottom of the groove along a distance of 13 mm ($\frac{1}{2}$ in.). See Fig. 7 and Fig. 8. The base of the machine shall not be held with the hand, or hands, while the crank is turned.

NOTE 8—Use of a scale is recommended to verify that the groove has closed 13 mm ($\frac{1}{2}$ in.).

11.4 Verify that an air bubble has not caused premature closing of the groove by observing that both sides of the groove have flowed together with approximately the same shape. If a bubble has caused premature closing of the groove, reform the soil in the cup, adding a small amount of soil to make up for that lost in the grooving operation and repeat 11.1-11.3. If the soil slides on the surface of the cup, repeat 11.1-11.3 at a higher water content. If, after several trials at successively higher water contents, the soil pat continues to slide in the cup or if the number of blows required to close the groove is always less than 25, record that the liquid limit could not be determined, and report the soil as nonplastic without performing the plastic limit test.

11.5 Record the number of drops, N , required to close the groove. Remove a slice of soil approximately the width of the spatula, extending from edge to edge of the soil cake at right angles to the groove and including that portion of the groove in which the soil flowed together, place in a container of known mass, and cover.

11.6 Return the soil remaining in the cup to the dish. Wash and dry the cup and grooving tool and reattach the cup to the carriage in preparation for the next trial.

11.7 Remix the entire soil specimen in the dish adding distilled water to increase the water content of the soil and decrease the number of blows required to close the groove. Repeat 11.1-11.6 for at least two additional trials producing successively lower numbers of blows to close the groove. One of the trials shall be for a closure requiring 25 to 35 blows, one for closure between 20 and 30 blows, and one trial for a closure requiring 15 to 25 blows.

11.8 Determine the water content, W_n , of the soil specimen from each trial in accordance with Test Method D2216.

11.8.1 Determination of initial masses (container plus moist soil) should be performed immediately after completion of the test. If the test is to be

interrupted for more than about 15 minutes, determine the mass of the water content specimens already obtained at the time of the interruption.

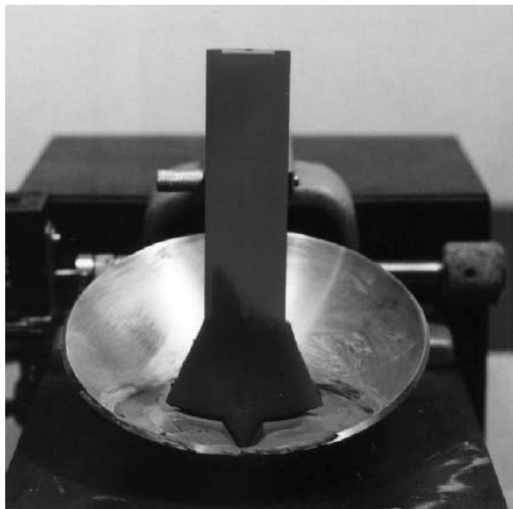

FIG. 6 Example of Grooving Tool Placed in a Properly Grooved Soil Pat



FIG. 7 Grooved Soil Pat in Liquid Limit Device



FIG. 8 Soil Pat After Groove Has Closed

12. Calculation

12.1 Plot the relationship between the water content, W_n , and the corresponding number of drops, N , of the cup on a semilogarithmic graph with the water content as ordinates on the arithmetical scale, and the number of drops as abscissas on a logarithmic scale. Draw the best straight line through the three or more plotted points.

12.2 Take the water content corresponding to the intersection of the line with the 25-drop abscissa as the liquid limit of the soil and round to the nearest whole number. Computational methods may be substituted for the graphical method for fitting a straight line to the data and determining the liquid limit.

ONE-POINT LIQUID LIMIT—METHOD B

13. Procedure

13.1 Proceed as described in 11.1-11.5 except that the number of blows required to close the groove shall be 20 to 30. If less than 20 or more than 30 blows are required, adjust the water content of the soil and repeat the procedure.

13.2 Immediately after removing a water content specimen as described in 11.5, reform the soil in the cup, adding a small amount of soil to make up for that lost in the grooving and water content sampling processes.

13.2.1 As an alternative to reforming the soil in the brass cup after removing the water content specimen, the soil remaining in the cup can be removed from the cup, remixed with the soil in the mixing container and a new specimen placed in the cup as described in 11.1.

13.3 Repeat 11.2-11.5

13.4 If the second closing of the groove requires the same number of drops or no more than two drops difference, secure another water content specimen. If the difference of the number of drops between the first and second closings of the groove is greater than two, remix the entire specimen and repeat the procedure, beginning at 13.1, until two successive closures having the same number of drops or no more than two drops difference are obtained.

NOTE 9—Excessive drying or inadequate mixing will cause the number of blows to vary.

13.5 Determine water contents of the two specimens in accordance with 11.8.

14. Calculation

14.1 Determine the liquid limit for each water content specimen using one of the following equations:

$$LL^n = W^n * \left(\frac{N}{25}\right)^{0.121}$$

OR

$$LL^n = k * W^n$$

where:

LL_n = one point liquid limit for given trial, %,

N = number of blows causing closure of the groove for given trial,

W_n = water content for given trial, %, and

k = factor given in Table 1.

14.1.1 The liquid limit, LL , is the average of the two trial liquid-limit values, to the nearest whole number (without the percent designation).

14.2 If the difference between the two trial liquid-limit values is greater than one percentage point, repeat the test as described in 13.1 through 14.1.1.

PLASTIC LIMIT

15. Preparation of Test Specimen

15.1 Select a 20-g or more portion of soil from the material prepared for the liquid limit test; either, after the second mixing before the test, or from the soil remaining after completion of the liquid limit test. Reduce the water content of the soil to a consistency at which it can be rolled without sticking to the hands by spreading or mixing continuously on the glass plate or in the mixing/storage dish. The drying process may be accelerated by exposing the soil to the air current from an electric fan, or by blotting with paper, that does not add any fiber to the soil. Paper such as hard surface paper toweling or high wet-strength filter paper is adequate.

16. Procedure

16.1 From this plastic-limit specimen, select a 1.5 to 2.0 g portion. Form the selected portion into an ellipsoidal mass.

16.2 Roll the soil mass by one of the following methods (hand or rolling device):

16.2.1 *Hand Method*—Roll the mass between the palm or fingers and the ground-glass plate with just sufficient pressure to roll the mass into a thread of uniform diameter throughout its length (see Note 10). The thread shall be further deformed on each stroke so that its diameter reaches 3.2 mm ($\frac{1}{8}$ in.), taking no more than 2 min (see Note 11). The amount of hand or finger pressure required will vary greatly according to the soil being tested, that is, the required pressure typically increases with increasing plasticity. Fragile soils of low plasticity are best rolled under the outer edge of the palm or at the base of the thumb.

TABLE 1 Factors for Obtaining Liquid Limit from Water Content and Number of Drops Causing Closure of Groove

N (Number of Drops)	k (Factor for Liquid Limit)
20	0.973
21	0.979
22	0.985
23	0.990
24	0.995
25	1.000
26	1.005
27	1.009
28	1.014
29	1.018
30	1.022

NOTE 10—A normal rate of rolling for most soils should be 80 to 90 strokes per minute, counting a stroke as one complete motion of the hand forward and back to the starting position. This rate of rolling may have to be decreased for very fragile soils. NOTE 11—A 3.2-mm ($\frac{1}{8}$ -in.) diameter rod or tube is useful for frequent comparison with the soil thread to ascertain when the thread has reached the proper diameter.

16.2.2 *Rolling Device Method*—Attach smooth unglazed paper to both the top and bottom plates of the plastic limit-rolling device. Place the soil mass on the bottom plate at the midpoint between the slide rails. Place the top plate in contact with the soil mass(es). Simultaneously apply a slight downward force and back and forth motion to the top plate so that the top plate comes into contact with the side rails within 2 min (see Notes 10 and 12). During this rolling process, the end(s) the soil thread(s) shall not contact the side rail(s). If this occurs, roll a smaller mass of soil (even if it is less than that mentioned in Section 16.1).

NOTE 12—In most cases, two soil masses (threads) can be rolled simultaneously in the plastic limit-rolling device.

16.3 When the diameter of the thread becomes 3.2 mm, break the thread into several pieces. Squeeze the pieces together, knead between the thumb and first finger of each hand, reform into an ellipsoidal mass, and re-roll. Continue this alternate rolling to a thread 3.2 mm in diameter, gathering together, kneading and re-rolling, until the thread crumbles under the pressure required for rolling and the soil can no longer be rolled into a 3.2-mm diameter thread (see Fig. 9). It has no significance if the thread breaks into threads of shorter length. Roll each of these shorter threads to 3.2 mm in diameter. The only requirement for continuing the test is that these threads can be reformed into an ellipsoidal mass and rolled out again. The operator shall at no time attempt to produce failure at exactly 3.2-mm diameter by allowing the thread to reach 3.2 mm, then reducing the rate of rolling or the hand pressure, or both, while continuing the rolling without further deformation until the thread falls apart. It is permissible, however, to reduce the total amount of deformation for feebly plastic soils by making the initial diameter of the ellipsoidal mass nearer to the required 3.2-mm final diameter. If crumbling occurs when the thread has a diameter greater than 3.2 mm, this shall be considered a satisfactory end point,

provided the soil has been previously rolled into a thread 3.2 mm in diameter. Crumbling of the thread will manifest itself differently with the various types of soil. Some soils fall apart in numerous small aggregations of particles, others may form an outside tubular layer that starts splitting at both ends. The splitting progresses toward the middle, and finally, the thread falls apart in many small platy particles. Fat clay soils require much pressure to deform the thread, particularly as they approach the plastic limit. With these soils, the thread breaks into a series of barrel-shaped segments about 3.2 to 9.5 mm ($\frac{1}{8}$ to $\frac{3}{8}$ in.) in length.

16.4 Gather the portions of the crumbled thread together and place in a container of known mass. Immediately cover the container.

16.5 Select another 1.5 to 2.0-g portion of soil from the plastic-limit specimen and repeat the operations described in 16.1 and 16.2 until the container has at least 6 g of soil.

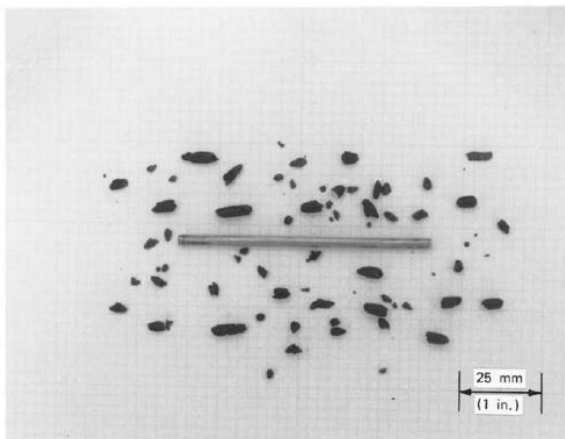

FIG. 9 Lean Clay Soil at the Plastic Limit

16.6 Repeat 16.1-16.5 to make another container holding at least 6 g of soil. Determine the water content of the soil contained in the containers in accordance with Test Method D2216. See 11.8.1.

17. Calculation

17.1 Compute the average of the two water contents (trial plastic limits) and round to the nearest whole number. This value is the plastic limit, *PL*. Repeat the test if the difference between the two trial plastic limits is greater than the acceptable range for two results listed in Table 2 for single-operator precision, that is, 1.4 percentage points; i.e., (2.8 ± 0.5) .

PLASTICITY INDEX

18. Calculation

18.1 Calculate the plasticity index as follows:

$$PI = LL - PL$$

where:

LL = liquid limit (whole number), and
PL = plastic limit (whole number).

18.1.1 Both *LL* and *PL* are whole numbers. If either the liquid limit or plastic limit could not be determined, or if the plastic limit is equal to or greater than the liquid limit, report the soil as nonplastic, NP.

19. Report: Test Data Sheet(s)/Form(s)

19.1 The terminology used to specify how data are recorded on the test data sheet(s)/form(s), as given below, is covered in 1.9.

19.2 Record as a minimum the following information:

19.2.1 Sample/specimen identifying information, such as project name, project number, boring number, depth (m or ft).

19.2.2 Description of sample, such as approximate maximum grain size, estimate of the percentage of sample retained on the 425- μ m (No. 40) sieve, as-received water content.

19.2.3 Details of specimen preparation, such as wet or dry (air-dried or oven-dried), method of removing particles larger than the 425- μ m (No. 40) sieve.

19.2.4 Any special specimen selection process used, such as removal of sand lenses from an intact (undisturbed) sample.

19.2.5 Equipment used, such as hand rolled or mechanical rolling device for plastic limit, manual or mechanical liquid limit device, metal or plastic grooving tool.

19.2.6 Liquid limit, plastic limit, and plasticity index to the nearest whole number, omitting the percent designation. If the liquid limit or plastic limit tests could not be performed, or if the plastic limit is equal to or greater than the liquid limit, report the soil as nonplastic, NP.

19.2.7 Procedure by which liquid limit was performed, if it differs from the multipoint method.

20. Precision and Bias

20.1 *Precision*—Criteria for judging the acceptability of test results obtained by these test methods on a range of soil types are given in Tables 2 and 3. In performing these test methods, Method A and the Wet Preparation Method (except soil was air-dried) were used.

20.1.1 These estimates of precision are based on the results of the interlaboratory program conducted by the ASTM Reference Soils and Testing Program.⁶ In this program, some laboratories performed three replicate tests per soil type (triplicate test laboratory), while other laboratories performed a single test per soil type (single-test laboratory). A description of the soils tested is given in 20.1.5. The precision estimates vary with soil type and method(s) used. Judgment is

required when applying these estimates to another soil and method used (Method A or B, or Wet or Dry Preparation Method).

20.1.2 The data in Table 2 are based on three replicate tests performed by each triplicate test laboratory on each soil type. The single operator and multilaboratory standard deviation shown in Table 2, Column 4, were obtained in accordance with Practice E691, which recommends each testing laboratory perform a minimum of three replicate tests. Results of two properly conducted tests performed by the same operator on the same material, using the same equipment, and in the shortest practical period of time should not differ by more than the single-operator d_{2s} limits shown in Table 2, Column 5. For definition of d_{2s} see Footnote C in Table 2. Results of two properly conducted tests performed by different operators and on different days should not differ by more than the multilaboratory d_{2s} limits shown in Table 2, Column 5.

20.1.3 In the ASTM Reference Soils and Testing Program, many of the laboratories performed only a single test on each soil type. This is common practice in the design and construction industry. The data for each soil type in Table 3 are based upon the first test results from the triplicate test laboratories and the

single test results from the other laboratories. Results of two properly conducted tests performed by two different laboratories with different operators using different equipment and on different days should not vary by more than the d_{2s} limits shown in Table 3, Column 5. The results in Table 2 and Table 3 are dissimilar because the data sets are different.

20.1.4 Table 2 presents a rigorous interpretation of triplicate test data in accordance with Practice E691 from pre-qualified laboratories. Table 3 is derived from test data that represents common practice.

20.1.5 *Soil Types*—Based on the multilaboratory test results, the soils used in the program are described below in accordance with Practice D2487. In addition, the local names of the soils are given.

CH—Fat clay, CH, 99 % fines, LL=60, PI=39, grayish brown, soil had been air dried and pulverized. Local name—Vicksburg Buckshot Clay
CL—Lean clay, CL, 89 % fines, LL=33, PI=13, gray, soil had been air dried and pulverized. Local name—Annapolis Clay
ML—Silt, ML, 99 % fines, LL=27, PI=4, light brown, soil had been air dried and pulverized. Local name—Vicksburg Silt

20.2 *Bias*—There is no acceptable reference value for these test methods; therefore, bias cannot be determined.

21. Keywords

21.1 activity; Atterberg limits; liquid limit; plasticity index; plastic limit

TABLE 2 Summary of Test Results from Triplicate Test Laboratories (Atterberg Limits)

(1) Soil Type	(2) Number of Triplicate Test Laboratories			(3) Average Value ^A (Percentage Points)			(4) Standard Deviation ^B (Percentage Points)			(5) Acceptable Range of Two Results ^C (Percentage Points)		
	LL	PL	PI	Type Test								
				LL	PL	PI	LL	PL	PI	LL	PL	PI
<i>Single-Operator Results (Within-Laboratory Repeatability)</i>												
CH	13	13	13	59.8	20.6	39.2	0.7	0.5	0.8	2	1	2
CL	14	13	13	33.4	19.9	13.6	0.3	0.4	0.5	1	1	1
ML	12	11	11	27.4	23.4 ^D	4.1 ^D	0.5	0.3	0.6	2	1	2
<i>Multilaboratory Results (Between-Laboratory Reproducibility)</i>												
CH	13	13	13	59.8	20.6	39.2	1.3	2.0	2.5	4	6	7
CL	14	13	13	33.4	19.9	13.6	1.0	1.2	1.7	3	3	5
ML	12	11	11	27.4	23.4 ^D	4.1 ^D	1.3	0.9	1.9	4	3	5

^A The number of significant digits and decimal places presented are representative of the input data. In accordance with Practice D6026, the standard deviation and acceptable range of results can not have more decimal places than the input data.

^B Standard deviation is calculated in accordance with Practice E691 and is referred to as the 1s limit.

^C Acceptable range of two results is referred to as the d_{2s} limit. It is calculated as $-1.960 \cdot \sqrt{2} \cdot 1s$, as defined by Practice E177. The difference between two properly conducted tests should not exceed this limit. The number of significant digits/decimal places presented is equal to that prescribed by this test method or Practice D6026. In addition, the value presented can have the same number of decimal places as the standard deviation, even if that result has more significant digits than the standard deviation.

^D For the ML soil, 2 out of 14 triplicate test laboratories reported the soil as nonplastic.

TABLE 3 Summary of Single-Test Result from Each Laboratory (Atterberg Limits)^A

(1) Soil Type	(2) Number of Test Laboratories	(3) Average Value (Percentage Points)			(4) Standard Deviation (Percentage Points)			(5) Acceptable Range of Two Results (Percentage Points)		
		LL	PL	PI	Type Test					
					LL	PL	PI	LL	PL	PI
CH	24	59.9	20.4	39.5	2.1	2.7	3.1	6	7	9
CL	24	33.3	19.9	13.4	0.8	1.3	1.6	2	4	4
ML	18	27.1	23.2 ^B	3.9 ^B	1.3	1.2	1.8	4	3	5

^A For column footnotes, see Table 3.

^B For the ML soil, 6 out of 24 laboratories reported the soil as nonplastic.

A.7 ASTM D2487 – 10 Classification of Soils for Engineering Purposes

1. Scope

1.1 This practice describes a system for classifying mineral and organo-mineral soils for engineering purposes based on laboratory determination of particle-size characteristics, liquid limit, and plasticity index and shall be used when precise classification is required.

NOTE 1—Use of this standard will result in a single classification group symbol and group name except when a soil contains 5 to 12 % fines or when the plot of the liquid limit and plasticity index values falls into the crosshatched area of the plasticity chart. In these two cases, a dual symbol is used, for example, GP-GM, CL-ML. When the laboratory test results indicate that the soil is close to another soil classification group, the borderline condition can be indicated with two symbols separated by a slash. The first symbol should be the one based on this standard, for example, CL/CH, GM/SM, SC/CL. Borderline symbols are particularly useful when the liquid limit value of clayey soils is close to 50. These soils can have expansive characteristics and the use of a borderline symbol (CL/CH, CH/CL) will alert the user of the assigned classifications of expansive potential.

1.2 The group symbol portion of this system is based on laboratory tests performed on the portion of a soil sample passing the 3-in. (75-mm) sieve (see Specification E11).

1.3 As a classification system, this standard is limited to naturally occurring soils.

NOTE 2—The group names and symbols used in this test method may be used as a descriptive system applied to such materials as shale, claystone, shells, crushed rock, etc. See Appendix X2.

1.4 This standard is for qualitative application only.

NOTE 3—When quantitative information is required for detailed designs of important structures, this test method must be supplemented by laboratory tests or other quantitative data to determine performance characteristics under expected field conditions.

1.5 This standard is the ASTM version of the Unified Soil Classification System. The basis for the classification scheme is the Airfield Classification System developed by A. Casagrande in the early 1940s.² It became known as the Unified Soil Classification System when several U.S. Government Agencies adopted a modified version of the Airfield System in 1952.

1.6 *This standard does not purport to address all of the safety concerns, if any, associated with its use. It is the responsibility of the user of this standard to establish appropriate safety and health practices and determine the applicability of regulatory limitations prior to use.*

1.7 *This practice offers a set of instructions for performing one or more specific operations. This document cannot replace education or experience and should be used in conjunction with professional*

judgment. Not all aspects of this practice may be applicable in all circumstances. This ASTM standard is not intended to represent or replace the standard of care by which the adequacy of a given professional service must be judged, nor should this document be applied without consideration of a project's many unique aspects. The word "Standard" in the title of this document means only that the document has been approved through the ASTM consensus process.

2. Referenced Documents

2.1 ASTM Standards:³

- C117 Test Method for Materials Finer than 75- μ m (No. 200) Sieve in Mineral Aggregates by Washing
- C136 Test Method for Sieve Analysis of Fine and Coarse Aggregates
- C702 Practice for Reducing Samples of Aggregate to Testing Size
- D420 Guide to Site Characterization for Engineering Design and Construction Purposes
- D422 Test Method for Particle-Size Analysis of Soils
- D653 Terminology Relating to Soil, Rock, and Contained Fluids
- D1140 Test Methods for Amount of Material in Soils Finer than No. 200 (75- μ m) Sieve
- D2216 Test Methods for Laboratory Determination of Water (Moisture) Content of Soil and Rock by Mass
- D2217 Practice for Wet Preparation of Soil Samples for Particle-Size Analysis and Determination of Soil Constants
- D2488 Practice for Description and Identification of Soils (Visual-Manual Procedure)
- D3740 Practice for Minimum Requirements for Agencies Engaged in Testing and/or Inspection of Soil and Rock as Used in Engineering Design and Construction
- D4083 Practice for Description of Frozen Soils (Visual-Manual Procedure)
- D4318 Test Methods for Liquid Limit, Plastic Limit, and Plasticity Index of Soils
- D4427 Classification of Peat Samples by Laboratory Testing
- D6913 Test Methods for Particle-Size Distribution (Gradation) of Soils Using Sieve Analysis
- E11 Specification for Woven Wire Test Sieve Cloth and Test Sieves

3. Terminology

3.1 *Definitions*—Except as listed below, all definitions are in accordance with Terminology D653.

NOTE 4—For particles retained on a 3-in. (75-mm) U.S. standard sieve, the following definitions are suggested:

Cobbles—particles of rock that will pass a 12-in. (300-mm) square opening and be retained on a 3-in. (75-mm) U.S. standard sieve, and

Boulders—particles of rock that will not pass a 12-in. (300-mm) square opening.

3.1.1 *clay*—soil passing a No. 200 (75- μ m) U.S. standard sieve that can be made to exhibit plasticity (putty-like properties) within a range of water contents and that exhibits considerable strength when air dry. For classification, a clay is a fine-grained soil, or the fine-grained portion of a soil, with a plasticity index equal to or greater than 4, and the plot of plasticity index versus liquid limit falls on or above the “A” line.

3.1.2 *gravel*—particles of rock that will pass a 3-in. 75-mm sieve and be retained on a No. 4 (4.75-mm) U.S. standard sieve with the following subdivisions:

Coarse—passes 3-in. (75-mm) sieve and retained on $\frac{3}{4}$ -in. (19-mm) sieve, and

Fine—passes $\frac{3}{4}$ -in. (19-mm) sieve and retained on No. 4 (4.75-mm) sieve.

3.1.3 *organic clay*—a clay with sufficient organic content to influence the soil properties. For classification, an organic clay is a soil that would be classified as a clay except that its liquid limit value after oven drying is less than 75 % of its liquid limit value before oven drying.

3.1.4 *organic silt*—a silt with sufficient organic content to influence the soil properties. For classification, an organic silt is a soil that would be classified as a silt except that its liquid limit value after oven drying is less than 75 % of its liquid limit value before oven drying.

3.1.5 *peat*—a soil composed of vegetable tissue in various stages of decomposition usually with an organic odor, a dark-brown to black color, a spongy consistency, and a texture ranging from fibrous to amorphous.

3.1.6 *sand*—particles of rock that will pass a No. 4 (4.75-mm) sieve and be retained on a No. 200 (75- μ m) U.S. standard sieve with the following subdivisions:

Coarse—passes No. 4 (4.75-mm) sieve and retained on No. 10 (2.00-mm) sieve,

Medium—passes No. 10 (2.00-mm) sieve and retained on No. 40 (425- μ m) sieve, and

Fine—passes No. 40 (425- μ m) sieve and retained on No. 200 (75- μ m) sieve.

3.1.7 *silt*—soil passing a No. 200 (75- μ m) U.S. standard sieve that is nonplastic or very slightly plastic and that exhibits little or no strength when air dry. For

classification, a silt is a fine-grained soil, or the fine-grained portion of a soil, with a plasticity index less than 4 or if the plot of plasticity index versus liquid limit falls below the “A” line.

3.2 *Definitions of Terms Specific to This Standard:*

3.2.1 *coefficient of curvature, C_c*—the ratio $(D_{30})^2 / (D_{10} D_{60})$, where D_{60} , D_{30} , and D_{10} are the particle sizes corresponding to 60, 30, and 10 % finer on the cumulative particle-size distribution curve, respectively.

3.2.2 *coefficient of uniformity, C_u*—the ratio D_{60} / D_{10} , where D_{60} and D_{10} are the particle diameters corresponding to 60 and 10 % finer on the cumulative particle-size distribution curve, respectively.

4. Summary

4.1 As illustrated in Table 1, this classification system identifies three major soil divisions: coarse-grained soils, fine-grained soils, and highly organic soils. These three divisions are further subdivided into a total of 15 basic soil groups.

4.2 Based on the results of visual observations and prescribed laboratory tests, a soil is catalogued according to the basic soil groups, assigned a group symbol(s) and name, and thereby classified. The flow charts, Fig. 1 for fine-grained soils, and Fig. 3 for coarse-grained soils, can be used to assign the appropriate group symbol(s) and name.

5. Significance and Use

5.1 This standard classifies soils from any geographic location into categories representing the results of prescribed laboratory tests to determine the particle-size characteristics, the liquid limit, and the plasticity index.

5.2 The assigning of a group name and symbol(s) along with the descriptive information required in Practice D2488 can be used to describe a soil to aid in the evaluation of its significant properties for engineering use.

5.3 The various groupings of this classification system have been devised to correlate in a general way with the engineering behavior of soils. This standard provides a useful first step in any field or laboratory investigation for geotechnical engineering purposes.

5.4 This standard may also be used as an aid in training personnel in the use of Practice D2488.

5.5 This standard may be used in combination with Practice D4083 when working with frozen soils.

TABLE 1 Soil Classification Chart

Criteria for Assigning Group Symbols and Group Names Using Laboratory Tests ^A				Soil Classification			
				Group Symbol	Group Name ^B		
COARSE-GRAINED SOILS	Gravels (More than 50 % of coarse fraction retained on No. 4 sieve)	Clean Gravels (Less than 5 % fines ^C)	$Cu \geq 4$ and $1 \leq Cc \leq 3^D$	GW	Well-graded gravel ^F		
			$Cu < 4$ and/or $[Cc < 1$ or $Cc > 3]^D$	GP	Poorly graded gravel ^F		
	More than 50 % retained on No. 200 sieve	Gravels with Fines (More than 12 % fines ^C)		Fines classify as ML or MH	GM	Silty gravel ^{F,G}	
				Fines classify as CL or CH	GC	Clayey gravel ^{F,G}	
		Sands (50 % or more of coarse fraction passes No. 4 sieve)	Clean Sands (Less than 5 % fines ^H)	$Cu \geq 6$ and $1 \leq Cc \leq 3^D$	SW	Well-graded sand ^I	
				$Cu < 6$ and/or $[Cc < 1$ or $Cc > 3]^D$	SP	Poorly graded sand ^I	
Sands with Fines (More than 12 % fines ^H)		Fines classify as ML or MH	SM	Silty sand ^{F,G,I}			
		Fines classify as CL or CH	SC	Clayey sand ^{F,G,I}			
FINE-GRAINED SOILS	Silt and Clays Liquid limit less than 50	inorganic	$PI > 7$ and plots on or above "A" line ^J	CL	Lean clay ^{K,L,M}		
			$PI < 4$ or plots below "A" line ^J	ML	Silt ^{K,L,M}		
	50 % or more passes the No. 200 sieve	Silt and Clays Liquid limit 50 or more	inorganic	PI plots on or above "A" line	CH	Fat clay ^{K,L,M}	
				PI plots below "A" line	MH	Elastic silt ^{K,L,M}	
			organic		$\frac{\text{Liquid limit} - \text{oven dried}}{\text{Liquid limit} - \text{not dried}} < 0.75$	OL	Organic clay ^{K,L,M,N} Organic silt ^{K,L,M,O}
HIGHLY ORGANIC SOILS	Primarily organic matter, dark in color, and organic odor			PT	Peat		

^A Based on the material passing the 3-in. (75-mm) sieve.

^B If field sample contained cobbles or boulders, or both, add "with cobbles or boulders, or both" to group name.

^C Gravels with 5 to 12 % fines require dual symbols:

GW-GM well-graded gravel with silt

GW-GC well-graded gravel with clay

GP-GM poorly graded gravel with silt

GP-GC poorly graded gravel with clay

^D $Cu = D_{60}/D_{10}$ $Cc = (D_{30})^2 / D_{10} \times D_{60}$

^E If soil contains ≥ 15 % sand, add "with sand" to group name.

^F If fines classify as CL-ML, use dual symbol GC-GM, or SC-SM.

^G If fines are organic, add "with organic fines" to group name.

^H Sands with 5 to 12 % fines require dual symbols:

SW-SM well-graded sand with silt

SW-SC well-graded sand with clay

SP-SM poorly graded sand with silt

SP-SC poorly graded sand with clay

^I If soil contains ≥ 15 % gravel, add "with gravel" to group name.

^J If Atterberg limits plot in hatched area, soil is a CL-ML, silty clay.

^K If soil contains 15 to < 30 % plus No. 200, add "with sand" or "with gravel," whichever is predominant.

^L If soil contains ≥ 30 % plus No. 200, predominantly sand, add "sand" to group name.

^M If soil contains ≥ 30 % plus No. 200, predominantly gravel, add "gravelly" to group name.

^N $PI \geq 4$ and plots on or above "A" line.

^O $PI < 4$ or plots below "A" line.

^P PI plots on or above "A" line.

^Q PI plots below "A" line.

NOTE 5—Notwithstanding the statements on precision and bias contained in this standard: The precision of this test method is dependent on the competence of the personnel performing it and the suitability of the equipment and facilities used. Agencies that meet the criteria of Practice D3740 are generally considered capable of competent and objective testing. Users of this test method are cautioned that compliance with

Practice D3740 does not in itself assure reliable testing. Reliable testing depends on several factors; Practice D3740 provides a means for evaluating some of those factors.

6. Apparatus

6.1 In addition to the apparatus that may be required for obtaining and preparing the samples and conducting the prescribed laboratory tests, a plasticity chart, similar to Fig. 4, and a cumulative particle-size distribution curve, similar to Fig. 5, are required.

NOTE 6—The "U" line shown on Fig. 4 has been empirically determined to be the approximate "upper limit" for natural soils. It is a good check against erroneous data, and any test results that plot above or to the left of it should be verified.

7. Sampling

7.1 Samples shall be obtained and identified in accordance with a method or methods, recommended in Guide D420 or by other accepted procedures

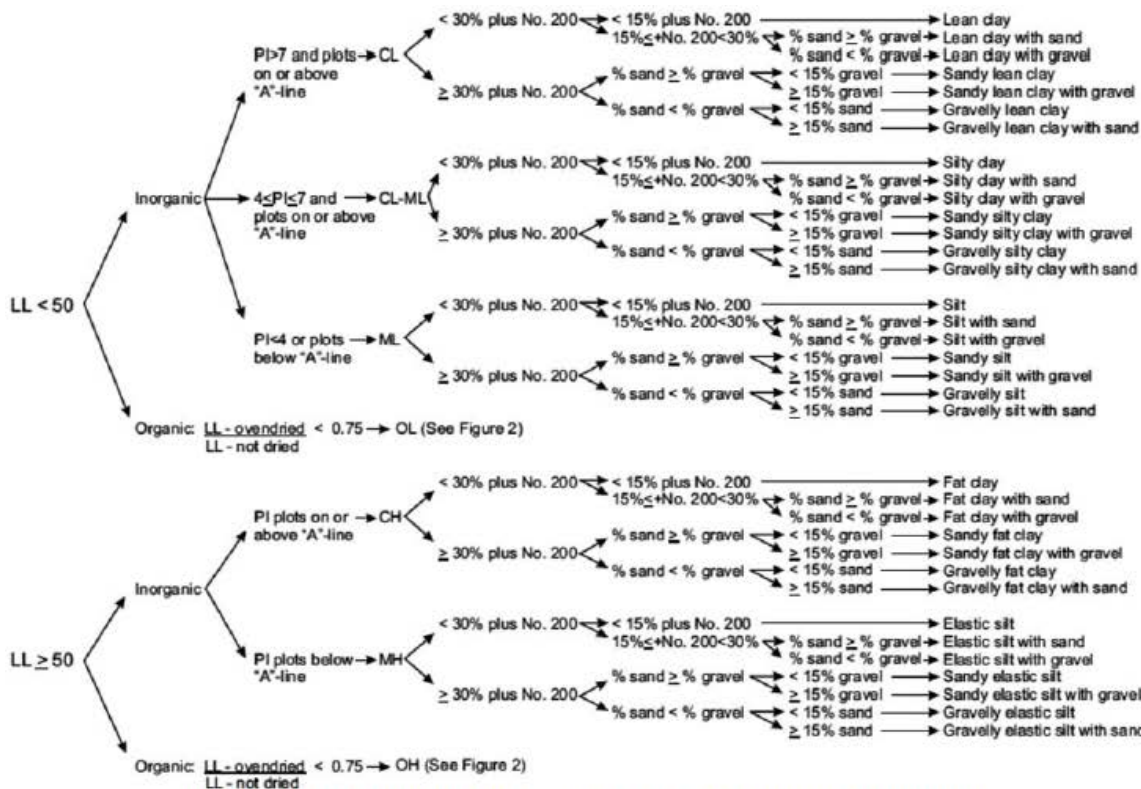

FIG. 1 Flow Chart for Classifying Fine-Grained Soil (50 % or More Passes No. 200 Sieve)

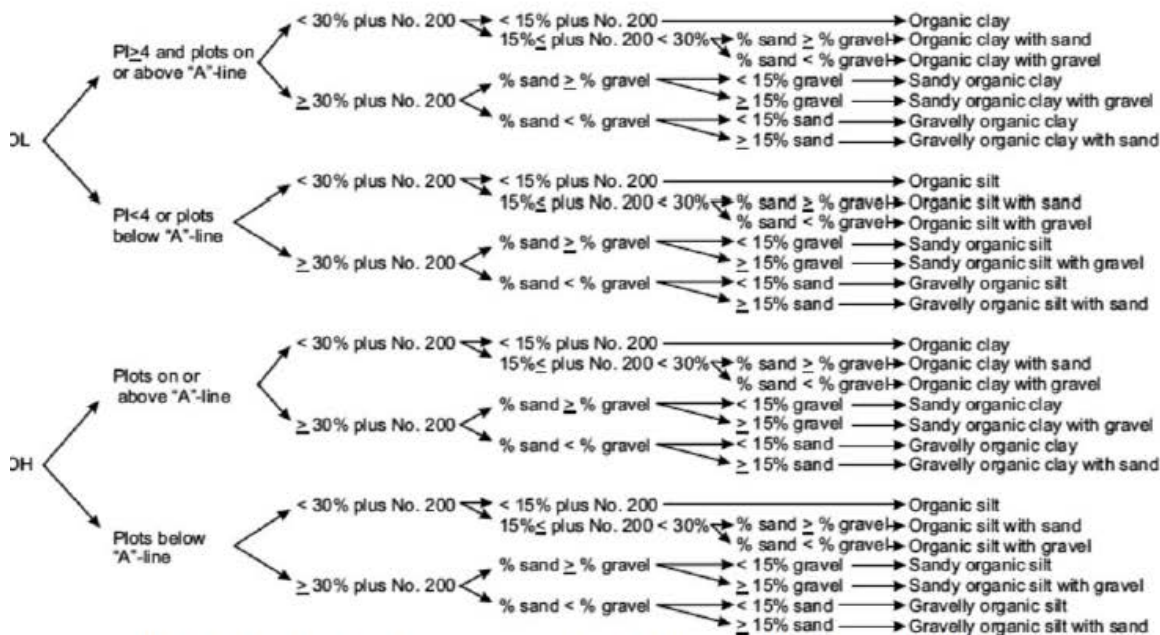

FIG. 2 Flow Chart for Classifying Organic Fine-Grained Soil (50 % or More Passes No. 200 Sieve)

7.2 Test Methods D6913 provides guidance on selecting size of specimen. Two test methods are provided in this standard. The methods differ in the significant digits recorded and the size of the specimen (mass) required. The method to be used may be specified by the requesting authority; otherwise

Method A shall be performed. Whenever possible, the field samples should have weights two to four times larger than shown.

7.3 If the field sample or test specimen is smaller than the minimum recommended amount, the report shall include an appropriate remark.

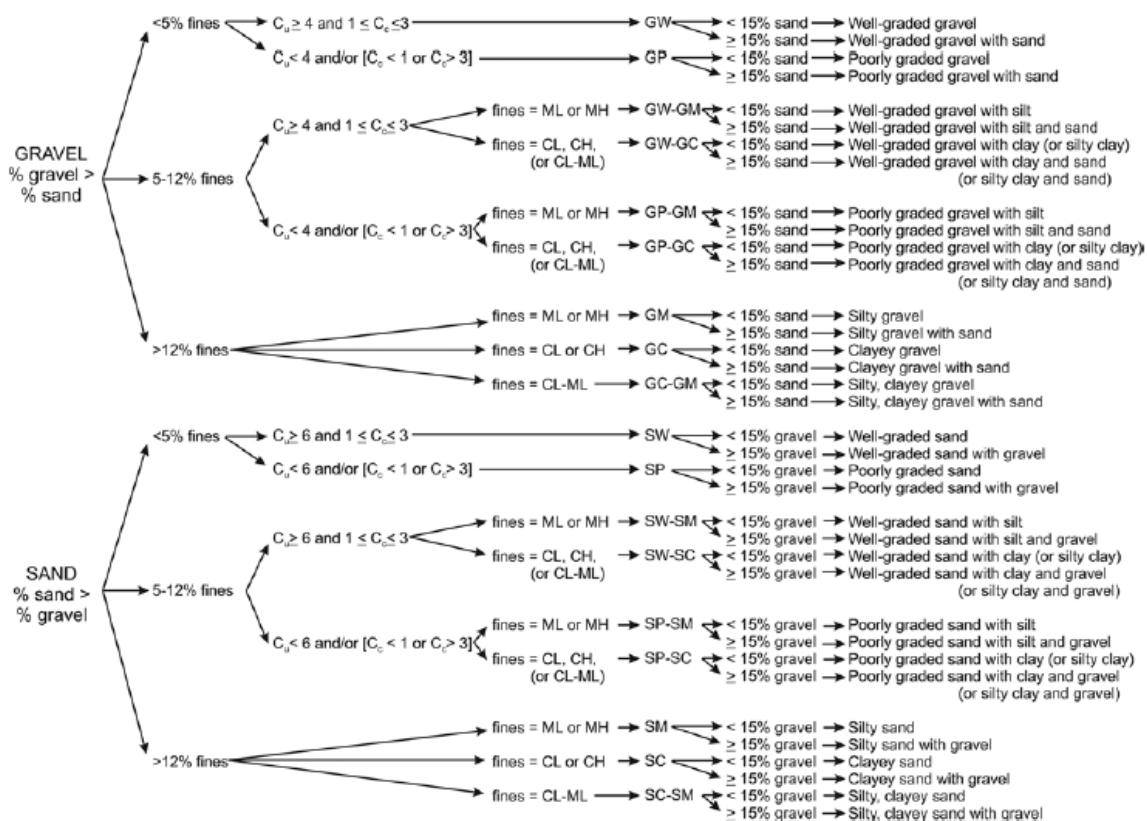

FIG. 3 Flow Chart for Classifying Coarse-Grained Soils (More Than 50 % Retained on No. 200 Sieve)

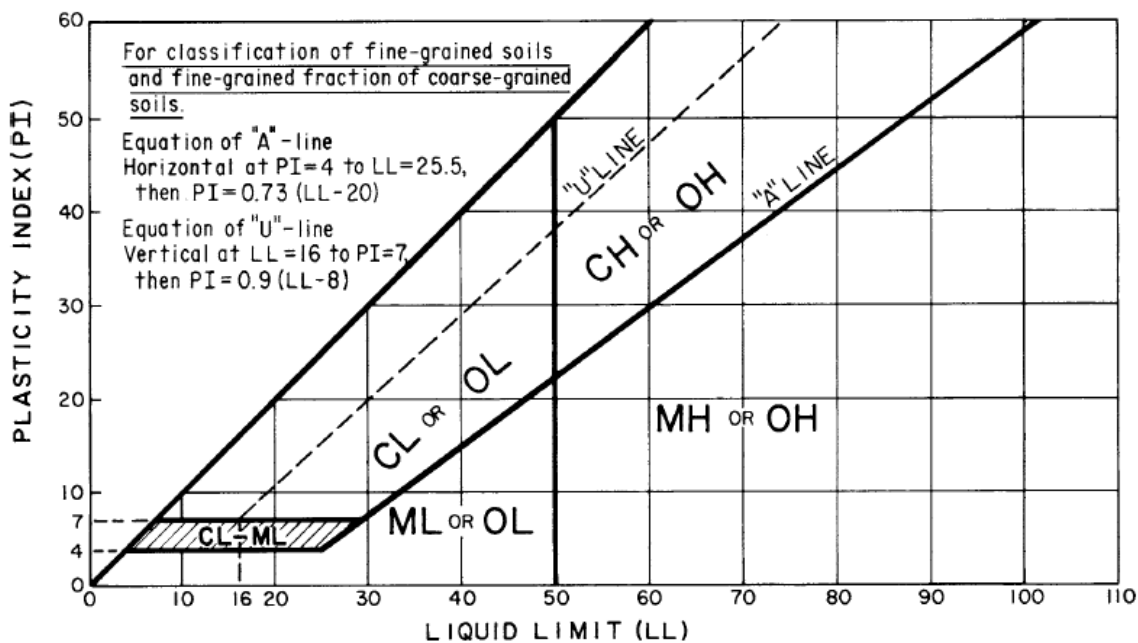

FIG. 4 Plasticity Chart

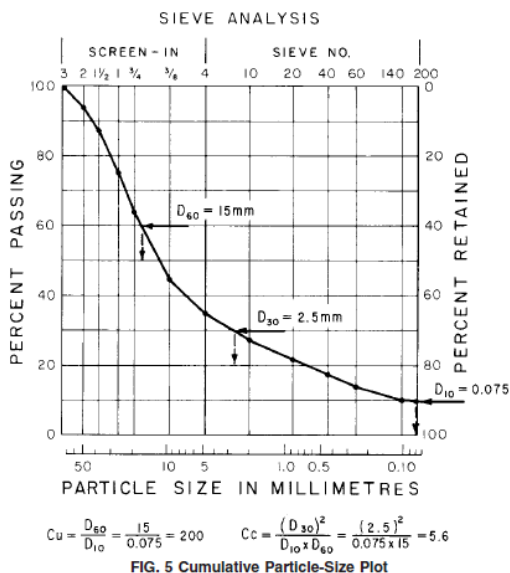

FIG. 5 Cumulative Particle-Size Plot

8. Classification of Peat

8.1 A sample composed primarily of vegetable tissue in various stages of decomposition and has a fibrous to amorphous texture, a dark-brown to black color, and an organic odor should be designated as a highly organic soil and shall be classified as peat, PT, and not subjected to the classification procedures described hereafter.

8.2 If desired, classification of type of peat can be performed in accordance with Classification D4427.

9. Preparation for Classification

9.1 Before a soil can be classified according to this standard, generally the particle-size distribution of the minus 3-in. (75-mm) material and the plasticity characteristics of the minus No. 40 (425-μm) sieve material must be determined. See 9.8 for the specific required tests.

9.2 The preparation of the soil specimen(s) and the testing for particle-size distribution and liquid limit and plasticity index shall be in accordance with accepted standard procedures. Two procedures for preparation of the soil specimens for testing for soil classification purposes are given in Appendixes X3 and X4. Appendix X3 describes the wet preparation method and is the preferred method for cohesive soils that have never dried out and for organic soils.

9.3 When reporting soil classifications determined by this standard, the preparation and test procedures used shall be reported or referenced.

9.4 Although the test procedure used in determining the particle-size distribution or other considerations may require a hydrometer analysis of the material, a hydrometer analysis is not necessary for soil classification.

9.5 The percentage (by dry weight) of any plus 3-in. (75-mm) material must be determined and reported as auxiliary information.

9.6 The maximum particle size shall be determined (measured or estimated) and reported as auxiliary information.

9.7 When the cumulative particle-size distribution is required, a set of sieves shall be used which include the following sizes (with the largest size commensurate with the maximum particle size) with

other sieve sizes as needed or required to define the particle-size distribution:

3-in. (75-mm)
 3/4-in. (19.0-mm)
 No. 4 (4.75-mm)
 No. 10 (2.00-mm)
 No. 40 (425- μ m)
 No. 200 (75- μ m)

9.8 The tests required to be performed in preparation for classification are as follows:

9.8.1 For soils estimated to contain less than 5 % fines, a plot of the cumulative particle-size distribution curve of the fraction coarser than the No. 200 (75- μ m) sieve is required. A semi-log plot of percent passing versus particle-size or sieve size/sieve number is plotted as shown in Fig. 5.

9.8.2 For soils estimated to contain 5 to 15 % fines, a cumulative particle-size distribution curve, as described in 9.8.1, is required, and the liquid limit and plasticity index are required.

9.8.2.1 If sufficient material is not available to determine the liquid limit and plasticity index, the fines should be estimated to be either silty or clayey using the procedures described in Practice D2488 and so noted in the report.

9.8.3 For soils estimated to contain 15 % or more fines, a determination of the percent fines, percent sand, and percent gravel is required, and the liquid limit and plasticity index are required. For soils estimated to contain 90 % fines or more, the percent fines, percent sand, and percent gravel may be estimated using the procedures described in Practice D2488 and so noted in the report.

10. Preliminary Classification Procedure

10.1 Class the soil as fine-grained if 50 % or more by dry weight of the test specimen passes the No. 200 (75- μ m) sieve and follow Section 3.1.2.

10.2 Class the soil as coarse-grained if more than 50 % by dry weight of the test specimen is retained on the No. 200 (75- μ m) sieve and follow Section 12.

11. Procedure for Classification of Fine-Grained Soils (50 % or more by dry weight passing the No. 200 (75- μ m) sieve)

11.1 The soil is an inorganic clay if the position of the plasticity index versus liquid limit plot, Fig. 4, falls on or above the "A" line, the plasticity index is greater than 4, and the presence of organic matter does not influence the liquid limit as determined in 11.3.2.

NOTE 7—The plasticity index and liquid limit are determined on the minus No. 40 (425 μ m) sieve material.

11.1.1 Classify the soil as a *lean clay*, CL, if the liquid limit is less than 50. See area identified as CL on Fig. 4.

11.1.2 Classify the soil as a *fat clay*, CH, if the liquid limit is 50 or greater. See area identified as CH on Fig. 4.

NOTE 8—In cases where the liquid limit exceeds 110 or the plasticity index exceeds 60, the plasticity chart may be expanded by maintaining the same scale on both axes and extending the "A" line at the indicated slope.

11.1.3 Classify the soil as a *silty clay*, CL-ML, if the position of the plasticity index versus liquid limit plot falls on or above the "A" line and the plasticity index is in the range of 4 to 7. See area identified as CL-ML on Fig. 4.

11.2 The soil is an inorganic silt if the position of the plasticity index versus liquid limit plot, Fig. 4, falls below the "A" line or the plasticity index is less than 4, and presence of organic matter does not influence the liquid limit as determined in 11.3.2.

11.2.1 Classify the soil as a *silt*, ML, if the liquid limit is less than 50. See area identified as ML on Fig. 4.

11.2.2 Classify the soil as an *elastic silt*, MH, if the liquid limit is 50 or greater. See area identified as MH on Fig. 4.

11.3 The soil is an organic silt or clay if organic matter is present in sufficient amounts to influence the liquid limit as determined in 11.3.2.

11.3.1 If the soil has a dark color and an organic odor when moist and warm, a second liquid limit test shall be performed on a test specimen which has been oven dried at $110 \pm 5^\circ\text{C}$ to a constant weight, typically over night.

11.3.2 The soil is an organic silt or organic clay if the liquid limit after oven drying is less than 75 % of the liquid limit of the original specimen determined before oven drying (see Procedure B of Practice D2217).

11.3.3 Classify the soil as an *organic silt* or *organic clay*, OL, if the liquid limit (not oven dried) is less than 50 %. Classify the soil as an *organic silt*, OL, if the plasticity index is less than 4, or the position of the plasticity index versus liquid limit plot falls below the "A" line. Classify the soil as an *organic clay*, OL, if the plasticity index is 4 or greater and the position of the plasticity index versus liquid limit plot falls on or above the "A" line. See area identified as OL (or CL-ML) on Fig. 4.

11.3.4 Classify the soil as an *organic clay* or *organic silt*, OH, if the liquid limit (not oven dried) is 50 or greater. Classify the soil as an *organic silt*, OH, if the position of the plasticity index versus liquid limit plot falls below the "A" line. Classify the soil as an *organic clay*, OH, if the position of the plasticity index versus liquid-limit plot falls on or above the "A" line. See area identified as OH on Fig. 4.

11.4 If less than 30 % but 15 % or more of the test specimen is retained on the No. 200 (75- μ m) sieve, the words "with sand" or "with gravel" (whichever is predominant) shall be added to the group name. For example, lean clay with sand, CL; silt with gravel, ML. If the percent of sand is equal to the percent of gravel, use "with sand."

11.5 If 30 % or more of the test specimen is retained on the No. 200 (75- μ m) sieve, the words

“sandy” or “gravelly” shall be added to the group name. Add the word “sandy” if 30 % or more of the test specimen is retained on the No. 200 (75- μ m) sieve and the coarse-grained portion is predominantly sand. Add the word “gravelly” if 30 % or more of the test specimen is retained on the No. 200 (75- μ m) sieve and the coarse-grained portion is predominantly gravel. For example, sandy lean clay, CL; gravelly fat clay, CH; sandy silt, ML. If the percent of sand is equal to the percent of gravel, use “sandy.”

12. Procedure for Classification of Coarse-Grained Soils (more than 50 % retained on the No. 200 (75- μ m) sieve)

12.1 Class the soil as gravel if more than 50 % of the coarse fraction [plus No. 200 (75- μ m) sieve] is retained on the No. 4 (4.75-mm) sieve.

12.2 Class the soil as sand if 50 % or more of the coarse fraction [plus No. 200 (75- μ m) sieve] passes the No. 4 (4.75-mm) sieve.

12.3 If 12 % or less of the test specimen passes the No. 200 (75- μ m) sieve, plot the cumulative particle-size distribution, Fig. 5, and compute the coefficient of uniformity, C_u , and coefficient of curvature, C_c , as given in Eqs 1 and 2.

$$C_u = D_{60}/D_{10}$$

$$C_c = (D_{30})^2 / (D_{10} * D_{60})$$

where:

D_{10} , D_{30} , and D_{60} = the particle-size diameters corresponding to 10, 30, and 60 %, respectively, passing on the cumulative particle-size distribution curve, Fig. 5.

NOTE 9—It may be necessary to extrapolate the curve to obtain the D_{10} diameter.

12.3.1 If less than 5 % of the test specimen passes the No. 200 (75- μ m) sieve, classify the soil as a *well-graded gravel*, GW, or *well-graded sand*, SW, if C_u is greater than or equal to 4.0 for gravel or greater than 6.0 for sand, and C_c is at least 1.0 but not more than 3.0.

12.3.2 If less than 5 % of the test specimen passes the No. 200 (75- μ m) sieve, classify the soil as *poorly graded gravel*, GP, or *poorly graded sand*, SP, if either the C_u or the C_c criteria for well-graded soils are not satisfied.

12.4 If more than 12 % of the test specimen passes the No. 200 (75- μ m) sieve, the soil shall be considered a coarsegrained soil with fines. The fines are determined to be either clayey or silty based on the plasticity index versus liquid limit plot on Fig. 4. (See 9.8.2.1 if insufficient material available for testing) (see Note 7).

12.4.1 Classify the soil as a *clayey gravel*, GC, or *clayey sand*, SC, if the fines are clayey, that is, the position of the plasticity index versus liquid limit plot,

Fig. 4, falls on or above the “A” line and the plasticity index is greater than 7.

12.4.2 Classify the soil as a *silty gravel*, GM, or *silty sand*, SM, if the fines are silty, that is, the position of the plasticity index versus liquid limit plot, Fig. 4, falls below the “A” line or the plasticity index is less than 4.

12.4.3 If the fines plot as a silty clay, CL-ML, classify the soil as a *silty, clayey gravel*, GC-GM, if it is a gravel or a *silty, clayey sand*, SC-SM, if it is a sand.

12.5 If 5 to 12 % of the test specimen passes the No. 200 (75- μ m) sieve, give the soil a dual classification using two group symbols.

12.5.1 The first group symbol shall correspond to that for a gravel or sand having less than 5 % fines (GW, GP, SW, SP), and the second symbol shall correspond to a gravel or sand having more than 12 % fines (GC, GM, SC, SM).

12.5.2 The group name shall correspond to the first group symbol plus “with clay” or “with silt” to indicate the plasticity characteristics of the fines. For example, well-graded gravel with clay, GW-GC; poorly graded sand with silt, SP-SM (See 9.8.2.1 if insufficient material available for testing).

NOTE 10—If the fines plot as a *silty clay*, CL-ML, the second group symbol should be either GC or SC. For example, a poorly graded sand with 10 % fines, a liquid limit of 20, and a plasticity index of 6 would be classified as a poorly graded sand with silty clay, SP-SC.

12.6 If the specimen is predominantly sand or gravel but contains 15 % or more of the other coarse-grained constituent, the words “with gravel” or “with sand” shall be added to the group name. For example, poorly graded gravel with sand, clayey sand with gravel.

12.7 If the field sample contained any cobbles or boulders or both, the words “with cobbles,” or “with cobbles and boulders” shall be added to the group name. For example, silty gravel with cobbles, GM.

13. Report

13.1 The report should include the group name, group symbol, and the results of the laboratory tests. The particle-size distribution shall be given in terms of percent of gravel, sand, and fines. The plot of the cumulative particle-size distribution curve shall be reported if used in classifying the soil. Report appropriate descriptive information according to the procedures in Practice D2488. A local or commercial name or geologic interpretation for the material may be added at the end of the descriptive information if identified as such. The test procedures used shall be referenced.

NOTE 11—*Example: Clayey Gravel with Sand and Cobbles (GC)*—46 % fine to coarse, hard, subrounded gravel; 30 % fine to coarse, hard, subrounded sand; 24 % clayey fines, LL = 38, PI = 19; weak reaction with HCl; original field sample had 4 % hard, subrounded cobbles; maximum dimension 150 mm.

In-Place Conditions—firm, homogeneous, dry, brown,
Geologic Interpretation—alluvial fan.

NOTE 12—Other examples of soil descriptions are given in
Appendix X1.

14. Precision and Bias

14.1 Criteria for acceptability depends on the
precision and bias of Test Methods D422, D1140 and
D4318.

15. Keywords

15.1 Atterberg limits; classification; clay; gradation;
gravel; laboratory classification; organic soils; sand;
silt; soil classification; soil tests

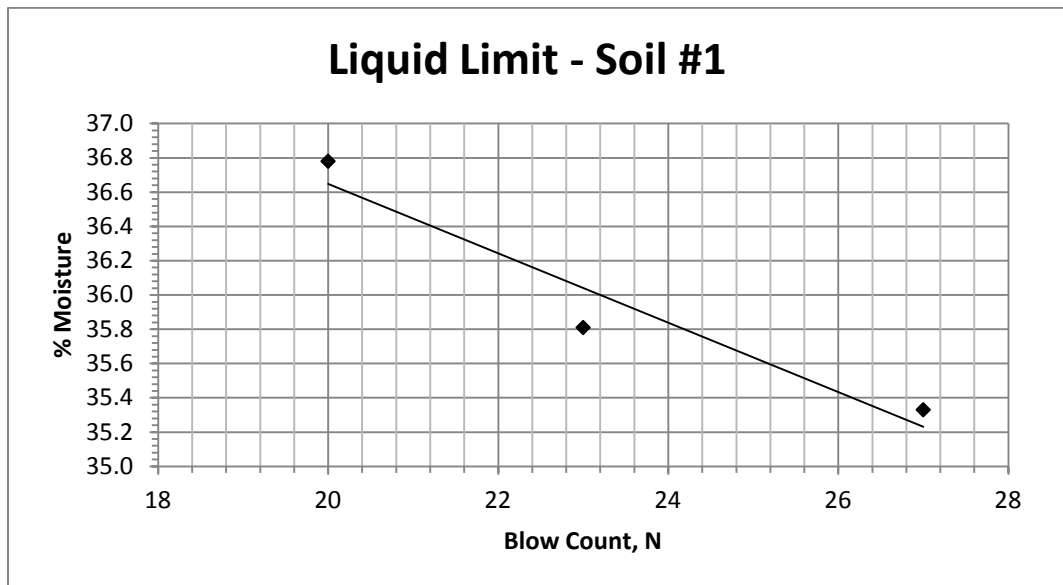
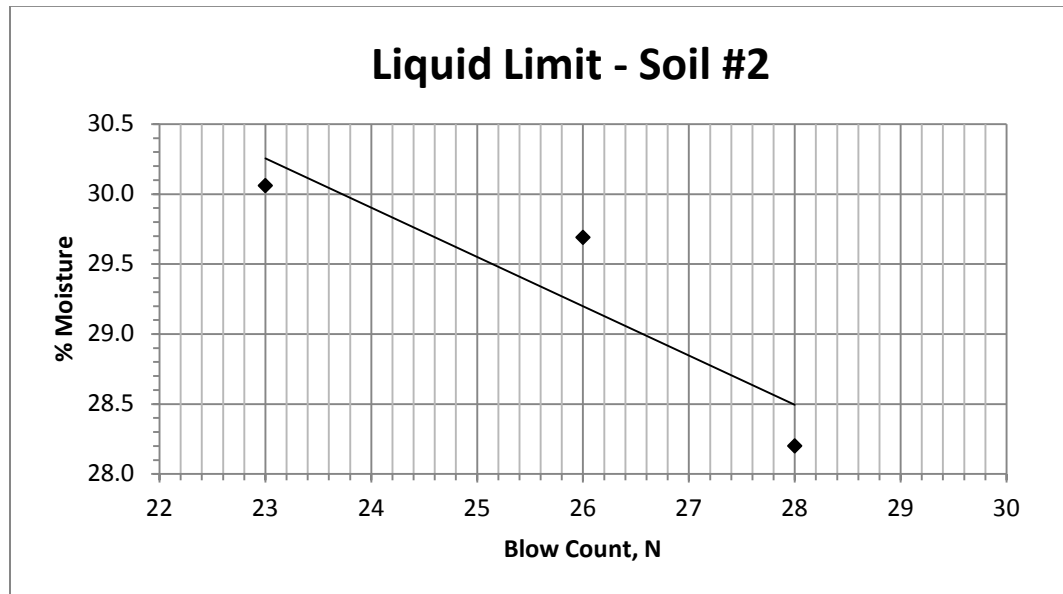
APPENDIX B**Figure B.1: Liquid Limit Test Results for Soil #1****Figure B.2: Liquid Limit Test Results for Soil #2**

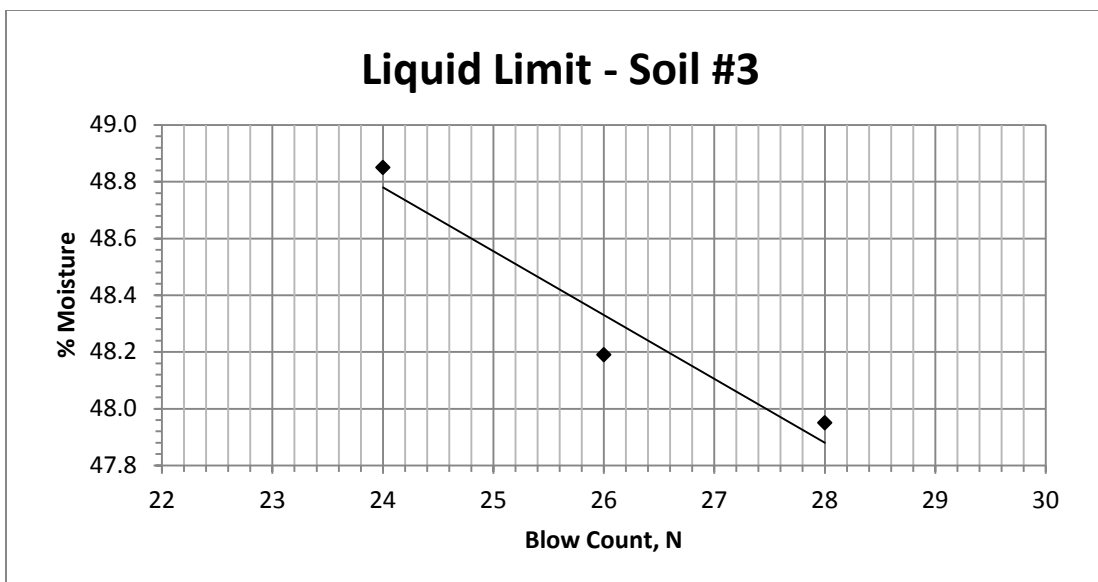

Figure B.3: Liquid Limit Test Results for Soil #3

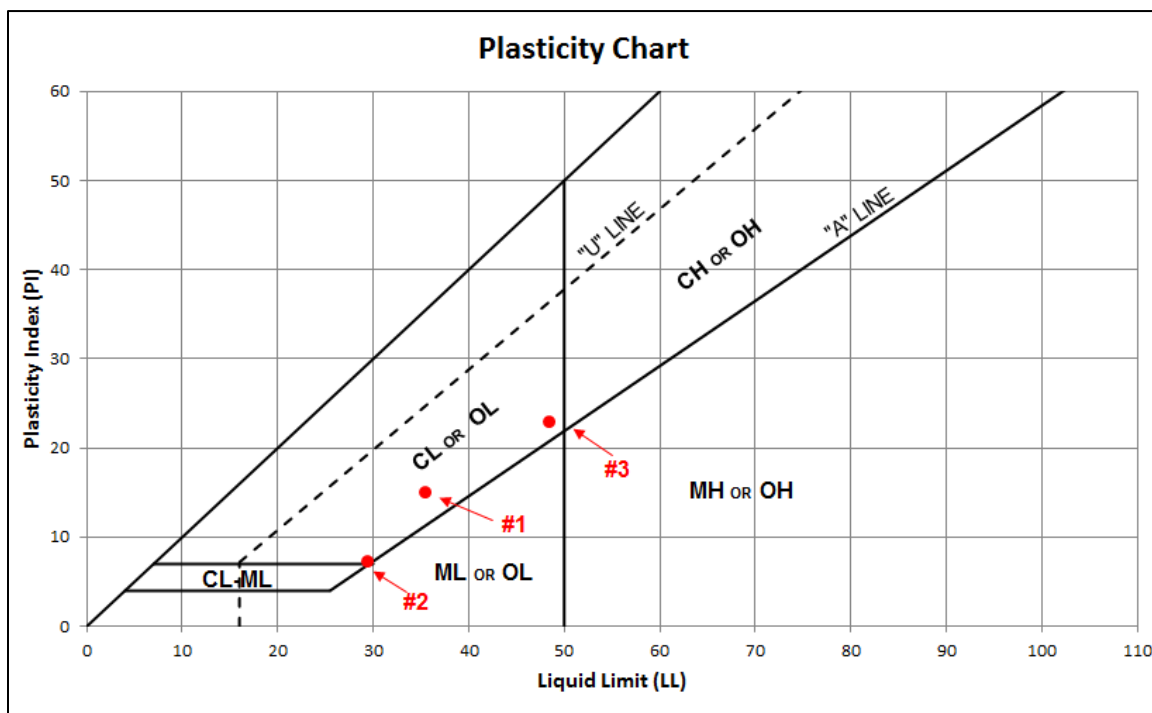

Figure B.4: Plasticity Chart with Data Overlay for Soil #1, #2, and #3

Table B.1: Variability and Average Loss Due to Dissolved Particles of Standard Laboratory Analysis at Different Manufactured Concentrations

Manufactured Concentration	170 mg/L	160 mg/L	140 mg/L	135 mg/L	130 mg/L	120 mg/L	115 mg/L	100 mg/L	75 mg/L
Laboratory-Analyzed TSS Concentrations (mg/L)	128.1	129.3	103.1	91.0	87.2	76.6	106.4	96.8	70.5
	126.2	121.8	112.0	94.7	91.9	72.3	92.3	109.9	68.8
	125.3	114.0	110.2	95.4	90.7	77.7	94.2	94.7	71.3
	126.0	126.9	103.1	89.5	81.6	76.2	84.2	84.2	64.7
	136.4	116.8	106.6	99.9	87.7	102.5	85.6	84.2	64.8
		125.3	94.5					93.8	58.2
		122.0	102.8					83.3	56.9
		114.4	96.9					82.5	58.3
		126.3	96.9						60.5
		119.8	100.4						73.2
		119.4							65.8
		123.1							67.6
		121.9							68.3
		124.2							74.3
	119.2								
Average (mg/L) =	128.4	121.6	102.7	94.1	87.8	81.1	92.5	91.2	65.9
St Dev (mg/L) =	4.6	4.5	5.8	4.1	4.0	12.2	8.8	9.5	5.7
Ave Loss (mg/L) =	41.6	38.4	37.4	40.9	42.2	38.9	22.5	8.8	9.1
CV (%) =	3.6	3.7	5.6	4.3	4.6	15.0	9.6	10.5	8.6

Table B.2: Tabulation of Figure 5.4 – Soil #3 with Top Chamber of the Filtration Apparatus Mostly Filled with Air, Using Grade 3 Filter Paper and a TSS Concentration of 100 mg/L

Soil #3 made at 100 mg/L							
Time (s)	Volume (mL)						
0:00:00	0	0:19:30	6324	0:40:30	9281	1:01:30	11396
0:00:30	304	0:20:00	6413	0:41:00	9344	1:02:00	11442
0:01:00	647	0:20:30	6499	0:41:30	9408	1:02:30	11484
0:01:30	980	0:21:00	6585	0:42:00	9455	1:03:00	11527
0:02:00	1272	0:21:30	6676	0:42:30	9518	1:03:30	11571
0:02:30	1561	0:22:00	6755	0:43:00	9571	1:04:00	11612
0:03:00	1798	0:22:30	6840	0:43:30	9642	1:04:30	11657
0:03:30	2042	0:23:00	6922	0:44:00	9685	1:05:00	11699
0:04:00	2264	0:23:30	7014	0:44:30	9738	1:05:30	11745
0:04:30	2479	0:24:00	7090	0:45:00	9790	1:06:00	11782
0:05:00	2681	0:24:30	7158	0:45:30	9845	1:06:30	11825
0:05:30	2866	0:25:00	7236	0:46:00	9898	1:07:00	11869
0:06:00	3054	0:25:30	7311	0:46:30	9953	1:07:30	11909
0:06:30	3228	0:26:00	7389	0:47:00	10009	1:08:00	11952
0:07:00	3391	0:26:30	7464	0:47:30	10058	1:08:30	11994
0:07:30	3563	0:27:00	7533	0:48:00	10109	1:09:00	12034
0:08:00	3712	0:27:30	7605	0:48:30	10162	1:09:30	12075
0:08:30	3860	0:28:00	7681	0:49:00	10213	1:10:00	12117
0:09:00	4018	0:28:30	7760	0:49:30	10264	1:10:30	12158
0:09:30	4147	0:29:00	7827	0:50:00	10310	1:11:00	12198
0:10:00	4288	0:29:30	7891	0:50:30	10358	1:11:30	12239
0:10:30	4412	0:30:00	7962	0:51:00	10406	1:12:00	12279
0:11:00	4539	0:30:30	8026	0:51:30	10464	1:12:30	12320
0:11:30	4668	0:31:00	8096	0:52:00	10508	1:13:00	12360
0:12:00	4790	0:31:30	8164	0:52:30	10559	1:13:30	12400
0:12:30	4908	0:32:00	8232	0:53:00	10603	1:14:00	12439
0:13:00	5019	0:32:30	8295	0:53:30	10656	1:14:30	12479
0:13:30	5141	0:33:00	8361	0:54:00	10710	1:15:00	12520
0:14:00	5246	0:33:30	8427	0:54:30	10757	1:15:30	12560
0:14:30	5355	0:34:00	8498	0:55:00	10803	1:16:00	12599
0:15:00	5464	0:34:30	8546	0:55:30	10851	1:16:30	12638
0:15:30	5566	0:35:00	8611	0:56:00	10896	1:17:00	12676
0:16:00	5664	0:35:30	8683	0:56:30	10943	1:17:30	12716
0:16:30	5768	0:36:00	8740	0:57:00	10989	1:18:00	12757
0:17:00	5864	0:36:30	8803	0:57:30	11041	1:18:30	12795
0:17:30	5966	0:37:00	8865	0:58:00	11081	1:19:00	12832
0:18:00	6053	0:37:30	8925	0:58:30	11128	1:19:30	12873
0:18:30	6149	0:38:00	8986	0:59:00	11172	1:20:00	12910
0:19:00	6241	0:38:30	9048	0:59:30	11217		
		0:39:00	9106	1:00:00	11262		
		0:39:30	9166	1:00:30	11304		
		0:40:00	9230	1:01:00	11353		

Table B.3: Tabulation of Figure 5.5 – Soil #3 with Top Chamber of Filtration Apparatus Full of Water, Using Grade 3 Filter Paper and a TSS Concentration of 100 mg/L

Soil #3 made at 100 mg/L 450 mmHg				Soil #3 made at 100 mg/L 200 mmHg			
Time (s)	Volume (mL)			Time (s)	Volume (mL)		
0:00:00	0	0:20:30	10612	0:00:00	0	0:20:30	6152
0:00:30	60	0:21:00	10764	0:00:30	200	0:21:00	6231
0:01:00	801	0:21:30	10905	0:01:00	500	0:21:30	6308
0:01:30	1541	0:22:00	11059	0:01:30	800	0:22:00	6385
0:02:00	2041	0:22:30	11198	0:02:00	1078	0:22:30	6462
0:02:30	2478	0:23:00	11342	0:02:30	1343	0:23:00	6535
0:03:00	2911	0:23:30	11486	0:03:00	1588	0:23:30	6608
0:03:30	3272	0:24:00	11627	0:03:30	1817	0:24:00	6681
0:04:00	3626	0:24:30	11760	0:04:00	2032	0:24:30	6751
0:04:30	3968	0:25:00	11899	0:04:30	2236	0:25:00	6821
0:05:00	4293	0:25:30	12033	0:05:00	2443	0:25:30	6891
0:05:30	4584	0:26:00	12165	0:05:30	2630	0:26:00	6957
0:06:00	4880	0:26:30	12299	0:06:00	2815	0:26:30	7023
0:06:30	5171	0:27:00	12429	0:06:30	2985	0:27:00	7088
0:07:00	5443	0:27:30	12557	0:07:00	3147	0:27:30	7153
0:07:30	5694	0:28:00	12692	0:07:30	3310	0:28:00	7216
0:08:00	5942	0:28:30	12826	0:08:00	3461	0:28:30	7281
0:08:30	6182	0:29:00	12934	0:08:30	3609	0:29:00	7342
0:09:00	6421	0:29:30	13061	0:09:00	3752	0:29:30	7400
0:09:30	6640	0:30:00	13186	0:09:30	3885	0:30:00	7463
0:10:00	6864	0:30:30	13309	0:10:00	4025	0:30:30	7521
0:10:30	7079	0:31:00	13434	0:10:30	4152	0:31:00	7581
0:11:00	7294	0:31:30	13554	0:11:00	4277	0:31:30	7638
0:11:30	7489	0:32:00	13669	0:11:30	4403	0:32:00	7696
0:12:00	7690	0:32:30	13792	0:12:00	4518	0:32:30	7755
0:12:30	7885	0:33:00	13910	0:12:30	4634	0:33:00	7807
0:13:00	8084	0:33:30	14029	0:13:00	4746	0:33:30	7861
0:13:30	8279	0:34:00	14140	0:13:30	4855	0:34:00	7919
0:14:00	8473			0:14:00	4963	0:34:30	7975
0:14:30	8640			0:14:30	5066	0:35:00	8028
0:15:00	8811			0:15:00	5169	0:35:30	8079
0:15:30	8993			0:15:30	5270	0:36:00	8130
0:16:00	9166			0:16:00	5364	0:36:30	8179
0:16:30	9345			0:16:30	5460	0:37:00	8231
0:17:00	9508			0:17:00	5550	0:37:30	8282
0:17:30	9666			0:17:30	5652	0:38:00	8332
0:18:00	9833			0:18:00	5739	0:38:30	8382
0:18:30	9990			0:18:30	5830	0:39:00	8431
0:19:00	10168			0:19:00	5903	0:39:30	8478
0:19:30	10305			0:19:30	5990	0:40:00	8528
0:20:00	10462			0:20:00	6069	0:40:30	8574
						0:41:00	8620
						0:41:30	8668
						0:42:00	8711
						0:42:30	8760

0:43:00	8810
0:43:30	8855
0:44:00	8893
0:44:30	8938
0:45:00	8988
0:45:30	9025
0:46:00	9067
0:46:30	9116
0:47:00	9155
0:47:30	9175
0:48:00	9237
0:48:30	9278
0:49:00	9320
0:49:30	9361
0:50:00	9400
0:50:30	9441
0:51:00	9481
0:51:30	9520
0:52:00	9558
0:52:30	9596
0:53:00	9635
0:53:30	9674
0:54:00	9711
0:54:30	9749
0:55:00	9784
0:55:30	9822
0:56:00	9860

Soil #3 made at 100 mg/L 400 mmHg	
Time (s)	Volume (mL)
0:00:00	0
0:00:30	387
0:01:00	818
0:01:30	1330
0:02:00	1756
0:02:30	2104
0:03:00	2452
0:03:30	2793
0:04:00	3088
0:04:30	3428
0:05:00	3717
0:05:30	4004
0:06:00	4300
0:06:30	4532
0:07:00	4801
0:07:30	5011
0:08:00	5246
0:08:30	5479
0:09:00	5684
0:09:30	5902
0:10:00	6095
0:10:30	6307
0:11:00	6497
0:11:30	6677
0:12:00	6856
0:12:30	7024
0:13:00	7185
0:13:30	7345
0:14:00	7515
0:14:30	7679
0:15:00	7831
0:15:30	7992
0:16:00	8137
0:16:30	8280
0:17:00	8452
0:17:30	8583
0:18:00	8721
0:18:30	8861
0:19:00	8998
0:19:30	9136
0:20:00	9273
0:20:30	9404
0:21:00	9540

0:21:30	9674
0:22:00	9805
0:22:30	9933
0:23:00	10056
0:23:30	10184
0:24:00	10305
0:24:30	10425
0:25:00	10548
0:25:30	10667
0:26:00	10787
0:26:30	10901
0:27:00	11018
0:27:30	11133
0:28:00	11251
0:28:30	11363
0:29:00	11474
0:29:30	11587
0:30:00	11698
0:30:30	11800
0:31:00	11910
0:31:30	12017
0:32:00	12125
0:32:30	12233
0:33:00	12348

Table B.4: Tabulation of Figure 5.6 – Soil #2 with Top Chamber of Filtration Apparatus Filled with Water, Using Grade 3 Filter Paper and TSS Concentrations of 100 mg/L and 110 mg/L

Soil #3 made at 100 mg/L				Soil #3 made at 110 mg/L	
400 mmHg				450 mmHg	
Time (s)	Volume (mL)			Time (s)	Volume (mL)
0:00:00	0	0:19:30	7272	0:00:00	0
0:00:30	553	0:20:00	7346	0:00:30	596
0:01:00	1057	0:20:30	7412	0:01:00	1235
0:01:30	1515	0:21:00	7479	0:01:30	1957
0:02:00	1923	0:21:30	7542	0:02:00	2698
0:02:30	2331	0:22:00	7608	0:02:30	3163
0:03:00	2668	0:22:30	7669	0:03:00	3786
0:03:30	2959	0:23:00	7730	0:03:30	4354
0:04:00	3236	0:23:30	7789	0:04:00	4935
0:04:30	3503	0:24:00	7847	0:04:30	5384
0:05:00	3739	0:24:30	7904	0:05:00	5844
0:05:30	3950	0:25:00	7961	0:05:30	6297
0:06:00	4171	0:25:30	8016	0:06:00	6712
0:06:30	4356	0:26:00	8067	0:06:30	7120
0:07:00	4537	0:26:30	8119	0:07:00	7508
0:07:30	4715	0:27:00	8170	0:07:30	7882
0:08:00	4883	0:27:30	8224	0:08:00	8243
0:08:30	5043	0:28:00	8272	0:08:30	8589
0:09:00	5194	0:28:30	8322	0:09:00	8941
0:09:30	5331	0:29:00	8370	0:09:30	9246
0:10:00	5466	0:29:30	8416	0:10:00	9581
0:10:30	5616	0:30:00	8462	0:10:30	9884
0:11:00	5727	0:30:30	8511	0:11:00	10180
0:11:30	5841	0:31:00	8555	0:11:30	10476
0:12:00	5952			0:12:00	10751
0:12:30	6064			0:12:30	11052
0:13:00	6169			0:13:00	11312
0:13:30	6279			0:13:30	11592
0:14:00	6369			0:14:00	11840
0:14:30	6466			0:14:30	12099
0:15:00	6557			0:15:00	12339
0:15:30	6642			0:15:30	12591
0:16:00	6733			0:16:00	12890
0:16:30	6820			0:16:30	13182
0:17:00	6899			0:17:00	13402
0:17:30	6980			0:17:30	13651
0:18:00	7056			0:18:00	13860
0:18:30	7130			0:18:30	14071
0:19:00	7203				

Table B.5: Tabulation of Figure 5.7 – Soil #3 with Top Chamber of Filtration Apparatus Filled with Water, Using Grade 3 Filter Paper and TSS Concentrations of 90 mg/L, 100 mg/L, and 110 mg/L

Soil #3 made at 90 mg/L					Soil #3 made at 100 mg/L		
300 mmHg					400 mmHg		
Time (s)	Volume (mL)				Time (s)	Volume (mL)	
0:00:00	0	0:19:30	7028	0:41:30	10381	0:00:00	0
0:00:30	257	0:20:00	7125	0:42:00	10436	0:00:30	387
0:01:00	661	0:20:30	7217	0:42:30	10498	0:01:00	818
0:01:30	999	0:21:00	7315	0:43:00	10559	0:01:30	1330
0:02:00	1375	0:21:30	7406	0:43:30	10621	0:02:00	1756
0:02:30	1681	0:22:00	7499	0:44:00	10684	0:02:30	2104
0:03:00	1981	0:22:30	7586	0:44:30	10740	0:03:00	2452
0:03:30	2273	0:23:00	7673	0:45:00	10799	0:03:30	2793
0:04:00	2514	0:23:30	7761	0:45:30	10859	0:04:00	3088
0:04:30	2757	0:24:00	7848	0:46:00	10915	0:04:30	3428
0:05:00	2981	0:24:30	7935	0:46:30	10974	0:05:00	3717
0:05:30	3204	0:25:00	8025	0:47:00	11030	0:05:30	4004
0:06:00	3410	0:25:30	8102	0:47:30	11090	0:06:00	4300
0:06:30	3600	0:26:00	8189	0:48:00	11144	0:06:30	4532
0:07:00	3790	0:26:30	8269	0:48:30	11210	0:07:00	4801
0:07:30	3993	0:27:00	8349	0:49:00	11262	0:07:30	5011
0:08:00	4146	0:27:30	8426	0:49:30	11319	0:08:00	5246
0:08:30	4309	0:28:00	8505	0:50:00	11375	0:08:30	5479
0:09:00	4470	0:28:30	8586	0:50:30	11428	0:09:00	5684
0:09:30	4652	0:29:00	8660	0:51:00	11483	0:09:30	5902
0:10:00	4777	0:29:30	8737	0:51:30	11538	0:10:00	6095
0:10:30	4928	0:30:00	8814	0:52:00	11592	0:10:30	6307
0:11:00	5062	0:30:30	8888	0:52:30	11645	0:11:00	6497
0:11:30	5200	0:31:00	8963	0:53:00	11704	0:11:30	6677
0:12:00	5341	0:31:30	9038	0:53:30	11757	0:12:00	6856
0:12:30	5465	0:32:00	9107	0:54:00	11815	0:12:30	7024
0:13:00	5591	0:32:30	9182	0:54:30	11863	0:13:00	7185
0:13:30	5721	0:33:00	9251	0:55:00	11915	0:13:30	7345
0:14:00	5842	0:33:30	9322			0:14:00	7515
0:14:30	5957	0:34:00	9391			0:14:30	7679
0:15:00	6077	0:34:30	9460			0:15:00	7831
0:15:30	6195	0:35:00	9531			0:15:30	7992
0:16:00	6303	0:35:30	9598			0:16:00	8137
0:16:30	6416	0:36:00	9665			0:16:30	8280
0:17:00	6520	0:36:30	9730			0:17:00	8452
0:17:30	6624	0:37:00	9800			0:17:30	8583
0:18:00	6727	0:37:30	9869			0:18:00	8721
0:18:30	6829	0:38:00	9930			0:18:30	8861
0:19:00	6927	0:38:30	9992			0:19:00	8998
		0:39:00	10065				
		0:39:30	10126				
		0:40:00	10189				
		0:40:30	10253				
		0:41:00	10316				

0:19:30	9136
0:20:00	9273
0:20:30	9404
0:21:00	9540
0:21:30	9674
0:22:00	9805
0:22:30	9933
0:23:00	10056
0:23:30	10184
0:24:00	10305
0:24:30	10425
0:25:00	10548
0:25:30	10667
0:26:00	10787
0:26:30	10901
0:27:00	11018
0:27:30	11133
0:28:00	11251
0:28:30	11363
0:29:00	11474
0:29:30	11587
0:30:00	11698
0:30:30	11800
0:31:00	11910
0:31:30	12017
0:32:00	12125
0:32:30	12233
0:33:00	12348

Soil #3 made at 110 mg/L 225 mmHg	
Time (s)	Volume (mL)
0:00:00	0
0:00:30	169
0:01:00	378
0:01:30	600
0:02:00	764
0:02:30	956
0:03:00	1128
0:03:30	1289
0:04:00	1444
0:04:30	1600
0:05:00	1723
0:05:30	1856
0:06:00	1978
0:06:30	2099
0:07:00	2209
0:07:30	2321
0:08:00	2423
0:08:30	2524
0:09:00	2622
0:09:30	2716
0:10:00	2804
0:10:30	2892
0:11:00	2978
0:11:30	3058
0:12:00	3136
0:12:30	3211
0:13:00	3285
0:13:30	3359
0:14:00	3431
0:14:30	3500
0:15:00	3568
0:15:30	3632
0:16:00	3697
0:16:30	3758
0:17:00	3819
0:17:30	3880
0:18:00	3942
0:18:30	3995
0:19:00	4033
0:19:30	4109
0:20:00	4160

0:20:30	4212
0:21:00	4265
0:21:30	4315
0:22:00	4366
0:22:30	4415
0:23:00	4463
0:23:30	4512
0:24:00	4558
0:24:30	4607
0:25:00	4655
0:25:30	4696
0:26:00	4740
0:26:30	4782
0:27:00	4825
0:27:30	4869
0:28:00	4904
0:28:30	4950
0:29:00	4990
0:29:30	5030
0:30:00	5067
0:30:30	5107
0:31:00	5147
0:31:30	5185
0:32:00	5222
0:32:30	5259

Table B.6: Tabulation of Figure 5.8 – Soil #1 Using Grade 3 Filter Paper with Three Replicates of a TSS Concentration at 100 mg/L and Similar Pressures

Soil #1 made at 100 mg/L				Soil #1 made at 100 mg/L			
350 mmHg				325 mmHg			
Time (s)	Volume (mL)			Time (s)	Volume (mL)		
0:00:00	0	0:20:00	6790	0:00:00	0	0:20:00	7302
0:00:30	365	0:20:30	6896	0:00:30	367	0:20:30	7408
0:01:00	796	0:21:00	6989	0:01:00	815	0:21:00	7519
0:01:30	1137	0:21:30	7087	0:01:30	1115	0:21:30	7619
0:02:00	1478	0:22:00	7183	0:02:00	1414	0:22:00	7722
0:02:30	1760	0:22:30	7279	0:02:30	1690	0:22:30	7824
0:03:00	2012	0:23:00	7370	0:03:00	1988	0:23:00	7928
0:03:30	2247	0:23:30	7463	0:03:30	2262	0:23:30	8029
0:04:00	2466	0:24:00	7556	0:04:00	2515	0:24:00	8126
0:04:30	2672	0:24:30	7648	0:04:30	2759	0:24:30	8226
0:05:00	2872	0:25:00	7738	0:05:00	2980	0:25:00	8323
0:05:30	3061	0:25:30	7828	0:05:30	3195	0:25:30	8420
0:06:00	3233	0:26:00	7915	0:06:00	3392	0:26:00	8512
0:06:30	3406	0:26:30	8007	0:06:30	3588	0:26:30	8611
0:07:00	3566	0:27:00	8098	0:07:00	3776	0:27:00	8700
0:07:30	3728	0:27:30	8181	0:07:30	3958	0:27:30	8793
0:08:00	3885	0:28:00	8267	0:08:00	4131	0:28:00	8881
0:08:30	4033	0:28:30	8351	0:08:30	4294	0:28:30	8974
0:09:00	4183	0:29:00	8433	0:09:00	4459	0:29:00	9060
0:09:30	4322	0:29:30	8518	0:09:30	4626	0:29:30	9151
0:10:00	4468	0:30:00	8600	0:10:00	4781	0:30:00	9241
0:10:30	4608			0:10:30	4925		
0:11:00	4740			0:11:00	5072		
0:11:30	4868			0:11:30	5218		
0:12:00	4991			0:12:00	5358		
0:12:30	5116			0:12:30	5498		
0:13:00	5242			0:13:00	5631		
0:13:30	5371			0:13:30	5763		
0:14:00	5471			0:14:00	5891		
0:14:30	5590			0:14:30	6021		
0:15:00	5706			0:15:00	6146		
0:15:30	5823			0:15:30	6269		
0:16:00	5935			0:16:00	6394		
0:16:30	6049			0:16:30	6512		
0:17:00	6155			0:17:00	6627		
0:17:30	6266			0:17:30	6746		
0:18:00	6367			0:18:00	6860		
0:18:30	6477			0:18:30	6972		
0:19:00	6577			0:19:00	7082		
0:19:30	6690			0:19:30	7197		

Soil #1 made at 100 mg/L 350 mmHg	
Time (s)	Volume (mL)
0:00:00	0
0:00:30	343
0:01:00	748
0:01:30	1135
0:02:00	1456
0:02:30	1737
0:03:00	1930
0:03:30	2145
0:04:00	2339
0:04:30	2542
0:05:00	2721
0:05:30	2884
0:06:00	3061
0:06:30	3206
0:07:00	3372
0:07:30	3495
0:08:00	3644
0:08:30	3775
0:09:00	3906
0:09:30	4033
0:10:00	4161
0:10:30	4286
0:11:00	4397
0:11:30	4515
0:12:00	4623
0:12:30	4738
0:13:00	4850
0:13:30	4953
0:14:00	5059
0:14:30	5165
0:15:00	5265
0:15:30	5364
0:16:00	5464
0:16:30	5555
0:17:00	5660
0:17:30	5749
0:18:00	5841
0:18:30	5934
0:19:00	6021
0:19:30	6113
0:20:00	6200
0:20:30	6290
0:21:00	6372

0:21:30	6458
0:22:00	6540
0:22:30	6624
0:23:00	6708
0:23:30	6787
0:24:00	6868
0:24:30	6940
0:25:00	7030
0:25:30	7103
0:26:00	7179
0:26:30	7255
0:27:00	7333
0:27:30	7400
0:28:00	7480
0:28:30	7553
0:29:00	7620
0:29:30	7700
0:30:00	7764

Table B.7: Tabulation of Figure 5.9 – Soil #1 Using Grade 5 Filter Paper with Two Replicates of a TSS Concentration of 100 mg/L and Similar Pressures

Soil #1 made at 100 mg/L 225 mmHg		0:19:00	1180	Soil #1 made at 100 mg/L 200 mmHg		0:19:00	1177
Time (s)	Volume (mL)	0:19:30	1196	Time (s)	Volume (mL)	0:19:30	1193
0:00:00	0	0:20:00	1213	0:00:00	0	0:20:00	1207
0:00:30	44	0:20:30	1223	0:00:30	60	0:20:30	1221
0:01:00	128	0:21:00	1245	0:01:00	147	0:21:00	1235
0:01:30	199	0:21:30	1259	0:01:30	219	0:21:30	1249
0:02:00	260	0:22:00	1275	0:02:00	282	0:22:00	1262
0:02:30	314	0:22:30	1290	0:02:30	340	0:22:30	1276
0:03:00	364	0:23:00	1306	0:03:00	391	0:23:00	1288
0:03:30	409	0:23:30	1320	0:03:30	437	0:23:30	1301
0:04:00	450	0:24:00	1334	0:04:00	479	0:24:00	1313
0:04:30	489	0:24:30	1348	0:04:30	520	0:24:30	1326
0:05:00	526	0:25:00	1363	0:05:00	556	0:25:00	1338
0:05:30	562			0:05:30	592		
0:06:00	595			0:06:00	625		
0:06:30	629			0:06:30	658		
0:07:00	659			0:07:00	687		
0:07:30	688			0:07:30	716		
0:08:00	715			0:08:00	743		
0:08:30	743			0:08:30	771		
0:09:00	769			0:09:00	796		
0:09:30	795			0:09:30	820		
0:10:00	820			0:10:00	844		
0:10:30	843			0:10:30	870		
0:11:00	866			0:11:00	890		
0:11:30	889			0:11:30	913		
0:12:00	911			0:12:00	932		
0:12:30	933			0:12:30	954		
0:13:00	954			0:13:00	973		
0:13:30	975			0:13:30	992		
0:14:00	996			0:14:00	1014		
0:14:30	1016			0:14:30	1030		
0:15:00	1035			0:15:00	1048		
0:15:30	1055			0:15:30	1065		
0:16:00	1073			0:16:00	1082		
0:16:30	1092			0:16:30	1100		
0:17:00	1111			0:17:00	1116		
0:17:30	1128			0:17:30	1131		
0:18:00	1146			0:18:00	1147		
0:18:30	1162			0:18:30	1162		

Table B.8: Tabulation of Figure 5.10 – Soil #1 Using Grade 5 Filter Paper with Five Replicates of a TSS Concentration of 100 mg/L and a Consistent Pressure of 575 mmHg

Soil #1 made at 100 mg/L		Soil #1 made at 100 mg/L		Soil #1 made at 100 mg/L		Soil #1 made at 100 mg/L	
575 mmHg		575 mmHg		575 mmHg		575 mmHg	
Time (s)	Volume (mL)	Time (s)	Volume (mL)	Time (s)	Volume (mL)	Time (s)	Volume (mL)
0:00:00	0	0:00:00	0	0:00:00	0	0:00:00	0
0:00:30	70	0:00:30	75	0:00:30	55	0:00:30	82
0:01:00	147	0:01:00	169	0:01:00	154	0:01:00	176
0:01:30	180	0:01:30	248	0:01:30	269	0:01:30	278
0:02:00	259	0:02:00	301	0:02:00	380	0:02:00	351
0:02:30	313	0:02:30	406	0:02:30	407	0:02:30	459
0:03:00	364	0:03:00	484	0:03:00	434	0:03:00	551
0:03:30	380	0:03:30	551	0:03:30	499	0:03:30	643
0:04:00	395	0:04:00	610	0:04:00	575	0:04:00	727
0:04:30	408	0:04:30	629	0:04:30	641	0:04:30	732
0:05:00	420	0:05:00	648	0:05:00	703	0:05:00	756
0:05:30	434	0:05:30	666	0:05:30	764	0:05:30	777
0:06:00	477	0:06:00	696	0:06:00	820	0:06:00	829
0:06:30	525	0:06:30	770	0:06:30	881	0:06:30	898
0:07:00	555	0:07:00	805	0:07:00	919	0:07:00	954
0:07:30	583	0:07:30	869	0:07:30	976	0:07:30	1009
0:08:00	611	0:08:00	935	0:08:00	1031	0:08:00	1054
0:08:30	636	0:08:30	956	0:08:30	1059	0:08:30	1093
0:09:00	664	0:09:00	1023	0:09:00	1119	0:09:00	1162
0:09:30	692	0:09:30	1064	0:09:30	1163	0:09:30	1209
0:10:00	717	0:10:00	1083	0:10:00	1197	0:10:00	1260
0:10:30	726	0:10:30	1150	0:10:30	1257	0:10:30	1301
0:11:00	760	0:11:00	1192	0:11:00	1281	0:11:00	1348
0:11:30	779	0:11:30	1223	0:11:30	1330	0:11:30	1384
0:12:00	801	0:12:00	1249	0:12:00	1376	0:12:00	1430
0:12:30	820	0:12:30	1311	0:12:30	1411	0:12:30	1465
0:13:00	840	0:13:00	1360	0:13:00	1450	0:13:00	1504
0:13:30	860	0:13:30	1390	0:13:30	1500	0:13:30	1550
0:14:00	880	0:14:00	1443	0:14:00	1537	0:14:00	1583
0:14:30	899	0:14:30	1483	0:14:30	1574	0:14:30	1617
0:15:00	919	0:15:00	1515	0:15:00	1612	0:15:00	1655
0:15:30	961	0:15:30	1560	0:15:30	1648	0:15:30	1700
0:16:00	968	0:16:00	1617	0:16:00	1683	0:16:00	1741
0:16:30	1012	0:16:30	1655	0:16:30	1717	0:16:30	1778
0:17:00	1027	0:17:00	1696	0:17:00	1751	0:17:00	1811
0:17:30	1047	0:17:30	1704	0:17:30	1787	0:17:30	1858
0:18:00	1064	0:18:00	1771	0:18:00	1820	0:18:00	1859
0:18:30	1081	0:18:30	1802	0:18:30	1851	0:18:30	1905
0:19:00	1098	0:19:00	1813	0:19:00	1890	0:19:00	1940
0:19:30	1116	0:19:30	1824	0:19:30	1900	0:19:30	1978
0:20:00	1139	0:20:00	1834	0:20:00	1962	0:20:00	1982

Soil #1 made at 100 mg/L	
575 mmHg	
Time (s)	Volume (mL)
0:00:00	0
0:00:30	46
0:01:00	150
0:01:30	185
0:02:00	272
0:02:30	349
0:03:00	423
0:03:30	501
0:04:00	553
0:04:30	593
0:05:00	658
0:05:30	713
0:06:00	769
0:06:30	775
0:07:00	785
0:07:30	799
0:08:00	815
0:08:30	834
0:09:00	887
0:09:30	936
0:10:00	979
0:10:30	1040
0:11:00	1047
0:11:30	1094
0:12:00	1136
0:12:30	1179
0:13:00	1203
0:13:30	1251
0:14:00	1280
0:14:30	1323
0:15:00	1365
0:15:30	1403
0:16:00	1450
0:16:30	1465
0:17:00	1494
0:17:30	1541
0:18:00	1568
0:18:30	1599
0:19:00	1657
0:19:30	1678
0:20:00	1711

Table B.9: Tabulation of Figure 5.11 – Soil #1 Using Grade 5 Filter Paper with Three Replicates of a TSS Concentration of 85 mg/L and a Consistent Pressure of 575 mmHg

Soil #1 made at 85 mg/L		Soil #1 made at 85 mg/L		Soil #1 made at 85 mg/L	
575 mmHg		575 mmHg		575 mmHg	
Time (s)	Volume (mL)	Time (s)	Volume (mL)	Time (s)	Volume (mL)
0:00:00	0	0:00:00	0	0:00:00	0
0:00:30	57	0:00:30	52	0:00:30	74
0:01:00	121	0:01:00	157	0:01:00	184
0:01:30	166	0:01:30	241	0:01:30	255
0:02:00	217	0:02:00	359	0:02:00	349
0:02:30	225	0:02:30	460	0:02:30	434
0:03:00	238	0:03:00	515	0:03:00	516
0:03:30	251	0:03:30	526	0:03:30	601
0:04:00	293	0:04:00	553	0:04:00	674
0:04:30	320	0:04:30	621	0:04:30	739
0:05:00	372	0:05:00	680	0:05:00	813
0:05:30	419	0:05:30	739	0:05:30	856
0:06:00	430	0:06:00	794	0:06:00	906
0:06:30	490	0:06:30	858	0:06:30	965
0:07:00	515	0:07:00	907	0:07:00	1010
0:07:30	545	0:07:30	963	0:07:30	1058
0:08:00	583	0:08:00	1011	0:08:00	1103
0:08:30	589	0:08:30	1068	0:08:30	1146
0:09:00	654	0:09:00	1109	0:09:00	1191
0:09:30	677	0:09:30	1163	0:09:30	1242
0:10:00	719	0:10:00	1211	0:10:00	1297
0:10:30	723	0:10:30	1256	0:10:30	1300
0:11:00	745	0:11:00	1297	0:11:00	1301
0:11:30	790	0:11:30	1339	0:11:30	1302
0:12:00	817	0:12:00	1379	0:12:00	1319
0:12:30	857	0:12:30	1419	0:12:30	1325
0:13:00	915	0:13:00	1480	0:13:00	1341
0:13:30	918	0:13:30	1510	0:13:30	1390
0:14:00	919	0:14:00	1547	0:14:00	1425
0:14:30	919	0:14:30	1584	0:14:30	1460
0:15:00	919	0:15:00	1625	0:15:00	1493
0:15:30	928	0:15:30	1663	0:15:30	1535
0:16:00	932	0:16:00	1696	0:16:00	1554
0:16:30	940	0:16:30	1741	0:16:30	1608
0:17:00	947	0:17:00	1772	0:17:00	1617
0:17:30	956	0:17:30	1803	0:17:30	1663
0:18:00	1004	0:18:00	1868	0:18:00	1700
0:18:30	1006	0:18:30	1901	0:18:30	1730
0:19:00	1049	0:19:00	1938	0:19:00	1759
0:19:30	1078	0:19:30	1970	0:19:30	1789
0:20:00	1099	0:20:00	2011	0:20:00	1816

Table B.10: Tabulation of Figure 5.12 – Soil #1 Using Grade 5 Filter Paper at a Pressure of 575 mmHg, Comparing TSS Concentrations of 85 mg/L and 100 mg/L

Soil #1 made at 100 mg/L		Soil #1 made at 100 mg/L		Soil #1 made at 100 mg/L		Soil #1 made at 100 mg/L	
575 mmHg		575 mmHg		575 mmHg		575 mmHg	
Time (s)	Volume (mL)	Time (s)	Volume (mL)	Time (s)	Volume (mL)	Time (s)	Volume (mL)
0:00:00	0	0:00:00	0	0:00:00	0	0:00:00	0
0:00:30	70	0:00:30	75	0:00:30	55	0:00:30	82
0:01:00	147	0:01:00	169	0:01:00	154	0:01:00	176
0:01:30	180	0:01:30	248	0:01:30	269	0:01:30	278
0:02:00	259	0:02:00	301	0:02:00	380	0:02:00	351
0:02:30	313	0:02:30	406	0:02:30	407	0:02:30	459
0:03:00	364	0:03:00	484	0:03:00	434	0:03:00	551
0:03:30	380	0:03:30	551	0:03:30	499	0:03:30	643
0:04:00	395	0:04:00	610	0:04:00	575	0:04:00	727
0:04:30	408	0:04:30	629	0:04:30	641	0:04:30	732
0:05:00	420	0:05:00	648	0:05:00	703	0:05:00	756
0:05:30	434	0:05:30	666	0:05:30	764	0:05:30	777
0:06:00	477	0:06:00	696	0:06:00	820	0:06:00	829
0:06:30	525	0:06:30	770	0:06:30	881	0:06:30	898
0:07:00	555	0:07:00	805	0:07:00	919	0:07:00	954
0:07:30	583	0:07:30	869	0:07:30	976	0:07:30	1009
0:08:00	611	0:08:00	935	0:08:00	1031	0:08:00	1054
0:08:30	636	0:08:30	956	0:08:30	1059	0:08:30	1093
0:09:00	664	0:09:00	1023	0:09:00	1119	0:09:00	1162
0:09:30	692	0:09:30	1064	0:09:30	1163	0:09:30	1209
0:10:00	717	0:10:00	1083	0:10:00	1197	0:10:00	1260
0:10:30	726	0:10:30	1150	0:10:30	1257	0:10:30	1301
0:11:00	760	0:11:00	1192	0:11:00	1281	0:11:00	1348
0:11:30	779	0:11:30	1223	0:11:30	1330	0:11:30	1384
0:12:00	801	0:12:00	1249	0:12:00	1376	0:12:00	1430
0:12:30	820	0:12:30	1311	0:12:30	1411	0:12:30	1465
0:13:00	840	0:13:00	1360	0:13:00	1450	0:13:00	1504
0:13:30	860	0:13:30	1390	0:13:30	1500	0:13:30	1550
0:14:00	880	0:14:00	1443	0:14:00	1537	0:14:00	1583
0:14:30	899	0:14:30	1483	0:14:30	1574	0:14:30	1617
0:15:00	919	0:15:00	1515	0:15:00	1612	0:15:00	1655
0:15:30	961	0:15:30	1560	0:15:30	1648	0:15:30	1700
0:16:00	968	0:16:00	1617	0:16:00	1683	0:16:00	1741
0:16:30	1012	0:16:30	1655	0:16:30	1717	0:16:30	1778
0:17:00	1027	0:17:00	1696	0:17:00	1751	0:17:00	1811
0:17:30	1047	0:17:30	1704	0:17:30	1787	0:17:30	1858
0:18:00	1064	0:18:00	1771	0:18:00	1820	0:18:00	1859
0:18:30	1081	0:18:30	1802	0:18:30	1851	0:18:30	1905
0:19:00	1098	0:19:00	1813	0:19:00	1890	0:19:00	1940
0:19:30	1116	0:19:30	1824	0:19:30	1900	0:19:30	1978
0:20:00	1139	0:20:00	1834	0:20:00	1962	0:20:00	1982

Soil #1 made at 100 mg/L	
575 mmHg	
Time (s)	Volume (mL)
0:00:00	0
0:00:30	46
0:01:00	150
0:01:30	185
0:02:00	272
0:02:30	349
0:03:00	423
0:03:30	501
0:04:00	553
0:04:30	593
0:05:00	658
0:05:30	713
0:06:00	769
0:06:30	775
0:07:00	785
0:07:30	799
0:08:00	815
0:08:30	834
0:09:00	887
0:09:30	936
0:10:00	979
0:10:30	1040
0:11:00	1047
0:11:30	1094
0:12:00	1136
0:12:30	1179
0:13:00	1203
0:13:30	1251
0:14:00	1280
0:14:30	1323
0:15:00	1365
0:15:30	1403
0:16:00	1450
0:16:30	1465
0:17:00	1494
0:17:30	1541
0:18:00	1568
0:18:30	1599
0:19:00	1657
0:19:30	1678
0:20:00	1711

Soil #1 made at 85 mg/L	
575 mmHg	
Time (s)	Volume (mL)
0:00:00	0
0:00:30	57
0:01:00	121
0:01:30	166
0:02:00	217
0:02:30	225
0:03:00	238
0:03:30	251
0:04:00	293
0:04:30	320
0:05:00	372
0:05:30	419
0:06:00	430
0:06:30	490
0:07:00	515
0:07:30	545
0:08:00	583
0:08:30	589
0:09:00	654
0:09:30	677
0:10:00	719
0:10:30	723
0:11:00	745
0:11:30	790
0:12:00	817
0:12:30	857
0:13:00	915
0:13:30	918
0:14:00	919
0:14:30	919
0:15:00	919
0:15:30	928
0:16:00	932
0:16:30	940
0:17:00	947
0:17:30	956
0:18:00	1004
0:18:30	1006
0:19:00	1049
0:19:30	1078
0:20:00	1099

Soil #1 made at 85 mg/L	
575 mmHg	
Time (s)	Volume (mL)
0:00:00	0
0:00:30	52
0:01:00	157
0:01:30	241
0:02:00	359
0:02:30	460
0:03:00	515
0:03:30	526
0:04:00	553
0:04:30	621
0:05:00	680
0:05:30	739
0:06:00	794
0:06:30	858
0:07:00	907
0:07:30	963
0:08:00	1011
0:08:30	1068
0:09:00	1109
0:09:30	1163
0:10:00	1211
0:10:30	1256
0:11:00	1297
0:11:30	1339
0:12:00	1379
0:12:30	1419
0:13:00	1480
0:13:30	1510
0:14:00	1547
0:14:30	1584
0:15:00	1625
0:15:30	1663
0:16:00	1696
0:16:30	1741
0:17:00	1772
0:17:30	1803
0:18:00	1868
0:18:30	1901
0:19:00	1938
0:19:30	1970
0:20:00	2011

Soil #1 made at 85 mg/L	
575 mmHg	
Time (s)	Volume (mL)
0:00:00	0
0:00:30	74
0:01:00	184
0:01:30	255
0:02:00	349
0:02:30	434
0:03:00	516
0:03:30	601
0:04:00	674
0:04:30	739
0:05:00	813
0:05:30	856
0:06:00	906
0:06:30	965
0:07:00	1010
0:07:30	1058
0:08:00	1103
0:08:30	1146
0:09:00	1191
0:09:30	1242
0:10:00	1297
0:10:30	1300
0:11:00	1301
0:11:30	1302
0:12:00	1319
0:12:30	1325
0:13:00	1341
0:13:30	1390
0:14:00	1425
0:14:30	1460
0:15:00	1493
0:15:30	1535
0:16:00	1554
0:16:30	1608
0:17:00	1617
0:17:30	1663
0:18:00	1700
0:18:30	1730
0:19:00	1759
0:19:30	1789
0:20:00	1816

Table B.11: Tabulation of Figure 5.13 – Soil #1 Using Grade 5 Filter Paper after Mixing Apparatus Modification, with Three Replicates of a TSS Concentration of 100 mg/L and a Consistent Pressure of 575 mmHg

Soil #1 made at 100 mg/L 575 mmHg	
Time (s)	Volume (mL)
0:00:00	0
0:00:30	67
0:01:00	142
0:01:30	230
0:02:00	253
0:02:30	277
0:03:00	348
0:03:30	416
0:04:00	470
0:04:30	532
0:05:00	567
0:05:30	625
0:06:00	680
0:06:30	684
0:07:00	685
0:07:30	693
0:08:00	703
0:08:30	713
0:09:00	719
0:09:30	729
0:10:00	776
0:10:30	784
0:11:00	824
0:11:30	863
0:12:00	875
0:12:30	914
0:13:00	931
0:13:30	958
0:14:00	986
0:14:30	1016
0:15:00	1060
0:15:30	1088
0:16:00	1130
0:16:30	1135
0:17:00	1141
0:17:30	1185
0:18:00	1219
0:18:30	1240

0:19:00	1282
0:19:30	1284
0:20:00	1286

Soil #1 made at 100 mg/L 575 mmHg	
Time (s)	Volume (mL)
0:00:00	0
0:00:30	57
0:01:00	149
0:01:30	249
0:02:00	283
0:02:30	362
0:03:00	441
0:03:30	511
0:04:00	569
0:04:30	625
0:05:00	682
0:05:30	727
0:06:00	771
0:06:30	814
0:07:00	855
0:07:30	894
0:08:00	931
0:08:30	968
0:09:00	1001
0:09:30	1068
0:10:00	1072
0:10:30	1073
0:11:00	1074
0:11:30	1082
0:12:00	1090
0:12:30	1098
0:13:00	1108
0:13:30	1119
0:14:00	1168
0:14:30	1194
0:15:00	1226
0:15:30	1250
0:16:00	1274
0:16:30	1300
0:17:00	1324
0:17:30	1348
0:18:00	1372
0:18:30	1404

0:19:00	1426
0:19:30	1447
0:20:00	1470

Soil #1 made at 100 mg/L	
575 mmHg	
Time (s)	Volume (mL)
0:00:00	0
0:00:30	51
0:01:00	135
0:01:30	151
0:02:00	184
0:02:30	290
0:03:00	342
0:03:30	414
0:04:00	462
0:04:30	505
0:05:00	549
0:05:30	591
0:06:00	633
0:06:30	715
0:07:00	722
0:07:30	725
0:08:00	728
0:08:30	729
0:09:00	729
0:09:30	752
0:10:00	764
0:10:30	798
0:11:00	821
0:11:30	866
0:12:00	891
0:12:30	917
0:13:00	943
0:13:30	968
0:14:00	993
0:14:30	1020
0:15:00	1054
0:15:30	1079
0:16:00	1100
0:16:30	1128
0:17:00	1153
0:17:30	1173
0:18:00	1194
0:18:30	1220
0:19:00	1240
0:19:30	1261
0:20:00	1282

Table B.12: Tabulation of Figure 5.14 – Soil #1 Using Grade 5 Filter Paper after Mixing Apparatus Modification, with Two Replicates of a TSS Concentration of 85 mg/L and a Consistent Pressure of 575 mmHg

Soil #1 made at 85 mg/L 575 mmHg	
Time (s)	Volume (mL)
0:00:00	0
0:00:30	46
0:01:00	144
0:01:30	247
0:02:00	311
0:02:30	312
0:03:00	328
0:03:30	346
0:04:00	405
0:04:30	422
0:05:00	506
0:05:30	546
0:06:00	585
0:06:30	627
0:07:00	668
0:07:30	727
0:08:00	755
0:08:30	774
0:09:00	806
0:09:30	863
0:10:00	898
0:10:30	927
0:11:00	956
0:11:30	988
0:12:00	1022
0:12:30	1060
0:13:00	1060
0:13:30	1089
0:14:00	1135
0:14:30	1180
0:15:00	1180
0:15:30	1214
0:16:00	1239
0:16:30	1266
0:17:00	1311
0:17:30	1323
0:18:00	1348

0:18:30	1385
0:19:00	1407
0:19:30	1436
0:20:00	1483

Soil #1 made at 85 mg/L 575 mmHg	
Time (s)	Volume (mL)
0:00:00	0
0:00:30	49
0:01:00	156
0:01:30	259
0:02:00	362
0:02:30	468
0:03:00	472
0:03:30	497
0:04:00	524
0:04:30	617
0:05:00	677
0:05:30	745
0:06:00	779
0:06:30	846
0:07:00	900
0:07:30	961
0:08:00	993
0:08:30	1059
0:09:00	1099
0:09:30	1146
0:10:00	1213
0:10:30	1215
0:11:00	1292
0:11:30	1298
0:12:00	1353
0:12:30	1405
0:13:00	1453
0:13:30	1486
0:14:00	1517
0:14:30	1538
0:15:00	1632
0:15:30	1639
0:16:00	1642
0:16:30	1643
0:17:00	1644
0:17:30	1659
0:18:00	1667

0:18:30	1679
0:19:00	1711
0:19:30	1722
0:20:00	1767

Table B.13: Tabulation of Figure 5.15 – Soil #1 Using Grade 5 Filter Paper after Mixing Apparatus Modification at a Pressure of 575 mmHg, Comparing TSS Concentrations of 85 mg/L and 100 mg/L

Soil #1 made at 100 mg/L 575 mmHg	
Time (s)	Volume (mL)
0:00:00	0
0:00:30	67
0:01:00	142
0:01:30	230
0:02:00	253
0:02:30	277
0:03:00	348
0:03:30	416
0:04:00	470
0:04:30	532
0:05:00	567
0:05:30	625
0:06:00	680
0:06:30	684
0:07:00	685
0:07:30	693
0:08:00	703
0:08:30	713
0:09:00	719
0:09:30	729
0:10:00	776
0:10:30	784
0:11:00	824
0:11:30	863
0:12:00	875
0:12:30	914
0:13:00	931
0:13:30	958
0:14:00	986
0:14:30	1016
0:15:00	1060
0:15:30	1088
0:16:00	1130
0:16:30	1135
0:17:00	1141
0:17:30	1185
0:18:00	1219
0:18:30	1240

0:19:00	1282
0:19:30	1284
0:20:00	1286

Soil #1 made at 100 mg/L 575 mmHg	
Time (s)	Volume (mL)
0:00:00	0
0:00:30	57
0:01:00	149
0:01:30	249
0:02:00	283
0:02:30	362
0:03:00	441
0:03:30	511
0:04:00	569
0:04:30	625
0:05:00	682
0:05:30	727
0:06:00	771
0:06:30	814
0:07:00	855
0:07:30	894
0:08:00	931
0:08:30	968
0:09:00	1001
0:09:30	1068
0:10:00	1072
0:10:30	1073
0:11:00	1074
0:11:30	1082
0:12:00	1090
0:12:30	1098
0:13:00	1108
0:13:30	1119
0:14:00	1168
0:14:30	1194
0:15:00	1226
0:15:30	1250
0:16:00	1274
0:16:30	1300
0:17:00	1324
0:17:30	1348
0:18:00	1372
0:18:30	1404

0:19:00	1426
0:19:30	1447
0:20:00	1470

Soil #1 made at 100 mg/L	
575 mmHg	
Time (s)	Volume (mL)
0:00:00	0
0:00:30	51
0:01:00	135
0:01:30	151
0:02:00	184
0:02:30	290
0:03:00	342
0:03:30	414
0:04:00	462
0:04:30	505
0:05:00	549
0:05:30	591
0:06:00	633
0:06:30	715
0:07:00	722
0:07:30	725
0:08:00	728
0:08:30	729
0:09:00	729
0:09:30	752
0:10:00	764
0:10:30	798
0:11:00	821
0:11:30	866
0:12:00	891
0:12:30	917
0:13:00	943
0:13:30	968
0:14:00	993
0:14:30	1020
0:15:00	1054
0:15:30	1079
0:16:00	1100
0:16:30	1128
0:17:00	1153
0:17:30	1173
0:18:00	1194
0:18:30	1220
0:19:00	1240
0:19:30	1261
0:20:00	1282

Soil #1 made at 85 mg/L	
575 mmHg	
Time (s)	Volume (mL)
0:00:00	0
0:00:30	46
0:01:00	144
0:01:30	247
0:02:00	311
0:02:30	312
0:03:00	328
0:03:30	346
0:04:00	405
0:04:30	422
0:05:00	506
0:05:30	546
0:06:00	585
0:06:30	627
0:07:00	668
0:07:30	727
0:08:00	755
0:08:30	774
0:09:00	806
0:09:30	863
0:10:00	898
0:10:30	927
0:11:00	956
0:11:30	988
0:12:00	1022
0:12:30	1060
0:13:00	1060
0:13:30	1089
0:14:00	1135
0:14:30	1180
0:15:00	1180
0:15:30	1214
0:16:00	1239
0:16:30	1266
0:17:00	1311
0:17:30	1323
0:18:00	1348
0:18:30	1385
0:19:00	1407
0:19:30	1436
0:20:00	1483

Soil #1 made at 85 mg/L	
575 mmHg	
Time (s)	Volume (mL)
0:00:00	0
0:00:30	49
0:01:00	156
0:01:30	259
0:02:00	362
0:02:30	468
0:03:00	472
0:03:30	497
0:04:00	524
0:04:30	617
0:05:00	677
0:05:30	745
0:06:00	779
0:06:30	846
0:07:00	900
0:07:30	961
0:08:00	993
0:08:30	1059
0:09:00	1099
0:09:30	1146
0:10:00	1213
0:10:30	1215
0:11:00	1292
0:11:30	1298
0:12:00	1353
0:12:30	1405
0:13:00	1453
0:13:30	1486
0:14:00	1517
0:14:30	1538
0:15:00	1632
0:15:30	1639
0:16:00	1642
0:16:30	1643
0:17:00	1644
0:17:30	1659
0:18:00	1667
0:18:30	1679
0:19:00	1711
0:19:30	1722
0:20:00	1767

Table B.14: Tabulation of Figure 5.16 – Soil #1 Using 934-AH Filter Paper, with Three Replicates of a TSS Concentration of 100 mg/L and a Consistent Pressure of 575 mmHg

Soil #1 made at 100 mg/L		Soil #1 made at 100 mg/L		Soil #1 made at 100 mg/L	
575 mmHg		575 mmHg		575 mmHg	
Time (s)	Volume (mL)	Time (s)	Volume (mL)	Time (s)	Volume (mL)
0:00:00	0	0:00:00	0	0:00:00	0
0:00:30	808	0:00:30	890	0:00:30	890
0:01:00	1765	0:01:00	1984	0:01:00	1950
0:01:30	2442	0:01:30	2616	0:01:30	2651
0:02:00	2960	0:02:00	3073	0:02:00	3112
0:02:30	3350	0:02:30	3510	0:02:30	3637
0:03:00	3698	0:03:00	3823	0:03:00	3940
0:03:30	3942	0:03:30	4067	0:03:30	4300
0:04:00	4183	0:04:00	4341	0:04:00	4611
0:04:30	4451	0:04:30	4593	0:04:30	4882
0:05:00	4670	0:05:00	4843	0:05:00	5122
0:05:30	4905	0:05:30	5018	0:05:30	5359
0:06:00	5113	0:06:00	5211	0:06:00	5550
0:06:30	5298	0:06:30	5407	0:06:30	5760
0:07:00	5470	0:07:00	5576	0:07:00	5887
0:07:30	5639	0:07:30	5727	0:07:30	5981
0:08:00	5797	0:08:00	5877	0:08:00	6129
0:08:30	5976	0:08:30	6036	0:08:30	6302
0:09:00	6117	0:09:00	6194	0:09:00	6449
0:09:30	6236	0:09:30	6329	0:09:30	6605
0:10:00	6391	0:10:00	6454	0:10:00	6726
0:10:30	6541	0:10:30	6577	0:10:30	6874
0:11:00	6591	0:11:00	6698	0:11:00	6998
0:11:30	6624	0:11:30	6724	0:11:30	7123
0:12:00	6757	0:12:00	6805	0:12:00	7224
0:12:30	6848	0:12:30	6886	0:12:30	7332
0:13:00	6965	0:13:00	6984	0:13:00	7466
0:13:30	7083	0:13:30	7104	0:13:30	7579
0:14:00	7181	0:14:00	7205	0:14:00	7656
0:14:30	7283	0:14:30	7284	0:14:30	7785
0:15:00	7388	0:15:00	7368		
0:15:30	7483	0:15:30	7464		
0:16:00	7565	0:16:00	7571		
0:16:30	7655	0:16:30	7648		
0:17:00	7774	0:17:00	7724		
0:17:30	7855				
0:18:00	7934				
0:18:30	8049				

Table B.15: Tabulation of Figure 5.17 – Soil #1 Using 934-AH Filter Paper, with Three Replicates of a TSS Concentration of 85 mg/L and a Consistent Pressure of 575 mmHg

Soil #1 made at 85 mg/L		Soil #1 made at 85 mg/L		Soil #1 made at 85 mg/L	
575 mmHg		575 mmHg		575 mmHg	
Time (s)	Volume (mL)	Time (s)	Volume (mL)	Time (s)	Volume (mL)
0:00:00	0	0:00:00	0	0:00:00	0
0:00:30	866	0:00:30	893	0:00:30	920
0:01:00	1943	0:01:00	1961	0:01:00	1990
0:01:30	2639	0:01:30	2570	0:01:30	2642
0:02:00	3114	0:02:00	3099	0:02:00	3092
0:02:30	3594	0:02:30	3439	0:02:30	3500
0:03:00	3915	0:03:00	3793	0:03:00	3848
0:03:30	4211	0:03:30	4098	0:03:30	4037
0:04:00	4497	0:04:00	4360	0:04:00	4312
0:04:30	4767	0:04:30	4521	0:04:30	4553
0:05:00	5005	0:05:00	4720	0:05:00	4771
0:05:30	5221	0:05:30	4929	0:05:30	4975
0:06:00	5424	0:06:00	5132	0:06:00	5166
0:06:30	5611	0:06:30	5320	0:06:30	5333
0:07:00	5786	0:07:00	5494	0:07:00	5499
0:07:30	5985	0:07:30	5657	0:07:30	5667
0:08:00	6148	0:08:00	5818	0:08:00	5819
0:08:30	6279	0:08:30	5973	0:08:30	5960
0:09:00	6430	0:09:00	6127	0:09:00	6109
0:09:30	6628	0:09:30	6261	0:09:30	6232
0:10:00	6633	0:10:00	6387	0:10:00	6367
0:10:30	6700	0:10:30	6516	0:10:30	6489
0:11:00	6834	0:11:00	6641	0:11:00	6625
0:11:30	6960	0:11:30	6757	0:11:30	6660
0:12:00	7069	0:12:00	6854	0:12:00	6700
0:12:30	7188	0:12:30	7002	0:12:30	6797
0:13:00	7302	0:13:00	7097	0:13:00	6899
0:13:30	7398	0:13:30	7197	0:13:30	7020
0:14:00	7507	0:14:00	7300	0:14:00	7107
0:14:30	7617	0:14:30	7390	0:14:30	7197
0:15:00	7720	0:15:00	7501	0:15:00	7296
		0:15:30	7598	0:15:30	7378
		0:16:00	7692	0:16:00	7489
				0:16:30	7575
				0:17:00	7663
				0:17:30	7753

Table B.16: Tabulation of Figure 5.18 – Soil #1 Using 934-AH Filter Paper at a Pressure of 575 mmHg, Comparing TSS Concentrations of 85 mg/L and 100 mg/L

Soil #1 made at 100 mg/L		Soil #1 made at 100 mg/L		Soil #1 made at 100 mg/L		Soil #1 made at 85 mg/L	
575 mmHg		575 mmHg		575 mmHg		575 mmHg	
Time (s)	Volume (mL)	Time (s)	Volume (mL)	Time (s)	Volume (mL)	Time (s)	Volume (mL)
0:00:00	0	0:00:00	0	0:00:00	0	0:00:00	0
0:00:30	808	0:00:30	890	0:00:30	890	0:00:30	866
0:01:00	1765	0:01:00	1984	0:01:00	1950	0:01:00	1943
0:01:30	2442	0:01:30	2616	0:01:30	2651	0:01:30	2639
0:02:00	2960	0:02:00	3073	0:02:00	3112	0:02:00	3114
0:02:30	3350	0:02:30	3510	0:02:30	3637	0:02:30	3594
0:03:00	3698	0:03:00	3823	0:03:00	3940	0:03:00	3915
0:03:30	3942	0:03:30	4067	0:03:30	4300	0:03:30	4211
0:04:00	4183	0:04:00	4341	0:04:00	4611	0:04:00	4497
0:04:30	4451	0:04:30	4593	0:04:30	4882	0:04:30	4767
0:05:00	4670	0:05:00	4843	0:05:00	5122	0:05:00	5005
0:05:30	4905	0:05:30	5018	0:05:30	5359	0:05:30	5221
0:06:00	5113	0:06:00	5211	0:06:00	5550	0:06:00	5424
0:06:30	5298	0:06:30	5407	0:06:30	5760	0:06:30	5611
0:07:00	5470	0:07:00	5576	0:07:00	5887	0:07:00	5786
0:07:30	5639	0:07:30	5727	0:07:30	5981	0:07:30	5985
0:08:00	5797	0:08:00	5877	0:08:00	6129	0:08:00	6148
0:08:30	5976	0:08:30	6036	0:08:30	6302	0:08:30	6279
0:09:00	6117	0:09:00	6194	0:09:00	6449	0:09:00	6430
0:09:30	6236	0:09:30	6329	0:09:30	6605	0:09:30	6628
0:10:00	6391	0:10:00	6454	0:10:00	6726	0:10:00	6633
0:10:30	6541	0:10:30	6577	0:10:30	6874	0:10:30	6700
0:11:00	6591	0:11:00	6698	0:11:00	6998	0:11:00	6834
0:11:30	6624	0:11:30	6724	0:11:30	7123	0:11:30	6960
0:12:00	6757	0:12:00	6805	0:12:00	7224	0:12:00	7069
0:12:30	6848	0:12:30	6886	0:12:30	7332	0:12:30	7188
0:13:00	6965	0:13:00	6984	0:13:00	7466	0:13:00	7302
0:13:30	7083	0:13:30	7104	0:13:30	7579	0:13:30	7398
0:14:00	7181	0:14:00	7205	0:14:00	7656	0:14:00	7507
0:14:30	7283	0:14:30	7284	0:14:30	7785	0:14:30	7617
0:15:00	7388	0:15:00	7368			0:15:00	7720
0:15:30	7483	0:15:30	7464				
0:16:00	7565	0:16:00	7571				
0:16:30	7655	0:16:30	7648				
0:17:00	7774	0:17:00	7724				
0:17:30	7855						
0:18:00	7934						
0:18:30	8049						

Soil #1 made at 85 mg/L	
575 mmHg	
Time (s)	Volume (mL)
0:00:00	0
0:00:30	893
0:01:00	1961
0:01:30	2570
0:02:00	3099
0:02:30	3439
0:03:00	3793
0:03:30	4098
0:04:00	4360
0:04:30	4521
0:05:00	4720
0:05:30	4929
0:06:00	5132
0:06:30	5320
0:07:00	5494
0:07:30	5657
0:08:00	5818
0:08:30	5973
0:09:00	6127
0:09:30	6261
0:10:00	6387
0:10:30	6516
0:11:00	6641
0:11:30	6757
0:12:00	6854
0:12:30	7002
0:13:00	7097
0:13:30	7197
0:14:00	7300
0:14:30	7390
0:15:00	7501
0:15:30	7598
0:16:00	7692

Soil #1 made at 85 mg/L	
575 mmHg	
Time (s)	Volume (mL)
0:00:00	0
0:00:30	920
0:01:00	1990
0:01:30	2642
0:02:00	3092
0:02:30	3500
0:03:00	3848
0:03:30	4037
0:04:00	4312
0:04:30	4553
0:05:00	4771
0:05:30	4975
0:06:00	5166
0:06:30	5333
0:07:00	5499
0:07:30	5667
0:08:00	5819
0:08:30	5960
0:09:00	6109
0:09:30	6232
0:10:00	6367
0:10:30	6489
0:11:00	6625
0:11:30	6660
0:12:00	6700
0:12:30	6797
0:13:00	6899
0:13:30	7020
0:14:00	7107
0:14:30	7197
0:15:00	7296
0:15:30	7378
0:16:00	7489
0:16:30	7575
0:17:00	7663
0:17:30	7753

Table B.17: Tabulation of Figure 5.20 – Soil #1 Dilution Test Using 934-AH Filter Paper and no Vacuum, with Estimated Concentrations of 100 mg/L, 50 mg/L and 20 mg/L

260 mL		250 mL		250 mL	
Soil #1 made at 100 mg/L		2x Diluted		5x Diluted	
Time (s)	Volume (mL)	Time (s)	Volume (mL)	Time (s)	Volume (mL)
00:00	0	00:00	0	00:00	0
00:13	10	00:10	10	00:07	10
00:29	20	00:18	20	00:14	20
00:45	30	00:28	30	00:20	30
01:00	40	00:39	40	00:30	40
01:16	50	00:49	50	00:41	50
01:34	60	00:59	60	00:52	60
01:52	70	01:10	70	01:17	70
02:10	80	01:21	80	01:29	80
02:28	90	01:33	90	01:43	90
02:45	100	01:46	100	01:57	100
03:06	110	01:58	110	02:11	110
03:28	120	02:11	120	02:25	120
03:51	130	02:25	130	02:40	130
04:14	140	02:40	140	02:56	140
04:38	150	02:56	150	03:13	150
05:03	160	03:12	160	03:30	160
05:30	170	03:29	170	03:49	170
05:59	180	03:47	180	04:08	180
06:26	190	04:08	190	04:30	190
07:00	200	04:28	200	04:51	200
07:34	210	04:52	210	05:16	210
08:09	220	05:19	220	05:42	220
08:47	230	06:05	230	06:12	230
09:38	240	07:30	240	06:50	240
10:47	250	09:29	250	07:59	250

Table B.18: Tabulation of Figure 5.21 – Soil #1 with No Vacuum Using 934-AH Filter Paper, with Eight Replicates at a Manufactured TSS Concentration of 115 mg/L

117.6 mg/L	325 mL	106.4 mg/L	300 mL	105.3 mg/L	350 mL	95.2 mg/L	400 mL
Soil #1 made at 115 mg/L		Soil #1 made at 115 mg/L		Soil #1 made at 115 mg/L		Soil #1 made at 115 mg/L	
Time (s)	Volume (mL)	Time (s)	Volume (mL)	Time (s)	Volume (mL)	Time (s)	Volume (mL)
00:00	0	00:00	0	00:00	0	00:00	0
00:07	10	00:07	10	00:07	10	00:07	10
00:14	20	00:17	20	00:15	20	00:15	20
00:20	30	00:26	30	00:22	30	00:23	30
00:27	40	00:35	40	00:30	40	00:32	40
00:34	50	00:43	50	00:37	50	00:39	50
00:40	60	00:52	60	00:45	60	00:47	60
00:48	70	01:02	70	00:53	70	00:56	70
00:55	80	01:12	80	01:00	80	01:04	80
01:03	90	01:22	90	01:09	90	01:12	90
01:11	100	01:33	100	01:18	100	01:21	100
01:19	110	01:44	110	01:27	110	01:30	110
01:28	120	01:55	120	01:36	120	01:40	120
01:38	130	02:06	130	01:46	130	01:50	130
01:47	140	02:19	140	01:55	140	01:59	140
01:57	150	02:31	150	02:06	150	02:10	150
02:07	160	02:43	160	02:18	160	02:21	160
02:17	170	02:57	170	02:29	170	02:32	170
02:29	180	03:12	180	02:40	180	02:44	180
02:41	190	03:27	190	02:53	190	02:57	190
02:53	200	03:41	200	03:06	200	03:10	200
03:06	210	03:58	210	03:19	210	03:23	210
03:20	220	04:15	220	03:34	220	03:38	220
03:35	230	04:34	230	03:49	230	03:53	230
03:50	240	04:53	240	04:05	240	04:07	240
04:08	250	05:14	250	04:23	250	04:24	250

92.3 mg/L	300 mL
Soil #1 made at 115 mg/L	
Time (s)	Volume (mL)
00:00	0
00:08	10
00:17	20
00:25	30
00:34	40
00:42	50
00:51	60
01:01	70
01:11	80
01:20	90
01:30	100
01:40	110
01:51	120
02:01	130
02:12	140
02:23	150
02:35	160
02:49	170
03:01	180
03:15	190
03:30	200
03:44	210
04:00	220
04:17	230
04:34	240
04:53	250

94.2 mg/L	300 mL
Soil #1 made at 115 mg/L	
Time (s)	Volume (mL)
00:00	0
00:07	10
00:15	20
00:22	30
00:29	40
00:36	50
00:44	60
00:52	70
00:59	80
01:08	90
01:16	100
01:25	110
01:34	120
01:43	130
01:54	140
02:04	150
02:15	160
02:26	170
02:38	180
02:50	190
03:04	200
03:18	210
03:31	220
03:47	230
04:04	240
04:23	250

84.2 mg/L	300 mL
Soil #1 made at 115 mg/L	
Time (s)	Volume (mL)
00:00	0
00:09	10
00:18	20
00:27	30
00:36	40
00:45	50
00:54	60
01:04	70
01:14	80
01:24	90
01:35	100
01:46	110
01:57	120
02:08	130
02:20	140
02:32	150
02:46	160
03:00	170
03:14	180
03:28	190
03:44	200
04:00	210
04:17	220
04:37	230
04:56	240
05:16	250

85.6 mg/L	300 mL
Soil #1 made at 115 mg/L	
Time (s)	Volume (mL)
00:00	0
00:07	10
00:15	20
00:21	30
00:29	40
00:37	50
00:45	60
00:54	70
01:02	80
01:11	90
01:19	100
01:28	110
01:38	120
01:48	130
01:58	140
02:10	150
02:21	160
02:32	170
02:44	180
02:57	190
03:10	200
03:25	210
03:40	220
03:56	230
04:14	240
04:32	250

Table B.19: Tabulation of Figure 5.22 – Soil #1 with No Vacuum Using 934-AH Filter Paper, with Eight Replicates at a Manufactured TSS Concentration of 100 mg/L

96.8 mg/L	300 mL	109.9 mg/L	300 mL	94.7 mg/L	300 mL	84.2 mg/L	300 mL
Soil #1 made at 100 mg/L		Soil #1 made at 100 mg/L		Soil #1 made at 100 mg/L		Soil #1 made at 100 mg/L	
Time (s)	Volume (mL)	Time (s)	Volume (mL)	Time (s)	Volume (mL)	Time (s)	Volume (mL)
00:00	0	00:00	0	00:00	0	00:00	0
00:08	10	00:08	10	00:08	10	00:08	10
00:17	20	00:16	20	00:16	20	00:16	20
00:25	30	00:25	30	00:24	30	00:25	30
00:33	40	00:33	40	00:32	40	00:32	40
00:42	50	00:42	50	00:40	50	00:41	50
00:52	60	00:51	60	00:48	60	00:48	60
01:00	70	01:00	70	00:57	70	00:57	70
01:10	80	01:09	80	01:06	80	01:07	80
01:19	90	01:19	90	01:14	90	01:16	90
01:30	100	01:28	100	01:24	100	01:26	100
01:41	110	01:39	110	01:33	110	01:37	110
01:50	120	01:50	120	01:43	120	01:48	120
02:02	130	02:01	130	01:55	130	01:59	130
02:13	140	02:13	140	02:04	140	02:11	140
02:26	150	02:25	150	02:15	150	02:23	150
02:38	160	02:38	160	02:26	160	02:36	160
02:51	170	02:52	170	02:39	170	02:49	170
03:06	180	03:05	180	02:51	180	03:03	180
03:20	190	03:20	190	03:04	190	03:17	190
03:35	200	03:36	200	03:18	200	03:30	200
03:51	210	03:52	210	03:33	210	03:44	210
04:08	220	04:08	220	03:48	220	04:01	220
04:26	230	04:27	230	04:04	230	04:18	230
04:45	240	04:47	240	04:21	240	04:35	240
05:06	250	05:07	250	04:41	250	04:53	250

84.2 mg/L	300 mL
Soil #1 made at 100 mg/L	
Time (s)	Volume (mL)
00:00	0
00:08	10
00:17	20
00:25	30
00:34	40
00:42	50
00:51	60
01:01	70
01:09	80
01:20	90
01:30	100
01:40	110
01:50	120
02:01	130
02:13	140
02:25	150
02:38	160
02:51	170
03:04	180
03:19	190
03:33	200
03:50	210
04:06	220
04:23	230
04:41	240
05:01	250

93.8 mg/L	300 mL
Soil #1 made at 100 mg/L	
Time (s)	Volume (mL)
00:00	0
00:08	10
00:16	20
00:25	30
00:33	40
00:42	50
00:51	60
00:59	70
01:08	80
01:17	90
01:27	100
01:37	110
01:47	120
01:57	130
02:08	140
02:20	150
02:31	160
02:44	170
02:57	180
03:10	190
03:24	200
03:40	210
03:55	220
04:12	230
04:29	240
04:50	250

83.3 mg/L	300 mL
Soil #1 made at 100 mg/L	
Time (s)	Volume (mL)
00:00	0
00:08	10
00:17	20
00:25	30
00:33	40
00:41	50
00:50	60
00:59	70
01:08	80
01:17	90
01:27	100
01:37	110
01:47	120
01:58	130
02:09	140
02:20	150
02:31	160
02:43	170
02:57	180
03:10	190
03:24	200
03:39	210
03:54	220
04:10	230
04:28	240
04:47	250

82.5 mg/L	300 mL
Soil #1 made at 100 mg/L	
Time (s)	Volume (mL)
00:00	0
00:09	10
00:19	20
00:29	30
00:39	40
00:48	50
00:59	60
01:10	70
01:20	80
01:31	90
01:43	100
01:55	110
02:08	120
02:20	130
02:32	140
02:48	150
03:01	160
03:16	170
03:31	180
03:47	190
04:04	200
04:22	210
04:40	220
05:01	230
05:21	240
05:44	250

Table B.20: Tabulation of Figure 5.23 – Soil #1 with No Vacuum Using 934-AH Filter Paper, Comparison of Four Replicates of Manufactured TSS Concentrations of 115 mg/L and 100 mg/L, Using Large Volumes

Soil #1 made at 115 mg/L						Soil #1 made at 115 mg/L	
Time (s)	Volume (mL)					Time (s)	Volume (mL)
00:00	0	06:50	3481	14:10	4603	00:00	0
00:10	84	07:00	3520	14:20	4622	00:10	14
00:20	141	07:10	3556	14:30	4637	00:20	78
00:30	189	07:20	3590	14:40	4656	00:30	193
00:40	307	07:30	3626	14:50	4673	00:40	361
00:50	469	07:40	3660	15:00	4693	00:50	536
01:00	623	07:50	3696			01:00	681
01:10	789	08:00	3725			01:10	844
01:20	937	08:10	3759			01:20	1012
01:30	1084	08:20	3790			01:30	1158
01:40	1229	08:30	3821			01:40	1297
01:50	1358	08:40	3850			01:50	1439
02:00	1495	08:50	3877			02:00	1552
02:10	1618	09:00	3906			02:10	1670
02:20	1749	09:10	3935			02:20	1767
02:30	1852	09:20	3961			02:30	1894
02:40	1957	09:30	3990			02:40	1990
02:50	2056	09:40	4015			02:50	2084
03:00	2153	09:50	4042			03:00	2187
03:10	2242	10:00	4067			03:10	2268
03:20	2326	10:10	4094			03:20	2352
03:30	2400	10:20	4119			03:30	2422
03:40	2479	10:30	4141			03:40	2498
03:50	2553	10:40	4167			03:50	2569
04:00	2622	10:50	4190			04:00	2631
04:10	2691	11:00	4214			04:10	2699
04:20	2754	11:10	4239			04:20	2761
04:30	2815	11:20	4260			04:30	2819
04:40	2872	11:30	4282			04:40	2874
04:50	2930	11:40	4305			04:50	2927
05:00	2987	11:50	4328			05:00	2979
05:10	3035	12:00	4349			05:10	3027
05:20	3094	12:10	4370			05:20	3077
05:30	3139	12:20	4391			05:30	3125
05:40	3185	12:30	4411			05:40	3170
05:50	3232	12:40	4431			05:50	3212
06:00	3278	12:50	4453			06:00	3250
06:10	3323	13:00	4473			06:10	3295
06:20	3362	13:10	4493			06:20	3331
06:30	3401	13:20	4512			06:30	3369
06:40	3439	13:30	4530			06:40	3405
		13:40	4550				
		13:50	4569				
		14:00	4585				

06:50	3444
07:00	3474
07:10	3511
07:20	3543
07:30	3577
07:40	3608
07:50	3640
08:00	3670
08:10	3703
08:20	3731
08:30	3760
08:40	3789
08:50	3818
09:00	3843
09:10	3870
09:20	3898
09:30	3924
09:40	3949
09:50	3974
10:00	3998
10:10	4025
10:20	4047
10:30	4070
10:40	4094
10:50	4117
11:00	4139
11:10	4162
11:20	4185
11:30	4208
11:40	4227
11:50	4247
12:00	4269
12:10	4290
12:20	4309
12:30	4330
12:40	4349
12:50	4369
13:00	4388
13:10	4406
13:20	4426
13:30	4444
13:40	4461
13:50	4481
14:00	4497
14:10	4515
14:20	4533
14:30	4550

14:40	4568
14:50	4584
15:00	4601

Soil #1 made at 115 mg/L	
Time (s)	Volume (mL)
00:00	0
00:10	8
00:20	49
00:30	122
00:40	260
00:50	417
01:00	565
01:10	714
01:20	848
01:30	985
01:40	1102
01:50	1231
02:00	1347
02:10	1453
02:20	1548
02:30	1641
02:40	1731
02:50	1812
03:00	1889
03:10	1963
03:20	2028
03:30	2090
03:40	2157
03:50	2215
04:00	2268
04:10	2322
04:20	2372
04:30	2420
04:40	2467
04:50	2511
05:00	2555
05:10	2596
05:20	2636
05:30	2676
05:40	2713
05:50	2751
06:00	2785
06:10	2821
06:20	2852
06:30	2886
06:40	2916
06:50	2950
07:00	2977
07:10	3007

07:20	3036
07:30	3063
07:40	3090
07:50	3118
08:00	3144
08:10	3170
08:20	3195
08:30	3218
08:40	3239
08:50	3260
09:00	3280
09:10	3300
09:20	3320
09:30	3340
09:40	3361
09:50	3380
10:00	3399
10:10	3418
10:20	3437
10:30	3455
10:40	3473
10:50	3491
11:00	3508
11:10	3526
11:20	3544
11:30	3561
11:40	3578
11:50	3595
12:00	3611
12:10	3628
12:20	3644
12:30	3661
12:40	3677
12:50	3692
13:00	3708
13:10	3724
13:20	3738
13:30	3754
13:40	3769
13:50	3784
14:00	3798
14:10	3813
14:20	3828
14:30	3842
14:40	3856
14:50	3870
15:00	3884

Soil #1 made at 115 mg/L	
Time (s)	Volume (mL)
00:00	0
00:10	19
00:20	77
00:30	191
00:40	360
00:50	534
01:00	677
01:10	834
01:20	993
01:30	1146
01:40	1280
01:50	1439
02:00	1569
02:10	1699
02:20	1830
02:30	1940
02:40	2059
02:50	2165
03:00	2272
03:10	2377
03:20	2461
03:30	2551
03:40	2640
03:50	2722
04:00	2801
04:10	2877
04:20	2952
04:30	3019
04:40	3089
04:50	3154
05:00	3212
05:10	3277
05:20	3336
05:30	3392
05:40	3448
05:50	3502
06:00	3553
06:10	3603
06:20	3653
06:30	3700
06:40	3746
06:50	3792
07:00	3834
07:10	3875

07:20	3916
07:30	3958
07:40	3998
07:50	4039
08:00	4074
08:10	4111
08:20	4147
08:30	4186
08:40	4220
08:50	4256
09:00	4288
09:10	4322
09:20	4354
09:30	4386
09:40	4417
09:50	4447
10:00	4478
10:10	4507
10:20	4536
10:30	4564
10:40	4593
10:50	4619
11:00	4647
11:10	4672
11:20	4698
11:30	4724
11:40	4750
11:50	4774
12:00	4797
12:10	4822
12:20	4845
12:30	4869
12:40	4891
12:50	4916
13:00	4936
13:10	4959
13:20	4981
13:30	5002
13:40	5024
13:50	5046
14:00	5063
14:10	5086
14:20	5107
14:30	5125
14:40	5146
14:50	5166
15:00	5185

Soil #1 made at 100 mg/L	
Time (s)	Volume (mL)
00:00	0
00:10	13
00:20	67
00:30	171
00:40	352
00:50	524
01:00	679
01:10	835
01:20	998
01:30	1148
01:40	1281
01:50	1397
02:00	1524
02:10	1638
02:20	1753
02:30	1856
02:40	1965
02:50	2034
03:00	2122
03:10	2191
03:20	2267
03:30	2339
03:40	2401
03:50	2466
04:00	2525
04:10	2582
04:20	2640
04:30	2695
04:40	2750
04:50	2791
05:00	2831
05:10	2880
05:20	2923
05:30	2968
05:40	3005
05:50	3043
06:00	3082
06:10	3120
06:20	3156
06:30	3191
06:40	3226
06:50	3264
07:00	3292
07:10	3324

07:20	3355
07:30	3385
07:40	3412
07:50	3441
08:00	3470
08:10	3497
08:20	3522
08:30	3550
08:40	3574
08:50	3601
09:00	3623
09:10	3645
09:20	3669
09:30	3692
09:40	3717
09:50	3740
10:00	3762
10:10	3785
10:20	3805
10:30	3826
10:40	3848
10:50	3869
11:00	3890
11:10	3910
11:20	3930
11:30	3950
11:40	3969
11:50	3989
12:00	4006
12:10	4026
12:20	4044
12:30	4062
12:40	4080
12:50	4099
13:00	4115
13:10	4133
13:20	4151
13:30	4168
13:40	4185
13:50	4200
14:00	4218
14:10	4235
14:20	4250
14:30	4268
14:40	4284
14:50	4299
15:00	4312

Soil #1 made at 100 mg/L	
Time (s)	Volume (mL)
00:00	0
00:10	11
00:20	68
00:30	194
00:40	361
00:50	533
01:00	697
01:10	864
01:20	1033
01:30	1180
01:40	1318
01:50	1472
02:00	1606
02:10	1739
02:20	1875
02:30	2000
02:40	2112
02:50	2221
03:00	2329
03:10	2428
03:20	2529
03:30	2613
03:40	2699
03:50	2780
04:00	2858
04:10	2937
04:20	3008
04:30	3074
04:40	3144
04:50	3208
05:00	3270
05:10	3326
05:20	3385
05:30	3445
05:40	3491
05:50	3548
06:00	3586
06:10	3637
06:20	3685
06:30	3729
06:40	3774
06:50	3816
07:00	3854
07:10	3895

07:20	3935
07:30	3973
07:40	4009
07:50	4049
08:00	4079
08:10	4120
08:20	4151
08:30	4181
08:40	4216
08:50	4246
09:00	4277
09:10	4308
09:20	4340
09:30	4366
09:40	4397
09:50	4424
10:00	4451
10:10	4479
10:20	4506
10:30	4535
10:40	4559
10:50	4582
11:00	4608
11:10	4638
11:20	4660
11:30	4682
11:40	4703
11:50	4728
12:00	4750
12:10	4772
12:20	4795
12:30	4817
12:40	4838
12:50	4858
13:00	4878
13:10	4900
13:20	4922
13:30	4939
13:40	4958
13:50	4977
14:00	4998
14:10	5017
14:20	5035
14:30	5050
14:40	5069
14:50	5091
15:00	5108

Soil #1 made at 100 mg/L	
Time (s)	Volume (mL)
00:00	0
00:10	18
00:20	76
00:30	208
00:40	378
00:50	552
01:00	700
01:10	860
01:20	1011
01:30	1163
01:40	1304
01:50	1440
02:00	1568
02:10	1696
02:20	1813
02:30	1925
02:40	2030
02:50	2131
03:00	2222
03:10	2326
03:20	2406
03:30	2486
03:40	2568
03:50	2646
04:00	2717
04:10	2787
04:20	2852
04:30	2916
04:40	2977
04:50	3036
05:00	3094
05:10	3149
05:20	3202
05:30	3258
05:40	3303
05:50	3351
06:00	3396
06:10	3443
06:20	3485
06:30	3529
06:40	3569
06:50	3611
07:00	3651
07:10	3689

07:20	3728
07:30	3765
07:40	3802
07:50	3837
08:00	3871
08:10	3906
08:20	3938
08:30	3970
08:40	4003
08:50	4035
09:00	4065
09:10	4095
09:20	4125
09:30	4154
09:40	4182
09:50	4213
10:00	4237
10:10	4265
10:20	4292
10:30	4317
10:40	4344
10:50	4370
11:00	4394
11:10	4419
11:20	4445
11:30	4469
11:40	4493
11:50	4515
12:00	4538
12:10	4562
12:20	4583
12:30	4606
12:40	4628
12:50	4649
13:00	4672
13:10	4687
13:20	4713
13:30	4733
13:40	4755
13:50	4774
14:00	4794
14:10	4813
14:20	4833
14:30	4852
14:40	4871
14:50	4891
15:00	4908

Soil #1 made at 100 mg/L	
Time (s)	Volume (mL)
00:00	0
00:10	19
00:20	81
00:30	195
00:40	375
00:50	538
01:00	704
01:10	870
01:20	1020
01:30	1179
01:40	1329
01:50	1474
02:00	1615
02:10	1761
02:20	1887
02:30	2015
02:40	2137
02:50	2254
03:00	2366
03:10	2478
03:20	2578
03:30	2677
03:40	2776
03:50	2863
04:00	2957
04:10	3036
04:20	3119
04:30	3196
04:40	3274
04:50	3347
05:00	3413
05:10	3482
05:20	3549
05:30	3610
05:40	3672
05:50	3731
06:00	3788
06:10	3845
06:20	3899
06:30	3951
06:40	4002
06:50	4053
07:00	4099
07:10	4150

07:20	4194
07:30	4237
07:40	4282
07:50	4327
08:00	4366
08:10	4407
08:20	4447
08:30	4486
08:40	4525
08:50	4566
09:00	4598
09:10	4635
09:20	4669
09:30	4703
09:40	4738
09:50	4771
10:00	4805
10:10	4835
10:20	4866
10:30	4897
10:40	4929
10:50	4959
11:00	4988
11:10	5018
11:20	5046
11:30	5073
11:40	5102
11:50	5130
12:00	5156
12:10	5184
12:20	5209
12:30	5234
12:40	5260
12:50	5285
13:00	5309
13:10	5333
13:20	5358
13:30	5380
13:40	5405
13:50	5427
14:00	5451
14:10	5475
14:20	5495
14:30	5517
14:40	5539
14:50	5560
15:00	5581

Table B.21: Tabulation of Figure 5.24 – Soil #1 with No Vacuum Using 934-AH Filter Papers, with Five Replicates at a Manufactured TSS Concentration of 170 mg/L and Consistent Volumes

128.1 mg/L	300 mL	126.2 mg/L	300 mL	125.3 mg/L	300 mL	126.0 mg/L	300 mL
Soil #1 made at 170 mg/L		Soil #1 made at 170 mg/L		Soil #1 made at 170 mg/L		Soil #1 made at 170 mg/L	
Time (s)	Volume (mL)	Time (s)	Volume (mL)	Time (s)	Volume (mL)	Time (s)	Volume (mL)
00:00	0	00:00	0	00:00	0	00:00	0
00:06	10	00:07	10	00:06	10	00:07	10
00:12	20	00:14	20	00:13	20	00:14	20
00:18	30	00:21	30	00:20	30	00:20	30
00:24	40	00:28	40	00:27	40	00:28	40
00:30	50	00:35	50	00:34	50	00:35	50
00:36	60	00:42	60	00:41	60	00:42	60
00:42	70	00:49	70	00:49	70	00:50	70
00:49	80	00:57	80	00:57	80	00:58	80
00:55	90	01:05	90	01:05	90	01:06	90
01:03	100	01:13	100	01:13	100	01:14	100
01:10	110	01:22	110	01:22	110	01:23	110
01:18	120	01:31	120	01:31	120	01:32	120
01:26	130	01:41	130	01:40	130	01:41	130
01:34	140	01:50	140	01:50	140	01:51	140
01:42	150	02:00	150	02:00	150	02:01	150
01:51	160	02:11	160	02:10	160	02:11	160
02:00	170	02:22	170	02:21	170	02:22	170
02:10	180	02:33	180	02:32	180	02:34	180
02:20	190	02:46	190	02:44	190	02:46	190
02:31	200	02:59	200	02:57	200	02:58	200
02:43	210	03:12	210	03:11	210	03:12	210
02:55	220	03:27	220	03:25	220	03:27	220
03:08	230	03:43	230	03:41	230	03:42	230
03:22	240	04:00	240	03:58	240	03:58	240
03:36	250	04:20	250	04:16	250	04:15	250

136.4 mg/L	300 mL
Soil #1 made at 170 mg/L	
Time (s)	Volume (mL)
00:00	0
00:06	10
00:13	20
00:21	30
00:28	40
00:35	50
00:42	60
00:50	70
00:58	80
01:07	90
01:15	100
01:24	110
01:34	120
01:43	130
01:54	140
02:04	150
02:15	160
02:26	170
02:38	180
02:51	190
03:05	200
03:19	210
03:34	220
03:51	230
04:09	240
04:28	250

Table B.22: Tabulation of Figure 5.25 – Soil #1 with No Vacuum Using 934-AH Filter Papers, with Fifteen Replicates at a Manufactured TSS Concentration of 160 mg/L and Consistent Volumes

129.3 mg/L	300 mL	121.8 mg/L	300 mL	114.0 mg/L	300 mL	126.9 mg/L	300 mL
Soil #1 made at 160 mg/L		Soil #1 made at 160 mg/L		Soil #1 made at 160 mg/L		Soil #1 made at 160 mg/L	
Time (s)	Volume (mL)	Time (s)	Volume (mL)	Time (s)	Volume (mL)	Time (s)	Volume (mL)
00:00	0	00:00	0	00:00	0	00:00	0
00:07	10	00:08	10	00:07	10	00:08	10
00:14	20	00:16	20	00:15	20	00:16	20
00:20	30	00:24	30	00:24	30	00:25	30
00:27	40	00:31	40	00:32	40	00:34	40
00:34	50	00:39	50	00:42	50	00:44	50
00:41	60	00:47	60	00:50	60	00:54	60
00:49	70	00:56	70	01:00	70	01:04	70
00:56	80	01:04	80	01:10	80	01:14	80
01:04	90	01:13	90	01:20	90	01:25	90
01:12	100	01:23	100	01:29	100	01:36	100
01:21	110	01:33	110	01:40	110	01:48	110
01:30	120	01:43	120	01:51	120	01:59	120
01:39	130	01:53	130	02:02	130	02:12	130
01:48	140	02:04	140	02:13	140	02:24	140
01:58	150	02:14	150	02:26	150	02:37	150
02:08	160	02:27	160	02:38	160	02:51	160
02:19	170	02:40	170	02:52	170	03:07	170
02:30	180	02:52	180	03:07	180	03:22	180
02:42	190	03:06	190	03:21	190	03:39	190
02:54	200	03:20	200	03:36	200	03:56	200
03:08	210	03:36	210	03:53	210	04:15	210
03:21	220	03:52	220	04:11	220	04:33	220
03:36	230	04:10	230	04:29	230	04:54	230
03:51	240	04:27	240	04:49	240	05:16	240
04:07	250	04:48	250	05:10	250	05:41	250

116.8 mg/L	300 mL
Soil #1 made at 160 mg/L	
Time (s)	Volume (mL)
00:00	0
00:07	10
00:15	20
00:24	30
00:33	40
00:41	50
00:50	60
00:59	70
01:09	80
01:19	90
01:29	100
01:39	110
01:50	120
02:02	130
02:14	140
02:26	150
02:39	160
02:53	170
03:07	180
03:22	190
03:38	200
03:55	210
04:13	220
04:32	230
04:51	240
05:14	250

125.3 mg/L	300 mL
Soil #1 made at 160 mg/L	
Time (s)	Volume (mL)
00:00	0
00:07	10
00:15	20
00:23	30
00:31	40
00:38	50
00:46	60
00:55	70
01:03	80
01:12	90
01:21	100
01:30	110
01:40	120
01:51	130
02:01	140
02:12	150
02:24	160
02:36	170
02:48	180
03:02	190
03:16	200
03:31	210
03:47	220
04:04	230
04:22	240
04:42	250

122.0 mg/L	300 mL
Soil #1 made at 160 mg/L	
Time (s)	Volume (mL)
00:00	0
00:08	10
00:17	20
00:26	30
00:35	40
00:44	50
00:53	60
01:03	70
01:12	80
01:22	90
01:33	100
01:44	110
01:54	120
02:06	130
02:18	140
02:30	150
02:44	160
02:58	170
03:11	180
03:26	190
03:42	200
03:59	210
04:16	220
04:34	230
04:54	240
05:15	250

114.4 mg/L	300 mL
Soil #1 made at 160 mg/L	
Time (s)	Volume (mL)
00:00	0
00:08	10
00:17	20
00:26	30
00:34	40
00:43	50
00:52	60
01:01	70
01:11	80
01:20	90
01:30	100
01:41	110
01:52	120
02:03	130
02:14	140
02:27	150
02:39	160
02:53	170
03:07	180
03:22	190
03:37	200
03:53	210
04:11	220
04:30	230
04:49	240
05:11	250

126.3 mg/L	300 mL
Soil #1 made at 160 mg/L	
Time (s)	Volume (mL)
00:00	0
00:08	10
00:16	20
00:25	30
00:33	40
00:41	50
00:50	60
00:59	70
01:08	80
01:18	90
01:27	100
01:37	110
01:47	120
01:58	130
02:09	140
02:21	150
02:34	160
02:47	170
03:00	180
03:15	190
03:30	200
03:45	210
04:02	220
04:20	230
04:39	240
05:00	250

119.8 mg/L	300 mL
Soil #1 made at 160 mg/L	
Time (s)	Volume (mL)
00:00	0
00:08	10
00:17	20
00:26	30
00:35	40
00:44	50
00:53	60
01:03	70
01:13	80
01:23	90
01:34	100
01:45	110
01:55	120
02:08	130
02:20	140
02:32	150
02:45	160
03:00	170
03:15	180
03:30	190
03:46	200
04:04	210
04:21	220
04:41	230
05:01	240
05:23	250

119.4 mg/L	300 mL
Soil #1 made at 160 mg/L	
Time (s)	Volume (mL)
00:00	0
00:06	10
00:12	20
00:18	30
00:24	40
00:30	50
00:36	60
00:42	70
00:49	80
00:56	90
01:03	100
01:11	110
01:19	120
01:27	130
01:35	140
01:44	150
01:53	160
02:02	170
02:12	180
02:23	190
02:34	200
02:46	210
02:58	220
03:10	230
03:25	240
03:39	250

123.1 mg/L	300 mL
Soil #1 made at 160 mg/L	
Time (s)	Volume (mL)
00:00	0
00:07	10
00:14	20
00:22	30
00:29	40
00:37	50
00:44	60
00:52	70
01:00	80
01:09	90
01:18	100
01:27	110
01:36	120
01:46	130
01:56	140
02:06	150
02:17	160
02:28	170
02:39	180
02:52	190
03:04	200
03:18	210
03:32	220
03:49	230
04:05	240
04:22	250

121.9 mg/L	300 mL
Soil #1 made at 160 mg/L	
Time (s)	Volume (mL)
00:00	0
00:06	10
00:13	20
00:20	30
00:27	40
00:34	50
00:41	60
00:48	70
00:56	80
01:04	90
01:12	100
01:20	110
01:29	120
01:38	130
01:47	140
01:57	150
02:07	160
02:18	170
02:28	180
02:40	190
02:52	200
03:05	210
03:18	220
03:34	230
03:49	240
04:06	250

124.2 mg/L	300 mL
Soil #1 made at 160 mg/L	
Time (s)	Volume (mL)
00:00	0
00:07	10
00:14	20
00:21	30
00:28	40
00:35	50
00:42	60
00:50	70
00:58	80
01:06	90
01:14	100
01:23	110
01:32	120
01:41	130
01:50	140
02:00	150
02:10	160
02:21	170
02:33	180
02:45	190
02:57	200
03:10	210
03:24	220
03:38	230
03:54	240
04:11	250

119.2 mg/L	300 mL
Soil #1 made at 160 mg/L	
Time (s)	Volume (mL)
00:00	0
00:07	10
00:14	20
00:21	30
00:28	40
00:35	50
00:43	60
00:51	70
00:58	80
01:06	90
01:15	100
01:24	110
01:33	120
01:42	130
01:52	140
02:02	150
02:13	160
02:24	170
02:35	180
02:48	190
03:01	200
03:16	210
03:30	220
03:46	230
04:02	240
04:20	250

Table B.23: Tabulation of Figure 5.26 – Soil #1 with No Vacuum Using 934-AH Filter Papers, with Ten Replicates at a Manufactured TSS Concentration of 140 mg/L and Consistent Volumes

94.5 mg/L	300 mL	102.8 mg/L	300 mL	96.9 mg/L	300 mL	96.9 mg/L	300 mL
Soil #1 made at 140 mg/L		Soil #1 made at 140 mg/L		Soil #1 made at 140 mg/L		Soil #1 made at 140 mg/L	
Time (s)	Volume (mL)	Time (s)	Volume (mL)	Time (s)	Volume (mL)	Time (s)	Volume (mL)
00:00	0	00:00	0	00:00	0	00:00	0
00:07	10	00:06	10	00:06	10	00:07	10
00:14	20	00:13	20	00:13	20	00:14	20
00:20	30	00:19	30	00:20	30	00:21	30
00:26	40	00:26	40	00:27	40	00:28	40
00:33	50	00:33	50	00:34	50	00:35	50
00:40	60	00:39	60	00:41	60	00:42	60
00:47	70	00:46	70	00:48	70	00:50	70
00:54	80	00:53	80	00:56	80	00:58	80
01:02	90	01:00	90	01:03	90	01:05	90
01:10	100	01:07	100	01:12	100	01:14	100
01:18	110	01:15	110	01:20	110	01:22	110
01:26	120	01:23	120	01:28	120	01:31	120
01:35	130	01:32	130	01:38	130	01:40	130
01:44	140	01:41	140	01:47	140	01:50	140
01:53	150	01:50	150	01:57	150	02:00	150
02:03	160	01:59	160	02:07	160	02:10	160
02:13	170	02:09	170	02:17	170	02:21	170
02:24	180	02:19	180	02:28	180	02:32	180
02:35	190	02:30	190	02:39	190	02:43	190
02:47	200	02:42	200	02:51	200	02:56	200
02:59	210	02:54	210	03:05	210	03:09	210
03:14	220	03:06	220	03:18	220	03:22	220
03:27	230	03:20	230	03:33	230	03:37	230
03:42	240	03:34	240	03:49	240	03:53	240
03:56	250	03:48	250	04:06	250	04:09	250

100.4 mg/L	300 mL
Soil #1 made at 140 mg/L	
Time (s)	Volume (mL)
00:00	0
00:07	10
00:14	20
00:20	30
00:27	40
00:34	50
00:41	60
00:48	70
00:55	80
01:03	90
01:11	100
01:19	110
01:28	120
01:37	130
01:46	140
01:55	150
02:05	160
02:16	170
02:27	180
02:38	190
02:50	200
03:03	210
03:16	220
03:30	230
03:45	240
04:01	250

103.1 mg/L	300 mL
Soil #1 made at 140 mg/L	
Time (s)	Volume (mL)
00:00	0
00:06	10
00:13	20
00:19	30
00:25	40
00:31	50
00:38	60
00:43	70
00:51	80
00:58	90
01:06	100
01:13	110
01:20	120
01:28	130
01:37	140
01:46	150
01:55	160
02:05	170
02:15	180
02:26	190
02:37	200
02:49	210
03:01	220
03:15	230
03:29	240
03:44	250

112.0 mg/L	300 mL
Soil #1 made at 140 mg/L	
Time (s)	Volume (mL)
00:00	0
00:07	10
00:15	20
00:21	30
00:28	40
00:36	50
00:43	60
00:50	70
00:57	80
01:05	90
01:13	100
01:21	110
01:30	120
01:39	130
01:48	140
01:58	150
02:08	160
02:18	170
02:29	180
02:42	190
02:54	200
03:07	210
03:21	220
03:35	230
03:50	240
04:07	250

110.2 mg/L	300 mL
Soil #1 made at 140 mg/L	
Time (s)	Volume (mL)
00:00	0
00:08	10
00:16	20
00:23	30
00:31	40
00:38	50
00:46	60
00:54	70
01:02	80
01:11	90
01:19	100
01:28	110
01:37	120
01:47	130
01:58	140
02:08	150
02:18	160
02:29	170
02:41	180
02:54	190
03:07	200
03:20	210
03:35	220
03:50	230
04:06	240
04:22	250

103.1 mg/L	300 mL
Soil #1 made at 140 mg/L	
Time (s)	Volume (mL)
00:00	0
00:07	10
00:15	20
00:22	30
00:29	40
00:36	50
00:43	60
00:50	70
00:57	80
01:05	90
01:13	100
01:21	110
01:30	120
01:39	130
01:48	140
01:58	150
02:08	160
02:19	170
02:30	180
02:41	190
02:54	200
03:07	210
03:20	220
03:35	230
03:49	240
04:06	250

106.6 mg/L	300 mL
Soil #1 made at 140 mg/L	
Time (s)	Volume (mL)
00:00	0
00:06	10
00:13	20
00:20	30
00:26	40
00:33	50
00:40	60
00:47	70
00:54	80
01:01	90
01:09	100
01:17	110
01:25	120
01:34	130
01:43	140
01:52	150
02:02	160
02:12	170
02:22	180
02:34	190
02:46	200
02:58	210
03:11	220
03:25	230
03:40	240
03:57	250

Table B.24: Tabulation of Figure 5.27 – Soil #1 with No Vacuum Using 934-AH Filter Papers, with Five Replicates at a Manufactured TSS Concentration of 135 mg/L and Consistent Volumes

91.0 mg/L	300 mL	94.7 mg/L	300 mL	95.4 mg/L	300 mL	89.5 mg/L	300 mL
Soil #1 made at 135 mg/L		Soil #1 made at 135 mg/L		Soil #1 made at 135 mg/L		Soil #1 made at 135 mg/L	
Time (s)	Volume (mL)	Time (s)	Volume (mL)	Time (s)	Volume (mL)	Time (s)	Volume (mL)
00:00	0	00:00	0	00:00	0	00:00	0
00:06	10	00:07	10	00:07	10	00:07	10
00:13	20	00:15	20	00:14	20	00:14	20
00:19	30	00:22	30	00:21	30	00:20	30
00:25	40	00:29	40	00:28	40	00:26	40
00:31	50	00:37	50	00:35	50	00:33	50
00:37	60	00:44	60	00:43	60	00:40	60
00:45	70	00:52	70	00:51	70	00:47	70
00:51	80	01:00	80	00:58	80	00:54	80
00:58	90	01:08	90	01:06	90	01:01	90
01:06	100	01:16	100	01:14	100	01:08	100
01:14	110	01:24	110	01:23	110	01:15	110
01:22	120	01:33	120	01:32	120	01:23	120
01:30	130	01:42	130	01:41	130	01:32	130
01:38	140	01:52	140	01:51	140	01:40	140
01:47	150	02:02	150	02:01	150	01:49	150
01:56	160	02:12	160	02:12	160	01:58	160
02:05	170	02:23	170	02:22	170	02:08	170
02:16	180	02:35	180	02:33	180	02:18	180
02:26	190	02:46	190	02:45	190	02:28	190
02:37	200	02:59	200	02:58	200	02:40	200
02:49	210	03:12	210	03:11	210	02:51	210
03:01	220	03:25	220	03:25	220	03:03	220
03:14	230	03:40	230	03:40	230	03:17	230
03:28	240	03:55	240	03:56	240	03:31	240
03:43	250	04:11	250	04:13	250	03:45	250

99.9 mg/L	300 mL
Soil #1 made at 135 mg/L	
Time (s)	Volume (mL)
00:00	0
00:07	10
00:14	20
00:21	30
00:27	40
00:34	50
00:41	60
00:49	70
00:57	80
01:04	90
01:12	100
01:20	110
01:29	120
01:38	130
01:47	140
01:57	150
02:06	160
02:17	170
02:28	180
02:40	190
02:53	200
03:06	210
03:18	220
03:33	230
03:48	240
04:04	250

Table B.25: Tabulation of Figure 5.28 – Soil #1 with No Vacuum Using 934-AH Filter Papers, with Five Replicates at a Manufactured TSS Concentration of 130 mg/L and Consistent Volumes

87.2 mg/L	300 mL	91.9 mg/L	300 mL	90.7 mg/L	300 mL	81.6 mg/L	300 mL
Soil #1 made at 130 mg/L		Soil #1 made at 130 mg/L		Soil #1 made at 130 mg/L		Soil #1 made at 130 mg/L	
Time (s)	Volume (mL)	Time (s)	Volume (mL)	Time (s)	Volume (mL)	Time (s)	Volume (mL)
00:00	0	00:00	0	00:00	0	00:00	0
00:08	10	00:08	10	00:08	10	00:08	10
00:17	20	00:17	20	00:17	20	00:17	20
00:25	30	00:24	30	00:24	30	00:24	30
00:32	40	00:32	40	00:32	40	00:32	40
00:41	50	00:41	50	00:41	50	00:41	50
00:50	60	00:50	60	00:49	60	00:49	60
00:58	70	00:59	70	00:58	70	00:58	70
01:07	80	01:07	80	01:07	80	01:07	80
01:17	90	01:17	90	01:17	90	01:16	90
01:26	100	01:26	100	01:26	100	01:25	100
01:36	110	01:36	110	01:36	110	01:35	110
01:46	120	01:46	120	01:46	120	01:45	120
01:57	130	01:57	130	01:57	130	01:56	130
02:07	140	02:08	140	02:07	140	02:07	140
02:19	150	02:20	150	02:20	150	02:19	150
02:31	160	02:32	160	02:32	160	02:31	160
02:43	170	02:44	170	02:44	170	02:44	170
02:56	180	02:58	180	02:58	180	02:56	180
03:10	190	03:13	190	03:12	190	03:11	190
03:24	200	03:27	200	03:26	200	03:25	200
03:39	210	03:42	210	03:42	210	03:40	210
03:56	220	03:59	220	03:59	220	03:56	220
04:13	230	04:18	230	04:17	230	04:14	230
04:30	240	04:35	240	04:35	240	04:33	240
04:50	250	04:55	250	04:55	250	04:53	250

87.7 mg/L	300 mL
Soil #1 made at 130 mg/L	
Time (s)	Volume (mL)
00:00	0
00:09	10
00:18	20
00:26	30
00:34	40
00:43	50
00:52	60
01:01	70
01:11	80
01:21	90
01:31	100
01:41	110
01:53	120
02:04	130
02:16	140
02:28	150
02:41	160
02:54	170
03:08	180
03:24	190
03:39	200
03:56	210
04:13	220
04:33	230
04:52	240
05:14	250

Table B.26: Tabulation of Figure 5.29 – Soil #1 with No Vacuum Using 934-AH Filter Papers, with Five Replicates at a Manufactured TSS Concentration of 120 mg/L and Consistent Volumes

76.6 mg/L	300 mL	82.3 mg/L	300 mL	77.7 mg/L	300 mL	76.2 mg/L	300 mL
Soil #1 made at 120 mg/L		Soil #1 made at 120 mg/L		Soil #1 made at 120 mg/L		Soil #1 made at 120 mg/L	
Time (s)	Volume (mL)	Time (s)	Volume (mL)	Time (s)	Volume (mL)	Time (s)	Volume (mL)
00:00	0	00:00	0	00:00	0	00:00	0
00:06	10	00:07	10	00:07	10	00:06	10
00:12	20	00:15	20	00:14	20	00:13	20
00:18	30	00:22	30	00:21	30	00:19	30
00:23	40	00:29	40	00:29	40	00:25	40
00:30	50	00:36	50	00:37	50	00:32	50
00:36	60	00:44	60	00:44	60	00:39	60
00:42	70	00:51	70	00:52	70	00:46	70
00:49	80	00:59	80	01:00	80	00:53	80
00:56	90	01:07	90	01:09	90	01:01	90
01:03	100	01:15	100	01:17	100	01:09	100
01:10	110	01:24	110	01:26	110	01:16	110
01:17	120	01:32	120	01:35	120	01:24	120
01:25	130	01:42	130	01:46	130	01:33	130
01:33	140	01:51	140	01:56	140	01:42	140
01:42	150	02:01	150	02:05	150	01:51	150
01:51	160	02:11	160	02:16	160	02:00	160
02:00	170	02:22	170	02:27	170	02:11	170
02:10	180	02:34	180	02:39	180	02:21	180
02:20	190	02:45	190	02:52	190	02:32	190
02:31	200	02:57	200	03:06	200	02:43	200
02:42	210	03:11	210	03:20	210	02:56	210
02:54	220	03:25	220	03:34	220	03:08	220
03:07	230	03:38	230	03:50	230	03:22	230
03:20	240	03:54	240	04:06	240	03:36	240
03:36	250	04:11	250	04:24	250	03:51	250

102.5 mg/L	300 mL
Soil #1 made at 120 mg/L	
Time (s)	Volume (mL)
00:00	0
00:06	10
00:12	20
00:19	30
00:25	40
00:31	50
00:38	60
00:45	70
00:52	80
00:59	90
01:06	100
01:14	110
01:22	120
01:30	130
01:38	140
01:46	150
01:55	160
02:05	170
02:16	180
02:26	190
02:37	200
02:48	210
03:00	220
03:13	230
03:27	240
03:41	250

Table B.27: Tabulation of Figure 5.30 – Soil #1 with No Vacuum Using 934-AH Filter Papers, with Five Replicates at a Manufactured TSS Concentration of 115 mg/L and Consistent Volumes

106.4 mg/L	300 mL	92.3 mg/L	300 mL	94.2 mg/L	300 mL	84.2 mg/L	300 mL
Soil #1 made at 115 mg/L		Soil #1 made at 115 mg/L		Soil #1 made at 115 mg/L		Soil #1 made at 115 mg/L	
Time (s)	Volume (mL)	Time (s)	Volume (mL)	Time (s)	Volume (mL)	Time (s)	Volume (mL)
00:00	0	00:00	0	00:00	0	00:00	0
00:07	10	00:08	10	00:07	10	00:09	10
00:17	20	00:17	20	00:15	20	00:18	20
00:26	30	00:25	30	00:22	30	00:27	30
00:35	40	00:34	40	00:29	40	00:36	40
00:43	50	00:42	50	00:36	50	00:45	50
00:52	60	00:51	60	00:44	60	00:54	60
01:02	70	01:01	70	00:52	70	01:04	70
01:12	80	01:11	80	00:59	80	01:14	80
01:22	90	01:20	90	01:08	90	01:24	90
01:33	100	01:30	100	01:16	100	01:35	100
01:44	110	01:40	110	01:25	110	01:46	110
01:55	120	01:51	120	01:34	120	01:57	120
02:06	130	02:01	130	01:43	130	02:08	130
02:19	140	02:12	140	01:54	140	02:20	140
02:31	150	02:23	150	02:04	150	02:32	150
02:43	160	02:35	160	02:15	160	02:46	160
02:57	170	02:49	170	02:26	170	03:00	170
03:12	180	03:01	180	02:38	180	03:14	180
03:27	190	03:15	190	02:50	190	03:28	190
03:41	200	03:30	200	03:04	200	03:44	200
03:58	210	03:44	210	03:18	210	04:00	210
04:15	220	04:00	220	03:31	220	04:17	220
04:34	230	04:17	230	03:47	230	04:37	230
04:53	240	04:34	240	04:04	240	04:56	240
05:14	250	04:53	250	04:23	250	05:16	250

85.6 mg/L	300 mL
Soil #1 made at 115 mg/L	
Time (s)	Volume (mL)
00:00	0
00:07	10
00:15	20
00:21	30
00:29	40
00:37	50
00:45	60
00:54	70
01:02	80
01:11	90
01:19	100
01:28	110
01:38	120
01:48	130
01:58	140
02:10	150
02:21	160
02:32	170
02:44	180
02:57	190
03:10	200
03:25	210
03:40	220
03:56	230
04:14	240
04:32	250

Table B.28: Tabulation of Figure 5.31 – Soil #1 with No Vacuum Pressure Using 934-AH Filter Papers, with Seven Replicates at a Manufactured TSS Concentration of 100 mg/L and Consistent Volumes

96.8 mg/L	300 mL	109.9 mg/L	300 mL	94.7 mg/L	300 mL	84.2 mg/L	300 mL
Soil #1 made at 100 mg/L		Soil #1 made at 100 mg/L		Soil #1 made at 100 mg/L		Soil #1 made at 100 mg/L	
Time (s)	Volume (mL)	Time (s)	Volume (mL)	Time (s)	Volume (mL)	Time (s)	Volume (mL)
00:00	0	00:00	0	00:00	0	00:00	0
00:08	10	00:08	10	00:08	10	00:08	10
00:17	20	00:16	20	00:16	20	00:16	20
00:25	30	00:25	30	00:24	30	00:25	30
00:33	40	00:33	40	00:32	40	00:32	40
00:42	50	00:42	50	00:40	50	00:41	50
00:52	60	00:51	60	00:48	60	00:48	60
01:00	70	01:00	70	00:57	70	00:57	70
01:10	80	01:09	80	01:06	80	01:07	80
01:19	90	01:19	90	01:14	90	01:16	90
01:30	100	01:28	100	01:24	100	01:26	100
01:41	110	01:39	110	01:33	110	01:37	110
01:50	120	01:50	120	01:43	120	01:48	120
02:02	130	02:01	130	01:55	130	01:59	130
02:13	140	02:13	140	02:04	140	02:11	140
02:26	150	02:25	150	02:15	150	02:23	150
02:38	160	02:38	160	02:26	160	02:36	160
02:51	170	02:52	170	02:39	170	02:49	170
03:06	180	03:05	180	02:51	180	03:03	180
03:20	190	03:20	190	03:04	190	03:17	190
03:35	200	03:36	200	03:18	200	03:30	200
03:51	210	03:52	210	03:33	210	03:44	210
04:08	220	04:08	220	03:48	220	04:01	220
04:26	230	04:27	230	04:04	230	04:18	230
04:45	240	04:47	240	04:21	240	04:35	240
05:06	250	05:07	250	04:41	250	04:53	250

84.2 mg/L	300 mL
Soil #1 made at 100 mg/L	
Time (s)	Volume (mL)
00:00	0
00:08	10
00:17	20
00:25	30
00:34	40
00:42	50
00:51	60
01:01	70
01:09	80
01:20	90
01:30	100
01:40	110
01:50	120
02:01	130
02:13	140
02:25	150
02:38	160
02:51	170
03:04	180
03:19	190
03:33	200
03:50	210
04:06	220
04:23	230
04:41	240
05:01	250

93.8 mg/L	300 mL
Soil #1 made at 100 mg/L	
Time (s)	Volume (mL)
00:00	0
00:08	10
00:16	20
00:25	30
00:33	40
00:42	50
00:51	60
00:59	70
01:08	80
01:17	90
01:27	100
01:37	110
01:47	120
01:57	130
02:08	140
02:20	150
02:31	160
02:44	170
02:57	180
03:10	190
03:24	200
03:40	210
03:55	220
04:12	230
04:29	240
04:50	250

83.3 mg/L	300 mL
Soil #1 made at 100 mg/L	
Time (s)	Volume (mL)
00:00	0
00:08	10
00:17	20
00:25	30
00:33	40
00:41	50
00:50	60
00:59	70
01:08	80
01:17	90
01:27	100
01:37	110
01:47	120
01:58	130
02:09	140
02:20	150
02:31	160
02:43	170
02:57	180
03:10	190
03:24	200
03:39	210
03:54	220
04:10	230
04:28	240
04:47	250

82.5 mg/L	300 mL
Soil #1 made at 100 mg/L	
Time (s)	Volume (mL)
00:00	0
00:09	10
00:19	20
00:29	30
00:39	40
00:48	50
00:59	60
01:10	70
01:20	80
01:31	90
01:43	100
01:55	110
02:08	120
02:20	130
02:32	140
02:48	150
03:01	160
03:16	170
03:31	180
03:47	190
04:04	200
04:22	210
04:40	220
05:01	230
05:21	240
05:44	250

Table B.29: Tabulation of Figure 5.32 – Soil #1 with No Vacuum Pressure Using 934-AH Filter Papers, with Fourteen Replicates at a Manufactured TSS Concentration of 75 mg/L and Consistent Volumes

70.5 mg/L	300 mL	68.8 mg/L	300 mL	71.3 mg/L	300 mL	64.7 mg/L	300 mL
Soil #1 made at 75 mg/L		Soil #1 made at 75 mg/L		Soil #1 made at 75 mg/L		Soil #1 made at 75 mg/L	
Time (s)	Volume (mL)	Time (s)	Volume (mL)	Time (s)	Volume (mL)	Time (s)	Volume (mL)
00:00	0	00:00	0	00:00	0	00:00	0
00:08	10	00:06	10	00:09	10	00:08	10
00:16	20	00:12	20	00:19	20	00:17	20
00:25	30	00:18	30	00:28	30	00:29	30
00:33	40	00:24	40	00:40	40	00:39	40
00:41	50	00:30	50	00:49	50	00:50	50
00:49	60	00:37	60	01:00	60	01:01	60
00:57	70	00:44	70	01:11	70	01:13	70
01:07	80	00:51	80	01:22	80	01:24	80
01:16	90	00:59	90	01:33	90	01:36	90
01:25	100	01:07	100	01:45	100	01:49	100
01:35	110	01:15	110	01:56	110	02:01	110
01:45	120	01:23	120	02:08	120	02:14	120
01:55	130	01:32	130	02:22	130	02:28	130
02:06	140	01:40	140	02:35	140	02:42	140
02:16	150	01:50	150	02:49	150	02:57	150
02:29	160	01:59	160	03:03	160	03:13	160
02:40	170	02:09	170	03:18	170	03:29	170
02:52	180	02:19	180	03:33	180	03:45	180
03:05	190	02:29	190	03:50	190	04:03	190
03:20	200	02:41	200	04:06	200	04:20	200
03:33	210	02:53	210	04:25	210	04:39	210
03:49	220	03:06	220	04:42	220	04:59	220
04:05	230	03:20	230	05:01	230	05:21	230
04:22	240	03:38	240	05:21	240	05:40	240
04:39	250	03:58	250	05:44	250	05:59	250

64.8 mg/L	300 mL
Soil #1 made at 75 mg/L	
Time (s)	Volume (mL)
00:00	0
00:06	10
00:12	20
00:18	30
00:24	40
00:30	50
00:36	60
00:43	70
00:49	80
00:56	90
01:03	100
01:10	110
01:17	120
01:25	130
01:34	140
01:41	150
01:51	160
02:00	170
02:09	180
02:19	190
02:30	200
02:40	210
02:52	220
03:05	230
03:17	240
03:31	250

58.2 mg/L	300 mL
Soil #1 made at 75 mg/L	
Time (s)	Volume (mL)
00:00	0
00:07	10
00:14	20
00:22	30
00:29	40
00:37	50
00:45	60
00:54	70
01:02	80
01:11	90
01:20	100
01:29	110
01:38	120
01:49	130
01:59	140
02:11	150
02:22	160
02:33	170
02:46	180
02:59	190
03:11	200
03:26	210
03:41	220
03:57	230
04:13	240
04:33	250

56.9 mg/L	300 mL
Soil #1 made at 75 mg/L	
Time (s)	Volume (mL)
00:00	0
00:08	10
00:16	20
00:24	30
00:31	40
00:40	50
00:48	60
00:56	70
01:05	80
01:14	90
01:23	100
01:32	110
01:42	120
01:52	130
02:02	140
02:13	150
02:24	160
02:36	170
02:49	180
03:02	190
03:15	200
03:30	210
03:45	220
04:02	230
04:18	240
04:37	250

58.3 mg/L	300 mL
Soil #1 made at 75 mg/L	
Time (s)	Volume (mL)
00:00	0
00:07	10
00:15	20
00:22	30
00:29	40
00:36	50
00:44	60
00:52	70
01:00	80
01:08	90
01:16	100
01:25	110
01:34	120
01:43	130
01:52	140
02:02	150
02:12	160
02:23	170
02:33	180
02:45	190
02:57	200
03:10	210
03:23	220
03:37	230
03:51	240
04:07	250

60.5 mg/L	300 mL
Soil #1 made at 75 mg/L	
Time (s)	Volume (mL)
00:00	0
00:07	10
00:15	20
00:21	30
00:28	40
00:35	50
00:42	60
00:50	70
00:57	80
01:05	90
01:14	100
01:23	110
01:31	120
01:41	130
01:51	140
02:01	150
02:11	160
02:22	170
02:33	180
02:45	190
02:57	200
03:10	210
03:24	220
03:38	230
03:52	240
04:10	250

73.2 mg/L	300 mL
Soil #1 made at 75 mg/L	
Time (s)	Volume (mL)
00:00	0
00:06	10
00:12	20
00:18	30
00:24	40
00:29	50
00:36	60
00:42	70
00:48	80
00:55	90
01:02	100
01:09	110
01:16	120
01:24	130
01:32	140
01:40	150
01:49	160
01:58	170
02:07	180
02:18	190
02:28	200
02:40	210
02:51	220
03:04	230
03:17	240
03:29	250

65.8 mg/L	300 mL
Soil #1 made at 75 mg/L	
Time (s)	Volume (mL)
00:00	0
00:07	10
00:14	20
00:21	30
00:27	40
00:35	50
00:42	60
00:50	70
00:57	80
01:05	90
01:13	100
01:22	110
01:31	120
01:40	130
01:49	140
01:59	150
02:09	160
02:19	170
02:31	180
02:43	190
02:54	200
03:08	210
03:21	220
03:35	230
03:50	240
04:08	250

67.6 mg/L	300 mL
Soil #1 made at 75 mg/L	
Time (s)	Volume (mL)
00:00	0
00:07	10
00:14	20
00:21	30
00:28	40
00:35	50
00:42	60
00:50	70
00:57	80
01:05	90
01:14	100
01:22	110
01:30	120
01:39	130
01:49	140
01:59	150
02:08	160
02:19	170
02:30	180
02:41	190
02:53	200
03:06	210
03:19	220
03:34	230
03:49	240
04:05	250

68.3 mg/L	300 mL
Soil #1 made at 75 mg/L	
Time (s)	Volume (mL)
00:00	0
00:06	10
00:13	20
00:20	30
00:27	40
00:35	50
00:42	60
00:49	70
00:57	80
01:05	90
01:13	100
01:22	110
01:30	120
01:39	130
01:48	140
01:58	150
02:08	160
02:19	170
02:30	180
02:42	190
02:53	200
03:06	210
03:19	220
03:34	230
03:48	240
04:04	250

74.3 mg/L	300 mL
Soil #1 made at 75 mg/L	
Time (s)	Volume (mL)
00:00	0
00:07	10
00:14	20
00:21	30
00:28	40
00:36	50
00:43	60
00:50	70
00:58	80
01:06	90
01:15	100
01:24	110
01:32	120
01:41	130
01:50	140
02:00	150
02:10	160
02:21	170
02:32	180
02:44	190
02:56	200
03:09	210
03:22	220
03:37	230
03:52	240
04:08	250

Table B.30: Variability of Rapid Filtration without Vacuum Assist When Categorized into Target TSS Concentrations

Targets		
70 mg/L	→	65 < X < 75
85 mg/L	→	80 < X < 90
100 mg/L	→	95 < X < 105
115 mg/L	→	110 < X < 120
130 mg/L	→	125 < X < 135

Target Concentrations										
70 mg/L		85 mg/L		100 mg/L		115 mg/L		130 mg/L		
Data Series	4 min. value (mL)	Data Series	4 min. value (mL)	Data Series	4 min. value (mL)	Data Series	4 min. value (mL)	Data Series	4 min. value (mL)	
71.3 mg/L	196.3	82.5 mg/L	197.6	96.8 mg/L	215.3	119.8 mg/L	207.8	126.9 mg/L	202.1	
70.5 mg/L	226.9	84.2 mg/L	210.0	95.4 mg/L	242.4	116.8 mg/L	212.8	126.3 mg/L	218.8	
74.3 mg/L	245.0	87.7 mg/L	212.4	96.9 mg/L	244.4	114.0 mg/L	213.9	125.3 mg/L	227.6	
65.8 mg/L	245.6	84.2 mg/L	216.3	103.1 mg/L	246.5	114.4 mg/L	213.9	129.3 mg/L	245.6	
67.6 mg/L	246.9	84.2 mg/L	219.4	96.9 mg/L	246.5	110.2 mg/L	236.3	128.1 mg/L	266.0	
68.3 mg/L	247.5	81.6 mg/L	222.2	99.9 mg/L	247.5	119.2 mg/L	238.8	126.2 mg/L	240.0	
68.8 mg/L	251.0	87.2 mg/L	222.4	100.4 mg/L	249.4	112.0 mg/L	245.9	125.3 mg/L	241.1	
73.2 mg/L	269.0	83.3 mg/L	224.3	102.8 mg/L	258.0	119.4 mg/L	264.1	126.0 mg/L	241.2	
		85.6 mg/L	232.2	103.1 mg/L	260.5			136.4 mg/L	235.0	
		82.3 mg/L	243.5	102.5 mg/L	264.5					
		89.5 mg/L	261.2							
Average =	241.0		223.8		247.5		229.2		235.3	
St Dev. =	21.36		17.16		13.52		20.12		17.93	
Range =	219.7 to 262.4 mL		206.6 to 240.9 mL		234.0 to 261.0 mL		209.1 to 249.3 mL		217.3 to 253.2 mL	

Table B.31: Tabulation of Figure 5.33 – Soil #1 with No Vacuum Using 934-AH Filter Papers, Nine Replicates at a Target TSS Concentration of 130 mg/L

128.1 mg/L	300 mL	126.2 mg/L	300 mL	125.3 mg/L	300 mL	126.0 mg/L	300 mL
Soil #1 made at 170 mg/L		Soil #1 made at 170 mg/L		Soil #1 made at 170 mg/L		Soil #1 made at 170 mg/L	
Time (s)	Volume (mL)	Time (s)	Volume (mL)	Time (s)	Volume (mL)	Time (s)	Volume (mL)
00:00	0	00:00	0	00:00	0	00:00	0
00:06	10	00:07	10	00:06	10	00:07	10
00:12	20	00:14	20	00:13	20	00:14	20
00:18	30	00:21	30	00:20	30	00:20	30
00:24	40	00:28	40	00:27	40	00:28	40
00:30	50	00:35	50	00:34	50	00:35	50
00:36	60	00:42	60	00:41	60	00:42	60
00:42	70	00:49	70	00:49	70	00:50	70
00:49	80	00:57	80	00:57	80	00:58	80
00:55	90	01:05	90	01:05	90	01:06	90
01:03	100	01:13	100	01:13	100	01:14	100
01:10	110	01:22	110	01:22	110	01:23	110
01:18	120	01:31	120	01:31	120	01:32	120
01:26	130	01:41	130	01:40	130	01:41	130
01:34	140	01:50	140	01:50	140	01:51	140
01:42	150	02:00	150	02:00	150	02:01	150
01:51	160	02:11	160	02:10	160	02:11	160
02:00	170	02:22	170	02:21	170	02:22	170
02:10	180	02:33	180	02:32	180	02:34	180
02:20	190	02:46	190	02:44	190	02:46	190
02:31	200	02:59	200	02:57	200	02:58	200
02:43	210	03:12	210	03:11	210	03:12	210
02:55	220	03:27	220	03:25	220	03:27	220
03:08	230	03:43	230	03:41	230	03:42	230
03:22	240	04:00	240	03:58	240	03:58	240
03:36	250	04:20	250	04:16	250	04:15	250

136.4 mg/L	300 mL
Soil #1 made at 170 mg/L	
Time (s)	Volume (mL)
00:00	0
00:06	10
00:13	20
00:21	30
00:28	40
00:35	50
00:42	60
00:50	70
00:58	80
01:07	90
01:15	100
01:24	110
01:34	120
01:43	130
01:54	140
02:04	150
02:15	160
02:26	170
02:38	180
02:51	190
03:05	200
03:19	210
03:34	220
03:51	230
04:09	240
04:28	250

126.9 mg/L	300 mL
Soil #1 made at 160 mg/L	
Time (s)	Volume (mL)
00:00	0
00:08	10
00:16	20
00:25	30
00:34	40
00:44	50
00:54	60
01:04	70
01:14	80
01:25	90
01:36	100
01:48	110
01:59	120
02:12	130
02:24	140
02:37	150
02:51	160
03:07	170
03:22	180
03:39	190
03:56	200
04:15	210
04:33	220
04:54	230
05:16	240
05:41	250

126.3 mg/L	300 mL
Soil #1 made at 160 mg/L	
Time (s)	Volume (mL)
00:00	0
00:08	10
00:16	20
00:25	30
00:33	40
00:41	50
00:50	60
00:59	70
01:08	80
01:18	90
01:27	100
01:37	110
01:47	120
01:58	130
02:09	140
02:21	150
02:34	160
02:47	170
03:00	180
03:15	190
03:30	200
03:45	210
04:02	220
04:20	230
04:39	240
05:00	250

125.3 mg/L	300 mL
Soil #1 made at 160 mg/L	
Time (s)	Volume (mL)
00:00	0
00:07	10
00:15	20
00:23	30
00:31	40
00:38	50
00:46	60
00:55	70
01:03	80
01:12	90
01:21	100
01:30	110
01:40	120
01:51	130
02:01	140
02:12	150
02:24	160
02:36	170
02:48	180
03:02	190
03:16	200
03:31	210
03:47	220
04:04	230
04:22	240
04:42	250

129.3 mg/L	300 mL
Soil #1 made at 160 mg/L	
Time (s)	Volume (mL)
00:00	0
00:07	10
00:14	20
00:20	30
00:27	40
00:34	50
00:41	60
00:49	70
00:56	80
01:04	90
01:12	100
01:21	110
01:30	120
01:39	130
01:48	140
01:58	150
02:08	160
02:19	170
02:30	180
02:42	190
02:54	200
03:08	210
03:21	220
03:36	230
03:51	240
04:07	250

Table B.32: Tabulation of Figure 5.34 – Soil #1 with No Vacuum Using 934-AH Filter Papers, Eight Replicates at a Target TSS Concentration of 115 mg/L

119.8 mg/L	300 mL	116.8 mg/L	300 mL	114.0 mg/L	300 mL	114.4 mg/L	300 mL
Soil #1 made at 160 mg/L		Soil #1 made at 160 mg/L		Soil #1 made at 160 mg/L		Soil #1 made at 160 mg/L	
Time (s)	Volume (mL)	Time (s)	Volume (mL)	Time (s)	Volume (mL)	Time (s)	Volume (mL)
00:00	0	00:00	0	00:00	0	00:00	0
00:08	10	00:07	10	00:07	10	00:08	10
00:17	20	00:15	20	00:15	20	00:17	20
00:26	30	00:24	30	00:24	30	00:26	30
00:35	40	00:33	40	00:32	40	00:34	40
00:44	50	00:41	50	00:42	50	00:43	50
00:53	60	00:50	60	00:50	60	00:52	60
01:03	70	00:59	70	01:00	70	01:01	70
01:13	80	01:09	80	01:10	80	01:11	80
01:23	90	01:19	90	01:20	90	01:20	90
01:34	100	01:29	100	01:29	100	01:30	100
01:45	110	01:39	110	01:40	110	01:41	110
01:55	120	01:50	120	01:51	120	01:52	120
02:08	130	02:02	130	02:02	130	02:03	130
02:20	140	02:14	140	02:13	140	02:14	140
02:32	150	02:26	150	02:26	150	02:27	150
02:45	160	02:39	160	02:38	160	02:39	160
03:00	170	02:53	170	02:52	170	02:53	170
03:15	180	03:07	180	03:07	180	03:07	180
03:30	190	03:22	190	03:21	190	03:22	190
03:46	200	03:38	200	03:36	200	03:37	200
04:04	210	03:55	210	03:53	210	03:53	210
04:21	220	04:13	220	04:11	220	04:11	220
04:41	230	04:32	230	04:29	230	04:30	230
05:01	240	04:51	240	04:49	240	04:49	240
05:23	250	05:14	250	05:10	250	05:11	250

110.2 mg/L	300 mL
Soil #1 made at 140 mg/L	
Time (s)	Volume (mL)
00:00	0
00:08	10
00:16	20
00:23	30
00:31	40
00:38	50
00:46	60
00:54	70
01:02	80
01:11	90
01:19	100
01:28	110
01:37	120
01:47	130
01:58	140
02:08	150
02:18	160
02:29	170
02:41	180
02:54	190
03:07	200
03:20	210
03:35	220
03:50	230
04:06	240
04:22	250

119.2 mg/L	300 mL
Soil #1 made at 160 mg/L	
Time (s)	Volume (mL)
00:00	0
00:07	10
00:14	20
00:21	30
00:28	40
00:35	50
00:43	60
00:51	70
00:58	80
01:06	90
01:15	100
01:24	110
01:33	120
01:42	130
01:52	140
02:02	150
02:13	160
02:24	170
02:35	180
02:48	190
03:01	200
03:16	210
03:30	220
03:46	230
04:02	240
04:20	250

119.4 mg/L	300 mL
Soil #1 made at 160 mg/L	
Time (s)	Volume (mL)
00:00	0
00:06	10
00:12	20
00:18	30
00:24	40
00:30	50
00:36	60
00:42	70
00:49	80
00:56	90
01:03	100
01:11	110
01:19	120
01:27	130
01:35	140
01:44	150
01:53	160
02:02	170
02:12	180
02:23	190
02:34	200
02:46	210
02:58	220
03:10	230
03:25	240
03:39	250

112.0 mg/L	300 mL
Soil #1 made at 140 mg/L	
Time (s)	Volume (mL)
00:00	0
00:07	10
00:15	20
00:21	30
00:28	40
00:36	50
00:43	60
00:50	70
00:57	80
01:05	90
01:13	100
01:21	110
01:30	120
01:39	130
01:48	140
01:58	150
02:08	160
02:18	170
02:29	180
02:42	190
02:54	200
03:07	210
03:21	220
03:35	230
03:50	240
04:07	250

Table B.33: Tabulation of Figure 5.35 – Soil #1 with No Vacuum Using 934-AH Filter Papers, Ten Replicates at a Target TSS Concentration of 100 mg/L

95.4 mg/L	300 mL	102.8 mg/L	300 mL	96.9 mg/L	300 mL	96.9 mg/L	300 mL
Soil #1 made at 135 mg/L		Soil #1 made at 140 mg/L		Soil #1 made at 140 mg/L		Soil #1 made at 140 mg/L	
Time (s)	Volume (mL)	Time (s)	Volume (mL)	Time (s)	Volume (mL)	Time (s)	Volume (mL)
00:00	0	00:00	0	00:00	0	00:00	0
00:07	10	00:06	10	00:06	10	00:07	10
00:14	20	00:13	20	00:13	20	00:14	20
00:21	30	00:19	30	00:20	30	00:21	30
00:28	40	00:26	40	00:27	40	00:28	40
00:35	50	00:33	50	00:34	50	00:35	50
00:43	60	00:39	60	00:41	60	00:42	60
00:51	70	00:46	70	00:48	70	00:50	70
00:58	80	00:53	80	00:56	80	00:58	80
01:06	90	01:00	90	01:03	90	01:05	90
01:14	100	01:07	100	01:12	100	01:14	100
01:23	110	01:15	110	01:20	110	01:22	110
01:32	120	01:23	120	01:28	120	01:31	120
01:41	130	01:32	130	01:38	130	01:40	130
01:51	140	01:41	140	01:47	140	01:50	140
02:01	150	01:50	150	01:57	150	02:00	150
02:12	160	01:59	160	02:07	160	02:10	160
02:22	170	02:09	170	02:17	170	02:21	170
02:33	180	02:19	180	02:28	180	02:32	180
02:45	190	02:30	190	02:39	190	02:43	190
02:58	200	02:42	200	02:51	200	02:56	200
03:11	210	02:54	210	03:05	210	03:09	210
03:25	220	03:06	220	03:18	220	03:22	220
03:40	230	03:20	230	03:33	230	03:37	230
03:56	240	03:34	240	03:49	240	03:53	240
04:13	250	03:48	250	04:06	250	04:09	250

100.4 mg/L	300 mL
Soil #1 made at 140 mg/L	
Time (s)	Volume (mL)
00:00	0
00:07	10
00:14	20
00:20	30
00:27	40
00:34	50
00:41	60
00:48	70
00:55	80
01:03	90
01:11	100
01:19	110
01:28	120
01:37	130
01:46	140
01:55	150
02:05	160
02:16	170
02:27	180
02:38	190
02:50	200
03:03	210
03:16	220
03:30	230
03:45	240
04:01	250

103.1 mg/L	300 mL
Soil #1 made at 140 mg/L	
Time (s)	Volume (mL)
00:00	0
00:06	10
00:13	20
00:19	30
00:25	40
00:31	50
00:38	60
00:43	70
00:51	80
00:58	90
01:06	100
01:13	110
01:20	120
01:28	130
01:37	140
01:46	150
01:55	160
02:05	170
02:15	180
02:26	190
02:37	200
02:49	210
03:01	220
03:15	230
03:29	240
03:44	250

99.9 mg/L	300 mL
Soil #1 made at 135 mg/L	
Time (s)	Volume (mL)
00:00	0
00:07	10
00:14	20
00:21	30
00:27	40
00:34	50
00:41	60
00:49	70
00:57	80
01:04	90
01:12	100
01:20	110
01:29	120
01:38	130
01:47	140
01:57	150
02:06	160
02:17	170
02:28	180
02:40	190
02:53	200
03:06	210
03:18	220
03:33	230
03:48	240
04:04	250

106.6 mg/L	300 mL
Soil #1 made at 140 mg/L	
Time (s)	Volume (mL)
00:00	0
00:06	10
00:13	20
00:20	30
00:26	40
00:33	50
00:40	60
00:47	70
00:54	80
01:01	90
01:09	100
01:17	110
01:25	120
01:34	130
01:43	140
01:52	150
02:02	160
02:12	170
02:22	180
02:34	190
02:46	200
02:58	210
03:11	220
03:25	230
03:40	240
03:57	250

103.1 mg/L	300 mL
Soil #1 made at 140 mg/L	
Time (s)	Volume (mL)
00:00	0
00:07	10
00:15	20
00:22	30
00:29	40
00:36	50
00:43	60
00:50	70
00:57	80
01:05	90
01:13	100
01:21	110
01:30	120
01:39	130
01:48	140
01:58	150
02:08	160
02:19	170
02:30	180
02:41	190
02:54	200
03:07	210
03:20	220
03:35	230
03:49	240
04:06	250

102.5 mg/L	300 mL
Soil #1 made at 120 mg/L	
Time (s)	Volume (mL)
00:00	0
00:06	10
00:12	20
00:19	30
00:25	40
00:31	50
00:38	60
00:45	70
00:52	80
00:59	90
01:06	100
01:14	110
01:22	120
01:30	130
01:38	140
01:46	150
01:55	160
02:05	170
02:16	180
02:26	190
02:37	200
02:48	210
03:00	220
03:13	230
03:27	240
03:41	250

Table B.34: Tabulation of Figure 5.36 – Soil #1 with No Vacuum Using 934-AH Filter Papers, Eleven Replicates at a Target TSS Concentration of 85 mg/L

89.5 mg/L	300 mL	87.2 mg/L	300 mL	81.6 mg/L	300 mL	87.7 mg/L	300 mL
Soil #1 made at 135 mg/L		Soil #1 made at 130 mg/L		Soil #1 made at 130 mg/L		Soil #1 made at 130 mg/L	
Time (s)	Volume (mL)	Time (s)	Volume (mL)	Time (s)	Volume (mL)	Time (s)	Volume (mL)
00:00	0	00:00	0	00:00	0	00:00	0
00:07	10	00:08	10	00:08	10	00:09	10
00:14	20	00:17	20	00:17	20	00:18	20
00:20	30	00:25	30	00:24	30	00:26	30
00:26	40	00:32	40	00:32	40	00:34	40
00:33	50	00:41	50	00:41	50	00:43	50
00:40	60	00:50	60	00:49	60	00:52	60
00:47	70	00:58	70	00:58	70	01:01	70
00:54	80	01:07	80	01:07	80	01:11	80
01:01	90	01:17	90	01:16	90	01:21	90
01:08	100	01:26	100	01:25	100	01:31	100
01:15	110	01:36	110	01:35	110	01:41	110
01:23	120	01:46	120	01:45	120	01:53	120
01:32	130	01:57	130	01:56	130	02:04	130
01:40	140	02:07	140	02:07	140	02:16	140
01:49	150	02:19	150	02:19	150	02:28	150
01:58	160	02:31	160	02:31	160	02:41	160
02:08	170	02:43	170	02:44	170	02:54	170
02:18	180	02:56	180	02:56	180	03:08	180
02:28	190	03:10	190	03:11	190	03:24	190
02:40	200	03:24	200	03:25	200	03:39	200
02:51	210	03:39	210	03:40	210	03:56	210
03:03	220	03:56	220	03:56	220	04:13	220
03:17	230	04:13	230	04:14	230	04:33	230
03:31	240	04:30	240	04:33	240	04:52	240
03:45	250	04:50	250	04:53	250	05:14	250

84.2 mg/L	300 mL
Soil #1 made at 100 mg/L	
Time (s)	Volume (mL)
00:00	0
00:08	10
00:16	20
00:25	30
00:32	40
00:41	50
00:48	60
00:57	70
01:07	80
01:16	90
01:26	100
01:37	110
01:48	120
01:59	130
02:11	140
02:23	150
02:36	160
02:49	170
03:03	180
03:17	190
03:30	200
03:44	210
04:01	220
04:18	230
04:35	240
04:53	250

84.2 mg/L	300 mL
Soil #1 made at 100 mg/L	
Time (s)	Volume (mL)
00:00	0
00:08	10
00:17	20
00:25	30
00:34	40
00:42	50
00:51	60
01:01	70
01:09	80
01:20	90
01:30	100
01:40	110
01:50	120
02:01	130
02:13	140
02:25	150
02:38	160
02:51	170
03:04	180
03:19	190
03:33	200
03:50	210
04:06	220
04:23	230
04:41	240
05:01	250

83.3 mg/L	300 mL
Soil #1 made at 100 mg/L	
Time (s)	Volume (mL)
00:00	0
00:08	10
00:17	20
00:25	30
00:33	40
00:41	50
00:50	60
00:59	70
01:08	80
01:17	90
01:27	100
01:37	110
01:47	120
01:58	130
02:09	140
02:20	150
02:31	160
02:43	170
02:57	180
03:10	190
03:24	200
03:39	210
03:54	220
04:10	230
04:28	240
04:47	250

82.5 mg/L	300 mL
Soil #1 made at 100 mg/L	
Time (s)	Volume (mL)
00:00	0
00:09	10
00:19	20
00:29	30
00:39	40
00:48	50
00:59	60
01:10	70
01:20	80
01:31	90
01:43	100
01:55	110
02:08	120
02:20	130
02:32	140
02:48	150
03:01	160
03:16	170
03:31	180
03:47	190
04:04	200
04:22	210
04:40	220
05:01	230
05:21	240
05:44	250

84.2 mg/L	300 mL
Soil #1 made at 115 mg/L	
Time (s)	Volume (mL)
00:00	0
00:09	10
00:18	20
00:27	30
00:36	40
00:45	50
00:54	60
01:04	70
01:14	80
01:24	90
01:35	100
01:46	110
01:57	120
02:08	130
02:20	140
02:32	150
02:46	160
03:00	170
03:14	180
03:28	190
03:44	200
04:00	210
04:17	220
04:37	230
04:56	240
05:16	250

85.6 mg/L	300 mL
Soil #1 made at 115 mg/L	
Time (s)	Volume (mL)
00:00	0
00:07	10
00:15	20
00:21	30
00:29	40
00:37	50
00:45	60
00:54	70
01:02	80
01:11	90
01:19	100
01:28	110
01:38	120
01:48	130
01:58	140
02:10	150
02:21	160
02:32	170
02:44	180
02:57	190
03:10	200
03:25	210
03:40	220
03:56	230
04:14	240
04:32	250

82.3 mg/L	300 mL
Soil #1 made at 120 mg/L	
Time (s)	Volume (mL)
00:00	0
00:07	10
00:15	20
00:22	30
00:29	40
00:36	50
00:44	60
00:51	70
00:59	80
01:07	90
01:15	100
01:24	110
01:32	120
01:42	130
01:51	140
02:01	150
02:11	160
02:22	170
02:34	180
02:45	190
02:57	200
03:11	210
03:25	220
03:38	230
03:54	240
04:11	250

Table B.35: Tabulation of Figure 5.37 – Soil #1 with No Vacuum Using 934-AH Filter Papers, Eight Replicates at a Target TSS Concentration of 70 mg/L

70.5 mg/L	300 mL	71.3 mg/L	300 mL	68.8 mg/L	300 mL	73.2 mg/L	300 mL
Soil #1 made at 75 mg/L		Soil #1 made at 75 mg/L		Soil #1 made at 75 mg/L		Soil #1 made at 75 mg/L	
Time (s)	Volume (mL)	Time (s)	Volume (mL)	Time (s)	Volume (mL)	Time (s)	Volume (mL)
00:00	0	00:00	0	00:00	0	00:00	0
00:08	10	00:09	10	00:06	10	00:06	10
00:16	20	00:19	20	00:12	20	00:12	20
00:25	30	00:28	30	00:18	30	00:18	30
00:33	40	00:40	40	00:24	40	00:24	40
00:41	50	00:49	50	00:30	50	00:29	50
00:49	60	01:00	60	00:37	60	00:36	60
00:57	70	01:11	70	00:44	70	00:42	70
01:07	80	01:22	80	00:51	80	00:48	80
01:16	90	01:33	90	00:59	90	00:55	90
01:25	100	01:45	100	01:07	100	01:02	100
01:35	110	01:56	110	01:15	110	01:09	110
01:45	120	02:08	120	01:23	120	01:16	120
01:55	130	02:22	130	01:32	130	01:24	130
02:06	140	02:35	140	01:40	140	01:32	140
02:16	150	02:49	150	01:50	150	01:40	150
02:29	160	03:03	160	01:59	160	01:49	160
02:40	170	03:18	170	02:09	170	01:58	170
02:52	180	03:33	180	02:19	180	02:07	180
03:05	190	03:50	190	02:29	190	02:18	190
03:20	200	04:06	200	02:41	200	02:28	200
03:33	210	04:25	210	02:53	210	02:40	210
03:49	220	04:42	220	03:06	220	02:51	220
04:05	230	05:01	230	03:20	230	03:04	230
04:22	240	05:21	240	03:38	240	03:17	240
04:39	250	05:44	250	03:58	250	03:29	250

65.8 mg/L	300 mL
Soil #1 made at 75 mg/L	
Time (s)	Volume (mL)
00:00	0
00:07	10
00:14	20
00:21	30
00:27	40
00:35	50
00:42	60
00:50	70
00:57	80
01:05	90
01:13	100
01:22	110
01:31	120
01:40	130
01:49	140
01:59	150
02:09	160
02:19	170
02:31	180
02:43	190
02:54	200
03:08	210
03:21	220
03:35	230
03:50	240
04:08	250

67.6 mg/L	300 mL
Soil #1 made at 75 mg/L	
Time (s)	Volume (mL)
00:00	0
00:07	10
00:14	20
00:21	30
00:28	40
00:35	50
00:42	60
00:50	70
00:57	80
01:05	90
01:14	100
01:22	110
01:30	120
01:39	130
01:49	140
01:59	150
02:08	160
02:19	170
02:30	180
02:41	190
02:53	200
03:06	210
03:19	220
03:34	230
03:49	240
04:05	250

68.3 mg/L	300 mL
Soil #1 made at 75 mg/L	
Time (s)	Volume (mL)
00:00	0
00:06	10
00:13	20
00:20	30
00:27	40
00:35	50
00:42	60
00:49	70
00:57	80
01:05	90
01:13	100
01:22	110
01:30	120
01:39	130
01:48	140
01:58	150
02:08	160
02:19	170
02:30	180
02:42	190
02:53	200
03:06	210
03:19	220
03:34	230
03:48	240
04:04	250

74.3 mg/L	300 mL
Soil #1 made at 75 mg/L	
Time (s)	Volume (mL)
00:00	0
00:07	10
00:14	20
00:21	30
00:28	40
00:36	50
00:43	60
00:50	70
00:58	80
01:06	90
01:15	100
01:24	110
01:32	120
01:41	130
01:50	140
02:00	150
02:10	160
02:21	170
02:32	180
02:44	190
02:56	200
03:09	210
03:22	220
03:37	230
03:52	240
04:08	250

Table B.36: Tabulation of Figure 5.38 – Soil #1 with No Vacuum Using Grade GF/F Filter Paper, Two Replicates of Manufactured TSS Concentrations of 160 mg/L, 140 mg/L and 120 mg/L

160 mg/L	300 mL	160 mg/L	300 mL	160 mg/L	300 mL	140 mg/L	300 mL
Time (s)	Volume (mL)	Time (s)	Volume (mL)	Time (s)	Volume (mL)	Time (s)	Volume (mL)
00:00	0	00:00	0	00:00	0	00:00	0
00:32	10	00:36	10	00:32	10	00:33	10
01:05	20	01:15	20	01:06	20	01:06	20
01:39	30	01:56	30	01:26	30	01:39	30
02:14	40	02:41	40	02:10	40	02:11	40
02:49	50	03:14	50	02:45	50	02:46	50
03:25	60	03:59	60	03:19	60	03:23	60
04:02	70	04:43	70	03:53	70	03:58	70
04:42	80	05:26	80	04:29	80	04:34	80
05:22	90	06:13	90	05:10	90	05:13	90
06:02	100	07:01	100	05:46	100	05:50	100
06:45	110	07:49	110	06:28	110	06:33	110
07:28	120	08:40	120	07:10	120	07:14	120
08:16	130	09:38	130	07:56	130	08:00	130
09:02	140	10:32	140	08:42	140	08:46	140
09:53	150	11:29	150	09:28	150	09:31	150
10:46	160	12:32	160	10:17	160	10:20	160
11:43	170	13:36	170	11:07	170	11:10	170
12:39	180	14:44	180	12:04	180	12:06	180
13:43	190	15:54	190	13:02	190	13:05	190
14:47	200	17:07	200	14:02	200	14:14	200
15:57	210	18:25	210	15:03	210	15:17	210
17:08	220	19:46	220	16:12	220	16:15	220
18:24	230	21:12	230	17:26	230	17:27	230
19:49	240	22:40	240	18:43	240	18:44	240
21:19	250	24:20	250	20:07	250	20:08	250

140 mg/L	300 mL
Time (s)	Volume (mL)
00:00	0
00:33	10
01:10	20
01:50	30
02:27	40
03:06	50
03:48	60
04:27	70
05:05	80
05:50	90
06:33	100
07:18	110
07:53	120
08:50	130
09:54	140
10:47	150
11:43	160
12:47	170
13:48	180
14:54	190
16:05	200
17:17	210
18:35	220
19:56	230
21:21	240
22:49	250

140 mg/L	300 mL
Time (s)	Volume (mL)
00:00	0
00:32	10
01:07	20
01:41	30
02:15	40
02:53	50
03:32	60
04:09	70
04:48	80
05:30	90
06:10	100
06:56	110
07:38	120
08:27	130
09:17	140
10:08	150
11:04	160
12:00	170
13:01	180
14:07	190
15:13	200
16:27	210
17:43	220
19:05	230
20:38	240
22:10	250

120 mg/L	300 mL
Time (s)	Volume (mL)
00:00	0
00:34	10
01:13	20
01:49	30
02:28	40
03:09	50
03:50	60
04:30	70
05:12	80
05:58	90
06:41	100
07:29	110
08:19	120
09:09	130
10:02	140
10:57	150
11:54	160
12:54	170
13:56	180
15:02	190
16:08	200
17:20	210
18:36	220
19:58	230
21:25	240
22:58	250

120 mg/L	300 mL
Time (s)	Volume (mL)
00:00	0
00:32	10
01:07	20
01:44	30
02:23	40
02:58	50
03:37	60
04:17	70
04:55	80
05:38	90
06:19	100
07:29	110
07:52	120
08:38	130
09:29	140
10:19	150
11:13	160
12:13	170
13:07	180
14:10	190
15:13	200
16:20	210
17:32	220
18:49	230
20:07	240
21:32	250