

إقرار

أنا الموقع أدناه مقدم الرسالة التي تحمل العنوان:

## Swarm Robotics with Circular Formation Motion Including Obstacles Avoidance

أقر بأن ما اشتملت عليه هذه الرسالة إنما هو نتاج جهدي الخاص، باستثناء ما تمت الإشارة إليه  
حيثما ورد، وإن هذه الرسالة ككل أو أي جزء منها لم يقدم من قبل لنيل درجة أو لقب علمي أو  
بحثي لدى أي مؤسسة تعليمية أو بحثية أخرى.

### DECLARATION

The work provided in this thesis, unless otherwise referenced, is the  
researcher's own work, and has not been submitted elsewhere for any  
other degree or qualification

Student's name:

اسم الطالب/ة: عبدالقادر عادل عبدالقادر المبيض

Signature:

التوقيع: 

Date:

التاريخ: 04 أكتوبر 2015

**Bed The Islamic University Gaza**  
**Deanery of Higher Studies**  
**Faculty of Information Technology**  
**Information Technology Program**



**الجامعة الإسلامية - غزة**  
**عمادة الدراسات العليا**  
**كلية تكنولوجيا المعلومات**  
**برنامج تكنولوجيا المعلومات**

# **Swarm Robotics with Circular Formation Motion Including Obstacles Avoidance**

**By:**

**Abed Alkader Adel Almobayed**

**(120110435)**

**Supervised by:**

**Prof. Nabil M. Hewahi**

**A Thesis Submitted in Partial Fulfillment of the Requirements for the  
Degree of Master in Information Technology**

**September 2015 – 1436 H**



هاتف داخلي: 1150

مكتب نائب الرئيس للبحث العلمي والدراسات العليا

الرقم..... Ref

التاريخ..... ج س ع/35  
Date.....  
2015/09/21

## نتيجة الحكم على أطروحة ماجستير

بناءً على موافقة شئون البحث العلمي والدراسات العليا بالجامعة الإسلامية بغزة على تشكيل لجنة الحكم على أطروحة الباحث/ عبد القادر عادل عبد القادر المبيض لنيل درجة الماجستير في كلية تكنولوجيا المعلومات برنامج تكنولوجيا المعلومات وموضوعها:

### تحريك سرب من الروبوتات باستخدام التشكيل الدائري متضمناً تجاوز العوائق Swarm Robotics with Circular Formation Motion Including Obstacles Avoidance

وبعد المناقشة العلنية التي تمت اليوم الاثنين 07 ذو الحجة 1436هـ، الموافق 2015/09/21م الساعة الثانية عشرة ظهراً بمبنى القدس، اجتمعت لجنة الحكم على الأطروحة والمكونة من:

.....	مشرفاً و رئيساً	أ.د. نبيل محمود حويحي
.....	مناقشاً داخلياً	د. أشرف يونس مغاري
.....	مناقشاً خارجياً	أ.د. سامي سليم أبو ناصر

وبعد المداولة أوصت اللجنة بمنح الباحث درجة الماجستير في كلية تكنولوجيا المعلومات / برنامج تكنولوجيا المعلومات.

واللجنة إذ تمنحه هذه الدرجة فإنها توصيه بتقوى الله ولزوم طاعته وأن يسخر علمه في خدمة دينه ووطنه.

والله ولي التوفيق،،،

نائب الرئيس للبحث العلمي والدراسات العليا

عبد الرؤوف علي المناعمة



## ABSTRACT

The robots science has been developed over the past few years, where robots have become used to accomplish difficult, repetitive or that need accuracy tasks, which is hard for humans to carry out and complete accurately as the accuracy that provided by robots.

In this thesis we propose an algorithm to control the motion of swarm of robotics and make them able to avoid obstacles. The proposed solution is based on forming the robots in circular fashion. A group set of robots consists of multiple groups of robots, each group of robots consists of robots forming a circular shape and each group set is a circular form of robots. The proposed algorithm is concerned with first locating the randomly generated robots in groups and secondly with the swarm robot motion and finally with the swarm obstacle avoidance and swarm reorganization after crossing the obstacle.

The proposed algorithm has been simulated with five different obstacles with various numbers of randomly generated robots. The results show that the swarm in the circular form can deal with the obstacles very effectively by passing the obstacles smoothly. The proposed algorithm has been compared with flocking algorithm and it is shown that the circular formation algorithm does not need extensive computation after obstacle avoidance whereas the flocking algorithm needs extensive computation. In addition, the circular formation algorithm maintains every robot in its group after avoiding the obstacles whereas with flocking algorithm does not.

**Keywords:** Robotics, Swarm Robotics, Circular Formation, Obstacle Avoidance

## ملخص الدراسة

### التحكم في سرب من الروبوتات باستخدام التشكيل الدائري واجتياز العوائق

شهد علم الروبوتات تطور على مدى السنوات القليلة الماضية، حيث أصبحت الروبوتات تستخدم في إنجاز الاعمال الصعبة أو المتكررة أو التي تحتاج دقة والتي من الصعب على العنصر البشري القيام بها وإنجازها بدقة تعادل الدقة التي يوفرها الروبوتات.

نقدم في هذه الأطروحة خوارزمية تتحكم في حركة سرب من الروبوتات وتجعلها قادرة على اجتياز العوائق التي تواجهها، حيث أن الحل المطروح يعتمد على تشكيل الروبوتات بشكل دائري بوجود مجموعة من الروبوتات تتكون من مجموعات تحتوي على روبوتات منسقة بشكل دائري بداخلها و كل مجموعة هي عبارة عن شكل دائري من الروبوتات. تهتم الخوارزمية المقترحة بتحديد الروبوتات -الموزعة عشوائيا -داخل مجموعات وثانيا بالتحكم في حركة سرب الروبوتات وأخيرا باجتياز العوائق وإعادة التنظيم بعد عملية الاجتياز. كما أن هذه الخوارزمية تم محاكاتها من خلال وجود خمسة عوائق مختلفة مع أعداد مختلفة من الروبوتات الموزعة عشوائيا. أظهرت النتائج أن السرب ذو التشكيل الدائري بإمكانه التعامل مع العوائق بكفاءة ويجتازها بسهولة. تم مقارنة الخوارزمية المقترحة بخوارزمية التدفق حيث تبين أن خوارزمية التشكيل الدائري لا تحتاج الى عمليات حسابية كثيرة بعد اجتياز العائق بينما التدفق تحتاج الى عمليات كثيرة. كذلك فإن خوارزمية التشكيل الدائري تحتفظ بكل روبوت داخل مجموعته بعد اجتياز العائق بينما التدفق لا يقوم بذلك .

#### كلمات مفتاحية:

سرب الروبوتات، تشكيل دائري، اجتياز العوائق.

## ACKNOWLEDGEMENT

*First Alhamdulleah for everything,*

*For my brothers who sacrificed their lives for the sake of Allah*

*I would like to thank **my father** and his wife my second mother for providing me unconditional support and encouragement throughout my time in postgraduate.*

*My wonderful wife, **Eman**, for her patience and forbearance through my studying and preparing this work, and my sons, **amera, soad, mayada, adel, khtab, rahaf, and lian**, whom I do all of this for them.*

*For the soul of my mother.*

*Special thanks to my supervisor **Prof. Nabil M. Hewahi** for his constant guide, challenging discussions and advices, I would like to express my appreciation to him.*

**Abed Alkader Adel Almobayed**

**September 2015**

## Table of Contents

<b>ABSTRACT</b> .....	2
ملخص الدراسة .....	3
<b>ACKNOWLEDGEMENT</b> .....	4
<b>Table of Contents</b> .....	5
<b>Chapter 1: INTRODUCTION</b> .....	11
<b>1.1 Statement of the problem</b> .....	14
1.1.1 Objectives .....	14
1.1.2 Main Objective .....	14
1.1.3 Specific Objectives.....	14
<b>1.2 Significance of the Thesis</b> .....	15
1.2.1 Scope and Limitations.....	15
<b>1.3 Methodology</b> .....	15
<b>1.4 Evaluation</b> .....	17
<b>1.5 Tools, Equipment's and Methods</b> .....	17
<b>Chapter 2: Related work</b> .....	18
<b>2.1. Introduction</b> .....	18
<b>2.2. Swarm Robotics Approaches</b> .....	18
<b>CHAPTER 3: Methodology and Proposed Model</b> .....	26
<b>3.1. Data Collection:</b> .....	26
<b>CHAPTER 4: Experimentation Results and Discussion</b> .....	53
<b>4.1 Experimental Environment and Tools</b> .....	53
<b>4.2 Data Preparation</b> .....	53
<b>4.3 Simulation Experiments</b> .....	54
4.3.1 Experiment #1: First Obstacle.....	54
4.3.2 Experiment #2: Second Obstacle .....	60
4.3.3 Experiment #3: Third Obstacle .....	66
4.3.4 Experiment #4: Fourth Obstacle.....	71
4.3.5 Experiment #5: Fifth Obstacle .....	77
<b>4.4 Results Discussion and Evaluation</b> .....	83
<b>4.4.1 Comparative Study</b> .....	83

4.4.1.1	Initial Organization .....	83
4.4.1.2	Movement.....	83
4.4.1.3	Obstacles Avoidance .....	84
4.4.1.4	Post Obstacle Organization .....	85
4.4.1.5	Advantages .....	86
4.4.1.6	Drawbacks .....	86
4.4.2	Discussion .....	87
<b>CHAPTER 5 : Conclusion And Future Work .....</b>		<b>88</b>
<b>5.1 Conclusion .....</b>		<b>88</b>
<b>5.2 Future Work.....</b>		<b>91</b>
<b>References.....</b>		<b>90</b>



## List of Tables

Table 4-1: List of the five main experiments .....	53
Table 4-2: Every type of the five obstacles has four different number of robots as experiments....	54
Table 4-3: Initial organization comparison .....	83
Table 4-4 : Movement comparison .....	83
Table 4-5 : Obstacle avoidance comparison .....	84
Table 4-6 : Post organization comparison .....	85
Table 4-7 : Advantages comparison .....	86
Table 4-8: Drawbacks comparison .....	86

## List of Figures

Figure 1-1:Diagram shows the five steps of Methodology Approach.....	15
Figure 1-2: A robot set with ten groups of robots .....	16
Figure 1-3: Circular formation for nine hundred robots .....	16
Figure 2-1: Tringular formation robots[8].....	23
Figure 2-2: Final Grid Structured Configuration [27] .....	24
Figure 3-1: Methodology flowchart .....	26
Figure 3-2: Graph illustrate Distance Calculation .....	27
Figure 3-3: Graph Illustrate the change of (x, y) position use to calculate slop "m" .....	27
Figure 3-4: Graph Illustrate then line crosses the Y-Axis .....	28
Figure 3-5: Graph Illustrate the new points on the circumference of the circle .....	28
Figure 3-6: Graph Illustrate new point that use to define the centers for Group Sets in the circular formation .....	29
Figure 3-7: Graph IllustrateS the Circle and Circumference .....	30
Figure 3-8: Graph Illustrate the Center of Circle and three points around the Circumference.....	31
Figure 3-9: Distribute Robots Randomly.....	32
Figure 3-10: Circular formation center of (x, y).....	33
Figure 3-11: Illustrate Graph Display the Circular formation for 15 robots.....	33
Figure 3-12: Graph Illustrate New Position Of Robots from 16 to 100 Position.....	34
Figure 3-13: Graph Illustrate the four Group sets on Circular Formation Contain 16 New Robots Position.....	35
Figure 3-14: Graph Illustrate The Four Group sets on Circular Formation Contain 17 New Robots Position.....	35
Figure 3-15: Simulation Results for Orgnizaing 35 Robots in Circulare Formation.....	36
Figure 3-16: Swarm Robotics Move Forward.....	38
Figure 3-17: The Five Considered Obstacles .....	39
Figure 3-18: First obstcale is the Obstacale that Allows the Passage only one robot .....	41
Figure 3-19: Demonstration of what are W, OC and DRH.....	41
Figure 3-20: Graph Illustrate path Of Robots Over Obstacles and the Cxy' center of new Circular formation .....	42
Figure 3-21: Second Obstacle Type that Allows One Group Set to Pass the Obstacle .....	43
Figure 3-22: Graph Illustrate details of first obstacles.....	44
Figure 3-23: The third Obstcale allows the passage of only one robot .....	45
Figure 3-24: Ilustrat the Path of Move for robots on swarm robotics with the third obstcale type .....	46
Figure 3-25: Fourth Obstcale Allows the Passage of Group Set to Mid Distance (in between the three obstcales) and One Robots to Pass between the Two Blocks.....	48
Figure 3-26: Ilustrat The Path of move For Robots on Swarm Robotics .....	48
Figure 3-27: Fifth Obstacles have tow gaps every one of them allow one robot to pass.....	50
Figure 3-28: Graph Illustrate the Fifth Obstacles and the Path of Robots to Pass the Obstacles....	51

Figure 4-1: The first obstacle.....	54
Figure 4-2: Experiment #1, the first obstacle with 100 robots before passing any robot .....	55
Figure 4-3: Experiment #1, the first obstacle with 100 robots after passing some robots .....	55
Figure 4-4: Experiment #1, the first obstacle with 100 robots after passing all the robots .....	56
Figure 4-5: Experiment #1.2, the first obstacle with 50 robots before passing any robot .....	56
Figure 4-6: Experiment #1.2, the first obstacle with 50 robots after passing some robots .....	57
Figure 4-7: Experiment #1.2, the first obstacle with 50 robots after passing all robots .....	57
Figure 4-8: Experiment #1.3, the first obstacle with 25 robots before passing any robot .....	58
Figure 4-9: Experiment #1.3, the first obstacle with 25 robots after passing some robots .....	58
Figure 4-10: Experiment #1.3, the first obstacle with 25 robots after passing all robots.....	59
Figure 4-11: Experiment #1.4, the first obstacle with 16 robots before passing any robot .....	60
Figure 4-12: Experiment #1.4, the first obstacle with 16 robots after passing some robots .....	60
Figure 4-13: Experiment #1.4, the first obstacle with 16 robots after passing some robots .....	60
Figure 4-14: Experiment #1.4, the first obstacle with 16 robots after passing all robots.....	60
Figure 4-15: The second obstacle.....	61
Figure 4-16: Experiment #2.1, the second obstacle with 100 robots before passing any robot .....	61
Figure 4-17: Experiment #2.1, the second obstacle with 100 robots after passing some robots ...	61
Figure 4-18: Experiment #2.1, the second obstacle with 100 robots after passing all robots .....	62
Figure 4-19: Experiment #2.2, the second obstacle with 50 robots before passing any robot .....	62
Figure 4-20: Experiment #2.2, the second obstacle with 50 robots after passing some robots .....	62
Figure 4-21: Experiment #2.2, the second obstacle with 50 robots after passing all robots .....	63
Figure 4-22: Experiment #2.3, the second obstacle with 25 robots before passing any robot .....	63
Figure 4-23: Experiment #2.3, the second obstacle with 25 robots after passing some robots .....	64
Figure 4-24: Experiment #2.3, the second obstacle with 25 robots after passing all robots .....	64
Figure 4-25: Experiment #2.4, the second obstacle with 16 robots before passing any robot .....	65
Figure 4-26: Experiment #2.4, the second obstacle with 16 robots after passing some robots .....	65
Figure 4-27: Experiment #2.4, the second obstacle with 16 robots after passing all robots .....	65
Figure 4-28: Illustrate the Path of Move for robots on swarm robotics with the third obstacle type .....	66
Figure 4-29: Experiment #3.1, the third obstacle with 100 robots before passing any robot .....	66
Figure 4-30: Experiment #3.1, the third obstacle with 100 robots after passing some robots .....	67
Figure 4-31: Experiment #3.1, the third obstacle with 100 robots after passing all robots .....	67
Figure 4-32: Experiment #3.2, the third obstacle with 50 robots before passing any robot.....	68
Figure 4-33: Experiment #3.2, the third obstacle with 50 robots after passing some robots .....	68
Figure 4-34: Experiment #3.2, the third obstacle with 50 robots after passing all robots .....	68
Figure 4-35: Experiment #3.3, the third obstacle with 25 robots before passing any robot.....	69
Figure 4-36: Experiment #3.3, the third obstacle with 25 robots after passing some robots .....	69
Figure 4-37: Experiment #3.3, the third obstacle with 25 robots after passing all robots .....	69
Figure 4-38: Experiment #3.4, the third obstacle with 16 robots before passing any robot.....	70
Figure 4-39: Experiment #3.4, the third obstacle with 16 robots after passing some robots .....	70
Figure 4-40: Experiment #3.4, the third obstacle with 16 robots after passing all robots .....	70
Figure 4-41: Fourth Obstacles .....	71
Figure 4-42: Swarm robotics Path Over Fourth Obstacles .....	71
Figure 4-43: Experiment #4.1, the fourth obstacle with 100 robots before passing any robot .....	72
Figure 4-44: Experiment #4.1, the fourth obstacle with 100 robots after passing some robots.....	72

Figure 4-45: Experiment #4.1, the fourth obstacle with 100 robots after passing all robots.....	72
Figure 4-46: Experiment #4.2, the fourth obstacle with 50 robots before passing any robot .....	73
Figure 4-47: Experiment #4.2, the fourth obstacle with 50 robots after passing some robots.....	73
Figure 4-48: Experiment #4.2, the fourth obstacle with 50 robots after passing all robots.....	74
Figure 4-49: Experiment #4.3, the fourth obstacle with 25 robots before passing any robot .....	75
Figure 4-50: Experiment #4.3, the fourth obstacle with 25 robots after passing some robots.....	75
Figure 4-51: Experiment #4.3, the fourth obstacle with 25 robots after passing all robots.....	75
Figure 4-52: Experiment #4.4, the fourth obstacle with 16 robots before passing any robot .....	76
Figure 4-53: Experiment #4.4, the fourth obstacle with 16 robots after passing some robots.....	76
Figure 4-54: Experiment #4.4, the fourth obstacle with 16 robots after passing all robots.....	76
Figure 4-55: Fifth Obstacle .....	77
Figure 4-56: Swarm robotics Path Over the fifth obstacles .....	77
Figure 4-57: Experiment #5.1, the fifth obstacle with 100 robots before passing any robot.....	78
Figure 4-58: Experiment #5.1, the fifth obstacle with 100 robots after passing some robots.....	78
Figure 4-59: Experiment #5.1, the fifth obstacle with 100 robots after passing all robots.....	78
Figure 4-60: Experiment #5.2, the fifth obstacle with 50 robots before passing any robot.....	79
Figure 4-61: Experiment #5.2, the fifth obstacle with 50 robots after passing some robots .....	79
Figure 4-62: Experiment #5.2, the fifth obstacle with 50 robots after passing all robots .....	80
Figure 4-63: Experiment #5.3, the fifth obstacle with 25 robots before passing any robot.....	80
Figure 4-64: Experiment #5.3, the fifth obstacle with 25 robots after passing some robots.....	81
Figure 4-65: Experiment #5.3, the fifth obstacle with 25 robots after passing all robots.....	81
Figure 4-66: Experiment #5.4, the fifth obstacle with 16 robots before passing any robot.....	82
Figure 4-67: Experiment #5.4, the fifth obstacle with 16 robots after passing some robots.....	82
Figure 4-68: Experiment #5.4, the fifth obstacle with 16 robots after passing all robots .....	82
Figure 4-69: Forward moving for swarm robotic in circular formation .....	84
Figure 4-70: Illustrate forward moving for swarm robotic .....	84
Figure 4-71: Avoid Obstacles.....	85
Figure 4-72: Avoid Obstacles.....	85
Figure 4-73: Organize robots in circular formation after avoid obstacles.....	85
Figure 4-74: Organize robots after avoid obstacles.....	85

## Chapter 1: INTRODUCTION

Due to heavy duties or sometimes very accurate duties (duties performed in very narrow areas), human being cannot perform those tasks and it becomes very important to use robots.

With the revolution of technology and the expanding of discoveries and science, everyday human's passion to reach deep under sea and oceans and far away in the universe increase. Also reaching to undiscovered location and uneasy places is becoming very important in the science revolution. Robots are pre-programmed or controlled and can carry out tedious, boring or dangerous tasks, and also able to do works need to be accurate. In addition, robots might involve in searching for survivors and rescue during natural disasters and wars. Other robots might be used to carry out surgery tasks, and may be household works. The robot work might vary from simple to complex task.

Fortunately; robots has begun working in these places, where most of them have the ability to move wirily or wirelessly like Uav "an aircraft with no pilot on board" plane which flies without pilot, submarine or mobile robot[9]. For such tasks one robot won't be enough and there is a need to have more than one robot working together, "many of robots work together in same organizing" we can call them swarm robotics.

To study the swarm's behavior; scientists study the behavior of ants, bees and fish; and how they work together to find food or solve their problems. Based on the motion of swarms and swimming of flocks, researchers build their algorithms that behave like fish schools, bird flocks, and ants [9],[11],[13],[14],[15],[23].

Swarm robotics is the name which is given to group of robots working together in Autonomous; robots that performs behaviors or tasks which is particularly desirable in fields such as; space exploration, cleaning floors, mowing lawns, waste water treatment, rescue after any kind of disaster, and discovering the damaged area of Gas or contaminated with nuclear radiation[4],[24].

Researchers have worked in several fields related to swarm robotics; the way robotics can connect to each other by using simple techniques with little resources and how they share big tasks and solve them [24]. Researchers proposed several algorithms for swarm robotics to have one standalone algorithm for each robot; most of these approaches

are based on fish school and motion of the birds including v formation and triangular formation[19].

In this study we will develop a swarm robotics motion based on circular formation that will help them to move fast to be able to avoid obstacles and to easily preform themselves.

Robots are pre-programmed or controlled and can carry out tedious, boring or dangerous tasks, and also able to do works need to be accurate. In addition, robots might involve in searching for survivors and rescue during natural disasters and wars. Other robots might be used to carry out surgery tasks, and may be household works. The robot work might vary from simple to complex task.

Swarm robotics, a robotics group which make a move in a particular format with each other based on a simple connection to carry out a task, it's a new method of using collective behavior that moves according to a certain algorithm applied on each robot within the swarm to interact with each other and with their environment for doing difficult and complex tasks, where single robot cannot do. But a swarm of robots can perform this task through fragmentation and that each robot within the swarm implements its part – like others - to complete the main task successfully, the robot' design within swarm considered simple and not complicated, there are many different kinds of robots that are used in swarms of robots, including:

**Ant robotics:** This model follows the traditional way of ant life and communication, by producing pheromones to give signals to other ants. In 1991, James McLurkin, provided the robot with special sensors, infrared and communication system to be able to follow the signs and interpret the signals received from other robots. An algorithm was developed to mimic the ant behavior on robots and several experiments were conducted to test and discover the distribution of the ants workload performed[18].

**Kilobot:** In 2010, Small robot doesn't exceed a length of 3.3 cm, was produced in the Self-organizing Systems Research Group at Harvard University, and at a cost not exceeds \$ 15 for robot, as these robots can interact in doing tasks as a group, where single robot cannot do these tasks [22].

**Nanorobotics:** This technology is still in the process of growing up, where scientists aimed at nanometer-sized robot industry ( $10^{-9}$  meters), for use in medicine operations by

sending the robot into the bloodstream in the human body and some minor attempts in this area succeeded[8].

**Microbotics:** An idea to design a robot less than 1 mm size and has a simple characteristics for use in a swarm of robots[16].

These are some of the models and ideas put forward in the field of robotics industry, which can be used in the work of swarms of robots, where is the main objective of the joint between all of these models are the simple means of communication to enable communication with other robots in the swarm and the implementation of the tasks as groups.

The swarms of robots move using an algorithm designed to be distributed to all the robots in the swarm where this algorithm enable the movement coordination and distribution of tasks to robots in the swarm. The process of imitating the behavior of robots that work in group is the simulation. In this thesis, simulation will be used to show and test the behavior of the proposed work which is based on circular formation motion for the robots.

In most of swarm robotics research, researchers try to mimic the natural movement of fish, bees, or bird swarms[13],[15], and in many cases this might not help in the work of robots, for example, sometimes the fish swarm goes back or takes another path if it faces an obstacle that needs special reorganization. With birds swarms, the swarm does not have a leader to control or give orders to others in case of dangerous or a changing situation, this could be good in cases of self adaptation, but sometimes this is not good in real dangerous cases. We can divide Researchers work into three classifications:

1. Full real swarm mimicking: in which researchers make the robots works exactly as the natural swarm. The drawback of such kind of model is that it can't fit with any application domain.
2. Partially real swarm mimicking: in which researchers make the robot work as natural swarms for certain point of time and differently at other point of time. The advantage here is that a special robot reorganizing is done only whenever it is needed.
3. No real swarm mimicking: in which the whole motion and behavior of robots don't mimic any of natural swarms. This idea is based mainly on the main domain and environment where the robots work in. The

advantage here is that you can maintain a certain organization for all times with a predefined mechanism.

In this thesis, a proposal for a new approach to direct the motion of swarm of robots and how to avoid obstacles based on circular formation is presented. The proposed approach can be classified under type three where no real swarm mimicking is existing. The main advantage of this approach over other existing approaches is that it starts with organizing the swarm robots in circular formation based on certain criteria. The organization will be maintained and adapted based on faced obstacles. The reorganization of the robots form will not take time because every robot knows its previous location in its group. In other methods, the robot might need to change its location which means more time for the computation. Moreover, keeping the robot location in the same position within the same group means more natural, where the robot might have a certain subtask within its group.

The pros of adopting circular formation as a style for robotics swarm motion and obstacle avoidance are that robots groups can be maintained easily and at the same time can be disassembled and reassembled (grouped again) smoothly. Another advantage of this formation is that it internally forms square formations which might be useful to reorganize the robots in two ways if required. This second advantage "square formation" is not being used in this thesis.

## **1.1 Statement of the problem**

Finding a proper way for swarm robotics motion that help the swarm to move easily, systematically and reducing the reorganization effort while avoiding the obstacles.

### ***1.1.1 Objectives***

#### ***1.1.2 Main Objective***

Designing and developing an algorithm that guides and controls the swarm robotics motion including obstacle avoidance based on circular formation to allow robots to move, organize and reorganize themselves in a systematic way and to reduce the reorganizing time after avoiding the obstacles.

#### ***1.1.3 Specific Objectives***

- Investigating Swarm Robotics.
- Design circular formation algorithm.



- Implementing and simulating the proposed approach.
- Testing and evaluating algorithm in terms of motion behavior and obstacle avoidance.

## 1.2 Significance of the Thesis

- Developing a mechanism that will make robots move properly in various robot applications.
- Promote researcher to find a better way of swarm robotics motion and obstacle avoidance.
- Developing new way of swarm robotics organization and formation.

### 1.2.1 Scope and Limitations

- Minimum number of robots to make the circular formation is four robots.
- The obstacles positions are predefined.
- The obstacles size and shape are predefined.
- The direction of robots is forward.
- Robot within one circulation form can communicate with its closest neighbor.
- The closets two robots in two neighbor circles can communicate.

## 1.3 Methodology

The main steps that would be considered throughout the proposed approach are shown in Figure 1.1 and presented below.

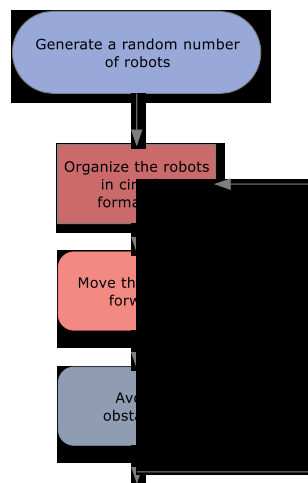

Figure 1-1:Diagram shows the four steps of Methodology Approach

1. Generate a random number of robots to have a swarm.
2. Organize the robots in circular formations, where every robot will be in a group related to circular formation. This means every circular formation is a cycle that has cyclic groups of robots on its circumference as shown in Figure 1.2 and Figure 1.3. We might have more than one circular formation.
3. Move the robots forward in a steady state.
4. Avoiding obstacles in case of facing an obstacle, and the swarm has to adapt itself based on the type of the obstacle. Various types of obstacles will be considered.
5. The swarm reorganizes itself after avoiding the obstacle in the same way as it was before facing the obstacle.
6. The swarm adaptation and reorganization will be evaluated.

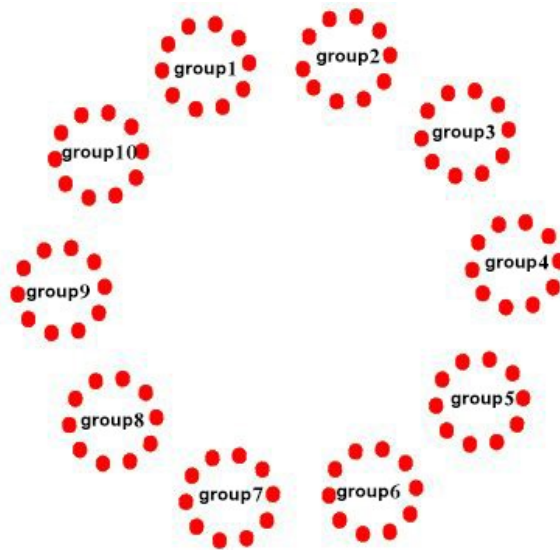

Figure 1-2: A robot set with ten groups of robots

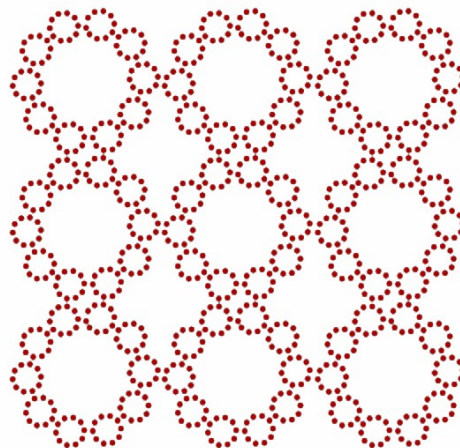

Figure 1-3: Circular formation for nine hundred robots

## 1.4 Evaluation

The proposed approach will be evaluated in terms of adaptation behavior of swarm reorganization and obstacles avoidance. A comparative study will be performed between our proposed approach and flocking algorithm presented by Yosuke Hanada and others[11]. In their approach, they are talking about adaptive flocking of large number of robots on a swarm robotics. Every robot navigate autonomously on unknowing environment with little connection tool for every robot. The approach is using Local Interactions algorithm that simulates swimming behavior of a school of fish, each robot uses sensing range to choose two neighbor robots to make triangular formation using fixed distance with it, and this operation will be repeated with every robot in the swarm robotics. After finishing the organization of triangular formation, the swarm robotics will move forwarding and avoids the obstacles [11]. The evaluation process will include:

- Organizing the robots from random distributed situations.
- Moving of swarm robotics.
- Avoiding obstacles.
- .Organizing and reorganizing swarm robotics after avoiding obstacles
- A variant set of predefined obstacles will be introduced to test the proposed system and to do the comparative study.

## 1.5 Tools, Equipment's and Methods

- Tools:
  - Programming language: Delphi XE7 (for designing simulation program)
- Equipment's:
  - Asus N56V : CPU 2.GHz ,Intel Core i7, Ram 16 GB

## Chapter 2: Related Work

### 2.1. Introduction

Swarm robotics is a new research field, where researchers seek to develop small robots that have the potential to communicate with each other with the least amount of resources consumption to carry out major operations that cannot be performed by a single robot.

### 2.2. Swarm Robotics Approaches

There are different approaches which have been adopted for swarm robotics. These approaches can be classified into three types, communication[10][20] , flocking[7, 9, 11, 13-15, 21, 25] and formation[5, 15, 28].

#### 2.2.1. Communication and Sensing

Swarm robotics is not always about the control and coordination of mobile agents, it entails the development of infrastructure for proper functioning such as communication, sensing, processing. Bayindir and Sahin[1] divided the interaction between robotics into two categories “Interaction via Sensing” and “Interaction via Communication”. Interaction via sensing is the simplest and the most limited type of communication between the robots. This type of communication requires the robots to distinguish between other robots and the environment objects [14]. Interaction via communication involves explicit communication with other robots by broadcast messages using robot identification numbers [14].

Short-term wireless communications is used to communicate between different robots that operate in different environments using ZigBee radio modem, expandable protocol and local communication to exchange different types of data between different types of robots. This way of communication allows the admission of a new robot to the swarm, or a robot out of the swarm, without the need to stop the swarm work. These robots can arrange tasks and navigate between robots, where the navigation is one of the important things that help robots in performing tasks. Such contacts are of little power consumption and uncomplicated data transfer between the robots, which adopts the sensors mechanisms like sensors exist in ants [18, 29].

Nouyan and Dorigo [20] develop a formation behavior based on chain, robots will be chain formation based on communicate through light signals. Two algorithm are

developed. In the first algorithm, robots signal one of three different colors : blue, green and red, based on the color of the LED "Light-emitting diode" ring around their body forming a cyclic directional pattern that allows them to determine the direction to follow along the robotic chain to reach the 'nest' or the 'goal' locations. In the second method, robots emit a light pattern that indicates the direction towards the 'nest', thus the robot follows the color to reach to the end of the chain to connect.

### **2.2.2. Flocking**

What distinguishes a swarm of robots is the movement, which is either organized or simulates swarms of nature like a swarm of fish or flock of birds. In the case of nature like swarm, robot is considered independent and moves autonomously. Every robot is having its own number despite that in the simulation environment the robot is considered a point in a two dimensional space.

The main problem facing these robots is that it is separated from the rest of the swarm and don't take complex communication devices. On the other hand, the main characteristics of this approach are the simplicity in the process of communication, movement independently and carrying a decentralized algorithm.

The goal of flocking is to simple the coordination of the communication process "low sensing" between the robots and to allow them to interact with each other.

Flocking did not receive much attention from fields outside biology until the mid '80s, when Reynolds[21] published a computer model of flocking that is considered seminal. Reynolds was one of the first to propose simple behaviors based on local sensing rules that, combined, could realize flocking with artificial agents. Reynolds developed a flock of virtual birds in which the individuals are able to sense the velocity and the range of the neighbors.

Flocking is the collective motion of a large number of self-propelled entities and is a collective animal behavior exhibited by many living beings such as birds [23], fish [15], bacteria and insects[18] . It is considered an emergent behavior arising from simple rules that are followed by individuals and does not involve any central coordination.

Lee and Chong [15] proposed robot swarms in triangular shapes. This triangular formation is used to facilitate the movement of the swarm concurrently and simulates the

movement of swarms of fish. The process of triangular formation is called "local interaction algorithm". In addition, another algorithm to make the swarm move forward simultaneously is developed. The swarm of robots keeps the organization of triangular formation during movement, which leads to a consumption of a lot of processes. Several experiments were conducted mainly to avoid obstacles by a swarm of robots.

The swarm of robots is going to be randomly distributed before reaching the obstacles and will be moving according to the gap width on the obstacle, so that one passes in the gap if it is allowed to pass, and two will pass if the width allows this. After passing the obstacle, a re-organization is performed to have again triangular formation to move again forward. This process is called "adaptation". In this approach the triangular formation might include different robots together other than the ones which were together before the obstacle avoidance. This mechanism is good in terms of speed, because the close robots will reform a group, but this is usually against the human activity nature. Usually people work in fixed groups, where each member in the group is having a certain task and this member can't go to another group because other groups might do other tasks that might not be suitable for the person's assigned task. In the same work, another method used to avoid obstacle through the subordination of a commander in which robots are assigned a robot as a leader. The group walks behind the leader through a process called "tracking". This study concluded that the triangular formation during the movement of a swarm of robots is good, but it allows only three neighbors for every robots in the swarm and use direct communication between them.

Xiang et al[27] complements the previous study presented in [5]. An algorithm to control the movement of swarm of robots enabling it to move in flocks and to avoid obstacles has been presented. When the swarm is to be gathered in a triangular form, an algorithm called "'SideLenTriangle" is applied, where each robot has a low sensing to enable locating itself and its neighbors of robots. The main goal of the robot is to be able to form a parallel triangle ribs between it and the robots nearby. The robot which is determined by the algorithm will be chosen randomly and then robots will continue its work until it reaches the triangular formation, which allows it to form a swarm.

Each robot has the same algorithm to work on. A simulation program has been developed to check the behavior of the robots. The authors talks about the possibility of avoiding obstacles and presents a single obstacle as a point in the simulation program. The

swarm needs to pass through next to it or pass around it with keeping the "SideLenTriangle".

Turgut et al.[25] developed a flocking behavior on autonomous robots based on using proximity sensors and a virtual heading sensor (VHS) and did not require external computation or communication devices. So, with using VHS swarm is able to measure the orientation of their neighbors and obstacle avoidance in absence of a common goal direction. The developed behavior is one of the first true implementation of Reynolds' [21] flocking behavior with real robots. The authors evaluated the performance of their behavior by using different metrics and validated it with the use of several robots. Celikkanat and Sahin [3], extending the work of Turgut et al. [17], the authors found that when insert some informed robots are the only ones in the group with knowledge of the goal direction that leads to increase the accuracy of motion of the group with respect to the desired goal direction..

Hayes and Dormiani-Tabatabaei describe a leaderless distributed flocking algorithm in [12]. They proposed two behaviors for robots flocking algorithm: collision avoidance and flock center. Firstly, based on collision sensors, robots can be avoidance any obstacle or another robot, and it mediates a turn away from the obstacle or robot. However, if the collision sensors is not active, robots is able to use flocking center to avoidance the obstacle. Flocking center generates a center of mass vector (CoM), robots compute the position and the velocity of the center of mass of their neighbors, in order to maintain cohesion and to align in the same direction to obtain an alignment term which may allow to get better performance. The authors used an o?-line machine learning optimization method to optimize the unknown parameters in the model. After optimization is performed, they validated their results on real robots.

Hanada et al. [11] proposed a novel algorithm for flocking that enables the robots to navigate autonomously in an environment populated with obstacles. Authors assumed all of the robots know the goal direction of flocking. Each robot dynamically selects two neighboring robots within its sensing range and maintains a uniform distance with them, and that allows three neighboring robots to form an isosceles triangle and remains constant through the obstacles. The results shown that the robots able to split into multiple groups or re-united into one according to obstacles conditions, and that they form equilateral triangles in the long-run as well..

Cao and Ren [2] , in this paper authors implement a virtual leader who is a neighbor of only a subset of a group of robots, and the robots only have local interaction and only partial measurements of the states of the virtual leader and the robots are neighbors. The authors proposed a distributed consensus tracking algorithm without velocity measurements under both fixed and switching network topologies. However, the virtual leader velocities can be changing based on dynamic case where the velocities are available but not the accelerations. Finally, the authors also performed numerical simulation as a proof of their concept.

### **Formation**

A fundamental problem in collective robotics is to have the group organize into global formations or patterns. These include simple patterns like circles, lines, uniform distribution within a circle or square, etc. In the presence of a central controller, these tasks are trivial, but this is not the case in a distributed system. The goal here is to have an entirely decentralized system in which each robot performs tasks autonomously based on information gathered by itself, preferably from its neighborhood.

An important feature in most of these systems is that the individual entities (robots) are not explicitly aware that they are involved in pattern formation, and certainly cannot direct it globally.

This section briefly discusses the work of other researchers in the area of pattern formation. The reader is cautioned that the amount of research done in this field is immense and this section covers only a few papers that have directly influenced the work presented in this chapter. In particular, the formation of a circle has been studied by two [5, 28].

Daniel and Aliasgar in [24] provides new approach for localization robots in unstructured environments, this approach depends on search and rescue operations and uses triangular formation in its movement. This formation is a formation of an equilateral triangle between every three robots to cover areas where a swarm of robots searching for food or looking to save victims, the researcher used "trigonometry" to find the distance between the robots. Each robot in the swarm would be equipped with sensors sufficient to calculate the potential field generated by obstacles and other robots relative to itself. Authors noticed that this experiment lacked of precision in the measurement of angles



between robots as the robots that have been developed can move at an angle of 90 degrees or 45 degrees only, also lack of precision in the measurement of distances between the robots as a result of the use of infrared. The result was that the simulation and movement of swarm robotics in which up to be more a quart like see in figure 2-1 , the drawback for this paper robotics need more controls in formulation and movenet.

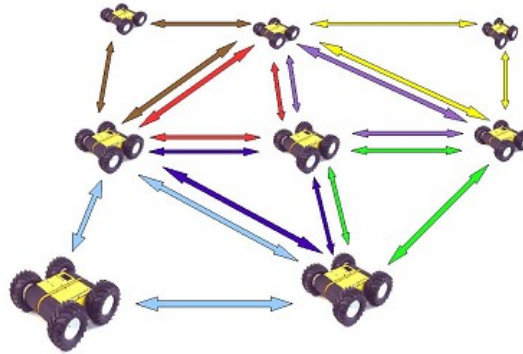

**Figure 2-1: Triangular formation robots[24]**

Grigoris and Kostas in [17] discussed an algorithm for distributed formation of a lattice structures using a team of mobile robots, based on network formation “lattice”. Network formation performs many challenges for this experiment which is the limitation in robot contacting and the decentralization. Robots operate according to three models: 1) going forward, 2) going to the right, and 3) going to the left. The simulation environment is 2D and the number  $n$  of robots is randomly distributed in the simulation environment. Authors assuming that the communication between these robots will be within a short range, each robot is contacting within a short circle around it with robots without any links, and there is an equation to calculate the distances between each robot and another. Authors solve the problem of movement of a swarm robotics to transform the coordinates of the network from bidirectional to unidirectional and then developing of the network structure which enables tracks definition through numbers to facilitate robots movement. Authors concluded that the algorithm is executed at a specific time, and the tools of communication between robots must be developed to contain GPS to determine the location and expands the use of the algorithm to deal with different types of robots and different types of general shapes.

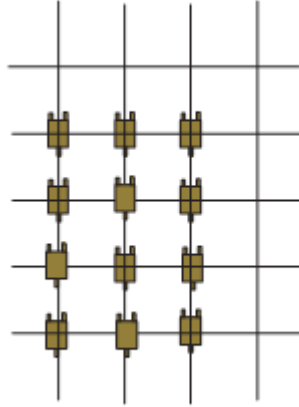

**Figure 2-2: Final Grid Structured Configuration [17]**

In [17] authors discussed the problem of distributed, autonomous area coverage using a team of mobile mini-robots that have limited sensing and computation capabilities. Authors envisage that team formation for mini-robots can be realized through simple, nature-inspired formation control algorithms such as flocking like V formation. Each mini-robots has a simple way communication allows it to communicate with the rest of the robots and has two wheels that allow it to move, and using Reynold Model[21] the swarm moves and follows a commander that determined by the team during the formation of the swarm which will cover the desired area. The communication with the robots performed via the leader and when the robot is not able to answer, the leader makes another action and sends it to another robot to follow it until forming the proper formation. When facing an obstacle the swarm begin to gather at the left of the swarm and a new leader will be chosen according to the obstacle faced and the avoiding obstacle algorithm will be applied which will make a new formation.

Yun et al.[28] , authors present a novel algorithm for circle formation for distributed autonomous mobile robots based on infrared range sensors, these algorithms contains from two methods, firstly, determine the midpoint between their nearest and farthest robots, then allow robots move toward midpoint, after that grouping the robots in a clusters. Secondly, based on infrared sensors robots will be sense the position of other robots and move in a direction of empty space for a distance equal to the radius of the desired circle. Finally, for more uniform distribution, every robots determine the two nearest robots and move towards the midpoint.

Ducatelle et al.[6] , present a communication based on network routing, capable of robots to communicate with each other's and exchanging messages through wireless

network. Authors proposed two different approaches. In the first approach, determine single robot as a leader and guide others robots to the target. While in the second approach, allow all robots in the swarm navigate back and forth between two targets. In this paper, authors used pheromone-mediated navigation in ant colonies to find the shortest path.

Defago and Konagaya [5] , present a method for circle formation, this method consists of two algorithms, first algorithm puts the robots along the boundary of a circle, and second algorithm arranging the robots along the boundary of a circle. The robots are initially in arbitrary positions, then each robots find the smallest enclosing circle (SEC) and then move to occupy positions along this circle, at most three robots can be defined the SEC. Every robots have the same configuration to computes the smallest enclosing circle (SEC), but they have own local coordinate systems and different views of the environment. The robots move to their position based on rules, every robot tries to move half the distance towards the mid-point of its nearest left and right robots.

The previous works and studies have talked about swam robotics motion in different formations like V and Fish school. In addition to areas covering capability for searching and saving missions. Our proposed approach is an attempt to reduce the computational complexity of some of the previous approaches and to make robots motion more simple and capable of avoiding obstacles regardless of the obstacles structure.

Our study is talking about new swam robotics circular formation mechanism which covers a large areas so the interaction between those robots becomes faster and the search mechanism becomes better. Unlike fish school motion, the circular formation motion does not need continuous computation during the motion. In addition, the communication between robots using circular formation is much easier than the V form. Every group set inside swarm robotics can work alone when separation between those groups occurs. When there is an obstacle, the swarm robotics can deal with this situation to avoid these obstacles.

## CHAPTER 3: Methodology and Proposed Model

This chapter contains detailed description of the steps of our methodology research. The proposed methodology is presented below and shown in Figure 3-1.

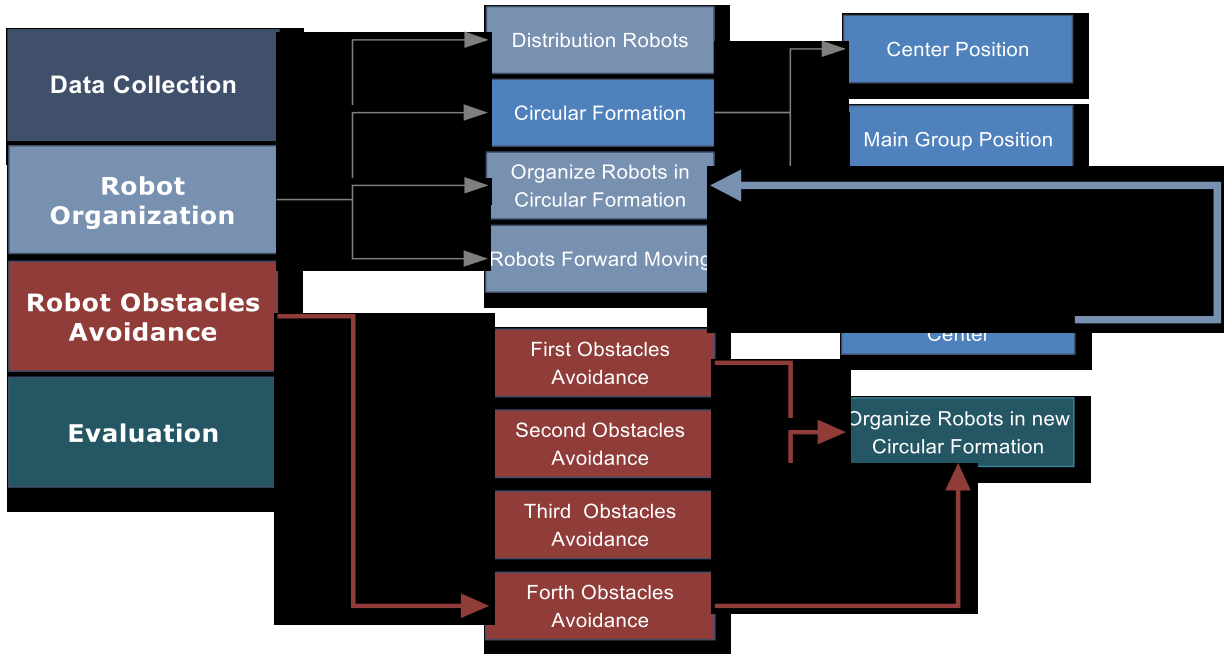

Figure 3-1: Methodology flowchart

### 3.1. Data Collection:

One of the major steps in our proposed approach is to have a certain formation for the robots to allow them to move smoothly and to maintain easy connection between them. The robot organization is based on circular formation in which robots are organized in circular groups.

To obtain the circular formation, a sequence of mathematical formulas have to be followed as shown in the next sections.

#### 3.1.1. Calculate distance between two points

The first step in our proposed approach is to generate points randomly representing robots. The number of robots is unlimited, but the minimum is four robots. One of the formulas that we need in our approach is finding the distance between two points in two dimension environment. The distance is obtained according to the following Formula:

1. Identify the coordinates of the first point: A ( $x_1, y_1$ ).
2. Identify the coordinates of the second point: B ( $x_2, y_2$ ).

- Calculate the distance between the two points A and B, this function is represented in Formula 3-1.

$$\text{Distance} = \sqrt{(x_2 - x_1)^2 + (y_2 - y_1)^2} \quad \text{Formula (3-1)}$$

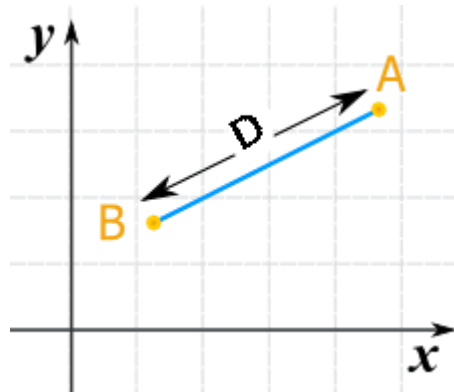

Figure 3-2: Graph illustrate Distance Calculation

### 3.1.2. Straight-Line Formula to Move the Robot from Point A to Point B

To move a robot from point A to point B in the simulation, it is necessary to determine the coordinates of the current point where the robot exist ( $x_1, y_1$ ) and the coordinates of the point at which it will move ( $x_2, y_2$ ). Formula 3-2 presets the used Formula.

$$y = (m * x) + b \quad \text{Formula (3-2)}$$

To determine  $y$ , we need to know and calculate the following:

- Determine the coordinates of the first point: A ( $x_1, y_1$ ).
- Determine the coordinates of the second point: B ( $x_2, y_2$ ).
- Calculate the Slope or Gradient "m", where m means how the line steeps as shown in Formula 3-3 and Figure 3-3.

$$m = \frac{\text{Change in Y}}{\text{Change in X}} \quad \text{Formula (3-3)}$$

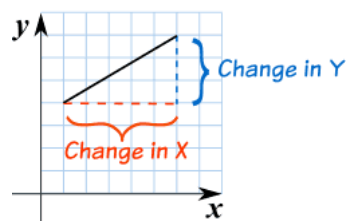

Figure 3-3: Graph Illustrate the change of (x, y) position use to calculate slop "m"

- Calculate "b" the y Intercept (where the line crosses the Y axis as show in Figure 3-4)
  - $b = 1$  (Constant where the line crosses the Y-Axis)

- $b = 0$  (where the line crosses the X-Axis)

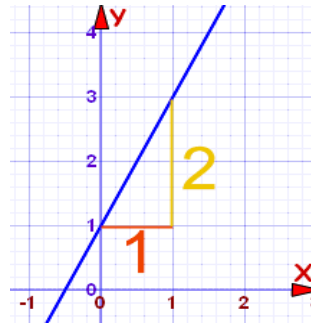

Figure 3-4: Graph Illustrate then line crosses the Y-Axis

### 3.1.3. The Formula to Determine the Points on the Circle Circumference

This Formula (3-4)(3-5) is used to determine the new points on the circumference of the circle as show in Figure 3-5.

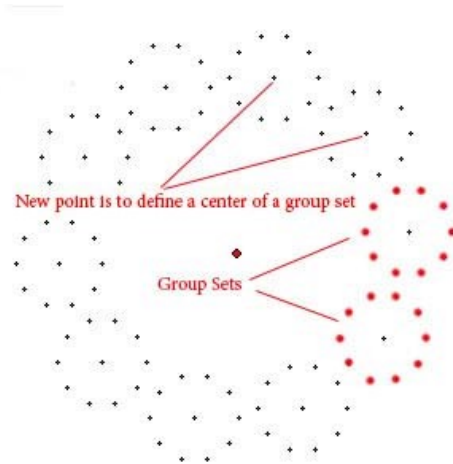

Figure 3-5: Graph Illustrate the new points on the circumference of the circle

$$\text{newpoint}(x', y') \gg x' = \text{Distance} * \cos \frac{\text{degree} * \pi}{180} + x \quad \text{Formula (3 - 4)}$$

$$\text{newpoint}(x', y') \gg y' = \text{Distance} * \sin \frac{\text{degree} * \pi}{180} + y \quad \text{Formula (3 - 5)}$$

In next step we use new point to define the centers for the circular formation for the group set on the central circle circumference as show in Figure 3-6. The required steps to do this process (And new coordinates on the circle circumference of the group set) are as below:



**Figure 3-6: Graph Illustrate new point that use to define the centers for Group Sets in the circular formation**

1. Determine the diameter R of the circle
2. Determine the center of the circle it takes from two point's in Formula (3-4) and Formula (3-5)
3. Determine the number of points we need to add on the circumference of the circle in Formula (3-4) and Formula (3-5).
4. Determine the angle degree we need to use by dividing the 360 degree of the circle in a number of points.
5. The new point on the circumference ( $x^n, y^n$ ).

The pseudo code description of calculate circumference of circle is given in Algorithm 3-1 and Figure 3-7.

Algorithm 3-1: Calculate circumference of circle

Purpose:	<b>Calculate of point position on circumference of circle</b>
Input:	<b>(R,degree, Center.x, Center.y, pn)</b>
Output:	<b><math>x^n, y^n</math></b>
Procedure:	<pre> {// BEGIN     Degree=360/pn     For K=1..pn Do         Degree=degree*pn         <math>x^n=R*(\text{Cos}(\text{degree}*\pi/180)+x;</math>         <math>y^n=R*(\text{sin}(\text{degree}*\pi/180)+y;</math>     }//END </pre>



Figure 3-7: Graph Illustrate the Circle and Circumference

### 3.1.4. Determining of the Circle Center Position of Three Points on the Circumference of a Circle

When the group set is separated from swarm robotics, and move away from swarm robotics its need leader to organize the position of every point in groupset, we have adopted in this study the group set center to be invisible group leader in the movement where each robot in the group can determine its place in the group set via its leader. To achieve this, we need to determine the group set center through detecting of three robots on the circumference of the group set as shown in Figure 3-8. We shall call it Centerf3p, the mathematical Formula can be defined as follows:

1. Determine three point's  $p_1(x_1, y_1)$ ,  $p_2(x_2, y_2)$ , and  $p_3(x_3, y_3)$  on circumference of the group set.

2. Find delta of  $y_1$

$$\delta y_1 = y_2 - y_1 \quad \text{Formula (3-6)}$$

3. Find delta of  $x_1$

$$\delta x_1 = x_2 - x_1 \quad \text{Formula (3-7)}$$

4. Find delta of  $y_2$

$$\delta y_2 = y_3 - y_2 \quad \text{Formula (3-8)}$$

5. Find delta of  $x_2$

$$\delta x_2 = x_3 - x_2 \quad \text{Formula (3-9)}$$

6. Find slope A

$$A = \delta y_1 / \delta x_1 \quad \text{Formula (3-10)}$$

7. Find slope B

$$B = \delta y_2 / \delta x_2 \quad \text{Formula (3-11)}$$

8. Find x and y points of center

$$x = (A * B(y_1 - y_3) + B * (x_1 - x_2) - A * (x_2 + x_3)) / (2 * (A - B)) \quad \text{Formula (3-12)}$$

$$y = 1 * \left( \frac{\text{Center.x} - \left( \frac{x_1 + x_2}{2} \right)}{A} + \frac{y_1 + y_2}{2} \right) \quad \text{Formula (3-13)}$$



The pseudo code description of calculating the center of circle from three points is given in Algorithm 3-2 and Figure 3-8.

Algorithm 3-2: Calculate the center of circle from three points

Purpose:	<b>Calculate the center of circle from position of three points</b>
Input:	<b>(p1x,p1y,p2x,p2y,p3x,p3y)</b> /*position x,y of three point */
Output:	<b>Center.x, Center.y</b>
Procedure:	<pre> {//BEGIN     λy1=p2y-p1y     λx1=p2x-p1x     λy2=p3y-p2y     λx2=p3x-p2x     a=λy1/λx1     b=λy2/λx2     Center.x= (a*b*(P1y-P3y)+b*(P1x-P2x)-a*(P2x+P3x))/(2*(a-b))     Center.y=-1*( Center.x-(P1x+P2x)/2)/a+(P1y+P2y)/2 } // END </pre>

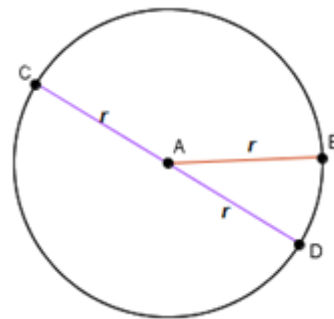

Figure 3-8: Graph Illustrate the Center of Circle and three points around the Circumference

## 3.2. Robot Organization

In this part, the approach followed by a swarm of robots from the beginning of the formation until the swarm starts moving forward is presented. The approach has been simulated using Delphi programming language.

### 3.2.1. Distributed robots

First, we generate random number of robots in our environment and then determine how many are there to prepare them for circular formation. The randomness generation is

for the number of robots as well as their locations in the environment. Figure 3-9 shows the robot distribution.

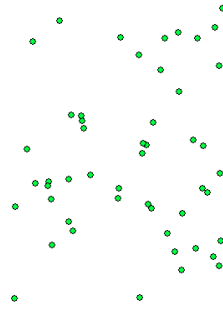

**Figure 3-9: Distribute Robots Randomly**

### 3.2.2. Circular formation

After random robots distribution process is completed, the swarm circular formation process starts. The main aim of this formation is to create groups of robots able to break away from the swarm and perform tasks separately and return to it without affecting the work. The circular formation consists of group sets ranges from one to ten group sets, the lowest number of robots in the formation is four robots to be able to perform a circular formation, and the largest number is one hundred robots, and if the number exceeds one hundred, a new circular formation will be formed.

### 3.2.3. Center the position

After completing the distribution process, we begin calculating the center of the circular formation, and this is done by taking the highest value for the coordinates of the robots in the value of x and the lowest value for the coordinates of the robots in the value of x, and then calculates the average so we get the value of the point x through the equation:

$$\mathbf{center.x} = \frac{\max(x_n) + \min(x_n)}{2} \quad \text{Formula (3-14)}$$

The value of y calculated the same way, we take the highest value for the coordinates of the robots in the value of y, and the lowest value for the coordinates of the robots in the value of y and then calculate the average using Formula 3-15.

$$\mathbf{center.y} = \frac{\max(y_n) + \min(y_n)}{2} \quad \text{Formula (3-15)}$$

This way we determine the circular formation Center (x, y) as shown in Figure 3-10:

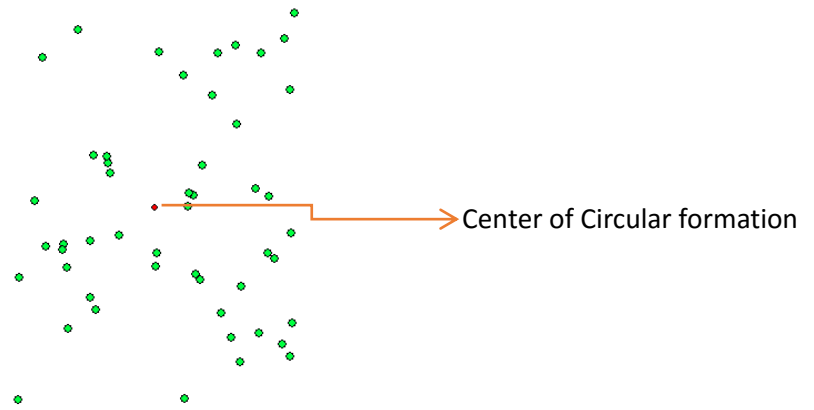

Figure 3-10: Circular formation center of (x, y)

### 3.2.4. Main group position

After finding the approximate center to start forming the circular formation, we determine the number of points that will be on the circumference of the main group circle, and it's determined by the number of points that will be located on the circumference of the main group circle based on the number of robots that have been distributed, if the number of robots is less than 16 robot, we form a major one circle where robots gather around its circumference and distributed equally, and this is done by dividing the circumference of a circle 360 degree angle on the number of robots to locate each robot on the circumference accurately, and the radius of the circle will be determined based on the following equation:

Find Center of Circle from three points on Circumference= Centerf3p using robot number multiple with 10 percent of robots number to define the diameter

$$diameter = Rn + (Rn * \frac{1}{10}) \quad \text{Formula (3-16)}$$

Where  $Rn$  (Robot number)

Figure 3-11 shows the diagram when we have one group.



Figure 3-11: Illustrate Graph Display the Circular formation for 15 robots.

If the number of robots became more than 15 robots, a group set will be created based on the number of robots. To know how many group sets we need on the circumference of a circle, we use a mathematical Formula. If the number of robots Between "16 to 39", we apply the following mathematical Formula:

$$Gsn=Rn \text{ Div } 4 \quad \text{Formula (3-17)}$$

Where *Gsn* (number of group sets)

This Formula applied to make every group set includes at least four robots, and when the number of robots is increased, the group sets will be increased also, and the robots will be distributed even up to 39 robots and 9 group sets.

If the number of robots is more than 39 the group sets become 10, so the minimum number of robots in a group set is 4, and the maximum number is 10 robots as we can see in Figure 3-12. This means the group sets within the circular formation ranges from 4 to 10 group sets.

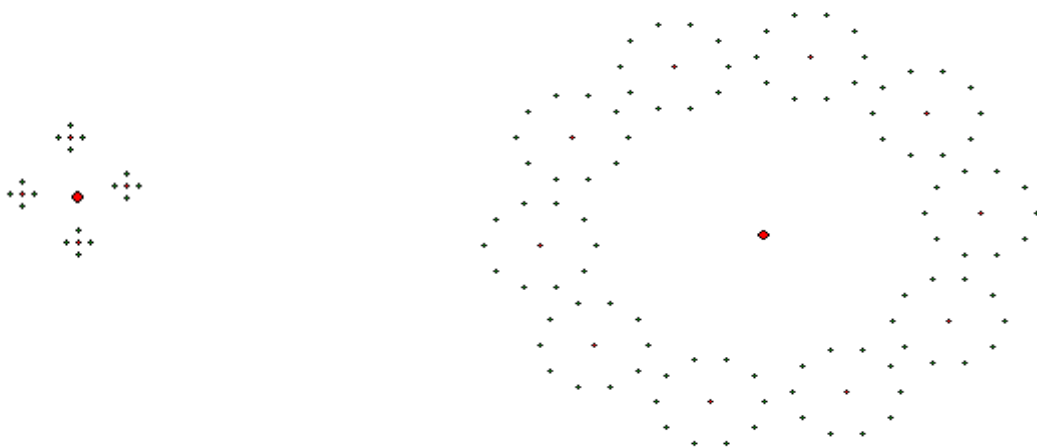

Figure 3-12: Graph Illustrate New Position Of Robots from 16 to 100 Position

### 3.2.5. Group Set Position

The circumference of the main circle is divided according to the group sets number so these points are the group sets centers according to the following equation:

$$CGF= Cang/ Gsn \quad \text{Formula (3-18)}$$

Where CGF (Find points position on Circle Circumference)

Circle angle =360.

Cang (degree).

By now, we identify the new coordinates where the robots in the swam move to it, and that occurs via the adoption of the coordinates that have been identified in all group sets within the circular formation.

Figure 3-13 is an example when the number of robots is equal to 16 so the group sets number is equal to 4.

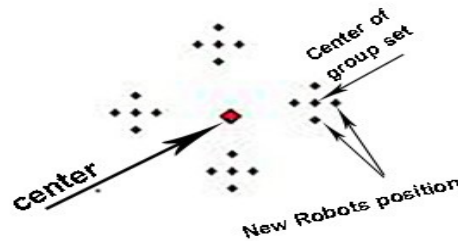

**Figure 3-13: Graph Illustrate the four Group sets on Circular Formation Contain 16 New Robots Position**

When the number of robots increases, the calculation will be via Formula 3-17 so the number of the group sets will increase. As an example when the number of robots is 17 the group sets will remain constant, but the number of robots within the group sets will be changed to become one of the group sets containing 5 robots, and the rest containing 4 robots, as shown in the Figure 3-14.

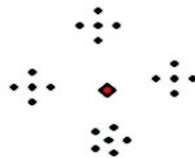

**Figure 3-14: Graph Illustrate The Four Group sets on Circular Formation Contain 17 New Robots Position**

### 3.2.6. Find Closest Robots to the Center of a Group Set

In order to make each robot reach the new coordinates that have been created in accordance with Formula 3-16, it needs to calculate the nearest coordinates for each robot, but due to the difficulty of applying this calculation because of the large number of robots that might reach to one hundred robot, it would be very time consuming. If we assume that we have a hundred robots and a hundred points we will need  $100 * 100$  calculation process. Instead, we use heuristic way to calculate the new position for every robot by calculating the nearest robots to center of every group set.

### 3.2.7. Organize Robots on Circular Formation

After finishing the calculation of the closest robots to the group set center, the robots are moved to the new coordinates in the circular formation, using the straight-line Formula so the robot moves from the current location to the new coordinates with fixed speed for all robots as shown in Figure 3-15.

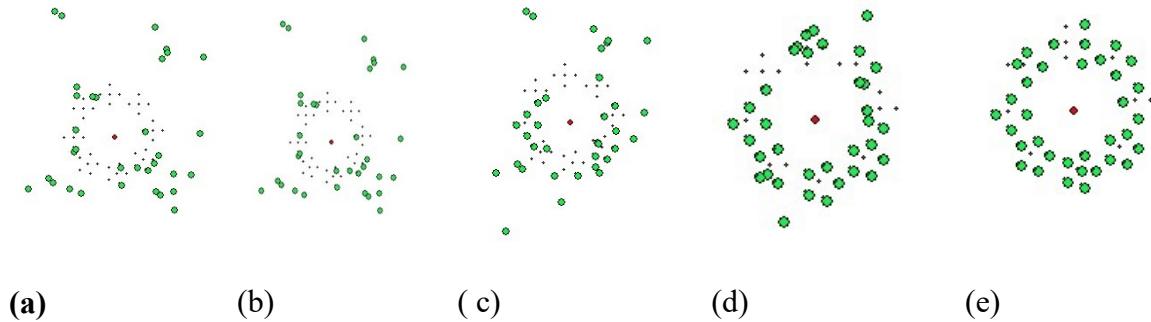

Figure 3-15: Simulation Results for Organizing 35 Robots in Circular Formation

Based on the explanation above, circular formation algorithm becomes as shown in Algorithm 3-3.

The pseudo code description to calculate the Swarm robotics circular formation is given in Algorithm 3-3.

Algorithm 3-3: Swarm robotics circular formation

Purpose:	Swarm robotics circular formation (code executed by a robot $r_i$ at the point $p_i$ )
Input:	$\{P_1, \dots, P_n\}$ set of position for robots $\{r_1, \dots, r_n\}$ , $C_{xy}$ Circular formation center
Output:	
Procedure:	<pre> {//BEGIN Perceived in the current position for every robots. <b>IF</b> <math>r_n &lt; 16</math> <b>THEN</b>     <b>FOR</b> <math>k_1 = 1, \dots, r_n</math> <b>DO</b>         <math>CP_n :=</math> Calculate New position of <math>r_n</math> On Circumference Of Circle <math>\in C_{xy}</math> /*algorithm 3-1*/         <math>\vec{M} :=</math> move <math>r_n</math> from <math>P_n</math> to <math>CP_n</math> /*formula 3-2,3-3,3-4*/     <b>END FOR</b> <b>EISE</b>     Calculate Center Of Group sets On Circumference Of Circle /*algorithm 3-1*/     <math>CPG_n :=</math> Calculate New position of <math>r_n</math> On Circumference Of group set /*algorithm 3-1*/     <b>FOR</b> <math>k_2 = 1, \dots, r_n</math> <b>DO</b>         <math>CP_n :=</math> Calculate New position of <math>r_n</math> On Circumference Of Circle of group set /*algorithm </pre>

```

3-1*/
END FOR
FOR  $k_3=1, \dots, GN$  DO /*group set number */
    FOR  $k_4=1, \dots, r_n - cpn$  DO /* CPn number of robot in every group set*/
    Psn:=min[dist(Pn,  $CPGn$ )] /* calculate min distance between robots n center of
group set */
    END FOR
END FOR
 $\vec{M}$ :=move  $r_n$  from Pn to  $CPn \in Psn$  /* formula 3-2,3-3,3-4*/
END IF
} // END

```

### 3.3. Robots Motion

#### 3.3.1. Robots Forward Motion

Upon completion of the circular formation process, the swarm robotics begins moving forward; in this study, we will only experience the forward motion of the swarm robotics.

All robots in the swarm move with one specific speed in one direction, making it easier and reduce necessary processes to maintain the composition of the circular formation during the movement. This process is done in a simulation environment via increasing the value of the coordinates on the x-axis by 1 pixel in every 0.2 seconds, which gives an opportunity for all robots to move at the same speed and about the same time as we see in Figure 3-16.

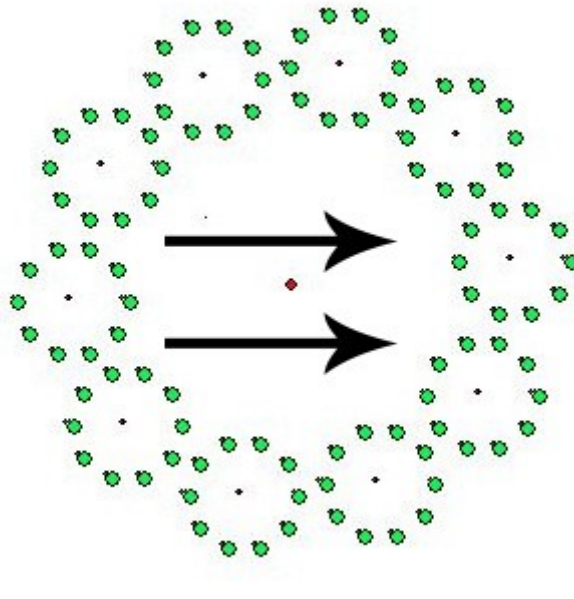

**Figure 3-16: Swarm Robotics Move Forward**

### **3.4. Robots Avoiding Obstacles**

Obstacle is anything that stand in the robot way during its movement, and there are multiple forms of obstacles. In this study, we consider a set of obstacles that carry specific characteristics to apply the avoiding obstacles algorithm on them to show how these obstacles can be avoided by the swarm robotics. Swarm robotics behaves differently based on the type of the faced obstacle

If the obstacle allows the passage of the circular formation completely, the swarm will move naturally without any change in movement or formation, but if the obstacle allows the passage of one group set, the swarm will begin to separate into groups and bypass the obstacle and then returns to the circular formation. But if the obstacle allows the passage of one robot only, each group set of the swarm will separate after reaching the beginning of the obstacle, and then each robot from the group set will separate to move individually to pass the obstacle and the reorganization is performed after robot passing. The passed robot will be again in the same group with the same location within the group. The obstacles we consider as case studies in our work are shown in Figure 3-17 and explained in details in the next sections.



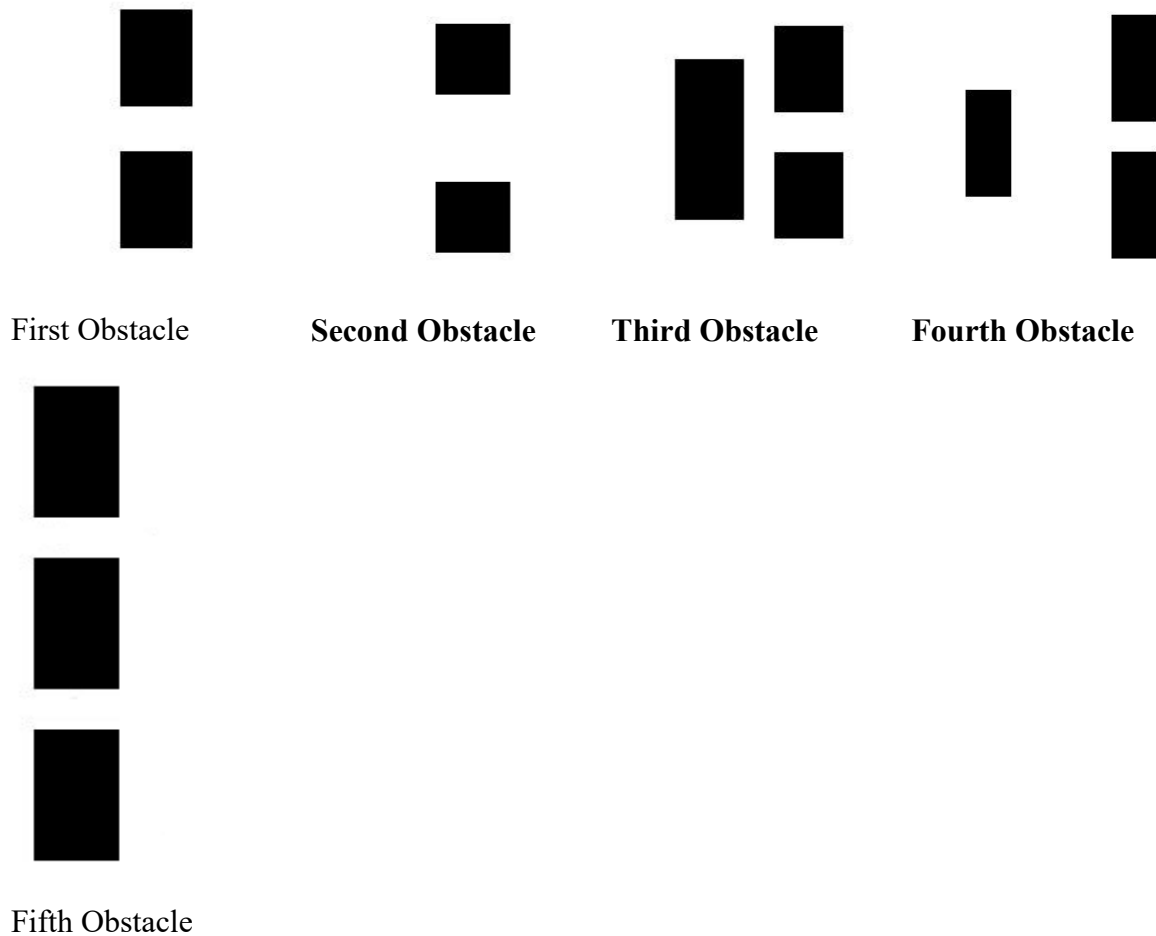

**Figure 3-17: The Five Considered Obstacles**

### 3.4.1. Mechanism of Group Set Movement

To move a group set of robots to separate it from the swarm, we have to determine the center of the group set, and to do that we need to take the coordinates of three robots on the group set circumference. We calculate from these coordinates the group set center using center of the circle Formula based on three points on the circumference. When detecting the group set center, it will be moved to the targeted point which the group set should go, when the center moves to a new coordinate, then a new robots coordinates will be calculated on the circumference of a circle according to the following equations:

1. Find Centerf3p (Rp1, Rp2, Rp3).
2. Move Centerf3p one point Forward.
3. Calculate new position on Circumference for robots.
4. Move robots to new position on Circumference of Circle.
5. Repeat steps from 1 to 4 until reaching the destination position.

The pseudo code description to Move Group Set is given in Algorithm 3-4

### Algorithm 3-4: Move Group Set

Purpose:	Move Group Set
Input:	Constant Pd= destination point <b>{p1,p2,p3} position of three robots on circumference of group set circle</b> <b>GSN group set number</b> {P1,...,Pn} set of position for robots on group set {r1,...,r <sub>n</sub> } ∈ GSN
Output:	Cg:=cx,cy <b>center of group set</b>
Procedure:	<pre> {//BEGIN Repeat Cg(cx,cy):= Centerf3p(p1,p2,p3) /* Algorithm 3-2 find center of group set from three point*/ <math>\vec{M}</math>=move (cx,cy) to pd /* formula 3-2,3-3,3-4*/   <b>FOR</b> k<sub>1</sub>=1,..., r<sub>n</sub> ∈ GS<sub>n</sub> <b>DO</b> CPn:=Calculate New position of r<sub>n</sub> On Circumference Of group set Circle ∈ Cg /*algorithm 3-1*/ <math>\vec{M}</math>:=move r<sub>n</sub> from Pn to CPn /* formula 3-2,3-3,3-4*/ <b>END FOR</b> Until ((cx,cy)= Pd) } // END           </pre>

After the robot passes the obstacle, it begins to go to the new coordinates that are created after the obstacle to re-organize it in a new circular formation. This is done by selecting the circular formation center after the obstacle by diameter and radius of the circular formation and then again the circular formation algorithm (Algorithm 3-3) will be applied.

### 3.4.2. Obstacles Avoidance

Here we are going to present the proposed system behavior when facing various types of obstacles. As mentioned before, we consider five different types of obstacles as case studies.

#### 3.4.2.1. First Obstacles

An obstacle with just one gap that allows the passage of a single robot, as we notice in Figure 3-18.



Figure 3-18: First obstacle is the Obstacle that Allows the Passage only one robot

We depend to bypass this obstacle on the definition of several points, the first point is the middle of the obstacle gap distance  $OC$  and the gap distance  $W$  (the distance between the two blocks). The  $OC$  can be computed using Formula 3-19. Figure 3-19 show  $OC$ ,  $W$  and  $DRH$  definitions using Formula 3-20.  $DRH$  is the required distance to stop the group set before individual robots start separating from the group set.

$$OC = W/2 \quad \text{Formula (3-19)}$$

$$DRH = diameter + \left(\frac{diameter}{2}\right) \quad \text{Formula (3-20)}$$

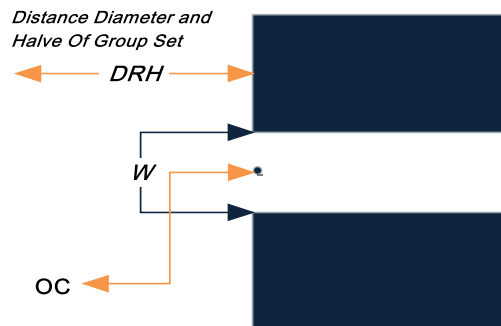

Figure 3-19: Demonstration of what are  $W$ ,  $OC$  and  $DRH$

When identifying these data the swarm begins moving and the group set begins to separate from the swarm, respectively, moving toward the obstacle, and the group set stops before obstacle by  $DRH$  allows it to have a distance to separate the robot from the group set then heading to the gap in the obstacle bypassing it.

After passing the obstacle, the robot sends a signal to the next robot to begin to move to pass the obstacle until the group set ends passing the obstacle and sends a signal to the next group set to pass the obstacle as shown in Figure 3-20 and continues to repeat this process until the entire swarm avoids the obstacle.  $C_{xy}'$  is the new center for the group set after obstacle avoidance. This process is being done instead of having more than one robot in the tunnel of the obstacle to avoid any dangerous that might exist within the tunnel or even after it. This process is shown in Algorithm 3-5.

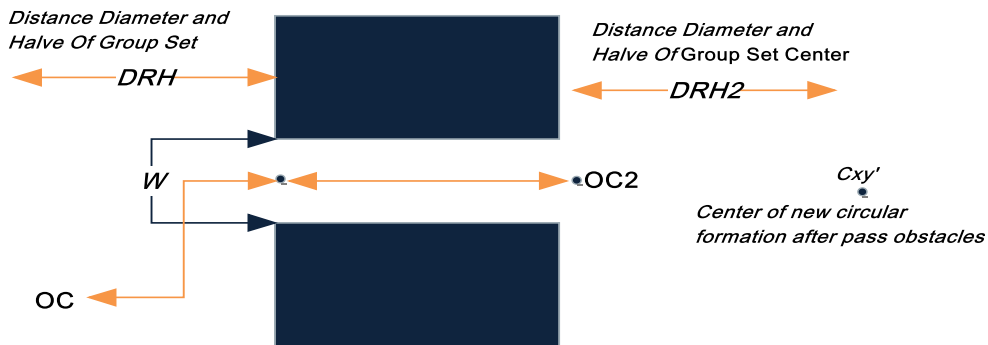

Figure 3-20: Graph Illustrate path Of Robots Over Obstacles and the  $C_{xy}'$  center of new Circular formation

The pseudo code description of move swarm robotics over first obstacles is given in Algorithm 3-5.

Algorithm 3-5: Move Swarm Robotics Over First Obstacles

Purpose:	<b>Avoid First Obstacles one robot can pass throw obstacles</b>
Input:	Constant $W$ = Width Of Gap on Obstacles, $O_c$ = Center of Gap begin of Obstacle <b><math>O_{c2}</math></b> = Center of Gap end of Obstacle <b><math>\{p_1, p_2, p_3\}</math></b> position of three robots on circumference of group set circle <b>GSN</b> group set number $\{P_1, \dots, P_n\}$ set of position for robots on group set $\{r_1, \dots, r_n\} \in \text{GSN}$ $DRH$ Distance Swarm Robotics Will Stop In Before Obstacles <b><math>C_{xy}'</math></b> New Circular Formation Center After Avoid Obstacles
Output:	$C_g := cx, cy$ <b>center of group set</b>
Procedure:	<b>//BEGIN</b> <b>Repeat</b> $C_g(cx, cy) := \text{Centerf3p}(p_1, p_2, p_3)$ /* Algorithm 3-2 find center of group set from three point*/ $\vec{M} = \text{move}(cx, cy)$ to $DRH$ /* formula 3-2,3-3,3-4*/

```

FOR  $k_1=1, \dots, r_n \in \text{GSn}$  DO
CPn:=Calculate New position of  $r_n$  On Circumference Of group set Circle  $\in Cg$ 
/*algorithm 3-1*/
 $\vec{M}$ :=move  $r_n$  from Pn to CPn          /* formula 3-2,3-3,3-4*/
END FOR
Until (Oc=DRH)      /*Stop move of Group set */
n1=1;
Repeat
 $\vec{M1}$  = move  $r_{n1}$  to Oc    /* formula 3-2,3-3,3-4*/
IF  $r_{n1}$  reach to Oc THEN n1=n1+1
 $\vec{M2}$  = move  $r_{n1-1}$  to Oc2  /* formula 3-2,3-3,3-4*/
Until ( $r_{n1} = r_n$ )
IF  $r_{n1}$  reach to Oc2 THEN
Cxy'= DRH2
END IF
Organizing Robots in circular formation /* Algorithm 3-3*/
} // END

```

### 3.4.2.2. Second Obstacles

As shown in Figure 3-21, this obstacle is assumed to allow one group set to pass through the gap.



**Figure 3-21: Second Obstacle Type that Allows One Group Set to Pass the Obstacle**

The swarm will be moved until reaching the appropriate distance so that the distance is  $DRH$ . The group set begins to separate from the swarm respectively toward the obstacle gap and passing the obstacle, where the group set moves using the Algorithm 3-4. After passing the obstacle the swarm re-organizes itself in circular formation using circular

formation Algorithm 3-3. As shown in Figure 3-22, DRH2, OC2 and Cxy' will be computed using Formula 3-21.

$$DRH2 = diameter + \left(\frac{diameter}{2}\right) \text{ and } Cxy' = DHR2 \quad \text{Formula (3-21)}$$

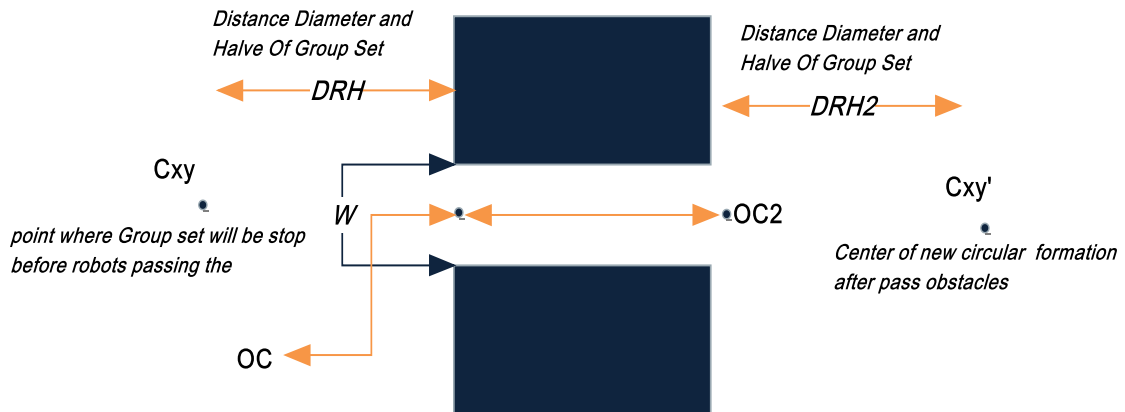

Figure 3-22: Graph Illustrate details of first obstacles

The pseudo code description of moving the swarm robotics over second obstacles is given in Algorithm 3-6.

Algorithm 3-6: Move Swarm Robotics Over Second Obstacles

Purpose:	<b>Avoid Second Obstacles witch Group Set can Pass throw the obstacles</b>
Input:	Constant W= Width Of Gap on Obstacles, Oc= Center of Gap begin of Obstacle <b>Oc2= Center of Gap end of Obstacle</b> {p1,p2,p3} <b>position of three robots on circumference of group set circle</b> <b>Gsn group set number</b> {P1,...,Pn} set of position for robots on group set {r1,...,r <sub>n</sub> } ∈ GSN <b>DRH</b> Distance Swarm Robotics Will Stop In Before Obstacles <b>Cxy'</b> New Circular Formation Center After Avoid Obstacles
Output:	Cg:=cx,cy <b>center of group set</b>
Procedure:	//BEGIN <b>Repeat</b> Cg(cx,cy):= Centerf3p(p1,p2,p3)    /* Algorithm 3-2 find center of group set from three point*/ $\vec{M}$ =move (cx,cy) to Oc    /* formula 3-2,3-3,3-4*/ <b>FOR</b> k <sub>1</sub> =1,..., r <sub>n</sub> ∈ GS <sub>n</sub> <b>DO</b>

```

CPn:=Calculate New position of  $r_n$  On Circumference Of group set Circle  $\in$  Cg
/*algorithm 3-1*/
 $\vec{M}$ :=move  $r_n$  from Pn to CPn          /* formula 3-2,3-3,3-4*/
END FOR
Until (CPn =Cxy')    /*Stop move of Group set */
Cxy'= DRH2
Organizing Robots in circular formation /* Algorithm 3-3*/
} // END

```

### 3.4.2.3. Third Obstacles

As shown in Figure 3-23, a complicated obstacle allows the passage of only one robot.



**Figure 3-23: The third Obstacle allows the passage of only one robot**

Two paths will be identified to avoid the obstacle as shown in Figure 3-23 where the robot picks a path according to the proximity of the group set center from point A or D. If it is closer to the point A, the path A, B, OC2 will be selected, if it is closer to the point D, the path D, C, OC2 will be selected. The swarm begins moving and the group set begins to separate from the swarm respectively going to points A, B and then the robots begin to separate from the group set heading to the point OC2 and then avoid the obstacle. Two group sets might move simultaneously, one following the path through A and other following the path through D.

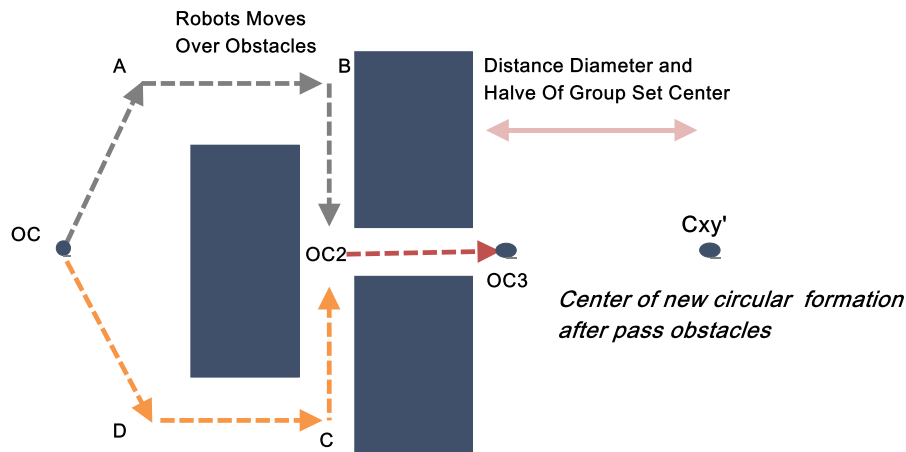

**Figure 3-24: Illustrate the Path of Move for robots on swarm robotics with the third obstacle type**  
 The pseudo code description of moving the swarm robotics over the third obstacles is given in Algorithm 3-7.

**Algorithm 3-7: Move Swarm Robotics Over Third Obstacles**

Purpose:	Avoid Third Obstacles <b>one robot can pass through obstacles</b>
Input:	Constant W= Width Of Gap on Obstacles, Oc= Center of Gap begin of Obstacle <b>Oc2= Center of Gap end of Obstacle</b> <b>{p1,p2,p3} position of three robots on circumference of group set circle</b> <b>GSN group set number</b> <b>{P1,...,Pn}</b> set of position for robots on group set $\{r_1, \dots, r_n\} \in \text{GSN}$ DRH Distance Swarm Robotics Will Stop In Before Obstacles <b>Cxy'</b> New Circular Formation Center After Avoid Obstacles
Output:	<b>Cg:=cx,cy center of group set</b>
Procedure:	<b>//BEGIN</b> <b>Repeat</b> <b>Cg(cx,cy):= Centerf3p(p1,p2,p3) /* Algorithm 3-2 find center of group set from three point*/</b> <b>IF Cg(cx,cy)&lt;Oc THEN ∈Axis Y</b> <b>IF Cg(cx,cy)&lt;Oc THEN ∈Axis x</b> $\vec{M}$ <b>=move (cx,cy) to Oc /*equations 3-2,3-3,3-4*/</b> <b>ELSE IF Cg(cx,cy)=Oc THEN ∈Axis x</b> $\vec{M}$ <b>=move (cx,cy) From Oc to A /*equations 3-2,3-3,3-4*/</b> <b>ELSE IF Cg(cx,cy)&lt;A THEN ∈Axis x</b> $\vec{M}$ <b>=move (cx,cy) From A to B /*equations 3-2,3-3,3-4*/</b>



```

END IF
ELSE IF Cg(cx,cy)>Oc THEN ∈Axis Y
    IF Cg(cx,cy)<Oc THEN ∈Axis x
         $\vec{M}$ =move (cx,cy) to Oc /*equations 3-2,3-3,3-4*/
        ELSE IF Cg(cx,cy)=Oc THEN ∈Axis x
             $\vec{M}$ =move (cx,cy) From Oc to D /*equations 3-2,3-3,3-4*/
            ELSE IF Cg(cx,cy)<D THEN ∈Axis x
                 $\vec{M}$ =move (cx,cy) From D to C /*equations 3-2,3-3,3-4*/
            END IF
        END IF
    END IF
FOR  $k_1=1, \dots, r_n \in \text{GSn}$  DO
    CPn:=Calculate New position of  $r_n$  On Circumference Of group set Circle ∈ Cg
    /*algorithm 3-1*/
     $\vec{M}$ :=move  $r_n$  from Pn to CPn /*equations 3-2,3-3,3-4*/
END FOR
Until (Oc=B or C) /*Stop move of Group set */
n1=1;
Repeat
     $\vec{M1}$  = move  $r_{n1}$  to Oc2 /*equations 3-2,3-3,3-4*/
    IF  $r_{n1}$  reach to Oc2 THEN n1=n1+1
     $\vec{M2}$  = move  $r_{n1-1}$  to Oc3 /*equations 3-2,3-3,3-4*/
    Until ( $r_{n1} = r_n$ )
    IF  $r_{n1}$  reach to Oc3 THEN
    Cxy'= DRH2
    END IF
Organizing Robots in circular formation /* Algorithm 3-3*/
} // END

```

#### 3.4.2.4. Fourth Obstacles

A complicated obstacle allows the passage of the group set to halfway and then allows the passage of single robot on the second half of the obstacle as shown in Figure 3-25

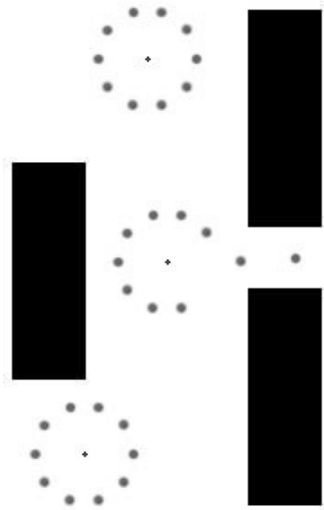

**Figure 3-25: Fourth Obstacle Allows the Passage of Group Set to Mid Distance (in between the three obstacles) and One Robots to Pass between the Two Blocks**

Two paths will be identified to avoid the obstacle as shown in Figure 3-26 where the group set picks a path according to the proximity of the group set center from point A or D. If it is closer to the point A, the path A, B, OC2 will be selected, otherwise, the path D, C, OC2 will be selected. The swarm begins moving and the group set begins to separate from the swarm respectively going to point A and then to point B heading to the point OC2, and then robot by robot starts avoiding the obstacle. Upon passing the obstacles the swarm fully reorganizes itself in a circular formation.

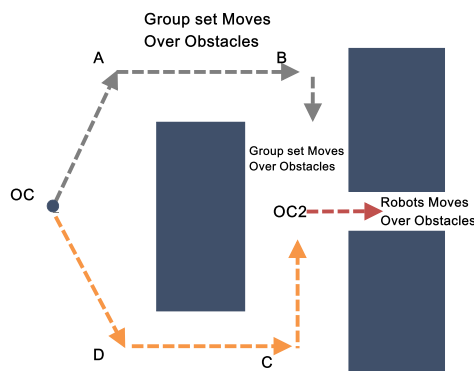

**Figure 3-26: Illustrat The Path of move For Robots on Swarm Robotics**

The pseudo code description of moving the swarm robotics over the fourth obstacle is given in Algorithm 3-8.

**Algorithm 3-8: Move Swarm Robotics Over Fourth Obstacles**

Purpose:	Avoid Fourth Obstacles One Group Set to mid of Obstacles and one Robot will pass Obstacles In Next mid every time
Input:	Constant W= Width Of Gap on Obstacles, Oc= Center of Gap begin of Obstacle

**Oc2**= Center of Gap end of Obstacle

{p1,p2,p3} **position of three robots on circumference of group set circle**

**GSN group set number**

{P1,...,Pn} set of position for robots on group set {r1,...,r<sub>n</sub>} ∈ GSN

DRH Distance Swarm Robotice Will Stop In Before Obastacles

**Cxy'** New Circular Formation Center After Avoid Obstacles

Output: Cg:=cx,cy      **center of group set**

Procedure: {/BEGIN

**Repeat**

Cg(cx,cy):= Centerf3p(p1,p2,p3) /\* Algorithm 3-2 find center of group set from three point\*/

**IF** Cg(cx,cy)=<Oc **THEN** ∈Axis Y

**IF** Cg(cx,cy)<Oc **THEN** ∈Axis x

$\vec{M}$ =move (cx,cy) to Oc /\* formula 3-2,3-3,3-4\*/

**ELSE IF** Cg(cx,cy)=Oc **THEN** ∈Axis x

$\vec{M}$ =move (cx,cy) From Oc to A /\* formula 3-2,3-3,3-4\*/

**ELSE IF** Cg(cx,cy)<A **THEN** ∈Axis x

$\vec{M}$ =move (cx,cy) From A to B /\* formula 3-2,3-3,3-4\*/

**ELSE IF** Cg(cx,cy)<B **THEN** ∈Axis x

$\vec{M}$ =move (cx,cy) From B to Oc2 /\* formula 3-2,3-3,3-4\*/

**END IF**

**ELSE IF** Cg(cx,cy)>Oc **THEN** ∈Axis Y

**IF** Cg(cx,cy)<Oc **THEN** ∈Axis x

$\vec{M}$ =move (cx,cy) to Oc /\* formula 3-2,3-3,3-4\*/

**ELSE IF** Cg(cx,cy)=Oc **THEN** ∈Axis x

$\vec{M}$ =move (cx,cy) From Oc to D /\* formula 3-2,3-3,3-4\*/

**ELSE IF** Cg(cx,cy)<D **THEN** ∈Axis x

$\vec{M}$ =move (cx,cy) From D to C /\* formula 3-2,3-3,3-4\*/

**ELSE IF** Cg(cx,cy)<C **THEN** ∈Axis x

$\vec{M}$ =move (cx,cy) From B to Oc2 /\* formula 3-2,3-3,3-4\*/

**END IF**

```

END IF
  FOR  $k_1=1, \dots, r_n \in \text{GSn}$  DO
     $CP_n :=$  Calculate New position of  $r_n$  On Circumference Of group set Circle  $\in C_g$ 
    /*algorithm 3-1*/
     $\vec{M} :=$  move  $r_n$  from  $P_n$  to  $CP_n$  /* formulas 3-2,3-3,3-4*/
  END FOR
Until ( $C_g = Oc_2$ ) /*Stop move of Group set */
n1=1;
Repeat
   $\vec{M1} =$  move  $r_{n1}$  to  $Oc_3$  /* formulas 3-2,3-3,3-4*/
  IF  $r_{n1}$  reach to  $Oc_3$  THEN  $n1=n1+1$ 
   $\vec{M2} =$  move  $r_{n1-1}$  to  $Cxy'$  /* formulas 3-2,3-3,3-4*/
  Until ( $r_{n1} = r_n$ )
  IF  $r_{n1}$  reach to  $Oc_3$  THEN
     $Cxy' = DRH_2$ 
  END IF
Organizing Robots in circular formation /* Algorithm 3-3*/
} // END

```

### 3.4.2.5. Fifth Obstacles

This Obstacle consists of a group of sections (in our case three) containing two gaps allowing the cross of a single robot every time as shown in the Figure 3-27.



Figure 3-27: Fifth Obstacles have two gaps every one of them allow one robot to pass.

The swarm robotics will move forward until it reaches the area away from the obstacles on DHR point so the group set can separate from the swarm robotics and move towards the obstacles. Two of the group sets can move toward the obstacles at the same time and each one of them will stop on a specific distance at Cxy point as shown in Figure 3-28. This process allows the separation of each robot from his group set and passes through the obstacles gap and then it sends a signal to the next robot to promote it to move and start avoiding the obstacle. This will continue until all the members of the group set finish, and at that moment the group set sends a signal to next group set to go through the same steps until all group sets are finished. Upon passing the obstacles, the swarm fully reorganizes itself in a circular formation.

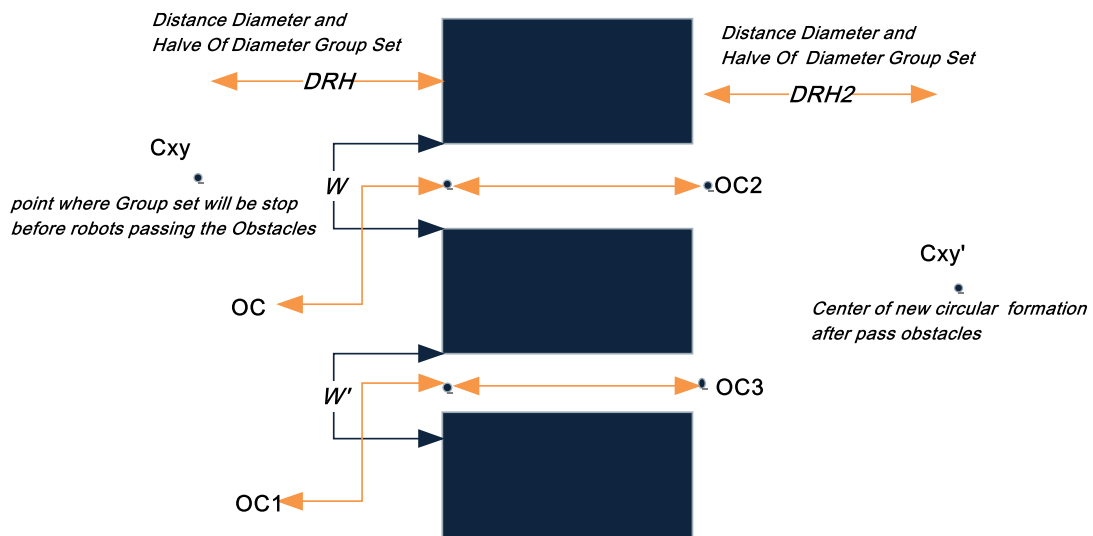

**Figure 3-28: Graph Illustrate the Fifth Obstacles and the Path of Robots to Pass the Obstacles.**

The pseudo code description of moving the swarm robotics over the fifth obstacle is given in Algorithm 3-9.

**Algorithm 3-9: Move Swarm Robotics Over Fifth Obstacles**

Purpose:	Avoid Fifth Obstacles One Group Set to mid of Obstacles and one Robot will pass Obstacles In Next mid every time
Input:	Constant $W$ = Width Of Gap on Obstacles, $O_c$ = Center of Gap begin of Obstacle $O_{c1}$ = Center of second Gap begin of Obstacle $O_{c2}$ = Center of Gap end of Obstacle $\{p_1, p_2, p_3\}$ position of three robots on circumference of group set circle <b>GSN</b> group set number $\{P_1, \dots, P_n\}$ set of position for robots on group set $\{r_1, \dots, r_n\} \in \text{GSN}$

DRH Distance Swarm Robotice Will Stop In Before Obastacles

Cxy' New Circular Formation Center After Avoid Obstacles

Output:

Cg:=cx,cy      **center of group set**

Procedure:

{//BEGIN

**FOR**  $k_1=1, \dots, r_n \in \text{GSn}$  **DO**

**Repeat**

Cg(cx,cy):= Centerf3p(p1,p2,p3)    /\* Algorithm 3-2 find center of group set from three point\*/

**IF** Cg(cx,cy)=<Oc **THEN** ∈Axis Y

**IF** Cg(cx,cy)<Oc **THEN** ∈Axis x

$\vec{M}$ =move (cx,cy) to Oc    /\* formulas 3-2,3-3,3-4\*/

**ELSE**

$\vec{M}$ =move (cx,cy) to Oc1    /\* formulas 3-2,3-3,3-4\*/

**END IF**

**Until** (Cg=Oc and Cg=Oc1)      /\*Stop move of Group set \*/

**END FOR**

**n1=1;**

**Repeat**

$\vec{M1}$  = move  $r_{n1}$  to (Oc2 or Oc3 )    /\* formulas 3-2,3-3,3-4\*/

**IF**  $r_{n1}$  reach to (Oc2 or Oc3 )    **THEN** n1=n1+1

$\vec{M2}$  = move  $r_{n1-1}$  to Cxy'    /\* formulas 3-2,3-3,3-4\*/

**Until** ( $r_{n1} = r_n$ )

**IF**  $r_{n1}$  reach to (Oc2 and Oc3 )    **THEN**

Cxy'= DRH2

**END IF**

**Organizing Robots in circular formation** /\* Algorithm 3-3\*/

}// END

## Chapter 4: Experimentation Results and Discussion

In this research, we have developed an algorithm that allows a swarm of robots to move forward in a circular formation with a capability of passing obstacles. Therefore, a simulation has been generated to simulate the swarm robotics in its movement and the way it passes the obstacles. Also in this chapter, we compare our proposed algorithm with flocking algorithm presented in[15] based on various factors.

### 4.1 Experimental Environment and Tools

All experiments have been carried out on Asus laptop processing power of 2.40 GHz CPU with 16GB RAM. The following are the used tools:

- **RAD Studio XE7:** as an "IDE" for Delphi programming language.
- **Microsoft Word:** the program is used for document typing.
- **Microsoft Excel:** we use excel to partition, organize and store datasets in tables. In addition, it is used for some simple preprocessing and analyzing the results.

### 4.2 Data Preparation

Several experiments related to the movement of a swarm robotics were performed using the circular formation. The experiments were developed to show the system behavior in terms of movement and avoidance of different types of obstacles. The experiments were based on five different types of obstacles, where each one of them has its own specifications as shown in Table 4.1 and will be explained later in the next sections.

**Table 4-1: List of the five main experiments**

<b>Experiment #1</b>	First obstacle
<b>Experiment #2</b>	Second obstacle
<b>Experiment #3</b>	Third obstacle
<b>Experiment #4</b>	Fourth obstacle
<b>Experiment #5</b>	Fifth obstacle

In all experiments we use a maximum of 100 robots which are distributed randomly. After the random distribution of the robots, we calculate the average of the farthest point and the nearest point on the X axis, and the nearest point and the farthest point on the Y axis. We use the average to determine the dimensions of a point that will be used as the circular formation center to be used by the robots as a center of a swarm. We

start determining the diameter of the circle, which is calculated based on the number of robots according to the formula (3-2), (3-3), (3-4).

Once the center of the swarm is identified and the diameter has been calculated, the process of computing the points on the circular formation circumference will start, this enables the formation of group sets. The points will act as centers for the group sets that the swarm will be formed from it and as a conclusion we will have 10 group sets.

### 4.3 Simulation Experiments

For every type of obstacles we implement four experiments using different number of robots as shown in Table 4.2.

**Table 4-2: Every type of the five obstacles has four different number of robots as experiments**

<b>EXP 1</b>	Using 100 Robots
<b>EXP 2</b>	Using 50 Robots
<b>EXP 3</b>	Using 25 Robots
<b>EXP 4</b>	Using 16 Robots

#### 4.3.1 Experiment #1: First Obstacle

The first obstacle is as shown in Figure 4.1.

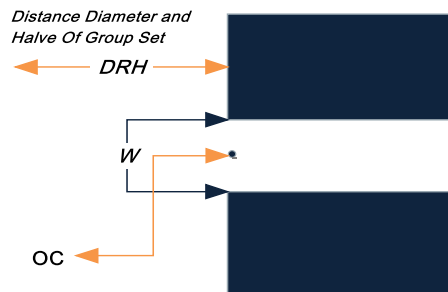

**Figure 4-1: The first obstacle**

In all the experiments related to this section, circular formation is created for the robots and the swarm moves forward avoiding the faced obstacle of type first obstacle. The swarm stops before the obstacle at the point far from the obstacle by DRH which is equal to (diameter + radius) of the swarm robotics and it's calculated according to the formula number (3-19). The first group set is separated from the swarm and move towards the obstacle until it reaches to a point far away from the obstacle by its radius and stops there. After that, the robots start separating one by one respectively going toward the obstacle gap to pass it. Upon passing the obstacle, the process of forming the circular formation will start behind the obstacle and the robots that pass the obstacle move towards their places in



the new circular formation. When the first group finishes crossing the obstacle, it sends a signal to the next group to begin to move towards the obstacle and so on till the full swarm avoids this obstacle.

#### 4.3.1.1 Experiment #1: First obstacle using 100 robots

In this experiment we use 100 robots. The robots are distributed to 10 robots in each group having ten groups. The swarm movement and obstacle avoidance are shown in Figures 4.2, 4.3 and 4.4.

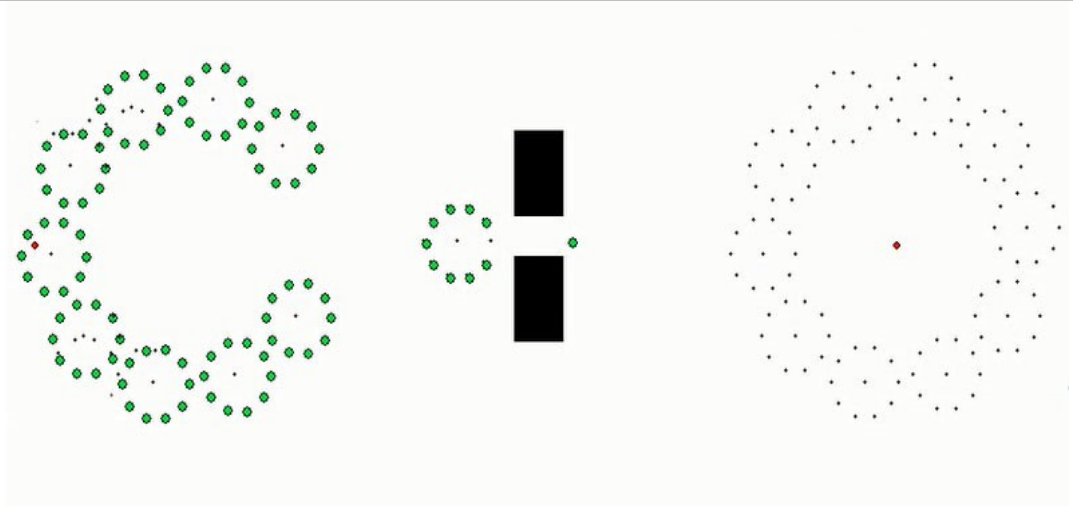

Figure 4-2: Experiment #1, the first obstacle with 100 robots before passing any robot

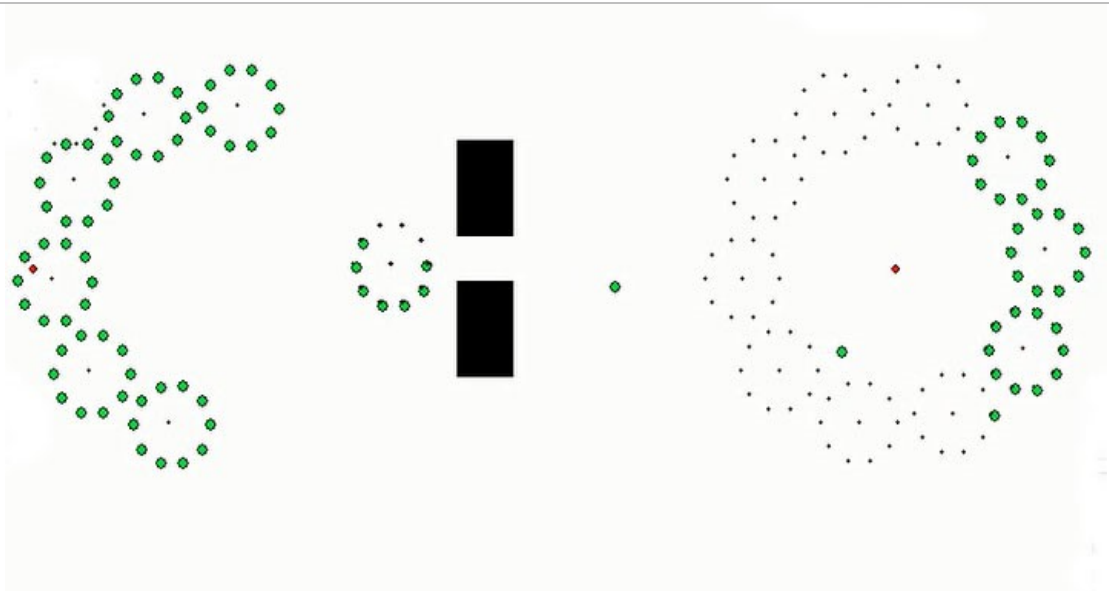

Figure 4-3: Experiment #1, the first obstacle with 100 robots after passing some robots

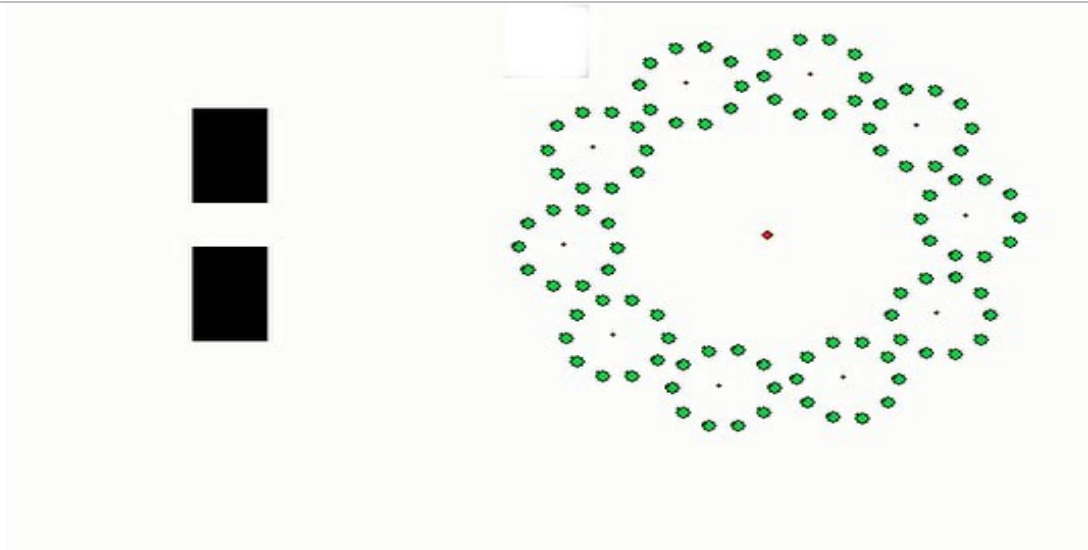

Figure 4-4: Experiment #1, the first obstacle with 100 robots after passing all the robots

#### 4.3.1.2 Experiment 1.2: First obstacle using 50 robots

In this experiment we use 50 robots that will be distributed randomly. The robots are distributed to 5 robots in each group having 10 groups. The swarm movement and obstacle avoidance are shown in Figures 4.5, 4.6 and 4.7.

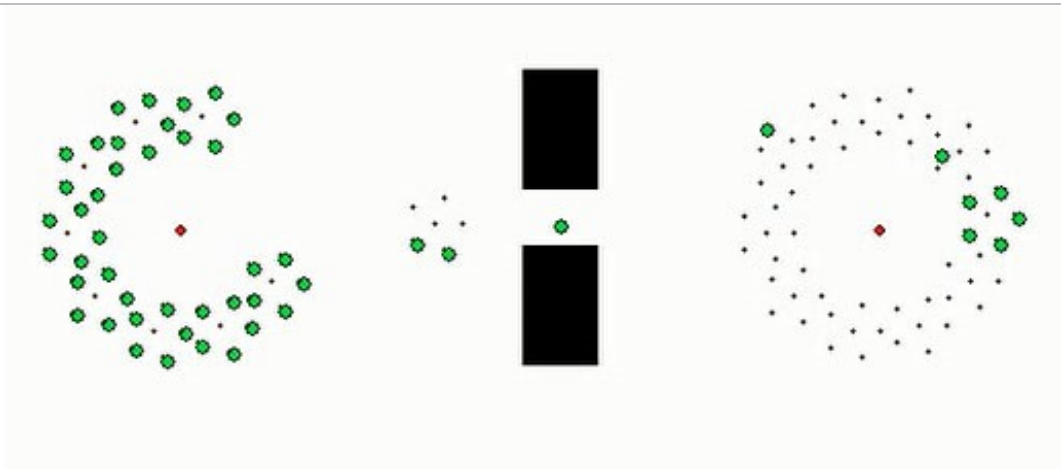

Figure 4-5: Experiment #1.2, the first obstacle with 50 robots before passing any robot

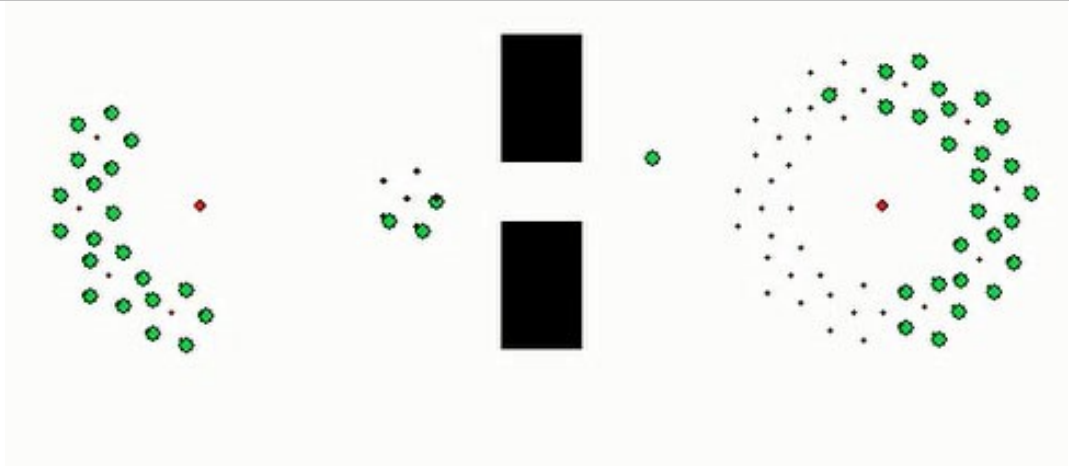

Figure 4-6: Experiment #1.2, the first obstacle with 50 robots after passing some robots

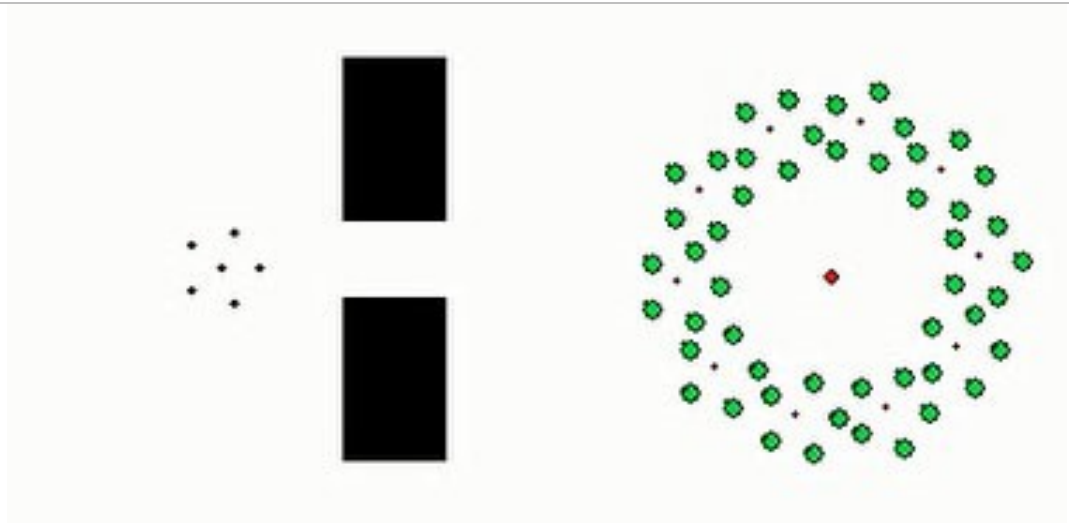

Figure 4-7: Experiment #1.2, the first obstacle with 50 robots after passing all robots

#### 4.3.1.3 Experiment 1.3: First obstacle using 25 robots

In this experiment we use 25 robots that will be distributed randomly. We have 6 group sets, 5 of them contain 4 robots and the sixth group contains 5 robots. The swarm movement and obstacle avoidance are shown in Figures 4.8, 4.9 and 4.10.

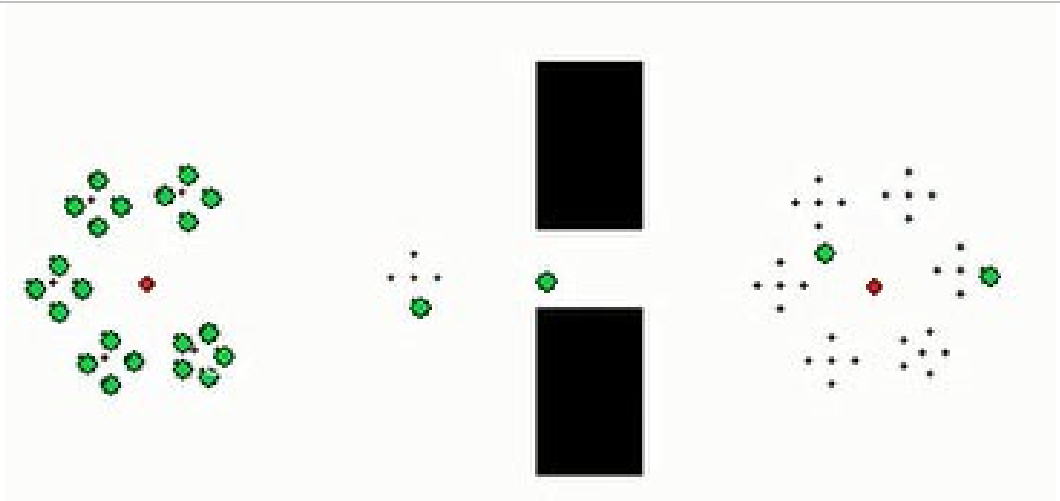

Figure 4-8: Experiment #1.3, the first obstacle with 25 robots before passing any robot

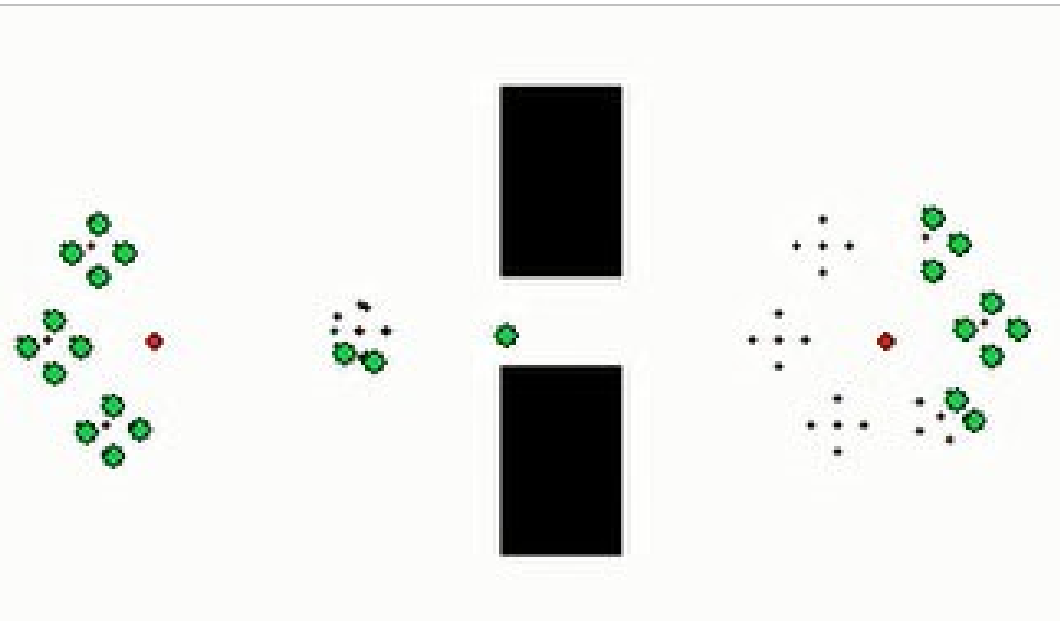
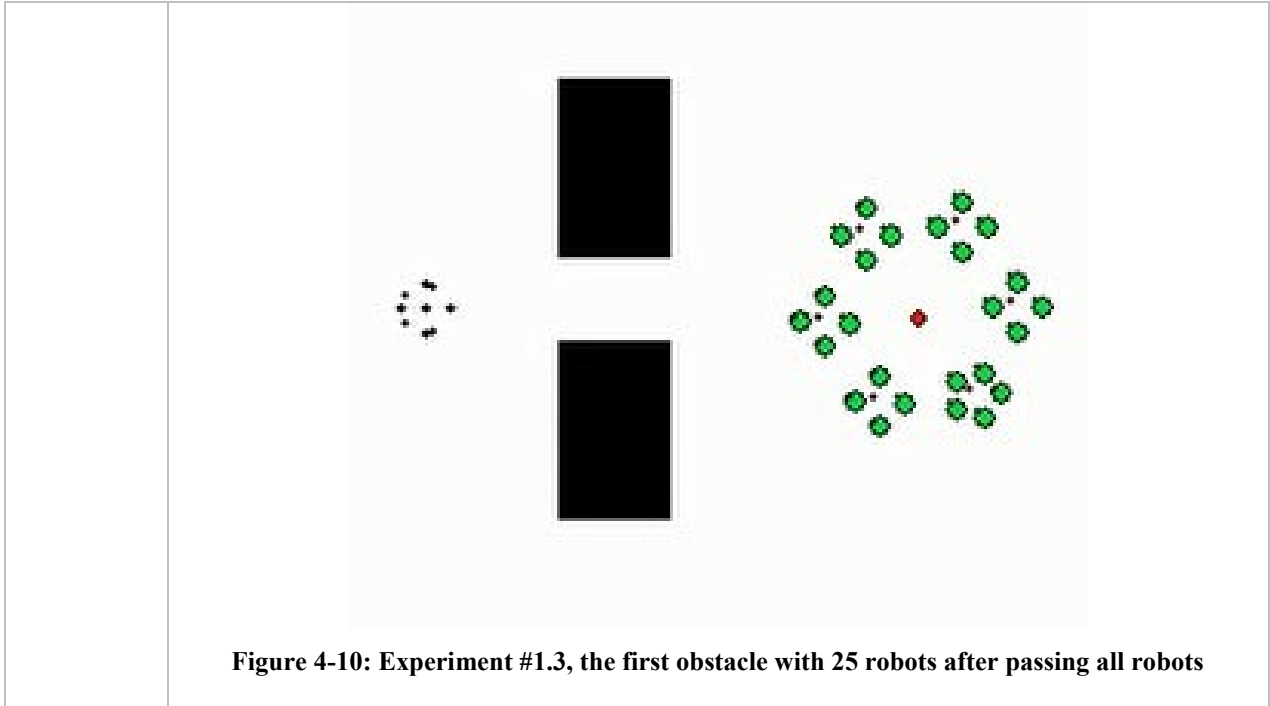
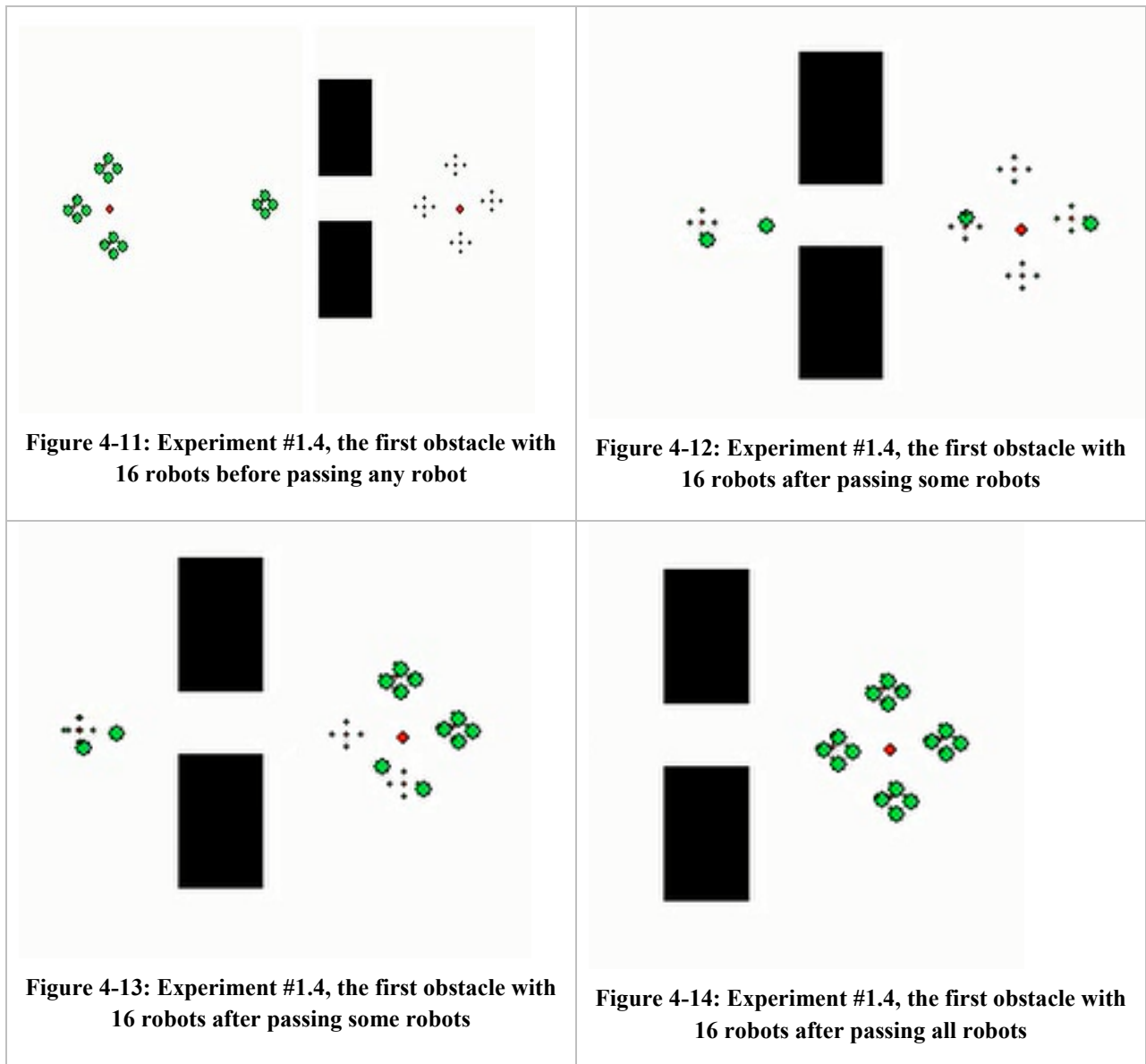

Figure 4-9: Experiment #1.3, the first obstacle with 25 robots after passing some robots



#### **4.3.1.4 Experiment 1.4: First obstacle using 16 robots**

In this experiment we use 16 robots that will be distributed randomly. The robots are distributed to 4 robots in each group having 4 groups. The swarm movement and obstacle avoidance are shown in Figures 4.11, 4.12, 4.13 and 4.14.



### 4.3.2 Experiment #2: Second Obstacle

The experiment will be performed on the second obstacle that is on Figure 4.15. Where this obstacle allows the passage of a group set through the obstacle gap where the swarm moves forward up to the point  $cxy$ , which is far away from the obstacle by the radius and diameter of the swarm, then the first group set separates from the swarm and moves toward the obstacle gap. The next group set begins separating from the swarm and moves towards the obstacle to perform the same as the previous task. After bypassing the obstacle across the gap by the group set, this group set starts forming the circular formation and going to its new place in the circular formation behind the obstacle at point  $DRH$  away from the obstacle by diameter and radius of the swarm. The new circular formation center will be the point  $cxy'$  which is located at  $DRH2$  distance.

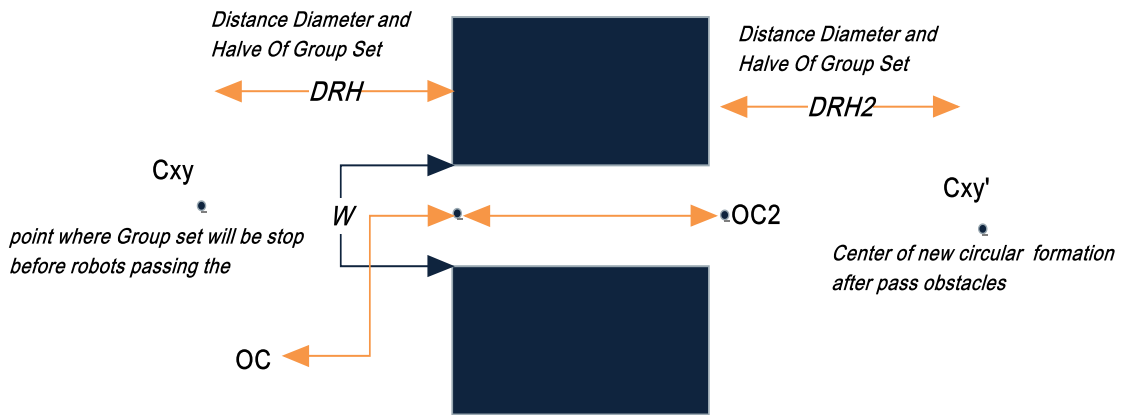

Figure 4-15: The second obstacle

#### 4.3.2.1 Experiment 2.1: Second obstacle using 100 robots

In this experiment, we get 10 group sets as shown in Figure 4.4.

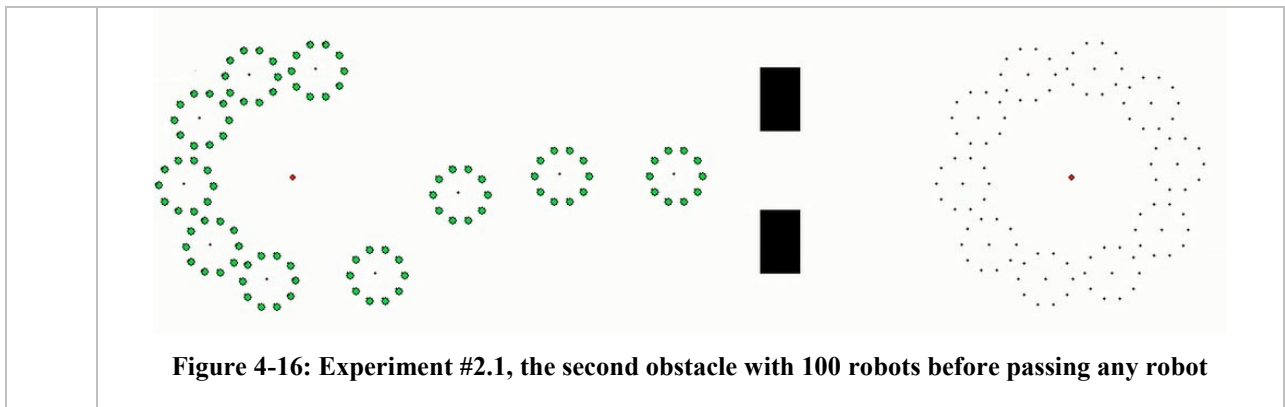

Figure 4-16: Experiment #2.1, the second obstacle with 100 robots before passing any robot

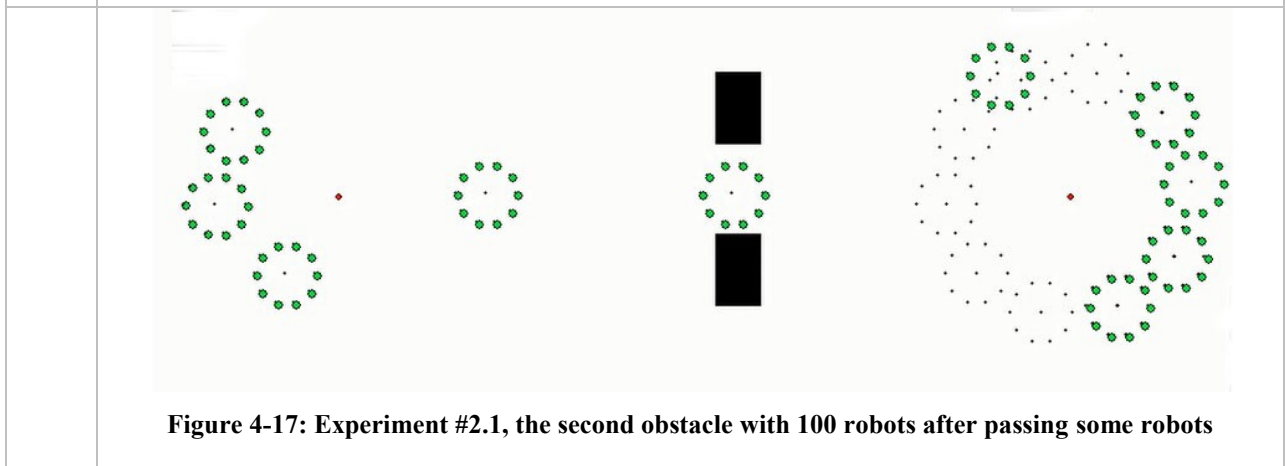

Figure 4-17: Experiment #2.1, the second obstacle with 100 robots after passing some robots

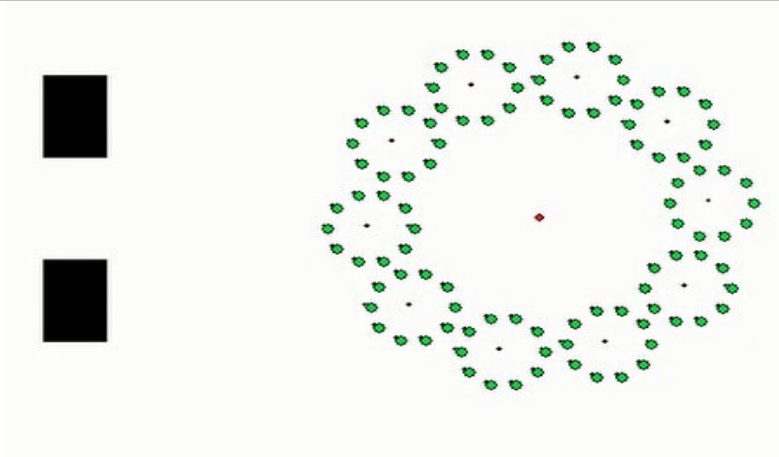

Figure 4-18: Experiment #2.1, the second obstacle with 100 robots after passing all robots

#### 4.3.2.2 Experiment 2.2. Second obstacle using 50 robots:

The circular formation will be formed after the distribution of the 50 robots randomly. We have 10 group sets and every one contains 5 robots. The swarm movement and obstacle avoidance are shown in Figures 4.19, 4.20 and 4.21.

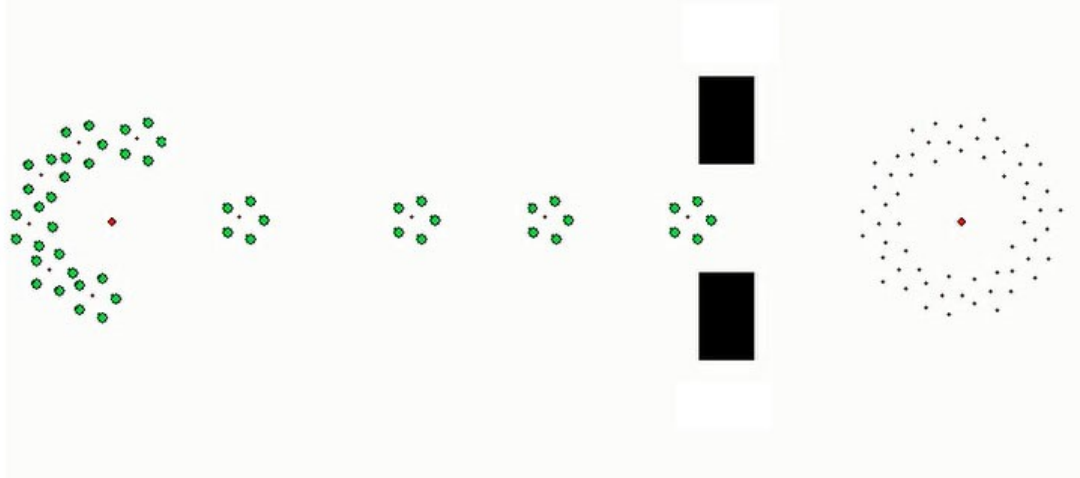

Figure 4-19: Experiment #2.2, the second obstacle with 50 robots before passing any robot

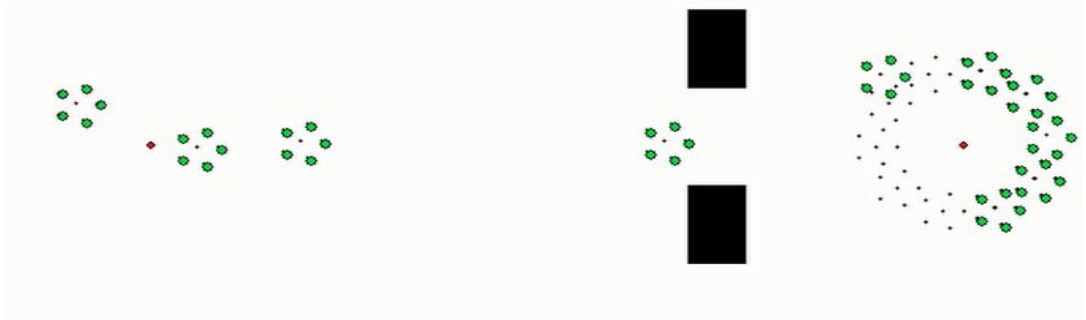
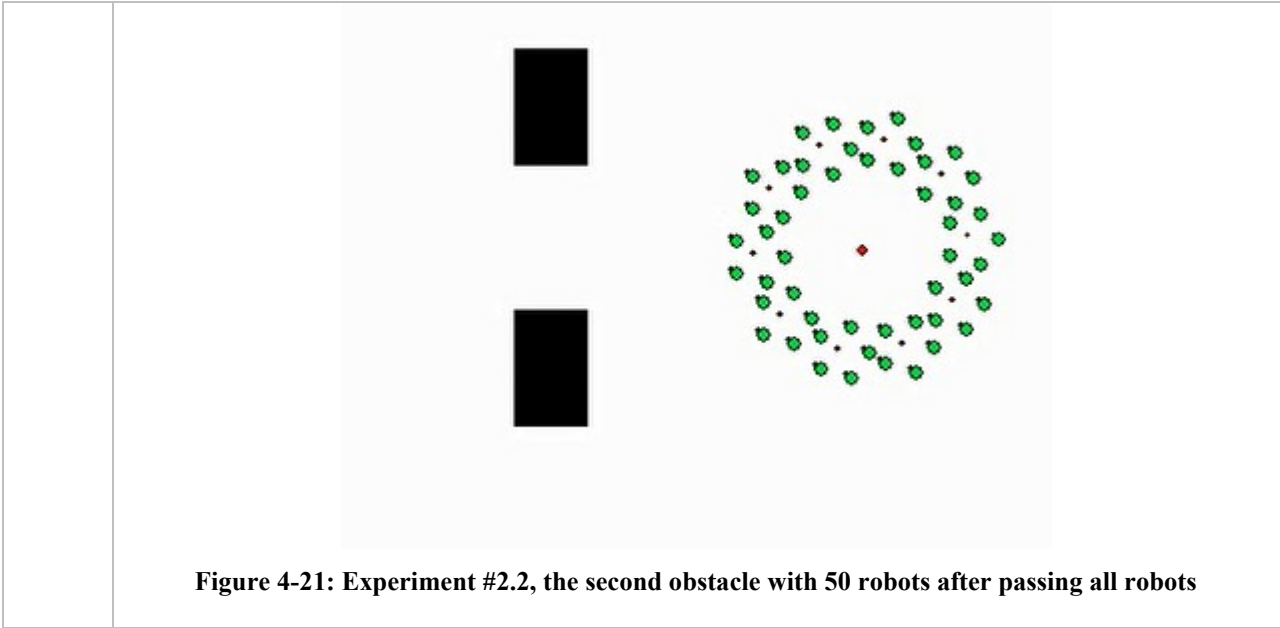

Figure 4-20: Experiment #2.2, the second obstacle with 50 robots after passing some robots





**4.3.2.3 Experiment 2.3: Second obstacle using 25 robots:**

In this experiment 6 group sets have been formed within the swarm where 5 of them contain 4 robots each and the sixth one contains 5 robots. The swarm movement and obstacle avoidance are shown in Figures 4.22, 4.23 and 4.24.

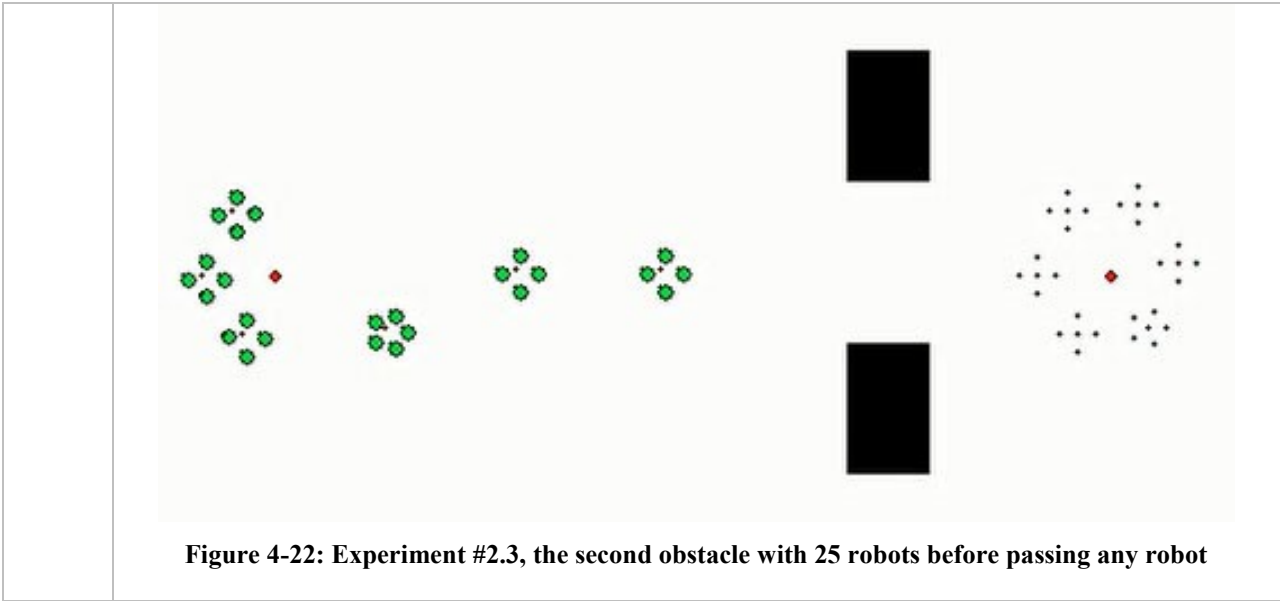

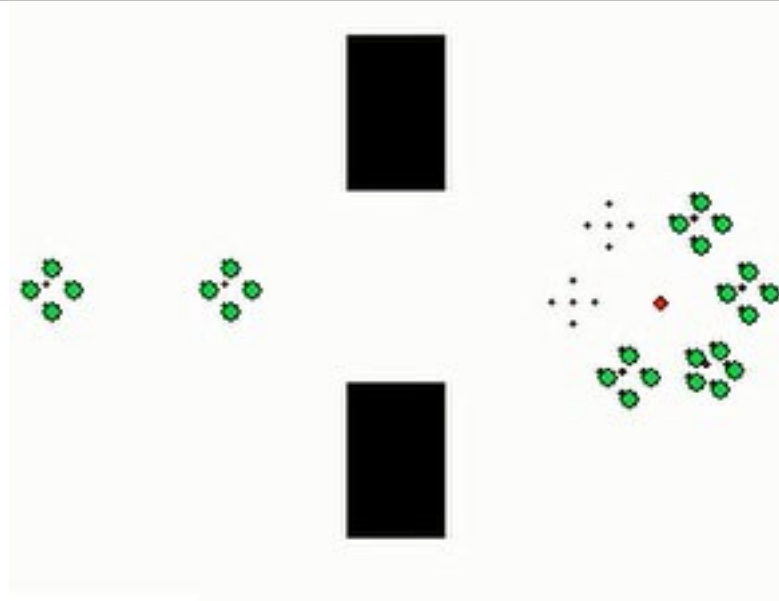

Figure 4-23: Experiment #2.3, the second obstacle with 25 robots after passing some robots

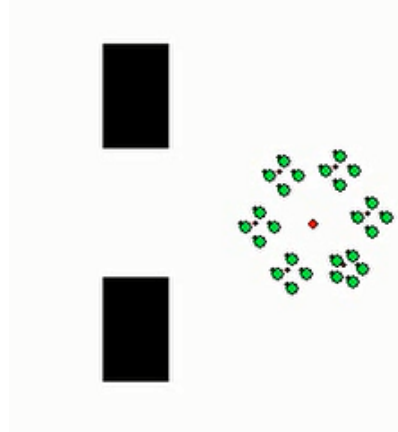

Figure 4-24: Experiment #2.3, the second obstacle with 25 robots after passing all robots

#### 4.3.2.4 Experiment 2.4: Second obstacle using 16 robots:

In this experiment, 4 group sets will be formed, each has 4 robots. The swarm movement and obstacle avoidance are shown in Figures 4.25, 4.26 and 4.27.

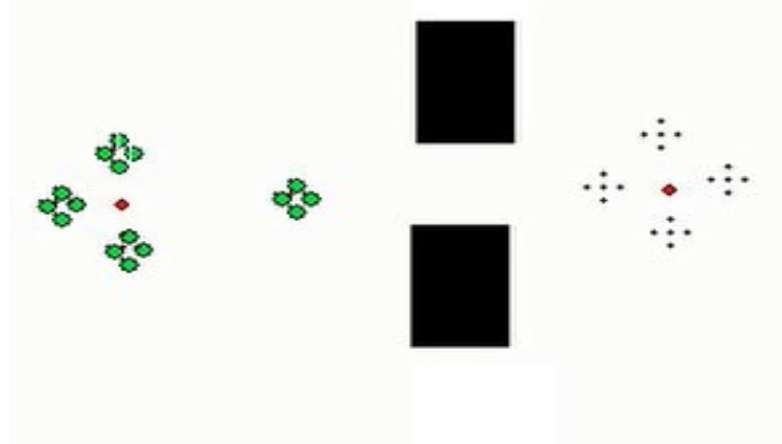

Figure 4-25: Experiment #2.4, the second obstacle with 16 robots before passing any robot

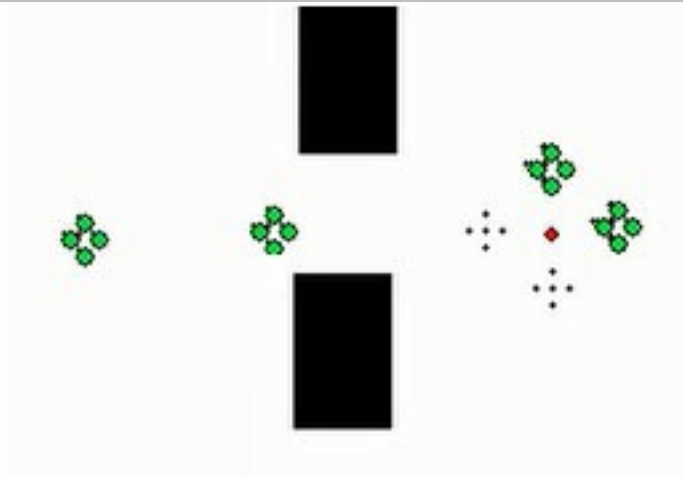

Figure 4-26: Experiment #2.4, the second obstacle with 16 robots after passing some robots

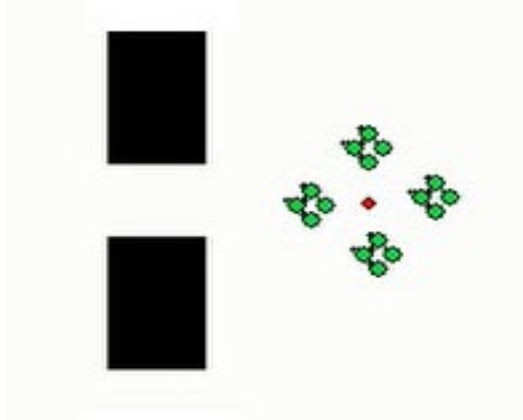

Figure 4-27: Experiment #2.4, the second obstacle with 16 robots after passing all robots

### 4.3.3 Experiment #3: Third Obstacle

The third obstacle is a complex one with three parts as we see in Figure 4.28. It allows just one robot to pass through it, the swarm will move forward until it reaches point OC. The first group set separates from the swarm, and the group-center will be measured, if the center is larger than OC coordinates on the Y-axis, the group set will move towards point D. once it reaches there, it will change direction and move to point C, and then the robots begin to separate one by one. Each robot then will move individually towards the point OC2 and then towards the point OC3, getting out of the complex obstacle. The robots then start moving to its place in the new circular formation behind the obstacle. We can see in this experiment that the swarm moves slowly because of the large number of calculations necessary to move the swarm and the group set to pass the obstacle, which only allows one robot only to cross it.

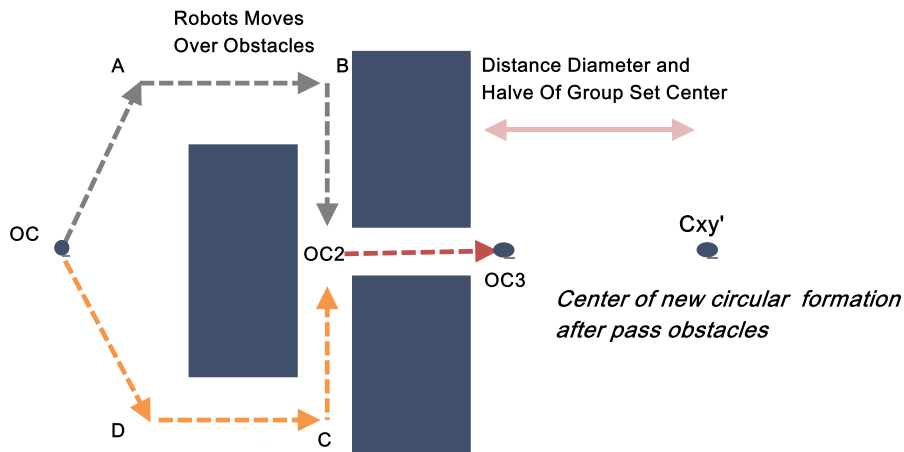

Figure 4-28: Illustrate the Path of Move for robots on swarm robotics with the third obstacle type

#### 4.3.3.1 Experiment 3.1: Third obstacle using 100 robots

There are 10 group sets in the circular formation and every group set has 10 robots. The swarm movement and obstacle avoidance are shown in Figures 4.29, 4.30 and 4.31.

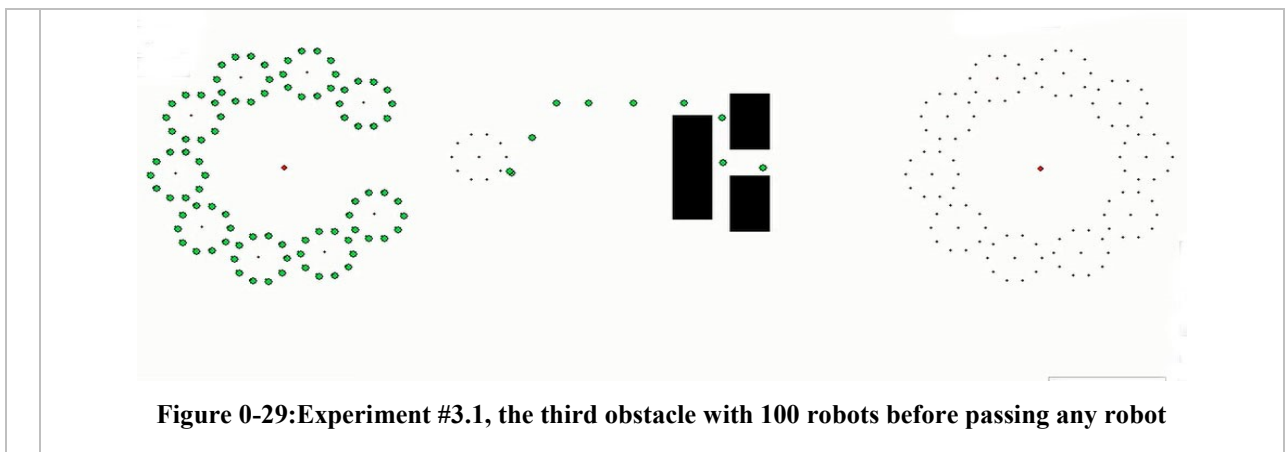
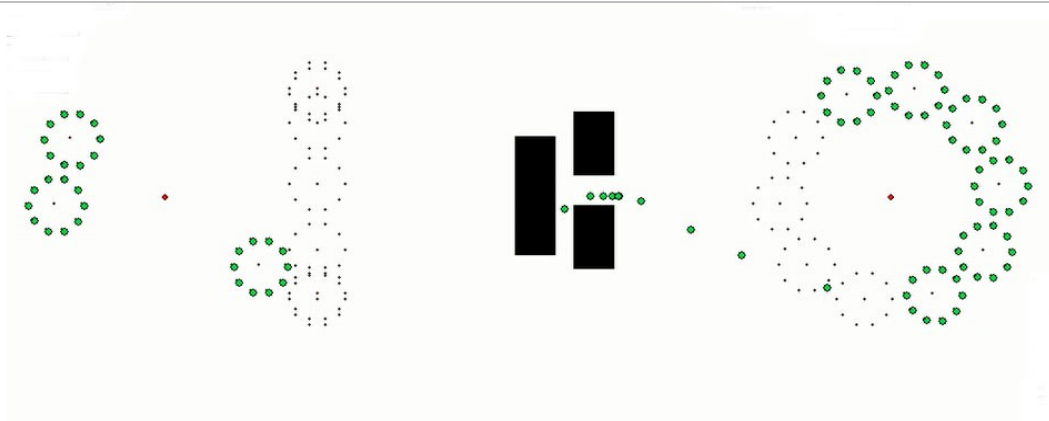
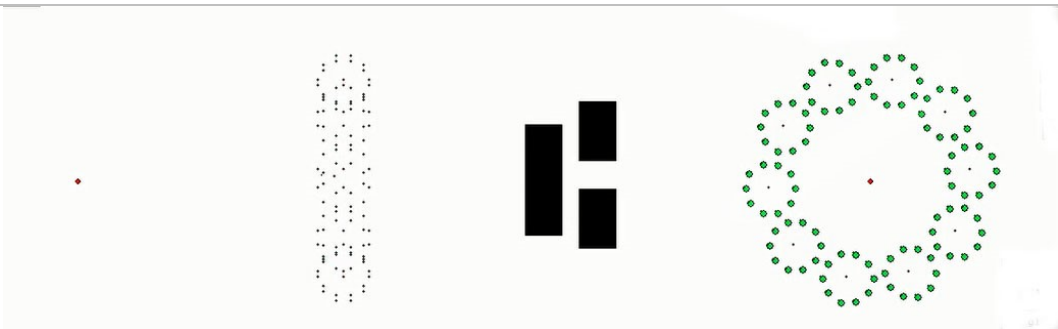

Figure 0-29: Experiment #3.1, the third obstacle with 100 robots before passing any robot



**Figure 4-30: Experiment #3.1, the third obstacle with 100 robots after passing some robots**



**Figure 0-31: Experiment #3.1, the third obstacle with 100 robots after passing all robots**

### 4.3.3.2 Experiment 3.2: Third obstacle using 50 robots

There are 10 group sets in the circular formation and every group set has 5 robots. The swarm movement and obstacle avoidance are shown in Figures 4.32, 4.33 and 4.34.

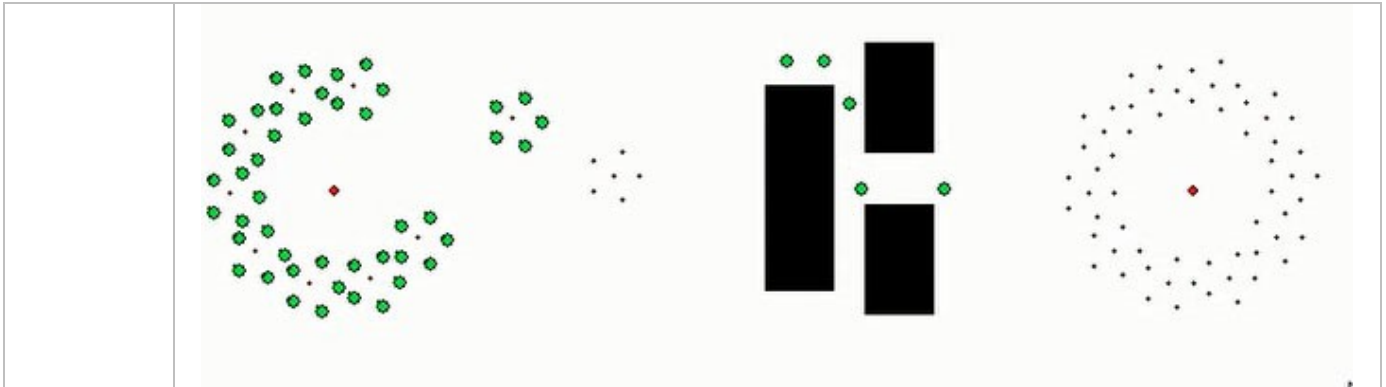

Figure 4-32: Experiment #3.2, the third obstacle with 50 robots before passing any robot

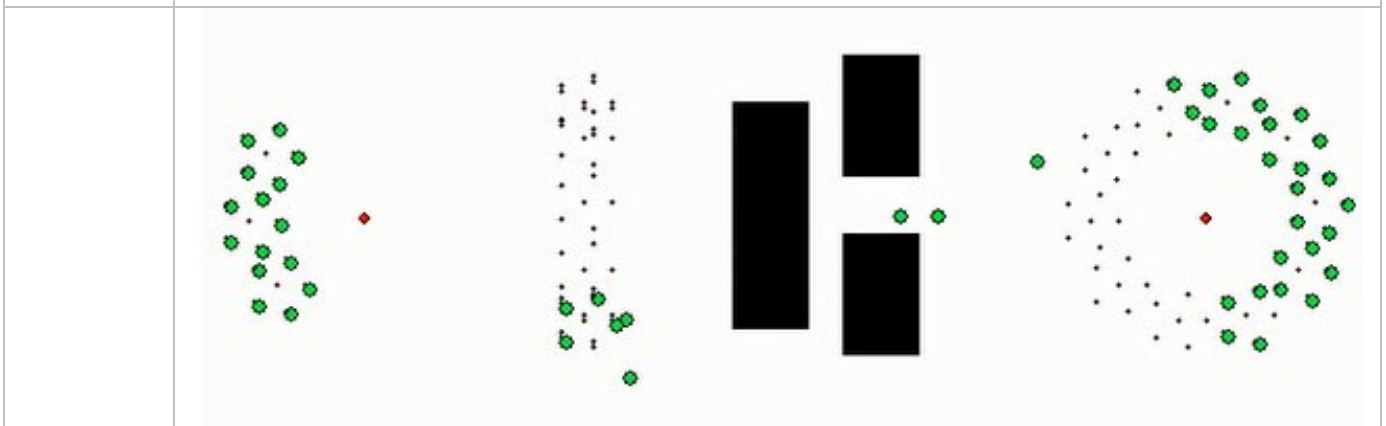

Figure 0-33: Experiment #3.2, the third obstacle with 50 robots after passing some robots

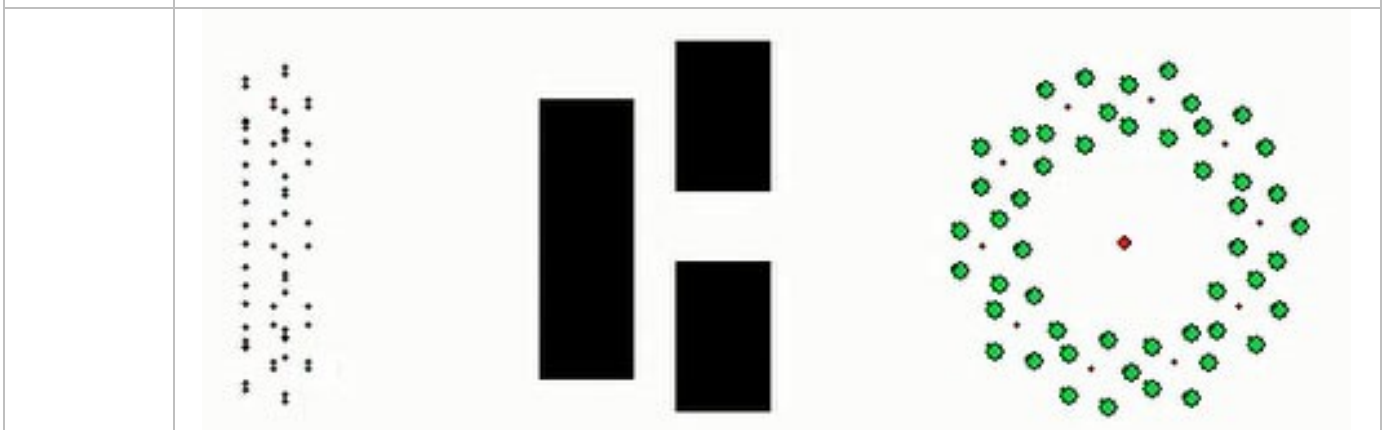
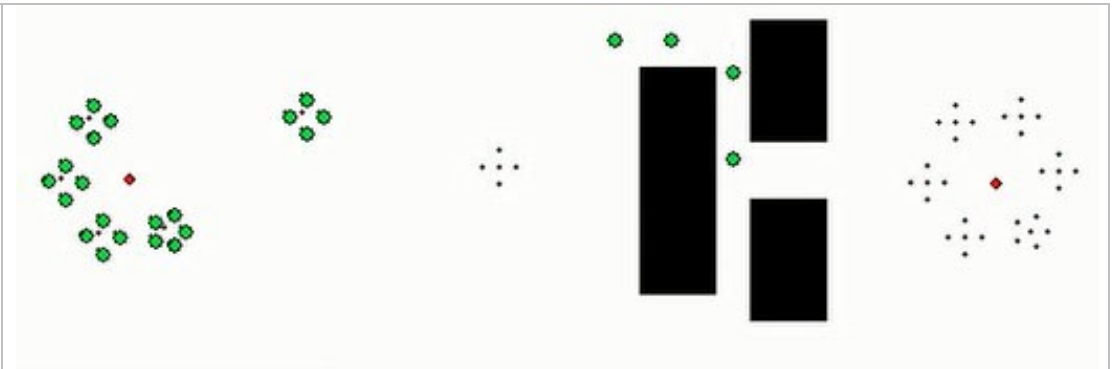
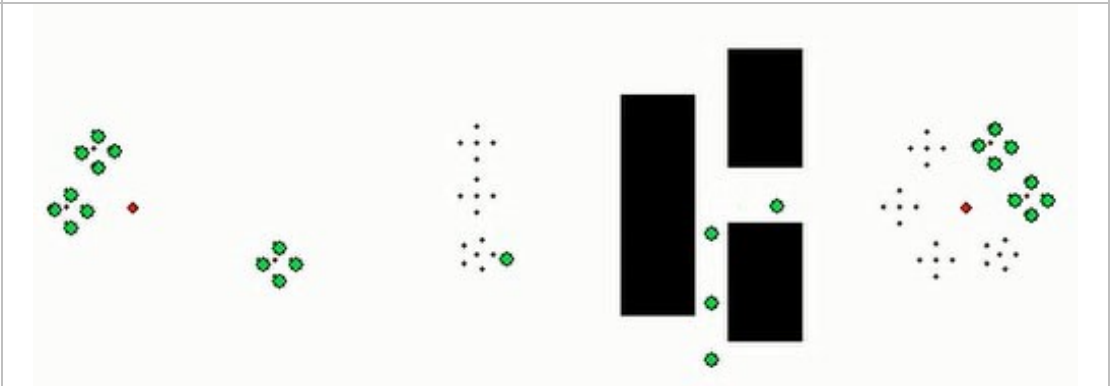
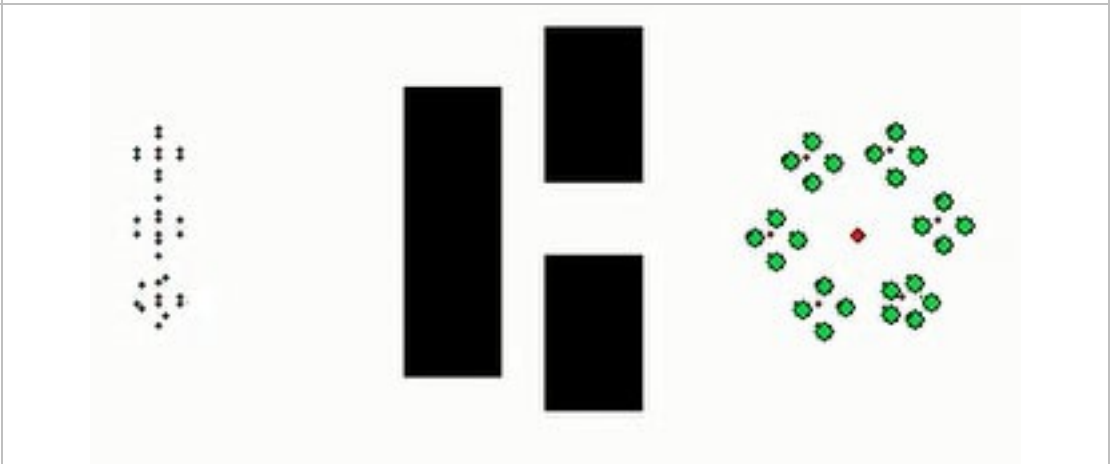

Figure 0-34: Experiment #3.2, the third obstacle with 50 robots after passing all robots

### 4.3.3.3 Experiment 3.3: Third obstacle using 25 robots

There are 6 group sets in the circular formation, 5 group sets contain 4 robots and the last one has 5 robots. The swarm movement and obstacle avoidance are shown in Figures 4.35, 4.36 and 4.37.

	 <p data-bbox="384 828 1503 904"><b>Figure 4-35: Experiment #3.3, the third obstacle with 25 robots before passing any robot</b></p>
	 <p data-bbox="384 1288 1503 1364"><b>Figure 4-36: Experiment #3.3, the third obstacle with 25 robots after passing some robots</b></p>
	 <p data-bbox="384 1825 1503 1897"><b>Figure 4-37: Experiment #3.3, the third obstacle with 25 robots after passing all robots</b></p>

#### 4.3.3.4 Experiment 3.4: Third obstacle using 16 robots:

There are 4 group sets in the circular formation and 4 robots within each group. The swarm movement and obstacle avoidance are shown in Figures 4.38, 4.39 and 4.40.



Figure 4-38: Experiment #3.4, the third obstacle with 16 robots before passing any robot

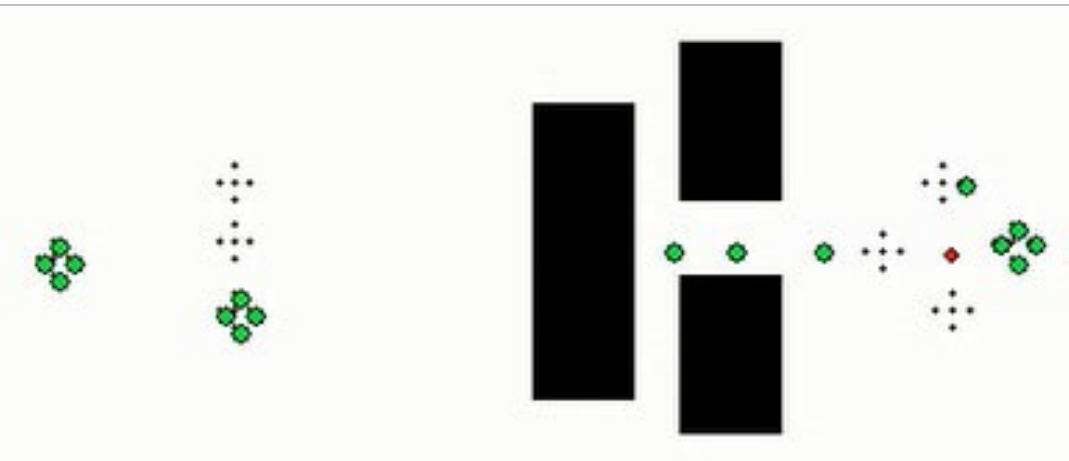

Figure 4-39: Experiment #3.4, the third obstacle with 16 robots after passing some robots

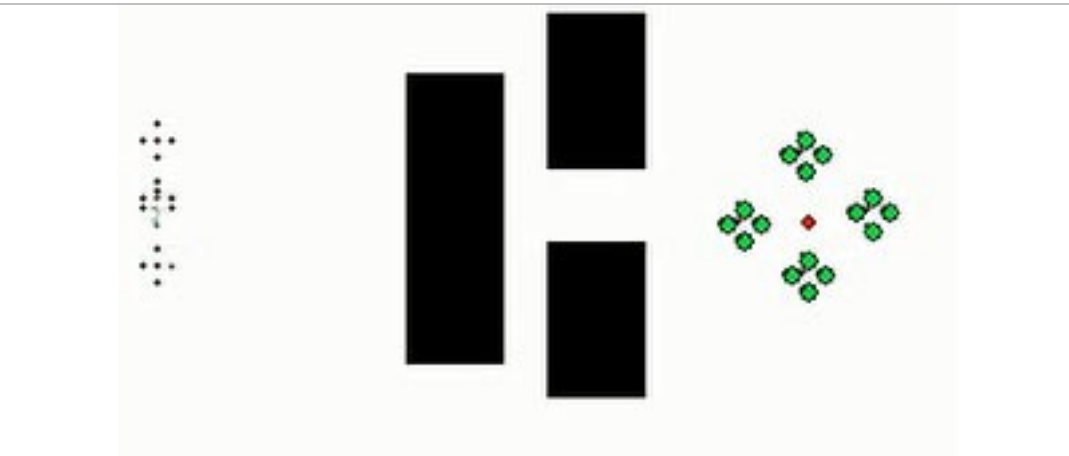

Figure 4-40: Experiment #3.4, the third obstacle with 16 robots after passing all robots



### 4.3.4 Experiment #4: Fourth Obstacle

In the fourth obstacle there are 4 parts which allow the group set to pass until the mid of the obstacle, then the robots will separate and continue its way to the end of the obstacle. The group set will move forward separately from the swarm until it reaches point OC. If the group-center coordinates on the Y-axis are larger than OC coordinates on the Y-axis, the group set will move towards point D, and once it reaches there, it will change direction and move to point C and when it's there, the group set will alter its path towards point OC2. When the group set reaches point OC2, it stops and the robots begin to separate one by one and each one will move individually towards the gap in the second half of the obstacle, getting out of it.

The robots then start the new circular formation, which formed far away by a diameter and radius of the circular formation after the obstacle, which referred to as DRH2. Finally, the robots will get out of the obstacle and form the new circular formation. The fourth obstacle is shown in Figures 4.41 and 4.42.

We can see in this experiment that the swarm moves slowly compared with the second experiment (experiment #2), because one robot moves and passes the second part of the obstacle.

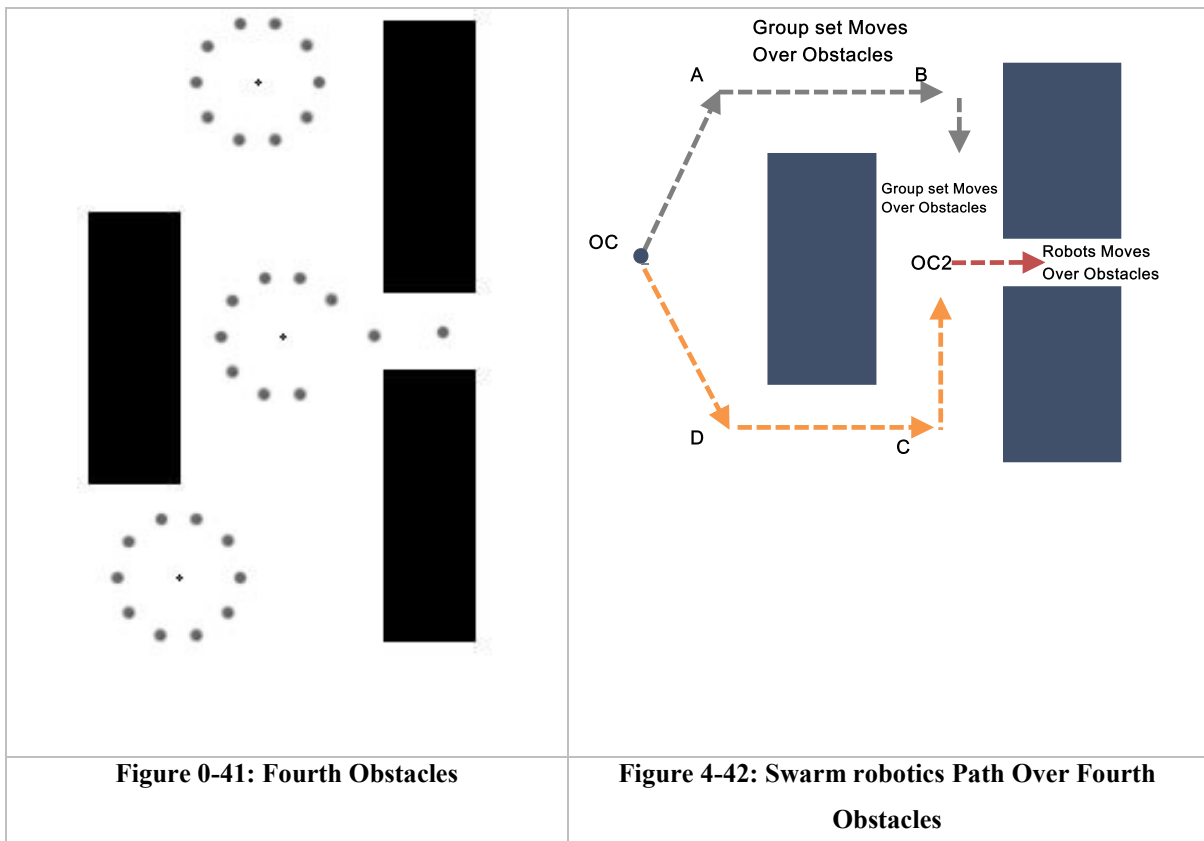

#### 4.3.4.1 Experiment 4.1: Fourth obstacle using 100 robots:

There are 10 group sets in the circular formation and every group set has 10 robots. The swarm movement and obstacle avoidance are shown in Figures 4.43, 4.44 and 4.45.

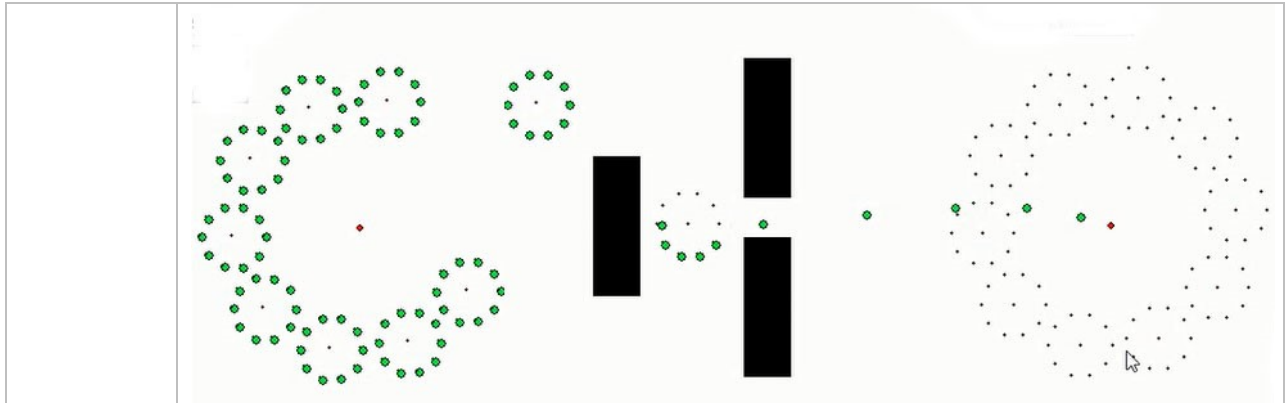

Figure 4-43: Experiment #4.1, the fourth obstacle with 100 robots before passing any robot

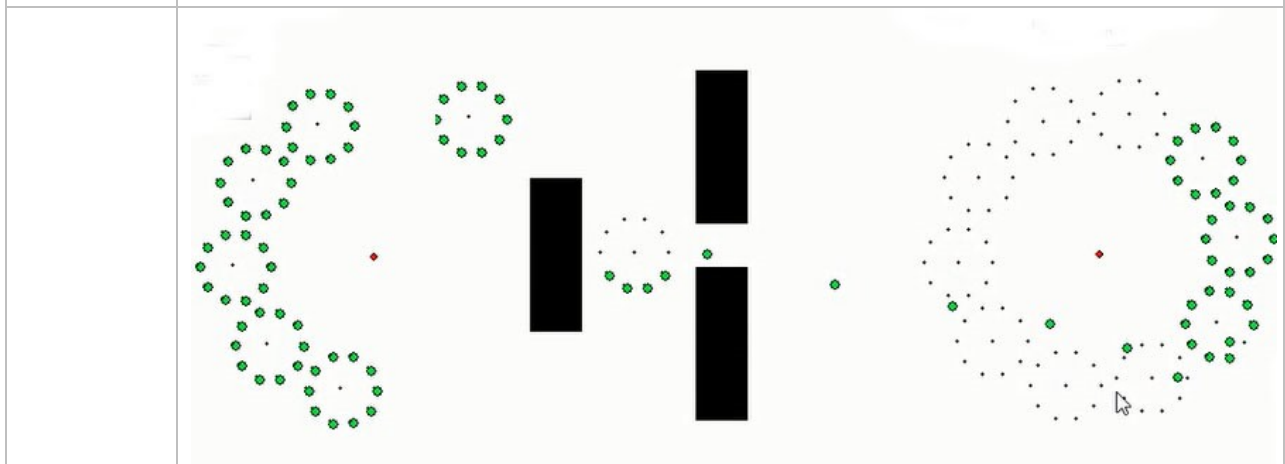

Figure 4-44: Experiment #4.1, the fourth obstacle with 100 robots after passing some robots

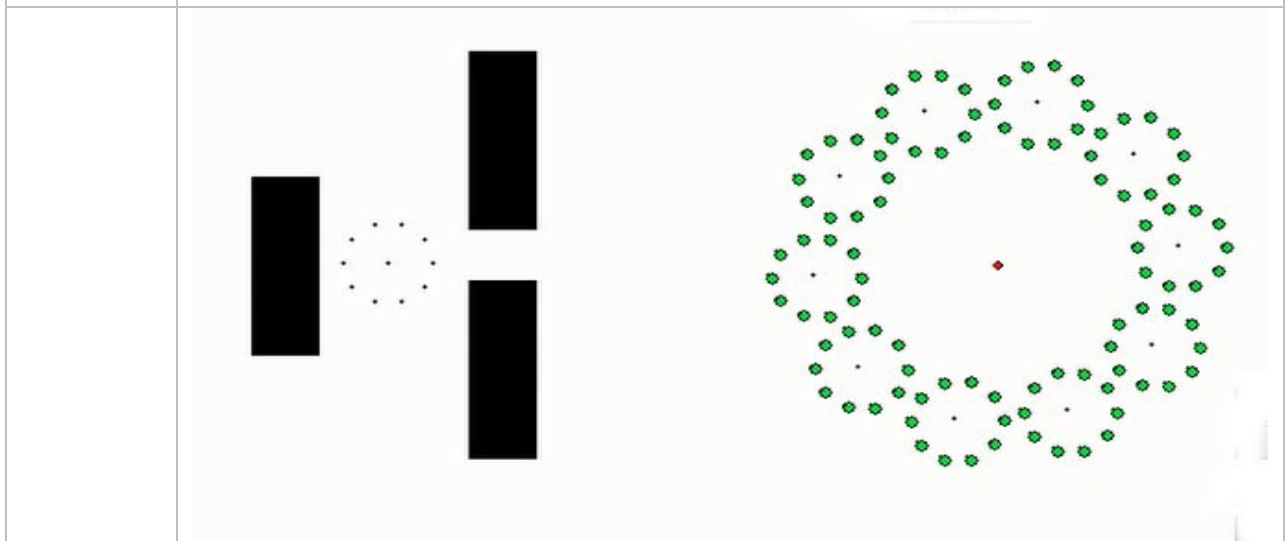

Figure 4-45: Experiment #4.1, the fourth obstacle with 100 robots after passing all robots

#### 4.3.4.2 Experiment 4.2: Fourth obstacle using 50 robots:

There are 10 group sets in the circular formation and every group has 5 robots. The swarm movement and obstacle avoidance are shown in Figures 4.46, 4.47 and 4.48.

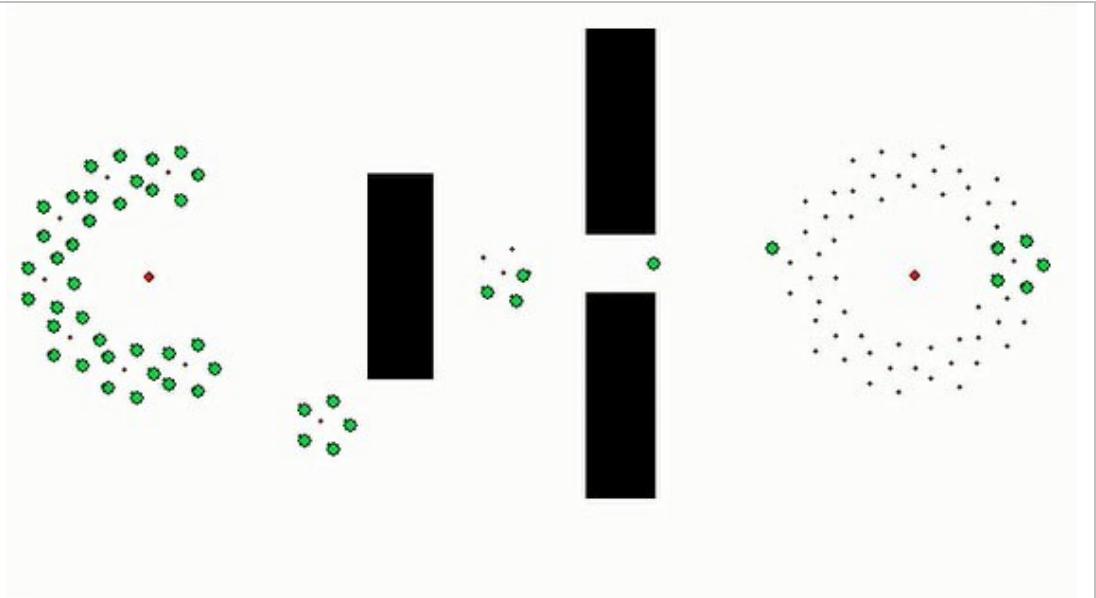

Figure 0-46: Experiment #4.2, the fourth obstacle with 50 robots before passing any robot

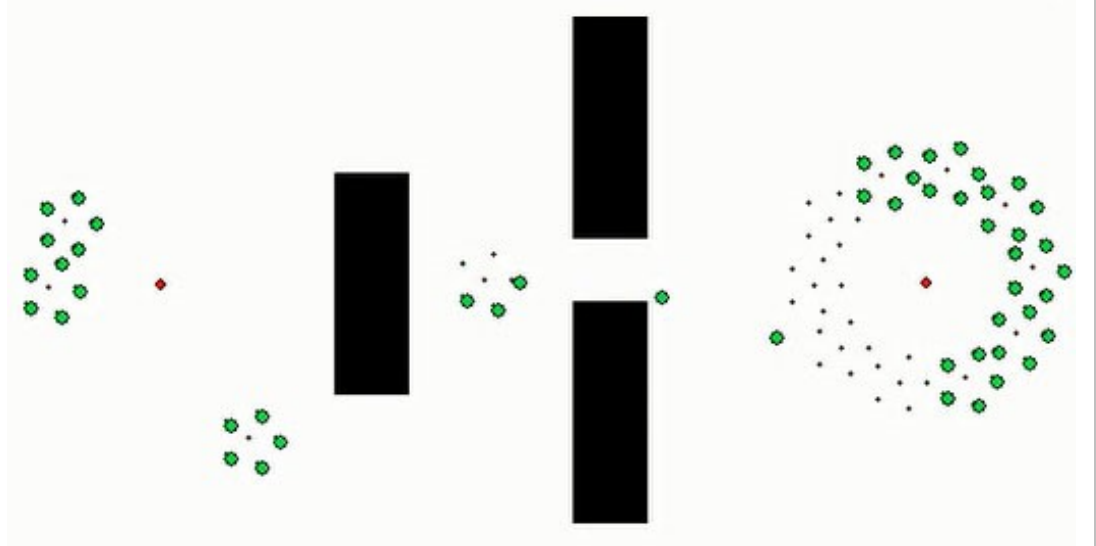
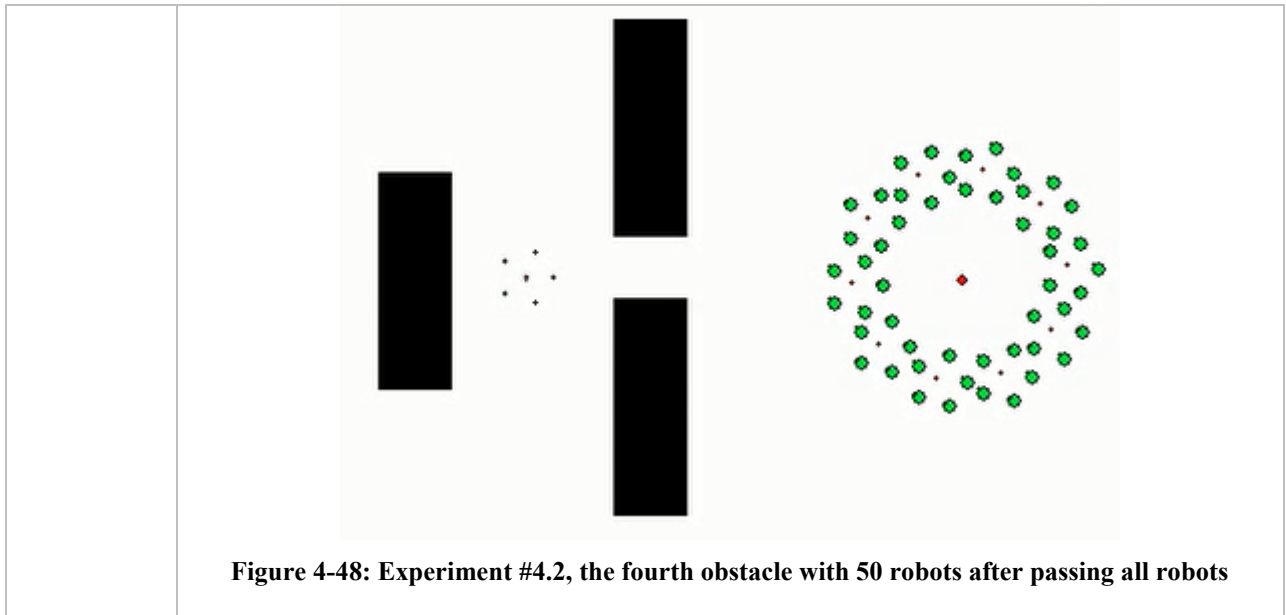

Figure 0-47: Experiment #4.2, the fourth obstacle with 50 robots after passing some robots



#### 4.3.4.3 Experiment 4.3: Fourth obstacle using 25 robots

There are 6 group sets in the circular formation and every group set has 4 robots except the last one contains 5 robots. The swarm movement and obstacle avoidance are shown in Figures 4.49, 4.50 and 4.51.

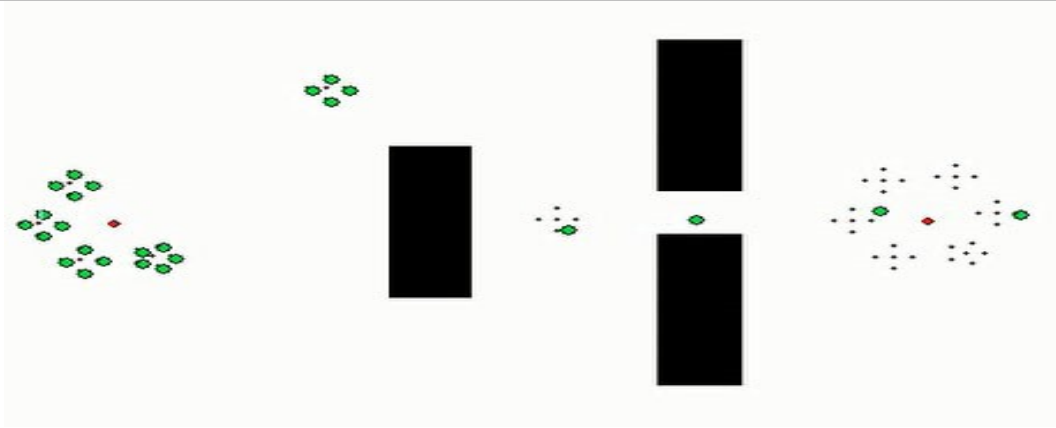

Figure 4-49: Experiment #4.3, the fourth obstacle with 25 robots before passing any robot

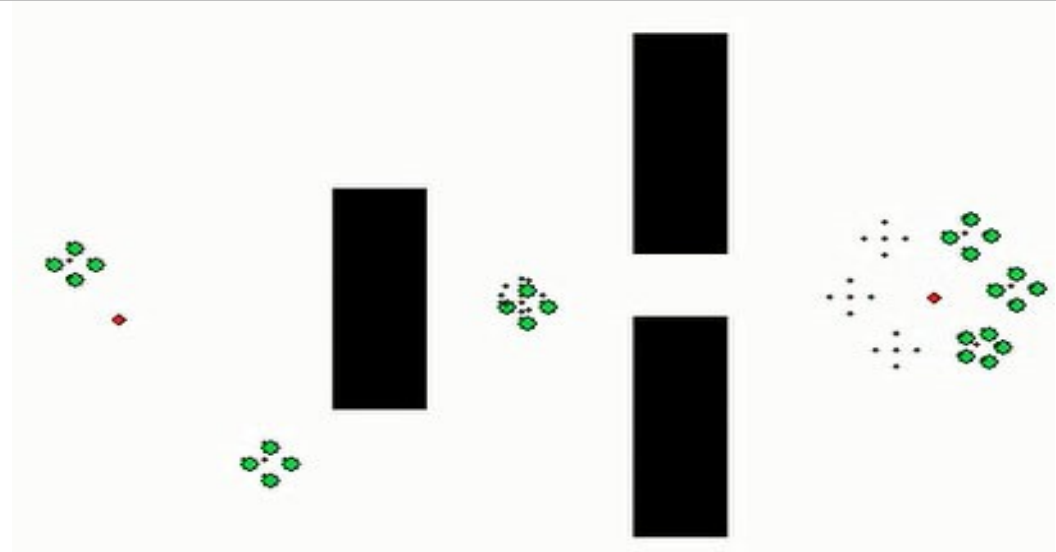

Figure 0-50: Experiment #4.3, the fourth obstacle with 25 robots after passing some robots

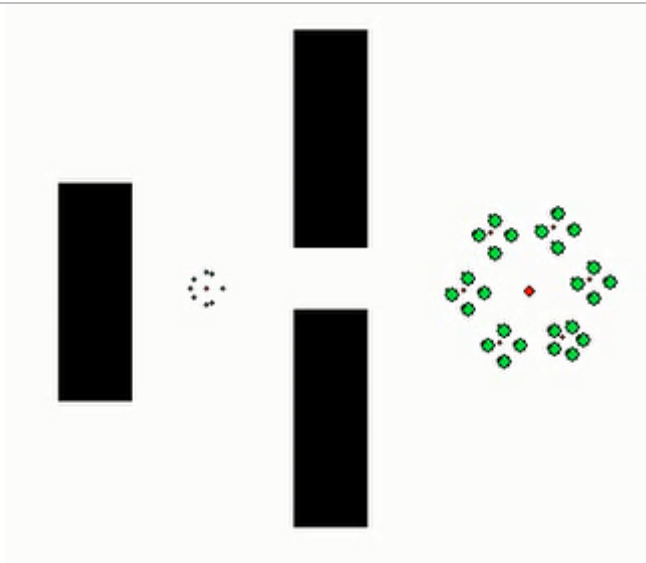

Figure 4-51: Experiment #4.3, the fourth obstacle with 25 robots after passing all robots

#### 4.3.4.4 Experiment 4.4: Fourth obstacle using 16 robots:

There are 4 group sets in the circular formation and every group set has 4 robots. The swarm movement and obstacle avoidance are shown in Figures 4.52, 4.53 and 4.54.

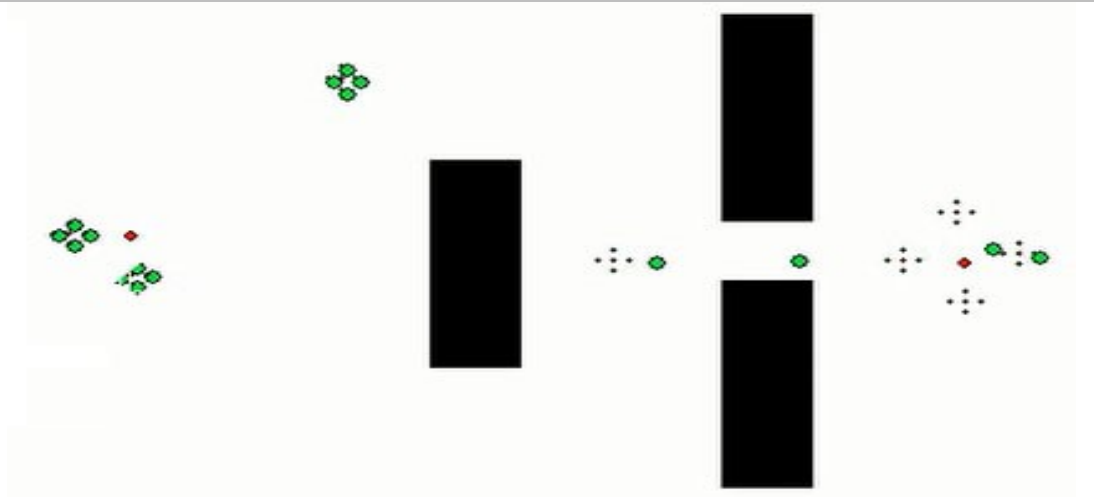

Figure 0-52: Experiment #4.4, the fourth obstacle with 16 robots before passing any robot

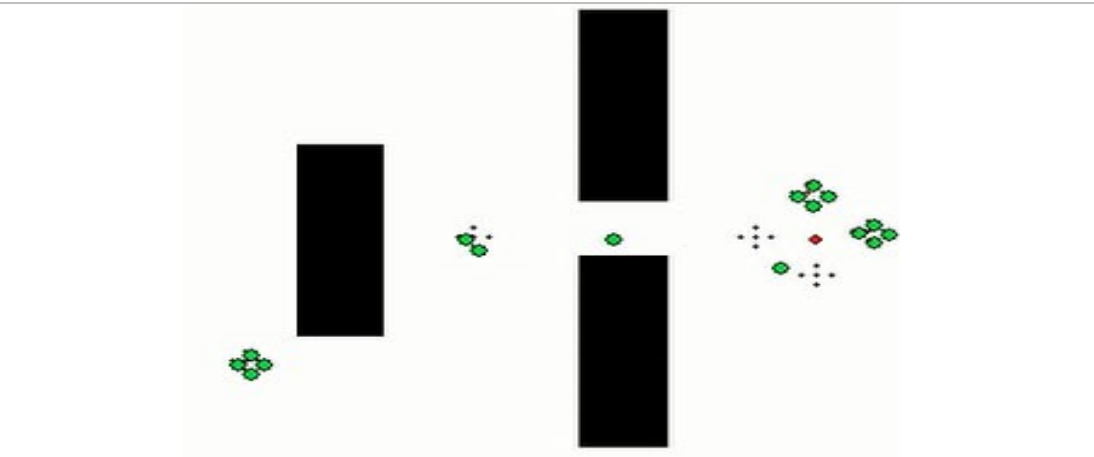

Figure 4-53: Experiment #4.4, the fourth obstacle with 16 robots after passing some robots

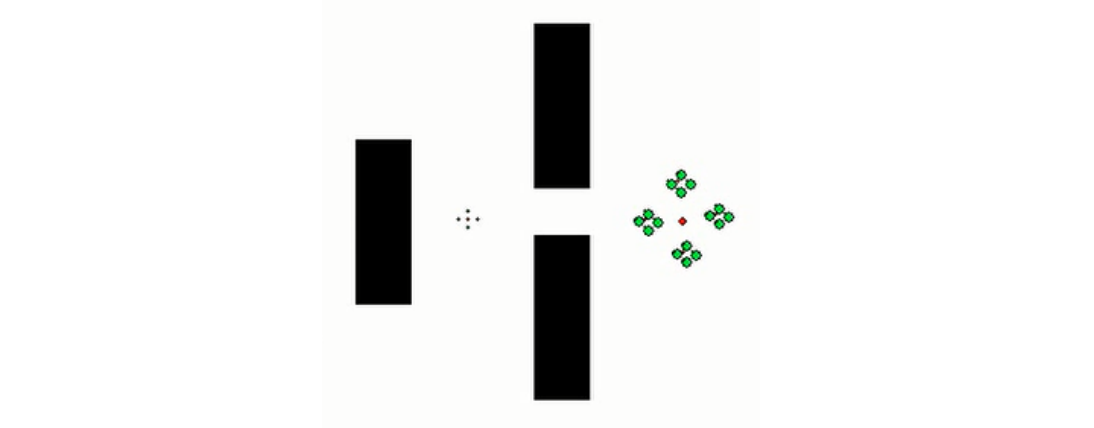
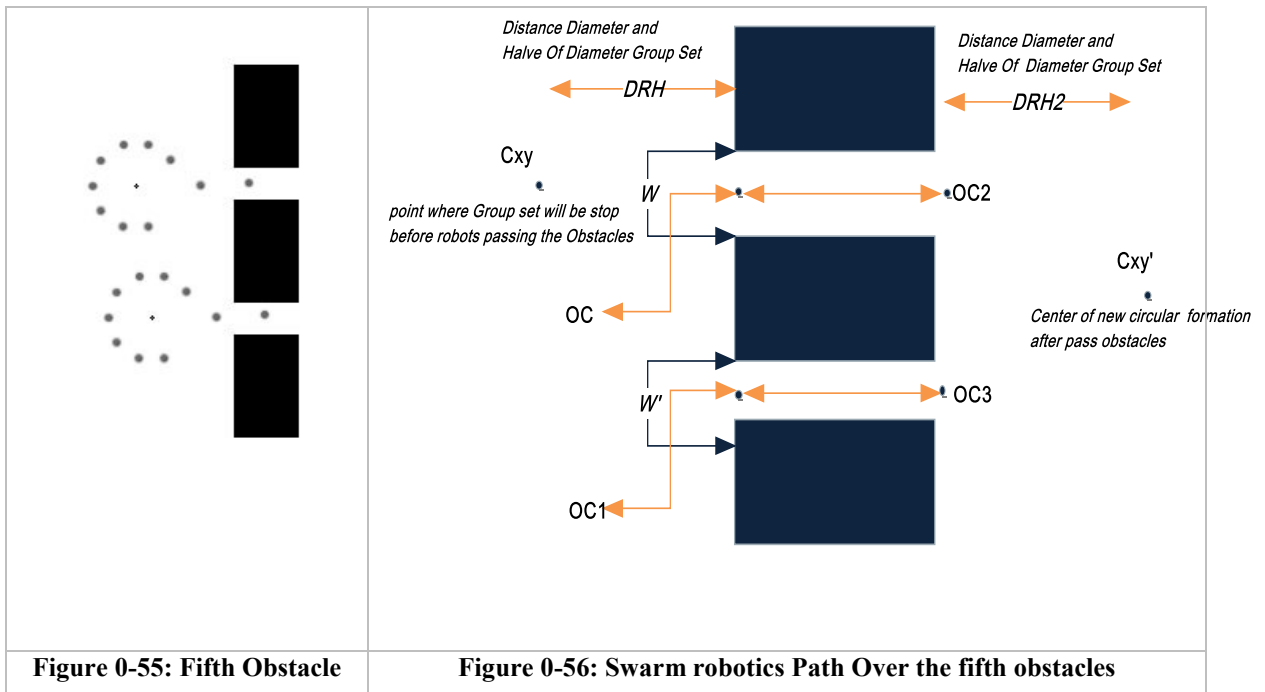

Figure 0-54: Experiment #4.4, the fourth obstacle with 16 robots after passing all robots

### 4.3.5 Experiment #5: Fifth Obstacle

In this obstacle, we can see 3 parts with 2 gaps as in Figures 4.55 and 4.56. Each gap allows one robot to pass through the obstacle and since there are 2 gaps, 2 robots will pass each time. The swarm will stop moving when reaching point CXY where the first and the second group sets will separate from the main swarm. If the first group set center coordinates on Y-axis is smaller or equal point CXY coordinates on Y-axis, the group set will move to the first gap, to point OC. In addition, if the group set center coordinates on Y-axis is larger than point CXY coordinates on Y-axis, the group set will move to the second gap, to point OC2. The group set will be at distance that equals its radius away from the obstacle.

The robots in both group sets will begin to separate and move towards the two gaps until they cross the obstacle. Eventually the new circular formation process is started and each robot will move to its new position until the whole swarm passes the obstacle. We can notice that this experiment is relatively faster than the third and fourth experiments (experiment #3 and experiment #4) considering the number of robots, which pass the obstacles each time. Accordingly, in this experiment two robots pass the obstacle each time instead of one.



#### 4.3.5.1 Experiment 5.1: Fifth obstacle using 100 robots

There are 10 group sets in the circular formation and every group set has 10 robots. The swarm movement and obstacle avoidance are shown in Figures 4.57, 4.58 and 4.59.

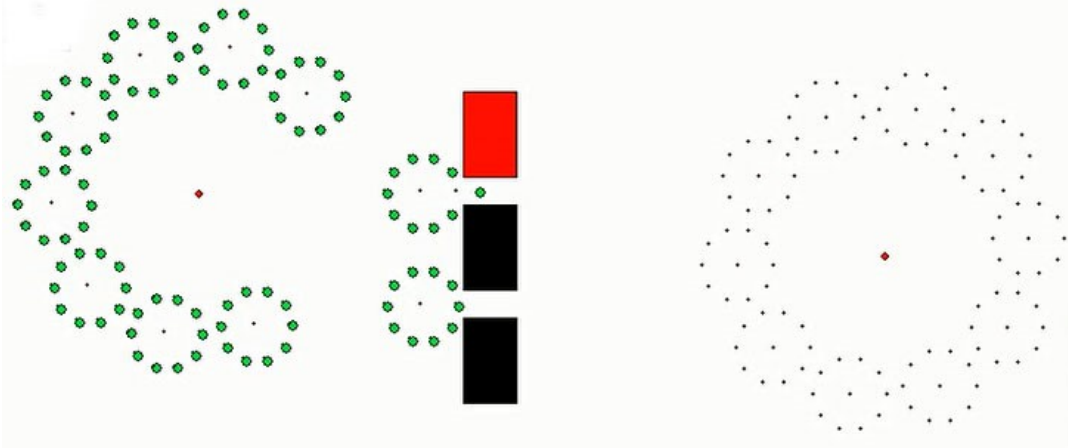

Figure 0-57: Experiment #5.1, the fifth obstacle with 100 robots before passing any robot

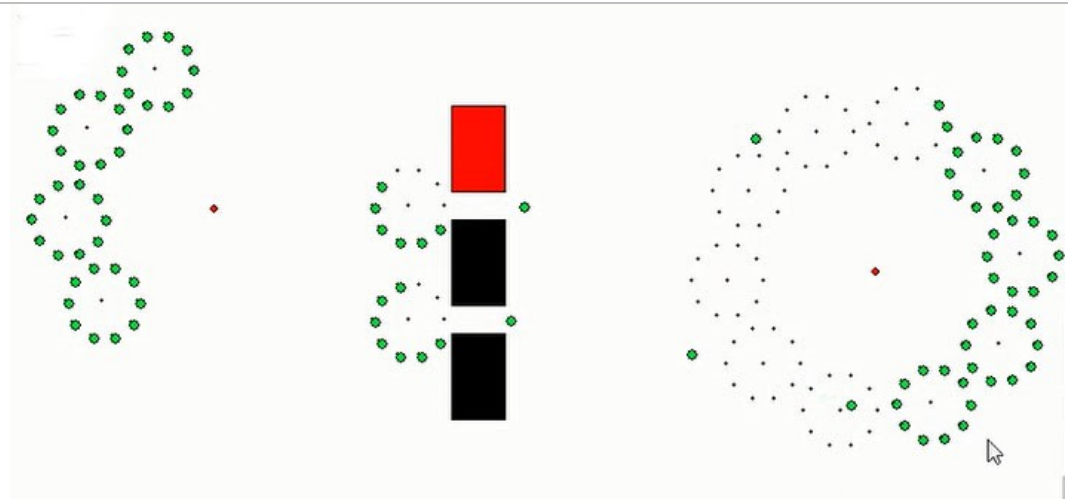

Figure 4-58: Experiment #5.1, the fifth obstacle with 100 robots after passing some robots

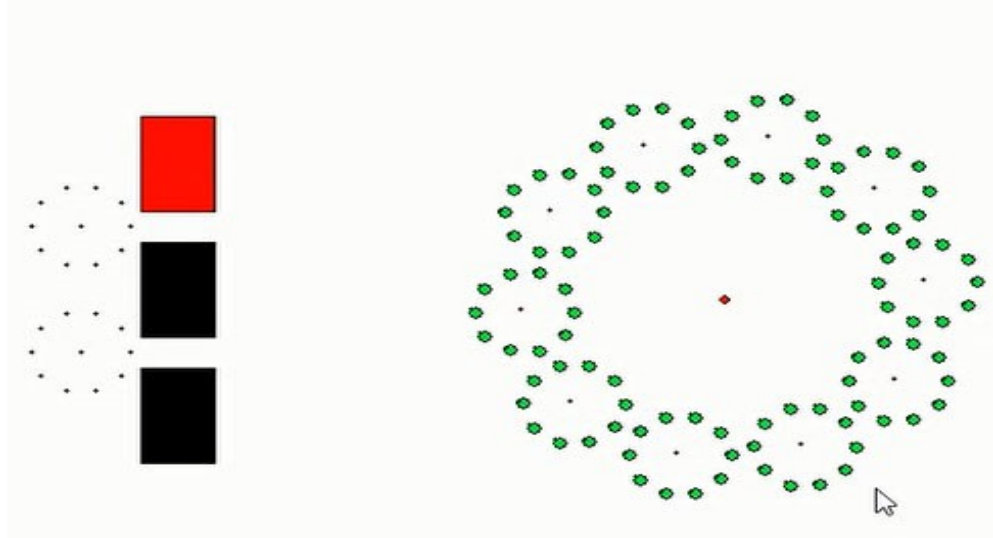

Figure 4-59: Experiment #5.1, the fifth obstacle with 100 robots after passing all robots



#### 4.3.5.2 Experiment 5.2: Fifth obstacle using 50 robots

There are 10 group sets in the circular formation and every group set has 5 robots on it. The swarm movement and obstacle avoidance are shown in Figures 4.60, 4.61 and 4.62.

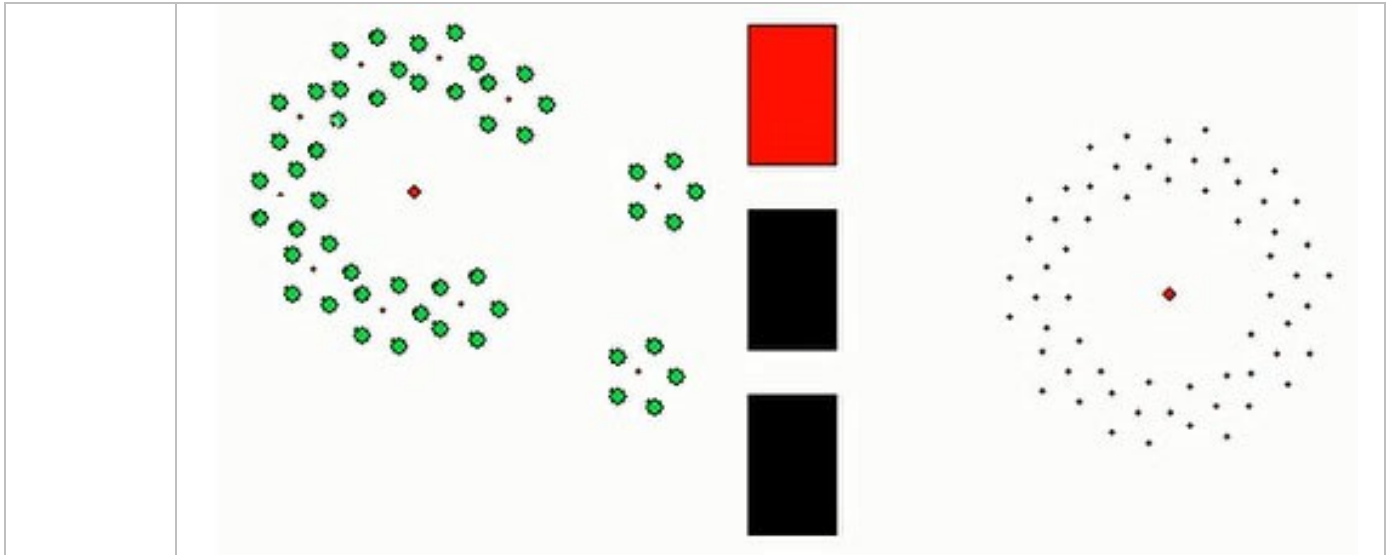

Figure 0-60: Experiment #5.2, the fifth obstacle with 50 robots before passing any robot

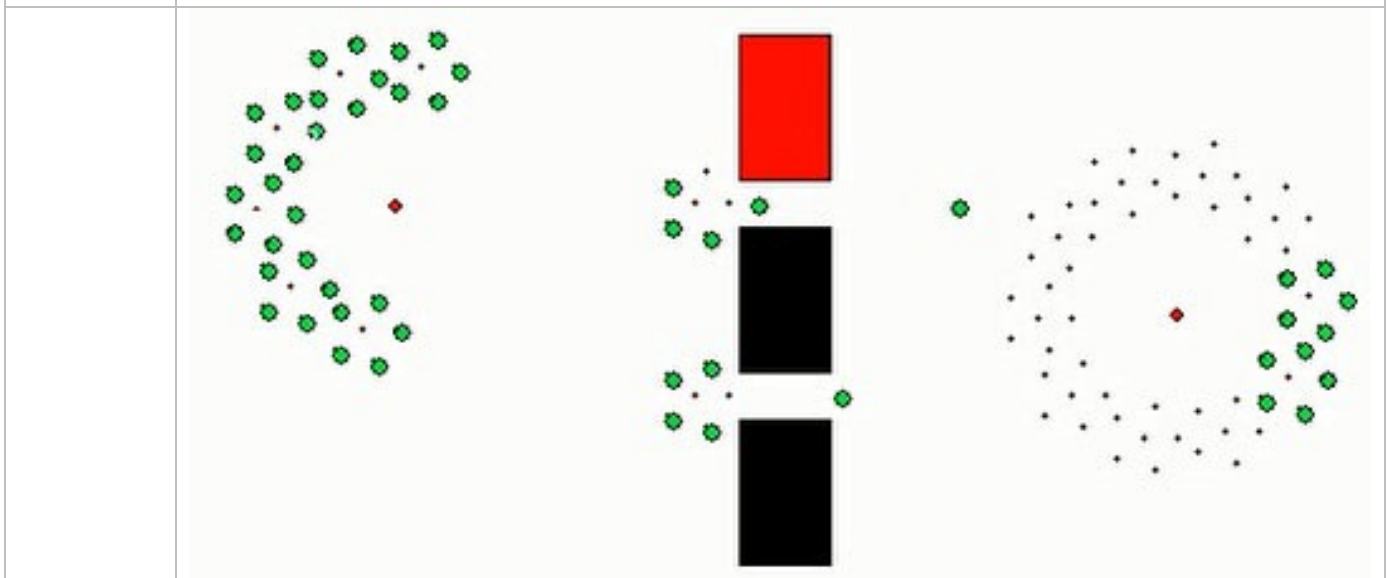
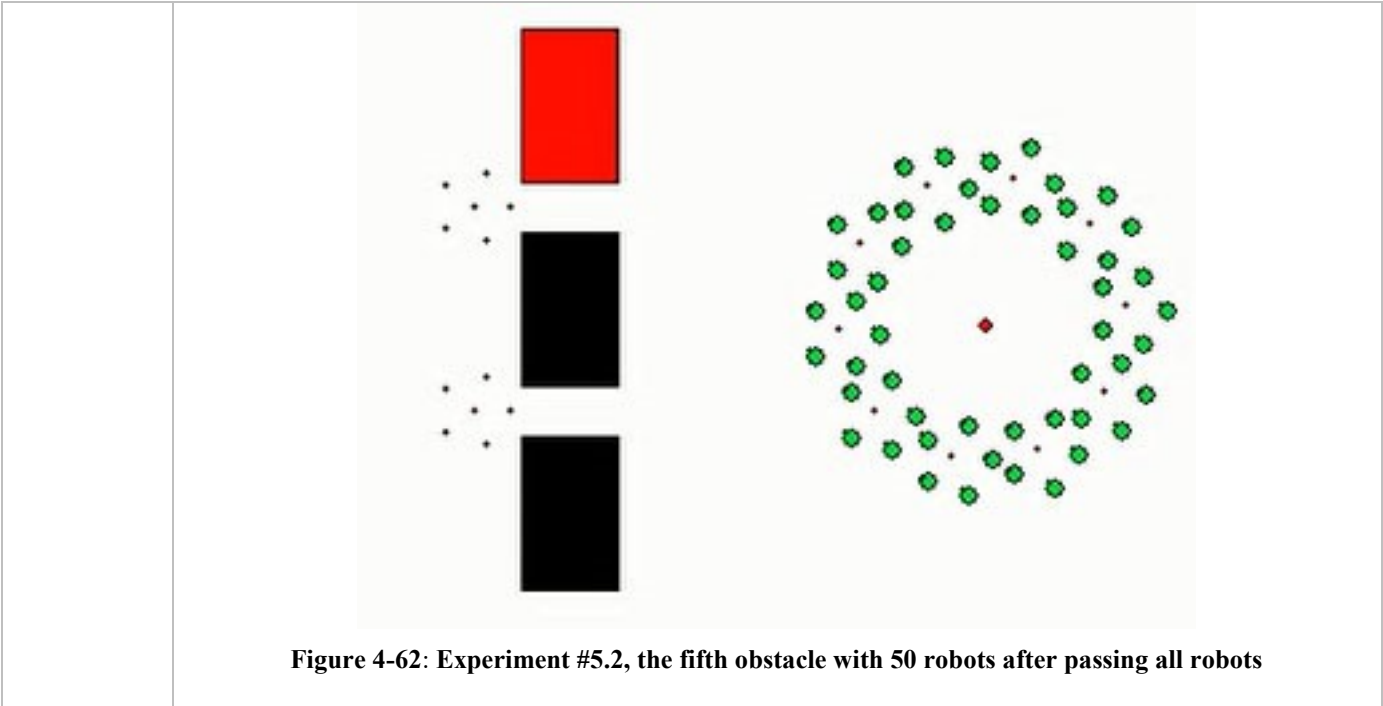
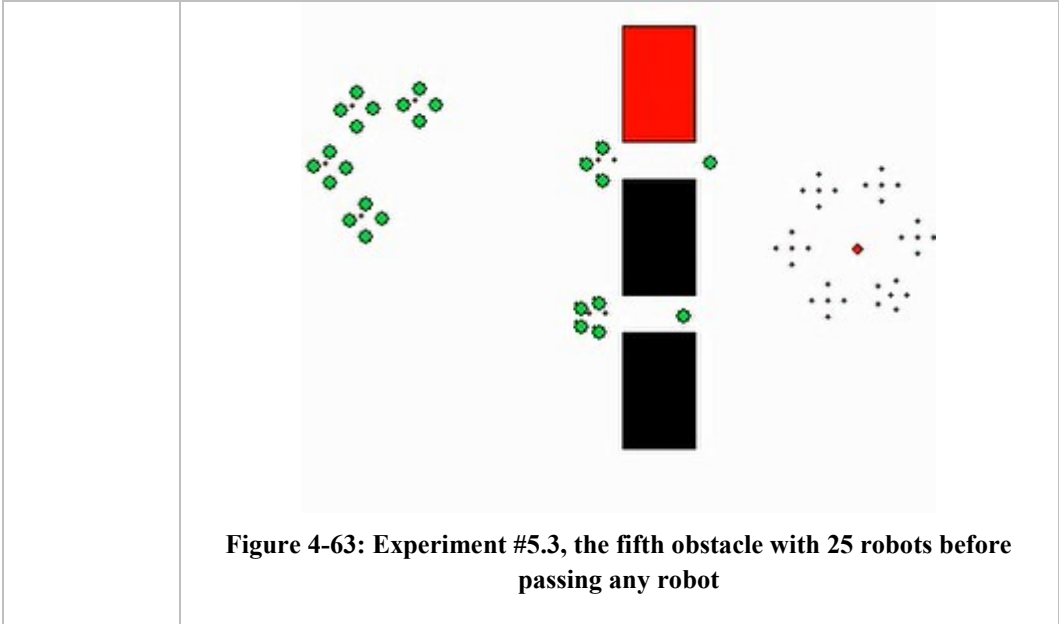

Figure 0-61: Experiment #5.2, the fifth obstacle with 50 robots after passing some robots



**4.3.5.3 Experiment 5.3: Fifth obstacle using 25 robots**

There are 6 group sets in the circular formation, 5 group sets have 4 robots and the last one has 5 robots. The swarm movement and obstacle avoidance are shown in Figures 4.63, 4.64 and 4.65.



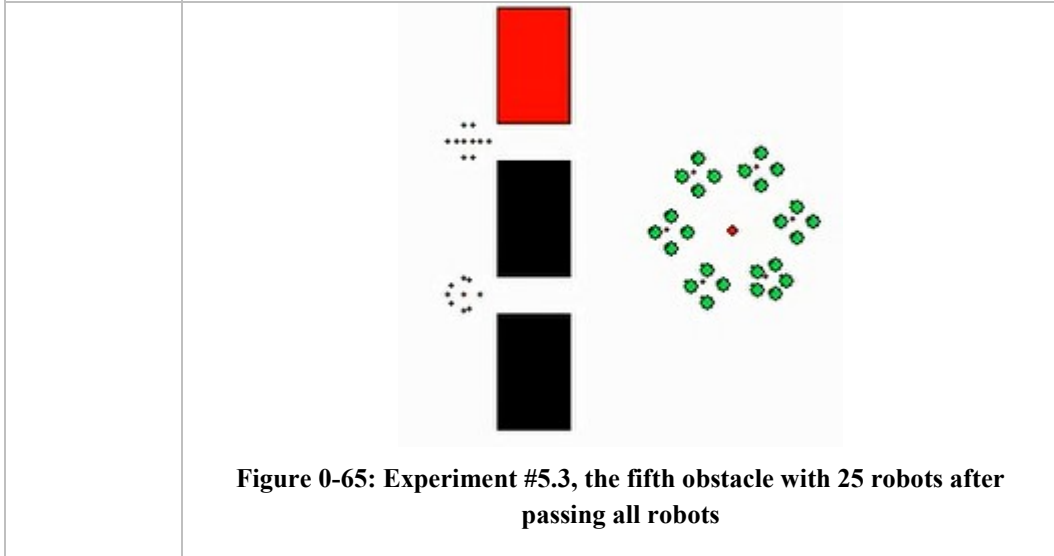
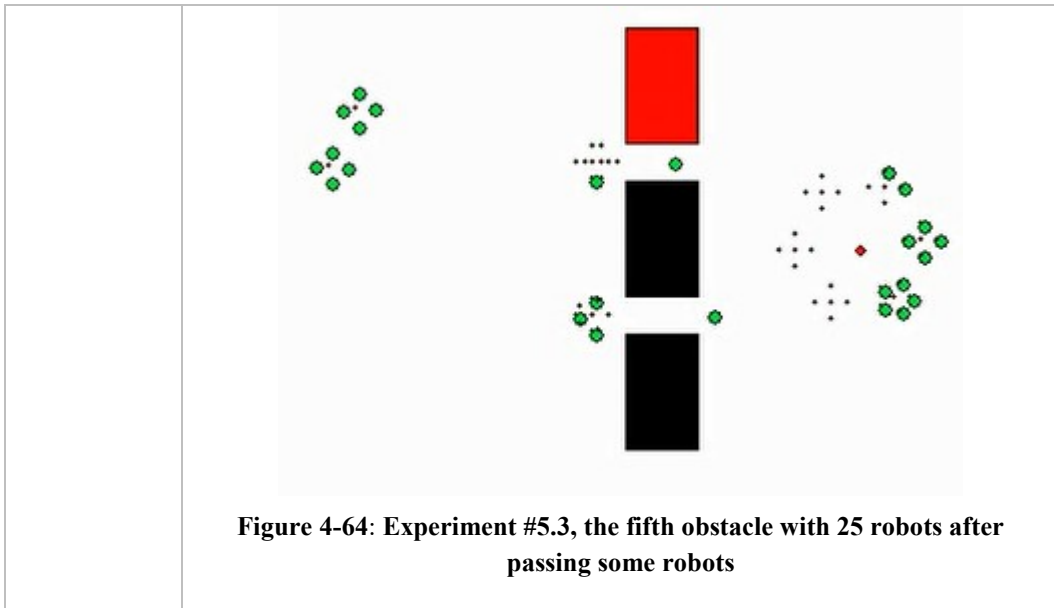

#### 4.3.5.4 Experiment 5.4: Fifth obstacle using 16 robots

There are 4 group sets in the circular formation with 4 robots on every one. The swarm movement and obstacle avoidance are shown in Figures 4.66, 4.67 and 4.68.

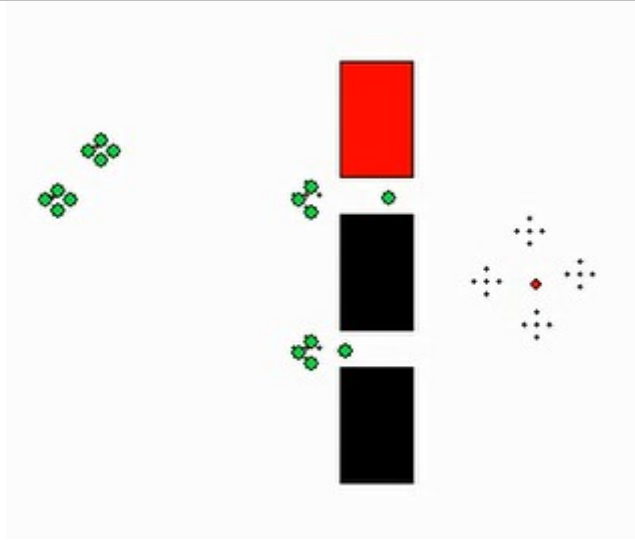

Figure 4-66: Experiment #5.4, the fifth obstacle with 16 robots before passing any robot

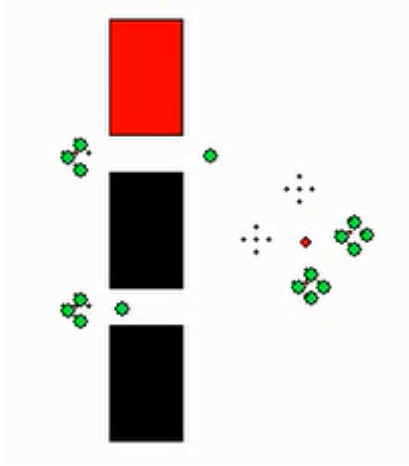

Figure 4-67: Experiment #5.4, the fifth obstacle with 16 robots after passing some robots

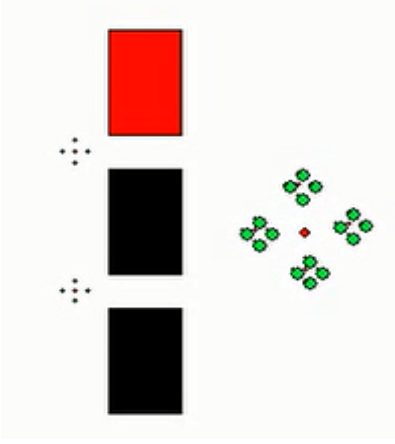

Figure 4-68: Experiment #5.4, the fifth obstacle with 16 robots after passing all robots

## 4.4 Results Discussion and Evaluation

Under this section we have two subsections, the first is a comparison between the circular formation algorithm and the flocking algorithm presented in [11] and the second is a discussion.

### 4.4.1 Comparative Study

We compare the results obtained by our proposed algorithm with the flocking algorithm presented in [5] based on the following points:

1. Initial organization (pre obstacle organization)
2. Movement
3. Obstacles avoidance
4. Post obstacle reorganization
5. Advantages
6. Drawbacks
7. The difference

#### 4.4.1.1 Initial Organization

The difference between the circular formation algorithm and the flocking algorithm concerning with the initial organization is shown in Table 4.3.

**Table 4-3: Initial organization comparison**

Circular formation algorithm	Flocking algorithm
<ol style="list-style-type: none"> <li>1. At first it distributes the robots randomly.</li> <li>2. Uses a Heuristic way to organize the robots in a circular formation as explained in chapter 3.</li> </ol>	<ol style="list-style-type: none"> <li>1. At first it distributes the robots randomly.</li> <li>2. Uses a “local active interaction” algorithm to organize the robots by making triangular formation as explained in chapter 2.</li> </ol>

#### 4.4.1.2 Movement

The difference between the circular formation algorithm and the flocking algorithm concerning with movement is shown in Table 4.4.

**Table 4-4 : Movement comparison**

Circular formation algorithm	Flocking algorithm
After organizing the robots in a circular formation, the swarm robotics start moving	After organizing the swarm robotics in triangular network, the robots start moving forward in the same

forward for all robots in the swarm robotics in the same speed and the same sequence as shown in Figure 4.69.

speed and the same sequence as shown in Figure 4.70.

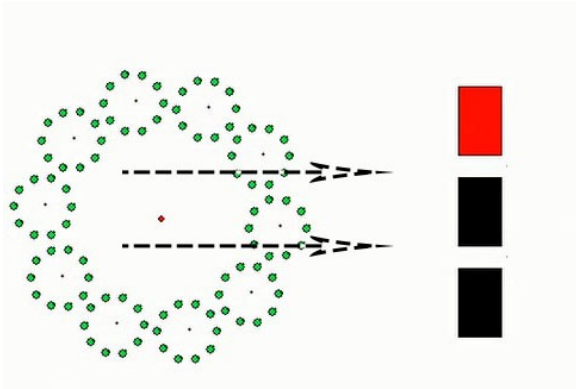

Figure 4-69: Forward moving for swarm robotic in circular formation

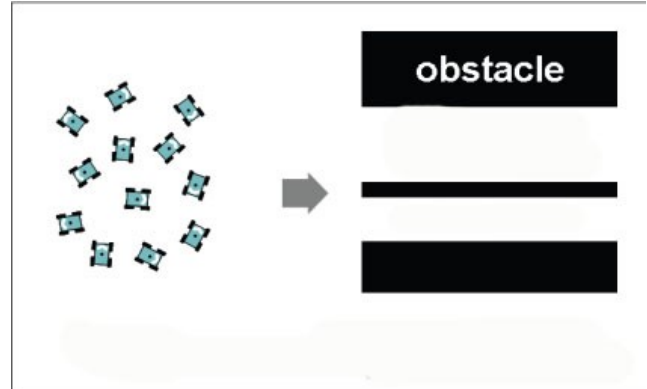

Figure 4-70: Illustrate forward moving for flocking algorithm

#### 4.4.1.3 Obstacles Avoidance

The difference between the circular formation algorithm and the flocking algorithm regarding obstacles avoidance is shown in Table 4.5.

Table 4-5 : Obstacle avoidance comparison

Circular formation algorithm	Flocking algorithm
<p>In this algorithm, we should define the obstacles and the points of the path that the robots will move through as an obstacle, if the obstacles allow the group set of the swarm robotics to pass through, then the group set will separate from the swarm robotics to avoid the obstacles alone. if the obstacles allow just one robot pass through it then the group set will again split into just one robot to move through the obstacles as shown in Figure 4.71</p>	<p>In this algorithm, the obstacles should be defined then an adaptation for robots in swarm robotics is going to be split into multiple smaller swarms to let every new swarm to move through the obstacles as shown in Figure 4.72</p>

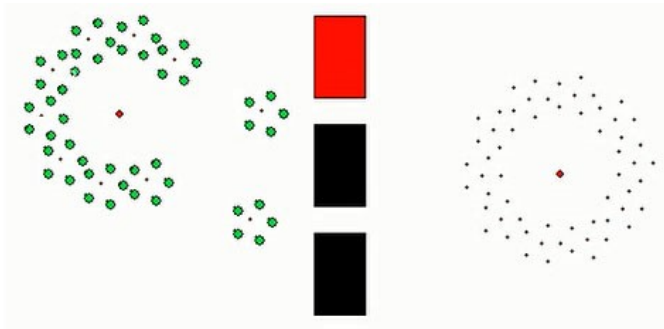

Figure 4-71: Avoid Obstacles circular formation

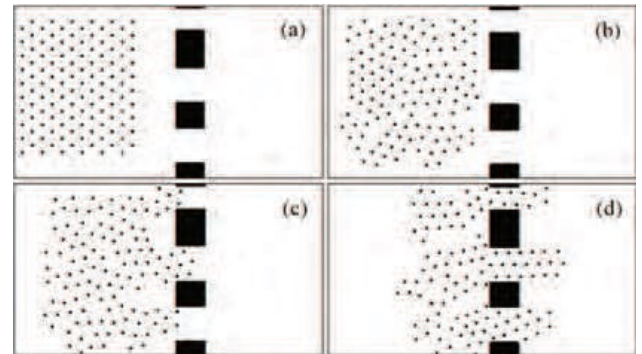

Figure 4-72: Avoid Obstacles flocking algorithm

#### 4.4.1.4 Post Obstacle Organization

The difference between the circular formation algorithm and the flocking algorithm concerning with the post obstacle organization is shown in Table 4.6.

Table 4-6 : Post organization comparison

Circular formation algorithm	Flocking algorithm
<p>After avoiding the obstacles a center of the circular formation is created to be adjacent to the center of obstacles far away from the obstacles as a diameter of the circular formation and a half, to let the robots organized in a new circular formation without calculating the new position, because every robot will move to its previous known position as shown in Figure 4.73</p>	<p>After avoiding the obstacles, the swarms will merge in a single swarm by calculating the distance between the nearest robots from every swarm by using sensing boundary between robots and calculating the smallest distance between other robots. In this step it will repeat the local interaction algorithm to recalculate the distances and to make a new triangular network as shown in Figure 4.74.</p>

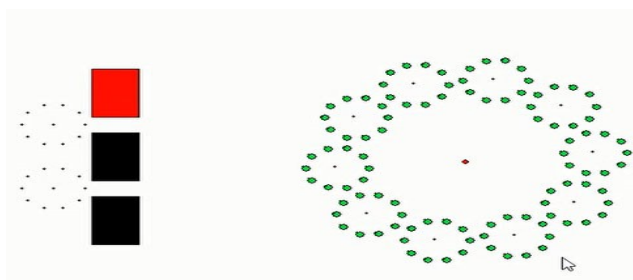

Figure 4-73: Organize robots in circular formation after avoid obstacles

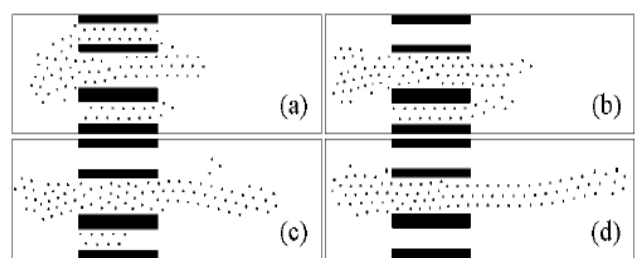

Figure 4-74: Organize robots after avoid obstacles flocking algorithm

#### 4.4.1.5 Advantages

The advantages of the circular formation algorithm and the flocking algorithm are shown in Table 4.7

**Table 4-7 : Advantages comparison**

Circular formation algorithm	Flocking algorithm
<p>In circular formation algorithm we have group sets that can split from the swarm and works individually to perform multiple tasks and return back to the circular formation, and when facing the obstacles such groups can adapt with the obstacle gap and passes through it according to the size of the obstacle gap. Upon completion of the transit, these groups maintain their organization by forming the circular formation and going straight forward.</p>	<p>The flocking algorithm can adapt to the obstacle by dividing the flock to small swarms that could pass through the obstacle, and return to regulate itself after coming out of the obstacle.</p>

#### 4.4.1.6 Drawbacks

The drawbacks of the circular formation algorithm and the flocking algorithm is shown in Table 4.8.

**Table 4-8: Drawbacks comparison**

Circular formation algorithm	Flocking algorithm
<ol style="list-style-type: none"> <li>1. The initial organization of the swarm takes a considerable time.</li> <li>2. Determining the points to define the swarm path through the obstacle takes a considerable time.</li> </ol>	<ol style="list-style-type: none"> <li>1. The initial organization of the swarm takes a considerable time.</li> <li>2. Also pre obstacle swarm splitting takes a considerable time.</li> <li>3. Post obstacle splitting takes a considerable time.</li> <li>4. High processing is needed to maintain the network of triangles in the transit called “Adapting” during the crossing.</li> <li>5. Post obstacle formed triangles may contain different robots that were in the same triangle form, which means inconsistency if every robot of a triangle of robots have different duty.</li> </ol>



#### **4.4.2 Discussion**

The circular formation performs the process of organizing the swarm only once, and does not need to repeat the process and computations related to it. While the flocking algorithm repeats the processes of forming and reorganizing the swarm so it needs more computations.

Regarding the obstacle crossing, the circular formation is characterized by the possibility of separation for each group where it can move independently to the obstacle so it does not require complex computational operations, but the flocking algorithm performs full adaptation for the swarm and thus it needs computations for each robot.

In circular formation, the swarm reorganization (post obstacle organization) does not need computations after crossing the obstacle where its groups automatically organized and identified. The only change will be the coordinates for the relocation of these groups. Unlike the flocking algorithm that is forced to fully reorganize the swarm after crossing the obstacle.

The possibility of separating the group sets from the swarm enables the circular formation to implement small tasks efficiently while maintaining the rest of the swarm away from danger. Also it's more efficient in searching tasks to find foods or even wounded people. The flocking algorithm could implement tasks that need a large number of robots working at the same time and tasks related to water environment due to the nature of the swarm which simulates the fish swarm, but the flocking algorithm uses the whole swarm to accomplish the tasks, putting the entire swarm at risk when dealing with dangerous environment.

## Chapter 5: Conclusion and Future Work

### 5.1 Conclusion:

Our study focused on designing and developing an algorithm that guides and controls the swarm robotics motion including obstacle avoidance based on circular formation to allow robots to move, organize and reorganize themselves in a systematic way and to reduce the reorganizing time after avoiding the obstacles. The swarm of robots contains a group sets that might face any of five defined different obstacles.

A simulation process has been performed for the algorithm of circular formation to show the behavior of the swarm robots during motion and obstacle avoidance.

The algorithm deals with a minimum of four robots to consider them as a swarm, if the number is less than four, the proposed algorithm does not work as is and a certain amendment is needed. If the number of robots exceeds 100, a new additional circular formation will be formed.

Twenty experiments have been conducted with five different types of obstacles. Each type of obstacles has four experiments with 100, 50, 25 and 16 robots. These numbers cover the majority of the possibilities for the robots distribution in the circular formation.

The behavior of the swarm forming the circular formation is considered from gathering the robots from their random distribution to the circular formation and moving towards the obstacles; and passing them. Based on the nature and the shape of the obstacle, one robot might pass at a time, two robots might pass at a time, a group set might pass at a time, or could be any number of robots less than a group set.

The obtained results have been generally compared with flocking algorithm. With circular formation movement of a swarm of robots using a circular configuration is better in terms of movement and organization. Regarding the obstacle crossing, the circular formation is characterized by the possibility of separation for each group where it can move independently to the obstacle so it does not require complex computational operations, but the flocking algorithm performs full adaptation for the swarm and thus it needs computations for each robot. One more advantage for circular formation over flocking algorithm is that each robot before passing the obstacle will be in the same group

after passing the obstacle. This will be good for two reasons; the first one is what we can call group harmony and the second one is the robot specific duty within the group.

## **5.2 Future Work:**

Some of the future directions are 1) simulate the circular formation algorithm in 3-D environment. 2) Consider more types of obstacles 3) considering various jobs for each group set. 4) Considering different job for each robot. 5) Considering different sizes and capabilities of the robots in the swarm.6) considering various jobs for swarm robotics in space.

## References

1. Bayindir, L. and E. Sahin, *A review of studies in swarm robotics*. Turkish Journal of Electrical Engineering, 2007. **15**(2): p. 115-147.
2. Cao, Y. and W. Ren, *Distributed coordinated tracking with reduced interaction via a variable structure approach*. Automatic Control, IEEE Transactions on, 2012. **57**(1): p. 33-48.
3. Çelikkanat, H. and E. Şahin, *Steering self-organized robot flocks through externally guided individuals*. Neural Computing and Applications, 2010. **19**(6): p. 849-865.
4. Cheng, K., Y. Wang, and P. Dasgupta. *Distributed area coverage using robot flocks*. in *Nature & Biologically Inspired Computing, 2009. NaBIC 2009. World Congress on*. 2009. IEEE.
5. Défago, X. and A. Konagaya. *Circle formation for oblivious anonymous mobile robots with no common sense of orientation*. in *Proceedings of the second ACM international workshop on Principles of mobile computing*. 2002. ACM.
6. Ducatelle, F., et al. *Communication assisted navigation in robotic swarms: self-organization and cooperation*. in *Intelligent Robots and Systems (IROS), 2011 IEEE/RSJ International Conference on*. 2011. IEEE.
7. Folino, G. and G. Spezzano, *An adaptive flocking algorithm for spatial clustering*, in *Parallel Problem Solving from Nature—PPSN VII*. 2002, Springer. p. 924-933.
8. Freitas, R.A., *Current status of nanomedicine and medical nanorobotics*. Journal of Computational and Theoretical Nanoscience, 2005. **2**(1): p. 1-25.
9. Geunho, L. and N.Y. Chong, *Adaptive flocking of robot swarms: Algorithms and properties*. IEICE transactions on Communications, 2008. **91**(9): p. 2848-2855.
10. Guo, H., Y. Meng, and Y. Jin. *Analysis of local communication load in shape formation of a distributed morphogenetic swarm robotic system*. in *Evolutionary Computation (CEC), 2010 IEEE Congress on*. 2010. IEEE.
11. Hanada, Y., G. Lee, and N.Y. Chong. *Adaptive flocking of a swarm of robots based on local interactions*. in *Swarm Intelligence Symposium, 2007. SIS 2007. IEEE*. 2007. IEEE.
12. Hayes, A.T. and P. Dormiani-Tabatabaei. *Self-organized flocking with agent failure: Off-line optimization and demonstration with real robots*. in *Robotics and Automation, 2002. Proceedings. ICRA'02. IEEE International Conference on*. 2002. IEEE.
13. Hereford, J. and C. Blum. *FlockOpt: A new swarm optimization algorithm based on collective behavior of starling birds*. in *Nature and Biologically Inspired Computing (NaBIC), 2011 Third World Congress on*. 2011. IEEE.
14. La, H.M. and W. Sheng. *Adaptive flocking control for dynamic target tracking in mobile sensor networks*. in *Intelligent Robots and Systems, 2009. IROS 2009. IEEE/RSJ International Conference on*. 2009. IEEE.
15. Lee, G. and N.Y. Chong, *Flocking controls for swarms of mobile robots inspired by fish schools*. 2008: INTECH Open Access Publisher.
16. Lehr, H., et al. *Microactuators as driving units for microbotic systems*. in *Photonics East'96*. 1996. International Society for Optics and Photonics.
17. Lionis, G. and K.J. Kyriakopoulos. *Decentralized lattice formation control for micro robotic swarms*. in *Intelligent Robots and Systems, 2009. IROS 2009. IEEE/RSJ International Conference on*. 2009. IEEE.
18. McLurkin, J., *The ants: a community of microrobots*. Massachusetts Institute of Technology. Bachelor's Thesis, 1995.
19. Meng, Y. and J. Gan. *Self-adaptive distributed multi-task allocation in a multi-robot system*. in *Evolutionary Computation, 2008. CEC 2008. (IEEE World Congress on Computational Intelligence). IEEE Congress on*. 2008. IEEE.

20. Nouyan, S. and M. Dorigo, *Chain formation in a swarm of robots*. IRIDIA, Université Libre de Bruxelles, Tech. Rep. TR/IRIDIA/2004-18, 2004.
21. Reynolds, C.W. *Flocks, herds and schools: A distributed behavioral model*. in *ACM Siggraph Computer Graphics*. 1987. ACM.
22. Rubenstein, M., C. Ahler, and R. Nagpal. *Kilobot: A low cost scalable robot system for collective behaviors*. in *Robotics and Automation (ICRA), 2012 IEEE International Conference on*. 2012. IEEE.
23. Scanniello, G. and U. Erra. *Software entities as bird flocks and fish schools*. in *Software Visualization (VISSOFT), 2013 First IEEE Working Conference on*. 2013. IEEE.
24. Stormont, D.P. and A. Kutiyanawala. *Localization using triangulation in swarms of autonomous rescue robots*. in *Safety, Security and Rescue Robotics, 2007. SSRR 2007. IEEE International Workshop on*. 2007. IEEE.
25. Turgut, A.E., et al., *Self-organized flocking in mobile robot swarms*. *Swarm Intelligence*, 2008. **2**(2-4): p. 97-120.
26. Watson, D.F., *Computing the n-dimensional Delaunay tessellation with application to Voronoi polytopes*. *The computer journal*, 1981. **24**(2): p. 167-172.
27. Xiang, L., Z. Yi, and Y.F. Fung. *Algorithm for swarm robot flocking behavior*. in *2009 4th International Conference on Autonomous Robots and Agents*. 2009.
28. Yun, X., G. Alptekin, and O. Albayrak, *Line and circle formation of distributed physical mobile robots*. 1997.
29. Zhang, B. and S. Gao. *The study of ZigBee technology's application in swarm robotics system*. in *Artificial Intelligence, Management Science and Electronic Commerce (AIMSEC), 2011 2nd International Conference on*. 2011. IEEE.