



2007

DESIGN AIDS FOR AIR VESSELS FOR TRANSIENT PROTECTION OF LARGE PIPE NETWORKS - A FRAMEWORK BASED ON PARAMETERIZATION OF KNOWLEDGE- BASE DERIVED FROM OPTIMIZED NETWORK MODELS

Dhandayudhapani Ramalingam
University of Kentucky, drama0@engr.uky.edu

Recommended Citation

Ramalingam, Dhandayudhapani, "DESIGN AIDS FOR AIR VESSELS FOR TRANSIENT PROTECTION OF LARGE PIPE NETWORKS - A FRAMEWORK BASED ON PARAMETERIZATION OF KNOWLEDGE-BASE DERIVED FROM OPTIMIZED NETWORK MODELS" (2007). *University of Kentucky Doctoral Dissertations*. 489.
http://uknowledge.uky.edu/gradschool_diss/489

ABSTRACT OF DISSERTATION

Dhandayudhapani Ramalingam

The Graduate School
University of Kentucky

2007

DESIGN AIDS FOR AIR VESSELS FOR TRANSIENT PROTECTION
OF LARGE PIPE NETWORKS - A FRAMEWORK BASED ON
PARAMETERIZATION OF KNOWLEDGE-BASE DERIVED FROM OPTIMIZED
NETWORK MODELS

ABSTRACT OF DISSERTATION

A dissertation submitted in partial fulfillment of the requirements
for the degree of Doctor of Philosophy in College of Engineering at the
University of Kentucky

By

Dhandayudhapani Ramalingam

Lexington, Kentucky

Director: Dr. Srinivasa Lingireddy, Associate Professor of Civil Engineering

Lexington, Kentucky

2007

Copyright © Dhandayudhapani Ramalingam 2007

ABSTRACT OF DISSERTATION

DESIGN AIDS FOR AIR VESSELS FOR TRANSIENT PROTECTION OF LARGE PIPE NETWORKS - A FRAMEWORK BASED ON PARAMETERIZATION OF KNOWLEDGE-BASE DERIVED FROM OPTIMIZED NETWORK MODELS

The need for optimal air vessel sizing tools, in protecting large pipe networks from undue transient pressures is well known. Graphical and other heuristic methods reported in literature are limited to sizing the air vessels for simple rising mains. Although attempts have been made to utilize optimization techniques, they have been largely unsuccessful due to their impractical computational requirements. This research work proposes a robust framework for developing surge protection design tools and demonstrates the usefulness of the framework through an example air vessel sizing tool. Efficiency and robustness of the proposed framework are demonstrated by developing a design aid for air vessel sizing for protecting large pipe network systems against excessive high pressures generated by rapid valve closures. The essence of the proposed framework is in identification of key transient response parameters influencing air vessel parameters from seemingly unmanageable transient response data. This parameterization helps in exploiting the similarity between transient responses of small pipe networks and

sub-sections of large pipe networks. The framework employs an extensive knowledge-base of transient pressure and flow scenarios defined from several small network models and corresponding optimal air vessel sizes obtained from a genetic algorithm optimizer. A regression model based on an artificial neural network was used on this knowledge-base to identify key parameters influencing air vessel sizes. These key parameters were used as input variables and the corresponding air vessel parameters as output variables to train the neural network model. The trained neural network model was successfully applied for large complex pipe networks to obtain optimal air vessel sizes for transient protection. The neural network model predictions were compared with optimal air vessel parameters to assess the efficacy of the proposed framework. The validity and limitation of the design aid developed and areas in the framework that need further research are also presented.

The proposed frame work requires generation of hundreds of optimization data for small and simple network systems which is a daunting task since genetic algorithm-based optimization is computationally expensive. Selection of a numerically efficient and sufficiently accurate transient analysis method for use inside a genetic algorithm based optimization scheme is crucial as any reduction in transient analysis time for a network system would tremendously reduce the computational costs of bi-level genetic algorithm optimization scheme. This research work also demonstrate that the ‘Wave Plan Method’ is computationally more efficient than the ‘Method of Characteristics’ for similar accuracies and the resulting savings in computational costs in the transient analysis of

pipe networks and subsequently in the genetic algorithm based optimization schemes are significant.

KEY WORDS: Hydraulic Transients, Wave Plan Method, Air Vessels, Optimization, Pipe Networks

Dhandayudhapani Ramalingam

January 29, 2007

DESIGN AIDS FOR AIR VESSELS FOR TRANSIENT PROTECTION
OF LARGE PIPE NETWORKS - A FRAMEWORK BASED ON
PARAMETERIZATION OF KNOWLEDGE-BASE DERIVED FROM OPTIMIZED
NETWORK MODELS

By

Dhandayudhapani Ramalingam

Dr. Srinivasa Lingireddy
Director of Dissertation

Dr. Kamyar C. Mahboub
Director of Graduate Studies

Date: January 29, 2007

RULES FOR THE USE OF DISSERTATIONS

Unpublished dissertations submitted for the Doctor's degree and deposited in the University of Kentucky Library are as a rule open for inspection, but are to be used only with regard to the rights of the authors. Bibliographical references may be noted, but quotations or summaries of parts may be published only with the permission of the author, and with the usual scholarly acknowledgements.

Extensive copying or publication of the dissertation in whole or in part also requires the consent of the Dean of the Graduate School of the University of Kentucky.

A library that borrows this dissertation for use by its patrons is expected to secure the signature of each user.

Name

Date

DISSERTATION

Dhandayudhapani Ramalingam

The Graduate School

University of Kentucky

2007

DESIGN AIDS FOR AIR VESSELS FOR TRANSIENT PROTECTION
OF LARGE PIPE NETWORKS - A FRAMEWORK BASED ON
PARAMETERIZATION OF KNOWLEDGE-BASE DERIVED FROM OPTIMIZED
NETWORK MODELS

DISSERTATION

A dissertation submitted in partial fulfillment of the requirements
for the degree of Doctor of Philosophy in College of Engineering at the
University of Kentucky

By

Dhandayudhapani Ramalingam

Lexington, Kentucky

Director: Dr. Srinivasa Lingireddy, Associate Professor of Civil Engineering

Lexington, Kentucky

2007

Copyright © Dhandayudhapani Ramalingam 2007

DEDICATION

I dedicate this dissertation work to my ever loving parents.

ACKNOWLEDGMENTS

The following dissertation, while an individual work, benefited from the insights and direction of several people. The author feels an enormous debt of respectful gratitude to his major advisor, Dr. Srinivasa Lingireddy, for his valuable and thoughtful guidance, keen interest, patience and tremendous encouragement throughout the course of this research effort. In particular the author is deeply thankful to Dr. Srinivasa Lingireddy for his guidance and help as a wonderful human being. Author is grateful to Dr. Don Wood for the support and encouragement extended in this research pursuit. The author is grateful to Dr. Srinivasa Lingireddy and Department of Civil Engineering for the financial support extended throughout this research effort. Author sincerely thanks the Director of Graduate Studies, Dr. Kamyar Mahboub for the support extended throughout the study. Author deeply thanks the other committee members for the critical insights, direction and encouragement offered throughout this research study.

Author is deeply grateful to three visiting research scholars at University of Kentucky, Dr. Neelakantan Thurvas, Dr. Chandramouli Viswanathan and Dr. Ramesh Teegavarappu for their help and encouragement. Author deeply thanks the support of his fellow students, all his friends and staff of the Department of Civil Engineering Office and Software Center, University of Kentucky. Author deeply appreciates the affection and support he enjoyed from his parents and siblings during this research study.

TABLE OF CONTENTS

Acknowledgments.....	iii
List of Tables.....	vi
List of Figures.....	vii
List of Files.....	viii
CHAPTER 1:INTRODUCTION.....	1
1.1. TRANSIENT ANALYSIS OF LARGE PIPE NETWORKS	1
1.2. AIR VESSELS FOR TRANSIENT PROTECTION OF LARGE PIPE NETWORKS	3
1.3. BASIC EQUATIONS - TRANSIENT ANALYSIS AND AIR VESSELS	6
1.4. LITERATURE REVIEW - DESIGN AIDS FOR AIR VESSELS	9
1.5. STATE OF THE ART AND RESEARCH NEEDS.....	16
1.6. RESEARCH OBJECTIVE	18
1.7. DISSERTATION ORGANIZATION.....	18
CHAPTER 2:DESIGN AIDS FOR AIR VESSELS FOR LARGE PIPE NETWORKS.....	20
2.1. INTRODUCTION	20
2.2. FRAMEWORK FOR DESIGN TOOLS	22
2.3. GA, ANN AND TRANSIENT SIMULATION PROGRAM.....	25
2.4. AIR VESSELS.....	26
2.5. KNOWLEDGEBASE.....	28
2.6. INPUT VARIABLES FOR ANN MODEL.....	30
2.7. ANN MODEL	32
2.8. APPLICATION OF TRAINED ANN MODEL.....	34
2.9. RESULTS AND DISCUSSION.....	39
2.10. UNCERTAINTIES AND SCOPE FOR FURTHER RESEARCH.....	41
2.11. SUMMARY AND CONCLUSIONS.....	43
CHAPTER 3:NUMERICAL COMPARISON OF WAVE PLAN METHOD AND METHOD OF CHARACTERISTICS.....	59
3.1 INTRODUCTION	59
3.2 OVERVIEW OF MOC AND WPM	62
3.2.1 METHOD OF CHARACTERISTICS (MOC).....	63
3.2.2 WAVE PLAN METHOD (WPM).....	64
3.3 DIMENSIONLESS NUMBERS AND SYSTEM TIME CONSTANTS.....	64
3.4 OBJECTIVES OF PRESENT STUDY	66
3.5 NUMERICAL EXPERIMENT.....	67
3.6 EFFECT OF STEADY STATE LINE FRICTION ON MODELING ACCURACIES	68
3.7 EFFECT OF EXCITER BEHAVIOR ON MODELING ACCURACIES	69

3.8	COMPUTATIONAL EFFICIENCY	69
3.8.1	WAVE PLAN METHOD.....	70
3.8.2	MOC FIRST ORDER	71
3.8.3	MOC SECOND ORDER	71
3.9	RESULTS AND DISCUSSION.....	71
3.10	ANALYSIS OF LARGE PIPE NETWORKS.....	74
3.10.1	SELECTION OF TIME INCREMENT	74
3.10.2	CONSTRAINT ON Δt BASED ON COURANT STABILITY CRITERIA	75
3.10.3	EXAMPLE APPLICATION.....	75
3.11	SUMMARY AND CONCLUSIONS.....	78
CHAPTER 4: COMPUTATIONAL TOOLS AND METHODOLOGY.....		91
4.1	INTRODUCTION	91
4.2	TRANSIENT SIMULATION PROGRAM.....	91
4.3	AIR VESSEL PARAMETER OPTIMIZATION MODULE	92
4.4	ANN MODEL DEVELOPMENT	93
CHAPTER 5: CONCLUSIONS AND DISCUSSION		96
APPENDIX.....		102
REFERENCES.....		104
VITA.....		113

LIST OF TABLES

Table 2.1 Key Parameters.....	45
Table 3.1 Hydraulic parameters and steady state results.....	79
Table 3.2 Summary of pulse magnitude analysis.....	80
Table 3.3 Number of segments and computational effort required for percentage error less than 2%	81
Table 3.4 Computational effort of MOC.....	82

LIST OF FIGURES

Figure 1.1 Example schematic of an air vessel.....	4
Figure 1.2 Wave actions at an air vessel (Wood and Funk 1996)	7
Figure 1.3 Schematic representation of a rising main with an air vessel.....	10
Figure 2.1 Network models used for knowledge-base development.....	46
Figure 2.2 Distribution of air vessel parameters.....	47
Figure 2.3 Actual and predicted value plots for ANN training.....	48
Figure 2.4 Actual and predicted value plots for ANN testing	49
Figure 2.5 Schematic of network model used for Case Study I.....	50
Figure 2.6 ANN predicted air vessel parameters vs. GA optimizer values	51
Figure 2.7 Schematic of network model used for Case Study II	52
Figure 2.8 Case Study II - Transient pressure heads at air vessel, node 6 and node 17 ...	53
Figure 2.9 Case Study II - Sensitivity of transient heads to outflow resistance	54
Figure 2.10 Case Study II - Sensitivity of transient heads to initial gas volume.....	55
Figure 2.11 Schematic of Network Model used for Case Study III.....	56
Figure 2.12 Case Study III - Transient pressure heads at three different nodes	57
Figure 2.13 Case Study III - Maximum pressure heads at various nodes in the pipe network	58
Figure 3.1 Space-time grid depicting characteristic lines.....	84
Figure 3.2 Wave actions at a friction orifice	84
Figure 3.3 Schematic of the hydraulic system considered for the case study.....	84
Figure 3.4 Percentage error versus number of segments ($L = 6583.7$ m, $R \leq 1.0$)	85
Figure 3.5 Percentage error versus number of segments ($L = 1097.3$ m, $R \leq 1.0$)	86
Figure 3.6 Percentage error versus number of segments ($L = 6583.7$ m, $R \geq 1.0$ and R ≤ 2.0).....	86
Figure 3.7 Percentage error versus frictional evaluative index.....	87
Figure 3.8 Head at the valve for 100 s simulation period.....	88
Figure 3.9 Network Example.....	89
Figure 3.10a. MOC Results	90
Figure 3.10b. WPM Results.....	90
Figure 4.1. Head at the valve	94
Figure 4.2. Flow at the valve	95

LIST OF FILES

1. PaniDiss.pdf

CHAPTER 1: INTRODUCTION

1.1. Transient Analysis of Large Pipe Networks

Hydraulic transients in water distribution systems are abnormal pressure situations caused by abrupt changes in flow rates. These are caused by events like power failure, main breaks, pump start-up and shut-down operations, sudden valve closure, check-valve slam, rapid demand variation, opening and closing of fire hydrants etc. Transient generating events are capable of producing both positive and negative pressure waves which travel at approximately the speed of sound in water. Magnitudes of these pressure waves are many-fold higher or lower than the normal operating pressures. Transients last for very short periods but are highly detrimental to the distribution system. They can potentially result in pipe bursts due to high pressure or pipe collapse due to very low pressure. Historically, much of the transient modeling efforts were directed towards transmission mains and penstocks with little or no attention to complex water distribution networks. Recent studies by the American Water Works Research Foundation (AWRF) indicated the potential for pathogen intrusion in drinking water distribution networks during transient generated low pressure events (LeChevallier et al. 2002 and Wang 2003). Transient modeling has also been directed towards overall optimization of water distribution networks and the associated system components (Zhang 1999, Bong and Karney 2006). Awareness of the importance of transient analysis in optimal design of water distribution systems coupled with the availability of efficient computational tools and the associated computational power has spurred the transient modeling activities in the recent past. Transient modeling of

water distribution systems is expected to grow exponentially once the seriousness of distribution system induced drinking water contamination is realized and the efforts to protect the distribution systems from transient pressures are seriously pursued.

Transient modeling of liquid flow in large pipe networks has always been a difficult and tedious task. There have been many methods developed for transient analysis and only a few have been successful in terms of acceptable level of accuracy of solution, programming ease, and computational efficiency. Wave plan method (WPM) is one such method that has been used with great success over the past quarter century or so by thousands of modelers around the world (Wood et al. 1966 and 2005). Fixed-grid method of characteristics (MOC) is another popular method that has been widely used (Streeter and Wylie 1967, Wylie and Streeter 1978, 1993, Karney and Ghidaoui 1997, McInnis 1992, Kwon 2005).

Computational requirements of transient modeling are not trivial even for small transmission mains. The computational requirements for transient modeling of large complex water distribution networks could be several orders of magnitude higher ranging from several minutes to a few hours on modern personal computers. Large computational times force the designers to simplify the network models (topological and/or numerical simplifications, e.g. neglecting pipe branches, lumping consumption in main nodes, estimating the unknown pipe friction and effective diameter) which at times could render the results to be far away from the reality. Proponents (Wood et al. 2005, Wood 2006) of “Wave Plan Method” claim that the method intrinsically requires fewer computations than “Method of Characteristics” for similar accuracy for transient analysis (especially for large pipe networks). Though WPM and MOC

solve the same set of governing equations, make similar assumptions, and adopt a numerical procedure for time simulation, they are significantly different in their underlying approaches. These differences call for a through analysis of the underlying computational frameworks of both MOC and WPM in an effort to understand

- i. If and when one method is computationally superior to the other
- ii. Are there any limitations or qualifications for the method that happens to be computationally superior
- iii. Under what circumstances the superiority of the method ceases to exist.

1.2. Air Vessels for Transient Protection of Large Pipe Networks

Transient protection of water distribution systems may require use of devices such as open surge tanks, air vessels, air/vacuum valves, pressure relief valves etc. Selection and design of suitable transient protection devices is dictated by the severity of transient causing events, distribution system characteristics, system operational procedures etc. Bong and Karney (2006) observes that “designing these critical transient protection systems is a challenging problem...” and “selection, installation, and operation of these hydraulic devices strongly depend on the specifics of the particular pipe system as well as experience/comfort of the designer/operator.” If not properly designed, these devices can worsen the transient response of the system (Bong and Karney 2006).

Air vessels, also known as closed surge tanks, are effective in protecting the distribution system against negative as well as positive pressures and are widely used in water distribution systems. Use of air vessels in controlling hydraulic transients is very well documented in the literature (Allievi 1937, Evans and Crawford 1954, Wood 1970, Stephenson 2002 and Di Santo

et. al 2002). Air vessels are expensive and their size used in practice varies from a few tens of cubic feet to few thousand cubic feet. A 1500ft³ bladder surge tank, which is a more advanced form of a general air vessel, could cost nearly \$50,000. Optimal sizing of air vessels thus becomes an important task of transient modeling and protection design studies. Typical arrangement of an air vessel, shown in Figure 1.1, consists of three components (1) the vessel (2) the connector pipe and (3) inlet and outlet orifices controlling flow to and from air vessel.

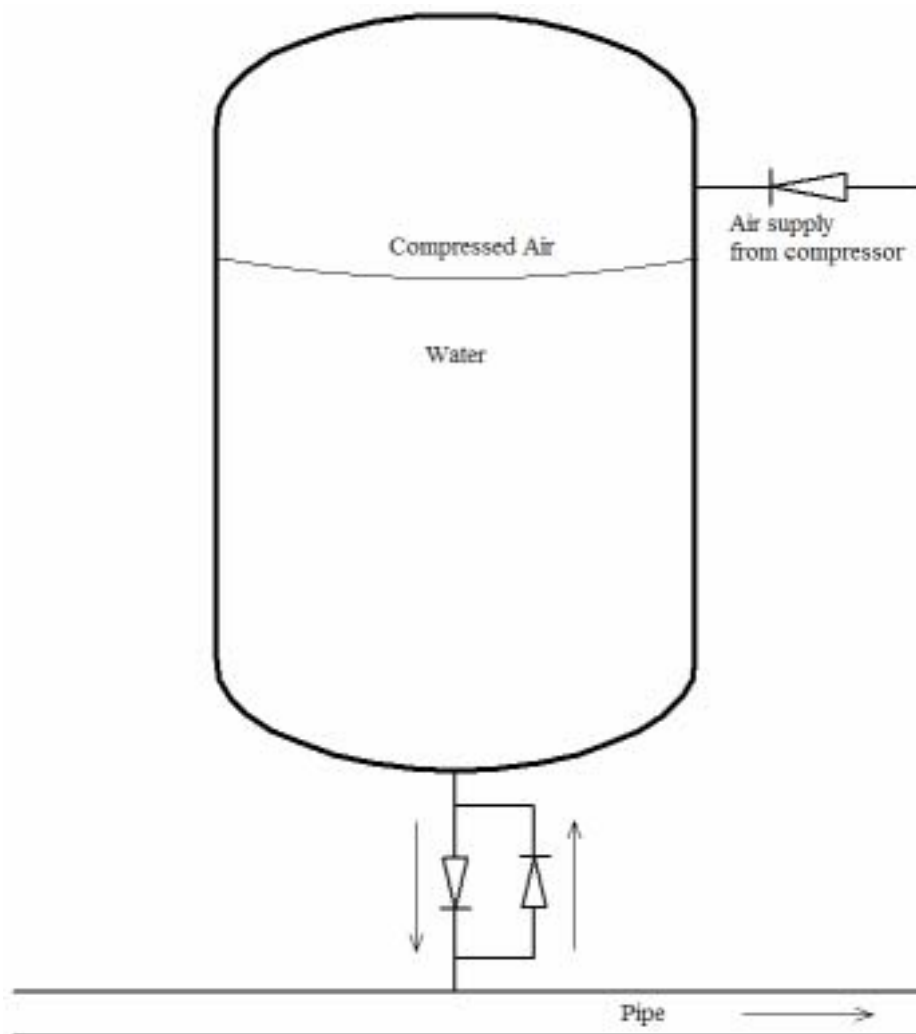

Figure 1.1 Example schematic of an air vessel

Decision variables associated with optimal sizing of air vessels are total volume of air vessel, initial gas volume, inflow resistance, outflow resistance, and a polytropic exponent. The resistance R is defined as $R = \Delta H / Q^2$, where ΔH = head drop in feet and Q = flowrate in ft³/s. These resistances correspond to the orifice sizes (and pipe diameters) provided for inflow and outflow from pipe system to air vessel. Inflow resistance governs the rate of flow into the pipe system where as outflow resistance governs the rate of flow into the air vessel. Value of polytropic exponent or the gas expansion constant has significant influence on the required air vessel size. The polytropic exponent (n) is close to 1 for small vessels discharging slowly (isothermal) and is closer to 1.4 for large vessels discharging faster (adiabatic) (Stephenson 2002).

Total volume of the air vessel consists of the volume of fluid in the vessel and the gas volume. Controlling negative initial transients (like those resulting from pump trip) requires fluid to be supplied to the system while controlling positive initial transients (like those resulting from rapid valve closures) requires enough volume of gas to accommodate fluid from the system. Any positive pressure spike is not likely to be followed by a negative pressure spike and vice versa. In general, the required size of air vessel is governed by severity of both negative and positive pressure scenarios of a system. However, in case of severe negative initial transients, total tank volume depends more on the initial fluid volume than initial gas volume and in case of severe positive initial transients, initial gas volume governs the total volume more than the initial fluid volume. The usual minimum and maximum values used for initial gas volume are 25% and 75% of total tank volume.

1.3. Basic Equations - Transient Analysis and Air Vessels

The following are the two equations governing flow of fluid in prismatic closed conduits under transient conditions (Wood et al. 2005, Almeida and Koelle 1992, Wylie and Streeter 1993).

Continuity equation,

$$\frac{\partial H}{\partial t} + \frac{a^2}{gA} \frac{\partial Q}{\partial x} = 0 \quad (1)$$

Momentum equation,

$$\frac{\partial H}{\partial x} = -\frac{1}{gA} \frac{\partial Q}{\partial t} + f(Q) \quad (2)$$

where Q = flow rate, H = pressure head, $f(Q)$ = friction slope expressed as a function of flow rate, A = pipe flow area, a = pipe celerity or wave speed, g = gravitational acceleration, and x and t the space-time coordinates. Advective terms are neglected in the above equations as they are negligibly small for most water distribution problems of practical importance.

Solution of Equations (1) and (2) with appropriate boundary conditions will yield head (H) and flow (Q) values in both spatial and temporal coordinates for any transient analysis problem. The above equations are first order hyperbolic partial differential equations in two independent variables (space and time) and two dependent variables (head and flow). Typical calculations involved at the air vessel using wave plan method are given below (Wood and Funk 1996). These calculations involve solving equations related to wave action at a side discharge orifice draining into an air vessel. Figure 1.2 depicts the wave action at an air vessel.

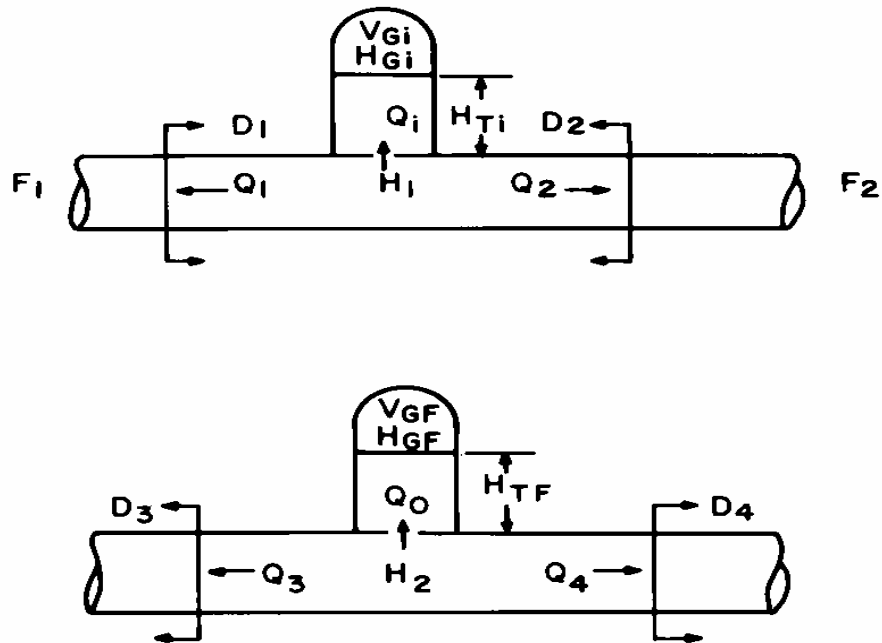

Conditions (Average) at Air Vessel

Figure 1.2 Wave actions at an air vessel (Wood and Funk 1996)

Assumptions in the air vessel analysis are (McInnis 1992) (1) “frictional and inertial effects in the tank are negligible” (2) “there is no significant absorption of gas by the fluid during the transient event” (3) “there is no significant mass of gas added to the system by the compressor during the transient event (that is, the surge is relatively of short duration)” (4) “the pressure variation in the tank is assumed to be hydrostatic” (5) a constant polytropic gas exponent is sufficient for transient simulation.

The wave action must account for the effect of the air vessel over the computational time interval, Δt . In order to do this accurately for a variety of conditions, the average inflow into the air chamber, Q_0 , may be incorporated into the wave analysis.

$$C_S Q_0 * Q_0 * = H_2 - (H_{GF} + H_{TF}) \quad (3)$$

where C_S is the orifice resistance term, Q_o is the average flow (over time, t) into the air chamber, H_2 is the line pressure, H_{GF} the air pressure and H_{TF} the liquid level in the surge tank (average values after wave action).

$$\text{The gas head is given by: } H_{GF} = H_0 V_0^K / (V_{Gi} - \Delta V_G)^K - H_A \quad (4)$$

where H_0 and V_0 are reference head and gas volume for the air vessel, H_A is atmospheric head and K is the gas expansion constant. V_{Gi} is the initial gas volume and ΔV_G is the change in gas volume over the time interval, Δt .

The liquid level is given by:

$$H_{TF} = H_{Ti} + \Delta V_G / A_T \quad (5)$$

where

H_{TF} is the liquid level in the surge tank after time Δt

H_{Ti} is the initial level

A_T is the cross sectional tank area

Change in gas volume over the time interval, Δt , can be computed by solving equation (6) by any technique suitable for solving a non-linear algebraic equation. Once V_G is determined the new average line head, gas volume, gas head and water level can be determined along with the new average flowrates. It should be noted that Equation 5 is very sensitive for small gas volumes and care is required when solving this relation. Newton Raphson extrapolation techniques may fail to produce a solution for very small gas volumes and an interval halving technique is employed for these situations in the computer program to avoid these difficulties.

$$C' \Delta V_G |\Delta V_G| - A' + B' \Delta V_G + C_0 / (V_{Gi} - \Delta V_G)^K = 0 \quad (6)$$

where

$$C' = C_s / \Delta t^2$$

$$A' = H_1 + H_A + 2D_2 + \frac{F_2}{F_1 + F_2} (2D_1 - 2D_2 + F_2 Q_2 - F_1 Q_1) - F_2 Q_2 - H_{Ti}$$

$$B' = \frac{F_1 F_2}{\Delta t (F_1 + F_2)} + \frac{1}{A_T}$$

$$C_0 = H_0 V_0^K$$

D_1, D_2 are impinging waves

A_1, A_2 are area of cross section of pipe

c_1, c_2 are wave speed in the pipe

$$F_1 = c_1 / g A_1 \text{ and } F_2 = c_2 / g A_2$$

1.4. Literature Review - Design Aids for Air Vessels

The need for optimal air vessel sizing tools in protecting large pipe networks from undue transient pressures is well known. Graphical and other heuristic methods reported in literature are limited to sizing the air vessels for simple rising main problems. While attempts have been made to utilize optimization techniques, they have been largely unsuccessful due to their impractical computational requirements. Much of the work on air vessels reported in literature was aimed at protecting simple rising main problems as described in the following section.

Hydraulic transients associated with rising mains protected by air vessels and means of designing the air vessels has been of interest in the academic community and industry since 1930s (Martino et al. 2004). Rising main problems refer to pipelines that pump water from a low elevation point to a high elevation point through a more or less continuously rising pipeline - classical pump-pipeline-reservoir system. Typical schematic of a rising main is shown in Figure 1.3.

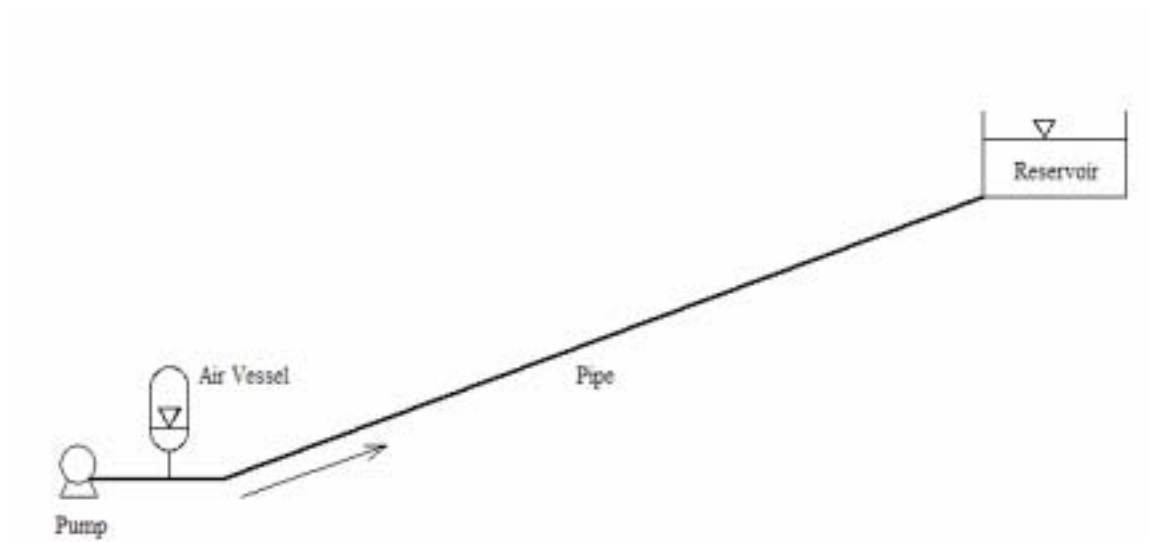

Figure 1.3 Schematic representation of a rising main with an air vessel

Pioneering research work on protecting rising main problems was conducted by Allievi in 1937 and Evangelisti in 1938 (Martino et al. 2004). Allievi (1937) defined two dimensionless parameters (1) a pipeline water hammer parameter defined as “a function of ratio of the steady state kinetic energy to the total potential energy in a unit length of pipe” (Evans and Crawford 1954) (2) an air chamber parameter defined as ratio of potential energy of air chamber to the kinetic energy of discharging liquid column. These two parameters were developed by assuming

isothermal expansion ($n=1$) of air and neglecting the frictional losses in the pipe system as well as entrance and exit losses in the air vessel.

Evangelisti in 1938 (Martino et al. 2004) developed graphs that aid in the sizing of air vessels, using incompressible flow theory neglecting pipe friction and assuming adiabatic expansion of air ($n=1.41$). Equations developed by Evangelisti allow for analytical solution if pipe friction is neglected and he introduced a dimension-less constant (ratio of steady state head loss to absolute steady state pressure) for use in numerical integration procedures for solution when pipe friction was considered (Martino et al. 2004). These graphs demonstrated the favorable role of pipe friction loss in attenuating over pressure oscillations.

In mid 1950s, Evans and Crawford (1954) developed design charts for air vessel sizing using (1) Allievi's parameters, (2) graphical method for transient analysis of pipelines (Angus 1937) and (3) a differential orifice (ratio of headloss of inlet orifice to outlet orifice was 2.5) in conjunction with air chambers. They introduced a third parameter (in addition to those shown by Allievi in 1937) for incorporating pipe friction losses in the design procedure and used a polytropic constant of 1.2 (midway between isothermic $n=1$ and adiabatic conditions $n=1.4$).

Computer based solutions became a common place for analyzing hydraulic transients by early 1970s. Graze and Forrest (1974) used computer solution of method of characteristics for transient analysis to distribute the frictional losses along the pipeline and re-created charts developed by Evans and Crawford (1954) for protecting raising mains. The maximum upsurges were markedly reduced and maximum down surges were slightly increased because of the

distribution of line friction. Ruus (1977) extended these charts to show extreme pressure profiles at the quarter-point from the reservoir also. Fok (1978) developed charts that showed extreme pressures at any point in the pipeline and also reported that use of polytropic value of 1.2 was more realistic. He also claimed that these charts can be applied to pipe networks if steady state kinetic energy of the network can be represented by an equivalent flow of single line.

Graze and Horlacher (1982) removed the orifice resistance from the analysis and included polytropic constant (n) as a variable and developed charts based on method of characteristics. They used the “rational thermo-dynamic equation” developed in 1968 by Graze in the study. This equation treated the polytropic constant as a variable of time during the transient phase inside the air chamber. Experimental and theoretical results agreed very well. However, it was not used by fellow researchers because of the difficulty in applying it in practice (Fok 1978). Charts developed by Graze and Horlacher presented extreme pressures along the entire length of pipeline. In 1986, the same authors re-introduced the orifice resistance in the analysis but treated it separately from the line friction. This study indicated the ratio of inlet to outlet orifice headloss could be from 10-30 as opposed to 2.5 used till then for an economical design of air vessel. Similar high values were obtained by Thorley and Enever (1984).

In 1989, Graze and Horlacher developed similar charts for valve closure scenarios without considering the orifice resistance and followed it with charts considering orifice resistance. In that work, Graze and Horlacher (1989) also showed how outlet resistance of air vessels can be used for efficient governing of turbines.

Thorley and Lastowiecki (1985) presented the first ever computer based iterative procedure for sizing air vessels for pipeline systems. In 2002 Stephenson used incompressible flow theory to develop nomographs for air vessel sizing for pump trip problems associated with rising mains and compared the results to those from full elastic analysis. He emphasized the importance of orifice resistances in economic sizing of air vessels and concluded that orifice resistances are more important in the air vessel design process than the polytropic index.

Di Santo et al. (2002) developed design charts for air vessel sizing for pump trip scenario when the downstream boundary condition is a vertical shaft discharging freely into atmosphere instead of the classical assumption of constant head reservoir used in other studies. He used rigid water column method and conducted field measurements to validate the results.

Besides being limited to rising main problems, these design charts can be applied only at preliminary design stage due to their simplifying assumptions (e.g. neglecting frictional losses), selection and range of parameters, limited accuracy of solutions and lack of completeness. Thorley (1991) emphasized that these design charts could only be used to provide an estimate to be used as a basic data for more detailed transient analysis and stated that usually a factor of safety of 1.2 or 1.25 should be used.

A genetic algorithms (GA) based bi-level optimization approach has been reported for design of surge tanks and air valves in water distribution networks (Wang et.al 1997 and Lingireddy et al. 2000). Popular optimization models (Kapelan et al. 2003, Vitkovsky et al. 2000, Lingireddy et al. 2000, Nash and Karney 1999, Wang et al. 1997, and Bong and Karney

2006) run transient simulations models several hundreds of times in obtaining the optimal solution. Bong and Karney (2006) studied the problem of optimal location of surge tanks and pressure relief valves and size of pressure relieve valves for a 29-pipe water distribution network for protection against transient pressures created by sudden valve closures. No sizing of surge tanks (or air vessels) was undertaken.

In summary, review of the literature on development of design aids for air vessels from 1934 to 2002 reveals that

1. All but the most recent works have addressed the classical pump-pipeline-reservoir type rising main problems. Each method essentially was an improvement from parameterization of pump-air vessel-reservoir problem.
2. Underlying philosophy was energy balance between kinetic energy of steady state conditions of the pipeline to the potential energy of the air vessel.
3. Studies had employed various water hammer analysis theories – graphical method, rigid column approximation, method of characteristics computer based transient analyses – for assessing the extreme pressure profiles along the pipeline.
4. All works were unanimous in recognizing the effect of inlet orifice resistance on economical sizing of air vessels. Outlet orifice size was found to be beneficial in throttling the minimum pressure in the pipeline after transient events caused by sudden valve closures.
5. Though the effect of polytropic constant in calculation of transient over pressures was well known, there was a divided opinion on the importance of polytropic

index in a design exercise, in particular while developing design aids. Stephenson (2002) contends that the air vessel sizing is more governed by inflow/outflow resistances than polytropic index. While Wood (1970) reported that adiabatic compression of air results in about 10% excess pressure than isothermal compression, Martino et al. (2002) reported that it was about 10-20%.

6. Though the “rational heat transfer” (RHT) method for analyzing thermodynamics of an air vessel is more accurate (Graze 1968), most of the works continued to use empirical formulae as before. This is mainly because of (1) difficulty in applying the equations and (2) research works were directed at other more critical issues involved in the design problem.
7. Low inlet orifice resistances result in adiabatic behavior of air and subsequently produce high oscillations in pressure profile at the air vessel. Also large air vessels were found to behave adiabatically.
8. High inlet orifice resistances results in isothermic behavior of air and subsequently produce smooth pressure profile at the air vessel. Small air vessels were found to behave isothermally.
9. Inlet orifice resistance was found to be very crucial in economical design of air vessels for low friction systems than high friction systems.

10. Design charts were inherently limited to simple pipeline systems (rising mains). Their application to pipe network systems were alluded (Fok 1978) but never demonstrated. Their application requires determining a pipeline that has equivalent steady state kinetic energy of the pipe network.
11. Though computationally expensive, bi-level genetic algorithm based optimization scheme (utilizing elastic transient analysis methods) can be used for air vessel sizing of simple pipelines and small distribution networks offering a more robust and detailed method than the design charts.
12. Though the genetic algorithm based approach can be applied for large water distribution systems, it poses a practical problem. The necessity for several hundreds of transient simulation runs within a genetic algorithm based optimization framework result in prohibitively expensive computational costs thereby rendering it an impractical alternative.

1.5. State of the Art and Research Needs

Review of past and contemporary work in the area of air vessel sizing and transient analysis of pipe networks reveals that:

1. Air vessels are effective in controlling both positive and negative transient pressures and are widely used protecting pipe networks and transmission mains.

2. Air vessel sizing is complex problem because of (a) dynamics of orifice resistances and (b) variable nature of ratio of initial gas volume required to initial fluid volume required.
3. Design aids for rising mains with specific boundary conditions are available and genetic algorithm optimization scheme is impractical for large systems because of computational expense of transient analysis.
4. No design aid is available for air vessels for protection of large pipe networks. Currently air vessels are designed at best by computationally intensive genetic algorithm optimization (Wang et al. 1997 and Lingireddy et al. 2000) or at worst by trial and error method involving numerous transient analyses (Stephenson 2002).
5. There exists an un-established claim that WPM is computationally efficient than MOC for similar modeling accuracies, especially for pipe networks. If true, it would significantly affect the use of GA based optimization schemes in the transient design domain.
6. Comprehensive transient analysis is required for design of transient protection devices for pipe networks. Simplification of network schematics does alter transient response of pipe networks.

7. With the importance of including transient analysis at the design stage being increasingly realized, any design aid for air vessels that can reduce the computational time involved in the design process would be very helpful.

1.6. Research Objective

The singular objective of the dissertation work is to probe the feasibility of developing design aids for air vessels for transient protection of large pipe networks and if feasible, to address any issue(s) involved in the process.

1.7. Dissertation Organization

This research work proposes and demonstrates a robust framework for developing design aids for optimal sizing of air vessels to protect large complex pipe networks and presents critical issues involved in the process. This dissertation is organized as follows. Chapter 2 and 3 are self-contained journal articles included as independent chapters. Chapter 2 (submitted to Journal of Water Resources Planning and Management, ASCE) presents and demonstrates the framework, the principal objective of the study. Chapter 2 also discusses the validity and limitation of the design aids developed and areas in the framework that need further research.

The frame work requires generation of hundreds of optimization data for small and simple network systems and is a daunting task as genetic algorithm based optimization is computationally expensive. It is obvious that any reduction in transient analysis time for a network system would tremendously reduce the computational costs of bi-level genetic algorithm optimization scheme. Hence selection of a numerically efficient and sufficiently accurate transient analysis method for use inside a genetic algorithm based optimization scheme

is crucial. Chapter 3 addresses this critical issue. Chapter 3 demonstrates that WPM (Wave Plan Method) is computationally efficient than MOC (Method of Characteristics) for similar accuracies and savings in computational costs are high in the transient analysis of pipe networks and subsequently in the genetic algorithm based optimization schemes. Chapter 4 presents more information about the tools and methodology described briefly in chapter 2. Chapter 5 presents additional findings, discussion and conclusions of this research study.

Copyright © Dhandayudhapani Ramalingam 2007

CHAPTER 2: DESIGN AIDS FOR AIR VESSELS FOR LARGE PIPE NETWORKS

2.1. Introduction

Hydraulic transients in water distribution systems are abnormal pressure situations caused by abrupt changes in flow rates. These are caused by events like power failure, main breaks, pump start-up and shut-down operations, sudden valve closure, check-valve slam, rapid demand variation, opening and closing of fire hydrants etc. Transient generating events are capable of producing both positive and negative pressure waves which travel at approximately the speed of sound in water. Magnitudes of these pressure waves are many folds higher or lower than the normal operating pressures. Transients last for very short periods but could be highly detrimental to the distribution system. They can potentially cause pipes to burst (due to high pressure) or pipes to collapse (due to very low pressure). Also the negative pressure conditions could result in pathogen intrusion within the water distribution systems (LeChevallier et al. 2002). Awareness of potential pathogen intrusion problems coupled with availability of powerful software tools has spurred the transient modeling activity in an effort to provide adequate protection for the water distribution systems.

Protection of water distribution systems may require use of devices such as air vessels, air/vacuum valves, pressure relief valves etc. Air vessels (also known as surge tanks) are effective against negative as well as positive pressures and are widely used in water distribution

systems. Air vessels are expensive and their size used in practice varies from a few cubic feet to few thousand cubic feet. Design tools for sizing air vessels are available for simple rising mains in the form of design charts for pump trip problems (Allievi 1937, Combes and Barot 1952, Evans and Crawford 1954, Graze and Forrest 1974, Russ 1977, Fok 1978 and Di Santo et al. 2002). Thorley and Lastowiecki (1985) presented the first ever computer based iterative procedure for sizing air vessels for pipeline systems. Graze and Horlacher (1986 and 1989) developed design charts for sizing of air vessels that protect rising mains from transient pressures created by a pump trip. Stephenson (2002) presented a nomograph based on incompressible flow theory for the same problem. As a discussion on Stephenson (2002) paper, Martino et al. (2002) presented the pioneering work of Evangelisti in 1938 in which Evangelisti had developed simple graphs for air vessel design for protecting pipe lines based on incompressible flow theory. Di Santo et al. (2002) developed design charts for air vessel sizing for pump trip scenario when the downstream boundary condition is a vertical shaft discharging freely into atmosphere instead of the classical assumption of constant head reservoir used in other studies.

Besides being limited to rising main problems, these design charts can be applied only at preliminary design stage due to their simplifying assumptions, selection and range of parameters, limited accuracy of solutions and lack of completeness. Thorley (1991) emphasized that these design charts could only be used to provide an estimate to be used as a basic data for more detailed transient analysis and stated that usually a factor of safety of 1.2 or 1.25 should be used.

A genetic algorithm (GA) based optimization approach has been reported for design of air vessels and air valves in water distribution networks (Wang et. al 1997 and Lingireddy et al.

2000). Though this approach can be applied for large water distribution systems, it poses a practical problem. The necessity for several hundreds of transient simulation runs within a GA based optimization framework results in high computational costs thereby rendering it an impractical alternative. For example if a transient simulation of a large distribution system requires 100 seconds of computational time, then a GA based optimization scheme requiring a minimum of 1000 such simulations requires a total computational time of 100000 seconds or approximately 28 hours.

This article proposes a robust framework for developing design tools that help in optimal sizing of air vessels for large pipe networks. The efficiency and robustness of the proposed framework is demonstrated by developing an optimal air vessel sizing tool for protecting large pipe networks against high transient pressures generated by rapid valve closures. The essence of the proposed framework is in identification of key transient response parameters of pipe networks influencing the required size of air vessels. Key contributing parameters were identified using an artificial neural network (ANN) model on a knowledgebase developed from optimized network models. The trained ANN model was then applied for sizing air vessels for large pipe networks with transient response data as input. Scope of this study was limited to demonstrating the potential for the proposed framework in developing design tools rather than to develop a comprehensive and general purpose air vessel sizing tool.

2.2. Framework for Design Tools

The proposed framework was developed after an extensive study of pressure/flow response of complex pipe networks to various transient generating events with and without

transient protection devices. Analyzing transient generating and wave propagation mechanics, the following observations can be made:

- The transient pressure profile at any location in the network reflects the effects of nearby boundary conditions and nearby network complexity.
- Optimal sizing of protection is primarily based on the transient pressure conditions prevailing at the region to be protected and need not be hydraulically influenced by conditions faraway from the region.
- The pressure/flow variation plots at the planned location for the transient protection device adequately reflect the severity of pressure transients within that region.
- If the pressure/flow variation plots at some location A do not reflect the severe pressure transients originating from some other location B in a pipe network, then the size of protection device at location A would have little or no influence in mitigating transient pressures at location B.
- A single device may not be able to protect a large pipe network entirely or economically. Various subsections/regions may need to be protected individually.
- One of the objectives of any optimization exercise is to protect the system against cavitation pressures. Any solution that results in pressures below liquid vapor pressures shall be treated as an infeasible solution. Hence formation and collapse of vapor cavities need not be considered in the transient simulation runs.

Based on these observations, the following three hypotheses are proposed which are then used for developing the framework for design tools:

- A. The transient pressure/flow profile at a point where protection needs to be provided can be used to identify key contributing parameters influencing required air vessel size.
- B. Initial phase of transient pressure/flow profile captures the severity of transient pressures; any protection that mitigates transient pressures in this phase has a good chance of being an adequate protection measure.
- C. Transient response of sub-sections of large network systems can be approximated by transient response of simple systems provided the simple systems have multi-pipe junctions, and other simple boundary conditions such as reservoirs and pumps.

The steps involved in developing the proposed framework are outlined in the following:

1. Create simple network models and generate transient events that produce a wide variety of transient response profiles.
2. Use a GA based optimizer to arrive at air vessel parameters that provide optimal protection for each of the simple network models (knowledgebase).
3. Identify common traits among these models that capture the essence of transient response characteristics independent of the size or complexity of network models.
4. Compile the common traits into input variables of an artificial neural network (ANN) model that may be trained to learn the relationships between transient response characteristics and the associated optimal air vessel parameters.
5. Use the trained ANN model to size air vessels for protecting bigger and complex systems.

The following section provides a brief description of computational tools used for the proposed framework.

2.3. GA, ANN and Transient Simulation Program

Genetic algorithms are a class of probabilistic optimization algorithms inspired by the biological evolution process (Goldberg and Kuo 1987). They use the concept of “Natural Selection” and “Genetic Inheritance” as illustrated by Darwin. They are particularly suitable for hard problems where little is known about the underlying search spaces and are widely used in business, science and engineering. There have been many applications of genetic algorithms to optimization problems in civil engineering. Lingireddy (1996 and 1998) has applied GA for problems in irrigation and ground water studies. Lingireddy and Ormsbee (1998) used GA for calibration of water distribution networks. Authors have successfully used GA for water quality parameter calibration of water distribution networks using hydraulic analysis module provided by EPANET (Rossman 2000) for fitness evaluation of individuals (Ramalingam et.al. 2004). Bong and Karney (2006) have applied GA for optimal location of transient protection devices for pipe networks. Zhang (1999) used GA for optimal design of water distribution networks including transient analysis.

In GA based optimization, the decision variables are cast into chromosomes and natural genetic operators are applied to generate a new population of decision vectors. Feasibility of the decision vectors are evaluated using a transient simulation model. Results from the transient simulation model are used for evaluating fitness function for each decision vector. A few best-fit decision vectors are then used for generating a new set of decision vectors. This procedure is repeated until a predefined optimality criterion is met. The first author has developed genetic algorithm and transient analysis programs for this study using object oriented language C++.

The transient simulation program developed for this study was based on numerically accurate and computationally efficient “Wave Plan Method” (Wood et.al 1966, Ramalingam et.al 2004 and Wood et al 2005). This program can analyze large complex networks with most common components of distribution systems like constant head reservoirs, junctions, dead ends, pumps, valves, open surge tanks, air vessels etc. Various transient inducing scenarios like pump trip, pump start-up, multiple stage valve closure etc. can be analyzed.

Artificial neural networks are mathematical models that mimic the pattern recognition and generalization capabilities of human brain. They belong to the domain of artificial intelligence (AI). They have been applied successfully in several areas of civil engineering (Aziz and Wong 1992, Lingireddy 1998, Lingireddy and Ormsbee 1998, Brion et al. 2001, Neelakantan et al. 2001 and Deka and Chandramouli 2003). An ANN modeling software called NeuroSort (2004), developed at University of Kentucky, was used for this study. A single hidden layer feed-forward neural network was trained by back propagation algorithm using iterative weight adjustment procedures and logistic sigmoid activation function.

2.4. Air Vessels

Decision variables in the air vessel optimization problem are the total volume of air vessel, initial gas volume, inflow resistance, outflow resistance, and polytropic exponent. The resistance R is defined as $R = \Delta H / Q^2$, where ΔH = head drop in feet and Q = flowrate in ft³/s.

These resistances correspond to the orifice sizes / pipe diameters provided for inflow and outflow between pipe system and air vessel. Inflow resistance governs the rate of flow into the pipe system where as outflow resistance governs the rate of flow into the air vessel. By proper design of outflow resistance, commonly known as “flow throttling”, it is possible to reduce the required size of air vessel (Wood 1970, Graze and Horlacher 1989 and Stephenson 2002). Optimization of outflow resistance reduces the overall size of the air vessel when the design objective is to limit the excessive over pressures in the system (Thorley and Lastowiecki 1985, Thorley 1991). Inflow resistance is not as critical as outflow resistance (Stephenson 2002), but could play a major role when the design objective is to limit the negative or low pressures in the system.

Total volume of air vessel consists of volume of fluid in the vessel and the gas volume. Controlling negative initial transients (like those resulting from pump trip) require fluid to be supplied to the system while controlling positive initial transients (like those resulting from rapid valve closures) require space to accommodate fluid from the system. Hence, in case of negative initial transients, tank volume is governed more by initial fluid volume than initial gas volume. In case of positive initial transients, initial gas volume governs the total volume more than the initial fluid volume. The usual minimum and maximum values used for initial gas volume are 25% and 75% of total tank volume.

Value of polytropic exponent or the gas expansion constant is another important variable that influences air vessel size. The polytropic exponent is close to 1 for a slow change in gas volume (isothermal) and close to 1.4 for rapid change in gas volume (adiabatic). Wood (1970) reported that adiabatic compression of air results in about 10% excess pressure than isothermal compression. Stephenson (2002) contends that sizing of air vessels is governed more by

inflow/outflow resistances than polytropic exponent. Depending on the nature of transient generating event and the pipe and flow characteristics, the polytropic exponent could vary from 1 to 1.4 during a transient simulation run. Because of these uncertainties and the relatively less importance associated with polytropic exponent, it is a general practice to use an average value of 1.2 for all transient modeling runs (Evans and Crawford 1954, Graze and Forrest 1971, Russ 1977 and Fok 1978). All transient model runs reported in this study were based on valve closure scenarios. In such cases outflow resistance plays a crucial role in attenuating the initial transients than the inflow resistance (inflow resistance is important only in controlling the subsequent negative pressures) and polytropic exponent.

2.5. Knowledgebase

Data for ANN model development was generated using three different small pipe network models. Figure 2.1 shows schematics of the network models used. Network characteristics were varied such that (1) they result in a diverse set of transient pressure/flow profiles and (2) they require air vessels of various sizes. It was achieved by varying one or more of the physical and hydraulic characteristics of the network. The list includes length and diameter of pipes, reservoir grades, nodal elevations, valve types, pump characteristics, valve closure time and allowable max/min heads in the system. Pumps in the network models were defined by conventional three point head-flow characteristics curve. Transient scenarios were created from rapid valve closures. Two standard types of valves (Needle and Butterfly) and another valve with custom defined characteristics were used in the network models. It is a well known fact that a

needle valve of certain resistance produces a much higher initial transient pressure compared to a butterfly valve of the same resistance (Wood et. al, 2005).

Bounds on air vessel parameters and allowable max/min pressure heads in the system were chosen based on standard field practices. Tank volume was varied between 0 to 100 cubic feet while initial gas volume was varied between 25 to 75% of tank volume. Lower and upper bounds of inflow and outflow resistances were varied between 0.001 and 50 s²/ft³. Bounds for allowable maximum pressure heads in the system were 300 ft and 920 ft (130 to 400psi). Allowable minimum pressure head in the system for all the scenarios was 0 ft.

Optimal protection for these large set of models was arrived using a GA based optimizer. An objective function that minimizes the total air vessel volume was used in GA optimizer. Design limits on system-wide maximum and minimum pressures were used as the constraints. Pressures in the network were allowed to drop below vapor pressure for all transient simulation runs thereby eliminating the need for cavitation modeling. Besides reducing computational time requirements, allowing the pressures to drop below vapor pressures help more efficient representation of relative severity of negative pressures. Any violation of constraints was incorporated into the fitness value by a simple penalty function. In the individual selection process for mating, certain infeasible solutions, where air vessel fully drains, were ignored. A population size of 40, a crossover probability of 65%, a mutation probability of 3.3%, 35 generations and roulette wheel selection were used for GA optimizer.

Selection of transient simulation time used for the optimization process was guided by “Hypothesis B”. This time period is crucial in keeping-down the computational time for

optimization. Total transient simulation time was selected such that it allowed capturing major transient action/reactions occurring around the point where the air vessel needs to be provided. Optimal design was carried out with this transient simulation model to arrive at an economical set of air vessel parameters (air vessel volume, initial gas volume, inflow resistance, and outflow resistance). The optimality of these parameters was verified by repeating transient simulation over a longer time period– i.e. until the new steady state conditions were reached. If the performance was not satisfactory, optimization was repeated with an increased simulation time. Two typical initial phase transient simulation times (“initial phase”) of 5 seconds and 10 seconds were found to be adequate for the example models used for the study. System wide maximum and minimum pressure were compared with the corresponding design limits. Wide variation in pressures suggests over sizing and the data set was discarded.

2.6. Input Variables for ANN Model

The optimization process described in the previous section has resulted in a large number of network models and the associated optimal air vessel parameters. The next step was to identify the associated network transient response parameters that constitute input variables for the ANN model. Size of an air vessel required to protect a system against excessive positive pressures could be influenced by a number of parameters related to physical characteristics of the system, steady state pressures and flows, the nature of transient conditions and the allowable pressures in the system.

Exploiting the similarities between transient response of simple and complex systems by identifying parameters that are common to these systems is crucial to building an efficient ANN model. The parameters were selected in such a way that they capture the essence of transient response independent of size and complexity of the network (Hypothesis C). All parameters representing physical characteristics of the network like pipe characteristics, elevation of nodes etc. were discarded. For each of the previously generated model runs, a host of parameters were extracted from the shapes of transient pressure/flow plots that characterized the transient event and the model's response. Much of the data extracted was from the pressure plots at the location of air vessel but without the air vessel at that location (i.e. with no protection). A total of 102 input variables were identified initially. They are categorized as follows, with numbers in parenthesis representing number of parameters:

- a) Design criteria - maximum and minimum allowable heads in the system. (2)
- b) Steady state conditions at the location of air vessel - head, flow and velocity (3)
- c) Parameters capturing statistical measures of the pressure head profile at the location of air vessel - minimum, maximum, mean, standard deviation and coefficient of variation, average head above maximum allowable head and average head below allowable minimum pressure head. (7)
- d) Time-span parameters capturing volumetric information - area of the pressure head profile above maximum allowable head, below minimum allowable head, below cavitation head and below zero head, captured as percentage time the pressure head exceeded or fell below the corresponding head to the total simulation time (4)

- e) Parameters capturing slope (initial, maximum positive and maximum negative) of transient pressure and flow profile – (1) captured over entire span of simulation and (2) only when the pressure head exceeded the design limits. (2×2×3 =12)
- f) Parameters capturing change in magnitude of head and flow associated with each slope (for both e1 and e2). (2×2×6=24)
- g) Parameters capturing absolute magnitude of heads and flows at the beginning and at the end of each slope (for both e1 and e2). (2×2×12=48)

2.7. ANN Model

The optimization exercise has resulted in a total of 325 diverse network models. Values of input variables for ANN models were extracted for each of these network models resulting 325 data sets. Out of these 325 sets, 250 sets were used for training and 75 sets for testing the ANN model. Optimal air vessel characteristics – inflow resistance, outflow resistance, air vessel volume and initial gas volume, form the output vector for the ANN model. Figure 2.2 shows the distribution of air vessel parameters across the generated data.

Input variables that potentially can have negative values were assigned a flag variable indicating the sign (1 indicating positive sign and 0 indicating negative) and is included in the input vector of ANN. Numerous ANN models, each differing in one or more of the following aspects viz. number of input variables, number of hidden layer neurons, order of the data set and type of weight adjusting procedure were developed in an effort to arrive at a most optimally trained ANN model. For every ANN model, the data set was shuffled randomly and it was

ensured that the data points with highest and lowest input/output variables were in the training set rather than in the testing set. This would avoid the need for extrapolation in the testing process.

Performance of each ANN model was evaluated using mean square error (MSE) values of training and testing sets. Less important input variables were discarded systematically by dual criteria (1) using RSI values in ANN training (Chandramouli et. al 2007) and (2) by simple physical reasoning. Relative strength index (RSI) is a measure of significance of an input variable in influencing an output variable. Its value ranges from -1 to +1. Larger absolute value indicates greater influence and the sign signifies the direction of influence. RSI is obtained by modifying the relative strength effect (defined as the partial derivative of the output value to the input value (Kim et al 2001)) by a normalizing constant. Any input variable that had consistently low RSI value was discarded. Trained ANN models were tested for the case of over learning by reducing the number of hidden layer neurons alone and evaluating the performance. This was done to ensure that performance of ANN model was not due to over-learning but rather by learning and generalizing relationships between transient response characteristics and air vessel parameters.

Few variables that had little or no change in magnitude were also discarded from the input variable list. These parameters though may be physically significant in influencing the air vessel sizing, do not contribute to better learning of data set by ANN. For example, the minimum allowable pressure in the system for all the data sets was zero and hence removing this variable

will have no negative effect on model training. However, this parameter should be retained kept when there is a significant variation in its value within the data sets.

32 key input variables were identified after the systematic weeding-out involving numerous ANN model training and testing exercises. Table 2.1 presents all the parameters, bounds and RSI values indicating their influence on air vessel parameters.

Final ANN model comprises 40 input variables (32 parameters and 8 sign flags), 40 hidden layer neurons, and 4 output variables. It was trained with iterative weight adjustment procedure. This ANN model performed well even with a lower number of hidden layer neurons of 10 suggesting that ANN model has not over-fit the data in training. Figures 2.3 and 2.4 show results from ANN model's training and testing respectively.

ANN model could not come-up with a clear pattern for inflow resistance both in training as well as testing. The fact that inflow (flow from air vessel into the pipeline) resistance is not that important in high pressure cases is reflected in the data generated by the GA optimizer. Similar behavior is shown by ANN model as well. Taking this into consideration and out of academic curiosity, inflow resistance discarded and ANN model development with the other three output parameters was tried. However, the model's performance was not significantly different.

2.8. Application of Trained ANN Model

The applicability and efficacy of the trained ANN model in sizing air vessels for networks that were not previously seen by the ANN are demonstrated on three different network models. Transient (valve closure) scenarios of varying degree were generated such that protection in the form of an air vessel was necessary for each of those scenarios. Critical input variables were extracted from these model runs. Care was taken to ensure that the input variables did not exceed the bounds used for training the ANN and the time span of initial phase of transient response of these systems were not significantly different from the ones used in the model development (time span < 10 s). The trained ANN model was used to predict the optimal air vessel parameters for each set of input variables.

Adequacy of prediction by ANN was verified by comparing the ANN predicted values (1) with those from a GA optimizer, when the GA based optimization was computationally feasible, and (2) by applying them to the network model and performing a transient simulation.

Case Study I: In this case, a system with 9 pipes and two loops as shown in Figure 2.5 was used. Being a small network, optimization time for this system, though significant, is not impracticable. This can be illustrated by calculating the computing effort involved. Transient analysis for a total simulation time of 10 seconds required 0.34 seconds on a *Pentium4 3.06 GHz* machine. The GA scheme employed a population size of 40 and a total number of generations of 35. With 40 transient simulations in each generation, the number of transient simulations needed for the optimization was 1400 (40×35). Corresponding computational time required was 8 minutes ($1400 \times 0.34 / 60$).

Various valve closure transient scenarios were created and the associated ANN input variables were extracted resulting in a total of 25 data sets. The trained ANN model was then used to predict the optimal set of output variables for each of the 25 data sets. Results from ANN model were compared with those from GA optimizer. Figure 2.6 presents the results from GA optimizer and ANN model. As evident from Figure 2.6, ANN predictions were reasonably close to the values from GA optimizer for parameters other than inflow resistance. On an average, ANN predicted values for total air vessel volume were off by 10.8ft^3 (range 25 to 85ft^3). Similarly, the initial gas volumes and outflow resistance values were off by 7ft^3 (range 15 to 45ft^3) and $3\text{s}^2/\text{ft}^3$ (range 0 to $7.5\text{s}^2/\text{ft}^3$), respectively. It should be noted that outflow resistance and initial gas volume are the most important parameters for attenuating positive surges. Inflow resistance predictions were in tune with ANN model performance in training.

Case Study II: Network schematic for this case is shown in Figure 2.7. This system comprises 25 pipes, two loops, one pump and one reservoir. Average length of each pipe segment is roughly 2000 ft. Average steady state pressure in the system was 150 psi (344 ft). A valve closure scenario was created and ANN input variables were extracted. With no protection, transient pressures at many nodes violated maximum design limit of 750 feet and minimum design limit of 0 feet. Since cavitation was not considered, the observed pressure heads dropped below the vapor pressure of water at several nodes. Figure 2.8 shows the pressure head variation at the location of air vessel, at node 6 (located close to the valve) and at node 17 (a location far away from the valve). The input variables extracted from the model run (without protection) were fed to the ANN model and the following air vessel parameters were obtained.

Inflow resistance – $40.3\text{ s}^2/\text{ft}^5$

Outflow resistance	–	45.8 s ² /ft ⁵
Tank volume	–	40.6 ft ³
Initial gas volume	–	25.2 ft ³

Results from a transient simulation with protection, incorporating the ANN predicted air vessel parameters, are shown in Figure 2.8. As evident from Figure 2.8, ANN predictions substantially reduced magnitude of high transient pressures from no protection case while completely eliminating the low pressure conditions. However, a closer look at Figure 2.8 reveals that the pressure around 10sec has exceeded the design limit of 750ft by about 20ft.

Transient analysis for a total simulation time of 10 seconds takes about 6 seconds of computational time for this network model. This requires a total of 140min of computational time for GA based optimizer. Therefore, GA based optimization was not attempted for this network model. Instead the ANN predicted air vessel parameters were adjusted slightly to obtain an optimal solution that minimizes the air vessel volume while satisfying all the pressure constraints.

As explained earlier, outflow resistance (OR) and initial gas volume (IGV) are more important parameters in economical design of air vessel in protecting pipelines from high pressures transients. One could bring the transient pressures into compliance by carefully adjusting OR and IGV values predicted by ANN. Reducing OR by 10% and increasing IGV by 10% appears to ensure complete protection. The adjusted parameters not only bring the pressures into compliance, but also ensure that the air vessel is not over sized. Figure 2.8 shows the pressure head variations with optimal set (adjusted) air vessel parameters.

Model sensitivity to changes in OR and IGV is demonstrated in Figures 2.9 and 2.10. Figure 2.9 illustrates the complex role played by OR in air vessel sizing. It can be observed that increasing the OR helps in keeping the transient pressures at air vessel near the design limit but worsens the situation at node 6 and 17 and decreasing the OR lowers the pressures at node 6 and 17 but increases the pressures at the air vessel (around time $t=10$ s). Lowering IGV increased the transient pressures everywhere, while increasing IGV brought down the pressures.

Case Study III: For this case, a multi-loop 89 pipe system shown in Figure 2.11 was used. A valve closure scenario was created and ANN input variables were extracted. Figure 2.12 shows the pressure heads (without protection) at air vessel and at two other nodes far away from the valve. Figure 2.13 shows the maximum heads at various locations of the system. With no protection, transient pressures at many nodes exceeded the maximum design limit of 850 feet. The input variables extracted from the transient model run (without protection) were fed to the ANN model and the following air vessel parameters were obtained.

Inflow resistance	–	$57.8 \text{ s}^2/\text{ft}^5$
Outflow resistance	–	$3.0 \text{ s}^2/\text{ft}^5$
Tank volume	–	59.2 ft^3
Initial gas volume	–	44.4 ft^3

Figure 2.13 shows the maximum heads at different locations of the system with ANN predicted air vessel parameters. With the exception of node 28, the pressures in rest of the system are within the design limit of 850ft. GA based optimizer would have required a computational

time of 537min or nearly 9hours (23sec per simulation times 1400 total number of transient simulations). Therefore, once again the ANN predicted air vessel parameters were adjusted so that pressure constraints are met at all the nodes in the system while making sure that the initial gas volume stayed as low as possible. Initially, a slight increase in initial gas volume alone has brought pressures down to the design limits. However, after a few trials, a more optimal solution was achieved by reducing the outflow resistance to $0.1\text{s}^2/\text{ft}^5$ and also reducing the initial gas volume to 36ft^3 . Figure 2.12 shows the pressure heads with protection using ANN based solution as well as the optimal solution obtained by trial and error.

Nearly 20% reduction in initial gas volume was possible with a significant reduction in outflow resistance (from 3.0 to $0.1\text{ s}^2/\text{ft}^5$). It may be noted that a resistance of $3.0\text{ s}^2/\text{ft}^5$ would correspond to a 6 inch pipe connection to the air vessel while a resistance of $0.1\text{ s}^2/\text{ft}^5$ would correspond to a 15 inch pipe connection. The air vessel for this model is located on a 10 inch diameter pipeline. Therefore, the $0.1\text{s}^2/\text{ft}^5$ outflow resistance solution (and hence the associated initial gas volume of 36ft^3) may not be considered practical.

2.9. Results and Discussion

The following observations can be made by analyzing the performance of ANN model for the three case studies:

1. For large network models of Case Studies II and III, the ANN predicted air vessel parameters reduced highest transient pressures to within 3% of the design limit.

2. Transient pressure profiles of the network models (Case Study II) are highly sensitive to initial gas volume and outflow resistance.
3. ANN has predicted initial gas volume within 20% of the optimal solution on an average, and within 10% for the two large network models.
4. Outflow resistance is an important parameter for air vessels protecting pipe networks from high transient pressures and ANN was able to predict both high outflow resistance values (Case Study II) as well as low outflow resistance values (Case study I and Case study III) equally well.
5. ANN appears to have learned the inverse relationship between initial gas volume and the outflow resistance for optimal protection as evident from Figure 2.6. If the ANN predicted value for initial gas volume is greater than the value from GA optimizer, the corresponding ANN predicted outflow resistance is lower than that from GA optimizer.
6. ANN has recognized the insensitivity of transient response to inflow resistances.

These observations demonstrate that the developed ANN model has learned and generalized the critical relationships between transient response characteristics and the associated air vessel parameters for optimal protection of large pipe networks. The 32 key parameters used as input variables for the ANN model appear to have captured the dynamics of transient phenomenon and how the air vessels change the transient response. Predictions close-to optimal solutions by the ANN model allow the modelers to minimize the number of trials in arriving at optimal protection of large pipe networks. Even for cases where the ANN predictions were significantly different, the highest pressures in the system were off by only 3% implying that the ANN is capable of providing a solution which is very close to the design limits, if not optimal.

Such close predictions despite the highly sensitive nature of initial gas volume and outflow resistance on transient response, show the efficacy of the proposed framework and the resulting ANN model as a design tool for air vessel sizing.

2.10. Uncertainties and Scope for Further Research

The main objective of this study was to develop a framework for generating design tools that help optimal sizing of air vessels. Although the case studies presented in this article show the efficacy of the proposed framework and the resulting ANN model (design tool), the framework as presented in this article has certain limitations as described in the following.

Parameter Identification and Extraction: Values of many of the ANN input variables extracted from transient model run depend on the time span over which they were extracted. Changing the time span could significantly affect the values of these variables. The knowledgebase used for training the ANN model used time spans based on the initial phase of transient response at the location of air vessel. ANN predictions could fail for those systems that have significantly different transient response time. This uncertainty demands further research in ascertaining the length of time span used in this research and propose changes if necessary. In addition, RSI values presented in Table 2.1 show the relative importance of the 32 significant input variables on optimal sizing of air vessels. Further analysis of these 32 variables is warranted to gain an in-depth understanding of physical significance of their relationships with air vessel characteristics.

Artificial Neural Networks: Performance of the ANN model could be improved if more data is available for training the ANN. In addition, it would be beneficial to have training dataset that encompasses all possible ranges for the air vessel parameters so the necessity for extrapolation by ANN would be minimized. For example, in Case Study III, the predicted inflow resistance value was 57.8, while the largest inflow resistance used in the training set was 50. A more robust and almost universal ANN could be trained if sufficient data that encompasses all practical ranges for air vessel parameters. Better ANN models could also be developed by resorting to more than one hidden layer, more number of neurons in the hidden layer(s), other training algorithms, different activation functions etc.

Normalization: Several of the variables used in building the ANN model are dimensional variables. Input variables, such as, slope of the pressure profile depend upon the transient simulation time increment (Δt). Normalization of this variable with respect to Δt could improve ANN's learning and generalization ability.

Genetic Algorithm Optimizer: Genetic algorithm approach intrinsically does not guarantee global optimum solution. Though solutions can be influenced by many parameters involved in the GA process, the chances of reaching better solution and global optimum is greatly improved by increasing the population size and number of generations. Though the population size and number of generations in the current exercise are found to be acceptable, higher values are desirable for improved performance. Since fitness evaluation of individuals requires transient simulation which involves considerable computational effort, the computational time for

optimization limits the size of population and number of generations. This is one of the reasons why shorter total transient simulation periods were used in generating the knowledgebase.

2.11. Summary and Conclusions

A simulation-optimization-regression based framework for developing transient protection design tools has been proposed. The applicability of the proposed framework for optimal sizing of air vessels in protecting large pipe networks from undue high pressure transients was demonstrated. The resulting design tool is an artificial neural network (ANN) model trained on a knowledgebase generated from a genetic algorithm (GA) based optimizer working with a large number of small pipe network models subjected to valve closure transient events. 32 key parameters (such as maximum, minimum and average transient heads, design pressure limits, severity of initial change in head etc.) constituted input variables for the ANN model. Air vessel parameters (initial gas volume, air vessel volume, inflow resistance and outflow resistance) constituted output variables for the ANN model.

Application of the air vessel sizing ANN model for three different pipe network models, demonstrated the efficacy and robustness of the proposed framework. ANN model predictions were within 10% of the critical optimal air vessel parameters for the two large pipe network models. The resulting high transient pressures were within 3% of design limits. Based on these and other results from the case studies, it may be concluded that the developed ANN model was able to learn and generalize the complex relationships between transient response characteristics

of a network model and the effects of air vessel parameters in mitigating the undue transient pressures.

Uncertainties associated with the proposed framework are discussed. Although 325 sets of data were used for training the ANN model, the complexity of the ANN architecture (40 input nodes, 40 hidden nodes, and 4 output nodes) call for much more data for efficient training of the ANN. An ANN model trained with a larger data set generated from network models of diverse boundary conditions is expected to perform at much higher levels of accuracy. Availability of reliable ANN models that can provide optimal set of parameters for surge protection devices can significantly reduce the time spent by the designers while allowing them to arrive at more economical designs.

Table 2.1 Key Parameters

S No.	Parameter			RSI Values							
	Name	Category	Physical Significance	Units	Upper Bound	Lower Bound	Inflow Requirement	Outflow Requirement	Task Values	Initial Gas Volume	Height Value
1	head_at_ar	b	Steady state head	ft	499.88	27.84	0.43	0.43	0.43	0.43	8.43
2	flow_at_ar	b	Steady state flow	ft ³ /s	22.36	4.69	0.36	-0.38	0.11	0.06	8.38
3	velocity_at_ar	b	Steady state velocity	ft/s	39.52	1.38	-0.38	0.08	0.04	0.04	8.08
4	nTotal_by_nA_MaxHead	d	Time span of +ve head above design max	%	52.52	0.00	0.11	0.04	0.24	0.19	6.24
5	nTotal_by_nB_MinHead	d	Time span of -ve head below design min	%	47.88	0.00	0.08	0.04	0.19	0.14	8.19
6	nTotal_by_nC_CriterionHead	d	Time span of -ve head below criterion head	%	47.80	0.00	-0.11	0.35	-0.03	-0.02	8.35
7	head_InitialSlope	e1	Severity of initial head change	ft/s	181733.00	20.00	0.04	0.19	-0.06	-0.05	8.19
8	head_PositiveSlope	e1	Severity of maximum head increase	ft/s	241514.00	107.96	0.04	0.14	-0.05	-0.12	8.14
9	head_NegativeSlope	e1	Severity of maximum head decrease	ft/s	249311.00	108.03	0.24	-0.06	-0.04	-0.03	8.24
10	head_InitialJump	f	Magnitude of initial head change	ft	844.70	0.09	0.35	-0.02	0.14	0.15	8.35
11	head_PositiveJump	f	Magnitude of maximum head increase	ft	1055.52	1.75	0.19	-0.05	-0.03	0.07	8.19
12	head_NegativeJump	f	Magnitude of maximum head decrease	ft	1089.11	1.75	-0.20	-0.02	0.22	0.23	8.23
13	head_InitialFlowJump	f	Magnitude of flow change associated with initial head change	ft ³ /s	4.20	0.00	-0.06	0.06	-0.71	-0.70	8.71
14	head_PositiveFlowJump	f	Magnitude of flow change associated with maximum head increase	ft ³ /s	2.08	0.00	-0.03	0.14	0.09	0.10	8.14
15	head_NegativeFlowJump	f	Magnitude of flow change associated with maximum head decrease	ft ³ /s	1.00	0.00	0.14	-0.12	0.07	-0.03	8.14
16	flow_InitialSlope	e1	Severity of initial flow change	ft ³ /s ²	1.00	0.00	-0.06	-0.03	0.00	0.00	8.06
17	flow_PositiveSlope	e1	Severity of maximum flow increase	ft ³ /s ²	999.13	0.09	0.15	-0.22	-0.10	-0.10	8.22
18	flow_NegativeSlope	e1	Severity of maximum flow decrease	ft ³ /s ²	509.13	0.30	-0.02	0.15	0.10	-0.31	8.31
19	flow_InitialJump	f	Magnitude of initial flow change	ft ³ /s ²	999.13	9.26	0.06	-0.71	-0.10	-0.11	8.71
20	flow_PositiveJump	f	Magnitude of maximum flow increase	ft ³ /s	4.20	0.00	-0.06	0.06	0.28	0.30	8.30
21	flow_NegativeJump	f	Magnitude of maximum flow decrease	ft ³ /s	2.14	0.00	-0.05	0.32	0.01	0.02	8.32
22	flow_InitialHeadJump	f	Magnitude of head change associated with initial flow change	ft	4.20	0.03	-0.05	0.07	0.00	0.30	8.30
23	flow_PositiveHeadJump	f	Magnitude of head change associated with maximum flow increase	ft	844.70	0.01	-0.01	0.01	0.12	0.13	8.13
24	flow_NegativeHeadJump	f	Magnitude of head change associated with maximum flow decrease	ft	1089.11	0.02	-0.04	0.00	-0.12	-0.15	8.15
25	avg_head_above_designMin	c	Magnitude of +ve head above design min	ft	1.00	0.00	0.06	-0.70	-0.11	0.04	8.70
26	avg_head_below_designMax	c	Magnitude of -ve head below design max	ft	844.70	0.01	0.00	0.01	0.12	0.13	8.13
27	min_head_at_ar	c	Transient minimum head	ft	1.00	0.00	0.14	0.10	-0.10	-0.09	8.14
28	max_head_at_ar	c	Transient maximum head	ft	2763.20	0.00	-0.51	-0.25	0.26	0.27	8.51
29	avg_head_at_ar	c	Transient average head	ft	1950.43	0.00	-0.12	-0.03	0.30	-0.30	8.30
30	std_deviation_head_at_ar	c	STD deviation of head profile	ft	3525.06	13.42	0.06	0.28	-0.08	-0.09	8.28
31	coeff_variation_head_at_ar	c	Coeff. Of variation of head profile	ft	1.00	0.00	-0.19	0.06	-0.01	0.00	8.19
32	max_allowable_head	a	Design max	ft	4573.93	341.15	-0.10	-0.63	0.58	0.57	8.63
				ft	665.54	166.47	-0.03	0.00	-0.15	0.40	8.40
				ft	2302.29	16.47	-0.13	-0.23	0.06	0.05	8.23
				ft	512.52	3.26	-0.22	-0.10	0.08	0.07	8.22
				ft	920.00	300.00	0.22	-0.10	-0.96	-0.96	8.96

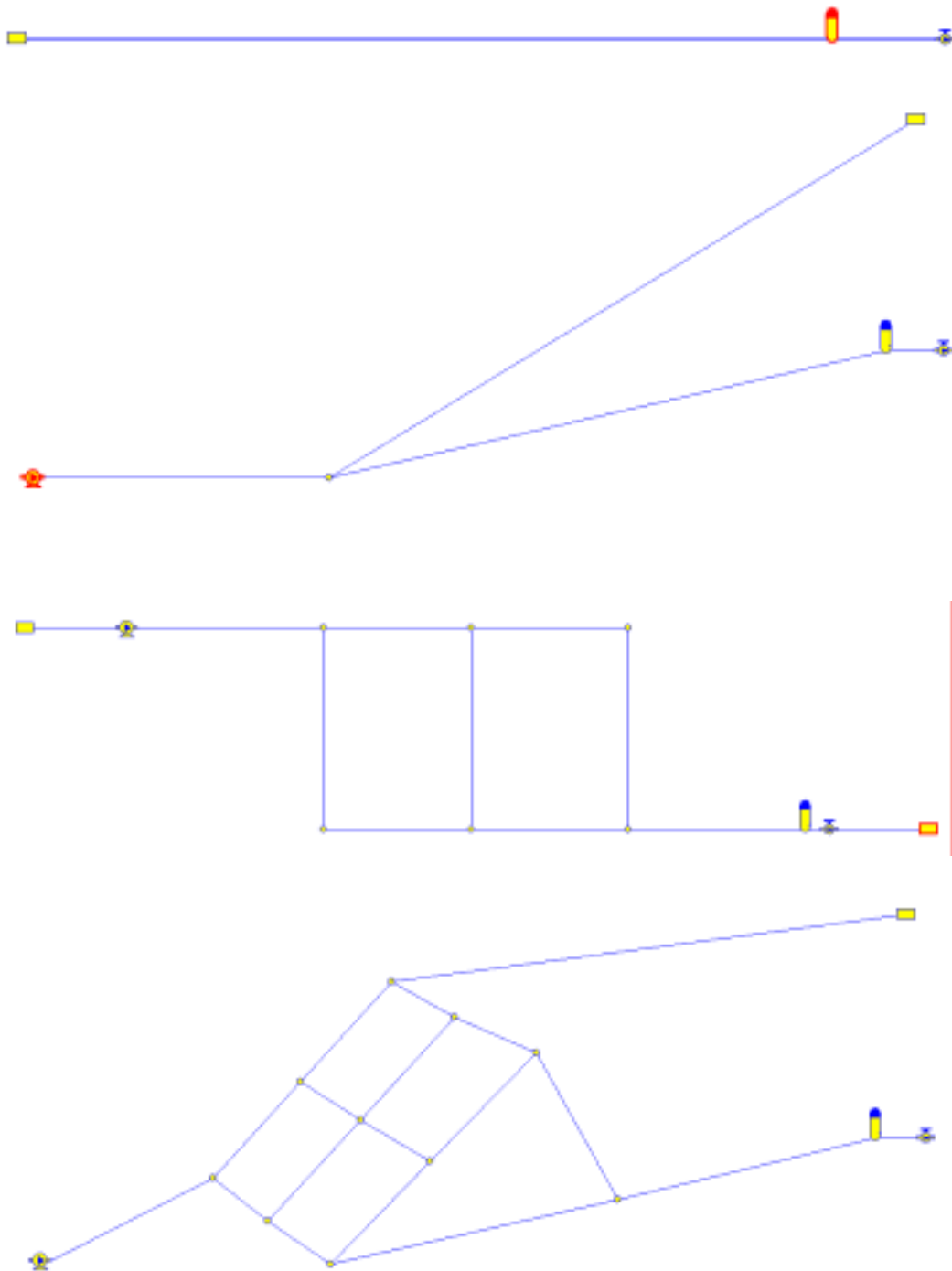

Figure 2.1 Network models used for knowledge-base development

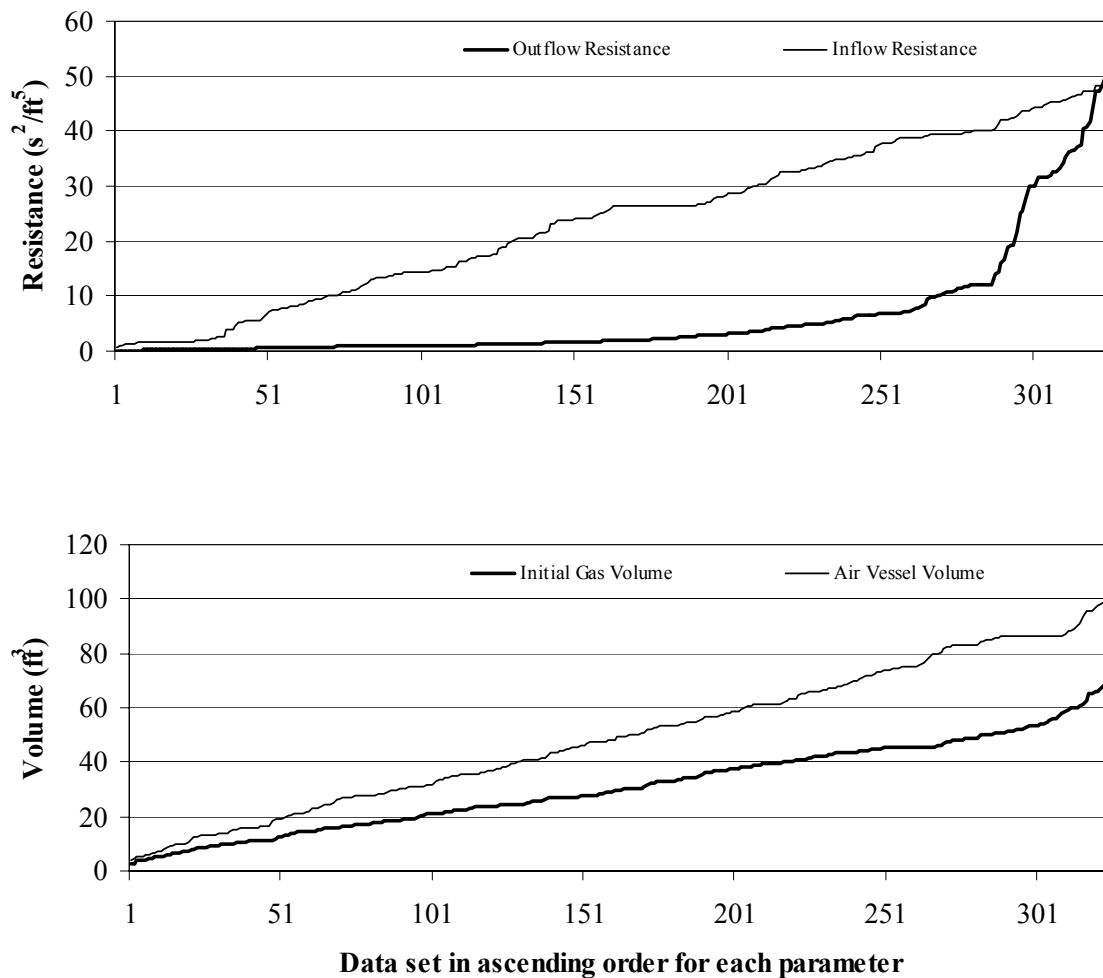

Figure 2.2 Distribution of air vessel parameters

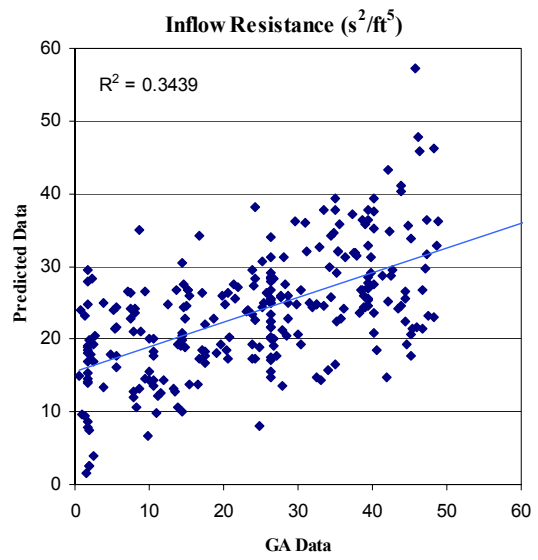
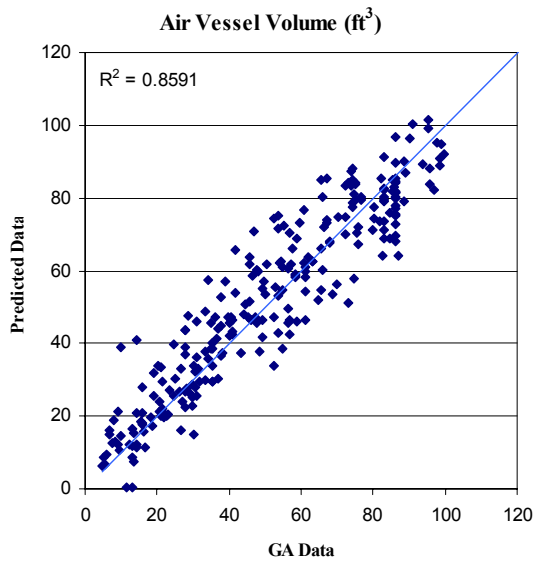
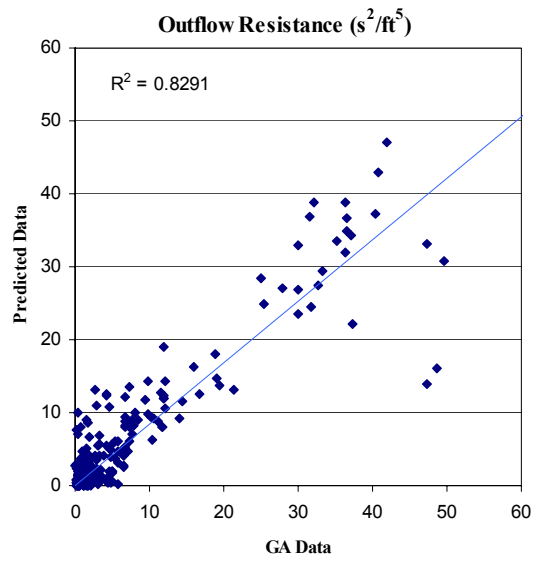
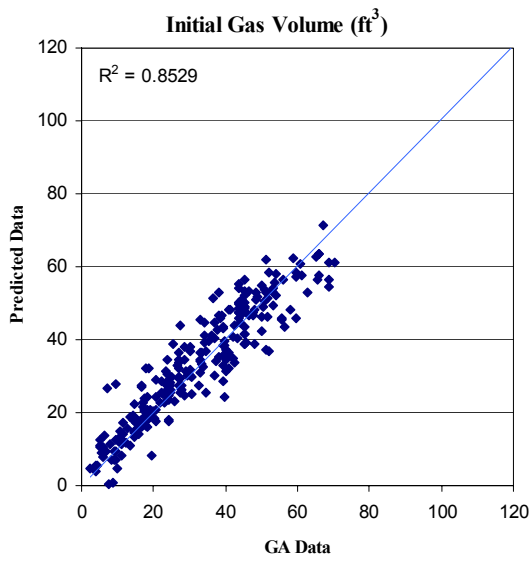

Figure 2.3 Actual and predicted value plots for ANN training

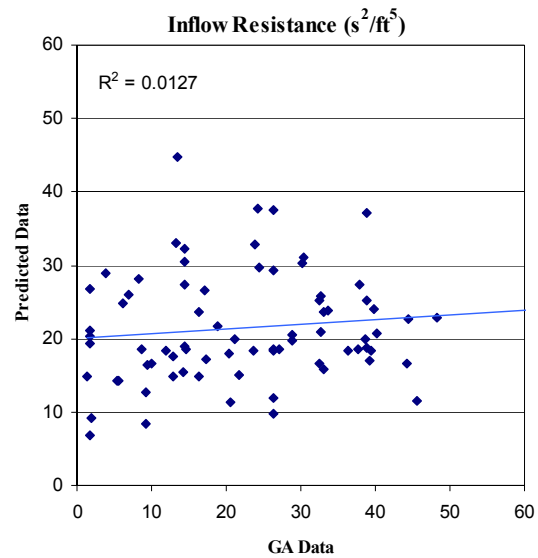
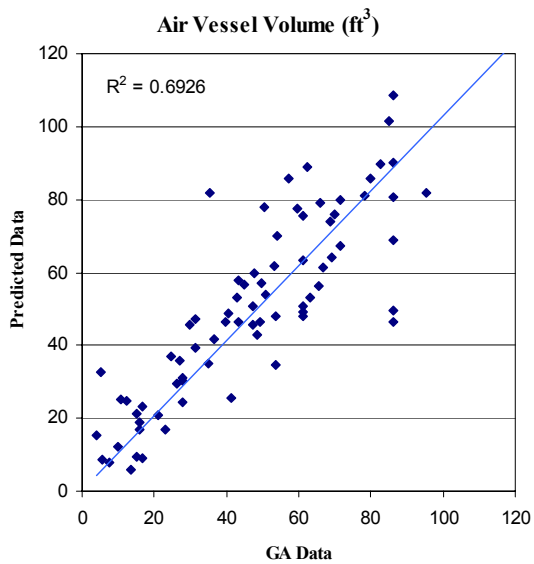
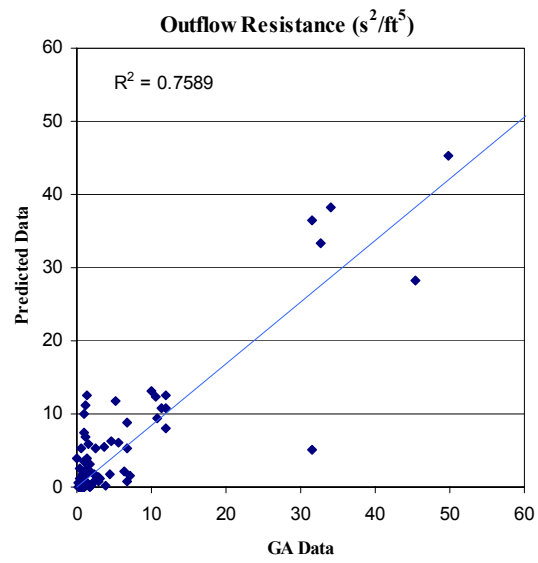
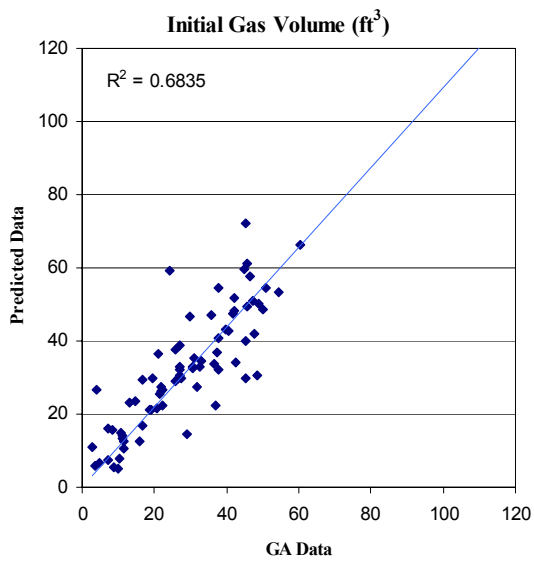

Figure 2.4 Actual and predicted value plots for ANN testing

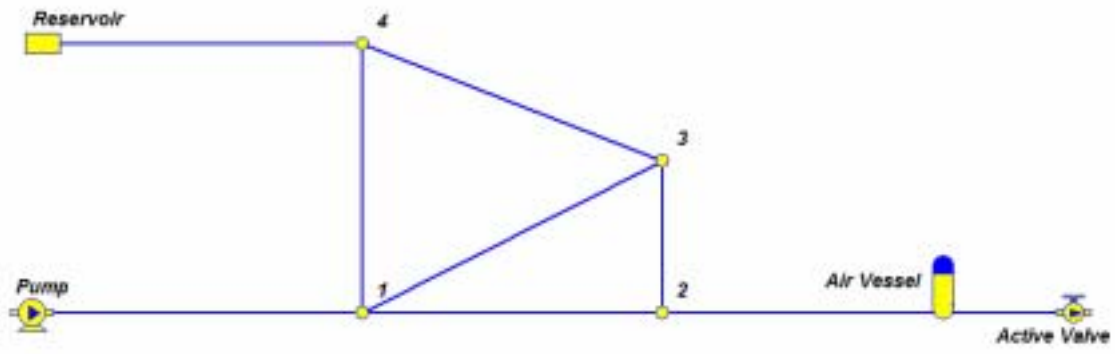

Figure 2.5 Schematic of network model used for Case Study I



Figure 2.6 ANN predicted air vessel parameters vs. GA optimizer values

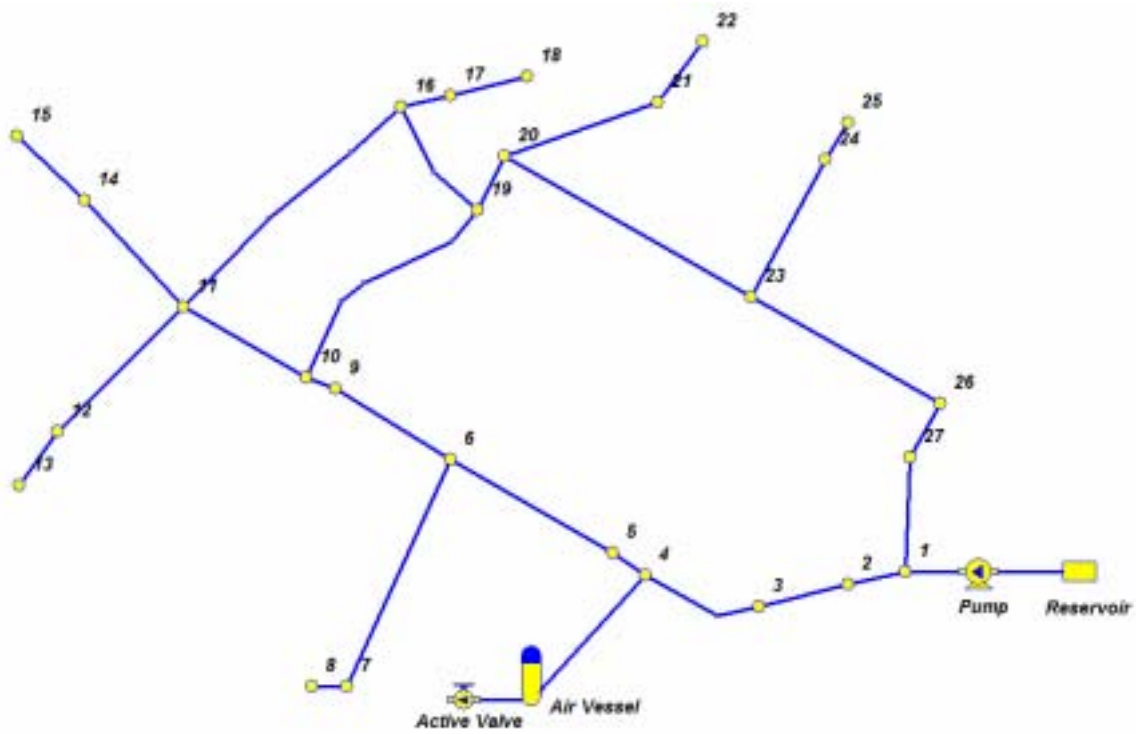

Figure 2.7 Schematic of network model used for Case Study II

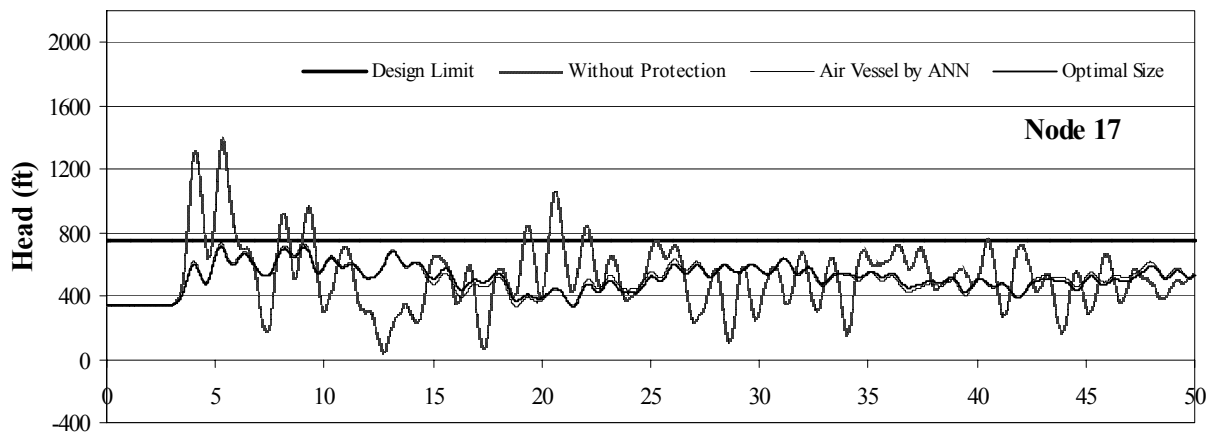
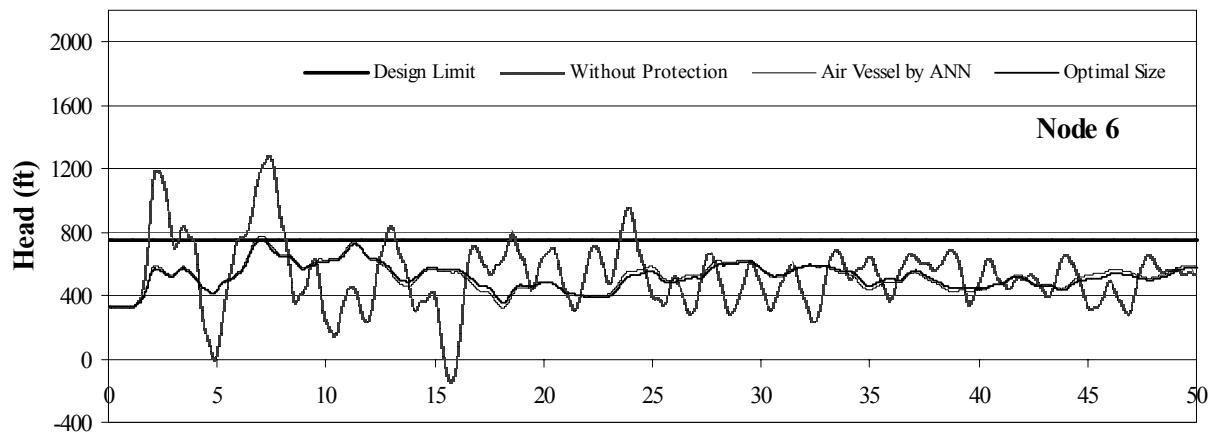
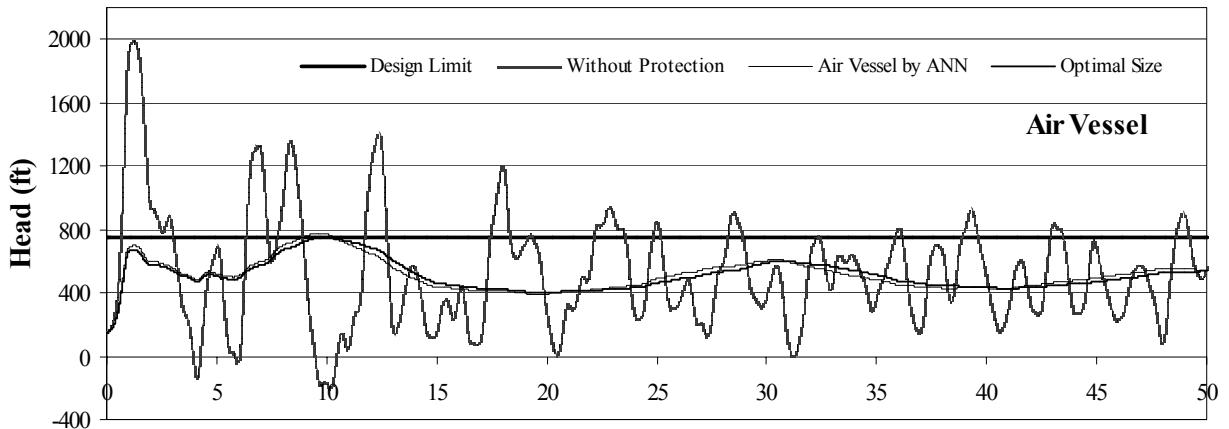

Figure 2.8 Case Study II - Transient pressure heads at air vessel, node 6 and node 17

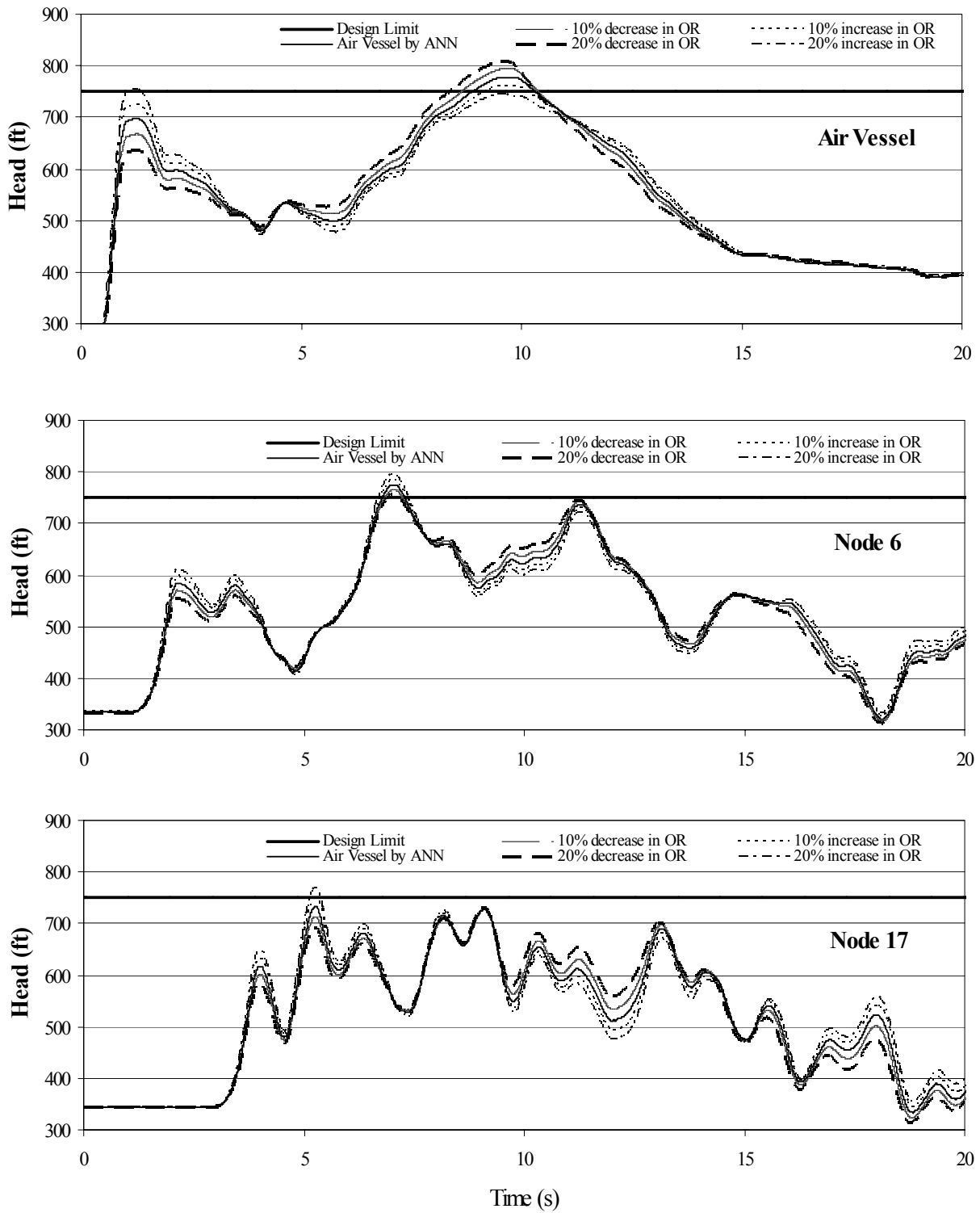

Figure 2.9 Case Study II - Sensitivity of transient heads to outflow resistance

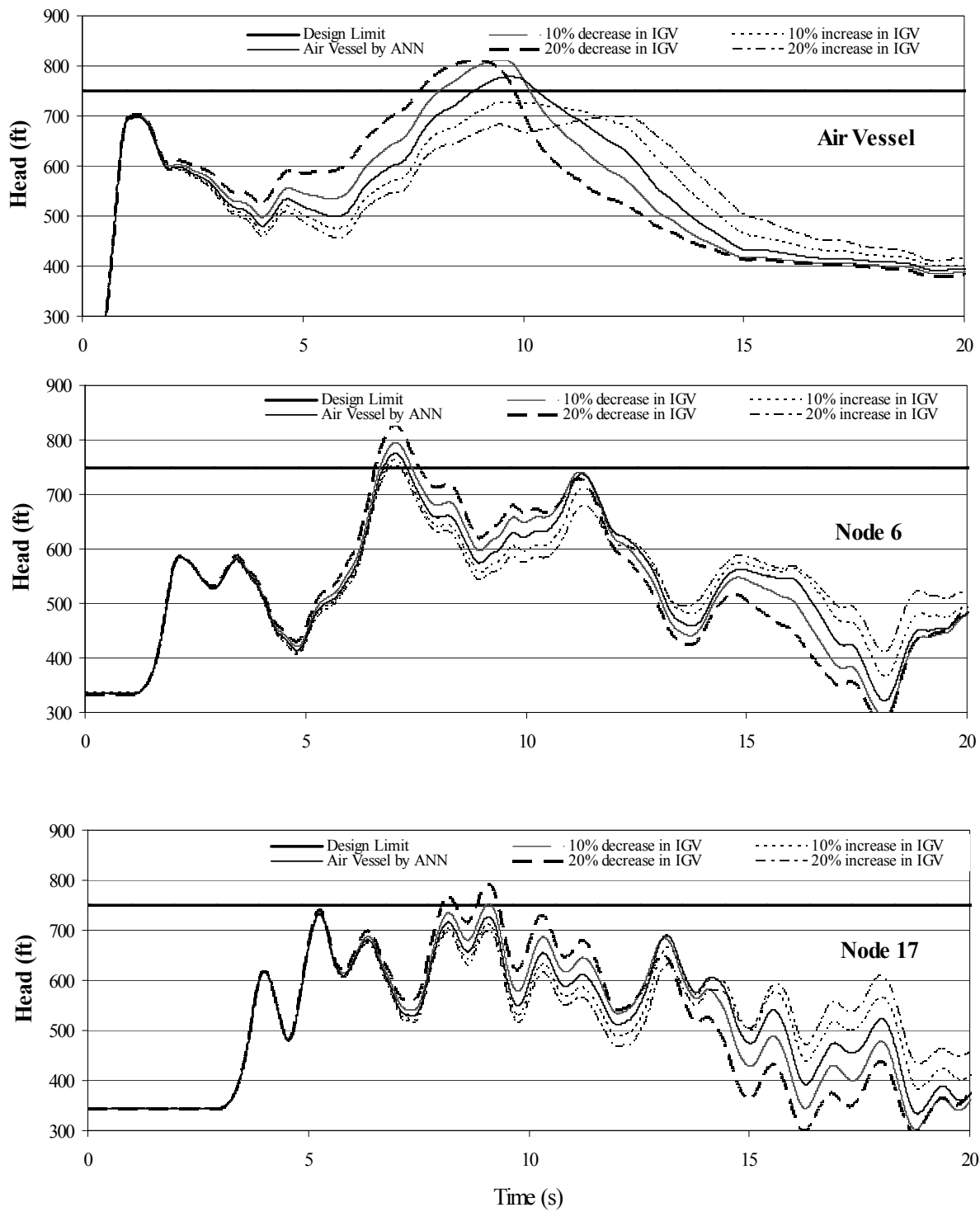

Figure 2.10 Case Study II - Sensitivity of transient heads to initial gas volume

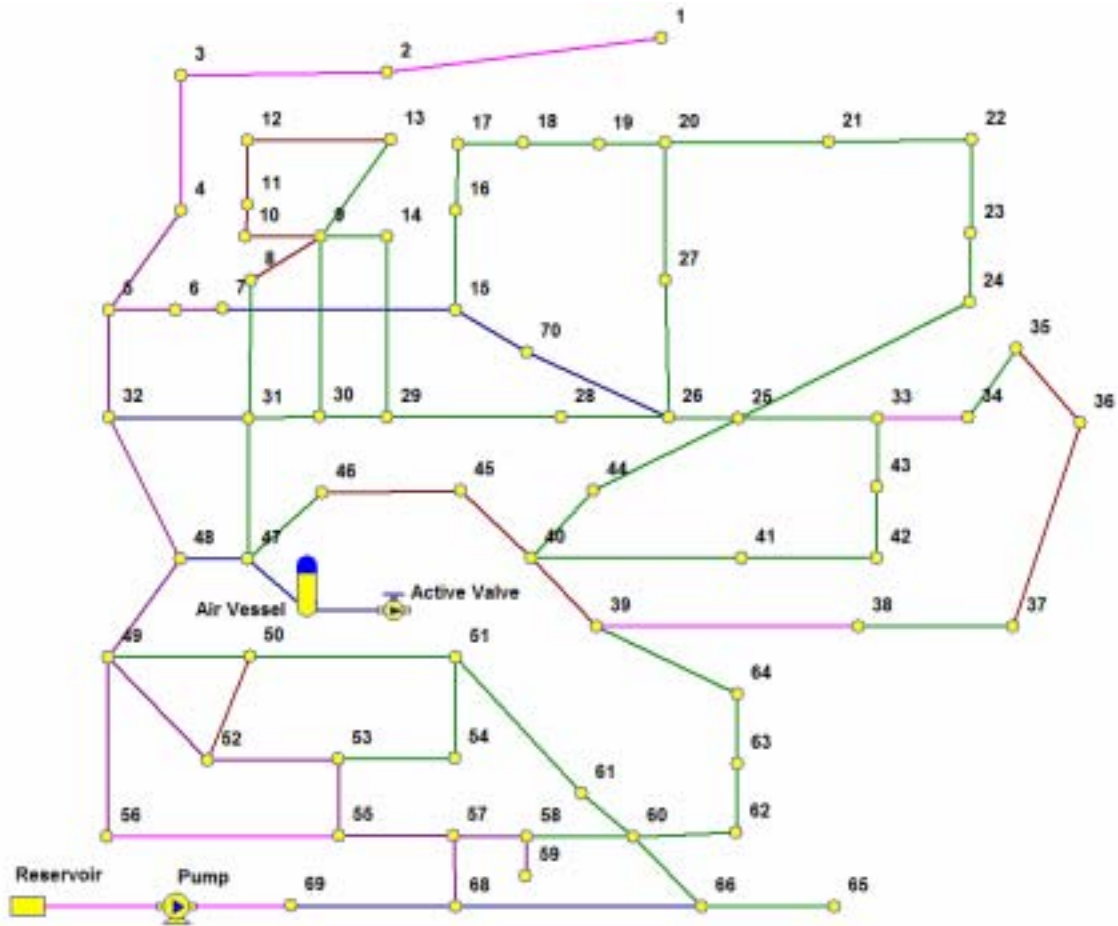

Figure 2.11 Schematic of Network Model used for Case Study III

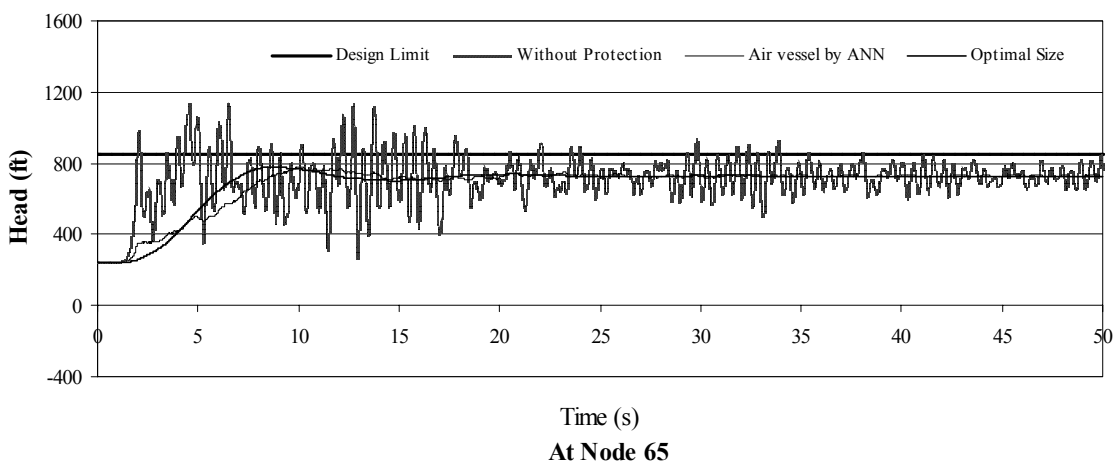
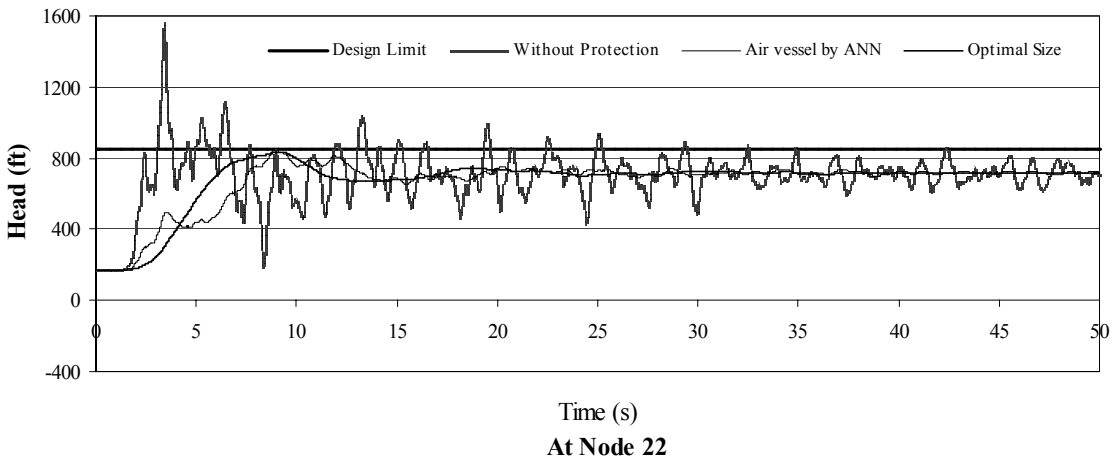
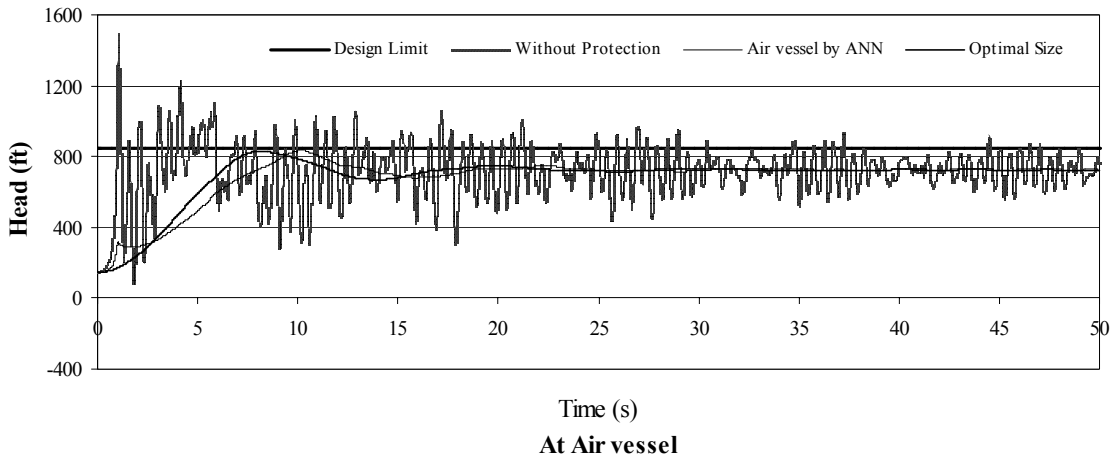

Figure 2.12 Case Study III - Transient pressure heads at three different nodes

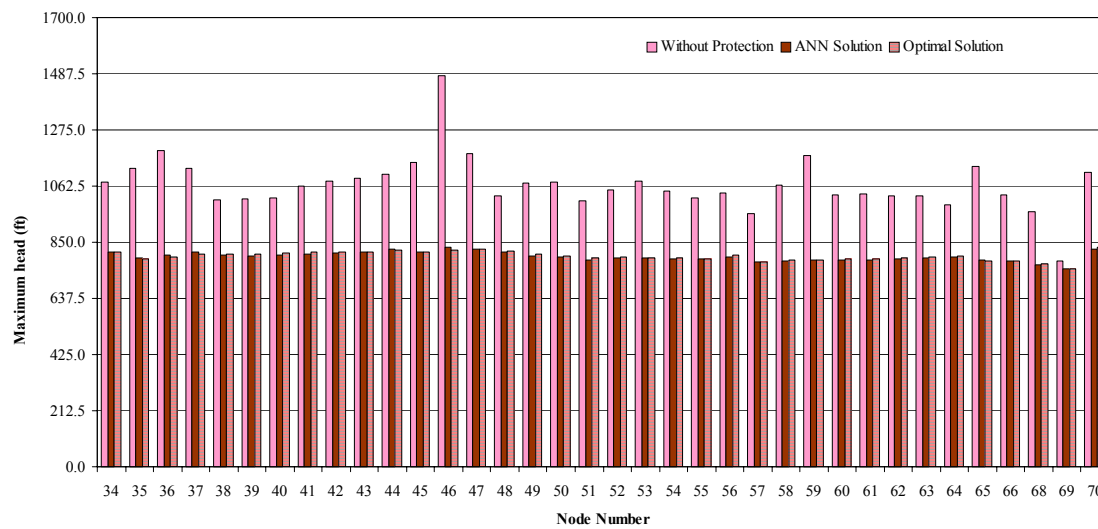
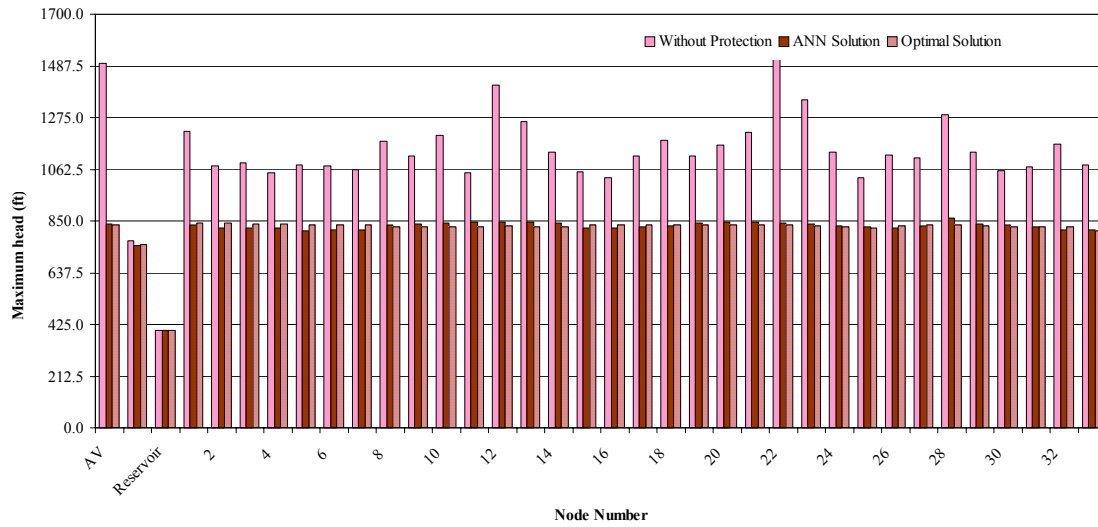

Figure 2.13 Case Study III - Maximum pressure heads at various nodes in the pipe network

Copyright © Dhandayudhapani Ramalingam 2007

CHAPTER 3: NUMERICAL COMPARISON OF WAVE PLAN METHOD AND METHOD OF CHARACTERISTICS

3.1 Introduction

Transient modeling of liquid flow in large pipe networks has always been a difficult and tedious task. There have been many methods developed for transient analysis and only a few have been successful in terms of acceptable level of accuracy of solution, programming ease, and computational efficiency. Wave plan method (WPM) is one such method that has been used with great success over the past quarter century or so by thousands of modelers around the world (Wood, Dorsch and Lightner 1966, and Wood, Lingireddy and Boulos 2005). Fixed-grid method of characteristics (MOC) is another popular method that has been widely used (Streeter and Wylie 1967, Wylie and Streeter 1978, 1993, Karney and Ghidaoui 1997). These two methods though solve the same governing equations, make similar assumptions, and adopt a numerical procedure for time simulation, they are significantly different in their underlying approaches and computational requirements.

Historically, much of the transient modeling efforts were directed towards transmission mains and penstocks with little or no attention to complex water distribution networks. Recent studies by the American Water Works Research Foundation (AWRF) indicated the potential for pathogen intrusion in drinking water distribution networks during transient generated low pressure events (LeChevallier et al. 2002). Findings of this nature spur growth in the transient

modeling activities directed towards complex drinking water distribution networks. Computational requirements of transient modeling are not trivial even for small transmission mains. The computational requirements for transient modeling of large complex water distribution networks could be several orders of magnitude higher ranging from several minutes to a few hours on modern personal computers. Despite the long computational time taken to calculate transients in pipe networks, the final solution obtained is still not accurate. This is due to topological and numerical simplifications (e.g. neglecting pipe branches, lumping consumption in main nodes, estimating the unknown pipe friction and effective diameter) that dampen or distort completely the transient event. In this context, it would be prudent to compare and contrast these two popular transient modeling approaches paying close attention to the computational efficiencies and numerical accuracies of solutions. While marginal differences in computational effort may not influence the decision making process, computational effort that is several orders of magnitude different from one method to another for similar accuracies would most certainly influence the decision making process. Computational time is also an important issue when a transient simulation model is used in an optimization framework. Popular optimization models (Kapelan et al. 2003, Vitkovsky et al. 2000, Lingireddy et al. 2000, Nash and Karney 1999, Wang et al. 1997 and Bong and Karney 2006) run transient simulations models several hundreds of times in obtaining the optimal solution.

A closer look at the two approaches indicates that the main difference between the two is the way the pressure wave is tracked between two boundaries of a pipe segment. The boundaries for pipe segment might include reservoirs, tanks, dead-end nodes, partially opened valves, pumps, junction nodes, surge control devices, vapor cavities etc. While MOC tracks a

disturbance in the time-space grid using a numerical method based on characteristics (Wylie and Streeter 1993, Streeter and Wylie 1967), the WPM tracks the disturbance based on wave propagation mechanics (Wood et al. 1966 and 2005). While there are several features that are common to both methods, there are also certain issues that are different and influence the accuracy and computational effort of each method and therefore warrant an in-depth study. Two main issues concerning the accuracy of solution and the computational effort of modeling hydraulic transients in large pipe networks are:

- Selection of computational time step Δt
- Adequacy of friction modeling (based on steady state friction factor)

Though no study has been reported for evaluating the numerical performance and computational efficiency of transient analysis methods for large pipe networks, some guidelines in terms of error analysis are available for first order MOC for single pipeline systems. Wylie and Streeter (1993) observed that in MOC, a firm criterion for selecting the number of segments based on friction is not possible as any error produced is heavily dependent on the amplitude and frequency of the disturbance. The same argument applies to WPM and for any transient analysis method. Wylie (1996) has studied this twin issue in first order MOC scheme and presented an error study in terms dimensionless numbers and time constants that can be used to evaluate “accuracy and range of validity of a solution procedure”.

The present work uses the same parameters which helps generalize characterization of different systems and evaluate the influence of frictional losses and system time constants in modeling accuracy and extends the study by applying these parameters to compare computational efficiency and accuracy of solution obtained by both first and second order MOC

and the WPM for single pipelines. Guidelines for selection of number of segments for WPM are developed. And the implications of these findings on transient modeling of large pipe networks are demonstrated.

Since the procedure for modeling hydraulic components is similar in both methods and there are no critical issues related to accuracy and computational effort associated with hydraulic components, the present work excluded modeling of hydraulic components from the discussion on computational efficiencies. Similarly computational issues involving cavitation, unsteady friction (Silva-Araya and Chaudhry 2001, Pezzinga 2000), non-linear pipe behavior, dissolved air in fluid and fluid structure interaction (FSI) are not considered.

3.2 Overview of MOC and WPM

The following are the two equations governing flow of fluid in prismatic closed conduits under transient conditions (Wood, Lingireddy and Boulos 2005, Almeida and Koelle 1992, Wylie and Streeter 1993)

Continuity equation,

$$\frac{\partial H}{\partial t} + \frac{a^2}{gA} \frac{\partial Q}{\partial x} = 0 \quad (1)$$

Momentum equation,

$$\frac{\partial H}{\partial x} = -\frac{1}{gA} \frac{\partial Q}{\partial t} + f(Q) \quad (2)$$

where Q = flow rate, H = pressure head, $f(Q)$ = friction slope expressed as a function of flow rate, A = pipe flow area, a = pipe celerity or wave speed, g = gravitational acceleration, and x

and t the space-time coordinates. Advective terms are neglected in the above equations as it is justified in most of the cases.

Solution of Eqs. (1) and (2) with appropriate boundary conditions will yield head and flow values in both spatial and temporal coordinates for any transient analysis problem. The above equations are first order hyperbolic partial differential equations in two independent variables (space and time) and two dependent variables (head and flow). Since both methods have been discussed adequately in the literature (Streeter and Wylie 1967, Wylie and Streeter 1978, 1993 and Wood, Lingireddy and Boulos 2005), only a brief account of each method is given in the following.

3.2.1 Method of Characteristics (MOC)

In the method of characteristics, the governing partial differential equations are converted to ordinary differential equations and then to a difference form for solution by a numerical method (Streeter and Wylie 1993). The solution space comprises two equations called “characteristic equations” along with two compatibility equations for any point in a space-time grid. Compatibility equations are valid only when the characteristics equations are satisfied. Figure 3.1 shows a typical space-time grid with characteristic equations. MOC divides the entire pipeline into a predetermined number of segments, writes the characteristic and compatibility equations for every grid location and then solves these equations for head and flow at all grid locations. The line friction of the entire pipeline is distributed in each of these segments. Various boundary conditions like reservoirs, valves, pumps and other devices are handled by combining the appropriate characteristic equation with the equations defining the boundary.

3.2.2 Wave Plan Method (WPM)

Wave plan method is based on the concept that transient pipe flow results from generation and propagation of pressure waves that occur as a result of a disturbance in the pipe system. A pressure wave, which represents a rapid pressure and associated flow change, travels at sonic velocity of the liquid-medium, and gets transmitted and reflected at all discontinuities in the pipe system. A pressure wave is also modified by the pipe friction. WPM consists essentially of two types of analyses called component analysis and junction analysis (Wood et al. 2005). Component analysis deals with the problem of transmission and reflection of pressure waves at a hydraulic device while junction analysis addresses the same problem at a pipe junction, a dead end node, or a constant head reservoir. The entire line friction is modeled as an equivalent orifice situated at the mid point of a pipeline or multiple orifices distributed uniformly throughout the pipeline. Figure 3.2 shows the schematic representation of wave action at a friction orifice. D_1 and D_2 represent the magnitudes of pressure waves approaching the friction orifice while D_3 and D_4 represent the magnitudes of pressure waves reflected off the friction orifice. H and Q along with appropriate subscripts represent head and flow respectively at appropriate locations.

Transmission and reflection at these friction orifices represent the effect of line friction on the pressure waves.

3.3 Dimensionless Numbers and System Time Constants

Wylie (1996) non-dimensionalized the basic equations using steady state flow and friction parameters, potential surge and travel time of the pipeline. The parameters used are defined as below

1. Steady state frictional loss $H_{fo} = \frac{fL}{D} \frac{(V_0)^2}{2g}$ where f = Darcy-Weisbach

friction factor, V_0 is steady state line velocity, D = diameter of the pipeline and A
= pipe flow area

2. Potential surge $H_s = \frac{a V_0}{g}$

3. Non-dimensional factor $R = \frac{fL}{2D} \frac{V_0}{a} = \frac{H_{fo}}{H_s}$

4. Evaluative index for friction in MOC (Wylie and Streeter, 1993) $\psi = \frac{f\Delta x}{2D} \frac{V_0}{a}$ was

represented in terms of R as $\psi = \frac{f\Delta x}{2D} \frac{V_0}{a} = \frac{R}{N}$ where N is number of segments in a
pipeline

5. Error $E = \frac{\Delta H}{H} = C_e \frac{R \frac{dv}{dt}}{F(N)}$ where ΔH is the deviation in the computational results

from the correct answer (obtained at a large value of N), C_e is the percentage error E

when $\frac{R \frac{dv}{dt}}{F(N)}$ is equal to 1 and $t = T/(L/a)$

The exponent in $F(N)$ is a function of R , dv/dt , time, t_m , at which comparison is made
and t_e , the dimensionless effective operator time. The coefficient is likely to vary differently for
 t_m and t_e less than 2 (T_m and T_e less than $2L/a$ s) than when the same dimensionless time

constants are greater than 2. Wylie (1996) reported that $F(N)$ for first order MOC is approximately N^2 for t_m equal to 2.

Use of H_s and R as defined here permits the characterization of pipelines into one of the comparing values of R (Liou 1991 and 1992). That means, “pipelines with the same R value will offer the same response if equal, scaled, initial and boundary conditions are applied. This observation removes the specific values of diameter, length, wave speed, etc. in discussions comparing one system with another” (Wylie 1996).

Moreover a value of R greater than or equal 1 represents case of attenuation and line packing when potential surge is less than the frictional head loss in the pipeline and a value of R less than 1 represents absence of attenuation and line packing.

3.4 Objectives of Present Study

1. Use these dimensionless parameters for first and second order MOC and WPM for evaluating the influence of friction modeling and system time constants on the modeling accuracy at a time where the effect of line friction reflects completely on the computed results in a classic pipeline reservoir-pipe-valve system with valve closure as the transient causing event. This is clearly when t_m and t_e less than 2 (T_m and T_e less than $2L/a$ s) but close to 2, i.e., head at the valve just before the end of one cycle (i.e., before the reflected wave from the reservoir impinges on the valve) for varying number of segments for each method.
2. Conduct the above error study for long pipeline and short pipeline where there is no attenuation and line packing (as is the case in large pipe networks), i.e., when $R < 1$

3. Conduct the error study for few cases to get an understanding of the difference in numerical performance of the three schemes when attenuation and line pack effect are present, i.e., when $R > 1$.
4. Study the computational efficiency of each scheme for a specified level of accuracy.
5. Discuss the implication of findings on the decision making process for transient analysis of large pipe networks.

3.5 Numerical Experiment

The effect of line friction and exciter behavior on modeling accuracy is studied by the classic reservoir-pipeline-valve problem. Figure 3.3 depicts the hydraulic system considered for this study. This pipeline connects a constant head reservoir on upstream end and a valve on the downstream end. Two scenarios, one with a very long pipeline ($L = 6583.7$ m, 8 cases) and the other with a relatively short pipeline ($L = 1097.3$ m, 8 cases) for $R < 1$ and another scenario very long pipeline (length = 6583.7 m, 6 cases) for $R > 1$ and $R < 2$ are considered. The valve resistance R is defined as $R = \Delta H / Q^2$, where ΔH = head drop across the valve in meters and Q = flowrate m^3/s is 19006.2. Table 3.1 summarizes hydraulic parameters of the three scenarios and steady state results for all the cases in each scenario.

Method of specified time-intervals approach was employed for MOC (Wylie and Streeter 1993). The Courant number was kept at one [$a * (\Delta t / \Delta x) = 1$] in all the cases, thus avoiding interpolation errors. Since the transient initiating event was an instantaneous valve closure, adjusting Δt to vary the number of segments while maintaining a Courant number of 1 was easily achieved. Instantaneous closure of the valve is the transient initiating event (valve closes

fully in one Δt) modeled in this example application. Percentage error of head at the valve just before the end of one cycle, is calculated using the accurate solution obtained from using large number of segments (1200 when $L=6583.7$ m and 1000 when $L=1097.3$ m)). Number of segments in the long pipe scenarios are ($L=6583.7$ m) {2, 3, 4, 6, 8, 12, 24, 60, 600, 1200} and associated Δt (also effective valve closure time) in seconds are {3.000,2.000,1.500,1.000,0.750,0.500,0.250,0.100,0.010,0.005}. Number of segments in the short pipe scenario are ($L = 1097.3$ m) {2,4,5,10,20,100,200,1000} and associated Δt (also effective valve closure time) in seconds are {0.500,0.250,0.200,0.100,0.050,0.010,0.005,0.001}. Hence scenario I has 80 configurations (8×10), scenario II has 64 (8×8) configurations and scenario III has 48 (6×8) configurations. Dimensionless parameters (R , dv/dt , C_e , N) are calculated for all configurations.

3.6 Effect of Steady State Line Friction on Modeling Accuracies

As discussed before, in MOC, both steady and unsteady friction approximations depends on the number of segments a pipeline is divided into. Frictional effects are computed by solving the compatibility equations at the intermediate points. For high line friction cases, Wylie and Streeter (1978) suggested the use of second order accurate procedure for the friction term resulting in compatibility equations that are nonlinear in flow rate. WPM handles the line friction by introducing an orifice with an equivalent resistance within the pipeline. The orifice resistance is calculated using the total steady state frictional headloss and the steady state flowrate through the pipeline. Line friction is evenly distributed when multiple orifices are used. Note that one set of computation is done at every junction of adjoining segments in MOC but in WPM each segment has a friction orifice and hence one set of computation is done for every segment.

Figures 3.4, 3.5 and 3.6 show the % error in head at the valve for each method for varying number of segments for each scenario for three values of R. Figure 3.7 shows the %

error of head versus the evaluative index for frictional accuracy $\psi = \frac{f\Delta x V_0}{2D a} = \frac{R}{N}$

3.7 Effect of Exciter Behavior on Modeling Accuracies

Analysis of results for exciter behavior on numerical accuracy is done using a spreadsheet program. Since there are two unknown variables C_e and $F(N)$ in the equation

$E = \frac{\Delta H}{H} = C_e \frac{R \frac{dv}{dt}}{F(N)}$, three types of analysis is done. In the first case, both variables were solved

for all methods, in second case C_e for MOC second order and WPM were kept same as obtained for MOC and exponent is solved and in the third case exponent was kept at 2 for all the cases and C_e was solved for. Table 3.2 summarizes the results.

3.8 Computational Efficiency

Computational effort in both methods is associated with the calculation of heads and flows along the pipeline and at the boundaries. Elements or devices forming a boundary either involve simple equations or non-linear quadratic equations. Techniques employed by both methods to solve these non-linear equations are similar, hence the computational effort needed at the boundaries in both the methods are comparable. Hence it would be sufficient to look into the computational effort needed in modeling the pipes by these methods.

3.8.1 Wave Plan Method

Component analysis is a generic procedure employed by WPM to analyze the wave action at various discontinuities in the system (Wood et al. 1966 and Wood 2005). It involves nonlinear equations solved by Newton-Raphson method. Traditionally, WPM made use of component analysis for friction orifice analysis as well.

However the friction orifice problem is simple enough that it can be handled more intuitively using the basic wave reflection mechanism. Equations involved in the friction orifice analysis are cast differently and solved by a simple iterative technique. It was found that the new approach is computationally cheaper than the former. It is worth while to notice that both methods solve the same equations but equations are set-up differently and adopt two different iterative techniques.

All the schemes are shown in the appendix. Numbers shown in the square brackets are the number of arithmetic or floating point operations (flops) involved in the statement. Addition, subtraction, multiplication, division and mod operations only are considered and each operation was counted as one. Assignment operations are not counted. 'res' in the equations represents the resistance of the friction orifice.

The new procedure for handling the friction is also shown appendix with the number of computations for each statement shown in parenthesis. This method needs more iteration in the early phase of transient analysis but needs less iteration later on. On an average it requires 2 iterations. The computational effort involved is $(5 + 2 \times 11 + 8)$ 35 flops.

3.8.2 MOC First Order

Since entire pipeline is divided into a number of segments for calculation of heads and flows and similar equations are solved for each grid point, computational effort can be ascertained by determining the total number computations associated with a grid location. 'res' in the equations represents the resistance of the one segment. Flop calculations are as shown in the appendix and MOC needs 33 operations per segment per time increment.

3.8.3 MOC Second Order

Though other mixed schemes (Almeida and Koelle 1992, Streeter and Wylie 1993) that are more accurate than MOC first order and less computationally expensive than MOC second order, the present study uses the second order scheme reported by Wylie and Streeter (1978) for its accuracy. MOC second order differs from MOC only in the fact that it has a nonlinear equation in flow rate. The Newton-Raphson method is used to solve the nonlinear equation and found that MOC second order scheme needs, on an average, two iterations for convergence. The number of computations for a single segment as shown in the appendix is $(9 + 2 \times 23 + 19) = 74$ flops.

Chaudhry (1979) proposed a predictor-corrector scheme which is supposed to be computationally more efficient than the MOC second order. Results from this scheme were either similar or slightly inferior to MOC second order and required 62 flops per segment per time increment.

3.9 Results and Discussion

It can be seen from Figures 3.4, 3.5 and 3.6 that

1. All methods are accurate at higher number of segments, regardless of value of R

2. Results from methods differed significantly when number of segments is low
3. WPM produces consistently more accurate results than both first and second order MOC schemes for lower segment cases
4. Results from WPM were much closer to the accurate solution even with just two segments. Maximum percentage error for WPM with two segments cases was 4.5% for $R < 1$ and 16% when $R > 1$. Maximum percentage error for MOC first and second order schemes are 46.8% and 23.4% for $R < 1$ and 89.5% and 69.2% when $R > 1$.

While Figures 3.4, 3.5 and 3.6 shows the performance for individual cases, Figure 3.7 shows the percentage error against the frictional evaluative index R/N for the all the configurations. It can be seen that percentage error for the maximum value of ($R/N=0.53$ for $R < 1$) is less than 5% while for MOC first and second order schemes are 46.8% and 23.3%. Corresponding results for WPM, MOC first order and MOC second order when ($R/N=1.01$ for $R > 1$) are 16.3%, 89.5% and 69.2%. WPM is more resilient against the value of frictional index than the MOC schemes.

It should be noted that the evaluative index should be far below 0.15 for accuracy of solution by MOC first order scheme as a general guidance for accurate solution (Streeter and Wiley 1978). Wylie (1996) reported that MOC first order scheme is accurate (1% error) for values less than 0.01.

Table 3.2 unveils the underlying relationship between percentage error and the dimensionless parameters.

1. For $R < 1$, from analysis type 1 and 3, it can be seen that for same number of segments WPM produces 14 times accurate results the MOC first order scheme and 7 times accurate results than MOC second order scheme
2. For $R < 1$, from analysis type 2, it can be concluded that for same accuracy WPM requires at most $N^{(2/5.5)}$ segments that of MOC first order scheme and $N^{(2.9/5.5)}$ segments that of MOC second order scheme
3. for $R > 1$, from analysis type 3, it can be seen that for same number of segments WPM produces 6 times accurate results the MOC first order scheme and 3 times accurate results than MOC second order scheme

For example, for less than 2% error in computed head, Table 3.3 summarizes the number of segments required for each method and associated computational effort. Note that for MOC schemes only $N-1$ computations are needed for N segments. For WPM N frictional orifice computations need to be made. The conclusions established above can be numerically verified using values in the table.

It should be noted that though computations can be done with single orifice for a system in WPM, .i.e., single segment case, for comparison across the three methods it was ignored. For cases when 2 orifices were suggested by the study for less than 2 percent error in computed head, one orifice would have been sufficient. As an example, Figure 3.8 shows the head at the valve for case-5 of scenario III for a two segment case MOC first order, MOC second order and WPM along with the accurate solution obtained with 1200 segments for a total simulation period of 100 seconds. It should be noted than WPM performs better than the other two MOC schemes.

Similar arguments can be made about the selection of number of arguments for the systems studied. Had the variation of number of segments been smoother and evenly spaced in

each system, the variation in number of segments for a particular accuracy across different systems would have been less especially in MOC second order scheme and WPM.

From Figure 3.8 it is safe to conclude that

1. for a value of R up to 0.5, it is sufficient to use only 2 friction orifices in WPM to ensure percentage error of less than 2%. WPM in that case would be at least 20 times computationally efficient than first and second order MOC schemes
2. for $R > 0.5$ and $R < 1$, it is sufficient to use 6 friction orifices to in WPM to ensure percentage error of less than 2%. WPM in that case would be at least 10 times computationally efficient than first and second order MOC schemes

3.10 Analysis of Large Pipe Networks

3.10.1 Selection of Time Increment

In general, selection of a computational time increment (Δt) for the transient simulation of a complex pipe networks has the following constraints

- Δt should be less than or equal to the smallest wave travel time (length/celerity) in the network (in the pipes modeled)
- Δt should be less than or equal to the minimum time span of boundary condition changes
- Δt should be the greatest common divisor (GCD) of travel times of all pipelines and minimum time span of boundary condition change

3.10.2 Constraint on Δt Based on Courant Stability Criteria

MOC requires that the ratio of distance step Δx to the time step Δt be equal to the wave speed “a” in the pipe. That is, the Courant number defined as $[a * (\Delta t / \Delta x)]$ should ideally be equal to one and must not exceed one for stability reasons (Chaudhry 1979). Since most pipeline systems have variety of different pipes with a range of wave speeds and lengths, it might be difficult to satisfy the Courant stability criterion for all pipes with a reasonable (and common) value of Δt (Karney and Ghidaoui 1997). This challenge is overcome by either adjusting the lengths and/or wave speeds of the pipes or allowing Courant number to be less than one. Allowing Courant number less than one requires a numerical interpolation which in turn leads to numerical damping and phase shift of the pressure wave in particular for fast transients and steep wave fronts (Chaudhry, 1987). The errors resulting from interpolations can be reduced by adopting larger number of segments that result in smaller computational time step (Karney and Ghidaoui 1997) that in turn increases the computational time requirements. Similar treatment of adjusting the wave speed or pipe lengths should be done in WPM also.

3.10.3 Example Application

To illustrate the impact of friction modeling, issues in selecting time increment for simulation, and computational effort associated with each method for a network or pipes, a small well publicized network model (Streeter and Wylie 1978) was employed. Figure 3.9 shows the schematic for this system.

Text along the pipelines denotes the pipe name and pipe length. Numbers shown in the box adjacent to each pipeline denote the wave speed in the pipeline. Transient initiating event is

the demand change at the dead end located in pipe P-7 over a period of 0.6 seconds i.e., demand of 30 cfs at time = 0 goes to zero in 0.6 seconds.

Steady state results indicated that the pipe frictional losses varied from 2ft to 68feet. Based on the inferences from Figure 3.5, one friction orifice would be sufficient for reasonable solution in case of WPM. However the number of segments needed in MOC needs to be found from the stability criteria first and then should be checked for adequacy of frictional modeling. Table 3.2 gives the travel time for the pipes.

Selection of time increment (Δt) has the following constraints.

- Δt should be less than or equal to smallest travel time
 - i.e. $\Delta t \leq 0.4 \text{ sec}$
- Δt should be less than or equal to the time span of boundary condition changes
 - i.e. $\Delta t \leq 0.6 \text{ sec}$
- Δt should be the greatest common divisor (GCD) of all travel times and all time span of boundary condition changes
 - i.e. $\Delta t = \text{GCD of } (0.4, 0.5, 0.6, 0.606, 0.7, 1.0) = 0.002 \text{ sec}$

It can be seen that the travel time of 0.606 seconds for pipe P-7 skews the Δt selection from a much bigger possible Δt value. If suppose 0.606 can be rounded to 0.6, then Δt can be 0.1 sec. But the error in doing so is that pipe P-1 and P-7 are modeled as 1980 feet long instead of 2000 feet. Alternatively, one could adjust the wave speed to account for these changes.

Adjusting pipe lengths and/or wave speeds that result in a larger Δt appears to be not a major issue for the example network under consideration. However, it may not always be possible to adjust the time increments to larger values. Consider a scenario where one of the pipes in the network is significantly shorter compared to the rest. For example, if pipe P-1 in the example network were 50ft long (instead of 2000ft), the resulting travel time would be 0.01515 seconds. Being the shortest travel time, this would control the selection of Δt even when all other travel times are adjusted to meet the GCD requirement. However, rounding 0.01515 seconds to a significantly higher value might imply a large adjustment to pipe lengths and/or wave speeds which could unduly affect the accuracy of results. Short pipes are common near pump stations when modeling large distribution networks. Since Δt controls the total number of segments for MOC and hence the total computational effort, it is worthwhile exploring the computational efforts needed both with shorter and adjusted Δt .

Table 3.4 illustrates the procedure for calculating computational effort for a total simulation period of 50 seconds for MOC first order scheme. WPM for Case1 and Case 2 requires 7.876×10^6 and 0.157×10^6 computations respectively.

Thus computational effort of MOC is 282 times greater than that of WPM in Case 1 and 4 times in Case 2. The results of head at the junction of pipes P1, P2 and P3 are shown for both methods in Figs. 10a and 10b.

3.11 Summary and Conclusions

Numerical accuracy and computational efficiency issues of Wave Plan Method (WPM) and Method of Characteristics (MOC) in solving basic unsteady flow equations in closed conduits were studied. Though both methods solve the same governing equations and make similar assumptions, they are significantly different in their approaches. Numerical accuracy of solution and computational effort, which are interdependent, were studied for both methods and their implications for practical applications were investigated.

Present study used non-dimensional parameters and time constants reported previously in the literature. Guidelines in the form of error study were developed for number of friction orifices to be used in WPM for acceptable level of accuracy. Number of segments required for a particular level of accuracy is governed by twin issues of frictional losses and system time constants. The study indicates that first and second order MOC schemes needs substantially larger number of segments within a pipeline for same level accuracy when compared to WPM.

Computational efforts for short and long pipelines and for a network of pipes associated with MOC first and second order schemes and WPM were explored and the results clearly indicate the computational advantages of WPM. The difference in computational effort could be several orders of magnitude depending on the time step chosen.

Results from the case study also indicate that the use of a two orifices in the entire pipeline with WPM is acceptable so long as the non-dimensional parameter R is less than 0.5 and six orifices for values of $R > 0.5$ and $R < 1$. This is not a very stringent requirement for most transient modeling studies especially for those dealing with large water distribution networks.

This means that for larger systems WPM can substantially reduce computational time while ensuring accurate results. Ability to efficiently handle large distribution systems is essential for transient generated pathogen intrusion studies. This saving in computational time could also be useful when a transient simulation is coupled with an optimization model where repeated transient simulations are needed.

Table 3.1 Hydraulic parameters and steady state results

S No.	Case #	Hazen-Williams Roughness Coefficient	Diameter (mm)	H _{reservoir} (m)	a (m/s)	V ₀ (m/s)	H _{fo} (m)	H _s (m)	R = H _{fo} /H _s
<u>L = 6583.7 m, R <= 1.0</u>									
1	a	120	128.3	182.9	1097.28	1.643	174.3	183.6	0.95
2	b	120	128.3	121.9	1097.28	1.320	116.4	147.6	0.79
3	c	120	128.3	91.4	1097.28	1.131	87.4	126.4	0.69
4	d	120	128.3	61.0	1097.28	0.908	58.3	101.6	0.57
5	e	120	205.0	121.9	1097.28	1.439	79.0	160.9	0.49
6	f	120	257.6	121.9	1097.28	1.222	44.8	136.7	0.33
7	g	120	307.1	121.9	1097.28	0.969	23.8	108.5	0.22
8	h	120	419.9	121.9	1097.28	0.564	6.0	63.1	0.10
<u>L = 1097.3 m, R <= 1.0</u>									
1	a	75	78.0	259.1	1097.28	2.432	271.8	256.5	1.06
2	b	90	78.0	228.6	1097.28	2.722	225.4	304.2	0.74
3	c	100	78.0	213.4	1097.28	2.908	209.7	325.1	0.65
4	d	120	78.0	121.9	1097.28	2.569	119.1	287.4	0.41
5	e	120	205.0	121.9	1097.28	2.137	27.4	238.9	0.11
6	f	120	257.6	121.9	1097.28	1.469	10.5	164.3	0.06
7	g	120	307.1	121.9	1097.28	1.061	4.7	113.9	0.04
8	h	120	419.9	121.9	1097.28	0.576	1.0	64.4	0.02
<u>L = 6583.7 m, R >= 1.0 and R <= 2.0</u>									
1	a	100	78.0	304.8	1097.28	1.350	304.0	151.0	2.01
2	b	100	78.0	243.8	1097.28	1.198	243.2	133.8	1.82
3	c	105	78.0	182.9	1097.28	1.076	182.4	120.3	1.52
4	d	120	78.0	152.4	1097.28	1.113	151.9	124.5	1.22
5	e	120	78.0	121.9	1097.28	0.988	121.5	110.4	1.10
6	f	120	78.0	100.6	1097.28	0.890	100.2	99.5	1.01

Table 3.2 Summary of pulse magnitude analysis

S. No.	Scenario	MOC 1st Order			MOC 2nd Order			WPM		
		Ce	Exponent	Sum of Squared Error	Ce	Exponent	Sum of Squared Error	Ce	Exponent	Sum of Squared Error
	Both Ce and Exponent are solved for all									
1	L = 6583.7 m, R <= 1.0	124.52	1.99	520.48	62.33	2.18	60.39	9.61	2.06	3.68
	L = 1097.3 m, R <= 1.0	10.76	1.99	22.47	5.47	2.17	18.45	0.79	2.03	5.49
	L = 6583.7 m, R >= 1.0 and R <= 2.0	135.86	1.98	896.74	148.45	2.67	161.68	22.95	2.06	8.19
	Ce kept constant and Exponent is solved for the MOC 2nd Order and WPM									
2	L = 6583.7 m, R <= 1.0	<i>124.52</i>	1.99	520.48	<i>124.52</i>	2.93	164.55	<i>124.52</i>	5.53	22.57
	L = 1097.3 m, R <= 1.0	<i>10.76</i>	1.99	22.47	<i>10.76</i>	2.95	91.56	<i>10.76</i>	5.72	14.66
	L = 6583.7 m, R >= 1.0 and R <= 2.0	<i>135.86</i>	1.98	896.74	<i>135.86</i>	2.58	174.04	<i>135.86</i>	4.32	303.16
	Exponent kept constant and Ce is solved for all									
3	L = 6583.7 m, R <= 1.0	125.21	2.00	520.55	51.88	2.00	71.13	9.06	2.00	3.71
	L = 1097.3 m, R <= 1.0	10.82	2.00	22.51	4.63	2.00	25.32	0.77	2.00	5.49
	L = 6583.7 m, R >= 1.0 and R <= 2.0	138.84	2.00	901.39	77.60	2.00	1008.03	21.57	2.00	9.05

Table 3.3 Number of segments and computational effort required for percentage error less than 2%

S No.	Case #	R	Number of Segments			Computational Effort Per Time Increment (flops)		
			MOC 1st Order	MOC 2nd Order	WPM	MOC 1st Order	MOC 2nd Order	WPM
<u>L = 6583.7 m, R <= 1.0</u>								
1	a	0.95	60	24	6	1947	1702	210
2	b	0.79	60	24	3	1947	1702	105
3	c	0.69	60	24	2	1947	1702	70
4	d	0.57	60	24	2	1947	1702	70
5	e	0.49	24	12	2	759	814	70
6	f	0.33	24	4	2	759	222	70
7	g	0.22	12	4	2	363	222	70
8	h	0.10	6	2	2	165	74	70
<u>L = 1097.3 m, R <= 1.0</u>								
1	a	1.06	100	20	5	3267	1406	175
2	b	0.74	100	20	4	3267	1406	140
3	c	0.65	100	20	2	3267	1406	70
4	d	0.41	100	10	2	3267	666	70
5	e	0.11	10	2	2	297	74	70
6	f	0.06	4	2	2	99	74	70
7	g	0.04	4	2	2	99	74	70
8	h	0.02	2	2	2	33	74	70
<u>L = 6583.7 m, R >= 1.0 and R <= 2.0</u>								
1	a	2.01	600	60	24	19767	4366	840
2	b	1.82	600	60	24	19767	4366	840
3	c	1.52	600	24	12	19767	1702	420
4	d	1.22	60	24	6	1947	1702	210
5	e	1.10	60	24	6	1947	1702	210
6	f	1.01	60	24	6	1947	1702	210

Table 3.4 Computational effort of MOC

Pipe Index	Case 1 ($\Delta t = 0.002$ sec)		Case 2 ($\Delta t = 0.1$ sec)	
	Number of Segments (N)	Number of Computations	Number of Segments (N)	Number of Computations
P-1	303	249150000	6	82500
P-2	500	411675000	10	148500
P-3	250	205425000	5	66000
P-4	200	164175000	4	49500
P-5	300	246675000	6	82500
P-6	350	287925000	7	99000
P-7	303	249150000	6	82500
P-8	250	205425000	5	66000
P-9	250	205425000	5	66000
Total Number of Computations = 2225×10^6		Total Number of Computations = 0.742×10^6		

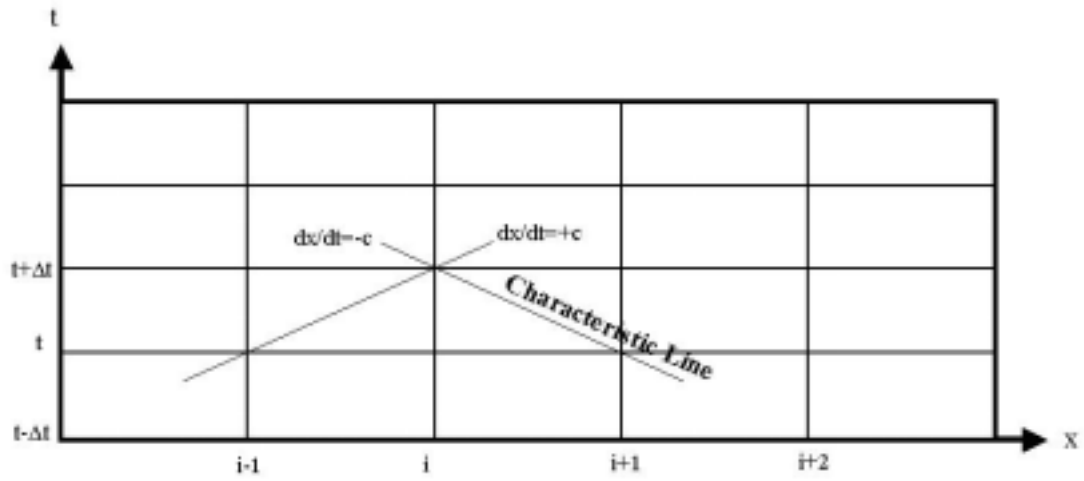

Figure 3.1 Space-time grid depicting characteristic lines

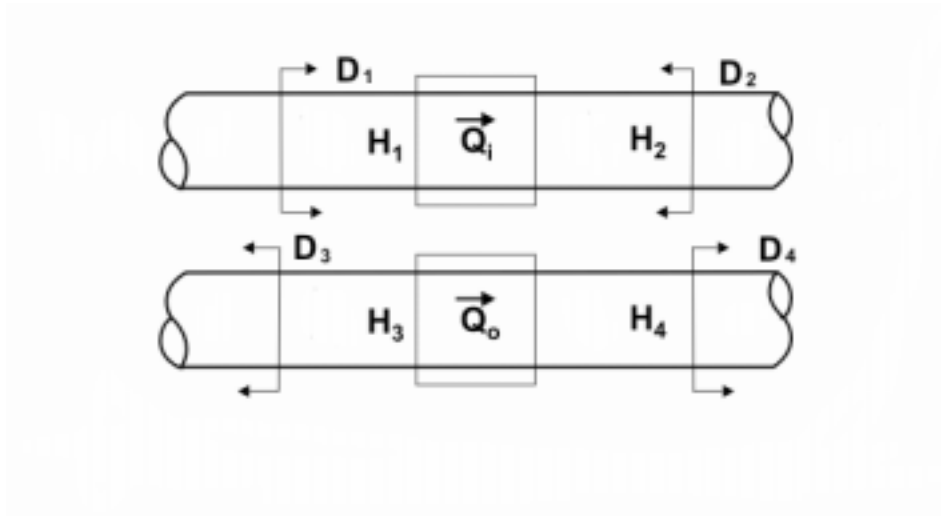

Figure 3.2 Wave actions at a friction orifice



Figure 3.3 Schematic of the hydraulic system considered for the case study

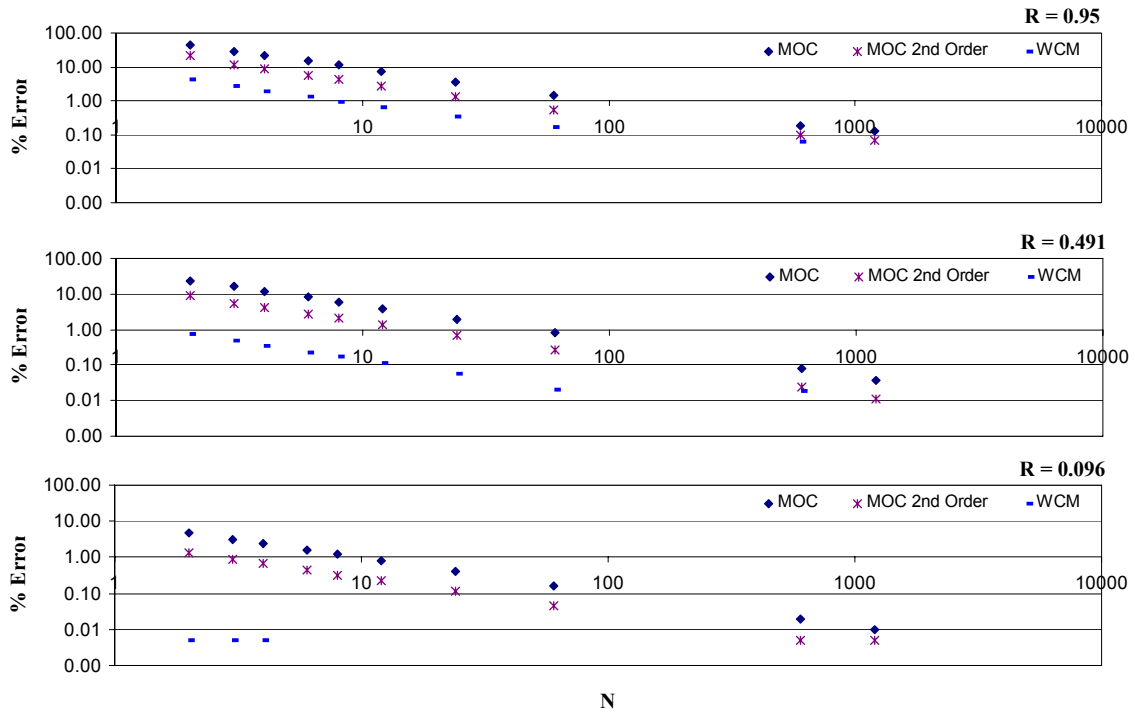

Figure 3.4 Percentage error versus number of segments (L = 6583.7 m, R <= 1.0)

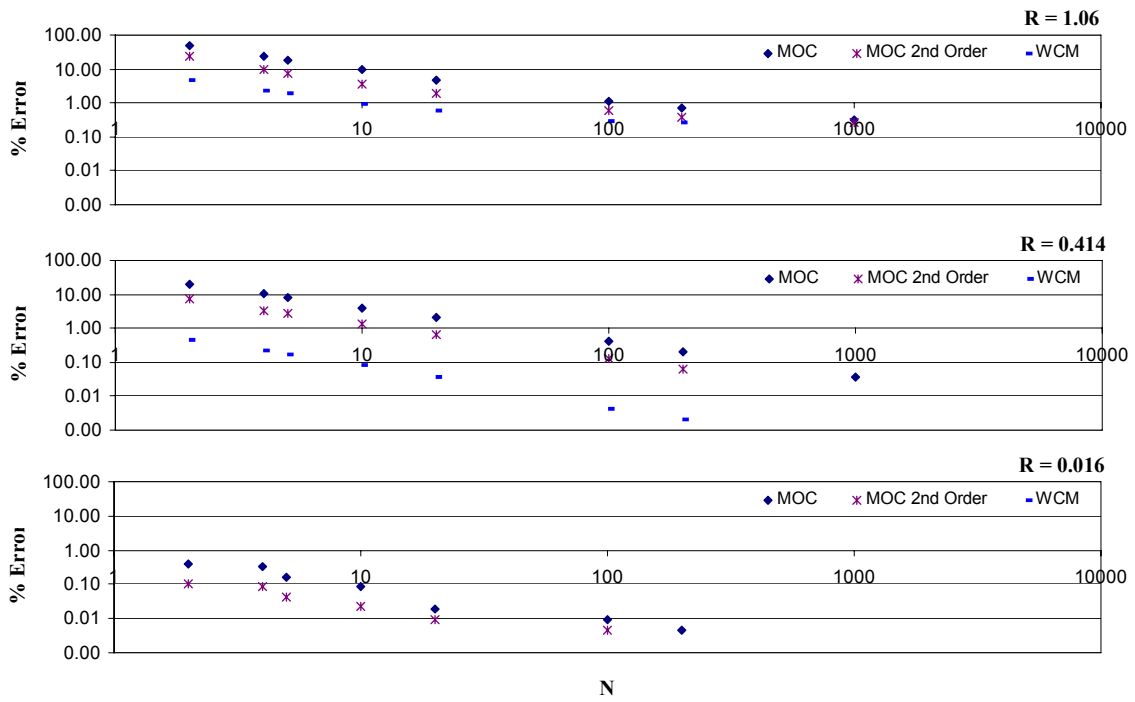

Figure 3.5 Percentage error versus number of segments ($L = 1097.3$ m, $R \leq 1.0$)

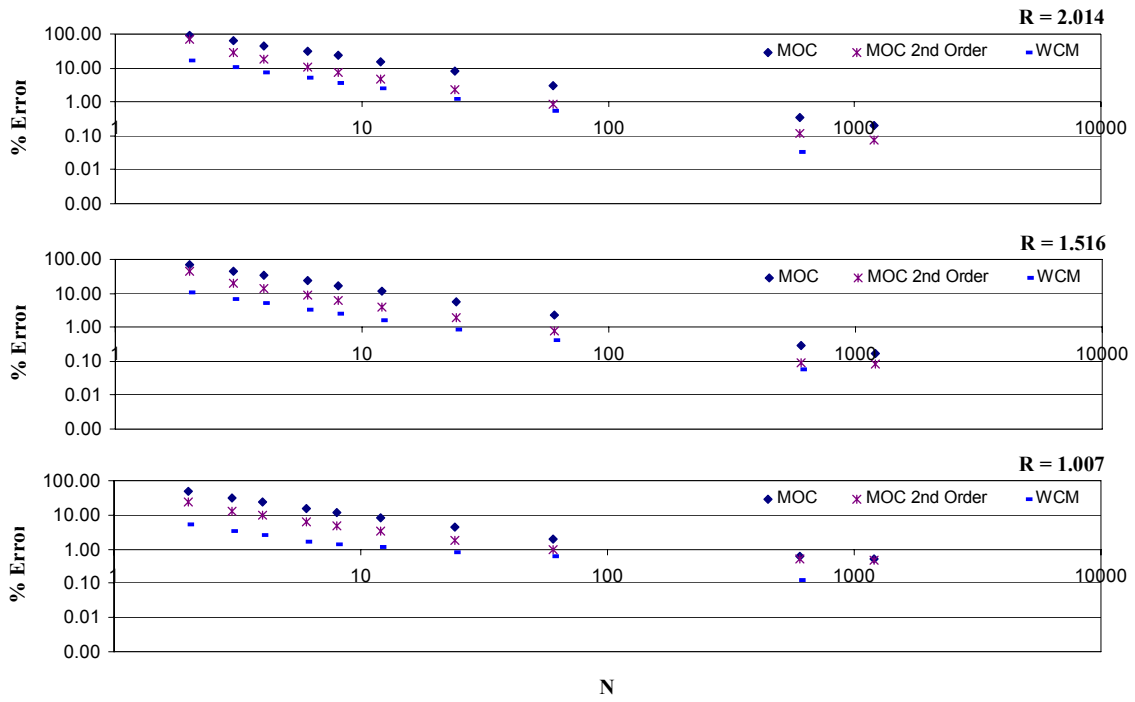

Figure 3.6 Percentage error versus number of segments ($L = 6583.7$ m, $R \geq 1.0$ and $R \leq 2.0$)

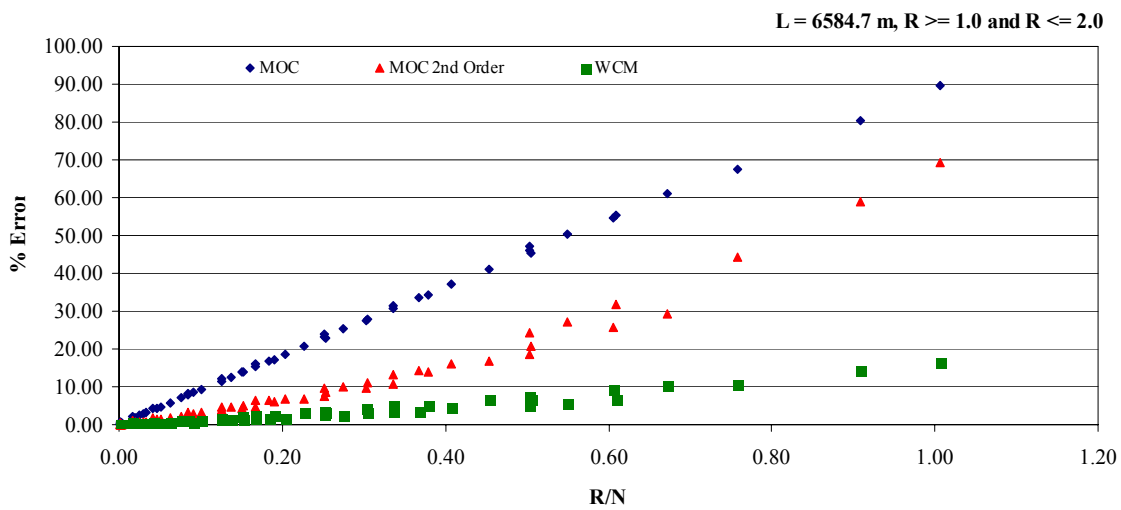
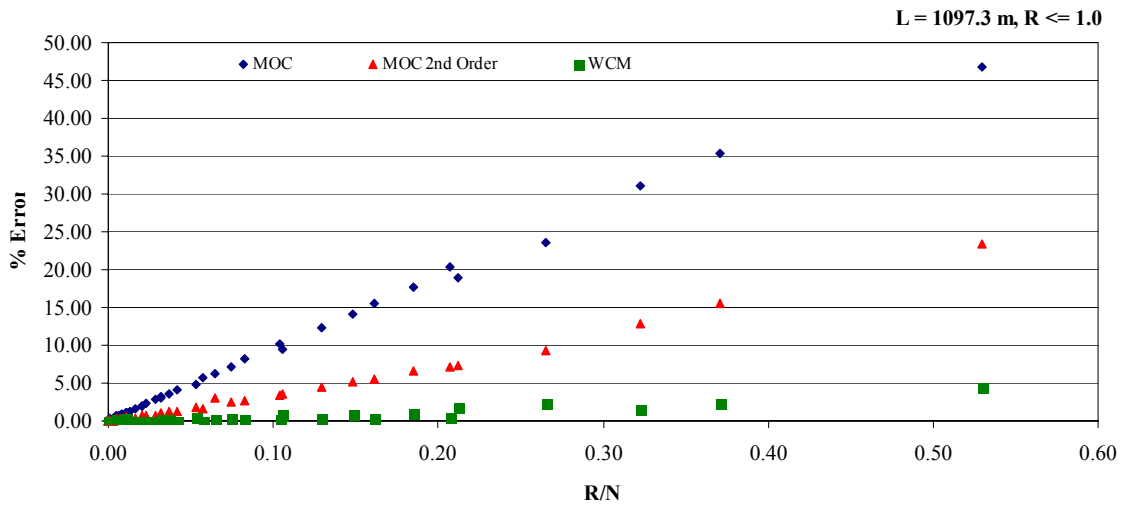
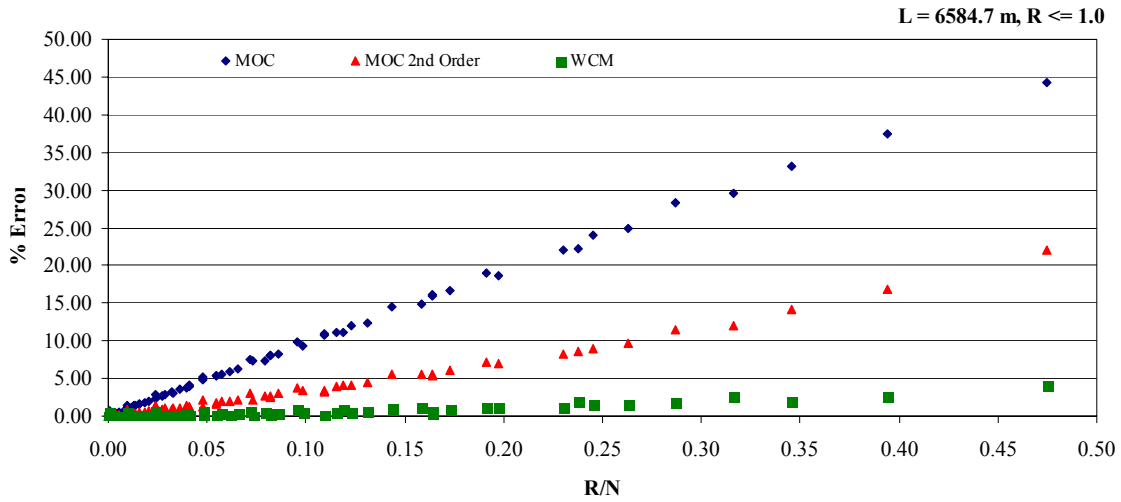

Figure 3.7 Percentage error versus frictional evaluative index

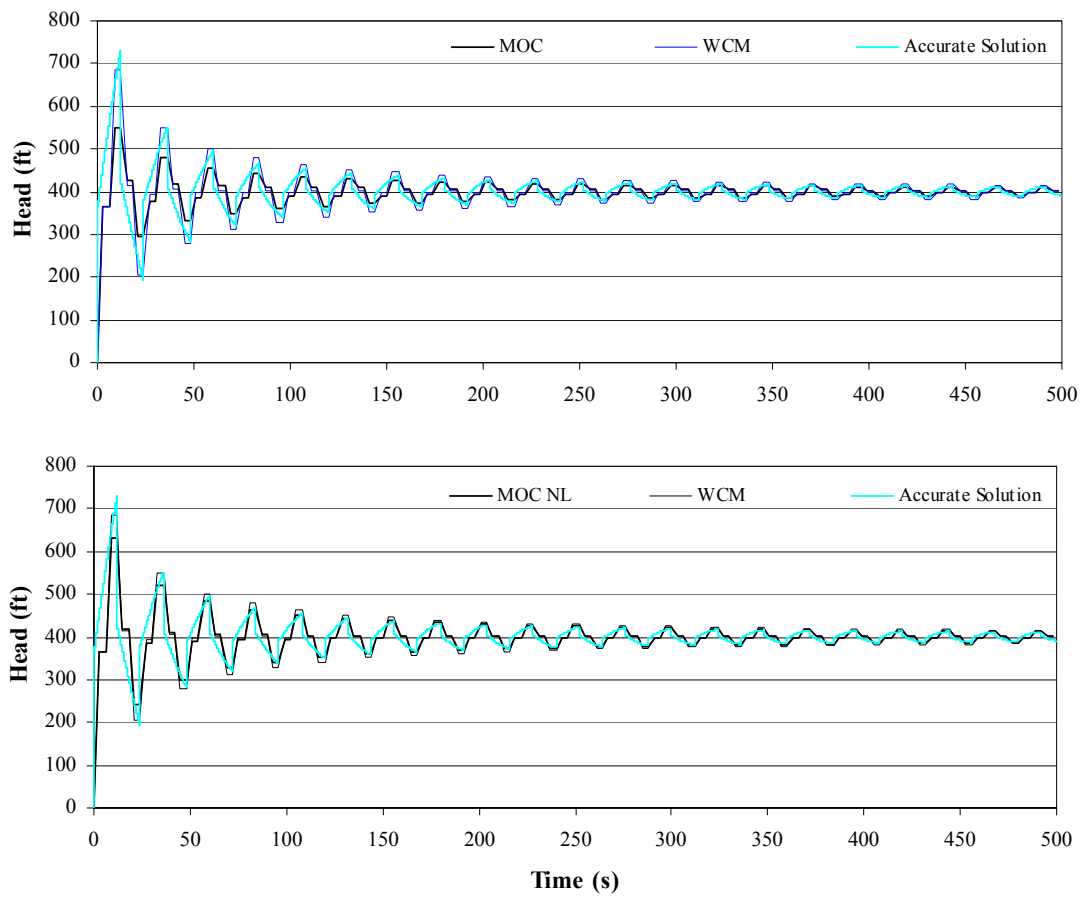

Figure 3.8 Head at the valve for 100 s simulation period

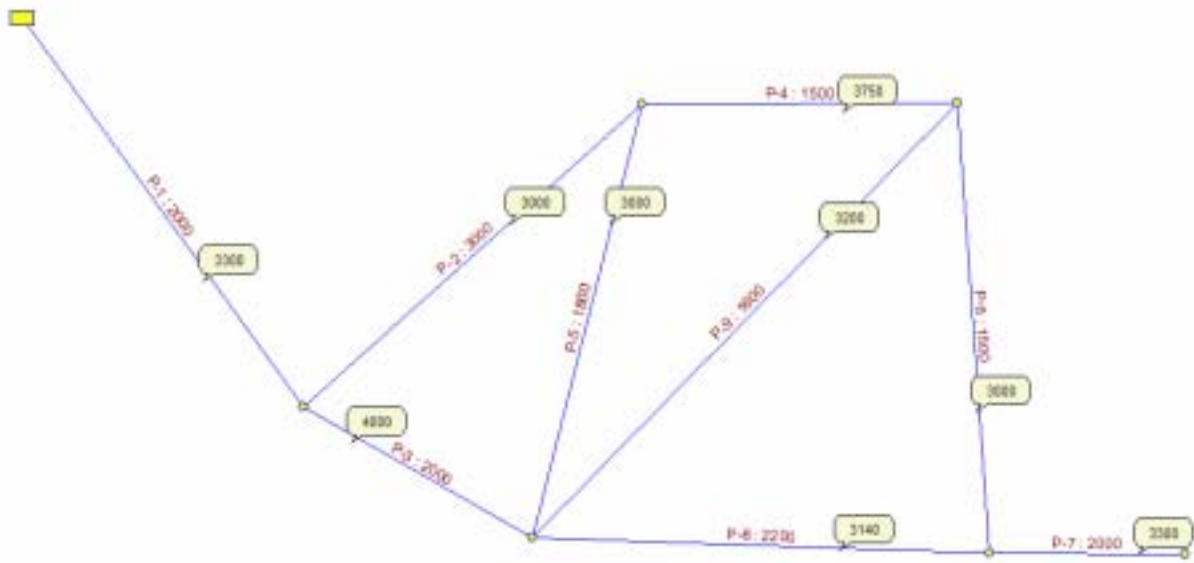

Figure 3.9 Network Example

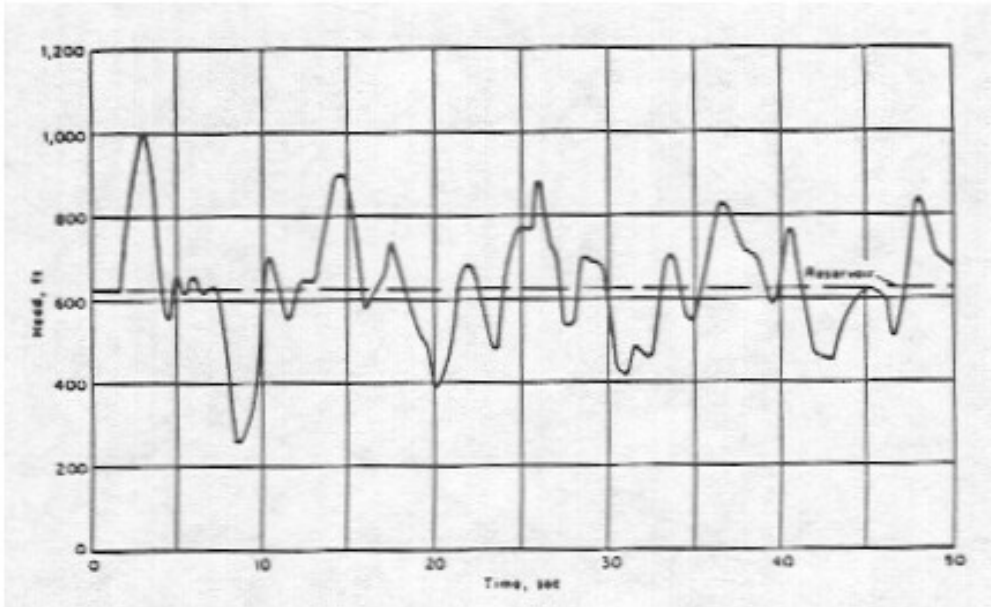

Figure 3.10a. MOC Results

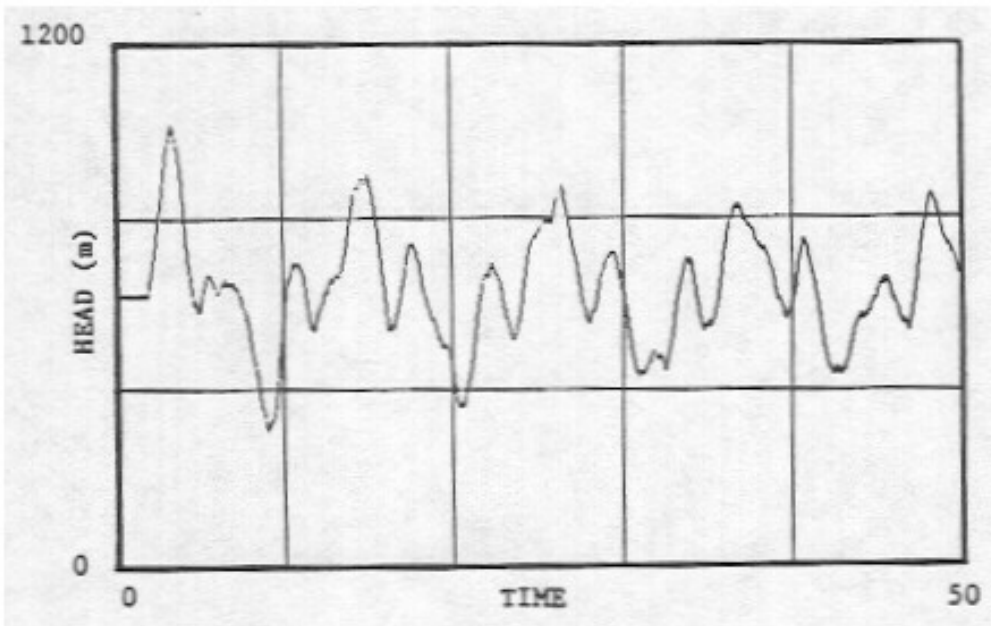

Figure 3.10b. WPM Results

Copyright © Dhandayudhapani Ramalingam 2007

CHAPTER 4: COMPUTATIONAL TOOLS AND METHODOLOGY

4.1 Introduction

This chapter describes the computational tools (modules) developed and employed in implementing the framework proposed in Chapter 2. In addition, a more detailed description on the methodology employed in extracting the knowledgebase for the ANN models is provided in this chapter. Following are the list of major computational modules developed for this research work.

- a) Transient simulation program in C++
- b) Genetic algorithm optimization scheme in C++
- c) ANN input variable value extraction module in C++

These modules were then integrated into a single program in Visual-C++ for transient simulation, air vessel parameters optimization, and ANN input extraction. The overall size of the program was approximately 10,000 lines. A spread sheet program was also developed to prepare and process data for ANN model development.

4.2 Transient Simulation Program

The transient simulation program developed for this study was based on numerically accurate and computationally efficient “Wave Plan Method” (Wood et.al 1966, Ramalingam et.al 2004 and Wood et al 2005). This program was written using object oriented programming (OOP)

concepts in C++ programming language. Object oriented paradigm (objects, modularity, extensibility and reusability) widely used for developing large programs naturally suits the programming requirements of transient simulation of large pipe networks.

The program developed can analyze large complex networks with most common components of distribution systems such as constant head reservoirs, junctions, dead ends, pumps, valves, open surge tanks, air vessels etc. Various transient inducing scenarios like pump trip, pump start-up, multiple stage valve closure etc. can be analyzed. Input to the program comes from a commercial pipe network analysis software PIPE2000-Surge (Wood and Lingireddy 2006). The transient modeling program developed in this work was also validated using PIPE2000-Surge software.

Dynamic change of components (change of an air vessel to a junction node) in the analysis mode tremendously saves time during the extraction of values of ANN input parameters. Program is extensible, extremely customizable and could be integrated with other programs easily with minimal change.

4.3 Air Vessel Parameter Optimization Module

This module was developed by integrating the transient simulation program with a genetic algorithm optimization scheme developed in C++ using a popular GA scheme (Goldberg 1989). An objective function that minimizes the total air vessel volume was used in GA optimizer. Fitness of an individual chromosome is given as

$$\text{Fitness} = 100 / \text{total tank volume}$$

Therefore, larger fitness implies a better solution and vice-versa. Design limits on system-wide maximum and minimum pressures were used as the constraints. Any violation of constraints was incorporated into the fitness function value by a simple penalty function. In the individual selection process for mating, certain infeasible solutions, where air vessel fully drains, were ignored. A population size of 40, a crossover probability of 65%, a mutation probability of 3.3%, 35 generations and roulette wheel selection were used for GA optimizer.

Modularity of the transient simulation program helps to check the design sufficiency of an optimal solution immediately after an optimization exercise.

4.4 ANN Model Development

This section supplements the information presented in chapter 2. Figures 4.1 and 4.2 present the head and flow variation associated with butterfly and needle valves. It can be seen that though both produce the same maximum head at the full closure time, the time profiles are completely different. The combined effect of initial profile of the head and flow and of their interaction with head and flow profile of nearby nodes have a significant say in the required air vessel parameters.

Several ANN models were developed and tested by varying the number of inputs, changing the architecture of the ANN and changing the training algorithm. All these models were evaluated first and if satisfactory then applied on a large network problem. Knowledgebase was then updated for any specific need of data. The procedure was continued until the ANN model's performance was satisfactory.

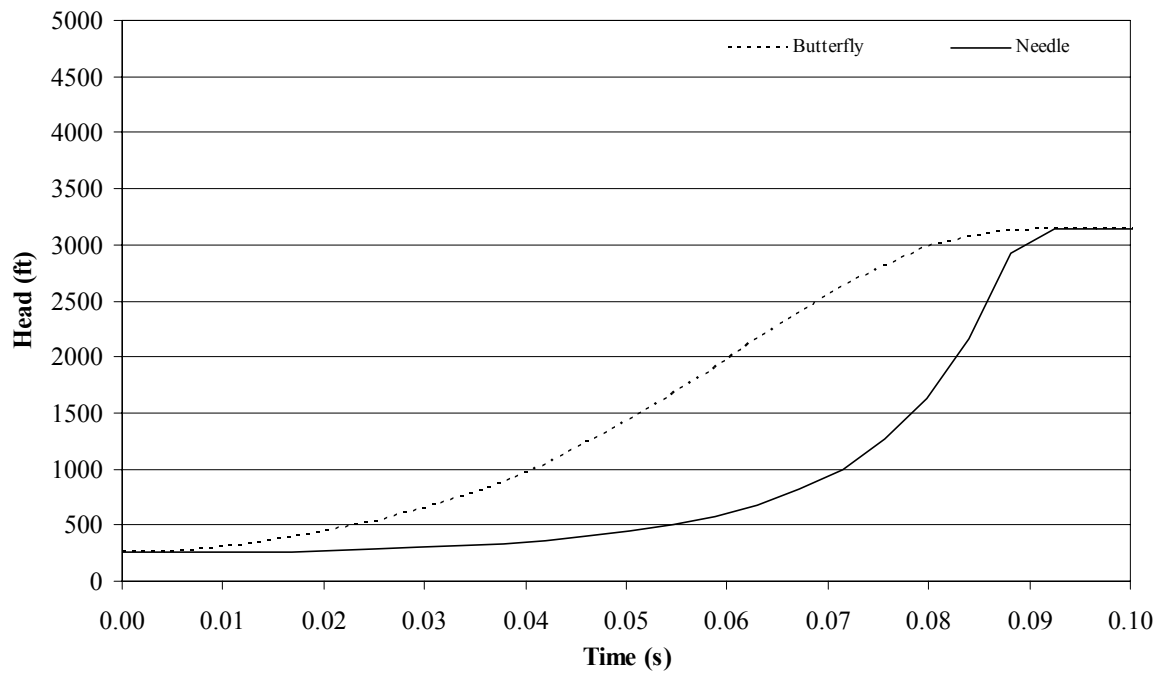
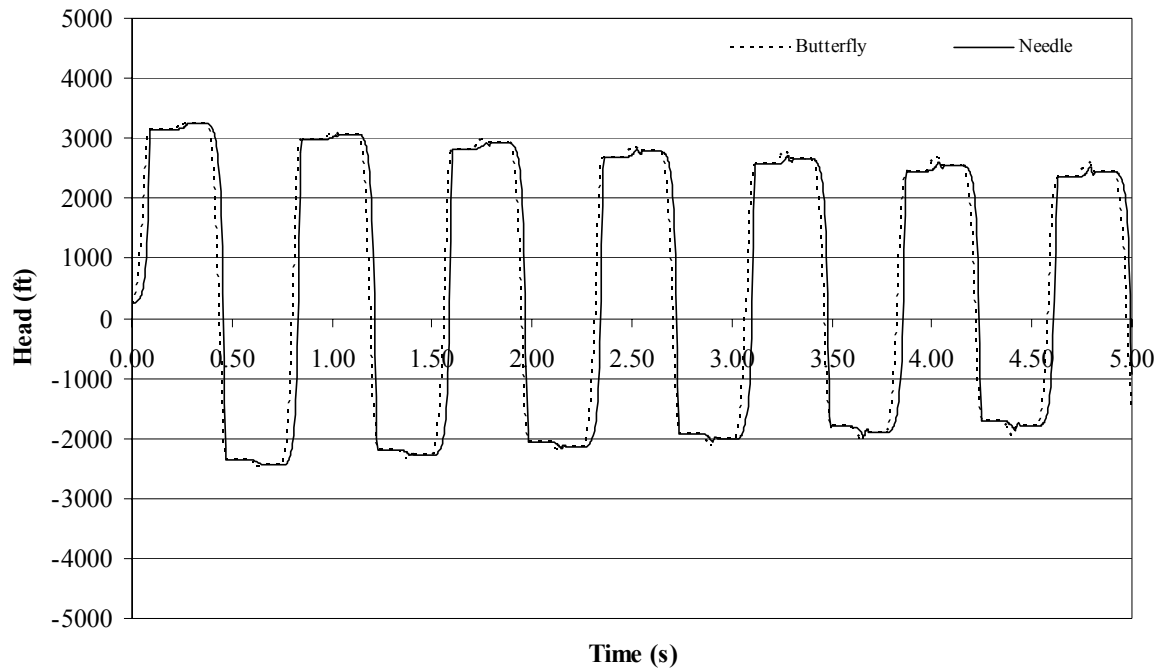

Figure 4.1. Head at the valve

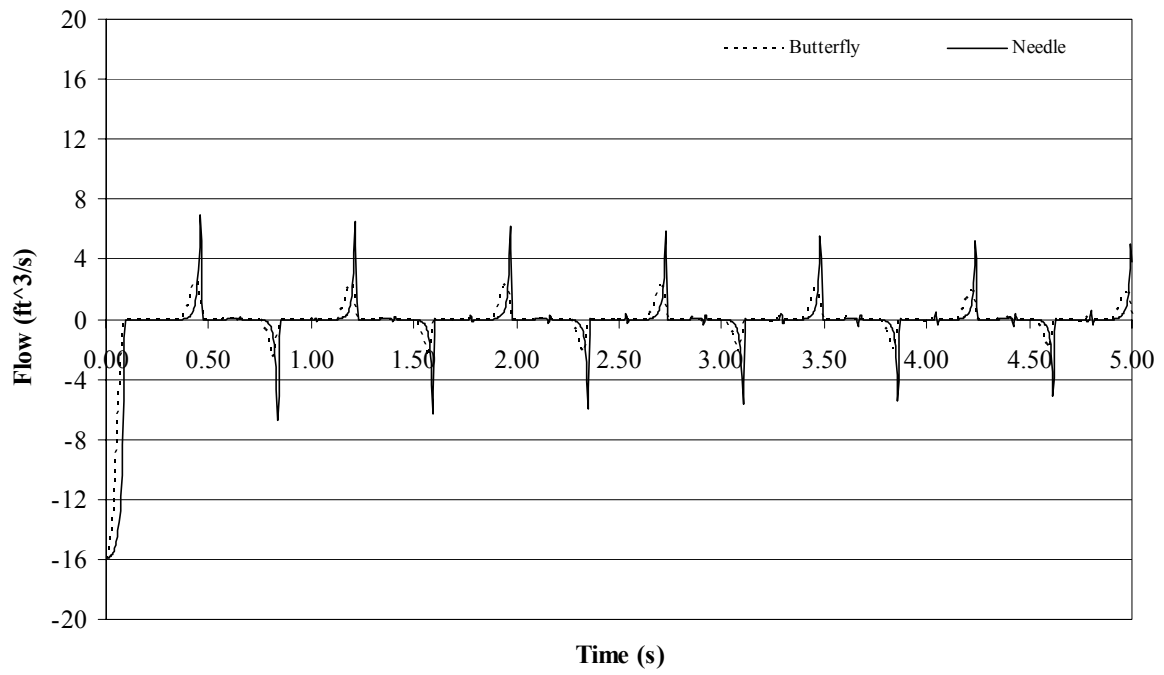
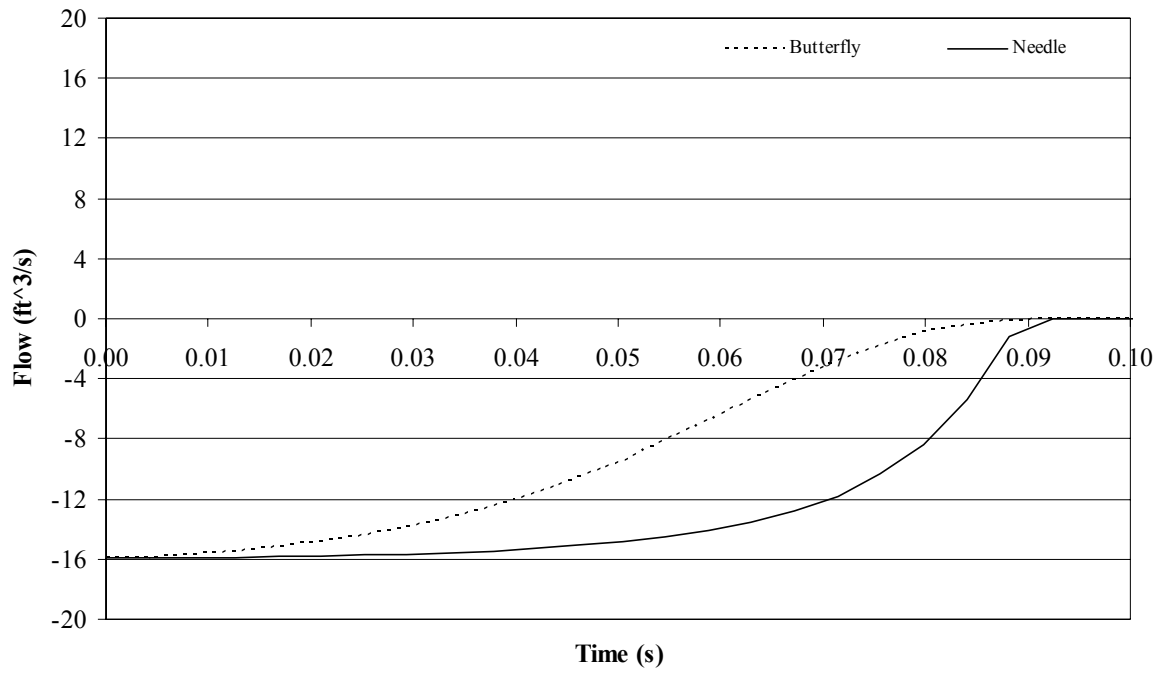

Figure 4.2. Flow at the valve

Copyright © Dhandayudhapani Ramalingam 2007

CHAPTER 5: CONCLUSIONS AND DISCUSSION

In the absence of design aids for air vessels for large distribution networks, a robust simulation-optimization-regression based framework for air vessel sizing has been developed. The applicability and effectiveness of the framework was demonstrated by developing a design aid for sizing air vessels protecting large distribution networks from undue transient pressures generated by rapid valve closures. This could substantially reduce the number of trials needed otherwise to arrive at the economical design. This becomes more important as the time required for transient analysis of large distribution networks is significant. Key issues involved in the development and application of the simulation-optimization-regression based framework were also studied. Research work also lists few tasks that could be undertaken immediately. The following lists other contributions of the research work.

1. The success of this conceptual research work lies in effective use of available tools in the hitherto uncharted area of analyzing transient response of pipe networks at the point where protection is to be provided and hence opens-up a whole new area for further transient protection research work.
2. This framework has identified 32 key parameters influencing the air vessel sizing from transient response data at the point where protection is to be provided by exploiting similarity in transient response between small and large network

models. Further analysis of these key parameters could provide greater insight into the transient response of large complex pipe networks which might lead to simplified transient modeling tools.

3. For the first time, ANN was applied in the complex transient analysis and design domain. Though the number of input parameters was high and the number of data sets used for training was moderate, ANN model's performance was good. ANN model was able to understand the critical relationship between the output (air vessel) parameters indicating the suitability of the tool in the transient domain.
4. Optimizing for the duration of the "initial phase" (needs further research) of the transient response and checking the adequacy for a longer time resulted in significant savings in computational costs.
5. The framework could be applied for sizing air vessels to protect systems against pump trips. A universal design aid for air vessel could be developed by creating large number of data sets encompassing most common values to train the ANN model.

The high computational costs involved in the application of the framework necessitated (a) selection of numerically efficient and sufficiently accurate transient analysis method for application in the design domain of pipe networks and (b) the exploration of ways to limit the

transient simulation time in the genetic optimization scheme. Findings related to these two issues are as follows:

1. Numerical accuracy and computational efficiency issues of Wave Plan Method (WPM) and Method of Characteristics (MOC) in solving basic unsteady flow equations in closed conduits were studied. Though both methods solve the same governing equations and make similar assumptions, they are significantly different in their approaches. Numerical accuracy of solution and computational effort, which are interdependent, were studied for both methods and their implications for practical applications were investigated.
2. Present study used non-dimensional parameters and time constants reported previously in the literature. Guidelines in the form of error study were developed for number of friction orifices to be used in WPM for acceptable level of accuracy. Results from the case studies also indicate that the use of two orifices in the entire pipeline with WPM is acceptable so long as the non-dimensional parameter R is less than 0.5 and six orifices for values of $R > 0.5$ and $R < 1$. This is not a very stringent requirement for most transient modeling studies especially for those dealing with large water distribution networks. This indicates that for larger systems WPM can substantially reduce computational time while ensuring accurate results.

3. Computational efforts for short and long pipelines and for a network of pipes associated with MOC first and second order schemes and WPM was explored and the results clearly indicate the computational advantages of WPM. The difference in computational effort could be several orders of magnitude depending on the time step chosen.
4. This saving in computational time is very significant when a transient simulation is coupled with an optimization model where repeated transient simulations are needed. It should be noted that ability to efficiently handle large distribution systems is essential for transient generated pathogen intrusion studies.
5. Suitability of wave plan method for this kind of exercise and non-necessity of cavitation analysis in a design problem were also demonstrated.

Uncertainties and scope for further research are presented in the remaining section.

Parameter Identification and Extraction: Values of many of the input parameters to ANN are dependent on the time span over which they are extracted. Hence changing the time span would significantly change the values of these parameters. From Hypothesis B (chapter 2) this time span used in the optimization process is at least the time span of first cycle of transient response and the same time span is used for extraction of values for the parameters. ANN model's prediction would fail for those systems that have significantly different transient response time.

Further research in ascertaining this time span for network models (i.e., establishing “Hypothesis B” firmly) would be very helpful for both optimization purposes and parameter extraction. Further analysis of 32 parameters, their RSI values and their effect on air vessel characteristics could give critical insight to air vessel design for pipe networks.

Artificial Neural Networks: ANN model’s training is generally improved by the number of data sets used to train them. With the high number of input parameters used here, ANN model would perform better if trained with more number of data sets that has more combinations of values for input parameters and output parameters. Bounds on each parameter can be increased by generating more data, making ANN model applicable for more cases than now. Better ANN model fitting could be done resorting to more than one hidden layer, more number of neurons, other training algorithms, type of activation function and values of parameters involved etc.

Normalization: Parameters used in the ANN model are dimensional. ANN would fail if the units are changed and hence, ANN has learned the process in a very specific way. Input parameters like slope of the pressure profile depend upon the transient simulation time increment (Δt). Systems used in developing the data set have different values for Δt . Hence any normalization with respect to Δt could improve ANN learning. Similarly normalizing other parameters could improve ANN model’s learning and performance.

Genetic Algorithm Optimizer: Genetic algorithm approach intrinsically does not guarantee global optimum. Though solutions can be influenced by many parameters involved in the GA process, the chances of reaching better solution and global optimum is greatly improved by

increasing the number of individuals, number of generations. Though the population size and number of generations in the current exercise are found to be very acceptable, higher value for them is desirable. Since fitness evaluation of individuals requires transient simulation which involves considerable computational effort, the computational time for optimization limits the size of population and number of generation. This is one of the reasons why small total transient simulation periods are used in the data generation process.

Independence of fitness evaluation of individuals makes parallel processing possible to help reduce the computation time. Parallel processing using multiple processors is widely used in solving computationally intensive problems using GA. Multi-threading, a technique in which more than one computational thread is used for simultaneously executing independent procedures in a single processor, was attempted here. In normal computations only one thread is used. This parallelization of fitness evaluation in a personal computer did not help in reducing the computational time. Improving the solution from GA using any technique would consequently improve ANN model's training and performance.

APPENDIX

A. Computational effort of friction orifice analysis in WPM

$F = a/(g \times A)$	(2)
$Q_0 = Q_i + (D_1 - D_2) / F$	(3)
Solve	
{ $Q_f = Q_0$	
$d_f = -res \times (Q_f \times Q_f - Q_i \times Q_i) / 2$	(7)
$Q_0 = Q_i + (D_1 - d_f - D_2) / (F)$	(4)
}until $(Q_f - Q_0)$ is negligible	
$M = F \times (Q_0 - Q_i)$	(2)
$H_3 = H_1 + 2 \times D_1 - M$	(3)
$H_4 = H_2 + 2 \times D_2 + M$	(3)

B. Computational effort for solution of equations at a grid location using MOC First Order

$F = a/(g \times A)$	(2)
$G = res \times g \times A \times \Delta t$	(3)
$Q_{i,t} = 0.5 \times ((Q_{i-1,t-1} + Q_{i+1,t-1}) + 1/F \times (H_{i-1,t-1} - H_{i+1,t-1}) + (Q_{i-1,t-1} \times Q_{i-1,t-1} + Q_{i+1,t-1} \times Q_{i+1,t-1}) \times G)$	(13)
$H_{i,t} = 0.5 \times 1/F \times ((Q_{i-1,t-1} - Q_{i+1,t-1}) + 1/F \times (H_{i-1,t-1} + H_{i+1,t-1}) + (Q_{i-1,t-1} \times Q_{i-1,t-1} - Q_{i+1,t-1} \times Q_{i+1,t-1}) \times G)$	(15)

C. Computational effort for solution of equations at a grid location using MOC Second Order

$$F = a/(g \times A) \quad (2)$$

$$G = \text{res} \times g \times A \times \Delta t \quad (2)$$

$$Q_2 = Q_{i,t-1}$$

$$\text{del}Q = 0$$

$$E = 0.5 \times ((Q_{i-1,t-1} + Q_{i+1,t-1}) + F \times (H_{i-1,t-1} - H_{i+1,t-1})) \quad (5)$$

Solve

{

$$C_p = G/8 \times (|Q_{i-1,t-1} + Q_2| \times (Q_{i-1,t-1} + Q_2) + |Q_{i+1,t-1} + Q_2| \times (Q_{i+1,t-1} + Q_2)) \quad (11)$$

$$C_{p_der} = G/4 \times (|Q_{i-1,t-1} + Q_2| + |Q_{i+1,t-1} + Q_2|) \quad (7)$$

$$\text{del}Q = -(C_p - Q_2 + E) / (C_{p_der} - 1) \quad (4)$$

$$Q_2 = Q_2 + \text{del}Q \quad (1)$$

}until delQ is negligible

$$Q_{i,t} = Q_2$$

$$H_{i,t} = 0.5/F \times ((Q_{i-1,t-1} - Q_{i+1,t-1}) + 1/F \times (H_{i-1,t-1} + H_{i+1,t-1}) + G/4 \times ((Q_{i-1,t-1} + Q_{i,t}) \times |(Q_{i-1,t-1} + Q_{i,t})| - (Q_{i+1,t-1} + Q_{i,t}) \times |(Q_{i+1,t-1} + Q_{i,t})|)) \quad (19)$$

REFERENCES

1. Allievi, L. (1937). "Air chambers for discharge pipes." Transactions of American Society of Mechanical Engineers, Vol. 59, 651-659.
2. Almeida, A.B. and Koelle, E. (1992). Fluid Transients in Pipe Networks, Computational Mechanics Publications, Southampton, Elsevier applied Science, London, UK.
3. Angus, R.W.(1937). "Air chambers and valves in relation to waer-hammer." Transactions of American Society of Mechanical Engineers, Vol. 59.
4. Aziz, A.R.A. and Wong, K.V. (1992). "A neural network approach to the determination of aquifer parameters." Ground Water, 30(2), 164-166.
5. Bong, S.J. and Karney, B.W. (2006). "Hydraulic optimization of transient protection devices using GA and PSO approaches.", Journal of Water Resources Planning and Management, ASCE, 132 (1), 44-52.
6. Brion, G.M., Neelakantan, T. and Lingireddy, S. (2001). "Using neural networks to predict peak Cryptosporidium concentrations." Journal of American Water Works Association, 93(1), 99-105.

7. Chandramouli, V. Lingireddy, S. and Brion, G.M. (2007) A Robust Training Terminating Criterion for Neural Network Modeling of Small Datasets, *ASCE Jl. of Computing in Civil Engineering*. (January 2007 - in press)
8. Chaudhry M.H. (1979). *Applied Hydraulic Transients*, Van Nostrand Reinhold Company, New York.
9. Chaudhry, M.H. (1987). *Applied Hydraulic Transients* (2nd Edition), Litton educational Publishing Inc., Van Nostrand Co, New York.
10. Combes, G. and Borot, R. (1952). “New graph for the calculation of air reservoirs account being taken of the losses of head.” *La Houille Blanche*, Grenoble, France, October-November.
11. Deka, P. and Chandramouli, V. (2003). “A fuzzy neural network model for deriving the river stage-discharge relationship.” *Hydrological Sciences – Journal*, 48(2), 197-209.
12. Di Santo, A.R., Fratino, U., Lacobellis, V. and Piccinni, A.f. (2002). “Effects of free outflow in rising mains with air chamber.” *Journal of Hydraulic Engineering*, American Society of Civil Engineers, 128(11), 992-1001.

13. Evans, W.E and Crawford, C.C (1954). "Design charts for air chambers on pump lines." Transactions of American Society of Civil Engineers, 119, 1025-1045.
14. Fok, A.T.K. (1978). "Design charts for air chambers on pump pipelines." Journal of the Hydraulics Division, American Society of Civil Engineers, 9, 1289-1303.
15. Goldberg, D.E., and Kuo, C.H. (1987). "Genetic algorithms in pipeline optimization." Journal of Computing in Civil Engineering, American Society of Civil Engineers, 1(2), 128-141.
16. Graze, H.R. and Forrest, J.A. (1974). "New design charts for air chambers." Fifth Australasian Conference on Hydraulics and Fluid Mechanics, Canterbury.
17. Graze, H.R. and Forrest, J.A. (1982). "Air chamber design charts." Eighth Australasian Conference on Hydraulics and Fluid Mechanics, University of New Castle.
18. Graze, H. R. and Horlacher, H. B. (1986). "Design charts for throttled (bypass) air chamber." Proc., 5th Int. Conf. Pressure Surges, BHRA, Cranfield, Hannover, 309–322.
19. Graze, H. R. and Horlacher, H. B. (1989). "Design of optimum sized air cushion surge chambers." Proc., 6th Int. Conf. Pressure Surges, BHRA, Cambridge, 383–397.

20. Kapelan, Z., Savic, D., and Walters, G. (2003). A hybrid inverse transient model for leakage detection and roughness calibration in pipe networks, *Journal of Hydraulic Research*, 41(5), 481-492.
21. Karney B.W., and Ghidaoui M.S. (1997). “Flexible discretization algorithm for fixed-grid MOC in pipelines”, *Journal of Hydraulic Engineering*, ASCE, 123(11), 1004-1011.
22. Kwon, H.J., (2005). Transient flow in water distribution system, Ph.D. dissertation, University of Southern California.
23. Kim, C.Y., Bae, G.J., Hong, S.W., Park, C.H., Moon, H.K. and Shin, H.S. (2001). “Neural network based prediction of ground surface settlements due to tunneling.” *Computers and Geotechnics*, 28, 517-547.
24. LeChevallier M.W., Gullick R.W. and Karim M. (2002). “The potential for health risks from intrusion of contaminants into the distribution system from pressure transients”, American Water Works Service Company, Inc., Voorhees, NJ : Distribution System White Paper prepared for the US Environmental Protection Agency.
25. Lingireddy, S. (1996) Optimal Land Grading based on Genetic Algorithms. *Jl. of Irrigation and Drainage Engineering*, ASCE, Jul-Aug, 183-188.
26. Lingireddy, S. (1998). “Aquifer parameter estimation using genetic algorithms and neural networks.” *Civil Engineering and Environmental Systems*, Vol. 15, 125-144.

27. Lingireddy S., Funk J.E., and Wang H. (2000). "Genetic algorithms in optimizing transient suppression devices", Proceedings, Joint Conference on Water Resources Engineering and Water Resources Planning & Management, EWRI of ASCE, Minnesota. Section (52), Chapter(2).
28. Lingireddy, S., and Ormsbee, L.E (1998). "Neural networks in optimal calibration of water distribution systems." Artificial Neural Networks for Civil Engineers: Advanced Features and Applications. Ed. I. Flood, and N. Kartam. American Society of Civil Engineers.
29. Lingireddy S., and Ormsbee L.E. (1999). "Optimal Calibration Model for Water Distribution Systems based on Genetic Algorithms." American Society of Civil Engineers 1999 Water Resources Planning & Management National Conference, Tempe, Arizona, June.
30. Martino G.D., Paola F.D., Fontana N. and Giugni M (2004). Discussion of "Simple Guide for Design of Air Vessels for Water Hammer Protection of Pumping Lines." by D. Stephenson. JI. Hydraulic Engineering, ASCE, 130, 273-275.
31. McInnis, D.A., (1992). Comprehensive hydraulic analysis of complex pipe systems, Ph.D. dissertation, University of Toronto, Canada.

32. Nash, G.A. and Karney, B. (1999). Efficient inverse transient analysis in series pipe systems. *Journal of Hydraulic engineering*, ASCE, 761-764.
33. Neelakantan, T., Brion, G.M. and Lingireddy, S. (2001). "Neural network modeling of Cryptosporidium and Giardia concentrations in the Delaware River." *Water Science and Technology*, 43(12), 125-132.
34. NeuroSort (2004). A Neural Network Modeling Platform, Department of civil Engineering, University of Kentucky, Lexington, KY.
35. Pezzinga G. (2000) Evaluation of unsteady flow resistances by quasi-2D or 1-D models, *Journal of Hydraulic Engineering*, ASCE, 126(10), 778-785.
36. Ramalingam, D., Lingireddy, S., Roman, W. and Fung, P (2004). Genetic Tools to Determine Optimal Set of Chlorine Decay Rates, California-Nevada AWWA Annual Fall Conference, October 11-15, Sacramento, CA.
37. Ramalingam, D., Lingireddy, S. and Wood D.J (2004). "Numerical comparison of wave plan method and method of characteristics for transient analysis of large pipe networks." Under Second Revision for possible publication in *Jl. of Hydraulic Engineering*, ASCE.
38. Rossman, L. (2000). A hydraulic and water quality analysis software module for pipe networks, US-Environmental Protection Agency, Cincinnati, Ohio.

39. Russ, E. (1977). "Charts for water-hammer in pipelines with air chambers." Canadian Journal of Civil Engineering, Vol 4.
40. Silva-Araya, F.W. and Chaudhry M.H. (2001). Unsteady friction in rough pipes, Journal of Hydraulic Engineering, ASCE, 127(7), 607-618.
41. Streeter V.L. and Wylie E. B. (1967). Hydraulic transients, McGraw-Hill, New York.
42. Stephenson D. (2002). "Simple guide for design of air vessels for water hammer protection of pumping lines." Journal of Hydraulic Engineering, American Society of Civil Engineers, 128, 792-797.
43. Thorley, A. R. D. (1991). Fluid transients in pipeline systems, D. L. George, U.K.
44. Thorley, A. R. D. and Enever, K.J. (1984). "Control and suppression of pressure surges in pipelines and tunnels", CIRIA Report 84, 22-23.
45. Thorley, A.R.D. and Lastowiecki, P. (1985). "Air vessel design for rising mains." Proceedings, International Conference on Pumping Stations, BHRA, Manchester, England. 89-98.

46. Vitkowsky, J.P., Simpson, A.R., and Lambert, M.F. (2000). Leak detection and calibration issues using transient and genetic algorithms. *Journal of Water Resources Planning and Management*, ASCE, 126(4), 262-265.
47. Wang, H. (2003). Laboratory verification of intrusion during pressure transients in simulated water distribution system, M.S. Thesis, Department of Civil and Environmental Engineering, Tulane University,
48. Wang, H., Lingireddy, S. and Funk, J.E. (1997). The application of genetic algorithm in optimizing the closed surge tanks/air release/vacuum valves in pipeline system. M.S. Thesis, Department of Mechanical Engineering, University of Kentucky.
49. Wood, D.J. (1970). "Pressure surge attenuation utilizing an air chamber." *Journal of the Hydraulics Division, American Society of Civil Engineers*, 96(HY5), 1143-1156.
50. Wood, D.J. (2005). "Waterhammer analysis – Essential and easy (and efficient)." *Journal of Environmental Engineering, American Society of Civil Engineers*, 113 (8), 1123-1131.
51. Wood, D.J. and Funk, J.E. (1996). SURGE reference manual, Civil engineering software center, University of Kentucky.
52. Wood, D.J., Lingireddy, S., and Boulos, P.F. (2005). Pressure wave analysis of transient flow in pipe distribution systems (First Edition), MWH Soft, Pasadena, Ca, USA.

53. Wood, D.J., Dorsch R.G. and Lightner C. (1966). "Wave-plan analysis of unsteady flow in closed conduits", Journal of the Hydraulics Division, Proceedings of ACSE, 92, No. HY2, 83-110.
54. Wylie, E.B. (1996) Unsteady internal flows-Dimensionless numbers and time constants, 7th International Conference on Pressure Surges and Transients in Pipelines and Open Channels, BHR Group, Harrogate, UK, 16-18 April, 283-288.
55. Wylie, E. B., and Streeter V.L. (1978). Fluid transients, McGraw-Hill, New York.
56. Wylie, E.B., and Streeter V.L. (1993). Fluid transients in systems, Prentice-Hall, Englewood Cliffs, N.J.
57. Zhang, Z. (1999). "Fluid transients and pipeline optimization using genetic algorithms", Ph.D. dissertation, University of Toronto.

VITA

Dhandayudhapani Ramalingam was born in the province of Tamilnadu in India on May 11th of 1974. After completing his high school he joined the Bharat Institute of Science and Technology at Chennai, India for his BS in Civil Engineering. After his graduation in 1995, he worked in civil engineering industry for a year before he joined Anna University, Chennai, India for his MS in Hydrology and Water Resources Engineering. After his graduation in 1998, he worked in software industry for a year and later joined Center for Water Resources, Anna University, Chennai, India, as a Research Associate. He worked there in State funded water resources project for two years before coming to University of Kentucky for his Ph.D.