

12-2011

# A Conceptual Framework and Simulation Modeling Of Engineering Change Management in a Collaborative Environment

Krishna Rao Reddi  
*Syracuse University*

Follow this and additional works at: [http://surface.syr.edu/mae\\_etd](http://surface.syr.edu/mae_etd)

 Part of the [Materials Science and Engineering Commons](#)

---

## Recommended Citation

Reddi, Krishna Rao, "A Conceptual Framework and Simulation Modeling Of Engineering Change Management in a Collaborative Environment" (2011). *Mechanical and Aerospace Engineering - Dissertations*. Paper 62.

This Dissertation is brought to you for free and open access by the College of Engineering and Computer Science at SURFACE. It has been accepted for inclusion in Mechanical and Aerospace Engineering - Dissertations by an authorized administrator of SURFACE. For more information, please contact [surface@syr.edu](mailto:surface@syr.edu).

## **ABSTRACT**

Engineering Change Management (ECM) in a collaborative environment is a complex process and is crucial to the Original Equipment Manufacturer (OEM) to ensure low product development time and cost. In this thesis, the ECM in a collaborative environment has been studied and a conceptual framework to support the process is presented. New Product Development (NPD) and ECM processes have been modeled and simulated to study the associated process dynamics.

An extensive review of the literature indicated that the research on ECM in a collaborative environment is very limited. The review also highlighted that, (i) the ECM frameworks from past research do not support a flexible ECM workflow and (ii) the ECM process in a collaborative environment has never been modeled and studied.

A Service Oriented Architecture (SOA) based conceptual framework for ECM process in a collaborative environment, which supports an agile ECM process, is presented along with a case study to demonstrate its implementation. NPD and ECM process templates have been developed. These developed process templates can be used to model and the study the dynamics of the NPD and ECM processes within an organization and in a collaborative environment. The process templates are later used to model and simulate the ECM process, within an organization and a sample collaborating network. The effects of various process parameters and ECM management policies on the NPD lead time have been studied.

**A CONCEPTUAL FRAMEWORK AND SIMULATION MODELING OF  
ENGINEERING CHANGE MANAGEMENT IN A COLLABORATIVE ENVIRONMENT**

by

**Krishna R. Reddi**

B.E., Andhra University, 2004  
M.E., Osmania University, 2006

Dissertation

Submitted in partial fulfillment of the requirements for the degree of

**Doctor of Philosophy in *Mechanical Engineering***

**Syracuse University**

**December 2011**



## **ACKNOWLEDGEMENTS**

First and foremost, I would like to express my deep gratitude to my advisor Dr. Young Moon, for his timely advice and support. His vast knowledge, critical thinking and patience have helped me a lot in progressing, both professionally and personally.

I thank my parents for their love and support. Special thanks to my brother Kiran for his timely advice and my sister Vani for helping me with the industry survey. I also thank my brother Sateesh, sister Suneetha and niece Shivani for always being there for me and lifting my spirits during my hard times.

I thank my research colleagues Weilin and Bochao for their suggestions and feedback. I sincerely appreciate the Department of Mechanical and Aerospace Engineering for their extended long-term support.

Finally, I thank all my friends who have helped me in one way or the other.

## TABLE OF CONTENTS

<b>ABSTRACT</b> .....	<b>I</b>
<b>ACKNOWLEDGEMENTS</b> .....	<b>IV</b>
<b>TABLE OF CONTENTS</b> .....	<b>V</b>
<b>LIST OF TABLES</b> .....	<b>XIV</b>
<b>LIST OF FIGURES</b> .....	<b>XV</b>
<b>1 INTRODUCTION</b> .....	<b>1</b>
1.1 INTRODUCTION .....	1
1.2 BACKGROUND .....	8
1.2.1. <i>Reasons for ECs</i> .....	11
1.2.2. <i>EC Classification</i> .....	13
1.2.3. <i>A Typical ECM Process</i> .....	18
1.2.4. <i>ECM Strategies</i> .....	20
1.2.5. <i>ECM Metrics</i> .....	22
1.2.6. <i>System Dynamics</i> .....	23
1.2.1.1 Feedback and Casual Loop Diagrams.....	24
1.2.1.2 Stocks and Flows .....	29
1.2.7. <i>Service Oriented Architecture</i> .....	32
<b>2 LITERATURE REVIEW</b> .....	<b>35</b>
2.1 FRAMEWORKS .....	36

2.1.1	<i>ECM within an Organization</i> .....	36
2.1.2	<i>ECM in a collaborative environment</i> .....	38
2.1.2.1	Parameter-based framework.....	38
2.1.2.2	Web-based framework .....	39
2.2	TOOLS TO SUPPORT ECM:.....	41
2.2.1	<i>Design Structure Matrix</i> .....	41
2.2.2	<i>Risk Matrix</i> .....	41
2.2.3	<i>Feature-Property matrix</i> .....	42
2.2.4	<i>C-FAR Matrix</i> .....	43
2.2.5	<i>VR Technology</i> .....	43
2.2.6	<i>CPM Tool</i> .....	44
2.2.7	<i>Change Propagation Tools</i> .....	44
2.2.8	<i>Process Simulation Models</i> .....	46
<b>3</b>	<b>PROBLEM DEFINITION</b> .....	<b>50</b>
3.1	MOTIVATION.....	50
3.2	RESEARCH PROBLEM AND METHODOLOGY .....	53
3.3	RESEARCH OVERVIEW .....	56
<b>4</b>	<b>A FRAMEWORK FOR ENGINEERING CHANGE PROPAGATION</b> .....	<b>59</b>
4.1	OVERVIEW .....	59
4.2	APPROACH.....	59
4.2.1	<i>EC class</i> .....	61

4.2.1.1	Initiator .....	62
4.2.1.2	Target .....	62
4.2.1.3	Type of change (TOC) .....	62
4.2.1.4	Likelihood .....	63
4.2.2	<i>Propagation class</i> .....	63
4.2.3	<i>Implementation</i> .....	64
4.2.4	<i>Procedure and logic</i> .....	66
4.2.4.1	Summarization of the steps .....	66
4.3	CASE STUDY .....	68
4.3.1	<i>Product description</i> .....	68
4.3.2	<i>Component identification procedure</i> .....	70
4.3.3	<i>Results</i> .....	72
4.4	CONCLUSIONS AND LIMITATIONS .....	72
<b>5</b>	<b>A FRAMEWORK FOR ENGINEERING CHANGE MANAGEMENT USING SERVICE ORIENTED ARCHITECTURE</b> .....	<b>74</b>
5.1	OVERVIEW .....	74
5.2	THE FRAMEWORK .....	75
5.2.1	<i>SOA based ECM System</i> .....	75
5.2.2	<i>SOA based ECM service providers</i> .....	77
5.2.3	<i>Services for ECM processes</i> .....	78
5.2.3.1	Change Propagation Identification service .....	78
5.2.3.2	EC Request service .....	80



5.2.3.3	EC Review service.....	80
5.2.3.4	EC Status service .....	80
5.2.3.5	EC Search service .....	81
5.2.3.6	EC Notification service .....	81
5.2.3.7	Data Update service.....	81
5.2.3.8	EC Impact service:.....	82
5.2.3.9	EC Approval Service .....	82
5.2.3.10	EC Contact service.....	82
5.2.3.11	Information system interaction service.....	83
5.2.3.12	Monitoring Service.....	83
5.2.4	<i>Database</i> .....	83
5.2.4.1	EC Request Table .....	83
5.2.4.2	EC Review Table .....	84
5.2.4.3	EC Review Results Table .....	84
5.2.4.4	EC Notification Table.....	84
5.2.4.5	EC Propagation Results Table .....	84
5.2.4.6	EC Approval Table .....	84
5.2.4.7	Design Data Table .....	85
5.2.4.8	EC Details Table.....	85
5.2.4.9	EC Dependencies Table.....	85
5.3	CASE STUDY .....	85
5.3.1	<i>Product Description:</i> .....	85

5.3.2	<i>Supply Chain</i> .....	87
5.4	CONCLUSION AND DISCUSSION .....	90
<b>6</b>	<b>SYSTEM DYNAMICS ORGANIZATION TEMPLATES .....</b>	<b>92</b>
6.1	INTRODUCTION .....	92
6.2	SYSTEM DYNAMICS BASED ORGANIZATION TEMPLATES .....	92
6.2.1	<i>Base Model</i> .....	95
6.2.2	<i>Templates for Supplier Integration to carry out NPD and ECM</i> .....	98
6.2.2.1	Supplier Involved from Concept development phase to Manufacturing:..	98
6.2.2.2	Supplier involved in Design and manufacturing of the product:.....	99
6.2.2.3	Supplier involved only in manufacturing the product:.....	100
6.2.2.4	Supplier Involved in Concept and Design: .....	101
6.2.2.5	Supplier Involved in Detailed Design only: .....	102
6.3	SYSTEM DYNAMICS SUPPLY CHAIN MODEL .....	103
6.3.1	<i>Assumptions</i> .....	103
6.3.2	<i>Model Parameters</i> .....	104
6.3.3	<i>Results</i> .....	105
6.3.3.1	Result 1: .....	105
6.3.3.2	Result 2: .....	106
6.3.3.3	Result 3: .....	110
6.4	CONCLUSIONS .....	112
<b>7</b>	<b>MODELING AND SIMULATION OF NEW PRODUCT DEVELOPMENT AND ENGINEERING CHANGE MANAGEMENT WITHIN AN ORGANIZATION.....</b>	<b>114</b>

7.1	INTRODUCTION .....	114
7.2	THE MODEL: .....	114
7.2.1	<i>Assumptions</i> .....	114
7.2.2	<i>NPD and ECM Processes and workflow</i> .....	116
7.2.3	<i>Total Resources and Resource Composition</i> .....	119
7.2.4	<i>Resource Allocation Priority</i> .....	120
7.2.5	<i>Processing Rates</i> .....	121
7.3	RESULTS AND CONCLUSIONS.....	123
7.3.1	<i>Case 1:</i> .....	123
7.3.2	<i>Case 2:</i> .....	125
7.3.3	<i>Case 3:</i> .....	127
7.3.4	<i>Conclusions:</i> .....	131
<b>8</b>	<b>SIMULATION MODEL VERIFICATION AND VALIDATION.....</b>	<b>133</b>
8.1	ECM SURVEY .....	133
8.2	OEM TEMPLATE VERIFICATION AND VALIDATION.....	134
8.3	CONCLUSION.....	137
<b>9</b>	<b>MODELING AND SIMULATION OF NEW PRODUCT DEVELOPMENT AND ENGINEERING CHANGE MANAGEMENT IN A COLLABORATIVE ENVIRONMENT.....</b>	<b>139</b>
9.1	INTRODUCTION .....	139
9.2	RESEARCH METHODOLOGY: .....	140
9.2.1	<i>Enhanced Templates:</i> .....	140

9.2.2	<i>Model Logic:</i> .....	142
9.2.3	<i>Resources and Resource Composition</i> .....	143
9.2.4	<i>Phase Overlap</i> .....	144
9.2.5	<i>Processing Quality</i> .....	144
9.2.6	<i>Processing Rate</i> .....	146
9.2.7	<i>Resource Allocation Priority</i> .....	146
9.2.8	<i>Outsourcing</i> .....	147
9.2.9	<i>EC grouping</i> .....	147
9.2.10	<i>EC Propagation</i> .....	148
9.3	RESULTS: .....	148
9.3.1	<i>Case 1:</i> .....	149
9.3.2	<i>Case 2:</i> .....	151
9.3.3	<i>Case 3:</i> .....	153
9.3.3.1	Effect of Resources .....	154
9.3.3.2	Effect of Percentage Phase Overlap .....	155
9.3.3.3	Effect of Processing Quality .....	157
9.3.3.4	Effect of NPD Processing Rate .....	158
9.3.3.5	Effect of ECM Processing Rate .....	160
9.3.3.6	Effect of EC Grouping.....	161
9.3.3.7	Effect of Outsourcing .....	162
9.4	CONCLUSIONS AND FUTURE WORK:.....	164
<b>10</b>	<b>CONCLUSIONS AND FUTURE WORK .....</b>	<b>166</b>

10.1	CONTRIBUTIONS .....	168
10.2	FUTURE WORK .....	170
<b>11</b>	<b>BIBLIOGRAPHY .....</b>	<b>171</b>
<b>12</b>	<b>APPENDIX.....</b>	<b>180</b>
12.1	ENGINEERING CHANGE MANAGEMENT INDUSTRY SURVEY QUESTIONNAIRE AND ANALYSIS .....	180
12.2	ORGANIZATION PROCESS TEMPLATES.....	190
12.3	MODELS.....	203
12.3.1	<i>Supply Chain Model from Basic Templates.....</i>	<i>204</i>
12.3.2	<i>Single Organization Model.....</i>	<i>206</i>
12.3.3	<i>OEM Template Validation Model.....</i>	<i>208</i>
12.3.4	<i>Supply Chain Model from Enhanced Templates .....</i>	<i>210</i>
12.4	MODELS FORMULAE.....	218
12.4.1	<i>Formulae of Supply Chain Model from Basic Templates .....</i>	<i>219</i>
12.4.2	<i>Formulae of Single Organization Model .....</i>	<i>241</i>
12.4.2.1	View 1.....	241
12.4.2.2	View 2.....	258
12.4.3	<i>Formulae of Supply Chain Model from Enhanced Templates.....</i>	<i>305</i>
12.4.3.1	OEM View 1.....	305
12.4.3.2	OEM View 2.....	328
12.4.3.3	CMS View 1 .....	357
12.4.3.4	CMS View 2 .....	378
12.4.3.5	MS View 1 .....	407

12.4.3.6 MS View 2 .....	424
12.4.3.7 CDS View 1 .....	447
12.4.3.8 CDS View 2 .....	453
<b>13 VITA .....</b>	<b>467</b>

**LIST OF TABLES**

Table 1: NPD Phase Processing Quality .....	118
Table 2: Resource Composition values .....	120
Table 3: Phase Priority for Resource Allocation .....	121
Table 4: Components to Resource type ratios .....	122
Table 5: The 8 Variables representing the ECM and NPD process within an organization ..	124
Table 6: Resource Composition .....	144
Table 7: Processing quality data .....	145
Table 8: Allocation Priority.....	147
Table 9: The 31 Variables representing the ECM and NPD process across the supply chain .....	150

## **LIST OF FIGURES**

Figure 1: EC classification and causes.....	13
Figure 2: Typical ECM workflow.....	19
Figure 3: Causal loop diagram example.....	27
Figure 4: Basic patterns of system behavior.....	28
Figure 5: System Dynamics modeling basics .....	29
Figure 6: SOA reference architecture .....	33
Figure 7: Engineering Change Management Literature Summary .....	35
Figure 8: Top five pressures pushing companies to improve the Change Management process.....	50
Figure 9: Causal Loop Diagram of NPD and ECM parameters .....	55
Figure 10: Screenshots of an implementation of the framework .....	65
Figure 11: Change Propagation framework Implementation Logic .....	67
Figure 12: Schematic representation of Attribute-component-component dependencies ..	68
Figure 13: 3-D model of the toothbrush.....	69
Figure 14: An example of dependencies database.....	71
Figure 15: Change propagation result for the discussed case.....	72
Figure 16: Middleware level components of the proposed SOA based ECM system .....	76
Figure 17: A flexible ECM business process between 3 companies. ....	79
Figure 18: Case Study product 3-D model of tooth brush.....	86
Figure 19: The Case Study Supply Chain .....	87
Figure 20: Case Study Implementation of SOA based ECM framework.....	89



Figure 21: Schematic Figure of the Organization Templates.....	92
Figure 22: Toothbrush product hierarchy.....	93
Figure 23: Original Equipment Manufacturer Model Template.....	96
Figure 24: The Model Template for Supplier involved from Concept development to Manufacturing phases .....	99
Figure 25: The Model Template for Supplier involved in Design and Manufacturing phases .....	100
Figure 26: The Model Template for Supplier involved in Manufacturing phase.....	101
Figure 27: The Model Template for Supplier involved in Concept and Design phases .....	102
Figure 28: The Model Template for Supplier involved in Design phase.....	103
Figure 29: Model 3 Result 1 Graph 1 .....	105
Figure 30: Model 3 Result 1 Graph 2 .....	106
Figure 31: Model 3 Result 2 Graph 1 .....	107
Figure 32: Model 3 Result 2 Graph 2 .....	108
Figure 33: Model 3 Result 2 Graph 3 .....	109
Figure 34: Model 3 Result 3 Graph 1 .....	110
Figure 35: Model 3 Result 3 Graph 2 .....	111
Figure 36: Model 3 Result 3 Graph 3 .....	111
Figure 37: Schematic of NPD and ECM Processes within an organization .....	116
Figure 38: Effects of process parameters on NPD lead time .....	124
Figure 39: The effect of Interactions between the process parameters on the NPD lead time. .....	125

Figure 40: Effects of process parameters and their interactions on the NPD lead time.....	126
Figure 41: Influence of NPD and ECM processing rates, and allocation priority and EC batch size, on NPD lead time (resources 50) .....	128
Figure 42: Influence of resources and processing quality, and NPD and ECM processing rates on NPD .....	129
Figure 43: Influence of percentage phase overlap and resource composition, and resources and processing quality on NPD lead time .....	130
Figure 44: Influence of percentage phase overlap and resource composition, and NPD and ECM processing rates on NPD lead time .....	131
Figure 45: Schematic of OEM template verification.....	134
Figure 46: NPD process performance for varying magnitude of the peaks .....	136
Figure 47: Schematic diagram of the supply chain model interactions .....	142
Figure 48: Effect of the Process Parameters on Lead Time using Factorial design approach of DOE .....	149
Figure 49: Pareto chart showing the effects of selected 13 factors on lead time with all variables at High state. ....	152
Figure 50: Pareto chart showing the effects of selected 13 factors on lead time with all variables at Low state. ....	153
Figure 51: Effect of organization resources when all variable are set constant at high .....	154
Figure 52: Effect of organization resources when all variable are set constant at low .....	155
Figure 53: Effect of Percentage phase overlap when all variable are set constant at high .	156
Figure 54: Effect of Percentage phase overlap when all variable are set constant at low ..	156

Figure 55: Effect of Processing quality on lead time when all variable are set constant at high .....	157
Figure 56: Effect of Processing quality on lead time when all variable are set constant at low .....	158
Figure 57: Effect of NPD Processing rate on lead time when all variable are set constant at high.....	159
Figure 58: Effect of NPD Processing rate on lead time when all variable are set constant at low.....	159
Figure 59: Effect of ECM Processing rate on lead time when all variable are set constant at high.....	160
Figure 60: Effect of ECM Processing rate on lead time when all variable are set constant at low.....	160
Figure 61: Effect of EC grouping on lead time when all variable are set constant at high...	161
Figure 62: Effect of EC grouping on lead time when all variable are set constant at low....	162
Figure 63: Effect of outsourcing on lead time when all variable are set constant at high...	162
Figure 64: Effect of Outsourcing on lead time when all variable are set constant at low ...	163

# **1 INTRODUCTION**

## **1.1 Introduction**

Undeniably, in an industrial economy products are developed and marketed to address specific needs of the customers. Changing customer needs create new market opportunities, necessitating development of new products from time to time.

Understandably, the development of the products involves various phases representing the level of maturity of the product ideas and the designs. Starting with altogether brainstorming of ideas and developing concepts to address potentially new market opportunities, the New Product Development (NPD) process encompasses developing designs for the product, prototyping and testing of the product designs, production ramp-up, product assembly and testing, and market introduction. In sum, the companies administer a well-planned and controlled NPD process to develop products with high quality at minimum cost and lead time (Cho 2005). Equally important, the NPD process is perceived by organizations, as a strategic tool to address the new market opportunities and stay competitive.

Typically, companies launch products at regular intervals by either modifying the existing product or developing a new one. As the product evolves through the NPD process, changes need to be made to the product designs (Nadia 2006). In all cases, the changes to the products are implemented to make them competitive in the market place by improving its performance, eliminating defects, upgrading the technology or enhancing its functionality. For example when the product is made to order, the changes may be

proposed by the customer to accommodate their new requirements. As a result, changes need to be made to the product designs at different phases of the NPD process. The later they are proposed the greater is the time and effort needed (Nadia 2006). The changes are implemented differently depending upon the NPD phase at which they are implemented. Changes during the early phases (Concept and Design) of the NPD process are implemented in an iterative manner leading to evolution of a feasible product design (Li 2009). The distinct changes proposed/discovered during or after the prototyping phase of the NPD process, by when most of the product design is frozen, are implemented using a controlled formal process. These changes that are proposed and implemented after the prototyping phase are called Engineering Changes (ECs).

Essentially, an EC can be considered as “an alteration in the approved configuration of a product related item” (US Military Standard 480B, 1988). An item can be a document or a physical component of the product structure (Riviera *et al.*, 2002). ECs occur in many forms including dimensions, fits, forms, functions and materials of products or their components. An EC is said to be a necessary evil. It is necessary in the sense that it increases the quality and performance of the product, while it is evil in the sense that it costs the company in terms of extra expense and time. An EC helps in improving the level of customer satisfaction with the product, since many of these changes are initiated by the customer as new requirements or to improve the user experience. The companies also initiate modified specifications or manufacturing changes as they see that their customers are better served with the EC (Bhuiyan *et al.*, 2006). ECs are also proposed to increase the functionality of the product in the latter stages of the product life cycle or to replace an

obsolete technology. While these are the desirable effects of an EC, ECs also introduce undesirable effects such as longer product lead time, as well as extra cost in terms of personnel and material scrap. In addition, ECs introduce numerous significant changes to the product data, which require a significant effort to handle.

Properly planned and managed ECs are great assets to any organization because they, in fact, enable the organization to match the technological innovation of competitors and, thus, maintain a competitive advantage. Poor management of ECs no doubt leads to poor performance of a corporation due to expensive or unnecessary purchases, high scrap expenses, production delays, loss of market share, slow market responsiveness, *etc.* (Diprima, 1982). The Engineering Change Management (ECM) is a complex process. The complexity in implementing an EC can be understood from the fact that it generally demands widespread involvement of more than one functional area or a whole organization. In order to address the complexity, companies need to adopt a well-defined procedure to manage an EC-- starting with their EC proposal to ultimate implementation. Typically, ECM committees are formed to address effects of ECs. An EC coordinator is appointed to manage and coordinate all the EC-related activities throughout its life cycle.

Recently, a growing number of companies are adopting a collaborative product development process through which the combined capabilities can be precisely utilized. Companies are seeking for worthwhile subcontractors with complementary capabilities or entering into collaborative development contract to improve their overall effectiveness and the quality of their products. Overall, the design, manufacture and assembly of a product

are not confined to a single company (Rouibah and Caskey, 2003; Li and Qiu, 2006; Tavcar and Duhovnik, 2006). In such an environment, ECs in any component of a product can affect several other members of the collaborative network or supply chain. Accordingly, the ECs need to be communicated to all the affected entities across the collaborative network or the supply chain. An ECM process in such an environment or, in general, should:

1. support various communications among collaborators
2. ensure the involvement of all the stakeholders in the EC process
3. establish common vocabularies and guidelines for ECs
4. control the ECM process over the collaborative network
5. identify and estimate the scope of impact of ECs and ECM policies (Rouibah and Caskey 2003; Terwiesch and Christoph 1999; Huang et al. 2001; Tavcar and Duhovnik 2005).

The ECM across the supply chain is different from the one confined within one organization since it needs to engage otherwise independent entities (organizations) working towards a common goal of ECM. To illustrate, each of the organizations that are part of the product development and the manufacturing has their own way of functioning and addressing ECs. Presumably, while these individual ECM processes share common basic steps such as change proposal, approval, and implementation, there can be significant differences in their detail procedures (Klein et al., 2007). Hence, the ECM process in a collaborative environment should also be agile enough to accommodate the differences in the procedures of the partner organizations and should thus also be capable of bringing all

these organizations onto a common platform and ensure a smooth flow of information between them.

Thus, the ECM process is important and convincing because it influences product lead time, product cost, and productivity of the NPD process (Jarratt 2004). As an overview, the ECM process is complex since it requires the attention of cross functional personnel, and when several companies are involved collaboratively in managing engineering changes the complexity increases dramatically because of their supplier– customer relationship. Therefore, it is necessary to establish a system architecture and set of procedures and policies that control the interaction and flow of information among various stakeholders. To ensure proper control on the planning and implementation of ECs, tools that can assist the decision making by providing useful information are required. To better manage an EC, the research presented in this dissertation addresses the above two aspects of the ECM process by presenting a framework to support an agile ECM process in a collaborative environment and to estimate the impact of the ECs.

Arguably, in planning and implementation of an EC, identification and estimation of the impact of ECs to support the decision making process is essential (Huang et al. 2001, Tavcar and Duhovnik 2005). Granted, it is required to identify how other components are affected by an EC. The dependencies of different components of a given product may be direct or indirect with respect to an EC. That is, when a component is affected by a change in another component that is directly caused by the EC, the dependency is called indirect. Namely, the dependency relationships can become too complex to be handled by a person



with single technical perspective. It then requires multidisciplinary knowledge to ensure identification of all the dependencies between the components of the product. In order to capture and document all the necessary dependencies, numerous people from different disciplines should likewise be involved from the design phase. Correctly understood, such an involvement makes the identification of affected components complete during EC processing. Identification process can be automated by capturing the dependencies in a retrievable format (Browning, 2001). A framework for change propagation is presented in chapter 4, which readily provides a provision to capture the tacit knowledge of component dependencies during the initial phases of fundamental product development. The notable information is later retrieved to identify the components affected by an EC.

Acknowledging the agility requirements of ECM process in a collaborative environment, service-oriented architecture (SOA) technology, which is solely characterized for enabling agile processes, is adopted to support the ECM process. An ECM process framework based on Service Oriented Architecture (SOA) is presented in chapter 5. In this context an ECM framework is a combination of system architecture, process definitions and policies that enable organizations to manage ECs in a planned manner. The presented framework enables flexible ECM processes across the supply chain. While collaborating with Original Equipment Manufacturer (OEM), the suppliers can adopt their own uniquely augmenting ECM process reflecting their management policies. This framework enables the ECM process to use the same pool of services in virtual space to represent business processes dealing with an EC. The services in the virtual pool can be physically present at and owned by any partner in the network but are available to and can be accessed by any

authorized member of the collaborative network. Each service can accomplish an individual task; and a group of sequentially performed tasks constitute a business process as for example, an ECM process, in the collaborative network (Yongyi, 2009).

The complexity of the ECM process involving meaningful multiple organizations also necessitates the study of the effects of the ECM procedures and policies on the entire supply chain and OEM performance before actually implementing the procedures and policies. ECM simulation provides an insight of the factors effecting the ECM process and help in identifying the leverage points of the process that can be used to study the dynamics implicit in the process. Also, by simulating the ECM process, the effects of the policy changes can be clearly visualized without actually adopting or implementing them. This research (presented in chapter 6, 7, and 9) investigates the dynamics of the ECM process and its reliable effects on NPD process performance.

To enable simulation of the interactions between suppliers and OEM during the NPD project, the NPD and ECM process templates of organizations are proposed which can be assembled together to form a supply chain. The fact that suppliers interact with the OEM at specific points during the NPD process is exercised to develop these templates. Initially, the concept of the templates is surely proved by modeling and simulating a simple supply chain. Later the templates are improved with added functionality of prioritizing of resource allocation, grouping of ECs for processing, and inclusion of phases within the ECM process. The improved templates have been then used to model and simulate NPD and ECM processes within an organization and across a viable supply chain.

## 1.2 Background

Engineering Change (EC) is an alteration to the design, or documentation of any component of a product. In general, these changes emerge after the product is released into the market after the new product development team has been dispersed. There are different reasons for an EC. Whatever may be the reason, they improve the products' competitiveness in the market place. Engineering Change Management process is a set of defined procedures to manage the life cycle of an EC from its origin to its documentation after implementation.

The importance of ECM can be explained from the stimulating fact that it is intricately linked to the issues related to product success and New Product Development (NPD). The issues, at least, related to product development include (Jarratt 2004)

- Regulation
- Economic and technological difference
- Changing market place

### Regulation

First and foremost, regulations govern the specifications of many products and drive the NPD process. Any change in the regulations will lead to an observable change in the specification of a product and hence an EC emerges. These regulations generally define the required performance of the product: for example, the safety, or environmental performance. Automobile and aircraft engines are the two sectors that are largely governed by these regulations. An aircraft engine should be extensively capable of sustaining a bird hit or the composition of the exhaust gases cannot exceed certain limits.

### Economic and technological difference

Low cost and high product performance has always been the main goal of any new product development projects. Globalization has shrunk the physical boundaries and expanded the market place across continents. The market place, as a result, is fragmented with a variety of economic conditions, technological development, and governing regulations ensuing differences in demand for technology and cost of the product. Organizations have been striving to address the specific needs of these fragments with minimum possible cost. Important as it is one of the strategies to reduce cost is to design the product such that it can address the requirements of all the market place fragments. Companies have been adopting techniques like modular design where in base modules, which are common to all product variants, are developed; and the specific needs of the customer are addressed by additional fragment specific modules or modifications to the base modules. For instance, automobile companies have been steadily marketing the same aesthetic design with varying engines and control systems in different market segments. Likewise, aircrafts manufacturing companies modify the civilian aircraft design to cater to military needs.

### Changing market place

Because, there is a difference in the demographics of the market place across the world, each product should address these differences in order to be competitive and successful. The product specifications are sometimes governed by the attitude of the market place. NPD aims, to target all the sections of the market place. While customer demand is ever evolving, expectations are increasing with respect to the quality and

performance of the product. In this dynamic market scenario, ECs help in upgrading your product to match the new market opportunities created based on changing customer needs.

In addition to these factors there are a few issues that the ECM is related to the product success.

- Response time to market
- Product cost
- Quality.

#### Response time to market

Being first to a particular segment in the market place gives the 'pioneer advantage'. The initial response to a new product is always addressed by ECs. A faster response to the initial reaction to a new product ensures better product reviews, and there by greater demand. There is an evolving tendency to release the product to a selected audience before production ramp-up or officially launching the product into the market. The product is seemingly improved according to the feedback from the users, and all these are addressed with ECs. A remarkably good ECM process ensures faster and economical implementation of the EC.

#### Product cost

Though EC implementation benefits the product performance and is always meant to improve the products' competitiveness in the market place, it is associated, for the most part with extra costs in the form of scrap, rework, or additional man hours. The cost of implementing ECs, chiefly affects the total production cost of the product and hence its

price. Sometimes, a product with a competitive pricing and good market share may not be profitable enough as expected due to the additional costs from ECs (Jarratt 2004). An efficient ECM ensures minimum implementation cost.

### Quality

As an immediate appeal, quality is always the first priority and is directly related to customer satisfaction and product success. ECs not only address most of the product quality issues, but also improve product performance. An effective ECM ensures that all goals of the EC are attained.

#### **1.2.1. Reasons for ECs**

There are many reasons why an EC is requested. Whatever may be the reason it is aimed either to reduce the costs or improve the performance of the product. The reasons for an EC (Lee 2006, Diprima 1982, Frank 1980) are,

- **Error Correction/ Careless Mistakes:** Design errors that go undetected during the design and manufacturing can be detected at any point they emerge during the product life cycle. These can be due to misinterpretation of customer needs or miscommunication between engineers.
- **Safety:** Product safety is a vital issue of any product. Whatsoever the product is, it should be safe to use subsequently under all the possible working conditions. ECs to correct these issues are of high priority and can cause huge commercial damage unquestionably to the organization if not avoided or resolved immediately.

- **Malfunction:** Product responds unexpectedly in certain working or environmental conditions which were overlooked during the testing of the product.
- **Poor Communication:** The misinterpretation of data between stakeholders or due to the misinterpretation of the customer requirements into specifications of the product.
- **Product Quality:** When the product quality is compromised under certain working conditions or the product does not meet the specifications it is expected or designed for.
- **Snow balling:** A change in a component due a change in another component related to it some way.
- **Manufacturability:** Improve the manufacturability of the product in order to increase productivity of the shop floor.
- **Improve Functionality:** Improve the functionality of the product to address new market opportunities or to keep the product competitive.
- **Adapt to Market:** Changing customer needs create an overall opportunity in the market, and an EC can be proposed to modify the present product to address the new market opportunity.
- **Service Requests:** Servicing the sold products can help detect defects in the product design or means to improve the product's reliability based on the technical support

interaction with the customers and their experience from the problems they are servicing.

**1.2.2. EC Classification**

Above all, the ECs are classified for better control and management of the ECM process. The classifications are based on various criteria which indicate the purpose and potential advantages of the classification. Namely, the criteria of classification include purpose, origin, urgency, timing, effect, component characteristics, and combination of effect and urgency. The main goal of the classification is to unerringly increase the overall productivity of the ECM process by reducing the production set up time, reducing the impact of the EC, and grouping of ECs for processing them in batches. Each of the classification ensuring these is briefed below,

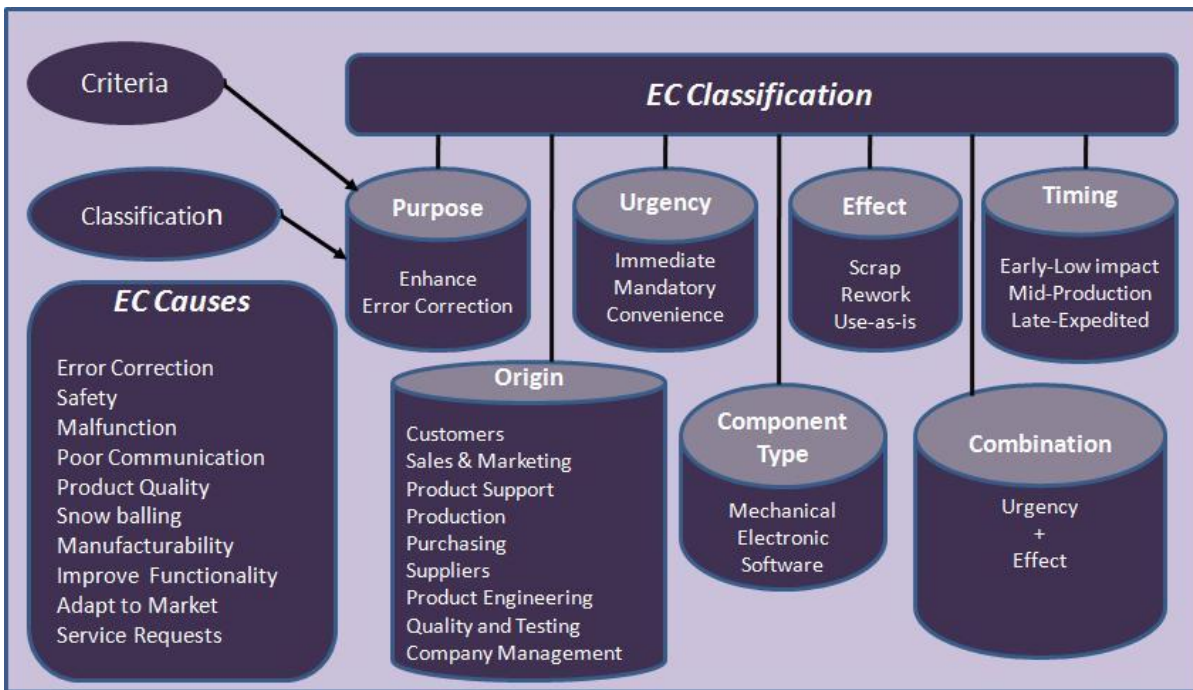

Figure 1: EC classification and causes



### Purpose

In a cogent manner, the ECs can be classified into two types based on their purpose of initiation (Eckert 2004). For greater strategic coherence, this classification helps in prioritizing the implementation of the ECs so that the impact of the ECs is low. For example, the emergent changes are processed and implemented ahead of the initiated changes in order to reduce the impact which in this case is the risk of losing customer confidence and warrants safety risk.

- Initiated Changes: These changes, at all times, are proposed to *Adapt, Improve or Enhance* the product performance. These are initiated from sources outside the product itself and aim to improve the product competitiveness.
- Emergent Changes: Emergent changes are proposed to *correct an error* in the design of the product. These emerge from an error arising within the product. The expectation is that these types of ECs should be implemented immediately to address the concerns of product performance.

### Origin

This is based on the source that proposed the change. The change proposal can come from any source (Frank 1980, Jarratt et al. 2006) either from within the organization from any department or from any supplier. This sort of classification, to a great degree, is best used to filter the ECs worth for further consideration at preliminary stages of ECM. Sources known for technological competency can have a high priority over the rest for faster decision making. The sources include:

- Customers
- Sales & Marketing
- Product Support
- Production
- Purchasing
- Suppliers
- Product Engineering
- Quality and Testing
- Company Management

These changes can come from the shop floor (production) aiming, cost reduction and machine utilization, the quality assurance (Quality and Testing) to address issue detected or based on product improvement studies, the purchasing department to address the various differences with vendor availability, and from the sales and marketing to make the changes to product specifications to address a new development in the market.

### Urgency

This classification is based on the urgency with which the change should be addressed to ensure least damage or impact. The changes are classified as (Diprima 1982, Frank 1980)

- Immediate/Crash Basis: This type of ECs has to be processed immediately to, address a safety issue, or defect in the design to avoid habitual economical loss, or to avoid loss of market share.

- Mandatory/ Scheduled on a first in-first out basis: These Changes have to be implemented at some point of time for better product performance but are not economical to be implemented immediately. Rather, these changes can be scheduled to be implemented at the appropriate time.
- Convenience/ held in a batch file for processing: These changes are not economical when implemented individually, but are primarily worth implementing at some point of time. At best these are batched together to process and implement them as a group.

### Timing

ECs can be classified based upon the timing of their proposal during the product life cycle. This classification, in detail, is for products with long production lead time (Reidelbach 1991, Rouibah and Caskey2003) generally used to understand the NPD process.

- Early, Low Impact ECs: These are the changes proposed early in the life-cycle of the product-- generally before the design is not finalized and are characterized by low impact.
- Mid-Production ECs: These changes occur after the design is released, the orders are placed with suppliers and manufacturing of the product has just started. These changes can cause disruptions but can be contained with good ECM process.
- Late, Expedited ECs: These changes occur in the final stages of production and can cause delays. If the component is not critical, it is advised that the change is implemented after the product is delivered.

### Effect

At the heart of the matter, this classification is based on the effect of an EC on the product (Barzizza 2001). This classification also aims to reduce the impact of the ECs by providing a solid base for prioritizing the implementation of ECs.

- Scrap: The product is considered as scrap due to this type of ECs. These EC is due to a serious flaw observed or experienced in design or safety of the product. This type of change has the greatest impact and can be costly.
- Rework: This type of change does not scrap a product but affects some components of the product which can be reworked. These changes affect the crucial performance of the product.
- Use-as-is: This type of change has no immediate impact on the product. These may include improving product performance or incorporating new technologies. Since there is no flaw in the product, the product can be used as it is; and EC can invariably be implemented at the appropriate time.

### Component Characteristic

This type of classification is based on the type of the change and the components affected by the EC. These can be based on the product configuration. ECs are classified based on the affected components which consecutively are part of a whole system.

Notably, in an automobile the ECs can be classified by the sub systems as braking system, engine, chassis etc. In general, these can be based on (Lee 2006, Klein 2007)

- Mechanical ECs: ECs proposed to the mechanical systems of the product.

- Electronics ECs: ECs proposed for the Electronic systems of the product. This EC can be independent or affect the mechanical systems; in that case a new mechanical EC would arise.
- Software ECs: ECs to software application systems that control the mechanical and electronic systems are grouped under this category. A flaw in the logic of the control can result in this EC.

Apart from all these above types of classification, ECs can, in fact, be classified based on a combination of Effect and Urgency (Balcerak 1992). ECs are first classified by urgency and effect and then combined together and prioritized for further processing and implementation.

### **1.2.3. A Typical ECM Process**

An EC Committee (comprised of members from Product Design, Accounts, Production, Manufacturing and Marketing departments) headed by an EC coordinator, actually manage the life cycle of an EC. From the outset the ECM Process is comprised of four stages: (i) Propose, (ii) Approve, (iii) Plan and Implement, and (iv) Document.

- i. Proposal of ECs: ECs can be proposed by any stakeholder and are initially shortlisted by an EC committee for further consideration. At this stage, it is based on the source and expertise of the EC committee that judges if an EC is realistically worth investigating.
- ii. Approval of ECs: The stakeholders affected by the shortlisted ECs are notified, and each stakeholder is asked to analyze the virtual impact of the EC from their perspective, which is later reviewed at a meeting. At this point, the payoffs of the EC

implementation are fully discussed, and its worth is debated. Officially, the decision of EC implementation is justified simply based on the impact analysis from all the stakeholders and the market payoffs. The preliminary details of EC implementation, if approved, are ultimately communicated to all the stakeholders. Technically speaking, this phase is exhaustive in terms of the technical and economical knowledge transfer. This phase ends with the approval of the EC by all the authorities concerned.

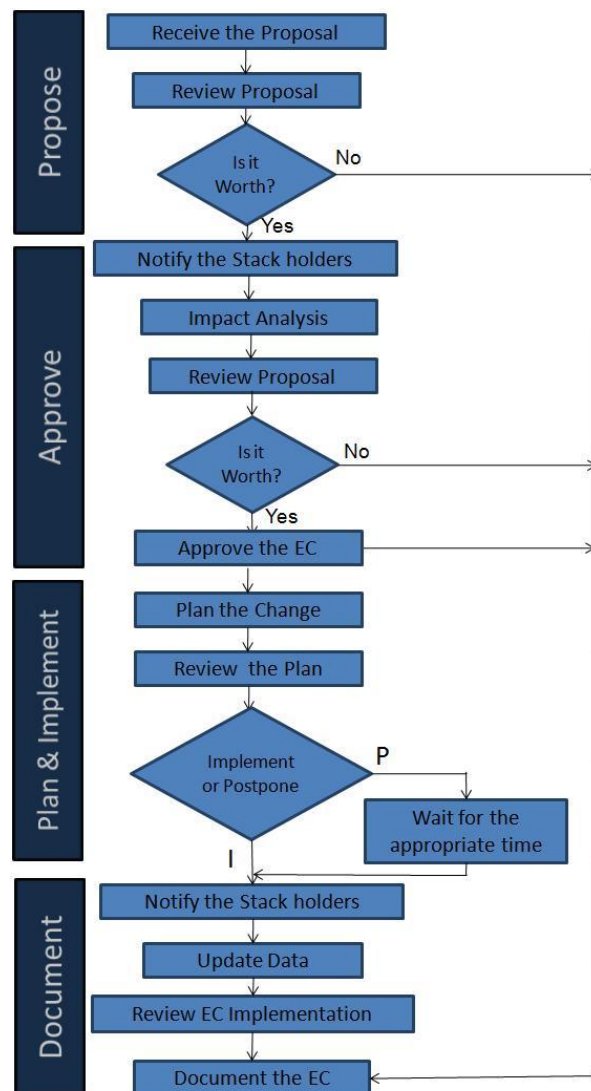

Figure 2: Typical ECM workflow.

- iii. Plan and Implement EC: Once an EC is approved, a detailed plan for its implementation is skillfully prepared and the metrics, to ensure that it is implemented the right way, are defined. All the stakeholders are notified, and the plan of implementation is discussed and finalized. The ECM implementation is reviewed based on the corresponding metrics defined in the plan.
- iv. Documentation: The product data is updated and after implementation of the EC, the experiences are documented to ensure that the tacit knowledge from the implementation is captured and stored. This generally involves problems encountered and the way they were genuinely addressed. In a word, the lifecycle of an EC always ends with documentation.

#### **1.2.4. ECM Strategies**

Characteristically, a good ECM aims to improve the cost, time and quality of the products to the market. A good change management process is characterized by early, efficient, and effective changes. There are different strategies (Riviera 2002, Fricke 2000) to cope with and ensure a good ECM process.

- Prevention: This strategy intends to reduce the number of emergent changes (changes from within the product). While eliminating the errors in the design process is impossible, they can be commonly avoided and reduced by adopting a well-planned product design process. At times there is a certain degree of uncertainty involved in the design process which decreases as the design progresses and finalizes. It is advisable to plan the product architecture to enable a few parameters to be frozen early in the design process, while leaving few others to

- accommodate changes in the later stages. Techniques like Quality Function Deployment can be forcefully adopted to prevent Changes.
- **Front-Loading:** This strategy aims to intensively detect the changes early in the design process, so that the impact of these changes will be smaller. Practices like concurrent engineering and involvement of suppliers and customers early in the design process, along with techniques like design for manufacturing, failure mode and effects analysis help to achieve the motive. Taking the ever-changing customer demands into consideration, it is asserted that techniques like “Design for Changeability” can help as it avoids finalizing the demand at the early stages of the design and includes flexibility, agility, robustness and adaptability. This makes it possible to react quickly to the changes in the market place.
  - **Effective ECM:** Taking note of the fact that all the changes are not absolutely essential, this strategy compares the effective efforts required and the benefits possible from implementing the change, to take a decision whether to implement or avoid the change. On any level, it is important to differentiate between the necessary and unnecessary changes to ensure an effective ECM process.
  - **Efficient ECM:** Correctly understood, the changes considered vital should be implemented in an efficient manner making optimal use of the resources like capital and time. This strategy most certainly emphasizes the detailed planning of EC implementation to ensure the least possible use of resources. It requires a flexible ECM process and a good communication network to notify the EC information to all the stakeholders as fast as possible.



- Learning: Continuous improvement of the Product design and ECM process is important to ensure a good Product. Critiquing is a good practice to improve any process. The attitude of the stakeholders towards implementation of an EC should be supportive and this is only possible by educating them about the necessity and importance of ECs. It is also important that all the stakeholders have a clear idea of the whole process of ECM and flow of information. Thus this strategy emphasizes, on capturing and reuse of tacit knowledge, in addition to informing the importance of the EC to the stakeholders.

#### **1.2.5. ECM Metrics**

The performance (Fricke 2000) of an ECM process can be accessed based on three factors:

- Number of Active ECs: The number of ECs at any given point of time depends on various factors which include: definition of the EC that the organization uses, product complexity, and the efficiency of the ECM process. The more the number of active ECs, the less efficient is the ECM process. An issue with many active ECs is that engineers should work on multiple ECs and switching from one EC to another takes a certain amount of non-productive 'mental set up' time.
- EC life cycle time: The time taken by an EC to go through its entire life cycle indicates the performance of the ECM process. Alternatively, the larger the cycle-time, the lower the performance of the ECM process. It has been found that for each day of processing an EC, there are two weeks of non-productive time, on average. Hence,

- an excessively bureaucratic ECM process (where a lot of time is taken for approval and monitoring of the EC implementation) results in low performance.
- EC cost: The higher the cost of an EC, the lower the efficiency of the ECM process.
- The ensuing cost of an EC can be divided into two components: tangible and intangible. Tangible costs can easily be estimated such as scrap costs, cost of extra working hours, etc. Intangible costs cannot be quantified because these include missed sales, loss of customer goodwill, etc. Another noticeable way of measuring the performance of the ECM process is the difference between the expected cost and time of an EC to the actual cost and time (the greater the difference, the lower the performance).

#### **1.2.6. System Dynamics**

Use of information technology and innovative management methods has improved performance of business processes, thus moving the bottlenecks from within the process to the interfaces between processes. System analysis methods are the best in dealing with these bottlenecks at the process interfaces. In short, a system is defined as a group of inter dependent or autonomous components working together for a common cause. In some cases, an element of a system can itself be considered as a system. Considering a business process, the “systems” of people and technology work together to design, manufacture, market and distribute products and services. In general the complexity of a system is attributed not to the complexity of its components but the interactions between its components.

'Systems Thinking' (Sterman 2000, Forrester 1968) constitutes one of the system analysis methods which provides tools for better understanding of complex systems. Instead of viewing an event within the system, as a consequence of an external event; the systems approach views the internal structure of the system responsible for the event. The focus of systems thinking would be on the internal structure of the system, trying to identify patterns of behavior within the system that could characterize an issue or an event. These patterns of behavior of the system are attributed to the feedback structures within the system.

#### **1.2.1.1 Feedback and Casual Loop Diagrams**

Casual diagrams represent the structure of the system in the form of linear cause-and-effect chains. These diagrams capture the hypothesis of reasons behind the problem being addressed. They capture the influences in the system which are initially assumed to be responsible for the dynamics of the system by the stakeholders. Casual diagrams contain system variables connected with casual linkages denoted by arrows associated with a sign (positive or negative) at their head. A negative sign at the arrow (linkage) head indicates that a change in the variable at the tail produces a change in the opposite direction of the variable at the head. A positive sign at the arrow head indicates that a change in the variable at the tail produces a change in the same direction of the variable at the head. For example:

For  $A \longrightarrow^+ B$ , An increase (decrease) in A, would lead to an increase (decrease) in B above (below) what it would have been in the absence of the change.

Mathematically,  $\frac{\partial A}{\partial B} > 0$

For A  $\longrightarrow$  B, An increase (decrease) in A, would lead to a decrease (increase) in B below (above) what it would have been in the absence of the change.

Mathematically,  $\frac{\partial A}{\partial B} < 0$

It should be noted that the polarity between any two variables should not be ambiguous. If there is unambiguity between any two variables, it is an indication of multiples links or casual paths between the two variables in discussion.

When the change in a component of the system influences the same component over time through the established linkages, it said to be part of a closed feedback loop or casual loop. The feedback represents the transmission of information about the system thereby influencing the system's functioning and its dynamic behavior. Like the linkages the feedback loops also are associated with a polarity positive (or Reinforcing) and negative (or Balancing). When a change in a loop propagates within the loop to reinforce the change or change the variable in the same direction as the initial change, it is called a Reinforcing or Positive loop. If a change in the variable of the loop propagates within the loop to counteract the change or change the original variable in the opposite direction as the initial change it is called Balancing Loop or Negative loop. The polarity of a casual loop is determined by two methods:

1. The polarity of the loop can be determined by counting the number of negative linkages in the loop. If the number of negative linkages in a loop are even the loop is

positive (+ve) or reinforcing (R) and if the number is odd then the loop is negative (-ve) or balancing (B).

- Tracing the change in a variable along the loop to determine the effect of that change back on the original variable is another method of determining the loop polarity. If the final effect is against the initial change, it is balancing or negative loop. If the final effect is adding to the initial change, then the loop is reinforcing or positive loop.

For example mathematically the polarity of a loop below can be explained by the following equation.

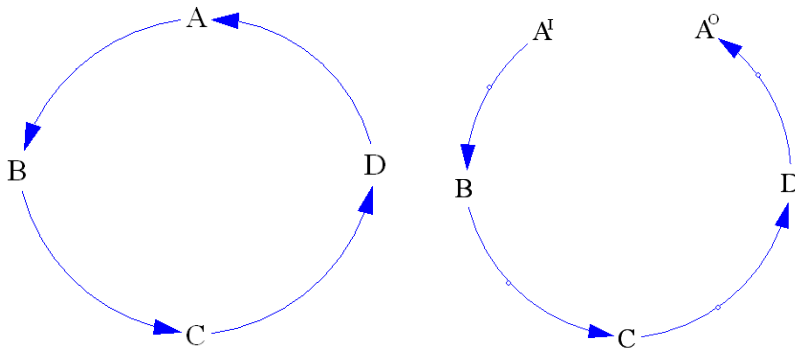

$$Polarity = SGN\left(\frac{\partial A^O}{\partial A^I}\right)$$

$$\frac{\partial A^O}{\partial A^I} = \left(\frac{\partial A^O}{\partial B}\right)\left(\frac{\partial B}{\partial C}\right)\left(\frac{\partial C}{\partial D}\right)\left(\frac{\partial A^O}{\partial A^I}\right)$$

Where,

The SGN( ) is the signum function, which returns +1 if the argument is positive and -1 if the argument is negative.

$A^O$  is Variable A output and  $A^I$  is Variable A input.

The Figure 3 represents a sample causal loop diagram. This particular causal diagram identifies the system variables in a NPD and ECM process and links them with effect-and-chain relationships. The NPD lead time is further detailed with the different phases of the NPD process that, in turn, effect the lead time in the slides.

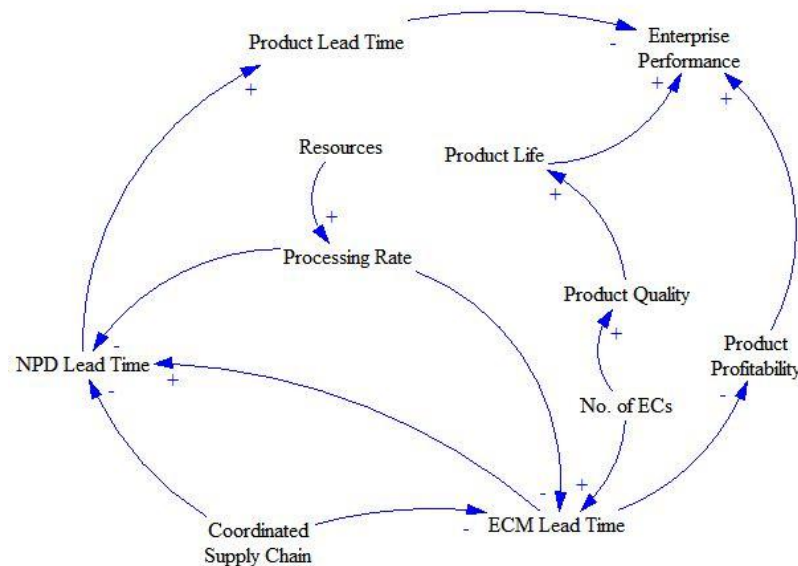

Figure 3: Causal loop diagram example

The system behavior (Sterman 2000) is the resultant of four basic patterns of behavior that could emerge individually or in combination.

#### Exponential Growth:

A known initial quantity grows and the rate of growth increases over time following an exponential function. This is caused by a positive feedback loop which amplifies the initial change leading to faster change of the system in the same direction.

Goal-seeking: An initial quantity which may be less or greater than the desired target moves towards the target. This is caused by a negative or balancing feedback loop which tries to counteract the change in the system leading the system to stability or desired state.

Oscillation: The quantity fluctuates about a desired level. The value follows an exponential growth followed exponential decay. This pattern is caused by a feedback loop. Unlike the Goal-seeking behavior here the system constantly overshoots the desired state trying to get back to the desired state.

Exponential growth together with oscillation, Goal-seeking behavior together with oscillation, and exponential growth with goal-seeking (S-Shaped curve) are a few combinations of the above basic patterns of system behavior.

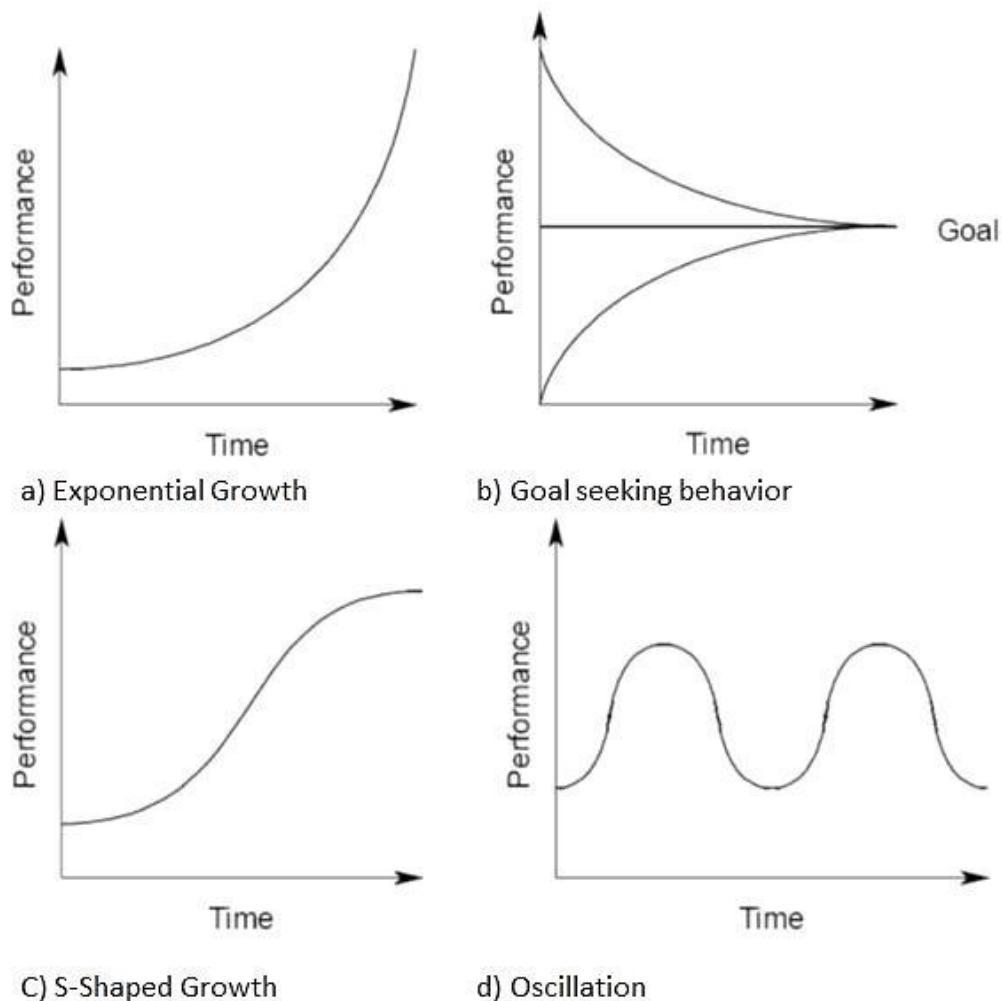

Source: Sterman (2000)

Figure 4: Basic patterns of system behavior

### 1.2.1.2 Stocks and Flows

Though the casual diagrams capture the structure of the system, they are never complete. As the understanding of the system improves so does the casual diagrams, leading to an ever evolving effort. The casual diagram does not identify the stocks and flows in the system. The stocks ad flows are essential to understand the dynamics of any system.

Stocks are accumulations. They describe the status of the system at any point of time. Each stock has inflows and outflows the difference between which accumulates in the stock and creates delays. These stocks decouple the inflows and outflows throughout and are the source of equilibrium /in-equilibrium. Admittedly, the flows represent the rate at which the stocks accumulate or change. Classically as described by Forrester (1968) the stocks and flows are represented by water flowing in and out of a bath tub or reservoir. In this respect, the bathtub is the stock and the water inside the tub depends upon the rate of inward and outward flow of water.

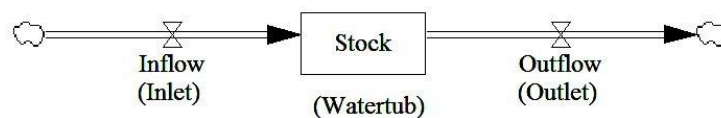

#### Symbolic Notations

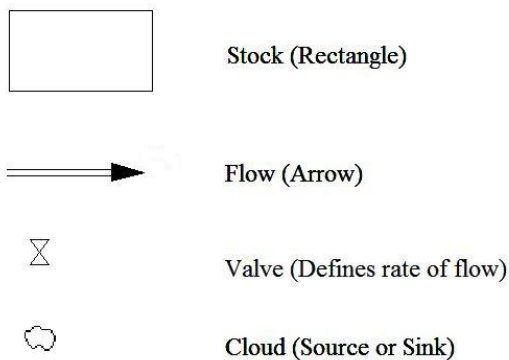

Figure 5: System Dynamics modeling basics



Figure 5 shows the general structure of stock and flow. The stocks are represented by rectangles and the flows are represented by arrows. The valve over the arrow defines the rate of flow thereby regulating it, and the cloud represents a source or sink. The source represents the stocks from which the flows which flow into the system (model) originate while sink represents the stocks into which the outflows of the system (model) terminate.

System Dynamics is a simulation modeling technique wholly based on the methods of systems thinking which helps in modeling and simulating complex systems. The System Dynamics methodology constructs a model with stocks, flows, time delays, variables and feedback loops to represent a system or part of a system. System Dynamics has been used in the field of project management, process management, human resource management, research and knowledge management for NPD, experimental aerodynamics and plant design. System Dynamics models addressing a particular issue can easily be extended to address additional questions or issues in addition to the issues they are built to address.

The various steps involved in system dynamics modeling include:

- (i) representing the system hierarchy and structure in the form casual loop diagrams;
- (ii) identifying and defining the stocks, flows, variables and delays within the system;
- (iii) simulating the model to analyze the system behavior under various conditions governed by the values of the variables; and
- (iv) using the simulation results to validate, refine and understand the system and interrelationships of its components over the entire simulation duration.

As mentioned earlier, stocks, flows, time delays, auxiliary variables and feedback loops, constitute a System Dynamics simulation model of any system. Stocks represent accumulations of an item or information in the modeled system at any given moment of time during the simulation period. For example, system's (i.e. organization's) stock of finished goods or cash is represented with stocks. Flows represent the rate of movement of units to and from the stocks in the model: that is, the production rate of goods. Auxiliary variables represent the external factors that influence the system components. For example, the market conditions, availability of resources. Feedback loops formed by linkages connecting the components of the system capture the interactions and behavior. The systems functional logic is defined by the mathematical equations of stock, flows, and auxiliary variables in the model.

The systems approach is being applied in fields like social sciences and engineering to enhance the understanding of complex systems. ECM process across the supply chain is a complex process considering the level of interactions required between the stakeholders to during the process. Going by the definition of the systems, the ECM across the supply chain can be identified as a system each of whose components can be considered as systems too. The system as defined and assumed by system dynamics modeling technique is a collection of interdependent or independent components (can be systems) working together towards a common goal. The System Dynamics modeling methodology adopts a systems approach to model a distinct problem.

### **1.2.7. Service Oriented Architecture**

SOA is an application integration technology. On any level, modern businesses greatly rely on technology to run successfully and efficiently. No one application can manage a business completely; applications should work together with other applications to support the business from end to end. Consequently, this is made possible only by proper integration of applications. Unlike other application integration technologies, SOA does not try to embed the applications; instead it breaks an application into reusable parts (services) and links them together.

SOA is “an architectural style for creating Enterprise IT Architecture that exploits the principles of service orientation to achieve a tighter relationship between the business and the information systems that support the business” (Bobby, 2008). It is being considered as an effective methodology to enable communication across the enterprises. SOA is primarily a methodology that enables the use of resources across boundaries and firewalls over the internet. Every business process is modeled as a set of independent services tailored sequentially. Every service can invoke every other service by messaging that is made possible by XML based technologies. These XML based standards and protocols define the message structure and contents to enable the communication between available services over the web.

Clearly, small and medium-sized companies constitute a major part of the supply chains in all the sectors of the industry. Frequently, these companies lack the capabilities to upgrade technologies to remain competitive. With decreasing ratios of price and performance, SOA offers a viable option to share resources and implement efficient

business processes across the companies (Tavcar and Duhovnik, 2006; Liqing, 2008).

Companies that collaborate to develop, manufacture, and market products can use SOA to communicate effectively across the supply chain and to maintain a single access point to shared product data (Fan, 2010).

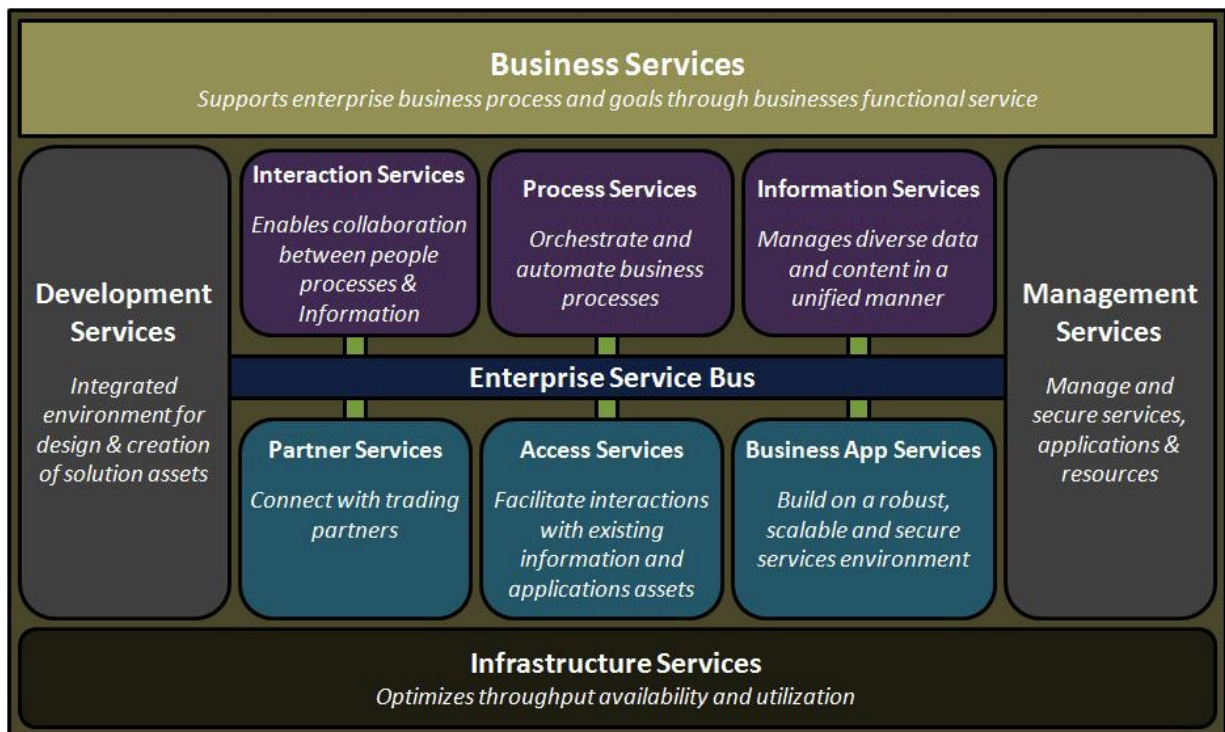

Source: Bobby (2008)

Figure 6: SOA reference architecture

The SOA reference architecture presents a conceptual view of the required capabilities to develop and implement an SOA-based application. A typical SOA consists of six types of service providers along with service connectivity and service support capabilities (Figure 6). The six types of services can be categorized into two:

1. a set of services aiming to integrate the people, processes, and information;
2. a set of services focusing on providing client access to the existing services.

All these services are connected via an enterprise service bus (ESB) and surrounded by capabilities that support the development and maintenance of services. In effect, these services provide a runtime time environment for execution of the service providers. For more detailed information on SOA, please refer to dedicated books on SOA like Bieberstein et al. (2005), Bobby (2008) and Gullledge and Deller (2009).

SOA integrates the business process with the people who manage it and the data that is used for it within or across the boundaries of an enterprise. Above all, SOA can be considered as a technology which is capable to support human interaction, provide and manage access to information, collaborate with partners by sharing the applications (services), and build and modify business applications. With these capabilities, SOA can be used as a platform to ultimately support the ECM process across the supply chain.

## 2 LITERATURE REVIEW

The published literature on EC has been examined and briefed in this section along with the applications of the System Dynamics simulation methodology. The literature on ECM is classified into 4 main groups based on the manner in which the work is linked to ECM. These categories include

- Review
- Effects
- Tools
- Frameworks

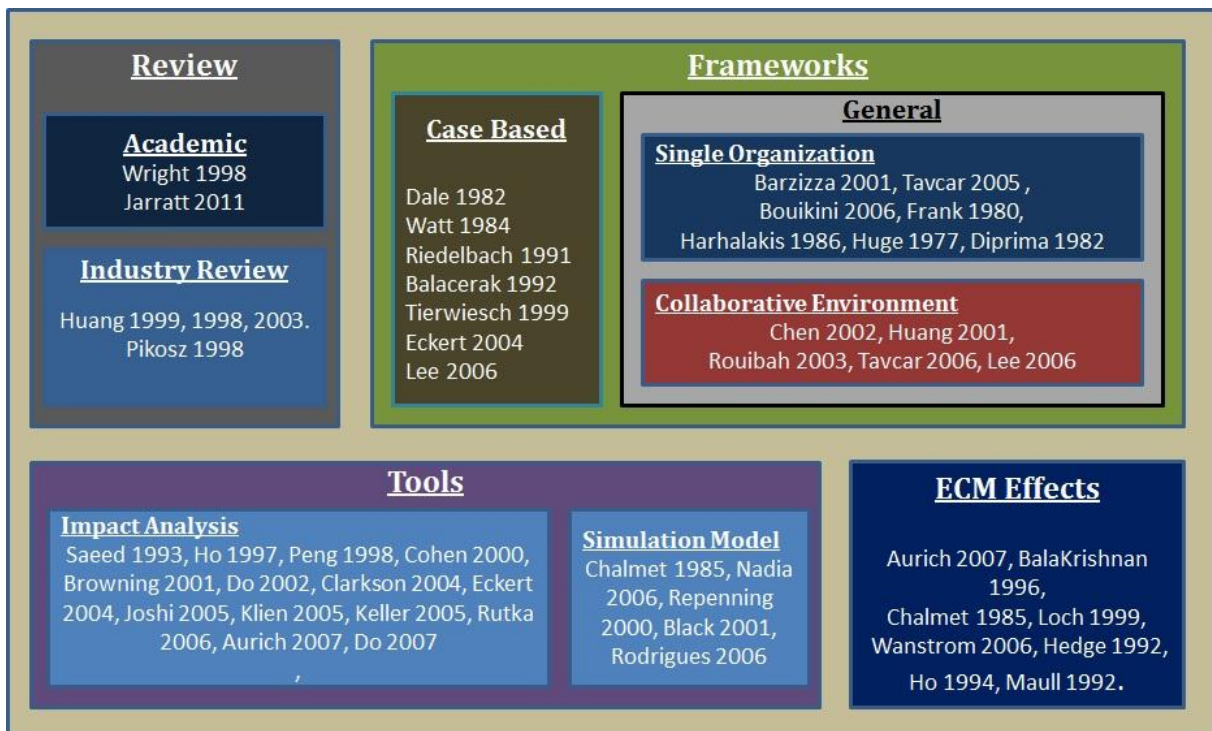

Figure 7: Engineering Change Management Literature Summary

Essentially, the review category is comprised of two sub-sections: academic review and industry review. The academic review section includes the review of published academic research (Wright 1997, Jarratt et al. 2011) and the ECM practices in the industry (Huang and Mak 1999, 1998, Huang et al. 2003, and Pikosz and Malmqvist 1998). The effects category includes the research on the study and estimating the impact of ECs on various systems like material requirements planning system, product schedule, and resource management etc. The research done architectures, process definitions and policies of ECM systems are categorized under frameworks. The frameworks category includes frameworks proposed for addressing specific issues in organizations represented by case based section and for general cases of organizations. On the whole, the tools category includes the tools developed to study and logically estimate the impact of ECs and is part of the ECM frameworks for an organization. The categories relevant to the research presented in this thesis, tools and frameworks are thoroughly briefed to further identify the drawbacks and existing unaddressed issues.

## **2.1 Frameworks**

### **2.1.1 ECM within an Organization**

Frank (1980) described an ECM process which emphasized on the approval and planning of the EC. It is more like a design perspective of the ECM. The importance of the complete information of an EC is asserted. The 'What', 'How', 'Where', 'When', and 'Why' of an EC should, indeed, be determined during the planning of an EC and should be passed on to the concerned departments for implementation upon approval. Although the level of

detail in planning an EC is adequate, less is told and briefed about the implementation of the EC.

Unlike Frank (1980), Diprima (1982) proposed an ECM process in which he presented the implementation part of an EC emphasizing the 'Concurrent Engineering' way of functioning. It is assumed that the decision of EC implementation has already been taken by the design department and the EC Committee plans and implements it. The importance of advance planning and monitoring are stressed with a monthly report outlining the EC activity costs incurred and a brief analysis of the change before its implementation. Diprima also stresses the documentation of experiences after the implementation of an EC, which helps in improving the process by capturing the tacit knowledge gained from actual experience. Harhalakis (1986) described the manner in which the ECs should be handled by a Material Requirements Planning (MRPII) system. He proposed a combination of computer aided procedures and decision making manual intervention to support the MRPII System.

Barzizza (2001) proposed a methodology for an EC implementation from a manufacturing perspective. It was assumed that the decision of implementing the EC has already been made and the manufacturing department is responsible for implementing the EC at an appropriate time. This work suggests a mathematical methodology that, on the whole, indicates the appropriate time and cost to implement an EC.

Tavcar (2005) proposed a General EC process consisting of five steps including Change Request, Change Preparation, Change Approval, Change of Documentation, and Implementation in Production. The quality of communication affects the first three steps while the Clear definition of the process and the information system affects all the above



stated steps of ECM. The above-mentioned general ECM Process has been modified for two different environments, individual production and mass production.

After all, products produced from individual production are unique and hence the EC process should be sufficiently flexible to respond quickly. Better supplier relationship is required to ensure quicker response time, which is consistent with Reidelbach's (1991) explicit views on long lead time production environments.

In contrast, another Method using the product feature evolution to manage a change during the design phase of product life cycle has been proposed by Bouikni (2006). A shared product features table is used to establish the disciplines affected by a change in a particular feature. Once an EC is accepted, a change estimator categorizes the effect of the change on each discipline as incremental (improvement and not anti) or decremental (has negative effects). The disciplines with decremental effects are included in the discussions and a common solution is arrived at by using the "Negotiation process interface". After this, it is assumed that the change is approved for implementation.

## **2.1.2 ECM in a collaborative environment**

### **2.1.2.1 Parameter-based framework**

During product design, engineers (across the supply chain) determine and/or change parameters (Rouibah 2003). These parameters represent the specifications of the product that are derived from customer requirements. If so, since people across the supply chain work with these parameters during the product design, capturing the relationship between them determines the extent of suppliers' and design partners' involvement of in the product life cycle. Theoretically, a network of these parameters link data, people,

documents, and procedures, within an enterprise or across the enterprises in the supply chain. As it turns out, an EC affects a parameter which then identifies the data and people affected, and thereafter drive the workflow as the change propagates across the network. Each parameter has people accessing it under different roles with each role having a different task to perform on it. While, the use of this kind of parameter network helps in visualization of the change propagation and execution status, it simply is difficult to establish a finite network for complex products (due to the large number of parameters involved). In the case of a complex product, it is required to select the appropriate critical parameters. It is suggested that the parameters which are affected by/affect the components across partners be designated as parameters in such cases. This approach is product specific and not agile. Though the concept seems convincing the results of its implementation have not been discussed.

#### **2.1.2.2 Web-based framework**

ECM across organizations has also been addressed by using web technology. Huang et al. (2001) proposed an ECM process to support the basic functions of ECM that particularly includes placing an EC request, keeping an EC log, EC evaluation, and EC notice. This process allowed simultaneous access of the specific EC data by many users regardless of their geographic location. The ECs are not discussed live but are evaluated separately by each participant, and the EC coordinator pools those individual evaluations into an EC report for approval. This is proposed on a client-server architecture consisting a web server, ECM application server and client. The web server subsequently stores the data and EC forms, while the ECM application server processes the data and transfers data between the

web server and the client. This process enables fast access of data across the network. However, the framework is not flexible and cannot support organization specific ECM process. While the industrial surveys, indicate that organizations have different ECM systems depending on the industry.

In a similar manner, Lee et al. (2006), Chen et al. (2002) and Tavcar and Duhovnik (2006) presented a similar framework for ECM in an allied concurrent engineering environment or distributed engineering environment. Lee et al. (2006) used the knowledge management techniques to capture the tacit knowledge from the formal and informal collaboration in the supply chain, and semantic web technology to put the captured knowledge in context. Next both Chen et al. (2002) and Tavcar and Duhovnik (2006) used a wide area network (WAN) to connect all the suppliers to the PDM/PLM system/server that in turn connected to the PDM/PLM system of the manufacturer to administer ECM in a distributed environment. While all these frameworks support online collaboration, they are not agile and as a result cannot support tailored product/company specific ECM processes.

The agility of an enterprise greatly depends upon its capability to handle ECs efficiently and effectively. Organizations tend to have a different ECM process for different components of the product depending upon the importance of the component in the whole assembled product or its characteristics that make it necessary to be handled differently, like software, electronic and/or mechanical components. Though the core tasks of ECM in all the organizations are the same, they can still choose a different way to coordinate the tasks (Klein et al., 2007; Huang et al., 2001). The web services can be used to enhance the integrated system of various collaborative manners and systems (Li and Qiu, 2006).

## **2.2 Tools to Support ECM:**

A significant number of tools have been developed to assess the impact of ECs. As demonstrated, the tools are categorized based on the distinguishing core component and briefed below.

### **2.2.1 Design Structure Matrix**

Browning (2001) in his review on the application of Design Structure Matrix (DSM) to system decomposition and integrated problems mentioned, DSM as a popular representation and analysis tool for system modeling. A DSM, which is used to display relationship between components of a system in a compact visual and advantageous format, can also provide an indication of how change may propagate through a product. Intelligent system decomposition and integration analysis is facilitated by the use of DSMs. The system here can be a product, process or an organization.

### **2.2.2 Risk Matrix**

Eckert et al. (2004) based on a study conducted in Westland Helicopters, identified two types of changes: the emergent changes and the initiated changes. This particular study was based on the interviews conducted with the company's employees. The interviewed designers commented that they typically expected up to four follow up changes arising from each initiating change. The key to successful change management lies therefore in understanding the state of design and the connectivity between parts of a design. The source of change, interdependencies between parts and systems, types of propagation

behaviour, consequences of change on product quality, cost, and time to market, and the state of tolerance margins on key parameters need to be taken under consideration for successful change management. They proved that by capturing the design knowledge and experience, in the form of experienced designers in the company, an automatic tool to identify the EC propagation can be developed. This work has further led to the development of a computer support tool by Clarkson et al. (2004) to identify the risk of a change.

Clarkson et al. (2004) report an analysis of change propagation from their case study in Westland Helicopters. They also developed elaborate mathematical models based on likelihood, impact and risk DSMs, to predict the combined risk of change propagation in terms of likelihood and impact of the change. This paper concentrated on capturing past experience about the propagation of change between systems, in terms of the likelihood of their occurrence and the impact, such changes would have. The chief managers during the interviews mentioned that the designers frequently failed to realize how their work would influence the others. The change Propagation originating from an initial change resulted in changes in up to four components/systems, and the unexpected changes ranged from 5% to 50%.

### **2.2.3 Feature-Property matrix**

Bouikni et al. (2006) proposed a model that aimed at controlling the information flow needed to support a product definition evolution while, at the same time, ensuring its validation by all the involved disciplines. This model can be applied both to the product design and to the modification phases of the product life cycle. A product feature-discipline relationship table was used to identify the vital disciplines affected by a particular feature.

An estimator of change predicts the type of impact, detrimental or beneficial, on every discipline due to a change in a particular discipline. The affected disciplines are identified from the shared product feature table. This model identifies the affected disciplines due to a change in a feature but does not identify the affected components or sub-assemblies that are affected.

#### **2.2.4 C-FAR Matrix**

Cohen et al. (2000) proposed a data representation model that facilitated change and change propagation in the design representation of engineering products. They proposed a methodology 'CFAR' to extract information from the STEP data format, a recognized standard of design data representation. The product was chiefly broken down into elements which were later considered as attributes. A matrix called the C-FAR matrix, comprising of linkage values, linked one attribute of an entity to one attribute of another entity. This model is appropriate for small and relatively simple products due to its computational complexity.

#### **2.2.5 VR Technology**

Aurich and Martin (2007) developed a change impact matrix, derived from the Virtual Reality (VR) analysis, which captured the relationships between various Production elements. The impact of a particular EC is estimated with the help of VR on the elements of the production system. The EC's are grouped based on the impact analysis and the EC projects (a group of EC's which are selected to be implemented simultaneously) are defined.

### **2.2.6 CPM Tool**

Keller et al. (2005) proposed a Change Prediction Method (CPM) tool to visualize, the change propagation and how multiple views are used in the context. The tool uses enhanced information visualization techniques such as multiple views and fisheye techniques for displaying the desired information in the context of change management. The change prediction method gave a good indication of future change likelihood without the need for detailed knowledge of the product development process. The resulting visualizations due to the tool offered new possibilities for designers in the industry to analyze and view change propagation data, in order that they be not overwhelmed by the complexity of the component interactions.

### **2.2.7 Change Propagation Tools**

Do et al. (2007, 2002) proposed a product data model that supported product data views and engineering changes. This model consists of base product configurations, assembly structures, product data views, and engineering change history. The model maintained consistency between the base product definition, product data views and engineering changes. A change propagation procedure was proposed based on the defined product data model. The proposed propagation procedure consisted of three phases: (i) Identification of changed products in the base product definition, (ii) The retrieval of corresponding parts in product data views and (iii) The product data views are changed according to the change history of the product structures portrayed in the base product

definition. A critical issue is that the application of this propagation model is limited since it is based on the proposed product data model and not a standard product data format.

Rutka et al. (2006) developed a model to support the decision-making process in engineering change management. The model captured the tacit knowledge of the dependencies between the various systems of a product and identified the impact and risk of an engineering change. Though the model captured the dependencies between the systems, it ignored the dependencies between the attributes of the product and the systems (that are part of the product). It required more human intervention when the change was not defined in detail or was defined in terms of an attribute of the product. The main reason for this was that the model ignored the attribute-component dependency. The model was intended to manage a change during the design phase also, which made it more complex with the presence of more attributes to define a change. This is because the design is not frozen in the design stage and may change due to any reason at any time.

Yang et al. (2004) and Rouibah and Caskey (2003) introduced a concept to manage ECs and engineering workflow, utilizing a parametric network. Here, the word 'parameter' refers to a critical attribute such as the product performance, geometry, etc. This parameter-based approach links an engineering workflow to product data, and therefore can propagate ECs and engineering tasks across company borders. The parameters are identified and assigned to a particular company in a network of companies to manage and respond to the changes in more efficient manner. Though this method is effective for less complex products, the number of parameters increases drastically and so does the



complexity of the network. Namely, the parameters selection is another cumbersome task in case of a complex product.

### **2.2.8 Process Simulation Models**

Simulation models of the ECM and NPD processes have been developed by a few researchers to understand the process dynamics and assist in the decision making process of the ECM. Chalmet et al. (1985) developed a mathematical model of a firm aiming at reducing the inventory losses due to an EC. The effects of ECs on production lot sizing have been studied assuming that EC makes the inventory of products obsolete. Nadia et al. (2006) developed and simulated the Engineering Change Request (ECR) process in NPD process to conclude that processing of ECs in batches is advantageous compared to processing immediately as the ECs are being requested.

Repenning (2000) developed a model of a multi-project NPD process and successfully illustrated the phenomenon of fire fighting in an organization due to changes in the later phases of the NPD process. The NPD project was modeled as a set of tasks, and the existence of the firefighting phenomenon in the present NPD executing industries was demonstrated. To study the dynamics of the process, an increased number of tasks was introduced at a particular time during the simulation. It was concluded that until a certain magnitude of increase in the number of tasks (tipping point), the system returns to its normal performance level after a brief period of underperformance immediately following the period when the higher number of tasks was introduced. Beyond the tipping point, the

system would remain in an undesirable steady state of underperformance, leading to a vicious cycle of sudden demand for resources before the product launches.

Black and Repenning (2001) presented an advanced version of the model presented by Repenning (2000) to investigate the policies that a manager should adopt in order to counter or avoid the firefighting phenomenon. The implementation of the model presented by Repenning (2000) to study the potential dynamics of the NPD process of an electronics manufacturing organization was described. The NPD project was modeled as a group of parts that exist in any of the following four states: (i) parts to be designed, (ii) prototyped parts, (iii) tested parts, and (iv) revised parts. The resources assumed were of a single type -- "engineers" thereby ignoring the specializations and the fact that varying demand for specific resources (such as design, production, marketing etc.) exists throughout various phases of the NPD process. It was concluded that the combination of multi-project dynamics and human psychology are leading to the firefighting in a NPD process. Allocation of resources to current projects ahead of the future projects is leading to a vicious cycle of huge demand for resources in later part of the projects (Repenning 2001, Black and Repenning 2001).

System dynamics and cybernetics (Rodrigues et al. 2006) are used to model the change management in NPD project. The model is classified into three sectors: project workflow sector, competent project staff sector, and project staff salary and revenue sector. The NPD project is described by three stocks, namely, "work to be done," "work in progress," and "work finished." Work flow between these stocks is determined by the

productivity of the available competent project staff. The work that failed to meet the requirement is sent back to the “work in progress” stock via “rework” stock. Likewise the model also includes the recruitment and training of the project staff along with the cost perspective of the NPD project.

Though the simulation models represent the NPD process and changes within the process, the main drawback of these simulation models is that these models do not consider the ECM process as a formal process and fail to acknowledge the phases of the ECM process. They also do not consider the phases within the NPD and the flow of work between those phases. Identifying the phases within the process is vital, as it helps to understand the work flow along with the process dynamics by identifying the leverage points of the process. A manufacturing organization consists of various functional departments and, in most cases, the different phases within the product development process are controlled by different departments. For example, the prototyping and production ramp-up are planned and controlled by the production department while the concept and design phases are planned and controlled by the design departments. Consideration of the phases within the processes would also help model interactions between these processes, which would further facilitate realistic modeling of the process and management policies. As it appears, better process modeling would enable superior understanding of the process dynamics and accurate estimation of the impact of the management policies like resource allocation, batch processing etc.

The ECM process in a collaborative environment evidently has never been modeled. The interactions between the suppliers and the Original Equipment Manufacturer (OEM) have also not been modeled and the effect of suppliers ECM process parameters on the OEM performance is not studied. With certainty, the ability to study the influence of supplier process parameters on the OEM performance would help to better identify and manage the impact.

In sum, the literature highlights the need for an agile ECM process and the lack of a framework that enables it. In addition, the literature also does not have any comprehensive NPD and ECM process simulation models that can help study the interactions and dynamics of the processes.

### 3 PROBLEM DEFINITION

#### 3.1 Motivation

Prevailing industry surveys (Aberdeen Group 2007, Huang 2001) highlighted the importance of the change management and its role in the success of a product. The survey by Aberdeen group (Aberdeen group 2007) emphasized the importance of ECM by accessing the perception of the industry on it. Figure 8 summarizes the survey responses by listing the top 5 pressures (defined as “external forces that impact an organization’s market position, competitiveness, or business operations”) on companies to improve the change management performance.

<b>Pressures</b>	<b>Response</b>
Shortening development lead times	63%
Market need for a quick response to quality issues	43%
Challenge of implementing change in complex, global supply chains	35%
Rapidly changing market requirements for product capabilities	29%
Reduced product development budgets	20%

Source: Aberdeen Group, September 2007

Figure 8: Top five pressures pushing companies to improve the Change Management process.

Apart from reducing the development time, quality issues, managing the change implementation in complex global supply chains, changing market requirements and reduction in the budget for research and development have been identified as the driving forces for improved ECM systems. The industry surveys (Aberdeen group 2007, Huang 2001) considered the ECM process to be closely linked to organization performance and suggested that the laggard organizations need to:

- Centralize Product data: Product data should be captured and managed properly in order to ensure the right data is available at the right time. Developing this capability, in whatever form, is considered a basic requirement for performance enhancement.
- Extend change impact analysis: Organizations should eventually take a systems perspective and consider a broader scale in planning the ECs to avoid any unintended impact in the downstream departments and supply chain.
- Leverage collaboration and collaboration technology: Adopt better collaboration capabilities and ensure active cross-functional debate on the change management.
- Formalize change management process: Develop and adopt a formal Engineering change management process recognizing the various phases within the process including review, planning, and implementation of ECs. This is required to ensure consistent decision making and continuous process improvement.

The results from other surveys also reported (Jarratt et al. 2006, Huang 1999) that

- In the automotive sector, a third to a half of the engineering capacity is engaged by ECs and 20-50% of the tooling costs are due to EC implementation.
- 30% of the engineering efforts of the engineering firms have been spent on managing ECs.
- A 1988 report of the fortune 500 companies, estimated the annual cost of administering ECs for each company to be in the range of 3.4 million to 7.7 million dollars.

Thus, the importance of ECM can be asserted from the fact that it influences the product lead times, product Quality, market response with regard to changing market conditions and the productivity of the NPD process. It also manages the organization response to new market opportunities or changing market conditions. The profitability of a product is influenced by the ability to analyze and absorb the impact of an EC (Jarratt et al. 2006). Better the ability to analyze and absorb an EC, greater is the ability to lower the additional costs due to EC implementation that eventually results in greater profitability.

The literature review draws attention to limited academic research on ECM and its interactions with the NPD process, in spite of the importance of the engineering changes and engineering change management in the context of organization performance.

The past research on ECM has the following limitations:

1. The ECM frameworks presented do not assist a flexible workflow, but nevertheless it is desired to have a flexible workflow considering the wide variety of components and organizations that are part of the supply chain working for the common cause of ECM.
2. The developed NPD process simulation models do not acknowledge the ECM process as a separate process and also do not include the phases within the NPD and ECM processes.
3. The interactions of suppliers with the Original Equipment Manufacturer (OEM) during product development is not investigated nor modeled.

4. There is no work that helps to identify the critical parameters in a collaborative product development environment which have relatively greater influence on process performance compared to other process parameters.

Taking the above drawbacks of the previous research, in this research we developed frameworks for change propagation and ECM process that can be adopted and embedded to an existing enterprise system. The ECM and NPD process templates of organizations have been developed to enable the modeling and simulation of these processes within an organization and across the supply chain.

### **3.2 Research problem and Methodology**

In this research, the dynamics of the ECM process and its interactions with NPD process has been investigated. The process parameters and their effects on the organization performance have been investigated. The process parameters considered include the process parameters from all the organizations that are part of the product development process. While the methodology adopted in developing the frameworks for change propagation (Chapter 4) and ECM across supply chain (Chapter 5) have been thoroughly explained in detail in the corresponding chapters, the methodology adopted to study the process dynamics is described below.

The NPD and ECM processes of an organization are modeled using System Dynamics with causal loop diagrams identifying the relationship between the NPD and ECM process parameters. As presented in Figure 9, six feedback loops (L1 through L6) have been constructed and used in the model. At best, it is assumed that a company counters a change



in its market share by making changes to its products either to gain or maintain the market share depending upon the direction of the change. Each change initiated by an organization to modify a product is generally considered as an EC.

Specific causal relationships captured in the developed model are presented in Figure 9. In the loop L1, a decrease in the market share would increase the number of ECs that would in turn enhance the product's competitiveness in the market place (Jarratt 2004). The higher product competitiveness spurs the sales and thereby the market share. The loop L2 includes the market shares of ECs linkage followed by the effect of number of ECs on product quality. The number of ECs increases the product quality, which in turn improves the product's competitiveness in the market, understandably increasing the product market share. For the Loop L3, any increase in the number of ECs, would increase the number of ECs to be processed, and further would lead to an increase in the ECM lead time. Any increase of ECM lead time would increase the response time for any market opportunity, thereby reducing the product's competitiveness. For the Loop L4, any ECs proposed before the product's release to the market would increase the NPD lead time, which increases the response time to the market. Furthermore, increase in response time reduces the level of the product's competitiveness. For the Loop L5, an increase in the number of ECs increases the ECs to be processed, which again prolongs ECM lead time. Increase in ECM lead time would increase the response time, which further makes the product less competitive and therefore may lead to a fall or loss of market share. In the cases as shown in the Loop L6, if the ECs and their propagation occur before the product's release, that would increase the NPD lead time. Increase in NPD lead time would delay the

product release to the market, which decreases the product’s competitiveness (due to lose, of customer trust and sales to other products) and there after the product’s market share. While L1, L2, are negative loops, L3, L4, L5, and L6 are positive loops. In all probability, the final result would be the combined effect of all these loops.

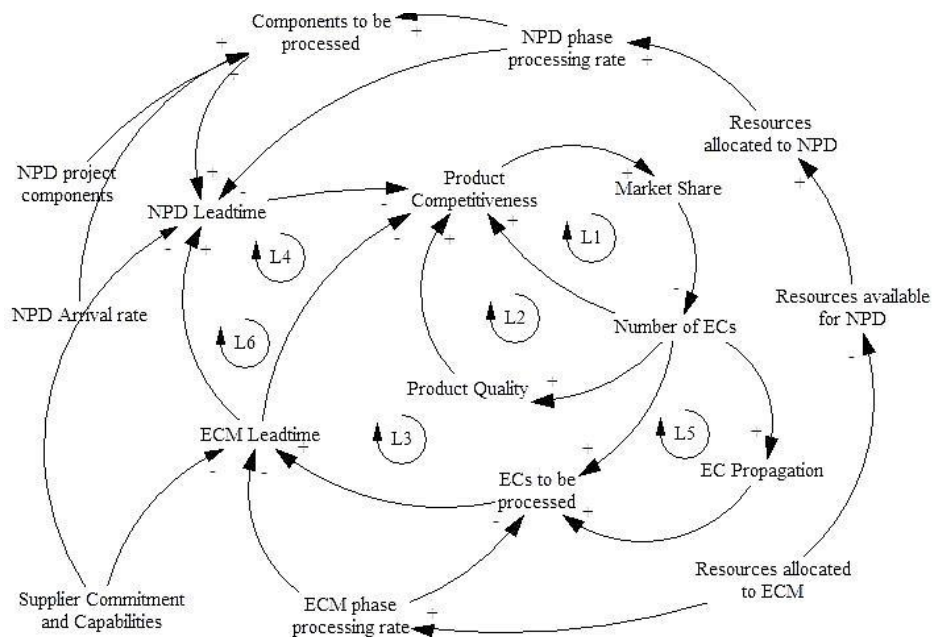

- L1: Market Share--Number of ECs--Product Competitiveness
- L2: Market Share--Number of ECs--Product Quality--Product COnpitiiveness--Market Share
- L3: Market Share--Number of ECs--ECs to be processed--ECM Leadtime--Product Competitiveness--Market Share
- L4: Market Share--Number of ECs--ECs to be processed--ECM Leadtime--NPD Leadtime--Product Competitiveness--Market Share
- L5: Market Share--Number of ECs--EC Propagation--ECs to be processed--ECM Leadtime--Product Competitiveness--Market Share
- L6: Market Share--Number of ECs--EC Propagation--ECs to be processed--ECM Leadtime--NPD Leadtime--Product Competitiveness--Market Share

Figure 9: Causal Loop Diagram of NPD and ECM parameters

The effects of the ECM and NPD process parameters on the organization performance have been further studied by modeling and simulating the processes. It

appears that while observing that NPD lead time exists in all the loops, it is considered as an indicator of the process performance, and the arbitrary influence of all the process parameters on the NPD lead time is studied from the model results.

### **3.3 Research Overview**

Collaborative product development involves an Original Equipment Manufacturer working together with suppliers for the common goal of designing, manufacturing and marketing a product profitably. The involvement of otherwise autonomous entities, propagation of changes (especially from a component handled by one supplier to a component handled by another supplier), and the iterative nature of the process, make the EC implementation in collaborative environment a highly complex process. ECM implementation in such an environment requires the communication and co-ordination of resources across the physical boundaries of organizations which are governed by different principles/policies. In this complex setup, it is important to understand the crucial dynamics of the ECM process and its effect on the OEM performance. Incidentally, it is also desirable to know the effect and importance of a supplier or an EC on the ECM process performance. Hence, a model to meaningfully represent and simulate the ECM process across the supply chain is presented in this research.

The goal of the research is to model and simulate an ECM process across supply chain model so that the concurring dynamics of the ECM process and its effect on the NPD process performance can be studied. Initially efforts are made to understand the ECM

process before attempting to develop the ECM process model in a collaborative environment.

The engineering change propagation considered as the source of uncertainty in the ECM process has been studied, and a framework based on the object oriented concepts has been proposed. This framework solely captures the knowledge during the first two phases of the NPD process i.e. concept development and detailed design phases and stores it in a retrievable format. The information is later used to generate a list of effected components due to the EC by providing the EC information like attribute affected, component affected etc. The details of the framework are described in the Chapter 4.

The ECM process within an organization and across a supply chain has been studied. Acknowledging the agility requirements for the ECM process across the supply chain, a SOA based framework is proposed. The proposed framework enables the suppliers to have a unique ECM process reflecting its managing policies while collaborating with the OEM. The details of the framework are presented in Chapter 5.

To enable the simulation of the interactions in a collaborative environment, the NPD and ECM process templates of organizations have been developed. System dynamics simulation technique is used to model the OEM and the supplier templates. These unique templates represent suppliers participating at different stages of the NPD and ECM processes. At first, for modeling the ECM process across the supply chain, these organization templates are assembled and connected accordingly to represent the interactions in the collaborative environment. Once the ECM process is modeled successfully, it can at once be simulated for different policy options by varying the values of

the appropriate variables. Initially basic organization templates are developed and are used to model and simulate a simple supply chain to prove the utility and advantages of the templates. The details of the organization templates and the advantages of the concept are presented in Chapter 6.

The functionality of the initially developed OEM template is enhanced and used to model the ECM and NPD processes within an organization. As can be seen, the simulation model set up and the results of the ECM and NPD processes within an organization are presented in Chapter 7. The OEM template is then validated using an industry survey and previously published research (Repenning 2000 and Black and Repenning 2001), the details of which are presented in Chapter 8. Later the supplier templates are developed from the base OEM and used to model the ECM and NPD processes in a collaborative environment. The details of the model representing the NPD and ECM processes in a collaborative environment are fully presented in Chapter 9. The consolidated conclusions and contributions of this research as a whole are presented in Chapter 10.

## **4 A FRAMEWORK FOR ENGINEERING CHANGE PROPAGATION**

### **4.1 Overview**

In this chapter a framework is presented, to automate the identification of affected parts due to an EC after capturing the component and attribute dependencies of the product. The attribute-component and component-component relationships are characteristically captured during the design phase and are used later to identify the affected parts due to a proposed EC. The presented framework adopts concurrent engineering concepts, which are well understood and accepted methodology in designing products in industry. It is easier and practical to capture all the possible dependencies between the attributes and the components within a product during the design phase. Once the dependency data is captured and stored in a retrievable format, the identification process can be automated.

### **4.2 Approach**

As it stands, though there are some research works (Clarkson *et al.*, 2004; Rutka *et al.*, 2006) addressing the propagation of change, it was a part of a work that emphasized on how to estimate impacts of propagation and risk of the ECs. Mathematical models were developed to express the impact of an EC in terms of relevant time and cost. In this chapter the aim is to address the propagation of change with the focus on identifying all the components of a product that are affected by an EC.

While a few others (Eckert *et al.*, 2004; Keller *et al.*, 2005; Rutka *et al.*, 2006) have tried to address the propagation of the change during all the phases of the entire product

life cycle, the framework presented in this chapter addresses the changes only after the design is finalized. It is considered that an EC in product data during the design phase is very complicated because the product data is not fixed and is subjected to change anytime.

Identifying the affected parts after the design is finalized can be simpler because the product data is determined by then. The clear-cut mechanics of change propagation can be more cogently understood by concentrating on the ECs after the design is finalized. Empirically, this also makes sense because there are a large number of EC Requests made immediately after the product is prototyped or released to the market according to Bhuiyan *et al.* (2006). Considering ECs after the product design is finalized requires relatively less amount of information to define any change in product data or to identify the components affected by the EC.

DSMs (Browning, 2001; Clarkson *et al.*, 2004; Eckert *et al.*, 2004; Rutka *et al.*, 2006) and other tables (Bouikni *et al.*, 2006; Aurich and Martin, 2007) have been used to capture the component-component, component-attribute dependencies but their use was limited to parts with a few number of components or dependencies. Though some papers (Clarkson *et al.*, 2004; Eckert *et al.*, 2004; Aurich and Martin, 2007; Rutka *et al.*, 2006) addressed the ECs in complex parts, the models presented require significant human involvement. This is because when the parts have more components affecting each other, nested DSM tables need to be developed to capture all these noticeably diverse dependencies. This also leads to a considerable increase in the number and dimensions of the DSM.

When the matrix dimensions increase or the number of matrices increase, the retrieval of dependency information from the DSMs becomes difficult to automate. Object-

oriented concepts can improve the identification of propagation and the subsequent retrievals, yet no prior works have used the concepts. Use of object-oriented concepts along with a good database management can help to systematically identify all the components affected by a specific change in a component. At the same time the use of object-oriented concepts makes it easier and efficient to store and retrieve information from a database storing the dependency information. Engineers involved in the design of the product from all the disciplines are provided with the framework that helps them to capture the dependencies between components during the design phase. Depending on the discipline and background of the engineer, the views of the dependency between the components differ. Hence most of, if not all, the possible dependencies can be captured.

The proposed framework comprises of two user interfaces and a database. After the data is entered into the database via a user-friendly interface during a design phase, it is retrieved during the ECM later. The User interface titled 'Components Dependency' is used to save the dependencies into the database, while the user interface titled 'EC Propagation' is used to retrieve the data from the database. 'EC Propagation' also lists the affected parts due to a particular Type of Change (TOC) in the product or its component.

The current framework uses two classes: (1) EC class and (2) Propagation class.

#### **4.2.1 EC class**

EC class instances (objects) capture the principal relationships between the various components and attributes of the product during the design phase. This information is retrieved to establish the components affected by an EC.

The EC class is defined by the following attributes:



- Initiator
- Target
- TOC
- Likelihood.

#### **4.2.1.1 Initiator**

First and foremost, the Initiator is the component that is known to be affected by the EC at a given point of time. The affected targets are determined based on the initiator. This Initiator may be an attribute that is proposed to be changed or a component identified to be changed. At a particular point in the change propagation, there can be multiple initiators. Each Initiator along with the TOC undergoes identifying the Target and the TOC.

#### **4.2.1.2 Target**

The Target is the component that is identified to be affected in a particular way by a particular TOC in the corresponding Initiator Component. A combination of TOC and the Initiator identifies a corresponding combination of TOC and Target.

#### **4.2.1.3 Type of change (TOC)**

This defines the TOC the component is going through due to the EC. Such underlying change types can be industry-specific. Depending upon the industry, the framework can be used according to the way the TOC is defined. Some examples of industries which have different types of manufacturing processes, design processes or materials, *etc.* are the aerospace, air conditioner manufacturing and computer manufacturing industries. Industry-specific TOCs are also used to represent any possible way a component can be affected due

to the change in another component. However, this TOC of the initiator and the target need not be in the same domain. For example, if there is an EC for the physical size of the electric vehicle, the change it initiates would propagate to the motor probably affecting its electric specifications. A few possible typical entries for the TOC are Material, Shape, and Size, *etc.*

#### **4.2.1.4 Likeliness**

This defines the likeliness that a change in the Initiator affects the Target. Depending upon the impact of the change on the Initiator, the change can influence or may not influence the Target by a large extent. The likeliness is indirectly defined by the extent to which the Initiators change. Sometimes the Target is affected when the Initiator undergoes a change of certain magnitude or more. The likeliness that the Initiator undergoes a change of such magnitude defines the likeliness of the Target being affected by a change in the Initiator.

The initiator and target fields can be selected from a list of components imported from the Computer Aided Design (CAD) software. Though this feature is not included in the present framework, it can be usefully implemented where the CAD is used to a large extent. The TOC field lists the possible ways in which the initiator can affect the target. This list can include all the types based on history. Likeliness field is chosen from a list of three possibilities: 'High', 'Medium' and 'Low'.

#### **4.2.2 Propagation class**

Propagation class is used to create an object that identifies the affected components based on the TOC in the initiator or change in the attribute of the product. Each object in

the propagation class has two attributes: (1) Initiator and (2) TOC. The 'initiator' as defined earlier is the component that is affected by a change at a particular point of time.

The 'type of change' is the way in which the Initiator is affected by a change. These two attributes combine to identify the components affected by a particular EC. Using the two values given for 'Initiator' and 'Type of Change', the Propagation class searches the database for matching records repeatedly until it finds all the possible affected parts. The values of the Initiator and TOC for a given iteration of comparing the records do not change. Each iteration of the records comparing process has a different set of Initiator and TOC taken together. The logic used for this process is explained in the next section.

### **4.2.3 Implementation**

As stated earlier the framework (Figure 10) has two user interfaces: the first, the 'Components Dependency' interface, and the second, the 'EC Propagation' interface. The 'Components Dependency' interface asks a user to choose a value from a list of possible values for each required field. The user can add a value if not found in the list of possible values. This interface captures and stores the dependency data into the database. It asks the user minimum data that is required to define a dependency for our purpose. Ordinarily, the required data includes 'initiator', 'target', 'type of change', and 'likeliness of the change to occur'.

The initiator field lists all the possible components of the product that can affect other components while the target field lists all the components that can be affected by a change in other components. Similarly, the TOC lists all the ways these targets can be affected whereas the likeliness field lists the three possible values of 'High', 'Medium' and

'Low'. The 'EC Propagation' requires only two fields to identify the affected parts due to a particular change in a component. The interface lists all the possible values for Initiator and TOC in the same way as stated above. Once the initiator and TOC are selected from the respective lists, clicking the 'List of Affected Components' button in the Propagation Check screen opens a report with a list of components affected due to that particular TOC in the initiator. The procedure followed in identifying the affected components is explained in the following section.

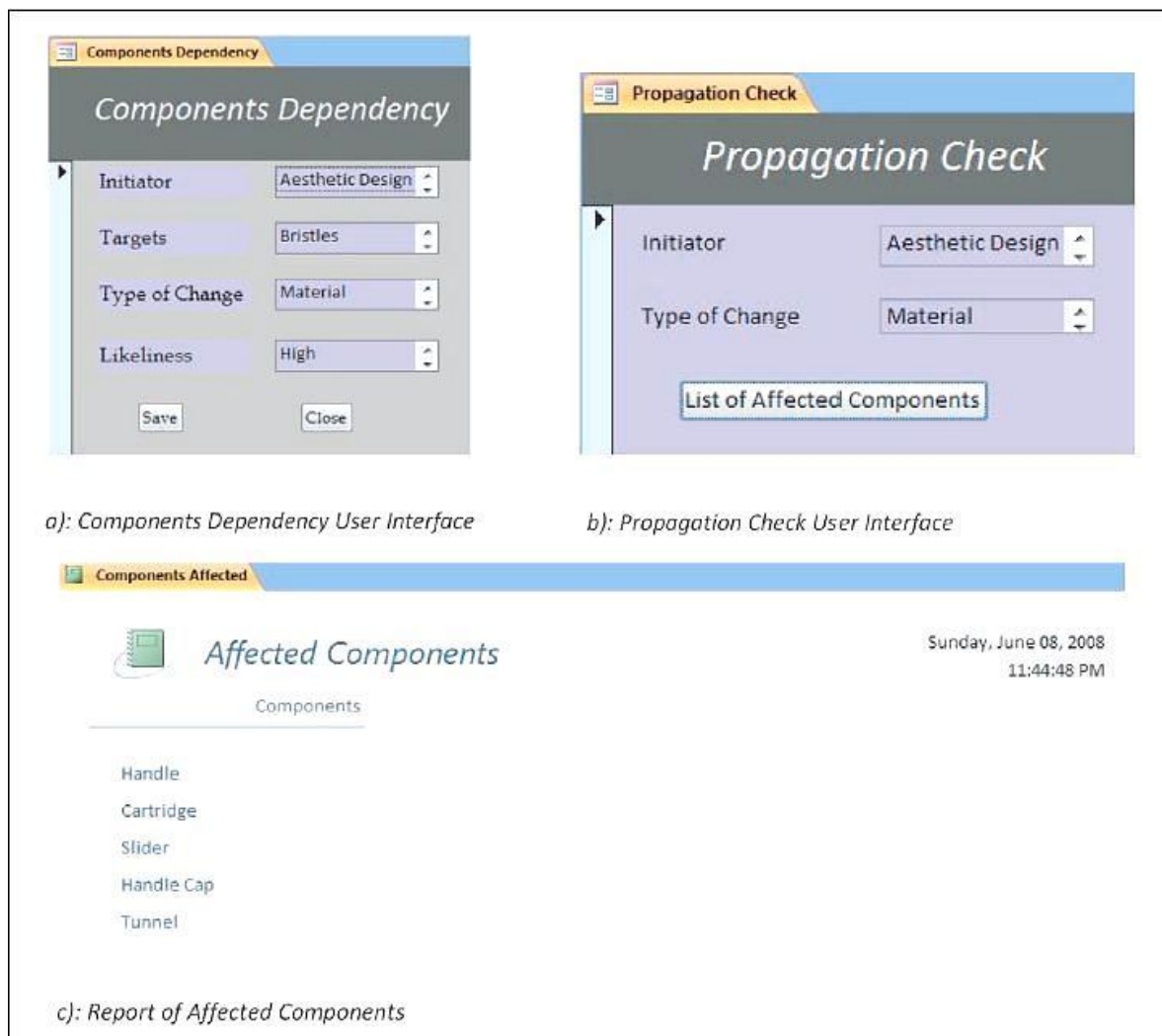

Figure 10: Screenshots of an implementation of the framework

#### **4.2.4 Procedure and logic**

Once a component (Initiator) is identified to be affected by the EC at the first level, then the way in which it is affected, determines the TOC. Based on these two 'Initiator' and 'Type of Change', the propagation is initiated and at the end we come with a list of affected components. Since the scope includes only EC requests of the products that are already designed and prototyped, a database that defines the versatile relationship between components is constructed and documented by the time an EC request comes in. Once an EC request has been made then the Initiator and the TOC are identified based on the EC request. The initiator and the TOC are input to the propagation class that coherently identifies the various levels of affected components level by level. At each level, the previous level components act as initiator components. A component that is already used as an initiator component is not considered as an initiator for the levels further down. Finally, a list of affected components is identified.

##### **4.2.4.1 Summarization of the steps**

Step 1: The framework is used to capture the dependencies between the components of the product during the design phase of the product life cycle. The data is recorded by the engineers through the Components Dependency interface and saved into the database by the proposed framework.

Step 2: The product is designed and prototyped, and the database of dependencies is ready. When an EC proposal comes in, it is analyzed and the initiator and the TOC or attribute are identified.

Step 3: The initiator and the TOC are selected from the lists in the Propagation Check screen and the 'List of Affected Components' button is pressed. This gives a list of components affected by the proposed TOC in the initiator.

Step 4: All the personnel related to the requested components are notified of the change and asked to review the extent of the impact.

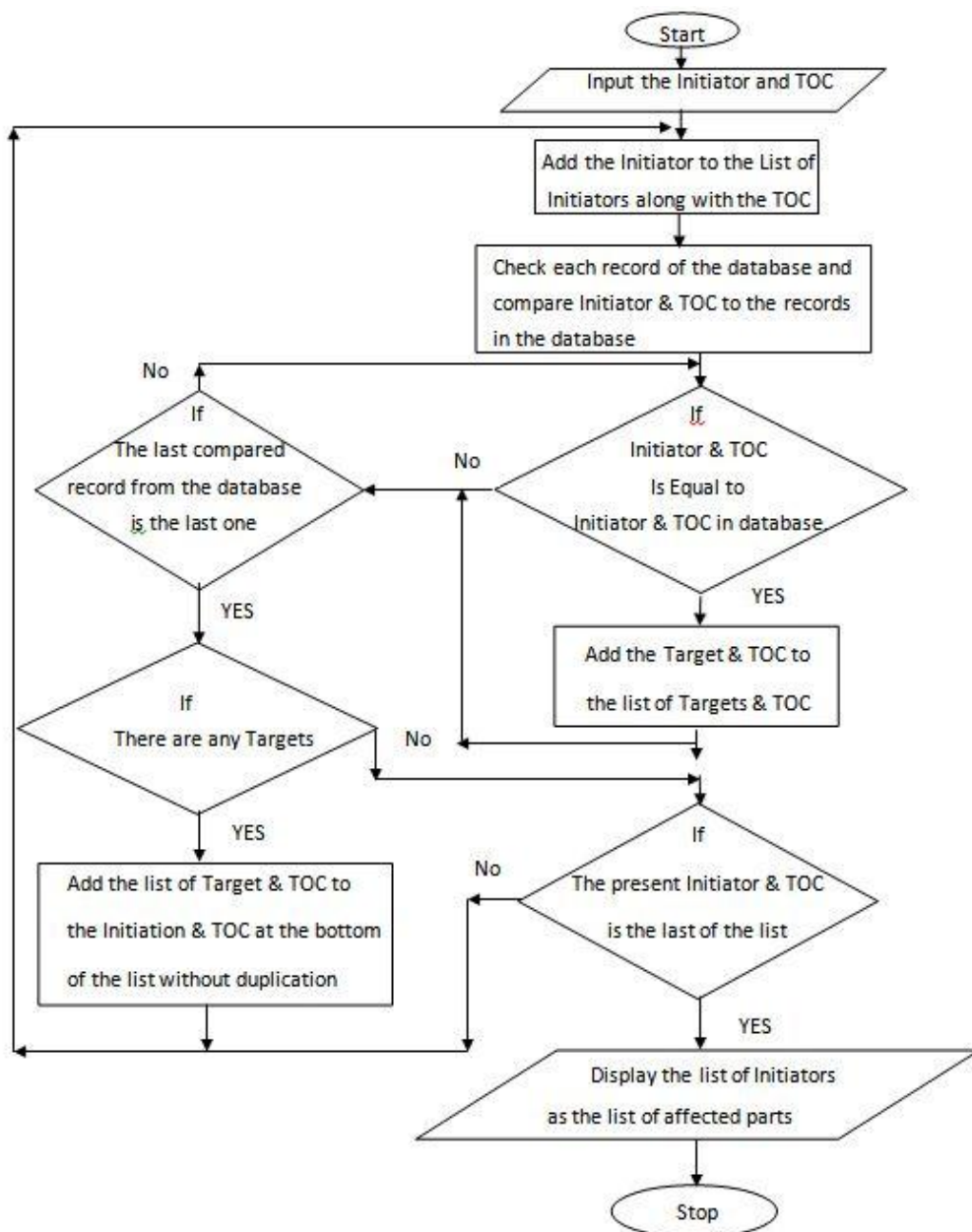

Figure 11: Change Propagation framework Implementation Logic

### 4.3 Case study

#### 4.3.1 Product description

A new toothbrush with built-in toothpaste has been developed and used here to illustrate the developed framework. The development of the toothbrush has gone through a typical product development process from idea generation to manufacturing. The toothbrush is made up of a Handle, Cartridge, Paste delivery Tube, Slider, Handle cap and Bristles.

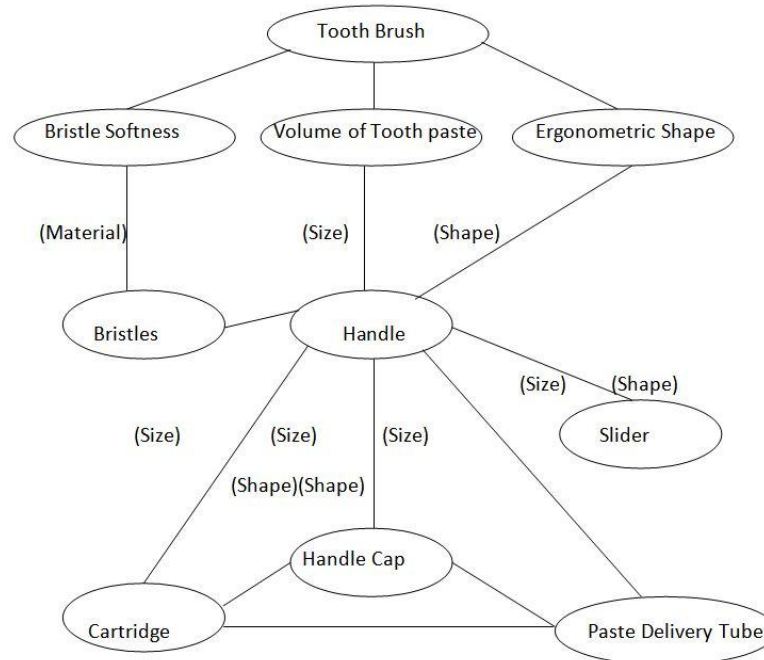

Figure 12: Schematic representation of Attribute-component-component dependencies

The handle has a cylindrical hole along its length irrespective of its external shape. The cartridge is a flexible cylindrical tube that resides inside the cylindrical hole of the handle. A slider that moves along the cylindrical hole in the handle slides along the length of the handle and compresses the flexible tube cartridge, to deliver paste from the cartridge to the bristles through a delivery tube which extends from the handle connecting the cartridge

to the bristles. In addition, the paste delivery tube has an interface with the cartridge via the handle. The paste delivery tube can be latched to the handle when not in use. The bristles are inserted along the pattern of holes drilled in the handle. A handle cap covers the cartridge and sliders restricting them to the cylindrical hole in the handle. For better understanding please refer to Figures 12 and 13.

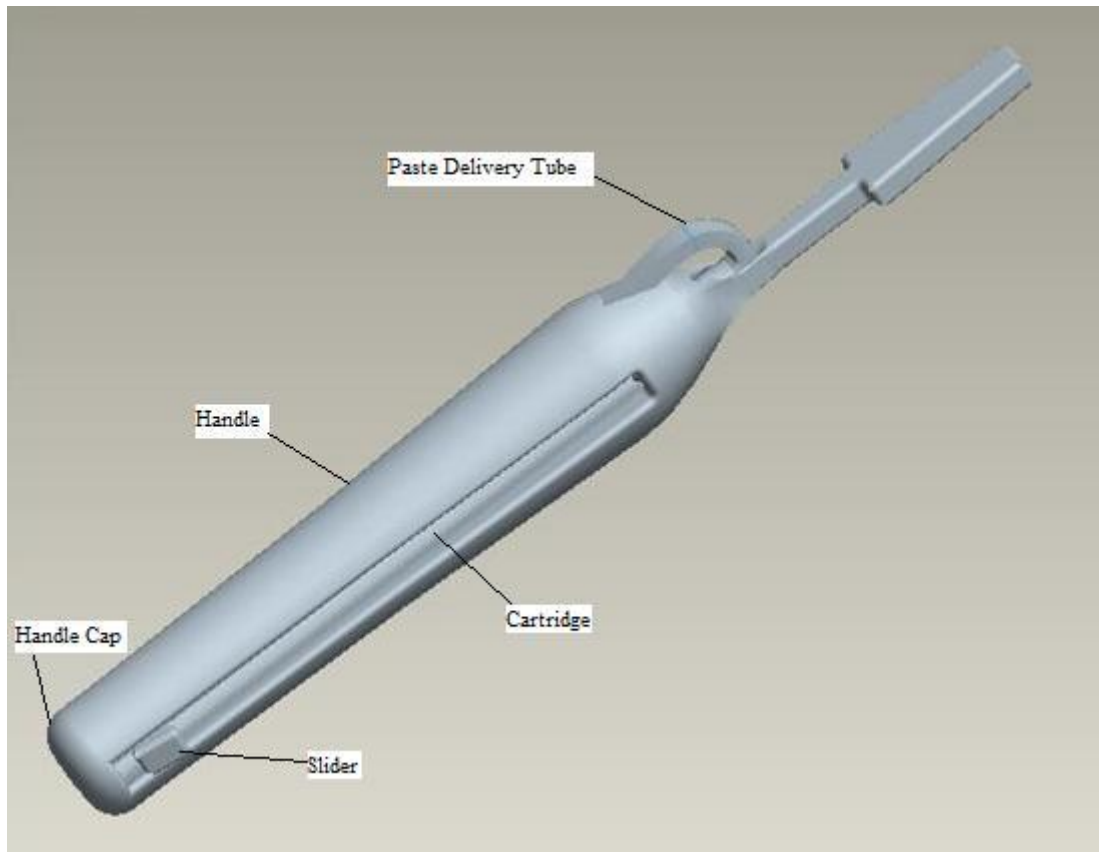

Figure 13: 3-D model of the toothbrush

The customer needs for this particular toothbrush were collected by interviewing potential customers. These include: (1) sufficient volume of the paste in the cartridge, (2) softness of the bristles, and (3) aesthetic or ergonomic design of the handle.



Considering a request for change in the volume of paste the brush can hold, we have implemented the above discussed concept to identify the affected components. The steps for implemented procedure are as follows:

Step 1: The framework has been used to capture the dependencies between the components of the Toothbrush during the design phase. We recorded the data through the Components Dependency interface and saved them into the database by the proposed framework.

Step 2: The database of dependencies like the one in Figure 14 is ready. The EC proposal to change the volume of the paste came in; was analyzed; and then the initiator was identified as 'Vol. of Paste' and the TOC as 'Attribute'.

Step 3: The 'Vol. of Paste' and the 'Attribute' were selected from the lists in the Propagation Check screen and the 'List of Affected Components' button was pressed. This gave a list of components affected by the proposed TOC in the initiator as in Figure 10.

Step 4: All the personnel related to the requested components are notified of the change and asked to review the extent of the impact.

#### **4.3.2 Component identification procedure**

Steps involved in identifying the affected components:

Step 1: The propagation starts with the 'Vol. of Paste' as Initiator.

Step 2: The program checks for 'Vol. of Paste' in the 'Initiator' column and then picks up the 'Target' component and the 'Type of Change' from Figure 14. Here the 'Target' component is 'Cartridge' and 'Type of Change' is 'Size'.

Initiator	Type of Change	Target	Type of Change	Likelihood
Vol. of Paste	Attribute	Cartridge	Size	High
Ergonomic Shape	Attribute	Handle	Shape	High
Bristles Softness	Attribute	Bristles	Material	Low
Handle	Size	Cartridge	Size	Medium
Handle	Size	Paste Delivery Tube	Size	Low
Handle	Size	Slider	Size	Low
Handle	Size	Handle Cap	Size	Low
Handle	Material	Handle Cap	Material	Low
Handle	Shape	Paste Delivery Tube	Shape	Low
Handle	Shape	Handle Cap	Shape	Low
Cartridge	Size	Handle	Size	High
Cartridge	Size	Slider	Size	Medium
Cartridge	Size	Paste Delivery Tube	Size	Medium
Slider	Size	Handle	Size	Medium
Slider	Size	Cartridge	Size	Low
Paste Delivery Tube	Size	Cartridge	Size	Low
Bristles	Size	Handle	Size	Low
Bristles	Material	Handle	Geometry	Low

Figure 14: An example of dependencies database

Step 3: These two are taken as an input for the next level; and thereafter, a row with 'Cartridge' and 'Size' as the 'Initiator' and 'Type of change', respectively, is searched. If we find one, then the propagation goes further or else it stops at this level. Here, we have 'Handle', 'Slider' and 'Handle Cap' as the affected 'Target' components.

Step 4: For the next level, these components 'Handle', 'Slider' and 'Handle Cap' are the 'Initiator' components and 'Type of Change' being the same, 'Size'.

Step 5: Further down, we identify the:

- 'Paste Delivery Tube', 'Slider' and 'Handle' as the Targets from 'Handle'
- 'Handle' and 'Cartridge' as the Targets from 'Slider'
- 'Handle Cap' does not have any target as it does not affect any components.

Step 6: As 'Slider', 'Handle', 'Cartridge' have already been the 'Initiator' components before, they are ignored; and 'Paste Delivery Tube' is the only component which did not act as 'Initiator'.

Step 7: Going further down, 'Paste Delivery Tube' does not affect any components and hence the final list of affected components are 'Cartridge', 'Handle', 'Slider', 'Handle Cap' and 'Paste Delivery Tube'.

### 4.3.3 Results

The following figure 15 shows the propagation result for an EC related to the performance factor of the toothbrush, *i.e.*, Volume of paste.

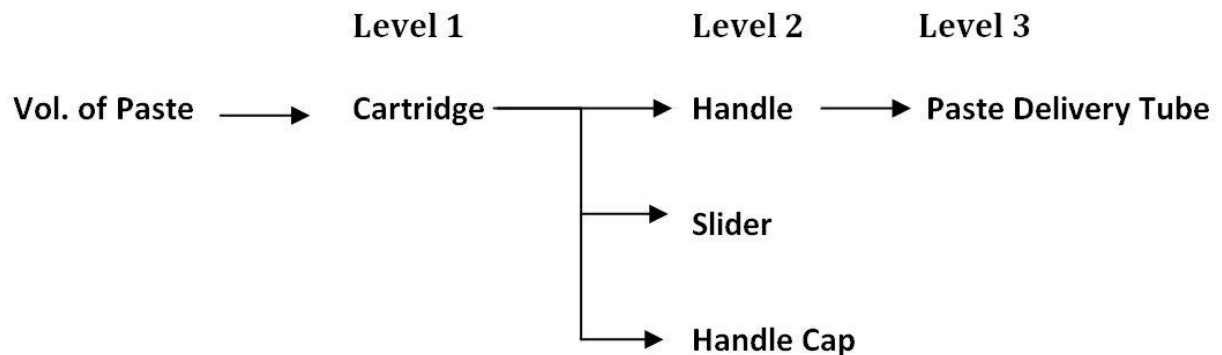

Figure 15: Change propagation result for the discussed case

## 4.4 Conclusions and limitations

A simple model can effectively identify the components affected by an EC provided all the relationships between the components are captured during the design stage. High

quality cross-functional project teams are identified as one of the key factors for the success in Product Development (Cooper and KleinSchmidt, 2007). Use of such teams will help to capture all the possible dependencies and make the described tool effective.

In case any dependencies are not identified they will probably be identified in the future when a change comes in and can be added to the database of dependencies at that point of time. This gradually improves the effectiveness of the model over time eliminating the uncertainties. Ignoring the Design phase of the product life cycle substantially increases the complexity of the EC propagation. Complex parts have more dependency data and the resultant database is large. This model can handle large databases with ease, with the availability of latest database technologies. Use of advanced concepts like object-oriented programming and relational databases increases the performance of the framework. Human intervention is minimized to a large extent by linking the attributes to the components. This model identifies the components and the way they are affected and does not measure the impact or risk of a particular EC. It is assumed that a change in the product data during design phase is part of the design of the product and is taken care of efficiently. Though it takes a fair amount of effort to capture the dependencies between various components the increased use of design methodology like concurrent engineering makes it easy. The present model greatly depends upon the accuracy of the dependency information captured during the design phase and so greatly relies on the expertise and experience of the designers to foresee the possible changes to each component of the product and its affect on other components. In the future, factors that determine the risk and impact of an EC can be merged into the model.

## **5 A FRAMEWORK FOR ENGINEERING CHANGE MANAGEMENT USING SERVICE ORIENTED ARCHITECTURE**

### **5.1 Overview**

The introduction and the literature review sections highlight the necessary criterion for an ECM process in a collaborative environment, together with the drawbacks of the ECM process frameworks proposed in the past. The frameworks published till dates have not adequately addressed the agility requirement of the ECM process. In this chapter, we aim to address it by adopting SOA methodology to support and carry out ECM process across the supply chain. We modeled ECM process based on SOA methodology to investigate if the SOA can address the agility requirement of the ECM process.

SOA considers a business process as a set of tasks performed in a sequence. It divides a business process into basic units called 'services' where each service performs a task (Jerstad 2005). These services are modeled with interfaces to interact with each other by sending and receiving XML messages that contain encrypted input and output data of the services. These services are later grouped together in the required sequence to form a business process. In an SOA adopted environment business processes can be made using the same services but not necessarily coupled in the same order or using the same set of services. SOA thus can provide the necessary agility the ECM process requires to address all the concerns of the stakeholders in the supply chain.

In order to adopt SOA for modeling the ECM process we proposed a framework in which we defined the necessary service providers in line with general SOA service providers

and explained their properties and purpose in the ECM context. The atomic services are identified and briefed along with the task they perform. Each service requires an input that it processes to generate an output. These services can be used to develop hybrid ECM processes that can address both the concerns of the suppliers and the manufacturer in processing ECs. This framework is presented in detail in the following section.

## **5.2 The Framework**

### **5.2.1 SOA based ECM System**

The main components of the system (Figure 16) include Service repository, Service registry, Communication backbone, and ECM Governance model. The service repository contains two types of service providers, out of which one type integrates people, processes and information, while the other provides client access to the existing services (which can be partner's services or newly developed services). The service registry contains the directory of the services along with their details like the service provider, the address, its function and protocol to invoke it. Communication backbone enables communication between the service provider and the service consumer. Moreover, it acts as a service provider for the service consumer and as a service consumer to the service provider and simplifies the communications between services/partners. ECM governance model defines the commonly agreed standards to build, maintain and terminate the services in the network. This is a contract between the service providers and service consumers and defines the service level agreements that manage the use of services. ECM process logic and control is defined and exercised by the ECM governance model. In addition to these the

system contains a services support component that is the ECM service management and development component of the proposed framework. This component manages development, testing and implementation of new services. It also manages the security of the resources by including basic authentication to access them etc. The clients from within the organization and the partners are connected to the communication backbone through certain interfaces.

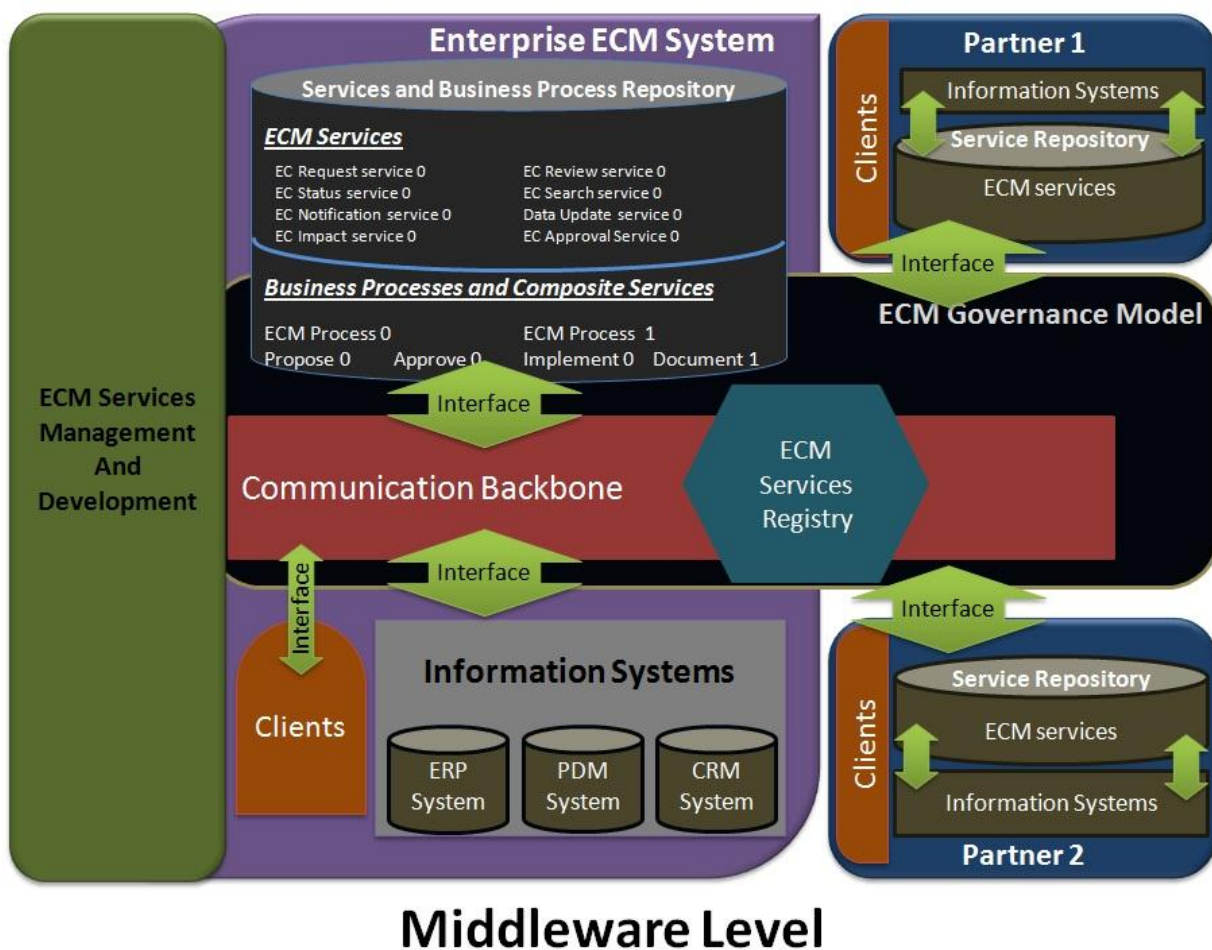

Figure 16: Middleware level components of the proposed SOA based ECM system

### **5.2.2 SOA based ECM service providers**

An ECM process implementing SOA technology in its workflow has the following types of service providers: (i) ECM Interaction Services, ECM Process Services, ECM Information Services, ECM Partner Services, ECM Business Application Services and ECM Access Services.

ECM Interaction Services enable engineers to interact with the ECM system. These are Graphical User Interfaces (GUI's) available on the user's desktops which provide access to the business processes or services of the ECM system. Nonetheless, these services guide and enable users perform various tasks of ECM by invoking available services.

ECM Process Services automate the ECM approval process, change propagation process, cost and time estimation, notification of the changes to the partners, etc. Each process is modeled as a service or composite-service that can be invoked independently by any authorized personnel. These services are mainly meant to improve the productivity of the personnel and reduce the non-productive time wherever possible.

ECM Information Services maintain, monitor and manage the database, which contains dependency information, EC proposal history, and other data that readily define the EC status. These services ensure a single and consistent source of data to the stakeholders.

ECM Partner Services firmly integrate the partners systems to ones ECM system. The partners can collaborate and participate in the ECM process with the help of these services. These services also ensure that the partners, as usual, can access the data required by



them. With authorization and specific guidelines data security is ensured during the process.

ECM Business Application services introduce new services to enhance the ECM functionality. This set of services helps in building new services to address the concerns of the users, or adapt to changing business scenario.

ECM Access Services provide access of already existing databases or applications to the proposed ECM system.

The services for the ECM processes are wholly identified such that each of them, perform a specific task, is autonomous and independently manageable. These services are listed below, with a brief notes on the functionality of each one. These are typical services, and may vary in terms of the input or output requirements depending upon the companies using it.

### **5.2.3 Services for ECM processes**

The services that are certainly part of the ECM system are listed below along with a brief description that includes the possible input and the output of the corresponding services.

#### **5.2.3.1 Change Propagation Identification service**

This Service identifies the affected parts along with the way in which it is affected, defined by 'type of change'. All the dependencies are carefully considered and a list of

affected parts along with the way in which they are affected is given as an output to this service (Reddi 2009).

Input: The changed “Component” and the “Type” of change, the component is undergoing.

Output: A list of components affected.

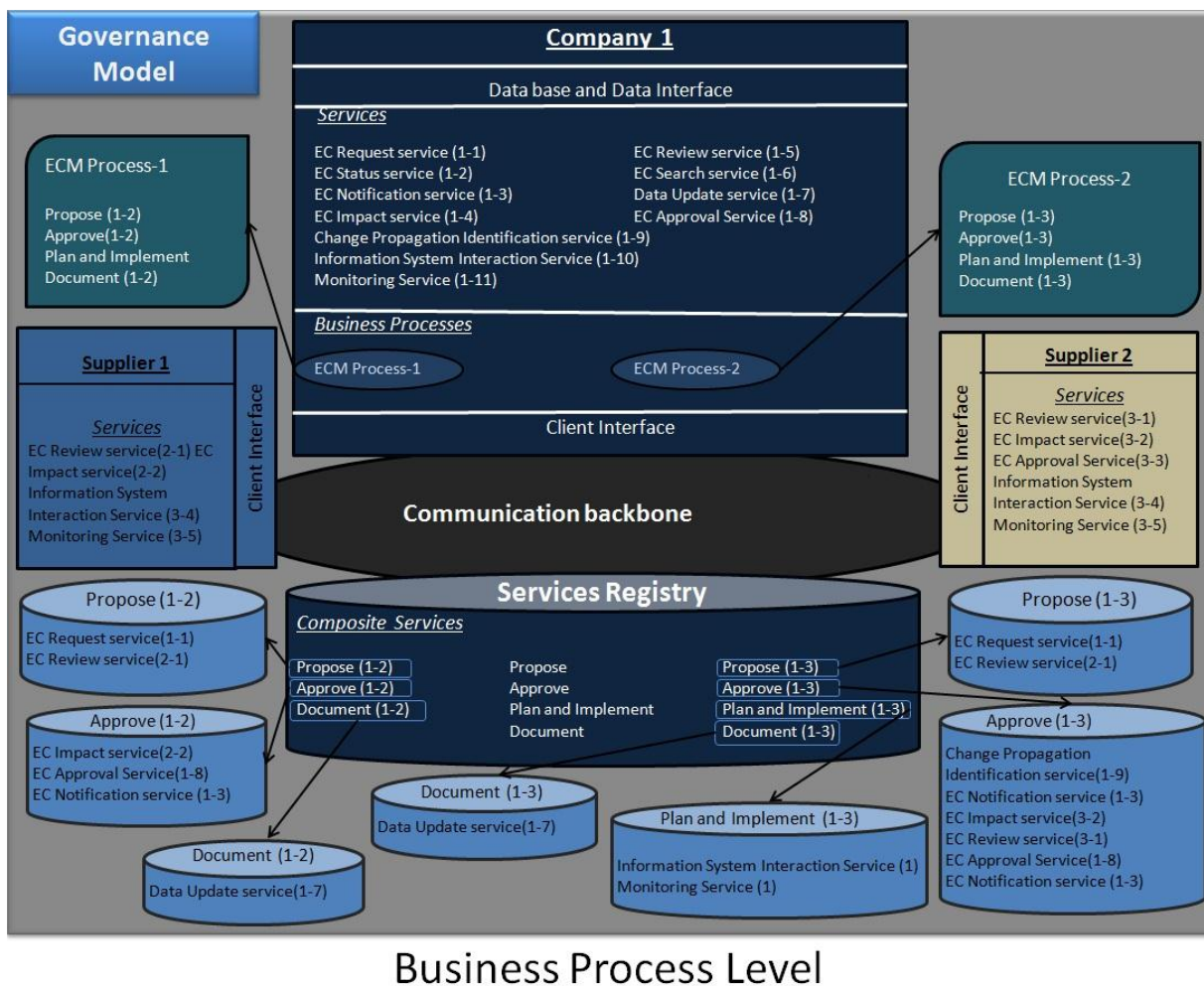

Figure 17: A flexible ECM business process between 3 companies.

### **5.2.3.2 EC Request service**

This service, if invoked, allows the user to enter text describing the proposed change. The service is by default addressed to the EC coordinator of the organization. This helps and guides the user in requesting an EC.

Input: Takes a “description” of the change proposed to a particular component.

Output: The Request is delivered to the Destination address.

### **5.2.3.3 EC Review service**

This acts as a platform for relevant discussion. All the participants can post their messages and all the members who are part of the review session can see the message and reply to that message. Presumably, this serves as a dashboard and records all the discussions at all phases of an EC process. At the end of each session, the EC coordinator summarizes the discussion in a specified format.

### **5.2.3.4 EC Status service**

This service informs the user about the present status of an EC. This service takes an Identification number of the EC as an input and gives the status of the EC in terms of the step number and textual description that describe that step.

Input: The ID of an EC.

Output: The status of the EC in terms of the ECM process step it is being processed, at that particular time along with a description of the same.

#### **5.2.3.5 EC Search service**

This allows the user to search for an EC, based upon any defined criteria that may include keywords search.

Input: Keywords or Description of the EC.

Output: Identification numbers of related ECs.

#### **5.2.3.6 EC Notification service**

This service delivers messages to a designated number of recipients. It delivers the message in a particular format that includes the EC ID, Affected component, Type of change, step ID, and description.

Input: The Destination Addresses and the Message content regarding EC change.

Output: The message delivered to all the destinations.

#### **5.2.3.7 Data Update service**

This Service updates the data stored in the database. The service has a restricted access and only authorized personnel can invoke it.

Input: The Specific location of the data to be changed and all the identification details. And the product data changes to be made.

Output: The specified data is updated.

#### **5.2.3.8 EC Impact service:**

The impact of an EC expressed in terms of the time and cost, the concerned company has to sustain in excess. This requires data of time and costs of various design and productions activities.

Express the impact of an EC in terms of time and cost.

Note: This service can invoke the EC propagation identification service within or during its execution.

#### **5.2.3.9 EC Approval Service**

When an EC is approved for implementation by a EC committee, this service is triggered to obtain the approval of the other concerned authorities. This by default has a list of addresses whose authorization is required to advance with EC implementation. This service communicates with the authorities and receives their approval in predefined (digital signature, etc.) format.

#### **5.2.3.10 EC Contact service**

This service enables a user to contact the person in-charge for a particular EC. This EC takes in the EC ID and the text description of the user's concern or questions to the address attached to the EC ID. Here the person in-charge can be EC coordinator or the in-charge in a partner company.

Input: Identification number of an EC and Text description.

Output: Message delivered to the EC in charge.

#### **5.2.3.11 Information system interaction service**

This service provides access to the information systems in the network. This service helps in planning and implementing an EC. It queries the information systems to get the data necessary for planning the implementation of an EC.

#### **5.2.3.12 Monitoring Service**

This service assists specifically in monitoring the implementation of the EC by providing the EC implementation status data, to compare with the metrics established during the planning of the EC. This service either requests information from any addressed personnel or retrieves information from the information systems via Information system interaction service to provide the implementation status data.

### **5.2.4 Database**

The data for managing the whole ECM process is stored and maintained in a database containing data tables. These tables are managed and monitored by information services. The fields in the tables are not fixed and can be added if necessary to address a specific component's additional requirement. Some tables that are part of a typical ECM process are described below.

#### **5.2.4.1 EC Request Table**

This table stores applicable details of an EC request. It saves the sender, receiver, and description along with an EC Identification (ID) number.

#### **5.2.4.2 EC Review Table**

This table stores the review status of an EC. This saves the text of the review discussion on a particular EC. The fields include EC ID, the status of the EC and the discussion text.

#### **5.2.4.3 EC Review Results Table**

The review results store the final decision after a review session. The fields of this table are EC ID, review result, and next recommended step in the ECM process.

#### **5.2.4.4 EC Notification Table**

The details of EC Notification are stored in this table. It specifies the step at which the EC is being processed along with a date, the affected component, and its type of change. This also saves a description of the EC that addresses all the possible questions otherwise regarding its status and effect.

#### **5.2.4.5 EC Propagation Results Table**

This table is used to save the propagation results for use during the EC review. It saves the EC ID, component affected by the EC and a list of components that are affected by the change in the component.

#### **5.2.4.6 EC Approval Table**

This saves the EC details along with contact information of the people who have authorized an EC. It saves the EC ID, Authority Name, Authority Contact and the comments of the authorization authority.

#### **5.2.4.7 Design Data Table**

This saves the critical design data of the product. The critical design data is the data considered to affect the performance and the physical appearance of the product.

#### **5.2.4.8 EC Details Table**

This table stores the status of every EC processing; during which it is either implemented or rejected. The data regarding the fate of all the ECs implemented or rejected are stored in this table for book keeping. It saves EC ID, EC Requestor, Status, and Comments.

#### **5.2.4.9 EC Dependencies Table**

This table stores the dependency data of the component. It stores the way a certain type of change in component affects the other components. It also stores the likeliness that a change of one particular type affects a particular component. It stores the initiators and target details along with the type of change and likeliness.

### **5.3 Case Study**

#### **5.3.1 Product Description:**

A new toothbrush (Figure 18) with built-in provision to hold toothpaste has been developed and adopted here to illustrate the developed framework. While the product is not yet commercialized, it is chosen because the concept behind the framework can be explained clearly. The development of the toothbrush has gone through a typical product development process from idea generation to manufacturing. The toothbrush is made up of Handle, Cartridge, Paste-delivery Tube, Slider, Handle Cap, and Bristles. The handle has a



cylindrical hole along its length irrespective of its external shape. The Cartridge is a flexible cylindrical tube that resides inside the cylindrical hole of the handle. A slider that moves along the cylindrical hole in the handle slides along the length of the handle and compresses the flexible tube cartridge, to deliver paste from the cartridge to the bristle through a delivery tube, which extends from the handle connecting the cartridge to the bristles. The paste delivery tube has an interface with the cartridge via the handle. The paste delivery tube can be latched to the handle when not in use. The bristles are inserted along the pattern of holes drilled in the handle. A handle cap covers the cartridge and sliders distinctly restricting them to the cylindrical hole in the handle.

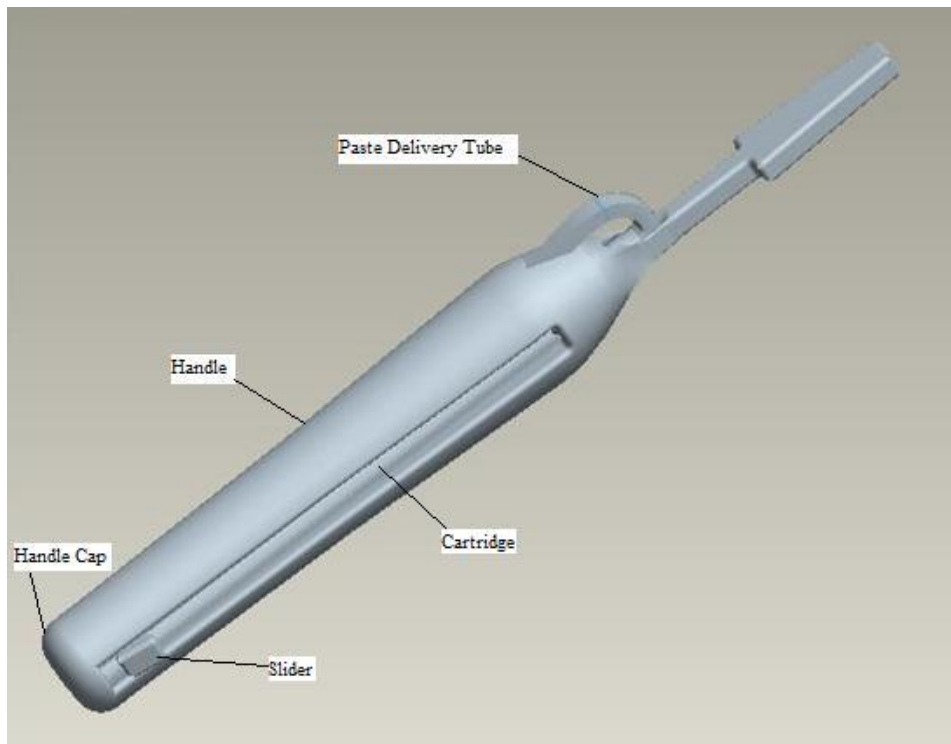

Figure 18: Case Study product 3-D model of tooth brush

### 5.3.2 Supply Chain

Suppliers (Figure 19) supply Cartridges and Paste-delivery tube of the toothbrush assembly.

Supplier 1: Supplies Cartridges.

Supplier 2: Supplies Paste-delivery Tube.

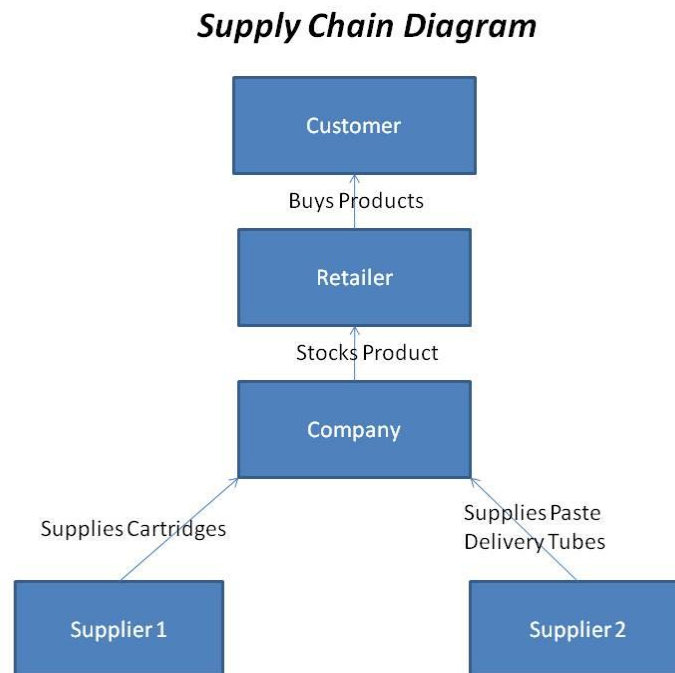

Figure 19: The Case Study Supply Chain

A simulated case study illustrates the use of the proposed framework to manage an EC. The flow of data during the ECM process and the manner in which the services are used is shown in the figure 20. Though the company adopts different ECM processes with the two suppliers, the data used is more or less the same except in some cases where additional data fields within the same data tables are used to store the data. The invoking of services

from other services can be automatic or manual based on the context of the ECM process. The tables in the database act as a medium to manage and transfer data.

The Supplier1 proposed the change with the help of EC Request Service that automatically assigned an EC ID number, and stored it along with requestor info in the EC Request Table. The EC Request service notified the EC Coordinator who invoked the EC Review Service. The EC Review Service was used to collaborate with the Supplier1 and discuss the EC. The decision to eventually consider the EC for further consideration was made following which the EC Notification Service was invoked and used to notify the stakeholders (Company, Supplier1 and Supplier2 in the present case).

The EC Approval step was started at an appropriate time determined by the EC Coordinator making sure the impact analysis by all the stakeholders was, of course, complete and available for discussion. The EC Impact Service was invoked which in-turn invoked the EC Propagation Identification Service during the impact analysis and identified the affected parts and their parameters. The EC Review Service was used to discuss the impact analysis of the Company, Supplier1 and Supplier2. The decision to implement the EC was made and the EC Approval Service was invoked to get the authorization from the concerned authorities for implementing the EC.

When the Approval process was complete, the EC Approval Service notified the EC Coordinator who, in turn, started the EC implementation planning process and invoked the Information System Interaction Service, to access the necessary production planning data. The metrics for monitoring the EC implementation process were defined and the data was

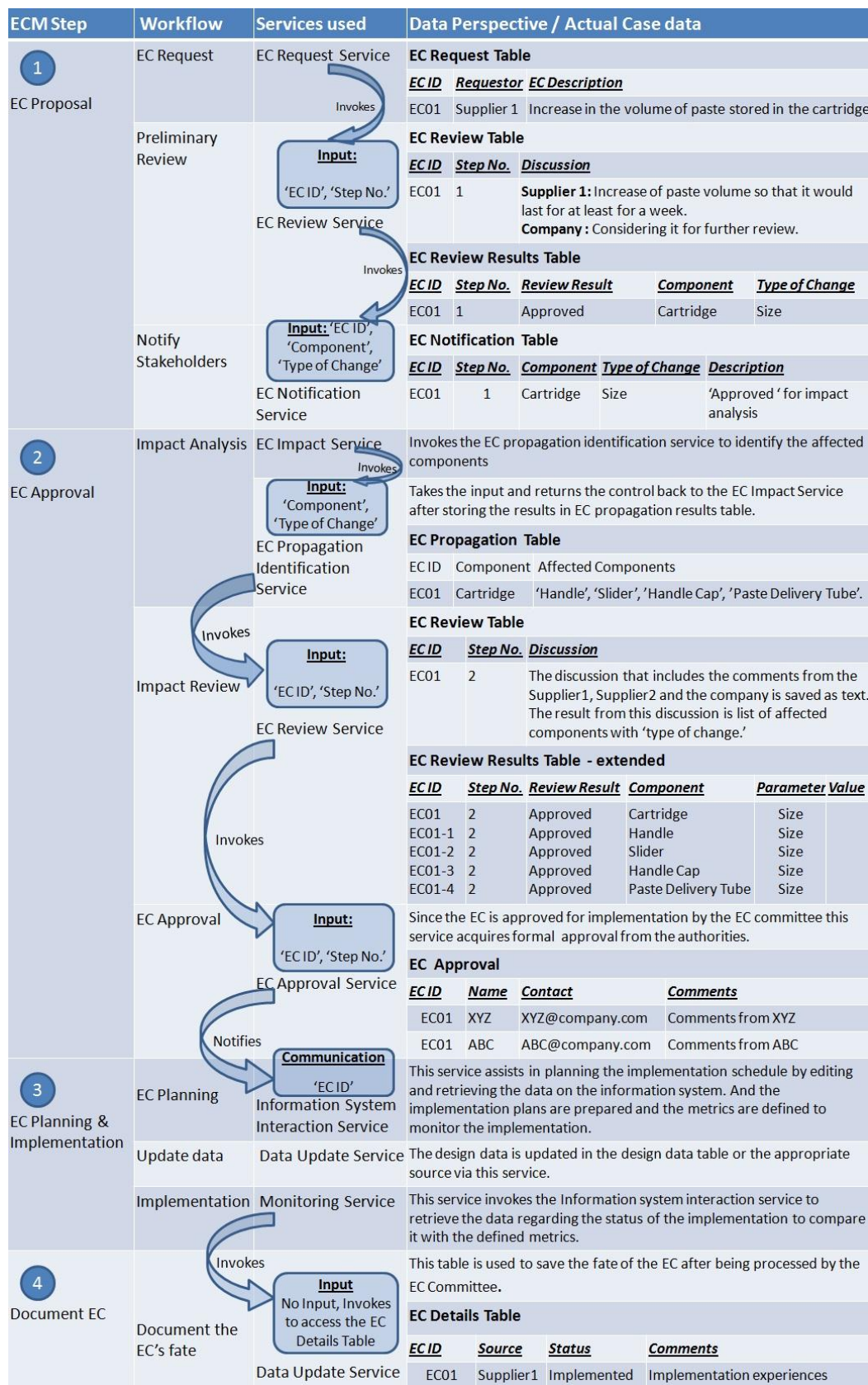

Figure 20: Case Study Implementation of SOA based ECM framework

updated using the Data Update Service. The Monitoring Service was used to compare the defined metrics to the implementation status that was obtained from Information System Interaction Service invoked by the Monitoring Service.

The EC Documentation Service is invoked when the implementation is complete and the comments from the implementation team are stored in the EC Details Table. The figure 20 shows the workflow and data perspective of the entire implementation process.

#### **5.4 Conclusion and Discussion**

Implementing ECM workflow on a SOA platform makes the workflow flexible. SOA with the web services has enabled companies to, successfully remove redundancies and use effective collaboration tools (Bieberstein 2005). SOA unifies the people and data, which is the basic requirement for an effective business process. It is advised to maintain a single repository of all the data and information needed during the product life cycle, to tackle the issue of frequent product changes in collaborative product development and manufacturing environment. In addition to effective communication across the supply chain, an adequate business process to manage the change should be in place to foresee the trouble caused by an EC (Holton 2008).

The presented framework enables to maintain a single point data access by following a predefined known governance policy, allowing suppliers to access the same data source across the Internet via information services. The governance policy wholly, defines and manages the authorizations of who can access what, and who can update the data etc.

Effective communication can be established by incorporating advanced techniques such as discussion boards, video conferences, etc. Tools that provide assistance in the ECM process can be modeled as services and can be interfaced into the ECM workflow at corresponding decision points. This framework allows the companies to utilize the best resources available to them altogether and also uses an available set of services tailored together to develop customized ECM workflow. Maintenance of these kinds of systems doesn't cost much since there is no downtime and the services can be built and added to the collection independently. With appropriate data and assumptions, this system can be simulated using advanced techniques like agent-based systems (Li 2006) to study the dynamics of this ECM based SOA process.

This framework is the first step towards the use of SOA for better and effective inter-company ECM management. This framework can be integrated into existing ERP systems also, for example, using NetWeaver platform of SAP we can integrate this ECM system to SAP enterprise system (Ferguson 2007, Maurizio 2007). This framework is best suited for collaborative supply networks where multiple organizations need to communicate to approve, plan and implement ECs. The main drawback of this proposed ECM framework is it doesn't consider the costs incurred in the EC life cycle process. Continuing research is under way to address these issues.

## 6 SYSTEM DYNAMICS ORGANIZATION TEMPLATES

### 6.1 Introduction

The concept of organization templates of NPD and ECM processes is presented in this chapter. The utility of the developed process templates have been demonstrated by modeling the NPD and ECM processes across a sample supply chain. The simulation model utilizes a variety of organization templates assembled together to represent a supply chain. The simulation model results are prudently analyzed and presented to establish the influence of various process parameters on the performance of the supply chain, indicated by the NPD process lead time.

### 6.2 System Dynamics based organization Templates

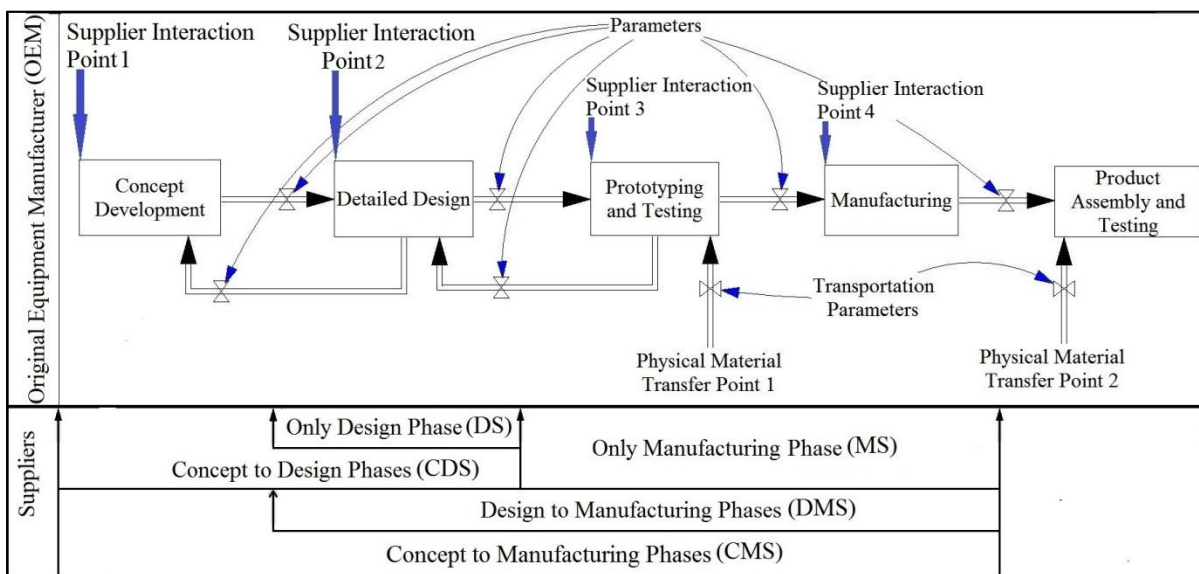

Figure 21: Schematic of the Organization Templates

The organization templates have been proposed considering the fact that the organizations communicate with their suppliers at more-or-less fixed stages in the NPD process. The communication with the suppliers may involve physical transfer of material or just sharing of information. Figure 21 shows the types of suppliers and the corresponding phases of their NPD process that is of interest to the OEM. While the OEM template has all the NPD phases, the supplier template only includes the phases of interest to the OEM determined by the extent of their collaboration with the OEM.

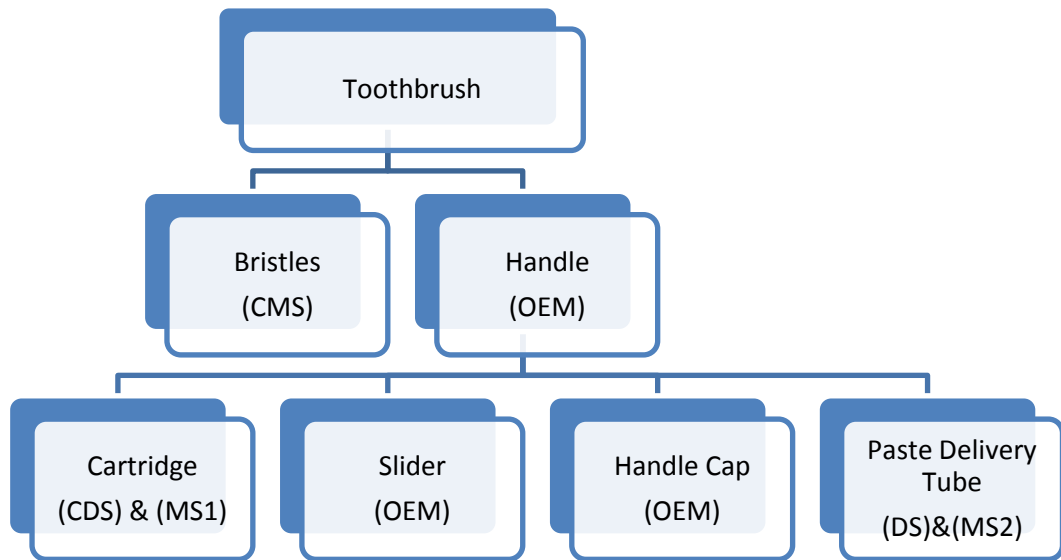

Figure 22: Toothbrush product hierarchy

The toothbrush product that has been introduced in the previous two chapters is used to describe the flow of information and materials between the OEM and suppliers in a collaborative environment.

At the start of the concept development phase of the OEM, it has the entire product details of the toothbrush (refer to Figure 22) like the components of the toothbrush, and



the suppliers. At the supplier interaction point 1 (Figure 21) before the start of the concept development phase, the OEM provides the specifications of the bristles and cartridge to the suppliers CMS and CDS respectively. The OEM starts the concept development of handle, slider handle cap and past delivery tube. At the supplier interaction point 2 the OEM transfers the concepts of paste delivery tube to the supplier DS for detailed design. At supplier interaction point 3 the suppliers CDS and DS transfer the cartridge and paste delivery tube detailed designs respectively to the OEM for prototyping. The OEM transfers the detailed designs of the cartridge and paste delivery tube to the suppliers MS1 and MS2 respectively for prototyping. At the physical material transfer point 1 the suppliers CMS, MS1 and MS2 transfer the prototypes of bristles, cartridge, and paste delivery tube respectively to the OEM for prototype assembly and testing. After successful prototype assembly and testing at the supplier interaction point 4, the OEM transfers the instructions for production ramp-up to the suppliers CMS, MS1 and MS2. After the production of the components the suppliers CMS, MS1 and MS2 transfer the bristles, cartridges, and paste delivery tubes respectively to the OEM for product assembly and testing.

Based on the above discussed interactions between the OEM and the suppliers, NPD and ECM process templates have been developed. The OEM process template is considered the base template representing the entire NPD process while, the supplier process templates are developed by editing the OEM process template. The supplier process templates consist of appropriate NPD phases indicating the extent of collaboration with the OEM.

### **6.2.1 Base Model**

The base model represents the Original Equipment Manufacturer (OEM) or an organization, in general. It constitutes the NPD and ECM processes of the organization, enabling interactions with suppliers at appropriate time. The NPD process essentially consists of five main phases which regularly include concept generation, detailed design, prototyping and testing, production ramp-up and product assembly and testing. The ECM process includes several phases of the ECM, such as EC request proposal, EC approval, EC planning and implementation and EC documentation. The basic factors that influence the workflow across these phases of NPD and ECM are identified and represented in the model as variables that can be changed to vary the model behavior accordingly.

It is assumed that a NPD project arrives at a specific rate (for example, 1 or several per year) and each NPD project can be divided into smaller independently workable parts called as 'components'. Upon arrival of the NPD, the number of components in the NPD is decided and the components are transferred to the appropriate organizations for processing. These organizations include the OEM and the suppliers participating in the NPD process from the concept phase. The organizations design and test the product design in the three phases of Concept, Detailed design and Prototyping. Once the product prototype is tested, the production ramp up starts aiming to produce the product by a quantity determined by the sales forecast estimates.

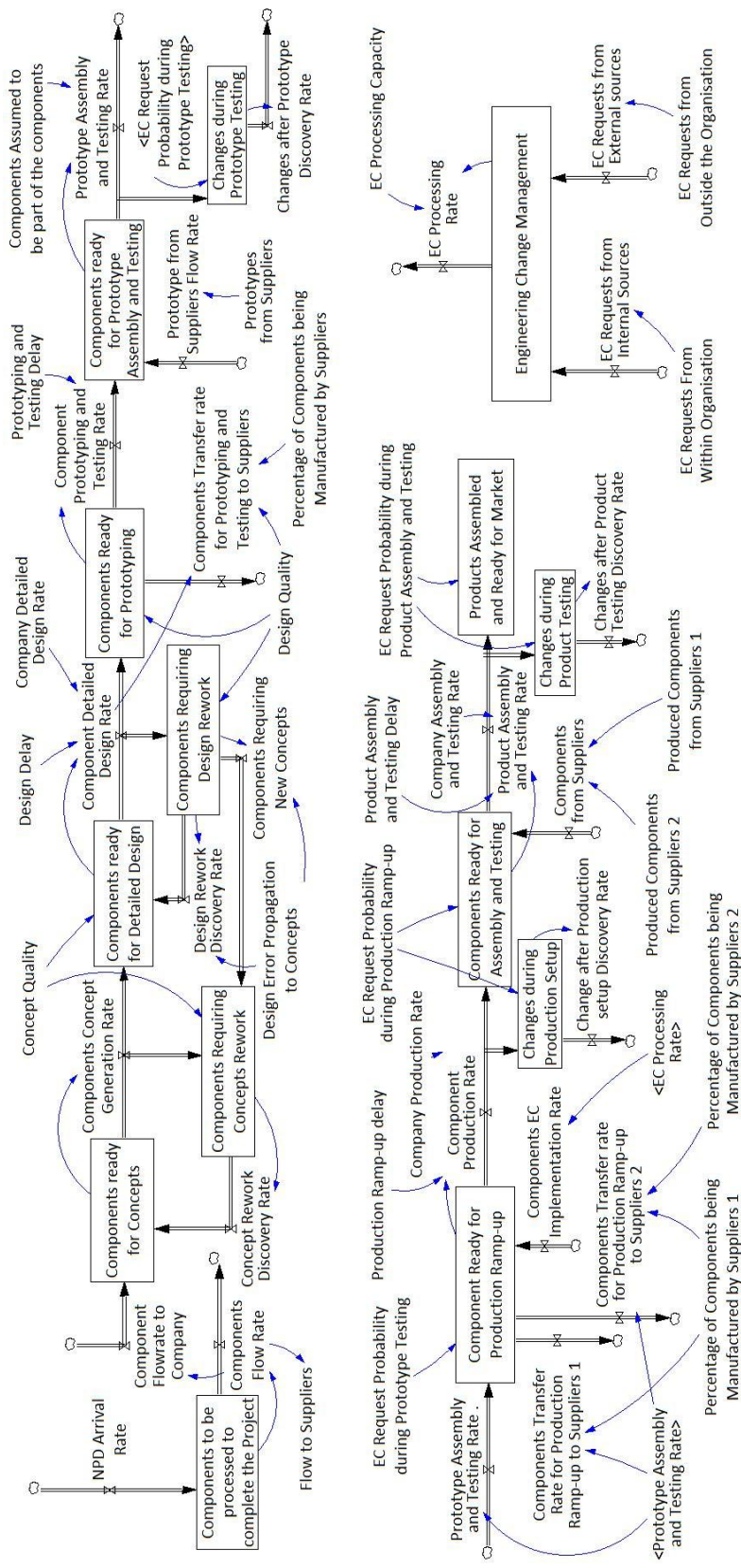

Figure 23: Original Equipment Manufacturer Model Template

The feedback loops at each phase of the NPD assumes a certain percentage of error in the process. For example, during the concepts processing work, the components with concept errors are collected separately and send back the loop to rework the concepts introducing a delay that is governed by the rate at which the errors are discovered. The error in later stages of NPD is also assumed to propagate to the previous phases of the process. For example, a certain portions of design errors discovered are sent back to concepts processing assuming the error has propagated leading to reevaluation of concepts.

The components (Detailed designs/design concepts in the form of manufacturing drawings/selected technologies) flow out of the OEM to the suppliers for prototyping, as the detailed designs of components are completed. The Prototyped components (manufactured prototypes) flow back to the OEM as they are manufactured by the suppliers. The components are transferred to the suppliers for production ramp up after the product prototype is successfully assembled and tested. The components (ready for product assembly) flow into the OEM from the suppliers for product assembly and testing after being produced.

The changes that are discovered during and after prototype assembly are considered as ECs and are processed using a standard ECM process. The components affected by ECs, when discovered are transferred to the ECM where, the EC is analyzed, planned, implemented, and documented. The propagation of the changes is then taken into context with the help of a propagation index that has a value above 1, and determines the magnitude of EC propagation across the components. ECRs are also assumed to come in

from the suppliers and customers. The components affected by ECs flow back from the ECM, where the EC is planned and analyzed, to the suppliers or the OEM for implementation (to the production phase for rework).

## **6.2.2 Templates for Supplier Integration to carry out NPD and ECM**

The OEM model described above is modified accordingly to represent the suppliers involved in various phases of product development. For convenience, the suppliers are assumed to be involved in various phases from the concept development to product testing. This section altogether presents the templates of suppliers involved in various stages of the product development.

### **6.2.2.1 Supplier Involved from Concept development phase to Manufacturing:**

This template represents the cases where the OEM defines the specifications and the supplier designs and manufactures the components accordingly.

The components flow from the OEM to the supplier once the number of components that are part of the NPD project and those handled by each supplier are decided. The Supplier develops the concepts, designs the product and manufactures the prototype to the guidelines laid out by the OEM. The components in the form of prototypes flow back to the OEM for prototype assembly and testing. The components are sent to the supplier for production after the prototype has been assembled and tested successfully. The manufactured components flow to the OEM as they are manufactured, for product assembly and testing. Similar to the base model, these templates also have the feedback

loops for every process to take the errors into consideration. The ECM has requests coming from internal and external sources. The external sources include the OEM, and suppliers downstream if any. Similar to the base model, the components affected by ECs are multiplied by a propagation index to address the EC propagation.

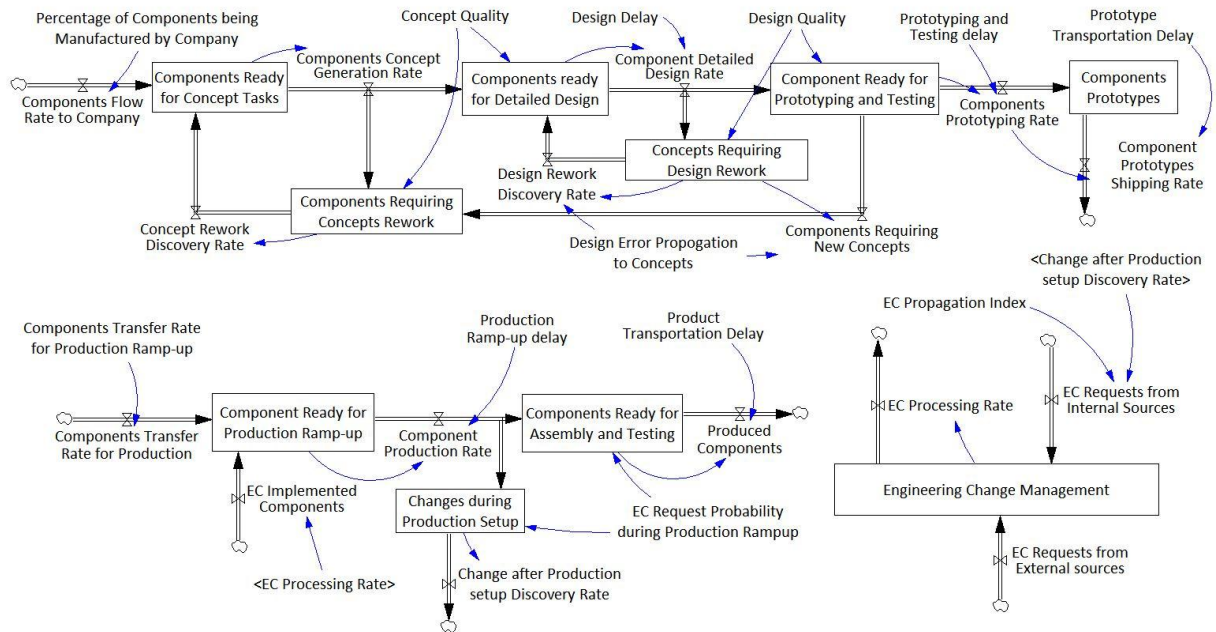

Figure 24: The Model Template for Supplier involved from Concept development to Manufacturing phases

### 6.2.2.2 Supplier involved in Design and manufacturing of the product:

This template represents the supplier who designs the component in accordance to the specifications provided by the OEM. The OEM completes the concept generation of the components and decides on the specifications like technologies used, performance requirements etc. and sends the component specifications to the supplier. The Components are transferred from the OEM to this type of supplier, after the concept generation stage. The supplier designs the components to the specifications received from the OEM. The

component is prototyped and transferred back to the OEM for prototype assembly and testing. After the successful testing of the product prototype the components are sent to the supplier along with the sales forecast info for production ramp-up. The supplier manufactures the components and sends to the OEM for product assembly and testing. This Supplier has its own ECM process that handles the EC requests coming from external and internal sources. Each EC has a propagation index that carries a value more than 1 to represent the components affected due to change propagation.

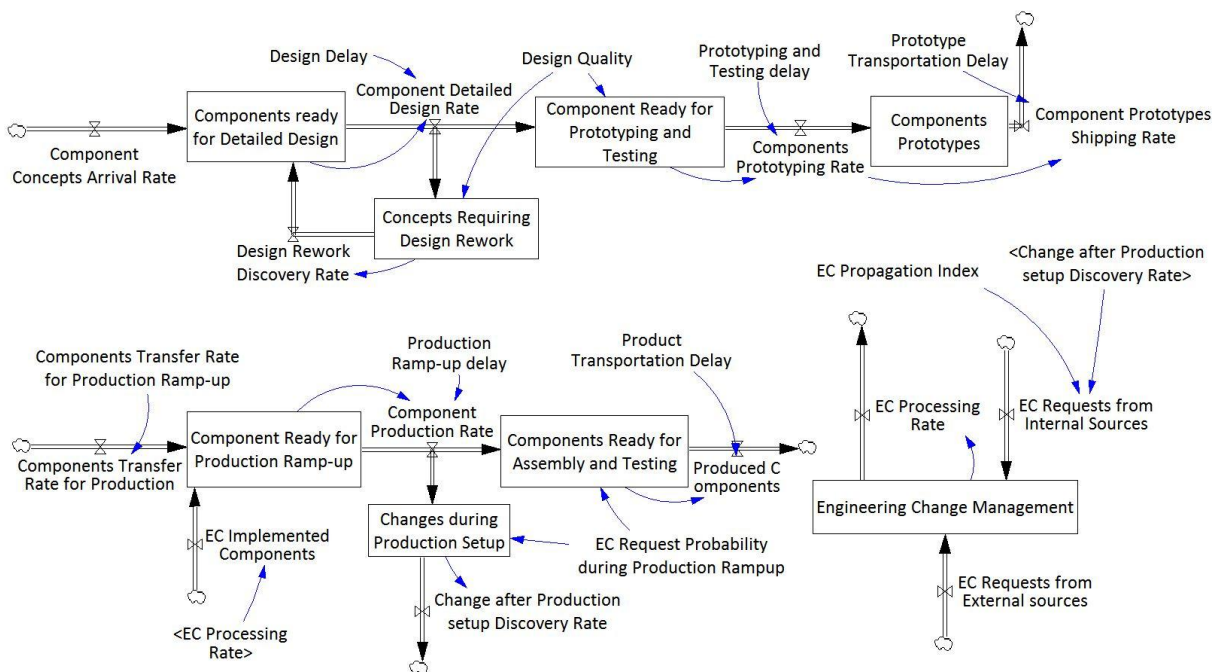

Figure 25: The Model Template for Supplier involved in Design and Manufacturing phases

### 6.2.2.3 Supplier involved only in manufacturing the product:

This template represents the supplier involved in manufacturing the product with ideally no or minimal involvement in the product design. As the OEM completes the

detailed design of the components, a part of those that are being manufactured by suppliers are sent to the suppliers, who manufacture the prototypes of the components and send them back to the OEM. Once the product prototype assembly is tested and approved for production ramp up, the components flow to the supplier who manufactures them and sends back to the OEM for product assembly and testing. In this case, the ECM handles the requests that come after the production setup. This mainly analyzes the ECs to decide if the component needs re\work or has to be manufactured from scrap. This type of supplier does have the ECM process but are assumed to plan only the implementation process of the ECs.

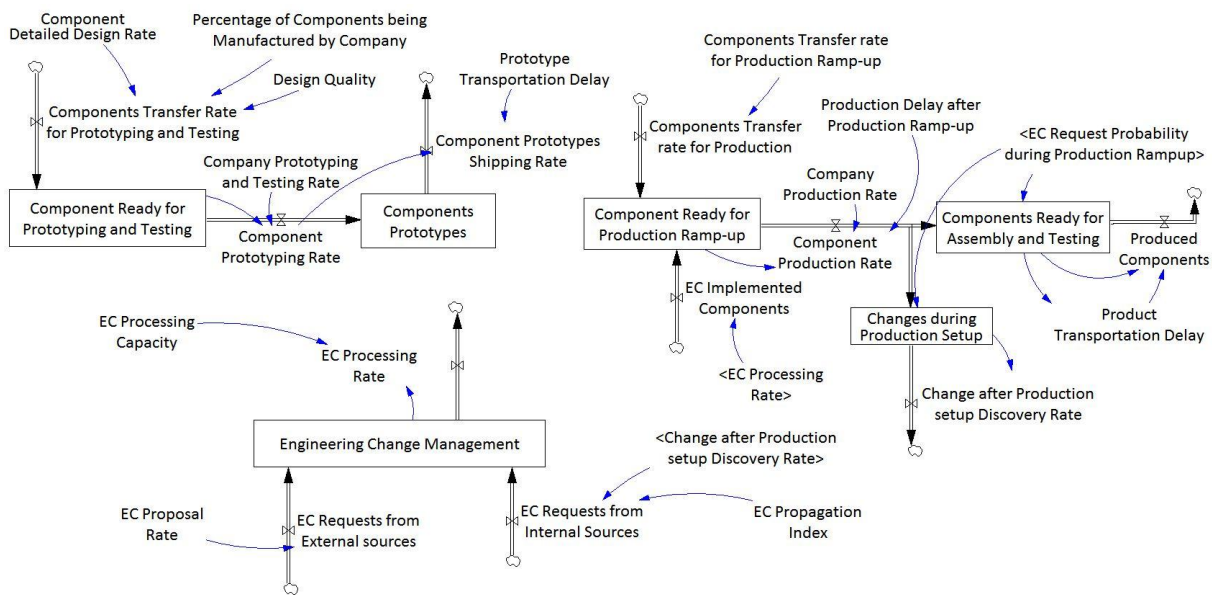

Figure 26: The Model Template for Supplier involved in Manufacturing phase

**6.2.2.4 Supplier Involved in Concept and Design:**

This template represents the design partners who only participate in the concept and detailed design phases of product lifecycle. The components flow from the OEM to the



supplier after the components of the NPD are decided. The components flow back to the OEM as they are designed, and this supplier does not have a separate ECM process but does participate in the ECM process of the OEM.

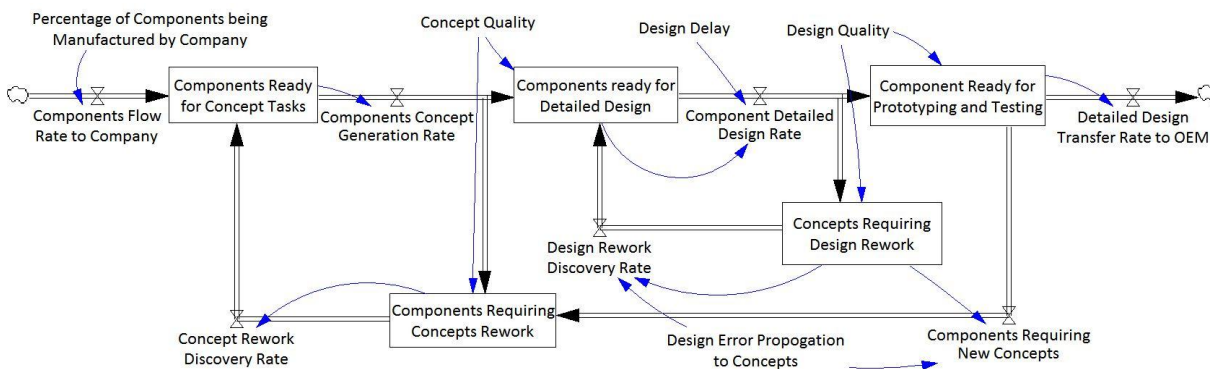

Figure 27: The Model Template for Supplier involved in Concept and Design phases

#### 6.2.2.5 Supplier Involved in Detailed Design only:

This Template represents the cases where the OEM selects the technologies and specifications of the components to be designed and manufactured. Having selected the technologies the OEM may outsource the designing work to an engineering partner who has expertise in those technologies. The concepts of the components are transferred to the supplier who designs the components and send the designs back to OEM upon completion. The design process errors are represented by the feedback loop presented in the template. This type of supplier does not have a separate ECM but does participate in the ECM process of the OEM.

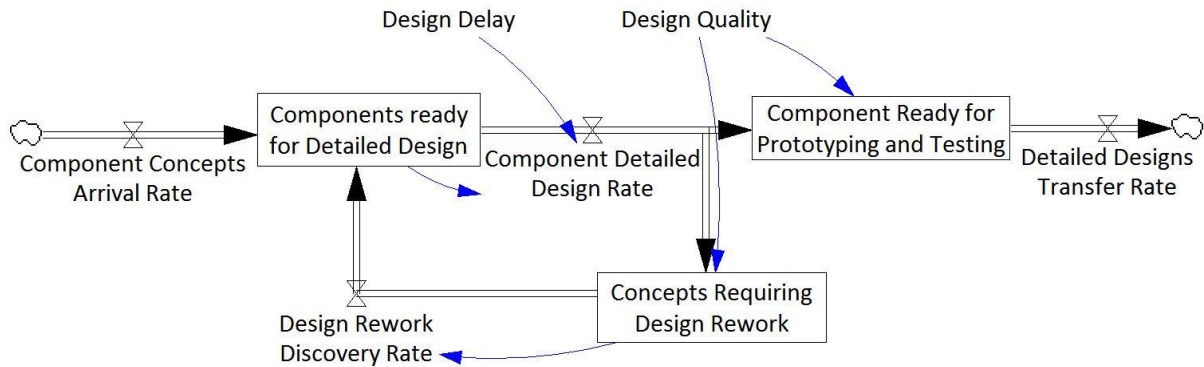

Figure 28: The Model Template for Supplier involved in Design phase

### 6.3 System Dynamics Supply Chain Model

This is the model of a simple supply chain consisting of an OEM and two suppliers. While one supplier ‘supplier 0’ collaborates from the concept to the manufacturing phases, another supplier ‘supplier 1’ is a manufacturer who collaborates for the manufacturing phase only. The resources are assumed to be infinite. This model is built using the templates proposed. The OEM template is assembled with two corresponding templates and is connected to represent the transfer of components at appropriate points in the NPD process. The model is simulated with a combination of parameters and the enterprise performance is studied from the product lead time.

#### 6.3.1 Assumptions

- The resources have not been considered, assuming infinite resources are available for processing the components.
- The number of suppliers is limited to 2 to keep the model simple. One supplier involves from the concept phase to the product assembly and testing phases, while the other involves only in manufacturing.
- The NPD project can be divided into components that can be processed independently.

- The changes to the components after the prototyping phase are dealt by the ECM committee.
- The communications responsible for physical transfer of components are ignored while only the physical movement of components is modeled.
- The model is basic and does not include the ECM process details and policies.
- Under normal working conditions each phase is expected to take 10 weeks and the whole NPD process of a year.
- The ECs are assumed to be processed as they come into ECM stock of the model.
- All the processing rates are assumed to be constant though they can be varied if necessary.
- A transportation delay of one week is assumed to move materials between the OEM and the suppliers.

### **6.3.2 Model Parameters**

- The Overlap of NPD Phases of all the organizations,
- The EC Capacity (the number of ECs an organization can process per unit time),
- The Percentage of Components outsourced to the suppliers by the OEM,
- The Quality of processed components at each phase of the NPD,
- The EC propagation indexes which indicate the propagation of a change in a component to other components,

### 6.3.3 Results

#### 6.3.3.1 Result 1:

Varying the NPD phase overlap, (all other parameters kept constant) the product lead time is graphed. It is observed that for greater phase overlap, the product lead time is shorter; and the demand for resources is greater (Figure 29).

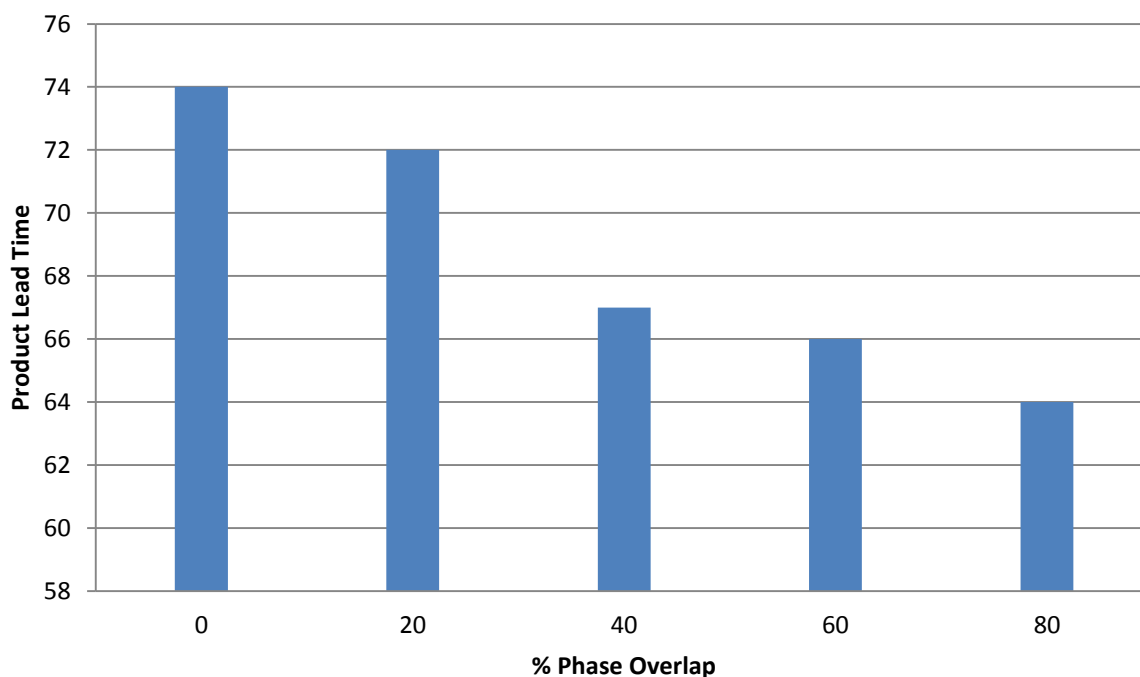

Figure 29: Model 3 Result 1 Graph 1

For higher overlap of NPD phases, it can be observed that the ECs are detected early in the NPD process, (Figure 30) and need to be processed simultaneously along with unprocessed components. These ECs are additional work and thus increase the demand for resources.

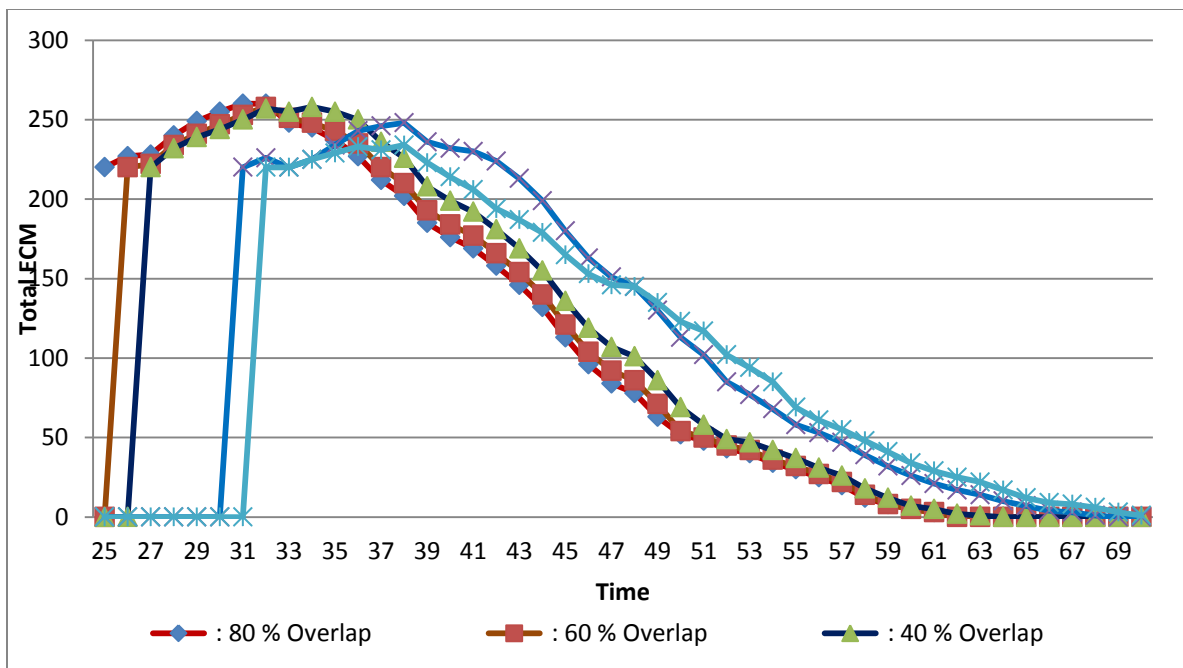

Figure 30: Model 3 Result 1 Graph 2

### 6.3.3.2 Result 2:

Varying the EC capacity, (expressed in terms of the percent of components handled by the respective organization) (all the other parameters are kept constant) the product lead time is graphed. The results are plotted for four conditions, of which the first case has EC capacity of the entire supply chain varying (represented by “All Vary”), while the other three cases have only one of the OEM (represented by “OEM Vary”) or the two suppliers (represented by “Sup 0 Vary” and “Sup 1 Vary”). While the EC capacity of one organization is varied, the EC capacity of the rest of the organizations is kept constant at 10% of their component processing rate (Figure 31).

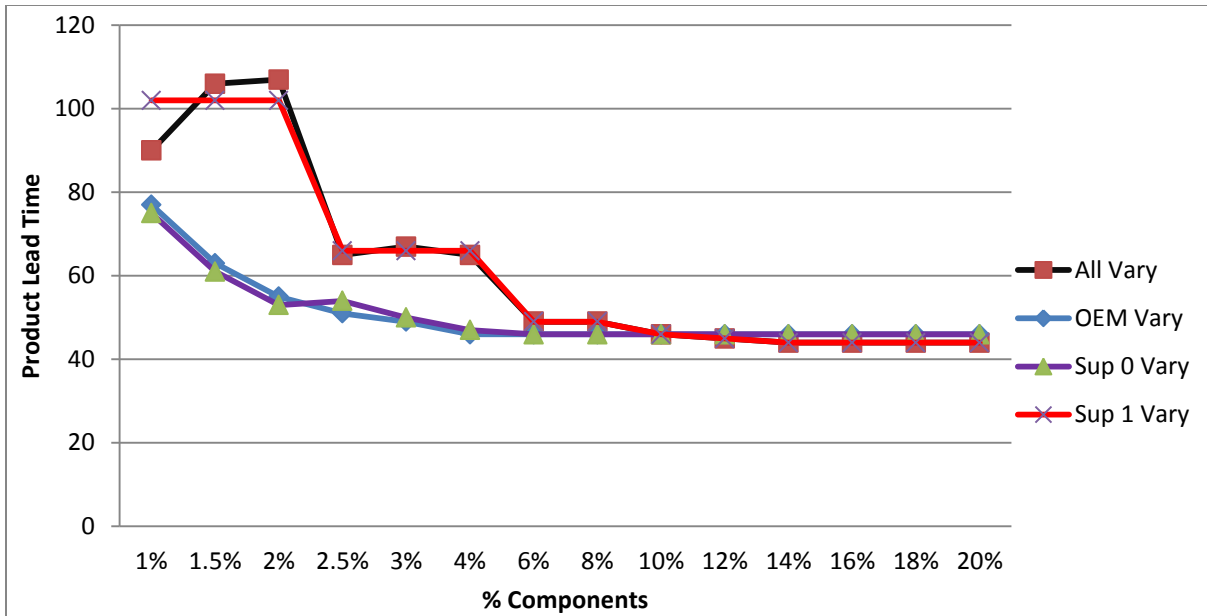

Figure 31: Model 3 Result 2 Graph 1

From the graph the following observations can be made:

- Each supplier has an optimum EC Capacity beyond which any additional EC capacity does not result in any decrease in lead time. From the graph, it can be stated that the optimum EC capacity for OEM and Supplier 'Sup 0' is about 6%, beyond which there is no change in the lead time for larger EC Capacities. Similarly for the Supplier 'Sup 1' the optimum EC Capacity is 14%.
- From the graph (Figure 31) Supplier 'Sup 1' can be identified as a critical supplier. The reason is as follows, the least possible lead time is obtained in two cases, where the EC capacities of all the organizations vary and only Supplier 'Sup 1' vary. For other two cases, the EC capacity of the supplier 'Sup1' is set constant at 10%; and the least lead time is not attained irrespective of the EC Capacity of OEM or Supplier 'Sup 0'. This is possible because in the first two cases, the EC Capacity of the supplier

‘Sup 1’ is increased over the 14% optimum mark while for the rest of the cases, it is set at 10%.

The above statement of Supplier ‘sup 1’ being critical to the supply chain is demonstrated in the Figure 32. The conditions are same as the previous graph (Refer to Figure 31) except that the EC Capacity of the organizations is kept constant at 5% (instead of 10% for the previous case) while EC Capacity of any one organization is varied. One can see a relative increase of the minimum lead time for cases when the EC Capacities of the OEM and supplier ‘Sup 0’ is varied. This is because, while the optimum EC Capacity of Supplier ‘Sup 1’ is 14% it is kept Constant at 5% for these two cases, which is, by far, worst compared to the previous case where the EC Capacities are kept constant at 10%.

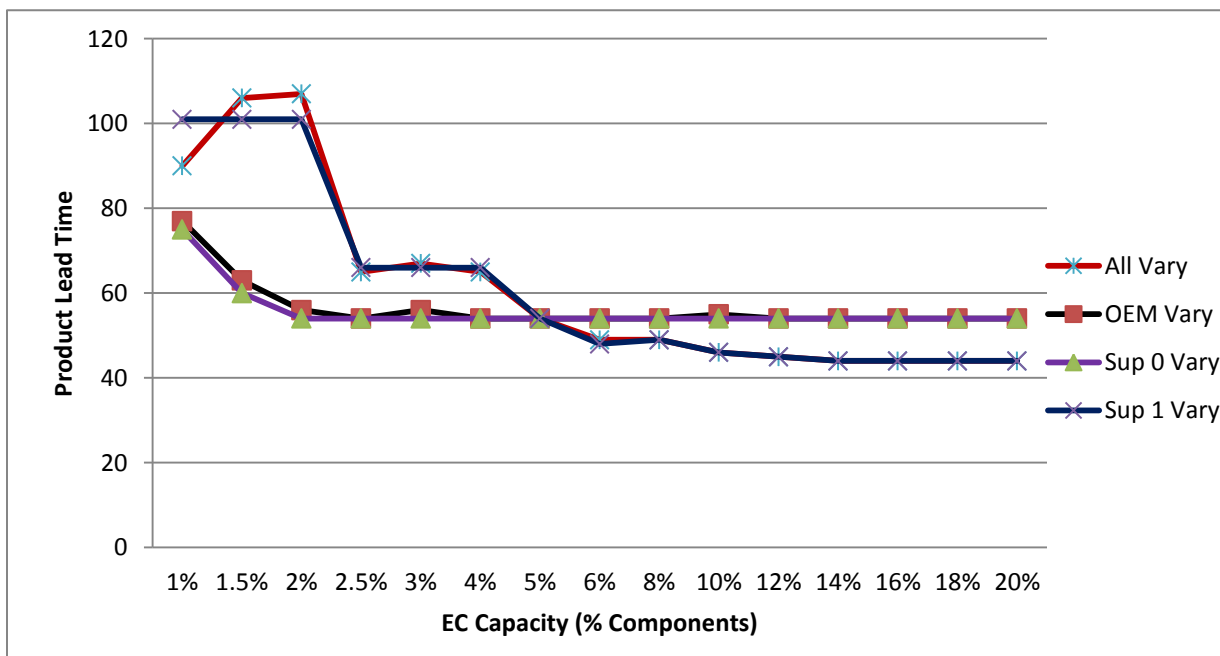

Figure 32: Model 3 Result 2 Graph 2

The product lead times are plotted for constant EC Capacity of all the organizations (Figure 33). The shape of the curve is same as the case of only supplier 'Sup 1' varying. This asserts the importance of a supplier in a supply chain and the fact that Supplier 'Sup 1' is critical to the supply chain. The performance of the supply chain is equal to the performance of the supplier 'sup 1' in most cases. Offering further insight, the rightmost data point in the Figure 33 is obtained when the EC Capacity of the entire supply is assumed to vary normally as follows:

OEM EC Capacity = INTEGER (RANDOM NORMAL (5, 25, 15, 8, 0))

Supplier 'Sup0' EC Capacity = INTEGER (RANDOM NORMAL (2, 40, 20, 16, 0))

Supplier 1 Capacity = INTEGER (RANDOM NORMAL (1, 12, 6, 5, 0))

(Notation: RANDOM NORMAL ({min} , {max} , {mean} , {stdev} , {seed} ))

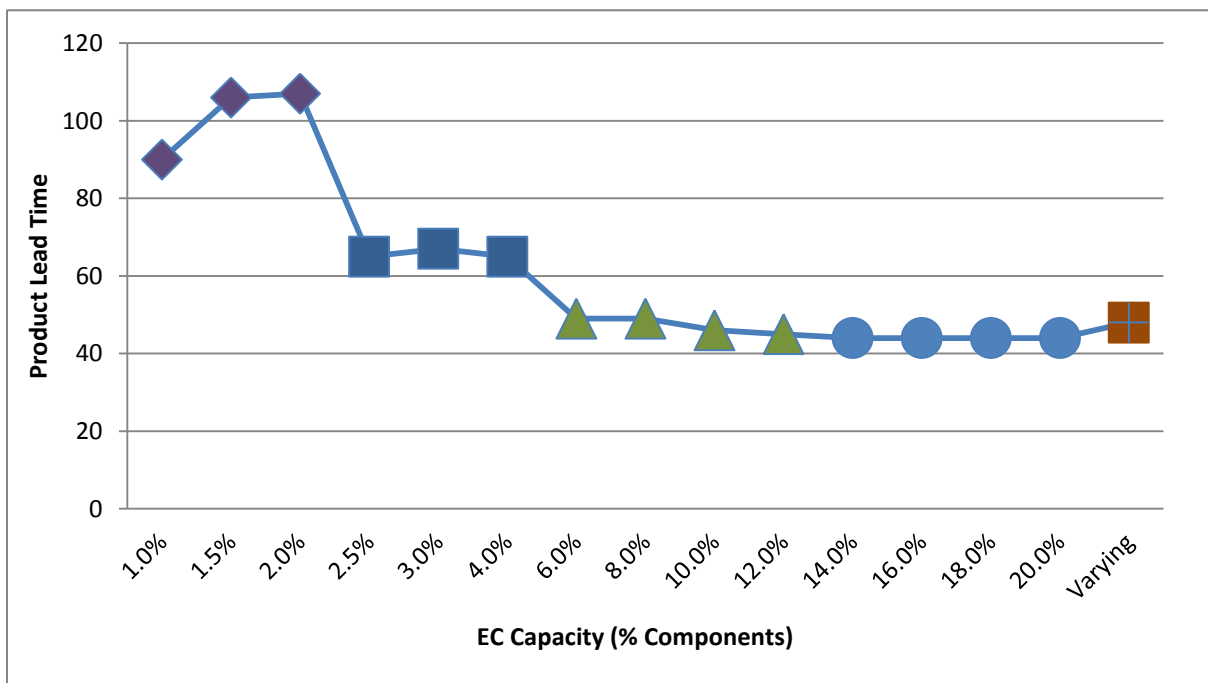

Figure 33: Model 3 Result 2 Graph 3



### 6.3.3.3 Result 3:

Varying the percentage of components being outsourced to the suppliers, the product lead time is graphed. For constant processing rates, EC capacity and other parameters there is the optimum percentage of components handled by suppliers at which the product lead time is the minimum (Figure 34). For this particular case of the supply chain, the least product lead time is possible when 30% of the components are outsourced to suppliers. At the above stated optimum value of ‘% of components handled by suppliers’, the ECs processing time also is minimum, irrespective of the time when the ECs are processed or the number of ECs processed over the product lead time. This can be seen from the zoomed part of the below graph (Figure 35).

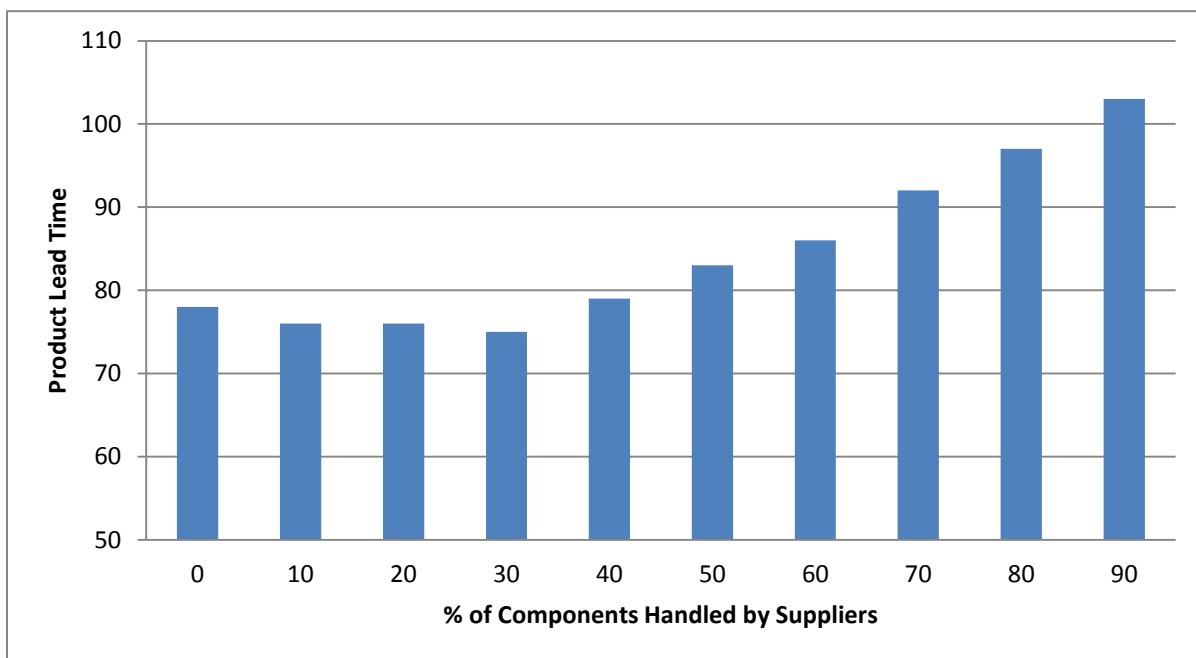

Figure 34: Model 3 Result 3 Graph 1

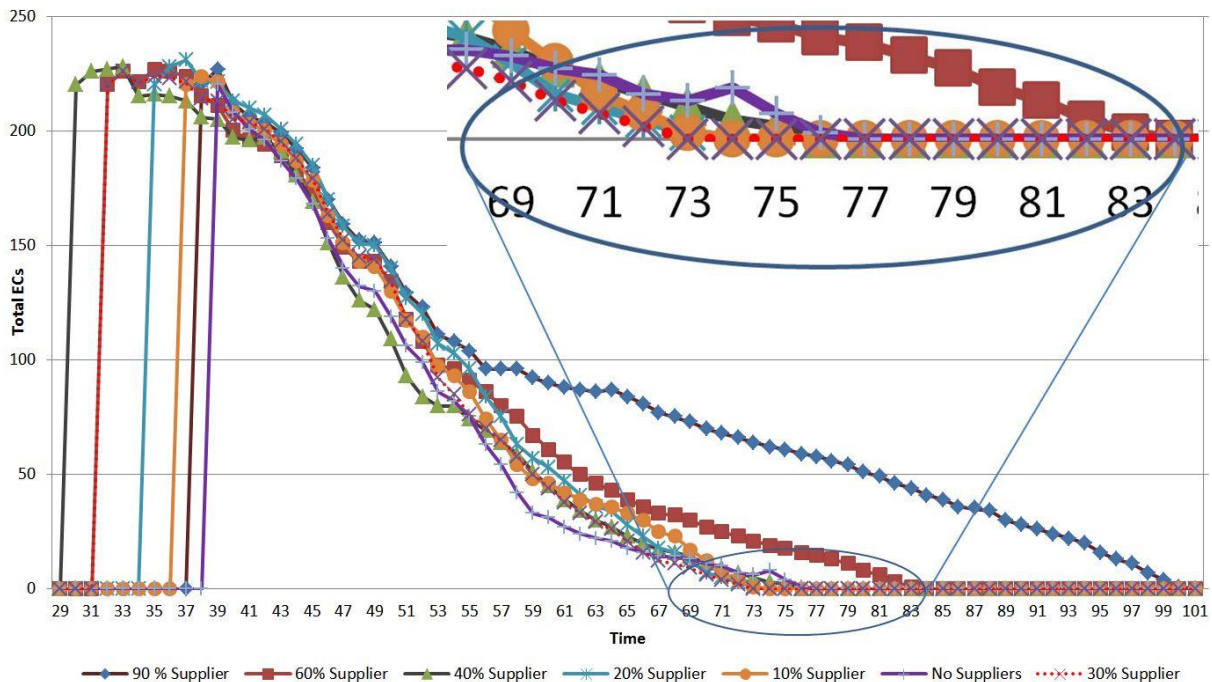

Figure 35: Model 3 Result 3 Graph 2

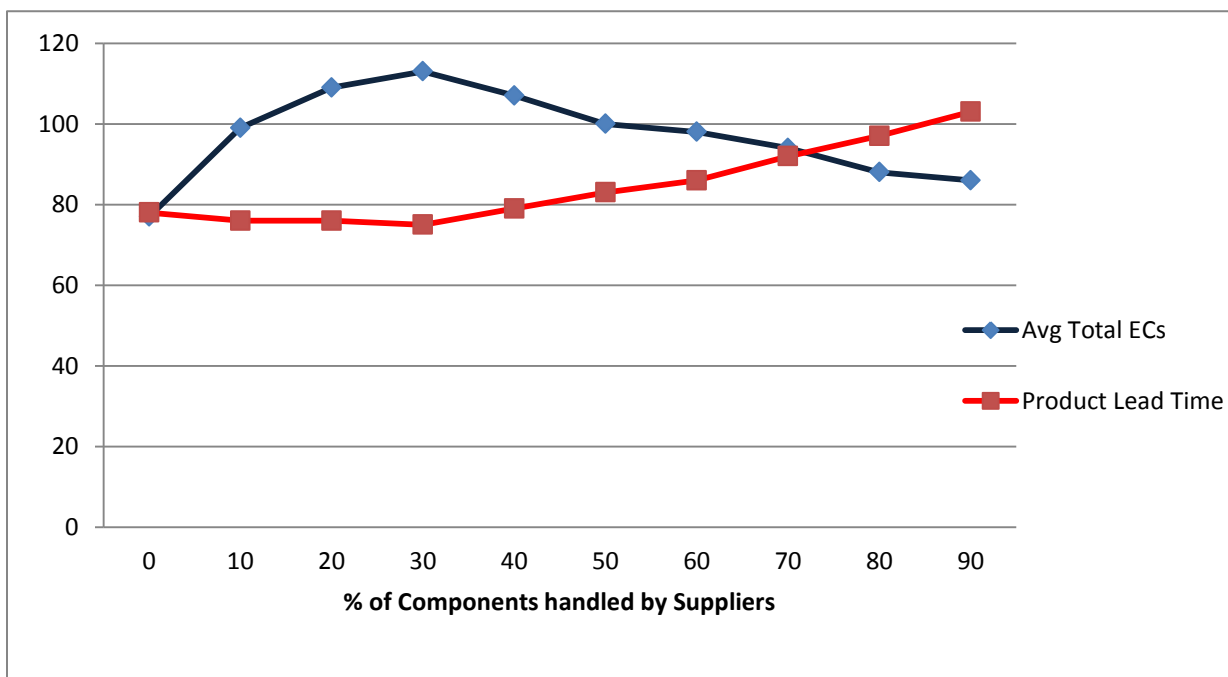

Figure 36: Model 3 Result 3 Graph 3

The 'Avg Total ECs' is defined by the formula, total number of ECs processed, over the time for which ECs are processed by the ECM process. In the Graph (Figure 36) below, the 'Avg Total ECs' is maximum, when the product lead time is minimum. Though this seems contradictory, it can be explained from the fact that, the total processing time of ECs is minimum when the product lead time is minimum. And since the time for which ECs are processed by ECM process is in the denominator of the formulae that defines the 'Avg Total ECs', it is maximum for minimum product lead time.

#### **6.4 Conclusions**

From the convincing results, we can conclude that, for every configuration of supply chain with different processing rates, EC capacities, etc., there appears to be a tradeoff between supplier involvement, phase overlap and supplier specific EC Capacity that results in least product lead time. As observed in the results, all the parameters when isolated have an optimum value. Estimating the values of parameters from past data, optimum values to some extent of unknown parameters can be estimated by the simulation model. For example, the values of parameters like the processing rates, EC processing capacity etc can be estimated from past data. And the values of parameters like number of components that can be outsourced and EC capacity required for faster product development process can be estimated. Though the accuracy of this model greatly depends on the ability of estimating the parameter values, the results can be useful to identify and study the important areas of the NPD and ECM process that should be taken care of so as to obtain low NPD lead times. For example, we can say from the results that EC Capacity has greater influence on the

product lead time. Like the strength of the chain is the strength of the weakest link, the performance of the supply chain is governed by a single supplier, referred to as critical supplier. The ability of a single supplier does influence the performance of the whole supply chain as seen in the case of varied EC Capacities. The supply chain performance is very low when any one supplier has low EC processing capability; and, similarly, when the supplier has more than a particular value (referred to as optimal value) of EC capacity, it has no significant effect on the supply chain performance. Hence the supplier capabilities (represented by variables like processing rate, EC Capacity, etc.) do influence the supply chain performance and thus the OEM performance significantly.

Hence modeling and simulating a detailed ECM process helps in analyzing the NPD and ECM processes policies in advance. It also helps in studying the impact of the ECM process on the supply chain performance. This also emphasizes that each supplier plays an important role in a supply chain and with unmotivated and uncommitted suppliers, delivering a good product with low cost and high quality is impossible.

## **7 MODELING AND SIMULATION OF NEW PRODUCT DEVELOPMENT AND ENGINEERING CHANGE MANAGEMENT WITHIN AN ORGANIZATION**

### **7.1 Introduction**

In this chapter, we have developed a SD simulation model for the NPD and ECM processes based on the OEM template presented in chapter 6. The functionality of the template has been enhanced and the effects of different parameters on the NPD lead time are studied. In modeling the NPD process it is assumed that the NPD project is approved and actual product development process is marked by the concept development phase (Ulrich and Eppinger 2008). The organization performance is assumed to be indicated by the NPD lead time, given its importance in the success of a product. The influence of various factors such as number of resources, resource composition, resource allocation priority etc., on the lead-time of the NPD and ECM processes has been comprehensively studied in this Chapter.

### **7.2 The Model:**

#### **7.2.1 Assumptions**

The following assumptions have been made in modeling the NPD and ECM processes.

- The NPD project has been assumed to be approved after being planned.
- The organization performance can be represented by the NPD lead time.
- The NPD project consists of components that can be processed independently.
- The resources available can be categorized based on their core competencies.

- As part of the NPD project, concepts and designs of each of the components need to be developed first, followed by prototyping, production ramp-up, and assembling into a final product.
- The changes to products during and after the prototyping phase are processed as ECs via the ECM process, while the changes within the concept and design phases are processed within the same phases as rework.
- The magnitude of changes at different phases such as concept, design, prototyping and assembly can vary in order to study the dynamics of the process with respect to it.
- There exists a desired rate of component processing for each NPD and ECM phases.
- The number of components that a particular type of resource can at least process in a given time (component to resource ratio) can be estimated.
- All types of resources are required to process a component processed in a particular phase.
- The project is considered to be complete, when all the components are processed and are ready for market release.

The resources requirement for each phase is calculated using the components to resources ratios and desired processing rates. The resources are allocated according to priority; and if the resources are insufficient for attaining the desired processing rates, the components to resource ratios are used to determine the actual processing rates possible from the available resources. The resource allocation priority defines the order in which the available resources are assigned in the NPD and ECM phases. From resources allocated to each phase, the possible processing rate for each resource type is calculated, and the lowest

processing rate is picked as processing rate at that phase. The propagation of an EC is determined by the status of the project. The earlier the EC is proposed and implemented during the NPD project, the lesser the number of components is affected by the EC. The model (Refer to 12.3.2) along with assumptions and its parameters are further discussed in this section.

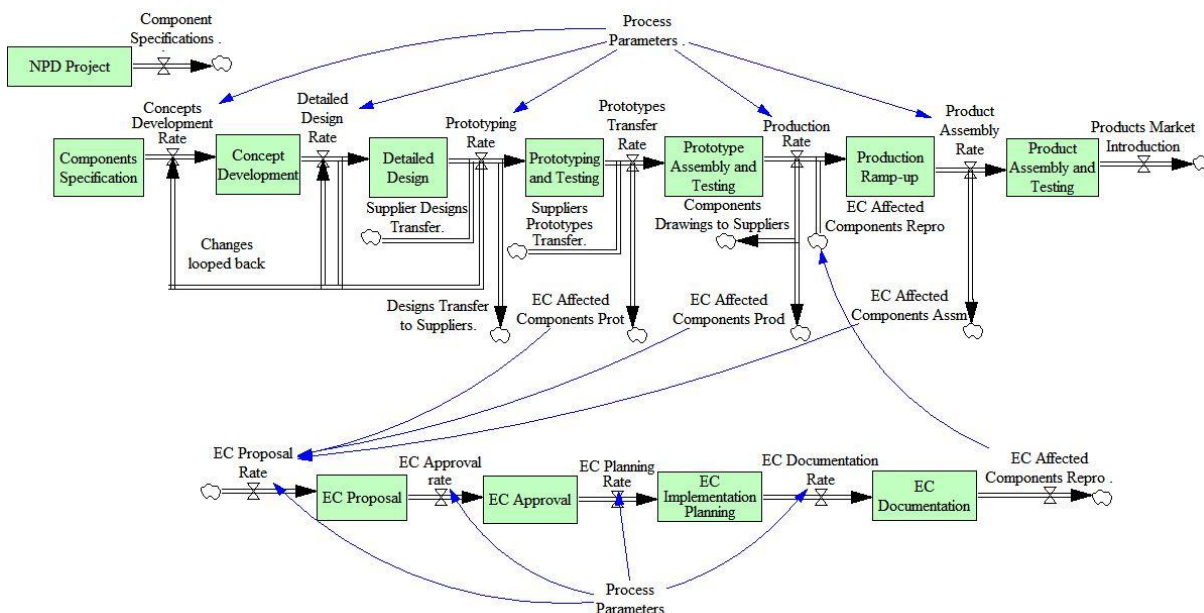

Figure 37: Schematic of NPD and ECM Processes within an organization

### 7.2.2 NPD and ECM Processes and workflow

The NPD process consists of five phases:

- (i) Concept Development,
- (ii) Detailed Design,
- (iii) Prototyping and Testing,
- (iv) Production Ramp up, and
- (v) Product Assembly and Testing.

On the other hand, the ECM Process consists of four Phases:

- (i) EC Proposal,
- (ii) Approval,
- (iii) Planning and Implementation, and
- (iv) Documentation.

A planned and approved NPD project enters the concept phase where the number of components constituting the NPD project and details like functional specifications of each component are determined. Specifics like geometry, material, and tolerances, as well, are appended to each component during the detailed design phase; and component drawings are thereafter sent for prototyping. After the components are prototyped during the prototyping and testing phase, the phase ends with all the components being prototyped and tested. The production phase starts when all the components are prototyped and tested and is followed by the assembly and testing phase where all the individual components are assembled and tested to complete the NPD project. Of the total number of components processed, a certain percentage of components are assumed to be defective, thus returned to the previous phases for rework or are processed formally through the ECM process. The percentage of the processed components assumed to be defective at each phase is determined from the variable, "NPD phase processing quality". Three different levels of processing quality (low, medium and high) are assumed for simulation of the model. The actual data used in the current model are in Table 1. In the table, the numbers corresponding to the concept and design quality indicate the proportion of error-free components processed in the concept and design phases, respectively. While the EC request probabilities indicate the proportion of the processed components that are affected by ECs and required to be re-processed via the ECM process.



Table 1: NPD Phase Processing Quality

Level	Concept Quality	Design Quality	EC Request Probability during Prototype Testing	EC Request Probability during Production Ramp-up	EC Request Probability during Product Assembly and Testing
Low	0.75	0.75	0.25	0.2	0.15
Medium	0.85	0.85	0.2	0.15	0.1
High	0.95	0.95	0.15	0.1	0.05

The errors discovered in the components during the design phase, are re-processed through feedback loops between the design and concept phases. There is always a certain percentage of the components that have been processed but have turned out to be defective. The errors discovered during or after the prototyping phase are formally handled by an ECM process. The approval, planning, and documentation of the EC are completed and sent back to the production phase of the NPD process for implementation. The number of errors discovered during the concept and design phases depends upon the quality of processing in those phases. For all the other phases, the errors discovered are represented by the probability of EC requests in each phase.

The degree of overlaps between various phases in the NPD process can vary and are managed in terms of the number of components processed in the previous phase. For a given percentage of overlap, the next phase starts only when the said percentage of the total components has been processed in the present phase. The model is simulated at three levels of phase overlap: 0%, 50% and 100%.

The ECs that are discovered during the NPD process are assumed to be ECs proposed by stakeholders within the organization. These are designated as “EC Requests from within organization,” while the ECs proposed by the stakeholders outside the organization are called the “EC Requests from external sources”. All the changes processed through the ECM process are sent to the production phase of the NPD either for rework, scraping, or re-manufacturing the component. The ECM policy of grouping or not grouping of ECs for processing is also modeled in the ECM process. When the ECs are grouped (indicated by a non-zero EC batch size), the ECs are put on hold until the number of proposed ECs exceeds the pre-determined batch size. The ECs are assumed to propagate and the extent of the impact is determined by the state of the whole NPD project. The number of components assembled and ready for market release determines the propagation index that sets the percentage of the components affected by the ECs.

### **7.2.3 Total Resources and Resource Composition**

The total resources are assumed to consist of two categories: dedicated resources and shared resources. The dedicated resources include Design resources, Production resources, Quality & Testing resources, and Marketing resources. The shared resources include Design & Production resources and Production & Quality resources. The size of each resource is set as a proportion of the total available resources. For instance, the high dedicated level consists of 30% design resources, 30% production resources, 10% quality resources, 10% marketing resources, 10% design & production resources and 10% production & quality resources. While the dedicated resources can address only the corresponding resource type demands, the shared resources are first used to address one

type of resource demand followed by the other. For example the design and production resources are allocated to address the demand for design resource first followed by the production resource. The simulation has been run for different resource compositions in order to study the effect of the resource composition on the lead time. The actual data used in the simulation can be found in Table 2.

Table 2: Resource Composition values

	<b>Resource Composition</b>	High Dedicated (HD)	High Shared (HS)	Balanced Composition (BC)
Dedicated Resources	Design Resources	0.3	0.1	0.2
	Production Resources	0.3	0.1	0.2
	Quality & Testing Resources	0.1	0.1	0.1
	Marketing Resources	0.1	0.1	0.1
Shared Resources	Design & Production Resources	0.1	0.3	0.2
	Production & Quality Resources	0.1	0.3	0.2

#### **7.2.4 Resource Allocation Priority**

The resources are allocated to different phases of the NPD and ECM processes according to a pre-defined phase priority. The priority in which the resources are allocated is defined by assigning an integer (from 1 to 9, since the total number of phases of NPD and ECM processes is 9) to each of the NPD and ECM phases, 9 being the highest priority and 1 being the lowest. The actual priority schemes used in the simulation can be found in Table 3.

The dedicated resources are first allocated to all the phases, followed by the shared resources. Of the shared resources, the design and production resources are first allocated

to address the requirement for design resources followed by the production resource. The production and quality resources are allocated to address the production resource requirement followed by the quality and testing resource.

Table 3: Phase Priority for Resource Allocation

Priority	Phases								
	New Product Development					Engineering Change Management			
	Concept	Design	Prototyping	Production	Assembly	EC Proposal	EC Approval	EC Implementation	EC Documentation
NPD	9	8	7	6	5	4	3	2	1
ECM	5	4	3	2	1	9	8	7	6
Mixed	9	8	3	2	1	4	5	6	7

### 7.2.5 Processing Rates

Based on the average processing rates, the required resources for each phase are determined from the component to resource type ratios for each of the NPD and ECM phases. The available resources are allocated in the order of the allocation priority. If the available resources are sufficient, they are allocated to meet the resource demand completely. If the available resources are less than the required resources for any phase, the processing rate is determined based on the available resources observed for that phase. The ratios of components to resource type indicate the number of components one resource type can process within the simulation time unit (a week) and is used to determine the resource

requirement from components processing rate and vice versa. But when the number of components to be processed is low then, the number of resources required is given in table 4.

Table 4: Components to Resource type ratios

Phases	Components to be processed	Variable description	Resource Type			
			Design Resources	Production Resources	Quality & Testing Resources	Marketing Resources
Concept	$\geq 6$	Components per Resource	4	5	6	4
	$< 6$	Resources Required	1	0	0	1
Design	$\geq 6$	Components per Resource	2	4	6	6
	$< 6$	Resources Required	1	1	0	0
Prototyping	$\geq 4$	Components per Resource	3	3	3	4
	$< 4$	Resources Required	1	0	1	0
Production	$\geq 8$	Components per Resource	5	3	6	8
	$< 8$	Resources Required	1	1	0	0
Assembly	$\geq 8$	Components per Resource	8	8	4	8
	$< 8$	Resources Required	0	1	1	0
EC Proposal	$\geq 6$	Components per Resource	6	6	6	4
	$< 6$	Resources Required	1	0	1	1
EC Approval	$\geq 4$	Components per Resource	2	4	4	4
	$< 4$	Resources Required	1	0	1	1
EC Implementation	$\geq 8$	Components per Resource	4	3	4	8
	$< 8$	Resources Required	1	1	1	0
EC Documentation	$\geq 10$	Components per Resource	10	10	10	10
	$< 10$	Resources Required	1	1	0	0

### **7.3 Results and Conclusions**

The NPD lead time is considered as the indicator of process performance; hence the influence of the parameters on the NPD is studied. The influence of eight variables representing the ECM and NPD processes on the NPD lead time has been studied.

The simulation model (Appendix 12.3.2) was modeled and defined using the Vensim SD simulation tool (VENTANA Systems Inc. 2010). The model has been simulated for a range of values including the simulation data representing Design of Experiments (DOE) full factorial design of eight variables with 3 levels each. A total of 6,651 unique simulations have been carried out and the results have been analyzed using effects plot and interactions plot. Later, the results from the simulation data representing the 2 level factorial design of eight variables with 2 levels each has been used to simulate the model. The Pareto chart indicating the influence of each parameter and their interactions on the NPD lead time has been drawn. The DOE analysis of the results shows the aggregate influence of the process parameters and their interactions on the NPD lead time. A few of the indicated interactions between the variables have been studied using additional plots.

#### **7.3.1 Case 1:**

The results corresponding to the simulation data (Table 5) of eight variable, 3 level general full factorial design (Minitab Inc. 2011) are used to plot the effects (Figure 38) and interactions plot. The higher the slope of the plot, greater is the effect of the parameter on the NPD lead time. This means that resources, NPD processing rates, processing quality and phase overlap have significant effect on the lead time, while allocation priority has a

noticeable effect. Inevitably, it can be observed that higher resources, NPD processing rates, process quality and phase overlap result in lower lead times. And the ECM resource allocation priority is advantageous in most cases compared to NPD resource allocation priority.

Table 5: The 8 Variables representing the ECM and NPD process within an organization

Levels		Low	Medium	High
Organization NPD and ECM Process Parameters	EC Batch Size	40	20	0
	Processing Quality	High	Medium	Low
	ECM Processing Rates	50	30	10
	Processing Rate	100	60	20
	Phase Overlap	100	50	0
	Resources	200	120	40
	Allocation Priority	ECM	Combo	NPD
	Resource Composition	70	50	30

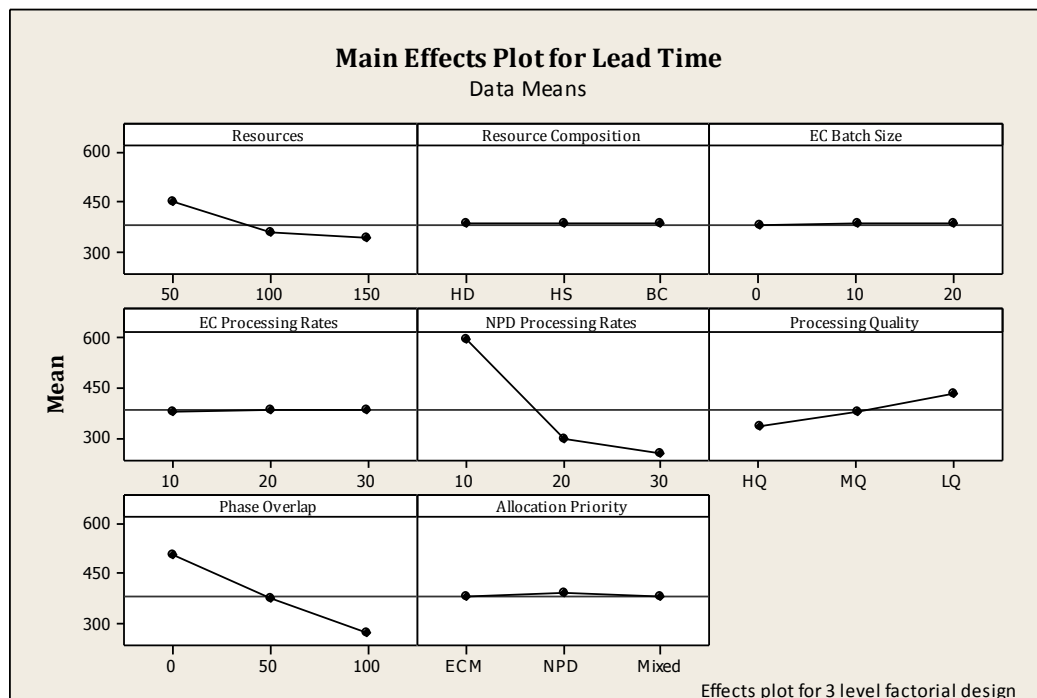

Figure 38: Effects of process parameters on NPD lead time

The influence of one parameter on another parameter’s effect on the NPD lead time can be seen in the interactions plot (Figure 39). The difference between the slopes of the lines in the interaction plot determines the magnitude of the interaction between the considered variables. Eventually, resources seem to have interactions with all the other variables while, NPD processing rates has interacts with processing quality, phase overlap and allocation priority. Interactions also exist between the processing quality, phase overlap and allocation priority.

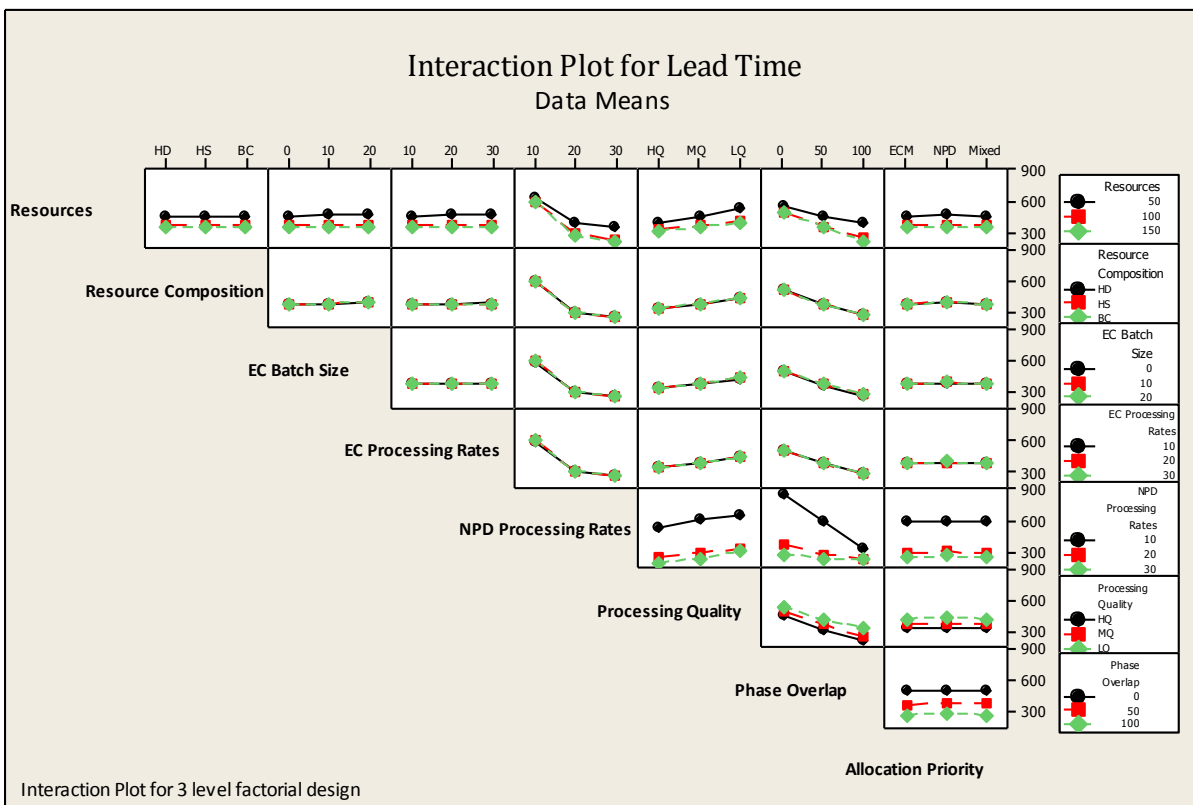

Figure 39: The effect of Interactions between the process parameters on the NPD lead time.

**7.3.2 Case 2:**

The results from the simulation data corresponding to eight variable 2 level factorial design (Table 5 levels low and high) have been used to plot the Pareto graph (Figure 40).

The Pareto graph shows the largest 30 effects of process parameters and their interactions,



on the lead time. As indicated earlier the NPD processing rates, phase overlap, processing quality and resources have significant effect on the lead time. Allocation priority, EC processing rates and EC batch size have noticeable effect on the lead time. Though the magnitude of the effect varies all parameters have influential effect on the lead time and thus cannot be ignored (as long as the magnitude of their effect crosses the red line). In addition to the effect of single parameters, the interaction between the parameters pairs NPD processing rates and phase overlap, resources and phase overlap, resources and NPD processing rates, processing quality and phase overlap, resources and processing quality, resources and EC processing rates, NPD processing rates and allocation priority, processing quality and allocation priority, and EC processing rates and allocation priority are significant.

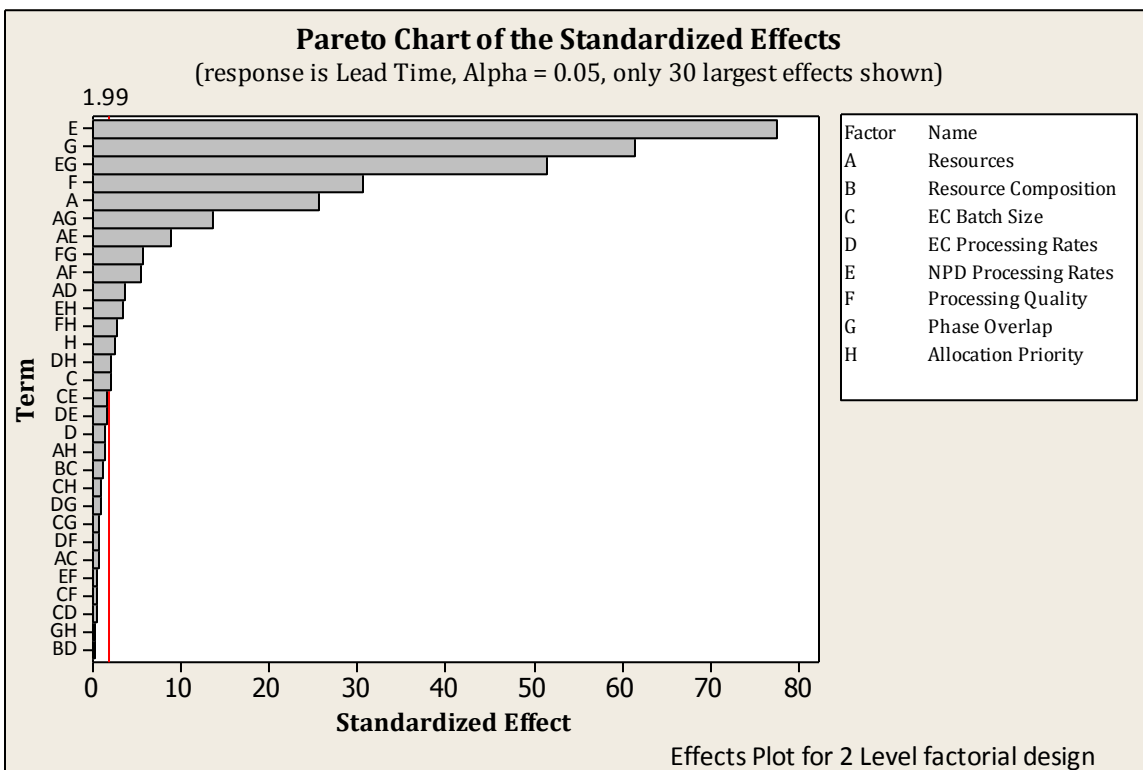

Figure 40: Effects of process parameters and their interactions on the NPD lead time.

### 7.3.3 Case 3:

To study the interactions between the variables, the model was simulated for all the combinations of eight variables values, each with 3 values representing low, medium and high states. The eight variables are:

- (i) resources (i.e. Total Resources)
- (ii) resource composition
- (iii) processing quality
- (iv) EC batch size
- (v) NPD processing rates
- (vi) ECM processing rates
- (vii) NPD phase overlap, and
- (viii) allocation priority.

These 8 variables are paired to form 4 sets of variable combinations:

- (i) Allocation Priority - EC Batch Size
- (ii) Resources - Processing Quality
- (iii) NPD processing rates - ECM phase processing rates
- (iv) NPD phase overlap - Resource Composition.

Each set has 9 combinations (Low-Low, Low-Medium, Low-High, Medium-Low, Medium-Medium, Medium-High, High-Low, High-Medium and High-High) of the three levels of the two variables that form the set. Graphs are plotted to study the effect of interaction between 2 sets of variables while the other two sets are kept constant.

In most cases ECM priority (Figure 41) is advantageous when the resources are low except for a few cases, for example when the resources are low with low NPD processing rates and EC grouping, where NPD priority result in lower lead times. The EC processing rate has no effect on the lead time when the ECs are not grouped, but has a noticeable influence on NPD lead time when the ECs are grouped. The EC grouping is advantageous when the resources are low with high NPD processing rates.



Figure 41: Influence of NPD and ECM processing rates, and allocation priority and EC batch size, on NPD lead time (resources 50)

Higher processing quality (Figure 42) always results in lower NPD lead times and when combined with high resources and high processing rates result in lowest lead times. Effect of EC processing rate varies with varying resources, for low resources it has a degrading effect indicating

low EC processing rate is beneficial and for moderate resources the moderate EC processing rate is beneficial. Similarly, when resources are high, high EC processing rates are advantageous. For low NPD processing rates the effect of increase in the resources from moderate to high resources is minimum, compared to the case when NPD processing rates are moderate and high.

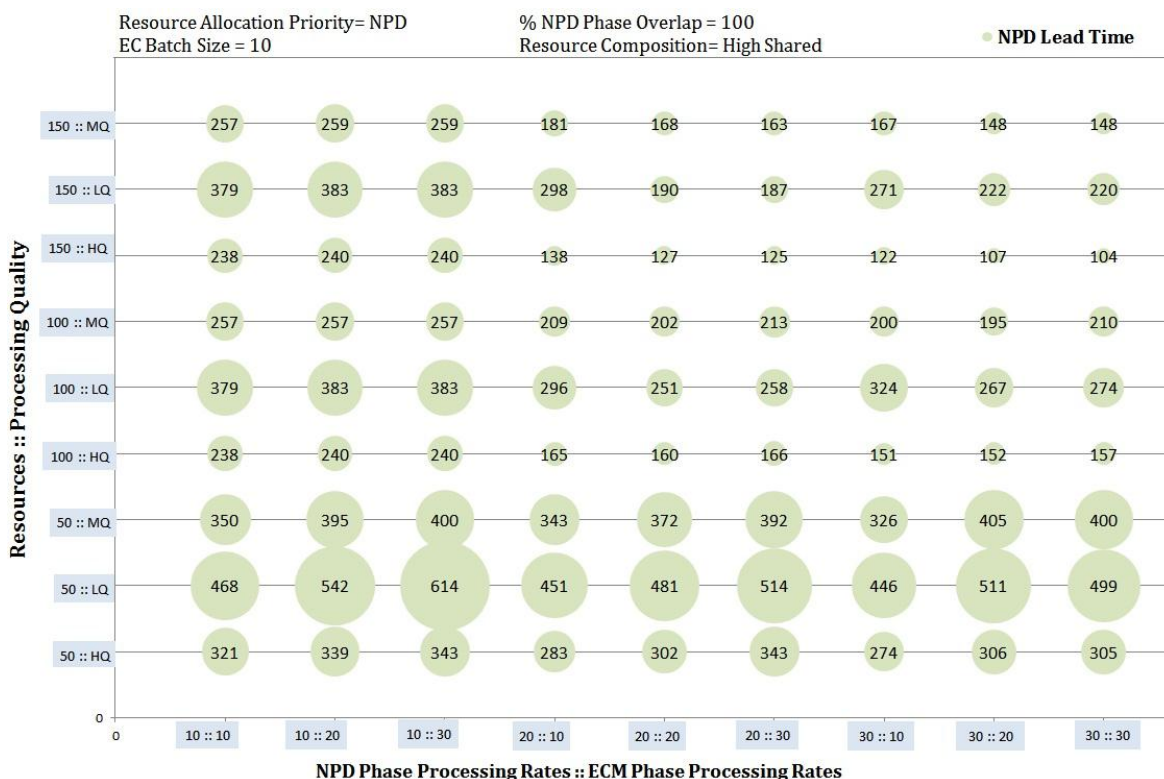

Figure 42: Influence of resources and processing quality, and NPD and ECM processing rates on NPD

The resource composition (Figure 43) does not demonstrate any noticeable influence on the lead time within the range of simulation data. With increase in resources the influence of phase overlap on the lead time remarkably increases. With low resources, the influence of phase overlap is limited, while with moderate and high resources, the influence is significant. Similarly, at low phase overlap the influence of resources is minimal; and at higher phase overlap, the influence is found to be significant.



Figure 43: Influence of percentage phase overlap and resource composition, and resources and processing quality on NPD lead time

For any given NPD and ECM processing rates with moderate resources (Figure 44), the NPD lead time decreases significantly with increase in phase overlap. Similarly for any given phase overlap with moderate resources, increase in NPD processing rates decreases the lead time. Assuming that the EC processing rate at least is a minimum 10 components per week, it does not influence the lead time for any given phase overlap and NPD processing rate with moderate resources.

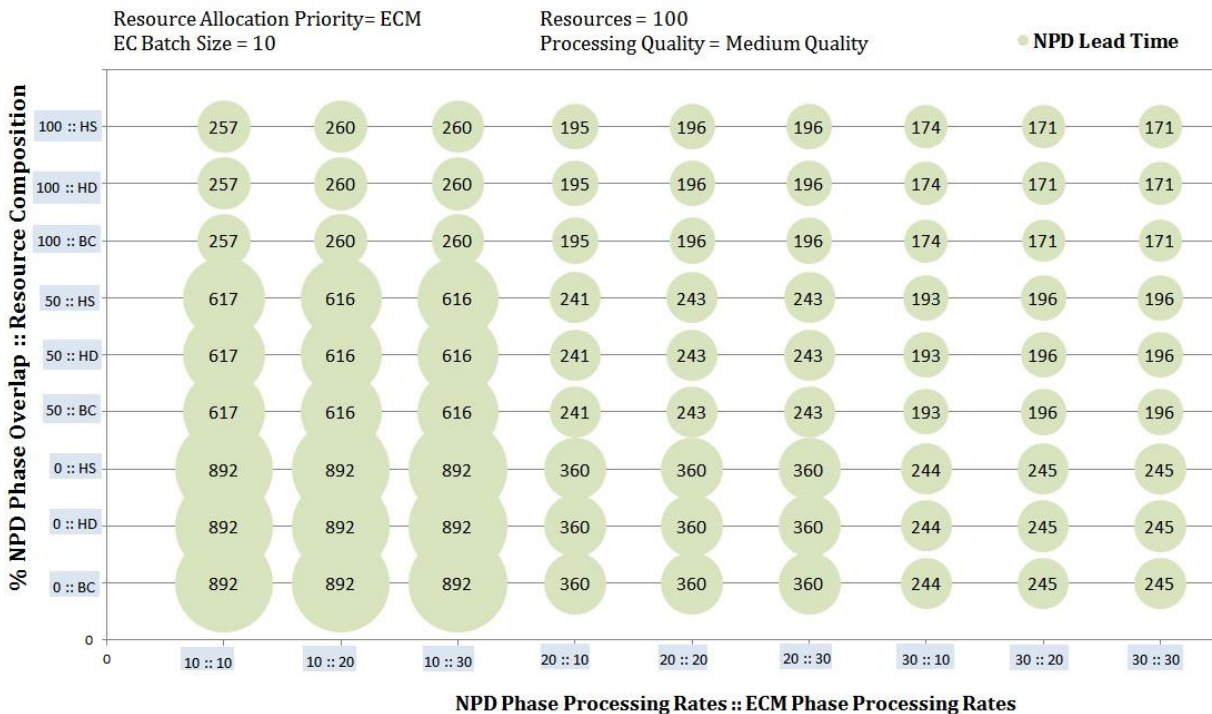

Figure 44: Influence of percentage phase overlap and resource composition, and NPD and ECM processing rates on NPD lead time

**7.3.4 Conclusions:**

Some of the process parameters like NPD processing rates, phase overlap, processing quality and resources demonstrate a significant influence on NPD lead time. Interactions between the process parameters exist and also have a significant influence on the NPD lead time. Because of the interactions, any specific value for any parameter is not always beneficial. For low resources ECM resource allocation priority is advantageous compared to NPD resource allocation priority. High processing quality at all the NPD and ECM process phases results in low lead times. Similarly, higher resources and NPD processing rates should normally ensure lower NPD lead times. When the resources are low, EC grouping is advantageous with NPD resource allocation priority and ECM resource

allocation priority is advantageous without EC grouping. To ensure low NPD lead time the effect of all the parameters should complement each other as far as possible.

This simulation model can provide managers with necessary data to make informed strategic decisions by examining the effects of a chosen strategy. Insights developed from these results can help managers in reliably planning and executing NPD projects. Typically, managers use the history of the process to quantify the established process variables such as phase processing quality and components to resource type ratios. Based on the present NPD process parameter values, the managers, indeed, can select an appropriate case to elicit some useful information for process improvement. Infact, for any given resources and processing quality the ECM and NPD processing rates should complement each other in order to ensure the least possible NPD lead time.

The accuracy of the model results relies on the accuracy of process parameters, which is always associated with some uncertainty. This, combined with the uncertainty in the future NPD projects, may not result in simulation results that are absolutely accurate down to the numbers. But nevertheless the results would familiarize managers with the dynamics and interactions underlying/between the process parameters.

## **8 SIMULATION MODEL VERIFICATION AND VALIDATION**

### **8.1 ECM Survey**

The core assumptions noted in developing the templates have been verified using an industry survey (Survey Questionnaire presented in Appendix section 12.1). A survey consisting of 24 questions was given to employees of manufacture to order organizations that collaborate with suppliers in the role of the Original Equipment Manufacturer.

The phases within the NPD process were accepted by 80% of the survey respondents. The NPD phases include concept development, detailed design, prototyping and testing, production ramp-up and product assembly and testing. 95% of the respondents agreed that they would divide the NPD project into independently workable parts which would later be assembled together to complete the project. The categorization of the suppliers based on their involvement in the NPD process was accepted by about 95% of the survey respondents.

While 45% of the respondents agreed that a formal engineering change management process is in place to guide personnel with engineering changes, 55% did not agree that a formal engineering change process exists. Notwithstanding, all the respondents have indicated that personnel do not change product data without being reviewed by all the personnel associated with the product data. This indicates that a formal ECM process is being adopted though; it is not formally recognized and defined as a change management process.



## 8.2 OEM Template Verification and Validation

The OEM template that has been used to develop the other organization templates has been verified by gradual addition of features and reviewing the results for consistency at each level. Figure 45 shows the different stages of organization templates development. The models 1, 2 and 4 (presented in chapter 7) represent the NPD and ECM processes in an organization while the model 3 (presented in chapter 6) and 5 (presented in chapter 9) represent the NPD and ECM processes in a collaborative environment. The number of parameters has been increased from model 1 to model 4 and the results at each stage have been reviewed for consistency.

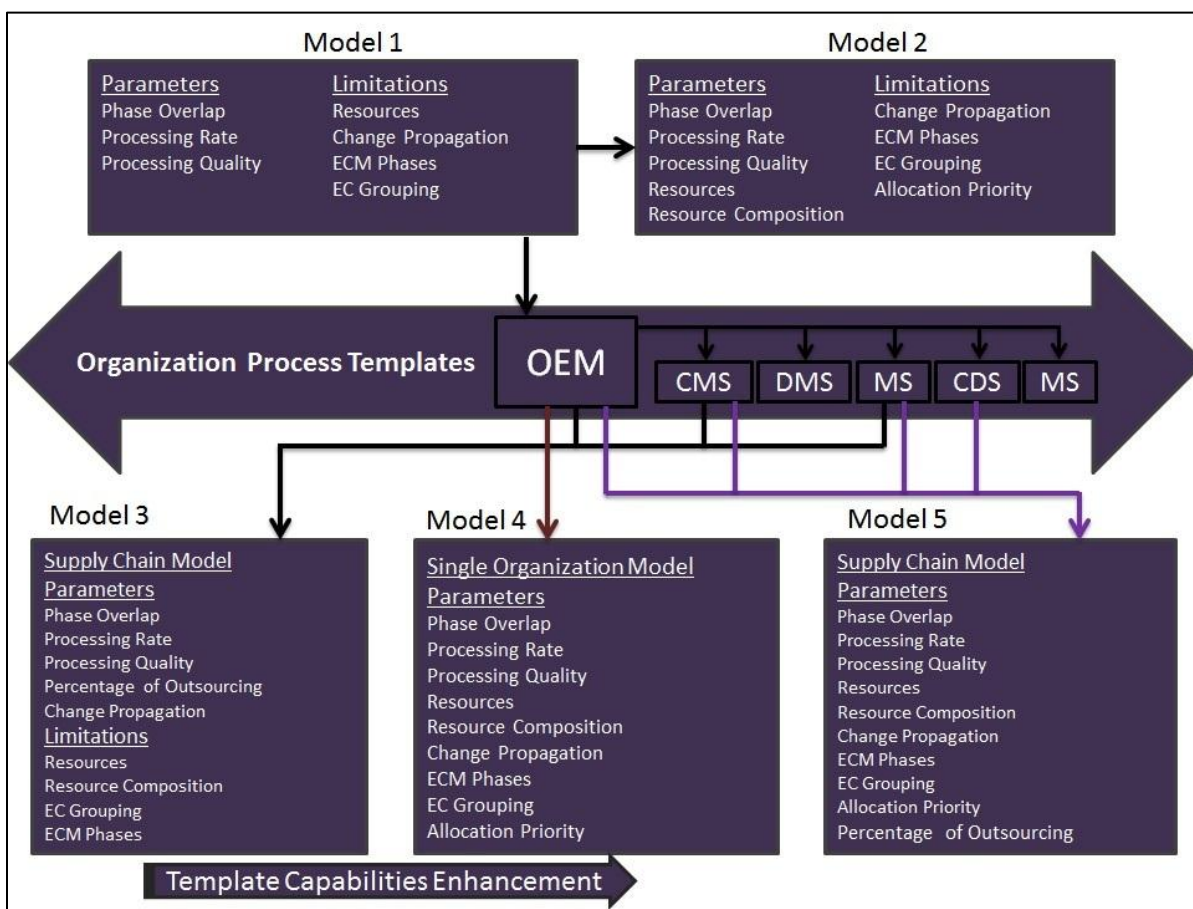

Figure 45: Schematic of OEM template verification

The OEM template which is the base template (from which the supplier templates have been generated by modifying the NPD phases) has been, by and large, validated using the data from the previous work presented by Repenning 2000 and Black and Repenning (2001). The NPD and ECM processes of the OEM were modified to emulate the models presented by Repenning (2000, 2001) and Black and Repenning (2001). The modifications done to the OEM template to imitate the model presented include:

- (i) It is assumed that the changes are only in the individual components and not in the product assembly. This means that the change request probability in the assembly and testing phase is zero. And ECs are proposed at the end of prototyping and testing phase and during the production phases only.
- (ii) The NPD phases concept, design, and prototyping are assumed to represent the “early phase”, while the production, assembly & testing and ECM are assumed to represent the “current phase” in the Repenning’s model. The EC documentation phase has been side lined; and the phases EC proposal, EM approval and EC implementation of the ECM process have been assumed as a single phase instead of the three phases.
- (iii) The number of changes in the early (concept and design) phase is one third of that in the current stage (production and assembly).
- (iv) At the end of each year components are transferred from early phase to current phase, while the components from current phase are thereafter released into the market.

- (v) A NPD project constituting of a definite number of components is started every year and another NPD project is completed and released to the market.

The model was simulated for duration of 13 years, with one time increase in the number of components constituting the NPD project, in the 3<sup>rd</sup> year. The increase in the number of components was defined as a fraction of the components in the base case (1000 components). The value of the fraction is increased from 0 to 1 with increments of 0.1, where 0 represents the base case of 1000 components and 1 indicates 2000 components. The performance was measured as “quality”-defined as the number of components processed divided by the number of components in the NPD project.

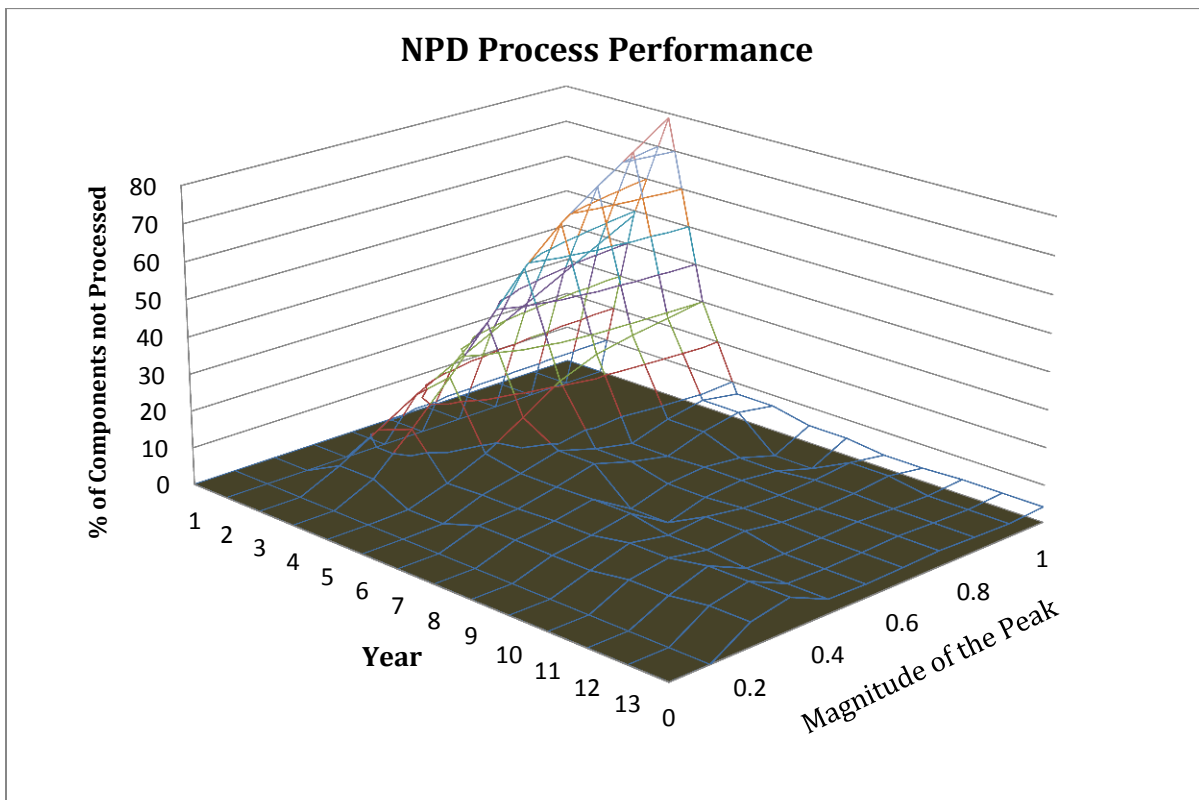

Figure 46: NPD process performance for varying magnitude of the peaks

Figure 46 shows the performance of the NPD process as % of unprocessed components which is defined as the difference  $(1 - \text{quality})$  multiplied by 100. The system performance for a period of 13 years and various magnitudes of test peaks varying from 0 to 1 have been, consequently, recorded and plotted (Figure 46). For test peaks 0.1 and 0.2 the performance of the process, plummets after the peak is introduced, but recovers to its normal state of performance over the next couple of years. But for all the test peaks from 0.3 to 1, the system performance falls immediately after the peak is introduced and the system recovers to a steady state of performance that is below the normal state of performance. This condition would drastically increase the demand for resources just before the product launch so as to make it possible to get the system back to normal state of performance. This would repeat annually and such a condition is called firefighting, by virtue of fact that it represents the same phenomenon described by Repenning (2000, 2001) and Black and Repenning (2001).

### **8.3 Conclusion**

The NPD process model discussed in this research is very complex, compared to the model presented by Black and Repenning (2001), in terms of the level of process detail, inclusion of resource disciplines, and resource allocation. The present model also includes the ECM process, along with the NPD process, which makes it much more complex. In order to ensure that the results obtained from this model are acceptable, we need to validate the results for a known case with known results. As discussed above, when the present model is modified to imitate the assumptions of the previous work by Black and Repenning (2001), it

duplicated the same phenomenon of firefighting indicating that the core logic within this complex model structure is right and the results valid. And since the supplier templates are modeled by edited the OEM template; deleting the appropriate phases and process parameters, while keeping the process logic the same, they are also expected to be validated.

## **9 MODELING AND SIMULATION OF NEW PRODUCT DEVELOPMENT AND ENGINEERING CHANGE MANAGEMENT IN A COLLABORATIVE ENVIRONMENT**

### **9.1 Introduction**

In this chapter, we use enhanced versions of the templates (Appendix 12.2) for the OEM and suppliers (presented in chapter 6) to model a supply chain consisting of three types of suppliers and OEM. System Dynamics simulation models (Forrester 1968, Sterman 2000) of a sample supply chain have been developed utilizing the enhanced templates (Reddi and Moon 2011b) to study the interactions and dynamics of the NPD and ECM processes. The suppliers considered in this model are

- (i) the Concept to Design Supplier (CDS) who participates in the concept development and detailed design phases of the NPD project,
- (ii) the Concept to Manufacturing Supplier (CMS), who participates in the concept development, detailed design, prototyping, and production ramp-up phases of the NPD process, and
- (iii) the Manufacturing Supplier (MS) who participates in the prototyping and the production ramp-up phases of the NPD process.

The interactions between the OEM and the suppliers are modeled and simulated under various parameter settings representing different supply chain configurations. The effects of the considered parameters on the supply chain performance are studied.

## **9.2 Research Methodology:**

The initial templates (Chapter 6, Reddi and Moon 2011b) were of basic detail and were limiting and only good enough to demonstrate the advantages of the developed templates. The modeled templates did not include the phases within ECM process, Resource allocation priority, and capability to model the batch processing of ECs. This chapter presents a supply chain model developed by using the enhanced versions of these templates presented in chapter 6. In short, the enhanced templates include the provisions for prioritizing the resource allocation to the phases of the NPD and ECM phases, grouping the ECs for processing, and the phases within the ECM process.

### **9.2.1 Enhanced Templates:**

In a collaborative product development setting, the suppliers interact with OEMs at specific stages during the NPD process. Having discerned typical patterns of the interactions, several templates for all the informed organizations in the supply chain have been aptly presented in chapter 6. Since then, the templates have been enhanced to include additional phases of the ECM process, EC grouping, and prioritized resource allocation to the phases of NPD. The enhanced templates are used to model a supply chain consisting of one OEM and three types of suppliers: Concept to Design Supplier (CDS), Concept to Manufacturing Supplier (CMS), and Manufacturing Supplier (MS).

The ECM process that was modeled as single phase in the previous templates (presented in chapter 6) has been expanded and modeled by including EC proposal, EC approval, EC implementation and EC documentation phases. The capability of processing

ECs in batches has been embedded in the enhanced templates. The size of the batches can be defined during the simulation set up; a value of zero indicates that the ECs are processed immediately while, in this respect, a non-zero value indicates the batch size. During the project execution the ECs are only processed in groups and are delayed until a group of size equal or greater than the indicated EC batch size is accumulated. However, in the final stages of the project, when the ECs are proposed infrequently, they are processed immediately upon proposal to avoid any unnecessary delay. The status of the project is defined by the percentage of components processed in the production-ramp up phase. The order in which the resources are allocated to the phases of the NPD and ECM processes can be changed and are not fixed.

In addition to the above improvements, the resources (which were assumed to be infinite in the initial models [presented in chapter 6] to ensure the completion of the NPD project within a year) are considered to be limited. To coordinate with the limited number of resources, the phase overlap is changed from a time-based parameter to a project-status-based parameter. The phase overlap in the initial templates (presented in chapter 6) was defined in terms of the time delay, i.e. the time after which a phase starts following the start of the previous phase. In the enhanced templates, the phase overlap is defined in terms of the number of components processed in the previous phase instead of the time, the details of which are presented in the following model logic (Section 9.2.2). These changes attempt to address the limitations of the organization templates presented in chapter 6 by increasing the functionality and eliminating the impractical assumptions like unlimited resources. Assuming that limited resources make it necessary to include



additional functionality such as priority based resource allocation. These changes as a whole, bring the model closer to reality because organizations normally have limited resources; and always need the flexibility in allocating resources to address long-term and short-term goals.

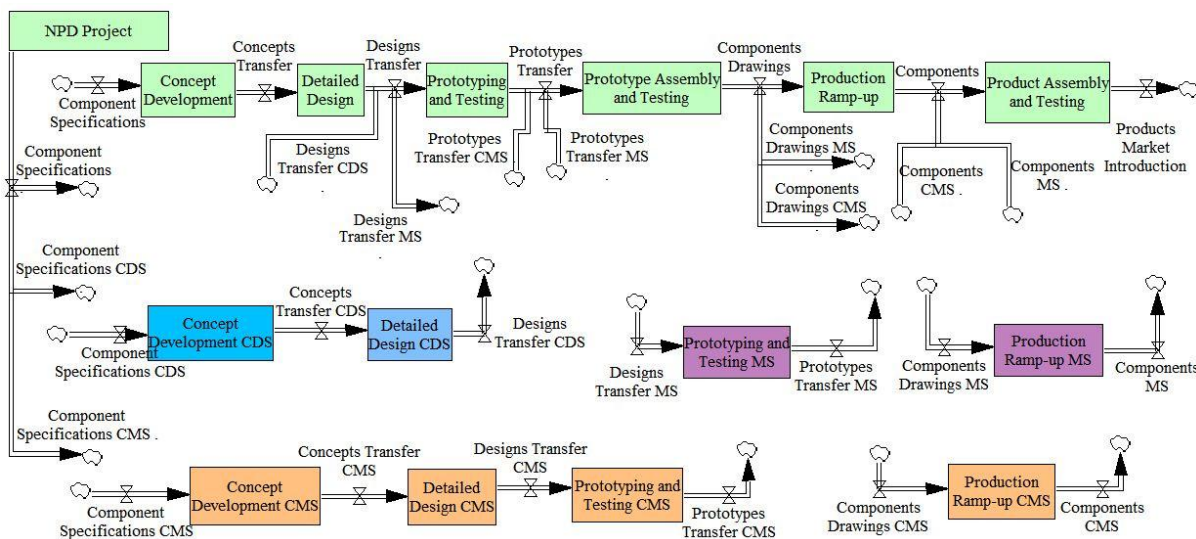

Figure 47: Schematic diagram of the supply chain model interactions

### 9.2.2 Model Logic:

The NPD project starts with an OEM determining the number of components constituting the NPD project and the percentage of the components to be handled by each of the suppliers. The components are then transferred to organizations designing the corresponding components. The components concepts are developed and followed by the detailed designs. The detailed designs from the CDS are transferred to the OEM, from where the detailed designs are again transferred to the MS and OEM for prototyping. After the prototyping, the components are sent from the CMS and MS to the OEM for prototype assembly and testing. The prototype assembly and testing are considered complete when

all the components of the project are prototyped and transferred to the OEM for assembly and testing. Once the prototype assembly and testing is complete, appropriate proportions of the prototypes defined by the percentage of components manufactured by the organizations are transferred to the OEM, MS and CMS for production ramp-up. The produced components are then transferred to the OEM for product assembly and testing. The assembled and tested products are then considered ready for market release. The entire NPD project is considered complete when all the components are, indeed, ready for market release. Figure 47 shows the schematic of the simulation model logic.

The process characteristics such as resources, resource composition, phase overlap, processing quality, processing rate, allocation priority, out sourcing, change propagation and EC grouping have been considered and simulated to study their effect on the OEM performance.

### **9.2.3 Resources and Resource Composition**

The components at each phase are processed by shared resources as well as dedicated resources. The examples of the dedicated resources are the design resources, production resources, quality and testing resources, and marketing resources. The shared resources include design & production resources and production & quality resources. While the dedicated resources are allocated to address the respective demands, the shared resources are dynamically allocated to address the demand for any one of the dedicated resources. The design & production resources are allocated to meet the demand for design or production resources, while the production & quality resources are used to meet the

demand for production or quality and testing resources. An example of the resource composition values used in the model simulation corresponding to the levels high dedicated and high shared can be found in Table 6.

Table 6: Resource Composition

	Resource Type					
	Design Resource Type	Production Resource Type	Quality and Testing Resource Type	Marketing Resource Type	Design and Production Resource Type	Production and Quality Resource Type
High Dedicated	0.3	0.3	0.1	0.1	0.1	0.1
High Shared	0.15	0.15	0.1	0.1	0.25	0.25

#### 9.2.4 Phase Overlap

The phase overlap represents the percentage of overlapping between the NPD phases and expressed in terms of the components processed by the previous phase. For a given percentage of phase overlap  $P$ , processing at any phase starts when the  $(100-P)$  percentage of NPD project components are processed at the previous phase. For example, for a phase overlap of 75% the design phase starts when 25% of the component concepts are developed. This indicates an overlap of 75% between the design and concept phases. Similarly for 0% phase overlap the design phase only starts when 100% of component concepts are developed in the concept phase.

#### 9.2.5 Processing Quality

At each phase as the components are processed, only a percentage of the processed components, representing defect/error free components are considered ready for next

processing phase. While the other proportion of the components, considered defective are either looped back to the previous phases for reprocessing or processed using the ECM process. For example, at the end of the concept phase, all the defective components are fed back for concept reprocessing, while at the end of the detailed design phase, the defective designs are either sent to the concept phase or detailed design phase for reprocessing. The components that require reprocessing after and during the prototyping and testing phase of NPD process are processed through a formal ECM process. The number of changes processed by any organization is the product of total number of changes and percentage of NPD project components handled by the organization.

The processing quality in the concept and detailed design phases is defined by the percentage of error-free concepts or designs developed. Similarly, the processing quality in the prototyping and testing, production ramp-up, and assembly and testing phases, is defined by the percentage of processed components effected by proposed ECs. A range of realistic values (Ahmed and Kanike 2007) (Refer to Table 7) is assumed to simulate the model so as to study the effects of the processing quality, and its interactions with other values, on the NPD lead time.

Table 7: Processing quality data

	NPD Phases				
	Concept Development	Detailed Design	Prototyping	Production Ramp-up	Assembly and Testing
High	0.9	0.95	0.05	0.03	0.02
High-Medium	0.85	0.9	0.1	0.06	0.04
Medium	0.8	0.85	0.15	0.1	0.05
Medium-Low	0.75	0.8	0.2	0.15	0.1
Low	0.7	0.75	0.25	0.2	0.15

### **9.2.6 Processing Rate**

Each organization has a desirable processing rate, which would be the actual processing rate if available resources were presumably sufficient. If the resources are not sufficient, the processing rate is adjusted based on the available number of resources. At regular intervals (such as weekly), the number of resources logically required to attain the desired processing rate is calculated based on the components to resource type ratios. The components to resource type ratios define the number of components a single resource of any resource type can process within the simulation time unit. If the available resources are greater than the required resources, the desired processing rate is the actual processing rate. Otherwise, it is calculated from the available resources and the components to resource ratios.

### **9.2.7 Resource Allocation Priority**

The order in which the resources are allocated to the different phases of NPD and ECM processes is defined by the allocation priority. An integer (Between 1 to 9, since the number of the total NPD and ECM phases is 9) is assigned to each of the phases that indicate the order of resource allocation. Higher the number is, the higher its priority is. In other words, the phase with integer value of 9 is first allocated with resources while the phase with integer value of 1 is allocated resources last.

During resource allocation, the dedicated resources are first allocated to address the demand for resources, followed by the shared resources. After the allocation of dedicated resources, the design and production resources are allocated to address the demand for

design resources followed by production resources. In the next stage, the production and quality resources are allocated to address the demand for production resources followed by the demand for quality and testing resources. The priority of each phase corresponding to the ECM, NPD and combination priority conditions can be found in Table 8.

Table 8: Allocation Priority

Priority	Phases									
	New Product Development					Engineering Change Management				
	Concept	Design	Prototyping	Production	Assembly	EC Proposal	EC Approval	EC Implementatio	EC Documentatio	
NPD	9	8	7	6	5	4	3	2	1	
ECM	5	4	3	2	1	9	8	7	6	
Combo	9	8	7	2	1	6	5	4	3	

### 9.2.8 Outsourcing

The outsourcing is defined as a percentage of NPD project components that are processed by suppliers. The percentage of outsourcing chiefly is the sum of the percentages of components handled by all the suppliers (CDS, CMS and MS in this case) expressed as percentage of the components constituting the NPD project.

### 9.2.9 EC grouping

The organization may adopt various alternate strategies to process the components affected by ECs depending upon the available resources and time. It may process the components as they are proposed to ensure the least possible time or can group them and

then process in batches to ensure better resource utilization and productivity. An EC batch size of 0 indicates that the components are processed as soon as they are proposed; and any value other than zero indicates the minimum batch size or components queue required to be processed. As long as the number of components waiting to be processed via ECM is less than the minimum batch size, the components are not processed.

### **9.2.10 EC Propagation**

When an EC is proposed, it would generally affect multiple components due to change propagation. To address this indispensable phenomenon in the ECM process, all approved ECs are multiplied with an EC propagation index. The index of 1 or higher indicates that multiple components are being affected by a single EC. The value of the EC propagation index depends upon the NPD project status. The status of the project is indicated by the number of components manufactured, signifying the completion of the project. The greater the number of manufactured components is, the greater the value of the propagation index is. The values of the EC propagation index for 25%, 50% and 75% project completion are 1.2, 1.4 and 1.6 respectively.

## **9.3 Results:**

The System Dynamics model (Appendix 12.3.4) of NPD and ECM processes has been simulated to study the effects of the process parameters on NPD lead time. The processing of a NPD project consisting of 1000 components is simulated. The duration of the simulation was set to ensure all the components are processed and are ready for market introduction. The period of time from the time the NPD is initiated to the time when all the components

are ready for market introduction is defined as NPD lead time. The NPD lead time is considered to be a measure of process performance and the effect of all system parameters and their interactions on the lead time are thoroughly studied. The details of the simulations set up, and results are discussed below.

**9.3.1 Case 1:**

For this case, 31 process parameters were considered with 2 levels high and low. The values of the model factors or variables corresponding to these two levels used in the simulation can found in Table 9. Factorial design from the Design of Experiments (DOE) (Anthony 2003) methodology was used to generate the simulation data and analyze the model results.

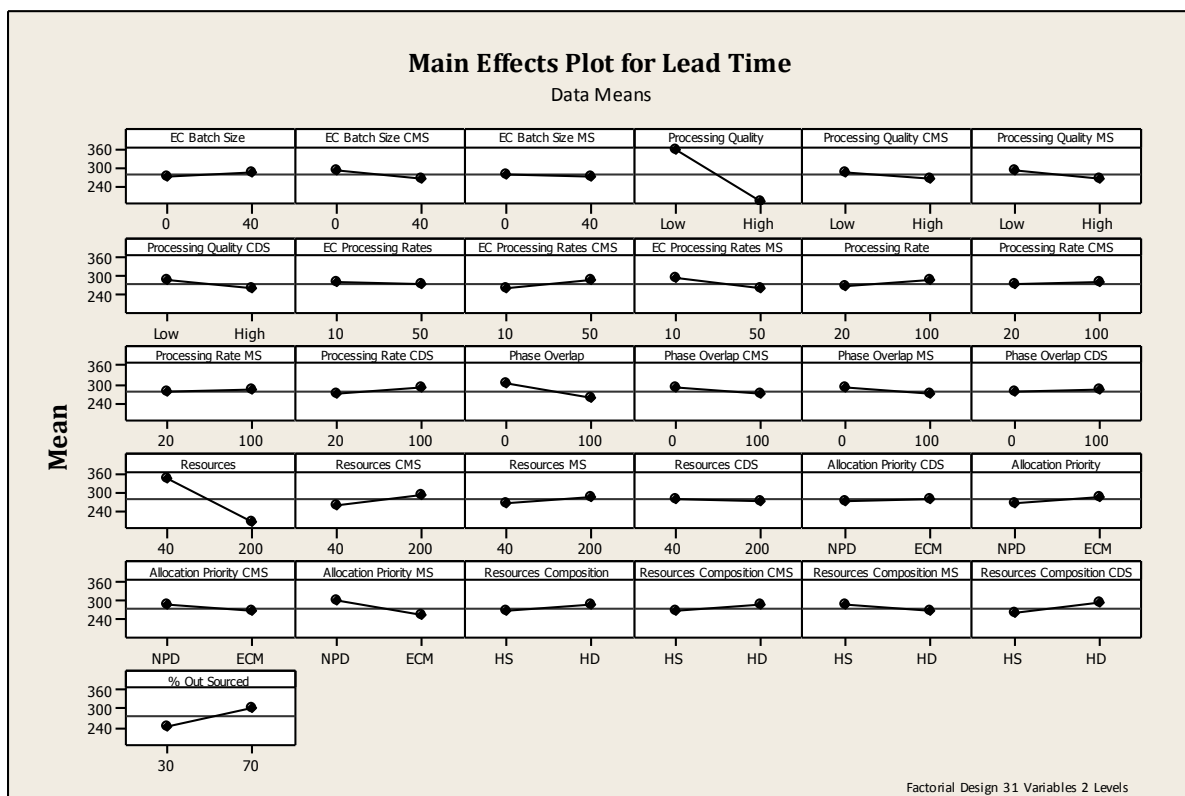

Figure 48: Effect of Process Parameters on Lead Time using Factorial design approach of DOE



Table 9: The 31 Variables representing the ECM and NPD process across the supply chain

Process Parameters		Low	High
Original Equipment Manufacturer Process Parameters	EC Batch Size	40	0
	Processing Quality	High	Low
	ECM Processing Rates	50	10
	Processing Rate	100	20
	Phase Overlap	100	0
	Resources	200	40
	Resources Composition	HD	HS
	Allocation Priority	ECM	NPD
	% Out Sourced	70	30
Concept to Manufacturing Supplier Process Parameters	EC Batch Size CMS	40	0
	Processing Quality CMS	High	Low
	ECM Processing Rates CMS	50	10
	Processing Rate CMS	100	20
	Phase Overlap CMS	100	0
	Resources CMS	200	40
	Allocation Priority CMS	ECM	NPD
	Resources Composition CMS	HD	HS
Manufacturing Supplier Process Parameters	EC Batch Size MS	40	0
	Processing Quality MS	High	Low
	ECM Processing Rates MS	50	10
	Processing Rate MS	100	20
	Phase Overlap MS	100	0
	Resources MS	200	40
	Resources Composition MS	HD	HS
	Allocation Priority MS	ECM	NPD
Concept to Design Supplier Process Parameters	Processing Quality CDS	High	Low
	Processing Rate CDS	100	20
	Phase Overlap CDS	100	0
	Resources CDS	200	40
	Allocation Priority CDS	ECM	NPD
	Resources Composition CDS	HD	HS

The graphs showing the effect of each factor on the lead time are shown in Figure 48. The effects plots of all factors impart a non-zero slope indicating that all the factors affect the NPD lead time. The factors such as resources, processing quality, allocation priority and percentage of outsourced components effect the NPD lead time to a greater extent while the rest of the factors have a relatively smaller effect in the NPD lead time.

### **9.3.2 Case 2:**

Using the factorial method of DOE, the effects of the 13 variables, representing the interactions between the OEM and suppliers, are studied at 2 levels. The exact values of the 13 variables, used in the simulation can be found summarized in Table 9. Keeping the values of all the system parameters at low and high values the model was simulated using the generated simulation data for 13 selected parameters. The simulation results described were later analyzed using the factorial design methodology of DOE. The Pareto graphs in Figures 49 and 50 show the effect of each process parameter on the lead time. It is observed that the number of factors effecting and extent of their effect on NPD lead time varies, based upon the state of the other variables which are set constant at one of the two levels low and high. When the factors (refer to Figure 49) are kept constant at level high, processing rate is the only factor that has significant effect. But, when the factors are kept at level low (Figure 50), the processing rate (G) and allocation priority (L) have a significant influence on the NPD lead time, while processing rate MS shows relatively smaller influence. The EC batch size which had a noticeable influence on the NPD lead time when the parameters were set constant at high, does not demonstrate any stipulated effect on

the NPD lead time when the variables are kept constant at level low, indicating the existence of an interaction.

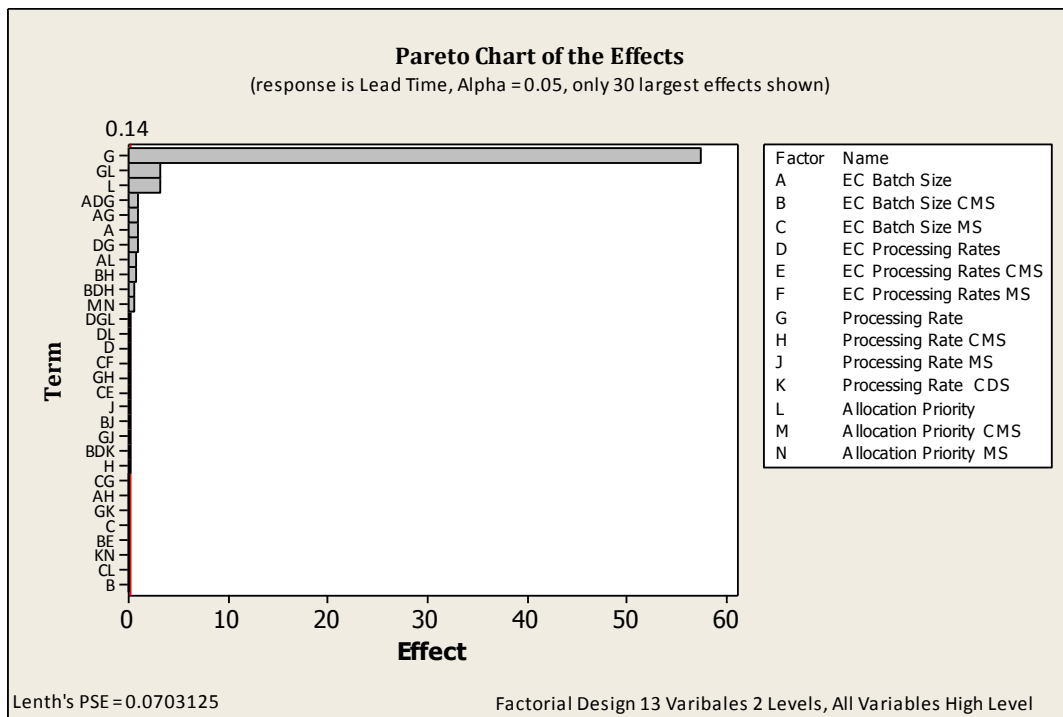

Figure 49: Pareto chart showing the effects of selected 13 factors on lead time with all variables at High state.

The increase in the quantity of factors and magnitude of the effect, from the case when variables are kept constant at level high to level low can be observed in Figures 49 and 50. When the variables are set high (Figure 49), the OEM has a significant effect on the NPD lead time. The variables, processing rate, allocation priority, EC batch size and combinations of these variables demonstrate the highest impact on the lead time, followed by combinations of concept to manufacturing supplier and manufacturing supplier variables. When the variables are set low (Figure 49), the OEM affects the lead time significantly followed by the suppliers. The effect of suppliers has considerably increased

compared to the previous case. It can be observed that, the influence of the suppliers on the NPD lead time is greater when the process variables level is low compared to high.

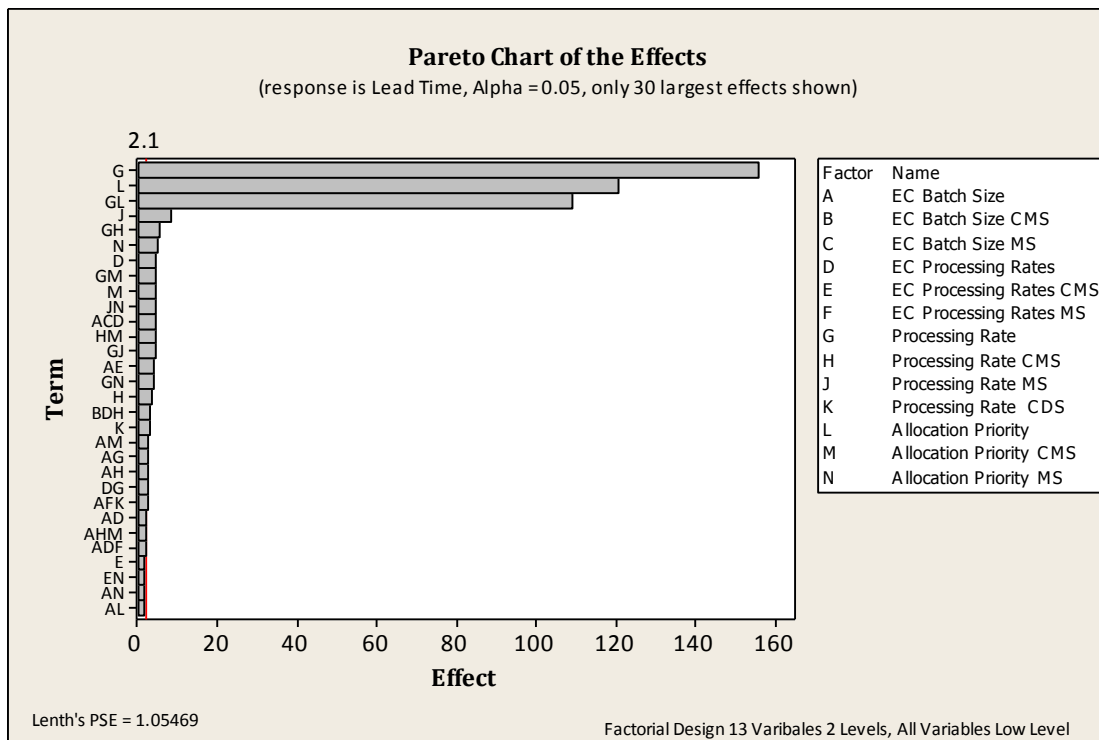

Figure 50: Pareto chart showing the effects of selected 13 factors on lead time with all variables at Low state.

### 9.3.3 Case 3:

The model has been simulated by varying a single variable, while all the rest of the variables are kept constant at two levels low, and high. Each parameter is simulated for a range of 5 values to study the effect of each of them on the NPD lead time, when all the other variables are at low and high levels. From the simulated results, the effect of each parameter of the OEM, and suppliers on the NPD lead time is studied and discussed below. Graphs are drawn to compare the effect of similar parameters of the organizations that are

part of the supply chain and the resource allocation priority strategy of the supply chain on the OEM lead time.

**9.3.3.1 Effect of Resources**

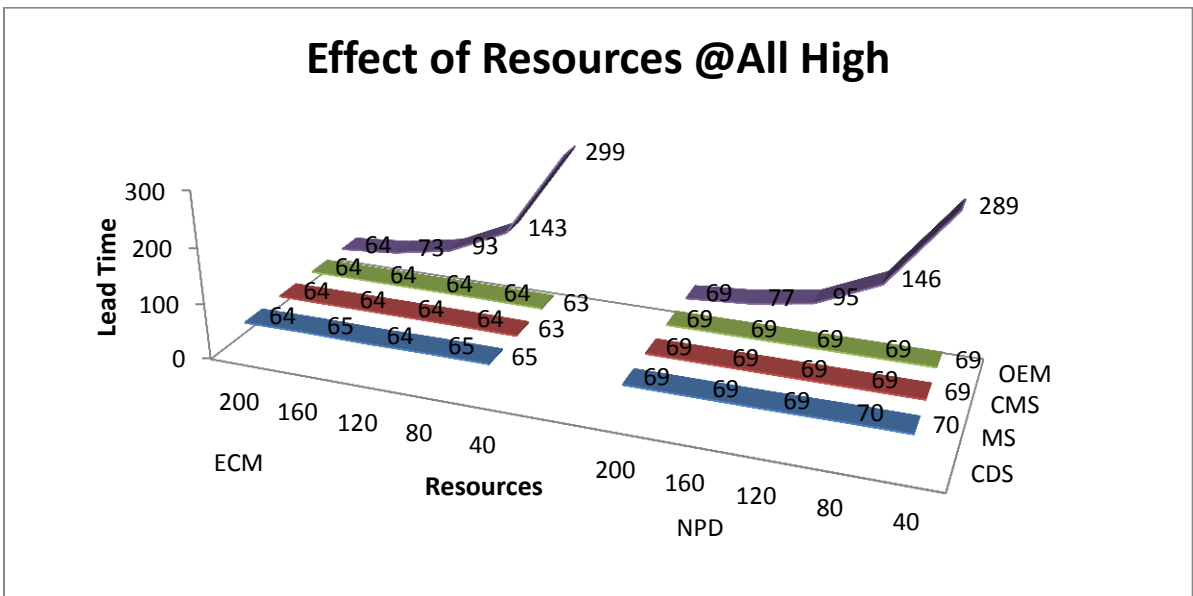

Figure 51: Effect of organization resources when all variable are set constant at high

The optimum resources of the OEM, varies with change of the status of all the other variables from high to low. While the number of resources of the suppliers does not seem to affect the lead time given that the quantity is more than the minimum 40. For the case when the variables are set at high (Figure 51), 200 resources for the OEM seem to result in lowest NPD lead time. The slope is relatively high at lowest point of the curve (Figure 51) indicating that there can be further decrease in lead time with increase in OEM resources.

The resources of the organizations do not have any significant effect when the variables are set at low (Figure 52) compared to cases when the variables are set at high, where the OEM resources have a significant effect on the lead time. It can also be noted

that 80 resources is optimum for the OEM, MS and CDS while 40 resources is optimum for CMS.

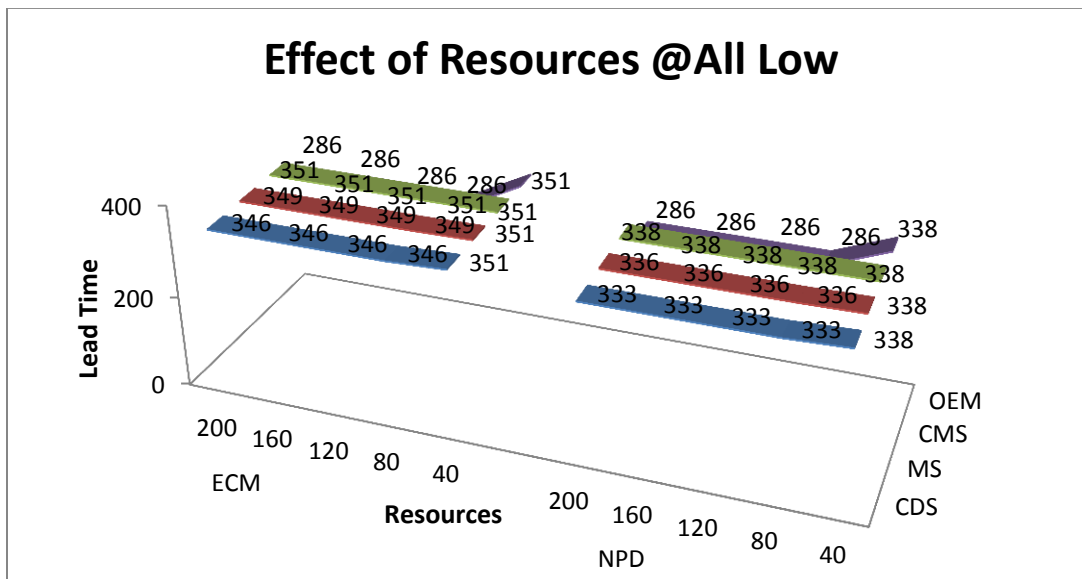

Figure 52: Effect of organization resources when all variable are set constant at low

### 9.3.3.2 Effect of Percentage Phase Overlap

The percentage of phase overlap of the suppliers does not affect the lead time significantly when the variables are set at high (Figure 53), but when the variables are set at low (Figure 54) the phase overlap of the manufacturing supplier effects the lead time. 0% phase overlap for the suppliers is advantageous when the variables are set at high but when the variables are set at low a non-zero phase overlap is advantageous. In all the cases, 0% phase overlap deteriorates the OEM performance thus increasing the lead time. Only the OEM phase overlap seems to have a strong influence on the lead time; and it is greater when the variables are set at high compared to low. When the variables are set at high, the ECM resources allocation priority is advantageous; but when in contrast the variables are set at low, the NPD resources allocation priority is advantageous.

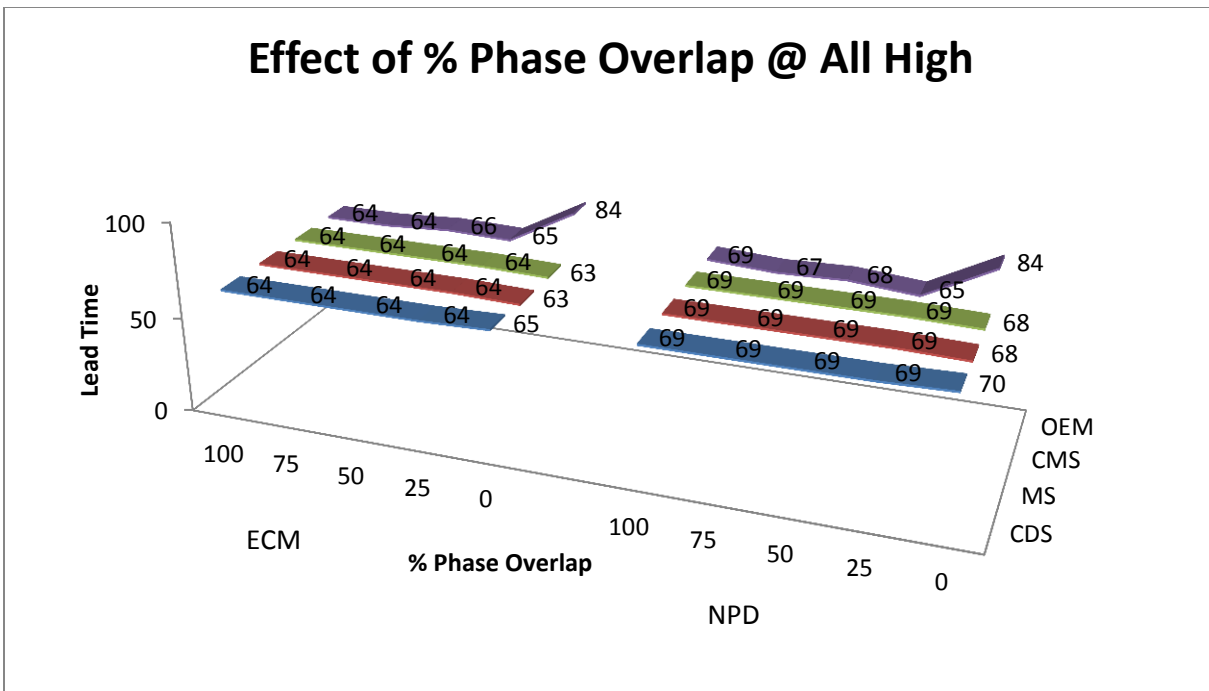

Figure 53: Effect of Percentage phase overlap when all variable are set constant at high

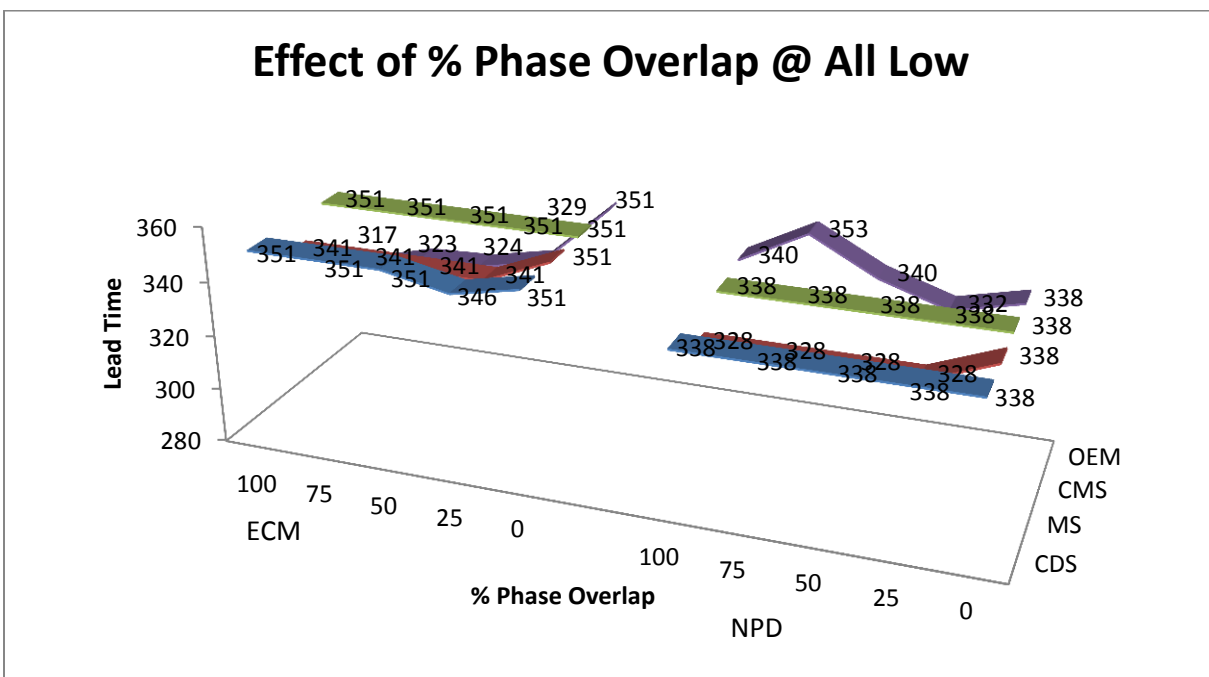

Figure 54: Effect of Percentage phase overlap when all variable are set constant at low

9.3.3.3 **Effect of Processing Quality**

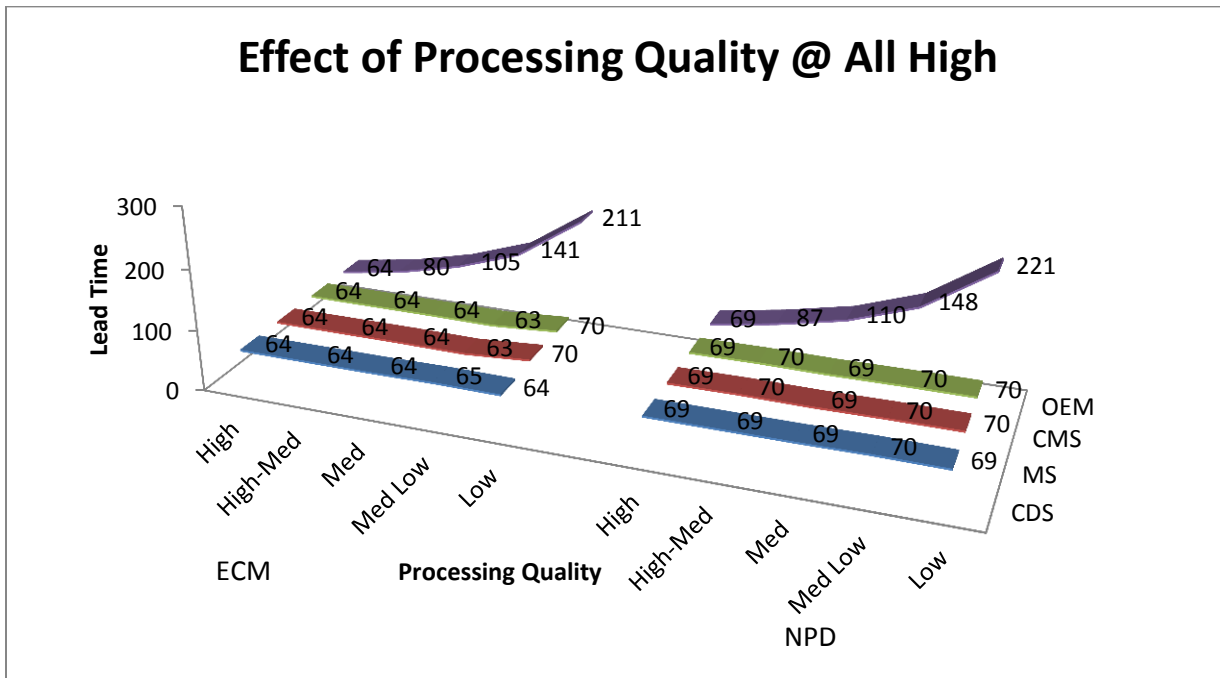

Figure 55: Effect of Processing quality on lead time when all variable are set constant at high

The processing quality of the suppliers does not affect the lead time significantly compared to the OEM processing quality which has a strong effect on the lead time. The higher the processing quality of the OEM, lower is the NPD lead time. When the variables are set at high (Figure 55) the ECM resources allocation priority is advantageous for all levels of processing quality of the organization in the supply chain, but when the variables are set at low (Figure 56) the NPD is advantageous. The actual values of the processing quality for each of the NPD phases can be seen in Table 6.



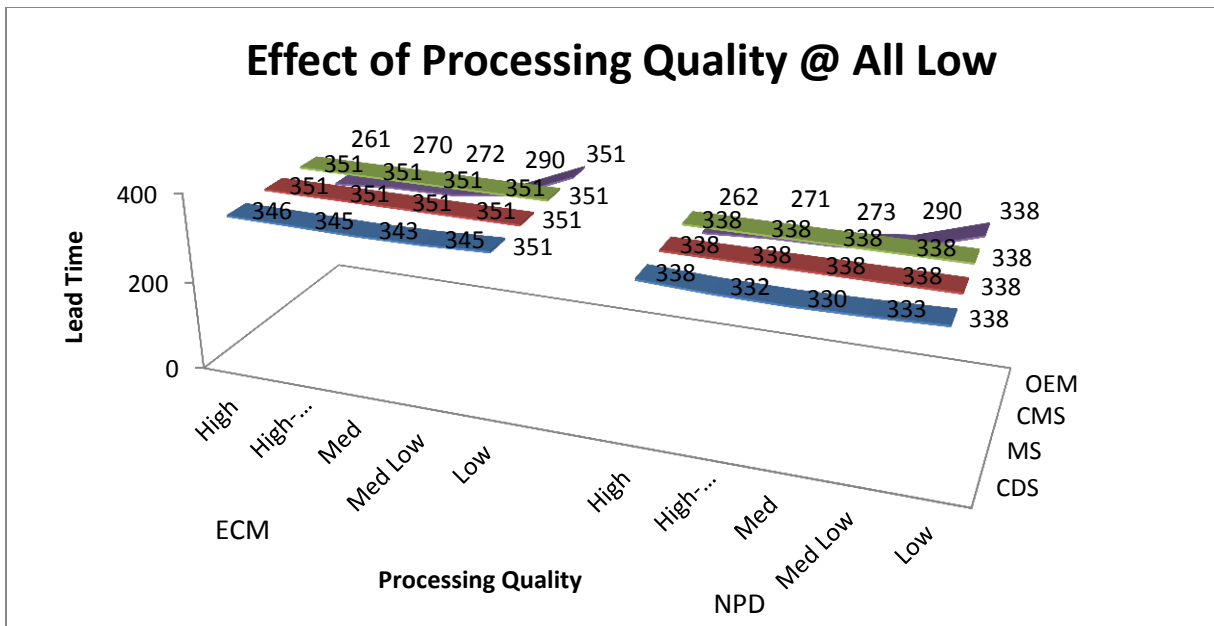

Figure 56: Effect of Processing quality on lead time when all variable are set constant at low

### 9.3.3.4 Effect of NPD Processing Rate

The NPD processing rates of the suppliers do not have a significant effect on the lead time assuming that it is more than the minimum (20 resources) considered. The NPD processing rate of the OEM has a considerable influence; and also indicates an optimum processing rate, corresponding to the status of the other variables (high or low). When the variables are set at high (Figure 57) the optimum processing rate for NPD allocation priority is 60, and for ECM priority it is 80 components per week. Similarly, with variables set at low (Figure 58), the optimum NPD processing rate of OEM is 20 for both NPD and ECM allocation priorities. It can be observed that the optimum NPD processing rate, resulting in lowest lead time keeps shifting endlessly according to the state of the variables. It can also be observed that ECM priority is advantageous when all the other variables are set at high (Figure 57) while NPD priority is advantageous when the variables are set at low (Figure 58).

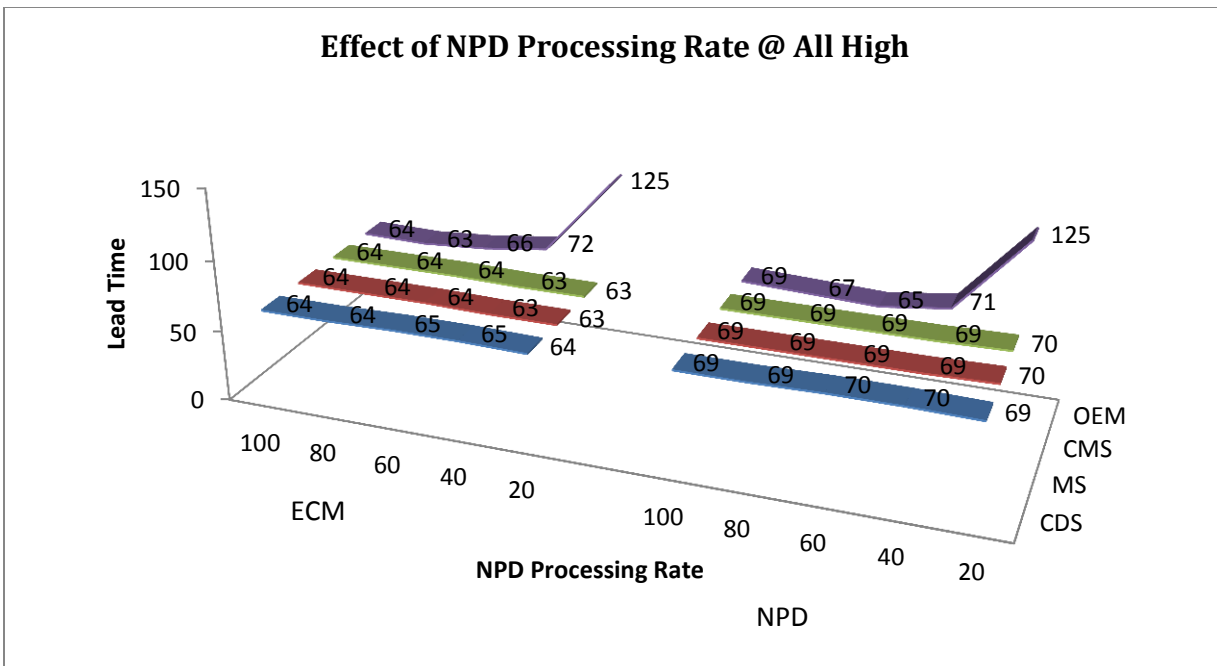

Figure 57: Effect of NPD Processing rate on lead time when all variable are set constant at high

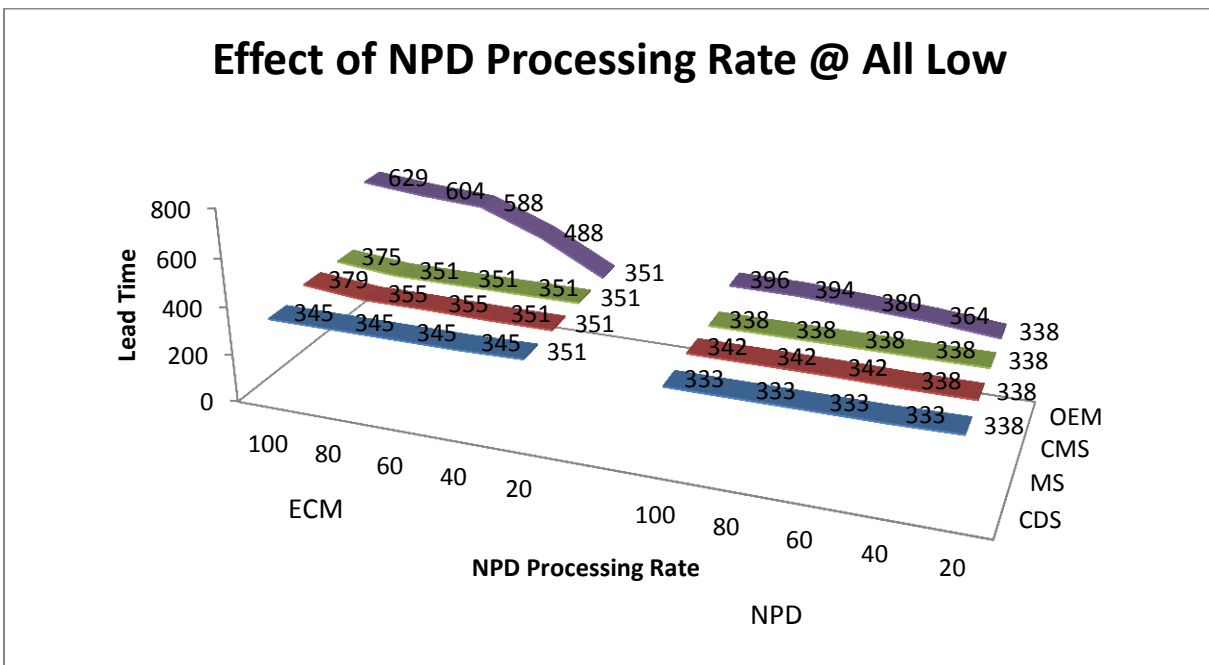

Figure 58: Effect of NPD Processing rate on lead time when all variable are set constant at low

9.3.3.5 Effect of ECM Processing Rate

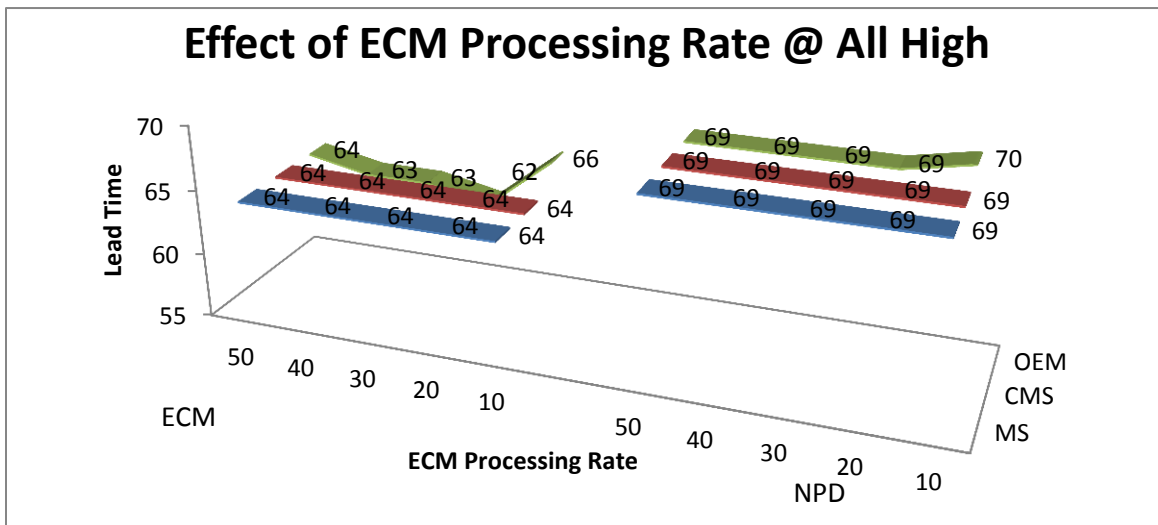

Figure 59: Effect of ECM Processing rate on lead time when all variable are set constant at high

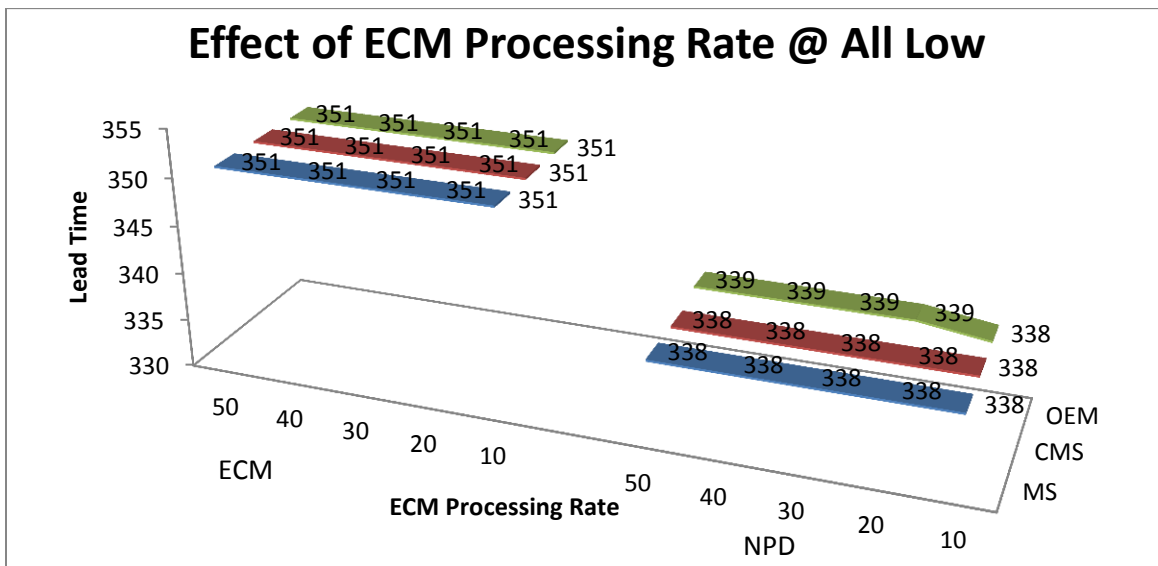

Figure 60: Effect of ECM Processing rate on lead time when all variable are set constant at low

The ECM processing rates of the suppliers do not affect the lead time (Figures 59, and 60) significantly implying that the lowest processing rate of 10 components per week is good enough for both the cases (variables levels high, and low). ECM processing rate has a greater effect on the lead time with ECM resource allocation priority, compared to NPD allocation priority. The ECM processing rate for the OEM has an optimum value, which

results in the lowest NPD lead time, when the variables are set at high (Figure 59). The optimum value of OEM processing rate is 20 components per week when the variables are set at high for both NPD and ECM allocation priorities. When the variables are set at low (Figure 60), then an ECM processing rate of 10 components per week for all organizations in the supply chain is good enough to avoid deteriorated process performance.

**9.3.3.6 Effect of EC Grouping**

The EC grouping of the OEM has considerable effect on the lead time in most of the cases (Figures 61, and 62). The suppliers do not have any significant effect on the lead time for all the variable levels and allocation priorities. A group size greater than 0, either degrades or does not improve the OEM performance, emphasizing that grouping of ECs is not advantageous. But EC grouping can be considered as long as it does not deteriorate the process performance because processing in groups is overtly considered to be more productive (Nadia 2006) compared to individual components.

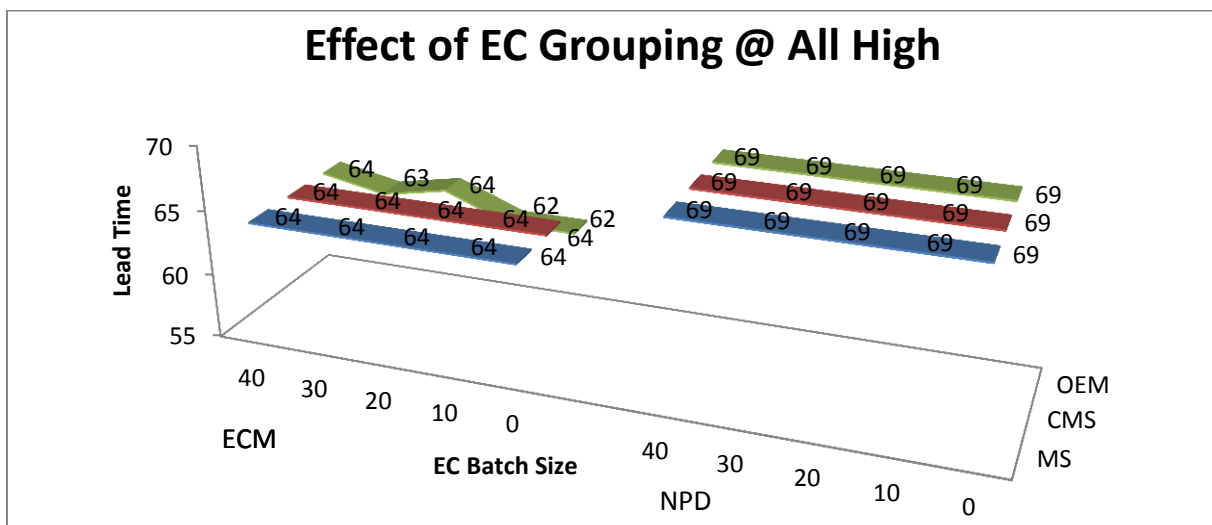

Figure 61: Effect of EC grouping on lead time when all variable are set constant at high

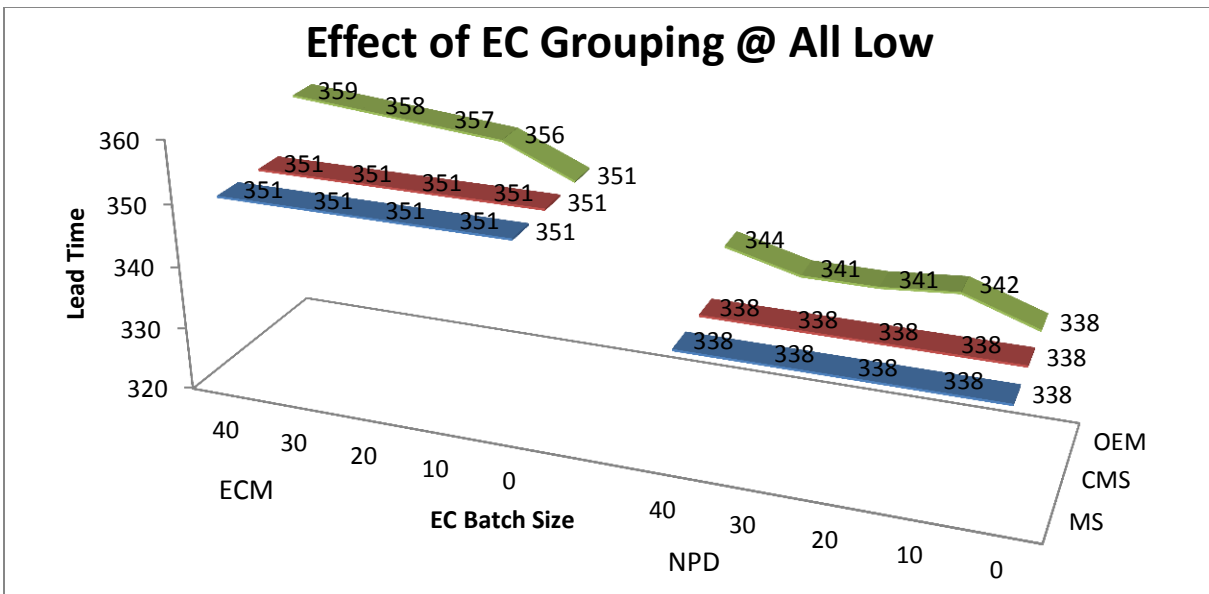

Figure 62: Effect of EC grouping on lead time when all variable are set constant at low

**9.3.3.7 Effect of Outsourcing**

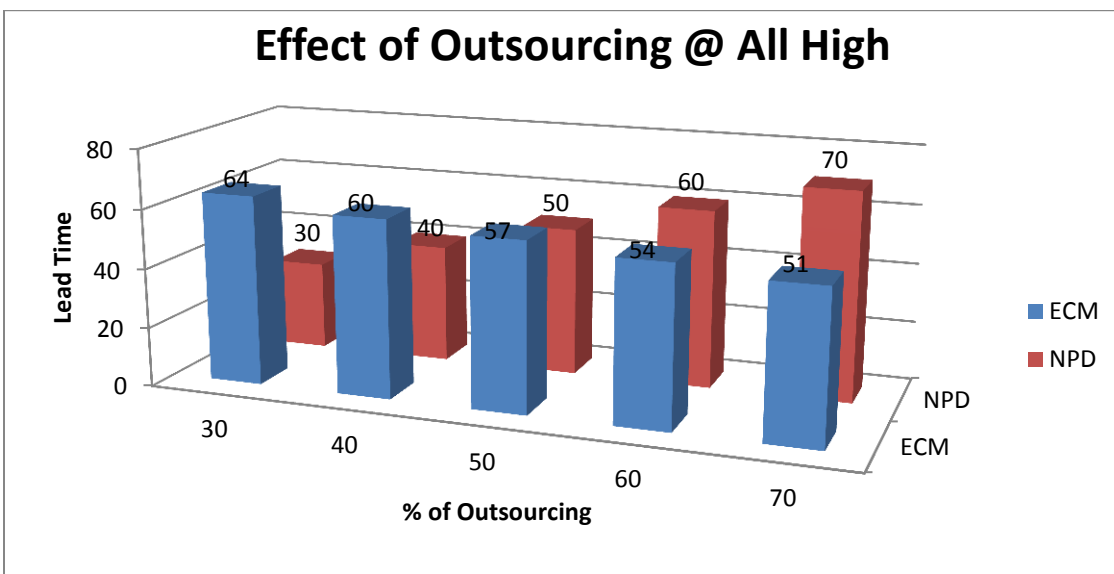

Figure 63: Effect of outsourcing on lead time when all variable are set constant at high

When the variables are set at high the lead time for NPD resource allocation priority increases with increase in outsourcing, but with ECM resource allocation priority it

decreases with increase in outsourcing. This indicates that the outsourcing is advantageous with NPD resource allocation priority, while it is the opposite with ECM allocation priority, with the variables set at high (Figure 63). This indicates that when an organization has adequate resources and good NPD and ECM processes in place to ensure high processing quality, it would be advantageous to follow the NPD or ECM resources allocation strategy depending upon the extent of outsourcing. For a higher percentage of outsourcing, ECM priority is keenly advantageous whereas, on the other hand, for lower percentages of outsourcing NPD priority is advantageous.

When the variables are set constant at low (Figure 64) then it is always advantageous to follow the NPD priority resource allocation strategy.

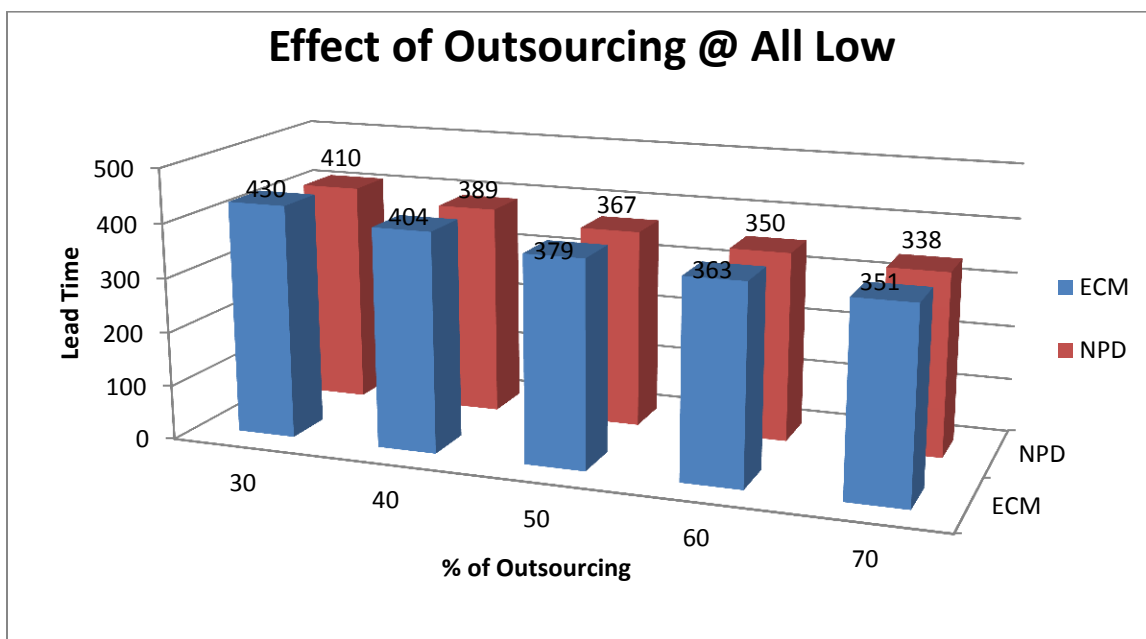

Figure 64: Effect of Outsourcing on lead time when all variable are set constant at low

#### 9.4 Conclusions and Future Work:

The conclusions from the simulation results can be summarized as following,

- All the system parameters should be complementing each other in order to attain the best achievable NPD lead time. The best or lowest NPD lead time is not possible by managing a few process parameters.
- When a few parameters are assumed to be constant there exists, an optimum value for other parameters beyond which there is either no improvement in the performance or degraded performance. For example, when all process parameters are constant there exists, a processing rate beyond which there is no decrease or change in lead time.
- The effect of any single process parameter on the NPD lead time varies with respect to the status or magnitude of the other system parameters.
- The OEM process parameters always affect the NPD performance while the effect of the participating suppliers is dominant only when the process parameters are low or limited.
- For an OEM involved in collaborative product design, NPD resource allocation priority is advantageous with scarce resources and low quality process conditions while ECM is advantageous with adequate resources and high and moderate quality process conditions.
- Grouping ECs does not make any difference to the process performance and hence processing the ECs, as they are proposed is advantageous.

The accuracy of the model results depend on the numerical values of the parameters. Though the numerical values are not used from an industry, realistic values were assumed to study the effect of the NPD and ECM process parameters on the supply chain performance.



## **10 CONCLUSIONS AND FUTURE WORK**

The conclusion from the research can be summarized as follows:

- In spite of its importance in the industry, academic research on engineering change management is limited, compared to other product life cycle topics like product life cycle management or new product development.
- Engineering Change Management tools are of great help to manage the ECM process and the impact of EC implementation. To ensure an effective Engineering Change Management process tools that can assist in visualizing the impact of an EC and ECM policies before adopting them are required.
- A simple change propagation framework or tool can effectively identify the components affected by an EC provided all the relationships between the components are captured during the design stage. Even in the absence of an effective process it emphasizes the importance of establishing the logical and physical relationships between project components at the concept and design phase, and reduces the risk of NPD project failure (Chapter 4).
- Implementing ECM workflow on a SOA platform makes it flexible and allows maintaining a single point data access. A predefined known governance policy is required to manage the access of the suppliers to the same data source across the internet via information services (Chapter 5).

- SOA based ECM framework enables the companies to utilize the best resources available to them altogether and also uses an available set of services tailored together to develop customized ECM workflow (Chapter 5).
- Simulation of the NPD and ECM processes highlights the leverage points of the processes and help to avoid bottlenecks within the process (Chapter 6, 8 and 9).
- For every configuration of supply chain with different process parameters like processing rates etc. there seems to be a tradeoff between supplier involvement, phase overlap, and supplier specific EC capacity that results in least product lead time (Chapter 6).
- Like the strength of the chain is the strength of the weakest link, the performance of the supply chain can be significantly influenced by a single supplier. The ability of a single supplier does influence the performance of the whole supply chain as explained in chapter 6.
- Most of the ECM process parameters have an optimum point when the impact of other variables on supply chain performance is constant or ignored (Chapter 7 and 9).
- Within a single organization (without collaborative product development), with a low performing ECM and NPD process and limited resources, allocating resources to the ECM process phases ahead of the NPD process would lead to a lower lead time (Chapters 7).
- Within a single organization grouping ECs does not make any difference to the process performance and hence processing the ECs, as early as possible after they are proposed is advantageous (Chapter 7 and 9).

- For an OEM involved in collaborative product design, NPD resource allocation priority is advantageous with scarce resources and low quality process conditions while ECM is advantageous with adequate resources and high and moderate quality process conditions.
- Interactions between the process parameters exist and also have a significant influence on the NPD lead time. Due to the interactions any specific value for any parameter is not always beneficial (Chapter 7).
- All process parameters affect the supply chain performance; while the magnitude of the effect varies. Interactions exist between the process parameters i.e. the value of one variable influences the effect of another variable on the process performance (Chapter 9).
- To ensure low NPD lead time the effect of all the parameters should complement each other as far as possible.
- The OEM always have a significant effect on the supply chain performance while the suppliers have a significant influence only when the resources are limited and the process parameters are low (Chapter 6 and 9).

## **10.1 Contributions**

- A change propagation framework that can be used to identify the effected components by a proposed EC has been developed. This framework captures the tacit knowledge of the dependencies during the concept and design

phases and uses it to list the affected components in the case of an EC. The implementation logic of the framework is also presented using a case study.

- A Service Oriented Architecture based ECM process framework that enables a custom, flexible ECM process has been developed. All the organizations can have unique ECM processes, collaborating with the OEM. This framework enables the collaborating organizations to have unique ECM processes, which vary based upon the importance and complexity of the component developed. The possible services that constitute the ECM process workflow are identified and the interaction interfaces defined. This addresses the lack of any research on ECM system frameworks enabling flexible workflow.
- The organization templates that can be used to model and simulate the NPD and ECM processes, within an organization and across the supply chain, are developed. These templates are based on the fact that the OEM communicates/interacts with the suppliers at specific points during the NPD process. These templates are built using the system dynamics modeling methodology which makes it easier to expand and add additional logic to these templates. The NPD process phases modeled include concept development, detailed design, prototyping and testing, production-ramp up, and assembly and testing. The ECM process phases modeled include EC proposal, EC approval, EC implementation and EC documentation. Process parameters like processing rate, resources, resource composition, phase overlap, EC group size, and EC propagation have been included in the model.

These templates can be used to model the ECM process interactions within an organization (Chapter 7) and in a collaborative multi organization environment (Chapter 9). This section of the research addresses the lack of ECM process simulation models and can be used by organizations to model the ECM processes of their supply chains.

## **10.2 Future Work**

The limitation of the process simulation models presented is that they are validated qualitatively using previous research and not industry data. Any future use of the simulation models should consider this. Another limitation of this modeling approach is the expertise required to estimate the values of the process parameters. Existence of past process data would be of great help in estimating the process parameters values, in the absence of which it would be almost impossible. The results of the simulation model are as good as the accuracy in estimating the process parameters. Future work can include expanding the number of suppliers and using industry data to access the practical use of these kinds of models. Though the concept of the organization templates is accepted in the academic and industrial circles it lacks the actual implementation in an industry. It also requires the expertise to map the templates to represent the actual processes in industry.

## **11 BIBLIOGRAPHY**

1. Aberdeen Group 2007, *Engineering Change Management 2.0: Better Business Decisions from Intelligent Change Management*, Aberdeen Group.
2. Ahmed, S. & Kanike, Y. 2007, "ENGINEERING CHANGE DURING A PRODUCT'S LIFECYCLE", *INTERNATIONAL CONFERENCE ON ENGINEERING DESIGN, ICED'07* CITE DES SCIENCES ET DE L'INDUSTRIE, PARIS, FRANCE, 28 - 31 AUGUST 2007, pp. 174.
3. Antony, J. 2003, *Design of Experiments for Engineers and Scientists*, Elsevier Science & Technology Books.
4. Aurich, J. & Martin, R. 2007, "Engineering Change Impact Analysis in Production Using VR" in *Digital Enterprise Technology* Springer, USA, pp. 75.
5. Balcerak, K.J. & Dale, B.G. 1992, "Engineering change administration: the key issues", *Computer Integrated Manufacturing Systems*, vol. 5, no. 2, pp. 125.
6. Barzizza., R., Caridi., M. & Cigolini., R. 2001, "Engineering change: a theoretical assessment and a case study", *Production planning & control.*, vol. 12, no. 7, pp. 717.
7. Bhuiyan, N., Gatard, G. & Thomson, V. 2006, "Engineering change request management in a new product development process", *European Journal of Innovation Management*, vol. 9, no. 1, pp. 5.
8. Bieberstein, N., Bose, S., Walker, L. & Lynch, A. 2005, "Impact of service-oriented architecture on enterprise systems, organizational structures, and individuals", *IBM SYSTEMS JOURNAL*, vol. 44, no. 4, pp. 691.
9. Black, L.J. & Repenning, N.P. 2001, "Why firefighting is never enough: preserving high-quality product development", *System Dynamics Review*, vol. 17, no. 1, pp. 33.

10. Bobby, W. 2008, *Exploring IBM SOA Technology & Practice*, 1st edn, Maximum Press.
11. Bouikni, N., Desrochers, A. & Louis, R. 2006, "A Product Feature Evolution Validation Model for Engineering Change Management", *Journal of computing and information science in engineering*, [Online], vol. 6, no. 2, pp. 188.
12. Browning, T.R. 2001, "Applying the design structure matrix to system decomposition and integration problems: A review and new directions", *IEEE transactions on engineering management*, vol. 48, no. 3, pp. 292.
13. Chen, Y.M., Shir, W.S. & Shen, C.Y. 2002, "Distributed engineering change management for allied concurrent engineering", *International Journal for Computer Integrated Manufacturing*, vol. 15, no. 2, pp. 127.
14. Cho, S.H. & Eppinger, S.D. 2005, "A Simulation-Based Process Model for Managing Complex Design Projects", *IEEE Transactions on Engineering Management*, vol. 52, no. 3, pp. 316.
15. Clarkson, P.J., Simons, C. & Eckert, C. 2004, "Predicting change propagation in complex design", *Journal of mechanical design*, vol. 126, no. 5, pp. 788.
16. Cohen, T., Navathe, S.B. & Fulton, R.E. 2000, "C-FAR, change favorable representation", *Computer aided design*, [Online], vol. 32, no. 5-6, pp. 321.
17. Cooper, R.G. & KleinSchmidt, E.J. 2007, "Winning businesses in product development: The critical success factors", *Research Technology Management*, vol. 50, no. 3, pp. 52.
18. Diprima, M. 1982, "Engineering Change Control and Implementation Considerations", *Production and Inventory Management*, vol. First Quarter, pp. 81.

19. Do, N. & Jang, M.K. 2002, "A Structure-Oriented Product Data Representation of Engineering Changes for Supporting Integrity Constraints", *International Journal of Advanced Manufacturing Technology*, vol. 20, no. 8, pp. 564-570.
20. Do, N., Choi, I.J. & Song, M. 2007, "Propagation of engineering changes to multiple product data views using history of product structure changes", *International Journal of Computer Integrated Manufacturing*, vol. 21, no. 1, pp. 19.
21. Eckert, C., Clarkson, P.J. & Zanker, W. 2004, "Change and customisation in complex engineering domains", *Research in engineering design*, vol. 15, no. 1, pp. 1.
22. Fan, L. 2010, "Collaborative Fixture Design and Analysis Using Service Oriented Architecture", *IEEE transactions on automation science and engineering*, .
23. Ferguson, R. 2007, "SAP pushes SOA, on demand", *eWeek*, vol. 24, no. 15, pp. 11.
24. Forrester, J.W. 1968, *Principles of Systems: Text and Workbook*, Wright-Allen Press, Inc.
25. Frank D., N. 1980, "Engineering change: too important to leave to the engineers", *Annual conference proceedings - American Production and Inventory Control Society.*, pp. 270.
26. Fricke, E., Gebhard, B., Negele, H. & Igenbergs, E. 2000, "Coping with Changes: Causes, Findings and Strategies", *Systems Engineering*, vol. 3, no. 4, pp. 169.
27. Gullledge., T. & Deller., G. 2009, "Service-oriented concepts: bridging between managers and technologists", *Industrial Management & Data Systems*, vol. 109, no. 1, pp. 5.
28. Harhalakis, G. 1986, "Engineering Changes for Made-to-Order Products: How an MRPII System should handle them", *Engineering Management International*, vol. 4, pp. 19.



29. Holton, J. & Dastmalchi, B. 2008, *Manufacturing Outsourcing for Small and Mid-Size Companies: Ten Key Challenges and How to Address Them*, Symphony Consulting, Inc.
30. Huang, G.Q. & Mak, K.L. 1999, "Current practices of engineering change management in UK manufacturing industries", *International journal of operations production management*, vol. 19, no. 1, pp. 21.
31. Huang, G.Q. & Mak, K.L. 1998, "Computer aids for engineering change control", *Journal of Materials Processing Technology*, vol. 76, pp. 187.
32. Huang, G.Q., Yee, W.Y. & Mak, K.L. 2003, "Current practice of engineering change management in Hong Kong manufacturing industries", *Journal of materials processing technology*, vol. 139, no. 1-3, pp. 481.
33. Huang, G.Q., Yee, W.Y. & Mak, K.L. 2001, "Development of a Web-Based system for engineering change management", *Robotics and Computer Integrated Manufacturing*, vol. 17, pp. 255.
34. Idoughi, D. 2010, "Towards new web services based supervisory systems in complex industrial organizations: Basic principles and case study", *Computers in Industry*, vol. 61, no. 3, pp. 235.
35. Jarratt, T.A.W. 2004, *A Model-Based Approach to Support the Management of Engineering Change*, Cambridge University.
36. Jarratt, T.A.W., Eckert, C.M., Caldwell, N.H.M. & Clarkson, P.J. 2011, "Engineering change: an overview and perspective on the literature", *Research in Engineering Design*, no. 22, pp. 103.

37. Jarratt, T.A.W., Eckert, C.M. & Clarkson, P.J. 2006, "Pitfalls of engineering change: change practise during complex product design" in *Advances in Design. Springer Series in Advanced Manufacturing*, eds. H. Elmaraghy & W. Elmaraghy, Springer London, London, pp. 413.
38. Jerstad, I., Dustdar, S. & Thanh, D.V. 2005, "A service oriented architecture framework for collaborative services", *Enabling Technologies: Infrastructure for Collaborative Enterprise, 2005. 14th IEEE International Workshops on*, pp. 121.
39. Keller, R., Eckert, C.M. & Clarkson, P.J. 2005, "Multiple Views to Support Engineering Change Management for Complex Products", *Proceedings of the Third International Conference on Coordinated & Multiple Views in Exploratory Visualization CMV 2005* : IEEE Computer Society, London, UK., July 5, 2005., pp. 33.
40. Klein., M., Poltrock., S. & Handel., M. 2007, *A Coordination-Theoretic Approach to Understanding Process Differences*, MIT Sloan Working Paper 4637-07 edn, CCI Working Paper No. 2007-005.
41. Lee, H.J., Ahn, H.J. & Kim, J.W. 2006, "Capturing and reusing knowledge in engineering change management: A case of automobile development", *Information systems frontiers*, vol. 8, no. 5, pp. 375.
42. Li, D.W. & Qiu, Z.M. 2006, "State-of-the -art Technologies and methodologies for collaborative product development", *International journal of production research*, vol. 44, no. 13, pp. 2525.

43. Li, W. & Moon, Y.B. 2009, "A simulation model for managing engineering changes along with new product development", *ICEIS 2009 - 11th International Conference on Enterprise Information Systems*, pp. 13.
44. Liqing, F., Jagdish, A.S., Anbuselvan, B.N. & Bok Shung-Hwee, s. 2008, "Integrated fixture design and analysis system based on service-oriented architecture", *IEEE International Conference on Automation Science and Engineering, 2008. (CASE 2008.)* Arlington, VA, 23-26 Aug. 2008, pp. 656.
45. Maurizio, A., Girolami, L. & Jones, P. 2007, "EAI and SOA: factors and methods influencing the integration of multiple ERP systems (in an SAP environment) to comply with the Sarbanes-Oxley Act", *Journal of Enterprise Information Management*, vol. 20, no. 1, pp. 14.
46. Minitab, I. 2011, *Minitab 16 Statistical Software*, 16th edn.
47. Nadia, B., Gatard, G. & Thomson, V. 2006, "Engineering change request management in a new product development process", *European Journal of Innovation Management*, vol. 9, no. 1, pp. 5.
48. Pikosz, P. & Malmqvist, J. 1998, "A Comparative Study of Engineering Change Management in Three Swedish Engineering Companies", *1998 ASME Design Engineering Technical Conference ASME*, Atlanta, GA, pp. 1.
49. Reddi, K.R. & Moon, Y.B. 2009, "A framework for managing engineering change propagation", *International Journal of Innovation and Learning*, vol. 6, no. 5, pp. 461.

50. Reddi, K.R. & Moon, Y.B. 2011a, "A framework for engineering change management in enterprise resource planning using service-oriented architecture", *Int. J. Business Information Systems*, vol. 8, no. 1, pp. 46.
51. Reddi, K.R. & Moon, Y.B. 2011b, "System dynamics modeling of engineering change management in a collaborative environment", *The International Journal of Advanced Manufacturing Technology*, vol.55, no. 9-12, pp. 1225.
52. Reidelbach P.E., M.A. 1991, "Engineering Change Management for Long-Lead-Time Production Environments", *Production and Inventory Management Journal*, vol. 32, no. 2, pp. 84.
53. Repenning, N.P. 2002, "A Simulation-Based Approach to Understanding the Dynamics of Innovation Implementation", *Organization Science*, vol. 13, no. 2, pp. 109.
54. Repenning, N.P. 2001, "Understanding fire-fighting in new product development", *The Journal of Product Innovation Management*, vol. 18, pp. 285.
55. Repenning, N.P. 2000, "A dynamics model of resource allocation in multi-project research and development systems", *System Dynamics Review*, vol. 16, no. 3, pp. 173.
56. Riviera, A., Dacunha, C. & Tollenaere, M. 2002, "Performances in Engineering Changes Management", *Recent advances in integrated design and manufacturing in mechanical engineering*, , pp. 369.
57. Rodrigues, L.L.R., Dharmaraj, N. & Rao, B.R.S. 2006, "System dynamics approach for change management in new product development", *Management Research News*, vol. 29, no. 8, pp. 512.

58. Rouibah, K. & Caskey, K.R. 2003, "A workflow system for the management of inter-company collaborative engineering processes", *Journal of Engineering Design*, vol. 14, no. 3, pp. 273.
59. Rutka, A., Guenov, M.D., Lemmens, Y., Schmidt-Schäffer, T. & Coleman, P. 2006, "Methods for engineering change propagation analysis", *25th International congress of the aeronautical sciences* Hamburg, Germany, 3-8, September, 2006.
60. Sterman, J.D. 2000, *Business Dynamics Systems Thinking and Modeling for a Complex World*, Irwin McGraw-Hill.
61. Tavcar., J. & Duhovnik., J. 2006, "Engineering Change Management in Distributed Environment with PDM/PLM Support", *Manufacturing the Future, Concepts - Technologies - Vision.*, eds. V. Kordic., A. Lazinica. & M. Merdan., Germany, pp. 751.
62. Tavcar., J. & Duhovnik., J. 2005, "Engineering change management in individual and mass production", *Robotics and Computer-Integrated Manufacturing.*, vol. 21, no. 3, pp. 205.
63. Terwiesch, C. & Christoph H, L. 1999, "Managing the process engineering change orders: The case of the climate control system in automobile development", *Journal of Product Innovation Management*, no. 16, pp. 160.
64. Ulrich, K.T. & Eppinger, S.D. 2008, *Product Design and Development*, 4th edn, McGraw-Hill Irwin.
65. Umar, A. 2009, "Reengineering for service oriented architectures: A strategic decision model for integration versus migration", *The Journal of systems and software*, vol. 82, no. 3, pp. 448.

66. US Military Standard 480B 1988, *Military Standard: Configuration control, Engineering changes, deviations and waivers*, Department of Defense, USA.
67. VENTANA Systems Inc. 2010, *Vensim Professional*.
68. Wright, I.C. 1997, "A Review of research into engineering change management: implications for product design", *Design Studies*, vol. 18, pp. 33.
69. Yang, J., Goltz, M. & Han, S. 2004, "Parameter-based Engineering Changes for a Distributed Engineering Environment", *Concurrent Engineering: Research and Applications*, vol. 12, no. 4, pp. 275.
70. Yongyi, Z. 2009, "Research on service-oriented workflow management system architecture", *Proceedings - 2009 9th International Conference on Hybrid Intelligent Systems, HIS 2009*, vol. 2, pp. 369.