

2016

Localization, Visualization And Evacuation Guidance System In Emergency Situations

Jingyan Tang Ms

University of Massachusetts Amherst

Follow this and additional works at: https://scholarworks.umass.edu/masters_theses_2



Part of the [Other Electrical and Computer Engineering Commons](#)

Recommended Citation

Tang, Jingyan Ms, "Localization, Visualization And Evacuation Guidance System In Emergency Situations" (2016). *Masters Theses*. 377.

https://scholarworks.umass.edu/masters_theses_2/377

This Open Access Thesis is brought to you for free and open access by the Dissertations and Theses at ScholarWorks@UMass Amherst. It has been accepted for inclusion in Masters Theses by an authorized administrator of ScholarWorks@UMass Amherst. For more information, please contact scholarworks@library.umass.edu.

**LOCALIZATION, VISUALIZATION AND EVACUATION GUIDANCE SYSTEM IN
EMERGENCY SITUATIONS**

A Thesis Presented

by

JINGYAN TANG

Submitted to the Graduate School of the
University of Massachusetts Amherst in partial fulfillment
of the requirements for the degree of

MASTER OF SCIENCE IN ELECTRICAL AND COMPUTER ENGINEERING

May 2016

Department of Electrical and Computer Engineering

**LOCALIZATION, VISUALIZATION AND EVACUATION GUIDANCE
SYSTEM IN EMERGENCY SITUATIONS**

A Thesis Presented

by

JINGYAN TANG

Approved as to style and content by:

Aura Ganz, Chair

C. Mani Krishna, Member

Russell Tessier, Member

Christopher V. Hollot, Department Head
Department of Electrical and Computer
Engineering

ABSTRACT

LOCALIZATION, VISUALIZATION AND EVACUATION GUIDANCE SYSTEM IN EMERGENCY SITUATIONS

MAY 2016

JINGYAN TANG, B.S., CHANGSHA UNIVERSITY OF SCIENCE AND TECHNOLOGY

M.S.E.C.E., UNIVERSITY OF MASSACHUSETTS AMHERST

Directed by: Professor Aura Ganz

Urban search and rescue is needed for a variety of emergencies or disasters, including tornadoes, floods, dam failures, technological accidents, and terrorist activities. The efficiency to save people is becoming very important.

With the development of the technology, people are trying to find a better way to help people get out of the dangerous places as soon as possible. DIORAMA system has been proposed to help with this problem and turns out very successful on improving efficiency during emergency situation. However, the current DIORAMA system is not perfect for all scenarios, for example, there are some outdoor environments do not support GPS service. Also, the RFID reader is very heavy for responders to carry and the indoor environment is not applicable for DIORAMA system. Besides, there are lack of forensic visualization toolkits that are able to help the incident commander analyze the responders' behavior and efficiency.

In this project, we propose a Localization, Visualization and Evacuation Guidance System in Emergency Situations. The functionalities in this system include localization in outdoor environments using BLE. Besides, for outdoor environments, some forensic visualization toolkit that can help the responder analyze the responders' behavior with the capability of visualization and representation of data clearly as well as replay the task, detect anomalies and visualize the anomalies clearly is also provided in improving the efficiency and organization in the future task. In addition, the system also includes an indoor localization, navigation guidance and visualization system that provides guidance for people to exit a dangerous building as soon as possible. This

system is able to localize the position of evacuees, and construct the exit path that helps reduce the escape time as well as provide a navigation guidance that is able to guide the user to the exit. In addition, an analyst simulation application is provided to simulate the evacuees in a building and evaluate the evacuation time for evacuees given specific path generation algorithm.

TABLE OF CONTENTS

	Page
ABSTRACT	iii
LIST OF FIGURES.....	vi
CHAPTER	
1. INTRODUCTION.....	1
2. LITERATURE SURVEY	4
3. SYSTEM OVERVIEW.....	8
4. OUTDOOR LOCALIZATION AND VISUALIZATION SYSTEM	9
4.1 Objectives	9
4.2 Methods and Implementation Details.....	10
4.2.1 Localization for Responders	10
4.2.2 Localization of Beacons Based on Mobile Phone Localized by GPS	15
4.2.3 Outdoor Forensic Visualization Tools	16
5. INDOOR LOCALIZATION, NAVIGATION GUIDANCE AND VISUALIZATION SYSTEM	58
5.1 Objectives	58
5.2 Methods and Implementation Details.....	58
5.2.1 Real Time Navigation Guidance System	61
5.2.2 Simulation System	69
6. FUTURE WORK	76
BIBLIOGRAPHY	77

LIST OF FIGURES

Figure	Page
1. System Overview	8
2. Propagation model for Samsung with case outdoor.....	11
3. Grid Based Sampling Algorithm.....	13
4. Nearest Neighbor Based Algorithm	14
5. GUI for responder localization.....	15
6. Evacuees localization architecture	16
7. Architecture of Charts Interactive Visual Analytics Tool.....	21
8. Main menu	23
9. Task part in main menu	24
10. Evacuee part in main menu	25
11. Overview of evacuees - from pie chart to bar chart	26
12. Overview of evacuees - from bar chart to stacked line chart	27
13. Only triage evacuee overview	27
14. Pie chart for all evacuees.....	28
15. Bar chart for all evacuees	29
16. Total times for all evacuees.....	30
17. Reminding dialog for bar chart	31
18. Detail information for evacuee.....	31
19. Stacked line chart for all evacuees	32
20. Checking list of detailed information in stacked line chart.....	33
21. List of detailed evacuees with red priority	34
22. Only red evacuees layout - from bar chart to stacked line chart.....	35
23. Only red evacuees layout - from stacked line chart to details.....	35
24. Responder part in main menu	37

25. Responder overview - from bar chart to stacked line chart	37
26. Bar chart for responders	38
27. Reminding dialog	39
28. Detail information for specific responder	39
29. Stacked line chart for responders	40
30. Reminding dialog	40
31. Responder overview - from stacked line chart to detail list.....	41
32. Layout for responder 21 - from pie chart to bar chart.....	42
33. Detail information for responder 21	43
34. Others in main menu	44
35. Device information.....	45
36. Detail information	45
37. Animation display in Google map	49
38. Interactive widgets	50
39. Decision tree.....	52
40. Anomaly visualization	53
41. Abnormal individual and list.....	53
42. Detail information for anomalies	54
43. Methods.....	55
44. Overviews	56
45. Text and button	56
46. Timeline slider	57
47. Systems Architecture	59
48. Communications	60
49. Real Time Navigation Guidance System	61
50. Propagation Model	63

51. Deploy layout in Knowles Engineering building.....	63
52. Graph Nodes and Links.....	64
53. Algorithm	64
54. Evacuees navigation guidance app UI	66
55. Incident Commander App UI.....	67
56. Display evacuees and paths.....	68
57. Block an exit	68
58. Before and after block an exit	69
59. Simulation System	70
60. Overview of simulation module.....	71
61. Simulation App UI.....	72
62. Add evacuees	73
63. Layout after add evacuees.....	73
64. Animation and interactive tools	74
65. Evacuation time visualization	75

CHAPTER 1

INTRODUCTION

Nowadays, people are focusing more and more on the frequency and severity of mass-casualty incidents (MCIs) caused by natural disasters or terrorist attacks, which results in large number of casualties, increased during the last decade. To handle the large number of casualties that exceed the capability of the response, DIORAMA system is designed to help incident commander and responders with their work to bring order to the chaos as they direct rescue operations for Mass Casualty Incidents (MCI) by the use of rapid information collection and accurate resource tracking [1]. And this system turns out very successfully on improving the efficiency and organization of the urban search and rescue task.

In the DIORAMA system, when the responders reached the place of the mass casualty, they will apply the DIORAMA equipment, which include electronic tag reflecting the severity of the evacuees' injury and tracking the evacuees' location, and a RFID reader to locate all these tags accurately. The evacuees' injury level includes four levels, red, yellow, green and black to represent the serious degree of the evacuees from light injured to dead. And the emergency responders will triage these evacuees first by using these tags, then they will evacuate these evacuees according to the injury level and the locations.

The DIORAMA system makes use of android smart phone, which is able to implement Google Map to keep track of the location of evacuees and responders. GPS is used to localize the position of evacuees and emergency responders. Besides, emergency responders are carrying RFID readers in the task to collect the signal strength of the RFID tags that are attached to each to detect if the evacuees are moved or not after triage. All the information including each evacuee's position, priority, triage time, evacuation time as well as the responders' positions are transmitted to the server are been shared by responders and Incident Commanders.

However, the GPS is not available at some places and the RFID readers are very heavy for emergency responders to carry during the emergency situation especially when the environment

is not spacious, besides, the RFID reader is very expensive and the antenna is fragile, which would cause a lot of cost. As a result, BLE (Bluetooth Low Energy), which is a wireless personal area network technology designed to provide considerably reduced power consumption and cost while maintaining a similar communication range, is introduced to localize the responders when GPS is not available or replace the use of RFID and RFID readers when GPS is available to provide convenience to emergency responders as well as save the cost.

Moreover, a series of forensic visualization toolkits that would assist analyzing the work by retrospect the scenario of the task that has been done would be very helpful in improving the behavior and efficiency in rescue task.

Besides, this system is not applicable for indoor environment since GPS is not accurate and the Google Map is not able to provide an accurate outline for indoor environments. As a result, an indoor intelligent emergency guidance system is also extremely necessary in Urban Search and Rescue especially the indoor emergency case such as fire and so on. For example, the Tianjin explosions that take place on August 12, 2015 caused a significant lose of people lives near the explosion area. People were trying very hard to get away from the building near the area. An intelligent guidance navigation system would be significantly helpful in this scenario.

In this project, we present a work Localization, Visualization and Evacuation Guidance System for Emergency Situation. The project includes two parts. The first part Outdoor Localization and Visualization System implements BLE tags to keep track of the position of responders or evacuees to help the emergency responder evacuate the evacuees as soon as possible as well as provide forensic visualization tools to incident commander to analyze the behavior and performance of responders. The work includes localization of responders based on BLE when responders are carrying the android smartphone, and localization of evacuees when evacuees are carrying the BLE tags and responders localized by GPS. Besides, a series of forensic visualization tools is also supported to enable the incident commanders to analyze the efficiency and performance of responders to improve the organization and behavior in the future tasks. The

visualization toolkits include the capabilities to display different kind of charts to show the evacuees and responder information in multiple ways and allow the user to choose what to see. In addition, the visualization toolkits also include an anomaly detection work that is able to detect and visualize the anomalies for the data collected from the Urban Search and Rescue task executed with diorama system with the ability of displaying animation for the scenario. The second part Indoor Localization, Navigation Guidance and Visualization System provides a Real Time Evacuation Guidance System and Simulation System for indoor environments to provide guidance for the user to help the user navigate to the exit as soon as possible. There are primarily two parts supporting the purpose. The Real Time Evacuation System aims to provide navigation guidance to evacuees during emergency situation in real time. It contains two applications. One is the Incident Commander Application that used to generate path for evacuees and control the exits including block or open exits, another one is the Evacuees Navigation Guidance Application that is primarily responsible for localize the position of evacuees, get the generated path from server as well as display the path to the evacuees. The Simulation System aims to provide abilities to simulate the motion of evacuees as well as calculate the evacuation time given specific path generation algorithm. We will provide Analyst Simulation Application to achieve these purposes. Based on the limitation of CPU and memory of the Samsung Galaxy Note, when there are over 1000 evacuees need to be calculated in the system, the calculation will become extremely slow, which cannot be accepted in the emergency situation.

In the next chapter, we describe the related literature survey regarding Localization, Navigation Guidance System and Data Visualization Tools. Chapter 3 describes the system overview of the project. Chapter 4 states the implementation of Outdoor Localization and Visualization System. Chapter 5 describes the Indoor Localization, Navigation Guidance and Visualization System. Chapter 6 examines future work and the final part introduces the references.

CHAPTER 2

LITERATURE SURVEY

In this section, we summaries some previous work regarding BLE implementation, localization, data visualization methods as well as some emergency navigation methods and simulation methods.

Nowadays, people are interested in the use of Bluetooth Low Energy (BLE). The feasibilities of the use of BLE technique have been well researched in many aspects. First of all, the feasibility study about the Bluetooth Low Energy (BLE) based wireless sensors has been investigated [2]. And it turns out that the BLE based wireless sensor system has some advantages over other sensors such as low power consumption, good data throughput, which allows the BLE to be used in wireless network.

Also, because of the difficulty of enable the indoor positioning system available at every possible location within the environment, the feasibility of introducing BLE beacons into an unrestricted indoor environment has been assessed to determine if BLE is able to achieve the goal of “indoor GPS” [3]. The result shows significant positioning improvement over existing WIFI infrastructure is possible in BLE system.

On the other hand, to achieve the goal of localization, a lot of hardware sensors have been introduced and some techniques have been investigated. The feasible sensors include WIFI based localization [4], BLE based localization [3] and other techniques. The localization methods include Peer Assistance [4], trilateration and so on.

Based on the survey on BLE and localization technique, we find that BLE excels other techniques in localization work in many aspects, such as low power consumption, light weighted and short connection time [3].

Visualization tools provide a great significance in many fields. “By visualizing information, we turn it into a landscape that you can explore with your eyes, a sort of information map. And when you’re lost in information, an information map is kind of useful.”-David

McCandless, author, data journalist, and information designer [5]. Different kinds of visualization tools have been introduced in biology, network security, computer field [6] and so on.

Another good way to visualize data is anomaly visualization, which is based on the technique of anomaly detection. The most popular anomaly detection techniques include Classification Based Anomaly Detection Techniques, Nearest Neighbor-Based Anomaly Detection Techniques, Clustering-Based Anomaly Detection Techniques and so on. Classification is used to learn a model from a set of labeled data instances (training) and then, classify a test instance into one of the classes using the learned model (testing) [7]. There are a lot of anomaly detection techniques that use different classification algorithm to build classifiers. For example, Neural Networks-Based Anomaly Detection Technique applies neural networks in multi-class as well as single class settings. In addition, Bayesian Network-Based Anomaly Detection and Rule-Based Anomaly Detection also take use of classification method.

In addition to visualization, another important work in our system is to implement the emergency navigation system. The emergency navigation system is developed both in outdoor environments and indoor environments.

Existing outdoor evacuation guidance system includes massive multi-agent server-client based evacuation guidance system, which built an evacuation guide system based on GPS-capable cellular phones [8], and static nodes based navigation routes generation system that implements static nodes to generate a network as well as solve the coverage problem as a support infrastructure [9].

For outdoor navigation, people can use GPS based navigation system as navigation guidance tool, however, in most indoor environments, the standard GPS receiver is unrealistic since the fading of signal. As a result, indoor feasible methods need to be developed. Common indoor navigation guidance methods include Dijkstra Algorithm, A* Algorithm, sample algorithm and so on. Also, some novel algorithm has been introduced to solve specific problems. For example, a distributed navigation system for indoor environment has been investigated, which

takes use of dangerous level to provide the guiding path to exits, and it provides a convenient system to direct objects to the nearest exit [10]. Another example implements a new mechanism to rescue people from dangerous building and guide them to the safety exit based on wireless sensor networks [11].

Some other techniques have been used to take congestion into account, which is beneficial when there are massive evacuees. For example, a novel congestion-aware navigation algorithm has been developed to help navigating people in a large building [12]. This project uses the moving speed to evaluate the congestion degree and use the sensors to display the escape directions.

Another example provides a distributed flow based guiding protocol in wireless sensor networks [13]. The method used a traffic flow model to transform the people density of a route into people's walk speed to reduce the computational cost and the communication overhead. In addition, load-balancing method have also been introduced in navigation guiding problems [14] [15]. This kind of framework is able to prevent people from following the local optimal guiding direction with the longer evacuation time in total.

In the aspect of simulation in emergency situation, common simulation modules include flow based simulation model, cellular automata model, agent based model and so on [16]. A flow-based model models the density of nodes in continuous flows and enables the user to construct a simulated physical environment as a network of nodes. The cellular automata modeling of evacuees involve the discretization of space by dividing space and modeling the node density in individual floor cells. While the agent based modeling individualizes the movement of groups.

Some novel simulation tools have also been investigated for emergency navigation process to be used in different scenarios. For example, for metro stations, a simulation tool has been introduced to simulate the passenger evacuation under fire emergency [17]. This method compares simulation results of different evacuation simulation scenarios of fire, and then

evaluates the evacuation capability of the station and then identifies the bottleneck of the metro station in fire emergency.

Another example is based on fuzzy logic, which aims to derive a mathematical model for the pedestrian evacuation and shows that the parameters involved in the proposed fuzzy model have prominent influences on the evacuation time and dynamical features of pedestrian evacuation [18].

Compared to these works, my project Localization, Navigation Guidance and Visualization system accomplished a lot of achievements. First of all, for outdoor environments, we use a novel algorithm to develop GPS independent localization method for responders in outdoor environments based on stationary BLE tags. In addition, we develop a forensic visualization tool to visualize forensic analysis and anomaly detection, which is novel in emergency situation. Besides, for indoor environments, we developed real time localization and navigation guidance system to help evacuees exit dangerous buildings as soon as possible. Also, we provide a simulation tool for navigation guidance system, which can be used in both offline and real time.

CHAPTER 3

SYSTEM OVERVIEW

This project includes two parts, the Outdoor Localization and Visualization System, and the Indoor Localization, Navigation Guidance and Visualization System as shown in figure 1.

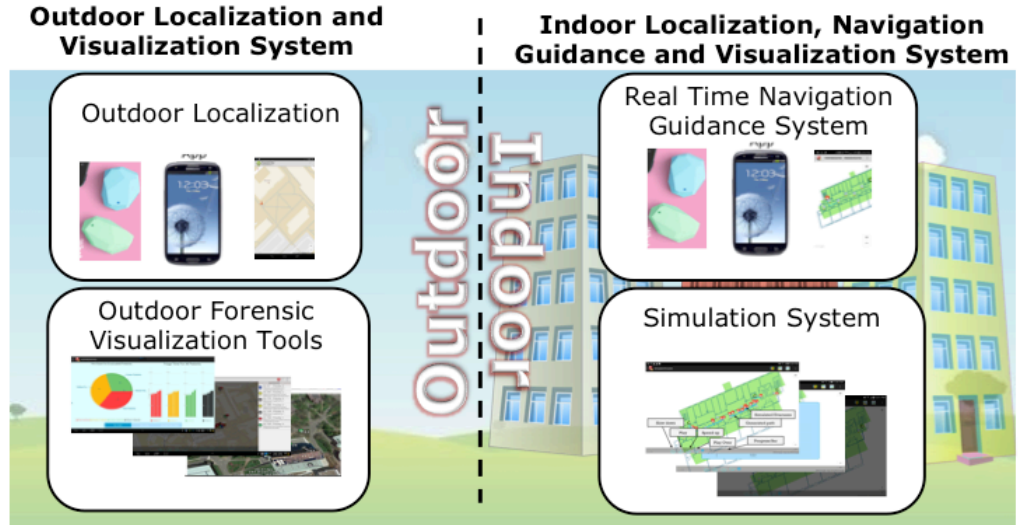

Figure 1 System Overview

The Outdoor Localization and Visualization work for Diorama mainly includes the localization for responders and evacuees in outdoor environment, which provides localization of responder when GPS is not available and provides localization for evacuees when responders' positions are provided by GPS to determine if evacuees have moved after triage, and also the forensic visualization part of the outdoor environment, which includes the Charts Representation of Data, Anomaly Detection Application and Google Earth Implementation of Data Visualization. The Indoor Localization, Navigation Guidance and Visualization work mainly includes the localization of user in indoor environment, navigation guidance which implements path generation algorithm that provides a guiding path for user, and visualization that display the optimal path for user as well as simulate the motion of evacuees and calculate evacuation time given specific algorithm. The detailed implementation methods will be discussed in next sections.

CHAPTER 4

OUTDOOR LOCALIZATION AND VISUALIZATION SYSTEM

4.1 Objectives

The Outdoor Localization and Visualization System aims to provide a localization and visualization result for responders, evacuees and incident commanders in emergency situation, the localization result can be used to localize responders when GPS is not available for responders or detect if the evacuees have moved after triage or not. The visualization function can be used to display the responders and the evacuees clearly.

There are several functionalities need to be accomplished to achieve these goals.

- Localization of the responders

For the current DIORAMA system, localization of responders is achieved by GPS, which is very convenient when the responders are carrying android smartphone and the GPS is available. However, for the places where GPS is not available, localization of responder should be achieved by other ways. In our system, we make use of BLE network to achieve the localization of the responders.

- Localization of the evacuees

For the places where GPS is available, since the evacuees' first positions are determined by the responders' android smartphones via GPS, after the responders triaged the evacuees, there is no way to allow the evacuees post the new positions to the responders initiatives. As a result, the localization of evacuees through a new network becomes extremely important for us to detect if evacuees have moved or not after triage. In our system, we use BLE network to achieve the purpose of localize the evacuees who are carrying BLE tags with them.

- Visualization of evacuees and responders

The visualization part of the evacuees is primarily responsible for displaying the evacuees and responders clearly based on the data collected from the rescue task for the Incident

Commanders to analyze the efficiency and performance in order to improve the task organization and performance in the future.

4.2 Methods and Implementation Details

4.2.1 Localization for Responders

For the scenario where GPS is not available, we need to localize the responders based on the BLE network. The BLE tags are deployed beforehand and the responder uses android smartphone, which has the capability to receive the RSSI of the BLE tags. The RSSI readings are used to estimate the approximate position of the responder.

4.2.1.1 Calibration of BLE in Outdoor Environment

In order to get an accurate localization result, it is significant to get a proper distance estimation model, which reflects the relationship between the distance of tag and mobile device and the received RSSI. As a result, we need to design and execute the experiment carefully. There are several important points need to be considered to get the optimal distance estimation model. First of all, the position of test bed. Since the signal strength of RSSI differs with the change of the environment. The location of test bed should be similar with the real scenario of DIORAMA system, so that we need to set the location outside and put it in an open space. In addition, the weather is also another condition that we need to think about. The Bluetooth Low Energy (BLE) Estimote Beacon radio signals are heavily absorbed by water, the rain will reduce the beacon's signal strength. So we need to carry out the experiment when there is not rain and snow. Moreover, the devices are also important, since different devices have different capability of receiving signals, it is significant to set the device as what we usually use in DIORAMA system. Besides, as the cover of device may also influence the received signal strength, we decide to carry out two groups of experiment at the same time so that we can get the distance estimation model for both mobile phones with and without case and the mobile phone we choose Samsung Galaxy III as it is what we will use in DIORAMA system. What's more, to eliminate the difference of the mobile phone direction, we collect the data for both four directions mobile phone, which are face

to tag, back to tag, left to tag and right to tag. Last but not least, to eliminate the minor difference between different tags, we choose 10 tags and collect each tag 100 RSSI for each of the four directions. Besides, since the Estimote Beacon can propagate up to 220 feet, we collect BLE RSSI readers every 3 feet from 0 feet to 219 feet.

The log-normal model is the best model that fits the indoor propagation since it has two parameters to model the problems of multipath (n) and fading which is a random variable

$$RSSI = RSSI_0 + 10 * n * \log(d/d_0) + X_g$$

Where $RSSI_0$ value is the signal power measured at distance d_0 [19]. By feeding our sample RSSI readers into the model, we get the propagation model as follows. We set d_0 as 3 feet, which is our calibration unit, and $RSSI_0$ is the RSSI reader when the distance is 0.

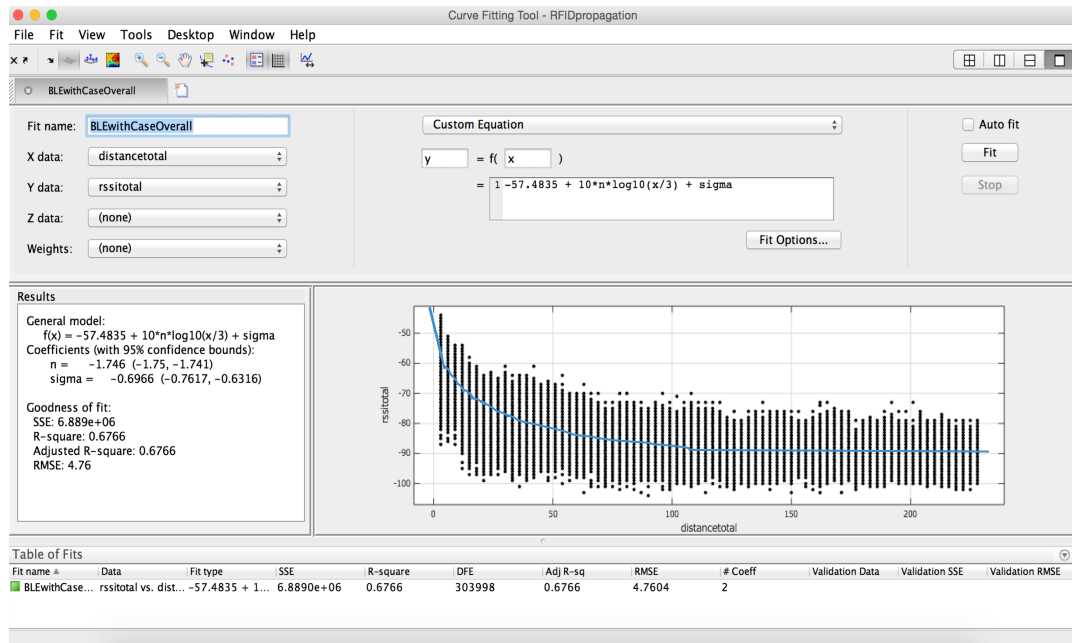

Figure 2 Propagation model for Samsung with case outdoor

The propagation model of figure 2:

$$RSSI(d) = -57.4835 + 10 * (-1.746) * \log(d/3) - 0.6966$$

4.2.1.2 Localization of responder based on stationary BLE in outdoor environment

As the GPS is not applicable all the time and the accuracy of GPS is not optimal in some places, we need to try new ways to localize the position of responders. Bluetooth Low Energy (BLE) is an excellent potential option in DIORAMA system for its low weight, low cost and long lifetime. In order to get the location of responders who are carrying mobile devices with them by applying Bluetooth Low Energy, we need to localize the responders with the known positions of stationary Estimote Beacons.

To get the localization result of responders based on the stationary beacons, there are a lot of algorithms that we can apply. But in our case we developed two algorithms that would match our needs to provide average localization accuracy better than 25 feet.

- Grid Based Sampling Algorithm for Localization

Because of the instability of BLE signal strength, it is not practical to use traditional localization algorithm such as trilateration algorithm. As a result, I developed an algorithm named Grid Based Sampling Algorithm to make it feasible in BLE case. The Grid Based Sampling Algorithm is based on grid division of geology area. For the scenario space, we divide the area into hundreds of grids as shown in figure 3.

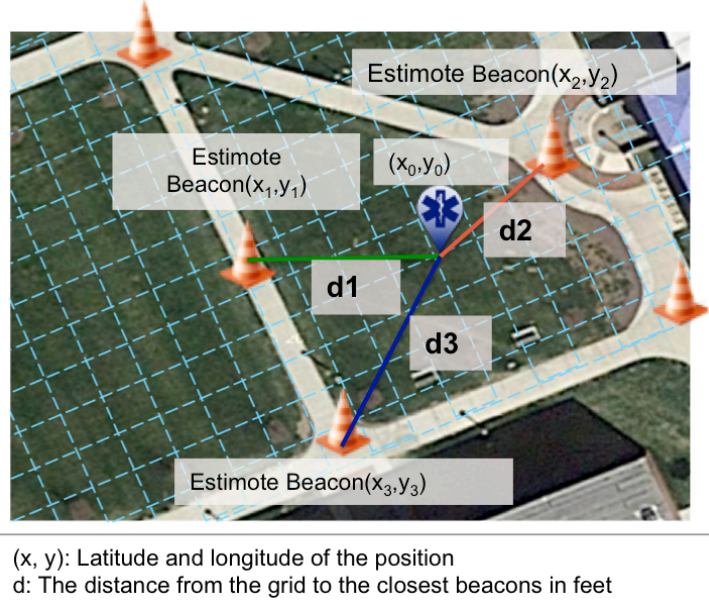

Figure 3 Grid Based Sampling Algorithm

Based on the received RSSI and the propagation model, we get an estimate distance of the responder to each beacon, and then we start calculate the distance of each grid to each beacon. Based on this, we find the grid that best approximate the estimate distance of the propagation model, which has the distances to the stationary beacons closest to the estimate distances to each beacons, which means we need to find out the grid point (x_0, y_0) , which minimize

$$|\sqrt{(x_0 - x_1)^2 + (y_0 - y_1)^2} - d_1| + |\sqrt{(x_0 - x_2)^2 + (y_0 - y_2)^2} - d_2| + (|\sqrt{(x_0 - x_3)^2 + (y_0 - y_3)^2} - d_3|$$

- Nearest Neighbor Based Algorithm for Localization

Another algorithm that can contribute to the localization of responders based on stationary BLE beacons is Nearest Neighbor Based Algorithm that based on the fact that the closer the beacon to the mobile phone, the more accurate the distance result. In this algorithm, we regard the closest beacon provides the biggest priority distance information, so the estimate position of responder will fall in the range of the closest beacon. Besides, in other beacons, we

choose two closest and then calculate the most possible position of the responder as shown in figure 4.

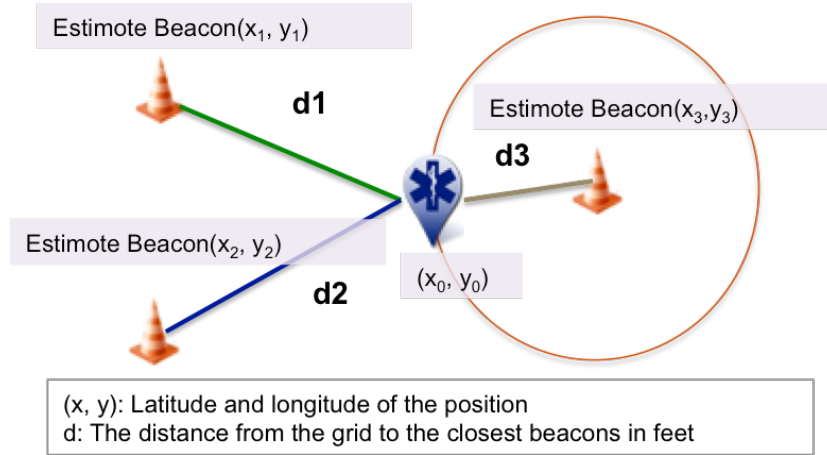

Figure 4 Nearest Neighbor Based Algorithm

The implementation detail of the algorithm is first to get the RSSI of each beacon, and then calculate the distance to each beacon based on the propagation model mentioned in previous section. The next step is to find out the closest beacon and then get the distance, which can be used to draw a circle with a radius of the distance and with a core of the beacon as shown on figure 4. The equation can be represented as

$$\sqrt{(x_0 - x_1)^2 + (y_0 - y_1)^2} = d_1$$

Then we need to find out the approximate position of the responder which minimize

$$\left| \sqrt{(x_0 - x_2)^2 + (y_0 - y_2)^2} - d_2 \right| + \left| \sqrt{(x_0 - x_3)^2 + (y_0 - y_3)^2} - d_3 \right|$$

By testing, we find the Grid Based Sampling Algorithm provides a better result when the responder is not close to any BLE tag, however, the Nearest Neighbor Based Algorithm provides a better result when the responder is very close to a BLE tag. So we combine these two algorithms together in the future to provide a better result.

4.2.1.3 GUI

The user interface for the responder localization is achieved by implement Google Maps. The functionalities need to be achieved by the Responder Localization Interface includes

deploy the BLE tags as well as display the localization result of the responder. For our system, we use an item list to allow the user to deploy the BLE tags in a given position, and the localization result of the responder will be shown in the Google Map as shown in figure 5.

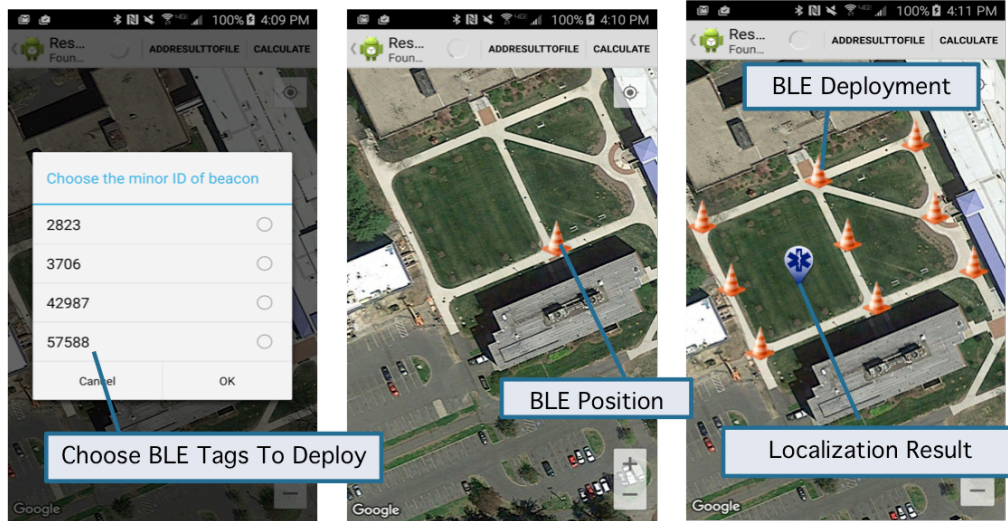

Figure 5 GUI for responder localization

4.2.2. Localization of Beacons Based on Mobile Phone Localized by GPS

In addition to localize responder based on stationary beacons, it would also be helpful to localize the evacuees based on the position of responders who are carrying mobile devices with them. The point of localizing the evacuees based on the responders' positions is that after the responder triaged the evacuees, the evacuees may move, which is not aware by the responders or the incident commanders because the evacuees do not carry mobile device with them so that their position information will not be updated unless the responders update them. As a result, it would be very helpful if the position of the evacuees can be localized by the responders.

The system architecture of the evacuees' localization is shown in figure 6.

As shown in figure 6, the localization of evacuees can be achieved by following steps. First of all, the responder will get all the information of the evacuees including RSSI and ID, and then this information will be packaged and sent to DIORAMA Server, then the localization engine will get the application and execute the localization process.

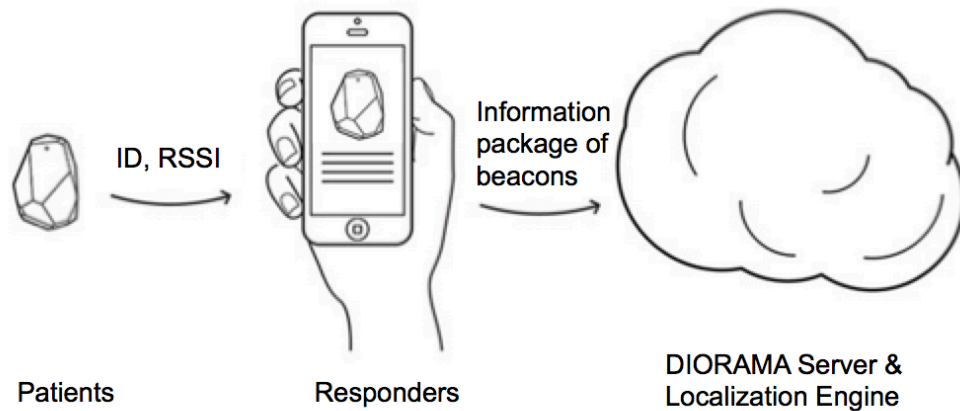

Figure 6 Evacuees localization architecture

4.2.3. Outdoor Forensic Visualization Tools

The post incident visualization system aims to reproduce the scenario that happened during the incident for the outdoor environments so that the responders are able to analyze their behavior and performance during the task to improve their efficiency in the future. The visualization system includes three parts, the charts part, anomaly detection part and the Google earth implementation part. We will discuss the details of these parts in the following sections.

4.2.3.1 Charts Interactive Visual Analytics Tool

The work Charts Interactive visual Analytics Tool is based on android operating system and aim to visualization the data gathered from an urban search and rescue task by exploit diorama system. There are several parts of functionalities needs to be accomplished to achieve this goal.

- An overview menu to enable user take a quick look at the whole application distinctly

The main menu aims to achieve the function of showing the overview of the system, it is able to enumerate all categories of the whole system, which including object, chart type, content type so that the user is able to choose directly the information that he is interested.

- Showing the evacuees information elaborately

The evacuee information is the most important part in the system, since the processing of rescuing evacuees plays a crucial role in the task of diorama system, displaying the information of evacuees elaborately and interactive with its related responder is also necessary for allowing user understand the distribution of evacuees with different priority and the task time spent on each evacuee so that it is applicable to analyze if the evacuees are rescued in the right order or if the efficiency is good enough.

- Presenting the responders information clearly

It is also significant to display the information of responder, since the responders are the primary task executors who carry out the mission with discipline and knowledge of the organization in diorama system. The information about responder should also be related to relevant evacuees and comparison of other responders, which result in the ability to analyze if the responder finish their work in the right pattern or is there a space to improve the efficiency of their work.

- Describing weather information, visibility information and device information

Weather information and visibility information is necessary since the weather condition and visibility condition may affect the process of task since it is harder for responders to detect evacuees or evacuate evacuees in dark day or rainy and snowy day, however, disaster happens in severe weather frequently. As a result, it is critical to show this information that allows the user think about how to improve the task during bad condition. Device information is also necessary by reminding user switch their outdated device if necessary.

- The hierarchy of the data should be clear

Since the data gather from the task is trivial and perplexing, the way to layering these information plays a crucial role in the system. There are information for evacuees, responders, visibility and weather condition, also these information should be partitioned by different

parameter such as task and priority. The way to layering this system is the most important challenge in the project. This objective is achieved by using adapter, navigation and interactive function in this project.

- Interactive function is necessary in this system

Due to the complexity and trivial of the data that need to be visualized, interactive function makes it convenient for user to navigate to the information that he is interested. This capability is accomplished by implementing some click events and quick switch between fragments. Detailed implementation information will be discussed in later sections.

To layer the trivial and redundant data collected from the task of the diorama system and make the whole system well organized, it is vital to design the main architecture methodically and distinctly. In this project, there are two applications, Urban Search and Rescue Interactive Visualization application and Heat map visualization application. Since these two applications are totally separate applications, we need to regard the architecture independently.

4.2.3.1.1 Architecture

For Urban Search and Rescue Interactive Visualization application, since the information for this application is trivial and complicated, it is substantial necessary to classify them base on the classification. First of all, in this application I classify the object of the information, which is evacuees, responders, devices and weather condition, as the first layer. In addition, I separate the filter for these information as the second layer, the evacuee information can be summarized together as overview or be filtered by priority, and all the responders' information can be put together as overview or distributed separately. Moreover, I separate the type of charts, including pie chart, bar chart and stacked line chart, or list of detailed information as the second layer. Furthermore, the task option is the global choice, which is used for constrain the layout that will show up for the entire interface.

The architecture diagram for my visualization of data gathered from diorama system can be shown as figure 7

As shown in the evacuee part of figure 7, user can check the information of evacuees by color, and by task.

The evacuee information that can be observed in the application including:

- Pie chart showing the number of evacuees with different priority
- Bar chart showing the triage time and evacuation time for evacuees
- Stacked line chart showing the number of evacuees at different time
- List of evacuees' detailed information, includes Evacuees ID, Responder ID, Priority, Triage Time and Evacuation Time

From the responder part of figure 7, it is remarkable that we can investigate the information of responder by the overview, which is the summary of responders, or we can inspect the information of specific responder, all these information can be filtered by task.

For the overview responder information, the data we can check includes:

- Bar chart showing the triage time and evacuation time for each responder
- Stacked line chart showing the triage number and evacuation number of responders at each time
- List of detailed information for responders, the detailed information includes:
 - Triaged evacuees by each responder
 - Evacuated evacuees by each responder
 - Triage time and evacuation time of each responder

For any specific responder, the information that are available for checking including:

- Pie chart showing the distribution of evacuees with different priority that are triaged and evacuated by this responder
- Bar chart exhibiting the triage time and evacuation time for each evacuee triaged or evacuated by this responder

- Stacked line chart showing the triage number and evacuation number of evacuees that are triaged and evacuated by this responder at each time
- Detailed information for this responder, the detailed information includes:
 - Triaged evacuees by this responder
 - Evacuated evacuees by this responder
 - Triage time and evacuation time of each responder

From the other information part in the figure 7, other information data includes device information and detail information, which can also be partitioned as three parts: Incident Information, Weather Condition and Visibility Condition.

- For device information, we need to know
 - Hardware and software of incident commander
 - Hardware and software of responder
 - Hardware and software of server
 - Localization used device
- For detail information, we need to know
 - Incident Information, which includes Incident ID, Start Time, Finish Time, Location and so on
 - Weather Condition
 - Visibility Condition

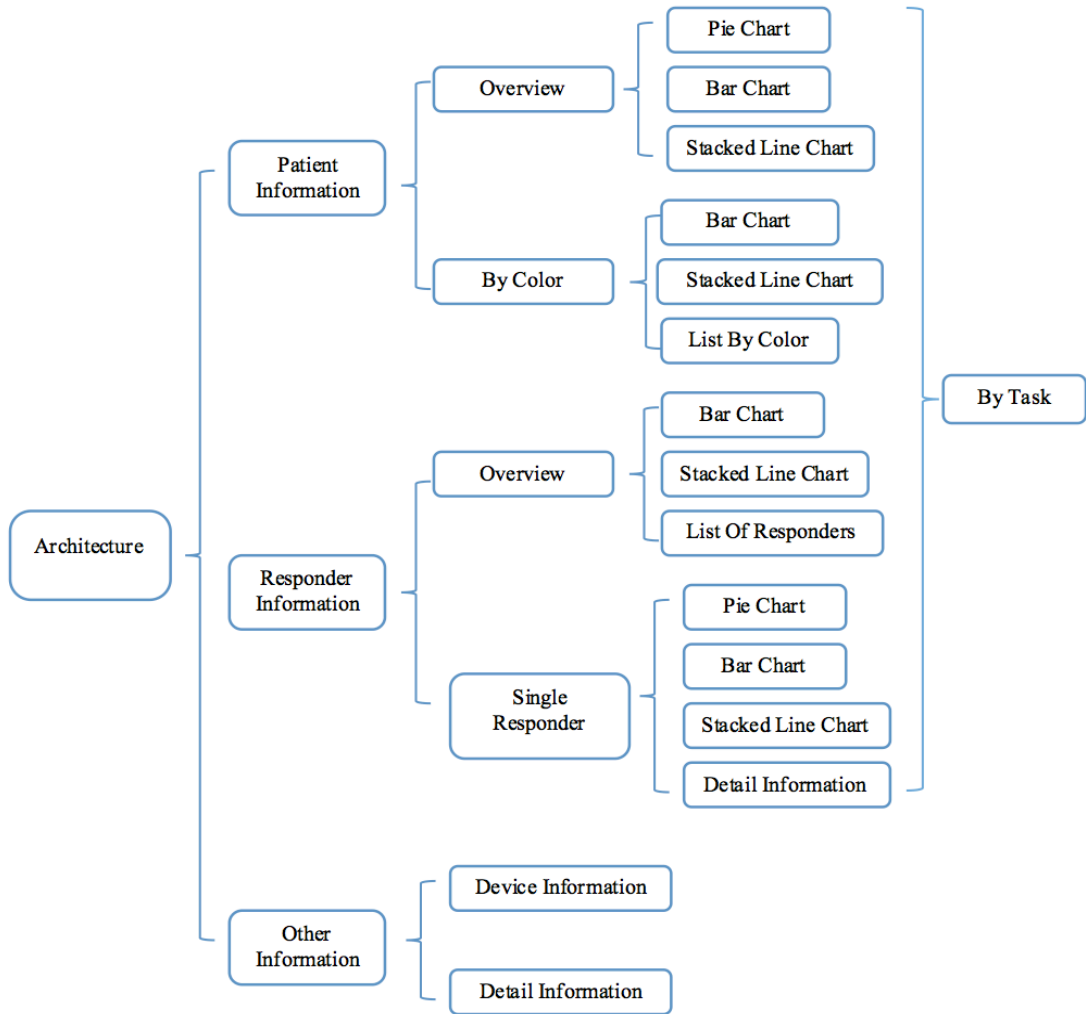

Figure 7 Architecture of Charts Interactive Visual Analytics Tool

4.2.3.1.2 Main Menu

As I mentioned in previous parts, the data collected from the diorama system is trivial and complicated, which makes it crucial to design a visualization tool that allows the user be able to understand the structure of the system quickly and clearly. As a result, it is necessary to design a systematic and well-organized main menu to assist the user to understand the visualization tool.

The main menu part shows part of the architecture of the system, from the layout of main menu, which is shown in figure 8, it is convenient to see that the first layer and second layer of the whole system presented in figure 7 is included in main menu, the first layer is divided by the object of the information, it contains evacuees, responders, and other information including device and weather condition. The second layer is divided based on the content of these object information. For example, the evacuee information is divided by different priority. And due to the number of responders will not be too much, we can separate each of them so that we are able to find out the information for each specific responder. The third layer of the structure will be illustrated detailed in later sections.

In addition, the main menu is designed as a notification window drawer so that the user can take it out by clicking the notification button or by swiping the screen from the left edge of the interface to the right. He can also hide the notification window by swiping it to the left or clicking anywhere else outside the notification window.

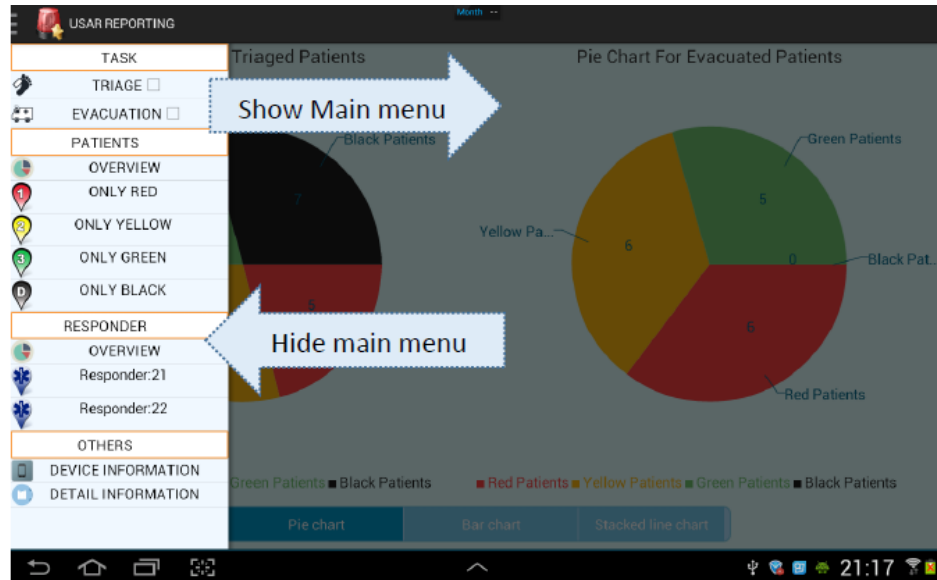

Figure 8 Main menu

In figure 8, there are four parts of content that I'd like to explain elaborately, TASK part, EVACUEE part, RESPONDER part and OTHERS part, which will be illustrated in the following sections.

From the main menu, the user will be able to understand the whole structure of this system thoroughly, so he can choose the information he is interested and can directly navigate to the corresponding layout. Also, the function of drawer which can be unfold and closed by swiping the screen would be very convenient for the user to take it out without detour, besides, the space will be enough other layout.

4.2.3.1.3 Task

There is no doubt that it exists some pattern in the substantial amount of data collected from the diorama system. After I observed these data diligently, I find out that almost all these data of evacuees and responders can be divided by two tasks, triage and evacuation. As a result, it is necessary to classify the information of evacuees and responders with respect to the task status so that the user will be able to investigate the information without bothered by other irrelevant data.

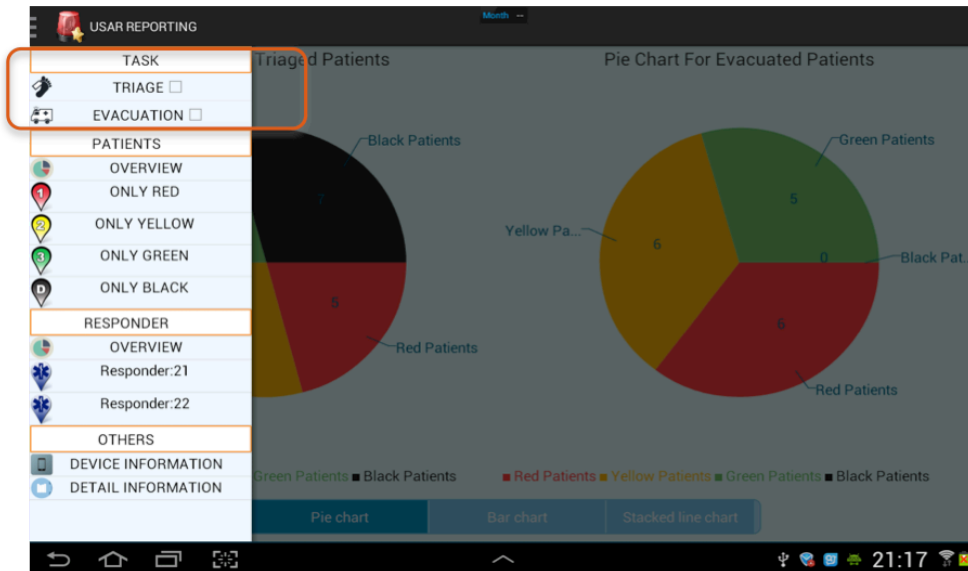

Figure 9 Task part in main menu

In the task part, there are two check boxes provided to allow the user choose the way to look at all the information for evacuees and responders as shown in figure 9. If the user wants to filter the information by task, he can achieve this by checking the check box of triage and evacuation in the top of the main menu. The possible options are below:

- Both of the triage and evacuated options are checked.

By doing so, the user will be able to check both of the triage information for evacuees and responders.

- Only the triage option is checked.

If the user chose only the triaged option, then the evacuated part information will be filtered, and only the triage information will show up in the interface.

- Only the evacuate option is checked.

If only the evacuated option is checked, then the interface will only show the evacuation information for evacuees and responders.

- Neither of the triage option and evacuate option is checked.

If nothing checked in the main menu, then the interface will show both of the triage information and evacuate information as a default status.

The task part facilitates the routine to check all the evacuees and responder information by task. It enables the user to filter irrelevant information just by checking check boxes, which is very convenient. Besides, putting the task part in the top of the main menu makes it clear for the user to understand the function of these check boxes. Since the task status works as a global parameter in the whole system, showing it at the top part of main menu reminds the user to check it at first, and then he will never need to change the status again if not necessary.

4.2.3.1.4 Evacuees

Evacuees are the most important part in the urban search and rescue part, since the core purpose of the task is to rescue these evacuees efficiently and properly. And the evacuees' data collected from the diorama system can reflect the efficiency and the sequence of these evacuees that have been triaged and evacuated directly. Therefore, presenting the evacuees data clearly and elaborately would be significantly helpful for analyzing the task performance.

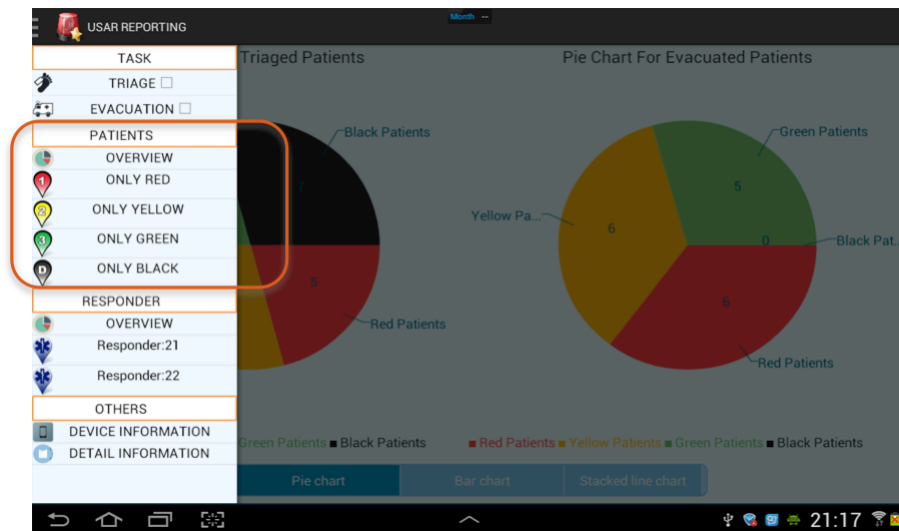

Figure 10 Evacuee part in main menu

From the evacuee part in main menu as shown in figure 10, we can see it clearly that there are three options available for the user to check the evacuee information. In the evacuee

part, the user can choose the way to check the information for evacuees. He can choose to check by overview, which can show all the information for evacuees by pie chart, bar chart and stacked line chart, or by color, which will show the evacuees with only the chosen priority. Also, the user can check the information by specific responder, by doing so, the user will be able to see the evacuees triaged by specific responder, to make this application precisely, I combined this part with the responder part together, to check this in detail, please see the responder part.

- Overview

There are three parts contained in overview layout for evacuees, pie chart, bar chart and staked line chart. The detailed information about these charts will be explained in this section. If the user click the overview button below evacuee as shown in figure 10, he will be able to see the information for all evacuees by pie chart, bar chart and stacked line chart, and these chart can be switched by swiping the screen as shown in the figure 11 and figure 12, figure 11 shows the navigation from pie chart to bar chart by swiping the screen to the left, figure 12 shows the navigation from bar chart to staked line chart by swiping the screen to the left.

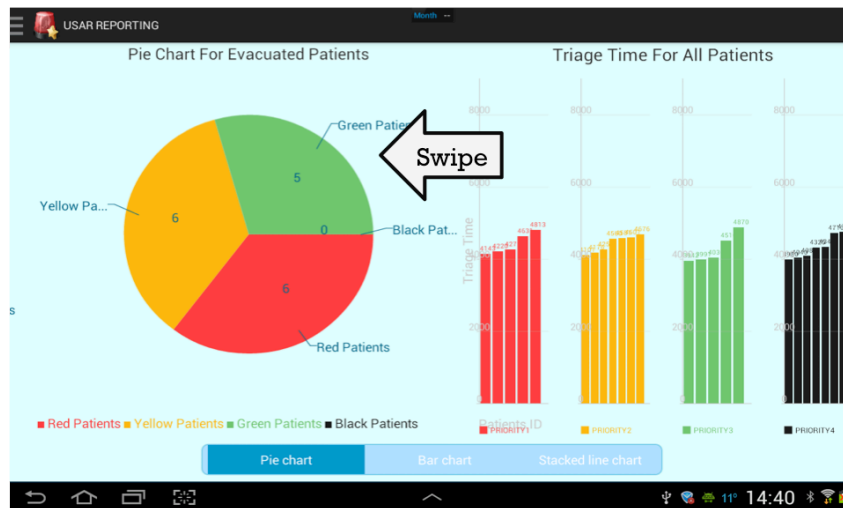

Figure 11 Overview of evacuees - from pie chart to bar chart

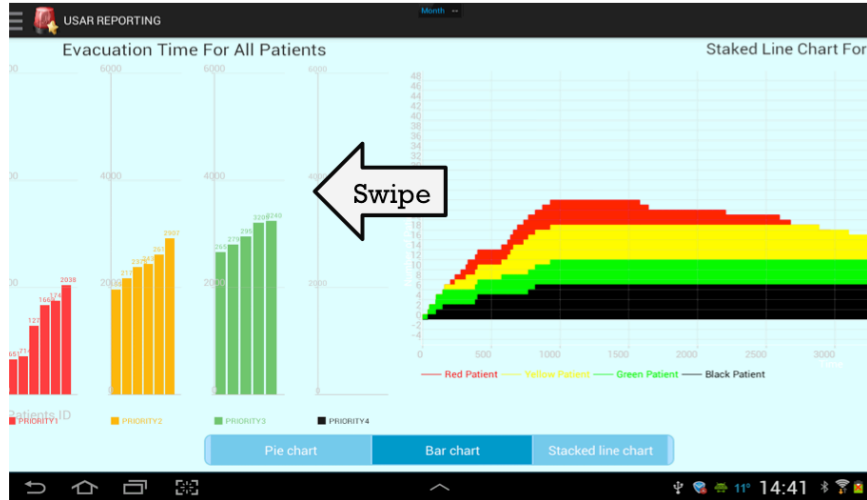

Figure 12 Overview of evacuees - from bar chart to stacked line chart

Besides, if the user checks only the triage at main menu, he will only see the triage information for evacuees, likewise for evacuation checkbox, as mentioned in previous section. Figure 13 shows the layout for overview evacuees with only triaged checkbox checked.

In figure 13, we can also notice the option bar shows at the bottom of the interface, which shows the status of the current layout, the dark part of bar shows the current type of chart.

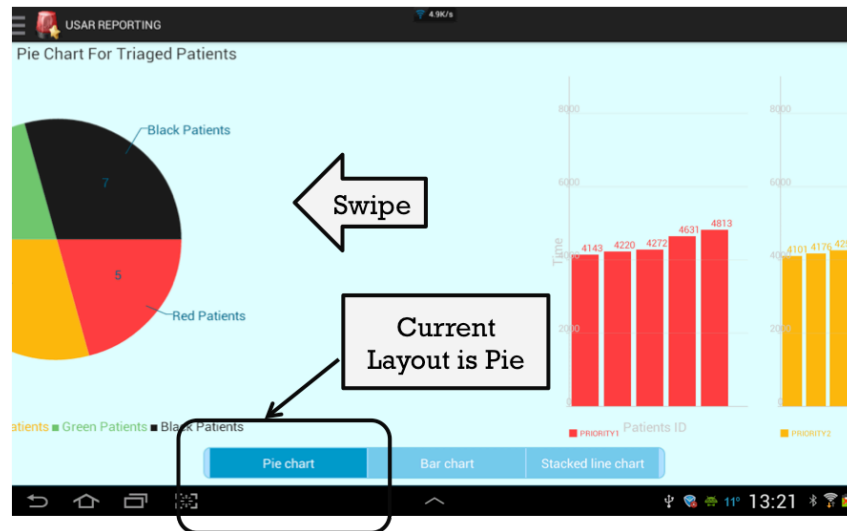

Figure 13 Only triage evacuee overview

As shown above, the overview part consists of three kinds of charts, to explain the functions of the application; it is necessary to introduce the usage of these charts elaborately.

- Pie Chart

The pie chart is the first part of the overview of evacuee information, because it shows distinctly the distribution of the number of evacuees with different priorities.

Figure 14 shows the pie chart for all the evacuees. Left part is the distribution of triaged evacuees, and right part is the evacuated evacuees. If the user click only triage checkbox in main menu as I mentioned in section before, only the triage part of the pie chart will show up, likewise for evacuation condition.

In the pie chart, the number in each color shows the amount of evacuees with different priorities. As shown in figure 14, we can know that in this trial, the amount of triaged evacuees with priority red is 5, these with priority yellow is 7, 5 triaged evacuees has a priority green, and 7 evacuees are with priority black, which means there are 7 dead evacuees in this triage. Likewise, the evacuated evacuee part shows the distribution of evacuated evacuees.

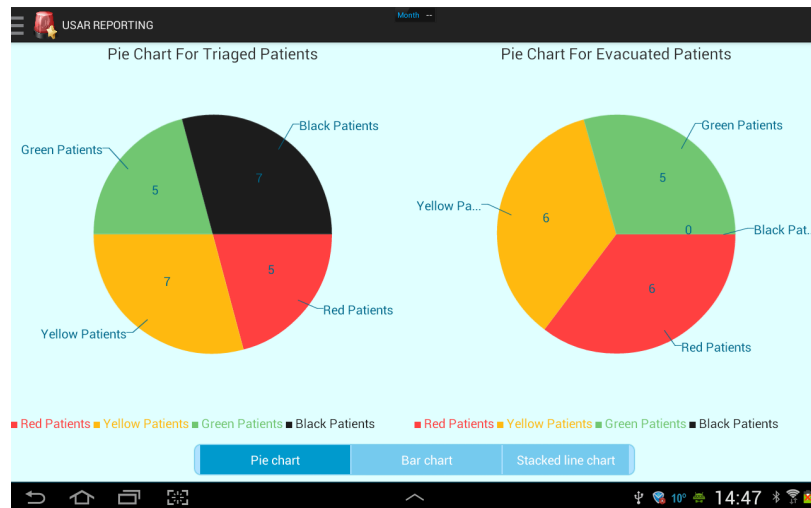

Figure 14 Pie chart for all evacuees

- Bar Chart

The bar chart is the second part of the overview of all evacuees. It shows the triaged time and evacuated time for each evacuees, and the bar chart is classified by priority and sorted by ascending order as shown in figure 15.

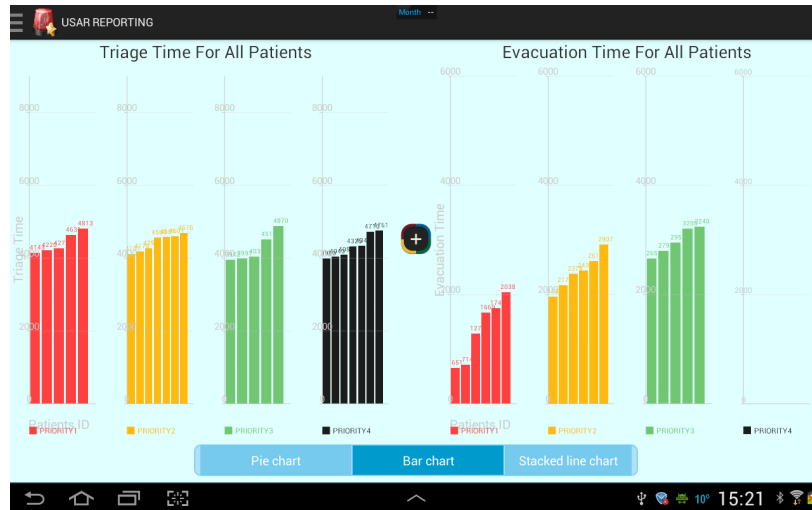

Figure 15 Bar chart for all evacuees

Similar to pie chart mentioned above, the color in the bar chart shows the information for evacuees with different priority.

In the bar chart, the x-axis is the evacuee id, and the y-axis is the triage time, which shows in the left part in figure 15, or evacuated evacuees, which presented in the right part of figure 15, all these time are presented in seconds. In this application, triaged time is calculated from the task starts time to the specific evacuee triaged time, evacuation time are calculated from the triage task finish time to the time that each evacuee is evacuated.

The plus button showing in the middle of the layout provides a function to present the total amount of time spent on each evacuee, if the user click this button, then a layout showing the total time for all evacuees will show up, as shown in figure 16.

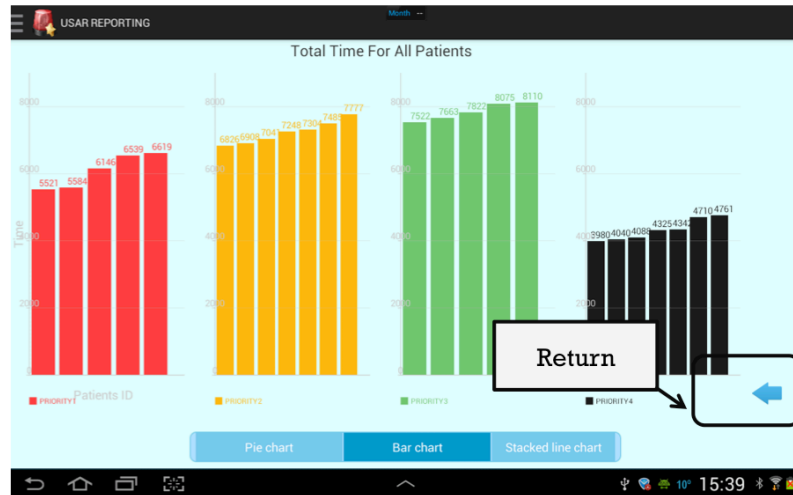

Figure 16 Total times for all evacuees

It is also necessary to mention that at the bottom right of the layout there is a return button, which allows the user to come back to the previous layout instead of redirect from main menu, which is convenient for user.

Moreover, the user is able to check the detailed information for each evacuee by clicking each bar in the bar chart. By doing so, the user will be able to see a remind dialog first to show the evacuee ID and triage or evacuate time as shown in figure 17.

If the user clicks yes in the reminding dialog, he will be able to view the detail information for this evacuee. The detail information for each evacuee includes evacuee ID, responder ID, triage time, evacuate time and total time spent on this evacuee, besides the location information is also provided as shown in figure 18.



Figure 17 Reminding dialog for bar chart



Figure 18 Detail information for evacuee

- Stacked Line Chart

The third part of the overview for all evacuees is stacked line chart. The stacked line chart shows the number of evacuees at each time. The x-axis is the time in seconds, the y-axis is the number of evacuees as shown in figure 19.

In figure 19, it is clearly to see that there are ascending part and descending part in the chart, the ascending part shows the number of evacuees that have been triaged, and the descending part show the number of evacuees that have been evacuated. From the chart, we can clearly know when the evacuation task starts.

As I mentioned in previous part, the color in stacked line chart shows the evacuees number with different priorities. Since in the diorama system, the sequence of evacuate evacuees would be red evacuees first, yellow second, green third, and the black evacuees will not be evacuated.

So in the stacked line chart, the triage sequence is not important, but in the evacuation part, the yellow should decrease after all the red evacuees have been evacuated, which means the red part of the stacked line chart become zero, and the green part should decrease after yellow become zero, the black part should not decrease. As a result, it will be clear if something that is not appropriate happens, for example, in figure 19, the green evacuees start to decrease before yellow become zero. So the user should think about what happens during the triage.

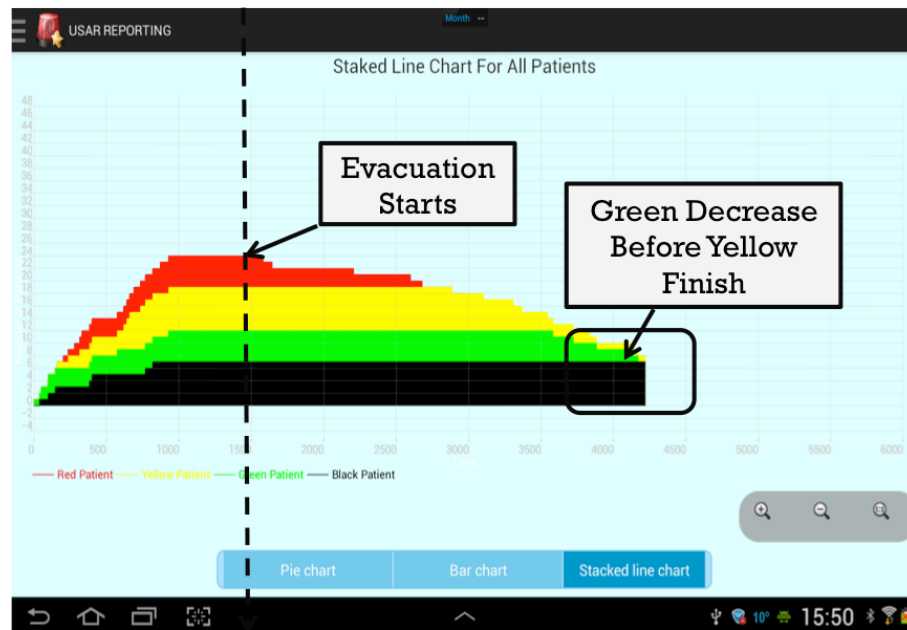

Figure 19 Stacked line chart for all evacuees

From the stacked line chart, the user can clearly see the maximum of evacuees and know this point is the time when the evacuation task starts. Besides, if some disorder happens, it would be clearly shown in this layout.

In addition, if the user clicks the chart in the layout, he will be able to see the list of detailed information for evacuees with different priority as shown in figure 20.

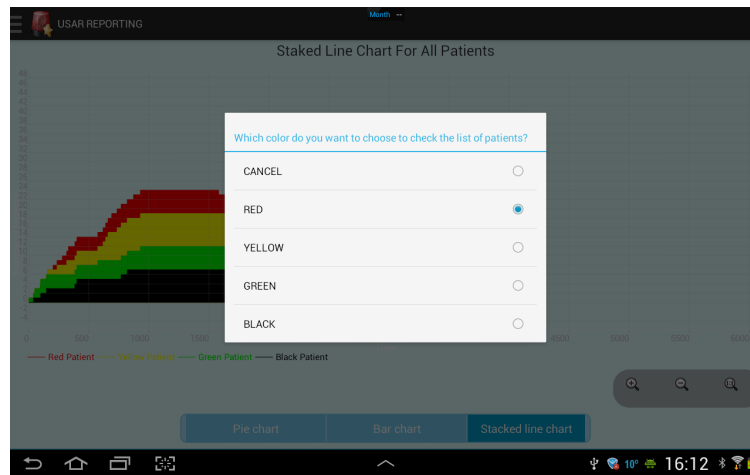

Figure 20 Checking list of detailed information in stacked line chart

As shown in figure 20, the user is able to choose the list for specific color that he is interested, if the user want to check the evacuee information for all red evacuees, he can click red, and then the list of detailed evacuees for all evacuees with red priority will display as shown in figure 21. The return button shown in this layout plays the same function with what I mentioned before, which is to return back to the previous layout.

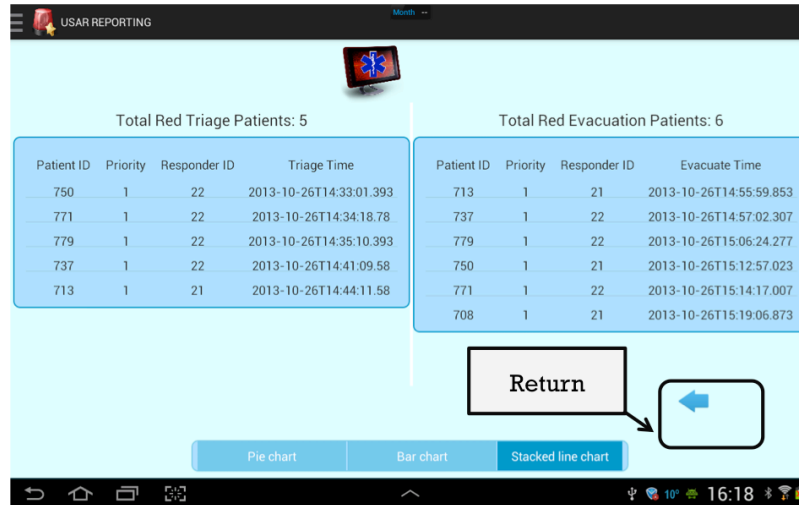

Figure 21 List of detailed evacuees with red priority

- Only One Color

The evacuees during the diorama system will be triaged as four priorities, red, yellow, green, and black, and red priority is the highest priority, which will be evacuated before evacuees with other priorities. Likewise, evacuees with other priorities will be evacuated with order of yellow second, green third. Evacuees with black priority will not be evacuated, since it means the evacuees are dead. As a result, it is necessary to classify this layout with different priorities to enable the user inspect the evacuees with the priority that he is interested.

As shown in figure 8, the user is able to choose to check the evacuees with different priority by clicking the ONLY RED/ ONLY YELLOW/ ONLY GREEN /ONLY BLACK button below the EVACUEE in main menu. In this section, I will take ONLY RED as an example; other color filters are working the same way.

If the user chooses ONLY RED below EVACUEE in the main menu, he will be able to see the information for all evacuees with priority red. Since this part only cares about the evacuees with priority red, there is no need to show the pie chart which showing the comparison of the number of evacuees with different priority. As a result, I put the list of detailed information for red evacuees instead of pie chart. Therefore, the only red part contains three sections, bar

chart, stacked line chart and list of detailed information for all evacuees as shown in figure 22 and figure 23. Figure 22 shows the navigation from bar chart to stacked line chart by swiping the screen to the left. Figure 23 shows the navigation from staked line chart to list of evacuees with priority red by swiping the screen to the left.

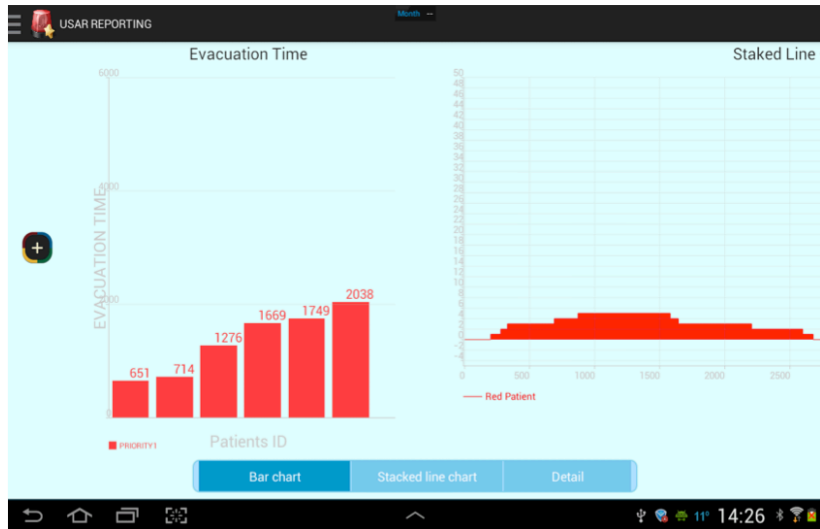

Figure 22 Only red evacuees layout - from bar chart to stacked line chart

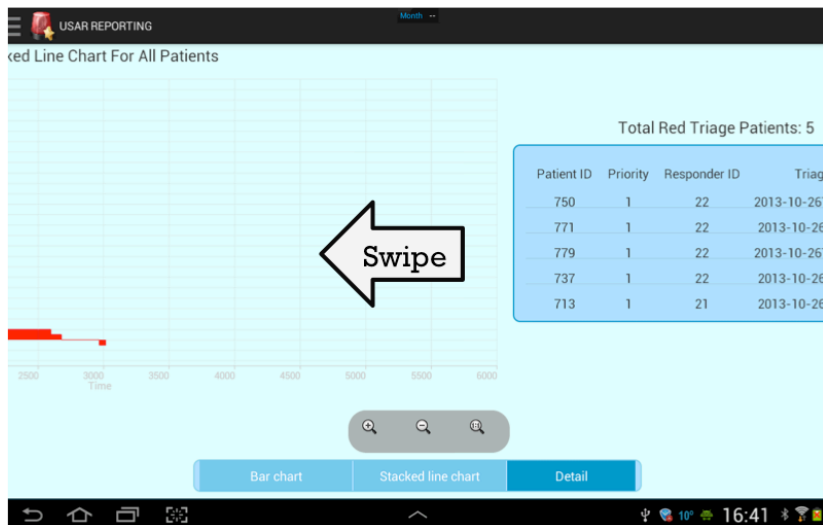

Figure 23 Only red evacuees layout - from stacked line chart to details

The bar chart and stacked line chart already explained elaborately in previous section, I would not repeat it here.

As mentioned above, evacuees are the most important part of the urban search and rescue task, the visualization of the evacuee data makes it significantly for user to analyze the difficulty of the task by looking at the pie chart showing the distribution of evacuees with different priorities. In addition, the user is able to check the efficiency of the task by looking at the triage time and evacuation time presented in bar chart. Besides, the staked line charts used in this visualization part make it easier for user to monitor if these evacuees are rescued in the optimal order.

4.2.3.1.5 Responders

Responders, the primary executor of the urban search and rescue task, play a significantly important role in the system, therefore, there is no doubt that I have to put responder information as an essential part of the system. In addition, the triage time and evacuation time executed by responders directly reflect the efficiency of the whole task. As a result, visualization of the responder information will provide substantial help for analyzing the task.

As shown in figure 24, the responder part consists of two parts, the overview part and the part for specific responders, which are responder 20 and responder 21 in this case. In the overview part, the overview information for responders are presented, is includes the triage time and evacuation time of the responder spent presented as bar chart, the sequence of these responders commit to each task presented as staked line chart, also the list of detailed information for all responders.

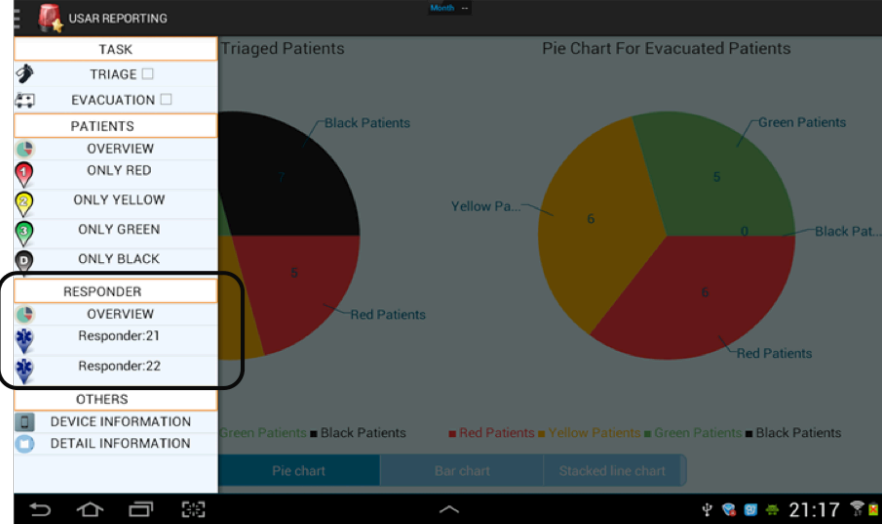

Figure 24 Responder part in main menu

- Overview

In the overview part, the layout includes bar chart, which shows the triage time and evacuation time for all responders, and staked line chart, which shows the triage sequence and evacuation sequence of the responders, besides, the list of detailed information for all responders.

Similar to evacuee part, the navigation between these different layouts will be achieved by swiping the screen, as shown in figure 25. The dark part showing in the status bar refers to the type of current layout.

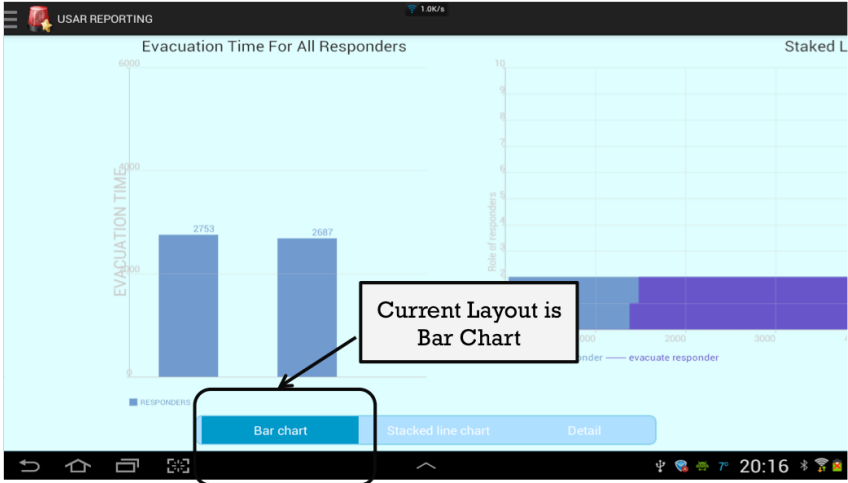

Figure 25 Responder overview - from bar chart to stacked line chart

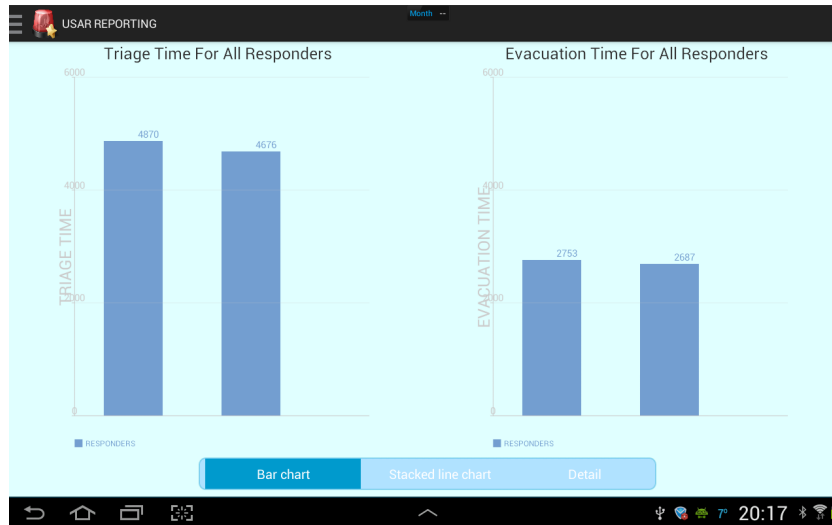

Figure 26 Bar chart for responders

- Bar Chart

The bar chart of the responder shows the triage time and evacuation time for all evacuees triaged and evacuated by specific responder. The x-axis is the id of responder; the y-axis is the triage time or evacuation time of responder by seconds. As shown in figure 26, the left part of the layout is the triage time of the responders, and the right part is the evacuation time of the responders. From this figure, we also know that there are only two responders participate in this task. The first responder spent 4870 seconds on triage all the evacuees and the second responder spent 4676 seconds on triage all the evacuees. Likewise, from the right part of the figure, we can easily get that the first responder evacuate all the evacuees with 2753 seconds, and the second responder evacuate all the evacuees with 2587 seconds.

If the user is interested in the detailed information of each responder, he can achieve this by clicking each bar in the layout. If the user clicked any bar in the interface, a reminding dialog will show up to remind the user if he is interested in the information for each responder as shown in figure 27.

If the user choose yes in the reminding dialog showing in figure 27, he will be able to see the detailed information for this responder that chosen in bar chart. The format for detailed information for each responder can be seen in figure 28.

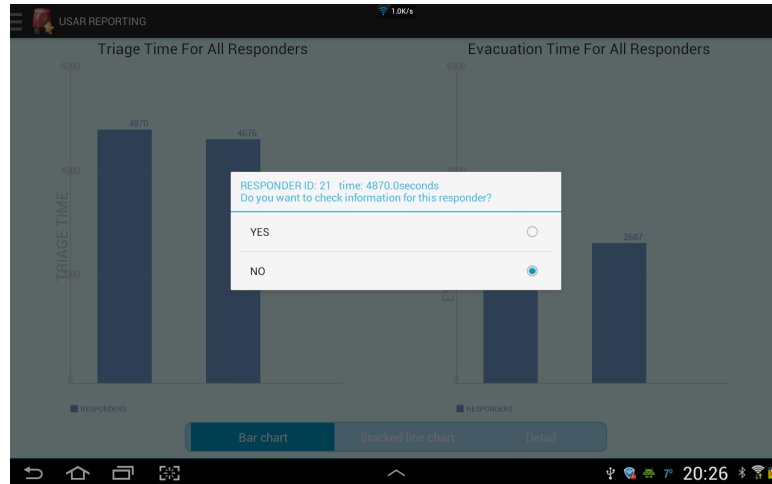

Figure 27 Reminding dialog

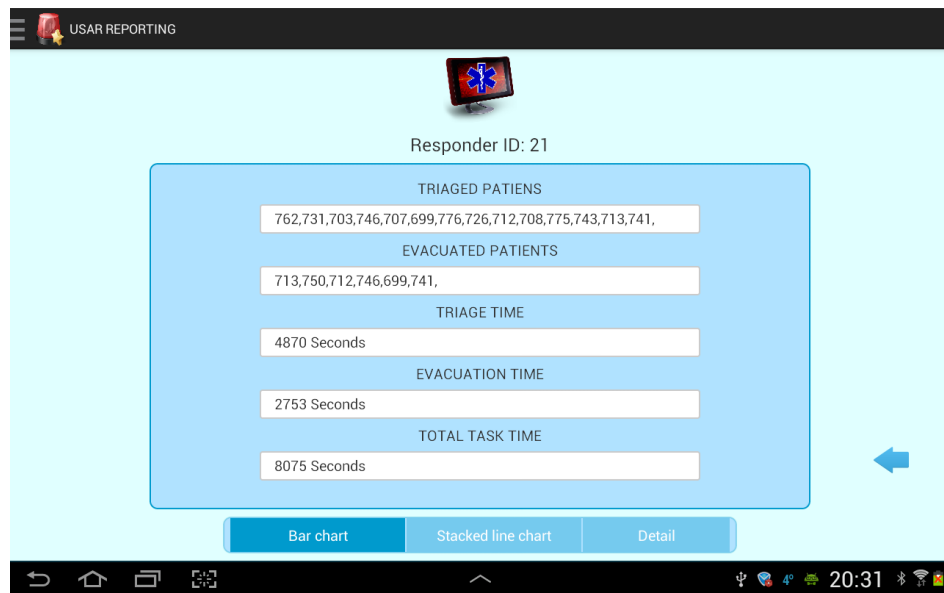

Figure 28 Detail information for specific responder

- Stacked Line Chart

The stacked line chart is used to present the triage time and evacuate time for all responders, as shown in figure 29. As shown in the figure, there are total two responders took part

in the task, these responders starts to triage student almost at the same time, and after about 1400 seconds, one responder starts to evacuate the evacuees, and then another responder starts to evacuate evacuees, about 4000 seconds after the task starts, the evacuation task ends one by one.

If the user is interested in the detailed information for the responders, he can click the staked line chart, and then a reminding dialog will show up to remind if the user want to check the information list for responders as shown in figure 30.

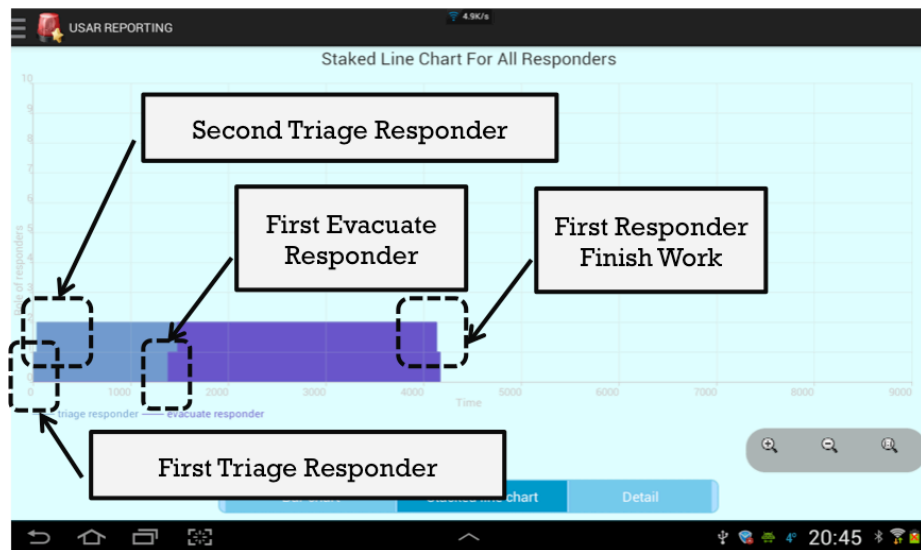

Figure 29 Stacked line chart for responders

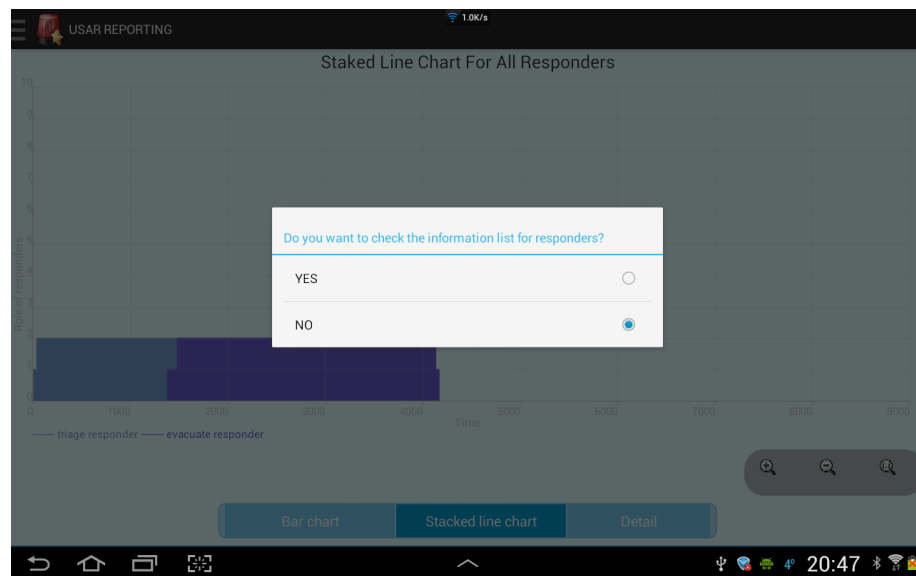

Figure 30 Reminding dialog

- List of Detail Information for Responders

In addition to check the list of detailed information for responders by clicking the stacked line chart, the user can also check the information by swiping the screen to left as shown in figure 31.

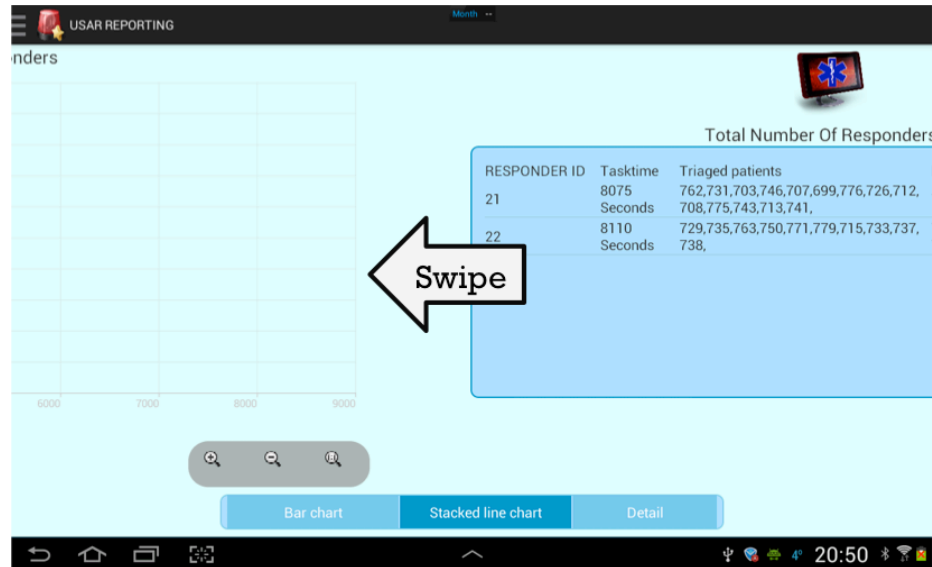

Figure 31 Responder overview - from stacked line chart to detail list

In the list of detail for responders, the user is able to see all the responders listed in the layout, including the task time for each responder, triaged evacuees by each responder and evacuated evacuees by each responder.

- Specific Responder

The specific responder part includes two parts, the charts showing the evacuees triaged and evacuated by this responder, the detailed information for this responder.

To make the user interface precisely, this part includes the information of evacuees triaged and evacuated by this responder. Therefore, this part consists of four parts, pie chart showing the distribution of evacuees with different priorities, bar chart showing the triage time and evacuation time for evacuees, stacked line chart displaying the triage and evacuate sequence by the responder, the detailed information for this responder.

Since the evacuees triaged by the responder may differ from the evacuees evacuated by this evacuees, the number and priority of the evacuees in the triage part may not be the same with these in the evacuation part.

All these layouts are navigated by swiping the screen, for example figure 32 shows the navigation from pie chart to bar chart.

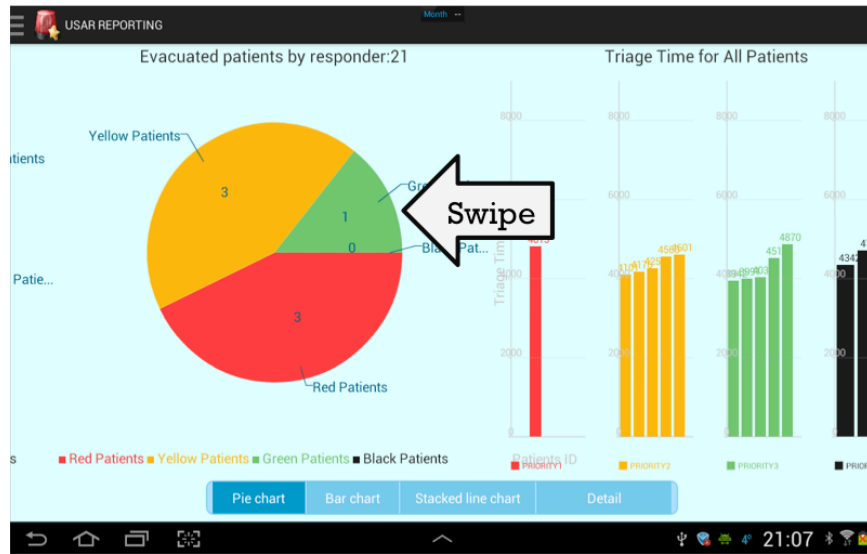

Figure 32 Layout for responder 21 - from pie chart to bar chart

Since the pie chart, bar chart and staked line chart are already explained elaborately in previous section, I will focus on introducing the detailed information for the responder. As shown in figure 33, the detailed information for specific responder includes evacuees triaged and evacuated by the responder, triage time, evacuation time and total task time of this responder.



Figure 33 Detail information for responder 21

From the responder part, the user can not only get the information for responders by charts but also by lists, so the user is able to compare the efficiency to triage and evacuate evacuees from bar chart, he can also understand the sequence of triage and evacuate evacuees from stacked line chart. Besides, the user can also check the list of evacuees triaged and evacuated by each responder from the lists. In addition, the evacuees filtered by each responder is also included in this part. As a result, the responder part information is essential in the application.

4.2.3.1.6 Others

As shown in the main menu in figure 34, there are two parts constitute to the OTHER part, device information and detail information. The detailed information includes incident information, weather condition and visibility condition. Since the diorama system are supported by advanced devices such as android application and server, it is vital to keep these devices updated enough to satisfy the needs for diorama system. In addition, the Urban Search and Rescue Interactive Visual Analytics application is used for analyze task in incidents, it is necessary to point out which incident we choose for this application. Moreover, the weather

condition and visibility condition is necessary to mention because the user should also analyze if the weather and visibility condition affects the efficiency of the task and it is helpful for figuring out how to improve the efficiency in bad weather or visibility condition.

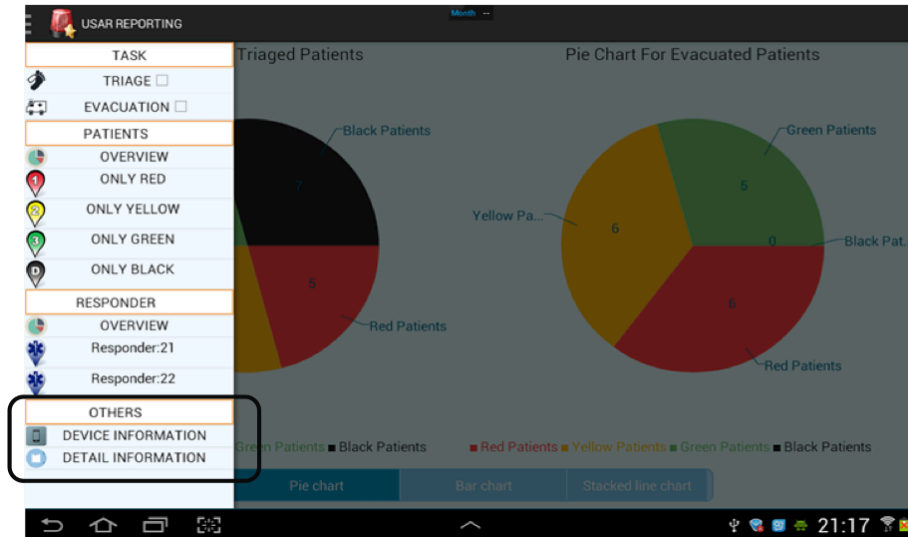

Figure 34 Others in main menu

If the user clicks DEVICE INFORMATION under the OTHERS in the main menu, the user will be able to see the device information in the diorama system as shown in figure 35. In the figure, we can know that software and hardware information for incident commander, responder, server are needed, also the localization tool will also be checked in the system.



Figure 35 Device information

If the user clicks detail information under the OTHERS, the detail information including the incident information, weather condition and visibility condition will be presented as shown in figure 36.

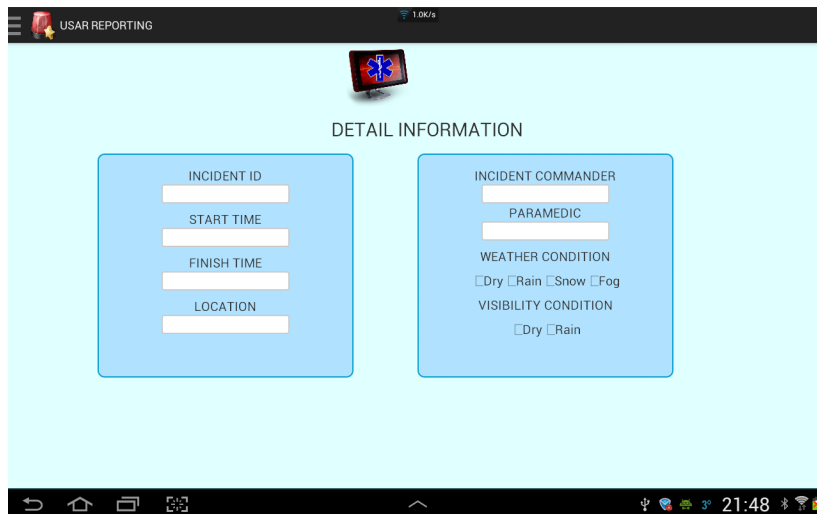

Figure 36 Detail information

From the detail part, the user can not only get the device information for incident commander, responder, server and localization, but also the incident information, weather

condition and visibility condition, both of these are very important for analyze the task in diorama system.

4.2.3.2 Anomaly Detection Visualization Tools

The work Anomaly Detection Visualization Tools consists of two parts, animation and anomaly detection. The purpose of the animation is to replay the scenario of the Urban Search and Rescue task, which includes displaying the movement and operation of responders and evacuees as well as achieve the interactive functionalities. In addition, the anomaly detection aims to find out and present the user with the abnormal situation directly and clearly. There are several parts of functionalities needs to be accomplished to achieve these goals.

- Reproduce the scene of the task

To make the user familiar with the task, it is necessary to replay the animation happened in the scenario. The animation includes the movement of evacuees and responders, which represents to the geographic change of them, and also the operation of responders such as triage, evacuation and end evacuation, which consists of the primary task of the responders.

- Achieve the functionality of interactively animation display

Since the animation of responders and evacuees includes everything happened regarding the movement and operation, there might be some period of the animation that the user is not interested in, then it would be significantly helpful for the user to skip some fragments or speed up/ slow down the animation. Besides, it is also important to allow the user know the timeline and progress of the animation.

- Anomaly Detection

Since the animation of responders and evacuees are informative and contains substantial amount of data, the user might be overwhelmed by this and find its hard to find the important information, it is necessary to find out the abnormal situation happened in the task and show them to the user. The detected anomalies should include evacuee anomalies such as evacuation order anomaly, which represents that the evacuation order does not conform to the regular pattern. For

example, the priority yellow evacuee, who should be evacuated after priority red evacuee, is evacuated before evacuee with priority red. Or some other anomalies such as evacuate before triage, responder tracked, and responder move outside the designated area should also be detected in the system.

- Anomalies visualization

The anomalies detected by the anomaly detection system should be visualized to the user so that the user can pay attention to the abnormal situations. The visualization of the user should be shown directly on the Google map, which is also used for display the animation of evacuees and responders, so that the user is able to watch the anomaly directly and clearly. Besides, some details about the anomalies should also be presented in the application.

To achieve the functions listed in the previous part, the corresponding measurements need to be implemented includes following techniques.

- Google Map implementation

The geographically presentation of evacuees and responders plays an essential role in animation display. One of the best ways in android to display individual geographically is to use the Google map, which provides the ability to display responders and evacuees in different latitude and longitude as well as the capability of showing the surrounding environment.

- Real Time Identical Display

The animation display should also be identical with the real time so that the user is able to understand the relationship between the movement and operation of responders and evacuees with the time. The timestamp property of evacuees and responders should be used to accommodate the animation of evacuees and responders. In addition, a timeline should also be implemented to show the time status of the animation.

- Interpolation Algorithm

In order to provide the user with a smooth animation, the interpolation algorithm is also applied in the application. Since the data gathered from the Diorama system is limited, display the animation according to the data might not be able to provide user with a smooth animation, it is very necessary to add the interpolation algorithm to the animation so that the animation display is quite smooth and provide the user with a good user experience.

- Interactive Functions

The interactive functions are achieved by using some widgets such as progress bar that shows the timeline of the animation as well as enables the user to change the progress of the animation display. Besides, some buttons such as play/pause button, speed up/slow down button and replay button can also provide the user with the ability of interactive.

- Anomaly Detection

The anomaly detection will take use of the rule-based anomaly detection technique and uses the decision tree as the classifier. Besides, the classification type this system belongs to is multi-class classification, which classifies the responders and evacuees into different classifications. By analyzing the properties of the responders and evacuees as well as implementing the decision tree, it is convenient to determine if a responder and evacuee is abnormal or normal and which anomalies does it have.

- Anomaly Visualization

The visualization is based on the animation interface, and the anomalies will be shown directly on the animation in Google Map. Besides, the total number of anomalies and the detail information for each anomaly can also be shown in the animation interface.

4.2.3.2.1 Animation

As I mentioned in previous section, the purpose of creating the replay animation is to display the scenario of the evacuees and responder movements and operation to the user so that the user would be able to get familiar with the scenario. Besides, display the animation

interactively is also an important element in the animation part as it enables the user to view the part that he is interested in and skip the part that he is not.

For the animation part, the first function that needs to be achieved is the simple animation that is able to reproduce the task scenario by showing the evacuees and responders from the perspective of both time and space. The location property and timestamp property of evacuees and responders play significant roles in this case. Besides, Google map is implemented to show the responders and evacuees geographically and timeline is used to display them on the phase of time. Figure 37 shows the visualization effect of the animation on the Google map.

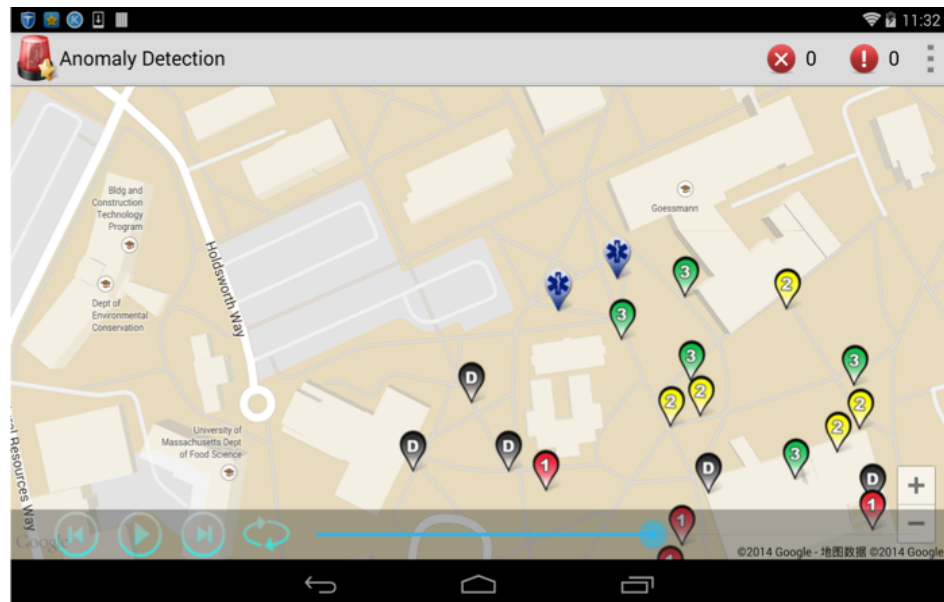

Figure 37 Animation display in Google map

In addition, to make the animation smooth and provide user with a wonderful user experience, interpolation algorithm is implemented. In this system, for each two successive data update between the same evacuee and the same responder, 20 points are added geographically and temporally.

Besides, to make the application interactive and flexible, some widgets are also applied in this system. Progress bar is used to show the timeline of the animation; in addition, it can be moved forward or backward to change the progress of the animation. Moreover, play/pause

button can be used to play the animation or pause the animation. Speed up and slow down buttons are also provided to enable the user speed up or slow down the animation. The fastest speed is 1 second in animation represents 100 seconds in reality, when reach this speed, the speed cannot be speed up any more, and a toast will present to show that “Already Reached Fastest Speed”. The slowest speed is 1 second in animation with respect to 1 second in reality, when reach this speed, the slow down button will not work any more and a toast will show “Already Reached Slowest Speed”. Further more, a play over button is also employed in the animation to replay the animation from the beginning. The visualization of the interactive widgets can be shown in figure 38.

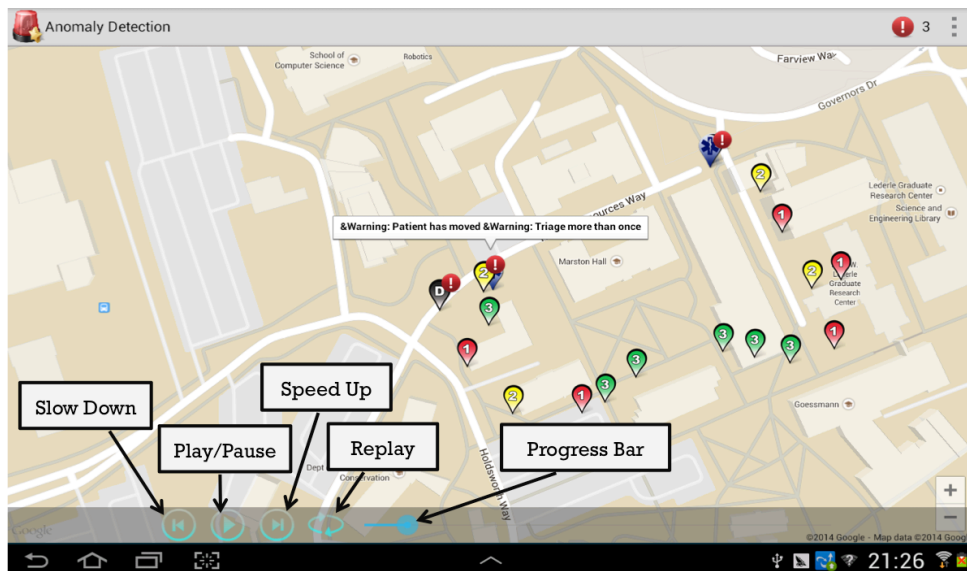

Figure 38 Interactive widgets

As a result, the animation can be displayed smoothly on the user interface, and the progress bar is able to show the timeline of the animation as well as change the progress of the animation flexibly. In addition, the interactive widget can work successfully.

4.2.3.2.2 Anomaly Detection and Visualization

In order to help the user be aware of the anomalies happened in the task, it is beneficial to find out the anomalies and visualize them to the users. The abnormal individual should include

both evacuee and responder, so the evacuee anomalies and responder anomalies should be detected and displayed in the application. Besides, for the evacuees, the anomalies include the evacuee and responder anomalies includes Triage at Evacuation Time, Evacuee Movement, Triage after Evacuation, Triage after End Evacuation, Evacuee Priority Change, Evacuation Order Wrong, Evacuation after End Evacuation, Evacuation More Than Once, End Evacuation More Than Once and so on. For the responders, since the operation anomalies of responders can be reflected on evacuees, so the only anomalies we should think about is the movement anomaly, which consists of Responder Move Outside the Allocated Area and responder Tracked Anomaly. All these anomalies should be detected systematically in the system and should be shown clearly and directly.

For the anomaly detection part, the technique we use is the rule-based anomaly detection. A rule based anomaly detection technique is an anomaly detection technique using classification algorithm to build classifiers. A basic multi-class rule based technique consists of two steps. The first step is to learn rules from the training data using a rule-learning algorithm, which is, in our case, decision trees. The second step is for each test instance, finding the rule that best captures the test instance. In the decision tree, each node corresponds to a non-categorical attribute, and each arc to a possible value of the categorical attribute for the records described by the path from the root to the leaf. In the system, the non-categorical attribute represents to the properties of the responder or the evacuee. For example, for a given evacuee, both of the priority and the assessment type are the non-categorical attributes. And red, yellow, green, black represents the values of the priority. The end of each branch is the classification of the object, which, in our case, is represented as anomalies or normal object.

The rule learning part of the system is to build a decision tree based on the existing data collected by the Diorama system. The decision tree of this application can be shown in figure 39. Since one evacuee or responder may have more than one anomaly, after each determination, the evacuee or responder still need to be determined if they have other anomalies.

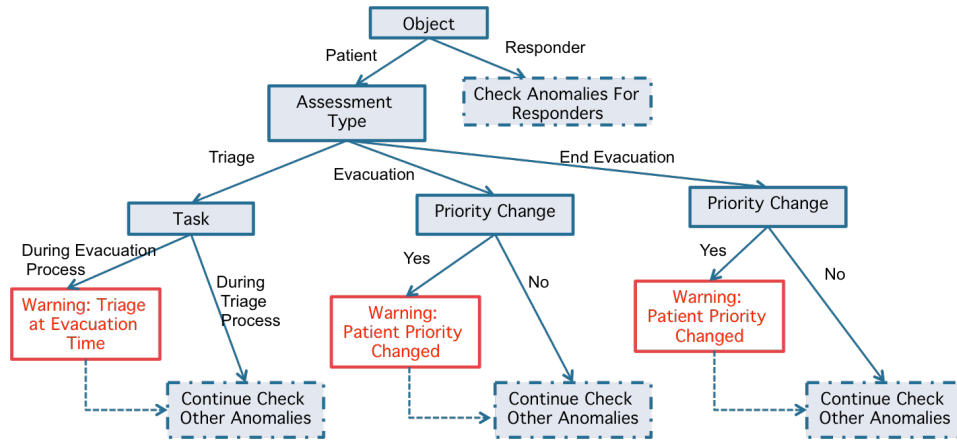

Figure 39 Decision tree

To display the anomalies directly to the user, the anomaly visualization functions should also be achieved in this system. In our anomaly visualization part, any evacuees or responders with anomalies would be marked as a warning individual on the Google map and shown in the animation. Besides, when the user clicks each icon of the evacuee or responder, the anomalies regarding this evacuee or responder would be displayed, as shown on figure 40. In addition, the warning button on the menu bar would show with the total number of anomalies as shown on figure 41. Moreover, when the user click the button, all the anomalies can be shown in the anomaly list together with the functionality of displaying the detail information about the abnormal evacuee or responder, as shown on figure 42.



Figure 40 Anomaly visualization

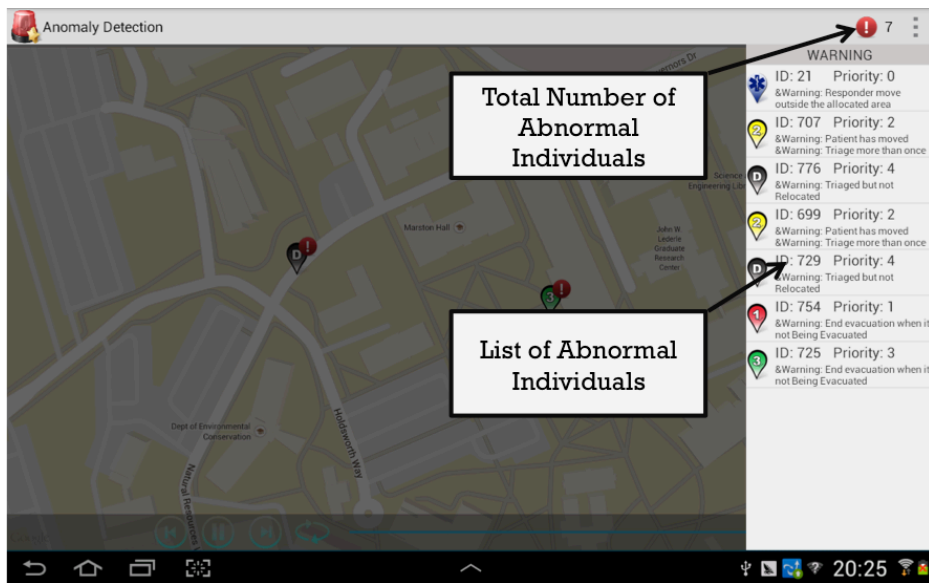

Figure 41 Abnormal individual and list

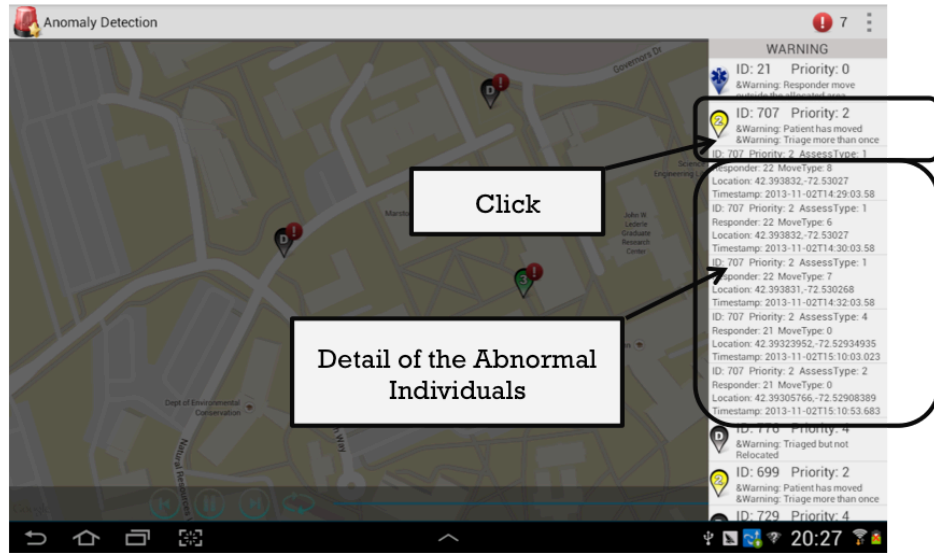

Figure 42 Detail information for anomalies

Based on the decision tree and the visualization tools, the anomalies can be detected successfully and shown clearly with the animation.

4.2.3.3 Google Earth Implementation Visualization Tool

In addition to the Charts Interactive Visual Analytics Tool and the Anomaly Detection Visualization Tool, it would also be helpful to provide a 3D reproduction of the scenario to help the responder analyze the environment so as to improve the efficiency in the future task. The Objectives in this work includes following items.

- Displaying animation

Being able to display the animation is a very important part in reproducing the scenario in the task. Displaying the animation in 3D environment would be significantly helpful to remind the responder what happened in the real task, which can be used to analyze the task as well as obtain more experience in the task.

- Adding timeline to animation

Making the animation identical to real time would also be important to help the responder analyze the task performance. Besides, it can reflect the efficiency in the task directly so that the responder would be able to get more experience from the task.

- Being able to show animation for each separate individual

If a user is interested in the performance of one responder, it is beneficial to show only the animation for the single individual so that unrelated information would be able to be filtered out.

To achieve the functionalities of displaying the animation in Google Earth, there are two ways can be used properly, using the JavaScript language or the KML language. JavaScript allows us to query the data from the server directly, however, the result of the animation would not be very smoothly. And the KML language allows us to display the animation smoothly, but it's inconvenient to adjust the result according to our needs. As a result, we use the combination of these two methods, which provides flexibility as well as a smooth result of the animation. JavaScript language is responsible for handle the time data and achieve the interactive functions, whereas the KML language is responsible for setting the time to timeline as well as displaying the balloon to enable the interactive functions.

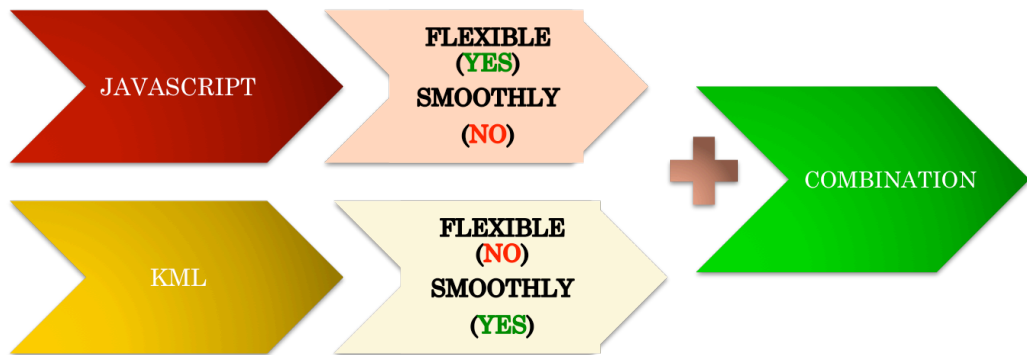

Figure 43 Methods

To reproduce the task scenario and the environment, we use Google Earth to display the responders, evacuees and the environments. There are three primary parts in the system as shown in figure 44.

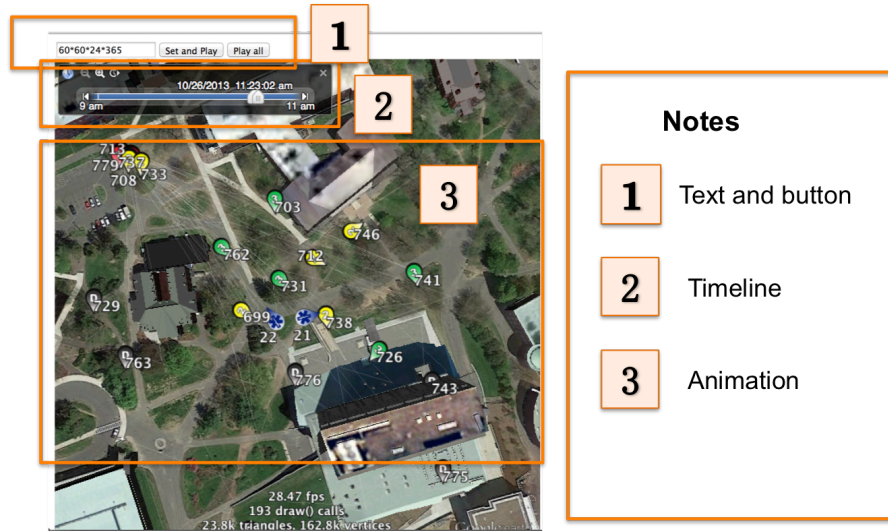

Figure 44 Overviews

As shown in the figure, the first part is the text and button part, which is used to choose the display speed and start the animation. The text part allows the user to set a self-defined play speed. The detailed information of the text and button part can be seen in figure 45. In our case, one second in Google earth animation equals to input seconds in reality.

The Play all button enables the user to play all evacuees and responders.

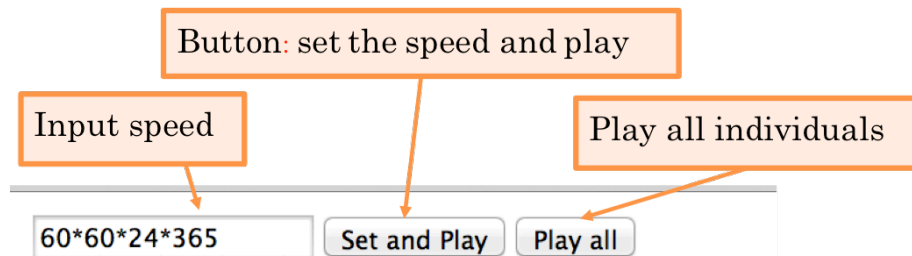

Figure 45 Text and button

The second part is the timeline part, which allows the user to adjust the play status of the animation including adjust the play speed or change the start time of the animation as shown in the figure 46.



Figure 46 Timeline slider

The third part displays the animation in the task. It allows the user to display the movement of each responder and evacuees and the 3D enables the user to check the environment around each responder or evacuee.

CHAPTER 5

INDOOR LOCALIZATION, NAVIGATION GUIDANCE AND VISUALIZATION SYSTEM

5.1 Objectives

The Indoor Localization, Navigation Guidance and Visualization System aims to provide a navigation guidance tool for the users to get out of a dangerous building as soon as possible.

There are several functionalities need to be accomplished to achieve these goals.

- Localization of the evacuees

To provide a helpful and accurate navigation guidance to the user, the localization acts as an important role. The localization result of the user acts as the start point of the navigation guidance application and will be used to generate the navigation path. The localization result will also be used to monitor the flow of evacuees in the building.

- Generate and Display the Path to user to provide navigation guidance

The path generation and presentation is the most important part in the navigation guidance system. The result of the path would directly influence the use experience of the path as well as determine the efficiency for the evacuees to find the optimal exit and minimize the evacuation time.

- Simulation

To simulate the scenario that many evacuees are gathered in the same building, we need a simulation tool to visualize the result of the evacuees that are directed to different path as well as calculate the evacuation time.

5.2 Methods and Implementation Details

The Indoor Localization, Navigation Guidance and Visualization System include two major parts, the Real Time Navigation Guidance System and the Simulation System as shown in figure 47. In the entire system, the Blueprint part and the Evacuation Path Generation Algorithm

is required by both Real Time Navigation System and the Simulation System. For the Real Time Navigation System, which is marked as green, the Evacuation Path Generation Algorithm takes the input from localization module and the interaction part of Incident Commander User Interface, and generates the path for all evacuees, which will be shown in both Incident Commander User Interface and the Evacuees User Interface. For the Simulation System, the Evacuation Path Generation Algorithm Module takes the input from the Interaction part of the Analyst UI, which includes the positions of the evacuees as well as the exits status. With these input, it will generate the path for all evacuees, which will be simulated to generate the motion of all the evacuees and the performance evaluation, which will be shown in the visualization part of the Analyst UI.

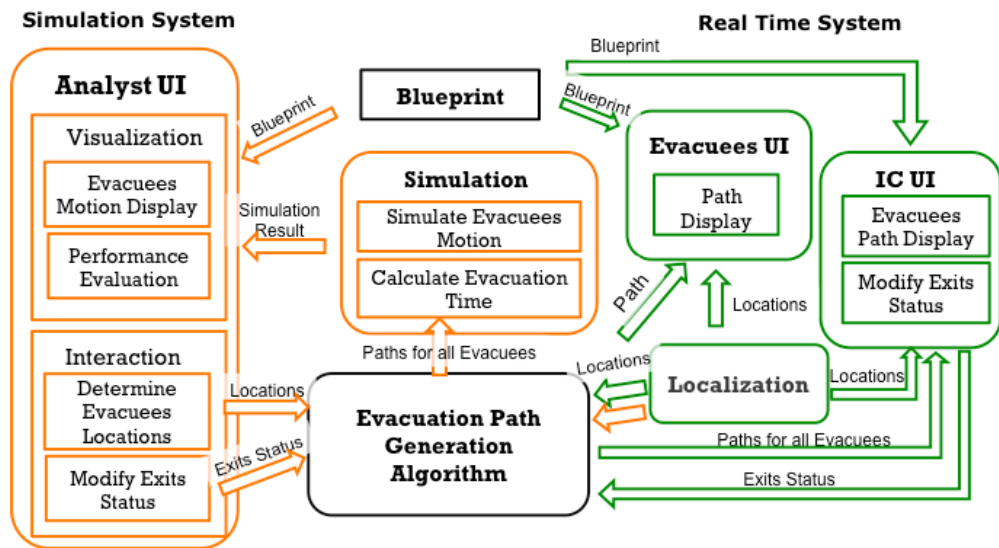

Figure 47 Systems Architecture

The Real Time Navigation Guidance System implements two applications, the Incident Commander Application and Evacuees Navigation Guidance Application. The Simulation System implements one application, which is the Analyst Simulation Application. The Incident Commander Application and Evacuees Navigation Guidance Application is used during the emergency situation, the Incident Commander Application is used by the Incident Commander to provide the ability to control the exit status such as block or open an exit as well as calculate the

optimal path for all evacuees. The Evacuee Navigation Guidance Application is used by the evacuee to provide the location of evacuee as well as display the optimal path that is generated by the Incident Commander Application. The Analyst Simulation Application is used by the analyst to evaluate the performance of path generation algorithm and simulate the motion of evacuees. Server will be introduced to help with the data share between the applications. The communication process includes communication between sensor and client, client and server. The figure 48 displays the communication process in the system. As shown in the figure 48, the communication between client and server is achieved by http request, and the communication between the client and the sensor is achieved by Bluetooth communication.

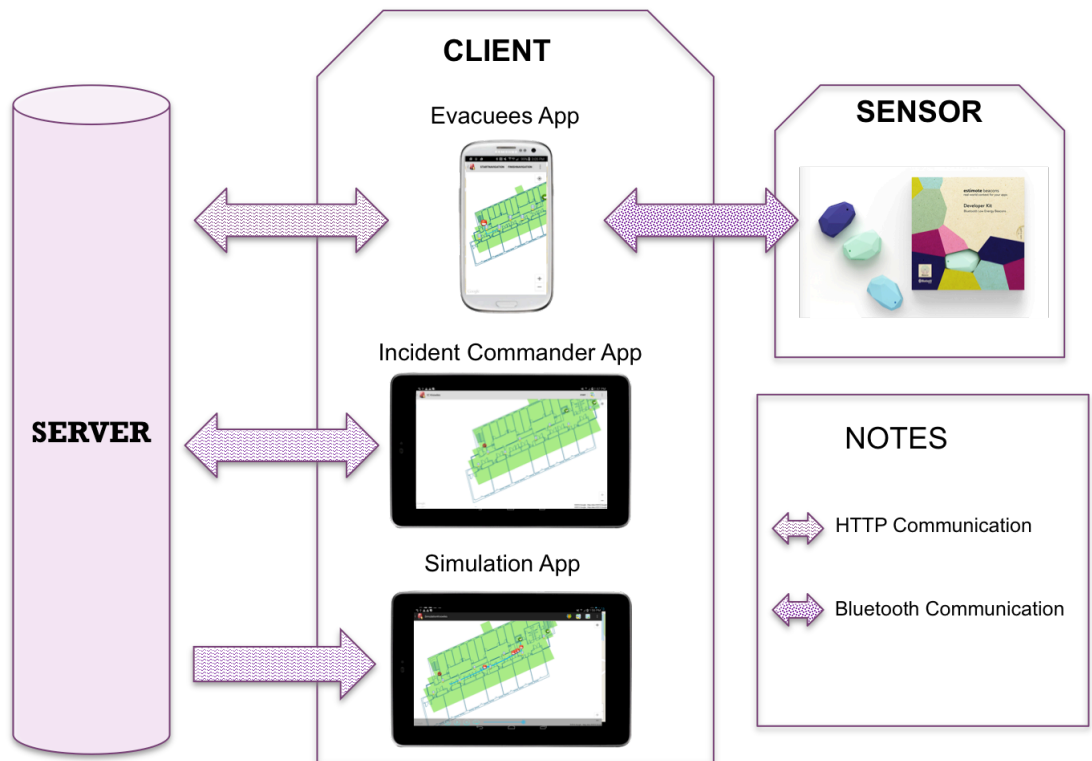

Figure 48 Communications

The detailed information for each part will be discussed in following sections.

5.2.1 Real Time Navigation Guidance System

The Real Time Navigation Guidance System includes five modules as shown in figure 49, Localization Module that localize the location of the evacuees, Evacuation Path Generation Algorithm Module that generates the shortest path for all evacuees to exit, Incident Commander User Interface Module that provides visualization to Incident Commander and interact with the Evacuation Path Generation Algorithm Module, the Evacuees User Interface Module that provides visualization to Evacuees, and the Blueprint that provides visualization environment for visualization tools. We will talk about the details of the modules in following sections.

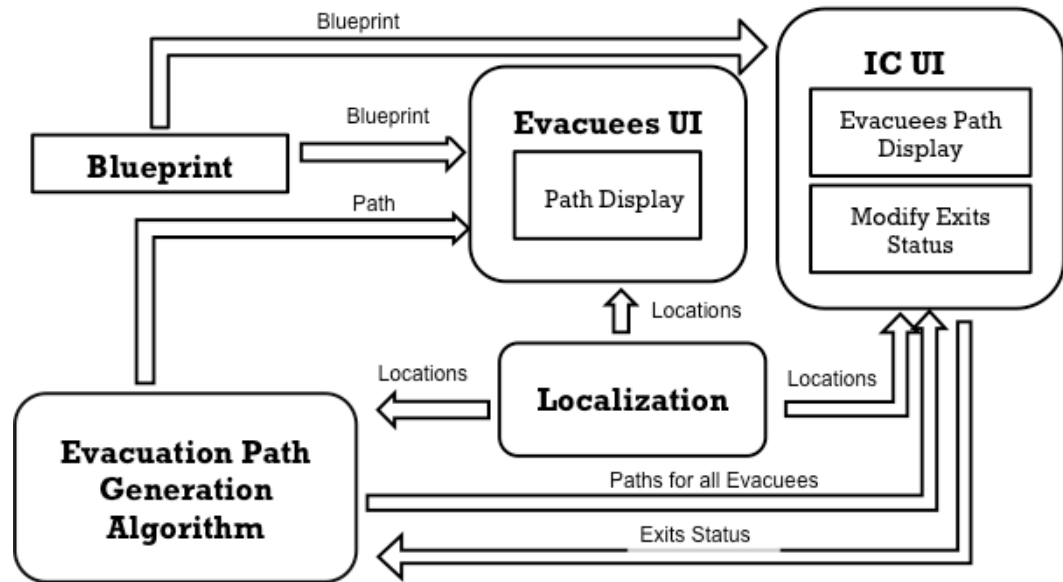

Figure 49 Real Time Navigation Guidance System

5.2.1.1 Localization Module

The purposes to localize the evacuees include provide the evacuees and Incident Commander with the position information of the evacuees, so that the evacuees are aware of their own position, which will prevent the evacuees from being panicked by unfamiliar environment. In addition, the localization result will also be used by Incident Commander as the input of the path generation algorithm.

The localization module runs in the Evacuees Application. The localization result is achieved by using BLE (Bluetooth Low Energy). The evacuees' smart phones are able to get the signal strength from the deployed BLE beacons. The signal strength reflects the distance between the BLE beacon and the evacuee. The closer the evacuee to a BLE beacon, the bigger the BLE beacon to the evacuee. As a result, from the BLE beacon, we are able to find the closest beacon to an evacuee by finding the biggest signal strength.

To get a better localization result, we need a combination of a proper deployment and proper settings for BLE beacons.

For the Indoor Localization, Navigation Guidance and Visualization System, the experiment site we choose is Knowles Engineer Building, Floor 3, which has a depth of 146 feet and has a width of 4 feet. Regarding the BLE features, since the Advertising interval of BLE range from 0.1s to 2s, but the shorter the interval, the more consuming for the battery life. So In our test, we set the advertising interval of BLE to 1s to save the battery and get the most signals.

Besides, the broadcasting power ranges from -30 dBm to 4 dBm, which produces the stable range from 5 feet to 230 feet shown in spec. Besides, since the valid RSSI value should be larger than -90 to provide reliable enough RSSI. In our case, we want the each beacon covers at least 20 feet and provide a reliable value in 20 feet. So we set the broadcasting power as 0dm, which has a distance range of 160 feet to make sure the value of the RSSI in a reliable range.

In this case, the battery life is 32 months, which is long enough.

To get the difference between mobile phones with case and without case, we use two Samsung Galaxy III to collect the RSSI of 10 BLE tags. Based on the environment of Knowles Engineer Building, we collect 100 RSSI data for each BLE tag in each direction every 3 feet from 0 feet to 70 feet.

The propagation model for Samsung Galaxy III can be seen in figure 50. The propagation model for Samsung Galaxy III is

$$RSSI(d) = -60.58 + 10 * (-1.367) * \log(d/3)$$

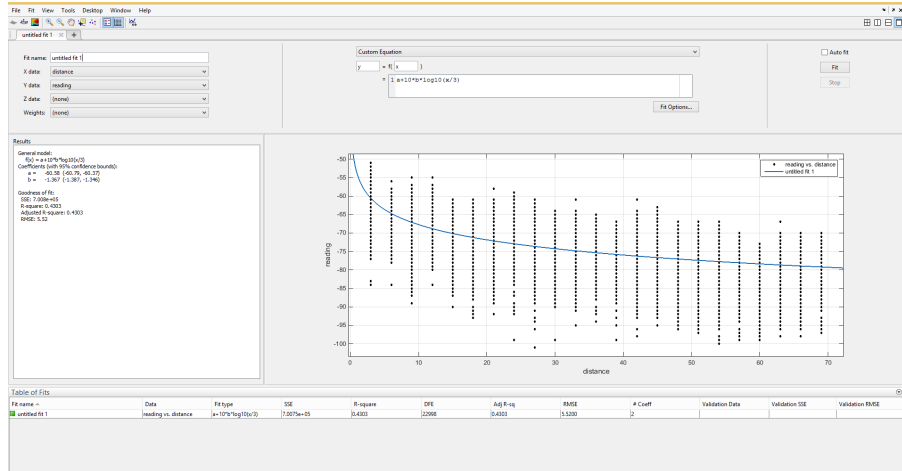

Figure 50 Propagation Model

Based on the propagation model and the settings, to make sure the deployment of tags covers all the areas in Knowles Engineer Building, and each beacon has a valid cover range of 20 feet, the layout design and tags deployment method can be shown in figure 51, which makes sure wherever the responder is, at least one beacon will give a valid RSSI read as shown in figure 51, and that is enough for now because we will set the closest beacon as the position for the user.



Figure 51 Deploy layout in Knowles Engineering building

5.2.1.2 Navigation Path Generation Algorithm

The Navigation Path Generation Algorithm is implemented in Incident Commander Application. To generate the optimal path for Evacuees, the Evacuation Path Generation Algorithm takes the evacuees positions as input. The graph that is required in the algorithm includes the nodes, which is represented by the middle point of the travel path aligned to the BLE

placement position and the exits point, and the links that connects every two adjacent points as shown in figure 52. The path generation algorithm we use Dijkstra algorithm with the weight represented by the distance of the geographical path. The complexity of this algorithm is $m*n^2$ where n represents the number of nodes in the system, and m represents the number of evacuees. An imaginary final exit point will be introduced to connect all the exits with a weight 0 as shown in figure 53.

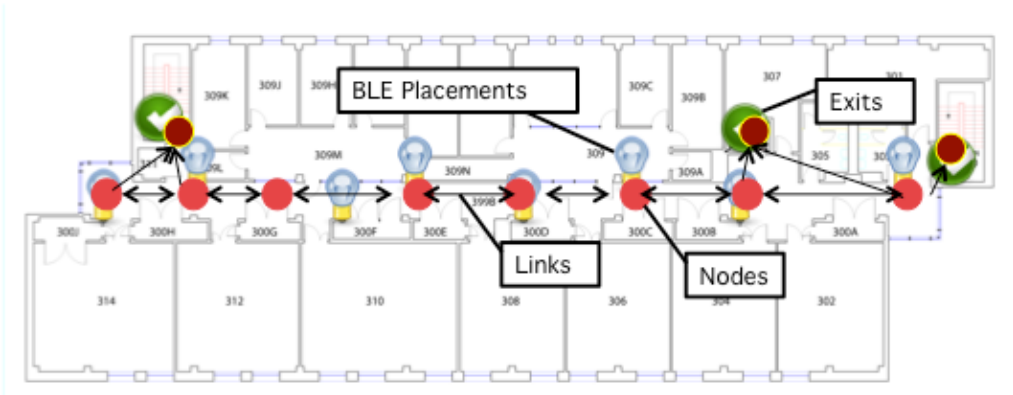

Figure 52 Graph Nodes and Links

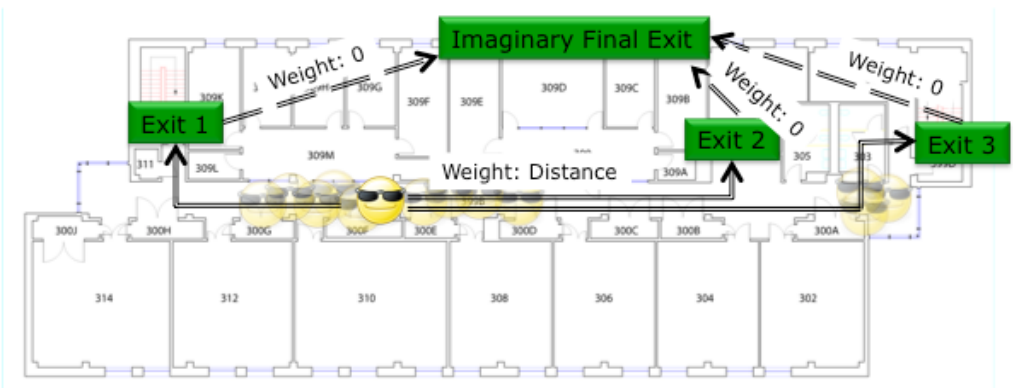

Figure 53 Algorithm

5.2.1.3 Evacuees Navigation Guidance App UI

The Evacuees Navigation Guidance App is used by the evacuee during the emergency situation; it aims to provide the evacuees with clear navigation guidance to exit the dangerous buildings as soon as possible. It is primarily responsible for display the generated path to the

evacuees. Moreover, it is also important to display the instruction that shows the way to exit the corresponding exit clearly.

The achievements of the Evacuees Navigation Guidance App User Interface include following items.

- Display the Layout of the Building

In order to help the Evacuees understand the surrounding environment, the layout of the building will be provided on the User Interface. Google Map will be implemented to provide evacuees a better understanding of the environment with the attachment of the building blueprint.

- Display the Path Information

Displaying the path information to the evacuees clearly is extremely important during the emergency situation since the efficiency of the evacuation progress will be slow down if the evacuee does not understand the instruction and follow the incorrect path.

We will use a clear user interface to show the evacuees the way to exit the building with the path generated by Incident Commander. First of all, we will display the optimal path that is generated by Incident Commander to the evacuees. Moreover, the text instruction will be provided to help the evacuee better understand the path. In addition, an animation will be displayed to show the demonstration of how to exit the building following the optimal path.

The Evacuees Navigation Guidance App user interface is shown in figure 54. We take the Knowles Engineer Building as an example. When the evacuee starts the application, the Google Map with layout attachment will be displayed in the user interface. Then the user is able to start the navigation by clicking the STARTNAVIGATION button, the localization result will be shown in the Google Map and posted to the server, which will be used by the Incident Commander to generate the optimal path for the evacuee. Then the evacuee will be able to get the optimal path and display it in the user interface as shown in figure 54.

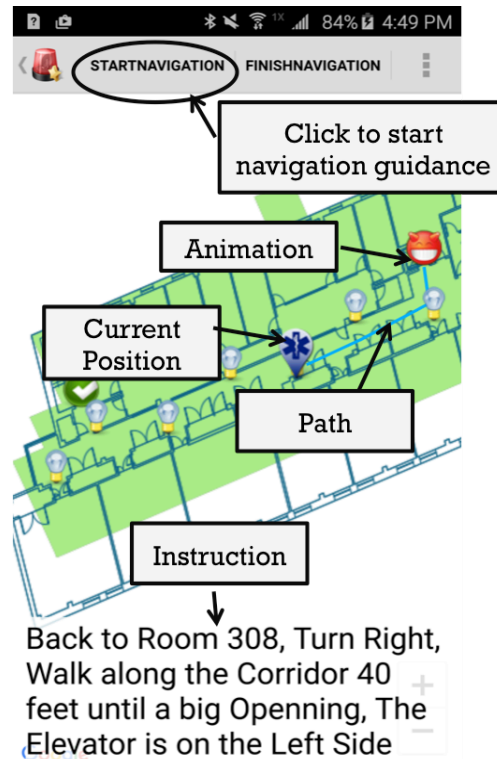

Figure 54 Evacuees navigation guidance app UI

5.2.1.4 Incident Commander App UI

The Incident Commander Application is used by the Incident Commander during the emergency situation. The user interface aims to display the shortest paths for all the evacuees as well as control the exit status including block or open an exit. When the Incident Commander clicks the button start, he will first get the position of all the evacuees. Then if the Incident Commander click Calculate Path button, the optimal path will be generated by path generation algorithm, which is able to provide the shortest path for all evacuees, at the mean time, the shortest path will be displayed in the user interface.

The achievements of the Incident Commander Application User Interface include following items.

- Incident Commander App UI Overview

To enable the Incident Commander understand the emergency situation and the evacuees status, we provide a clear user interface to display the Incident Commanders with clear layout of the building as well as a convenient way to operate the application as shown in figure 55. First of all, the building layout is attached to the Google Map which allows the Incident Commander understand the environment. In addition, the position of evacuees will be displayed clearly in the application. Moreover, clear buttons will be provides to allow the Incident Commander operate the application as well as generate path for all evacuees.

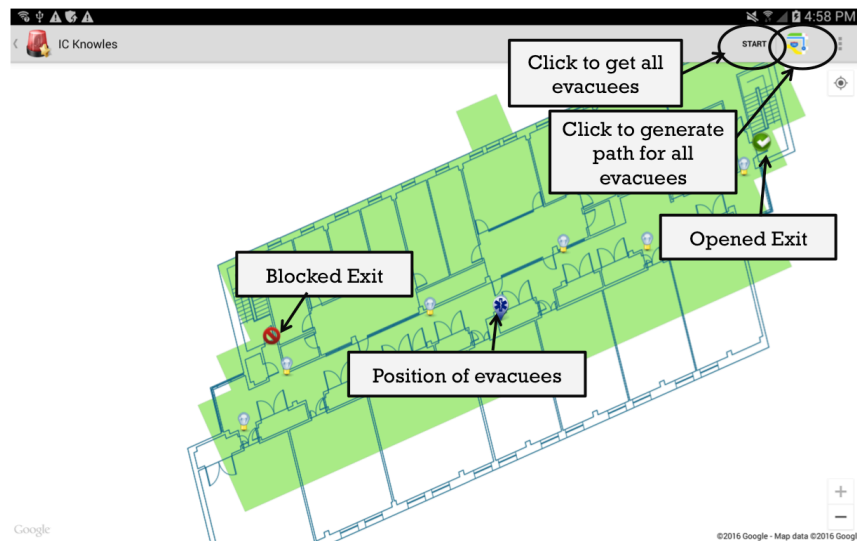

Figure 55 Incident Commander App UI

- Display the Positions and Paths of Evacuees

After the path generation algorithm generates the path for all evacuees, the path will be send to the Incident Commander Application. Then the Incident Commander Application User Interface will be able to display the positions and generated path for evacuees as shown in figure 56.

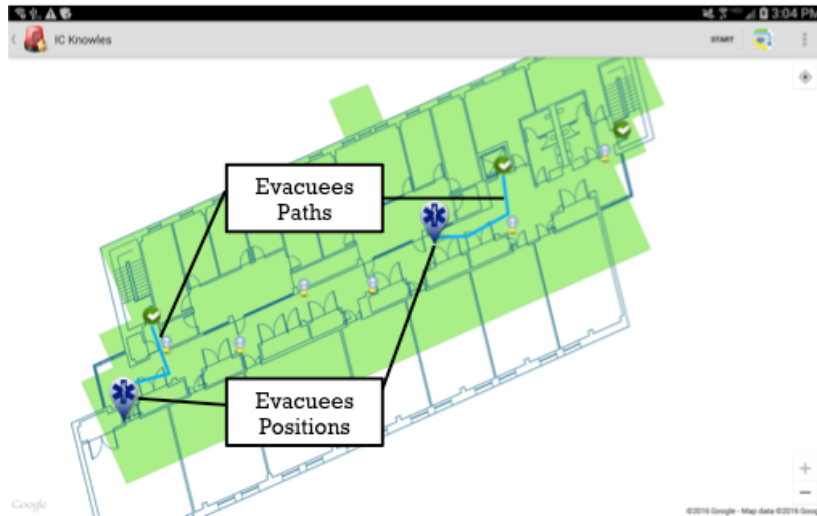

Figure 56 Display evacuees and paths

- Control the Exit Status

Another task for Incident Commander is to control the exit status. For example, when an exit should not be used by the evacuees, the Incident is able to block or open the exit by just click the Exits icons. When the Incident Commander clicks an exit icon, a dialog will show up to make sure the Incident Commander does want to block the exit, if the Incident Commander clicks OK, the exit will be blocked as shown in figure 57.

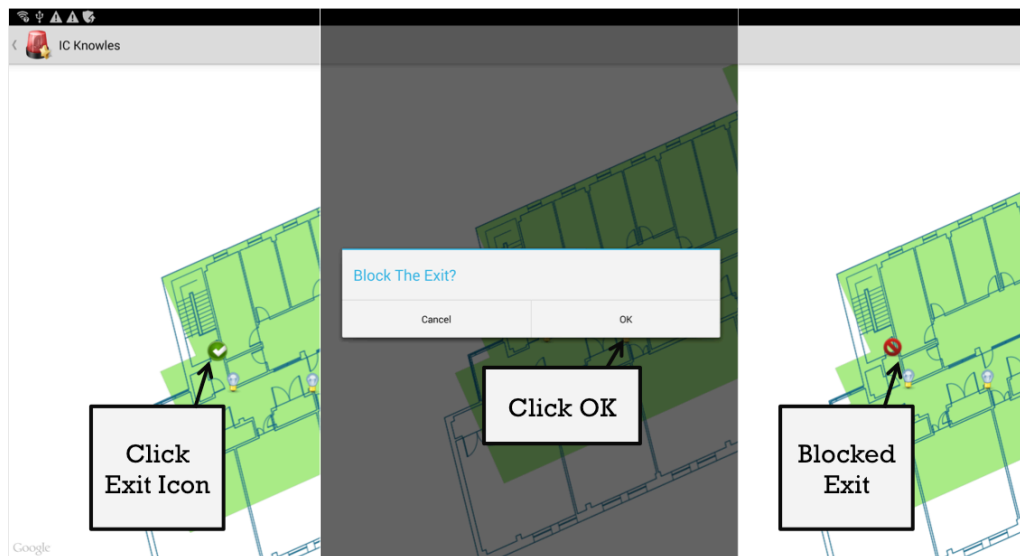

Figure 57 Block an exit

After the Incident Commander blocked the exit, the generated path will be different. For example, as shown in figure 58, before the Incident Commander blocked, an evacuee will be directed to one path as shown in the left part. However, if the exit is blocked, the evacuee will be directed to another path as shown in the right part.

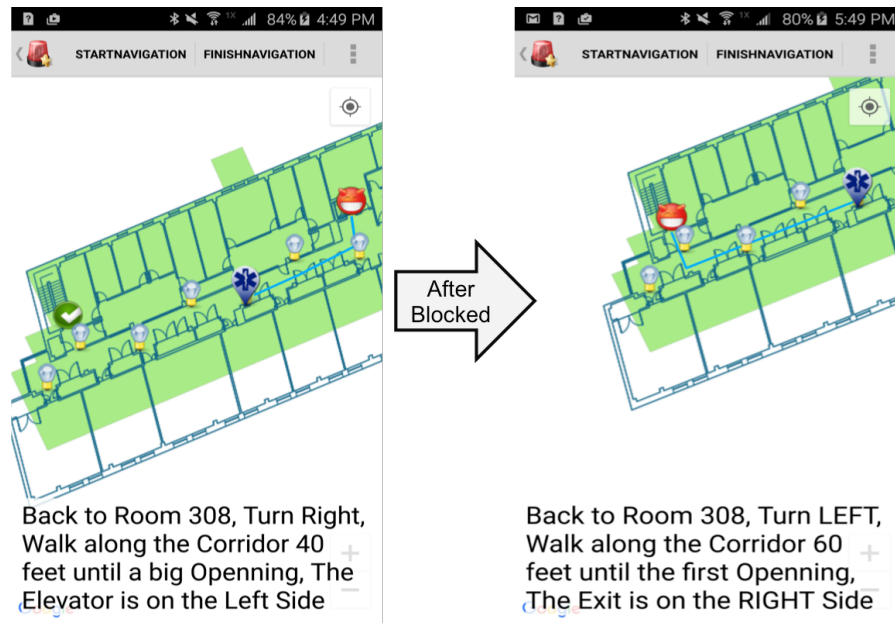

Figure 58 Before and after block an exit

5.2.2 Simulation System

The Simulation System includes four modules as shown in black parts of figure 59, Analyst User Interface Module that is responsible for providing the evacuees locations and modify the exits status as well as display the visualization result of simulation, the Evacuation Path Generation Algorithm Module that generates the shortest path for all evacuees to exit, Simulation Module that parse the path to visualization and performance evaluation, and the Blueprint that provides visualization environment for visualization tools. In addition, the simulation system can also take the localization result from the real time navigation guidance system simulate the evacuees based on the real time evacuees' locations. The Evacuation Path

Generation Algorithm Module is the same as the Real Time Evacuation System, so we will not reiterate it. The following sections will focus on other modules.

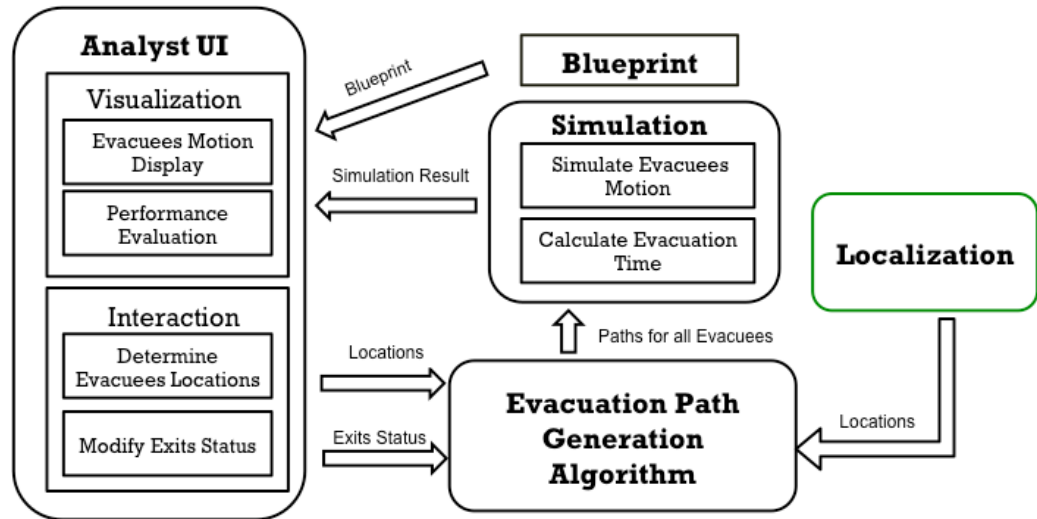

Figure 59 Simulation System

5.2.2.1 Simulation

The Simulation Module is used for analysts to measure the performance of the algorithm. The input of the simulation application includes the location of all the evacuees, the path generated for each evacuee. With these inputs, the Simulation Module will calculate the total evacuation time, average evacuation time and also the evacuation time for each evacuee. Also, it will generate the motion pattern for each evacuee. The simulation result includes the motion of the evacuees and the performance evaluation. The overview of the Analyst Simulation Application can be shown in figure 60.

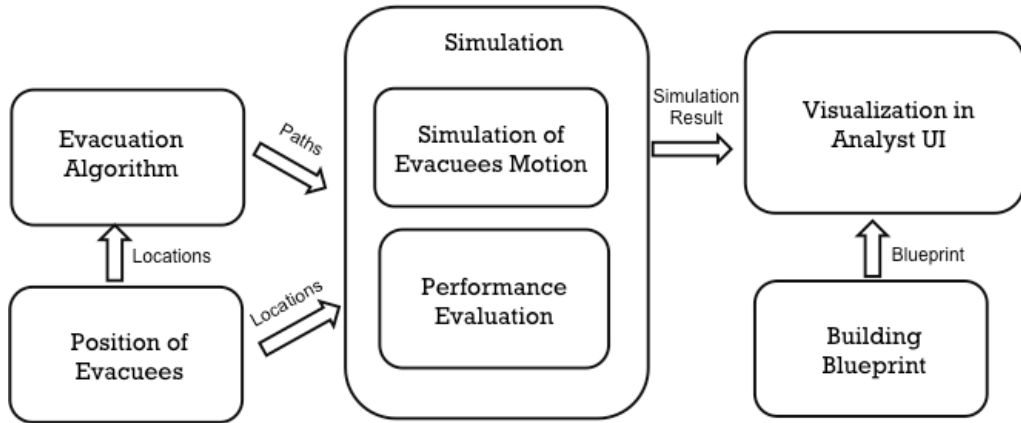

Figure 60 Overview of simulation module

5.2.2.2 Analyst Simulation App UI

The Analyst Simulation Application UI aims to visualize the performance of a path generation algorithm. First of all, it will provide an animation to display the motion of evacuees with interactive tools such as play/pause, speed up/slow down, replay or adjust the progress of the animation. In addition, the performance evaluation such as the total evacuation time, average evacuation time and also the evacuation time for each evacuee.

The achievement of the Analyst Simulation Application UI will include following items.

- Overview User Interface

To enable the users better use the simulation application, we provide a clear user interface for the user as shown in figure 61. The user interface will first provide a clear layout of the building shown in Google Map. Besides, the functional buttons are provided on top of the layout, which is very convenient for the user to use. In addition, interactive tools are provides to enable the user control the progress of the animation, which will be discussed in details later.

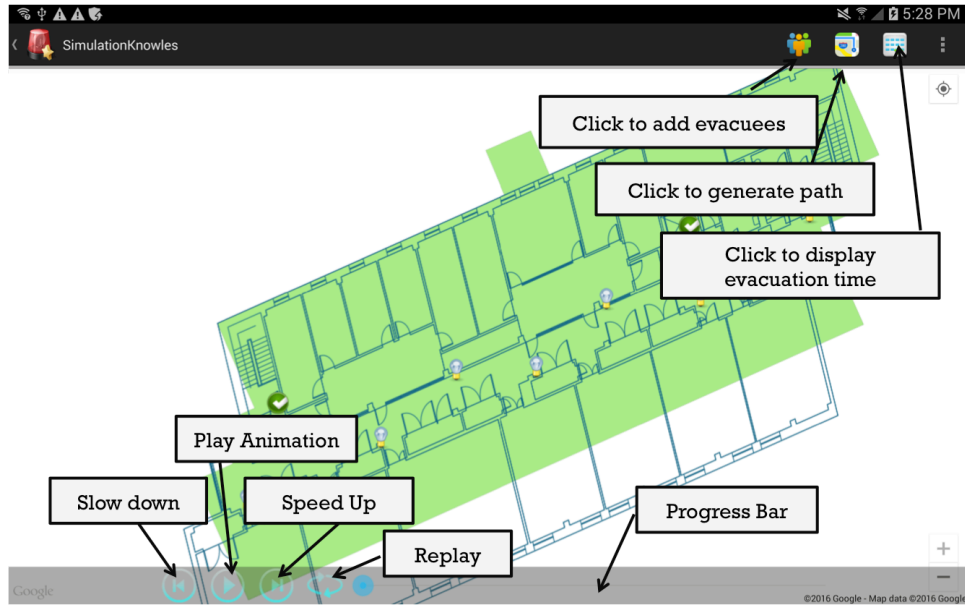

Figure 61 Simulation App UI

- Add Evacuees

To test the path generation algorithm, the simulation application will be able to allow the user automate add the evacuees or manually, or take the locations from the localization module of real time system. Then the given evacuees will be used as the input of the path generation algorithm. In this project, we provide a convenient way to allow the user add the evacuees manually or automatically by clicking the add evacuees button. After the user click the add evacuees button, a dialog will show up to allow the user choose the way to add the evacuees as shown in figure 62. If the user chooses to add evacuees manually, he is able to add evacuees manually by click the positions in the building layout, or he can add the evacuees automatically by choose at automatically and input the evacuees' number. Then the evacuees will be added automatically at randomly in the layout as shown in figure 63. In this example, we add 20 evacuees automatically.

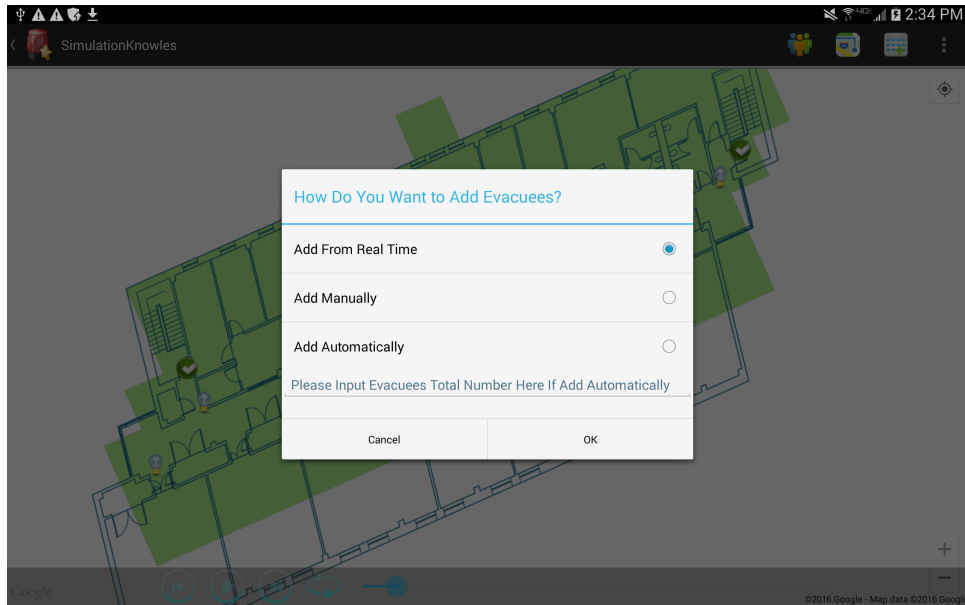

Figure 62 Add evacuees

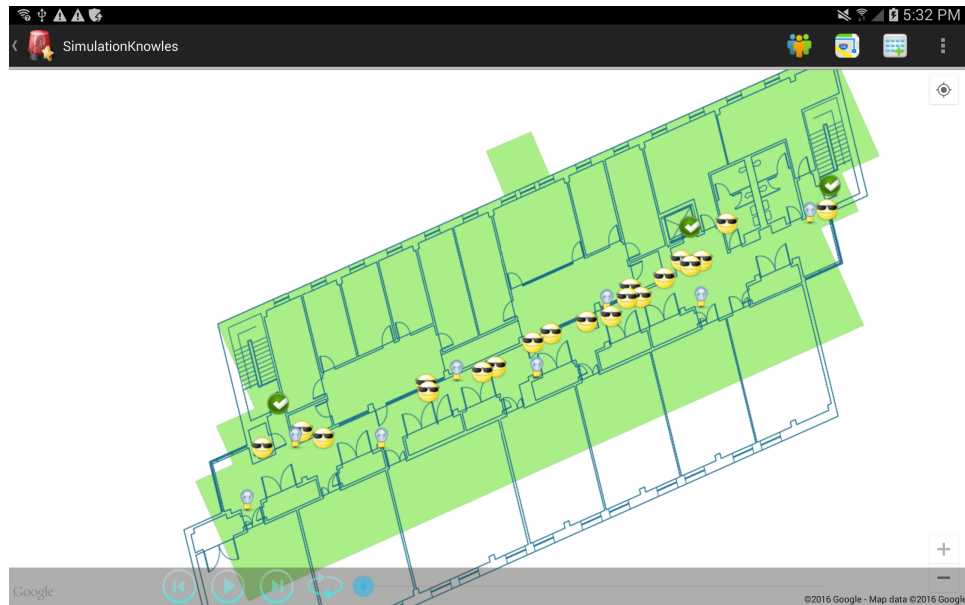

Figure 63 Layout after add evacuees

- Display the Animation of the Evacuees Motion with Interactive Tools

Another important feature of the Analyst Simulation Application UI is to display the animation of the evacuees' motion with interactive tools. With the output form the simulation module, we will be able to display the motion of the evacuees clearly. In addition, interactive

tools will be provided to help the user view the animation more conveniently. For example, the user is able to play or pause the animation by click the play/pause button, and he is also able to speed up, slow down or replay the animation by click corresponding button. In addition, draggable progress bar will be provided to help the user adjust the animation progress convenient as shown in figure 64.

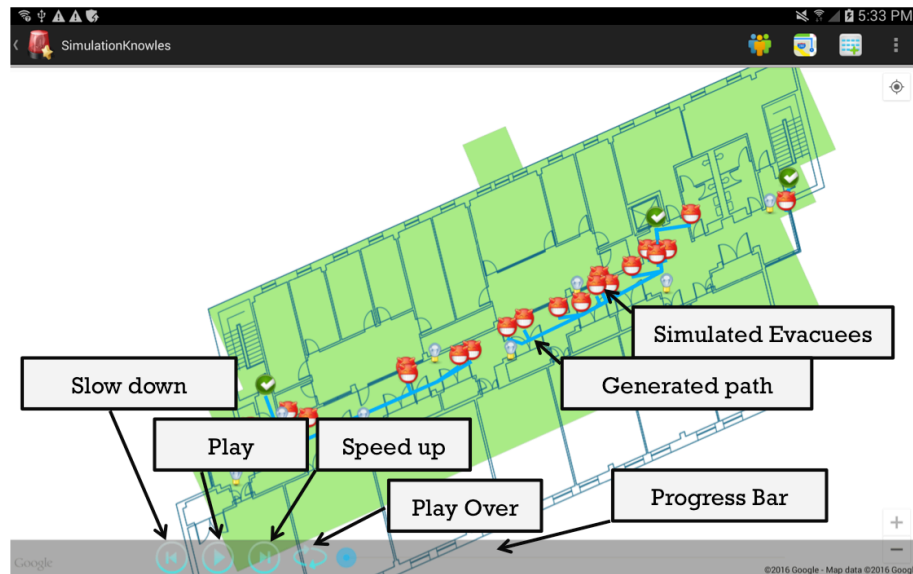

Figure 64 Animation and interactive tools

- Display the Evacuation Time for Evacuees

The evacuation time for evacuees can be calculated based on the given path with the consideration of the congestion by simulation module. Therefore, the user interface will display the total evacuation time, average evacuation time and the evacuation time for each evacuee on the user interface as shown in figure 65.



Figure 65 Evacuation time visualization

CHAPTER 6

FUTURE WORK

The future work includes following items.

- Improve the localization algorithm.

The average localization accuracy of the current localization algorithm is about 20 feet for outdoor environment, hopefully, with more tests and better localization algorithms, we can get a better localization result, which would improve the system.

- Improve navigation guidance system.

The current navigation guidance system works very well in Knowles Engineering based on the existing building tests. However, more tests should be done in more possible buildings to verify if the system works well in every case. Also, improvements might be necessary when the system is applied in different environments and different scenarios.

Besides, the current navigation guidance system only works for evacuees without any disabilities. However, in real scenario, people need wheelchair or vision impaired people might also need to use the application, in this case, we need to improve our system to make it applicable for those people.

BIBLIOGRAPHY

- [1] Aura Ganz, Xunyi Yu, James Schafer, Sophie D'Hauwe; "DIORAMA: Dynamic Information Collection and Resource Tracking Architecture", 32nd Annual International Conference of the IEEE EMBA Buenos Aires, Argentina, August 31- September 4, 2010
- [2] Elke Mackensen, Matthias Lai; "Bluetooth Low Energy (BLE) Based Wireless Sensors", IEEE, 2012
- [3] Myungin Ji, Jooyoung Kim, Juil Jeon, Youngsu Cho; "Analysis of Positioning Accuracy Corresponding to The Number of BLE Beacons in Indoor Positioning System", Advanced Communication Technology (ICACT), 2015 17th International Conference, July 2015
- [4] Hongbo Liu, Jie Yang, Sidhom, S., Yan Wang; "Accurate WiFi Based Localization for Smartphones Using Peer Assistant", Mobile Computing, IEEE Transactions on (Volume: 13, Issue: 10), Oct. 2014
- [5] David McCandless; "The Visual Miscellaneum", 2012
- [6] Eric F. Pettersen, Thomas D. Goddard, Conrad C. Huang; "UCSF Chimera-A visualization system for exploratory research and analysis", October 2004
- [7] Varun ChanDola, ArinDam Banerjee, Vipin Kumar; "Anomaly Detection: A survey"
- [8] Yuu Nakajima, Hironori Shiina, Shohei Yamane, Toru Ishida; "Disaster Evacuation Guide: Using a Massively Multiagent Server and GPS Mobile Phones", Proceedings of the 2007 International Symposium on Applications and the Internet, 2007
- [9] Maxim A. Batalin, Gaurav S. Sukhatme; "Coverage, exploration and deployment by a mobile robot and communication network", Proceedings of the International Workshop on Information Processing in Sensor Networks pp. 376-391, April 2003
- [10] Yu-Chee Tseng, Meng-Shiuan Pan, Yuen-Yung Tsai; "A Distributed Emergency Navigation Algorithm For Wireless Sensor Networks", IEEE Computers, 2006
- [11] ADEL ALI AHMED, M. M. AI-SHABOTI, ABDULHAKIM AL-ZUBAIRI, "An Indoor Emergency Guidance Algorithm Based on Wireless Sensor Networks", Cloud Computing (ICCC), 2015 International Conference, April 2015
- [12] Yongle Chen, Limin Sun, Feng Wang, Xinyun Zhou; "Congestion-aware Indoor Emergency Navigation Algorithm for Wireless Sensor Networks", Global Telecommunications Conference, 2011 IEEE
- [13] Po-Yu Chen, Zan-Feng Kao, Wen-Tsuen Chen, Chi-Han Lin; "A Distributed Flow-Based Guiding Protocol in Wireless Sensor Networks", Parallel Processing (ICPP), 2011 International Conference, Sept. 2011
- [14] Chi-Han Lin, Po-Yu Chen, Wen-Tsuen Chen; "An Adaptive Guiding Protocol for Crowd Evacuation Based on Wireless Sensor Networks", Vehicular Technology Conference (VTC Spring), 2013 IEEE 77th, June 2013

- [15] Lien-Wu Chen, Jen-Hsiang Cheng, Yu-Chee Tseng; “Evacuation Time Analysis and Optimization for Distributed Emergency Guiding Based on Wireless Sensor Networks”, Connected Vehicles and Expo (ICCVE), 2012 International Conference, Dec. 2012
- [16] Gabriel Santos, Benigno E. Aguirre; “A Critical Review of Emergency Evacuation Simulation Models”, NIST Workshop on Building Occupant Movement during Fire Emergencies, 2004
- [17] Wang Xiudan, Chen Shaokuan, Zhou Yangfan, Peng Hongqin, Cui Yang; “Simulation on Passenger Evacuation under Fire Emergency in Metro Station”, Intelligent Rail Transportation (ICIRT), 2013
- [18] Bin Zhu, Tao Liu, Yongchuan Tang; “Research on pedestrian evacuation simulation based on fuzzy logic”, Computer-Aided Industrial Design and Conceptual Design, 2008
- [19] Agusti Corbacho Salas; “Indoor Positioning System based on Bluetooth Low Energy”, ScholarWork@Polytechnic University of Catalonia, 2014