

2018

SkinnySensor: Enabling Battery-Less Wearable Sensors Via Intrabody Power Transfer

Neev Kiran

Follow this and additional works at: https://scholarworks.umass.edu/masters_theses_2



Part of the [Electrical and Computer Engineering Commons](#)

Recommended Citation

Kiran, Neev, "SkinnySensor: Enabling Battery-Less Wearable Sensors Via Intrabody Power Transfer" (2018). *Masters Theses*. 694.
https://scholarworks.umass.edu/masters_theses_2/694

This Open Access Thesis is brought to you for free and open access by the Dissertations and Theses at ScholarWorks@UMass Amherst. It has been accepted for inclusion in Masters Theses by an authorized administrator of ScholarWorks@UMass Amherst. For more information, please contact scholarworks@library.umass.edu.

**SKINNYSENSOR: ENABLING BATTERY-LESS
WEARABLE SENSORS VIA INTRABODY POWER
TRANSFER**

A Thesis Presented

by

NEEV KIRAN

Submitted to the Graduate School of the
University of Massachusetts Amherst in partial fulfillment
of the requirements for the degree of

MASTER OF SCIENCE IN ELECTRICAL AND COMPUTER ENGINEERING

September 2018

Electrical and Computer Engineering

© Copyright by Neev Kiran 2018

All Rights Reserved

**SKINNYSENSOR: ENABLING BATTERY-LESS
WEARABLE SENSORS VIA INTRABODY POWER
TRANSFER**

A Thesis Presented

by

NEEV KIRAN

Approved as to style and content by:

Sunghoon Ivan Lee, Co-chair

Daniel Holcomb, Co-chair

Yeonsik Noh, Member

Christopher V. Hollot, Department Chair
Electrical and Computer Engineering

DEDICATION

This research is dedicated to my parents, my grandparents, my sister, my brother and mine to be life partner who has been the sole purpose of my existence and without their love and prayers, I would not have been able to achieve anything in life. I will always be grateful for their eternal love.

ACKNOWLEDGMENTS

This document is the result of fifteen-month long extensive research on the subject matter. During this research and throughout my years here at the University of Massachusetts, Amherst I have received insight, support, and encouragement from many people, to whom, I am grateful from the bottom of my heart. First of all, I thank God Almighty whose munificence has enabled me to achieve success in this research and His support has given me the strength to stay committed to my goals in times of despair and despondency. I would like to extend my sincere gratitude towards my advisor Prof. Sunghoon Ivan Lee, for his continuous encouragement, academic guidance, and inspirational words through this entire journey. His support and enabling collaboration with all external project partners helped me in turning this fictional idea into reality. I would like to thank my co-advisor Prof. Daniel Holcomb for his practical advice, insightful comments and counselling through the course of my research. I am also sincerely grateful to Prof. Yeonsik Noh for his very valuable comments on this thesis. I am indebted to Jeremy Gummesson-Research Scientist at College of Information and Computer Sciences, for his valuable guidance in providing the technical knowledge of the subject matter, for his critical views and resources from Sensor Hardware Lab. This work would not have been possible without his guidance. I am also sincerely grateful to Prof. Rui Wang for his advice and for sharing his expertise in PCB fabrication. I would like to acknowledge the support of my colleague Divya Chitkara for a one-month collaboration in the course of this research. I greatly appreciate the support of my friend Jiteshri for her assistance in experimental data collection along with her encouragement during the difficult phase of this research. My appreciation also goes to AHHA research students for creating

a friendly and stimulating atmosphere. I am also greatly thankful for the administrative staff of Electrical and Computer Engineering Department (especially Barbara Barnett) for their support and assistance during the thesis submission phase. I owe a large debt to the Institute of International Education and United States Education Foundation of Pakistan for believing in me and granting me this opportunity to acquire higher education in the University of Massachusetts, Amherst. It is my pleasure to acknowledge the support of my friends notably Atif Yasin, Wardah Ejaz, Abeera Ansari and Arfa Ansari for their friendship and motivation. My deepest gratitude goes to my parents, my sister, my brother and mine to be life partner for their endless love and tireless support throughout this whole journey.

Neev Kiran

Amherst, MA

August 2018

ABSTRACT

SKINNYSENSOR: ENABLING BATTERY-LESS WEARABLE SENSORS VIA INTRABODY POWER TRANSFER

SEPTEMBER 2018

NEEV KIRAN

B.E., NED UNIVERSITY OF ENGINEERING AND TECHNOLOGY, KARACHI,
PAKISTAN

M.S.E.C.E., UNIVERSITY OF MASSACHUSETTS AMHERST

Directed by: Professor Sunghoon Ivan Lee and Professor Daniel Holcomb

Tremendous advancement in ultra-low-power electronics and radio communications has significantly contributed towards the fabrication of miniaturized biomedical sensors capable of capturing physiological data and transmitting them wirelessly. However, most of the wearable sensors require a battery for their operation. The battery serves as one of the critical bottlenecks to the development of novel wearable applications, as the limitations offered by batteries are affecting the development of new form-factors and longevity of wearable devices. In this work, we introduce a novel concept, namely Intra-Body Power Transfer (IBPT), to alleviate the limitations and problems associated with batteries, and enable wireless, batteryless wearable devices. The innovation of IBPT is to utilize the human body as the medium to transfer power to passive wearable devices, as opposed to employing on-board batteries for each individual device. The proposed platform eliminates the on-board rigid battery

for ultra-low-power and ultra-miniaturized sensors such that their form-factor can be flexible, ergonomically designed to be placed on small body parts. The platform also eliminates the need for battery maintenance (e.g., recharging or replacement) for multiple wearable devices other than the central power source. The performance of the developed system is tested and evaluated in comparison to traditional Radio Frequency based solutions that can be harmful to human interaction. The system developed is capable of harvesting on average $217 \mu\text{W}$ at 0.43 V and provides an average sleep/high impedance mode voltage of 4.5 V .

TABLE OF CONTENTS

	Page
ACKNOWLEDGMENTS	v
ABSTRACT	vii
LIST OF TABLES	xi
LIST OF FIGURES	xii
 CHAPTER	
1. INTRODUCTION	1
1.1 Outline of the Thesis	4
2. RELATED WORKS	5
2.1 Passive Wearable Sensors – Energy Harvesting	5
2.1.1 Thermal Energy	5
2.1.2 Photovoltaic/Solar Energy	6
2.1.3 Radio Frequency (RF) Energy	6
2.1.4 Motion and Vibration	7
2.2 Passive Wearable Sensors – Energy Transfer	8
2.3 Intra-Body Communications	9
3. INTRA-BODY POWER TRANSFER TECHNOLOGY–OVERVIEW	11
3.1 Intra-body Transmission Methods	12
3.1.1 Galvanic Coupling Intra-Body Transmission	12
3.1.2 Capacitive Coupling Intra-Body Transmission	14
3.1.3 Considerations and Justifications of the Coupling Method for the Proposed System	15

3.2	Factors Affecting Intra-Body Transmission	15
3.2.1	Electrical Properties of Human Body Tissues	15
3.2.1.1	Human body Circuit Model	17
3.2.2	Coupling Between Human Body and Environment	17
3.2.3	Safety Regulations	18
3.2.4	Current Density	19
3.2.5	Specific-Energy Absorption Rate	20
3.2.6	Power Density	20
3.2.7	Contact Current Intensity	21
4.	TRANSCEIVER DESIGN FOR INTRA BODY POWER	
	TRANSFER	22
4.1	System Design Considerations	22
4.1.1	Operating Frequency Range	22
4.1.2	Contact Current Intensity	23
4.1.3	Specific-Energy Absorption Rate (SAR)	23
4.1.4	Power Density	24
4.1.5	Current Density	24
4.2	Proposed System Architecture	24
4.2.1	Interrogator Design	26
4.2.2	Electrode Design	27
4.2.3	Transponder/Receiver Design	28
4.3	Experimental Setup	30
5.	RESULTS AND ANALYSIS	31
5.1	Transponder Design Parameter Optimization	31
5.2	Effect of Varying Distance Between Interrogator and Transponder	35
5.3	Effect of Varying Longitudinal Distance between Transponder Electrode and Human Skin	37
5.4	System Reliability Evaluation	39
5.5	Discussion	41
6.	CONCLUSION AND FUTURE WORK	42
	BIBLIOGRAPHY	44

LIST OF TABLES

Table	Page
2.1 Summary of energy harvesting via different sources [50]	8
3.1 Frequency distribution for IEEE 802.15.6 WBAN [2]	11
3.2 Restrictions on current density [1]	19
3.3 Maximum recommended SAR values [1]	20
3.4 Restrictions on contact current intensity [1]	21
4.1 Transmitter voltage and power profile w.r.t frequency	26
5.1 Comparison between harvested power using IBPT with RF based power transfer techniques.	41

LIST OF FIGURES

Figure	Page
1.1 A conceptual illustration of IBPT	3
3.1 Galvanic-coupled intra-body transmission method	13
3.2 Capacitive-coupled intra-body transmission method	14
3.3 Four electrodes based human arm circuit model.....	18
4.1 Block diagram of the SkinnySensor system	25
4.2 Hardware implementation of the interrogator	25
4.3 Electrode design	27
4.4 Hardware implementation of the transponder	29
4.5 Intra-body power transfer experimental setup.....	30
5.1 Harvested voltage with varying number of harvesting stages - high impedance (4 M Ω)	33
5.2 Harvested power with varying number of harvesting stages - high impedance (4 M Ω)	33
5.3 Harvested power with varying number of harvesting stages - low impedance (1 k Ω)	34
5.4 Harvested voltage with varying number of harvesting stages - low impedance (1 k Ω)	35
5.5 Harvested power and voltage with varying distance between interrogator and transponder - high impedance (4 M Ω)	36
5.6 Harvested power and voltage with varying distance between interrogator and transponder - low impedance (1 k Ω)	37

5.7	Harvested power and voltage with varying longitudinal distance between transponder electrode and human skin - high impedance (4 M Ω)	38
5.8	Harvested power and voltage with varying longitudinal distance between transponder electrode and human skin - low impedance (1 k Ω)	39
5.9	Voltage and power over time - high impedance (4 M Ω)	40
5.10	Voltage and power over time - low impedance (1 k Ω)	40
6.1	PCB realization of transponder	43

CHAPTER 1

INTRODUCTION

The phenomenal growth of semiconductor devices and MEMS technologies have been stimulated by the downscaling of transistor dimensions leading to a constant shrink in size and cost of unit computing. This advancement inspired the growth of new technology areas such as wearable devices enabling ubiquitous computing to infiltrate every aspect of our lives. These include consumer-level wearable sensors such as smart watches, smart chest bands, smart headbands, and smart ring sensors, and medical-purpose wearable/implantable sensors such as hearing aids, pacemakers, and deep brain stimulators which in combination, result in an enhanced healthcare and lifestyle. Thus, the existence of intelligent, miniaturized and low-power sensors has accelerated the proliferation of wearable devices for wellness and healthcare [8]. Most of these wearable sensors are battery powered for their operation and despite the tremendous advances in semiconductor devices the use of on-device batteries as the primary source of power poses a number of challenges that serve as the key barrier to widespread use of numerous, seamless wearable sensors [23, 66].

Major challenges associated with battery-powered sensors include:

1. Battery is often the largest component that takes up most of the physical space of wearable devices. This impedes the development of new form factors (e.g., flexible [42, 62] or tattoo-like sensors [26, 27]) and further miniaturization of wearable sensors, making it difficult to place sensors on small parts of the body, such as fingernail [25], in-ear [37], and in-mouth [7].

2. Over the past few decades, technological advancement of battery energy density (per physical volume) has been much slower compared to other core technologies contributing to the realization of wearable devices (e.g., computational capacity, memory size, and wireless transfer speed) [39, 52, 51]. Battery energy density has followed the linear trend as compared to exponential improvement for other technologies (e.g., Moore’s law) [23]. Thus, battery serves as one of the critical bottlenecks to the development of novel wearable applications.
3. Periodic maintenance of batteries is a tedious task as the recharging and replacement of multiple, heterogeneous devices at different time periods in a network of over hundred sensors can be exasperating and significantly degrades user adherence to the technologies [9, 10].
4. The lifetime of a battery’s utilization is limited. Any battery available in the market cannot be expected to supply energy for an infinite amount of time and will wear out eventually, because recharging cause battery capacities to degrade over time. For example, implantable devices have a predetermined lifetime and requires surgical replacement of depleted battery cells leading to high cost for patients and the health care system [45].
5. Owing to the robust growth of portable (including wearable) devices, battery waste has been one of the fastest growing waste streams, which introduces significant environmental impacts [11]. Reducing the amount of battery waste can reduce greenhouse gas emissions and save natural resources (i.e., virgin material) [11, 16].

In this work, we introduce a novel concept, namely Intra-Body Power Transfer (IBPT), to alleviate the aforementioned limitations and problems associated with batteries, and enable wireless, batteryless wearable devices. The fundamental technological innovation of IBPT is to utilize human body as the medium to transfer power from a

source (e.g., a battery or energy supply unit) to on-body wearable devices, as opposed to employing on-board batteries for each individual device. The proposed platform eliminates the on-board rigid battery for ultra-low-power and ultra-miniaturized sensors such that their form-factor can be flexible, ergonomically designed to be placed on small body parts. The platform also eliminates the need for battery maintenance (e.g., recharging or replacement) for multiple wearable devices other than the central power source.

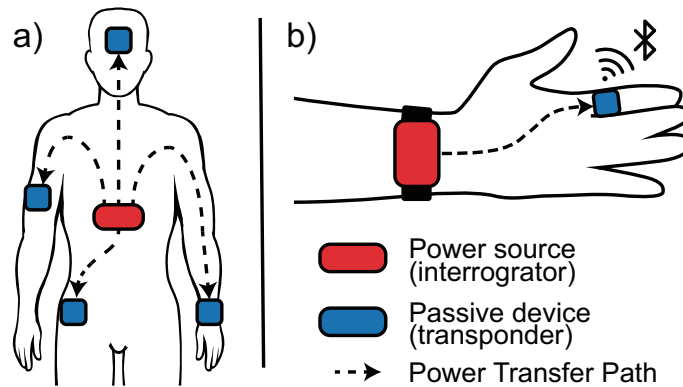

Figure 1.1: (a) A conceptual illustration of IBPT that uses the human body as the medium to transfer power from a source (e.g., a battery or energy harvesting unit) to passive wearable devices. (b) The prototype system that we used to demonstrate the concept of IBPT, which contains a wrist-worn, battery-powered interrogator and a finger-worn, batteryless transponder that can collect sensor data and transmit wirelessly.

To demonstrate and validate the concept of IBPT, we implemented a prototype system that consists of: 1) wrist-worn, battery-powered interrogator capable of transmitting time-varying electromagnetic signals through the human body and 2) finger-worn, batteryless transponder (passive wearable devices) that can be powered from the transmitted signals via human skin, collect sensor data, and wirelessly transfer the collected data to other devices (or back to the interrogator). Our main contributions include:

- Development and optimization of a novel embedded system architecture for the battery-powered interrogator and batteryless transponders.
- Implementation of a prototype consisting of a wrist-worn interrogator and a finger-worn transponder.
- Evaluation and demonstration of the prototype transponder’s reliable power harvesting capabilities. The proposed system could support between 190 μ W to 217 μ W of power at the transponder.
- Evaluation of important design parameters, such as distance, body posture, motion, and potential environmental factors that may affect the system performance.

1.1 Outline of the Thesis

The remainder of this thesis document is organized as follows:

Chapter 2 explores the existing approaches to harvest energy as well as on-going research regarding intra-body communication.

Chapter 3 focuses on the core idea behind intra-body transmission methods and the inherent challenges associated with the system design for IBPT.

Chapter 4 describes the implementation details of SkinnySensor and our experimental methodology.

Chapter 5 presents the evaluation of our measurement setup and discussion of results.

Chapter 6 summarizes the results and discusses the scope for adoption of the technology for future research.

CHAPTER 2

RELATED WORKS

In order to alleviate the aforementioned limitations of contemporary battery technologies, energy harvesting from available ambient sources has proved to be a promising solution [59]. This chapter first discusses possible sources for energy harvesting and their corresponding limitations, which inspires the exploration of capabilities of an alternative approach known as Wireless Power Transfer (WPT), that utilizes an active energy source to wirelessly charge the battery or continuously power battery-less sensors. Furthermore, relevant related work is presented regarding intra-body communications that serve as the fundamental groundwork inspiring this research of energy transfer through the human body.

2.1 Passive Wearable Sensors – Energy Harvesting

Wearable sensor devices can be made self-sustaining by harvesting energy from ambient environmental sources or human-generated power sources. These energy harvesting approaches can be either active or passive. Common energy sources for passive technologies include thermal energy [57], photovoltaic/solar energy [12, 20], ambient Radio Frequency (RF) energy [21, 56, 58], and motion and vibration [32, 34, 53].

2.1.1 Thermal Energy

Energy scavenging via thermoelectric generators could provide compact, low weight and maintenance-free operation of sensors, potentially providing $20 \mu\text{W cm}^{-2}$ [30]

power by extracting energy from human body temperature gradient but thermoelectric devices have a low energy conversion efficiency and their application is limited due to high-temperature gradient requirements ($> 10^{\circ}\text{C}$).

2.1.2 Photovoltaic/Solar Energy

Solar energy based power harvesting is a mature technology that has been in use for decades [41, 17], but its utilization for wearable technology is limited due to one of its limiting factor that is the system needs to be continuously exposed to a light source, unless the device is equipped with energy storage elements, such as batteries or ultra-capacitors [41]. Unfortunately, wearable devices are commonly used in indoor environments for a long period where the light source is artificial which is insufficient to harvest sufficient amount of energy. Additionally, occlusions caused by clothing often significantly limit the energy intake [33].

2.1.3 Radio Frequency (RF) Energy

Ambient RF energy is considered an appealing source of power, owing to ubiquitous deployment of RF signals in urban and suburban areas (e.g TV and cellular transmissions from base stations). However, the signal power level in indoor settings is substantially low for powering wearable devices. Additionally, smartphones/tablets transmit RF energy but these cellular transmissions only occur during calls/text or data transmission and the control over transmitted power level is decided by the base station instead of the handset [31]. UHF RFID tag based sensor network have shown to harvest power in μW range ($1 - 160\mu\text{W}$), capable of operating low-power sensors such as accelerometer and temperature sensors [13]. Other RF signals, such as Wi-Fi have shown to support a similar range of power. However, the high frequency range (2.4 GHz for Wi-Fi and 300 MHz - 3 GHz for UHF) poses safety and health concerns offered by electromagnetic radiation whereas passive LF and HF based RFID tags offer very short read ranges (e.g., $1\text{m} - 4\text{m}$) due to the inherent characteristics of

the noisy air channel [42], which may not be practical for human subjects that are highly mobile in nature. Moreover, the high water content of the human body can detune the RFID tag’s antenna and shift the frequency response out of the readable frequency bands of the tag resulting in shorter read ranges, lower read rates or no signal detection making it inadequate for wearable technology. RF communication systems also undergo many types of losses, such as the skin effect, where alternating current gets distributed within the conductor, resulting in an increase in the effective resistance of the conductor at higher frequencies and mismatch loss due to the improper matching impedance of consecutive stages forming standing waves and loss of power.

2.1.4 Motion and Vibration

Energy harvesting from vibration (i.e., movement) is another promising energy source. Many solutions that leverage oscillator, electromagnetic, and piezoelectric generators have been proposed to harvest energy during motion. Experiments by Kymissis *et al.* for harvesting locomotive motion energy revealed that $250mW$ [29] power can be scavenged from shoes during walking, and the nanogenerators consisting an array of piezoelectric nanowires harvest $2.8mWcm^{-3}$ average power density [65]. Additionally, energy can be harvested using piezoelectric or micro-electromagnetic generators. The power harvesting efficiency exhibited by electromagnetic generator solutions prove to be more promising [3]. Motion and vibration-based energy can serve as clean and renewable energy sources in low-power wearable devices, but the piezoelectric materials used for the harvester degrade over time due to depolarization, where polarity decreases with a number of switching cycles - this is often referred as electric fatigue [61, 15].

Many other human-body characteristics can generate power to operate wearable devices [44]. Energy scavenged from sweat [5], friction between the body and smart

Table 2.1: Summary of energy harvesting via different sources [50]

Source	Placement	Harvested Power
Thermal	Human	$20 \mu\text{W cm}^{-2}$
Solar	Human	$4 \mu\text{W cm}^{-2}$
RF	Human	$0.1 \mu\text{W cm}^{-2}$
Vibration	Human	$40 \mu\text{W cm}^{-2}$

textiles [28], have also shown to harvest couple mW of power. However, the applicability of these power sources to wearable devices is constrained as they can only operate in scenarios where sufficient sources of power (e.g., motion, thermal gradient, the presence of sweat) are available and thus, cannot guarantee continuous energy supply. More importantly, transferring the power harvested from the energy harvesters to wearable devices located at different body parts (e.g., based on wires) remains a challenge.

2.2 Passive Wearable Sensors – Energy Transfer

Instead of exploiting the potential energy generated by the host, energy could be transferred wirelessly to remote wearable sensors by an external unit for either recharging or continuously powering the sensor. This energy transfer can be achieved either via optical transmission, electromagnetic radiation or through ultrasonic waves. Optical-charging methods deploy photovoltaic cell at the sensor node that can receive power from a laser diode operating in the near-infrared range [36]. Ultrasonic Power Transfer (UPT) is an emerging WPT technology which utilizes ultrasound to transfer power and has attracted growing research attention due to its comparative efficiency, immunity to electromagnetic radiation and its ability to traverse through multiple mediums such as air, fluid, or solid medium, including metal barriers [43, 6]. Nonetheless, wireless power transmission through electromagnetic radiation is widely

used WPT method [35] capable of delivering sufficient power to sensor nodes. This energy accessing technique commonly consists of the far-field and the near-field transmissions. Energy transfer through a pair of antennas undergoing magnetic coupling is a typical near-field transmission method that can transfer power in the Watts level but its efficiency decreases significantly as the distance between the antennas increase making it inappropriate for wearable sensors as it restricts the mobility of users.

To extend the distance of WPT, RF-based far-field power transfer has provided promising results. The far-field RF based WPT platform can support comparatively larger separation distances but they require accurate alignment and designing of the antenna and often require direct lines of sight. With RF technology, all the aforementioned limitations such as detuning effect with the human body, propagation power losses etc. become significant. In order to have sufficient power for the sensor node, the transmission energy density has to be higher (approximately 1W), which can introduce risks of excessive RF energy exposure leading to harmful biological effects such as excessive heating of the body tissue, significantly damaging it [19].

Alternatively, the conductive fabric can be weaved into clothes and can distribute power to different areas on the body. Malleable conductive materials can also be applied on the skin to transfer power [55]. Worgan *et al.* connected two coils with a pair of long elastic conductive strips to relay power from one coil to the other [63]. The coils are made from flexible material so that they can be easily stitched onto normal clothes but the reliability of these clothes and maintenance is still a major research challenge.

2.3 Intra-Body Communications

IBPT is extended based on the concept of Intra-Body Communication (IBC), a wireless communication technology that uses the human body as the signal propagation medium. IBC has emerged as an appealing technology capable of providing

better energy-efficiency and built-in security for connecting wearable and implantable biomedical sensors compared to traditional Body Area Network (BAN) [4]. In late 2011, the standardization of new Wireless Body Area Network (WBAN) protocol, IEEE 802.15.6 [2] by task group (TG6) was ratified which gave recognition to this new Physical Layer (PHY) that is non-RF technique based on IBC. The conventional Electric Field IBC was introduced by Zimmerman in 1995 [67]. The inhibition of communication signal to the users' proximity help in confining energy within the human skin rather than being dissipated into the surrounding environment, which results in lower power consumption. Research has shown that IBC technique is an attractive solution for short-range communications as it can support transmission power as low as 1 *mW* and data rates greater than 10 *Mb/s* [60]. Additionally, a unique human body motion sensor has also been introduced that utilizes electric field IBC concepts to sense motion [14].

CHAPTER 3

INTRA-BODY POWER TRANSFER TECHNOLOGY–OVERVIEW

IBPT is a novel wireless power harvesting technique that utilizes human body to transfer power from a source (e.g., a battery or energy supplying unit) to passive wearable devices, as opposed to employing on-board batteries for each individual device. Scientific premise of the IBPT technology is grounded in the fundamentals of IBC technologies. The standardized IBC (i.e., IEEE 802.15.6 standard) outlines three PHY schemes i.e. Narrowband (NB), Ultra-wideband (UWB), and Human body communication (HBC). NB and UWB are based upon RF propagation techniques, while HBC is non-RF based communication technique that utilizes human body tissues for signal propagation [2].

Frequency band allocation for each physical layer is summarized in Table: 3.1 as follows:

Table 3.1: Frequency distribution for IEEE 802.15.6 WBAN [2]

	Frequency
Narrow Band (NB)	Implantable Devices 402 MHz – 405 MHz Wearable Application 863 MHz – 956 MHz Medical Demands 2360 MHz – 2400 MHz
Ultra Wideband (UWB)	3 GHz – 5 GHz 6 GHz – 10 GHz
Human Body Communication (HBC)	Centered at 21 MHz and Bandwidth = 5.25 MHz

The following characteristics substantiate the growing interest in intra-body transmission technique:

- Contrary to standard wireless transmission technologies intra-body signal transmission is uniquely based on body proximity and directly benefits from the presence of human body.
- Operating frequency is considerably lower than RF based propagation techniques due to which transmitted signal is mainly confined within and near human body resulting in less signal leakage through skin.
- Since the transmission is independent of antenna size and shape, operating frequency can be lowered for a comparatively lower power consumption without compromising on the form factor of the device [67].
- The wavelength of carrier signal is larger as compared to the electrode size resulting in lower signal interference.
- Same frequency band can be reused by WBAN for other users with minimal interference due to signal confinement.

3.1 Intra-body Transmission Methods

In order to propagate electrical signals via human body tissue, two general coupling methods have been developed 1) Galvanic Coupling (Waveguide) and 2) Capacitive Coupling (Electric Field).

3.1.1 Galvanic Coupling Intra-Body Transmission

Galvanic coupling differentially couples time-varying electrical signal through human tissues. A simplified illustration detailing the operating principle of the method

is shown in Figure 3.1(a). A pair of coupler electrodes and a pair of detector electrodes are coupled to the human body for transmission. One electrode of the pair at coupler represents the transmitted signal while the other acts as a ground terminal. Similarly, at the detector, one of the electrodes acts as ground terminal while the other receives the signal. The signal is differentially induced across the coupler electrodes and a primary current flow is established between the two coupler electrodes while the secondary current propagates through conductive human tissues as shown in Figure 3.1(b). The alternating current flow through body parts controls the amount of coupling due to the establishment of a potential difference across detector electrodes. For galvanic coupling method ionic fluids act as the signal carrier rather than electromagnetic waves in an air medium.

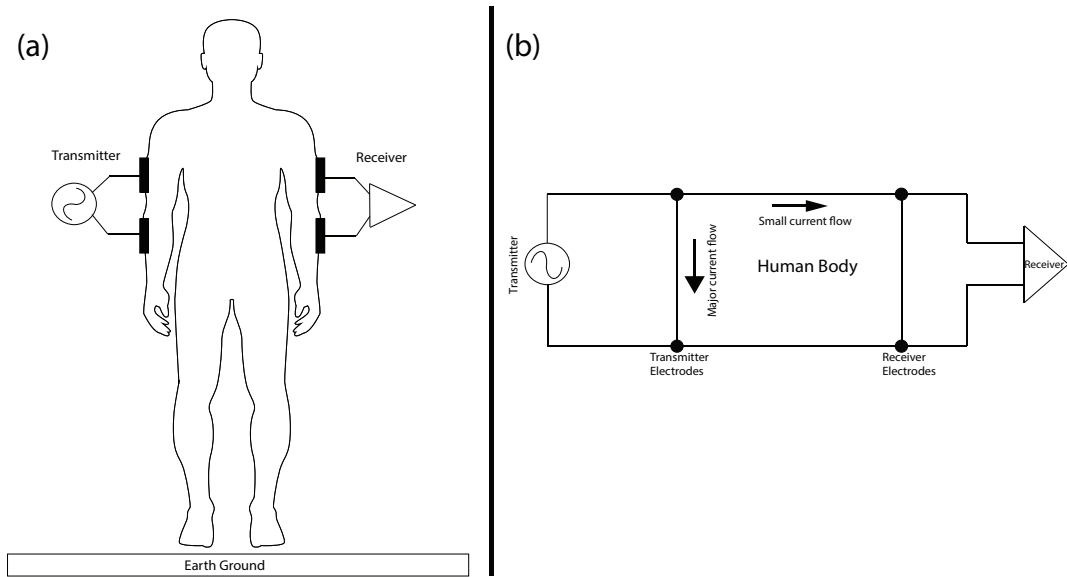

Figure 3.1: (a) Galvanic-coupled intra-body transmission method. (b) Current flow establishment between electrodes for galvanic method [48].

3.1.2 Capacitive Coupling Intra-Body Transmission

The theory of capacitive coupled human body transmission relies upon the electric field based capacitive coupling between the human body and its surrounding environment as depicted in Figure 3.2(a). Both the coupler and the detector electrodes have their signal electrode attached to the human body which forms the conductive path for signal propagation, while the ground electrode at each side is subjected into the air to provide the return path. The signal is generated between the two pairs of electrodes by making a current loop through the external ground. The coupler electrode induces the electric field into the human body which is controlled by an electric potential. The conductive body tissues form the forward path between the two body attached electrodes and the ground electrodes get capacitively coupled to each other via air or external ground. A simplified circuit modelling capacitively coupled intra-body transmission is illustrated in Figure 3.2(b).

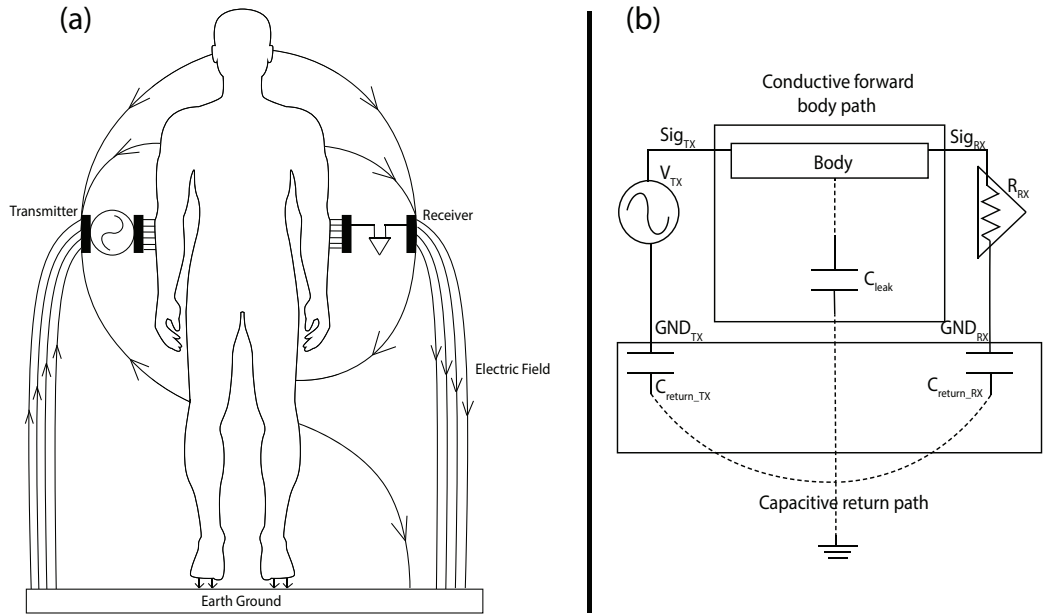

Figure 3.2: (a) Capacitive-coupled intra-body transmission method. (b) Simplified circuit model for capacitive coupling [64].

3.1.3 Considerations and Justifications of the Coupling Method for the Proposed System

A broad range of approaches exist that utilize both the coupling methods to explore the conductivity of human tissues. For galvanic coupling based approaches, the major amount of signal is propagated between the two transmitter electrodes and a highly attenuated signal is obtained at the receiver. Thus, the galvanic coupled communication techniques achieve very low transmission efficiency as well as low data rates. Additionally, for galvanic coupling, the signal quality is significantly influenced by the dielectric properties of human tissues. Capacitive coupling offers high variation because return path is coupled via the surrounding environment and the capacitive coupling between external ground and the ground electrodes make frequency selection an important design parameter that plays a major role for achieving high transmission efficiency. Although capacitive coupling method has its own limitations its implementation has indicated that we can achieve data rates as high as 10Mb/s and a high channel gain [48]. Moreover, capacitive coupling does not need to have a direct contact with the skin, which may be ideal for loosely coupled wearable devices. Since the objective of this research is achieving high transmission efficiency we employ capacitive coupling to transfer power through human skin.

3.2 Factors Affecting Intra-Body Transmission

In order to achieve higher transmission efficiency through the human body, the following parameters have to be taken into account.

3.2.1 Electrical Properties of Human Body Tissues

The electrical properties of human tissue significantly influence the propagation of the coupled signal through the human body. The two major properties are relative permittivity (ϵ_r) and electrical conductivity (σ). The electrical conductivity is the

current density within the body tissues due to applied electric field while relative permittivity is the dipole density induced as a response of the electric field applied across the electrodes. Many factors contribute towards the variation of the aforementioned properties and decide the tissue conductivity, such as

- Body temperature
- Moisture content of the skin as well as the water content of tissues
- Operating frequency range
- Tissue type and cellular membrane intactness

Research conducted on human tissues studying the effects of different operating frequency revealed that dielectric properties of living tissue vary differently with frequency dispersions. In order to characterize the electrical properties of biomaterials, Schwan [47] introduced the concept of frequency dispersion. The dispersion refers to the behaviour of human tissues at various frequency ranges. It was observed that conductivity increases while the permittivity declines within these frequency dispersions. Additionally, the tissue conductivity within the lower frequency range of 1 Hz to 100 kHz, has minimal increment whereas permittivity shows a significant decrease over this range of frequency. At higher frequency (300 MHz to several GHz), the electrical signal wavelength becomes comparable to the human body channel length and body radiates energy acting as an antenna (dipole antenna). It is required to find a frequency range where a balance between electrical conductivity and relative permittivity is established. This range of frequency should not exceed the human safety regulations either. Thus optimal frequency range selection is the key design challenge for human body based transmission systems.

3.2.1.1 Human body Circuit Model

The electric properties of human tissue are key design parameters for designing an effective human body based transceiver and modelling the medium (i.e. human body) characteristics significantly assists in design parameter optimization. The human body can be modelled as a communication channel to investigate the propagation of electrical signal for predicting transmission efficiency. In order to model the electrical properties of human body tissues, equivalent RC elements could be employed for prediction of signal leakages through body channel for different frequency ranges. Zimmerman [67] proposed a simplified version of the circuit model for body channel (inter-electrode impedance were ignored). The model consists of the body as well as environmental capacitance as shown in Figure: 3.3. In the model, A is the capacitive coupling between the transmitter signal electrode and the transmitter ground electrode, B is the capacitive coupling between the transmitter ground electrode and the body, C is the capacitive coupling between the transmitter signal electrode and the body, D is the capacitive coupling between the transmitter ground electrode and the environment, E is the capacitive coupling between the body and the environment, F is the capacitive coupling between the body and the receiver signal electrode, G is the capacitive coupling between the receiver ground electrode and the environment ground, H is the capacitive coupling between the receiver signal electrode and the body.

3.2.2 Coupling Between Human Body and Environment

The coupling between the body and environment i.e. the return path for capacitive coupled body transmission causes significant signal leakages. The coupling capacitance between the ground electrode and the external earth ground (D, G in Figure: 3.3) are generally small [64] and hence becomes the most critical component affecting signal transmission at low frequencies. In low-frequency range, the body

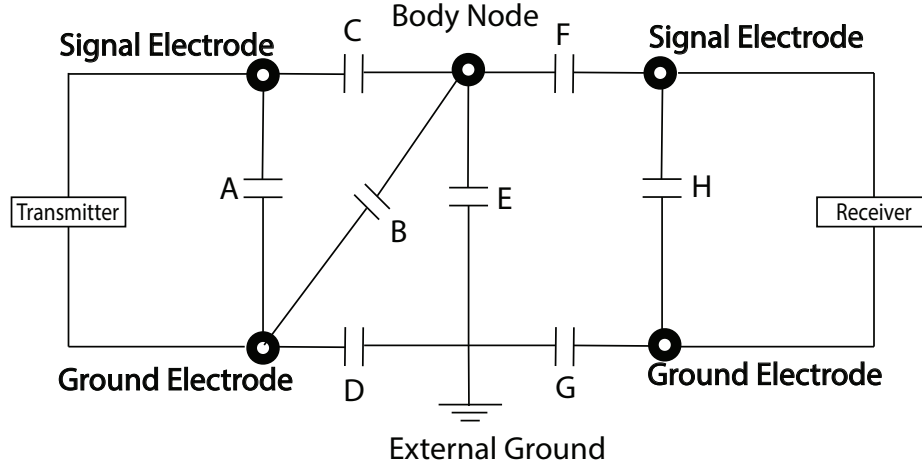

Figure 3.3: Four electrodes based human arm circuit model [67]

path impedance can be neglected. When the frequency range is above 10 MHz the body impedance (B, C, F in Figure: 3.3) also becomes comparable to the impedance offered by environmental capacitance (E, D, G in Figure: 3.3) and hence further affect signal transmission efficiency as the involvement of the body, affects the capacitive return path. It was reported that the operating frequency should be below 100 MHz to minimize the radiation of the signal out of the body and avoid significant channel variation [48].

3.2.3 Safety Regulations

Human body transmission poses a possible health risk with dangers of electrical shock. Therefore, compliance of safety regulations enforced by national commissions such as Federal Communications Commission (FCC) for limiting exposure to time-varying electric, magnetic and electromagnetic fields, based on the guidelines of International Commission on Non-Ionizing Radiation Protection (ICNIRP) [1] be-

comes essential. The exposure to time-varying electromagnetic field induces internal body currents and energy absorption in tissues which are directly dependent upon the coupling mechanisms and the frequency of operation. The physical quantities used to specify the basic restrictions on exposure to EMF are as follows:

- Current Density (J)
- Specific-Energy Absorption Rate (SAR)
- Power Density (S)
- Contact Current Intensity (Ic)

3.2.4 Current Density

Very high current density can have adverse effects on nervous system functions and the basic restrictions for different frequency ranges are listed in Table: 3.2. As

Table 3.2: Restrictions on current density [1]

Frequency	Current Density mA/m ²
$f < 1 \text{ Hz}$	8
$1 \text{ Hz} < f < 4 \text{ Hz}$	$8/f$
$4 \text{ Hz} < f < 1 \text{ kHz}$	2
$1 \text{ kHz} < f < 10 \text{ MHz}$	$f/500$

per Table: 3.2, the most stringent restrictions are set in the frequency range between $4 \text{ Hz} < f < 1 \text{ kHz}$, where the maximum current density is 2 mA/m^2 .

3.2.5 Specific-Energy Absorption Rate

Specific Absorption Rate (SAR) is the rate at which energy is absorbed by the human body when exposed to time varying electromagnetic field. It is defined as the power absorbed per mass of tissue and is expressed as watts per kilogram (W/kg) [24]. SAR restrictions are provided to prevent whole-body heat stress and excessive localized tissue heating. Table: 3.3 gives maximum recommended SAR values for the general public population.

Table 3.3: Maximum recommended SAR values [1]

Specificity	Max. SAR W/kg
Whole body average SAR	0.08
Localized SAR in head and trunk	2
Localized SAR in limbs	4

3.2.6 Power Density

Restrictions on power density prevent excessive heating in tissue at or near the body surface. Power density restrictions are significant in the frequency range of 10 GHz - 300 GHz. Maximum recommended power density for the general public is 10 W/m^2 .

3.2.7 Contact Current Intensity

Contact current is the amount of current that flows when the human body comes in contact with an object at a different electric potential [1]. ICNIRP poses restrictions on contact current as well to avoid shock and burn hazards. Table: 3.4 summarizes the maximum recommended contact current for the general public.

Table 3.4: Restrictions on contact current intensity [1]

Frequency	Contact Current mA
$f < 2.5 \text{ kHz}$	0.5
$2.5 \text{ kHz} < f < 100 \text{ kHz}$	$0.2f$
$100 \text{ kHz} < f < 110 \text{ MHz}$	20
$100 \text{ kHz} < f < 110 \text{ MHz}$ for limbs	45

For any application involving human subjects the irritation, heating, and destruction of human tissue has to be limited in compliance with the above mentioned regulations and hence the regulations significantly affect the design parameters for the proposed system.

CHAPTER 4

TRANSCEIVER DESIGN FOR INTRA BODY POWER TRANSFER

The feasibility and novelty of the proposed power transfer approach can be explored only with a dedicated hardware setup ensuring compliance of the safety guidelines by ICNIRP [1]. In this chapter, enabled by the system developed, the concept of capacitive coupled IBPT will be demonstrated and investigations of the harvested power with varying design parameters will be conducted to obtain optimal parameters. Section 4.1 defines the system requirements and the main design parameters. The system architecture is explained in Section 4.2. The experimental setup and initial results for design optimization are presented in Section 4.3.

4.1 System Design Considerations

In order to design an effective power transfer system utilizing human body as a transmission medium, it is necessary to address all design challenges that influence energy harvesting at the passive wearable sensor along with fulfilling safety requirements for measurements on human subjects. In this section, we present the key design considerations for transmitted power.

4.1.1 Operating Frequency Range

The current design focuses on developing a wrist-worn interrogator that can transfer power to a remote wearable sensor on the finger. In this setup, most of the signal transmission occurs through the skin tissues rather than traversing into the bones. Gabriel *et al.* [18] presented a variation of dielectric properties for different human

tissues and it was observed that the electrical conductivity of human skin is very low ($200 \mu\text{S}/m$) for lower frequency range but increases significantly beyond 100 kHz whereas permittivity of human skin is very low for higher frequency range that is beyond 100 MHz. From his study, it can be concluded that the signal transmission via human skin encounters significant electromagnetic interference for frequencies below 100 kHz. On the other hand, at higher frequencies - 300 MHz to several GHz, the signal wavelength becomes comparable to the human body channel length and the body radiates energy acting as an antenna. Hence, an optimal frequency for our experimental setup should be higher than 100 kHz, to avoid electromagnetic (EM) interference, and lower than 100 MHz, to minimize the radiation of the signal out of the body.

4.1.2 Contact Current Intensity

The intensity of electric shock through human body due to intra-body signal transmission is determined by the induced current intensity at particular frequencies. The maximum induced current intensity for body transmission that is considered harmless for humans in the frequency range of 100 kHz to 100 MHz (optimal for our setup) is 20 mA for entire body. For limbs the current intensity should be 45 mA in the frequency range of 10 MHz - 110 MHz [1]. For our current setup, the experiments involve human arm as the prime location where electrodes are mounted for measurements and therefore, in order to comply with this limit, the contact current intensity should always be below 45 mA.

4.1.3 Specific-Energy Absorption Rate (SAR)

Exposure to time-varying electrical signal results in absorption of energy in tissues that depend on the coupling mechanisms and the frequency involved. Referring to Table: 3.3 from Section 3.2.5 the maximum recommended SAR for human arm

(localized limb) as per our experimental setup is 4 W/kg [1] and failure to comply with this limit might result in heat stress and localized tissue heating.

4.1.4 Power Density

The ICNIRP [1] regulations for power density apply for frequency between 10 GHz - 300 GHz (that is 10 W/m^2 for general public), and therefore does not apply on the frequency range selected for current design.

4.1.5 Current Density

Current density safety restrictions are applicable between 1 Hz and 10 MHz in order to prevent effects on nervous system functions. For the selected frequency range (100 kHz - 100 MHz) the current density ranges from 200 mA/m^2 - 200 A/m^2 [1].

4.2 Proposed System Architecture

A block diagram of the proposed system is shown in Figure 4.1. Four main segments of the IBPT system are on-body surface electrodes, human body as transmission medium, interrogator (transmitter) and transponder (receiver).

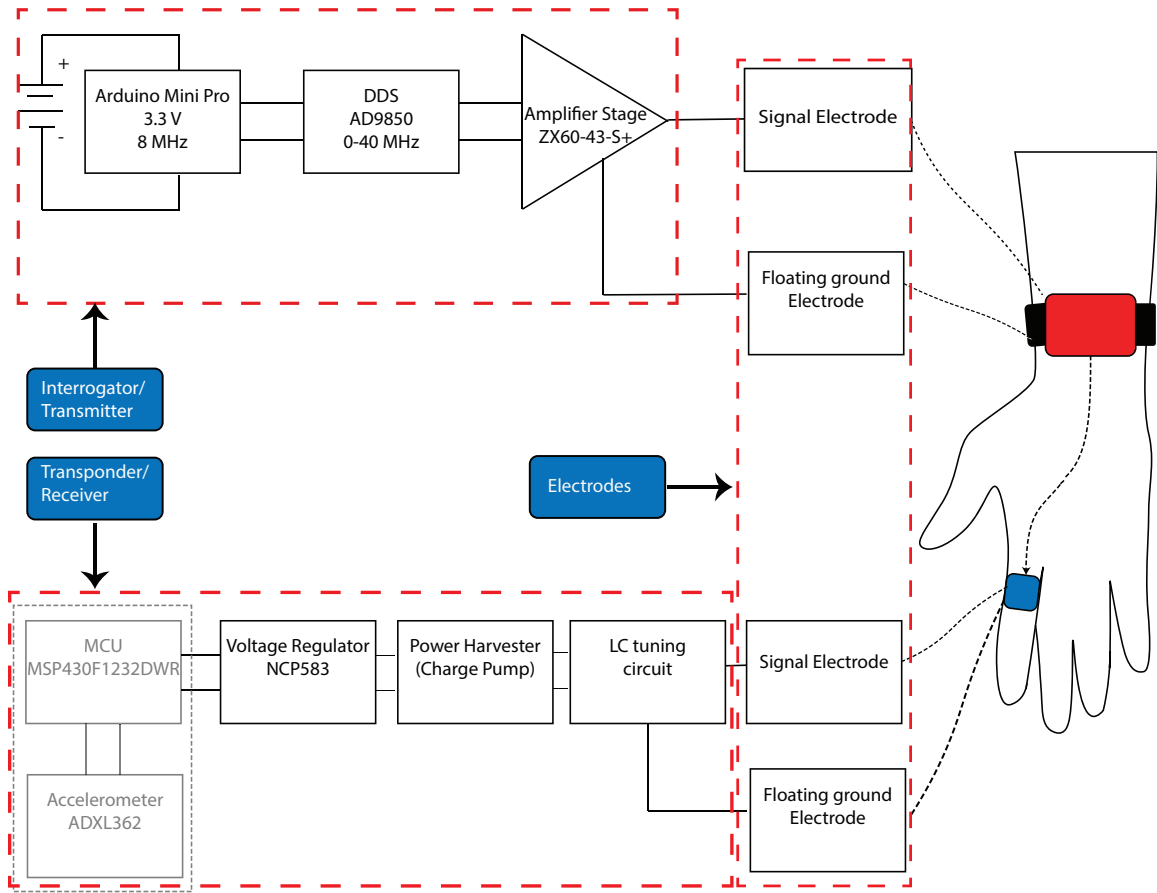

Figure 4.1: Block diagram of the SkinnySensor system.

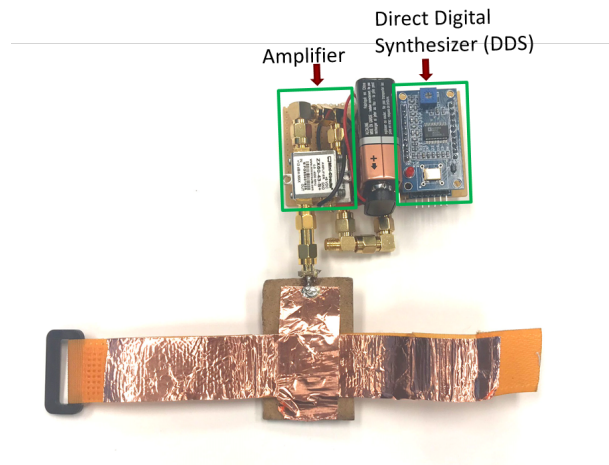

Figure 4.2: Hardware implementation of the interrogator.

4.2.1 Interrogator Design

It is critical to preserve the capacitive return path for the design. Any type of earth-grounded instruments such as function generator, or oscilloscope etc., if connected to the prototype can short the return path and the prototype would not emulate the real electric-field IBPT. Therefore, experimental measurements have to be conducted with either battery-powered equipment or by using balun which can isolate the prototype’s ground electrode from the external earth ground. In order to emulate electric field based signal transmission, a battery-powered signal generator was designed that acts as an interrogator. The interrogator board is based on the Ad9850 Direct Digital Synthesizer (DDS) that is designed with programmable frequency capability controlled by Arduino mini pro (3.3 V) as shown in Figure 4.2. The output frequency for the design is configured to vary from 10 MHz to 40 MHz. A cascaded amplifier stage using ZX60-43-S+ increases the voltage and power level that can be harvested at the receiver side. Power and peak-to-peak voltage values for the time-varying electrical signal injected into the human skin using our device for multiple frequencies are provided in Table 4.1. In order to measure the voltage of the signal we used DSOX1102A (0-70 MHz) oscilloscope with FTB-1-1*A15+ balun for ground isolation.

Table 4.1: Transmitter voltage and power profile w.r.t frequency

Frequency (MHz)	Voltage (V _{p-p})	Power (mW)
10	4.78	10.519
20	3.03	7.295
30	2.19	4.581
40	1.05	3.020

4.2.2 Electrode Design

The electrodes to contact the skin of a human subject are prepared, as shown in Figure 4.3. The signal electrode is formed on the front side using a copper foil, and the ground electrode on the back side is of 99% pure copper plate. The SMA connector is soldered at the edge of the electrode to enable connection with the signal and ground terminals of the amplifier output on our interrogator design (Figure 4.2). The copper foil tape that is used for signal electrode provides stable contact with the human skin. The size of the interrogator electrodes is: $4\text{cm} \times 13\text{cm}$ for signal electrode and $4.5\text{cm} \times 3.5\text{cm}$ for ground electrode. The transponder electrode size is $4\text{cm} \times 7\text{cm}$ for signal electrode and $2.5\text{cm} \times 2.5\text{cm}$ for ground panel. The thickness of the dielectric between the signal electrode and the ground electrode for both the interrogator and transponder is 2.5mm . These electrodes were copper-based due to the high conductivity of copper without repeated spreading of conductive paste on the electrodes (as in pre-wet electrodes) which is inconvenient and may cause inflammation of the skin [22]. Copper electrodes allow good conductivity with loosely fit electrodes as well. The front side that is the signal electrode for both the interrogator and the transponder is shown in Figure 4.3(a) and the back side that is the ground electrode for both the interrogator and the transponder is shown in Figure 4.3(b).

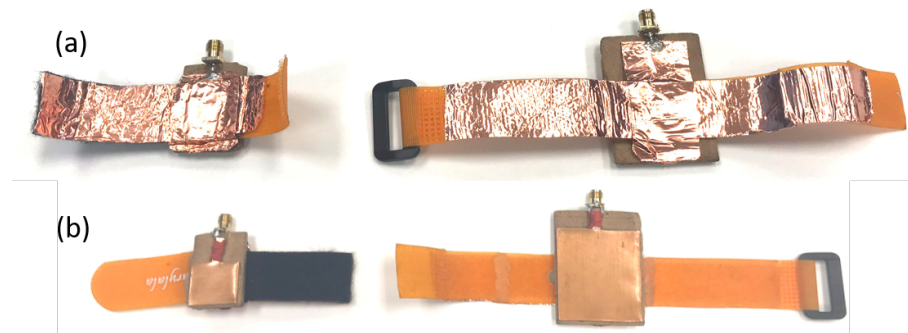

Figure 4.3: Electrode design: (a) Front side of electrodes: signal electrodes for the interrogator and the transponder. (b) Backside of electrodes: ground electrodes for the interrogator and the transponder.

4.2.3 Transponder/Receiver Design

A highly sensitive transponder is developed as shown in Figure 4.4. The signal coupled from the body is first tuned using LC tank circuit. It is further rectified using multiple stage voltage doubling stages (power harvesting stage). Power harvesting stage consists of charge pump regulator stages that deliver power by charging and discharging capacitors. In the charge pump regulator, the capacitor connection is altered by the diodes in order to control charging and discharging of the capacitors. The charge pump based regulators consist of very few components with no inductors in the design. Therefore, the entire charge pump can be integrated on a single chip to reduce system cost. The current design for charge pump is the basic design, a more advanced charge pump regulator based on MOSFETs can further enhance the power harvesting capabilities of the transponder. For the current design low threshold, RF Schottky diodes (HSMS-285C) are used to maximize the voltage output of the charge pump. A detailed comparison of the system with a different number of harvesting stages (charge pump stages) is presented in Section 5.1 . Finally, this DC voltage is applied across a large storage capacitor (10uF) which accumulates charge over time. The DC voltage obtained is supplied to a low-power 1.8V Voltage Regulator (NCP583) that will be connected to the microcontroller and accelerometer (not part of the design as yet). It should be noted that the power harvester is a non-linear device and its efficiency is load dependent. Therefore, the receiver must be tuned to provide an output voltage in the presence of the desired load.

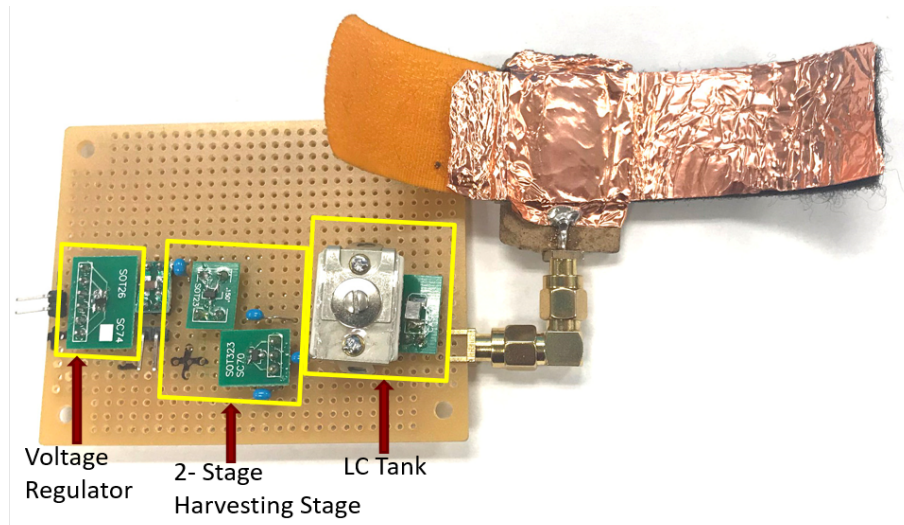

Figure 4.4: Hardware implementation of the transponder.

Load Requirements

Microcontroller MSP430F1232

Power Consumption:

- Low Supply Voltage Range 1.8 V to 3.6 V
- Active mode: 200 μ A @ 1 MHz, 2.2 V
- Standby mode: 0.7 μ A

Accelerometer ADXL362:

Power Consumption:

- 1.8 μ A at 100 Hz ODR, 2.0 V supply
- 3.0 μ A at 400 Hz ODR, 2.0 V supply
- 270 nA motion activated wake-up mode
- 10 nA standby current

4.3 Experimental Setup

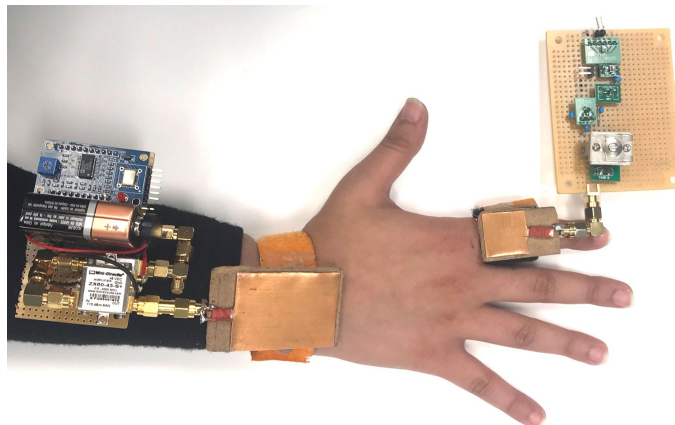

Figure 4.5: Intra-body power transfer experimental setup.

The capacitive coupled IBPT experiment setup is shown in Figure 4.5. The interrogator is mounted on the human subject's wrist while the transponder is mounted on the finger. During experiments, the signal electrodes for interrogator and transponder are attached to the skin while the ground electrode (back side of the electrode design - Figure 4.3(b)) are subjected into the air for capacitive coupling of the return path. For the voltage measurements, we used high impedance load that is $4\text{ M}\Omega$ (emulating sleep mode of MCU) and the harvested power was calculated by recording the current drawn by a low impedance that is $1\text{ k}\Omega$ (emulating active mode of MCU). For the experiments 5 readings were taken, one at each corner of our lab (Advanced Human & Health Analytics (AHHA) Laboratory in College of Information and Computer Sciences) and one in the centre of the lab to reduce the effect of electromagnetic interference due to lab equipment. Additionally, the distance of the arm from the external ground (floor) was 74 cm. The voltage and current measurements were performed using a battery powered Keysight U1282A 4 – 1/2 - Handheld Digital Multimeter in order to avoid any grounding effects from the earth grounded instruments.

CHAPTER 5

RESULTS AND ANALYSIS

Normal human activities and body postures such as walking, eating, sitting etc. influence the direction of the propagation of electrical signal when the intra-body transmission is employed. The power transfer using IBPT based wearable device can be established via three different routes. The signal either couples over the surface of the human skin, across the inner human body tissue, or through the air surrounding the human body. Although, our system guides the signal through human skin or inner tissues the signal leakage through the air surrounding the human body during body movements is inevitable. Additionally, when the human body is in motion the contact between electrodes and the human skin varies which can influence the power transfer efficiency. In order to make the system reliable even when worn in a loose fit manner, it is necessary to study the effects of distance between the signal electrode and the human skin. Additionally, the variation of the channel length (that is the distance between the interrogator and transponder) causes signal strength to change during movement which also becomes an important parameter for system evaluation. This chapter first studies the effect of varying power harvesting stages for the transponder to obtain an optimized design. Next, we evaluate the optimized system for different parameters that can affect the power harvested.

5.1 Transponder Design Parameter Optimization

Influences of different power harvesting stages on the harvested voltage and power are investigated in this section. The harvesting stage doubles the voltage of incoming

signal and with an increasing number of harvesting stages the voltage increases but the power available at the output declines. Therefore, there is a trade-off between the power and voltage that depend on harvesting stages. In this section, we try to find the optimum number of harvesting stages which is capable of delivering a sufficient amount of voltage that can charge the capacitor along with satisfying the power requirements of the load. In order to find the voltage across the capacitor when MCU is in sleep mode we used a high impedance load ($4\text{ M}\Omega$), and to estimate the power consumption of MCU when it is in active mode the current across low impedance ($1\text{ k}\Omega$) was measured. One of the challenges of incorporating microcontroller and sensors with IBPT is the ability to manage large power consumption of these devices. The resulting power consumption is very high and harvester might not be able to continuously supply power to the devices. One method to overcome this challenge was to use a large storage capacitor to accumulate the charge which is incorporated in our design. Once sufficient voltage is obtained by the system with MCU and sensors, they can operate in burst mode, polling sensors periodically (duty cycling MCU) which is the immediate future work of this research. Here we limit the study to the harvested power using the IBPT.

In order to optimize the transponder a comparison of the system with a different number of harvesting stages is presented. It can be observed from the plots in Figure 5.3 that the amount of power harvest with 2 stage charge pump is $218\text{ }\mu\text{W}$ for low impedance (1 K) at 30 MHz and for the same frequency we obtain (Refer Figure 5.1) 3.75 V in sleep mode (high impedance mode) which is sufficient to turn microcontroller on (we need above $2.2 + -0.2\text{ V}$ voltage so that we remain above the MCU turn-on voltage($1.8\text{ V} - 3.6\text{ V}$)). Although increasing the number of stages increases the voltage at the capacitor but the power level is quite low and we do not require any further increment in the voltage level. The design with 1 stage power harvester cannot be used as it does not provide voltage in the range of our chosen threshold

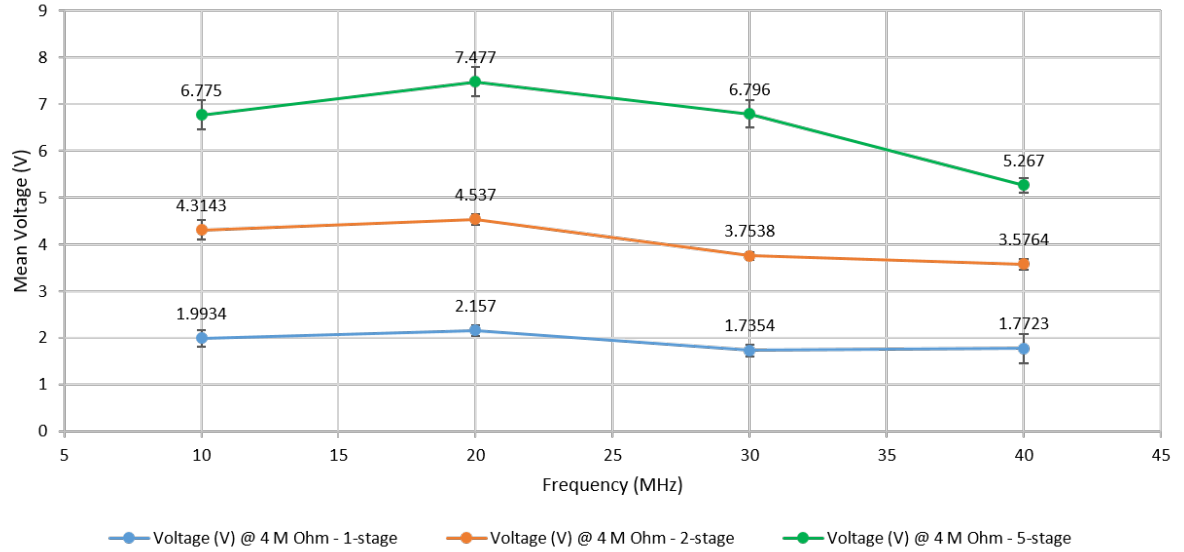

Figure 5.1: Harvested voltage with varying number of harvesting stages - high impedance ($4\text{ M}\Omega$).

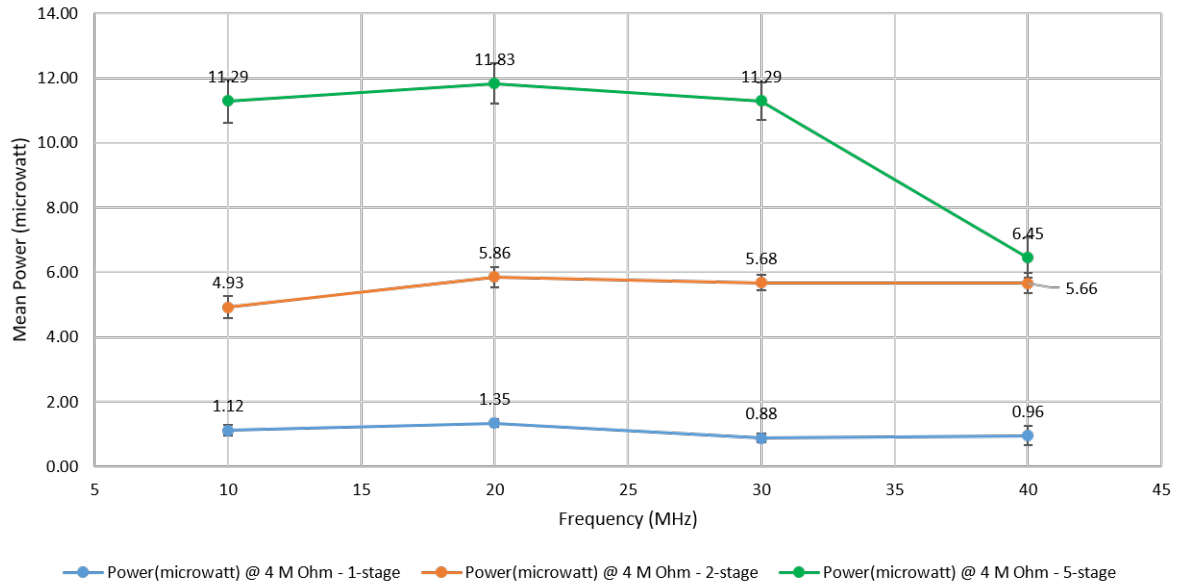

Figure 5.2: Harvested power with varying number of harvesting stages - high impedance ($4\text{ M}\Omega$).

$2.2 \pm 0.2\text{V}$ although power level in active mode (low impedance mode) is quite high for 1 stage harvester. Furthermore, we obtain maximum harvested power for

2- stage harvester in low impedance mode at 30 MHz indicating the power transfer efficiency is high at this frequency. Therefore, we selected 2 - stage power harvester as the optimal harvester which should be operated at 30 MHz. In this configuration the sleep mode (high impedance mode) voltage is 3.75 V and active mode (low impedance mode) harvested power is 218 μ W. An additional observation was made that the standard deviation for the data points (power as well as voltage) for 1- stage is less as compared to that for increasing stages - highest for 5- stage. This shows that adding more stages adds instability to the system. Therefore, achieving high voltage and power level with a minimum number of stages is considered optimized design.

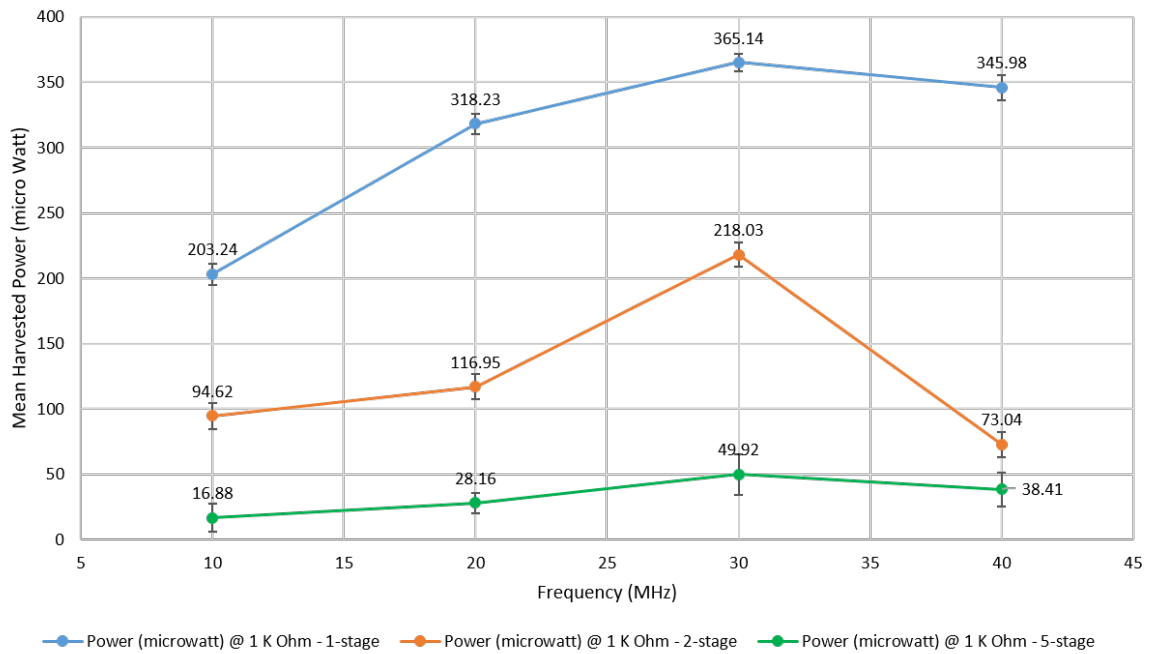

Figure 5.3: Harvested power with varying number of harvesting stages - low impedance (1 k Ω).

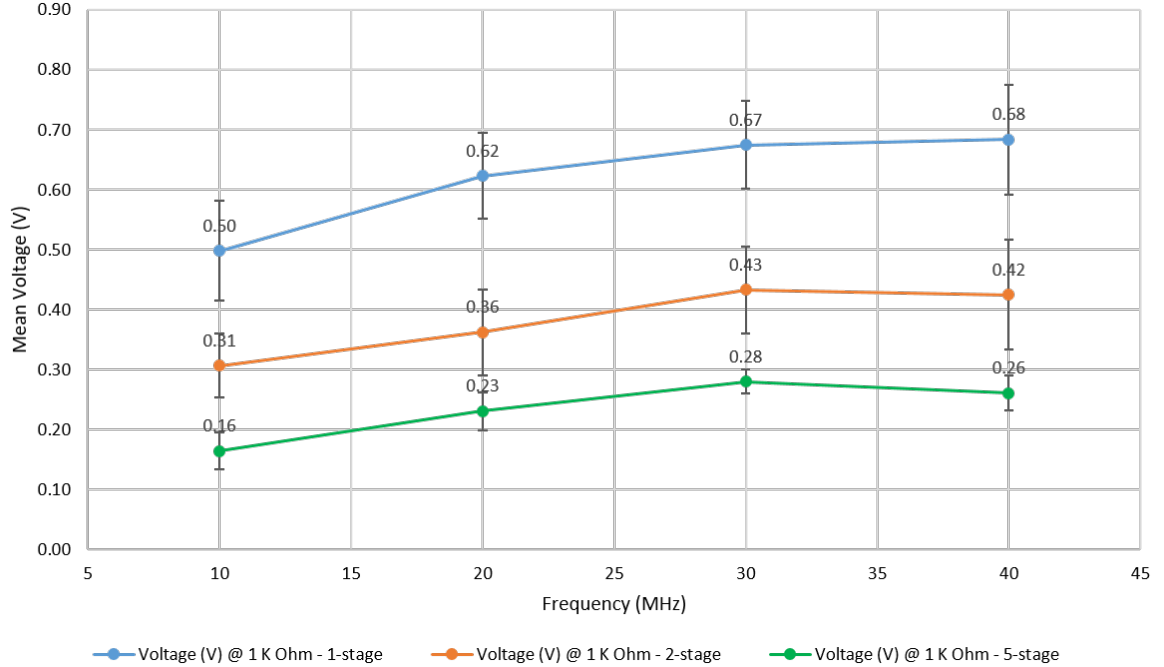

Figure 5.4: Harvested voltage with varying number of harvesting stages - low impedance ($1\text{ k}\Omega$).

5.2 Effect of Varying Distance Between Interrogator and Transponder

The goal of this experiment was to analyze the variation in harvested power and voltage at the transponder with varying distance between the interrogator and the transponder. When the time-varying electrical signal is coupled to the human skin it disperses in multiple directions [54] due to which power loss occurs. In order to evaluate the efficiency of the designed system with varying distance we fix the position of the transponder electrodes to the finger (that is signal electrode is attached to the skin while the ground electrode subjected in air) while the interrogator electrode is moved along the arm changing the distance by 5 cm for each data recording. The voltage measurements were recorded with high impedance load that is $4\text{ M}\Omega$ (emulating sleep mode of MCU) and the harvested power was calculated by recording

the current drawn by the low impedance that is $1\text{ k}\Omega$ (emulating active mode of MCU). The experiment was conducted 5 times for each distance at different locations in our lab in order to minimize the effect of electromagnetic radiation from other lab equipment.

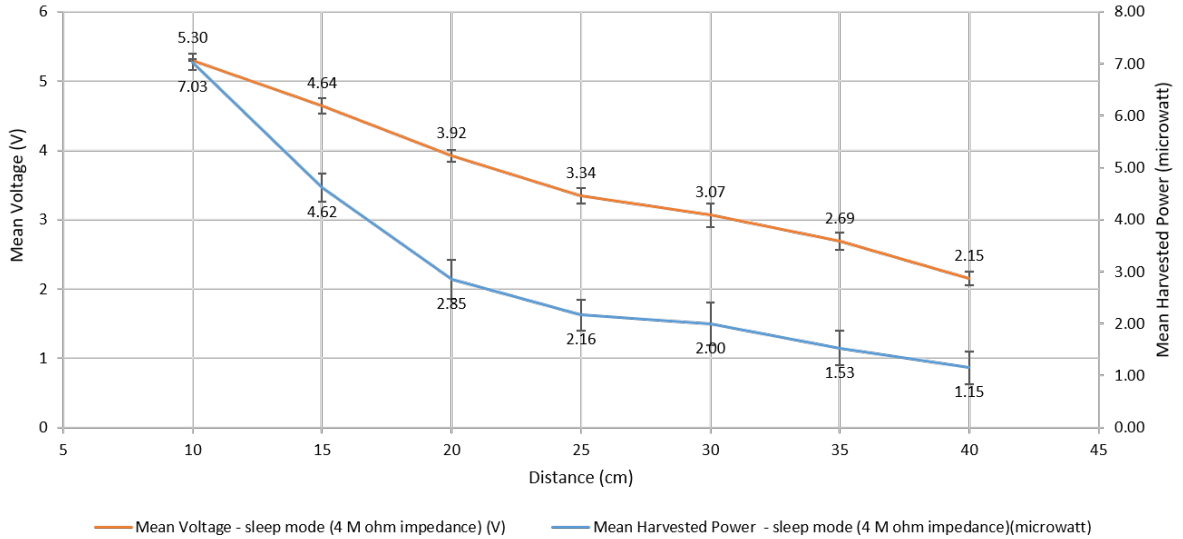

Figure 5.5: Harvested power and voltage with varying distance between interrogator and transponder - high impedance ($4\text{ M}\Omega$).

Figure 5.5 shows the experimental results for the effect of distance on the power harvested for $1\text{ k}\Omega$ and Figure 5.6 illustrates the voltage level in high impedance measurement mode using the prototype for IBPT evaluation. The plot shows the mean harvested power and mean output voltage of 5 recordings for each measurement on one human subject. The error bars show the standard deviation of the data points and by observation, it can be concluded that the amount of variation in data points and the error or uncertainty in the reported measurement is quite low for harvested power(active/low impedance mode) and the output voltage(sleep/high impedance mode). From Figure 5.5, it can be concluded that although power harvested drops with increasing distance between the interrogator and the transponder but the voltage level is above the threshold level that is 2.2 V (MCU requirement). If we perform

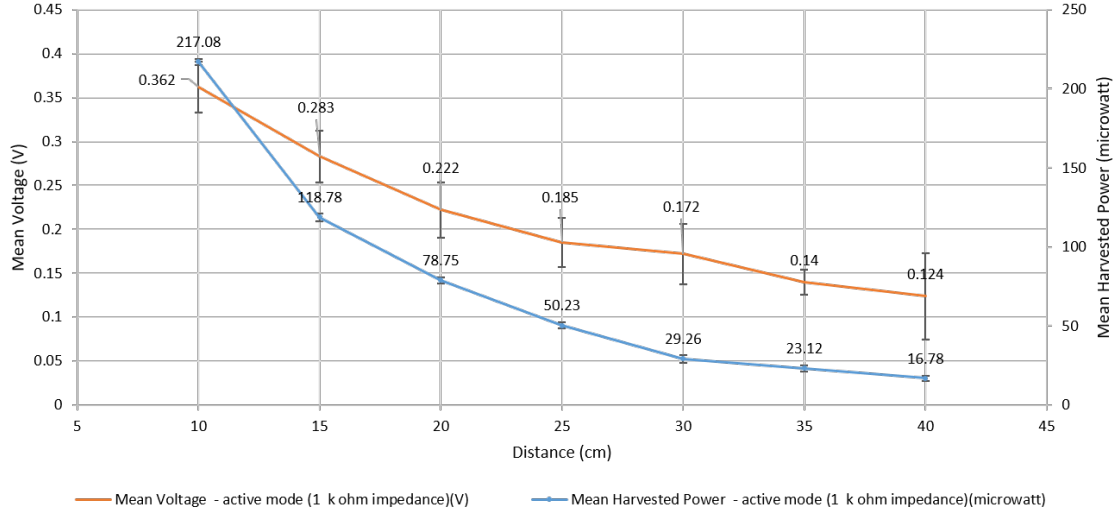

Figure 5.6: Harvested power and voltage with varying distance between interrogator and transponder - low impedance ($1\text{ k}\Omega$).

duty cycling of MCU the capacitor can supply power efficiently even with increasing distances. Moreover, since the power injected from the interrogator is quite low we can increase the power level while ensuring compliance with safety regulations to obtain higher power harvesting and operate microcontrollers for longer active mode intervals. Moreover, from Figure 5.6, we observe that power harvested drops significantly approximately $100\text{ }\mu\text{W}$ when the distance increases from 10 cm to 15 cm indicating that distance between interrogator and transponder plays a significant role in the amount of power harvested.

5.3 Effect of Varying Longitudinal Distance between Transponder Electrode and Human Skin

In order to evaluate the signal propagation for loosely fit electrodes, harvested power and voltage level was recorded for varying height of the signal electrode with respect to the human skin. The experimental setup was similar as explained in Section 4.3. The only difference was that we used a smaller signal electrode for the

transponder having the size of $4\text{cm} \times 3.5\text{cm}$ for the feasibility of holding the electrode above the skin. The signal electrode was suspended in air with the help of plastic forceps to avoid capacitive coupling between human skin and the signal electrode. The voltage measurements were recorded with the high impedance load ($4\text{M}\Omega$) and the harvested power was calculated by recording the current drawn by the low impedance ($1\text{k}\Omega$). The same measurement equipment was used as in the previous experiment.

The harvested power and voltage level achieved over multiple separations between

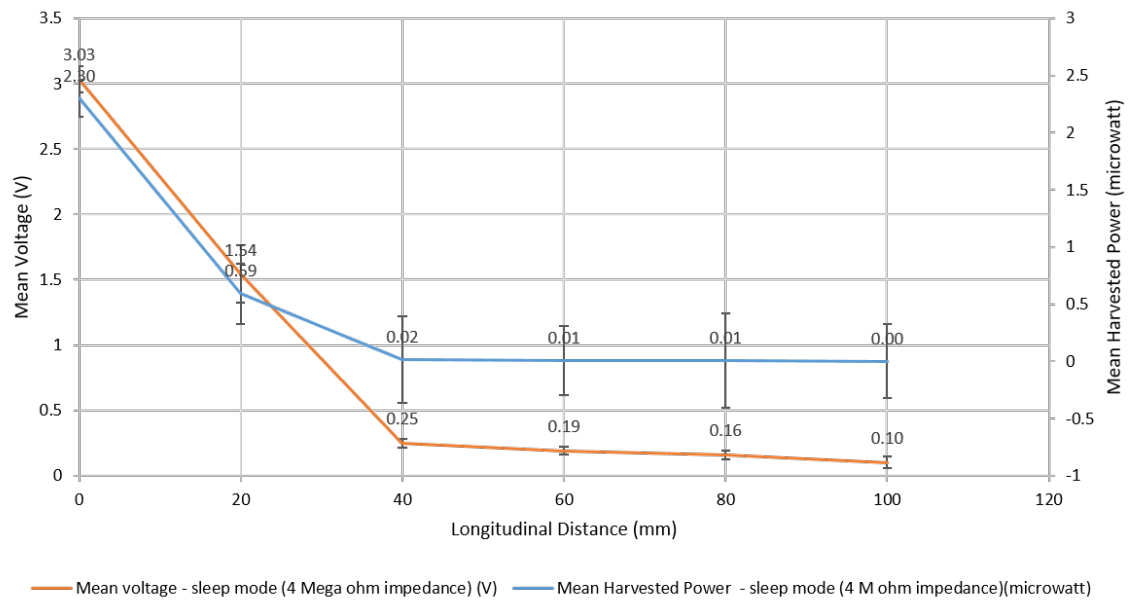

Figure 5.7: Harvested power and voltage with varying longitudinal distance between transponder electrode and human skin - high impedance ($4\text{M}\Omega$).

the signal electrode for the transponder and human skin is illustrated in Figure 5.7 and Figure 5.8. It was observed that the power and voltage level significantly drops if the electrode is moved away from human skin indicating that the maximum amount of signal propagation was routed via human skin and tissues because as soon as the contact distance between the skin and electrode increases a decline of power and voltage is observed. Additionally, it can be concluded that the recommended distance

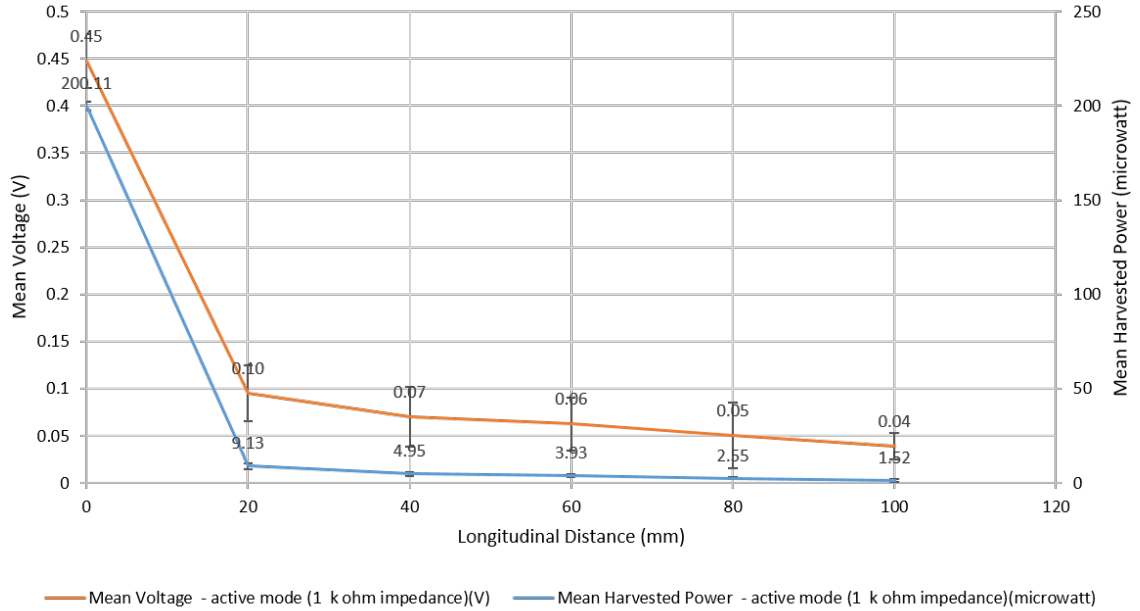

Figure 5.8: Harvested power and voltage with varying longitudinal distance between transponder electrode and human skin - low impedance ($1\text{ k}\Omega$).

between the signal electrode and the human skin for efficient transmission is between $0 - 20\text{mm}$.

5.4 System Reliability Evaluation

The anticipated usage of wearable sensors includes continuous hand motion. Therefore, it is necessary to validate that the power harvested sustains for long time intervals during normal hand movement. The similar measurement setup was used as the previous experiment. Voltage and power through $1\text{ k}\Omega$ and $4\text{ M}\Omega$ were recorded for 60 seconds ensuring the subject moves her hand rigorously making circular hand movements. The system exhibited reliable operation for 1 minute with $212\text{ }\mu\text{W}$ mean harvested power in active/low impedance mode and 3.33 V mean output voltage in sleep/high impedance mode as shown in Figure 5.9 and Figure 5.9.

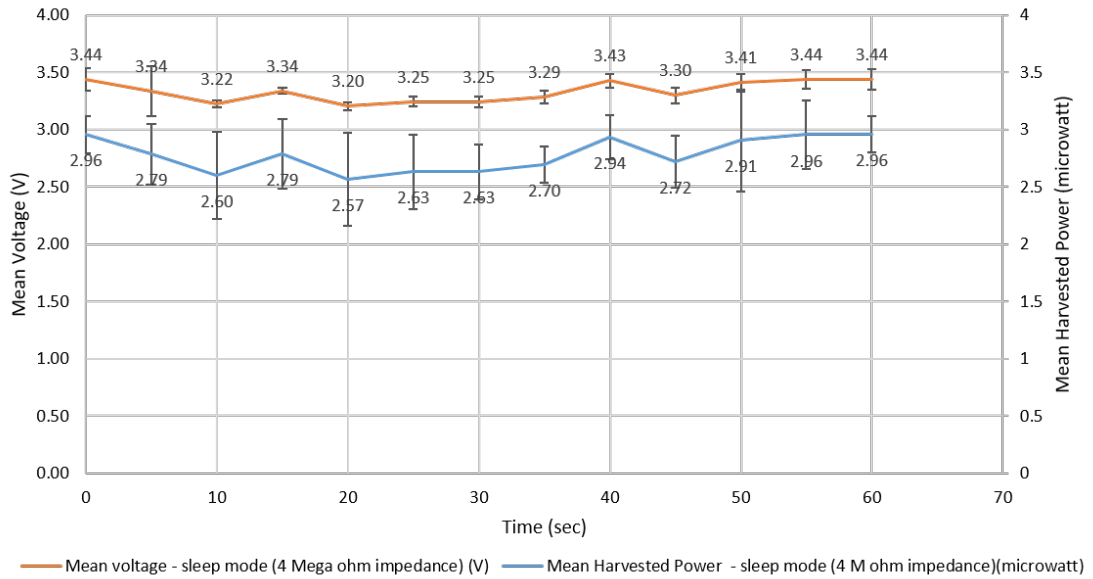

Figure 5.9: Voltage and power over time - high impedance (4 MΩ).

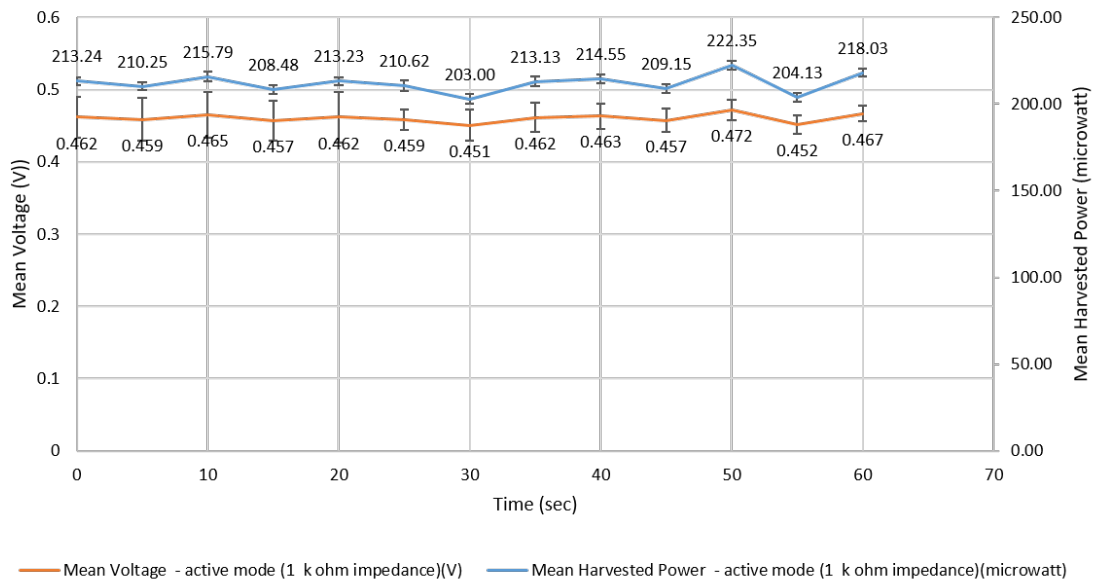

Figure 5.10: Voltage and power over time - low impedance (1 kΩ).

Table 5.1: Comparison between harvested power using IBPT with RF based power transfer techniques.

Method	Frequency (MHz)	Output Power (μW)
Intra-Body Power Transfer	30	217
Radio Frequency (RF)	1000	140 O’Driscoll (2011) [38]
Radio Frequency (RF)	1000	5 Poon (2010) [40]
Radio Frequency (RF)	2400	2.3 Shih (2011) [49]

5.5 Discussion

The evaluation platform presented here offers significant insight into the developed system and the concept of IBPT. We demonstrated that the harvested power is significantly dependent upon parameters such as the distance between the interrogator and the transponder as well as separation between electrode and skin. Additionally, the system was verified to be reliable when the subject performs rigorous hand motion. The parameter optimization Section 5.1 revealed that the maximum power is harvested when the system is operated at 30 MHz. It was also demonstrated that the system developed is capable of harvesting on average 217 μW in low impedance mode and provides an average high impedance mode voltage of 4.5 V. The harvested power is comparable to existing Radio Frequency (RF) based power transfer techniques but with an advantage of using lower frequency signal which is safe for human interaction. The Table 5.1 compares the harvested power using IBPT with RF-based solutions. An additional advantage of IBPT is that similar range of power is harvested at the transponder with very low power signal coupled through human body as compared to traditional RF based solutions which transmit approximately 1W power [46].

CHAPTER 6

CONCLUSION AND FUTURE WORK

IBPT is a novel concept that can deliver power to ultra-miniaturized batteryless wearable sensors that can be mounted on any part of the body, even smaller body parts such as fingertip, in-ear, and in-mouth, where it is difficult to package the sensor, embedded processor, communication modules into an integrated system with a large battery. This innovative technology utilizes the human body itself as the transmission medium for powering on-body sensors. The cost and energy efficiency, at relatively lower frequency range and lower human health-related risks, make it an appealing alternative to RF-based power transmission techniques used for wearable technology. The technology underlying this research is composed of an interrogator capable of transmitting time-varying electric signals via human body to transmit power and an ultra-miniaturized, batteryless transponder (passive wearable sensors) that can be powered from the transmitted signals for collecting sensory data. IBPT is an innovative way of simplifying the configurations of BAN and can substantially reduce the manufacturing cost of sensors, as it will eliminate the use of a battery and any RF-based communication devices. Furthermore, the technology makes the system more user-friendly as users would no longer have to recharge multiple sensors - users will simply need to recharge a single battery socket.

In this study, we focused on designing an optimized transponder capable of harvesting maximum power for the target load that is a Microcontroller and an Accelerometer. As the return path for electric field intra-body transmission is provided by the environment, the optimization phase included the selection of an operating

frequency that overcomes the parasitic coupling effects and provides maximum signal propagation through human body which was found to be 30 MHz. At this low frequency, the system harvests power which is comparable to the traditional RF-based power transfer techniques. The system was demonstrated to be stable and can harvest power during motion as well. Future design efforts for this project focus on improvements in the current design including duty cycling the active mode data collection of Microcontroller to adjust the power budget for low power application sensors. Additionally, the physical design improvements include PCB based miniaturized version of the current prototype. The first transponder PCB has been manufactured (i.e. shown in Figure 6.1) and is currently in the testing phase. And we anticipate developing a real-world application such as a gesture recognition system that uses this technology because we believe this technology has tremendous potential and wearable technology can take significant advantages from the idea of IBPT.

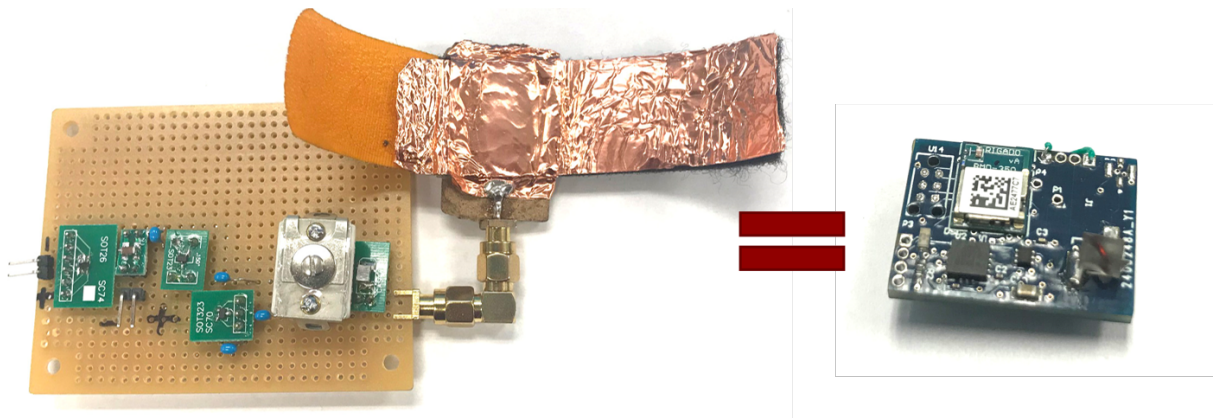

Figure 6.1: PCB realization of transponder.

BIBLIOGRAPHY

- [1] Guidelines for limiting exposure to time-varying electric, magnetic, and electromagnetic fields. *International Commission on Non-Ionizing Radiation Protection (ICNIRP)* (1997), 513–514.
- [2] Part 15.6: Wireless body area networks. *IEEE Standard for Local and metropolitan area networks IEEE Std 802.15.6-2012* (Feb 2012), 1–271.
- [3] Arroyo, E., Badel, A., Formosa, F., Wu, Y., and Qiu, J. Comparison of electromagnetic and piezoelectric vibration energy harvesters: Model and experiments. *Sensors and Actuators A: Physical* 183 (2012), 148 – 156.
- [4] Bae, J., and Yoo, H. The effects of electrode configuration on body channel communication based on analysis of vertical and horizontal electric dipoles. *IEEE Transactions on Microwave Theory and Techniques* 63, 4 (April 2015), 1409–1420.
- [5] Bandodkar, Amay J, You, Jung-Min, Kim, Nam-Heon, Gu, Yue, Kumar, Rajan, Mohan, AM Vinu, Kurniawan, Jonas, Imani, Somayeh, Nakagawa, Tatsuo, Parish, Brianna, et al. Soft, stretchable, high power density electronic skin-based biofuel cells for scavenging energy from human sweat. *Energy & Environmental Science* 10, 7 (2017), 1581–1589.
- [6] Bao, Xiaoqi, Biederman, Will, Sherrit, Stewart, Badescu, Mircea, Bar-Cohen, Yoseph, Jones, Christopher, Aldrich, Jack, and Chang, Zensheu. High-power piezoelectric acoustic-electric power feedthru for metal walls. vol. 6930, pp. 6930 – 6930 – 8.
- [7] Becker, Felix, Lapatki, Bernd, and Paul, Oliver. Miniaturized six-degree-of-freedom force/moment transducers for instrumented teeth with single sensor chip. *IEEE Sensors Journal* 18, 6 (2018), 2268–2277.
- [8] Berglund, Mary Ellen, Duvall, Julia, and Dunne, Lucy E. A survey of the historical scope and current trends of wearable technology applications. In *Proceedings of the 2016 ACM International Symposium on Wearable Computers* (2016), ACM, pp. 40–43.
- [9] Bergmann, Jeroen HM, Chandaria, Vikesh, and McGregor, Alison. Wearable and implantable sensors: the patients perspective. *Sensors* 12, 12 (2012), 16695–16709.

- [10] Bergmann, JHM, and McGregor, AH. Body-worn sensor design: what do patients and clinicians want? *Annals of biomedical engineering* 39, 9 (2011), 2299–2312.
- [11] Boyden, Anna, Soo, Vi Kie, and Doolan, Matthew. The environmental impacts of recycling portable lithium-ion batteries. *Procedia CIRP* 48 (2016), 188–193.
- [12] Brunelli, D., Moser, C., Thiele, L., and Benini, L. Design of a solar-harvesting circuit for batteryless embedded systems. *IEEE Transactions on Circuits and Systems I: Regular Papers* 56, 11 (Nov 2009), 2519–2528.
- [13] Buettner, Michael, Prasad, Richa, Sample, Alanson, Yeager, Daniel, Greenstein, Ben, Smith, Joshua R, and Wetherall, David. Rfid sensor networks with the intel wisp. In *Proceedings of the 6th ACM conference on Embedded network sensor systems* (2008), ACM, pp. 393–394.
- [14] Cohn, Gabe, Gupta, Sidhant, Lee, Tien-Jui, Morris, Dan, Smith, Joshua R., Reynolds, Matthew S., Tan, Desney S., and Patel, Shwetak N. An ultra-low-power human body motion sensor using static electric field sensing. In *Proceedings of the 2012 ACM Conference on Ubiquitous Computing* (New York, NY, USA, 2012), UbiComp '12, ACM, pp. 99–102.
- [15] Deng, Qian, Kammoun, Mejd, Erturk, Alper, and Sharma, Pradeep. Nanoscale flexoelectric energy harvesting. *International Journal of Solids and Structures* 51, 18 (2014), 3218 – 3225.
- [16] Dewulf, Jo, Van der Vorst, Geert, Denturck, Kim, Van Langenhove, Herman, Ghyoot, Wouter, Tytgat, Jan, and Vandeputte, Kurt. Recycling rechargeable lithium ion batteries: Critical analysis of natural resource savings. *Resources, Conservation and Recycling* 54, 4 (2010), 229–234.
- [17] Dondi, Denis, Bertacchini, Alessandro, Brunelli, Davide, Larcher, Luca, and Benini, Luca. Modeling and optimization of a solar energy harvester system for self-powered wireless sensor networks. *IEEE Transactions on industrial electronics* 55, 7 (2008), 2759–2766.
- [18] Gabriel, Camelia. Compilation of the dielectric properties of body tissues at rf and microwave frequencies. 272.
- [19] Gandhi, Om P., Morgan, L. Lloyd, de Almeida de Salles, Alvaro Augusto, Han, Yueh-Ying, Herberman, Ronald B., and Davis, Devra Lee. Exposure limits: the underestimation of absorbed cell phone radiation, especially in children. *Electromagnetic biology and medicine* 31 1 (2012), 34–51.
- [20] Grosse-Puppenthal, Tobias, Hodges, Steve, Chen, Nicholas, Helmes, John, Taylor, Stuart, Scott, James, Fromm, Josh, and Sweeney, David. Exploring the design space for energy-harvesting situated displays. In *Proceedings of the 29th Annual Symposium on User Interface Software and Technology* (New York, NY, USA, 2016), UIST '16, ACM, pp. 41–48.

- [21] Gupta, Vikram, Kandhalu, Arvind, and Rajkumar, Ragunathan (Raj). Energy harvesting from electromagnetic energy radiating from ac power lines. In *Proceedings of the 6th Workshop on Hot Topics in Embedded Networked Sensors* (New York, NY, USA, 2010), HotEmNets '10, ACM, pp. 17:1–17:6.
- [22] Hachisuka, K., Nakata, A., Takeda, T., Terauchi, Y., Shiba, K., Sasaki, K., Hosaka, H., and Itao, K. Development and performance analysis of an intra-body communication device. In *TRANSDUCERS '03. 12th International Conference on Solid-State Sensors, Actuators and Microsystems. Digest of Technical Papers (Cat. No.03TH8664)* (June 2003), vol. 2, pp. 1722–1725 vol.2.
- [23] Hodges, Steve. Batteries not included: powering the ubiquitous computing dream. *Computer* 46, 4 (2013), 90–93.
- [24] Jin, Jian-Ming. Electromagnetics in magnetic resonance imaging. *IEEE Antennas and Propagation Magazine* 40, 6 (Dec 1998), 7–22.
- [25] Kao, Hsin-Liu Cindy, Dementyev, Artem, Paradiso, Joseph A, and Schmandt, Chris. Nailo: fingernails as an input surface. In *Proceedings of the 33rd Annual ACM Conference on Human Factors in Computing Systems* (2015), ACM, pp. 3015–3018.
- [26] Kao, Hsin-Liu Cindy, Holz, Christian, Roseway, Asta, Calvo, Andres, and Schmandt, Chris. Duoskin: Rapidly prototyping on-skin user interfaces using skin-friendly materials. In *Proceedings of the 2016 ACM International Symposium on Wearable Computers* (2016), ACM, pp. 16–23.
- [27] Kao, Hsin-Liu Cindy, Mohan, Manisha, Schmandt, Chris, Paradiso, Joseph A, and Vega, Katia. Chromoskin: Towards interactive cosmetics using thermochromic pigments. In *Proceedings of the 2016 CHI Conference Extended Abstracts on Human Factors in Computing Systems* (2016), ACM, pp. 3703–3706.
- [28] Kwak, Sung Soo, Kim, Han, Seung, Wanchul, Kim, Jihye, Hinchet, Ronan, and Kim, Sang-Woo. Fully stretchable textile triboelectric nanogenerator with knitted fabric structures. *ACS nano* 11, 11 (2017), 10733–10741.
- [29] Kymissis, John, Kendall, Clyde, Paradiso, Joseph, and Gershenfeld, Neil. Parasitic power harvesting in shoes. In *Proceedings of the 2Nd IEEE International Symposium on Wearable Computers* (Washington, DC, USA, 1998), ISWC '98, IEEE Computer Society, pp. 132–.
- [30] Leonov, V., Torfs, T., Fiorini, P., and Hoof, C. Van. Thermoelectric converters of human warmth for self-powered wireless sensor nodes. *IEEE Sensors Journal* 7, 5 (May 2007), 650–657.
- [31] Lönn, S, Forssén, U, Vecchia, P, Ahlbom, A, and Feychting, M. Output power levels from mobile phones in different geographical areas; implications for exposure assessment. *Occupational and Environmental Medicine* 61, 9 (2004), 769–772.

- [32] Loreto Mateu, Francesc Moll. Review of energy harvesting techniques and applications for microelectronics, 2005.
- [33] Magno, M., and Boyle, D. Wearable energy harvesting: From body to battery. In *2017 12th International Conference on Design Technology of Integrated Systems In Nanoscale Era (DTIS)* (April 2017), pp. 1–6.
- [34] Mitcheson, P. D., Yeatman, E. M., Rao, G. K., Holmes, A. S., and Green, T. C. Energy harvesting from human and machine motion for wireless electronic devices. *Proceedings of the IEEE* 96, 9 (Sept 2008), 1457–1486.
- [35] Mou, Xiaolin, and Sun, Hongjian. Wireless power transfer: Survey and roadmap.
- [36] Murakawa, K., Kobayashi, M., Nakamura, O., and Kawata, S. A wireless near-infrared energy system for medical implants. *IEEE Engineering in Medicine and Biology Magazine* 18, 6 (Nov 1999), 70–72.
- [37] Nguyen, Anh, Raghebi, Zohreh, Banaei-Kashani, Farnoush, Halbower, Ann C, and Vu, Tam. Libs: a low-cost in-ear bioelectrical sensing solution for health-care applications. In *Proceedings of the Eighth Wireless of the Students, by the Students, and for the Students Workshop* (2016), ACM, pp. 33–35.
- [38] O’Driscoll, S., Poon, A. S. Y., and Meng, T. H. A mm-sized implantable power receiver with adaptive link compensation. In *2009 IEEE International Solid-State Circuits Conference - Digest of Technical Papers* (Feb 2009), pp. 294–295,295a.
- [39] Paradiso, Joseph A, and Starner, Thad. Energy scavenging for mobile and wireless electronics. *IEEE Pervasive computing*, 1 (2005), 18–27.
- [40] Poon, A. S. Y., O’Driscoll, S., and Meng, T. H. Optimal frequency for wireless power transmission into dispersive tissue. *IEEE Transactions on Antennas and Propagation* 58, 5 (May 2010), 1739–1750.
- [41] Raghunathan, Vijay, Kansal, Aman, Hsu, Jason, Friedman, Jonathan, and Srivastava, Mani. Design considerations for solar energy harvesting wireless embedded systems. In *Proceedings of the 4th international symposium on Information processing in sensor networks* (2005), IEEE Press, p. 64.
- [42] Ranganathan, Vaishnavi, Gupta, Sidhant, Lester, Jonathan, Smith, Joshua R, and Tan, Desney. Rf bandaid: A fully-analog and passive wireless interface for wearable sensors. *Proceedings of the ACM on Interactive, Mobile, Wearable and Ubiquitous Technologies* 2, 2 (2018), 79.
- [43] Roes, M. G. L., Hendrix, M. A. M., and Duarte, J. L. Contactless energy transfer through air by means of ultrasound. In *IECON 2011 - 37th Annual Conference of the IEEE Industrial Electronics Society* (Nov 2011), pp. 1238–1243.
- [44] Roundy, Shad, and Trolier-McKinstry, Susan. Materials and approaches for on-body energy harvesting. *MRS Bulletin* 43, 3 (2018), 206–213.

- [45] S, Narasimhan, X, Wang, and S, Bhunia. Implantable electronics: emerging design issues and an ultralight-weight security solution. In *Proceedings of the 2010 Annual International Conference of the IEEE Engineering in Medicine and Biology Society* (2010), IEEE, pp. 6425–6428.
- [46] Sample, A. P., Yeager, D. J., Powledge, P. S., Mamishev, A. V., and Smith, J. R. Design of an rfid-based battery-free programmable sensing platform. *IEEE Transactions on Instrumentation and Measurement* 57, 11 (Nov 2008), 2608–2615.
- [47] Schwan, Herman P. Electrical properties of tissue and cell suspensions**this work was supported in part by grants from the united states public health service, h-1253(c2-4) and in part by the office of naval research, 119289. vol. 5 of *Advances in Biological and Medical Physics*. Elsevier, 1957, pp. 147 – 209.
- [48] Seyedi, Mirhojjat, Kibret, Behailu, Lai, Daniel, and Faulkner, Michael. A survey on intrabody communications for body area network applications.
- [49] Shih, Y., Shen, T., and Otis, B. A 2.3 microwatt wireless intraocular pressure/temperature monitor. In *2010 IEEE Asian Solid-State Circuits Conference* (Nov 2010), pp. 1–4.
- [50] Silva, F. A. Handbook of energy harvesting power supplies and applications [book news]. *IEEE Industrial Electronics Magazine* 10, 2 (June 2016), 67–68.
- [51] Starner, Thad. Thick clients for personal wireless devices. *Computer* 35, 1 (2002), 133–135.
- [52] Starner, Thad E. Powerful change part 1: batteries and possible alternatives for the mobile market. *IEEE Pervasive computing* 2, 4 (2003), 86–88.
- [53] Stephen, N.G. On energy harvesting from ambient vibration. *Journal of Sound and Vibration* 293, 1 (2006), 409 – 425.
- [54] Swaminathan, M., Cabrera, F. S., Pujol, J. S., Muncuk, U., Schirner, G., and Chowdhury, K. R. Multi-path model and sensitivity analysis for galvanic coupled intra-body communication through layered tissue. *IEEE Transactions on Biomedical Circuits and Systems* 10, 2 (April 2016), 339–351.
- [55] Tajima, Yuki, Noda, Akihito, and Shinoda, Hiroyuki. Signal and power transfer to actuators distributed on conductive fabric sheet for wearable tactile display. In *Haptic Interaction* (Singapore, 2018), Shoichi Hasegawa, Masashi Konyo, Ki-Uk Kyung, Takuya Nojima, and Hiroyuki Kajimoto, Eds., Springer Singapore, pp. 163–169.
- [56] Talla, V., Pellerano, S., Xu, H., Ravi, A., and Palaskas, Y. Wi-fi rf energy harvesting for battery-free wearable radio platforms. In *2015 IEEE International Conference on RFID (RFID)* (April 2015), pp. 47–54.

- [57] Venkatasubramanian, R., Watkins, C., Stokes, D., Posthill, J., and Caylor, C. Energy harvesting for electronics with thermoelectric devices using nanoscale materials. In *2007 IEEE International Electron Devices Meeting* (Dec 2007), pp. 367–370.
- [58] Visser, H. J., and Vullers, R. J. M. Rf energy harvesting and transport for wireless sensor network applications: Principles and requirements. *Proceedings of the IEEE* 101, 6 (June 2013), 1410–1423.
- [59] Vullers, Rudd JM, Van Schaijk, Rob, Visser, Hubregt J, Penders, Julien, and Van Hoof, Chris. Energy harvesting for autonomous wireless sensor networks. *IEEE Solid-State Circuits Magazine* 2, 2 (2010), 29–38.
- [60] Wegmueller, M. S., Oberle, M., Felber, N., Kuster, N., and Fichtner, W. Signal transmission by galvanic coupling through the human body. *IEEE Transactions on Instrumentation and Measurement* 59, 4 (April 2010), 963–969.
- [61] Wei, Chongfeng, and Jing, Xingjian. A comprehensive review on vibration energy harvesting: Modelling and realization. *Renewable and Sustainable Energy Reviews* 74 (2017), 1 – 18.
- [62] Weigel, Martin, Lu, Tong, Bailly, Gilles, Oulasvirta, Antti, Majidi, Carmel, and Steimle, Jürgen. Iskin: flexible, stretchable and visually customizable on-body touch sensors for mobile computing. In *Proceedings of the 33rd Annual ACM Conference on Human Factors in Computing Systems* (2015), ACM, pp. 2991–3000.
- [63] Worgan, P., Pappas, O., Omirou, T., and Collett, M. Flexible on-body coils for inductive power transfer to iot garments and wearables. In *2015 IEEE 2nd World Forum on Internet of Things (WF-IoT)* (Dec 2015), pp. 297–298.
- [64] Xu, R., Zhu, H., and Yuan, J. Electric-field intrabody communication channel modeling with finite-element method. *IEEE Transactions on Biomedical Engineering* 58, 3 (March 2011), 705–712.
- [65] Xu, Sheng, Hansen, Benjamin J., and Wang, Zhong Lin. Piezoelectric-nanowire-enabled power source for driving wireless microelectronics. *Nature communications* 1 (2010), 93.
- [66] Zhang, Tengxiang, Yi, Xin, Yu, Chun, Wang, Yuntao, Becker, Nicholas, and Shi, Yuanchun. Touchpower: Interaction-based power transfer for power-as-needed devices. *Proceedings of the ACM on Interactive, Mobile, Wearable and Ubiquitous Technologies* 1, 3 (2017), 121.
- [67] Zimmerman, T. G. Personal area networks: Near-field intrabody communication. *IBM Systems Journal* 35, 3.4 (1996), 609–617.