



## Durham E-Theses

---

### *Evaluation of land management impacts on low flows in northern England*

SMITH, KATIE, ANNE

#### How to cite:

---

SMITH, KATIE, ANNE (2012) *Evaluation of land management impacts on low flows in northern England*, Durham theses, Durham University. Available at Durham E-Theses Online: <http://etheses.dur.ac.uk/3501/>

#### Use policy

---

The full-text may be used and/or reproduced, and given to third parties in any format or medium, without prior permission or charge, for personal research or study, educational, or not-for-profit purposes provided that:

- a full bibliographic reference is made to the original source
- a [link](#) is made to the metadata record in Durham E-Theses
- the full-text is not changed in any way

The full-text must not be sold in any format or medium without the formal permission of the copyright holders.

Please consult the [full Durham E-Theses policy](#) for further details.

# **Evaluation of land management impacts on low flows in northern England**

Msc by Research Thesis

**Katie Anne Smith** Bsc (Hons) Dunelm

St Cuthbert's Society

Durham University

Department of Geography

## **Declaration of Copyright**

I confirm that no part of the material presented in this thesis has been previously submitted by me or any other person for a degree in this or any other university. In all cases, where it is relevant, material from the work of others has been acknowledged.

The copyright of this thesis rests with the author. No quotation from it should be published without prior consent and information derived from it should be acknowledged.

## **Abstract**

Low flows are becoming an increasing issue in the UK. The effect of an increasing population on water supply demand is bringing awareness of the issue of extreme low flows risk to the attention of water and environmental managers across the country. Summer droughts in the Lake District in 2010 which followed winter flooding have raised the question of whether land management can be applied to reduce low flows risk in the area. This is the issue considered in this project. This master's thesis, funded by the Adaptive Land-use for Flood Alleviation (ALFA) project of the EU set out to discover whether land management, vegetation change or changes in farming practices, could help reduce the risk of extreme low flows in Cumbria, England.

The hydrological model CRUM3 was applied to simulate the river discharge of the Dacre Beck under different land management change scenarios. Sensitivity analysis and a rigorous Generalised Likelihood Uncertainty Estimation experiment proved the model's efficiency at predicting low flows discharges as well as flood peaks. Results of vegetation change scenarios demonstrated that a cover of natural grassland provided the best water supply to the river during low flows. Increases in cover of the land by each 1% of the catchment area in natural grassland resulted in a 1% increase in stream discharge during extreme low flows periods. The location of the land assigned to vegetation change was shown to be insignificant. Scenarios of improved agricultural practice were modelled to simulate the reduction of compaction in the catchment by soil aeration. This revealed more impressive increases in river discharge during extreme low flows than the vegetation change. Though the compaction scenarios were theoretical, feasible increases in low flows discharge could reach 100%.

Since flooding has also been a proven issue in this region, the scenarios were also assessed for their impacts on high flows. The most beneficial vegetation type at reducing high flows was deciduous woodland, though this had been seen to have a negative effect on low flows. Natural grassland had negligible effect on catchment high flows. Compaction reduction was however discovered

to be a potential simultaneous management solution to both high and low flows, as whilst potentially increasing low flows by up to 100%, it could also decrease high flows by up to 8%. Further research would be required to make accurate estimates of the potential improvements to high and low flows, but this project has demonstrated that reducing compaction is definitely beneficial to the catchment hydrology.

## Acknowledgements

I would like to firstly thank my supervisors, Dr Sim Reaney, Dr Richard Hardy and Professor Stuart Lane who have helped me hugely in the first research project of my academic life. They have been incredibly patient and encouraging while I tackled the steep learning curve of hydrological modelling. A huge thank you to Dr Nick Odoni who gave his clever and enthusiastic help in devising an efficient sampling strategy; and to Dr Dave Milledge who helped me track down all the data I required. Thanks to the Environment Agency for that data. Dr Ian Pattison whose previous work was the basis of this research was a huge help, and Calum Baugh's advice on the model was invaluable. Everyone at the Eden Rivers Trust and all those involved in the ALFA project gave enormous support, and particular thanks go to Lucy Dugdale and Tom Dawson. All those who helped with the fieldwork; Ed, Lizzie, Steph, Ian, Ben, Alex and all the other research Master's students who kept me laughing. Finally thanks to my moral supporters; Alex, Bobbi and Duncan, to my parents Sue and Mike and the rest of the family who have endured my geographical ravings!

# Contents

## Chapter One:

<b>Introduction.....</b>	<b>1</b>
1.1 Introduction.....	2
1.2 The Importance of Low Flows.....	6
1.3 Land Use Change and Catchment Hydrology .....	13
1.3.1 Vegetation Change .....	13
1.3.2 Compaction.....	15
1.3.3 Previous Land Use Change Research Methods .....	16
1.4 Hydrological Models and Low Flows .....	17
1.5 Aim and Research Questions .....	19
1.5.1 Research Questions .....	19
1.6 Thesis Structure .....	21

## Chapter Two:

<b>Study Catchment Characteristics .....</b>	<b>22</b>
2.1 The Dacre Beck Catchment.....	23
2.2 Location.....	23
2.3 Catchment Characteristics.....	23
2.3.1 Topography.....	23
2.3.2 Channel Network .....	24
2.3.3 Rainfall.....	26
2.4 Geomorphology .....	26
2.4.1 Bedrock Geology .....	29
2.4.2 Superficial Deposits .....	30
2.4.3 Soils .....	30
2.5 Land-Use .....	33
2.5.1 Agriculture.....	33
2.5.2 Land Cover .....	34
2.6 Ecology.....	34

2.7	Potential for Research and Current Projects .....	36
2.8	Summary .....	36

**Chapter Three:**

<b>Methods.....</b>	<b>38</b>	
3.1	Introduction.....	39
3.2	Hydrological Modelling of Low Flows.....	39
3.3	The Connectivity of Runoff Model.....	39
3.3.1	CRUM3 Structure.....	40
3.3.1.1	Weather .....	40
3.3.1.2	Hydrological Processes .....	42
3.3.1.3	Landscape .....	47
3.3.1.4	River Channel .....	49
3.3.2	Data Requirements .....	50
3.3.3	Sensitivity Analysis .....	51
3.3.4	Generalised Likelihood Uncertainty Estimation (GLUE).....	51
3.4	Studying Land Use Change.....	52
3.4.1	Vegetation Change in CRUM3.....	53
3.4.2	Compaction Levels and Soil Aeration .....	55
3.5	Reaching a Simultaneous High and Low Flow Hydrological Management Solution .....	62
3.6	Summary .....	62

**Chapter Four:**

<b>The Effective Modelling of Low Flows.....</b>	<b>64</b>	
4.1	Introduction.....	65
4.2	Model Choice.....	65
4.3	Sensitivity Analysis .....	68
4.3.1	Parameter Ranges.....	72
4.3.2	Results.....	73
4.4	Generalised Likelihood Uncertainty Estimation (GLUE) .....	79
4.4.1	Parameter Choices .....	79
4.4.2	Latin Hypercube Sampling.....	82



4.4.3	Objective Functions .....	85
4.4.4	Results .....	88
4.5	The Final Model Performance .....	90
4.6	Summary .....	93

**Chapter Five:**

**Assessing the Effects of Vegetation Change on Low Flows Hydrology 94**

5.1	Introduction.....	95
5.2	Spatially Distributed Vegetation Simulation .....	95
5.2.1	Land Cover Parameter Values.....	95
5.3	Blanket Changes .....	101
5.4	Slope Changes.....	104
5.4.1	Scenario Development.....	104
5.4.2	Results.....	104
5.5	River Buffer Changes .....	109
5.5.1	Scenario Development.....	109
5.5.2	Results.....	110
5.6	SCIMAP Changes .....	111
5.6.1	Scenario Development.....	111
5.6.2	Results.....	112
5.7	Summary .....	115

**Chapter Six:**

**Assessing the Effects of Soil Compaction on Low Flows Hydrology...117**

6.1	Introduction.....	118
6.2	Fieldwork .....	118
6.2.1	Results.....	119
6.2.2	Implications .....	125
6.3	Modelling .....	126
6.3.1	Application of Fieldwork Findings.....	126
6.3.2	Parameter Development.....	126
6.3.3	Scenarios.....	127
6.3.3.1	Scenario Development .....	127

6.3.3.2 Basic Change Results .....	129
6.3.3.3 Elevation Driven Change Results .....	130
6.4 Summary .....	133

**Chapter Seven:**

<b>Land Use Management and Extreme Low Flows .....</b>	<b>135</b>
7.1 Introduction.....	136
7.2 Implementing Vegetation Change Scenarios.....	136
7.2.1 Slope Scenarios.....	136
7.2.2 Buffer Strip Scenarios .....	137
7.2.3 SCIMAP Scenarios .....	138
7.2.4 Summary of Vegetation Change Options.....	140
7.3 Implementing Compaction Reduction Scenarios.....	141
7.4 Summary .....	143

**Chapter Eight:**

<b>Simultaneous Management of Extreme High and Low Flows Risk.....</b>	<b>144</b>
8.1 Introduction.....	145
8.2 High Flows Impact of Modelled Change Scenarios .....	145
8.2.1 Vegetation Change .....	145
8.2.1.1 Blanket Vegetation Change .....	146
8.2.1.2 Slope Vegetation Changes .....	147
8.2.1.3 Buffer Strip Vegetation Change .....	149
8.2.1.4 SCIMAP Vegetation Changes.....	150
8.2.1.5 Vegetation Change Summary.....	151
8.2.2 Compaction.....	152
8.2.2.1 Basic Scenarios .....	152
8.2.2.2 Elevation Driven Scenarios.....	153
8.3 Implications for Feasible Management Approaches.....	155
8.4 Summary .....	156

**Chapter Nine:**

<b>Discussions and Conclusions.....</b>	<b>157</b>
9.1 Introduction.....	158
9.2 Research Questions: Core Findings and Discussions.....	158

9.3	Recommendations for Future Work.....	164
9.4	Concluding Remarks .....	165
	<b>Bibliography.....</b>	<b>167</b>
<b>Appendix 1</b>		
	<b>CRUM3 Parameters User Guide .....</b>	<b>189</b>
A1.1	Input Files .....	190
A1.1.1	Main Parameter File .....	191
A1.1.2	Weather .....	192
A1.1.3	Channels.....	194
A1.1.4	Spatial Data .....	194
A1.1.5	Soil.....	196
A1.1.6	Land cover.....	197
A1.1.7	Text Files .....	199
A1.1.8	ASCII Files.....	199
A1.2	Output Files.....	199
A1.2.1	Excel Files .....	199
A1.2.2	Ascii Files.....	200
A1.3	General Comments.....	201
<b>Appendix 2</b>		
	<b>Sensitivity Analysis Input Values.....</b>	<b>202</b>
<b>Appendix 3</b>		
	<b>Sensitivity Analysis Response Graphs .....</b>	<b>206</b>
A3.1	Remaining 'Unresponsive' Low Flows Response Graphs.....	207
A3.2	High Flows Response Graphs .....	209

# Table of Figures

Figure 1.2 Numbers of floods worldwide 1997-2007 .....	2
Figure 1.1 People affected by drought Number in each continent. ....	2
Figure 1.3 Global Changes in Extremes .....	3
Figure 1.4 Large-scale relative changes in annual runoff .....	5
Figure 1.5 Levels of water stress in England .....	8
Figure 1.6 Percentage change in average annual runoff across Britain.....	10
Figure 2.1 Location of the Dacre Beck catchment .....	24
Figure 2.2 Elevation of the Dacre Beck catchment .....	25
Figure 2.3 Slope of the Dacre Beck catchment.....	25
Figure 2.4 Average annual rainfall for the Eden catchment .....	27
Figure 2.5 Weather data from Newton Rigg.....	28
Figure 2.6 Hydrograph for the Dacre Beck HY09/10.....	29
Figure 2.7 Simplified bedrock geology of the Dacre Beck.....	31
Figure 2.8 Superficial deposits of the Dacre Beck catchment.....	31
Figure 2.9 Soils of the Dacre Beck catchment .....	32
Figure 2.10 Land Cover Map of the Dacre Beck catchment .....	32
Figure 2.11 Salmon and Trout Fry Density Results 2002-2009 for the Dacre Beck.....	35
Figure 3.1 Structural Representation of the CRUM3 model.....	40
Figure 3.2 Conceptual diagram of the hydrological processes of CRUM3.....	42
Figure 3.3 Schematic of the landscape module structure .....	47
Figure 3.4 Methods of flow routing.....	48
Figure 3.5 SCIMAP Connectivity Development.....	54
Figure 3.6 Schematic of a Grassland Aerator .....	56
Figure 3.7 Photographs of the Ritchie Grassland Aerator©. ....	57
Figure 3.8 'Drip-type' Rainfall Simulator.....	59
Figure 3.9 Manometer for the control of rainfall intensity .....	59
Figure 3.10 Drop former design (Holden and Burt, 2002). ....	60
Figure 3.11 Plot set up underneath the Rainfall Simulator.....	61

Figure 4.1 Popular rainfall-runoff models within a quadrant framework of complexity.....	66
Figure 4.2 Observed versus Base Value Modelled Discharge.....	71
Figures 4.3a-p Response of Sensitive Parameters to Perturbation (low flows response).....	78
Figure 4.4 Average % change for Q01, Q05, Q95 and Q99 for each model parameter. ....	81
Figure 4.5 Latin hypercube sampling of a 5x5 matrix.....	83
Figure 4.6 Sampling coverage for 2500 samples of a 2 dimensional parameter space using random sampling and Latin hypercube sampling.....	84
Figures 4.7a-j Dotty Plots of GLUE model performances. ....	90
Figure 4.8 Hydrographs of the observed and top 10 GLUE model realisations	91
Figure 5.1 Reclassified LCM2000 to 9 Land Covers.....	96
Figure 5.2 Blanket Land Cover Change Scenarios effect on Q99.....	102
Figure 5.3 Area covered by slope scenarios: Dark blue to be changed, light blue to remain as in LCM2000.....	105
Figure 5.4 Overall effects of the four slope land cover change scenarios on Q99.....	106
Figure 5.5 10° slope scenario impacts on Q99.....	107
Figure 5.6 15° slope scenario impacts on Q99.....	107
Figure 5.7 20° slope scenario impacts on Q99.....	108
Figure 5.8 25° slope scenario impacts on Q99.....	108
Figure 5.9 Area covered by buffer strip scenarios.....	110
Figure 5.10 River buffer scenario impacts on Q99.....	111
Figure 5.11 SCIMAP Network Index Map .....	112
Figure 5.12 Area covered by the SCIMAP land cover scenarios. ....	113
Figure 5.13 Overall impact of SCIMAP scenarios on Q99 .....	114
Figure 5.14 Impact of the 0.7, 0.8, 0.9 and 1.0 SCIMAP scenarios on Q99....	114
Figure 6.1 Hydrograph results of rainfall simulations in field 1 .....	120
Figure 6.2 Hydrograph results of rainfall simulations in field 2.....	120
Figure 6.3 Photograph of the downslope edge of the rainfall simulation plot after simulation number 6.....	121

Figure 6.4 Soil moisture vs. discharge curves for rainfall simulations in Field 1 .....	124
Figure 6.5 Soil moisture vs. discharge curves for rainfall simulations in Field 2 .....	124
Figure 6.6 Area covered by the elevation driven scenarios. ....	128
Figure 6.7 Effects of changing the compaction level of the whole catchment on Q99. ....	129
Figure 6.8 Effects of upland reductions in compaction levels on Q99.....	130
Figure 6.9 Effect of reducing upland areas to light compaction and lowland areas to moderate compaction from a heavily compacted state on Q99. ....	132
Figure 8.1 Response of Q01 and Q99 to blanket changes in vegetation. ....	146
Figure 8.2 Response of Q01 and Q99 to 15° vegetation change scenario ....	148
Figure 8.3 Response of Q01 and Q99 to 20° vegetation change scenario ....	148
Figure 8.4 Response of Q01 and Q99 to buffer vegetation change scenarios	149
Figure 8.5 Response of Q01 and Q99 to SCIMAP 0.7 and 0.8 scenarios .....	150
Figure 8.6 Response of Q01 and Q99 to the basic compaction change scenarios. ....	153
Figure 8.7 Response of Q01 to the elevation driven compaction change scenarios .....	154
Figure 8.8 Response of Q01 to reducing upland areas to light compaction and lowland areas to moderate compaction from a heavily compacted state. ....	155
Figure A1.1 Parameter Interrelationship in CRUM3.....	190
Figure A3.1 'Unresponsive' low flows sensitivity analysis response graphs ...	208
Figure A3.2 High flows sensitivity response graphs.....	214

# List of Tables

Table 1.1 Summary of research on the effects of climate change on drought and water resources. ....	12
Table 4.1 Critical evaluation of currently available hydrological models .....	70
Table 4.2 Parameter Values for Sensitivity Analysis.....	72
Table 4.3 Performance measures for assessing the goodness of fit of hydrological models. ....	87
Table 4.4 Parameter values for the top 10 ranking GLUE model realisations...	92
Table 5.1 Catchment area covered by each Land Cover type .....	97
Table 5.2 Land Cover Parameter Values from the literature.....	98
Table 5.3 Soil Parameter Values from the literature .....	99
Table 5.4 Land cover distribution within each of the 4 slope scenarios .....	106
Table 6.1 Parameter values used to derive CRUM3 compaction scenarios. ...	127
Table 7.1 Summary statistics for the slope vegetation change scenarios.....	137
Table 7.2 Current proportions of land cover within the buffer strip vegetation change scenarios.....	138
Table 7.3 Summary statistics for the SCIMAP vegetation change scenarios..	139
Table 7.4 Current proportions of land covers in the SCIMAP scenarios .....	139
Table 7.5 Comparison of feasible vegetation change options.....	141
Table 8.1 Summary statistics for potentially implementable vegetation change scenarios .....	151
Table A1.1 Main Parameter Descriptions .....	191
Table A1.2 Weather Parameter Descriptions.....	193
Table A1.3 Channel Parameter Descriptions.....	194
Table A1.4 Spatial Parameter Descriptions .....	196
Table A1.5 Soil Parameter Descriptions .....	197
Table A1.6 Land Cover Parameter Descriptions.....	198
Table A2.1 Input values for each sensitivity analysis run.....	205

# List of Abbreviations

<b>Abbreviation</b>	<b>Definition</b>
ALFA	Adaptive Land-use for Flood Alleviation
BADC	British Atmospheric Data Centre
Bare	Bare Soils
BGS	British Geological Survey
Brack	Bracken
CCIRG	Climate Change Impacts Review Group
CEH	Centre for Ecology and Hydrology
CLUE	Conversion of Land Use and its Effects
cm	centimetres
Coni	Coniferous Woodland
CRUM3	Connectivity of Runoff Model 3
Deci	Deciduous Woodland
DEFRA	Department for Agriculture Food and Rural Affairs
Deve	Developed Land
DW	Darcy Weisbach (friction factor)
EA	Environment Agency
FAO	Food and Agriculture Organisation
FDC	Flow Duration Curve
FEH	Flood Estimation Handbook
GIS	Geographical Information Systems
GLUE	Generalised Likelihood Uncertainty Estimation
GLUE1	Top ranking GLUE model realisation
HSU	Hydrologically Similar Units
ha	hectares
hr	hour
IDHM	Institute of Hydrology Distributed Model
Imp G	Improved Grassland
IMPEL	Integrated Model to Predict European Land Use
in	inches
K decay	Decay in saturated conductivity
Ksat	Saturated Conductivity



LAI	Leaf Area Index
LCM2000	Land Cover Map 2000
m	metres
m <sup>2</sup>	square metres
m <sup>3</sup>	cubic metres
mm	millimetres
MATLAB	Matrix Laboratory
Nat G	Natural Grassland
NS	Nash Sutcliffe
OLF	Overland Flow
PEE	Proportional Error of Estimate
PET	Potential Evapotranspiration
Q	Discharge
Q01	Discharge exceeded 1% of the year
Q05	Discharge exceeded 5% of the year
Q95	Discharge exceeded 95% of the year
Q99	Discharge exceeded 99% of the year
RCM	Regional Climate Model
REE	Reduced Error Estimate
ReFEH	Revitalised Flood Estimation Handbook
RMAE	Relative Mean Absolute Error
RMSE	Root Mean Squared Error
RNS	Relative Nash Sutcliffe
RR	Random Roughness coefficient
s	second
SCIMAP	Sensitive Catchment Integrated Modelling and Analysis Platform
SHE	Système Hydrologique Européen
SSSI	Site for Special Scientific Interest
Std. dev.	Standard Deviation
SWAT	Soil and Water Assessment Tool

# List of Equation Terms

Equation Term	Description	Units
$a$	surface albedo	Decimal %
$a$ and $b$	coefficients	n/a
$B_v$	base value discharge value	$\text{m}^3 \text{s}^{-1}$
$C$	crucible weight	g
$C_0, C_1,$ and $C_2$	routing coefficients	
$Cd_i$	change in discharge for $i = Q01, Q05, Q95$ and $Q99$	
$D_c$	weight of dry sediment in crucible	g
$D_m$	dry sediment mass	g
$d$	water table depth	m
$dc$	decay factor for the change in conductivity with depth	
$dp$	surface depression storage capacity	mm
$d_s$	current second of the day	s
$e_{ms}$	surface emissivity	
$e_\theta$	moisture dependent evaporation rate	
$F_{cd}$	final change in discharge	$\text{m}^3 \text{s}^{-1}$
$ff$	friction factor	
$F_i$	flow assigned to each cell	
$F_X$ and $F_Y$	cumulative probability distribution functions of $X$ and $Y$ respectively	
$G$	soil heat flux	
$g$	gravity constant	
$h$	hydraulic head	m
$IS_m$	initial soil moisture	ml or %
$i_t$	infiltration rate	
$K_d$	soils conductivity at the water table depth	$\text{m s}^{-1}$
$K_{sat}$	soil saturated conductivity	
LAI	Leaf Area Index	
$n$	sample size	n/a
$\bar{O}$	average observed discharge	$\text{m}^3 \text{s}^{-1}$

$O_i$	observed discharge at time $i$	$\text{m}^3 \text{s}^{-1}$
$P$	perturbed discharge value	$\text{m}^3 \text{s}^{-1}$
$\bar{P}$	average predicted discharge	$\text{m}^3 \text{s}^{-1}$
$PET_{PT}$	potential daily evapotranspiration	
$PET_{PT}$	potential evapotranspiration rate	
$P_i$	predicted discharge at time $i$	$\text{m}^3 \text{s}^{-1}$
$P_s$	plot moisture storage capacity	$\text{mm}^3$
$Q$	current discharge	$\text{m}^3 \text{s}^{-1}$
$Q_1$	discharge from the previous time step	$\text{m}^3 \text{s}^{-1}$
$R_{ES}$	amount of solar radiation reaching the Earth's surface	
$r_{lw}$	reflected long wave radiation	
$R_n$	net radiation	
$RR$	random roughness coefficient	
$r_{sw}$	reflected short wave radiation	
$R_{TA}$	amount of solar radiation at the top of the atmosphere	
$s$	slope of the energy gradient	
$S_m$	soil moisture	%
$t_a$	air temperature	$^{\circ}\text{C}$
$T_a$	air temperature	$^{\circ}\text{C}$
$T_{a(s)}$	current air temperature	$^{\circ}\text{C} \text{s}^{-1}$
$td$	time between midday and the maximum temperature occurring	
$tf_v$	throughflow volume per second	$\text{m}^3 \text{s}^{-1}$
$t_{max}$	daily maximum temperature	$^{\circ}\text{C}$
$t_{min}$	daily minimum temperature	$^{\circ}\text{C}$
$t_p$	transpiration rate	
$T_s$	soil temperature	$^{\circ}\text{C}$
$U$	inflow from the upstream reach	
$U_1$	inflow from the upstream reach from the previous time step	
$v$	velocity of the overland flow	
$v$	flow concentration factor (a positive constant)	
$W_c$	weight of wet sediment in crucible	g
$W_m$	wet sediment mass	g

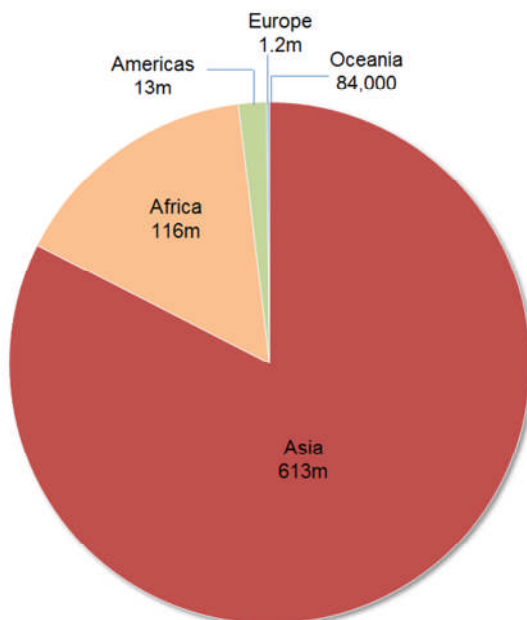
$wt$	height of the water table above the bedrock	m
$x$	horizontal distance between model cells	m
$y$	width of the routing facet	m
$\alpha$	surface roughness	
$\alpha_{PT}$	Priestly-Taylor constant of 1.26	
$\beta$	slope gradient	
$\beta_i$	slope from the central cell to neighbour $i$	
$\gamma$	psychometric constant	
$\Delta$	slope of the saturation vapour pressure temperature relationship	
$\varepsilon_X$ and $\varepsilon_Y$	random numbers ( $\varepsilon_X, \varepsilon_Y \in [0,1]$ )	
$\theta$	soil moisture content	

# Chapter One:

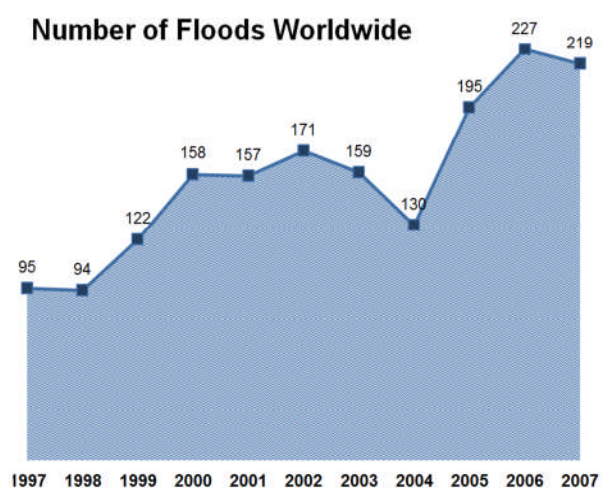
*Introduction*

## 1.1 Introduction

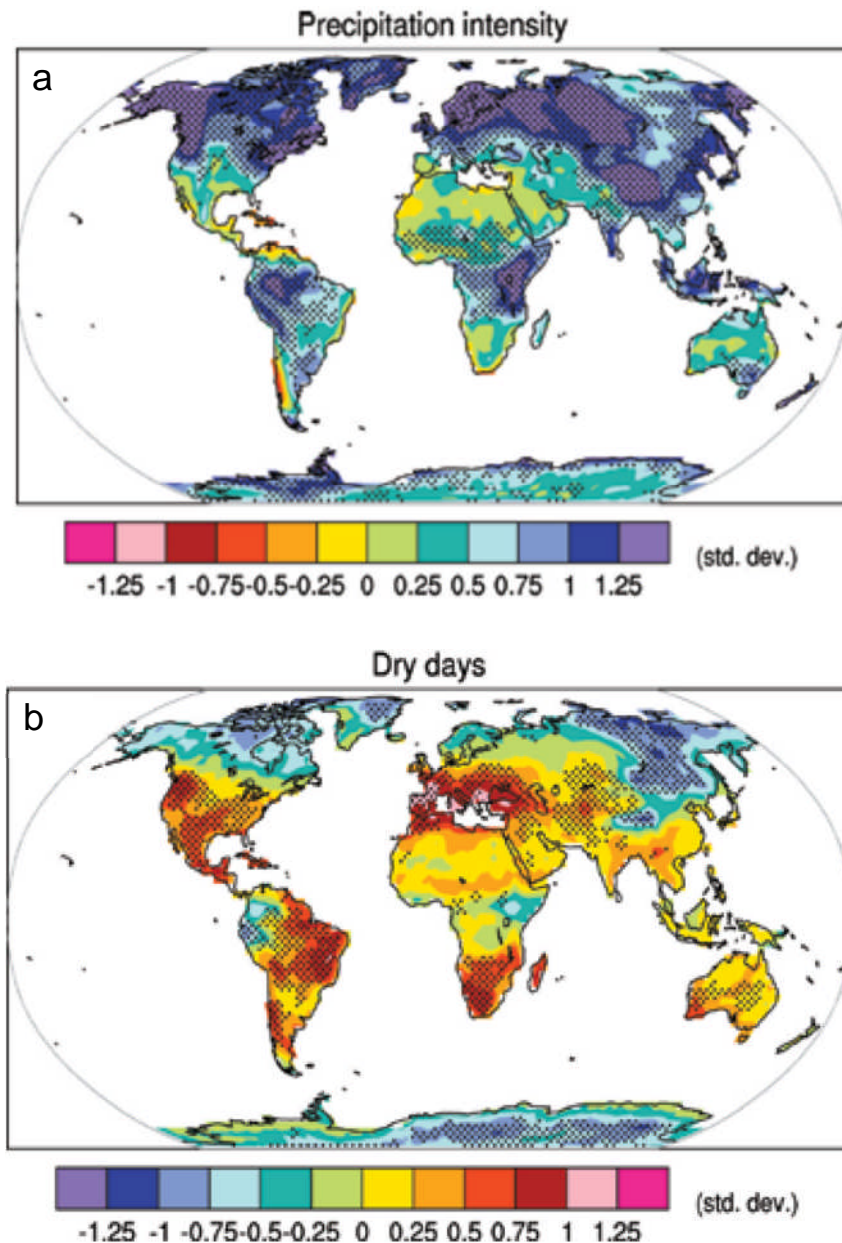
Almost one fifth of the world's population (1.2 billion people) live in areas where the water is physically scarce (World Health Organisation, 2009) and by 2025 nearly 2 billion people will be living in water-short regions (Black and King, 2009). Figure 1.1 shows the number of people in each continent affected by drought from 1999-mid 2008. Paradoxically, the number of people affected by floods is also high, with China, India and the USA each suffering over 50 floods from 1999-2008, affecting more than 200 million people (Black and King, 2009). The number of floods worldwide rose by 230% in 2007 since 1997 (see figure 1.2) and, with climate change, is expected to continue increasing. Across the globe, environmental managers and policy makers are becoming increasingly concerned about the effects of climate change on extreme river flows. Both flooding and drought are widespread issues that are predicted to become exacerbated by altered temperatures and rainfall patterns. Figures 1.3a and b show the projected changes in precipitation intensity and number of dry days respectively across the world for the period 2080-2099 in comparison to 1980-1999 (Intergovernmental Panel on Climate Change, 2008).



**Figure 1.2 People affected by drought**  
Number in each continent 1999 to mid-2008 data from (CRED).



**Figure 1.1 Numbers of floods worldwide**  
1997-2007 data from (Black and King, 2009).



**Figure 1.3 Global Changes in Extremes** based on multi-model simulations from nine global coupled climate models in 2080-2099 relative to 1980-1999 for the A1B scenario. **3a** Changes in spatial patterns of precipitation intensity (defined as the annual total precipitation divided by the number of wet days). **3b** Changes in spatial patterns of dry days (defined as the annual maximum number of consecutive dry days). Stippling denotes areas where at least 5 of the nine models concur in determining that the change is statistically significant. Extreme indices are calculated only over land. The changes are given in units of standard deviations (*IPCC, 2008*).

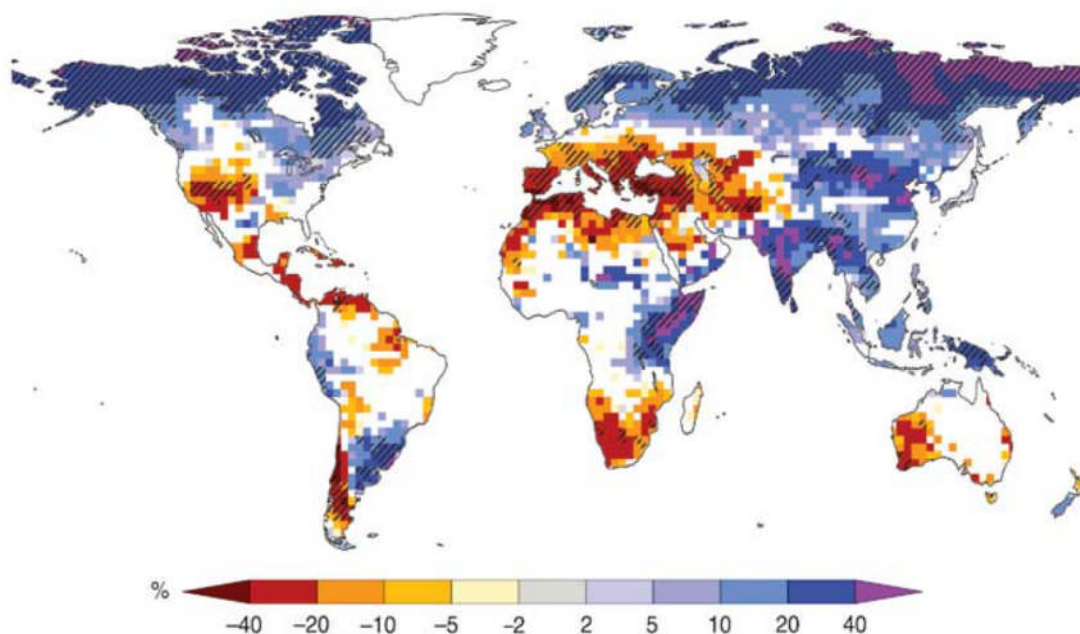
It can be seen from these figures that those areas projected to experience an increase in precipitation intensity are high latitude and equatorial regions. Areas projected to see an increase in dry days are mostly in the tropics, with southern Africa, Central America, Brazil and the Mediterranean worst affected. There are few areas expected to experience increases in both precipitation intensity and dry days, however the United Kingdom is one of these, with a 1-1.25+ std. dev. increase in precipitation intensity, and a 0.25-1+ std. dev. increase in dry days.

Whilst the annual runoff in the UK is projected to increase slightly, with a maximum increase of 10% in northern Scotland (see Fig. 1.4), the IPCC Climate Change and Water Technical Paper demonstrates that this will not be a constant increase, but will likely be the result of periods of intensely high flows, interspersed by prolonged periods of extreme low flows.

Across the United Kingdom, periods of extreme low flows have been causing issues with water supply, water quality, ecology and general river integrity. Therefore, management methods that can potentially both alleviate high river flows and supplement low river flows are being sought. With many studies concentrating on the reduction of floods, little work has been carried out on the prevention of extreme low flows in England. With such a variable climate, it is essential that both issues be tackled simultaneously, as discrete efforts to manage one hydrological extreme will likely exacerbate the other.

In 2010, following a severe flood winter in 2009, Cumbria in northern England saw the driest start to the year since 1929. This weather resulted in an extremely dry summer, and with reservoir levels at 61.4% of their usual levels, hosepipe bans were enforced across the region for the first time in 14 years (Kennedy and Carrell, 2010). With the dominant agricultural industry in the region, this drought caused widespread loss of income as farmers struggled to irrigate their land. It is possible that had the flood water been managed more efficiently to reduce the flood peak and to store the water for the following summer, the extreme events of the hydrological year could have been prevented.





**Figure 1.4 Large-scale relative changes in annual runoff for the period 2090-2099, relative to 1980-1999.**

White areas are where less than 66% of the ensemble of 12 models agree on the sign of change, and hatched areas are where more and 90% of models agree (*IPCC, 2008*).

With the many reservoirs in the Lake District, it seems surprising that this region suffers from drought; but with agricultural land being the dominant land cover in the region, issues such as the compaction of soils, large areas of open land and few areas of natural vegetation cause the land to be very poor at slowing down and storing water. Alongside large scale management methods such as water reservoirs and floodplain restoration, smaller efforts including improving agricultural practice and implementing vegetation change wherever possible can be hugely beneficial in smoothing a river's hydrological regime throughout the year (e.g. Lane et al., 2005).

This introductory chapter reviews the importance of low flows in the UK. It then outlines the current literature surrounding the effects of land use changes on low flows, and will then go on to discuss previous applications of hydrological models in studies of hydrological extremes. This assessment of previous studies reveals a need for further research in this subject area, and so the second part of this chapter outlines the aim and research questions of this research.

## 1.2 The Importance of Low Flows

Low flows are a natural and essential part of every river's flow regime; however extreme low flows are detrimental to the human population, to the ecology, and to the river's own morphology. With the hazards of drought and water pollution so closely linked to periods of extreme low flows; awareness of low flows, how they are manifested, and how they can be prevented will be increasingly necessary as demand on water resources is intensified with increasing population.

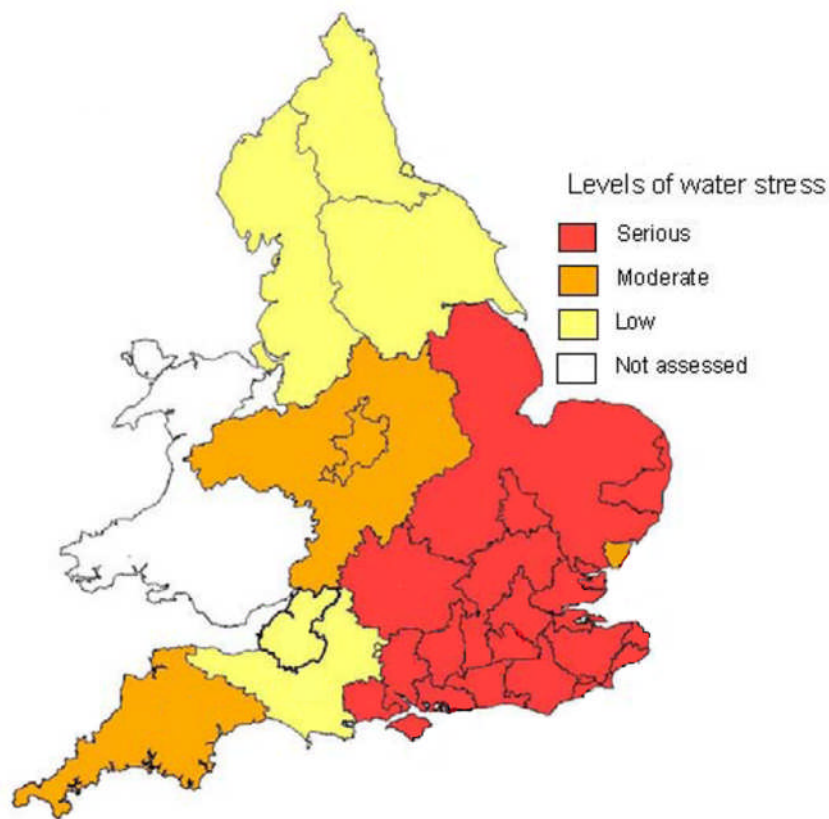
It is important to make the distinction between low flows and drought. Low flows are an important part of river flow regimes and occur in all hydroclimatic regions. Smakhtin (2001) explains that low flows are a natural seasonal phenomenon, while droughts are a more general phenomenon and are characterized by much more than just low flows. There are three broadly accepted types of drought. Firstly, a 'meteorological drought' consists of a period of below average rainfall, whilst the second, 'hydrological drought', is concerned with river discharge. Finally, 'agricultural drought' indicates a moisture deficiency within the soils (Jones, 1997; Wilhite, 2000b; Brogan and Cunnane, 2005). Low flows do not necessarily constitute a drought as not all meteorological droughts develop into hydrological droughts, but conversely many seemingly insignificant meteorological droughts may cumulate to instigate a severe hydrological drought (Tallaksen et al., 2006; van Lanen, 2006). Therefore, whilst low flows are essential to maintain the natural variability of river habitats; *extreme* low flows may be considered an indicator of hydrological and agricultural drought conditions in the catchment, making them an important consideration for river catchment management schemes.

Water resources are the principal concern for society in terms of low flows management. Reports such as the McKinsey report (2030 Water Resources Group, 2009), the Environment Agency (EA) water resources report in England and Wales (2008) and the European Environment Agency report on water resources in Europe (2009) demonstrate the importance of water security for society. Drought plans are now a compulsory part of every water company's policy (United Utilities, 2008). The EA produces Catchment Abstraction

Management Strategies (e.g. Environment Agency, 2006) to assess water availability, and to prevent abstractions from causing damage to the environment and other abstractors. The EA now have 'hands-off flows' regulations which mean that when river discharge falls below a certain level, non-essential abstractions are halted (Environment Agency, 2009b). EA reports (2007c; 2008) illustrate the current high demand for water and how this will be exacerbated with climate change and an increasing population. Figure 1.5 shows the levels of water stress across England. The Environment Agency developed this map by considering where current and future household demand for water is a high proportion of the freshwater resources available. It can be seen from Figure 1.5 that most of the south-east and eastern England is seriously water stressed.

A report by the Chartered Institute of Water and Environmental Managers (2006) similarly suggests that demand for water will increase, and with 50% of water abstractions in England and Wales being used for agriculture (Department for Agriculture Food and Rural Affairs (DEFRA), 2009), farmers will be particularly affected by water shortages. Thus, in order to maintain adequate water resources provision to the population, low flows management in many catchments in the UK needs to be seriously considered.

While being important for river ecology in terms of variability and seasonality of habitat, extreme low flows can be severely detrimental to many ecosystems. Extremely reduced flows have an effect on water temperature which can cause lethargy or death in higher organisms, such as fish (Allan and Flecker, 1993; Caissie, 2006). Lack of flushing flows causes sedimentation in depressions which reduces refugia and extreme low flows can also cause disconnection of pools from the main river stem, resulting in the stranding of fish (Caruso, 2001; Armstrong et al., 2003). Low velocities can encourage algal blooms (Caruso, 2001) and decreased flow volumes increase fine sediment content and in stream pollution levels, which may severely threaten an ecosystem (Salmon & Trout Association, 2009a). Over abstraction of river systems, causing extreme low flows, also causes shifts in invertebrate assemblages, invasions of non-native species, reduced growth of aquatic flora and disconnection of floodplains (Salmon & Trout Association, 2009b).



**Figure 1.5 Levels of water stress in England** (*Environment Agency, 2008*)

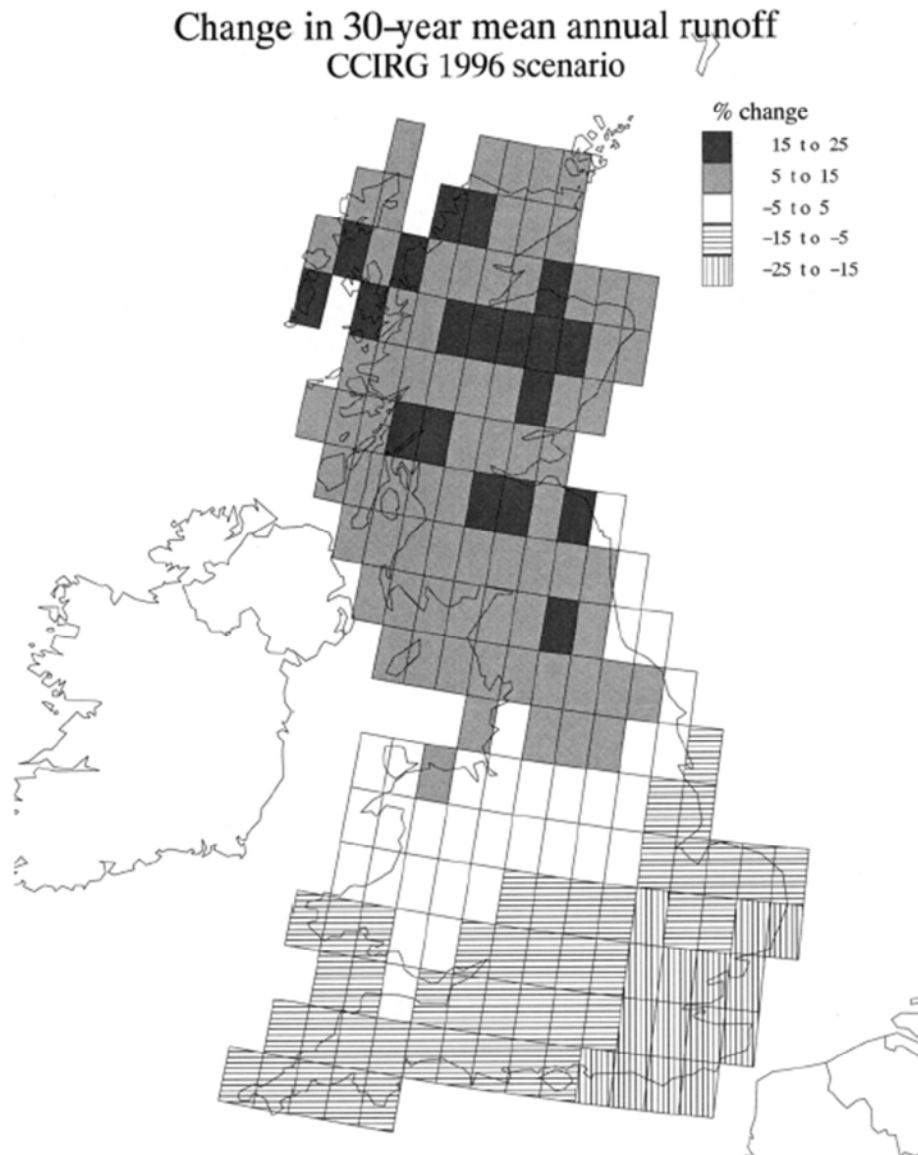
The detrimental effects of low flows on crop production, water resources and ecosystems have a huge effect on the economy. Reduced crop yields result in reduced income for farmers, which then increase food and timber prices. Easterling and Mendelsohn (2000) outline the need to assess the economic impact of droughts on agriculture in order to develop insurance programs to prevent such issues in the future. Hydropower production is also reduced during low flows, making energy costs higher (Wilhite and Vanyarkho, 2000). Water companies struggle not only from lack of water to supply to the public, but it is also harder to purify water which has a higher concentration of pollutants. Industries struggle to meet requirements when diluting effluent as they have less water available (Rodda, 2000).

Droughts can cause disaster, destruction and economic loss in the UK, just as high as flood events have done. However, recently, they have received much less media and research attention (Rodda, 2000). This reduction in media attention could be because droughts are a creeping phenomenon and their impacts are therefore not always ascribed to the drought event itself (Wilhite,

2000a; Wilhite and Vanyarkho, 2000). In the UK, public awareness of drought risk was greatly increased by the extreme events of summer 2003, and to a lesser extent summer 2010. Studies on the characteristics of low flows in the UK by Beran and Gustard (1977), Young *et al.* (2000) and Marsh *et al.* (2007) have demonstrated that droughts are a recurring feature of the British climate, and that they are strongly influenced by catchment characteristics such as land use and underlying geology. Trends in low flows and droughts have been extensively assessed (Douglas *et al.*, 2000; Hisdal *et al.*, 2001; Zaidman *et al.*, 2001; Hannaford and Marsh, 2006; Hannaford and Marsh, 2008; Bordi *et al.*, 2009) though the general opinion that they are getting more frequent and severe is not validated in many cases. Marsh *et al.* (2007) concluded that rather than getting more frequent, extreme low flow events occur in clusters when several dry years follow each other in succession. What is clear though is that despite little change in water supply in recent years, with increased demand from a growing population, increased abstraction pressure could severely affect flows making extreme low flows more common.

There is extensive literature on the effects of climate change on low flows and droughts, as well the resultant effect on water demand. Some examples of predicted effects are outlined in Table 1.1. Again, there does not appear to be much consistency in the results obtained. Few recent studies on the potential impacts of climate change investigate the regional spatial patterns of future projected runoff, however Figure 1.6 demonstrates the variation in the change in 30-year annual runoff by 2050 across the UK, as projected by the CCIRG1996 scenario (Arnell, 1998). The percentage change in summer runoff is projected to be much more significant.

Finally, there is also large uncertainty associated with the use of climate projections, and additional uncertainty surrounding hydrological modelling (Booij *et al.*, 2006; Wilby and Harris, 2006) which make estimates of future water resources difficult. Large uncertainties included in future runoff projections add hesitations in the decision making processes for current water management as well as in plans for long term future water conservation efforts.



**Figure 1.6 Percentage change in average annual runoff across Britain, under the 1996 CCIRG scenario (Arnell, 1998)**

Results indicate that different catchments respond very differently to changes in precipitation and temperature, with the greatest implications for low flows occurring in flashy, upland catchments (Young et al., 2000; Arnell, 2003).

The dramatic detrimental effects of extreme low flows on the agriculture, ecology, economy, and public and industrial water supply demonstrates that they should be an important consideration in catchment research and management. Furthermore, the aforementioned research shows that climate change could potentially cause low flows in upland catchments to become more extreme and therefore even more of an issue.

Article	Location	Predictions
(Pilling and Jones, 2002)	Wye catchment, Wales	<ul style="list-style-type: none"> <li>• Under the 2080-2099 scenario, summer and autumn flows show marked reductions of 17% and 12% respectively. Flow in August could decrease by 28.6%</li> <li>• Approximately 80% of the decrease in summer flow is due to lower rainfall receipt</li> </ul>
(Arnell, 2003)	Britain	<ul style="list-style-type: none"> <li>• By 2050 runoff decreases in summer in all but the most northern catchments. Decreases range from 5 to 30% depending on climate scenario</li> <li>• Reductions in Q95 are apparent by 2020, and could be reduced by as much as 45% in southern catchments by 2080</li> </ul>
(Fowler and Kilsby, 2004)	UK	<ul style="list-style-type: none"> <li>• In Scotland, maximum drought duration is projected to decrease by up to 50% by 2070</li> <li>• Maximum drought severity across the UK may increase by up to 125% by 2070, with smaller increase in the northern and western regions</li> <li>• Short term drought events are projected to increase in frequency by at least 35% in all regions except northern Scotland with a maximum increase of 118% in southern Scotland</li> </ul>
(Lehner et al., 2006)	Europe	<ul style="list-style-type: none"> <li>• 100-year droughts show strong increases in frequency for large areas of southern and south-eastern Europe, reaching return periods of 10 years and below in extreme cases</li> <li>• Northern Europe shows a reduction on 100-year droughts</li> <li>• Strong increases in water use for eastern Europe due to their increased economic activity may cause or intensify hydrological or operational droughts</li> </ul>
(Wilby and Harris, 2006)	River Thames England	<ul style="list-style-type: none"> <li>• Under A2 emissions there is an 83% likelihood of reduced low flows by 2080</li> <li>• Under A2 projected changes in Q95 vary between -10% to -22% for CATCHMOD, and between -15% to -34% for REGMOD (the two hydrological models used) by 2080</li> </ul>

(Blenkinsop and Fowler, 2007)	British Isles	<ul style="list-style-type: none"> <li>• Hadley driven RCMs project increases in drought frequency over most of the British Isles.</li> <li>• ECHAM-driven models project decreases in drought occurrence in Scotland, northwest England and Ireland but increases over England and Wales</li> <li>• Maximum severity of drought events is likely to decrease in most regions</li> <li>• Decreases in the maximum duration of drought events are also projected by most models</li> </ul>
(Fowler et al., 2008)	Eden catchment, Cumbria	<ul style="list-style-type: none"> <li>• Mean flows are projected to decrease in all seasons, except winter. The largest decreases are projected for summer (~-60%) with -15% for spring and autumn and +15% for winter</li> <li>• Low flows (Q95) are projected to decrease in magnitude by 70-80% in summer and autumn</li> </ul>
(Steele-Dunne et al., 2008)	Ireland	<ul style="list-style-type: none"> <li>• Under the A1B scenario, an amplification of the seasonal cycle in stream flow is evident in all catchments by 2021- 2060</li> <li>• Due to the combination of reduced summer precipitation, increased temperature and increased evaporation, stream flow is expected to decrease by 20% to 60% from May to September.</li> <li>• A significant increase in the risk of extremely low summer flow is expected in all catchments.</li> </ul>
(Feyen and Dankers, 2009)	Europe	<ul style="list-style-type: none"> <li>• In the frost free season minimum flows are projected to decrease in most parts of Europe, except in the most northern and north-eastern regions. Reductions of 20 to 40% are projected.</li> <li>• In many regions, the reductions in minimum flows are projected to be relatively less severe at larger recurrence intervals than for those with shorter return periods.</li> <li>• Only in the most northern and north-eastern parts of Europe are streamflow droughts projected to become less severe</li> <li>• Climate change will cause more river basins in Europe to be affected by severe water stress, resulting in increased competition for available water resources.</li> </ul>

**Table 1.1 Summary of research on the effects of climate change on drought and water resources.**



### **1.3 Land Use Change and Catchment Hydrology**

The hydrological cycle interacts strongly with terrestrial processes. Consequently, land use changes such as afforestation, deforestation, urbanisation and soil compaction may have major consequences for hydrology at local, regional and global scales (Wilkinson, 1992; Calder, 1993). Land use change in the UK is dominated by the growth of urban areas, changes in the agricultural sector and the extension of forests and woodlands (Parry et al., 1992).

#### **1.3.1 Vegetation Change**

In the UK, between 1933 and 1980, about one million hectares (15% of the nation's rough land) were transferred to improved farmland, and there was an expansion of cultivated land use by 25% between 1945 and 1980 which was largely responsible for the declines in broadleaved woodland, semi natural vegetation and grasslands (Parry et al., 1992). This change, coupled with concerns about climate change and extreme hydrological events, is one of the reasons why the literature surrounding land use change effects on hydrology is dominated by vegetation changes, particularly afforestation and deforestation.

Changes between forests and agricultural land dramatically influence many hydrological processes; including runoff generation, rates of evapotranspiration, and interception losses. Law (1960), cited in Wilkinson (1992), concluded that afforestation of the Stocks Reservoir Catchment would result in a 20% loss of runoff. Catchment experiments in the Balquhidder catchments in Scotland (Eeles and Blackie, 1993; Gustard and Wesselink, 1993; Johnson and Whitehead, 1993) conclude that with increasing afforestation; mean flow decreases, annual minimum flows are lower, and the storage needed to maintain a given yield increases. The Coalburn experimental catchment on the River Irthing in England was also set up to assess the influence of drainage and afforestation on river flows (Archer, 2003), and has been the subject of several research studies (Robinson, 1993; Robinson, 1998; Robinson et al., 1998). Bosch and Hewlett (1982) and Farley et al. (2005) used data from 94 and 504 national and worldwide catchment experiments respectively to discern that

different types of trees influence runoff to different levels; with Pine and Eucalypt trees lowering total runoff volumes most (sometimes exceeding a 75%, or 400mm reduction), while deciduous hardwoods have less influence (100 to 200mm reduction).

Calder and Newson (1979) describe how the evaporation losses from afforestation are greater with higher annual rainfall. They explain that catchments which do not have significant rock aquifers, and rely on summer rainfall to support low flows, will experience severe adverse effects from forest interception losses. Paired catchment studies at Plynlimon in Wales (Hudson et al., 1997; Marc and Robinson, 2007) showed that evaporation losses from the forested Severn catchment were much higher (30%) than the grassland catchment of the Wye (18%) (Jones, 1997). Calder (1993) revealed that, although for different reasons, evaporation losses from forests will be higher than from grasslands during both rainy and drought periods. Marc and Robinson (2007) discovered that not only did transpiration losses decrease dramatically with felling of forests (falling from 250mm to 0mm over the period from 1972 to 2004); they also decreased by 100mm before the felling occurred which they attributed to the maturity of the trees. Evaporation is greatly influenced by albedo which increases from 0.18 to 0.24 with a change from deciduous woodland to agricultural grassland (Rogers, 1994), and deforestation increases the solar radiation received at the ground surface by as much as 150 times due to the removal of the shading tree canopy (Changnon and Semonin, 1979).

Beven (2004) points out that not only does change in land cover itself affect the hydrology but so also do the processes involved, such as road building, compaction of soils by heavy machinery, and the digging of ditches for drainage, and that these processes could exacerbate the effects of afforestation. Calder (1993) considers the aspect and location of the forestry within the catchment important, as the evaporation from short crops is determined by the net radiation they receive. Many reviews of the effect of vegetation change on hydrology also mention the feedbacks between land use change and climate at various scales, particularly the effects afforestation and

deforestation on rainfall intensities, patterns and distributions (Calder, 1993; Rogers, 1994; Glantz, 2000; Pielke et al., 2006).

These studies show that the vast majority of research has been focused on afforestation and deforestation, and that little work has been done on vegetation changes of other natures, such as conversions of wild grasslands to cropland. It is also clear that the influence of vegetation changes on flood peaks has been well examined, and that although it is clear that afforestation can reduce annual flow volumes, literature is lacking on the influence of vegetation on seasonal extreme low flow events.

### **1.3.2 Compaction**

Changes in land use towards agriculture also affect the hydrological regime by increasing the compaction of the soils. Compaction affects infiltration, overland flow, throughflow, and recharge to groundwater by changing the infiltration and throughflow rates within the soil. Compaction can originate from overgrazing with too high stock densities, the repeated use of heavy machinery, particularly if certain tracks develop, and many other agricultural practices. Again, DEFRA (2009) offer advice on when grazing is unsuitable, the risk of poaching, and that methods to relieve soils from compaction such as aeration and spiking should be considered, as well as installing hard standing around permanent feeders and water troughs.

The effects of compaction, both by machinery ((Hawkins and Brown, 1963; Soane, 1980; Jansson and Johansson, 1998)), and livestock ((Ferrero, 1991; Betteridge et al., 1999; Ferrero and Lipiec, 2000)), on soil characteristics such as hydraulic conductivity, porosity, and infiltration rates have been extensively studied. It has been found that low pressure tyres reduce the amount of compaction caused by machinery (Boguzas and Hakansson, 2001), whilst rubber tracks cause compaction of the topsoil but less deep compaction (Febo and Planeta, 2000). Servadio *et al.* (2001) discovered that wheeled machinery reduced the saturated conductivity of soil from 18.5 mm hr<sup>-1</sup> to 3.3 mm hr<sup>-1</sup> with one pass, and to 1.1 mm hr<sup>-1</sup> after 4 passes. Tracked vehicles reduced saturated conductivity less, with one pass resulting in hydraulic conductivity of 11.2 mm hr<sup>-1</sup>, and four passes giving 7.5 mm hr<sup>-1</sup>. Flowers and Lal (1998)

determined that the effect of compaction penetrate up to depths of 60cm, though the greatest effects are seen in the top 10cm. Livestock compaction varies with the animal, as well as the stocking density, Betteridge *et al.* (1999) found that cattle caused soil disturbance through upward downward movement, while sheep cause surface compaction. Stock also reduce the vegetation cover, causing soil crusting and reduced overland flow resistance (Ferrero, 1991). Heathwaite *et al.* (1990) found that infiltration capacity was 80% less on grazed areas compared to fields with no stock.

Agricultural methods such as soil aeration, and subsoiling have been used to reduce the compaction levels on farmland, though soil aeration focuses on the surface compacted layer, down to a maximum of 8 inches deep. The beneficial effects of soil aeration on the structural properties of the soils are outlined in Douglas *et al.* (1998), who observed increases in the volume, size and number of macropores in the upper 100mm that affected the infiltration rate, soil strength and accumulation of organic matter. They advise aerating with few cuts, using equipment with small tyre-soil contact stresses, and at times when the soil is relatively dry, in order to return optimum infiltration and short-term water storage capacity to the soils.

Despite the wide range of literature on the effects of compaction on soil properties, the subsequent impacts of these compaction driven soil changes upon river flows has not yet been properly considered. Hence, there is a research need to investigate the scale of the effects of compaction on extreme low flows or flood events.

### **1.3.3 Previous Land Use Change Research Methods**

Many recent studies have been based around paired catchment experiments where two similar basins are measured concurrently, in one of which the land use has been altered (Jones, 1997; Blöschl *et al.*, 2007). These studies have proved popular in identifying potential flood risk prevention methods, but none have been carried out solely to look at low flows (Johnson, 1998). The approach poses difficulties in finding two basins that are identical in every respect other than land cover. It is also extremely difficult to extrapolate from the results and use to them to predict quantitatively the effects in another basin (Bosch and

Hewlett, 1982; Jones, 1997). It is now considered that hydrological modelling may be a more appropriate method of testing the effects of land use changes on a catchment's hydrology; and Jones (1997) states that '*fully distributed, physically based finite element simulation models like IHDM (Institute of Hydrology Distributed Model) now offer the best way forward*'. Early modelling of land use effect on low flows was carried out by Tallaksen and Erichsen (1994) and Querner *et al.* (1997). Other examples of more recent modelling of water resources and land use change include Bormann *et al.* (1999); Wooldridge *et al.* (2001); Calder (2003) and Calder *et al.* (2003); Croke *et al.* (2004); Bari and Smettem (2006); and Krause *et al.* (2007). Lambin (2004) outlines the progression of modelling land use changes from statistical models e.g. CLUE (Conversion of Land Use and its Effects) (Veldkamp and Fresco, 1996) to dynamic simulation models like IMPEL (Integrated Model to Predict European Land Use) (Rounsevell and *et al.*, 1998).

#### **1.4 Hydrological Models and Low Flows**

It is suggested herein that hydrological modelling is the best way forward for catchment response studies since it provides a means of testing the effects of changes to the system, without the problems associated with carrying out physical changes in catchment experiments. Hydrological models have been used widely in studies of hydrological processes themselves, but also in assessing the potential effects of climate change and land use change on flooding and water resources, or the potential downstream effects of channel engineering works or floodplain development (Mulligan, 2004). The most sophisticated models available at the moment are fully spatially distributed, physically based models. A spatially distributed model has the advantage that it can implement any changes in parameter values in their correct spatial context (Beven, 2004); while physically based models incorporate a linked system of submodels, simulating the transfer processes and storages within the river basin (Jones, 1997). Two large physically based models are the Système Hydrologique Européen (SHE) model, and the Institute of Hydrology Distributed Model (IHDM), of which Beven *et al.* (1987) considered SHE was better suited to modelling lowland catchments and IHDM for the uplands. These early models

were criticised for their large data needs and costs, as well as issues with uncertainty and equifinality (Beven, 2004).

There has since been a trend towards simpler, more targeted models such as Soil and Water Assessment Tool (SWAT) (e.g. (Spruill et al., 2000)). Governmental organisations such as the Environment Agency use the Centre for Ecology and Hydrology's lumped conceptual model, the Flood Estimation Handbook (CEH, 1999). Due to its popularity and ease of use, this model has been used widely in governmental decision making processes. More recently, this model has been updated to the ReFEH (Kjeldsen, 2007b) which is considered an improvement on the FEH as it enables a more direct and transparent description of flood-generating mechanisms, and introduces the concepts of seasonal variation in soil moisture content, rainfall and baseflow (Center for Ecology and Hydrology, 2011). TOPMODEL (Beven and Kirkby, 1976) is a popular semi-distributed model, that uses the concept of Hydrologically Similar Units (HSU's) to give a representation of spatial variation. TOPMODEL has also undergone some improvements to develop the Dynamic TOPMODEL (Beven and Freer, 2001a), which allows dynamically variable upslope contributing areas. CRUM3 (Reaney et al., 2007) is an example of a spatially distributed model that simulates the spatial variation in the catchment using raster (grid) datasets. Fully distributed models had previously been avoided due to their high computational demand, but with networking advances, computer clusters, cloud computing and similar methods of advanced processing power, they have recently become increasingly popular.

The recent focus in hydrological research on flood risk reduction measures has meant that many models have been written and calibrated with an emphasis and accuracy biased towards high flows. It would therefore be valuable to discover whether hydrological models are appropriate for use in studies of low flow events, as little work has been done on this previously. Previous research which has modelled low flows have been concerned with the effect of climate change on drought (Wetherald and Manabe, 2002; Charlton et al., 2006; Wilby and Harris, 2006; Blenkinsop and Fowler, 2007; Steele-Dunne et al., 2008; Feyen and Dankers, 2009). A few studies have used hydrological models to assess the impact of human interactions on low flows (Wang and Cai, 2009),

such as land use change studies (none of which focus solely on low flows), or abstraction studies (Eheart, 1999; Dunn et al., 2003; Parkin et al., 2007). Some hydrological modelling studies however, have been centred on discovering more about the processes and characteristics of drought (Bravar and Kavvas, 1991; Giorgi et al., 1996; Jones and Lister, 1998; Granier et al., 1999; Henriques and Santos, 1999; Botter et al., 2007). Xu *et al.* (2010) discuss the uncertainties involved in modelling extreme hydrological events, which can be as high as 40% for a flood estimation of a return period of 200 years. Xu *et al.* (2010) do not however, attempt to quantify the uncertainties surrounding estimations of extreme low flow events.

## 1.5 Aim and Research Questions

It is evident from this literature that extreme low flows are a threatening hazard in today's society, and that the study of low flows has been relatively neglected. Research has indicated that hydrological modelling of flood events has been extremely successful; and modelling of extreme low flows should be possible with physically based, fully distributed models, given that accurate process representation is considered and included. The influence of land use change on hydrology is well documented, but is so varied and unique to each catchment scenario that further specific investigations should be carried out before management schemes are implemented. This leaves a great opportunity for geographical research to consider the potential effects of land use change on extreme low flows via the innovative methodology of hydrological modelling. Therefore, in order to address the apparent gap in previous geographical literature, the aim of this Master's project is:

***To determine whether land management can be used to reduce the risk of extreme low flows.***

### 1.5.1 Research Questions

To fulfil the aim above, three research questions will be considered:

**1) *Are hydrological models appropriate for the investigation of low flow events?***

As demonstrated in the above review of the literature, previous developments of hydrological models have concentrated on high flows simulation for the investigation of flood risk. Therefore, it would be valuable to assess how well these models perform in predicting low flow events, particularly as droughts in the UK have recently become a fairly frequent and intense hydrological hazard. Since hydrological processes interact very differently during low flows as compared with high flows, the type of model chosen will largely determine its applicability to low flows research. Similarly, process representation will be extremely important in the model's capability to simulate low flow periods.

**2) *How can land use changes affect low flows hydrology?***

Land use changes can have a strong effect on the catchment hydrology. Therefore, it is possible to implement land use change for the management of hydrological extremes. For example, it is recognised that planting wooded buffer strips alongside river channels can help reduce flood peaks (Carroll et al., 2004). The effect of land use changes on low flows has been very rarely considered in comparison with high flows. This research question will consider the effects of land use change on catchment low flows, attempting to determine whether vegetation changes, or any other land use management techniques, might increase low flows discharges.

**3) *Can land use changes help manage low flows without exacerbating flood risk?***

Finally, it is important that those land management techniques that may help manage low flows do not exacerbate flood risk. The land management methods examined to answer the second research question will be assessed for their high flows responses. This research question aims to develop a simultaneous high and low flows management solution.



## **1.6 Thesis Structure**

This chapter has highlighted the requirement of further research into the concept of land use change for the management of low flows. It has also revealed the previous lack of application of hydrological models in such low flows simulation studies. Chapter 2 will describe the river catchment in which this study is focussed, including information on its hydrological and geomorphological characteristics, as well as its current land use and ecological status. Chapter 3 will outline the methods used to investigate and answer the research questions outlined above. Chapter 4 seeks to answer the first research question, and examines the possibility of effectively modelling low flows. Chapters 5 and 6 assess the effects of vegetation change and soil compaction on low flows hydrology respectively. These were the two land use management techniques identified within the study catchment for their potential for low flows improvement. Chapter 7 interprets the results of Chapters 5 and 6 and considers the potential for implementation of those land management techniques proven to be beneficial to low flows. Chapter 8 considers the final research question. This chapter revisits the management options assessed for their low flows potential and determines their impacts on high flows. Finally, Chapter 9 reviews the core findings of this Masters project, with some discussion and potential areas for further research.

# Chapter Two:

*Study Catchment Characteristics*

## **2.1 The Dacre Beck Catchment**

This chapter will give detail on the characteristics of the Dacre Beck catchment, and will justify the choice of this study area in accordance with the conditions stated in Chapter One. The hydrology (2.3) and geomorphology (2.4) will be investigated to gain insight into the hydrological behaviour of the catchment. Land use and history (2.5) will then be considered to determine the feasible land-use changes that could be implemented in the area, and finally the ecology (2.6) will be reviewed to include an idea of ecological vulnerability to hydrological extremes within the catchment.

## **2.2 Location**

The Dacre Beck catchment is a 37km<sup>2</sup> sub-catchment of the River Eden within the Cumbrian Lake District National Park. The gauging station of the catchment, at the village of Dacre, is located approximately 8km south-west of Penrith and 30km south-south-east of Carlisle (Figure 2.1). The M6 passes nearby through Penrith and the A66 cuts across the northern tip of the catchment connecting Penrith in the east with Keswick in the west. The Ullswater Lake is located to the south-east of the catchment

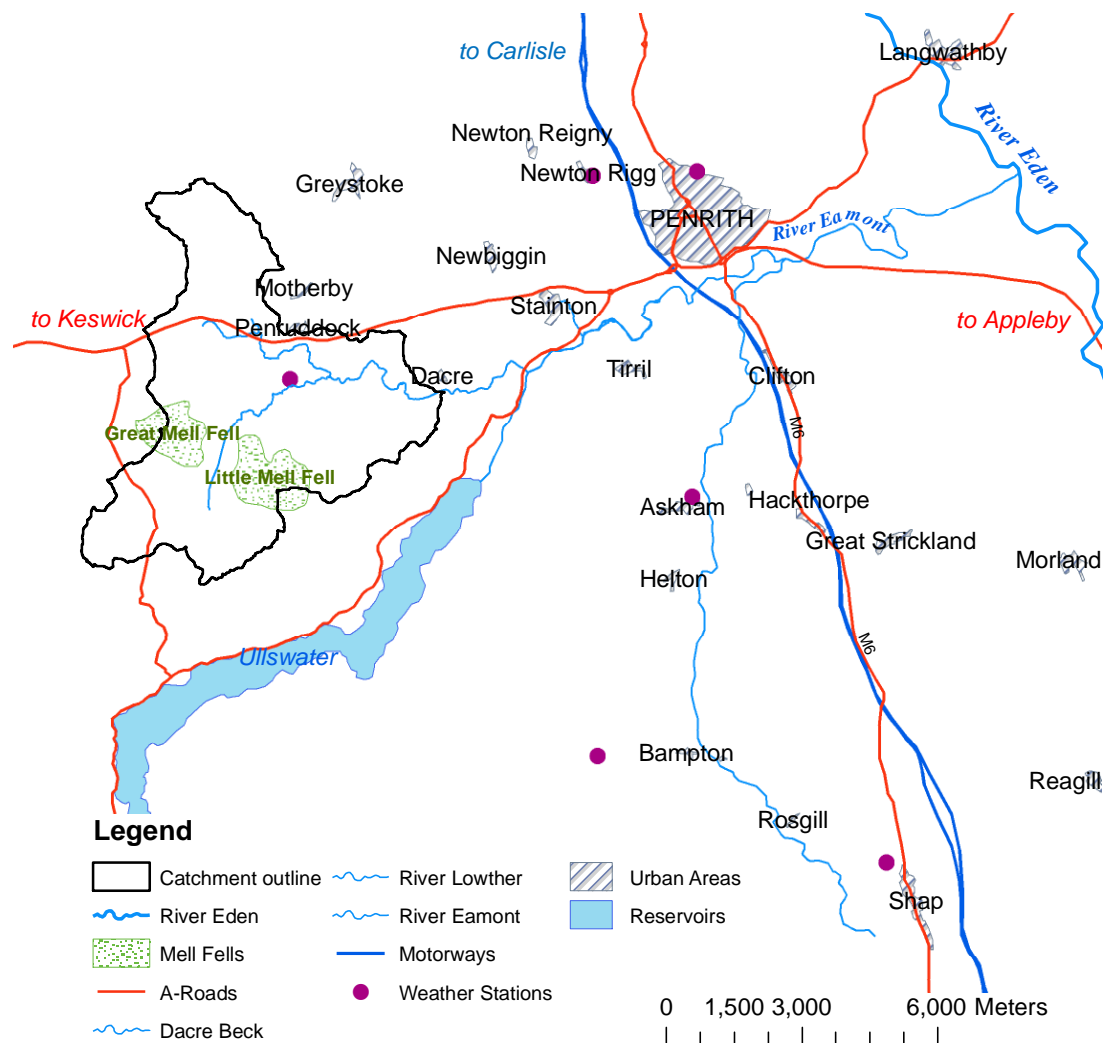
## **2.3 Catchment Characteristics**

The characteristics of a catchment play a major role in determining its suitability for hydrological modelling. Factors affecting the hydrology of the Dacre Beck catchment are the topography (2.3.1) the channel network (2.3.2) and the local rainfall patterns (2.3.3).

### **2.3.1 Topography**

The elevation range of the Dacre Beck catchment (Figure 2.2) is 376.6m. Its highest point, at 535m above mean sea level (AMSL), is at the peak of Great Mell Fell in the western upland part of the catchment. Its lowest point at 158.4m AMSL is at the outlet at the village of Dacre in the eastern lowlands. Little Mell Fell in the south east of the catchment reaches 503.8m in elevation, while the uplands in the far south reach 470m. The slope gradient of the catchment

(Figure 2.3) is greatest in the upland areas, reaching  $27^\circ$  surrounding the Great and Little Mell Fells. Once through the valley between Great and Little Mell Fell, the land becomes much flatter, mostly remaining below  $5^\circ$  in slope. The flattest land is located in the northern tip of the catchment, an area popular with dairy and cattle farming. There are however, a few steep banks to the north of the river channel in the eastern lowlands.

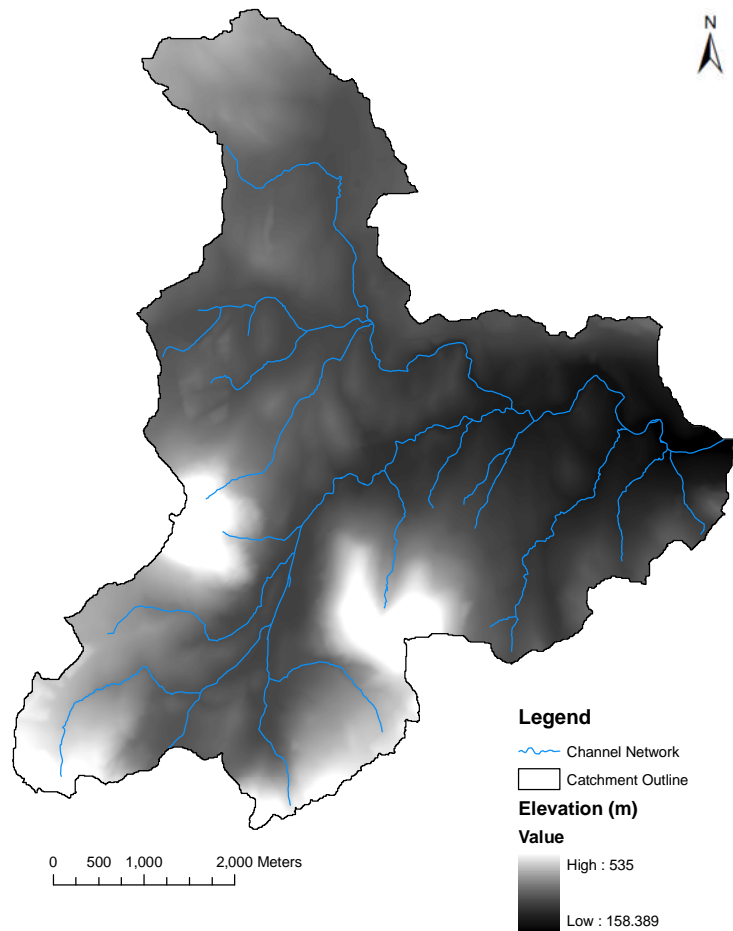


**Figure 2.1 Location of the Dacre Beck catchment**

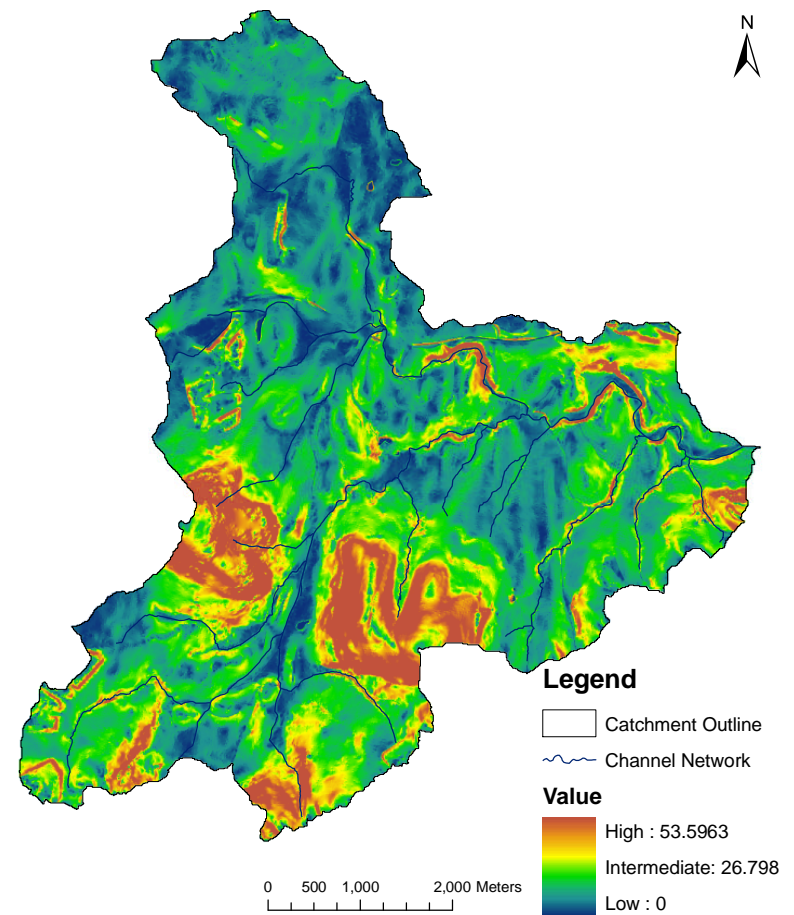
(derived from Ordnance Survey Maps obtained through Edina Digimap)

### 2.3.2 Channel Network

The channel network of the Dacre Beck catchment is shown on figures 2.2 and 2.3. Thackthwaite Beck rises in the south of the catchment, near Ulcat Row and flows in a northerly direction between Great Mell Fell and Little Mell Fell. At Hutton, Thackthwaite Beck and the southerly flowing Skitwath Beck meet to form Dacre Beck which flows east towards the village of Dacre.



**Figure 2.2 Elevation of the Dacre Beck catchment**  
 (taken from the 5m resolution Nextmap data by Intermap)



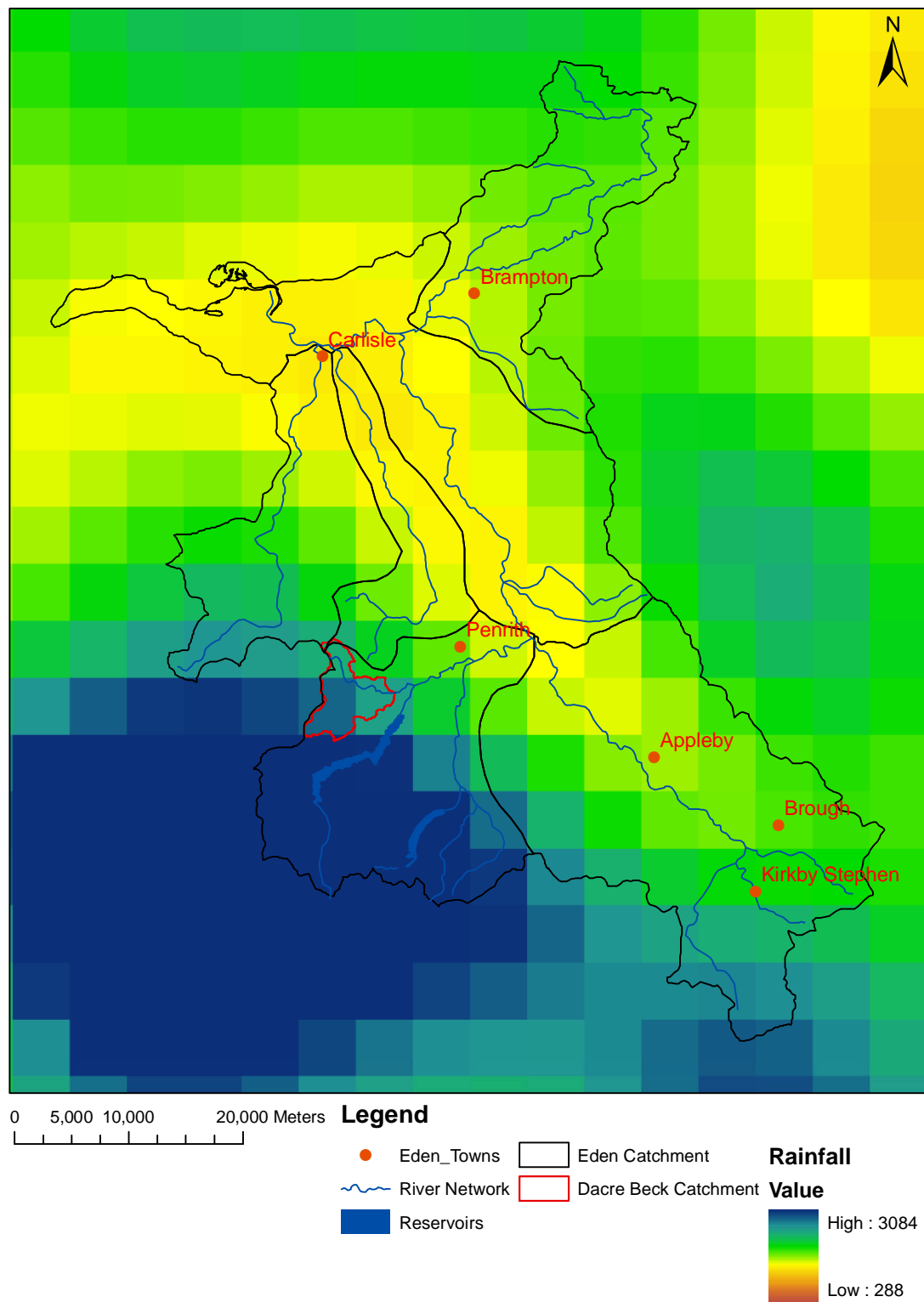
**Figure 2.3 Slope of the Dacre Beck catchment**  
 (derived from the 5m resolution Nextmap data by Intermap)

### 2.3.3 Rainfall

Figure 2.4 shows the average yearly rainfall (mm) across the Eden catchment at a 5km resolution. This figure shows that in the context of the River Eden catchment, which ranges from 827mm year<sup>-1</sup> in Carlisle to 2244mm year<sup>-1</sup> in the uplands to the south-west of Ullswater, the Dacre Beck receives a large amount of rainfall, averaging 1616mm year<sup>-1</sup>. It receives its highest volumes in the far south, 1891mm year<sup>-1</sup>, and it's lowest in the northern tip of the catchment with 1375mm year<sup>-1</sup>. Figure 2.5 shows weather data from the Newton Rigg gauging station for the hydrological years 2002-2010. This record indicates that the Dacre Beck catchment experiences very cyclic diannual patterns of temperature with hot summers peaking at around 25°C at the hottest part of the day, and cold winters with night time temperature dropping below -10°C in recent years. The annual rainfall patterns are less discernible, though 2006 and 2009 demonstrated very wet winter months, followed in both cases by considerably dry spring months. There are several short periods of a week to a month when daily rainfall commonly exceeds 20mm day<sup>-1</sup>, however for the majority of the record rainfall volumes remain below 10mm day<sup>-1</sup>. A hydrograph for the hydrological year 2009/2010 is shown in figure 2.6; this year demonstrates the catchments tendency towards both extreme high flows in the winter and extreme low flows in the summer. The hydrograph shows the flashy nature of the catchment as the river discharge at the outlet at Dacre Bridge closely match the peaks of the rainfall at Newton Rigg, and the discharge returns to low flow values fairly promptly after the rainfall peaks have passed. The river flows very close to dry in the summer months from May until September, but peaks in winter can reach 25m<sup>3</sup> s<sup>-1</sup>.

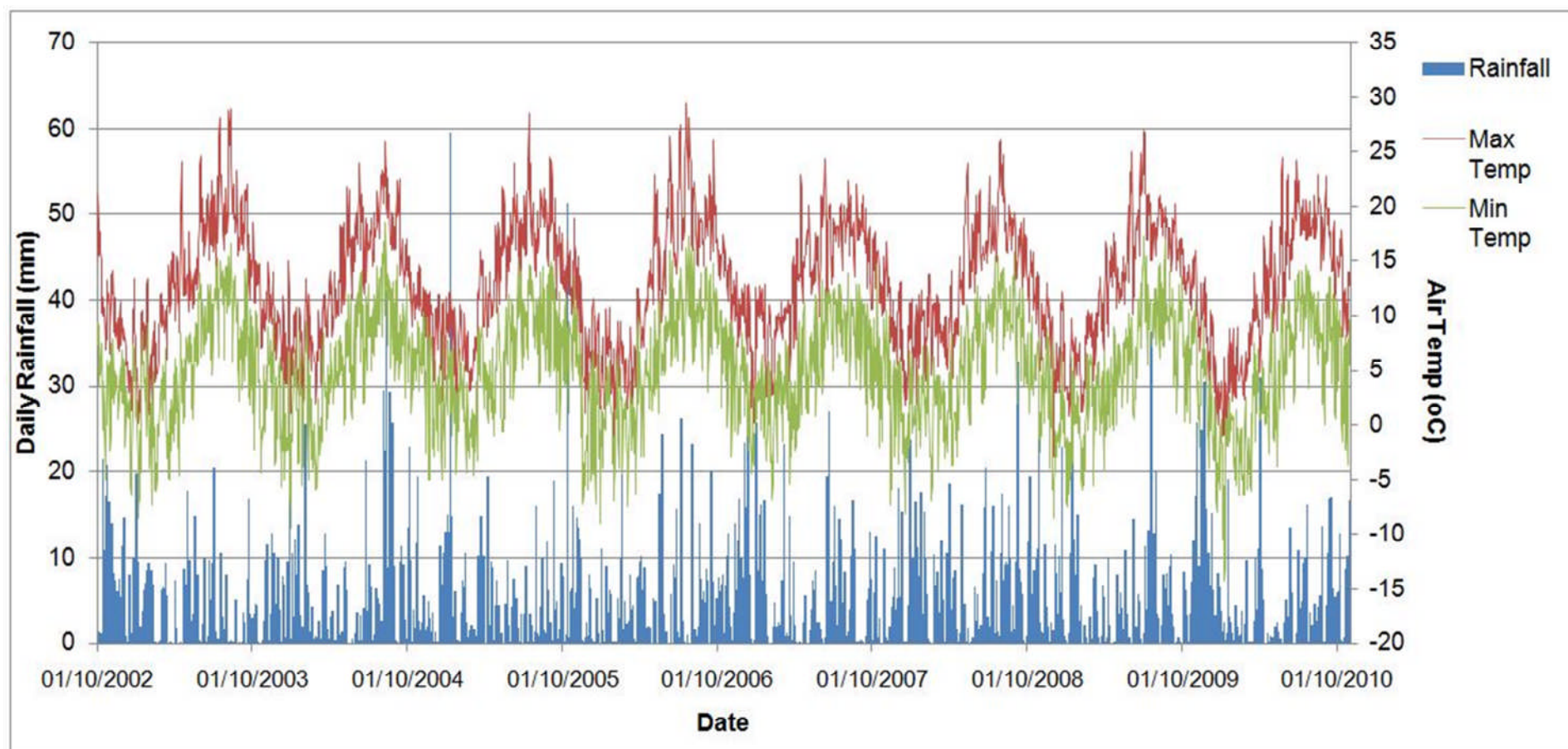
## 2.4 Geomorphology

Another set of catchment characteristics that play an important role in the catchments hydrological response to rainfall is the geomorphology. This consists of the bedrock geology (2.4.1), the superficial deposits (2.4.2) and the soils (2.4.3). These factors determine how the water in the catchment is routed to the catchment outlet, and therefore are largely responsible for the water's residence time.



**Figure 2.4 Average annual rainfall for the Eden catchment**

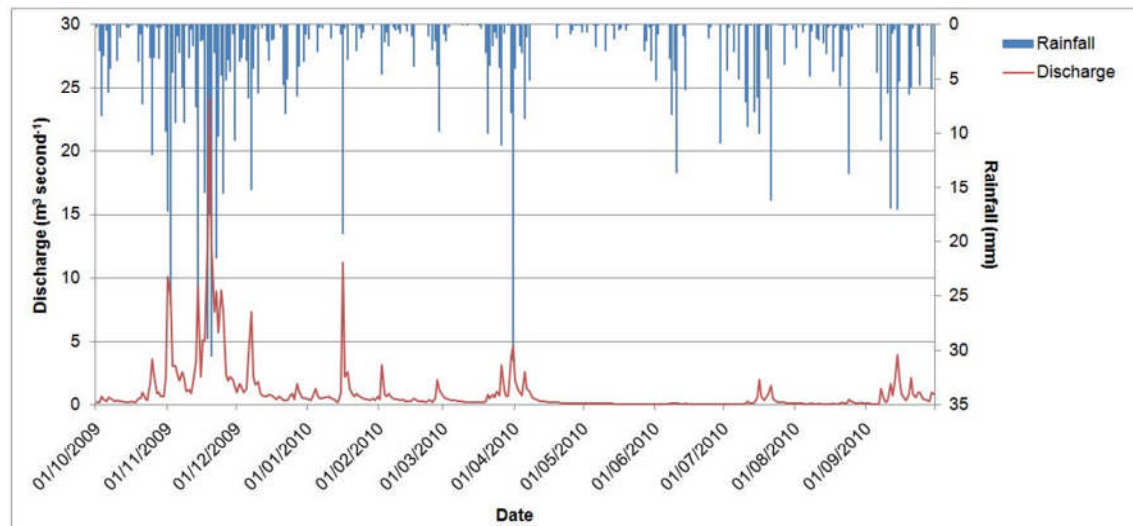
*(Met Office: Perry and Hollis, 2005)*



**Figure 2.5 Weather data from Newton Rigg for the hydrological years 2002-2010**

*(British Atmospheric Data Centre)*





**Figure 2.6 Hydrograph for the Dacre Beck HY09/10**

(Data from the Environment Agency and the British Atmospheric Data Centre)

### 2.4.1 Bedrock Geology

The bedrock geology of the Dacre Beck catchment is largely responsible for the flashiness of the river response. The majority of the catchment is underlain by conglomerates and igneous rocks, with volcanics in the southern uplands, and mudstones to the west, as shown in figure 2.7. The northern tip of the catchment has a predominantly limestone geology, with outcrops of shales and limestones. The volcanics in the south are the Birker Fell Andesite Formation, part of the Borrowdale Volcanic Group (Akhurst and *et al.*, 1997) which has a very low hydraulic conductivity (Dingman, 1994). This low conductivity makes the abundant rainfall in this high elevation area runoff very quickly. Similarly, the Tarn Moor and Buttermere formation mudstones in the east, which are members of the Skiddaw Group (Burgess and Wadge, 1974) are fine grained geologic units with low permeability. The conglomerate that covers the majority of the catchment, particularly the lowlands, is known as the Mell Fell conglomerate. It is a clast supported rock made up of well rounded clasts that are very poorly sorted. The rounding of the clasts suggests reworking, and it is thought that the conglomerate has resulted from the deposition of a series of alluvial fans (McCormac, 2003).

The limestones are a mixture of the Yoredale group, the Great Scar Limestone Group, Alston Formation and the Eskett Limestone Formation. The sandstones and shales are also parts of the Eskett and Great Scar Limestone Formations. In the low lying northern tip of the catchment, the permeability of the bedrock is

a little higher, with porosities of limestones reaching 0.56, in comparison with a maximum of 0.2 in andesitic rocks (Dingman, 1994).

### **2.4.2 Superficial Deposits**

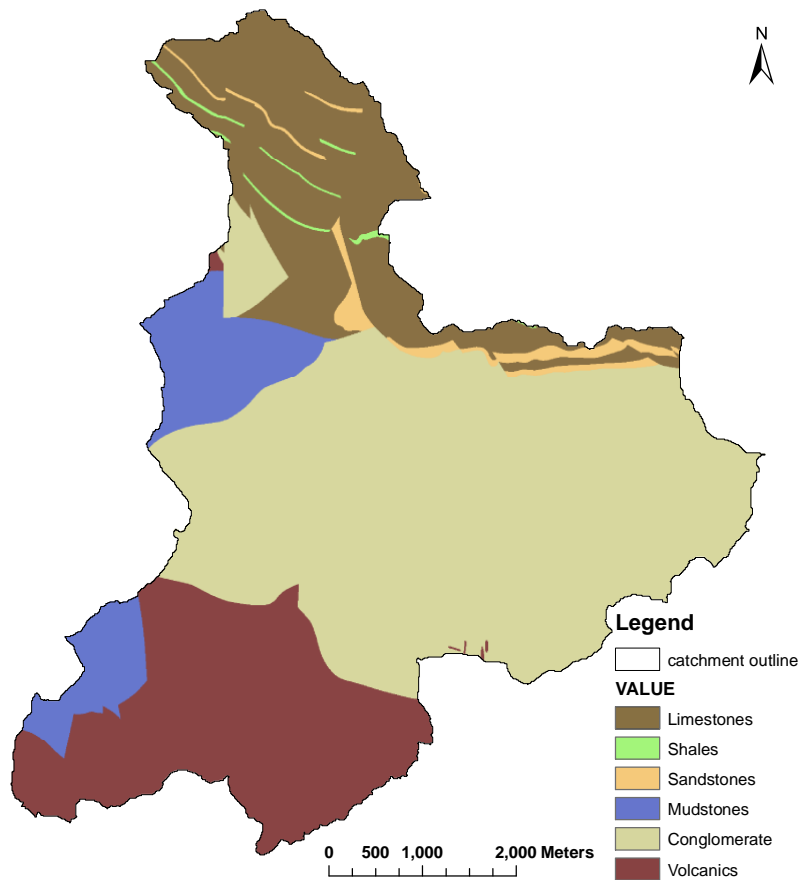
Above the bedrock geology are the superficial deposits, formed throughout the quaternary. The British Geological Survey's (BGS) superficial geology map is shown in figure 2.8. As the survey only includes deposits formed *in situ* there are several areas of missing data, particularly in the uplands where mass movements have occurred. The majority of the Dacre Beck catchment is covered with glacial till, however there are several areas of fluvial and peat deposits. Along much of the channel network are alluvium deposits, and just to the south of the river upstream of Hutton is an alluvial fan deposit. In the north-east there is an area of glaciofluvial deposits. There are river terrace deposits at the confluence of the Thackthwaite and Skitwath Beck at Hutton, and also in the uplands. There are several peat deposits which have a high porosity of 0.92 (Dingman, 1994), mostly areas of mid elevation in the south, between the Mell Fells, and also in the west. Most of the superficial deposits are unconsolidated sediments forming relatively thin onshore spreads (BGS website). Therefore, while not expected to perform a large role in water storage in the catchment, this layer provides a vital connection between the soils and the bedrock, and so the hydraulic conductivity of this layer should be considered when assessing the infiltration, throughflow, and recharge of the catchment.

### **2.4.3 Soils**

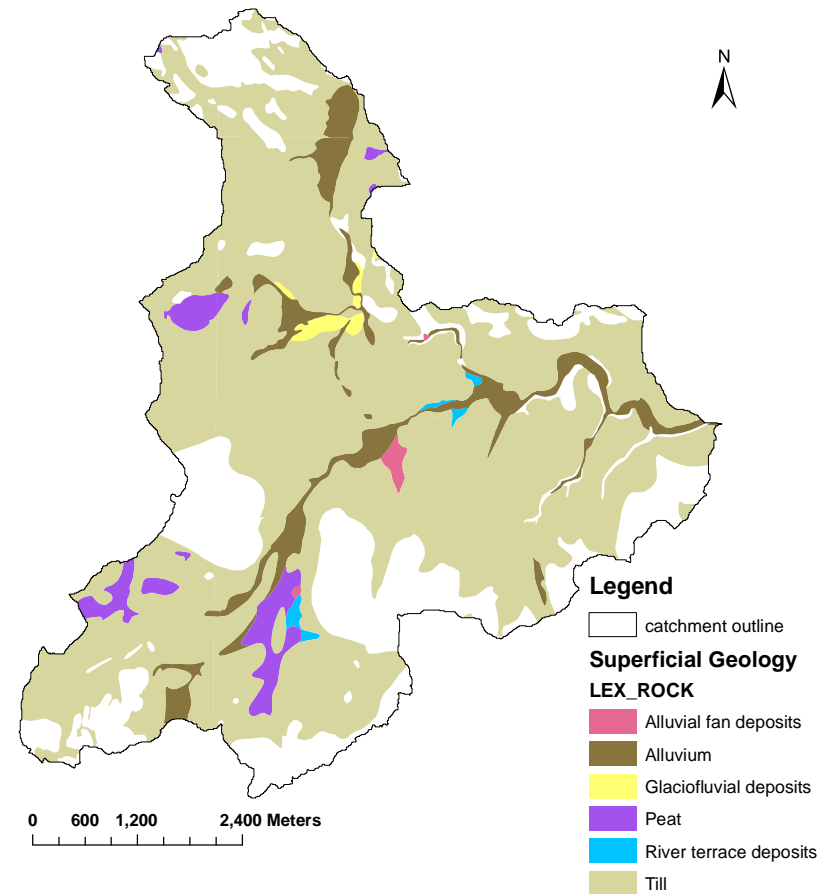
The soils of the Dacre Beck catchment are shown in figure 2.9. There are six different soil units in the Dacre Beck catchment: Cambic stagnogley soils, typical stagnogley soils, typical brown earths, typical brown podzolic soils, raw oligofiborous peat soils and lithomorphic humic ranker.

The cambic stagnogley soils are the predominant soil type in the catchment. These are seasonally waterlogged slowly permeable soils with no clay content in the subsoil. They occur widely in lowland Britain (Thompson, 2007).

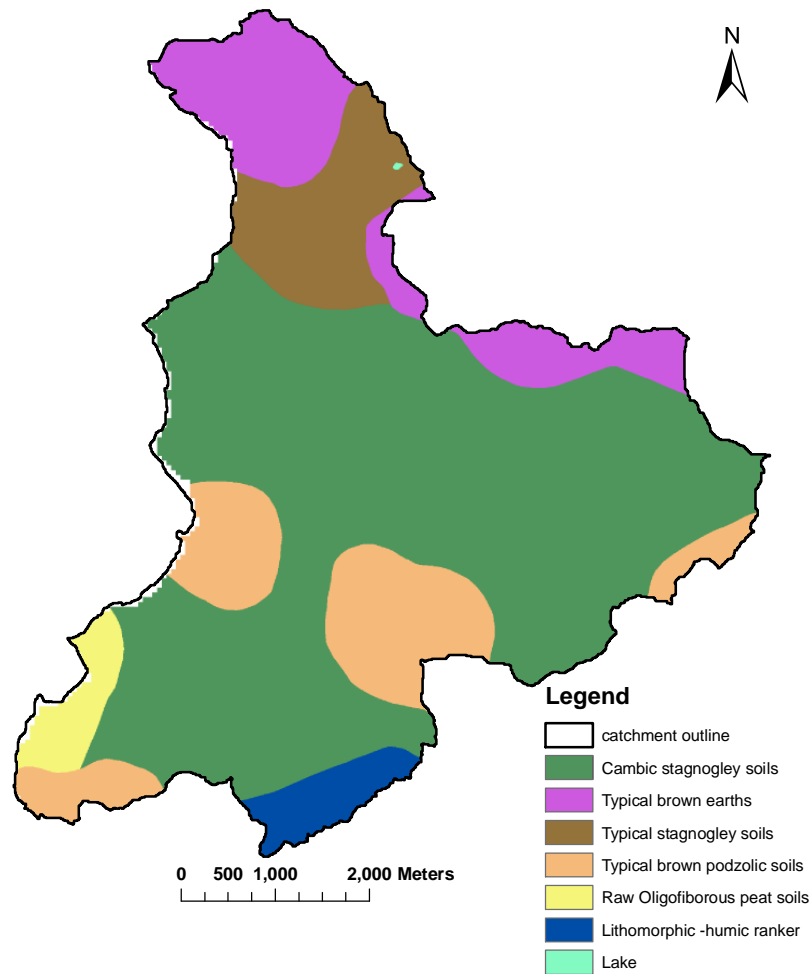
The typical stagnogley soils, found across a large part of the northern tip of the catchment have the same characteristics except they are clay enriched.



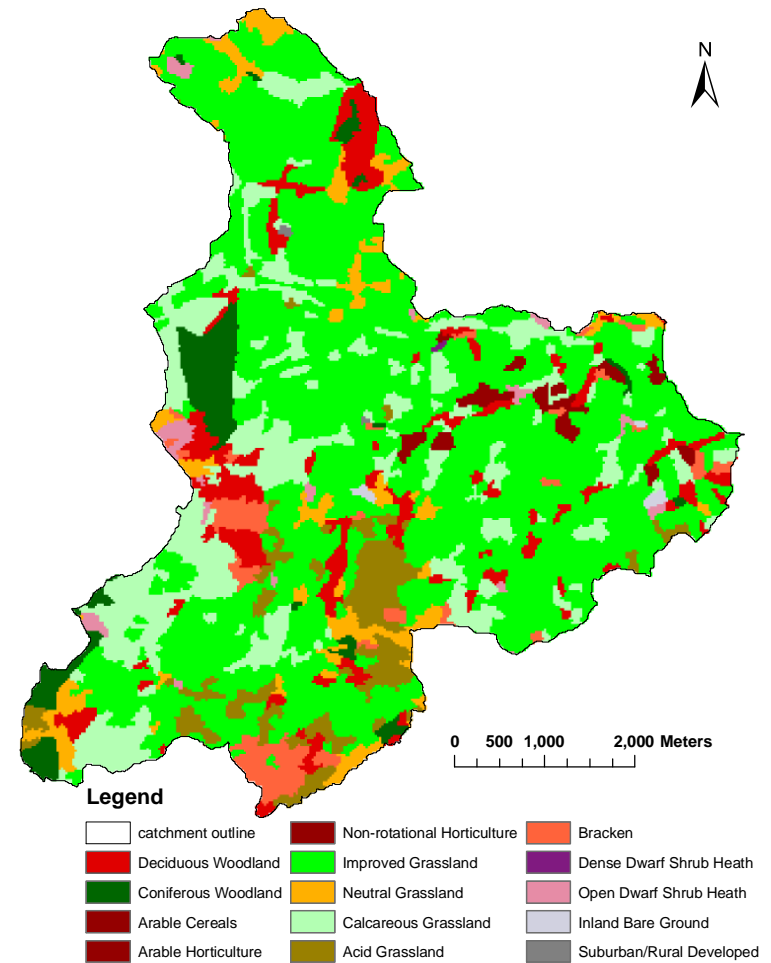
**Figure 2.7 Simplified bedrock geology of the Dacre Beck**  
*(Derived from geology maps from Edina Digimap by the BGS)*



**Figure 2.8 Superficial deposits of the Dacre Beck catchment**  
*(from Edina Digimap by the BGS)*



**Figure 2.9 Soils of the Dacre Beck catchment**  
 (data from NATMAP 5000 provided by LandIS, Cranfield University)



**Figure 2.10 Land Cover Map of the Dacre Beck catchment**  
 (Land Cover Map 2000, Centre for Ecology and Hydrology)

The typical brown earths which cover most of the northern edge of the catchment are common brown soils found at elevations below 300m and are usually in agricultural use.

The typical brown podzolic soils located mostly at the highest elevations of the catchment are dark soils rich in aluminium and organic matter. These soils usually form under natural or semi-natural vegetation.

The raw oligofiborous peat soils found in the south-west of the catchment, overlying the peat superficial deposit are undrained organic soils that accumulated under waterlogged conditions, and that have remained wet to within 20cm of the surface since their formation.

The lithomorphic humic ranker in the south-east corner of the catchment are non-calcareous shallow soils, formed over bedrock with a peaty topsoil.

These soil units show that a large part of the catchment has waterlogged soils for at least one season of the year however, apart from the peat soils in the south-west, these soils will all potentially become dry in periods of little rainfall. The map also shows the influence that elevation has in determining the local soil type.

## **2.5 Land-Use**

The land-use of the catchment also has an important effect on its hydrological response. Through variations in the structure of the catchment surface, as well as local influences on water cycling, land cover can cause dramatic alterations in the hydrological regime. Vegetation differences such as grasslands and coniferous woodlands, as described in chapter one, can alter the evaporation, evapotranspiration and infiltration rates of the surrounding area. Similarly, whether the land is naturally vegetated or under intense farming, or indeed is urban has a profound effect on infiltration and catchment runoff.

### **2.5.1 Agriculture**

Under its natural land cover, the Dacre Beck catchment would be entirely forested, but it was cleared in the middle ages for agriculture, leaving the majority of the catchment as improved grassland. To emphasise the proportion of agriculture in the region, the River Eden catchment as a whole is 95%

agricultural, with urban land covering just 1% of the catchment area (Environment Agency, 2009a). The upland areas of the Dacre Beck catchment are mostly sheep farms as sheep cope better with the steep and rough terrain, and are also more resilient to overwintering out on the hillslopes. In contrast the lowland areas, north of the Mell Fells are mostly dairy and beef cattle farms. These farms are more intensive than the sheep farms, and are more susceptible to heavy compaction on the soils. There are also currently two chicken farms in the catchment, one at Hutton and one in the far north of the catchment.

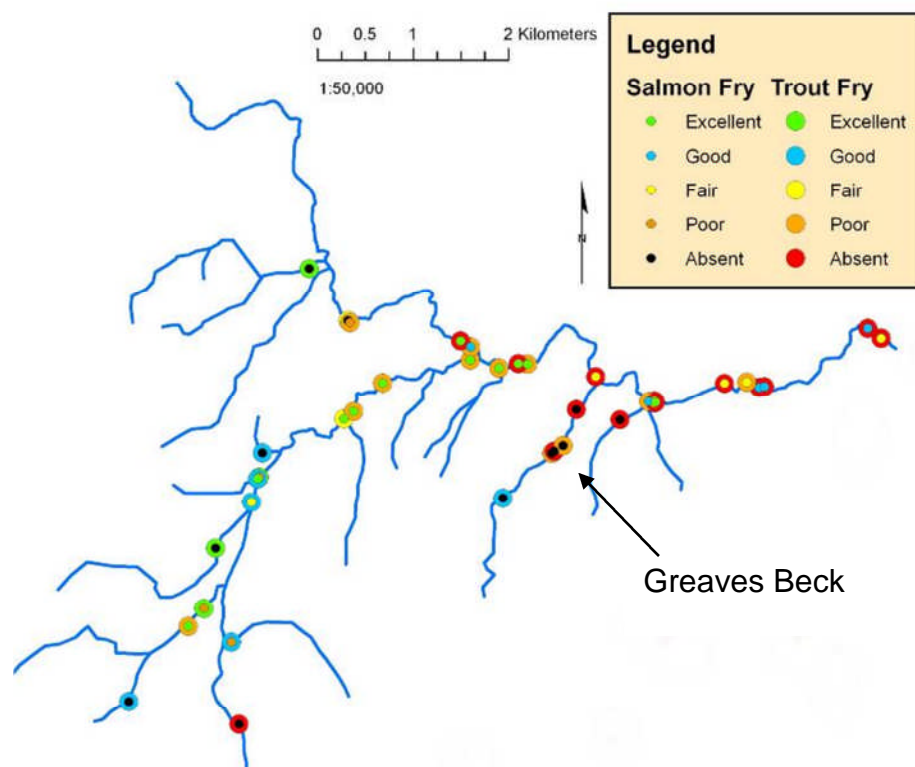
### **2.5.2 Land Cover**

The vast majority of the Dacre Beck catchment is under agricultural use, as shown in figure 2.10 which shows the Centre for Ecology and Hydrology's (CEH) Land Cover Map 2000. From this the catchment can be broadly categorised to have four major land cover types: coniferous woodland, deciduous woodland, natural grassland (calcareous, neutral and acid) and improved grassland. The other land covers that cover a relatively small area in the catchment are arable land, bracken, heath-land, bare soils and urban areas. The majority of the catchment is under improved grassland, with patches of natural grassland among it. There is quite a large expanse of acid grassland on Little Mell Fell, whilst Great Mell Fell is mostly deciduous woodland and calcareous grassland. There is a large conifer plantation just north of Great Mell Fell that has been planted over the past decade. The largest expanses of bracken appear to be at high elevations atop Great Mell Fell, and in the far south-east of the catchment. Arable land and horticulture are exclusive to areas very close to the river banks in the lowland catchment to the north-east. A table of the percentage area of the catchment under each land cover classification is given in table 5.1.

## **2.6 Ecology**

The lower section of the Dacre Beck, northwest of Hutton, is designated as part of the River Eden and tributaries Site for Special Scientific Interest (SSSI). However, the SSSI is currently classified by Natural England as being in an

unfavourable condition due to fertiliser use, invasive freshwater species, overgrazing, and water pollution from both agricultural runoff and from discharges (Natural England, 2011). Alternatively, under the Water Framework Directive, the Dacre Beck has been classified as being of Good Ecological Status, due to its positive fish records and high invertebrate numbers. Electrofishing survey by the Eden Rivers Trust have found juvenile Atlantic Salmon and Brown Trout throughout the catchment, with Dacre Beck supporting good to excellent fry populations (figure 2.11). Salmon are found to spawn high up in the headwaters of the Dacre Beck catchment, which is exceptional and trout are found in several of the smaller tributaries (Eden Rivers Trust, 2010). In general though, trout dominate the headwaters, whilst salmon dominate lower downstream. A notable exception to the generally productive status of the Dacre Beck is Greaves Beck which was noted during the survey as being '*visibly impacted by stock*' (Dugdale, 2010).



**Figure 2.11 Salmon and Trout Fry Density Results 2002-2009 for the Dacre Beck**

Surveys have also recorded the presence of Eels, Lamprey, Bullhead, Stone Loach, Minnows and Stickleback in the Dacre Beck. There are also historic

records of White-Clawed crayfish in the lower reaches of the beck (Dugdale, 2011 per. comm.). Salmon, Trout, Lamprey, and White-Clawed Crayfish are designated species under the EU Habitats Directive, and are designated as Biodiversity Action Plan Species.

## **2.7 Potential for Research and Current Projects**

The location of Dacre Beck in North West England has been identified as an area of the UK that is likely to experience dramatic climatic change; with central estimates of annual temperature change for a high emissions scenario reaching +5°C by 2080, and summer precipitation decreasing by 30% in the same scenario (DEFRA UK Climate Projections, 2011). The upland nature of the catchment along with its largely impermeable geology give it a flashy hydrological regime, which Arnell (2003) and Young *et al.* (2000) described as being the most vulnerable catchments to changes in precipitation and temperature, particularly with low flows.

The Dacre Beck sub-catchment is part of the Defra Eden Demonstration Test Catchments Project, and has been identified by the Adaptive Land Use for Flood Alleviation (ALFA) project as a catchment within the Eden that is worth considering for future management efforts. This research in the catchment means that the knowledge base of the catchment is fast increasing, the area is fairly well instrumented, and that many research and governing bodies are interested in the results of studies in this region.

## **2.8 Summary**

The small area (37km<sup>2</sup>) of the catchment is ideal for this study as the impacts of land-use activities on hydrological processes can only be verified at smaller scales (up to some tens of sq kilometres) where they can be distinguished from natural processes and other sources of degradation (Food and Agriculture Organisation, 2000). The flashy nature of the catchment is also beneficial for studies using hydrological modelling as response to rainfall is fast, and there is little groundwater influence in the river flow. This allows for short timescale studies of a year or so without neglecting the usually lengthy process of



groundwater flow contribution. The ecological status of the river also suggests that there are many valuable species living there that could potentially be suffering from high concentrations of fertilisers and sediment in the river. This issue will be being exacerbated by extreme low flows discharges in the summer. As the catchment is predominantly improved grassland, there is a definite need for land management. There is scope for some areas of the catchment to be reverted to other, more natural, vegetation types; or for the agricultural land to be managed to increase soil storage capacities across the catchment. Therefore, the benefits of management scenarios such as this on the flashy hydrological regime of the Dacre Beck catchment will be assessed within this project.

# Chapter Three:

*Methods*

### **3.1 Introduction**

This chapter covers the methods used to answer the three research questions consecutively. The first section of this chapter (3.2) describes the hydrological model chosen to simulate the Dacre Beck catchment for the majority of the research objectives, and will outline the methods involved in the uncertainty analysis and calibration of the model. The second section (3.3) describes how changes in land-use were considered using fieldwork and modelling simulations. Finally, the methods used to assess the potential for simultaneous flow management solutions (3.4) will be specified.

### **3.2 Hydrological Modelling of Low Flows**

As discussed in Chapter One, hydrological modelling provides a means of testing scenarios of catchment change, without the risk of physically based studies. They also allow for larger scale and extreme scenarios testing which wouldn't be possible with field based methods. Fully distributed, physically based models are currently the most complex and advanced hydrological models (Jones, 1997), which seek to simulate the interactions of several hydrological processes within an accurate spatial context (Beven and Freer, 2001a). It is this sort of model that was chosen to simulate the Dacre Beck catchment, the Connectivity of Runoff Model (CRUM3). The justification of this choice of model is given in Chapter Four, section 2.

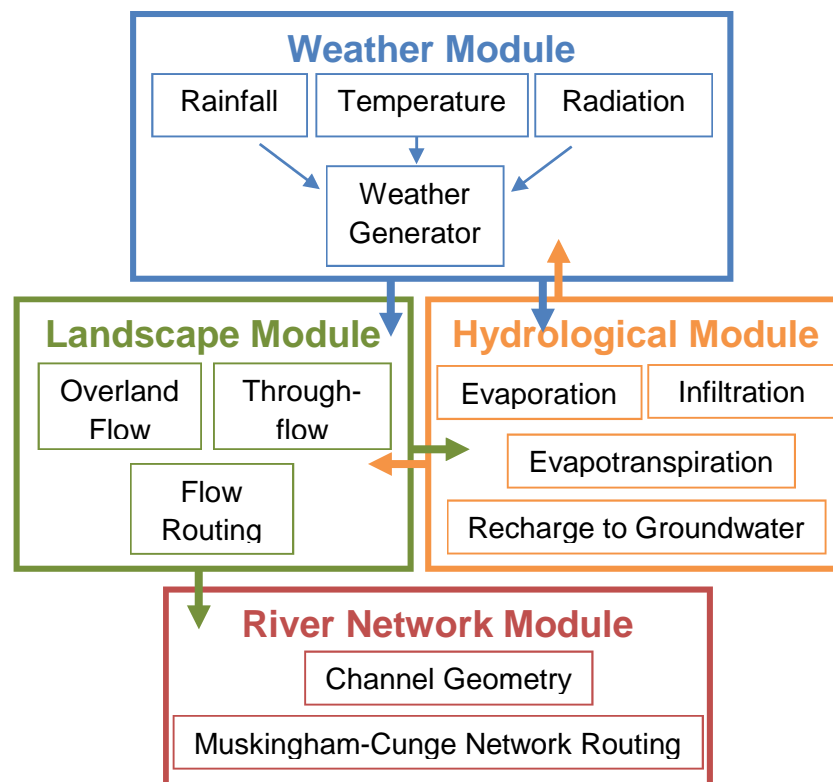
### **3.3 The Connectivity of Runoff Model**

CRUM3 is a fully distributed, object-orientated, process-based hydrological model developed in C++ by Dr. Sim Reaney of Durham University. It requires a minimal parameter set which allows simulations of many UK catchments using river flow data available from the Environment Agency and Met Office weather data from the British Atmospheric Data Centre (BADC). The model was developed with the intention of addressing questions regarding the impacts of climate change and land management upon hydrological extremes and water quality (Lane et al., 2009) thus making it ideal for this study. The model has been used academically for studies in south-east Spain (Reaney et al., 2007;

Reaney, 2008) as well as in the UK in the River Rye catchment, North Yorkshire (Lane et al., 2009) and more recently in the Dacre Beck catchment itself (Baugh, 2010; Pattison, 2010).

### 3.3.1 CRUM3 Structure

The structure of CRUM3 can be divided into four main process modules: weather, hydrological, landscape and river channel, as shown in figure 3.1.



**Figure 3.1 Structural Representation of the CRUM3 model**

#### 3.3.1.1 Weather

Despite the resolution of the majority of weather records being at the daily level, CRUM3 has the ability to output per-minute discharge predictions. It does this using a stochastic weather generator, based on the approach used by Mulligan (1996). The generator takes daily rainfall totals from a tipping bucket rain gauge and uses a Monte Carlo model to reproduce random storms throughout the day, totalling the observed rainfall volume. Daily minimum and maximum temperature are also required by the weather module, which are interpolated into per-second temperatures using:

$$T_{a(s)} = \frac{\sin\left(\frac{d_s + td + (12 \times 60 \times 60)}{4 \times 60 \times 60} + 1\right)}{2} \times (t_{max} - t_{min}) + t_{min}$$

(EQ1)

where:

$T_{a(s)}$  is current air temperature (per second),

$d_s$  is the current second of the day,

$td$  is the time between midday and the maximum temperature occurring,

$t_{max}$  is the daily maximum temperature, and

$t_{min}$  is the daily minimum temperature.

Soil temperature is related to air temperature by:

$$T_s = a \times t_a + b$$

(EQ2)

where:

$T_s$  is the soil temperature,

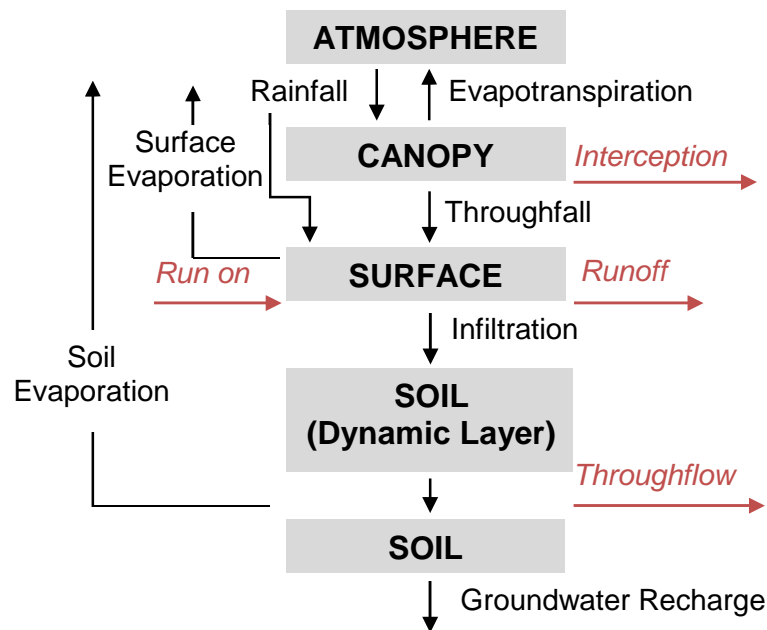
$t_a$  is the air temperature, and

$a$  and  $b$  are coefficients parameterised from observed data (Lane et al., 2009).

The model also uses the start day of the year and the latitude of the catchment to calculate the solar radiation throughout the year. The daily rainfall record, as well as daily minimum and maximum temperature records have been obtained from the British Atmospheric Data Centre (BADC) record of a gauging station at Newton Rigg. Although just outside of the Dacre Beck catchment, the Newton Rigg station has been chosen over the station at Hutton due to its longer and more reliable rainfall record, and the availability of temperature data from the same site which are not recorded at the gauging station at Hutton. For the purpose of this study, concentrating on low flows, each individual storm peak does not need to be accurately predicted, making this weather generator an ideal resolution to an important scaling issue. In this study, an output time step of 15 minutes was used to correspond with the 15 minute resolution discharge records available from the Environment Agency.

### 3.3.1.2 Hydrological Processes

Figure 3.2 shows a conceptual diagram of the hydrological process representation of CRUM3. Rainfall, as calculated by the weather generator either falls directly onto the surface or is intercepted by the vegetation, which is controlled by the canopy gap fraction, vegetation height, vegetation growth rate and interception depth. Water that is intercepted fills the canopy store which once full is either evaporated or drains to the surface as throughfall. Water that is intercepted fills the canopy store which once full is either evaporated or drains to the surface as throughfall.



**Figure 3.2 Conceptual diagram of the hydrological processes of CRUM3**

*Processes outside of the one dimensional module are shown in red italics (after Reaney, et al. (2007)).*

CRUM3 has two available methods of calculating potential evapotranspiration, the Penman-Montieth (Penman, 1948; Monteith, 1965) and the Priestly-Taylor (Priestley and Taylor, 1972) methods. The Penman-Monteith method is the more advanced and preferred method; however it is very data intensive, requiring temperature, relative humidity, wind speed, solar radiation, and vegetation characteristics (Dingman, 1994). As this is not available for the Dacre Beck catchment, the Priestly-Taylor method was selected for use in this study, as below:

$$PET_{PT} = \frac{\alpha_{PT}\Delta(R_n - G)}{\Delta\gamma} \quad (EQ3)$$

where:

$PET_{PT}$  is the potential daily evapotranspiration,

$\alpha_{PT}$  is the Priestly-Taylor constant of 1.26 (Jensen et al., 1990),

$\Delta$  is the slope of the saturation vapour pressure temperature relationship,

$R_n$  is the net radiation,

$G$  is the soil heat flux, and

$\gamma$  is the psychrometric constant.

Net radiation, which plays a very important role in controlling potential evapotranspiration rates, is determined by the amount of energy arriving at the top of the atmosphere and subsequently the amount of energy that reaches the Earth's surface. The amount of energy arriving at the top of the atmosphere is dependent on the Earth-Sun geometry and the amount that reaches the Earth's surface is less than this due to scattering. The amount of scattering depends on the depth of the atmosphere, and the local weather conditions. Of these local weather conditions, cloud cover is considered to have the most influence (Dingman, 1994), and the model uses the relationship in equation 4 to determine the reduction on energy receipt on a cloud free day due to scattering.

$$R_{ES} = R_{TA} \times 0.5 \quad (EQ4)$$

where:

$R_{ES}$  is the amount of solar radiation reaching the Earth's surface, and

$R_{TA}$  is the amount of solar radiation at the top of the atmosphere.

The amount of solar radiation reaching the Earth's surface is reduced by 50% on days determined to have cloud cover, which are all rainy days, and a selection of non-rainy days determined using a Monte Carlo model. Once the radiation has reached the Earth's surface, it can then be either directly reflected, or reflected as long wave radiation. The amount directly reflected is determined by the albedo of the surface, given by:

$$r_{sw} = R_{ES} \times a$$

(EQ5)

where:

$r_{sw}$  is the reflected short wave radiation, and  
 $a$  is the surface albedo.

The amount reflected as long wave radiation is determined by the surface emissivity and the temperature by:

$$r_{lw} = e_{ms} \times (5.6696 \times 10^{-3})(T_a + 273.15)^4 \quad (EQ6)$$

where:

$r_{lw}$  is the reflected long wave radiation,  
 $e_{ms}$  is the surface emissivity, and  
 $T_a$  is the air temperature (°C).

The remainder of the total solar radiation reaching the surface, after long and short wave radiation have been reflected, is free to drive the evapotranspiration process.

Evapotranspiration occurs from several stores in the hydrological module, and determining the amount of actual evapotranspiration from the potential evapotranspiration is difficult (Lane et al., 2009). CRUM3 evaporates water in the following order: (1) water on the vegetation; (2) transpiration; (3) water on the soil surface; and (4) water in the soil. The rate of evapotranspiration from intercepted water and surface detention storage is at the same rate as the potential rate. Potential transpiration rates are determined by Scott (2000):

$$t_p = PET_{pT} \times (-0.21 + 0.7^{LAI}) \quad (EQ7)$$

where:

$t_p$  is the transpiration rate,  
 $PET_{pT}$  is the potential evapotranspiration rate, and  
 $LAI$  is the Leaf Area Index.

Actual transpiration rate is related to the rooting depth of the vegetation and the availability of water within the dynamic layer and the main soil store. The



amount of water available for evaporation from the soil is limited by the retention characteristics of the soil, by:

$$e_{\theta} = PET_{PT} \times \theta \quad (EQ8)$$

where:

$e_{\theta}$  is the soil moisture dependent evaporation rate,  
 $PET_{PT}$  is the potential evapotranspiration rate, and  
 $\theta$  is the soil moisture content (Lane et al., 2009).

It is important to understand these processes of evapotranspiration as they are largely controlled by the vegetation through albedo, vegetation height, vegetation growth rate etc., and so will be one of the processes within the catchment expected to change dramatically with changes in land-use.

The detention and depression stores represent water stored on the soil surface. The detention store refers to water held above the surface, while the depression store retains water within the troughs of the surface due to roughness. The depth of the surface depression store is determined from surface slope and roughness, using the relationship of (Kirkby et al., 2002):

$$\frac{dp}{\alpha} = 0.11 \exp\left(\frac{-0.02\beta}{\alpha}\right) \quad (EQ9)$$

where:

$dp$  is the surface depression storage capacity (mm),  
 $\alpha$  is the surface roughness, and  
 $\beta$  is the slope gradient (Reaney et al., 2007).

The value for  $\alpha$  can be related to the random roughness coefficient ( $RR$ ) (Allmaras et al., 1966) by:

$$RR = 0.657\alpha \quad (EQ10)$$

Infiltration is an important process, as it controls whether the water is routed vertically down through the soil, or horizontally as runoff. Soil structure is the

principal control on infiltration rates, with particle size, porosity, bulk density and organic matter influencing water's ability to flow through it. Saturated hydraulic conductivity also drives infiltration as it controls the ease at which water flows through the soil (Dingman, 1994). CRUM3 uses a soil moisture storage based simplification of the Green and Ampt (1911) equation to calculate infiltration, developed by Kirkby (1975; 1985):

$$i_t = a + \frac{b}{\theta} \quad (\text{EQ11})$$

where:

$i_t$  is the infiltration rate,

$\theta$  is the soil moisture, and

$a$  and  $b$  are coefficients.

Runoff in CRUM3 can be generated by infiltration excess (Hortonian), as saturated overland flow (through the saturation of either the dynamics layer or the full soil column) or as return overland flow. Infiltration excess flow overland flow occurs when the rainfall is greater than the infiltration capacity of the soil. This is often caused by a heavily compacted top layer of the soil known as 'capping' or when there has been a long period of dry weather causing 'baking' of the soil (Food and Agriculture Organisation, 2000). Here, the soil will infiltrate the water at its maximum rate, and the rest of the rainfall will be routed as runoff. In the case of saturated overland flow, the soil is saturated and no more water can be infiltrated into the soil, causing of the rainfall to be routed as runoff. Return overland flow occurs when water routed to a cell within the model exceeds the storage capacity of the cell causing water to overflow out of the cell (Lane et al., 2009).

The soil depth plays a large role in the amount of water that can be infiltrated, and hence the hydrological routing of water around the catchment within the model. Soil depth has been shown to be related to the geomorphological form of the landscape (Huggett and Cheesman, 2002) and thus in CRUM3 the surface topography of catchments are categorised into ridges, slopes, channels and plains, with soil depths normally assigned in the structure:

Channels > Plains > Ridges > Slopes

Recharge to groundwater is determined by the minimum hydraulic conductivity at the base of the soil store and the hydraulic conductivity of the bedrock (Lane et al., 2009).

### 3.3.1.3 Landscape

CRUM3 uses spatial information in the form of raster grid structures. Each model cell generates and receives water laterally via run on/runoff (overland flow) and throughflow (figure 3.3).

Overland flow, as mentioned previously, can occur as infiltration excess, saturation excess or return overland flow. Overland flow may be laminar, transitional, turbulent, or any combinations of the three (Abrahams et al., 1986). Therefore, the model uses the Darcy Weisbach equation to describe flow conditions (Baird, 1997):

$$v = \sqrt{\frac{8gRs}{ff}} \quad (\text{EQ12})$$

where:

$v$  is the velocity of the overland flow,

$g$  is the gravity constant,

$s$  is the slope of the energy gradient, and

$ff$  is the friction factor (Abrahams et al., 1992).

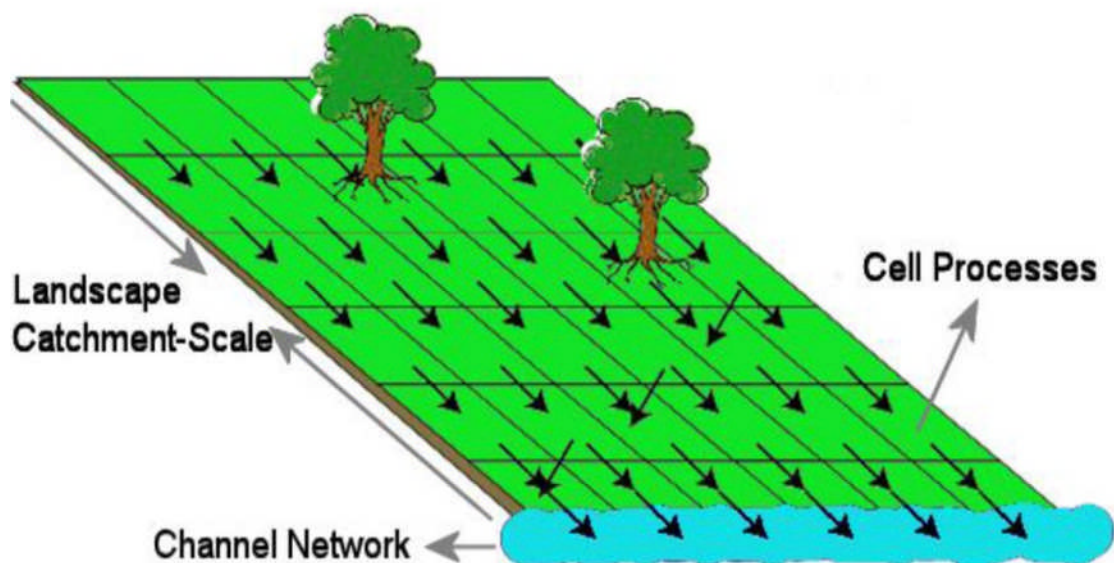


Figure 3.3 Schematic of the landscape module structure

Routing of overland flow within the model is calculated using the FD8 algorithm (Quinn et al., 1991). Unlike single flow routing of D8 (O'Callaghan and Mark, 1984; Band, 1986; Morris and Heerdegen, 1988), FD8 allows water to flow from one cell to multiple others, and vice versa as shown in figure 3.4, therefore enabling the model to represent both flow dispersion, and flow concentration. On hillslopes, flow is distributed to all of the lower neighbouring cells. The amount assigned to each cell is determined on a slope-weighted basis (Freeman, 1991; Quinn et al., 1991) by:

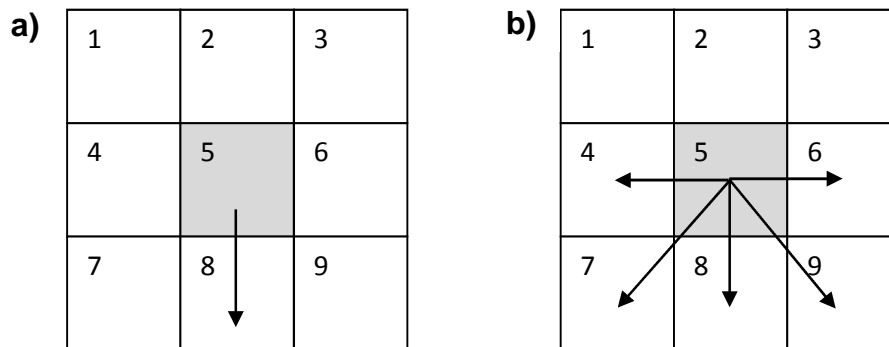
$$F_i = \frac{\beta_i^v}{\sum_{i=1}^8 \beta_i^v} \quad (\text{EQ13})$$

where:

$\beta_i$  is the slope from the central cell to neighbour  $i$ , and

$v$  is flow concentration factor (a positive constant).

The greater the value of  $v$ , which is recommended to be between 4 and 6 for distributed modelling, the greater the flow concentration (Holmgren, 1994).



**Figure 3.4 Methods of flow routing** a) single flow routing (D8); b) multiple flow routing (FD8). After Pattison (2010).

Throughflow represents the subsurface transfer of water between cells, which within the model occurs solely in the saturated zone, as flow within the unsaturated zone is considered insignificant. The amount of throughflow in the saturated zone is determined by Darcy's Law:

$$tf_v = wt \times y \times K_d \frac{dh}{dx} \quad (\text{EQ14})$$

where:

$tf_v$  is the throughflow volume per second ( $m^3 s^{-1}$ ),

$wt$  is the height of the water table above the bedrock (m),

$y$  is the width of the routing facet (m),

$K_d$  is the soils conductivity at the water table depth ( $m s^{-1}$ ),

$h$  is the hydraulic head (m), and

$x$  is the horizontal distance between model cells (m).

Soil conductivity at the depth of the water table is defined as:

$$K_d = K_{sat} \exp\left(\frac{-d}{dc}\right) \quad (EQ15)$$

where:

$K_{sat}$  is the soil saturated conductivity,

$d$  is the water table depth, and

$dc$  is the decay factor for the change in conductivity with depth.

#### 3.3.1.4 River Channel

Within the channel network, movement of water is modelled using the Muskingham-Cunge model (Ponce and Lugo, 2001). River reaches are associated with landscape cells and receive inflow from overland flow and throughflow. A reach may be connected to an abstraction or discharge to other channels in the network (Lane et al., 2009). The outflow from a reach is determined by:

$$Q = (C_0 \times U) + (C_1 \times U_1) + (C_2 \times Q_1) \quad (EQ16)$$

where:

$Q$  is the current discharge,

$Q_1$  is the discharge from the previous time step,

$U$  is the inflow from the upstream reach,

$U_1$  is the inflow from the upstream reach from the previous time step, and

$C_0$ ,  $C_1$ , and  $C_2$  are routing coefficients (see (Lane et al., 2009) for further details).

### **3.3.2 Data Requirements**

CRUM3 requires weather data and spatial information as inputs into the model. Also where available, discharge data from the catchment outflow is useful for model validation. The weather data required is in the form of daily precipitation as well as minimum and maximum temperature. This data was acquired from the British Atmospheric Data Centre (BADC), the National Environment Research Council's Designated Data Centre for the atmospheric sciences. The BADC website contains daily to hourly climatological data for the UK, with 54 Met Office MIDAS stations within the Eden catchment. The CRUM3 weather generator then simulates daily storms from the daily precipitation data to form a per minute time series. This per minute time series is then used to generate a set of variable time steps with the length of the time step being inversely proportional to hydrological activity (shorter time steps during storm events). This detailed temporal structure is required because the hydrological processes of runoff generation, transmission and connectivity occur on these timescales. The model is also able to output discharge data on a 15 minute time step, the flow duration and low flow event statistics can then be compared with the 15 minute observed discharge records available from the Environment Agency. However, a direct comparison at the 15 minute level is not possible because of the difference in storm placement during the day from the stochastic weather generator. Within the Dacre Beck catchment, the discharge record is sited at Dacre Bridge, and the record spans from August 2000 to present. This is one of the shorter records available from the Environment Agency, as some locations in the Eden catchment reach as far back as 1959.

In the development of this project, to assess the impacts of land use change on extreme flows in the Dacre Beck catchment, it was decided that the hydrological year 2009-2010 was the most recent year that demonstrated good examples of both flood events and drought seasons (as shown in figure 2.6). Therefore, this project will simulate the catchment behaviour in this time one year time period, looking closely at the extreme flow events. Once it was decided that this year was going to be studied, the BADC MIDAS weather station at Hutton in the Dacre Beck catchment was thought to be the best to use as it is the only station within the catchment. However, the record at this site did not extend into 2010,

and so other stations in the area were considered. Newton Rigg was the nearest station at a similar elevation to Hutton (see locations in figure 2.1), and the record was similar enough in 2009 where data was available for comparison that it was decided that the Newton Rigg record would be used for the entire hydrological year for consistency.

### **3.3.3 Sensitivity Analysis**

Sensitivity analysis is an integral part of the modelling process (Saltelli et al., 2000). With fully distributed models such as CRUM3, which have a large number of model parameters, sensitivity analysis can determine which processes have the most influence on the catchment hydrological behaviour (Castaings et al., 2009). This preliminary assessment can ease calibration (Crosetto et al., 2000) as it demonstrates which parameters dramatically influence the model outputs, and conversely which have little effect, allowing for a more targeted approach to calibration. Each model parameter is given an upper and lower bound which can be determined from the literature, and values are then sampled uniformly within this range whilst maintaining all other parameters at a base value. Further analysis can be carried out by varying more than one parameter at once. An objective function or a statistical function of the hydrograph, such as the maximum or minimum discharge, is then chosen to assess effect of the parameter perturbation on the model output. This is done by plotting a response surface of the objective function against the differing values of the parameter. When more than one parameter is adjusted, these plots become multi-dimensional. A sensitive parameter will show a large difference in the model output, whilst an insensitive parameter will have little effect. A full description of the process undergone to perform the sensitivity analysis of the CRUM3 model within the Dacre Beck catchment follows in chapter 4.

### **3.3.4 Generalised Likelihood Uncertainty Estimation (GLUE)**

Following sensitivity analysis, methods of uncertainty estimation are also fast becoming an essential process in modelling projects. With results often being used to implement management decisions, the uncertainties inherent in model predictions and projections need to be made explicit. Errors in initial and

boundary conditions, the calibration data and in the model itself, all tend to introduce uncertainty in the model predictions that should be assessed (Beven, 2004). Recently, the concept of equifinality within models has revolutionised perceptions of model calibration. Equifinality is the idea that more than one model structure or combination of model parameters (model realisation) can lead to the same strength of model performance (e.g. (Beven, 2006). Some more recent uncertainty techniques have developed this idea and base their methods on the statement that there is no one optimum model parameter set, but rather an ensemble of acceptable ('behavioural') model structures (Beven, 2006).

A popular example of this approach to model assessment is the Generalised Likelihood Uncertainty Estimation (GLUE) technique, developed by Beven and Binley (1992). The GLUE technique uses Bayesian estimators to evaluate the likelihood that differing combinations of model parameters are good predictors of the catchment behaviour (Wainwright and Mulligan, 2004). Usually, the Monte Carlo method is used to randomly sample a huge number of parameter combinations (several thousand to millions of combinations) which are then assessed by an objective function, as with sensitivity analysis. An informal likelihood measure is used to weight the behavioural models whilst rejecting the non-behavioural ones. All of these good parameter sets will give different predictions, but if we associate a measure of belief with each set of predictions (highest for optimum, zero for models that have been rejected) then we can estimate the resulting uncertainty by weighting the predictions of all the acceptable models by their associated degree of belief (Beven, 2004). This way any subsequent model runs use the ensemble of behavioural models and weight the results accordingly to give the best possible predictions and projections. The exact methods used to perform GLUE analysis in this project will be detailed in Chapter 4.

### **3.4 Studying Land Use Change**

The effects of land use change on catchment hydrology can be studied in a variety of ways, as outlined in Chapter 1. Popular methods include modelling



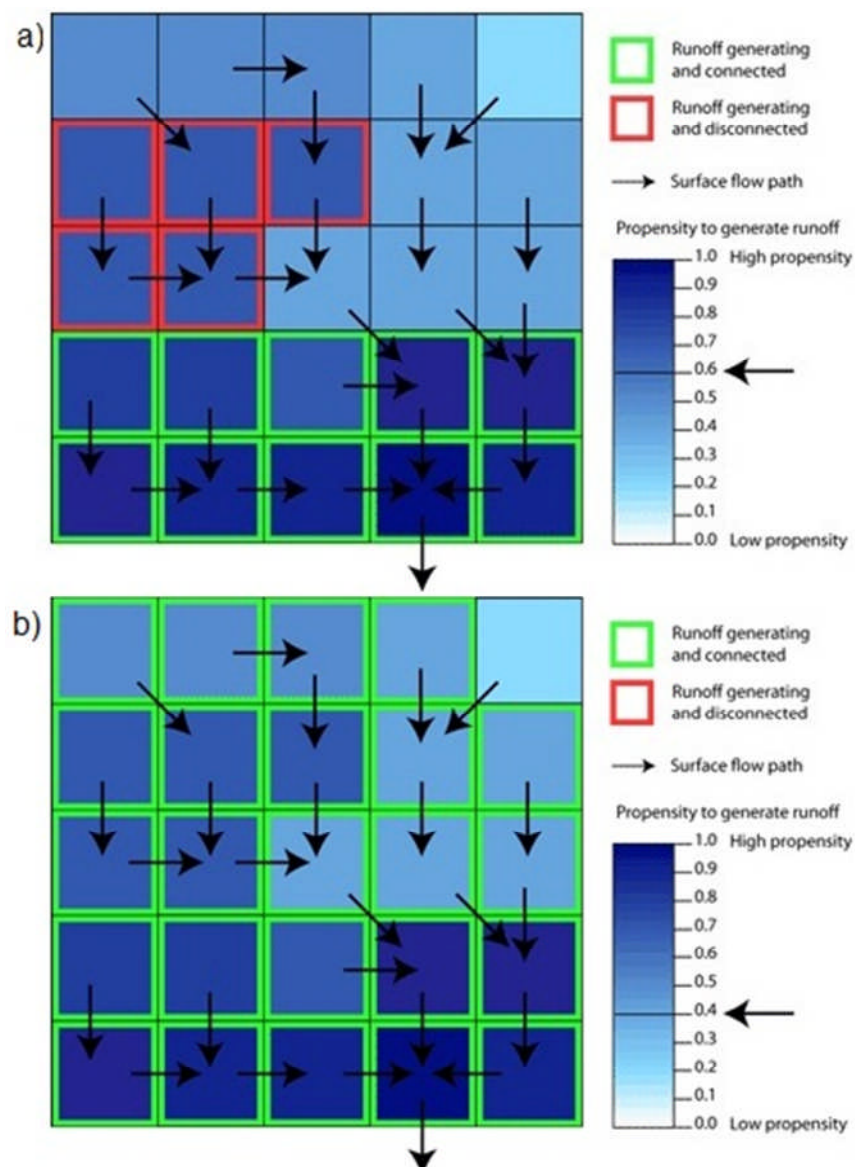
the catchment and simulating changes in land cover, as well as complex field studies which often compare two hydrologically similar catchments. The first part of this study will utilise the hydrological model CRUM3 to simulate large scale land cover changes, whilst the second part will look at smaller, field scale variations in hydrological behaviour due to land management using a rainfall simulator.

### **3.4.1 Vegetation Change in CRUM3**

Once sensitivity analysis and GLUE analysis have been used to assess the performance of CRUM3 in modelling low flows, the model can be used to simulate changes in catchment land cover. Spatial information on the current land cover was obtained from the Centre for Ecology and Hydrology in the form of a land cover map. The most up to date available version of this information at the time of the analysis was the Land Cover Map 2000, shown in figure 2.10. This map was re-classified (as described in chapter 5) into 9 land covers: deciduous woodland; coniferous woodland; natural grassland; improved grassland; arable land; bracken; heath; bare ground and developed land. The effects of land cover changes on the catchment hydrology were then simulated by creating different land cover maps for inclusion in the hydrological model runs. Each land cover was researched to determine values of land cover and soil parameters included in the model such as albedo, vegetation height, soil porosity and saturated conductivity. To begin with, blanket changes in catchment land cover were modelled to assess model response, as well as to gain some extreme bounds on flood and drought discharge values. After this some more specific changes in land cover were simulated such as planting woodland on land over a certain slope value, and creating woodland or natural grassland buffer strips alongside the river channel.

The hydrological connectivity of the channels within the catchment was also determined to consider targeted approaches to land use change. Hydrological connectivity was predicted using the Network Index map produced by the Sensitive Catchment Integrated Modelling and Analysis Platform (SCIMAP) model (Lane et al., 2003). SCIMAP is a diffuse pollution model in nature, but this aspect of it utilises an integral risk model which determines the risk of an

area being hydrologically connected to rivers and streams. Hydrological connectivity describes the ease at which water moves through the landscape, in SCIMAP the probability of continuous flow from each point in the landscape to the river channel network is assessed (Lane et al., 2011). It is this part of the model that was used in this study. Reaney et al. (2007) and Lane et al. (2009) describe a method of conceptualising a catchment's connectivity as a series of points, each one of which can be seen as having either a connected or disconnected state at any one time.



**Figure 3.5 SCIMAP Connectivity Development** a) during light rainfall – some runoff generating areas remain disconnected; b) during heavier rainfall – previously disconnected runoff generating areas are connected via newly runoff generating areas.

[www.scimap.org.uk/connectivity](http://www.scimap.org.uk/connectivity) (Lane et al., 2011).

Figure 3.5a shows a conceptual landscape during a period of light rainfall. In this case, cells with a medium or high propensity to generate runoff become activated in the model, but not all active cells are connected, due to their flow path routing. If the rainfall were to become heavier (figure 3.5b) cells with a lower propensity to generate runoff would be activated, and previously disconnected cells may be given a route to become connected to the channel.

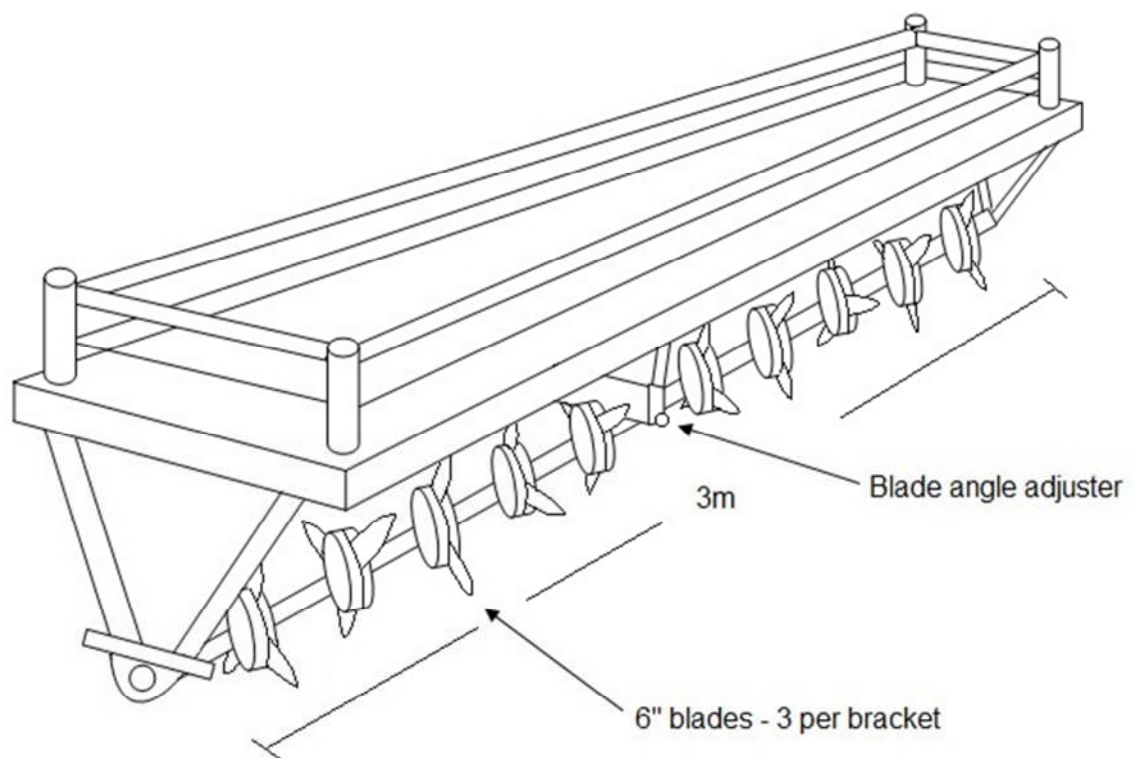
Therefore, during rainfall events, a greater number of points in the landscape will become connected, whilst after the rainfall event the landscape dries up and becomes less connected (Buckley, 2010). The likelihood of places to become connected is demonstrated by a network index; places in the landscape with a higher network index are likely to be connected for longer periods of time than places with lower network index values. These index values range from 0 to 1, as shown in figure 5.11. This map allowed for areas of above a certain network index to be identified as areas where changes in land use might have an especially influential impact on the catchment hydrological behaviour, and may potentially lead to hydrological disconnection.

### **3.4.2 *Compaction Levels and Soil Aeration***

It has previously been identified that compaction levels within the Eden catchment can have a dramatic effect on flood peaks (Pattison, 2010). By reducing the amount of water that can infiltrate into the soil, compaction can both heighten flood peaks and exacerbate low flows in drought periods. In the Dacre Beck catchment, much of the land use is improved grassland used as pastoral farmland. This means that practices such as the use of heavy machinery alongside the grazing of cattle and sheep are likely to be causing a significant reduction in the storage capacity of the soils. Two methods were used to assess the effect of soil compaction on the catchment hydrology in the Dacre Beck catchment; field work, and modelling scenarios.

Firstly, the influence of compaction on soil infiltration was assessed using a rainfall simulator and a soil aerator. Soil aeration is becoming a common farming tool on compacted grassland soils to help oxygen supply, intake of fertilisers, and infiltration of surface water, thus reducing runoff risks (Collings, 2009). Aeration has been identified as a tool for reducing the effects of

compaction in farmland areas and is a relatively simple and low cost operation. Figure 3.6 shows a basic diagram of a Ritchie Grassland Aerator<sup>®</sup>. The model of aerator used in these field studies was the 3 meter No. 863 model, with 18 brackets, each holding three 6 inch Boron blades. These blades produce parallel slits in the soil 6 inches deep, as shown in figure 3.7. The blades can also be rotated up to an angle of 10° using the adjuster screw; this helps shatter the compacted soil between the aerator slits as the blades penetrate and exit at an angle (Ritchie Agricultural, 2011). The adjuster screw works by angling the two rotors at the pivot point in the centre of the aerator, thus pushing the rotors into a subtle 'v' shape. Pivoting the blades to their maximum angle is recommended on semi-permanent or permanent pastures that experience heavy compaction. Water ballast tanks may also be fitted within the caging above the blades to ensure the blades penetrate the soil to their maximum depth.



**Figure 3.6 Schematic of a Grassland Aerator**

The soil compaction levels across the Dacre Beck catchment were originally intended to be assessed using a hand held mini-disc infiltrometer (Decagon Devices, 2011) as well as a penetrometer (PitchCare, 2011), however the

fieldwork required to sample enough different land uses with an adequate number of repetitions was ultimately regarded as beyond the scope of this study. Therefore, the immediate effect of the soil aeration on infiltration rates in fields was studied in order to determine the potential benefit of this practice.



**Figure 3.7** Photographs of the Ritchie Grassland Aerator© in use (left) and (right) the slits produced on the grassland surface immediately after aeration.

The fields used in the study were located just outside of the Dacre Beck catchment to the north of the Dalemmain estate, near Stainton. This location was ideal as the soils and geology remained consistent with the catchment and the elevation replicated the lowland areas of the catchment, where the majority of the intense cattle farming takes place. The owner of the land allowed access to water – this was important for the rainfall simulator, as will be discussed below. The first field has been used for sheep grazing with a low stocking density over the past decade, and so was considered to represent fairly low soil compaction. The second field however had been used for grazing horses with a high stocking density, and hence this field could be used to represent very high soil compaction.

The infiltration capabilities of the soils were studied using a rainfall simulator. This was chosen over the hand held mini-disc infiltrometer due to the size of the slits that would be produced by the soil aerator. The rainfall simulator covers a ground area of approximately 1.5m<sup>2</sup> while the mini-disc infiltrometer has a diameter of 4.5cm (Decagon Devices, 2011). Rainfall simulators allow for comprehensive infiltration studies as the exact amount of water inputted into

study plot is regulated and the amount of runoff can also be captured. Rainfall simulators currently exist in two designs: 'spray-type' simulators that spray water from a sprinkler nozzle under high pressure; and 'drip-type' simulators that gravitationally drip water from overhead apparatus (Bowyer-Bower and Burt, 1989). 'Spray-type' simulators more accurately simulate the intensity and drop size distribution than 'drip-type' simulators; however they require water pumps and constant access to huge amounts of water, as much of the water falls outside of the study plot (Bowyer-Bower and Burt, 1989). Rather than accurately replicate a natural rainfall event, this study required accurate measurements of the water inputs into the soil and a relatively constant evenly distributed rainfall simulation so it was decided that 'drip-type' simulation was preferable in this case.

The 'drip-type' rainfall simulator used is described in Bowyer-Bower and Burt (1989), Foster *et al.*, (2000) and Holden and Burt (2002) and is shown in figure 3.8. At the very top of the simulator sat two 25 litre containers, sealed with glass Mariotte tubes to release the air whilst maintaining a constant head. When the taps were switched on at these containers, gravity channelled water down through 10mm diameter plastic tubing and through the manometer (Figure 3.9). For more detailed rainfall simulation studies, the tap on this manometer can be used to adjust the rainfall intensity; such that the bigger the water level difference between the two glass tubes on the manometer, the higher the rainfall intensity. In this study, the tap was fully open during all experiments, allowing the greatest possible rainfall intensity. It was however a useful tool to ensure that there was high pressure throughout the system. Water was then taken through more tubing up into the Perspex drip chamber. This chamber was formed of two large sheets of 8mm thick Perspex, the top layer solid and the second layer containing a matrix of 627 (19x33) drop formers (Figure 3.10). These two Perspex sheets were set 8mm apart and sealed to form an air tight container. There was an air outlet in the opposite top corner to the water inlet, which was bunged once the chamber had filled with water. Once the system was air-tight, the water began to drip through the drop formers.

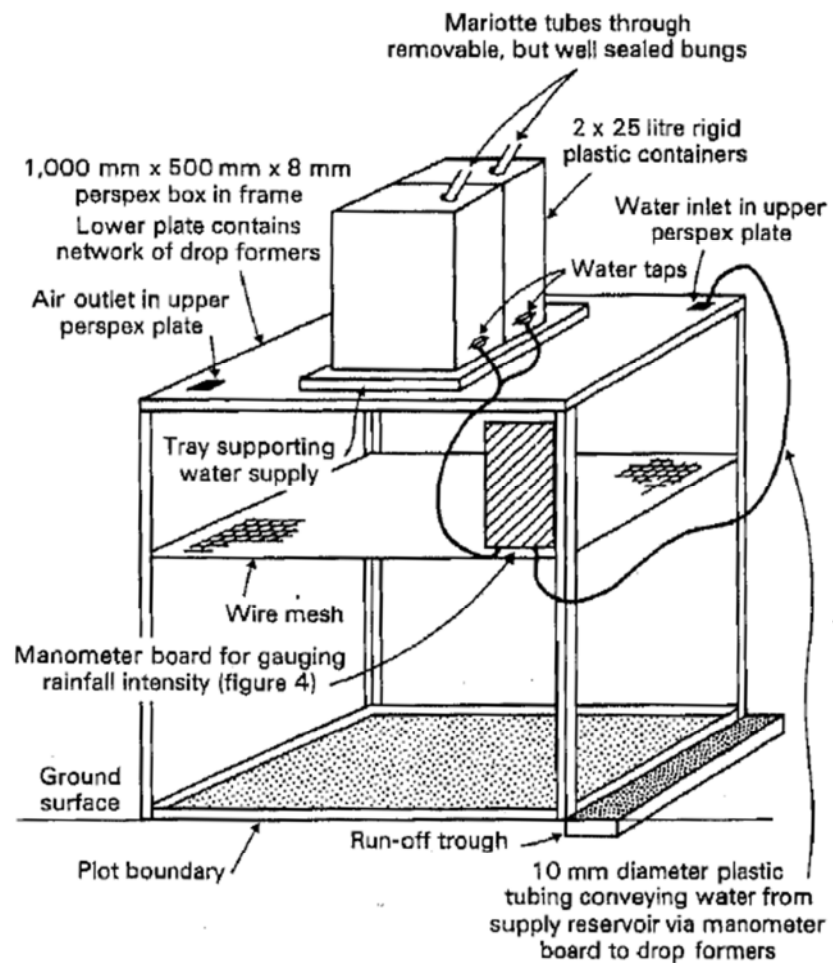


Figure 3.8 'Drip-type' Rainfall Simulator (Bowyer-Boyer and Burt, 1989).

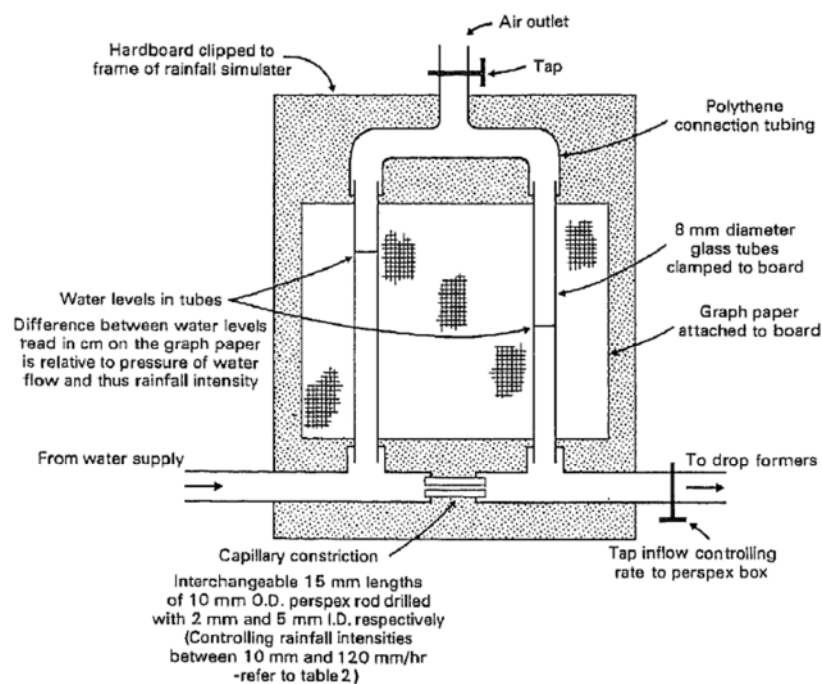
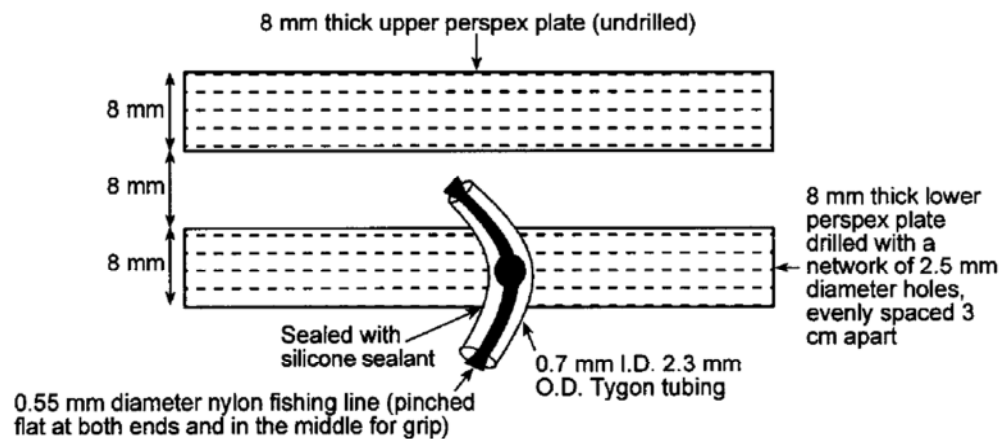


Figure 3.9 Manometer for the control of rainfall intensity (Bowyer-Bower and Burt, 1989)

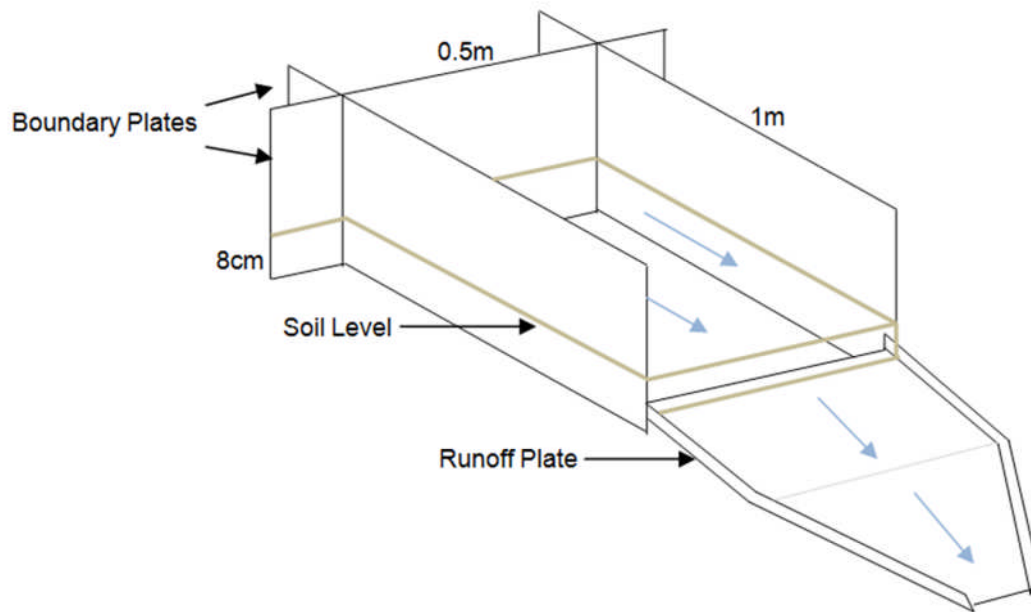


**Figure 3.10 Drop former design** (Holden and Burt, 2002).

These drop formers were 15mm lengths of 'Tygon' tubing with a 0.7mm inside diameter and a 2.3mm outside diameter. These were sealed into the 627 2.5mm holes in the lower Perspex plate. Through these Tygon tubes were threaded 25mm lengths of 0.55mm diameter nylon fishing wire pinched flat at each end to prevent them slipping out. Water entered the Tygon tubes from the chamber, and dripped off the end of the nylon fishing wire at a constant rate. Hung approximately 200mm off the bottom of the frame of this chamber was a 1000x1500mm wire mesh in order to break up the water drops into a distribution of drop sizes closer to that of natural rainfall. The dimensions of this mesh provide a strong control on the size of the droplets produced (Holden and Burt, 2002), so a 3x3mm mesh was used, following Bowyer-Bower and Burt (1989). These sections of the rainfall simulator were supported by a metal frame with 2m maximum legs which were adjustable for levelling the apparatus on uneven ground.

The ground section of the rainfall simulator consisted of three metal boundary plates and a runoff plate (figure 3.11). The two side boundary plates were 1.2m long and the back boundary plate was 0.9m long, slotted together leaving a plot of 1x0.5m with 20cm overlap outside the plot boundary. The boundary plates were buried 8-10cm into the ground in order to contain shallow throughflow. The front edge of the plot was then dug out to create space for the runoff plate. Again, the top edge of the runoff plate was inserted 8cm deep, pushed back a few centimetres so it sat underneath the front edge of the plot.





**Figure 3.11 Plot set up underneath the Rainfall Simulator**

The very front of the runoff plate was set deeper still to allow the runoff to flow toward the lip and pour into a collector dug deep enough to sit fully underneath the lip of the runoff plate. This set up allowed the rainfall simulator to rain into the plot, saturate the soil within the plot, and then for the runoff, and the shallow throughflow to be caught and measured by the runoff plate. The rainfall intensity was measured using a standard rain gauge placed within the plot.

Rain gauge and runoff measurements were taken every ten minutes to begin with, and more frequently as required as the runoff became stronger; so that ultimately a discharge per second could be calculated. It was necessary to measure the rainfall as the rainfall intensity was not constant, and that the pressure in the system decreased as the two containers drained. This could have been caused by a leak, or by loss of pressure through the container lids not sealing properly. Therefore the containers were topped up regularly to maintain high rainfall intensity, and this was factored into the results.

Once the results of the soil aeration were assessed, compaction levels in the Dacre Beck catchment were then simulated using the CRUM3 model. Soil parameters such as porosity, soil depth and saturated conductivity were available for perturbation within the model, allowing for a detailed analysis of how different compaction levels may influence the infiltration capacities of the

soils, and ultimately the river discharge. The results of the field studies were used to design compaction reduction modelling scenarios that gave insight into the potential effects of soil aeration application across the catchment. Full details of the model parameter values used to assess compaction are given in chapter 6.

### **3.5 Reaching a Simultaneous High and Low Flow Hydrological Management Solution**

During the model runs that will be used to assess the impacts of land use change on extreme low flows, both high and low flow statistical analyses will be carried out. In doing this, if land use management solutions are found that increase river discharge during extreme low flow periods, they can be revisited to consider their effect on high flow events. If any changes appear to be simultaneously beneficial to both extreme high and low flows, be it dramatically or only slightly, they will be considered in more detail in an attempt to determine some solutions that can be practically implemented within the catchment.

### **3.6 Summary**

A variety of methods were used in this study to examine whether land use change can be used to manage extreme low flows. Initially to determine whether modelling would be an appropriate tool for such a study, the capabilities of the fully distributed hydrological model CRUM3 were examined using Sensitivity Analysis and the Generalised Likelihood Uncertainty Estimation techniques. Next, the model was used to simulate land use changes within the catchment. The effects of these changes on the catchment hydrology were assessed using statistical analysis of the model outputted hydrographs. Extreme low flows were considered initially, but once a suitable range of land use scenarios had been simulated, those that had a positive influence on low flows were also assessed as to their effect on extreme high flows. Soil compaction has been identified as one of the land management issues in the catchment. Soil aeration is a technique that can be used to reduce the effects of compaction in improved grassland areas, and the effect of this management

solution was assessed using rainfall simulation experiments. The potential effect of reducing compaction levels across the catchment were also realised with modelling simulations. The simultaneous high and low flows hydrological modelling approach was designed with the view to finding a management solution that could improve both high and low flow behavioural tendencies in the catchment.

# Chapter Four:

*The Effective Modelling of Low  
Flows*

## **4.1 Introduction**

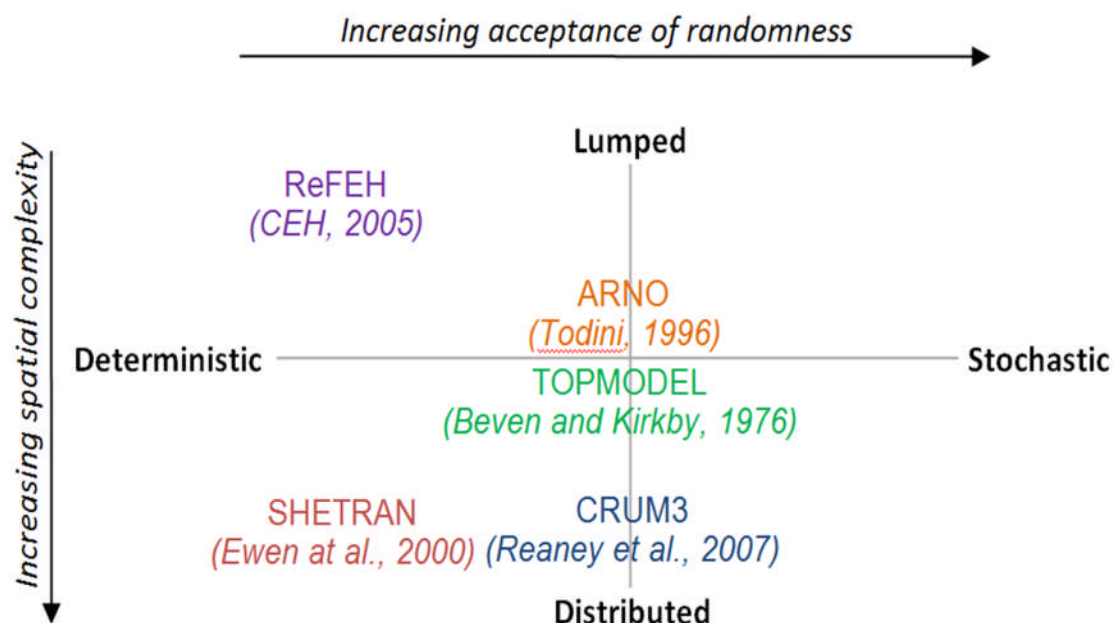
This chapter considers the first of the three research questions specified in Chapter One:

### ***Are hydrological models appropriate for the investigation of low flow events?***

It has been discussed that hydrological modelling is a valuable tool for studies of catchment response to various changes, from land use change to climate change. However, previous research has concentrated on eliminating flood risk and hence studies have focussed on the extreme high flows within hydrographs. Few studies have utilised hydrological modelling to examine extreme low flows. Therefore, before the central question of this project can be considered - can land use changes help alleviate the risk of extreme low flows – it must first be discovered whether hydrological models can accurately represent the hydrological processes that generate periods of extreme low flows. This chapter will describe the steps undertaken to answer this question. First the choice of model complexity and type is justified (section 4.2). The chosen model was then assessed for its sensitivity to different hydrological processes as described in section 4.3. Section 4.4 demonstrates the model being analysed with Generalised Likelihood Uncertainty Estimation, which rigorously tests the model performance and produces an ensemble of the best model realisations. Finally (4.5), the ultimate model output is scrutinised against the observed data to gain an idea of its performance capabilities.

## **4.2 Model Choice**

Hydrological models are often referred to as rainfall-runoff models, as they are commonly used to simulate the processes that follow rainfall inputs into the catchment, including runoff and its routing into the channel network. There are over 100 different hydrological models in current use over the world (Singh and Woolhiser, 2002). These vary in complexity and statistical method with two common characterisations: deterministic or stochastic, and lumped or distributed, as demonstrated in figure 4.1.



**Figure 4.1 Popular rainfall-runoff models within a quadrant framework of complexity.**

Lumped catchment models are of the coarsest spatial resolution and consider the whole system as a single unit (Karvonen et al., 1999) with spatially homogeneous soils, land covers etc. Whilst they are very user friendly and fast to run, lumped catchment models cannot represent or simulate spatial variations in catchment characteristics such as land cover. A very well used lumped hydrological model is the Flood Estimation Handbook (FEH) (CEH, 1999) and its more recent revitalisation (ReFEH) (Kjeldsen, 2007b). Semi-distributed models can divide the catchment into sub-basins, as in the ARNO model (Todini, 2007) but semi-distributed models also commonly split the catchment into areas known as Hydrologically Similar Units (HSU's), which is the method used in TOPMODEL (Beven and Kirkby, 1976). Fully distributed models such as the Connectivity of Runoff Model (CRUM3) (Reaney et al., 2007) simulate spatial variations in parameters by dividing the catchment, usually into a grid of cells, and use raster datasets to give the model spatial information of soil types, geology, land cover etc. The resolution of the raster grids depend on the purpose of the simulations, as the finer the resolution the more computationally demanding the model runs become. Fully distributed models are by far the most complex, and better represent the spatial complexity

of hydrological processes within catchments, however they are usually deemed too computationally demanding for many studies.

The degree of randomness introduced by the model in order to understand natural variability is dependent on whether the model is deterministic or stochastic. Deterministic models do not consider randomness, and so give only one outcome from a simulation with one set of inputs and parameter values. Stochastic models allow for randomness and uncertainty in the parameters (Beven and Freer, 2001b). Most rainfall-runoff models are deterministic, and virtually no models are fully stochastic. Some models like CRUM3 (Reaney et al., 2007) however, have some parts that are described stochastically while other parts of the model are fully deterministic (Singh, 1995).

Table 4.1 outlines the strengths and limitations of the most popular currently available hydrological models, with some indication as to their applicability for this study. A range of model types were considered including lumped as well as spatially distributed models. It can be seen from this table that lumped catchment models such as FEH, ReFEH, and PDM would not be appropriate for this study as they cannot represent spatially variable land covers, and thus could not simulate the effects of land use changes in specific locations. Furthermore, ReFEH, ARNO and PDM can be ruled out as they are conceptual models. This means that the parameters they use are not ascribed a physical meaning, and thus, again, it is not possible to represent the effects land use changes by perturbing parameter values. Similarly, TOPMODEL is only semi-distributed so suffers the same shortfalls as those models previously mentioned. Therefore, in order to assess the effects of land use changes, a fully spatially distributed, physically based model would be required.

SHE is an example of one of the early hydrological models, now deemed somewhat out-dated. It is a very data intense model, which would require large amount of data to be downloaded and measured in the field to specify the thousands of parameter values, and issues of uncertainty have been highlighted in the literature (Beven, 2004). SHETRAN more up-to-date, but was designed and is used primarily for modelling sediment transport and pollution pathways. For these reasons, the Connectivity of Runoff Model (CRUM3) was chosen for

this particular research project. This study did not require a stochastic model; however CRUM3 uses a stochastic weather generator to simulate 15 minute time step discharge from a daily rainfall record. This allows for some inclusion of natural rainfall variability in the model, however outputs were considered as daily averages so this stochastic element of the model did not introduce any drastic uncertainties. Being fully distributed, CRUM3 is computationally demanding, with runs at a 50m resolution on a laptop computer taking 4 hours; however the computing power of Durham University's High Performance Linux Distributed Computer Cluster allowed for large modelling experiments to be done over a time period of a week. The full structure of the CRUM3 model is given in Chapter 3, and a CRUM3 user guide is given in appendix 1.

### **4.3 Sensitivity Analysis**

As mentioned in Chapter 3, sensitivity analysis is a key process in the preliminary stage of a modelling study. In order to understand which of the parameters included in the CRUM3 model have a significant impact on the catchment behaviour, each parameter was perturbed individually from the base values. These base values were taken from two previous studies that calibrated the CRUM3 model in the Dacre Beck catchment (Baugh, 2010; Pattison, 2010). These studies were of snowmelt hydrology and the effects of land use change on flood events in the catchment, so the base value calibration may not be entirely appropriate for this study of low flows responses in the catchment. The model's base value output compared to the observed discharge for the study period is shown in figure 4.2. Although this shows significant underestimation of flood peaks, and a slight overestimation during periods of low flows, the model does at least show the correct hydrograph shape. Flood peaks are simulated, if underestimated, and the periods of low flows are simulated at the correct times of the year. This suggests that as a starting point, this model shows reasonable result and, although calibration will be required, the model is representing the catchment response to rainfall events.



Name	Type	Strengths	Limitations
FEH	Lumped, deterministic	<ul style="list-style-type: none"> <li>- Assesses the rarity of notable rainfalls/floods (CEH, 1999).</li> <li>- Provides a 'standard procedure' framework that is popular with policymakers (Kjeldsen et al., 2008).</li> </ul>	<ul style="list-style-type: none"> <li>- Dependent on catchment characteristics (Pattison, 2010)</li> <li>- Overestimates flood peaks compared to flood frequency curves with statistical method (Pattison, 2010)</li> <li>- Not appropriate for catchments less than 0.5km<sup>2</sup> (Kundzewicz, 2000)</li> <li>- Gauged data is on shorter timescales than is available (Kjeldsen et al., 2008)</li> </ul>
ReFEH	Lumped, deterministic, conceptual	<ul style="list-style-type: none"> <li>- Update of FEH</li> <li>- Improved data</li> <li>- New baseflow and PDM loss models</li> <li>- More flexible hydrograph shape (Kjeldsen, 2007a)</li> </ul>	<ul style="list-style-type: none"> <li>- Poor performance on heavily urbanised catchments (Faulkner and Barber, 2009)</li> <li>- No way of assessing land use changes</li> </ul>
PDM	Lumped, conceptual	<ul style="list-style-type: none"> <li>- Recognises spatially variable storage capacity</li> <li>- Has been widely applied to global catchments (Moore, 2007)</li> <li>- Performs as well as more complicated models with many more parameters (Moore and Clarke, 1981)</li> </ul>	<ul style="list-style-type: none"> <li>- Abstract parameters (not physically meaningful), difficult to manipulate to represent land use changes (Moore, 2007)</li> <li>- Difficult to calibrate and adjust parameters (Moore, 2007) making sensitivity analysis problematic</li> </ul>
ARNO	Semi-distributed, conceptual	<ul style="list-style-type: none"> <li>- Entirely driven by the total catchment soil moisture storage which is related to dynamic contributing areas and drainage amounts (Todini, 1996)</li> <li>- Some physically based parameters:</li> </ul>	<ul style="list-style-type: none"> <li>- Not many physically representable parameters, difficult to use for land use changes</li> </ul>

		evapotranspiration, percolation etc. (Todini, 1996)	
TOPMODEL	Semi-distributed, quasi-physically based	<ul style="list-style-type: none"> <li>- Sub-divides catchments in a dynamic way (HSU's)</li> <li>- One of few simple models that makes use of a Digital Terrain Model (DTM) (Beven, 1997)</li> <li>- Possible to view the outputs of the model in a spatial context (Beven, 1997)</li> </ul>	<ul style="list-style-type: none"> <li>- Steady-state transmissivity of water table (Beven and Freer, 2001a)</li> <li>- Topographic index does not consider geological information (Beven, 1997)</li> <li>- Cannot represent changes in land covers (Pattison, 2010)</li> </ul>
CRUM3	Fully distributed, physically based	<ul style="list-style-type: none"> <li>- Physically based parameter set for which values can be obtained from literature (Reaney et al., 2007)</li> <li>- Spatially distributed, can represent different land covers (Reaney et al., 2007)</li> </ul>	<ul style="list-style-type: none"> <li>- More computationally demanding</li> <li>- Simplified process representation (Pattison, 2010)</li> </ul>
SHE	Fully distributed, physically based	<ul style="list-style-type: none"> <li>- Physically meaningful parameters, sensitive parameters can be reinforced with field measurements and results can be qualitatively assessed (Bathurst, 1986)</li> <li>- Distributed, can model land use change</li> </ul>	<ul style="list-style-type: none"> <li>- Data intense (difficult to obtain, many parameters)</li> <li>- Important to include field measurements in calibration process (Bathurst and O'Connell, 1992)</li> </ul>
SHETRAN	Fully distributed, physically based	<ul style="list-style-type: none"> <li>- Development of SHE</li> <li>- Gives detailed descriptions of flow and transport in time and space, good for impact assessments (Ewen et al., 2000)</li> </ul>	<ul style="list-style-type: none"> <li>- Preferential flow through the unsaturated zone is not modelled, despite being known to be important (Ewen et al., 2000)</li> <li>- Significant uncertainty in parameter estimates (Pattison, 2010)</li> </ul>

**Table 4.1 Critical evaluation of currently available hydrological models**

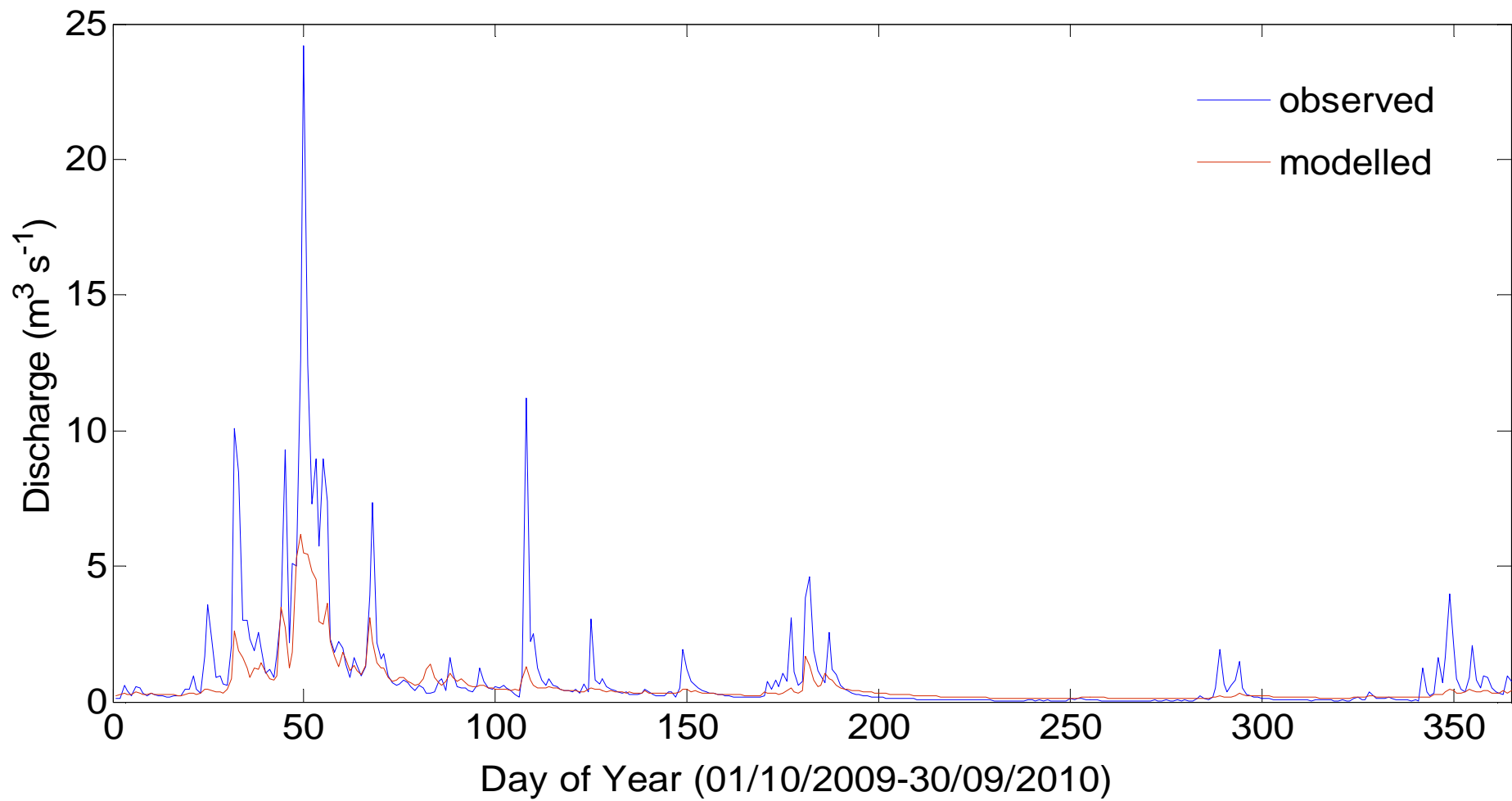


Figure 4.2 Observed versus Base Value Modelled Discharge observed discharge readings courtesy of the Environment Agency.

### 4.3.1 Parameter Ranges

A list of the parameters in the model, along with their feasible ranges (drawn from various literatures) is given in table 4.2.

Parameter	Lower Limit	Base Value	Upper Limit
<b>Soil Parameters</b>			
Saturated Conductivity ( $K_{\text{sat}}$ ) (m/s)	$1 \times 10^{-8}$	$2 \times 10^{-4}$	$1 \times 10^{-3}$
$K_{\text{decay}}$ with depth	-9	-3	-1
Soil Porosity ( $\Phi$ ) (decimal %)	0.01	0.451	0.7
Soil Depth Channels (m)	0.1	1.0	2.0
Soil Depth Slopes (m)	0.05	0.16	1.2
Soil Depth Ridges (m)	0.2	0.5	1.5
Soil Depth Plains (m)	0.2	0.5	1.5
Root Layer Depth (m)	$1 \times 10^{-5}$	0.05	0.5
Root Layer $K_{\text{sat}}$ (m/s)	$2 \times 10^{-5}$	$9 \times 10^{-3}$	$2 \times 10^{-2}$
Root Layer $b$ parameter	0	4.05	16
Bedrock Conductivity (m/s)	$1 \times 10^{-11}$	$2.5 \times 10^{-10}$	$1 \times 10^{-7}$
Green and Ampt $a$ parameter (mm/hr)	0	10	100
Green and Ampt $b$ parameter (mm/hr)	0	5	100
<b>Land Cover Parameters</b>			
Canopy Gap Fraction (decimal %)	0	0.2	1.0
Maximum Vegetation Height (m)	0	1.0	15
Canopy Interception depth (m)	0	0.002	0.01
Albedo (decimal percentage)	0.05	0.1897	0.5
Darcy Weisbach friction factor	0	75	500
Per cent of cell with overland flow (decimal %)	0.1	0.3	1.0
Vegetation Growth Rate (g/sec/m <sup>2</sup> )	0	0.02	1
Vegetation Growth Temp Threshold (°C)	0	5	10
<b>Channel Routing Parameters</b>			
Hydraulic geometry $k$	0.1	1.0	2.0
Hydraulic geometry $m$	0.1	0.32	0.5
Discharge per unit width	0.1	5.0	10.0

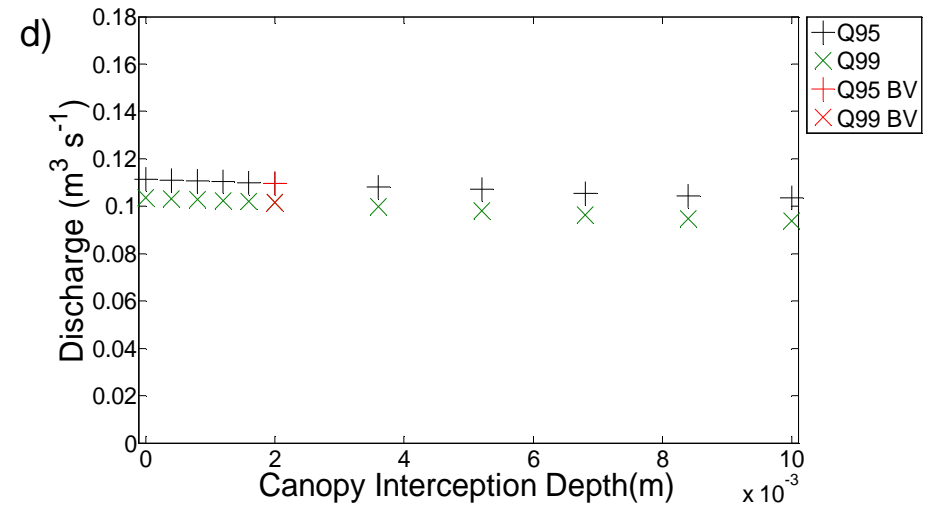
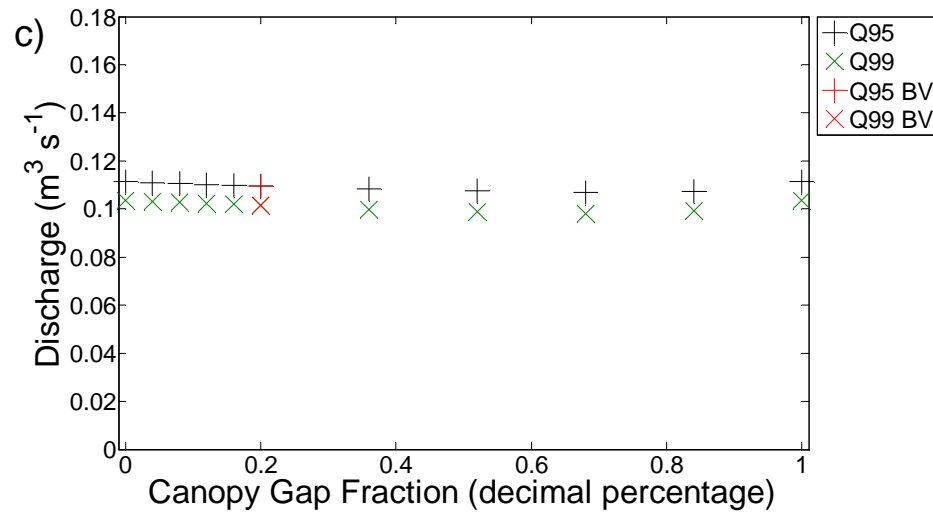
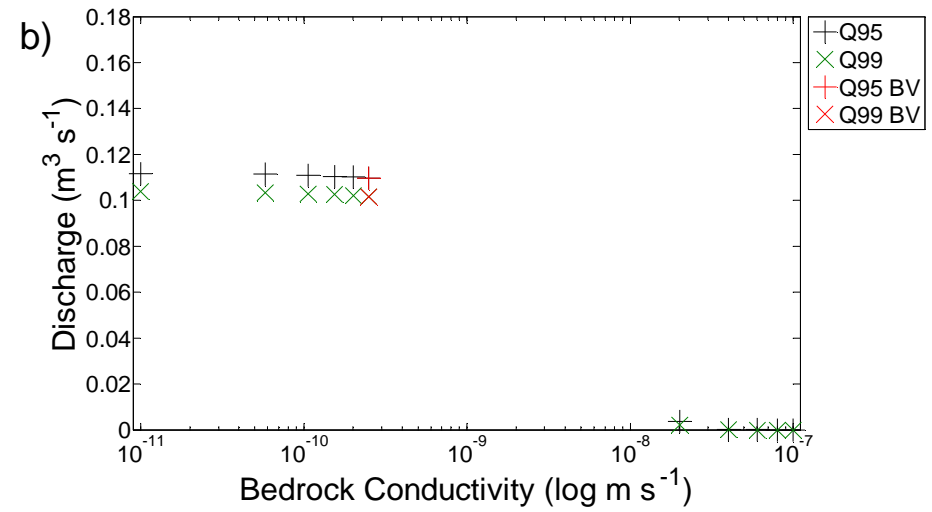
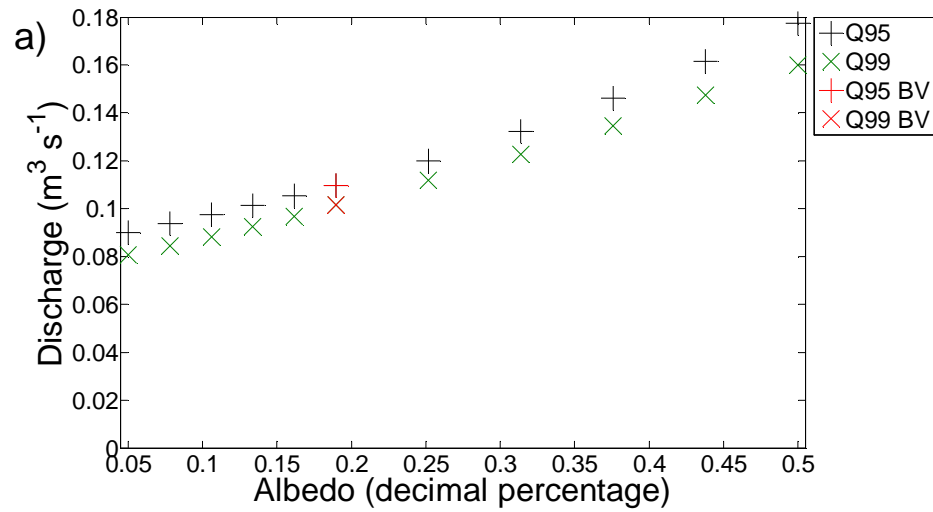
**Table 4.2 Parameter Values for Sensitivity Analysis** Sources: (Clapp and Hornberger, 1978; Dingman, 1994; Reaney et al., 2005; Baugh, 2010; Pattison, 2010).

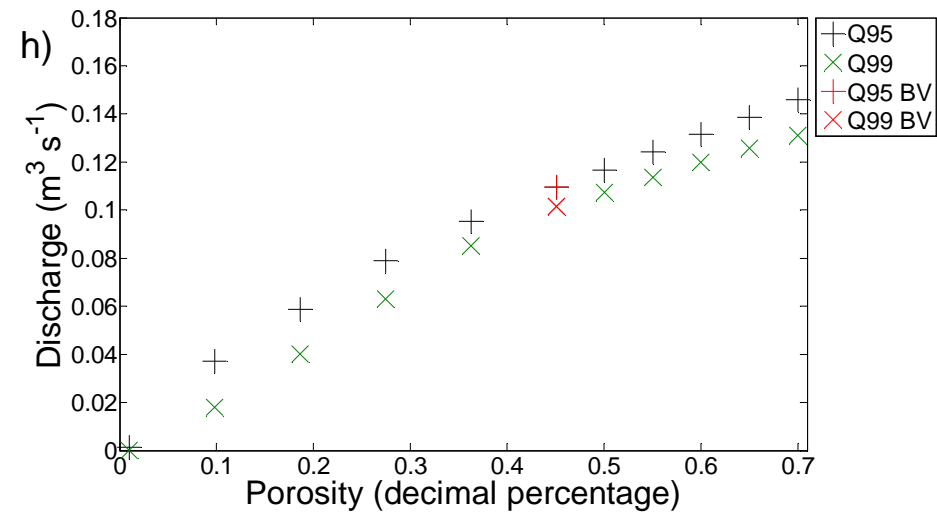
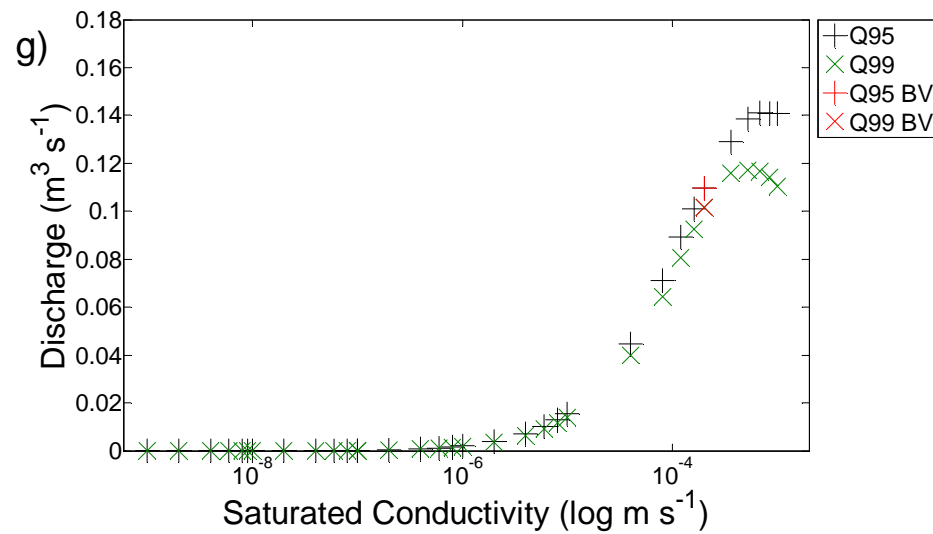
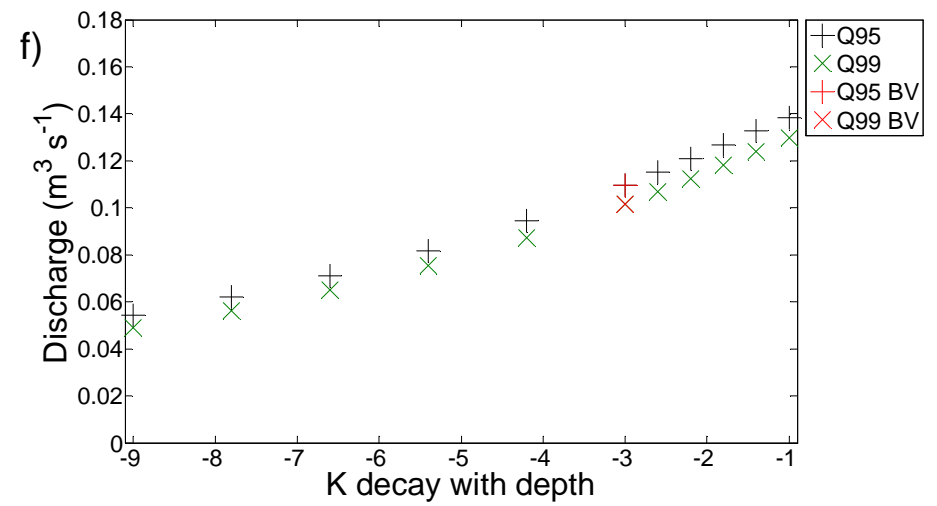
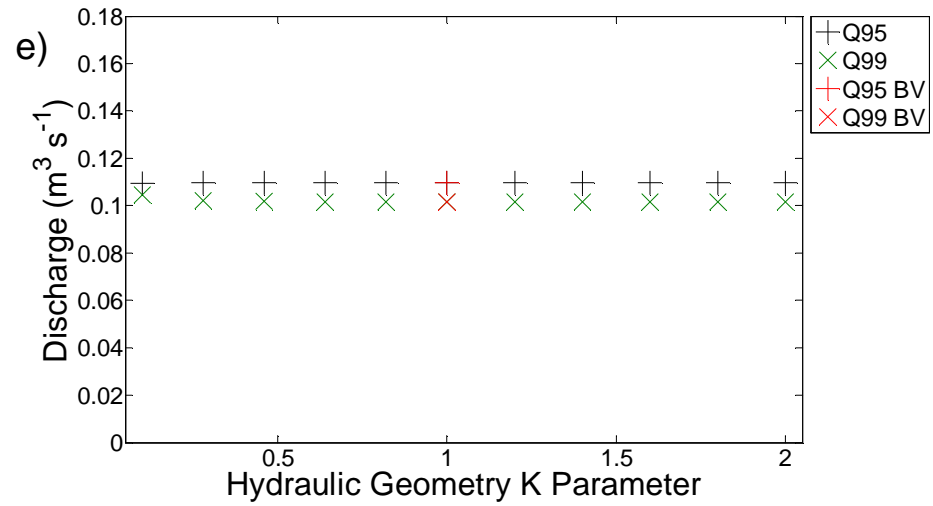
The upper and lower limits were extended slightly beyond the realms of the likely physical values in order to test the model's response to extreme parameter values.

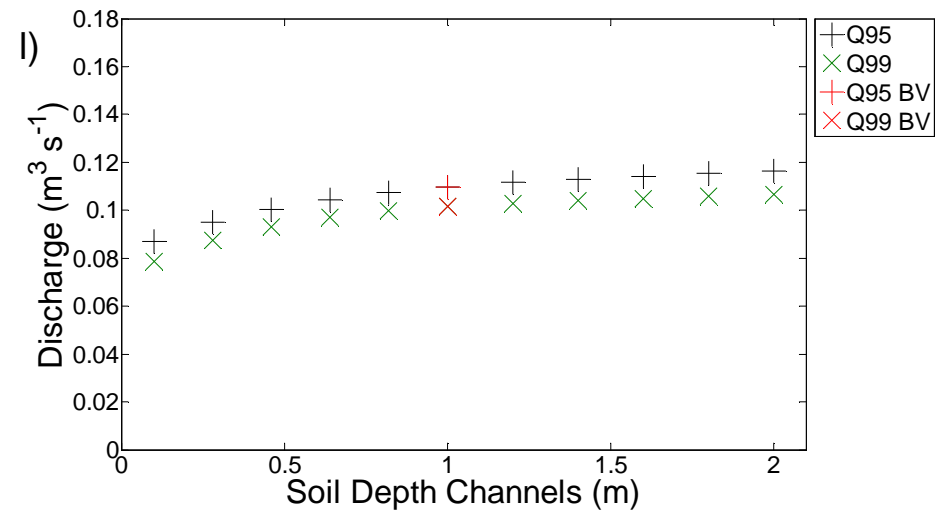
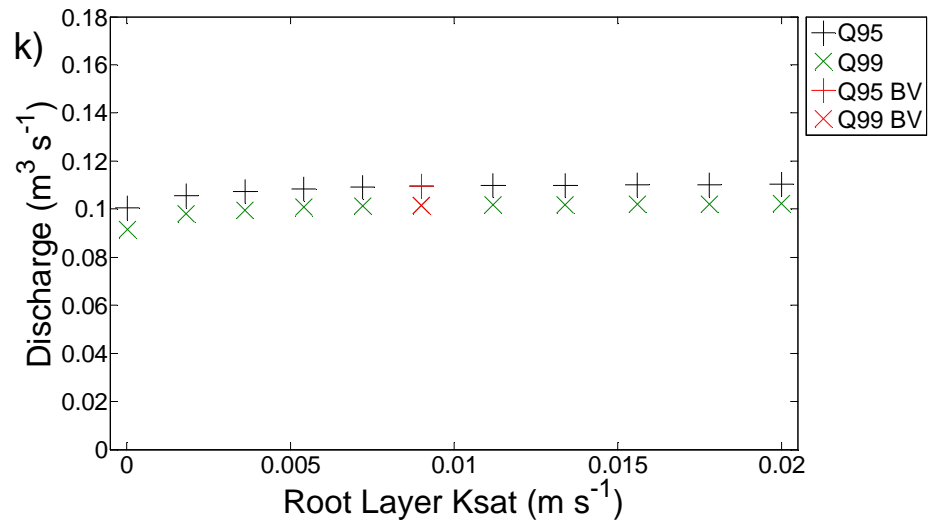
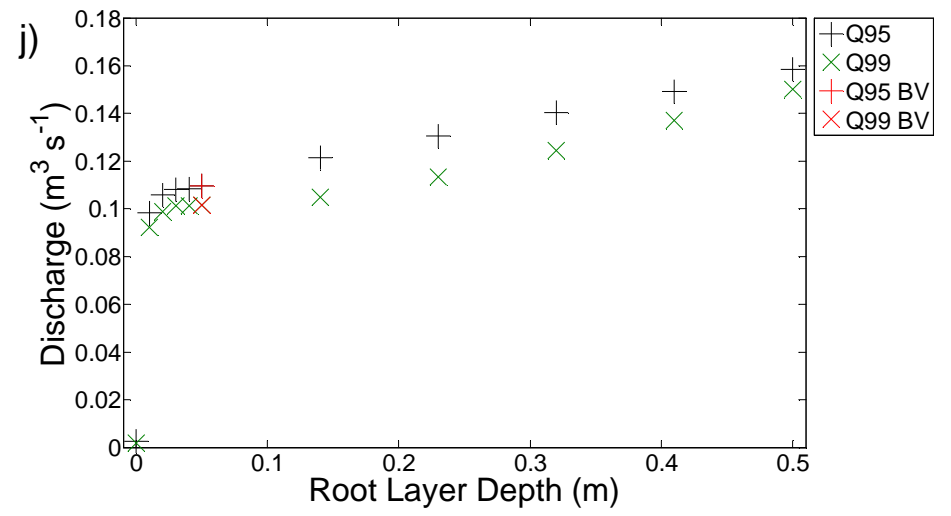
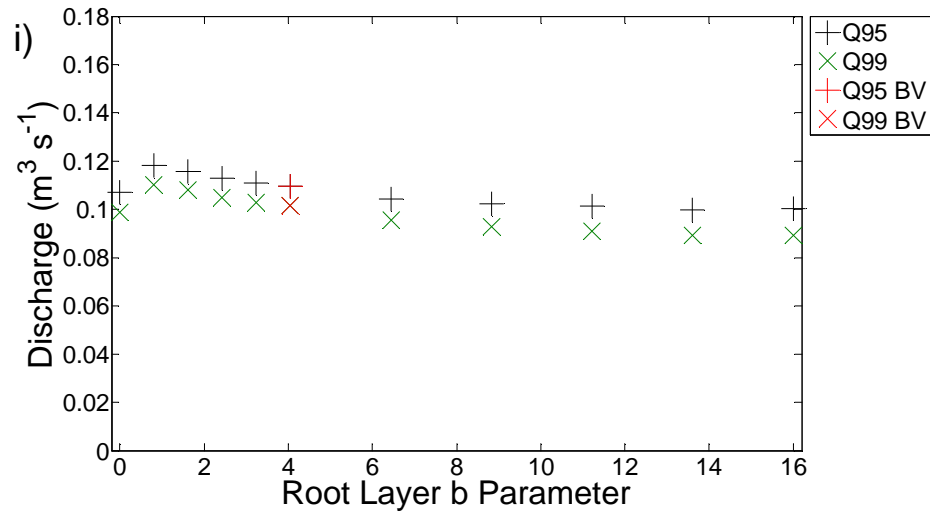
#### **4.3.2 Results**

The results of the sensitivity analysis were considered using the flow duration curve (FDC). Flow duration curves describe the frequency distribution of the complete flow regime. With the FDC it is possible to determine the percentage of time that a specified flow is equalled or exceeded (Crocker et al., 2003), or in the case of this study to calculate flow indices such as Q95. Q95 is the flow equalled or exceeded 95 per cent of the time, and so represents low flows, whilst Q05, which is the flow equalled or exceeded five per cent of the time, represents high flows. Calculations were done using the MATLAB (Matrix Laboratory) software, that allows the same calculations to be repeated quickly and accurately thus reducing human error. The following graphs show the results of the sensitivity analysis. The graphs included are those of the parameters which showed a significant variation in low flow discharges as the parameter value was varied. The discharge per unit width, Darcy Weisbach Friction Factor, Green and Ampt A and B parameters, Hydraulic geometry M value, maximum vegetation height, percentage of cell with overland flow, and the vegetation growth rate showed very little or no response. This shows that in CRUM3's simulations of the catchment, these parameters have a very small influence on the routing of the water from rainfall to the channel. Most of the parameters listed as being unresponsive are those which represent overland flow. In the Dacre Beck catchment during periods of low flow, overland flow is a relatively insignificant hydrological process in comparison to others such as evaporation, evapotranspiration and throughflow. This process enabled the selection of the parameters that have the most influence on base flow in the catchment.

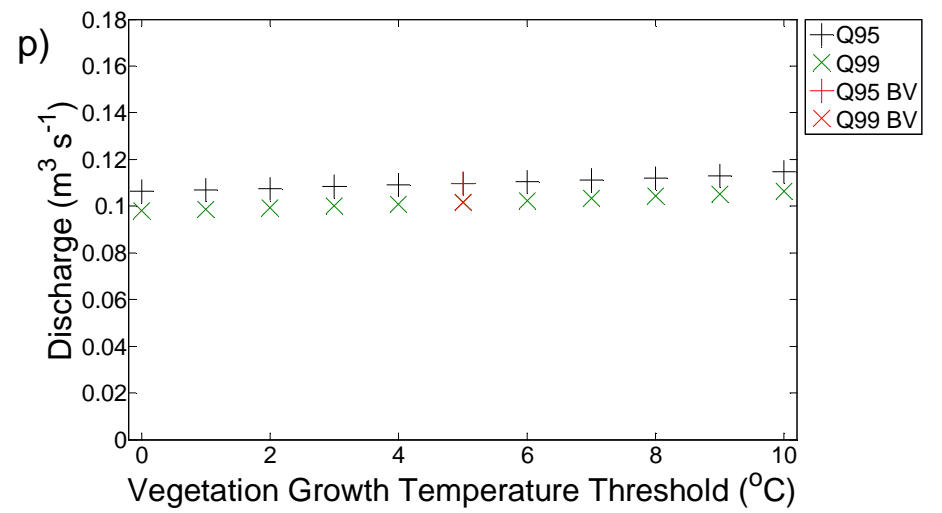
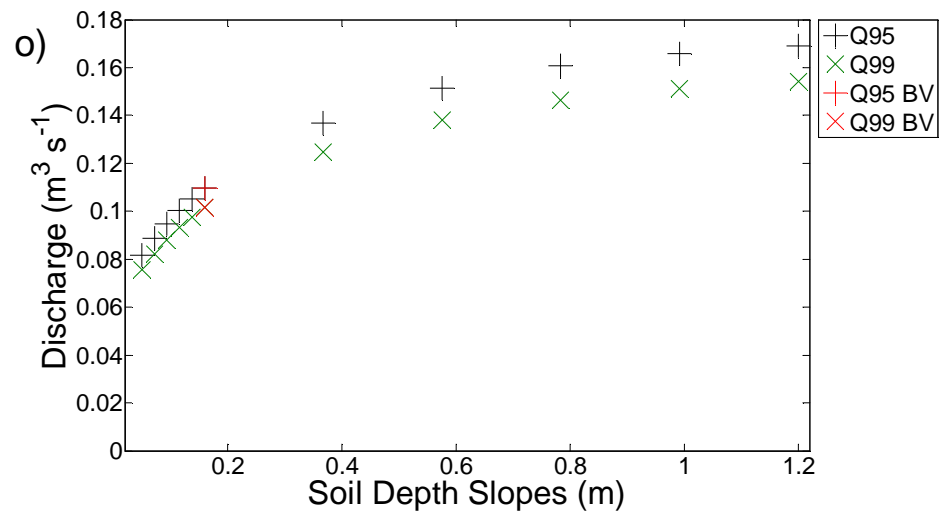
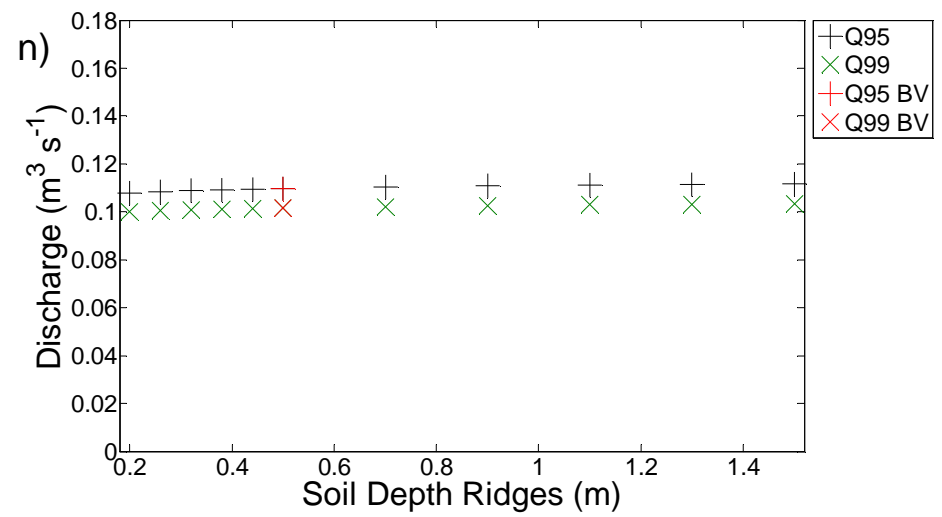
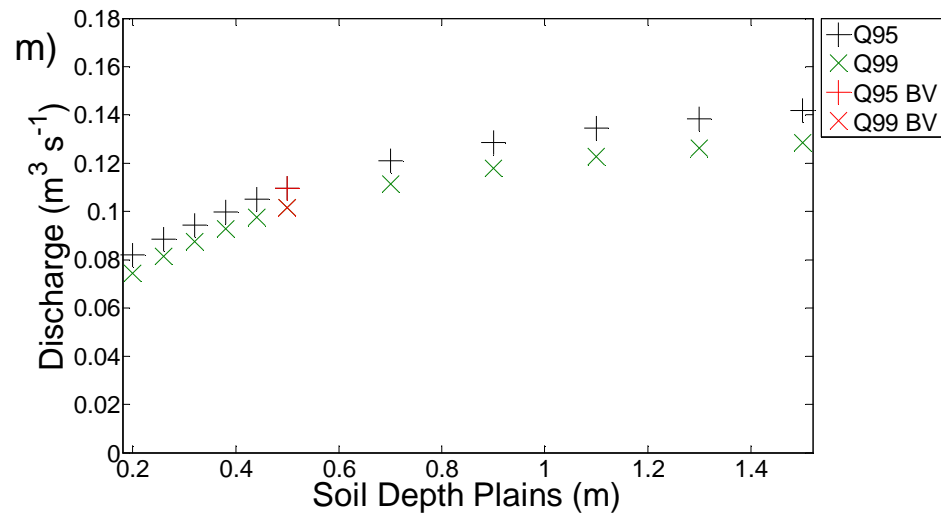
Consequently, the remaining 16 parameters showed definite responses as they were perturbed between the upper and lower bounds given in table 4.2.











**Figures 4.3a-p Response of Sensitive Parameters to Perturbation (low flows response):** a) albedo, b) bedrock conductivity, c) canopy gap fraction, d) canopy interception depth, e) hydraulic geometry K value, f) K decay with depth, g) saturated conductivity (K sat), h) porosity, i) root layer b, j) root layer depth, k) root layer saturated conductivity, l) soil depth channels, m) soil depth plains, n) soil depth ridges, o) soil depth slopes, p) vegetation growth temperature threshold. *BV = Base value.*

The use of Q95 and Q99 as objective functions in the graphs of parameter sensitivity given in figures 4.3a-p demonstrates how each parameter affects the low flows of the Dacre Beck catchment. We can therefore, consider how adjusting these processes by way of land use changes might help increase low flows discharges in the catchment. Parameters of particular note are the albedo (4.3a), bedrock conductivity (4.3b), saturated conductivity (4.3g), porosity (4.3h), and the four soil depths (4.3l to o).

As the albedo is increased it gives a steadily increasing response for low flows with the top albedo value of 0.5 giving a Q99 value of  $0.16\text{m}^3\text{ s}^{-1}$ , compared to a  $0.1\text{m}^3\text{ s}^{-1}$  base value. This shows that as the land cover is lightened, to become more reflective, low flows discharge is increased.

The bedrock conductivity has little effect on the low flows discharge below the base value of  $2.5\text{E}^{-10}$ . Above  $2.2\text{E}^{-08}$  the Q95 and Q99 values steadily decrease and above  $8.1\text{E}^{-08}$  the discharge is reduced to 0 (these points were excluded from the graph for scaling reasons). This implies that the bedrock conductivity at low values had little influence on the catchment low flows, but porous bedrocks have the potential to dramatically reduce the Q95 and Q99. More runs would be required between the base value and  $2.2\text{E}^{-08}$  to determine the exact bedrock conductivity that begins to influence the low flows.

The shape of the response curve for soil's saturated conductivity (Ksat) remained unclear with the first ten runs so this was extended to 31 runs. The low flows gave little response to saturated conductivity below  $10^{-6}$ , above which the low flows are dramatically increased. There was an upper limit to this trend though, as above  $5.2\text{E}^{-03}$  the low flows begin to decrease. This demonstrates that to an extent, the more easily the water can flow through the saturated soils, the higher the catchment low flows discharges can be. However, if the water can be lost from the soils too easily, it can be detrimental to the low flows.

The porosity gives a similar result to the albedo, in that it has a steadily positive effect on the low flows discharge as it is increased. A porosity value of 0.7 has the potential to increase  $Q_{99}$  by  $0.03\text{m}^3\text{ s}^{-1}$  from the base value which shows that more porous soils that can store more water are more ideally suited to supplying low flows discharge.

The four soil depths all respond in a similar way, giving logarithmic curve response surfaces. These curves show that deeper soils are more beneficial to low flows, but that the deeper they get, the less any further increase in depth can improve the low flows discharge.

Now that the parameters had been individually assessed, the next step in the modelling process was to gain an understanding of parameter interaction. The parameters need to be perturbed simultaneously to represent the way in which the Dacre Beck catchment hydrology behaves as a whole.

#### **4.4 Generalised Likelihood Uncertainty Estimation (GLUE)**

Generalised Likelihood Uncertainty Estimation (GLUE) is a method of assessing the uncertainty in hydrological model predictions (Beven and Binley, 1992; Beven, 1993). It involves developing ensembles of parameters that are sampled from distributions. The model is then run with these parameter sets, producing multiple sets of model outputs (Stedinger et al., 2008). As discussed in Chapter 3, this method recognises the concept of equifinality, which within modelling is the idea that many different combinations of parameters could ultimately lead to similar model output (Beven and Freer, 2001b). This means that we could have many different parameter sets that perform equally well at predicting the observed river discharge.

##### **4.4.1 Parameter Choices**

In undertaking GLUE analysis, the most responsive parameters according to the sensitivity analysis must be determined. Commonly, no more than six model parameters would be included in the GLUE experiment as the number of model runs required to sample the ranges of each parameter space would be too computationally demanding (Reaney, 2011 per. comm.). The results from the

sensitivity analysis were assessed by calculating the maximum percentage change of the perturbed Q01, Q05, Q95 and Q99 values from the base value equivalents from within the range of parameter values tested. These percentage changes were then all ascribed their positive values, and averaged to give an overall change that considered both the high and the low flows, as the high flows would need to be considered later in the project. The equations used for these calculations are given below:

$$F_{cd} = \left( \frac{\sum_{i=1}^n Cd_i}{n} \right) \quad (EQ17)$$

$$Cd_i = \left| \left( \frac{P - B_v}{B_v} \right) * 100 \right| \quad (EQ18)$$

where:

$F_{cd}$  is the final change in discharge;

$Cd_i$  is the change in discharge for  $i = Q01, Q05, Q95$  and  $Q99$ ;

$P$  is the perturbed discharge value; and

$B_v$  is the base value discharge value

The resultant ranking of the 24 parameters is shown in figure 4.4. The first four parameters: bedrock conductivity, root layer depth, porosity and saturated conductivity all stand out as being significantly important in driving the hydrology of the Dacre Beck catchment in the CRUM3 model, standing above 70% whilst all other parameters lay below the 40% line. More than four parameters were thought to be required to gain an accurate representation of the catchment processes, as the model at base values significantly underestimates the flood peaks, and overestimates the low flows, as shown in figure 4.2. It then became difficult to determine a break point in the parameter rankings, so the sensitivity analysis results of the low flows responses were examined more closely. The top ten parameters ranked for their overall sensitivity were the same as the top ten parameter ranked for the sensitivity with low flows, whilst hydraulic geometry  $k$  was ranked 16<sup>th</sup> for the low flows, but 11<sup>th</sup> overall. Therefore, it was decided that as this project is concentrating mostly on the low flows, the top ten parameters would be chosen for development into the GLUE experiment.

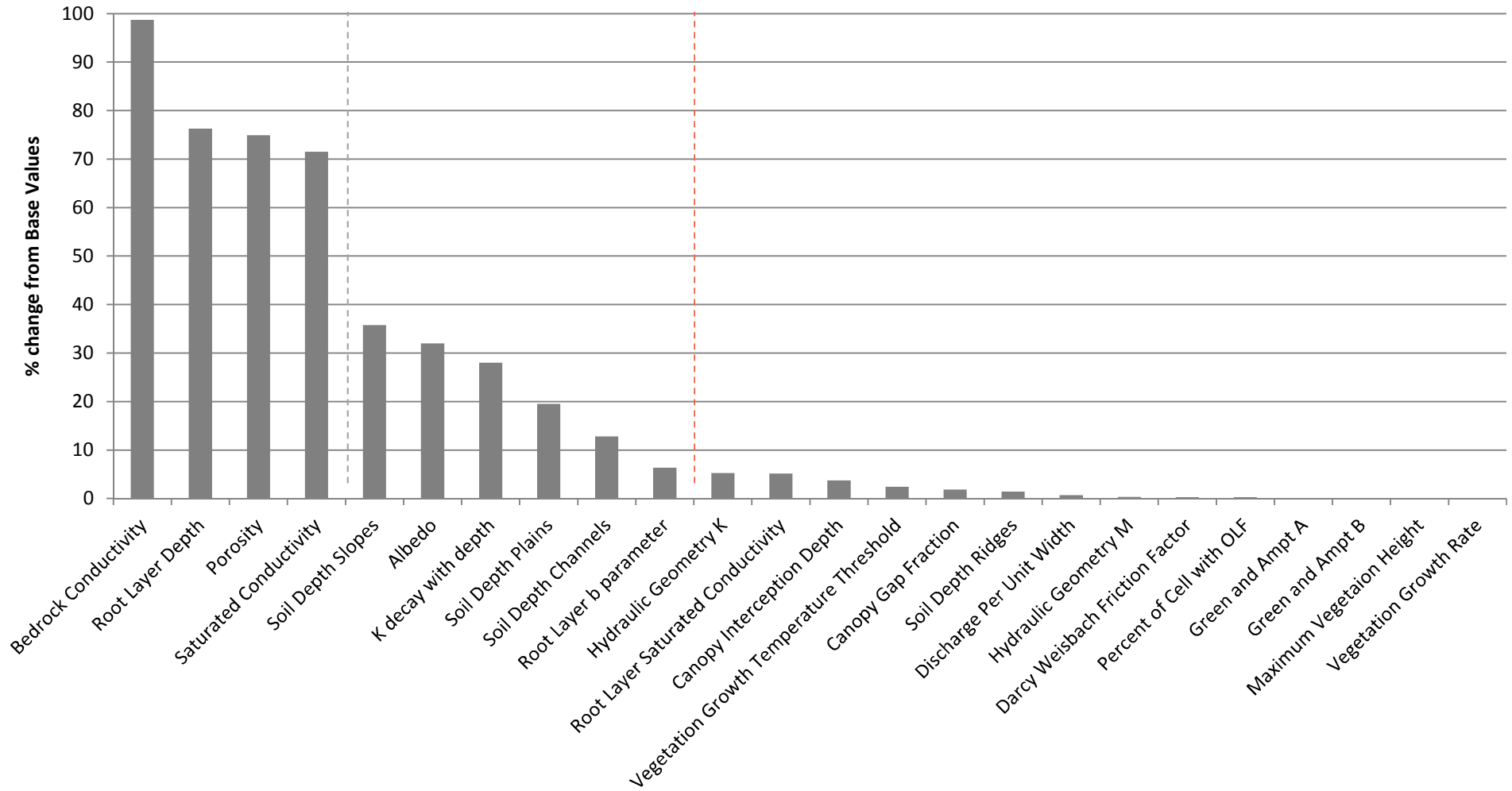


Figure 4.4 Average % change for Q01, Q05, Q95 and Q99 for each model parameter.

It was recognised that commonly only six parameters are included in a GLUE experiment, but the high performance computing capabilities and mathematical expertise available at Durham University meant that not only was it possible to do exceptionally large numbers of model runs in a relatively short timeframe, but also feasible was the development of a more efficient method of sampling this ten dimensional parameter space than the usual Monte Carlo method of random sampling.

#### 4.4.2 Latin Hypercube Sampling

Since the Monte Carlo sampling technique depends on random number generation to sample the parameter space (Landau and Binder, 2005), it requires huge numbers of model realisations to be run. It is believed that  $10^n$  model runs (where  $n$  is the number of parameters being perturbed) should sufficiently cover the parameter space with Monte Carlo sampling (Reaney, 2011 per. comm.), which with ten parameters would require some 10,000,000,000 model runs in this case. Therefore, a more efficient technique was sought. The Latin Hypercube sampling technique is one such method, which is inspired by the Latin square experimental design. The purpose of Latin Hypercube sampling (LHS) is to ensure that each value (or a range of values) of a variable is represented in the samples, whether it might turn out to be important or not. The requirement of LHS is that in a matrix of data, each row and each column contains only one sample (Cheng and Druzdzel, 2000). A demonstration of how the Latin Hypercube sampling works is shown in figure 4.5 which is a sample on a 5 by 5 matrix.

For each sample  $[i,j]$ , the sample values of  $X,Y$  are determined by:

$$X = F_X^{-1}((i - 1 + \varepsilon_X)/n)$$

$$Y = F_Y^{-1}((i - 1 + \varepsilon_Y)/n)$$

(EQ 19)

Where:

$n$  is the sample size;

$\varepsilon_X$  and  $\varepsilon_Y$  are random numbers ( $\varepsilon_X, \varepsilon_Y \in [0,1]$ );

and  $F_X$  and  $F_Y$  are the cumulative probability distribution functions of  $X$  and  $Y$  respectively.

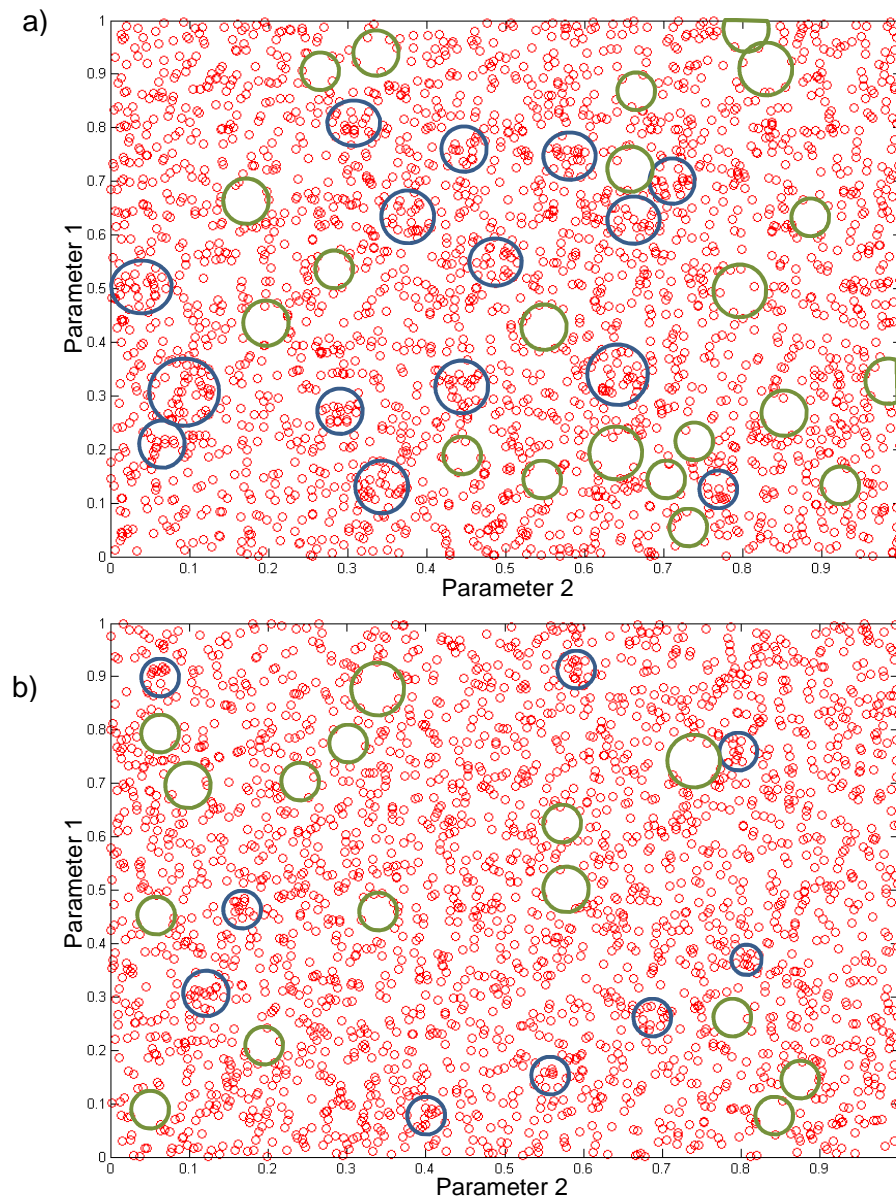
5				4	
4					5
3		1			
2	2				
1			3		
Y/X	1	2	3	4	5

**Figure 4.5 Latin hypercube sampling of a 5x5 matrix** (Cheng and Druzdzel, 2000)

The Latin Hypercube sampling technique used in this project was designed with the help of Dr Nick Odoni of Durham University, and was developed in MATLAB with the *lhsdesign* (Latin Hypercube sample) function. The *lhsdesign* function  $X=lhsdesign(n,p)$  generates a Latin Hypercube sample  $X$  containing  $n$  values on each of  $p$  variables. For each column, the  $n$  values are randomly distributed with one from each interval  $(0,1/n)$ ,  $(1/n,2/n)$ , ...,  $(1-1/n,1)$ , and they are randomly permuted (MathWorks<sup>®</sup>, 2011). The *lhsdesign* function in MATLAB also iteratively generates Latin Hypercube samples to find the best one according to the criteria of 'maximin' which maximises the minimum distance between points and 'correlation' which reduces correlation. The number of iterations is also definable. For this study, the criterion was set to 'maximin', and the number of iterations used was 100. A sample size of 5000 was decided to be sufficient, on top of which the base values were run 5 times, star points were run 3 times each, and factorial points (also known as corner points or cube points) were added. These additional points ensured the parameter space was sampled to its limits. This created 5192 model runs, which with Durham's high performance computing cluster took 8 days to complete.

The difference in sampling coverage between random sampling and the LHS function chosen is demonstrated in figure 4.6 which show scatter plots of a 2500 point sample of a 2 dimensional parameter space. Areas of significant clustering on the plots are highlighted with blue circles, whilst 'holes' where the parameter space has not been effectively sampled are highlighted with green circles. Although the two plots represent different samples, and therefore the

locations of the holes and clustering cannot be directly compared; it is apparent that random sampling in figure 4.6a shows many more, and larger areas of clustering within the 2500 samples than the LHS in figure 4.6b. Some clustering still occurs in the LHS, but it is less common and the areas are smaller in size. Conversely, it seems that the LHS method is still subject to 'holes' though, again, they tend to be smaller in area. It is apparent in figure 4.6b that the extreme corners are not all sampled, which reinforces the requirement of the additional star and factorial points.



**Figure 4.6 Sampling coverage for 2500 samples of a 2 dimensional parameter space** using a) random sampling and b) Latin hypercube sampling. Areas of significant clustering are shown within blue circles, sampling 'holes' are highlighted with green circles.



#### **4.4.3 Objective Functions**

Once the 5192 GLUE model runs had completed, an appropriate objective function (performance measure) was required to assess each model's performance at predicting the observed values throughout the year. Many methods were considered for their viability in this study, and each of which are detailed in table 4.2.

The majority of model performance measures weight the model's capabilities of predicting high flows preferentially by squaring the errors, which are commonly largest for flood peaks. The Nash Sutcliffe Model Efficiency measure is by far the most common technique, though this still gives a greater weight to high flows periods. Methods potentially viable for a low flows study such as this include Relative Mean Absolute Error (RMAE), Proportional Error of Estimate (PEE) and Relative Nash Sutcliffe model efficiency (RNS). A combination of the RMAE and RNS was chosen to assess the model outputs of the GLUE experiment. RNS is a non-dimensional method that gives a performance measure from zero to one with one being perfect simulation and zero being worse than random. As RMAE is dimensional, and gives the best models a low value, the RMAE values were adjusted to range between 0 and 1 and then reversed to allow them to be averaged with the RNS values to give a final performance value. Before the performance measures were calculated the observed and predicted discharges were averaged daily to give a 365 day record. This was done in order to eliminate the effect of the stochastic weather generator on the 15 minute time step data.

	Objective Function	Equation	Viability	Reference
1	Sum of Squared Residuals	$G = \sum_{i=1}^n (O_i - P_i)^2$	<ul style="list-style-type: none"> <li>• Very common</li> <li>• Biased towards high flow errors</li> <li>• Output is dependent on the number of observations</li> <li>• Dimensional</li> </ul>	(Diskin and Simon, 1977)
2	Sum of Absolute Errors	$G = \sum_{i=1}^n  O_i - P_i $	<ul style="list-style-type: none"> <li>• Output is dependent on the number of observations</li> <li>• Dimensional</li> </ul>	(Stephenson, 1979)
3	Root Mean Squared Error	$RMSE = \left( \frac{1}{n} \sum_{i=1}^n (O_i - P_i)^2 \right)^{\frac{1}{2}}$	<ul style="list-style-type: none"> <li>• Biased towards high flow errors</li> <li>• Dimensional</li> <li>• Not influenced by the number of observations</li> </ul>	(Patry and Marino, 1983; Wagener et al., 2004)
4	Relative Mean Absolute Error	$RMAE = \frac{1}{n} \sum_{i=1}^n \left  \frac{P_i - O_i}{O_i} \right $	<ul style="list-style-type: none"> <li>• Relative – weights high and low flows evenly</li> <li>• Dimensional</li> <li>• Not influenced by the number of observations</li> </ul>	
5	Proportional Error of Estimate	$PEE = \left[ \sum_{i=1}^n \left( \frac{O_i - P_i}{O_i} \right)^2 \right]^{\frac{1}{2}}$	<ul style="list-style-type: none"> <li>• Relative – weights high and low flow evenly</li> </ul>	(Manley, 1978)

6	Reduced Error Estimate	$REE = \left[ \frac{\sum_{i=1}^n (O_i - P_i)^2}{\sum_{i=1}^n (O_i - \bar{O})^2} \right]^{\frac{1}{2}}$	<ul style="list-style-type: none"> <li>Biased towards high flows, insensitive to errors in low flows</li> </ul>	(Green and Stephenson, 1986)
7	Coefficient of Determination	$r^2 = \left( \frac{\sum_{i=1}^n (O_i - \bar{O})(P_i - \bar{P})}{\sqrt{\sum_{i=1}^n (O_i - \bar{O})^2} \sqrt{\sum_{i=1}^n (P_i - \bar{P})^2}} \right)^2$	<ul style="list-style-type: none"> <li>Too complex</li> </ul>	Bravais-Pearson: mentioned in Krause <i>et al.</i> (2005)
8	Nash Sutcliffe Model Efficiency	$R^2 = \frac{F_o^2 - F^2}{F_o^2} \text{ where;}$ $F^2 = \sum_{i=1}^n (O_i - P_i)^2$ $F_o^2 = \sum_{i=1}^n (O_i - \bar{O})^2$ <p>Alternatively:</p> $NS = 1 - \frac{\sum_{i=1}^n (O_i - P_i)^2}{\sum_{i=1}^n (O_i - \bar{O})^2}$	<ul style="list-style-type: none"> <li>Most common modern method</li> <li>Dimensionless</li> <li>Insensitive. Poor models give high correlation whilst better models give only slightly higher correlation</li> <li>Values of &gt;0.65 thought to be behavioural (Pattison, 2010)</li> </ul>	(Nash and Sutcliffe, 1970; Wainwright and Mulligan, 2004)
9	Relative Nash Sutcliffe Model Efficiency	$NS_{rel} = 1 - \frac{\sum_{i=1}^n \left( \frac{O_i - P_i}{O_i} \right)^2}{\sum_{i=1}^n \left( \frac{O_i - \bar{O}}{\bar{O}} \right)^2}$	<ul style="list-style-type: none"> <li>Relative – weights high and low flows evenly</li> <li>Dimensionless</li> </ul>	(Krause <i>et al.</i> , 2005)

**Table 4.43 Performance measures for assessing the goodness of fit of hydrological models:** explanation of terms given in text below.

Terms within performance measures:

$O_i$  = Observed discharge at time  $i$ ;

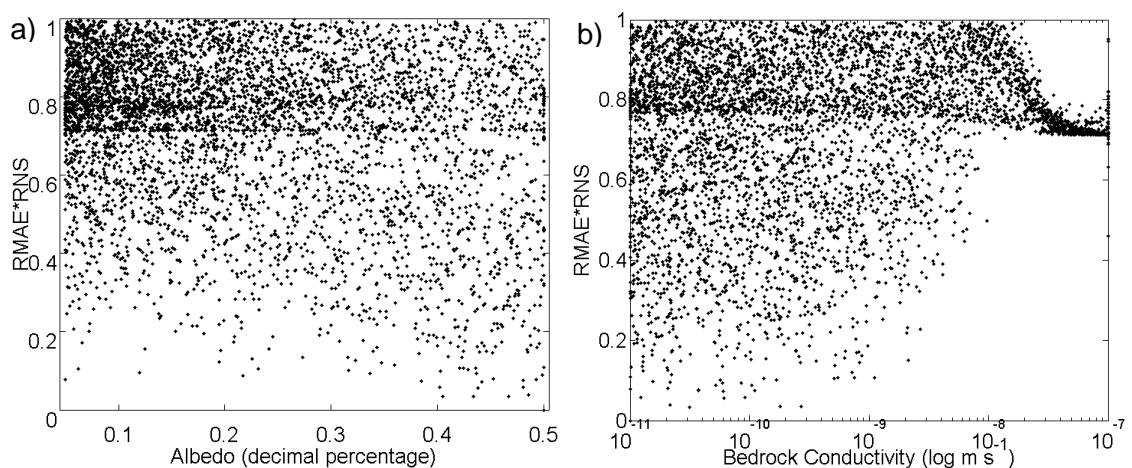
$P_i$  = Predicted discharge at time  $i$ ;

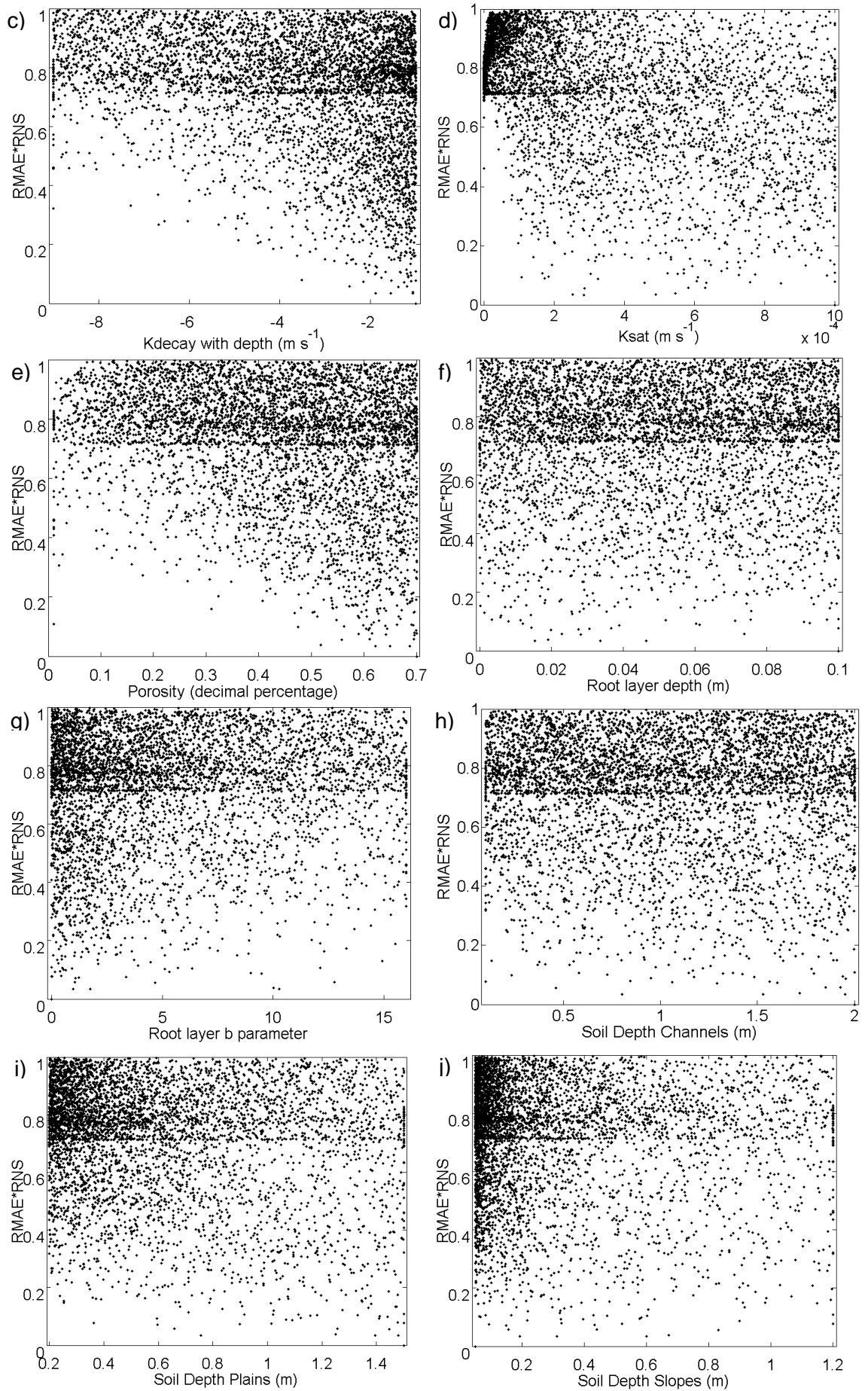
$\bar{O}$  = Average observed discharge;

$\bar{P}$  = Average predicted discharge

#### 4.4.4 Results

The results of the GLUE experiment are represented in the dot plots shown in figures 4.7a-j. The dot plots show the variation in model performance across the range of each of the ten parameters included in the experiment. The model performance measure (RMAE\*RNS) tended to cluster the model runs above the 0.7 line. This was found to be due to the RMAE measure that originally clustered the runs below a value of 1, within a range of errors of  $0.000319$  to  $3.671\text{m}^3\text{ s}^{-1}$ , so once rescaled to a 0 to 1 range the clustering was found to be at 0.7. As RMAE is not a dimensionless performance measure, this shows us that it was common for the model to have an error less than  $\pm 1\text{m}^3\text{ s}^{-1}$ . For most of the parameters the model performance ranged fairly evenly across the parameter ranges, however for bedrock conductivity the performance remained consistently around the 0.7 mark for all runs above a value of approximately  $3\text{E}^{-08}$ . This shows us that the model does not give realistic results when bedrock conductivity is set above this limit. Other than this result, it seems the model is performing well across the ranges of model parameters. Therefore, the top ten models ranked according to the RMAE\*RNS performance measure were chosen for further development.





**Figures 4.7a-j Dotty Plots of GLUE model performances:** a) albedo, b) bedrock conductivity, c) saturated conductivity (k) decay with depth, d) saturated conductivity (ksat), e) porosity, f) root layer depth, g) root layer b parameter, h) soil depth channels, i) soil depth plains and j) soil depth slopes.

#### **4.5 The Final Model Performance**

The overall performance of the top ten GLUE runs is shown in figure 4.8a where the discharge predictions throughout the year are shown in comparison with the observed hydrograph. Figure 4.8b shows the December flood peak on day 50 of the hydrological year (19<sup>th</sup> November 2009) in more detail with the ten days prior to and after the event. Figure 4.8c shows the first summer drought period, from mid-April until early July. It is evident from these figures that the model continues to underestimate the flood peaks, though it is significantly smaller underestimation than was given by the base value run. The model also marginally overestimates the low flows but again on a much smaller scale than the base value run.

Also for the low flows, the range of the ten runs spans across the observed value, whilst for the flood peak all ten models realisations underestimate the peak value. Statistically, within the ten parameter realisations, the model overestimates daily discharge for 141 days of the year (39%), and underestimates it for 54 days (16%). This demonstrates that this model is actually performing better for the low flows than for the high flows. This is to be expected to some extent, due to the fact that the model uses a stochastic rainfall generator. This means that the exact timings of a rainfall event may not reflect reality, affecting hydrograph lag times, and potentially redistributing clusters of rainfall events, leading to a smaller flood peak. Table 4.4 shows the parameter figures applied to the model to produce the results of the top ten GLUE model realisations. This table clearly shows that problem of equifinality exists here. The parameter values vary widely between the sets, showing that very different values of each parameter can, in the right combination, result in similarly valid model predictions. At first, only the top GLUE parameter set was going to be used further in the land use change study, however with this revelation, the top ten GLUE model realisations will all be considered. This is important as the catchment could be behaving in any of these, rather different, arrangements of process behaviour.

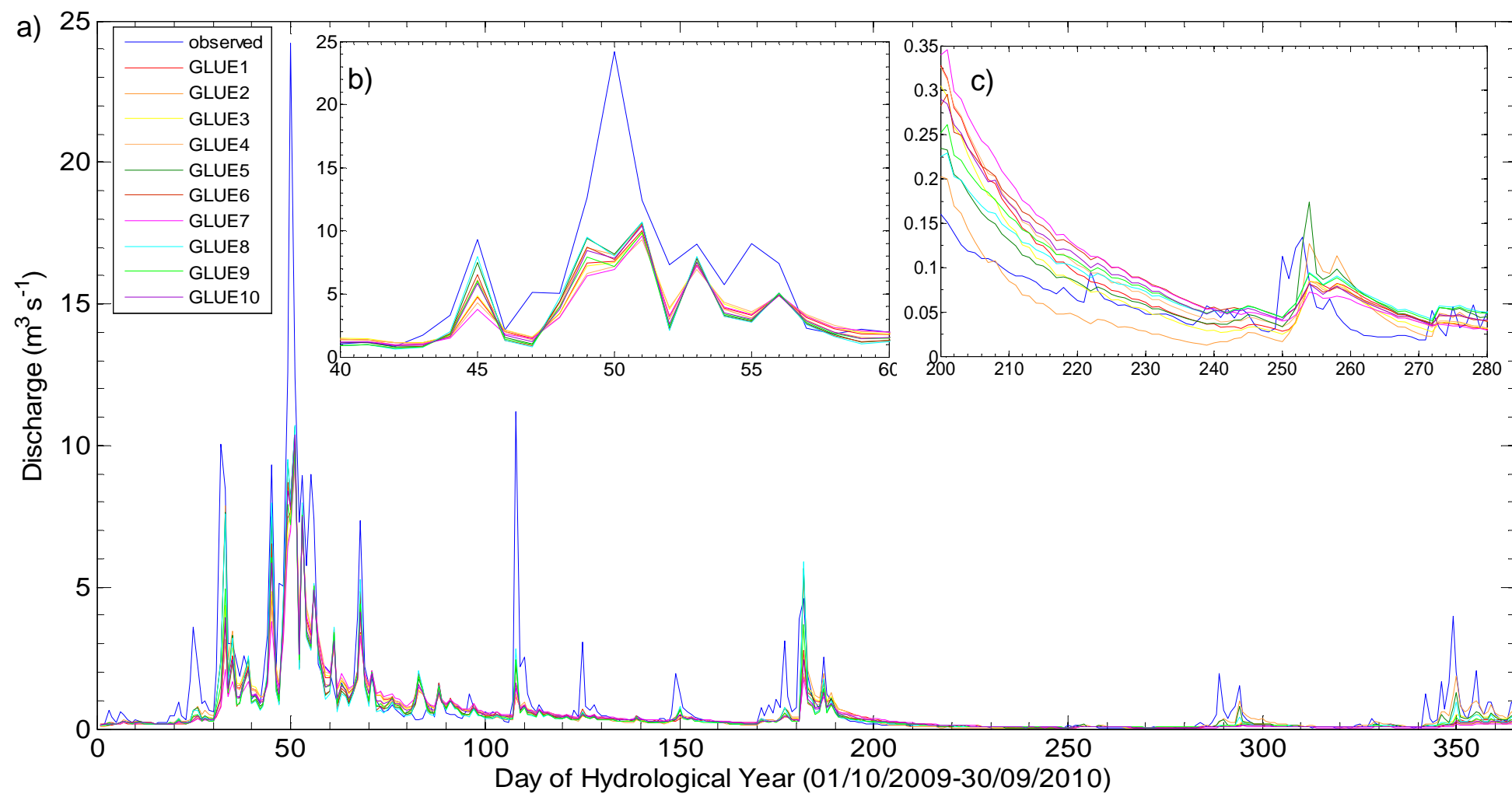


Figure 4.8 Hydrographs of the observed and top 10 GLUE model realisations: a) full year, b) December flood, c) summer low flow period.

Rank	Run Number	Ksat	K decay with depth	Porosity	Soil Depth Channels	Soil Depth Slopes	Soil Depth Plains	Root Layer Depth	Root Layer b Parameter	Bedrock Conductivity	Albedo
1	897	0.000384	-7.90994	0.329145	0.926333	0.239067	0.231553	0.086478	12.65906	5.67E-11	0.063741
2	5062	0.000144	-7.01545	0.124239	0.252728	1.160748	0.592479	0.075122	1.703211	1.95E-11	0.264933
3	3672	0.000308	-8.30599	0.24086	0.815259	1.082471	0.255653	0.09153	5.716344	4.70E-11	0.165383
4	3398	0.000418	-8.86569	0.368242	1.40304	0.584311	0.202939	0.044899	10.50353	1.82E-11	0.071208
5	678	9.84E-05	-3.46532	0.149931	1.694192	0.07259	0.728167	0.059822	8.916647	1.65E-11	0.201041
6	864	0.000129	-8.10222	0.447952	0.332402	0.203753	0.496142	0.048631	2.4412	1.52E-10	0.107498
7	272	0.000154	-8.66788	0.356616	0.236234	0.919246	1.135628	0.098712	13.54327	2.48E-11	0.159844
8	3811	7.95E-05	-4.00485	0.250026	1.550333	0.139076	0.488939	0.027401	2.809888	1.06E-10	0.184776
9	4300	8.80E-05	-3.36154	0.21451	1.202489	1.161791	0.290063	0.072544	1.124891	2.03E-09	0.171266
10	1234	0.000159	-6.89114	0.344193	1.423448	0.427163	0.421126	0.003415	0.27961	4.21E-10	0.064202

Table 4.4 Parameter values for the top 10 ranking GLUE model realisations



## **4.6 Summary**

The CRUM3 hydrological model was chosen as potentially suitable for the enquiry as to whether land use changes could help manage low flows in the Dacre Beck catchment. Being a physically based, spatially distributed model CRUM3 will allow for various land cover scenarios and other land use management improvement methods to be simulated. The model was then assessed for its appropriateness in estimating the low flows discharge of the Dacre Beck catchment. Sensitivity analysis revealed that 16 of the original 24 model parameters showed significant adjustment of Q95 and Q99 with perturbations of the parameter within the ranges specified in the literature. Of these 16, the responses of the albedo, bedrock conductivity, saturated conductivity and the soil depths were of particular note. Ten of these parameters were chosen to develop further with a Generalised Likelihood Uncertainty Estimation (GLUE) experiment.

This experiment used Latin hypercube sampling to efficiently sample the 10 dimensional parameter space, and 5192 model realisations were developed. The results of these model runs were assessed for their performance using a combination of the Relative Mean Absolute Error (RMAE) and the Relative Nash Sutcliffe (RNS) objective functions. The top ten ranking model realisations were then studied in detail, concluding that whilst they still underestimate flood peaks slightly, and most overestimate the low flows, they perform significantly better than the base values parameter set. The model in these cases actually performs better at predicting low flows than high flows, and the model has been deemed appropriate for the study of low flows. To account for the problem of equifinality within the model, the top ten GLUE model realisations will all be considered in the further research into the effects of land use changes on the catchment hydrology.

# Chapter Five:

*Assessing the Effects of Vegetation  
Change on Low Flows Hydrology*

## **5.1 Introduction**

Land use changes, particularly in the form of vegetation change, have the potential to dramatically alter the hydrological regime of a river catchment. The effects of afforestation and deforestation on UK catchment hydrology have been well documented, with the experimental paired catchment field studies in Plynlimon in Wales (Hudson et al., 1997; Marc and Robinson, 2007) and the Balquhiddar catchments in Scotland (Eeles and Blackie, 1993; Gustard and Wesselink, 1993; Johnson and Whitehead, 1993) demonstrating the potential long term impacts. However, the effects of other types of vegetation change have been studied much less. Research efforts into potential effects of vegetation change have mostly been field studies, and very few have applied hydrological models to assess the impacts of vegetation change on extreme flows. It has been shown in Chapter 4 that the CRUM3 hydrological model is appropriate for investigative low flows simulations. Therefore, this chapter will outline the scenarios developed to assess vegetation change within the catchment, and the results of the impact of these scenarios on the low flows of the Dacre Beck catchment.

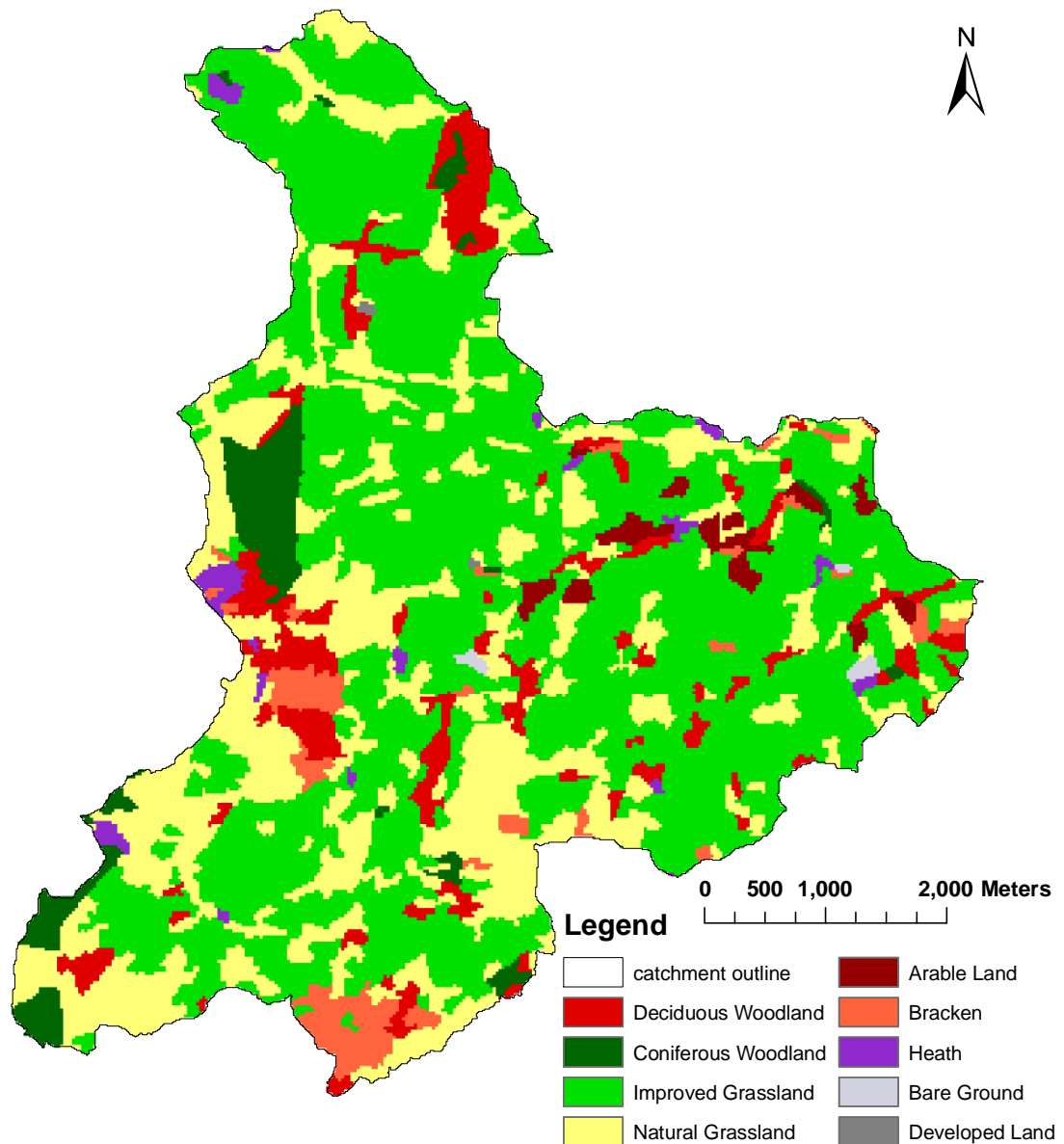
## **5.2 Spatially Distributed Vegetation Simulation**

The 10 behavioural model parameter sets from the GLUE analysis chosen for progression for use in the simulations of vegetation change were calibrated using a spatially homogeneous catchment land cover and soil properties. Before simulations of vegetation change scenarios could be designed, it was necessary to develop these model configurations to satisfactorily simulate the catchment hydrology with spatially variable land cover.

### **5.2.1 Land Cover Parameter Values**

Many of the parameters included in the CRUM3 model are strongly dependent on vegetation. Therefore, rather than using one value to represent the entire catchment, as was done in Chapter 4, it is at this stage important to discern how these parameters vary under different vegetation types. Not only do the land cover parameters describe the vegetation type, but the soil parameters are also indirectly affected, and thus vary between land covers. The original 14 land

covers described by the Centre for Ecology and Hydrology's Land Cover Map 2000 (LCM2000) (Figure 2.10) were reclassified leaving 9 land covers, or vegetation types, as shown in figure 5.1. The Arable Cereals, Arable Horticulture and Non-rotational Horticulture were grouped to produce a general 'Arable' land cover. Acid, Calcareous and Neutral Grassland were grouped to produce a 'Natural Grassland' land cover, and the Dense Dwarf and Open Dwarf Shrub Heath were combined to produce a 'Heath' land cover. All other land covers remained individually represented.



**Figure 5.1 Reclassified LCM2000 to 9 Land Covers**

Table 5.1 outlines the area of the catchment covered by each land use according to the LCM2000.

Land Cover	% area	Area (km <sup>2</sup> )
Deciduous	7.3	2.701
Coniferous	3.9	1.443
Improved Grass	55.3	20.461
Natural Grass	27.3	10.101
Arable Land	1.6	0.592
Bracken	3.1	1.147
Heath	1.1	0.407
Bare Ground	0.2	0.074
Developed	0.07	0.0259

**Table 5.21 Catchment area covered by each Land Cover type**

The hydrological literature was used to determine typical values for, or relationships between, the parameter values for each of these nine land covers. Table 5.2 gives the literature values for the land cover parameters whilst table 5.3 gives the literature values for the soil parameters under each land cover type. Base values, as explained in Chapter 4 section 3, were taken from the previous calibration of the CRUM3 model for the Dacre Beck catchment by Baugh (2010) and Pattison (2010). Where the literature quoted figures as zero, parameters were set at a value of  $1^{E-9}$  as the sensitivity analysis demonstrated the model giving inappropriate results with some parameters at a zero value (as can be seen in figure 4.3j). This is understandable as division by zero gives an infinite number of solutions. Values for the percentage of cell with overland flow were not found in the literature, as it is a parameter unique to the CRUM3 model and was set to base values across the range of land covers. The same was done with the root layer b parameter. Values of the Green and Ampt A and B were unavailable in the literature, and were shown to be insensitive within the model; so they were uniformly ascribed their base values. Finally, the bedrock conductivity was not varied between land covers as it is not a parameter likely to be affected by the surface vegetation and is known to be fairly consistent across the Dacre Beck catchment.

Land Cover	Interception Depth (m)	Gap Fraction	Albedo	Max Veg. Height	DW Friction Factor	Veg. Growth Rate	% Cell with O.L.F.	Growth Temp Threshold
Deciduous Woodland	0.00287	0.2	0.18	18.2	1.5	0.00004372	0.3	7.2
Coniferous Woodland	0.00296	0.2	0.15	24.3	1.5	0.00001653	0.3	5
Improved Grassland	0.0015	0.05	0.2	1.35	8.3	0.000055	0.3	4
Natural Grassland	0.0015	0.05	0.25	1.35	8.3	0.000075	0.3	4
Arable Land	0.00289	0.4	0.25	1.44	2.17	0.0006	0.3	4
Bracken	0.0009	0.05	0.22	2.5	1.91	0.00029	0.3	7.5
Heath	0.002	0.05	0.15	1.35	1.91	0.00065	0.3	5
Bare Ground	1E <sup>-9</sup>	1E <sup>-9</sup>	0.18	0.0001	0.5	1E <sup>-9</sup>	0.3	5
Developed Land	1E <sup>-9</sup>	1E <sup>-9</sup>	0.16	0.0001	0.5	1E <sup>-9</sup>	0.3	5
<b>Base Values</b>	<b>0.002</b>	<b>0.2</b>	<b>0.1897</b>	<b>1</b>	<b>75</b>	<b>0.02</b>	<b>0.3</b>	<b>5</b>
Sources	(Breuer and Frede, 2003) (UK&EU)	(Reaney et al., 2005)	(Barry and Chambers, 1966; Maidment, 1993; Dingman, 1994; Breuer and Frede, 2003)	(Næsset, 1997; Breuer et al., 2003; Herbst et al., 2007)	(Gilley et al., 1992; Gilley and Kottowitz, 1994; Abrahams et al., 1995; Musleh and Cruise, 2006; Parsons and Abrahams, 2009)	(Sims and Singh, 1978; Cropper and Golz, 1993; Birch et al., 2000; Ganapathi, 2006)	NOT IN LIT (Reaney et al., 2005)	(Kozlowski et al., 1962; Birch et al., 2000; Kilpeläinen et al., 2005)

Table 5.2 Land Cover Parameter Values from the literature

Land Cover	Soil depth channels (m)	Soil depth slopes (m)	Soil depth ridges (m)	Soil depth plains (m)	root layer k sat (m/s)	k sat (m/s)	Root layer depth (m)
Deciduous Woodland	1.5	0.24	0.75	0.75	0.0000264	0.00132	0.03
Coniferous Woodland	1.3	0.2	0.625	0.625	0.00000461	0.00023	0.02
Improved Grassland	1	0.16	0.5	0.5	0.0000064	0.00051	0.01
Natural Grassland	1	0.16	0.5	0.5	0.0000026	0.00051	0.01
Arable Land	0.986	0.158	0.493	0.493	0.0000102	0.00028	0.0099
Bracken	1.1	0.18	0.6	0.6	0.0000026	0.00028	0.015
Heath	1.1	0.18	0.6	0.6	0.0000026	0.00028	0.015
Bare Ground	1	0.16	0.5	0.5	0.009	0.00013	0.05
Developed Land	1	0.16	0.5	0.5	0.009	0.00013	0.05
<b>BASE VALUES</b>	<b>1</b>	<b>0.16</b>	<b>0.5</b>	<b>0.5</b>	<b>0.009</b>	<b>0.0002</b>	<b>0.05</b>
Sources	(Pattison, 2010)	(Pattison, 2010)	(Schulze et al., 1996; Pattison, 2010)	(Schulze et al., 1996; Pattison, 2010)	(Pattison, 2010)	(Gonzalez-Sosa et al., 2010)	(Pattison, 2010)

Table 5.3 Soil Parameter Values from the literature (continued on next page)

Land Cover	Root layer B	Green Ampt A (mm/hr)	Green Ampt B (mm/hr)	Porosity (dec %)	K decay with depth	Bedrock conductivity (m/s)
Deciduous Woodland	4.05	10	5	0.74	-9.8	2.5E <sup>-10</sup>
Coniferous Woodland	4.05	10	5	0.73	-9.8	2.5E <sup>-10</sup>
Improved Grassland	4.05	10	5	0.628-0.882 (0.63)	-4.9	2.5E <sup>-10</sup>
Natural Grassland	4.05	10	5	0.63	-4.37	2.5E <sup>-10</sup>
Arable Land	4.05	10	5	0.47	-4.37	2.5E <sup>-10</sup>
Bracken	4.05	10	5	0.784	-6	2.5E <sup>-10</sup>
Heath	4.05	10	5	0.8305	-6	2.5E <sup>-10</sup>
Bare Ground	4.05	10	5	0.41	-7.8	2.5E <sup>-10</sup>
Developed Land	4.05	10	5	0.41	-7.8	2.5E <sup>-10</sup>
<b>BASE VALUES</b>	<b>4.05</b>	<b>10</b>	<b>5</b>	<b>0.451</b>	<b>-3</b>	<b>2.5E<sup>-10</sup></b>
Sources	NOT IN LIT	NOT IN LIT	NOT IN LIT	(Meyles et al., 2006; Gonzalez-Sosa et al., 2010)	(Youngs, 1976; Beven, 1984; Elsenbeer et al., 1999)	SHOULDN'T BE INFLUENCED BY VEG

Table 5.3 cont. Soil Parameter Values from the literature



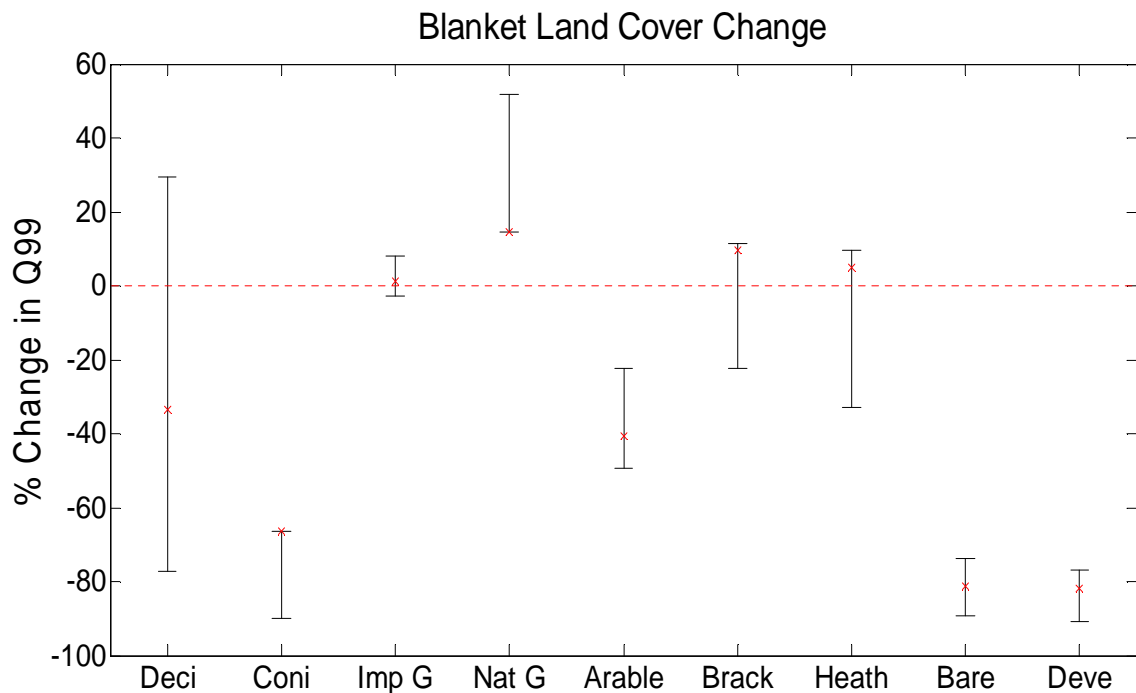
The Darcy Weisbach Friction Factor and the vegetation growth rate were very difficult to locate in the literature, and were often derived from other measurements (such as biomass). This may explain why the values for these parameters varied so widely from the base values.

The values of the parameters from the literature often varied significantly from the values used in the top ten GLUE model realisations. The current area of each land use was taken into account as the parameters were rescaled to proportionally average the total parameter values used in each of the initial ten GLUE runs. This resulted in individual parameter values for each GLUE run representing each of the land cover types. For example, the soil depth channels parameter for deciduous woodland for the GLUE1 model realisation was 1.3199, whereas for the GLUE2 model realisation the same parameter was ascribed a value of 0.3601. This was because to produce an accurate representation of the observed catchment discharge, GLUE1 originally used a soil depth channels value of 0.9263, whereas GLUE2 used the much smaller value of 0.2527. This parameter rescaling retained the relationship between the different land covers, whilst keeping the model calibrated to simulating the catchment behaviour.

The rescaled parameter values could now be used to create parameter files for each type of land cover, and the land cover map used by the model could be altered to represent any distribution of land cover across the catchment. Each of the top ten GLUE model realisations would be run for each land cover change scenario in order to gain a range in the possible catchment responses, depending on which GLUE run is taken to be an accurate representation of the catchment hydrology.

### **5.3 Blanket Changes**

The first land cover change scenarios modelled were blanket changes. These were used mostly as extreme case scenarios to see in what way the catchment discharge responded to each land cover. Figure 5.2 shows the results of the blanket change runs. Each of the 10 GLUE model realisations were run with each of the 9 land covers set as blanket cover across the entire catchment.



**Figure 5.2 Blanket Land Cover Change Scenarios effect on Q99**

The results are given in terms of the percentage change in Q99 between each run and its respective GLUE run with the land cover as in the LCM2000. Q99 is the discharge value that is exceeded for 99 per cent of the year, which in this study is being used as a measure of extreme low flows. The red crosses show the results of the top ranking GLUE model realisation (GLUE1) and the error bars indicate the range in possible outcomes within the top ten GLUE model realisations.

It can be seen that blanket vegetation change to deciduous woodland gives the widest range of results, with the potential to increase (improve) Q99 by 29.6%, while it could also decrease Q99 by 77.2%. Coniferous woodland gives definite negative results in Q99 adjustment, worsening the discharge value by between 66.23 and 89.83%. The majority of parameters were very similar between woodland types, except for the root layer saturated conductivity and the main soil saturated conductivity. This suggests that the saturated conductivities are largely responsible for the significant difference in catchment response between deciduous and coniferous woodland.

Improved grassland gives a far smaller response than the woodlands, as expected as the catchment is currently 55.3% improved grassland. Improved

grassland gives a range in values from -2.87 to 8.03%. Natural grassland provides the only wholly positive response in Q99, with a maximum increase of 51.79%. This equates to an increase in discharge value of  $0.0083\text{m}^3 \text{s}^{-1}$ . The minimum amount a blanket change to natural grassland would increase Q99 is 14.46%, or  $0.0036\text{m}^3 \text{s}^{-1}$ . This reliably positive response in comparison to the woodland scenarios is due to the fact that natural grassland provides the roughness required to slow the water down and allow it to infiltrate into the soils, whilst not increasing the evapotranspiration rate or the interception by leaf coverage, with a lower gap fraction and interception depth than woodland. In fact, the roughness provided by natural grassland is much higher than woodland, as tree trunks are significantly sparser than grassland stalks and blades.

Arable land shows a negative impact on catchment extreme low flows, with decreases in Q99 of -22.23% to -49.35%. Bracken and heath produce similar responses in Q99 mostly resulting in a negative impact on Q99, -22.37% and -32.95% respectively, but potentially increasing the discharge by 11.37 and 9.56% respectively. Finally, bare ground and developed land have the most negative impact on Q99, with their worst outcomes being -90.26 and -92.13%, and their best being -76.28 and -79.25% respectively. This is not surprising as removing all vegetation in the bare soils scenario gives the catchment a very low roughness, with little friction, and no interception capabilities allowing most rainwater to runoff very quickly, therefore impeding the catchment's water storage potential and significantly decreasing the low flows discharge. Similarly, with developed land the water has no access to the soils due to hard standing coverage and will also runoff preferentially to infiltration, thus dramatically increasing flood peaks, and decreasing low flows. The only parameter that varies between the bare ground and developed land covers is the albedo, which is slightly smaller for developed land, and is thus accountable for the slight variation in response between the two. Even though improved grassland, arable land, bare soils and developed land are not land covers being considered for catchment change, it is interesting to see the low flows response regardless.

## **5.4 Slope Changes**

The first set of scenarios used to test potentially implementable land cover changes for the management of low flows were those of changing the land cover on the slopes of the catchment.

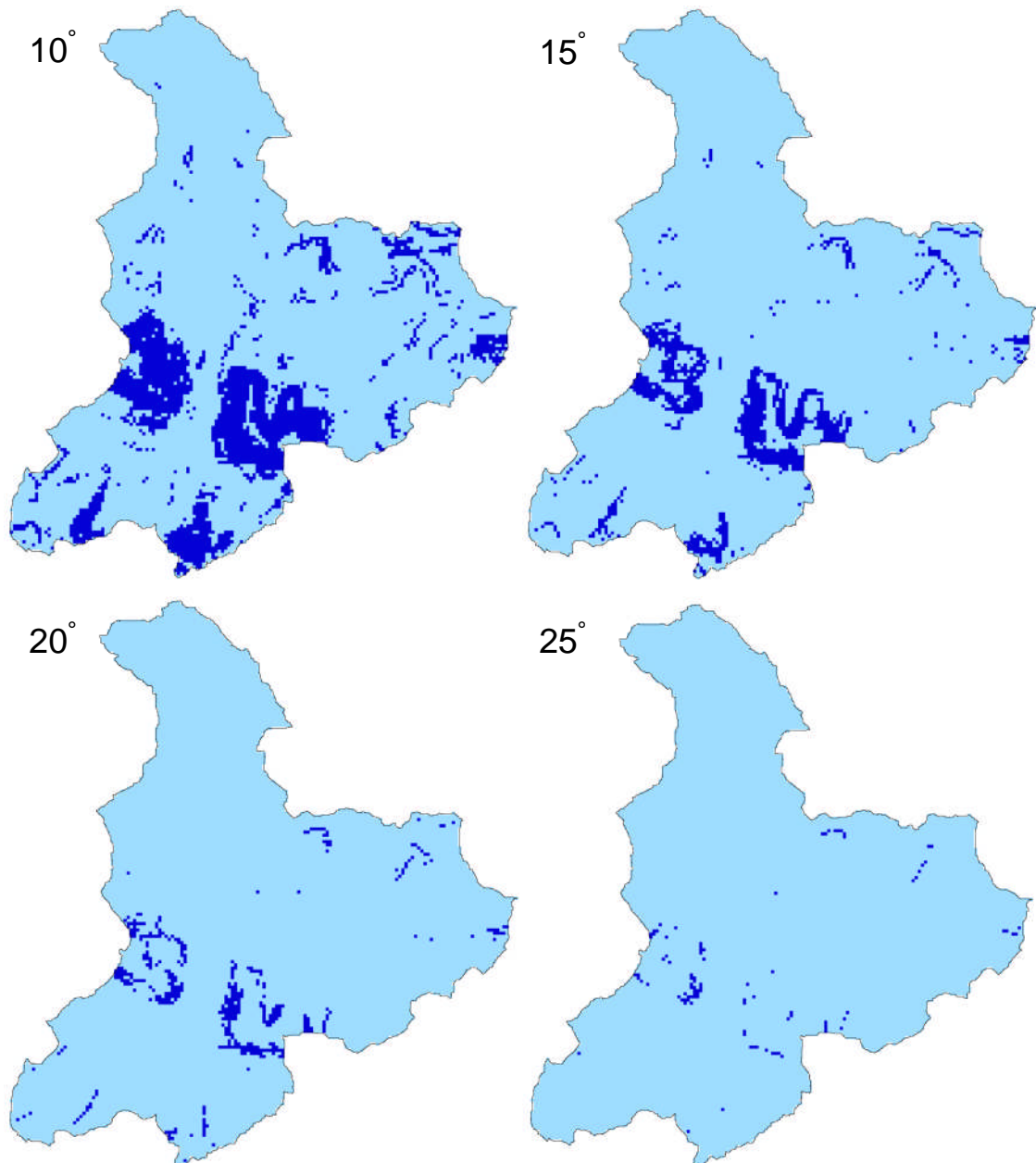
### **5.4.1 Scenario Development**

These scenarios were developed from the idea that arable and pasture land is difficult to cultivate and access above a certain slope angle. Various quotes are given as to the maximum 'mowable' slope angle, though not many recent studies have been done with modern vehicles. Vaisanen (1996) state that the maximum uphill gradient for a loaded tractor is  $14^{\circ}$ , whilst Spencer and Owen (1981) suggest that slopes above an angle of  $18^{\circ}$  are difficult to descend without skidding. More recent online forums (e.g. GroundtradesXchange (2003-2007)) give advice ranging from  $10^{\circ}$ - $23^{\circ}$ . Therefore, four scenarios were developed in which all land above slope values of  $10^{\circ}$ ,  $15^{\circ}$ ,  $20^{\circ}$  and  $25^{\circ}$  were designated for land cover change. The areas this covered are shown in the maps in figure 5.3. The  $10^{\circ}$  slope scenario (which includes all land with a slope gradient above  $10^{\circ}$ ) covers 20.86% of the total catchment area, the  $15^{\circ}$ ,  $20^{\circ}$  and  $25^{\circ}$  slopes cover 8.9, 3.25 and 0.73% of the catchment respectively.

Table 5.4 demonstrates how much of the total catchment area is currently dedicated within these scenarios to each land use. In each of the four scenarios natural grassland is the most dominant land cover, closely followed by improved grassland. The higher the slope angle, the less improved grassland is included in the area to be changed, proportionally. There is always a fair amount of deciduous woodland, and bracken also covers a sizeable proportion of the scenarios. Arable land and heath are not common on slopes, and bare ground and developed land aren't seen at all except for the very small amount of bare ground included in the  $10^{\circ}$  scenario.

### **5.4.2 Results**

A graph showing the results of all four scenarios together for comparison is shown in figure 5.4. Each of the four slopes are shown within each land cover block reading from left to right,  $10^{\circ}$  to  $25^{\circ}$ .



**Figure 5.3 Area covered by slope scenarios:** Dark blue to be changed, light blue to remain as in LCM2000.

The graph shows that the higher the slope we designate to change, the smaller the response in Q99. This is understandable as smaller amounts of land are being changed with an increase in slope gradient allocated. Overall, the results show a similar trend to that seen in the blanket change runs, except that bracken and heath give a generally more positive result than could be seen under blanket change.

Land Cover	% total catchment area			
	10°	15°	20°	25°
Deciduous	2.6	1.47	0.78	0.175
Coniferous	0.65	0.29	0.099	0.015
Improved Grass	5.4	1.72	0.5	0.106
Natural Grass	6.7	3.25	1.2	0.25
Arable Land	0.13	0.08	0.061	0.015
Bracken	2.2	1.31	0.48	0.14
Heath	0.16	0.05	0.023	0.023
Bare Ground	0.0078	0	0	0
Developed	0	0	0	0

Table 5.4 Land cover distribution within each of the 4 slope scenarios

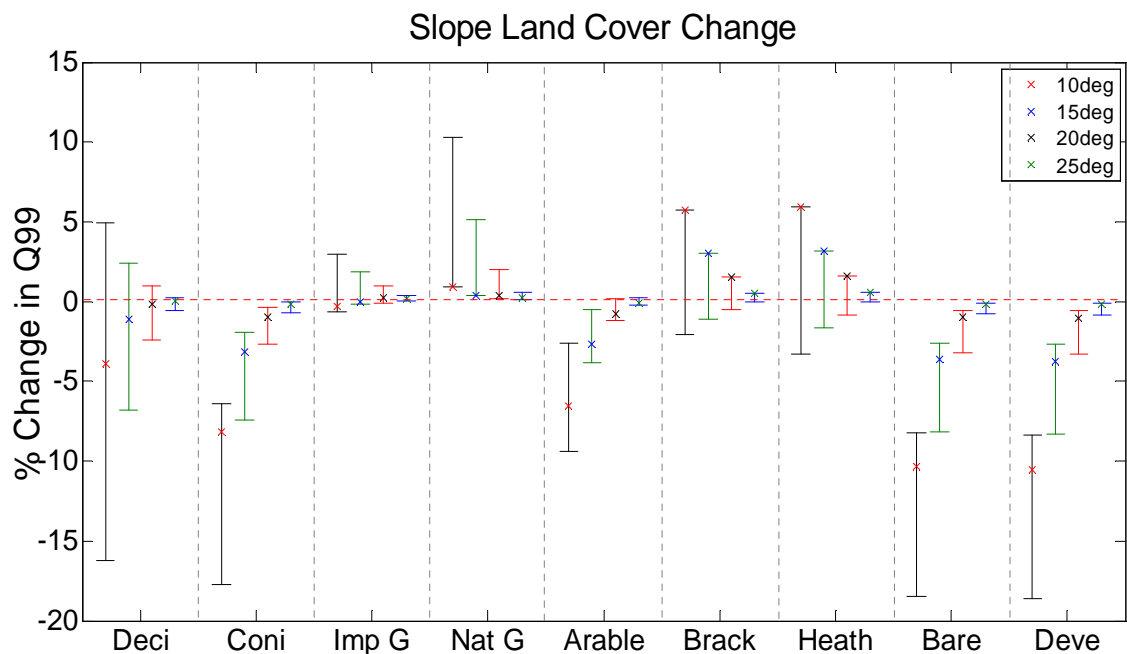


Figure 5.4 Overall effects of the four slope land cover change scenarios on Q99

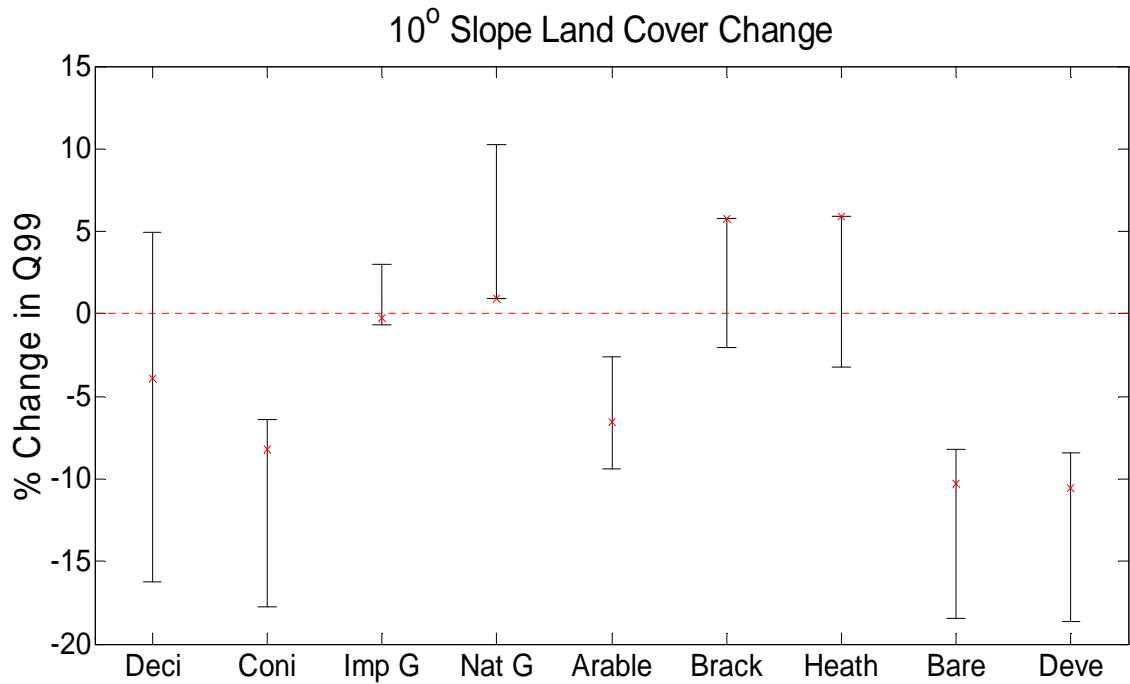


Figure 5.5 10° slope scenario impacts on Q99

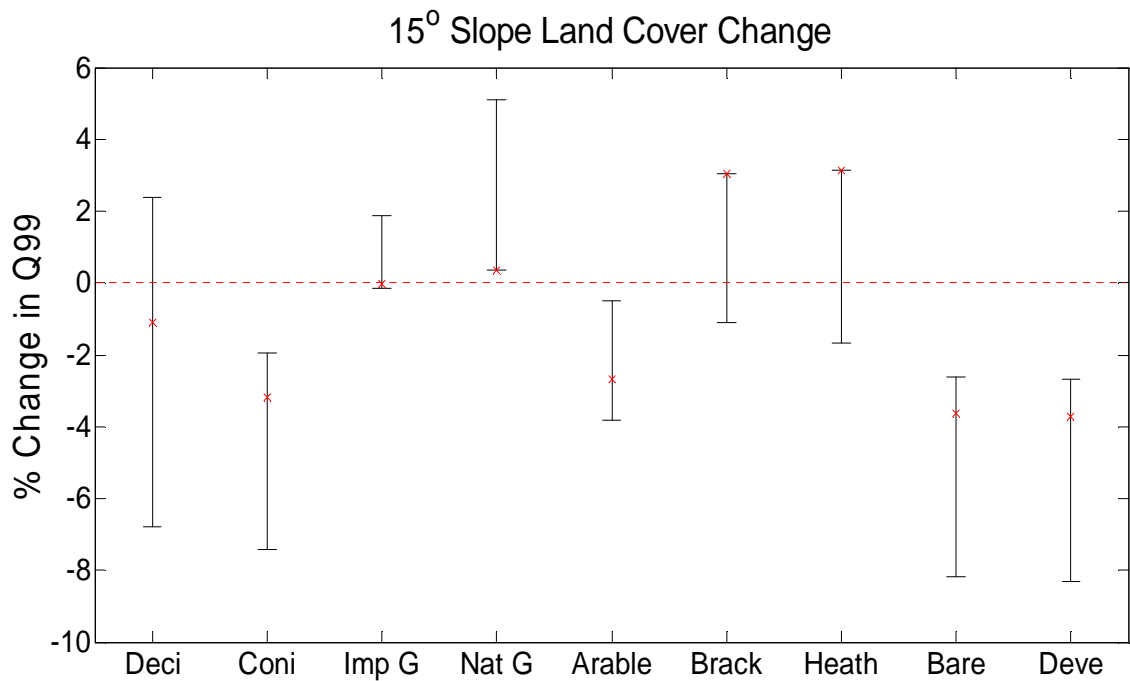


Figure 5.6 15° slope scenario impacts on Q99

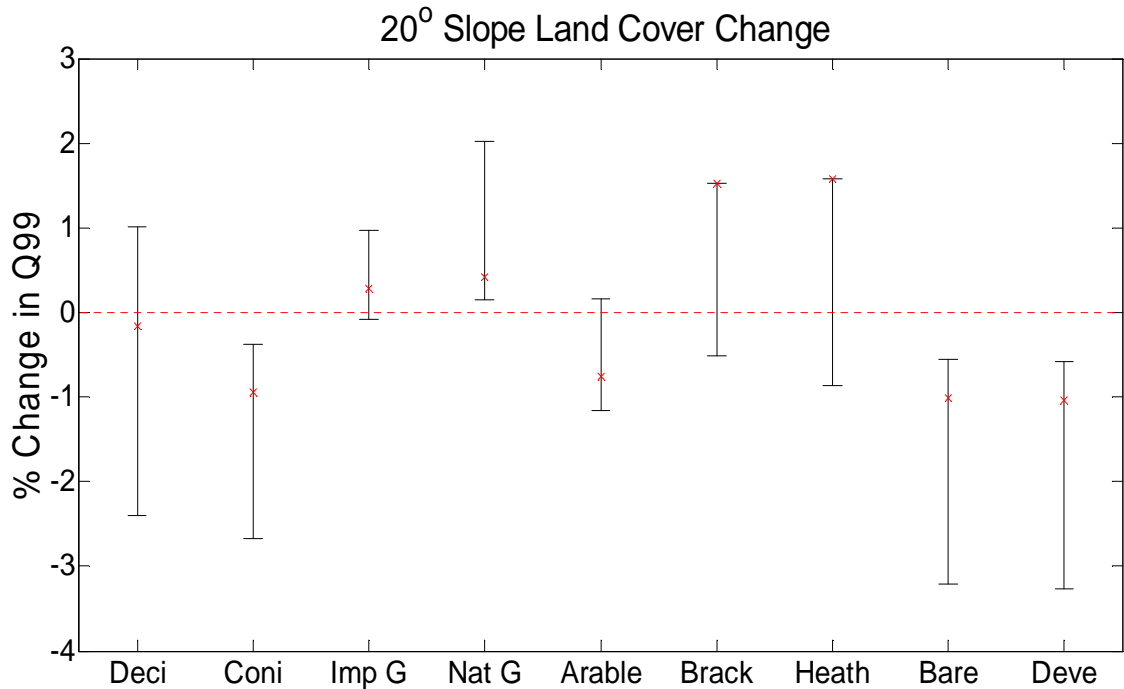


Figure 5.7 20° slope scenario impacts on Q99

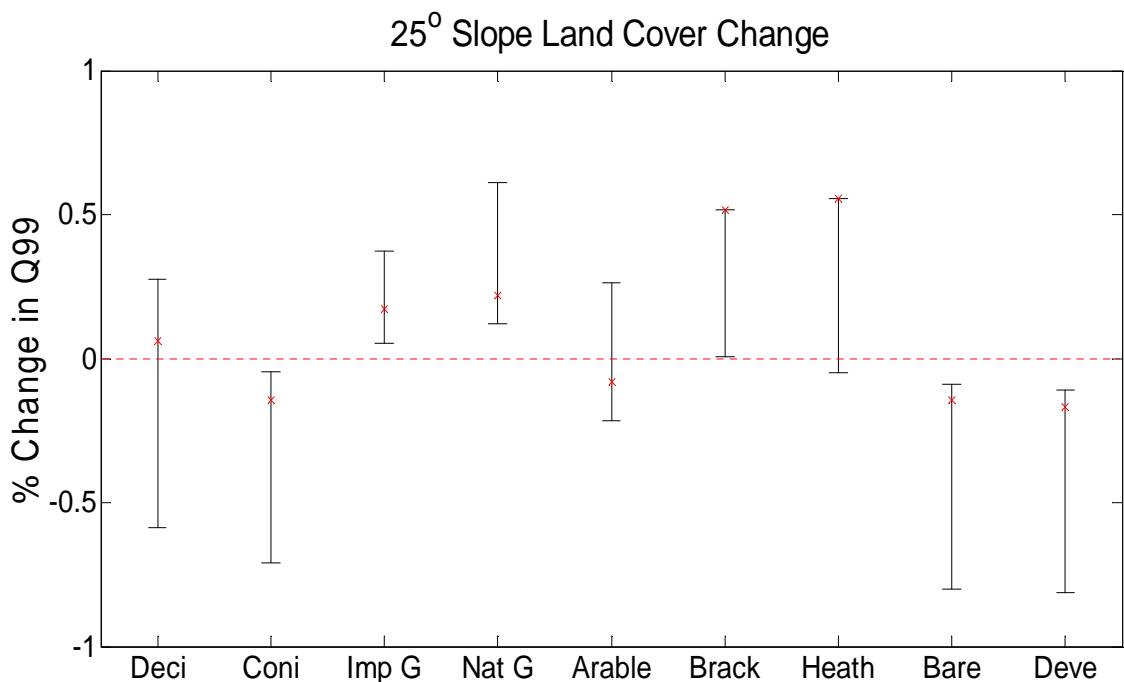


Figure 5.8 25° slope scenario impacts on Q99

Figures 5.5, 5.6, 5.7 and 5.8 show the slope scenarios individually. It is evident from the individual slope change graphs that the responses in Q99 are much the same, just on smaller scales as we increase the slope value we designate for change. Only the 25° graph looks to show slightly different results, as the improved grassland and bracken land covers show wholly positive effects, and the heath lies only very slightly below the 0 line. In all scenarios the natural



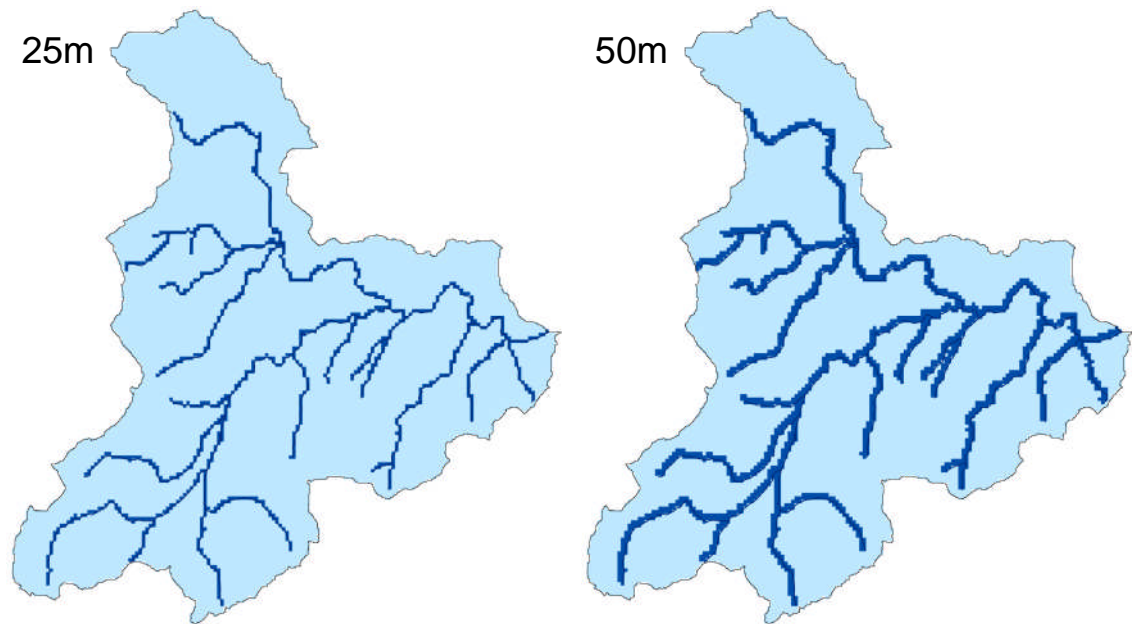
grassland gives the best increase in Q99, and is the only land cover that guarantees a positive response. The ranges in the natural grassland improvement are 0.91-10.26, 0.37-5.11, 0.15-2.02 and 0.12-0.61% for the 10, 15, 20 and 25° slope scenarios respectively. Coniferous woodland, bare ground and developed land all give consistently negative results as with the blanket runs, and the deciduous woodland land cover straddles the 0 line in all scenarios. Bracken and heath perform fairly well, and are more likely to be beneficial to low flows than detrimental, but it depends on which GLUE model realisation truly represents the catchment behaviour. Improved grassland gives mostly positive results, but doesn't have the potential to improve Q99 as much as the natural grassland does, and it could in the first three scenarios decrease Q99. Arable land has a wholly negative effect on the catchment low flows for the 10 and 15° scenarios, edges above the 0 line in the 20 and 25° scenarios. This suggests that very small increases in the amount of arable land in the catchment have a small impact on the Q99 value. Overall though, natural grassland gives the best results in the slope land cover change scenarios.

## **5.5 River Buffer Changes**

The second set of management oriented scenarios was to create buffer strips along the river channels in the catchment.

### **5.5.1 Scenario Development**

These scenarios were developed due to the fact that buffer strips (or riparian zones) are commonly used in flood alleviation schemes to slow the water entering the channel during a storm (Carroll et al., 2004). These buffer strips are usually wooded or wet grassland in nature, and are very beneficial to both in stream (Murphy et al., 1986) and terrestrial ecology (Machtans et al., 1996) as well as helping with bank stability and reducing erosion risk (Barling and Moore, 1994). Two scenarios were designed, buffer strips of 25 and 50m wide on each side of the channels. These widths were chosen due to the 50m resolution of the model. Maps of the area covered by these scenarios are given in figure 5.9

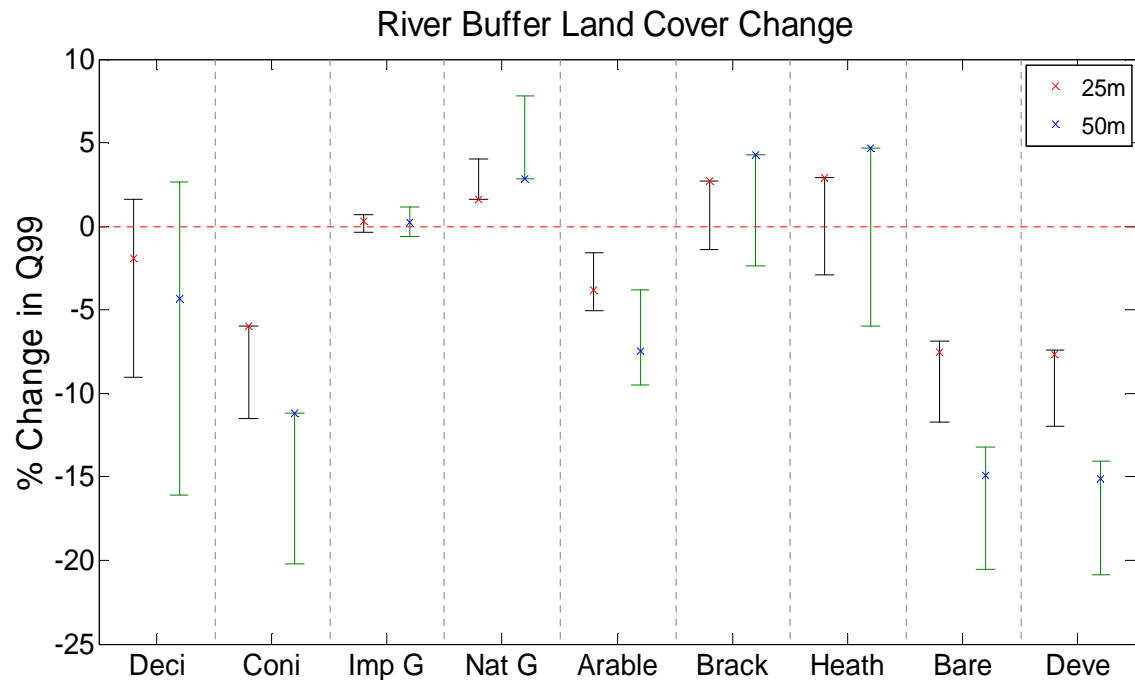


**Figure 5.9 Area covered by buffer strip scenarios:** Dark blue areas to be changed, light blue to remain as in LCM2000

The 25m buffer strip scenario covers approximately 7.6% of the catchment ( $2.8\text{km}^2$ ), whilst the 50m scenario covers 16% ( $5.92\text{km}^2$ ).

### 5.5.2 Results

Figure 5.10 shows the results of the buffer strip scenario runs. The 25m scenario results are shown on the left hand side of each land cover block, whilst the 50m scenario results are shown on the right. Again the less land we commit to change, the less response the Q99 value shows, and again the trend in results matches those of the blanket scenarios. The coniferous woodland, arable land, bare soils and developed land all show wholly negative effects on the catchment Q99 value, whilst the deciduous woodland, improved grassland, bracken and heath land covers are split between potentially giving both positive or negative effects. Only the natural grassland gives consistently positive results, which range from values of 1.61 to 4.04% for the 25m scenario and 2.83 to 7.84% for the 50m scenario. Interestingly, deciduous woodland, which is commonly chosen for buffer strip implementation to alleviate flood risk, has the potential to reduce extreme low flow discharge values by up to 9.06% in the 25m scenario, and 16.09% in the 50m scenario. Conversely, deciduous woodland could also increase Q99 by 1.6 and 2.65% for the 25 and 50m scenarios respectively.



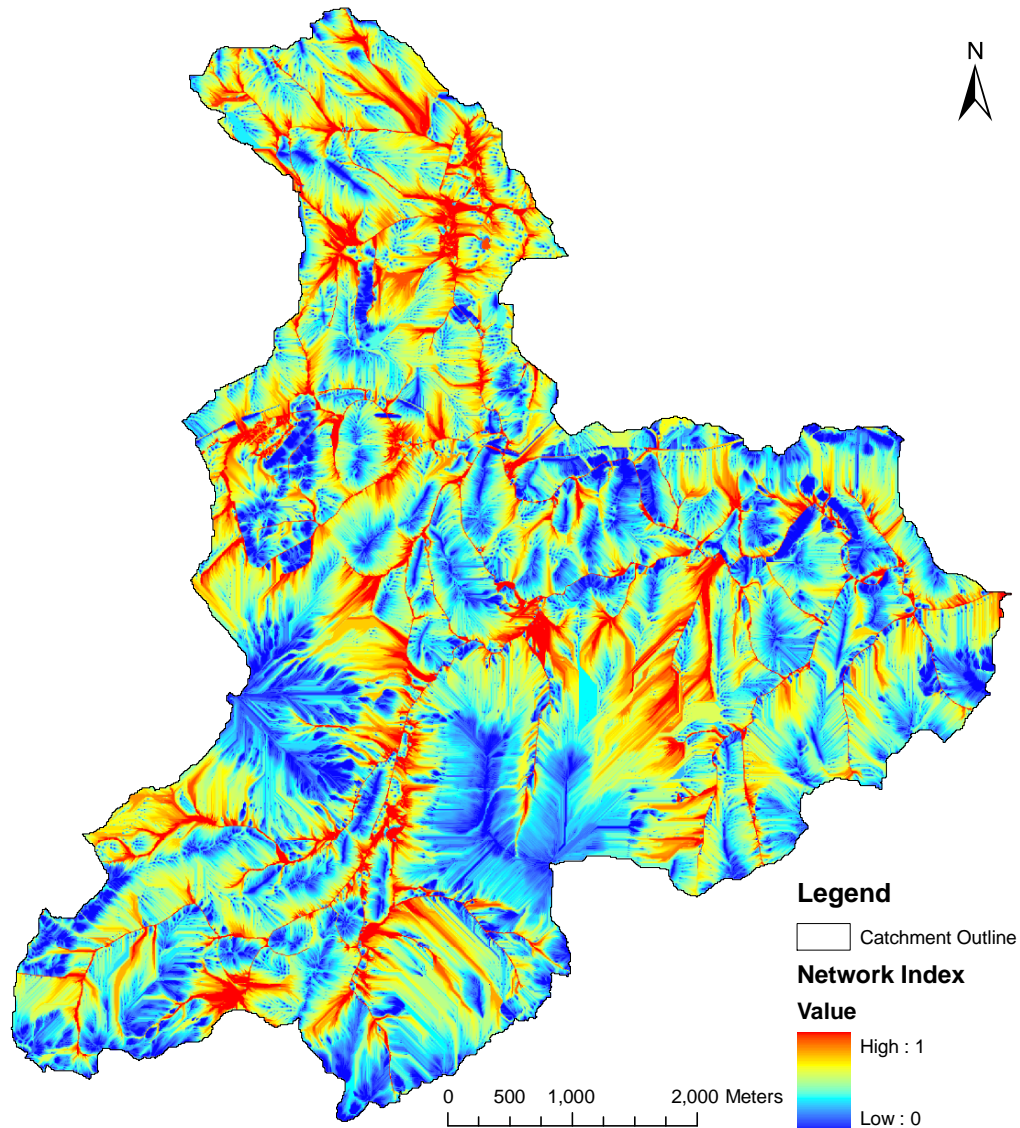
**Figure 5.10 River buffer scenario impacts on Q99**

## 5.6 SCIMAP Changes

As discussed in Chapter 3, the SCIMAP model develops risk maps of hydrological connectivity (Lane et al., 2003). It was understood that the use of such a risk map in the Dacre Beck catchment would allow more targeted approaches to land cover change, focussing on the areas of the catchment that have a strong influence on the channel discharge. The way in which the SCIMAP model produces a hydrological connectivity (or network index) map is outlined in Chapter 4, section 4.1.

### 5.6.1 Scenario Development

The SCIMAP network index map is shown in figure 5.11. The hydrologically connected land areas, with an index value of 1 are shown in red, and the decreasing connectivity is then shown through the spectrum of colours to blue which shows areas that are hydrologically disconnected. This map was first resampled to a 50m resolution by averaging the index values for the 100 5m x 5m cells within the 50m x 50m cell. This was done in MATLAB as the values are continuous; previous resampling of integer value maps was done in ArcGIS.

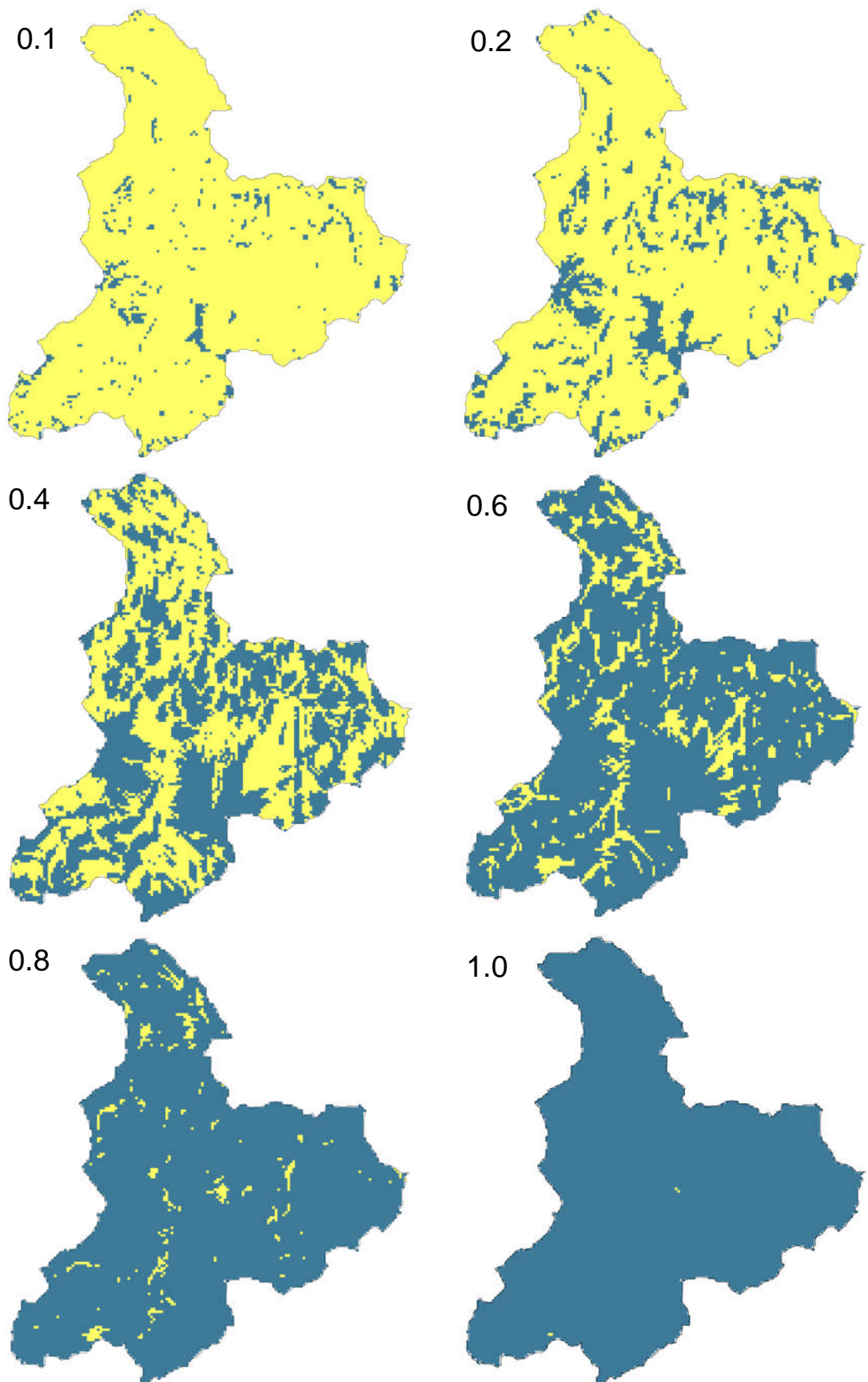


**Figure 5.11 SCIMAP Network Index Map**

This 50m network index map was then used to create 10 land cover change scenarios, changing all land above a network index of 0.1, 0.2, 0.3, 0.4.....to 1.0. Maps showing the land coverage for a selection of these scenarios are given in figure 5.12. The scenarios gradually covered less and less land, such that 0.1 (94.82%), 0.2 (84.02%), 0.3 (69.28%), 0.4 (49.58), 0.5 (30.6%), 0.6 (16.68%), 0.7 (8.76%), 0.8 (3.75%), 0.9 (1.24%) and 1.0 (0.03%). Therefore, the scenarios below an index value of 0.6 were unrealistic for catchment management but were run for extreme case comparison purposes anyway.

### **5.6.2 Results**

The overall results of the 10 SCIMAP scenarios are shown in figure 5.13. The results read left to right from the 0.1 through to the 1.0 scenario.



**Figure 5.12** Area covered by the SCIMAP land cover scenarios: blue indicates land to be changed, yellow indicates land to remain as in the LCM2000.

As with both the slope and the buffer scenarios it is apparent that the Q99 response decreases in scale as less land is designated for change. The same trend can be seen once again between the land cover types, and it is perhaps even more prominent in this case that the natural grassland is the best land cover type for increasing low flows discharge.

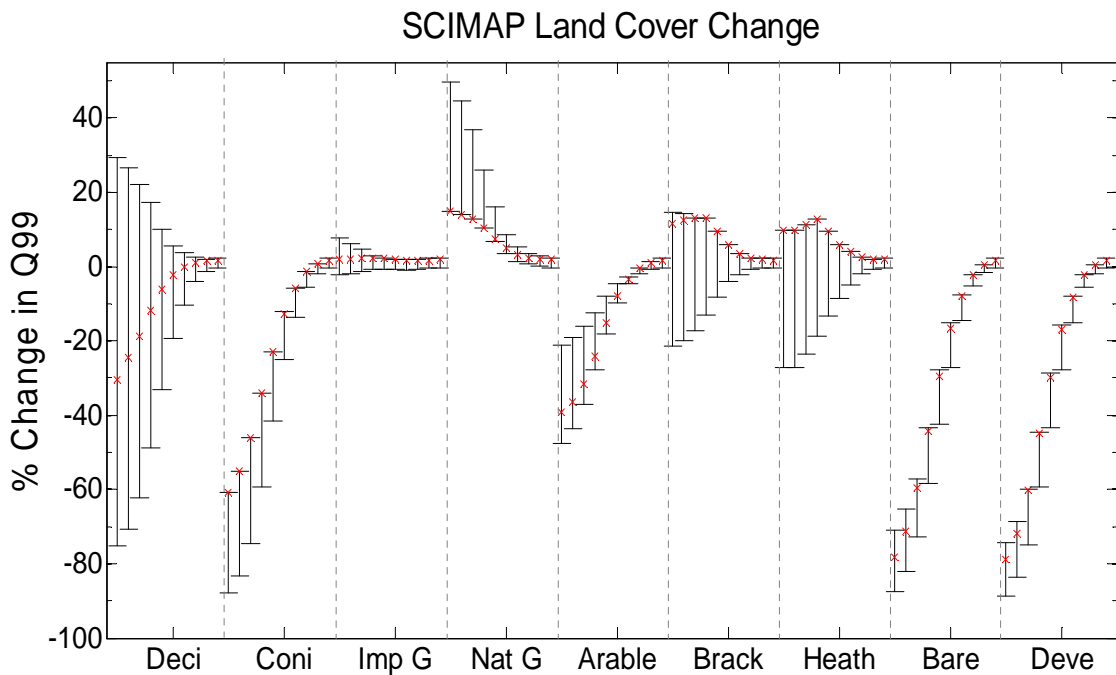


Figure 5.13 Overall impact of SCIMAP scenarios on Q99

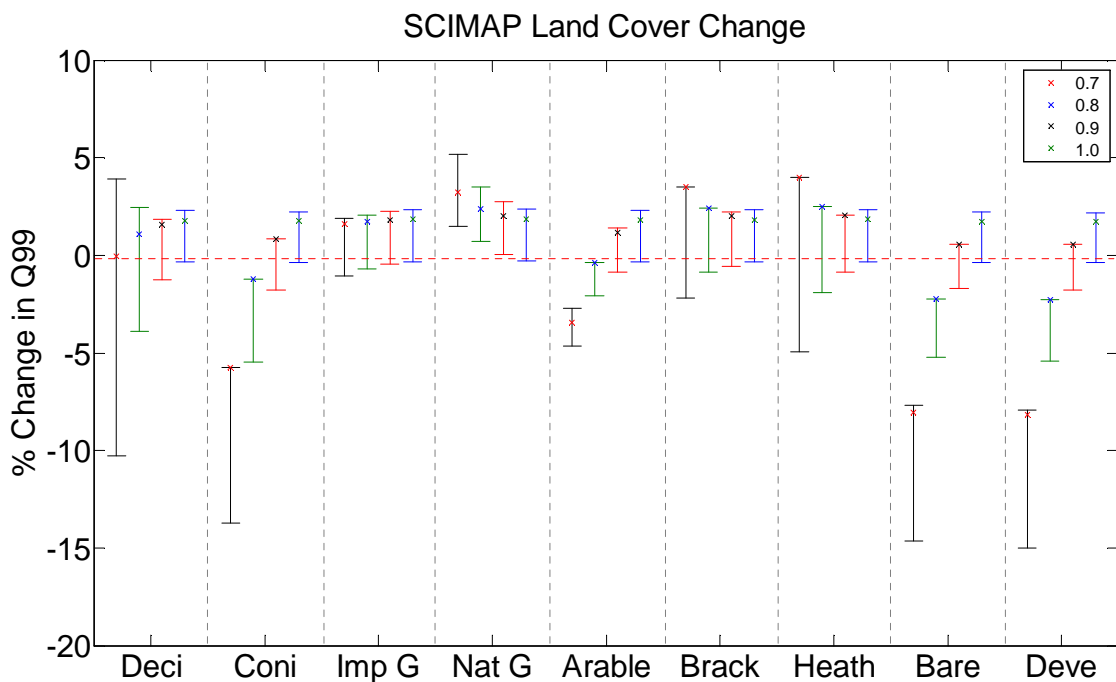


Figure 5.14 Impact of the 0.7, 0.8, 0.9 and 1.0 SCIMAP scenarios on Q99

One interesting feature to pick out of these results is that all land covers follow a steady trend tending toward 0, except for the heath runs, which show a peak in the upper limit on the 0.4 scenario. As previously mentioned, the most of the lower network index value runs cover far too much of the catchment's land to be feasible. Therefore, figure 5.14 shows the results from the 0.7, 0.8, 0.9 and 1.0 SCIMAP scenarios in more detail. From this graph, we can see that, as previously, the natural grassland shows the best improvements to the catchment extreme low flows discharge. The natural grassland had the potential to increase Q99 by 5.15, 3.51, 2.74 and 2.37% for the 0.7, 0.8, 0.9 and 1.0 scenarios respectively. The heath was the next best, if we only consider the upper potential figure, followed by the bracken. Bracken was however more consistently positive. Improved grassland showed little change, though this land cover had the least risk of strongly worsening Q99 after the natural grassland. Again, overall the natural grassland is the best land cover for increasing low flows discharge.

## **5.7 Summary**

The top ten GLUE model realisations were applied to discover how vegetation change can impact the low flows of the Dacre Beck catchment. Parameters describing the nine different land covers derived from the Centre for Ecology and Hydrology's Land Cover Map 2000 were sought from the literature. These parameter values were then rescaled for application in the CRUM3 model. Blanket changes in land cover from current use were modelled to determine the catchment's extreme response to each land cover. The extreme low flows discharge value (Q99) was seen to increase in response to a change to natural grassland. Coniferous woodland, arable land, bare soil and developed land gave strongly negative results, whilst deciduous woodland, bracken and heath demonstrated mixed responses depending on which of the GLUE model realisations was applied. Improved grassland also gave a mixed response, but on a relatively small scale, as over half of the catchment is already under an improved grassland use.

Changes in land cover above a slope angle of 10, 15, 20 and 25° were the first set of model scenarios used to assess potentially implementable low flows management efforts. Natural grassland was seen to be the most effective land cover in increasing extreme low flows discharge, potentially initiating a 10.26, 5.11, 2.02 and 0.61% increase in Q99 for the 10, 15, 20 and 25° scenarios respectively. The next scenarios involved changing the land cover in 25 and 50m wide buffer strips along each side of the river channels. Again, natural grassland proved the best land cover at increasing low flows. In this case the change had the potential to increase Q99 by 4.04 and 7.84% for the 25 and 50m buffer scenarios respectively. Finally the SCIMAP hydrological connectivity map was used to apply targeted land cover change in areas likely to directly contribute water to the channel. The results of these land cover changes were consistent with the previous scenarios as natural grassland was again the most dependably beneficial land cover for low flows discharge. Q99 here was increased by 5.15, 3.51, 2.74 and 2.37% for the 0.7, 0.8, 0.9 and 1.0 scenarios respectively.

These results show that natural grassland is the best land cover at providing water to the channel during periods of low flow regardless of where it is placed in the catchment. Of the scenarios sampled, 7.84% was the maximum increase in Q99 achieved with a reasonable area of land designated for change. This was the 50m buffer strip scenario. This scenario is unlikely to be implementable due to the location of the land required to make the change, so 5.15% was the next best, achieved by changing all land above a SCIMAP network index value of 0.7. The feasibility of applying these land cover change scenarios will be assessed further in chapter 7.



# Chapter Six:

*Assessing the Effects of Soil  
Compaction on Low Flows  
Hydrology*

## **6.1 Introduction**

Soil compaction is an issue for catchment hydrology in all catchments that are dominated by a farming land use (Hamza and Anderson, 2005). Compaction caused both by machinery (Hawkins and Brown, 1963; Arndt, 1966) and by stock (Heathwaite et al., 1990) has been documented to increase overland flow as it decreases soil porosity, bulk density, infiltration capacity and saturated conductivity. The ploughing of arable land causes compaction from the weight of the vehicles used, especially on farmland tracks. Pastoral land that contains high stocking densities also suffers from compaction from the animals' hooves, as well as suffering from overgrazing which causes soil degradation. These issues have the potential to greatly increase flood peaks as well as exacerbating low flows discharge (O'Connell et al., 2007). Compaction also poses a risk to crops as less water is stored in the surface soils where plant roots have access. One of the more recent methods used by farmers to alleviate the issue of compaction on their land is to aerate the soils using a soil aerator. The effects of soil aeration on crop yields (Douglas et al., 1995; Douglas, 1997; Douglas et al., 1998) and nutrient loading have been assessed (van Vliet et al., 2006), however the overall effect of reduced compaction on catchment hydrology has yet to be realised. This chapter will first outline the effect of soil aeration on infiltration rates, which was studied with fieldwork. The second part of this chapter will go on to apply the fieldwork findings to develop modelling scenarios, which were then used to assess the potential benefits of reducing the compaction levels in the Dacre Beck catchment.

## **6.2 Fieldwork**

The fieldwork was carried out in two adjacent fields in Stainton (grid references NY 48089 28541 and NY 48558 28616 for fields 1 and 2 respectively), just outside the catchment boundary. These sites were chosen due to access availability and remained appropriate due to the same soils, geology, and land management practices as the farms within the Dacre Beck. The impacts of a 'Ritchie Grassland Aerator<sup>®</sup>' on the infiltration capacities of the soil were assessed using a 'drip type' rainfall simulator. The methods used in the field

study, as well as descriptions and diagrams of the equipment used, are given in detail in Chapter 3 (3.4.2).

The first field location was a lightly compacted field that has been used for sheep grazing of a low stocking density for the past ten years at least. The second field location was a heavily compacted field that has been used for high density horse grazing. These two fields represent a good proportion of the range in compaction levels across the Dacre Beck catchment. Three rainfall simulation experiments were carried out in each field on a range of slope angles before soil aeration, and three simulations were carried out after soil aeration. The post-aeration simulations were situated as close to the original locations as possible, without the soil being liable to be affected by the first experiment. For each rainfall simulation, the plot was set up, as described in Chapter 3, and the rainfall simulator was started. Rainfall intensity and runoff were then measured at appropriate intervals until the runoff became constant. The rainfall simulator was then turned off, and runoff was measured until it stopped.

### **6.2.1 Results**

Figures 6.1 and 6.2 show the hydrographs produced by the simulations in field 1 and field 2 respectively. The solid lines show the pre-aeration simulations and the dashed lines show the post-aeration simulations. The pre-aeration runs in the first field show the same trend in response, except that the first run reached a maximum runoff peak two times higher than the second run. The first and second runs demonstrated lag times of 40 minutes from when rainfall was started and strong runoff began, whilst the third took 50 minutes. The runoff then reached constant flow within 20 minutes, 10 minutes and 15 minutes for runs 1, 2 and 3 respectively; 60, 50 and 55 minutes after rainfall was started. The second and third runs then took 22 and 12 minutes respectively for the runoff to stop after the rainfall was shut off, longer than the 7 minutes it took for runoff to stop in the first run.

The post-aeration simulations in the first field gave mixed results. The first post-aeration run (run 4) shown in purple gave a similar shaped trend to the pre-aeration runs, but had a delayed response, with runoff values less than  $3.4\text{E}^{-07}\text{ m}^3\text{ s}^{-1}$  until 70 minutes after rainfall was started.

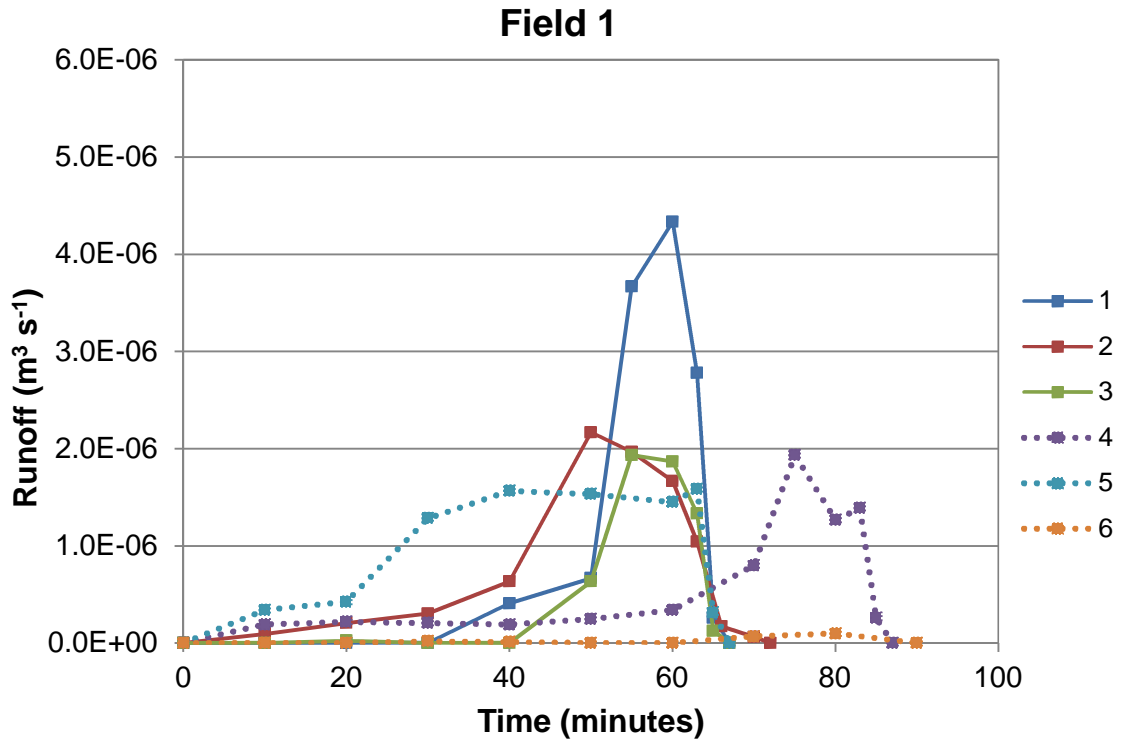


Figure 6.1 Hydrograph results of rainfall simulations in field 1 (lightly compacted)

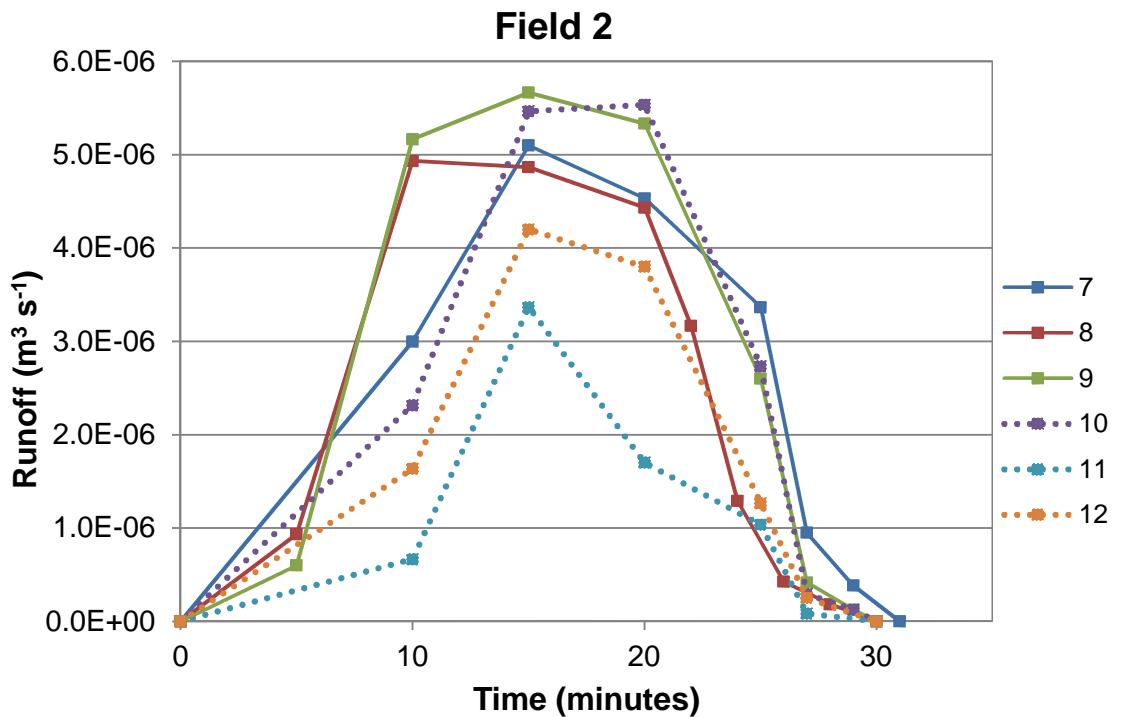


Figure 6.2 Hydrograph results of rainfall simulations in field 2 (heavily compacted)

The second post-aeration run (run 5) gave significant runoff of  $1.28\text{E}^{-06} \text{ m}^3 \text{ s}^{-1}$  after just 30 minutes, but showed a smaller peak runoff than the pre-aeration runs, reaching  $1.58\text{E}^{-06} \text{ m}^3 \text{ s}^{-1}$  just before rainfall was shut off at 63 minutes into the simulation. This smaller runoff peak cannot necessarily be attributed to the aeration as it is within bounds of the natural variability of the pre-aerated runoff results. Constant runoff in this case was achieved after 40 minutes. Regardless of this, the rainfall was not stopped until 60 minutes in for consistency. The third post aeration run (run 6) gave minimal runoff values, not exceeding  $9.8\text{E}^{-08} \text{ m}^3 \text{ s}^{-1}$  for a full 90 minutes, after which the rainfall was stopped. It became apparent as the rainfall simulator was being dismantled that the runoff in this case had sought an alternative flow path. When the runoff plate was lifted away, there was evident ponding underneath in the hole that had been dug for runoff collection (as shown in figure 6.3). This implied that the water had been using the slits in the soil cut by the aerator to gain access to the subsoil (approximately 10-15cm below the surface) and had then been flowing laterally downhill as shallow throughflow.



**Figure 6.3 Photograph of the downslope edge of the rainfall simulation plot after simulation number 6.**

The results from the second field (fig. 6.2) were very different. To begin with on this heavily compacted field the runoff in the pre-aeration runs started as early as 5 minutes after the rainfall was started. Constant runoff was achieved within

15 minutes after the rainfall had started in run 7, and within 10 minutes for runs 8 and 9. The runoff took a similar time to stop after the rainfall had been turned off as in the first field, taking 16 minutes for run 7 and 10 minutes for runs 8 and 9. The three runs (7, 8 and 9) show very consistent results, following the same shape trend, and reaching runoff peaks of  $4.53\text{E}^{-06}$ ,  $4.93\text{E}^{-06}$  and  $5.67\text{E}^{-06} \text{ m}^3 \text{ s}^{-1}$ . The post-aeration runs in this second field show little change from the pre-aeration runs. All three runs (10, 11 and 12) gave runoff after 10 minutes, with constant runoff after 15 minutes. The second post-aeration run (run 11) gave a slightly smaller runoff peak than most of the other runs on this field, reaching  $3.37\text{E}^{-06} \text{ m}^3 \text{ s}^{-1}$  compared to  $5.53\text{E}^{-06}$  and  $4.2\text{E}^{-06} \text{ m}^3 \text{ s}^{-1}$  for runs 10 and 12 respectively, but again this cannot necessarily be attributed to the aeration as the runoff peaks of runs 10 and 12 are comparable with the pre-aeration runoff peaks. Visual observation at this site demonstrated that the slits created by the aerator were not providing a route down through the soil as had been seen in the previous field, but instead they were merely ponding up with water creating puddles, and that overland flow was not disrupted at all.

Whilst the hydrographs shown in figures 6.1 and 6.2 give a good representation of the observations seen in the field study, they do not account for the slight temporal variations in rainfall intensity, or of the differing antecedent soil moisture. Therefore, figure 6.4 and 6.5 show plots of the soil moisture against the runoff discharge for each of the runs in fields 1 and 2 respectively. Soil moisture was calculated by multiplying the soil store within the plot ( $180,000\text{mm}^3$ ) by the soil porosity (0.45 (Clapp and Hornberger, 1978)). This potential soil moisture capacity was then adjusted to reflect the initial soil moisture. Initial soil moisture was determined in the laboratory from soil samples taken from near the plot before the simulation. Soil moisture was calculated as per equation 20.

$$S_m = \frac{W_m - D_m}{D_m} \times 100 \quad (\text{EQ 20})$$

$$W_m = W_c - C \quad (\text{EQ 21})$$

$$D_m = D_c - C \quad (\text{EQ 22})$$

where:

$S_m$  is the soil moisture (%)

$W_m$  is the wet sediment mass (g)

$D_m$  is the dry sediment mass (g)

$W_c$  is the weight of the wet sediment in a crucible (g)

$D_c$  is the weight of the dry sediment in a crucible (g), and

$C$  is the crucible weight (g)

The initial soil moisture of the plot was calculated by:

$$IS_m(ml) = \left( \frac{P_s}{100} \right) \times S_m \quad (EQ 23)$$

where:

$IS_m$  is the initial soil moisture (ml)

$P_s$  is the plot moisture storage capacity ( $mm^3$ ), and

$S_m$  is the soil moisture (%)

This initial soil moisture value was then used to create a time series of soil moisture in the plot by adding in the water input into the plot (rainfall minus runoff), and the time series was then converted back into percentage form by:

$$IS_m (\%) = \left( \frac{IS_m (ml)}{P_s} \right) \times 100 \quad (EQ 24)$$

The plots in figures 6.4 and 6.5 demonstrate the storage capacities of the soils before and after aeration. The first field pre-aerated simulations behave as one would expect; runoff was not seen until soil moisture was at values of 27.8, 28.8 and 29.2% for runs 1, 2 and 3 respectively, after which runoff discharge increased rapidly with further rainfall input into the system. As previously discussed, the responses of this field to aeration varied between simulations. Run 5 showed a similar reaction to the pre-aeration runs, with runoff seen at a soil moisture value of 29.6%. However, figure 6.4 indicates that the soils had the potential either to store more water, or to transport some water as shallow throughflow, as further water input into the post saturation had a smaller and slower positive influence on runoff discharge. Run 4 demonstrated that the soil could store almost twice as much water before significant runoff was initiated, with runoff above  $5E^{-07}$  not exceeded until a soil moisture value of 48.1%. Run 6

showed that no runoff was achieved, and that throughout the duration of the simulation the soil moisture never exceeded 50%.

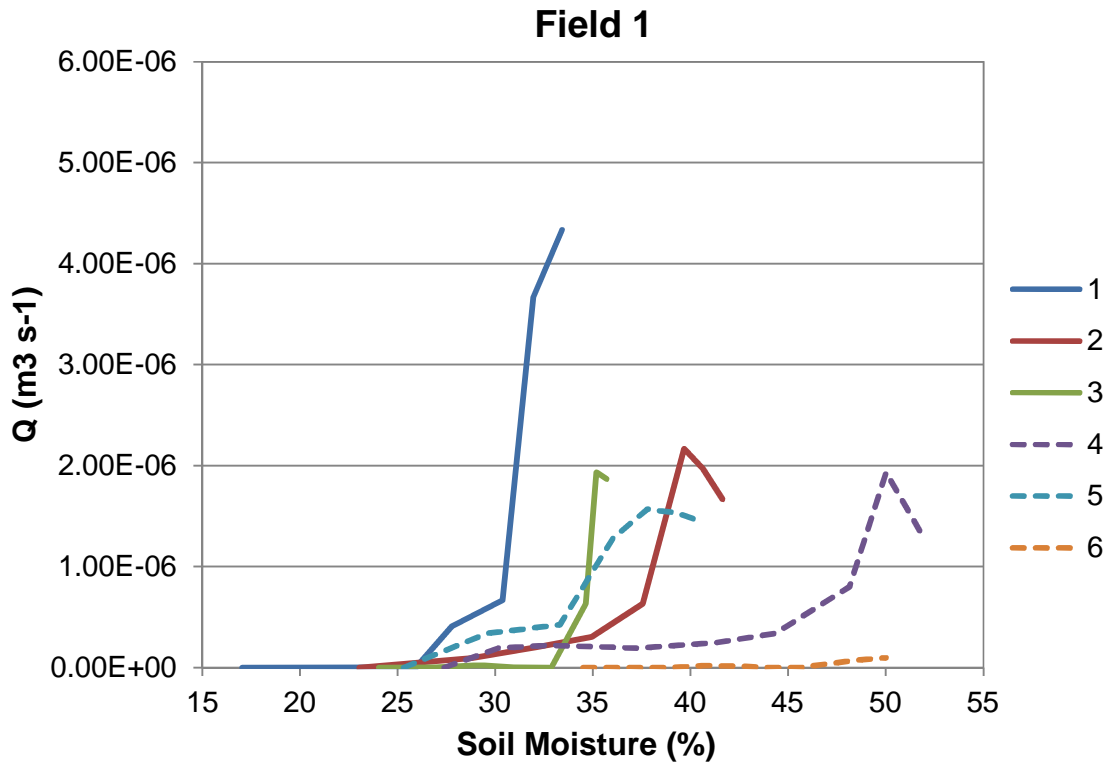


Figure 6.4 Soil moisture vs. discharge curves for rainfall simulations in Field 1

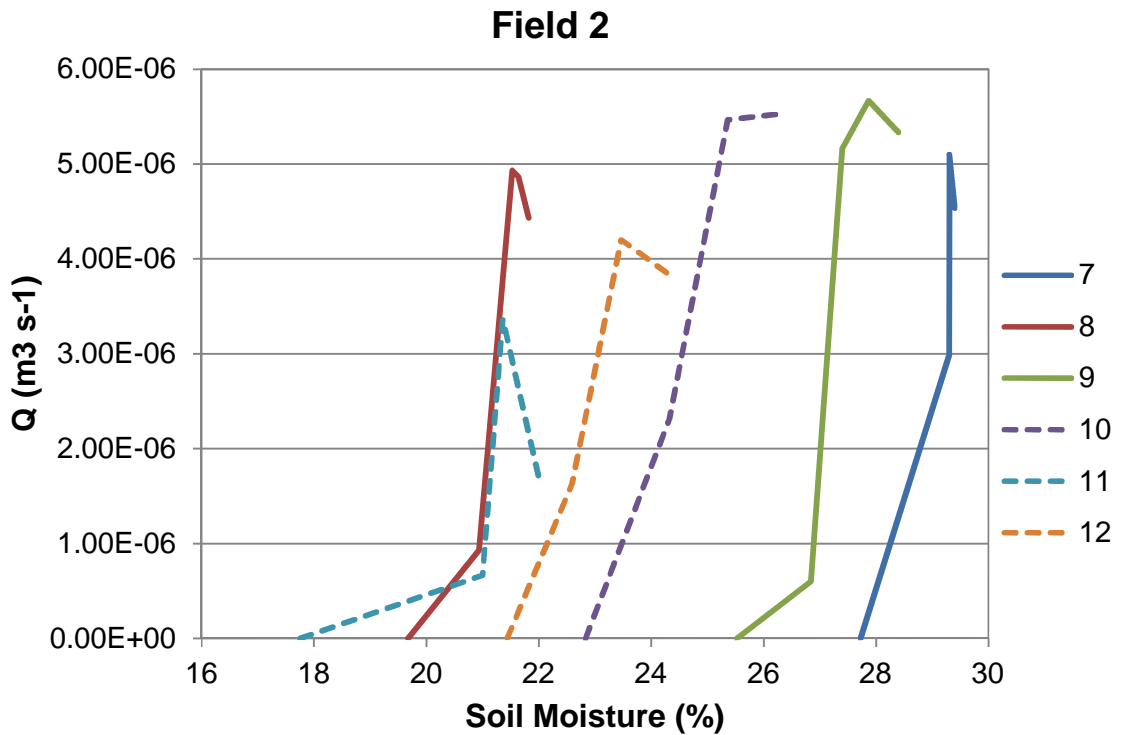


Figure 6.5 Soil moisture vs. discharge curves for rainfall simulations in Field 2



Field 2, shown in figure 6.5, immediately contrasts the results seen in field 1. Here we can see that runoff began long before the soil managed to become saturated. Saturated soil samples taken and analysed in the laboratory suggested the soils became saturated at an average of 51% in field 1 and 34% in field 2. This reinforces the issues that surround compaction in agricultural environments. Here the runoff began instantaneously, with the initial soil moisture levels 27.7, 19.7 and 25.5% for runs 7 8 and 9 respectively. Discharge rates exceeded those seen in the first field, with the soil containing similar, if not slightly lower soil moistures than field 1.

As previously discussed, the aeration had little effect on this field with runs 10 and 12 producing instant runoff at 22.8 and 21.4% soil moisture, and a fast increase in discharge with further rainfall input. Run 11 showed slightly better water storage potential than runs 10 and 12 though, increasing soil moisture by 3.24% from 17.75 to 21% before runoff became dramatic.

### **6.2.2 Implications**

This rainfall simulation experiment into the effect of soil aeration on field hydrological properties revealed a number of observations. Firstly, it is evident that the catchment does suffer from heavy compaction in some areas, and that this is caused by the management of the land, rather than the physical properties of the soils. Secondly, in lightly compacted fields, the effects of soil aeration vary in significantly. The effects can be negligible, but they can also sometimes increase soil water storage capacity by up to 100%, and can delay runoff peaks. In one simulation, the soil aeration served to route the water down through the surface soil layer, allowing the majority of rainwater to be conveyed across the field as shallow throughflow. Thirdly, in heavily compacted fields, it was apparent that soil aeration did very little to improve the fast runoff response to rainfall. The compacted layer of the soil was so impermeable, and so deep that the slits caused by the aerator made no difference to the routing of the rainwater. It has been suggested that several passes of the soil aerator in different directions could improve the response in heavily compacted fields (Dawson, 2011b), but this further research was beyond the scope of this study.

### **6.3 Modelling**

In order to understand how efforts to reduce the soil compaction levels in the catchment could help with managing low flows, various representative scenarios were developed for the CRUM3 model to simulate the way in which the catchment would respond. A full description of the CRUM3 model is given in Chapter 3.

#### **6.3.1 Application of Fieldwork Findings**

It was originally intended that measurements such as infiltration rate and soil porosity could be taken in the field to directly apply to the CRUM3 model parameters of saturated conductivity, porosity, root layer depth etc. However, time restraints and the equipment available meant that these measurements could not be sampled in the diversity of locations and quantity required. Instead, the observations that the catchment obviously suffers from heavy compaction levels in some fields, and that these heavily compacted soils show little response to aeration, were used to develop various scenarios of compaction reduction across the catchment.

#### **6.3.2 Parameter Development**

Three compaction levels were chosen for study; light, moderate and heavy. The model parameter relationships between these compaction levels were derived from those used by Pattison (2010). The parameters used to develop these relationships are given in Table 6.1. These parameter relationships were then applied to the top GLUE model realisation parameter values in three sets; assuming the land is currently lightly compacted, assuming the land is currently moderately compacted, and assuming the land is currently heavily compacted. Two of the original nine land covers were considered; the improved grassland, and the arable land, as these were the only two likely to be suffering from compaction, and the only two where soil aeration can be implemented as part of the farming routine. Each of the land covers were then adjusted from their assumed original state of compaction to the other two possibilities. This resulted in twelve parameter sets, excluding the assumed current state, for each of the 10 GLUE model realisations.

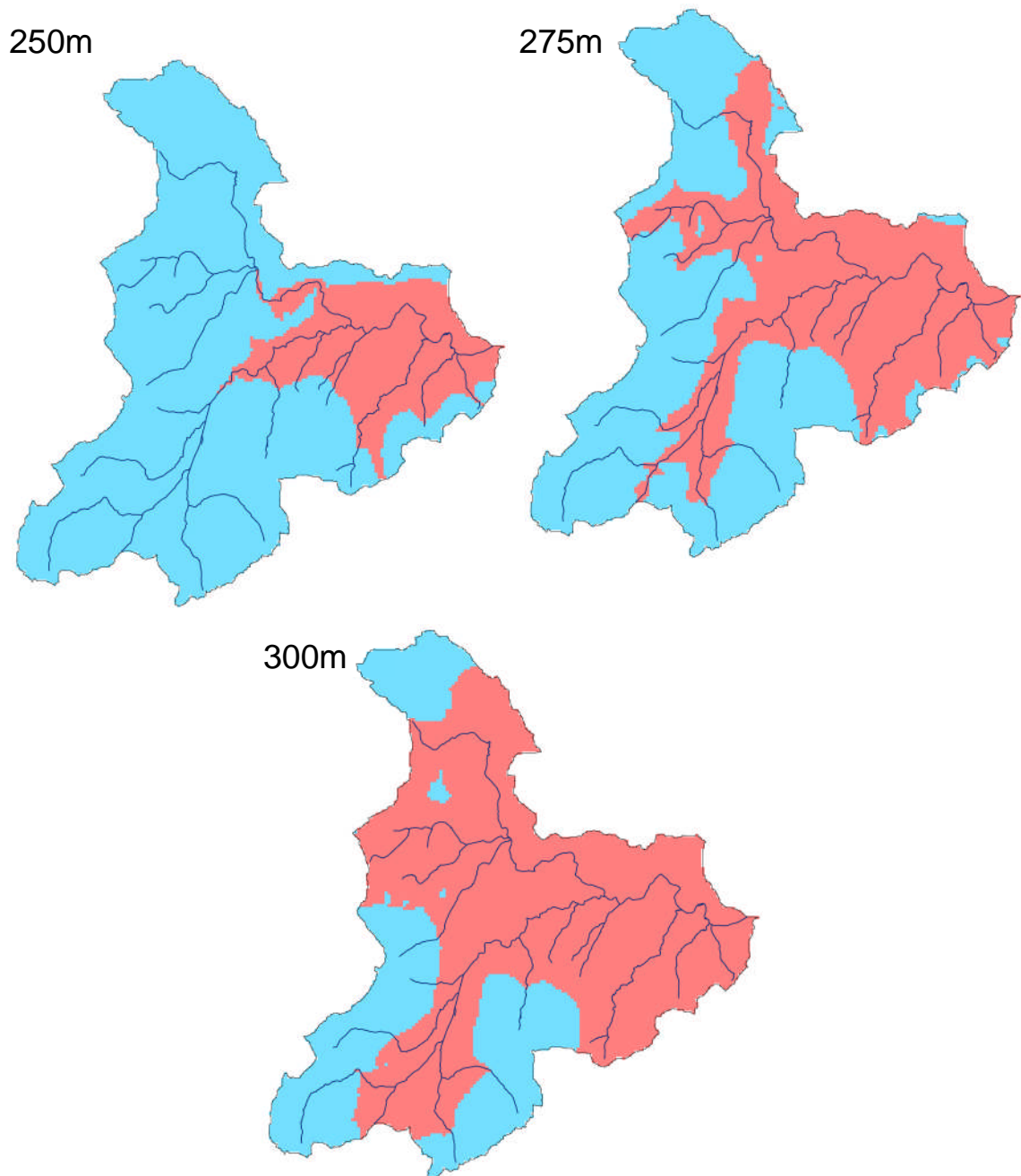
### 6.3.3 Scenarios

#### 6.3.3.1 Scenario Development

Two sets of scenarios were developed, the basic changes and the elevation driven changes. The changes involved altering the entire catchment's areas of arable land and improved grassland from their assumed current compaction level to the alternate two states. The elevation driven changes were developed with the idea that the more heavily compacted soils are more difficult to decompact with the soil aerator, and that the most intense farmland is in the lowland areas of the catchment.

<b>Compaction Level</b> <b>Parameter</b>	<b>Light</b>	<b>Medium</b>	<b>Heavy</b>
<b>Porosity</b>	0.55	0.515 (x 0.936)	0.492 (x 0.8945)
<b>Ksat</b>	6.95E-4	6.95E-5 (÷ 10)	6.95E-6 (÷ 100)
<b>Root Layer Ksat</b>	6.95E-5	6.95E-6 (÷ 10)	6.95E-7 (÷ 100)
<b>Soil Depth Channels</b>	1.0	0.978 (x 0.97774)	0.971 (x 0.97138)
<b>Soil Depth Slopes</b>	0.16	0.156 (x 0.97774)	0.155 (x 0.97138)
<b>Soil Depth Ridges</b>	0.5	0.489 (x 0.97774)	0.485 (x 0.97138)
<b>Soil Depth Plains</b>	0.5	0.489 (x 0.97774)	0.485 (x 0.97138)
<b>Root Layer Depth</b>	0.01	0.00978 (x 0.97774)	0.00971 (x 0.97138)

**Table 6.1 Parameter values used to derive CRUM3 compaction scenarios.** Italics indicate the relationship to the Light compaction level (Pattison, 2010)

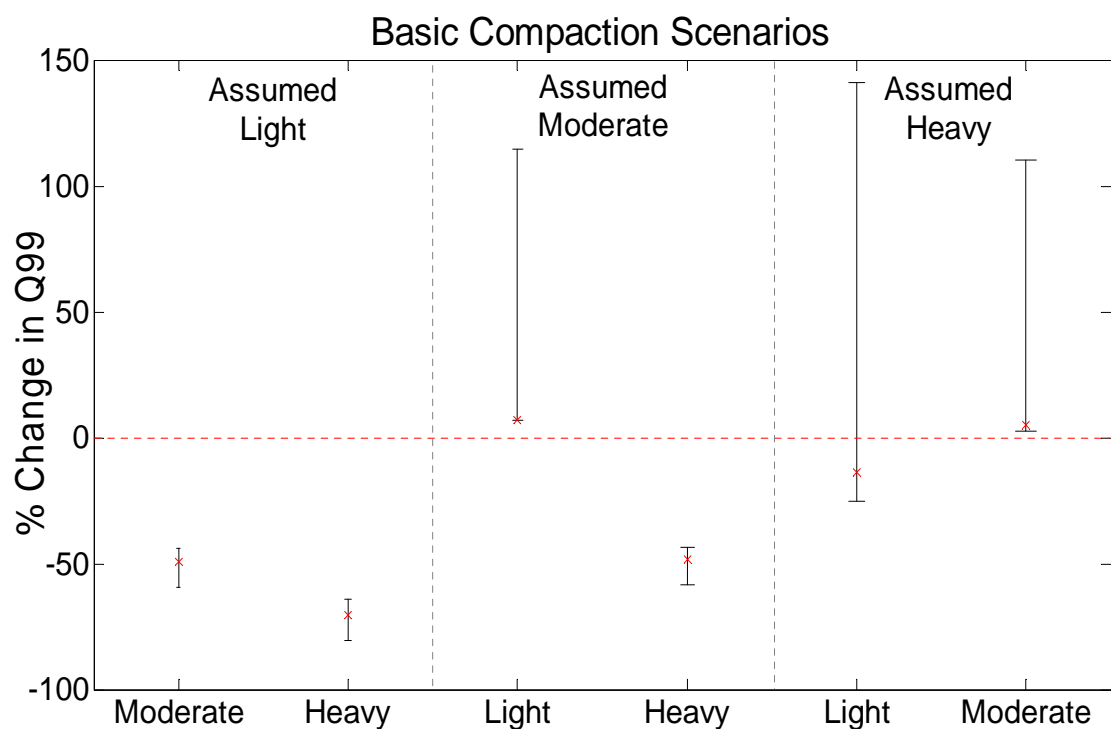


**Figure 6.6 Area covered by the elevation driven scenarios.** Blue represents upland area, pink represents lowland area.

Therefore, dividing elevations of 250, 275 and 300m were used to represent the upland vs lowland areas of the catchment (the areas these covered are shown in figure 6.6). These elevation divisions were then used to run scenarios where all land above these elevation values were changed from moderate to light; and from heavy to moderate or light. Finally, scenarios assuming the catchment was heavily compacted changed the upland areas to light compaction and the lowland areas to moderate compaction.

### 6.3.3.2 Basic Change Results

The results from the basic compaction change scenarios (adjusting the compaction levels of the entire catchment's arable land and improved grassland) are shown in figure 6.7. Again, the red crosses indicate the results of the top GLUE model realisation (GLUE1), whilst the error bars represent the range of outcomes seen within the top ten GLUE model realisations.



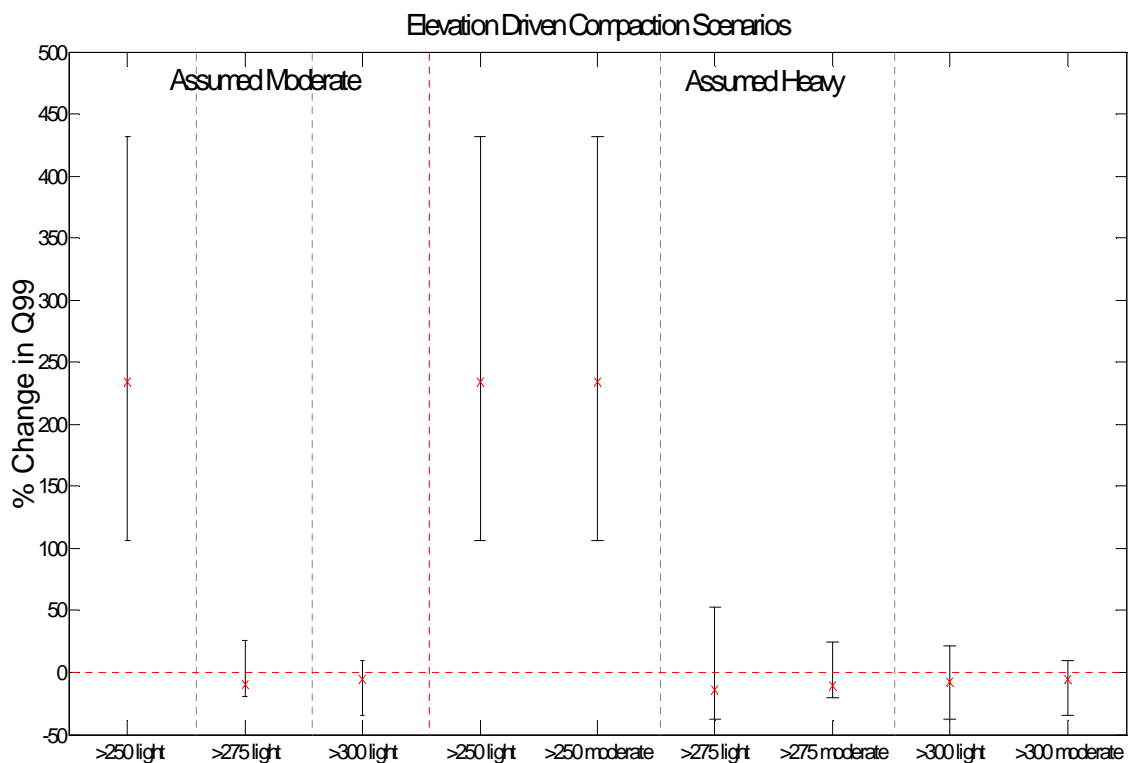
**Figure 6.7 Effects of changing the compaction level of the whole catchment on Q99** left block indicates increases from light to moderate and heavy compaction, central block indicates changes from moderate to light and heavy compaction, and right block indicates decreases from heavy to light and moderate compaction. Red x's show the results from the GLUE1 parameter set whilst the bars indicate the range in results within the top 10 GLUE parameter sets.

The overall impression of these results is that decreasing compaction levels increases Q99 (improves low flows discharge) and increasing compaction levels decreases Q99 (worsens low flows discharge). Reducing all the arable land and improved grassland in the catchment from moderately compacted to light compaction has the potential to increase Q99 by between 7.13% and 114.85%. Reducing this same land from a heavily compacted state to a moderately compacted state can increase Q99 by 2.64 to 110.24%, whilst reducing the land all the way to light compaction could increase Q99 by 141%, though it could also decrease Q99 by 25.35%. This potential decrease in Q99 shows that for

some of the GLUE model realisations a substantial increase in soil water storage capacity could be detrimental to low flows, as this then deprives the channels of water they would usually see under a less compacted scenario. It is unlikely however that the entire catchment is heavily compacted, so it unlikely that soil aeration could increase the soil water storage capacity to an extent to which it would be detrimental to low flows discharge.

### 6.3.3.3 Elevation Driven Change Results

The elevation driven compaction change scenarios give a slightly more realistic impression of the ways in which compaction levels could be reduced across the catchment. Figure 6.8 shows the results given by reducing the compaction levels in the upland areas of the catchment.



**Figure 6.8 Effects of upland reductions in compaction levels on Q99** left block indicates reducing all land above 250, 275 and 300m elevation from moderate to light compaction, right block indicates reducing all land above 250, 275 and 300m elevation from both heavy to light compaction and from heavy to moderate compaction.

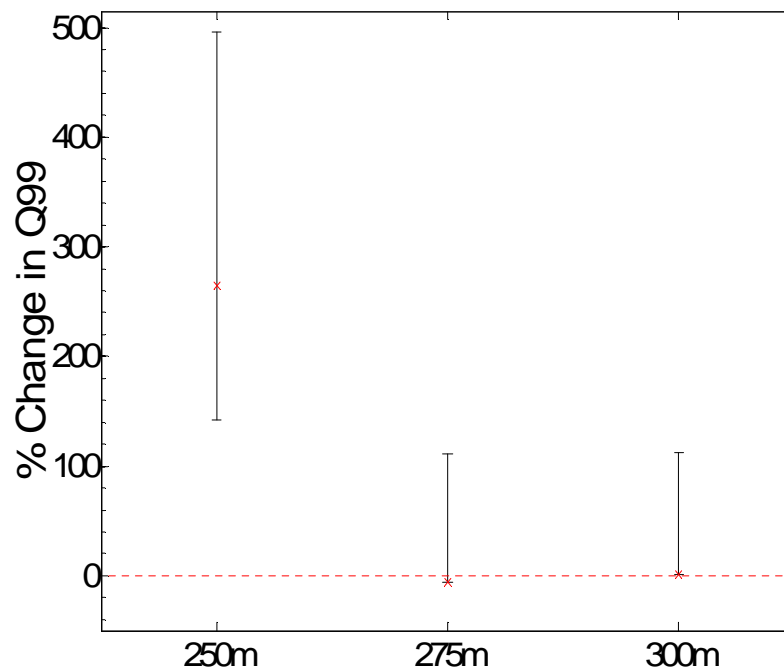
It is apparent from this figure that the smaller area of upland land that is reduced in compaction, the smaller the improvement in Q99. If the catchment is assumed to be moderately compacted, and all land above an elevation of 250m

is reduced to light compaction, Q99 can be increased by 106.84 to 432.21%. Alternatively, if only the land above 275m is reduced to light compaction the Q99 value can be increased by 25.86%, but could also be reduced by 19.44%. Similarly if only the land above 300m is reduced to light compaction, the Q99 could be increased by 9.94%, or decreased by 33.96%. This shows that decompressing small areas of the upland catchment could actually be detrimental to low flows, potentially because this allows water to be stored high up in the catchment, where it is unlikely to ever reach the main river channel. Decompressing the soils above 250m gives wholly positive results because these small amounts of upland storage that are detrimental to low flows are outweighed by the large amounts of storage at lower elevations which are capable of slowly feeding the streams in periods of low flow.

Similar results are seen in the assumed originally heavy scenarios. Decompressing the agricultural land above an elevation of 250m in this case increases low flow by 106.84 to 432.2% when reduced to moderate compaction, and by 106.84 to 432.22% when reduced to light compaction – almost identical results. This indicates that reducing the compaction above 250m to a level of moderately compacted gives significant improvements to Q99, but that reducing compaction beyond that gives no further improvement to the catchment low flows discharge. In the 275 and 300m scenarios, decreasing the compaction levels to moderate has the potential to increase Q99 by 24.76 and 9.59% respectively, or to decrease Q99 by 20.62 and 34.25% respectively. Reducing these areas all the way to light compaction brings up the potential increase in Q99 to 52.47 and 21.30% for the 275 and the 300m scenarios respectively, but also gives stronger risk of decreasing Q99, potentially by 38.12 and 37.92% for the 275 and 300m scenarios respectively.

These results demonstrate that actually, although it might be more difficult to reduce the compaction of the soils in the lower elevation areas of the catchment, it is in these areas that storage of water in the soils to feed the low flows discharge is especially important. Further scenarios with the catchment assumed to be heavily compacted were run, sampling the effect of reducing the upland areas to light compaction, and reducing the lowland areas to moderately compacted. The results of these runs are shown in figure 6.9. In these cases we

see strongly positive results in all cases. Only the 275m scenario dips below the zero line by 5.83%. The 250m scenario gives a range of a 141.88 to a 495.86% increase in Q99, whilst the 275 and 300m scenarios could increase Q99 by up to 110.98 and 112.64% respectively. It is interesting that the 275m scenario is the worst performing, showing that this scenario doesn't necessarily quite achieve a balance in storage that improves low flows and storage that deprives the channel of water during low flows as well as the other two scenarios.



**Figure 6.9 Effect of reducing upland areas to light compaction and lowland areas to moderate compaction from a heavily compacted state on Q99 with upland/lowland divisions set at 250, 275 and 300m elevation.**

Again, it is unlikely that all of the agricultural land in the catchment is in a heavily compacted state, but these scenarios reinforce the concept that reducing the soil compaction in the lowlands is especially good for the low flows discharge. Interestingly though, it is evident by comparison, that reducing the entire catchment from heavy to light can increase low flows by 141%, whilst increasing the uplands from heavy to light, and the lowlands from heavy just to moderate compaction can increase low flow by up to 496%. This demonstrates that over-aerating the soils, allowing them to store too much water can detract from the overall improvement in low flows. As previously discussed however, it is difficult to improve the storage capacity of heavily compacted soils, so it is



unlikely that the catchment farmers will risk over-aerating the soils and encounter this issue.

#### **6.4 Summary**

The potential effects of reducing the compaction levels in the catchment on low flows discharge was examined using two methods, field work and modelling. Firstly, the efficiency of a soil aerator in increasing the infiltration capacities of the soils was examined in the field using a rainfall simulator. This experiment demonstrated that soils in lightly compacted fields can respond in a number of ways from delayed runoff response to preferential subsurface flow. In a lightly compacted field, it is possible that a soil aerator can increase the soil water storage capacity by at least 100%. In heavily compacted fields however the soil aerator was shown to have a negligible effect on the infiltration capacities of the soil. Further research would be valuable in this subject, as the deterioration in the response of the soils over time after aeration is not yet known. Also, the potential of repeatedly aerating the heavily compacted soils until they are capable of storing rainwater is potentially implementable but whether this would succeed or not is also unknown.

Secondly, the potential effects of reducing the compaction levels across the entire catchment were modelled using the CRUM3 hydrological model. Basic scenarios, reducing the catchment wide compaction levels of all agricultural land showed potential increases in Q99 of 115% with a change from moderate to light, 100% with a change from heavy to moderate, and 141% with a change from heavy to light compaction. Considering the discovery that heavily compacted soils are difficult to aerate, and that farming is most intense in the lowland, scenarios preferentially aerating the upland area of the catchment were designed. These scenarios showed the potential to increase Q99 by 432% if compaction levels on all land above 250m in elevation were reduced. If only the land above and elevation of 275 or 300m was treated for compaction issues, the result was much less beneficial for low flows, and could potentially exacerbate them. This demonstrates that improving the storage capacities of the lower lying areas nearer the channels is the most important for improving

low flows discharge. Finally, assuming the catchment is heavily compacted, reducing the upland areas to light compaction and the lowland areas to moderate compaction showed a potential 496% increase in Q99. These dramatic results are from fairly extreme case scenarios, but they still demonstrate that reducing the compaction of the soils in the catchment would have a substantial effect on increasing low flows discharge.

# Chapter Seven:

*Land Use Management and  
Extreme Low Flows*

## **7.1 Introduction**

A range of possible land use management strategies to improve extreme low flows discharge levels have been modelled for their potential effectiveness in Chapters 5 and 6. Chapter 5 assessed some vegetation change scenarios ranging from buffer strips to targeting highly connected areas. Chapter 6 examined the effect of reducing soil compaction on catchment low flows discharge. A range of outcomes were recognised from the results of the modelling so this chapter will review the scenarios studied as to their practical feasibility and their potential benefit. A cost-benefit style approach will be used to consider which of the studied scenarios could be put forward to the land managers in the catchment for implementation.

## **7.2 Implementing Vegetation Change Scenarios**

Chapter 5 assessed three sets of vegetation change scenarios in an attempt to find a management option that would improve catchment low flows discharge. This section will now go on to determine whether these scenarios could be implemented, and if so which give the best improvement to low flows.

### **7.2.1 Slope Scenarios**

The slope scenarios simulated the effect of converting all land above a certain slope angle to different land covers. These scenarios were designed as it is difficult for agricultural vehicles to work on steep slopes (Spencer and Owen, 1981). Four slope angles were sampled: 10, 15, 20, and 25 degrees. As discussed in Chapter 5, the best land cover in these scenarios for increasing Q99 was natural grassland. Table 7.1 outlines the area covered by each scenario (how much land would have to be converted) and their potential improvements in Q99. The current land cover (what the land would have to be converted from) is given in table 5.4. From table 7.1 it is apparent that the 10° scenario would require a change of far too much land (20.86% of the total catchment area) to be feasible. The 25° scenario has minimal influence on Q99, with a maximum of a 0.61% increase and not enough for it to be worthwhile, therefore, the 15 and 20° scenarios are left as a possibility.

Run	% catchment	Area (km <sup>2</sup> )	Increase in Q99 (%) with change to natural grassland	
			Lower Limit	Upper Limit
10°	20.86	7.72	0.91	10.26
15°	8.9	3.293	0.37	5.10
20°	3.25	1.20	0.15	2.02
25°	0.73	0.27	0.12	0.61

**Table 7.1 Summary statistics for the slope vegetation change scenarios**

It is worth noting from table 5.4 that over half of land covered by these scenarios is already under natural grassland use. This adjusts the amount of land required to be converted quite dramatically, leaving only 5.65 and 2.05% for the 15 and 20° scenarios respectively, or 2.09 and 0.76km<sup>2</sup> in order to achieve the increases in Q99 given in table 7.1.

### **7.2.2 Buffer Strip Scenarios**

The river buffer strip scenarios were developed with the idea that buffer strips are often implemented by land managers to control river high flows. Introducing buffer strips of 25 and 50m wide both sides of the channels were modelled using each of the 9 land covers. Again, natural grassland stood out as being the most effective at improving low flows discharge, with 1.61 to 4.04% and 2.83 to 7.84% for the 25 and 50m scenarios respectively. The 25m scenario covers 7.6% of the catchment and the 50m scenario covers 16%. However, again a fair amount of this land is already natural grassland, reducing these values to 5.5% and 12.2% for the 25 and 50m scenarios respectively. This makes the 25m scenario directly comparable to the 15° slope scenario and it gives slightly worse results, with only a 4.04% maximum increase in Q99 compared with the 15° value of 5.10%. These scenarios are unlikely to be implementable regardless, due to the location of the land required for change. Most of the land directly adjacent to the river is owned by farmers, and is currently under agricultural use.

Land Cover	% total catchment area		% land for change	
	25m	50m	25m	50m
<b>Deciduous Woodland</b>	0.95	1.53	13.38	11.06
<b>Coniferous Woodland</b>	0.19	0.25	2.68	1.81
<b>Improved Grassland</b>	3.3	7.09	46.68	51.26
<b>Natural Grassland</b>	2.1	3.9	29.66	28.15
<b>Arable Land</b>	0.2	0.47	2.89	3.4
<b>Bracken</b>	0.17	0.39	2.36	2.85
<b>Heath</b>	0.15	0.18	2.14	1.31
<b>Bare Ground</b>	0.015	0.023	0.21	0.16

**Table 7.2 Current proportions of land cover within the buffer strip vegetation change scenarios.**

Table 7.2 shows what proportion of the land ascribed for change is currently under which land use (developed land was not featured). A fair proportion of the near stream land is also deciduous woodland. Over half of the land within 50m of the river channels is currently improved grassland, whilst 28% is natural grassland. The Environment Agency, who are likely to be decision makers in vegetation change implementation projects, only have direct influence on works carried out within 8 meters of the river bank e.g. (Environment Agency, 2007a; Environment Agency, 2007b). Also, the deciduous woodland in place alongside the river channel is very efficient at reducing high flows discharge (as will be discussed in Chapter 8) and so it is unlikely that managers will agree to replace this with natural grassland.

### **7.2.3 SCIMAP Scenarios**

The final set of scenarios modelled for the improvement of low flows discharge were the SCIMAP scenarios. These scenarios targeted areas of a high hydrological connectivity in an attempt to disconnect areas of the catchment, thus allowing them to store water for longer periods and supplement the river during periods of low flow.

Scenario	Area (%)	Area (km <sup>2</sup> )	Increase in Q99 with change to natural grassland	
			Lower Limit	Upper Limit
0.1	94.82	35.08	14.88	0.1
0.2	84.02	31.09	14.14	0.2
0.3	69.28	25.63	12.84	0.3
0.4	49.58	18.34	10.29	0.4
0.5	30.6	11.32	6.77	16.21
0.6	16.68	6.17	3.41	8.46
0.7	8.76	3.24	1.5	5.15
0.8	3.75	1.39	0.7	3.51
0.9	1.24	0.46	0.05	2.74
1	0.03	0.01	-0.3	2.37

Table 7.3 Summary statistics for the SCIMAP vegetation change scenarios

Land Cover	% total catchment area				% land for change			
	0.7	0.8	0.9	1.0	0.7	0.8	0.9	1.0
Deciduous Woodland	0.725	0.407	0.175	0	8.243	10.805	14.103	0
Coniferous Woodland	0.319	0.112	0.008	0	3.623	2.966	0.641	0
Improved Grassland	4.591	1.889	0.662	0.024	52.174	50.212	53.205	75
Natural Grassland	2.830	1.259	0.383	0.008	32.156	33.475	30.769	25
Arable Land	0.088	0.032	0.008	0	0.996	0.847	0.641	0
Bracken	0.112	0.016	0.008	0	1.268	0.424	0.641	0
Heath	0.128	0.048	0	0	1.449	1.271	0	0
Bare Ground	0.008	0	0	0	0.091	0	0	0

Table 7.4 Current proportions of land covers in the SCIMAP scenarios

Table 7.3 shows the potential increases in Q99 under each of the scenarios, and as discussed in Chapter 5, the 0.6 and below scenarios cover too much land to be implementable. Table 7.4 shows the current land covers under each scenario above the 0.7 scenario, and again developed land was not seen. It can be seen from table 7.4 that the majority of the land cover is improved grassland in all of the four SCIMAP scenarios considered. There is some natural grassland though, which brings down the percentage of land required to be changed to 5.93, 2.5, 0.86 and 0.022% for the 0.7, 0.8, 0.9 and 1.0 scenarios respectively. Again, this brings the SCIMAP 0.7 run into a similar realm as the slope 15° and the 25m buffer strip runs, which with a maximum increase in Q99 of 5.15% does make it ever so slightly better than the slope 15° run (5.10%) and a fair bit better than the 25m buffer run (4.04%), however it does cover a slightly smaller area.

#### **7.2.4 Summary of Vegetation Change Options**

Table 7.5 shows a summary of all of the potentially feasible land cover change management scenarios. This shows that per unit area, the 25m buffer and the SCIMAP 0.8 scenarios give the best increase in Q99. However, the 25m buffer strip will be difficult to implement, and the SCIMAP 0.8 scenario with the total land it would cover doesn't provide a strong enough improvement in Q99, neither does the 20° slope scenario. Therefore, the SCIMAP 0.7 and the 15° slope scenarios give the next best results, producing an increase in Q99 of 5.15 or 5.10% respectively. It is actually evident from this table, that there is little difference between the scenarios; changing the land cover to natural grassland is beneficial to low flows. There is some significance as to the location of the change however, as demonstrated in the difference in the increase in Q99 per area between the SCIMAP 0.7 and 0.8 scenarios. This shows that when targeting the more connected areas, and re-routing the water to slower flow paths is increasingly beneficial to low flows. Similarly, there is a noticeable difference between the buffer 25 and the SCIMAP 0.7 scenarios, showing that land located adjacent to the river is more effective at reducing low flows per unit area than land with a SCIMAP connectivity of above 0.7.



Scenario	Scenario area to be changed to natural grassland		Increase in Q99 with change to natural grassland (%)		Maximum increase in Q99 (%) per area	
	%	km <sup>2</sup>	Lower Limit	Upper Limit	per %	per km <sup>2</sup>
<b>Buffer 25</b>	5.5	2.035	2.83	7.84	1.425	3.853
<b>Slope 15</b>	5.65	2.09	0.37	5.1	0.903	2.440
<b>Slope 20</b>	2.05	0.756	0.15	2.02	0.985	2.672
<b>SCIMAP 0.7</b>	5.93	2.194	1.5	5.15	0.868	2.347
<b>SCIMAP 0.8</b>	2.5	0.925	0.7	3.51	1.404	3.795

**Table 7.5 Comparison of feasible vegetation change options.**

### 7.3 Implementing Compaction Reduction Scenarios

The second method of increasing the catchment's low flows discharge that was assessed was reducing the soil compaction levels. A set of eighteen scenarios were run to model the effect of reducing soil compaction on Q99. It is difficult to determine which are feasible in these scenarios as it is not certain where along the heavily to lightly compacted continuum the Dacre Beck catchment lies. There are currently 20.46km<sup>2</sup> of improved grassland (pasture) and 0.592km<sup>2</sup> of arable land in the Dacre Beck catchment. The soil aerator used in the field studies has been in use for 3 months and has so far been used to aerate 1.15 km<sup>2</sup> of farmland in the River Eden catchment as a whole (Dawson, 2011a per. comm.). This has been fairly light use of the aerator, and it is hoped that this could be improved so more land is covered next summer. There is a set period in which the aerator can be used, as the ground needs to be dry enough to traverse with machinery.

It was determined in Chapter 6 that if all the arable land in the catchment was heavily compacted, and the lowland areas were decreased to moderately compacted, whilst the upland areas were decreased to lightly compacted, the increase in Q99 could be by as much as 496%. It is unlikely that the entire catchment is that heavily compacted so this figure is upper limit of what may be achievable. However, it has been seen that the catchment suffers from compaction in some areas, so it is likely that the whole catchment averages

being moderately compacted, though some areas might be lightly compacted, and some heavily compacted. The scenario whereby the upland areas were decreased to lightly compacted could represent the level of storage increase that we could achieve in time, across the catchment. Therefore, though the storage may be in the lowland areas (where actually it was found in chapter 6 was more valuable to low flows enhancement) the increase in Q99 of 432% could be achievable, if the vast majority of the agricultural land is aerated. The amount of land reduced in this 250 meter scenario was 15.17 km<sup>2</sup> (58.7% of the entire catchment's agricultural land).

It is unlikely that all farmers in the catchment will be open to aerating the soils on their land, as it is a modern practice they are not familiar with, and will require time and money to implement. However, many farmers have so far been positive about the aerator, and workshops and demonstrations led by the Eden River's Trust are increasing local knowledge steadily. Therefore, if only one half of the farmland in the 250m scenario (758 hectares) could be aerated, this could still increase low flows discharge to more than triple its current levels. This is ambitious following the current rate of aeration, so it may take a few years to achieve the coverage required.

An additional issue with the compaction scenarios is that it is unclear to what level the aerator can bring the soils up to. It may be that aerating a moderately compacted soil will only bring it up some of the way towards becoming lightly compacted. This again demonstrates the probability of a significant overestimation in the figures for the decompaction scenarios. However, if half of the agricultural land in the catchment can be aerated over time, and if the aerator can only bring the catchment soils up to half way between moderately and lightly compacted, the Q99 discharge value could still be brought up by up to 108%, still over double its current levels. Also, in the fieldwork it was seen that the aerator could increase soil water storage levels by at least 100%. This indicates that the aerator can have a strong influence on adjusting the soil properties.

Overall, despite the large assumptions made in the compaction modelling scenarios, the huge improvements possible with the reduction of soil

compaction suggest that this is likely to be a better low flows management strategy than the vegetation change. In the vegetation change scenarios, it was possible to increase the Q99 value by a maximum of 5.15%, whereas it seems compaction reduction could improve Q99 by much more than this, and could quite likely be in the region of 100% increases or more.

#### **7.4 Summary**

The modelling scenarios outlined in chapters 5 and 6 have been assessed for their feasibility as low flows management solutions. Natural grassland had been identified as the best land cover for supplementing the river discharge during low flows. Therefore, the vegetation change scenarios were re-evaluated to take into account how much of the land was already natural grassland. Of the vegetation change scenarios sampled, the 15° slope and the SCIMAP 0.7 proved to be the best options that gave reasonable increases in Q99 with implementable areas of change. These scenarios gave maximum increases in Q99 of around 5.1%. It became apparent that the location of the land to be changed was fairly irrelevant, as scenarios covering similar areas of land all produced similar increases in Q99.

The compaction change scenarios gave more drastic results, with the potential to increase Q99 by up to 496%. These scenarios could be unrealistic however, as many assumptions were made in their development. If these assumptions are broken down and considered individually, it seems that it could still be possible to increase low flows by 100% by aerating 7.5-10 km<sup>2</sup> of the catchment's agricultural land to bring them up half a 'compaction level' from moderate to moderate-light compaction. It seems that soil aeration and better agricultural practice to reduce compaction (e.g. lower stocking densities, hard standings, tracks etc.) are the more important land use management options to consider for practical application in the Dacre Beck catchment.

# Chapter Eight:

*Simultaneous Management of  
Extreme High and Low Flows Risk*

## **8.1 Introduction**

This chapter considers the final research question posed in Chapter 1:

***Can land use changes help manage low flows without exacerbating flood risk?***

Potential methods of increasing low flows discharge have been assessed using the hydrological model CRUM3. Chapter 5 reviewed the effect of some changes in vegetation cover on the low flows discharge, whilst chapter 6 assessed the benefit of reducing compaction across the agricultural land in the catchment. It has however been recognised that extreme high flows are also an issue in the Dacre Beck catchment (Pattison, 2010). Therefore, this chapter will reconsider the scenarios modelled in Chapters 5 and 6 to determine their impacts on high flows. It is important that if the scenarios proven to increase low flows discharge are considered for practical implementation, they do not exacerbate the high flows. Whilst this study has concentrated on reducing the risks posed by extreme low flows, the aim of this project as a whole is to determine whether there are any land management solutions that could simultaneously reduce both high and low flows risk in the Dacre Beck catchment.

## **8.2 High Flows Impact of Modelled Change Scenarios**

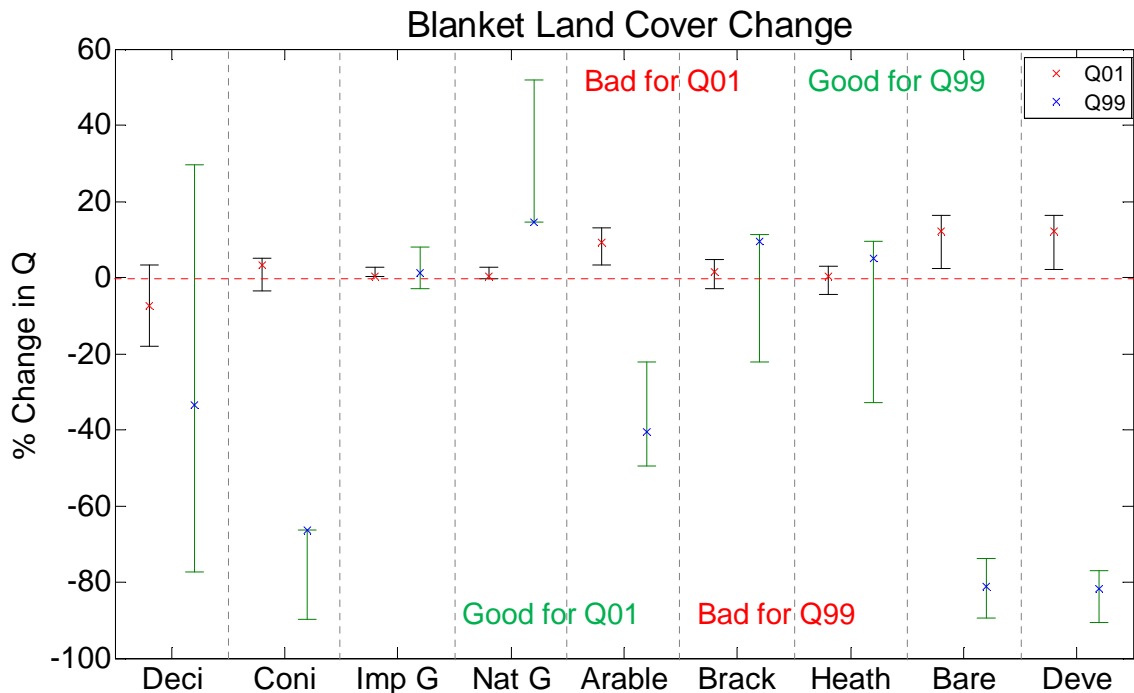
In the same way that Q99 (the discharge value exceeded for 99% of the year) was used as the measure of extreme low flows, Q01 (the discharge value exceeded 1% of the year, or the flow level that occurs for 3.65 days of the year) will be used as the measure of extreme high flows.

### ***8.2.1 Vegetation Change***

The first land management options to be assessed were those of vegetation change. It was discovered in Chapter 5 that in general, a change in land cover to natural grassland was the most beneficial to low flows, and that areas of high connectivity ( $>0.8$ ) and areas within 25m of the channel were the most effective at increasing Q99. Each of the vegetation change scenarios will now be assessed for their influence on high flows.

### 8.2.1.1 Blanket Vegetation Change

Firstly, blanket changes were implemented to gain insight into the extreme response of the catchment to each of the 9 land cover types included in the study. Figure 8.1 shows the responses of both high and low flow to blanket change to each of the land cover types for comparison.



**Figure 8.1 Response of Q01 and Q99 to blanket changes in vegetation** (Deci= deciduous woodland, Coni= coniferous woodland, Imp G= improved grassland, Nat G= natural grassland, Arable= arable land, Brack= bracken, Bare= bare ground, Deve= developed land).

As with the low flows graphs in Chapters 5 and 6, the crosses indicate the response of the top GLUE model realisation (GLUE1) whilst the error bars represent the possible range of outcomes within the top 10 GLUE model realisations. The Q01 responses are shown on the left of each block, in red and black, and the Q99 responses are shown on the right, in blue and green. In contrast to the low flows, for the high flows the objective is to decrease the discharge value, so the vegetation types that sit below the zero line are the most beneficial to high flows. Ideally then, the high flows Q01 bar on the left would sit wholly below the 0 line, and the low flows Q99 bar on the right would sit wholly above it.

It is apparent that the deciduous woodland land cover is the most effective at decreasing high flows discharge, giving a maximum decrease of 18.07% (a decrease of  $0.86\text{m}^3\text{ s}^{-1}$ ). It may however also increase Q01 by 3.4%. Other land covers that may be beneficial to high flows are coniferous woodland, bracken and heath. Arable land, bare soils and developed land are all detrimental to high flows, whilst improved grassland and natural grassland have very small effect, with slight increases in Q01 of 0.4 to 2.53% for improved grassland and a decrease in Q01 of -0.31% to an increase of 2.71% for natural grassland.

Unlike the low flows responses, none of the land covers guarantee a decrease in high flows. Deciduous woodland appears to be the best land cover for high flows, though it could potentially decrease low flows by 77.2%. Natural grassland however, which has the potential to increase Q99 by up to 51.79%, only risks an increase in Q01 of 2.71%. These are the extreme case scenarios, and they demonstrate that the best land cover types for reducing high and low flows risk are not complementary.

#### *8.2.1.2 Slope Vegetation Changes*

Four scenarios of slope changes were assessed. These were based upon the realisation that land above a certain slope is difficult to cultivate, and therefore land owners would be likely to consider vegetation change in these areas in light of the potential benefit to the river. All land above slope angles of 10, 15, 20 and 25° was adjusted to each of the 9 land covers. The 10° scenario was rejected due to the area of land it required to be changed (20.86%) and the 25° scenario was rejected due to the negligible improvement it had on the catchment low flows.

Figures 8.2 and 8.3 show the effect of the 15 and 20° slope scenarios respectively on the high and the low flows. Again it can be seen that none of the land covers perform well at reducing the high flows discharge in either the 15 or the 20° slope scenarios. Deciduous woodland gives the largest decrease in Q01, with 2.31 and 0.84% for the 15 and 20° scenarios respectively. In these scenarios, deciduous woodland could decrease Q99 by 6.79% in the 15° scenario and 2.41% in the 20° scenario. For the natural grassland land cover, the increases in Q99 of 5.11% (15°) and 2.02% (20°) give increases in Q01 of

0.54% (15°) and 0.29 (20°). Overall then, the change of high slope areas to deciduous woodland has a worse impact on low flows than changing the areas to natural grassland has on high flows.

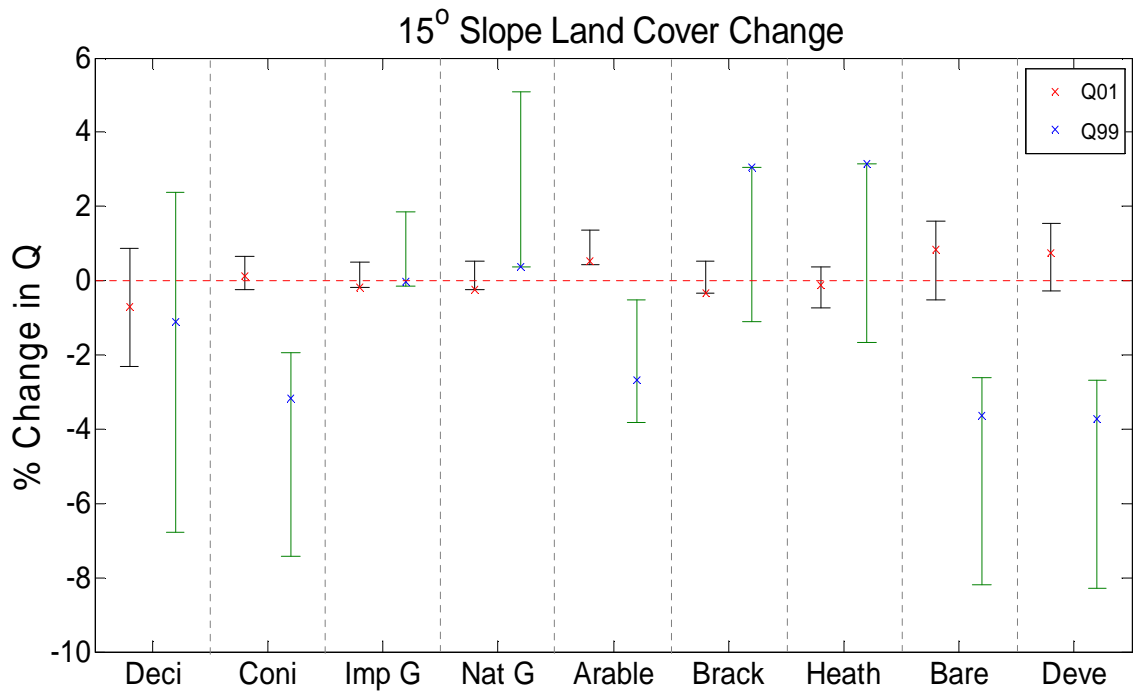


Figure 8.2 Response of Q01 and Q99 to 15° vegetation change scenario

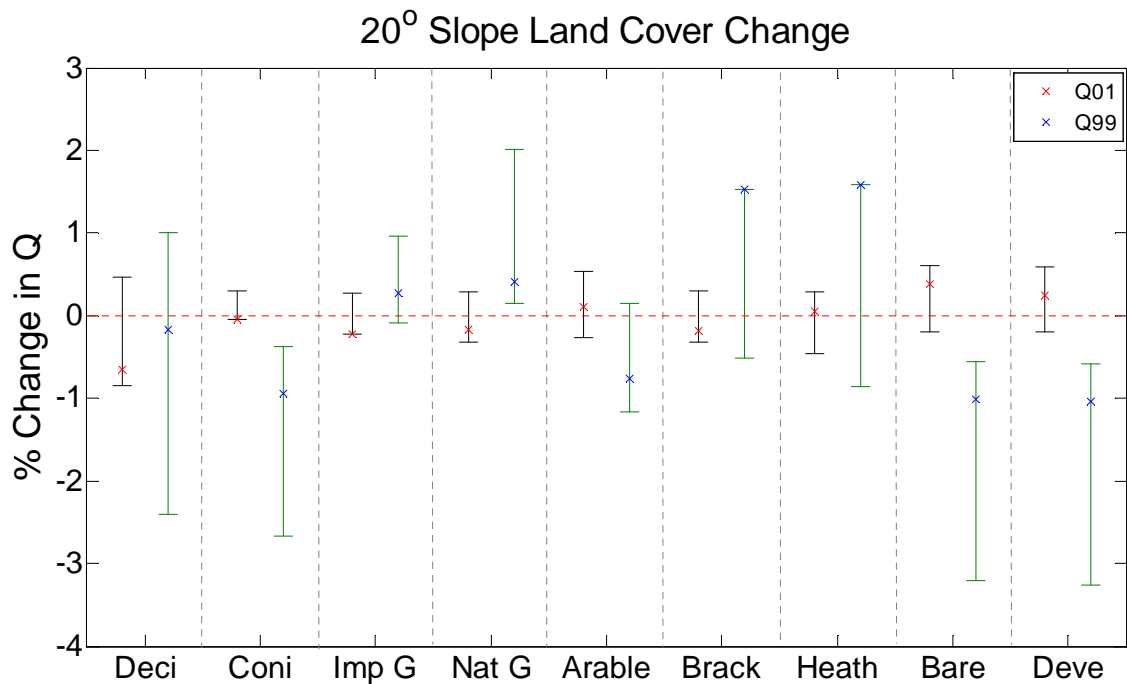
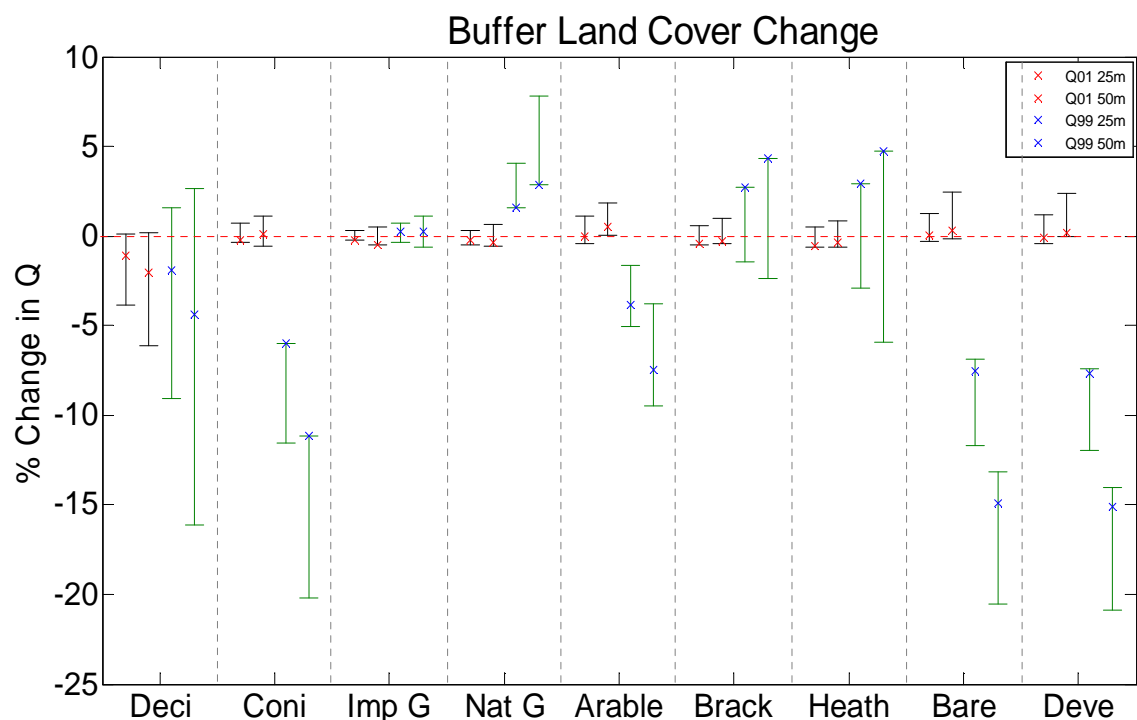


Figure 8.3 Response of Q01 and Q99 to 20° vegetation change scenario



### 8.2.1.3 Buffer Strip Vegetation Change

The buffer strip scenarios modelled land cover change on all land within 25 and 50m of the river channels. The responses of Q01 and Q99 to the 25m and 50m scenarios are shown in figure 8.4. In this figure, the Q01 responses are shown in black and red, with the 25m scenario on the far left of each land cover block and the 50m scenario to its right. The Q99 responses are shown in green and blue, again with the 25m scenario to the left of the 50m scenario, which is at the far right of each land cover block.



**Figure 8.4 Response of Q01 and Q99 to buffer vegetation change scenarios**

A stronger result is seen in the Q01 response to deciduous woodland in these scenarios, though again it is the only land cover to show much impact on the high flows discharge. The 25m buffer scenario gives a potential reduction in Q01 of 3.83%, while risking a reduction in Q99 of 9.06%. The 50m buffer scenario gives a larger potential reduction in Q01 of 6.12%, but also risks a larger reduction in Q99 of 16.09%. The natural grassland land cover in these scenarios gives a potential increase in Q99 of 4.04% for the 25m and 7.84% for the 50m scenarios. These risk increasing Q01 by 0.32 and 0.61% respectively. As previously seen, the coniferous woodland, arable land, bare ground and developed land give detrimental responses to both high and low flows, whilst

improved grassland, bracken and heath could be either beneficial or detrimental to high and low flows, depending on which of the GLUE model realisations is applied.

### 8.2.1.4 SCIMAP Vegetation Changes

The final set of vegetation changes considered for the management of low flows was that of SCIMAP hydrologically connected areas. The hydrological connectivity index values ranged from 0 to 1, so all land above certain connectivity values was sampled for vegetation change (see Chapter 5.6). In Chapter 7 it was determined that the scenarios of all land above index values of 0.7 and 0.8 were the only two scenarios that covered an appropriate area of land, whilst still giving a reasonable increase in Q99. Therefore, figure 8.5 shows the responses of Q01 and Q99 to these scenarios. The Q01 responses are shown on the left of each land cover block in black and red, with the 0.7 scenario to the left of the 0.8 scenario. The Q99 responses are shown on the right of each land cover block, in green and blue, again with 0.7 to the left of 0.8.

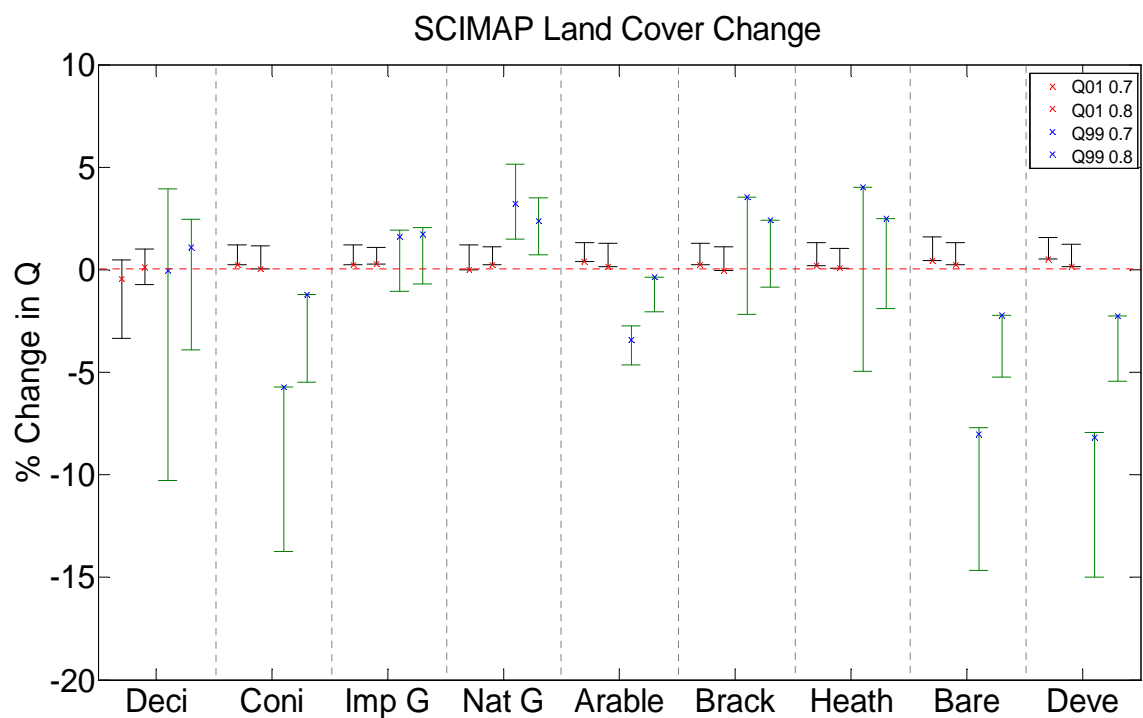


Figure 8.5 Response of Q01 and Q99 to SCIMAP 0.7 and 0.8 scenarios

In these scenarios, the majority of the land covers for which the Q01 response had straddled the 0 line in most of the previous scenarios, show a wholly positive response – increasing the high flows discharge. The only land covers that produce a negative response in Q01 are the deciduous woodland, which can potentially decrease Q01 by 3.35 and 0.73% for the 0.7 and 0.8 scenarios respectively, and the bracken in the 0.8 scenario, which could decrease Q01 by 0.04%. All other land covers worsen the high flows when placed in highly connected areas. Again the low flows were only improved by the natural grassland, and in these scenarios this had the potential to worsen high flows by 1.22 and 1.16% for the 0.7 and 0.8 scenarios respectively.

*8.2.1.5 Vegetation Change Summary*

Table 8.1 shows a summary of the changes to natural grassland considered in chapter 7, along with their impacts on Q01. This demonstrates whilst natural grassland can have positive impacts on Q99; the response in Q01 is comparatively negligible. None of the scenarios guarantee a positive change in Q99 and a negative change in Q01.

Run	Area to be changed to natural grassland		Change in Q99 with change to natural grassland (high = good)		Change in Q01 with change to natural grassland (low = good)	
	%	km <sup>2</sup>	worst	best	worst	best
Buffer 25	5.5	2.035	0.16	4.04	0.32	-0.47
Buffer 50	13.9	5.143	2.83	7.84	0.61	-0.37
Slope 15	5.65	2.09	0.37	5.10	0.54	-0.26
Slope 20	2.05	0.756	0.15	2.02	0.29	-0.32
SCIMAP 0.7	5.93	2.194	1.49	5.15	1.22	0.004
SCIMAP 0.8	2.5	0.925	0.7	3.51	1.13	0.25

**Table 8.1 Summary statistics for potentially implementable vegetation change scenarios**

The SCIMAP runs demonstrate the worst response in Q01 as there is no chance that the change could decrease the high flows discharge, and they have the potential to increase Q01 by more than 1%. This remains a very small increase though, and none of the scenarios that were chosen as potentially beneficial to low flows show a strong increase in high flows discharge. Therefore, whilst it is not possible to tackle both extreme high and low flows risk with vegetation change; it is possible to reduce low flows discharge without exacerbating the high flows.

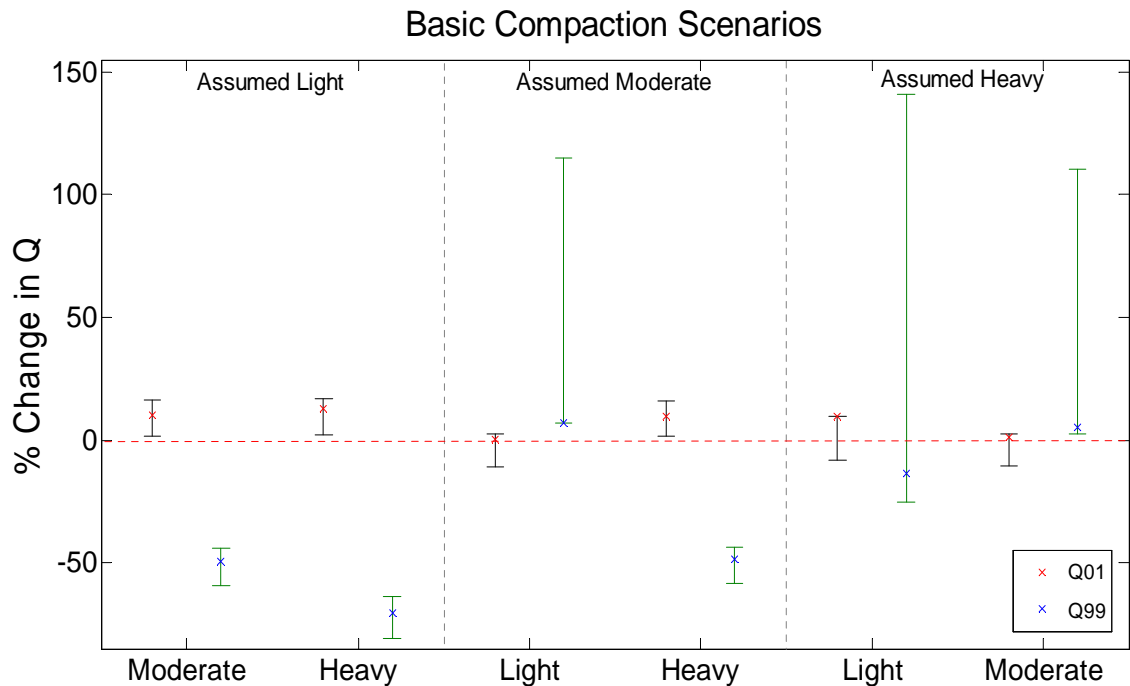
### **8.2.2 Compaction**

The second potential low flows management solution assessed was that of reducing the compaction levels across the catchment (Chapter 6). Observations from fieldwork studying the effect of soil aeration on the soils in the catchment were applied to the CRUM3 model, using parameter values derived from the literature, to predict the potential effect of long term and large scale soil aeration use across the catchment on low flows discharges. These modelling scenarios were also considered for their impacts on high flows discharges.

#### *8.2.2.1 Basic Scenarios*

Firstly, the basic scenarios of changing the entire catchment from each of the three compaction levels to the alternate two were re-examined. Figure 8.6 shows the high and low flows responses to these scenarios. Again, Q01 is shown on the left in black and red, whilst Q99 is shown on the right in green and blue. It is evident that increasing compaction levels results in higher high flows discharge, and lower low flows discharge, which highlights the requirement for this issue to be managed.

Interestingly, as was the case for the low flows, reducing the catchment from heavy to moderate gives a better response in the high flows that reduction from heavy to light. The reduction from moderate compaction to light compaction gave a response in Q01 ranging from +2.5% to -10.87%. Heavy to moderate gave +2.7% to -10.4% and heavy to light gave +9.9 to -8.09%.



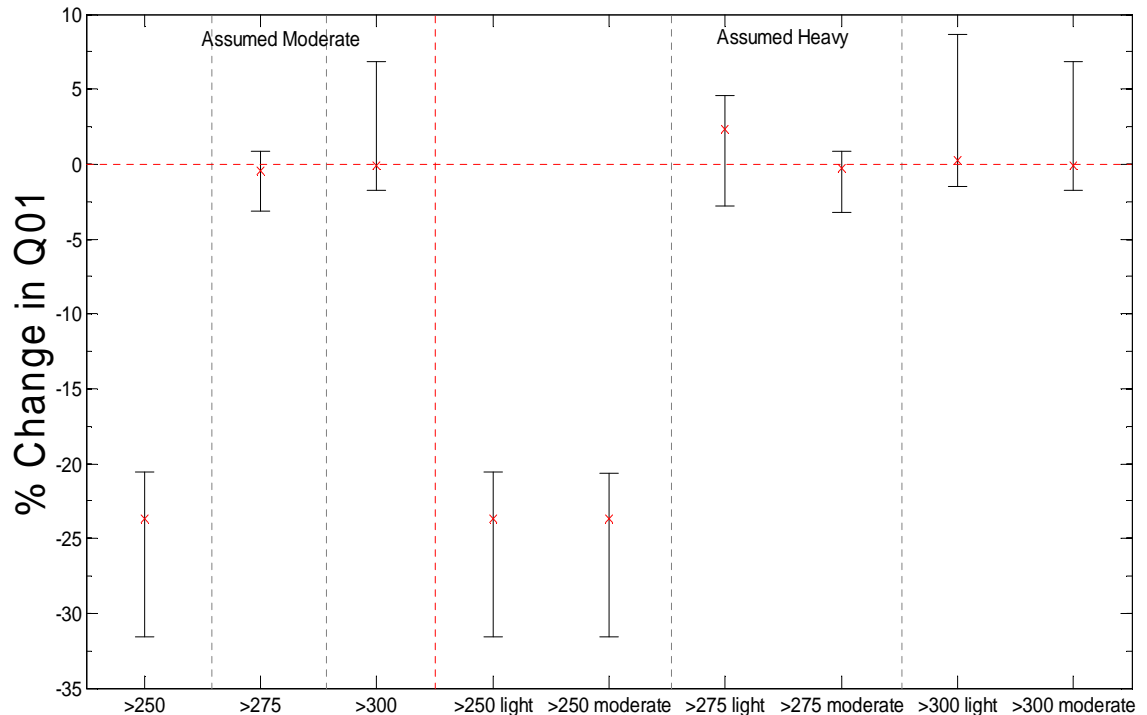
**Figure 8.6 Response of Q01 and Q99 to the basic compaction change scenarios** left block indicates increases from light to moderate and heavy compaction, central block indicates changes from moderate to light and heavy compaction, and right block indicates decreases from heavy to light and moderate compaction.

#### 8.2.2.2 Elevation Driven Scenarios

The elevation driven scenarios were derived considering that the most intense farmland is in the lowland areas of the catchment, and that it was more difficult to reduce the compaction on the more heavily compacted soils. The effect of the reducing the compaction of the land above different elevations on high flows is given in figure 8.7. The Q99 responses were left out of this graph due to the huge scale differences.

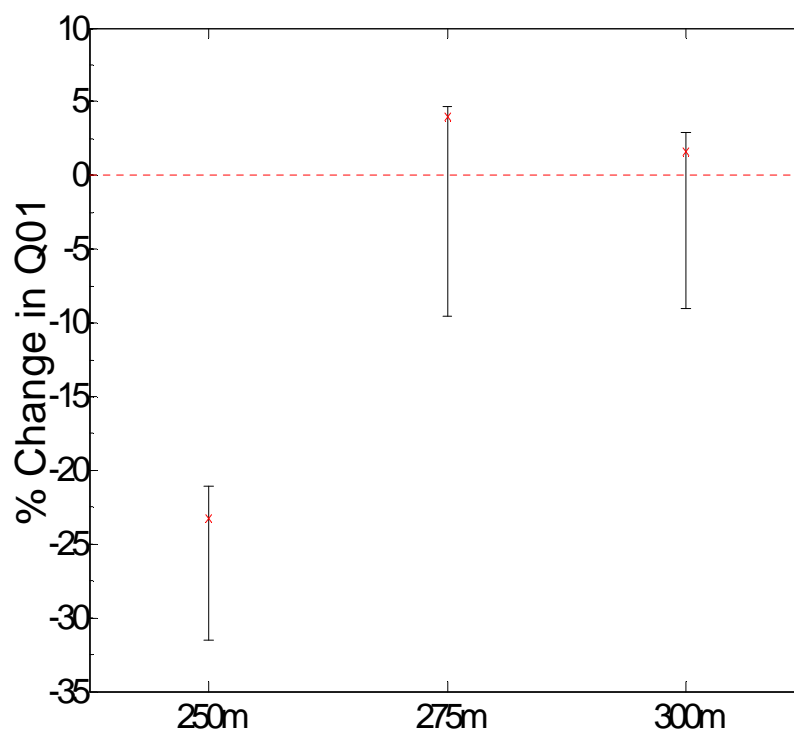
It can be seen in figure 8.8 that the response of Q01 to the elevation driven scenarios is very similar to that seen in Q99 in Chapter 6 (figure 6.9). Only the reduction of compaction above the elevation of 250m shows significant improvement on the high flows discharge. Aerating more land gives a greater improvement in Q01. Reducing the compaction of the land just at high elevations is most often more likely to be detrimental to high flows than beneficial. However, reducing the compaction of all land above 250m has the potential to decrease high flows by 20.6 to 31.6%. Again, nearly exactly the same results are seen between the moderate to light, heavy to moderate and

moderate to light scenarios. These results are not as strong as the 432% increases seen for the high flows, but they are still very significant reductions in flood period discharge.



**Figure 8.7 Response of Q01 to the elevation driven compaction change scenarios** left block indicates reducing all land above 250, 275 and 300m elevation from moderate to light compaction, right block indicates reducing all land above 250, 275 and 300m elevation from both heavy to light compaction and from heavy to moderate compaction.

Finally, the response of Q01 to the scenario that decreased the lowland area to moderately compacted, and the upland area to lightly compacted is shown in figure 8.8. Here, there is a maximum improvement of the high flows by 31.5%. Unlike the low flows response, this is not a betterment on the scenario where just the upland was aerated. This demonstrates that unlike the low flows, the areas close to the channels are less important for the reduction of high flows. The location of the area aerated is less significant in the alleviation of high flows risk.



**Figure 8.8** Response of Q01 to reducing upland areas to light compaction and lowland areas to moderate compaction from a heavily compacted state with upland/lowland divisions set at 250, 275 and 300m elevation.

### 8.3 Implications for Feasible Management Approaches

It was concluded in Chapter 7 that with vegetation change, improvements of low flow of up to 5.1% could be feasible. Reducing compaction in the catchment however had the potential to increase low flows by much more than this. Although estimates are currently unrealistic, at values of 496%, with the careful consideration of assumptions it should be possible to increase low flows by around 100%. This will require a few years of aeration on as much farmland as possible (ideally 7.5-10 km<sup>2</sup>), but should be achievable. Taking high flows into consideration, it has become apparent that vegetation change will not reduce high flows risk. It is important to note that though changes to natural grassland proposed may not decrease low flows discharge, they will also not increase them; high flows remain unaffected by vegetation change to natural grassland. Conversely, the response of high flows to reduction in compaction levels across the catchment is favourable. The 432% increase in Q99 seen with a reduction of compaction on land above 250m is paralleled by a reduction in Q01 of 31.6%. When brought down to more realistic levels, as was done with the low

flows, it is more likely that the reduction in high flows discharge will be around the 7-8% region.

It was shown that deciduous woodland was the only land cover that was beneficial to high flows discharge. Therefore it might possible to offset the reduction caused in low flows from planting deciduous woodland to alleviate high flows by carrying out extensive efforts in soil aeration. Soil aeration itself will serve as both a high and low flows alleviation solution, though it gives more significant improvements to low flows than to high flows.

#### **8.4 Summary**

The scenarios assessed to find a management solution for extreme low flows risk were re-evaluated for their impact on high flows. It was found that though natural grassland was the most effective land cover for supplementing low flows discharge, deciduous woodland was the best land cover for reducing high flows discharge. Deciduous woodland was definitely detrimental to low flows, though in all scenarios natural grassland showed minimal increase in high flows. This shows that a simultaneous high and low flows management solution cannot be found in solely in a single vegetation change. However, increases in the proportion of natural grassland in the catchment serve to reduce low flows risk without exacerbating high flows.

The reduction of the soil compaction in the catchment was known to be highly beneficial to low flows. It was discovered that the effect of compaction reduction on high flows was also favourable, though not to the same extent as for low flows. It is possible that the reduction of compaction in the catchment could increase low flows discharge by around 100%, and it is also possible that this could decrease high flows discharge by 7 or 8%. These figures are very uncertain in comparison with the vegetation change scenarios, as many assumptions were required to be made in the scenario development; however these lessened and considered estimates from the model outputs seem reasonable. Therefore, it is possible to achieve simultaneous management of both extreme high and low flows through the careful management and reduction of soil compaction on agricultural land.



# Chapter Nine:

*Discussions and Conclusions*

## 9.1 Introduction

This thesis aimed to determine whether land management can be used to reduce the risk of extreme low flows. Studies of land cover change and land management impacts on low flows have been relatively neglected in comparison to studies regarding high flows, and the potential in modelling extreme low flows had yet to be realised. The Dacre Beck catchment in Cumbria was chosen for study, which had been previously assessed for potential land management solutions to extreme high flows (Pattison, 2010). Cumbria suffers from both extreme high and low flows, which severely affect the area's agricultural industry (Kennedy and Carrell, 2010), water supply and in-stream ecology. Therefore, it was suggested that a simultaneous management solution for both high and low flows was needed for the land managers in the area.

## 9.2 Research Questions: Core Findings and Discussions

Three research questions were developed in order to fulfil the aim of this thesis. The outcomes of each question will be considered individually, outlining the core findings.

- 1) *Are hydrological models appropriate for the investigation of low flow events?*

In order to determine whether land management could be used to reduce the risk of extreme low flows, it was first required to assess whether the hydrological models that are used to study high flows were appropriate for the investigation of low flow events. Physically based, spatially distributed models were decided to be the most appropriate type of model to use, from which the Connectivity of Runoff Model 3 (CRUM3) was selected for assessment. A sensitivity analysis of CRUM3 showed that the albedo, bedrock conductivity, saturated conductivity, porosity and the four soils depths were the most important parameters in the derivation of catchment low flows (Q99). A generalised likelihood uncertainty estimation (GLUE) experiment was undertaken using the 10 most sensitive parameters for both high and low flows,

sampled using the Latin hypercube technique. The 5,192 model realisations were ranked using a combination of the Relative Nash Sutcliffe (RNS) and the Relative Mean Absolute Error (RMAE) objective functions, which provided the low flows estimation an equal weighting to the high flows. The top ten ranked model realisations were then considered for their ability to predict low flows.

It was apparent that the CRUM3 model was capable of predicting low flow events as well as high flows, and was in fact slightly more efficient at predicting low flows than high flows across the range of model parameter sets included. The CRUM3 model has the tendency to underestimate flood peaks (as shown in figure 4.8 and as discussed in Pattison, 2010 pp.333), whilst low flows were sometimes overestimated and sometimes underestimated, depending on the model parameter set employed. The top ten ranking model realisations showed very different parameter values which demonstrated a case of equifinality within the model. Therefore, although it cannot be certain that the process representation is accurate; the model is capable of simulating the observed discharge record for the year 09/10. It became clear from this that a suite of model realisations, to cover a range of process representations, would need to be included in simulations of land management scenarios, as the modelled catchment could potentially respond in a variety of ways.

The top ten model realisations were chosen for the progression into further research. These ten gave a reasonable range of potential compositions, and that they therefore gave a good indication of the range of potential catchment responses. The further down in the RNS RMAE ranking, the model realisations became less capable of predicting the catchment behaviour. Therefore it was important that the simulations were run with enough model realisations to account for the issue of equifinality, but with high enough ranking realisations that the model still gave good predictions of the observed discharge.

An uncertainty experiment of this scale has never before been performed on the hydrological model CRUM3 and, furthermore, has never been used in a study investigating low flows. GLUE experiments have been carried out on many other hydrological models including TOPMODEL (Freer et al., 1996), HYMOD (Montanari, 2005), WASMOD (Jin et al., 2010), and DTVGM (Li et al., 2010).

GLUE has also been applied to other non-hydrological models including ecological, crop and water quality models, as outlined in Stedinger et al. (2008). Within hydrological modelling, GLUE has been used to assess the uncertainties within the models and goodness of fit in model outputs e.g. (Romanowicz and Beven, 2006), and results of GLUE experiments have not before been projected forward into modelling studies of the impacts of change.

*2) How can land use changes affect low flows hydrology?*

Once it was determined that the hydrological model and its configuration were appropriate for the investigation of low flows, various scenarios of potential land use changes were simulated. Firstly, scenarios of vegetation change, including coniferous and deciduous woodland, improved and natural grassland, arable land, bracken and heath, bare ground and developed land were considered. Scenarios of blanket vegetation change across the entire catchment were used to determine the extreme responses to each land cover, and it was determined that natural grassland was the only vegetation type to provide increases in low flows discharges with all ten model realisations. This discovery was consistent throughout the range of vegetation change scenarios that included adapting all land above certain slope angles, implementing buffer strips (or riparian zones) and adapting all land above a certain hydrological connectivity index value. With all of these scenarios natural vegetation was the most efficient land cover at supplementing low flows discharge. The increases in discharge with change to natural grassland were between 0.9 and 1.4% per 1% of catchment changed. The benefit of change to natural grassland was greatest in locations with very high hydrological connectivity (Network index value 0.8 and above), or within 25 meters of the river channel.

Secondly, the reduction of soil compaction in the catchment was considered. Fieldwork was undertaken to assess the effect of a soil aerator on the infiltration capacities of the soils in lightly and heavily compacted fields. It was discovered that in lightly compacted fields the aerator could increase the soil moisture capacity by over 100%, and could dramatically reduce overland flow. Heavily compacted fields were less responsive. The compaction levels of the catchment were then simulated and adjusted using the CRUM3 model. The reduction of

compaction levels of all land above 250m in elevation was shown to potentially increase Q99 by over 400%. These estimates were extreme scenarios, based on many assumptions, as it is uncertain to what level the soils of the Dacre Beck catchment are compacted. However, once the assumptions were broken down and considered individually, it was recognised that it should be possible to aerate a large proportion of the catchment's agricultural land and reduce the compaction by at least half a level on the scale shown in Table 6.1 (e.g. from moderate to moderate-light). This would still give an increase in the catchment Q99 by some 100%.

It was determined that although the response of the catchment to soil aeration was much more uncertain than to vegetation change; the potential increase in low flows discharge was so much more significant that decompaction efforts would still be the preferential option for land managers. If the modelled scenarios of compaction change were taken to be extreme case scenarios, the 496% potential increase in Q99 far exceeds the 52% potential increase from the extreme case scenario of blanket vegetation change to natural grassland.

Modelling studies that consider the effects of land use change on catchment hydrology have been fairly popular in the UK e.g. (Eeles and Blackie, 1993; Bormann et al., 1999; Acreman et al., 2003; Archer, 2003), however very few focus on the effects on low flows. The practical applications of the findings of modelling studies are rarely considered, and are often impracticable. Results reinforce the findings of Bosch and Hewlett (1982) and Farley et al. (2005) that coniferous woodland reduces runoff far more than deciduous woodlands. This study further demonstrates the effects each vegetation change in each location would have, and how much land would have to be converted to achieve that result.. Soil compaction scenarios were driven by the first ever physical testing of the effects soil aeration on soil infiltration properties. The rainfall simulation technique used to study this has previously been applied mainly in peatland areas e.g. (Holden and Burt, 2002), or arid regions e.g. (Schlesinger et al., 1999), but it allowed for a controlled, large scale infiltration experiment in the lake district region. Simulation of the effects of reduced soil compaction has been previously studied e.g. (Pattison, 2010). This study again agrees with previous work on compaction reduction, demonstrating that reducing

compaction levels reduced high flows discharge. Previous studies have modelled the effects of reduced stocking density or reduced machinery use which is not practically feasible, whereas this study shows that soil compaction issues can be dramatically reduced by using a soil aerator, a practice that is unlikely to compromise the working efficiency of the farm.

3) *Can land use changes help manage low flows without exacerbating flood risk?*

The land management scenarios had been assessed for their effects on low flows, but it was important to ascertain whether those determined as beneficial to low flows were also beneficial to high flows, or whether they would exacerbate flood risk. The response of Q01 to the scenarios studied was therefore examined. This revealed that the best vegetation type for reducing high flows discharge was deciduous woodland. However, unlike natural grassland for low flows, deciduous woodland did not decrease high flows for all of the ten model realisations, in some cases, the discharge was increased by additional deciduous woodland. Deciduous woodland has also been seen to significantly decrease Q99, to worsen the low flows. Although scenario changes to natural grassland did not decrease high flows, they didn't significantly increase them. The maximum increase in Q01 within the changes to natural grassland considered for low flows management was 1.22%. This demonstrated that increasing natural grassland in the catchment served to help manage low flows without exacerbating flood risk, but that it was not a simultaneous high and low flows management solution.

Conversely the compaction reduction scenarios showed very similar responses in the high flows as was seen with the low flows. Scenarios that served to increase catchment low flows discharge also decreased high flows. The response was not as strong in percentage form, but gave a higher response in absolute values, with the 496% ( $0.08 \text{ m}^3 \text{ s}^{-1}$ ) increase seen in low flow paralleled by a 32% ( $1.65 \text{ m}^3 \text{ s}^{-1}$ ) decrease in high flows. This indicated that reducing compaction could be a simultaneous solution. For the high flows, once the scenarios were broken down for more realistic consideration, the potential decrease in Q01 was more in the region of 7 to 8%, however this is still a

significant amount, and more importantly, is a reduction rather than an increase. Again then, when comparing vegetation change and soil compaction management, it seems that soil compaction management is by far the most effective extreme flows risk reduction method, for both high and low flows.

The best locations to carry out the soil aeration require further investigation. Whilst reducing the compaction on all land above 250m in elevation gives a better response in both high and low flows than reducing the compaction across the entire catchment's agricultural land; reducing the compaction of the lowland catchment to moderate, and the upland catchment to light from heavy gives a better result still for the low flows. This is due to travel times and flow pathways of the water through the catchments soils; allowing more water to be stored in the uplands, then slowly delivering to the river, provides the water in to the stream at the right time. By contrast, reduced compaction across the entire catchment allows the stored water to reach the river more quickly. More scenarios of compaction change across the catchment would be required to determine the best locations for soil aeration within the catchment; though it seems that allowing more water to be stored in the upland catchment areas is undeniably beneficial to the alleviation of extreme low flows.

Finding potential solutions for one hydrological extreme (flooding or low flows) is very common in hydrological research. Very few studies attempt to tackle both extremes simultaneously. Whilst this research has focussed on low flows, and then referred back to determine the impacts on high flows, it still has demonstrated that resolving one problem has the potential to exacerbate the other. With climate change expected to increase the occurrence and intensity of both hydrological extremes in the United Kingdom (Intergovernmental Panel on Climate Change, 2008) this study has reinforced the requirement of simultaneous modelling studies that lead to simultaneous management approaches. Unfortunately in this particular catchment there is no obvious management solution that will reduce both flood and drought risk, however there are solutions that will increase low flows without also increasing high flows. Comprehensive understanding of the impacts of land use change is very important in decision making, and investigating the other side of the flow

duration curve is often overlooked. Therefore it is hoped that this study will encourage future research efforts to take a similar simultaneous approach.

### 9.3 Recommendations for Future Work

This thesis has explored the modelling of low flows response to land use management and the effect of soil aeration on catchment hydrology. Due to time constraints many potential areas of further research were identified without the possibility of inclusion in this thesis.

- *Soil aeration fieldwork*

The fieldwork done to assess the effect of the soil aerator on infiltration rates gave a very brief overview of the range in potential soil response. To gain an accurate representation of the way in which soils respond to aeration, a much larger experiment should be undertaken. Though rainfall simulation proved to be a valuable method of assessing the infiltration capacities of the soil, it is a very time consuming process so the quantity of results initially expected was not achieved in this study. The simulations should ideally be repeated many times to accurately document the overall soil response, as it was shown that the results of the rainfall simulation experiments can vary hugely from one location within a field to the next. Also, different soil types will have a huge influence on the response to aeration, so this should be considered.

The effect of soil aeration over time would also be valuable research. This study simply measured the infiltration response before and after aeration, but repeated experiments throughout the year could help determine the longer term responses. It is likely that aeration in different soil types will last different lengths of time, so it would be worth knowing for example if clay dominant soils might need aerating more often than sand dominant soils, and if so by how much. Soil aeration also has the potential to drastically reduce sediment and phosphorous pollution (van Vliet et al., 2006), and field studies in this area give more potential for further research.

- *Compaction measurements*



Alongside the soil aeration fieldwork, it would be valuable to know where along the soil compaction continuum of levels the Dacre Beck catchment lies. If measurements of saturated conductivity, soil porosity and root layer depth could be taken in a range of agricultural fields, it would be better understood to what extent the compaction issue could be resolved. These measurements, if repeated around 50 times before and after soil aeration, would also be good indicators of how soil aeration affects the soil properties, and would be much quicker than rainfall simulation experiments. The scale of these measurements provides a difficulty though, as mentioned in Chapter 3, a handheld mini-disc infiltrometer is smaller than the holes created by the aerator, and all of these soil properties can vary significantly within one field.

- *Land drainage*

Land drainage is a major issue in the hydrological regime of agricultural catchments (Robinson, 1990; Jones, 1997), and is evident across much of the agricultural land in the Dacre Beck catchment. It was originally intended to examine the potential effects of under-drainage on the hydrology of the Dacre Beck catchment, however this would not have been possible within the CRUM3 model, and developing a second hydrological model for use in simulating the catchment was beyond the time constraints of this study. It would be difficult to gain a true understanding of the effect of land drainage in the catchment as the locations and integrities of the drains that have been employed are largely unknown. A theoretical study of the effect of blocking or removing some of these drains on low flows would be interesting. A simple distributed hydrological model such as FLOODMAP (under development for such studies by Dr. D. G. Milledge, originally (Yu and Lane, 2006a; Yu and Lane, 2006b)) could be used to simulate the effect of various land drain distributions across the catchment on both high and low flows. Aerating the soils could go some way to reducing the requirement for land drainage.

#### **9.4 Concluding Remarks**

It was discovered in this study that physically based distributed models can be applied to low flows simulations just as effectively as for high flows. The

hydrological model CRUM3 was applied to the Dacre Beck catchment in Cumbria to discover a simultaneous solution to both flooding and drought risk in the area. It was shown that vegetation change, introducing as much natural grassland to the catchment as possible, could benefit catchment low flows, but would not serve as both a high and low flows solution. However, rigorous efforts to reduce the soil compaction issues within the catchment's agricultural land could provide the solution required; and the aeration of the soils, particularly in the lowland areas of the catchment, is a method in which this solution could be implemented.

Extreme events in the water cycle cause damage, disruption and loss of life. According to IPCC projections, there will be an increase in the length and severity of droughts, and more seasonal and regional changes in floods with climate change (Harding and Warnaas, 2011). Management solutions to alleviate both extreme high and low flows will need to be seriously considered if water security is going to be maintained and flood events are to be constrained. The proposed solutions within the Dacre Beck catchment have the potential to dramatically increase water reliability in the catchment, and if compaction levels continue to be managed into the future, the positive effects could go a long way towards counteracting the predicted effects of climate change. If these proposed solutions were adopted across the larger River Eden catchment and perhaps even across northern England, the availability of summer water across the entire region could be drastically improved, and with the United Utilities pipeline links to other regions of the country, this water would benefit a vast proportion of the country's population. Along with water availability, if implemented in the larger scale, increasing summer flows and reducing extreme floods will hugely support riverine ecology, potentially saving endangered species such as the white clawed crayfish and the locally threatened salmon and trout populations. With the potential for the suggested, relatively simple, procedures to make such a difference to the flow of our rivers, getting as many local farmers and significant land owners as well as governmental and non-governmental organisations on board to help implement compaction reduction and natural grassland restoration could be the key to returning our rivers back to their natural flow regimes.

# Bibliography

- 2030 Water Resources Group** (2009). Charting Our Water Future: Economic frameworks to inform decision-making.
- Abrahams, A. D., Parsons, A. J. & Hirsch, P.** (1992). Field and laboratory studies of resistance to interrill overland flow on semi-arid hillslopes, southern Arizona. *In: Parsons, A. J. & Abrahams, A. D.* (eds.) *Overland Flow: Hydraulics and Erosion Mechanics*. London: UCL Press.
- Abrahams, A. D., Parsons, A. J. & Luk, S. H.** (1986). Resistance to overland flow on desert hillslopes. *Journal of Hydrology*, 88, 343-363.
- Abrahams, A. D., Parsons, A. J. & Wainwright, J.** (1995). Effects of vegetation change on interrill runoff and erosion, Walnut Gulch, southern Arizona. *Geomorphology*, 13, 37-48.
- Acreman, M. C., Riddington, R. & Booker, D. J.** (2003). Hydrological impacts of floodplain restoration: a case study of the River Cherwell, UK. *Hydrology and Earth System Sciences*, 7, 75-85.
- Akhurst, M. C. & Et Al.** (1997). Geology of the West Cumbria district. *Memoir of the British Geological Survey*, Sheets 28, 37, and 47 (England and Wales).
- Allan, J. D. & Flecker, A. S.** (1993). Biodiversity Conservation in Running Waters. *BioScience*, 43, 32-43.
- Allmaras, R. R., Burwell, R. E., Larson, W. E. & Holt, R. F.** (1966). Total porosity and random roughness of the interrow zone as influenced by tillage. *U.S. Department of Agricultural Conservation Research Report*. Washington D. C.
- Archer, D.** (2003). Scale effects on the hydrological impact of upland afforestation and drainage using indices of flow variability: the River Irthing, England. *Hydrology and Earth System Sciences*, 7, 325-338.
- Armstrong, J. D., Kemp, P. S., Kennedy, G. J. A., Ladle, M. & Milner, N. J.** (2003). Habitat requirements of Atlantic salmon and brown trout in rivers and streams. *Fisheries Research*, 62, 143-170.

- Arndt, W.** (1966). IV. - The effect of traffic compaction on a number of soil properties. *Journal of Agricultural Engineering Research*, 11, 182-187.
- Arnell, N. W.** (1998). Climate change and water resources in Britain. *Climatic Change*, 39, 83-110.
- Arnell, N. W.** (2003). Relative effects of multi-decadal climatic variability and changes in the mean and variability of climate due to global warming: future streamflows in Britain. *Journal of Hydrology*, 270, 195-213.
- Baird, A. J.** (1997). Overland flow generation and sediment mobilisation by water. In: **In Thomas, D. S. G.** (ed.) *Arid Zone Geomorphology*. Chichester: Wiley.
- Band, L. E.** (1986). Topographic partition of watersheds with digital elevation models. *Water Resources Research*, 22, 15-24.
- Bari, M. A. & Smettem, K. R. J.** (2006). A conceptual model of daily water balance following partial clearing from forest to pasture. *Hydrology and Earth System Sciences*, 10, 321-337.
- Barling, R. & Moore, I.** (1994). Role of buffer strips in management of waterway pollution: A review. *Environmental Management*, 18, 543-558.
- Barry, R. G. & Chambers, R. E.** (1966). A preliminary map of summer albedo over England and Wales. *Quarterly Journal of the Royal Meteorological Society*, 92, 543-548.
- Bathurst, J. C.** (1986). Sensitivity analysis of the Systeme Hydrologique Europeen for an upland catchment. *Journal of Hydrology*, 87, 103-123.
- Bathurst, J. C. & O'connell, P. E.** (1992). Future of distributed modelling: The Systeme Hydrologique Europeen. *Hydrological Processes*, 6, 265-277.
- Baugh, C. A.** (2010). *The Impact of Climate Change upon the Snowmelt Hydrology of an Upland UK Catchment*. Msc by Research, Durham University.
- Beran, M. A. & Gustard, A.** (1977). A study into the low-flow characteristics of British rivers. *Journal of Hydrology*, 35, 147-157.
- Betteridge, K., Mackay, A. D., Shepherd, T. G., Barker, D., J., Budding, P. J., Devatier, B. P. & Costall, D. A.** (1999). Effect of cattle and sheep treading on surface configuration of a sedimentary hill soil. *Australian Journal of Soil Research*, 37, 743-760.

- Beven, K.** (1984). Infiltration into a class of vertically non-uniform soils. *Hydrological Sciences*, 29, 425-434.
- Beven, K.** (1993). Prophecy, reality and uncertainty in distributed hydrological modeling. *Advances in Water Resources*, 16, 41-51.
- Beven, K.** (1997). TOPMODEL: A critique. *Hydrological Processes*, 11, 1069-1085.
- Beven, K.** (2006). A manifesto for the equifinality thesis. *Journal of Hydrology*, 320, 18-36.
- Beven, K. & Freer, J.** (2001a). A dynamic TOPMODEL. *Hydrological Processes*, 15, 1993-2011.
- Beven, K. & Freer, J.** (2001b). Equifinality, data assimilation, and uncertainty estimation in mechanistic modelling of complex environmental systems using the GLUE methodology. *Journal of Hydrology*, 249, 11-29.
- Beven, K. J.** (2004). *Rainfall-runoff modelling: the primer*, John Wiley & Sons.
- Beven, K. J. & Binley, A. M.** (1992). The future of distributed models: model calibration and uncertainty prediction. *Hydrological Processes*, 6, 279-298.
- Beven, K. J., Calver, A. & Morris, E. M.** (1987). The Institute of Hydrology distributed model. *Technical report No. 98*. Wallingford: Institute of Hydrology.
- Beven, K. J. & Kirkby, M. J.** (1976). Toward a simple physically-based variable contributing area of catchment hydrology. *Working Paper No. 154*.
- Birch, C. P. D., Vuichard, N. & Werkman, B. R.** (2000). Modelling the Effects of Patch Size on Vegetation Dynamics: Bracken under Grazing. *Annals of Botany*, 85, 63-76.
- Black, M. & King, J.** (2009). *The Atlas of Water: Mapping the world's most critical resource*, London, Earthscan.
- Blenkinsop, S. & Fowler, H. J.** (2007). Changes in drought frequency, severity and duration for the British Isles projected by the PRUDENCE regional climate models. *Journal of Hydrology*, 342, 50-71.
- Blöschl, G., Ardoin-Bardin, S., Bonell, M., Dorninger, M., Goodrich, D., Gutknecht, D., Matamoros, D., Merz, B., Shand, P. & Szolgay, J.** (2007). At what scales do climate variability and land cover change

impact on flooding and low flows? *Hydrological Processes*, 21, 1241-1247.

- Boguzas, V. & Hakansson.** (2001). Barley yield losses simulation under Lithuanian conditions using the Swedish soil compaction model. *In: The International Conference on Sustainable Agriculture in Baltic States*, 2001 Estonian Agricultural University, Tartu, Estonia., 24-28.
- Booij, M. J., Huisjes, M. & Hoekstra, A. Y.** (2006). Uncertainty in climate change impacts on low flows. *In: Demuth, S., Iahs International Commission on Water Resources Systems & Flow Regimes from International Experimental and Network Data* (eds.) *Climate Variability and Change - Hydrological Impacts*. IAHS,.
- Bordi, I., Fraedrich, K. & Sutera, A.** (2009). Observed drought and wetness trends in Europe: an update. *Hydrology and Earth System Sciences*, 13, 1519-1530.
- Bormann, H., Diekkrüger, B. & Hauschild, M.** (1999). Impacts of landscape management on the hydrological behaviour of small agricultural catchments. *Physics and Chemistry of the Earth, Part B: Hydrology, Oceans and Atmosphere*, 24, 291-296.
- Bosch, J. M. & Hewlett, J. D.** (1982). A review of catchment experiments to determine the effect of vegetation changes on water yield and evapotranspiration. *Journal of Hydrology*, 55, 3-23.
- Botter, G., Porporato, A., Daly, E., Rodriguez-Iturbe, I. & Rinaldo, A.** (2007). Probabilistic characterization of base flows in river basins: Roles of soil, vegetation, and geomorphology. *Water Resour. Res.*, 43, W06404.
- Bowyer-Bower, T. a. S. & Burt, T. P.** (1989). Rainfall simulators for investigating soil response to rainfall. *Soil Technology*, 2, 1-16.
- Bravar, L. & Kavvas, M. L.** (1991). On the physics of droughts. II. Analysis and simulation of the interaction of atmospheric and hydrologic processes during droughts. *Journal of Hydrology*, 129, 299-330.
- Breuer, L., Eckhardt, K. & Frede, H.-G.** (2003). Plant parameter values for models in temperate climates. *Ecological Modelling*, 169, 237-293.
- Breuer, L. & Frede, H. G.** (2003). PlaPaDa - an online plant parameter data drill for eco-hydrological modelling approaches. Institute for Landscape Ecology and Resources Management.

- Brogan, L. & Cunnane, C.** (2005). Low flows and low flows distributions for Ireland. *National Hydrology Seminar*.
- Buckley, C. P.** (2010). *Inverse modelling of diffuse pollution sources in the River Eden catchment*. Masters, Durham University.
- Burgess, I. C. & Wadge, A. J.** (1974). *The Geology of the Cross Fell Area*, London, HMSO for the Institute of Geolical Sciences,.
- Caissie, D.** (2006). The thermal regime of rivers: a review. *Freshwater Biology*, 51, 1389-1406.
- Calder, I. R.** (1993). Hydrologic effects of land-use change. *In: Maidment, D. R.* (ed.) *Handbook of Hydrology*. USA: McGraw-Hill Inc.
- Calder, I. R.** (2003). Assessing the water use of short vegetation and forests: Development of the Hydrological Land Use Change (HYLUC) model. *Water Resour. Res.*, 39, 1318.
- Calder, I. R. & Newson, M. D.** (1979). Land-use and upland water resources in Britain - A strategic look 1. *JAWRA Journal of the American Water Resources Association*, 15, 1628-1639.
- Calder, I. R., Reid, I., Nisbet, T. R. & Green, J. C.** (2003). Impact of lowland forests in England on water resources: Application of the Hydrological Land Use Change (HYLUC) model. *Water Resour. Res.*, 39, 1319.
- Carroll, Z. L., Bird, S. B., Emmett, B. A., Reynolds, B. & Sinclair, F. L.** (2004). Can tree shelterbelts on agricultural land reduce flood risk? *Soil Use and Management*, 20, 357-359.
- Caruso, B. S.** (2001). Regional river flow, water quality, aquatic ecological impacts and recovery from drought. *Hydrological Sciences Journal*, 46, 677-699.
- Castaings, W., Dartus, D., Le Dimet, F. X. & Saulnier, G. M.** (2009). Sensitivity analysis and parameter estimation for distributed hydrological modeling: potential of variational methods. *Hydrology and Earth System Sciences*, 13, 503-517.
- Ceh** (1999). *Flood Estimation Handbook*. Wallingford: Centre for Ecology and Hydrology.
- Center for Ecology and Hydrology.** (2011). *Revitalisation of the FSR/FEH rainfall-runoff method website* [Online]. CEH. Available: <http://www.ceh.ac.uk/feh2/FEHReFH.html> [Accessed 19/09/2011].

- Changnon, S. A., Jr. & Semonin, R. G.** (1979). Impact of man upon local and regional weather. *Rev. Geophys.*, 17, 1891-1900.
- Charlton, R., Fealy, R., Moore, S., Sweeney, J. & Murphy, C.** (2006). Assessing the Impact of Climate Change on Water Supply and Flood Hazard in Ireland Using Statistical Downscaling and Hydrological Modelling Techniques. *Climatic Change*, 74, 475-491.
- Chartered Institution of Water and Environmental Management (Ciwem)** (2006). Catchment management: land-use and water. London: CIWEM.
- Cheng, J. & Druzdzel, M. J.** (2000). Latin Hypercube Sampling in Bayesian Networks. *Uncertain Reasoning*. Pittsburgh: American Association for Artificial Intelligence.
- Clapp, R. B. & Hornberger, G. M.** (1978). Empirical equations for some soil hydraulic properties. *Water Resources Research*, 14, 601-604.
- Collings, A.** (2009). Aerators keep grassland fresh. *Farmers Weekly Interactive: Making the Farming Connection* [Online].
- Cred.** *EM-DAT: The OFDA/CRED International Disaster Database* [Online]. Brussels, Belgium: Universite Catholique de Louvain. [Accessed].
- Croke, B. F. W., Merritt, W. S. & Jakeman, A. J.** (2004). A dynamic model for predicting hydrologic response to land cover changes in gauged and ungauged catchments. *Journal of Hydrology*, 291, 115-131.
- Crocker, K. M., Young, A. R., Zaidman, M. D. & Rees, H. G.** (2003). Flow duration curve estimation in ephemeral catchments in Portugal. *Hydrological Sciences Journal*, 48, 427-439.
- Cropper, W. P. & Golz, H. L.** (1993). Simulation of the carbon dynamics of a Florida slash pine plantation. *Ecological Modelling*, 66, 231-249.
- Crosetto, M., Tarantola, S. & Saltelli, A.** (2000). Sensitivity and uncertainty analysis in spatial modelling based on GIS. *Agriculture Ecosystems & Environment*, 81, 71-79.
- Dawson, T.** (2011a). *RE: Soil aeration with the Eden Rivers Trust, Summer 2011*. Personal Communication to Smith, K. A.
- Dawson, T.** (2011b). *RE: The use of a soil aerator on heavily compacted soils*. Personal Communication to Smith, K. A.



- Decagon Devices.** (2011). *Mini Disc Tension Infiltrometer Website* [Online]. Available: <http://www.decagon.com/products/lysimeters-and-infiltrometers/mini-disk-tension-infiltrometer/> [Accessed].
- Defra Uk Climate Projections.** (2011). *UKCP09 Maps and Key Findings for North West England* [Online]. Available: <http://ukclimateprojections.defra.gov.uk/content/view/292/499/> [Accessed].
- Department for Agriculture Food and Rural Affairs (Defra)** (2009). Protecting our Water, Soil and Air: A good code of practice for farmers, growers and land managers. Norwich: The Stationary Office (TSO).
- Dingman, S. L.** (1994). *Physical hydrology*, Macmillan Pub. Co.
- Diskin, M. H. & Simon, S.** (1977). A procedure for the selection of objective functions for hydrologic simulation models. *Journal of Hydrology*, 34, 129-149.
- Douglas, E. M., Vogel, R. M. & Kroll, C. N.** (2000). Trends in floods and low flows in the United States: impact of spatial correlation. *Journal of Hydrology*, 240, 90-105.
- Douglas, J. T.** (1997). Soil compaction effects on second-harvest yields of perennial ryegrass for silage. *Grass and Forage Science*, 52, 129-133.
- Douglas, J. T., Crawford, C. E. & Campbell, D. J.** (1995). Traffic Systems and Soil Aerator Effects on Grassland for Silage Production. *Journal of Agricultural Engineering Research*, 60, 261-270.
- Douglas, J. T., Koppi, A. J. & Crawford, C. E.** (1998). Structural improvement in a grassland soil after changes to wheel-traffic systems to avoid soil compaction. *Soil Use and Management*, 14, 14-18.
- Dugdale, L.** (2010). In-Stream Ecological Characterisation. Eden Demonstration Test Catchment Project.
- Dugdale, L.** (2011). *RE: The ecology of the Dacre Beck*. Personal Communication to Smith, K. A.
- Dunn, S. M., Stalham, M., Chalmers, N. & Crabtree, B.** (2003). Adjusting irrigation abstraction to minimise the impact on stream flow in the East of Scotland. *Journal of Environmental Management*, 68, 95-107.

- Easterling, W. E. & Mendelsohn, R.** (2000). Estimating the economic impacts of drought on agriculture. In: **Wilhite, D. A.** (ed.) *Drought: A global assessment, Volume 1*. London: Routledge.
- Eden Rivers Trust** (2010). Results of the 2009 Salmonid Fry Electrofishing Surveys & Eden Catchment Overview. *Section Six: The Lake District Sub-Catchment*. Penrith: Eden Rivers Trust,.
- Eeles, C. W. O. & Blackie, J. R.** (1993). Land-use changes in the Balquhider catchments simulated by a daily streamflow model. *Journal of Hydrology*, 145, 315-336.
- Eheart, J.** (1999). Low-Flow Frequency Exacerbation by Irrigation Withdrawals in the Agricultural Midwest under Various Climate Change Scenarios. *ASCE Conf. Proc.*, 102, 252.
- Elsenbeer, H., Newton, B. E., Dunne, T. & De Moraes, J. M.** (1999). Soil hydraulic conductivities of latosols under pasture, forest and teak in Rondonia, Brazil. *Hydrological Processes*, 13, 1417-1422.
- Environment Agency** (2006). The Eden and Esk Catchment Abstraction Management Strategy. Penrith: Environment Agency,.
- Environment Agency** (2007a). Living on the Edge: A guide to the rights and responsibilities of riverside occupation. Bristol: Environment Agency.
- Environment Agency** (2007b). Thames Region Land Drainage Byelaws. Bristol: Environment Agency.
- Environment Agency** (2007c). Water for people and the environment - Developing our water resources strategy for England and Wales. Bristol: Environment Agency.
- Environment Agency** (2008). Water resources in England and Wales - current state and future pressures. Bristol: Environment Agency,.
- Environment Agency** (2009a). Eden Catchment Flood Management Plan: Summary Report December 2009. Warrington: Environment Agency.
- Environment Agency** (2009b). North West Region Drought Plan. Bristol: Environment Agency,.
- European Environment Agency** (2009). Water resources across Europe - confronting water scarcity and drought. Copenhagen: EEA.

- Ewen, J., Parkin, G. & O'connell, E.** (2000). SHETRAN: Distributed River Basin Flow and Transport Modelling System. *Journal of Hydrologic Engineering*, 5, 250-258.
- Farley, K. A., Jobbágy, E. G. & Jackson, R. B.** (2005). Effects of afforestation on water yield: a global synthesis with implications for policy. *Global Change Biology*, 11, 1565-1576.
- Faulkner, D. S. & Barber, S.** (2009). Performance of the Revitalised Flood Hydrograph method. *Journal of Flood Risk Management*, 2, 254-261.
- Febo, P. & Planeta, A.** (2000). Wheels or tracks for tractors of the future? *Macchine e Motori Agricoli*, 58, 50-52.
- Ferrero, A. F.** (1991). Effect of compaction simulating cattle trampling on soil physical characteristics in woodland. *Soil and Tillage Research*, 19, 319-329.
- Ferrero, A. F. & Lipiec, J.** (2000). Determining the effect of trampling on soils in hillslope woodlands. *International Agrophysics*, 14, 9-16.
- Feyen, L. & Dankers, R.** (2009). Impact of global warming on streamflow drought in Europe. *Journal of Geophysical Research*, 114.
- Flowers, M. D. & Lal, R.** (1998). Axle load and tillage effects on soil physical properties and soybean grain yield on a mollic ochtaqualf in northwest Ohio. *Soil Tillage Research*, 48, 21-35.
- Food and Agriculture Organisation** (2000). Manual on integrated soil management and conservation practices. In: **Fao** (ed.) *Land and Water Bulletin No. 8*. Rome: FAO,.
- Foster, I. D. L., Fullen, M. A., Brandsma, R. T. & Chapman, A. S.** (2000). Drip-screen rainfall simulators for hydro- and pedo-geomorphological research: the Coventry experience. *Earth Surface Processes and Landforms*, 25, 691-707.
- Fowler, H. J. & Kilsby, C. G.** (2004). Future increases in UK water resource drought projected by a regional climate model. *Hydrology: Science & Practice for the 21st Century*. British Hydrological Society.
- Fowler, H. J., Tebaldi, C. & Blenkinsop, S.** (2008). Probabilistic estimates fo climate change impacts on flows in the River Eden, Cumbria. *BHS 10th National Hydrology Symposium*. Exeter: British Hydrological Society.

- Freeman, T. G.** (1991). Calculating catchment area with divergent flow based on a regular grid. *Computers and Geosciences*, 17, 413-422.
- Freer, J., Beven, K. & Ambrose, B.** (1996). Bayesian Estimation of Uncertainty in Runoff Prediction and the Value of Data: An Application of the GLUE Approach. *Water Resour. Res.*, 32, 2161-2173.
- Ganapathi, M.** (2006). *Influence of Organics, Micronutrients and Plant Regulators on Productivity Potential in Carrot*. Doctor of Philosophy, University of Agricultural Sciences.
- Gilley, J. E. & Kottowitz, E. R.** (1994). Maximum Surface Storage Provided by Crop Residue. *Journal of Irrigation and Drainage Engineering*, 120, 591-606.
- Gilley, J. E., Kottowitz, E. R. & Wieman, G. A.** (1992). Darcy-Weisbach Roughness Coefficients for Gravel and Cobble Surfaces. *Journal of Irrigation and Drainage Engineering*, 118, 104-112.
- Giorgi, F., Mearns, L. O., Shields, C. & Mayer, L.** (1996). A regional model study of the importance of local versus remote controls of the 1988 drought and the 1993 flood over the Central United States. *Journal of Climate*, 9, 1150-1162.
- Glantz, M. H.** (2000). Drought follows the plough: A cautionary note. In: **Wilhite, D. A.** (ed.) *Drought: A global assessment*. London: Routledge.
- Gonzalez-Sosa, E., Braud, I., Dehotin, J., Lassabatère, L., Angulo Jaramillo, R., Lagouy, M., Branger, F., Jacqueminet, C., Kermadi, S. & Michell, K.** (2010). Impact of land use on the hydraulic properties of the topsoil in a small French catchment. *Hydrological Processes*, 24, 2382-2399.
- Granier, A., Bréda, N., Biron, P. & Villetta, S.** (1999). A lumped water balance model to evaluate duration and intensity of drought constraints in forest stands. *Ecological Modelling*, 116, 269-283.
- Green, I. R. A. & Stephenson, D.** (1986). Criteria for comparison of single event models. *Hydrological Sciences*, 31.
- Green, W. H. & Ampt, G. A.** (1911). Studies on soil physics: Part 1: The flow of air and water through soils. *Journal of Agricultural Science*, 4, 1-24.

- Groundtradesexchange.** (2003-2007). *Mowable Slope* [Online]. Available: <http://www.groundtradesexchange.com/forums/hardscaping/5885-mowable-slope.html> [Accessed 12/09/2011].
- Gustard, A. & Wesselink, A. J.** (1993). Impact of land-use change on water resources: Balquhider catchments. *Journal of Hydrology*, 145, 389-401.
- Hamza, M. A. & Anderson, W. K.** (2005). Soil compaction in cropping systems: A review of the nature, causes and possible solutions. *Soil and Tillage Research*, 82, 121-145.
- Hannaford, J. & Marsh, T.** (2006). An assessment of trends in UK runoff and low flows using a network of undisturbed catchments. *International Journal of Climatology*, 26, 1237-1253.
- Hannaford, J. & Marsh, T. J.** (2008). High-flow and flood trends in a network of undisturbed catchments in the UK. *International Journal of Climatology*, 28, 1325-1338.
- Harding, R. J. & Warnaas, T. A.** (2011). Water and global change: The WATCH Projection Outreach Report. *In: Centre for Ecology and Hydrology* (ed.). Wallingford: NERC Centre for Ecology and Hydrology.
- Hawkins, J. C. & Brown, N. J.** (1963). Tillage practices and mechanisation. *Netherlands Journal of Agricultural Science*, 11, 140-144.
- Heathwaite, A. L., Burt, T. P. & Trudgill, S. T.** (1990). Land use controls on sediment delivery in lowland agricultural catchments. *In: Boardman, J., Foster, I. D. L. & Dearing, J.* (eds.) *Soil Erosion on Agricultural Land*. Chichester: Wiley.
- Henriques, A. G. & Santos, M. J. J.** (1999). Regional drought distribution model. *Physics and Chemistry of the Earth, Part B: Hydrology, Oceans and Atmosphere*, 24, 19-22.
- Herbst, M., Roberts, J. M., Rosier, P. T. W., Taylor, M. E. & Gowing, D. J.** (2007). Edge effects and forest water use: A field study in a mixed deciduous woodland. *Forest Ecology and Management*, 250, 176-186.
- Hisdal, H., Stahl, K., Tallaksen, L. M. & Demuth, S.** (2001). Have streamflow droughts in Europe become more severe or frequent? *International Journal of Climatology*, 21, 317-333.

- Holden, J. & Burt, T. P.** (2002). Infiltration, runoff and sediment production in blanket peat catchments: implications of field rainfall simulation experiments. *Hydrological Processes*, 16, 2537-2557.
- Holmgren, P.** (1994). Multiple flow direction algorithms for runoff modelling in grid based elevation models: An empirical evaluation. *Hydrological Processes*, 8, 327-334.
- Hudson, J. A., Crane, S. B. & Blackie, J. R.** (1997). The Plynlimon water balance 1969-1995: the impact of forest and moorland vegetation on evaporation and streamflow in upland catchments. *Hydrology and Earth System Sciences*, 1, 409-427.
- Huggett, R. J. & Cheesman, J.** (2002). *Topography and the environment*, Prentice Hall.
- Intergovernmental Panel on Climate Change** (2008). Climate and Water: Technical Paper of the Intergovernmental Panel on Climate Change. In: Bates, B., Kundzewicz, Z. W., Palutikof, J. & Wu, S. (eds.). Geneva: IPCC.
- Jansson, K.-J. & Johansson, J.** (1998). Soil changes after traffic with a tracked and a wheeled forest machine: a case study on a silt loam in Sweden. *Forestry*, 71, 57-66.
- Jensen, M. E., Burmann, R. D. & Allen, R. G.** (1990). Evaporation and irrigation water requirements. *ASCE manual and reports on engineering practice*. American Society of Civil Engineers.
- Jin, X. L., Xu, C. Y., Zhang, Q. & Singh, V. P.** (2010). Parameter and modeling uncertainty simulated by GLUE and a formal Bayesian method for a conceptual hydrological model. *Journal of Hydrology*, 383, 147-155.
- Johnson, R.** (1998). The forest cycle and low river flows: a review of UK and international studies. *Forest Ecology and Management*, 109, 1-7.
- Johnson, R. C. & Whitehead, P. G.** (1993). An introduction to the research in the Balquhiddy experimental catchments. *Journal of Hydrology*, 145, 231-238.
- Jones, J. a. A.** (1997). *Global hydrology: processes, resources and environmental management*, Longman.

- Jones, P. D. & Lister, D. H.** (1998). Riverflow reconstructions for 15 catchments over England and Wales and an assessment of hydrologic drought since 1865. *International Journal of Climatology*, 18, 999-1013.
- Karvonen, T., Koivusalo, H., Jauhiainen, M., Palko, J. & Weppling, K.** (1999). A hydrological model for predicting runoff from different land use areas. *Journal of Hydrology*, 217, 253-265.
- Kennedy, M. & Carrell, S.** (2010). Drought risk hits Cumbria just months after floods. *The Guardian*. London: Guardian Newspapers Ltd.
- Kilpeläinen, A., Peltola, H. & Ryyppö, A.** (2005). Scots pine responses to elevated temperature and concentration: growth and wood properties. *Tree Physiology*, 25, 75-83.
- Kirkby, M., Bracken, L. & Reaney, S.** (2002). The influence of land use, soils and topography on the delivery of hillslope runoff to channels in SE Spain. *Earth Surface Processes and Landforms*, 27, 1459-1473.
- Kirkby, M. J.** (1975). Hydrograph modelling strategies. In: **Peel, R., Chisholm, M. & Haggert, P.** (eds.) *Processes in Physical and Human Geography*. London: Heineman.
- Kirkby, M. J.** (1985). Hillslope Hydrology. In: **Anderson, M. G. & Burt, T. P.** (eds.) *Hydrological forecasting*. Wiley.
- Kjeldsen, T.** (2007a). Flood Estimation Handbook: Supplementary Report No. 1 - The revitalised FSR/FEH rainfall-runoff method. Wallingford: Centre for Ecology & Hydrology.
- Kjeldsen, T., Jones, D. & Bayliss, A.** (2008). Improving the FEH statistical method. In: Flood and Coastal Management Conference 2008, 2008 University of Manchester. Environment Agency/Defra.
- Kjeldsen, T. R.** (2007b). Flood Estimation Handbook: Supplementary Report No.1. Wallingford: Centre for Ecology and Hydrology.
- Knighton, D.** (1998). *Fluvial forms and processes: a new perspective*, Arnold.
- Kozlowski, T. T., Winget, C. H. & Torrie, J. H.** (1962). Daily Radial Growth of Oak in Relation to Maximum and Minimum Temperature. *Botanical Gazette*, 124, 9-17.
- Krause, P., Boyle, D. P. & Bäse, F.** (2005). Comparison of different efficiency criteria for hydrological model assessment. *Advances in Geosciences*, 5, 89-97.

- Krause, S., Jacobs, J. & Bronstert, A.** (2007). Modelling the impacts of land-use and drainage density on the water balance of a lowland–floodplain landscape in northeast Germany. *Ecological Modelling*, 200, 475-492.
- Kundzewicz, Z. W.** (2000). Book Reviews: Flood Estimation Handbook (Procedures for Flood Frequency Estimation). *Hydrological Sciences*, 45, 929-930.
- Lambin, E. F.** (2004). Modelling Land Use Change. In: **Wainwright, J. & Mulligan, M.** (eds.) *Environmental Modelling: Finding Simplicity in Complexity*. Chichester: Wiley & Sons.
- Landau, D. P. & Binder, K.** (2005). *A guide to Monte Carlo simulations in statistical physics*, Cambridge University Press.
- Lane, P. N. J., Best, A. E., Hickel, K. & Zhang, L.** (2005). The response of flow duration curves to afforestation. *Journal of Hydrology*, 310, 253-265.
- Lane, S. N., Brookes, C. J., Hardy, R. J., Holden, J., James, T. D., Kirkby, M. J., McDonald, A. T., Tayefi, V. & D., Y.** (2003). Land management, flooding and environmental risk: new approaches to a very old question. *Proceedings of the Chartered Institute for Water and Environmental Management National Conference*.
- Lane, S. N., Heathwaite, L., Bierozza, M., Milledge, D. G. & Reaney, S. M.** (2011). *SCIMAP: Diffuse Risk Modelling Framework Website* [Online]. Available: <http://www.scimap.org.uk/> [Accessed 17/09/2011].
- Lane, S. N., Reaney, S. M. & Heathwaite, A. L.** (2009). Representation of landscape hydrological connectivity using a topographically driven surface flow index. *Water Resources Research*, 45.
- Lehner, B., Döll, P., Alcamo, J., Henrichs, T. & Kaspar, F.** (2006). Estimating the Impact of Global Change on Flood and Drought Risks in Europe: A Continental, Integrated Analysis. *Climatic Change*, 75, 273-299.
- Leopold, L. B. & Maddock, T.** (1953). The hydraulic geometry of stream channels and some physiographic implications. *U.S. Geological Survey Professional Paper*, 252.
- Li, L., Xia, J., Xu, C. Y. & Singh, V. P.** (2010). Evaluation of the subjective factors of the GLUE method and comparison with the formal Bayesian method in uncertainty assessment of hydrological models. *Journal of Hydrology*, 390, 210-221.



- Machtans, C. S., Villard, M.-A. & Hannon, S. J.** (1996). Use of Riparian Buffer Strips as Movement Corridors by Forest Birds  
Utilización de franjas riparias amortiguadoras como corredores por aves de bosque. *Conservation Biology*, 10, 1366-1379.
- Maidment, D. R.** (1993). *Handbook of hydrology*, McGraw-Hill.
- Manley, R. E.** (1978). Simulation of Flows in Ungauged Basins. *Hydrological sciences Bulletin*, 23, 85-101.
- Marc, V. & Robinson, M.** (2007). The long-term water balance (1972-2004) of upland forestry and grassland at Plynlimon, mid-Wales. *Hydrology and Earth System Sciences*, 11, 44-60.
- Marsh, T., Cole, G. & Wilby, R.** (2007). Major droughts in England and Wales, 1800–2006. *Weather*, 62, 87-93.
- Mathworks®** (2011). MATLAB R2011a.
- Mccormac, M.** (2003). *The Upper Palaeozoic rocks and Quaternary deposits of the Shap and Penrith District, Cumbria (part of Sheet 30, England and Wales)*.
- Meyles, E. W., Williams, A. G., Ternan, J. L., Anderson, J. M. & Dowd, J. F.** (2006). The influence of grazing on vegetation, soil properties and stream discharge in a small Dartmoor catchment, southwest England, UK. *Earth Surface Processes and Landforms*, 31, 622-631.
- Montanari, A.** (2005). Large sample behaviours of the generalized likelihood uncertain estimation (GLUE) in assessing the uncertainty of rainfall-runoff simulations. *Water Resources Research*, 41.
- Monteith, J. L.** (1965). Evaporation and Environment. *Symposium of the Society for Experimental Biology*, 19, 205-234.
- Moore, R. J.** (2007). The PDM rainfall-runoff model. *Hydrology and Earth System Sciences*, 11, 483-499.
- Moore, R. J. & Clarke, R. T.** (1981). A distribution function approach to rainfall-runoff modelling. *Water Resour. Res.*, 17, 1367-1382.
- Morris, D. G. & Heerdegen, R. G.** (1988). Automatically derived catchment boundaries and channel networks and their hydrological applications. *Geomorphology*, 1, 131-141.

- Mulligan, M.** (1996). Modelling the complexity of land surface response to climate variability in Mediterranean environments. *In: Anderson, M. G. & Brooks, S. M.* (eds.) *Advances in hillslope processes*. Chichester: Wiley.
- Mulligan, M.** (2004). Modelling catchment hydrology. *In: Mulligan, M.* (ed.) *Environmental Modelling: Finding Simplicity in Complexity*. Chichester: Wiley & Sons.
- Murphy, M. L., Heifetz, J., Johnson, S. W., Koski, K. V. & Thedinga, J. F.** (1986). Effects of Clear-cut Logging with and without Buffer Strips on juvenile Salmonids in Alaskan Streams. *Canadian Journal of Fisheries and Aquatic Sciences*, 43, 1521-1533.
- Musleh, F. A. & Cruise, J. F.** (2006). *Functional Relationships of Resistance in Wide Flood Plains with Rigid Unsubmerged Vegetation*, ASCE.
- Næsset, E.** (1997). Determination of mean tree height of forest stands using airborne laser scanner data. *ISPRS Journal of Photogrammetry and Remote Sensing*, 52, 49-56.
- Nash, J. E. & Sutcliffe, J. V.** (1970). River flow forecasting through conceptual models part I - A discussion of principles. *Journal of Hydrology*, 10, 282-290.
- Natural England.** (2011). *Nature on the Map* [Online]. Natural England. Available: <http://www.natureonthemap.naturalengland.org.uk/> [Accessed 19/09/2011].
- O'callaghan, J. F. & Mark, D. M.** (1984). The extraction of drainage networks from digital elevation data. *Computer Vision, Graphics and Image Processing*, 28, 323-344.
- O'connell, E., Ewen, J., O'donnell, G. & Quinn, P.** (2007). Is there a link between agricultural land-use management and flooding? *Hydrology and Earth System Sciences*, 11, 96-107.
- Parkin, G., Birkinshaw, S. J., Younger, P. L., Rao, Z. & Kirk, S.** (2007). A numerical modelling and neural network approach to estimate the impact of groundwater abstractions on river flows. *Journal of Hydrology*, 339, 15-28.

- Parry, M. L., Hossell, J. E. & Wright, L. J.** (1992). Land use in the United Kingdom. *In: Whitby, M. C.* (ed.) *Land Use Change: Causes and Consequences*. HMSO.
- Parsons, A. J. & Abrahams, A. D.** (2009). *Geomorphology of desert environments*, Springer.
- Patry, G. G. & Marino, M.** (1983). Nonlinear runoff modeling: parameter identification. *Journal of Hydraulic Engineering*, 109, 865-880.
- Pattison, I.** (2010). *Rural Land Management Impacts on Catchment Scale Flood Risk*. Doctor of Philosophy, Durham University.
- Penman, H. L.** (1948). Natural Evaporation from Open Water, Bare Soil and Grass. *Proceedings of the Royal Society of London. Series A, Mathematical and Physical Sciences*, 193, 120-145.
- Pielke, R. A., Beltran-Przekurat, A., Hiemstra, C. A., Lin, J., Nobis, T. E., Adegoke, J., Nair, U. S. & Niyogi, D.** (2006). Impacts of regional land use and land cover on rainfall: an overview. *In: Demuth, S., IAHS International Commission on Water Resources Systems & Flow Regimes from International Experimental and Network Data* (eds.) *Climate variability and change - hydrological impacts*. Wallingford: IAHS Press.
- Pilling, C. G. & Jones, J. a. A.** (2002). The impact of future climate change on seasonal discharge, hydrological processes and extreme flows in the Upper Wye experimental catchment, mid-Wales. *Hydrological Processes*, 16, 1201-1213.
- Pitchcare.** (2011). *Soil Compaction Tester / Penetrometer Website* [Online]. Available: <http://www.pitchcare.com/shop/agronomy-tools/soil-compaction-tester-penetrometer.html> [Accessed 17/09/2011].
- Ponce, V. M. & Lugo, A.** (2001). Modeling looped ratings in Muskingham-Cunge routing. *Journal of Hydrologic Engineering*, 119-124.
- Priestley, C. H. B. & Taylor, R. J.** (1972). On the Assessment of Surface Heat Flux and Evaporation Using Large-Scale Parameters. *Monthly Weather Review*, 100, 81-92.
- Querner, E. P. E. A.** (1997). Impact of land use, climate change and groundwater abstraction on streamflow droughts using physically based models. *In: FRIEND '97. Regional Hydrology: Concepts for Sustainable*

- Water Resource Management 1997 Proceedings of the Postojna, Slovenia. IAHS.
- Quinn, P., Beven, K., Chevallier, P. & Planchon, O.** (1991). The prediction of hillslope flow paths for distributed hydrological modelling using digital terrain models. *Hydrological Processes*, 5, 59-79.
- Reaney, S.** (2011). *RE: Advice on GLUE*. Personal Communication to Smith, K. A.
- Reaney, S., Wade, T., Lane, S. & Conlan, K.** (2005). Effects of Climate Change on River Water Quality. UK Water Industry Research Ltd.
- Reaney, S. M.** (2008). The use of agent based modelling techniques in hydrology: determining the spatial and temporal origin of channel flow in semi-arid catchments. *Earth Surface Processes and Landforms*, 33, 317-327.
- Reaney, S. M., Bracken, L. J. & Kirkby, M. J.** (2007). Use of the Connectivity of Runoff Model (CRUM) to investigate the influence of storm characteristics on runoff generation and connectivity in semi-arid areas. *Hydrological Processes*, 21, 894-906.
- Ritchie Agricultural.** (2011). *Ritchie Grassland Aerator Website* [Online]. Available: <http://www.ritchie-d.co.uk/content/grassland-aerators> [Accessed 17/09/2011].
- Robinson, M.** (1990). Impact of improved land drainage on river flows. Wallingford: Institute of Hydrology.
- Robinson, M.** (1993). Impacts of plantation forestry on streamflow regimes - a case study. *In: British Hydrological Society*, ed. Proceedings of the fourth national hydrology symposium, 1993. BHS.
- Robinson, M.** (1998). 30 years of forest hydrology changes at Coalburn; water balance and extreme flows. *Hydrology and Earth System Sciences*, 2, 233-238.
- Robinson, M., Moore, R. E., Nisbet, T. R. & Blackie, J. R.** (1998). *From moorland to forest: the Coalburn catchment experiment*, Wallingford, Institute of Hydrology.
- Rodda, J. C.** (2000). Drought and water resources. *In: Wilhite, D. A.* (ed.) *Drought: A global assessment*. London: Routledge.

- Rogers, P.** (1994). Hydrology and water quality. *In: Meyer, W. B. & Turner li, B. L.* (eds.) *Changes in Land Use and Land Cover: A global perspective*. Cambridge: Cambirdge University Press.
- Romanowicz, R. J. & Beven, K. J.** (2006). Comments on generalised likelihood uncertainty estimation. *Reliability Engineering & System Safety*, 91, 1315-1321.
- Rounsevell, M. D. A. & Et Al.** (1998). Integrating biophysical and socio-economic models for land use studies. *In: ITC & ISSS Conference on Geo-Information for Sustainable Land Management, 1998 Enschede*. 17-21.
- Salmon & Trout Association** (2009a). The effects of exceed fine sediment in rivers. London: Salmon & Trout Association,.
- Salmon & Trout Association** (2009b). River and groundwater abstraction. London: Salmon & Trout Association.
- Saltelli, A., Tarantola, S. & Campolongo, F.** (2000). Sensitivity Analysis as an Ingredient of Modeling. *Statistical Science*, 15, 377-395.
- Schlesinger, W. H., Abrahams, A. D., Parsons, A. J. & Wainwright, J.** (1999). Nutrient losses in runoff from grassland and shrubland habitats in Southern New Mexico: I. rainfall simulation experiments. *Biogeochemistry*, 45, 21-34.
- Schulze, E.-D., Mooney, H. A., Sala, O. E., Jobbagy, E., Buchmann, N., Bauer, G., Canadell, J., Jackson, R. B., Loreti, J., Oesterheld, M. & Ehleringer, J. R.** (1996). Rooting depth, water availability, and vegetation cover along an aridity gradient in Patagonia. *Oecologia*, 108, 503-511.
- Scott, H. D.** (2000). *Soil physics: agricultural and environmental applications*, Iowa State University Press.
- Servadio, P., Marsili, A., Pagliali, M., Pellegrini, S. & Vignozzi, N.** (2001). Effects on some clay soil qualities following the passage of rubber tracked and wheeled tractors in central Italy. *Soil and Tillage Research*, 61, 143-155.
- Sims, P. L. & Singh, J. S.** (1978). The Structure and Function of Ten Western North American Grasslands: III. Net Primary Production, Turnover and

- Efficiencies of Energy Capture and Water Use. *Journal of Ecology*, 66, 573-597.
- Singh, V. P.** (1995). *Computer models of watershed hydrology*, Highlands Ranch, Colo., Water Resources Publications.
- Singh, V. P. & Woolhiser, D. A.** (2002). Mathematical Modeling of Watershed Hydrology. *Journal of Hydrological Engineering*, 7, 270-293.
- Smakhtin, V. U.** (2001). Low flow hydrology: a review. *Journal of Hydrology*, 240, 147-186.
- Soane, D. D.** (1980). Soil degradation attributable to compaction under wheels and its control. *In: Boels, D., Davies, D. B. & Johnston, A. E.* (eds.) *Soil Degradation: Proceedings of the land use seminar on soil degradation*. Rotterdam: A. A. Balkema,.
- Spencer, H. B. & Owen, G. M.** (1981). A device for assessing the safe descent slope of agricultural vehicles. *Journal of Agricultural Engineering Research*, 26, 277-286.
- Spruill, C. A., Workman, S. R. & Taraba, J. L.** (2000). Simulation of daily and monthly stream discharge from small watersheds using the SWAT model. *Transactions of the American Society of Agricultural Engineers*, 43, 1431-1439.
- Stedinger, J. R., Vogel, R. M., Lee, S. U. & Batchelder, R.** (2008). Appraisal of the generalized likelihood uncertainty estimation (GLUE) method. *Water Resources Research*, 44.
- Steele-Dunne, S., Lynch, P., Mcgrath, R., Semmler, T., Wang, S., Hanafin, J. & Nolan, P.** (2008). The impacts of climate change on hydrology in Ireland. *Journal of Hydrology*, 356, 28-45.
- Stephenson, D.** (1979). Direct optimisation of muskingham routing coefficients. *Journal of Hydrology*, 41, 161-165.
- Tallaksen, L. M. & Erichsen, B.** (1994). Modelling low flow response to evapotranspiration. *In: FRIEND: Flow Regimes from International Experimental and Network Data*, 1994 Braunschweig. IAHS.
- Tallaksen, L. M., Hisdal, H. & Van Lanen, H. a. J.** (2006). Propagation of drought in a groundwater fed catchment, the Pang in the UK. *In: Demuth, S., IAHS International Commission on Water Resources*

- Systems & Data, F. R. F. I. E. a. N.** (eds.) *Climate Variability and Change: Hydrological Impacts*. IAHS.
- Thompson, D.** (2007). The National Soil Map and Soil Classification. *National Soil Resources Institute: Information Paper*. Cranfield University.
- Todini, E.** (1996). The ARNO rainfall-runoff model. *Journal of Hydrology*, 175, 339-382.
- Todini, E.** (2007). Hydrological catchment modelling: past, present and future. *Hydrology and Earth System Sciences*, 11, 468-482.
- United Utilities** (2008). Final Statutory Drought Plan. Warrington: United Utilities,.
- Vaisanen, U.** (1996). Comparison of Tractor and Tractor/Wheeled Skidder Logging Methods. *Berau Forest Management Project*. Jakarta: European Union & Ministry of Forestry and Estate Crops.
- Van Lanen, H. a. J.** (2006). Drought propagation through the hydrological cycle. *In: Demuth, S., Iahs International Commission on Water Resources Systems & Flow Regimes from International Experimental and Network Data* (eds.) *Climate variability and change: hydrological impacts*. IAHS.
- Van Vliet, L. J. P., Bittman, S., Derksen, G. & Kowalenko, C. G.** (2006). Aerating Grassland before Manure Application Reduces Runoff Nutrient Loads in a High Rainfall Environment. *J. Environ. Qual.*, 35, 903-911.
- Veldkamp, A. & Fresco, L. O.** (1996). CLUE: a conceptual model to study the Conversion of Land Use and its Effects. *Ecological Modelling*, 85, 253-270.
- Wagener, T., Wheater, H. & Gupta, H. V.** (2004). *Rainfall-runoff modelling in gauged and ungauged catchments*, Imperial College Press.
- Wainwright, J. & Mulligan, M.** (2004). *Environmental modelling: finding simplicity in complexity*, Chichester, Wiley.
- Wang, D. & Cai, X.** (2009). Detecting human interferences to low flows through base flow recession analysis. *Water Resour. Res.*, 45, W07426.
- Wetherald, R. T. & Manabe, S.** (2002). Simulation of hydrologic changes associated with global warming. *J. Geophys. Res.*, 107, 4379.

- Wilby, R. L. & Harris, I.** (2006). A framework for assessing uncertainties in climate change impacts: Low-flow scenarios for the River Thames, UK. *Water Resour. Res.*, 42, W02419.
- Wilhite, D. A.** (2000a). Drought as a natural hazard. *In: Wilhite, D. A.* (ed.) *Drought: A global assessment*. London: Routledge.
- Wilhite, D. A.** (2000b). *Drought: a global assessment*, Routledge.
- Wilhite, D. A. & Vanyarkho, O.** (2000). Drought: Pervasive impacts of a creeping phenomenon. *In: Wilhite, D. A.* (ed.) *Drought: A global assessment*. London: Routledge.
- Wilkinson, B. H.** (1992). Hydrological factors. *In: Whitby, M. C.* (ed.) *Land Use Change: the Causes and Consequences*. HMSO.
- Wooldridge, S., Kalma, J. & Kuczera, G.** (2001). Parameterisation of a simple semi-distributed model for assessing the impact of land-use on hydrologic response. *Journal of Hydrology*, 254, 16-32.
- World Health Organisation.** (2009). *10 facts about water scarcity* [Online]. WHO. [Accessed 28/03/2012 2012].
- Xu, Y.-P., Booij, M. & Tong, Y.-B.** (2010). Uncertainty analysis in statistical modeling of extreme hydrological events. *Stochastic Environmental Research and Risk Assessment*, 24, 567-578.
- Young, A. R., Round, C. E. & Gustard, A.** (2000). Spatial and temporal variations in the occurrence of low flow events in the UK. *Hydrology and Earth System Sciences*, 4, 35-45.
- Youngs, E. G.** (1976). Determination of the variation of hydraulic conductivity with depth in drained lands and the design of drainage installations. *Agricultural Water Management*, 1, 57-66.
- Yu, D. & Lane, S. N.** (2006a). Urban fluvial flood modelling using a two-dimensional diffusion wave treatment, part 1: Mesh resolution effects. *Hydrological Processes*, 207, 1541-1565.
- Yu, D. & Lane, S. N.** (2006b). Urban fluvial flood modelling using a two-dimensional diffusion wave treatment, part 2: Development of a sub grid-scale treatment. *Hydrological Processes*, 207, 1567-1583.
- Zaidman, M. D., Rees, H. G. & Young, A. R.** (2001). Spatio-temporal development of streamflow droughts in north-west Europe. *Hydrology and Earth System Sciences*, 5, 733-751.



# Appendix 1

## *CRUM3 Parameters User Guide*

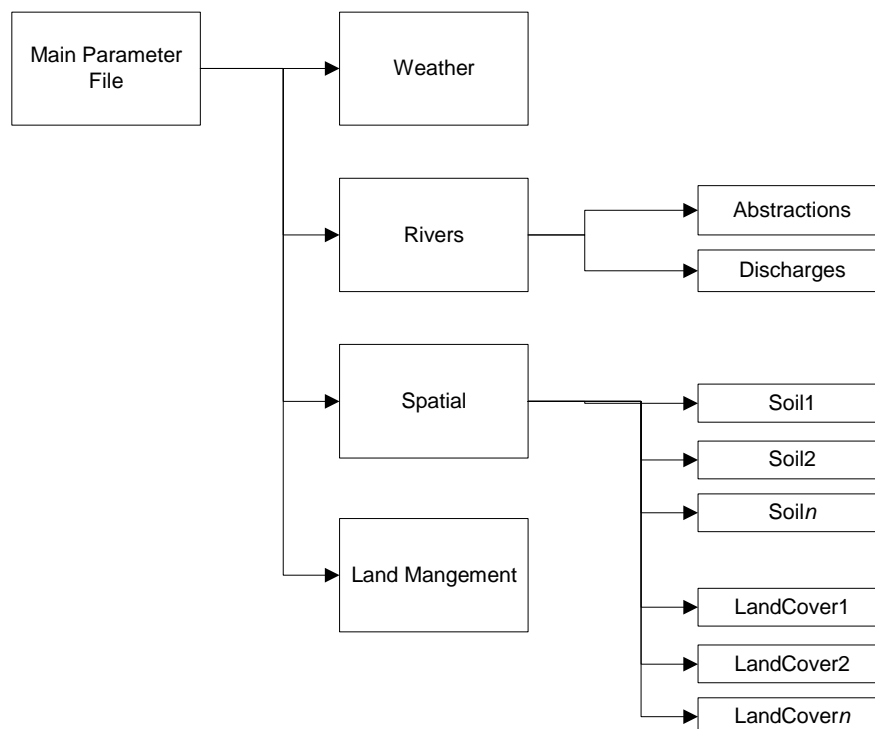
## CRUM3 Parameters User Guide

Katie Smith & Dr Sim Reaney

- CRUM stands for Connectivity of Runoff Model
- DOPLO is the old name for CRUM3
- fullyDist.exe is CRUM3

### A1.1 Input Files

The parameter files are all ASCII text files made up of a file header, a tag and a value. The file header identifies the type of parameter file (soils, land cover, rivers, etc.). The following lines are made up of a text tag and a value separated by a space. The model expects a certain data type for each tag, as defined in the tables below. The tags are case sensitive. The final line, currently, needs to have no linefeed. The interrelationship between the parameter files is shown in Figure 1.



**Figure A1.1** Parameter Interrelationship in CRUM3

### A1.1.1 Main Parameter File

This is the parameter file passed to the model at the start of the simulation. It contains the filenames of the rest of the model parameter files, described below, and global model options.

Must have the header “CRUM3\_main\_par\_file”

Tag	Description
weatherParFilename	Contains the tags and parameter values to describe the weather.
channelNetworkParFile	Contains the tags and parameter values to describe the river channels.
spatialParFilename	Contains the tags and parameter values to describe the spatial datasets.
hydroOnly	This is a hook for future versions of the model that will handle biogeochemical processes, such as nitrogen cycling. Currently, this should be left as ‘yes’ “yes” or “no”
runBenchmark	Selects if the model benchmark is run prior to the simulation. The benchmark consists of 24, 1 hour time steps for the currently defined catchment. This gives an indication of the time taken to simulate the current catchment on the current hardware. “yes” or “no”
runSilent	Sets if information on the current discharge and other model output is written to the console. If running the model on a computer cluster, it prevents the creation of long log files that duplicate information on the main output file. “yes” or “no”
runChannels	If set to ‘no’, only the hillslope section of the model will run. The channel routing component will not be run. “yes” or “no”
simulateSnowmelt	Run of the snow melt model or not “yes” or “no” string

**Table A1.1** Main Parameter Descriptions

**A1.1.2 Weather**

Must have the header "CRUM3\_weather\_par\_file"

Tag	Description
dailyWeatherFilename	Describes the daily weather. Has information on the daily rainfall, minimum and maximum temperatures. String
weatherGenType	Set the weather generator to be used. Valid strings are "stormG", "UKCP09" and "file". StormG uses the stochastic storm generator and "file" reads 5 minute data from a file. String
weatherTimeSeriesFilename	If "file" is selected in <i>weatherGenType</i> then, this defines the file from which the 5 minute data is read. String
stormParamFilename	If "stormG" is selected, this file describes the distribution of the rainfall intensities and storm sizes. String.
UKCP09TimeSeriesFilename	If 'UKCP09' is selected as the weather generator type, then this tag is required and defines the link to the UKCP09 WG file that defines the weather time series. String
evapoTransModel	Selects which evapotranspiration model is used from Penman-Monteith ("PM") and Priesley – Taylor ("PT"). PM = Penman Monteith – requires lots of data PT = Priestley Taylor - less dependent on measurements of wind speed etc which are difficult to obtain. String
outputWeather	Selects if the weather is written out to a file. "yes" or "no". Output is in csv format String
startDoY	The day of the year on which the simulation starts. If UKCP09 is the weather data source, this parameter is automatically set from the UKCP09 WG input data. Int.
rainfallModGridFilename	The filename of the rainfall modification grid. string
temperatureModGridFilename	The filename of the temperature modification

	grid. string
latitude	Latitude of the catchment. Used for calculation of solar radiation.
environmentalLapseRate	Decay of temperature (oC) of the atmosphere with height (per 1000m)
metStationHeight	elevation of weather station used to derive the weather data text file, meters Above sea level.

**Table A1.2** Weather Parameter Descriptions

**Notes:**

The stochastic weather generator StormG takes the measured characteristics of rainfall intensity and storm sizes from 'stormParamFilename' and uses this information to create a per second weather time series for the day. The StormG weather generator takes a daily total rainfall, minimum and maximum temperatures to create rainfall, solar radiation, potential evapotranspiration and temperature information.

### A1.1.3 Channels

Must have the header “CRUM3\_rivers\_par\_file”

Tag	Description
hydraulicGeomK	The value of the hydraulic geometry K parameter. See Leopold and Maddock (1953) and Knighton (1998).
hydraulicGeomM	The value of the hydraulic geometry M parameter. See Leopold and Maddock (1953) and Knighton (1998).
hydraulicGeomB	The value of the hydraulic geometry B parameter. See Leopold and Maddock (1953) and Knighton (1998).
hydraulicGeomF	The value of the hydraulic geometry F parameter. See Leopold and Maddock (1953) and Knighton (1998).
hydraulicGeomA	The value of the hydraulic geometry A parameter. See Leopold and Maddock (1953) and Knighton (1998).
hydraulicGeomC	The value of the hydraulic geometry C parameter. See Leopold and Maddock (1953) and Knighton (1998).
qPerUnitWidth	The discharge per unit width parameter of the Muskingham-Cunge model (Ponce and Lugo 2001)

**Table A1.3** Channel Parameter Descriptions

#### Notes:

For details of the hydraulic geometry information, see Leopold and Maddock (1953) and Knighton (1998).

### A1.1.4 Spatial Data

Must have the header “CRUM3\_spatial\_data\_par\_file”

Tag	Description
demFilename	The filename of the Arc ASCII digital elevation model. String.
lcovFilename	The filename of the Arc ASCII land cover map. String.
soilsFilename	The filename of the Arc ASCII soils map. String.

routeToReachFilename	The filename of the Arc ASCII file describing which landscape cell route water to which river channel reach. String.
topoFormFilename	The filename of the Arc ASCII classified digital elevation model into topographic form classes. Classes: 1 = plane 2 = ridge 4 = slopes 5 = channel The ridges, channels and plane classes are derived from the classification of the topographic forms in an application such as ENVI or LandSerf. The slope class is derived from the thresholding of the slope values derived from the DEM such that all cells with a slope gradient greater than x are deemed to be in the slope class String.
soilDepthMapFilename	The filename of the Arc ASCII soils depth map. Depths in metres. String.
soilnParFile	The model will expect to find a tag for each unique number in the dataset identified by the <i>soilsFilename</i> tag. Replace the <i>n</i> in the tag with the integer value relating to the value is the grid. If there is no map, set this parameter to 'none' and the values will be read from read from the parameter file defined for type zero. String
landCovnParFile	The model will expect to find a tag for each unique number in the dataset identified by the <i>lcovFilename</i> tag. Replace the <i>n</i> in the tag with the integer value relating to the value is the grid. If there is no map, set this parameter to 'none' and the values will be read from read from the parameter file defined for type zero. String
networkConnectionsFile name	Describes the connections between the different reaches of the river channel network. Use netConnectivity.exe to calculate this input.
outputGrids	Option to output grid of the model state during the model run. "yes" or "no". String
outputGridsInterval	The interval in days at which the output grids will be written. Only active if <i>outputGrids</i> is yes. Integer.

outputGridName	<p>Valid strings are:</p> <ul style="list-style-type: none"> <li>• alt - the altitude of the cell</li> <li>• soilDepth - the depth of the soil (metres)</li> <li>• thetaSoil - the soil moisture in the main soil</li> <li>• thetaRoot - the soil moisture in the root zone</li> <li>• massBalance - The per cell water mass balance (1 = good)</li> <li>• maxRunoffVel - the maximum runoff velocity since the last time the grid was requested</li> <li>• vegHeight - the height of the vegetation (m)</li> <li>• recharge - the amount of water that has gone to groundwater (aquifer) since the last call to getGrid()</li> <li>• snowVolume - the volume of snow stored at that location in the landscape (m3)</li> <li>• waterSurface - the surface water surface = alt + dpStore + dtStore</li> <li>• waterTable - the water table surface = alt - dist to watertable</li> <li>• waterTableMaxSlope - the maximum water table slope per cell</li> </ul>
calculateConnectivity	<p>Calculates the current connectivity of the surface flows in the model using the network index approach. See Lane et al. 2009 WRR “yes” or “no”. String</p>

**Table A1.4** Spatial Parameter Descriptions

### **A1.1.5 Soil**

Must have the header “CRUM3\_soil\_par\_file”

Tag	Description
soilDepthChannels	The depth of the soil in areas of the landscape classified as channels (in the file defined by <i>topoFormFilename</i> ). Double
soilDepthSlopes	The depth of the soil in areas of the landscape classified as slopes (in the file defined by <i>topoFormFilename</i> ). Double



soilDepthRidges	The depth of the soil in areas of the landscape classified as ridges (in the file defined by <i>topoFormFilename</i> ). Double
soilDepthPlane	The depth of the soil in areas of the landscape classified as planes (in the file defined by <i>topoFormFilename</i> ). Double
rootLayerKsat	The saturated conductivity of the soil in the root layer. ( $\text{m s}^{-1}$ ) Double.
ksat	The saturated conductivity of the soil. ( $\text{m s}^{-1}$ ) Double.
rootLayerDepth	The depth of the root layer (metres). Double
rootLayerB	The <i>b</i> parameter of the root layer. Describes the relationship between the soil moisture and the hydraulic conductivity. Dimensionless.
greenAmptAmmhr	The <i>a</i> parameter of the simplified Green and Ampt infiltration model ( $\text{mm hr}^{-1}$ ). Double.
greenAmptBmmhr	The <i>b</i> parameter of the simplified Green and Ampt infiltration model ( $\text{mm hr}^{-1}$ ). Double.
porosity	The porosity of the soil (decimal percentage). A value of one is all pore space and a value of zero is no pore space (i.e. solid). Double
kDecayWithDepth	defines the decay of soil conductivity with depth. Negative Value
bedRockConductivity	bedrock conductivity – the rate at which water will move into the bedrock from the base of the soil column.

**Table A1.5** Soil Parameter Descriptions

Notes:

For sample ranges for different soil types, see Dingman (1994).

There will be one soil parameter file per soil type defined in 'soilsFilename'. If 'soilsFilename' is set to 'none', then the soil properties will be read from soil parameter file defined for soil type zero.

#### **A1.1.6 Land cover**

Must have the header "CRUM\_landcover\_par\_file"

Tag	Description
interceptionDepthM	The depth of the interception store within the vegetation canopy (metres). Double.
gapFrac	The canopy gap fraction (decimal percentage). Double.
albedo	The surface albedo – the fraction of solar radiation reflected by the surface (decimal percentage). 1= high reflection (e.g. snow), 0 = low reflection, e.g. tarmac). Double.
vegMaxHeight	The maximum height of the vegetation (Metres). Double.
darcyWeisbachFrictionFactor	The Darcy-Weisbach friction factor (dimensionless). Low values equate to a smooth surface, high values to a rough surface. Double.
vegGrowthRate	The rate at which vegetation grows when above the vegetation grow threshold. g sec <sup>-1</sup> m <sup>2</sup> double
pcentOfCellWithFlow	The percentage of the soil surface over which overland flow occurs. (decimal percentage). Double.
growthTempThreshold	The temperature below which growth will not occur (°C). Double.
sowJDay	Julian Day Sow Crops
lastPossibleHarvestJDay	Julian Day Harvest Crops (last possible)
harvestBiomass	The final amount of biomass (units?), Double.
daysAtHarvestBiomass	
growthTempThreshold	temp (°C) below which vegetation does not grow
pcnetOfCellWithFlow	The percentage of the surface over which overland flow occurs. 0-1. Double

**Table A1.6** Land Cover Parameter Descriptions

Notes:

There will be one land cover parameter file per land cover type defined in 'lcovFilename'. If 'lcovFilename' is set to 'none', then the land cover properties will be read from the land cover parameter file defined for land cover type zero.

### **A1.1.7 Text Files**

- e.g. weather.txt = weather file, requires daily rainfall, daily min temperature and daily max temperature
- must be laid out as a tab delimited text file with rainfall in column 1, min temp in column 2 and max temp in column 3.
- Wharfe2 = storm properties text file as previously mentioned
- db50\_network.txt = Dacre beck 50m resolution channel network in text format.
- used in the networkConnectionsFilename row of the spatial parameter file
- gives cell ids, where each cell routes to, reach length, slope, and monitoring.
- each cell that has a 1 under monitoring will output its own monitored reach output file (.xls) with discharge and water volume values.

### **A1.1.8 ASCII Files**

- db50\_dem.asc = 50m resolution DEM of Dacre Beck
- db50\_ids.asc = defines cells with streams.
- used in the routeToReachFilename row of the spatial parameter file
- db50\_topo.asc = defines hillslopes, floodplains, channels and ridges at a 50m resolution for Dacre beck
- used in the topoFormFilename row of the spatial parameter file
- db50\_const1 = a blank catchment grid with constant value of 1.

## **A1.2 Output Files**

### **A1.2.1 Excel Files**

- run0\_discharge

- named after the primary parameter file
- outputs values for the channel network outflow cell as defined by - 2 in db50\_network.txt
- outputs values of
  - time (decimal days),
  - rainfall (mm),
  - discharge ( $\text{m}^3\text{s}^{-1}$ )
- not a 15min record, but rather for each iteration of the model.
- run0\_weather
  - outputs weather variables for the network outflow cell if you have selected 'yes' in outputWeather in the weather parameter file
  - outputs values of
    - time (decimal days),
    - rainfall (mm),
    - temperature ( $^{\circ}\text{C}$ ),
    - solar Radiation ( $\text{W m}^{-2}$ ),
    - evapotranspiration ( $\text{mm hr}^{-1}$ ),
    - soiltheta (soil moisture) (decimal percentage) and
    - roottheta (root/dynamic layer moisture content) (decimal percentage)
- run0\_discharge.csv\_monitoredReach\_0
  - output of discharge values for the first reach selected as '1' in the 'monitored' column of the networkConnectionsFilename text file (in our case the db50\_network.txt file)
  - presumably if we had more than one selected as one we may end up with output files of run0\_discharge.csv\_monitoredReach\_1 and run0\_discharge.csv\_monitoredReach\_2 etc.
  - outputs values of
    - time (decimal days)
    - discharge ( $\text{m}^3\text{s}^{-1}$ )
    - water volume ( $\text{m}^3 \text{ts}^{-1}$ )

### **A1.2.2 Ascii Files**

- these output files are selected in the spatial parameter file.

- currently we have
  - mass balance
  - soil theta
  - root theta
  - water surface
  - water table
  - additional available 'outputGridNames' are defined in table A1.4

### A1.3 General Comments

- Do not use spaces in file names – it confuses the model, as with Matlab, use underscores '\_' instead.
- Everything in °C, meters and seconds unless stated otherwise (e.g. Green Ampt in mm/hr)
- All spatial files must be in Arc GIS ASCII grid format
- When rerunning the model make a new folder and copy in all the parameter files, text files and fully\_Dist, otherwise if you have used the same main parameter file, your outputs will be overwritten. If you change the name of your main parameter file (e.g. from run0 to run1) each output set will be prefixed with the new name (run1...).
- Create a batch file in Notepad that says:
  - fullyDist.exe run0.par
    - you can change the name of run0.par but you have to remember to change it here.
  - Double click on this batch file to run CRUM3 with all the parameter files specified in run0.par
- All parameter, text and ascii files used in the model must be in the same folder as each other, the model and this batch file, output files will also be sent to this folder.
- The default sowing day of the year is day 90 and the default harvest date is 305. These defaults can be set in the land cover parameter file.
- CRUM3 can simulate up to 100 different land covers or soils. These can be defined in soil $n$ ParFile and landCov $n$ ParFile in the spatial data parameter file as in table A1.4

# Appendix 2

## *Sensitivity Analysis Input Values*

Parameter	run0	run1	run2	run3	run4	Base Value	run5	run6	run7	run8	run9
<b>Soil Parameters</b>											
$K_{\text{sat}}$ (m/s)	1E <sup>-07</sup>	4.01E <sup>-05</sup>	8.01E <sup>-05</sup>	1.2E <sup>-04</sup>	1.6E <sup>-04</sup>	2E <sup>-04</sup>	3.6E <sup>-04</sup>	5.2E <sup>-04</sup>	6.8E <sup>-04</sup>	8.4E <sup>-04</sup>	1E <sup>-03</sup>
ksat (m/s) 2nd runs	1E <sup>-09</sup>	2E <sup>-09</sup>	4E <sup>-09</sup>	6E <sup>-09</sup>	8E <sup>-09</sup>	1E <sup>-08</sup>	2E <sup>-08</sup>	4E <sup>-08</sup>	6E <sup>-08</sup>	8E <sup>-08</sup>	9E <sup>-09</sup>
ksat (m/s) 3rd runs	1E <sup>-07</sup>	2E <sup>-07</sup>	4E <sup>-07</sup>	6E <sup>-07</sup>	8E <sup>-07</sup>	1E <sup>-06</sup>	2E <sup>-06</sup>	4E <sup>-06</sup>	6E <sup>-06</sup>	8E <sup>-06</sup>	1E <sup>-05</sup>
$K_{\text{decay}}$ with depth	-9	-7.8	-6.6	-5.4	-4.2	-3	-2.6	-2.2	-1.8	-1.4	-1
$\Phi$ (decimal percentage)	0.01	0.0982	0.1864	0.2746	0.3628	0.451	0.5008	0.5506	0.6004	0.6502	0.7
Soil Depth Channels (m)	0.1	0.28	0.46	0.64	0.82	1	1.2	1.4	1.6	1.8	2
Soil Depth Slopes (m)	0.05	0.072	0.094	0.116	0.138	0.16	0.368	0.576	0.784	0.992	1.2
Soil Depth Ridges (m)	0.2	0.26	0.32	0.38	0.44	0.5	0.7	0.9	1.1	1.3	1.5
Soil Depth Plains (m)	0.2	0.26	0.32	0.38	0.44	0.5	0.7	0.9	1.1	1.3	1.5
Root Layer Depth (m)	1E <sup>-05</sup>	1E <sup>-02</sup>	2E <sup>-02</sup>	3E <sup>-02</sup>	4E <sup>-02</sup>	0.05	0.14	0.23	0.32	0.41	0.5
Root Layer $K_{\text{sat}}$ (m/s)	2E <sup>-05</sup>	1.82E <sup>-03</sup>	3.61E <sup>-03</sup>	5.41E <sup>-03</sup>	7.20E <sup>-03</sup>	0.009	0.0112	0.0134	0.0156	0.0178	0.02

Root Layer <i>b</i> parameter	0	0.81	1.62	2.43	3.24	4.05	6.44	8.83	11.22	13.61	16
Bedrock Conductivity (m/s)	1E <sup>-11</sup>	5.8E <sup>-11</sup>	1.06E <sup>-10</sup>	1.54E <sup>-10</sup>	2.02E <sup>-10</sup>	2.5E <sup>-10</sup>	2.02E <sup>-08</sup>	4.015E <sup>-08</sup>	6.01E <sup>-08</sup>	8.005E <sup>-08</sup>	1E <sup>-07</sup>
Green and Ampt <i>a</i> parameter (mm/hr)	0	2	4	6	8	10	28	46	64	82	100
Green and Ampt <i>b</i> parameter (mm/hr)	0	1	2	3	4	5	24	43	62	81	100
<b>Land Cover Parameters</b>											
Canopy Gap Fraction (decimal percentage)	0	0.04	0.08	0.12	0.16	0.2	0.36	0.52	0.68	0.84	1
Maximum Vegetation Height (m)	0	0.2	0.4	0.6	0.8	1	3.8	6.6	9.4	12.2	15
Canopy Interception depth (m)	0	4E <sup>-04</sup>	8E <sup>-04</sup>	0.0012	0.0016	0.002	0.0036	0.0052	0.0068	0.0084	0.01
Albedo (decimal percentage)	0.05	0.0779	0.1059	0.1338	0.1618	0.1897	0.2518	0.3138	0.3759	0.4379	0.5
Darcy Weisbach friction factor	0	15	30	45	60	75	160	245	330	415	500



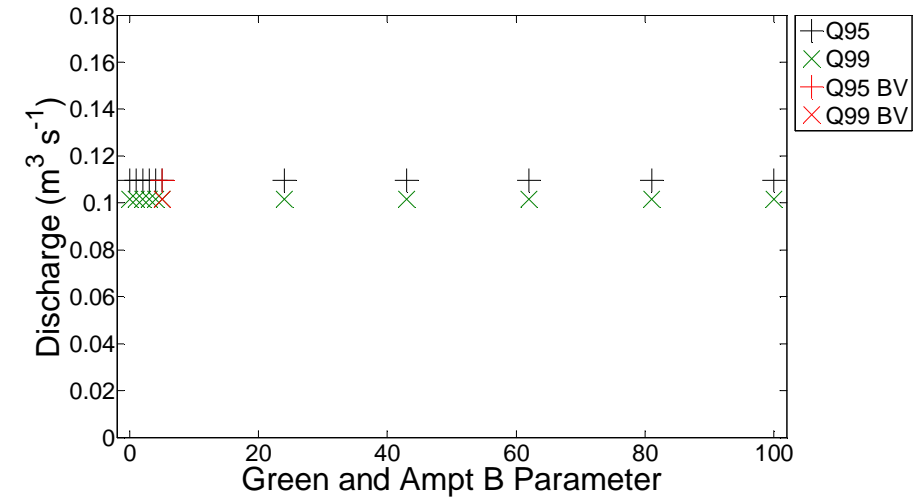
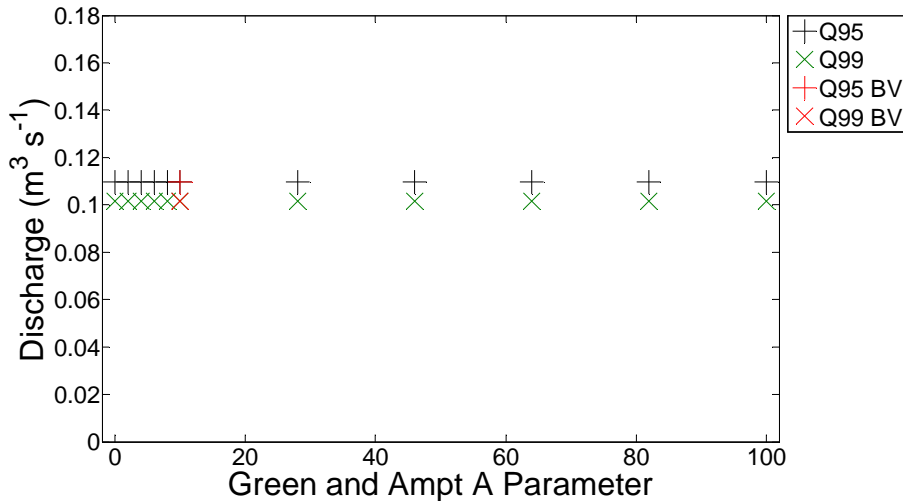
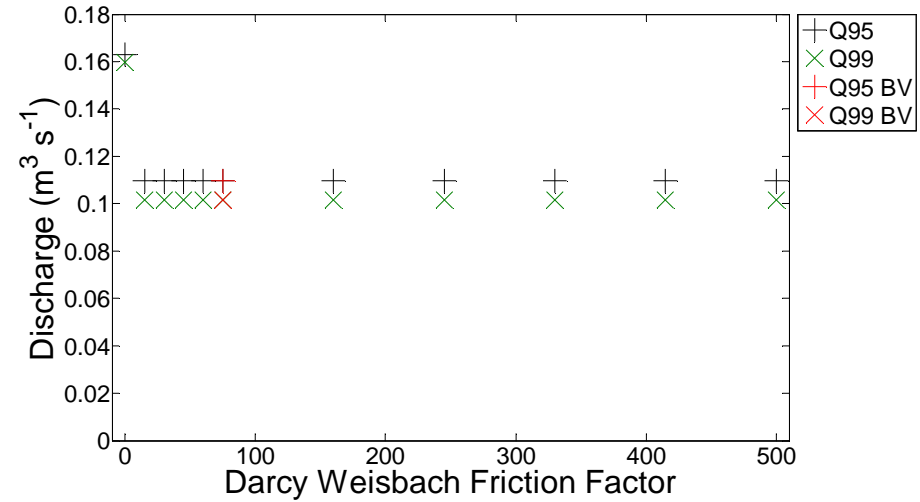
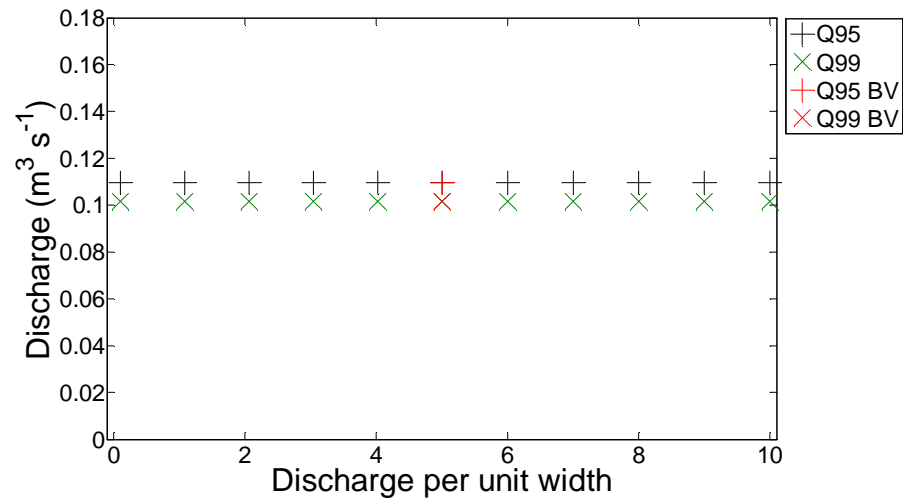
Percent of cell with overland flow (decimal percentage)	0.1	0.14	0.18	0.22	0.26	0.3	0.44	0.58	0.72	0.86	1
Vegetation Growth Rate (g/s/m <sup>2</sup> )	0	0.004	0.008	0.012	0.016	0.02	0.216	0.412	0.608	0.804	1
Growth Temp Threshold (oC)	0	1	2	3	4	5	6	7	8	9	10
<b>Channel Routing Parameters</b>											
Hydraulic geometry <i>k</i>	0.1	0.28	0.46	0.64	0.82	1	1.2	1.4	1.6	1.8	2
Hydraulic geometry <i>m</i>	0.1	0.144	0.188	0.232	0.276	0.32	0.356	0.392	0.428	0.464	0.5
Discharge per unit width	0.1	1.08	2.06	3.04	4.02	5	6	7	8	9	10

**Table A2.1** Input values for each sensitivity analysis run

# Appendix 3

*Sensitivity Analysis Response  
Graphs*

**A3.1 Remaining 'Unresponsive' Low Flows Response Graphs**



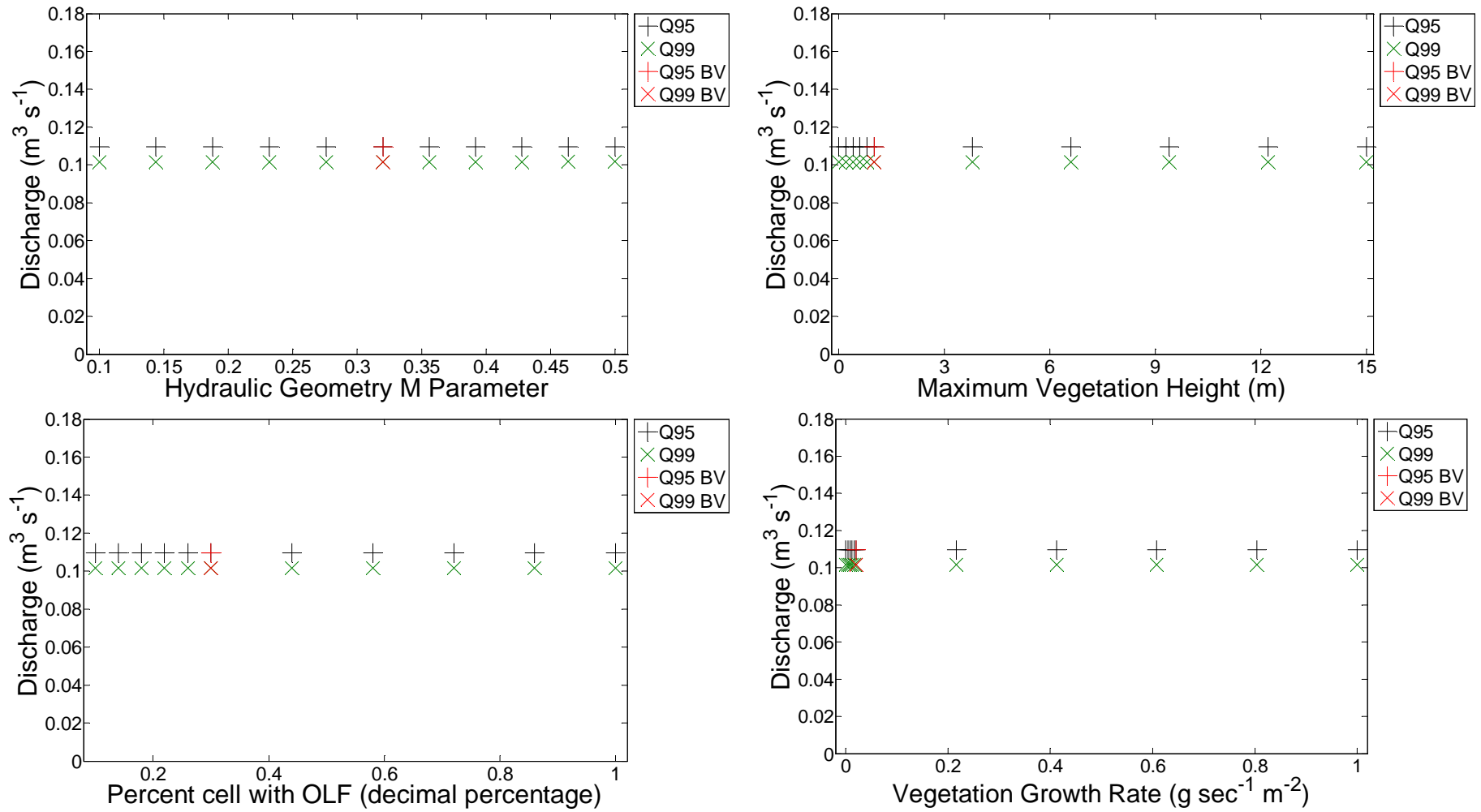
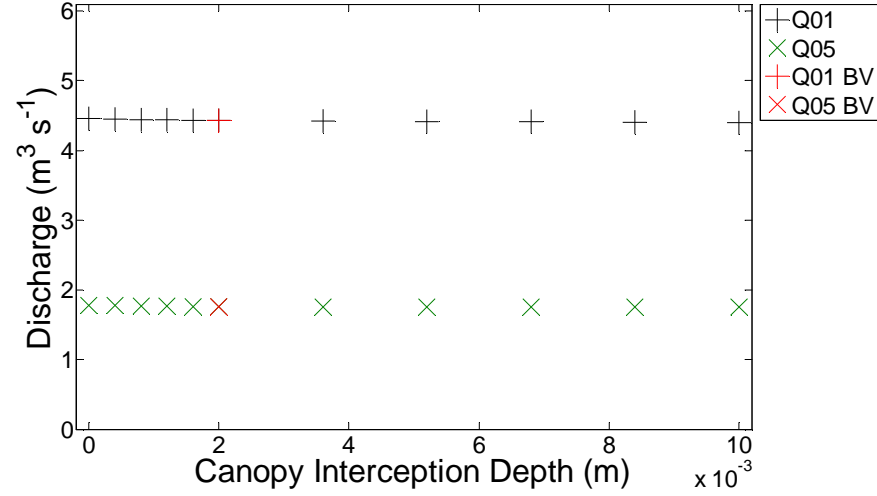
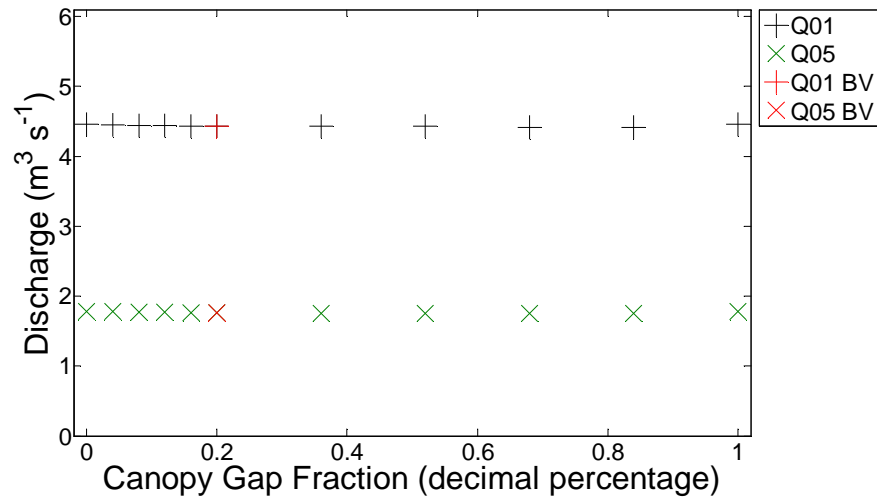
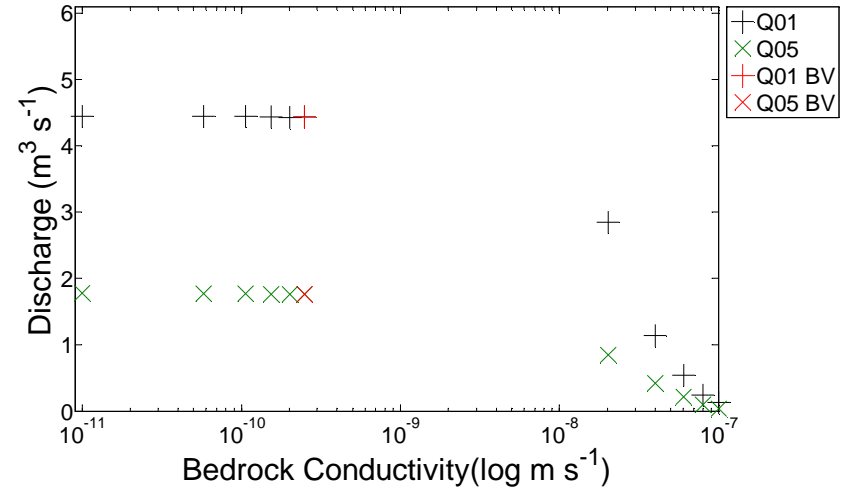
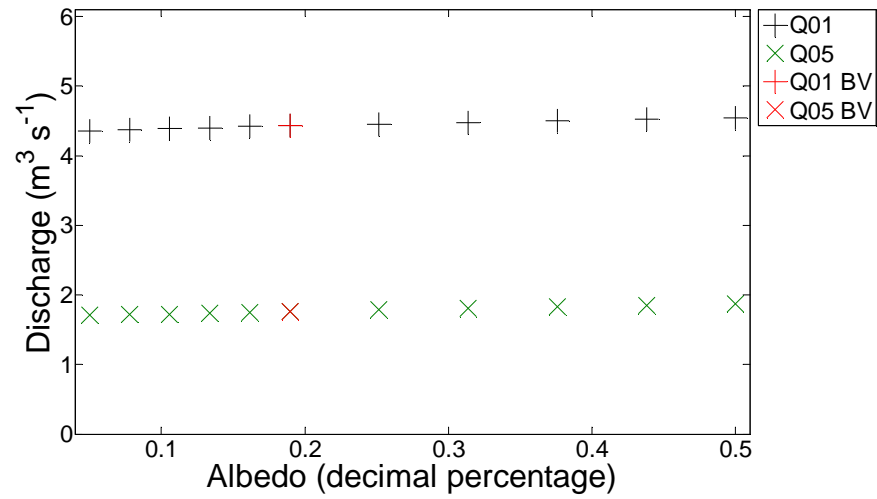
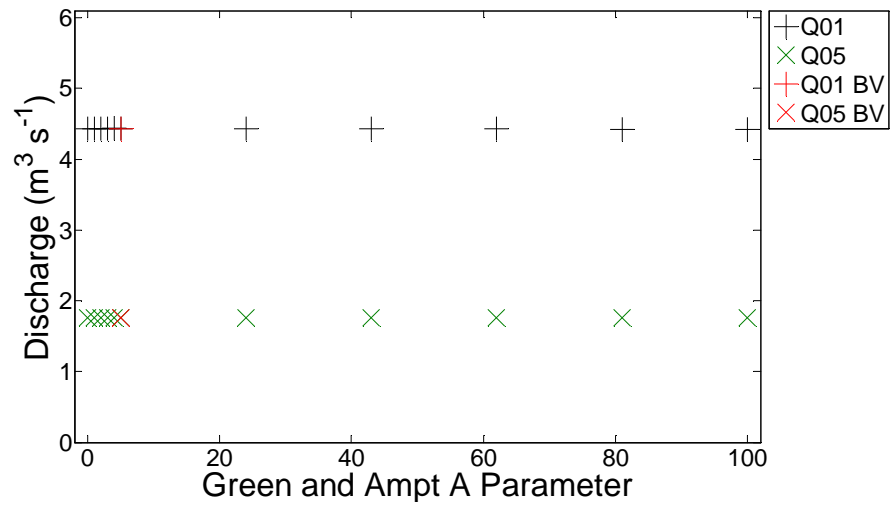
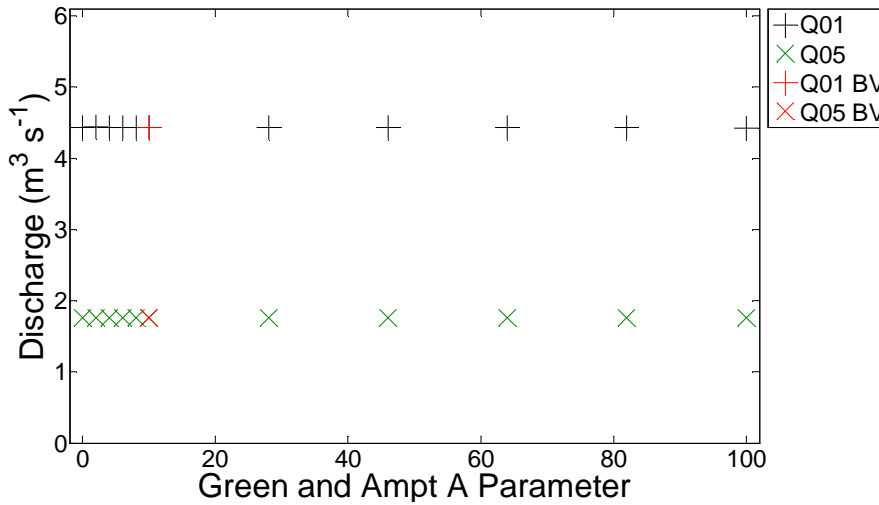
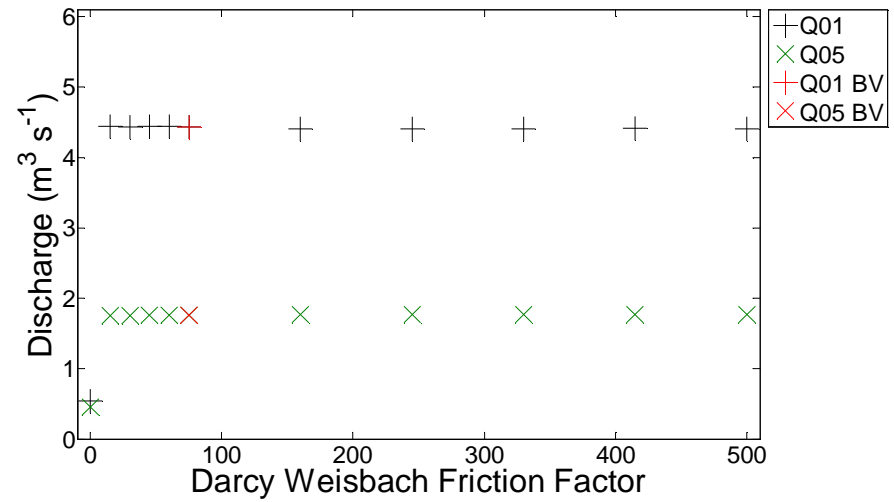
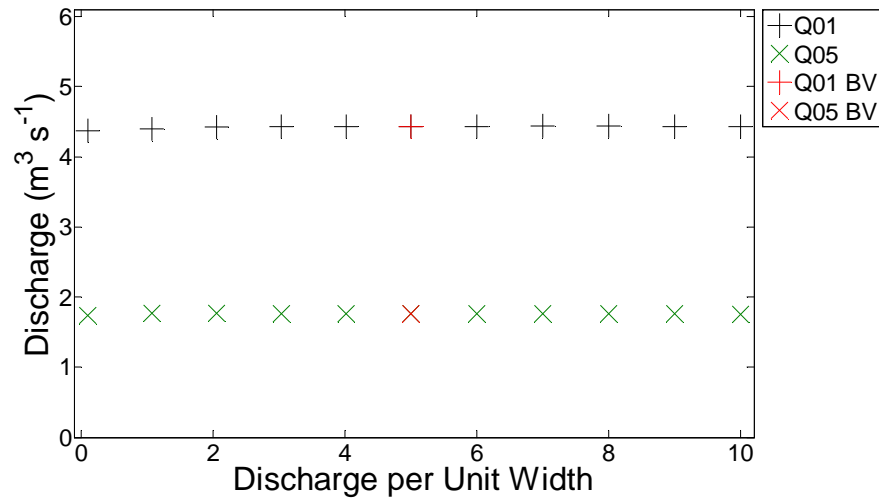
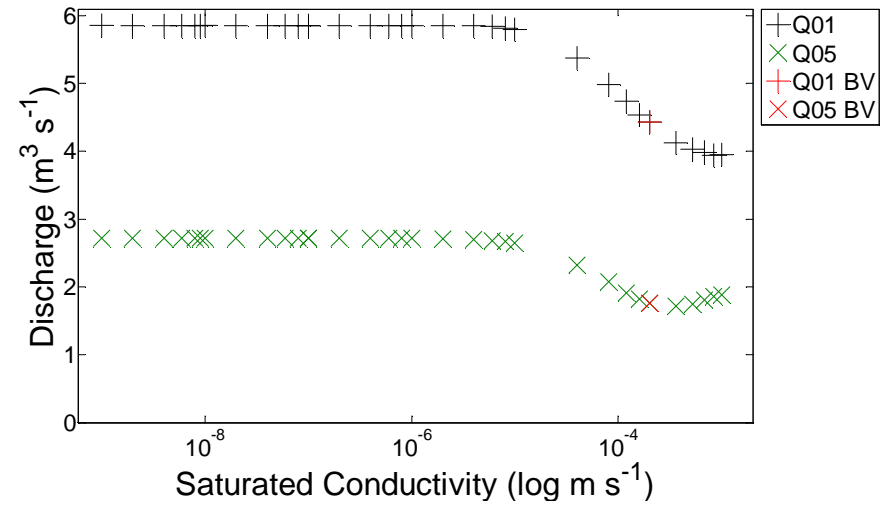
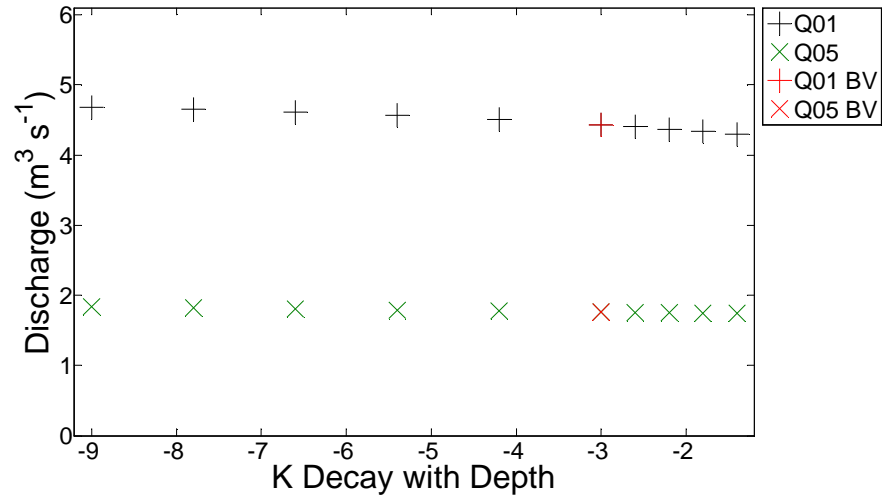
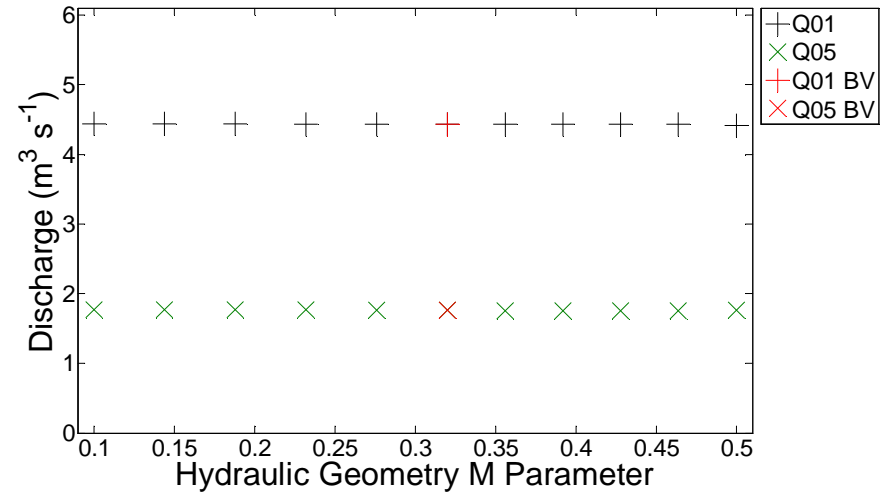
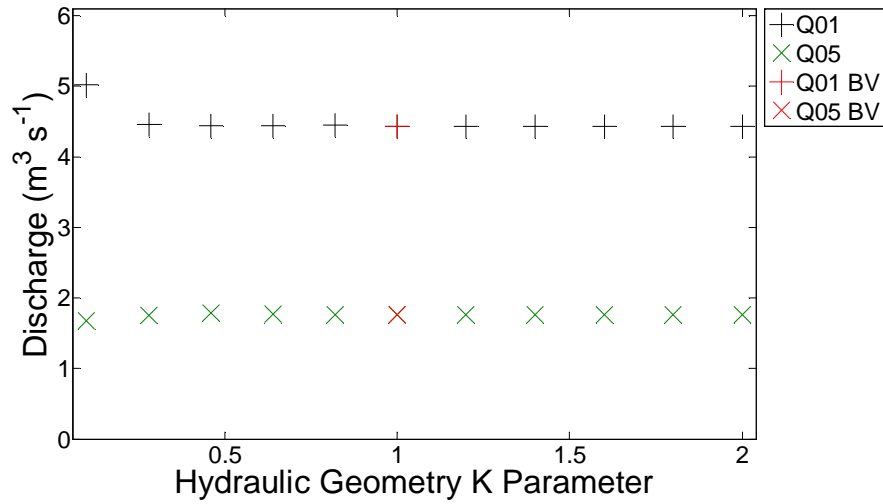


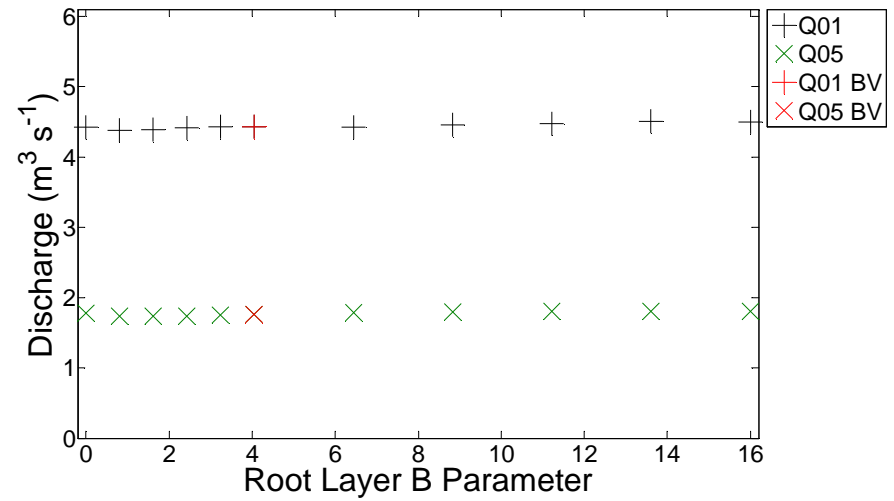
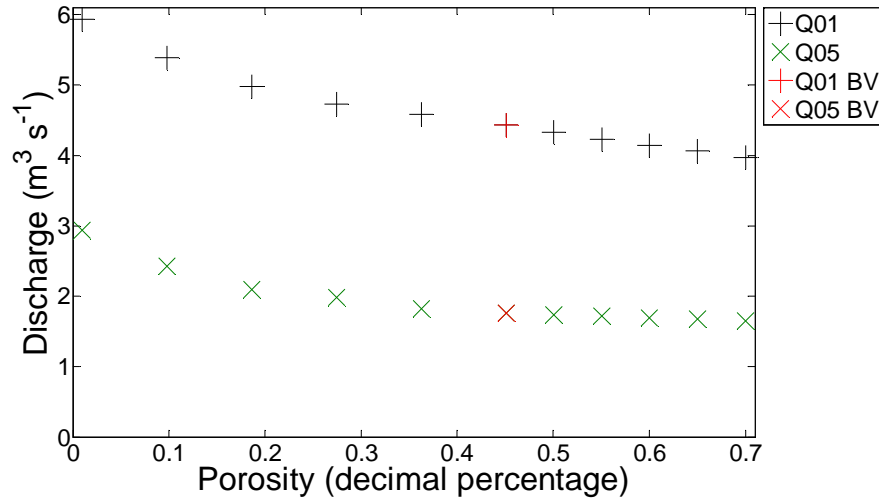
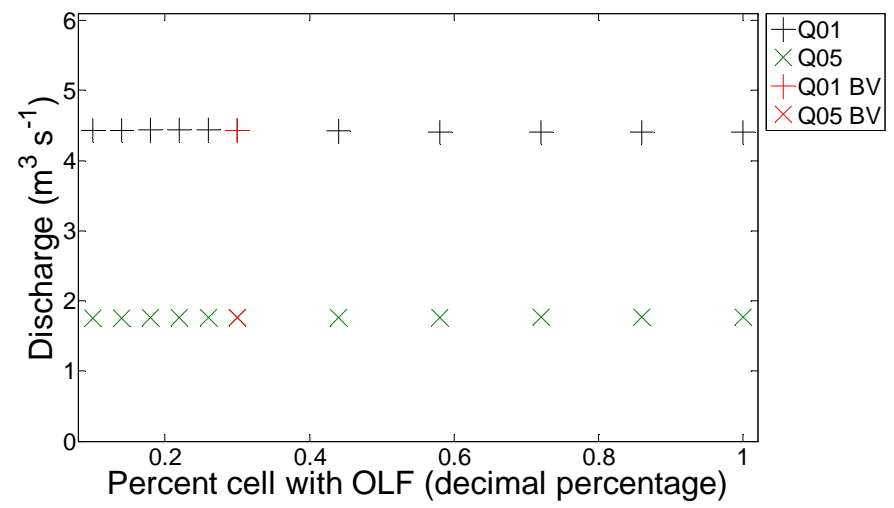
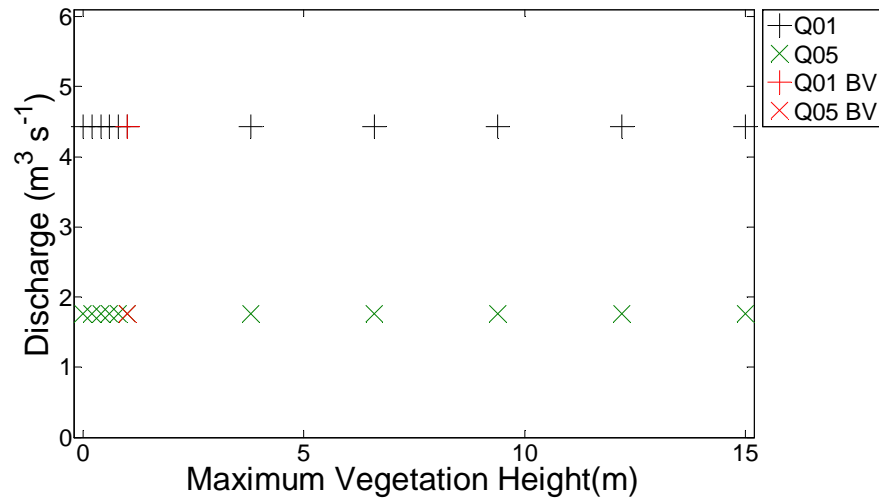
Figure A3.1 'Unresponsive' low flows sensitivity analysis response graphs responsive graphs shown in figure 4.3

### A3.2 High Flows Response Graphs

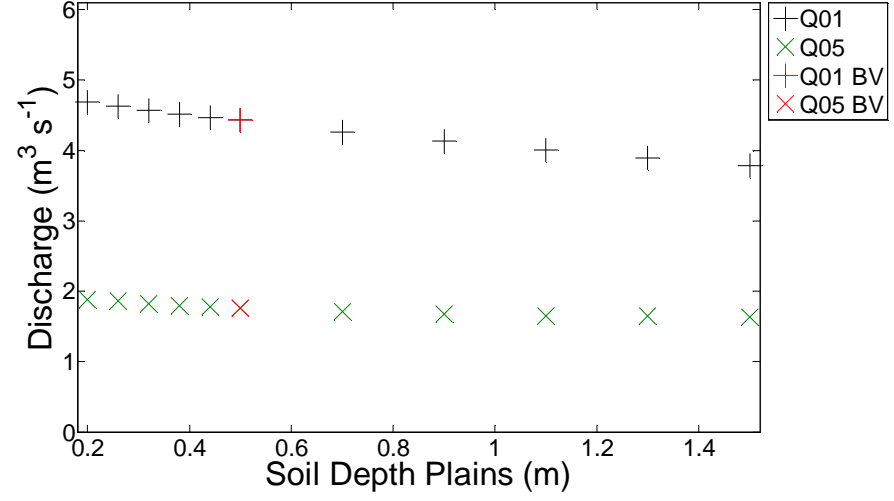
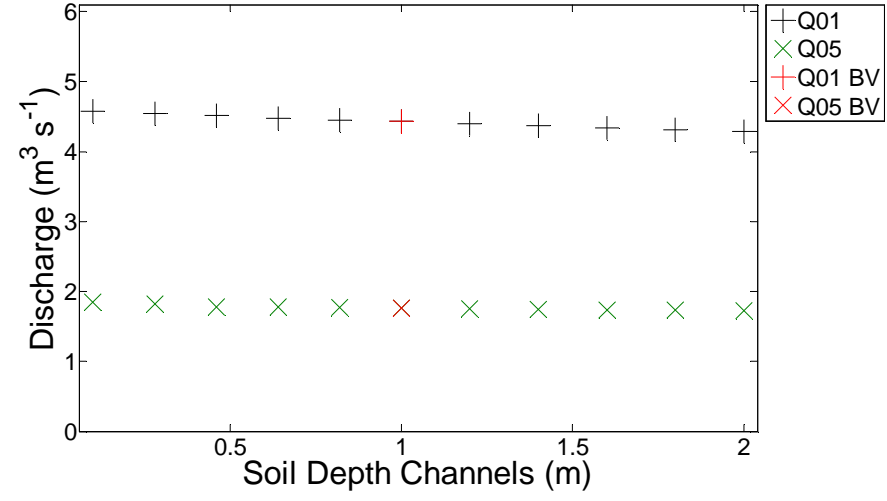
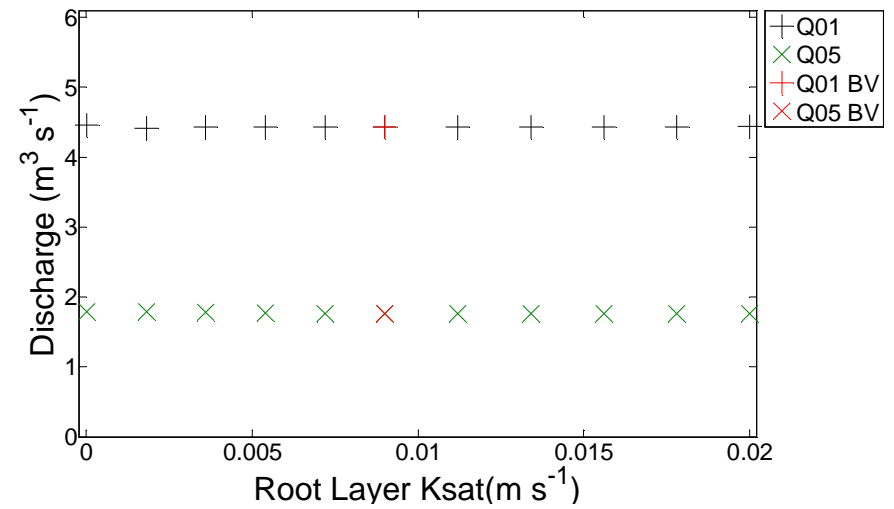
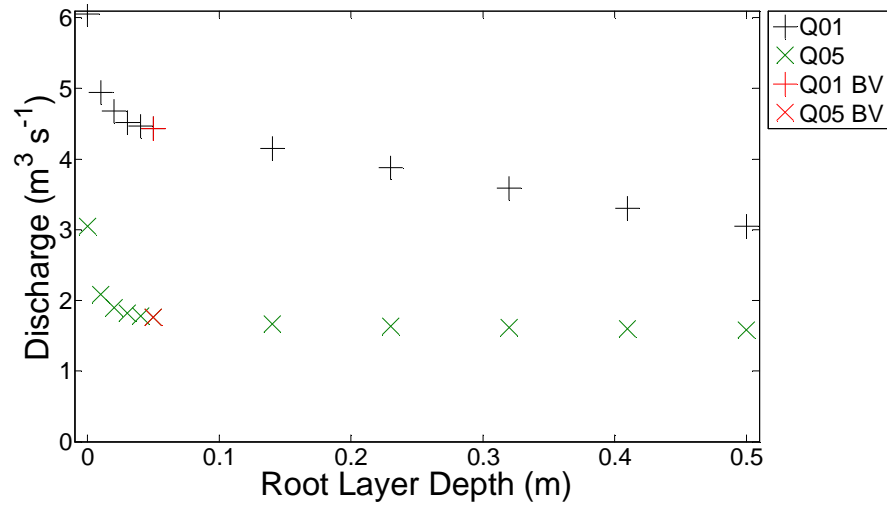












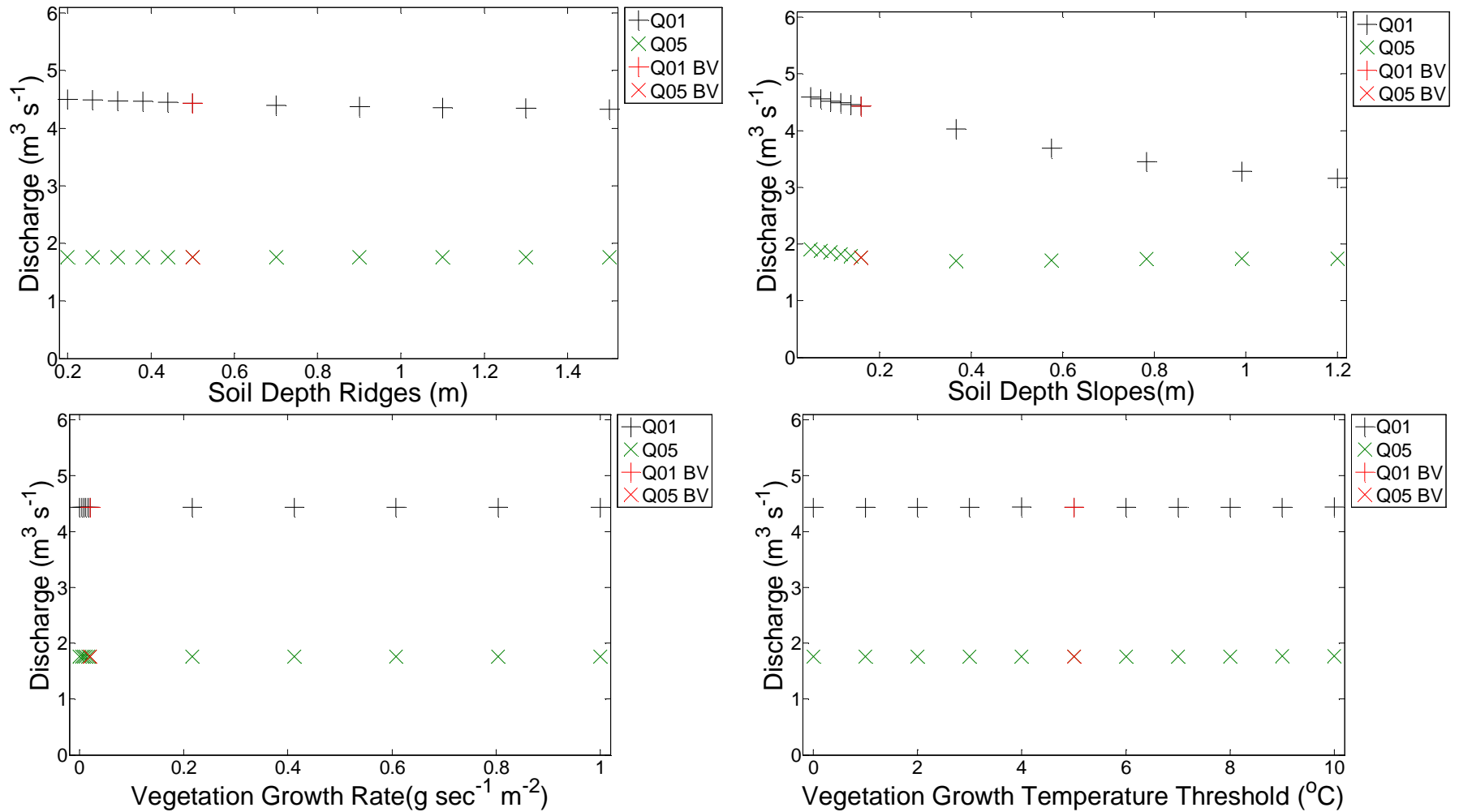


Figure A3.2 High flows sensitivity response graphs