

1-1-2015

Solids Accumulation Rates of Latrines at Rural Schools in Nimba County, Liberia

Caraline M. Murphy

University of South Florida, caralinemurphy@gmail.com

Follow this and additional works at: <http://scholarcommons.usf.edu/etd>

 Part of the [Civil Engineering Commons](#)

Scholar Commons Citation

Murphy, Caraline M., "Solids Accumulation Rates of Latrines at Rural Schools in Nimba County, Liberia" (2015). *Graduate Theses and Dissertations*.

<http://scholarcommons.usf.edu/etd/5545>

This Thesis is brought to you for free and open access by the Graduate School at Scholar Commons. It has been accepted for inclusion in Graduate Theses and Dissertations by an authorized administrator of Scholar Commons. For more information, please contact scholarcommons@usf.edu.

Solids Accumulation Rates of Latrines at Rural Schools in Nimba County, Liberia

by

Caraline M. Murphy

A thesis submitted in partial fulfillment
of the requirements for the degree of
Master of Science in Civil Engineering
Department of Civil and Environmental Engineering
College of Engineering
University of South Florida

Major Professor: James R. Mihelcic, Ph.D.
Maya Trotz, Ph.D.
Jaime Corvin, Ph.D.

Date of Approval:
March 16, 2015

Keywords: Sub-Saharan Africa, West Africa, sanitation, aerobic degradation, anaerobic degradation, pit contents, feminine waste

Copyright © 2015, Caraline M. Murphy

DEDICATION

To the community of Saclepea City, Nimba County, Liberia.

ACKNOWLEDGMENTS

First and foremost, I would like to thank my friends and family in Saclepea, Nimba County, Liberia for accepting me with open arms and hearts into their community for two years.

To Dr. Mihelcic, I want to extend the greatest gratitude for pushing me, encouraging me, chastising me when needed, editing and just being a wonderful support in this endeavor. Thank you for never giving up on me and helping me succeed despite the setbacks. I would also like to thank Dr. Corvin and Dr. Trotz for their time, energy and support.

I want to thank my roommates, Rebecca Martinez and Amanda Copple, for helping me in so many aspects and supporting me, both emotionally and professionally, in our Peace Corps service. I also want to thank Sarah Ness. Not only were you a pillar of strength and one of my best friend's in Liberia, but you have greatly motivated and encouraged me for as long as I have known you. To Fidel Hamoud, you have been an amazing source of consistent and positive support to me, and I love you.

Finally, I would like to thank my parents for their love and support. Thank you mom for letting me pursue my journey in Liberia even though you were scared and nervous, and my dad for your unwavering support and coming to meet the people who became my family in Liberia.

This material is based upon work supported by the National Science Foundation under Grant No. 0965743. Any opinions, findings, and conclusions or recommendations expressed in this material are those of the author and do not necessarily reflect the views of the National Science Foundation.

TABLE OF CONTENTS

LIST OF TABLES	iii
LIST OF FIGURES	iv
ABSTRACT.....	vi
CHAPTER 1: INTRODUCTION.....	1
1.1 Sanitation and the Developing World.....	1
1.2 Sanitation and Sub-Saharan Africa.....	2
1.3 Sanitation and Poverty	4
1.4 Sanitation in Schools – Sub-Saharan Africa and Developing World	5
1.5 Motivation.....	9
1.6 Objectives	10
CHAPTER 2: BACKGROUND AND LITERATURE REVIEW	13
2.1 Liberian Context	13
2.2 Improved Sanitation Facilities – Latrines	15
2.2.1 Simple/Traditional Pit Latrines.....	16
2.2.2 Ventilated Improved Pit (VIP) Latrines.....	17
2.2.3 Pour-Flush Latrines.....	18
2.2.4 Composting Latrines	20
2.3 Composition and Characteristics of Human Waste (Excreta)	21
2.3.1 Menstrual Fluid Characteristics and Feminine Waste	22
2.4 Latrine Design.....	26
2.5 Solids Accumulation Rates	32
2.5.1 Fecal Generation Rates	32
2.5.2 Additional Factors Affecting Accumulation Rates.....	36
2.6 Degradation of Solids and Transport of Liquids in the Pit	36
2.7 Literature of Solids Accumulation Rates.....	40
2.8 Pit Additives.....	46
CHAPTER 3: METHODS.....	48
3.1 Site Description.....	48
3.2 School Descriptions	50
3.2.1 Johnny Voker High School (JVS).....	51
3.2.2 Johnny Voker High School (JVS) Latrines	52
3.2.3 ULICA Mission School	53
3.2.4 ULICA Mission School Latrines	54
3.2.5 Red Cross School.....	55

3.2.6 Red Cross School Latrines.....	55
3.3 Experimental Design.....	56
3.3.1 Latrine Characteristics and Preliminary Measurements	56
3.3.2 Measuring Apparatus	59
3.4 Measuring Methodology.....	61
3.4.1 Depth Measurements	61
3.4.2 Number of Users	62
3.4.3 Safety Protocols	63
3.5 Methods for Measurement of Accumulation Rates in Literature	64
3.6 Methods for Modelling of Accumulation Rates in Pit Latrines.....	67
3.6.1 Brouckaert et al. (2013) –South Africa Study	67
3.6.2 Todman et al. (2014) –Tanzania Study.....	72
3.7 Best Methods for Measuring Accumulation Rates in Rural Areas.....	76
CHAPTER 4: RESULTS AND DISCUSSION.....	78
4.1 Reasons for Lack of Slab to Pit Content Depth Data.....	78
4.2 Depth of Pit Contents.....	79
4.3 Estimated Accumulation Rates	85
4.4 Potential Issues and Limitations	85
4.4.1 Pit Content Samples and Depth Measurements	86
4.4.2 Sample Size Limitations	87
4.4.3 Test Subjects and Lack of Survey Data	88
CHAPTER 5: CONCLUSIONS AND RECOMMENDATIONS	91
5.1 Overview and Conclusions	91
5.2 Practical Implications of the Study.....	93
5.3 Recommendation for Future Research.....	96
REFERENCES	100
APPENDIX A: PERMISSIONS FOR THE USE OF TABLES AND FIGURES	119

LIST OF TABLES

Table 1 Minimum Requirements for Latrine Siting Locations.....	27
Table 2 Solids Accumulation Rates for Latrine Pit Design.....	30
Table 3 Quantity of Wet Faeces Excreted by Adults (in grams per person per day)	33
Table 4 Average Wet Fecal Generation Rates for Individuals	34
Table 5 Studies on Reported Solids Accumulation Rates of Pit Latrines.....	42
Table 6 Preliminary School Latrine Data	57
Table 7 Slab to Pit Contents Depth Measurements for Latrines.....	80

LIST OF FIGURES

Figure 1 Map of Liberia.....	13
Figure 2 Improved and Unimproved Sanitation Technologies.....	15
Figure 3 Traditional/Simple Pit Latrine.....	16
Figure 4 Ventilated Improved Pit (VIP) Latrine.....	18
Figure 5 Pour-Flush Latrine.....	19
Figure 6 Double-nit VIP Latrine.....	20
Figure 7 Solids Accumulation Process (Mass Balance).....	29
Figure 8 Order of Physical (p) and Biological Processes (b) Occurring in Pit Latrine.....	36
Figure 9 Latrine Pit Showing Four Theoretical Sludge Layers.....	39
Figure 10 Map of Saclepea City, Nimba County and Surrounding Areas.....	48
Figure 11 Picture of the Main Road in Saclepea, Liberia.....	49
Figure 12 Vendors and Women Buying/Selling at Saclepea Market.....	50
Figure 13 Overcrowding of Students in an 11 th Grade Classroom at JVS.....	51
Figure 14 Main School Building at JVS during Morning Devotion at 8:00 am.....	52
Figure 15 JVS Boys' Latrine (left) and Girls' Latrine (right).....	53
Figure 16 ULICA Mission School VIP Latrine (left), Traditional Latrine (middle), and Latrine Superstructure (right).....	54
Figure 17 Red Cross School Boys' Latrine (left) and Girls' Latrine (right).....	55
Figure 18 Map of the Locations of the Three Study Schools.....	56
Figure 19 Common Latrine Pit Hole Found at Three Study Schools.....	58
Figure 20 Rectangular Latrine Pit Hole in Four Latrines at ULICA Mission School.....	58

Figure 21 Measuring Apparatus Used to Measure Slab to Pit Contents Depth..... 60

Figure 22 Bucket with Bleach Solution and Coffee Container after Measurement 64

Figure 23 Laser Distance Meter Technique for Measuring Accumulation Rates 65

Figure 24 Side View of ULICA Latrines with Slab to Pit Contents Depth..... 82

Figure 25 User Rates at School in Zwedru, Grand Gedeh County, Liberia 89

ABSTRACT

Access to appropriate sanitation facilities as well as access to clean drinking water are considered fundamental human rights (Carr, 2001; Bjorklund & Sjodin, 2010), yet roughly 2.5 billion people on the planet lack access to an improved form of sanitation (WHO/UNICEF, 2014). Additionally, many entities responsible for emergency excreta management and sanitation management design guidelines, specifically solids accumulation rates in latrine pits, use rates that are 30-60 years old and may be established from dated knowledge on diet and lifestyle trends (Franceys et al., 1992; Harvey et al., 2002; Harvey, 2007). Using solids accumulation rates that are dated as well as non-local can lead to under design of latrine pits (latrine pits fill faster than expected and designed) or over design of latrine pits (resources and materials are over used in construction and design).

Previous research showed that solids accumulation rates in pit latrines ranged from 18 L/person/year to 70 L/person/year though no accumulation rates have been reported for schools. The reported differences in solids accumulation rates were found to depend largely on local user rates and behaviors, the amount of material added to the latrine (both organic and inorganic matter), and the porosity of the soil surrounding the pit. Wood (2013) suggested that solid waste could compose 10-40% of waste accumulated in a pit. Furthermore, fecal generation rates of individuals were also found to differ by country, region and individual (Franceys et al., 1992).

An assessment of several methods for measuring accumulation rates was also performed. It was determined that the laser distance meter technique, as well as the use of a graduated metal

rod were the best two ways to determine slab to pit content depths in rural communities. Compared to other methods, such as the stereographic imaging technique, and the automated laser scanner technique, the laser distance meter technique and the use of a graduated rod require less expertise and do not require camera and computer resources.

This study also developed a method to assess solids accumulation rates of latrines at three rural schools in Saclepea County, Nimba County, Liberia. Depth measurements were taken from the latrine slab to the surface of the pit contents from early May 2014 until mid-June 2014. The accumulation rates were found to be extremely similar for each latrine for all measurements taken, with differences in depth of only 1-3 cm observed over the six-week measurement period.

Little research was identified on the effects of feminine waste on solids accumulation rates in latrines and no literature was found concerning the effects of feminine excretions on the degradation of pit contents. More research is thus needed to assess the possible effects the addition of menstrual blood and menstrual excretions can have on degradation rates as well as the lifespan of viruses and other infectious agents in pit contents and the surrounding soil. This is particularly important with the presence of contaminated wastes from victims of Ebola Virus Disease being disposed of in latrines and other sanitation infrastructure in rural areas of West Africa.

CHAPTER 1: INTRODUCTION

1.1 Sanitation and the Developing World

It is currently estimated that 2.5 billion people in the world do not have access to improved sanitation (WHO/UNICEF, 2014) and 2.2 million people die every year from diarrheal diseases related to the improper disposal of waste and excreta (WHO/UN-Water, 2012). The United Nations Children's Fund (UNICEF) reports that 88% of diarrheal deaths are directly attributed to inadequate sanitation, lack of access to clean water and substandard hygiene and health practices (UNICEF, 2006). In fact, in 2012, there were approximately 280,000 diarrhea deaths that were directly caused by inadequate sanitation (Pruss-Ustun et al., 2014). A significant majority of those deaths, particularly among infants and young children, occur in third world countries where sanitation facilities can be inadequate and in some places non-existent.

The Human Right to Water and Sanitation: Securing access to water for basic needs report emphasizes that access to appropriate sanitation and potable water is considered to be a basic human need and human right (Carr, 2001; Bjorklund & Sjodin, 2010). However, as detailed in the previous paragraph, many people in countries around the world still suffer from a lack of available water and sanitation resources, and thus do not live in healthy and sanitary environments. Additionally, when provided, sanitation facilities may be designed and constructed incorrectly, placed in unlit and remote areas, which can be hazardous for a user's personal safety, and are too few in quantity to fully address the need of the population being served.

1.2 Sanitation and Sub-Saharan Africa

The United Nations Department of Economic and Social Affairs (UNDESA) estimates that while unsanitary practices have decreased worldwide there are still one billion people who practice open defecation (UNDESA, 2012; WHO/UNICEF, 2014). Open defecation is most prevalent in Sub-Saharan Africa, Asia and Oceania. In fact, it is estimated that 222 million people in Africa are without access to improved sanitation and 86 million people in West Africa alone¹ practice open defecation (WHO/UNICEF, 2012). Furthermore, recent estimates suggest that roughly 25% of the population in Sub-Saharan Africa currently practice open defecation (WHO/UNICEF, 2014).

According to a report compiled by WHO/UNICEF for the Joint Monitoring Programme for Water Supply and Sanitation (JMP), compared to other African regions, West Africa has some of the lowest proportions of their population (approximately 25%) using improved sanitation facilities (WHO/UNICEF, 2012). Thus, with a population of 245 million people, roughly 186.2 million people living in West Africa still live without improved sanitation. This lack of improvement of sanitation facilities in West Africa is startling.

Given the number of people forced to engage in unsanitary practices, and that use unimproved sanitation facilities in West Africa, it is not surprising that these practices can be huge catalysts for the spread of disease. For example, a United Nations (UN) Water (UN-Water) and UNDESA joint report recently discussed that open defecation is the primary route for fecal-oral transmission of disease for most children, and directly contributes to the large number of children dying from diarrheal related disease and illness (UN-Water & UNDESA, 2014). In fact, West

¹ According to the African Ministers' Council on Water (AMCOW) regional classifications, the West African region consists of the following countries: Benin, Burkina Faso, Cape Verde, Cote d'Ivoire, Gambia, Ghana, Guinea, Guinea-Bissau, Liberia, Mali, Mauritania, Niger, Nigeria, Senegal, Sierra Leone and Togo (WHO/UNICEF, 2014).

Africa has the highest under-five mortality rate in all developing regions with 191 child deaths per 1,000 live births (WHO/UNICEF, 2012).

Despite efforts by the UN, non-governmental organizations (NGOs), governments, and public and private sectors, only five of the 54 African countries, specifically Algeria, Egypt, Libya, Morocco and Tunisia, are on track to satisfy the Millennium Development Goals' (MDGs) sanitation target of reducing by half the population without access to improved sanitation. Furthermore, the number of people without improved sanitation in Sub-Saharan Africa² increased from 28% to 33% from 1990 - 2012 (WHO/UNICEF, 2014).

Urbanization is thought to be one potential reason for an increase in the number of people in Africa without access to improved sanitation. The United Nations Environment Programme (UNEP) reports that approximately 38% of the population in West Africa lives in urban areas. Many reasons for migration include improved access to health, education and employment opportunities. However, urban growth rates tend to exceed capacities for municipalities to provide adequate services, including water supply, waste disposal and sanitation (UNEP, 2002). In addition, there are now 19 cities in Africa with populations that exceed one million inhabitants, and estimates suggest that urban settlements (urban slums) in African nations are increasing five times more rapidly than urban slums in industrialized nations (Chelala, 2014). According to the United Nations Human Settlement Programme (UNHABITAT), an urban slum is an area with a lack of basic services (sanitation, potable water, electricity), and adequate housing, and is plagued by overcrowding, unhealthy and hazardous locations, insecure tenure and social exclusion (UNHABITAT, 2003). Sub-Saharan Africa is estimated to have the highest prevalence of urban

² Sub-Saharan Africa consists of all countries in the AMCOW regions of Central Africa, Eastern Africa, Southern Africa, and Western Africa (WHO/UNICEF, 2012).

slums worldwide with an anticipated population of 400 million inhabitants by 2020 (UN-Water & UNDESA, 2014).

1.3 Sanitation and Poverty

Poverty, in its most basic terms, is defined by an inadequate monetary foundation in which to afford the means to have a proper diet and/or home. However, critics argue that people also require specific social and cultural needs aside from monetary needs. Therefore, the distinction of relative poverty was created. It defines poverty in the sense that “people are poor if they fall below prevailing standards of living in a given societal context” (UNESCO, 2014).

The 2013 MDGs Report showed that roughly 48% of the population of Sub-Saharan Africa subsists on less than \$1.25 USD/day and the number of people living in extreme poverty increased from 290 million to 414 million from 1990 to 2010 (UNDESA, 2013). As the population continues to increase in Sub-Saharan Africa the number of people in poverty may also be expected to continue to increase.

One large problem associated with poverty and sanitation is the rural-urban disparity in coverage as well as wealth disparities associated with the availability and use of improved sanitation. An analysis performed by UN officials of 35 countries in Sub-Saharan Africa reported that 90% of households in the richest urban quintile had direct access to improved sanitation, while less than 50% of rural inhabitants, including the wealthiest households, had direct access to improved sanitation (UNDESA, 2012). Additionally, slum populations in Sub-Saharan Africa are expected to increase to 400 million inhabitants by 2020; and yet sanitation facilities have not improved in quantity or quality for these areas to meet the current demand. One example in Liberia, the country focus of this research, is the presence of only four toilets in West Point, an urban slum in Monrovia, Liberia which hosts 70,000 people (Lijas, 2014).

1.4 Sanitation in Schools – Sub-Saharan Africa and Developing World

The Plan of Implementation of the World Summit on Sustainable Development in 2002 emphasized the improvement of water and sanitation in schools as a main priority and, in 2005, the United Nations Commission on Sustainable Development also stressed the need for better hygiene education in schools (UNICEF, 2006).

Additionally, to meet MDG Number 2 (i.e., ensure that, by 2015, children everywhere, boys and girls alike, will be able to complete a full course of primary schooling) and MDG Number 3 (i.e. eliminate gender disparity in primary and secondary education, preferably by 2005, and in all levels of education no later than 2015), improved water and sanitation infrastructure as well as improved practices are necessary to maintain and increase enrollment, learning, and retention of students in schools. Importantly, many female students may find it difficult to attend school during menstruation and/or puberty due to inadequate facilities (e.g. lack of separate latrines for males and females, no feminine water disposal areas and no available materials for washing).

According to the World Health Organization (WHO), toilets should be provided at a school at a ratio of one toilet per 25 girl students, and one toilet plus one urinal per 50 boy students (WHO, 2009). At many schools in Liberia, that ratio is not met (personal observation of author). In Saclepea City, Nimba County, Liberia, where the thesis author served as a science teacher during her Peace Corps service as part of the Master's International program at the University of South Florida (<http://cee.eng.usf.edu/peacecorps/>), the average student to toilet ratio was 150 – 200 students (both boys and girls) for every toilet at Johnny Voker High School (JVS). Additionally, of the eight Ventilated Improved Pit (VIP) latrines on the JVS campus only one toilet each for males and females was unlocked and available to serve the students during instructional periods. One toilet on campus was locked and allowed only for K-1 and K-2 students (kindergarten-aged

children), and another was locked and only allowed for specific teachers and administrative personnel (personal observation).

A study in Kenya investigated the impact and effectiveness of school interventions for water, sanitation and hygiene (WASH) education in Kenyan schools, particularly the presence of *E. Coli* hand contamination (Greene et al., 2012). The study found that infrastructure and education interventions did not impact students' risk of having *E. coli* hand contamination, and the establishment of new sanitation facilities (certain schools with sanitation interventions increased the number of latrines available to students) actually increased student's risk of both exposure to *E. coli* and having *E. coli* hand contamination.

Many factors may have contributed to these results, including the degree to which hands were contaminated during defecation, whether the student washed with soap/water prior to hands being tested, quality and length of hand washing, and the level of contamination on washing facilities. Additionally, researchers found that available hand washing resources (soap, adequate water, etc.) were more prevalent immediately following intervention and deteriorated in availability with time (Greene et al., 2012).

Studies like the Kenyan study (Greene et al., 2012) suggest that interventions and education in schools is only half the solution. However, improvements in infrastructure combined with hygiene education may still be effective methods to allow people, particularly young children and school children, to change their behaviors. Jenkins et al. (2005) suggests that making sanitation infrastructure more user friendly, safer, easier to clean and maintain, and free from odor is a greater motivator at increasing usage than health considerations.

Gender considerations are also paramount in school sanitation. In developing countries, roughly half of schools lack sufficient latrines for female students and teachers (UNICEF, 2012).

An increased focus on menstrual hygiene management has brought to focus the challenges females, especially school-aged females, face in regards to adequate and appropriate sanitation and ways to improve it.

Menstrual hygiene management (MHM) is defined as the ability for women and adolescent girls to use clean menstrual management material to absorb or collect blood that can be changed when needed during menstruation, can be washed with soap and water as required in privacy, and can be disposed of in available and adequate facilities (Sommer & Sahin, 2013). Unfortunately, many schools lack the infrastructure, technology or knowledge to effectively assist adolescent girls and women with their sanitary needs. Many times the latrines available at schools are unclean (personal observation), too few in number and lack privacy and space (Sommer & Sahin, 2013). Additionally, sources of water can be located far from the latrines which prevents proper hand washing, cleaning of feminine materials (rags, materials used for collecting blood), and disposal of feminine waste in appropriate containers. Many times feminine waste is either disposed in latrines, which can cause greater accumulation rates of latrine pits, or feminine materials are reused in an unsanitary manner to avoid public disposal out of embarrassment (Kjellen et al., 2012).

By constructing appropriate sanitation facilities to meet gender specific needs, one may increase the use of sanitation facilities and thus reduce unsanitary practices. Spedoske (2015) suggests that to best incorporate gender into sanitation design, Gender Mainstreaming should be practiced. Gender Mainstreaming is achieved through gender equity, where the processes used to design, construct and manage are considered fair by both men and women. In her report, Spedoske (2015) suggests incorporating men in discussions of feminine hygiene which will promote better understanding in the need for latrine designs to fit the needs of both men and women.

As already discussed, sanitation in Liberia, West Africa is very underdeveloped. Many schools in Liberia suffer from an inadequate ratio of latrines to students, as well as some schools are absent of latrines (personal observation), and few to none consider the needs of the users, particularly female students. While building latrines will reduce the proportion of students without access, building sustainable, user-friendly and gender appropriate latrines that use local solids accumulation rates for sustainable design, will promote further adoption, help minimize the fecal-oral transmission disease cycle and potentially prolong the life of the sanitation facilities.

The author of this thesis served as a Peace Corps Volunteer in Saclepea, Nimba County, Liberia from August 2012 until August 2014, in accordance with the Peace Corps Master's International Program at the University of South Florida (Mihelcic & Hokanson, 2005; Mihelcic et al., 2006). For her primary service, she served as a secondary science and math teacher at the local government school, JVS.

The most common diseases in Saclepea City, according to local health authorities, are malaria, typhoid and diarrheal illness/disease. All of these diseases are prevalent in the developing world, particularly in West African countries, where access to adequate water supplies, sanitation, and health care facilities is very limited, and exposure to infectious disease agents is very high (WHO/TDR, 2012). As mentioned previously, Liberia is one of the poorest and least developed countries in West Africa with a low HDI value of 0.412 (UNDP, 2014). Currently, it is estimated that 1.7 million people in Liberia (almost half of the population), have no latrine and practice open defecation on a consistent basis. Approximately 3,000 people die each year from diarrhea, and 90% of these deaths are attributed to poor health and sanitation practices (WSP, 2012).

Sizing the pit of a latrine requires the knowledge of many aspects including user numbers, required life of the latrine, cross-sectional area and the solids accumulation rate. Unfortunately,

there is limited literature available on analysis of solids accumulation rates in latrines, and very little literature related to solids accumulation rates in school latrines. There is thus a need for research to determine solids accumulation rates in schools to allow for proper and sustainable latrine design, as children are in great need for improved sanitation because they are at the highest risk for contracting diarrhea and other diseases associated with inadequate water and sanitation (Exley et al., 2015).

1.5 Motivation

As evidenced by the situation in West Africa, specifically Liberia, an improvement in sanitation facilities would greatly decrease the levels of disease, particularly diarrheal diseases, within West Africa and other developing regions. However, despite best efforts to fulfill MDG Number 7, Target c (to halve, by 2015, the proportion of the population without sustainable access to safe drinking water and sanitation), it is estimated that 2.4 billion people in the world will still be without access to improved sanitation in 2015 (WHO/UNICEF, 2014). Therefore, safe disposal methods of human waste as well as containment infrastructure are needed to break the fecal-oral disease transmission cycle, and promote better health at local levels and national levels. Also, the construction and use of improved sanitation facilities, such as VIP latrines, should continue to be a major practice in preventing the spread of harmful diseases as improved facilities are an efficient and easy method of reducing the fecal-oral disease transmission cycle.

Unfortunately, in many instances, latrines are designed using solids accumulation rates that were researched and tested in different geographical and cultural environments as well as for different assumed population/user rates than the populations the latrines are currently serving. This may lead to under design (and thus the latrine will not meet its expected life) or over design (which can lead to extra human resources inputted into the design that are not needed). Countries

that suffer from inadequate sanitation and health are located across the globe in different geographic, demographic and socioeconomic environments. By streamlining latrine design that does not consider local contexts, latrine designers are disregarding geographical and climate differences, demographic differences, as well as cultural differences.

Solids accumulation rates in a pit latrine are highly dependent on the amount of excreta produced by the individuals using the latrine, the material/s used for anal cleansing, other materials (feminine waste, graywater, rubbish) disposed of in the latrine pit, and the environment of the pit, such as the temperature, water content and placement of the pit relative to the water table, which can affect overall degradation of solids (Mihelcic et al., 2009).

The accumulation rates of solids is defined most basically as the volume of material (excreta, anal cleansing material, etc.) placed into the latrine pit per person (individual using the latrine) per year that is not degraded by biological processes and thus accumulates in the pit (Mihelcic et al., 2009; Still & Foxon, 2012). Accordingly, to the knowledge of this thesis's author, no literature is available on solids accumulation rates measured and tested at schools in Sub-Saharan Africa. Most accumulation rates that can be used for schools, particularly in emergency situations (refugee camps), are often provided by UNICEF and UNHCR excreta management manuals and are based on rates that were acquired over 20 – 30 years ago (Harvey et al., 2002; Harvey, 2007). Therefore, in order to provide the most accurate design specifications for latrine pit designs for schools, research on the best ways to measure local data and conduct analyses is recommended to fully understand accumulation rates.

1.6 Objectives

The main objective of this research was to develop and use field measurements to determine the solids accumulation rates of traditional and VIP latrines at three schools in Saclepea

City (Liberia), specifically JVS, Red Cross School, and ULICA Mission School. Accurate and locally appropriate solids accumulation rates of VIP pit latrines, particularly in Liberian schools, should thus enable more accurate pit sizing and design.

Unfortunately, due to the Ebola Virus Disease (EVD) outbreak that first began in Guinea then infiltrated into Liberia and Sierra Leone in 2014, and has since been the cause of over 2,413 documented deaths in Liberia (CNN Library, 2014), Peace Corps Volunteers (including the thesis author) were forced to evacuate from West Africa in early August 2014, prior to completion of the data collection component of this research. The first EVD cases reported to the author by local authorities occurred in Liberia in March 2014; some estimates suggest the first case of the West African EVD outbreak was in Guinea in December 2013 (BBC, 2015). Because Nimba County shares a border with Guinea, it was considered a possibility that EVD could reach the area. No EVD case was reported there until April 2014 (BBC, 2015). Due to the outbreak, a substantial portion of the field measurements initially proposed for this research could not be completed; and the prevalence of EVD in Liberia resulted in great difficulty in continuing to obtain appropriate health and safety protection to prevent exposure to pathogens found in human excreta.

The thesis research objectives, therefore, were changed to:

- 1) Perform an extensive and critical literature review on characteristics of solids disposed of into latrine pits and solids accumulation rates measured in pit latrines in developing countries, with a focus on latrines within Sub-Saharan Africa. Because literature on school latrine solids accumulation rates is extremely limited, all available data on solids accumulation rates was compiled and evaluated.
- 2) Assess possible effects of female processes (excretion of menstrual fluid, disposal of feminine waste products) on accumulation rates in pit latrines.

- 3) Describe and assess methods to measure solids accumulation rates in latrines to determine best methods for local assessment of accumulation in rural settings.

CHAPTER 2: BACKGROUND AND LITERATURE REVIEW

2.1 Liberian Context

Liberia is a small tropical country, located 6 degrees N, 9 degrees West, on the African continent and has an approximate population of 4 million people (CIA, 2014). It shares common borders with Sierra Leone, Guinea and Cote D'Ivoire. A significant portion of the population is indigenous; it is estimated that only 5% of the population are direct descendants of American slaves who settled the area in the mid-19th century (BBC, 2014). There are many indigenous tribes within the country and 17 distinct dialects are spoken amongst the population.

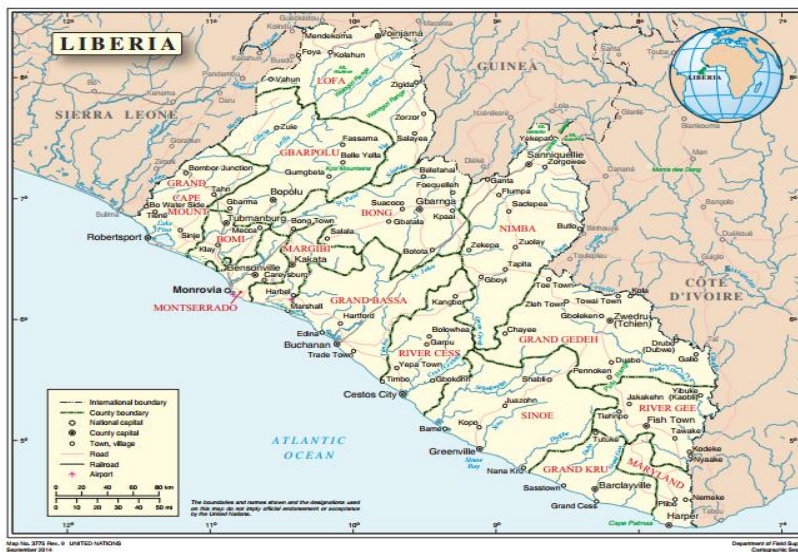

Figure 1 Map of Liberia.

(With Permission, Source: www.un.org/Depts/Cartographic/map/profile/liberia.pdf)

On the Human Development Index (HDI), Liberia ranks 175 out of 187 countries and territories with an HDI value of 0.412 (low human development category). The HDI is defined as “an average measure of basic human development achievements in a country” (UNDP, 2014). The low human development index for Liberia reveals that average rates of lifespan, education, gender equality and income equality are very low compared to many countries in the world.

Liberia spent 14 years in an intense civil war (1989 – 2003) that critically disrupted development and caused the destruction of infrastructure and the deterioration of many government sectors. A large majority of the population fled to the capital city, Monrovia, moved into the interior of the country or into neighboring countries, Guinea, Sierra Leone and Cote D’Ivoire, as refugees (personal observation). With the destruction of government institutions, much of the health and sanitation infrastructure was destroyed or damaged. To meet some of these reconstruction challenges, efforts to revitalize the hydroelectric dam outside of Monrovia as well as a water treatment facility in Robertsport, Grand Cape Mount County are underway; however, the poor and overcrowded areas of Monrovia and the interior areas of Liberia still lack simple water and sanitation infrastructure (personal observation of author).

West Point, an urban slum in Monrovia, houses approximately 70,000 people, with access to only 4 public toilets. In Clara Town, another urban slum, which houses 75,000 people, there are 11 public toilets and 22 public water taps (IRIN, 2009). Most people urinate in the waterways and defecate between houses or into plastic bags which are then thrown over houses as a means of disposal. Many Liberian’s refer to this practice as “midnight flight” or “dudu boy” (Hamoud, 2015; personal observations of author).

2.2 Improved Sanitation Facilities – Latrines

Latrines are considered the most basic form of sanitation. The primary purpose of a latrine is to provide a barrier between people and the pathogens found in human excreta (Mihelcic et al., 2009). Sanitation facilities are described in two ways – improved and unimproved. An unimproved sanitation facility is a facility that does not ensure hygienic separation of human excreta from human contact, and an improved sanitation facility is one that ensures separation of excreta from human contact (UNICEF, 2010).

Interestingly, Exley et al. (2015) found that the presence of *E. coli* in latrines in urban and rural Tanzania was lower for shared (public) latrines (considered as “unimproved” in Figure 2) than for improved latrines, with 9 vs 18 *E. coli*/100mL. The results from this study find that shared latrines should not be considered “unimproved” solely based on the increase in the number of users. Exley et al. (2015) did find increased *E. coli* contamination of unimproved latrines, specifically latrines that did not contain slabs, which supports the idea that improved facilities help protect against increased exposure to pathogens. Figure 2 highlights common sanitation methods that are considered improved and unimproved (WHO/UNICEF, 2014).

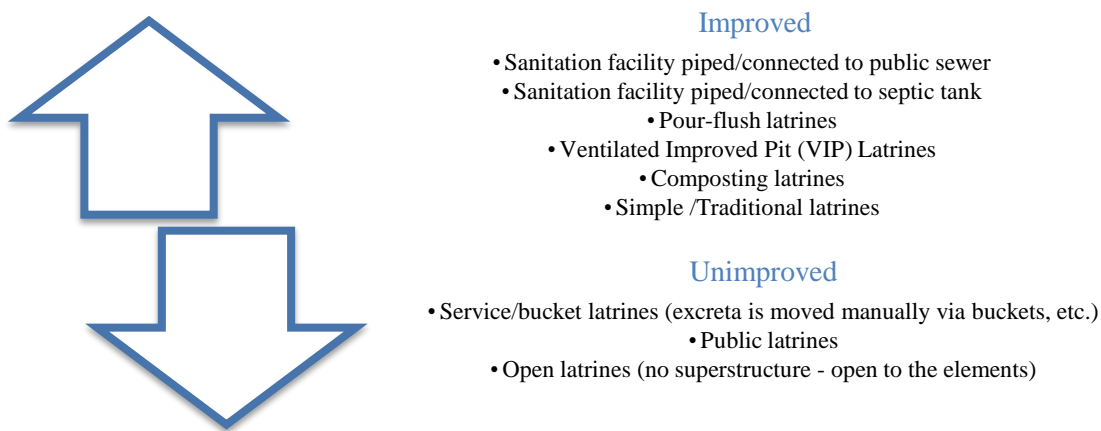

Figure 2 Improved and Unimproved Sanitation Technologies

Besides public health interests, when designing latrines it is also important to consider culture. Avvannavar & Mani (2008) have identified three cultural aspects that must be understood to effectively address sanitation from a cultural standpoint: psychological deterrents of handling human wastes, social aspects, specifically gender and religious influences, and the overall economic wellbeing of the population being served.

2.2.1 Simple/Traditional Pit Latrines

Simple (unventilated) or traditional pit latrines are the least expensive and most basic form of improved sanitation. Because traditional pit latrines are simple and cheap, they are also the most common type of latrine found in the developing world (Mihelcic et al., 2009). Traditional pit latrines contain three main components: pit dug into the ground (circular or rectangular), hygienic slab cover or floor, and a squat hole for the disposal of excreta into the pit. Additionally, to provide privacy for the user and protection from the elements, a superstructure is constructed around the latrine with a door and angled roof.

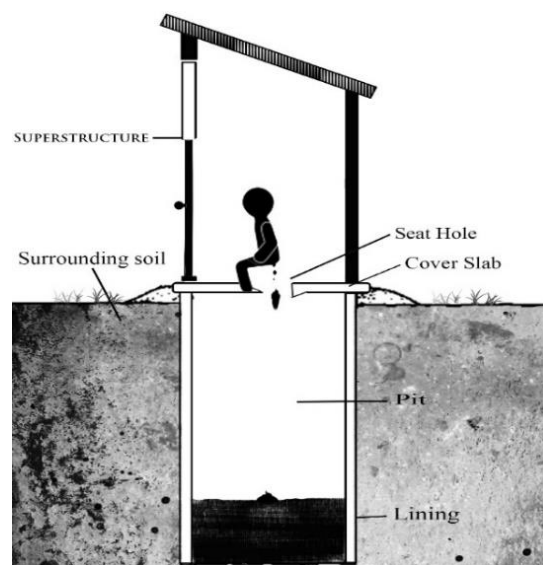

Figure 3 Traditional/Simple Pit Latrine

Traditional pit latrines typically suffer from several problems. The main problems include odor, breeding of flies and other insects, possibility of collapse due to dampness and the undermining of soil, the breeding of pathogens on wet slabs, and the danger of falling into the pit associated with an improperly sized hole (Mihelcic et al., 2009).

2.2.2 Ventilated Improved Pit (VIP) Latrines

VIP Latrines are very similarly constructed to traditional pit latrines and share the basic design components - pit dug into the ground, hygienic slab covering, and squat hole. The major difference is the use of a vent pipe covered with a fly screen which allows air to circulate out of the pit and away from the latrine, thus reducing odors and insects (MIWR-GONU et al., 2009). The pipe greatly reduces fly presence in the latrine, as flies are attracted to light and will move to the fly screen where they will suffer from dehydration and die. The reduction of flies and other insects is extremely important because fecal particles on latrine-habiting insects can be easily transferred, and can contaminate food and water (Mihelcic et al., 2009).

The most efficient design of a VIP latrine is with the door or entry opening facing into the prevailing wind to allow for proper airflow through the latrine. Air flowing over the pipe causes air inside the pipe to flow out and be replaced with air entering through the pit opening (squat hole) (Reed, 2014). To best maintain proper air flow, the pit opening should be kept permanently open.

According to Reed (2014), the recommended minimum internal diameters for the ventilation pipe are 15 cm (smooth pipe) and 20 – 25 cm (rough pipe), and the recommended size for the fly screen mesh (located at the top of the ventilation pipe) is 1.5 mm x 1.2 mm. Also, the top of the ventilation pipe should be unobstructed and at least 0.5 m taller than the surrounding buildings. The ventilation pipe should be fixed securely into a hole in the pit cover slab. Some designs (see Figure 4) place the ventilation pipe outside of the superstructure which can be attached

with metal straps to the outside walls. Other VIP designs, specifically the latrines used in this study, place the pipe inside of the superstructure. Figure 4 shows an example of a ventilated pit latrine design where the ventilation pipe is located outside of the latrine superstructure.

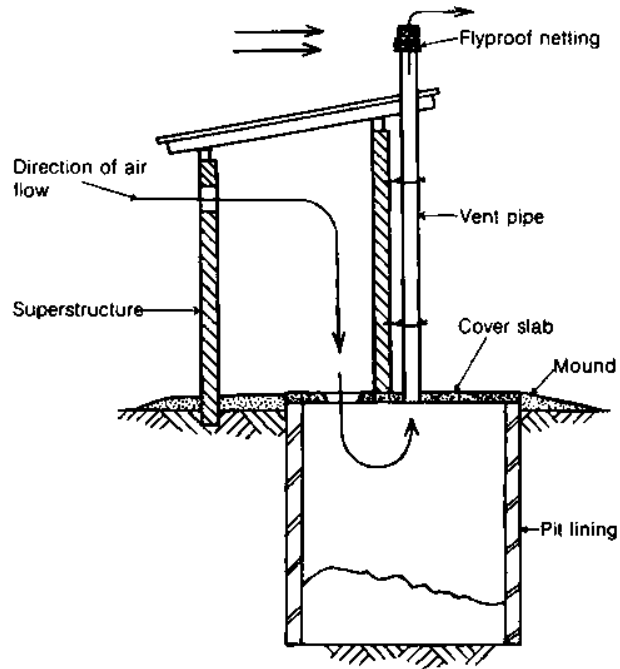

Figure 4 Ventilated Improved Pit (VIP) Latrine
(With Permission; Source: Franceys et al., 1992)

2.2.3 Pour-Flush Latrines

Pour-flush latrines use water to flush solids from a bowl into a pit. The pit can be either located below or offset from the latrine structure, which enables pour-flush latrines to be constructed inside houses with the pit located in an offset location outside of the house. The main difference between other latrine technologies and pour-flush latrines is the presence of a bowl with a water seal trap, traditionally a porcelain bowl, in which water is used after excretion to both cleanse the bowl and flush the excreted contents into the pit. The bowl also serves as a trap to

prevent flies entering the pit and odors passing into the latrine (Mihelcic et al., 2009; Galvin, 2013). Figure 5 shows a typical design of a pour-flush latrine with an offset collection pit.

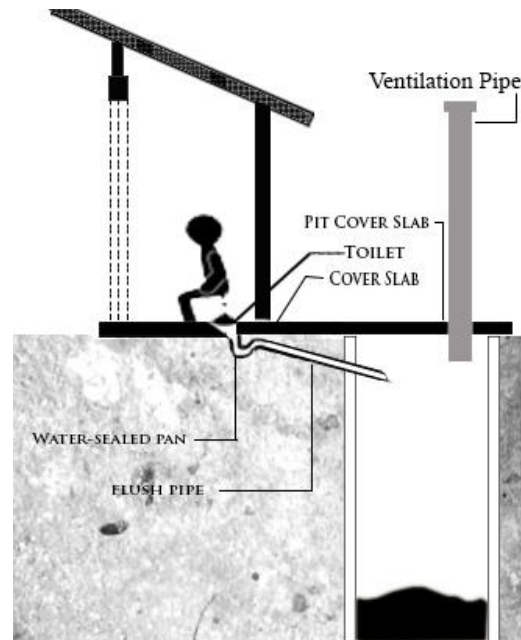

Figure 5 Pour-Flush Latrine

For proper construction of pour-flush latrines, the installed bowl must be level. Also, the drain pipe that connects the bowl to an offset pit must have a slope of 1:5 to 1:15 (height-to-length ratio) for proper movement of contents into the pit. Some limitations of pour-flush latrines include an inability to be constructed in areas with high water tables, particularly if groundwater is used for drinking water, as the pit contents may pollute the water sources. Anal cleansing materials (excluding tissue) must be disposed of in other locations to prevent damage to the system or clogging of the pipe. Also, a year-round supply of water is needed to flush the latrine. A typical flush per use requires about 1 – 5 L, so a person using the latrine 5 times per day may require 20 – 25 L of water per day for flushing (Fry et al., 2008; Mihelcic et al., 2009).

2.2.4 Composting Latrines

Composting latrines are on-site sanitation facilities that convert human excrement into compostable material that can be used as a soil amendment (Mehl, et al., 2010; Galvin, 2013; Wilbur, 2014). The design of composting latrines includes construction of the latrine and sealed pit above ground making it a sanitation technology conducive for areas where high water tables may be present. A common design for composting latrines is the use of two chambers that are used alternately; while one chamber is in use, the waste in the other pit is being composted (Mihelcic et al., 2009). Figure 6 shows the design of a composting latrine with two chambers.

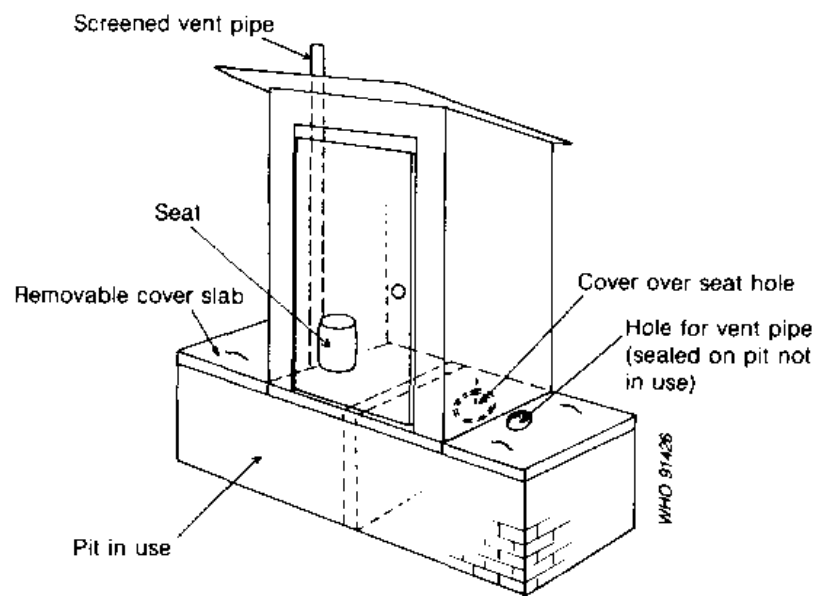

Figure 6 Double-nit VIP Latrine
(With Permission; Source: Franceys et al., 1992)

The basic design of a dry composting latrine includes a urine collection receptacle and a large chamber to store feces. While urine contains valuable nutrients (Mihelcic et al., 2011), it can have adverse effects on the composting process, such as minimizing air circulation and aeration of compost due to an increase in the moisture content of the solids, and urine's high nitrogen content

can lower the carbon to nitrogen ratio of feces below the most optimal ratio (30:1) (Mihelcic et al., 2009; Wilbur, 2014).

The chambers are typically sized to adequately collect and compost feces in a year-long time period. The lower slab or *base platform* is constructed and cured first, the chamber walls then constructed on top of the *base platform*, and then the latrine slab constructed on top of the chamber walls. The superstructure is then constructed on top of the latrine slab. Access doors may be constructed into the back of each latrine chamber to be used to manually turn sludge to promote aeration (add oxygen to contents) as well as to remove waste once it has composted. Some doors are constructed of weak mortar which can be easily broken when access to the chamber is required. There are other designs of composting latrines which include: single or multi-chambered, electric or manual, water-based or waterless, urine-diverting or mixed, and designs for single and multi-story structures (Hurtado, 2005; Wilbur, 2014; Anand & Apul, 2014).

2.3 Composition and Characteristics of Human Waste (Excreta)

Human waste (excreta) consists of feces and urine which the body excretes as waste products. Human feces consist of roughly 70 – 80% water and 20 – 30% solid matter (Jensen et al., 1976; Torondel, 2010). The water content of stool is dependent on both liquid intake and digestive function. An analysis of 26 feces samples found that 84% of solid matter is organic and the remaining 16% is fixed solids (inorganic material). The organic matter of feces is composed mainly of bacteria (> 30%) (Stephen & Cummings, 1980) and residual dietary fiber (17%) (Todman et al., 2014). Past literature has reported bacterial components of feces as 30%, but quantification was performed utilizing less precise processes, such as direct microscopic counts where weight was assessed assuming average size of the bacteria, and the bacterial component is believed to have been underestimated (Stephen & Cummings, 1980; Torondel, 2010).

Vinneras et al. (2001) estimated that between 30 – 45 kg (30 – 45 L) of wet feces are produced per person per year. Some estimates suggest that an average individual produces 0.12 – 0.14 L of feces and roughly 0.6 – 1.5 L of urine daily (Buckley et al., 2008; Still & Foxon, 2012). Overall, on average, one stool per person per day is produced, but can vary from one per week to up to five per day (Lentner et al., 1981). The average volume of nitrogen and phosphorus excreted annually in a person's urine has been estimated to be 4 L/person-year and 0.365 L/person-year (Lentner et al., 1981). Mihelcic et al. (2011) performed a geospatial analysis to quantify the phosphorus available from human urine and feces on global, regional and specific country scales for two population scenarios (2009 and 2050). Averages of animal protein and plant protein ingested per country population were quantified and used to estimate phosphorus production. Average phosphorus production in human urine and feces was determined to be 0.404 – 0.611 L/person-year (2009 baseline year) with possible increases to 1,578 – 978,730 metric tonnes annually (2050 scenario).

The amount of feces and urine excreted by individuals is highly dependent upon water consumption, climate, diet and occupation (Torondel, 2010). Individuals with diets high in meat and low fiber foods produce smaller volumes of fecal matter than those who subsist on high fiber foods (Guyton, 1992).

2.3.1 Menstrual Fluid Characteristics and Feminine Waste

Many studies report female student attendance and registration in school declines during puberty (beginning of menstruation) because of a lack of appropriate sanitation facilities as well as a lack of available feminine materials (UNICEF, 2012; Sommer & Sahin, 2013). With the recent efforts and studies to assess and improve sanitation and feminine hygiene products as well

as their availability and use (Crofts & Fisher, 2012; Beksinska et al., 2015), there may be an increase in the disposal of menstrual fluids and/or materials into school latrines.

The effects of menstrual fluid and disposal of menstrual hygiene products have not been considered in the analysis of solids accumulation rates in pit latrines nor have the effects of menstrual fluid been considered on degradation of pit solids. Much of the liquid excreted into latrine pits is considered to infiltrate into the surrounding soils, assuming proper design, construction and soil composition surrounding the latrine pit. Therefore, it may be that menstrual fluid effects can be considered negligible; however more analysis is needed. Menstrual waste can pose an effect on accumulation rates as many types of sanitary napkins and tampon applicators are not biodegradable and may be disposed of in latrine pits.

Nahar & Ahmed (2006) estimates that an average woman will experience 3,000 days of menstruation in her lifetime with an average menstrual blood loss of 35 – 50 mL per cycle (Warrilow et al., 2004). The average menstrual cycle length (days where bleeding was present) is estimated between two and nine days, with the most common length being five days (Collett et al., 1954). However, certain population studies in Goteburg, Sweden showed that approximately 10% of women may experience blood losses of greater than 80 mL per cycle (Hallberg et al., 1966). Similar to excretion rates of feces and urine, rates of blood in menstrual fluid and volume of menstrual fluid excreted greatly vary. Fraser et al. (1985) studied 28 women's menstrual cycle fluid losses (pre-weighted sanitary pads/tampons were given to participants who then used the pads and placed used pads in containers which were then weighed and measured by researchers) and found that blood proportions ranged from 1.6% to 81% in menstrual fluid; but typically blood made up only 36% of total menstrual loss. The largest proportion of menstrual fluid loss in the study was found to be endometrial tissue fluid. The amount of menstrual fluid depends mainly on

excretions from other sources including exudates, endometrial glands, and cervical and vaginal secretions, which can vary from individual to individual.

Blood is composed of roughly 4,000 different components, the four most important components being red cells (erythrocytes), white cells (leukocytes), platelets (thrombocytes) and plasma. Normal blood pH is between 7.35 and 7.45.

Blood-borne pathogens also exist in menstrual blood. Therefore, with disposal of menstrual blood and feminine hygiene products into latrines and other sanitation facilities, there is the presence of blood-borne pathogens in pits (Graham & Polizzotto, 2013). Examples of blood-borne pathogens include hepatitis B, hepatitis C, and human immunodeficiency virus (HIV). Literature suggests that blood-borne viruses can persist on inanimate surfaces for more than one week, but there was no data identified on time of virus survival in pit latrines (Johnson et al., 1994; Kramer et al., 2006).

In their lifetime, an average woman will use 7,000 – 10,000 sanitary menstrual items, such as pads/towels, tampons, etc., generating a total estimated mass of menstrual waste between 125 and 150 kg (Bharadwaj & Patkar, 2004; Stewart et al., 2009; House et al., 2012). In the United States, approximately 12 billion disposable feminine products are thrown away each year, and are often disposed of in trash receptacles and toilets/latrines (Bharadwaj & Patkar, 2004). In a survey conducted in urban slums in New Delhi, India, approximately 92% of respondents reported discarding their feminine hygiene waste/materials, with only a 5.4% reuse rate of feminine waste/materials. In villages and rural settings, the rate of reuse was higher. It was also reported that some girls were educated by their mothers to discard feminine hygiene waste into pit latrines to prevent the materials being seen by men or used for witchcraft (Garg et al., 2001; Kjellen et al., 2012).

Analyses of disposal rates of feminine products and items (towels, old clothes, etc.) in developing countries have not been widely conducted; but disposal of feminine products may pose a problem with pit latrine fill rates by increasing the amount of non-biodegradable material added to the pit and thus causing a latrine pit to fill faster than expected. According to Kjellen et al. (2012) sanitary napkins take up to one year to decompose, except for the plastic inlay which does not decompose, and rags used for feminine hygiene can generally take much longer than one year to decompose (actual length is unknown at this time). Furthermore, thermophilic conditions sustained for an extended period of time as well as periodic aeration of the pit contents are required to properly decompose of sanitary napkins, especially in solids waste used for composting (Kjellen et al., 2012).

An analysis was performed in Tongarr, near Durban, South Africa to look at categorization of material present in fecal sludge, such as feminine waste products. The study performed by the Pollution Research Group (PRG) at the University of KwaZulu-Natal in Durban, South Africa (Niwagaba et al., 2014) investigated characteristics of pit contents for urine diverting toilets and household and community ablution block VIP latrines (in metro Durban), and also investigated the categorization of material in fecal sludge in on-site sanitation facilities (in Tongarr). The latter part of the study is discussed here. Three samples were collected from dry VIP pit latrines and a urine diverting toilet, which were then manually sorted into different categories, weighed and the data used to estimate percent of total wet mass. The results concluded that 85% of material was fecal sludge, 7 – 8% was paper, 1 – 2% was textiles, and 1% was feminine waste. No analysis was done in this study to account for user disposal habits into the pit latrines nor was it specifically stated if the latrines were household or community.

Given the data reported by Niwagaba et al. (2014) it is suggested that the presence of feminine waste in the types of sanitation facilities tested in Tongarr, near Durban, South Africa may be low. However, there is little knowledge to know if these findings can be considered similar in other countries or in the Durban metro area. Past research done by the Water Research Commission (WRC) of South Africa and reported in many reports suggests that 12.5 – 25% of pit contents are non-biodegradable material (Brouckaert et al., 2013; Still & Foxon, 2012). Some reports have mentioned burning of feminine waste and special wells constructed to compost sanitary napkins, which could explain why percentages of waste in pit latrines could be low (Ten, 2007). Still the mentioned initiatives to dispose of feminine waste are pilot projects and limited to specific local areas (Ten, 2007).

It is also not clear if menstrual waste is accounted for as a portion of anal cleansing material in solids accumulation rates. Besides the above mentioned study, no other literature on solids accumulation rates in latrines assessed by the thesis author discussed the impacts of feminine waste on accumulation rates. Therefore research should be done to analyze how menstrual waste loads impact solids accumulation rates in latrines to determine if other options for feminine waste disposal may make an impact in reducing filling of pit latrines.

2.4 Latrine Design

Latrines are designed and built with the overall purpose of removing excreta from the environment to prevent human contact with excreted pathogens and contaminated material. Ideally, when designing for a particular lifespan of latrines the dominate factors are the estimated rates of accumulated solids produced by the using population, and the rate at which the solids will degrade in the pit. The WRC in South Africa, however, reports that accurate determination of lifespans of pit latrines requires understanding of social factors, such as demographics and user

behaviors, and geophysical and biological factors, such as the interactions between the structure, soil and the water table, the composition of excreted and disposed material into the pit, and the degradation rate of solids, to properly design, construct and close pit latrines (Still & Foxon, 2012). Therefore, when siting and designing a latrine, it is imperative to use proper construction and design methods and consider social factors in the design that can help promote use of the latrine, such as privacy for women, and correctly shaped squat holes (Mihelcic et al., 2009).

Additionally, the constructed pit in latrines should be reinforced to prevent rodents from entering the pit between the soil and hygienic slab, and the superstructure of the pit should be screened wherever openings are located and have tight fitting doors to prevent bats and other animals from entering into the latrine pit and superstructure. This is especially important for protecting people from diseases passed on by these animals, such as Ebola from bats and Hantavirus from rodents, but also to prevent these animals from coming into contact with excreted pathogens and potentially infecting other areas.

There are many factors to consider when siting the location for construction of a new latrine. Many of the factors involve siting latrines a specified distance from houses and water sources, constructing the latrine pit above groundwater levels and on land with certain soil properties. Table 1 specifies the minimum requirements for siting different latrine types.

Table 1 Minimum Requirements for Latrine Siting Locations

Latrine Siting Factors	Types of Latrines			
	Traditional Pit	VIP	Pour-Flush	Composting
Location				
Min. distance to house (m)	10 to 20	10 to 20	n/a	n/a
Minimum distance to water source (m)	30	30	30	n/a
Location relative to water source	downhill of source	downhill of source	downhill of source	downhill of source

Table 1 Continued

Min. distance from pit bottom to groundwater table (m)	1.5	1.5	3	n/a
Can be built in high water table areas and/or in floodplains	no	no	no	yes
Soil Conditions	Uniform with no cracks	Uniform with no cracks	Low clay content, stable and firm	n/a

Latrine selection is also highly dependent upon the geography and soil conditions of the area as well as the needs and social factors of the community. For example, in areas where water tables are high and the use of human excrement is socially acceptable to use as fertilizer, composting latrines may be the most feasible on-site sanitation option, whereas in areas with low groundwater tables, the other three latrine options (traditional pit, VIP and pour-flush) may be more feasible and socially acceptable.

The primary purpose of the pit in a latrine is not to treat the waste but to serve as a barrier between pathogens and humans (Mihelcic et al., 2009). As mentioned previously, traditional and VIP latrines are constructed over a pit, pour-flush latrines are constructed either over or offset from the pit, and composting latrines have above ground chambers to collect and process waste. When addressing the design of a particular latrine, a major design component is proper depth of the latrine pit. The pit must be dug to the correct depth to allow for continued use by the serving community without failure of the latrine (i.e. filling too quickly, etc.) over a set time period. The pit depth is based on several factors, including the volume of fecal waste that accumulates per person per year (i.e. solids accumulation rate which is a function of deposition of materials into the pit and degradation of the pit contents), the number of users of the latrine, the cross-sectional area and the design life of the latrine (Bhagwan et al., 2008).

The first step to determine the required pit depth is to determine an acceptable solids accumulation rate. Accumulation rates can be determined by using the principle of Conservation of Mass, and the basic mass equation: $Inflow - Reaction - Outflow = Accumulation$ (Foxon et al., 2011) as shown in Figure 7.

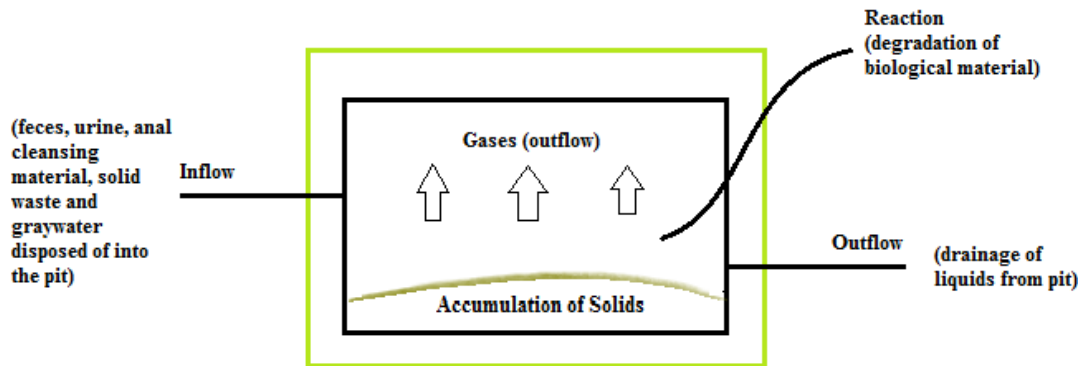

Figure 7 Solids Accumulation Process (Mass Balance)
(Adapted, Source: Foxon et al., 2011)

Inflow consists of urine, feces, anal cleansing material, water, detergents and rubbish, etc., *Reactions* are primarily anaerobic (i.e. they occur in the absence of oxygen) though some aerobic processes may occur (presence of oxygen). *Outflow* is drainage from the pit, and any organic carbon present/dissolved in this outflow (WINSA & WRC, 2011).

In pit latrines, solids enter the pit (*inflow*) and then exit the pit through infiltration of particles into surrounding soil (part of *outflow*), and the degradation of organic matter (*reactions*) into liquids and gases, specifically methane, carbon dioxide, ammonia and nitrogen, that can then escape the pit (*outflow*) (Still & Foxon, 2012).

As mentioned by Torondel (2010) determining accurate average and widely accepted solids accumulation rates can be difficult. To most accurately represent accumulation rates for latrine

design, local fecal generation rates, how much fecal matter is produced per person per day, should be tested (which can then be converted into solids accumulation rates) and considered, as well as the common types of anal cleansing materials used in the local setting. This data, when acquired, is essential to accurately determining local solids accumulation rates that can be used to design the pit size needed to best serve the latrine users.

However, many communities lack the knowledge, technical skills and necessary resources to perform these tests, especially in Liberia, West Africa (personal observation of author). Thus, in many designs, solids accumulation rates are assumed for relative location to groundwater tables and type of anal cleansing material use. For example, Franceys et al. (1992) and Mihelcic et al. (2009) state that the following quantities are reasonable averages of solids accumulation rates when local data are not available.

Table 2 Solids Accumulation Rates for Latrine Pit Design

Location	Anal Cleansing Material	Solids Accumulation Rates (L/person-year)	Reference
Above water table	Biodegradable	60	Mihelcic et al. (2009); Franceys et al. (1992)
Above water table	Bulky/Non-biodegradable	90	Mihelcic et al. (2009); Franceys et al. (1992)
Below water table	Biodegradable	40	Mihelcic et al. (2009); Franceys et al. (1992)
Below water table	Bulky/Non-biodegradable	60	Mihelcic et al. (2009); Franceys et al. (1992)

In addition, the number of latrine users may also vary depending on the serving population. For households, the number of users can be easier to ascertain because household numbers tend to

remain more static (although in some cases fluctuations during testing periods can prove a challenge) and quantifiable than number of users for public-use latrine or latrines constructed for larger populations, such as schools and churches, where populations tend toward greater fluctuation (personal observation of author). Cross-sectional pit areas are also based on local preference. For example, latrine pits are typically designed to be 1 to 1.5 m wide to provide sufficient room for excavation. Equation (1) can be used to help determine the required pit depth (Mihelcic et al., 2009):

$$\text{Pit depth} = \frac{\text{Accumulation rate} \times 10^{-3} \times \text{Number of users} \times \text{Service life}}{\text{Cross-sectional area}} \quad (1)$$

where pit depth equals the depth of the pit hole (m), accumulation rate equals the volume of excreta produced per person per year (L/person/year), 10^{-3} is a conversion factor to convert the L units to m^3 , number of users equals the number of individuals using the latrine, and service life is the expected life of the latrine (i.e., the time before the pit fills) (years).

After determining the required pit depth it is necessary to add an additional 0.5 m to the depth, which will account for the 0.5 m depth below the ground surface needed to properly decommission the latrine and fill with soil to provide a sanitary cap on the pit contents (Mihelcic et al., 2009). As seen from Equation (1), the solids accumulation rate is very important in the determination of pit depth, because it reveals the rate at which the pit is considered to be filling on a yearly basis. If the pit depth is too low, possibly due to an underestimation of solids accumulation rate of the using population, the pit may fill more quickly than anticipated and thus require construction of a new pit before expected.

2.5 Solids Accumulation Rates

A solids accumulation rate is the rate at which organic and inorganic matter disposed into a latrine pit (usually in the form of feces, urine, and anal cleansing material) is collected into the pit, after the organic matter has been degraded to the largest possible extent. The solids accumulation rate can thus be defined as the total volume of fecal and anal cleansing matter, as well as other matter (greywater, solid waste, etc.) that one person disposes of in a latrine pit per year minus the drainage of liquids into the surrounding soil and the volume of the solid matter in the latrine that decomposes over a certain time period.

For this thesis, solids accumulation rates will be reported in units of liters of excreta per person per year (L/person-year). Because a large portion of solids accumulation in latrines is based on the amount of matter excreted by people into the latrine, fecal generation rates (amount of excreted material per person) are discussed in detail and are reported in liters of excreta per person per day (L/person-day) or grams per person per day (g/person-day). Fecal generation rates are considered the amount of material excreted into the pit previous to the degradation of the excreted matter.

2.5.1 Fecal Generation Rates

As mentioned in Section 2.3.1, the amount of fecal matter excreted by an individual is based largely on climate and location of residence, diet and the person's state of health (Feachem et al., 1983). Generally, vegetarians produce larger wet fecal weights/volumes than groups with other diets, rural communities yield higher fecal weights/volumes than urban areas and children, the elderly and adolescent produce smaller wet fecal weights/volumes than adults (Feachem et al., 1983).

The most precise way to obtain accurate measurements of the mass of excreta per person from a particular region is through direct measurement (Franceys et al., 1992). A compilation of results from seven different studies that measured the fecal generation rates (in this case the quantity of wet feces excreted per person) of adults in six different countries were presented in Franceys et al. (1992) and then referenced and discussed by Foxon et al. (2006) and Torondel (2010). The six countries that were assessed in the seven studies were China (fecal rates of men were measured), India (2 studies), Peru (rural Indians), Uganda (villagers), Malaysia (rural population) and Kenya. As seen in Table 3, the range of quantity of wet feces produced by individuals from the studies differed by 311 g/person-day (Scott, 1952; Cranston & Burkitt, 1975) and minimally by 5 g/person-day (Balasegaram & Burkitt, 1976; Burkitt et al., 1974).

Table 3 Quantity of Wet Faeces Excreted by Adults (in grams per person per day)
(With Permission; Source: Franceys et al., 1992)

Place	Quantity	Reference
China (men)	209	Scott (1952)
India	255	Macdonald (1952)
India	311	Tandon & Tandon (1975)
Peru (rural Indians)	325	Crofts (1975)
Uganda (villagers)	470	Burkitt et al. (1974)
Malaysia (rural)	465	Balasegaram & Burkitt (1976)
Kenya	520	Cranston & Burkitt (1975)

Other studies, including more recent studies of fecal generation rates amongst countries has also be compiled and assessed (Niwagaba, 2009). Table 4 shows average wet fecal rates for

individuals around the world. Values range from 0.08 to 0.52 L/person-day (80 to 520 g/person-day).

Table 4 Average Wet Fecal Generation Rates for Individuals
(Adapted; Source: Niwagaba, 2009)

Location	Fecal Quantity ^a (L/person-day)	Reference
-	0.08 - 0.14	Lentner et al. (1981)
-	0.15	Feachem et al. (1983)
-	0.25 – 0.35	Feachem et al. (1983)
Sweden	0.11 - 0.12	Jonsson et al. (2005)
Sweden	0.14	Vinneras et al. (2006)
China	0.32	Gao et al. (2002)
Kenya	0.52	Pieper et al. (1987)
Thailand	0.12 – 0.40	Schouw et al. (2002)

^aDensity of fecal matter of 1000 g/L assumed for reported rates

Lentner et al. (1981) compiled excretion rates from measurements performed in studies between the 1920's and 1960's. The low rate reported (0.08 L/person-day) may be a result of the eating habits and lifestyle during the time period of study which does not consider current dietary practices (Schouw et al., 2002; Vinneras et al., 2006).

Vinneras et al. (2006) performed investigations of excreta generation rates in three locations (apartment/housing communities) in Sweden. The urine, feces, greywater and biodegradable waste was collected from all inhabitants for testing. As seen in Table 4, 0.14 L/person-day was reported in the study as the average fecal generation rate of individuals from all three communities, which was higher than the current Swedish design value of 0.1 L/person-day.

Schouw et al. (2002) analyzed the fecal excretion levels of 15 people in three areas of Southern Thailand, and determined no variance in chemical composition in excreted material between all three locations based on age, sex, occupation or religion. The only significance in variation of excretion rates was from elderly people, who excreted larger amounts of total wet matter than younger people. Schouw et al. (2002) suggest this difference in fecal generation rates may be the result from increased fluid intake from elderly people to reduce the risk of constipation.

Comparatively, the fecal generation rates compiled and presented by Franceys et al. (1992) and fecal generation rates compiled by Niwagaba (2009) show very similar rates. The only main difference is the lower rates (0.08 – 0.14 L/person-day and 0.11 – 0.14 L/person-day) discussed in Lentner et al. (1981) and in Jonsson et al. (2005) and Vinneras et al. (2006). The relatively low rates provided by Lentner et al. (1981) were from data of studies done from the 1920's to 1960's, which may be different due to the diet and lifestyle trends at that time. The lower rates shown from studies conducted in Sweden by Jonsson et al. (2005) and Vinneras et al. (2006) may also suggest differences in diet and lifestyle in Sweden compared to other countries assessed.

Feachem et al. (1983) suggests that the average of fecal generation rates in developed countries/regions (specifically, Europe and North America) may be lower than in developing regions by 0.1 – 0.2 L/person-day. The reported average rates for developed regions (Europe and North America) was 0.15 L/person-day (presented in Table 3), and rates averaged from studies in developing nations yielded values of 0.25 – 0.35 L/person-day (presented in Table 3). The low average fecal generation rates reported by Feachem et al. (1983) for Europe could help explain the lower rates in Sweden compared to the other studies discussed in Table 3 and Table 4.

2.5.2 Additional Factors Affecting Accumulation Rates

The user population of a latrine may increase and decrease depending on how many households use the latrine, the family dynamic (people living in the house or leaving for certain amounts of time which cause user numbers to fluctuate), and the possibility that the latrine predated the current occupants of the household/s. Thus, to appropriately assess solids accumulation rates, direct measurements and follow-ups (via survey, etc.) with the testing community are required to adequately analyze data, account for movement of people, and changes in cleansing patterns.

2.6 Degradation of Solids and Transport of Liquids in the Pit

There are three main physical and biological factors that impact the rate at which solids accumulate in a latrine pit: 1) the addition of new biodegradable and non-biodegradable material into the pit, 2) the amount of liquid transferred in and out of the latrine pit, and 3) the amount of material degraded (Buckley et al., 2008). Latrine pits can contain a range of material in the pits, including feces, urine, anal cleansing materials and solid waste (Still & Foxon, 2012; Bakare et al., 2012). Figure 8 shows the physical and biological processes that occur in pit latrines.

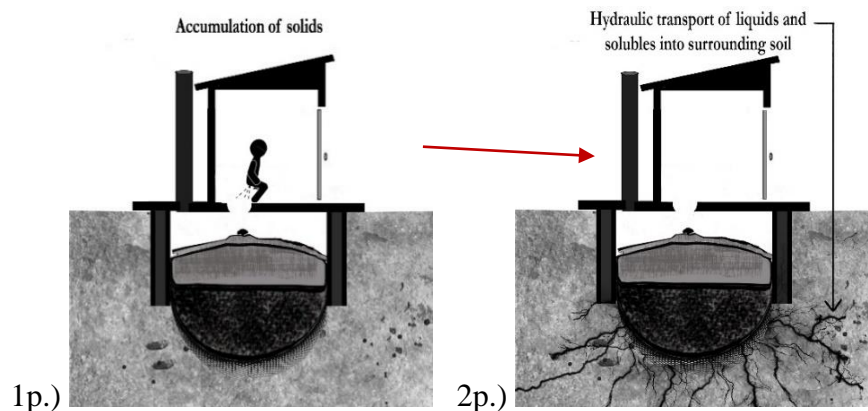

Figure 8 Order of Physical (p) and Biological Processes (b) Occurring in Pit Latrine

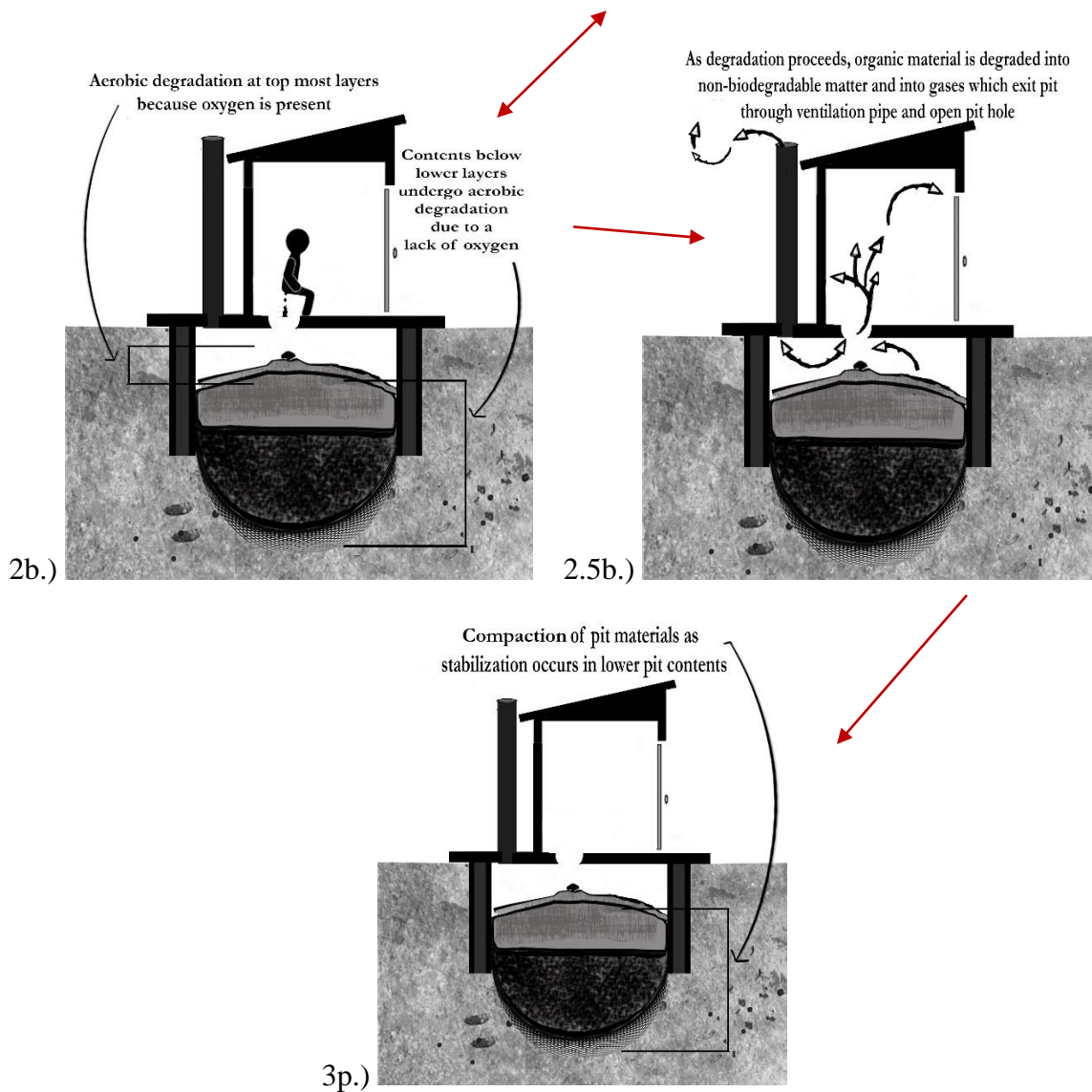

Figure 8 Continued

The solids accumulation rate, the hydraulic transport behavior of the soluble pit contents and compaction of pit materials can be constituted as physical processes (Foxon et al., 2006). Hydraulic transport, the draining of soluble constituents and water into the surrounding soil and/or infiltrating into the pit, is highly dependent upon the geographical characteristics of the environment and soil (Nwaneri et al., 2008). Where water tables are high, there may be infiltration of water and soluble constituents from the pit into the surrounding soil, such as in the study

conducted by Todman et al. (2014) where groundwater infiltration greatly increased measurements of pit filling rates in three latrines in Ifakara, Tanzania.

Biological processes are characterized by the degradation of organic material accumulated in the latrine pit. Oxygen is more present at the surface of pit contents which some researchers (Buckley et al., 2008; Still & Foxon, 2012) suggest provides for aerobic processes being both present and dominant in the top most layer (suggested to be a few mm in depth) of pit solids. Anaerobic digestion processes are present below the aerated surface layer of the pit.

Torondel (2010) suggests that both aerobic and anaerobic digestion may be present in the top layer of the pit; however, Buckley et al. (2008) suggests that aerobic degradation is the leading process at the surface of the pit due to the presence of oxygen. Regardless of the dominate process at the top most layer, the degradation of the solids should cause the rate of solids accumulated in the pit to be lower than the rate at which they are added (Nwaneri et al., 2008).

Buckley et al. (2008) hypothesize that sludge in pit latrines can be characterized into four distinct layers. Figure 9 represents a visual representation of the layer orientation in a latrine pit according to their article. Layer (1) is very small and contains sludge/solids with large amounts of biodegradable material undergoing aerobic processes (degradation in presence of oxygen). Layer (2) contains solids/sludge undergoing anaerobic digestion (oxygen is less plentiful due to cover from top layer) and layer (3) is an anaerobic layer that lacks oxygen due to further compaction by solids in upper two layers and further movement of liquids into the surrounding soil. Finally, layer (4) is the stabilized layer of degradation, where no further organic material degradation occurs.

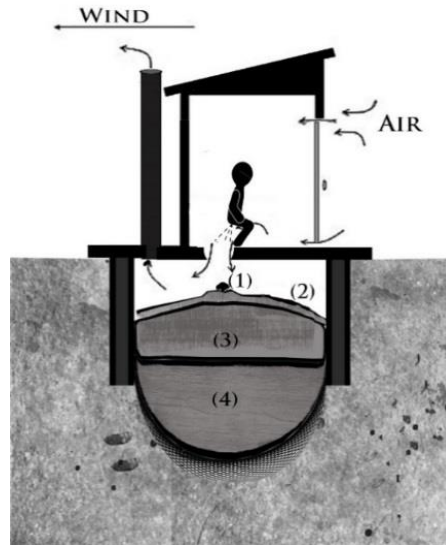

Figure 9 Latrine Pit Showing Four Theoretical Sludge Layers
(Adapted; Source: Buckley et al., 2008)

Aerobic digestion is thought to occur at the top most layer of solids, where oxygen dependent microbes breakdown biodegradable organic material resulting in an increase of temperature and creation of carbon dioxide and biomass (Torondel, 2010; Still & Foxon, 2012). The aerobic degradation process proceeds rapidly compared to anaerobic degradation processes because oxygen is depleted quickly in the first few millimeters of the pit contents (Bhagwan et al., 2008). Criticism of the Buckley et al. (2008) four layer model suggests that given the low numbers of aerobic bacteria in fresh feces it cannot be comfortably assumed if aerobic digestion is solely responsible for the degradation at the surface level (Torondel, 2010); nor is it clear or tested if other processes, such as extracellular hydrolases, could play a role in the rapid digestion. However, it seems accepted that there is at least the presence (however small or large) of aerobic processes at the top most layer of matter in pit latrines.

Anaerobic degradation occurs in the lower layers of solids in the pit where there is an absence of oxygen. It involves the degradation and stabilization of organic materials under

anaerobic conditions (absence of oxygen) by microorganisms which then produce biogases, particularly methane and carbon dioxide, and biomass (Foxon, et al., 2006). Anaerobic digestion consists of four processes: hydrolysis, acidogenesis, acetogenesis, and methanogenesis (Griffin, 2012). Hydrolysis occurs when hydrolytic bacteria convert organic matter, such as carbohydrates, proteins and fats, into soluble organic monomers. Monomers are molecular compounds that can react with other molecules to form long molecular chains. In acidogenesis, the organic monomers (hydrolysis products) are then converted into volatile fatty acids, alcohols, carbon dioxide, and hydrogen. Acetogenesis then converts the acidogenesis products into acetic acid, carbon dioxide, and hydrogen. In the final process, methanogenesis, methanogenic Archaea then use the acido/acetogenesis products to generate methane (Griffin, 2012). The extent of conversion of biodegradable organic material into biomass and gases is referred to as solids stabilization. A fully stabilized system is considered to have no highly biodegradable component remaining.

2.7 Literature of Solids Accumulation Rates

Literature on analyses of solids accumulation rates is limited and varied. While studies have been performed to assess accumulation rates in septic tanks, the amount of moisture present in the septic tank/pit due to inflow from greywater directly affects solids accumulation rates, and as such does not provide a reliable guideline for filling rates of dry sanitation systems, such as traditional, VIP and composting latrines where flushing does not occur (Still & Foxon, 2012).

In the 1950's, Wagner & Lanoix (1958) published a report on excreta disposal for rural areas, and reported solids accumulation rates from WHO data acquired from measurements conducted in Brazil. The rates determined from the studies and then reported by Wagner & Lanoix (1958) suggest that latrine solids accumulation rates were approximately 40 L/person-year in wet pits that contain biodegradable anal cleansing material. A recommended rate of 60 L/person-year

was suggested as a design value for dry latrine pits (Wagner & Lanoix, 1958; Franceys et al., 1992; Still et al., 2012; Still & Foxon, 2012). Though these rates were reported roughly 60 years, many organizations (Harvey et al., 2002; Harvey, 2007) still reportedly use these values as guidelines for both latrine design and to calculate the estimated life of latrine pits.

A number of studies have been commissioned by the WRC in South Africa to determine solids accumulation rates in different South African municipalities to better assist in determining when pits will fill up and how to address the issue of managing full pit latrines. One research report published by the WRC (Still et al., 2009) discusses seven VIP latrine case studies in four areas in South Africa: KwaZulu-Natal, Eastern Cape, Mpumalanga and Limpopo. However, only two studies conducted in KwaZulu-Natal reported solids accumulation rates of latrines. The methods for assessment of solids accumulation rates are not discussed in detail in the studies, rather only data of accumulation rates is reported.

The first study was conducted in Inadi, a peri-urban area, located in the KwaZulu-Natal province. Twenty-seven houses and latrines were visited in 2006; all houses had Phungalutho (VIP latrine with domed pit cover and superstructure roof) latrines built in 1995. Accumulation rates for 19 of the 27 latrines were recorded with an average rate of 52 L/person-year. The remaining latrines were either not in use or had reached capacity and did not allow for previous survey of fill rates.

The second study was conducted in the Mbazwana area of KwaZulu-Natal, which has a low density rural population. Two surveys were conducted in 2000 and 2006 to assess and estimate solids accumulation rates in the latrines. In the 2006 survey, approximately 25 latrines were surveyed; the average accumulation rates were assessed for 19 of the 25 latrines and were reported to be 29 L/person-year. The 2000 survey assessed 16 latrines and reported an average fill rate of

18 L/person-year. Still et al. (2009) explains that the higher accumulation rates recorded in 2006 may be a result from an increase of users for certain latrines which were not calculated into the recorded user values.

Other studies have been performed on solids accumulation rates of pit latrines in South Africa and Indonesia. A compilation of results of studies conducted by the WRC in South Africa show solids accumulation rates ranging from 18.5 L/person-year to 69.4 L/person-year (Still, 2002; Still & Foxon, 2012).

A study of accumulation rates in six cities across the country in Indonesia recorded an average rate of 25 L/person-year with higher rates up to 41 L/person-year for pits that were emptied frequently (Mills et al., 2014). Table 5 compares the accumulation rates that were recorded for the various studies discussed above.

Table 5 Studies on Reported Solids Accumulation Rates of Pit Latrines

Location/s	Province/ Country	Area Type	Latrine Type	Sample Size (# of latrines)	Average Accumulation Rates (L/person- year)	Year of Analysis	Assisting Partner	Reference
Inadi	KwaZulu- Natal, SA	peri-urban area	House ^b	27	52	2006	-	Still et al., 2009
Mbazwana	KwaZulu- Natal, SA	low density, rural	House ^b	25	29	2000	Partners in Development	Still et al., 2009
Mbazwana	KwaZulu- Natal, SA	low density, rural	House ^b	16	18	2006	Partners in Development	Still et al., 2009
Bester's Camp	KwaZulu- Natal, SA	peri-urban settlement	n/a	159	70	1995	Durban Corporation	Still et al., 2012
Rural villages	Limpopo, SA	low density, rural	House ^b	100	43	2009	Tsongang (NGO)	Still et al., 2012

Table 5 Continued

Six Cities ^a	Indonesia	varied populat. and climate	House ^b	107	25	2014	-	Mills et al., 2014
-------------------------	-----------	--------------------------------------	--------------------	-----	----	------	---	-----------------------

^aBogar, Banjarmasin, Banda Aceh, Makassar, Palu, Ambon

^bHouse is reference to household latrine

As previously mentioned, the Inadi and Mbazwana studies produced accumulation rates that were different, perhaps due the relative population in those areas (peri-urban vs. low density rural) but this was not able to be confirmed.

Bester's Camp (see Table 5) is a peri-urban settlement in the KwaZulu-Natal province in South Africa. A majority of the latrines studied were built between 1991 and 1992. Measurements of pit depths in latrines were taken in 2003 and 2005 to assess the accumulation rates; however, the specific methods of measurements were not directly discussed in Still et al. (2012). As seen in Table 5 the average solids accumulation rate was 70 L/person-year and the median value was 64 L/person-year with a sample size of 159 latrines assessed. Comparatively, the solids accumulation rates reported at Bester's Camp are the highest recorded accumulation rates in all studies compared in Table 5. There are two factors that most likely influenced the high rates: (1) Bester's camp is a very dense urban settlement, which may suggest larger number of users per latrine, and users in the area were prone to dispose of household waste into pits, and (2) the latrines are not well drained due to the soil composition of the area (Still, 2002).

The study conducted in Limpopo Province was overseen by the Non-governmental Organization (NGO), Tsogang, which was involved in rural water and sanitation in the area. Tsogang oversaw the measurements of sludge depth of 100 latrine pits, all built between 1997 and 2000, in five rural villages in the province. The average solids accumulation rate for the latrines was 43 L/person-year, and the median value was 39 L/person-year (Still et al., 2009). It should be

noted that in the study seven of the 100 latrines studied showed accumulation rates of over 80 L/person/year and eight showed accumulation rates below 20 L/person-year. While no explanations have been provided by the authors as to the discrepancies, it may be that the latrines with lower accumulation rates have fewer users than believed due to fluctuation of household members over testing period, a higher rate of degradation, less disposal of inorganic materials into the pit, differences in water table levels or other reasons.

Mills et al., (2014) studied accumulation rates of six cities across Indonesia: Bogar, Banjarmasin, Banda Aceh, Makassar, Palu and Ambon. The cities were selected to include a wide variance in population and density, topography, soil composition, groundwater levels and differences in environment, such as swamps, flood prone areas, etc. The study included 190 household surveys to understand toilet and water use, and 107 assessments to determine different aspects of sanitation facilities, including measurements of depth of pit contents. Approximately 83% of questioned households used single pit sanitation systems and the other 17% used fiberglass tanks or septic tanks. To determine solids accumulation rates, Mills et al. (2014) multiplied the bottom sludge depth by the pit dimensions and divided by the average number of users and the years since the pit was last emptied. The study found that the average accumulation rate was 25 L/person-year. The median accumulation rate, however, was calculated to be 13 L/person-year; the authors suggest that the high average value is due to the high rates of pit emptying by households. Norris (2000), Howard (2003) and Mills et al. (2014) found higher accumulation rates for the first year of filling, which they suggest may be caused by microorganisms needing up to two years to reach solids decomposition activity levels necessary to highly impact accumulation rates.

One study conducted by the WRC in Mafunze in South Africa attempted to analyze accumulation rates of non-fecal matter in latrine pits. Non-fecal matter is defined as household wastes and materials that are used for anal cleansing or disposed of into the pit, such as newspaper, plastic bags, and any textiles or plastics. The latrines were rated on a three point scale where: (1) was no non-fecal matter present, (2) was minimal amount of non-fecal matter present, and (3) was high non-fecal matter present. Each pit was assessed and roughly half of the pits were rated as a (2) with an overall median accumulation rate of 33 L/person-year, and the other half rated as a (3) with a median pit rate of 50 L/person-year. A small portion (actual numbers not discussed) of the pits were rated as a (1). From the results of the study, Still et al. (2012) suggests that disposal of non-fecal matter into pits may almost double the average fill rates of a latrine, and may explain why accumulation rates are much higher than expected in many South African municipalities.

The majority of solids accumulation rates reported in the studies were within the minimum design rates outlined by Franceys et al. (1992) and Mihelcic et al. (2009) which range from 40 L/person-year to 90 L/person-year. The accumulation rates reported from the Mbazwana study (Still et al., 2009), the Limpopo study (Still et al., 2009) and the study in Indonesia (Mills et al., 2014) were below the design rates outlined by Franceys et al. (1992) and Mihelcic et al. (2009). Additionally, Norris (2000) addressed sludge build up in septic tanks, biological digesters and pit latrines, and recommended a design rate of 29 L/person-year, which is lower than the recorded average filling rate in all studies except the Indonesia study and the 2000 survey for Mbazwana.

Simply using averaged and recommended values may lead to under-designed sanitation facilities, such as latrines filling too quickly for their estimated design life and therefore leaving users with improperly designed latrines for their needs (fill up to quickly for design life). Over designing a latrine pit, however, could result in added costs, and greater consumption of materials

for construction and maintenance. Locally measured accumulation rates and pit content analyses are the best way to prevent over and under designing of sanitation facilities.

The large margin of solids accumulation rates reported in this chapter shows that rates vary largely between countries. These differences are likely due to population density differences, cultural practices associated with hygiene and sanitation, and diet, as the fecal generation rates per individual varied greatly and differed between individual countries. Given these differences most latrines have unique sludge characteristics, which can affect degradation rates of solids, and therefore accumulation rates.

2.8 Pit Additives

Pit additive material can be separated into two categories: (1) material that is added to reduce odors and insect activity, and (2) material that is added to aid in waste/solids degradation and reduce the accumulation rate (Still & Foxon, 2012). Examples of material that is added to reduce odors and insects is dry carbonaceous material, such as sawdust and ash, and others such as lime (Brikke & Bredero, 2003). Also, carbonaceous materials, specifically sawdust and ash, have much higher carbon to nitrogen ratios (C/N), 200-500 and 25, respectively, than untreated feces, which make them viable options for increasing the C/N of feces to 20-35, which is optimal for composting of solids as desired in a composting latrine (Mihelcic et al., 2009; Mehl, et al., 2010; Wilbur, 2014).

Some studies have been performed to test the efficacy of microbial or microbially-derived products to treat and reduce pit latrine contents. Foxon et al. (2009) performed two trials of additives added to pit latrine contents. The first trial analyzed effectiveness of the additives under both aerobic and anaerobic conditions, where samples were tightly sealed closed to test effectiveness of the additive under anaerobic conditions, and other samples left open to the air to

test effectiveness under aerobic conditions. The samples were then placed in a fumigated cupboard for approximately 46 days.

Findings revealed only small fractions of mass were lost in the anaerobic samples; the average mass loss among the anaerobic samples was approximately 0.036 kg/m^2 (mass/surface area). In the aerobic samples, high rates of mass loss were recorded with an average rate of mass loss of 0.80 kg/m^2 . However, no discernable improvement in mass loss was found in the additive samples compared to the control group samples, and in many cases the regressed line for the control group fell above the regressed line for the additive samples. Trial 2 tested the same process but with added water to the samples, and found similar results. Foxon et al. (2009) determined that pit latrine contents with commercial pit latrine additives had no statistically significant effect on the rate of mass loss and therefore treatment with pit-latrines additives was not able to accelerate the production of biodegradation of pit contents. Thus it is concluded that addition of additives does not impact the solids accumulation rates.

CHAPTER 3: METHODS

3.1 Site Description

Saclepea City is a semi-rural community with an estimated population of less than 20,000 people (Trussell & Moore, 2012). It is located approximately 375 km from the Liberian capital, Monrovia. Figure 10 shows the exact location of Saclepea City within Nimba County, the second most populated county in Liberia.



Figure 10 Map of Saclepea City, Nimba County and Surrounding Areas
(With Permission, Source: <http://movedtomonrovia.blogspot.com/2011/03/map-of-ivorian-refugee-locations-in.html>)

There are two main weather seasons in Saclepea, the rainy season (May-October), and the dry season (November to April) (personal observation of thesis author). During the rainy season, it can rain almost daily and temperatures are held constant around 75-85 degrees Fahrenheit.

During the dry season, the harmattan blows from the Sahara Desert and provides relief from the relative humidity, but can bring high winds and dust the roads (Pettersen, 2014).

Saclepea's ethnic composition consists of three main groups: the Mah, the Gio (or Dan) and the Mandingo. Mah and Gio are the two main tribes in Nimba County and speak their respective dialects, Mano and Gio, which share many similarities in diction, phrasing and overall language structure (personal observation of thesis author). Mandingo is a term used for the Islamic people present in the community and who speak Mandingo, which is very similar to Bambara (main dialect in Mali) and derives words and phrasing from Arabic. Typically, the Mandingo in Saclepea are also some of the wealthiest and most prosperous businessmen and women, and commonly own cook shops (restaurants) and tea shops (coffee shops).

There is one main road in Saclepea where a majority of business owners hold shop and/or reside. This same road is also the main road from Nimba County to the three Southeast counties that border Cote D'Ivoire: Grand Gedeh, River Cess and Maryland.



Figure 11 Picture of the Main Road in Saclepea, Liberia
(With Permission, Source: RPCV John O'Malley)

Additionally, Saclepea City is one of the main hubs for economic activity in Nimba County. Outside of Monrovia, Saclepea City has the largest weekly market in Liberia. Farmers, vendors and others come from all over Nimba County, Grand Gedeh County and Bong County to sell produce, electronics, plastic materials (i.e. buckets, dishes, etc.) and other marketable products at the weekly market.



Figure 12 Vendors and Women Buying/Selling at Saclepea Market
(With Permission, Source: RPCV John O'Malley)

3.2 School Descriptions

In the study, slab to pit content surface depths were measured of latrines located at three school campuses in Saclepea City, Nimba County, Liberia. All three schools hosted pre-k, primary, junior and senior high class sections on the campus. For assessment purposes, all class sections were considered as potential users of the school latrines. At Johnny Voker High School (JVS) and the Red Cross School campuses, latrines were designated for both male and female populations, whereas latrines on the ULICA Mission School campus were considered unisex (no gender specifications were located on the latrine superstructure).

3.2.1 Johnny Voker High School (JVS)

JVS is the only government school in the whole of Saclepea District, and the school at which the thesis author served as an educator and technical adviser. Besides being the only government school, it is one of four high schools in the district, and is also the least expensive to attend. The average cost for tuition is between 1400-1800 LD, approximately \$17.5 to \$25.5 USD (based on an exchange rate of 80 LD = 1 USD).

The student population for JVS was estimated at around 1500 students. Approximately 600 students were enrolled in the junior and senior high school sections, respectively, in the 2013-2014 school year. There were 300 students enrolled in the pre-k and primary school sections. Due to a lack of classrooms as well as desks, there were only two sections of each senior high class. Because each class section had approximately 200 students, there were roughly 100 students per classroom. Figure 13 shows the overcrowding present in most senior and junior high classrooms at JVS.



Figure 13 Overcrowding of Students in an 11th Grade Classroom at JVS

The JVS campus consists of four separate classroom buildings, a library and laboratory building, and two small administrative buildings. Each classroom building has between two and six classrooms. During the school day, primary sections and senior sections attended the morning session of school, which ran from 8:00 am – 1:00 pm. The junior high section attended the afternoon session of school, which ran from 1:30 pm – 5:30 pm.



Figure 14 Main School Building at JVS during Morning Devotion at 8:00 am
(With Permission, Source: RPCV John O'Malley)

3.2.2 Johnny Voker High School (JVS) Latrines

There are three latrine superstructures on the JVS campus. Two of the latrine superstructures consist of four latrine stalls, while the other latrine superstructure consists of two latrine stalls. The date of construction is unknown as well as the entity responsible for the construction of the latrines.

The latrines are separated by male and female, with labels provided on the latrine doors. Unfortunately, three of the four female latrines are remained locked at all times. Reasons for lockage provided by the principal include safety hazards (young children falling into the hole), and

the potential for greater uncleanliness of the latrines if more are available to students (Gontee, 2014).



Figure 15 JVS Boys' Latrine (left) and Girls' Latrine (right)

3.2.3 ULICA Mission School

ULICA Mission School is located on the ULICA Mission about a five minute walk southeast from the JVS campus. ULICA stands for the United Liberia Inland Church Academy. The Mission is funded by ULICA parishioners as well as outside religious sources and private donors in the United Kingdom. Every year in April a religious group of approximately eight to ten doctors and nurses from the United Kingdom travel to the Mission and spend a week assessing and working at the clinic.

The ULICA Mission compound consists of a primary, junior and senior high school, medical clinic, guesthouse, chapel as well as houses and facilities for employees and others. The school consists of two buildings. The main building hosts the administrative offices, library and

several classrooms. The other building is currently under construction, but includes 3-5 classrooms where elementary classes are conducted.

The student population at ULICA Mission School is estimated to be less than that at JVS, however due to the evacuation accurate registration and attendance numbers were not acquired. ULICA Mission School does have adequate facilities to allow students from all grade levels to attend at the same time and for an increased amount of time, usually from 8:00 am – 2:00 pm.

3.2.4 ULICA Mission School Latrines

There are two latrine superstructures (each with approximately four stalls) that serve the school, as well as various other latrine superstructures (each with two to four stalls) that serve the medical clinic, employee households and the guesthouse. These latrines were not tested; however, in retrospect should have been tested to provide comparisons between household and school accumulation rates.



Figure 16 ULICA Mission School VIP Latrine (left), Traditional Latrine (middle), and Latrine Superstructure (right)

3.2.5 Red Cross School

The Red Cross School is located across the road from the JVS football field and campus. Recently, the primary section at the school has been changed to a government primary school which allows students to attend school for free for pre-k to sixth grade students. The junior and senior high school sections are private and have tuition rates higher than those at JVS. The student population at Red Cross School is less, estimated at about 50% of the population at JVS. Like ULICA, the Red Cross School has adequate facilities to allow all sections of the school to attend during the day for an extended amount of time.

3.2.6 Red Cross School Latrines

There are four latrines that serve the school – two female latrines and two male latrines. The latrines were constructed by UNICEF; however, no construction date could be identified by the local school population. The latrines are constructed within the same superstructure and all four share a common rectangular-shaped pit (all latrine pit holes service the same pit).



Figure 17 Red Cross School Boys' Latrine (left) and Girls' Latrine (right)

3.3 Experimental Design

The experimental design for the measuring of accumulation rates in pit latrines at schools in Saclepea City, Liberia that is proposed for this study consists primarily of using locally available materials. The measurements that were completed in the field are considered preliminary measurements to determine best practices for measuring upon reopening of the schools (and regular use of school latrines), which previous to the Ebola Virus Disease (EVD) outbreak, was scheduled for mid-August 2014. A discussion of the preliminary measurements of the latrines as well as the design apparatus constructed to determine the depth from the latrine slab to the accumulated solids is presented in this section.

3.3.1 Latrine Characteristics and Preliminary Measurements

The three schools in the study were selected due to similarities in user population, proximity with one another (roughly a quarter to half-mile apart), and easily accessible school latrines. Figure 18 shows an approximate map of the location of the schools relative to one another.

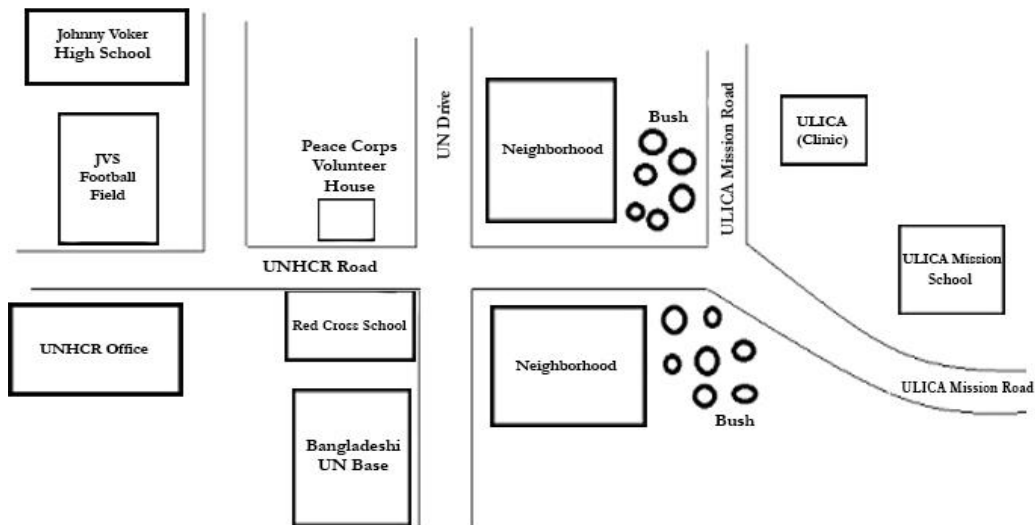

Figure 18 Map of the Locations of the Three Study Schools

Qualitative and quantitative data for each latrine were compiled during the first day of depth measurements. The pit shape (rectangular or circular), dimensions of the pit hole (squat hole) opening, type of latrine (VIP or traditional), user gender (female, male or unisex), if the latrine was open to all or locked and available only to a few, and the entity responsible for construction were documented. Table 6 shows a compilation of the data assessed at each latrine location regarding the above stated parameters.

Table 6 Preliminary School Latrine Data

Latrine Title	Sex	Pit Shape	Type of Pit; Single or Shared	Pit Opening Circular Diameter (cm)	Pit Opening Length (cm)	Pit Rectangular Opening width (cm)	Locking procedure	Entity responsible for construction
JVS-B2	Male	circle	Single	21	46	4-4.5	lock	n/a
JVS-B3	Male	circle	Single	23	45	4-4.5	lock	n/a
JVS-B4	Male	circle	Single	21	46	4-4.5	open	n/a
JVS-U1L	Unisex	Rectangle	Shared	19	46	4-4.5	open	n/a
JVS-U2R	Unisex	Rectangle	Shared	19	46	4-4.5	open	n/a
JVS-G1	Female	circle	Single	23	46	4-4.5	open	n/a
RCC-M1L	Male	Rectangle	Shared	23	42	4-4.5	open	UNICEF
RCC-M2R	Male	Rectangle	Shared	23	42	4-4.5	open	UNICEF
RCC-F1L	Female	Rectangle	Shared	22	42	4-4.5	open	UNICEF
RCC-F2R	Female	Rectangle	Shared	23	42	4-4.6	open	UNICEF
ULICA-1A	Unisex	Rectangle	Shared	30	44	4-4.6	open	n/a
ULICA-2A	Unisex	Rectangle	Shared	32	43	4-4.6	open	n/a
ULICA-4A	Unisex	Rectangle	Shared	30	44	4-4.6	open	n/a
ULICA-2B	Unisex	Rectangle	Shared	-	26	24	open	n/a
ULICA-3B	Unisex	Rectangle	Shared	-	26	24	open	n/a
ULICA-4B	Unisex	Rectangle	Shared	-	26	24	open	n/a

To determine the relative pit hole size, a ruler was used to measure the diameter of the circular part of the hole, and the rectangular hole width. A tape measure was used to measure the length of the hole (rectangle plus circle). Figure 19 shows the orientation of the measurements taken of each latrine hole except for the rectangular holes found in one set of ULICA mission school latrines (see Figure 20). The length and width of the rectangular holes was measured using a tape measure.

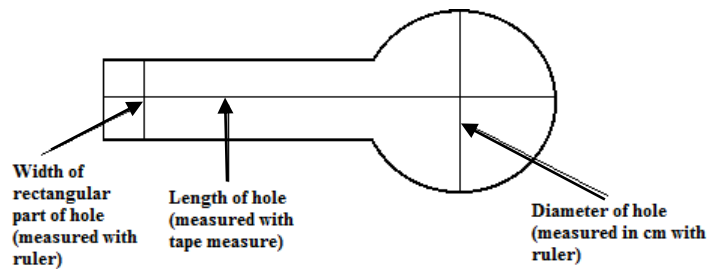

Figure 19 Common Latrine Pit Hole Found at Three Study Schools

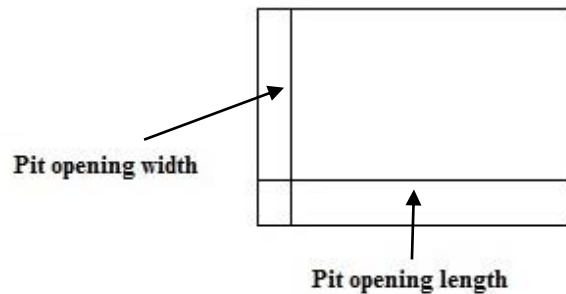

Figure 20 Rectangular Latrine Pit Hole in Four Latrines at ULICA Mission School

Photos were also taken, using a Canon *PowerShot* A2300 camera, of each latrine interior to show orientation of the pit hole and vent pipe, and overall condition of the latrine slab/interior. Figures 15, 16, and 17 provided in Sections 3.2.1 to 3.2.6 show that the male latrines at both JVS and Red Cross School have a greater level of filth than the female latrines. Unfortunately, because no survey was able to be completed by the school populations, there is no data to clearly identify possible reasons for the increased filth. Additionally, Figures 19 and 20, and Table 6 also showed that the relative size of each pit hole was the same among all latrines, except for the traditional pit latrines present at ULICA, where the holes were larger and rectangular in shape.

3.3.2 Measuring Apparatus

The apparatus used to measure the preliminary pit depth measurements of the latrines was constructed using household objects that were available to the thesis author. The apparatus was constructed of an aluminum segmented tent rod that was attached, using duct tape, to the center of the plastic lid of a small rectangular coffee container. A slit half the length of the coffee container lid was cut and the small end of the rod fitted through the cut into the end of the slit (center of the lid). The slit was then taped closed using duct tape, and the tent rod taped to the lid (both on top and under the lid) to prevent movement of the rod length both into and out of the coffee container. After the apparatus was constructed, the coffee container height was measured and the length of the rod was measured using a tape measure. The coffee container had a height of 7 cm and the rod had a length of 414 cm (when connected to the coffee container). Figure 21 shows a drawing of the design apparatus used for measuring the slab to pit contents depth in the latrine pits, as well as the length and height measurements of the rod and coffee container.

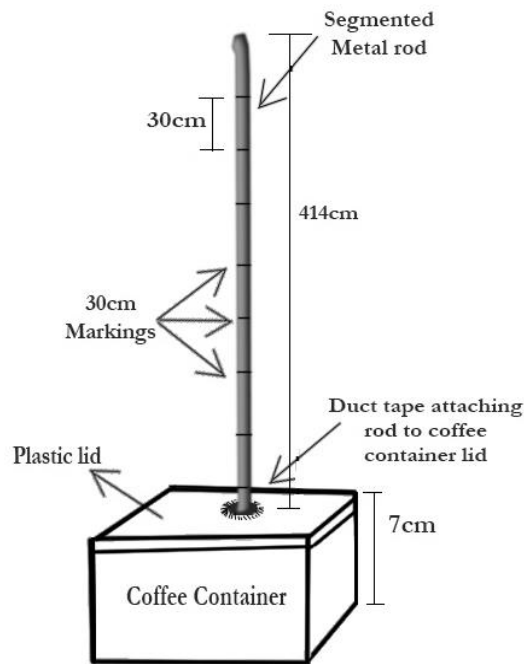

Figure 21 Measuring Apparatus Used to Measure Slab to Pit Contents Depth

The segmented tent rod was used for several reasons, most important was its ability to fit down the hole. Because the latrine superstructures are very small and low in height, a straight rod/stick could not fit inside the latrine superstructure nor fit properly at the angle needed to put the rod/stick into the latrine. Another option was to use a measuring stick with a weight at the end, but keeping the rod at a 90 degree angle proved difficult. The segmented rod allowed for measuring using a rigid type rod (which is easier to keep straight up – 90 degrees) that had sufficient length, and did not have the hassle of trying to maneuver a solid rod (and a potentially too short rod) into the pit. The other reasons the segmented tent rod was used was its availability, its smooth surface to easily place measured tick marks, and ease in cleaning the rod (it fit into a bucket with bleach water).

3.4 Measuring Methodology

The following section discusses the method used to measure the slab to pit content depth in each of the tested school latrines. Additionally, a brief discussion on user numbers and the safety protocols undertaken for measuring are also discussed.

3.4.1 Depth Measurements

To measure the depth of the solids in the pit latrine, the design apparatus was lowered into the pit until the coffee container rested on the solids. The rod was then held at a ninety degree angle and the ruler placed on the top of the pit latrine hole to be flush with the rod. White correction fluid was used to mark the measurement of the depth of the solids to the top of the slab (point where the ruler and rod met) and a pen mark placed on the white correction fluid mark. Several latrine pit solids levels were deep enough to allow for the thesis author to use either the ruler or tape measure to measure from the top of the rod to the white correction fluid mark and then subtract that measurement from the length of the rod (414 cm) to get the solids to slab depth.

However, some latrines had a lower depth from the slab to the solids surface. To calculate the height of these latrines, the rod was used as a measuring tool. Previous to measuring the latrines, the apparatus length was measured (container height + rod length) and a mark was placed using tape and white correction fluid to mark every 30 cm on the rod. Therefore, when the rod was lowered, the thesis author was able to count by 30 cm until the rod reached the bottom. The value used by counting by 30 cm was then told to the volunteer's roommate, who served as the scribe for the research, and she recorded the value. Then a mark using white correction fluid was placed where the ruler placed on the slab met the rod and marked with a marker (to identify it apart from the 30 cm markings). Depending on whichever marking was closer, the 30 cm marking below or 30 cm above the measured depth mark, the depth was calculated by measuring from the

closer marking to the mark made between the ruler and rod. If it was measured from the above marking the difference between the above marking and the depth marking would be subtracted from the above marking to calculate the accurate depth of the pit. If the depth was measured from the below marking, then the difference between the below marking and the depth marking would be added to the below marking to calculate the accurate depth of the pit. An example of the depth calculations is discussed below.

Assuming that the depth marking is above the 210 cm marking (which would make 210 cm the below marking), then the depth of the pit solids to slab is as follows: 210 cm + measure from the 210 cm marking to the depth marking = depth of the solids to the slab. Similarly, if the depth marking is below the 210 cm marking (the above marking), then the depth of the pit solids to slab is as follows: 210 cm – measure from the 210 cm marking to the depth marking = depth of the solids to the slab.

3.4.2 Number of Users

The number of users is the number of people that use the pit latrine on a regular basis. For households, it is usually the number of people in the household. However, for public latrines and school latrines the number of users is more difficult to identify. In particular, school latrines are difficult due to fluctuations in student attendance throughout the week/month/school year, varied use of latrines by students (what latrine is available at the time or considered most clean), if latrines are available to the general public to use (many schools do not have fences around the schools so anyone can use the latrines), and how many students choose to use the latrines.

The number of users is most often quantified in research through the use of user surveys where the using population reports on the latrine/s being assessed, such as in the research

performed by Todman et al. (2014) and Mills et al. (2014) on accumulation rates in Tanzania and in Indonesia.

Surveys were to be given out to students at the three schools during the August-December 2014 school semester to assess student use of school latrines. Unfortunately, due to the EVD outbreak, it was not possible to administer the surveys.

3.4.3 Safety Protocols

Because the thesis author was working in latrines to make measurements, several precautionary measures were taken to prevent direct contact with the excreted wastes. Rubber gloves were worn at all times in the latrine and when handling the design apparatus, and were washed in a bleach solution at the end of each measuring session. Additionally, a scarf was worn around the mouth and nose to mask the strong odors from the latrines, allow for better breathing as well as prevent flies and other insects from landing in/on the thesis author's mouth and nostrils.

To prevent the contaminated material that got on the bottom of the coffee container from contaminating any other surfaces, a small bucket with a bleach solution was carried and the coffee container was placed in it after each measurement was performed at each school. The lid was removed from the container so that the rod and lid could be properly wiped and stored for carrying to the next school. The contaminated bleach solution was discarded in the pour-flush latrine in the thesis author's house at the end of each measurement session, and the bucket thoroughly washed and the wash water also discarded in the pour-flush latrine.

Figure 22 shows the bucket with the bleach solution and coffee container after a latrine depth measurement. Additionally, the other items used including a ruler, tape measure and white correction fluid (to mark where the top of the slab hit the rod to measure the depth) were wiped with anti-bacterial wipes after each measuring session at each school.



Figure 22 Bucket with Bleach Solution and Coffee Container after Measurement

3.5 Methods for Measurement of Accumulation Rates in Literature

There are several methods that have been discussed in literature for measuring and estimating accumulation rates in pit latrines. This thesis discusses methods used to measure accumulation rates.

Several methods were briefly discussed in Bakare (2012) and Still & Foxon (2012) to execute measurements of pit latrine accumulation rates. The methods discussed were (1) the laser distance meter technique, (2) the stereographic imaging technique, and (3) the automated laser scanner technique. As per Still & Foxon (2012), these methods are described in use as a measure to test the effectiveness of pit latrine additives in promoting greater degradation of pit contents, but can still be used to measure solids accumulation rates caused by latrine usage only (without the use of pit additives).

Method (1) the laser distance meter technique consists of measuring the distance between the top of the latrine slab and the top of the pit contents using an infrared distance laser meter

(similar to what was used in the Todman et al. (2014) study) or an equivalent distance meter. To use this method, it is suggested that five to ten measurements of an observed portion of pit contents should be measured and averaged to get an appropriate distance between the latrine slab and pit contents. To most accurately assess the depth between the slab and pit contents, measurements at various angles should be considered. Figure 23 shows angles of measurement that should be considered. The actual height measurement of each measurement point is calculated by multiplying the measured distance by the cosine of the angle, where actual height (h) = distance (m) x cos (θ).

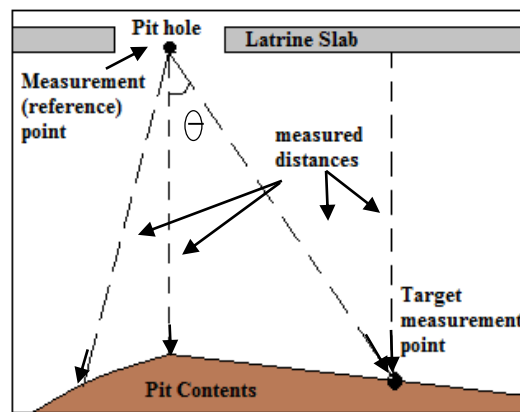

Figure 23 Laser Distance Meter Technique for Measuring Accumulation Rates
(Adapted; Source: Still & Foxon, 2012)

To calculate the accumulation rate using method (1), the average distance at time = 0 (date of first measurement) is subtracted by the averaged distance at a later time/date (t). While not specifically mentioned in the literature, it is assumed that the above subtraction (where t=0 is subtracted by a later measurement) is performed several times by several different measurement data throughout the study time of the latrine pits. The accumulation (for this method it is provided

in meters) is plotted against time, and then a best-fit straight line (linear regression) of the graph is generated which serves as a surrogate for the accumulation rate in the pit.

Method (2), the stereographic imaging technique, involves the usage of two stereoscopic digital photographs to measure the spatial coordinates of points on the surface of the pit contents. Stereoscopic photography is used to create three dimensional images. The points assessed are then used to map out in three dimensions the shape of the surface of the pit contents. In practice, a digital camera is lowered through the pit hole into the pit via a supporting rod. The supporting rod is supported by a three-legged structure that can be adjusted for accurate leveling. Additionally, the supporting camera rod can be rotated to several preset positions (angles, etc.) that can be locked in place by a locating pin which is located on the top of the platform of the three-legged structure.

Buckley et al. (2008) has proposed that the stereographic imaging technique is more accurate than both method (1) and the use of a long metal rod (steel rod, graduated rod, etc.) to measure the distances between the latrine slab and the pit contents. The belief of greater accuracy in measurement is because the level of solids accumulating in the pit is not level and often has a somewhat pyramidal shape due to the addition of material through the latrine hole (new material is concentrated in that area and can create a mound) (Bakare, 2012). To measure the distances between the latrine slab and pit content level, the volume of headspace above the pit can be calculated by integrating the height measurements across the now mapped surface of the pit contents. The accumulation rate can then be assessed by looking at the volume change of the headspace of the pit over time, or alternatively, by the change in distance between the average surface coordinate measured and the measurement point (see method (1) diagram to visualize the points just discussed).

Method (3), the automated laser scanner technique, shares some similarities with method (2) in that the surface of the pit contents is mapped in a similar fashion. The main difference is that the laser scanner is programmed to scan for a large quantity of points on the pit content surface and then output data is automatically converted to a table of coordinates.

This method is easier to conduct in the field than method (2), as exact placement of a supporting structure (3-legged structure) for every measurement and the use of preset angles and settings may not be required, and the data is automatically processed and converted. While not mentioned, it is assumed that the same methods for determining the accumulation rates in method (2) are also appropriate in this method.

3.6 Methods for Modelling of Accumulation Rates in Pit Latrines

Two studies were identified in the literature that provide models to determine the solids accumulation rates in pit latrines (Brouckaert et al., 2013; Todman et al., 2014). The first study (Brouckaert et al., 2013) in South Africa took measurements directly from the pit contents being removed from the latrine, and used data from the pit contents (water content, etc.) to estimate a degradation rate to help model accumulation rates in the latrines. The second study (Todman et al., 2014) was conducted in Ifakara, Tanzania and performed depth measurements of latrine pits for 12-18 months and used the data acquired to perform linear regressions as well as used data acquired from a sludge sample (water content, etc.) to generate estimated parameters and model the accumulation rates in the latrines.

3.6.1 Brouckaert et al. (2013) –South Africa Study

Brouckaert et al. (2013) obtained measurements from two latrines (in May 2010) in eThekweni Municipality, South Africa, to determine parameters for the modelling of accumulation

rates in latrines. In the study, the core part of the model considers only the portion of accumulated solids that consists of the material that is visually homogeneous (particles size of roughly 1 mm) and made up largely of biodegradable material. Importantly, because the origin of the solids accumulating in the pit is considered heterogeneous (different people, different fecal composition, etc.), the model is formulated on a volume basis to reduce complexities arising from density variations. As explained by Brouckaert et al. (2013), the component of the accumulated material that is composed of non-biodegradable material (refuse, solid waste, etc.) undergoes no biological transformation, and is therefore considered in isolation from the other materials in the pit; thus, it is not greatly considered in the modelling of the solids accumulation rate of the latrines. Also, during removal of the material from the pits, it was estimated that the volume of non-biodegradable material (large extraneous material) was 25% of the total accumulated material or 0.7 m³.

The two pit latrines assessed in the study were located in the same community in the eThekweni Municipality, and were viewed to have similar user profiles, geography and climate, and design/construction. The reported average number of users for both latrines was seven. The average pit depth of the latrines is 2 m, and the average cross-sectional area is 1.4 m²; both latrines were filled to within 0.2 m of the top of the pit. It was not discussed if the latrines were public-use or household, but given the small number of users it is suspected that the latrines serviced 1-2 households. Samples for the study were obtained during manual removal of the accumulated material, and taken at specific depths of the latrine pit during removal. The samples were taken at the top of the pit, 0.5 m below the top of the pit, 1m below the top of the pit, and 2 m (the bottom of the pit), and stored in lined, sanitized and sealed plastic containers.

The top most sample was collected from the first shovelful of the accumulated solids in the pit latrine. Using a graduated rod with 0.5 m, 1 m and 2 m markings (which was placed directly

in the full latrine pit), the samples were collected when the level of the pit contents remaining in the pit during removal reached the next marked height. The amount of material acquired for each sample was not documented, however, samples retrieved were greater than or equal to 100 g (50 g used to measure COD and 50 g used to determine composition of material).

To determine the sludge accumulation model, Brouckaert et al. (2013) used the following equations to determine rates of degradation, total volume of both biodegradable and non-biodegradable material at specific time periods and the general equation to assess the level of material in the pit at a certain age.

To begin analysis of degradation of the material in the latrine pit, one must consider an initial volume of biodegradable material (V_{bo}), an initial volume of non-biodegradable material (V_{ubo}), and a degradation in volume (m^3) of biodegradable material that will then form km^3 of new non-biodegradable material. The volume of new non-biodegradable material (V_{Nubo}) is assumed to be initially zero. Thus, the degradation rate of the biodegradable material was assumed as a first-order reaction:

$$\frac{dV_{bo}}{d\theta} = -r * V_b \quad (2)$$

where r is the rate constant of biodegradation ($days^{-1}$) of the pit contents and V_b is the volume of biodegradable material in the pit.

When the biodegradable material has remained in the pit for a specific time (θ), the non-biodegradable material formed due to degradation (V_{Nub}) during time (θ) is:

$$V_{Nub}(\theta) = kV_{bo}(1 - e^{-r\theta}) \quad (3)$$

where the initial volume of biodegradable material (V_{bo}) is subtracted by the remaining volume after biodegradation occurs to yield the amount of new non-biodegradable material (V_{Nub}) and the original non-biodegradable material present at age (θ) is $V_u(\theta) = V_{ubo}$ (the initial non-biodegradable material).

Thus, given the volume of solids in the pit (V_b), the amount of new non-biodegradable material (V_{Nub}), and amount of original non-biodegradable material at a given age (θ) (represented by $V_u(\theta)$), the total volume present in the pit at age θ is the sum:

$$V(\theta) = V_b(\theta) + V_{Nub}(\theta) + V_u(\theta) \quad (4)$$

where the total volume is equal to the volume of the solids in the pit plus the newly produced non-biodegradable material plus the original non-biodegradable material present in the pit. Using the proper substitution for $V_{Nub}(\theta)$ from Equation (3) and $V_u(\theta) = V_{ubo}$, the appropriate substitutions can now be made to change Equation (4) to:

$$V(\theta) = V_{ubo} + kV_{bo} + (1 - k)V_{bo} * e^{-r\theta} \quad (5)$$

where $(1 - k)V_{bo} * e^{-r\theta}$ represents $V_b(\theta)$ which is calculated by take the whole amount of solids in the pit and subtracting the amount of those solids that was newly converted to non-biodegradable material.

To now assess and determine estimated height of the pit contents in the latrine at specific times the below equation was developed. The ratio of the total volume present to the volume of originally non-biodegradable material at a given age (θ) is calculated using the following equation:

$$\phi(\theta) = \frac{V_\theta}{V_u(\theta)} = \frac{V_\theta}{V_{ubo}} = 1 + k \frac{V_{bo}}{V_{uo}} + (1 - k) \frac{V_{bo}}{V_{ubo}} e^{-r\theta} \quad (6)$$

where Equation (5) was simply divided by the non-biodegradable material (V_u) at a given age/time (θ) to yield Equation (6). Equation (6) can now be used to estimate the height of the entire pit contents in a latrine (assuming known pit dimensions) when the pit has been in use for a set time, such as from time, T (i.e. since the pit started accumulating).

Additionally, using Equations (5) and (6) and the ratio of original biodegradable material to biodegradable material ($\times e^{-r\theta}$), the fraction of the biodegradable material present in the pit can be calculated over a specific time or at a particular pit level. The following equation (with the proper substitutions) yields the fraction of biodegradable material present in the pit contents:

$$\beta(\theta) = \frac{V_b(\theta)}{V(\theta)} = \frac{\frac{V_{bo}}{V_{ubo}} e^{-r\theta}}{1 + k \frac{V_{bo}}{V_{ubo}} + (1 - k) \frac{V_{bo}}{V_{ubo}} e^{-r\theta}} \quad (7)$$

where the biodegradable pit contents at time θ are divided by the total volume of the pit contents at time θ to yield a ratio of volume of biodegradable material to overall material in the pit.

Assumptions were made in the model that the amount of material discarded into the pit latrines was constant. Therefore, assuming that a constant rate of addition of material in the latrine pit over the tested time period (from t to T), the total volume of material in the latrine pit for that time period can now be calculated:

$$V(t, T) = R_u * T \int_t^T f_u(\tau) * \phi(\tau) d\tau \quad (8)$$

where the appropriate substitutions can be made for $\int_t^T f_u(\tau) * \Phi(\tau)d\tau$ to now yield:

$$V(t, T) = R_u \left[\left(1 + k \frac{V_{bo}}{V_{ubo}} \right) (T - \tau) + \left(1 - k \frac{V_{bo}}{V_{ubo}} \right) \frac{(e^{-rt} - e^{-rT})}{r} \right] \quad (9)$$

where $V(t, T)$ corresponds to the volume of material in the pit (level of material in the pit) at time (t), R_u is the rate of addition of non-biodegradable material, and the latter part of the equation corresponds to the fraction of biodegradable material that exists from time, T (beginning of accumulation) to time, t (any time after the beginning of accumulation), where $0 < t < T$.

The data acquired from the equations can be used to determine values for the fitted parameters used in the model. The values for R_u , k (yield of non-biodegradable matter resulting from degradation of biodegradable material), r and V_{bo}/V_{ubo} (ratio of biodegradable to non-biodegradable material) as well as several parameters determined from analyzing the ash added to the latrine pit were inputted into the model to assess different relationships such as the accumulation rate against the % of non-biodegradable material in the feed to assess years until fill up of the latrine.

3.6.2 Todman et al. (2014) –Tanzania Study

For the study (Todman et al., 2014), fifty latrines in two villages, Sululu and Signali, and in the town of Ifakara, Tanzania were monitored and assessed for 18 months. The inhabitants of both the villages and town are involved with subsistence agriculture, and their diet is predominantly vegetarian. Households were located within the village, and the latrines were placed outside of the compound. Average users per latrine ranged from two to fourteen users.

All of the latrines monitored were constructed in soil and had an average depth of approximately 2 m. The accumulation rates of the 50 latrines were measured every two months

over the 18 month period. A laser level sensor (similar instrument used in method (1) in Section 3.5.1) was used to measure the level of the solids below the ground level. These measurements were then used to infer an accumulation rate using linear regression (where the slope of the line was estimated to be the average accumulation rate). The linear regression was conducted utilizing the MATLAB algorithm *robustfit* which iteratively reweighted least squares with the bisquare weighting function.

To determine the average number of users, the users were given a survey to complete to estimate the number of users of each latrine pit in the community. Each time the solids level in the pit was measured, surveys were given to the users. By consistently acquiring user data, the researchers were able to establish a more accurate user average per latrine because fluctuations in use and population were considered throughout the study. To determine when the latrines had been constructed, detailed questions about latrine age were given at the onset of the investigation. The age of the latrine, used by the data recorded in the survey, took the initial start time (t_1) which was defined as the user approximated age of the latrine (time elapsed since last emptying of pit) with $t_2 = t_1 + 1$, where t was presented in days for analysis.

To best quantify the average fecal generation mass of users, 15 stool surveys were conducted amongst households in the testing sites. The mass, Total Solids (TS) and Volatile Solids (VS) were determined for men and women in the area as well as an average stool weight.

At the end of the study, solids samples were acquired from the top and bottom of the pits and analyzed for TS and VS, which was used to help estimate the hydrolysis constant. Solids samples were placed in enclosed 1 L containers with 100 mL of anaerobic water. The gas production of the samples was then measured, and the hydrolysis constant was fitted to the gas production data to help estimate a rate of degradation for the samples.

To determine an appropriate accumulation model, the following equations were used, along with the experimental data, to determine both model inputs and parameters. To determine the volume of degradable material entering the pit, the VS fractions were used, assuming all initial VS are considered biodegradable.

$$V_{s,dry}(T) = Q_{in}f_{ts0}N \{1 - f_{vs0} + kf_{vs0}\}T + (1 - k)f_{vs0} \frac{1 - e^{-rT}}{r} \quad (10)$$

where $V_{s,dry}$ (m³) is dry volume of accumulated solids, T (days) is the estimated age of the latrine pit, Q_{in} (m³/person-day) is volume of feces that enters the latrine pit per person per day, f_{ts0} is the volume fraction of TS in feces, N is the number of users of the latrine, f_{vs0} is the volumetric fraction of VS as a fraction of the TS, r (day⁻¹) is the hydrolysis constant, and k is a representation of the volume of material that remains in the latrine pit after degradation occurs (which is expressed in this study as fraction of VS). While in the previous study discussed (Brouckaert et al., 2013), k represented the non-biodegradable products and the microbial biomass; in this study k was determined by averaging the VS present at the bottom of the latrine pits.

To determine the volume of the pit contents, Todman et al. (2014) used the following equation:

$$V_s(T) = \frac{V_{s,dry}(T)}{(1 - f_w)} \quad (11)$$

In Equation (11), V_s (m³) is the volume of the pit contents at a given time (T), and f_w is the volume fraction of water in the pit contents that cannot drain. In this study, the assumption was made that free water could infiltrate easily and quickly into the soil. This assumption was based upon

infiltration tests on the soil at the surface of the ground and suggested quick infiltration into the soil. While the authors acknowledge that infiltration may be different among the lower soil profiles, as well as from pore clogging, data to quantify these effects is scarce and proves difficult to simulate the process of infiltration at lower soil profiles.

To calculate the accumulation rate of the latrines, the change in volume was considered along with the pit area, to yield the following equation:

$$F = \frac{1}{A} \frac{V_s t_2 - V_s(t_1)}{t_2 - t_1} \quad (12)$$

where F is the accumulation rate (fill rate), A is the pit area, and t_1 and t_2 are the start and end times. Thus, by using the appropriate substitutions for V_s (see Equation (10)), the accumulation rate, F , can be simulated by the following equation:

$$F = \frac{Q_{inf} t_{s0} N}{A(1-f_w)(t_2-t_1)} \left[1 - f_{vs0} + k f_{vs0} (t_2 - t_1) + (1 - k) f_{vs0} \frac{e^{-rt_1} - e^{-rt_2}}{r} \right] \quad (13)$$

where Equation (13) does not include the addition of other waste into the pit (solid waste, greywater, etc.). Contrary to the previous study where roughly 20% of the pit contents was considered non-biodegradable material, the latrines tested in this study in Tanzania had very low levels of other materials disposed into the latrine pits. Of the 50 latrines studied, only four latrines had old clothes found in the pit; thus, the addition of other materials was neglected.

To calculate the fraction of VS in the pit contents at a time t (days), the following equation is used:

$$f_{vs}(t) = \frac{kF_{vs0} + (1-k)f_{vs0}e^{-rt}}{1 - f_{vs0} + k f_{vs0} + (1-k)f_{vs0}e^{-rt}} \quad (14)$$

where the top part of Equation (14) measures the quantity of VS at time t (amount of VS subtracted by the remaining VS after degradation at time t), and the denominator represents the remaining TS in the pit contents at time t (1 subtracted by the initial VS plus the amount of VS remaining after biodegradation). Equation (14) can then be used over a range of times (from beginning of pit life to any age of the pit). The V_s values from Equation (14) over the time range analyzed can then be used to calculate the approximate depth (d) of material in the pit:

$$d = \frac{V_s(t)}{A} \quad (15)$$

where the range of depths calculated can then be graphed and analyzed to estimate accumulation rates of the tested latrines.

3.7 Best Methods for Measuring Accumulation Rates in Rural Areas

Several methods have been discussed that can be used to measure accumulation rates in pit latrines. However, several of them require technology (stereoscopic digital equipment, computers with the proper technical software, etc.) that is not found or available in rural communities in developing countries. Thus, the methods that can be used to measure accumulation rates in latrines in rural areas are limited. The most likely methods that can be used involve the use of less complex resources, such as method (1), the laser distance meter technique, which was partly used by Todman et al. (2014) to measure and then model accumulation rates in latrines in Tanzania, or

similar methods that involve measuring pit to slab distances with items such as metal rods (graduated rods) placed into the pit (Mills et al., 2014).

Another difficulty may be ways to accurately measure biological samples, such as stool samples, water content, VS, TS, COD and BOD, which all can be used to help assess the biodegradation of the materials in the pit latrine. Resources that would easily exist in scientific labs and medical institutions can be lacking in rural communities.

CHAPTER 4: RESULTS AND DISCUSSION

The main objectives of this thesis were to: (1) perform a literature review on characteristics of solids excreted and/or disposed of into latrine pits and solids accumulation rates measured in pit latrines in developing countries, (2) assess the possible effects of female processes (excretion of menstrual fluid, disposal of feminine waste products) on accumulation rates in pit latrines, and (3) assess methods to measure solids accumulation rates in latrines to determine best methods for local assessment of accumulation in rural settings. Chapter 2 discussed the characteristics of solids and material present in the pit of a pit latrine, and also assessed the potential effects of both feminine processes and waste on accumulation rates in pit latrines. Chapter 3 discussed different methods that were used to both measure accumulation rates and model accumulation rates, and briefly discussed the most likely methods to use in rural settings.

While the objectives of the research were mainly discussed in the previous chapters, this chapter discusses the reasons for the lack of data presented and discussed in the study, the results obtained in the short study of pit latrines at rural schools in Saclepea City, and limitations in obtaining accurate slab to pit content depth results.

4.1 Reasons for Lack of Slab to Pit Content Depth Data

As mentioned previously in this thesis, evacuation of the thesis author from Liberia due to the Ebola Virus Disease (EVD) epidemic was the main catalyst for the incomplete research, and the lack of sufficient data to show accurate and definitive conclusions of solids accumulation in

pit latrines at rural schools in Liberia. The data that was obtained for the four measurement periods that were taken for the slab to solids depth are presented and discussed.

It should be noted that measurements for Johnny Voker High School (JVS) are not presented. The data was misplaced in the evacuation process (10 hour period between notification of evacuation and actual leaving from site to the capital city of Monrovia) and unfortunately left in Saclepea City, Liberia; therefore the JVS slab to pit content depth data cannot be presented in the study. The preliminary data of the latrines (see Table 6) which was compiled at the beginning of the measuring period, previous to actual depth measurements, was documented for JVS. The main reason for the misplacement of data was due to it being contained in a separate notebook. The school at JVS has a fence around it and therefore measurements were conducted on a slightly different schedule due to the availability of the Principal, Mr. Harding Gontee, or other school officials with keys to open the campus for measurement. At the time it proved a valuable way to organize the data; however its negative implications are now strongly felt.

4.2 Depth of Pit Contents

The depth from the slab (including the slab thickness) to the surface of the pit contents was measured for four VIP latrines at the Red Cross School, four latrines (2 VIP and 2 Traditional) at the ULICA Mission School, and three VIP latrines at JVS (data is not presented because it was misplaced during evacuation). One measurement of depth was done for each slab to pit content depth for each latrine assessed. Table 7 shows the depth measurements taken for the latrines at Red Cross School and ULICA Mission School. Additionally, the table also includes the type of latrines and the function of latrines (i.e. student latrine, staff latrine, etc.). This distinction was most valuable for the JVS latrines because several latrines were locked and only used for specific populations such as the pre-k/kindergarten populations or faculty and staff.

Table 7 Slab to Pit Contents Depth Measurements for Latrines

School	Latrine Type	Function	Latrine Title	Pit Depths (cm)			
				3-May & 4-May	17-May	1-Jun	14-Jun
JVS	VIP	pre-k latrine	JVS-B2	n/a	n/a	n/a	n/a
JVS	VIP	teacher lat.	JVS-B3	n/a	n/a	n/a	n/a
JVS	VIP	sch. latrine	JVS-B4	n/a	n/a	n/a	n/a
JVS	VIP	sch. latrine	JVS-G1	n/a	n/a	n/a	n/a
RCC	VIP	sch. latrine	RCC-M1L	95.5	96	96	95.6
RCC	VIP	sch. latrine	RCC-M2R	95.5	96	96	95.5
RCC	VIP	sch. latrine	RCC-F1L	105.7	106.5	106	105.75
RCC	VIP	sch. latrine	RCC-F2R	105.7	106.5	105.5	105.75
ULICA	VIP	sch. latrine	ULICA-1A	119	119	117	120
ULICA	VIP	sch. latrine	ULICA-2A	134.5	133.75	135	135.5
ULICA	VIP	sch. latrine	ULICA-4A	137.5	137.5	138	138
ULICA	Traditional	sch. latrine	ULICA-2B	340	340	341	340
ULICA	Traditional	sch. latrine	ULICA-3B	316	315	315	316

The measurements for the latrines were taken at roughly two week intervals. Other studies took measurements at longer periods of time, such as Todman et al. (2014), which took slab to pit contents depth measurements of latrines in Tanzania every two months. While another study (Mills et al., 2014) measured the actual depth of pit contents (top of pit contents to bottom of latrine pit) of sanitation facilities in Indonesia at the assessment period (measurements only occurred one time). Thus, given the variety of measurement periods and measuring methods, the tested measurement period may be deemed acceptable.

The depths presented in Table 7 do not show a great difference in values with time for all latrines. In fact, most measurements are either consistent or decrease/increase by small amounts (1-3 cm). The depths of the traditional latrines at ULICA Mission School had the deepest depths of all of the latrines measured. The depths were roughly 180 to 220 cm deeper than the VIP latrines at ULICA Mission School and Red Cross School. One possible explanation is that the traditional latrines have not been in consistent use, and a large portion of the pit contents have been degraded

and begun stabilizing. This assumption is made due to the relatively hard surface of the pit contents and the absence of visible water or liquid in the pit contents (as seen through the pit hole with a headlamp). The small increases seen in the depths in the traditional latrines is most likely due to error in the measuring process by the thesis author (results expected should have yielded a decrease in depth due to the assumption that little to no new material was being added).

The latrine pits of the seven VIP latrines tested had pit contents with much shallower depths and relatively similar depths to one another. The shallowest depth was in the boys' latrine at the Red Cross School, with depths of 95.5 cm to 96 cm. The two pit holes in the boys' latrines shared similar results because they shared the same pit. The relatively equal depths suggest that the pit holes are used at very similar rates.

Interestingly, the girls' latrine depths were deeper than the males by about 10 cm although the same pit was shared for all latrines. This may be a result of several factors. One factor is that the girls' latrines were used less than the male latrines. Unfortunately, because surveys were not provided to the students to assess user usage, etc., it is an assumption of the thesis author. When the thesis author had asked female students at JVS (unable to ask at Red Cross School or ULICA Mission School) in passing if they used the latrines, female students' reported reasons for not using the latrines included fear of getting infections from the pit by squatting over the latrine pit, or that they preferred to use latrines at their home because school latrines were not clean.

Another possible factor for the greater depths may be due to the pit itself. If the pit was not leveled at the bottom, it may be that the contents slid to the boys' side of the latrine pit causing the depth to increase faster. The ULICA Mission School VIP latrines had depths of between 119 cm and 137.5 cm. Similar to the Red Cross School VIP latrines, the ULICA Mission School VIP latrines all shared a common pit. The superstructure for the latrines at ULICA was estimated to

be one to two feet shorter and one third smaller in area and height than the latrines at Red Cross School and JVS.

The latrines were not gender specific, therefore it is unknown if certain VIP latrines were used by one gender over the other. The different depths within the pit may suggest that the first (ULICA 1) latrine hole in the four latrine superstructure was used far more frequently than the other two latrine holes (ULICA 3 and ULICA 4). Another likely explanation is that the pit itself is not level and perfectly rectangular, and causes increased accumulation of material on one side of the pit. This seems possible given the relatively similar depths ULICA 3 and ULICA 4, which showed differences of only about 3 cm, with the latrine closest to the left-side (ULICA 1) showing a shallower depth from the slab to the pit contents than the far right latrine (ULICA 4). Figure 24 better shows the increasing pit depth from right to left at ULICA Mission School.

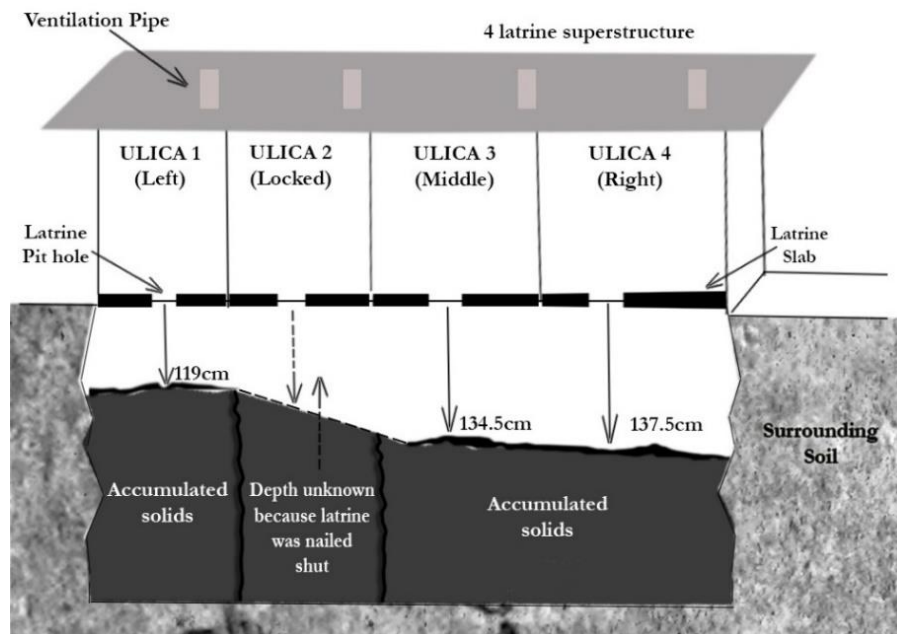

Figure 24 Side View of ULICA Latrines with Slab to Pit Contents Depth

Despite the differences within the depths of the latrines compared to one another, specifically the traditional latrines versus the VIP latrines, the overall depth changes per each latrine hole were very small (1-3 cm). There are a few likely explanations for this occurrence. It is very feasible that the latrines were not in regular use during the testing period as school was not in session, which both decreases the accumulation rate and may decrease the level of degradation in the pit. Nwaneri (2009) suggests that a high presence of microorganisms, which are introduced into the pit through fresh feces and other organic materials (some anal cleansing materials, leaves, etc.), can promote a higher level of degradation. Therefore, a lack of fresh feces and organic material may decrease the input of microorganisms needed to continually degrade pit contents.

Another reason may be due to the fact that since the measurements in this study were taken relatively close together (two weeks apart) there was no significant change in the degradation of the contents, particularly if there was no addition of material to the pit. Because anaerobic degradation (i.e. no oxygen) is significantly slower than the aerobic degradation process (Nwaneri et al., 2008) that is said to occur in the first and second layers of the pit (see Figure 9, Section 2.6, Chapter 2), the rate of degradation in the tested school latrines may be small if the rate of aerobic degradation is small or no longer occurring.

Another possibility, and the most likely, are errors that occurred within the measuring process. The measuring apparatus used was marked at 30 cm intervals along the entire length of the segmented metal tent rod. The measurement markings were made with white correction fluid, with the bottom of the marking line representing the 30 cm mark. However, human error when making the markings could have resulted in differences of a few millimeters in the markings which could add up to a centimeter or two of error in the overall measurements.

Furthermore, human error occurring during the measuring process may have also resulted in errors in measurements. An inconsistent measuring of the depth using the 30 cm markings, such as accidentally measuring from the center of the mark or the top of the mark instead of the bottom of the marking, could account for additional error in the latrine pit depths. Measuring the depths in triplicate may reduce the error in the depth measurements because an overall average depth obtained from several measurements may have more accurately measured the pit depth under the latrine hole.

Additionally, the pits were only tested in the latrine pit hole area, where the pit content level may be slightly elevated compared to the overall height of the pit as the newer material tends to mound in the area under the latrine hole. This is considered to be a small error, as most pits did not seem to have the presence of much new material (the pits were relatively dry or slightly moist (Red Cross School latrines)).

When lowering the measuring apparatus into the pit the measurements were taken when the coffee container rested on top of the pit contents. Because the inside of the latrine pit is extremely dark, the apparatus had to be lowered until it rested on the pit contents and the placement then viewed using a headlamp. The dark interior of the pit did not allow for a great visual of the other parts of the pit to make a surface level comparison, which may be why the pit contents showed similarities in depths. Also, the coffee container was likely placed on the highest part of the pit contents because it could only be measured through the circular part of the latrine hole. Because the degradation processes of the pits are not completely known (what stages of degradation are occurring at what material levels) nor is there enough information to predict a degradation rate, it is unclear why there is very little difference in the latrine depth measurements, and why some latrines saw a slight decrease in the overall depth from the slab (suggests an increase

of material in the pit despite the assumption that little to no material seemed to be added during the measuring timeline).

4.3 Estimated Accumulation Rates

Accumulation rates can be measured with several different methods as described in Chapter 3. Unfortunately, due to several limitations including lack of data, resources and time, an estimation of accumulation rates at JVS, Red Cross School and ULICA Mission School could not be completed. While depth measurements were obtained for the month of May 2014 and part of June 2014, the results yielded very similar depths, which could suggest accumulation rates that are very small. Additionally, the number of users of the latrines as well as the characteristics of the pit contents, such as the water content, a measure of the COD and BOD as well as a measure of other useful information in the pit contents was not completed.

Without pit content samples and user rates and numbers, as well as known pit measurements and areas of the latrine pits, estimates of accumulation rates cannot be adequately calculated in this study. This is because all of the equations provided in this study (see Equation (1), Section 2.4, Chapter 2, and Equations (2) – (15) presented in Section 3.5), require most or all of the information just listed in order to calculate and estimate accumulation rates.

4.4 Potential Issues and Limitations

There were several issues and limitations to this study. The largest issue and limitation was the lack of data: latrine pit measurement data (area and original depth of the latrine pit), slab to pit contents depth data, pit content characteristic data and data obtained via survey from latrine users. The lack of data was a direct result of the thesis author's evacuation due the EVD epidemic in Liberia.

4.4.1 Pit Content Samples and Depth Measurements

Samples of the school latrine pit contents were not able to be obtained due to time and resource limitations. Samples of the pit contents could have allowed for testing of the water content, COD, BOD and other factors that could be used to help determine and potentially estimate degradation rates of the pit contents. Tests of pit samples were taken in several studies, particularly the two studies discussed in Chapter 3 (Brouckaert et al. 2013; Todman et al., 2014), which used the data to estimate hydrolysis rates of contents as well as other parameters which were then used as inputs to model accumulation rates.

The lack of pit dimensions of all of the latrines studied was also a limitation in the study. The entity responsible for the construction of the latrines at JVS was unknown to the faculty and staff at the school. The Red Cross School latrines were constructed by UNICEF, but could not be reached despite several communication attempts, and the ULICA Mission School latrine construction was assumed to have been done by the Mission. The information for the ULICA latrines was to have been acquired when the Fall 2014 school semester began. Measurements of the pit dimensions proved impossible given the available measuring tools (tape measure, ruler), and the length and width of the latrine pit being very large for Red Cross School and ULICA Mission School latrines (four latrine stalls to one pit).

Measuring of the school latrine depths began at the beginning of the summer vacation (May 2014) for the schools. The plan for this research was to use the measurements taken during the summer as preliminary measurements to establish depth before regular use of latrines resumed. Additionally, it was thought that the summer testing period could be used as a way to improve the measuring process and allow for the attainment of needed materials, such as a laser tape measure,

to more accurately measure the depth measurements when school began in August 2014. Unfortunately, due to time constraints, testing by using a laser tape measure did not occur.

As seen in Table 7 (Section 4.1, Chapter 4), the data retrieved for the slab to pit content depths in the latrines were very similar for each latrine in the testing period (early May to mid-June). Most likely human error involved with measuring of the depths was the cause for the data similarities. Inaccurate measurement markings on the rod, too large of a measuring scale (cm may have been too large to measure very small changes), potential over or under estimates caused by measuring the rod while it was in the pit using a ruler or measuring tape, inaccuracies in the mental math of the thesis author, and potential estimates based on previous data may have been the culprits in the data outcomes. It has also been suggested by the thesis author that the degradation of pit contents was relatively low as little to no material was considered to be added to the latrines, probably because school was no longer in session.

4.4.2 Sample Size Limitations

The sample size reported for this study was 9 latrines (initially 12 latrines with JVS). The three schools were chosen due to proximity with one another as well as similar compositions in school populations (all schools have the same range of grade levels). The data for three latrines at JVS were excluded in this study. As mentioned previously in this section, the JVS latrines were not included because the data was left in Saclepea, Liberia during the evacuation. Additionally, previous to the misplacement of data, three boys' latrines, three girls' latrines and one unisex latrine at JVS were initially not included in the study because the latrines were locked and therefore not accessible to the thesis author for testing. The three girls' latrines were both locked and the location of the key unknown by the staff and faculty of JVS.

There were several latrines that were excluded in the study at the ULICA Mission School. One VIP latrine at the school was excluded because the door had been nailed shut which prevented testing of the latrine pit. Two traditional latrines at the school were also excluded. One of the latrines was overgrown with foliage and broken down, which made it both difficult to enter the latrine area as well as it was assumed to use the latrine. The other traditional latrine was located at the end of the set of latrines. When the thesis author attempted to lower the measuring apparatus into the latrine pit, animals suspected to be bats were seen flying around the pit, possibly due to the presence of a foreign object entering the area. Because fruit bats are considered to be carriers of EVD and the type of bat in the latrine was not identified, the latrine was thus excluded for safety reasons. All latrines at the Red Cross School were included in this study as all were unlocked and easily accessible to the thesis author.

4.4.3 Test Subjects and Lack of Survey Data

The subjects in this study were the students, faculty and staff at the three schools: JVS, Red Cross School and ULICA Mission School. All three schools had grades pre-k through twelfth grade. Unfortunately, the numbers of registered students and the number of current faculty and staff were not obtained for the study. The number of registered students and present faculty was going to be assessed after the first month of the Fall 2014 school semester by obtaining the information from the school registrars. The month long wait period was to account for late student registration as well as the removal of students who could not pay the registration fees. Typically, it took a month for final registration to be completed (all paid students in school and all non-paid students put out of school).

A survey was created for both the student populations as well as the faculty and staff populations at the schools. Unfortunately, due to the Peace Corps evacuation of volunteers as well

as the timing involved with achieving IRB approval, the surveys were not administered to the test populations. Instead it was determined that an amendment could be made to add a few questions to the survey done by another Peace Corp Volunteer also serving in Liberia, which had received IRB approval (Ness, 2015). Unfortunately, again, the evacuation due to the EVD epidemic made that impossible to pursue.

A study done at a government high school in Zwedru, Grand Gedeh County, Liberia (the neighboring county to the East of Nimba County) was conducted by a fellow Master's International student and Peace Corps Volunteer (Ness, 2015). In the study, the population of the school was surveyed on questions that sought to determine user preferences of latrines at the school. Information that was surveyed also included use of latrines by the using population. While the sample size (709 students) and location are different, the data provides some insight into use of school latrines. Figure 25 provides the percentages of student answers to the question: Do you use the school latrines?

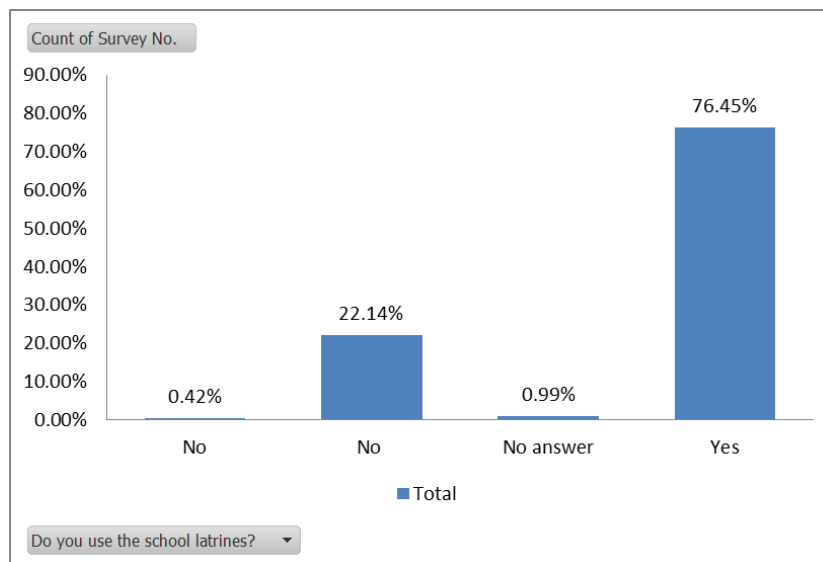

Figure 25 User Rates at School in Zwedru, Grand Gedeh County, Liberia (With Permission, Source: Ness, 2015)

The study found that roughly 76 – 77% of students surveyed reported using the school latrines. Additionally, the study also found that 26% of students reported using the latrines every day, 30.5% reported using the latrines two to three times a week and 31% reported using the latrines one time a week (Ness, 2015). Thus, it can be determined that the students that reported using the school latrines appear to do so on a fairly regular basis.

While the tested population for the Ness (2015) study is different than the test population for this study, the data acquired may be similar to what would have been acquired if this study had been completed. This is because the test populations were of a similar age and composition, and both schools were government schools in neighboring counties of Liberia. Therefore, the information was provided in this thesis to show possible user rates of school latrines in Liberia.

CHAPTER 5: CONCLUSIONS AND RECOMMENDATIONS

5.1 Overview and Conclusions

Given the large range of accumulation rates provided by literature, which range from 18 L/person-year to 70 L/person-year (see Table 5, Section 2.7, Chapter 2), it is difficult to both assess and determine solids accumulation rates that can be universally relevant. While values of accumulation rates reported by Wagner & Lanoix (1958) based on World Health Organization data from Brazil in the 1950's, and rates established by Franceys et al. (1992) are still used by many organizations today to build latrines, particularly in emergency situations (Harvey et al., 2002), the rates are 30 to 60 years old. In addition, changes in diet, lifestyle and knowledge of health and sanitation have changed in the past 30 – 60 years (WHO/FAO, 2003; William & Lewis, 2009). Thus, it is unreasonable to assume that solids accumulation rates from the past are completely relevant to this day and age.

Solids accumulation rates of sanitation facilities, specifically latrines, are highly subject to both the local environment and the local user of the latrines. Therefore, stool surveys of user populations and user surveys with local populations should be conducted to best assess user usage as well as the materials used and disposed of into the latrine pit. Because solids accumulation rates are the amount of material deposited in the pit minus the amount of material that is biodegraded, the local understanding of what material (amount of fecal material, anal cleansing material, solid waste, etc.) is deposited into the latrine pit at what rate is very important.

There are several methodologies that can be used to measure accumulation rates. Of the three methods discussed in this thesis, it was determined that the laser distance meter technique

(method (1)) and the use of a graduated rod to measure slab to pit content depths were the best methods to use to determine accumulation rates in the field in rural communities. The methods are considered best because neither requires sophisticated measuring equipment, the measuring materials (laser and graduated rod) do not require additional resources such as access to electricity, and the level of technical knowledge needed to use the equipment is low. While the other methods are considered more accurate, the stereographic imaging technique (method (2)), and the automated laser scanner technique (method (3)) required superior camera and computer technology that is not found in most rural communities. Brouckaert et al. (2013) did obtain measurements by collecting sludge samples to determine COD, BOD, VS and other biological determinants of the sludge to model the accumulation rates; however, the method requires a pit emptying system and access to laboratory equipment. Thus, the method is also considered too technical to be used in many rural settings.

The measurements performed in this study used the rod measuring system to perform slab to pit content depth measurements. The two traditional latrines measured showed the deepest depth measurements, which suggested a lower level of use compared to the other seven VIP latrines and also a potentially increased amount of stabilization of the pit contents, due to the depth, hardness of the pit content surface, and absence of any noticeable liquid. The seven VIP latrines tested revealed to have the same measurements of depth per latrine in all tests. While this is probably largely due to measurement error, the usage of the latrines was considered to be low because school was no longer in session, and without the disposal of new material into the pit the aerobic degradation process was expected to be low. Thus, the degradation of the pits in the latrine may be undergoing mostly anaerobic degradation which is much slower than aerobic degradation.

Recommendations for using the measurement techniques developed for this research include measuring the slab to pit contents depth in triplicate to more accurately assess the actual depth from the slab to the pit contents in school latrines. Ideally, the use of a laser measuring device is believed to be the most accurate tool for measuring depths of contents in pit latrines. However, if unavailable it is best then to find a means to use the design apparatus developed in this study (or similar design) to perform angled measurements of the pit contents which would provide for a better analysis of the pit content depth and variations of pit content surface level in areas further into the pit (and not just below the pit latrine hole).

The surveying of potential users at schools is another important item, particularly to assess the number of users that use the latrine, the behaviors of the students (e.g., anal cleansing materials, solid waste disposal, feminine waste disposal), reasons for not using the latrines, overall perceptions of the latrines, and general idea of acceptance or non-acceptance of school provided sanitation. It is recommended that all levels of students – primary, junior and senior-high students – be surveyed to understand all of the behaviors of the entire student population in regards to on-site sanitation. Additionally, surveying faculty and teachers can provide insight into knowledge gaps that exist between the two populations (students and teachers) and ways to improve communication and sanitation access at schools.

5.2 Practical Implications of the Study

As mentioned previously, latrines act as both a storage container for excreted waste and also as a barrier in the fecal-oral transmission disease cycle. Latrines and other improved sanitation facilities are imperative to prevent contamination of food, water, surfaces and other areas by excreted pathogens. This is evidenced by Exley et al. (2015) who found the presence of *E. coli* in pit latrines to be much more prevalent in latrines without hygienic slabs or with broken slabs.

Thus, better constructed, maintained and improved latrines can help prevent the spread of pathogens, such as *E. coli*, which can be responsible for diarrheal illness.

Utilizing global exposure data and exposure-risk relationships, Pruss-Ustun et al. (2014) determined that the main determinants for diarrhea deaths were inadequate drinking water, inadequate sanitation, and inadequate hand hygiene. These authors reported that approximately 842,000 diarrheal-related deaths are attributed to these determinants, with 280,000 deaths resulting from inadequate sanitation. While solids accumulation rates may not be identified as a direct factor in promoting health, the proper design of a latrine pit to serve the needed population for the designed time is a direct factor. Though this study is focused on assessing how fast the latrine pit fills up through accumulation of solids, it also discusses the importance of determining accumulation rates to better design latrines to serve their main purpose of reducing excreta-human contact and therefore improving overall health. Additionally, solids accumulation rates directly influence the life of a latrine. If latrines keep filling up too rapidly based on incorrect solids accumulation data, then provisions of sanitation facilities will continue to decline and create a further health risk.

Furthermore, children are much more susceptible to diarrheal illnesses and are at a greater health risk when exposed to excreted pathogens in developing countries where sanitation and clean water facilities are lacking (UNICEF/WHO, 2009). This is evidenced by the lack of inadequate sanitation facilities as observed in this study by the very large student-to-toilet ratio at all of the schools tested in this study, as well as the high mortality rate of under-five children in West Africa. It is therefore imperative that latrines be designed correctly for children, which falls in line with this study's aim to assess solids accumulation rates at schools to accurately provide the correct pit

depth designs to properly store feces and improve the sanitation facility's role as serving as a barrier to the fecal-oral disease transmission cycle.

Assessing solids accumulation rates of sanitation facilities at schools appears to be a new research topic. No literature was identified in this study that directly test solids accumulation rates of school sanitation facilities. The implications for proper testing and determining rough design accumulation rates of solids in latrines are numerous. From assessment, average depths of latrine pits can be established as well as potential behaviors of users at school. This can then provide further information for establishing rough cost estimates of construction and reinforcement of the pits, expected average design life of school latrines, estimates of user behavior, and the result of accumulation due to breaks in the school schedule (winter and summer breaks) and possible effects on accumulation from lack of new material being added to the pit for periods of time.

Recent efforts in South Africa have been pushing to make menstrual cups more affordable and available for use to women. One study suggests that women reported they would use the menstrual cups if both available and affordable, and found the cups significantly better for comfort, collection of menstrual excretions, quality, and appearance (Beksinska et al., 2015). The respondents also reported that there may be a pool of potential users of menstrual cups in more rural and low-resource areas. While the use of menstrual cups could significantly reduce the solid waste disposed into on-site sanitation facilities (i.e. latrines, pour-flush and even sewerage systems) which could reduce overall solids accumulation rates, the requirements needed for the use of menstrual cups may not be satisfied in low-resource settings. One of the main requirements for menstrual cups is the use of potable water for cleaning. The WHO/UNICEF Joint Monitoring Programme for Water Supply and Sanitation reports that 64% of the population in Sub-Saharan Africa has access to an improved drinking water source (WHO/UNICEF, 2014). Thus, 36% of

people in Sub-Saharan Africa do not have access to improved water, therefore rendering women within this underserved population the inability to use or maintain the level of cleanliness that a menstrual cup requires. The implications for infection or health problems caused by using a menstrual cup with improper means for cleaning may be large. Thus, in order to promote the use of menstrual cups, reduce the solid waste presence in on-site sanitation facilities and reduce accumulation rates, direct communication between sanitation and water quality designers and female menstrual product promoters, researchers and developers is imperative.

5.3 Recommendation for Future Research

Three main research recommendations from this study concern the following topics: more in-depth research into the degradation effects and process rates that are occurring in pit latrines, assessing solids accumulation rates of pit latrines in schools, and assessing the potential effects of feminine waste on solids accumulation rates within latrine pits as well as the potential effects of menstrual excretions on pit degradation.

Research has been done to assess the biological and chemical processes that pit contents are undergoing in the pit latrine as well as the pit contents characterization (Buckley et al., 2008; Nwaneri et al., 2008; Nwaneri, 2009). Buckley et al. (2008) suggests that aerobic degradation exists and is dominant at the top most surface layer of the pit contents, and that the lower layers undergo anaerobic degradation until stabilization. Studies, such as Bakare et al. (2012) assessed pit content samples at varying depths to determine the characterization of the contents. Results from Bakare (2012) found that COD levels, which indicate the degree of degradation of organic material in the pit contents, decreased with depth, which suggests that the degree of stabilization of latrine contents increases with depth. Nwaneri (2009) also found similar results. However, in Bakare (2012) the degree of stabilization was found to vary drastically among the test latrines.

Therefore, more research should be done to assess degradation rates within the separate layers of pit latrine contents to better understand the rate of the processes that are occurring in the pit latrine, particularly in relation with depth. Additionally, Mills et al. (2014) suggested that complete removal of pit contents can slow down the level of degradation by nearly two years of newly added material to the pit. It was suggested by Mills et al. (2014) and others that leaving a small amount of old material in the pit can reduce the period of time of degradation of pit contents after pits have been emptied. Further research on this topic could prove valuable, particularly in South Africa and other regions, where pit emptying campaigns are ongoing.

There were no studies yet identified by the thesis author that have assessed accumulation rates of latrines at schools. Much of the research discussed in this study was for household latrines, or latrines that were assumed to serve a few households given the site descriptions and user numbers provided in the studies (Still et al., 2002; Still et al., 2009; Still et al., 2012; Mills et al., 2014). Harvey et al. (2002) and (2007) discuss the construction and design of school latrines in emergency situations, such as in refugee camps. The rates recommended for use are rates identified by Franceys et al. (1992) and reported in this thesis in Table 2, Section 2.4, Chapter 2, however Harvey (2007) does recommend using local rates when available.

The proper maintenance and user life of latrines is paramount, especially in schools, because children are at very high risk for illnesses, such as diarrhea, that can be caused by inadequate water and sanitation (UNICEF, 2012). Analyses of accumulation rates at schools of varying student populations can provide insight into helping best determine appropriate pit design and construction for different school campuses. While it has been argued that local analyses are the best option to prevent over designing and under designing of latrines, research of school latrine accumulation rates can help provide school accumulation design rates in situations where latrines

must be built quickly and time for analysis is limited, such as in the case of serving a temporarily displaced population.

The effects of menstrual waste and excretions on degradation of the contents of pit latrines has not been assessed in literature nor has research been conducted to assess the effects of menstrual waste on solids accumulation rates in pit latrines. As stated previously in this thesis, the effects of vaginal and menstrual excretions may be considered negligible due to leaching from the pit.

However, given the recent Ebola Virus Disease epidemic in West Africa it may be important to look at the effects of blood and other bodily fluids in the pit latrines to determine the length of time viruses can subsist in the latrine pit or the surrounding soil. Bacteria and viruses are much smaller than helminth eggs and protozoa, which make them more able to travel through subsoil and potentially contaminate groundwater sources (Sugden, 2006). Carr (2001) reports that viruses may be able to survive in soil from 6 to 180 days. Therefore, more analysis should be performed on pit contents to assess not only survival of pathogens, particularly viruses in pit contents, but also in the surrounding soil. Recent research has assessed virus removal in anaerobic sludge blanket reactors and waste stabilization ponds (Symonds, et al., 2014; Verbyla & Mihelcic, 2015).

Solid waste in latrines has been estimated to account for roughly 20-25% of pit contents, and in some cases up to 40% (Wood, 2013). The composition of the material of solid waste in pit latrines, particularly feminine waste, is rarely reported. In addition, no information was identified on this topic in school latrines. As mentioned in Section 2.3.1, the plastic lining of sanitary pads never decomposes and other parts of the sanitary pad can take up to a year to decompose (Kjellen et al., 2012). Thus, feminine waste is nonbiodegradable waste that will accumulate within the pit.

Solid waste has been estimated to exacerbate the accumulation process, which is suggested by the Water Research Commission in South Africa in greatly reducing the design life of pit latrines. More research should be considered in determining the average presence of feminine waste in pit contents throughout the developing world. By determining the presence, a solution may be more easily developed in dealing with feminine waste in a way that will not disrupt sanitation efforts, such as fully biodegradable feminine use products.

REFERENCES

- Avvannavar, S. M., & Mani, M. (2008). A conceptual model to people's approach to sanitation. *Science of the Total Environment*, 390(1), 1-12.
- Bakare, B. F. (2012). *Scientific and Management Support for Ventilated Improved Pit Latrines (VIP) Sludge Content*. University of KwaZulu-Natal, School of Chemical Engineering. Durban: University of KwaZulu-Natal. Retrieved January 8, 2015, from <http://prg.ukzn.ac.za/docs/default-source/dissertation/5-04-mb.pdf?sfvrsn=0>
- Bakare, B. F., Foxon, K. M., Brouckaert, C. J., & Buckley, C. A. (2012). *Variation in VIP latrine sludge contents*. University of KwaZulu-Natal, School of Chemical Engineering. Durban: Water Research Commission. Retrieved October 10, 2014, from <http://www.ajol.info/index.php/wsa/article/viewFile/81023/71248>
- Balasegaram, M., & Burkitt, D. P. (1976). Stool characteristics and western diseases. *Lancet*, 1, 152.
- BBC. (2014, September 18). *Liberia Profile*. Retrieved October 2, 2014, from BBC News: <file:///D:/Thesis/Thesis/Introduction%20sources/BBC%20News%20-%20Liberia%20country%20profile%20-%20Overview.htm>
- BBC. (2015, February 10). *Ebola: Mapping the Outbreak*. Retrieved February 17, 2015, from BBC News Africa: <http://www.bbc.com/news/world-africa-28755033>

- Beksinska, M. E., Smit, J., Greener, R., Todd, C. S., Lee Mei-Ling, T., Maphumulo, V., & Hoffmann, V. (2015, February 15). Acceptability and Performance of the Menstrual Cup in South Africa: A Randomized Crossover Trial Comparing the Menstrual Cup to Tampons or Sanitary Pads. *Journal of Women's Health, 24*(2), 151-158.
- Bhagwan, J. N., Still, D. A., Buckley, C. A., & Foxon, K. M. (2008). Challenges with up-scaling dry sanitation technologies. *Water Science & Technology, 58*(1), 21-27.
- Bharadwaj, S., & Patkar, A. (2004). *Menstrual Hygiene and Management in Developing Countries: Taking Stock*. Mumbai: Social Development Consultants. Retrieved January 6, 2015, from <http://www.ircwash.org/resources/menstrual-hygiene-and-management-developing-countries-taking-stock>
- Bjorklund, G. & Sjodin, J. (2010). *The Human Right to Water and Sanitation. Securing Access to Water for Basic Needs*. Swedish Water House. Trosa, Sweden: Trosa Tryckeri. Retrieved March 1, 2015, from http://www.siwi.org/documents/Resources/Policy_Briefs/Policy_Brief_Human_Rights_to_Water_web.pdf
- Brikke, F., & Bredero, M. (2003). *Linking technology choice with operation and maintenance in the context of community water supply and sanitation*. World Health Organization and IRC Water and Sanitation Centre. Geneva: World Health Organization. Retrieved January 8, 2015, from Brikke, F., & Bredero, M. (2003). Linking technology choice with operation and maintenance in the context of community water supply and sanitation. Geneva: World Health Organization.
- Brouckaert, C. J., Foxon, K. M., & Wood, K. (2013). Modelling the filling rate of pit latrines. *Water SA, 39*(4), 555-562.

- Buckley, C. A., Foxon, K. M., Brouckaert, C. J., Rodda, N., Nwaneri, C., Balboni, E., Couderc, A., Magagna, D. (2008). *Scientific Support for the Design and Operation of Ventilated Improved Pit Latrines (VIPs) and the Efficacy of Pit Latrine Additives*. Pretoria: Water Research Commission. Retrieved November 10, 2014, from <http://www.wrc.org.za/Knowledge%20Hub%20Documents/Research%20Reports/TT357-08%20Developing%20communities.pdf>
- Burkitt, D. P. (1974). Dietary fibre and diseases. *Journal of the American Medical Association*, 229(8), 1068-1074.
- Carr, R. (2001). Excreta-related infections and the role of sanitation in the control of transmission. In WHO, L. Fewtrell, & J. Bartram (Eds.), *Water Quality - Guidelines, Standards and Health: Assessment of risk and risk management for water-related infectious disease*. London: IWA Publishing. Retrieved January 8, 2015, from <http://www.bvsde.paho.org/bvsacd/who/asses.pdf>
- Chelala, C. (2014, September 21). *Water: A Big Challenge for Africa*. Retrieved October 10, 2014, from The Globalist: <http://www.theglobalist.com/water-a-big-challenge-for-africa/>
- CIA. (2014, June 20). *Liberia*. Retrieved October 10, 2014, from The World Factbook: <https://www.cia.gov/library/publications/the-world-factbook/geos/li.html>
- CNN Library. (2014, November 1). *Ebola Fast Facts*. Retrieved November 22, 2014, from CNN Health: <http://www.cnn.com/2014/04/11/health/ebola-fast-facts/>
- Collett, M. E., Wertenberger, G. E., & Fiske, V. M. (1954). The effect of age upon the pattern of the menstrual cycle. *Fertility and Sterility*, 5(5), 437-448.
- Cranston, D., & Burkitt, D. P. (1975). Diet, bowel behaviour and disease. *Lancet*, 306(7923), 37.

- Crofts, T., & Fisher, J. (2012). Menstrual hygiene in Ugandan schools: an investigation of low-cost sanitary pads. *Journal of Water, Sanitation and Hygiene for Development*, 2(1), 50-58.
- Exley, J. L. R., Liseka, B., Cumming, O., & Ensink, J. H. J. (2015). The Sanitation Ladder, What Constitutes an Improved Form of Sanitation? *Environmental Science & Technology*, 49(2), 1086-1094.
- Feachem, R. G., Bradley, D. J., Garelick, H., & Mara, D. D. (1983). *Sanitation and disease: health aspects of excreta and wastewater management*. World Bank Studies in Water Supply and Sanitation 3, Wiley: Chichester, UK.
- Foxon, K. M., Buckley, C. A., Brouckaert, C. J., & Bakare, B. F. (2011). How fast do pits and septic tanks fill up? Implications for design and maintenance. *What Happens When the Pit is Full? Developments in on-site Faecal Sludge Management (FSM)* (pp. 9-10). Durban, South Africa: Water Research Commission. Retrieved February 15, 2015, from <http://www.readbag.com/ecosanres-pdf-files-whathappenswhenthepitisfullfsmseminarreportsouthafricanodemarch2011>
- Foxon, K. M., Naidoo, S. A., Brouckaert, C. J., Harrison, J., Pfaff, B., Remigi, E., Rodda, N., Buckley, C. A. (2006). *Can VIP Additives Make A Difference?* University of KwaZulu-Natal, Pollution Research Group. Durban: WISA Biennial Conference and Exhibitions 2006. Retrieved November 20, 2014, from <http://www.ajol.info/index.php/wsa/article/viewFile/76759/67198>

- Foxon, K. M., Mkhize, S., Reddy, M., & Buckley, C. A. (2009). *Laboratory protocols for testing the efficacy of commercial pit latrine additives*. University of KwaZulu-Natal, Pollution Research Group. Durban: WISA Biennial Conference and Exhibitions 2008. Retrieved November 20, 2014, from <http://www.ajol.info/index.php/wsa/article/viewFile/76759/67198>
- Franceys, R., Pickford, J., & Reed, R. (1992). *A Guide to the Development of on-Site Sanitation*. World Health Organization. Geneva: World Health Organization. Retrieved June 15, 2014, from http://www.who.int/water_sanitation_health/hygiene/envsan/onsitesan.pdf
- Fraser, I., McCarron, G., Markham, R., & Resta, T. (1985). Blood and total fluid content of menstrual discharge. *Obstet. Gynecol.*, 65, 194-198.
- Fry, L. M., Mihelcic, J. R., & Watkins, D. W. (2008). Water and Non-Water-Related Challenges of Achieving Global Sanitation Coverage. *Environmental Science & Technology*, 42(4), 4298-4304.
- Galvin, C. (2013). *Embodied Energy and Carbon Footprint of Household Latrines in Rural Peru: The Impact of Integrating Resource Recovery*. University of South Florida, Civil and Environmental Engineering. Tampa: University of South Florida. Retrieved January 25, 2015, from http://usfmi.weebly.com/uploads/5/3/9/2/5392099/galvin_thesis_final.pdf
- Garg, S., Sharma, N., & Sahay, R. (2001). Socio-cultural aspects of menstruation in an urban slum in Delhi, India. *Reproductive Health Matters*, 9(17), 16-25.
- geoview.info. (Retrieved 2014). *Nimba County*. Retrieved November 16, 2014, from [geoview.info: http://lr.geoview.info/nimba_county,2274688](http://lr.geoview.info/nimba_county,2274688)
- Gontee, H. (2014, May). Personal communication with JVS Principal concerning why latrines were locked on campus. Saclepea City, Liberia.

- Graham, J. P., & Polizzotto, M. L. (2013). Supplemental Material - Pit Latrines and Their Impacts on Groundwater Quality: A Systematic Review. *Environmental Health Perspectives, 121*(5), 521 - 530.
- Greene, L. E., Freeman, M. C., Akoko, D., Saboori, S., Moe, C., & Rheingans, R. (2012). Impact of a School-Based Hygiene Promotion and Sanitation Intervention on Pupil Hand Contamination in Western Kenya: A Clustered Randomized Trial. *Am J Trop Med Hyg, 87*(3), 385–393.
- Griffin, L. P. (2012). *Anaerobic Digestion of Organic Wastes: The Impact of Operating Conditions on Hydrolysis Efficiency and Microbial Community Composition*. Colorado State University, Department of Civil and Environmental Engineering, Fort Collins. Retrieved January 8, 2015, from http://erefdn.org/images/uploads/Griffin_Laura.pdf
- Guyton, A. C. (1992). *Human Physiology and Mechanisms of Disease*. Philadelphia: W. B. Saunders Company.
- Hallberg, L., Hogdahl, A. M., Nilsson, L., & Rybo, G. (1966). Menstrual blood loss: a population study. *Acta Obstet Gynecol Scand, 45*, 320-351.
- Hamoud, F. (2015, February 20). Personal communication.
- Harvey, P. (2007). *Excreta Disposal in Emergencies: A Field Manual*. Loughborough University. Leicestershire, UK: WEDC. Retrieved February 17, 2015, from <http://www.unicef.org/eapro/unprotected-EDEprelims.pdf>

- Harvey, P., Baghri, S., & Reed, B. (2002). *Emergency Sanitation: Assessment and Programme Design*. Loughborough University, Water, Engineering and Development Centre. Leicestershire, UK: Water, Engineering and Development Centre. Retrieved February 17, 2015, from <http://www.sheltercentre.org/sites/default/files/Emergency%20Sanitation%20%28WEDC%29.pdf>
- House, S., Mahon, T., & Cavill, S. (2012). *Menstrual Hygiene Matters. A Resource for Improving Menstrual Hygiene around the World*. London: Water Aid. Retrieved January 8, 2015, from <http://www.poline.org/node/579119>
- Hurtado, D. (2005). *Compost Latrines in Rural Panama: Design, Construction and Evaluation of Pathogen Removal*. Michigan Technological University, Civil and Environmental Engineering. Houghton: Michigan Technological University. Retrieved March 1, 2015, from <http://cee.eng.usf.edu/peacecorps/5%20-%20Resources/Theses/Sanitation/2005Hurtado.pdf>
- Jenkins, M.W., & Curtis, V. (2005). Achieving the 'good life': Why some people want latrines in rural Benin. *Social Science and Medicine*, 61(11), 2446-2459.
- Johnson, R. W., Blatchley III, E. R., & Mason, D. R. (1994). HIV and the Bloodborne Pathogen Regulation: implications for the wastewater industry. *Water Environment Research*, 66(5), 684-691.

- Jonsson, H., Baky, A., Jeppsson, U., Hellstrom, D., & Karrman, E. (2005). *Composition of urine, faeces, greywater and biowaste for utilization in the URWARE model*. Industrial Electrical Engineering and Automaton, Lund University. Gothenberg, Sweden: Chalmers University of Technology. Retrieved January 8, 2015, from <https://www.iea.lth.se/publications/Reports/LTH-IEA-7222.pdf>
- Kjellen, M., Pensulo, C., Nordqvist, P., & Fogde, M. (2012). *Global Review of Sanitation System Trends and Interactions with Menstrual Management Practices: Report for the Menstrual Management and Sanitation Systems Project*. Stockholm, Sweden: Stockholm Environment Institute. Retrieved January 6, 2015, from <http://www.sei-international.org/publications?pid=2044>
- Kramer, A., Shwebke, I., & Kampfe, G. (2006). How long do nosocomial pathogens persist on inanimate surfaces? A systematic review. *BMC Infectious Diseases*, 6(130), 1-8.
- Lentner, C., Lentner, C., & Wink, A. (1981). Vol. 1, Units of measurement, body fluids, composition of the body, nutrition. In C. Lentner, *Geigy Scientific Tables* (pp. 108-112). Basel, Switzerland: Ciba-Geigy.
- Lijas, P. (2014, August 14). *Liberia's West Point Slum Reels From the Nightmare of Ebola*. Retrieved January 11, 2015, from time.com: <http://time.com/3158244/liberia-west-point-slum-ebola-disease-quarantine/>
- Mehl, J., Gibson, D. A., Izurieta, R., Kaiser, J., Hurtado, D., & Mihelcic, J. R. (2010). Pathogen Destruction and Solids Decomposition in Composting Latrines: Study of Fundamental Mechanisms and User Operation in Rural Panama. *Journal of Water and Health*, 9(1), 187-199.

- Mihelcic, J. R., & Hokanson, D. (2005). Educational Solutions: For a more Sustainable Future. (N. N. Agardy, Ed.) *Environmental Solutions*, 25-28.
- Mihelcic, J. R., Fry, L. M., Myre, E. A., Phillips, L. D., & Barkdoll, B. D. (2009). *Field Guide to Environmental Engineering for Development Workers: Water, Sanitation and Indoor Air*. Reston: ASCE Press.
- Mihelcic, J. R., Fry, L. M., & Shaw, R. (2011). Global potential of phosphorus recovery from human urine and feces. *Chemosphere*, 84(6), 832-839.
- Mihelcic, J. R., Phillips, L. D., & Watkins, D. W. (2006). Integrating a Global Perspective into Engineering Education & Research: Engineering International Sustainable Development. *Environmental Science*, 23(3), 426-438.
- Mills, F., Blackett, I., & Taylor, K. (2014). Assessing on-site systems and sludge accumulation rates to understand pit emptying in Indonesia. *37th WEDC International Conference*, (pp. 1-6). Hanoi.
- MIWR-GONU, MWRI-GOSS, & UNICEF. (2009). *Technical Guidelines for the Construction and Management of Household Latrines*. United Nations Children's Fund and Basic Services Fund South Sudan, Ministry of Water Resources and Irrigation. Retrieved January 8, 2015, from <http://www.bsf-south-sudan.org/content/bsf-guidelines>
- Munala, G. (2012). *Socio-cultural Influences and Management that Determine Sanitation Facilities Use in the Informal Settlements*. Retrieved January 6, 2015, from <http://www.huussi.net/wp-content/uploads/2013/07/Gerryshom-Munala-NEW-16-May-2012.pdf>

- Nahar, Q., & Ahmed, R. (2006). *Addressing special needs of girls Challenges in school*. WaterAid. UNICEF and WaterAid Bangladesh. Retrieved January 6, 2015, from <http://www.wateraid.org/~media/Publications/special-needs-girls-school-bangladesh.pdf>
- Ness, S. (2015). *Evaluation of School VIP Latrine Design and User Preferences and Motivations for Adopting Communal Sanitation Technologies in Zwedru, Liberia*. University of South Florida, Civil and Environmental Engineering. Tampa: University of South Florida. Retrieved March 1, 2015.
- Niwagaba, C. (2009). *Treatment Technologies for Human Faeces and Urine*. Swedish University of Agricultural Sciences. Uppsala: Swedish University of Agricultural Sciences. Retrieved January 8, 2015, from http://pub.epsilon.slu.se/2177/1/niwagaba_c_091123.pdf
- Niwagaba, C., Mbeguere, M., & Strande, L. (2014). Faecal Sludge Quantification, Characterisation and Treatment Objectives. In M. Bassan, D. Brdjanovic, B. Dangol, P. Dodane, C. Hooijmans, C. Lopez-Vazquez, M. Mbeguere, G. Mikhael, B. Diaz-Aguado, C. Niwagaba, I. Kengne, J. Ramsay, P. Reymond, D. Robbins, M. Ronteltap, L. Strande, E. Tilley, *Faecal Sludge Management: Systems Approach for Implementation and Operation* (pp. 19-44). London: IWA Publishing.
- Norris, G. (2000). *Sludge Build-up in Septic Tanks, Biological Digesters and Pit Latrines in South Africa*. Water Research Commission. Pretoria: Water Research Commission. Retrieved October 10, 2014, from <http://www.wrc.org.za/Pages/DisplayItem.aspx?ItemID=8271&FromURL=%2FPages%2FAllKH.aspx%3F>

- Nwaneri, C. F. (2009). *Physico-chemical characteristics and biodegradability of contents of ventilated improved pit latrines (VIPs) in eThekweni Municipality*. University of KwaZulu-Natal, School of Biological and Conservation Sciences. Durban: University of KwaZulu-Natal. Retrieved February 24, 2015, from <http://prg.ukzn.ac.za/docs/default-source/dissertation/1-29-mb.pdf?sfvrsn=0>
- Nwaneri, C. F., Foxon, K. M., Bakare, B. F., & Buckley, C. A. (2008). *Biological Degradation Processes Within A Pit Latrine*. University of KwaZulu-Natal, Pollution Research Group. Durban: WISA 2008 Conference, Sun City. Retrieved February 24, 2015, from http://www.researchgate.net/publication/267715964_BIOLOGICAL_DEGRADATION_PROCESSES_WITHIN_A_PIT_LATRINE
- Petterson, D. R. (2014, August 27). *Liberia*. Retrieved November 13, 2014, from <http://www.britannica.com/EBchecked/topic/339254/Liberia/55258/Climate>
- Pruss-Ustun, A., Bartram, J., Clasen, T., Colford, J. M. Jr., Cumming, O., Curtis, V., Bonjour, S., Dangour, A. D., De France, J., Fewtrell, L., Freeman, M. C., Gordon, B., Hunter, P. R., Johnston, R. B., Mathers, C., Mausezahl, D., Medlicott, K., Neira, M., Stocks, M., Wolf, J., Cairncross, S. (2014). Burden of disease from inadequate water, sanitation and hygiene in low- and middle-income settings: a retrospective analysis of data from 145 countries. *Tropical Medicine and International Health*, 19(8), 894-905.
- Reed, B. (2014). *WEDC Guide 027: Ventilated Improved Pit (VIP) Latrines*. Loughborough University. Leicestershire, UK: WEDC. Retrieved January 8, 2015, from <http://wedc.lboro.ac.uk/resources/booklets/G027-VIP-latrines-on-line.pdf>

- Schouw, N. L., Danteravanich, S., Mosbaek, H., & Tjell, J. C. (2002). Composition of human excreta – a case study from Southern Thailand. *Science of The Total Environment*, 286(1-3), 155-166.
- Scott, J. (1952). *Health and Agriculture in China*. London: Faber & Faber.
- Spedoske, S. (Retrieved 2015). *Incorporating issues of gender into design of latrine*. University of South Florida, Civil and Environmental Engineering. Tampa: University of South Florida. Retrieved February 15, 2015, from usfmi.weebly.com/technical-briefs.html
- Sommer, M., & Sahin, M. S. (2013). Overcoming the Taboo: Advancing the Global Agenda for Menstrual Hygiene Management for Schoolgirls. *American Journal of Public Health*, 103(9), 1556-1559.
- Stephen, A., & Cummings, J. (1980). The microbial contribution to human faecal mass. *J Med Microbiol.*, 13(1), 45-46.
- Stewart, K., Powell, M., & Greer, R. (2009). An alternative to conventional sanitary protection: would women use a menstrual cup? *Journal of Obstetrics and Gynaecology*, 29(1), 49-52.
- Still, D. A. (2002). *After the Pit Latrine is Full...What then? Effective Options for Pit Latrine Management*. Partners in Development. Durban: Biennial Conference of the Water Institute of Southern Africa (WISA) 2002. Retrieved November 8, 2014, from <http://www.ewisa.co.za/literature/files/207%20Paper.PDF>

- Still, D. A., & Foxon, K. M. (2012). *Tackling the Challenges of Full Pit Latrines, Volume 2: How fast do pit toilets fill up? A scientific understanding of sludge build up and accumulation in pit latrines*. Pretoria: Water Research Commission. Retrieved October 10, 2014, from http://www.susana.org/_resources/documents/default/2-1712-wrc-1745-tackling-the-challenges-of-full-pit-latrines--volume-2.pdf
- Still, D. A., Salisbury, R. H., Foxon, K. M., Buckley, C. A., & Bhagwan, J. N. (2012). *The Challenges of Dealing with Full VIP Latrines*. South Africa: Water Research Commission. Retrieved October 10, 2014, from http://www.ewisa.co.za/literature/files/294_237%20Still.pdf
- Still, D. A., Walker, N., & Hazelton, D. (2009). *Basic Sanitation Services in South Africa: Learning from the past, planning for the future*. Partners in Development. South Africa: Water Research Commission. Retrieved October 10, 2014, from <http://www.orangesenqurak.org/UserFiles/File/OtherV2/Basic%20Sanitation%20Services%20in%20SA%20WRC%202009.pdf>
- Sugden, S. (2006, April). *Well Fact Sheet: The Microbiological Contamination of Water Supplies*. (S. Cairncross, Editor) Retrieved February 25, 2015, from WELL: <http://www.lboro.ac.uk/well/resources/fact-sheets/fact-sheets-htm/Contamination.htm>
- Symonds, E. M., Verbyla, M. E., Lukasik, J. O., Kafle, R. C., Breitbart, M., & Mihelcic, J. R. (2014). A case study of enteric virus removal and insights into the associated risk of water reuse for two wastewater treatment pond systems in Bolivia. *Water Research*, 65, 257-270.

- Ten, V. T. (2007). *Menstrual Hygiene: A Neglected Condition for the Achievement of Several Millennium Development Goals*. Europe External Policy Advisors. Retrieved January 6, 2015, from http://www.eepa.be/wcm/dmdocuments/BGpaper_Menstrual-Hygiene.pdf
- Todman, L. C., van Eekert, M. H. A., Templeton, M. R., Hardy, M., Gibson, W. T., Torondel, B., Abdelahi, F., & Ensink, J. H. J. (2014). Modelling the fill rate of pit latrines in Ifakara, Tanzania. *Journal of Water, Sanitation and Hygiene for Development*, 1-16.
- Torondel, B. (2010). *Sanitation Ventures Literature Review: on-site sanitation waste characteristics*. London: London School of Hygiene & Tropical Medicine. Retrieved October 10, 2014, from <http://www.ircwash.org/sites/default/files/Torondel-2010-Sanitation.pdf>
- Trussell, M. R. & Moore, R. E. (2012). Local Economic Development in Africa: The Case of Saclepea, Liberia. *Journal of Sustainable Development in Africa*, 14(8), 15-33.
- UNDESA. (2012). *The Millennium Development Goals Report 2012*. United Nations, Department of Economic and Social Affairs of the United Nations Secretariat. New York: United Nations. Retrieved June 15, 2014, from <http://mdgs.un.org/unsd/mdg/Resources/Static/Products/Progress2012/English2012.pdf>
- UNDESA. (2013). *The Millennium Development Goals Report - 2013*. United Nations, Department of Economic and Social Affairs of the United Nations Secretariat. New York: United Nations. Retrieved June 15, 2014, from <http://www.un.org/millenniumgoals/pdf/report-2013/mdg-report-2013-english.pdf>

- UNDP. (2014). *Human Development Report 2014 Sustaining Human Progress: Reducing Vulnerabilities and Building Resilience*. United Nations Development Programme. New York: United Nations Development Programme. Retrieved January 8, 2015, from <http://hdr.undp.org/sites/default/files/hdr14-report-en-1.pdf>
- UNESCO. (2014). *International Migration - Poverty*. Retrieved January 8, 2015, from [www.unesco.org: http://www.unesco.org/new/en/social-and-human-sciences/themes/international-migration/glossary/poverty/](http://www.unesco.org/new/en/social-and-human-sciences/themes/international-migration/glossary/poverty/)
- UNHABITAT. (2003). *The challenge of slums: global report on human settlements*. United Nations Human Settlement Programme. London: Earthscan Publications. Retrieved January 8, 2015, from mirror.unhabitat.org/pmss/getElectronicVersion.aspx?nr=1156&alt=1
- UNICEF. (2006). *Progress for Children: A report card on water and sanitation (No. 5)*. United Nations Children's Fund. New York: United Nations Children's Fund. Retrieved October 10, 2014, from https://www.unicef.is/efni/progress_for_children/UNICEF_progress_for_children_5.pdf
- UNICEF. (2010, March). *West and Central Africa Overview: Access to water and sanitation: a few definitions*. Retrieved November 5, 2014, from [www.unicef.org: http://www.unicef.org/wcaro/overview_2570.html](http://www.unicef.org/wcaro/overview_2570.html)
- UNICEF. (2012). *Pneumonia and diarrhoea: Tackling the deadliest diseases for the world's poorest children*. United Nations Children's Fund. New York: United Nations Children's Fund. Retrieved February 26, 2015, from http://www.unicef.org/eapro/Pneumonia_and_Diarrhoea_Report_2012.pdf

- UNICEF/WHO. (2009). *Diarrhoea: Why children are dying and what can be done*. United Nations Children's Fund. World Health Organization. Geneva, Switzerland: WHO Press. Retrieved March 1, 2015, from http://www.unicef.org/media/files/Final_Diarrhoea_Report_October_2009_final.pdf
- UN-Water, & UNDESA. (2014, May 16). *International Decade for Action 'Water for Life' 2005-2015*. Retrieved January 10, 2015, from www.un.org: <http://www.un.org/waterforlifedecade/africa.shtml>
- Verbyla, M. E., & Mihelcic, J. R. (2015). A review of virus removal in wastewater treatment pond systems. *Water Research*, 71, 107-124.
- Vinnerås, B. (2001). *Faecal separation and urine diversion for nutrient management of household biodegradable waste and wastewater*. Agricultural Engineering, Swedish University of Agricultural Sciences. Retrieved January 6, 2015, from <http://pub.epsilon.slu.se/3817/>
- Vinnerås, B., Palmquist, H., Balmér, P., Weglin, J., Jensen, A., Andersson, Å., Jönsson, H. (2006). The characteristics of household wastewater and biodegradable waste - a proposal for new Swedish norms. *Urban Water*, 3, 3-11.
- Wagner, E G. & Lanoix, J. N. (1958). *Excreta Disposal for Rural Areas and Small Communities*. World Health Organization. Geneva: World Health Organization. Retrieved November 10, 2014, from http://www.pssurvival.com/ps/Sanitation/Excreta_Disposal_For_Rural_Areas_And_Small_Communities_No-39_1958.pdf
- Warrilow, G., Kirkham, C., Ismail, K. M. K., Wyatt, K., Dimmock, P., & O'Brien, S. (2004). Quantification of menstrual blood loss. *The Obstetrician & Gynaecologist*, 6(2), 88-92.

- WHO. (2009). *Water, Sanitation and Hygiene Standards for Schools in Low-cost Settings*. (J. Adams, J. Bartram, Y. Chartier, & J. Sims, Eds.) Geneva: WHO Press. Retrieved January 6, 2015, from http://www.who.int/water_sanitation_health/publications/wash_standards_school.pdf
- WHO/FAO. (2003). *Diet, Nutrition and the Prevention of Chronic Diseases*. World Health Organization and Food and Agriculture Organization of the United Nations. Geneva: WHO Press. Retrieved February 26, 2015, from http://whqlibdoc.who.int/trs/who_trs_916.pdf
- WHO/TDR. (2012). *Global Report: For Research on Infectious Diseases of Poverty*. World Health Organization, Special Programme for Research and Training in Tropical Diseases. Geneva: WHO Press. Retrieved January 8, 2015, from http://whqlibdoc.who.int/publications/2012/9789241564489_eng.pdf?ua=1
- WHO/UNICEF. (2008). *A Snapshot of Sanitation in Africa*. World Health Organization and United Nations Children's Fund, Joint Monitoring Programme for Water Supply and Sanitation. New York: WHO Press. Retrieved June 15, 2014, from http://www.unicef.org/wcaro/wcaro_SnapshotSanitationAfrica_En.pdf
- WHO/UNICEF. (2012). *A Snapshot of Drinking Water and Sanitation in Africa - 2012 Update*. World Health Organization and United Nations Children's Fund, Joint Monitoring Programme for Water Supply and Sanitation. Geneva: African Ministers' Council on Water (AMCOW). Retrieved June 15, 2014, from http://www.wssinfo.org/fileadmin/user_upload/resources/Africa-AMCOW-Snapshot-2012-English-Final.pdf

- WHO/UNICEF. (2012). *Progress on Drinking Water and Sanitation: 2012 Update*. World Health Organization and United Nations Children's Fund, Joint Monitoring Programme for Water Supply and Sanitation. New York: WHO Press. Retrieved June 15, 2014, from <http://www.unicef.org/media/files/JMPreport2012.pdf>
- WHO/UNICEF. (2014). *Progress on Drinking Water and Sanitation Update*. World Health Organization and United Nations Children's Fund, Joint Monitoring Programme for Water Supply and Sanitation. Geneva: WHO Press. Retrieved June 15, 2014, from http://www.unicef.org/gambia/Progress_on_drinking_water_and_sanitation_2014_update.pdf
- WHO/UN-Water. (2012). *UN-Water global annual assessment of sanitation and drinking-water (GLAAS) 2012 report: the Challenge of Extending and Sustaining Services*. World Health Organization and UN-Water. Geneva: WHO Press. Retrieved June 15, 2014, from http://www.un.org/waterforlifedecade/pdf/glaas_report_2012_eng.pdf
- Wilbur, P. A. (2014). *An Evaluation of the Use of Composting Latrines and the Perceptions of Excrement in Ngabe Communities in Panama*. University of South Florida, Civil and Environmental Engineering. Tampa: University of South Florida. Retrieved January 25, 2015, from <http://scholarcommons.usf.edu/etd/5331/>
- William, J., & Lewis, M. (2009). *Health Investments and Economic Growth: Macroeconomic Evidence and Microeconomic Foundations*. The World Bank, Development Economics Vice Presidency. Washington, D.C.: The World Bank. Retrieved February 27, 2015, from <https://openknowledge.worldbank.org/bitstream/handle/10986/4072/WPS4877.pdf?sequence=1>

- WINSA, & WRC. (2011). What Happens When the Pit is Full? Developments in on-site Faecal Sludge Management (FSM). *FSM Seminar* (p. 43). Durban: WINSA. Retrieved November 16, 2014, from http://www.ecosanres.org/pdf_files/WhatHappensWhenThePitIsFullFSMSeminarReportSouthAfricaNodeMarch2011.pdf
- Wood, K. (2013). *Transformation of Faecal Sludge in VIPS: Modelling Fill Rate with an Unsteady-State Mass Balance*. University of KwaZulu-Natal. Durban: University of KwaZulu-Natal. Retrieved February 26, 2015, from http://www.unicef.org/eapro/Pneumonia_and_Diarrhoea_Report_2012.pdf
- WSP. (2012). *Economic Impacts of Poor Sanitation in Africa*. World Bank, Water and Sanitation Program, New York: World Bank. Retrieved January 8, 2015, from <http://siteresources.worldbank.org/INTAFRICA/Resources/economic-impacts-of-poor-sanitation-in-africa-factsheet.pdf>

APPENDIX A: PERMISSIONS FOR THE USE OF TABLES AND FIGURES

Below is the permission for the use of Figure 1.

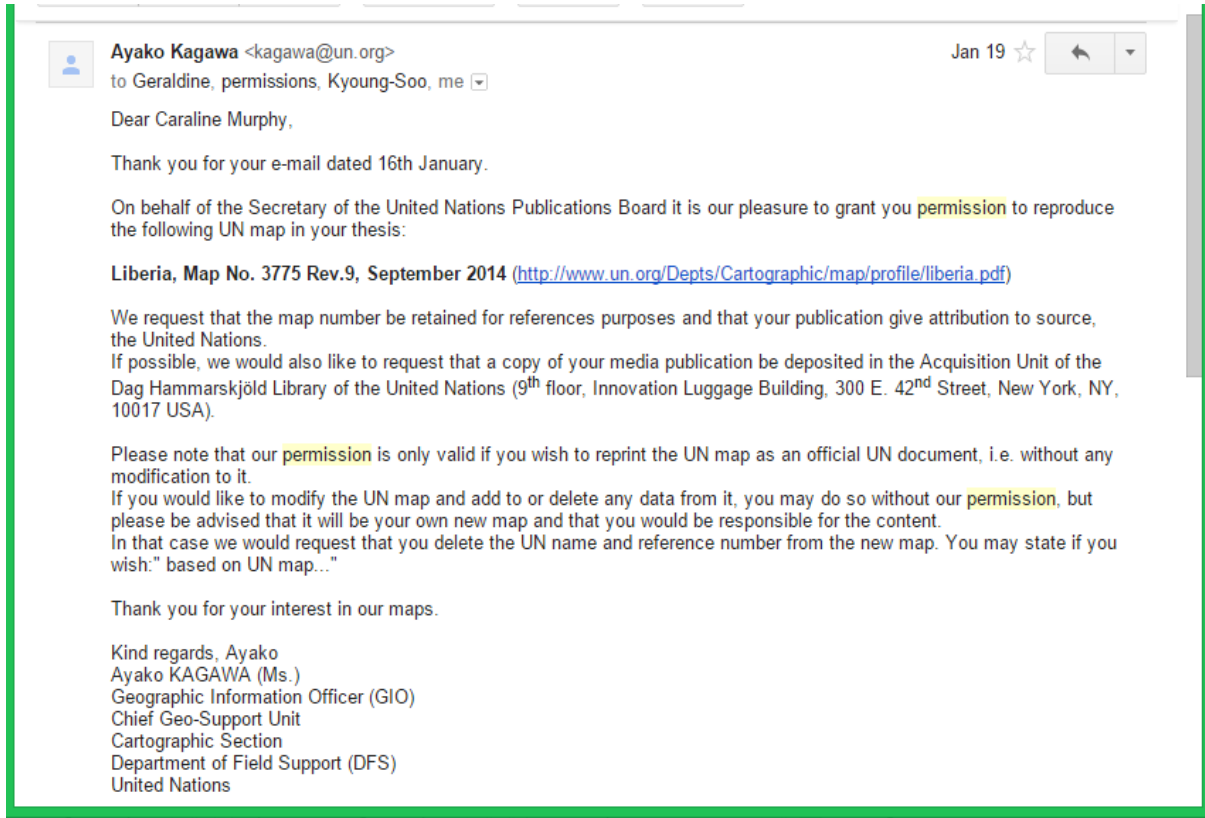

 **Ayako Kagawa** <kagawa@un.org>
to Geraldine, permissions, Kyoung-Soo, me ▾

Jan 19 ☆ ↶ ▾

Dear Caraline Murphy,

Thank you for your e-mail dated 16th January.

On behalf of the Secretary of the United Nations Publications Board it is our pleasure to grant you **permission** to reproduce the following UN map in your thesis:

Liberia, Map No. 3775 Rev.9, September 2014 (<http://www.un.org/Depts/Cartographic/map/profile/liberia.pdf>)

We request that the map number be retained for references purposes and that your publication give attribution to source, the United Nations.

If possible, we would also like to request that a copy of your media publication be deposited in the Acquisition Unit of the Dag Hammarskjöld Library of the United Nations (9th floor, Innovation Luggage Building, 300 E. 42nd Street, New York, NY, 10017 USA).

Please note that our **permission** is only valid if you wish to reprint the UN map as an official UN document, i.e. without any modification to it.

If you would like to modify the UN map and add to or delete any data from it, you may do so without our **permission**, but please be advised that it will be your own new map and that you would be responsible for the content.

In that case we would request that you delete the UN name and reference number from the new map. You may state if you wish: "based on UN map..."

Thank you for your interest in our maps.

Kind regards, Ayako
Ayako KAGAWA (Ms.)
Geographic Information Officer (GIO)
Chief Geo-Support Unit
Cartographic Section
Department of Field Support (DFS)
United Nations

Appendix A (continued)

Below is the permission for the use of Table 3, and Figures 4 and 6.

Dear Caraline,

Thank you for completing the online form and for your interest in WHO health information products.

On behalf of the World Health Organization, we are pleased to authorize your request to reproduce the WHO material as detailed in the form below.

This permission is subject to the following conditions:

- This is a non-exclusive permission to reproduce the material detailed below.
- Please ensure that the original WHO source is appropriately acknowledged with the appropriate bibliographical reference including publication title, author, publisher, volume/edition number, page numbers, copyright notice year and the URL reference and the date accessed.
- The material will be reproduced as it was published by WHO and no changes should be made to the content or meaning. Publishers may reformat the material in the style of the publication.
- The use of WHO materials should be factual and used in an appropriate context;
- The material should not be reproduced for use in association with product marketing or promotional activities. In no event should the WHO information products be used in promotional materials e.g. products brochures, or company-sponsored web sites, annual reports, or other publications for distribution to, and/or non-educational presentations for, either the general public, or pharmacists, doctors, nurses, etc.
- There should be no suggestion that WHO endorses any specific company or products in the article, book etc. or in the manner of distribution of the article, book etc.
- The WHO logo and emblem shall not be reproduced.
- All reasonable precautions have been taken by the World Health Organization to verify the information contained in its published material. However, the published material is being distributed without warranty of any kind, either expressed or implied, and you are entirely responsible for reproducing and displaying the material in your publication. In no event shall the World Health Organization be liable for damages arising from its use.
- WHO reserves the right to withdraw the permission in the event a condition is not respected.

We thank you for your interest in WHO and our published information.

Kind regards,

Joelle Jacquier
WHO PRESS

Appendix A (continued)

[DataCol Web] Form to request permission to reproduce or reprint WHO copyrighted material 🖨️

Inbox x

 **internet@who.int** 11:26 AM (32 minutes ago) ☆ ↩️ ▼

to permissions, me ▼

DataCol Web: Form to request permission to reproduce or reprint WHO copyrighted material
=====

ID: 155894

Section: Contact details

* Title
* Ms

* First name
* Caraline

* Family name
* Murphy

* Organization/affiliation
* University of South Florida

* Web site address
*

* Type of organization/affiliation
* Academic

* If other, please specify
*

* Position
* Graduate Student

Appendix A (continued)

* Telephone
* [+15752022390](tel:+15752022390)

* Fax
* +

* Address
* 4202 E Fowler Ave, Tampa, FL 33620

* Country
* United States of America

* Email
* caralinemurphy@gmail.com

Section: Information about WHO material to be reproduced

* Full title of WHO publication, document or web page from which the reproduction is to be made
* Franceys, R., Pickford, J., & Reed, R. (1992). A Guide to the Development of on-Site Sanitation. World Health Organization. Geneva: WHO.

* Web site URL where this material is published
* http://www.who.int/water_sanitation_health/hygiene/envsan/onsitesan.pdf

* ISBN / WHO Reference Number
*

* Year of Publication
* 1992

* Please select the item(s) to be reproduced
* Table, Figure

* For each item selected, please provide a reference and page number, if entire document indicate entire document

* Table 5.1 Quantity of wet faeces excreted by adults (in grams per person per day), pg.34

Table 5.3. Suggested maximum sludge accumulation rates (litres per person per year), pg. 36

Figure 6.3 Simple-pit latrine, pg. 49

Appendix A (continued)

Figure 6.5 Ventilated Improved Pit Latrine, pg. 51

Figure 6.7 Double-nit VIP latrine, pg. 53

- * Subject of interest
- * Sanitation

Section: Information about your publication

* Please provide the title of your publication that the above materials are to be published in, if you plan to reprint the entire document, please indicate the title of the entire document

* Solids Accumulation Rates of Latrines at Rural Schools in Nimba County, Liberia

- * The item reproduced will be published as
- * As part of another publication

* Publishing format

* print

* If web please provide URL / If other, please specify

* Print run (if applicable)

* Target audience and planned distribution

* Faculty and students of University of South Florida; Academic community

* Planned publication date

* March 20, 2015

* If your publication is to be sold, please indicate the planned selling price

* Not to be sold

* If your publication is sponsored or funded by an organisation other than your own, please provide additional information

* This material is based upon work supported by the National Science Foundation under Grant No. 0965743.

Appendix A (continued)

Below is the permission for the use of Figure 10.

Permission to use photo in Masters thesis Inbox x

 **Caroline Murphy** <caralinemurphy@gmail.com> 11/5/14 ☆ ↩ ▾
to mmjonesmm ▾

Hi Matt,

My name is Caroline Murphy and I am a recently evacuated Peace Corps Volunteer from Liberia. I was looking for maps of Nimba County (I served in Saclepea) and stumbled on your photos and blog. I am working on my Masters in Civil Engineering, which is focusing on sanitation at the school I was teaching at in Saclepea. I need a map to show my exact location in the county/country.

I was wondering if I could get **permission** from you to use the map of Nimba County that also shows Liberia's borders with Ivory Coast and Guinea. You entitled it as such on your blog - **Map of the Liberian-Ivorian Frontier, Draft 3**

I hope all is well for you in Liberia and you haven't lost too many loved ones from EVD.

Take care and thank you.

...

 **Matt** <mmjonesmm@gmail.com> 11/5/14 ☆ ↩ ▾
to me ▾

Hi Caraline,

Sure, you're most welcome. It's pretty easy for me to change the Map, remove the battle locations and personalize with your information, if you want. Just send me anything you needed added. Good luck with your thesis otherwise.

Best,

Matt

...

Appendix A (continued)

Below is the permission for the use of Figures 11, 12 and 14

Picture **Permission** for Thesis Inbox x

 **Caraline Murphy** <caralinemurphy@gmail.com> Jan 7 ☆ ↩ ▾
to john ▾
Hi John,

I am seeking **permission** to use some pictures of students at JVS campus as well as pictures of the Saclepea City that you took when you visited about a year and a half ago.

If you have any latrine pictures or pictures of sanitation in Westpoint and other places in Liberia may I get those from you and use them in the thesis?

Thanks!
...

 **John J. O'Malley** <john@jomalley.co> Jan 7 ☆ ↩ ▾
to me ▾
Hi Caraline,

I took many pictures of Westpoint and your school in Saclepea, and you are welcome to use any of them that you already have or that I will email over for you.

Are you only looking for latrine photos? I know have have a few of people defecating on Westpoint beach, pictures of the vast tracts of trash, and probably a photo of the latrines there (from outside). What sort of Saclepea photos can I send you?

Cheers,

J

Appendix A (continued)

Below is the permission for the use of Figure 25.

User Rate info Inbox x 📄 🖨️ 🌐

 **Sarah Ness** 📧 Feb 27 ☆ ↩️ ⌵

to me ⌵

Here is some data for user rates. Let me know if you need anything else.

Whew, thesis!

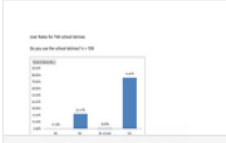

W User Rates for T...