

2014

Investigation of sustainable pavement technologies evaluating warm mix asphalt using recycled asphalt materials

Ashley Faye Buss
Iowa State University

Follow this and additional works at: <https://lib.dr.iastate.edu/etd>

 Part of the [Civil Engineering Commons](#)

Recommended Citation

Buss, Ashley Faye, "Investigation of sustainable pavement technologies evaluating warm mix asphalt using recycled asphalt materials" (2014). *Graduate Theses and Dissertations*. 13652.
<https://lib.dr.iastate.edu/etd/13652>

This Dissertation is brought to you for free and open access by the Iowa State University Capstones, Theses and Dissertations at Iowa State University Digital Repository. It has been accepted for inclusion in Graduate Theses and Dissertations by an authorized administrator of Iowa State University Digital Repository. For more information, please contact digirep@iastate.edu.

**Investigation of sustainable pavement technologies evaluating warm mix asphalt
using recycled asphalt materials**

by

Ashley Buss

A dissertation submitted to the graduate faculty
in partial fulfillment of the requirements for the degree of
DOCTOR OF PHILOSOPHY

Major: Civil Engineering (Civil Engineering Materials)

Program of Study Committee:
R. Christopher Williams, Major Professor
Vernon R. Schaefer
Kejin Wang
William W. Simpkins
Robert W. Stephenson

Iowa State University

Ames, Iowa

2014

Copyright © Ashley Buss, 2014. All rights reserved.

TABLE OF CONTENTS

LIST OF TABLES	iv
LIST OF FIGURES	viii
ACKNOWLEDGEMENTS	xiv
EXECUTIVE SUMMARY	xv
CHAPTER 1 INTRODUCTION	1
1.1 Background	1
1.2 Problem Statement and Objectives	2
1.3 Methodology and Approach	3
1.4 Significance of Work	7
1.5 Report Organization.....	7
CHAPTER 2 LITERATURE REVIEW	9
2.1 Background of Warm Mix Asphalt.....	9
2.2 WMA Technologies.....	11
2.3 Earlier WMA Studies.....	17
2.4 Dynamic Modulus, Moisture Conditioning, and Hamburg Wheel Tracking Test Studies Investigating the Use of WMA	19
2.5 Warm Mix Asphalt Fatigue Studies.....	21
2.6 Investigation of Warm Mix Asphalt and Low Temperature Cracking Studies	22
2.7 Warm Mix Asphalt Emissions Monitoring and Fuel Benefits.....	23
2.8 Warm Mix Asphalt Pavement Performance Studies	24
2.9 Summary of Literature Review.....	24
CHAPTER 3 EXPERIMENTAL PLAN	26
3.1 Phase I Summary	26
3.2 Materials	27
3.3 Experimental Testing Plan for Phase II	28
3.4 Pavement Survey Plan	36
3.5 Testing Methodology and Equipment.....	37
CHAPTER 4 MIXTURE PERFORMANCE TEST RESULTS AND ANALYSIS	55
4.1 Dynamic Modulus Results and Analysis	55
4.2 Flow Number Results	84
4.3 Semi-Circular Bending Test	92
4.4 Indirect Tensile Strength Test and TSR Results	102
4.5 Hamburg Wheel Tracking Test Results	113

4.6 Curing Study Results and Analysis.....	117
CHAPTER 5 ORIGINAL AND RECOVERED BINDER TEST RESULTS AND ANALYSIS.....	124
CHAPTER 6 PAVEMENT PERFORMANCE DATA AND ANALYSIS USING MEPDG SOFTWARE.....	135
6.1 Pavement Performance Surveys	136
6.2 Comparison of Performance Data on Typical Pavement Structures for Low, Medium, and High Traffic Levels	137
6.3 Input Data for MEPDG Comparison of Actual Pavement Structure and Field Performance Data.....	145
CHAPTER 7 COMPARISON AND CORRELATIONS OF MIXTURE PERFORMANCE DATA	153
7.1 Mixture Ranking for Each Performance Test	154
7.2 Performance Test Correlations	172
CHAPTER 8 CONCLUSIONS AND RECOMMENDATIONS.....	183
REFERENCES	187
APPENDIX A JOB MIX FORMULAS	192
APPENDIX B VOLUMETRIC DETAILS	200
APPENDIX C DYNAMIC MODULUS VALUES	206
APPENDIX D FLOW NUMBER VALUES.....	216
APPENDIX E SCB VALUES.....	221
APPENDIX F INDIRECT TENSILE STRENGTH DATA SHEETS.....	228
APPENDIX G HAMBURG WHEEL TRACKING TEST DETAILS.....	240
APPENDIX H CURING STUDY HAMBURG TEST DETAILS.....	250
APPENDIX I BINDER TESTING DETAILS	254
APPENDIX J PAVEMENT PERFORMANCE DETAILS	264
APPENDIX K PAVEMENT PERFORMANCE DETAILS.....	265

LIST OF TABLES

Table 3.1 Summary table of mixes for Phase I and Phase II	28
Table 3.2 Testing plan for dynamic modulus and flow number	30
Table 3.3 Testing plan for semi-circular bending test	31
Table 3.4 Testing plan for the Hamburg wheel tracking test.....	32
Table 3.5 Testing plan for HMA indirect tensile strength samples	33
Table 3.6 Testing plan for WMA indirect tensile strength samples	33
Table 3.7 Testing plan for original and recovered binders	35
Table 3.8 Plan of study for curing study in the Hamburg wheel tracking test	36
Table 4.1 Summarized ANOVA table for Field Mix 2 with a SP-RM design	63
Table 4.2 P-Values for FM2 dynamic modulus comparisons.....	65
Table 4.3 FM3 summarized ANOVA table	68
Table 4.4 P-values for the FM3 split-plot/repeated measures analysis	69
Table 4.5 Summarized ANOVA table Split plot Repeated measures design for FM4.....	73
Table 4.6 P-values for the FM4 split-plot/repeated measures analysis	74
Table 4.7 Split-plot repeated measures ANOVA analysis for FM5	77
Table 4.8 P-values for the FM5 split-plot/repeated measures analysis	77
Table 4.9 FM7 Split-plot repeated measures ANOVA Analysis.....	81
Table 4.10 Summary table of the statistically significant factors by WMA additive type	83
Table 4.11 FM2 p-values for comparing tensile strength values.....	103
Table 4.12 FM3 p-values for comparing tensile strength values.....	105
Table 4.13 FM4 p-values for comparing tensile strength values.....	107
Table 6.1 Traffic inputs for MEPDG modeling.....	146

Table 6.2 Pavement survey summary for 2011	148
Table 6.3 Comparison and rankings of mixes for predicted AC rutting, E^* and E^* ratio.....	150
Table 7.1 Ranking of mixes by stripping inflection point	155
Table 7.2 Ranking of mixes by fracture toughness.....	157
Table 7.3 Ranking of mixes by work of fracture	158
Table 7.4 Ranking of mixtures by stiffness measured by SCB testing.....	159
Table 7.5 Ranking of mixtures by dynamic modulus measured at 4°C.....	161
Table 7.6 Ranking of mixtures by dynamic modulus measured at 21°C.....	162
Table 7.7 Ranking of mixtures by dynamic modulus measured at 37°C.....	163
Table 7.8 Ranking of mixtures by tensile strength ratio	164
Table 7.9 Ranking of mixes by indirect tensile strength	165
Table 7.10 Ranking of mixtures by flow number	166
Table 7.11 Ranking of mixtures by binder according to high, medium, and low properties	167
Table 7.12 Ranking of mixes according to low temperature z-score	169
Table 7.13 Ranking of mixes according to intermediate temperature z-score	170
Table 7.14 Ranking of mixes according to high temperature z-score	171
Table 7.15 Overall rank using the average z-score for low, medium, and high temperature ranges	172
Table B.1 Volumetric data for cores.....	200
Table B.2 FM5 field-compacted dynamic modulus	203
Table B.3 FM5 lab-compacted dynamic modulus	203
Table B.4 FM6 field-compacted dynamic modulus	203
Table B.5 FM6 lab-compacted dynamic modulus	204
Table B.6 FM7-0 field-compacted dynamic modulus	204

Table B.7 FM7-0 lab-compacted dynamic modulus.....	204
Table B.8 FM7-5 lab-compacted dynamic modulus.....	205
Table B.9 FM7-7 lab-compacted dynamic modulus.....	205
Table C.1 FM1 dynamic modulus data (used only for MEPDG analysis)	207
Table C.2 Field Mix 2 dynamic modulus values (kPa)	208
Table C.3 Field Mix 3 dynamic modulus values (kPa)	209
Table C.4 FM4 dynamic modulus values (kPa).....	210
Table C.5 FM5 dynamic modulus values	211
Table C.6 FM6 dynamic modulus values	213
Table C.7 FM7 dynamic modulus values	215
Table D.1 Flow number values.....	216
Table E.1 All SCB values	221
Table F.1 Indirect tensile strength for FM2 lab-compacted	229
Table F.2 Indirect tensile strength for FM2 field-compacted.....	230
Table F.3 Indirect tensile strength for FM3 lab-compacted	231
Table F.4 Indirect tensile strength for FM3 field-compacted.....	232
Table F.5 Indirect tensile strength for FM4 lab-compacted	233
Table F.6 Indirect tensile strength for FM4 field-compacted.....	234
Table F.7 Indirect tensile strength for FM5	235
Table F.8 Indirect tensile strength for FM6	236
Table F.9 Indirect tensile strength for FM7	237
Table F.10 Indirect tensile strength for FM7-5.....	238
Table F.11 Indirect tensile strength for FM7-7.....	239

Table H.1 Hamburg test result details.....	250
Table H.2 Hamburg test result details.....	251
Table H.3 Hamburg test result details.....	253
Table H.4 Hamburg test result details.....	253
Table I.1 FM2 binder data	254
Table I.2 FM2 BBR binder data	255
Table I.3 FM3 binder data	256
Table I.4 FM3 BBR binder data	257
Table I.5 FM4 binder data	258
Table I.6 FM4 BBR binder data	259
Table I.7 FM5 binder data	260
Table I.8 FM6 binder data	261
Table I.9 FM7 binder data	262
Table J.1 Pavement performance data	264

LIST OF FIGURES

Figure 2.1 Foamed asphalt system (Csanyi, 1959).....	11
Figure 2.2 Warm mix additive Evotherm® manufactured by MeadWestvaco	13
Figure 2.3 WMA additive Sasobit® (Sasol Wax North America Corporation	14
Figure 2.4 Astec double barrel asphalt foaming plant modification.....	16
Figure 2.5 Advera synthetic zeolite WMA additive for foaming asphalt.....	17
Figure 3.1 Map of the Phase II study pavement locations (Google Earth, 2013).....	27
Figure 3.2 Diagram showing the scope of phase II	29
Figure 3.3 Test set up for the dynamic modulus test	39
Figure 3.4 Permanent shear strain versus number of loading cycles (Witczak, Kaloush, Pellinen, El-Aasyouny, & Von Quintus, 2002)	42
Figure 3.5 Original proposed loading frame for SCB testing (draft standard).....	43
Figure 3.6 Loading frame designed at Iowa State University (Courtesy of Sheng Tang).....	43
Figure 3.7 Typical SCB load versus average load line displacement (P-u) curve.....	44
Figure 3.8 Example graph showing how stiffness is calculated	47
Figure 3.9 Indirect tensile strength test set up	48
Figure 3.10 Hamburg wheel tracking test results	50
Figure 3.11 Binder testing equipment (a) Dynamic shear rheometer (b) Rolling thin film oven (c) Pressure aging vessel (d) Bending beam rheometer	52
Figure 3.12 Rotary evaporator binder recovery system (Photo courtesy of Sheng Tang).....	54
Figure 4.1 Diagram of split-plot design and experimental factors	57
Figure 4.2 Non-transformed dynamic modulus data	58
Figure 4.3 Dynamic modulus data with a log transformation	58
Figure 4.4 FM2 (HMA/Evotherm) dynamic modulus master curves.....	60

Figure 4.5 FM3 (HMA/Sasobit) dynamic modulus master curves.....	66
Figure 4.6 FM4 (HMA/Foaming) dynamic modulus master curves	70
Figure 4.7 FM5 (Evotherm only) dynamic modulus master curves	75
Figure 4.8 FM6 (Evotherm) dynamic modulus master curves	78
Figure 4.9 FM7 (Evotherm with 0%, 5%, 7% Shingles) dynamic modulus master curves	79
Figure 4.10 FM2 flow number comparison	86
Figure 4.11 Strain versus cycles plot for FM2 (HMA/Evotherm).....	86
Figure 4.12 FM3 flow number comparison	87
Figure 4.13 Strain versus cycles plot for FM3 (HMA/Sasobit).....	87
Figure 4.14 Flow number comparisons for FM4.....	88
Figure 4.15 Strain versus cycles plot for FM4 (HMA/Foam)	88
Figure 4.16 Flow number comparison for FM5.....	89
Figure 4.17 Strain versus cycles plot for FM5 (Evotherm)	89
Figure 4.18 Flow number comparison for FM6.....	90
Figure 4.19 Strain versus cycles plot for FM6 (Evotherm)	90
Figure 4.20 Flow number comparison for FM7.....	91
Figure 4.21 Strain versus cycles plot for FM7 (Evotherm and Shingles).....	91
Figure 4.22 SCB results for FM2 (HMA/Evotherm).....	96
Figure 4.23 SCB results for FM3 (HMA/Sasobit).....	97
Figure 4.24 SCB results for FM4 (HMA/Foam)	98
Figure 4.25 SCB results for FM5 and FM6 (Evotherm).....	99
Figure 4.26 SCB results for FM7-0 (Evotherm with 0% Shingles).....	100
Figure 4.27 SCB results for FM7-5 and FM7-7 (Evotherm with 5% and 7% Shingles).....	101

Figure 4.28 FM2 IDT peak strength (HMA/Evotherm)	104
Figure 4.29 FM2 TSR results (HMA/Evotherm).....	104
Figure 4.30 FM3 IDT peak strength (HMA/Sasobit)	106
Figure 4.31 FM3 TSR results (HMA/Sasobit).....	106
Figure 4.32 FM4 IDT peak strength (HMA/Foam)	108
Figure 4.33 FM4 TSR results (HMA/Foam)	108
Figure 4.34 FM5 IDT peak strength (Evotherm).....	109
Figure 4.35 Tensile Strength Ratio for FM5.....	110
Figure 4.36 FM6 IDT peak strength (Evotherm).....	111
Figure 4.37 TSR values for FM6 (Evotherm).....	111
Figure 4.38 FM7 IDT peak strength (Evotherm with 0%, 5%, and 7% Shingles)	112
Figure 4.39 FM7 TSR results (Evotherm with 0%, 5%, and 7%)	113
Figure 4.40 FM2 Hamburg rutting depth versus passes (HMA/Evotherm)	115
Figure 4.41 FM3 Hamburg rutting depth versus passes (HMA/Sasobit)	115
Figure 4.42 FM4 Hamburg rutting depth versus passes (HMA/Foam)	116
Figure 4.43 FM5 and FM6 Hamburg rutting depth versus passes (Evotherm)	116
Figure 4.44 FM7 Hamburg rutting depth versus passes (Evotherm with 0%, 5%, and 7% Shingles).....	117
Figure 4.45 Hamburg results comparing curing temperature and time for FM2 HMA and WMA.....	118
Figure 4.46 Stripping inflection point for FM2 comparing HMA with WMA, curing time and temperature (SIP for FM2 cores is 20,000).....	119
Figure 4.47 FM5 Hamburg wheel tracking test results with variable time and temperatures	120
Figure 4.48 Stripping inflection point for FM5 comparing curing time and temperature	120
Figure 4.49 FM6 Hamburg wheel tracking test results with variable time and temperatures	121

Figure 4.50 Stripping inflection point for FM6 comparing curing time and temperature	121
Figure 5.1 FM2 (HMA/Evotherm) binder test results (a) DSR original and RTFO aged (b) DSR PAV aged (c) BBR low temperature	129
Figure 5.2 FM3 (HMA/Sasobit)binder test results (a) DSR original and RTFO aged (b) DSR PAV aged (c) BBR low temperature	130
Figure 5.3 FM4 (HMA/Foam) binder test results (a) DSR original and RTFO aged (b) DSR PAV aged (c) BBR low temperature	131
Figure 5.4 FM5 (Evotherm) binder test results (a) DSR original and RTFO aged (b) DSR PAV aged (c) BBR low temperature	132
Figure 5.5 FM6 (Evotherm) binder test results (a) DSR original and RTFO aged (b) DSR PAV aged (c) BBR low temperature	133
Figure 5.6 FM7 (Foaming) binder test results (a) DSR original and RTFO aged (b) DSR PAV aged (c) BBR low temperature	134
Figure 6.1 Average transverse crack spacing for 2011 and 2012 condition surveys.....	137
Figure 6.2 Average rutting depth for 2011 and 2012 condition surveys	137
Figure 6.3 Model simulations performed for each mixture	139
Figure 6.4 Pavement designs for low, medium, and high traffic levels.....	140
Figure 6.5 MEPDG predicted alligator cracking	142
Figure 6.6 MEPDG predicted total rutting	143
Figure 6.7 MEPDG predicted IRI.....	143
Figure 6.8 Pavement structures used in MEPDG analysis	147
Figure 6.9 Total AC rutting depth predicted by the MEPDG (a) FM2 (b) FM3 (c) FM4	152
Figure 7.1 Binder properties compared with dynamic modulus at 4°C.....	174
Figure 7.2 Binder properties compared with dynamic modulus at 21°C.....	174
Figure 7.3 Binder properties compared with dynamic modulus at 37°C.....	175
Figure 7.4 Binder Properties compared with flow number.....	176
Figure 7.5 Binder properties compared with SCB work of fracture measured at PG+22	177

Figure 7.6 Binder properties compared with SCB stiffness measured at PG+22.....	177
Figure 7.7 Dynamic modulus at 4°C compared with fracture toughness at PG+22.....	178
Figure 7.8 Dynamic modulus at 4°C compared with stiffness at PG+22.....	179
Figure 7.9 Dynamic modulus at 4°C compared with stiffness at PG+10.....	179
Figure 7.10 Dynamic modulus at 4°C compared with stiffness at PG-2.....	179
Figure 7.11 Relationship of tensile strength ratio and stripping inflection point.....	180
Figure 7.12 Relationship of high temperature binder grade and stripping inflection point for cores.....	181
Figure 7.13 Relationship of high temperature binder grade and stripping inflection point for gyratory-compacted samples.....	182
Figure 7.14 Relationship of flow number and high temperature dynamic modulus.....	182
Figure A.1 Field Mix 2 Job Mix Formula - WMA additive is Revix.....	192
Figure A.2 Field Mix 3 Job Mix Formula - WMA additive is Sasobit.....	193
Figure A.3 Field Mix 4 Job Mix Formula - WMA Double Barrel Green Foaming.....	194
Figure A.4 FM5 Job Mix Formula - WMA additive is Evotherm.....	195
Figure A.5 FM6 Job Mix Formula - WMA additive is Evotherm.....	196
Figure A.6 FM7-0 (0% Shingles) Job Mix Formula - WMA additive is Evotherm.....	197
Figure A.7 FM7-5 (5% Shingles) Job Mix Formula - WMA additive is Evotherm.....	198
Figure A.8 FM7-7 (7% Shingles) Job Mix Formula - WMA additive is Evotherm.....	199
Figure G.1 Rutting depth for FM2.....	240
Figure G.2 SIP for FM2.....	240
Figure G.3 Creep slope, stripping slope, and slope ratio for FM2.....	241
Figure G.4 Rutting depth for FM3.....	242
Figure G.5 SIP for FM3.....	243
Figure G.6 Creep slope, stripping slope, and slope ratio for FM3.....	244

Figure G.7 Rutting depth for FM4245

Figure G.8 SIP for FM4245

Figure G.9 Creep slope, stripping slope, and slope ratio for FM4.....246

Figure G.10 Rutting depth for FM5 and FM6246

Figure G.11 SIP for FM5 and FM6247

Figure G.12 Creep slope, stripping slope, and slope ratio for FM5 and FM6247

Figure G.13 Rutting depth for FM7-0, FM7-5, and FM7-7248

Figure G.14 SIP for FM7-0, FM7-5, and FM7-7.....248

Figure G.15 Creep slope, stripping slope, and slope ratio for FM7.....249

ACKNOWLEDGEMENTS

I would like to first thank God for all the blessings and opportunities I have been given. A very special thank you goes to my husband and my family for their support, love and encouragement.

I would like to thank my major professor, Dr. R. Christopher Williams for his support and invaluable guidance throughout graduate school. I would also like to thank Dr. Vern Schaefer, Dr. Kejin Wang, Dr. William Simpkins and Dr. Robert Stephenson for serving on my committee, for their guidance throughout this research and the education that they have provided during my time in graduate school. Thank you to Dr. Scott Schram and the materials staff at the Iowa Department of Transportation for their help in accomplishing this research.

Graduate school has been an experience that will forever enrich my life. I would like to thank the graduate students and support staff whom I have had the opportunity to work with every day. Thank you for all the help in the laboratory and in the field. I have enjoyed working together and building life-long friendships.

Thank you to the Iowa Highway Research Board for funding this research and their commitment to improving our infrastructure system.

EXECUTIVE SUMMARY

The implementation of warm mix asphalt (WMA) is becoming more widespread with a growing number of contractors utilizing WMA technologies to take advantage of reduced mixing and compaction temperatures, reduced fuel consumption and improved compactability. WMA technology has demonstrated to have beneficial economic value as well as environmental value in other parts of the United States and Europe. The identified economic value is due to the reduction of hot mix asphalt (HMA) plant temperatures by 50-100°F, saving fuel and allowing for improved field compaction (reduction in roller coverage) and/or longer haul distances. The environmental benefits of WMA additives include reduced HMA plant emissions because of the reduced plant production temperatures as well as reduced worker exposure to fumes during the production/construction process.

Problem statement and objectives

This research was completed in two phases. Phase I showed differences between control HMA mixes and WMA mixtures in moisture conditioning and dynamic modulus performance. Phase II of this study will further evaluate the performance of plant-produced WMA mixtures. This is will be done by conducting more mixture tests at a broader range of temperatures, adding the Hamburg wheel tracking test, adding additional pavements to the study, performing pavement condition surveys and comparing pavement condition data with the mechanistic-empirical pavement design guide's forecast for pavement damage over the next 20 years. Further objectives detailing curing behavior, quality assurance testing, and hybrid technologies are outlined as follows:

1. Compare the predicted and observed field performance of existing WMA trials produced in the previous Phase I study to that of HMA control sections to determine if Phase I

conclusions are translating to the field.

2. Identify any curing effect (and timing of the effect) of WMA mixtures and binders in the field. Determine how the field compacted mixture properties and recovered binder properties of WMA compares to those of HMA over time for technologies common to Iowa.
3. Identify protocols for WMA sample preparation for volumetric and performance testing which best simulate field conditions.

Experimental plan

In 2009, three pavements were constructed with mixes having both hot mix asphalt and warm mix asphalt test sections as part of a Phase I WMA study. Mix was compacted at the construction sites, without reheating, and additional mix was collected to later reheated and compact in the laboratory. Virgin binder, collected from the tank at the asphalt plant, was sampled for further binder analysis during construction. Phase I testing included indirect tensile strength, dynamic modulus and flow number testing. Phase I conclusions indicated some differences between the WMA mix properties and HMA properties; however, trends were not present over all the mixes tested. In 2010, additional WMA pavements were constructed and added to the WMA study as part of a Phase II project. Phase II utilizes the information in Phase I to show a broader picture of how WMA additives impact the asphalt pavements. The Phase II study incorporates more testing at a wider range of temperatures, testing of pavement cores, extracted binder tests and pavement condition surveys of WMA mixes located and produced in Iowa.

Phase I and Phase II of the WMA investigation contained eleven total mixes. All mixes were produced in asphalt plants and used to construct asphalt roadways throughout the state of Iowa. For each mix, samples were compacted in a Superpave gyratory compacter the day of

production, reheated and compacted in the laboratory. In addition to the gyratory compacted samples, field cores were taken after one or two years of in-service aging. For each mix, tank binder was collected and tested. Binder was recovered from cores and tested. Dynamic modulus, flow number, semi-circular bending test, indirect tensile strength (TSR), Hamburg wheel tracking tests were performed on all mixes. A curing study was also performed in the Hamburg on three mixes. Mixture properties were statistically compared and factors within each mix were analyzed by performing an analysis of variance. Binder performance grading was conducted on all mixes included in the study. Pavement survey data was collected for two years and compared with the MEPDG pavement performance results. Mixture and binder performance data was used to rank mixes and standardized rankings were used to compare overall performance of the mixtures. All of these different areas of study together, provide a holistic view of the detectable impact WMA additives have on HMA pavements.

Conclusions and recommendations

Based on the mixes tested in this study and the collected data from measured test parameters in this research, the following can be concluded:

- WMA additives do show statistical differences in mixture properties in some of the mixes tested. These differences will not always be statistically different from mixture to mixture. Multiple factors such as WMA additive type, construction conditions and mixture variability all play a role in determining the extent of which WMA and HMA mixes differ.
- Curing time and temperature greatly influences the stripping inflection point in the Hamburg. The lower WMA temperature with curing times below 2 hours, did not perform as well as the samples cured and compacted at HMA temperature or for longer curing durations.
- On average, WMA had lower flow numbers when compared with the HMA control unless

the reduced stiffness is offset by recycled materials added to the mixture.

- Cores usually performed better in the Hamburg compared to gyratory samples. The shingles in FM7-7 greatly increased the performance of that mixture in the Hamburg. Between HMA and WMA samples, one did not consistently perform better than the other.
- Comparing tensile strength ratio and stripping inflection point values showed that more mixes fall below a SIP of 10,000 (and 14,000) as compared to a TSR of 0.80.
- SCB tests did show some good correlations with other measured material properties but the test data is generally too variable to be able to calculate statistical differences at low alpha levels.
- The Sasobit mixture exhibited a significantly lower indirect tensile strength compared with the HMA control.
- The mixes with recycled asphalt shingles (RAS) (5% and 7%) did not perform well in TSR tests.
- RAS had a much greater influence on recovered binder properties than the Recycled asphalt pavement (RAP).
- All recovered binders from field cores showed an increase in high temperature by at least 5°C.
- Data from pavement performance show distresses in the field but do not show large differences in performance between HMA and WMA sections.

Based on the results of this research, the following suggestions are recommended:

- The curing study shows that there are effects of time and temperature for the mixture conditioning. The higher temperature or longer curing durations for a mix consistently showed improved results with Hamburg testing. Using the Hamburg as a standard in Iowa

will help to identify WMA practices that may lead to inferior performance.

- The mixture with 7% RAS showed a substantial increase in performance in the Hamburg. Other tests, such as fatigue testing or low temperature tests will compliment a Hamburg test specification.
- Additional warm mixes that use RAS should be studied because the TSR values were very low for the 7% RAS mixture. The reduction may be due to the combination of increased RAS at a low temperature.
- Continuation of the pavement conditioning surveys may help to identify differences in performance between HMA and WMA in the future but warm mix additives did not appear to influence recovered binder properties after 1 or two years in the field.
- The TSR value showed no correlation to the SIP measured in a Hamburg test. The Hamburg was generally more selective of mixes; therefore, mixes that have previously passed the TSR minimums will likely need to be reevaluated in the Hamburg for the new SIP specification that replaces the TSR criteria.
- The WMA additives should continue to be used as long as moisture susceptibility and rutting resistance can be shown to be equal to that of HMA pavements.

CHAPTER 1 INTRODUCTION

1.1 Background

The implementation of warm mix asphalt (WMA) has become more widespread with a growing number of contractors utilizing WMA technologies to take advantage of reduced mixing and compaction temperatures, reduced fuel consumption and better compactability. WMA technology has demonstrated to have beneficial economic value as well as environmental value in parts of the United States and Europe. The identified economic value is due to the reduction of hot mix asphalt (HMA) plant temperatures by 50-100°F, saving fuel and allowing for improved field compaction (reduction in roller coverage) and/or longer haul distances. The environmental benefits of WMA additives include reduced HMA plant emissions because of the reduced plant production temperatures as well as reduced worker exposure to fumes during the production/construction process. Furthermore, plants located in urban areas have lower air quality impacts on neighboring properties and to the public in general. The first WMA project in Iowa was produced in June 2008 and demonstrated lower production temperatures while density specifications were being met concurrently on a local agency project in Polk County. The initial assessment by the contractor producing this mix did not readily find the fuel economy/savings, which is likely due to the relatively small mix quantity produced.

Studies throughout the U.S. have shown WMA technologies can impact properties of both the asphalt binder and mixture. The Iowa Highway Research Board (IHRB) Phase I study found performance testing results on plant produced mixes was statistically different between HMA and WMA with compaction type (lab versus field) and selected technology each playing a role. It was also shown that some technologies may impact the performance grade of the binder due to the reduced production temperature.

An important conclusion from Phase I found the source of the differences in mixture performance may originate from how the mix was designed. All of the field projects included in the study for Phase I were let and designed as HMA. Warm mix additives or water injection systems were added with no changes to the job mix formula (JMF) when comparing HMA and WMA. The findings in Phase I were similar to results found in NCHRP Project 9-43, which led to recommended mix design practices for WMA. This project will address the issue of how observed differences in lab performance testing translate to the field. Pavement conditioning studies along with laboratory mixture testing in Phase II will help to answer how laboratory test results relate to field condition surveys. Curing studies will help to show the impact the curing time and temperature will have on the WMA mixture properties. The sensitivity WMA shows to curing will be critical in recommending standard quality assurance procedures for WMA. The impact that reheating has on WMA specimens should be evaluated for both curing time and temperature. The effect of curing for different durations and temperatures will be evaluated in the newly implemented moisture conditioning standard in Iowa, the Hamburg wheel tracking test. The samples cured at different times and temperatures will be compared with field cores. Similarly, the potential for moisture-related damage and the role temperature plays will be evaluated. Testing of field cores will be used to directly compare HMA and WMA to establish the impact WMA additives have on pavement material properties after 1 or 2 years in the field.

1.2 Problem statement and objectives

The results of Phase I showed differences between control HMA mixes and WMA mixtures in moisture conditioning and dynamic modulus performance. Phase II of this study will further evaluate the performance of plant-produced WMA mixtures. This is will be done by conducting

more mixture tests at a broader range of temperatures, adding Hamburg wheel tracking tests, adding additional pavements to the study, performing pavement condition surveys and comparing pavement condition data with the MEPDG design guide's forecast for pavement damage over the next 20 years. Further objectives detailing curing behavior, quality assurance testing, and hybrid technologies are outlined as follows:

1. Compare the predicted and observed field performance of existing WMA trials produced in the previous Phase I study to that of HMA control sections to determine if Phase I conclusions are translating to the field.
2. Identify any curing effect (and timing of the effect) of WMA mixtures and binders in the field. Determine how the field compacted mixture properties and recovered binder properties of WMA compares to those of HMA over time for technologies common to Iowa.
3. Identify protocols for WMA sample preparation for volumetric and performance testing which best simulate field conditions.

1.3 Methodology and approach

To achieve the objectives of the research project a comprehensive study of multiple WMA technologies, pavement types and designs must be studied. The approach focused on developing an understanding of the material properties by testing plant produced mixes under a variety of conditions. Phase I of this project focused on obtaining material properties and evaluating moisture susceptibility. Phase II also included studying material properties and moisture susceptibility but other important tests and additional mixes were added. Another important part of phase II was monitoring the condition of the HMA and WMA pavement sections included in this study.

A comprehensive literature review for WMA was developed in phase I and the phase II literature review focused on updating WMA literature with current projects and leading developments that are ongoing in the WMA industry. The WMA technologies have continued to evolve much faster than available published information, however, a review of the published information allows for further investigation of typical concerns that have accompanied WMA, such as moisture susceptibility, quality control/quality assurance and overall performance. To answer the question whether HMA and WMA are going to perform differently in the field, results from Phase I will be used as input values into the Mechanistic-Empirical Pavement Design Guide (MEPDG). The phase I data will be used to determine if differences between the dynamic modulus of asphalt mixtures and differences in the performance grade (PG) binder values in HMA and WMA can lead to measureable differences in the MEPDG results which will forecast the amount of pavement distress that occurs over a pavement's lifetime. The MEPDG uses models to help predict pavement performance based on local environmental conditions and loading patterns. This model uses local climate data, traffic data and measured material properties to forecast the pavement distresses that will occur in the pavement over its design life. The dynamic modulus (E^*) is an important material property that is used as an input into the MEPDG model and can help predict deformation under various loading conditions and pavement temperatures. Pavement structures were developed using Iowa DOT plan sets and the Iowa DOT pavement management information system (PMIS). The E^* data from both HMA and WMA mixes are used as inputs into the MEPDG design guide and MEPDG results can be statistically analyzed. Phase I often showed statistical differences in the E^* values when comparing WMA with the control HMA. The MEPDG will help to show if the statistical differences found in the laboratory study will also impact the long-term predicted pavement performance. It is currently

unknown if the statistical differences that are reflected in the laboratory testing will impact the overall field performance where many factors can influence pavement performance. Several pavement structures were studied and results were compared for HMA and WMA. The pavement conditioning surveys were performed and the distresses were recorded. The measured material properties from the phase I laboratory testing, actual traffic data from the Iowa DOT, and actual pavement structures from plan sets were input into the MEPDG model for comparisons of the HMA and WMA distresses. The distresses evaluated by the MEPDG were compared against the pavement performance data. This study helps to further the understanding of how differences in HMA and WMA material properties measured in laboratory performance tests relate to actual pavement condition and field performance. The pavement surveys are used to determine if a certain type of distress is prevalent in WMA and if WMA performance is approximately equal to the control HMA sections.

Additional WMA pavement projects were added to the phase II study and WMA material from the additional projects was collected during the fall 2010 construction season. The material collected during phase I, construction season 2009, were HMA mixes that incorporated WMA technology and there were no modifications to the HMA job mix formula (JMF) to compensate for effects of the WMA except for the reduced production temperatures. The phase I experimental testing plan considered important factors such as: the type of WMA technology and mixture performance, when compaction occurred (reheated/not reheated), moisture conditioning and the use of recycled material. Phase II testing also includes these factors but expands the scope of the study to include a broader variety of WMA mix designs and additional performance testing to better characterize the asphalt material over a wider range of temperatures and loading conditions. Field cores from all of the pavement sections are also included into phase II.

Depending upon the year of construction, pavement cores will have 1 or 2 years of insitu aging and service life.

Performance testing will include dynamic modulus tests at a range of temperatures and frequencies, flow number, indirect tensile strength, Hamburg wheel tracking tests, semi-circular bending test at low temperatures and performance grade binder tests. The HMA and WMA material properties will be compared and the influence of the various factors, such as reheating, will be investigated.

Moisture conditioning remains a primary concern for WMA mixes. At the beginning of this study, AASHTO T-283 was the standard for evaluating moisture susceptibility in Iowa, requiring a TSR value of 80%. This standard has recently changed from TSR values to stripping inflection points as measured by the Hamburg wheel tracking test. AASHTO T-283 testing was performed for all of the mixes and additional testing with the Hamburg wheel tracking test at the Iowa DOT was performed. The combination of these tests will better characterize the moisture susceptibility of the WMA mixes compared to the HMA mixes. Furthermore, a curing study investigating various temperatures and curing times is used to evaluate mixture moisture susceptibility using the Hamburg wheel tracking test. Cores collected in the field were also included in the Hamburg performance testing.

The statistical analysis tools, analysis of variance (ANOVA) and Tukey multiple comparison testing, will help to identify differences in the test data and material properties. Phase I included examining the effects of the variables, such as WMA technology, reheated or immediately compacted as well as moisture conditioning effects. The performance test data of the mixtures from phase I will be included in the analysis and compared with the dynamic modulus (master curves), flow number and moisture susceptibility testing of the phase II

material. Phase II will examine all of these variables and in addition, evaluate predicted and actual field performance, recovered binder properties, the impacts of RAP/RAS and conduct performance testing over a wide range of temperatures and loading conditions.

1.4 Significance of work

The outline methodology and approach will provide the following results: (1) Evaluation and characterization of how the WMA technologies studied in phase I impact pavement performance for both predicted (MEPDG) and actual (pavement surveys). (2) Evaluation of how WMA compares to HMA in multiple performance tests and (3) Evaluation of the benefits of utilizing a WMA technology in Iowa. (4) Identify the appropriate methods/procedures for material selection (e.g. asphalt binder grade and amount of RAP/RAS is allowable). (5) Evaluation of the impact time and temperature have on WMA and (6) evaluation and integration of WMA technology into Iowa DOT and local jurisdictional quality control/quality assurance procedures. This research provides a better understanding of how to utilize green technologies in the HMA industry that have been shown to reduce HMA plant emissions via the reduction in plant production temperature and plant fuel consumption while still using recycled asphalt materials in the mixtures. The reduction in emissions also reduces worker exposure to fumes during load out, placement and compaction. WMA technology may have additional benefits in providing longer haul distances and/or longer construction seasons as well as the ability to place thicker lifts.

1.5 Dissertation organization

The dissertation is divided into eight chapters followed by appendices with important testing information. The first chapter is an introduction that provides a brief background about

WMA and the problem statement. Also included in the introduction are the objectives, methodology, significance of work and the organization of the dissertation. Chapter 2 is the literature review which provides a background of WMA, a history of how WMA was implemented in the United States, information about WMA technologies and prior research that has occurred in the WMA asphalt industry. Chapter 3 explains the experimental plan and the testing procedures used in evaluating asphalt material properties. Details about the test procedures, theory and application are also provided. Chapter 4 presents the asphalt mixture performance test results which include dynamic modulus tests, flow number tests, semi-circular bending tests, indirect tensile strength tests and Hamburg wheel tracking tests. Chapter 5 presents the binder test results where the rheological properties of the virgin tank binders is compared with the binder that was recovered from the field cores after 1 or 2 years in the field. Chapter 6 presents the pavement performance data collected at one and two years of service life. Chapter 7 is a comparison of the mixture results. Chapter 8 presents the summary, conclusions and recommendations for further research. Appendices of important test results are also provided.

CHAPTER 2 LITERATURE REVIEW

Warm mix asphalt research continues to be an important topic in the field of asphalt pavements. The technologies for reducing mixing and compaction temperature have been widely implemented across the country and research has continued monitoring the performance of WMA pavements. A summarized version of the history of WMA is included in this literature review but the primary intention for this literature review is to compile some of the most current research performed on WMA pavements and to summarize findings. A more detailed history of the introduction and implementation of WMA to the asphalt industry and be found in IHRB Report TR-599 (Buss, 2011).

The literature review summarizes the background of specific types of WMA technologies. Some early studies and important findings will be summarized. Ongoing current research in the area of WMA will also be summarized. Since WMA has been introduced to the asphalt paving industry, the primary concern has been moisture conditioning. Other areas of importance include dynamic modulus and flow number, fatigue studies, low temperature cracking, emissions monitoring, fuel benefits as well as pavement performance studies. These areas of study will be included in the literature review. Warm mix asphalt remains an important topic of interest to contractors and owner agencies in Iowa.

2.1 Background of warm mix asphalt

The discovery of warm mix asphalt began in the 1950's with foamed asphalt. Having water mix with hot asphalt was a problem in the early days of asphalt paving but it was found that controlled foaming had some benefits for the paving and soil stability industry. Controlling foamed asphalt began at Iowa State University by Professor L.H. Csanyi (Csanyi, 1959). This

study showed that the foamed asphalt using steam gave the mix unique properties which included decreased viscosity and being softer at low temperatures. Dr. Csanyi developed a nozzle for foaming asphalt which used steam. Figure 2.1 shows a picture of the foaming asphalt device developed by Csanyi. Further studies showed that there were no differences between the use of water or steam (Lee, 1980) and the use of water requires less energy as compared to steam. The foamed asphalt was further studied in the mid 1980's and found that curing temperature, length and moisture conditions dramatically affect the strength of foamed asphalt mixtures that contain sand and RAP (Roberts F. E., 1984). Prior to the year 2000, very few studies were performed on warm mix asphalt. Within the last decade, interest in using WMA to achieve reduced mixing and compaction temperatures and other benefits has significantly increased the need to better understand WMA additives and the effects on asphalt material properties.

In the past 15 years, the increased regulations on emissions in the European Union raised concerns about reducing the emissions of HMA production (Jones, 2004). The development of several technologies that lower the temperature of HMA production proved to be viable additives and/or processes for achieving the necessary emission reductions (Newcomb, 2007). The driving force of WMA technologies are the many potential benefits and especially the reduction in fuel cost and emissions. The benefits could potentially impact a company's bottom line by saving money, creating a better working environment because of the reduction in fumes and creating less impact on the surrounding community during the construction process. Before all of these benefits can be fully realized, WMA technologies must produce mixes that are performing just as well or better than traditional HMA mixes (D'Angelo, et al., 2008). Many pavements in Europe were constructed using WMA technologies and reduced temperatures and emissions were

achieved. Further monitoring of these pavements showed that the WMA mixes performed just as well as the HMA pavement sections placed with the same mixes. The success of the implementation of WMA in Europe helped to generate momentum for research, demonstration projects and use of WMA in the United States.

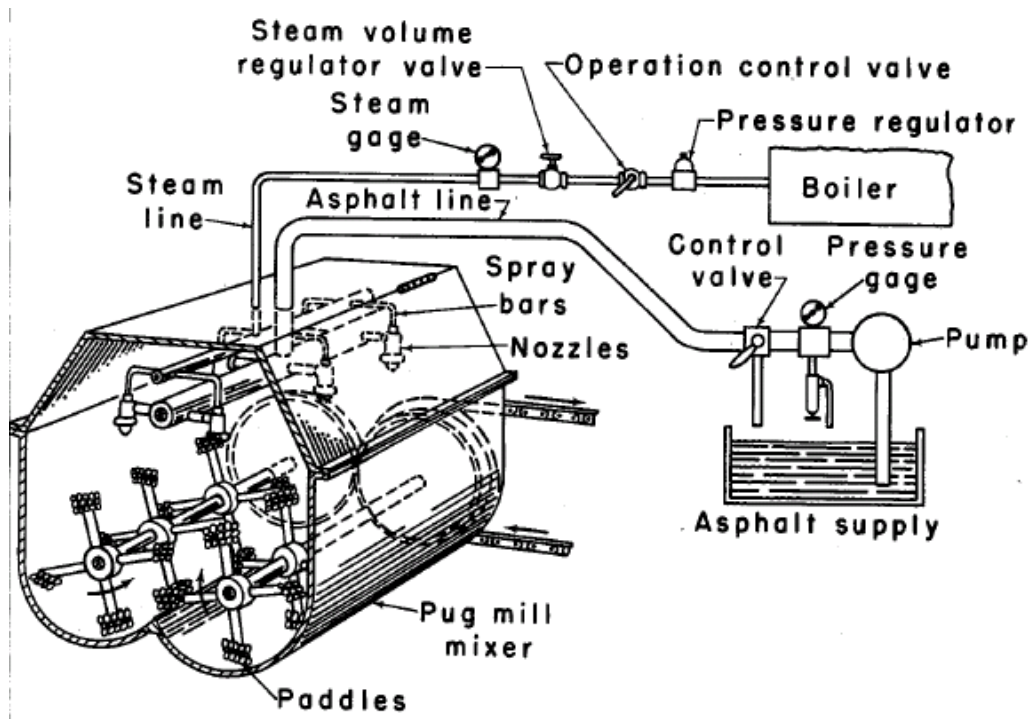

Figure 2.1 Foamed asphalt system (Csanyi, 1959)

2.2 WMA technologies

Four main categories of WMA technologies exist. The technology is either in the form of an additive or an asphalt plant modification. The main categories include: chemical additives, wax additives, foamed asphalt mix-additives and foamed asphalt-plant modifications. For this study, the chemical additive Evotherm®, the wax additive Sasobit® and the foamed asphalt-plant modification Astec Double Barrel Green System® were used. There are many WMA technologies available on the market today. The literature review only included the technologies that were investigated throughout the Phase II study and a brief introduction to synthetic zeolites.

The phase I Iowa DOT report provides further detail on some of the other technologies available (Buss, 2011).

Evotherm[®] is a product that was developed by MeadWestvaco in 2003 and there have been several versions of Evotherm over the past decade. It is recommended that Evotherm be added at rate of 0.5 percent by weight of binder (Hurley, 2006). The Evotherm uses a Dispersed Asphalt Technology (DAT) as the delivery system. Figure 2.2 shows the Evotherm-M1 additive that is manufactured by MeadWestvaco.

MeadWestvaco states that the DAT system has a unique chemistry customized for aggregate compatibility (Corrigan, 2008). Evotherm production temperature at the plant ranges from 185-295°F (85-115°C). An approximate total tonnage produced to date is over 17,000 tons as of February 2008 (D'Angelo, et al., 2008). The chemistry is currently delivered with a relatively high asphalt residue (approximately 70 percent). Unlike traditional asphalt binders, Evotherm is stored at 176°F (80°C). In most Evotherm field trials, the product is pumped directly off a tanker truck (Hurley & Prowell, 2005).

Several laboratory and field studies have been conducted in order to evaluate the performance of Evotherm. These studies include but are not limited to: NCAT's Evaluation of Evotherm for use in Warm Mix Asphalt, McAsphalt Industries Limited evaluated Evotherm in the field at the City of Calgary, Aurora, and in Ramara Township, all in Ontario (Davidson, 2005). Field studies were also conducted in Fort Worth and San Antonio, Texas. A case study was performed at NCAT to determine the moisture susceptibility in WMA and Evotherm DAT was the WMA technology used for that study. The Virginia Department of Transportation (DOT) conducted a field study where one of the three WMA projects used Evotherm (Diefenderfer et al., 2007).



Figure 2.2 Warm mix additive Evotherm® manufactured by MeadWestvaco

Sasobit® is a Fischer-Tropsch paraffin wax. Sasobit is a product of Sasol Wax, South Africa. Sasol Wax has been marketing Sasobit in Europe and Asia since 1997 (D'Angelo, et al., 2008). Figure 2.3 shows the WMA additive Sasobit. It is described as an "asphalt flow improver." The Fischer-Tropsch (F-T) process produces the fine crystalline, long chain aliphatic hydrocarbon that makes up the product Sasobit. The production process begins with coal gasification using the F-T process. The gasification of coal involves the treating of white hot hard coal or coke with a blast of steam (Corrigan, 2008). The gasification process produces a mixture of carbon monoxide and hydrogen. As this occurs carbon monoxide is converted into a hydrocarbon mixture with molecular chain lengths of 1 to 100 carbon atoms and greater. There are naturally occurring paraffin waxes but these differ from Sasobit in the lengths of the carbon chains. Sasobit hydrocarbon chains range from 40-115 carbon atoms and natural paraffin waxes range from 22 to 45 carbon atoms (Corrigan, 2008). The longer chains give Sasobit a higher

melting temperature of approximately 210°F (99°C) and fully dissolve in asphalt at 240°F (116°C). Sasobit allows a reduction in production temperatures of 18-54°F. Sasol Wax recommends adding Sasobit at 3 percent by weight of the mix to gain the desired reduction in viscosity and should not exceed 4 percent due to a possible adjustment of the binder's low temperature properties. Direct blending of solid Sasobit at the plant is not recommended because it will not give a homogeneous distribution of the Sasobit in the asphalt (Corrigan, 2008).



Figure 2.3 WMA additive Sasobit® (Sasol Wax North America Corporation (www.sasolwax.us.com/pdf/SasobitHandling-BlendingGuidelineUSA.pdf))

Sasobit has been used in both laboratory and field studies. Several studies that have utilized Sasobit will be discussed. NCAT performed a laboratory study using Sasobit (Hurley, 2006), the Virginia DOT performed two field studies with Sasobit (Diefenderfer et al., 2007), and Sasobit use was discussed in the FHWA publication about European WMA practice (D'Angelo, et al., 2008). A recent study has evaluated Sasobit and shown that Sasobit improves the asphalt binder and Sasobit mixtures typically are equal to or exceed the rutting performance of HMA mixtures (Jamshidi, 2013). There are other studies that demonstrate that wax based WMA modifiers have higher rut depths at 10,000 passes when compared with HMA mixtures (Toraldó, 2013).

Sasobit has been used in many projects and since 1997, more than 142 projects totaling more than 10 million tons of mix have been paved using Sasobit (D'Angelo, et al., 2008). The projects were constructed in Austria, Belgium, China, Czech Republic, Denmark, France,

Germany, Hungary, Italy, Macau, Malaysia, Netherlands, New Zealand, Norway, Russia, Slovenia, South Africa, Sweden, Switzerland, the United Kingdom and the United States. Lastly, Sasobit[®] was used in deep patches on the Frankfurt Airport in Germany. Twenty-four inches of HMA were placed in a 7.5 hour period. The runway was reopened to jet aircraft at a temperature of 185°F (85°C) (D'Angelo, et al., 2008).

The Astec Double Barrel Green system is made by Astec, Inc. and is shown in Figure 2.4. The Double Barrel Green system is an option that can be included with new drum mixer/dryers or it can be added as a retro fit. Only the addition of water is needed. The system uses water to produce foamed warm mix asphalt. The temperature can be reduced by approximately 50°F and it is estimated that 14 percent less fuel is needed as a result (Astec, Inc., 2007). The approximate total tonnage produced as of February 2008 was over 4,000 tons (D'Angelo, et al., 2008). There are also many other plant modifications that foam asphalt and work in a similar manner as the system shown below; however, since foamed asphalt in this research study was produced using the Double Barrel Green system, it is the only plant modification discussed in detail. The other plant modifications use a very similar system of adding water to the asphalt binder to produce the foamed asphalt.

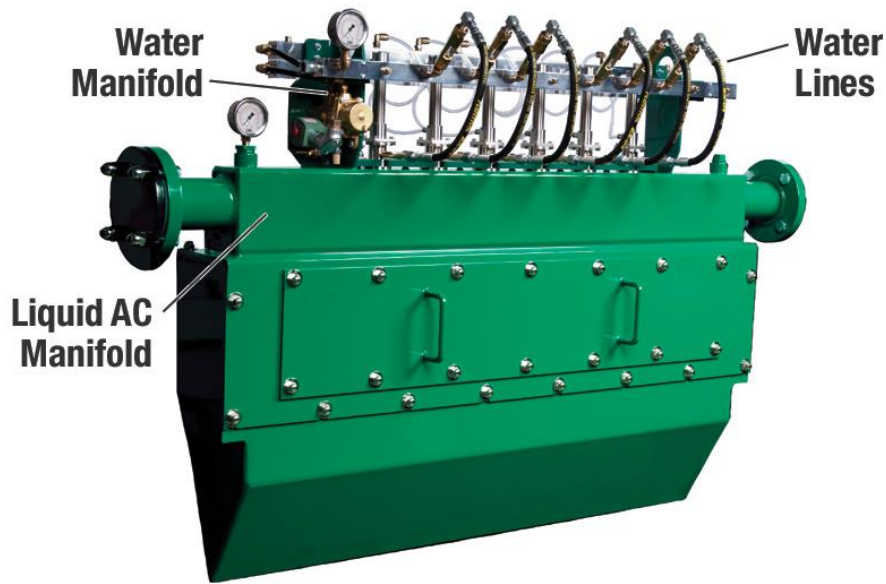

Figure 2.4 Astec double barrel asphalt foaming plant modification (Astec Industries: www.astecinc.com/index.php?option=com_content&view=article&id=117&Itemid=188)

Another common type of WMA additive is synthetic zeolite. Advera, manufactured by PQ Corporation, is an example of a commonly used synthetic zeolite and is shown in Figure 2.5. This technology has the same foaming mechanism for asphalt binders that the plant modifications use. The framework silicates that make up zeolite have large vacancies in their crystalline structure and this allows large cations and water molecules to be stored. The zeolites are characterized by their ability to lose and absorb water without damage to their crystal structures (Corrigan, 2008). The water trapped within the molecular structure is released when the molecules heat up and the water released into the asphalt turns to steam which acts as the foaming agent. Phase I of Investigation of Warm Mix in Iowa (TR-599) (Buss, 2011) investigated the use of synthetic zeolites in the laboratory. This technology was not used in the field projects during the phase II portion of the study. Synthetic zeolites reduce the mixing and compaction temperatures but negatively affected the TSR values.



Figure 2.5 Advera synthetic zeolite WMA additive for foaming asphalt

2.3 Earlier WMA studies

There were various teams of researchers and practitioners who evaluated WMA in the early 2000's to investigate whether the WMA technologies could be implemented in the United States. National Center for Asphalt Technology (NCAT) performed the first major studies on the additives Asphamin, Evotherm, and Sasobit. These products were found to have lowered production and compaction temperatures. Moisture conditioning remained a concern for WMA. WMA has been proven to have similar or better compactability than traditional HMA mixes in both field and laboratory studies (Hurley, 2006). Evotherm was found to reduce air void content the most. These studies also indicate that moisture conditioning is a concern in WMA laboratory tests (Hurley, 2006), (Kvasnak, 2009).

The major implementation of WMA began in Europe due to the Kyoto protocol which pledged to reduce emissions of CO₂ by 15% in 2010 (Jones, 2004). The new standards encouraged the asphalt industry to implement new technologies that would reduce emissions and reduce consumption of resources while creating a more sustainable pavement industry (D'Angelo, et al., 2008). The development of these technologies were further encouraged by

European agencies to develop WMA additives or processes that would have practical benefits such as improved compactability, reduced temperature, a longer paving season and longer haul distances (D'Angelo, et al., 2008), (Newcomb, 2007). Additional benefits also include an improved working environment by means of reducing the temperature creating a cooler work environment and a reduction of fumes.

NAPA performed a study tour in 2002 and soon after, WMA research began at the National Center for Asphalt Technology (NCAT) at Auburn University to investigate the reduced production and placement temperature of WMA. Demonstration projects proved that WMA technologies lower the production and compaction temperatures. The laboratory tests showed that there were some measureable differences in the mix properties. The WMA improved compactability but the indirect tensile strength was lower compared to control mixes and some moisture damage occurred (Hurley & Prowell, 2005). There was reduction in mixing and compaction temperatures but the series of studies that NCAT performed, indicated that susceptibility to moisture damage may be of increased concern for WMA pavements.

In 2007, through the International Technology Scanning Program of the Federal Highway Administration, a U.S. materials team visited Europe with the objective of assessing various WMA technologies. Overall performance of WMA sections was similar with HMA performance if not better (D'Angelo, et al., 2008). The process for incorporating the new technologies began by partnering between WMA developers and owner agencies. Then, once successful laboratory evaluations were complete, field trials are performed. Once the technology proves to be successful in a field trial, the products are incorporated into standards and become recognized additives by the roadway owners.

2.4 Dynamic modulus, moisture conditioning, and Hamburg wheel tracking test studies investigating the use of WMA

Moisture damage, caused by a loss of bond between the asphalt binder or the mastic and the aggregate under traffic loading, can result in a decrease of strength and durability in the asphalt mixture ultimately affecting its long-term performance (Xiao, Jordan, & Amir Khanian, 2009). Moisture damage causes stripping of the asphalt pavement (Roberts, Kandhal, Lee, & Kennedy, 1996). Stripping in HMA pavements may be induced by as many as five mechanisms including detachment, displacement, spontaneous emulsification, pore pressure, and hydraulic scouring. There are many variables that can impact a mix's susceptibility to stripping and these include the type of mix, asphalt cement characteristics, aggregate characteristics, environment, traffic, construction practice, the use of anti-strip additives and the common factor is the presence of moisture (Roberts, Kandhal, Lee, & Kennedy, 1996). There are two major types of moisture damage and they are failure of adhesion and failure of cohesion.

A recent study investigated the mechanical properties of plant-produced warm-mix asphalt mixtures. This study found that the WMA dosage, production temperature and binder properties all significantly affected the performance test results of the dynamic modulus and Hamburg tests. Stripping inflection points for foamed asphalt and Sasobit show to be lower than the HMA control mixtures (Zezelew, 2012). This reinforces the findings of earlier studies that WMA is susceptible to moisture conditioning (Kvasnak, 2009), (Hurley, 2006).

NCHRP 9-43 investigated the moisture susceptibility of WMA by using AASHTO T283 and concluded that there will be differences between WMA and HMA mixes that use the same aggregate and binder. It is likely the WMA will have increased moisture susceptibility compared to an HMA mixture if an anti-strip additive is not used. The lower temperature may also lead to reduced rutting resistance (NCHRP 9-43, 2010) The Evotherm mixture evaluated in NCHRP 9-

43 included an anti-strip additive and so the reduction in moisture sensitivity was not captured in this study. Anti-stripping dosage rates may vary between HMA mixes and WMA mixes. NCHRP 9-43 also investigated the changes necessary in the WMA mix design process. Very few changes were implemented in the mix design process. The main differences are the mixing and compaction temperatures, the coating and compactability evaluation during the laboratory evaluation of the mix design and the specimen preparation is dependent on the additive which is used. There is also a recommendation that the flow number be performed in order to evaluate the rutting susceptibility of the WMA. This concern is reduced when RAP is added to the mixture.

High amounts of RAP have been used with WMA and have shown to work (Mallick, 2008), (Howard, 2013). One recent study used 25% and 40% RAP with rubber in an asphalt mix and found that the addition of WMA helped to mitigate the stiffness increase caused by high amounts of RAP. This study also notes that more research is needed for asphalt rubber mixes that incorporate the use of WMA (Mogawer W. A., 2013).

Short term conditioning can factor into the moisture susceptibility of an asphalt mix. NCHRP 9-43 recommended the short-term conditioning continue to be 2 hours but should be done at the field compaction temperature so as to simulate the binder absorption and stiffening that occurring during the field production (NCHRP 9-43, 2010). Other studies have further investigated the laboratory conditioning protocols. The NCHRP 9-43 study found that plant mix has experienced more conditioning prior to compaction than the laboratory mixed samples which may reduce the bonding strength between aggregates and binder. This study also found that the resilient modulus was more sensitive to conditioning temperature than conditioning time. Extracted binder from cores was compared with samples that were plant mixed-lab compacted. The binder from the cores was found to have higher stiffness in DSR testing (Yin, 2013).

Evotherm 3G was compared with an HMA control in dynamic modulus and in rutting related tests. Overall, the WMA was found to have caused a reduction in the dynamic modulus except for frequencies lower than 0.5 Hz at 40°C. The WMA also did not perform as well as the HMA in rutting related flow number testing and Hamburg wheel tracking tests (Clements, 2012). Another study also reported similar findings of reduced rutting performance, reduced TSR values, and poorer performance in the asphalt pavement analyzer (APA) (Rushing, 2013).

A recent study that investigated moisture susceptibility in Sasobit mixtures shows that the PURWheel test, a wheel tracking test, had the ability to better discern moisture damage performance when compared to the TSR and was able to better relay more useful damage information. There is a need for further investigation into relating the PURWheel parameters to field performance (Doyle, 2013).

2.5 Warm mix asphalt fatigue studies

Fatigue studies will investigate the potential improvement in fatigue cracking for WMA. NCHRP 9-43 concluded that the fatigue resistance of WMA and HMA are similar for mixtures made from the same asphalt binders and aggregates having the same volumetric properties.

Sulfur warm mix was evaluated for fatigue cracking and this study showed that the lower air voids with 30% sulfur mix performed better than the control which had 4% air voids as evaluated by AASHTO T321 (Taylor, 2010).

A wax based WMA was studied in the 4 point bending test at 20°C in strain control mode. The compaction temperature did not influence the fatigue resistance of the WMA mixture. The conclusion is based on the WMA mix showing similar fatigue resistance as the HMA

mixture even though the WMA was compacted at 120°C and the HMA was compacted at 160°C (Toraldo, 2013).

Overall, not many WMA studies have included fatigue cracking likely because it is often assumed that WMA has no negative effect of the fatigue life of pavement. This will be a more important issue as higher amounts of RAP and RAS are incorporated into WMA pavements.

2.6 Investigation of warm mix asphalt and low temperature cracking studies

NCHRP 9-43 investigated the low temperature characteristics of binders but not many studies include low temperature tests on WMA mixes (NCHRP 9-43, 2010). Thermal stress-restrained specimen tests (TSRST) testing was done at the University of Nevada Reno and showed that no statistical differences were found for sulfur warm mix additives (Taylor, 2010).

The semi-circular bending (SCB) test is a low temperature test procedure that was performed at Iowa State University for studying the low temperature cracking properties of warm mix asphalt for this study. A study in Connecticut showed that fracture energy and toughness measured in the SCB and Disc Shaped Compact Tension test (DCT) at low temperatures showed no significant differences by mix at the same test temperatures (Bernier, 2013). Another study found that the SCB values correlated with the toughness index of laboratory-produced mixtures. This study tested samples at intermediate temperatures but the correlation shows that SCB is a viable way of testing WMA samples and can be correlated to other tests (Kim, 2012).

Evotherm 3G was recently evaluated and low temperature testing found that WMA mixes had greater fracture energy than an HMA control at -2°C testing in the DCT. There were no

significant differences at the lower testing temperatures of -12 and -22 but WMA had a significantly lower peak load than the HMA (Clements, 2012).

2.7 Warm mix asphalt emissions monitoring and fuel benefits

Emissions monitoring is very important in urban areas and the use of WMA can help reduce asphalt plant emissions. This has been studied in multiple regions throughout the world. In 2005, the Ramara Township field study showed a 45% reduction in carbon dioxide, 63.1% reduction in carbon monoxide, 41.2% reduction in sulfur dioxide and a 58% reduction in oxides of nitrogen. The average stack gas temperature was reduced by 41°C (Davidson, 2005). Other investigations have also indicated that there are reductions in the asphalt plant emissions due to the use of WMA technologies (D'Angelo, et al., 2008).

The fuel benefits of WMA show that a reduction of 10-35% can be expected with the use of WMA (D'Angelo, et al., 2008). Other studies show that a 40-60% reduction in fuel can be achieved and has been proven by contractors (Davidson, 2005).

A lifecycle cost analysis was performed that compared a HMA with a synthetic zeolite WMA. The lifecycle cost analysis took into account many factors but found that throughout the entire life cycle, the impacts of WMA are almost equal to the impacts of HMA when the same RAP content is used. This study found that the reduction in manufacturing temperatures is offset by the greater impacts of the additives used, in the case of this study, synthetic zeolites (Vidal, 2013).

2.8 Warm mix asphalt pavement performance studies

In 2011, there was a survey sent out to state agencies and was published in the Association of Asphalt Paving Technologists Annual Meeting proceedings which asked about the current usage of WMA. Approximately 87% of the respondents indicated that WMA was used in their state. The four top WMA technologies listed were Evotherm, Double Barrel Green, “Other”, and Sasobit. Just over 70% of the respondents indicated that their state has a moisture sensitivity requirement for mixes and that over 40% use AASHTO T-283. The most common requirement for aging a WMA mixture is 2 hours which is similar to the current protocols. The last question asked if the state/agency observed any moisture damage related field distresses in WMA mixes and there were no respondents who answered “Yes”. This survey is important because many laboratory studies indicate that WMA mixes will have inferior moisture susceptibility performance but in the field, no differences have yet been documented (Mogawer W. A., 2011).

Overall, WMA field sections perform well. The NCAT Test Track tested 20 Aspha-min cores and there are no signs of moisture damage and the pavement is performing well (Hurley & Prowell, 2005). There are many other studies which indicate similar results (Diefenderfer et al., 2007), (D'Angelo, et al., 2008), (Kasozi, 2012).

2.9 Summary of literature review

The implementation of WMA has been occurring at a steadily increasing rate since 2007. The overall field studies have shown good performance of the mixes and the additives help to achieve reduced mixing and compaction temperatures. Laboratory studies have shown that differences do occur in mixture properties between WMA and HMA mixes. The research within

this dissertation will evaluate the impact of WMA for the state of Iowa to ensure that WMA is fully characterized using local materials and mix designs. The literature review has demonstrated the need for further studies to evaluate the documented differences in moisture conditioning and Hamburg wheel tracking tests. Only limited information on WMA low temperature cracking on lab samples and field cores is available. Pavement evaluations of the WMA test sections will also help to ensure that WMA is a viable technology for the State of Iowa.

CHAPTER 3 EXPERIMENTAL PLAN

3.1 Phase I summary

In 2009 four pavements were constructed having both hot mix asphalt and warm mix asphalt test sections. Mix was compacted at the construction site, without reheating, and then mix was later reheated and compacted in the laboratory. Virgin binder from the tank at the asphalt plant was also collected in the field for study. The mixture testing plan included dynamic modulus, flow number and tensile strength ratio. The performance grade binder testing was performed. This study indicated some differences between the WMA mix properties and HMA properties; however, trends were not present over all the mixes tested. Phase II was designed to continue monitoring pavements, investigate low temperature cracking, investigate Hamburg wheel tracking test data and perform a curing study while expanding the number of test sections incorporated into the study.

The phase II study will overlap with some of the information presented in the Phase I study but the phase II project utilizes the information in phase I to show a broader picture of how WMA additives impact the asphalt pavements. Phase I included a mix labeled “FM1” which was not included in phase II because it was not constructed on a state highway. This pavement was constructed a year before the other phase II pavements. The phase II study incorporates more testing at a wider range of temperatures, testing of pavement cores, extracted binder tests and pavement condition surveys of WMA mixes located and produced in Iowa. The combination of the multiple components of the phase II study provides a holistic view of the measureable impact WMA additives have on HMA pavements.

3.2 Materials

Appendix A contains the job mix formulas provided to the researchers by the contractors on the day of construction. Table 3.1 shows a summary of the mixes that were included in this project and important mixture information. The pavements chosen for this study are located at various locations in the state of Iowa. Figure 3.1 shows the locations for each pavement selected to be part of the research study. Each of the major types of WMA, chemical/wax/foaming, are included in this study. All mixtures tested in this study are field produced mixes. Mix types range from 300 thousand to 10 million ESALs. The phase I pavements were constructed in 2009 and the pavements added for phase II were constructed in 2010. Most of the pavements included approximately 20% RAP with the exception of FM6. The FM7 project studies the use of shingles with WMA and includes 0%, 5% and 7% recycled asphalt shingles (RAS).

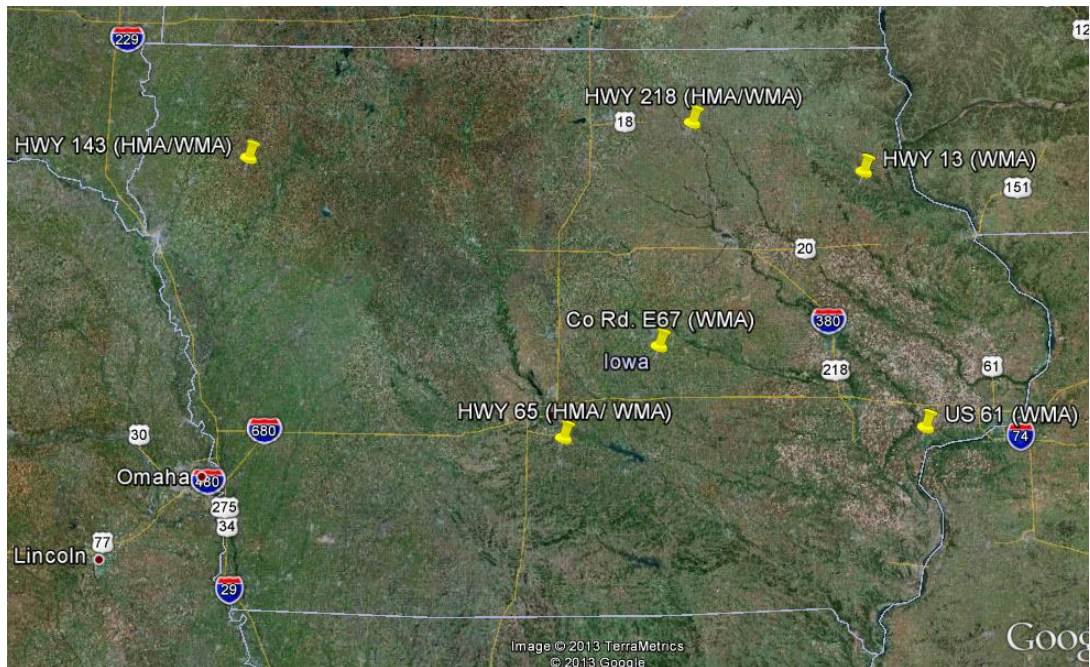

Figure 3.1 Map of the Phase II study pavement locations (Google Earth, 2013)

Table 3.1 Summary table of mixes for phase I and phase II

Code	Year	Road Name	Project Location	Project Number	Mix Design Number	WMA Technology	Mix Type	Binder Grade	RAP	RAS
FM2	2009	U.S. Route 218	Charles City, IA Bypass	NHSX-218-9(129)--3H-34	ABD9-2036R2	Evotherm	HMA 10M	64-28	17%	--
FM3	2009	Iowa Hwy 143	North of Marcus, IA	STP-143-1(4)--2C-18	ABD9-3030	Sasobit	HMA 3M	64-22	20%	--
FM4	2009	U.S. Route 65	SB Lanes of US 65 North of Indianola, IA	STP-065-3(57)--2C-91	1BD9-024Rev5	Foaming	HMA 3M	64-22	20%	--
FM5	2010	County Hwy E67	East of Laurel, IA	STP-S-C064(110)-5E-64	1BD10-096	Evotherm	HMA 300K	64-22	20%	--
FM6	2010	Iowa Hwy 13	South of Strawberry Point, IA	MP-013-2(704)59--76-22	ABD0-2043R1	Evotherm	HMA 1M	64-22	5%	--
FM7-0	2010	U.S. Route 61	Northbound lanes between Muscatine, IA and Blue Grass, IA	HSIPX-061-4(107)--3L-70	ABD10-5016	Evotherm	HMA 1M	58-28	20%	--
FM7-5	2010	U.S. Route 61		HSIPX-061-4(107)--3L-70	ABD10-5017	Evotherm	HMA 1M	58-28	13%	5%
FM7-7	2010	U.S. Route 61		HSIPX-061-4(107)--3L-70	ABD10-5018	Evotherm	HMA 1M	58-28	6%	7%

3.3 Experimental testing plan for phase II

The comprehensive testing program is designed to evaluate the overall performance of the pavement and to see if there are detectable differences in the test results between HMA and WMA technologies. The testing plans are categorized according to the particular pavement distress that is being evaluated. The testing is categorized by performance grade binder testing, extraction and recovery evaluations, curing effects, high temperature mixture evaluation, low temperature mixture evaluation and moisture sensitivity.

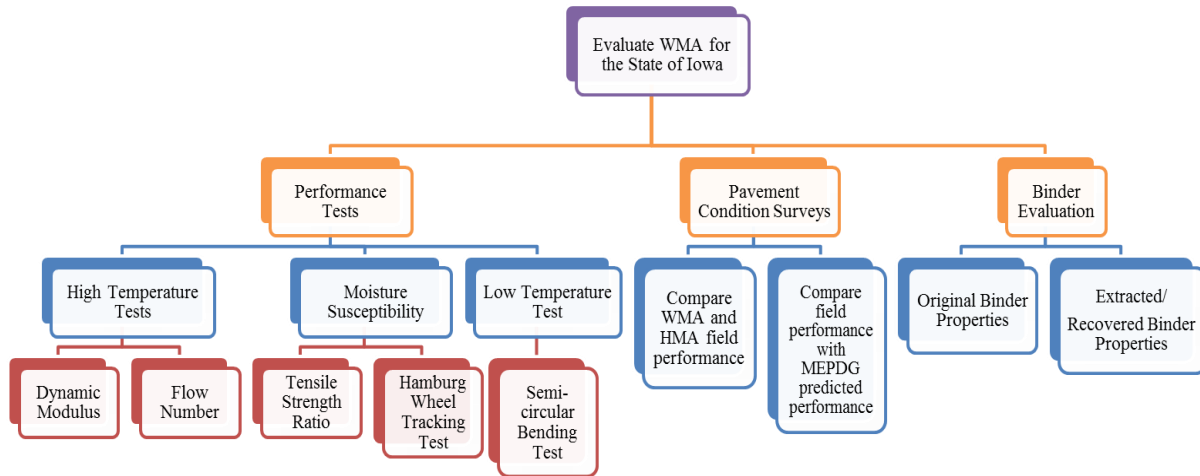

Figure 3.2 Diagram showing the scope of phase II

3.3.1 High temperature evaluation

Table 3.2 displays the experimental plan for dynamic modulus and flow number testing. Each “X” represents one test sample. The samples categories shaded in grey represent the samples that were tested in the phase I study and the categories shaded in black indicate a HMA control mixture was not produced for that pavement. Samples are categorized by WMA and HMA, reheated and not-reheated (also designated as “lab-compacted” and “field-compacted”) and moisture conditioned and not-moisture conditioned. There are total of 5 samples for each category with the exception of not-reheated samples for FM4 and FM6 which was due to inclement or challenging field conditions that did not allow for enough time to compact all 20 samples. Non-reheated mix was collected as loose mix at the asphalt plant and compacted a short time after collection in a Superpave gyratory compactor at the asphalt plant without the reheating process. Reheated mix was compacted in the Iowa State University Asphalt Laboratory. For the FM7 mixture category, only the 0% shingles was tested and evaluated for differences between reheated and not reheated. It is hypothesized the use of 5% and 7% shingles will further mask the difference between the stiffness of reheated and not-reheated samples. The most detectable

difference will be in the mix with no shingles. Half of all samples were moisture conditioned by vacuum saturating to 80%, frozen and then kept in a hot water bath as directed in AASHTO T-283. Moisture conditioning dynamic modulus samples will show if moisture conditioning has a significant effect of the pavement stiffness and if this effect is different between HMA and WMA pavements. Dynamic modulus is performed at low strains and is considered to be a non-destructive test. The same samples used for dynamic modulus testing were also used in flow number tests. The flow number tests will compare rutting resistance and the point at which samples reach tertiary flow under repeated loadings.

Table 3.2 Testing plan for dynamic modulus and flow number

Mixes	Reheated Mix				Not-Reheated Mix			
	HMA		WMA		HMA		WMA	
	MC	NMC	MC	NMC	MC	NMC	MC	NMC
FM2	XXXXX	XXXXX	XXXXX	XXXXX	XXXXX	XXXXX	XXXXX	XXXXX
FM3	XXXXX	XXXXX	XXXXX	XXXXX	XXXXX	XXXXX	XXXXX	XXXXX
FM4	XXXXX	XXXXX	XXXXX	XXXXX	XXXXX	XXXXX	XXXX	XXXX
FM5			XXXXX	XXXXX			XXXXX	XXXXX
FM6			XXXXX	XXXXX			XXX	XXX
FM7- 0% Shingles			XXXXX	XXXXX			XXXXX	XXXXX
FM7- 5% Shingles			XXXXX	XXXXX			na	na
FM7- 7% Shingles			XXXXX	XXXXX			na	na

3.3.2 Low temperature evaluation

Low temperature testing was performed using the semi-circular bending test according to the University of Minnesota draft standard (Marasteanu & Xue, 2012). Tests were conducted at 2°C below the low temperature performance grade (LTPG-2), ten degrees Celsius above the low temperature performance grade (LTPG+10) and 22°C above the low temperature performance

grade (LTPG+22). All temperature increments are in Celsius because it is the standard measuring protocol for the performance grading system. The LTPG used is the low temperature grade of the virgin binder at the time of construction, provided by the asphalt supplier. This study will compare the field cores and the laboratory compacted cores in low temperature cracking. Four samples for each temperature category were tested. The test results will show fracture toughness, a function of size and peak strength, and fracture energy, a function of size and the area underneath the stress-strain graph of the sample.

Table 3.3 Testing plan for semi-circular bending test

Mixes	Field Cores			Laboratory Compacted		
	LTPG-2	LTPG+10	LTPG+16	LTPG-2	LTPG+10	LTPG+16
FM2 HMA	XXXX	XXXX	XXXX	XXXX	XXXX	XXXX
FM2 WMA	XXXX	XXXX	XXXX	XXXX	XXXX	XXXX
FM3 HMA	XXXX	XXXX	XXXX	XXXX	XXXX	XXXX
FM3 WMA	XXXX	XXXX	XXXX	XXXX	XXXX	XXXX
FM4 HMA	XXXX	XXXX	XXXX	XXXX	XXXX	XXXX
FM4 WMA	XXXX	XXXX	XXXX	XXXX	XXXX	XXXX
FM5 WMA	XXXX	XXXX	XXXX	XXXX	XXXX	XXXX
FM6 WMA	XXXX	XXXX	XXXX	XXXX	XXXX	XXXX
FM7- 0% Shingles	XXXX	XXXX	XXXX	XXXX	XXXX	XXXX
FM7- 5% Shingles	XXXX	XXXX	XXXX	XXXX	XXXX	XXXX
FM7- 7% Shingles	XXXX	XXXX	XXXX	XXXX	XXXX	XXXX

3.3.3 Moisture susceptibility evaluation

Moisture susceptibility is an area of concern for WMA pavements. The reduction in mixing and compaction temperatures may contribute to incomplete drying of aggregates which can lead to pavement damage in the form of stripping. Moisture susceptibility was evaluated by TSR and the Hamburg wheel tracking test (HWTT). The Hamburg testing plan is shown in Table 3.4. Each X represents a sample and all samples were paired according to their air voids and

tested in the Hamburg at the Iowa DOT Materials Laboratory. There was not enough FM4 WMA mix to test lab compacted samples but the cores for FM4 WMA were tested. FM5, FM6 and FM7 have no corresponding HMA mixes, shown in Table 3.4; the dashes represent no samples tested for that category. This plan will compare HMA and WMA, field cores and gyratory samples, variable amounts of shingles used with WMA and will also be compared with TSR results. A curing study will further investigate the effects of oven aging compared standard HMA Hamburg results. The results from this study will be used when comparing data from the curing study to compare field cores and gyratory cores to compare HMA and WMA mix performance.

Table 3.4 Testing plan for the Hamburg wheel tracking test

Mixes	Field Cores		Field Collected-Gyratory Compacted Mix	
	HMA	WMA	HMA	WMA
FM2	XXXX	XXXX	XXXX	XXXX
FM3	XXXX	XXXX	XXXX	XXXX
FM4	XXXX	XXXX	XXXX	--
FM5	--	XXXX	--	XXXX
FM6	--	XXXX	--	XXXX
FM7- 0% Shingles	--	XXXX	--	XXXX
FM7- 5% Shingles	--	XXXX	--	XXXX
FM7- 7% Shingles	--	XXXX	--	XXXX

Indirect tensile (IDT) strength testing was performed on dry and moisture conditioned samples. Table 3.5 shows the testing plan for HMA samples and Table 3.6 shows the WMA samples. Samples for determining TSR values and comparing reheating effects were 4 inches in diameter. The cores collected were six inches in diameter. In order to compare laboratory samples with field cores, it was necessary to compact 6" diameter IDT samples in the laboratory as well. This study will show how HMA and WMA compare in IDT strength and TSR values as well as give a direct comparison to the difference between moisture susceptibility detected in the Hamburg and the AASHTO T-283 test for WMA pavements. This section is important for the long term viability of WMA mixes since the moisture conditioning has shown to be a concern in

other laboratory tests. It will also have a significant impact in future QC/QA policies for evaluating WMA.

Table 3.5 Testing plan for HMA indirect tensile strength samples

Mixes	HMA					
	4" Field IDT		4" Lab IDT		6" FIELD CORES FOR IDT	6" Lab IDT
	MC	NMC	MC	NMC		
FM2	XXXXXX	XXXXXX	XXXXXX	XXXXXX	XXX	XXX
FM3	XXXXXX	XXXXXX	XXXXXX	XXXXXX	XXX	XXX
FM4	XXX	XXX	XXXXXX	XXXXXX	XXX	XXX

Table 3.6 Testing plan for WMA indirect tensile strength samples

Mixes	WMA					
	4" Field IDT		4" Lab IDT		6" FIELD CORES FOR IDT	6" Lab IDT
	MC	NMC	MC	NMC		
FM2	XXXXXX	XXXXXX	XXXXXX	XXXXXX	XXX	XXX
FM3	XXXXXX	XXXXXX	XXXXXX	XXXXXX	XXX	XXX
FM4	XXX	XXX	XXXXXX	XXXXXX	XXX	XXX
FM5	XXX	XXX	XXXXXX	XXXXXX	XXX	XXX
FM6	XXX	XXX	XXXXXX	XXXXXX	XXX	XXX
FM7-0	XXXXXX	XXXXXX	XXXXXX	XXXXXX	XXX	XXX
FM7-5			XXXXXX	XXXXXX	XXX	XXX
FM7-7			XXXXXX	XXXXXX	XXX	XXX

3.3.4 Original binder and recovered binder properties

Original binder properties were evaluated to see if there are initial differences between the WMA binders and the HMA binder. The Superpave performance grade (PG) binder system was used for grading the binders. All binder tests were performed in triplicate. This was performed in the phase I study but continued with the additional construction projects added in phase II. The original PG grades conformed to all binder grades provided by the supplier. The

phase I BBR data was repeated for the Phase II study due to a mechanical error in the ISU Laboratory BBR. The new test results are presented in this dissertation.

Binder from pavement cores was extracted and recovered to evaluate the impact of WMA additives after some time in the field. The extracted binder properties will also help to show how RAP influences the performance grade and whether there are detectable benefits from using warm mix asphalt additives. The pavement cores were collected in summer 2011 after one or two years in service, depending on the roadway. The binder recovery was performed on only the surface layer which consisted of the mixtures used in this study.

The tests and associated aging performed on the binder included the following: dynamic shear rheometer (DSR) tests (AASHTO, 2007), rolling thin film oven testing (RTFO) (AASHTO, 2007), pressure aging vessel (PAV) (AASHTO, 2007) and bending beam rheometer (BBR) testing (AASHTO, 2007). The RTFO and PAV aged binders were aged according to AASHTO standards, T-240 and R-28, respectively. Table 3.7 shows the full testing plan. This plan allows for comparison of binder in the field with the virgin binder properties. Comparing the differences between recovered and virgin binders will help to show the impact, if any, WMA has on binder properties. The binder properties impact the amount of recycled materials that can be added to a mix. WMA may allow for higher incorporations of recycled asphalt materials if a binder stiffness reduction is detectable in WMA pavements. This study will help to show if WMA additives allow for higher amounts of recycled material based on the detection of stiffness reduction.

Table 3.7 Testing plan for original and recovered binders

Binder	Virgin Binder DSR	RTFO DSR	Recovered RTFO DSR	PAV DSR	Recovered PAV DSR	BBR	Recovered BBR
FM2 WMA	XXX	XXX	XXX	XXX	XXX	XXX	XXX
FM2 HMA	XXX	XXX	XXX	XXX	XXX	XXX	XXX
FM3 WMA	XXX	XXX	XXX	XXX	XXX	XXX	XXX
FM3 HMA	XXX	XXX	XXX	XXX	XXX	XXX	XXX
FM4 WMA	XXX	XXX	XXX	XXX	XXX	XXX	XXX
FM4 HMA	XXX	XXX	XXX	XXX	XXX	XXX	XXX
FM5 WMA	XXX	XXX	XXX	XXX	XXX	XXX	XXX
FM6 WMA	XXX	XXX	XXX	XXX	XXX	XXX	XXX
FM7-0	XXX	XXX	XXX	XXX	XXX	XXX	XXX
FM7-5	--	--	XXX	--	XXX	--	XXX
FM7-7	--	--	XXX	--	XXX	--	XXX

3.3.5 Effects of curing on warm mix asphalt

The curing of WMA samples is currently performed at the reduced compaction temperature. This study focuses on how HMA and WMA performance results in the Hamburg wheel tracking test change due to different curing times and temperatures to evaluate the impact reduced temperatures have. Phase II investigates the differences in sample responses to HWTT by comparing the test results of samples cured for different durations and at various temperatures. The curing durations chosen were 2 and 4 hours. A curing time of six hours is not practical in industry. The curing temperatures included 120°C, 135°C and 150°C. The cured samples were tested in the HWTT. Mixes for testing were chosen based on initial Hamburg testing and the amount of mix that remained after previous testing. The following table shows the Hamburg pairs that were tested. Each “X” represents a sample that was paired and tested in the Hamburg wheel tracking test. This data will be compared with the data collected in the moisture conditioning study and the field cores. The intent is to determine how long curing should take place and at which temperature in order to have comparable test results in the Hamburg wheel

tracking test between HMA and WMA as well as determining which temperature and time combination best simulate the field core Hamburg test results.

Table 3.8 Plan of study for curing study in the Hamburg wheel tracking test

Mixes	120°C		135°C		150°C	
	2 Hours	4 Hours	2 Hours	4 Hours	2 Hours	4 Hours
FM2 HMA	--	--	--	--	XXXXXX	XXXX
FM2 WMA	XXXXXX	XX	XXXXXX	XXXX	XXXXXX	XX
FM5 WMA	XX	XX	XX	XX	XX	--
FM6 WMA	XX	XX	XX	XX	XX	--

3.4 Pavement survey plan

Each of the mixes studied have physical pavement locations in Iowa which allows for annual pavement condition surveys. The pavement conditioning survey information will be used to compare overall performance of each pavement section and to investigate any differences between the HMA and WMA sections. The projects were too large to survey the entire pavement so three 500 foot sections were selected randomly within the stationing for each mixture. The survey occurred on those sections. The surveyed areas were marked with roadway marking paint and were to be surveyed the following year. Primary measurements include the length and severity of transverse, longitudinal, edge cracking, rutting and popouts. Studying this evidence will show if WMA and HMA have similar performance in the field. Field condition data can also be used to examine usefulness of the mechanistic-empirical pavement design guide for Iowa pavements. The pavement field condition surveys can be compared with the performance data from the laboratory. The comparison can be done using the MEPDG design software. Results from Phase I will be used as input values into the MEPDG software and the software will use models to predict pavement performance based on both local environmental and loading

patterns. The dynamic modulus and binder data will be used in the models to predict deformation under the simulated local traffic loading conditions and pavement temperatures. The plan sets for each projects was used to develop the pavement structure and county soil surveys were used to estimate the soil properties. The pavement performance predictions based on the mixture performance data compared with the actual pavement performance will help to show potential areas of concern for WMA additives. The comparison will also show if WMA sections are predicted to perform equally to HMA over a long period of time and field performance surveys will show if WMA is performing equally to HMA in the field after two or three years of service in the field.

3.5 Testing methodology and equipment

This section provides a background of the performance tests, specialized equipment and test procedures used in this study. Cumulatively, these tests will provide information about the high, low and intermediate temperature performance, rutting resistance, low temperature cracking resistance, indirect tensile strength, susceptibility to moisture damage, virgin binder performance grade and recovered binder performance grade of an asphalt pavement. This collected data will be analyzed in order to determine the overall performance for each mixture studied and how the WMA additives influenced the performance results. Performance results can also be compared with each pavement's field conditioning survey results to determine how laboratory performance tests compare with field data.

3.5.1 *Dynamic modulus*

The purpose of dynamic modulus testing is to define the material stress to strain relationship under continuous sinusoidal loading for a range of temperatures and frequencies. Dynamic modulus testing measures the stiffness of the asphalt and can be used to determine which mixes may be more susceptible to performance issues including rutting, fatigue cracking and thermal cracking. The testing set up, shown in Figure 3.3, is based on NCHRP report 547 (Witczak M. , 2005). The test is performed at three temperatures (4, 21, 37°C) and nine frequencies (25, 15, 10, 5, 3, 1, 0.5, 0.3, 0.1 Hz) yielding 27 test results per sample. The equipment used is a universal testing machine (UTM) manufactured by IPC Global based in Australia and three linear variable differential transformers (LVDT). The dynamic modulus values (E^*) are used to construct master curves which can be used to compare the various categories (Witczak, 2005). The dynamic modulus test was performed under strain controlled conditions and is considered to be a non-destructive test because of the low levels of strain. The target strain used was 80 microstrain which is considered to be well within the elastic region of the material. The strain response was measured using the 3 LVDTs that were positioned on mounted brackets at the beginning of each test. The brackets were attached using super glue. Samples used in this research were compacted to the precise size needed for the dynamic modulus testing.

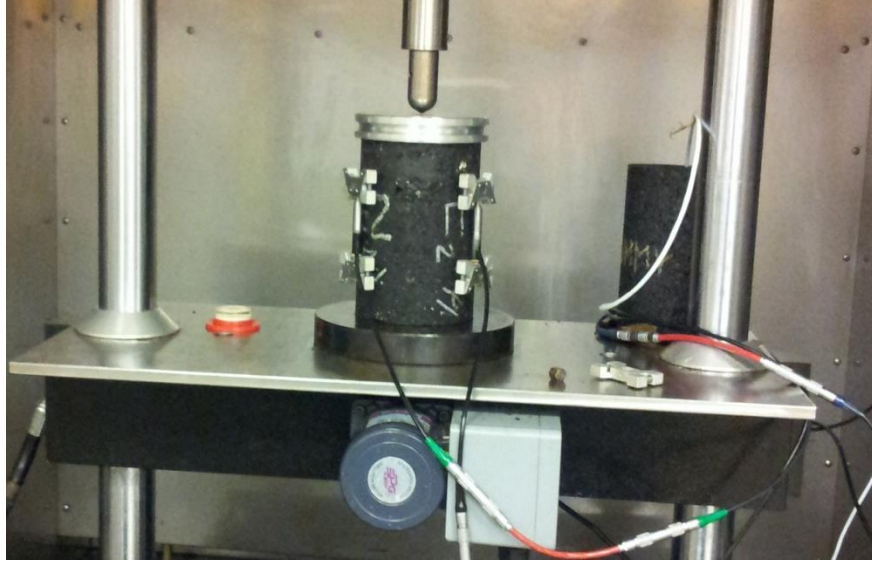

Figure 3.3 Test set up for the dynamic modulus test

The dynamic modulus is expressed mathematically as the maximum peak recoverable axial strain (Witczak, 2005):

$$E^* = \frac{\sigma_o}{\varepsilon_o} \quad (\text{Eqn. 3-1})$$

The complex modulus (or dynamic modulus, E^*) when written in terms of the real and imaginary portion is expressed as:

$$E^* = E' + iE'' = |E^*| \cos\varphi + i|E^*| \sin\varphi \quad (\text{Eqn. 3-2})$$

$$\varphi = \frac{t_i}{t_p} \times (360) \quad (\text{Eqn. 3-3})$$

where

E^* = complex modulus;

E' = storage or elastic modulus;

E'' = loss or viscous modulus;

φ = phase angle;

t_i = time lag between a cycle of stress and strain (s);

t_p = time for stress cycle (s); and

i = imaginary number.

When a material is purely elastic, $\varphi=0$ and for a purely viscous material, $\varphi=90^\circ$ (Witczak, 2005).

Comparison of dynamic modulus results is best done when results are developed into master curves. The principle of time-temperature superposition is used and this allows for the E^* values and phase angles, obtained during testing, to be shifted along the frequency axis. This helps characterize how a mix may perform at a frequency or temperature which was not tested. The data from the dynamic modulus testing is fitted to a sigmoid function. The shift factors are determined based on the data collected in the dynamic modulus testing and on the Williams-Landel-Ferry (WLF) equation (Williams, Landel, & Ferry, 1955):

$$\log \alpha_t = \frac{C_1(T-T_s)}{C_2+T-T_s} \quad (\text{Eqn. 3-4})$$

where

C_1 and C_2 are constants;

T_s is the reference temperature; and

T is the temperature of each individual test.

In general, modulus master curves are modeled by the sigmoidal function expressed as:

$$\log |E^*| = \delta + \frac{\alpha}{(1+e^{\beta-\gamma(\log t_r)})} \quad (\text{Eqn. 3-5})$$

where

t_r = reduced time of loading at reference temperature;

δ = minimum value of E^* ;

$\delta + \alpha$ = maximum value of E^* ; and

β, γ = parameters describing the shape of the sigmoidal function.

Typically, the sigmoidal function used for developing master curves is based on reduced frequency instead of reduced time. For this study, the Witczak predictive equation presented in the same form as the previous equation is used and this will allow for a graphical representation of a mixture specific master curve. The equation is described as (Witczak, 2005):

$$\log|E^*| = \delta + \frac{\alpha}{(1+e^{\beta-\gamma(\log(f_r)+\alpha_t)})} \quad (\text{Eqn. 3-6})$$

where

$\log|E^*|$ = log of dynamic modulus;

δ = minimum modulus value;

f_r = reduced frequency;

α = span of modulus values;

α_t = shift factor according to temperature; and

β, γ = shape parameters.

3.5.2 Flow number

The non-destructive dynamic modulus test allows researchers to conduct additional testing on the same sample. Dynamic modulus samples were used in flow number testing. The flow number test is a destructive test which measures the point where the asphalt material reaches tertiary flow. The testing procedure for the flow number test is based on the repeated load permanent deformation test which is explained in NCHRP Reports 465 and 513. A typical plot, shown in Figure 3.4, illustrates how accumulated permanent deformation increases with the number of applied load cycles; the three types of deformation that occur during testing are

primary, secondary and tertiary flow. The flow number is defined as the number of loading cycles at the beginning of the tertiary zone. Flow number was conducted at 37°C and at a frequency 1 Hz with a loading time of 0.1 second and a rest period of 0.9 second. The loading level was 600 kPa. The test is complete once 10,000 pulses have been reached or a strain of 5.5% has occurred. The deformation verses number of pulses is plotted and the strain rate versus number of pulses is also plotted. The flow number is determined by the minimum strain rate and the corresponding pulse number.

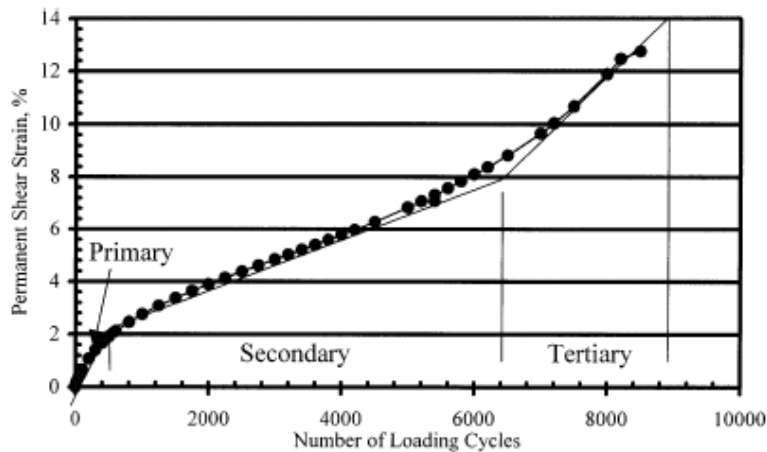

Figure 3.4 Permanent shear strain versus number of loading cycles (Witczak, Kaloush, Pellinen, El-Aasyouny, & Von Quintus, 2002)

3.5.3 Semi-circular bending test

The purpose of the semi-circular bending test is to calculate the fracture energy, fracture toughness and stiffness of asphalt samples at low temperatures. The original loading frame proposed in the standard is shown in Figure 3.5. A similar frame, Figure 3.6, was designed by Sheng Tang at Iowa State. The new frame was needed because only LVDTs instead of LLD gauges were available for measuring strain.

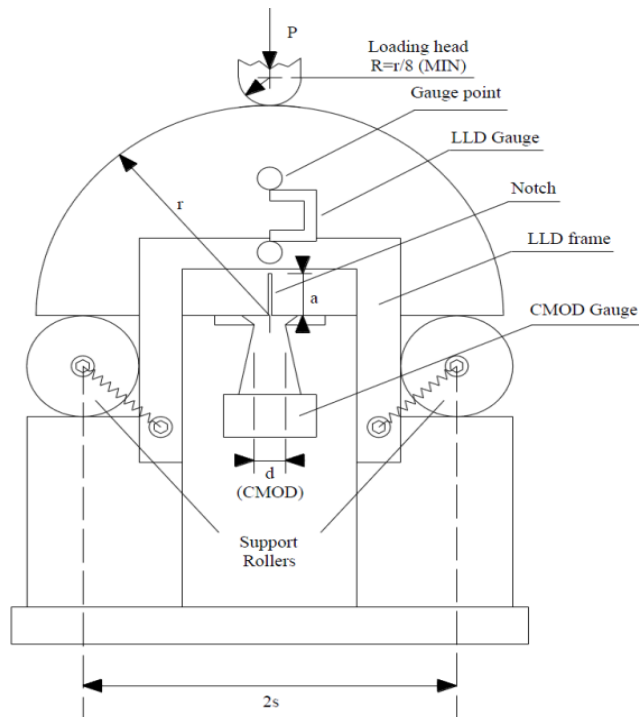

Figure 3.5 Original proposed loading frame for SCB testing (draft standard)

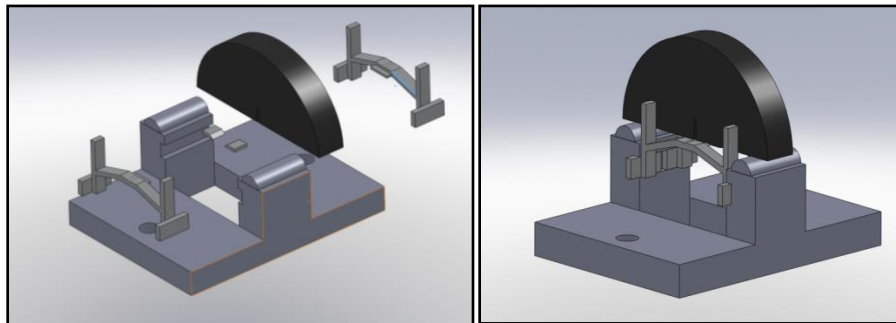

Figure 3.6 Loading frame designed at Iowa State University (Courtesy of Sheng Tang)

SCB samples were prepared from cores and gyratory samples. A notch of 15mm was cut with a band saw using a masonry blade. Sample preparation deviated from the standard procedure due the restrictions of working with cores. The layers that need to be tested are located on the surface and a limited number of cores were available. Each core needed to make 4 SCB samples. Top 50 mm of the core was used to create four semi-circles approximately 25 mm thick. Gyratory samples were also compacted to 50 mm and cut into four semi-circles. This

allowed for minimal waste of material while creating gyratory samples as similar as possible to the cores. The environmental chamber was cooled using liquid nitrogen and samples were conditioned in the test chamber for 2 hours prior to testing. The (crack mouth opening displacement) CMOD gage is attached to the specimen. A small contact load of 0.3 kN is applied at a rate of 0.3 ± 0.02 kN with a displacement rate of 0.05mm/s. A seating load is up to 0.6 ± 0.02 kN is applied in stroke control with a displacement rate of 0.005mm/s. Three small amplitude loading cycles are applied to ensure contact between the loading head and the specimen. Once an initial load of 1kN is reached, the system changes from stroke control to CMOD control. The CMOD is kept at a constant rate of 0.0005 mm/s for the entire duration of the test to ensure the crack propagating at the notch opens at a constant rate. The test is stopped when the load is lower than 0.5kN or when CMOD gauge range limit is reached.

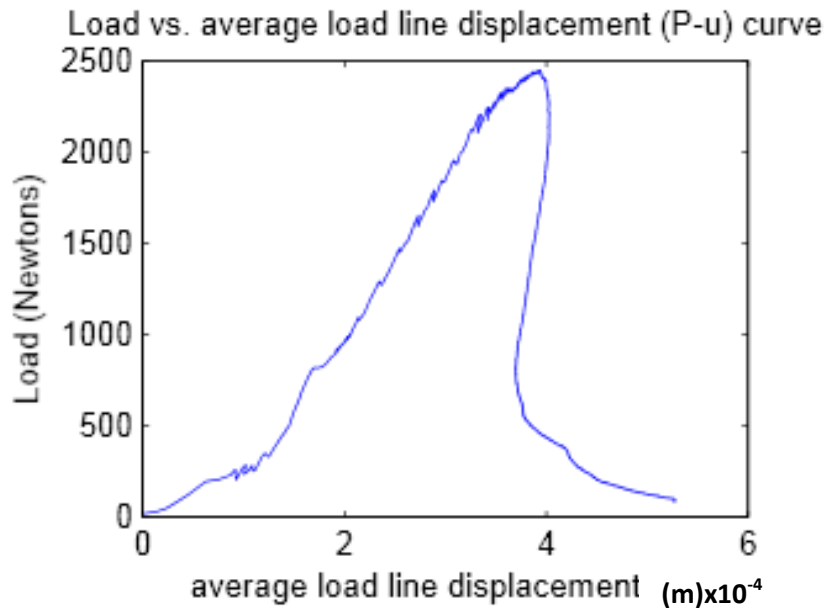

Figure 3.7 Typical SCB load versus average load line displacement (P-u) curve

The fracture energy, fracture toughness and stiffness are calculated for each specimen tested. In order to calculate the fracture energy, the work of fracture must first be estimated. The work of fracture is the area under the curve of the stress strain graph and the area extrapolated under the tail of the curve. The area under the curve is calculated using the following equation:

$$W = AREA = \sum_{i=1}^n (u_{i+1} - u_i) \cdot (P_i) + \frac{1}{2} \cdot (u_{i+1} - u_i) \cdot (P_{i+1} - P_i) \quad (\text{Eqn. 3-7})$$

where

- P_i = applied load (N) at the i load step application
 P_{i+1} = applied load (N) at the $i + 1$ load step application;
 u_i = average displacement at the i step;
 u_{i+1} = average displacement at the $i + 1$ step.

To extrapolate the area under the tail of the curve, first, a power law with an assumed coefficient equal to -2 for the post peak stress-strain curve with P values lower than 60% of the peak load (Marasteanu & Xue, 2012):

$$P = \frac{c}{u^2} \quad (\text{Eqn. 3-8})$$

The coefficient, c is found by fitting $W_{tail} = \int_{u_c}^{\infty} P d(u) = \int_{u_c}^{\infty} \frac{c}{u^2} d(u) = \frac{c}{u_c}$

(Eqn. 3-9) to the stress-strain curve below 60% of the peak load. The stress-strain curve is extrapolated to P=0. The equation used in the extrapolation is:

$$W_{tail} = \int_{u_c}^{\infty} P d(u) = \int_{u_c}^{\infty} \frac{c}{u^2} d(u) = \frac{c}{u_c} \quad (\text{Eqn. 3-9})$$

where

- u = integration variable equal to average displacement;
 u_c = average displacement value at which the test is stopped

Work of total fracture is the sum of W and W_{tail} :

$$W_f = W + W_{tail} \quad (\text{Eqn. 3-10})$$

The stress intensity factor (K_I) is found using the following equation (Lim et al., 1994, Li and Marasteanu, 2004):

$$\frac{K_I}{\sigma_0 \sqrt{\pi a}} = Y_{I(0.8)} \quad (\text{Eqn. 3-11})$$

where

- σ_0 = $\frac{P}{2rt}$
 P = applied load (MN)
 r = specimen radius (m)
 t = specimen thickness (m)
 a = notch length (m);
 Y_I = the normalized stress intensity factor (dimensionless).

For the dimensions of the SCB samples used in the draft AASHTO specification, Y_I is calculated as follows:

$$Y_{I(0.8)} = 4.782 + 1.219 \left(\frac{a}{r}\right) + 0.063 \exp(7.045 \left(\frac{a}{r}\right)) \quad (\text{Equation 3-12})$$

Fracture toughness equations are derived using linear elastic fracture mechanics, meaning that the material is behaving within the linear elastic zone at the test temperature. This assumption is reasonable because the modulus changes less than 5% for the time range of the test and also where the material cracking begins will be small (Marasteanu & Xue, 2012).

Stiffness is calculated as the slope of the linear part of the ascending load-displacement curve as shown in Figure 3.8. Stiffness is measured in kN/mm.

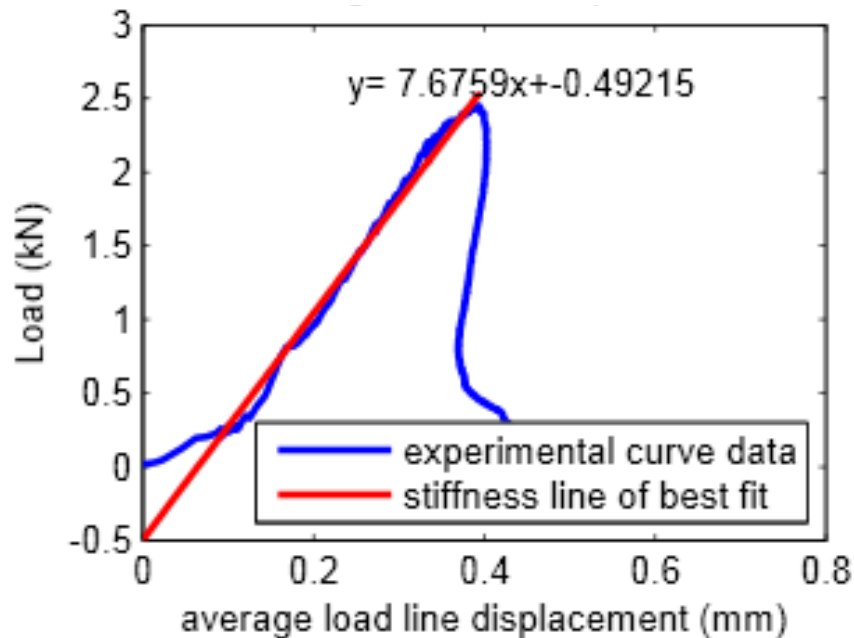

Figure 3.8 Example graph showing how stiffness is calculated

3.5.4 Indirect tensile strength and tensile strength ratio (TSR) measurements

The tensile strength ratio test follows AASHTO T-283. Samples for measuring TSR values are 4 inches in diameter and 63.5 mm thick. Six inch diameter samples were needed to compare with 6 inch diameter field cores. The six inch diameter samples were 3.5 inches (88.8 mm) thick. This varies from the standard but it is the largest size that would fit correctly in the steel loading head at the ISU asphalt laboratory. The sample preparation followed the field-

mixed, laboratory-compacted protocol and half of the samples were moisture conditioned. Moisture conditioning begins by separating samples into a dry and wet subset. Subsets are determined by pairing the samples according to air voids. Within each pair, one is randomly assigned to be tested dry or moisture conditioned and tested wet. The samples selected for moisture conditioning are vacuum saturated such that 70-80% of voids are filled with water. Samples are immediately placed in a freezer at -18°C , wrapped in plastic wrap, in a zip lock bag with a tablespoon of water for a minimum of 16 hours. Samples are then placed in a 60°C water bath for 24 ± 1 hours and then placed in a 25°C water bath for 2 hours. The moisture conditioned samples are then tested. The testing set up is shown in Figure 3.9. The load is applied by lowering the constant rate of movement of the testing machine head, 50 mm/min. The maximum compressive strength of the specimen is recorded and a vertical crack appears in the sample. The TSR is the ratio of the wet strength divided by the dry strength, expressed as a percentage. TSR was recently taken out of the Iowa DOT QC/QA moisture susceptibility protocol. The Iowa DOT specification required a TSR of 80% for a passing mixture.

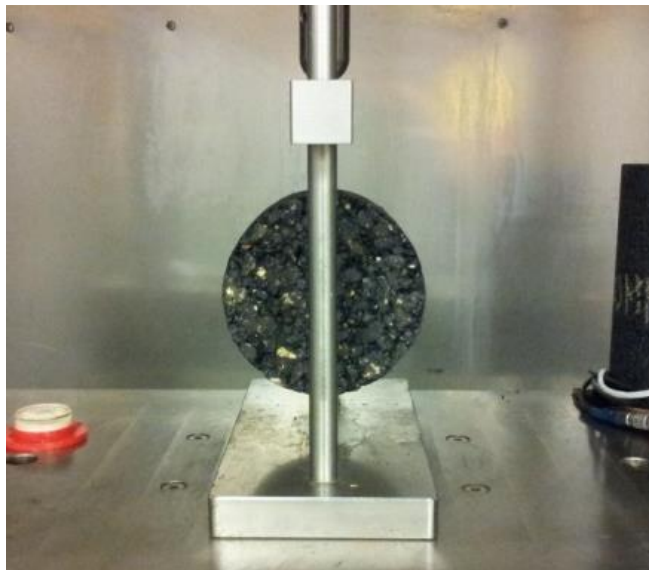

Figure 3.9 Indirect tensile strength test set up

3.5.5 Hamburg wheel tracking test

The Hamburg wheel tracking test was performed according to AASHTO T-324. The samples used in this study are 6 inches in diameter and 60.33 mm tall. Both pavement cores and plant produced/gyratory compacted samples were tested for this study. The wheel tracker device used for the Hamburg testing was manufactured by Precision Machine & Welding. Testing was performed at the Iowa Department of Transportation by the Office of Materials staff. The test measures the amount of rutting occurring in samples as a heavy metal wheel passes over the samples. Rutting depth is measured using a LVDT. The pressure from the wheel is 158 pounds at the center and the entire test apparatus must be level. The samples are cut with a saw along a secant line so there is no space or gap when two samples are joined together for testing. All samples were tested in 50°C water and conditioned for 30 minutes. The results were calculated using the spreadsheet provided by the Iowa DOT which follows standard AASHTO T324 guidelines. Figure 3.10 shows an example of how the stripping inflection point is determined. The red line is the best fit curve and the inflection slopes are shown in black. The horizontally decreasing linear line is determined by the first steady-state portion of the experimental curve and the vertically decreasing line shows the second steady-state portion of the curve. The stripping inflection point is the number of wheel passes that have elapsed where these two lines cross on the graph. A minimum stripping inflection point must be met in order to determine if samples meet moisture susceptibility requirements. The SIP requirements will change based on the type of mix.

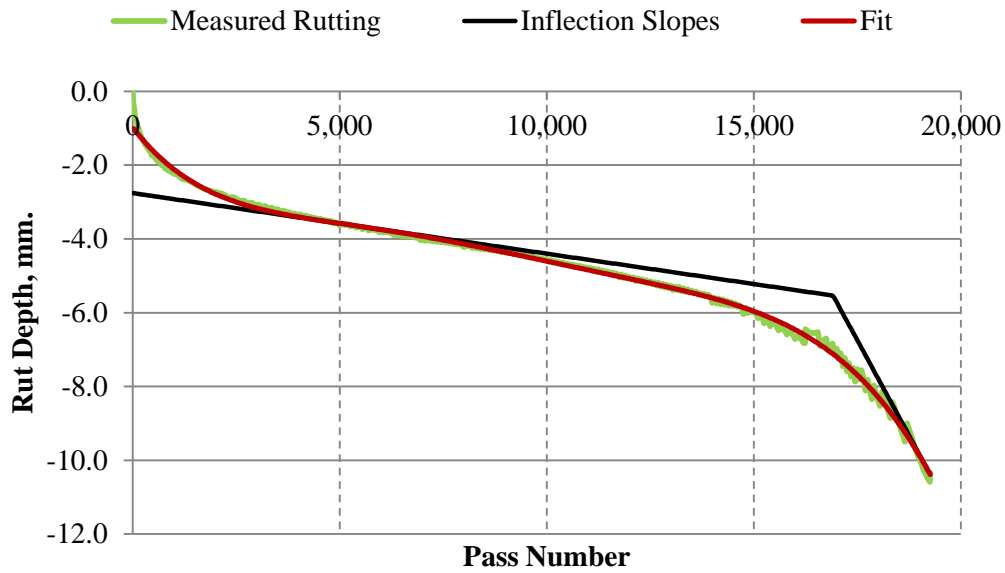

Figure 3.10 Hamburg wheel tracking test results

3.5.6 Performance grade binder tests

The rheological properties of the asphalt binders were tested in Phase I and further testing was performed and analyzed in Phase II. The binder testing followed Superpave standard specification for Performance Graded Asphalt Binders, AASHTO M320. This will test each binder's performance grade and give detailed information about the rheological differences between the binders. This testing was performed for recovered and virgin binders. First, virgin binders were tested in the dynamic shear rheometer according to AASHTO T-315, having a high temperature failure parameter of $G^*/\sin(\delta) = 1.0$ kPa. The DSR, shown in Figure 3.11(a), is manufactured by TA Instruments and is model AR 1500ex. Binder was then short-term aged in the RTFO to simulate the aging that occurs during the construction process. RTFO ageing was performed according to AASHTO T-240. The RTFO, shown in Figure 3.11(b), is model CS325-B manufactured by James Cox & Sons, Inc. The RTFO aged binder is tested in the DSR with a failure parameter of $G^*/\sin(\delta)$ equal to 2.2 kPa. The remaining RTFO binder is placed in the PAV for long term aging at 100°C at 2.1 MPa for 20 hours. This simulates aging in the field that

occurs over 7-10 years in service. PAV testing was performed according to AASHTO R28. The PAV used in this study, shown in Figure 3.11(c), was manufactured by Applied Systems, Inc. After PAV aging, the binder is degassed and BBR beams are prepared. The BBR test measures low temperature properties according to AASHTO T-313. The BBR at Iowa State, shown in Figure 3.11(d), is manufactured by Cannon Instrument Company. AASHTO M320 requires that the creep stiffness at the specified low temperature grade be less than or equal to 300 MPa at 60 seconds. Rheology testing for recovered binder was performed in the same way except binders were not RTFO aged because the aging that occurs during construction is assumed to have already taken place. It is also expected that recovered binder will be stiffer than the binder tested in the laboratory because of natural aging that occurring in the top layer of asphalt pavements due to oxidation and sun exposure in the field.



Figure 3.11 Binder testing equipment (a) Dynamic shear rheometer (b) Rolling thin film oven (c) Pressure aging vessel (d) Bending beam rheometer

3.5.7 Extraction and recovery of asphalt binder

Extraction and recovery was performed according to ASTM D2172 and ASTM D5404, respectively. Toluene was used as the solvent to avoid using harsher chemicals. Two centrifuges were used in the extraction process. The first centrifuge uses an aluminum bowl and filter paper to filter out the aggregates from the asphalt-toluene solution. The very fine particles were then removed using the second high speed centrifuge, HM-750R. The high speed filterless centrifuge is designed to take out mineral fines that pass the filter in the first centrifuge. The solvent

suspension is transferred through a funnel into an aluminum beaker that is rotating at 11,000 rpm. Liquid is forced upward due to the centrifugal force and spills over the top of the beaker into the overflow collection. The mineral filler remains in the beaker and the solvent-binder solution is collected. Once the binder is fully separated from the aggregate, the solution is placed in the rotary evaporator system for distillation.

The rotary evaporator binder recovery system is shown in Figure 3.12. The rotary evaporator system uses nitrogen gas so no oxidation of the asphalt will occur during recovery. There are two dry ice condensers used for trapping toluene vapors before entering the pump. Once the toluene is fully distilled, the binder will be ready for subsequent performance grade binder tests.

Prior to performing extraction and recovery on field cores, the recovery process was calibrated by using a binder that had already been tested. The binder was dissolved in toluene and then recovered using the same process that will be used for the cores. The recovered binder was tested in the DSR to ensure that the rheological properties were similar to the original binder properties. Binder properties were matched only when glass marbles were used in the rotary evaporator to ensure all of the toluene was distilled off. When marbles were not used, the binder displayed a significantly reduced stiffness. At least three marbles were used for each recovery.

This testing study series found that toluene does not work with the Sasobit additive. The binder properties of the recovered Sasobit binder were extremely soft and could not pass a DSR test at low temperatures. A second extraction of the Sasobit binder was performed using normal propyl bromide which gave adequate results.



Figure 3.12 Rotary evaporator binder recovery system (Photo courtesy of Sheng Tang)

CHAPTER 4 MIXTURE PERFORMANCE TEST RESULTS AND ANALYSIS

The performance testing results and analysis are contained in this chapter. The results will be shown in graphical form with tabulated values also provided in referenced appendices. Statistical analysis in this chapter will focus on the results within each test. There will be additional analysis focusing on the comparing the test results between mixes in Chapter 7.

4.1 Dynamic modulus results and analysis

The dynamic modulus results show the differences between stiffness under dynamic loading for a wide range of temperatures and frequencies. The primary factors of interest include comparing HMA and WMA, moisture conditioned samples and non-moisture conditioned samples, and the effect of reheating the mixture in the laboratory. Dynamic modulus master curves were developed for each mixture tested. The master curves plot the average dynamic modulus values over all temperatures and frequencies tested. The upper right portion of the graph represents stiffer material responses at low temperatures and/or high frequencies. The lower left portion of the graph represents material behavior at high temperatures and/or lower frequencies. The graphs are shown in log-log scale. In some cases, actual differences between mixtures can be masked by the log-log scale, especially at the high modulus values which indicate low temperature and/or high frequency. Statistical analysis will help to identify any of these differences that may be masked by the master curve.

The dynamic modulus results must be statistically analyzed using a split-plot repeated measures design due to the nature of the test. The dynamic modulus test is a repeated measures test because there are multiple dynamic modulus values which are measured over a range of frequencies on the same sample. This analysis is important because of how the random error is

accounted for. The variation in samples treated the same will go into the sum of squares for the error term. This variation could result from slight differences in air voids, slightly different aggregate structures, and slightly different binder absorption, etc. The temperature and frequency measurements are repeated on the same sample multiple times and the analysis needs to account for taking multiple readings from the same sample. The error term in the repeated measures part of the experiment is due to the interaction between temperature/frequency and the samples. The error term in the repeated measure portion captures the inconsistency of temperature/frequency effects across different samples. This analysis compares the average dynamic modulus over all frequencies and temperatures for the whole plot factors.

There are three major factors of interest that this analysis is designed to investigate. The first is the difference between HMA and WMA samples. The HMA/WMA comparison can be made for FM2, FM3 and FM4 only. The second factor of interest is comparing the impact reheating has on the samples. Finally, the analysis compares the effect of moisture conditioning on the dynamic modulus values. Many of the mixtures will have a portion of the analysis that changes slightly. For example, FM5 and FM6 have no HMA produced. Each of these differences will be discussed for each individual analysis.

A diagram of the statistical analysis categorizing the factors of interest is shown in Figure

4.1. The whole plot factors, or the main factors of interest, include:

- HMA compared with WMA,
- moisture conditioned compared with non-moisture conditioned samples, and
- reheated mix versus not reheated mix.

The whole plot of the experiment is the sample that undergoes testing at multiple frequencies. The sub plot is the sample at a given frequency and temperature. The sub-plot factors are the different frequencies and test temperatures. This is illustrated in Figure 4.1.

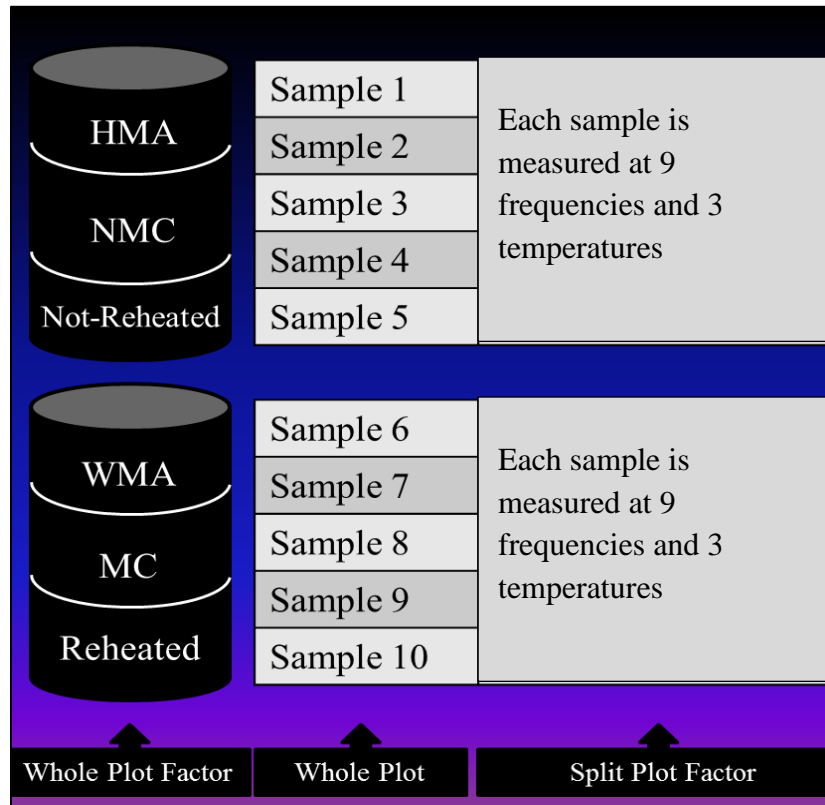

Figure 4.1 Diagram of split-plot design and experimental factors

Prior to the analysis, the assumption of equal variance in the data is greatly impacted by the test temperature with 4°C having the largest variance and the highest dynamic modulus values. To correct this, a log transformation was performed on the data set. Figure 4.2 and Figure 4.3 demonstrate the differences in variance when the data is transformed.

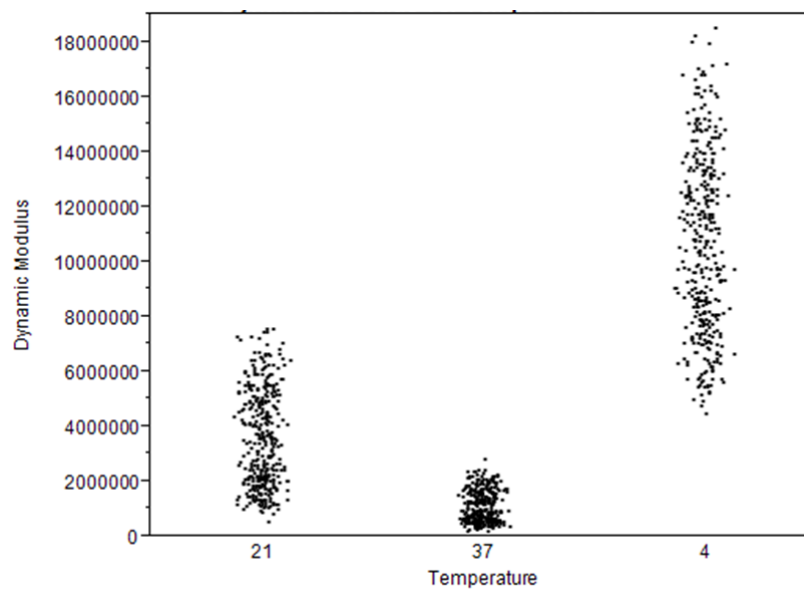

Figure 4.2 Non-transformed dynamic modulus data

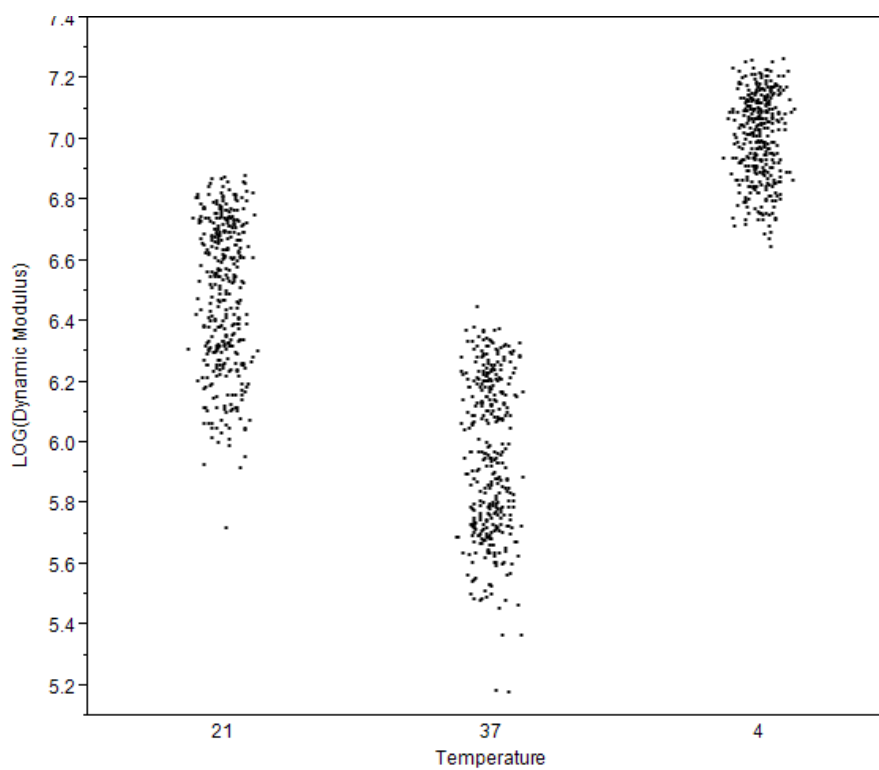

Figure 4.3 Dynamic modulus data with a log transformation

Further analysis was performed which separated each of the whole plot factors and each test temperature. Since the data was separated by temperature, a log transformation was not performed. This additional analysis is helpful when considering interactions and their effects as well as breaks up the data for a comparison that can easily be made when examining a factor for a specific data set. A four-way interaction is difficult to explain but separating the analyses helps to break up the different sections making it easier to explain the interaction that is occurring. The analyses that are repeated at separate temperatures are confounded with the analyses performed at the other temperatures because the same samples were used and this will be considered when analyzing results. For each analysis, the samples were broken into groups such that the all samples within a comparison are equal except for the whole plot factor being evaluated. The sub-plot factor is the frequency and it is of little interest to evaluate how frequencies influence the dynamic modulus but it is more important to ensure that the trends measured for the whole plot factor are repeated over all the range of frequencies tested. Breaking down the data into smaller groups helps to evaluate and quantify the differences observed in the test samples.

For each mixture, the first portion of the dynamic modulus statistical analysis shows where statistical differences and interactions exist and the second portion of the analysis breaks up the data into segmented portions to evaluate how statistical interactions are influencing the test data.

4.1.1 FM2 master curve and dynamic modulus statistical analysis

FM2 had a HMA control mixture and an experimental WMA mixture produced in the field on consecutive days. There were five samples produced for each category studied, for a

total of 40 samples. Figure 4.4 shows the dynamic modulus master curve. The moisture conditioned samples appear as a dashed line and the non-moisture conditioned samples are a solid line. The dark red and orange represent HMA and the blue and light blue represent the WMA. The low modulus (indicating high temperatures) shows the WMA mixes to be lower. The moisture conditioned WMA samples appear also to be lower at the intermediate and higher modulus values. There appears to be little difference between non-moisture conditioned HMA and WMA modulus values at high modulus values. The log-log scale of the master curve masks differences between the measured values, making the statistical analysis an important part of determining the differences between mixture properties.

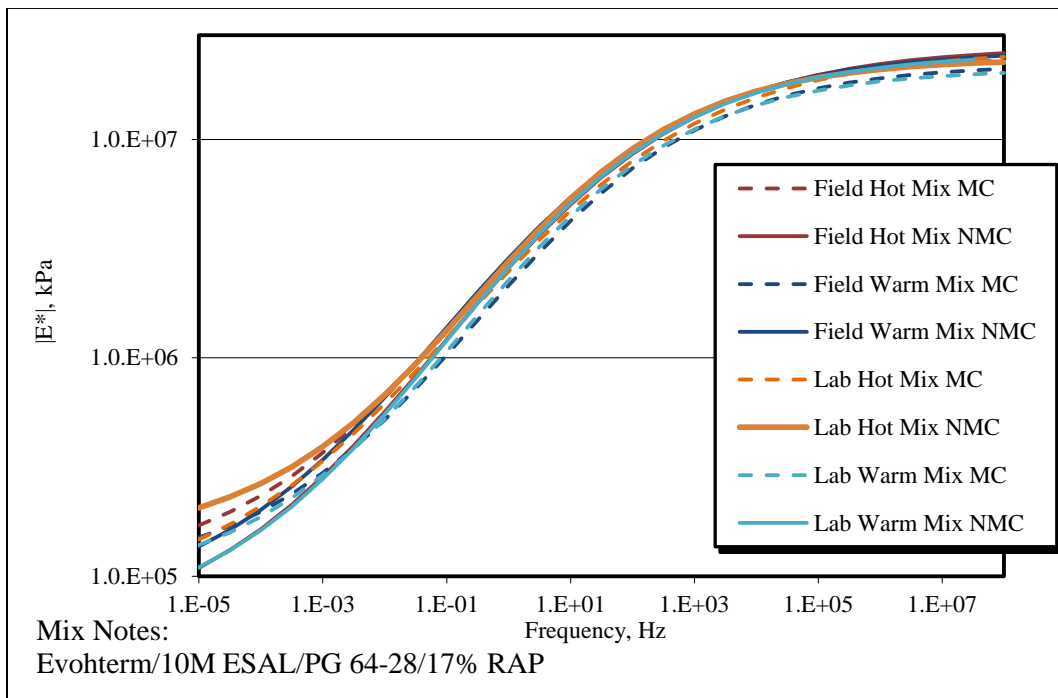

Figure 4.4 FM2 (HMA/Evotherm) dynamic modulus master curves

In order to determine how the HMA and WMA impact the overall results of the dynamic modulus, a split plot/repeated measures test is used in the statistical analysis. The first whole plot factors in this experiment are HMA/WMA, moisture conditioned/non-moisture conditioned and

reheated/not reheated. The whole plot factor is the comparison of the dynamic modulus results at all frequencies and temperatures between the whole factor, for example, HMA samples and the WMA samples. To correct this The ANOVA table is shown in Table 4.1 and is broken into the whole plot and sub plot sections of the analysis. The p-values for each factor and factor interactions are also shown in the ANOVA table. The full analysis output is available in Appendix K. The FM2 statistical analysis of the whole plot factors showed statistical differences between HMA and WMA as well as moisture conditioned and non-moisture conditioned samples. There is also a whole plot interaction between conditioning and whether the samples were compacted right away or reheated. The student's t-test is used as a multiple comparison test when only two levels are compared and if more than two are compared, Tukey honestly significant difference (HSD) tests are used. The student's t-test showed that HMA is statistically higher than WMA. Reheating the samples did show statistical differences but moisture conditioning the samples led to a statistical reduction in dynamic modulus. For this mixture, the laboratory compacted samples had little change in dynamic modulus regardless of moisture conditioning. The non-reheated compacted samples showed more sensitivity to moisture conditioning, showing a larger drop in dynamic modulus compared to the reheated samples.

The subplot factors of temperature and frequency are significant as would be expected. There is an interaction between temperature and frequency. The interaction between temperature and frequency exists whether or not the data transformation is applied. If no data transformation is applied, larger differences in frequency exist at lower temperatures than at higher temperatures. In the case of the data with the log transformation, the test temperature of 37°C shows higher fluctuations between frequencies than 4°C.

There are interactions that occur between sub plots and whole plots. The first interaction is a 3-way interaction between Mixture*Temperature*Compaction (compaction indicating whether the sample was reheated or not when it was compacted). This indicates that the differences in dynamic modulus between reheated and not-reheated mixtures for WMA and HMA samples will vary with testing temperature. There is an interaction between moisture conditioned samples and temperature. This interaction indicates that the dynamic modulus values are going to be impacted differently depending on the test temperature and whether a sample has been moisture conditioned. There appears to be very little difference at higher test temperatures but lower test temperatures show a more distinguishable differences between moisture conditioned and non-moisture conditioned samples. The statistically significant 3-way interaction of mix*temperature*moisture conditioning shows that the differences that were seen in the two-way interaction of temperature*moisture conditioning are different for HMA and WMA mixes. Differences in dynamic modulus appear to be largest between moisture conditioned (MC) and non-moisture conditioned (NMC) samples in WMA samples tested at 21°C. The other three way interaction is between compaction (comp)*temperature*moisture conditioned. The moisture conditioning generally reduces the dynamic modulus but we see little change for the non-reheated samples and a slight increase in dynamic modulus for lab compacted samples that were moisture conditioned and tested at 37°C.

Table 4.1 Summarized ANOVA table for Field Mix 2 with a SP-RM design

	DF	P-Value
Whole Plot	7	
Treatment		
<i>MIX (HMA/WMA)</i>	1	0.0055
<i>Cond (MC/NMC)</i>	1	0.0043
<i>COMP (Reheated/Not Reheated)</i>	1	0.1342
<i>MIX*Cond</i>	1	0.1743
<i>MIX*COMP</i>	1	0.9715
<i>Cond*COMP</i>	1	0.0449
<i>MIX*Cond*COMP</i>	1	0.748
Samples [Treatment]	32	<0.0001
Sub Plot	26	
Treatment		
<i>Temperature</i>	2	<.0001
<i>Frequency</i>	8	<.0001
<i>Temperature*Frequency</i>	16	<.0001
Whole Plots * Sub Plots	182	
Whole Plot and Sub Plot		
<i>Mix*Temperature</i>	2	0.6649
<i>COMP*Temperature</i>	2	0.1763
<i>Mix*COMP*Temperature</i>	2	0.0077
<i>Temperature*Cond</i>	2	<.0001
<i>Mix*Temperature*Cond</i>	2	0.0023
<i>COMP*Temperature*Cond</i>	2	0.0092
<i>Mix*COMP*Temperature*Cond</i>	2	0.5266
<i>Mix*Frequency</i>	8	0.9884
<i>COMP*Frequency</i>	8	0.9593
<i>Mix*COMP*Frequency</i>	8	0.9958
<i>Mix*Temperature*Frequency</i>	16	0.9893
<i>COMP*Temperature*Frequency</i>	16	0.9331
<i>Mix*COMP*Temperature*Frequency</i>	16	0.9998
<i>Cond*Frequency</i>	8	0.0578
<i>Mix*Cond*Frequency</i>	8	0.999
<i>COMP*Cond*Frequency</i>	8	0.9458
<i>Mix*COMP*Cond*Frequency</i>	8	0.9146
<i>Temperature*Cond*Frequency</i>	16	0.2218
<i>Mix*Temperature*Cond*Frequency</i>	16	0.9654
<i>COMP*Temperature*Cond*Frequency</i>	16	0.9289
<i>Mix*COMP*Cond*Frequency</i>	16	0.9477
Error	832	
Corrected Total	1079	

The dynamic modulus data is separated into different categories in order to make direct comparisons between the samples that are treated the same. This also will help to interpret the interactions identified in the overall analysis. The data divided into subsets will create a split plot repeated measures analysis because the sub plot factor is each tested frequency and the analysis is separated by temperature. The samples were repeatedly measured at the various frequencies. The split plot was broken up into four different categories, with each category being analyzed at the three test temperatures:

- not reheated/not moisture conditioned, analyzed for 4, 21, 37°C;
- reheated/not moisture conditioned, analyzed for 4, 21, 37°C;
- not reheated/moisture conditioned; analyzed for 4, 21, 37°C;
- reheated/moisture conditioned, analyzed for 4, 21, 37°C.

Statistical differences are always expected among frequencies and temperatures. The real factor of interest is the difference between HMA and WMA and when that difference occurs. The categories separate all of the samples so only the factor of interest, remains to be different for all the samples. The statistical analysis, Table 4.2, showed that there were no statistical differences between HMA and WMA for non-moisture conditioned samples regardless if compacted right away or reheated. There were differences at the $\alpha=0.05$ level for 4 and 37°C and the p-value for 21°C just slightly above alpha at 0.052 which suggests evidence for the difference between HMA and WMA for the reheated samples that were moisture conditioned. The samples that were moisture conditioned and compacted with no reheating showed only a difference at 21°C. HMA was the statistically higher average for all of the categories that showed statistical differences. Comparison of non-moisture conditioned samples and moisture conditioned samples showed that there were no statistical differences at the significance level of $\alpha=0.05$ for HMA

samples. The statistical differences occurred for non-reheated WMA samples at temperatures 4 and 21°C and 37°C gives a p-value of 0.066, which also is suggestive of a difference. The reheated WMA samples show a difference between MC and NMC at 21°C. By comparing the p-values at the different temperature, it may suggest that moisture conditioning differences are most evident at intermediate temperatures with three of the four testing categories giving p-values close to or below 0.05. There was very little evidence that reheating had much of an effect on the dynamic modulus except for the non-moisture conditioned HMA samples at 37°C which showed the non-reheated mixture having higher dynamic modulus values. This could indicate a possible difference in the oven temperature at the plant compared with ISU asphalt laboratory oven or perhaps differences in compaction occurring at different days.

Table 4.2 P-Values for FM2 dynamic modulus comparisons

HMA WMA					NMC MC				
Temperature, °C		4	21	37	Temperature, °C		4	21	37
Reheated	NMC	0.2171	0.8068	0.3980	Not Reheated	HMA	0.2902	0.0536	0.8025
Reheated	MC	0.0455	0.0526	0.0182	Not Reheated	WMA	0.0157	0.0004	0.0663
Not Reheated	NMC	0.9677	0.7221	0.2648	Reheated	HMA	0.1325	0.1550	0.0747
Not Reheated	MC	0.2297	0.0091	0.3052	Reheated	WMA	0.1242	0.0045	0.2212
Lab versus Field									
Temperature, °C		4	21	37					
HMA	NMC	0.9909	0.3329	0.0399					
WMA	NMC	0.2657	0.1759	0.0707					
HMA	MC	0.9545	0.4090	0.9630					
WMA	MC	0.8498	0.2959	0.3010					

4.1.2 FM3 master curve and dynamic modulus statistical analysis

The analysis for FM3 is very similar to FM2 because all the same factors are investigated and each category has a total of 5 samples. Figure 4.5 shows the master curves average for each

category. There is little difference that can be distinguished at the high dynamic modulus values but the lower values indicate the reheated-moisture conditioned-HMA values are the highest at high temperatures and that the lowest is the moisture conditioned-not reheated-HMA, indicating that this mixture may be more susceptible to reheating differences. There appears to be more spread in the moisture conditioned data (dashed lines) than there is in the non-moisture conditioned samples at high and intermediate temperatures.

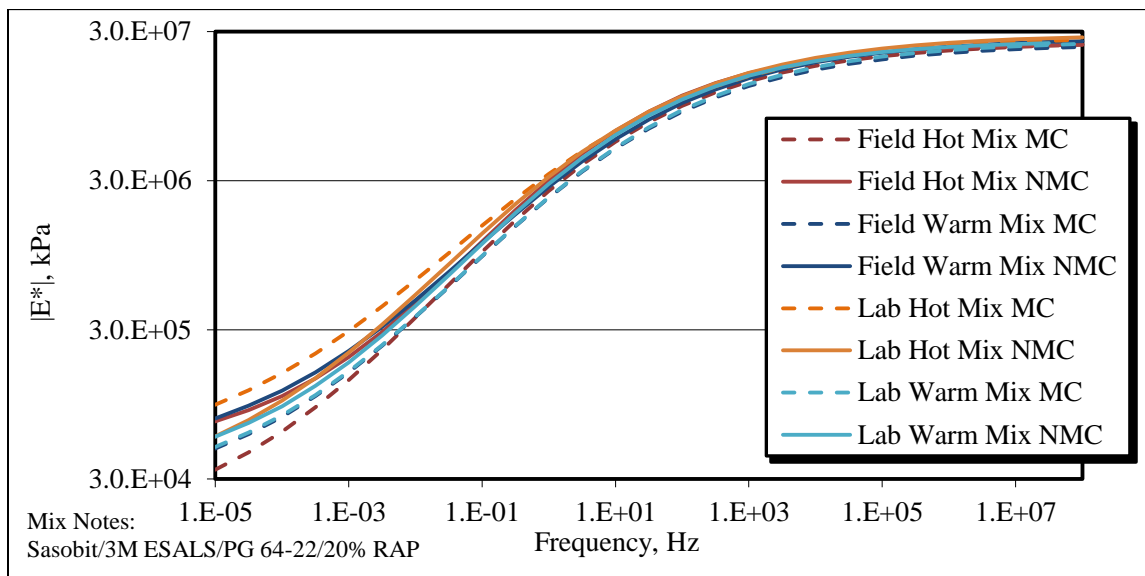

Figure 4.5 FM3 (HMA/Sasobit) dynamic modulus master curves

The statistical analysis for FM3 is identical to the analysis performed for FM2 because all of the same factors are studied and the same number of samples was made for each category. Like FM2, there was the overall analysis with the log data transformation and then the data was separated into subsets to look at each factor individually. The entire ANOVA table is shown in Table 4.3. The whole plot factors are all statistically significant. The HMA mixes, lab compacted mixes and non-moisture conditioned samples were found to have statistically higher dynamic modulus values.

The only statistically significant interaction between the whole plot factors is mix*compaction. The interaction plot showed that the HMA samples that were reheated in the lab were stiffer compared with the reheated WMA samples. This interaction is logical because the HMA samples are reheated at a higher temperature than the WMA samples and this temperature difference could cause an interaction.

The sub plot factors of temperature and frequency are statistically significant as well as the temperature-frequency interaction. The interaction shows the same variances that occur in FM2 with greater differences at 37 °C than at 4 due to the log transformation. The difference in frequency would be greater for 4°C if no log transformation was applied.

Table 4.3 FM3 summarized ANOVA table

		DF	P-Value
Whole Plot	Treatment	7	
	<i>MIX (HMA/WMA)</i>	1	0.0001
	<i>Cond (MC/NMC)</i>	1	0.0013
	<i>COMP (Reheated/Not Reheated)</i>	1	0.0103
	<i>MIX*Cond</i>	1	0.2453
	<i>MIX*COMP</i>	1	0.0038
	<i>Cond*COMP</i>	1	0.355
	<i>MIX*Cond*COMP</i>	1	0.0936
	Samples [Treatment]	32	<.0001
Sub Plot	Treatment	26	
	<i>Temperature</i>	2	<.0001
	<i>Frequency</i>	8	<.0001
	<i>Temperature*Frequency</i>	16	<.0001
Whole Plots * Sub Plots		182	
Whole Plot and Sub Plot	<i>Mix*Temperature</i>	2	<.0001
	<i>COMP*Temperature</i>	2	0.0177
	<i>Mix*COMP*Temperature</i>	2	<.0001
	<i>Temperature*Cond</i>	2	<.0001
	<i>Mix*Temperature*Cond</i>	2	0.2872
	<i>COMP*Temperature*Cond</i>	2	0.0706
	<i>Mix*COMP*Temperature*Cond</i>	2	0.0039
	<i>Mix*Frequency</i>	8	0.9855
	<i>COMP*Frequency</i>	8	0.0483
	<i>Mix*COMP*Frequency</i>	8	<.0001
	<i>Mix*Temperature*Frequency</i>	16	0.0611
	<i>COMP*Temperature*Frequency</i>	16	0.9883
	<i>Mix*COMP*Temperature*Frequency</i>	16	0.5884
	<i>Cond*Frequency</i>	8	0.9991
	<i>Mix*Cond*Frequency</i>	8	0.9849
	<i>COMP*Cond*Frequency</i>	8	0.3181
	<i>Mix*COMP*Cond*Frequency</i>	8	0.9698
	<i>Temperature*Cond*Frequency</i>	16	0.9991
	<i>Mix*Temperature*Cond*Frequency</i>	16	0.9948
	<i>COMP*Temperature*Cond*Frequency</i>	16	0.9036
<i>Mix*COMP*Cond*Frequency</i>	16	0.9999	
Error	832		
Corrected Total	1079		

The data was separated into subsets and simplified ANOVA analysis was performed. The P-values are shown in Table 4.4. HMA and WMA show statistical differences in all three temperatures. The statistical differences between HMA and WMA are evident in all reheated samples except for the re-heated-NMC at 4°C. The only difference for the non-reheated samples shows HMA and WMA to be different for NMC samples at 4°C. All the statistical differences show HMA having the higher dynamic modulus value. The process of re-heating the HMA at a higher temperature is the most likely reason for the difference. The NMC/MC comparison shows no evidence of any differences at 37°C and no differences for re-heated HMA samples. The not-reheated HMA shows a difference at 4 and 21°C but the p-value for not-reheated WMA at 21°C is slightly higher than $\alpha=0.05$. The HMA-MC category shows reheated samples with statistically higher dynamic modulus values at 21 and 37°C.

Table 4.4 P-values for the FM3 split-plot/repeated measures analysis

HMA WMA					NMC MC				
Temperature, °C		4	21	37	Temperature, °C		4	21	37
Reheated	NMC	0.2723	0.0426	0.0472	Not Reheated	HMA	0.0230	0.0271	0.0922
Reheated	MC	0.0151	0.0052	0.0030	Not Reheated	WMA	0.0236	0.0589	0.3406
Not Reheated	NMC	0.0075	0.1610	0.8675	Reheated	HMA	0.4448	0.7135	0.4021
Not Reheated	MC	0.1790	0.1428	0.1709	Reheated	WMA	0.0437	0.0351	0.1316
Lab versus Field									
Temperature, °C		4	21	37					
HMA	NMC	0.3187	0.2095	0.0660					
WMA	NMC	0.2939	0.6095	0.7982					
HMA	MC	0.0827	0.0195	0.0037					
WMA	MC	0.7679	0.9289	0.0900					

4.1.4 FM4 master curve and dynamic modulus statistical analysis

FM4 compares the same factors as FM2 and FM3 but due to inclement weather only six samples were compacted for the WMA/non-reheating category, leaving only three when half are moisture conditioned. This causes an unbalanced ANOVA analysis; however, the statistical program JMP will account for these changes in the analysis. The master curves are shown in Figure 4.6. There appears to be no clear trends in the master curve comparisons. The only evidence of a difference is the reheated-WMA-NMC values at intermediate temperatures appear higher than all other mixes.

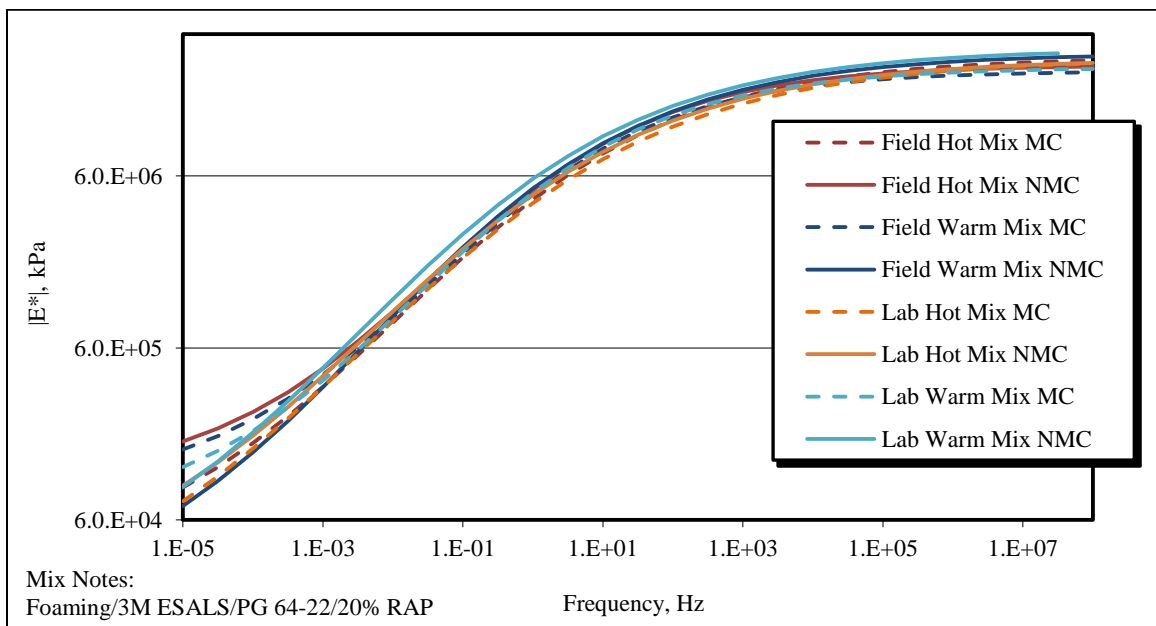

Figure 4.6 FM4 (HMA/Foaming) dynamic modulus master curves

The whole plot factors of mixture and conditioning are statistically significant. The influence of whether the sample was reheated did not influence the dynamic modulus values. Reheating samples was a concern for foamed asphalt but this mix did not show statistical differences. A significant interaction between mix and compaction does exist and shows that the

dynamic modulus values for the WMA mixture had a larger increase compared with the HMA which saw no increase due to reheating the mixture. The sub plot factors of temperature and frequency are significant as well as their interaction. This is the same interaction seen in FM2 and FM3.

The whole plot and subplot interactions show seven statistically significant interactions. The first interaction, mix*temperature, shows that the differences between HMA and WMA E* values will change for different temperatures. For this mixture, the largest difference between HMA and WMA occurs at 21°C but is relatively the same for WMA and HMA. The interaction of comp*temperature shows a larger difference in dynamic modulus between reheated and non-reheated samples at 37°C than at 4 and 21°C. This is likely due in part to the data transformation. The three-way interaction of mix*comp*temperature shows similar trends. The WMA mix is more susceptible to reheating than the HMA but those differences depend on the test temperature. The interaction of temperature*cond shows that the influence of moisture conditioning has the greatest effect at the 21°C test temperature. The three-way interaction of mix*temperature*conditioning shows that the effect of moisture conditioning is different for HMA and WMA and is also dependent on test temperature. The interaction of mix*temperature*frequency shows that temperature and frequency will impact HMA and WMA differently.

The p-values for the FM4 data subset comparisons are shown in Table 4.6. The yellow highlighted p-values indicate the different sample sizes. The differences in sample size should be taken into consideration when making conclusions. The HMA/WMA comparison shows WMA having statistically higher dynamic modulus values for all reheated samples except for reheated-MC at tested at 4°C. The not-reheated samples give no p-value less than 0.05, indicating no

differences between WMA and HMA stiffness. The analysis seems to indicate that reheating WMA samples are stiffer than reheated HMA samples but this difference is mostly likely due mixture variability because of the 9 day lapse between the HMA and WMA mix production due to inclement October weather. The MC/NMC comparison shows the most difference evident at 21°C. The only mixture showing no changes due to moisture conditioning is the not-reheated WMA category. The reheated WMA is different at 4 and 21°C while not-reheated HMA mixes show differences at 21 and 37°C.

Table 4.5 Summarized ANOVA table Split plot Repeated measures design for FM4

	DF	P-Value	
Whole Plot	Treatment	7	
	<i>MIX (HMA/WMA)</i>	1	0.0002
	<i>Cond (MC/NMC)</i>	1	0.0002
	<i>COMP (Reheated/Not Reheated)</i>	1	0.2904
	<i>MIX*Cond</i>	1	0.6179
	<i>MIX*COMP</i>	1	0.0052
	<i>Cond*COMP</i>	1	0.1989
	<i>MIX*Cond*COMP</i>	1	0.1674
Samples [Treatment]	32	<.0001	
Sub Plot	Treatment	26	
	<i>Temperature</i>	2	<.0001
	<i>Frequency</i>	8	<.0001
	<i>Temperature*Frequency</i>	16	<.0001
Whole Plots * Sub Plots		182	
Whole Plot and Sub Plot	<i>Mix*Temperature</i>	2	<.0001
	<i>COMP*Temperature</i>	2	<.0001
	<i>Mix*COMP*Temperature</i>	2	<.0001
	<i>Temperature*Cond</i>	2	<.0001
	<i>Mix*Temperature*Cond</i>	2	<.0001
	<i>COMP*Temperature*Cond</i>	2	0.086
	<i>Mix*COMP*Temperature*Cond</i>	2	0.0001
	<i>Mix*Frequency</i>	8	0.6653
	<i>COMP*Frequency</i>	8	0.5289
	<i>Mix*COMP*Frequency</i>	8	0.7984
	<i>Mix*Temperature*Frequency</i>	16	0.0314
	<i>COMP*Temperature*Frequency</i>	16	0.9944
	<i>Mix*COMP*Temperature*Frequency</i>	16	0.6169
	<i>Cond*Frequency</i>	8	0.9738
	<i>Mix*Cond*Frequency</i>	8	0.0968
	<i>COMP*Cond*Frequency</i>	8	0.8301
	<i>Mix*COMP*Cond*Frequency</i>	8	0.31
	<i>Temperature*Cond*Frequency</i>	16	0.7413
	<i>Mix*Temperature*Cond*Frequency</i>	16	0.9631
<i>COMP*Temperature*Cond*Frequency</i>	16	1	
<i>Mix*COMP*Cond*Frequency</i>	16	0.9803	
Error	832		
Corrected Total	1079		

Table 4.6 P-values for the FM4 split-plot/repeated measures analysis

HMA WMA					NMC MC				
Temperature, °C		4	21	37	Temperature, °C		4	21	37
Reheated	NMC	0.0069	0.0007	0.0512	Not Reheated	HMA	0.7391	0.0346	0.0398
Reheated	MC	0.1155	0.0232	0.0092	Not Reheated	WMA	0.1236	0.3018	0.6006
Not Reheated	NMC	0.0513	0.8999	0.4016	Reheated	HMA	0.1482	0.0365	0.0685
Not Reheated	MC	0.8365	0.3369	0.1428	Reheated	WMA	0.0005	0.0330	0.2449
Lab versus Field									
Temperature, °C		4	21	37					
HMA	NMC	0.9769	0.0630	0.7877					
WMA	NMC	0.1181	0.0320	0.0808					
HMA	MC	0.0827	0.2159	0.9799					
WMA	MC	0.9954	0.6683	0.3380					

4.1.5 FM5 master curve and dynamic modulus statistical analysis

FM5 had only a WMA mixture produced using the additive Evotherm with no HMA control mixture. The analysis will focus on comparing the effects of reheating the mixture and moisture conditioning. Figure 4.7 shows the master curves for the FM5 samples. The master curve for the non-reheated/NMC is shown as a dash line because of its similarities to the reheated/NMC line so that each can be compared. If the line was not a dashed line, this would completely cover one of the lines due to the close values. This is clear evidence of the impact moisture conditioning has on this mix. Reheated and not-reheated samples both have clear reductions in moduli due to moisture conditioning effects and there appears to be no change attributed to the re-heating of the mixture. There were not as many non-reheated samples compacted as there were reheated samples in the lab. This is due to the “laboratory” set up in the field and its logistical challenges. The oven was not located within close proximity of the gyratory compactor. This increased the amount of time needed to compact samples because mixture and tools had to be transported between the two areas. Six dynamic modulus samples

were produced (six IDT samples were also compacted that day). The statistical analysis uses a square root transformation instead of a log transformation that was used for the FM2, FM3 and the FM4 mixes. This is because a new UTM was used for mixes FM5, FM6 and FM7. The distribution of the data was slightly different from the older piece of equipment and the raw data files output dynamic modulus in a different unit, MPa. The log transformation does not work as well for the FM5, FM6 and FM7 datasets so a square root transformation was applied.

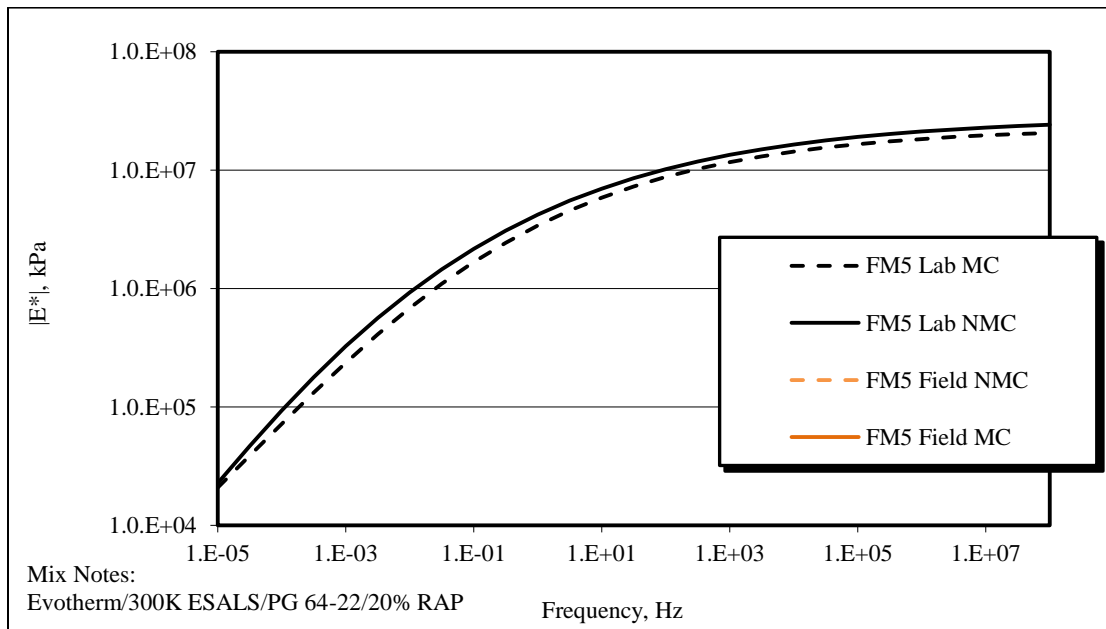

Figure 4.7 FM5 (Evotherm only) dynamic modulus master curves

The ANOVA analysis shows that the moisture conditioning will significantly reduce the dynamic modulus value of the conditioned samples. Reheating did not have a significant influence and there was not an interaction between conditioning and compaction. The subplot factors of temperature, frequency and the temperature*frequency are significant.

The whole plot and subplot interactions show four of statistical significance. The first interaction of comp*temperature shows that the effects of reheating the samples is different depending upon the test temperature. For this set of data, the largest differences between reheated/non-reheated dynamic modulus values appear at 37°C. This may change depending

upon the transformation of the data used. The interaction of temperature*moisture conditioning shows that change between non-moisture conditioned and moisture conditioned samples will change depending on test temperature. The largest difference between the moisture conditioned and non-moisture conditioned dynamic modulus values occurs at 4°C and the difference is smaller as the temperature is increased. The three-way interaction of comp*temperature*moisture conditioning indicates that the differences in E^* at different temperatures when comparing MC and NMC samples, will also depend on whether the samples were reheated or not reheated. The interaction of moisture conditioning and frequency indicates that the difference in dynamic modulus for NMC and MC samples may be different depending upon the test frequency; however, the interaction plot appears to show relatively parallel lines.

The ANOVA analysis subsets compared the re-heating effect indicates there are no statistical differences between loose mix compacted at the time of production and loose mix that is reheated and compacted at the Iowa State laboratory. The comparison between MC and NMC, Table 4.8, shows that all categories indicate statistical differences between these samples. The NMC category has the statistically higher modulus for all categories compared. The subplot factors of temperature, frequency and the interaction of temperature and frequency are all statistically significant.

Table 4.7 Split-plot repeated measures ANOVA analysis for FM5

		DF	P-Value
Whole Plot	Treatment	3	
	<i>Cond (MC/NMC)</i>	1	<.0001
	<i>COMP (Reheated/Not Reheated)</i>	1	0.5826
	<i>Cond*COMP</i>	1	0.3112
Samples [Treatment] & Random		12	<.0001
Sub Plot	Treatment	26	
	<i>Temperature</i>	2	<.0001
	<i>Frequency</i>	8	<.0001
	<i>Temperature*Frequency</i>	16	<.0001
Whole Plots * Sub Plots		78	
Whole Plot and Sub Plot	<i>COMP*Temperature</i>	2	<.0001
	<i>Temperature*Cond</i>	2	<.0001
	<i>COMP*Temperature*Cond</i>	2	0.0005
	<i>COMP*Frequency</i>	8	1.0000
	<i>COMP*Temperature*Frequency</i>	16	0.9942
	<i>Cond*Frequency</i>	8	0.0008
	<i>COMP*Cond*Frequency</i>	8	0.7558
	<i>Temperature*Cond*Frequency</i>	16	0.8918
	<i>COMP*Temperature*Cond*Frequency</i>	16	1.0000
Error		312	
Corrected Total		431	

Table 4.8 P-values for the FM5 split-plot/repeated measures analysis

		NMC and MC Comparison		
Temperature, °C		4	21	37
Field	WMA	0.0032	0.0097	0.0159
Lab	WMA	0.0006	0.0001	0.0019

4.1.6 FM6 master curve and dynamic modulus statistical analysis

The master curves for FM6 are presented in Figure 4.8. Similar working condition challenges as described for FM5 were also encountered at the laboratory set up for FM6 so only a limited number of not-reheated samples could be compacted. In addition, one of the non-reheated compacted samples had high air voids leaving only two samples for testing. The master

curves show the reheated-NMC samples having the higher dynamic modulus values at low temperatures. The other three mixes show master curves within close proximity to each other. The statistical analysis is limited due to the limited number of not-reheated samples. The only statistical comparison that can be made is evaluating the impact of moisture conditioning on reheated samples. This analysis found that NMC samples are statically higher than MC samples at 4°C. No differences were observed at 21 and 37°C.

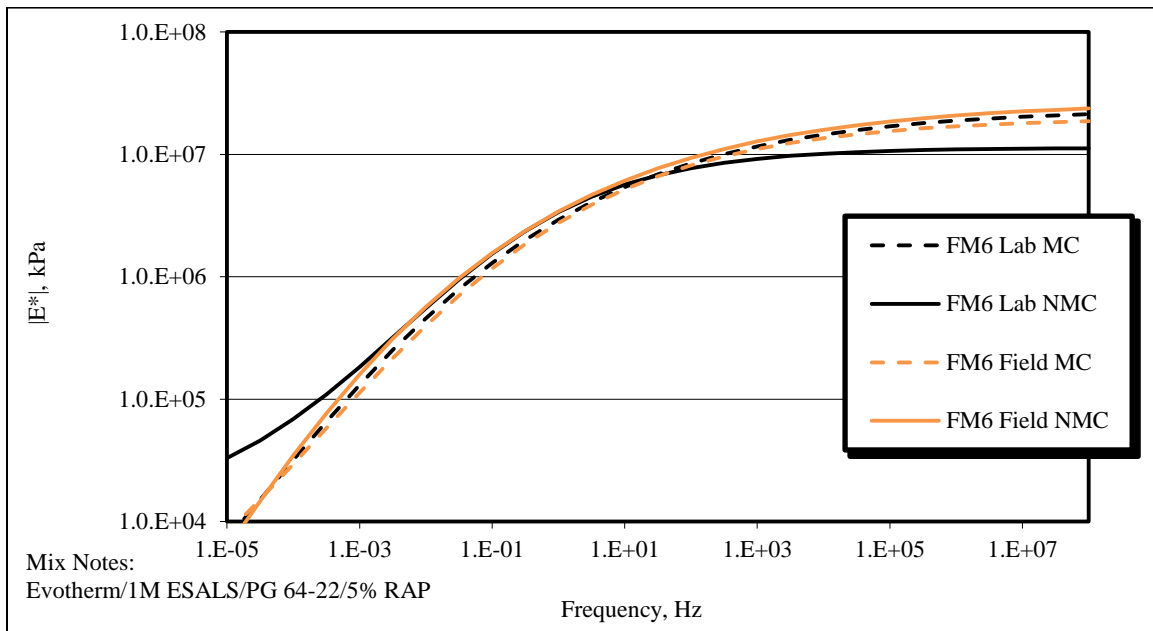

Figure 4.8 FM6 (Evotherm) dynamic modulus master curves

4.1.7 FM7 master curve and dynamic modulus statistical analysis

Figure 4.9 shows the dynamic modulus master curves for FM7. Five samples were compared for each group and only reheated samples were evaluated. The master curves show the importance of temperature when evaluating a mix. The purple line indicates FM7-7 which contains 7% shingles. FM7-7 is the stiffest mixture at low temperatures but is one of the softest at high temperatures. It appears the trends for the high temperatures are almost opposite of the

trends at the lower temperatures. The upper portion of the curve appears to be to show all the mixes within close proximity but the log-log scale can mask the actual differences.

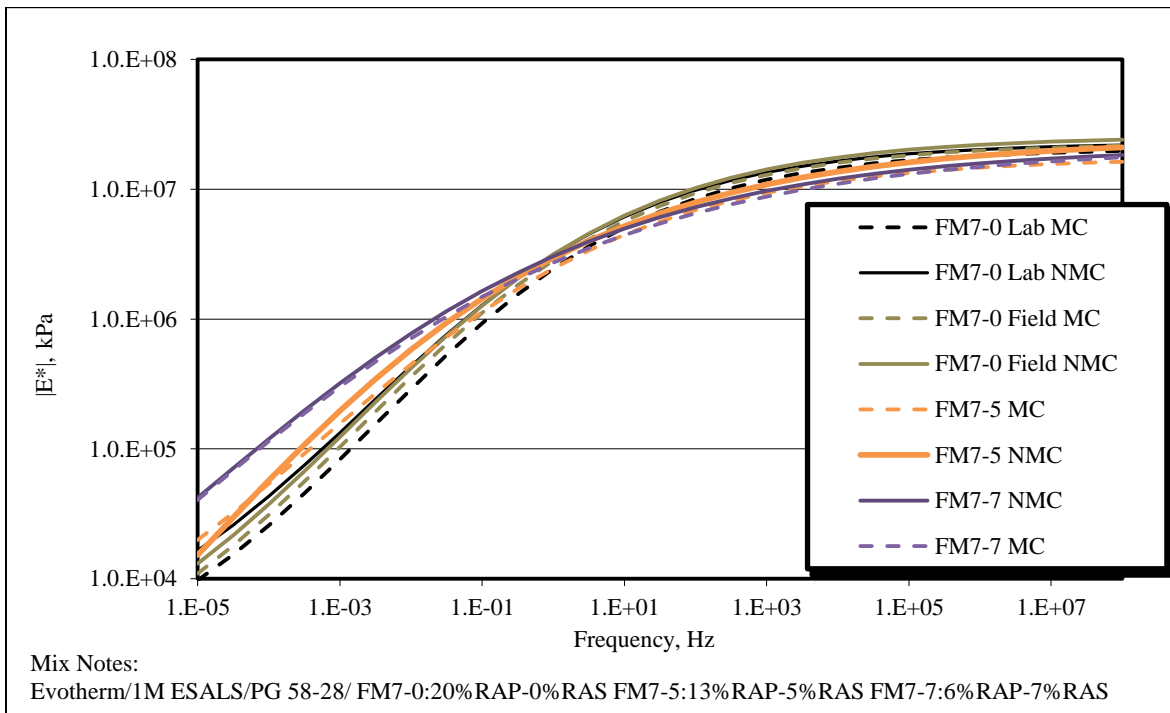

Figure 4.9 FM7 (Evotherm with 0%, 5%, 7% Shingles) dynamic modulus master curves

The split-plot reheated measures design investigates the influence of mix and moisture conditioning on the WMA-RAS mixtures. The ANOVA table for the statistical analysis is shown in Table 4.9. The analysis uses a square root transformation, which was also done for FM5. The whole plot factors of mix (0%, 5% and 7% RAS) and conditioning (moisture conditioned and non-moisture conditioned samples) are of interest. Both mixture type and moisture conditioning were statistically significant. The multiple comparison testing showed that the dynamic modulus for FM7-0 was statistically higher than FM7-5 and FM7-7. The difference is reflected in the graph of the dynamic modulus master curve for FM7-0 in the upper portion of the curve. This is unexpected because the binder data for FM7-7 is stiffer than FM7-0 at high temperatures. Non-moisture conditioned samples have higher dynamic modulus values compared with the moisture

conditioned samples. There is no interaction between mix*conditioning. The subplot factors of temperature, frequency and the temperature*frequency interaction are statistically significant. This has been observed in all other mixes. There are four interactions between the wholeplot and subplot factors. The interaction of mix*temperature is significant. The interaction plots for mix*temperature show the greatest difference in dynamic modulus at 4°C. The largest difference in E* appears to be in mix FM7-0. FM7-5 and FM7-7 appear to give relatively similar results. The interaction of temperature*conditioning shows little change between NMC and MC at 37°C but greater changes at 21 and 4°C. There is a three way interaction of mix*temperature*conditioning. The reason for this interaction is due to the changes in NMC and MC at different temperature as well as the changes that we see in the different mixes. There is a slight increase in dynamic modulus values for moisture conditioned samples compared with non-moisture conditioned samples at 4 and 37°C for mix FM7-7 and this is likely one of the main causes for the interaction. The influence of moisture conditioning may have had a reduced impact on the dynamic modulus for FM7-7 because of the high initial stiffness at high temperatures causing the mixture to be less susceptible to the effects of moisture conditioning, especially the effects of the 60°C water bath. Finally, there is an interaction between mix and frequency. This interaction can be observed in the master curves. The mixes FM7-5 and FM7-7 show similar values but FM7-0 is to FM7-7 and FM7-5 at low frequencies but as the frequencies increase, the material response becomes stiffer at the higher frequencies.

Table 4.9 FM7 Split-plot repeated measures ANOVA Analysis

		DF	P-Value
Whole Plot	Treatment	5	
	<i>MIX (0%, 5%, 7% RAS)</i>	2	0.0005
	<i>Cond (MC/NMC)</i>	1	0.0044
	<i>MIX*Cond</i>	2	0.1199
	Samples [Treatment]	24	<.0001
Sub Plot	Treatment	26	
	<i>Temperature</i>	2	<.0001
	<i>Frequency</i>	8	<.0001
	<i>Temperature*Frequency</i>	16	<.0001
Whole Plots * Sub Plots		78	
Whole Plot and Sub Plot	<i>Mix*Temperature</i>	2	<.0001
	<i>Temperature*Cond</i>	2	<.0001
	<i>Mix*Temperature*Cond</i>	2	<.0001
	<i>Mix*Frequency</i>	8	<.0001
	<i>Mix*Temperature*Frequency</i>	16	0.129
	<i>Cond*Frequency</i>	8	0.2008
	<i>Mix*Cond*Frequency</i>	8	1
	<i>Temperature*Cond*Frequency</i>	16	0.9996
	<i>Mix*Temperature*Cond*Frequency</i>	16	1
Error	624		
Corrected Total	809		

4.1.8 Summary analysis of dynamic modulus results

The purpose of this section is to show which factors are consistently significant for all of the mixes studied. Each mixture producing HMA and WMA show statistical differences for each mix and conditioning is also significant for each mix. Reheating was only significant for the wax additive mixture. The subplot factors, temperature and frequency, were significant for each mixture. This would be expected. The interaction of temperature*frequency is statistically significant for all mixes. If there is no data transformation taken, the largest differences in E^* between frequencies occur at 4°C and the differences in E^* between the frequencies reduce as the test temperatures increase. The interaction of temperature and moisture conditioning was

significant for all the mixes. For FM2 and FM3 the largest differences between MC and NMC samples occurred at 21°C; the largest difference for FM4 occurred at 37°C. The three-way interaction of mix*compaction*temperature is also significant for all three mixes. The reason for this interaction occurring is not the same for the three mixes.

Table 4.10 Summary table of the statistically significant factors by WMA additive type

WMA Technology		Chemical Additive	Wax Additive	Plant Foaming
Whole Plot	Treatment	P-Value	P-Value	P-Value
	<i>MIX (HMA/WMA)</i>	0.0055	0.0001	0.0002
	<i>Cond (MC/NMC)</i>	0.0043	0.0013	0.0002
	<i>COMP (Reheated/Not Reheated)</i>	0.1342	0.0103	0.2904
	<i>MIX*Cond</i>	0.1743	0.2453	0.6179
	<i>MIX*COMP</i>	0.9715	0.0038	0.0052
	<i>Cond*COMP</i>	0.0449	0.355	0.1989
	<i>MIX*Cond*COMP</i>	0.748	0.0936	0.1674
Samples [Treatment]		<0.0001	<.0001	<.0001
Sub Plot	Treatment			
	<i>Temperature</i>	<.0001	<.0001	<.0001
	<i>Frequency</i>	<.0001	<.0001	<.0001
	<i>Temperature*Frequency</i>	<.0001	<.0001	<.0001
Whole Plots * Sub Plots				
Whole Plot and Sub Plot	<i>Mix*Temperature</i>	0.6649	<.0001	<.0001
	<i>COMP*Temperature</i>	0.1763	0.0177	<.0001
	<i>Mix*COMP*Temperature</i>	0.0077	<.0001	<.0001
	<i>Temperature*Cond</i>	<.0001	<.0001	<.0001
	<i>Mix*Temperature*Cond</i>	0.0023	0.2872	<.0001
	<i>COMP*Temperature*Cond</i>	0.0092	0.0706	0.086
	<i>Mix*COMP*Temperature*Cond</i>	0.5266	0.0039	0.0001
	<i>Mix*Frequency</i>	0.9884	0.9855	0.6653
	<i>COMP*Frequency</i>	0.9593	0.0483	0.5289
	<i>Mix*COMP*Frequency</i>	0.9958	<.0001	0.7984
	<i>Mix*Temperature*Frequency</i>	0.9893	0.0611	0.0314
	<i>COMP*Temperature*Frequency</i>	0.9331	0.9883	0.9944
	<i>Mix*COMP*Temperature*Frequency</i>	0.9998	0.5884	0.6169
	<i>Cond*Frequency</i>	0.0578	0.9991	0.9738
	<i>Mix*Cond*Frequency</i>	0.999	0.9849	0.0968
	<i>COMP*Cond*Frequency</i>	0.9458	0.3181	0.8301
	<i>Mix*COMP*Cond*Frequency</i>	0.9146	0.9698	0.31
	<i>Temperature*Cond*Frequency</i>	0.2218	0.9991	0.7413
	<i>Mix*Temperature*Cond*Frequency</i>	0.9654	0.9948	0.9631
	<i>COMP*Temperature*Cond*Frequency</i>	0.9289	0.9036	1
<i>Mix*COMP*Cond*Frequency</i>	0.9477	0.9999	0.9803	

4.2 Flow number results

Flow number data in phase I was calculated using Excel and the raw data files. The values were re-evaluated using a MATLAB program that fits a curve which allows for a better estimation and lower variability in determining the flow number data. Data was grouped according to mixes, additives, reheating and condition. The title of “field” or “lab” refers to where the sample was compacted: “Field” is equivalent to no reheating/gyratory compacted and “Lab” is equivalent to reheating mixture in the laboratory and then compacting the sample in a gyratory. The statistical analysis compared samples that were treated similarly with the factor of interest being the only difference. Each of the flow number averages are shown and compared statistically. The graphs showing the accumulated strain are also shown for each mix. The graphs are shown in semi-log scale. The flow number is the point on the curve where tertiary flow is reached.

FM2 flow number data is shown in Figure 4.10 and Figure 4.11. The moisture conditioning appears to show an increase in flow number for both WMA and HMA. The WMA values appear to be slightly lower in the columns. These trends are also illustrated in the strain versus cycles graph showing the HMA lines shifted more to the right compared to the WMA data. The statistical analysis found statistical differences between reheated mixtures.

FM3 results are shown in Figure 4.12 and Figure 4.13. The HMA appears to have slightly higher flow numbers in the reheated mixes. The HMA reheated moisture conditioned samples appear to have the highest flow number and the NMC is three times higher than most of the WMA mixture categories. The HMA mixture appears to be sensitive to the reheating showing an increase in flow number compared the WMA mixture that was reheated at WMA temperatures.

The statistical analysis did confirm that the flow numbers are statistically different for the reheated mixtures.

FM4 results are shown in Figure 4.14 and Figure 4.15. The differences due to moisture conditioning are not evident in the FM4 mix but the WMA had a higher initial flow number prior to moisture conditioning. The reduction in the flow number appears to be similar for all the FM4 categories tested. The statistical analysis showed evidence of a reheating effect but it is not limited to only the WMA samples.

FM5 and FM6 did not have the same number of field and laboratory compacted samples but when averages for the groups are compared, no evidence for differences exist. The flow number comparison for FM5, Figure 4.16, shows the field (not-reheated) averages being slightly higher, especially the NMC samples. The strain versus cycle graph, Figure 4.17, shows the NMC samples performing better than the MC samples. The FM6 comparison, Figure 4.18 and Figure 4.19, appears to show lab compacted samples to have higher averages. The conditioning comparisons show the effect moisture conditioning has on flow numbers for samples treated the same. The analysis found there are no statistical trends that can prove how much moisture conditioning will affect flow number results. The data suggest that either flow number is not negatively impacted from the moisture conditioning or that flow number results are too variable to adequately detect differences in the mixture.

FM7 flow number results are shown in Figure 4.21. The FM7-0 mix was compacted with and without reheating effects. The reheated mix shows increased flow number values and is comparable with the FM7-5 reheated flow number results. The FM7-7 mixture shows a significantly increased flow number indicating a large increase in stiffness. The samples did not

fail after 10,000 load cycles at 37°C for the moisture conditioned and non-moisture conditioned samples.

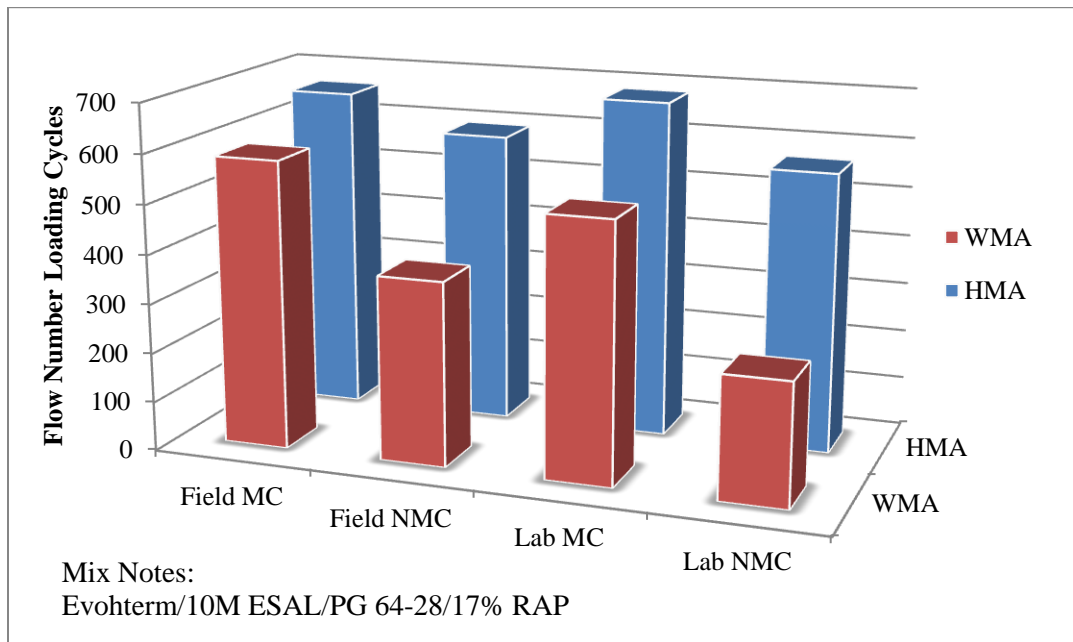

Figure 4.10 FM2 flow number comparison

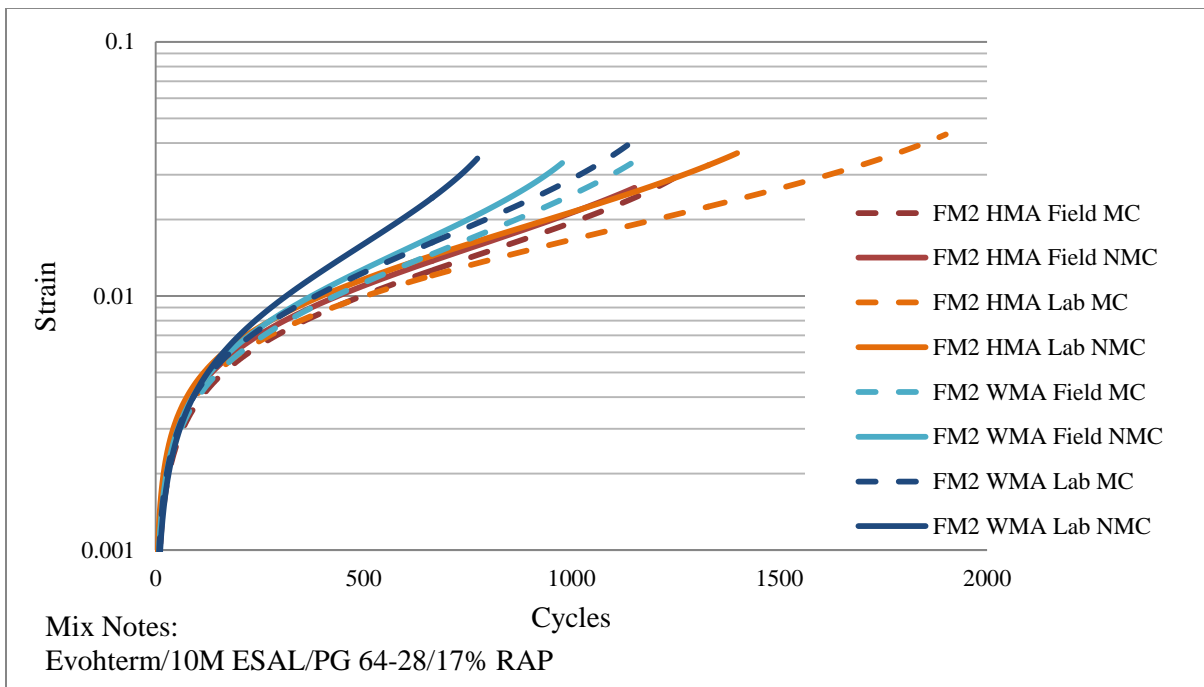

Figure 4.11 Strain versus cycles plot for FM2 (HMA/Evohterm)

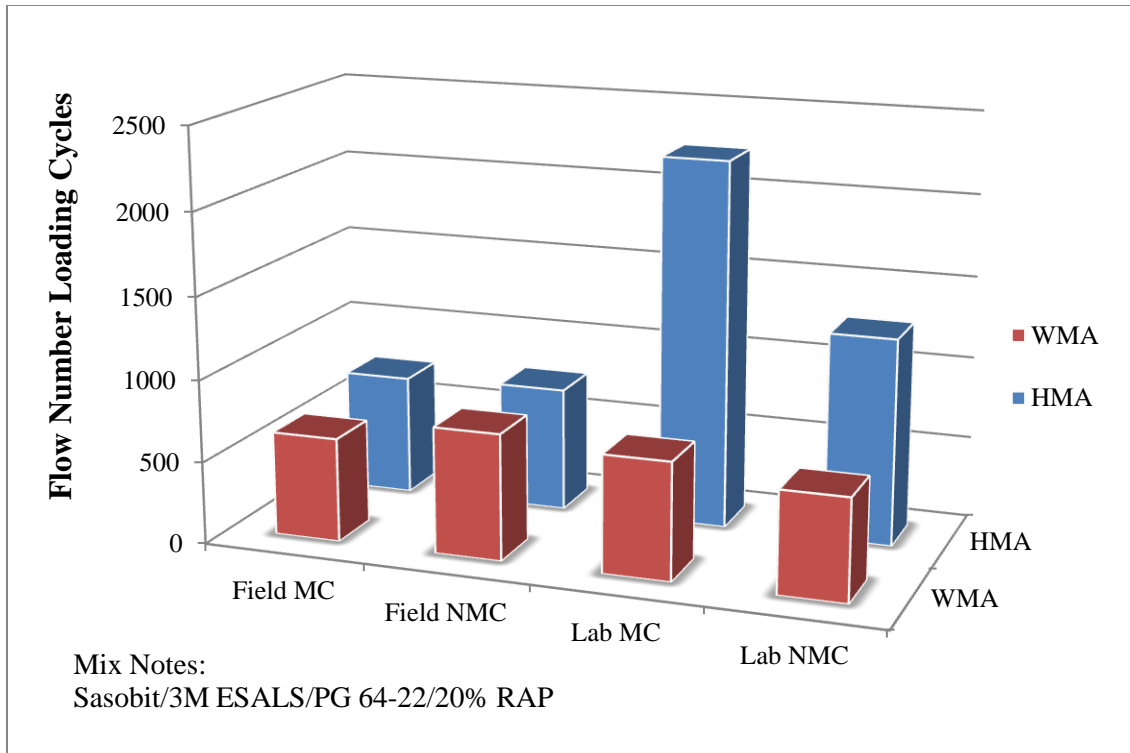

Figure 4.12 FM3 flow number comparison

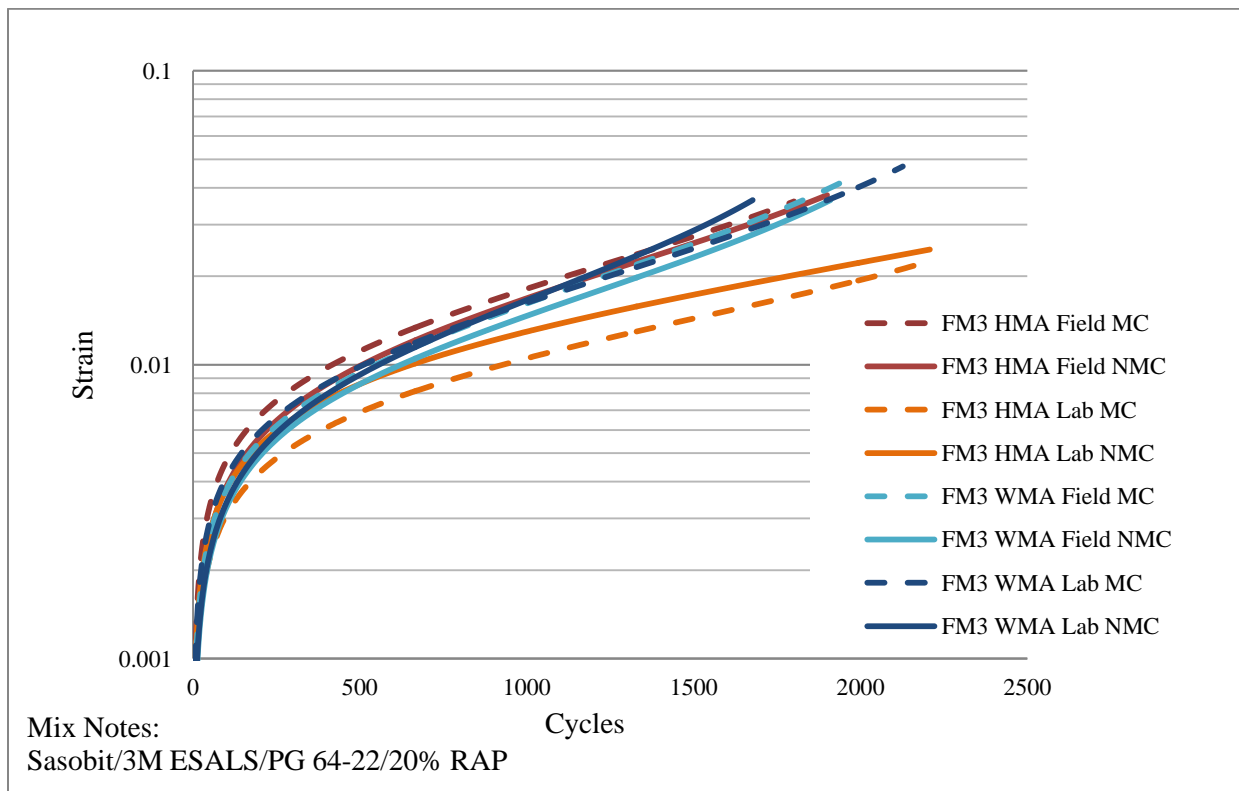

Figure 4.13 Strain versus cycles plot for FM3 (HMA/Sasobit)

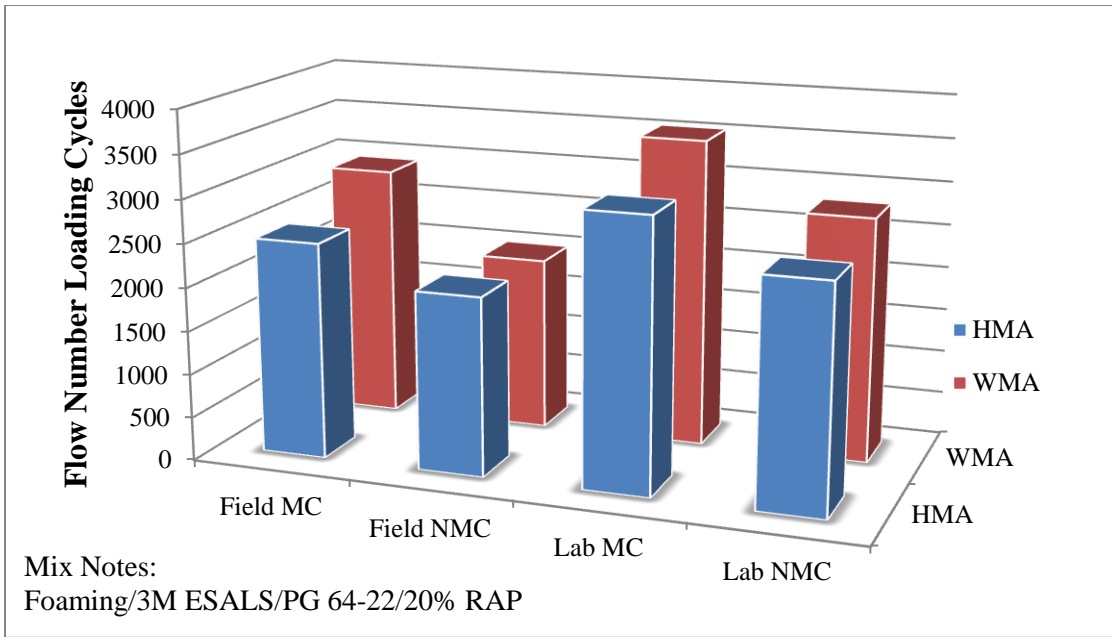

Figure 4.14 Flow number comparisons for FM4

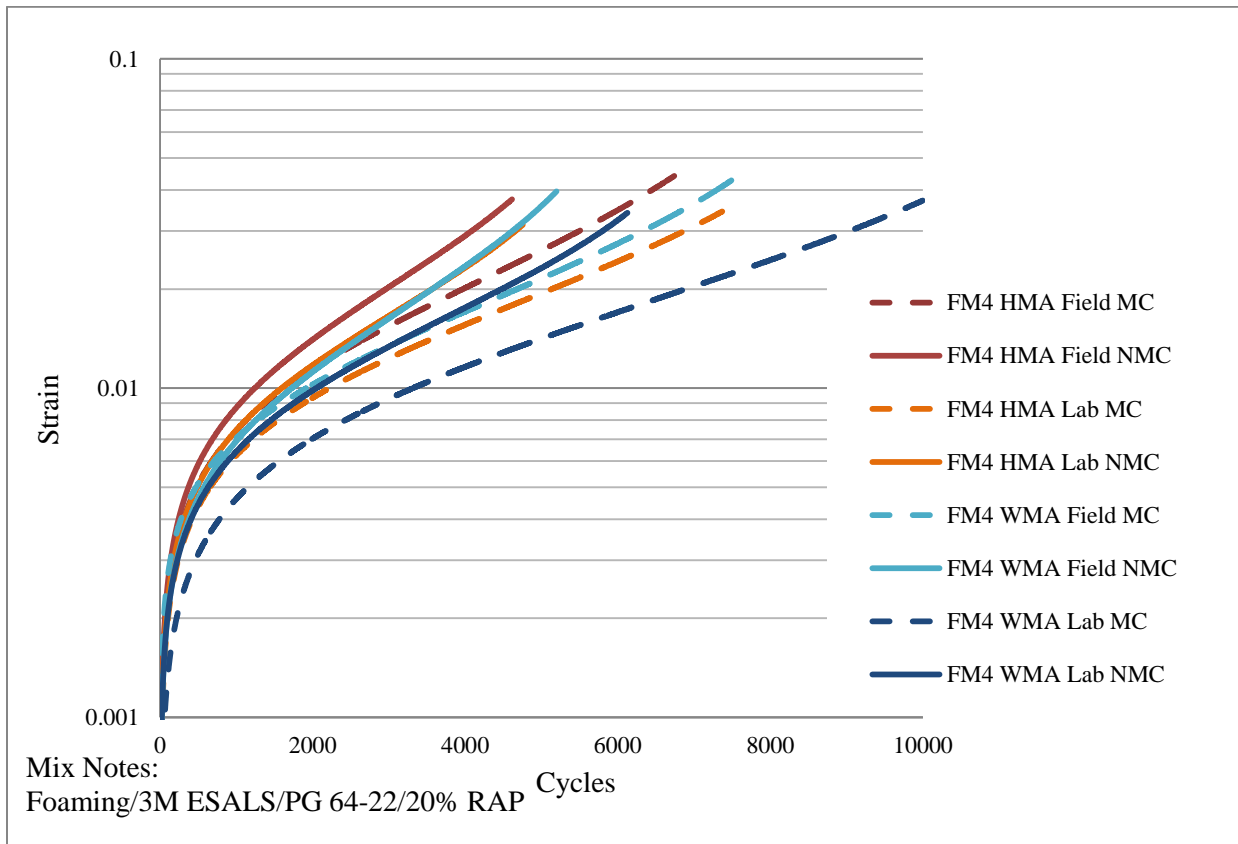

Figure 4.15 Strain versus cycles plot for FM4 (HMA/Foam)

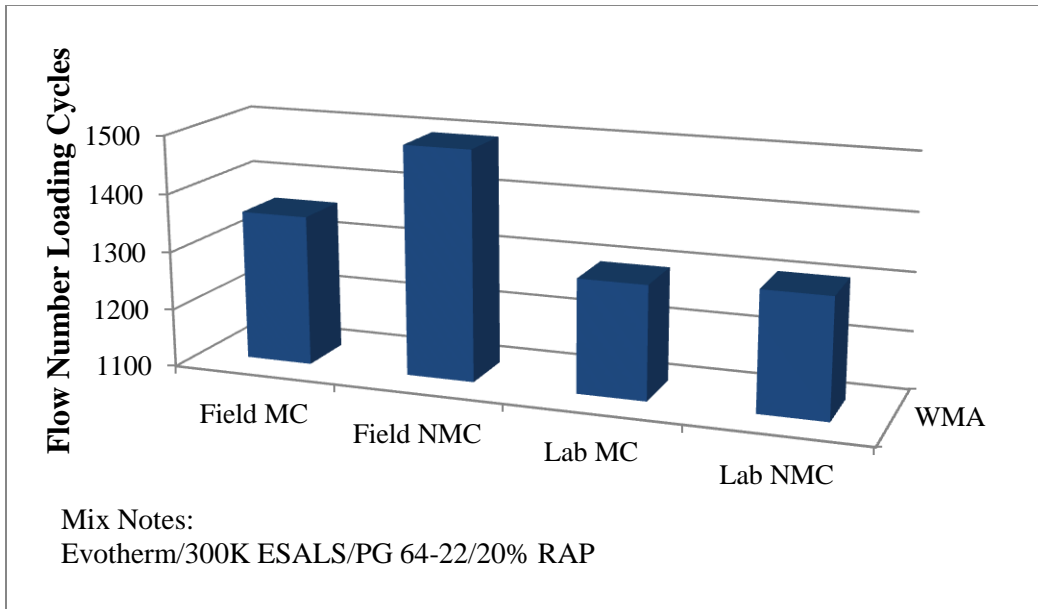

Figure 4.16 Flow number comparison for FM5

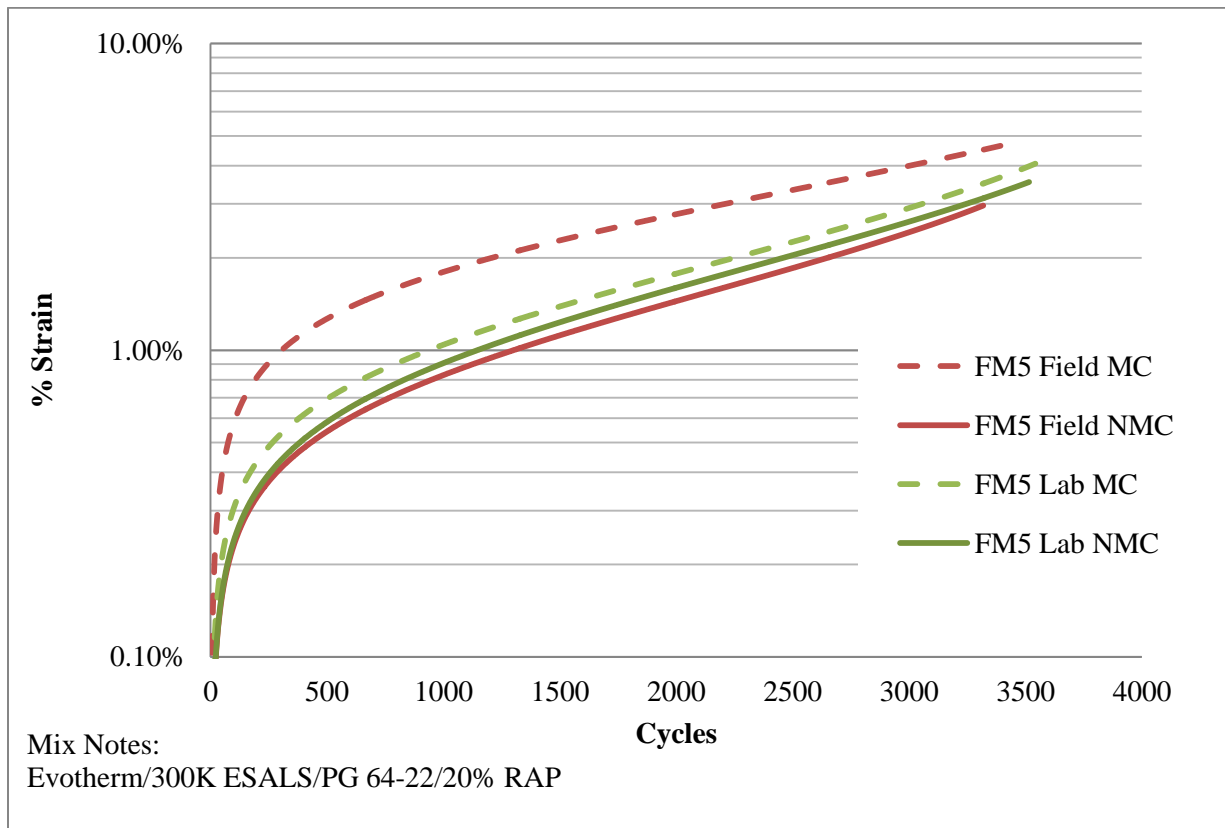

Figure 4.17 Strain versus cycles plot for FM5 (Evotherm)

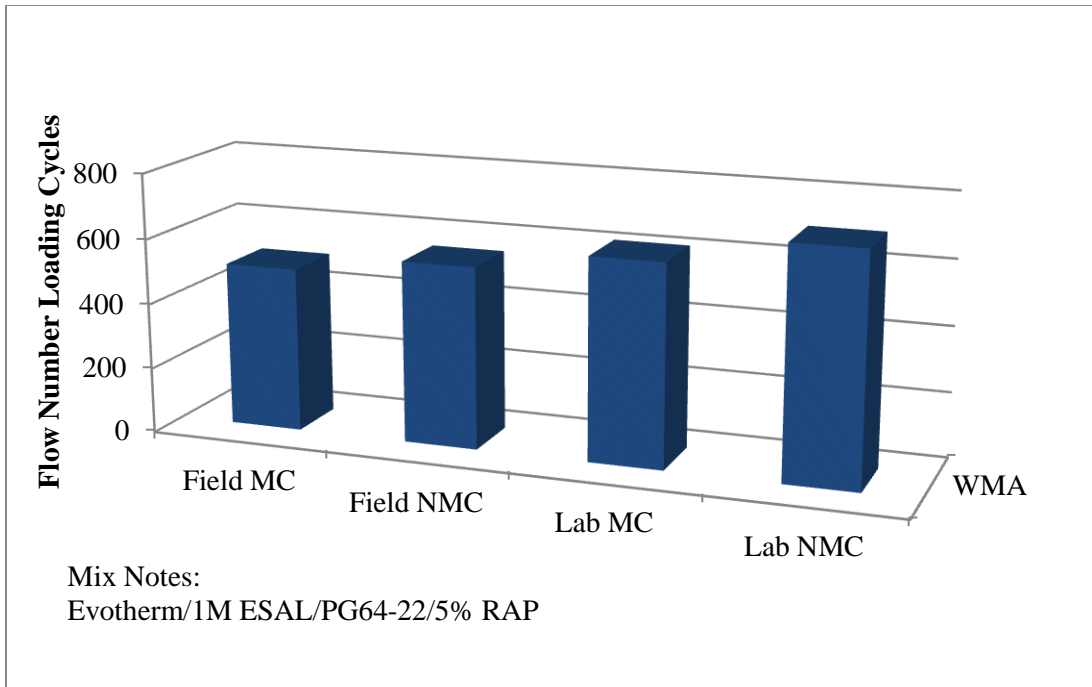

Figure 4.18 Flow number comparison for FM6

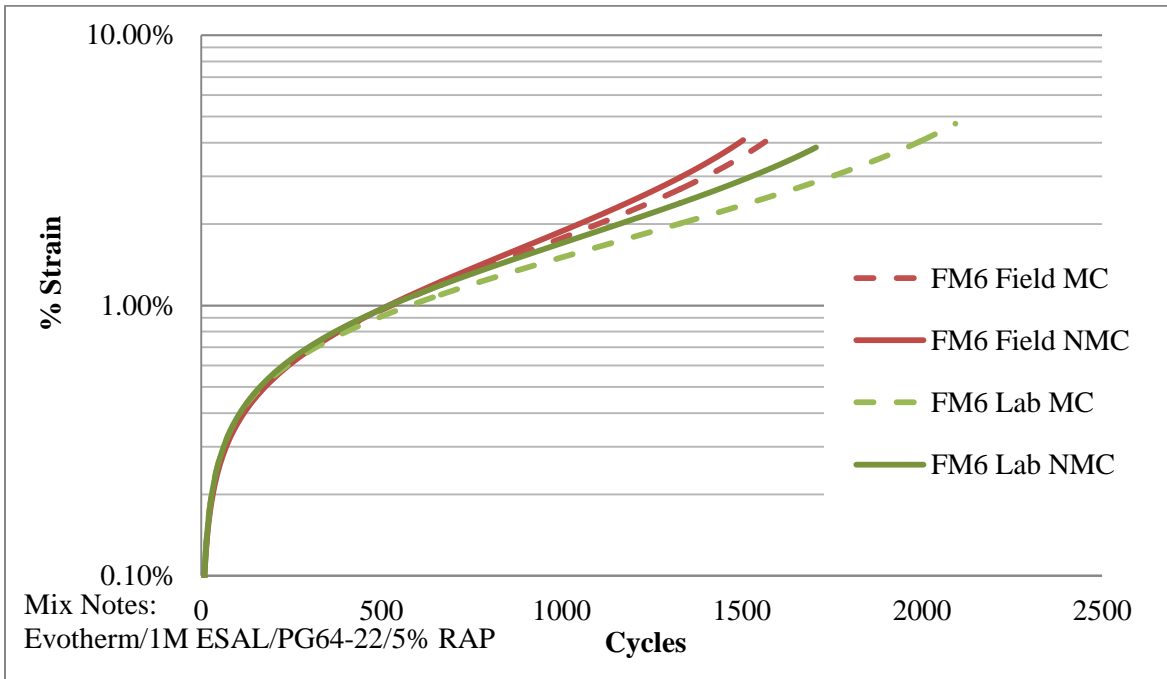

Figure 4.19 Strain versus cycles plot for FM6 (Evotherm)

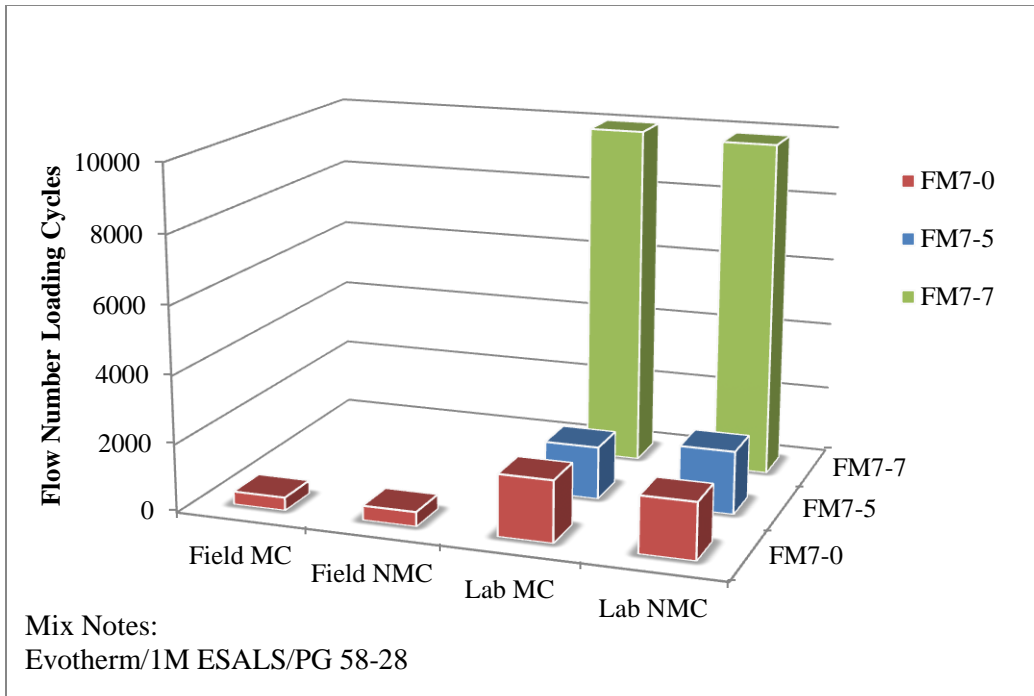

Figure 4.20 Flow number comparison for FM7

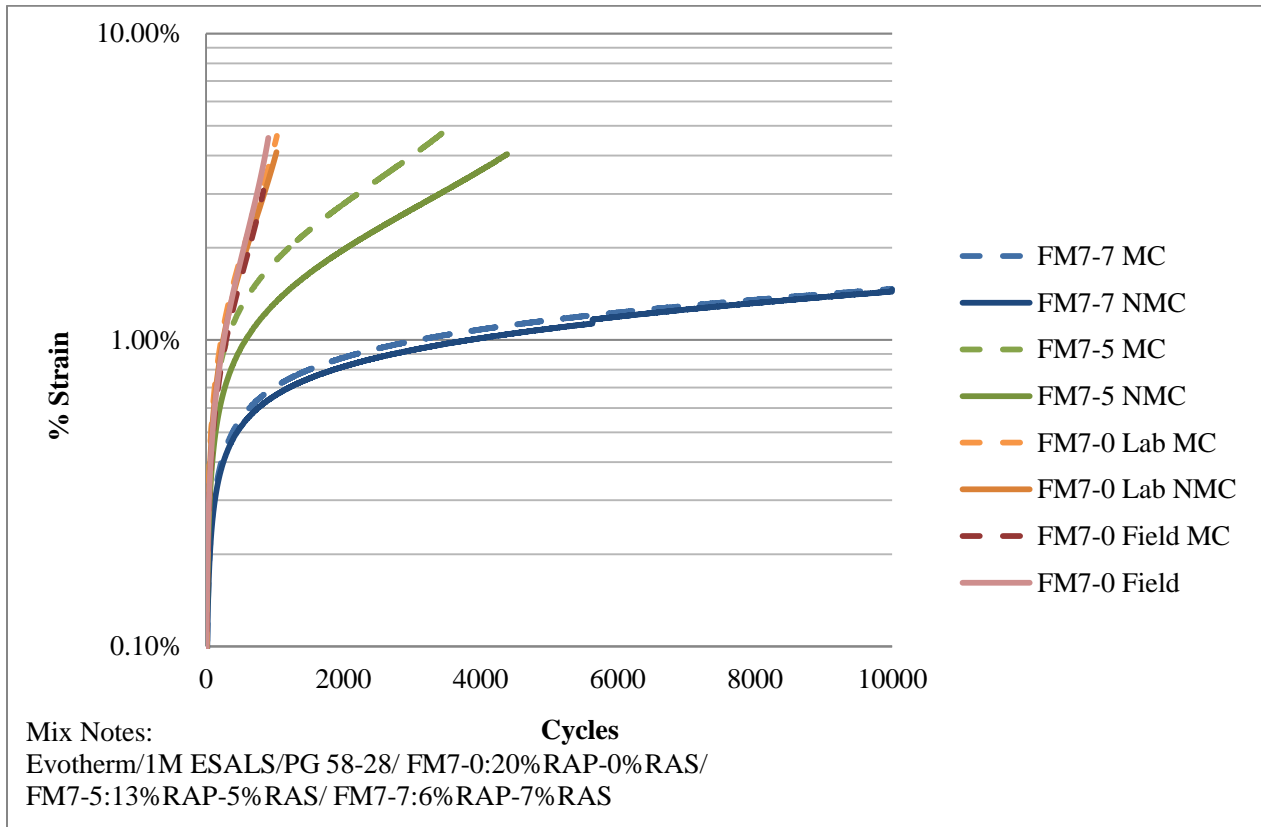

Figure 4.21 Strain versus cycles plot for FM7 (Evotherm and Shingles)

4.3 Semi-circular bending test

During this study, the semi-circular bending test was in the beginning stages of evaluation at Iowa State. This test evaluates low temperature properties. Each mix is evaluated separately in this section. The graphs show fracture energy on the left, fracture toughness in the middle and stiffness values on the right. Error bars represent one standard deviation, indicating a high level of variability in the results. This variability in the test parameters should be addressed for future projects to improve the test. There may also be other parameters developed in the future that will provide more information about material properties, such as studying the rate of change with time and temperature for stiffness and fracture energy. Further test sensors may also help in reducing noise in the data. The statistical analysis for each test was done by separating the results into subsets and comparing the factor of interest. The comparison testing utilized the student's t-test. The factor of interest for SCB testing included HMA versus WMA comparisons and cores versus laboratory samples. There was no moisture conditioning or reheating effects evaluated for SCB.

4.3.1 FM2 semi-circular bending test results and analysis

The data for the SCB test is shown in Figure 4.22. In the graphs below, the fracture energy tends to decrease with temperature and stiffness will increase with decreasing temperature. The high variability makes the testing data less valuable but there are some statistical differences that were found for FM2. There were no statistical significant differences found between the WMA and HMA cores. The stiffness values for the lab samples showed statistical differences at -6°C and there is possible evidence of a difference at -30°C with a p-value of 0.0507. The other factor of interest is to compare is the difference between samples compacted in the lab and the field cores. The fracture energy for the laboratory compacted

samples was statistically higher at -18°C for both HMA and WMA. The fracture energy for WMA at -6°C also shows higher values for the lab samples.

The FM2 showed the most differences compared with all other mixes. In general, the SCB did not find many statistical differences between the HMA and WMA samples. Based on the graphs, the SCB is showing somewhat variable results. It is recommended to first find ways of improving the repeatability by reducing the amount of variability. This will improve the tests and also help to better identify differences in mixes.

4.3.2 FM3 semi-circular bending test results and analysis

The FM3 SCB graphs are shown in Figure 4.23. There are few differences between the testing results. The first observable difference is the WMA cores appear to be slightly higher in stiffness, on average than the WMA lab values and the stiffness values inversely mirror this trend, which is expected. The HMA core and lab comparison appear slightly different in stiffness. Statistical analysis results are suggestive of this difference with a p-value of 0.0549 at -24°C . No other statistical differences were identified using SCB data.

4.3.3 FM4 semi-circular bending test results and analysis

The FM4 data is shown in Figure 4.24. The stiffness trend for the HMA cores was checked and confirmed. The cores for the WMA mixes appear to have higher stiffness values but there is high variability in the testing data. All of the toughness values are similar. The average fracture energy values decrease with decreasing temperatures. The statistical differences identified when comparing HMA and WMA samples are for the FM4 cores show that the fracture energy at -30°C is higher for HMA and that the stiffness for WMA is statistically higher at -30°C . This would suggest that the HMA is more resistant to thermal cracking at -30°C for the core samples.

4.3.4 FM5 semi-circular bending test results and analysis

For mixes FM5, FM6 and FM7 no HMA control was produced but a comparison between the cores and laboratory can give valuable information about mixture properties. The graphs for FM5 are in Figure 4.25 and show similar values for cores and laboratory samples. The laboratory samples show slightly different trends with temperature compared with the cores and with what would be expected. This is likely due to high variability in the test. The toughness values are similar between lab and core samples. The statistical difference identified by ANVOA was that the fracture energy for the laboratory samples was statistically higher than the fracture energy for the cores at -24°C. This may indicate that the laboratory samples have more cracking resistance at -24°C and this is expected because of oxidation and aging due to sun exposure that happens in the field would reduce the resistance to thermal cracking.

4.3.5 FM6 semi-circular bending test results and analysis

The graphs for FM6 are in Figure 4.25 and show similar fracture energy values but the stiffness from the cores is higher on average. The toughness values also appear to be similar. The statistical analysis found no statistical differences between the cores and laboratory values. The trends of the results appear to show reasonable values and verify that the data between lab and cores is similar.

4.3.6 FM7 semi-circular bending test results and analysis

The results for FM7 are shown in Figure 4.26 and Figure 4.27. FM7-0 has a higher stiffness than FM7-7 and FM7-5 which is initially unexpected because stiffness should typically increase with the increase of RAS. It is interesting that this is directly comparable to the dynamic modulus results at 4°C which show FM7-0 having higher stiffness than FM7-5 and FM7-7, with FM7-7 having the lowest stiffness. The increase in shingles for FM7 is not correlated with an

increase in stiffness at low temperatures. FM7-0 did contain more RAP at 20% where RAS and RAP accounted for 13% of the mix in FM7-5 and 6% of the mix in FM7-7. The increase in RAS from 5% to 7% does not increase the stiffness significantly at low temperatures. The only statistically significant difference is when the cores for FM7-7 are compared with laboratory samples. The fracture toughness for FM7-7 is higher for the cores than the laboratory samples. The stiffness for the cores is also statistically higher for the cores compared with the laboratory samples.

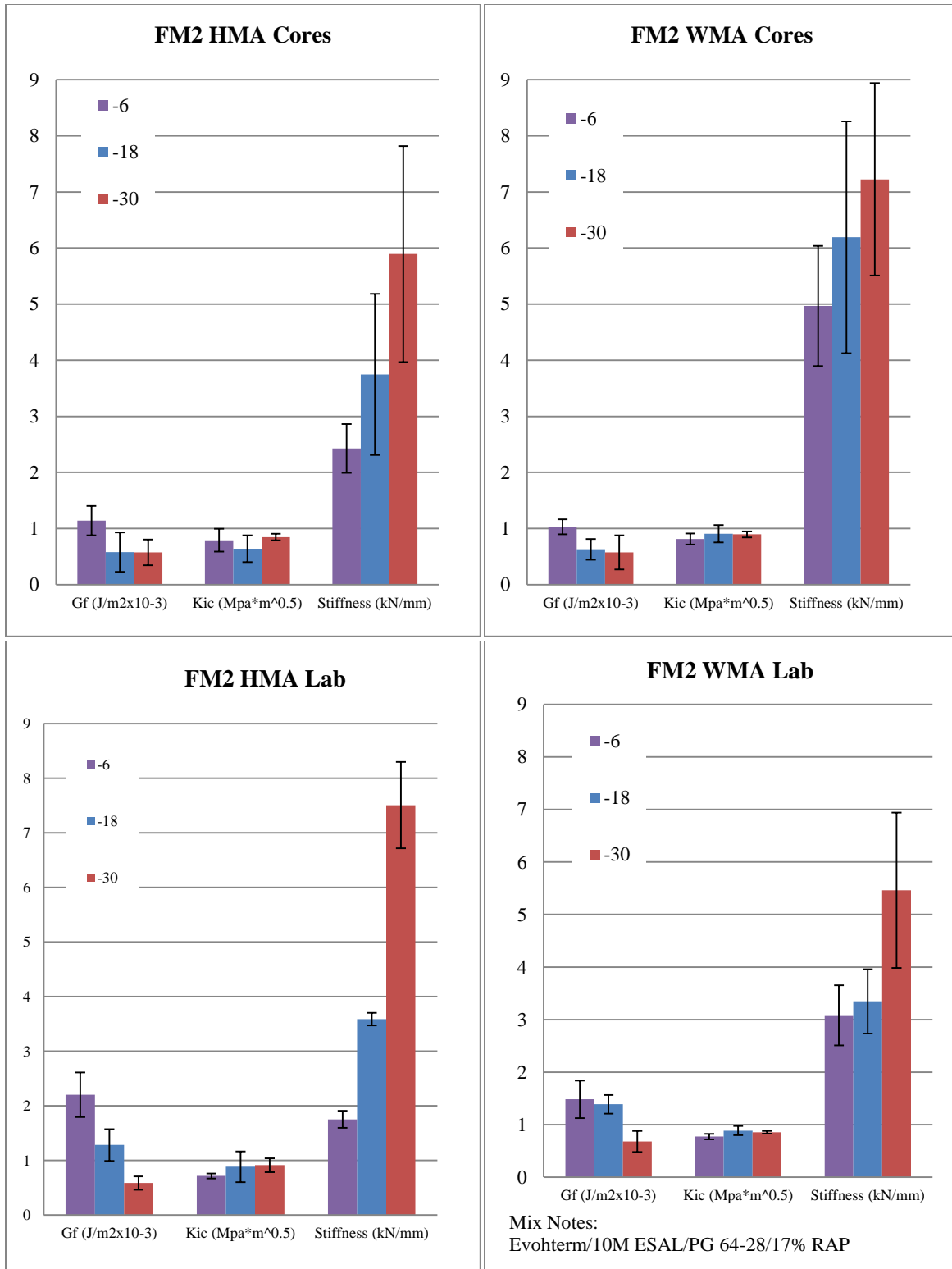

Figure 4.22 SCB results for FM2 (HMA/Evothertm)
 (Average core air voids are HMA=7.6% and WMA=8.6%; pavement cored after 2 years of service life)

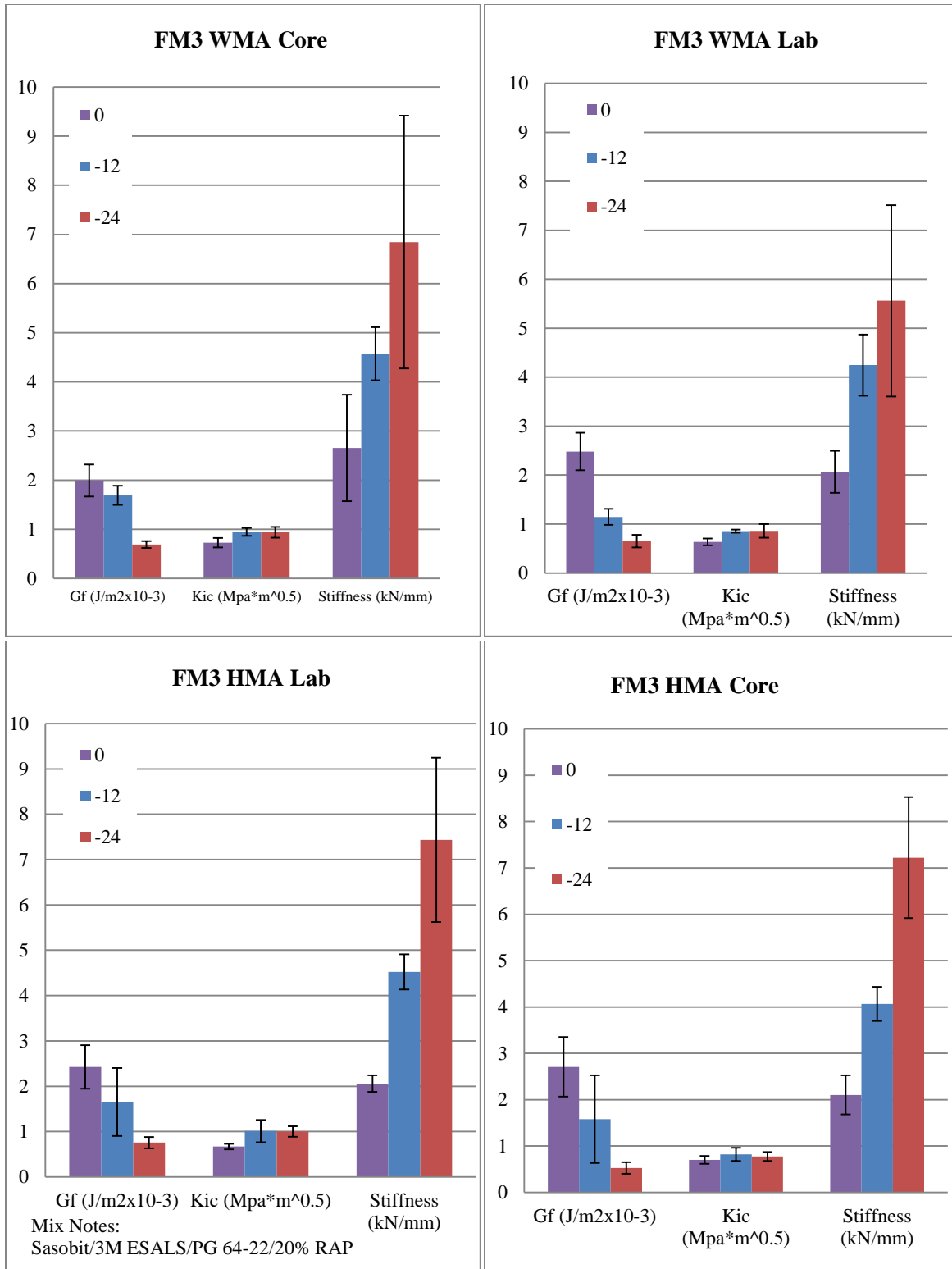

Figure 4.23 SCB results for FM3 (HMA/Sasobit)

(Average core air voids are HMA=8.4% and WMA=8.0%; pavement cored after 2 years of service life)

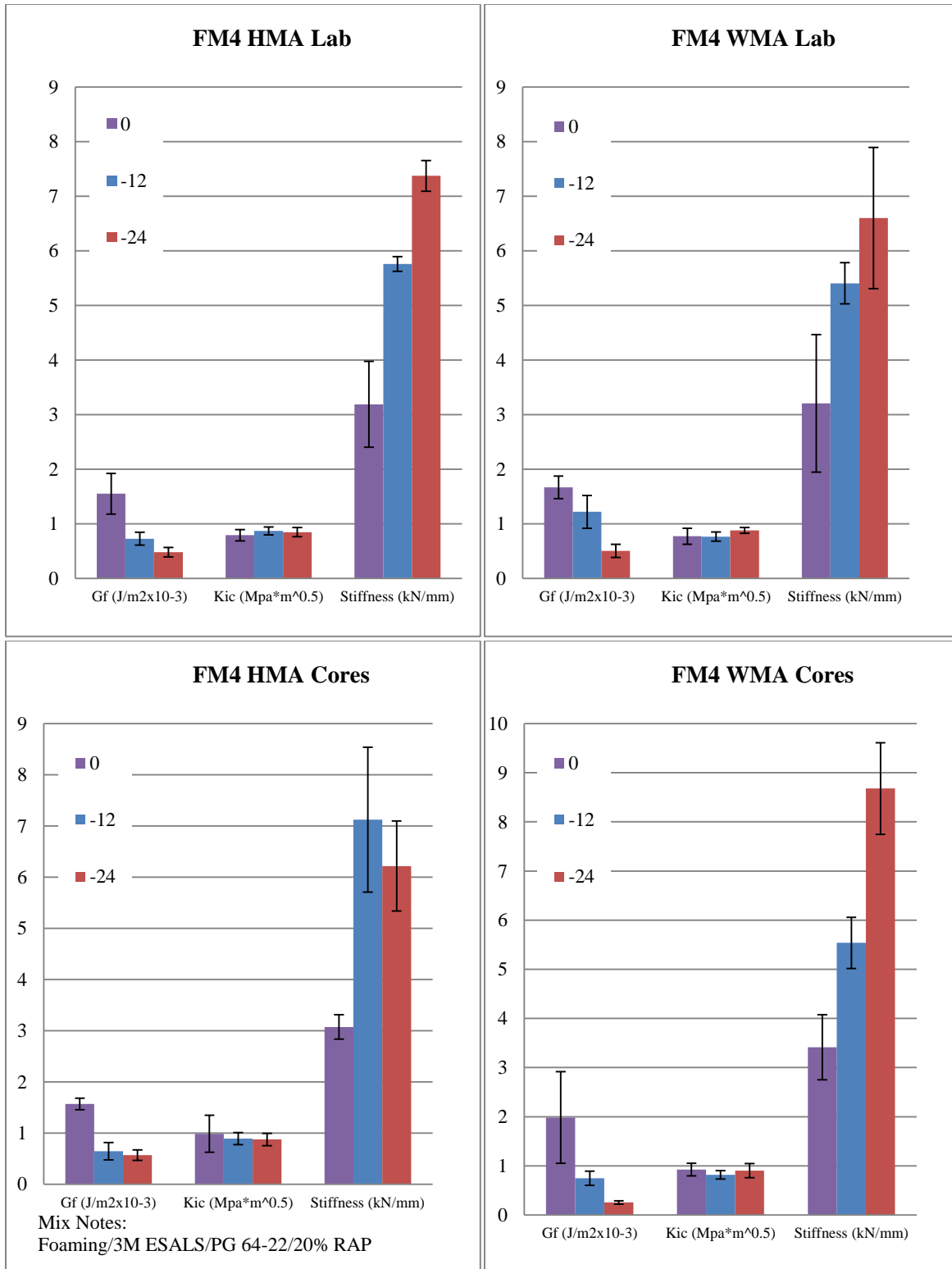

Figure 4.24 SCB results for FM4 (HMA/Foam)
 (Average core air voids are HMA=4.3% and WMA=3.45%; pavement cored after 2 years of service life)

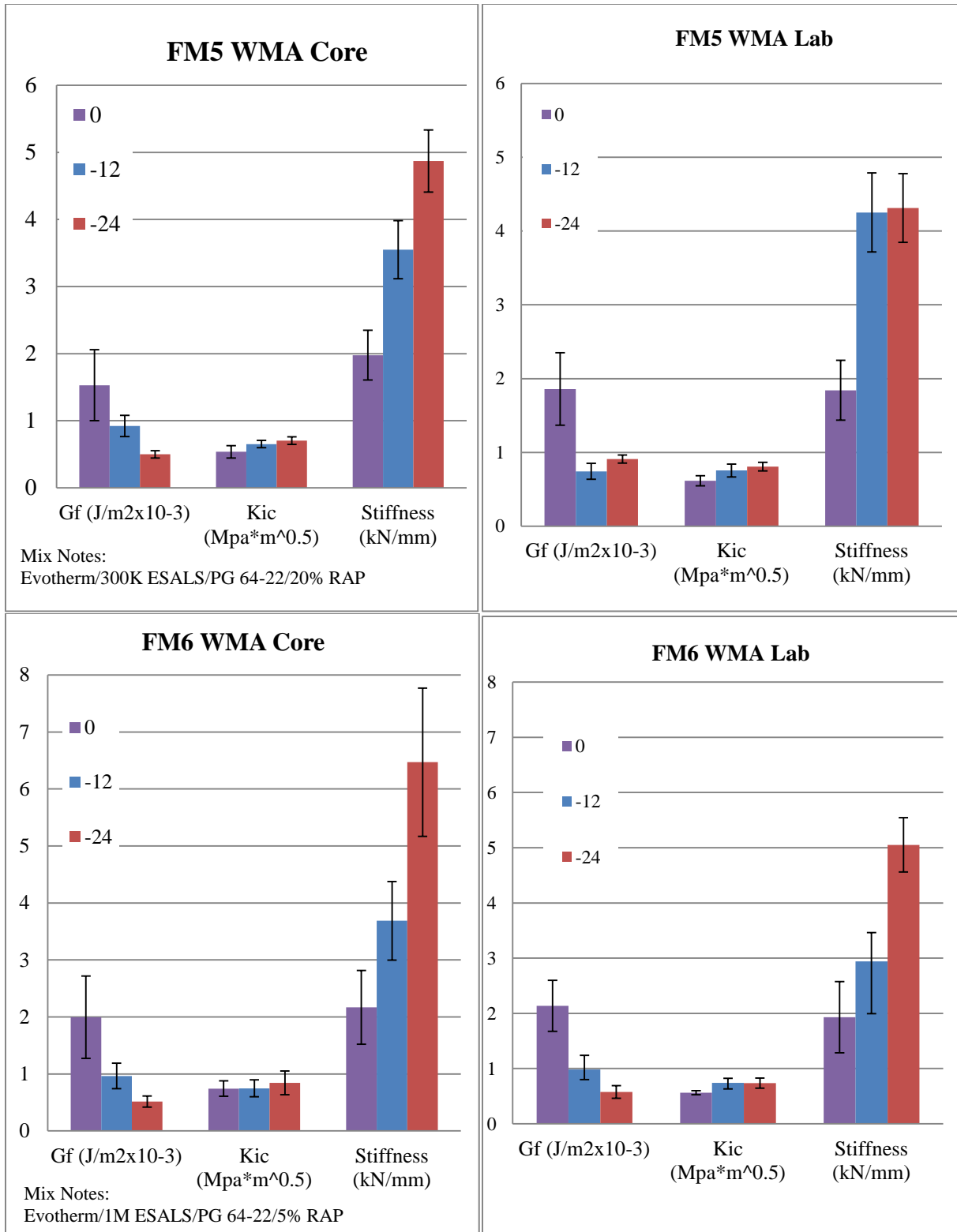

Figure 4.25 SCB results for FM5 and FM6 (Evotherm)

(Average core air voids are FM5=9.2% and FM6=7.4%; pavement cored after 1 year of service life)

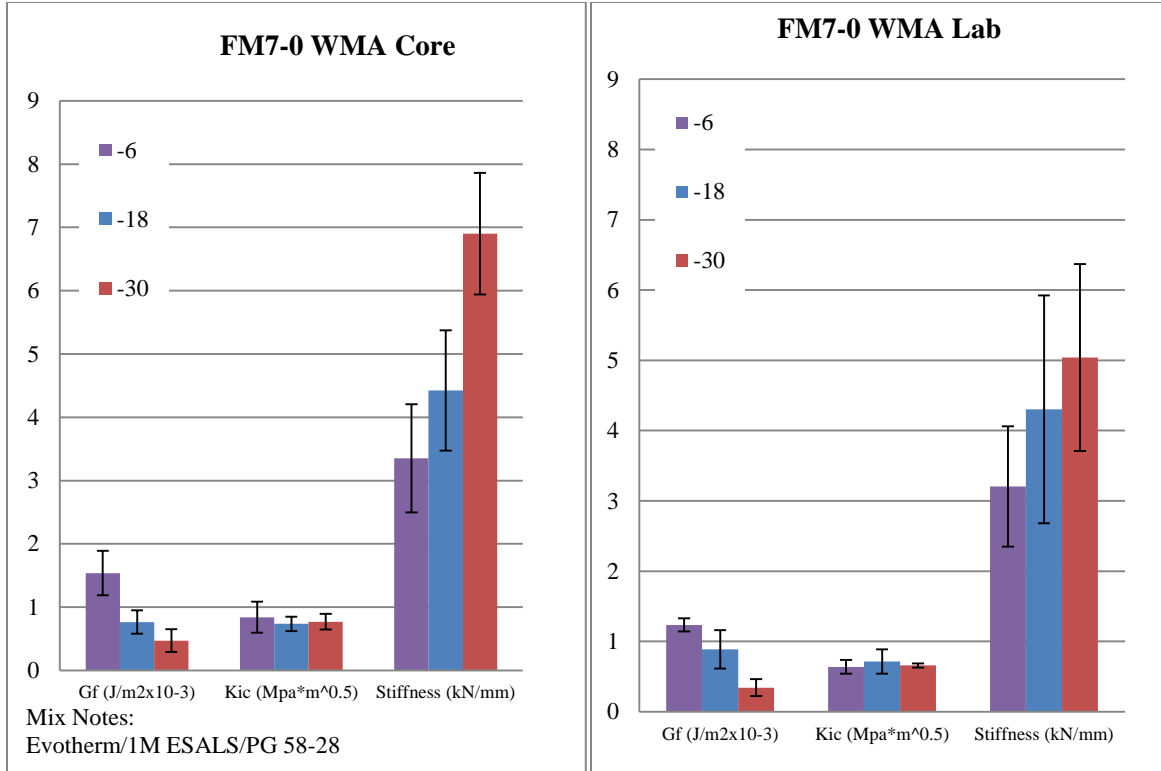

Figure 4.26 SCB results for FM7-0 (Evotherm with 0% Shingles)

(Average core air voids are FM7-0=8.4%, FM7-5=7.8 and FM7-7=7.6%; pavement cored after 1 year of service life)

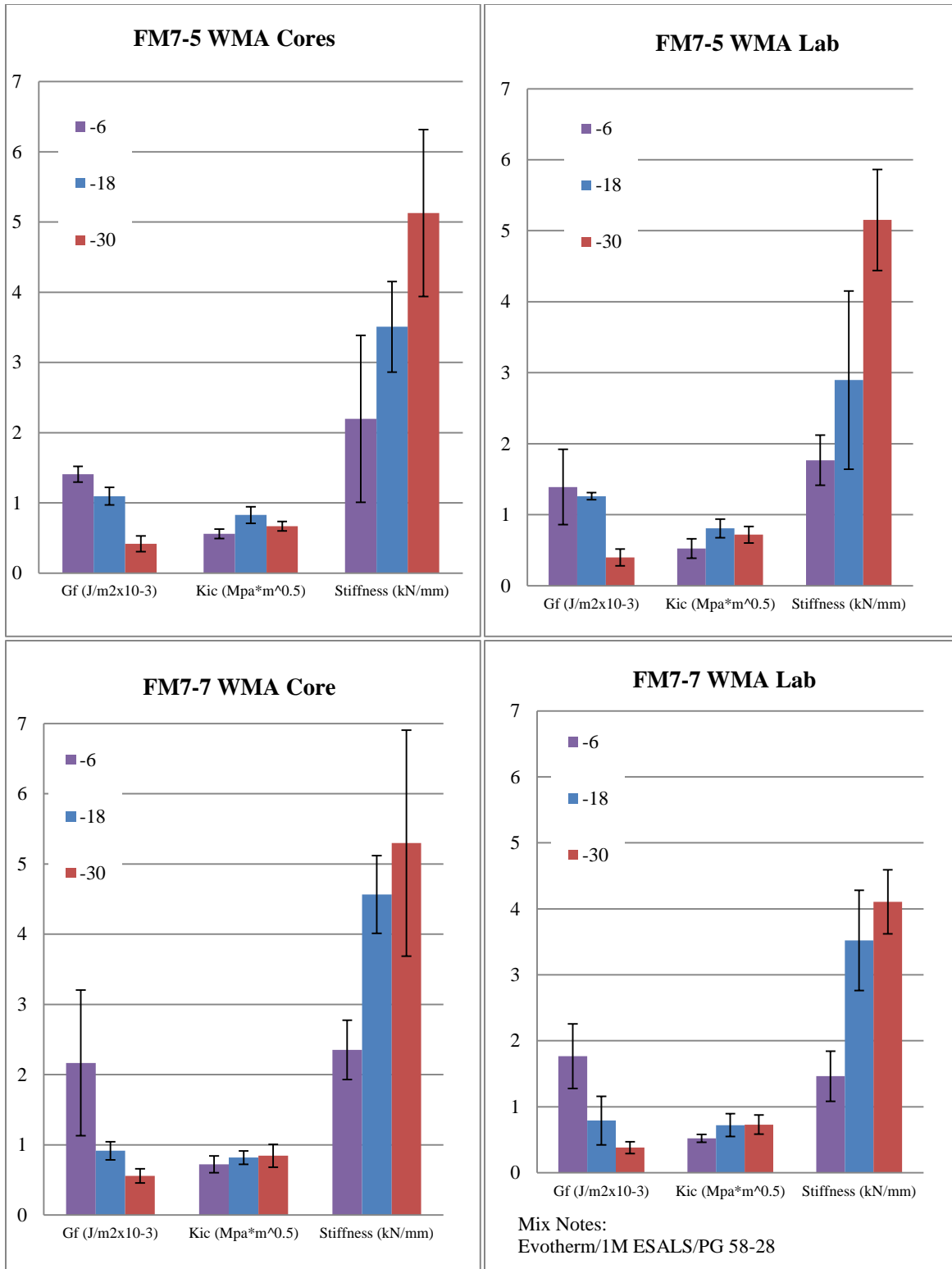

Figure 4.27 SCB results for FM7-5 and FM7-7 (Evotherm with 5% and 7% Shingles)

4.4 Indirect tensile strength test and TSR results

The indirect tensile strength analysis has two primary evaluations. The first is evaluating the strength of the samples and the second is evaluating the TSR. This analysis is presented in the phase I report but additional samples were compacted and cores were also tested. AASHTO T-283 tends to have a negative bias towards mixtures with higher unconditioned tensile strengths and typically, smaller NMA mixtures have greater unconditioned tensile strengths than larger NMA mixtures. Cores were not moisture conditioned because of the limited number of cores available. The 6" laboratory compacted samples were moisture conditioned but some of the results are questionable. This is most likely due to the part of the moisture conditioning that involves a hot water bath at 60°C. If the sample is large and at elevated temperatures there may be a greater likelihood of inadvertently damaging the sample during the moisture conditioning process. The graphs in this section show all of the groups of samples that were tested with labels for each category at the bottom of the graph.

The graphs in this section are designed for easy comparisons between the multiple factors studied. The pattern fill in the columns represents the moisture conditioned sample pair that will be used to calculate the TSR values. The Iowa DOT had a moisture susceptibility standard where TSR values must be equal to or greater than 80%. This standard has recently been changed to the Hamburg wheel tracking test. This study tested both Hamburg samples and TSR samples and a comparison of the two tests will be performed in Chapter 7.

The statistical analysis will be performed by categorizing all of the samples according to their mix, conditioning, reheated or not-reheated and the comparisons will be performed using student's t-test. The t-test will compare samples that are treated the same except for the factor of interest that is being tested for in the analysis. Identifying trends between different mixes was

done in phase I and no one trend can be applied to every category and mix. For this reason, the data was broken into segmented portions so each individual factor could be studied for all of the mixes for the phase II analysis.

4.4.1 FM2 peak strength and TSR results and analysis

The strength results of FM2 are shown in Figure 4.28 and the TSR results are in Figure 4.29. The moisture conditioned samples all reach the 80% minimum in TSR values. The cores show considerably higher strengths than the lab comparisons. This may be due to several factors such as differences in compaction or sample composition. The HMA and WMA strength graphs appear to have similar trends and a large impact due to reheating effects is not evident.

The p-values show that the WMA cores have higher strength values when compared with the HMA values. This is most likely due to the addition of Evotherm 3G which can act as an anti-stripping agent. The NMC samples that were not-reheated also had statistically higher strength values. There were no differences between HMA and WMA found in samples that were moisture conditioned. The effect of reheating the samples will be evaluated for strength and for TSR. The statistical analysis found that reheating had no impact on TSR values. The next statistical comparison investigates the reduction in strength due to moisture conditioning by evaluating TSR values.

Table 4.11 FM2 p-values for comparing tensile strength values

6"	HMA versus WMA			Effects of reheating			TSR Comparisons HMA versus WMA	
	Core	NMC	0.0111					
4"	Field	MC	0.3370	HMA	MC	0.8056	Field	0.0146
	Field	NMC	0.0339	HMA	NMC	0.0648		
4"	Lab	MC	0.0915	WMA	MC	0.0444	Lab	0.2325
	Lab	NMC	0.0196	WMA	NMC	0.0525		
6"	Lab	MC	0.1415	--	--	--	--	--
	Lab	NMC	0.6082	--	--	--	--	--

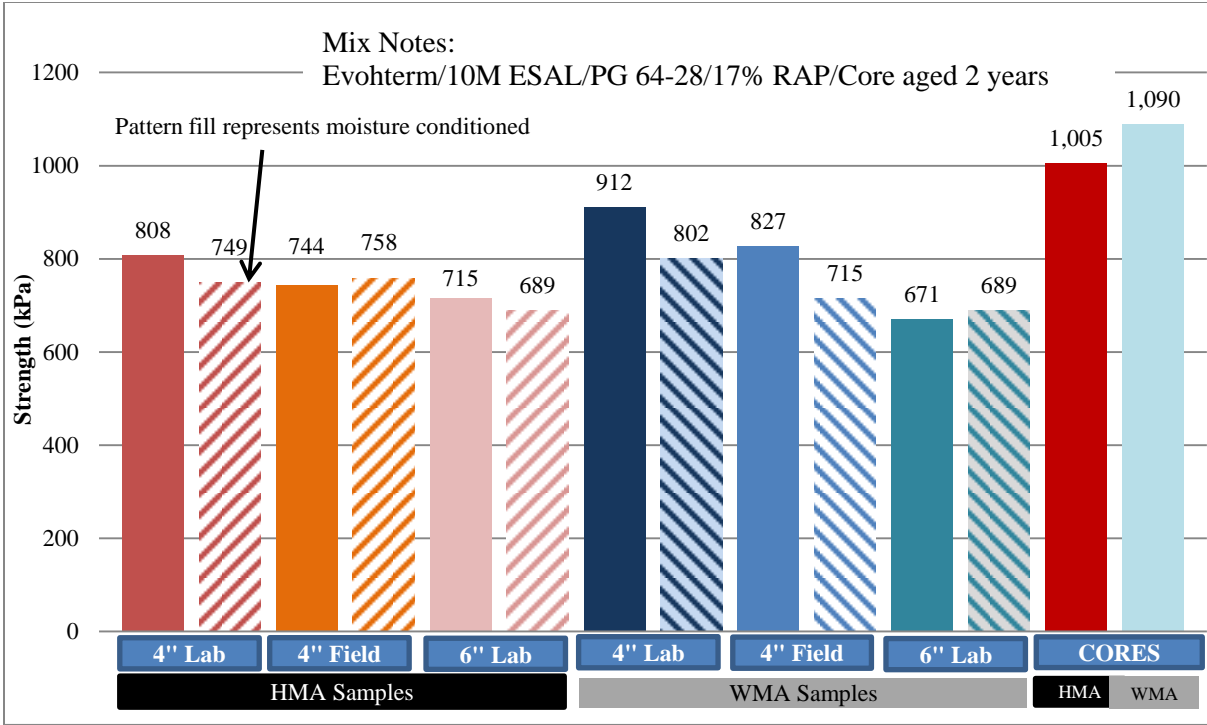

Figure 4.28 FM2 IDT peak strength (HMA/Evotherm)
(Average core air voids are HMA=3.4% and WMA=7.6%)

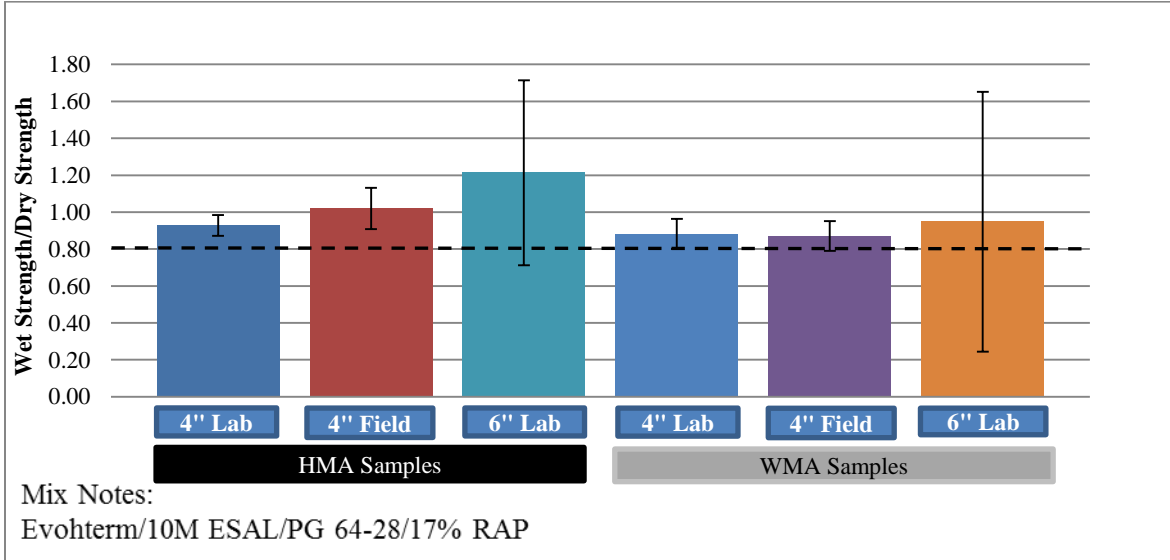

Figure 4.29 FM2 TSR results (HMA/Evotherm)

4.4.2 FM3 peak strength and TSR results and analysis

The FM3 analysis samples indicate a decrease in the WMA samples for the gyratory compacted mixes. The effect of reheating the samples will be evaluated for strength and for TSR.

The statistical analysis found that reheating had no impact on TSR values. The next statistical comparison investigates the reduction in strength due to moisture conditioning by evaluating TSR values.

The strength results for FM3 are shown in Figure 4.30. These show a difference between the HMA and WMA strengths. The WMA field samples appear to be the most susceptible to moisture damage. The cores show the opposite having higher strength values for the WMA cores. All of the TSR values just meet or exceed the minimum criteria for passing as shown in Figure 4.31. The statistical analysis shows that HMA samples have statistically higher strength values and this applies to all the samples tested except for the cores. The cores show no statistical difference. The effects of reheating were evaluated and show that reheating caused statistical difference in the WMA samples that were moisture conditioned. The reheated samples gave a higher strength value. There was not any evidence of a reheating effect in the TSR values. The impact of the WMA additive on TSR values also found that there was some evidence of WMA negatively impacting the TSR values. The TSR values show a statistically significant reduction in the not-reheated category. There is less evidence of a reduction in the reheated samples.

Table 4.12 FM3 p-values for comparing tensile strength values

	HMA versus WMA			Effects of reheating			TSR Comparisons HMA versus WMA	
	Core	NMC						
6"	Core	NMC	0.5347					
4"	Field	MC	<0.0001	HMA	MC	0.1939	Field	0.0295
	Field	NMC	0.0021	HMA	NMC	0.0699		
4"	Lab	MC	<0.0001	WMA	MC	0.0067	Lab	0.0849
	Lab	NMC	<0.0001	WMA	NMC	0.3638		
6"	Lab	MC	0.0029	--	--	--	--	--
	Lab	NMC	0.0005	--	--	--	--	--

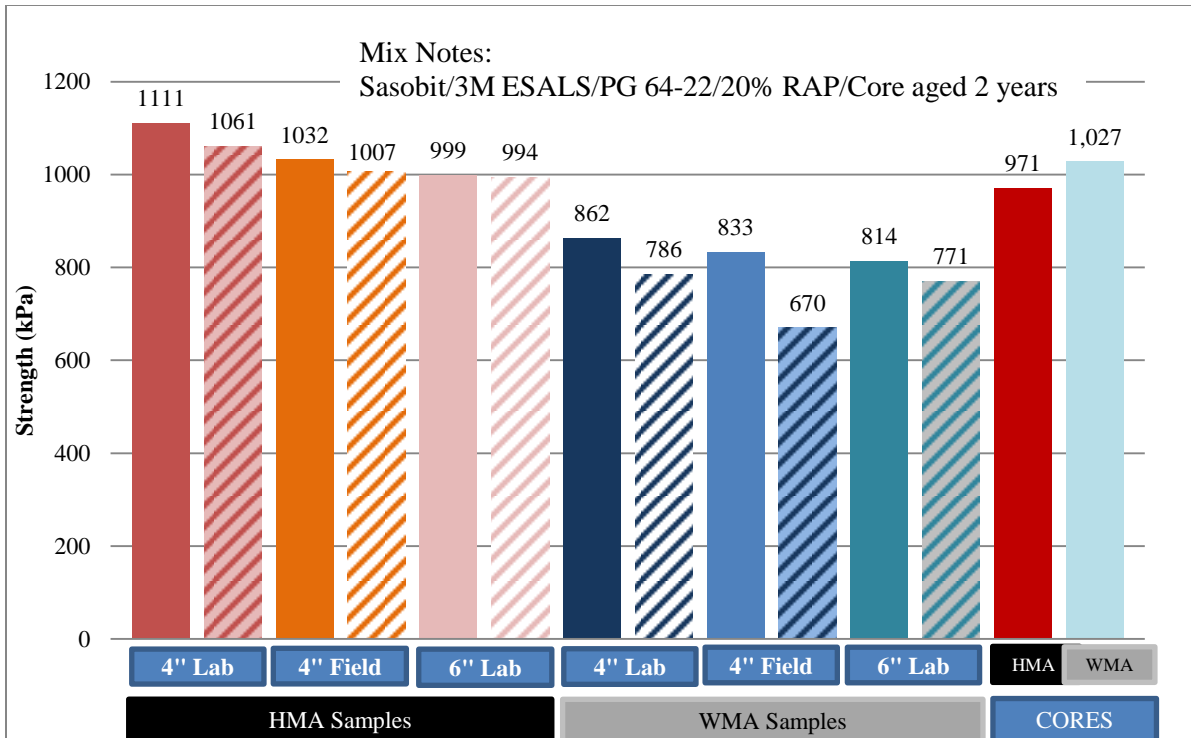

Figure 4.30 FM3 IDT peak strength (HMA/Sasobit)
(Average core air voids are HMA=8.0% and WMA=7.8%)

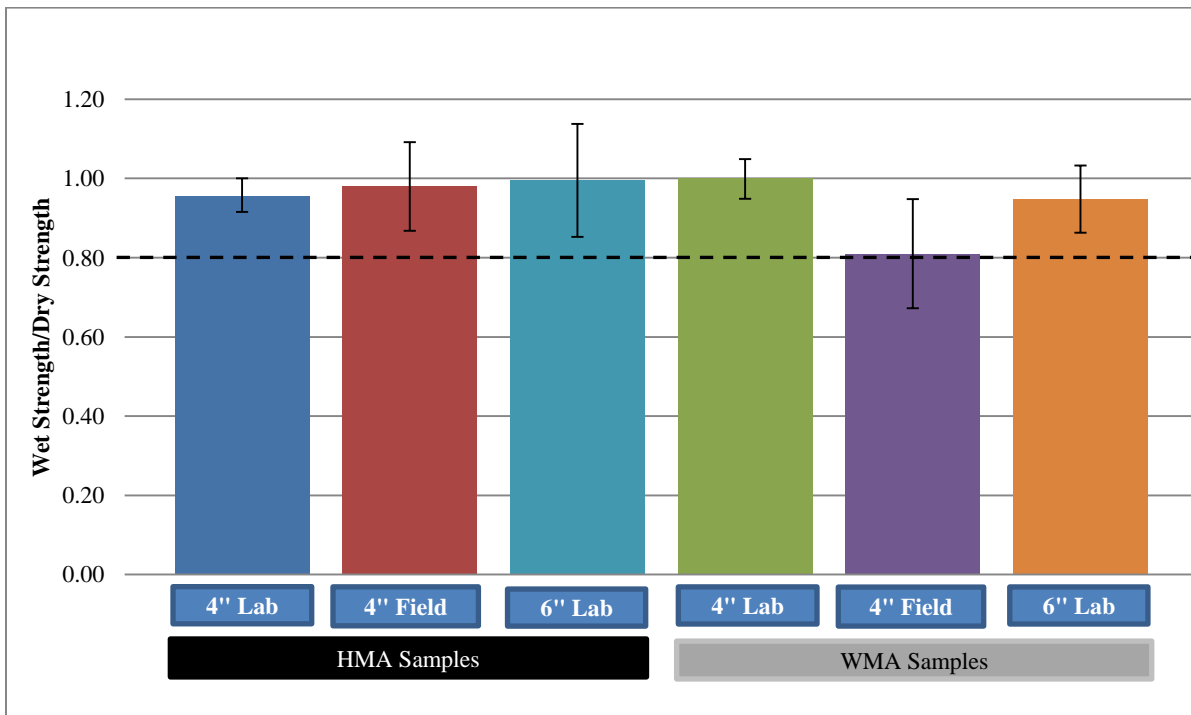

Figure 4.31 FM3 TSR results (HMA/Sasobit)

4.4.3 FM4 peak strength and TSR results and analysis

All strength values for FM4 are shown in Figure 4.32. The TSR values for FM4 are shown in Figure 4.33. An ANOVA analysis comparing the impact reheating had TSR found that, for all the mixes tested, the only mix that had statistically significant differences is FM4 WMA. This may be due to the benefit of the “foamed” asphalt not being available when the mix is reheated at the reduced warm mix temperatures. Since the benefit of the foaming is gone after the water evaporates, the reheating at reduced temperature may have made the lab sample more susceptible to moisture damage because it was compacted at too low of a temperature. Evaporation of the water will account for losing the viscosity reducing benefits and this describes one theory why the non-reheated TSR samples give a higher TSR value than the reheated samples. The ANOVA analysis comparing the tensile strength values is shown in Table 4.13. The comparisons show there are a number of differences indicating that each factor studied identified some differences.

Table 4.13 FM4 p-values for comparing tensile strength values

6"	HMA versus WMA			Effects of reheating			TSR Comparisons HMA versus WMA	
	Core	NMC	0.2060					
4"	Field	MC	0.0063	HMA	MC	0.0001	Field	0.001
	Field	NMC	0.0207	HMA	NMC	0.0933		
4"	Lab	MC	0.0020	WMA	MC	0.0855	Lab	0.0124
	Lab	NMC	0.0400	WMA	NMC	0.0005		

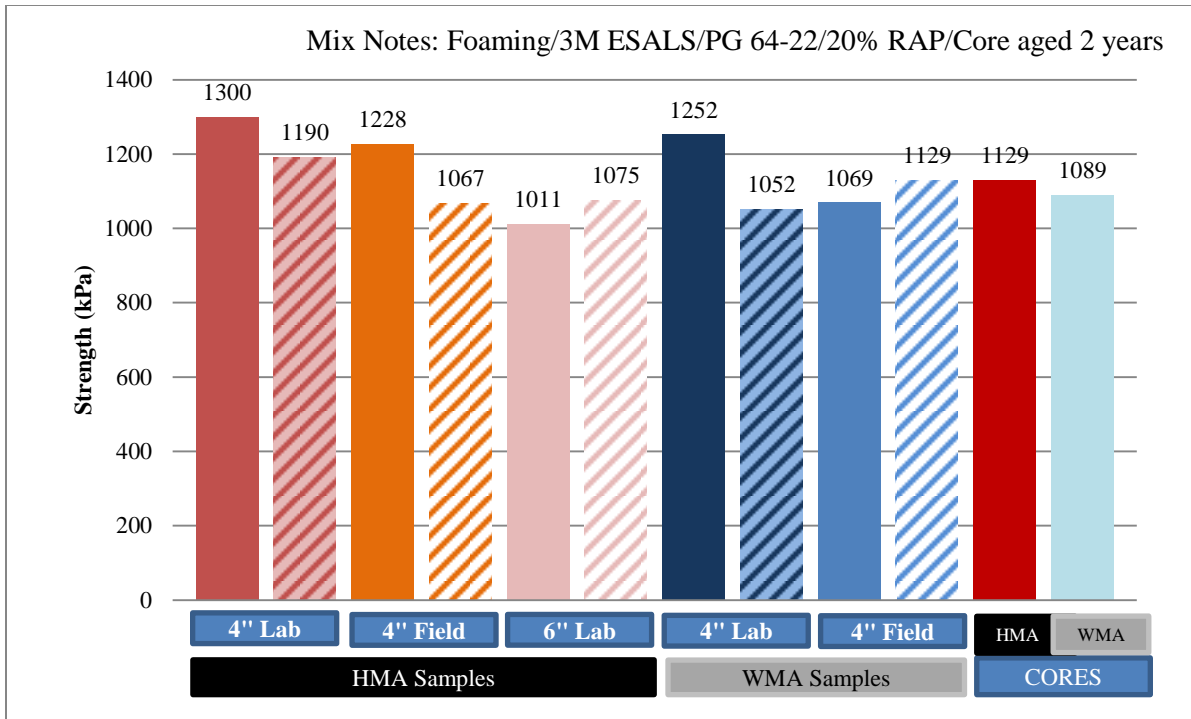

Figure 4.32 FM4 IDT peak strength (HMA/Foam)
 (Average core air voids are HMA=6.5% and WMA=5.2%)

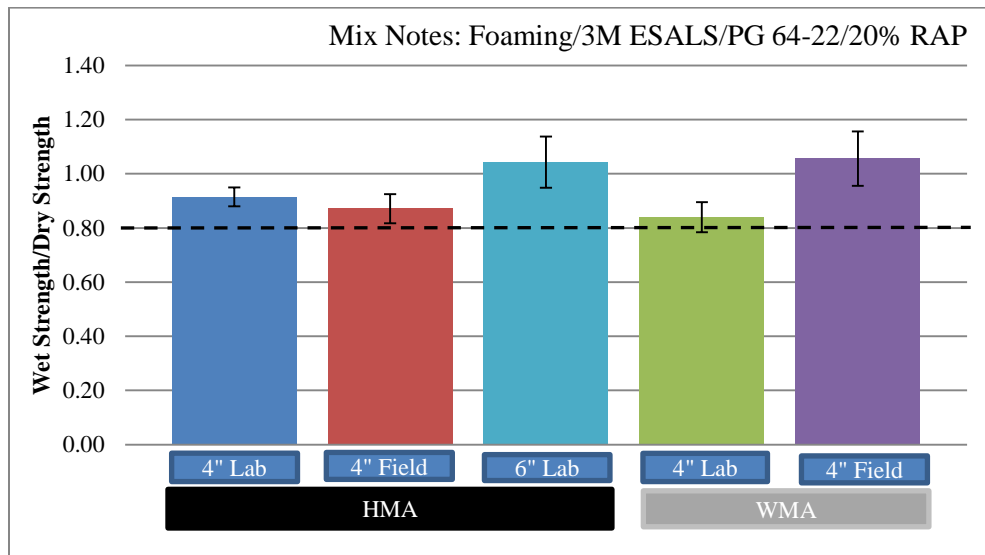

Figure 4.33 FM4 TSR results (HMA/Foam)

4.4.4 FM5 peak strength and TSR results and analysis

The strength values for FM5 are shown in Figure 4.34 and the TSR values are shown in Figure 4.36. The strength values show a reduction in strength between the 4" and the 6" samples

with the core having the lowest IDT strength. The core strength values also showed relatively high variability. The TSR averages all meet or exceed the minimum requirement of 80%. The statistical analysis focused on identifying the impacts of reheating the WMA samples. Reheating showed to have no effect on the TSR values nor was there any impact on overall strength values. The strength values between 4" and 6" were not statistically studied because this information would not be helpful for examining the impact of WMA.

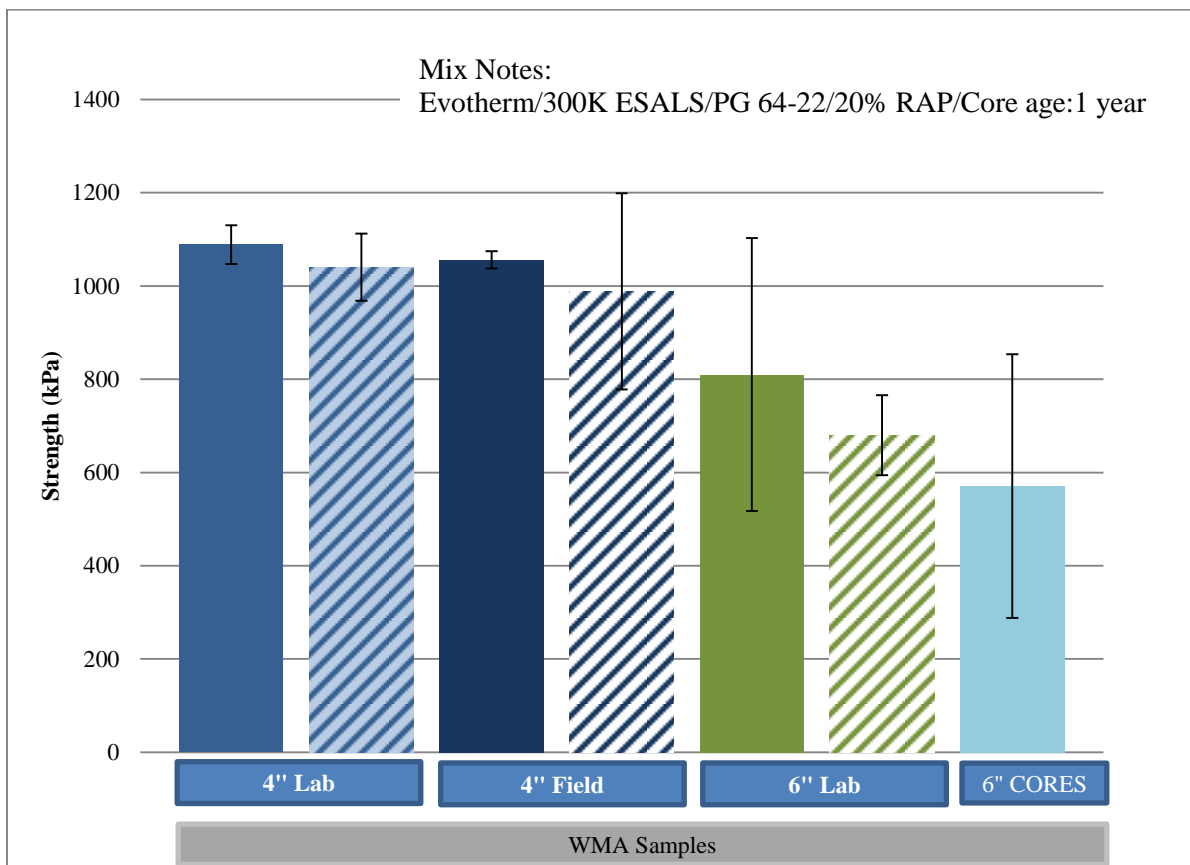

Figure 4.34 FM5 IDT peak strength (Evotherm)
(Average core air voids are 9.3%)

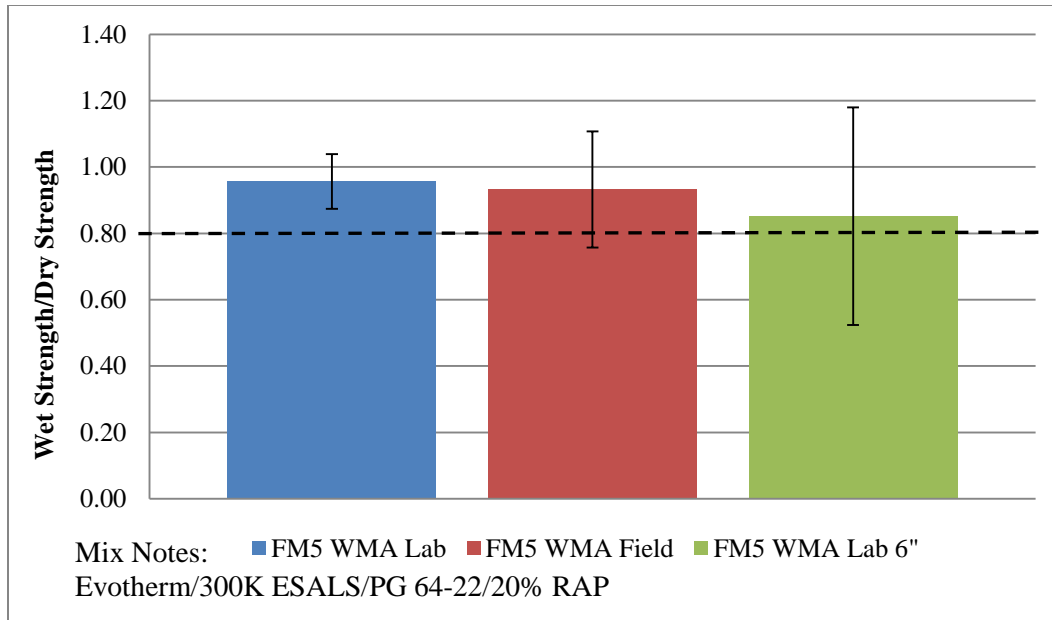

Figure 4.35 Tensile Strength Ratio for FM5

4.4.5 FM6 peak strength and TSR results and analysis

The results for the FM6 strength values are shown in Figure 4.36 and the TSR values are shown in Figure 4.37. The strength values do not appear to change due to reheating effects. Similar to what was shown in FM5, the 6" samples have a lower strength due to the size effect. The 6" cores have a higher strength than the lab-compacted samples on average, giving very similar values as the 4" samples. The averages of the TSR values all exceed the 80% minimum requirement. The impact of reheating was studied using ANOVA and the results show that there are no statistical differences between reheating and not reheating a sample. The ANOVA analysis results are limited in that the MC/non-reheated samples (field) only had two compacted. There is no evidence to suggest that for this mix, reheating has an impact on the TSR or the strength values.

The statistical analysis found that the reheating effect on the moisture conditioned samples is significant with the laboratory samples showing higher strength values.

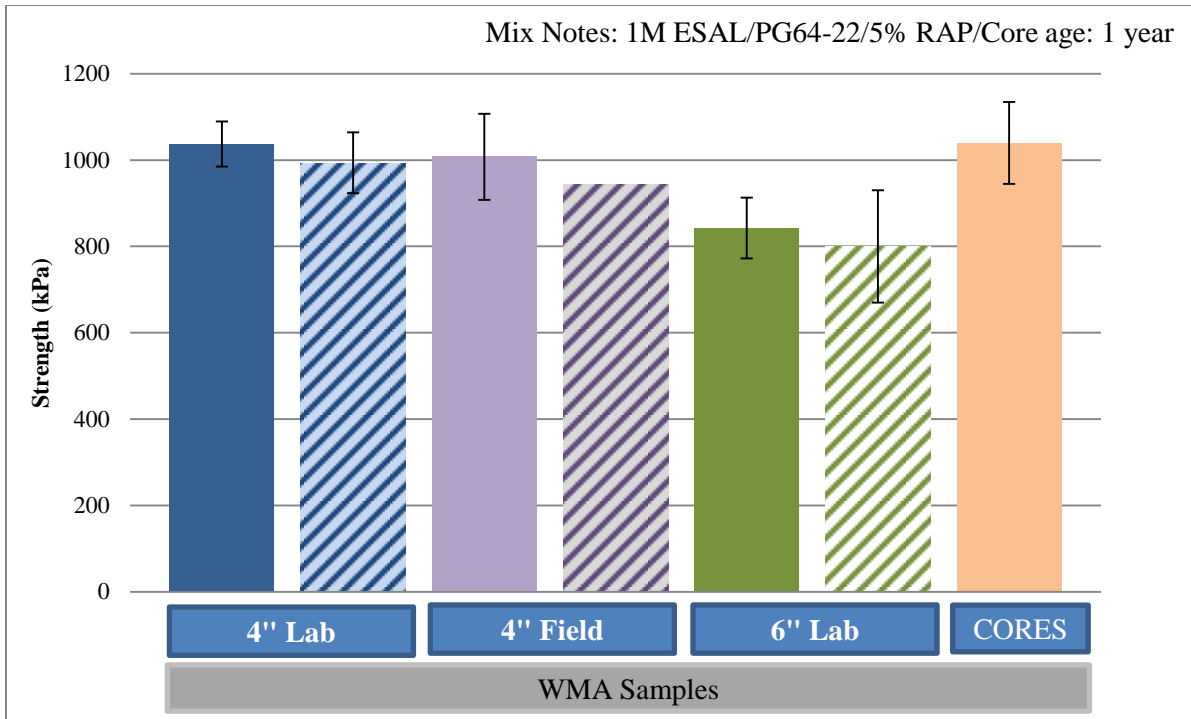

Figure 4.36 FM6 IDT peak strength (Evotherm)
 (Average core air voids are 8.0%)

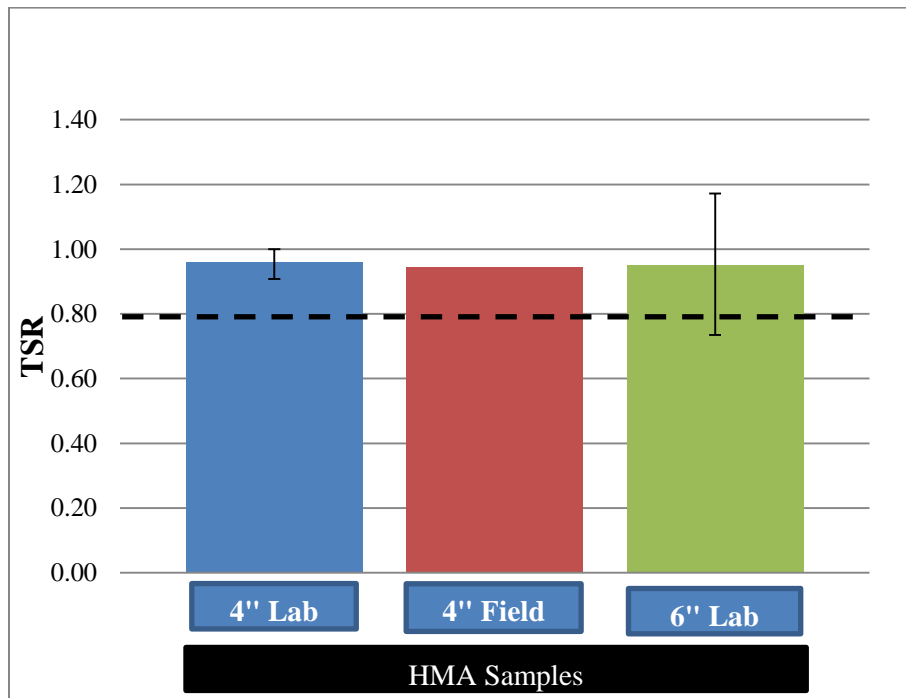

Figure 4.37 TSR values for FM6 (Evotherm)

4.4.6 FM7 peak strength and TSR results and analysis

The strength values for all of the FM7 mixes are shown in Figure 4.38. The strength values show that the mixes with the different amounts/types of recycled material have very similar strength values when the sample has not been moisture conditioned. Six inch samples have a reduced strength compared with the 4" samples. The TSR values are shown in Figure 4.39 and indicate that this mixture is prone to moisture susceptibility because not all of the samples reach a TSR value of 80%. The lowest is FM7-7. This mixture is a shoulder mix so it is not a concern for this particular pavement in the field but if this mixture was ever to be placed on a roadway that has a moisture susceptibility requirement, anti-stripping additives would be required. The moisture conditioning appears to be more of a problem when there is an increase the RAS content. FM7-0 shows the re-heated effects with the reheated samples having slightly higher average. All of the cores tested appear to have very similar strength values and these strength values correlate well with the 6" strength values for the gyratory compacted samples.

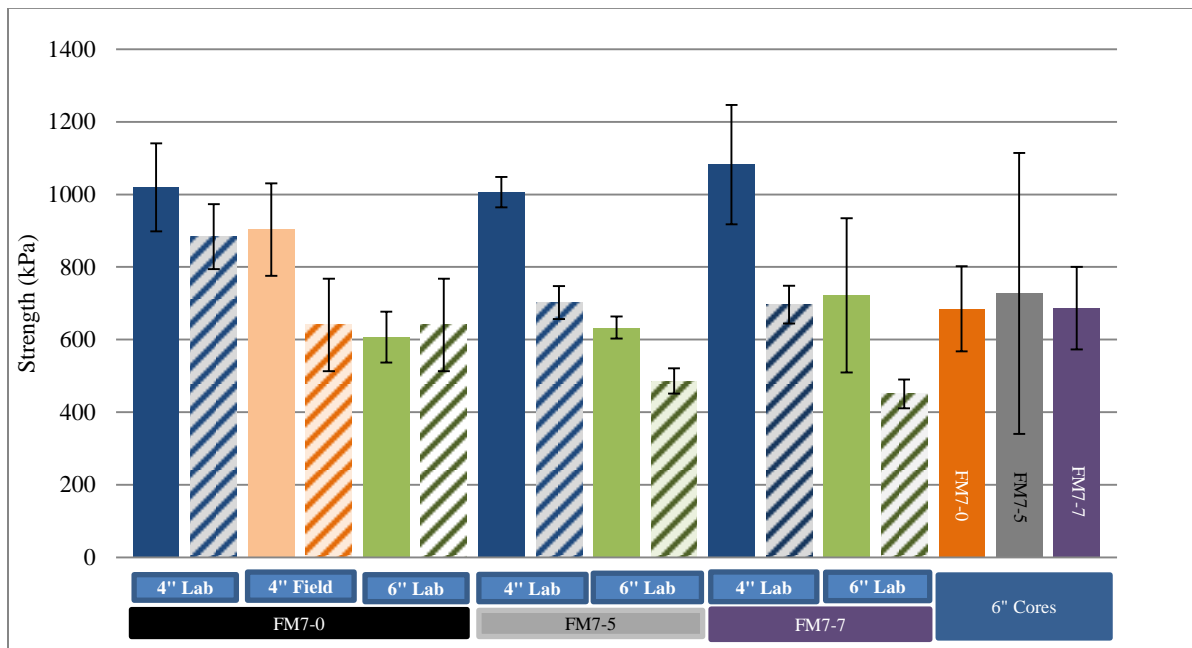

Figure 4.38 FM7 IDT peak strength (Evotherm with 0%, 5%, and 7% Shingles)
 (Age of cores is 1 year. Average core air voids are FM7-0=8.0%, FM7-5=8.6% and FM7-7=10.6%)

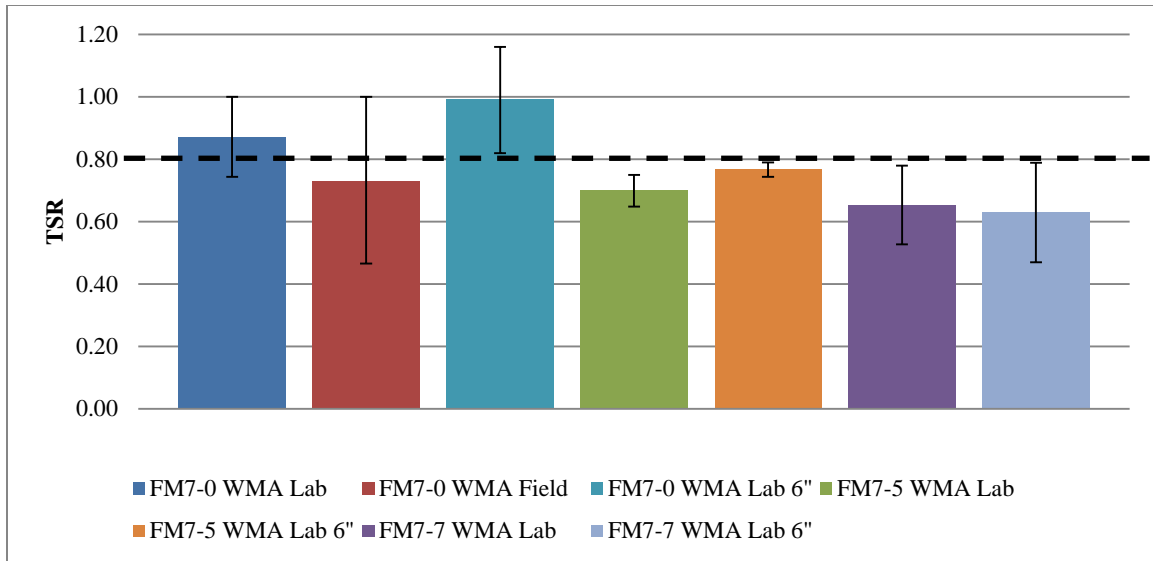

Figure 4.39 FM7 TSR results (Evotherm with 0%, 5%, and 7%)

4.5 Hamburg wheel tracking test results

This section presents the Hamburg wheel tracking test results. The important comparisons are comparing field cores for HMA and WMA mixes as well as HMA and WMA gyratory samples. The HMA was compacted at HMA temperatures and WMA was compacted at WMA temperatures. Too few replicates were tested in order to perform an ANOVA analysis but the graphs generated from the test allow for comparison of mixture performance. Each line represents testing of 4 samples. The average for each set is used to graph the line according to the sample properties. The solid lines represent the cores extracted from the pavement and the dashed lines represent the gyratory compacted samples. Additional Hamburg information for each mix can be found in Appendix G: Hamburg Wheel Tracking Test Details. This will show stripping inflection point values and important slope information. These test results will be used with the IDT to identify possible correlations between the IDT and HWTT.

The HWTT results for FM2 are located in Figure 4.40. The cores show good performance and no stripping inflection point. The WMA core shows a slightly lower average rutting depth

compared to the HMA samples. The gyratory compacted samples did not perform as well as the cores and for each core/gyratory pair the WMA performed better than the HMA samples. The HWTT results for FM3 are shown in Figure 4.41. The WMA results between lab and cores are comparable. The HMA gyratory sample results showed better performance than the core results. The HWTT results for FM4 are shown in Figure 4.42. FM4 exceeds minimum performance standards for both HMA and WMA cores with lab compacted HMA showing relatively higher rutting values but no SIP.

Hamburg results for mixes FM5 and FM6 are graphed on the same plot in Figure 4.43. The green lines represent FM5 and the orange lines represent FM6. The samples show reduced performance when compacted in the gyratory. These results indicate that these mixes are good for curing study which investigates the impact curing has on the rutting results in order to match what is happening in the field. The results for FM7 are shown in Figure 4.44. FM7 results show trends that are directly opposite from what the TSR average suggest. The FM7-7, which has the lowest TSR, also has the lowest rutting average. FM7-0 shows the highest rutting values and FM7-0 passed the TSR minimum criteria. The FM7-0 HWTT mixes show differences in the rutting pattern but past 5,000 cycles, the rutting values are similar. This suggests that passing the HWTT may be correlated with binder stiffness.

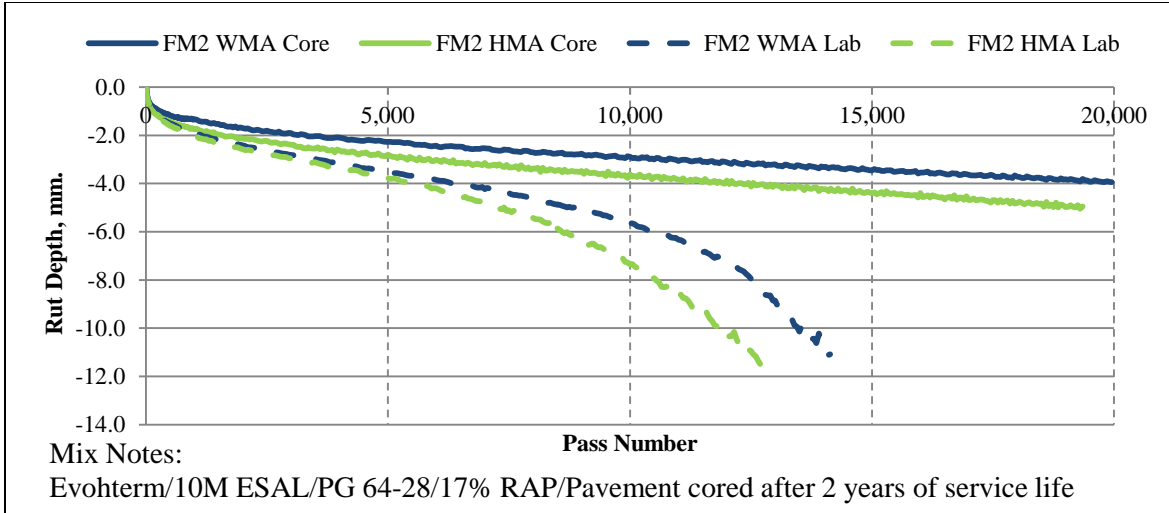

Figure 4.40 FM2 Hamburg rutting depth versus passes (HMA/Evothertm)
 (Average core air voids are HMA=7.3% WMA=7.1%)

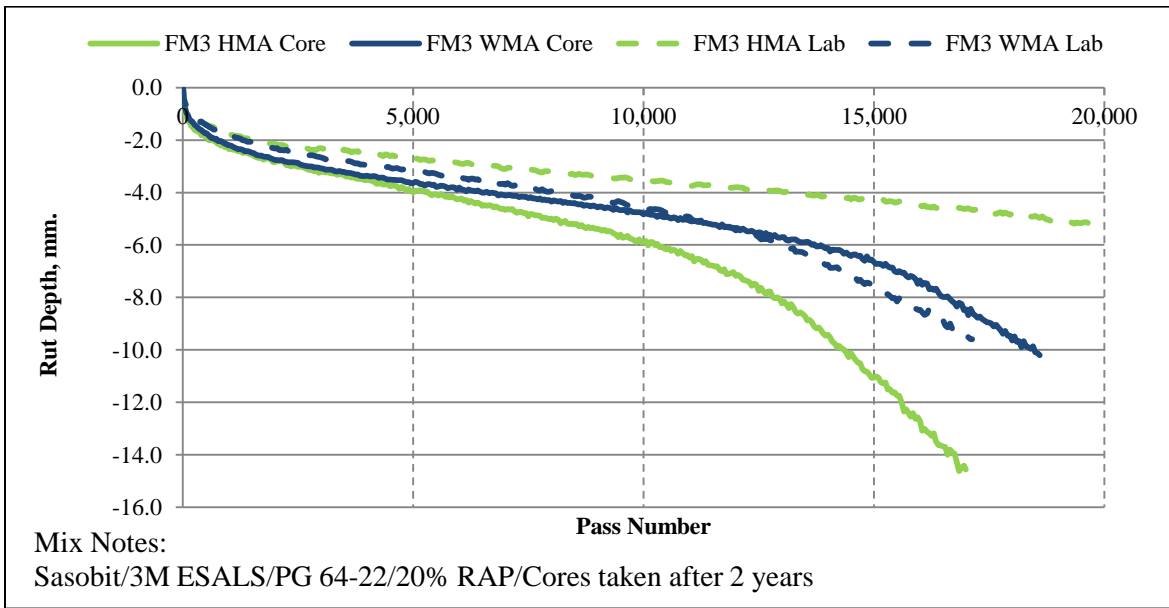

Figure 4.41 FM3 Hamburg rutting depth versus passes (HMA/Sasobit)
 (Average core air voids are HMA=8.2% and WMA=7.8%)

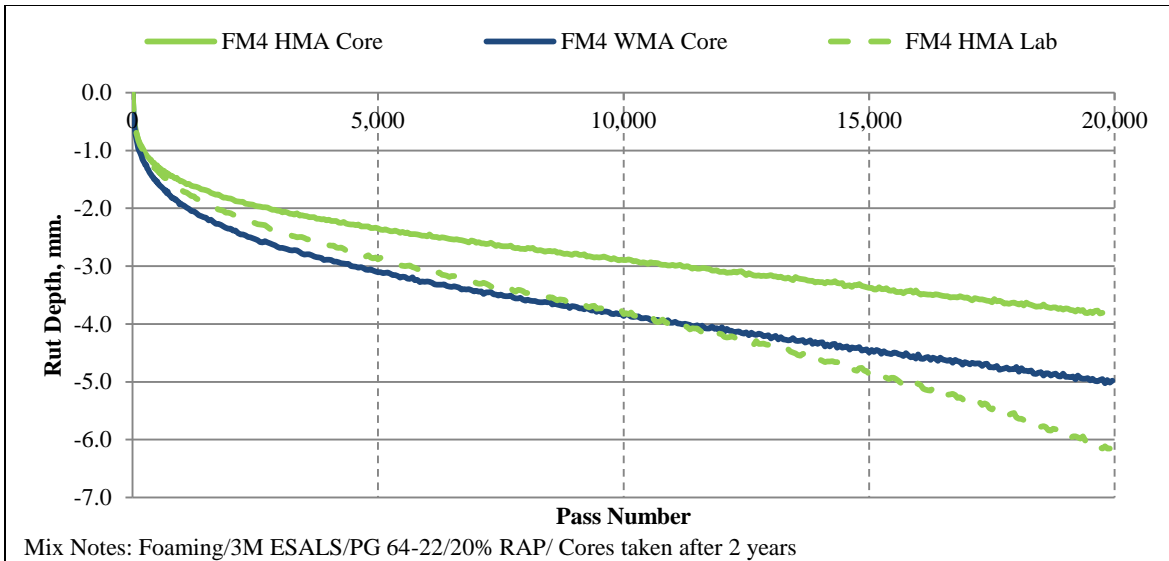

Figure 4.42 FM4 Hamburg rutting depth versus passes (HMA/Foam)
 (Average core air voids are HMA=5.8% and WMA=4.6%)

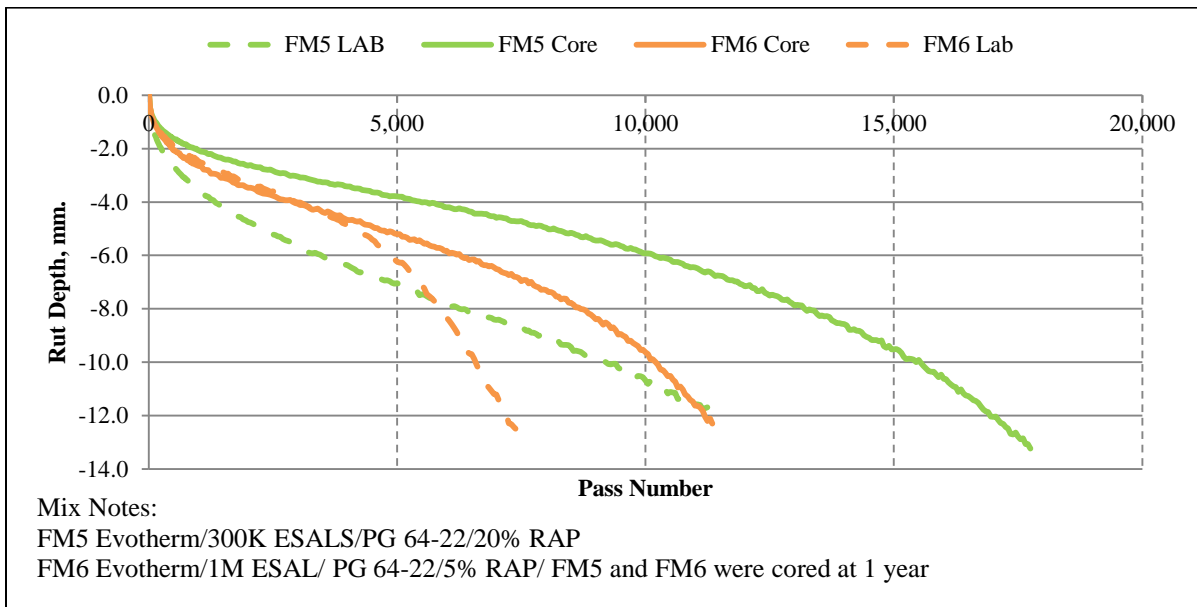

Figure 4.43 FM5 and FM6 Hamburg rutting depth versus passes (Evotherm)
 (Average core air voids are FM5=11.3% and FM6=7.1%)

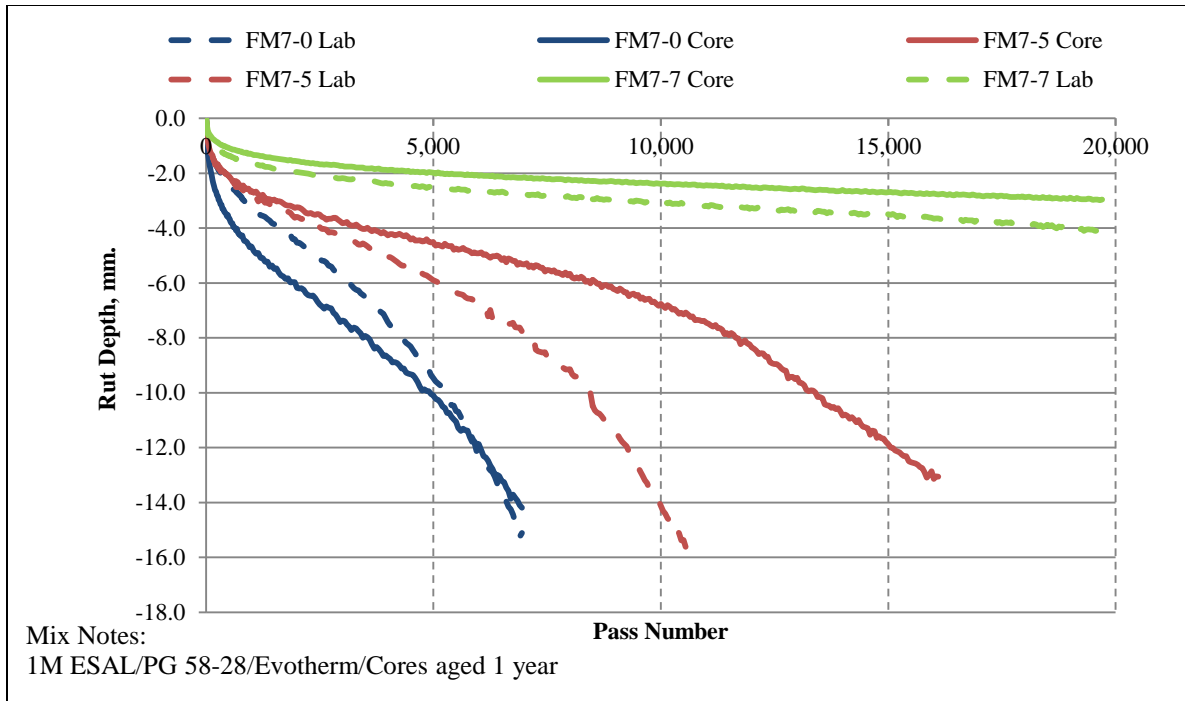

Figure 4.44 FM7 Hamburg rutting depth versus passes (Evotherm with 0%, 5%, and 7% Shingles)

(Average core air voids are FM7-0= 8.2%, FM7-5=8.2% and FM7-7=10.8%)

4.6 Curing study results and analysis

The curing study was performed in the Hamburg wheel tracking test and investigated the impact of time and temperature on the Hamburg wheel tracking test results. The curing times were either 2 or 4 hours and the temperatures were 120, 135 and 150°C. The curing study was performed on FM2, FM5 and FM6. All of these mixes used Evotherm as a WMA additive. The laboratory samples were compacted to the exact dimensions for the test and cores heights were cut to the test sample height.

The curing times were compared against the cores taken from the roadway. The dash lines represent only 2 hours of curing. Figure 4.45 shows the comparisons for FM2 which includes WMA and HMA. The WMA and HMA cores performed well with no evidence of stripping. The HMA mixes are denoted in the graph as red or orange lines. The WMA is shown

in blue or green lines. The WMA with only 2 hours of curing at 120°C and 135°C were the poorest performing mixes. The HMA mix with 2 hours of curing at 150°C was similar with the WMA mix that was cured under the same conditions. A conditioning time of 4 hours also increased the results of the HWTT. The HMA and WMA both showed similar rutting depths when cured at 4 hours at 150°C and this was similar with the rutting depths of the tested cores. The data for FM2 WMA four hours at 150°C showed some noise in the data but there was not significant rutting or signs of stripping. The SIP values for FM2 are shown in Figure 4.43. For this mix, the HMA samples cured for 2 hours at 150°C showed similar values to the WMA samples cured for 4 hours at 120°C. Samples conditioned for the two hour curing time at 120 and 135°C showed low stripping inflection points and would not pass the 14,000 pass number SIP specification but higher temperatures or longer curing times would increase the SIP values so that mix would pass the required specification.

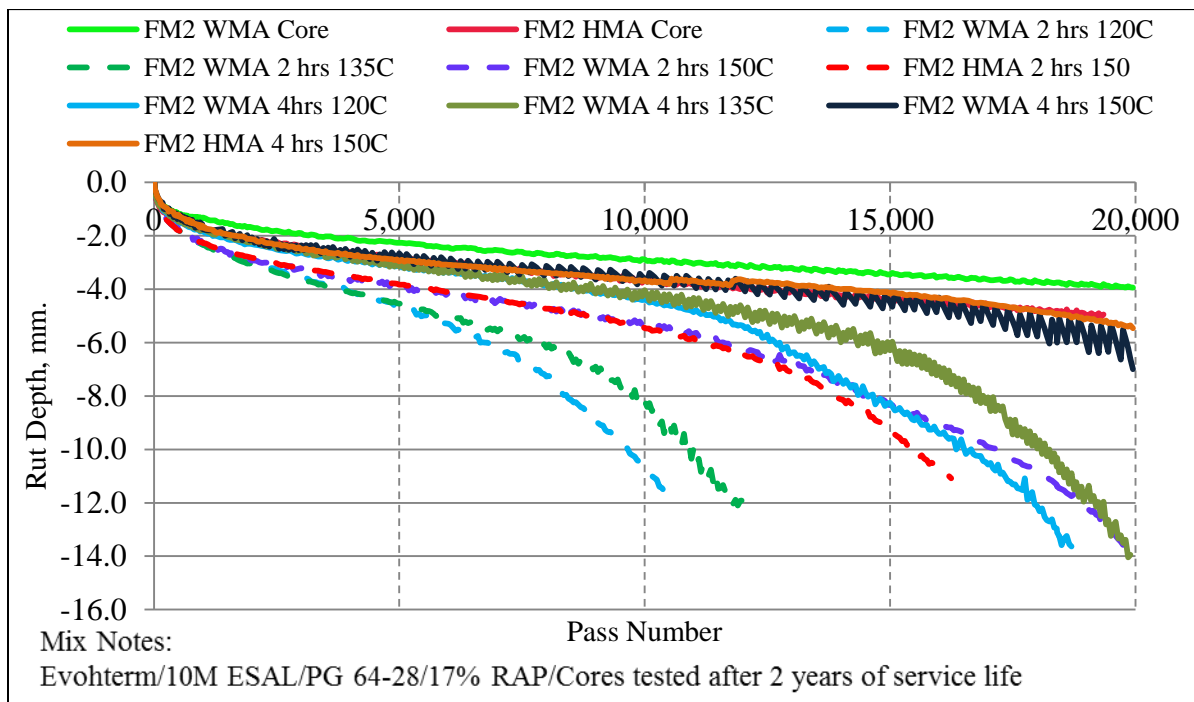

Figure 4.45 Hamburg results comparing curing temperature and time for FM2 HMA and WMA

(Average core air voids are HMA=6.7% and WMA=7.1%)

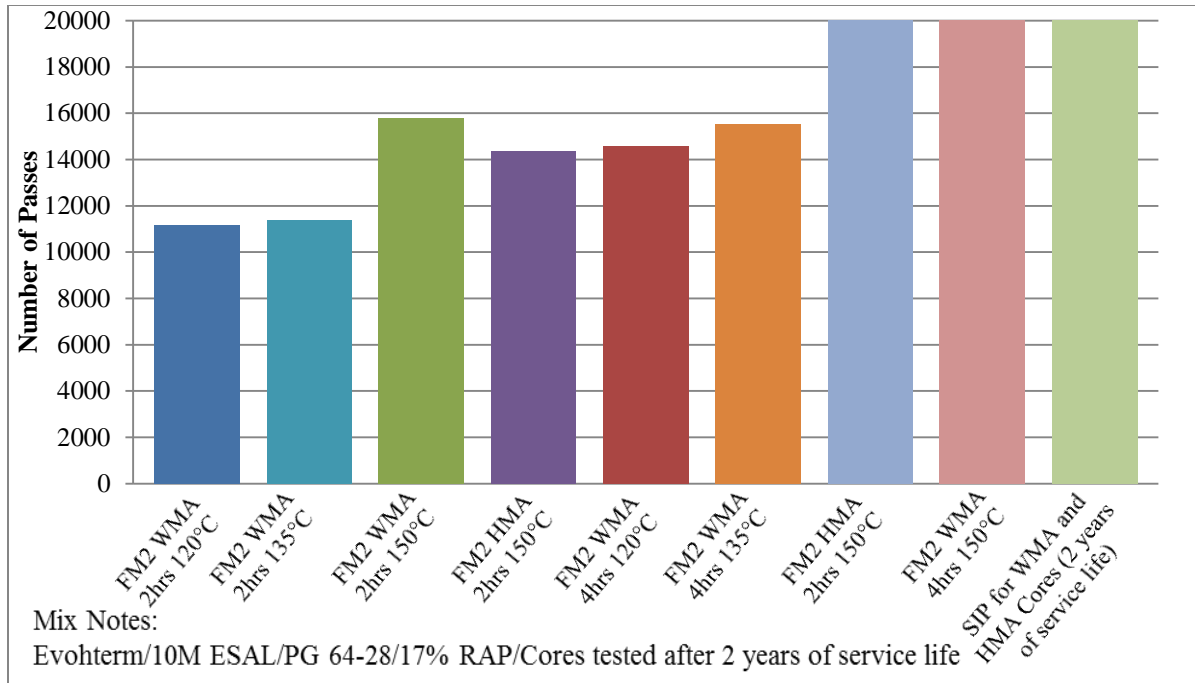

Figure 4.46 Stripping inflection point for FM2 comparing HMA with WMA, curing time and temperature (SIP for FM2 cores is 20,000)
 (Average core air voids are HMA=6.7% and WMA=7.1%)

FM5 contains the additive Evotherm and only WMA was produced for this project. The curing times were 2 or 4 hours at 120, 135 and 150°C. Conditioning for 4 hours at 150°C was not done because that duration would already exceed the normal aging protocol for HMA. The results for FM5 are shown in Figure 4.47. The curing times of 2 hours are indicated by dash lines. The longer curing times and the higher temperatures performed better in the Hamburg test. The field core test results were most similar to the curing condition of 4 hours at 120°C. The curing time of 4 hours at 150°C performed best with no indication of stripping in both HMA and WMA mixes. The stripping inflection point values for FM5 are shown in Figure 4.48. Two hours of curing at 150°C had the best results with no stripping. Curing the samples for four hours instead of two hours, increased the SIP from a value that failed mix criteria to a passing value. This test is highly susceptible to the aging characteristics of the asphalt and the temperature at

which the mix is cured at. The higher temperatures and longer curing time produced better results, taking a failing SIP value to a passing value.

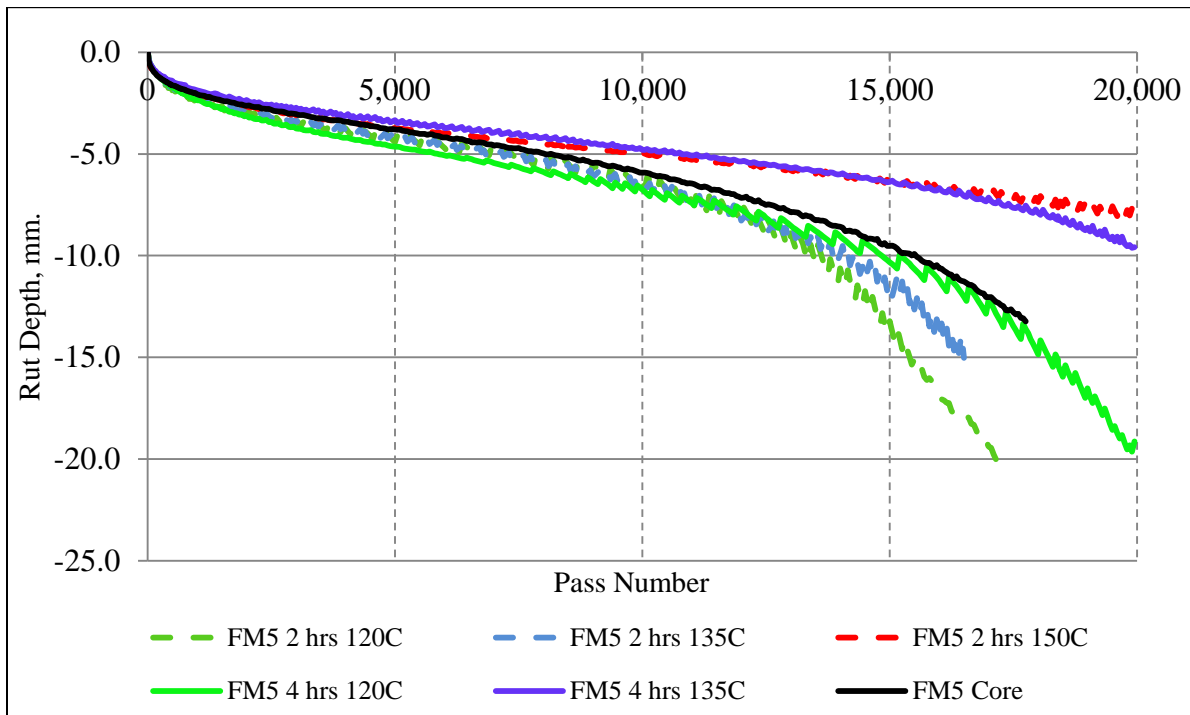

Figure 4.47 FM5 Hamburg wheel tracking test results with variable time and temperatures
(Average core air voids are 11.3%)

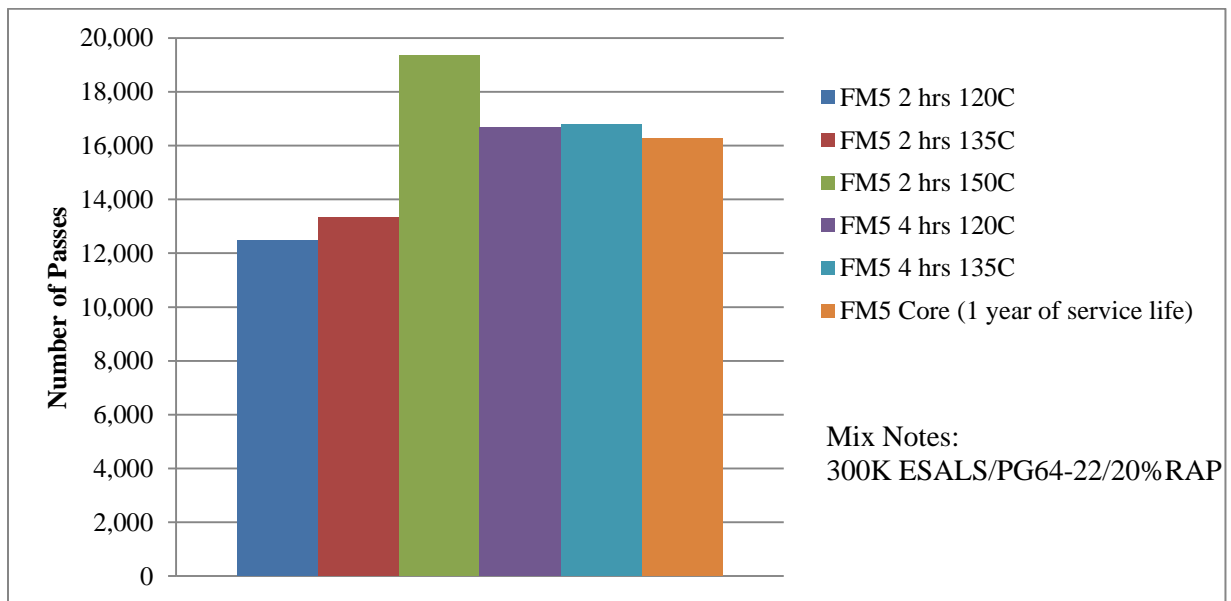

Figure 4.48 Stripping inflection point for FM5 comparing curing time and temperature
(Average core air voids are 11.3%)

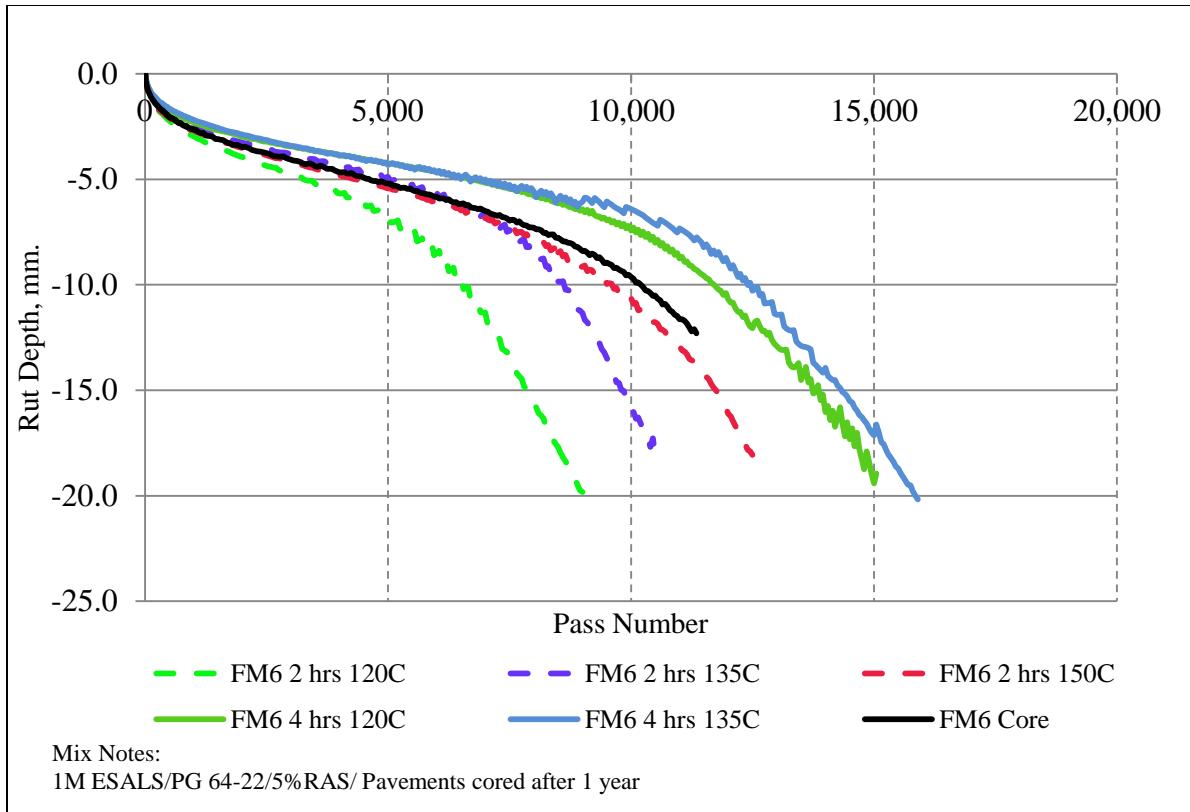

Figure 4.49 FM6 Hamburg wheel tracking test results with variable time and temperatures
(Average core air voids are 7.1%)

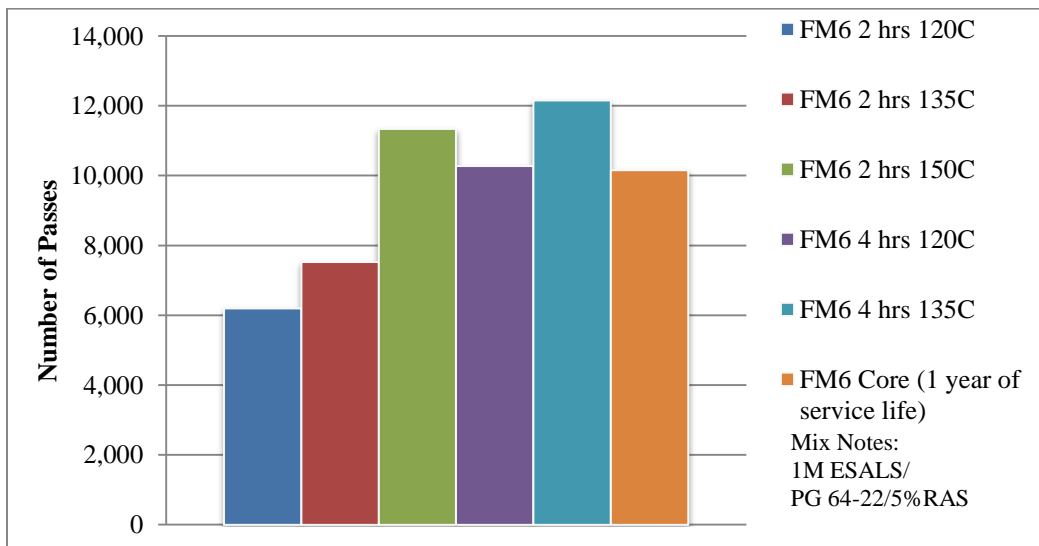

Figure 4.50 Stripping inflection point for FM6 comparing curing time and temperature
(Average core air voids are 7.1%)

The results for FM6 are shown in Figure 4.49. The dash lines indicate two hours of conditioning. The black line is the rutting measured in the core. The samples at two hours conditioning and 120°C show the highest rutting and moisture susceptibility. The core performs similarly as conditioning for two hours at 150°C. The mixes cured for four hours performed the best with 135°C having a higher SIP than 120°C. This mix did not perform well in the Hamburg test. The cores had higher air voids than the other mixes and laboratory samples were produced to match the higher air voids and this would account for the lower performance of this mix as compared to some of the other mixes. The SIP values are shown in Figure 4.50. The SIP values increase with temperature and curing time. None of the SIP values were very high but they provide a clear comparison between the temperature and curing time.

Overall, these results display the role that time and temperature have on the Hamburg test results. The samples cured at lower temperatures and shorter the curing times, generally indicated poorer performance in the Hamburg test. There was no single curing time and temperature that matched the cores exactly for all mixes but curing the WMA for 2 hours at 120°C and 135°C had repeatedly poorer results. For FM2, 4 hours at 150°C matched the core results best for both HMA and WMA samples. FM5 showed that, 4 hours at 120°C matched the field core samples best. For FM6, the curing time of 2 hours at 150°C best matched the Hamburg test results for the field cores. All of these mixes indicate reduced performance when cured for 2 hours at 120°C and 135°C when compared to the field cores but in general, there is a reduction between gyratory compacted cores and the lab compacted cores. Although air voids were designed to be similar, the air void distribution will be different in the core samples which may account for the differences. FM5 had 20% RAP and FM6 had only 5% RAP and was an overall finer mix. The higher RAP content was likely the reason the FM5 mixes at 4 hours at 135°C and

2 hours at 150°C showed low rutting resistance and no stripping inflection point. These values show clear trends of higher temperatures and curing times performing better in the Hamburg test. FM6 did not perform well in the Hamburg test but did show passing values for the TSR. The indirect tensile strength test and TSR did not delineate the differences in the mixes as well as the Hamburg. The Hamburg also shows the clear influence of curing time and temperature on the sample test results. For FM2 HMA and WMA samples that were compacted at the same curing times and temperatures, showed comparable HWTT results. The samples showed that there was very little difference in the mixes due to the additive. This shows that the differences in the SIP values are due to the lower temperatures and not the additives. This will be a concern for contractors as HWTT is the specified criteria for evaluating moisture conditioning in Iowa. These results indicate that WMA samples have lower SIP than the HMA samples. This is not because of the additive but because of the temperature reduction. The lower temperatures do not perform as well and this will be a concern for practitioners as the HWTT is going to be used an evaluation of the mix.

CHAPTER 5 ORIGINAL AND RECOVERED BINDER TEST RESULTS AND ANALYSIS

In phase I, the Superpave performance grade (PG) testing was performed for all mixes. The PG tests were also completed for the additional mixes added to the study for the phase II portion. This section presents the original binder data for each of the mixes separately. Also included in the phase II binder study is the performance grade evaluation of the recovered binder from pavement cores. The pavement cores show the binder properties in the field and the final PG grade of the binder after being mixed with some recycled properties and some aging in the field. The binder extraction and recovery process may increase the aging of the asphalt but to minimize the impact the process was calibrated and the same individual performed all of the extractions. All of the original binder data and the recovered data are plotted in the same charts allowing for easy comparison. The recovered binder was not tested as virgin binder but was tested as having undergone RTFO aging. The RTFO aging simulates the hardening that occurs during construction and because this binder has undergone this process, it is assumed that the RTFO aged binder is the best comparison. The recovered binder had only spent 1 to 2 years in the field so PAV aging was performed on the recovered binders in order to do the BBR testing.

The graphs presented in this section show the test results and the tabulated data is presented in Appendix I: Binder Testing Details. The tables give the failure temperatures for each test and the exact values for each test result. All tests were run in triplicate and the graphs show the average of the test results. The comparisons that are going to be important in this section are comparisons between HMA and WMA binder properties in the cores and in the original binders which have undergone aging. The binders will show different low temperature properties and it is important to see if there are any low-temperature benefits of WMA binders.

Similarly, the high temperature comparison will ensure that no negative effects are occurring due to WMA additives.

For the FM2 binder data, the DSR results in Figure 5.1(a), show the virgin HMA binder as the softest. The HMA has a slightly lower failure temperature compared with the WMA but the trend is reversed for the RTFO aged binder showing WMA with a lower failure temperature. The recovered binder shows almost identical results indicating that there were no differences between the HMA and WMA binders after two years in the field and after binder recovery. The PAV graph, Figure 5.1(b), shows similar failures for the original binders and the HMA recovered binder performs slightly better in the PAV DSR test showing an approximate 3°C difference. The BBR data, Figure 5.1(c), shows the HMA original binder having the lowest failure temperature followed by the WMA failure temperature with just under a 0.5°C difference; both binders meet the -28°C minimum. The HMA recovered binder has a slightly lower failure temperature having an approximate 0.2°C difference. The binder data shows that the RAP and in-field aging have increased the low temperature grade of the binder but the high temperature grade exceeds the high temperature binder requirements. There is 17% RAP in this mix and the recovered binder grade reflects the changes due to RAP and two years of in-service aging.

Figure 5.2(a) shows the FM3 binder testing results for DSR. The HMA and WMA binders have similar original properties. The data results lay directly on top of each other making the line appear as a green and orange dashed line. The RTFO data shows similar results between HMA and WMA DSR results. The recovered binders also show relatively similar increases with HMA being slightly stiffer. The stiffness differences are approximately 3°C. The Sasobit mix was initially extracted with toluene which left a very soft sticky binder that failed immediately in the DSR. The toluene was an adequate solvent for all of the mixes, the only exception is the

Sasobit mixture. For this mix, toluene did not perform well as a solvent. One hypothesis is that the wax and binder structure trapped the solvent within the molecular structure. The binder was subjected to a long period of time in the rotary evaporator without any success in stiffening the binder. Additional cores were used to extract more FM3 binder, this time using a normal propyl bromide based solvent. The n-propyl-bromide appeared to adequately dissolve the Sasobit.

Toluene is still a widely used solvent in Europe and is a less toxic alternative to normal propyl bromide and trichloroethylene. The effect of solvent type when extracting binder containing Sasobit should be further evaluated. The PAV data for FM3 is shown in Figure 5.2(b). The PAV results for HMA and WMA binders are similar. The recovered binder shows that the WMA is slightly stiffer at the intermediate temperatures. BBR data, Figure 5.2(c) shows the WMA having a slightly higher low temperature grade but in the recovered binder data, there is very little difference between HMA and WMA values.

FM4 binder data is shown in Figure 5.3 and compares HMA binder with foamed asphalt as the additive. The original binder results actually show the same binder because the “foaming” occurred on a plant modification but there was a 9 day time lapse between the collection of the binders. In order to ensure that each tank binder had the same properties, both tank binders were evaluated. The binder results show exactly the same properties when WMA and HMA are compared. Figure 5.3(a) shows the DSR results. The recovered binder also shows similar high temperature grades. The PAV results, Figure 5.3(b) also show similar binder properties between the foamed and HMA binders. This is expected as the foaming process should leave no long-term impacts on the binder. The low temperature binder grade will be influenced by the addition of RAP and aging in the field. The low temperature grades, Figure 5.3(c) are similar between the

HMA and WMA recovered binders. The WMA for both original and recovered is only slightly higher than the HMA binder.

The FM5 mix contains 20% RAP. The DSR data, shown in Figure 5.4(a), displays an increase in the high temperature grade of about 10.4°C in the recovered binder. The PAV data, Figure 5.4(b), show the 5°C increase in the intermediate test results. The low temperature binder grade increased about 6°C due to the addition of RAP, as shown in Figure 5.4(c).

The FM6 mixture only contains 5% RAP. The DSR data, Figure 5.5, shows a 7.5°C increase in the high temperature binder grade. This increase is due to RAP and aging in the field. The PAV results, Figure 5.5(b) also show an increase in stiffness for the recovered binder, having an increase of 3.2°C. The BBR data is shown in Figure 5.5(c). The low temperature is higher by 1.6°C. This is unexpected because there is only 5% RAP added in this mixture. The cores for FM5 and FM6 were both in the field for one year prior to extraction and the locations are within 125 miles of each other. The trends in comparing the FM5 and FM6 mixes help to show the influence that RAP has on the recovered binder properties. Knowing this will help to better evaluate the role WMA plays in the recovered binder properties. The FM6 had an increase in low temperature of about 1.6°C with 5% RAP. FM5 had an increase of 6°C in the low temperature grade with the addition of 20% RAP.

FM7 results are shown in Figure 5.6 and this set of binders show WMA being used with recycled asphalt shingles. The FM7-0 contained 20% RAP, FM7-5 contains 5% RAS and 13% RAP, FM7-7 contains 6% RAP with 7% shingles. The impact of the added use of shingles while using the WMA additive shows the increase in binder stiffness that can be expected. The original binder met a PG 58-28. The DSR testing showed that as more binder replacement occurred with the recycled binder, the high temperature increases. This trend is also found at intermediate and

low temperature testing with the stiffness increasing from FM7-0 to FM7-7. Figure 5.6(c) shows the 5% RAS increased the low temperature by approximately 6.5°C and the 7% RAS increased the low temperature by 13°C compared to FM7-0. This increase is expected due to the relatively high stiffness of binders in RAS. This stiffness is reflected in some of the mixture testing. FM7-7 performed very well in the HWTT compared to both FM7-5 and FM7-0. The RAS made a mixture that was failing the Hamburg pass with wide margin. This increase in stiffness was not evident in the dynamic modulus values at 4°C but was reflected in the flow number tests at a higher 37°C. The SCB trends correlated with the dynamic modulus results and did not reflect the higher stiffness of the FM7-7 binder.

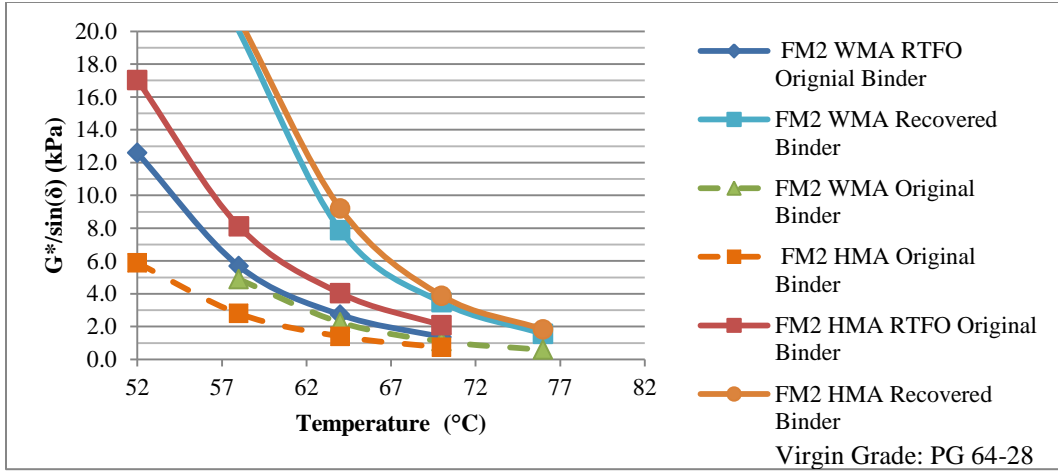

(a)

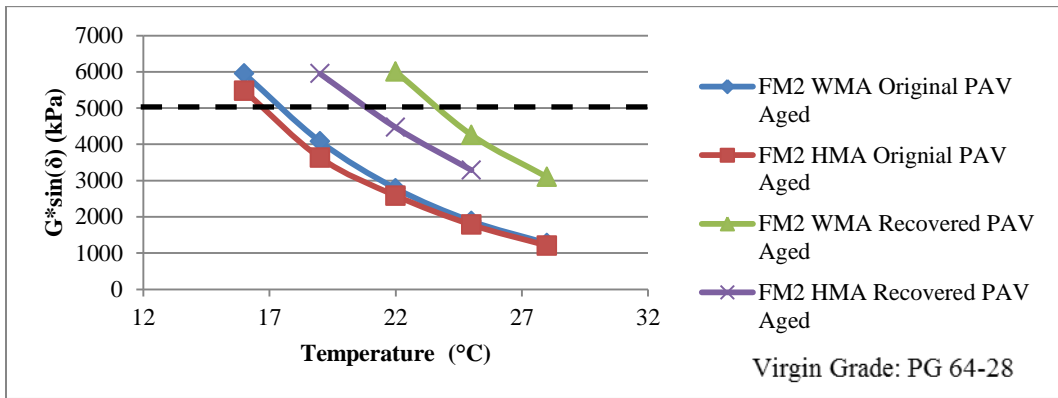

(b)

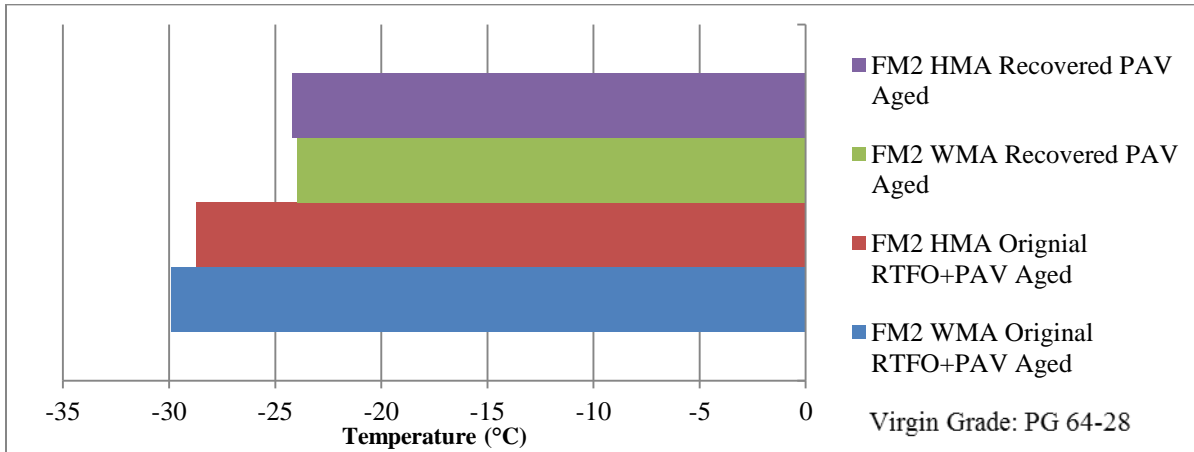

(c)

Figure 5.1 FM2 (HMA/Evotherm) binder test results (a) DSR original and RTFO aged (b) DSR PAV aged (c) BBR low temperature

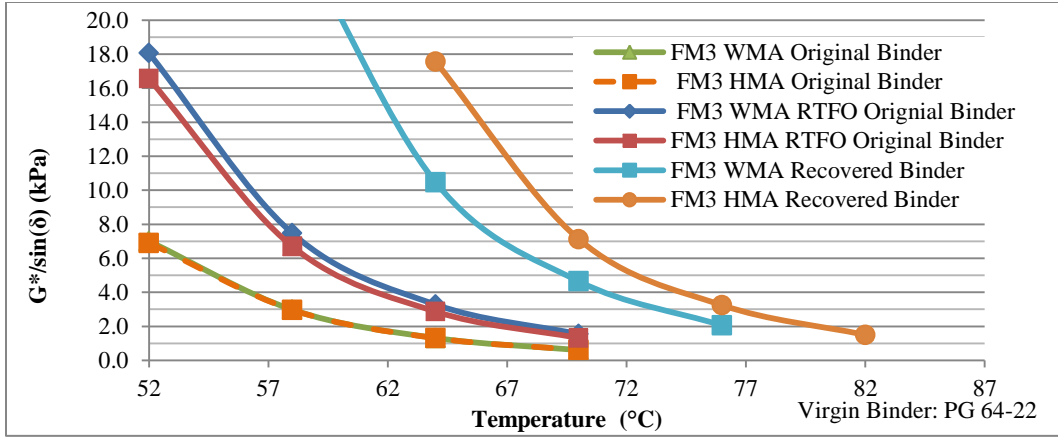

(a)

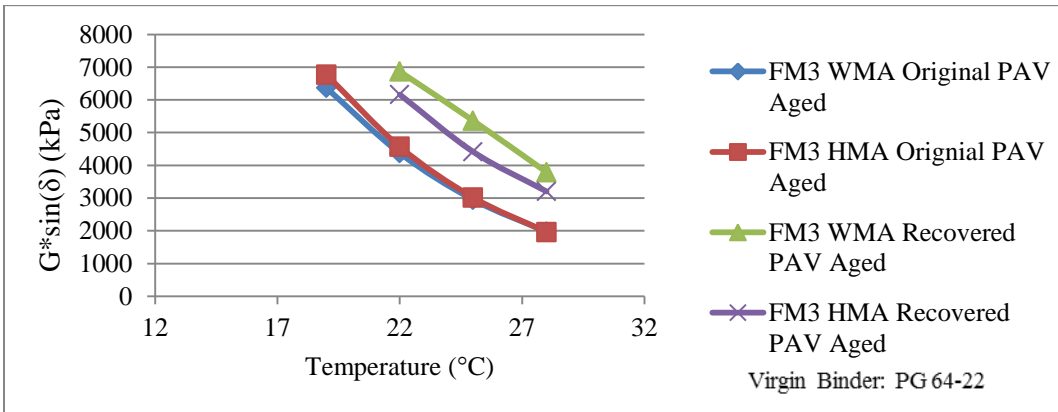

(b)

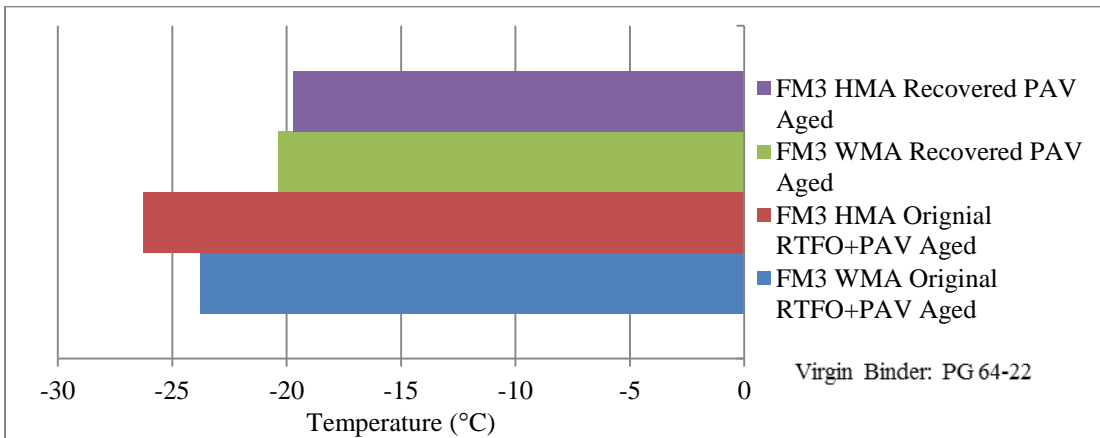

(c)

Figure 5.2 FM3 (HMA/Sasobit) binder test results (a) DSR original and RTFO aged (b) DSR PAV aged (c) BBR low temperature

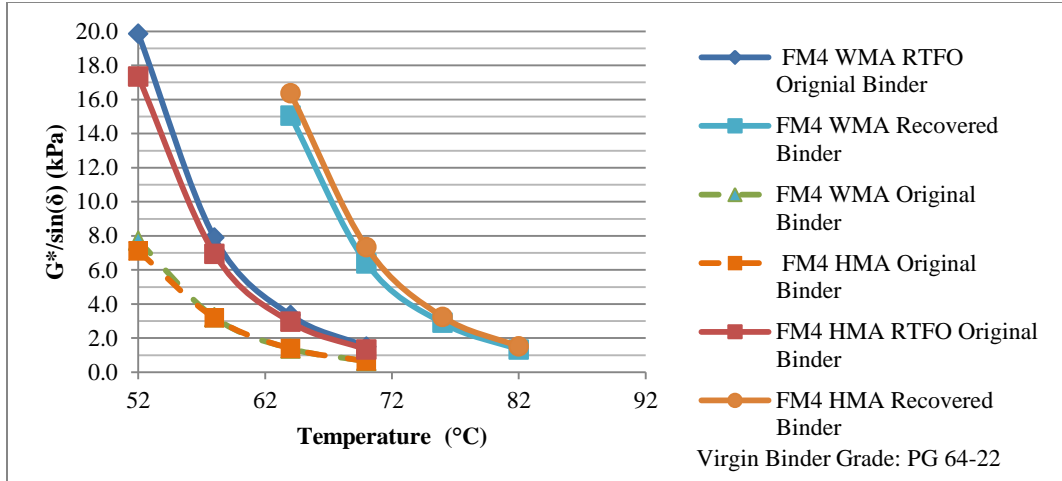

(a)

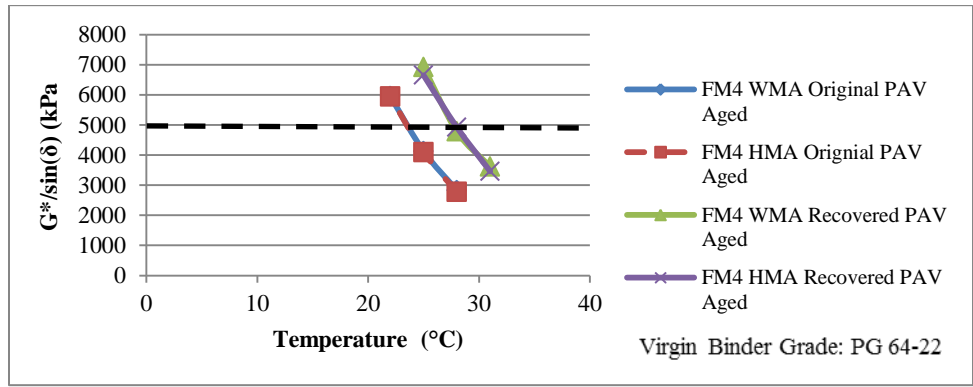

(b)

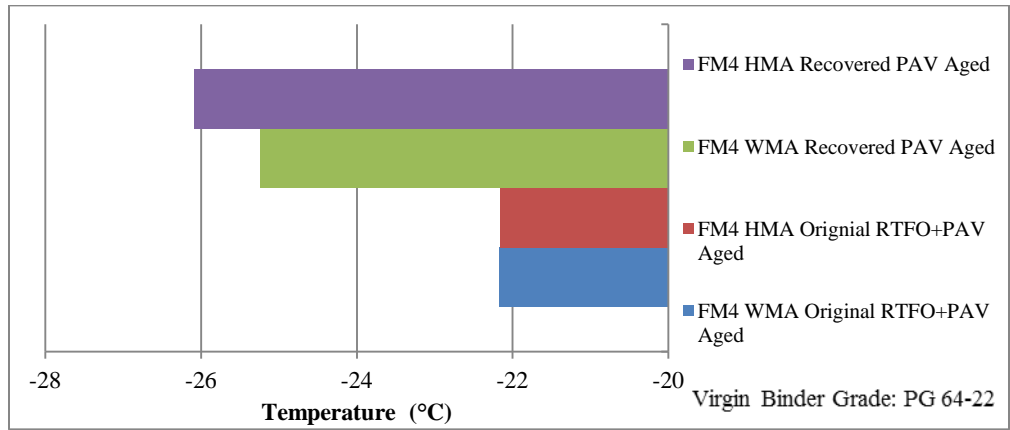

(c)

Figure 5.3 FM4 (HMA/Foam) binder test results (a) DSR original and RTFO aged (b) DSR PAV aged (c) BBR low temperature

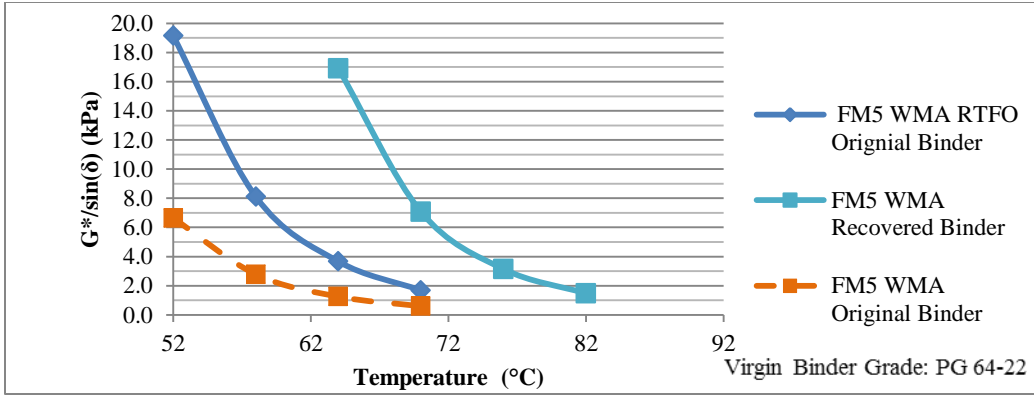

(a)

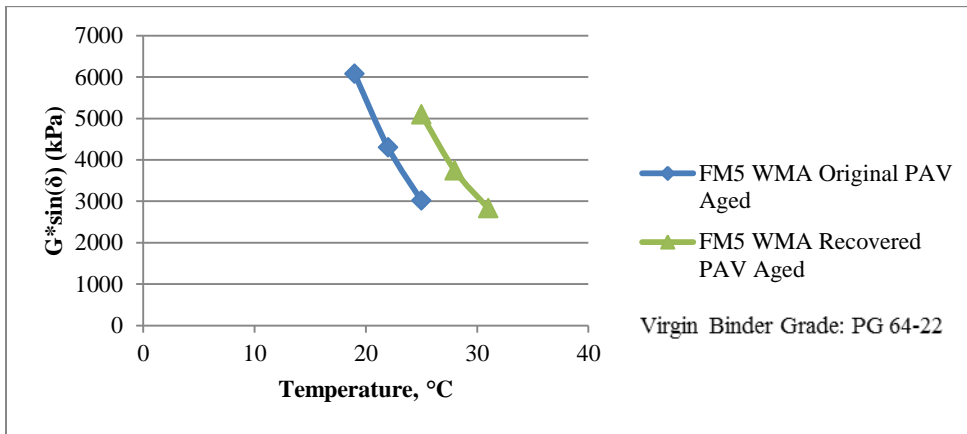

(b)

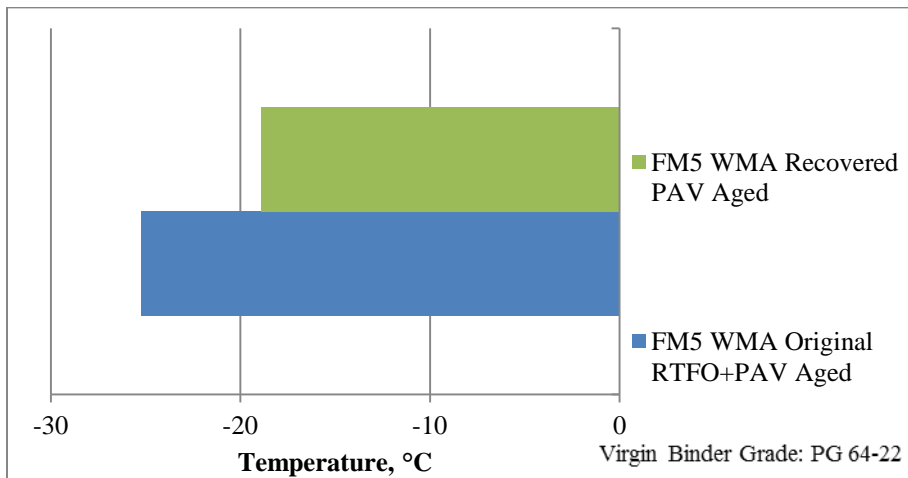

(c)

Figure 5.4 FM5 (Evotherm) binder test results (a) DSR original and RTFO aged (b) DSR PAV aged (c) BBR low temperature

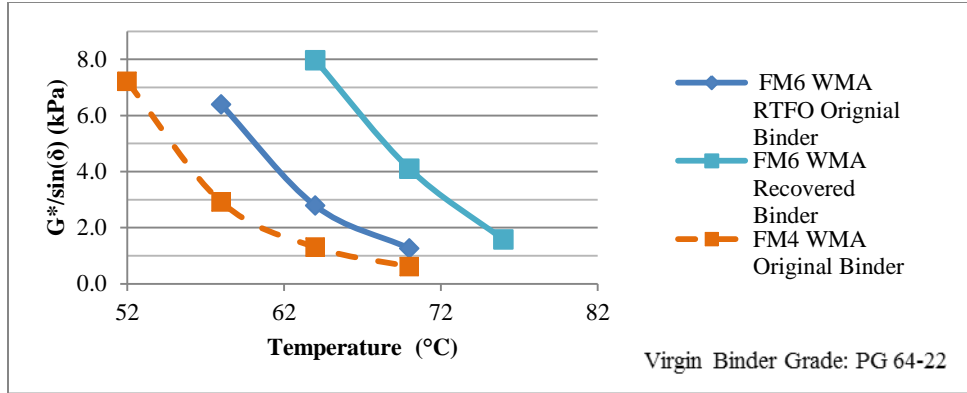

(a)

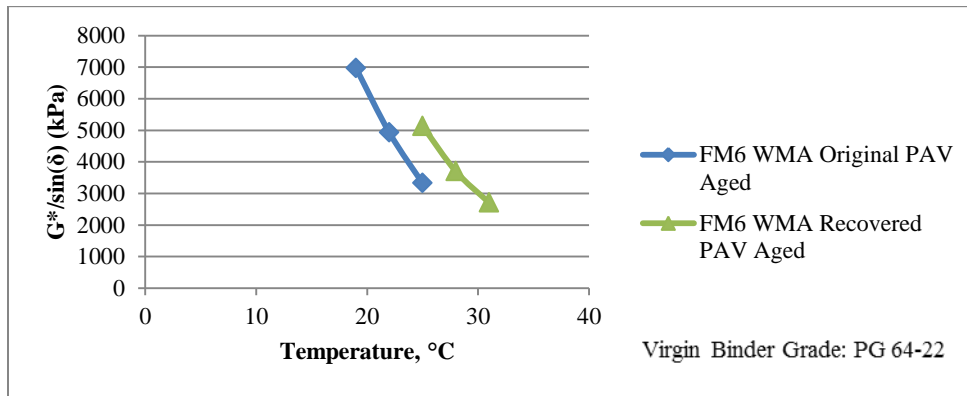

(b)

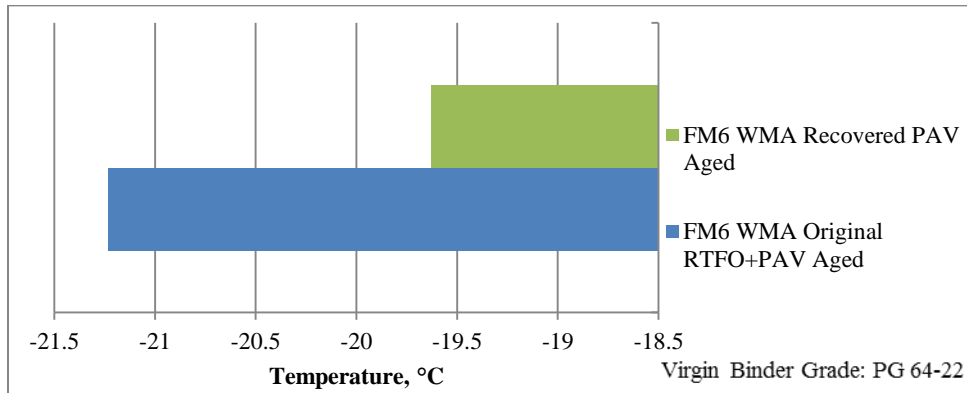

(c)

Figure 5.5 FM6 (Evotherm) binder test results (a) DSR original and RTFO aged (b) DSR PAV aged (c) BBR low temperature

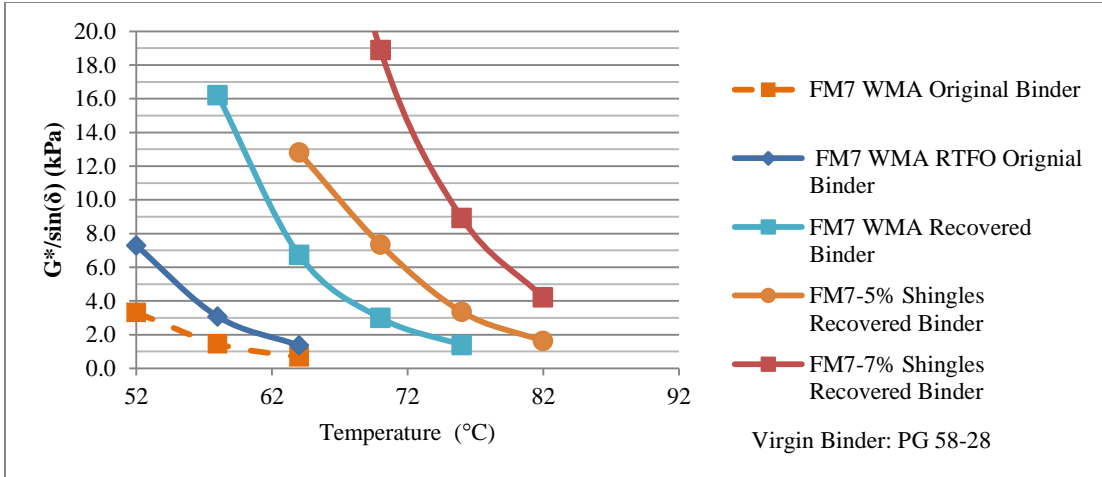

(a)

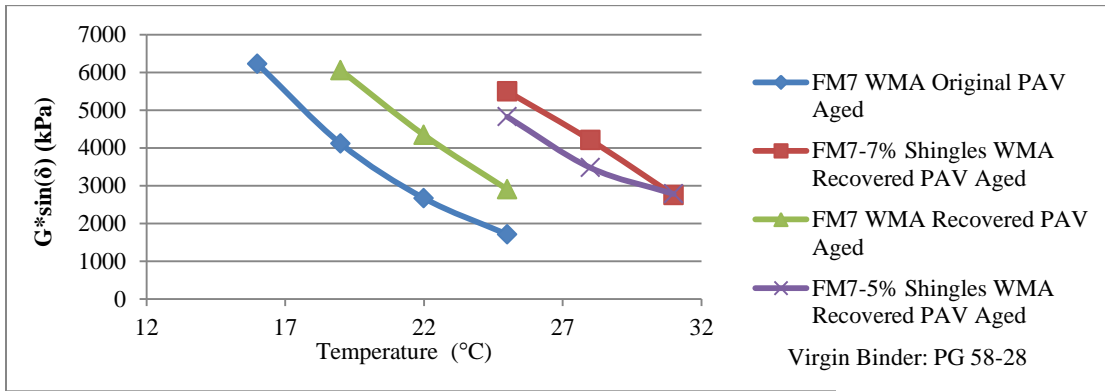

(b)

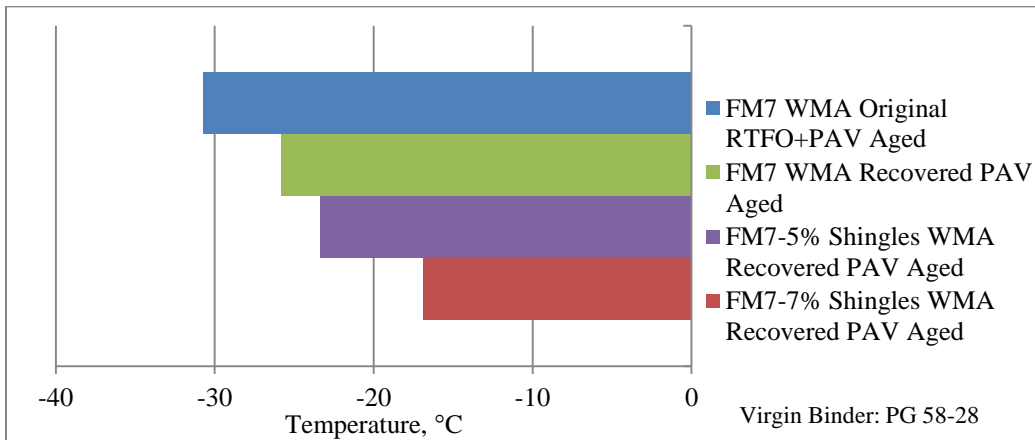

(c)

Figure 5.6 FM7 (Foaming) binder test results (a) DSR original and RTFO aged (b) DSR PAV aged (c) BBR low temperature

CHAPTER 6 PAVEMENT PERFORMANCE DATA AND ANALYSIS USING MEPDG SOFTWARE

The mixes used for this study are plant produced and were designed and used in Iowa roadways. The benefit of incorporating test section into a study is that it allows for a pavement performance evaluation and comparison. FM2, FM3 and FM4 all have HMA test sections along with WMA test sections. FM5 and FM6 are only warm mixes but the performance data will give an indication of how well these pavements perform in the field compared with performance test results. FM7 uses WMA and variable levels of RAP and RAS in the mixture. Each roadway was surveyed at three 500ft. sections. The main performance indicators are transverse cracking, rutting, longitudinal cracking and popouts. This chapter includes a brief section comparing the pavement performance data that was collected in 2011 and 2012. The second part of the chapter uses the MEPDG to predict pavement performance with typical Iowa roadway designs and traffic levels. The third section uses the MEPDG prediction models with the roadway pavement structure while closely estimating material properties. The MEPDG will be used with the dynamic modulus performance data for each different mix. Each mix performance data will be used to predict the distresses for typical pavement structures at low medium and traffic levels. The same pavement structure will be used to evaluate the different mixes. This will show how the differences in dynamic modulus and binder data will change for the different mixes. Using the same pavement structure and traffic levels, difference performance and binder data will help to compare and contrast the forecasted mixture performances by the MEPDG. The pavement performance will not adequately compare between mixes because there are too many outside variables such as location, underlying pavement structure and subgrade differences.

The actual pavement structure will be estimated and will compare the actual pavement performance with the MEPDG predicted values. The analysis uses the performance data from

dynamic modulus tests and binder testing. The pavement structures used are based on the actual pavement structure from Iowa DOT plan sets and reasonable estimates of the material properties in the underlying pavement structure. The modeling results will be compared with the actual pavement performance data to see how well the model results match the actual pavement performance data after two years in service and to forecast the pavement performance after 20 years.

The sections in the chapter are designed to compare the performance of the HMA and WMA. It will also help to evaluate the MEPDG suitability for Iowa and the compare how MEPDG predictions correspond with actual performance in the field.

6.1 Pavement performance surveys

The pavement surveys were performed for 2011 and 2012. All the pavements were constructed in the fall so the pavement surveys also took place in the fall at one and two years of service. The pavement sections selected for performance evaluation were chosen at random. The full project was divided in to 500ft sections and each section was assigned a number. The numbers were randomly chosen and the pavement location with the corresponding number was evaluated. The sections were easy to find the following year with the exception of FM4. The sections were in similar locations but not at the exact spot which was done for FM3 and FM2. Rutting values are also more variable from point to point on the roadways. The most prevalent pavement distresses are transverse cracking and rutting, shown in Figure 6.1 and Figure 6.2, respectively. The pavements with the high transverse cracking are overlays on concrete pavement. A full summary of the pavement distresses is located in Appendix J: Pavement Performance Details.

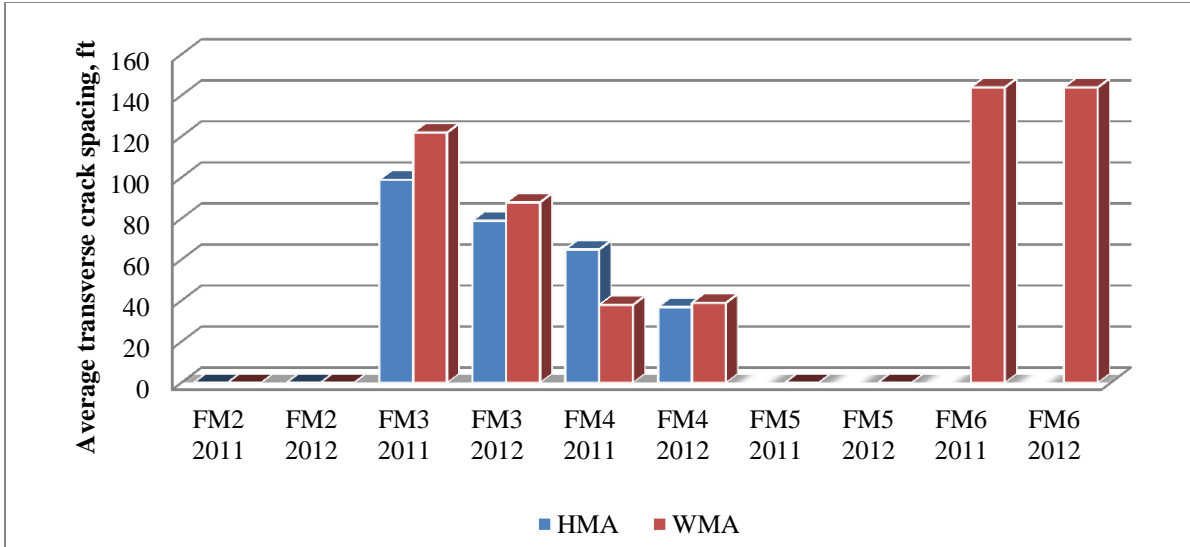

Figure 6.1 Average transverse crack spacing for 2011 and 2012 condition surveys

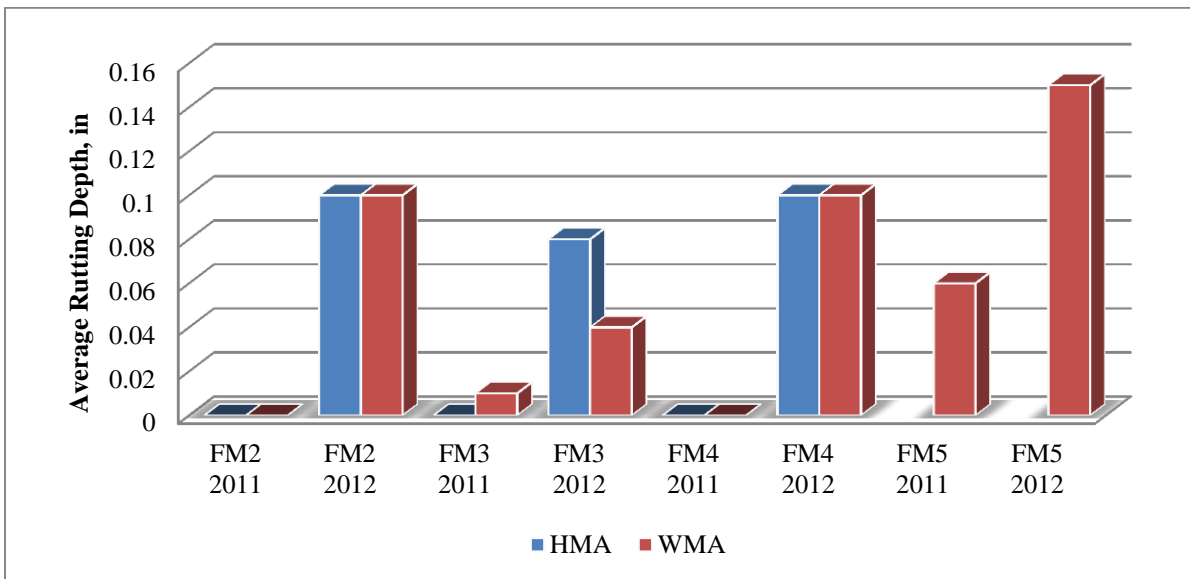

Figure 6.2 Average rutting depth for 2011 and 2012 condition surveys

6.2 Comparison of performance data on typical pavement structures for low, medium, and high traffic levels

The objective of this section is to begin by showing how WMA may change the predicted performance values using dynamic modulus and binder data from HMA and WMA mixes. The changes in E^* will impact pavement performance and determine which types of pavement

cracking change the most. The dynamic modulus values are going to have different performance responses under different traffic loading and different pavement design structures. The final purpose of this section is to investigate how the long term pavement performance will change between E^* values that are statistically different.

This section of the study is the only section that uses the data from FM1. For FM1, a HMA and WMA mix was produced in 2008 but it is not part of the Iowa DOT roadway system. The performance data was collected and used in this section for predicting the pavement performance on a virtual pavement structure. This section uses the performance data from the Phase I study where four mixes were produced, each with an HMA and WMA experimental mix. Mix was compacted in a gyratory compactor at the asphalt plant to avoid reheating mixture. The reheating factor is important because of the implications for current quality control/quality assurance programs. The collected loose mix was reheated and compacted in the same gyratory at Iowa State. Moisture conditioning was performed on half of all the samples according the AASHTO T-283 (AASHTO, 2007).

The MEDPG software version 1.01 was used to study the pavement performance data and investigate the impact the additives have on long term performance. The Phase I statistical analysis indicated differences between HMA and WMA values. These differences will be compared with the MEDPG predicted performance. All of the predictions of the MEDPG are the same except for the dynamic modulus values and the binder data. The analysis uses three different pavement designs and traffic levels that are typical for Iowa roadways. The pavement designs used were recommended by the Iowa DOT office of design. The three designs and traffic levels will detect sensitivity of E^* to layer thickness which is a function of standards traffic loading. The MEDPG will also help with comparing following factors of interest: HMA versus

WMA, reheated versus not reheated, moisture conditioned versus not moisture conditioned, low, medium, high traffic pavement design. Figure 6.3 shows the model simulations for each mix.

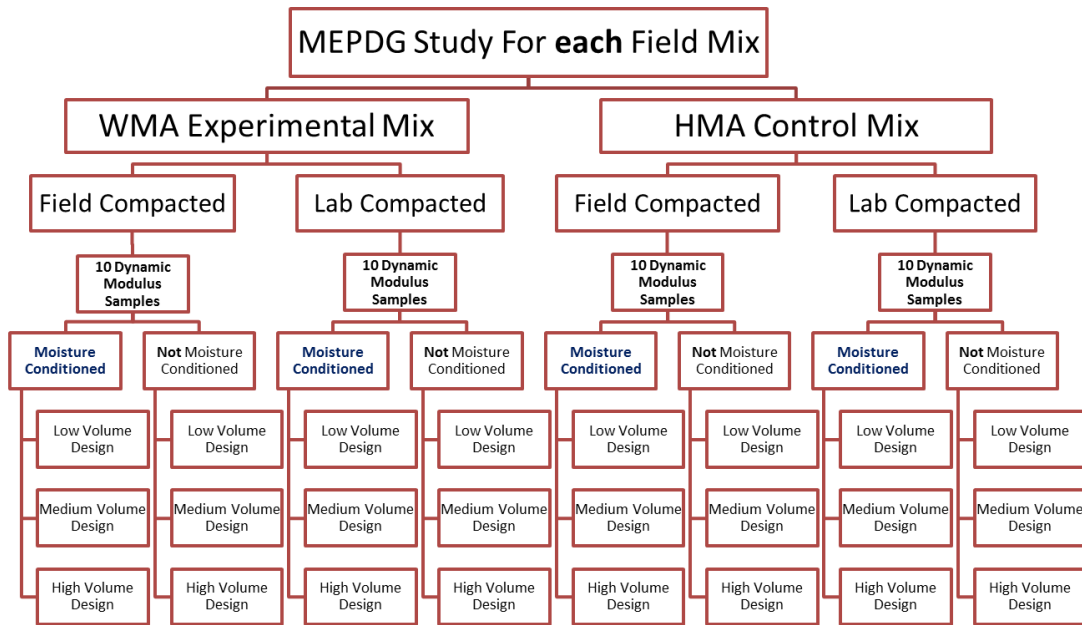

Figure 6.3 Model simulations performed for each mixture

Three pavement designs were used to see how the pavement distresses varied from different thicknesses and traffic loading. The pavement structures, Figure 6.4, represent low, medium and high traffic level designs with average annual daily truck traffic (AADTT) of 100, 700 and 2000, respectively. The traffic distributions utilized the default values regardless of traffic level. The pavement structures are based on typical Iowa roadway thicknesses that use standard Iowa aggregates, for each of the given AADTT traffic levels. The climate file remained the same for all model runs and was generated by interpolating several Iowa stations. A typical Iowa subgrade classification of A-7-6 was used. All MEPDG inputs were a level three design with the exception of the material properties of the asphalt layers. All data inputs remained the same except for the pavement designs, traffic levels and asphalt material properties.

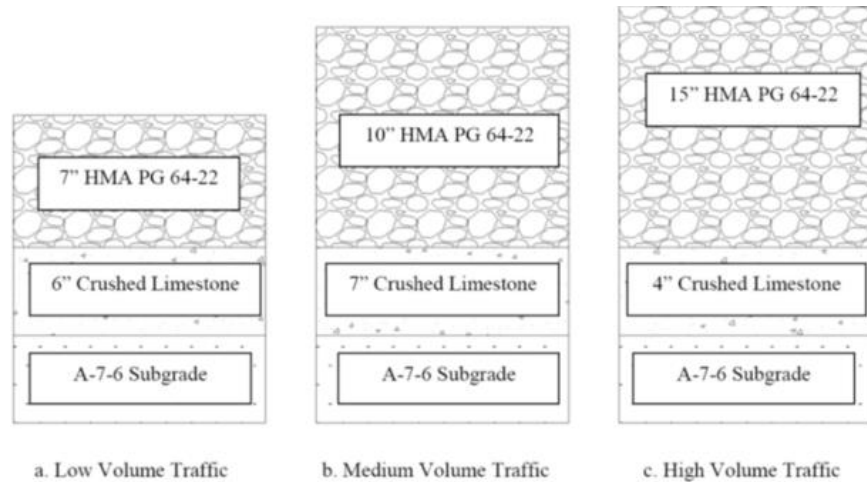

Figure 6.4 Pavement designs for low, medium, and high traffic levels

The MEPDG requires dynamic modulus inputs for 5 temperatures and 6 frequencies. The dynamic modulus testing was performed at 3 temperatures and 9 frequencies. The E^* data can be shifted based on the theory of time-temperature superposition and added to the MEPDG (Witczak M. , 2005). If an asphalt sample is loaded at a high frequency at a lower temperature, the material response can be correlated to a lower frequency at a higher temperature using shift factors. The relationship between temperature and shift factor is linear. A linear equation can be used to determine the shift factor at a higher or lower temperatures which can then be used to shift the E^* values to give the E^* value that corresponds to material responses at -10°C and 54°C .

MEPDG prediction results are shown in Figure 6.5, Figure 6.6, Figure 6.7. The figures present alligator cracking, total rutting and IRI, respectively, as calculated by the MEPDG. The data is categorized by all of the variables studied. There are two data points in each category, one field compacted (not-reheated/gyratory compacted) and the other is the reheated laboratory response. The differences between field and lab compacted can be observed by noting how far apart the data points in each category are from each other. All pavement distresses appear to follow the same trend between the various pavement distresses. The medium level pavement

design consistently had higher pavement distresses with a few exceptions. The interactions of “mix” (HMA versus WMA), “moisture conditioning” or “mcond” (conditioned versus not conditioned), and “compaction” or “comp” (field versus laboratory compaction) were evaluated in any combination. For this study, the MEPDG model used averages so only two way interactions of the factors listed were evaluated. These interactions can be compared with the laboratory data to determine if there are trends in both the laboratory data and the pavement performance model.

For FM1, there is a large difference between field and laboratory compacted HMA samples as shown by the large separation of the black dots in each category. The differences between average pavement distresses for HMA and WMA don't appear to be significant except in the case of IRI. The HMA has a higher average roughness compared to the WMA values. There are differences between the pavement performance data and the E* data. This may be due to averaging E* for the model runs, in order to reduce the number of runs and also the ANOVA analysis looks at overall trends but doesn't specifically break each E* value into its specific category. Interaction plots were plotted using averages to see if there may be interactions that showed up in the E* data. The interaction plots showed an interaction between mix and moisture conditioning which was not evident in laboratory E* data.

FM2 shows the pavement performance for HMA and WMA are similar with the exception of several categories showing WMA with a slightly higher average pavement distress for the moisture conditioned samples. There doesn't appear to be a difference in the pavement distresses when comparing whether the samples were moisture conditioned or not. The data points with each category are spaced close together which indicates that there is no noticeable

difference in the modeled pavement distresses when comparing field or laboratory (reheated) compaction.

Field mix 3 shows similar trends to FM2. There are little differences in the pavement performance data for all variables. The only noticeable differences is the HMA average distress appears to be slightly lower than WMA for the moisture conditioned samples, alligator cracking and total rutting. The interaction of mix and compaction is the only detectible interaction in the pavement distresses.

Field mix 4 doesn't show differences in the variables for the alligator cracking and the total rutting but there is a large difference in the category of WMA/NMC/Field compacted for the IRI values. This is interesting because the other two pavement performance distresses did not indicate this difference. Mix*compaction appeared to be an interaction that also appear in the pavement performance data.

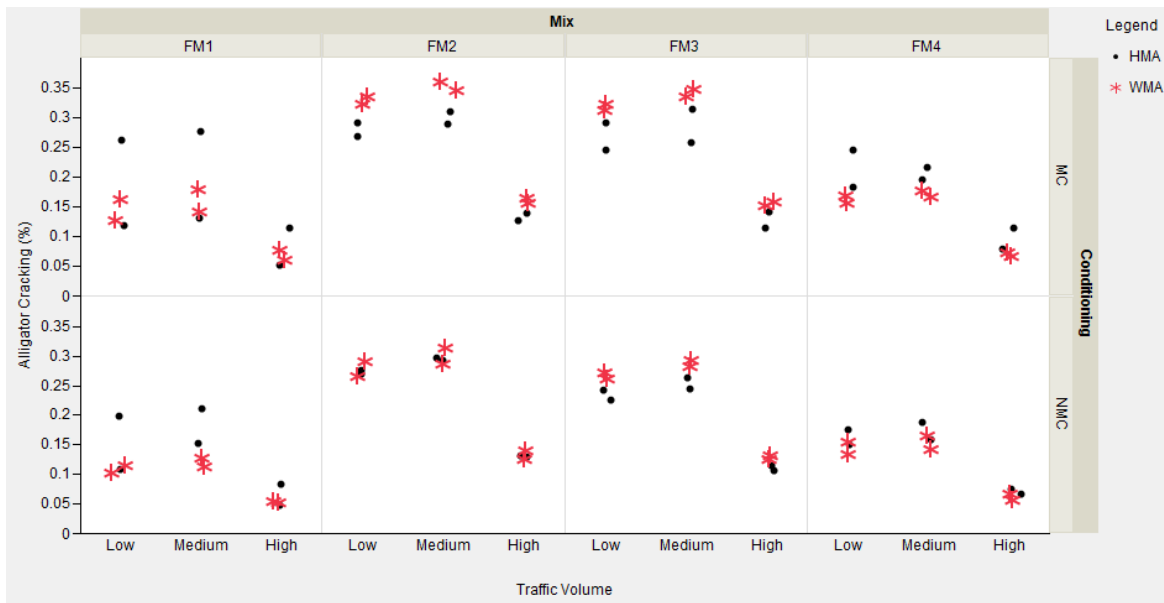

Figure 6.5 MEPDG predicted alligator cracking

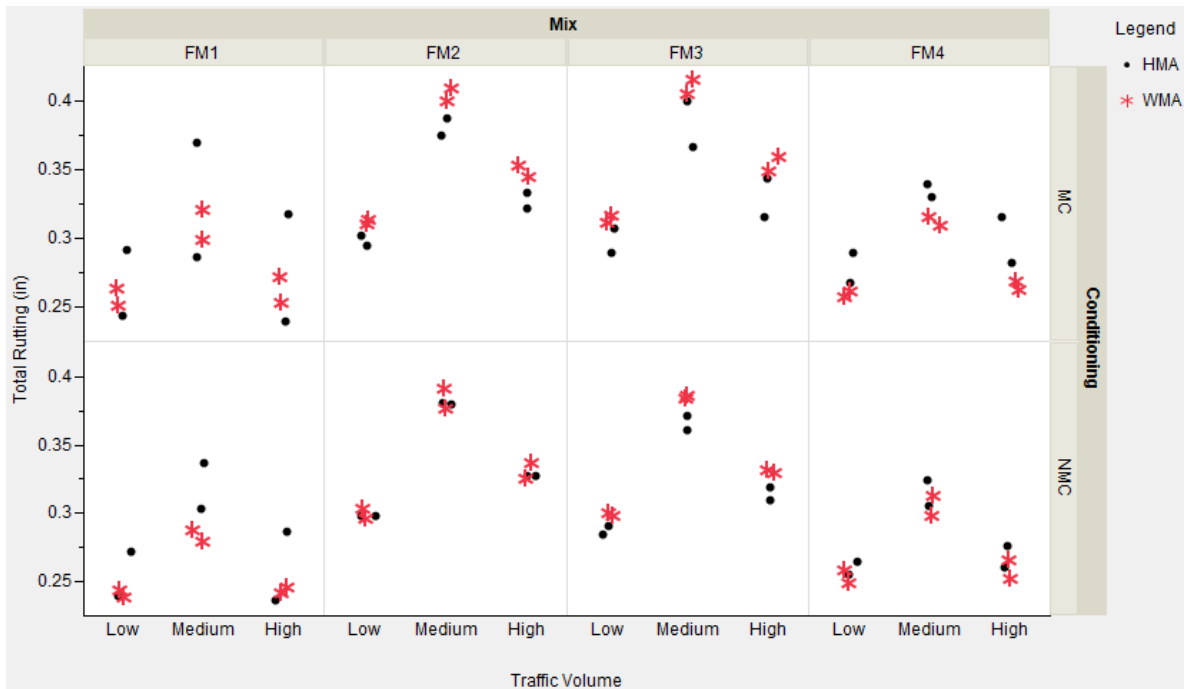

Figure 6.6 MEPSDG predicted total rutting

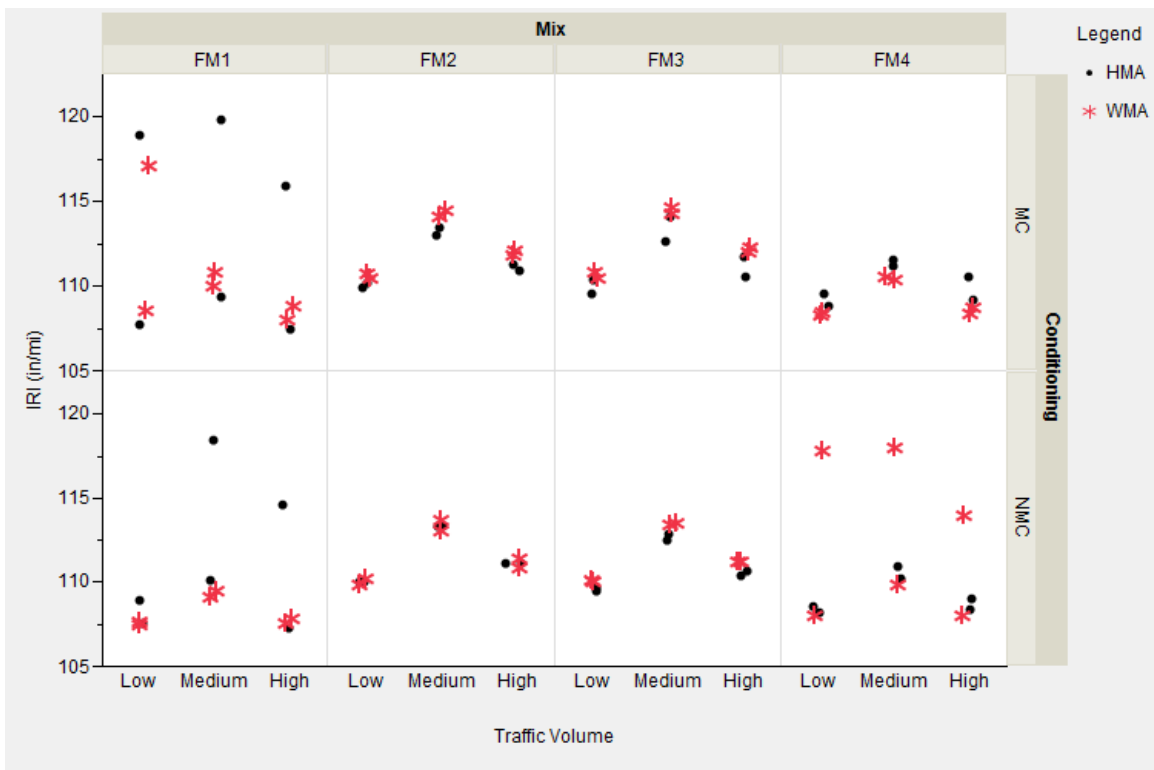

Figure 6.7 MEPSDG predicted IRI

6.2.1 Findings comparing model results

The MEPDG can be used as a tool to help designers reasonably choose the pavement design that best fits their needs based upon pavement performance predictions. The MEPDG predicted pavement responses show that, in most cases, there was little to no difference when comparing HMA and WMA over a long period of time. The data shows some differences between the various treatment conditions and some distress responses that reflect the phase I laboratory data analysis but specific trends were not seen in every mix variable studied. This may be due general field variability. Total rutting and alligator cracking followed similar trends but the IRI would, at times, display a result that wouldn't match with the rutting and alligator cracking trends. The pavement designs showed similar trends in most cases, with the medium level pavement design having the highest distress levels. The ANOVA table in phase I appeared to show more differences than the MEPDG pavement performance data. In this study, average E* values were used for the model runs. Each mix had 24 categories for a total of 96 runs. In order to study the distribution of all mix samples, 960 runs will need to be performed. Doing this will help to show statistically what the differences are and further strengthen the conclusions. Generating an MEPDG run for each sample will give a distribution and variance for each sample set within each treatment category. This will allow a more detailed statistical analysis of the MEPDG pavement performance data. The MEPDG is a powerful tool for pavement design and material engineers; however, further model validation and calibration is necessary but continuing these efforts will provide for faster pavement material evaluation and pavement designs which result in longer pavement life.

6.3 Input data for MEPDG comparison of actual pavement structure and field performance data

The MEPDG is a software program that utilizes both mechanistic and empirical design methods. The AASHO road test, performed in the 1950's, is what many of the empirical pavement design principles are currently based on. Since the 1950's the typical traffic loads have increased and design of pavement material has improved, e.g. polymer-modified asphalts. The MEPDG provides a framework in which the engineer determines design inputs for traffic, desired reliability, climate, and pavement structure (NCHRP, 2004). The MEPDG also allows for engineers to assign a "level of reliability" to their pavement designs. The higher the level of reliability, the more conservative the pavement design will be to account for variability. There are also different levels of input depending on how much data was collected for this particular pavement design. Level 1 is the most detailed data and Level 3 is general design inputs. The various input levels impact the reliability because it is assumed there is more uncertainty in Level 3 inputs; therefore, the program accounts for the higher degree of variability in the different levels. The MEDPG also allows for design of rehabilitated pavements. The ability of the engineer to input detailed material information, in this case E^* and $G^*/\sin(\delta)$, allows for the engineer to see how differences in the pavement materials will impact the pavement design.

Prior studies (Mohamed, 2005) have shown that the MEPDG is sensitive to the E^* values of the asphalt concrete (AC) layer and that reasonable pavement performance prediction can be obtained using the software which gives reasonable pavement performance results (Mohamed, 2005). The inputs data for the MEPDG was determined based on looking at plan sets from each of the projects as well as traffic data and soil survey references to best estimate subgrade properties. Table 6.1 shows the average annual daily truck traffic (AADTT) levels for each roadway. Traffic volume adjustment factors were based on the defaults provided in the program

because they represent reasonable assumptions for these roadways. The pavement structures for each roadway are shown in Figure 6.8. The existing pavement layers include an AC layer for FM2 and jointed plain concrete pavement (JPCP) for FM3 and FM4. Material property values for the existing pavement structure were based on looking at information given in the plan sets as well as pictures of the pavements prior to reconstruction. The subgrade information was determined by looking at soil survey books for each pavement location. The soil type which was most predominant in the area was used.

Table 6.1 Traffic inputs for MEPDG modeling

	FM2	FM3	FM4
Initial two-way AADTT	1932	357	975
Number of lanes in design direction (%)	2	1	2
Percent of trucks in design direction (%)	50	50	50
Percent of trucks in design lane (%)	60	100	60
Operational speed, mph	55	55	55

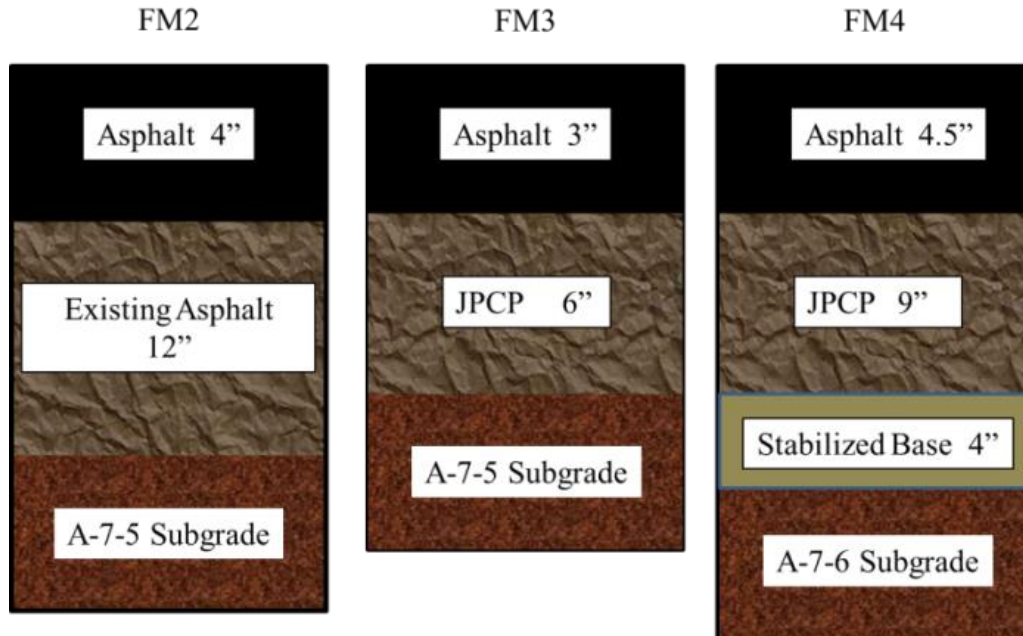

Figure 6.8 Pavement structures used in MEPDG analysis

6.3.1 Results and analysis

The data collection includes the pavement distress occurring in the field and the E^* values measured in the laboratory. These E^* values were input into the MEPDG and predicted pavement distresses were modeled. A comparison between predicted pavement distresses, actual pavement distresses and the measured E^* values will be analyzed in this section.

The pavement surveys used in this analysis were conducted at 2 years after construction. As shown in the previous section, additional annual pavement surveys were also performed but only the first year's pavement survey results were used for this portion of the study. The pavement surveys were conducted in accordance with the Long Term Pavement Performance program (Miller, 2003). Three sections of 500 ft. in length were chosen at random for each control and experimental pavement. The three pavements used for the study were surveyed and the distresses evaluated are summarized in Table 6.2. The roadway designated FM2 was in good condition with no signs of pavement distresses. The other roadways surveyed showed some distresses as

indicated Figure 6.1. Both pavements had insignificant amounts of rutting in each section. The primary concern for FM3 and FM4 is the transverse cracking. The distance between transverse cracks was measured and averaged over the distance of the 500 ft. pavement survey sections. FM4 had higher transverse cracking in the WMA than the HMA section. FM3 had more transverse cracking in the HMA sections. The longitudinal cracking was minor. There was an average of 3 ft. of longitudinal cracking per 500 ft. section surveyed from FM3-WMA, with no cracking in the HMA. There was an average of 18 ft. of longitudinal cracking per 500 ft. section for FM4 HMA with no longitudinal cracking in the surveyed WMA pavement sections. There were a few pop-outs as indicated in Table 6.2. For FM3 and FM4, the WMA seemed to have more edge cracking. The edge cracking consisted of primarily hairline cracks. This may be construction related but each WMA section, on average, had higher instances of edge cracking for FM3 and FM4.

Table 6.2 Pavement survey summary for 2011

		HMA	WMA
Transverse Crack Spacing ft.	FM3	99	122
	FM4	65	38
Average Rutting, in	FM3	0	0.01
	FM4	0	0
Longitudinal Cracking per section, ft.	FM3	0	3
	FM4	18	0
Number of pop-outs per section	FM3	2	0
	FM4	1	1
Edge cracking (minor)*, ft.	FM3	2	27
	FM4	0	50

Laboratory E* values were used in the MEPDG rutting model. The rutting in the AC layer was predicted using the MEPDG. The mixes were ranked according to the amount of predicted rutting in the AC layer. The ranks of the mixes are shown in Table 6.3 in the column labeled “AC rutting”. The measured E* values were also averaged and given a rank according to

the mix variables. A higher rank indicates a higher E^* value which is synonymous with the mix having stiffer material properties. The E^* values for MC and NMC samples were individually compared at each frequency and temperature. The ratio of the moisture conditioned and the non-moisture conditioned samples were calculated and then averaged. The E^* ratio shows which mixes may be more sensitive to moisture conditioning. Typically, the dynamic modulus decreases after moisture conditioning but this did not occur in all cases, as shown in Table 6.5. One explanation for this is that the moisture conditioned samples tested were not the same sample that is tested prior to conditioning. With the coefficient of variation typically being in the range of 15%, it would not be statistically unlikely that a dynamic modulus ratio could measure at or slightly above 1.0 for a well performing mix. Figure 6.2 compares these results for each mix. The E^* ratios calculated differently than the E^* rankings. The E^* ratios are taken as an average of the ratio between each specific frequency and temperature individually and the E^* rank is calculated by comparing the averages of the entire set of E^* values for each temperature and frequency.

For each pavement surveyed, predictions for rutting in the AC layer were forecasted over 20 years and are shown in Figure 6.9 sections a, b, and c. For each mix, the graph of rutting categorized by the experimental factors is shown as well as an HMA and WMA job mix formula (JMF). The binder data was used in the JMF model but the measured E^* values were replaced with only mix properties. This allowed for a comparison between level 1 and level three in the MEPDG to determine any prediction bias when working with level 1 inputs for the mix data compared to measured E^* values.

Table 6.3 Comparison and rankings of mixes for predicted AC rutting, E* and E* ratio

	FM2			FM3			FM4		
	AC Rutting	Ave E* Rank	E* Ratio	AC Rutting	Ave E* Rank	E* Ratio	AC Rutting	Ave E* Rank	E* Ratio
HMA Lab NMC	6	2	0.95	1	1	1.06	6	5	0.92
HMA Lab MC	5	6		2	2		8	8	
HMA Field NMC	3	3	1.06	3	3	0.85	2	3	0.89
HMA Field MC	1	4		6	6		7	4	
WMA Lab NMC	4	5	1.00	5	4	0.89	1	1	0.94
WMA Lab MC	7	8		8	7		3	6	
WMA Field NMC	2	1	0.89	4	5	0.88	4	2	1.07
WMA Field MC	8	7		7	8		5	7	

For FM2, the JMF predicted higher rutting for the WMA and similar rutting for the HMA pavement. For FM3 the JMF predicted lower rutting, on average, for WMA and showed a comparable prediction of rutting for HMA. For FM4, the JMF predicted higher rutting for both the WMA and HMA pavements. Using the JMF to predict rutting gave an over prediction of rutting for WMA in two of the three pavements and HMA was over predicted in one of the three pavements studied.

6.3.2 Findings for prediction of pavement performance based on actual pavement structure

The data from the pavement surveys do not show large differences in performance between the WMA and HMA pavements at two years of service life. FM2 was the best performing pavement with no signs of visible pavement distresses for all six of the 500 foot sections surveyed for both the hot mix and warm mix asphalt. FM3 and FM4 showed transverse cracking, which was concentrated in some areas but the distance was averaged over the length of the 500 foot section to show a comparison between the two pavement sections. The transverse cracking is likely more prevalent in FM3 and FM4 because of reflective cracking from the underlying PCC layers. FM2 has asphalt as the underlying pavement structure. The rutting in all the pavements surveyed is minor and not detectable through manual measurements. The predicted MEPDG rutting correlated well with the initial rutting measurements; both show very

small amounts of rutting. The longitudinal cracking was minor as well. Minor edge cracking was only identified at WMA sections surveyed. Actual transverse cracking was not compared in detail with the predicted transverse cracking because the low temperature data used default values. It is interesting that for FM3, there was significant transverse cracking for this pavement structure using the defaults. Low temperature testing is being conducted to further investigate the transverse cracking.

Dynamic modulus values correlated fairly well with the E^* ratio. The E^* ratio showed virtually no difference between the HMA and WMA but averages were used which may mask some of the finer details. When comparing the average E^* ranks and the AC rutting, the moisture conditioned samples were ranked lower except for a couple exceptions in FM2. Moisture conditioning consistently showed increased rutting, on average for these mixes.

The transverse cracking is likely due to reflective cracking. The MEPDG is a powerful tool for pavement design and material engineers; however, further model validation and calibration is necessary but continuing these efforts will provide for faster pavement material evaluation and pavement designs which result in longer pavement life.

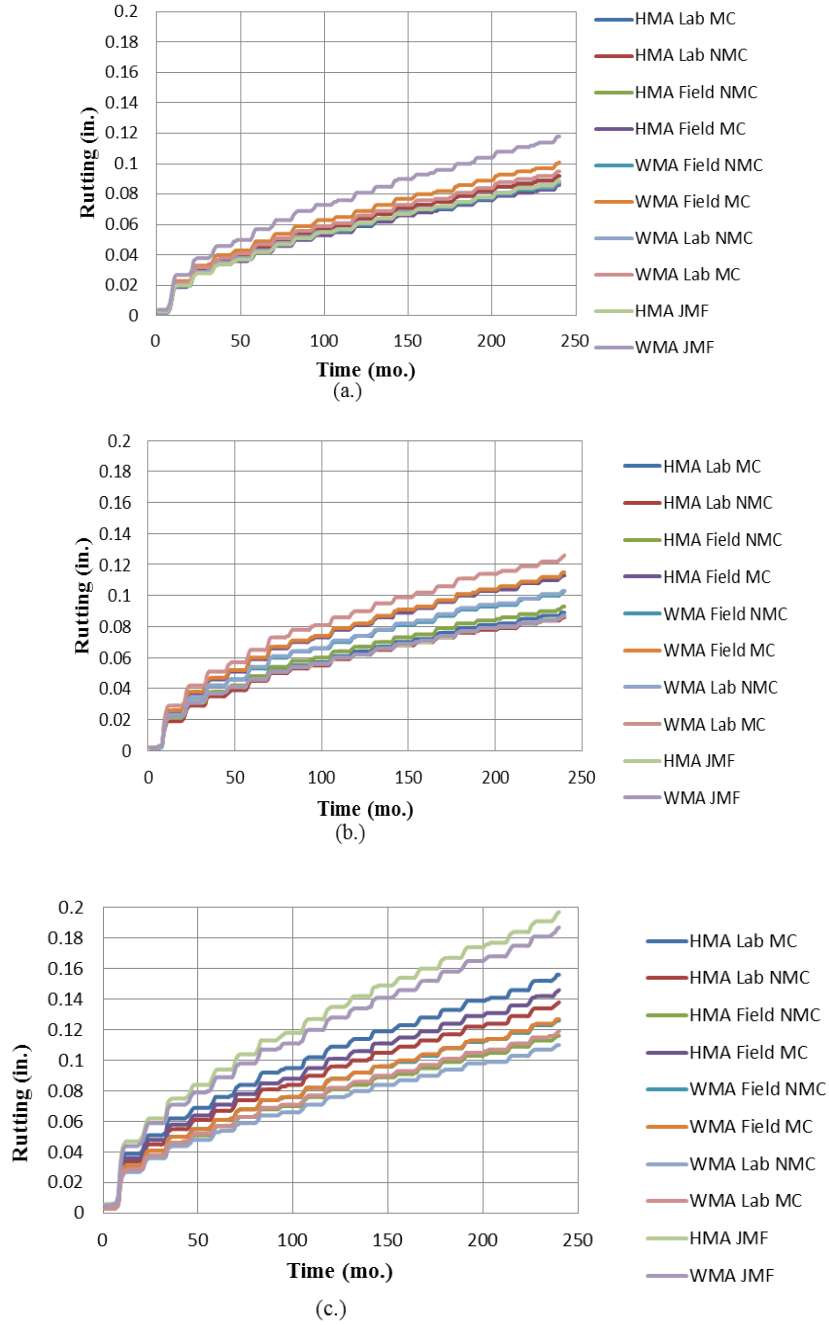

Figure 6.9 Total AC rutting depth predicted by the MEPDG (a) FM2 (b) FM3 (c) FM4

CHAPTER 7 COMPARISON AND CORRELATIONS OF MIXTURE PERFORMANCE DATA

The objective of this chapter is to compare and contrast the overall performance of each mix tested in the study. The results section took a detailed, statistical approach at comparing the factors studied within the mixes. This chapter compares average values from the performance tests from all mixes studied to rank and compare how each mix performed relative to the other mixes included in this study. Results from the performance tests will be used to assign each mixture a ranking based on the overall average performance of that mix. A standardized z-score ranking will be calculated for each of the performance tests. Once each mix receives a standardized z-score, the z-scores can be compared with all other performance test scores. The z-score provides a simple reference, indicating how the test results compare with the overall average of all the mixes tested and indexing how far above or below average each mix falls.

Developing correlations between performance tests are also important. The mixtures are tested at a wide range of temperatures and the material properties measured within a certain temperature range should show some correlation. Other performance tests measure several parameters and in order to determine which parameter is the most useful, correlations to other repeatable tests will give an indication of how the material properties are related between the performance tests.

Each performance test measures different material properties at a different range of temperatures. Comparing mix materials and performance test data must consider the different material parameters. The overall mixes are ranked but first take into consideration the mix performance at low, medium and high temperatures. Each mix is given a z-score within each category. The z-score at each range is weighted equally because adequate performance in each temperature range is equally important for pavements in Iowa.

7.1 Mixture ranking for each performance test

The ranking of all mixes within each performance test provides a convenient way of determining, within the population of the mixes tested, how a certain mix compares with all of the others. Each performance test is included in this section. The indirect tensile strength tests only include the test results 4 inch samples because these are most commonly used.

7.1.1 Hamburg Wheel Tracking Test Mixture Rankings

The results for each mix that were compacted and compared with cores in Chapter 4 section 5 are included. The curing study samples were not included in the ranking due to the increased complication of conducting a mixture ranking as a function of curing time and temperature. The mixes were ranked according to the stripping inflection point (SIP) which is the Iowa DOT's criteria for determining moisture damage. If no stripping inflection point occurred during the test, the mixes were then ranked according to their final rut depth at 20,000 passes. The Hamburg test rankings by SIP are shown in Table 7.1. The mixture with the highest rank is the FM7-7 because of its low rutting depth at 20,000 wheel passes. FM4 and FM2 performed very well in the Hamburg test. Cores generally performed better than the samples that were compacted in the gyratory to the same air void. The overall rankings suggest that stiffer binders play a role in determining the SIP of the mixture. The mix FM7-0 ranked very low and the mix FM7-7 performed very well in the Hamburg due to the additional binder stiffness from the shingles.

Table 7.1 Ranking of mixes by stripping inflection point

RANK	Mix	ESAL	WMA/HMA	Type	SIP
1	FM7-7	1M	WMA	CORE	20000
2	FM4	3M	HMA	CORE	20000
3	FM2	10M	WMA	CORE	20000
4	FM2	10M	HMA	CORE	20000
5	FM4	3M	WMA	CORE	20000
6	FM4	3M	HMA	LAB	18675
7	FM7-7	1M	WMA	LAB	18195
8	FM3	3M	HMA	LAB	17003
9	FM3	3M	WMA	CORE	16808
10	FM3	3M	WMA	LAB	15370
11	FM5	300K	WMA	LAB	12515
12	FM3	3M	HMA	CORE	12481
13	FM2	10M	WMA	LAB	12428
14	FM7-5	1M	WMA	CORE	12428
15	FM6	1M	WMA	CORE	10160
16	FM5	300K	WMA	CORE	9783
17	FM2	10M	HMA	LAB	9251
18	FM7-5	1M	WMA	LAB	7926
19	FM6	1M	WMA	LAB	5916
20	FM 7-0	1M	WMA	CORE	5620
21	FM 7-0	1M	WMA	LAB	4533

*FM4 WMA lab-compacted was not tested

7.1.2 Semi-circular bending test mixture rankings

The SCB test measures three different parameters at three different test temperatures, to create nine different mixture rankings. The test temperatures were 2 degrees below the low temperature performance grade (LTPG-2), ten degrees above LTPG (LTPG+10) and 22 degrees above LTPG (LTPG+22). The three parameters measured by the test are fracture toughness, K_{ic} , the work of fracture, G_f , and the stiffness. The mixture rankings for fracture toughness are shown in Table 7.2. The table shows that FM3 HMA lab and FM3 WMA cores having the highest toughness for temperatures of LTPG-2 and LTPG+10. It is difficult to deduce clear trends from this type of ranking due to the high number of results but these ranks will be used in assigning z-

scores to compare these mixes and the K_{ic} values will be used to determine if there are correlations between low temperature SCB values and low temperature performance grade as measured in the BBR.

Table 7.3 shows the work of fracture rankings at each temperature. FM3 performed notably better at all three temperatures in this category. The tests for FM3 took longer meaning that more energy was exerted by the testing machine to break these mixes at all three temperatures. The increased time, caused more area under the stress-strain curve which translates to a higher work of fracture. This indicates that FM3 will perform better in low temperature situations. The FM2 cores produced noticeably poor results compared to other mixes in work of fracture for PG+10 and PG+22. This may be due to a test bias because FM2 has a LTPG of -28 and test temperatures were lower.

Table 7.4 shows the stiffness rankings for the SCB test. Stiffness is ranked from lowest to highest because a lower stiffness is desirable at lower temperatures, indicating that a mixture is less brittle and less prone to low temperatures cracking. The FM7-7 mix with a high amount of shingles measures the lowest stiffness for two of the three temperatures tested, giving this mix the highest ranking. FM2 and FM4 appear to have the highest in stiffness. This indicates that at the low temperatures, there is much more than the binder stiffness that plays into the stiffness values that are calculated according to the SCB test. Studies investigating the sensitivity of the designated test temperature due to low temperature performance grade on SCB test results should be performed. A study may show that a LTPG of -24 and test temperature of -26 may evaluate a mixture differently than a binder with a -28 LTPG tested at -30. The test may have a bias to higher test temperatures if a fracture energy level is set as a pass-fail criteria. Gradation will likely also play a role in the results.

Table 7.2 Ranking of mixes by fracture toughness

Rank for Kic at PG-2	Mix Category	Kic at PG-2 (Mpa*m ^{0.5})	Rank for Kic at PG+10	Mix Category	Kic at PG+10 (Mpa*m ^{0.5})	Rank for Kic at PG+22	Mix Category	Kic at PG+22 (Mpa*m ^{0.5})
1	FM3 HMA LAB	1.00	1	FM3 HMA LAB	1.01	1	FM4 HMA CORE	0.99
2	FM3 WMA CORE	0.94	2	FM3 WMA CORE	0.95	2	FM4 WMA CORE	0.93
3	FM2 HMA LAB	0.91	3	FM2 WMA CORES	0.91	3	FM7-0 WMA CORE	0.84
4	FM4 WMA CORE	0.90	4	FM4 HMA CORE	0.89	4	FM2 WMA CORES	0.81
5	FM2 WMA CORES	0.89	5	FM2 WMA LAB	0.89	5	FM4 HMA LAB	0.79
6	FM4 WMA LAB	0.88	6	FM2 HMA LAB	0.88	6	FM2 HMA CORES	0.79
7	FM4 HMA CORE	0.87	7	FM4 HMA LAB	0.87	7	FM2 WMA LAB	0.77
8	FM3 WMA LAB	0.86	8	FM3 WMA LAB	0.86	8	FM4 WMA LAB	0.77
9	FM2 WMA LAB	0.86	9	FM7-5 CORE	0.83	9	FM6 WMA CORE	0.74
10	FM4 HMA LAB	0.85	10	FM3 HMA CORE	0.82	10	FM3 WMA CORE	0.73
11	FM2 HMA CORES	0.85	11	FM7-7 CORE	0.82	11	FM7-7 CORE	0.72
12	FM6 WMA CORE	0.85	12	FM4 WMA CORE	0.82	12	FM2 HMA LAB	0.72
13	FM7-7 CORE	0.84	13	FM7-5 LAB	0.81	13	FM3 HMA CORE	0.70
14	FM5 WMA LAB	0.81	14	FM4 WMA LAB	0.77	14	FM3 HMA LAB	0.67
15	FM3 HMA CORE	0.78	15	FM5 WMA LAB	0.75	15	FM7-0 WMA LAB	0.64
16	FM7-0 WMA CORE	0.77	16	FM6 WMA CORE	0.75	16	FM3 WMA LAB	0.64
17	FM6 WMA LAB	0.74	17	FM6 WMA LAB	0.74	17	FM5 WMA LAB	0.62
18	FM7-7 LAB	0.73	18	FM7-0 WMA CORE	0.74	18	FM6 WMA LAB	0.56
19	FM7-5 LAB	0.72	19	FM7-7 LAB	0.72	19	FM7-5 CORE	0.56
20	FM5 WMA CORE	0.70	20	FM7-0 WMA LAB	0.72	20	FM5 WMA CORE	0.54
21	FM7-5 CORE	0.67	21	FM5 WMA CORE	0.65	21	FM7-5 LAB	0.52
22	FM7-0 WMA LAB	0.66	22	FM2 HMA CORES	0.64	22	FM7-7 LAB	0.52

Table 7.3 Ranking of mixes by work of fracture

Rank for Gf at PG-2	Mix Category	AVE Gf at PG-2 (J/m ²)	Rank for Gf at PG+10	Mix Category	AVE Gf at PG+10 (J/m ²)	Rank for Gf at PG+22	Mix Category	AVE Gf at PG+22 (J/m ²)
1	FM5 WMA LAB	909.2	1	FM3 WMA CORE	1691.1	1	FM3 HMA CORE	2709.6
2	FM3 HMA LAB	756.5	2	FM3 HMA LAB	1653.4	2	FM3 WMA LAB	2481.7
3	FM3 WMA CORE	690.8	3	FM3 HMA CORE	1581.6	3	FM3 HMA LAB	2425.0
4	FM2 WMA LAB	679.5	4	FM2 WMA LAB	1386.6	4	FM2 HMA LAB	2202.0
5	FM3 WMA LAB	651.8	5	FM2 HMA LAB	1282.2	5	FM7-7 CORE	2166.5
6	FM2 HMA LAB	586.1	6	FM7-5 LAB	1261.0	6	FM6 WMA LAB	2135.5
7	FM6 WMA LAB	575.6	7	FM4 WMA LAB	1221.2	7	FM6 WMA CORE	1995.3
8	FM2 WMA CORES	575.4	8	FM3 WMA LAB	1146.8	8	FM3 WMA CORE	1994.6
9	FM2 HMA CORES	574.2	9	FM7-5 CORE	1095.6	9	FM4 WMA CORE	1982.9
10	FM4 HMA CORE	569.4	10	FM6 WMA LAB	982.5	10	FM5 WMA LAB	1859.7
11	FM7-7 CORE	556.8	11	FM6 WMA CORE	964.4	11	FM7-7 LAB	1767.9
12	FM3 HMA CORE	527.2	12	FM5 WMA CORE	922.2	12	FM4 WMA LAB	1667.1
13	FM6 WMA CORE	514.6	13	FM7-7 CORE	915.4	13	FM4 HMA CORE	1570.3
14	FM4 WMA LAB	503.5	14	FM7-0 WMA LAB	888.1	14	FM4 HMA LAB	1551.4
15	FM5 WMA CORE	499.9	15	FM7-7 LAB	790.1	15	FM7-0 WMA CORE	1538.0
16	FM4 HMA LAB	481.7	16	FM7-0 WMA CORE	765.4	16	FM5 WMA CORE	1530.3
17	FM7-0 WMA CORE	472.3	17	FM4 WMA CORE	748.9	17	FM2 WMA LAB	1481.8
18	FM7-5 CORE	417.0	18	FM5 WMA LAB	743.3	18	FM7-5 CORE	1407.8
19	FM7-5 LAB	397.1	19	FM4 HMA LAB	727.4	19	FM7-5 LAB	1390.0
20	FM7-7 LAB	381.1	20	FM4 HMA CORE	644.4	20	FM7-0 WMA LAB	1235.6
21	FM7-0 WMA LAB	342.2	21	FM2 WMA CORES	627.6	21	FM2 HMA CORES	1141.2
22	FM4 WMA CORE	255.8	22	FM2 HMA CORES	576.6	22	FM2 WMA CORES	1031.5

Table 7.4 Ranking of mixtures by stiffness measured by SCB testing

Rank for Stiffness at PG-2	Mix Category	Stiffness (kN/mm)	Rank for Stiffness at PG+10	Mix Category	Stiffness (kN/mm)	Rank for Stiffness at PG+22	Mix Category	Stiffness (kN/mm)
1	FM7-7 LAB	4.11	1	FM7-5 LAB	2.9	1	FM7-7 LAB	1.46
2	FM5 WMA LAB	4.31	2	FM6 WMA LAB	2.94	2	FM2 HMA LAB	1.75
3	FM5 WMA CORE	4.87	3	FM2 WMA LAB	3.35	3	FM7-5 LAB	1.77
4	FM7-0 WMA LAB	5.04	4	FM7-5 CORE	3.51	4	FM5 WMA LAB	1.84
5	FM6 WMA LAB	5.05	5	FM7-7 LAB	3.52	5	FM6 WMA LAB	1.93
6	FM7-5 CORE	5.13	6	FM5 WMA CORE	3.55	6	FM5 WMA CORE	1.98
7	FM7-5 LAB	5.15	7	FM2 HMA LAB	3.59	7	FM3 HMA LAB	2.06
8	FM7-7 CORE	5.3	8	FM6 WMA CORE	3.69	8	FM3 WMA LAB	2.07
9	FM2 WMA LAB	5.46	9	FM2 HMA CORES	3.75	9	FM3 HMA CORE	2.1
10	FM3 WMA LAB	5.56	10	FM3 HMA CORE	4.07	10	FM6 WMA CORE	2.17
11	FM2 HMA CORES	5.89	11	FM5 WMA LAB	4.25	11	FM7-5 CORE	2.2
12	FM4 HMA CORE	6.22	12	FM3 WMA LAB	4.25	12	FM7-7 CORE	2.35
13	FM6 WMA CORE	6.47	13	FM7-0 WMA LAB	4.3	13	FM2 HMA CORES	2.43
14	FM4 WMA LAB	6.6	14	FM7-0 WMA CORE	4.42	14	FM3 WMA CORE	2.66
15	FM3 WMA CORE	6.84	15	FM3 HMA LAB	4.52	15	FM4 HMA CORE	3.07
16	FM7-0 WMA CORE	6.9	16	FM3 WMA CORE	4.57	16	FM2 WMA LAB	3.08
17	FM3 HMA CORE	7.22	17	FM7-7 CORE	4.57	17	FM4 HMA LAB	3.19
18	FM2 WMA CORES	7.23	18	FM4 WMA LAB	5.4	18	FM4 WMA LAB	3.21
19	FM4 HMA LAB	7.37	19	FM4 WMA CORE	5.54	19	FM7-0 WMA LAB	3.21
20	FM3 HMA LAB	7.44	20	FM4 HMA LAB	5.76	20	FM7-0 WMA CORE	3.35
21	FM2 HMA LAB	7.51	21	FM2 WMA CORES	6.19	21	FM4 WMA CORE	3.41
22	FM4 WMA CORE	8.68	22	FM4 HMA CORE	7.12	22	FM2 WMA CORES	4.97

7.1.3 Dynamic modulus test mixture rankings

The dynamic modulus values are shown in Table 7.5, Table 7.6, and Table 7.7. This test measures stiffness at 4, 21 and 37°C. The dynamic modulus test is run at nine frequencies. In order to make the rankings, the frequencies over the nine frequencies were averaged for each temperature and that is how the E*, shown in Table 7.5, Table 7.6, and Table 7.7 were

calculated. The stiffness increases with reducing temperature. The mixture FM4 shows the highest stiffness at all three temperatures. This indicates a high rutting resistance at high temperatures. Rankings for 4°C show lower E* as higher ranked because, similar to stiffness measured by the SCB, a lower E* indicates better resistance to low temperature cracking. The intermediate temperatures of 21°C is also ranked with the lowest E* having the highest rank. The lower E* values are assumed to have better resistance to fatigue cracking. High E* values are desired at high temperatures, indicating a mixture's ability to resist rutting.

Table 7.5 Ranking of mixtures by dynamic modulus measured at 4°C

Rank at 4C	Mix Name	E* Average at 4°C (kPa)	Rank at 4°C	Mix Name	E* Average at 4°C (kPa)
1	FM6 Lab NMC	6.53E+06	21	FM2 HMA Lab NMC	1.14E+07
2	FM7-5 MC	7.61E+06	22	FM7-0 Field NMC	1.15E+07
3	FM7-7 MC	8.23E+06	23	FM6 Field NMC	1.15E+07
4	FM7-7 NMC	8.80E+06	24	FM5 LAB NMC	1.16E+07
5	FM6 Field MC	9.07E+06	25	FM4 HMA Lab MC	1.16E+07
6	FM7-5 NMC	9.42E+06	26	FM5 FIELD NMC	1.17E+07
7	FM6 Lab MC	9.65E+06	27	FM3 WMA Lab MC	1.17E+07
8	FM2 WMA Lab MC	9.66E+06	28	FM3 HMA Field MC	1.24E+07
9	FM7-0 Lab MC	9.70E+06	29	FM3 WMA Field NMC	1.28E+07
10	FM2 WMA Field MC	9.73E+06	30	FM3 WMA Lab NMC	1.39E+07
11	FM5 Lab MC	9.92E+06	31	FM3 HMA Field NMC	1.40E+07
12	FM5 FIELD MC	1.02E+07	32	FM3 HMA Lab MC	1.40E+07
13	FM7-0 Field MC	1.03E+07	33	FM3 HMA Lab NMC	1.45E+07
14	FM2 WMA Lab NMC	1.06E+07	34	FM4 WMA Field MC	1.56E+07
15	FM2 HMA Lab MC	1.06E+07	35	FM4 WMA Lab MC	1.56E+07
16	FM2 HMA Field NMC	1.08E+07	36	FM4 HMA Field MC	1.58E+07
17	FM2 HMA Field MC	1.11E+07	37	FM4 HMA Field NMC	1.59E+07
18	FM2 WMA Field NMC	1.13E+07	38	FM4 HMA Lab NMC	1.59E+07
19	FM3 WMA Field MC	1.14E+07	39	FM4 WMA Field NMC	1.72E+07
20	FM7-0 Lab NMC	1.14E+07	40	FM4 WMA Lab NMC	1.84E+07

Table 7.6 Ranking of mixtures by dynamic modulus measured at 21°C

Rank at 21C	Mix Name	E* Average at 21°C (kPa)	Rank at 21°C	Mix Name	E* Average at 21°C (kPa)
1	FM2 WMA Field MC	3.01E+06	21	FM3 WMA Lab NMC	4.11E+06
2	FM2 WMA Lab MC	3.17E+06	22	FM6 Lab NMC	4.18E+06
3	FM7-5 MC	3.24E+06	23	FM7-0 Lab NMC	4.24E+06
4	FM7-7 MC	3.32E+06	24	FM7-0 Field NMC	4.31E+06
5	FM3 WMA Field MC	3.39E+06	25	FM6 Field NMC	4.35E+06
6	FM3 WMA Lab MC	3.41E+06	26	FM5 Lab MC	4.35E+06
7	FM2 HMA Lab MC	3.41E+06	27	FM3 HMA Field NMC	4.38E+06
8	FM7-0 Lab MC	3.49E+06	28	FM5 FIELD MC	4.39E+06
9	FM2 HMA Field NMC	3.60E+06	29	FM3 HMA Lab MC	4.47E+06
10	FM2 WMA Lab NMC	3.66E+06	30	FM3 HMA Lab NMC	4.56E+06
11	FM6 Field MC	3.69E+06	31	FM5 FIELD NMC	5.13E+06
12	FM7-7 NMC	3.73E+06	32	FM5 LAB NMC	5.18E+06
13	FM3 HMA Field MC	3.74E+06	33	FM4 HMA Lab MC	5.18E+06
14	FM7-5 NMC	3.77E+06	34	FM4 HMA Field MC	5.78E+06
15	FM2 HMA Lab NMC	3.82E+06	35	FM4 HMA Lab NMC	5.98E+06
16	FM6 Lab MC	3.88E+06	36	FM4 WMA Field MC	6.14E+06
17	FM2 HMA Field MC	3.88E+06	37	FM4 WMA Lab MC	6.33E+06
18	FM2 WMA Field NMC	3.89E+06	38	FM4 HMA Field NMC	6.58E+06
19	FM7-0 Field MC	3.96E+06	39	FM4 WMA Field NMC	6.61E+06
20	FM3 WMA Field NMC	3.96E+06	40	FM4 WMA Lab NMC	7.38E+06

Table 7.7 Ranking of mixtures by dynamic modulus measured at 37°C

Rank at 37C	Mix Name	E* Average at 37°C (kPa)	Rank at 37°C	Mix Name	E* Average at 37°C (kPa)
1	FM4 WMA Lab NMC	1.99E+06	21	FM2 HMA Lab MC	1.10E+06
2	FM5 LAB NMC	1.90E+06	22	FM2 WMA Field NMC	1.09E+06
3	FM4 HMA Lab MC	1.90E+06	23	FM6 Field MC	1.09E+06
4	FM4 WMA Lab MC	1.84E+06	24	FM2 HMA Field MC	1.08E+06
5	FM4 WMA Field MC	1.75E+06	25	FM6 Lab MC	1.07E+06
6	FM4 HMA Field NMC	1.74E+06	26	FM2 HMA Field NMC	1.07E+06
7	FM4 HMA Lab NMC	1.73E+06	27	FM7-0 Lab MC	1.05E+06
8	FM4 WMA Field NMC	1.69E+06	28	FM2 HMA Lab NMC	1.04E+06
9	FM5 FIELD NMC	1.62E+06	29	FM2 WMA Lab MC	1.03E+06
10	FM4 HMA Field MC	1.55E+06	30	FM3 HMA Field NMC	1.01E+06
11	FM5 Lab MC	1.35E+06	31	FM3 WMA Field NMC	1.00E+06
12	FM5 FIELD MC	1.33E+06	32	FM2 WMA Field MC	9.96E+05
13	FM6 Lab NMC	1.23E+06	33	FM3 WMA Lab NMC	9.66E+05
14	FM6 Field NMC	1.21E+06	34	FM7-0 Field MC	9.58E+05
15	FM3 HMA Lab MC	1.20E+06	35	FM2 WMA Lab NMC	9.49E+05
16	FM7-7 NMC	1.18E+06	36	FM3 WMA Field MC	9.45E+05
17	FM7-7 MC	1.17E+06	37	FM7-5 MC	9.30E+05
18	FM3 HMA Lab NMC	1.15E+06	38	FM3 HMA Field MC	8.90E+05
19	FM7-5 NMC	1.13E+06	39	FM7-0 Lab NMC	8.58E+05
20	FM7-0 Field NMC	1.12E+06	40	FM3 WMA Lab MC	8.40E+05

7.1.4 Indirect tensile strength rankings

The indirect tensile strength ranks were developed for the TSR and for the actual strength values shown in Table 7.8 and Table 7.9, respectively. The strength values included wet and dry values. Since TSR was an important measurement for determining the moisture susceptibility in many states, it was also included in the ranking evaluations. The highest average TSR is FM4-WMA-not reheated and the lowest TSR is the mixture with 7% singles. The highest strength is the FM4 mixes and the lowest tensile strength is FM7-0 which is a shoulder mixture with a PG 58-28 binder.

Table 7.8 Ranking of mixtures by tensile strength ratio

Rank	Mixture Category		4" Dia. TSR
1	FM4	Average TSR WMA Field Compacted	1.06
2	FM2	Average TSR HMA Field Compacted	1.02
3	FM3	Average TSR HMA Field Compacted	0.98
4	FM6	Average TSR WMA Lab Compacted	0.96
5	FM5	Average TSR WMA Lab Compacted	0.96
6	FM3	Average TSR HMA Lab Compacted	0.96
7	FM6	Average TSR WMA Field Compacted	0.94
8	FM5	Average TSR WMA Field Compacted	0.93
9	FM2	Average TSR HMA Lab Compacted	0.93
10	FM4	Average TSR HMA Lab Compacted	0.92
11	FM3	Average TSR WMA Lab Compacted	0.91
12	FM2	Average TSR WMA Lab Compacted	0.88
13	FM7-0	Average TSR WMA Lab Compacted	0.87
14	FM4	Average TSR HMA Field Compacted	0.87
15	FM2	Average TSR WMA Field Compacted	0.87
16	FM4	Average TSR WMA Lab Compacted	0.84
17	FM3	Average TSR WMA Field Compacted	0.81
18	FM7-0	Average TSR WMA Field Compacted	0.73
19	FM7-5	Average TSR WMA Lab Compacted	0.70
20	FM7-7	Average TSR WMA Lab Compacted	0.65

Table 7.9 Ranking of mixes by indirect tensile strength

Rank	Mixture	Strength (kPa)	Rank	Mixture	Strength (kPa)
1	FM4 HMA Lab NMC	1300	21	FM6 Lab MC	993
2	FM4 WMA Lab NMC	1252	22	FM5 Field MC	988
3	FM4 HMA Field NMC	1228	23	FM6 Field MC	942
4	FM4 HMA Lab MC	1190	24	FM2 WMA Lab NMC	912
5	FM4 WMA Field MC	1129	25	FM7-0 Field NMC	904
6	FM3 HMA Lab NMC	1111	26	FM7-0 Lab MC	883
7	FM5 Lab NMC	1089	27	FM3 WMA Lab NMC	862
8	FM7-7 Lab NMC	1082	28	FM3 WMA Field NMC	833
9	FM4 WMA Field NMC	1069	29	FM2 WMA Field NMC	827
10	FM4 HMA Field MC	1067	30	FM2 HMA Lab NMC	808
11	FM3 HMA Lab MC	1061	31	FM2 WMA Lab MC	802
12	FM5 Field NMC	1056	32	FM3 WMA Lab MC	786
13	FM4 WMA Lab MC	1052	33	FM2 HMA Field MC	758
14	FM5 Lab MC	1040	34	FM2 HMA Lab MC	749
15	FM6 Lab NMC	1037	35	FM2 HMA Field NMC	744
16	FM3 HMA Field NMC	1032	36	FM2 WMA Field MC	715
17	FM7-0 Lab NMC	1020	37	FM7-5 Lab MC	702
18	FM6 Field NMC	1008	38	FM7-7 Lab MC	697
19	FM3 HMA Field MC	1007	39	FM3 WMA Field MC	670
20	FM7-5 Lab NMC	1006	40	FM7-0 Field MC	641

7.1.5 Flow number mixture rankings

Several factors for each mixture were included in the flow number comparison. The higher ranking mixes indicate higher flow number values. Flow number is the point in the stress-strain graph at which the mixture reaches tertiary flow under a 600 kPa load applied at 1Hz. The flow number rankings are shown in Table 7.10. The stiffer mixes perform better in this test and it is also sensitive to the amount of recycled material within a mixture. The higher flow number values represent increased rutting resistance. The softer binders do not typically perform as well in the flow number test. FM4 performed relatively high, only behind the mixture with 7% shingles. The lowest flow number average is the category FM2-WMA-Lab-NMC, with a flow number of only 249.

Table 7.10 Ranking of mixtures by flow number

Rank	Category	FN	Rank	Category	FN
1	FM7-7 Lab MC	10000	21	FM3 HMA Field MC	731
2	FM7-7 Lab NMC	9850	22	FM3 WMA Lab MC	714
3	FM4 WMA Lab MC	3542	23	FM6 Lab MC	702
4	FM4 HMA Lab MC	3106	24	FM2 HMA Lab MC	682
5	FM4 WMA Field MC	2924	25	FM2 HMA Field MC	661
6	FM4 WMA Lab NMC	2810	26	FM3 WMA Field MC	632
7	FM4 HMA Lab NMC	2575	27	FM3 WMA Lab NMC	621
8	FM4 HMA Field MC	2486	28	FM6 Lab NMC	618
9	FM3 HMA Lab MC	2239	29	FM7-0 Field MC	596
10	FM4 HMA Field NMC	2051	30	FM2 HMA Field NMC	592
11	FM4WMA Field NMC	2006	31	FM2 WMA Field MC	585
12	FM7-5 Lab NMC	1856	32	FM2 HMA Lab NMC	565
13	FM7-5 Lab MC	1545	33	FM6 Field MC	556
14	FM5 Field MC	1494	34	FM2 WMA Lab MC	523
15	FM5 Field NMC	1358	35	FM6 Field NMC	502
16	FM5 Lab MC	1305	36	FM7-0 Lab MC	439
17	FM5 Lab NMC	1295	37	FM7-0 Lab NMC	382
18	FM3 HMA Lab NMC	1260	38	FM2 WMA Field NMC	374
19	FM3 WMA Field NMC	768	39	FM7-0 Field NMC	285
20	FM3 HMA Field NMC	755	40	FM2 WMA Lab NMC	249

7.1.6 Binder rankings

The binder rankings shown in Table 7.11 rank all tested mixes by failure temperature at high, medium and low temperatures. The high, intermediate and low temperature binder failure test temperatures are shown with the corresponding rank. The binders for recovered and original tank are noted. The recovered binder is higher than the tank binder due to in-field stiffening and the addition of RAP or RAS binder extracted from the mixture. The low temperature is ranked from lowest failure temperature to highest, reflecting the fact that a lower performance grade is better for low temperature cracking resistance.

Table 7.11 Ranking of mixtures by binder according to high, medium, and low properties

High Temp Rank	MIX	High Temp	Intermediate Rank	MIX	Int.	Low Temp Rank	MIX	Low
1	FM7-7 WMA Recovered	HIGH	1	FM2 HMA Tank	16.8	1	FM7 WMA RTFO Tank	-30.7
2	FM7-5 WMA Recovered	79.4	2	FM2 WMA Tank	17.4	2	FM7-0 WMA Recovered	-29.9
3	FM4 HMA Recovered	79.0	3	FM7 WMA RTFO Tank	17.6	3	FM2 WMA Tank	-29.9
4	FM3 HMA Recovered	79.0	4	FM2 HMA Recovered	20.5	4	FM2 HMA Tank	-28.7
5	FM5 WMA Recovered	78.8	5	FM5 WMA RTFO Tank	20.7	5	FM3 HMA Tank	-26.3
6	FM4 WMA Recovered	78.2	6	FM7-0 WMA Recovered	20.7	6	FM5 WMA RTFO Tank	-25.2
7	FM3 WMA Recovered	75.5	7	FM3 WMA RTFO Tank	21	7	FM2 HMA Recovered	-24.2
8	FM2 HMA Recovered	74.5	8	FM3 HMA Tank	21.3	8	FM2 WMA Recovered	-24
9	FM2 WMA Recovered	73.4	9	FM6 WMA RTFO Tank	21.9	9	FM3 WMA RTFO Tank	-23.8
10	FM6 WMA Recovered	73.4	10	FM4 HMA RTFO Tank	23.4	10	FM7-5 WMA Recovered	-23.4
11	FM7-0 WMA Recovered	72.4	11	FM4 WMA RTFO Tank	23.5	11	FM4 HMA RTFO Tank	-23.3
12	FM2 HMA Tank	69.3	12	FM2 WMA Recovered	23.6	12	FM4 WMA RTFO Tank	-22.9
13	FM5 WMA RTFO Tank	68.4	13	FM7-5 WMA Recovered	24.6	13	FM6 WMA RTFO Tank	-21.2
14	FM3 WMA RTFO Tank	67.2	14	FM5 WMA Recovered	25.1	14	FM3 WMA Recovered	-20.4
15	FM4 WMA RTFO Tank	67.1	15	FM6 WMA Recovered	25.1	15	FM4 HMA Recovered	-20.1
16	FM4 HMA RTFO Tank	66.2	16	FM3 HMA Recovered	25.4	16	FM3 HMA Recovered	-19.7
17	FM3 HMA Tank	66.1	17	FM3 WMA Recovered	25.7	17	FM6 WMA Recovered	-19.6
18	FM2 WMA Tank	65.9	18	FM7-7 WMA Recovered	25.9	18	FM4 WMA Recovered	-19.2
19	FM6 WMA RTFO Tank	65.9	19	FM4 WMA Recovered	27.6	19	FM5 WMA Recovered	-18.9
20	FM7 WMA RTFO Tank	60.5	20	FM4 HMA Recovered	27.9	20	FM7-7 WMA Recovered	-16.9

7.1.7 Overall mixture rankings

The objective of ranking the mixes for overall performance is to provide a simplistic way of looking at a big picture comparison of the mixes included in the study. The comparison can only be done if the test results for each mix are standardized. This is done by assigning each test result a z-score. This is done by subtracting the average value from all the test results and then dividing by the standard deviation of test results. Only mixture categories that exist in all mixes will be used. For example, no non-reheated mixes were compacted for FM7-5 and FM7-7 so the

non-reheated mixes were excluded. The standardized values allow comparisons of mixtures to be made as long as all of the same categories are included in the comparison. The z-scores were calculated such that a higher z-score represents a better result for each test. If a z-score is average, it will be zero. If a z-score is negative, it will be below average and if it is positive the score is above average. All performance and binder tests are performed within a certain temperature range and are assigned a temperature category of low, medium or high. A test result will be categorized as “low temperature” if the test temperatures is equal to or less than 4°C, the “medium temperature” category is test temperatures greater than 4°C and equal to or less than 30°C and the high temperature tests are greater than 30°C. The z-scores for each test are separated into their respective temperature categories and averaged for each mix.

The low test temperature ranks are shown in Table 7.12. The low temperature tests incorporates the standardized values from low temperature binder tests, dynamic modulus at 4°C, and the SCB results from all three test temperatures for all three test parameters calculated. The best performing mix is FM3. This mix had a virgin LTPG of -24. The lowest performing mix is FM4 HMA and WMA. This is most likely due to the high stiffness that this mix exhibited. The LTPG was also higher than the average of the mixes included in this study. FM4 is the southernmost mix within the state of Iowa but did exhibit a substantial amount of transverse cracking. This may be due to reflective cracking as well as thermal cracking.

Table 7.12 Ranking of mixes according to low temperature z-score

Low Temp Rank	Mix	LOW Z-Score (TEMP \leq 4°C)
1	FM3 HMA	0.41
2	FM3 WMA	0.38
3	FM7-7 WMA	0.20
4	FM2 HMA	0.18
5	FM6 WMA	0.14
6	FM7-5 WMA	0.07
7	FM2 WMA	0.06
8	FM5 WMA	0.00
9	FM7-0 WMA	-0.26
10	FM4 HMA	-0.31
11	FM4 WMA	-0.47

The intermediate test, Table 7.13, includes the average z-scores from the intermediate binder tests, 4" TSR values, 4" indirect tensile strength and dynamic modulus values measured at 21°C. The highest z-score is FM7-0. This mixture did have a PG58-28 PG binder and it exhibited below average E* values for dynamic modulus that helped increase the rank for intermediate temperatures. The mixtures, FM4 WMA and FM7-7, performed the poorest in the intermediate temperatures. The low result for FM7-7 is expected because these mixes use shingles and the intermediate binder failure temperature will be increased. Additional testing such as beam fatigue could be performed to provide additional information about the fatigue strength of each mix.

Table 7.13 Ranking of mixes according to intermediate temperature z-score

Int. Temp Rank	Mix	MEDIUM (4°C<TEMP≤30°C)
1	FM7-0 WMA	0.43
2	FM2 HMA	0.33
3	FM2 WMA	0.29
4	FM3 HMA	0.24
5	FM6 WMA	0.24
6	FM5 WMA	0.18
7	FM4 HMA	-0.03
8	FM7-5 WMA	-0.04
9	FM3 WMA	-0.07
10	FM7-7 WMA	-0.11
11	FM4 WMA	-0.62

The high temperature z-score, Table 7.14, includes the high temperature binder grade, flow number, dynamic modulus measured at 37°C, and the stripping inflection point. The highest performing mix is FM7-7 because of its high stiffness which will perform well in rutting. FM4 is also a stiffer mixture and shows evidence of also performing well in rutting. The lowest ranking mixture for high temperature is FM7-0. This mixture is for a shoulder and had a softer binder of PG 58-28. The combination of low traffic design and softer binder gives this mixture a low ranking in high temperature performance.

Table 7.14 Ranking of mixes according to high temperature z-score

High Temp Rank	Mix	HIGH (30°C≤TEMP)
1	FM7-7 WMA	1.20
2	FM4 WMA	0.97
3	FM4 HMA	0.84
4	FM5 WMA	0.17
5	FM3 HMA	0.02
6	FM3 WMA	-0.14
7	FM2 HMA	-0.23
8	FM2 WMA	-0.33
9	FM7-5 WMA	-0.41
10	FM6 WMA	-0.56
11	FM7-0 WMA	-0.79

The overall z-score was calculated by averaging the low, medium and high temperature z-score for each mix. The scores could be adjusted by giving different temperature ranges weighted factors. For example, Texas would give a lower factor to low temperature performance. In Iowa, pavement performance for all three temperature ranges is important because summer pavement temperatures are very warm, requiring rutting resistance and winter pavement temperatures can be very cold, requiring thermal cracking resistance. Intermediate temperature performance is also very important because some roadways in Iowa experience a considerable amount of truck traffic and heavy loading. Table 7.15 shows the overall average z-score. The z-scores begin to converge upon zero because a mix that exhibits excellent performance in one temperature range may not perform as well in another temperature range. The overall average shows FM7-7 with the highest ranking. This is because this mixture showed excellent scores in high temperature tests and above average in intermediate with only a slight decrease due to the low temperature z-score. The z-score was low for the low temperature range but had a low temperature z-score of only -0.60. Each HMA and WMA mixture ranking showed the HMA mix outranking the WMA mix. This is likely due to higher stiffness in the HMA, in general. This

does not prove statistical differences but shows a suggestive trend. Statistical differences within mixes are discussed in detail in Chapter 4. The lowest overall performing mix is FM7-0. This is due to the low stiffness of this mixture, poor TSR values, and poor Hamburg test results. This mixture is a shoulder mix and does not experience traffic loading. The overall rankings do not reflect the performance within a specific range of temperature but the overall performance of the mixes when compared with each other and how the standardized test results compare.

Table 7.15 Overall rank using the average z-score for low, medium, and high temperature ranges

Rank	Mix	AVERAGE Z-Score
1	FM7-7 WMA	0.43
2	FM3 HMA	0.22
3	FM4 HMA	0.17
4	FM5 WMA	0.12
5	FM2 HMA	0.10
6	FM3 WMA	0.06
7	FM2 WMA	0.01
8	FM4 WMA	-0.04
9	FM6 WMA	-0.06
10	FM7-5 WMA	-0.13
11	FM7-0 WMA	-0.21

7.2 Performance test correlations

The purpose of looking at correlations between the test results is to document how changes in one material property may influence other performance results. For example, if a binder is softer due to a WMA additive, it is important to show how a change in binder may influence the dynamic modulus results or Hamburg results. Another example is to show how changes in low temperature properties influence tests like the SCB and display any correlations of SCB stiffness with dynamic modulus, which is also a measurement of stiffness. By studying

these correlations, the relationships between the material properties are better understood. When additives or a new process changes the binder properties, the correlations will help to show which properties are the most influenced and which may not be impacted.

7.2.1 Comparison of dynamic modulus and binder properties

To compare the dynamic modulus values at each temperature, the average of all the tested frequencies was used. Figure 7.1, Figure 7.2 and Figure 7.3 show the trends of the dynamic modulus and display binder failure temperature on the y-axis and dynamic modulus on the x-axis. Figure 7.1 shows the values of the dynamic modulus at 4°C. The low temperature binders do not show strong R^2 values but the intermediate temperatures show better trends. Figure 7.2 shows the dynamic modulus values measured at 21°C. The intermediate binder failure temperatures show a better correlation than the high binder failure temperature. It is likely that the trend is better for the intermediate binder test temperatures because those temperatures are very close to the 21°C that the dynamic modulus values are measured. The trend of increasing dynamic modulus values with increasing binder temperatures should be somewhat related because each material property is a function of stiffness. The binder failure temperatures are related to the stiffness of the binder and the dynamic modulus should correlate with the stiffness of the binder as well. All the graphs show the appropriate trend of increasing dynamic modulus value with increasing binder failure temperature. To develop prediction models, the data would have to be further categorized by each factor that was investigated because of the potential impact each factor has on the mixture results and additional testing would be needed because of the limited number of test replicates. The trends do indicate a repeatable correlation but there may not be enough precision to predict one from the other.

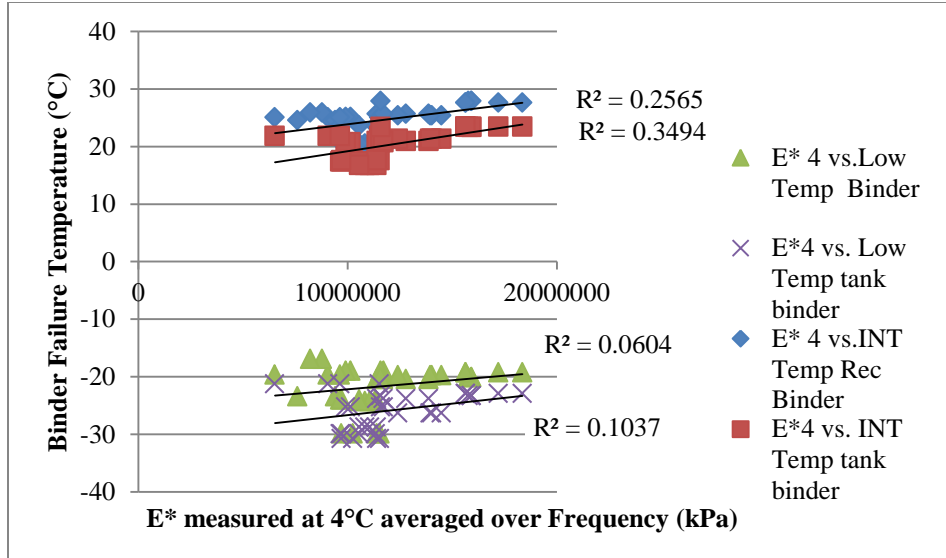

Figure 7.1 Binder properties compared with dynamic modulus at 4°C

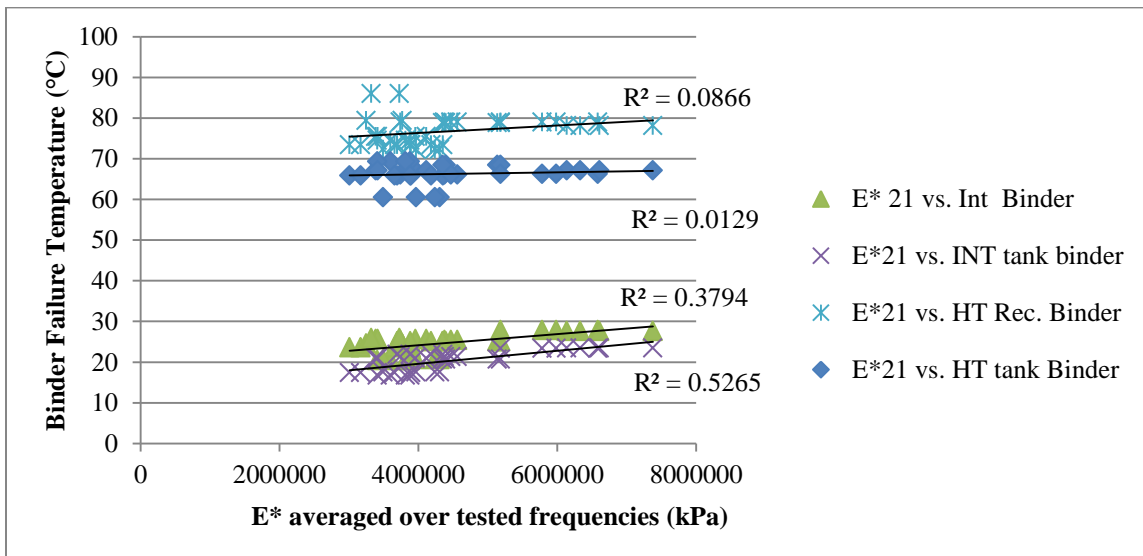

Figure 7.2 Binder properties compared with dynamic modulus at 21°C

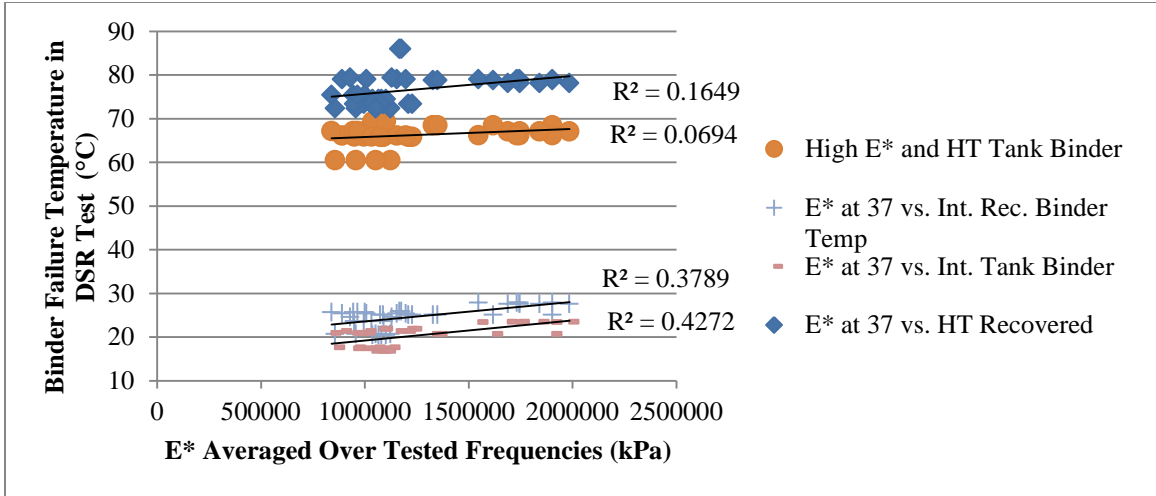

Figure 7.3 Binder properties compared with dynamic modulus at 37°C

Figure 7.3 does not show a strong relationship with the high temperature grade but trends improve when intermediate failure temperatures are compared. The general relationship at all test temperatures is an increasing modulus with binder stiffness.

7.2.2 Comparison of high temp binder grade and flow number

The test results for high temperature binder grade and flow number are compared in Figure 7.4. The flow number shows the best correlation with the recovered binder. The trends show that as the high temperature binder grade increases, the flow number increases. In general, the flow number is sensitive to the amount of RAP within a mixture and this is likely why the recovered binders show the best correlation. The trend shows that binder grade is important in rutting resistance and the point at which a mixture reaches tertiary flow is likely going to depend upon the binder grade of the mixture. This correlation is understood well within the industry but the influence of RAP on the flow number is especially important and Figure 7.4 shows the improvement in correlation when recovered binder is compared instead of the tank binder. This improvement is due to the inclusion of flow numbers with RAS and the RAS recovered binder.

The RAS mixtures for the flow number were not included in the tank binder data set because there is no way to incorporate the stiffness of the RAS binder with the tank binder. The binder replaced by the RAS during mixing would not be adequately represented in a binder-mix comparison. The wider range of data helps to improve the R^2 value. Further analysis could be performed where each of the factors that may influence the flow number are separated into different sections.

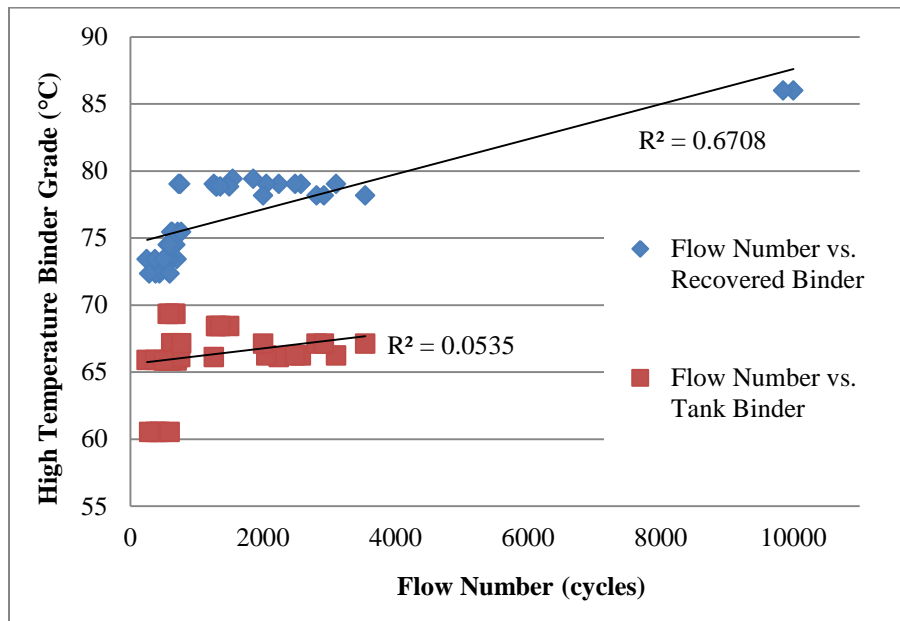

Figure 7.4 Binder properties compared with flow number

7.2.3 Comparison of semi-circular bend test and low temperature binder properties

The general trend in Figure 7.5 and Figure 7.6 show increasing work of fracture with increasing binder temperature and the stiffness at PG+22 when tested in the SCB becomes higher as the binder temperature decreases. Both of these trends are counterintuitive because one would expect higher fracture energy to represent a lower binder temperature grade. Binders with lower temperature grades have a reduced stiffness which allows them to maintain a stiffness level below the 300 MPa requirement, making the trend of increasing stiffness with decreasing binder content a cause for concern. The R^2 values are relatively low but the trends the trends are

suggestive. The aggregate orientation and placement within a sample plays a large role in this test which is probably why the R^2 values are fairly low and with high scatter. The general trends between the SCB test and its correlation with low temperature binder properties are important to look at because the SCB test is relatively new. Identifying trends that are counterintuitive illustrates that testing procedures may need to be reevaluated. The multiple binder grades used, which specifies different testing temperatures can also factor into the counterintuitive trends.

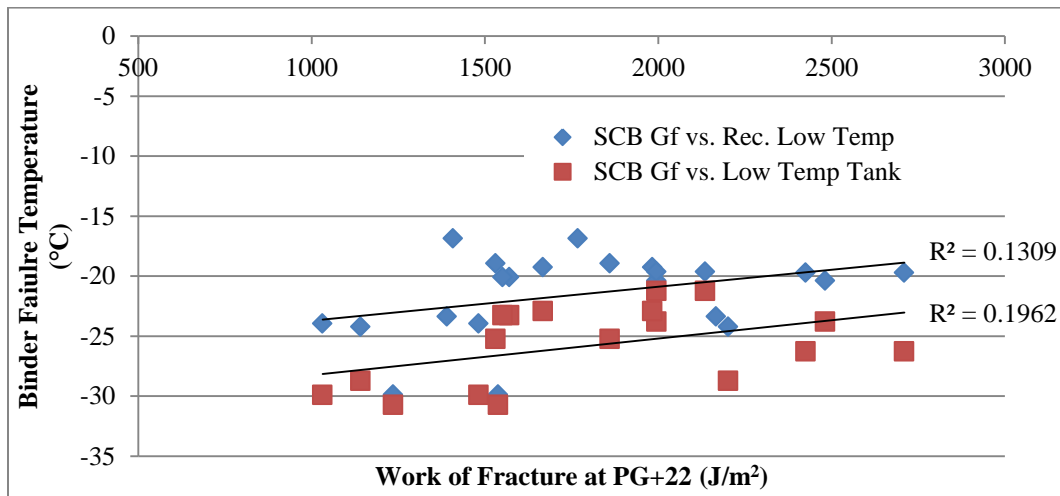

Figure 7.5 Binder properties compared with SCB work of fracture measured at PG+22

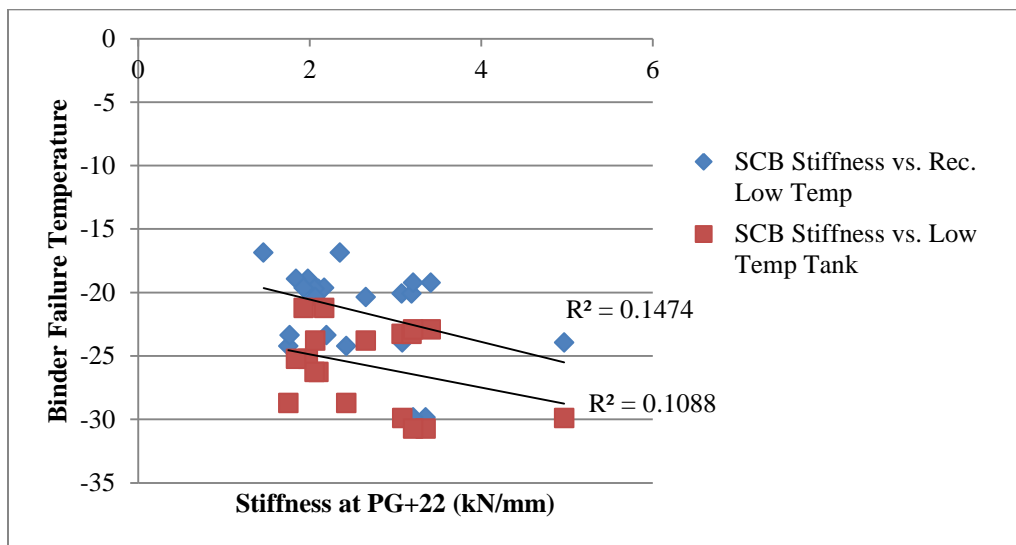

Figure 7.6 Binder properties compared with SCB stiffness measured at PG+22

7.2.4 Comparison of semi-circular bend test and dynamic modulus

No correlations between work of fracture and dynamic modulus were found at any SCB test temperature. The R^2 values were low and the data appeared scattered. The K_{ic} values measured in the SCB show an increasing trend with increasing E^* . This is expected because the K_{ic} is a function of the peak strength and a stiffer material would have a higher peak load. The trends are suggestive and show better trends at the higher SCB test temperatures. The K_{ic} is plotted against the E^* values at 4°C in Figure 7.7. The hypothesis of why this temperature has the best correlations is because the test temperatures are fairly close, PG+22 (0°C or -6°C , depending on LTPG) compared with 4°C . The best correlation with stiffness is the dynamic modulus values at 4°C compared with the stiffness values at LTPG+10, Figure 7.9. All comparisons of stiffness and dynamic modulus, Figure 7.8, Figure 7.9 and Figure 7.10 show the same trend of increasing stiffness with dynamic modulus, with some temperatures giving better correlations than others. Relating the SCB parameters with other tests that are used more within the asphalt industry, helps to show which parameters may be the most useful in the SCB tests and how they compare to other to other performance tests that have been used in industry for longer periods of time.

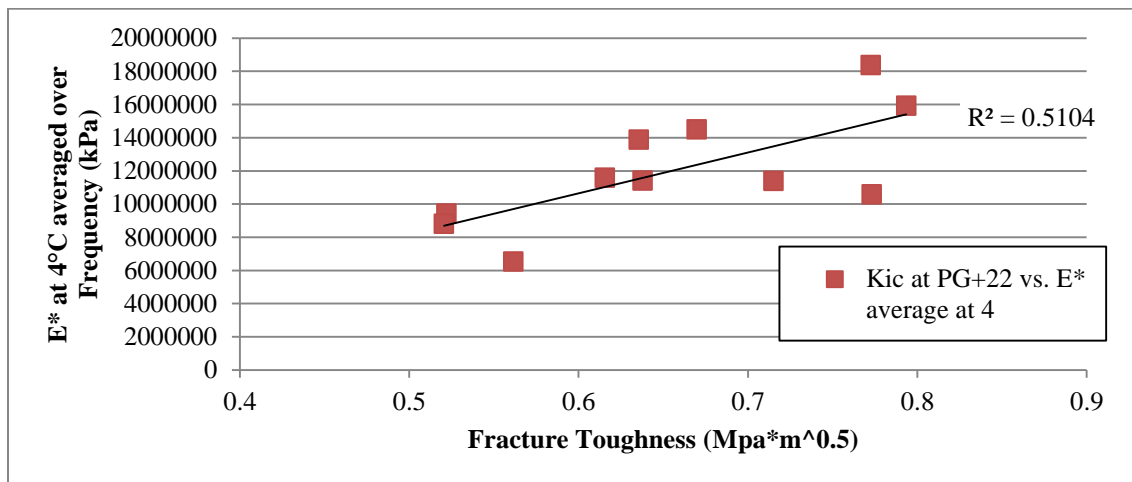

Figure 7.7 Dynamic modulus at 4°C compared with fracture toughness at PG+22

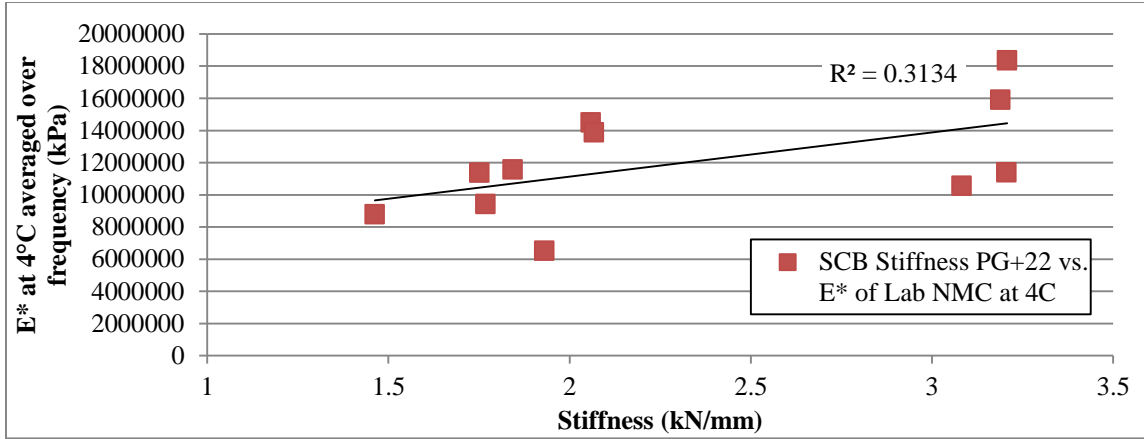

Figure 7.8 Dynamic modulus at 4°C compared with stiffness at PG+22

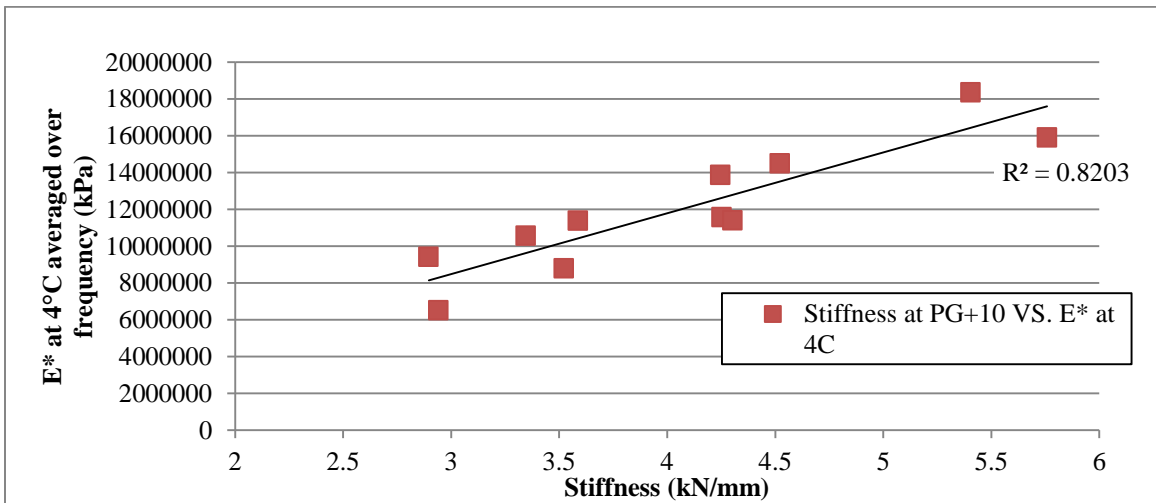

Figure 7.9 Dynamic modulus at 4°C compared with stiffness at PG+10

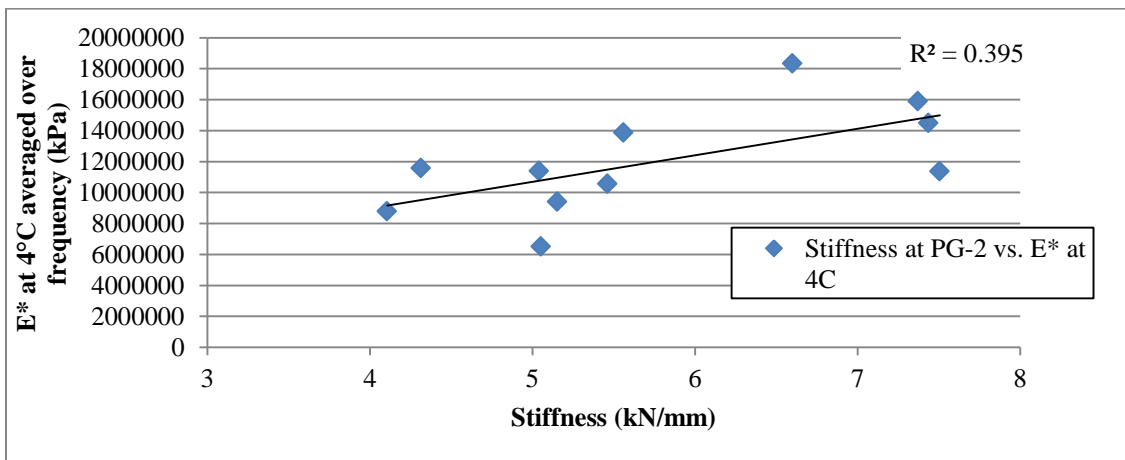

Figure 7.10 Dynamic modulus at 4°C compared with stiffness at PG-2

7.2.5 Comparison of tensile strength ratio and stripping inflection point

There is no correlation between stripping inflection point and tensile strength ratio. This is not unexpected because both are two very different ways of measuring for moisture susceptibility. The graph of TSR versus SIP is shown in Figure 7.11 with Hamburg cores shown in blue and gyratory compacted samples shown in red. It appears that the overall trend shows a slight increase in SIP values with increasing with TSR. The primary reason for showing this graph is to compare the moisture condition failure criteria. The Iowa DOT has recently changed moisture conditioning specifications to the Hamburg Wheel Tracking Test's SIP as the pass/fail criteria for moisture conditioning instead of TSR values. A notable comparison that will be important to contractors is the number of mixes that pass the TSR compared to a typical SIP value of 10,000 for designs less than 3 million ESALS and 14,000 for designs higher than 3 million ESALS. The graph indicates that there are more mixes that pass the TSR specification but fail the Hamburg specification but depends on the mix design. It is important for mixture designers to know that a mixture that had passed the TSR criteria of 80% may not meet the minimum requirement in the Hamburg wheel tracking test.

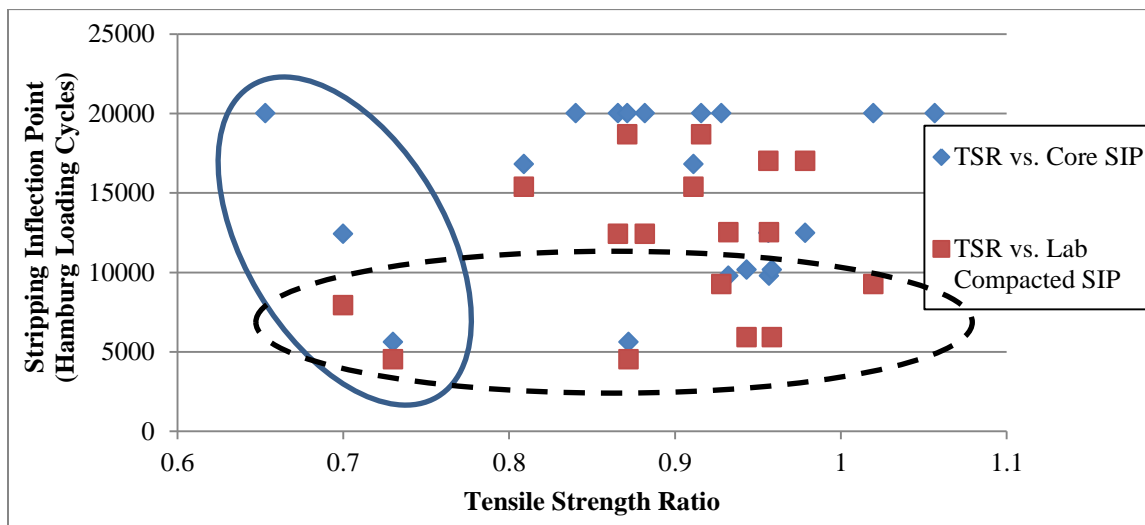

Figure 7.11 Relationship of tensile strength ratio and stripping inflection point

7.2.6 Comparison of high temperature binder grade and stripping inflection point

There is a general trend that can be seen between high temperature binder grade and the SIP measured in the Hamburg. The cores that were tested in the Hamburg plotted against the high temperature binder grades of the recovered and the tank binders are shown in Figure 7.12. The cores were stiffer than the lab compacted samples, shown in Figure 7.13. The cores had more stripping inflection data points that reached the 20,000 passes showing no stripping. This is why the correlations are lower for the cores than the lab samples. The best correlation is the lab samples versus the recovered high temperature binder grade. This is likely because there is a relationship between the SIP and binder stiffness; however, the R^2 value shows a lower correlation when the 20,000 SIP value is included.

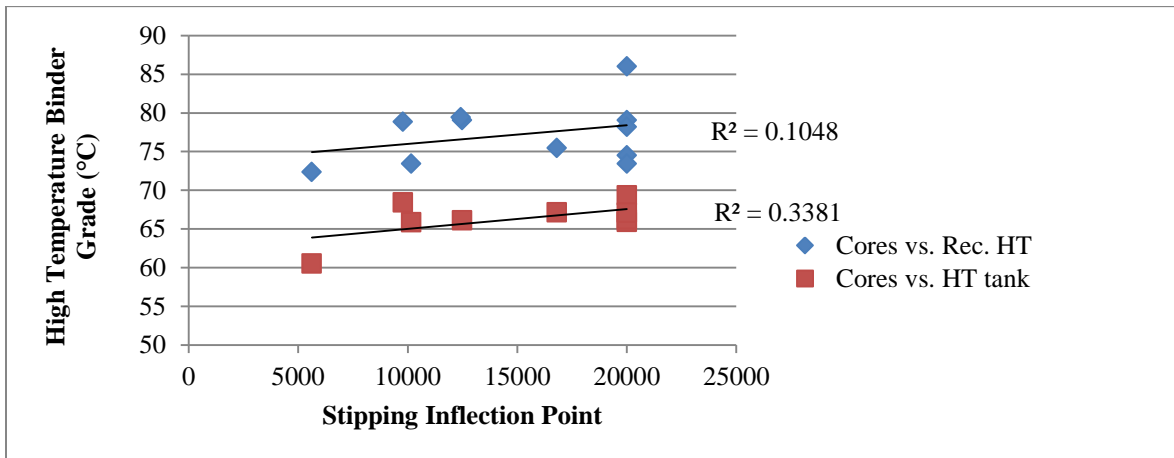

Figure 7.12 Relationship of high temperature binder grade and stripping inflection point for cores

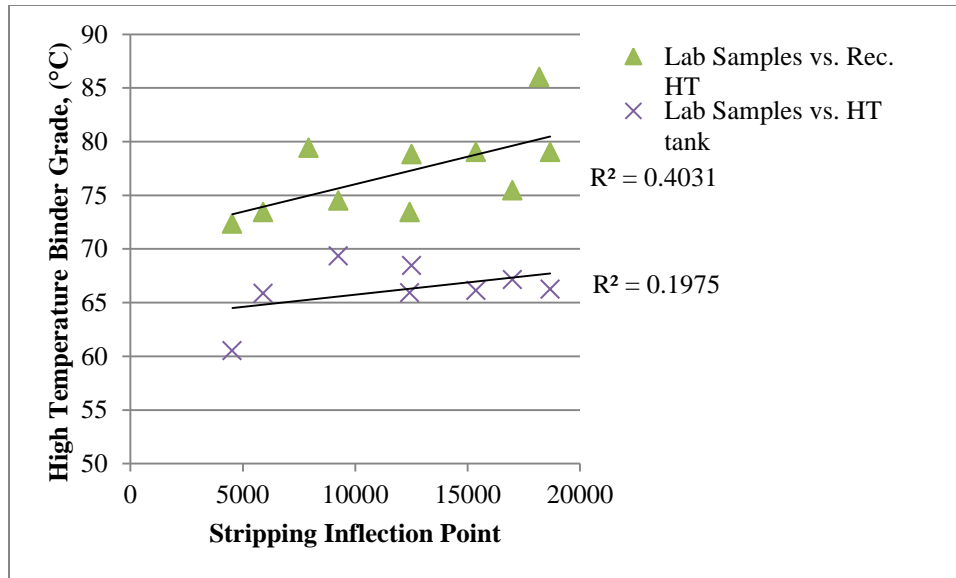

Figure 7.13 Relationship of high temperature binder grade and stripping inflection point for gyratory-compacted samples

7.2.7 Comparison of dynamic modulus measured at 37°C and flow number

There is a fairly strong trend of increasing flow number with increasing dynamic modulus. This is expected because the same samples are tested for each test. The loadings are different and the measurement is different. The mixture FM7-7 was excluded because tertiary flow was not reached.

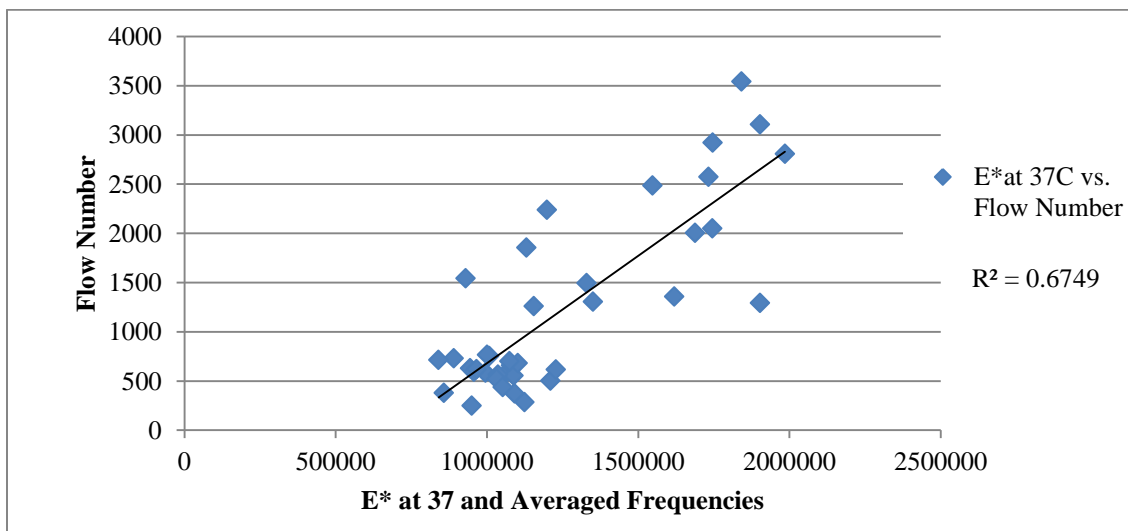

Figure 7.14 Relationship of flow number and high temperature dynamic modulus

CHAPTER 8 CONCLUSIONS AND RECOMMENDATIONS

The investigation of WMA studied eleven different mixes that were produced in asphalt plants throughout the state of Iowa. For each mix, samples were compacted in a Superpave gyratory compacter the day of production, reheated and compacted in the laboratory and cores were taken after one or two years of in-service aging. For each mix, tank binder was collected and tested. Binder was recovered from cores and tested. Dynamic modulus, flow number, semi-circular bending test, indirect tensile strength (TSR), Hamburg wheel tracking tests were performed on all mixes. A curing study was also performed in the Hamburg on three mixes. Mixture properties were statistically compared and factors within each mix were analyzed by performing an analysis of variance. Binder performance grading was conducted on all mixes included in the study. Pavement survey data was collected for two years and compared with the MEPDG pavement performance results. Mixture and binder performance data was used to rank mixes and standardized rankings were used to compare overall performance of the mixtures.

The advantages of WMA included reduced mixing and compaction temperatures. The pavement condition monitoring of the constructed pavements showed some pavement distresses in the field but there were no detectable differences between the WMA and HMA trial sections included in this study. The cores taken from the trial pavement sections showed similar recovered binder properties between WMA and HMA binders. All recovered binders showed an increase in high temperature by at least 5°C. The similarity between the WMA and HMA binders indicates that WMA may not be able to incorporate additional RAP compared with HMA. There is also additional concern that reduced mixing temperatures may not fully blend the recycled asphalt. The Sasobit additive was the exception and showed a lower recovered binder grade for the WMA recovered binder compared to the HMA recovered binder. The initial attempt to

recover the Sasobit binder using toluene as the solvent was not successful and normal propyl bromide was used. The combination of the Sasobit and the solvent may be influencing the recovered binder properties. The Sasobit mixture was also the only WMA mixture to show a reduction in indirect tensile strength compared with the HMA control mixture.

The recovered binder study demonstrated the high influence shingles have on the recovered binder properties compared to the recovered binder from mixtures with only RAP. The addition seven percent recycled asphalt shingles to the WMA mixture at reduced temperatures improved performance test results of the mixture except in recovered binder properties and tensile strength ratio. Recovered binder properties showed an increase in the low temperature PG grade and the tensile strength ratio decreased as higher percentages of shingles was added.

Statistical differences between WMA and HMA were identified in several mixture properties but these differences were not always the same between the mixtures studied. On average, the WMA exhibited lower flow number when compared with the HMA control unless the reduced stiffness is offset by recycled materials added to the mixture. The Hamburg wheel tracking test showed curing time and temperature greatly influences the stripping inflection point in the Hamburg. The lower WMA temperature with curing times at 2 hours did not perform as well as the samples cured and compacted at HMA temperature or for long curing durations. This difference has been shown in other studies (Yin, 2013) and maybe a concern in areas where pavements are more susceptible to rutting. Owner agencies should address curing time and temperature protocols for WMA based on the differences shown in the Hamburg section. If implementation of performance based specifications is occurring within an agency, the specification will need to reflect the differences in WMA. Currently, pavement performance in

the field between WMA and HMA is found to be similar; however, WMA pavements under extreme conditions simulated in the laboratory do exhibit different material behaviors.

The Hamburg test showed that cores generally perform better compared to gyratory compacted samples. This may be due to stiffening from aging that occurs insitu. As higher amounts of recycled asphalt shingles were added, the Hamburg results improved. The addition of 7% shingles to the WMA mixture FM7-7 greatly increased the performance of that mixture in the Hamburg test compared with FM7-0 and FM7-5. Hamburg tests showed no correlation between stripping inflection point and tensile strength ratio. It is important to note that a higher number of mixtures failed the Hamburg criteria of 10,000 wheel passes (14,000 for mixes with greater than 3 million ESALS) whereas most of the mixtures tested met the TSR ratio requirement of 0.80. This is important because the Hamburg is replacing the TSR specification for the State of Iowa.

The low temperature mixture performance of WMA should continue to be studied, especially as the percentage of recycled asphalt materials in mixtures increases. The SCB tests showed some good correlations with other measured material properties but the test data is generally too variable to be able to calculate statistical differences at low alpha levels. The low temperature properties are the primary area of concern for northern climates when higher amounts of recycled asphalt materials are added to the mixtures.

WMA mixtures should continue to be studied and based on the results of this research, the following recommendations highlight areas of concerns and where additional study is needed for WMA:

- Additional studies using multiple additives at different curing times and temperatures are needed. The curing study shows that there are effects of time and temperature for the mixture

conditioning that will influence performance test results. The higher temperature or longer curing durations for a mix consistently showed improved results with Hamburg testing.

Using the Hamburg as a standard in Iowa will help to identify WMA practices that may lead to inferior performance.

- The mixture with 7% shingles showed a substantial increase in performance in the Hamburg. Other tests, such as fatigue testing or low temperature tests will complement the testing performed in the Hamburg.
- Additional warm mixes that use RAS and higher amounts of RAP should be studied. The TSR values were very low for the 7% RAS mixture and this may be a concern for some agencies.
- Continuation of the pavement conditioning surveys may help to identify differences in performance between HMA and WMA in the future but warm mix additives did not show to influence recovered binder properties after 1 or two years in the field.
- The TSR value showed no correlation to the SIP measured in a Hamburg test. The Hamburg was generally more selective of mixes.
- The use WMA additives should continue as long as moisture susceptibility and rutting resistance can be shown to be equal to that of HMA pavements.

REFERENCES

- AASHTO. (2007). Designation R 28 Accelerated Aging of Asphalt Binder Using a Pressurized Aging Vessel (PAV). *Standard Specifications for Transportation Materials and Methods of Sampling and Testing, 27th Ed.* Washington, D.C.: American Association of State Highway and Transportation Officials.
- AASHTO. (2007). Designation T 240 Standard Method of Test for Effect of Heat and Air on a Moving Film of Asphalt Binder (Rolling Thin-Film Oven Test). *Standard Specifications for Transportation Materials and Methods of Sampling and Testing, 27th Ed.* Washington, D.C.: American Association of State Highway and Transportation Officials.
- AASHTO. (2007). Designation T 313 Determining the Flexural Creep Stiffness of Asphalt Binder Using the Bending Beam Rheometer (BBR). *Standard Specifications for Transportation Materials and Methods of Sampling and Testing, 27th Ed.* Washington, D.C.: American Association of State Highway and Transportation Officials.
- AASHTO. (2007). Designation T 315 Standard Method of Test for Determining the Rheological Properties of Asphalt Binder Using a Dynamic Shear Rheometer (DSR). *Standard Specifications for Transportation Materials and Methods for Sampling and Testing, 27th Ed.* Washington D.C.: American Association of State Highway and Transportation Officials.
- AASHTO. (2007). Designation T 316 Standard Method of Test for Viscosity Determination of Asphalt Binder Using Rotational Viscometer. *Standard Specifications for Transportation Materials and Methods of Sampling and Testing, 27th Ed.* Washington, D.C.: American Association of State Highway and Transportation Officials.
- AASHTO. (2007). Designation T283-07 Resistance of Compacted Hot Mix Asphalt (HMA) to Moisture Induced Damage. *Standard Specifications for Transportation Materials and Methods of Sampling and Testing, 27th Ed.*
- Astec Incorporated. (2013). *Warm Mix Asphalt Systems*. Retrieved July 16, 2013, from Astec Incorporated:
http://www.astecinc.com/index.php?option=com_content&view=article&id=117&Itemid=188)
- Astec, Inc. (2007, June). *Astec Double Barrel Green TM System: Success with Simplicity*. Retrieved March 2, 2009, from
http://www.astecinc.com/index.php?option=com_content&view=article&id=671:astec-double-barrel-green-system-success-with-simplicity&catid=58:latest-news&Itemid=509
- Bernier, A. Z. (2013, January). Warm-Mix Asphalt Pilot Project in Connecticut. *Transportation Research Record: Journal of the Transportation Research Board*, 106-116.

- Buss, A. R. (2011). *Investigation of Warm-Mix Asphalt Using Iowa Aggregates*. Ames, IA: Iowa State University Institute for Transportation.
- Clements, T. B. (2012). *The Effect of Loose Mix Aging on the Performance of Warm Asphalts*. Lino Lakes, MN: Association of Asphalt Paving Technologists.
- Corrigan, M. (2008). *Warm Mix Asphalt Technologies and Research*. Retrieved February 10, 2009, from Federal Highway Administration:
<http://www.fhwa.dot.gov/pavement/asphalt/wma.cfm>
- Csanyi, L. (1959). *Foamed Asphalt. Technical Bulletin No. 240*. Washington, D.C.: American Road Builders Association.
- D'Angelo, J., Harm, E., J., B., Baumgardner, G., Corrigan, M., Cowser, J., . . . Yeaton, B. (2008). *Warm Mix Asphalt: European Practice Publication FHWA-PL-08-007*. FHWA, U.S. Department of Transportation.
- Davidson, J. (2005). Evotherm Trial- Aurora, Ontario. *McAsphalt Industries Limited*.
- Davidson, J. (2005). Evotherm Trial- Ramara Township. *McAsphalt Industries Limited*.
- Diefenderfer et al. (2007). *Installation of Warm Mix Asphalt Projects in Virginia Report No.: FHWA/VTRC 07-R25*. Virginia Department of Transportation.
- Doyle, J. H. (2013). Rutting and Moisture Damage Resistance of High RAP Warm Mixed Asphalt: Loaded Wheel Tracking versus Conventional Methods. *Association of Asphalt Paving Technologists*.
- Google Earth. (2013). Iowa: 41deg59'41.43" N and 93deg17'39.09"W. Retrieved June 3, 2013
- Howard, I. D. (2013). Mertis of RAP dominated warm mixed flexible pavement base layers. *Association of Asphalt Paving Technologists*, (p. 21). Lino Lakes, MN.
- Hurley. (2006). *Evaluation of New Technologies for Use in WMA*. Auburn, AL: Auburn University.
- Hurley, G., & Prowell, B. (2005). *Evaluation of Evotherm for use in Warm-Mix Asphalt. Report No. NCAT Report 06-02*. Auburn, AL: National Center for Asphalt Technology.
- Jamshidi, A. O. (2013, January). Performance of Warm Mix Asphalt containing Sasobit (R): State-of-the-art. *Construction and Building Materials, Volume 38*, 530-553.
- Jones, W. (2004, Fall). *Warm Mix Asphalt Pavements: Technology of the Future*. Retrieved February 16, 2009, from Asphalt Institute:
http://www.asphaltinstitute.org/Upload/2004_Fall_Mag_Warm_Mix_Asphalt_Pavements.pdf

- Kasozi, A. H. (2012). Evaluation of Foamed Warm-Mix Asphalt Incorporating Recycled Asphalt Pavement for Volumetric and Mechanical Properties. *International Journal of Pavement Reserach and Technology*, 75-83.
- Kim, M. M. (2012). Characterization of Fracture Properties of Asphalt Mixtures as Measured by Semicircular Bend Test and Indirect Tension Test. *Transporation Reserach Record: Journal of the Transporation Reserach Board*, 2296(2012), 115-124. doi:10.3141/2296-12
- Kvasnak, A. W. (2009). Case Study of Warm Mix Asphalt Moisture Susceptibility in Birmingham. *Transporation Reserach Board 88th Annual meeting Compendium of Papers*. Washington, D.C.: Transportation Reserach Board of National Academies.
- Lee, D. (1980). *Treating Iowa's Marginal Aggregates and Soils by Foamix Process*. Ames, IA: Iowa State University.
- Mallick, R. K. (2008). Using Warm Mix Asphalt Technology to Incoporate Higher Percentage of Reclaimed Asphalt Pavement Material in Asphalt Mixes. *Transporation Reserach Record: Journal of the Transporation Reserach Board*, (pp. 71-79). Washington, D.C.
- Marasteanu, M., & Xue, L. (2012, April). DRAFT: Determining the fracture energy asphalt mixtures using the semi-circular bend geometry.
- Miller, J. B. (2003). *Distress Identification Manual for the Long-Term Pavement Performance Program* (. Federal Highway Administration. McLean, VA: Number: FHWA-RD-03-031. Retrieved from <http://www.fhwa.dot.gov/publications/research/infrastructure/pavements/ltpa/reports/03031/>
- Mogawer, W. A. (2011). Moisture Damage Characteristics of Warm Mix Asphalt Mixtures. *Association of Asphalt Paving Technologists*, 368-402.
- Mogawer, W. A. (2013). Evaluation of High RAP-WMA Asphalt Rubber Mixtures. *Association of Asphalt Paving Technologists*.
- Mohamed, M. W. (2005). Verification for the Calibrated Fatigue Cracking Model for the 2002 Design Guide. *Annual Meeting of the Association of Asphalt Paving Technologists*.
- Mohamed, M. W. (2005). Verification for the Calibrated Permanent Deformation Model for the 2002 Design Guide. *Association of Asphalt Paving Technologists*.
- NCHRP. (2004). NCHRP1-37A: Guide for Mechanistic-Empirical Design of New and Rehabilitated Pavement Strctures. *National Cooperative Highway Research Program*.
- NCHRP 9-43, A. A. (2010). *Mix Design Practices for Warm Mix Asphalt (In Press)*. Sterling, VA.

- Newcomb, D. (2007). *National Asphalt Pavement Association*. Retrieved February 16, 2009, from Hotmix.org: http://fsl.hotmix.org/mbc/Introduction_to_Warm-mix_Aspphalt.pdf
- Roberts, F. E. (1984). *Evaluation of Recycled Mixtures Using Foamed Asphalt*. Washington, D.C.: Transportation Research Board.
- Roberts, F., Kandhal, P., Lee, D., & Kennedy, T. (1996). *Hot Mix Asphalt Materials, Mixture Design, and Construction*. Lanham, MD.: National Asphalt Pavement Association Research and Education Foundation.
- Rushing, J. M. (2013). Assessment of Warm-Mix Asphalt for Heavy-Traffic Airfields. *Transportation Reserach Board 92nd Annual Meeting Compendium of Papers*, (p. 16). Washington, D.C.
- Sasol Wax North America Corporation. (n.d.). *Sasobit Handling and Blending Guidelines*. Retrieved June 22, 2013, from Sasol Wax: <http://www.sasolwax.us.com/pdf/SasobitHandling-BlendingGuidelineUSA.pdf>
- Taylor, A. T. (2010). Laboratory Evaluation of Sulfur-Modified Warm Mix. *Association of Asphalt Paving Technologists*, (pp. 403-442). Lino Lakes, MN.
- Toraldo, E. B. (2013, July). Laboratory investigation into the effects of working temperatres on wax-based warm mix asphalt. *Construction and Building Materials*, 44, 5.
- Vidal, R. M. (2013, May). Life cycle assessment of hot mix asphalt and zeolite-based warm mix asphalt with reclaimed asphalt pavement. *Resources, Conservation and Recycling*, 74, 101-114.
- Williams, M., Landel, R., & Ferry, J. (1955). The Temperature Dependence of Relaxation Mechanism in Amorphous Polymers and Other Glass-Liquids. *Journal of American Chemical Society*, Vol. 77, p. 370.
- Witczak, M. (2005). *NCHRP Report 547: Simple Performance Tests: Summary of Recommended Methods and Database*. Washington, D.C.: Transportation Research Board, National Highway Research Council.
- Witczak, M., Kaloush, K., Pellinen, T., El-Aasyouny, M., & Von Quintus, H. (2002). *NCHRP Report 465: Simple Performance Test for Superpave Mix Design*. National Cooperative Highway Research Program (NCHRP) .
- Xiao, F., Jordan, J., & Amirkhanian, S. (2009). Laboratory Investigation of Moisture Damage in Warm Mix Asphalt Containing Moist Aggregate. *Transportation Research Board 88th Annual Meeting Compendium of Papers. CD-ROM*. Washington, D.C.: Transportation Research Board of National Academies.

Yin, F. C. (2013). *Laboratory Conditioning Protocols for Warm-Mix Asphalt*. Lino Lakes, MN: Association of Asphalt Paving Technologists.

Zeleeuw, H. P. (2012). Laboratory evaluation of the mechanical properties of plant-produced warm-mix asphalt mixtures. *Road Materials and Pavement Design*.
doi:10.1080/14680629.2012.735799

APPENDIX A JOB MIX FORMULAS

County :	Floyd	Project :	NHSX-218-9(129)--3H-34	Mix No. :	ABD9-2056R2
Mix Size (in.) :	1/2 Type A	Contractor :	Mathy	Contract No. :	34-2189-129
Mix Type:	HMA 10M L - 2	Design Life ESAL's :	5,641,440	Date Reported :	09/01/09
Intended Use :	Surface	Project Location : On US 218, Charles City Bypass			

Aggregate	% in Mix	Source ID	Source Location	Bed	Gsb	%Abs	FAA
1/2" X 4 Quartzite	9.0%	AMN008	New Ulm Quartzite Quarry		2.620	0.72	45.0
1/2" ACC Stone	31.0%	A34008	Greene Limestone - Warnholtz	17 & 18	2.606	2.45	45.0
Man Sand	26.0%	A34008	Greene Limestone - Warnholtz	17 & 18	2.705	1.41	45.0
Concrete Sand	17.0%	A34516	Greene L.S. - Cedar Acres Resorts		2.606	0.76	38.0
RAP	17.0%	Hwy 218	*2RAP09-06 (4.63%)	**75%	2.635	1.65	42.4

Job Mix Formula - Combined Gradation (Sieve Size in.)

1"	3/4"	1/2"	3/8"	#4	#8	#16	#30	#50	#100	#200
Upper Tolerance										
100	100	100	94	72	53		24			6.7
100	100	95	87	65	48	32	20	8.8	5.8	4.7
100	100	88	80	58	43		16			2.7
Lower Tolerance										

Asphalt Binder Source and Grade: MIF @ LaCrosse PG 64-28

	Gyratory Data						Number of Gyration
	5.85	6.20	6.63	6.70	7.20		
% Asphalt Binder	2.297	2.315	2.332	2.335	2.345		N-Initial
Corrected Gmb @ N-Des.	2.459	2.444	2.429	2.427	2.412		8
Max. Sp.Gr. (Gmm)	85.3	87.3	88.3	88.4	89.6		N-Design
% Gmm @ N- Initial	94.4	95.7	97.1	97.3	98.2		96
%Gmm @ N-Max	6.6	5.3	4.0	3.8	2.8		N-Max
% Air Voids	18.0	17.7	17.4	17.4	17.5		152
% VMA	63.4	70.1	77.1	78.2	84.1	OUT	Gsb for Angularity
% VFA	10.31	11.12	11.97	12.11	13.02		Method A
Film Thickness	0.92	0.85	0.79	0.78	0.73		2.649
Filler Bit. Ratio	2.637	2.637	2.637	2.637	2.637		Pba / %Abs Ratio
Gsb	2.691	2.687	2.690	2.688	2.692		0.48
Gse	5.11	5.52	5.94	6.01	6.46		Slope of Compaction
Pbc	0.78	0.73	0.76	0.74	0.80		Curve
Pba	87.2	88.0	88.8	89.0	89.8		14.5
% New Asphalt Binder	1.031	1.031	1.031	1.031	1.031		Mix Gmm Linearity
Asphalt Binder Sp.Gr. @ 25c	1.60	1.60	1.60	1.60	1.60		Excellent
% Water Abs	4.96	4.96	4.96	4.96	4.96		Pb Range Check
S.A. m ² / Kg.	80.5	80.5	80.5	80.5	80.5		1.35
% + 4 Type 4 Agg. Or Better	24.7	24.7	24.7	24.7	24.7		Specification Check
% + 4 Type 2 or 3 Agg.	44	44	44	44	44		OUT Does Not Comply
Angularity-method A	1.3	1.3	1.3	1.3	1.3		TSR Check
% Flat & Elongated	83	83	83	83	83		
Sand Equivalent							

Disposition : An asphalt content of 6.6% is recommended to start this project.
 Data shown in 6.63% column is interpolated from test data.
 The % ADD AC to start project is 5.9%
 Comments : Final acceptance based on plant produced HMA. **% binder in RAP, ***% crushed particles in RAP.
% VFA is within specifications.

Copies to : Mathy Britt RCE HMA Tech. L. Wolff
 Lab (2) File
 Mix Designer & Cert.# : John Jorgenson EC 186 Signed : Jon Kleven

Figure A.1 Field Mix 2 Job Mix Formula - WMA additive is Revix

Form 956 ver. 7.0

Iowa Department of Transportation
Highway Division - Office of Materials
HMA Gytratory Mix Design

FM 3
Gmm = 2.44

County : Cherokee
 Mix Size (in.) : 1/2 Type A
 Mix Type: HMA 3M L-4
 Intended Use : Surface
 Project : STP-143-1(4)-2C-18
 Contractor : Tri State
 Design Life ESAL's : 3M
 Project Location : Ia143 from Marcus N. to Ia10
 Mix No. : ABD9-3030
 Contract No. : 18-1431-004
 Date Reported : 08/31/09

Aggregate	% in Mix	Source ID	Source Location	Beds	Gsb	%Abs	FAA
#4x#20 CM	30.0%	ASD004	Concrete Materials		2.607	0.69	47.0
1/2" cr. Grav. Ash	24.0%	A72534	Hallett, Ashton Sievert		2.620	1.93	47.0
1/2" to #4MR	8.0%	ASD006	Myrl & Roy		2.621	0.80	47.0
3/4" scr. Grav.	10.0%	A72534	Hallett, Ashton Sievert		2.600	1.85	41.0
sand Ash	8.0%	A72534	Hallett, Ashton Sievert		2.624	1.15	41.0
RAP	20.0%	ABC9-32	Hwy 18, Sioux Co.		2.643	0.35	43.7

Job Mix Formula - Combined Gradation (Sieve Size in.)

1"	3/4"	1/2"	3/8"	#4	#8	#16	#30	#50	#100	#200
Upper Tolerance										
100	100	99	89	69	41		18			6.1
100	100	92	82	62	36	21	14	8.5	5.3	4.1
100	100	85	75	55	31		10			2.1
Lower Tolerance										

Asphalt Binder Source and Grade: **Jebro, Sioux City PG64-22**

	Gytratory Data				Number of Gytrations
	5.00	5.50	5.71	6.00	
% Asphalt Binder	5.00	5.50	5.71	6.00	
Corrected Gmb @ N-Des.	2.310	2.353	2.360	2.369	N-Initial
Max. Sp.Gr. (Gmm)	2.483	2.469	2.458	2.444	7
% Gmm @ N-Initial	84.6	86.4	87.0	87.9	N-Design
%Gmm @ N-Max	94.2	96.5	97.2	98.1	86
% Air Voids	7.0	4.7	4.0	3.1	N-Max
% VMA	16.2	15.1	15.0	15.0	134
% VFA	57.0	68.9	73.4	79.5	Gsb for Angularity
Film Thickness	9.77	10.77	11.41	12.26	Method A
Filler Bit. Ratio	1.00	0.91	0.86	0.80	2.612
Gsb	2.619	2.619	2.619	2.619	Pba / %Abs Ratio
Gse	2.682	2.688	2.683	2.679	0.87
Pbe	4.12	4.55	4.81	5.17	Slope of Compaction
Pba	0.92	1.01	0.94	0.88	Curve
% New Asphalt Binder	81.0	82.8	83.5	84.3	12.6
Asphalt Binder Sp.Gr. @ 25c	1.030	1.030	1.030	1.030	Mix Gmm Linearity
% Water Abs	1.08	1.08	1.08	1.08	Good
S.A. m ² / Kg.	4.22	4.22	4.22	4.22	Pb Range Check
% + 4 Type 4 Agg. Or Better	100.0	100.0	100.0	100.0	1.00
% + 4 Type 2 or 3 Agg.	93.4	93.4	93.4	93.4	Specification Check
Angularity-method A	44	44	44	44	Comply
% Flat & Elongated	1.7	1.7	1.7	1.7	TSR Check
Sand Equivalent	82	82	82	82	

Disposition : An asphalt content of 5.7% is recommended to start this project.
 Data shown in 5.71% column is interpolated from test data.
 The % ADD AC to start project is 4.8%

Comments : _____

Copies to : Tri State _____

Mix Designer & Cert.# : T Huisman CI-515 Signed : _____

Figure A.2 Field Mix 3 Job Mix Formula - WMA additive is Sasobit

Form 955 ver. 7.0

Grmm = 2.5 *FM4 - Johnston*
Iowa Department of Transportation *Revised*
 Highway Division-Office of Materials *Mix Design*
 Proportion & Production Limits For Aggregates

County: Polk Project No.: ESFM-CO77(168)-5S-77 Date: 05/01/09
 Project Location: _____ Mix Design No.: 1BD9-021Rev5
 Contract Mix Tonnage: _____ Course: Surface Mix Size (in.): 1/2
 Contractor: Des Moines Asphalt & Paving Mix Type: HMA 3M Design Life ESAL's: 3,000,000

Material	Ident #	% in Mix	Producer & Location	Type (A or B)	Friction Type	Bed	Gsb	%Abs
1/2" cr. quartzite	ASD002	9.0%	Everest Dell Rapids, S.D.	A	2		2.647	0.29
3/8" chip	A85006	14.5%	M.M. Ames	A	4	47	2.669	0.78
man. sand	A85006	32.0%	M.M. Ames	A	4	47	2.679	0.80
sand	A77530	16.0%	Hallett, North Des Moines	A	4		2.658	0.66
3/4" chip	A85006	8.5%	M.M. Ames	A	4	47	2.675	0.79
RAP	RAP8-01	20.0%	Des Moines Asphalt				2.584	1.51

Type and Source of Asphalt Binder: PG64-22 Bituminous Materials

Material	Individual Aggregates Sieve Analysis - % Passing (Target)										
	1"	3/4"	1/2"	3/8"	#4	#8	#16	#30	#50	#100	#200
1/2" cr. quartzite	100	100	99	82	7.2	0.8	0.7	0.6	0.5	0.4	0.3
3/8" chip	100	100	100	95	30	4.0	2.0	1.8	1.2	1.1	1.0
man. sand	100	100	100	100	97	67	40	22	9.1	3.0	5.1
sand	100	100	100	100	96	86	67	40	10	10	0.4
3/4" chip	100	99	63	34	5.5	1.8	1.5	1.4	1.2	1.1	1.0
RAP	100	100	95	90	70	52	39	29	18	13	9.8

Preliminary Job Mix Formula Target Gradation											
Upper Tolerance	100	100	100	97	73	51		24			5.9
Comb Grading	100	100	96	90	66	46	32	20	8.4	3.9	3.9
Lower Tolerance	100	100	89	83	59	41		16			1.9
S.A. sq. m/kg	Total	4.43		+0.41	-0.27	0.38	0.52	0.56	0.51	0.48	1.26

Sieve Size in.	Production Limits for Aggregates Approved by the Contractor & Producer.											
	9.0% of mix 1/2" cr. quartzite		14.5% of mix 3/8" chip		32.0% of mix man. sand		16.0% of mix sand		8.5% of mix 3/4" chip		20.0% of mix RAP	
	Min	Max	Min	Max	Min	Max	Min	Max	Min	Max	Min	Max
1"	100.0	100.0	100.0	100.0	100.0	100.0	100.0	100.0	98.0	100.0		
3/4"	98.0	100.0	100.0	100.0	100.0	100.0	100.0	100.0	92.0	100.0		
1/2"	92.0	100.0	98.0	100.0	100.0	100.0	100.0	100.0	56.0	70.0		
3/8"	75.0	89.0	88.0	100.0	98.0	100.0	98.0	100.0	27.0	41.0		
#4	0.2	14.2	23.0	37.0	90.0	100.0	89.0	100.0	0.0	12.5		
#8	0.0	5.8	0.0	9.0	62.0	72.0	81.0	91.0	0.0	6.8		
#30	0.0	4.6	0.0	5.8	18.0	26.0	36.0	44.0	0.0	5.4		
#200	0.0	2.3	0.0	3.0	3.1	7.1	0.0	2.4	0.0	3.0		

Comments: _____
 Copies to: Des Moines Asphalt & Paving

The above target gradations and production limits have been discussed with and agreed to by an authorized representative of the aggregate producer.

Signed: _____
 Producer Signed: _____
 Contractor

Figure A.3 Field Mix 4 Job Mix Formula - WMA Double Barrel Green Foaming

E-47 WMA

Form 556 rev. 7.1

Iowa Department of Transportation
Highway Division - Office of Materials
WMA Gyratory Mix Design

County: Marshall Project: STP-S-CD64(110)-5E-64 Mix No.: 1BD10-096
 Mix Size (in.): 1/2 Type A Contract: Cessford Contract No.: 64-CD64-110
 Mix Type: HMA 300K None Design Life ESAL's: 3,000,000 Date: 08/27/10
 Intended Use: Surface Location: E67 from Iowa 14 east 3.5 miles

Aggregate	% In Mix	Source ID	Source Location	Beck	Gsb	%Abs	FAA
Sand	32.3%	A64302	Marshalltown/Martin Marietta		2.621	0.89	41.0
Med Sand	7.0%	A64004	Le Grand/Cessford Const Co	8-27	2.620	1.93	47.0
1/2 Asphalt	15.0%	A64004	Le Grand/Cessford Const Co	8-27	2.601	1.92	47.0
1/2 Chips	25.5%	A64004	Le Grand/Cessford Const Co	8-27	2.591	1.92	46.0
1/2 RAP	20.0%	ABC0-0000	20% RAP		2.368	1.92	41.9

Job Mix Formula - Combined Gradation (Sieve Size in.)

1"	3/4"	1/2"	3/8"	#4	#8	#16	#30	#50	#100	#200
Upper Tolerance										
100	100	100	94	89	52	36	27	9.2	4.7	3.8
100	100	98	87	62	47	36	23	9.2	4.7	3.8
100	100	91	80	55	42	36	19			1.8
Lower Tolerance										

Asphalt Binder Source and Grade:	Bimodular Data				PG 64-22 (AI = 3.6)	WMA Technology & Rate: (Evotherm 90 @ 0.3)
	Gyratory Data					
% Asphalt Binder	5.00	5.50	5.53	6.00		Number of GyroRuns
Corrected Gmb @ N-Dos.	2.328	2.345	2.346	2.359		N-Initial
Max. Sp. Gr. (Gmm)	2.451	2.432	2.431	2.415		7
% Gmm @ N-Initial	89.6	90.8	90.9	92.4		N-Design
% Gmm @ N-Max	92.8	97.2	97.3	98.4		58
% Air Voids	5.0	3.6	3.5	2.3		N-Max
% VMA	14.9	14.8	14.8	14.7		104
% VFA	66.4	75.8	76.3	84.2		Gap for Angularity
Filter Thickness	9.38	10.51	10.57	11.56		Method A
Filter Bit. Ratio	0.87	0.77	0.77	0.70		2.611
Gmb	2.600	2.600	2.600	2.600		Pba / %Abs Ratio
Ugc	2.603	2.641	2.642	2.642		0.40
Pba	4.39	4.92	4.98	5.41		Slope of Compaction
Pba	0.64	0.62	0.63	0.63		Curve
% New Asphalt Binder	79.5	81.5	81.6	83.1		18.3
Asphalt Binder Sp. Gr. @ 25c	1.030	1.030	1.030	1.030		Mix Gmm Linearity
% Water Abs	1.59	1.59	1.59	1.59		Excellent
S.A. m ² / Kg.	4.68	4.68	4.68	4.68		Pb Range Check
% + 4 Type 4 Agg. Or Better	85.6	85.6	85.6	85.6		1.90
% + 4 Type 2 or 3 Agg.	0.0	0.0	0.0	0.0		RAM Check
% + 4 Type 2	0.0	0.0	0.0	0.0		OK
Pinpoint Modulus of Type 2	0.0	0.0	0.0	0.0		Specification Check
Angularity-method A	41	41	41	41		Comply
% Flat & Elongated	0.0	0.0	0.0	0.0		TSR Check
Sand Equivalent	87	87	87	87		Not Required
Aggregate Type	A	A	A	A		
% Crushed	56	56	56	56		

Disposition: An asphalt content of 5.5% is recommended to start this project. Target plant temp is 250 °F
 Data shown in 5.53% column is interpolated from test data.
 The % ADD AC to start project is 4.5%
 Comments: QMA Verification OK. Final approval based upon plant produced mix.

Figure A.4 FM5 Job Mix Formula - WMA additive is Evotherm

Form 956 ver. 7.1

Iowa Department of Transportation
Highway Division - Office of Materials
WMA Gytratory Mix Design

County :	Clayton	Project :	MP-013-2(704)59--76-22	Mix No. :	ABD0-2043R 1
Mix Size (in.) :	1/2 Type A	Contractor :	R.C.P. Div. of Mathy	Contract No. :	22-0132-704
Mix Type:	HMA 1M L - 4	Design Life ESAL's :		Date:	09/30/10
Intended Use :	Surface	Location :	MP 59.05 - 72.89	On IA 13, from N. of Strawberry Point N. to Elkader	

Aggregate	% in Mix	Source ID	Source Location	Beds	Gsb	%Abs	FAA
5/8X3/8 Crushed	20.0%	A22084	MOYNA/CJ MOYNA & SONS	6-9	2.600	2.52	48.0
3/8"X3/16" Crushed	22.0%	A22084	MOYNA/CJ MOYNA & SONS	6-9	2.588	2.76	48.0
Man. Sand	22.0%	A22084	MOYNA/CJ MOYNA & SONS	6-9	2.669	1.83	48.0
Washed Sand	31.0%	A22522	MOYNA/CJ MOYNA & SONS		2.616	0.75	38.0
RAP	5.0%	ABC8-101	Hwy 52 (Classified) 80% crushed		2.661	1.68	43.4

Job Mix Formula - Combined Gradation (Sieve Size in.)

1"	3/4"	1/2"	3/8"	#4	#8	#16	#30	#50	#100	#200
Upper Tolerance										
100	100	100	97	72	55		30			5.7
100	100	98	90	65	50	39	26	14	6.6	3.7
100	100	91	83	58	45		22			1.7
Lower Tolerance										

Asphalt Binder Source and Grade: M.I.F. @ LaCrosse, WI PG 64-22 (A1 = 2.5) WMA Technology & Rate: Evotherm JG @ 0.5%

	Gytratory Data					Number of Gytrations
	5.50	5.83	6.46	6.50	7.00	
% Asphalt Binder	5.50	5.83	6.46	6.50	7.00	N-Initial
Corrected Gmb @ N-Des.	2.310	2.336	2.353	2.354	2.362	7
Max. Sp.Gr. (Gmm)	2.492	2.470	2.451	2.450	2.432	N-Design
% Gmm @ N-Initial	87.0	88.9	89.9	90.0	91.0	76
%Gmm @ N-Max	93.5	95.4	96.9	97.0	97.9	N-Max
% Air Voids	7.3	5.4	4.0	3.9	2.9	117
% VMA	16.7	16.0	16.0	16.0	16.2	Gsb for Angularity
% VFA	56.2	66.1	75.0	75.5	82.2	Method A
Film Thickness	7.81	8.75	9.81	9.87	10.81	2.634
Filler Bit. Ratio	0.89	0.79	0.70	0.70	0.64	Pba / %Abs Ratio
Gsb	2.620	2.620	2.620	2.620	2.620	0.71
Gsc	2.716	2.703	2.709	2.709	2.709	Slope of Compaction
Pbe	4.18	4.69	5.26	5.29	5.80	Curve
Pba	1.39	1.21	1.30	1.29	1.29	17.4
% New Asphalt Binder	94.6	94.9	95.5	95.5	95.8	Mix Gmm Linearity
Asphalt Binder Sp.Gr. @ 25c	1.032	1.032	1.032	1.032	1.032	Good
% Water Abs	1.83	1.83	1.83	1.83	1.83	Pb Range Check
S.A. m ² / Kg	5.36	5.36	5.36	5.36	5.36	1.50
% +4 Type 4 Agg. Or Better	99.6	99.6	99.6	99.6	99.6	RAM Check
% +4 Type 2 or 3 Agg.	0.0	0.0	0.0	0.0	0.0	OK
% -4 Type 2	0.0	0.0	0.0	0.0	0.0	
Fineness Modulus of Type 2	0.0	0.0	0.0	0.0	0.0	Specification Check
Angularity-method A	44	44	44	44	44	Comply
% Flat & Elongated	1.3	1.3	1.3	1.3	1.3	TSR Check
Sand Equivalent	79	79	79	79	79	Not Required
Aggregate Type	A	A	A	A	A	
% Crushed	67	67	67	67	67	94.1

Disposition : An asphalt content of 6.5% is recommended to start this project. Target plant temp is 240 °F

Data shown in 6.46% column is interpolated from test data.

The % ADD AC to start project is 6.2%

Comments : Final acceptance based on plant produced HMA.

Copies to : R.C.P. Div. of Mathy New Hampton RCE HMA Tech. G. Zidlicky
Lab. (2) File

Mix Designer & Cert.# : John Jorgenson EC 186 Signed : Jon Kleven

Figure A.5 FM6 Job Mix Formula - WMA additive is Evotherm

Form 956 ver. 7.1

FM7-0

0%

WMA + Shingles
0%

Iowa Department of Transportation

Highway Division - Office of Materials

WMA Gytratory Mix Design

County : muscatine Project : HSIPX-061-4(107)- 3L-70 Mix No. : ABD10-5016
 Mix Size (in.) : 3/4 Type A Contractor : Manatts Contract No. : 28214
 Mix Type: HMA 1M None Design Life ESAL's : Date: 09/01/10
 Intended Use : Shoulder Location : MP 92.8 - 105.8 From just N of IA 38 in Muscatine E to the Scott Co. line ne

Aggregate	% in Mix	Source ID	Source Location	Beds	Gsb	%Abs	FAA
3/4" Wash Chips	20.0%	A70002	MOSCOW/WENDLING QUARRIE	8-17	2.672	1.58	45.0
1/2" Wash Chip	25.0%	A70002	MOSCOW/WENDLING QUARRIE	8-17	2.649	1.16	45.6
1/4" Mansand	10.0%	A70002	MOSCOW/WENDLING QUARRIE	21A-24	2.764	1.18	47.7
3/8" Natural Sand	25.0%	A70504	ATALISSA-MCKILLIP/WENDLIN		2.631	0.52	38.2
RAP	20.0%	0	Main line & ABC09-0048		2.644	1.50	43.8

Job Mix Formula - Combined Gradation (Sieve Size in.)

1"	3/4"	1/2"	3/8"	#4	#8	#16	#30	#50	#100	#200
Upper Tolerance										
100	100	94	82	61	46		24			4.8
100	100	87	75	54	41	30	20	8.9	4.2	2.8
100	93	80	68	47	36		16			0.8
Lower Tolerance										

Asphalt Binder Source and Grade:	Flint Hills Davenport PG 58-28					WMA Technology & Rate:
One Binder Grade Adjustment Required	Gytratory Data					Evothorm 3G @ 0.625
% Asphalt Binder	4.30	4.50	4.59	5.00	5.30	Number of Gytrations
Corrected Gmb @ N-Des.	2.396	2.418	2.420	2.428	2.435	N-Initial
Max. Sp.Gr. (Gmm)	2.505	2.498	2.495	2.478	2.459	7
% Gmm @ N- Initial	89.8	90.9	91.1	91.7	93.5	N-Design
%Gmm @ N-Max	96.5	97.6	97.9	98.9	99.4	68
% Air Voids	4.4	3.2	3.0	2.0	1.0	N-Max
% VMA	13.8	13.2	13.2	13.3	13.3	104
% VFA	68.4	75.7	77.2	84.8	92.6	Gsb for Angularity
Film Thickness	10.17	10.63	10.86	11.95	13.08	Method A
Filler Bit. Ratio	0.69	0.66	0.65	0.59	0.54	2.659
Gsb	2.659	2.659	2.659	2.659	2.659	Pba / %Abs Ratio
Gsc	2.675	2.676	2.672	2.674	2.663	0.16
Pbc	4.08	4.26	4.35	4.79	5.24	Slope of Compaction
Pba	0.23	0.25	0.19	0.22	0.06	Curve
% New Asphalt Binder	77.2	78.3	78.7	80.5	81.7	17.3
Asphalt Binder Sp.Gr. @ 25c	1.037	1.037	1.037	1.037	1.037	Mix Gmm Linearity
% Water Abs	1.15	1.15	1.15	1.15	1.15	Good
S.A. m ² / Kg	4.01	4.01	4.01	4.01	4.01	Pb Range Check
% + 4 Type 4 Agg. Or Better	26.9	26.9	26.9	26.9	26.9	1.00
% + 4 Type 2 or 3 Agg.	12.6	12.6	12.6	12.6	12.6	RAM Check
% -4 Type 2	0.0	0.0	0.0	0.0	0.0	OK
Fineness Modulus of Type 2	0.0	0.0	0.0	0.0	0.0	
Angularity-method A	42	42	42	42	42	Specification Check
% Flat & Elongated	0.1	0.1	0.1	0.1	0.1	Comply
Sand Equivalent	99	99	99	99	99	TSR Check
Aggregate Type	A	A	A	A	A	Not Required
% Crushed	65	65	65	65	65	

Disposition : An asphalt content of 4.6% is recommended to start this project. Target plant temp is 250 °F
 Data shown in 4.59% column is interpolated from test data.

The % ADD AC to start project is 3.6%

Comments : binder grade adjustment waived on this project.

Copies to : Manatts ames, webb, fetters, mt.p. rce., dist.6 mtl., wendling qry's., gettings

Mix Designer & Cert.#: David Schau EC089

Signed :

Figure A.6 FM7-0 (0% Shingles) Job Mix Formula - WMA additive is Evothorm

Form 956 ver. 7.1

Iowa Department of Transportation

Highway Division - Office of Materials
WMA Gyrotory Mix Design

51
FM7-5

County :	Muscatine	Project :	HSIPX-061-4(107)- -3L-70	Mix No. :	ABD10-5017		
Mix Size (in.):	3/4 Type A	Contractor :	Manatts	Contract No. :	28214		
Mix Type:	HMA 1M None	Design Life ESAL's :		Date:	10/07/10		
Intended Use :	Shoulder	Location :	MP 92.8 - 105.8	N of IA 38 in Musc. E to Scott Co. line near Blue Grass			
Aggregate	% in Mix	Source ID	Source Location	Beds	Gsb	%Abs	FAA
5/8" Wash Chips	22.0%	A70002	Moscow/Wendling Quarries Inc	8-17	2.672	1.58	45.0
1/2" Wash Chip	25.0%	A70002	Moscow/Wendling Quarries Inc	8-17	2.649	1.16	45.6
1/4" Mansand	20.0%	A70002	Moscow/Wendling Quarries Inc	21A-24	2.764	1.18	47.7
3/8" Natural Sand	15.0%	A70504	Atalissa-Mckillip/Wendling Quarrie		2.631	0.52	38.2
1/2 RAP/RAS	18.0%	abc09-048			2.442	4.06	43.6

Job Mix Formula - Combined Gradation (Sieve Size in.)

1"	3/4"	1/2"	3/8"	#4	#8	#16	#30	#50	#100	#200
Upper Tolerance										
100	100	94	81	62	47		22			6.1
100	100	87	74	55	42	29	18	9.5	5.5	4.1
100	93	80	67	48	37		14			2.1
Lower Tolerance										

Asphalt Binder Source and Grade:	Flint Hills Dubuque				(AI = 3.6)	WMA Technology & Rate:
PG Blending Chart Required	Gyrotory Data					[Evotherm 3G @ 07%]
% Asphalt Binder	3.99	4.98	4.99	5.30		Number of Gyrotions
Corrected Gmb @ N-Des.	2.358	2.388	2.388	2.397		N-Initial
Max. Sp.Gr. (Gmm)	2.508	2.462	2.461	2.447	2.470	7
% Gmm @ N- Initial	87.4	90.3	90.3	91.7		N-Design
%Gmm @ N-Max	95.0	97.8	97.9	98.6		68
% Air Voids	6.0	3.0	3.0	2.0		N-Max
% VMA	14.2	14.0	14.0	14.0		104
% VFA	57.8	78.5	78.8	85.4		Gsb for Angularity
Film Thickness	7.89	10.46	10.49	11.26		Method A
Filler Bit. Ratio	1.13	0.86	0.85	0.79		2.645
Gsb	2.638	2.638	2.638	2.638		Pba / %Abs Ratio
Gse	2.665	2.655	2.652	2.649		0.15
Pbe	3.61	4.78	4.79	5.15		Slope of Compaction
Pba	0.40	0.26	0.21	0.16		Curve
% New Asphalt Binder	61.0	69.1	69.1	71.0		15.5
Asphalt Binder Sp.Gr. @ 25c	1.037	1.037	1.037	1.037		Mix Grm Linearity
% Water Abs	1.68	1.68	1.68	1.68		Fair
S.A. m ² / Kg.	4.57	4.57	4.57	4.57		Pb Range Check
% + 4 Type 4 Agg. Or Better	7.5	7.5	7.5	7.5		1.31
% + 4 Type 2 or 3 Agg.	0.0	0.0	0.0	0.0		RAM Check
% -4 Type 2	1.6	1.6	1.6	1.6		Allowable RAM exceeded
Fineness Modulus of Type 2	0.0	0.0	0.0	0.0		Specification Check
Angularity-method A	43	43	43	43		OUT Does Not Comply
% Flat & Elongated	0.1	0.1	0.1	0.1		TSR Check
Sand Equivalent	99	99	99	99		Not Required
Aggregate Type	A	A	A	A		
% Crushed	81	81	81	81		

Disposition : An asphalt content of 5.0% is recommended to start this project. Target plant temp is 250 °F
Data shown in 4.98% column is interpolated from test data.

The % ADD AC to start project is 3.4%

Comments : 5% ras, ras source is scott county landfill. Ras/rap blended at hma plant site.

Copies to : Manatts ames, webb, fetters, mt.p rec., dist.6 mtls., wendling gry's., gettings

Mix Designer & Cert.# : David Schau EC089 Signed : _____

Figure A.7 FM7-5 (5% Shingles) Job Mix Formula - WMA additive is Evotherm

Form 956 ver. 7.1

77
Iowa Department of Transportation
 Highway Division - Office of Materials
 WMA Gytratory Mix Design

County :	Muscatine	Project :	HSIPX-061-4(107)- -3L-70	Mix No. :	ABD10-5018
Mix Size (in.) :	3/4 Type A	Contractor :	Manatts	Contract No. :	28214
Mix Type:	HMA 1M None	Design Life ESAL's :		Date:	10/11/10
Intended Use :	Shoulder	Location :	MP 92.8 - 105.8	frm N of ia38 in Musc E to Scott Co. line near Blue Grass	
Aggregate	% in Mix	Source ID	Source Location	Beds	Gsb %Abs FAA
5/8" Wash Chips	23.0%	A70002	Moscow/Wendling Quarries Inc	8-17	2.672 1.58 45.0
1/2" Wash Chip	23.0%	A70002	Moscow/Wendling Quarries Inc	8-17	2.649 1.16 45.6
1/4" Mansand	21.0%	A70002	Moscow/Wendling Quarries Inc	21A-24	2.764 1.18 47.7
3/8" Natural Sand	18.0%	A70504	Atalissa-Mckillip/Wendling Quarrie		2.631 0.52 38.2
1/2 RAP/RAS	15.0%	abc0-048			2.305 6.10 43.5

Job Mix Formula - Combined Gradation (Sieve Size in.)

1"	3/4"	1/2"	3/8"	#4	#8	#16	#30	#50	#100	#200
Upper Tolerance										
100	100	93	81	63	49		23			5.6
100	100	86	74	56	44	30	19	9.4	5.0	3.6
100	93	79	67	49	39		15			1.6
Lower Tolerance										

Asphalt Binder Source and Grade:	Flint Hills (AI = 3.6)					WMA Technology & Rate:
Adjust grade to PG 52-34	Gytratory Data					(Evotherm 3G @ 0.7)
% Asphalt Binder	4.50	4.90	5.47	5.50	5.70	<u>Number of Gytrations</u>
Corrected Gmb @ N-Des.	2.321	2.353	2.364	2.364	2.378	N-Initial
Max. Sp.Gr. (Gmm)	2.483	2.451	2.437	2.436	2.427	7
% Gmm @ N- Initial	86.9	89.6	90.6	90.6	92.7	N-Design
%Gmm @ N-Max	94.5	96.9	97.8	97.9	98.3	68
% Air Voids	6.5	4.0	3.0	3.0	2.0	N-Max
% VMA	15.6	14.8	14.9	14.9	14.6	104
% VFA	58.2	73.0	79.9	80.2	86.2	<u>Gsb for Angularity</u>
Film Thickness	9.20	10.81	11.88	11.92	12.47	<u>Method A</u>
Filler Bit Ratio	0.89	0.76	0.69	0.69	0.66	2.633
Gsb	2.626	2.626	2.626	2.626	2.626	<u>Pba / %Abs Ratio</u>
Gse	2.658	2.636	2.645	2.644	2.641	0.15
Pbe	4.05	4.76	5.23	5.25	5.49	<u>Slope of Compaction</u>
Pba	0.48	0.15	0.28	0.27	0.22	<u>Curve</u>
% New Asphalt Binder	63.7	66.8	70.4	70.6	71.7	16.2
Asphalt Binder Sp.Gr. @ 25c	1.037	1.037	1.037	1.037	1.037	<u>Mix Gmm Linearity</u>
% Water Abs	1.89	1.89	1.89	1.89	1.89	Fair
S.A. m ² / Kg.	4.40	4.40	4.40	4.40	4.40	<u>Pb Range Check</u>
% + 4 Type 4 Agg. Or Better	6.0	6.0	6.0	6.0	6.0	1.20
% + 4 Type 2 or 3 Agg.	0.0	0.0	0.0	0.0	0.0	<u>RAM Check</u>
% -4 Type 2	1.0	1.0	1.0	1.0	1.0	Allowable RAM exceeded
Fineness Modulus of Type 2	0.0	0.0	0.0	0.0	0.0	
Angularity-method A	43	43	43	43	43	<u>Specification Check</u>
% Flat & Elongated	0.3	0.3	0.3	0.3	0.3	OUT Does Not Comply
Sand Equivalent	99	99	99	99	99	<u>TSR Check</u>
Aggregate Type	A	A	A	A	A	Not Required
% Crushed	78	78	78	78	78	

Disposition : An asphalt content of 5.5% is recommended to start this project. Target plant temp is 250 °F
 Data shown in 5.47% column is interpolated from test data.

The % ADD AC to start project is 3.9%

Comments : 7% ras, ras source is scott county landfill, rap/ras blended at plants site. binder grad bump waived on this project.

Copies to : Manatts ames, webb, fetters, mt.p rcr., dist.6 mtl., wendling qry's., gettings

Mix Designer & Cert.# : David Schau EC 089 Signed : _____

Figure A.8 FM7-7 (7% Shingles) Job Mix Formula - WMA additive is Evotherm

APPENDIX B VOLUMETRIC DETAILS

Table B.1 Volumetric data for cores

ROAD	MILE POST OR CORE NUMBER	LANE	HMA / WMA	Test	Height (mm)	Gmm	Pa
US 218	221.1	NBPL	HMA	HAMBURG	63	2.46	7.35%
US 218	221.15	NBPL	HMA	IDT	41	2.46	9.30%
US 218	221.35	NBPL	HMA	IDT	51	2.46	7.21%
US 218	221.2	NBPL	HMA	IDT	43	2.46	9.46%
US 218	221.3	NBPL	HMA	HAMBURG	66	2.46	6.22%
US 218	221.45	NBPL	HMA	HAMBURG	62	2.46	6.46%
US 218	221.25	NBPL	HMA	HAMBURG	65	2.46	13.69%
US 218	222.05	NBPL	HMA	T-283	89	2.46	10.89%
US 218	221	NBPL	HMA	T-283	88	2.46	5.62%
US 218	221.4	NBPL	HMA	T-283	89	2.46	7.17%
US 218	223	NBPL	WMA	IDT	48	2.46	8.26%
US 218	223.1	NBPL	WMA	HAMBURG	61	2.46	8.31%
US 218	223.05	NBPL	WMA	T-283	88	2.46	8.11%
US 218	223.2	NBPL	WMA	IDT	51	2.46	8.38%
US 218	223.15	NBPL	WMA	IDT	51	2.46	7.92%
US 218	223.3	NBL	WMA	HAMBURG	61	2.46	6.98%
US 218	223.45	NBL	WMA	HAMBURG	63	2.46	7.72%
US 218	223.4	NBL	WMA	T-283	88	2.46	6.55%
US 218	223.25	NBL	WMA	T-283	89	2.46	8.04%
US 218	223.35	NBL	WMA	HAMBURG	62	2.46	7.51%
ROUTE 143	#1		WMA	HAMBURG	62	2.44	6.84%
ROUTE 143	#2		WMA	T-283	91	2.44	7.79%
ROUTE 143	#3		WMA	IDT	51	2.44	7.74%
ROUTE 143	#4		WMA	HAMBURG	59	2.44	7.81%
ROUTE 143	#5		WMA	HAMBURG	61	2.44	7.68%
ROUTE 143	#6		WMA	IDT	48	2.44	8.20%
ROUTE 143	#7		WMA	T-283	89	2.44	8.20%
ROUTE 143	#8		WMA	HAMBURG	61	2.44	8.95%
ROUTE 143	#9		WMA	T-283	82	2.44	7.38%
ROUTE 143	#10		WMA	IDT	50	2.44	7.71%
ROUTE 143	#11		HMA	IDT	52	2.44	9.36%
ROUTE 143	#12		HMA	IDT	50	2.44	6.63%
ROUTE 143	#13		HMA	IDT	51	2.44	8.49%
ROUTE 143	#14		HMA	HAMBURG	62	2.44	8.64%
ROUTE 143	#15		HMA	T-283	90	2.44	7.79%

Table B.1 (Continued) Volumetric data for cores

ROUTE 143	#16		HMA	HAMBURG	63	2.44	8.40%
ROUTE 143	#17		HMA	T-283	85	2.44	8.61%
ROUTE 143	#18		HMA	HAMBURG	60	2.44	7.38%
ROUTE 143	#19		HMA	T-283	87	2.44	7.49%
ROUTE 143	#20		HMA	HAMBURG	59	2.44	8.39%
US 65	62.15	SBDL	HMA	T-283	88	2.45	11.74%
US 65	62.3	SBDL	HMA	IDT	51	2.45	3.50%
US 65	62.1	SBDL	HMA	HAMBURG	63	2.45	8.82%
US 65	62.2	SBDL	HMA	IDT	51	2.45	4.22%
US 65	62.25	SBDL	HMA	T-283	88	2.45	4.09%
US 65	62.5	SBDL	HMA	T-283	89	2.45	3.71%
US 65	62.4	SBDL	HMA	IDT	50	2.45	5.77%
US 65	62.05	SBDL	HMA	HAMBURG	63	2.45	4.41%
US 65	62.35	SBDL	HMA	HAMBURG	64	2.45	9.92%
US 65	62.45	SBDL	HMA	HAMBURG	62	2.45	5.22%
US 65	61.2	SBDL	WMA	T-283	87	2.45	3.52%
US 65	61.3	SBDL	WMA	T-283	90	2.45	4.46%
US 65	61.05	SBDL	WMA	HAMBURG	61	2.45	4.32%
US 65	61	SBDL	WMA	T-283	86	2.45	7.73%
US 65	60.8	SBDL	WMA	IDT	50	2.45	2.57%
US 65	60.85	SBDL	WMA	IDT	52	2.45	2.93%
US 65	61.25	SBDL	WMA	IDT	39	2.45	4.90%
US 65	61.1	SBDL	WMA	HAMBURG	61	2.45	4.71%
US 65	61.15	SBDL	WMA	HAMBURG	60	2.45	5.03%
US 65	60.9	SBDL	WMA	HAMBURG	61	2.45	4.35%
CO. RD. E 67	#1	EBL	WMA	HAMBURG	64	2.44	9.93%
CO. RD. E 67	#2	EBL	WMA	IDT	53	2.44	10.02%
CO. RD. E 67	#3	EBL	WMA	IDT	52	2.44	7.69%
CO. RD. E 67	#4	EBL	WMA	T-283	86	2.44	9.55%
CO. RD. E 67	#5	EBL	WMA	T-283	86	2.44	4.99%
CO. RD. E 67	#6	EBL	WMA	HAMBURG	63	2.44	12.33%
CO. RD. E 67	#7	EBL	WMA	T-283	89	2.44	13.47%
CO. RD. E 67	#8	EBL	WMA	HAMBURG	64	2.44	11.81%

Table B.1 (Continued) Volumetric data for cores

CO. RD. E 67	#9	EBL	WMA	HAMBURG	60	2.44	11.60%
CO. RD. E 67	#10	EBL	WMA	IDT	53	2.44	10.47%
IA 13	62.9	SBL	WMA	HAMBURG	63	2.45	7.96%
IA 13	62.5	SBL	WMA	IDT	50	2.45	6.06%
IA 13	68	SBL	WMA	IDT	51	2.45	8.48%
IA 13	62.5	NBL	WMA	HAMBURG	63	2.45	5.97%
IA 13	63.3	SBL	WMA	T-283	90	2.45	6.43%
IA 13	68.1	SBL	WMA	HAMBURG	62	2.45	6.19%
IA 13	63.1	SBL	WMA	IDT	51	2.45	7.57%
IA 13	68	NBL	WMA	T-283	89	2.45	6.82%
IA 13	67.7	NB	WMA	T-283	89	2.45	10.64%
IA 13	67.95	SBL	WMA	HAMBURG	61	2.45	8.09%
US 61	95.5	NB DSH	FM7-0	T-283	87	2.5	8.37%
US 61	95	NBDSH	FM7-0	HAMBURG	62	2.5	9.41%
US 61	98	NBDSH	FM7-0	HAMBURG	60	2.5	7.56%
US 61	94	NB DSH	FM7-0	IDT	53	2.5	8.20%
US 61	96.5	NB DSH	FM7-0	IDT	52	2.5	8.91%
US 61	97.5	NB DSH	FM7-0	T-283	86	2.5	6.43%
US 61	96	NB DSH	FM7-0	IDT	52	2.5	8.22%
US 61	94.5	NB DSH	FM7-0	T-283	89	2.5	9.08%
US 61	97	NBDSH	FM7-0	HAMBURG	60	2.5	8.70%
US 61	98.5	NBDSH	FM7-0	HAMBURG	62	2.5	7.81%
US 61	97.5	NBPSH	FM7-5	IDT	52	2.45	8.53%
US 61	98.7	NBPSH	FM7-5	T-283	91	2.45	6.53%
US 61	96.9	NBPSH	FM7-5	T-283	93	2.45	5.91%
US 61	97.8	NBPS	FM7-5	T-283	88	2.45	13.23%
US 61	96.3	NB PSH	FM7-5	IDT	49	2.45	7.79%
US 61	96	NBPSH	FM7-5	IDT	52	2.45	8.04%
US 61	96.6	NB PSH	FM7-5	HAMBURG	62	2.45	12.40%
US 61	98.4	NB PSH	FM7-5	HAMBURG	61	2.45	5.89%
US 61	98.05	NBPSH	FM7-5	HAMBURG	63	2.45	7.16%
US 61	97.2	NB PSH	FM7-5	HAMBURG	63	2.45	7.41%
US 61	104.4	NBDSH	FM7-7	HAMBURG	62	2.437	6.19%
US 61	104.6	NB DSH	FM7-7	IDT	54	2.437	7.38%
US 61	103.4	NB DSH	FM7-7	HAMBURG	64	2.437	8.67%
US 61	104.2	NB DSH	FM7-7	HAMBURG	62	2.437	9.67%
US 61	104	NB DSH	FM7-7	HAMBURG	62	2.437	11.13%
US 61	103.8	NBDSH	FM7-7	IDT	53	2.437	7.57%

Table B.1 (Continued) Volumetric data for cores

US 61	103	NBDSH	FM7-7	IDT	51	2.437	7.96%
US 61	103.6	NBDSH	FM7-7	T-283	88	2.437	9.15%
US 61	104.8	NBDSH	FM7-7	T-283	89	2.437	12.35%
US 61	103.2	NB DSH	FM7-7	T-283	89	2.437	10.44%

Table B.2 FM5 field-compacted dynamic modulus

Dry	Wt. Water	SSD	Gmb	Gmm	Pa
2634.1	1484.0	2640.6	2.28	2.44	6.66%
2633.4	1484.3	2640.9	2.28	2.44	6.69%
2635.6	1486.1	2643.9	2.28	2.44	6.71%
2636.1	1485.0	2643.1	2.28	2.44	6.71%
2634.7	1485.5	2643.5	2.28	2.44	6.75%
2633.3	1480.8	2638.6	2.27	2.44	6.79%
2633.8	1481.9	2640.6	2.27	2.44	6.84%
2635.7	1484.4	2644.4	2.27	2.44	6.88%

Table B.3 FM5 lab-compacted dynamic modulus

Dry	Wt. Water	SSD	Gmb	Gmm	Pa
2637.8	1485.9	2644.2	2.28	2.44	6.67%
2635.2	1485.9	2643.4	2.28	2.44	6.70%
2635.9	1484.2	2642.8	2.28	2.44	6.76%
2636.2	1485.7	2644.6	2.27	2.44	6.77%
2634.8	1481.2	2639.5	2.27	2.44	6.77%
2636.5	1482.8	2642.2	2.27	2.44	6.80%
2635.7	1484.4	2644.4	2.27	2.44	6.88%
2634.9	1480.5	2640.3	2.27	2.44	6.89%
2634.9	1481.1	2641.2	2.27	2.44	6.92%
2634	1483.4	2643.6	2.27	2.44	6.95%

Table B.4 FM6 field-compacted dynamic modulus

Dry	Wt. Water	SSD	Gmb	Gmm	Pa
2638.1	1485.5	2642.6	2.28	2.45	6.94%
2638.6	1483.6	2642.0	2.28	2.45	7.03%
2636.3	1483.1	2640.8	2.28	2.45	7.05%
2637.8	1482.2	2640.8	2.28	2.45	7.07%
2637.6	1482.1	2641.5	2.27	2.45	7.14%

Table B.5 FM6 lab-compacted dynamic modulus

Dry	Wt. Water	SSD	Gmb	Gmm	Pa
2635.9	1481.3	2641.3	2.27	2.45	7.33%
2636.9	1481.2	2641.7	2.27	2.45	7.33%
2638.8	1481.7	2643.5	2.27	2.45	7.37%
2635	1480.1	2640.3	2.27	2.45	7.38%
2636.7	1480.3	2641.5	2.27	2.45	7.40%
2634.9	1479.1	2640.6	2.27	2.45	7.48%
2636.9	1478.5	2641.4	2.27	2.45	7.52%
2634.5	1478.0	2640.0	2.27	2.45	7.54%
2634.9	1477.3	2640.0	2.27	2.45	7.58%
2635.4	1478	2641.8	2.26	2.45	7.65%

Table B.6 FM7-0 field-compacted dynamic modulus

Dry	Wt. Water	SSD	Gmb	Gmm	Pa
2694.0	1554.3	2700.6	2.35	2.50	5.80%
2686.3	1548.6	2693.0	2.35	2.50	5.92%
2690.6	1552.4	2700.4	2.34	2.50	6.06%
2694.1	1547.7	2700.0	2.34	2.50	6.29%
2691.7	1544.6	2695.9	2.34	2.50	6.29%
2694.7	1547.1	2700.3	2.34	2.50	6.34%
2690.8	1544.8	2696.6	2.34	2.50	6.37%
2687.4	1543.0	2693.5	2.34	2.50	6.38%
2690.5	1544.5	2697.8	2.33	2.50	6.50%
2692.1	1544.7	2698.7	2.33	2.50	6.50%

Table B.7 FM7-0 lab-compacted dynamic modulus

Dry	Wt. Water	SSD	Gmb	Gmm	Pa
2691.4	1545.4	2700.1	2.33	2.50	6.58%
2689.3	1542.3	2696.3	2.33	2.50	6.60%
2691.6	1544.2	2699.2	2.33	2.50	6.60%
2689.7	1542	2696.8	2.33	2.50	6.65%
2685.7	1537.6	2691.2	2.33	2.50	6.69%
2690.3	1540.1	2695.9	2.33	2.50	6.71%
2691.2	1538.3	2695	2.33	2.50	6.75%
2688.6	1537.4	2693.5	2.33	2.50	6.79%
2691.1	1537.4	2695.9	2.32	2.50	6.90%
2688.9	1536.4	2694.4	2.32	2.50	6.93%

Table B.8 FM7-5 lab-compacted dynamic modulus

Dry	Wt. Water	SSD	Gmb	Gmm	Pa
2632.9	1502.2	2658.2	2.28	2.450	7.04%
2634.9	1502.2	2661.5	2.27	2.45	7.23%
2636.5	1493.6	2655	2.27	2.450	7.34%
2634.1	1497.3	2659.6	2.27	2.45	7.50%
2632.6	1495.4	2658.1	2.26	2.450	7.58%
2628.2	1493	2654.3	2.26	2.450	7.63%
2633.2	1495.2	2658.8	2.26	2.450	7.63%
2632.9	1494.2	2657.8	2.26	2.450	7.64%
2632.9	1493.3	2657.1	2.26	2.45	7.66%
2634.4	1496.9	2663	2.26	2.450	7.79%
2633.4	1493.7	2659.7	2.26	2.450	7.82%
2633.1	1492.7	2659.6	2.26	2.450	7.90%
2631.5	1493.1	2659.5	2.26	2.450	7.91%
2633.8	1493.4	2661	2.26	2.450	7.93%

Table B.9 FM7-7 lab-compacted dynamic modulus

Sample	Dry	Wt. Water	SSD	Gmb	Gmm	Pa
24.00	2639.3	1507.6	2666.6	2.28	2.437	6.56
21.00	2638.1	1500.8	2661.6	2.27	2.437	6.74
25.00	2639.4	1500.8	2662.4	2.27	2.437	6.76
1	2631.8	1502.2	2662	2.27	2.437	6.89
23.00	2635.5	1499.2	2660.7	2.27	2.437	6.89
16.00	2639.4	1501.9	2666.0	2.27	2.437	6.96
3	2634.6	1488.9	2652	2.27	2.437	7.05
14.00	2639.1	1494.8	2662.2	2.26	2.437	7.24
2	2635.5	1495.6	2661.7	2.26	2.437	7.26
12.00	2639.3	1493.9	2661.8	2.26	2.437	7.27
15.00	2638.7	1503.7	2672.3	2.26	2.437	7.35
26.00	2638.7	1489.3	2658.0	2.26	2.437	7.35
22.00	2634.1	1492.2	2660.1	2.26	2.437	7.45
11.00	2639.5	1493.9	2664.7	2.25	2.437	7.49

APPENDIX C DYNAMIC MODULUS VALUES

The following tables show all of the dynamic modulus values collected during this study.

Table C.1 FM1 dynamic modulus data (used only for MEPDG analysis)

Mix	Temp °C	Moisture Conditioned	25Hz	15Hz	10Hz	5Hz	3Hz	1Hz	0.5Hz	0.3Hz	0.1Hz
Hot Mix Field	4	Y	1.72E+07	1.59E+07	1.52E+07	1.42E+07	1.33E+07	1.16E+07	1.08E+07	1.01E+07	8.33E+06
Hot Mix Field	21	Y	7.82E+06	6.89E+06	6.37E+06	5.48E+06	4.55E+06	3.29E+06	2.82E+06	2.51E+06	1.69E+06
Hot Mix Field	37	Y	2.79E+06	2.38E+06	2.07E+06	1.64E+06	1.21E+06	8.48E+05	6.36E+05	5.33E+05	3.85E+05
Hot Mix Field	4	N	1.80E+07	1.72E+07	1.59E+07	1.50E+07	1.43E+07	1.23E+07	1.12E+07	1.06E+07	8.65E+06
Hot Mix Field	21	N	7.89E+06	7.06E+06	6.48E+06	5.58E+06	4.68E+06	3.57E+06	3.09E+06	2.70E+06	1.87E+06
Hot Mix Field	37	N	2.97E+06	2.47E+06	2.16E+06	1.72E+06	1.27E+06	8.81E+05	6.60E+05	5.52E+05	3.97E+05
Warm Mix Field	4	Y	1.46E+07	1.35E+07	1.27E+07	1.15E+07	1.06E+07	8.93E+06	7.95E+06	7.52E+06	5.96E+06
Warm Mix Field	21	Y	6.02E+06	5.34E+06	4.81E+06	4.10E+06	3.33E+06	2.49E+06	2.11E+06	1.77E+06	1.21E+06
Warm Mix Field	37	Y	1.95E+06	1.63E+06	1.43E+06	1.14E+06	8.33E+05	6.16E+05	4.55E+05	3.89E+05	2.95E+05
Warm Mix Field	4	N	1.75E+07	1.59E+07	1.62E+07	1.48E+07	1.38E+07	1.18E+07	1.08E+07	1.00E+07	8.12E+06
Warm Mix Field	21	N	7.62E+06	6.83E+06	6.25E+06	5.32E+06	4.05E+06	3.28E+06	2.79E+06	2.39E+06	1.70E+06
Warm Mix Field	37	N	2.64E+06	2.20E+06	1.92E+06	1.54E+06	1.09E+06	7.65E+05	5.74E+05	4.81E+05	3.49E+05
Hot Mix Lab	4	Y	1.72E+07	1.63E+07	1.55E+07	1.43E+07	1.36E+07	1.16E+07	1.07E+07	9.96E+06	8.19E+06
Hot Mix Lab	21	Y	7.74E+06	7.12E+06	6.55E+06	5.64E+06	4.66E+06	3.57E+06	2.98E+06	2.67E+06	1.83E+06
Hot Mix Lab	37	Y	2.63E+06	2.21E+06	1.95E+06	1.56E+06	1.15E+06	8.27E+05	6.30E+05	5.31E+05	3.87E+05
Hot Mix Lab	4	N	1.96E+07	1.83E+07	1.76E+07	1.66E+07	1.61E+07	1.38E+07	1.28E+07	1.19E+07	9.71E+06
Hot Mix Lab	21	N	9.24E+06	8.50E+06	7.80E+06	6.82E+06	5.84E+06	4.51E+06	3.91E+06	3.46E+06	2.46E+06
Hot Mix Lab	37	N	3.41E+06	2.84E+06	2.48E+06	1.97E+06	1.45E+06	1.02E+06	7.66E+05	6.33E+05	4.39E+05
Warm Mix Lab	4	Y	1.71E+07	1.53E+07	1.47E+07	1.36E+07	1.28E+07	1.06E+07	9.69E+06	9.11E+06	7.24E+06
Warm Mix Lab	21	Y	7.18E+06	6.37E+06	5.76E+06	4.89E+06	3.97E+06	3.01E+06	2.58E+06	2.21E+06	1.54E+06
Warm Mix Lab	37	Y	2.22E+06	1.85E+06	1.62E+06	1.30E+06	9.61E+05	6.93E+05	5.34E+05	4.57E+05	3.48E+05
Warm Mix Lab	4	N	1.83E+07	1.72E+07	1.65E+07	1.51E+07	1.42E+07	1.19E+07	1.09E+07	1.01E+07	8.03E+06
Warm Mix Lab	21	N	8.38E+06	7.52E+06	6.87E+06	5.84E+06	4.82E+06	3.63E+06	3.08E+06	2.65E+06	1.86E+06
Warm Mix Lab	37	N	2.76E+06	2.27E+06	1.97E+06	1.55E+06	1.15E+06	8.13E+05	6.16E+05	5.16E+05	3.76E+05

Table C.2 Field Mix 2 dynamic modulus values (kPa)

Mix	Temp °C	Moisture Conditioned	25Hz	15Hz	10Hz	5Hz	3Hz	1Hz	0.5Hz	0.3Hz	0.1Hz
Hot Mix Field	4	Y	1.59E+07	1.45E+07	1.35E+07	1.23E+07	1.14E+07	9.35E+06	8.54E+06	7.80E+06	6.22E+06
Hot Mix Field	21	Y	6.80E+06	5.97E+06	5.40E+06	4.57E+06	3.72E+06	2.76E+06	2.32E+06	1.95E+06	1.42E+06
Hot Mix Field	37	Y	2.12E+06	1.75E+06	1.52E+06	1.24E+06	8.92E+05	6.77E+05	5.99E+05	5.20E+05	4.08E+05
Hot Mix Field	4	N	1.59E+07	1.43E+07	1.34E+07	1.21E+07	1.10E+07	9.10E+06	8.29E+06	7.52E+06	5.89E+06
Hot Mix Field	21	N	6.46E+06	5.57E+06	5.05E+06	4.21E+06	3.47E+06	2.53E+06	2.08E+06	1.77E+06	1.24E+06
Hot Mix Field	37	N	2.12E+06	1.75E+06	1.52E+06	1.25E+06	8.91E+05	6.78E+05	5.52E+05	4.93E+05	3.42E+05
Warm Mix Field	4	Y	1.43E+07	1.28E+07	1.20E+07	1.09E+07	9.95E+06	8.26E+06	7.26E+06	6.76E+06	5.28E+06
Warm Mix Field	21	Y	5.32E+06	4.67E+06	4.21E+06	3.54E+06	2.89E+06	2.12E+06	1.82E+06	1.45E+06	1.04E+06
Warm Mix Field	37	Y	1.94E+06	1.61E+06	1.39E+06	1.15E+06	8.31E+05	6.29E+05	5.43E+05	4.94E+05	3.75E+05
Warm Mix Field	4	N	1.64E+07	1.47E+07	1.39E+07	1.26E+07	1.14E+07	9.71E+06	8.88E+06	8.07E+06	6.42E+06
Warm Mix Field	21	N	6.88E+06	6.02E+06	5.41E+06	4.54E+06	3.70E+06	2.72E+06	2.30E+06	1.94E+06	1.53E+06
Warm Mix Field	37	N	2.17E+06	1.79E+06	1.56E+06	1.28E+06	9.11E+05	6.67E+05	5.40E+05	5.02E+05	3.96E+05
Hot Mix Lab	4	Y	1.55E+07	1.38E+07	1.29E+07	1.18E+07	1.07E+07	8.92E+06	8.15E+06	7.42E+06	5.88E+06
Hot Mix Lab	21	Y	5.78E+06	5.26E+06	4.81E+06	4.06E+06	3.31E+06	2.42E+06	2.04E+06	1.74E+06	1.25E+06
Hot Mix Lab	37	Y	2.08E+06	1.75E+06	1.56E+06	1.27E+06	9.45E+05	7.34E+05	6.16E+05	5.53E+05	4.01E+05
Hot Mix Lab	4	N	1.64E+07	1.49E+07	1.39E+07	1.26E+07	1.18E+07	9.64E+06	8.84E+06	8.03E+06	6.38E+06
Hot Mix Lab	21	N	6.67E+06	5.89E+06	5.30E+06	4.51E+06	3.65E+06	2.74E+06	2.27E+06	1.94E+06	1.36E+06
Hot Mix Lab	37	N	2.01E+06	1.65E+06	1.46E+06	1.18E+06	8.44E+05	6.63E+05	5.46E+05	5.46E+05	4.32E+05
Warm Mix Lab	4	Y	1.40E+07	1.26E+07	1.19E+07	1.08E+07	9.97E+06	8.19E+06	7.42E+06	6.76E+06	5.34E+06
Warm Mix Lab	21	Y	5.64E+06	4.98E+06	4.46E+06	3.73E+06	3.01E+06	2.19E+06	1.84E+06	1.57E+06	1.10E+06
Warm Mix Lab	37	Y	2.01E+06	1.69E+06	1.47E+06	1.21E+06	8.53E+05	6.60E+05	5.50E+05	4.87E+05	3.68E+05
Warm Mix Lab	4	N	1.53E+07	1.39E+07	1.30E+07	1.18E+07	1.09E+07	8.98E+06	8.08E+06	7.37E+06	5.76E+06
Warm Mix Lab	21	N	6.74E+06	5.78E+06	5.15E+06	4.27E+06	3.45E+06	2.50E+06	2.04E+06	1.76E+06	1.23E+06
Warm Mix Lab	37	N	1.86E+06	1.52E+06	1.39E+06	1.12E+06	8.13E+05	5.88E+05	5.02E+05	4.73E+05	2.87E+05

Table C.3 Field Mix 3 dynamic modulus values (kPa)

Mix	Temp °C	Moisture Conditioned	25Hz	15Hz	10Hz	5Hz	3Hz	1Hz	0.5Hz	0.3Hz	0.1Hz
Hot Mix Field	4	Y	1.78E+07	1.60E+07	1.49E+07	1.38E+07	1.30E+07	1.07E+07	9.76E+06	8.96E+06	6.77E+06
Hot Mix Field	21	Y	6.98E+06	6.06E+06	5.39E+06	4.48E+06	3.54E+06	2.50E+06	2.07E+06	1.65E+06	1.00E+06
Hot Mix Field	37	Y	2.02E+06	1.62E+06	1.36E+06	1.03E+06	7.06E+05	4.72E+05	3.44E+05	2.78E+05	1.89E+05
Hot Mix Field	4	N	1.90E+07	1.83E+07	1.72E+07	1.57E+07	1.48E+07	1.21E+07	1.10E+07	1.03E+07	7.95E+06
Hot Mix Field	21	N	8.03E+06	7.07E+06	6.32E+06	5.25E+06	4.19E+06	2.97E+06	2.42E+06	1.93E+06	1.20E+06
Hot Mix Field	37	N	2.30E+06	1.82E+06	1.51E+06	1.15E+06	8.12E+05	5.07E+05	3.60E+05	3.56E+05	2.57E+05
Warm Mix Field	4	Y	1.67E+07	1.48E+07	1.40E+07	1.27E+07	1.19E+07	9.78E+06	8.65E+06	8.11E+06	6.09E+06
Warm Mix Field	21	Y	6.30E+06	5.48E+06	4.89E+06	4.06E+06	3.22E+06	2.27E+06	1.86E+06	1.49E+06	9.29E+05
Warm Mix Field	37	Y	2.06E+06	1.67E+06	1.40E+06	1.10E+06	7.82E+05	5.44E+05	3.85E+05	3.36E+05	2.28E+05
Warm Mix Field	4	N	1.85E+07	1.68E+07	1.55E+07	1.43E+07	1.33E+07	1.10E+07	9.76E+06	9.22E+06	6.94E+06
Warm Mix Field	21	N	7.30E+06	6.36E+06	5.63E+06	4.69E+06	3.79E+06	2.69E+06	2.20E+06	1.79E+06	1.14E+06
Warm Mix Field	37	N	2.14E+06	1.72E+06	1.47E+06	1.15E+06	8.42E+05	5.76E+05	4.81E+05	3.53E+05	2.75E+05
Hot Mix Lab	4	Y	1.90E+07	1.77E+07	1.67E+07	1.54E+07	1.47E+07	1.22E+07	1.12E+07	1.04E+07	8.14E+06
Hot Mix Lab	21	Y	8.00E+06	7.12E+06	6.43E+06	5.44E+06	4.17E+06	2.74E+06	2.68E+06	2.38E+06	1.26E+06
Hot Mix Lab	37	Y	2.57E+06	2.01E+06	1.71E+06	1.33E+06	9.79E+05	6.89E+05	6.06E+05	4.82E+05	4.05E+05
Hot Mix Lab	4	N	1.99E+07	1.87E+07	1.75E+07	1.58E+07	1.53E+07	1.26E+07	1.16E+07	1.07E+07	8.40E+06
Hot Mix Lab	21	N	8.28E+06	7.33E+06	6.61E+06	5.59E+06	4.17E+06	2.74E+06	2.68E+06	2.38E+06	1.26E+06
Hot Mix Lab	37	N	2.54E+06	2.05E+06	1.73E+06	1.30E+06	9.46E+05	6.47E+05	4.89E+05	4.26E+05	2.66E+05
Warm Mix Lab	4	Y	1.72E+07	1.56E+07	1.45E+07	1.30E+07	1.22E+07	9.84E+06	8.83E+06	8.20E+06	6.13E+06
Warm Mix Lab	21	Y	6.28E+06	5.50E+06	4.96E+06	4.12E+06	3.22E+06	2.36E+06	1.79E+06	1.57E+06	9.26E+05
Warm Mix Lab	37	Y	1.85E+06	1.49E+06	1.26E+06	9.69E+05	6.99E+05	4.55E+05	3.41E+05	2.86E+05	2.15E+05
Warm Mix Lab	4	N	1.94E+07	1.78E+07	1.67E+07	1.53E+07	1.51E+07	1.19E+07	1.10E+07	9.82E+06	7.87E+06
Warm Mix Lab	21	N	7.51E+06	6.55E+06	5.81E+06	4.92E+06	4.00E+06	2.85E+06	2.42E+06	1.85E+06	1.12E+06
Warm Mix Lab	37	N	2.18E+06	1.74E+06	1.47E+06	1.13E+06	7.48E+05	5.01E+05	3.70E+05	3.09E+05	2.46E+05

Table C.4 FM4 dynamic modulus values (kPa)

Mix	Temp °C	Moisture Conditioned	25Hz	15Hz	10Hz	5Hz	3Hz	1Hz	0.5Hz	0.3Hz	0.1Hz
Hot Mix Field	4	Y	2.06E+07	2.01E+07	1.90E+07	1.75E+07	1.61E+07	1.41E+07	1.27E+07	1.22E+07	9.77E+06
Hot Mix Field	21	Y	1.00E+07	8.80E+06	8.00E+06	6.73E+06	5.54E+06	4.04E+06	3.52E+06	3.29E+06	2.08E+06
Hot Mix Field	37	Y	3.24E+06	2.68E+06	2.31E+06	1.81E+06	1.35E+06	8.72E+05	6.72E+05	5.65E+05	4.34E+05
Hot Mix Field	4	N	2.10E+07	2.00E+07	1.89E+07	1.74E+07	1.64E+07	1.43E+07	1.29E+07	1.24E+07	9.99E+06
Hot Mix Field	21	N	1.12E+07	9.93E+06	9.07E+06	7.80E+06	6.51E+06	4.94E+06	3.90E+06	3.58E+06	2.30E+06
Hot Mix Field	37	N	3.66E+06	2.97E+06	2.54E+06	1.98E+06	1.50E+06	1.02E+06	8.12E+05	6.90E+05	5.23E+05
Warm Mix Field	4	Y	2.02E+07	1.93E+07	1.77E+07	1.71E+07	1.67E+07	1.43E+07	1.32E+07	1.24E+07	1.01E+07
Warm Mix Field	21	Y	1.03E+07	9.22E+06	8.39E+06	7.24E+06	6.12E+06	4.61E+06	3.95E+06	3.22E+06	2.17E+06
Warm Mix Field	37	Y	3.65E+06	3.01E+06	2.57E+06	2.01E+06	1.49E+06	1.01E+06	7.86E+05	6.68E+05	5.22E+05
Warm Mix Field	4	N	2.25E+07	2.16E+07	2.04E+07	1.90E+07	1.81E+07	1.49E+07	1.43E+07	1.33E+07	1.09E+07
Warm Mix Field	21	N	1.12E+07	9.96E+06	8.95E+06	5.17E+06	6.57E+06	4.91E+06	4.14E+06	3.61E+06	2.42E+06
Warm Mix Field	37	N	3.69E+06	3.01E+06	2.56E+06	1.96E+06	1.38E+06	8.92E+05	7.15E+05	5.86E+05	4.07E+05
Hot Mix Lab	4	Y	1.95E+07	1.85E+07	1.75E+07	1.62E+07	1.56E+07	1.33E+07	1.23E+07	1.14E+07	9.41E+06
Hot Mix Lab	21	Y	9.15E+06	8.06E+06	7.36E+06	6.36E+06	5.27E+06	4.00E+06	3.43E+06	3.05E+06	2.08E+06
Hot Mix Lab	37	Y	3.19E+06	2.67E+06	2.34E+06	1.84E+06	1.34E+06	9.27E+05	7.18E+05	5.97E+05	4.32E+05
Hot Mix Lab	4	N	2.06E+07	1.96E+07	1.84E+07	1.74E+07	1.69E+07	1.44E+07	1.34E+07	1.24E+07	1.02E+07
Hot Mix Lab	21	N	9.85E+06	8.79E+06	8.05E+06	6.98E+06	6.00E+06	4.54E+06	3.90E+06	3.41E+06	2.34E+06
Hot Mix Lab	37	N	3.57E+06	2.98E+06	2.57E+06	2.02E+06	1.49E+06	1.00E+06	7.83E+05	6.78E+05	4.90E+05
Warm Mix Lab	4	Y	2.05E+07	1.97E+07	1.79E+07	1.66E+07	1.67E+07	1.36E+07	1.33E+07	1.24E+07	1.00E+07
Warm Mix Lab	4	N	2.40E+07	2.29E+07	2.15E+07	1.93E+07	1.96E+07	1.62E+07	1.55E+07	1.45E+07	1.17E+07
Warm Mix Lab	21	Y	1.09E+07	9.53E+06	8.71E+06	7.45E+06	6.30E+06	4.73E+06	3.72E+06	3.43E+06	2.24E+06
Warm Mix Lab	21	N	1.23E+07	1.08E+07	9.93E+06	8.64E+06	7.30E+06	5.55E+06	4.61E+06	4.39E+06	2.85E+06
Warm Mix Lab	37	Y	3.82E+06	3.19E+06	2.75E+06	2.15E+06	1.59E+06	1.07E+06	8.23E+05	6.87E+05	4.98E+05
Warm Mix Lab	37	N	4.19E+06	3.47E+06	2.96E+06	2.30E+06	1.70E+06	1.14E+06	8.73E+05	7.19E+05	5.17E+05

Table C.5 FM5 dynamic modulus values

Mix	Sample	Temperature	Moisture Conditioned	DYNAMIC MODULUS (Mpa)									
				25 Hz	20 Hz	10 Hz	5 Hz	2 Hz	1 Hz	0.5 Hz	0.2 Hz	0.1 Hz	
Warm Mix Field	2	4	Y	14013	13589	12559	11554	10281	9333	8422	7275	6469	
Warm Mix Field	4	4	Y	14856	14509	13548	12584	11313	10361	9430	8242	7395	
Warm Mix Field	5	4	Y	13841	13457	12448	11447	10175	9233	8312	7183	6411	
Warm Mix Field	Mean	4		1.42E+04	1.39E+04	1.29E+04	1.19E+04	1.06E+04	9.64E+03	8.72E+03	7.57E+03	6.76E+03	
Warm Mix Field	SD	4		5.43E+02	5.73E+02	6.06E+02	6.28E+02	6.29E+02	6.24E+02	6.16E+02	5.87E+02	5.52E+02	
Warm Mix Field	CoV	4		3.82E+00	4.14E+00	4.71E+00	5.29E+00	5.94E+00	6.48E+00	7.07E+00	7.75E+00	8.17E+00	
Warm Mix Field	3	4	N	15610	15228	14177	13133	11779	10768	9776	8526	7640	
Warm Mix Field	6	4	N	16119	15500	14413	13321	11929	10876	9860	8592	7694	
Warm Mix Field	7	4	N	15390	15002	13961	12922	11591	10589	9609	8377	7512	
Warm Mix Field	Mean	4		1.57E+04	1.52E+04	1.42E+04	1.31E+04	1.18E+04	1.07E+04	9.75E+03	8.50E+03	7.62E+03	
Warm Mix Field	SD	4		3.74E+02	2.49E+02	2.26E+02	2.00E+02	1.69E+02	1.45E+02	1.28E+02	1.10E+02	9.35E+01	
Warm Mix Field	CoV	4		2.38E+00	1.64E+00	1.59E+00	1.52E+00	1.44E+00	1.35E+00	1.31E+00	1.30E+00	1.23E+00	
Warm Mix Field	2	21	Y	7118	6784	5855	5022	4047	3390	2815	2164	1763	
Warm Mix Field	4	21	Y	6820	6501	5622	4839	3917	3294	2753	2131	1747	
Warm Mix Field	5	21	Y	7537	7185	6238	5383	4387	3721	3130	2441	2006	
Warm Mix Field	Mean	21		7.16E+03	6.82E+03	5.91E+03	5.08E+03	4.12E+03	3.47E+03	2.90E+03	2.25E+03	1.84E+03	
Warm Mix Field	SD	21		3.60E+02	3.44E+02	3.11E+02	2.77E+02	2.43E+02	2.24E+02	2.02E+02	1.70E+02	1.45E+02	
Warm Mix Field	CoV	21		5.03E+00	5.04E+00	5.27E+00	5.45E+00	5.89E+00	6.46E+00	6.97E+00	7.58E+00	7.89E+00	
Warm Mix Field	1	21	N	8001	7676	6702	5810	4760	4039	3397	2658	2191	
Warm Mix Field	3	21	N	8170	7797	6789	5865	4785	4057	3420	2692	2231	
Warm Mix Field	6	21	N	8353	8003	6981	6038	4931	4183	3524	2767	2290	
Warm Mix Field	7	21	N	8264	7897	6896	5983	4906	4172	3521	2774	2296	
Warm Mix Field	Mean	21		8.20E+03	7.84E+03	6.84E+03	5.92E+03	4.85E+03	4.11E+03	3.47E+03	2.72E+03	2.25E+03	
Warm Mix Field	SD	21		1.51E+02	1.40E+02	1.22E+02	1.05E+02	8.55E+01	7.53E+01	6.65E+01	5.69E+01	5.01E+01	
Warm Mix Field	CoV	21		1.84E+00	1.78E+00	1.78E+00	1.77E+00	1.76E+00	1.83E+00	1.92E+00	2.09E+00	2.23E+00	
Warm Mix Field	2	37	Y	2623	2436	1908	1498	1037	748.6	560.3	371.1	263.7	
Warm Mix Field	4	37	Y	2688	2540	2000	1582	1103	796.7	602.4	412	295.7	
Warm Mix Field	5	37	Y	2802	2598	2042	1618	1135	832	634.9	432.1	325	
Warm Mix Field	Mean	37		2.70E+03	2.52E+03	1.98E+03	1.57E+03	1.09E+03	7.92E+02	5.99E+02	4.05E+02	2.95E+02	
Warm Mix Field	SD	37		9.06E+01	8.21E+01	6.85E+01	6.16E+01	5.00E+01	4.19E+01	3.74E+01	3.11E+01	3.07E+01	
Warm Mix Field	CoV	37		3.35E+00	3.25E+00	3.46E+00	3.93E+00	4.58E+00	5.28E+00	6.24E+00	7.67E+00	1.04E+01	
Warm Mix Field	1	37	N	3138	2941	2293	1803	1254	908.6	684.2	459	320.7	
Warm Mix Field	3	37	N	3096	2912	2313	1853	1337	998.7	775.8	537.8	393.4	
Warm Mix Field	6	37	N	3107	2946	2381	1931	1393	1034	751.1	556.6	430.2	
Warm Mix Field	7	37	N	3383	3204	2562	2054	1499	1122	872.6	603.1	439.4	
Warm Mix Field	Mean	37		3.18E+03	3.00E+03	2.39E+03	1.91E+03	1.37E+03	1.02E+03	7.71E+02	5.39E+02	3.96E+02	
Warm Mix Field	SD	37		1.36E+02	1.36E+02	1.22E+02	1.09E+02	1.03E+02	8.83E+01	7.81E+01	6.01E+01	5.39E+01	
Warm Mix Field	CoV	37		4.27E+00	4.54E+00	5.13E+00	5.72E+00	7.50E+00	8.69E+00	1.01E+01	1.11E+01	1.36E+01	

Table C.5 (Continued) FM5 dynamic modulus values

Warm Mix Lab	3	4	Y	13159	12848	11887	10957	9738	8836	7961	6864	6120
Warm Mix Lab	4	4	Y	13495	13136	12135	11157	9891	8956	8051	6940	6178
Warm Mix Lab	6	4	Y	12063	11777	10896	10042	8937	8127	7330	6365	5705
Warm Mix Lab	8	4	Y									
Warm Mix Lab	10	4	Y	13414	13104	12161	11223	10007	9112	8226	7128	6372
Warm Mix Lab	Mean	4		1.30E+04	1.27E+04	1.18E+04	1.08E+04	9.64E+03	8.76E+03	7.89E+03	6.82E+03	6.09E+03
Warm Mix Lab	SD	4		6.62E+02	6.39E+02	5.95E+02	5.47E+02	4.84E+02	4.35E+02	3.90E+02	3.26E+02	2.81E+02
Warm Mix Lab	CoV	4		5.08E+00	5.03E+00	5.06E+00	5.04E+00	5.01E+00	4.97E+00	4.95E+00	4.77E+00	4.61E+00
Warm Mix Lab	1	4	N	15384	15052	14075	13079	11781	10798	9836	8619	7781
Warm Mix Lab	2	4	N	14396	14096	13144	12193	10838	10120	9171	7980	7116
Warm Mix Lab	5	4	N	15275	14880	13863	12808	11435	10428	9451	8223	7361
Warm Mix Lab	7	4	N	15531	15158	14112	13059	11710	10683	9683	8429	7536
Warm Mix Lab	9	4	N	15649	15213	14129	13066	11712	10685	9683	8436	7564
Warm Mix Lab	Mean	4		1.52E+04	1.49E+04	1.39E+04	1.28E+04	1.15E+04	1.05E+04	9.56E+03	8.34E+03	7.47E+03
Warm Mix Lab	SD	4		4.96E+02	4.56E+02	4.17E+02	3.79E+02	3.91E+02	2.72E+02	2.60E+02	2.44E+02	2.49E+02
Warm Mix Lab	CoV	4		3.26E+00	3.07E+00	3.01E+00	2.95E+00	3.40E+00	2.58E+00	2.71E+00	2.93E+00	3.33E+00
Warm Mix Lab	3	21	Y	7344	7008	6071	5223	4226	3559	2974	2307	1884
Warm Mix Lab	4	21	Y	6871	6615	5754	4966	4017	3380	2814	2182	1781
Warm Mix Lab	6	21	Y	6802	6519	5660	4880	3964	3343	2800	2180	1785
Warm Mix Lab	8	21	Y	6808	6568	5719	4928	3942	3313	2780	2158	1764
Warm Mix Lab	10	21	Y	7302	6992	6086	5267	4268	3588	3012	2371	1966
Warm Mix Lab	Mean	21		7.03E+03	6.74E+03	5.86E+03	5.05E+03	4.08E+03	3.44E+03	2.88E+03	2.24E+03	1.84E+03
Warm Mix Lab	SD	21		2.73E+02	2.39E+02	2.04E+02	1.79E+02	1.53E+02	1.28E+02	1.08E+02	9.40E+01	8.66E+01
Warm Mix Lab	CoV	21		3.89E+00	3.55E+00	3.48E+00	3.54E+00	3.74E+00	3.71E+00	3.77E+00	4.20E+00	4.72E+00
Warm Mix Lab	1	21	N	8405	8040	7035	6111	5004	4250	3577	2803	2292
Warm Mix Lab	2	21	N	7945	7577	6596	5699	4646	3930	3294	2563	2093
Warm Mix Lab	5	21	N	9193	7870	6777	5878	4808	4082	3439	2703	2230
Warm Mix Lab	7	21	N	8283	7888	6852	5920	4827	4087	3436	2688	2208
Warm Mix Lab	9	21	N	8467	8106	7102	6181	5084	4330	3656	2876	2375
Warm Mix Lab	Mean	21		8.46E+03	7.90E+03	6.87E+03	5.96E+03	4.87E+03	4.14E+03	3.48E+03	2.73E+03	2.24E+03
Warm Mix Lab	SD	21		4.57E+02	2.05E+02	2.03E+02	1.92E+02	1.73E+02	1.57E+02	1.40E+02	1.19E+02	1.04E+02
Warm Mix Lab	CoV	21		5.41E+00	2.59E+00	2.96E+00	3.23E+00	3.55E+00	3.79E+00	4.03E+00	4.38E+00	4.66E+00
Warm Mix Lab	3	37	Y	2809	2633	2090	1643	1163	855.9	643.3	438.3	311.2
Warm Mix Lab	4	37	Y	2498	2308	1798	1413	975.6	702.6	532.7	379.7	265.2
Warm Mix Lab	6	37	Y	2667	2491	1979	1578	1113	820.9	621.6	424.4	301.4
Warm Mix Lab	8	37	Y	2545	2378	1878	1485	1057	769.8	595.7	409.4	300.6
Warm Mix Lab	10	37	Y	3058	2856	2264	1812	1300	980.3	754.5	514.3	372.8
Warm Mix Lab	Mean	37		2.72E+03	2.53E+03	2.00E+03	1.59E+03	1.12E+03	8.26E+02	6.30E+02	4.33E+02	3.10E+02
Warm Mix Lab	SD	37		2.26E+02	2.18E+02	1.83E+02	1.54E+02	1.22E+02	1.04E+02	8.12E+01	5.03E+01	3.91E+01
Warm Mix Lab	CoV	37		8.33E+00	8.62E+00	9.14E+00	9.69E+00	1.08E+01	1.26E+01	1.29E+01	1.16E+01	1.26E+01
Warm Mix Lab	1	37	N	3720	3532	2857	2283	1665	1260	981.1	686.6	513.7
Warm Mix Lab	2	37	N	3043	2855	2251	1770	1260	930.6	708.8	487.2	357.2
Warm Mix Lab	5	37	N	3653	3458	2797	2245	1631	1229	953.3	656.7	475.8
Warm Mix Lab	7	37	N	3817	3593	2914	2333	1701	1285	991.1	680.9	498.1
Warm Mix Lab	9	37	N	4139	3904	3179	2570	1893	1435	1116	773.8	563.1
Warm Mix Lab	Mean	37		3.66E+03	3.45E+03	2.79E+03	2.23E+03	1.62E+03	1.22E+03	9.42E+02	6.50E+02	4.74E+02
Warm Mix Lab	SD	37		4.60E+02	4.40E+02	3.90E+02	3.36E+02	2.65E+02	2.12E+02	1.70E+02	1.19E+02	8.60E+01
Warm Mix Lab	CoV	37		1.26E+01	1.27E+01	1.40E+01	1.51E+01	1.64E+01	1.73E+01	1.81E+01	1.84E+01	1.82E+01

Table C.6 FM6 dynamic modulus values

				DYNAMIC MODULUS (Mpa)								
Mix	Sample	Temperature	Moisture Conditioned	25 Hz	20 Hz	10 Hz	5 Hz	2 Hz	1 Hz	0.5 Hz	0.2 Hz	0.1 Hz
Warm Mix Field	5	4	Y	12771	12407	11385	10383	9095	8154	7243	6140	5414
Warm Mix Field	6	4	Y	12205	11869	10926	9987	8783	7915	7093	6079	5393
Warm Mix Field	Mean	4		1.25E+04	1.21E+04	1.12E+04	1.02E+04	8.94E+03	8.03E+03	7.17E+03	6.11E+03	5.40E+03
Warm Mix Field	SD	4		4.00E+02	3.80E+02	3.25E+02	2.80E+02	2.21E+02	1.69E+02	1.06E+02	4.31E+01	1.48E+01
Warm Mix Field	CoV	4		3.20E+00	3.13	2.91	2.75	2.47	2.10	1.48	0.71	0.27
AVERAGE FOR MASTER CURVES				12488.00	12138.00	11155.50	10185.00	8939.00	8034.50	7168.00	6109.50	5403.50
STANDARD DEVIATION FOR MASTER CURVES												
COV FOR MASTER CURVES												
Warm Mix Field	2	4	N	15804	15431	14404	13350	11972	10903	9851	8526	7581
Warm Mix Field	3	4	N	15459	15064	13967	12947	11560	10521	9511	8253	7371
Warm Mix Field	4	4	N	14906	14567	13432	12323	10901	9800	8768	7542	6526
Warm Mix Field	1	4	N	14241	13879	12876	11846	10491	9470	8484	7253	6423
Warm Mix Field	Mean	4		1.54E+04	1.50E+04	1.39E+04	1.29E+04	1.15E+04	1.04E+04	9.38E+03	8.11E+03	7.16E+03
Warm Mix Field	SD	4		4.53E+02	4.34E+02	4.87E+02	5.17E+02	5.40E+02	5.60E+02	5.54E+02	5.08E+02	5.58E+02
Warm Mix Field	CoV	4		2.94E+00	2.89E+00	3.49E+00	4.02E+00	4.71E+00	5.38E+00	5.91E+00	6.27E+00	7.80E+00
AVERAGE FOR MASTER CURVES				1.54E+04	1.50E+04	1.39E+04	1.29E+04	1.15E+04	1.04E+04	9.38E+03	8.11E+03	7.16E+03
STANDARD DEVIATION FOR MASTER CURVES				4.53E+02	4.34E+02	4.87E+02	5.17E+02	5.40E+02	5.60E+02	5.54E+02	5.08E+02	5.58E+02
COV FOR MASTER CURVES				2.94E+00	2.89E+00	3.49E+00	4.02E+00	4.71E+00	5.38E+00	5.91E+00	6.27E+00	7.80E+00
Warm Mix Field	5	21	Y	6462	6159	5269	4466	3513	2878	2329	1714	1337
Warm Mix Field	6	21	Y	6069	5809	4990	4238	3347	2740	2221	1636	1274
Warm Mix Field	Mean	21		6.27E+03	5.98E+03	5.13E+03	4.35E+03	3.43E+03	2.81E+03	2.28E+03	1.68E+03	1.31E+03
Warm Mix Field	SD	21		2.78E+02	2.47E+02	1.97E+02	1.61E+02	1.17E+02	9.76E+01	7.64E+01	5.52E+01	4.45E+01
Warm Mix Field	CoV	21		4.44E+00	4.14E+00	3.85E+00	3.70E+00	3.42E+00	3.47E+00	3.36E+00	3.29E+00	3.41E+00
AVERAGE FOR MASTER CURVES				6.27E+03	5.98E+03	5.13E+03	4.35E+03	3.43E+03	2.81E+03	2.28E+03	1.68E+03	1.31E+03
STANDARD DEVIATION FOR MASTER CURVES												
COV FOR MASTER CURVES												
Warm Mix Field	2	21	N	7047	6699	5733	4872	3861	3177	2590	1933	1533
Warm Mix Field	3	21	N	7300	6962	5983	5118	4095	3395	2781	2094	1671
Warm Mix Field	4	21	N	7510	7162	6173	5292	4242	3533	2903	2182	1725
Warm Mix Field	1	21	N	7332	6952	5971	5088	4059	3367	2759	2067	1633
Warm Mix Field	Mean	21		7.29E+03	6.94E+03	5.96E+03	5.09E+03	4.07E+03	3.37E+03	2.76E+03	2.07E+03	1.64E+03
Warm Mix Field	SD	21		2.32E+02	2.32E+02	2.21E+02	2.11E+02	1.92E+02	1.79E+02	1.58E+02	1.26E+02	9.90E+01
Warm Mix Field	CoV	21		3.18E+00	3.35E+00	3.70E+00	4.14E+00	4.73E+00	5.33E+00	5.72E+00	6.10E+00	6.03E+00
AVERAGE FOR MASTER CURVES				7.29E+03	6.94E+03	5.96E+03	5.09E+03	4.07E+03	3.37E+03	2.76E+03	2.07E+03	1.64E+03
STANDARD DEVIATION FOR MASTER CURVES				2.32E+02	2.32E+02	2.21E+02	2.11E+02	1.92E+02	1.79E+02	1.58E+02	1.26E+02	9.90E+01
COV FOR MASTER CURVES				3.18E+00	3.35E+00	3.70E+00	4.14E+00	4.73E+00	5.33E+00	5.72E+00	6.10E+00	6.03E+00
Warm Mix Field	5	37	Y	2251	2059	1556	1185	773.7	530	392.8	255.4	179.7
Warm Mix Field	6	37	Y	2505	2318	1775	1361	899.1	615.2	450.5	286.5	197.3
Warm Mix Field	Mean	37		2.38E+03	2.19E+03	1.67E+03	1.27E+03	8.36E+02	5.73E+02	4.22E+02	2.71E+02	1.89E+02
Warm Mix Field	SD	37		1.80E+02	1.83E+02	1.55E+02	1.24E+02	8.87E+01	6.02E+01	4.08E+01	2.20E+01	1.24E+01
Warm Mix Field	CoV	37		7.55E+00	8.37E+00	9.30E+00	9.78E+00	1.06E+01	1.05E+01	9.68E+00	8.12E+00	6.60E+00
AVERAGE FOR MASTER CURVES				#REF!	#REF!	#REF!	#REF!	#REF!	#REF!	#REF!	#REF!	#REF!
STANDARD DEVIATION FOR MASTER CURVES												
COV FOR MASTER CURVES												
Warm Mix Field	2	37	N	2628	2424	1853	1422	939.3	645.7	473.4	306	211.9
Warm Mix Field	3	37	N	2704	2507	1938	1498	998	664.8	497.7	326.4	224.5
Warm Mix Field	4	37	N	2539	2337	1781	1361	888.2	606.6	439.7	279	190.2
Warm Mix Field	1	37	N	3421	3221	2544	1987	1392	990	731.7	466.7	312.1
Warm Mix Field	Mean	37		2.62E+03	2.42E+03	1.86E+03	1.43E+03	9.42E+02	6.39E+02	4.70E+02	3.04E+02	2.09E+02
Warm Mix Field	SD	37		82.585309	85.00784278	78.589652	68.636725	54.94382	29.66721	29.12668	23.77646	17.35002
Warm Mix Field	CoV	37		3.1477059	3.50885427	4.2313165	4.8098616	5.833709	4.642514	6.193651	7.826353	8.306746
AVERAGE FOR MASTER CURVES				2.62E+03	2.42E+03	1.86E+03	1.43E+03	9.42E+02	6.39E+02	4.70E+02	3.04E+02	2.09E+02
STANDARD DEVIATION FOR MASTER CURVES				8.26E+01	8.50E+01	7.86E+01	6.86E+01	5.49E+01	2.97E+01	2.91E+01	2.38E+01	1.74E+01
COV FOR MASTER CURVES				3.15E+00	3.51E+00	4.23E+00	4.81E+00	5.83E+00	4.64E+00	6.19E+00	7.83E+00	8.31E+00
Warm Mix Lab	4	4	Y	13063	12682	11633	10591	9264	8287	7369	6226	5455
Warm Mix Lab	5	4	Y	13752	13425	12413	11382	10046	9033	8054	6846	6007
Warm Mix Lab	6	4	Y	12803	12483	11508	10556	9311	8382	7482	6378	5633
Warm Mix Lab	8	4	Y	13189	12787	11777	10762	9456	8496	7561	6418	5624
Warm Mix Lab	9	4	Y	13526	13146	12053	10981	9627	8635	7682	6528	5762
Warm Mix Lab	Mean	4		1.33E+04	1.29E+04	1.19E+04	1.09E+04	9.54E+03	8.57E+03	7.63E+03	6.48E+03	5.70E+03
Warm Mix Lab	SD	4		3.76E+02	3.78E+02	3.62E+02	3.40E+02	3.16E+02	2.91E+02	2.63E+02	2.32E+02	2.05E+02
Warm Mix Lab	CoV	4		2.83E+00	2.93E+00	3.05E+00	3.13E+00	3.31E+00	3.40E+00	3.45E+00	3.58E+00	3.60E+00
AVERAGE FOR MASTER CURVES				1.33E+04	1.29E+04	1.19E+04	1.09E+04	9.54E+03	8.57E+03	7.63E+03	6.48E+03	5.70E+03
STANDARD DEVIATION FOR MASTER CURVES				3.76E+02	3.78E+02	3.62E+02	3.40E+02	3.16E+02	2.91E+02	2.63E+02	2.32E+02	2.05E+02
COV FOR MASTER CURVES				2.83E+00	2.93E+00	3.05E+00	3.13E+00	3.31E+00	3.40E+00	3.45E+00	3.58E+00	3.60E+00
Warm Mix Lab	1	4	N	14576	14194	13170	12114	10734	9704	8702	7453	6617
Warm Mix Lab	2	4	N	15077	14726	13668	12613	11239	10209	9197	7915	7020
Warm Mix Lab	3	4	N	14310	14026	12995	11936	10568	9555	8562	7337	6514
Warm Mix Lab	7	4	N	12256	12245	11277	10337	9115	8216	7342	6274	5553
Warm Mix Lab	10	4	N	14926	14528	13459	12370	10971	9921	8896	7649	6790
Warm Mix Lab	Mean	4		1.43E+04	1.39E+04	1.29E+04	1.19E+04	1.05E+04	9.52E+03	8.54E+03	7.33E+03	6.50E+03
Warm Mix Lab	SD	4		1.01E+02	9.88E+02	9.51E+02	8.97E+02	8.28E+02	7.70E+02	7.11E+02	6.27E+02	5.62E+02
Warm Mix Lab	CoV	4		7.10E+00	7.09E+00	7.36E+00	7.55E+00	7.87E+00	8.09E+00	8.32E+00	8.56E+00	8.65E+00

Table C.6 (Continued) FM6 dynamic modulus values

Warm Mix Lab	4	21	Y	6314	6007	5121	4337	3411	2796	2282	1706	1354
Warm Mix Lab	5	21	Y	6627	6286	5356	4536	3591	2963	2412	1796	1416
Warm Mix Lab	6	21	Y	6775	6467	5582	4780	3814	3177	2632	1997	1591
Warm Mix Lab	8	21	Y	6237	5938	5063	4293	3390	2792	2287	1717	1367
Warm Mix Lab	9	21	Y	6836	6492	5581	4738	3772	3121	2556	1917	1518
Warm Mix Lab	Mean	21		6.56E+03	6.24E+03	5.34E+03	4.54E+03	3.60E+03	2.97E+03	2.43E+03	1.83E+03	1.45E+03
Warm Mix Lab	SD	21		2.70E+02	2.56E+02	2.46E+02	2.23E+02	1.97E+02	1.79E+02	1.58E+02	1.27E+02	1.02E+02
Warm Mix Lab	CoV	21		4.12E+00	4.11E+00	4.60E+00	4.92E+00	5.48E+00	6.02E+00	6.47E+00	6.96E+00	7.05E+00
AVERAGE FOR MASTER CURVES				6.56E+03	6.24E+03	5.34E+03	4.54E+03	3.60E+03	2.97E+03	2.43E+03	1.83E+03	1.45E+03
STANDARD DEVIATION FOR MASTER CURVES				2.70E+02	2.56E+02	2.46E+02	2.23E+02	1.97E+02	1.79E+02	1.58E+02	1.27E+02	1.02E+02
COV FOR MASTER CURVES				4.12E+00	4.11E+00	4.60E+00	4.92E+00	5.48E+00	6.02E+00	6.47E+00	6.96E+00	7.05E+00
Warm Mix Lab	1	21	N	7376	7034	6055	5176	4143	3440	2835	2144	1707
Warm Mix Lab	2	21	N	6845	6527	5597	4740	3746	3092	2534	1909	1524
Warm Mix Lab	3	21	N	7311	6952	5993	5121	4104	3417	2817	2135	1704
Warm Mix Lab	7	21	N	6069	5783	4931	4185	3299	2714	2221	1667	1320
Warm Mix Lab	10	21	N	7347	6995	6039	5166	4154	3479	2882	2196	1770
Warm Mix Lab	Mean	21		6.99E+03	6.66E+03	5.72E+03	4.88E+03	3.89E+03	3.23E+03	2.66E+03	2.01E+03	1.61E+03
Warm Mix Lab	SD	21		5.59E+02	5.30E+02	4.81E+02	4.27E+02	3.71E+02	3.26E+02	2.80E+02	2.21E+02	1.84E+02
Warm Mix Lab	CoV	21		7.99E+00	7.96E+00	8.41E+00	8.76E+00	9.53E+00	1.01E+01	1.05E+01	1.10E+01	1.15E+01
AVERAGE FOR MASTER CURVES				6.99E+03	6.66E+03	5.72E+03	4.88E+03	3.89E+03	3.23E+03	2.66E+03	2.01E+03	1.61E+03
STANDARD DEVIATION FOR MASTER CURVES				5.59E+02	5.30E+02	4.81E+02	4.27E+02	3.71E+02	3.26E+02	2.80E+02	2.21E+02	1.84E+02
COV FOR MASTER CURVES				7.99E+00	7.96E+00	8.41E+00	8.76E+00	9.53E+00	1.01E+01	1.05E+01	1.10E+01	1.15E+01
Warm Mix Lab	4	37	Y	2327	2150	1642	1259	829.3	579.2	419.9	271.7	189.3
Warm Mix Lab	5	37	Y	2251	2059	1556	1185	773.7	530	392.8	255.4	179.7
Warm Mix Lab	6	37	Y	2452	2258	1746	1350	907.2	630.8	467.6	309.6	217
Warm Mix Lab	8	37	Y	2228	2067	1584	1225	812.4	570.6	419.1	277	199.4
Warm Mix Lab	9	37	Y	2497	2308	1771	1358	905.5	639	463.1	303.8	214.9
Warm Mix Lab	Mean	37		2.35E+03	2.17E+03	1.66E+03	1.28E+03	8.46E+02	5.90E+02	4.33E+02	2.84E+02	2.00E+02
Warm Mix Lab	SD	37		1.20E+02	1.12E+02	9.57E+01	7.64E+01	5.90E+01	4.52E+01	3.19E+01	2.27E+01	1.61E+01
Warm Mix Lab	CoV	37		5.09E+00	5.16E+00	5.77E+00	5.99E+00	6.98E+00	7.66E+00	7.39E+00	8.01E+00	8.05E+00
AVERAGE FOR MASTER CURVES				2.33E+03	2.15E+03	1.64E+03	1.26E+03	8.29E+02	5.79E+02	4.20E+02	2.72E+02	1.89E+02
STANDARD DEVIATION FOR MASTER CURVES				2.25E+03	2.06E+03	1.56E+03	1.19E+03	7.74E+02	5.30E+02	3.93E+02	2.55E+02	1.80E+02
COV FOR MASTER CURVES				2.45E+03	2.26E+03	1.75E+03	1.35E+03	9.07E+02	6.31E+02	4.68E+02	3.10E+02	2.17E+02
Warm Mix Lab	1	37	N	2601	2411	1867	1449	952.7	645.7	473.4	303.7	209.3
Warm Mix Lab	2	37	N	2545	2322	1774	1348	888.5	626.3	480.8	331.8	246.9
Warm Mix Lab	3	37	N	2963	2771	2143	1670	1139	813.7	597.4	392.9	275.4
Warm Mix Lab	7	37	N	2146	1970	1499	1152	762.9	518.5	388.9	253.7	179.2
Warm Mix Lab	10	37	N	2798	2623	2054	1594	1104	770.9	575.1	370	250.7
Warm Mix Lab	Mean	37		2.61E+03	2.42E+03	1.87E+03	1.44E+03	9.69E+02	6.75E+02	5.03E+02	3.30E+02	2.32E+02
Warm Mix Lab	SD	37		3.08E+02	3.07E+02	2.53E+02	2.05E+02	1.55E+02	1.18E+02	8.44E+01	5.49E+01	3.79E+01
Warm Mix Lab	CoV	37		1.18E+01	1.27E+01	1.35E+01	1.42E+01	1.60E+01	1.76E+01	1.68E+01	1.66E+01	1.63E+01
AVERAGE FOR MASTER CURVES				2.61E+03	2.42E+03	1.87E+03	1.44E+03	9.69E+02	6.75E+02	5.03E+02	3.30E+02	2.32E+02
STANDARD DEVIATION FOR MASTER CURVES				3.08E+02	3.07E+02	2.53E+02	2.05E+02	1.55E+02	1.18E+02	8.44E+01	5.49E+01	3.79E+01
COV FOR MASTER CURVES				1.18E+01	1.27E+01	1.35E+01	1.42E+01	1.60E+01	1.76E+01	1.68E+01	1.66E+01	1.63E+01

Table C.7 FM7 dynamic modulus values

				DYNAMIC MODULUS (Mpa)								
Mix	Sample	Temperature	Moisture Conditioned	25 Hz	20 Hz	10 Hz	5 Hz	2 Hz	1 Hz	0.5 Hz	0.2 Hz	0.1 Hz
Warm Mix Field	2	4	Y	13492	13030	11820	10622	9094	7974	6914	5663	4834
Warm Mix Field	3	4	Y	13690	13286	12088	10907	9406	8330	7263	5996	5181
Warm Mix Field	4	4	Y	14507	14031	12790	11563	10024	8896	7812	6496	5601
Warm Mix Field	5	4	Y	15909	15541	14384	13265	11771	10652	9558	8202	7256
Warm Mix Field	8	4	Y	14894	14478	13178	11896	10276	9097	7960	6581	5665
Warm Mix Field	Mean	4		1.45E+04	1.41E+04	1.29E+04	1.17E+04	1.01E+04	8.99E+03	7.90E+03	6.59E+03	5.71E+03
Warm Mix Field	SD	4		9.76E+02	1.00E+03	1.01E+03	1.04E+03	1.04E+03	1.03E+03	1.02E+03	9.77E+02	9.29E+02
Warm Mix Field	CoV	4		6.73	7.13	7.88	8.88	10.28	11.47	12.87	14.83	16.27
AVERAGE FOR MASTER CURVES				1.45E+04	1.41E+04	1.29E+04	1.17E+04	1.01E+04	8.99E+03	7.90E+03	6.59E+03	5.71E+03
STANDARD DEVIATION FOR MASTER CURVES				9.76E+02	1.00E+03	1.01E+03	1.04E+03	1.04E+03	1.03E+03	1.02E+03	9.77E+02	9.29E+02
COV FOR MASTER CURVES				6.73E+00	7.13E+00	7.88E+00	8.88E+00	1.03E+01	1.15E+01	1.29E+01	1.48E+01	1.63E+01
Warm Mix Field	1	4	N	16990	16425	15014	13672	11960	10691	9467	7969	6942
Warm Mix Field	6	4	N	16406	15878	14526	13180	11452	10167	8934	7437	6409
Warm Mix Field	7	4	N	16138	15559	14120	12738	10998	9738	8551	7097	6124
Warm Mix Field	9	4	N	16609	16102	14682	13279	11490	10173	8918	7406	6393
Warm Mix Field	10	4	N	14926	14528	13459	12370	10971	9921	8896	7649	6790
Warm Mix Field	Mean	4		1.62E+04	1.57E+04	1.44E+04	1.30E+04	1.14E+04	1.01E+04	8.95E+03	7.51E+03	6.53E+03
Warm Mix Field	SD	4		7.84E+02	7.27E+02	5.98E+02	5.04E+02	4.08E+02	3.59E+02	3.28E+02	3.23E+02	3.30E+02
Warm Mix Field	CoV	4		4.84	4.63	4.16	3.86	3.59	3.54	3.66	4.30	5.05
AVERAGE FOR MASTER CURVES				16213.80	15698.40	14360.20	13047.80	11374.20	10138.00	8953.20	7511.60	6531.60
STANDARD DEVIATION FOR MASTER CURVES				784.19	726.70	597.57	503.97	408.26	358.80	328.11	322.76	329.99
COV FOR MASTER CURVES				4.84	4.63	4.16	3.86	3.59	3.54	3.66	4.30	5.05
Warm Mix Field	2	21	Y	6578	6170	5131	4219	3181	2496	1941	1355	1015
Warm Mix Field	3	21	Y	6642	6303	5273	4371	3333	2644	2082	1478	1121
Warm Mix Field	4	21	Y	6929	6528	5459	4522	3441	2728	2136	1515	1149
Warm Mix Field	5	21	Y	8487	8046	6921	5939	4762	3971	3268	2521	2047
Warm Mix Field	8	21	Y	6562	6279	5264	4347	3275	2554	1977	1377	1033
Warm Mix Field	Mean	21		7.04E+03	6.67E+03	5.61E+03	4.68E+03	3.60E+03	2.88E+03	2.28E+03	1.65E+03	1.27E+03
Warm Mix Field	SD	21		8.23E+02	7.83E+02	7.42E+02	7.12E+02	6.57E+02	6.17E+02	5.57E+02	4.92E+02	4.36E+02
Warm Mix Field	CoV	21		11.68	11.74	13.23	15.22	18.27	21.43	24.44	29.83	34.28
AVERAGE FOR MASTER CURVES				6677.75	6320.00	5281.75	4364.75	3307.50	2605.50	2034.00	1431.25	1079.50
STANDARD DEVIATION FOR MASTER CURVES				171.03	150.26	134.83	124.26	108.83	101.87	90.56	77.37	65.51
COV FOR MASTER CURVES				0.03	0.02	0.03	0.03	0.03	0.04	0.04	0.05	0.06
Warm Mix Field	1	21	N	7936	7553	6388	5342	4110	3290	2595	1857	1421
Warm Mix Field	6	21	N	7992	7533	6388	5360	4186	3348	2586	1860	1399
Warm Mix Field	7	21	N	7645	7231	6075	5040	3834	3032	2372	1671	1255
Warm Mix Field	9	21	N	7866	7501	6336	5303	4081	3270	2578	1830	1381
Warm Mix Field	10	21	N	6929	6528	5459	4522	3441	2728	2136	1515	1149
Warm Mix Field	Mean	21		7.67E+03	7.27E+03	6.13E+03	5.11E+03	3.93E+03	3.13E+03	2.45E+03	1.75E+03	1.32E+03
Warm Mix Field	SD	21		4.37E+02	4.34E+02	3.96E+02	3.55E+02	3.04E+02	2.57E+02	2.00E+02	1.51E+02	1.16E+02
Warm Mix Field	CoV	21		5.69	5.98	6.47	6.94	7.73	8.20	8.17	8.65	8.76
AVERAGE FOR MASTER CURVES				7.67E+03	7.27E+03	6.13E+03	5.11E+03	3.93E+03	3.13E+03	2.45E+03	1.75E+03	1.32E+03
STANDARD DEVIATION FOR MASTER CURVES				4.37E+02	4.34E+02	3.96E+02	3.55E+02	3.04E+02	2.57E+02	2.00E+02	1.51E+02	1.16E+02
COV FOR MASTER CURVES				5.69E+00	5.98E+00	6.47E+00	6.94E+00	7.73E+00	8.20E+00	8.17E+00	8.65E+00	8.76E+00
Warm Mix Field	2	37	Y	1906	1709	1247	913.2	552.8	357.4	257.4	163.7	123.7
Warm Mix Field	3	37	Y	2232	2055	1527	1147	729.9	477.4	349.1	230.3	168.7
Warm Mix Field	4	37	Y	2133	1958	1433	1068	669.9	442.6	323.8	211	148
Warm Mix Field	5	37	Y	3412	3207	2504	1976	1396	1035	801.9	561.7	416.8
Warm Mix Field	8	37	Y	2526	2311	1709	1277	798.1	527.7	375.4	241.3	171.2
Warm Mix Field	Mean	37		2.44E+03	2.25E+03	1.68E+03	1.28E+03	8.29E+02	5.68E+02	4.22E+02	2.82E+02	2.06E+02
Warm Mix Field	SD	37		5.86E+02	5.78E+02	4.88E+02	4.13E+02	3.29E+02	2.68E+02	2.17E+02	1.59E+02	1.20E+02
Warm Mix Field	CoV	37		24.01	25.70	28.96	32.34	39.71	47.24	51.51	56.59	58.13
AVERAGE FOR MASTER CURVES				2199.25	2008.25	1479.00	1101.30	687.68	451.28	326.43	211.58	152.90
STANDARD DEVIATION FOR MASTER CURVES				257.05	248.94	192.48	152.15	104.06	71.67	50.61	34.29	22.07
COV FOR MASTER CURVES				11.69	12.40	13.01	13.82	15.13	15.88	15.50	16.21	14.43
Warm Mix Field	1	37	N	2854	2620	1973	1490	960.1	647.3	470.3	297.7	201.1
Warm Mix Field	6	37	N	2479	2263	1673	1251	796.7	527.2	382.5	249	177.5
Warm Mix Field	7	37	N	2332	2120	1535	1132	702.7	458	334.9	206.2	148
Warm Mix Field	9	37	N	2665	2447	1793	1332	828	548.3	392.4	249.9	171.2
Warm Mix Field	10	37	N	2516	2280	1663	1232	769.1	505.4	361.1	226.5	157.7
Warm Mix Field	Mean	37		2.57E+03	2.35E+03	1.73E+03	1.29E+03	8.11E+02	5.37E+02	3.88E+02	2.66E+02	1.59E+02
Warm Mix Field	SD	37		1.98E+02	1.92E+02	1.65E+02	1.34E+02	9.51E+01	7.01E+01	5.09E+01	3.58E+01	2.52E+01
Warm Mix Field	CoV	37		7.72	8.19	9.55	10.39	11.73	13.04	13.11	12.83	15.94
AVERAGE FOR MASTER CURVES				2569.20	2346.00	1727.40	1287.40	811.32	537.24	388.24	244.85	152.90
STANDARD DEVIATION FOR MASTER CURVES				198.44	192.09	164.88	133.77	95.14	70.05	50.91	39.33	25.58
COV FOR MASTER CURVES				7.72	8.19	9.55	10.39	11.73	13.04	13.11	12.83	15.94
Warm Mix Lab	2	4	N	15433	14948	13706	12469	10862	9671	8520	7055	5984
Warm Mix Lab	4	4	N	16618	16206	14996	13775	12145	10932	9745	8275	7242
Warm Mix Lab	5	4	N	16049	15654	14403	13140	11490	10269	9096	7641	6668
Warm Mix Lab	7	4	N	15589	15188	14014	12845	11315	10174	9064	7690	6754
Warm Mix Lab	9	4	N	15049	14675	13248	12422	11204	10186	9068	7694	6701
Warm Mix Lab	Mean	4		1.57E+04	1.47E+04	1.41E+04	1.29E+04	1.14E+04	1.02E+04	9.10E+03	7.67E+03	6.67E+03
Warm Mix Lab	SD	4		6.04E+02	1.78E+03	6.67E+02	5.56E+02	4.74E+02	4.50E+02	4.34E+02	4.32E+02	4.49E+02
Warm Mix Lab	CoV	4		3.84	12.06	4.74	4.30	4.16	4.39	4.77	5.63	6.73
AVERAGE FOR MASTER CURVES				1.57E+04	1.47E+04	1.41E+04	1.29E+04	1.14E+04	1.02E+04	9.10E+03	7.67E+03	6.67E+03
STANDARD DEVIATION FOR MASTER CURVES				6.04E+02	1.78E+03	6.67E+02	5.56E+02	4.74E+02	4.50E+02	4.34E+02	4.32E+02	4.49E+02
COV FOR MASTER CURVES				3.84E+00	1.21E+01	4.74E+00	4.30E+00	4.16E+00	4.39E+00	4.77E+00	5.63E+00	6.73E+00

APPENDIX D FLOW NUMBER VALUES

Table D.1 Flow number values

				Sample Number	Flow Number
FM2	HMA	Field	MC	1	381
FM2	HMA	Field	NMC	2	529
FM2	HMA	Field	NMC	3	402
FM2	HMA	Field	NMC	4	484
FM2	HMA	Field	MC	5	478
FM2	HMA	Field	NMC	6	479
FM2	HMA	Field	MC	7	613
FM2	HMA	Field	MC	8	1125
FM2	HMA	Field	NMC	9	1066
FM2	HMA	Field	MC	10	708
FM2	HMA	Lab	NMC	1	558
FM2	HMA	Lab	MC	2	688
FM2	HMA	Lab	NMC	3	574
FM2	HMA	Lab	MC	4	661
FM2	HMA	Lab	MC	5	629
FM2	HMA	Lab	NMC	6	565
FM2	HMA	Lab	NMC	7	507
FM2	HMA	Lab	MC	8	686
FM2	HMA	Lab	MC	9	748
FM2	HMA	Lab	NMC	10	621
FM2	WMA	Field	MC	1	520
FM2	WMA	Field	NMC	2	461
FM2	WMA	Field	NMC	3	388
FM2	WMA	Field	NMC	4	208
FM2	WMA	Field	MC	5	334
FM2	WMA	Field	NMC	6	419
FM2	WMA	Field	MC	7	558
FM2	WMA	Field	MC	8	1125
FM2	WMA	Field	MC	9	387
FM2	WMA	Field	NMC	10	392
FM2	WMA	Lab	NMC	1	287
FM2	WMA	Lab	MC	2	466
FM2	WMA	Lab	NMC	3	222
FM2	WMA	Lab	NMC	4	215
FM2	WMA	Lab	MC	5	393
FM2	WMA	Lab	NMC	6	195

Table D.1 (Continued) Flow number values

FM2	WMA	Lab	MC	7	447
FM2	WMA	Lab	MC	8	686
FM2	WMA	Lab	NMC	9	326
FM2	WMA	Lab	MC	10	621
FM3	HMA	Field	NMC	1	838
FM3	HMA	Field	MC	2	838
FM3	HMA	Field	NMC	3	755
FM3	HMA	Field	NMC	4	982
FM3	HMA	Field	NMC	5	500
FM3	HMA	Field	MC	6	648
FM3	HMA	Field	MC	7	863
FM3	HMA	Field	MC	8	781
FM3	HMA	Field	MC	9	527
FM3	HMA	Field	NMC	10	701
FM3	HMA	Lab	NMC	1	1127
FM3	HMA	Lab	MC	2	2098
FM3	HMA	Lab	MC	3	2261
FM3	HMA	Lab	NMC	4	1455
FM3	HMA	Lab	NMC	5	1400
FM3	HMA	Lab	NMC	6	1211
FM3	HMA	Lab	MC	7	478
FM3	HMA	Lab	NMC	8	1106
FM3	HMA	Lab	MC	9	4350
FM3	HMA	Lab	MC	10	2007
FM3	WMA	Field	NMC	1	783
FM3	WMA	Field	NMC	2	589
FM3	WMA	Field	NMC	3	676
FM3	WMA	Field	MC	4	688
FM3	WMA	Field	MC	5	632
FM3	WMA	Field	MC	6	586
FM3	WMA	Field	MC	7	723
FM3	WMA	Field	NMC	8	1266
FM3	WMA	Field	MC	9	530
FM3	WMA	Field	NMC	10	528
FM3	WMA	Lab	NMC	1	576
FM3	WMA	Lab	NMC	2	520
FM3	WMA	Lab	MC	3	722
FM3	WMA	Lab	MC	4	658
FM3	WMA	Lab	MC	5	705

Table D.1(Continued) Flow number values

FM3	WMA	Lab	NMC	6	586
FM3	WMA	Lab	NMC	7	831
FM3	WMA	Lab	MC	8	752
FM3	WMA	Lab	NMC	9	592
FM3	WMA	Lab	MC	10	735
FM4	HMA	Field	MC	1	2165
FM4	HMA	Field	NMC	2	1346
FM4	HMA	Field	NMC	3	1581
FM4	HMA	Field	MC	4	3148
FM4	HMA	Field	MC	5	2677
FM4	HMA	Field	NMC	6	2092
FM4	HMA	Field	NMC	7	2718
FM4	HMA	Field	MC	8	1898
FM4	HMA	Field	NMC	9	2518
FM4	HMA	Field	MC	10	2542
FM4	HMA	Lab	MC	1	2150
FM4	HMA	Lab	NMC	2	3249
FM4	HMA	Lab	NMC	3	1515
FM4	HMA	Lab	MC	4	2605
FM4	HMA	Lab	MC	5	2911
FM4	HMA	Lab	MC	6	3745
FM4	HMA	Lab	MC	7	4120
FM4	HMA	Lab	NMC	8	1849
FM4	HMA	Lab	NMC	9	2605
FM4	HMA	Lab	NMC	10	3656
FM4	WMA	Field	NMC	1	2931
FM4	WMA	Field	MC	2	2931
FM4	WMA	Field	NMC	3	1788
FM4	WMA	Field	NMC	4	1298
FM4	WMA	Field	MC	5	3421
FM4	WMA	Field	MC	6	2419
FM4	WMA	Lab	MC	1	3482
FM4	WMA	Lab	MC	2	3249
FM4	WMA	Lab	NMC	3	1979
FM4	WMA	Lab	MC	4	3515
FM4	WMA	Lab	NMC	5	1985
FM4	WMA	Lab	NMC	6	3409
FM4	WMA	Lab	NMC	7	3173
FM4	WMA	Lab	NMC	8	3502

Table D.1 (Continued) Flow number values

FM4	WMA	Lab	MC	9	3515
FM4	WMA	Lab	MC	10	3951
FM5	WMA	Field	MC	1	878
FM5	WMA	Field	NMC	2	1026
FM5	WMA	Field	NMC	3	1516
FM5	WMA	Field	MC	5	1680
FM5	WMA	Field	MC	6	1924
FM5	WMA	Field	NMC	7	1532
FM5	WMA	Lab	NMC	1	1248
FM5	WMA	Lab	NMC	2	1121
FM5	WMA	Lab	MC	3	1169
FM5	WMA	Lab	MC	4	1158
FM5	WMA	Lab	NMC	5	1487
FM5	WMA	Lab	MC	6	1278
FM5	WMA	Lab	NMC	7	1235
FM5	WMA	Lab	MC	8	1412
FM5	WMA	Lab	NMC	9	1385
FM5	WMA	Lab	MC	10	1509
FM6	WMA	Field	NMC	1	453
FM6	WMA	Field	NMC	3	549
FM6	WMA	Field	NMC	4	505
FM6	WMA	Field	MC	5	511
FM6	WMA	Field	MC	6	601
FM6	WMA	Lab	NMC	1	580
FM6	WMA	Lab	NMC	2	605
FM6	WMA	Lab	NMC	3	563
FM6	WMA	Lab	MC	4	671
FM6	WMA	Lab	MC	5	663
FM6	WMA	Lab	MC	6	706
FM6	WMA	Lab	NMC	7	544
FM6	WMA	Lab	MC	8	689
FM6	WMA	Lab	MC	9	782
FM6	WMA	Lab	NMC	10	796
FM7-0	WMA	Field	NMC	1	301
FM7-0	WMA	Field	MC	2	217
FM7-0	WMA	Field	MC	3	365
FM7-0	WMA	Field	MC	4	379
FM7-0	WMA	Field	MC	5	1678
FM7-0	WMA	Field	NMC	6	307
FM7-0	WMA	Field	NMC	7	271

Table D.1 (Continued) Flow number values

FM7-0	WMA	Field	MC	8	342
FM7-0	WMA	Field	NMC	9	256
FM7-0	WMA	Field	NMC	10	289
FM7-0	WMA	Lab	MC	1	356
FM7-0	WMA	Lab	NMC	2	359
FM7-0	WMA	Lab	MC	3	337
FM7-0	WMA	Lab	NMC	4	432
FM7-0	WMA	Lab	NMC	5	397
FM7-0	WMA	Lab	MC	6	663
FM7-0	WMA	Lab	NMC	7	429
FM7-0	WMA	Lab	MC	8	420
FM7-0	WMA	Lab	NMC	9	291
FM7-0	WMA	Lab	MC	10	419
FM7-5	WMA	Lab	MC	2	1578
FM7-5	WMA	Lab	MC	3	1401
FM7-5	WMA	Lab	NMC	3--1	1136
FM7-5	WMA	Lab	MC	6	1851
FM7-5	WMA	Lab	NMC	1	1597
FM7-5	WMA	Lab	NMC	7	2567
FM7-5	WMA	Lab	NMC	8	2125
FM7-5	WMA	Lab	MC	12	1382
FM7-5	WMA	Lab	MC	13	1514
FM7-7	WMA	Lab	MC	1	10000
FM7-7	WMA	Lab	MC	2	10000
FM7-7	WMA	Lab	MC	3	10000
FM7-7	WMA	Lab	NMC	12	10000
FM7-7	WMA	Lab	NMC	14	10000
FM7-7	WMA	Lab	MC	15	10000
FM7-7	WMA	Lab	NMC	16	10000
FM7-7	WMA	Lab	NMC	21	9097
FM7-7	WMA	Lab	MC	22	10000
FM7-7	WMA	Lab	NMC	23	10000
FM7-7	WMA	Lab	MC	25	10000
FM7-7	WMA	Lab	NMC	26	10000

APPENDIX E SCB VALUES

Table E.1 All SCB values

Test Temp	Sample	Work (J)	Ki Mpa*m ^{0.5}	Gf (J/m ²)	S (kN/mm)
-18	FM2 H2.1	0.27	0.40	269.49	2.21
-30	FM2 H2.2	0.61	0.58	541.74	3.92
-6	FM2 H2.3	0.92	0.98	848.12	4.95
-18	FM2 H2.4	0.55	0.47	511.71	2.92
-6	FM2 HMA 3.1	4.07	0.96	2710.80	2.69
-30	FM2 HMA 3.2	0.69	0.84	509.41	6.21
-18	FM2 HMA 3.3	1.46	0.86	1079.50	4.53
-30	FM2 HMA 3.4	0.81	1.14	635.39	8.41
-18	FM2 H 4.1	0.48	0.83	445.73	5.33
-6	FM2 H4.2	1.77	0.61	1351.10	2.67
-30	FM2 H 4.3	0.80	0.82	610.25	5.03
-6	FM2 H 4.4	1.29	0.62	1224.50	1.92
-30	FM2 W1.1	0.53	0.84	454.77	6.13
-6	FM2 W1.2	1.64	0.81	1133.10	3.67
-18	FM2 W1.3	0.89	0.91	767.54	5.10
-6	FM2 W 4.1	1.55	0.82	1055.00	4.60
-18	FM2 W 4.2	0.94	0.83	699.31	4.90
-30	FM2 W 4.3	1.88	0.92	1327.40	4.70
-30	FM2 W 4.4	0.51	0.93	349.96	9.20
-6	FM2 W 5.1	1.58	0.93	1101.60	5.46
-18	FM2 W 5.2	0.58	0.98	415.88	8.57
-30	FM2 W 5.3	0.57	2.03	921.32	6.34
-6	FM2 W5.4	1.22	0.69	836.18	6.14
-30	FM2 H1.1	0.76	1.80	1092.10	6.38
-6	FM2 H 1.2	3.94	0.75	2708.90	1.61
-18	FM2 H 1.3	1.47	0.85	1068.50	3.36
-18	FM2 H 1.4	1.56	0.96	1154.10	6.10
-6	FM2 H2.1	2.28	0.65	1711.90	1.70
-30	FM2 H2.2	0.48	0.78	336.45	7.68
-18	FM2 H2.3	1.73	0.75	1193.80	3.90
-30	FM2 H2.4	0.50	0.92	356.14	8.21
-30	FM2 H3.1	0.78	1.04	559.67	7.76
-18	FM2H3.2	2.42	0.97	1712.30	3.49
-6	FM2 H 3.3	3.02	0.75	2175.40	1.98

Table E.1 (Continued) All SCB values

-6	FM2 H 3.4	3.16	0.70	2211.70	1.71
-18	FM2 W 1.1	2.25	1.01	1532.00	3.55
-30	FM2 W1.2	0.83	0.86	627.81	6.83
-6	FM2 W1.3	3.27	0.78	2263.00	2.33
-30	fm2 w1.4	1.35	0.83	974.57	3.85
-6	FM2 W2.1	1.89	0.83	1447.00	3.59
-18	FM2W2.2	1.71	0.82	1186.70	4.12
-30	FM2 W 2.3	0.80	0.88	536.48	6.61
-18	FM2 W2.4	1.95	0.85	1441.00	2.81
-6	FM2 W1*.1	1.55	0.70	1144.20	3.46
-18	FM2 W1*.2	2.28	0.86	1568.20	2.91
-30	FM2 W1*.3	0.85	0.60	579.18	4.57
-6	FM2 W1*.4	2.50	0.77	1854.20	2.94
-12	FM3 H1.1	2.91	0.95	1980.10	4.31
-24	FM3 H1.2	0.99	0.87	700.08	6.54
0	FM3 H1.3	2.86	0.76	2060.40	2.59
0	FM3 H1.4	6.12	0.74	3974.50	1.72
0	FM3 H 2.1	13.55	1.19	8011.70	2.33
-24	FM3 H2.2	0.61	1.15	523.09	8.54
-12	FM3 H 2.3	1.27	0.84	1090.40	3.65
-24	FM3 H 2.4	0.58	0.78	418.01	8.07
-12	FM3 HMA 3.1	3.95	1.03	2694.60	3.41
0	FM3 HMA 3.2	2.77	0.60	2094.00	1.78
-24	FM3 HMA 3.3	0.68	0.68	467.58	5.75
-12	FM3 HMA 3.4	0.77	0.67	561.10	4.24
0	FM3 W 3.1	2.82	0.71	1810.50	3.79
-24	FM3 W 3.2	0.87	1.08	659.21	6.97
-12	FM3 W 3.3	2.31	0.88	1899.00	4.35
-12	FM3 W 3.4	2.29	0.94	1516.70	4.18
-24	FM3 W6.1	0.88	0.81	584.30	4.99
-12	FM3 W6.2	2.37	0.91	1657.70	5.19
0	FM3 W6.3	2.17	0.63	1801.60	1.50
0	FM3 W6.4	2.89	0.72	2371.80	3.34
-12	FM3 WMA 10.1	0.79	1.06	627.79	8.04
-24	FM3 WMA 10.2	1.05	0.94	641.49	10.43
0	FM3 WMA 10.3	5.69	0.86	3703.60	1.99
-24	FM3 WMA 10.4	1.00	0.93	771.81	4.97
-24	FM3 H 1.1	1.25	1.14	855.23	8.78
-12	FM3 H 1.2	2.91	1.31	2136.70	5.02
0	FM3 H 1.3	3.75	0.69	2662.80	1.89

Table E.1 (Continued) All SCB values

0	FM3 H 1.4	2.10	0.58	1451.90	2.26
-12	FM3 H2.1	1.70	0.87	1142.70	4.17
-24	FM3 H2.2	2.00	0.99	1262.70	4.38
0	FM3 H 2.3	3.55	0.71	2740.30	1.91
-12	FM3 H2.4	3.21	1.10	2435.70	4.26
-12	FM3 H 3.1	1.29	0.76	898.37	4.64
0	FM3 H 3.2	2.68	0.70	1871.90	2.17
-24	FM3 H 3.3	1.09	0.85	797.95	5.37
-24	FM3 H 3.4	0.91	1.03	616.44	8.16
-24	FM3 W1.1	1.04	0.72	788.67	3.14
0	FM3 W 1.2	3.87	0.65	2651.80	1.58
-12	FM3 W1.3	2.05	0.89	1334.00	4.32
-12	FM3 W1.4	2.94	1.01	2098.50	3.35
-12	FM3 W 2.1	1.36	0.85	1026.60	4.83
-24	FM3 W 2.2	0.98	1.03	637.80	7.54
0	FM3 W 2.3	3.55	0.70	2313.10	2.34
0	FM3 W 2.4	4.01	0.54	2918.90	0.91
0	FM3 W 3.1	2.90	0.65	2043.10	2.29
-12	FM3 W 3.2	1.42	0.83	1079.80	3.59
-24	FM3 W 3.3	0.75	0.92	529.02	6.67
-24	FM3 W3.4	1.66	0.78	1038.30	4.89
-24	FM4 H2.1	0.88	1.03	646.23	6.75
-12	FM4 H2.2	1.15	0.82	825.89	5.49
0	FM4 H2.3	2.17	0.82	1491.20	3.37
-24	FM4 H2.4	0.92	0.82	646.15	4.96
-24	FM4 H 4.1	0.79	0.91	555.48	6.27
0	FM4 H 4.2	2.35	0.76	1698.50	3.07
-12	FM4 H 4.3	0.72	0.96	490.05	7.97
-12	FM4 H 4.4	0.88	1.02	617.33	7.91
-12	FM4 H 7.1	1.33	0.77	994.18	3.23
-24	FM4 H 7.2	0.63	0.74	429.58	6.89
0	FM4 H 7.3	2.80	1.53	4072.50	2.78
0	FM4 H 7.4	2.10	0.84	1521.30	3.07
0	FM4 W 5.1	3.64	1.02	2598.60	2.54
-24	FM4 W 5.2	0.74	1.11	546.85	7.82
-12	FM4 W 5.3	0.58	0.73	440.26	5.61
-24	FM4 W 5.4	0.41	0.78	270.42	8.43
-24	FM4 WMA 6.1	0.43	0.82	280.22	8.45
-12	FM4 WMA 6.2	0.86	0.85	622.27	5.86
0	FM4 WMA 6.3	3.98	1.05	2943.30	4.13

Table E.1 (Continued) All SCB values

-12	FM4 WMA 6.4	1.37	0.92	906.25	5.90
-12	FM4 W 7.1	0.78	0.76	718.05	4.78
-24	FM4 W 7.2	0.23	0.90	216.78	10.00
0	FM4 W 7.3	1.56	0.82	1366.30	3.38
0	FM4 W 7.4	1.06	0.82	1023.20	3.60
-24	FM4 H 4.1	0.66	0.79	454.90	6.97
0	FM4 H4.2	2.58	0.78	1833.50	2.84
-12	FM4 H4.3	1.27	0.97	899.20	5.73
-12	FM4 H4.4	0.89	0.85	634.63	5.96
-24	FM4 H 5.1	1.39	0.94	1047.50	3.35
-12	FM4 H 5.2	1.22	0.74	769.75	4.76
0	FM4 H 5.3	2.19	0.76	1497.90	3.19
0	FM4 H 5.4	2.62	0.72	1827.70	2.07
0	FM4 H 6.1	3.15	0.97	2171.30	3.96
-12	FM4 H 6.2	0.93	0.80	669.98	5.66
-24	FM4 H6.3	0.81	1.03	580.08	7.40
-24	FM4 H6.4	0.60	0.81	410.04	7.54
0	FM4 H7.1	1.64	0.73	1046.30	3.88
-24	FM4 H7.2	0.53	0.79	378.84	7.58
-12	FM4 H 7.3	1.01	0.85	705.89	5.69
	FM4 H 7.4	1.16	0.74	771.00	4.03
-24	FM4 W1.1	0.51	0.81	393.11	6.90
-12	FM4 W1.2	1.32	0.86	945.12	5.47
0	WM4 W1.3	2.17	0.67	1395.40	2.61
-24	FM4 W1.4	0.60	0.91	412.58	8.31
-24	FM4 W2.1	0.78	0.86	568.76	5.63
-12	FM4 W 2.2	0.98	0.69	569.96	5.00
0	FM4 W 2.3	2.92	0.95	1877.70	5.00
0	FM4 W 2.4	2.17	0.83	1634.30	3.10
0	FM4W3.1	2.55	0.64	1760.80	2.12
-12	FM4W3.2	2.38	0.75	1541.10	2.39
-24	FM4W3.3	0.88	0.93	639.47	5.56
-12	FM4 W 3.4	1.55	1.14	1177.50	5.75
-12	FM5 2.1	1.53	0.64	1004.90	2.62
-24	FM5 2.2	0.82	0.72	549.09	4.37
0	FM5 2.3	2.49	0.50	1681.50	1.46
0	FM5 2.4	1.56	0.46	1037.10	2.33
-24	FM5 3.1	0.31	0.77	222.71	8.59
0	FM5 3.2	3.03	0.67	2208.30	2.04
-12	FM5 3.3	1.42	0.72	1023.10	3.19

Table E.1 (Continued) All SCB values

-24	FM5 3.4	0.77	0.70	508.15	5.29
0	FM5 W10.1	1.77	0.51	1194.30	2.09
-12	FM5 W10.2	8.49	0.66	573.93	4.92
-24	FM5 W10.3	0.62	0.63	442.51	4.95
-12	FM5 W10.4	1.07	0.59	738.70	3.47
0	FM5 1.1	2.04	0.57	1328.80	2.36
-24	FM5 1.2	1.44	0.85	1111.10	3.51
-12	FM5 1.3	1.11	0.74	745.96	5.00
-24	FM5 1.4	0.65	0.68	475.24	5.03
-24	FM5 2.1	1.30	0.85	882.83	4.21
-12	FM5 2.2	1.58	0.87	1192.30	3.78
0	FM5 2.3	2.52	0.65	1822.70	1.93
-12	FM5 2.4	1.28	0.76	849.93	3.98
-24	FM5 3.1	1.08	0.85	733.65	4.51
0	FM5 3.2	3.46	0.69	2518.80	1.68
-12	FM5 3.3	0.90	0.66	634.16	4.25
0	FM5 3.4	2.54	0.55	1768.50	1.40
0	FM6 2.1	1.91	0.60	1237.80	3.02
-12	FM6 2.2	0.88	0.67	734.17	3.70
-24	FM6 2.3	0.61	1.05	507.14	7.67
0	FM6 2.4		0.86		1.45
0	FM6 W 3.1	3.16	0.86	2681.30	2.17
-24	FM6 W 3.2	0.94	0.80	615.23	5.33
-12	FM6 W 3.3	2.05	0.96	1250.80	4.63
-24	FM6 W 3.4	0.37	0.57	280.65	5.35
-24	FM6 7.1	0.64	0.95	421.50	7.52
-12	FM6 7.2	0.98	0.62	853.47	3.03
0	FM6 7.3	3.36	0.65	2066.80	2.04
-12	FM6 7.4	1.39	0.74	1019.00	3.38
0	FM6 1.1	2.38	0.59	1617.90	2.82
-12	FM6 1.2	1.77	0.69	1238.10	2.60
-24	FM6 1.3	0.57	0.64	414.70	5.39
0	FM6 1.4	3.33	0.53	2237.50	1.38
-12	FM6 2.1	1.01	0.69	728.55	4.90
-24	FM6 2.2	0.91	0.72	672.82	4.40
0	FM6 2.3	3.94	0.53	2713.00	1.55
-24	FM6 2.4	0.97	0.86	646.20	5.48
0	FM6 4.1	2.80	0.60	1973.50	1.96
-24	FM6 4.2	0.82	0.72	568.54	4.94
-12	FM6 4.3	2.81	0.86	1974.70	2.68

Table E.1 (Continued) All SCB values

-12	FM6 4.4	1.39	0.73	980.83	3.54
-6	FM7-0 4.1	2.54	0.79	1563.80	3.55
-18	FM7-0 4.2	1.22	0.85	998.05	3.76
-30	FM7-0 4.3	0.29	0.68	219.27	5.84
-30	FM7-0 4.4	0.89	0.87	539.60	7.72
-18	FM7-0 5.1	1.07	0.82	759.60	5.47
-6	FM7-0 5.2	1.66	1.17	1981.00	4.48
-30	FM7-0 5.3	0.41	0.65	268.02	7.14
-6	FM7-0 5.4	1.99	0.82	1480.60	2.72
-30	FM7-0 7.1	0.88	0.88	609.16	6.36
-6	FM7-0 7.2	1.63	0.58	1126.60	2.66
-18	FM7-0 7.3	0.82	0.65	550.04	4.98
-18	FM7-0 7.4	1.15	0.63	754.01	3.49
-30	FM7-0 1.3	0.38	0.62	248.05	5.59
-18	FM7-0 1-1.1	0.92	0.79	666.67	5.14
-6	FM7-0 1-1.2	1.86	0.66	1327.80	3.40
-30	FM7-0 1-1.3	0.50	0.66	379.98	4.44
-18	FM7-0 1-1.4	1.63	0.92	1098.70	4.73
-6	FM7-0 2.1	1.56	0.56	1106.00	2.51
-18	FM7-0 2.2	1.52	0.56	1147.80	1.62
-6	FM7-0 2.4	1.88	0.77	1257.30	4.34
-30	FM7-0 4.1	0.36	0.68	243.47	6.59
-18	FM7-0 4.2	0.87	0.59	639.36	3.04
-6	FM7-0 4.3	2.03	0.57	1251.20	2.57
-30	FM7-0 4.4	0.69	0.68	497.46	3.54
-18	FM7-5 1.1	3.72	0.80	2819.90	3.39
-30	FM7-5 1.2	0.79	0.74	525.32	4.64
-6	FM7-5 1.3	4.43	0.68	2807.00	1.65
-6	FM7-5 1.4	1.41	0.54	979.92	2.99
-30	FM7-5 W5.1	0.56	0.58	430.69	4.55
-18	FM7-5 W5.2	1.62	1.00	1221.80	3.69
-6	FM7-5 W5.3	1.37	0.50	1021.30	1.95
-18	FM7-5 W5.4	1.49	0.72	1096.70	2.70
-6	FM7-5 6.1	1.26	0.51	823.13	
-30	FM7-5 6.2	0.68	0.68	449.01	4.42
-18	FM7-5 6.3	1.28	0.79	968.36	4.25
-30	FM7-5 6.4	0.38	0.67	263.03	6.91
-30	FM7-5 1.1	0.75	0.67	515.41	4.63
-18	FM7-5 1.2	1.74	0.71	1296.30	2.01
-6	FM7-5 1.3	2.26	0.57	1619.40	1.67

Table E.1 (Continued) All SCB values

-30	FM7-5 1.4	0.83	0.85	561.21	6.05
-6	FM7-5 2.1	2.10	0.58	1430.80	2.27
-30	FM7-5 2.2	0.25	0.45	174.40	4.53
-18	FM 7-5 2.3	1.65	0.90	1225.70	3.78
-6	FM7-5 2.4	0.91	0.32	641.78	1.44
-30	FM7-5 3.1	0.52	0.64	337.55	5.40
-6	FM7-5 3.3	2.55	0.62	1868.10	1.69
-6	FM7-7 7.1	1.23	0.57	894.33	2.93
-30	FM7-7 7.2	0.66	0.62	487.00	4.26
-18	FM7-7 7.3	1.00	0.78	754.72	4.45
-30	FM7-7 7.4	0.75	0.82	509.60	6.90
-6	FM 7-7 2.1	2.96	0.69	1901.40	2.32
-18	FM7-7 2.2	1.48	0.95	1055.70	4.62
-30	FM7-7 2.3	1.73	0.95	1229.40	3.60
-6	FM7-7 2.4	5.29	0.83	3355.80	2.25
-30	FM7-7 W 6.1	1.00	0.98	673.71	6.42
-6	FM7-7 W 6.2	3.50	0.80	2514.30	1.91
-18	FM7-7 W 6.3	1.26	0.83	883.03	5.27
-18	FM7-7 W 6.4	1.44	0.72	968.04	3.92
-6	FM7-7 2.1				
-18	FM7-7 2.2	0.68	0.50	480.75	3.74
-30	FM7-7 2.3	1.73	0.94	1211.90	3.60
-18	FM7-7 2.4	1.66	0.78	1197.80	3.31
-6	FM7-7 3.1	3.29	0.51	2272.80	1.34
-30	FM7-7 3.2	0.59	0.62	419.89	3.79
-18	FM7-7 3.3	0.99	0.70	691.72	4.43
-6	FM7-7 3.4	1.77	0.46	1296.60	1.16
-6	FM7-7 1.1	2.38	0.58	1734.30	1.89
-30	FM7-7 1.2	0.87	0.68	598.08	4.42
-18	FM7-7 1.3	3.09	0.91	2126.70	2.62
-30	FM7-7 1.4	0.70	0.68	506.45	4.61

APPENDIX F INDIRECT TENSILE STRENGTH DATA SHEETS

The following tables show the testing details and results for the indirect tensile strength data.

Table F.1 Indirect tensile strength for FM2 lab-compacted

		Laboratory Compacted									
Sample identification		FM2 W7 L	FM2 W9 L	FM2 W5 L	FM2 W3 L	FM2 W10 L	FM2 H6 L	FM2 H5 L	FM2 H7 L	FM2 H1 L	FM2 H4 L
Diameter, mm	D	100	100	100	100	100	100	100	100	100	100
H1		62.14	62.48	62.47	62.46	62.5	62.41	62.45	62.59	62.48	62.54
H2		62.18	62.44	62.48	62.53	62.52	62.46	62.41	62.54	62.46	62.66
H3		62.14	62.51	62.46	62.45	62.49	62.42	62.48	62.55	62.48	62.67
Thickness, mm	t	62.15	62.48	62.47	62.48	62.50	62.43	62.45	62.56	62.47	62.62
Dry Mass in Air, g	A	1125.3	1126.4	1125	1125.1	1124.5	1107.3	1111	1108.2	1108.5	1107.1
SSD Mass, g	B	1126.5	1128.5	1127	1126.9	1127	1110.5	1114	1111.2	1112.2	1110.2
Mass in Water, g	C	648.2	649.7	646.7	647.2	648.5	636.6	637.3	635.2	634	630.7
Volume (B-C), cm ³	E	478.3	478.8	480.3	479.7	478.5	473.9	476.7	476	478.2	479.5
Bulk specific Gravity (A/E)	G _{mb}	2.35	2.35	2.34	2.35	2.35	2.34	2.33	2.33	2.32	2.31
Maximum Specific Gravity	G _{mm}	2.46	2.46	2.46	2.46	2.46	2.46	2.46	2.46	2.46	2.46
% Air Voids [100 (G _{mm} -G _{mb})/G _{mm}]	P _a	4.36	4.37	4.79	4.66	4.47	5.02	5.26	5.36	5.77	6.14
Volume of Air Voids (PaE/100), cm ³	V _a	20.86	20.91	22.98	22.34	21.39	23.78	25.07	25.51	27.59	29.46
Load, N	P	9,399	9,478	8,774	8,170	8,876	8,382	8,508	7,887	7,784	7,127
Saturated- Sample Identification		FM2 W6 L	FM2 W4 L	FM2 W2 L	FM2 W8 L	FM2 W1 L	FM2 H8 L	FM2 H9 L	FM2 H10 L	FM2 H2 L	FM2 H3 L
H1		62.52	62.42	62.64	62.55	62.51	62.55	62.69	62.54	62.8	62.48
H2		62.56	62.5	62.56	62.52	62.62	62.47	62.59	62.5	62.81	62.52
H3		62.56	62.46	62.57	62.52	62.54	62.59	62.6	62.55	62.81	62.56
Thickness, mm	t'	62.55	62.46	62.59	62.53	62.56	62.54	62.63	62.53	62.81	62.52
Dry Mass in Air, g	A'	1126.4	1124.5	1126.3	1124.7	1124.5	1110.2	1109.9	1110.7	1110.2	1100.1
SSD Mass, g	B'	1128.1	1127.5	1128.7	1126.4	1127	1113.1	1113.3	1115.6	1113.1	1103.3
Mass in Water, g	C'	650.1	649.2	649.6	646.8	648.5	638.7	637.4	639.2	635.1	627
Volume (B-C), cm ³	E'	478	478.3	479.1	479.6	478.5	474.4	475.9	476.4	478	476.3
Bulk specific Gravity (A/E)	G _{mb} '	2.36	2.35	2.35	2.35	2.35	2.34	2.33	2.33	2.32	2.31
Maximum Specific Gravity	G _{mm} '	2.46	2.46	2.46	2.46	2.46	2.46	2.46	2.46	2.46	2.46
% Air Voids [100 (G _{mm} -G _{mb})/G _{mm}]	P _a '	4.21	4.43	4.44	4.67	4.47	4.87	5.19	5.23	5.59	6.11
Volume of Air Voids (PaE/100), cm ³	V _a '	20.11	21.19	21.25	22.40	21.39	23.10	24.72	24.90	26.70	29.10
SSD Mass, g	B'	1139.7	1139.9	1141.1	1140.2	1139.4	1131.1	1130.4	1129.4	1132.4	1123.1
Volume of Absorbed Water (B'-A), cm ³	J'	13.3	15.4	14.8	15.5	14.9	20.9	20.5	18.7	22.2	23
% Saturation (100J'/V _a)	S'	66.12368634	72.68889827	69.63240638	69.18136294	69.67116518	90.47937491	82.92498438	75.1126641	83.14859927	79.02455376
Load, N (lbf)	P'	8559	7859	7450	8075	7460	7753	7436	7707	7034	6894
Dry Strength [2000P'/ntD], kPa (psi)	S ₁	963	966	894	832	904	855	867	803	793	725
Wet Strength [2000P'/nt'D] (psi)	S ₂	871	801	758	822	759	789	756	785	713	702
Visual Moisture Damage (0 to 5)		1	2	2	0	1					
Cracked/Broken Aggregate?											
TSR (S ₂ /S ₁)		0.904902176	0.829404629	0.847471685	0.987581775	0.839752129	0.923380574	0.871488909	0.977646454	0.898852583	0.968906192

Table F.2 Indirect tensile strength for FM2 field-compacted

		Field Compacted									
Sample identification		FM2 W10 F	FM2 W8 F	FM2 W7 F	FM2 W2 F	FM2 W1 F	FM2 H6 F	FM2 H4 F	FM2 H9 F	FM2 H3 F	FM2 H2 F
Diameter, mm	D	100	100	100	100	100	100	100	100	100	100
H1		62.55	62.45	62.4	62.62	63.81	62.55	62.48	62.4	62.44	62.45
H2		62.45	62.4	62.38	62.58	63.61	62.49	62.47	62.41	62.4	62.4
H3		62.43	62.37	62.34	62.57	63.63	62.52	62.43	62.43	62.37	62.41
Thickness, mm	t	62.48	62.41	62.37	62.59	63.68	62.52	62.46	62.41	62.40	62.42
Dry Mass in Air, g	A	1125.8	1125.5	1121.7	1126.1	1128.5	1109.4	1111.4	1108.8	1111.1	1110.9
SSD Mass, g	B	1128.3	1127.7	1124.4	1129.3	1133.2	1113.9	1114.9	1110.7	1113.8	1113.4
Mass in Water, g	C	649.1	647.8	645.3	647.9	645.7	640.7	639.8	636.1	637.9	636.7
Volume (B-C), cm ³	E	479.2	479.9	479.1	481.4	487.5	473.2	475.1	474.6	475.9	476.7
Bulk specific Gravity (A/E)	G _{mb}	2.35	2.35	2.34	2.34	2.31	2.34	2.34	2.34	2.33	2.33
Maximum Specific Gravity	G _{mm}	2.46	2.46	2.46	2.46	2.46	2.46	2.46	2.46	2.46	2.46
% Air Voids [100 (G _{mm} -G _{mb})/G _{mm}]	P _a	4.50	4.66	4.83	4.91	5.90	4.70	4.91	5.03	5.09	5.27
Volume of Air Voids (PaE/100), cm ³	V _a	21.56	22.38	23.12	23.64	28.76	22.22	23.31	23.87	24.23	25.11
Load, N	P	8,720	8,489	7,986	8,228	7,274	7,422	7,242	7,853	7,022	6,944
Saturated- Sample Identification		FM2 W9 F	FM2 W5 F	FM2 W6 F	FM2 W4 F	FM2 W3 F	FM2 H7 F	FM2 H1 F	FM2 H10 F	FM2 H8 F	FM2 H5 F
H1		62.4	62.39	62.45	62.84	63.07	62.55	62.45	62.51	62.49	62.51
H2		62.42	62.24	62.44	62.78	63.16	62.55	62.44	62.48	62.34	62.59
H3		62.37	62.4	62.4	63.06	63.03	62.45	62.44	62.53	62.44	62.59
Thickness, mm	t'	62.40	62.34	62.43	62.89	63.09	62.52	62.44	62.51	62.42	62.56
Dry Mass in Air, g	A'	1128.7	1126.2	1125	1128.5	1128.4	1113	1109.3	1110.3	1108.4	1108.6
SSD Mass, g	B'	1130.8	1128.6	1127	1130.9	1132.2	1114.7	1112	1112.5	1110.9	1112.9
Mass in Water, g	C'	652	649	646.8	648.5	645.3	640.8	638.3	637.8	636.4	637.3
Volume (B-C), cm ³	E'	478.8	479.6	480.2	482.4	486.9	473.9	473.7	474.7	474.5	475.6
Bulk specific Gravity (A/E)	G _{mb'}	2.36	2.35	2.34	2.34	2.32	2.35	2.34	2.34	2.34	2.33
Maximum Specific Gravity	G _{mm'}	2.46	2.46	2.46	2.46	2.46	2.46	2.46	2.46	2.46	2.46
% Air Voids [100 (G _{mm} -G _{mb})/G _{mm}]	P _{a'}	4.17	4.54	4.77	4.90	5.79	4.53	4.81	4.92	5.04	5.25
Volume of Air Voids (PaE/100), cm ³	V _{a'}	19.98	21.80	22.88	23.66	28.20	21.46	22.77	23.36	23.93	24.95
SSD Mass, g	B'	1144.2	1141.5	1143.5	1145.6	1149.7	1130.2	1127.1	1129.5	1128.5	1130.3
Volume of Absorbed Water (B'-A), cm ³	J'	15.5	15.3	18.5	17.1	21.3	17.2	17.8	19.2	20.1	21.7
% Saturation (100J'/V _a)	S'	77.58199723	70.19919427	80.84630143	72.27338327	75.52973737	80.14547108	78.19006464	82.19693015	83.99184644	86.97536496
Load, N (lbf)	P'	7704	7617	6945	6243	6642	8119	6362	7721	7485	7506
Dry Strength [2000P'/πtD], kPa (psi)	S ₁	888.5443799	865.9763614	815.0999032	836.8927802	727.1566819	755.7575082	738.1370935	801.0114231	716.3636265	708.2171473
Wet Strength [2000P'/πt'D] (psi)	S ₂	786.0232174	777.8116188	708.2056789	631.930347	670.2576508	826.7747744	648.6166251	786.3713867	763.3528629	763.7815623
Visual Moisture Damage (0 to 5)											
Cracked/Broken Aggregate?											
TSR (S ₂ /S ₁)		0.884618974	0.898190359	0.868857518	0.755091168	0.921751347	1.093968324	0.878721082	0.981723062	1.065594113	1.078456749

Table F.3 Indirect tensile strength for FM3 lab-compacted

		Laboratory Compacted									
Sample identification		FM3 W5 L	FM3 W8 L	FM3 W7 L	FM3 W2 L	FM3 W6 L	FM3 H4 L	FM3 H6 L	FM3 H10 L	FM3 H2 L	FM3 H7 L
Diameter, mm	D	100	100	100	100	100	100	100	100	100	100
H1		62.46	62.44	62.48	62.39	62.53	62.46	62.49	62.43	62.58	62.49
H2		62.49	62.46	62.44	62.4	62.49	62.55	62.42	62.44	62.47	62.44
H3		62.47	62.48	62.52	62.39	62.53	62.44	62.45	62.48	62.46	62.45
Thickness, mm	t	62.47	62.46	62.48	62.39	62.52	62.48	62.45	62.45	62.50	62.46
Dry Mass in Air, g	A	1101.9	1100.3	1101.4	1100.2	1100.5	1100	1101.2	1099.8	1101.7	1101.5
SSD Mass, g	B	1107.8	1106	1106.4	1104.4	1104.1	1103.8	1105	1103.1	1104.8	1105.5
Mass in Water, g	C	632.5	630.3	630	628.3	627.1	629.4	629.8	628.3	628.6	628.8
Volume (B-C), cm ³	E	475.3	475.7	476.4	476.1	477	474.4	475.2	474.8	476.2	476.7
Bulk specific Gravity (A/E)	G _{mb}	2.32	2.31	2.31	2.31	2.31	2.32	2.32	2.32	2.31	2.31
Maximum Specific Gravity	G _{mm}	2.44	2.44	2.44	2.44	2.44	2.44	2.44	2.44	2.44	2.44
% Air Voids [100 (G _{mm} -G _{mb})/G _{mm}]	P _a	4.99	5.20	5.25	5.29	5.45	4.97	5.03	5.07	5.18	5.30
Volume of Air Voids (PaE/100), cm ³	V _a	23.70	24.76	25.01	25.20	25.98	23.58	23.89	24.06	24.68	25.27
Load, N	P	8,118	8,659	8,466	8,318	8,750	10,610	10,892	11,408	10,604	10,974
Saturated- Sample Identification		FM3 W1 L	FM3 W9 L	FM3 W3 L	FM3 W10 L	FM3 W4 L	FM3 H9 L	FM3 H5 L	FM3 H8 L	FM3 H1 L	FM3 H3 L
H1		62.45	62.49	62.51	62.55	62.58	62.48	62.44	62.53	62.56	62.48
H2		62.51	62.52	62.59	62.49	62.59	62.44	62.45	62.53	62.51	62.52
H3		62.47	62.46	62.59	62.51	62.58	62.52	62.4	62.51	62.49	62.51
Thickness, mm	t'	62.48	62.49	62.56	62.52	62.58	62.48	62.43	62.52	62.52	62.50
Dry Mass in Air, g	A'	1103.1	1099.3	1100.5	1102.2	1099.8	1101.2	1101	1100.7	1102.6	1101.5
SSD Mass, g	B'	1105.8	1103.5	1104.5	1106.8	1104.1	1105	1104.3	1104.7	1105.7	1105.5
Mass in Water, g	C'	630.6	628.7	628.6	630	627.9	630.9	629.3	629.6	629.2	628.8
Volume (B-C), cm ³	E'	475.2	474.8	475.9	476.8	476.2	474.1	475	475.1	476.5	476.7
Bulk specific Gravity (A/E)	G _{mb} '	2.32	2.32	2.31	2.31	2.31	2.32	2.32	2.32	2.31	2.31
Maximum Specific Gravity	G _{mm} '	2.44	2.44	2.44	2.44	2.44	2.44	2.44	2.44	2.44	2.44
% Air Voids [100 (G _{mm} -G _{mb})/G _{mm}]	P _a '	4.86	5.11	5.23	5.26	5.35	4.81	5.00	5.05	5.17	5.30
Volume of Air Voids (PaE/100), cm ³	V _a '	23.11	24.27	24.88	25.08	25.46	22.79	23.77	23.99	24.61	25.27
SSD Mass, g	B'	1122.7	1121.1	1119.9	1123.4	1121.7	1121.6	1122.1	1123.2	1123.7	1121.3
Volume of Absorbed Water (B'-A), cm ³	J'	19.6	21.8	19.4	21.2	21.9	20.4	21.1	22.5	21.1	19.8
% Saturation (100J'/V _a)	S'	84.81	89.83	77.99	84.53	86.01	89.52	88.77	93.78	85.72	78.37
Load, N (lbf)	P'	7500.00	7820.00	8246.00	7300.00	7714.00	10160.00	10580.00	10470.00	10628.00	10256.00
Dry Strength [2000P/πtD]], kPa (psi)	S ₁	827.25	882.56	862.62	848.71	891.03	1081.01	1110.28	1162.94	1080.06	1118.52
Wet Strength [2000P'/πt'D] (psi)	S ₂	764.23	796.67	839.08	743.37	784.70	1035.22	1078.88	1066.07	1082.21	1044.61
Visual Moisture Damage (0 to 5)											
Cracked/Broken Aggregate?											
TSR (S ₂ /S ₁)		0.92	0.90	0.97	0.88	0.88	0.96	0.97	0.92	1.00	0.93

Table F.4 Indirect tensile strength for FM3 field-compacted

		Field Compacted									
Sample identification		FM3 W10 F	FM3 W5 F	FM3 W3 F	FM3 W6 F	FM3 W2 F	FM3 H10 F	FM3 H8 F	FM3 H3 F	FM3 H5 F	FM3 H7 F
Diameter, mm	D	100	100	100	100	100	100	100	100	100	100
H1		62.38	62.35	62.39	62.49	62.44	62.52	62.42	62.46	63.39	65.3
H2		62.36	62.4	62.43	62.45	62.53	62.44	62.47	62.37	63.24	65.33
H3		62.43	62.28	62.45	62.51	62.46	62.43	62.46	62.43	63.3	65.38
Thickness, mm	t	62.39	62.34	62.42	62.48	62.48	62.46	62.45	62.42	63.31	65.34
Dry Mass in Air, g	A	1100.8	1089	1083.1	1087.5	1088.3	1090.6	1092	1088.8	1091.4	1087
SSD Mass, g	B	1105	1095.1	1088.2	1094.5	1094.9	1096	1097.5	1095.5	1099.9	1097
Mass in Water, g	C	630.7	621.4	616.2	619.1	619	622.6	622	618.2	617.9	608.2
Volume (B-C), cm ³	E	474.3	473.7	472	475.4	475.9	473.4	475.5	477.3	482	488.8
Bulk specific Gravity (A/E)	G _{mb}	2.32	2.30	2.29	2.29	2.29	2.30	2.30	2.28	2.26	2.22
Maximum Specific Gravity	G _{mm}	2.44	2.44	2.44	2.44	2.44	2.44	2.44	2.44	2.44	2.44
% Air Voids [100 (G _{mm} -G _{mb})/G _{mm}]	P _a	4.88	5.78	5.95	6.25	6.28	5.58	5.88	6.51	7.20	8.86
Volume of Air Voids (PaE/100), cm ³	V _a	23.15	27.39	28.11	29.70	29.88	26.43	27.96	31.07	34.70	43.31
Load, N	P	8,193	7,429	8,668	7,660	8,893	10,490	10,468	10,708	10,265	9,234
Saturated- Sample Identification		FM3 W9 F	FM3 W8 F	FM3 W4 F	FM3 W7 F	FM3 W1 F	FM3 H2 F	FM3 H9 F	FM3 H1 F	FM3 H4 F	FM3 H6 F
H1		62.53	62.68	62.58	62.52	62.65	62.55	62.48	62.57	62.49	64.34
H2		62.5	62.64	62.53	62.5	62.6	62.49	62.52	62.54	62.43	64.37
H3		62.53	62.62	62.55	62.56	62.55	62.59	62.49	62.47	62.47	64.42
Thickness, mm	t'	62.52	62.65	62.55	62.53	62.60	62.54	62.50	62.53	62.46	64.38
Dry Mass in Air, g	A'	1093.1	1088.8	1091.4	1089.9	1088.7	1109.6	1091	1089.2	1085.5	1088.5
SSD Mass, g	B'	1101	1094.7	1096.4	1096.5	1093.8	1113.5	1095.8	1095.2	1093	1098.5
Mass in Water, g	C'	631.6	622.2	621.3	620.5	617.8	634.2	621.8	619.5	616.9	613.9
Volume (B-C), cm ³	E'	469.4	472.5	475.1	476	476	479.3	474	475.7	476.1	484.6
Bulk specific Gravity (A/E)	G _{mb} '	2.33	2.30	2.30	2.29	2.29	2.32	2.30	2.29	2.28	2.25
Maximum Specific Gravity	G _{mm} '	2.44	2.44	2.44	2.44	2.44	2.44	2.44	2.44	2.44	2.44
% Air Voids [100 (G _{mm} -G _{mb})/G _{mm}]	P _a '	4.56	5.56	5.85	6.16	6.26	5.12	5.67	6.16	6.56	7.94
Volume of Air Voids (PaE/100), cm ³	V _a '	21.41	26.27	27.80	29.32	29.81	24.55	26.87	29.31	31.22	38.49
SSD Mass, g	B'	1117.9	1114	1117.6	1118.1	1114.5	1133.1	1117	1118.3	1112	1126.3
Volume of Absorbed Water (B'-A), cm ³	J'	24.8	25.2	26.2	28.2	25.8	23.5	26	29.1	26.5	37.8
% Saturation (100J'/V _a)	S'	115.84	95.93	94.23	96.18	86.54	95.74	96.77	99.30	84.87	98.20
Load, N (lbf)	P'	6434.00	7494.00	6323.00	5876.00	6797.00	9549.00	9719.00	9761.00	11274.00	9393.00
Dry Strength [2000P'/πt'D], kPa (psi)	S ₁	836.00	758.61	884.00	780.45	906.17	1069.13	1067.12	1092.11	1032.21	899.73
Wet Strength [2000P'/πt'D] (psi)	S ₂	655.15	761.55	643.51	598.27	691.23	971.98	990.02	993.82	1149.04	928.87
Visual Moisture Damage (0 to 5)											
Cracked/Broken Aggregate?											
TSR (S ₂ /S ₁)		0.78	1.00	0.73	0.77	0.76	0.91	0.93	0.91	1.11	1.03

Table F.5 Indirect tensile strength for FM4 lab-compacted

		Laboratory Compacted									
Sample identification		FM4 W9 L	FM4 W6 L	FM4 W8 L	FM4 W4 L	FM4 W1 L	FM4 H9 L	FM4 H6 L	FM4 H3 L	FM4 H5 L	FM4 H1 L
Diameter, mm	D	100	100	100	100	100	100	100	100	100	100
H1		62.31	62.28	62.41	62.42	62.41	62.28	62.77	62.35	62.3	62.51
H2		62.37	62.31	62.38	62.39	62.45	62.29	62.56	62.23	62.29	62.53
H3		62.35	62.37	62.38	62.47	62.46	62.27	62.38	62.33	62.36	62.44
Thickness, mm	t	62.34	62.32	62.39	62.43	62.44	62.28	62.57	62.30	62.32	62.49
Dry Mass in Air, g	A	1119.9	1119.1	1119	1118.7	1119.2	1119.3	1120	1117.8	1118.8	1119.2
SSD Mass, g	B	1122.6	1122.9	1121.9	1122	1122.6	1121	1121.5	1119.3	1119.9	1120.8
Mass in Water, g	C	646.5	646.3	645.1	645.2	644.5	646.2	645.4	644	643.5	643.8
Volume (B-C), cm ³	E	476.1	476.6	476.8	476.8	478.1	474.8	476.1	475.3	476.4	477
Bulk specific Gravity (A/E)	G _{mb}	2.35	2.35	2.35	2.35	2.34	2.36	2.35	2.35	2.35	2.35
Maximum Specific Gravity	G _{mm}	2.50	2.50	2.50	2.50	2.50	2.50	2.50	2.50	2.50	2.50
% Air Voids [100 (G _{mm} -G _{mb})/G _{mm}]	P _a	5.91	6.08	6.12	6.15	6.36	5.70	5.90	5.93	6.06	6.15
Volume of Air Voids (PaE/100), cm ³	V _a	28.14	28.96	29.20	29.32	30.42	27.08	28.10	28.18	28.88	29.32
Load, N	P	12,042	12,250	12,154	12,943	11,970	12,860	12,659	12,886	12,810	12,492
Saturated- Sample Identification		FM4 W10 L	FM4 W3 L	FM4 W5 L	FM4 W2 L	FM4 W7 L	FM4 H2 L	FM4 H7 L	FM4 H4 L	FM4 H8 L	FM4 H10 L
H1		62.44	62.44	62.59	62.43	62.5	62.42	62.32	62.28	62.38	62.27
H2		62.4	62.44	62.51	62.53	62.47	62.41	62.47	62.26	62.23	62.29
H3		62.46	62.47	62.5	62.49	62.52	62.48	62.34	62.32	62.33	62.24
Thickness, mm	t'	62.43	62.45	62.53	62.48	62.50	62.44	62.38	62.29	62.31	62.27
Dry Mass in Air, g	A'	1119.3	1119.2	1120.2	1118.3	1119.2	1120.1	1119.3	1118.3	1117.7	1118.3
SSD Mass, g	B'	1122.7	1121.6	1123.7	1120.8	1122.8	1120.9	1120.8	1119.7	1120	1120.3
Mass in Water, g	C'	647	645.2	646.6	644.2	645.2	645.8	645.8	644.2	644.1	644.1
Volume (B-C), cm ³	E'	475.7	476.4	477.1	476.6	477.6	475.1	475	475.5	475.9	476.2
Bulk specific Gravity (A/E)	G _{mb'}	2.35	2.35	2.35	2.35	2.34	2.36	2.36	2.35	2.35	2.35
Maximum Specific Gravity	G _{mm'}	2.50	2.50	2.50	2.50	2.50	2.50	2.50	2.50	2.50	2.50
% Air Voids [100 (G _{mm} -G _{mb})/G _{mm}]	P _{a'}	5.88	6.03	6.08	6.14	6.26	5.70	5.74	5.93	6.06	6.06
Volume of Air Voids (PaE/100), cm ³	V _{a'}	27.98	28.72	29.02	29.28	29.92	27.06	27.28	28.18	28.82	28.88
SSD Mass, g	B'	1143.5	1143.8	1144.3	1141.8	1144.6	1138.1	1137.8	1137.9	1138	1138.7
Volume of Absorbed Water (B'-A), cm ³	J'	24.2	24.7	25.3	23.1	25.4	18.8	17.8	20.1	19.2	19.5
% Saturation (100J'/V _a)	S'	86.49	86.00	87.18	78.89	84.89	69.48	65.25	71.33	66.62	67.52
Load, N (lbf)	P'	9856.00	9917.00	11188.00	10755.00	9908.00	11787.00	12130.00	11493.00	11509.33	11362.33
Dry Strength [2000P/πtD)], kPa (psi)	S ₁	1229.67	1251.38	1240.18	1319.91	1220.43	1314.54	1287.99	1316.70	1308.66	1272.56
Wet Strength [2000P'/πt'D] (psi)	S ₂	1005.00	1010.95	1138.99	1095.79	1009.28	1201.83	1238.00	1174.68	1175.84	1161.70
Visual Moisture Damage (0 to 5)											
Cracked/Broken Aggregate?											
TSR (S ₂ /S ₁)		0.82	0.81	0.92	0.83	0.83	0.91	0.96	0.89	0.90	0.91

Table F.6 Indirect tensile strength for FM4 field-compacted

Sample identification		Field Compacted							
		FM4 W2 F	FM4 W6 F	FM4 W5 F	FM4 H9 F	FM4 H10 F	FM4 H4 F	FM4 H2 F	FM4 H3 F
Diameter, mm	D	100	100	100	100	100	100	100	100
H1		62.51	62.31	62.39	62.49	62.4	62.53	62.45	62.54
H2		62.45	62.34	62.47	62.45	62.39	62.47	62.49	62.59
H3		62.41	62.36	62.45	62.48	62.45	62.51	62.4	62.52
Thickness, mm	t	62.46	62.34	62.44	62.47	62.41	62.50	62.45	62.55
Dry Mass in Air, g	A	1116.8	1118	1118	1119	1118.3	1120.6	1117.3	1119.2
SSD Mass, g	B	1121.1	1123.5	1124.1	1122.3	1123.7	1123.3	1119.8	1123
Mass in Water, g	C	646.3	647.6	646.1	644.8	645.8	643.9	641.7	643.8
Volume (B-C), cm ³	E	474.8	475.9	478	477.5	477.9	479.4	478.1	479.2
Bulk specific Gravity	G _{mb}	2.35	2.35	2.34	2.34	2.34	2.34	2.34	2.34
Maximum Specific Gravity	G _{mm}	2.50	2.50	2.50	2.50	2.50	2.50	2.50	2.50
% Air Voids [100P _a]	P _a	5.91	6.03	6.44	6.26	6.40	6.50	6.52	6.58
Volume of Air Voids	V _a	28.08	28.70	30.80	29.90	30.58	31.16	31.18	31.52
Load, N	P	10,270	10,366	10,798	12,412	13,154	12,029	11,633	11,019
Saturated- Sample Identification		FM4 W4 F	FM4 W1 F	FM4 W3 F	FM4 H5 F	FM4 H1 F	FM4 H8 F	FM4 H7 F	FM4 H6 F
H1		62.52	62.45	62.4	62.56	62.59	62.34	62.54	62.5
H2		62.48	62.32	62.42	62.54	62.57	62.62	62.56	62.44
H3		62.55	62.38	62.38	62.64	62.48	62.63	62.58	62.42
Thickness, mm	t'	62.52	62.38	62.40	62.58	62.55	62.53	62.56	62.45
Dry Mass in Air, g	A'	1119.2	1116.7	1117.7	1119.8	1119.6	1116.1	1115.9	1117.7
SSD Mass, g	B'	1123.2	1121.6	1122.6	1122.1	1123.6	1119.7	1119.1	1120.4
Mass in Water, g	C'	648.8	646.8	646.5	644.7	645.2	642.4	641.7	642.1
Volume (B-C), cm ³	E'	474.4	474.8	476.1	477.4	478.4	477.3	477.4	478.3
Bulk specific Gravity	G _{mb} '	2.36	2.35	2.35	2.35	2.34	2.34	2.34	2.34
Maximum Specific Gravity	G _{mm} '	2.50	2.50	2.50	2.50	2.50	2.50	2.50	2.50
% Air Voids [100P _a ']	P _a '	5.63	5.92	6.10	6.18	6.39	6.47	6.50	6.53
Volume of Air Voids	V _a '	26.72	28.12	29.02	29.48	30.56	30.86	31.04	31.22
SSD Mass, g	B'	1142	1142.2	1143.8	1140.2	1142.5	1139.7	1141.8	1141.3
Volume of Absorption	J'	25.2	24.2	25.8	21.2	24.2	19.1	24.5	22.1
% Saturation (10S')	S'	94.31	86.06	88.90	71.91	79.19	61.89	78.93	70.79
Load, N (lbf)	P'	11215.33	11068.33	10921.33	10774.33	10627.33	10480.33	10333.33	10186.33
Dry Strength [20S ₁]	S ₁	1046.82	1058.64	1100.99	1264.82	1341.72	1225.20	1185.94	1121.49
Wet Strength [20S ₂]	S ₂	1142.08	1129.52	1114.22	1096.06	1081.68	1067.01	1051.54	1038.35
Visual Moisture Damage (0 to 5)									
Cracked/Broken Aggregate?									
TSR (S ₂ /S ₁)		1.09	1.07	1.01	0.87	0.81	0.87	0.89	0.93

Table F.7 Indirect tensile strength for FM5

		Laboratory Compacted						Field Compacted			
Sample identification		FM5 L 5	FM5 L 4	FM5 L 1	FM5 L 9	FM5 L 3	FM5 3F	FM5 7F	FM5 2F	FM5 4F	
Diameter, mm	D	100	100	100	100	100	100	100	100	100	
H1		62.3	62.34	62.41	62.31	62.37	62.32	62.34	62.49	62.32	
H2		62.33	62.39	62.23	62.34	62.48	62.33	62.31	62.57	62.38	
H3		62.29	62.45	62.29	62.3	62.41	62.41	62.41	62.5	62.35	
Thickness, mm	t	62.31	62.39	62.31	62.32	62.42	62.35	62.35	62.52	62.35	
Dry Mass in Air, g	A	1099.1	1099.0	1098.8	1098.5	1097	1098.4	1096.4	1098.9	1098.1	
SSD Mass, g	B	1100.8	1100.6	1100.6	1099.9	1099.7	1099.9	1097.6	1099.5	1099.7	
Mass in Water, g	C	622.9	621.9	621.4	620.6	620.7	622.7	620.5	620.2	620.3	
Volume (B-C), cm ³	E	477.9	478.7	479.2	479.3	479	477.2	477.1	479.3	479.4	
Bulk specific Gravity (A/E)	G _{mb}	2.30	2.30	2.29	2.29	2.29	2.30	2.30	2.29	2.29	
Maximum Specific Gravity	G _{mm}	2.44	2.44	2.44	2.44	2.44	2.44	2.44	2.44	2.44	
% Air Voids [100 (G _{mm} -G _{mb})/G _{mm}]	P _a	5.74	5.91	6.03	6.07	6.14	5.67	5.82	6.04	6.12	
Volume of Air Voids (PaE/100), cm ³	V _a	27.45	28.29	28.87	29.10	29.41	27.04	27.76	0.06	29.36	
Load, N	P	10877.000	10715.000	10417.000	11048.000	10261.000	10,277	10,361	10527.000	10242.000	
Saturated- Sample Identification		FM5 L 10	FM5 L 7	FM5 L 8	FM5 L 2	FM5 L 6	FM5 1F	FM5 5F	FM5 6F		
H1		62.43	62.26	62.22	62.26	62.255	62.33	62.39	62.37		
H2		62.39	62.29	62.32	62.28	62.31	62.39	62.37	62.31		
H3		62.4	62.38	62.22	62.29	62.255	62.34	62.34	62.3		
Thickness, mm	t'	62.41	62.31	62.25	62.28	62.27	62.35	62.37	62.33		
Dry Mass in Air, g	A'	1099.1	1097.7	1097.7	1099.8	1098.7	1098.8	1096.3	1099.4		
SSD Mass, g	B'	1100.8	1099.4	1099.4	1101.4	1100.7	1100.0	1099.7	1100.6		
Mass in Water, g	C'	622.5	621	620.7	621.4	621.0	622.6	622.0	621.2		
Volume (B-C), cm ³	E'	478.3	478.4	478.7	480	479.7	477.4	477.7	479.4		
Bulk specific Gravity (A/E)	G _{mb'}	2.30	2.29	2.29	2.29	2.29	2.30	2.29	2.29		
Maximum Specific Gravity	G _{mm'}	2.44	2.44	2.44	2.44	2.44	2.44	2.44	2.44		
% Air Voids [100 (G _{mm} -G _{mb})/G _{mm}]	P _{a'}	5.82	5.96	6.02	6.10	6.13	5.67	5.94	6.01		
Volume of Air Voids (PaE/100), cm ³	V _{a'}	27.85	28.52	28.82	29.26	29.41	27.07	28.40	28.83		
SSD Mass, g	B'	1120.4	1119.7	1119.4	1121.7	1120.6	1118	1116.6	1122.2		
Volume of Absorbed Water (B'-A), cm ³	J'	21.3	20.7	20.6	23.2	23.6	19.2	20.3	22.8		
% Saturation (100J'/V _a)	S'	76.48	72.57	71.47	79.28	80.24	70.92	71.49	79.09		
Load, N (lbf)	P'	10957.000	9745.000	10492.000	9525.000	10196.000	8783.000	9841.000	10416.00		
Dry Strength [2000P/πtD], kPa (psi)	S ₁	1111.36	1093.29	1064.30	1128.65	1046.52	1049.27	1057.85	1071.93	1045.75	
Wet Strength [2000P'/πt'D] (psi)	S ₂	1117.74	995.65	1072.94	973.69	1042.34	896.73	1004.54	1063.92		
Visual Moisture Damage (0 to 5)											
Cracked/Broken Aggregate?											
TSR (S ₂ /S ₁)		1.01	0.91	1.01	0.86	1.00	0.85	0.95	0.99		

Table F.8 Indirect tensile strength for FM6

		Laboratory Compacted					Field Compacted		
Sample identification		FM6 L8	FM6 L6	FM6 L10	FM6 L7	FM6 L2	FM6 F6	FM6 F3	FM6 F2
Diameter, mm	D	100	100	100	100	100	100	100	100
H1		62.37	62.38	62.47	62.3	62.42	62.3	62.42	62.34
H2		62.4	62.35	62.47	62.4	62.39	62.24	62.42	62.44
H3		62.4	62.33	62.42	62.42	62.38	62.38	62.4	62.41
Thickness, mm	t	62.39	62.35	62.45	62.37	62.40	62.31	62.41	62.40
Dry Mass in Air, g	A	1099	1099.4	1097.6	1099.1	1098.4	1096.6	1098.2	1101.4
SSD Mass, g	B	1100.5	1100.3	1098.7	1101	1099.2	1098.1	1099.4	1103.0
Mass in Water, g	C	619.3	620.7	618.5	621.4	617.9	618.9	620.0	620.2
Volume (B-C), cm ³	E	481.2	479.6	480.2	479.6	481.3	479.2	479.4	482.8
Bulk specific Gravity (A/E)	G _{mb}	2.28	2.29	2.29	2.29	2.28	2.29	2.29	2.28
Maximum Specific Gravity	G _{mm}	2.45	2.45	2.45	2.45	2.45	2.45	2.45	2.45
% Air Voids [100 (G _{mm} -G _{mb})/G _{mm}]	P _a	6.86	6.51	6.78	6.54	6.93	6.67	6.58	6.96
Volume of Air Voids (PaE/100), cm ³	V _a	32.99	31.23	32.57	31.35	33.34	31.97	31.52	0.07
Load, N	P	10627.000	10086.000	9750.000	10562.000	9797.000	9,421	10,004	10196.000
Saturated- Sample Identification		FM6 L1	FM6 L3	FM6 L9	FM6 L5	FM6 L4	FM6 F1	FM6 F4	FM6 F5
H1		62.1	62.26	62.26	62.4	62.31	62.28	62.29	62.2
H2		62.2	62.3	62.28	62.4	62.31	62.28	62.34	62.2
H3		62.2	62.28	62.26	62.4	62.36	62.33	62.29	62.38
Thickness, mm	t'	62.17	62.28	62.27	62.40	62.33	62.30	62.31	62.26
Dry Mass in Air, g	A'	1098.4	1100.5	1098.6	1099.2	1099.0	1100.5	1098.8	1096.2
SSD Mass, g	B'	1099.8	1101.7	1100.1	1100.5	1100.5	1101.4	1100.4	1097.0
Mass in Water, g	C'	618.8	621.5	619.9	620.3	619.2	620.0	620.9	616.9
Volume (B-C), cm ³	E'	481	480.2	480.2	480.2	481.3	481.4	479.5	480.1
Bulk specific Gravity (A/E)	G _{mb} '	2.28	2.29	2.29	2.29	2.28	2.29	2.29	2.28
Maximum Specific Gravity	G _{mm} '	2.45	2.45	2.45	2.45	2.45	2.45	2.45	2.45
% Air Voids [100 (G _{mm} -G _{mb})/G _{mm}]	P _a '	6.87	6.54	6.70	6.65	6.88	6.77	6.54	6.88
Volume of Air Voids (PaE/100), cm ³	V _a '	33.04	31.38	32.16	31.91	33.09	32.58	31.38	33.04
SSD Mass, g	B'	1122.2	1124.3	1123.8	1123.4	1124.8	1124.7	1123.5	1121.5
Volume of Absorbed Water (B'-A), cm ³	J'	23.2	24.9	26.2	24.3	26.4	24.2	24.7	25.3
% Saturation (100J'/V _a)	S'	70.22	79.34	81.47	76.14	79.77	74.27	78.72	76.58
Load, N (lbf)	P'	9666.200	9749.000	9901.000	10183.700	9099.000	9410.000	2501.000	9027.00
Dry Strength [2000P'/πt'D], kPa (psi)	S ₁	1084.37	1029.77	993.87	1078.02	999.57	962.59	1020.41	1040.28
Wet Strength [2000P'/πt'D] (psi)	S ₂	989.87	996.53	1012.29	1038.97	929.39	961.62	255.54	923.03
Visual Moisture Damage (0 to 5)									
Cracked/Broken Aggregate?									
TSR (S ₂ /S ₁)		0.91	0.97	1.02	0.96	0.93	1.00	0.25	0.89

Table F.9 Indirect tensile strength for FM7

		Laboratory Compacted					Field Compacted				
Sample identification		FM7-0 L10	FM7-0 L7	FM7-0 L6	FM7-0 L5	FM7-0 L1	FM7-0 F9	FM7-0 F3	FM7-0 F7	FM7-0 F8	FM7-0 F5
Diameter, mm	D	100	100	100	100	100	100	100	100	100	100
H1		61.5569	61.722	61.5696	62.1538	62.2046	61.976	62.23	62.5	62.38	61.2
H2		61.7982	62.3062	62.103	62.2046	62.1792	62.2554	62.4078	62.34	62.19	61.15
H3		61.6458	61.722	62.1538	62.1538	62.1792	61.7982	62.3062	62.32	62.47	61.3
Thickness, mm	t	61.67	61.92	61.94	62.17	62.19	62.01	62.31	62.39	62.35	61.22
Dry Mass in Air, g	A	1122.1	1121.5	1123.4	1121.8	1120.5	1122.6	1122.8	1123.1	1123	1120.9
SSD Mass, g	B	1124.3	1123.5	1125.1	1123.2	1122.5	1125	1125.2	1125	1125.1	1123.1
Mass in Water, g	C	647.9	646	646.3	644.4	642.8	648	647.8	647	646.5	645.0
Volume (B-C), cm ³	E	476.4	477.5	478.8	478.8	479.7	477	477.4	478.0	478.6	478.1
Bulk specific Gravity (A/E)	G _{mb}	2.36	2.35	2.35	2.34	2.34	2.35	2.35	2.35	2.35	2.34
Maximum Specific Gravity	G _{mm}	2.50	2.50	2.50	2.50	2.50	2.50	2.50	2.50	2.50	2.50
% Air Voids [100(G _{mm} -G _{mb})/G _{mm}]	P _a	5.79	6.05	6.15	6.28	6.57	5.86	5.92	6.02	6.14	6.22
Volume of Air Voids (PaE/100), cm ³	V _a	27.56	28.90	29.44	30.08	31.50	27.96	28.28	0.06	29.40	29.74
Load, N	P	10643	10163	10352	10170	8298	8,631	7,466	10145	10665	7169.000
Saturated- Sample Identification		FM7-0 L9	FM7-0 L8	FM7-0 L2	FM7-0 L3	FM7-0 L4	FM7-0 F 1	FM7-0 F10	FM7-0 F6	FM7-0 F4	FM7-0 F2
H1		61.74	61.47	62.16	62.53	62.41	62.35	62.4	62.4	62.45	62.5
H2		61.49	62.22	62.42	62.33	62.17	62.3	62.4	62.38	62.4	62.33
H3		62.16	62.1	62.28	62.3	62.24	62.41	62.4	62.57	62.42	62.46
Thickness, mm	t'	61.80	61.93	62.29	62.39	62.27	62.33	62.40	62.39	62.43	62.42
Dry Mass in Air, g	A'	1122.4	1122	1122.6	1120.1	1121.2	1122.9	1119.3	1122.4	1123.8	1121.1
SSD Mass, g	B'	1123.9	1123.6	1123.9	1122.3	1122.6	1124.6	1121.8	1124.3	1126.1	1123.7
Mass in Water, g	C'	646.9	646.4	644.9	643.4	642.7	647.9	646	646.8	647.3	645.5
Volume (B-C), cm ³	E'	477	477.2	479	478.9	479.9	476.7	475.8	477.5	478.8	478.2
Bulk specific Gravity (A/E)	G _{mb'}	2.35	2.35	2.34	2.34	2.34	2.36	2.35	2.35	2.35	2.34
Maximum Specific Gravity	G _{mm'}	2.50	2.50	2.50	2.50	2.50	2.50	2.50	2.50	2.50	2.50
% Air Voids [100(G _{mm} -G _{mb})/G _{mm}]	P _{a'}	5.88	5.95	6.25	6.44	6.55	5.78	5.90	5.98	6.12	6.22
Volume of Air Voids (PaE/100), cm ³	V _{a'}	28.04	28.40	29.96	30.86	31.42	27.54	28.08	28.54	29.28	29.76
SSD Mass, g	B'	1141.4	1143.8	1144.8	1141.8	1143.6	1143.2	1140.8	1142.8	1145.8	1143.2
Volume of Absorbed Water (B'-A), J'		19	22.3	21.4	20	23.1	20.3	21.5	20.4	22.8	22.3
% Saturation (100J'/V _a)	S'	67.76	78.52	71.43	64.81	73.52	73.71	76.57	71.48	77.87	74.93
Load, N (lbf)	P'	9600	8884	8187	7870	8545	6084	8060.300	5775	5739	5742
Dry Strength [2000P'/πt'D], kPa (ps)	S ₁	1098.73	1044.95	1063.94	1041.39	849.47	886.10	762.74	1035.24	1089.00	745.54
Wet Strength [2000P'/πt'D] (psi)	S ₂	988.98	913.25	836.78	803.09	873.56	621.45	822.33	589.27	585.27	585.67
Visual Moisture Damage (0 to 5)					Yes 20%						
Cracked/Broken Aggregate?											
TSR (S ₂ /S ₁)		0.90	0.87	0.79	0.77	1.03	0.70	1.08	0.57	0.54	0.79

Table F.10 Indirect tensile strength for FM7-5

		Laboratory Compacted				
Sample identification		FM7-5 L6	FM7-5 L9	FM7-5 L10	FM7-5 L4	FM7-5 L2
Diameter, mm	D	100	100	100	100	100
H1		62.23	62.103	62.3824	62.2808	62.4586
H2		61.8871	62.23	61.976	62.3824	62.8142
H3		62.0776	62.484	61.976	62.357	62.23
Thickness, mm	t	62.06	62.27	62.11	62.34	62.50
Dry Mass in Air, g	A	1097.3	1098.7	1097.7	1098.3	1098.1
SSD Mass, g	B	1102.8	1103.7	1101.6	1102.6	1101.8
Mass in Water, g	C	624.6	624.4	621.2	621.7	615.8
Volume (B-C), cm ³	E	478.2	479.3	480.4	480.9	486
Bulk specific Gravity (A/E)	G _{mb}	2.29	2.29	2.28	2.28	2.26
Maximum Specific Gravity	G _{mm}	2.45	2.45	2.45	2.45	2.45
% Air Voids [100 (G _{mm} -G _{mb})/G _{mm}]	P _a	6.34	6.44	6.74	6.78	7.78
Volume of Air Voids (PaE/100), cm ³	V _a	30.32	30.85	32.36	32.61	37.80
Load, N	P	10304	9484	9747	9649	10002
Saturated- Sample Identification		FM7-5 L5	FM7-5 L1	FM7-5 L 8	FM7-5 L7	FM7-5 L3
H1		62.34	62.48	62.43	62.43	62.58
H2		62.31	62.66	62.27	62.71	62.5
H3		62.46	63.03	62.41	62.34	62.91
Thickness, mm	t'	62.37	62.72	62.37	62.49	62.66
Dry Mass in Air, g	A'	1098.4	1099.2	1098.5	1097.8	1099.6
SSD Mass, g	B'	1103.8	1102.8	1102.1	1102.7	1105.9
Mass in Water, g	C'	624.9	622.4	621.4	621.9	622.2
Volume (B-C), cm ³	E'	478.9	480.4	480.7	480.8	483.7
Bulk specific Gravity (A/E)	G _{mb} '	2.29	2.29	2.29	2.28	2.27
Maximum Specific Gravity	G _{mm} '	2.45	2.45	2.45	2.45	2.45
% Air Voids [100 (G _{mm} -G _{mb})/G _{mm}]	P _a '	6.38	6.61	6.73	6.80	7.21
Volume of Air Voids (PaE/100), cm ³	V _a '	30.57	31.75	32.33	32.72	34.88
SSD Mass, g	B'	1119.8	1123	1122.6	1121.8	1125.2
Volume of Absorbed Water (B'-A), cm ³	J'	22.5	24.3	24.9	23.5	27.1
% Saturation (100J'/V _a)	S'	73.59	76.54	77.01	71.83	77.69
Load, N (lbf)	P'	7163	6770	6733	7339	6479
Dry Strength [2000P'/πt'D], kPa (psi)	S ₁	1056.92	969.56	999.03	985.36	1018.78
Wet Strength [2000P'/πt'D] (psi)	S ₂	731.14	687.13	687.25	747.62	658.23
Visual Moisture Damage (0 to 5)						
Cracked/Broken Aggregate?						
TSR (S ₂ /S ₁)		0.69	0.71	0.69	0.76	0.65

Table F.11 Indirect tensile strength for FM7-7

		Laboratory Compacted				
Sample identification		FM7-7 L1	FM7-7 L12	FM7-7 L8	FM7-7 L7	FM7-7 L 22
Diameter, mm	D	100	100	100	100	100
H1		62.97	62.103	62.103	62.4078	63.9318
H2		62.94	62.992	62.4078	62.3062	63.7921
H3		62.63	62.5094	62.5856	62.3824	64.1096
Thickness, mm	t	62.85	62.53	62.37	62.37	63.94
Dry Mass in Air, g	A	1095.3	1099.6	1097.2	1098.4	1099.1
SSD Mass, g	B	1101.1	1103.7	1101.4	1102	1103.8
Mass in Water, g	C	621.4	618.5	616.3	616.1	609.4
Volume (B-C), cm ³	E	479.7	485.2	485.1	485.9	494.4
Bulk specific Gravity (A/E)	G _{mb}	2.28	2.27	2.26	2.26	2.22
Maximum Specific Gravity	G _{mm}	2.44	2.44	2.44	2.44	2.44
% Air Voids [100 (G _{mm} -G _{mb})/G _{mm}]	P _a	6.31	7.01	7.19	7.24	8.78
Volume of Air Voids (PaE/100), cm ³	V _a	30.25	33.99	34.87	35.18	43.39
Load, N	P	11454	11450	9860	11693	8901
Saturated- Sample Identification		FM7-7 L5	FM7-7 L6	FM7-7 L10	FM7-7 L4	FM7-7 L21
H1		62.5	62.52	62.4	63.56	63.78
H2		62.66	63.1	62.3	63.48	63.82
H3		62.87	62.88	62.34	63.8	63.76
Thickness, mm	t'	62.68	62.83	62.35	63.61	63.79
Dry Mass in Air, g	A'	1098.2	1098.5	1098.1	1098.7	1100.7
SSD Mass, g	B'	1104.2	1101.7	1103.6	1103.4	1104.0
Mass in Water, g	C'	620.1	617.1	618.6	614.9	611.5
Volume (B-C), cm ³	E'	484.1	484.6	485	488.5	492.5
Bulk specific Gravity (A'/E')	G _{mb} '	2.27	2.27	2.26	2.25	2.23
Maximum Specific Gravity	G _{mm} '	2.44	2.44	2.44	2.44	2.44
% Air Voids [100 (G _{mm} '-G _{mb} ')/G _{mm} ']	P _a '	6.91	6.98	7.09	7.71	8.29
Volume of Air Voids (Pa'E'/100), cm ³	V _a '	33.46	33.84	34.41	37.66	40.84
SSD Mass, g	B'	1122.4	1122.3	1124.6	1125.5	1129.5
Volume of Absorbed Water (B'-A), cm ³	J'	27.1	22.7	27.4	27.1	30.4
% Saturation (100J'/V _a)	S'	80.98	67.08	79.64	71.96	74.44
Load, N (lbf)	P'	7210	6825	7220	6315	6916
Dry Strength [2000P'/πt'D], kPa (psi)	S ₁	1160.26	1165.64	1006.50	1193.61	886.17
Wet Strength [2000P'/πt'D] (psi)	S ₂	732.34	691.50	737.23	631.98	690.25
Visual Moisture Damage (0 to 5)						
Cracked/Broken Aggregate?						
TSR (S ₂ /S ₁)		0.63	0.59	0.73	0.53	0.78

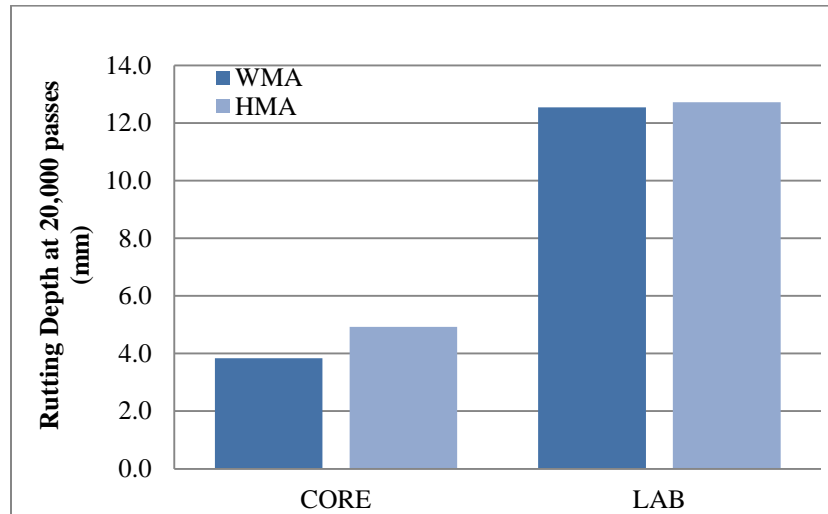
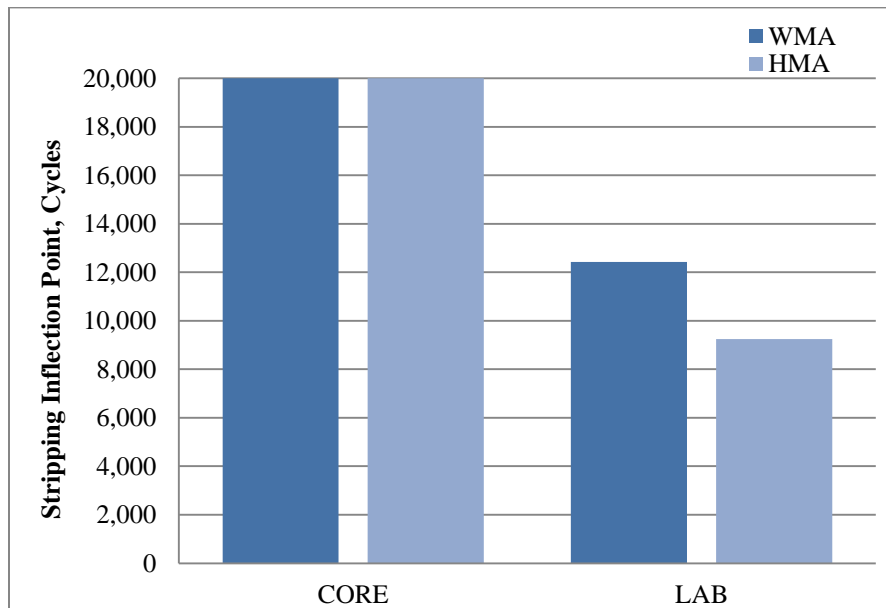
APPENDIX G HAMBURG WHEEL TRACKING TEST DETAILS**FM2 Hamburg Wheel Tracking Test****Figure G.1 Rutting depth for FM2****Figure G.2 SIP for FM2**

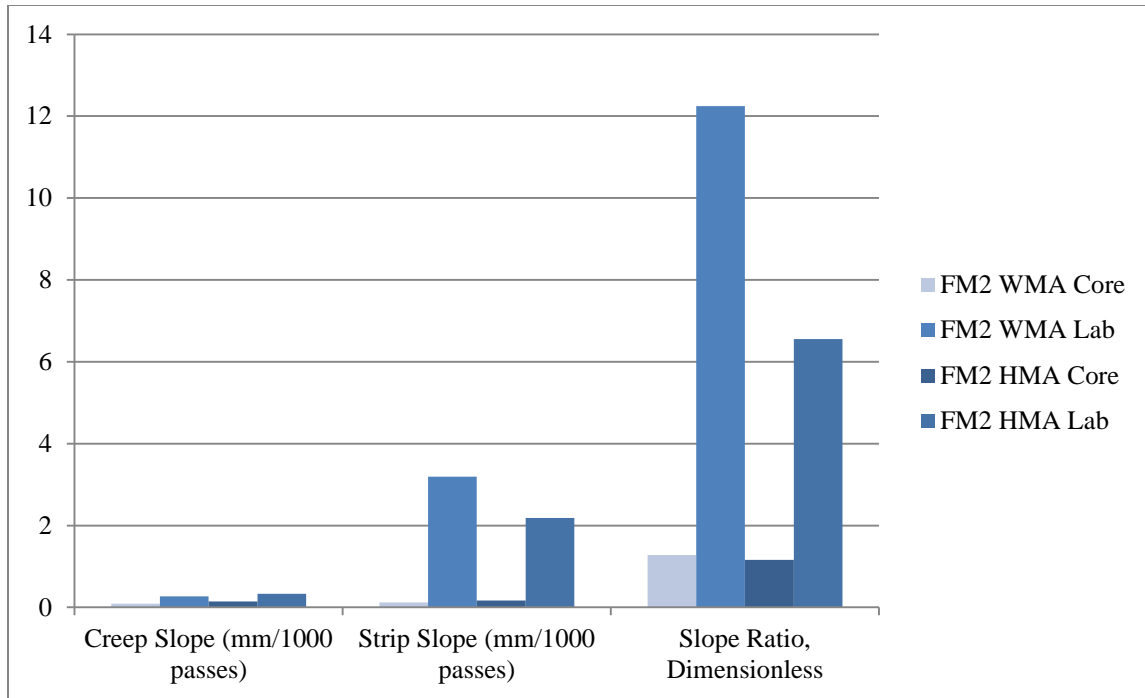

Figure G.3 Creep slope, stripping slope, and slope ratio for FM2

FM3 Hamburg Wheel Tracking Test

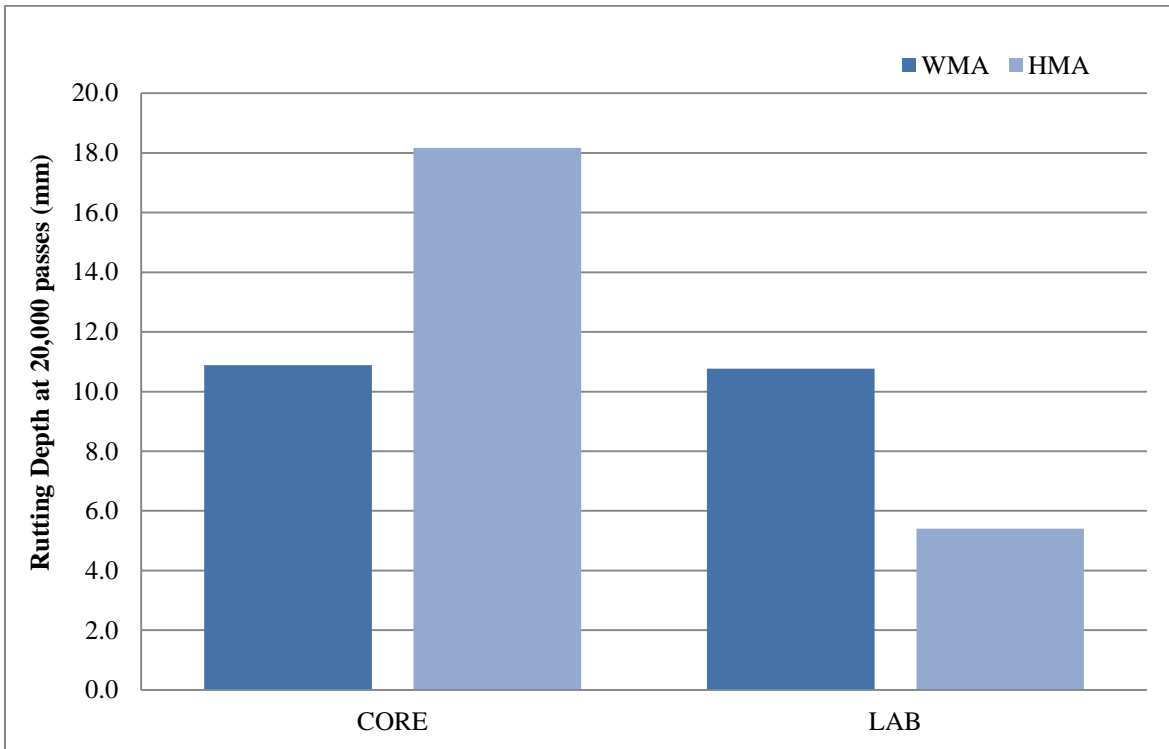

Figure G.4 Rutting depth for FM3

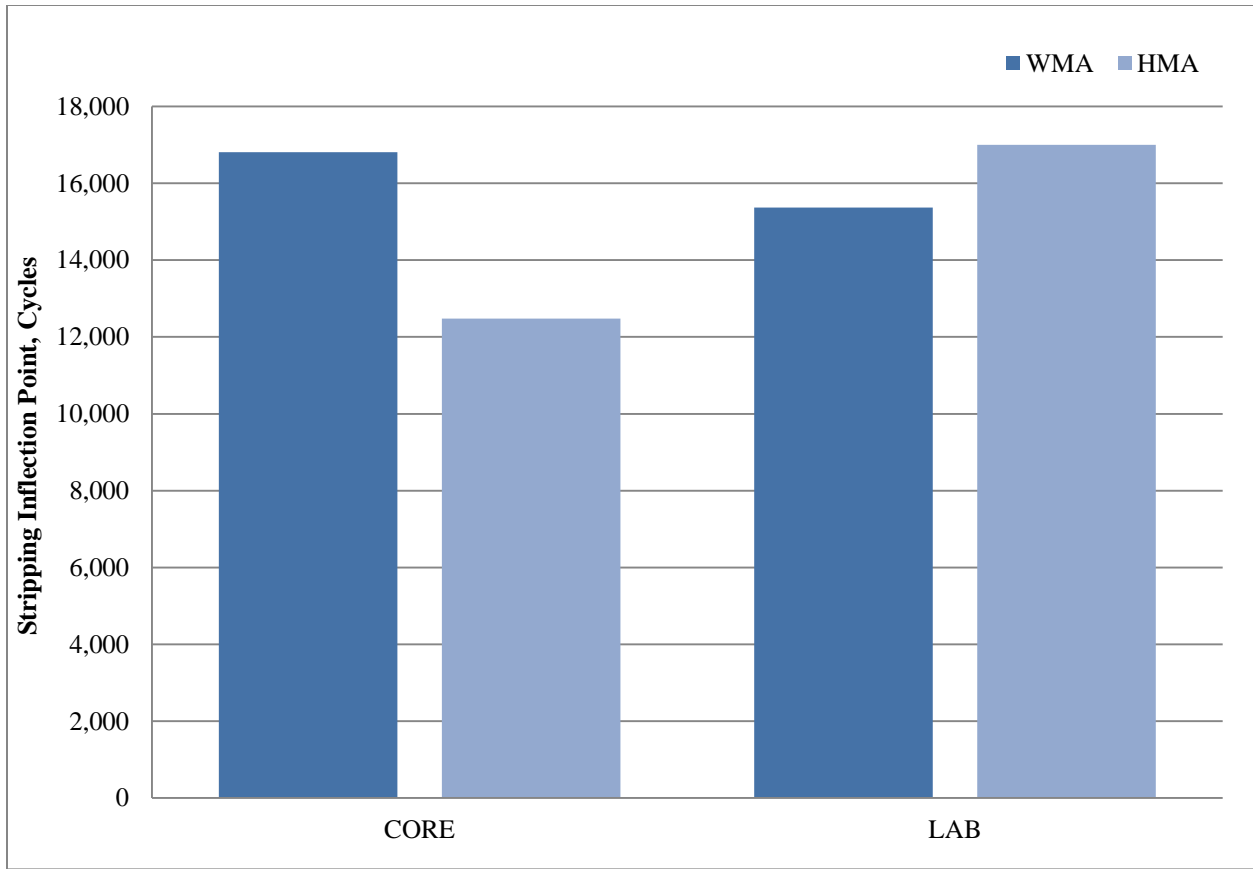

Figure G.5 SIP for FM3

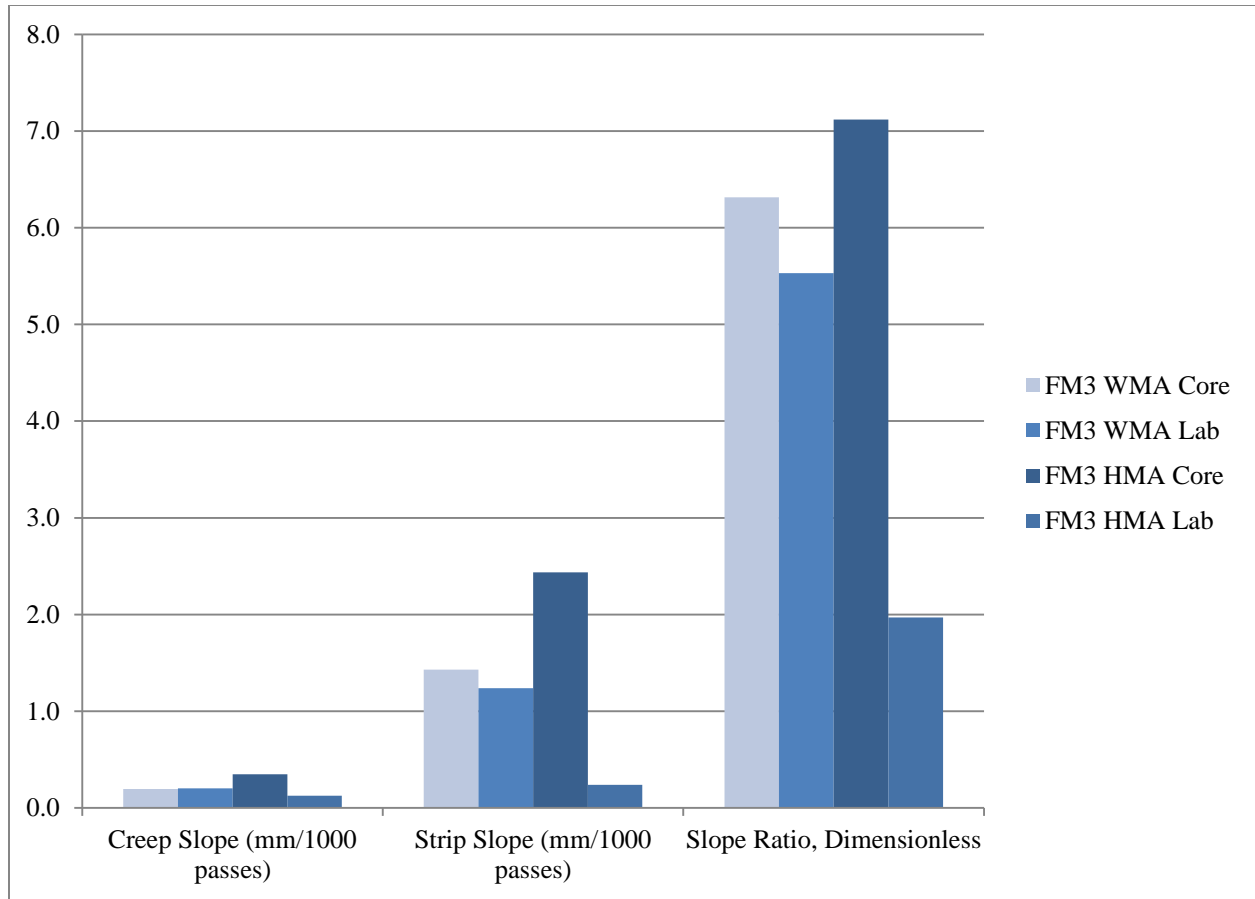

Figure G.6 Creep slope, stripping slope, and slope ratio for FM3

FM4 Hamburg Wheel Tracking Test

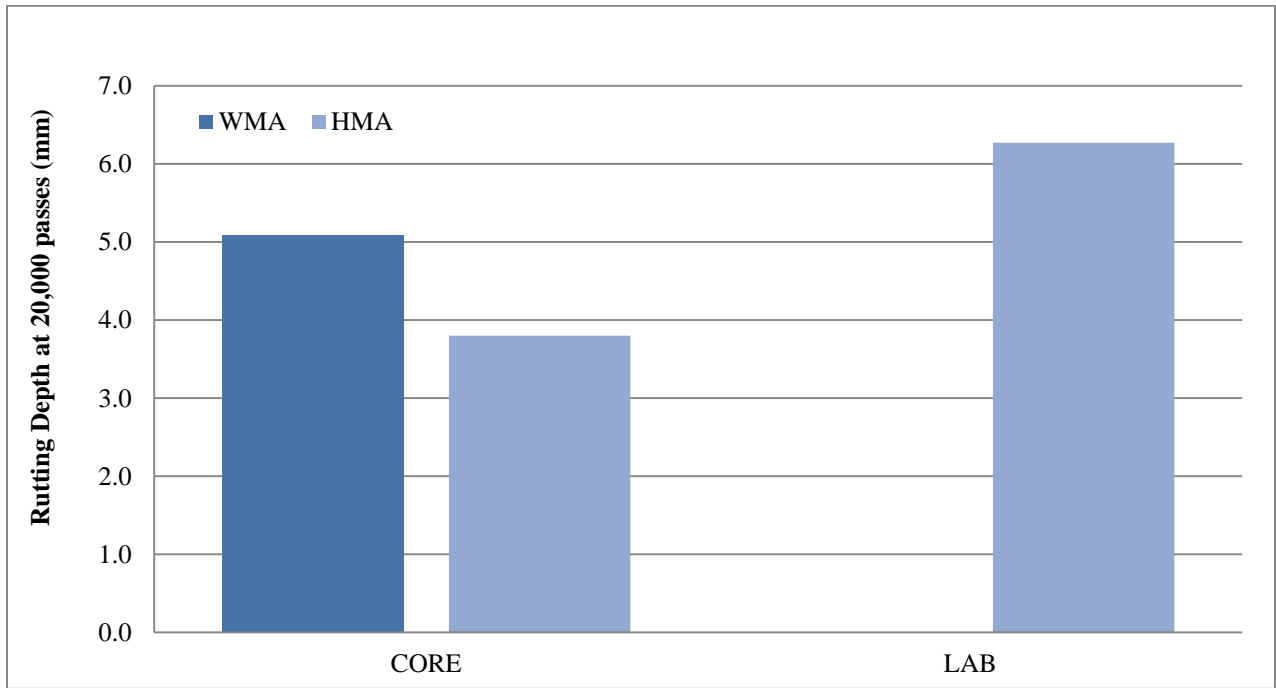

Figure G.7 Rutting depth for FM4

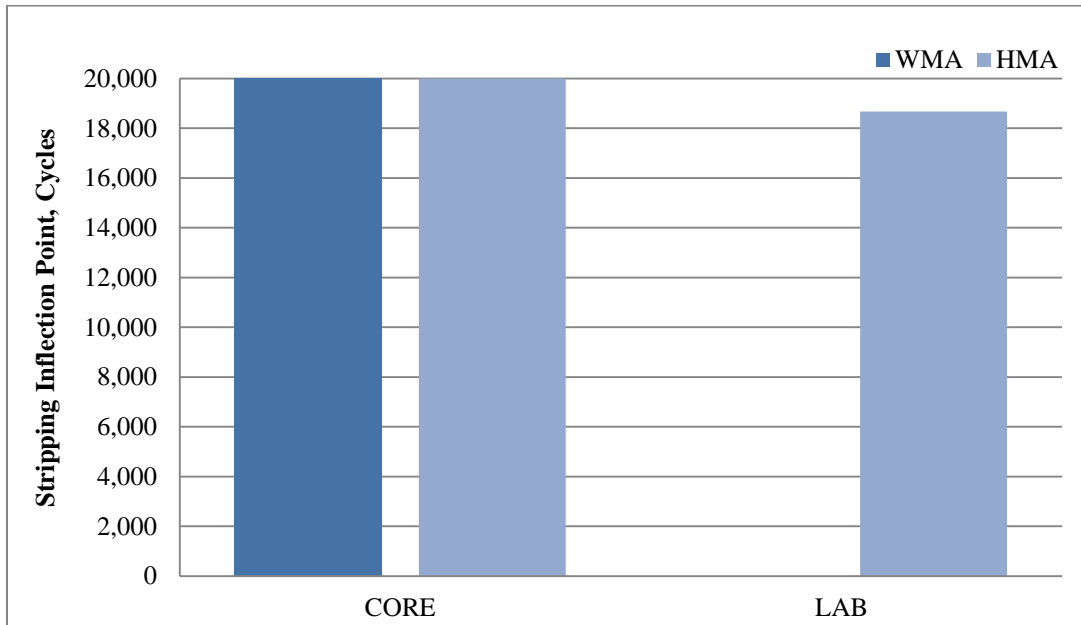

Figure G.8 SIP for FM4

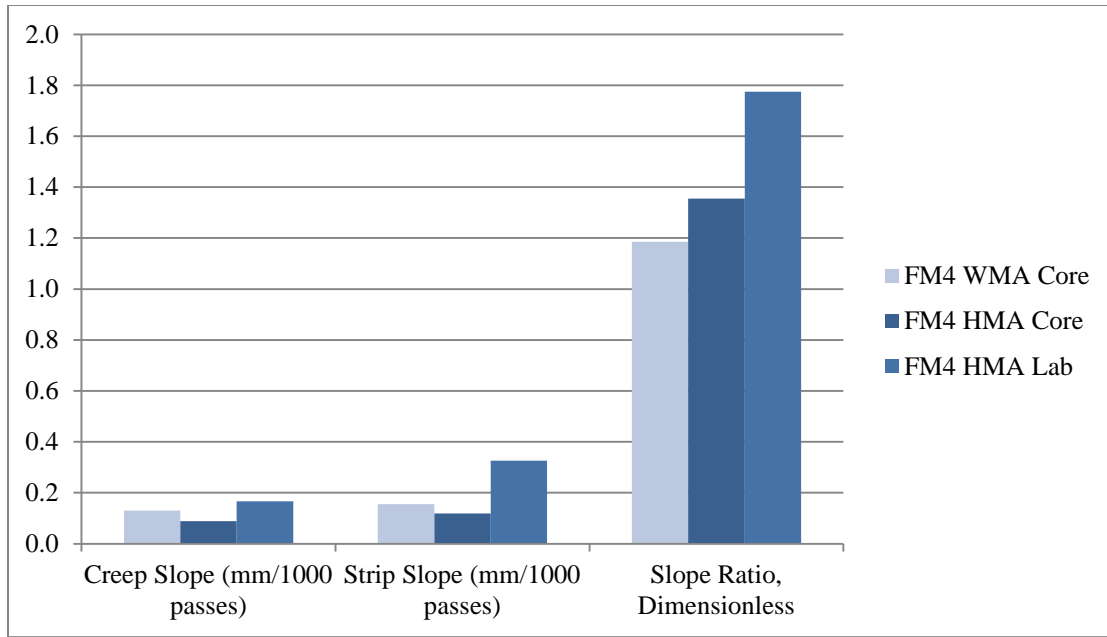

Figure G.9 Creep slope, stripping slope, and slope ratio for FM4

FM5 and FM6 Hamburg Wheel Tracking Test

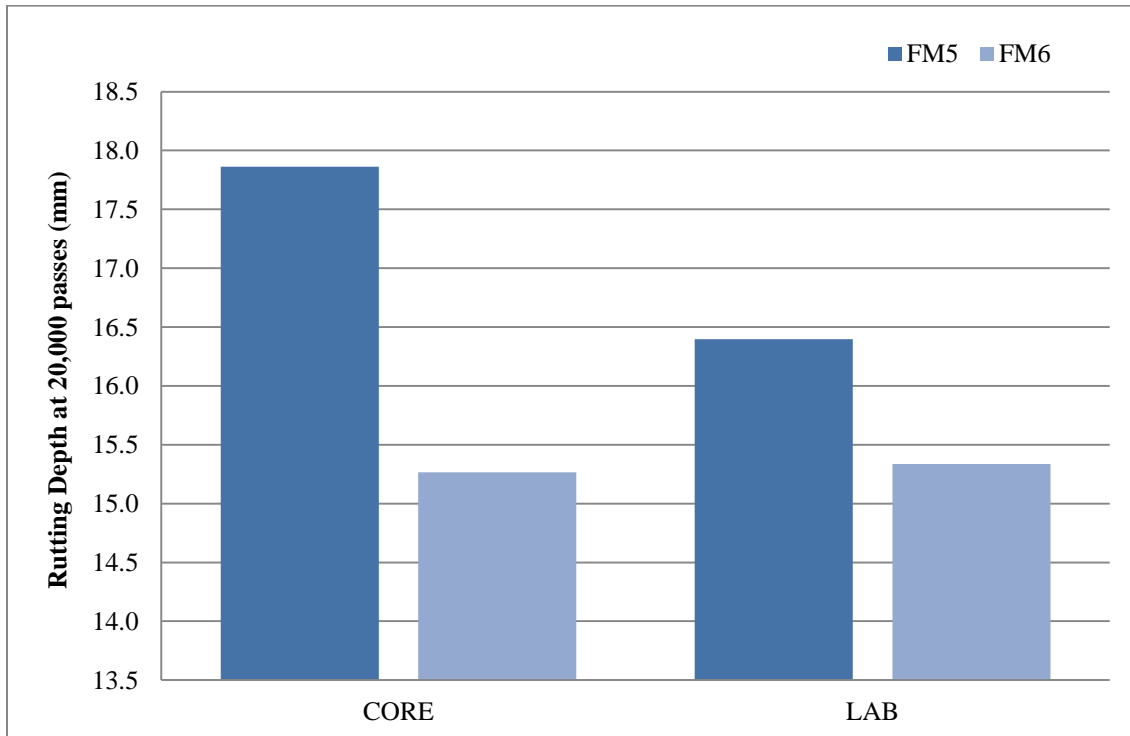

Figure G.10 Rutting depth for FM5 and FM6

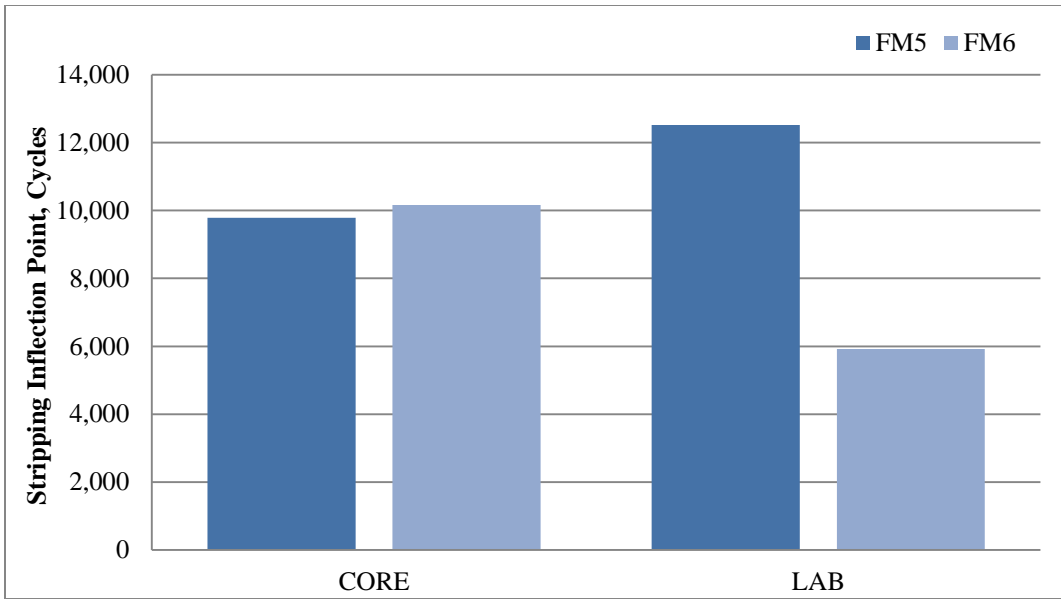

Figure G.11 SIP for FM5 and FM6

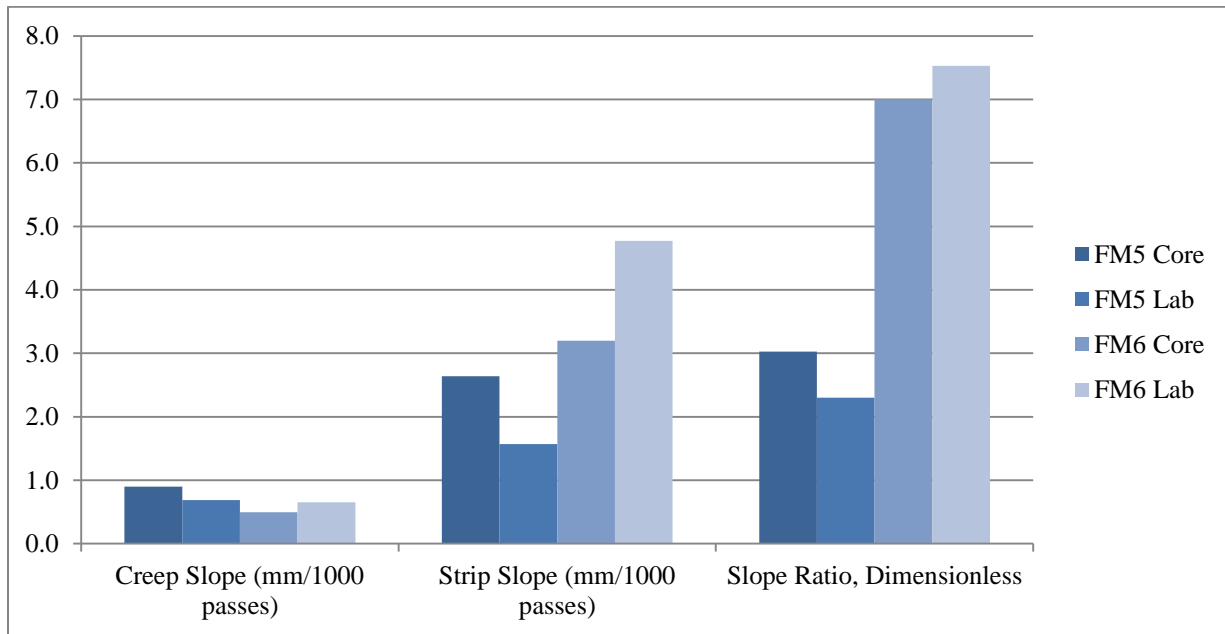

Figure G.12 Creep slope, stripping slope, and slope ratio for FM5 and FM6

FM7 Hamburg Wheel Tracking Test

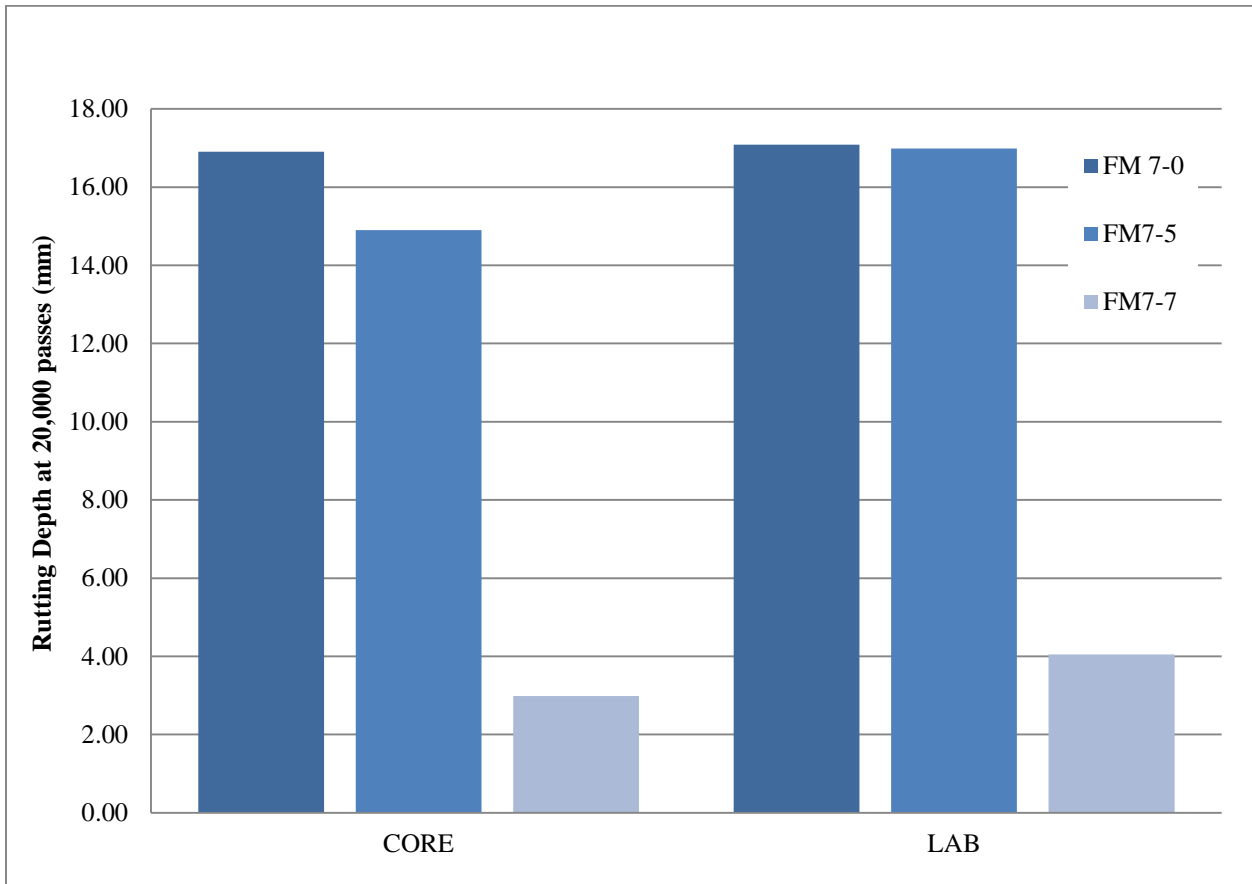

Figure G.13 Rutting depth for FM7-0, FM7-5, and FM7-7

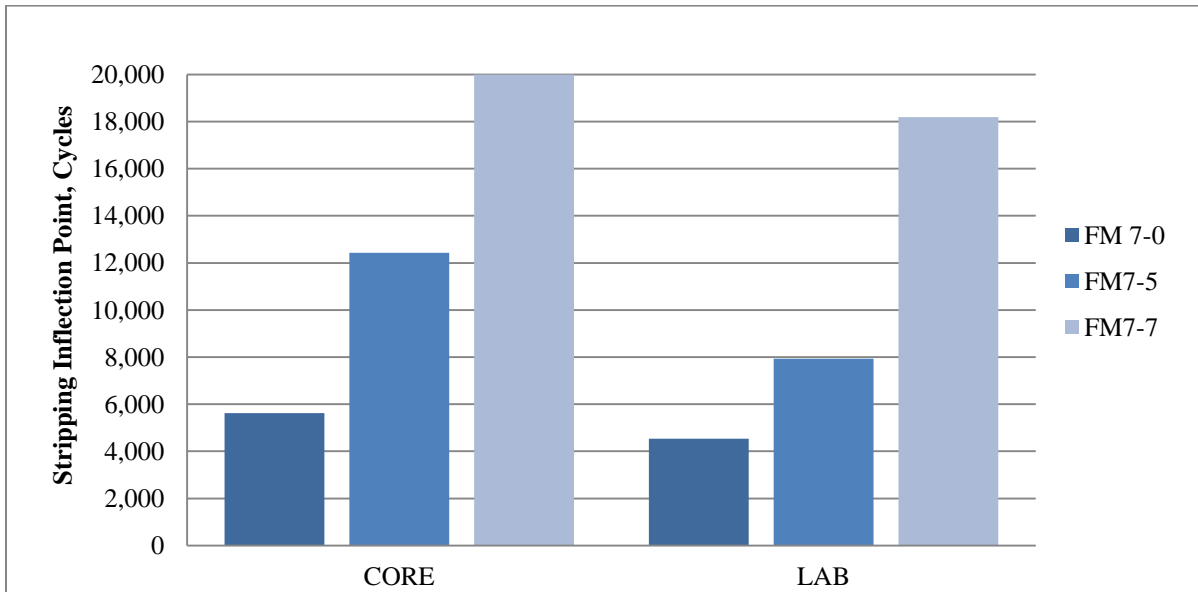

Figure G.14 SIP for FM7-0, FM7-5, and FM7-7

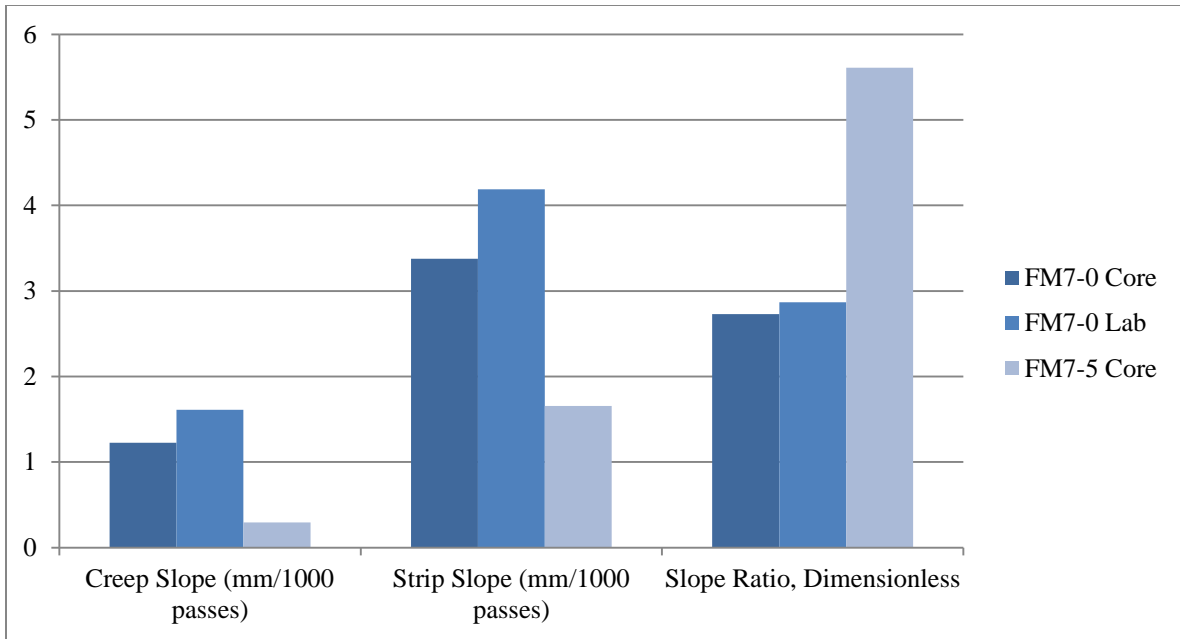

Figure G.15 Creep slope, stripping slope, and slope ratio for FM7

APPENDIX H CURING STUDY HAMBURG TEST DETAILS

Table H.1 Hamburg test result details

Test Number	1	2	3	AVERAGE	4
Mix	FM2 WMA	FM2 WMA	FM2 WMA		FM2 WMA
Curing Time (hours)	2	2	2	2	4
Curing Temp (°C)	120	120	120	120	120
Rut Depth (mm)					
5000 passes	-3.71	-4.28	-4.77	-4.25	-3.05
10,000 passes	-5.11	-8.57	-14.78	-9.48	-4.38
15,000 passes	-8.78	-17.52	-17.53	-14.61	-9.04
20,000 passes	-15.89	-17.52	-17.53	-16.98	-15.24
Failure Rut (mm)	-15.89	-17.52	-17.53	-16.98	-15.24
Creep Slope (mm/1000 passes)	-0.2266	-0.3822	-0.4820	-0.36	-0.1229
Strip Slope (mm/1000 passes)	-2.9889	-6.0451	-6.0406	-5.02	-2.9130
Slope Ratio	13.19	15.82	12.53	13.85	23.71
Stripping Inflection Point (passes)	14,613	10,812	8,060	11161.67	14,565
Air Void First Sample	7.24%	7.44%	7.48%		7.36%
Air Void Second Sample	7.36%	7.47%	7.53%		7.38%

Table H.2 Hamburg test result details

Test Number	5	6	7	AVERAGE	8	9	AVERAGE
Mix	FM2 WMA	FM2 WMA	FM2 WMA		FM2 HMA	FM2 HMA	
Curing Time (hours)	2	2	2	2	2	2	2
Curing Temp (°C)	150	150	150	150	150	150	150
Rut Depth (mm)							
5000 passes	-2.95	-3.56	-3.31	-3.27	-3.68	-4.13	-3.90
10,000 passes	-4.13	-4.80	-4.44	-4.46	-4.91	-6.56	-5.74
15,000 passes	-7.40	-6.27	-6.07	-6.58	-7.44	-13.14	-10.29
20,000 passes	-12.51	-9.63	-12.47	-11.53	-12.09	-16.05	-14.07
Failure Rut (mm)	-12.51	-9.63	-12.47	-11.53	-12.09	-16.05	-14.07
Creep Slope (mm/1000 passes)	- 0.1690	-0.2170	-0.1889	-0.19	-0.1856	-0.3062	-0.25
Strip Slope (mm/1000 passes)	- 1.3434	-1.1048	-2.5787	-1.68	-1.7937	-2.7991	-2.30
Slope Ratio	7.95	5.09	13.65	8.90	9.67	9.14	9.41
Stripping Inflection Point (passes)	13,406	16,983	16,971	15786.67	15,757	12,938	14347.50
				#DIV/0!			#DIV/0!
Air Void First Sample	6.99%	7.34%	7.43%	0.07	7.23%	7.51%	0.07
Air Void Second Sample	7.24%	7.37%	7.49%	0.07	7.50%	7.73%	0.08

Table H.2 (Continued) Hamburg test result details

Test Number	10	11	12	AVERAGE	13	14	AVERAGE	15
Mix	FM2 WMA	FM2 WMA	FM2 WMA		FM2 WMA	FM2 WMA		FM2 WMA
Curing Time (hours)	2	2	2	2	4	4	4	4
Curing Temp (°C)	135	135	135	135	135	135	135	150
Rut Depth (mm)								
5000 passes	-4.24	-4.38	-4.07	-4.23	-2.88	-3.08	-2.98	-2.76
10,000 passes	-7.14	-8.98	-6.80	-7.64	-4.00	-4.24	-4.12	-3.62
15,000 passes	-14.18	-14.72	-14.64	-14.51	-5.69	-6.60	-6.14	-4.54
20,000 passes	-14.18	-14.72	-14.64	-14.51	-10.04	-13.96	-12.00	-5.92
Failure Rut (mm)	-14.18	-14.72	-14.64	-14.51	-10.04	-13.96	-12.00	-5.92
Creep Slope (mm/1000 passes)	-0.3682	-0.4464	-0.3297	-0.38	0.1981	-0.2031	-0.20	0.1518
Strip Slope (mm/1000 passes)	-3.3524	-4.3206	-3.3132	-3.66	1.3669	-1.9579	-1.66	0.3406
Slope Ratio	9.10	9.68	10.05	9.61	6.90	9.64	8.27	2.24
Stripping Inflection Point (passes)	12,709	9,972	11,511	11397.33	16,062	15,043	15552.50	17,105
Air Void First Sample	7.19%	7.43%	7.54%		7.21%	7.38%		7.32%
Air Void Second Sample	7.33%	7.39%	7.88%		6.97%	7.42%		7.05%

Table H.3 Hamburg test result details

Test Number	17	18	Average FM2 HMA
Mix	FM2 HMA	FM2 HMA	
Curing Time (hours)	4	4	4
Curing Temp (°C)	150	150	150
Rut Depth (mm)			
5000 passes	-3.19	-2.81	-3.00
10,000 passes	-4.27	-3.63	-3.95
15,000 passes	-5.12	-4.49	-4.81
20,000 passes	-6.92	-6.76	-6.84
Failure Rut (mm)	-6.92	-6.76	-6.84
Creep Slope (mm/1000 passes)	-0.1192	-0.0952	-0.11
Strip Slope (mm/1000 passes)	-0.4220	-0.5789	-0.50
Slope Ratio	3.54	6.08	4.81
Stripping Inflection Point (passes)	15,089	15,447	15268.00
			#DIV/0!
Air Void First Sample	7.23%	7.67%	0.07
Air Void Second Sample	7.26%	7.48%	0.07

Table H.4 Hamburg test result details

Test Number	19	20	21	22	23
Mix	FM6	FM6	FM6	FM6	FM6
Curing Time (hours)	2	4	2	2	4
Curing Temp (°C)	135	135	120	150	120
Rut Depth (mm)					
5000 passes	-5.16	-4.19	-6.20	-3.77	-5.73
10,000 passes	-15.43	-6.63	-17.11	-6.62	-11.45
15,000 passes	-17.19	-15.14	-17.11	-15.35	-17.70
20,000 passes	-17.19	-17.63	-17.11	-15.35	-17.70
Failure Rut (mm)	-17.19	-17.63	-17.11	-15.35	-17.70
Creep Slope (mm/1000 passes)	-0.5506	-0.3986	-0.7008	-0.3056	-0.6568
Strip Slope (mm/1000 passes)	-3.8018	-3.2142	-3.9086	-2.8067	-4.0091
Slope Ratio	6.91	8.06	5.58	9.18	6.10
Stripping Inflection Point (passes)	7,531	12,163	6,203	11,341	10,279
Air Void First Sample	8.15%	8.31%	8.08%	8.07%	7.86%
Air Void Second Sample	8.12%	8.07%	8.64%	8.16%	7.62%

APPENDIX I BINDER TESTING DETAILS

Table I.1 FM2 binder data

FM2 RECOVERY STUDY										
VIRGIN BINDER	FM2 HMA Original Binder					FM2 WMA Original Binder				
	Tested at 10 rad/sec	G*/sin(δ) (kPa)				Tested at 10 rad/sec	G*/sin(δ) (kPa)			
	Temperature (°C)	Trial 1	Trial 2	Trial 3	Average	Temperature (°C)	Trial 1	Trial 2	Trial 3	Average
	52	5.62	6.15	5.87	5.88	58	4.530	5.425	4.7115	4.889
	58	2.70	2.90	2.77	2.79	64	2.110	2.479	2.1765	2.255
	64	1.36	1.46	1.39	1.40	70	1.029	1.200	1.063	1.097
70	0.71	0.75	0.73	0.73	76	0.529	0.615	0.6153	0.586	
Fail Temperature	66.78	67.22	67.06	67.02	Fail Temperature (2.2 kPa)	64.46	65.75	64.73	64.980	
RTFO MATERIAL TESTING IN DSR	ORIGINAL BINDER DATA (PHASE I)					RECOVERED BINDER DATA (PHASE II)				
	FM2 WMA RTFO Original Binder					FM2 WMA Recovered Binder				
	Tested at 10 rad/sec	G*/sin(δ) (kPa)				Tested at 10 rad/sec	G*/sin(δ) (kPa)			
	Temperature (°C)	Trial 1	Trial 2	Trial 3	Average	Temperature (°C)	Trial 1	Trial 2	Trial 3	Average
	52	12.18	12.13	13.45	12.58	58	20.020	--	--	20.020
	58	5.67	5.42	5.99	5.69	64	8.501	7.652	7.473	7.875
	64	2.74	2.57	2.86	2.72	70	3.574	3.456	3.392	3.474
	70	1.36	1.28	1.43	1.36	76	1.601	1.547	1.522	1.557
	Fail Temperature	65.94	65.44	66.32	65.90	Fail Temperature (2.2 kPa)	73.62	73.39	73.24	73.417
	FM2 HMA RTFO Original Binder					FM2 HMA Recovered Binder				
Tested at 10 rad/sec	G*/sin(δ) (kPa)				Tested at 10 rad/sec	G*/sin(δ) (kPa)				
Temperature (°C)	Trial 1	Trial 2	Trial 3	Average	Temperature (°C)	Trial 1	Trial 2	Trial 3	Average	
52	16.95	17.34	16.80	17.028	58	20.755			20.755	
58	8.10	8.24	8.00	8.113	64	9.201			9.201	
64	4.03	4.13	3.94	4.032	70	4.036	3.602	4	3.879	
70	2.07	2.13	2.02	2.072	76	1.843	1.804	1.835	1.827	
Fail Temperature	69.34	69.54	69.12	69.333	Fail Temperature (2.2 kPa)	74.61	74.30	74.58	74.497	
PAV MATERIAL TESTING IN DSR	ORIGINAL BINDER DATA (PHASE I)					RECOVERED BINDER DATA (PHASE II)				
	FM2 WMA Original PAV Aged					FM2 WMA Recovered PAV Aged				
	Tested at 10 rad/sec	G* sin(δ)				Tested at 10 rad/sec	G* sin(δ)			
	Temperature (°C)	Trial 1	Trial 2	Trial 3	Average	Temperature (°C)	Trial 1	Trial 2	Trial 3	Average
	28	1195.5	1338.5	1269.5	1267.833	28	3097			3097
	25	1770	1988.5	1880.5	1879.667	25	4410	4205	4165	4260
	22	2617	2950.5	2783.5	2783.667	22	6176	5992.5	5851	6006.5
	19	3839.5	4319.5	4078.5	4079.167	Fail Temperature (5000 kPa)	23.9	23.59	23.41	23.63333
	16	5556.5	6305	5984	5948.5					
	Fail Temperature (5000 kPa)	16.9	17.87	17.38	17.38333					
	FM2 HMA Original PAV Aged					FM2 HMA Recovered PAV Aged				
	Tested at 10 rad/sec	G* sin(δ)				Tested at 10 rad/sec	G* sin(δ)			
	Temperature (°C)	Trial 1	Trial 2	Trial 3	Average	Temperature (°C)	Trial 1	Trial 2	Trial 3	Average
	28	1188.5	1225.5	1201.5	1205.167	25	3539	3035	--	3287
25	1754.5	1819.5	1771	1781.667	22	4733	4201	4458	4464	
22	2576	2573.5	2598	2582.5	19	6214.5	5650	5980	5948.167	
19	3746	3384	3762	3630.667	Fail Temperature (5000 kPa)	21.08	20.07	20.37	20.50667	
16	5367	5624.5	5444	5478.5						

Table I.2 FM2 BBR binder data

BENDING BEAM RHEOMETER TEST	ORIGINAL BINDER DATA (PHASE I)					RECOVERED BINDER DATA (PHASE II)						
	FM2 WMA Original RTFO+PAV Aged					FM2 WMA Recovered PAV Aged						
	BBR					BBR						
	Temperature (°C)	Stiffness (Mpa)				Average	Temperature (°C)	Stiffness (Mpa)				Average
		Trial 1	Trial 2	Trial 3	Average			Trial 1	Trial 2	Trial 3	Average	
	-18	165	194	183	180.6667	-12	159	120	152	143.6667		
	-24	295	321	316	310.6667	-18	316	306	338	320		
	Temperature (°C)	m-value				Average	Temperature (°C)	m-value				Average
		Trial 1	Trial 2	Trial 3	Average			Trial 1	Trial 2	Trial 3	Average	
	-18	0.316	0.318	0.315	0.316333	-12	0.327	0.292	0.328	0.315667		
-24	0.266	0.270	0.256	0.264	-18	0.267	0.272	0.264	0.267667			
Failure Temperature	-29.92	-30.25	-29.5254	-29.8985	Failure Temperature	-24.7	-19.6	-24.625	-23.9583			
FM2 HMA Original RTFO+PAV Aged					FM2 HMA Recovered PAV Aged							
BBR					BBR							
Temperature (°C)	Stiffness (Mpa)				Average	Temperature (°C)	Stiffness (Mpa)				Average	
	Trial 1	Trial 2	Trial 3	Average			Trial 1	Trial 2	Trial 3	Average		
-18	164	173	180	172.3333	-12	143	123	136	134			
-24	294	311	329	311.3333	-18	279	233	280	264			
Temperature (°C)	m-value				Average	Temperature (°C)	m-value				Average	
	Trial 1	Trial 2	Trial 3	Average			Trial 1	Trial 2	Trial 3	Average		
-18	0.305	0.301	0.307	0.304333	-12	0.318	0.321	0.316	0.318333			
-24	0.270	0.250	0.271	0.263667	-18	0.273	0.263	0.271	0.269			
Failure Temperature	-28.8571	-28.1176	-29.1667	-28.7138	Failure Temperature	-24.4	-24.1724	-24.1333	-24.2297			

Table I.3 FM3 binder data

FM3 RECOVERY STUDY										
VIRGIN BINDER	FM3 HMA Original Binder					FM3 WMA Original Binder				
	Tested at 10 rad/sec	G*/sin(δ) (kPa)				Tested at 10 rad/sec	G*/sin(δ) (kPa)			
	Temperature (°C)	Trial 1	Trial 2	Trial 3	Average	Temperature (°C)	Trial 1	Trial 2	Trial 3	Average
	52	6.512	7.389	6.801	6.90	52	6.531	6.9535	7.533	7.006
	58	3.088	3.0195	2.79	2.97	58	2.855	2.9245	3.151	2.977
	64	1.354	1.3325	1.2255	1.30	64	1.271	1.3085	1.3654	1.315
70	0.6342	0.62665	0.5707	0.61	70	0.5948	0.59835	0.62055	0.605	
Fail Temperature	66.43	66.29	65.74	66.15	Fail Temperature (2.2 kPa)	66	66.11	66.41	66.173	
RTFO MATERIAL TESTING IN DSR	ORIGINAL BINDER DATA (PHASE I)					RECOVERED BINDER DATA (PHASE II)				
	FM3 WMA RTFO Original Binder					FM3 WMA Recovered Binder				
	Tested at 10 rad/sec	G*/sin(δ) (kPa)				Tested at 10 rad/sec	G*/sin(δ) (kPa)			
	Temperature (°C)	Trial 1	Trial 2	Trial 3	Average	Temperature (°C)	Trial 1	Trial 2	Trial 3	Average
	52	15.63	19.53	19.01	18.06	58	25.485	--	--	25.485
	58	6.49	8.1755	7.7455	7.47	64	10.120	10.585	10.45	10.385
	64	2.858	3.5575	3.4215	3.28	70	4.4815	4.720	4.6195	4.607
	70	1.384	1.6425	1.601	1.54	76	1.988	2.091	2.0535	2.044
	Fail Temperature	66.29	67.74	67.43	67.15	Fail Temperature (2.2 kPa)	75.14	75.71	75.52	75.457
	FM3 HMA RTFO Original Binder					FM3 HMA Recovered Binder				
	Tested at 10 rad/sec	G*/sin(δ) (kPa)				Tested at 10 rad/sec	G*/sin(δ) (kPa)			
	Temperature (°C)	Trial 1	Trial 2	Trial 3	Average	Temperature (°C)	Trial 1	Trial 2	Trial 3	Average
	52	16.28	17.22	16.16	16.553	64	17.560	--	--	17.560
	58	6.5885	6.9725	6.544	6.702	70	7.443	7.291	6.625	7.120
64	2.8325	2.9675	2.812	2.871	76	3.292	3.233	3.203	3.243	
70	1.3005	1.3565	1.2775	1.312	82	1.516	1.491	1.482	1.496	
Fail Temperature	66.04	66.34	65.95	66.110	Fail Temperature (2.2 kPa)	79.14	79.06	78.89	79.030	
PAV MATERIAL TESTING IN DSR	ORIGINAL BINDER DATA (PHASE I)					RECOVERED BINDER DATA (PHASE II)				
	FM3 WMA Original PAV Aged					FM3 WMA Recovered PAV Aged				
	Tested at 10 rad/sec	G*·sin(δ)				Tested at 10 rad/sec	G*·sin(δ)			
	Temperature (°C)	Trial 1	Trial 2	Trial 3	Average	Temperature (°C)	Trial 1	Trial 2	Trial 3	Average
	28	1949	1850.5	2114.5	1971.333	28	3644.5	3493.5	4234.5	3790.833
	25	2909	2794.5	3148.5	2950.667	25	5163	4943	5992	5366
	22	4322	4173	4626	4373.667	22	--	6866	--	6866
	19	6302.5	6092.5	6698.5	6364.5	Fail Temperature (5000 kPa)	25.44	24.96	26.67	25.69
	Fail Temperature (5000 kPa)	20.9	20.6	21.36	20.95333					
	FM3 HMA Original PAV Aged					FM3 HMA Recovered PAV Aged				
	Tested at 10 rad/sec	G*·sin(δ)				Tested at 10 rad/sec	G*·sin(δ)			
	Temperature (°C)	Trial 1	Trial 2	Trial 3	Average	Temperature (°C)	Trial 1	Trial 2	Trial 3	Average
	28	1924.5	2109.5	1856.5	1963.5	28	3202	4296	4296	3931.333
	25	2981.5	3249.5	2821.5	3017.5	25	4532	6069	6068.5	5556.5
22	4562.5	4937	4200	4566.5	22	6257	--	--	6257	
19	6809.5	7382	6113	6768.167	Fail Temperature (5000 kPa)	24.06	26.74	26.74	25.84667	
Fail Temperature (5000 kPa)	21.29	21.90	20.85	21.34667						

Table I.4 FM3 BBR binder data

BENDING BEAM RHEOMETER TEST	ORIGINAL BINDER DATA (PHASE I)					RECOVERED BINDER DATA (PHASE II)				
	FM3 WMA Original RTFO+PAV Aged					FM3 WMA Recovered PAV Aged				
	BBR					BBR				
	Temperature (°C)	Stiffness (Mpa)				Temperature (°C)	Stiffness (Mpa)			
		Trial 1	Trial 2	Trial 3	Average		Trial 1	Trial 2	Trial 3	Average
	-12	155	125	128	136	-6	142	149	138	143
	-18	308	244	245	265.6667	-12	257	274	259	263.3333
	Temperature (°C)	m-value				Temperature (°C)	m-value			
		Trial 1	Trial 2	Trial 3	Average		Trial 1	Trial 2	Trial 3	Average
	-12	0.324	0.301	0.324	0.316333	-6	0.331	0.328	0.329	0.329333
-18	0.274	0.273	0.261	0.269333	-12	0.291	0.29	0.286	0.289	
Failure Temperature	-24.88	-22.2143	-24.2857	-23.7933	Failure Temperature	-20.65	-20.4211	-20.0465	-20.3725	
FM3 HMA Original RTFO+PAV Aged					FM3 HMA Recovered PAV Aged					
BBR					BBR					
Temperature (°C)	Stiffness (Mpa)				Temperature (°C)	Stiffness (Mpa)				
	Trial 1	Trial 2	Trial 3	Average		Trial 1	Trial 2	Trial 3	Average	
-12		139	157	148	-6	129	146	153	142.6667	
-18	277	245	340	287.3333	-12	271	243	252	255.3333	
Temperature (°C)	m-value				Temperature (°C)	m-value				
	Trial 1	Trial 2	Trial 3	Average		Trial 1	Trial 2	Trial 3	Average	
-12		0.352	0.325	0.3385	-6	0.336	0.346	0.304	0.328667	
-18	0.271	0.260	0.271	0.267333	-12	0.294	0.29	0.282	0.288667	
Failure Temperature	-28.6421	-25.3913	-24.7778	-26.2704	Failure Temperature	-21.1429	-20.9286	-17.0909	-19.7208	

Table I.5 FM4 binder data

FM4 RECOVERY STUDY										
VIRGIN BINDER	FM4 HMA Original Binder					FM4 WMA Original Binder				
	Tested at 10 rad/sec	G*/sin(δ) (kPa)				Tested at 10 rad/sec	G*/sin(δ) (kPa)			
	Temperature (°C)	Trial 1	Trial 2	Trial 3	Average	Temperature (°C)	Trial 1	Trial 2	Trial 3	Average
	52	7.57	5.9645	7.8015	7.11	52	7.6945	7.927	7.5085	7.710
	58	3.1045	3.3125	3.136	3.18	58	3.185	3.3705	3.078	3.211
	64	1.369	1.422	1.375	1.39	64	1.39	1.407	1.352	1.383
70	0.63915	0.64765	0.65035	0.65	70	0.65325	0.6573	0.63625	0.649	
Fail Temperature	66.49	66.8	66.58	66.62	Fail Temperature (2.2 kPa)	66.64	66.65	66.36	66.550	
RTFO MATERIAL TESTING IN DSR	ORIGINAL BINDER DATA (PHASE I)					RECOVERED BINDER DATA (PHASE II)				
	FM4 WMA RTFO Original Binder					FM4 WMA Recovered Binder				
	Tested at 10 rad/sec	G*/sin(δ) (kPa)				Tested at 10 rad/sec	G*/sin(δ) (kPa)			
	Temperature (°C)	Trial 1	Trial 2	Trial 3	Average	Temperature (°C)	Trial 1	Trial 2	Trial 3	Average
	52	20.185	18.51	20.855	19.85	64	15.720	14.360	--	15.040
	58	8.1315	7.283	8.274	7.90	70	6.581	5.966	6.583	6.377
	64	3.4455	3.079	3.5165	3.35	76	2.931	2.813	2.931	2.892
	70	1.539	1.3805	1.583	1.50	82	1.340	1.292	1.367	1.333
	Fail Temperature	67.3	66.56	67.47	67.11	Fail Temperature (2.2 kPa)	78.27	77.89	78.35	78.170
	FM4 HMA RTFO Original Binder					FM4 HMA Recovered Binder				
	Tested at 10 rad/sec	G*/sin(δ) (kPa)				Tested at 10 rad/sec	G*/sin(δ) (kPa)			
	Temperature (°C)	Trial 1	Trial 2	Trial 3	Average	Temperature (°C)	Trial 1	Trial 2	Trial 3	Average
	52	17.66	16.995	17.335	17.330	64	17.660	15.440	15.99	16.363
	58	7.105	6.7805	6.9665	6.951	70	7.878	7.004	7.105	7.329
64	3.047	2.861	2.937	2.948	76	3.485	3.097	3.162	3.248	
70	1.358	1.301	1.3205	1.327	82	1.627	1.427	1.464	1.506	
Fail Temperature	66.42	66.07	66.2	66.230	Fail Temperature (2.2 kPa)	79.51	78.71	78.89	79.037	
PAV MATERIAL TESTING IN DSR	ORIGINAL BINDER DATA (PHASE I)					RECOVERED BINDER DATA (PHASE II)				
	FM4 WMA Original PAV Aged					FM4 WMA Recovered PAV Aged				
	Tested at 10 rad/sec	G*·sin(δ)				Tested at 10 rad/sec	G*·sin(δ)			
	Temperature (°C)	Trial 1	Trial 2	Trial 3	Average	Temperature (°C)	Trial 1	Trial 2	Trial 3	Average
	28	2778	2912.5	2794	2828.167	31	--	--	3616	3616
	25	4032.5	4244	4104.5	4127	28	4660	4579	5109	4782.667
	22	5772.5	6120	5945	5945.833	25	6472	7370.5	--	6921.25
	Fail Temperature (5000 kPa)	23.23	23.69	23.42	23.44667	Fail Temperature (5000 kPa)	27.39	27.23	28.23	27.61667
	FM4 HMA Original PAV Aged					FM4 HMA Recovered PAV Aged				
	Tested at 10 rad/sec	G*·sin(δ)				Tested at 10 rad/sec	G*·sin(δ)			
	Temperature (°C)	Trial 1	Trial 2	Trial 3	Average	Temperature (°C)	Trial 1	Trial 2	Trial 3	Average
	28	2583	2836	2901.5	2773.5	31	--	3245	3673	3459
	25	3808.5	4187	4263	4086.167	28	4922	4626	5221	4923
	22	5544.5	6089	6179	5937.5	25	6865	6431	--	6648
Fail Temperature (5000 kPa)	22.85	23.59	23.74	23.39333	Fail Temperature (5000 kPa)	27.92	27.29	28.43	27.88	

Table I.6 FM4 BBR binder data

BENDING BEAM RHEOMETER TEST	ORIGINAL BINDER DATA (PHASE I)					RECOVERED BINDER DATA (PHASE II)						
	FM4 WMA Original RTFO+PAV Aged					FM4 WMA Recovered PAV Aged						
	BBR					BBR						
	Temperature (°C)	Stiffness (Mpa)				Average	Temperature (°C)	Stiffness (Mpa)				Average
		Trial 1	Trial 2	Trial 3	Average			Trial 1	Trial 2	Trial 3	Average	
	-12	143	143	165	150.3333	-6	135	127	128	130		
	-18	283	265	250	266	-12	326	208	175	236.3333		
	Temperature (°C)	m-value				Average	Temperature (°C)	m-value				Average
		Trial 1	Trial 2	Trial 3	Average			Trial 1	Trial 2	Trial 3	Average	
	-12	0.308	0.309	0.309	0.308667	-6	0.331	0.334	0.326	0.330333		
-18	0.246	0.261	0.246	0.251	-12	0.272	0.273	0.278	0.274333			
Failure Temperature	-22.7742	-23.125	-22.8571	-22.9188	Failure Temperature	-19.1525	-19.3443	-19.25	-19.2489			
FM4 HMA Original RTFO+PAV Aged					FM4 HMA Recovered PAV Aged							
BBR					BBR							
Temperature (°C)	Stiffness (Mpa)				Average	Temperature (°C)	Stiffness (Mpa)				Average	
	Trial 1	Trial 2	Trial 3	Average			Trial 1	Trial 2	Trial 3	Average		
-12	132	131	150	137.6667	-6	134	125	137	132			
-18	314	259	284	285.6667	-12	295	273	274	280.6667			
Temperature (°C)	m-value				Average	Temperature (°C)	m-value				Average	
	Trial 1	Trial 2	Trial 3	Average			Trial 1	Trial 2	Trial 3	Average		
-12	0.339	0.304	0.306	0.316333	-6	0.339	0.326	0.333	0.332667			
-18	0.250	0.253	0.255	0.252667	-12	0.287	0.284	0.284	0.285			
Failure Temperature	-24.6292	-22.4706	-22.7059	-23.2686	Failure Temperature	-20.5	-19.7143	-20.0408	-20.085			

Table I.7 FM5 binder data

FM5 RECOVERY STUDY											
VIRGIN BINDER	FM5 WMA Original Binder										
	Tested at 10 rad/sec	G*/sin(δ) (kPa)									
	Temperature (°C)	Trial 1	Trial 2	Trial 3	Average						
	52	6.682	6.476	6.739	6.632						
	58	2.846	2.684	2.822	2.784						
	64	1.273	1.212	1.275	1.253						
	70	0.606	0.577	0.607	0.597						
Fail Temperature (2.2 kPa)		66.05	65.63	66.00	65.893						
RTFO MATERIAL TESTING IN DSR	ORIGINAL BINDER DATA (PHASE I)					RECOVERED BINDER DATA (PHASE II)					
	FM5 WMA RTFO Original Binder					FM5 WMA Recovered Binder					
	Tested at 10 rad/sec	G*/sin(δ) (kPa)				Tested at 10 rad/sec	G*/sin(δ) (kPa)				
	Temperature (°C)	Trial 1	Trial 2	Trial 3	Average	Temperature (°C)	Trial 1	Trial 2	Trial 3	Average	
	52	18.980	19.720	18.72	19.14	64	16.910	--		16.910	
	58	7.968	8.352	8.018	8.11	70	7.247	6.917	7.077	7.080	
	64	3.644	3.789	3.565	3.67	76	3.222	3.085	3.13	3.146	
	70	1.672	1.745	1.63	1.68	82	1.508	1.439	1.469	1.472	
Fail Temperature		69.520	68.130	67.67	68.44	Fail Temperature (2.2 kPa)		78.93	78.73	78.81	78.823
PAV MATERIAL TESTING IN DSR	ORIGINAL BINDER DATA (PHASE I)					RECOVERED BINDER DATA (PHASE II)					
	FM5 WMA Original PAV Aged					FM5 WMA Recovered PAV Aged					
	Tested at 10 rad/sec	G*·sin(δ)				Tested at 10 rad/sec	G*·sin(δ)				
	Temperature (°C)	Trial 1	Trial 2	Trial 3	Average	Temperature (°C)	Trial 1	Trial 2	Trial 3	Average	
					#DIV/0!	31	2832	--	--	2832	
	25	3084	2980	2991	3018.333	28	3942	3756	3526	3741.333	
	22	4401	4245	4256	4300.667	25	5361	5064	4862	5095.667	
19	6229	5992	5994	6071.667	22	--	--	6582	6582		
Fail Temperature (5000 kPa)		20.89	20.62	20.6	20.70333	Fail Temperature (5000 kPa)		25.54	25.06	24.73	25.11
BENDING BEAM RHEOMETER TEST	ORIGINAL BINDER DATA (PHASE I)					RECOVERED BINDER DATA (PHASE II)					
	FM5 WMA Original RTFO+PAV Aged					FM5 WMA Recovered PAV Aged					
		BBR					BBR				
	Temperature (°C)	Stiffness (Mpa)				Temperature (°C)	Stiffness (Mpa)				
		Trial 1	Trial 2	Trial 3	Average		Trial 1	Trial 2	Trial 3	Average	
	-12	115	105	111	110.3333	-6	78.3	88.1	88.4	84.93333	
	-18	230	249	210	229.6667	-12	188	215	153	185.3333	
	Temperature (°C)	m-value				Temperature (°C)	m-value				
Trial 1		Trial 2	Trial 3	Average	Trial 1		Trial 2	Trial 3	Average		
-12	0.327	0.321	0.336	0.328	-6	0.325	0.33	0.328	0.327667		
-18	0.271	0.28	0.278	0.276333	-12	0.271	0.272	0.27	0.271		
Failure Temperature		-24.8929	-25.0732	-25.7241	-25.2301	Failure Temperature		-18.7778	-19.1034	-18.8966	-18.9259

Table I.8 FM6 binder data

FM6 RECOVERY STUDY											
VIRGIN BINDER	FM4 WMA Original Binder										
	Tested at 10 rad/sec	G*/sin(δ) (kPa)									
	Temperature (°C)	Trial 1	Trial 2	Trial 3	Average						
	52	6.319	7.428	7.870	7.21						
	58	2.548	2.970	3.231	2.92						
	64	1.152	1.354	1.412	1.31						
70	0.527	0.637	0.666	0.61							
	Fail Temperature	65.16	66.44	66.73	66.11						
RTFO MATERIAL TESTING IN DSR	ORIGINAL BINDER DATA (PHASE I)					RECOVERED BINDER DATA (PHASE II)					
	FM6 WMA RTFO Original Binder					FM6 WMA Recovered Binder					
	Tested at 10 rad/sec	G*/sin(δ) (kPa)				Tested at 10 rad/sec		G*/sin(δ) (kPa)			
	Temperature (°C)	Trial 1	Trial 2	Trial 3	Average	Temperature (°C)	Trial 1	Trial 2	Trial 3	Average	
	58	6.134	6.456	6.571	6.39	64	8.267	7.736	7.906	7.970	
	64	2.666	2.839	2.843	2.78	70	3.498	3.247	5.55	4.098	
	70	1.219	1.283	1.288	1.26	76	1.680	1.425	1.612	1.572	
		Fail Temperature	65.570	65.980	66.01	65.85	Fail Temperature (2.2 kPa)	73.74	72.86	73.65	73.417
PAV MATERIAL TESTING IN DSR	ORIGINAL BINDER DATA (PHASE I)					RECOVERED BINDER DATA (PHASE II)					
	FM6 WMA Original PAV Aged					FM6 WMA Recovered PAV Aged					
	Tested at 10 rad/sec	G*·sin(δ)				Tested at 10 rad/sec		G*·sin(δ)			
	Temperature (°C)	Trial 1	Trial 2	Trial 3	Average	Temperature (°C)	Trial 1	Trial 2	Trial 3	Average	
						31	2705			2705	
	25	3505	3154	3317	3325.333	28	3901	3715	3482	3699.333	
	22	5207	4674	4905	4928.667	25	5542	5204	4649	5131.667	
19	NA	6805	7136	6970.5	22			5904	5904		
	Fail Temperature (5000 kPa)	22.31	21.44	21.84	21.86333	Fail Temperature (5000 kPa)	25.91	25.43	23.92	25.08667	
BENDING BEAM RHEOMETER TEST	ORIGINAL BINDER DATA (PHASE I)					RECOVERED BINDER DATA (PHASE II)					
	FM6 WMA Original RTFO+PAV Aged					FM6 WMA Recovered PAV Aged					
	BBR					BBR					
	Temperature (°C)	Stiffness (Mpa)				Temperature (°C)	Stiffness (Mpa)				
		Trial 1	Trial 2	Trial 3	Average		Trial 1	Trial 2	Trial 3	Average	
	-6	149	126	140	138.3333	-6	69.1	97.9	128	98.33333	
	-12	316	307	234	285.6667	-12	205	174	201	193.3333	
	Temperature (°C)	m-value				Temperature (°C)	m-value				
		Trial 1	Trial 2	Trial 3	Average		Trial 1	Trial 2	Trial 3	Average	
	-6	0.357	0.349	0.341	0.349	-6	0.333	0.349	0.326	0.336	
-12	0.294	0.294	0.291	0.293	-12	0.279	0.275	0.278	0.277333		
	Failure Temperature	-21.4286	-21.3455	-20.92	-21.2313	Failure Temperature	-19.6667	-19.973	-19.25	-19.6299	

Table I.9 FM7 binder data

		FM7 RECOVERY STUDY				
VIRGIN BINDER	FM7 WMA Original Binder					
	Tested at 10 rad/sec	G*/sin(δ) (kPa)				
	Temperature (°C)	Trial 1	Trial 2	Trial 3	Average	
	52	3.318	3.453	3.153	3.31	
	58	1.486	1.493	1.361	1.45	
64	0.679	0.699	0.620	0.67		
Fail Temperature	61.04	61.21	60.43	60.89		
RTFO MATERIAL TESTING IN DSR	ORIGINAL BINDER DATA (PHASE I)					
	FM7 WMA RTFO Original Binder					
	Tested at 10 rad/sec	G*/sin(δ) (kPa)				
	Temperature (°C)	Trial 1	Trial 2	Trial 3	Average	
	52	7.219	7.291	7.351	7.29	
	58	3.013	3.120	3.082	3.07	
	64	1.318	1.388	1.385	1.36	
	Fail Temperature	60.330	60.650	60.58	60.52	
	RTFO MATERIAL TESTING IN DSR	RECOVERED BINDER DATA (PHASE II)				
		FM7 WMA Recovered Binder				
		Tested at 10 rad/sec	G*/sin(δ) (kPa)			
		Temperature (°C)	Trial 1	Trial 2	Trial 3	Average
		58	15.970	16.040	16.61	16.207
		64	6.522	6.705	6.938	6.722
		70	2.985	2.938	3.039	2.987
76		1.378	1.366	1.411	1.385	
Fail Temperature (2.2 kPa)		72.30	72.25	72.51	72.353	
FM7-5% Shingles Recovered Binder						
Tested at 10 rad/sec		G*/sin(δ) (kPa)				
Temperature (°C)		Trial 1	Trial 2	Trial 3	Average	
58		38.97			38.970	
64		16.550	6.250	15.6	12.800	
70		7.269	7.477	7.264	7.337	
76	3.350	3.425	3.272	3.349		
82	1.624	1.649	1.591	1.621		
Fail Temperature (2.2 kPa)	79.27	79.63	79.33	79.410		
FM7-7% Shingles Recovered Binder						
Tested at 10 rad/sec	G*/sin(δ) (kPa)					
Temperature (°C)	Average					
64						
70	18.890					
76	8.912					
82	4.212					
Fail Temperature (2.2 kPa)	#REF!					
PAV MATERIAL TESTING IN DSR	ORIGINAL BINDER DATA (PHASE I)					
	FM7 WMA Original PAV Aged					
	Tested at 10 rad/sec	G*/sin(δ)				
	Temperature (°C)	Trial 1	Trial 2	Trial 3	Average	
	25	1631	1747	1751	1709.667	
	22	2545	2719	2738	2667.333	
	19	3915	4184	4232	4110.333	
	16	5929	6352	6400	6227	
	Fail Temperature (5000 kPa)	17.28	17.75	17.77	17.6	
	PAV MATERIAL TESTING IN DSR	RECOVERED BINDER DATA (PHASE II)				
		FM7 WMA Recovered PAV Aged				
		Tested at 10 rad/sec	G*/sin(δ)			
		Temperature (°C)	Trial 1	Trial 2	Trial 3	Average
		25		2866	2939	2902.5
		22	4747	4055	4219	4340.333
19		6650	5547	5970	6055.667	
Fail Temperature (5000 kPa)		21.54	19.99	20.52	20.68333	
FM7-5% Shingles WMA Recovered PAV Aged						
Tested at 10 rad/sec		G*/sin(δ)				
Temperature (°C)		Trial 1	Trial 2	Trial 3	Average	
31		3690	2249	2399	2779.333	
28		3814	3197	3413	3474.667	
25		5322	4509	4645	4825.333	
22			6245	6167	6206	
Fail Temperature (5000 kPa)	25.57	24.02	24.16	24.58333		
FM7-7% Shingles WMA Recovered PAV Aged						
Tested at 10 rad/sec	G*/sin(δ)					
Temperature (°C)	Trial 1	Trial 2	Trial 3	Average		
31	2749	--	--	2749		
28	3619	4536	4460	4205		
25	4694	5915	5884	5497.667		
Fail Temperature (5000 kPa)	24.09	26.9	26.76	25.91667		

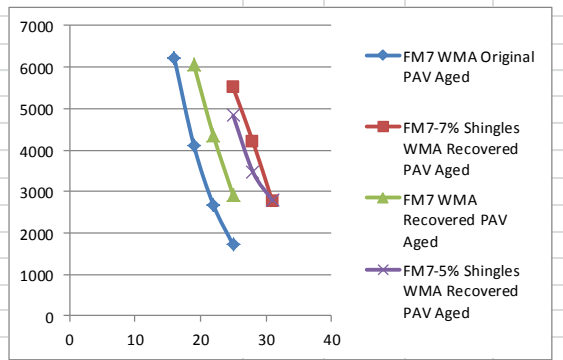
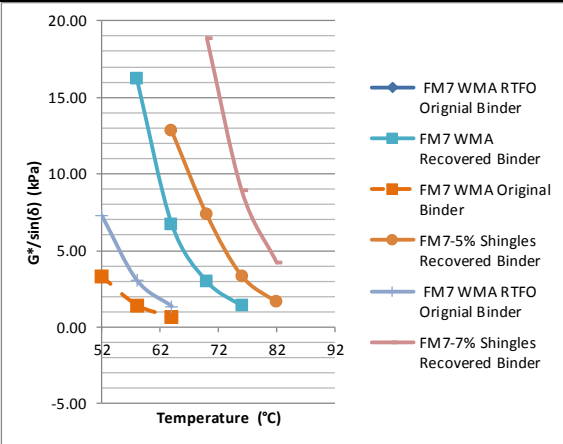

Table I.9 (Continued) FM7 binder data

ORIGINAL BINDER DATA (PHASE I)					RECOVERED BINDER DATA (PHASE II)				
FM7 WMA Original RTFO+PAV Aged					FM7 WMA Recovered PAV Aged				
Temperature (°C)	BBR				Temperature (°C)	BBR			
	Stiffness (Mpa)					Stiffness (Mpa)			
	Trial 1	Trial 2	Trial 3	Average		Trial 1	Trial 2	Trial 3	Average
-18	199	192	208	199.6667	-12	153	148	160	153.6667
-24	353	377	388	372.6667	-18	325	333	301	319.6667
Temperature (°C)	m-value				Temperature (°C)	m-value			
	Trial 1	Trial 2	Trial 3	Average		Trial 1	Trial 2	Trial 3	Average
	-18	0.333	0.325	0.338		0.332	-12	0.338	0.335
-24	0.252	0.269	0.267	0.262667	-18	0.279	0.286	0.282	0.282333
Failure Temperature	-30.4444	-30.6786	-31.06667	-30.7299	Failure Temperature	-25.8644	-26.2857	-25.4286	-25.85956
BENDING BEAM RHEOMETER TEST	<p>■ FM7 WMA Original RTFO+PAV Aged ■ FM7 WMA Recovered PAV Aged ■ FM7-5% Shingles WMA Recovered PAV Aged ■ FM7-7% Shingles WMA Recovered PAV Aged</p>				FM7-5% Shingles WMA Recovered PAV Aged				
					Temperature (°C)	BBR			
						Stiffness (Mpa)			
						Trial 1	Trial 2	Trial 3	Average
					-12	208	215	229	217.3333
					-18	376	380	399	385
					Temperature (°C)	m-value			
						Trial 1	Trial 2	Trial 3	Average
						-12	0.316	0.308	0.311
					-18	0.26	0.267	0.258	0.261667
					Failure Temperature	-23.7143	-23.1707	-23.2453	-23.37677
					FM7-7% Shingles WMA Recovered PAV Aged				
					Temperature (°C)	BBR			
						Stiffness (Mpa)			
						Trial 1	Trial 2	Trial 3	Average
-6	110	105	108	107.6667					
-12	206	194	194	198					
Temperature (°C)	m-value								
	Trial 1	Trial 2	Trial 3	Average					
	-6	0.307	0.304	0.306	0.305667				
-12	0.265	0.27	0.266	0.267					
Failure Temperature	-17	-16.7059	-16.9	-16.86863					

APPENDIX J PAVEMENT PERFORMANCE DETAILS

Table J.1 Pavement performance data

	FM2 2011		FM2 2012		FM3 2011		FM3 2012	
	HMA	WMA	HMA	WMA	HMA	WMA	HMA	WMA
Transverse Crack Spacing ft	0	0	0	0	99	122	79	88
Average Rutting, in.	0	0	0.1	0.1	0	0.01	0.08	0.04
Longitudinal Cracking per section, ft	0	0	0	0	0	3	0	0
Number of pop-outs per section	0	0	0	0	2	0	0	1
Edge cracking (minor)*, ft	0	0	0	0	2	27	0	23

Table J.1 (Continued) Pavement performance data

	FM4 2011		FM4 2012		FM5 2011	FM5 2012	FM6 2011	FM6 2012
	HMA	WMA	HMA	WMA	WMA	WMA	WMA	WMA
Transverse Crack Spacing ft.	65	38	37	39	0	0	144	144
Average Rutting, in.	0	0	0.1	0.1	0.06	0.15	NA	NA
Longitudinal Cracking per section, ft	18	0	6	0	0	0	0	0
Number of pop-outs per section	1	1	4	0	0	0	0	0
Edge cracking (minor)*, ft	0	50	17	0	0	0	0	0

APPENDIX K PAVEMENT PERFORMANCE DETAILS

Dynamic modulus statistical analysis for FM2

Response Dynamic Modulus

Summary of Fit

RSquare	0.992096
RSquare Adj	0.989749
Root Mean Square Error	465325.2
Mean of Response	5079115
Observations (or Sum Wgts)	1080

Analysis of Variance

Source	DF	Sum of Squares	Mean Square	F Ratio
Model	247	2.2611e+16	9.154e+13	422.7716
Error	832	1.8015e+14	2.165e+11	Prob > F
C. Total	1079	2.2791e+16		<.0001*

Tests wrt Random Effects

Source	SS	MS Num	DF Num	F Ratio	Prob > F
Mix	2.5e+13	2.5e+13	1	6.5642	0.0153*
COMP	3.9e+12	3.9e+12	1	1.0247	0.3190
Mix*COMP	7.1e+11	7.1e+11	1	0.1858	0.6693
Moisture Conditioned	7.2e+13	7.2e+13	1	19.0021	0.0001*
Mix*Moisture Conditioned	4.4e+12	4.4e+12	1	1.1498	0.2916
COMP*Moisture Conditioned	4.1e+12	4.1e+12	1	1.0686	0.3090
Mix*COMP*Moisture Conditioned	1.7e+12	1.7e+12	1	0.4392	0.5122
Temperature	1.8e+16	8.9e+15	2	41147.92	<.0001*
Mix*Temperature	1.6e+13	7.9e+12	2	36.5197	<.0001*
COMP*Temperature	1.1e+12	5.6e+11	2	2.5913	0.0755
Mix*COMP*Temperature	4.2e+12	2.1e+12	2	9.6819	<.0001*
Temperature*Moisture Conditioned	5e+13	2.5e+13	2	116.1625	<.0001*
Mix*Temperature*Moisture Conditioned	1.8e+12	8.9e+11	2	4.0900	0.0171*
COMP*Temperature*Moisture Conditioned	6.6e+11	3.3e+11	2	1.5249	0.2182
Mix*COMP*Temperature*Moisture Conditioned	1.2e+12	6.1e+11	2	2.8091	0.0608
Frequency	3.3e+15	4.2e+14	8	1932.073	<.0001*
Mix*Frequency	2.5e+12	3.1e+11	8	1.4541	0.1703
COMP*Frequency	4.1e+11	5.2e+10	8	0.2389	0.9835
Mix*COMP*Frequency	8.2e+10	1e+10	8	0.0472	1.0000
Temperature*Frequency	1.1e+15	7e+13	16	321.4433	<.0001*
Mix*Temperature*Frequency	1.3e+12	8.4e+10	16	0.3890	0.9851
COMP*Temperature*Frequency	4.7e+11	2.9e+10	16	0.1361	1.0000
Mix*COMP*Temperature*Frequency	6.8e+11	4.3e+10	16	0.1963	0.9998
Moisture Conditioned*Frequency	1e+13	1.3e+12	8	6.0555	<.0001*
Mix*Moisture Conditioned*Frequency	4.2e+11	5.3e+10	8	0.2449	0.9821
COMP*Moisture Conditioned*Frequency	1.6e+11	2e+10	8	0.0933	0.9994
Mix*COMP*Moisture Conditioned*Frequency	1e+11	1.3e+10	8	0.0593	0.9999
Temperature*Moisture Conditioned*Frequency	4.3e+12	2.7e+11	16	1.2397	0.2309
Mix*Temperature*Moisture Conditioned*Frequency	2.5e+11	1.6e+10	16	0.0725	1.0000
COMP*Temperature*Moisture Conditioned*Frequency	2.4e+11	1.5e+10	16	0.0695	1.0000
Mix*COMP*Temperature*Moisture Conditioned*Frequency	5e+11	3.1e+10	16	0.1451	1.0000
Sample Number[Mix,COMP,Moisture Conditioned]&Random	1.2e+14	3.8e+12	32	17.5922	<.0001*

Dynamic modulus statistical analysis for FM2 (Continued)

Effect Details

Mix

Effect Test

Sum of Squares	F Ratio	DF	Prob > F
2.5004e+13	6.5642	1	0.0153*

Effect Details

Mix

Effect Test

Denominator MS Synthesis: Sample Number[Mix,COMP,Moisture Conditioned]&Random

Least Squares Means Table

Level	Least Sq Mean	Std Error	Mean
HMA	5231274.1	83988.530	5231274
WMA	4926956.6	83988.530	4926957

LSMeans Differences Student's t

$\alpha = 0.050$ $t = 2.03693$

Level	Least Sq Mean
HMA A	5231274.1
WMA B	4926956.6

Levels not connected by same letter are significantly different.

LS Means Plot

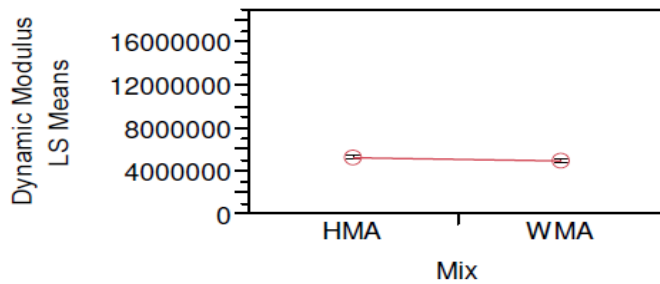

Dynamic modulus statistical analysis for FM2 (Continued)

COMP**Effect Test**

Sum of Squares	F Ratio	DF	Prob > F
3.9033e+12	1.0247	1	0.3190

Denominator MS Synthesis: Sample Number[Mix,COMP,Moisture Conditioned]&Random

Least Squares Means Table

Level	Least Sq Mean	Std Error	Mean
Field	5139233.3	83988.530	5139233
Lab	5018997.4	83988.530	5018997

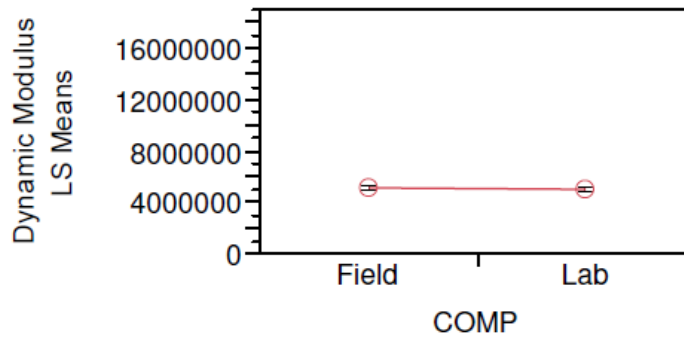
LS Means Plot

Dynamic modulus statistical analysis for FM2 (Continued)**Response Dynamic Modulus****Effect Details****Mix*COMP****Effect Test**

Sum of Squares	F Ratio	DF	Prob > F
7.0776e+11	0.1858	1	0.6693

Denominator MS Synthesis: Sample Number[Mix,COMP,Moisture Conditioned]&Random

Least Squares Means Table

Level	Least	
	Sq Mean	Std Error
HMA,Field	5265792.6	118777.72
HMA,Lab	5196755.6	118777.72
WMA,Field	5012674.1	118777.72
WMA,Lab	4841239.2	118777.72

Moisture Conditioned**Effect Test**

Sum of Squares	F Ratio	DF	Prob > F
7.2383e+13	19.0021	1	0.0001*

Denominator MS Synthesis: Sample Number[Mix,COMP,Moisture Conditioned]&Random

Least Squares Means Table

Level	Least		
	Sq Mean	Std Error	Mean
N	5338000.0	83988.530	5338000
Y	4820230.7	83988.530	4820231

LSMeans Differences Student's t $\alpha = 0.050$ $t = 2.03693$

Level	Least	
	A	Sq Mean
N	A	5338000.0
Y	B	4820230.7

Levels not connected by same letter are significantly different.

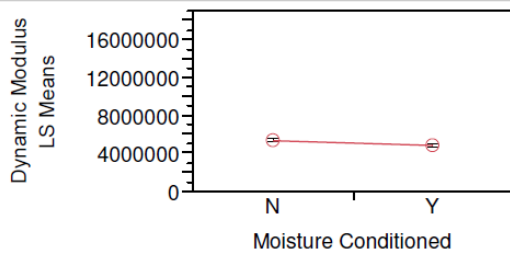
LS Means Plot**Mix*Moisture Conditioned****Effect Test**

Sum of Squares	F Ratio	DF	Prob > F
4.3797e+12	1.1498	1	0.2916

Denominator MS Synthesis: Sample Number[Mix,COMP,Moisture Conditioned]&Random

Dynamic modulus statistical analysis for FM2 (Continued)

Response Dynamic Modulus

Effect Details

Mix*Moisture Conditioned

Least Squares Means Table

Level	Least	
	Sq Mean	Std Error
HMA,N	5426477.8	118777.72
HMA,Y	5036070.4	118777.72
WMA,N	5249522.2	118777.72
WMA,Y	4604391.1	118777.72

COMP*Moisture Conditioned

Effect Test

Sum of Squares	F Ratio	DF	Prob > F
4.0706e+12	1.0686	1	0.3090

Denominator MS Synthesis: Sample Number[Mix,COMP,Moisture Conditioned]&Random

Least Squares Means Table

Level	Least	
	Sq Mean	Std Error
Field,N	5459511.1	118777.72
Field,Y	4818955.6	118777.72
Lab,N	5216488.9	118777.72
Lab,Y	4821505.9	118777.72

Mix*COMP*Moisture Conditioned

Effect Test

Sum of Squares	F Ratio	DF	Prob > F
1.6731e+12	0.4392	1	0.5122

Denominator MS Synthesis: Sample Number[Mix,COMP,Moisture Conditioned]&Random

Least Squares Means Table

Level	Least	
	Sq Mean	Std Error
HMA,Field,N	5483029.6	167977.06
HMA,Field,Y	5048555.6	167977.06
HMA,Lab,N	5369925.9	167977.06
HMA,Lab,Y	5023585.2	167977.06
WMA,Field,N	5435992.6	167977.06
WMA,Field,Y	4589355.6	167977.06
WMA,Lab,N	5063051.9	167977.06
WMA,Lab,Y	4619426.6	167977.06

Temperature

Effect Test

Sum of Squares	F Ratio	DF	Prob > F
1.7819e+16	41147.92	2	<.0001*

Denominator MS Synthesis: Residual

Least Squares Means Table

Level	Least		Mean
	Sq Mean	Std Error	
21	3543696	24524.791	3543696.1

Dynamic modulus statistical analysis for FM2 (Continued)

Response Dynamic Modulus

Effect Details

Temperature

Least Squares Means Table

Level	Sq Mean	Std Error	Mean
37	1052983	24524.791	1052983.3
4	10640667	24524.791	10640667

LSMeans Differences Tukey HSD

$\alpha = 0.050$ $Q = 2.34791$

Level	Least Sq Mean
4	A
21	B
37	C

Levels not connected by same letter are significantly different.

Mix*Temperature

Effect Test

Sum of Squares	F Ratio	DF	Prob > F
1.5815e+13	36.5197	2	<.0001*

Denominator MS Synthesis: Residual

Least Squares Means Table

Level	Sq Mean	Std Error
HMA,21	3648856	34683.292
HMA,37	1086133	34683.292
HMA,4	10958833	34683.292
WMA,21	3438537	34683.292
WMA,37	1019833	34683.292
WMA,4	10322500	34683.292

LS Means Plot

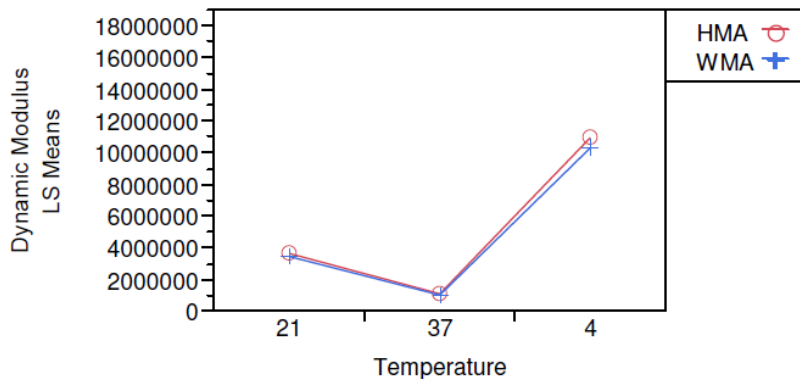

LSMeans Differences Tukey HSD

$\alpha = 0.050$ $Q = 2.85639$

Dynamic modulus statistical analysis for FM2 (Continued)

Response Dynamic Modulus

Effect Details

Mix*Temperature

LSMeans Differences Tukey HSD

Level		Least Sq Mean
HMA,4	A	10958833
WMA,4	B	10322500
HMA,21	C	3648856
WMA,21	D	3438537
HMA,37	E	1086133
WMA,37	E	1019833

Levels not connected by same letter are significantly different.

COMP*Temperature

Effect Test

Sum of Squares	F Ratio	DF	Prob > F
1.1222e+12	2.5913	2	0.0755

Denominator MS Synthesis: Residual

Least Squares Means Table

Level	Least Sq Mean	Std Error
Field,21	3601089	34683.292
Field,37	1075056	34683.292
Field,4	10741556	34683.292
Lab,21	3486303	34683.292
Lab,37	1030911	34683.292
Lab,4	10539778	34683.292

LS Means Plot

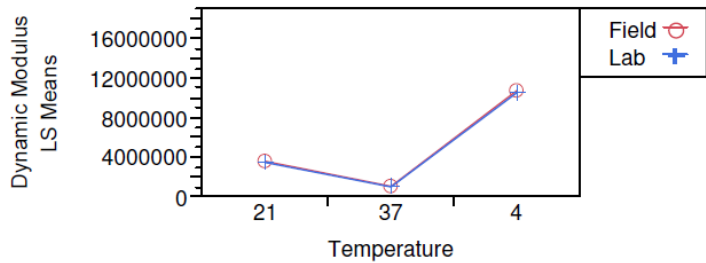

LSMeans Differences Tukey HSD

$\alpha = 0.050$ $Q = 2.85639$

Level		Least Sq Mean
Field,4	A	10741556
Lab,4	B	10539778
Field,21	C	3601089
Lab,21	C	3486303
Field,37	D	1075056
Lab,37	D	1030911

Levels not connected by same letter are significantly different.

Dynamic modulus statistical analysis for FM2 (Continued)

Response Dynamic Modulus

Effect Details

Mix*COMP*Temperature

Effect Test

Sum of Squares	F Ratio	DF	Prob > F
4.1928e+12	9.6819	2	<.0001*

Denominator MS Synthesis: Residual

LS Means Plot

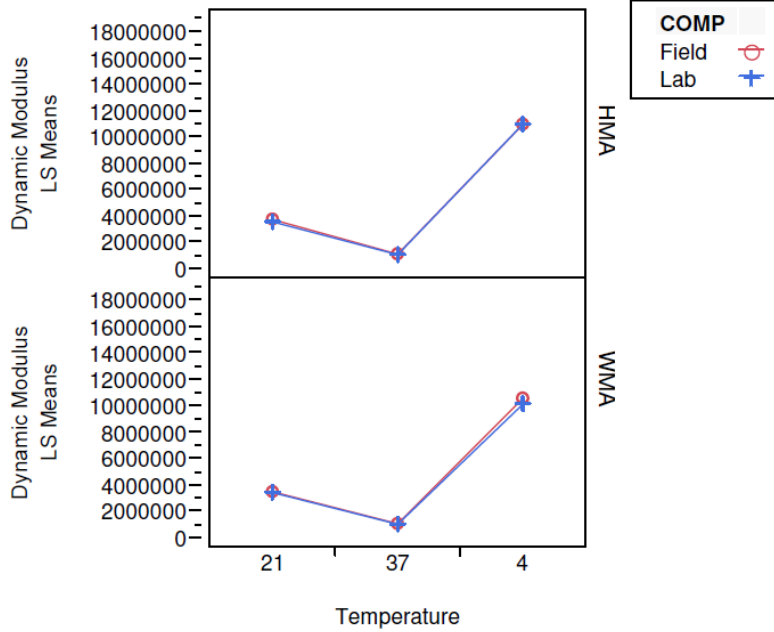

LSMeans Differences Tukey HSD

$\alpha = 0.050$ $Q = 3.2774$

Level	Least Sq Mean
HMA,Lab,4 A	10969889
HMA,Field,4 A	10947778
WMA,Field,4 B	10535333
WMA,Lab,4 C	10109667
HMA,Field,21 D	3739044
HMA,Lab,21 D E	3558667
WMA,Field,21 E	3463133
WMA,Lab,21 E	3413940
HMA,Field,37 F	1110556
HMA,Lab,37 F	1061711
WMA,Field,37 F	1039556
WMA,Lab,37 F	1000111

Levels not connected by same letter are significantly different.

Temperature*Moisture Conditioned

Effect Test

Sum of Squares	F Ratio	DF	Prob > F
----------------	---------	----	----------

Dynamic modulus statistical analysis for FM2 (Continued)

Response Dynamic Modulus

Effect Details

Temperature*Moisture Conditioned

Effect Test

Sum of Squares	F Ratio	DF	Prob > F
5.0305e+13	116.1625	2	<.0001*

Denominator MS Synthesis: Residual

Least Squares Means Table

Level	Least Sq Mean	Std Error
21,N	3802333	34683.292
21,Y	3285059	34683.292
37,N	1047667	34683.292
37,Y	1058300	34683.292
4,N	11164000	34683.292
4,Y	10117333	34683.292

LS Means Plot

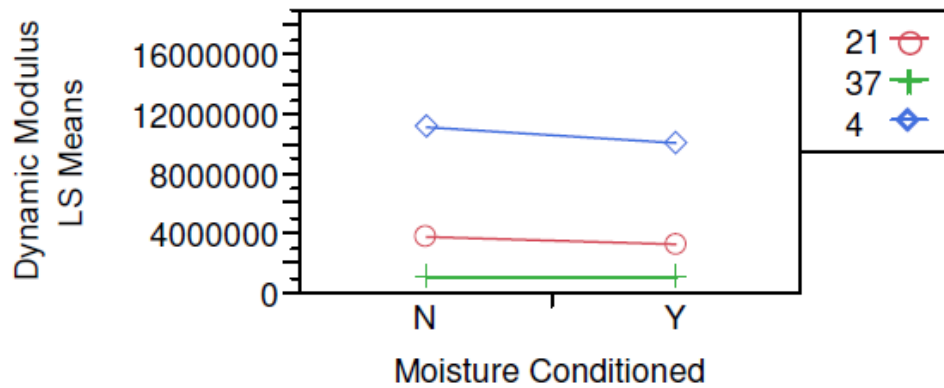

Mix*Temperature*Moisture Conditioned

Effect Test

Sum of Squares	F Ratio	DF	Prob > F
1.7712e+12	4.0900	2	0.0171*

Denominator MS Synthesis: Residual

Dynamic modulus statistical analysis for FM2 (Continued)

Response Dynamic Modulus

Effect Details

Mix*Temperature*Moisture Conditioned

LS Means Plot

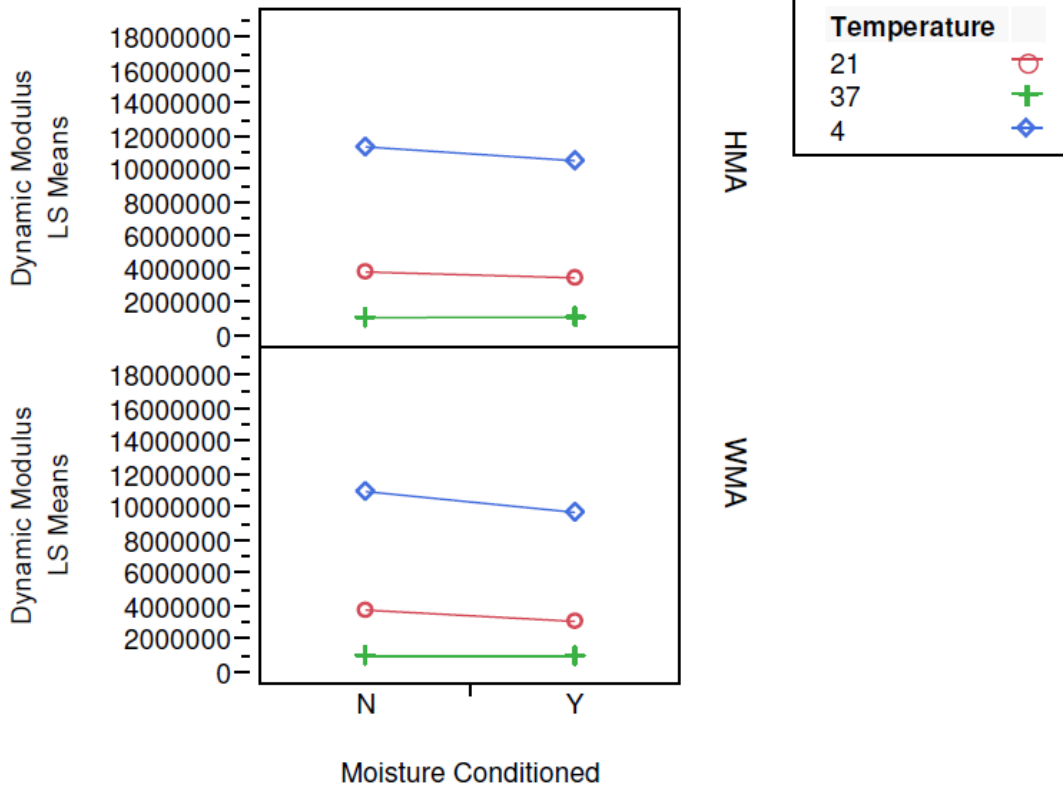

LSMeans Differences Tukey HSD

$\alpha = 0.050$ $Q = 3.2774$

Level	Least Sq Mean
HMA,4,N A	11375111
WMA,4,N B	10952889
HMA,4,Y C	10542556
WMA,4,Y D	9692111
HMA,21,N E	3833111
WMA,21,N E	3771556
HMA,21,Y F	3464600
WMA,21,Y G	3105518
HMA,37,Y H	1101056
HMA,37,N H	1071211
WMA,37,N H	1024122
WMA,37,Y H	1015544

Levels not connected by same letter are significantly different.

Dynamic modulus statistical analysis for FM2 (Continued)

COMP*Temperature*Moisture Conditioned**Effect Test**

Sum of Squares	F Ratio	DF	Prob > F
6.6037e+11	1.5249	2	0.2182

Denominator MS Synthesis: Residual

Response Dynamic Modulus**Effect Details****Mix*COMP*Temperature*Moisture Conditioned****Effect Test**

Sum of Squares	F Ratio	DF	Prob > F
1.2165e+12	2.8091	2	0.0608

Denominator MS Synthesis: Residual

Frequency**Effect Test**

Sum of Squares	F Ratio	DF	Prob > F
3.3468e+15	1932.073	8	<.0001*

Denominator MS Synthesis: Residual

Least Squares Means Table

Level	Least		
	Sq Mean	Std Error	Mean
0.1Hz	2502421.2	42478.185	2502421
0.3Hz	3232283.7	42478.185	3232284
0.5Hz	3598641.7	42478.185	3598642
10Hz	6508416.7	42478.185	6508417
15Hz	7063416.7	42478.185	7063417
1Hz	4062083.3	42478.185	4062083
25Hz	7939583.3	42478.185	7939583
3Hz	5055033.3	42478.185	5055033
5Hz	5750158.3	42478.185	5750158

Dynamic modulus statistical analysis for FM2 (Continued)

Mix*Frequency**Effect Test**

Sum of Squares	F Ratio	DF	Prob > F
2.5188e+12	1.4541	8	0.1703
Denominator MS Synthesis: Residual			

COMP*Frequency**Effect Test**

Sum of Squares	F Ratio	DF	Prob > F
4.1388e+11	0.2389	8	0.9835
Denominator MS Synthesis: Residual			

Mix*COMP*Frequency**Effect Test**

Sum of Squares	F Ratio	DF	Prob > F
8.1809e+10	0.0472	8	1.0000
Denominator MS Synthesis: Residual			

Temperature*Frequency**Effect Test**

Sum of Squares	F Ratio	DF	Prob > F
----------------	---------	----	----------

Dynamic modulus statistical analysis for FM2 (Continued)

Response Dynamic Modulus

Effect Details

Temperature*Frequency

Effect Test

Sum of Squares	F Ratio	DF	Prob > F
1.1136e+15	321.4433	16	<.0001*

Denominator MS Synthesis: Residual

LS Means Plot

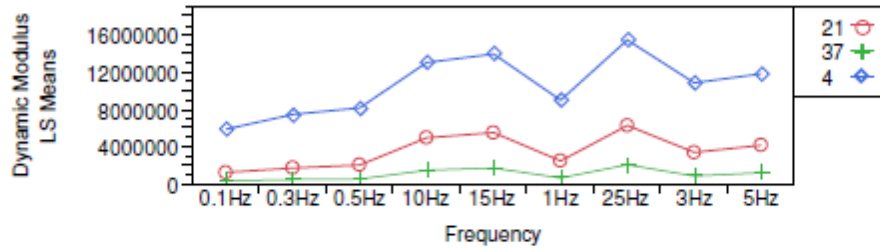

Mix*Temperature*Frequency

Effect Test

Sum of Squares	F Ratio	DF	Prob > F
1.3478e+12	0.3890	16	0.9851

Denominator MS Synthesis: Residual

COMP*Temperature*Frequency

Effect Test

Sum of Squares	F Ratio	DF	Prob > F
4.7134e+11	0.1361	16	1.0000

Denominator MS Synthesis: Residual

Mix*COMP*Temperature*Frequency

Effect Test

Sum of Squares	F Ratio	DF	Prob > F
6.8008e+11	0.1963	16	0.9998

Denominator MS Synthesis: Residual

Moisture Conditioned*Frequency

Effect Test

Sum of Squares	F Ratio	DF	Prob > F
1.0489e+13	6.0555	8	<.0001*

Denominator MS Synthesis: Residual

Dynamic modulus statistical analysis for FM2 (Continued)

Response Dynamic Modulus

Effect Details

Moisture Conditioned*Frequency

LS Means Plot

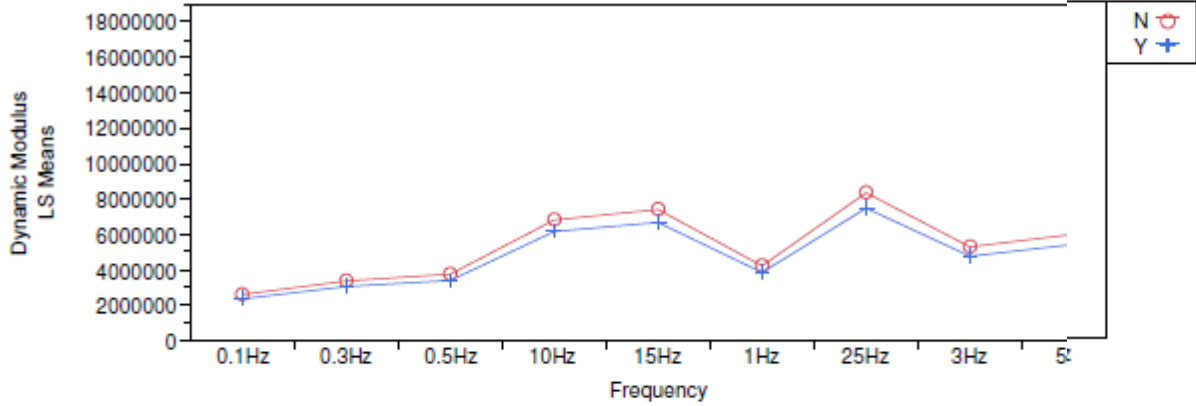

Mix*Moisture Conditioned*Frequency

Effect Test

Sum of Squares	F Ratio	DF	Prob > F
4.2422e+11	0.2449	8	0.9821

Denominator MS Synthesis: Residual

COMP*Moisture Conditioned*Frequency

Effect Test

Sum of Squares	F Ratio	DF	Prob > F
1.6157e+11	0.0933	8	0.9994

Denominator MS Synthesis: Residual

Mix*COMP*Moisture Conditioned*Frequency

Effect Test

Sum of Squares	F Ratio	DF	Prob > F
1.0268e+11	0.0593	8	0.9999

Denominator MS Synthesis: Residual

Temperature*Moisture Conditioned*Frequency

Effect Test

Sum of Squares	F Ratio	DF	Prob > F
4.2949e+12	1.2397	16	0.2309

Denominator MS Synthesis: Residual

Dynamic modulus statistical analysis for FM2 (Continued)

Response Dynamic Modulus**Effect Details****Temperature*Moisture
Conditioned*Frequency****Mix*Temperature*Moisture
Conditioned*Frequency****Effect Test**

Sum of Squares	F Ratio	DF	Prob > F
2.5118e+11	0.0725	16	1.0000

Denominator MS Synthesis: Residual

**COMP*Temperature*Moisture
Conditioned*Frequency****Effect Test**

Sum of Squares	F Ratio	DF	Prob > F
2.4071e+11	0.0695	16	1.0000

Denominator MS Synthesis: Residual

**Mix*COMP*Temperature*Moisture
Conditioned*Frequency****Effect Test**

Sum of Squares	F Ratio	DF	Prob > F
5.0285e+11	0.1451	16	1.0000

Denominator MS Synthesis: Residual

**Sample Number[Mix,COMP,Moisture
Conditioned]&Random****Effect Test**

Sum of Squares	F Ratio	DF	Prob > F
1.2189e+14	17.5922	32	<.0001*

Denominator MS Synthesis: Residual

Dynamic modulus statistical analysis for FM3

Response Dynamic Modulus

Summary of Fit

RSquare	0.992641
RSquare Adj	0.990456
Root Mean Square Error	558521.2
Mean of Response	6026835
Observations (or Sum Wgts)	1080

Analysis of Variance

Source	DF	Sum of Squares	Mean Square	F Ratio	Prob > F
Model	247	3.5007e+16	1.417e+14	454.3330	
Error	832	2.5954e+14	3.119e+11		Prob > F
C. Total	1079	3.5266e+16			<.0001*

Tests wrt Random Effects

Source	SS	MS Num	DF Num	F Ratio	Prob > F
Mix	1.3e+14	1.3e+14	1	22.5247	<.0001*
COMP	4.1e+13	4.1e+13	1	6.8121	0.0137*
Mix*COMP	1.2e+13	1.2e+13	1	2.0475	0.1621
COND	1.1e+14	1.1e+14	1	19.0864	0.0001*
Mix*COND	6.6e+12	6.6e+12	1	1.1129	0.2994
COMP*COND	1.8e+12	1.8e+12	1	0.3104	0.5813
Mix*COMP*COND	1.3e+13	1.3e+13	1	2.1661	0.1508
Temperature	2.8e+16	1.4e+16	2	45164.64	<.0001*
Mix*Temperature	7.1e+13	3.5e+13	2	113.2629	<.0001*
COMP*Temperature	2e+13	1e+13	2	32.7054	<.0001*
Mix*COMP*Temperature	5.2e+11	2.6e+11	2	0.8289	0.4369
Temperature*COND	8.3e+13	4.1e+13	2	132.6437	<.0001*
Mix*Temperature*COND	3.4e+12	1.7e+12	2	5.4628	0.0044*
COMP*Temperature*COND	4.2e+11	2.1e+11	2	0.6730	0.5104
Mix*COMP*Temperature*COND	5.8e+12	2.9e+12	2	9.3041	0.0001*
Frequency	4.6e+15	5.7e+14	8	1837.054	<.0001*
Mix*Frequency	5.3e+12	6.7e+11	8	2.1376	0.0302*
COMP*Frequency	1.1e+12	1.3e+11	8	0.4266	0.9055
Mix*COMP*Frequency	3.8e+11	4.7e+10	8	0.1516	0.9965
Temperature*Frequency	1.5e+15	9.5e+13	16	303.7120	<.0001*
Mix*Temperature*Frequency	3e+12	1.9e+11	16	0.6009	0.8847
COMP*Temperature*Frequency	6.8e+11	4.3e+10	16	0.1365	1.0000
Mix*COMP*Temperature*Frequency	7.3e+11	4.6e+10	16	0.1462	1.0000
COND*Frequency	1e+13	1.3e+12	8	4.0293	0.0001*
Mix*COND*Frequency	1.2e+12	1.4e+11	8	0.4615	0.8834
COMP*COND*Frequency	1e+12	1.3e+11	8	0.4108	0.9147
Mix*COMP*COND*Frequency	6.5e+11	8.2e+10	8	0.2622	0.9777
Temperature*COND*Frequency	3.3e+12	2.1e+11	16	0.6616	0.8331
Mix*Temperature*COND*Frequency	1.6e+12	1e+11	16	0.3221	0.9948
COMP*Temperature*COND*Frequency	1.7e+12	1.1e+11	16	0.3451	0.9923
Mix*COMP*Temperature*COND*Frequency	9.9e+11	6.2e+10	16	0.1978	0.9997
Sample Number[Mix,COMP,COND]&Random	1.9e+14	6e+12	32	19.1002	<.0001*

Effect Details

Mix

Effect Test

Sum of Squares	F Ratio	DF	Prob > F
1.3421e+14	22.5247	1	<.0001*

Dynamic modulus statistical analysis for FM3 (Continued)

Response Dynamic Modulus

Effect Details

Mix

Effect Test

Denominator MS Synthesis: Sample Number[Mix,COMP,COND]&Random

Least Squares Means Table

Level	Least		Mean
	Sq Mean	Std Error	
HMA	6379348.8	105041.81	6379349
WMA	5674320.2	105041.81	5674320

LSMeans Differences Student's t

$\alpha=0.050$ $t=2.03693$

Level		Least	
		Sq Mean	
HMA	A	6379348.8	
WMA	B	5674320.2	

Levels not connected by same letter are significantly different.

LS Means Plot

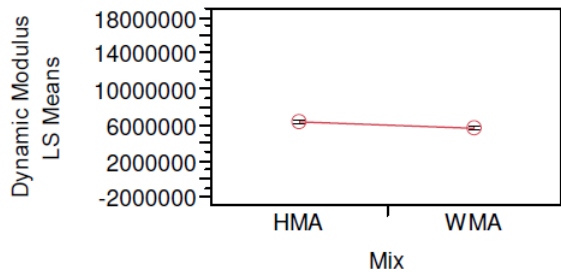

COMP

Effect Test

Sum of Squares	F Ratio	DF	Prob > F
4.0588e+13	6.8121	1	0.0137*

Denominator MS Synthesis: Sample Number[Mix,COMP,COND]&Random

Least Squares Means Table

Level	Least		Mean
	Sq Mean	Std Error	
field	5832975.1	105041.81	5832975
lab	6220694.0	105041.81	6220694

LSMeans Differences Student's t

$\alpha=0.050$ $t=2.03693$

Level		Least	
		Sq Mean	
lab	A	6220694.0	
field	B	5832975.1	

Levels not connected by same letter are significantly different.

Dynamic modulus statistical analysis for FM3 (Continued)

Response Dynamic Modulus

Effect Details

COMP

LS Means Plot

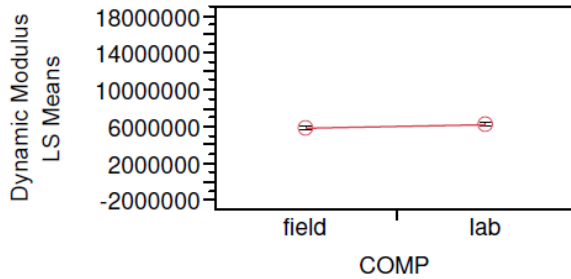

Mix*COMP

Effect Test

Sum of Squares	F Ratio	DF	Prob > F
1.22e+13	2.0475	1	0.1621

Denominator MS Synthesis: Sample Number[Mix,COMP,COND]&Random

Least Squares Means Table

Level	Sq Mean	Std Error
HMA,field	6079207.2	148551.55
HMA,lab	6679490.5	148551.55
WMA,field	5586743.0	148551.55
WMA,lab	5761897.5	148551.55

COND

Effect Test

Sum of Squares	F Ratio	DF	Prob > F
1.1372e+14	19.0864	1	0.0001*

Denominator MS Synthesis: Sample Number[Mix,COMP,COND]&Random

Least Squares Means Table

Level	Sq Mean	Std Error	Mean
N	6351330.9	105041.81	6351331
Y	5702338.2	105041.81	5702338

LSMeans Differences Student's t

$\alpha = 0.050$ $t = 2.03693$

Level	Sq Mean	Least Sq Mean
N	A	6351330.9
Y	B	5702338.2

Levels not connected by same letter are significantly different.

Dynamic modulus statistical analysis for FM3 (Continued)

Response Dynamic Modulus

Effect Details

COND

LS Means Plot

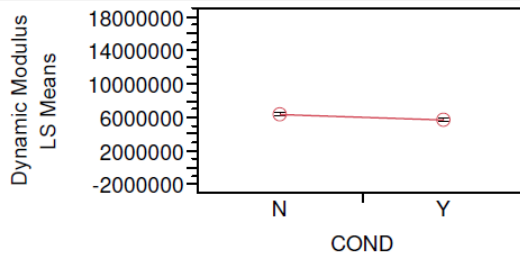

Mix*COND

Effect Test

Sum of Squares	F Ratio	DF	Prob > F
6.6308e+12	1.1129	1	0.2994

Denominator MS Synthesis: Sample Number[Mix,COMP,COND]&Random

Least Squares Means Table

Level	Sq Mean	Std Error
HMA,N	6625489.4	148551.55
HMA,Y	6133208.3	148551.55
WMA,N	6077172.3	148551.55
WMA,Y	5271468.2	148551.55

COMP*COND

Effect Test

Sum of Squares	F Ratio	DF	Prob > F
1.8497e+12	0.3104	1	0.5813

Denominator MS Synthesis: Sample Number[Mix,COMP,COND]&Random

Least Squares Means Table

Level	Sq Mean	Std Error
field,N	6198855.5	148551.55
field,Y	5467094.7	148551.55
lab,N	6503806.2	148551.55
lab,Y	5937581.8	148551.55

Mix*COMP*COND

Effect Test

Sum of Squares	F Ratio	DF	Prob > F
1.2906e+13	2.1661	1	0.1508

Denominator MS Synthesis: Sample Number[Mix,COMP,COND]&Random

Least Squares Means Table

Level	Sq Mean	Std Error
HMA,field,N	6476049.3	210083.62
HMA,field,Y	5682365.0	210083.62

Dynamic modulus statistical analysis for FM3 (Continued)

Response Dynamic Modulus

Effect Details

Mix*COMP*COND

Least Squares Means Table

Level	Least	
	Sq Mean	Std Error
HMA,lab,N	6774929.5	210083.62
HMA,lab,Y	6584051.6	210083.62
WMA,field,N	5921661.7	210083.62
WMA,field,Y	5251824.3	210083.62
WMA,lab,N	6232683.0	210083.62
WMA,lab,Y	5291112.1	210083.62

Temperature

Effect Test

Sum of Squares	F Ratio	DF	Prob > F
2.8178e+16	45164.64	2	<.0001*

Denominator MS Synthesis: Residual

Least Squares Means Table

Level	Least		
	Sq Mean	Std Error	Mean
21	4026129	29436.650	4026129.1
37	1016049	29436.650	1016048.9
4	13038326	29436.650	13038326

Mix*Temperature

Effect Test

Sum of Squares	F Ratio	DF	Prob > F
7.0664e+13	113.2629	2	<.0001*

Denominator MS Synthesis: Residual

Least Squares Means Table

Level	Least	
	Sq Mean	Std Error
HMA,21	4337427	41629.709
HMA,37	1077932	41629.709
HMA,4	13722688	41629.709
WMA,21	3714831	41629.709
WMA,37	954166	41629.709
WMA,4	12353964	41629.709

LS Means Plot

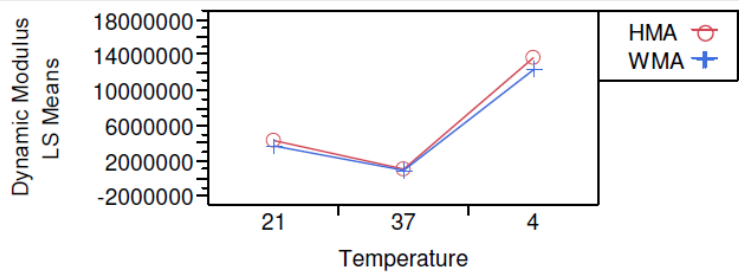

Dynamic modulus statistical analysis for FM3 (Continued)

Response Dynamic Modulus

Effect Details

COMP*Temperature

Effect Test

Sum of Squares	F Ratio	DF	Prob > F
2.0405e+13	32.7054	2	<.0001*
Denominator MS Synthesis: Residual			

Least Squares Means Table

Level	Least Sq Mean	Std Error
field,21	3864818	41629.709
field,37	971883	41629.709
field,4	12662224	41629.709
lab,21	4187440	41629.709
lab,37	1060215	41629.709
lab,4	13414427	41629.709

LS Means Plot

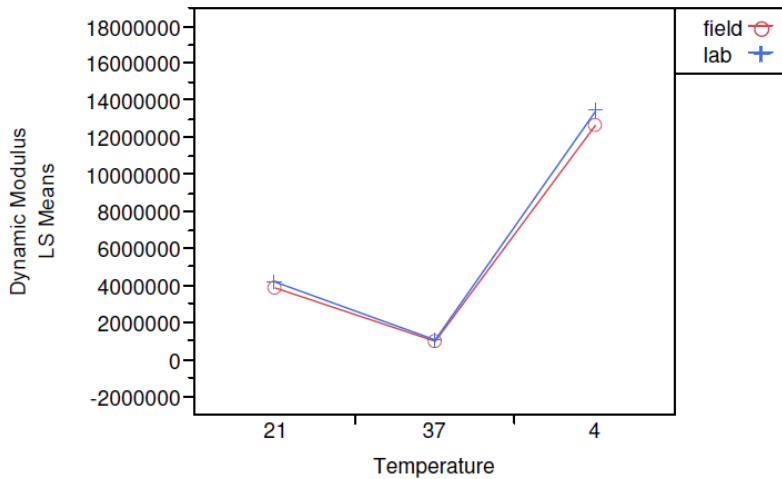

LSMeans Differences Tukey HSD

$\alpha = 0.050$ $Q = 2.85639$

Level	Least Sq Mean
lab,4 A	13414427
field,4 B	12662224
lab,21 C	4187440
field,21 D	3864818
lab,37 E	1060215
field,37 E	971883

Levels not connected by same letter are significantly different.

Mix*COMP*Temperature

Effect Test

Sum of Squares	F Ratio	DF	Prob > F
5.1713e+11	0.8289	2	0.4369

Dynamic modulus statistical analysis for FM3 (Continued)

Response Dynamic Modulus

Effect Details

Mix*COMP*Temperature

Effect Test

Denominator MS Synthesis: Residual

Temperature*COND

Effect Test

Sum of Squares	F Ratio	DF	Prob > F
8.2755e+13	132.6437	2	<.0001*

Denominator MS Synthesis: Residual

Least Squares Means Table

Level	Sq Mean	Std Error
21,N	4276163	41629.709
21,Y	3776095	41629.709
37,N	1044941	41629.709
37,Y	987157	41629.709
4,N	13732889	41629.709
4,Y	12343763	41629.709

Mix*Temperature*COND

Effect Test

Sum of Squares	F Ratio	DF	Prob > F
3.4082e+12	5.4628	2	0.0044*

Denominator MS Synthesis: Residual

LS Means Plot

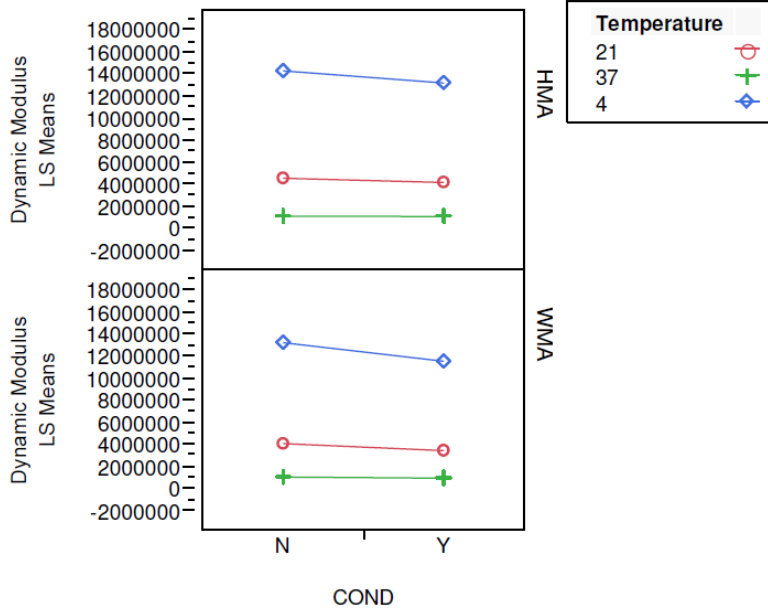

LSMeans Differences Tukey HSD

$\alpha = 0.050$ $Q = 3.2774$

Dynamic modulus statistical analysis for FM3 (Continued)

Response Dynamic Modulus**Effect Details****Mix*Temperature*COND****LSMeans Differences Tukey HSD**

Level		Least Sq Mean
HMA,4,N	A	14264919
WMA,4,N	B	13200858
HMA,4,Y	B	13180457
WMA,4,Y	C	11507069
HMA,21,N	D	4521008
HMA,21,Y	E	4153846
WMA,21,N	E	4031319
WMA,21,Y	F	3398344
HMA,37,N	G	1090542
HMA,37,Y	G	1065322
WMA,37,N	G	999340
WMA,37,Y	G	908992

Levels not connected by same letter are significantly different.

COMP*Temperature*COND**Effect Test**

Sum of Squares	F Ratio	DF	Prob > F
4.1991e+11	0.6730	2	0.5104

Denominator MS Synthesis: Residual

Mix*COMP*Temperature*COND**Effect Test**

Sum of Squares	F Ratio	DF	Prob > F
5.8047e+12	9.3041	2	0.0001*

Denominator MS Synthesis: Residual

LSMeans Differences Tukey HSD

$\alpha = 0.050$ $Q = 3.6497$

Dynamic modulus statistical analysis for FM3 (Continued)

Response Dynamic Modulus
Effect Details
Temperature*Frequency
LSMeans Differences Tukey HSD

Level		Least Sq Mean
4,25Hz	A	18318709
4,15Hz	B	16858046
4,10Hz	C	15861249
4,5Hz	D	14498199
4,3Hz	E	13672538
4,1Hz	F	11258370
4,0.5Hz	G	10175218
4,0.3Hz	H	9468748
21,25Hz	I	7333341
4,0.1Hz	I	7233854
21,15Hz	J	6433331
21,10Hz	K	5756364
21,5Hz	L	4818224
21,3Hz	M	3850521
21,1Hz	N	2739780
21,0.5Hz	O	2268454
37,25Hz	O P	2207977
21,0.3Hz	O P Q	1876585
37,15Hz	P Q	1779344
37,10Hz	Q R	1499999
21,0.1Hz	R S	1158561
37,5Hz	R S	1153563
37,3Hz	S T	827078
37,1Hz	T U	575279
37,0.5Hz	T U	440190
37,0.3Hz	T U	379010
37,0.1Hz	U	282001

Levels not connected by same letter are significantly different.

Mix*Temperature*Frequency

Effect Test

Sum of Squares	F Ratio	DF	Prob > F
2.9993e+12	0.6009	16	0.8847

Denominator MS Synthesis: Residual

COMP*Temperature*Frequency

Effect Test

Sum of Squares	F Ratio	DF	Prob > F
6.8145e+11	0.1365	16	1.0000

Denominator MS Synthesis: Residual

Mix*COMP*Temperature*Frequency

Effect Test

Sum of Squares	F Ratio	DF	Prob > F
7.2983e+11	0.1462	16	1.0000

Denominator MS Synthesis: Residual

Dynamic modulus statistical analysis for FM3 (Continued)

Response Dynamic Modulus

Effect Details

COND*Frequency

Effect Test

Sum of Squares	F Ratio	DF	Prob > F
1.0055e+13	4.0293	8	0.0001*

Denominator MS Synthesis: Residual

LS Means Plot

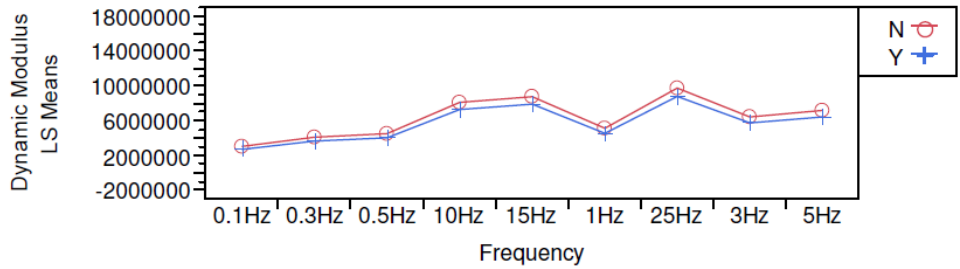

LSMeans Differences Tukey HSD

$\alpha = 0.050$ $Q = 3.49983$

Level	Least Sq Mean
N,25Hz	A 9751818.5
Y,25Hz	B 8821532.8
N,15Hz	B 8782194.4
N,10Hz	C 8119599.3
Y,15Hz	C 7931619.9
Y,10Hz	D 7292141.9
N,5Hz	D 7190414.7
N,3Hz	E 6456862.9
Y,5Hz	E 6456243.0
Y,3Hz	F 5776561.4
N,1Hz	G 5141003.9
Y,1Hz	H 4574615.3
N,0.5Hz	H 4528724.7
N,0.3Hz	I 4124920.8
Y,0.5Hz	I 4060516.6
Y,0.3Hz	J 3691307.6
N,0.1Hz	K 3066438.6
Y,0.1Hz	K 2716505.6

Levels not connected by same letter are significantly different.

Mix*COND*Frequency

Effect Test

Sum of Squares	F Ratio	DF	Prob > F
1.1517e+12	0.4615	8	0.8834

Denominator MS Synthesis: Residual

COMP*COND*Frequency

Effect Test

Sum of Squares	F Ratio	DF	Prob > F
----------------	---------	----	----------

Dynamic modulus statistical analysis for FM3 (Continued)**Response Dynamic Modulus****Effect Details****COMP*COND*Frequency****Effect Test**

Sum of Squares	F Ratio	DF	Prob > F
1.0252e+12	0.4108	8	0.9147

Denominator MS Synthesis: Residual

Mix*COMP*COND*Frequency**Effect Test**

Sum of Squares	F Ratio	DF	Prob > F
6.5431e+11	0.2622	8	0.9777

Denominator MS Synthesis: Residual

Temperature*COND*Frequency**Effect Test**

Sum of Squares	F Ratio	DF	Prob > F
3.3021e+12	0.6616	16	0.8331

Denominator MS Synthesis: Residual

Mix*Temperature*COND*Frequency**Effect Test**

Sum of Squares	F Ratio	DF	Prob > F
1.6075e+12	0.3221	16	0.9948

Denominator MS Synthesis: Residual

COMP*Temperature*COND*Frequency**Effect Test**

Sum of Squares	F Ratio	DF	Prob > F
1.7226e+12	0.3451	16	0.9923

Denominator MS Synthesis: Residual

Mix*COMP*Temperature*COND*Frequency**Effect Test**

Sum of Squares	F Ratio	DF	Prob > F
9.8747e+11	0.1978	16	0.9997

Denominator MS Synthesis: Residual

Sample**Number[Mix,COMP,COND]&Random****Effect Test**

Sum of Squares	F Ratio	DF	Prob > F
1.9066e+14	19.1002	32	<.0001*

Denominator MS Synthesis: Residual

FM4 Dynamic Modulus SPRM Log-Transformed Analysis

Response Dynamic Modulus

Summary of Fit

RSquare	0.994386
RSquare Adj	0.992509
Root Mean Square Error	573931.8
Mean of Response	8054663
Observations (or Sum Wgts)	971

Analysis of Variance

Source	DF	Sum of Squares	Mean Square	F Ratio
Model	243	4.2416e+16	1.746e+14	529.9079
Error	727	2.3947e+14	3.294e+11	Prob > F
C. Total	970	4.2655e+16		<.0001*

Variance Component Estimates

Component	Var Comp Est	Percent of Total
Sample Number[Mix,COMP,COND]&Random	1.3e+11	28.323
Residual	3.29e+11	71.677
Total	4.6e+11	100.000

These estimates based on equating Mean Squares to Expected Value.

Tests wrt Random Effects

Source	SS	MS Num	DF Num	F Ratio	Prob > F
Mix	9.7e+13	9.7e+13	1	25.2381	<.0001*
COMP	4.9e+11	4.9e+11	1	0.1267	0.7246
Mix*COMP	3.3e+13	3.3e+13	1	8.4991	0.0069*
COND	1.2e+14	1.2e+14	1	31.8736	<.0001*
Mix*COND	1.2e+13	1.2e+13	1	3.2487	0.0823
COMP*COND	9.8e+12	9.8e+12	1	2.5639	0.1205
Mix*COMP*COND	2.8e+12	2.8e+12	1	0.7228	0.4024
Temperature	3.4e+16	1.7e+16	2	51006.86	<.0001*
Mix*Temperature	3.4e+13	1.7e+13	2	51.0234	<.0001*
COMP*Temperature	4.6e+11	2.3e+11	2	0.6980	0.4979
Mix*COMP*Temperature	8.3e+12	4.2e+12	2	12.6661	<.0001*
Temperature*COND	6.1e+13	3.1e+13	2	93.2263	<.0001*
Mix*Temperature*COND	3.4e+13	1.7e+13	2	51.2290	<.0001*
COMP*Temperature*COND	1.1e+13	5.4e+12	2	16.2424	<.0001*
Mix*COMP*Temperature*COND	1.1e+12	5.7e+11	2	1.7455	0.1753
Frequency	5.3e+15	6.7e+14	8	2026.977	<.0001*
Mix*Frequency	8.4e+12	1e+12	8	3.1770	0.0015*
COMP*Frequency	1.5e+12	1.8e+11	8	0.5605	0.8106
Mix*COMP*Frequency	7.9e+12	9.9e+11	8	2.9999	0.0026*
Temperature*Frequency	9.9e+14	6.2e+13	16	187.6210	<.0001*
Mix*Temperature*Frequency	4.1e+12	2.6e+11	16	0.7751	0.7149
COMP*Temperature*Frequency	3.1e+12	2e+11	16	0.5946	0.8894
Mix*COMP*Temperature*Frequency	2.9e+12	1.8e+11	16	0.5554	0.9168
COND*Frequency	1.1e+13	1.3e+12	8	4.0893	<.0001*
Mix*COND*Frequency	3.4e+12	4.3e+11	8	1.3064	0.2368
COMP*COND*Frequency	2.4e+11	3e+10	8	0.0914	0.9994
Mix*COMP*COND*Frequency	3e+11	3.8e+10	8	0.1145	0.9987
Temperature*COND*Frequency	2.4e+12	1.5e+11	16	0.4485	0.9690
Mix*Temperature*COND*Frequency	5.6e+12	3.5e+11	16	1.0655	0.3848
COMP*Temperature*COND*Frequency	5.6e+11	3.5e+10	16	0.1057	1.0000
Mix*COMP*Temperature*COND*Frequency	8.5e+11	5.3e+10	16	0.1622	0.9999

FM4 Dynamic Modulus SPRM Log-Transformed Analysis (Continued)

Response Dynamic Modulus

Tests wrt Random Effects

Source	SS	MS	Num DF	Den DF	F Ratio	Prob > F
Sample Number[Mix,COMP,COND]&Random	1.1e+14	3.8e+12	28		11.6551	<.0001*

Effect Details

Mix

Effect Test

Sum of Squares	F Ratio	DF	Prob > F
9.6707e+13	25.2381	1	<.0001*

Denominator MS Synthesis: 0.9979*Sample Number[Mix,COMP,COND]&Random+0.0021*Residual

Least Squares Means Table

Level	Least Sq Mean	Std Error	Mean
HMA	7743419.9	84237.154	7743420
WMA	8390957.6	97560.523	8444620

LS Means Plot

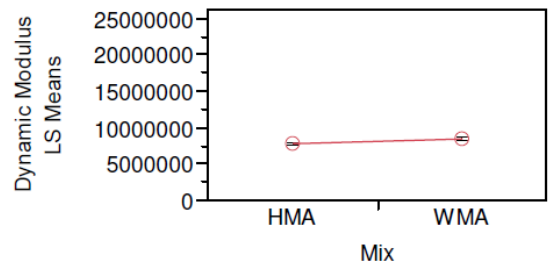

LSMeans Differences Student's t

$\alpha = 0.050$ $t = 2.04837$

Level	Least Sq Mean
WMA A	8390957.6
HMA B	7743419.9

Levels not connected by same letter are significantly different.

COMP

Effect Test

Sum of Squares	F Ratio	DF	Prob > F
4.8544e+11	0.1267	1	0.7246

Denominator MS Synthesis: 0.9979*Sample Number[Mix,COMP,COND]&Random+0.0021*Residual

Least Squares Means Table

Level	Least Sq Mean	Std Error	Mean
field	8044249.8	97560.523	8010230
lab	8090127.7	84237.154	8090128

LSMeans Differences Student's t

$\alpha = 0.050$ $t = 2.04837$

FM4 Dynamic Modulus SPRM Log-Transformed Analysis (Continued)

Response Dynamic Modulus

Effect Details

COMP

LSMeans Differences Student's t

Level	Least Sq Mean
lab A	8090127.7
field A	8044249.8

Levels not connected by same letter are significantly different.

Mix*COMP

Effect Test

Sum of Squares	F Ratio	DF	Prob > F
3.2567e+13	8.4991	1	0.0069*

Denominator MS Synthesis: 0.9979*Sample
Number[Mix,COMP,COND]&Random+0.0021*Residual

Least Squares Means Table

Level	Least Sq Mean	Std Error
HMA,field	7908365.8	119129.33
HMA,lab	7578473.9	119129.33
WMA,field	8180133.7	154532.93
WMA,lab	8601781.5	119129.33

LS Means Plot

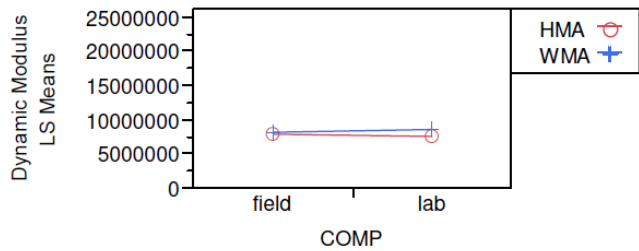

LSMeans Differences Tukey HSD

$\alpha = 0.050$ $Q = 2.73025$

Level	Least Sq Mean
WMA,lab A	8601781.5
WMA,field A B	8180133.7
HMA,field B C	7908365.8
HMA,lab C	7578473.9

Levels not connected by same letter are significantly different.

COND

Effect Test

Sum of Squares	F Ratio	DF	Prob > F
1.2213e+14	31.8736	1	<.0001*

Denominator MS Synthesis: 0.9979*Sample
Number[Mix,COMP,COND]&Random+0.0021*Residual

FM4 Dynamic Modulus SPRM Log-Transformed Analysis (Continued)

Response Dynamic Modulus

Effect Details

COMP*COND

Least Squares Means Table

Level	Least	
	Sq Mean	Std Error
field,N	8304905.5	138382.90
field,Y	7783594.1	137558.70
lab,N	8557171.9	119129.33
lab,Y	7623083.4	119129.33

Mix*COMP*COND

Effect Test

Sum of Squares	F Ratio	DF	Prob > F
2.7697e+12	0.7228	1	0.4024

Denominator MS Synthesis: 0.9979*Sample
Number[Mix,COMP,COND]&Random+0.0021*Resid

Least Squares Means Table

Level	Least	
	Sq Mean	Std Error
HMA,field,N	8107652.0	168474.31
HMA,field,Y	7709079.6	168474.31
HMA,lab,N	7874564.1	168474.31
HMA,lab,Y	7282383.6	168474.31
WMA,field,N	8502158.9	219580.78
WMA,field,Y	7858108.5	217499.40
WMA,lab,N	9239779.7	168474.31
WMA,lab,Y	7963783.2	168474.31

Temperature

Effect Test

Sum of Squares	F Ratio	DF	Prob > F
3.3603e+16	51006.86	2	<.0001*

Denominator MS Synthesis: Residual

Least Squares Means Table

Level	Least		Mean
	Sq Mean	Std Error	
21	6301104	32840.373	6284665.5
37	1730389	32672.505	1732802.1
4	16170073	32672.505	16141059

Mix*Temperature

Effect Test

Sum of Squares	F Ratio	DF	Prob > F
3.3614e+13	51.0234	2	<.0001*

Denominator MS Synthesis: Residual

Least Squares Means Table

Level	Least	
	Sq Mean	Std Error
HMA,21	5956549	42778.351

FM4 Dynamic Modulus SPRM Log-Transformed Analysis (Continued)

Response Dynamic Modulus

Effect Details

Mix*Temperature

Least Squares Means Table

Level	Sq Mean	Std Error
HMA,37	1649705	42778.351
HMA,4	15624006	42778.351
WMA,21	6645659	49839.474
WMA,37	1811074	49396.185
WMA,4	16716140	49396.185

LS Means Plot

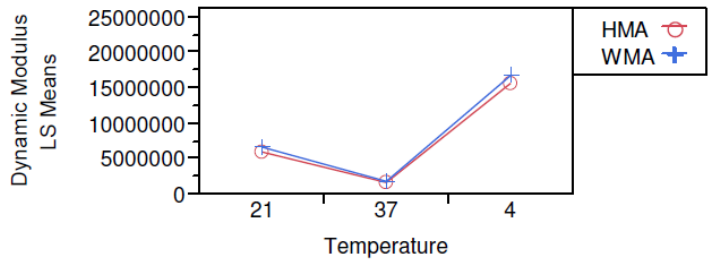

LSMeans Differences Tukey HSD

$\alpha = 0.050$ Q = 2.85735

Level	Least Sq Mean
WMA,4 A	16716140
HMA,4 B	15624006
WMA,21 C	6645659
HMA,21 D	5956549
WMA,37 E	1811074
HMA,37 E	1649705

Levels not connected by same letter are significantly different.

Mix*COMP*Temperature

Effect Test

Sum of Squares	F Ratio	DF	Prob > F
8.3444e+12	12.6661	2	<.0001*

Denominator MS Synthesis: Residual

Temperature*COND

Effect Test

Sum of Squares	F Ratio	DF	Prob > F
6.1417e+13	93.2263	2	<.0001*

Denominator MS Synthesis: Residual

Least Squares Means Table

Level	Sq Mean	Std Error
21,N	6656144	46679.495
21,Y	5946064	46205.900
37,N	1783271	46205.900

FM4 Dynamic Modulus SPRM Log-Transformed Analysis (Continued)

Response Dynamic Modulus

Effect Details

Temperature*COND

Least Squares Means Table

Level	Least Sq Mean	Std Error
37,Y	1677508	46205.900
4,N	16853701	46205.900
4,Y	15486444	46205.900

Mix*Temperature*COND

Effect Test

Sum of Squares	F Ratio	DF	Prob > F
3.3749e+13	51.2290	2	<.0001*

Denominator MS Synthesis: Residual

COMP*Temperature*COND

Effect Test

Sum of Squares	F Ratio	DF	Prob > F
1.07e+13	16.2424	2	<.0001*

Denominator MS Synthesis: Residual

LS Means Plot

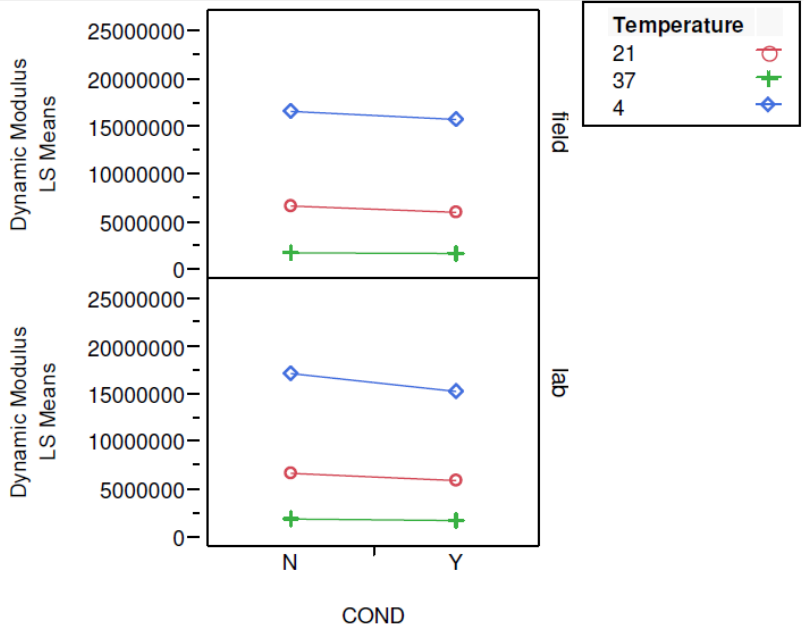

Frequency

Effect Test

Sum of Squares	F Ratio	DF	Prob > F
5.3415e+15	2026.977	8	<.0001*

Denominator MS Synthesis: Residual

FM4 Dynamic Modulus SPRM Log-Transformed Analysis (Continued)

Response Dynamic Modulus

Effect Details

Frequency

Least Squares Means Table

Level	Least Sq Mean	Std Error	Mean
0.1Hz	4364726	56590.439	4357073.9
0.3Hz	5619245	56590.439	5613947
0.5Hz	6059343	56590.439	6046073.4
10Hz	10018709	56590.439	10010744
15Hz	10867850	56590.439	10850984
1Hz	6684736	56590.439	6676554.6
25Hz	11780594	56590.439	11766387
3Hz	8221621	56590.439	8204001
5Hz	8987875	57458.293	8974723.3

Mix*Frequency

Effect Test

Sum of Squares	F Ratio	DF	Prob > F
8.372e+12	3.1770	8	0.0015*

Denominator MS Synthesis: Residual

LS Means Plot

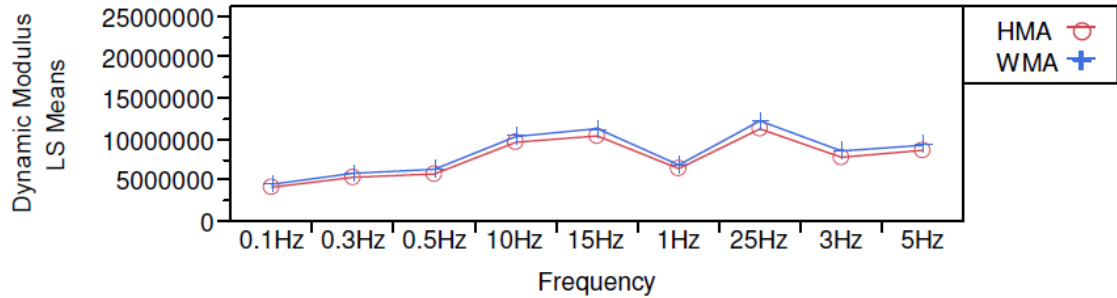

LSMeans Differences Tukey HSD

$\alpha = 0.050$ $Q = 3.50144$

FM4 Dynamic Modulus SPRM Log-Transformed Analysis (Continued)

Response Dynamic Modulus

Effect Details

Mix*Frequency

LSMeans Differences Tukey HSD

Level		Least Sq Mean
WMA,25Hz	A	12259679
WMA,15Hz	B	11311070
HMA,25Hz	B	11301508
HMA,15Hz	C	10424629
WMA,10Hz	C	10363357
HMA,10Hz	D	9674060
WMA,5Hz	D	9300838
HMA,5Hz	E	8674913
WMA,3Hz	E	8618577
HMA,3Hz	F	7824665
WMA,1Hz	G	6909103
HMA,1Hz	H	6460370
WMA,0.5Hz	H	6343397
WMA,0.3Hz	I	5862522
HMA,0.5Hz	I	5775289
HMA,0.3Hz	J	5375968
WMA,0.1Hz	K	4550074
HMA,0.1Hz	K	4179377

Levels not connected by same letter are significantly different.

COMP*Frequency

Effect Test

Sum of Squares	F Ratio	DF	Prob > F
1.4771e+12	0.5605	8	0.8106

Denominator MS Synthesis: Residual

Mix*COMP*Frequency

Effect Test

Sum of Squares	F Ratio	DF	Prob > F
7.9052e+12	2.9999	8	0.0026*

Denominator MS Synthesis: Residual

FM4 Dynamic Modulus SPRM Log-Transformed Analysis (Continued)

Response Dynamic Modulus
Effect Details
Mix*COMP*Frequency
LSMeans Differences Tukey HSD

Level		Least Sq Mean
WMA,lab,25Hz	A	12610906
WMA,field,25Hz	B	11908453
HMA,field,25Hz	B C	11633231
WMA,lab,15Hz	B C	11602495
WMA,field,15Hz	C D	11019646
HMA,lab,25Hz	D	10969784
HMA,field,15Hz	D E	10748119
WMA,lab,10Hz	D E F	10636324
HMA,lab,15Hz	F G	10101139
WMA,field,10Hz	E F G	10090391
HMA,field,10Hz	G H	9969597
WMA,lab,5Hz	H I	9416824
HMA,lab,10Hz	I	9378524
WMA,field,5Hz	I	9184852
HMA,field,5Hz	I J	8875089
WMA,lab,3Hz	I J	8856952
HMA,lab,5Hz	J	8474736
WMA,field,3Hz	J K	8380202
HMA,field,3Hz	K	7894149
HMA,lab,3Hz	K	7755182
WMA,lab,1Hz	L	7059834
WMA,field,1Hz	L M	6758371
HMA,field,1Hz	L M N	6567266
WMA,lab,0.5Hz	L M N	6508026
HMA,lab,1Hz	M N O	6353474
WMA,field,0.5Hz	M N O P	6178768
WMA,lab,0.3Hz	N O P Q	6058118
HMA,field,0.5Hz	O P Q R	5785863
HMA,lab,0.5Hz	P Q R	5764715
WMA,field,0.3Hz	P Q R	5666927
HMA,field,0.3Hz	Q R	5492226
HMA,lab,0.3Hz	R	5259709
WMA,lab,0.1Hz	S	4666555
WMA,field,0.1Hz	S	4433594
HMA,field,0.1Hz	S	4209752
HMA,lab,0.1Hz	S	4149003

Levels not connected by same letter are significantly different.

Temperature*Frequency
Effect Test

Sum of Squares	F Ratio	DF	Prob > F
9.8883e+14	187.6210	16	<.0001*
Denominator MS Synthesis: Residual			

FM4 Dynamic Modulus SPRM Log-Transformed Analysis (Continued)

Response Dynamic Modulus

Effect Details

Temperature*Frequency

LS Means Plot

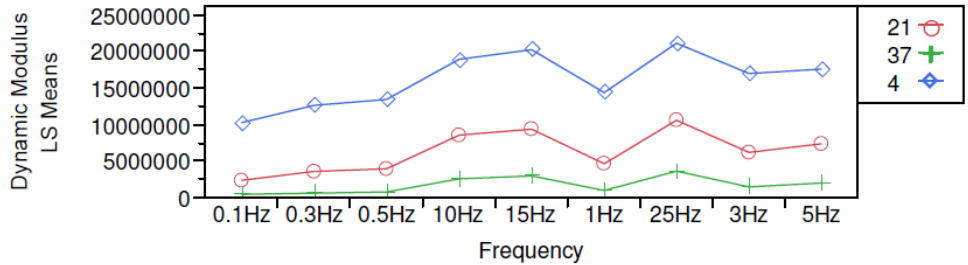

LSMeans Differences Tukey HSD

$\alpha = 0.050$ $Q = 3.71129$

Level	Least Sq Mean
4,25Hz	21109004
4,15Hz	20217359
4,10Hz	18920671
4,5Hz	17577151
4,3Hz	16983000
4,1Hz	14391072
4,0.5Hz	13454560
4,0.3Hz	12623528
21,25Hz	10607439
4,0.1Hz	10254308
21,15Hz	9388213
21,10Hz	8559245
21,5Hz	7377665
21,3Hz	6201188
21,1Hz	4665616
21,0.5Hz	3951194
37,25Hz	3625337
21,0.3Hz	3587720
37,15Hz	2997977
37,10Hz	2576210
21,0.1Hz	2371657
37,5Hz	2008810
37,3Hz	1480675
37,1Hz	997521
37,0.5Hz	772274
37,0.3Hz	646487
37,0.1Hz	468213

Levels not connected by same letter are significantly different.

Mix*Temperature*Frequency

Effect Test

Sum of Squares	F Ratio	DF	Prob > F
4.0852e+12	0.7751	16	0.7149

Denominator MS Synthesis: Residual

Response Dynamic Modulus

Effect Details

COMP*Temperature*Frequency

Effect Test

Sum of Squares	F Ratio	DF	Prob > F
3.1336e+12	0.5946	16	0.8894

Denominator MS Synthesis: Residual

Mix*COMP*Temperature*Frequency

Effect Test

Sum of Squares	F Ratio	DF	Prob > F
2.9271e+12	0.5554	16	0.9168

Denominator MS Synthesis: Residual

COND*Frequency

Effect Test

Sum of Squares	F Ratio	DF	Prob > F
1.0776e+13	4.0893	8	<.0001*

Denominator MS Synthesis: Residual

LS Means Plot

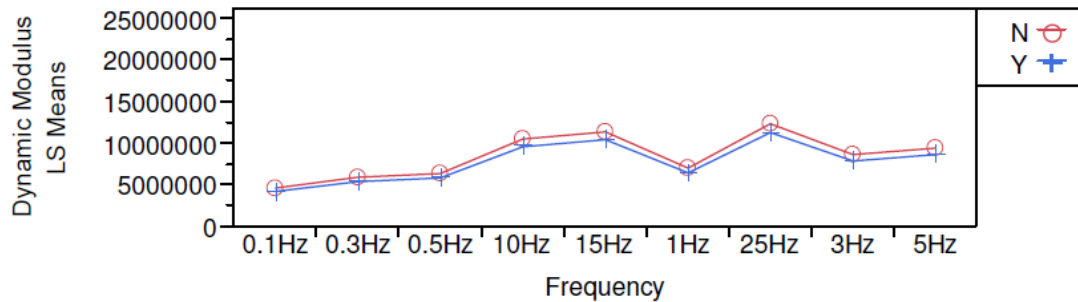

LSMeans Differences Tukey HSD

$\alpha = 0.050$ $Q = 3.50144$

Response Dynamic Modulus

Effect Details

COND*Frequency

LSMeans Differences Tukey HSD

Level		Least Sq Mean
N,25Hz	A	12308695
N,15Hz	B	11336104
Y,25Hz	B	11252492
N,10Hz	C	10489967
Y,15Hz	C	10399596
Y,10Hz	D	9547451
N,5Hz	D	9387231
N,3Hz	E	8607264
Y,5Hz	E	8588519
Y,3Hz	F	7835978
N,1Hz	G	6983568
Y,1Hz	H	6385904
N,0.5Hz	H	6336826
N,0.3Hz	I	5875364
Y,0.5Hz	I	5781860
Y,0.3Hz	J	5363126
N,0.1Hz	K	4554330
Y,0.1Hz	K	4175122

Levels not connected by same letter are significantly different.

Mix*COND*Frequency

Effect Test

Sum of Squares	F Ratio	DF	Prob > F
3.4425e+12	1.3064	8	0.2368

Denominator MS Synthesis: Residual

COMP*COND*Frequency

Effect Test

Sum of Squares	F Ratio	DF	Prob > F
2.4093e+11	0.0914	8	0.9994

Denominator MS Synthesis: Residual

Mix*COMP*COND*Frequency

Effect Test

Sum of Squares	F Ratio	DF	Prob > F
3.0164e+11	0.1145	8	0.9987

Denominator MS Synthesis: Residual

Temperature*COND*Frequency

Effect Test

Sum of Squares	F Ratio	DF	Prob > F
2.364e+12	0.4485	16	0.9690

Denominator MS Synthesis: Residual

Response Dynamic Modulus

Effect Details

Mix*Temperature*COND*Frequency

Effect Test

Sum of Squares	F Ratio	DF	Prob > F
5.6156e+12	1.0655	16	0.3848

Denominator MS Synthesis: Residual

COMP*Temperature*COND*Frequency

Effect Test

Sum of Squares	F Ratio	DF	Prob > F
5.5693e+11	0.1057	16	1.0000

Denominator MS Synthesis: Residual

Mix*COMP*Temperature*COND*Frequency

Effect Test

Sum of Squares	F Ratio	DF	Prob > F
8.5485e+11	0.1622	16	0.9999

Denominator MS Synthesis: Residual

Sample

Number[Mix,COMP,COND]&Random

Effect Test

Sum of Squares	F Ratio	DF	Prob > F
1.075e+14	11.6551	28	<.0001*

Denominator MS Synthesis: Residual

Field Mix 5 Dynamic Modulus Analysis**Response SQRT(Dynamic Modulus)
Summary of Fit**

RSquare	0.998733
RSquare Adj	0.99825
Root Mean Square Error	1.26375
Mean of Response	69.28153
Observations (or Sum Wgts)	432

Analysis of Variance

Source	DF	Sum of Squares	Mean Square	F Ratio	Prob > F
Model	119	392748.27	3300.41	2066.547	
Error	312	498.28	1.60	Prob > F	
C. Total	431	393246.55		<.0001*	

Tests wrt Random Effects

Source	SS	MS Num	DF Num	F Ratio	Prob > F
COMP	17.6261	17.6261	1	0.3191	0.5826
Moisture Conditioned	3814.88	3814.88	1	69.0616	<.0001*
COMP*Moisture Conditioned	61.7475	61.7475	1	1.1178	0.3112
Temperature	294918	147459	2	92331.47	<.0001*
COMP*Temperature	111.206	55.6032	2	34.8159	<.0001*
Temperature*Moisture Conditioned	109.348	54.6739	2	34.2341	<.0001*
COMP*Temperature*Moisture Conditioned	24.5643	12.2821	2	7.6905	0.0005*
Frequency	70413.8	8801.72	8	5511.193	<.0001*
COMP*Frequency	0.32423	0.04053	8	0.0254	1.0000
Temperature*Frequency	502.897	31.4311	16	19.6805	<.0001*
COMP*Temperature*Frequency	2.39207	0.1495	16	0.0936	1.0000
Moisture Conditioned*Frequency	43.9395	5.49244	8	3.4391	0.0008*
COMP*Moisture Conditioned*Frequency	7.99873	0.99984	8	0.6260	0.7558
Temperature*Moisture Conditioned*Frequency	15.0499	0.94062	16	0.5890	0.8918
COMP*Temperature*Moisture Conditioned*Frequency	1.86693	0.11668	16	0.0731	1.0000
Sample Number[COMP,Moisture Conditioned]&Random	662.866	55.2388	12	34.5878	<.0001*

Effect Details**COMP****Effect Test**

Sum of Squares	F Ratio	DF	Prob > F
17.626117	0.3191	1	0.5826

Denominator MS Synthesis:

Sample Number[COMP,Moisture Conditioned]&Random

Least Squares Means Table

Level	Least Sq Mean	Std Error	Mean
Field	69.020758	0.58393531	69.0208
Lab	69.437993	0.45231435	69.4380

Field Mix 5 Dynamic Modulus Analysis (Continued)

**Moisture Conditioned
Effect Test**

Sum of Squares	F Ratio	DF	Prob > F
3814.8828	69.0616	1	<.0001*

Denominator MS Synthesis:
Sample Number[COMP,Moisture Conditioned]&Random

Least Squares Means Table

Level	Least Sq Mean	Std Error	Mean
N	72.298490	0.52228762	72.4483
Y	66.160261	0.52228762	66.1148

LSMeans Differences Student's t

$\alpha =$
0.050 t=
2.17881

LSMean[i] By LSMean[j]

Mean[i]-Mean[j]	N	Y
Std Err Dif		
Lower CL Dif		
Upper CL Dif		
N	0	6.13823
	0	0.73863
	0	4.5289
	0	7.74756
Y	-6.1382	0
	0.73863	0
	-7.7476	0
	-4.5289	0

Level	Least Sq Mean
N A	72.298490
Y B	66.160261

Levels not connected by same letter are significantly different.

**COMP*Moisture Conditioned
Effect Test**

Sum of Squares	F Ratio	DF	Prob > F
61.747474	1.1178	1	0.3112

Denominator MS Synthesis:
Sample Number[COMP,Moisture Conditioned]&Random

Least Squares Means Table

Level	Least Sq Mean	Std Error
Field,N	71.699408	0.82580924
Field,Y	66.342109	0.82580924
Lab,N	72.897573	0.63966908
Lab,Y	65.978414	0.63966908

Field Mix 5 Dynamic Modulus Analysis (Continued)

**Temperature
Effect Test**

Sum of Squares	F Ratio	DF	Prob > F
294918.36	92331.47	2	<.0001*

Denominator MS Synthesis:
Residual

Least Squares Means Table

Level	Least Sq Mean	Std Error	Mean
21	67.35160	0.10876625	67.365
37	37.15848	0.10876625	37.387
4	103.17804	0.10876625	103.093

LSMeans Differences Tukey HSD

$\alpha =$
0.050 Q=
2.35503

LSMean[i] By LSMean[j]

Mean[i]-Mean[j]	21	37	4
Std Err Dif			
Lower CL Dif			
Upper CL Dif			
21	0	30.1931	-35.826
	0	0.15382	0.15382
	0	29.8309	-36.189
	0	30.5554	-35.464
37	-30.193	0	-66.02
	0.15382	0	0.15382
	-30.555	0	-66.382
	-29.831	0	-65.657
4	35.8264	66.0196	0
	0.15382	0.15382	0
	35.4642	65.6573	0
	36.1887	66.3818	0

Level		Least Sq Mean
4	A	103.17804
21	B	67.35160
37	C	37.15848

Levels not connected by same letter are significantly different.

**COMP*Temperature
Effect Test**

Sum of Squares	F Ratio	DF	Prob > F
111.20639	34.8159	2	<.0001*

Denominator MS Synthesis:
Residual

Field Mix 5 Dynamic Modulus Analysis (Continued)**Least Squares Means Table**

Level	Least Sq Mean	Std Error
Field,21	67.29979	0.17197454
Field,37	36.24422	0.17197454
Field,4	103.51827	0.17197454
Lab,21	67.40342	0.13321090
Lab,37	38.07274	0.13321090
Lab,4	102.83782	0.13321090

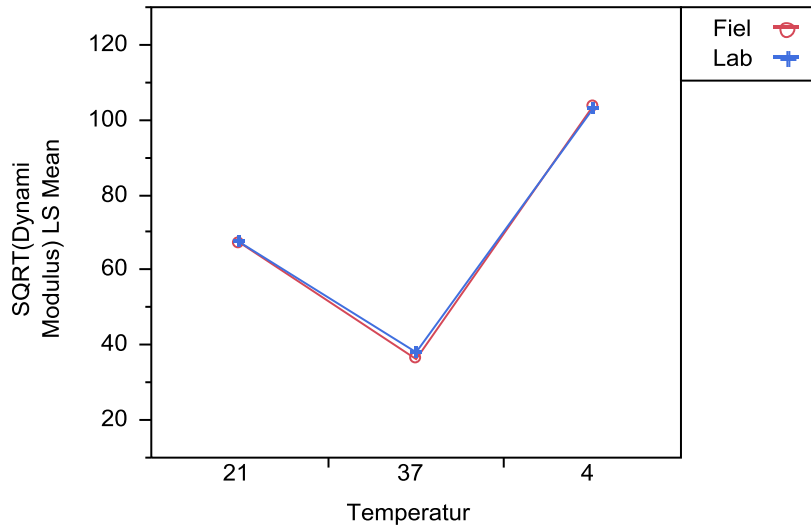
LS Means Plot

Field Mix 5 Dynamic Modulus Analysis (Continued)

LSMeans Differences Tukey HSD

$\alpha=0.050$ $Q=2.86752$

LSMean[i] By LSMean[j]

Mean[i]-Mean[j] Std Err Dif Lower CL Dif Upper CL Dif	Field,21	Field,37	Field,4	Lab,21	Lab,37	Lab,4
Field,21	0 0 0 0	31.0556 0.24321 30.3582 31.753	-36.218 0.24321 -36.916 -35.521	-0.1036 0.21753 -0.7274 0.52015	29.227 0.21753 28.6033 29.8508	-35.538 0.21753 -36.162 -34.914
Field,37	-31.056 0.24321 -31.753 -30.358	0 0 0 0	-67.274 0.24321 -67.971 -66.577	-31.159 0.21753 -31.783 -30.535	-1.8285 0.21753 -2.4523 -1.2047	-66.594 0.21753 -67.217 -65.97
Field,4	36.2185 0.24321 35.5211 36.9159	67.2741 0.24321 66.5766 67.9715	0 0 0 0	36.1149 0.21753 35.4911 36.7386	65.4455 0.21753 64.8217 66.0693	0.68045 0.21753 0.05667 1.30423
Lab,21	0.10363 0.21753 -0.5202 0.72741	31.1592 0.21753 30.5354 31.783	-36.115 0.21753 -36.739 -35.491	0 0 0 0	29.3307 0.18839 28.7905 29.8709	-35.434 0.18839 -35.975 -34.894
Lab,37	-29.227 0.21753 -29.851 -28.603	1.82853 0.21753 1.20475 2.45231	-65.446 0.21753 -66.069 -64.822	-29.331 0.18839 -29.871 -28.79	0 0 0 0	-64.765 0.18839 -65.305 -64.225
Lab,4	35.538 0.21753 34.9142 36.1618	66.5936 0.21753 65.9698 67.2174	-0.6804 0.21753 -1.3042 -0.0567	35.4344 0.18839 34.8942 35.9746	64.7651 0.18839 64.2249 65.3053	0 0 0 0

Level		Least Sq Mean
Field,4	A	103.51827
Lab,4	B	102.83782
Lab,21	C	67.40342
Field,21	C	67.29979
Lab,37	D	38.07274
Field,37	E	36.24422

Levels not connected by same letter are significantly different.

Temperature*Moisture Conditioned

Effect Test

Sum of Squares	F Ratio	DF	Prob > F
109.34787	34.2341	2	<.0001*

Denominator MS Synthesis:

Residual

Field Mix 5 Dynamic Modulus Analysis (Continued)

Least Squares Means Table

Level	Least Sq Mean	Std Error
21,N	70.14152	0.15381870
21,Y	64.56168	0.15381870
37,N	39.77852	0.15381870
37,Y	34.53844	0.15381870
4,N	106.97542	0.15381870
4,Y	99.38066	0.15381870

LS Means Plot

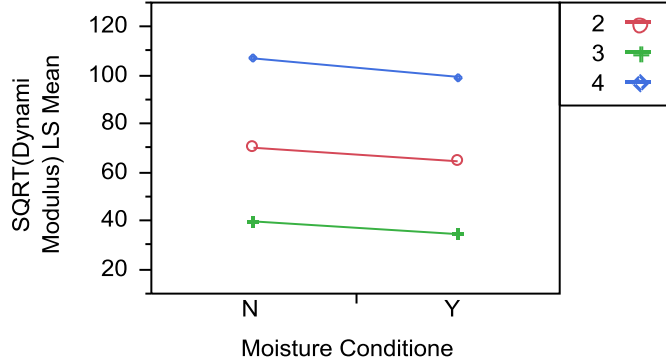

LSMeans Differences Tukey HSD

$\alpha=0.050$ $Q=2.86752$

LSMean[i] By LSMean[j]

Mean[i]-Mean[j] Std Err Dif Lower CL Dif Upper CL Dif	21,N	21,Y	37,N	37,Y	4,N	4,Y
21,N	0	5.57984	30.363	35.6031	-36.834	-29.239
	0	0.21753	0.21753	0.21753	0.21753	0.21753
	0	4.95606	29.7392	34.9793	-37.458	-29.863
	0	6.20362	30.9868	36.2269	-36.21	-28.615
21,Y	-5.5798	0	24.7832	30.0232	-42.414	-34.819
	0.21753	0	0.21753	0.21753	0.21753	0.21753
	-6.2036	0	24.1594	29.3995	-43.038	-35.443
	-4.9561	0	25.4069	30.647	-41.79	-34.195
37,N	-30.363	-24.783	0	5.24009	-67.197	-59.602
	0.21753	0.21753	0	0.21753	0.21753	0.21753
	-30.987	-25.407	0	4.61631	-67.821	-60.226
	-29.739	-24.159	0	5.86387	-66.573	-58.978
37,Y	-35.603	-30.023	-5.2401	0	-72.437	-64.842
	0.21753	0.21753	0.21753	0	0.21753	0.21753
	-36.227	-30.647	-5.8639	0	-73.061	-65.466
	-34.979	-29.399	-4.6163	0	-71.813	-64.218
4,N	36.8339	42.4137	67.1969	72.437	0	7.59476
	0.21753	0.21753	0.21753	0.21753	0	0.21753
	36.2101	41.79	66.5731	71.8132	0	6.97098
	37.4577	43.0375	67.8207	73.0608	0	8.21854
4,Y	29.2391	34.819	59.6021	64.8422	-7.5948	0
	0.21753	0.21753	0.21753	0.21753	0.21753	0
	28.6154	34.1952	58.9784	64.2184	-8.2185	0
	29.8629	35.4428	60.2259	65.466	-6.971	0

Field Mix 5 Dynamic Modulus Analysis (Continued)

Level		Least Sq Mean
4,N	A	106.97542
4,Y	B	99.38066
21,N	C	70.14152
21,Y	D	64.56168
37,N	E	39.77852
37,Y	F	34.53844

Levels not connected by same letter are significantly different.

COMP*Temperature*Moisture Conditioned**Effect Test**

Sum of Squares	F Ratio	DF	Prob > F
24.564274	7.6905	2	0.0005*

Denominator MS Synthesis:

Residual

Least Squares Means Table

Level	Least Sq Mean	Std Error
Field,21,N	69.89626	0.24320872
Field,21,Y	64.70332	0.24320872
Field,37,N	38.12656	0.24320872
Field,37,Y	34.36188	0.24320872
Field,4,N	107.07541	0.24320872
Field,4,Y	99.96113	0.24320872
Lab,21,N	70.38679	0.18838867
Lab,21,Y	64.42004	0.18838867
Lab,37,N	41.43049	0.18838867
Lab,37,Y	34.71500	0.18838867
Lab,4,N	106.87544	0.18838867
Lab,4,Y	98.80020	0.18838867

Field Mix 5 Dynamic Modulus Analysis (Continued)

LS Means Plot

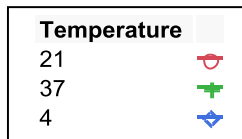
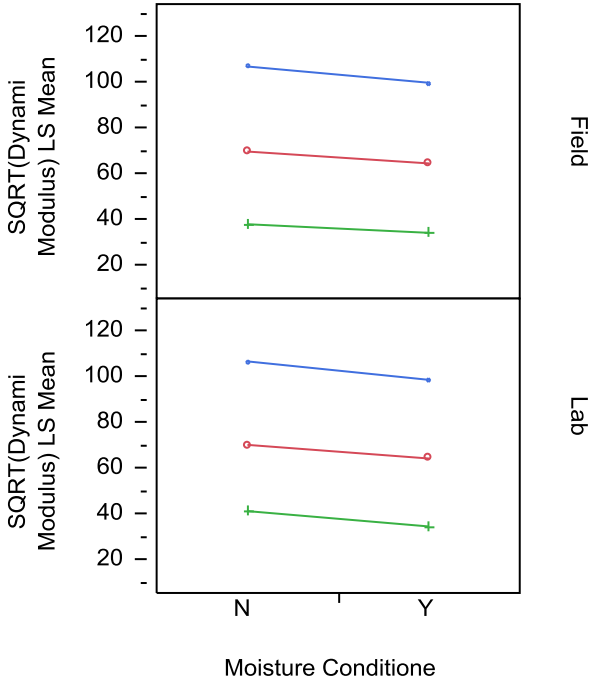

Frequency

Effect Test

Sum of Squares	F Ratio	DF	Prob > F
70413.783	5511.193	8	<.0001*

Denominator MS Synthesis:
Residual

Least Squares Means Table

Level	Least Sq Mean	Std Error	Mean
0.1 Hz	49.046817	0.18838867	49.0846
0.2 Hz	53.284974	0.18838867	53.3316
0.5 Hz	59.141239	0.18838867	59.1908
1 Hz	63.744378	0.18838867	63.7995
10 Hz	80.441152	0.18838867	80.4989
2 Hz	68.755603	0.18838867	68.8075
20 Hz	85.731225	0.18838867	85.7814
25 Hz	87.539968	0.18838867	87.6043
5 Hz	75.379027	0.18838867	75.4351

Field Mix 5 Dynamic Modulus Analysis (Continued)**COMP*Frequency****Effect Test**

Sum of Squares	F Ratio	DF	Prob > F
0.32423171	0.0254	8	1.0000

Denominator MS Synthesis:
Residual

Temperature*Frequency**Effect Test**

Sum of Squares	F Ratio	DF	Prob > F
502.89692	19.6805	16	<.0001*

Denominator MS Synthesis:
Residual

COMP*Temperature*Frequency**Effect Test**

Sum of Squares	F Ratio	DF	Prob > F
2.3920713	0.0936	16	1.0000

Denominator MS Synthesis:
Residual

Moisture Conditioned*Frequency**Effect Test**

Sum of Squares	F Ratio	DF	Prob > F
43.939511	3.4391	8	0.0008*

Denominator MS Synthesis:
Residual

Field Mix 5 Dynamic Modulus Analysis (Continued)

Least Squares Means Table

Level	Least Sq Mean	Std Error
N,0.1 Hz	51.533839	0.26642181
N,0.2 Hz	55.952972	0.26642181
N,0.5 Hz	62.012417	0.26642181
N,1 Hz	66.741409	0.26642181
N,10 Hz	83.771982	0.26642181
N,2 Hz	71.852329	0.26642181
N,20 Hz	89.158100	0.26642181
N,25 Hz	91.072431	0.26642181
N,5 Hz	78.590935	0.26642181
Y,0.1 Hz	46.559795	0.26642181
Y,0.2 Hz	50.616976	0.26642181
Y,0.5 Hz	56.270061	0.26642181
Y,1 Hz	60.747347	0.26642181
Y,10 Hz	77.110323	0.26642181
Y,2 Hz	65.658876	0.26642181
Y,20 Hz	82.304349	0.26642181
Y,25 Hz	84.007504	0.26642181
Y,5 Hz	72.167120	0.26642181

LS Means Plot

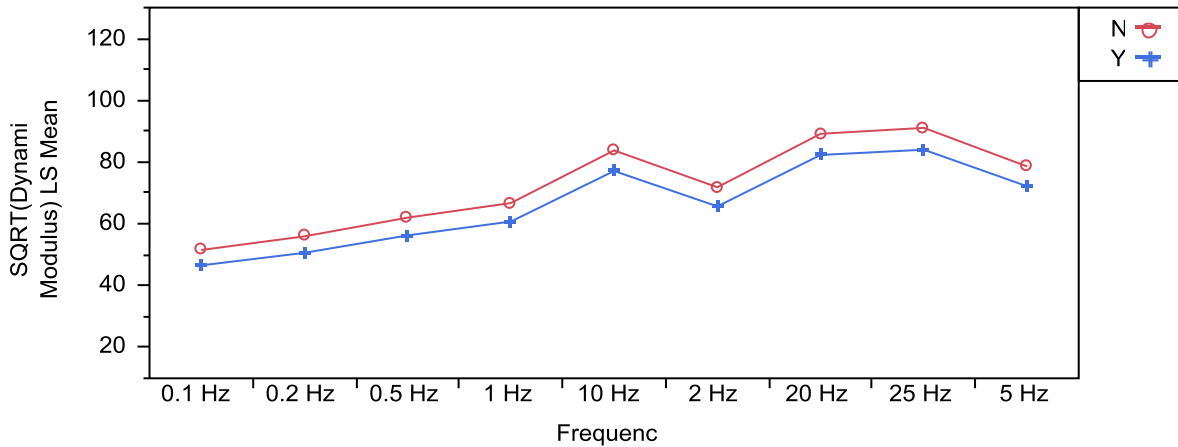

Field Mix 5 Dynamic Modulus Analysis (Continued)

LSMeans Differences Tukey HSD

$\alpha=0.050$ $Q=3.51844$

Level		Least Sq Mean
N,25 Hz	A	91.072431
N,20 Hz	B	89.158100
Y,25 Hz	C	84.007504
N,10 Hz	C	83.771982
Y,20 Hz	D	82.304349
N,5 Hz	E	78.590935
Y,10 Hz	F	77.110323
Y,5 Hz	G	72.167120
N,2 Hz	G	71.852329
N,1 Hz	H	66.741409
Y,2 Hz	H	65.658876
N,0.5 Hz	I	62.012417
Y,1 Hz	I	60.747347
Y,0.5 Hz	J	56.270061
N,0.2 Hz	J	55.952972
N,0.1 Hz	K	51.533839
Y,0.2 Hz	K	50.616976
Y,0.1 Hz	L	46.559795

Levels not connected by same letter are significantly different.

COMP*Moisture Conditioned*Frequency

Effect Test

Sum of Squares	F Ratio	DF	Prob > F
7.9987291	0.6260	8	0.7558

Denominator MS Synthesis:
Residual

Field Mix 5 Dynamic Modulus Analysis (Continued)**Least Squares Means Table**

Level	Least Sq Mean	Std Error
Field,N,0.1 Hz	51.191586	0.42124987
Field,N,0.2 Hz	55.547998	0.42124987
Field,N,0.5 Hz	61.518518	0.42124987
Field,N,1 Hz	66.172492	0.42124987
Field,N,10 Hz	83.057577	0.42124987
Field,N,2 Hz	71.273142	0.42124987
Field,N,20 Hz	88.434894	0.42124987
Field,N,25 Hz	90.160850	0.42124987
Field,N,5 Hz	77.937613	0.42124987
Field,Y,0.1 Hz	46.599510	0.42124987
Field,Y,0.2 Hz	50.648628	0.42124987
Field,Y,0.5 Hz	56.367467	0.42124987
Field,Y,1 Hz	60.875196	0.42124987
Field,Y,10 Hz	77.362353	0.42124987
Field,Y,2 Hz	65.822975	0.42124987
Field,Y,20 Hz	82.626453	0.42124987
Field,Y,25 Hz	84.404664	0.42124987
Field,Y,5 Hz	72.371733	0.42124987
Lab,N,0.1 Hz	51.876091	0.32629874
Lab,N,0.2 Hz	56.357945	0.32629874
Lab,N,0.5 Hz	62.506316	0.32629874
Lab,N,1 Hz	67.310327	0.32629874
Lab,N,10 Hz	84.486387	0.32629874
Lab,N,2 Hz	72.431515	0.32629874
Lab,N,20 Hz	89.881306	0.32629874
Lab,N,25 Hz	91.984012	0.32629874
Lab,N,5 Hz	79.244256	0.32629874
Lab,Y,0.1 Hz	46.520080	0.32629874
Lab,Y,0.2 Hz	50.585324	0.32629874
Lab,Y,0.5 Hz	56.172654	0.32629874
Lab,Y,1 Hz	60.619499	0.32629874
Lab,Y,10 Hz	76.858293	0.32629874
Lab,Y,2 Hz	65.494778	0.32629874
Lab,Y,20 Hz	81.982245	0.32629874
Lab,Y,25 Hz	83.610345	0.32629874
Lab,Y,5 Hz	71.962507	0.32629874

Temperature*Moisture Conditioned*Frequency**Effect Test**

Sum of Squares	F Ratio	DF	Prob > F
15.049945	0.5890	16	0.8918

Denominator MS Synthesis:

Residual

COMP*Temperature*Moisture Conditioned*Frequency**Effect Test**

Sum of Squares	F Ratio	DF	Prob > F
1.8669252	0.0731	16	1.0000

Denominator MS Synthesis:

Residual

Field Mix 5 Dynamic Modulus Analysis (Continued)**Sample Number[COMP,Moisture Conditioned]&Random Effect Test**

Sum of Squares	F Ratio	DF	Prob > F
662.86599	34.5878	12	<.0001*

Denominator MS Synthesis:

Residual

Least Squares Means Table

Level	Least Sq Mean	Std Error
[Field,N]1	70.701760	0.24320872
[Field,N]3	71.883422	0.24320872
[Field,N]7	72.513042	0.24320872
[Field,Y]2	66.267242	0.24320872
[Field,Y]4	65.265234	0.24320872
[Field,Y]5	67.493851	0.24320872
[Lab,N]101	73.722493	0.24320872
[Lab,N]102	69.894587	0.24320872
[Lab,N]105	72.858551	0.24320872
[Lab,N]107	73.362794	0.24320872
[Lab,N]109	74.649439	0.24320872
[Lab,Y]103	66.401057	0.24320872
[Lab,Y]104	65.220234	0.24320872
[Lab,Y]106	64.079895	0.24320872
[Lab,Y]108	66.581189	0.24320872
[Lab,Y]110	67.609694	0.24320872

FM7 Dyanmic Modulus Analysis**Response SQRT(Dynamic Modulus)
Summary of Fit**

RSquare	0.99351
RSquare Adj	0.992079
Root Mean Square Error	2.742956
Mean of Response	62.21428
Observations (or Sum Wgts)	1080

Analysis of Variance

Source	DF	Sum of Squares	Mean Square	F Ratio
Model	195	1018207.8	5221.58	694.0073
Error	884	6651.0	7.52	Prob > F
C. Total	1079	1024858.9		<.0001*

Tests wrt Random Effects

Source	SS	MS Num	DF Num	F Ratio	Prob > F
Mix	4907.53	2453.77	2	9.6110	0.0005*
Moisture Conditioned	2375.36	2375.36	1	9.3039	0.0044*
Mix*Moisture Conditioned	1153.48	576.739	2	2.2590	0.1199
Temperature	675294	337647	2	44877.11	<.0001*
Mix*Temperature	7088.05	1772.01	4	235.5206	<.0001*
Temperature*Moisture Conditioned	522.342	261.171	2	34.7126	<.0001*
Mix*Temperature*Moisture Conditioned	960.185	240.046	4	31.9049	<.0001*
Frequency	153365	19170.6	8	2547.997	<.0001*
Mix*Frequency	3155.95	197.247	16	26.2164	<.0001*
Temperature*Frequency	2011.74	125.734	16	16.7114	<.0001*
Mix*Temperature*Frequency	311.514	9.73481	32	1.2939	0.1290
Moisture Conditioned*Frequency	83.1208	10.3901	8	1.3810	0.2008
Mix*Moisture Conditioned*Frequency	15.9008	0.9938	16	0.1321	1.0000
Temperature*Moisture Conditioned*Frequency	25.1197	1.56998	16	0.2087	0.9996
Mix*Temperature*Moisture Conditioned*Frequency	16.2328	0.50728	32	0.0674	1.0000
Sample Name[Mix,Moisture Conditioned]&Random	8680.49	255.309	34	33.9334	<.0001*

Effect Details**Mix****Effect Test**

Sum of Squares	F Ratio	DF	Prob > F
4907.5316	9.6110	2	0.0005*

Denominator MS Synthesis:

Sample Name[Mix,Moisture Conditioned]&Random

Least Squares Means Table

Level	Least Sq Mean	Std Error	Mean
FM7-0	64.290804	0.68759998	64.2908
FM7-5	59.456483	0.97241321	59.4565
FM7-7	60.819040	0.97241321	60.8190

FM7 Dyanmic Modulus Analysis (Continued)

LS Means Plot

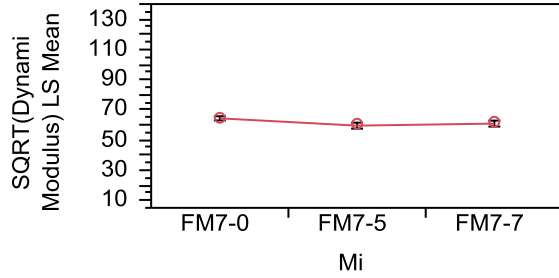

Moisture Conditioned

Effect Test

Sum of Squares	F Ratio	DF	Prob > F
2375.3597	9.3039	1	0.0044*

Denominator MS Synthesis:

Sample Name[Mix,Moisture Conditioned]&Random

Least Squares Means Table

Level	Least Sq Mean	Std Error	Mean
N	63.085370	0.72479401	63.9136
Y	59.958848	0.72479401	60.5150

LS Means Plot

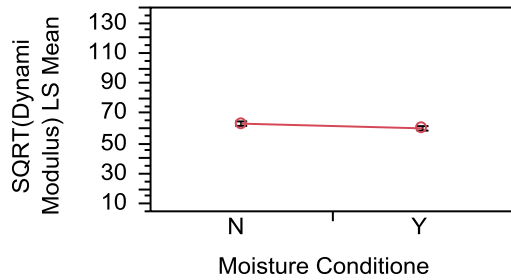

Mix*Moisture Conditioned

Effect Test

Sum of Squares	F Ratio	DF	Prob > F
1153.4770	2.2590	2	0.1199

Denominator MS Synthesis:

Sample Name[Mix,Moisture Conditioned]&Random

Least Squares Means Table

Level	Least Sq Mean	Std Error
FM7-0,N	66.398308	0.9724132
FM7-0,Y	62.183300	0.9724132
FM7-5,N	62.090323	1.3752000
FM7-5,Y	56.822642	1.3752000
FM7-7,N	60.767480	1.3752000
FM7-7,Y	60.870600	1.3752000

FM7 Dyanmic Modulus Analysis (Continued)

LS Means Plot

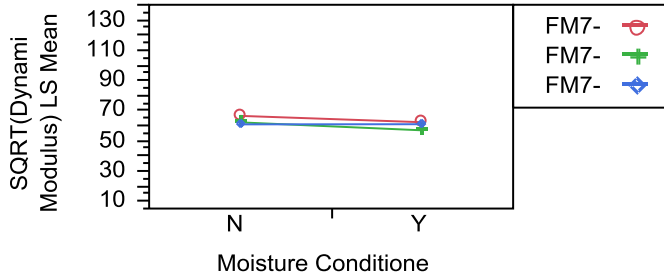

Temperature

Effect Test

Sum of Squares	F Ratio	DF	Prob > F
675293.66	44877.11	2	<.0001*

Denominator MS Synthesis:
Residual

Least Squares Means Table

Level	Least Sq Mean	Std Error	Mean
21	58.594082	0.15238646	59.1519
37	30.803987	0.15238646	30.5308
4	95.168258	0.15238646	96.9601

Mix*Temperature

Effect Test

Sum of Squares	F Ratio	DF	Prob > F
7088.0475	235.5206	4	<.0001*

Denominator MS Synthesis:
Residual

Least Squares Means Table

Level	Least Sq Mean	Std Error
FM7-0,21	60.82529	0.20444789
FM7-0,37	29.71130	0.20444789
FM7-0,4	102.33582	0.20444789
FM7-5,21	57.14019	0.28913298
FM7-5,37	30.08910	0.28913298
FM7-5,4	91.14015	0.28913298
FM7-7,21	57.81676	0.28913298
FM7-7,37	32.61156	0.28913298
FM7-7,4	92.02879	0.28913298

FM7 Dyanmic Modulus Analysis (Continued)

LS Means Plot

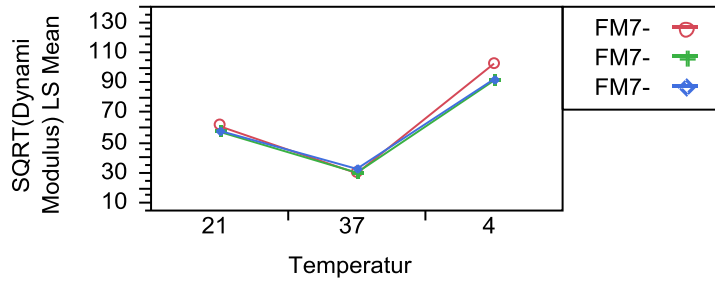

Temperature*Moisture Conditioned Effect Test

Sum of Squares	F Ratio	DF	Prob > F
522.34220	34.7126	2	<.0001*

Denominator MS Synthesis:
Residual

Least Squares Means Table

Level	Least Sq Mean	Std Error
21,N	60.313458	0.21550700
21,Y	56.874705	0.21550700
37,N	31.401607	0.21550700
37,Y	30.206367	0.21550700
4,N	97.541046	0.21550700
4,Y	92.795471	0.21550700

FM7 Dyanmic Modulus Analysis (Continued)**LSMeans Differences Student's t** $\alpha=0.050$ $t=1.96265$

LSMean[i] By LSMean[j]

Mean[i]-Mean[j] Std Err Dif Lower CL Dif Upper CL Dif	21,N	21,Y	37,N	37,Y	4,N	4,Y
21,N	0	3.43875	28.9119	30.1071	-37.228	-32.482
	0	0.30477	0.30477	0.30477	0.30477	0.30477
	0	2.84059	28.3137	29.5089	-37.826	-33.08
	0	4.03692	29.51	30.7053	-36.629	-31.884
21,Y	-3.4388	0	25.4731	26.6683	-40.666	-35.921
	0.30477	0	0.30477	0.30477	0.30477	0.30477
	-4.0369	0	24.8749	26.0702	-41.265	-36.519
	-2.8406	0	26.0713	27.2665	-40.068	-35.323
37,N	-28.912	-25.473	0	1.19524	-66.139	-61.394
	0.30477	0.30477	0	0.30477	0.30477	0.30477
	-29.51	-26.071	0	0.59708	-66.738	-61.992
	-28.314	-24.875	0	1.7934	-65.541	-60.796
37,Y	-30.107	-26.668	-1.1952	0	-67.335	-62.589
	0.30477	0.30477	0.30477	0	0.30477	0.30477
	-30.705	-27.267	-1.7934	0	-67.933	-63.187
	-29.509	-26.07	-0.5971	0	-66.737	-61.991
4,N	37.2276	40.6663	66.1394	67.3347	0	4.74557
	0.30477	0.30477	0.30477	0.30477	0	0.30477
	36.6294	40.0682	65.5413	66.7365	0	4.14741
	37.8258	41.2645	66.7376	67.9328	0	5.34374
4,Y	32.482	35.9208	61.3939	62.5891	-4.7456	0
	0.30477	0.30477	0.30477	0.30477	0.30477	0
	31.8839	35.3226	60.7957	61.9909	-5.3437	0
	33.0802	36.5189	61.992	63.1873	-4.1474	0

Level		Least Sq Mean
4,N	A	97.541046
4,Y	B	92.795471
21,N	C	60.313458
21,Y	D	56.874705
37,N	E	31.401607
37,Y	F	30.206367

Levels not connected by same letter are significantly different.

**Mix*Temperature*Moisture Conditioned
Effect Test**

Sum of Squares	F Ratio	DF	Prob > F
960.18459	31.9049	4	<.0001*

Denominator MS Synthesis:
Residual

FM7 Dyanmic Modulus Analysis (Continued)

LS Means Plot

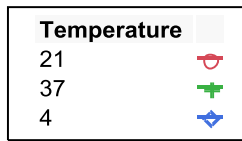
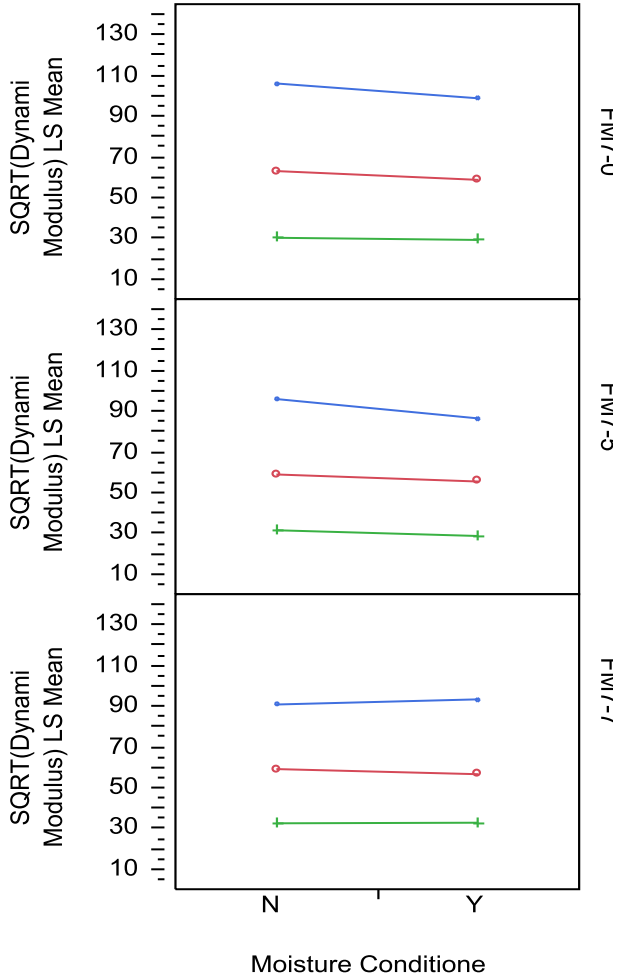

Frequency

Effect Test

Sum of Squares	F Ratio	DF	Prob > F
153365.18	2547.997	8	<.0001*

Denominator MS Synthesis:
Residual

FM7 Dyanmic Modulus Analysis (Continued)**Least Squares Means Table**

Level	Least Sq Mean	Std Error	Mean
0.1 Hz	42.529942	0.26394110	42.4115
0.2 Hz	46.395883	0.26394110	46.4399
0.5 Hz	51.784788	0.26394110	52.0342
1 Hz	56.077776	0.26394110	56.5111
10 Hz	72.211358	0.26394110	73.3748
2 Hz	60.953108	0.26394110	61.6019
20 Hz	77.294746	0.26394110	78.6693
25 Hz	79.089951	0.26394110	80.5785
5 Hz	67.361430	0.26394110	68.3072

Mix*Frequency**Effect Test**

Sum of Squares	F Ratio	DF	Prob > F
3155.9499	26.2164	16	<.0001*

Denominator MS Synthesis:

Residual

Least Squares Means Table

Level	Least Sq Mean	Std Error
FM7-0,0.1 Hz	42.056224	0.35411414
FM7-0,0.2 Hz	46.572127	0.35411414
FM7-0,0.5 Hz	52.782383	0.35411414
FM7-0,1 Hz	57.811140	0.35411414
FM7-0,10 Hz	76.865135	0.35411414
FM7-0,2 Hz	63.548406	0.35411414
FM7-0,20 Hz	82.793085	0.35411414
FM7-0,25 Hz	85.044215	0.35411414
FM7-0,5 Hz	71.144519	0.35411414
FM7-5,0.1 Hz	41.142600	0.50079302
FM7-5,0.2 Hz	44.873858	0.50079302
FM7-5,0.5 Hz	50.117883	0.50079302
FM7-5,1 Hz	54.253842	0.50079302
FM7-5,10 Hz	69.740578	0.50079302
FM7-5,2 Hz	58.965889	0.50079302
FM7-5,20 Hz	74.656914	0.50079302
FM7-5,25 Hz	76.279575	0.50079302
FM7-5,5 Hz	65.077205	0.50079302
FM7-7,0.1 Hz	44.391001	0.50079302
FM7-7,0.2 Hz	47.741663	0.50079302
FM7-7,0.5 Hz	52.454097	0.50079302
FM7-7,1 Hz	56.168346	0.50079302
FM7-7,10 Hz	70.028361	0.50079302
FM7-7,2 Hz	60.345028	0.50079302
FM7-7,20 Hz	74.434238	0.50079302
FM7-7,25 Hz	75.946062	0.50079302
FM7-7,5 Hz	65.862566	0.50079302

FM7 Dyanmic Modulus Analysis (Continued)

LS Means Plot

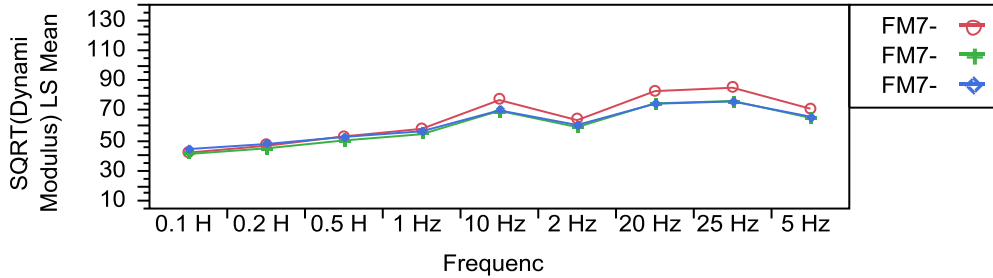

**Temperature*Frequency
Effect Test**

Sum of Squares	F Ratio	DF	Prob > F
2011.7362	16.7114	16	<.0001*

Denominator MS Synthesis:
Residual

Least Squares Means Table

Level	Least Sq Mean	Std Error
21,0.1 Hz	37.29342	0.45715939
21,0.2 Hz	41.59505	0.45715939
21,0.5 Hz	47.75132	0.45715939
21,1 Hz	52.72571	0.45715939
21,10 Hz	70.56021	0.45715939
21,2 Hz	58.01397	0.45715939
21,20 Hz	76.22581	0.45715939
21,25 Hz	78.10205	0.45715939
21,5 Hz	65.07918	0.45715939
37,0.1 Hz	15.62103	0.45715939
37,0.2 Hz	18.20178	0.45715939
37,0.5 Hz	21.79427	0.45715939
37,1 Hz	24.77319	0.45715939
37,10 Hz	39.89213	0.45715939
37,2 Hz	29.29419	0.45715939
37,20 Hz	45.27290	0.45715939
37,25 Hz	47.06486	0.45715939
37,5 Hz	35.32153	0.45715939
4,0.1 Hz	74.67538	0.45715939
4,0.2 Hz	79.39081	0.45715939
4,0.5 Hz	85.80877	0.45715939
4,1 Hz	90.73442	0.45715939
4,10 Hz	106.18173	0.45715939
4,2 Hz	95.55116	0.45715939
4,20 Hz	110.38552	0.45715939
4,25 Hz	112.10294	0.45715939
4,5 Hz	101.68358	0.45715939

FM7 Dyanmic Modulus Analysis (Continued)**Mix*Temperature*Frequency****Effect Test**

Sum of Squares	F Ratio	DF	Prob > F
311.51381	1.2939	32	0.1290

Denominator MS Synthesis:

Residual

Moisture Conditioned*Frequency**Effect Test**

Sum of Squares	F Ratio	DF	Prob > F
83.120752	1.3810	8	0.2008

Denominator MS Synthesis:

Residual

Mix*Moisture Conditioned*Frequency**Effect Test**

Sum of Squares	F Ratio	DF	Prob > F
15.900828	0.1321	16	1.0000

Denominator MS Synthesis:

Residual

Temperature*Moisture Conditioned*Frequency**Effect Test**

Sum of Squares	F Ratio	DF	Prob > F
25.119687	0.2087	16	0.9996

Denominator MS Synthesis:

Residual

Mix*Temperature*Moisture Conditioned*Frequency**Effect Test**

Sum of Squares	F Ratio	DF	Prob > F
16.232801	0.0674	32	1.0000

Denominator MS Synthesis:

Residual

Sample Name[Mix,Moisture Conditioned]&Random**Effect Test**

Sum of Squares	F Ratio	DF	Prob > F
8680.4928	33.9334	34	<.0001*

Denominator MS Synthesis:

Residual