

2010

Investigation of warm-mix asphalt using Iowa aggregates

Ashley Faye Buss
Iowa State University

Follow this and additional works at: <https://lib.dr.iastate.edu/etd>

 Part of the [Civil and Environmental Engineering Commons](#)

Recommended Citation

Buss, Ashley Faye, "Investigation of warm-mix asphalt using Iowa aggregates" (2010). *Graduate Theses and Dissertations*. 11644.
<https://lib.dr.iastate.edu/etd/11644>

This Thesis is brought to you for free and open access by the Iowa State University Capstones, Theses and Dissertations at Iowa State University Digital Repository. It has been accepted for inclusion in Graduate Theses and Dissertations by an authorized administrator of Iowa State University Digital Repository. For more information, please contact digirep@iastate.edu.

Investigation of warm-mix asphalt using Iowa aggregates

by

Ashley F. Buss

A thesis submitted to the graduate faculty
in partial fulfillment of the requirements for the degree of
MASTER OF SCIENCE

Major: Civil Engineering

Program of Study Committee:
R. Christopher Williams, Major Professor
Vernon R. Schaefer
Kelly C. Strong

Iowa State University

Ames, Iowa

2010

Copyright © Ashley F. Buss, 2010. All rights reserved.

TABLE OF CONTENTS

LIST OF TABLES	vi
LIST OF FIGURES	ix
ACKNOWLEDGEMENTS	xi
ABSTRACT	xii
CHAPTER I INTRODUCTION	1
1.1 Background	1
1.2 Problem Statement	2
1.3 Objectives.....	2
1.4 Methodology	2
1.5 Hypothesis.....	3
1.6 Thesis Organization.....	3
CHAPTER II LITERATURE REVIEW.....	5
2.1 Literature Introduction	5
2.2 Background	5
2.2.1 Foamed Asphalt Studies Prior to 1985.....	5
2.2.2 Recent WMA Work	8
2.2.3 International WMA Projects	19
2.2.4 WMA Projects in the United States	21
2.3 Benefits of Warm Mix Asphalt	24
2.4 Emerging and Available warm mix asphalt technologies	28
2.4.1 Evotherm.....	29
2.4.2 Sasobit.....	36
2.4.3 Aspha-min.....	40

2.4.4 Advera.....	44
2.4.5 WAM-Foam.....	45
2.4.6 Aspahltan B.....	46
2.4.7 Double Barrel Green.....	46
2.4.8 Low Energy Asphalt.....	48
2.4.9 WMA summary of cost and studies utilizing one WMA technology.....	49
2.5 Investigations of Warm Mix Asphalt and Observations.....	51
2.6 Literature Review Summary.....	58
CHAPTER III EXPERIMENTAL PLAN.....	60
CHAPTER IV FIELD MIX DETAILS AND SAMPLE PREPARATION.....	70
4.1 Field Mix Details.....	70
4.2 Sample Preparation.....	73
CHAPTER V BINDER TESTING RESULTS.....	75
5.1 Field Mix 1- Evotherm 3G.....	75
5.2 Field Mix 2- Revix.....	80
5.3 Field Mix 3 Sasobit.....	85
5.4 Field Mix 4 Double Barrel Green Foaming.....	90
CHAPTER VI PERFORMANCE TESTING RESULTS.....	96
6.1 Indirect Tensile Strength Testing Results.....	96
6.2 Dynamic Modulus Testing Results.....	97
6.3 Master Curves.....	98
6.4 Flow Number Results.....	109
6.4.1 Field Mix 1- Flow Number Results.....	109
6.4.2 Field Mix 2- Flow Number Results.....	110

6.4.3 Field Mix 3- Flow Number Results	110
6.4.4 Field Mix 4- Flow Number Results	110
6.4.5 Overall Flow Number Comparison	111
CHAPTER VII STATISTICAL ANALYSIS	115
7.1 Indirect Tensile Statistical Analysis	116
7.1.1 Field Mix 1 ITS- Evotherm Technology	116
7.1.2 Field Mix 2 ITS- Revix Technology	117
7.1.3 Field Mix 3 ITS- Sasobit Technology	117
7.1.4 Field Mix 4 ITS- Foaming Technology	119
7.2 Dynamic Modulus Statistical Analysis	120
7.2.1 Field Mix 1 Dynamic Modulus- Evotherm	121
7.2.2 Field Mix 2 Dynamic Modulus- Revix Technology	122
7.2.3 Field Mix 3 Dynamic Modulus- Sasobit Technology	124
7.2.4 Field Mix 4 Dynamic Modulus- Double Barrel Green Foaming Technology	125
7.3 Flow Number	127
7.3.1 Field Mix 1 Flow Number Data Analysis- Evotherm Technology	127
7.3.2 Field Mix 2 Flow Number Data Analysis- Sasobit Technology	127
7.3.3 Field Mix 3- Flow Number Data Analysis	128
7.3.4 Field Mix 4- Flow Number Data Analysis	128
7.4 Statistical Analysis Summary	128
Chapter VIII Discussion and Conclusion	130
8.1 Field Mix 1 Discussion	130
8.2 Field Mix 2 Discussion	130
8.3 Field Mix 3 Discussion	131
8.4 Field Mix 4 Discussion	132
8.5 Discussion of Limitations	132
8.6 Conclusions	133
8.7 Recommendations for Additional Research	134
REFERENCES	136
APPENDIX A: JOB MIX FORMULAS	144

APPENDIX B: VOLUMETRICS	149
APPENDIX C: ITS AND TENSILE STRENGTH RATIO DATA	164
APPENDIX D: DYNAMIC MODULUS VALUES	178
APPENDIX E- FLOW NUMBER RESULTS	182
APPENDIX F: SAS OUTPUT DATA	186
Section F-1: Field Mix 1 ITS Statistical Analysis- Peak Loads.....	186
Section F-2: Field Mix 2 ITS Statistical Analysis- Peak Loads	189
Section F-3: Field Mix 3 ITS Statistical Analysis Output- Peak Load	193
Section F-4: Field Mix 4 ITS Statistical Analysis Output– Peak Load.....	196
Section F-5: Field Mix 1 Dynamic Modulus Statistical Analysis Output.....	199
Section F-6: Field Mix 2 Dynamic Modulus Statistical Analysis Output.....	204
Section F-7: Field Mix 3 Dynamic Statistical Analysis Output.....	208
Section F-8: Field Mix 4 Dynamic Modulus Statistical Analysis Output	213
Section F-9: Field Mix 1 Flow Number Statistical Analysis Output	218
Section F-10: Field Mix 1 Cycles to 3% Strain Statistical Analysis.....	221
Section F-11: Field Mix 2 Flow number Statistical Analysis Output	225
Section F-12: Field Mix 2 Cycles to 3% Strain Statistical Analysis Output	228
Section F-13: Field Mix 3 Flow Number Statistical Analysis Output	231
Section F-14: Field Mix 3 Cycles to 3% Strain Statistical Analysis Output	234
Section F-15: Field Mix 4 Flow Number Statistical Analysis Output	237
Section F-16: Field Mix 4 Cycles to 3% Strain Statistical Analysis Output	239

List of Tables

Table 2.1: Technologies observed in Europe by the scan team (D'Angelo, et al., 2008)	16
Table 2.2 Ramara Township Field Study: Combustion Gas Sampling Results (Davidson, 2005)	31
Table 2.3: Summary of WAM-Foam® Projects in Europe (Kristjansdottir, 2006)	46
Table 2.4: Summary of WMA Technology Costs (Middleton & Forfylow, 2009)	50
Table 3.1: Performance Test of Warm Mix Asphalt Technologies	63
Table 4.1: Weather Data for Field Mix 1 Production (NOAA, 2008)	71
Table 4.2: Weather Data for Field Mix 2 Production (NOAA, 2009)	71
Table 4.3: Weather Data for Field Mix 3 Production (NOAA, 2009)	72
Table 4.4: Weather Data for Field Mix 4 Production (NOAA, 2009)	73
Table 5.1.1: BBR Stiffness and m-value data for Evotherm 3G and Control Binders.....	79
Table 5.2.1: Bending Beam Rheometer Stiffness and m-value data for Revix and Control Binders .	84
Table 5.3.1: Bending Beam Rheometer Stiffness and m-value for Revix and Control Binders	89
Table 5.4.1: Bending Beam Rheometer Stiffness and m-value for Foamed and Control Binders	94
Table 6.1.1: Tensile strength ratios	96
Table 6.1.2: Average peak load values	97
Table 7.1: field mix 1 ITS ANOVA table	116
Table 7.2: Field mix 2 ITS ANOVA table	117
Table 7.3: Field mix 3 ITS ANOVA table	118
Table 7.4: Field mix 4 ITS ANOVA table	119
Table 7.6: Field mix 1 dynamic modulus ANOVA table	122
Table 7.7: Field mix 2 dynamic modulus ANOVA table	123
Table 7.8: Field mix 3 dynamic modulus ANOVA table	125
Table 7.9: Field mix 4 dynamic modulus ANOVA table	126
Table B-1: Field Mix 1 Dynamic Modulus Lab Compacted Samples	149
Table B-2: Field Mix 1 ITS Laboratory Compacted Samples	150
Table B-3: Field Mix 1 Dynamic Modulus Field Compacted Samples	151
Table B-4: Field Mix 2 Dynamic Modulus Laboratory Compacted Samples	152
Table B-5: Field Mix 2 Indirect Tensile Strength Laboratory Compacted Samples	153
Table B-6: Field Mix 2 Dynamic Modulus Field Compacted Samples	154
Table B-7: Field Mix 2 Indirect Tensile Strength Field Compacted Samples	155
Table B-8: Field Mix 3 Dynamic Modulus Laboratory Compacted Samples	156
Table B-9: Field Mix 3 Indirect Tensile Strength Laboratory Compacted Sample	157

Table B-10: Field Mix 3: Dynamic Modulus Field Compacted Samples	158
Table B-11: Field Mix 3 Indirect Tensile Field Compacted Strength Samples	159
Table B-12: Field Mix 4 Dynamic Modulus Laboratory Compacted Samples	160
Table B-13: Field Mix 4 Indirect Tensile Strength Laboratory Compacted Samples	161
Table B-14: Field Mix 4 Dynamic Modulus Field Compacted Samples	162
Table B-15: Field Mix 4 Indirect Tensile Strength Field Compacted Samples	163
Table C-1: Field Mix 1 WMA Indirect Tensile Strength and Tensile Strength Ratio Data	164
Table C-2: Field Mix 1 HMA Indirect Tensile Strength and Tensile Strength Ratio Data	165
Table C-3: Field Mix 2 WMA Lab Compacted Indirect Tensile Strength and Tensile Strength Ratio Data	166
Table C-4: Field Mix 2 HMA Lab Compacted Indirect Tensile Strength and Tensile Strength Ratio Data	167
Table C-5: Field Mix 2 WMA Field Compacted Indirect Tensile Strength and Tensile Strength Ratio Data	168
Table C-6: Field Mix 2 HMA Field Compacted Indirect Tensile Strength and Tensile Strength Ratio Data	169
Table C-7: Field Mix 3 WMA Laboratory Compacted Indirect Tensile Strength and Tensile Strength Ratio Data	170
Table C-8: Field Mix 3 WMA Laboratory Compacted Indirect Tensile Strength and Tensile Strength Ratio Data	171
Table C-9: Field Mix 3 WMA Field Compacted Indirect Tensile Strength and Tensile Strength Ratio Data	172
Table C-10: Field Mix 3 HMA Field Compacted Indirect Tensile Strength and Tensile Strength Ratio Data	173
Table C-11: Field Mix 4 WMA Lab Compacted Indirect Tensile Strength and Tensile Strength Ratio Data	174
Table C-12: Field Mix 4 HMA Laboratory Compacted Indirect Tensile Strength and Tensile Strength Ratio Data	175
Table C-13: Field Mix 4 WMA Field Compacted Indirect Tensile Strength and Tensile Strength Ratio Data	176
Table C-14: Field Mix 4 HMA Field Compacted Indirect Tensile Strength and Tensile Strength Ratio Data	177
Table D-1: Field Mix 1 Dynamic Modulus Values.....	178

Table D-2 Field Mix 2 Dynamic Modulus Values.....	179
Table D-3 Field Mix 3 Dynamic Modulus Values.....	180
Table D-4 Field Mix 4 Dynamic Modulus Values.....	181
Table E-1 Field Mix 1 Flow Number Values	182
Table E-2 Field Mix 2 Flow Number Values	183
Table E-3 Field Mix 3 Flow Number Values.....	184
Table E-4 Field Mix 4 Flow Number Values.....	185

List of Figures

Figure 2.1: Foamed Asphalt Nozzle (Csanyi, 1959)	6
Figure 2.2: Foamed Asphalt System (Csanyi, 1959)	7
Figure 2.3: Chronology of tasks of Phase I of NCHRP Project 09-43 (Transportation Research Board, 2007)	13
Figure 2.4: Tasks for Phase I of NCHRP 09-47 (Transportation Research Board, 2008)	14
Figure 2.5: Scan team observing a WAM-Foam section in Norway (D'Angelo, et al., 2008)	17
Figure 2.6: Process of incorporating new technologies into existing specifications in France	19
Figure 2.7: Air Void percent in cores from field vs. Time (Al-Rawashdeh, 2008)	51
Figure 2.8: Experimental Plan for Studying the Effects of WMA Additives on Workability and Durability of Asphalt Mixture Containing RAP (Austerman, Mogawer, & Bonaquist, 2009)	54
Figure 2.9: Test Plan for the evaluation of WMA additive with RAP (Tao & Mallick, 2009)	56
Figure 3.1 Diagram showing the categories of samples procured form each field mix	62
Figure 3.2 Permanent shear strain versus number of loading cycles:	69
Figure 5.1.1: Rotational viscometer comparison of Evotherm 3G and control binder	76
Figure 5.1.2 Comparison of failure temperatures for Evotherm 3G and Control binders.....	77
Figure 5.1.3 Comparison of $G^*/\sin(\delta)$ for Original and RTFO aged Binders	77
Figure 5.1.4: Comparison of $G^*\sin(\delta)$ values for PAV aged Evotherm 3G and Control Binders ...	78
Figure 5.1.5: Comparison of average stiffness values for Evotherm 3G and control binders	79
Figure 5.1.6: Comparison of average m-values for Evotherm 3G and control binders	80
Figure 5.2.1: Rotational viscometer comparison of Revix and Control Binder	81
Figure 5.2.2: Comparison of failure temperatures for Revix and control binders	81
Figure 5.2.3: Comparison of $G^*/\sin(\delta)$ for Original and RTFO aged Binders	82
Figure 5.2.4: Comparison of $G^*\sin(\delta)$ values for PAV aged Evotherm 3G and Control Binders	83
Figure 5.2.5: Comparison of average stiffness values for Revix and control binders	84
Figure 5.2.6: Comparison of average m-values for Revix and control binders	85
Figure 5.3.1: Rotational viscometer comparison of Sasobit and Control Binder	86
Figure 5.3.2: Comparison of failure temperatures for Sasobit and control binders	87
Figure 5.3.3: Comparison of $G^*/\sin(\delta)$ for Original and RTFO aged Binders	87
Figure 5.3.4: Comparison of $G^*\sin(\delta)$ values for PAV aged Sasobit and control binders	88
Figure 5.3.5: Comparison of average stiffness values for Revix and control binders	89
Figure 5.3.6 Comparison of average m-values for Revix and control binders	90
Figure 5.4.1: Rotational viscometer comparison of Foamed and Control Binder	91

Figure 5.4.2: Comparison of failure temperatures for Foamed and control binders 92

Figure 5.4.3: Comparison of $G^*/\sin(\delta)$ for Original and RTFO aged Binders 92

Figure 5.4.4: Comparison of $G^*\sin(\delta)$ values for PAV aged Foamed and control binders 93

Figure 5.4.5: Comparison of average stiffness values for Foamed and control binders 94

Figure 5.4.6: Comparison of average m-values for Foamed and control binders 95

Figure 6.3.1: Field Mix 1 comparison of field compacted mixes 99

Figure 6.3.2: Field Mix 1 comparison of lab compacted mixes 100

Figure 6.3.3: Field Mix 1 comparison of field compacted HMA and laboratory compacted HMA. 100

Figure 6.3.4: Field Mix 1 comparison of laboratory compacted WMA and field compacted WMA
..... 101

Figure 6.3.5: Field Mix 1 comparison of all mixes 101

Figure 6.3.6: Field Mix 2 comparison of field compacted mixes 102

Figure 6.3.7: Field Mix 2 comparison of laboratory compacted mixes 102

Figure 6.3.8: Field Mix 2 comparison of laboratory compacted and field compacted HMA 103

Figure 6.3.9: Field Mix 2 comparison of field compacted and laboratory compacted WMA 103

Figure 6.3.10: Field Mix 2 comparison of all mixes 104

Figure 6.3.11: Field Mix 3 comparison of field compacted mixes 104

Figure 6.3.12: Field Mix 3 comparison of laboratory compacted mixes 105

Figure 6.3.13: Field Mix 3 comparison of field compacted and laboratory compacted HMA 105

Figure 6.3.14: Field Mix 3 comparison of field compacted and laboratory compacted WMA 106

Figure 6.3.15: Field Mix 3 comparison of all mixes 106

Figure 6.3.16: Field Mix 4 comparison of field compacted HMA and WMA 107

Figure 6.3.17: Field Mix 4 comparison of laboratory compacted HMA and WMA 107

Figure 6.3.18: Field Mix 4 comparison of field compacted and laboratory compacted HMA 108

Figure 6.3.19: Field Mix 4 comparison of field compacted and laboratory compacted WMA 108

Figure 6.3.20: Field Mix 4 comparison of all mixes 109

Figure 6.4.1: Field Mix 1: Flow Number Test Data 111

Figure 6.4.2: Field Mix 2: Flow Number Test Data 112

Figure 6.4.3: Field mix 3: flow number test data 113

Figure 6.4.4: Field mix 4: flow number test data 114

Figure 7.1: Tukey grouping of field mix 4 ITS results 119

Figure 7.2: Duncan grouping of field mix 4 ITS results 120

ACKNOWLEDGMENTS

This research was funded by Iowa Department of Transportation

I would like to thank God for all the blessings and opportunities I have been given. A very special thank you goes to my husband and my family for all of their encouragement, love and support.

I would like to thank my major professor, Dr. R. Christopher Williams for his support and invaluable guidance throughout this research work. Thank you to Professor Vern Schaefer and Dr. Kelly Strong for serving on my committee and for their commitment to education. I have learned so much since I began my studies at Iowa State. Thank you to Dr. Andrea Kvasnak for her help and suggestions throughout this research. I would also like to thank all of my friends and teachers in the Civil, Construction and Environmental Engineering Department.

I would also like to express my gratitude to the other graduate students for their help and support in the lab, especially Mr. Mohamed Rashwan. The collaborative atmosphere within the geotechnical and materials engineering graduate students has made graduate school a fun, educational and enriching experience. Thank you to Mr. John Hinrichsen for all of his help and expertise during testing at the Iowa Department of Transportation and to Dr. Scott Schram for his continued collaboration throughout this research.

ABSTRACT

Warm mix asphalt (WMA) has been on the horizon of new asphalt technologies and now it is at the forefront of many research and field projects. The process of investigating the implementation of WMA is a task that many state and local agencies are now facing. The typical WMA production temperature ranges from 30 to 100°F lower than typical hot-mix asphalt (HMA). This temperature reduction leads to several benefits for asphalt paving. One of the driving forces of WMA research is the potential for a reduction in energy, fuel consumption and emissions. In accord with emission reduction is the reduced fuel consumption which is an attractive economic benefit. Other benefits include longer haul distances, colder weather paving, reduction of asphalt fumes during paving operations, higher recycled asphalt pavement (RAP) content and a less extreme working environment.

The three main types of WMA are organic wax additives, chemical additives, and plant foaming processes. Presented in this study are performance testing results from field produced WMA (and a control HMA) for each of the three main types of WMA technologies. WMA is showing promising results in laboratory testing throughout the United States and Canada; however, one particular distress that has been documented in laboratory testing is moisture damage. It is hypothesized that the lower aggregate temperatures do not allow for complete drying of the aggregate and can lead to stripping.

There are three main objectives to be addressed through this research. The first is to evaluate field produced WMA mixes with a field produced control HMA mix. The second is to identify potential quality control/quality assurance (QC/QA) concerns and determine if reheating a WMA mixture to prepare a sample will impact the performance testing results. The third objective is to address the WMA moisture susceptibility concerns.

The Iowa Department of Transportation produced four field WMA mixes and four control HMA mixes which were used in this research project. Each mix was produced for a different project at different plant locations. The corresponding control mixes to each WMA mix differed only by the WMA additive. For each project, loose HMA and WMA mix was

collected at the time of production and binder from the tank was collected for each mix. Field compacted samples were prepared at the job site and laboratory samples were reheated and compacted at a later date. Indirect tensile strength (ITS) and dynamic modulus samples were procured from each mix produced. Half of the ITS and dynamic modulus samples were moisture conditioned according to AASHTO T283. In total, 284 samples were procured from the field produced mixtures for dynamic modulus, flow number and indirect tensile strength performance testing.

The ITS testing results will include peak loads and tensile strength ratios. Each of these values will be considered when performing the data analysis. The dynamic modulus testing results will help to determine the material stress to strain relationship under continuous sinusoidal loading. The loadings are applied at various frequencies and temperatures to define the material property characteristics over a wide range of conditions. Dynamic modulus testing measures the stiffness of the asphalt under dynamic loading at various temperatures and frequencies, thus it is used to determine which mixes may be more susceptible to performance issues including rutting, fatigue cracking and thermal cracking.

The overall findings of these experiments suggest a difference in the performance of HMA and WMA mixes. The binder results show that the mixing and compaction temperatures are reduced and that the benefits of WMA mentioned in the literature review are realized. While the benefits of the technologies continue to drive the production of more WMA mixes, studying the performance testing results will help to show if there is a net benefit to using WMA. Three of the four field mixes indicate superior performance of the HMA mix to that of the produced WMA in many aspects of the tests performed. There were mixed results for the foaming technology because the WMA mix did perform superior in dynamic modulus and flow number tests but there was a nine day elapse between the production of the foamed WMA mix and the HMA mix due to weather delays. This may have caused a higher degree of variability between the two mixes. The dynamic modulus results show that the interaction of the mix, compaction type and moisture conditioning are statistically significant in all four field mixes. This suggests that the combination of all three factors play a role in determining

material response. The master curves do not display a high degree of overall variability but do show differences in mix responses at high temperatures.

Further investigation of WMA technologies will be beneficial to both contractors and owner agencies. The experiments showed statistical differences between the control and WMA for all four field mixes tested. Three field mixes indicate higher laboratory performance results in the HMA mix. The foamed WMA mix showed improved laboratory performance when compared to the control HMA. As WMA is produced in larger quantities and as WMA technologies begin to be used together it is important to continue looking at the pavement performance data and performance testing results in order adapt the QC/QA programs to evolving technologies.

CHAPTER I INTRODUCTION

1.1 Background

Warm mix asphalt (WMA) has been an intensely researched topic within the HMA community for several years. Many owner agencies are beginning the process of implementing these technologies and many research projects are investigating the use, performance and benefits of WMA technologies. The literature review summarizes some of the important research that has taken place as well as publications that have led to the wide spread use of WMA additives. There are many benefits to the implantation of WMA, but the primary benefit is the lower mixing and compaction temperatures which can lead to reduced emissions and costs for contractors (D'Angelo et al., 2008). Another benefit of WMA is that the improved workability allows for higher percentages of recycled asphalt pavement (RAP) in a mix. Several studies (Roberts et al., 1984; Kvasnak, et al. 2009) have shown that WMA is more susceptible to moisture damage than HMA control mixes.

The WMA production temperature can range from 30 to 100°F lower than typical hot-mix asphalt (HMA) (D'Angelo et al., 2008). This temperature reduction leads to several benefits for asphalt paving. One of the driving forces of WMA is the potential for a reduction in energy, fuel consumption and emissions. In accord with emission reduction is reduced fuel consumption which is an attractive economic benefit. Other benefits include longer haul distances, colder weather paving, reduction of asphalt fumes during paving operations, higher recycled asphalt pavement (RAP) content and a less extreme working environment (D'Angelo et al., 2008). The three main types of WMA are organic wax additives, chemical additives, and plant foaming processes (Hodo et al., 2009). Laboratory and field test results are presented for each of the three types of WMA. WMA is showing promising results in laboratory testing throughout the United States and Canada. One potential distress that has occurred in laboratory testing is moisture damage. It is hypothesized that the lower aggregate temperatures do not allow for complete drying of the aggregate and can lead to stripping (Hurley, 2006).

1.2 Problem Statement

The implementation of WMA is becoming more widespread with a growing number of contractors utilizing various WMA technologies. The literature review suggests that some of the benefits of WMA may come at a cost in terms of long term pavement performance and moisture susceptibility. Asphalt performance tests can be a good way of measuring material responses and those responses can be correlated to pavement performance. There has only been a limited number of studies performed that look at the factors of mix type (HMA/WMA), compaction type (field/laboratory compaction) and whether a sample is moisture conditioned or not moisture conditioned. It is important for owner/agencies to know that the WMA technologies and/or the reduction in mixing and compaction temperatures do not hinder the durability and long term pavement performance.

1.3 Objectives

There are three main objectives to be addressed through this research. The first is to evaluate field produced WMA mixes with a field produced control HMA mix. The second is to identify potential quality control/quality assurance (QC/QA) concerns and determine if reheating a WMA mixture to prepare a sample will impact the performance testing results. The third objective is to address the WMA moisture susceptibility concerns.

1.4 Methodology

The experimental plan uses field produced mixes. Using field produced mixes gives researchers the ability to use a product that would most simulate the actual pavement. The first objective addresses comparing field produced WMA mixes with a field produced control HMA mix. The comparison will be done by reviewing data from performance testing. The tests include indirect tensile strength (ITS), dynamic modulus testing and flow number testing. Binder test results will also be reviewed. The second objective is addressed by half of the samples being compacted in the field and the other half of the samples being procured from reheated mix and compacted in the laboratory. A statistical analysis of the performance test results will help to determine if reheating the WMA mixes impacts the

performance of the material. The third objective will be investigated by moisture conditioning half of the samples according to AASHTO T-283 guidelines and comparing the performance testing results.

1.5 Hypothesis

The following hypotheses were formulated, addressed by performing laboratory tests and conclusions were made based on statistical analysis:

- HMA and WMA have different performance testing results due to either a change in viscosity or a reduction in temperature.
- WMA has higher moisture susceptibility potentially due to the reduction in temperatures causing incomplete drying of aggregates.
- WMA mix performance is dependent on whether samples are field compacted or reheated and compacted in a laboratory.

As a result of the extensive laboratory testing, these additional hypotheses were addressed:

- How do the various factors of mix type, compaction type and whether or not a sample has been moisture conditioned interact with each other to determine the material response?
- How does the difference between HMA and WMA vary over a range of testing temperatures?
- Is the WMA mixing and compaction temperature reduction reflected in binder properties when tests such as rotational viscometer and dynamic shear rheometer are performed?

Answering these questions allows for a better understanding of the materials that are being produced for Iowa roadways.

1.6 Thesis Organization

This thesis is divided into eight chapters. The first is an introduction that provides a summary and background information about WMA. The introduction also provides a problem statement, objectives, methodology and the hypotheses of the research compiled herein as well as provides an overview of the organization of the thesis. Chapter 2 is the

literature review which highlights the history of WMA and recently completed WMA research projects. Chapter 3 outlines the experimental plan and discusses the type of WMA additives and the various laboratory tests used throughout the project. Chapter 4 provides field mix details and how samples were collected and prepared. Weather information about the day of production is provided as well as the procedure used for moisture conditioning. Chapter 5 gives an overview of the binder testing results. Chapter 6 provides the performance testing results from the ITS testing, dynamic modulus testing and flow number testing. This chapter also includes the developed master curves from dynamic modulus testing. Chapter 7 is the statistical analysis of the data. For the analysis, the statistical analysis methodology is discussed and an analysis of each test result, organized by field mix, is provided. Finally, Chapter 8 provides a summary discussion for each field mix, conclusions and makes recommendations.

CHAPTER II LITERATURE REVIEW

2.1 LITERATURE INTRODUCTION

Warm mix asphalt has been on the horizon of new asphalt technologies and now it is at the forefront of many research and field projects. The process of investigating the implementation of warm mix asphalt is a task that many state and local agencies are now faced with. The intent of the literature review is to present information about warm mix asphalt (WMA) for the evaluation of WMA use in the State of Iowa including presenting various WMA technologies and reviewing the findings of laboratory and field tests conducted throughout the world.

There are many reasons why WMA may be useful in Iowa. Included in the literature review is a detailed look at the benefits that WMA has to offer. Some of the benefits include lower plant air emissions and fuel consumption, the possibility of colder weather paving, higher recycled asphalt pavement (RAP) and better working conditions. This literature review also summarizes and discusses the background of WMA, the benefits of WMA, provides an overview of the technologies available, reviews some of the WMA studies and experiments as well as presenting their observations and conclusions.

2.2 BACKGROUND

2.2.1 Foamed Asphalt Studies Prior to 1985

The Work of L.H. Csanyi

Controlling the properties of foamed asphalt was first developed at Iowa State University and reported in 1959 by Professor L.H. Csanyi (Csanyi, 1959). The unique characteristics of foamed asphalt include: an increase in volume, decrease in viscosity, softer at lower temperatures, change in surface tension that gives the asphalt increased adhesion and the asphalt regains its original properties when the foam breaks. Utilizing the foamed asphalt characteristics required procedures that would control the foaming of the asphalt. Figure 2.1 shows the foamed asphalt nozzle developed by Csanyi. The asphalt is introduced at 280°F at 2.5 pounds of pressure and saturated steam is introduced at 40 pounds of pressure. The foaming characteristics are influenced by the design of the nozzle tip, the quantity and

pressure of the steam and the pressure of the asphalt. One nozzle has a discrete discharge capacity and more than one nozzle would be used during the mixing process. Figure 2.2 shows a schematic of the entire mixing process (Csanyi, 1959).

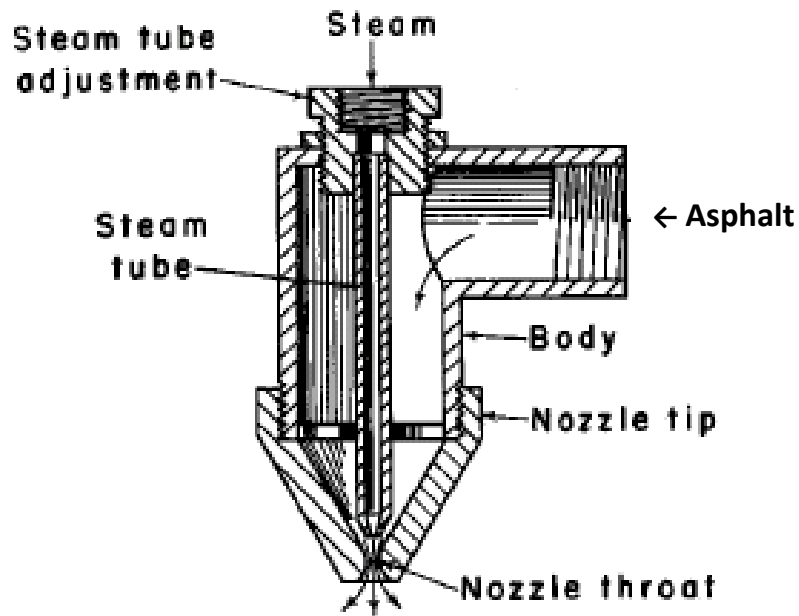

Figure 2.1: Foamed Asphalt Nozzle (Csanyi, 1959)

The controlled foaming process allows for foamed asphalt studies on various types of mixes which included: standard specification mixes, ungraded aggregate mixes, soil stabilization both in place and in plants, asphalt cement slurry seal coat mixes, and coal briquetting mixes. The tests conducted on standard specification mixes are of the most interest for this literature review. The results of the testing showed that foamed asphalt allowed for a more uniform distribution of the asphalt throughout the mix, aggregate temperatures as low as 240°F could be used without changing the characteristics of the mix and cold mixes may be prepared in which cold, wet aggregates are used (Csanyi, 1959).

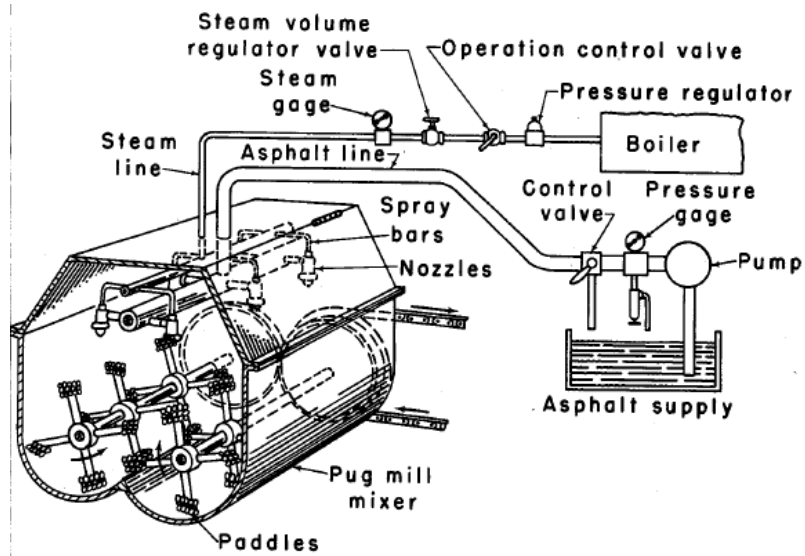

Figure 2.2: Foamed Asphalt System (Csanyi, 1959)

Foamed asphalt base stabilization was used in 1961 by the Jay W. Craig Company of Minneapolis for the ball park of the Minnesota Twins. The foamed asphalt allowed for construction work during cooler and more inclement weather of late April and May. Csanyi also used foamed asphalt in surfacing mixes with ungraded aggregate for low volume roads. Using the foamed asphalt for this type of project lead to a savings of 25 to 30 percent in asphalt and the ability to put traffic on the material one hour after it was laid (Csanyi, 1962).

Treating Iowa's Marginal Aggregates and Soils by Foamix

Csanyi's patent rights were acquired by Mobil of Australia. Dr. D.Y. Lee of Iowa State University performed a study in 1979-1980 that further investigated the use of foamed asphalt using the new methods developed by Mobil of Australia. Where Csanyi used steam to foam the asphalt, the Mobil technique used water. Dr. Lee's study found that there was no difference between using water or steam except water requires less energy. This study evaluated thirteen aggregates and aggregate blends plus two recycled asphalt pavement materials as well as two asphalt cements for foamed asphalt mixes. Some mixes were gravel and some were soil. One especially noteworthy conclusion of this study was that the addition of small amounts of either hydrated lime or Portland cement improves the resistance to water action of a foamed mix (Lee, 1980).

Evaluation of Recycled Mixtures Using Foamed Asphalt

A study was performed in 1984 at the University of Texas at Austin which evaluated the feasibility of using foamed asphalt to recycle asphalt mixtures and compared to the properties of foamed mixtures with those of conventional cold mixtures. This study concluded that curing temperature, length and moisture conditions dramatically affect the strength of foamed asphalt mixtures that contain sand and salvaged pavement materials. This study also found that the foamed asphalt specimens prepared from both the salvaged pavement materials and the sand exhibited equivalent or superior engineering properties to specimens prepared by using either the emulsions or a cut back (Roberts et al., 1984).

2.2.2 Recent WMA Work

By ratifying the Kyoto protocol, the European Union has pledged to reduce emissions of CO₂ by 15% by 2010 (Jones, 2004). This encouraged the asphalt industry sector in different European countries to take a proactive approach in reducing emissions and reducing consumption of resources as a means of adopting sustainable development ethos (D'Angelo, et al., 2008). Environmental concerns regarding the emissions produced during the production of HMA was one of the factors that led to the development of several technologies in Europe aiming to lower the temperature at which asphalt is produced, mixed, and placed. For instance, the German Bitumen Forum was established in 1997 to launch optimum basis for the evaluation of potential health hazards that arise from dealing with bitumen (Ruhl et al., 2006). One of the first challenges that the forum tackled were means to lower the emissions arising from HMA and reducing the asphalt paving temperature, which was regarded as one of the viable means to accomplish this objective. Along that path, several European companies started to conduct experiments to develop technologies that would enable temperature reduction during the production and mixing of asphalt (Newcomb, 2007).

Additional drivers that further encouraged European agencies to adopt WMA technologies were the potential practical benefits such as improvement in the compactability of the asphalt mixture, hence allowing the extension of the paving season and permitting longer

haul distances (D'Angelo et al., 2008; Newcomb 2007). Furthermore, benefits related to improving the working environment in the production and placement stages of HMA are valuable for the welfare of the workers. Reduction in HMA temperature would result in two direct advantages for the labor force: reduction of fumes in surrounding areas to the workers and the ability to operate in a cooler work environment (Newcomb, 2007).

WMA in the United States

NAPA Study Tour, 2002

The National Asphalt Pavement Association (NAPA) sent a study team to Europe to evaluate and research three of the adopted European technologies in the summer of 2002. The NAPA study team visited asphalt production facilities, paving sites and completed road sections in Germany and Norway to study the use of synthetic zeolite, WAM foam, and synthetic paraffin wax additive technologies (Cervarich, 2003). Although the warm mix technologies were regarded as promising, certain questions persisted over its applicability to the United States in terms of climatic conditions, mix designs and construction practices. The need to initiate a research program to assist in answering these concerns was cited along with the necessity to implement demonstration projects that help in validating the performance of these technologies. Moreover, NAPA invited a select group of European experts to introduce the European experience with WMA to the American HMA industry at the 2003 NAPA annual meeting in San Diego (Cervarich, 2003).

2003 NAPA Annual Convention

The invited European delegation comprised a representative of the German Bitumen Forum and representatives from several European companies. A representative of the German Asphalt Pavement Association presented an overview on the use of organic additives such as synthetic paraffin wax in producing warm mixtures. These long chained hydrocarbons are extracted using the Fischer-Tropsch process to be used in reducing the viscosity of the binder and thus the mixing and compaction temperatures. These additives were validated by research conducted in the laboratory and the field spanning about five years.

Representatives from Shell Global Solutions and Kolo-Veidekke presented the WMA technology developed through their joint venture in 1995 named the WAM-Foam® process. This technology was developed on the grounds that European companies were urged to reduce their CO₂ emissions and to utilize the most environmentally friendly alternatives (Cervarich, 2003). WAM-Foam® is obtained from two components, a soft binder and a hard binder during the mixing stage. Firstly, the soft binder is mixed with the aggregates at temperatures ranging between 212° and 250° F, then the hard binder is added resulting in foam that helps lubricate the mixture and improves the workability at low temperatures (Kuennen, 2004). Demonstration projects using WAM-Foam® were performing adequately in Norway from 1999 to 2002 according to the speakers (Cervarich, 2003).

Representatives from the German company Eurovia Services GmbH introduced Aspha-min®, a synthetic zeolite WMA technology. Aspha-min® consists of crystalline hydrated aluminum silicates which help reduce the temperatures of production and placement by about 50° F. The performance of test sections constructed with Aspha-min® did not show notable discrepancies in performance when compared to standard mixtures (Cervarich, 2003).

NCAT WMA Research Program

Following the 2002 NAPA study tour, researching WMA began at the National Center for Asphalt Technology (NCAT) at Auburn University to investigate the methodologies of reducing the production and the placement temperatures of asphalt mixtures (Rea, 2003). This research program was started upon an agreement by NAPA, the Federal Highway Administration (FHWA) and several WMA technology suppliers. The investigations conducted by the research program focused on the feasibility of utilizing WMA technologies in the United States and the findings of those investigations on three technologies: Aspha-min®, Evotherm® and Sasobit® were published by NCAT (Corrigan, 2008).

World of Asphalt Symposium, Nashville, 2004

A three hour demonstration of the Aspha-min® process was conducted at the World of Asphalt conference in Nashville, Tennessee in order to promote the benefits of WMA technologies to the paving industry in the United States. A conventional HMA and Aspha-min® mats were laid. There was a difference of 80° F between the two materials. The paving crew reported that the WMA was easier in handling and placement while attaining the same density (Jones, 2004).

WMA Technical Working Group

A Technical Working Group (TWG) was formed by NAPA and FHWA with the purpose of assessing and validating WMA technologies and implementing WMA strategies and practices in a way that facilitate the sharing of information on various WMA technologies among government agencies and the industry. The group includes representatives from a variety of government agencies and industry bodies such as the FHWA, NAPA, NCAT, State Highway Agencies, State Pavement Associations, HMA industry, workforce, and National Institute for Occupational Safety and Health (NIOSH) (Corrigan, 2008).

The WMA TWG has recognized several important research needs that would require investigation that were incorporated into two projects by the National Cooperative Highway Research Program (NCHRP); NCHRP project 09-43 and 09-47 (Corrigan, 2008).

NCHRP 09-43

The 09-43 project “Mix Design Practices for Warm Mix Asphalt Technologies” was endorsed by the NCHRP in 2007 with the purpose of development of a manual of practice for the mix design procedure of WMA that would be based on performance. This manual of practice is to be designed suitably to be used by technicians and engineers in the asphalt sector. The targeted mix design procedure is to be compatible with the SuperPave methodology and versatile for utilization with different WMA technologies (Transportation Research Board, 2007). The objectives of this project were planned to be achieved through the accomplishments of two phases. The first phase comprises a number of tasks that are

outlined in Figure 2.3. The second phase will commence with the implementation of the experiment approved in task 4 of phase one and based on the outcome of the experiments, a final version of the WMA design method shall be prepared. Consequently, the design method should be validated using data and materials acquired from completed field projects. Currently, phase one has commenced and its outcomes are pending.

NCHRP 09-47

The second NCHRP WMA project is titled "Engineering Properties, Emissions, and Field Performance of Warm Mix Asphalt Technologies" and began in 2008. The main objectives of this project are to investigate the relationship between the engineering properties of WMA binders and mixtures as well as the practical field performance of WMA pavements. In addition, the project should provide relative relationships between the performance of WMA pavements and those constructed with HMA. The same way, a comparison of the practices and costs associated with the production and the placement of pavements using the HMA and WMA will be conducted (Corrigan, 2008). The project included WMA technologies of different natures and each of these technologies will be used in a minimum of two full scale trials. Full scale trials stipulate the use of a quantity ranging between 1,500 to 5,000 tons of the WMA technology placed with conventional equipment on an in-service road (Transportation Research Board, 2008). Project 09-47 includes two main phases with each phase composed of several tasks. Figure 2.4 shows an outline of the tasks of phase I.

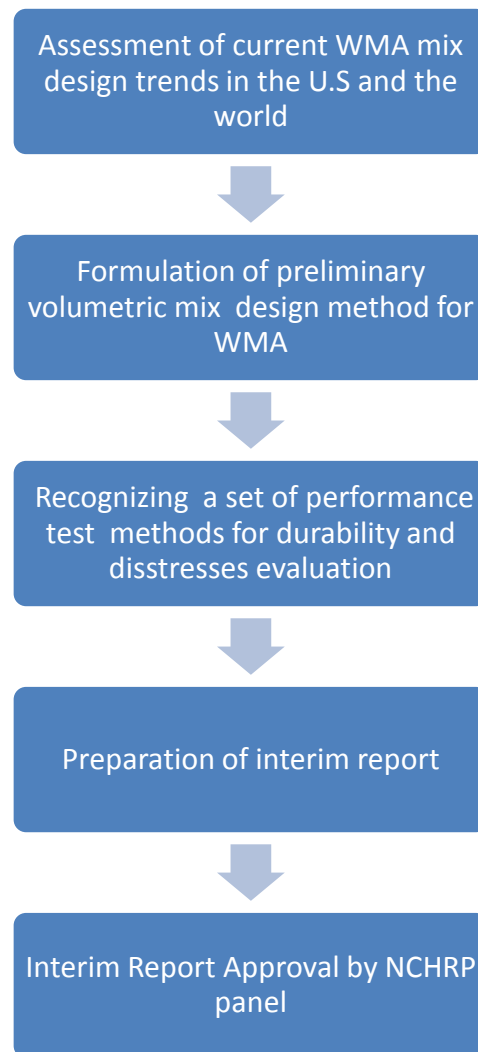

Figure 2.3: Chronology of tasks of Phase I of NCHRP Project 09-43 (Transportation Research Board, 2007)

Upon the approval of the first phase, the second phase will commence with the execution of the work plan approved in the first phase of the project. Finally, a proposal for the laboratory evaluation of the performance of the WMA technology and a final report summing up the findings and outlining the results of the project will be prepared (Transportation Research Board, 2008).

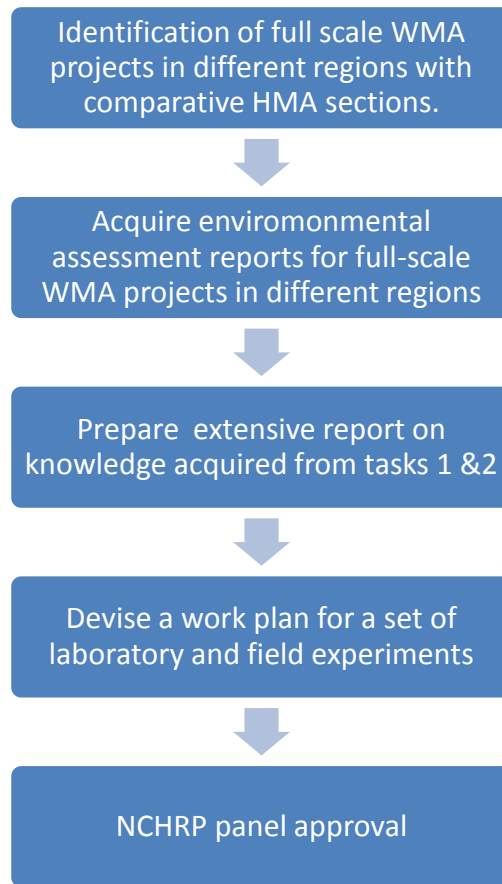

Figure 2.4: Tasks for Phase I of NCHRP 09-47 (Transportation Research Board, 2008)

2007 FHWA European Scan Tour

Through the International Technology Scanning Program of the Federal Highway Administration, a U.S. materials team, comprised of experts from different agencies and companies, visited the following European countries in 2007: Belgium, France, Germany and Norway with the objective of assessing various WMA technologies. The members of the International Technology Scanning Program represented: FHWA, NAPA, Asphalt Institute, several State DOTs and contractors. The team explored various technologies and held discussions with different agencies with respect to the methods of implementation of these technologies. Technologies encountered during the scan tour can be classified by type: foaming process, chemical additives and organic wax additives. The foaming process technologies introduce small amounts of water to hot asphalt either through a foaming nozzle or a hydrophilic material like zeolite, this water turns into steam and results in an

expansion of the binder phase with an associated reduction in the mix viscosity. Table 2.1 outlines the WMA technologies observed in Europe by the FHWA team. The number of processes being developed promotes the need for a system of assessment for new technologies (D'Angelo, et al., 2008).

In all countries visited during the tour, WMA was expected to offer an equivalent performance or even better than HMA. In Norway for instance, the delegates observed six sections built with WAM-foam technology as shown in Figure 2.5. Generally, the condition of the pavements was very good except for the presence of some rutting that was attributed to the use of studded tires, which is allowed in Norway. The Norwegian Public Roads Administration has provided data on 28 WAM-Foam sections with an age between 2 to 8 years. It was reported that the performance of the WAM-Foam sections was similar to HMA overlays used previously (D'Angelo, et al., 2008).

In Germany, there are criteria for incorporating new materials in field trials as it must be installed on the right-hand lane of high traffic roadways with the length of the sections overlaid not less than 1,640 ft. The investigating team observed a number of WMA stone mastic asphalt sections on the Autobahn located between Cologne and Frankfurt. Data on seven sections built with four different WMA technologies was presented to the scan team. Those technologies are Sasobit®, Asphaltan-B®, Aspha-min® and Asphalt modified with Licomont®. The performance of all seven sections was as good as or better than the control sections built with conventional HMA technology.

Moreover, a number of WMA additive suppliers furnished performance data to the scan team for a number of trial sections where the performance of the WMA was on par with the HMA performance if not better (D'Angelo, et al., 2008).

Table 2.1: Technologies observed in Europe by the scan team (D'Angelo, et al., 2008)

WMA Process	Process Type	Additive	Plant Production Temperature	Reported use in
Sasobit	Organic Wax Additive	2.5% by weight of binder	266-338°F is recommended	Germany and other countries
Asphaltan-B		2.5% by weight of binder	266-338°F is recommended	Germany
Licomont		3 % by weight of binder	266-338°F is recommended	Germany
3E LT/ Ecoflex		N/A	54-72 drop from HMA	France
Aspha-min	Chemical Additive	0.3 % by total weight of mix	266-338°F is recommended	France, Germany and U.S.
ECOMAC		N/A	At 113 °F	France
LEA	Foaming Process	0.2-0.5 % by weight of binder	At < 212 °F	France, Spain and Italy
LEAB	Foaming Process	0.1 % by weight of binder	At 194°F	Netherlands
LT Asphalt	Foaming Process	0.5-1.0 % by weight of a filler	At 194°F	Netherlands
WAM-Foam	Foaming Process		230-248°F	France, Norway and other countries
Evotherm	Chemical Additive		185-239°F	France, Canada and U.S.



Figure 2.5: Scan team observing a WAM-Foam section in Norway (D'Angelo, et al., 2008)

In France, the Department of Eure-et-Loir, a district located southwest of Paris has conducted field trials with Aspha-min® and ECOMAC®. Meanwhile, the city of Paris has performed some experiments with a number of WMA technologies starting from 2004. A toll road operator managing a number of toll roads in the southwest region of Paris built a trial section with Aspha-min® in 2003 on a road that carries a daily traffic of 21,000 vehicles in both traveling directions. The performance of the trial section was satisfactory (D'Angelo, et al., 2008).

The scan team also looked into how different agencies in the visited countries stipulate and integrate WMA into their established specifications and applications. One factor identified by the scan team as very helpful in the process of incorporating WMA into specifications is the fact that most European paving contracts contain a 2-5 year warranty period.

In Norway, the Norwegian Public Roads Administration has permitted the use of WMA as an alternative to HMA on the condition that the WMA pavements must adhere to all specifications stipulated for HMA. Meanwhile, in Germany the incorporation of any

constituent materials requires a proof of its “established suitability”. In the case of WMA technologies such as Sasobit®, Asphaltan-B® and Aspha-min®, their suitability was acquired from the satisfactory test trials and demonstrations under heavy traffic for a minimum period of 5 years. Furthermore, a bulletin “Merkblatt” came out in August 2006 presenting general remarks and guidelines for using WMA acting as a cornerstone for the formulation of standardized construction method in the future. Finally, in France there is a certain procedure for new technologies to be incorporated into the specification to be available for use. A chart showing the chronological steps of this procedure is illustrated in Figure 2.6 (D'Angelo, et al., 2008).

The scan team has recommended the construction of similar evaluation systems for new products in the United States. The team has also noted that the application of WMA in Europe was not as widespread as they had expected and they cited two reasons for that. The first reason is the fact that the oldest sections built with WMA were just elapsing their workmanship warranty periods hence, contractors are still cautious until they can develop a confidence in the long term performance of the technology before any further expansion in its utilization. The second reason is the higher cost of using WMA technologies in place of HMA even when fuel savings are taken into consideration (D'Angelo, et al., 2008).

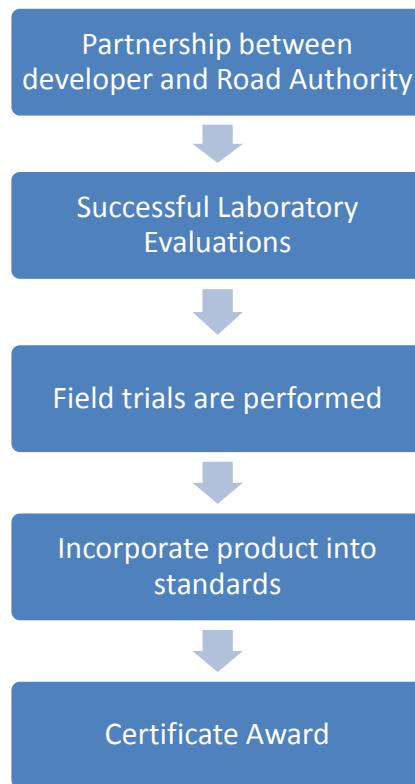

Figure 2.6: Process of incorporating new technologies into existing specifications in France

2.2.3 International WMA Projects

Germany

A runway was refurbished overnight by using the WMA technology, Sasobit®. Sections of 60 m in width and 15 m in length and a thickness of nearly 0.5 m were removed and rebuilt during each night shift (Sasol Wax, 2003; Hansen, 2006; Zettler, 2006).

Two runways in a Hamburg airport in Germany were paved with Stone Mastic Asphalt (SMA) with 3% of Sasobit® added. The first runway was built in July 2001 with a total area of 60,000 m². Satisfactory pavement performance along with enhanced compactibility was reported despite the significant reduction of pavement temperature by around 30°C. In June 2003, a larger runway in the same airport was paved with SMA that incorporated Sasobit® (Sasol Wax, 2003).

WMA was placed on a runway in a Berlin airport with a total area of 135,000 m² and an asphalt layer of about 12 cm in thickness. A 3% dosage of Sasobit was incorporated into the asphalt mix used for this runway which was fully shutdown during the entire span of construction (Sasol Wax, 2004).

Canada

In August 2005, three trial sections of WMA were placed in Montreal, Canada using Aspha-min® zeolite. The HMA control segment was mixed at a 160°C while the Aspha-min® sections were mixed at temperature ranging between 130-135°C. The paving temperature of the Aspha-min® sections was lower (110-125°C) than the hot mix asphalt (140-150°C) (Davidson, 2007).

Three other projects were placed in 2006 using Aspha-min®. The first was a demonstration project on a section of Autoroute 55 southeast of Drummondville placed using 280 tons of WMA in August. The other two projects were constructed in late November with ambient temperatures ranging between 0 and 5°C. In those two projects zeolite was incorporated into the control HMA and a significant improvement in compaction was reported (Davidson, 2007).

On the other hand, Lafarge Canada conducted some WMA trial experiments using WAM-Foam® technology in northeast Calgary. Meanwhile, seven demonstrations of the Evotherm® technology were conducted in Canada between 2005 and 2007 consuming nearly 10,000 tons of warm mix (Davidson, 2007).

United Kingdom

While the condition of the M6 motorway near Birmingham, United Kingdom was deteriorating alarmingly, any road maintenance and renovation was impossible during peak times of traffic. Thus, the only feasible time for the repair work was at night. Sasobit® WMA technology was used in renovating the damage of nearly one Km over eight night shifts so that proper compaction could be accomplished at relatively lower temperatures

thus, the repaired section would need less time to cool down and be able to withstand traffic in a shorter time span than conventional hot mix asphalt. It was reported that all three layers of the pavement were placed at temperatures lower than the conventional HMA by 20-30°C (Sasol Wax, 2006).

Additionally, a dense base course with a thickness of 20 mm which incorporated WAM Foam was manufactured and laid in 2001. The texture of the WMA mix and its stiffness modulus were reported to be similar to conventional HMA mixtures (Kristjansdottir, 2006).

Norway

In September 2000, the first field trial of WAM-Foam® process was conducted on a major road in Hobøl, Norway. Moreover, on a section of FV 82 road a wearing course of WMA utilizing the WAM-Foam® technology was placed in April 2001. Investigations of the rut depths conducted between 2000 and 2003 have shown that the rut depths of WMA and HMA sections were quite similar (Kristjansdottir, 2006).

2.2.4 WMA Projects in the United States

NCAT

An asphalt demonstration project incorporating Aspha-min® was built in Orlando, Florida in February 2004. It was reported that the use of the warm mix technology has lowered the production and compaction temperatures by 35° F than the temperatures of the control mix. Testing samples from the field in the laboratory obtained results that came in agreement with the laboratory study conducted by the NCAT (Hurley & Prowell, 2005).

On the other hand, two sections, N1 and E9 built in October 2005 using WMA incorporating Evotherm® on the NCAT test track has performed adequately. The WMA mixtures incorporating Evotherm® include two base courses with a thickness of 2 inches that were mixed and placed at 225 °F. After 5.6 million ESALs, it was reported that the average rutting observed in the sections constructed with Evotherm® did not exceed 6 millimeters (Zettler, 2006; Crews, 2006; Brown, 2007; Brown 2008).

Ohio

A demonstration project was conducted on sections of SR 541 in Ohio under the supervision of the Ohio Department of Transportation. A section was laid using conventional HMA as the control mix with other sections built using three WMA technologies: Aspha-min®, Sasobit® and Evotherm® (Brown, 2007; Morrison, 2007; Powers, 2007). The Aspha-min® additive was added at 0.3% by total weight of the mix while Sasobit® was added at 1.5 % of the total binder at the plant. Environmental testing on the emissions produced by the four sections have shown that the Aspha-min® and Sasobit® had lower emissions of sulfur dioxide, nitrogen oxides, volatile organic compounds and carbon monoxide in comparison to the control mix. On the other hand, the Evotherm® section had produced higher emissions of sulfur dioxide, nitrogen dioxide and volatile organic compounds but it has reduced emissions of carbon monoxide (Morrison, 2007).

Wyoming

Warm mix asphalt was used in the reconstruction effort of the east road entrance of the Yellowstone National Park, Wyoming under the supervision of FHWA division, Western Federal Lands Highway Division (Wagner, 2007). Three sections with a total distance of approximately 7 miles were laid using a control HMA mix, 8,750 tons of Advera® warm mix and 7,450 tons of Sasobit® warm mix was utilized in the field project. The Sasobit® admixture was added at a rate of 1.5% by weight of the binder while the Advera® additive was added at a dosage of 0.3% by weight of total mix. Results generated from this field trial has revealed that the workers did not observe any trouble in handling the warm mix asphalt and there were no signs of moisture susceptibility in the warm mixtures (Neitzke, 2007).

Missouri

Three warm mix technologies were utilized in sections of Hall Street, St. Louis, Missouri in 2006. The high temperature of the HMA was the main reason suspected for the formation of bumps in this slow moving traffic region. Hence, Sasobit®, Aspha-min® and Evotherm® additives were used to investigate whether the use of WMA would eradicate the formation

of bumps on that street. Under the supervision of the Missouri DOT, a total of 7,000 tons of warm mix were placed with the field compaction temperature varying between 200 and 250°F. In addition to the testing efforts conducted by the contractor and the Missouri DOT, mobile labs from FHWA and NCAT were available to conduct testing on the placed sections. Satisfactory rut depths were reported for the WMA sections and no bumps were observed (Prowell & Hurley, 2007).

Tennessee

A warm mix demonstration project was carried out in the city of Chattanooga, Tennessee in June 2007 using 4,000 ton of warm mix incorporating the Double Barrel Green® technology. The warm mix utilized in that project included 50% recycled asphalt and it was handled at 270° F with lower consumption of fuel and less emissions and odors (Brown, 2007). Sections of roads in Hillsboro Pike were rebuilt using four different WMA technologies: Double Barrel Green®, Advera® zeolites, Sasobit® and Evotherm® (Brown, 2008).

Texas

WMA was demonstrated at the American Public Works Association in September 2007 where 3,000 tons of Evotherm® warm mix was used in applying the final surface of the pavement on top of a lime stabilized subgrade a strong base layer. The warm mix was mixed at 220 to 240° F and placed at 200° F with the compaction taking place without any noted difficulty (Brown, 2008).

The American Public Works Association's street construction demo of warm mix drew some 250 people last September. "We've done about 5,000 tons of warm mix through various demos, so our plant people are very comfortable with the process," said Harry Bush of Vulcan Materials, which supplied the mix (Brown, 2008). "The temperature of the mat under the paver was about 100 degrees less than normal hot mix. And compaction went very smoothly."

New York

In Courtland County, New York during September 2006, a demonstration project was conducted utilizing the French WMA technology, Low Energy Asphalt (LEA). The results of the demonstration were satisfactory as the technology permits the discharge of the mix at the plant in the range between 190 and 200°F (Harder, 2007). Several demonstration projects and trials followed during 2006 and 2007 (Brown, 2007).

2.3 Benefits of Warm Mix Asphalt

The benefits of WMA are dependent upon which technology is utilized. There are varying degrees of benefits for each different method. This is an overview of the benefits thus far realized by the industry but the specific benefits for each technology, in some cases, are not entirely quantified. Some benefits may not yet be completely economically quantifiable such as emission reduction. Also the benefit may be a variable cost such as the asphalt binder cost. If stricter emissions standards are implemented there may be higher economic potential for WMA. The purpose of this section is to present the potential benefits of WMA. Since WMA technology is in the beginning stages of implementation, there are many questions about benefits that have not yet been answered.

One of the driving forces of WMA research is the potential for it to reduce energy and fuel consumption and therefore reduce emissions. The typical WMA production temperature is in the range of 30 to 100°F lower than typical hot-mix asphalt (HMA) (Newcomb, 2007). Often times only a slight reduction in temperature is achieved (10 to 15°F) but the reduction can lead to energy savings and significantly reduce emissions. The WMA technology is available for potentially greater temperature reductions (Newcomb, 2007). For WMA production in Europe, the reduction in temperature has led to burner fuel savings that typically range from 20 to 35 percent (D'Angelo, et al., 2008). There is a possibility of greater fuel savings (50 percent or more) when processes such as low-energy asphalt concrete (LEAB) and low-energy asphalt (LEA) are used because the aggregates or a portion of the aggregates are not heated above the boiling point of water (D'Angelo, et al., 2008).

Air Quality

The WMA technology reduces the asphalt's temperature at the time of paving and there are several resulting benefits. These include an improved and cooler working environment, decreased exposure to asphalt fumes, higher employee retention, and an improved quality of work (Newcomb, 2007). According to the National Institute for Occupational Safety and Health (NIOSH) website, the current recommended exposure limit (REL) for asphalt fumes is $5\text{mg}/\text{m}^3$ as total particulate matter (TPM) during any 15 minute period (Roberts, Kandhal, Lee, & Kennedy, 1996). The reduced temperatures of WMA will produce fewer fumes and create better paving environments in areas such as tunnels or underground paving (Kristjansdottir, 2006).

In unison with reduction of fumes, is the reduction of odors. As the asphalt production temperatures are reduced through WMA technologies, this would reduce odors commonly associated with plant and paving operations (Newcomb, 2007). Less odors would minimize the impact asphalt paving can have in urban areas.

Environmental Protection Agency Regulations

As the country and the world move to become more sustainable, more requirements about pollution will be implemented. One example of a more stringent air pollution policy is the Clean Air Interstate Rule (CAIR). The CAIR will achieve the largest reduction in air pollution in more than a decade. CAIR emission standards applies to 28 eastern states (including Iowa) and achieving the required reductions is predominately focused on controlling emissions from power plants but states are given the option to meet an individual state emissions budget through measures of the state's choosing. The Environmental Protection Agency (EPA) has shown that cap-and-trade systems have worked for other programs and will be used in the CAIR for both SO_2 and NO_x . Both SO_2 and NO_x are emissions created in the production of HMA. The EPA's website states the following about the CAIR cap-and-trade for SO_2 and NO_x (U.S. Environmental Protection Agency, 2009):

EPA already allocated emission "allowances" for SO₂ to sources subject to the Acid Rain Program. These allowances will be used in the CAIR model SO₂ trading program. For the model NO_x trading programs, EPA will provide emission "allowances" for NO_x to each state, according to the state budget. The states will allocate those allowances to sources (or other entities), which can trade them. As a result, sources are able to choose from many compliance alternatives, including: installing pollution control equipment; switching fuels; or buying excess allowances from other sources that have reduced their emissions.

The asphalt industry, with WMA technology, would potentially be an example of a “source that has reduced their emissions” causing the asphalt industry to have “excess allowances” and would potentially be able to sell these to a non-compliant pollution source. This strategy would help put an economic value on the emission reductions seen in WMA. The CAIR will be completely implemented by 2015 (U.S. Environmental Protection Agency, 2009). Specifically for Iowa, the CAIR will reduce SO₂ emissions by 5% and NO_x emissions by 49% (U.S. Environmental Protection Agency, 2008).

WMA Paving Benefits

There are numerous paving benefits for WMA. Some of these include: less compaction effort, longer haul distances, and a better workability with high RAP mixes. WMA has been shown in both field and laboratory studies to have similar or better compactability than traditional HMA mixes (Hurley, 2006). A laboratory study conducted at the National Center for Asphalt Technology (NCAT) compared three different WMA additives to traditional HMA. The additives used were Evotherm®, Sasobit®, and Aspha-min®. The study found that all three additives aided in the compaction significantly compared to the control sample with no WMA additive. It was also found that Evotherm® reduced the air void content the most (Hurley, 2006). On a project in Canada, located on Autoroute 55 southeast of Drummondville, Aspha-min® zeolite was found to be a compaction aid in the field in comparison to a similar mix without zeolite (Davidson, 2007). Another study was conducted using the Astec Double Barrel Green® System and found that the WMA foaming

technology provided compaction effort similar to HMA mixes but at a lower temperature (Wielinski et al., 2009).

Cooling Rate

Another potential benefit of WMA is longer haul distances. The haul distances can be lengthened for two different reasons. The first is that WMA has a smaller differential between the mix temperature and the ambient temperature which results in a slower rate of cooling as well as better compactability at a lower temperature (D'Angelo, et al., 2008). In the publication, "Warm Mix Asphalt: European Practice," Sasobit® has been reported to allow a hauling time of 9 hours for a project in Australia (D'Angelo, et al., 2008).

Throughout the literature review, little information was found specifically addressing the rate of cooling for WMA. Cooling rates for HMA are variable and depend on at least five factors. These factors are: air temperature, base temperature, mix laydown temperature, layer thickness, and wind velocity (Scherocman, 1996).

Crack Sealant Improvements

Another potential benefit of WMA is increased smoothness when crack sealant is on the underlying layer. This benefit was observed in the field on an Evotherm® project in Fort Worth, Texas. In the past, the Texas Department of Transportation (TxDOT) used a crack sealant on the road and the sealant would expand and create bumps after the application of HMA. The Evotherm® lowered the temperature of the asphalt and the decrease in temperature helped avoid expansion of the sealer thus increasing the smoothness of the roadway (MeadWestvaco, 2008).

Lower Temperature Paving

The Iowa DOT Construction Manual specifies that HMA mixtures shall not be placed after November 15, except with approval of the Engineer (Iowa Department of Transportation, 2008). There are several factors that determine the production temperature for WMA mixes produced during cool weather such as the WMA technology used, ambient conditions, and

haul distance but WMA technology provides the ability to pave in cooler temperatures and still obtain density (D'Angelo, et al., 2008). Case studies in Germany have utilized various technologies to place pavement when ambient temperatures were between -3 and 4°C (27 and 40°F). The density results were higher for the WMA when compared to the same compaction effort as the HMA pavement.

Incorporating WMA with RAP Paving

Lower production temperature for RAP mixes is a potential benefit of WMA. The viscosity reducing properties of WMA additives such as Sasobit® or Advera®, has been shown in numerous studies to enhance the workability of RAP mixes. The incorporation of higher RAP percentages could potentially save money because less virgin aggregate and less virgin binder would need to be purchased. This cost savings would be variable due to the potential for high fluctuations in virgin binder prices (Tao & Mallick, 2009). Several studies have incorporated both WMA and RAP and some of these studies will be described in Section 2.5.

To summarize, WMA offers many benefits to the workers, contractors, citizens and government agencies. The lower temperatures create cooler working conditions and reduced worker exposure to fumes. The contractors may benefit from fuel savings. Studies have shown that fuel savings can reach up to 30%. The lower temperatures reduce the amount of odor that the asphalt plants emit. There is an additional benefit because asphalt plants could potentially be placed in areas of non-attainment. This would create shorter haul distances in these areas.

2.4 Emerging and Available Warm Mix Asphalt Technologies

Presented in this section are the main types of WMA technologies available as well as a discussion of the specific processes and additives for each type. Several studies that have investigated only one specific WMA technology are also discussed in this section. Other studies that investigated several WMA technologies or processes will be discussed in

Section 2.5. The technologies presented represent commonly used technologies and may not incorporate all types of processes available worldwide.

There are three main types of WMA technologies. These include foaming, organic wax additives, and chemical processes. Foaming technologies use small amounts of water in the binder to foam the binder which lowers the viscosity. There are several foaming technologies available such as Aspha-min®, WAM-Foam® developed by Shell Petroleum and Kolo-Veidekke and the Astec Double Barrel Green® system. The most common example of an organic wax additive used in WMA is a Fisher-Tropsch wax. These are created by the treatment of hot coal with steam in the presence of a catalyst. The chemical additive used in WMA is in the form of an emulsion and then mixed with hot aggregate. The mixing temperature ranges between 185-240°F (Hodo et al., 2009). The most commonly used chemical additive is Evotherm®. These technologies will be examined in more detail.

The following is an overview representing most WMA technologies available. Each section will discuss the developer, the manufacturer's recommendations, the results of studies which have utilized the technology and the recommendations made in regard to the specific technology tested.

2.4.1 EVOTHERM®

Evotherm® is a product that was developed by MeadWestvaco in 2003. It is recommended that Evotherm® be added at rate of 0.5 percent by weight of binder (Hurley, 2006). The Evotherm® uses a Dispersed Asphalt Technology (DAT) as the delivery system.

MeadWestvaco states that the DAT system has a unique chemistry customized for aggregate compatibility (Corrigan, 2008). The newest version of Evotherm® is the Evotherm 3G® (also called REVIX™). As of November 2008, MeadWestvaco is partnering with Ergon Asphalt & Emulsion, Inc., an Ergon Company, and Mathy Construction Company to market Evotherm 3G® (MeadWestvaco, 2008). This is water free and does not rely on binder foaming or other methods of viscosity reduction. Mathy states that the technology is based

on work that shows the additives provide a reduction in the internal friction between aggregate particles and the thin films of binders used to produce bituminous mixtures when subjected to high shear rates during mixing and high shear stresses during compaction (Corrigan, 2008).

Evotherm® production temperature at the plant ranges from 185-295°F (85-115°C). An approximate total tonnage produced to date is over 17,000 tons as of February 2008 (D'Angelo, et al., 2008). The chemistry is currently delivered with a relatively high asphalt residue (approximately 70 percent). Unlike traditional asphalt binders, Evotherm® is stored at 176°F (80°C). In most Evotherm® field trials, the product is pumped directly off a tanker truck (Hurley & Prowell, 2005).

Several laboratory and field studies have been conducted in order to evaluate the performance of Evotherm®. These studies include but are not limited to: NCAT's Evaluation of Evotherm® for use in Warm Mix Asphalt, McAsphalt Industries Limited evaluated Evotherm® in the field at the City of Calgary, Aurora, and in Ramara Township, all in Ontario. Field studies were also conducted in Fort Worth and San Antonio, Texas. A case study was performed at NCAT to determine the moisture susceptibility in WMA and Evotherm® DAT was the WMA technology used for that study. The Virginia Department of Transportation (DOT) conducted a field study where one of the three WMA projects used Evotherm® (Diefenderfer et al., 2007).

Evotherm Field Projects in Canada

The objective of the City of Calgary field study was to compare Evotherm® to HMA and to gain experience with Evotherm®. The target mix temperature for compaction in this study was 203°F (95°C) and the approximate mix temperature to achieve that was 290°F (143°C). This field study concluded that the mix created no issues during production or placement. Compaction is comparable with HMA and the same equipment can be used. The mix process does not present any problems with a batch plant (Davidson, 2006).

The field evaluation in Ramara Township in Ontario, Canada had similar objectives to the City of Calgary project. Emissions data was collected during this paving job. A 2 tonne batch plant with baghouse with a production rate of 125 tonnes per hour was used in this study and Evotherm® emulsion arrived onsite at a temperature of 199 to 203°F (93 to 95°C). The plant operator mentioned that the emulsion was slower to pump and that the batch size had to be reduced because of the capacity of the asphalt cement weigh hoper. This is because the emulsion is only 68 to 70 percent asphalt and as a result, 46 percent more liquid material is needed per tonne of mix (Davidson, 2005). The smoke stack data showed that emissions were significantly reduced. Table 2.2 shows the emissions data measured from the smoke stack.

Table 2.2: Ramara Township Field Study: Combustion Gas Sampling Results (Davidson, 2005).

Combustion Gas	Concentration		% Reduction
	Hot Mix	Warm Mix	
Oxygen	14.6 %	17.5 %	
Carbon Dioxide	4.8 %	2.6 %	45.8
Carbon Monoxide	70.2 %	25.9 %	63.1
Sulphur Dioxide	17.2 ppm	10.1 ppm	41.2
Oxides of Nitrogen (as NO)	62.2 ppm	26.1 ppm	58.0
Average Stack Gas Temperature	162°C	121°C	

The conclusions reached as a result of this field study are the same as the City of Calgary project and that the mix processes did not cause any problems with the baghouse. Some recommendations are that Evotherm® emulsion should be manufactured between 67-69 percent residue to prevent too high of a viscosity that could cause pumping issues.

The next field test was performed by McAsphalt in Aurora, Ontario. The mix was produced in a drum plant with a wet scrubber and a production rate of 225 tonnes per hour. The mix temperature used was approximately 226°F (130°C) The target compaction temperature of 203°F (95°C) (Davidson, 2005). The conclusions were similar to the conclusions stated for the City of Calgary and the Ramara Townships field tests.

Evotherm® Field Projects in Texas

The TxDOT performed Evotherm® field test in San Antonio and in Fort Worth. The San Antonio field test was performed with the purpose to evaluate the production, placement, and compaction of WMA compared to HMA and to evaluate the short and long-term performance of WMA compared to HMA (Button, Estakhri, & Wimsatt, 2007). This project was performed on August 31, 2006. The production rate was about 190 tons per hour (HMA production is typically 250 tons per hour for this plant). The lower production rate was due to high moisture content in the aggregate stock piles. Due to the high moisture content in the aggregate, the fuel consumed was the same for the warm mix as for the hot mix. No moisture problems occurred in the baghouse. The WMA was produced at 220°F (104°C) and the control mix was produced at 320°F (160°C). Some of the observations/conclusions made on this project were (Button, Estakhri, & Wimsatt, 2007):

- The HMA had an optimum asphalt content of 4.8 percent and the WMA optimum asphalt content was 4.2 percent.
- The WMA was compacted at temperatures ranging from 170°F to 210°F (77°C to 99°C) and HMA was placed at 305°F (152°C). Nuclear density tests showed 92.1 to 95 percent for WMA and the tests averaged 94.2 percent for the HMA.
- This section was open to traffic 2 hours after placement.
- Cores of the roadway, taken one month after placement, showed that no further densification was occurring.
- Indirect tensile strength (ITS) was performed during mix design and on roadway cores. The control mix had a ITS of around 170 psi. During the mix process the tensile strength for the WMA was 60 psi but the WMA roadway core tensile strengths ranged from 121 to 178 psi.

At the time of the report, all tests were performing well. The TxDOT intends to continue monitoring the long-term performance of the WMA.

Evotherm Studies Performed by NCAT

In June 2006, NCAT presented their final report of a laboratory investigation to determine the applicability of Evotherm® in WMA applications including typical paving operations and environmental conditions commonly found in the United States and to evaluate the performance in quick traffic turn-over situations and in high temperature conditions. Evotherm® and control mixes were produced using both granite and limestone aggregate and binder grades of PG 64-22 and PG 76-22 (Hurley & Prowell, 2005). A 12.5mm nominal maximum aggregate size (NMAS) was used. The mix designs were verified at 300°F (149°C) and then the other combinations were compacted at three lower temperatures, 265°F, 230°F, and 190°F. The optimum asphalt content was 5.1% for granite and 4.8% for limestone by weight of the mixtures. In this study it was found that Evotherm® had little effect on the Maximum Specific Gravity (G_{mm}) of the mixture. The conclusions based on this laboratory study can be summarized as follows (Hurley & Prowell, 2005):

- Evotherm® lowers the air voids in the gyratory compactor for a given asphalt content. This may indicate a need to reduce the optimum asphalt content; however, at the time of this study it is believed that the optimum asphalt content of the mixture should be determined without Evotherm®. It is possible, when reducing the optimum asphalt content, to negate the improved compaction resulting from the addition of Evotherm®.
- Evotherm® improved the compactability in the Superpave Gyratory Compactor (SGC) and a vibratory compactor. Statistical analysis showed an average air void reduction of 1.4 percent and improved compaction noted as low as 190°F.
- Evotherm® increased the resilient modulus of an asphalt mix compared to the control mix at a given compaction temperature and same performance grade (PG) binder.
- Evotherm® decreased the rutting potential compared to the control mixes produced at the same temperature. The rutting potential increased with decreasing mixing and compaction temperature possibly due to the decreased age of the binder. The decreased rutting potential was correlated to improved compaction.

- The Evotherm® indirect tensile strengths (ITS) were lower, in some cases, compared to the control mixes.
- Visual stripping was observed in the control mixes for both the granite and limestone aggregates and visual stripping occurred with the limestone aggregate mix produced at 250°F (121°C) containing the original Evotherm® formula. Low tensile strength ratio (TSR) values were observed with the original Evotherm® formula and the limestone aggregate. The new Evotherm® formula increased the tensile strength and eliminated the visual stripping for the limestone aggregate.

The recommendations based on the Evotherm® laboratory analysis are as follows (Hurley & Prowell, 2005):

- The optimum asphalt content should be determined with a neat binder that has the same grade as the Evotherm® modified binder. Extra samples should be made with the Evotherm® so the production air void target can be adjusted.
- A minimum mixing temperature of 265°F (129°C) and a minimum compaction temperature of 230°F (110°C) is recommended. If mixing is below 265°F (129°C) it is recommended that the high temperature grade should be bumped by one grade to counteract the tendency for increased rutting susceptibility with decreasing production temperatures.
- Moisture sensitivity testing should be performed at anticipated field production temperatures.

This laboratory study will be a helpful model for the future experiments and the recommendations will be useful for future studies. This study is a good example of the type of data that can be expected when performing laboratory testing using Evotherm®.

One of the major concerns with WMA is its susceptibility to moisture damage. The hypothesis is that lower WMA temperatures will not adequately dry out the aggregate causing inadequate bonding between the asphalt binder and aggregate. NCAT performed a study addressing this issue using the Evotherm® DAT technology. The mixes tested were both laboratory and plant produced mixes. Both mixes contained limestone aggregate with an optimum asphalt content of 5.2% (Kvasnak et al., 2009). The moisture susceptibility tests

used in this study were the indirect tensile strength (ITS) tests and the Hamburg Wheel Tracking Device (HWTD) test. After samples were made, the ITS was measured and the absorbed energy was calculated. The acceptable absorbed energy value is recommended to be 70 or greater for unaged specimens and 55 or higher for aged specimens to be considered acceptable (Kvasnak et al., 2009). The TSR showed the WMA laboratory mix had a TSR of 69 percent and was below the 80% tensile strength ratio criteria. All HMA samples, laboratory and field produced, met the passing criteria for this test. All but one of the four WMA plant produced mix samples exceeded the 80% tensile strength criteria. The HWTD test was only performed on the plant produced samples. The test showed the HMA mix consistently produced a stripping inflection point above 10,000 cycles and the WMA mix produced a stripping inflection point that ranged between 5,000 to greater than 10,000 cycles. This study showed that the WMA moisture susceptibility results improved from the laboratory to the plant. This may be due to the Evotherm® DAT not blending adequately in a laboratory bucket mixer. The results may be better if the Evotherm® DAT had been mechanically blended with the binder prior to mixing. Overall, WMA showed to be more susceptible to moisture damage than HMA but most WMA samples did pass the moisture susceptibility criteria (Kvasnak et al., 2009).

Evotherm Field Projects in Virginia

The final study reviewed that used Evotherm® was a field study in Virginia. This was a 1.5 inch overlay in York County, Virginia performed October 26-November 2, 2006. The base binder used for the emulsion was a PG 70-22 (Diefenderfer et al., 2007). The weather was clear with highs around 60°F and a moderate breeze. The plant used was a Gencor counterflow drum plant. WMA was produced at temperatures ranging from 220°F to 230°F (104°C to 110°C) and approximately 530 tons of WMA were produced. The control HMA was produced at 300 to 310°F (149 to 154°C). This study found that asphalt content of the control mix was lower than that of the Evotherm® mix and no other volumetric differences were seen. The Evotherm® cores had slightly higher air void contents compared to the control but the difference was not statistically significant. Also, estimated voids from the uncorrected nuclear density measurements indicated slightly higher void contents and

variability for the Evotherm® section in comparison to the control section. This difference was statistically significant. Finally, Evotherm® specimens did not pass the rutting criteria when tested in the Asphalt Pavement Analyzer (APA) whereas control specimens had acceptable rutting resistance (Diefenderfer et al., 2007).

2.4.2 Sasobit®

Sasobit® is a Fischer-Tropsch paraffin wax. Sasobit® is a product of Sasol Wax, South Africa. Sasol Wax has been marketing Sasobit® in Europe and Asia since 1997 (D'Angelo, et al., 2008). It is described as an "asphalt flow improver." The Fischer-Tropsch (F-T) process produces the fine crystalline, long chain aliphatic hydrocarbon that makes up the product Sasobit®. The production process begins with coal gasification using the F-T process. The gasification of coal involves the treating of white hot hard coal or coke with a blast of steam (Corrigan, 2008). The gasification process produces a mixture of carbon monoxide and hydrogen. As this occurs carbon monoxide is converted into a hydrocarbon mixture with molecular chain lengths of 1 to 100 carbon atoms and greater. There are naturally occurring paraffin waxes but these differ from Sasobit® in the lengths of the carbon chains. Sasobit® hydrocarbon chains range from 40-115 carbon atoms and natural paraffin waxes range from 22 to 45 carbon atoms (Corrigan, 2008). The longer chains give Sasobit® a higher melting temperature of approximately 210°F (99°C) and fully dissolve in asphalt at 240°F (116°C). Sasobit® allows a reduction in production temperatures of 18-54°F. Sasol Wax recommends adding Sasobit® at 3 percent by weight of the mix to gain the desired reduction in viscosity and should not exceed 4 percent due to a possible adjustment of the binder's low temperature properties. Direct blending of solid Sasobit® at the plant is not recommended because it will not give a homogeneous distribution of the Sasobit® in the asphalt (Corrigan, 2008).

Sasobit® has been used in both laboratory and field studies. Several studies that have utilized Sasobit® will be discussed. NCAT performed a laboratory study using Sasobit®, the Virginia DOT performed two field studies with Sasobit®, and Sasobit® use was discussed in the FHWA publication about European WMA practice.

NCAT's Evaluation of Sasobit®

The report for NCAT's evaluation of Sasobit® was released in June 2005. The objectives in this study were to perform a laboratory study to determine if Sasobit® was applicable in typical paving operations and environmental conditions commonly found in the United States and also to evaluate the performance of mixes in quick traffic turn-over situations and high temperature condition (Hurley & Prowell, 2005). In this study, two aggregates (limestone and granite), three binders (PG 64-22, PG 70-22 and PG 76-22) and both a control Sasobit® and Sasoflex® which contains elastomer (SBS polymer) were mixed. Samples were prepared with oven dried aggregate. The mix design was verified at 300°F (149°C) and then the other combinations were then compacted at three lower temperatures (265, 230, and 190°F). Volumetric data showed that Sasobit® had little effect on the G_{mm} of the mixture. The Sasobit® mix tended to have lower air voids than the corresponding control mix in all 18 mix combinations and because of the lower air voids it appears to reduce the design asphalt content. No other changes in volumetric properties were impacted. Binder tests, APA rutting, strength gain, and moisture sensitivity were tested for all of the mixtures. Binder test results show that Sasobit® binders exhibit reduced aging in a rolling thin film oven (RTFO)/dynamic shear rheometer (DSR) test compared to a control binder (Hurley & Prowell, 2005).

The Sasobit® samples showed improved compaction in the vibratory compactor for all but four samples and this may be due to the SBS polymer stiffening the binder. It was found that Sasobit® did not affect the resilient modulus of an asphalt mix compared to the control. The ITS strengths were lower for the Sasobit® compared to the control in some cases. The strength gain experiment tested the rutting susceptibility of samples at different ages. There was no data to indicate that the Sasobit® was gaining strength with time. Moisture susceptibility was measured by HWTD tests and tensile strength ratios (TSR). Moisture susceptibility test results were variable. Reduced tensile strength and visual stripping were observed in both the control and Sasobit® mixes produced at 250°F (121°C). The addition

of AKZO Nobel Magnabond (Kling Beta 2912) improved the TSR values to acceptable levels. The recommendations from this laboratory study are (Hurley & Prowell, 2005):

- Modified binder including Sasobit® or Sasoflex® need to be engineered to the desired performance grade. In this study, a PG 58-22 was used and with the addition of 2.5 percent Sasobit® it was modified to a PG 64-22.
- Optimum asphalt content should be determined with a neat binder with the same grade as the Sasobit® modified binder and additional samples should be produced with Sasobit® so the field target density can be adjusted.
- A minimum mixing temperature of 265°F (129°C) and a minimum compaction temperature of 230°F (110°C) is recommended. If the mixing temperature is below 265°F (129°C) then the high temperature grade should be bumped by one grade to counteract the tendency for increased rutting susceptibility with decreasing production temperatures.
- Moisture sensitivity testing should be conducted at the anticipated field production temperatures and an anti-stripping agent should be added to the mix if moisture sensitivity results are not favorable.

Sasobit® Field Studies in Virginia

The first field study by the Virginia DOT was a 1.5 inch overlay in Rappahannock County, Virginia. Approximately 775 tons of WMA was paved. The mix was a 9.5mm NMA with a PG 64-22 containing 20% RAP and a design asphalt content of 5.5%. Morelife 3300 anti-strip additive was used at 0.5% by weight of binder. Sasobit®, in the form of prills, was added at a rate of 1.5% by weight of binder. The weather conditions on the day of paving were slightly overcast in the morning with temperatures in the upper 60's (°F) and by the afternoon the weather was clear with highs in the low 80's (°F). Stockpiles were damp from a 0.8 in of rain that occurred the day before paving. The plant was an Astec parallel flow drum plant with a coater box. HMA was produced at approximately 300°F (149°C) and Sasobit® was produced at 250°F (121°C) (Diefenderfer et al., 2007).

The second trial was a 1.5 inch overlay on Route 220 in Highland County, Virginia. This was performed on August 14 and 15, 2006. Approximately 634 tons of HMA was produced of which 320 tons was WMA. The weather was sunny on the 14th with high/low temperatures of around 86/68°F. Conditions were variable between plant and paving location on August 15th. The high/low temperature was approximately 72/68°F with overcast skies and an occasional light drizzle. The haul time was approximately 1 hour and 45 minutes. Due to the haul time, HMA was produced at temperatures of approximately 300 to 325°F (149 to 163°C) and WMA was produced at approximately 300°F (149°C). The temperatures behind the screed ranged from 280°F to 300°F for HMA and the temperatures behind the screed for WMA ranged from 250 to 275°F (121 to 135°C) (Diefenderfer et al., 2007).

For both trials, density and permeability testing, volumetrics, APA rut resistance, and TSR values were determined. The following conclusions were made as a result of these field tests (Diefenderfer et al., 2007):

- The use of Sasobit® did not cause substantial changes in volumetric properties.
- Average air void contents in Sasobit® cores were slightly less than control cores but the difference was not statistically significant.
- Permeability was similar for Sasobit® and control samples.
- The TSR test results were inconsistent.
- The rutting resistance of the Sasobit® WMA and HMA was not statistically different.

The Effect of Sasobit on CO₂ Emissions

A laboratory study was conducted at the Worcester Polytechnic Institute to examine how much Sasobit® reduced CO₂ emissions (Mallick et al, 2009). Both a control mix and an identical mix with 1.5% Sasobit® additive were tested. The CO₂ testing was performed by putting equal amounts of sample in separate sealed containers where the CO₂ emissions could be measured using an Accuro pump and 100-3,000 ppm active flow CO₂ Dräger tubes. The statistical analysis showed that at least one of the three independent variables,

Sasobit® content, temperature and added asphalt content had a statistically significant effect on CO₂ emissions. The linear regression analysis showed temperatures had a very significant relationship with CO₂ emissions. A statistical analysis of the data showed that Sasobit® is not directly responsible for any difference in CO₂ emissions but the reduction in temperature is significant. This study concluded that within the factors that were tested, the best way to reduce CO₂ emissions was by lowering the temperature of the mix and it was also shown that Sasobit® did not cause unwanted effects on emissions or volumetrics. Also, this study showed that the G_{mm} values were not statistically affected by Sasobit® addition (Mallick et al, 2009).

Sasobit® has been used in many projects and since 1997, more than 142 projects totaling more than 10 million tons of mix have been paved using Sasobit®. The projects were constructed in Austria, Belgium, China, Czech Republic, Denmark, France, Germany, Hungary, Italy, Macau, Malaysia, Netherlands, New Zealand, Norway, Russia, Slovenia, South Africa, Sweden, Switzerland, the United Kingdom and the United States. Lastly, Sasobit® was used in deep patches on the Frankfurt Airport in Germany. Twenty-four inches of HMA were placed in a 7.5 hour period. The runway was reopened to jet aircraft at a temperature of 185°F (85°C) (D'Angelo, et al., 2008).

2.4.3 Aspha-min®

Aspha-min® is produced by Eurovia Services GmbH, in Bottrop, Germany. Aspha-min® is a manufactured synthetic zeolite (Sodium Aluminum Silicate) that has been hydro thermally crystallized and is in a fine white powder form. The zeolite is 21 percent water by mass and the water is released in the temperature range of 185 to 360°F (85 to 182°C) The fine spray of water that is released creates a foaming effect in the binder that increases workability and aggregate coating at lower temperatures. The recommended addition rate is 0.3 percent by mass of the mix and there is a potential temperature reduction of 54°F compared to traditional HMA mixes. The reduction can lead to a 30 percent reduction in fuel energy consumption (Corrigan, 2008).

The framework silicates that make up zeolite have large vacancies in their crystalline structure and this allows large cations and water molecules to be stored. The zeolites are characterized by their ability to lose and absorb water without damage to their crystal structures (Corrigan, 2008).

Several studies have been performed using Aspha-min®. These studies include an NCAT laboratory analysis, studies by Eurovia, a laboratory evaluation performed at Michigan Technology University, some discussion from the publication "Warm Mix Asphalt: European Practice" and a short summary of a field projects in Canada that used Aspha-min®.

NCAT Evaluation of Aspha-min®

NCAT investigated the use of Aspha-min® zeolite in WMA. The objectives of this study were to determine the applicability of Aspha-min® to typical paving operations and environmental conditions commonly found in the United States, including the performance of mixes in quick traffic turn-over situations and high temperature conditions (Brown, 2007). In this study two aggregates (limestone and granite) and two binders (PG 58-22 and PG 64-22) were used. The control mixes had no zeolite and test results were compared to the mixes that contained zeolite. The mix designs were verified at 300°F. (149°C) then each combination was reevaluated at three lower temperatures (265, 230, 190°F).

Volumetric properties, resilient modulus, APA rutting, strength gain and moisture sensitivity were measured for each mix type. The results showed that Aspha-min® zeolite had little effect on G_{mm} of the mixture (Brown, 2007). Aspha-min® aided in compaction and lowered air voids compared to the control mix. Because of the reduced air voids, the addition of Aspha-min® zeolite could potentially reduce the design asphalt content. The resilient modulus tests showed that as air voids increased, the resilient modulus value decreased. A statistical analysis was performed on the data and observation of the F-statistic suggests that the binder grade had the most significant impact on the resilient modulus value and that the addition of zeolite did not significantly affect the resilient modulus. The APA rutting test

results showed that adding Aspha-min® zeolite did not increase or decrease rutting potential, the limestone rutted less than the granite and the rut depth increased as the compaction temperature decreased for all factor level combinations (Hurley & Prowell, 2005).

The strength gain data showed no evidence to support the need of a cure time for Aspha-min® mixes. The moisture sensitivity testing consisted of the HWTD test and TSR values. The TSR values showed that zeolite lowered TSR values compared to the control mix and most tests did not satisfy the recommended minimum value for Superpave mixes, the minimum TSR is 0.80. Hydrated lime was used as an anti-stripping agent and this brought TSR values to just under the minimum Superpave criteria (Hurley & Prowell, 2005). The results of the HWTD tests showed the stripping inflection point was lowered for the Aspha-min® zeolite mixes compared to the control mix. The addition of 1.5 percent dry lime improved the results.

NCAT's study also included a field demonstration project. The project was performed in February 2004 at Hubbard Construction's equipment yard in Orlando, FL. Aspha-min® was used and added at the rate of 0.3 percent by weight of total mix produced. Both control and warm mix were produced at 130 to 140 tons per hour. Production and laydown temperatures for the Aspha-min® were around 35°F cooler than the control. Plant produced samples were made using the Marshall method and associated volumetrics with TSR values and APA rutting potential of the mixtures evaluated. Results showed that Aspha-min® volumetrics, TSR values and rutting potential were comparable to the control mix values. Performance observations were made in March 2005, one year later. No pavement distress was observed for either the Aspha-min® or the control mix. Cores were taken and the cores showed air voids in the WMA was slightly higher than the control mixture. This could be due to normal variation. The average tensile strength of the Aspha-min® cores were higher than the control cores. In this case, Aspha-min® has performed equally well to the HMA. It should be mentioned that this section of pavement does not receive regular traffic and traffic may contribute to moisture damage (Hurley & Prowell, 2005).

Aspha-min® Field Studies

The producers of Aspha-min® performed a field study and the following is a summary of their findings. Their conclusions were that Aspha-min® did not create any problems from a storage or handling point of view. No visual differences were seen in the comparison of the zeolite WMA and the HMA three years after paving. The Aspha-min® reportedly lowered carbon dioxide emissions and production temperatures were reduced by 30°C and saved on wear and tear of the plant. It was also noted that on similar Aspha-min projects, ambient temperatures have ranged from above 30°C until nearly freezing (Barthel, Marchand, & Von Devivere, 2009).

A project in Germany used Aspha-min® to produce a base course that contained 45 percent RAP and ambient temperatures ranged from 30 to 37°F (-1 to 3°C) . Mix temperatures behind the paver ranged from 216 to 282°F (102 to 139°C). It was found that WMA increased the compactability of the mix. About 300,000 tons of Aspha-min® has been produced as of February 2008 (D'Angelo, et al., 2008).

Michigan Technological University Aspha-min® Laboratory Study

A study at Michigan Technological University performed a laboratory study to evaluate the performance of WMA made with Aspha-min using the Mechanistic-Empirical Pavement Design Guide (MEPDG) (Wei Goh et al., 2007). Used in this study was a mix with a NMAS of 12.5mm and a PG 64-22 binder. A control mix, WMA with 0.3% Aspha-min® and a WMA with 0.5% of Aspha-min were tested and the test results were put into the MEPDG Program. The study found that Aspha-min® does not affect the dynamic modulus value for the mixtures tested. The WMA decreased the predicted depth of rutting based on the MEPDG Level 1 (most detailed analysis) (Wei Goh et al., 2007). MEPDG modeling does have limitations and more research is needed to determine if the performance simulated by the MEPDG occurs in constructed pavements.

Aspha-min® Field Projects in Canada

The company Construction DJL Inc. is a large hot mix contractor in Quebec and has performed several field projects using Aspha-min® (Davidson, 2007). An Aspha-min® WMA mix and an HMA control mix was placed on city streets in Montreal during August/September 2005. The HMA was mixed at 320°F (160°C) and the WMA was mixed between 226 to 275°F (130-135°C). The laydown temperature was 284 to 302°F (140 to 150°C) for HMA and 230 to 257°F (110-125°C) for warm mix. During the 2006 construction season, three projects were paved using Aspha-min® WMA. The first project was for demonstration purposes and the last two were placed in late November with ambient air temperatures ranging from 30 to 41°F (-1 to +5°C). In the last two projects, the use of zeolite at the conventional HMA temperature aided in compaction at the lower temperatures that are commonly encountered during the late paving season (Davidson, 2007).

2.4.4 Advera®

Advera® is manufactured by PQ Corporation in Malvern, PA. Like Aspha-min®, Advera® is a manufactured zeolite (Sodium Aluminum Silicate) and 18-21 percent of its mass is water entrapped in the crystalline structure. The entrapped water is released at temperatures above 210°F (99°C). The water creates a foaming effect and the amount of water is less than 0.05 percent of the mix. The foaming allows for enhanced workability and because Advera® is inorganic, it does not change the performance grade of the mixture (Corrigan, 2008).

A Federal Highway Administration (FHWA), Western Federal Lands Highway Division project in Yellowstone National Park used both Sasobit® and Advera®. The haul distance was between 50 and 55 miles. The FHWA mobile asphalt testing lab performed tests on the asphalt samples collected from this project. The tests conducted included dynamic modulus and flow number (Corrigan, 2008). Fuel savings were estimated to range from 10-20% but the rapidly changing weather and moisture in the aggregate was thought to negatively affect the fuel consumption (Michael, 2007). Advera® is only typically used in the United States but the synthetic zeolite technology has been widely used under the name Aspha-min®.

Advera® is a finer gradation of Aspha-min®, with 100% passing the 0.075 mm (#200) sieve (D'Angelo, et al., 2008).

2.4.5 WAM-Foam®

WAM-Foam® is produced by Shell International Petroleum Company, Ltd. London, UK and Kolo-Veidekke, Oslo, Norway (Corrigan, 2008). WAM-Foam® is a two-component system which uses a soft asphalt binder and a hard asphalt binder. First, the aggregate is coated with the softer binder; then the introduction of a foamed hard binder enables lower mixing temperatures (Cervarich, 2003). The crucial step in the successful production of WAM-Foam® is a careful selection of the soft and hard components. It is also emphasized that the initial coating of the aggregate in the first mixing state is critical to prevent water from reaching the binder and aggregate interface. The reduction in plant temperature can lead to a plant fuel savings of 30 percent (Corrigan, 2008).

The United States Patent rights for WAM-Foam® belong to British Petroleum. Plant production temperatures can range from 230°F to 248°F (110°C to 120°C). WAM-Foam® is widely used and projects have reportedly been completed in France, Norway, Canada, Italy, Luxembourg, Netherlands, Sweden, Switzerland and United Kingdom as of February 2008 and at that time over 60,000 tons have been produced (D'Angelo, et al., 2008). It should also be mentioned that the WAM-Foam® production typically requires asphalt plant modifications to implement. Most of the WAM-Foam® research has been conducted by the developers. Table 2.3 gives a summary of some of the WAM-Foam® projects (Kristjansdottir, 2006).

Table 2.3: Summary of WAM-Foam® Projects in Europe (Kristjansdottir, 2006)

Location	RV120, Norway	FV82, Norway	UK
Date	September 2000	2001	April 2001
Type of mix	Dense asphalt concrete Ab11 with a 85 pen (final) binder	Dense asphalt concrete WAgb11 with a 180 pen (final) binder	20 mm (0.78 in) Dense Road Basecourse (DRB) with a 40/60 pen bitumen
Air voids [%], (WAM Foam compared to regular)	Identical average, 3.9%	Slightly higher for the warm mix	-
Rutting (WAM Foam compared to regular)	Marginally lower for the warm mix	Marginally higher for the warm mix	-

The City of Calgary did a study using Evotherm® that was mentioned earlier. At the time of this study, a trial section of WAM-Foam® was also produced. Several plant trials were needed to facilitate proper foaming of the hard binder. The mixing temperature was around 110°C and the typical laydown temperature was 100°C. The overall demonstration project was successful and plans for short and long term monitoring have been developed (Johnston, Da Silva, Soleymani, & Yeung, 2006).

2.4.6 Asphaltan B®

This technology is not used in the United States and will thus only be briefly described. The Asphaltan B® is a product of Romonta GmbH, in Amsdorf, Germany. This is created for "rolled asphalt". Asphaltan B® is created from Monton Wax. The origin of Monton Wax is in certain types of lignite or brown coal deposits formed during the Tertiary Period. The wax is insoluble in water and does not decompose over geologic time. Wax is extracted from coal by a toluene solvent that is distilled from the wax solution and removed with superheated steam. Asphaltan B® has a melting point of approximately 210°F. It acts as an "asphalt flow improver" much like the F-T waxes (Corrigan, 2008).

4.7 Double Barrel Green®

The Astec Double Barrel Green® system is made by Astec, Inc. The Double Barrel Green® system is an option that can be included with any new Astec Double Barrel® Drum mixer/dryer or it can be added as a retro fit. Only the addition of water is needed. The

system uses water to produce foamed warm mix asphalt. The temperature can be reduced by approximately 50°F and it is estimated that 14 percent less fuel is needed as a result (Astec, Inc., 2007). The approximate total tonnage produced as of February 2008 was over 4,000 tons (D'Angelo, et al., 2008).

Astec Double Barrel Green® Field Projects

Two paving demonstration projects were performed by Granite Construction from their Indio, California facility in early 2008 (Wielinski et al., 2009). The Astec Double Barrel Green® process was used. The objectives of the demonstration were to:

- Demonstrate that WMA with RAP could be produced and placed at lower temperatures while still having similar mix properties and field compaction as HMA
- Construct HMA and WMA test sections for side by side performance evaluations.

HMA and WMA samples were collected. The WMA samples were tested and/or compacted as soon as possible after they had been sampled in an effort to duplicate field compaction temperature. No reheating was performed on WMA. The HMA samples were collected and then compacted immediately or at a later time after reheating. One WMA property that was of considerable interest was the moisture content of the two mixes. It was found there was no significant difference between WMA and HMA mixes and moisture contents ranged from 0.08 to 0.02%. There were some concerns about variation in materials. The sand equivalent (SE) value was 55 for the first day and during the second and third day of production the SE values ranged between 68 and 71. It was observed that the crack sealer that was placed after milling on the WMA demonstration site one, did not swell. All WMA wet mixes met minimum mechanical property requirements. TSR values for both HMA and WMA were low and the WMA values were slightly lower comparatively. It was concluded from the field demonstrations that WMA can be placed, produced, and compacted at lower temperatures while achieving mix properties similar to HMA. Five months after placement the initial performance was excellent (Wielinski et al., 2009).

Evaluation of the Astec Double Barrel Green® System

A study was performed to examine the economic, environmental and mixture performance in order to assess WMA sustainability in Northern America. This study focused on the Astec Double Barrel Green® system. Included in this study were an economic and a mixture performance evaluation of WMA mixes containing RAP and Manufactured Shingle Modifier (MSMTM) produced using the Double Barrel Green® process in Vancouver, British Columbia (Middleton & Forfylow, 2009). This study made the following conclusions:

- The mix properties of the WMA produced with the Double Barrel Green® system were comparable to the HMA mixture.
- The APA testing recorded the rut susceptibility for WMA was sufficient.
- Moisture susceptibility testing using tensile strength testing determined that the Double Barrel Green® process does not negatively influence moisture susceptibility of mixes.
- RAP and MSMTM used with Double Barrel Green® did not significantly influence mix properties or performance based on lab tests.
- A 10 percent reduction in carbon monoxide, carbon dioxide and nitrogen oxides was determined with the process.
- A 24 percent reduction of energy was identified with the process.

2.4.8 Low Energy Asphalt (LEA)

Low Energy Asphalt (LEA) is a foaming technology process. There are three methods used to produce LEA and the method chosen depends on the plant set up. The methods are as follows (Ventura et al., 2009):

Method 1- The drying stage only affects the initial portion of the aggregates, which are then coated by bitumen. The remaining cold and wet portion then get added. All constitutive elements of the mix are subsequently mixed.

Method 2- The drying stage only affects an initial portion of the aggregates, which are mixed before the coating stage with the remaining moist portion.

Method 3- All aggregates are partially dried and then coated by the hot bitumen.

LEA is produced at temperatures less than 100°C (212°F) as of February 2008 over 100,000 tons of WMA have been produced by the LEA process (D'Angelo, et al., 2008).

2.4.9 WMA summary of cost and studies utilizing one WMA technology

The Evotherm[®] field projects in Canada proved that it did not present problems to the batch plant (Davidson, 2006) and that plant emissions were reduced (Davidson, 2007). Field projects in Texas showed that the Evotherm[®] reduced the optimum asphalt content. The Evotherm[®] mix did not perform as well in ITS testing but the Evotherm[®] roadway core performed similar to the HMA mix (Button, Estakhri, & Wimsatt, 2007). NCAT performed a laboratory study using Evotherm[®] and found it improved compaction effort, increased the resilient modulus and decreased rutting potential which correlated with improved compaction. This study also recommended that moisture sensitivity testing should be performed at the production temperatures (Hurley & Prowell, 2005). Overall, Evotherm[®] has performed well in tests as a WMA additive but there are some concerns with moisture susceptibility.

The NCAT study which uses Sasobit[®], a wax additive, showed that it did not appear to affect the G_{mm} but that the modified binder needs to be engineered in order to achieve the correct PG grading (Hurley & Prowell, 2005). Field studies in Virginia showed Sasobit[®] had similar properties to the control mixture (Diefenderfer et al., 2007). Sasobit[®] was shown to reduce emissions (Mallick et al, 2009).

Finally, the foamed asphalts are the other main type of WMA additive studied. The foaming can be induced by a synthetic zeolite additive such as Advera[®] or Aspha-min[®] or the foaming can be produced through a plant modification such as the Double Barrel Green system. The NCAT study showed that the zeolite additive did not significantly change volumetric properties and strength gain data did not support the need for a cure time (Hurley & Prowell, 2005). In field testing, Aspha-min[®] reduced emissions and increased compactability as well as used for cold weather paving in Canada (Davidson, 2007). Field studies using the Double Barrel Green System showed WMA had slightly lower TSR values

but initial pavement performance was excellent (Wielinski et al., 2009). Another study found no differences between the control and WMA mix and that the foaming process did not significantly influence mix properties or performance based on lab tests (Middleton & Forfyflow, 2009).

An important issue to address with WMA is the additional costs of the additive. Table 2.4 summarizes many of the associated costs for each type of WMA technology discussed (except Asphaltan B®).

Table 2.4: Summary of WMA Technology Costs (Middleton & Forfyflow, 2009).

Economic Component	WMA Technology					
	Evotherm®	Sasobit®	Aspha-min® (Zeolite), Advera (Zeolite)	Low Energy Asphalt (LEA)	WAM Foam®	Double Barrel® Green ¹
Equipment Modification or Installation Costs	\$1,000-\$5,000	\$5,000-\$40,000	\$5,000-\$40,000	\$75,000-\$100,000	\$60,000-\$85,000	\$100,000-\$120,000
Royalties	None	None	None	N/A	\$15,000 first yr / \$5,000 per plant / \$0.35 / t	None
Cost of Material	\$35-\$50 premium on Binder	\$1.75/kg	\$1.35/kg	None	\$75 premium on Soft Binder	None
Recommended Dosage Rate	30% Water / 70% AC	1.5-3% by weight of Binder	0.3% by weight of Mix	0.5% Coating additive weight of Binder	1.5% weight of Mix	2% Water to Binder
Approximate Increased Cost of Mix	\$3.50-\$4.00	\$2.00-\$3.00	\$3.60-\$4.00	\$0.50-\$1.00 (depending on use of coating additive)	\$0.27 + \$0.35 Royalty	None

¹ Requires Astec Double Barrel® Drum

Many laboratory and field evaluations have discussed and studied the use and effects of these technologies. The following section will describe studies that used one or more of the WMA technologies to answer questions about how these technologies effect various asphalt pavement properties such as moisture susceptibility, use of RAP, overall performance and compaction.

2.5 Investigations of Warm Mix Asphalt and Observations

In light of all the potential benefits of WMA, it is necessary that extensive investigations take place in order to evaluate the feasibility of WMA from an economic, societal and performance perspective. Many studies have investigated one or several of these aspects and this section will present some of the studies that have used WMA technology and investigated one of the above aspects. The studies and laboratory experiments incorporating WMA technology have very diverse objectives and various ways of evaluating and comparing the technology. Most studies have a similar HMA mix design as a control and many incorporate RAP into several mixes.

Some concerns are that NCAT studies found optimum asphalt contents via traditional HMA designs procedures, namely that optimum asphalt content can be reduced by 1/2 percent with the addition of WMA (Button, Estakhri, & Wimsatt, 2007). Another study examined at how air voids changed in the field over time. Cores were taken from WMA and control sections and the results are shown in Figure 2.7 (Al-Rawashdeh, 2008).

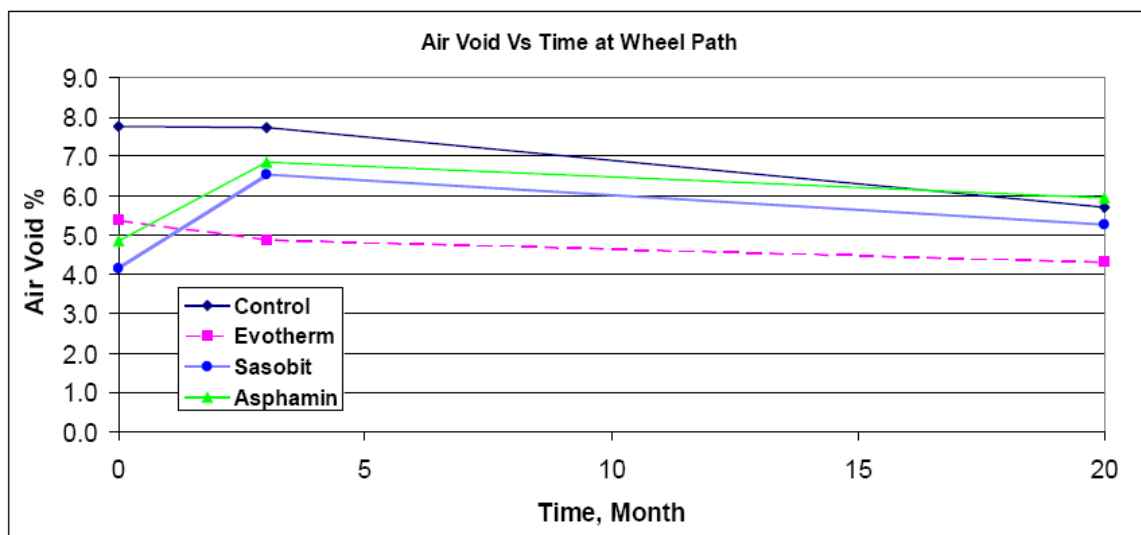

Figure 2.7: Air Void percent in cores from field vs. Time (Al-Rawashdeh, 2008)

There has also been some concern that WMA additives affect the performance grade of the binders. In the case of NCAT's Sasobit® laboratory study, a minimum mixing temperature

of 265°F (129°C) is recommended or the high temperature grade should be bumped one PG grade (Hurley & Prowell, 2005).

A study was done to investigate the effect of WMA additives on artificially long-term aged binders. The objectives of this study were to characterize the properties of WMA binders that contained long-term aged binders, using Aspha-min® and Sasobit® as additives. The long term aged binders would be representative of a RAP binder. The binders were aged by RTFO and pressure aging vessel (PAV) tests (Lee, Amirkhanian, Park, & Kim, 2008). Some of the conclusions made in this study were that virgin binder grade plays an important role in determining high failure temperature values of the recycled WMA binders. The DSR tests at intermediate temperatures showed that the WMA additives are not considered to have positive effects on resistance to fatigue cracking of recycled binders. Aspha-min® was found to stiffen the binder and lastly, this study concluded that binders containing recycled binder and WMA additives were observed to have lower resistance to low temperature cracking as determined by bending beam rheometer (BBR) testing. To satisfy current Superpave binder specifications, it is recommended to use a lower virgin binder grade even though the RAP content is only 15% (Al-Rawashdeh, 2008).

There have been several studies recently performed investigating the use of WMA additives and processes with high percentages of RAP. Trials in Germany have used 90-100 percent RAP using Aspha-min® zeolite and Sasobit® (D'Angelo, et al., 2008). Three studies were reviewed to investigate the performance of WMA used with RAP. A summary of each of the studies is provided.

Effects of WMA Additives on Workability and Durability of Asphalt Mixture Containing RAP

This study looked at the influence of the dose of two WMA additives (Advera® and Sasobit®) have on composite binder properties, mixture workability and mixture durability (Austerman, Mogawer, & Bonaquist, 2009). Two Superpave mixtures, a 12.5 mm with 10

percent RAP and a 19.0 mm with 25 percent RAP, were used in this study. The objectives were as follows (Austerman, Mogawer, & Bonaquist, 2009):

- Identify and select the most commonly specified WMA additives both nationally and regionally.
- Identify typical high and low dosage rates for the selected WMA additives.
- Evaluate the impact of WMA additives does on the performance grade of the binder.
- Evaluate the impact of WMA additive dose on the viscosity of the binder.
- Evaluate the impact of WMA additive dose on workability of HMA mixtures containing RAP.
- Evaluate the impact of WMA additives dose on the durability (moisture susceptibility resistance) of mixture containing RAP.

The Figure 2.8 shows a diagram that explains the experimental plan of this study. The first tests performed were binder testing to classify the performance grade and viscosity measurements were taken. The binder with 3 percent Sasobit® had the highest reduction in binder viscosity and 0.3 percent Advera® showed an increase in binder viscosity as compared with control. A torque based workability test was performed as well as durability testing using the HWTD. The WMA additives tested in the HWTD did not show the same durability as the control specimens even though the WMA showed improved workability of the control. The conclusions of this study were (Austerman, Mogawer, & Bonaquist, 2009):

- Adding Advera® WMA additive at the dosage tested (0.1% and 0.3%) did not change the performance grade of the base binder. It was found that the addition of 1.5% Sasobit® changed the performance grade of the base binder from a PG 64-28 to PG 70-22 and addition of 3.0% Sasobit® changed the PG 64-28 to a PG 70-16.
- Viscosity testing showed that the addition of Advera® additive to the binder at any dose had a marginal impact on the viscosity of the binder. The addition of Sasobit® reduced the viscosity of the binder, with the largest viscosity reduction occurring with the 3.0% Sasobit® dose.
- Workability testing showed that the addition of Advera® and Sasobit® additives at different dosages improved the workability of the mixture including the mixture containing 25% RAP.

- Durability testing indicated that the control mixtures exhibited better moisture susceptibility than the mixtures containing WMA additives. This indicates that the addition of anti-stripping agents may be necessary when using certain WMA additives. Lastly, durability testing may be an integral step when developing a mix design procedure for mixtures with WMA additives.

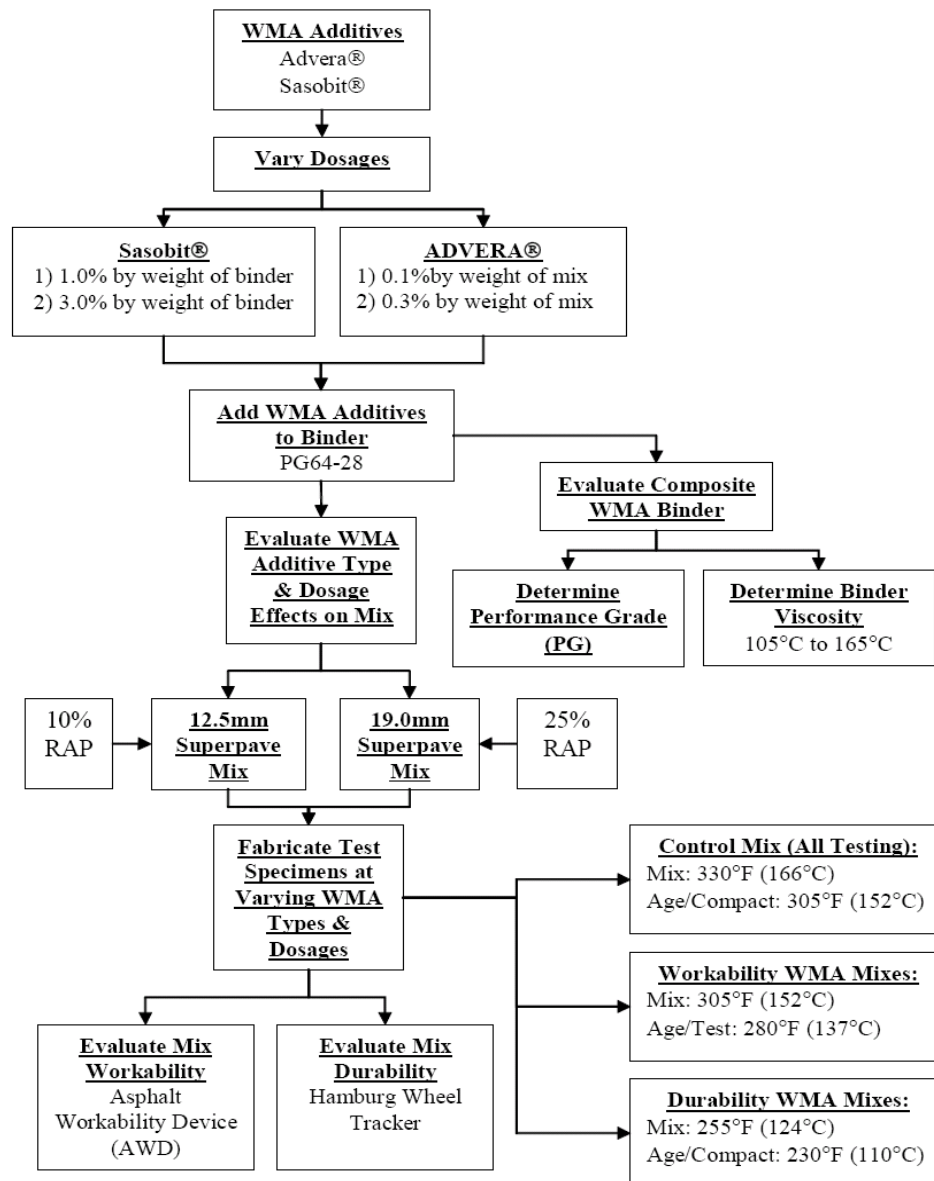

Figure 2.8: Experimental Plan for Studying the Effects of WMA Additives on Workability and Durability of Asphalt Mixture Containing RAP (Austerman, Mogawer, & Bonaquist, 2009)

Performance Study of Foamed WMA with High RAP Content

A study was performed by the U.S. Army Engineering Research and Development Center and NCAT that investigated the performance of foamed WMA with high RAP content (Hodo et al., 2009). The objective was to conduct field observations and laboratory testing to determine the applicability of foamed asphalt technology and high RAP content. A literature review was performed for this study and results showed several potential benefits for using foamed asphalt technology with RAP. A couple of the potential benefits for using foamed asphalt technology with RAP is that it is non-proprietary and there could be a significant cost reduction to produce the mix due to the high RAP content (Hodo et al., 2009). Field compacted mix specimens were collected from a WMA project that used WMA with no RAP and WMA with 50% RAP. The performance of these samples was evaluated by the HWTD and the APA. The test results showed that rutting would not be an issue. One year after the pavement has been in place, the performance of the WMA with 50% RAP is performing well and use of the high RAP content resulted in a significant cost reduction. More research on this subject is needed but the technique of foamed asphalt continues to look promising (Hodo et al., 2009).

Performance of WMA with 100% RAP Mixtures

The final RAP study reviewed was performed at Worcester Polytechnic Institute and investigated the feasibility of using Advera® zeolite and Sasobit H8® with 100 percent RAP mixtures. The WMA mixes and a control mix were compacted at 125°C. Figure 2.9 is a diagram of the testing plan (Tao & Mallick, 2009).

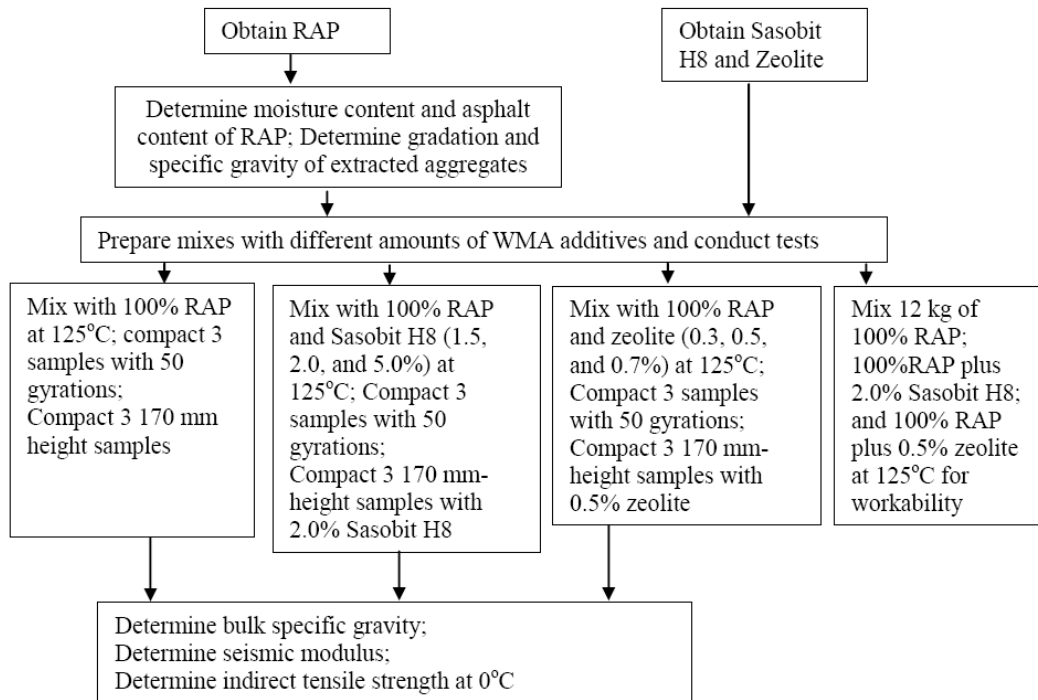

Figure 2.9: Test Plan for the evaluation of WMA additive with RAP (Tao & Mallick, 2009)

Overall, this study showed that Sasobit H8® and Advera® improve the workability of the RAP; however, the workability improvement may be limited depending on the NMAS and the percent fines. The study concluded that 100 percent RAP base course is feasible with the aid of the Sasobit or Advera zeolite but long-term performance of WMA modified RAP needs to be determined.

WMA Moisture Susceptibility Studies

Effect of WMA on pavement moisture susceptibility is an especially important topic when considering implementation of WMA. In laboratory studies, it has been shown that WMA could potentially decrease ITS and TSR (Hurley, 2006). Several studies and experiments that have explored this issue but first a more in-depth discussion about moisture damage in asphalt pavements will be presented.

Moisture damage, caused by a loss of bond between the asphalt binder or the mastic and the aggregate under traffic loading, can result in a decrease of strength and durability in the

asphalt mixture and ultimately affecting its long-term performance (Xiao, Jordan, & Amirkhanian, 2009). Moisture damage causes stripping of the asphalt pavement (Roberts, Kandhal, Lee, & Kennedy, 1996). Stripping in HMA pavements may be induced by as many as five mechanisms including detachment, displacement, spontaneous emulsification, pore pressure, and hydraulic scouring. There are many variables that can impact a mix's susceptibility to stripping and these include the type of mix, asphalt cement characteristics, aggregate characteristics, environment, traffic, construction practice, the use of anti-strip additives and the common factor is the presence of moisture (Roberts, Kandhal, Lee, & Kennedy, 1996). There are two major types of moisture damage and they are failure of adhesion and failure of cohesion.

A study was performed at Clemson University to investigate moisture damage in WMA mixtures containing moist aggregates (Xiao, Jordan, & Amirkhanian, 2009). The tests performed were the indirect tensile strength (ITS), TSR, deformation and toughness to investigate the mix performance. The experimental plan consisted of two WMA additives (Aspha-min® and Sasobit®), two moisture percentages (0% and ~0.5% by weight of dry aggregate) and three hydrated lime contents (0%, 1% and 2% by weight of dry aggregate). Also, two aggregate types were used (granite and schist) from three aggregate sources and one binder grade (PG 64-22) was used. All specimens were produced at optimum binder content. Some of the findings and conclusions from this study were (Xiao, Jordan, & Amirkhanian, 2009):

- Dry ITS values of the mixtures containing moist aggregate decreased compared to other mixtures. The decrease in ITS values was offset when hydrated lime was added.
- Wet ITS and TSR values showed that the addition of lime played a key role in improving the ITS and TSR values regardless of the mixture with or without moisture.
- In general, statistical analysis showed no significant difference in ITS values (dry or wet) amongst three types of WMA mixtures (control, Aspha-min®, and Sasobit®) under identical conditions.

- The deformation resistance of mixtures decreased when the aggregate contained moisture. The addition of hydrated lime increased the deformation resistance and the effect of WMA additive on deformation resistance was generally not significant.

Implementation Strategies

New technologies such as WMA can often take years to implement. There are many new technologies emerging every year and research can be very time intensive. The idea of a central database of new technology studies and experiment reports for governmental highway agencies have been discussed (Morgan, Peterson, Durham, & Surdahl, 2009). It is speculated that the number of hours researching will be reduced dramatically if such a database existed. A study was performed and recommendations of how to efficiently evaluate new technologies were provided. The evaluation includes a four step process of the following: 1) Preliminary Evaluation, 2) Program Formulation, 3) Evaluation and 4) Implementation (if accepted) and Remaining Tasks (Morgan, Peterson, Durham, & Surdahl, 2009).

Part of incorporating WMA into the asphalt paving industry is implementation. A potentially useful tool when implement sustainable technologies could be Green Roads. Green Roads presents evaluation guidelines for quantifying sustainable practices with roadway design and construction. The evaluation is based on a credits system but more studies are needed to more accurately distribute credits (Muench, Anderson, & Söderlund, 2009). The evaluation manual is currently accessible through the green roads website (Green Roads, 2007).

2.6 Literature Review Summary

The history of WMA shows an increasing use of the technology over the last decade. The driving force of WMA technologies are the many potential benefits and especially the reduction in fuel cost and emissions. The benefits could potentially impact a company's bottom line by saving them money, create a better working environment because of the reduction in fumes and create less impact on the surrounding community during the construction process. Before all of these benefits can be fully realized, it must be shown that

WMA technologies produce mixes that are of the same performance caliber as the traditional HMA mixes.

The literature presented an overview of commonly used WMA technologies and presented field and laboratory studies presented with many of the technologies. Other studies were presented that investigated several WMA technologies to evaluate the WMA potential for moisture susceptibility and the use of WMA in mixtures containing high percentages of RAP. The various WMA additives, even though they work differently, have similar impacts on the mix. The studies that investigated the use of the WMA technologies had similar reasons for using the additives and the advantages for chemical, wax and foamed modified WMA binders were virtually the same. The advantages for these technologies are:

- improves compactability,
- reduces emissions,
- decreased rutting potential due to the compaction improvements, and
- improved workability in standard WMA mixes and mixes with high RAP content.

One overlying disadvantage to the technologies is the moisture susceptibility concern. This is a concern mentioned in almost every study reviewed. Other disadvantages become more technology specific. Studies found that adding Evotherm can change the optimum binder content. Sasobit may change the binder grade and thus binders need to be engineered. The overall consensus of field and laboratory studies is that while the WMA technology looks very promising for the industry, more research and long-term performance studies are needed to ensure that pavement performance is equivalent to HMA mixes.

CHAPTER III EXPERIMENTAL PLAN

The objectives of the research were to evaluate WMA technologies produced in the field for Iowa DOT projects and make recommendations that address which WMA technologies met performance expectations and address potential quality control/ quality assurance (QC/QA) concerns. The QC/QA concerns are specific to the effects of reheating WMA samples for subsequent compaction and volumetric and performance testing. The effects of moisture conditioning on WMA mixes were also investigated. Field trials of the most promising technologies were constructed and laboratory performance testing was completed.

The Iowa Department of Transportation produced four field WMA mixes and four HMA control mixes which were used in this research project. Each mix was produced for a different project at different plant locations. The WMA was produced first and the HMA control mixture was produced on the following day unless weather delayed paving. The corresponding control mixes to each WMA mix differed only by the WMA additive. For each project, loose HMA and WMA mix was collected at the time of production and binder from the tank was collected for each mix. The WMA additives were terminally blended and no laboratory binder blending was performed. The field sampled binder and mix was taken to the Iowa State University for subsequent asphalt binder testing and mix performance testing.

The details of each mix design will be discussed in Chapter 4: Field Mix Details and Sample Preparation. The sample preparation includes both field compacted samples and reheated laboratory compacted samples. Mix samples are needed for dynamic modulus testing and indirect tensile testing (ITS). The dynamic modulus samples are 100mm diameter and 150mm in height. The ITS samples are 100mm in diameter and 62.5mm in height. Each field produced mix has ten field compacted dynamic modulus samples, ten field compacted indirect tensile strength samples as well as ten laboratory compacted dynamic modulus samples and ten lab compacted indirect tensile strength samples. Half of the lab compacted samples and half of the field compacted samples were moisture conditioned and represent the experimental samples whereas the unconditioned samples are the control samples. The

experimental plan will evaluate the effect moisture conditioning has on WMA mixtures and allow for comparison to HMA samples.

The samples that have undergone dynamic modulus testing will be used to develop master curves to determine if the mix properties change due to a laboratory reheating process to understand if there may be impacts on reheating WMA as part of the current Iowa DOT QC/QA process. The master curves can be compared to understand the effect of WMA technology on the stiffness of the asphalt mixtures. Figure 3.1 is a diagram which shows the different categories of mixtures produced and the samples procured for subsequent performance testing. For each field produced mixture there was a WMA experimental mix and an HMA control mix. Table 3.1 shows the sample sizes for each mix. Each x represents the samples size for that category. Several of the field compacted samples only had a samples size of six with three moisture conditioned samples and three non-moisture conditioned samples. Field mix 1 (FM1) did not have any field compacted ITS samples because this mix was produced before the scope of this research was defined. Field Mix 4 only had six field compacted samples of the WMA as indicated by the three “x”s within that row. In total, 284 samples were procured from the field produced mixtures for dynamic modulus, flow number and indirect tensile strength performance testing.

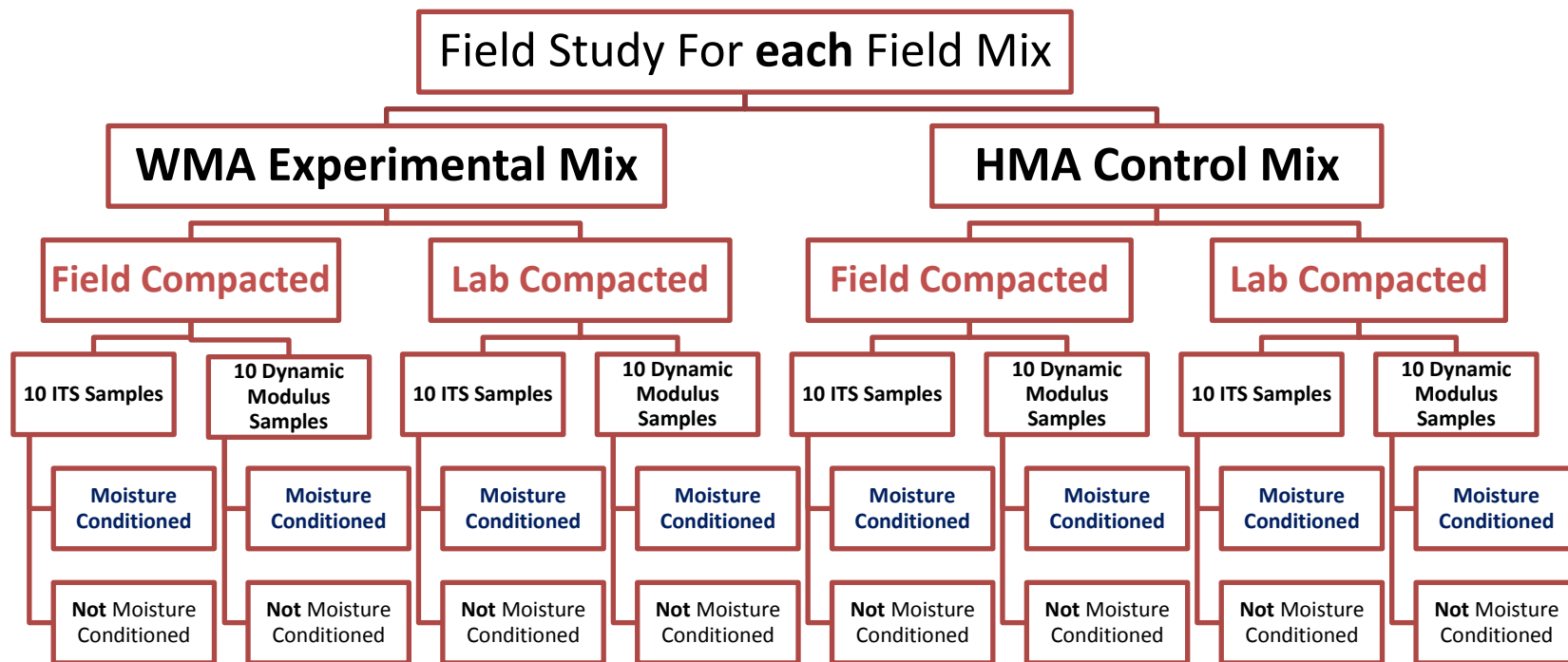

Figure 3.1: Diagram showing the categories of samples procured from each field mix

Table 3.1: Performance Testing Plan of Warm Mix Asphalt Technologies and Sample Sizes

Mix	Unconditioned					Conditioned					E* Ratio	Fn Ratio	TSR
	E*			Fn	ITS Strength	E*			Fn	ITS Strength			
	4.4°C	21 °C	37 °C			4.4	21	37					
FM1 HMA Field Compacted	xxx*	xxx	xxx	xxx	xxx	xxx	xxx	xxx	xxx	xxx	xxx	xxx	xxx
FM1 WMA (Evotherm 3G) Field Compacted	xxx	xxx	xxx	xxx	xxx	xxx	xxx	xxx	xxx	xxx	xxx	xxx	xxx
FM1 HMA Lab Compacted	xxxxx	xxxxx	xxxxx	xxxxx	xxxxx	xxxxx	xxxxx	xxxxx	xxxxx	xxxxx	xxxxx	xxxxx	xxxxx
FM1 WMA (Evotherm 3G) Lab Compacted	xxxxx	xxxxx	xxxxx	xxxxx	xxxxx	xxxxx	xxxxx	xxxxx	xxxxx	xxxxx	xxxxx	xxxxx	xxxxx
FM2 HMA Field Compacted	xxxxx	xxxxx	xxxxx	xxxxx	xxxxx	xxxxx	xxxxx	xxxxx	xxxxx	xxxxx	xxxxx	xxxxx	xxxxx
FM2 WMA (Revix) Field Compacted	xxxxx	xxxxx	xxxxx	xxxxx	xxxxx	xxxxx	xxxxx	xxxxx	xxxxx	xxxxx	xxxxx	xxxxx	xxxxx
FM2 HMA Lab Compacted	xxxxx	xxxxx	xxxxx	xxxxx	xxxxx	xxxxx	xxxxx	xxxxx	xxxxx	xxxxx	xxxxx	xxxxx	xxxxx
FM2 WMA (Revix) Lab Compacted	xxxxx	xxxxx	xxxxx	xxxxx	xxxxx	xxxxx	xxxxx	xxxxx	xxxxx	xxxxx	xxxxx	xxxxx	xxxxx
FM3 HMA Field Compacted	xxxxx	xxxxx	xxxxx	xxxxx	xxxxx	xxxxx	xxxxx	xxxxx	xxxxx	xxxxx	xxxxx	xxxxx	xxxxx
FM3 WMA (Sasobit) Field Compacted	xxxxx	xxxxx	xxxxx	xxxxx	xxxxx	xxxxx	xxxxx	xxxxx	xxxxx	xxxxx	xxxxx	xxxxx	xxxxx
FM3 HMA Lab Compacted	xxxxx	xxxxx	xxxxx	xxxxx	xxxxx	xxxxx	xxxxx	xxxxx	xxxxx	xxxxx	xxxxx	xxxxx	xxxxx
FM3 WMA (Sasobit) Lab Compacted	xxxxx	xxxxx	xxxxx	xxxxx	xxxxx	xxxxx	xxxxx	xxxxx	xxxxx	xxxxx	xxxxx	xxxxx	xxxxx
FM4 HMA Field Compacted	xxxxx	xxxxx	xxxxx	xxxxx	xxxxx	xxxxx	xxxxx	xxxxx	xxxxx	xxxxx	xxxxx	xxxxx	xxxxx
FM4 WMA (Double Barrel Green Foam) Field Compacted	xxx	xxx	xxx	xxx	xxx	xxx	xxx	xxx	xxx	xxx	xxx	xxx	xxx
FM4 HMA Lab Compacted	xxxxx	xxxxx	xxxxx	xxxxx	xxxxx	xxxxx	xxxxx	xxxxx	xxxxx	xxxxx	xxxxx	xxxxx	xxxxx
FM4 WMA (Double Barrel Green Foam) Lab Compacted	xxxxx	xxxxx	xxxxx	xxxxx	xxxxx	xxxxx	xxxxx	xxxxx	xxxxx	xxxxx	xxxxx	xxxxx	xxxxx

* “x” represents one sample and x within each cell represents sample size.

Types of Warm Mix Additives

The types of warm mix additives was limited to the additives that were used in the field produced mixes. There were four different WMA technologies used and they include: Evotherm 3G, Revix, Sasobit and the Double Barrel Green foamed asphalt. As discussed in the literature review, the Evotherm 3G and Revix are chemical modifiers, the Sasobit is a wax additive and the Double Barrel Green system adds water to foam the asphalt. It is expected that the different additives will affect the HMA mixes differently in the performance testing results. Each field mix had the WMA additive terminally blended or foamed on site thus no laboratory binder blending was performed. The WMA mixes were compacted at 120° C and the HMA was compacted at 150° C. The binder grades used are as follows:

- Field Mix 1 / Evotherm 3G project used 58-28;
- Field Mix 2 / Revix project used 64-28;
- Field Mix 3 / Sasobit project used 64-22; and
- Field Mix 4 / Double Barrel Green used 64-22.

Binder Testing

Binder testing on each warm mix binder and companion control binder was performed. The binder testing provides insight on the effects WMA technologies have on the binder properties. The tests and associated aging performed on the binder included the following: rotational viscometer testing (AASHTO, 2007), dynamic shear rheometer testing (AASHTO, 2007), rolling thin film oven testing (RTFO) (AASHTO, 2007), pressure aging vessel (PAV) (AASHTO, 2007) and bending beam rheometer (BBR) testing (AASHTO, 2007). The mixing and compaction temperatures determined by the rotational viscometer testing were not used in actual compaction because when the field mix was compacted, the tests on the binder had not been performed and the compaction temperature was kept the same for the field compacted and the laboratory compacted samples. The RTFO and PAV aged binders were aged according to AASHTO standards, T 240 and R 28, respectively.

Performance Testing

Performance testing will include indirect tensile strength (ITS), dynamic modulus testing and flow number testing. The main categories summarized in Figure 2.1 and Table 2.1 that will be compared for each of the four field mixes produced are:

- HMA field compacted, not moisture conditioned;
- HMA field compacted, moisture conditioned;
- WMA field compacted, not moisture conditioned;
- WMA field compacted, moisture conditioned;
- HMA laboratory compacted, not moisture conditioned;
- HMA laboratory compacted, moisture conditioned;
- WMA laboratory compacted, not moisture conditioned; and
- WMA laboratory compacted, moisture conditioned.

ITS testing will determine the peak loads and tensile strength ratios (TSR). The peak loads will help to compare the ultimate strengths of the control HMA mix with the ultimate strength of the corresponding experimental WMA mix. TSR ratios will help determine the effects of moisture conditioning on the mixes. The ITS test, as outlined in AASHTO T283, is a continuous load on the sample at the rate of 50mm/min (2in./min) until the sample reaches its peak load and the load is recorded. The TSR ratio is the ratio of the peak load of the moisture conditioned sample divided by the peak load of the non moisture conditioned sample. A ratio above 0.80 for mixtures is deemed passing (AASHTO, 2007).

Dynamic Modulus

The purpose of dynamic modulus testing is to define the materials stress to strain relationship under continuous sinusoidal loading. The loadings are applied at various frequencies and temperatures to define the material property characteristics over a wide range of conditions. Dynamic modulus testing measures the stiffness of the asphalt under dynamic loading at various temperatures and frequencies thus it is used to determine which mixes may be more susceptible to performance issues including rutting, fatigue cracking and thermal cracking. The set up for this testing is based on NCHRP report 547. The test is

performed at three temperatures (4, 21, 37°C) and nine frequencies (25, 15, 10, 5, 3, 1, 0.5, 0.3, 0.1 Hz) for each sample and yields 27 test results per sample. The dynamic modulus values (E^*) are used to construct master curves which can be used to compare the various categories (Witczak, 2005). The dynamic modulus test was performed under strain controlled conditions. The target strain was 80 microstrain which is considered to be well within the elastic region of the material. The strain response of the material was measured using 3 LVDTs that were positioned on mounted brackets at the beginning of each test. The brackets were attached using epoxy glue. The dynamic modulus test is considered to be a non-destructive test at low levels of strain in theory. Samples used in this research were compacted to the precise size needed for the dynamic modulus testing.

The dynamic modulus is expressed mathematically as the maximum peak recoverable axial strain (Witczak, 2005):

$$E^* = \frac{\sigma_o}{\varepsilon_o} \quad (3-1)$$

The complex modulus (or dynamic modulus, E^*) when written in terms of the real and imaginary portion is expressed as:

$$E^* = E' + iE'' = |E^*| \cos\varphi + i|E^*| \sin\varphi \quad (3-2)$$

$$\varphi = \frac{t_i}{t_p} \times (360) \quad (3-3)$$

where

E^* = complex modulus;

E' = storage or elastic modulus;

E'' = loss or viscous modulus;

φ = phase angle;

t_i = time lag between a cycle of stress and strain (s);

t_p = time for stress cycle (s); and

i = imaginary number.

When a material is purely elastic, $\varphi=0$ and for a purely viscous material, $\varphi=90^\circ$ (Witczak, 2005).

Master Curves

In order to compare the mixes, master curves were developed using the dynamic modulus data. The principle of time-temperature superposition is used and this allows for the E^* values and phase angles, obtained during testing, to be shifted along the frequency axis. This helps characterize how a mix may perform at a frequency or temperature which was not tested. The data from the dynamic modulus testing is fitted to a sigmoid function. The shift factors are determined based on the data collected in the dynamic modulus testing and on the Williams-Landel-Ferry (WLF) equation (Williams, Landel, & Ferry, 1955):

$$\log \alpha_t = \frac{C_1(T-T_s)}{C_2+T-T_s} \quad (3-4)$$

where

C_1 and C_2 are constants;

T_s is the reference temperature; and

T is the temperature of each individual test.

In general, modulus master curves are modeled by the sigmoidal function expressed as:

$$\log |E^*| = \delta + \frac{\alpha}{(1+e^{\beta-\gamma(\log t_r)})} \quad (3-5)$$

where

t_r = reduced time of loading at reference temperature;

δ = minimum value of E^* ;

$\delta + \alpha$ = maximum value of E^* ; and

β, γ = parameters describing the shape of the sigmoidal function.

Typically, the sigmoidal function used for developing master curves is based on reduced frequency instead of reduced time. For this study, the Witczak predictive equation presented in the same form as the previous equation is used and this will allow for a graphical representation of a mixture specific master curve. The equation is described as (Witczak, 2005):

$$\log|E^*| = \delta + \frac{\alpha}{(1+e^{\beta-\gamma(\log(f_r)+\alpha_t)})} \quad (3-6)$$

where

$\log|E^*|$ = log of dynamic modulus;

δ = minimum modulus value;

f_r = reduced frequency;

α = span of modulus values;

α_t = shift factor according to temperature; and

β, γ = shape parameters.

Flow Number

The same samples used in the dynamic modulus testing were then subjected to flow number testing. The flow number test is a destructive test which measures the point at which the asphalt material reaches tertiary flow. The testing procedure for the flow number test is based on the repeated load permanent deformation test which is explained in NCHRP Reports 465 and 513. A typical plot, shown in figure 3.2, illustrates how accumulated permanent deformation increases with the number of applied load cycles. This figure also illustrates the three types of deformation that occur when performing the flow number test which are: primary, secondary, and tertiary flow. The flow number is defined as the number of loading cycles at the beginning of the tertiary zone. For this research the test is conducted at 37°C and at a frequency 1 Hz with a loading time of 0.1 second and a rest period of 0.9 second. The test is complete once 10,000 pulses have been reached or a strain of 10% has occurred. The deformation verses number of pulses is plotted and the strain rate vs. number of pulses is also plotted. The flow number is determined by the minimum strain rate and the corresponding pulse number.

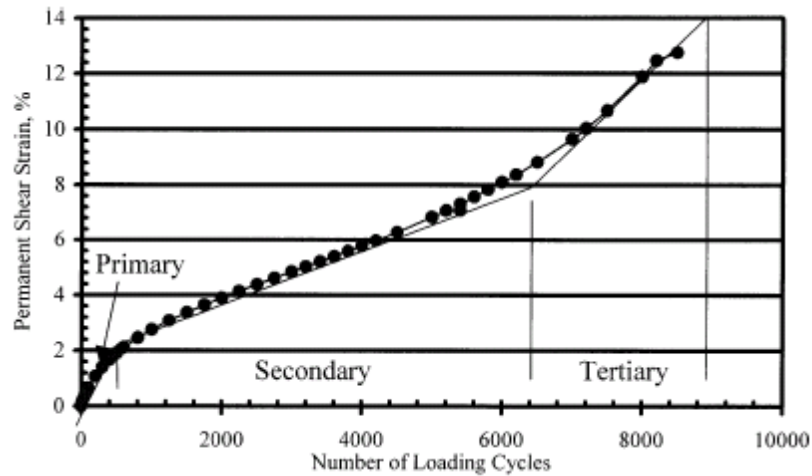

Figure 3.2 Permanent shear strain versus number of loading cycles: (Witczak, Kaloush, Pellinen, El-Aasyouny, & Von Quintus, 2002)

Statistical Analysis

A statistical analysis will be performed to determine if the differences between the means of the various categories can be considered statistically significant. The details of the type of comparison test used will be discussed in the statistical analysis section. Mean comparison tests will be used and all necessary assumptions will be addressed. Statistical analysis will help determine if the variables used in this research can be considered statistically significant and discussions will be presented regarding the implications of the findings of the statistical analysis. The main sections of the statistical analysis will be a detailed examination of the test data from ITS, dynamic modulus and the flow number testing. The major factors considered in this research are the effects of the WMA technology, the effect of moisture conditioning and the potential differences between field compacted samples and reheated laboratory compacted samples.

Completion of this experimental plan, will provide further insight into warm mix asphalt technologies performance and assess how the technologies can be integrated into QC/QA procedures. The results will help state agencies make an informed decision on any potential adjustments that may be necessary in evaluating the quality of a WMA within the agencies QC/QA program. The research will also add to the growing database of tested WMA mixes regionally and nationally.

CHAPTER IV

FIELD MIX DETAILS AND SAMPLE PREPARATION

4.1 Field Mix Details

The purpose of dedicating a chapter to the field mix details and sample preparation is to provide information about the projects, investigate other factors which may have impacted mix performance and to discuss sample preparation. A job mix formula for each project is provided in Appendix A. The field mix details will discuss the level of traffic that the mix was designed for, the date that paving took place, the weather, and how each field mix was sampled. The sample preparation section will provide information on how samples were made as well as sample volumetrics and the methods used for moisture conditioning.

The Evotherm 3G WMA and control HMA for the first field project was produced on June 27 and 28, 2008, respectively. The job mix formula is provided in Appendix A on page 141. The design life for this mix is 1 million ESALs and is intended to be used as a surface course and includes 33% classified RAP. Six HMA and six WMA dynamic modulus samples were compacted in the field for this project. The scope of this research project had not yet been defined and this is the reason fewer field samples were made and field compacted ITS samples were not created as did occur on ensuing projects. The weather for the days of production is shown in Table 4.1. There was 1.48 inches of precipitation recorded on June 27th. Both mixes were sampled from the top of the trucks just after loading.

The WMA Revix mix for the second field project was produced on Wednesday September 9, 2009 and the control HMA mix was produced on Thursday September 10, 2009. The job mix formula is provided on page 142 in Appendix A. The weather data for production days is provided in Table 4.2. The weather for this project was favorable and no precipitation had delayed production of the control mix. The design life for this mix is 5,641,440 ESALs (10million ESAL design level) and the project location is on US 218, the Charles City Bypass. The intended use for this mixture was for the wearing surface and contained 17% RAP and a PG 64-28 binder. The sampling occurred just prior to the mix being augured into trucks.

Table 4.1: Weather Data for Field Mix 1 Production (NOAA, 2008)

Station: Ames 5SE Location: Ames, Iowa Production Date: June 27, 2008	
Precipitation	1.48 in.
Precipitation in the last 24 hours	0.23 in.
Temperature	
Max Temperature	73 °F
Min Temperature	64 °F

Station: Ames 5SE Location: Ames, Iowa Production Date: June 28, 2008	
Precipitation	0.52 in.
Precipitation in the last 24 hours	1.48 in.
Temperature	
Max Temperature	85 °F
Min Temperature	58 °F

Table 4.2: Weather Data for Field Mix 2 Production (NOAA, 2009).

Location: Charles City, Iowa Date: September 9, 2009	
Precipitation	0.00 in.
Precipitation in the last 24 hours	0.00 in.
Temperature	
Max Temperature	81 °F
Min Temperature	53 °F

Location: Charles City, Iowa Date: September 10, 2009	
Precipitation	0.00 in.
Precipitation in the last 24 hours	0.00 in.
Temperature	
Max Temperature	80 °F
Min Temperature	55 °F

Field Mix 3 (FM3) was produced a few miles west of Sheldon, Iowa. The Sasobit WMA mix was produced September 22, 2009 and the control HMA mix was produced on September 23, 2009. Table 4.3 provides weather data for this project. The ground was fairly wet from the precipitation that had occurred during the previous 24 hours prior to paving. The job mix formula is provided on page 143 in Appendix A. The project location is IA 143 from Marcus North to IA 10. The design ESALs for this mix is three million and contained 20% RAP and a binder grade of PG 64-22. This mix was sampled using a bypass chute on the mix surge silo. This WMA mix contained high amounts of moisture due to the precipitation that had occurred in this area. The oven used for keeping the mixture warm for compaction had significant amounts of steam escaping each time the oven door was opened.

Table 4.3: Weather Data for Field Mix 3 Production (NOAA, 2009)

Location: Sheldon, Iowa Date: September 22, 2009		Location: Sheldon, Iowa Date: September 23, 2009	
Precipitation	0.01 in.	Precipitation	Trace
Precipitation in the last 24 hours	0.21 in.	Precipitation in the last 24 hours	0.01 in.
Temperature		Temperature	
Max Temperature	63 °F	Max Temperature	68 °F
Min Temperature	46 °F	Min Temperature	46 °F

Field Mix 4 was produced in Johnston, Iowa. This project experienced rain delays and thus there was a period of a week and two days between the production of the Double Barrel Green foam WMA mix and the control HMA. The weather for each day of production is shown in Table 4.4. The WMA mix was produced on October 21, 2009 and the HMA control mix was produced on October 30, 2009 with the weather good for paving both days. However, wind gusts of up to 40 mph were experienced on October 30, 2009. The job mix

formula is located in Appendix A on page 144. This is a surface course mix with a design life of 3 million ESALs and contains 20% RAP. Sampling for the HMA mix was taken from the top of several trucks. The trucks drove next to a high platform where the mix could be sampled. HMA was collected from at least 5 different trucks. Sampling for the WMA mix was performed by the contractor and was waiting in buckets when research personnel arrived to collect and compact the mix. The WMA production was delayed off and on all day due to the inclement (rainy) weather.

Table 4.4: Weather Data for Field Mix 4 Production (NOAA, 2009)

Station: Des Moines WSFO-JOHNST Location: Johnston, IA Production Date: October 21, 2009		Station: Des Moines WSFO-JOHNST Location: Johnston, IA Date: October 30, 2009	
Precipitation	0.34 in.	Precipitation	0.03 in.
Precipitation in the last 24 hours	0.01 in.	Precipitation in the last 24 hours	1.80 in.
Temperature		Temperature	
Max Temperature	67 °F	Max Temperature	62 °F
Min Temperature	45 °F	Min Temperature	39 °F

4.2 Sample Preparation

Loose mix was collected for four HMA/WMA field produced mixes for a total of eight different mixes. Half of the samples were compacted in the field the other half was compacted in the laboratory after being reheated. All samples were compacted at target air voids of 7% based on the known G_{mm} values for each mix, provided by the contractor, and a fixed volume. The ITS samples are 100mm in diameter and 62.5mm tall. The dynamic modulus samples are 100mm in diameter and 150mm tall. All samples were compacted using a Pine Superpave gyratory compactor. Tables showing all of the volumetric data are located in Appendix B. The air voids were measured by weighing the samples dry, weighing the samples in water and weighing the samples saturated surface dry.

Moisture conditioning was performed in accordance with AASHTO T-283, Resistance of Compacted Hot Mix Asphalt (HMA) to Moisture-Induced Damage (AASHTO, 2007). First, the samples were ranked according to air void content and every other sample was moisture conditioned. This step creates the control group of samples and the moisture conditioned group as well as ensures that the strength of the moisture conditioned sample can be compared to the most similar non-moisture conditioned sample. The next step is to compute the target weight range based on 70-80% saturation. The samples were placed in the vacuum container which is filled with potable water at room temperature so that the specimens have at least 25 mm of water above their surface. A vacuum pressure of 13 to 67 kPa was applied for a short time (approximately 5 to 10 minutes). Then the mass of the saturated specimens was measured. If the mass was below the target weight range, then the vacuum process is repeated. If the degree of saturation exceeded 80%, the sample was considered damaged and discarded. If target saturation was obtained, the specimen was covered tightly with a plastic film (Saran Wrap[®]). Each wrapped specimen was placed in a plastic bag containing 10 ± 0.5 mL of water and the bag sealed. Then the plastic bags containing the specimens were placed in a freezer set at $-18 \pm 3^\circ\text{C}$ for a minimum of 16 hours. When removed, the specimens are placed in a hot water bath at $60 \pm 1^\circ\text{C}$ for 24 ± 1 hour. The specimens should have a minimum of 25 mm of water above their surface. Finally, the specimens were placed in a water bath at $25 \pm 0.5^\circ\text{C}$ for 2 hours \pm 10 minutes and then the samples were tested for their indirect tensile strength.

CHAPTER V BINDER TESTING RESULTS

For each of the field mixes, binder was sampled and rheological testing was performed. The binder testing is useful in determining how the WMA additive affects the properties of the binder. As discussed in the literature review, some WMA additives may affect the binder grade and this testing helps to determine the extent of the differences between the HMA and WMA binders. The binder tests included DSR testing on the original binder, RTFO aged binder and PAV aged binder to determine the high and intermediate binder grade. BBR testing was performed on the PAV aged binder to determine low temperature binder grade and rotational viscometer testing was performed in order to compare the HMA mixing and compaction temperatures with those of the WMA. It should be noted that the rotational viscometer data may not fully quantify the effects of the WMA technologies (Bennert, Reinke, Mogawer, & Mooney, 2010). The rotational viscometer does give a binder viscosity comparison between the WMA additive and the HMA control binder. The results from the binder testing are to supplement and support the findings determined in the mix testing.

5.1 Field Mix 1- Evotherm 3G

The binder for FM1 is a PG 58-28. The data from the rotational viscometer test is shown in Figure 5.1.1. The mixing temperature for the HMA ranges from 155° C to 161° C. The mixing range for the WMA is 131° C to 135° C. The HMA compaction temperature range is 143.5° C to 148.5° C and the WMA compaction range is 122° C to 126° C. The WMA reduced the mixing temperature by an average of 25° C but the mixing range was reduced from a range of 6° C to a range of 4° C as compared to the HMA binder range. The WMA reduced the compaction temperature by an average of 22° C and the compaction temperature range was only reduced by 1° C as compared to the HMA binder range.

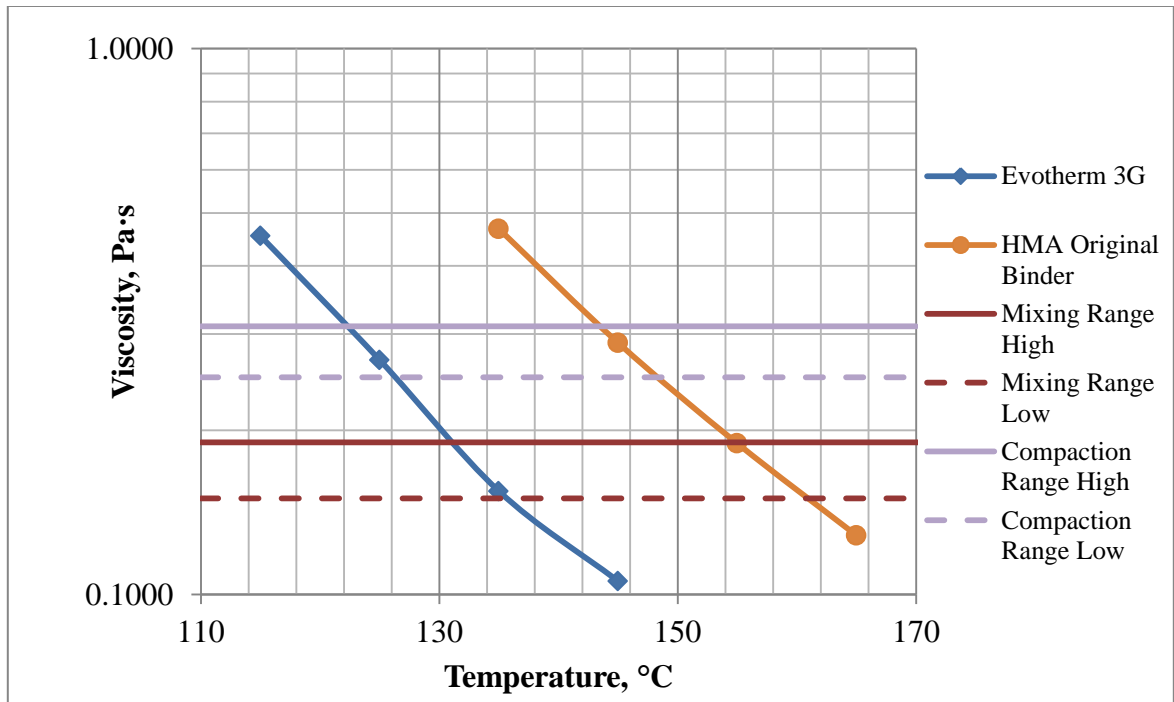

Figure 5.1.1: Rotational viscometer comparison of Evotherm 3G and control binder

Figure 5.1.2 compares average DSR continuous temperatures grades for the original, RTFO aged and PAV aged binders. The largest difference is between the HMA binder unaged and the WMA binder unaged with a continuous temperature grade difference of 7.7°C. It appears that as more aging takes place, there is a decrease in the difference in the rheological properties of the binder. Figure 5.1.3 the $G^*/\sin(\delta)$ of the original HMA/WMA binders and RTFO aged HMA/WMA binders. This figure shows the rheological properties over a range of temperatures in both a figure and table form. The $G^*/\sin(\delta)$ term is indicator for permanent deformation and is limited to 1.00 kPa for original binder and 2.20 kPa after RTFO aging. The trends of the $G^*/\sin(\delta)$ parameter continue through all of the temperatures tested. The permanent deformation may be more of a concern in the WMA mix however this mixture still passes the high temperature grading criteria for the PG 58 grade.

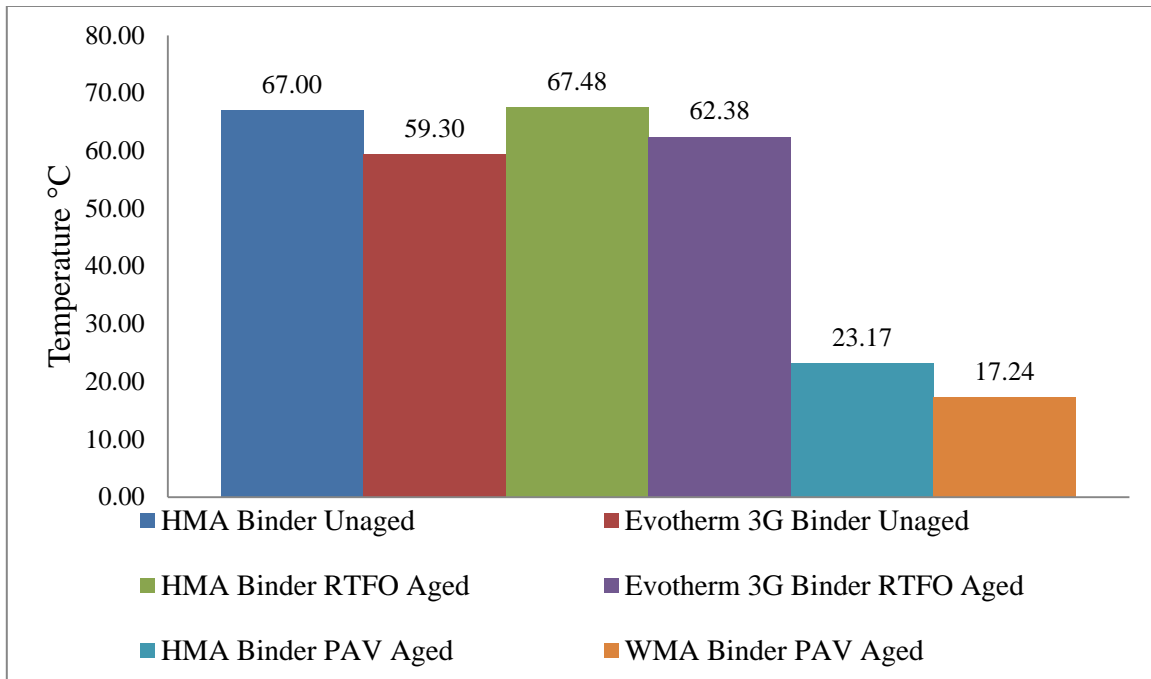

Figure 5.1.2 Comparison of failure temperatures for Evotherm 3G and control binders

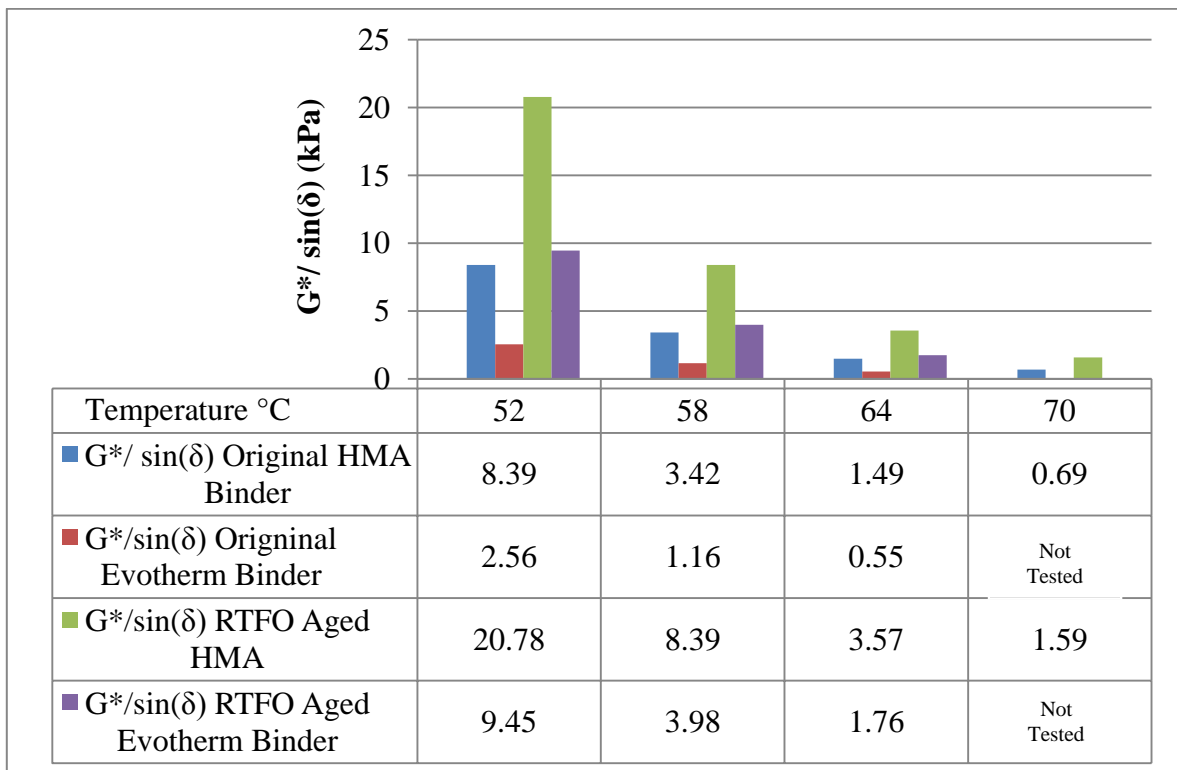

Figure 5.1.3: Comparison of $G^*/\sin(\delta)$ for original and RTFO aged binders

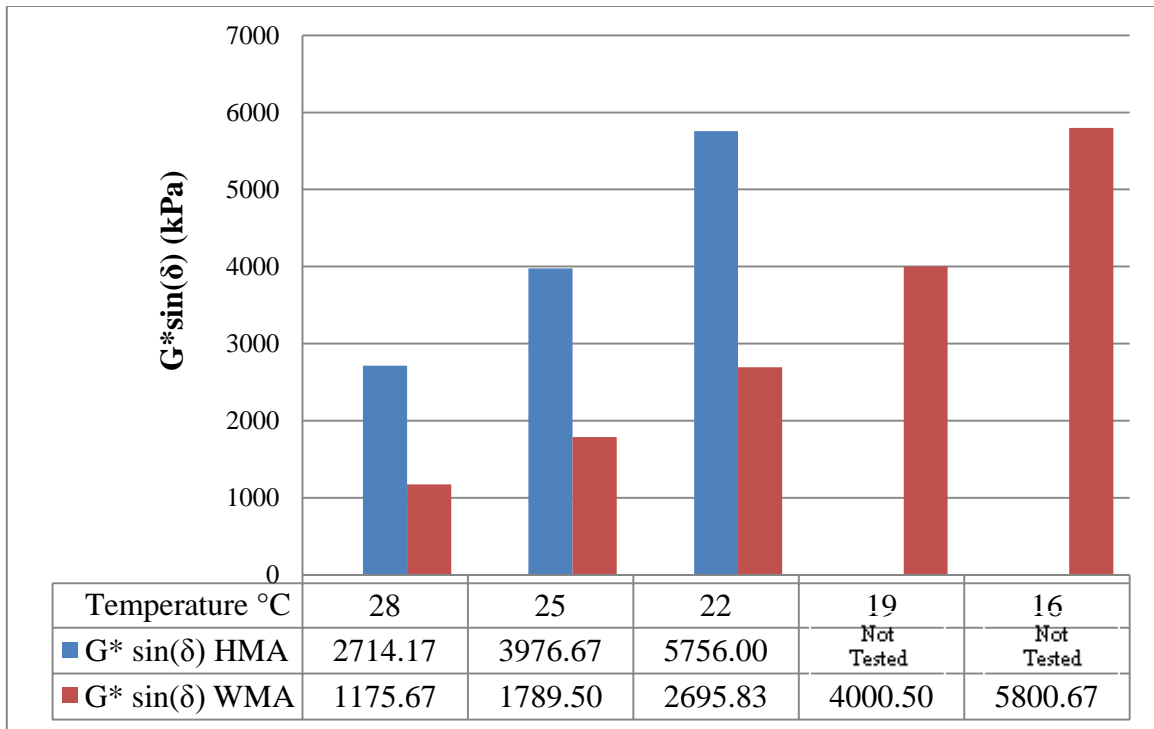

Figure 5.1.4: Comparison of $G^*\sin(\delta)$ values for PAV aged Evotherm 3G and Control Binders

The DSR testing on the PAV aged material showed a large difference between the binders' rheological properties. Fatigue cracking is governed by limiting $G^*\sin(\delta)$ to values of less than 5000 kPa (Asphalt Institute, 2003). This testing would indicate that the WMA binder is less susceptible to fatigue cracking depending upon the pavement structure.

Mass loss was measured for RTFO aged binders. The average mass loss for the HMA binder was 0.75% and the average mass loss for the WMA binder was 1.3% and is above the 1% tolerance.

The bending beam rheometer data shows reduced stiffness in the Evotherm 3G modified binder. Table 5.1.1 provides all of the stiffness and m-value data compiled for each beam tested. Figures 5.1.5 and 5.1.6 show comparison of the Evotherm 3G and control binder stiffness and m-values, respectively. The Evotherm 3G showed a lower stiffness and a higher m-value at each temperature tested. From the BBR results, the low temperature

binder grade of the Evotherm 3G is -28 and the HMA low binder grade is a -22. The stiffness for the HMA binder at -18°C exceeded the 300 MPa maximum for all three of the binder beams tested.

Table 5.1.1: BBR Stiffness and m-value data for Evotherm 3G and Control Binders

FM1 HMA Binder					FM1 WMA Binder Evotherm 3G				
Temp (°C)	S(t)	Avg. S(t)	m-value	Avg. m	Temp (°C)	S(t)	Avg. S(t)	m-value	Avg. m
-6	98.8	97.33	0.341	0.349	-6	47	48.93	0.386	0.390
-6	96.9		0.352						
-6	96.3		0.353						
-12	225	215.33	0.272	0.274	-12	113	132.00	0.305	0.300
-12	220		0.273						
-12	201		0.277						
-18	418	382.00	0.203	0.197	-18	301	278.67	0.253	0.245
-18	395		0.182						
-18	333		0.207						

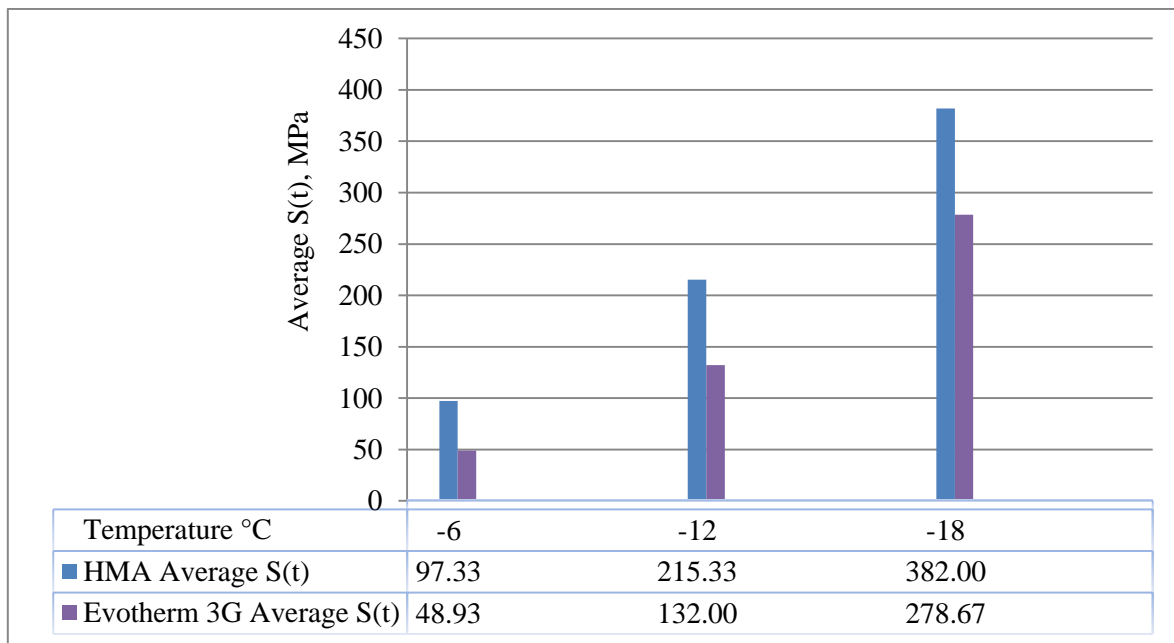

Figure 5.1.5: Comparison of average stiffness values for Evotherm 3G and control binders

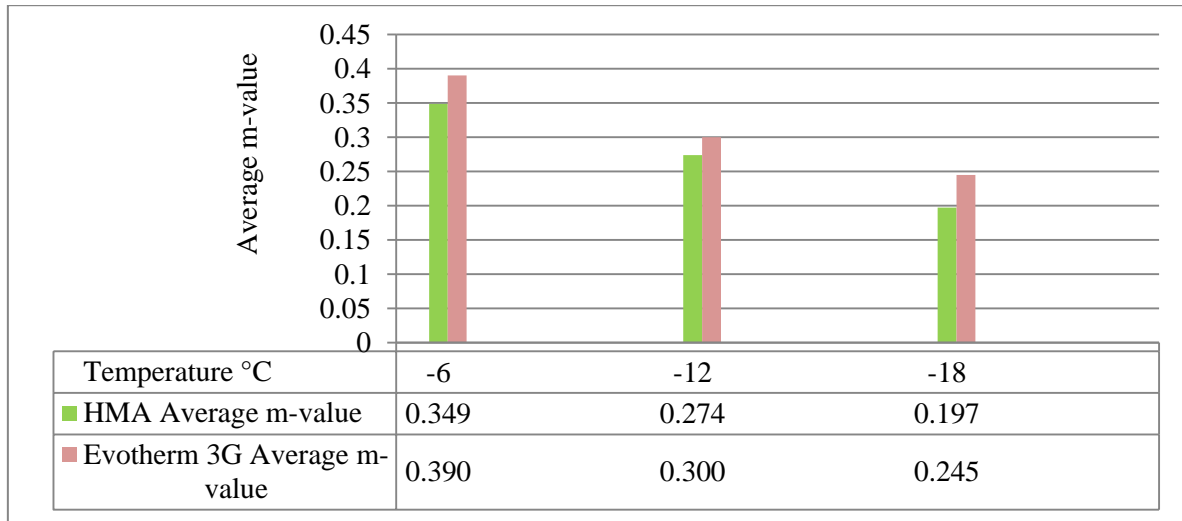

Figure 5.1.6: Comparison of average m-values for Evotherm 3G and control binders

5.2 Field Mix 2- Revix

The binder used in the FM2 project is a PG 64-28 and the warm mix technology is Revix. This is the next generation of the Evotherm 3G as discussed in the literature review. Figure 5.2.1 shows the data from the rotational viscometer testing. The mixing temperature range for the HMA is 163°C to 170°C. The mixing range for the Revix is 157°C to 164°C. The HMA compaction range is 151°C to 156°C and the compaction range for the WMA is 145°C to 150°C. The mixing and compaction ranges for the HMA and WMA are comparable and the range was not significantly reduced by the WMA additive. The Revix reduced the mixing temperature by an average of 6°C and the compaction temperature by an average of 6°C.

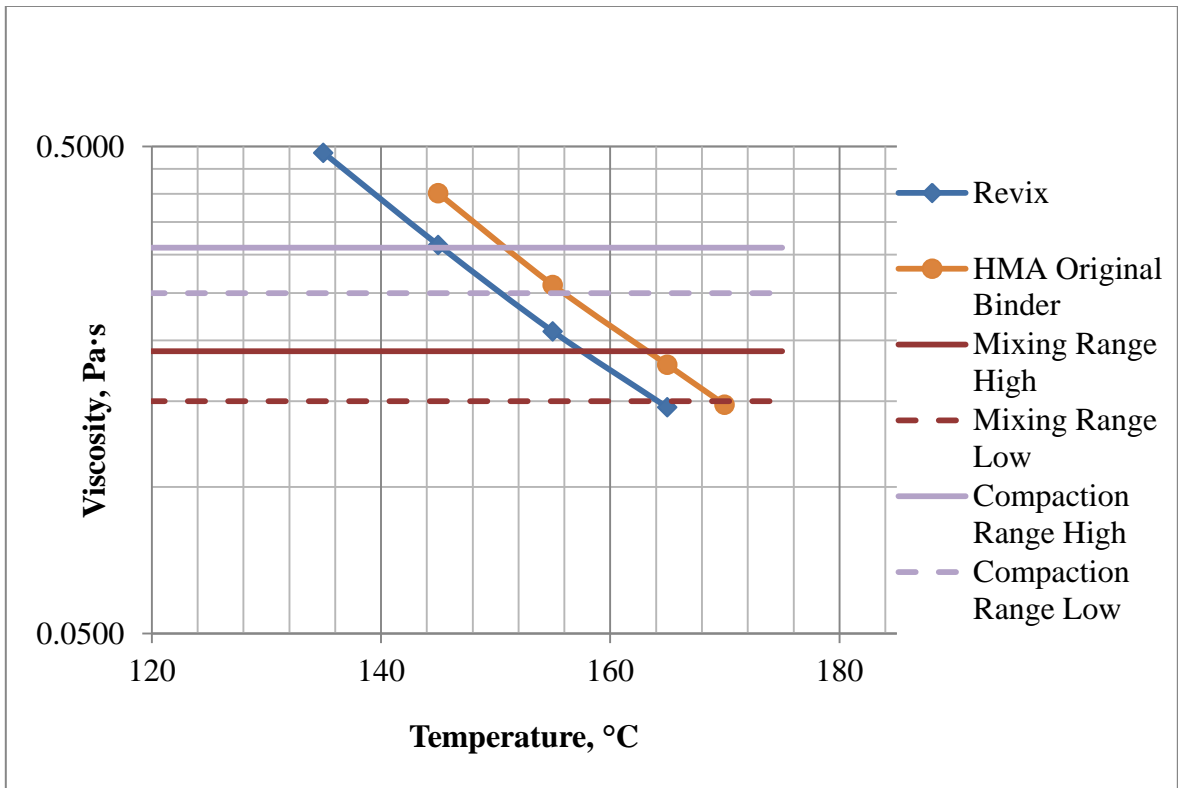

Figure 5.2.1: Rotational viscometer comparison of Revix and Control Binder

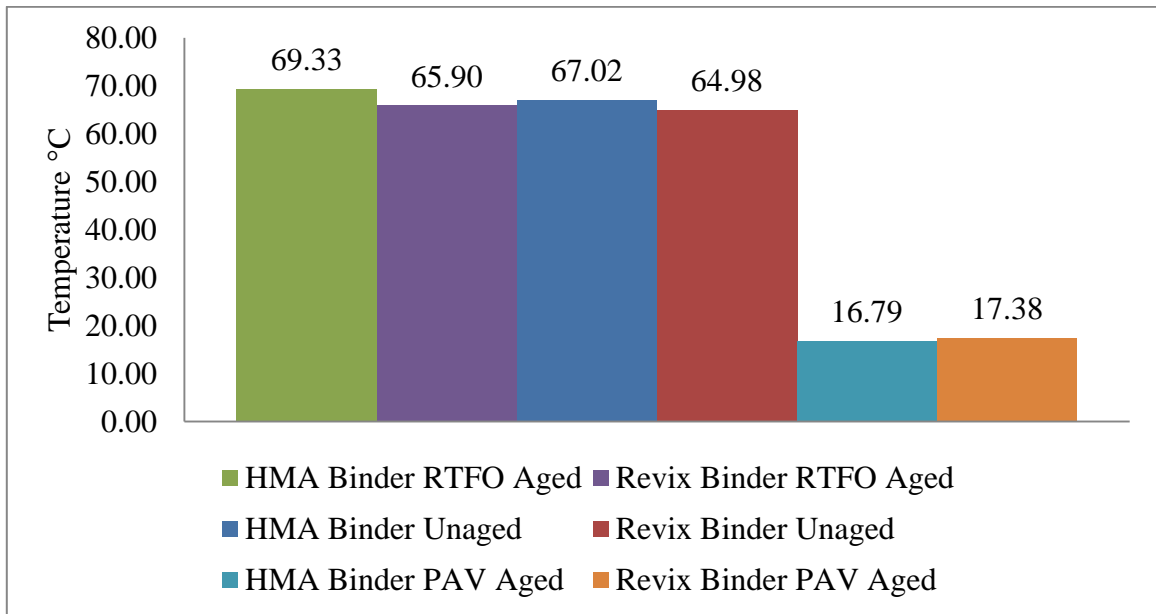

Figure 5.2.2: Comparison of failure temperatures for Revix and control binders

Figure 5.2.2 compares the average DSR failure temperatures for unaged, RTFO aged and PAV aged binders. The HMA and WMA binders are comparable with the average temperature differences being only 3.43°C for unaged, 2.04°C for RTFO aged and 0.59°C for PAV aged binders. Figure 5.2.3 compares the $G^*/\sin(\delta)$ values for the unaged and RTFO aged binders. The greatest difference between the $G^*/\sin(\delta)$ values occurred after RTFO aging at the lower temperatures.

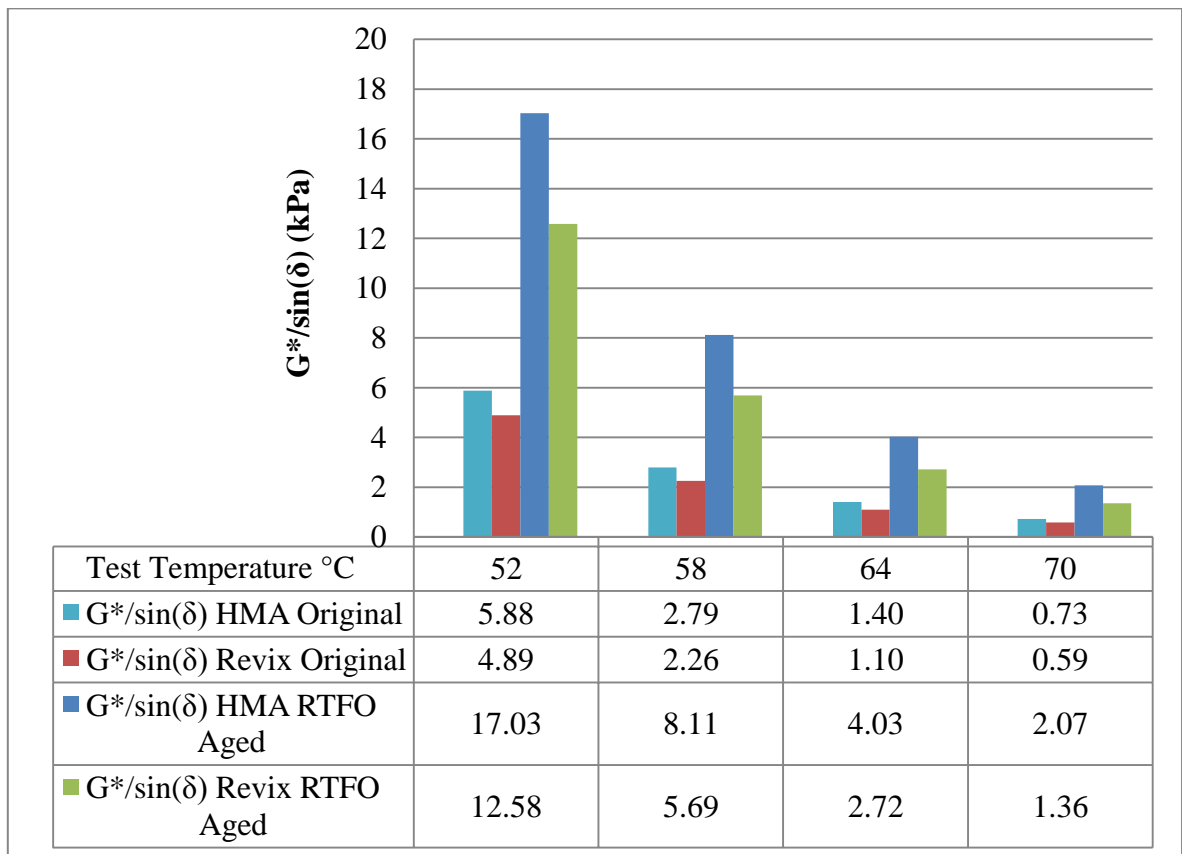

Figure 5.2.3: Comparison of $G^*/\sin(\delta)$ for Original and RTFO aged Binders

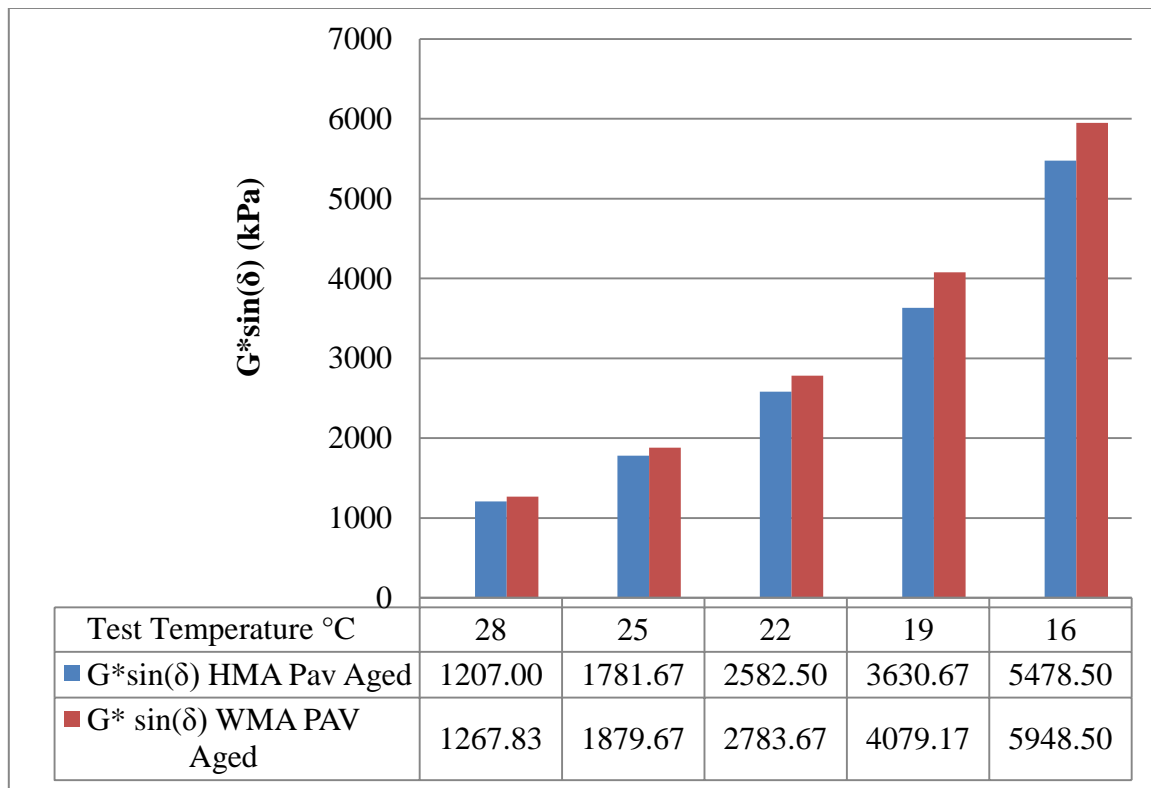

Figure 5.2.4: Comparison of $G^* \sin(\delta)$ values for PAV aged Evotherm 3G and Control Binders

Figure 5.2.4 shows the comparison of $G^* \sin(\delta)$ values. This test indicates the vulnerability to fatigue cracking. The differences are relatively small but with the WMA shows a consistently higher $G^* \sin(\delta)$ values which would indicate a higher susceptibility to fatigue cracking depending upon the pavement structure.

The mass loss during RTFO Aging was measured. The WMA had an average mass loss of 0.77% and average mass loss for HMA was 0.81%. Both binders were well within the acceptable range.

The bending beam rheometer data is shown in Table 5.2.1. Figures 5.2.5 and 5.2.6 show how the stiffness and m -value change as the temperature is reduced. The stiffness values are similar with the HMA being slightly higher. The HMA and WMA have the same low

temperature grade of -22°C . The m -value at -18°C did not meet the 0.300 minimum requirements as shown in Figure 5.2.6.

Table 5.2.1: Bending Beam Rheometer Stiffness and m -value data for Revix and Control Binders

FM2 HMA Binder					FM2 WMA Binder Revix				
Temp (°C)	S(t)	Avg. S(t)	m-value	Avg. m	Temp (°C)	S(t)	Avg. S(t)	m-value	Avg. m
-6	44.6	45.87	0.363	0.370	-6	38.8	39.93	0.390	0.390
-6	46.9		0.375						
-6	46.1		0.372						
-12	112	113.33	0.326	0.318	-12	95.3	102.6	0.328	0.322
-12	111		0.311						
-12	117		0.317						
-18	215	214.33	0.264	0.253	-18	196	202.67	0.269	0.256
-18	212		0.264						
-18	216		0.232						

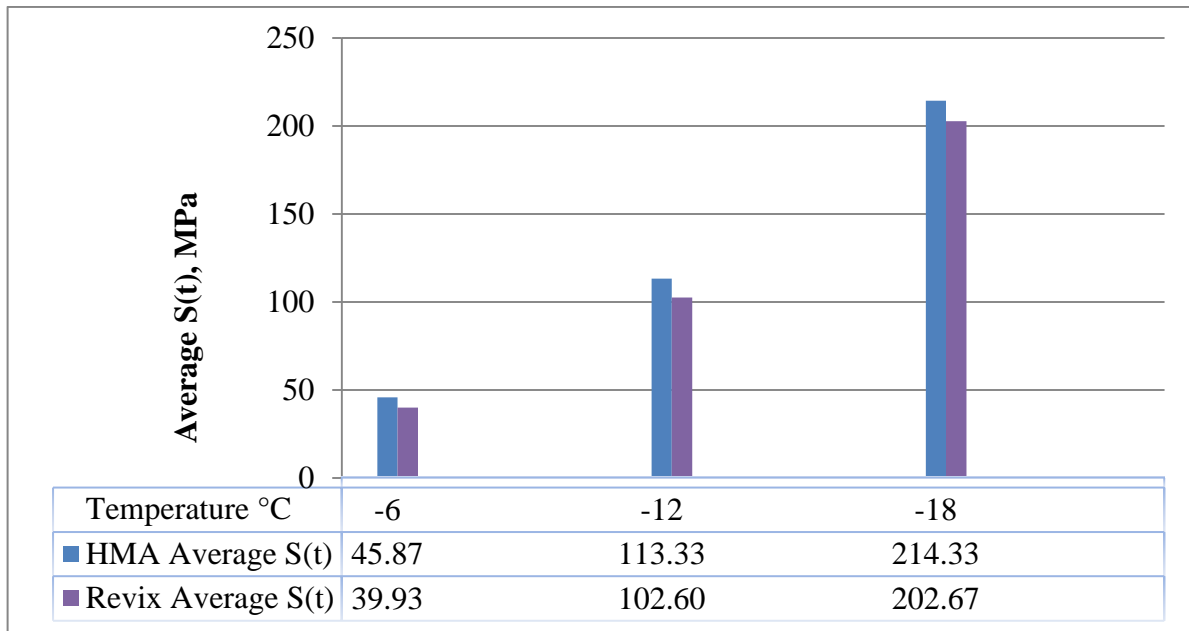

Figure 5.2.5: Comparison of average stiffness values for Revix and control binders

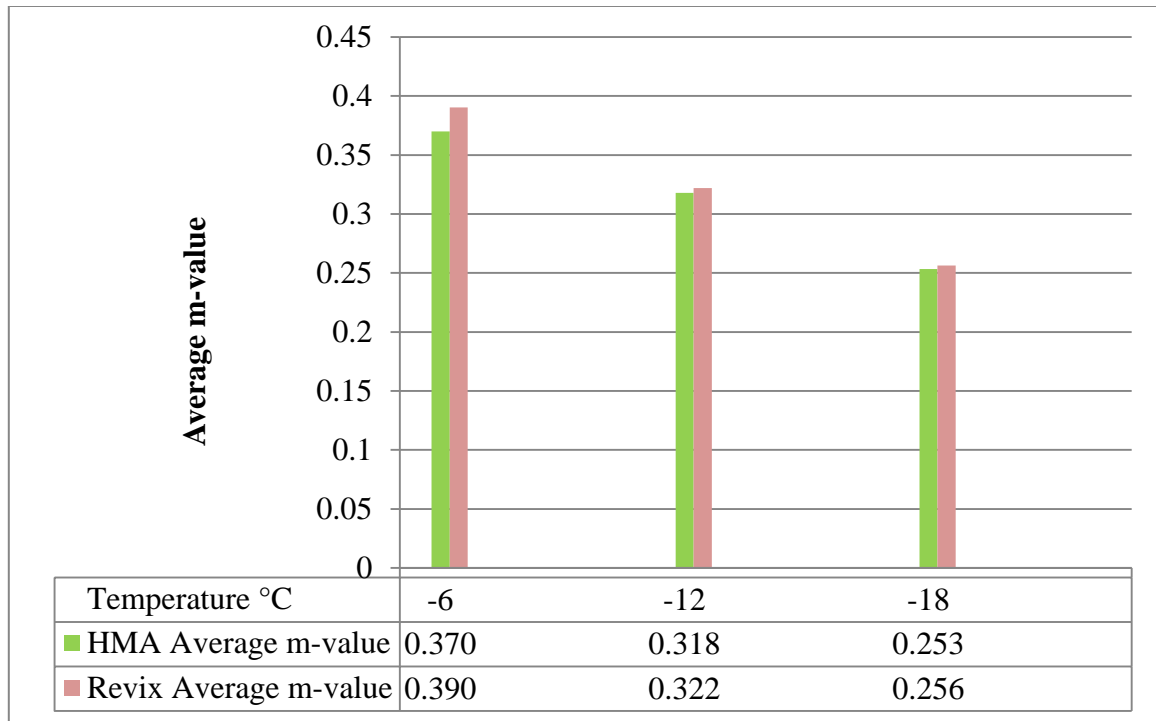

Figure 5.2.6: Comparison of average m-values for Revix and control binders

5.3 Field Mix 3- Sasobit

The binder for FM3 is a PG 64-22. The Sasobit wax was the WMA technology used on this project. The data from the rotational viscometer test comparing the WMA and HMA is shown in Figure 5.3.1. The mixing temperature for the HMA ranges from 153.5-160°C and WMA mixing range is from 146-153°C. The compaction range for the HMA is from 142-147°C and the Sasobit is from 135-140°C. The rotational viscometer tests show a 7°C decrease between the HMA and WMA binders for both the mixing and compaction range. The small difference in the viscosity between the HMA binder and the WMA binder supports findings by other researchers that this test is not sensitive differences in the binders; however, the DSR binder results show very similar values between the HMA and WMA binders.

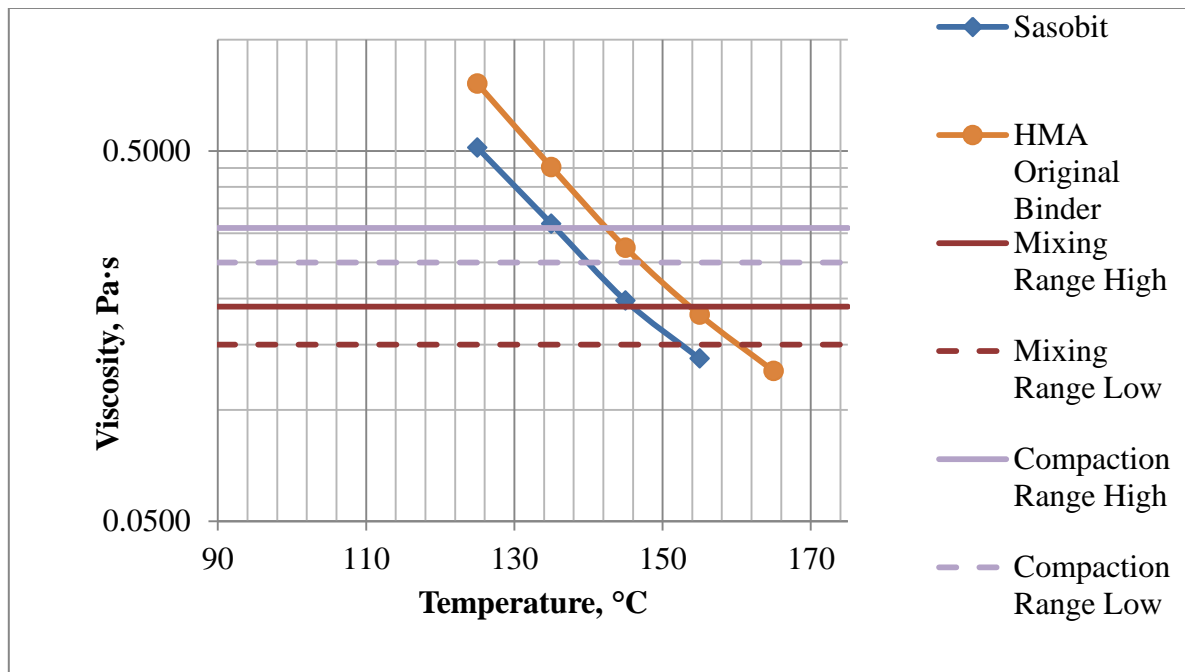

Figure 5.3.1: Rotational viscometer comparison of Sasobit and Control Binder

Figure 5.3.2 compares the average DSR failure temperatures for the unaged, RTFO aged and PAV aged binders. There is very little difference between the failure temperatures. The largest difference is 1.04°C. The $G^*/\sin(\delta)$ values shown in Figure 5.3.3 support the findings of the other tests by revealing only small differences between the values for the HMA and WMA binders. The PAV aged samples give similar $G^*\sin(\delta)$ values as shown in Figure 5.3.4.

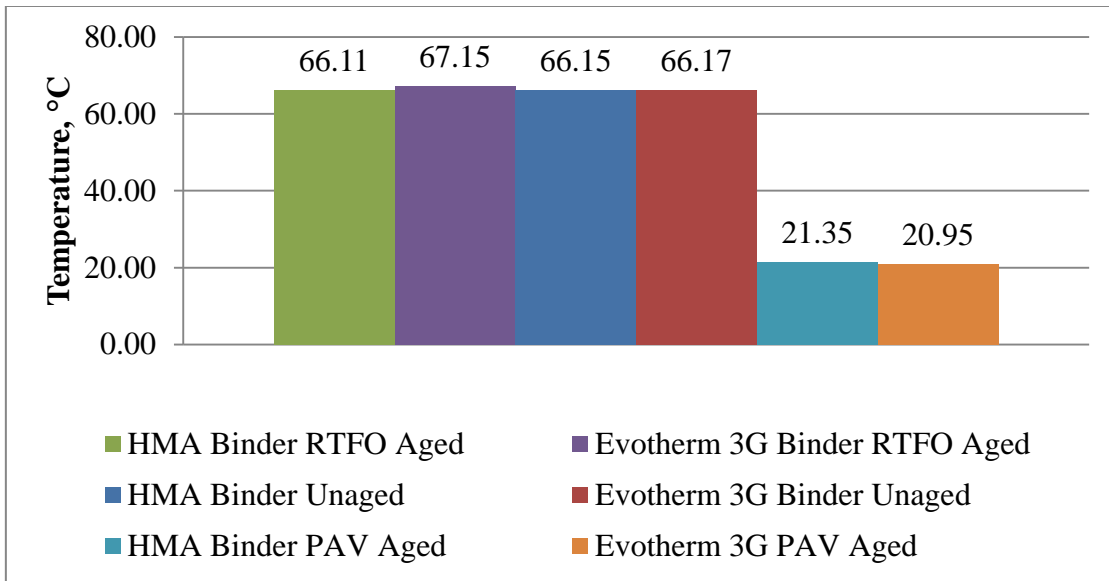

Figure 5.3.2: Comparison of failure temperatures for Sasobit and control binders

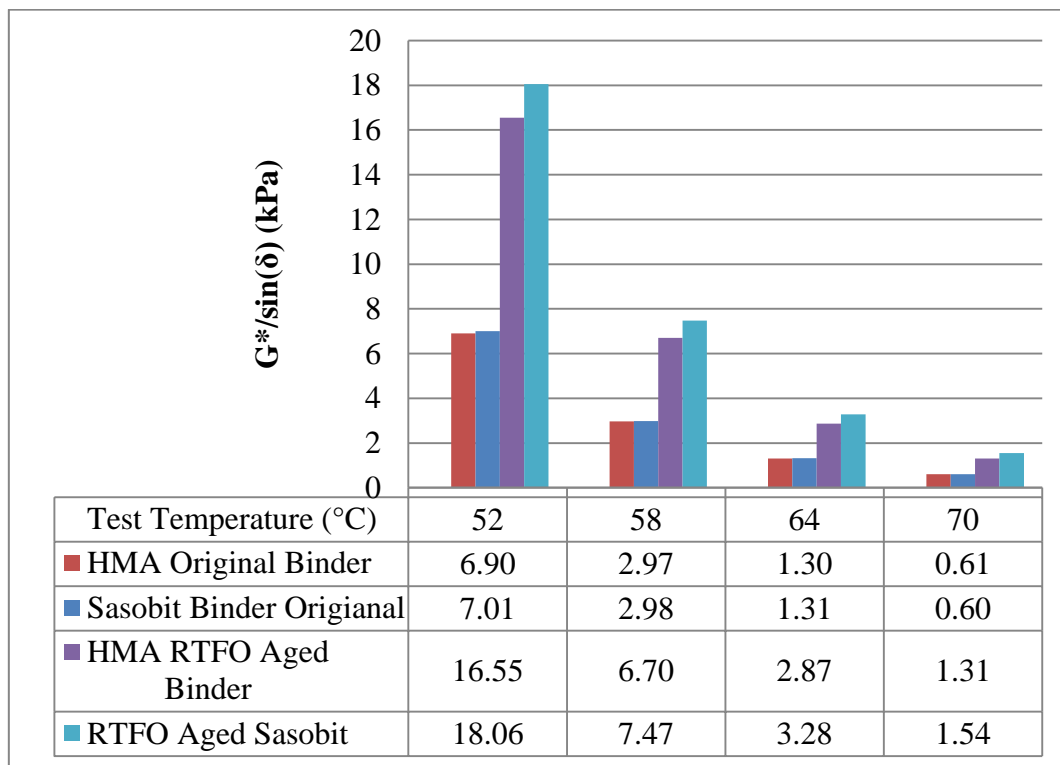

Figure 5.3.3: Comparison of $G^*/\sin(\delta)$ for Original and RTFO aged Binders

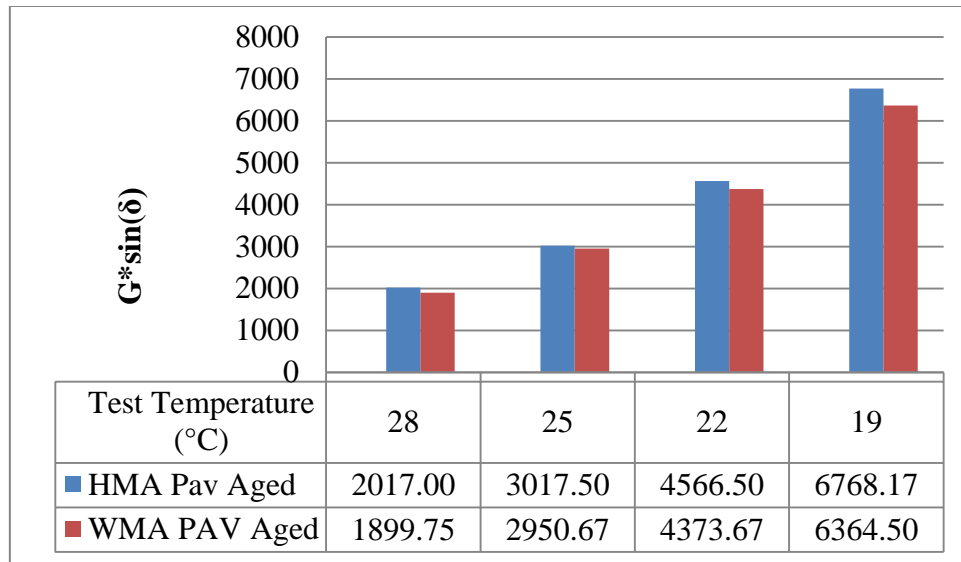

Figure 5.3.4: Comparison of $G^*\sin(\delta)$ values for PAV aged Sasobit and control binders

The mass loss was measured during the RTFO aging for WMA and the HMA binders. Each binder was under the 1% tolerance with the HMA binder losing 0.5% and the WMA losing 0.6% of mass. The mass loss is not a concern for the Sasobit WMA additive.

The compiled data for the BBR is located in Table 5.3.1. Figures 5.3.5 and 5.3.6 are graphs of the stiffness and the m-value, respectively. The stiffness of the HMA tends to be higher than the Sasobit binder and the difference is more prominent as the temperature is decreased. The m-value of the Sasobit is consistently lower than the control binder; however, neither binder meets the 0.300 m-value requirement for the -12°C test temperature and thus do not meet the -22 PG binder grade and grade out to be a -18 binder grade.

Table 5.3.1: Beam Rheometer Stiffness and m-value data for Revix and Control Binders

HMA Binder					Sasobit WMA Binder				
Temp (°C)	S(t)	Avg. S(t)	m-value	Avg. m	Temp (°C)	S(t)	Avg. S(t)	m-value	Avg. m
-6	95.1	95.8	0.369	0.373	-6	83.8	82.8	0.340	0.338
-6	99.3		0.381						
-6	92.9		0.369						
-12	199	204.0	0.277	0.283	-12	150	180.0	0.282	0.285
-12	220		0.279						
-12	193		0.292						
-18	474	407.7	0.191	0.217	-18	314	285.0	0.222	0.216
-18	367		0.227						
-18	382		0.233						

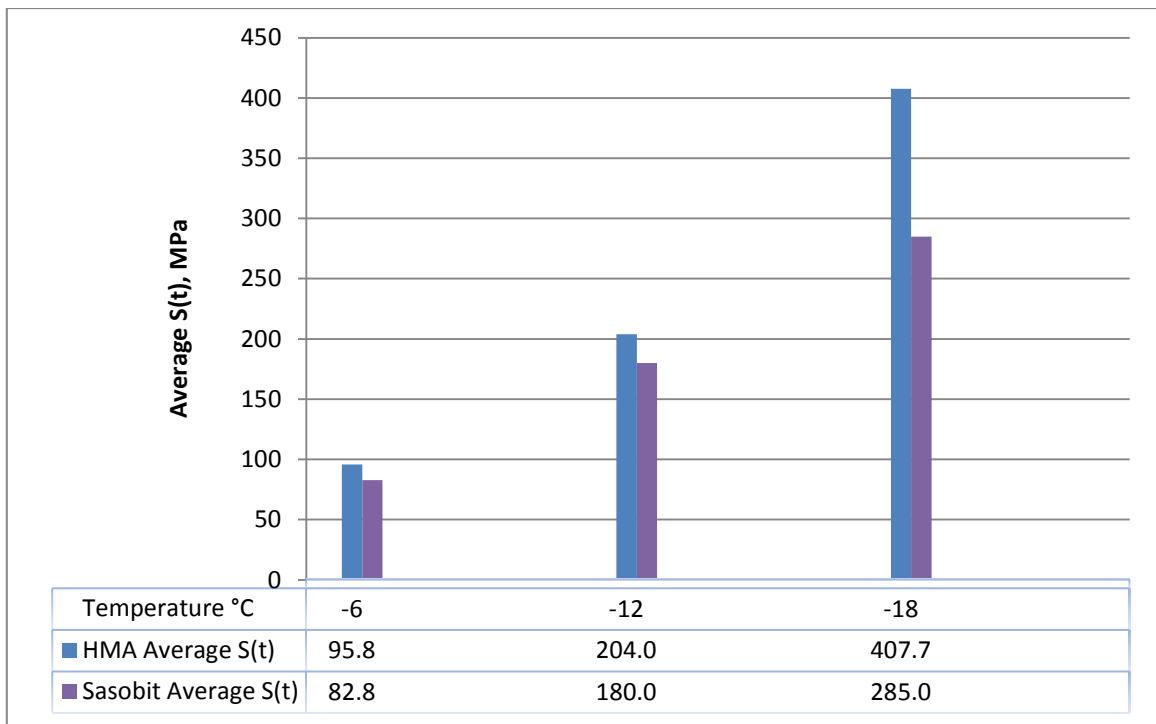

Figure 5.3.5: Comparison of average stiffness values for Revix and control binders

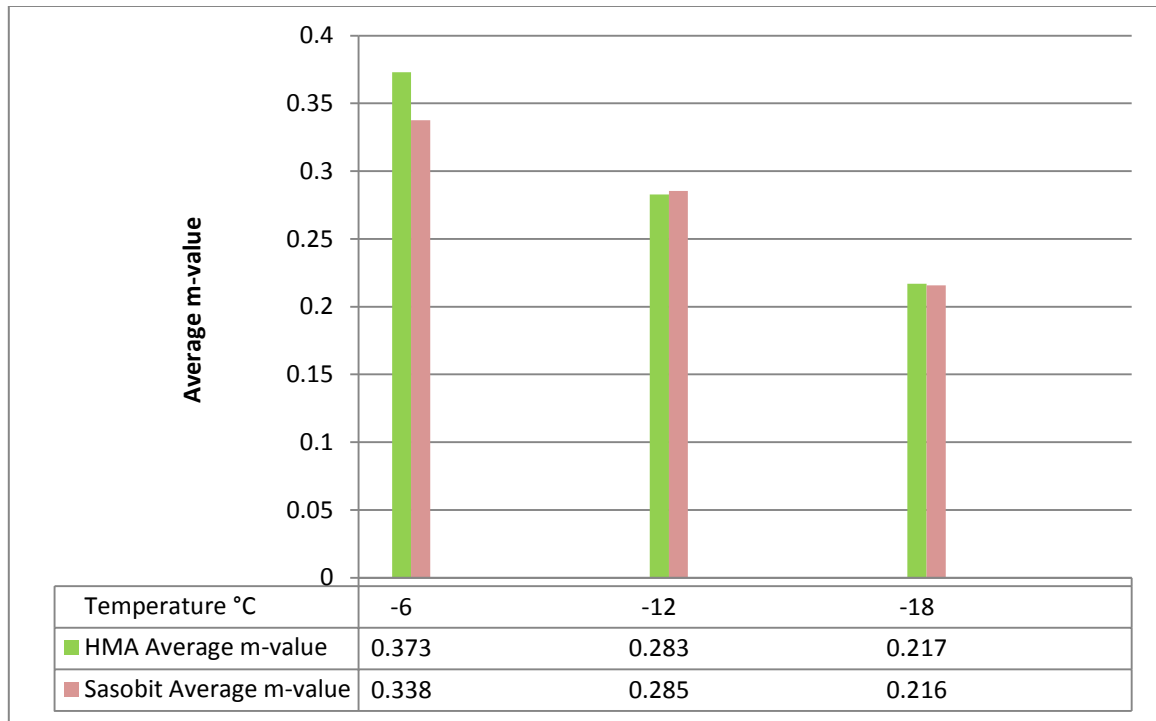

Figure 5.3.6 Comparison of average m-values for Revix and control binders

Overall the binders used in FM3 showed very little difference in all of the testing. This is cause for concern because the rotational viscometer showed low mixing and compaction temperatures. The test results call into question the potential of the “control” binder being mixed with the WMA Sasobit binder that was produced on the preceding day. This binder displays variable stiffness properties as the temperature is lowered to below -12°C . This was not seen in the Evotherm 3G or Revix binders.

5.4 Field Mix 4- Double Barrel Green Foaming

The double barrel green foaming technology was used for the fourth field mix. The base binder grade is PG 64-22. The data obtained from rotational viscometer results is shown in Figure 5.4.1. The mixing range for the HMA binder is 154 to 160°C . The mixing range for the foamed asphalt is 146.3 to 153°C . The compaction range is 142.5 to 147.5°C for the HMA binder and 135.5 to 140°C for the foamed binder. The overall difference is an average 7.25°C reduction in both the mixing and compaction temperature range. The DSR failure temperate comparing the HMA and foamed binders are shown in Figure 5.4.2. The

comparison shows that the HMA and the foamed asphalt for the unaged, RTFO aged and PAV aged have very similar failure temperatures and this supports the similar values documented in the rotational viscometer testing. Figure 5.4.3 shows the $G^*/\sin(\delta)$ values for unaged and RTFO aged binders. The comparison shows that the $G^*/\sin(\delta)$ values for the HMA and the WMA are similar. The similarities continue in the PAV aged binder comparison shown in Figure 5.4.3. The $G^*/\sin(\delta)$ are very similar throughout the testing temperatures. .

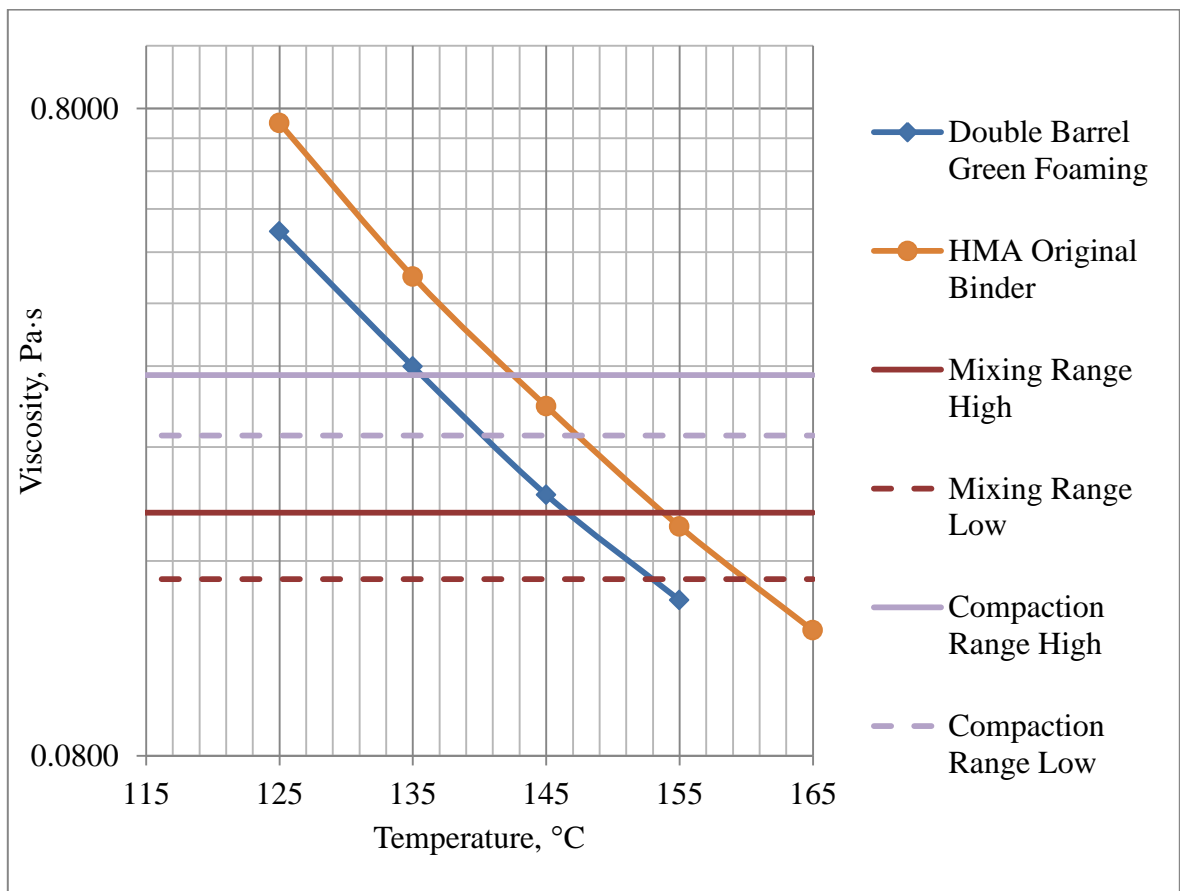

Figure 5.4.1: Rotational viscometer comparison of foamed and Control Binder

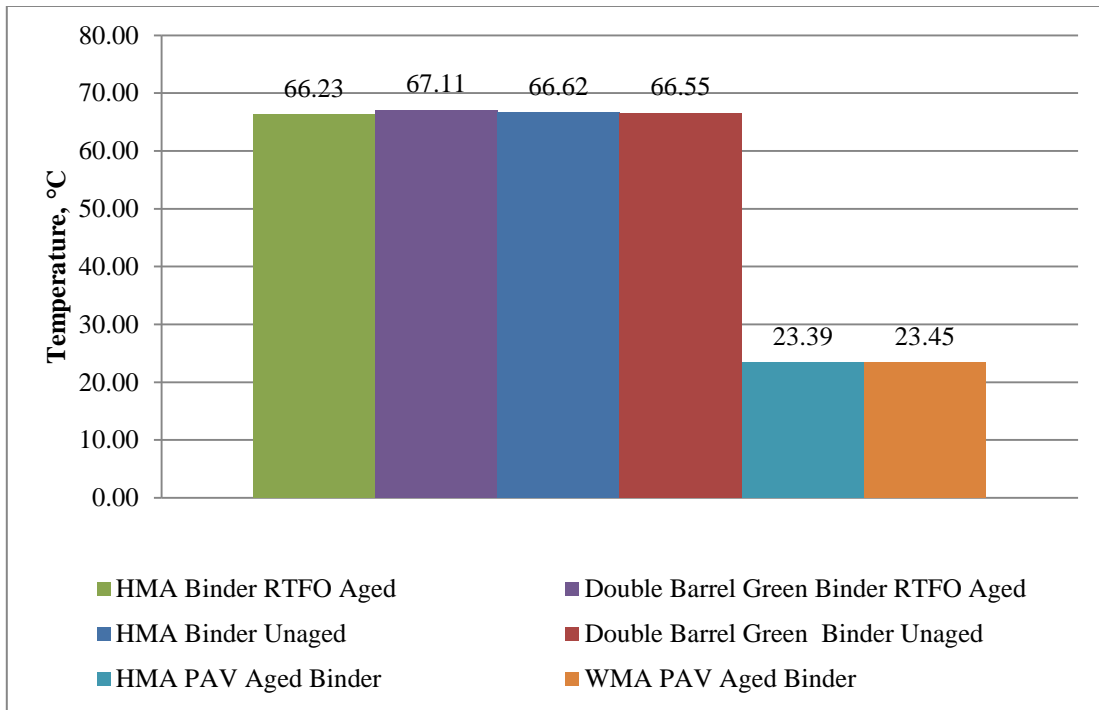

Figure 5.4.2: Comparison of failure temperatures for foamed and control binders

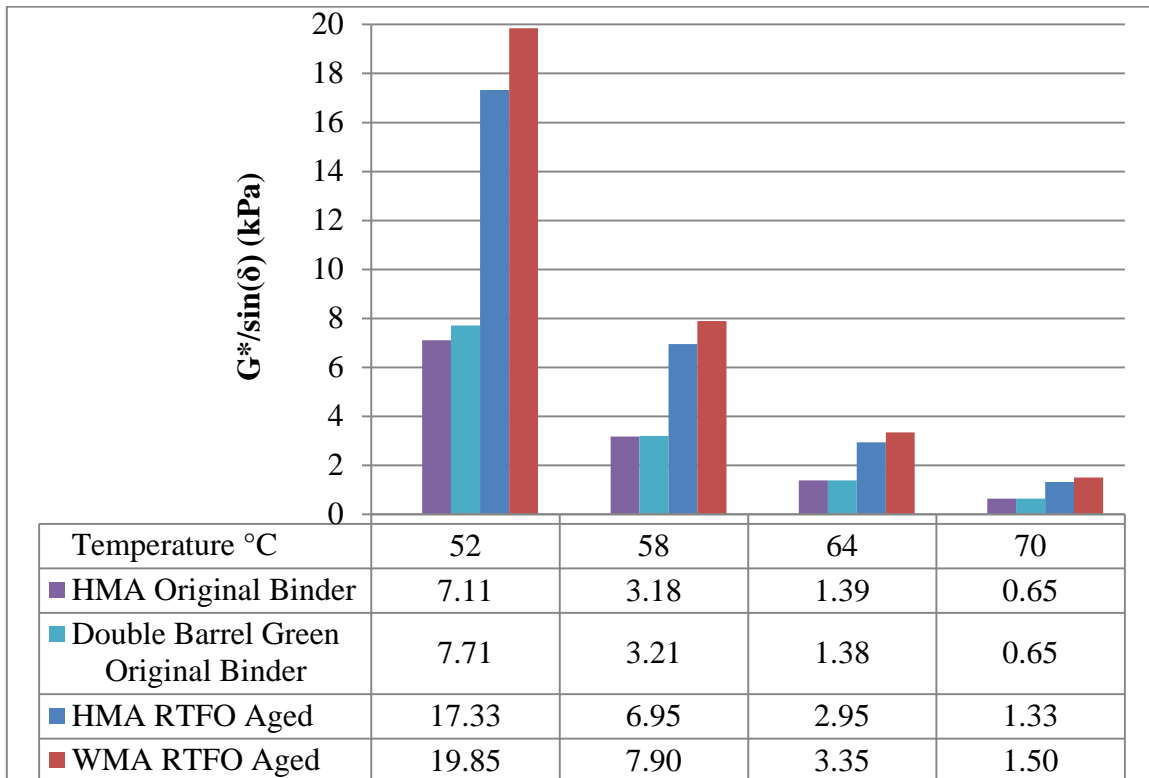

Figure 5.4.3: Comparison of $G^*/\sin(\delta)$ for Original and RTFO aged Binders

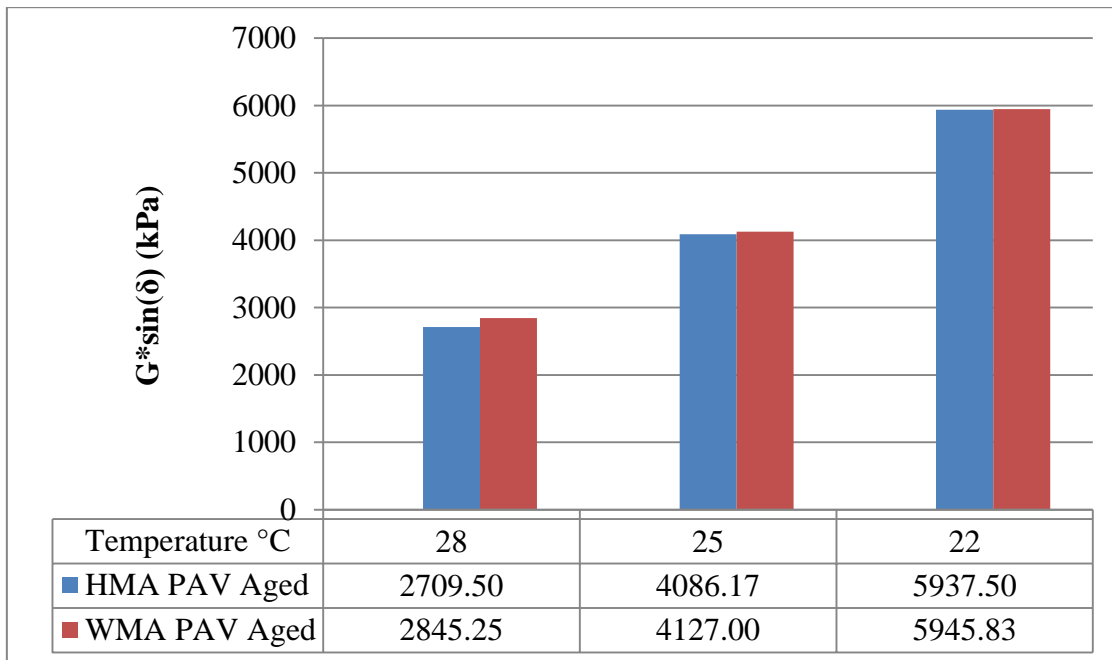

Figure 5.4.4: Comparison of $G^*\sin(\delta)$ values for PAV aged foamed and control binders

The mass loss during RTFO aging was measured and both the HMA and WMA binders met the mass loss requirements of less than 1%. The mass loss for the WMA binder was 0.4% and the mass loss for the HMA binder was 0.2%.

Table 5.4.1 provides the stiffness and m-values for each BBR beam tested. Figures 5.4.5 and 5.4.6 compare the average stiffness and the m-values respectively. The stiffness of the HMA tends to be slightly higher than the WMA but this difference is less prevalent as the temperature is decreased. The m-value of the foamed asphalt is lower than the control binder; however, neither binder meets the 0.300 m-value minimum requirement during the -12°C test and thus the binders do not meet the -22 PG binder grade.

Table 5.4.1: Beam Rheometer Stiffness and m-value data for foamed and Control Binders

HMA Binder					Foamed WMA Binder				
Temp (°C)	S(t)	Avg. S(t)	m-value	Avg. m	Temp (°C)	S(t)	Avg. S(t)	m-value	Avg. m
-6	96.9	96.5	0.336	0.334	-6	108	105.0	0.327	0.325
-6	89.6		0.329						
-6	103		0.338						
-12	236	257.3	0.266	0.250	-12	219	224.3	0.263	0.261
-12	237		0.273						
-12	299		0.212						
-18	378	380.7	0.211	0.205	-18	376	375.3	0.215	0.207
-18	350		0.207						
-18	414		0.196						

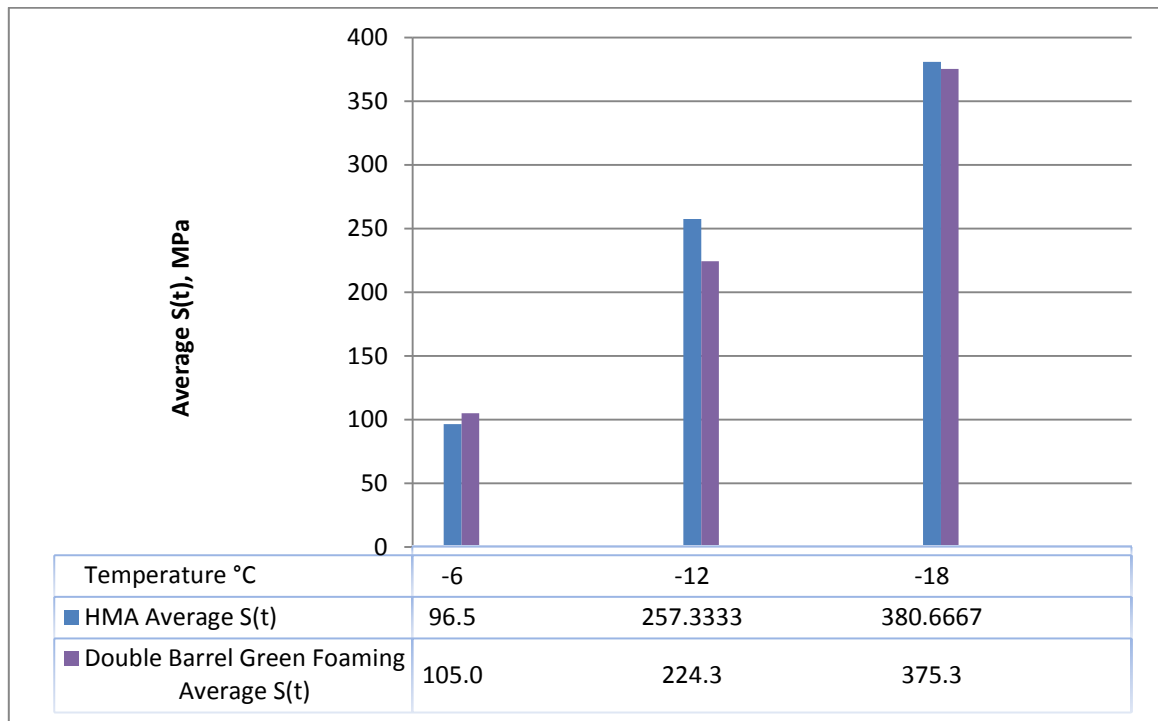

Figure 5.4.5: Comparison of average stiffness values for foamed and control binders

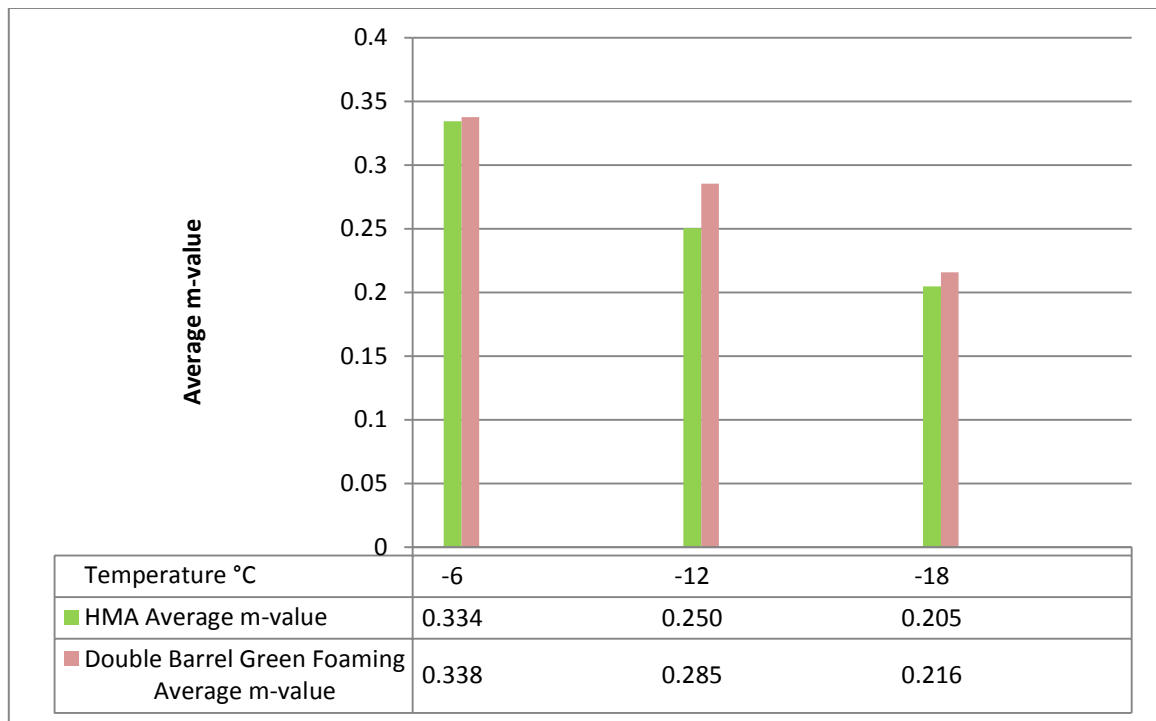

Figure 5.4.6: Comparison of average m-values for Foamed and control binders

CHAPTER VI PERFORMANCE TESTING RESULTS

6.1 Indirect Tensile Strength Testing Results

Table 6.1.1 provides a summary of the TSR ratios obtained during ITS testing. These values are the overall average of 5 TSR ratios. A complete data chart for all of the ITS samples is shown on pages 160 to 173 in Appendix C. Figure 6.1.2 shows the average peak loads obtained during the ITS testing. The mix with the highest average peak load is field mix 1 HMA that was produced in the lab and moisture conditioned. The lowest peak load was the FM3 field produced Sasobit mix that was moisture conditioned. This is the same mix that was produced during wet conditions and steam was observed when oven doors were opened. The HMA mixes had higher TSR values than the WMA mixes with the exception of the FM4 field produced samples. There were some differences between the field and lab mix although a clear trend is not visible. The results of the ITS will be discussed further in the statistical analysis chapter. The statistical analysis will address if the differences between the HMA versus WMA, laboratory versus field compacted and moisture conditioned versus non-moisture conditioned specimens are statistically significant

Table 6.1.1: Tensile strength ratios

FM1- Evotherm 3G	Lab	Field
Average TSR HMA	1.12	N/A
Average TSR WMA	1.03	N/A
FM2- Floyd Co. - Revix	Lab	Field
Average TSR HMA	0.93	1.02
Average TSR WMA	0.88	0.87
FM3- Marcus Sasobit	Lab	Field
Average TSR HMA	0.96	0.98
Average TSR WMA	0.91	0.81
FM4- Johnston Foaming	Lab	Field
Average TSR HMA	0.92	0.87
Average TSR WMA	0.84	1.06

Table 6.1.2: Average peak load values

FM1- Evotherm 3G	Lab		Field	
	MC*	NMC**	MC*	NMC**
Average Peak Load HMA	13,240	12,081	N/A	N/A
Average Peak Load WMA	10,483	10,136	N/A	N/A

FM2- Floyd Co. - Revix	Lab		Field	
	MC*	NMC**	MC*	NMC**
Average Peak Load HMA	7,365	7,938	7,439	7,297
Average Peak Load WMA	7,881	8,939	7,030	8,139

FM3- Marcus Sasobit	Lab		Field	
	MC*	NMC**	MC*	NMC**
Average Peak Load HMA	10,419	10,898	9,939	10,233
Average Peak Load WMA	7,716	8,462	6,585	8,169

FM4- Johnston Foaming	Lab		Field	
	MC*	NMC**	MC*	NMC**
Average Peak Load HMA	11,656	12,741	10,480	12,049
Average Peak Load WMA	10,325	12,272	11,068	10,478

*Moisture Conditioned

**Not Moisture Conditioned

6.2 Dynamic Modulus Testing Results

The dynamic modulus (E^*) values for each field mix are located in Appendix D. The E^* values shown are averages of a set of samples tested. The dynamic modulus values are simply the peak stress over the peak strain however obtaining those values from a large data file was completed in a timely manner by implementing the use of a macros which calculated the E^* values according to NCHRP 547 recommendations (Witczak, 2005). The E^* values were reviewed for potential outliers. The method for determining outliers included

looking at both the coefficient of variation and the standard deviation. Most of the categories had a sample size of five except for three (Shown in Table 2.1 in the experimental plan section). In order to determine if an outlier was present in a set, first, the coefficient of variation had to be greater than 13%. If the coefficient of variation exceeded 13% the maximum or minimum value was excluded from the calculation of the average and a new average, standard deviation and coefficient of variation was calculated. If the potential outlier was greater than two standard deviations from the mean, the value was considered an outlier and discarded from the E^* average that determines the master curve values.

Further discussion and comparison of E^* values is provided in the statistical analysis section. The statistical analysis is needed in order to determine if the various factors impacted the E^* values. The factors to be addressed are WMA versus HMA, laboratory compacted versus field compacted and moisture conditioned versus non-moisture conditioned.

In general, the E^* values increase as the temperature is decreased and the higher frequencies have higher associated E^* values. Temperature and frequency are statistically significant factors that impact the E^* values as will be shown in the statistical analysis section. Other factors investigated in this study include: type of mix (WMA/HMA), field/lab compacted samples, and moisture/non moisture conditioned samples. The impact these factors on E^* will be addressed in the statistical analysis.

6.3 Master Curves

The master curves provide an efficient way of comparing mixes based on the dynamic modulus over the entire range of testing temperatures and frequencies. The master curves were obtained from the average of the E^* values and graphed using a sigmoidal function and regression techniques are used in order to find the best fit line. Five graphs are shown for each of the four field mixes. The five graphs compare the following for each field project:

- Comparison of field compacted samples
 - HMA/WMA and Moisture Conditioned/Non-Moisture Conditioned

- Comparison of lab compacted samples
 - HMA/WMA and Moisture Conditioned/Non-Moisture Conditioned
- Comparison of lab versus field compacted HMA
 - Lab/Field and Moisture Conditioned/Non-Moisture Conditioned
- Comparison of lab versus field compacted WMA
 - Lab/Field and Moisture Conditioned/Non-Moisture Conditioned
- Comparison of all mixes.

The left side of the master curve indicates high temperature behavior and the right side indicates low temperature behavior. A higher line is desirable toward the left side of the graph indicating a higher stiffness at higher temperatures which is indicative of better rutting resistance. The lower E^* values are desirable toward the right side of the graph indicating a better resistance to thermal cracking. The highest variability is observed on the left side of the graph indicating greater differences between mixes at higher temperatures.

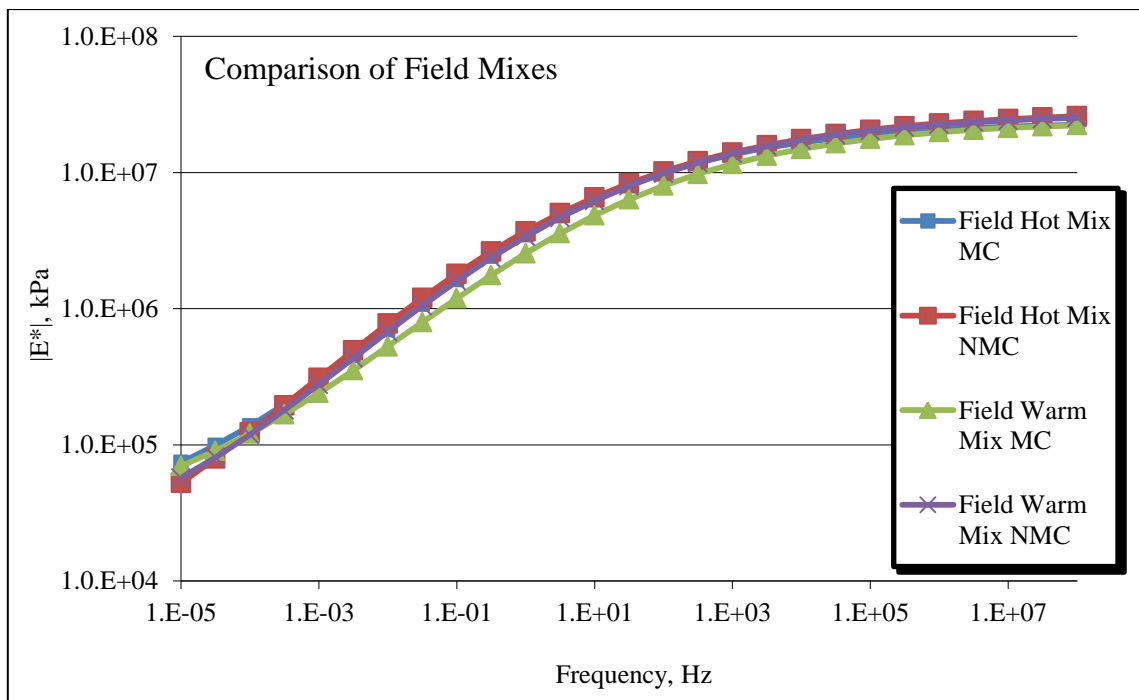

Figure 6.3.1: Field Mix 1 comparison of field compacted mixes

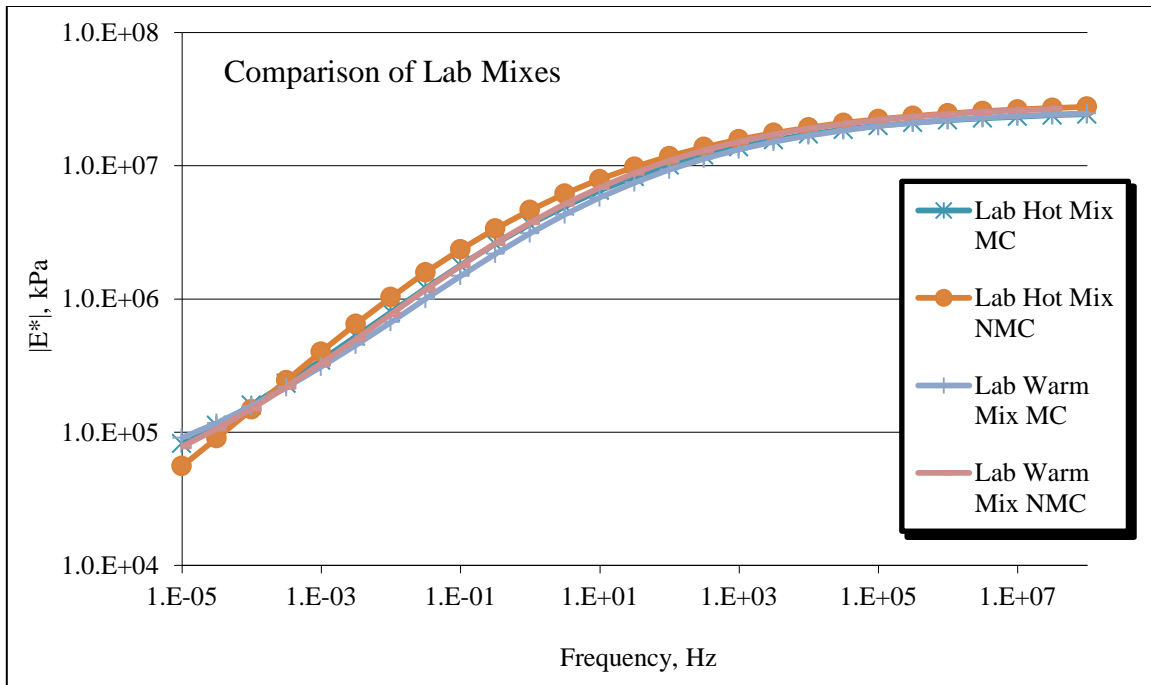

Figure 6.3.2: Field Mix 1 comparison of lab compacted mixes

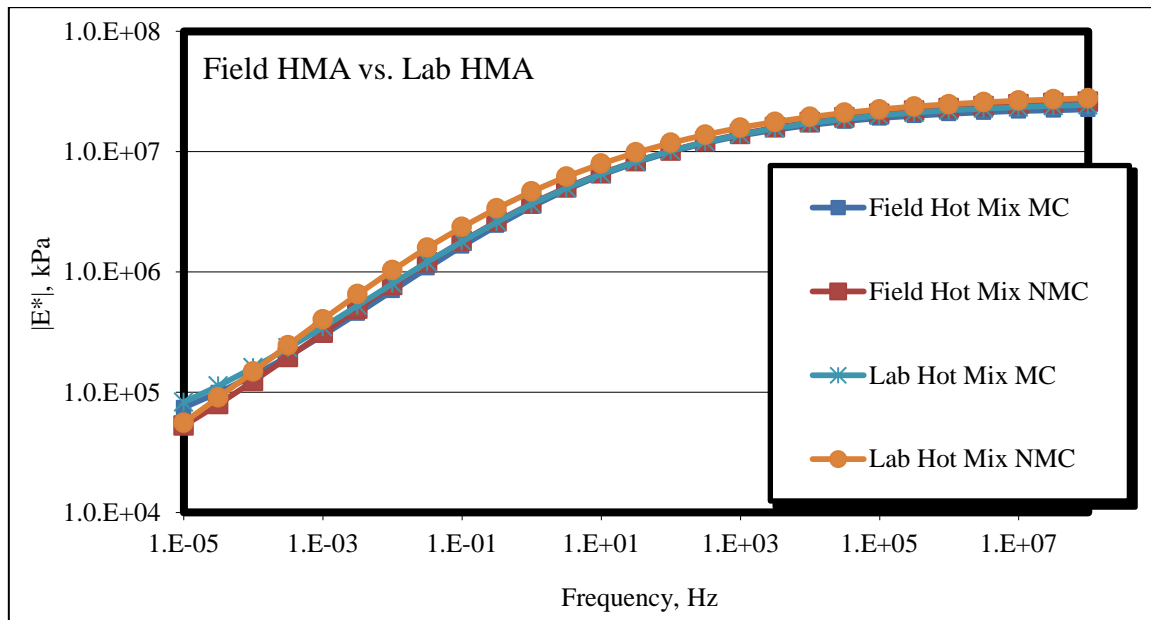

Figure 6.3.3: Field Mix 1 comparison of field compacted HMA and laboratory compacted HMA

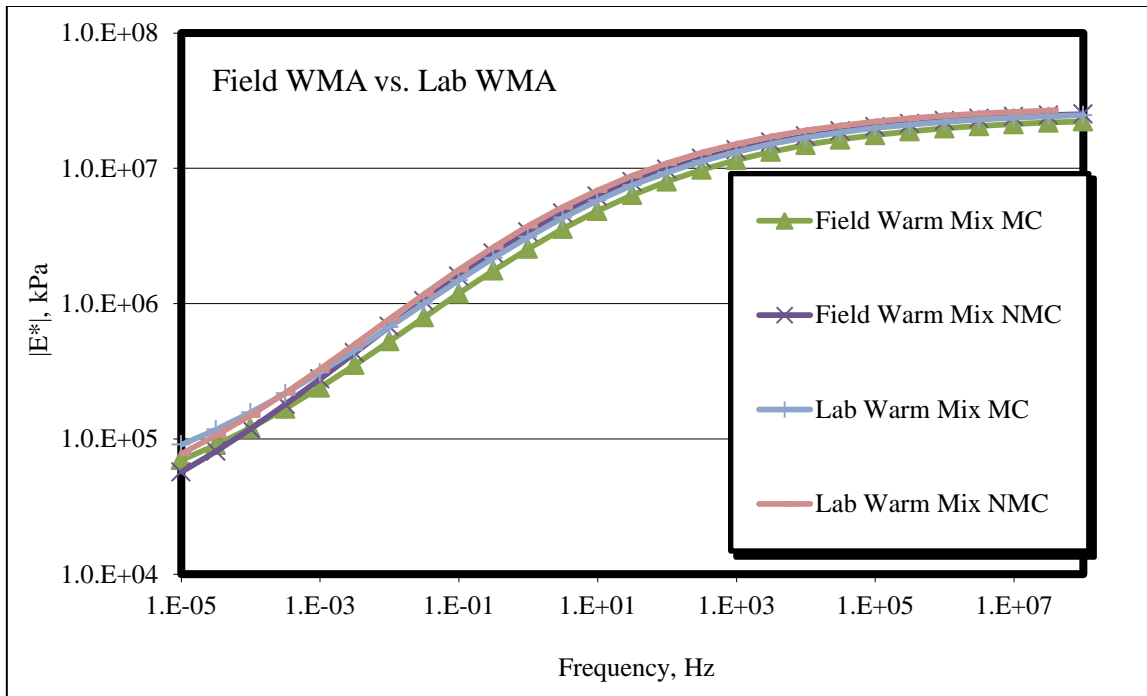

Figure 6.3.4: Field Mix 1 comparison of laboratory compacted WMA and field compacted WMA

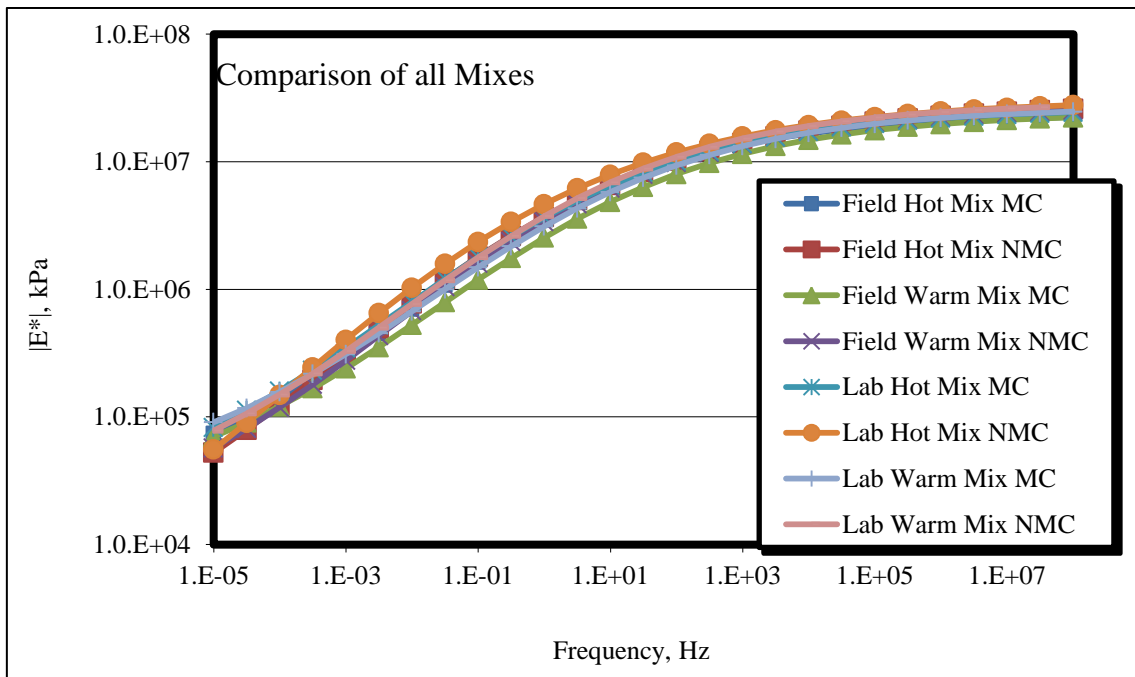

Figure 6.3.5: Field Mix 1 comparison of all mixes

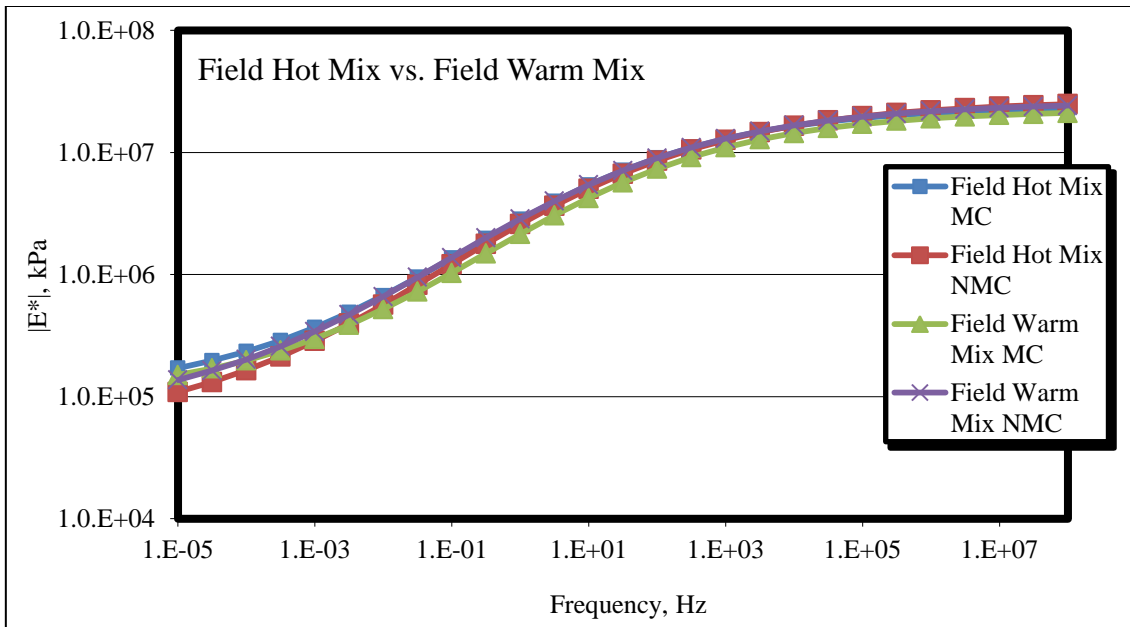

Figure 6.3.6: Field Mix 2 comparison of field compacted mixes

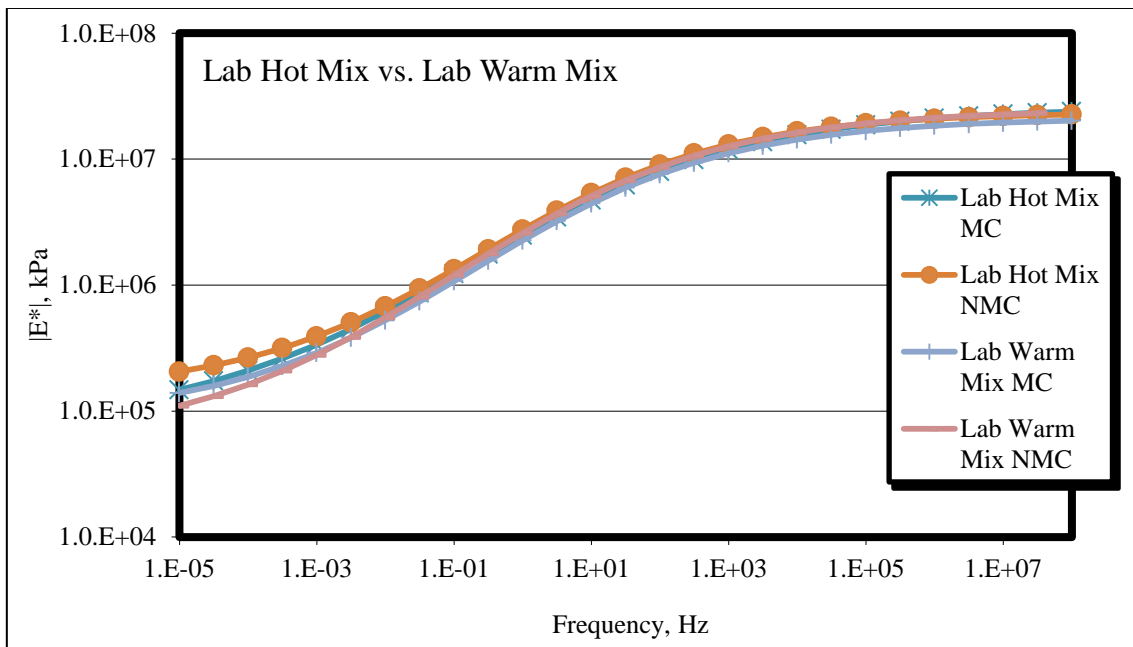

Figure 6.3.7: Field Mix 2 comparison of laboratory compacted mixes

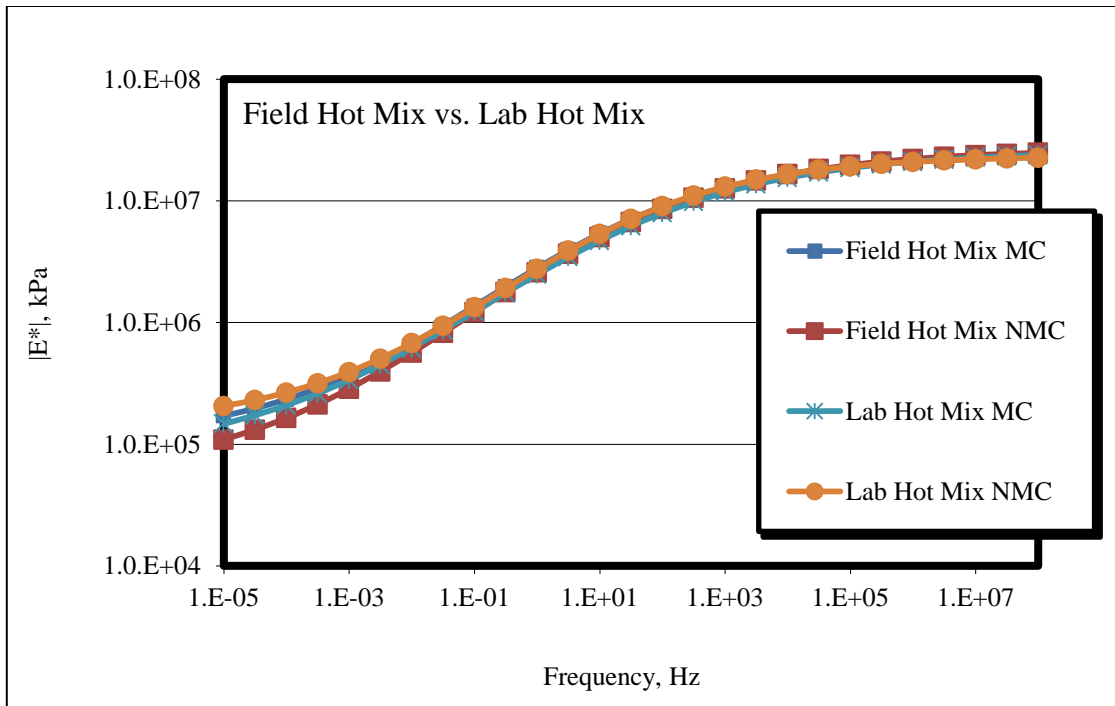

Figure 6.3.8: Field Mix 2 comparison of laboratory compacted and field compacted HMA

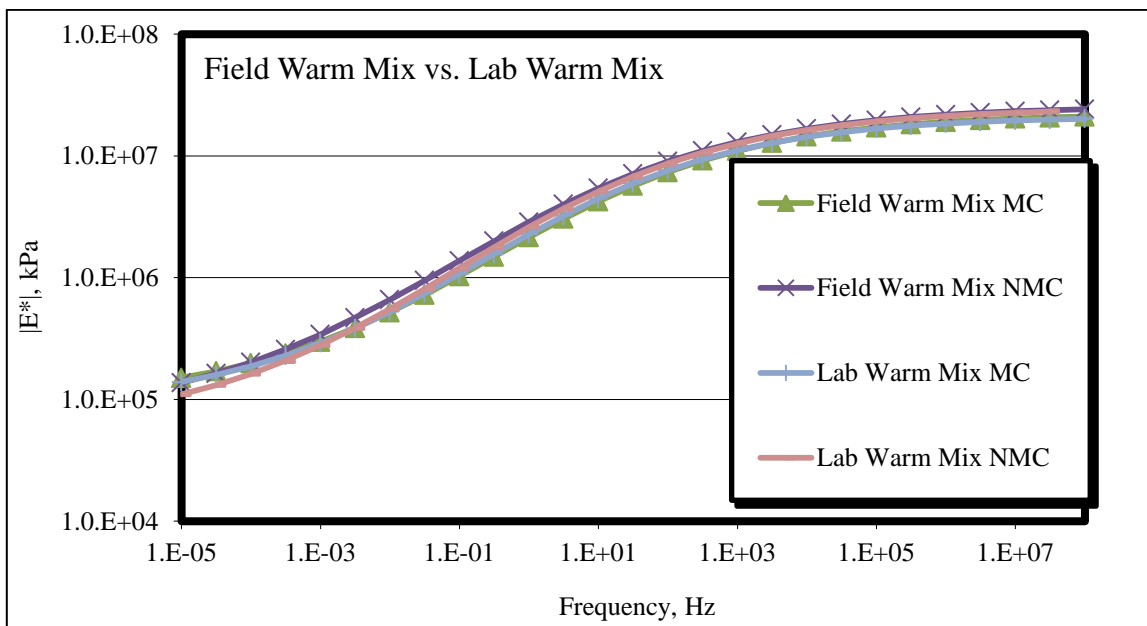

Figure 6.3.9: Field Mix 2 comparison of field compacted and laboratory compacted WMA

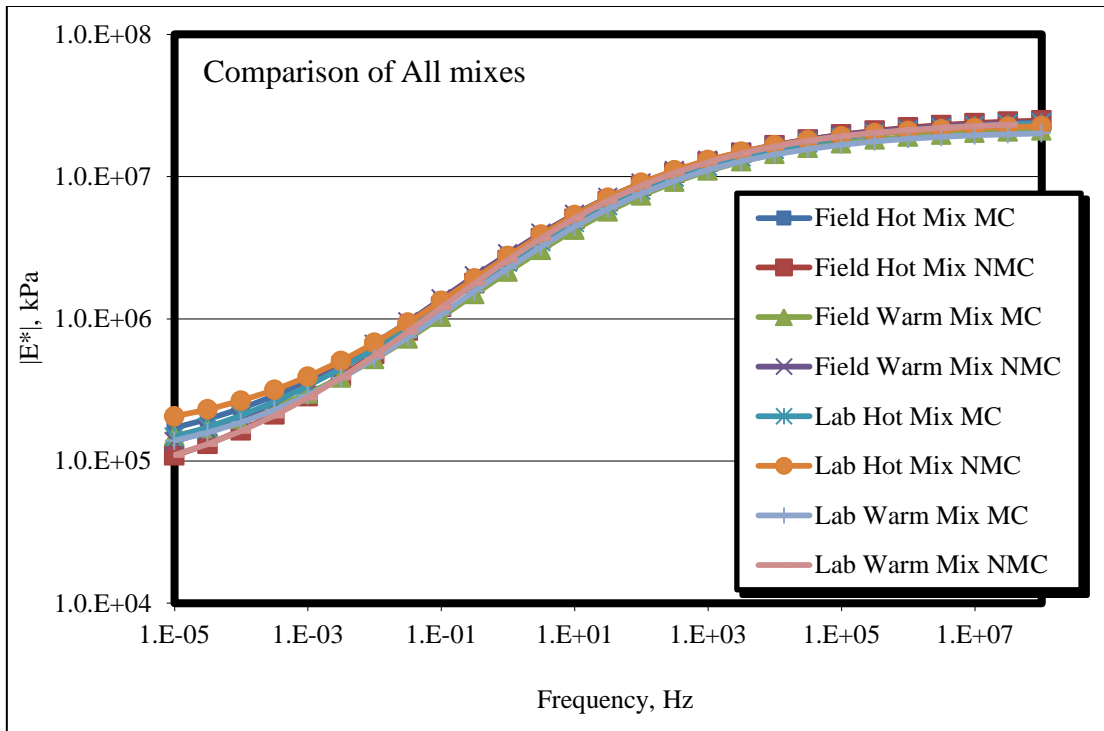

Figure 6.3.10: Field Mix 2 comparison of all mixes

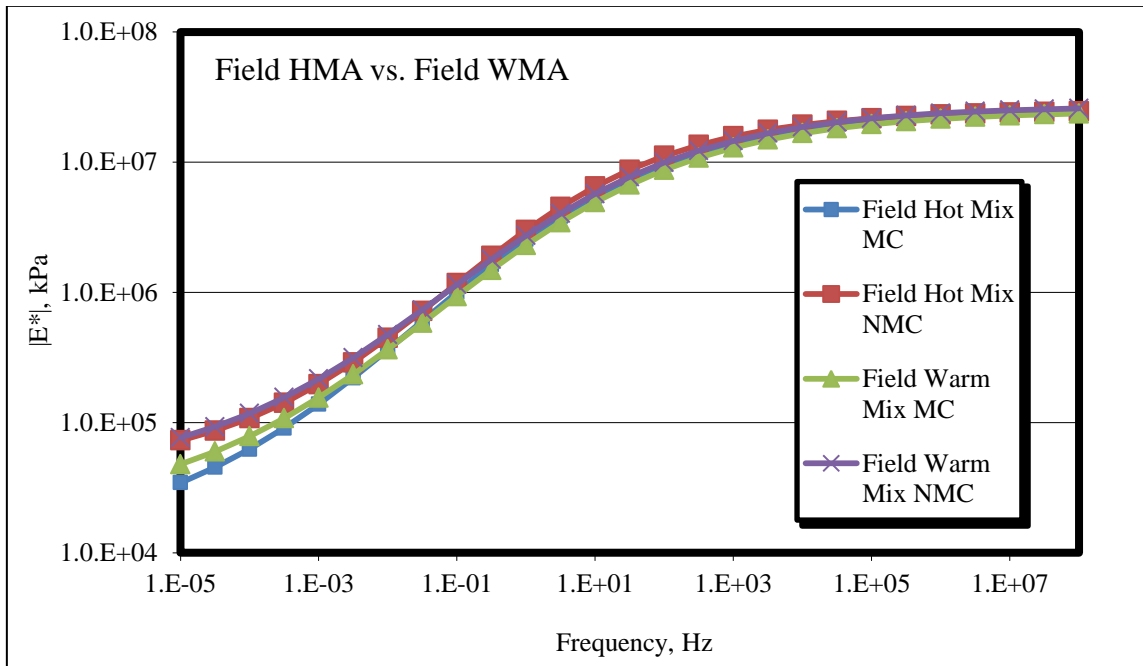

Figure 6.3.11: Field Mix 3 comparison of field compacted mixes

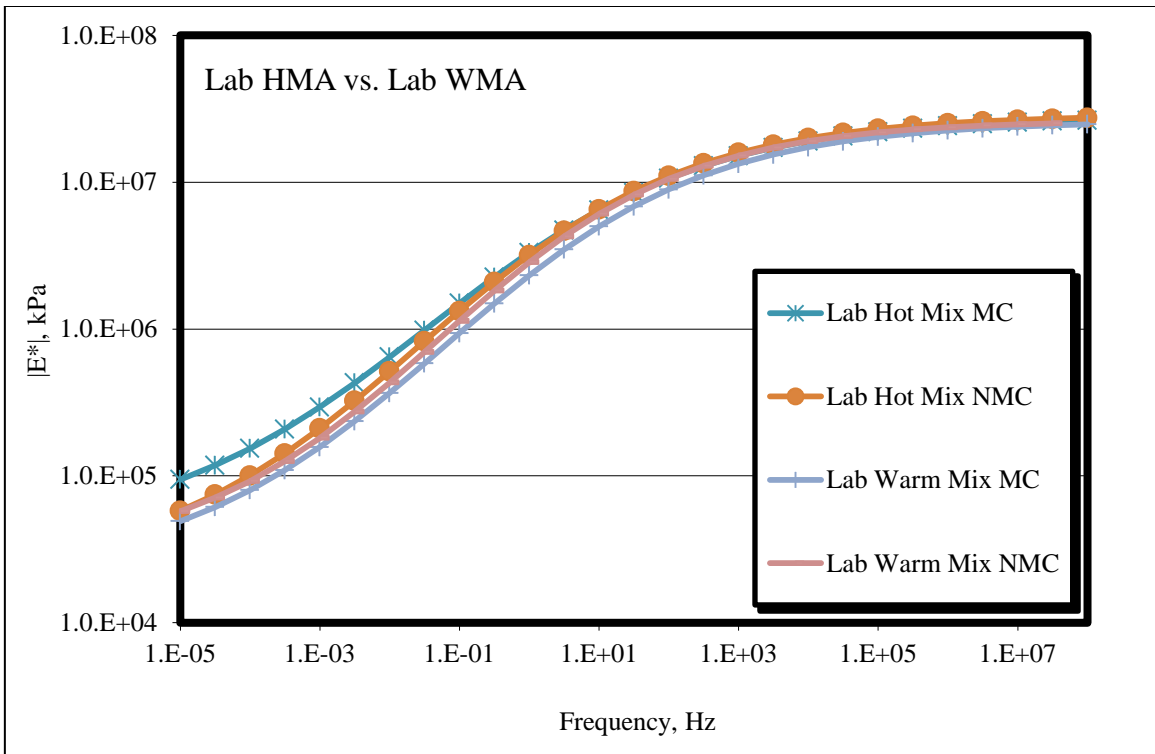

Figure 6.3.12: Field Mix 3 comparison of laboratory compacted mixes

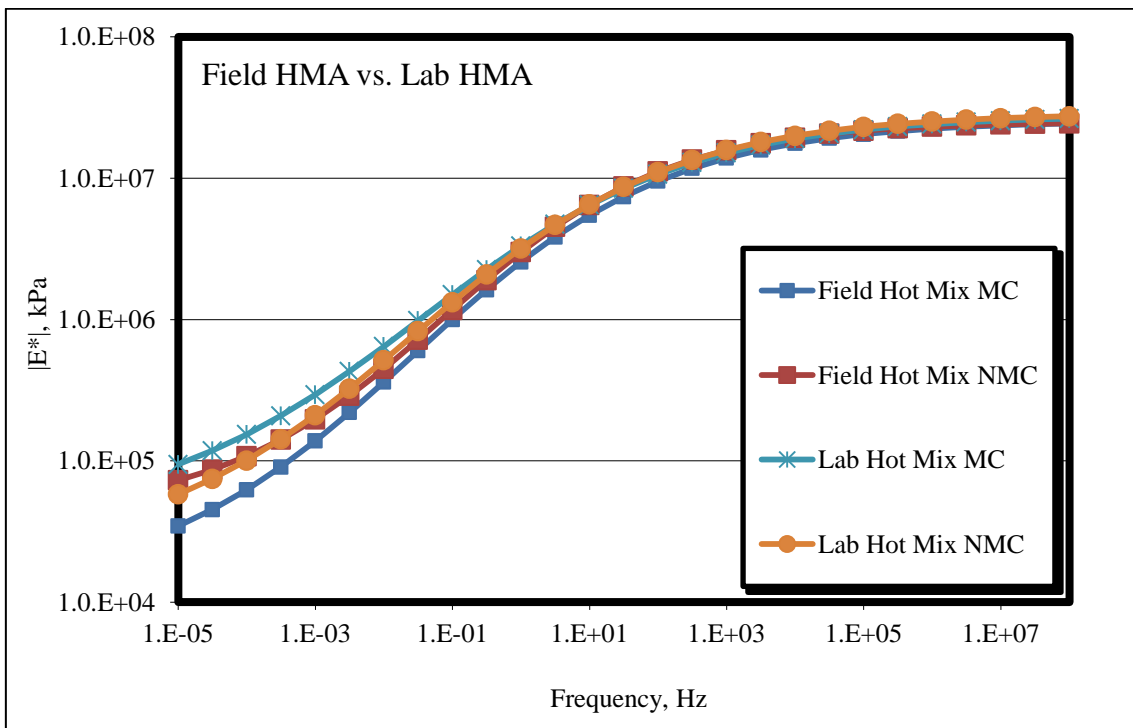

Figure 6.3.13: Field Mix 3 comparison of field compacted and laboratory compacted HMA

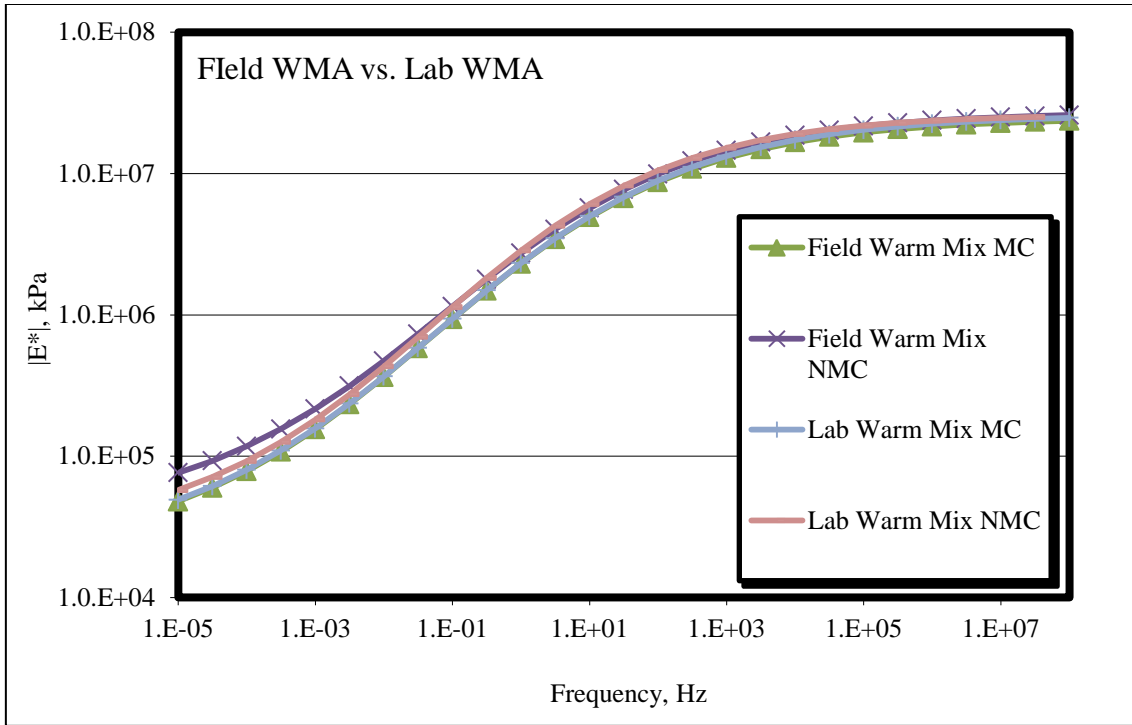

Figure 6.3.14: Field Mix 3 comparison of field compacted and laboratory compacted WMA

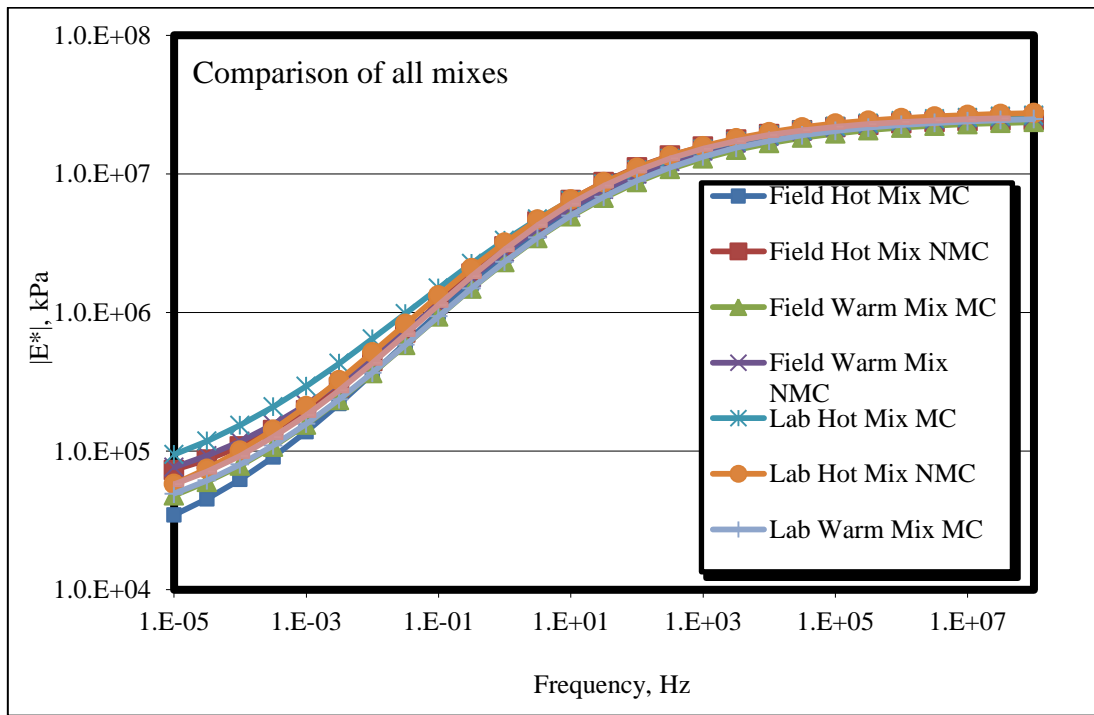

Figure 6.3.15: Field Mix 3 comparison of all mixes

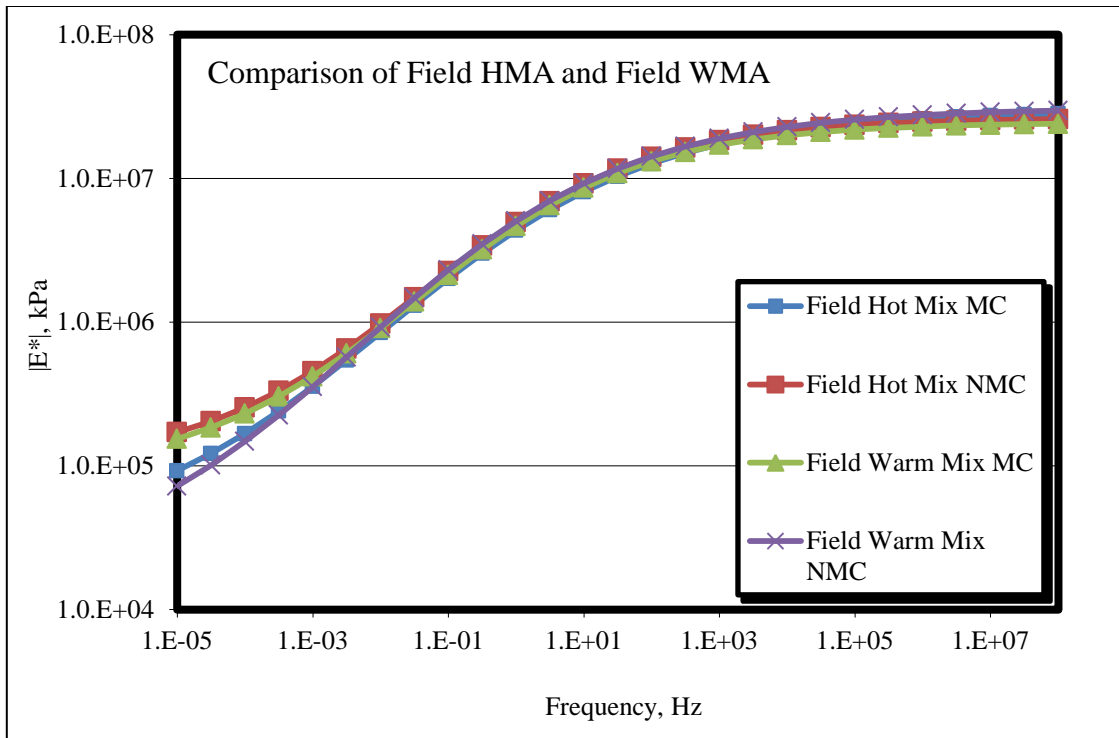

Figure 6.3.16: Field Mix 4 comparison of field compacted HMA and WMA

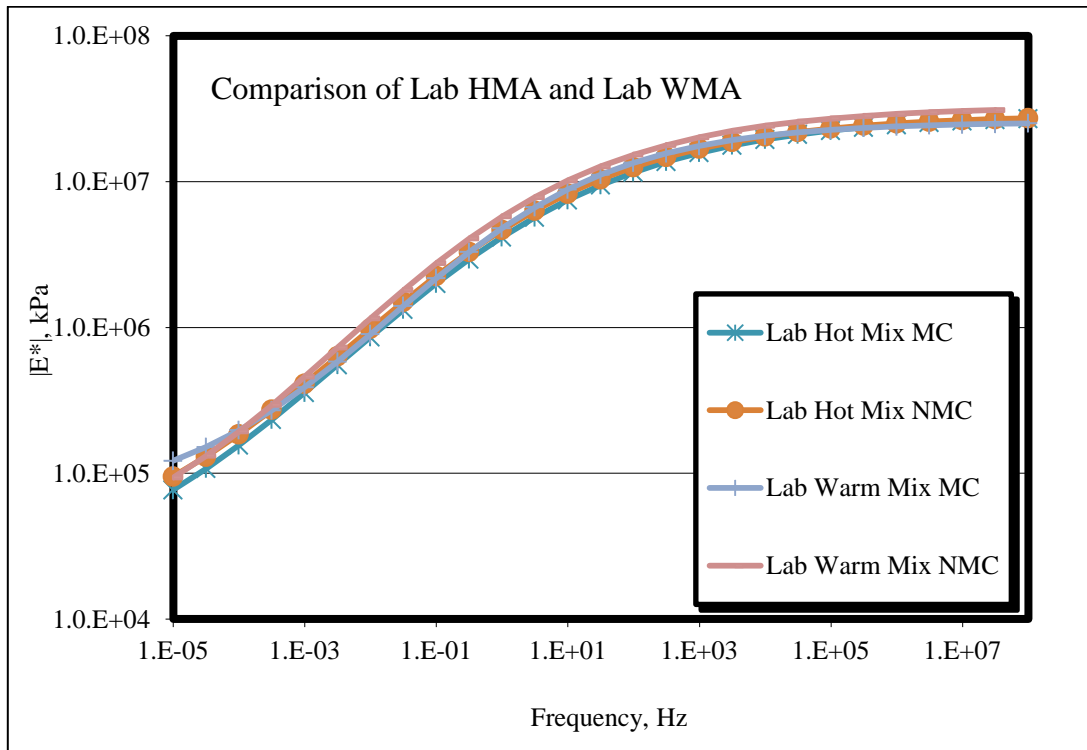

Figure 6.3.17: Field Mix 4 comparison of laboratory compacted HMA and WMA

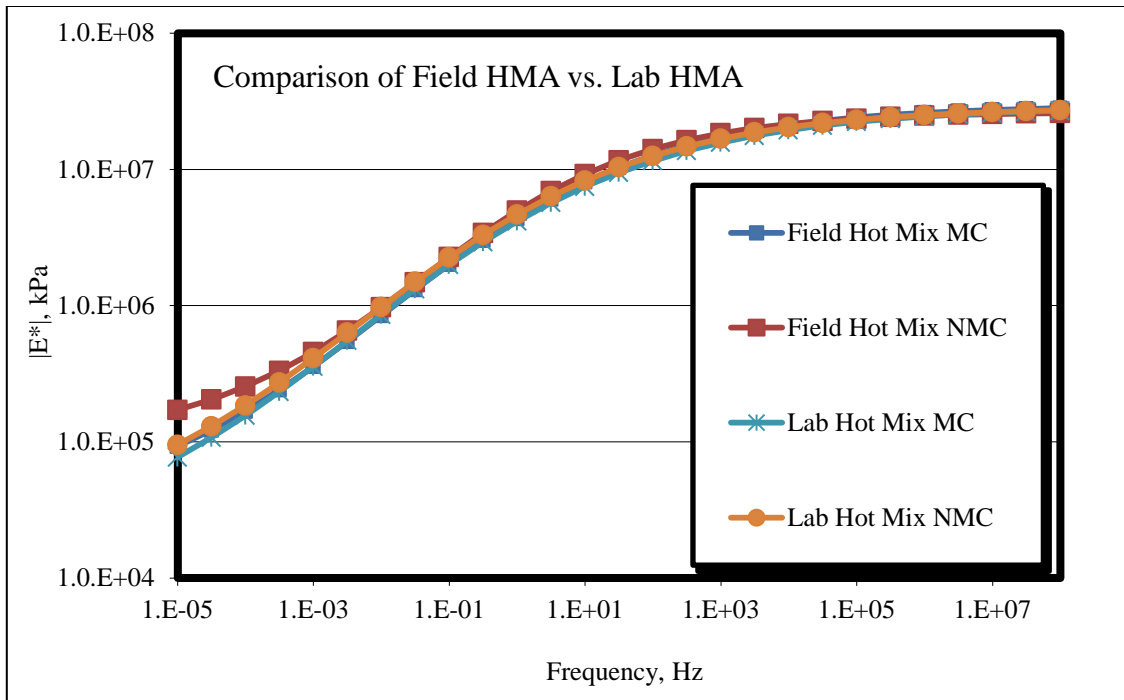

Figure 6.3.18: Field Mix 4 comparison of field compacted and laboratory compacted HMA

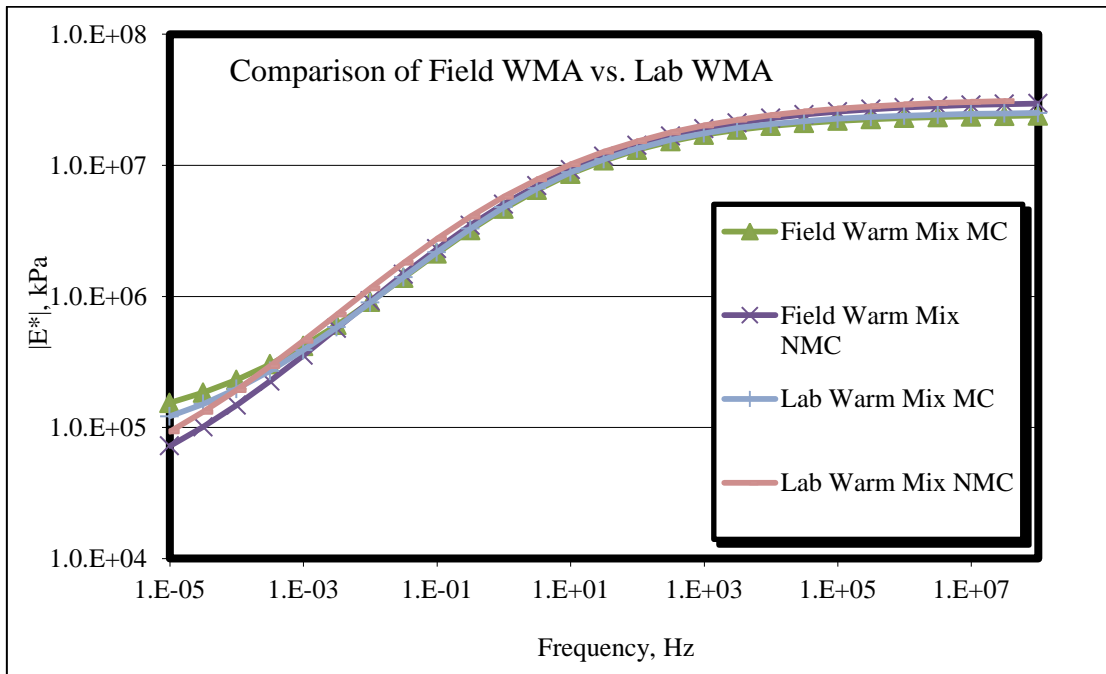

Figure 6.3.19: Field Mix 4 comparison of field compacted and laboratory compacted WMA

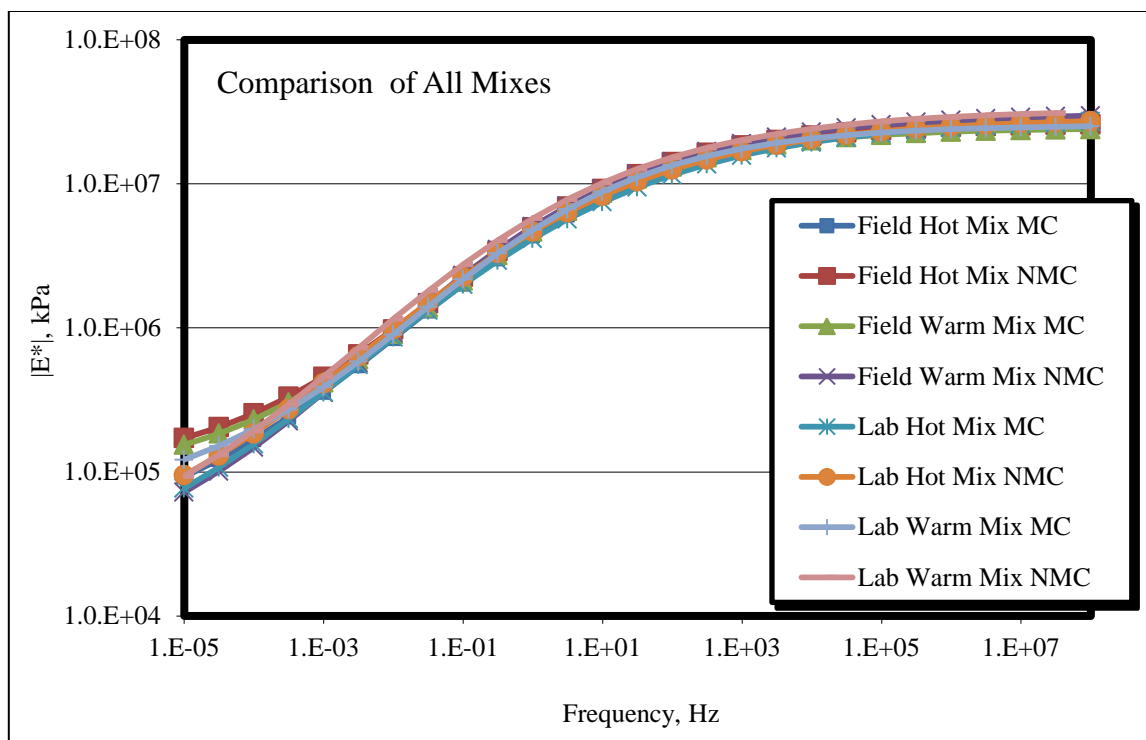

Figure 6.3.20: Field Mix 4 comparison of all mixes

6.4 Flow Number Results

All of the flow number averages are presented in the figures below. Each chart represents one of the four field produced mixes. The left side of the chart displays the flow number and the right side displays the number of cycles completed to reach three percent strain. The flow number and cycles to 3% strain for each sample are organized in tables provided in Appendix E.

6.4.1 Field Mix 1- Flow Number Results

The figure shows that the WMA values are consistently lower than the HMA values for this mix. The hot mix lab compacted samples gave the highest cycles to 3% strain and the HMA lab compacted- non moisture conditioned gave the highest flow number. The WMA values suggest the moisture conditioning had a strengthening effect on the WMA mix. One potential explanation for this is the 60°C hot water bath samples soak in for 24 hours may have stiffened the WMA binder or during the heating process, allowed for more binder absorption into the aggregate. An increase in the binder absorption may have strengthened

the binder-aggregate bond. The WMA additive is likely not playing a factor in this because the increase in strength is also observed in several of the HMA mixes.

6.4.2 Field Mix 2- Flow Number Results

The flow number data for FM2 shows very strong trends in all three of the categories tested. The data gives evidence that the HMA values are higher than the WMA values, that the field compacted samples are stronger than the laboratory compacted samples and that the moisture conditioned samples display higher values than the non-moisture conditioned samples. The HMA field compacted samples that were moisture conditioned gave the highest flow number and the highest number of cycles to 3% strain. The lowest values were the WMA lab compacted non moisture conditioned. The mix had the highest ESAL design out of all of the mixes tested but had the lowest averages in all of the flow number tested categories.

6.4.3 Field Mix 3- Flow Number Results

The field mix 3 test data doesn't show strong trends in the data except that the HMA lab compacted samples displayed the highest flow number value and the highest number of cycles to 3% strain. The other samples show very similar flow number values around 500 cycles and show similar values for cycles to 3% strain approximately 1700 cycles.

6.4.4 Field Mix 4- Flow Number Results

The general trends in the data indicate that the WMA values are higher than the HMA values for this mix. The data showed that moisture conditioning improved the sample performance in most categories. The highest flow number value was the WMA field compacted and moisture conditioned category. The highest cycles to 3% strain was WMA laboratory compacted and moisture conditioned. The portion of the graph displaying the cycles to 3% strain indicate that moisture conditioning has a strengthening effect on this mix.

6.4.5 Overall Flow Number Comparison

Overall, the flow number values of the hot mix indicated a slightly higher performance than the warm mix except in field mix 4. The Field mix 2, which had the highest ESAL design life, had the lowest performing flow number values. The moisture conditioning had varying effect on the flow number and cycles to 3% strain.

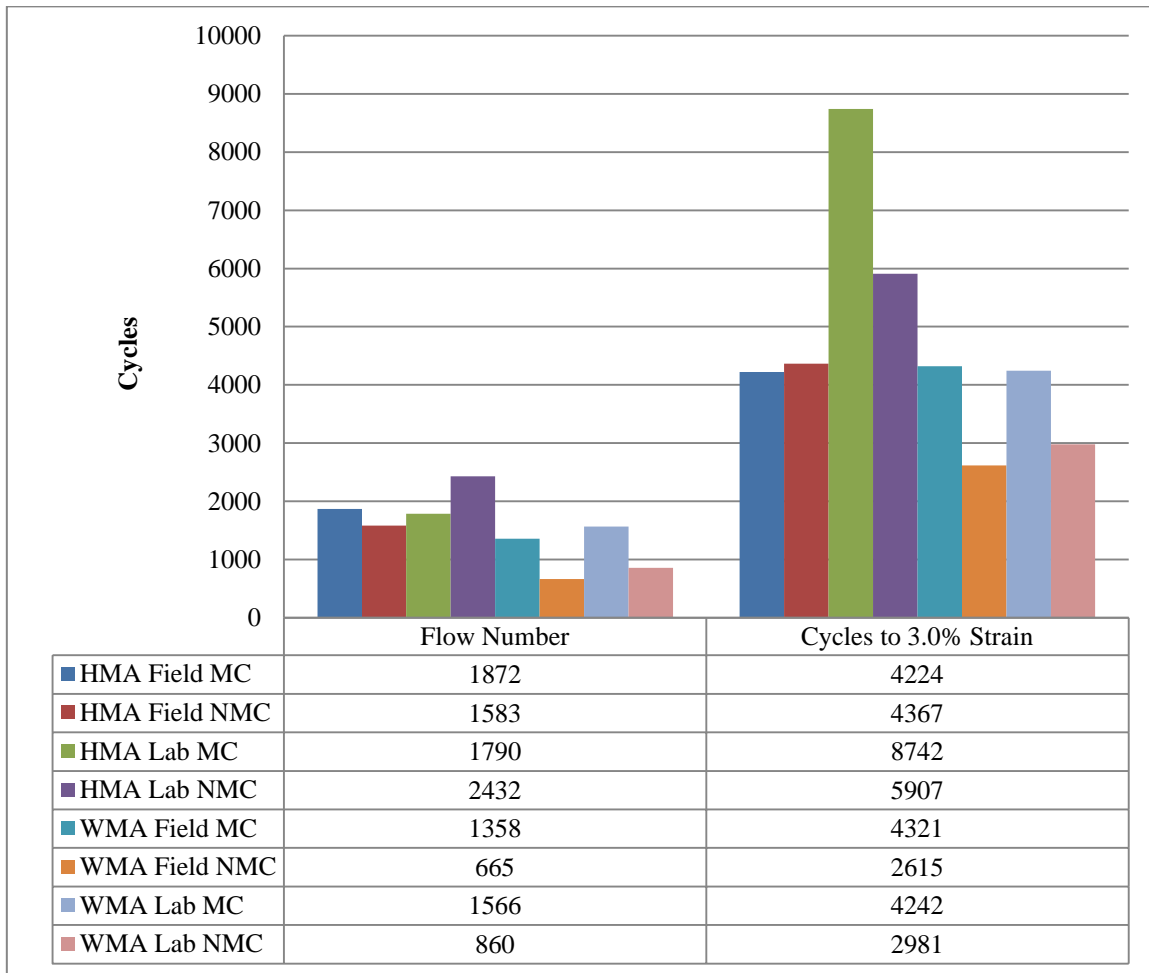

Figure 6.4.1: Field mix 1: flow number test data

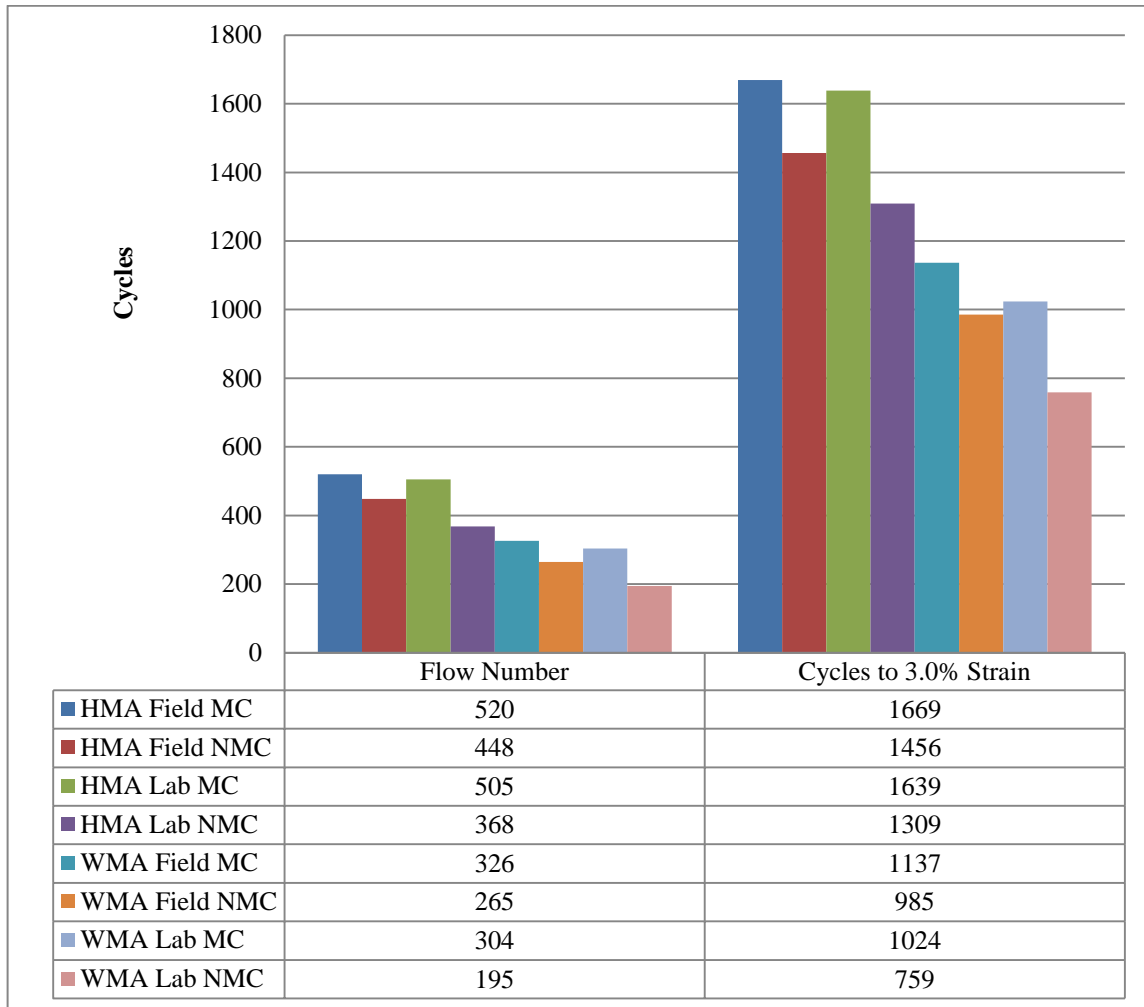

Figure 6.4.2: Field mix 2: flow number test data

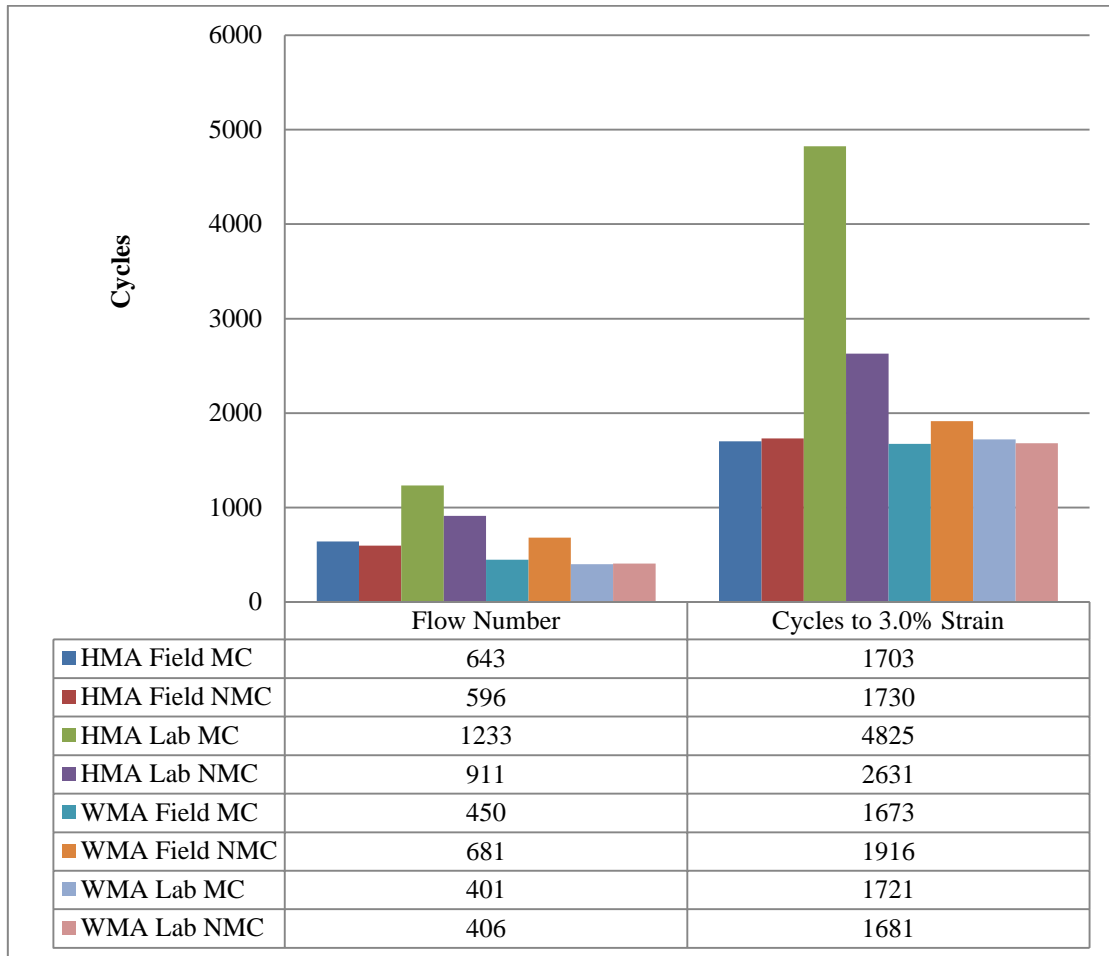

Figure 6.4.3: Field mix 3: flow number test data

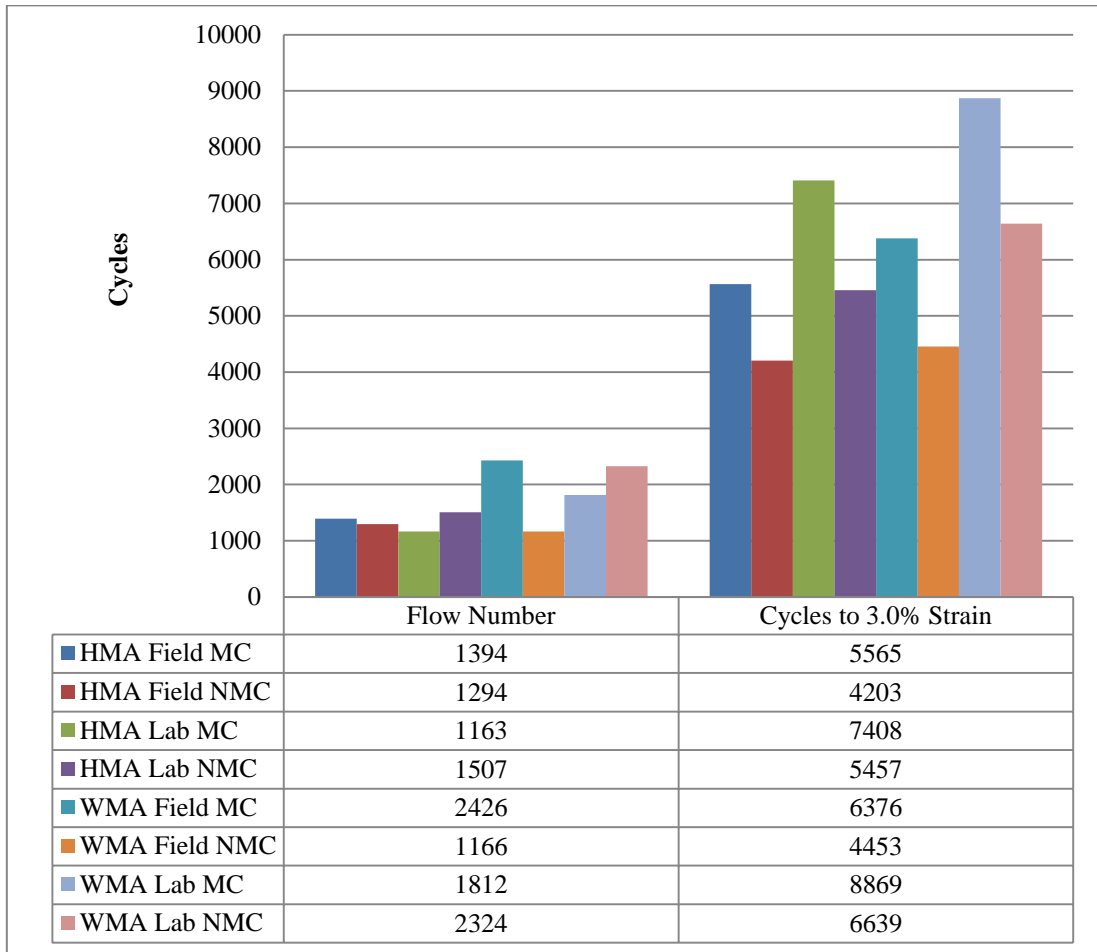

Figure 6.4.4: Field mix 4: flow number test data

CHAPTER VII STATISTICAL ANALYSIS

The methodology for the statistical analysis involves primarily testing the probability of a treatment effect within a population of tested samples or means comparison tests. The traditional method used to compare the treatment means is the analysis of variance, or ANOVA. The significance level used in the following analyses is $\alpha=0.05$. The ANOVA assumptions that must be satisfied are (Ramsey & Schafer, 2002):

- errors are independent;
- errors have constant variance;
- errors are normally distributed;
- independence;
- equal variances; and
- additive model.

For this experiment, several factors were investigated and thus a higher order ANOVA was needed. The calculations were performed using the computer program SAS version 9.2 (SAS Institute Inc., 2008). For each set of samples tested, a statistical analysis was performed and a discussion for the ITS, dynamic modulus and flow number is provided in the subsequent sections.

Abbreviated versions of the SAS output for each analysis is available in Appendix F. The purpose of the output is to provide validation of the assumptions listed above and to also provide a detailed analysis at how the categories within each mix compare. There are five main class variables; however, temperature and frequency are only used for the dynamic modulus testing. The following is a list of the class variables, the levels within each class variable and the SAS coding abbreviations for the associated class variable:

- mix type- HMA/WMA (SAS: mix);
- compaction type- field/laboratory compacted (SAS: comp);
- moisture conditioning- non-moisture/moisture conditioned samples (SAS: mcond);
- testing frequency- 25, 15, 10, 5, 3, 1, 0.5, 0.3, 0.1 Hz. (SAS: fre); and
- testing temperature- 4, 21, 37°C (SAS: temp).

7.1 Indirect Tensile Statistical Analysis

The ITS statistical analysis looks at both the peak loads and the TSR values for each mix. Abbreviated versions of each the SAS output for each mix can be found in Appendix F Sections F-1 through F-4. The class variables for this analysis include: mix type, compaction type and moisture/non-moisture conditioned.

7.1.1 Field Mix 1 ITS- Evotherm Technology

The statistical analysis included two class variables: the type of mix and the moisture conditioning. The compaction type was not a variable because this mix had no field compacted ITS samples. Each class variable had two levels. The mix type included HMA and WMA and the moisture conditioning included the moisture conditioned samples and the control non-moisture conditioned samples. The abbreviated ANOVA table shown below in Table 7.1 and illustrates very strong evidence that the mix types are different. The moisture conditioning and the interaction of mix and moisture conditioning show no evidence of difference. The Duncan grouping was used to compare the mean peak load of the HMA and WMA the means are 12,660 N and 10,310 N, respectively. An abbreviated version of the statistical analysis output is provided on page 182 in Appendix F.

Table 7.1: Field mix 1 ITS ANOVA table

Source	DF	Type I SS	Mean Square	F Value	Pr > F
mix	1	27626601.8	27626601.8	13.86	0.0018
mcond	1	2832033.8	2832033.8	1.42	0.2506
mix*mcond	1	824180	824180	0.41	0.5293

A statistical analysis comparison of the TSR values was performed in order to understand the differences between the TSR ratios of the HMA and WMA. The average HMA and WMA TSR values are 1.12 and 1.04, respectively. The means test showed no statistical difference between the WMA and HMA groups for the TSR values.

7.1.2 Field Mix 2 ITS- Revix Technology

The three class variables taken into consideration for FM2 are the mix type, compaction type and moisture conditioning. The levels for the compaction class variable include field and laboratory compacted samples. The mix type and moisture conditioning levels remain the same. The ANOVA table for the ITS peak load, Table 7.2, shows statistical differences in mix, compaction type, moisture conditioning and for the interaction of mix and moisture conditioning. The ANOVA table is an abbreviated version of the statistical analysis output and the analysis can be viewed in its entirety on page 185 of Appendix F. The average peak value of the HMA and the WMA is 7509 N and 7997 N, respectively. The Duncan grouping of all the mixes suggests that the WMA mix did not perform as well after moisture conditioning even though the WMA had the highest non-moisture conditioned strength.

Table 7.2: Field mix 2 ITS ANOVA table

Source	DF	Type I SS	Mean Square	F Value	Pr > F
mix	1	2381440	2381440	8.61	0.0061
comp	1	3073593.6	3073593.6	11.12	0.0022
mix*comp	1	733326.4	733326.4	2.65	0.1132
mcond	1	4221100.9	4221100.9	15.27	0.0005
mix*mcond	1	1886164.9	1886164.9	6.82	0.0136
comp*mcond	1	275892.1	275892.1	1	0.3253
mix*comp*mcond	1	365956.9	365956.9	1.32	0.2585

Comparison the TSR ratios included the class variables of mix type and compaction type. The WMA and HMA are statistically different with an F-value of 10.83 and a p-value of 0.0046. The average HMA and WMA TSR values are 0.97 and 0.87, respectively. The ANOVA analysis shows a slight statistical difference for the interaction of the mix and compaction type with an F-value of 3.16 and a p value of 0.0946 but is not considered to be strong evidence.

7.1.3 Field Mix 3 ITS- Sasobit Technology

The class variables are the type of mix, compaction and moisture conditioning. The levels are the same as in the previous analyses. The ANOVA table, Table 7.3, shows that the

statistically significant factors are the mix type, the compaction type, the moisture condition and the interaction of the mix and moisture conditioning. The HMA and WMA peak load averages are 10372.2 N and 7732.9 N, respectively. This data shows clear evidence of a difference between the two mixes. The Duncan and Tukey means tests also show the HMA and WMA being statistically different for all of the means tests. This is displayed in the statistical analysis output in Appendix F on page 189. The means comparison tests also show there is little evidence that within a mix, the field and laboratory compacting may not be a large factor in determining performance but when the average of the entire lab compacted and field compacted data sets are calculated there is then statistical difference. The interaction of the mix and the moisture conditioning suggests that the moisture conditioning affects the HMA and WMA differently. The field compacted, moisture conditioned WMA was the lowest performing set of samples and was statistically different from all of the other sample sets. The moisture conditioned samples of the HMA were not statistically different from the controlled non-moisture conditioned samples.

Table 7.3: Field Mix 3 ITS ANOVA table

Source	DF	Type I SS	Mean Square	F Value	Pr > F
mix	1	69656405.63	69656405.63	275.95	<.0001
comp	1	4124850.62	4124850.62	16.34	0.0003
mix*comp	1	49210.22	49210.22	0.19	0.6618
mcond	1	6016329.22	6016329.22	23.83	<.0001
mix*mcond	1	1515934.22	1515934.22	6.01	0.0199
comp*mcond	1	266179.23	266179.23	1.05	0.3122
mix*comp*mcond	1	653569.23	653569.23	2.59	0.1174

The TSR values show that the WMA and HMA are statistically different with an F-value of 10.50 and a p-value of 0.0051. The TSR means for HMA and WMA are 0.97 and 0.86, respectively. There is weak evidence for the interaction of the mix and compaction type to have a treatment effect. The p-value for the interaction is 0.0814.

7.1.4 Field Mix 4 ITS- Foaming Technology

The class variables for field mix four are mix type, compaction type and moisture conditioning. The levels are HMA/WMA, field/lab compaction and moisture/non-moisture conditioning. The FM4 ITS peak load ANOVA analysis, Table 7.4, has more statistically different factors listed than any of the other mixes tested. The Tukey grouping shown in Figure 7.1 displays the different class variables and the associated means. Different letters indicate which groups are statistically different when $\alpha=0.5$. The means listed by each group help to indicate the differences between the various groups. The Tukey grouping shows that there are differences in the WMA field and laboratory compacted samples. The lab compacted WMA non-moisture conditioned has the highest peak load from the WMA groups. The lab compacted WMA non-moisture conditioned was statistically different from the field compacted WMA non-moisture conditioned group for this test. The non-moisture conditioned samples for the HMA were not statistically different in terms of the field and laboratory compactations.

Table 7.4: Field mix 4 ITS ANOVA table

Source	DF	Type I SS	Mean Square	F Value	Pr > F
mix	1	3533448.1	3533448.1	17.7	0.0002
comp	1	5037843.93	5037843.93	25.24	<.0001
mix*comp	1	358213.93	358213.93	1.79	0.1911
mcond	1	12525700.69	12525700.69	62.76	<.0001
mix*mcond	1	244319.2	244319.2	1.22	0.278
comp*mcond	1	1438166.64	1438166.64	7.21	0.0121
mix*comp*mcond	1	4890200.65	4890200.65	24.5	<.0001

Tukey Grouping	Mean	N	cell
A	12741.4	5	Lab Hot Not Moisture Conditioned
B A	12271.8	5	Lab WMA Not Moisture Conditioned
B A C	12049.4	5	Field HMA Not Moisture Conditioned
B C	11656.3	5	Lab HMA Moisture Conditioned
D C	11068.3	3	Field WMA Moisture Conditioned
D	10480.3	5	Field HMA Moisture Conditioned
D	10478.0	3	Field WMA Not Moisture Conditioned
D	10324.8	5	Lab WMA Moisture Conditioned

Figure 7.1: Tukey grouping of field mix 4 ITS results

The TSR statistical analysis shows the compaction and the interaction of the mix and compaction to be statistically different with p-values of 0.0025 and <0.0001, respectively. The interaction is statistically significant due to the variability within the compaction factor. The Duncan grouping of the four groups gives a good illustration of how the mixes rank in TSR values. The field compacted WMA mix had the highest TSR values and is statistically different from the other mixes ($\alpha=0.05$). Although the TSR value for WMA field compacted is the highest, this did not have the overall highest peak load. The Duncan grouping is shown below in figure 7.2. This shows mixed results because the WMA had both the highest and lowest TSR ratios and the analysis indicates that the moisture conditioning process actually strengthened the samples. The opposite was seen in the HMA mix because there was no statistical difference between the lab and field compaction. It should be noted that the sample size for the field compacted WMA had only three TSR values.

Duncan's Multiple Range Test for TSR Values			
NOTE: This test controls the Type I comparisonwise error rate, not the experimentwise error rate.			
Alpha		0.05	
Error Degrees of Freedom		14	
Error Mean Square		0.001556	
Harmonic Mean of Cell Sizes		4.285714	
NOTE: Cell sizes are not equal.			
Number of Means	2	3	4
Critical Range	.05780	.06056	.06227
Means with the same letter are not significantly different.			
Duncan Grouping	Mean	N	cell
A	1.05667	3	Field WMA
B	0.91400	5	Lab HMA
C	0.87400	5	Field HMA
C	0.84200	5	Lab WMA

Figure 7.2: Duncan grouping of field mix 4 ITS results

7.2 Dynamic Modulus Statistical Analysis

The dynamic modulus test data had five class variables that were accounted for in the analysis. In order for the constant variance assumption to be satisfied, a square root

transformation was performed on the E^* values. A summarized version of the SAS output for each mix is provided in Appendix F. The output includes information about the number of observations used and class levels, ANOVA tables which show the statistically significant class variables, Duncan Groupings for mean comparisons within a class variable, a residual plot and a normal probability plot. When analyzing the ANOVA tables it is helpful to remember the abbreviations used in the SAS coding and they are as follows: compaction is abbreviated as comp, the moisture conditioning is abbreviated as mcond, temperature is abbreviated as temp, and frequency is abbreviated as fre.

7.2.1 Field Mix 1 Dynamic Modulus- Evotherm

The ANOVA table, shown in table 7.6, displays the significant factors and factor interactions for FM1. Each five individual factors are considered to be statistically significant. The important interactions are as follows: the mix*comp*mcond interaction, the mix*comp interaction and the mix*comp*temp. The mix *comp*mcond interaction implies that the combination of each of these factors influence the dynamic modulus response. The mix*comp*temp interaction implies that the different mixes and different compaction will impact the dynamic modulus response at the various temperatures.

The Duncan groupings show the average lab compacted sample with a higher dynamic modulus than the field compacted samples, the non-moisture conditioned samples have a higher E^* than the moisture conditioned samples and the HMA has a higher E^* than the WMA samples.

Table 7.6: Field mix 1 dynamic modulus ANOVA table

Source	DF	Type I SS	Mean Square	F Value	Pr > F
mix	1	6076743.8	6076743.8	492.57	<.0001
comp	1	2399557.4	2399557.4	194.5	<.0001
mix*comp	1	76266.3	76266.3	6.18	0.0132
mcond	1	6062662.8	6062662.8	491.43	<.0001
mix*mcond	1	23343.8	23343.8	1.89	0.1694
comp*mcond	1	61417.7	61417.7	4.98	0.026
mix*comp*mcond	1	825077.8	825077.8	66.88	<.0001
temp	2	905842464	452921231.8	36713	<.0001
mix*temp	2	262660.4	131330.2	10.65	<.0001
comp*temp	2	647266.9	323633.5	26.23	<.0001
mix*comp*temp	2	135907.9	67954	5.51	0.0042
mcond*temp	2	700519	350259.5	28.39	<.0001
mix*mcond*temp	2	20754.4	10377.2	0.84	0.4317
comp*mcond*temp	2	17184.1	8592	0.7	0.4987
mix*comp*mcond*temp	2	40842.9	20421.5	1.66	0.1918
fre	8	149925935	18740741.9	1519.09	<.0001
mix*fre	8	16011.8	2001.5	0.16	0.9955
comp*fre	8	17616.1	2202	0.18	0.9938
mix*comp*fre	8	4795.8	599.5	0.05	0.9999
mcond*fre	8	128622.3	16077.8	1.3	0.2387
mix*mcond*fre	8	23013.3	2876.7	0.23	0.9847
comp*mcond*fre	8	2285.8	285.7	0.02	1
mix*comp*mcond*fre	8	15225.9	1903.2	0.15	0.9962
fre*temp	16	3556100.4	222256.3	18.02	<.0001
mix*fre*temp	16	301497.6	18843.6	1.53	0.0842
comp*fre*temp	16	17138.7	1071.2	0.09	1
mix*comp*fre*temp	16	13192.3	824.5	0.07	1
mcond*fre*temp	16	54418.9	3401.2	0.28	0.9979
mix*mcond*fre*temp	16	18918.8	1182.4	0.1	1
comp*mcond*fre*temp	16	11128.3	695.5	0.06	1
mix*com*mco*fre*temp	16	36029.5	2251.8	0.18	0.9999

7.2.2 Field Mix 2 Dynamic Modulus- Revix Technology

The statistically significant factors are shown in table 7.7, the field mix 2 ANOVA table. There are statistically significant differences with all five of the class variables and several interactions that are statistically significant. The interaction of the mix and moisture conditioning implies that there is a treatment effect that is dependent upon each of the

categories. This suggests that the mixes are impacted by the moisture conditioning differently. The four way interaction of the mix, compaction, moisture conditioning and temperature show all of these factors played a role in the affecting the dynamic modulus value.

Table 7.7: Field mix 2 dynamic modulus ANOVA table

Source	DF	Type I SS	Mean Square	F Value	Pr > F
mix	1	1015250.7	1015250.7	90.31	<.0001
comp	1	197722	197722	17.59	<.0001
mix*comp	1	8961.4	8961.4	0.8	0.3722
mcond	1	925236.4	925236.4	82.3	<.0001
mix*mcond	1	1051377.6	1051377.6	93.53	<.0001
comp*mcond	1	680	680	0.06	0.8058
mix*comp*mcond	1	597982	597982	53.19	<.0001
temp	2	920420241	460210120.5	40938	<.0001
mix*temp	2	191625	95812.5	8.52	0.0002
comp*temp	2	8363.8	4181.9	0.37	0.6895
mix*comp*temp	2	133609.7	66804.8	5.94	0.0027
mcond*temp	2	941204.7	470602.4	41.86	<.0001
mix*mcond*temp	2	267819.8	133909.9	11.91	<.0001
comp*mcond*temp	2	57717.3	28858.6	2.57	0.0773
mix*comp*mcond*temp	2	147992	73996	6.58	0.0015
fre	8	176316185	22039523.1	1960.52	<.0001
mix*fre	8	28472.6	3559.1	0.32	0.9599
comp*fre	8	7124.1	890.5	0.08	0.9997
mix*comp*fre	8	8192.7	1024.1	0.09	0.9994
mcond*fre	8	159435.8	19929.5	1.77	0.0788
mix*mcond*fre	8	15248.7	1906.1	0.17	0.9948
comp*mcond*fre	8	9857.1	1232.1	0.11	0.9989
mix*comp*mcond*fre	8	21757.3	2719.7	0.24	0.9828
fre*temp	16	9613237.4	600827.3	53.45	<.0001
mix*fre*temp	16	27494	1718.4	0.15	1
comp*fre*temp	16	36432.1	2277	0.2	0.9997
mix*comp*fre*temp	16	15860.3	991.3	0.09	1
mcond*fre*temp	16	72444.2	4527.8	0.4	0.9821
mix*mcond*fre*temp	16	9983.2	624	0.06	1
comp*mcond*fre*temp	16	39592.4	2474.5	0.22	0.9995
mix*com*mco*fre*temp	16	48039.1	3002.4	0.27	0.9983

The Duncan groupings for each class variable are provided in the SAS output. These groupings show the square root of the average for each category and serves as a check of the ANOVA table to assist in validating the statistical difference within a group and determining which group has better average performance. The differences may seem trivial however by taking the square of the mean given in the Duncan grouping and comparing the values of the raw data the differences are more apparent. The square root of the dynamic modulus mean for the field compaction is 2024 and the laboratory compaction is 1997. The non-moisture conditioned samples have a higher dynamic modulus than the moisture conditioned samples and the HMA have a higher average dynamic modulus than the WMA samples.

7.2.3 Field Mix 3 Dynamic Modulus- Sasobit Technology

Similar to FM1 and FM2, the FM3 ANOVA table displays each of the five class variables as statistically significant, shown in table 7.8. The interactions assist in determining which combination of factors can impact the dynamic modulus values. The interaction of mix*comp shows that the type of mix and whether it was field or lab compacted will impact the dynamic modulus response. The type of mix and whether the samples were moisture conditioned will impact the dynamic modulus. The interaction of the mix*comp*mcond shows the combination of all these factors will impact the dynamic modulus response of the sample. By knowing that the combination of these factors impact pavement response and by quantifying the difference in the response, this will help lead to the development of more accurate methods of predicting the pavement performance.

The Duncan grouping for FM3 are shown on pages 205 in Appendix F. The HMA dynamic modulus values are higher than the WMA, the laboratory compacted samples show a higher dynamic modulus than the field compacted samples and the non-moisture conditioned samples have a higher dynamic modulus response than the moisture conditioned samples.

Table 7.8: Field mix 3 dynamic modulus ANOVA table

Source	DF	Type I SS	Mean Square	F Value	Pr > F
mix	1	4891633	4891633	364.96	<.0001
comp	1	1550413	1550413	115.68	<.0001
mix*comp	1	922370	922370	68.82	<.0001
mcond	1	3612270	3612270	269.51	<.0001
mix*mcond	1	289625	289625	21.61	<.0001
comp*mcond	1	108601	108601	8.1	0.0045
mix*comp*mcond	1	532800	532800	39.75	<.0001
temp	2	1.261E+09	630356439	47030.8	<.0001
mix*temp	2	972755	486377	36.29	<.0001
comp*temp	2	181086	90543	6.76	0.0012
mix*comp*temp	2	77897	38949	2.91	0.0552
mcond*temp	2	1274327	637164	47.54	<.0001
mix*mcond*temp	2	44733	22366	1.67	0.1891
comp*mcond*temp	2	3914	1957	0.15	0.8642
mix*comp*mcond*temp	2	27986	13993	1.04	0.3525
fre	8	218858220	27357277	2041.12	<.0001
mix*fre	8	48593	6074	0.45	0.8888
comp*fre	8	10584	1323	0.1	0.9993
mix*comp*fre	8	10838	1355	0.1	0.9992
mcond*fre	8	107181	13398	1	0.4347
mix*mcond*fre	8	14517	1815	0.14	0.9976
comp*mcond*fre	8	21409	2676	0.2	0.9909
mix*comp*mcond*fre	8	7796	975	0.07	0.9998
fre*temp	16	11059319	691207	51.57	<.0001
mix*fre*temp	16	139260	8704	0.65	0.8443
comp*fre*temp	16	27549	1722	0.13	1
mix*comp*fre*temp	16	24491	1531	0.11	1
mcond*fre*temp	16	31232	1952	0.15	1
mix*mcond*fre*temp	16	28314	1770	0.13	1
comp*mcond*fre*temp	16	32693	2043	0.15	1
mix*com*mco*fre*temp	16	26047	1628	0.12	1

7.2.4 Field Mix 4 Dynamic Modulus- Double Barrel Green Foaming Technology

The dynamic modulus response of the FM4 samples was different from the other three field mixes tested especially in regards to the WMA having higher dynamic modulus values. One explanation of the difference is the nine day duration that elapsed between the production of the HMA mix and the WMA mix due to rain delays. Four of the five factors are statistically

significant. The compaction type was not statistically significant and thus any of the interactions that are statistically significant and include compaction are a result of the variability in the other class variables. For example, the interaction of mix and compaction is statistically significant as a result of the variability in the mix (Ott, 2001).

Table 7.9: Field mix 4 dynamic modulus ANOVA table

Source	DF	Type I SS	Mean Square	F Value	Pr > F
mix	1	3249873	3249873	319.58	<.0001
comp	1	4709	4709	0.46	0.4964
mix*comp	1	1017906	1017906	100.1	<.0001
mcond	1	3356027	3356027	330.02	<.0001
mix*mcond	1	140236	140236	13.79	0.0002
comp*mcond	1	194105	194105	19.09	<.0001
mix*comp*mcond	1	133330	133330	13.11	0.0003
temp	2	1.22E+09	612000610	60182.6	<.0001
mix*temp	2	363814	181907	17.89	<.0001
comp*temp	2	77543	38771	3.81	0.0225
mix*comp*temp	2	122153	61076	6.01	0.0026
mcond*temp	2	703358	351679	34.58	<.0001
mix*mcond*temp	2	706170	353085	34.72	<.0001
comp*mcond*temp	2	129344	64672	6.36	0.0018
mix*comp*mcond*temp	2	51727	25864	2.54	0.0793
fre	8	2.12E+08	26508576	2606.79	<.0001
mix*fre	8	139377	17422	1.71	0.0917
comp*fre	8	43506	5438	0.53	0.8307
mix*comp*fre	8	96502	12063	1.19	0.3044
mcond*fre	8	95010	11876	1.17	0.3158
mix*mcond*fre	8	46777	5847	0.57	0.7989
comp*mcond*fre	8	6341	793	0.08	0.9997
mix*comp*mcond*fre	8	8705	1088	0.11	0.999
fre*temp	16	5143158	321447	31.61	<.0001
mix*fre*temp	16	132885	8305	0.82	0.6672
comp*fre*temp	16	79684	4980	0.49	0.9527
mix*comp*fre*temp	16	51941	3246	0.32	0.995
mcond*fre*temp	16	20197	1262	0.12	1
mix*mcond*fre*temp	16	42769	2673	0.26	0.9984
comp*mcond*fre*temp	16	10217	639	0.06	1
mix*com*mco*fre*temp	16	10269	642	0.06	1

The Duncan groupings show that the non-moisture conditioned samples have a higher dynamic modulus response, the WMA has a higher dynamic modulus than the HMA and there was not a statistical difference in the compaction type. It may be advantageous to continue investigating the foaming technology because there was nine days between the production of the HMA and WMA mixes.

7.3 Flow Number

The statistical analysis for the flow number data includes an analysis of the flow numbers and of the number of cycles to three percent strain. SAS was used to perform the statistical analysis and the SAS output is located in Appendix F on pages 213-234. The output includes ANOVA tables, Duncan groupings, residual plots and normal probability plots. The flow number tests have three class variables and those are the mix type, the compaction type as well as non-moisture and moisture conditioned samples.

7.3.1 Field Mix 1 Flow Number Data Analysis- Evotherm Technology

The ANOVA table for the FM1 flow number shows that the mix class variable is statistically significant. The ANOVA table showing the cycles to three percent strain displays mix, compaction, and moisture conditioning as the statistically significant factors and the interaction of the mix and compaction as well as the interaction of mix, compaction and moisture conditioning as statistically significant. Both tables show the mix as having the highest statistical difference. The Duncan groupings for the SAS output show that the HMA has higher flow number and cycles to three percent strain. The average of the lab is higher than the field compacted samples and the moisture conditioned samples is on average higher than the non-moisture conditioned samples.

7.3.2 Field Mix 2 Flow Number Data Analysis- Sasobit Technology

The ANOVA tables for FM2 flow number and cycles to three percent strain show the factors of the mix and the moisture conditioning are statistically significant. The HMA mix had higher average flow number and cycles to three percent strain when compared to the WMA mix and the moisture conditioned samples had higher averages when compared to the non-

moisture conditioned samples. The Duncan and Tukey groupings list the categories of samples in order the mean values and show which groups are statistically different from each other. This is displayed on page 220 in Appendix F. The groupings show that no particular group completely outranks the others but all of the HMA groups are all listed higher than the WMA groups.

7.3.3 Field Mix 3- Flow Number Data Analysis

The ANOVA table for the flow number data shows statistical differences in the mix category and for the interaction of mix and compaction type. The ANOVA table for the cycles to three percent strain similarly shows the mix class variable and the interaction of mix and compaction as statistically significant factors as well as the compaction type. The overall average of the lab compacted mixes are higher than the field compacted mixes. The average cycles for the HMA is higher than the WMA for both flow number and cycles to three percent strain.

7.3.4 Field Mix 4- Flow Number Data Analysis

The flow number ANOVA table for FM4 has the mix as the only statistically significant factor and the WMA has a higher average flow number than the HMA. The ANOVA table for 3% strain shows the mix, compaction type and moisture conditioning as significant factors. The lab compacted samples averaged higher cycles as did the warm mix and the moisture conditioned samples. All of the moisture conditioned samples for field mix 4 had a higher average than the non-moisture conditioned samples of the same group. For example, the moisture conditioned- laboratory compacted- WMA samples had a higher average cycles to 3% strain than the non-moisture conditioned- laboratory compacted- WMA samples.

7.4 Statistical Analysis Summary

The statistical analysis shows very strong evidence of differences in the HMA and WMA performance testing results. The first three field mixes performed similarly and show better performance testing data from the HMA mixes. The field mix which utilized the Double Barrel Green technology had better performance for the WMA mix but this mix also had an

added degree of variability due to weather delays which postponed the production of the control mix by nine days.

The main objectives of this project was to compare HMA and WMA, evaluate the effects of moisture conditioning and evaluate whether field versus laboratory compaction had a significant impact on the mix performance. The statistical analysis shows evidence that each of these factors is statistically significant in at least one situation. All four field mixes tested had the interaction of mix*compaction*moisture-conditioning as being statistically significant in the dynamic modulus data. This shows that all three of these factors influence the material response in the dynamic modulus testing so in order to continue improving asphalt testing procedures and pavement design models, the samples produced for performance testing must resemble the material response of the actual pavement.

The overall analysis shows that there are differences in the material response of the HMA and WMA mixes during performance testing and also the factors of compaction and moisture conditioning play a role in determining the material response during performance testing.

Chapter VIII Discussion and Conclusion

The purpose of the discussion is to summarize the statistical conclusions and to compare and contrast the differences between the HMA and WMA mixes within each field produced mix. The discussion will also address certain limitations of the experiment and provide recommendations for future research. The conclusions will summarize what discoveries were made as a result of this research project and provide suggestions for continued research.

8.1 Field Mix 1 Discussion

The WMA technology for this mix was Evotherm 3G. The binder used was a PG 58-28 and the binder testing showed evidence of the reduction in the mixing and compaction temperature. The indirect tensile strength test data showed that the mix was a statistically significant factor when comparing peak load and the HMA average peak load was greater than the peak load of the WMA samples. There was no statistical difference when comparing the TSR data. For this field mix, the field versus lab compaction was not tested using the ITS test. The dynamic modulus tests showed that the HMA and WMA were statistically different in their dynamic modulus response with HMA having a higher overall average. There was convincing evidence of a treatment effect for compaction type and moisture conditioning. The interaction of mix, compaction and moisture conditioning suggests that there is a difference when a mix is compacted. Flow number testing showed the mix type as a statistically significant factor and the data measuring cycles to three percent strain show that mix, compaction and moisture conditioning are statistically significant factors as well as the three-way interaction of the mix, compaction and moisture conditioning. By studying the results from these tests and the statistical evidence, the overall conclusion is that the HMA mix performed better than the Evotherm 3G mix in ITS peak load, the dynamic modulus test and in the flow number test data.

8.2 Field Mix 2 Discussion

The WMA technology for this mix was Revix. The binder was a PG 64-28. The indirect tensile strength test data shows that the mix, compaction type and moisture conditioning

were statistically significant factors as well as the interaction of mix and moisture conditioning. The TSR data showed a statistical difference between the HMA and WMA mixes. The dynamic modulus data found all five class variables were statistically significant. There were several statistically significant three way interactions and one four-way interaction. The Duncan grouping helped to show which groups had higher dynamic modulus values. The HMA had a higher average than the WMA, the field compacted samples had a higher average than lab compacted samples and moisture conditioned samples had a lower average than non-moisture conditioned samples. The flow number analysis showed the HMA had a higher average flow number and more cycles to three percent strain than the WMA. For this mix, there was little evidence to suggest that the WMA would perform as well as the traditional HMA mixes.

8.3 Field Mix 3 Discussion

The WMA technology used in this mix was Sasobit. The binder grade was a PG 64-22. The indirect tensile strength showed that the mix, compaction type, moisture conditioning, and the interaction of mix and moisture conditioning were the statistically significant factors. The field compacted moisture conditioned WMA samples were the lowest performing samples and that particular sample set was statistically different from all other sample sets. The TSR values show that WMA and HMA are statistically different with the HMA average being the higher of the two. The dynamic modulus test data showed each of the five variables as statistically significant. The interaction of the mix, compaction and moisture conditioning was statistically significant. Overall, HMA values were higher than WMA, lab compacted values were higher than field compacted and non-moisture conditioned samples were higher than moisture conditioned samples. The flow number analysis shows statistical differences between HMA and WMA as well as the interaction of mix and compaction type. When cycles to three percent strain were analyzed the same factors were statistically different and compaction type was also found to be statistically significant. The average flow number and average cycles to three percent strain was higher for the HMA samples than the WMA.

8.4 Field Mix 4 Discussion

The WMA technology for field mix four was the Double Barrel Green foaming technology. The binder used was a PG 64-22. The indirect tensile strength data showed the mix, compaction, moisture conditioning as well as the interaction of compaction, moisture conditioning and the interaction of mix, compaction and moisture conditioning were statistically significant when peak load data was analyzed. The Tukey groupings helped to show the rankings of the mixes and showed that overall, the values were fairly comparable but on average, moisture conditioned samples had a lower peak load. The TSR analysis showed that the compaction was a statistically significant factor. Dynamic modulus testing data showed that all class variables were statistically significant with the exception of compaction however the interaction of mix and compaction as well as the interaction of mix, compaction and moisture conditioning were found to be statistically different. The performance for this mix was different than the other three mixes tested due to the Duncan groupings showing a higher average dynamic modulus response for the WMA mix. The flow number test results also confirmed that the WMA mix had higher averages than the HMA mix.

8.5 Discussion of Limitations

There are several limitations to this experiment. Each field mix had only one associated WMA technology and this limits the ability to compare WMA technologies. Field produced mixes will entail higher variability than lab produced mixes. A benefit to the field produced mixes is that there are roadways in which the performance of the mix can be used as a benchmark to compare to the results of the performance testing. After performing the analysis it seems as though the WMA technology may play a role in determining the performance of a mix but the initial mix design will be a critical factor in the performance of a WMA mix. A poorly designed HMA mix will have a poorly performing WMA mix. Field mix four, which had the Double Barrel Green foaming WMA technology, had a different trend than the other three field mixes tested. The WMA mix for field mix 4 performed superior to the HMA in the dynamic modulus and flow number testing; however, the control mix was produced nine days after the WMA mix. This extra variability may explain the

difference in the trend and further research is needed on the comparison of the control HMA mix and foamed WMA mix.

8.6 Conclusions

The overall findings of this experiment suggest a difference in the performance of HMA and WMA mixes. The binder results show that the mixing compaction temperatures are reduced and that the benefits of WMA mentioned in the literature review are realized. While the benefits of the technologies continue to drive the production of more WMA mixes, studying the performance testing results will help to show if there is a net benefit to using WMA. Three of the four field mixes indicate superior performance of the HMA mix in many aspects of the tests performed. There were mixed results for the foaming technology because the WMA mix did perform superior in dynamic modulus and flow number tests. The use of foaming should be further investigated under a higher degree of control. In this case, there was a nine day elapse between the production of the WMA mix and the HMA mix due to weather delays. This may have caused a higher degree of variability between the two mixes. The dynamic modulus results show that the interaction of the mix, compaction type and moisture conditioning are statistically significant in all four field mixes. This suggests that the combination of all three factors play a role in determining material response. The master curves do not display a high degree of overall variability but do show differences in mix responses at high temperatures.

Further investigation of WMA technologies will be beneficial to both contractors and owner agencies. There is evidence that the field versus laboratory compaction may impact the dynamic modulus response. Quality control and quality assurance programs may want to consider a change in how and when field produced mixes are compacted. The field produced sample may resemble the actual pavement response better than the reheated laboratory sample. There is also evidence that WMA mix may impact the mix response to moisture conditioning. The overall moisture conditioning response was variable with the moisture conditioned samples performing better than non-moisture conditioned samples. This may be

due to the immersion of the sample in the 60°C water bath for 24 hours which may produce enough heat to allow for more asphalt absorption into the aggregate.

The experiment showed statistical differences between the control and WMA for all four field mixes tested. Three field mixes indicate higher overall performance from the HMA mix. Foaming was the only WMA technology in which WMA performed better in some instances. As WMA becomes produced in larger quantities and as WMA technologies begin to be used together it is important to continue looking at the pavement performance data and performance testing results in order to adapt the QC/QA programs to evolving technologies. Further research will help to ensure that the short term benefits of WMA that are realized during placement can be extended to long term pavement performance and life cycle cost analysis.

8.7 Recommendations for Additional Research

HMA is evolving as new technologies are developed and higher percentages of recyclable materials are incorporated into mix designs. In order to maintain optimal sustainability in our roadways, future research must address the issue of how these technologies impact the long term pavement performance. WMA is a tool which can help create more sustainable pavements by incorporating higher percentages of recycled asphalt pavement and/or recycled asphalt shingles (RAS) in a mix. Research that incorporates performance testing is recommended because it provides quantifiable material properties that can be correlated to field performance. The following provides an outline of additional research recommendations that would enhance the communities understanding of recycled materials and WMA:

- Continue the analysis of data within this study by incorporating the Mechanistic-Empirical Pavement Design Guide (M-E PDG) to investigate long term pavement performance.
- Conduct a field survey of the actual WMA pavement and compare with M-E PDG results over time.

- Investigate the use of high percentage RAP/fractionated RAP and/or RAS used in conjunction with WMA. Conduct performance testing to evaluate differences in mixing and compaction temperatures and address potential moisture susceptibility concerns. The extent of blending of the recycled materials at reduced mixing temperatures is an area of concern.
- Investigate how using two WMA technologies in conjunction impacts mix properties, e.g. foaming using a WMA additive.
- Reinvestigate field produced foamed WMA and control HMA mixes under a more controlled setting wherein production occurs on consecutive days. A plan which would address several of these concerns would be to produce a foamed WMA mix with a chemical modifier, such as Revix, the following day produce a foamed WMA mix and on the final day of paving produce the control HMA mix. The samples procured from these mixes could undergo ITS, dynamic modulus, and flow number testing
- Beam fatigue testing on control HMA and WMA mixes with high percentages of RAP/fractionated RAP or RAS would help determine the flexural stiffness and fatigue life of the mixes.
- Conduct low temperature fracture testing on the paired field produced HMA and WMA mixes to ensure low temperature mix performance will be met.
- Frequency sweeps on binders extracted from field produced WMA mixes with varying amounts of RAP/fractionated RAP and/or RAS would establish binder master curves which would help characterize the binders over a large range of temperatures and frequencies.

REFERENCES

- AASHTO. (2007). Designation R 28 Accelerated Aging of Asphalt Binder Using a Pressurized Aging Vessel (PAV). *Standard Specifications for Transportation Materials and Methods of Sampling and Testing, 27th Ed.* Washington, D.C.: American Association of State Highway and Transportation Officials.
- AASHTO. (2007). Designation T 240 Standard Method of Test for Effect of Heat and Air on a Moving Film of Asphalt Binder (Rolling Thin-Film Oven Test). *Standard Specifications for Transportation Materials and Methods of Sampling and Testing, 27th Ed.* Washington, D.C.: American Association of State Highway and Transportation Officials.
- AASHTO. (2007). Designation T 313 Determining the Flexural Creep Stiffness of Asphalt Binder Using the Bending Beam Rheometer (BBR). *Standard Specifications for Transportation Materials and Methods of Sampling and Testing, 27th Ed.* Washington, D.C.: American Association of State Highway and Transportation Officials.
- AASHTO. (2007). Designation T 315 Standard Method of Test for Determining the Rheological Properties of Asphalt Binder Using a Dynamic Shear Rheometer (DSR). *Standard Specifications for Transportation Materials and Methods for Sampling and Testing, 27th Ed.* Washington D.C.: American Association of State Highway and Transportation Officials.
- AASHTO. (2007). Designation T 316 Standard Method of Test for Viscosity Determination of Asphalt Binder Using Rotational Viscometer. *Standard Specifications for Transportation Materials and Methods of Sampling and Testing, 27th Ed.* Washington, D.C.: American Association of State Highway and Transportation Officials.
- AASHTO. (2007). Designation T283-07 Resistance of Compacted Hot Mix Asphalt (HMA) to Moisture Induced Damage. *Standard Specifications for Transportation Materials and Methods of Sampling and Testing, 27th Ed.* Washington, D.C.: American Association of State Highway and Transportation Officials.
- Al-Rawashdeh, A. (2008). *Performance Assessment of WMA Pavements*. Russ College of Engineering and Technology of Ohio University.
- Asphalt Institute. (2003). *Superpave Performance Graded Asphalt Binder Specification and Testing (SP-1)*. U.S.A.: Asphalt Institute.
- Astec, Inc. (2007, June). *Astec Double Barrel Green TM System: Success with Simplicity*. Retrieved March 2, 2009, from http://www.astecinc.com/index.php?option=com_content&view=article&id=671:astec-double-barrel-green-system-success-with-simplicity&catid=58:latest-news&Itemid=509
- Austerman, A., Mogawer, W., & Bonaquist, R. (2009). Evaluating the Effects of Warm Mix Asphalt Technology Additive Dosages on the Workability and Durability of Asphalt Mixtures Containing Recycled Asphalt Pavement. *Transportation Research Board 88th Annual*

- Meeting Compendium of Papers CD-ROM*. Washington D.C.: Transportation Research Board of National Academies.
- Barthel, W., Marchand, J., & Von Devivere, M. (2009). *Warm Asphalt Mixes by Adding a Synthetic Zeolite*. Retrieved February 16, 2009, from Eurovia: http://www.asphamin.de/fr/warm_asphalt_mixes_by_adding_a_sythetic_zeolite.pdf
- Bennert, T., Reinke, G., Mogawer, W., & Mooney, K. (2010). Assessment of Workability/Compactability of Warm Mix Asphalt. *Transportation Research Board 89th Annual Meeting Compendium of Papers*. CD-ROM. Washington, D.C.: Transportation Research Board of National Academies.
- Brown, D. (2007, October). Warm Mix Picks Up Steam. *Better Roads Magazine*.
- Brown, D. (2008, January/February). *Warm Mix. The Lights are Green*. Retrieved February 19, 2009, from Hot Mix Asphalt Technology: http://www.warmmixasphalt.com/submissions/60_20080116_warm_mix%20Jan-Feb%2008.pdf
- Brown, D. (2008, October 1). *Warm Mix: Green Is Cool*. Retrieved March 16, 2009, from Associated Construction Publications: <http://www.acppubs.com/article/CA6597208.html>
- Button, J., Estakhri, C., & Wimsatt, A. (2007). *A synthesis of Warm Mix Asphalt Report No.: FHWA/TX-07/0-5597-1*. Texas Department of Transportation.
- Cervarich, M. (2003, March/April). *Cooling Down the Mix: NAPA Explores New "Warm Mix Asphalt" Technologies Developed in Europe*. Retrieved February 16, 2009, from Warm Mix Asphalt: http://www.warmmixasphalt.com/submissions/27_20071127_Cooling_Down_the_Mix-Warm_Mix_Asphalt.pdf
- Corrigan, M. (2008). *Warm Mix Asphalt Technologies and Research*. Retrieved February 10, 2009, from Federal Highway Administration: <http://www.fhwa.dot.gov/pavement/asphalt/wma.cfm>
- Crews, E. (2006, April). *Evotherm, Warm Mix Asphalt Technology*. Retrieved March 16, 2009, from Asphalt Institute Spring Meeting: <http://www.flexiblepavements.org/documents/Evotherm-Crews.pdf>
- Csanyi, L. (1959). *Foamed Asphalt. Technical Bulletin No. 240*. Washington, D.C.: American Road Builders Association.
- Csanyi, L. (1962). *Foamed Asphalt for Economical Road Construction*. Civil Engineering 32(6).
- D'Angelo, J., Harm, E., J., B., Baumgardner, G., Corrigan, M., Cowsert, J., et al. (2008). *Warm Mix Asphalt: European Practice Publication FHWA-PL-08-007*. FHWA, U.S. Department of Transportation.

- Davidson, J. (2005). *Evotherm® Trial- Aurora, Ontario*. McAsphalt Industries Limited.
- Davidson, J. (2005). *Evotherm® Trial- Ramara Township*. McAsphalt Industries Limited.
- Davidson, J. (2006). *Evotherm® Trial- City of Calgary*. McAsphalt Industries Limited.
- Davidson, J. (2007). *Warm Asphalt Mix Technology- The Canadian Perspective*. Retrieved February 19, 2009, from McAsphalt Engineering Services. 2007 Australian Asphalt Pavement Association Industry Conference.: <http://www.aapa.asn.au/content/aapa/download/2007%20>
- Diefenderfer, S., McGhee, K., & Donaldson, B. (2007). *Installation of Warm Mix Asphalt Projects in Virginia Report No.: FHWA/VTRC 07-R25*. Virginia Department of Transportation.
- Green Roads. (2007). *The Green Roads Rating System*. Retrieved February 27, 2009, from <http://www.greenroads.us/1/home.html>
- Hansen, K. (2006). *Warm Mix Asphalt*. Retrieved February 17, 2009, from National Asphalt Pavement Association:
<http://cobweb.ecn.purdue.edu/~spave/NCAUPG/Activities/2006/Presentations%20HMA%20Conf.%2006/warm%20mix%20asphalt%20NCUPG%2001-06-Hansen.pdf>
- Harder, G. (2007). *Low Energy Asphalt- The Cool Mix*. Retrieved March 28, 2009, from New York State Department of Transportation:
<https://www.nysdot.gov/divisions/engineering/technical-services/trans-r-and-d-repository/TTNSprintNewsLtr07.pdf>
- Hodo, W., Kvasnak, A., & Brown, E. (2009). Investigation of Foamed Asphalt (Warm Mix Asphalt) with High Reclaimed Asphalt Pavement (RAP) Content for Sustainment and Rehabilitation of Asphalt Pavement. *Transportation Research Board 88th Annual Meeting Compendium of Papers*. Washington, D.C.: Transportation Research Board of National Academies.
- Hurley, G. (2006). *Evaluation of New Technologies for Use in WMA*. Auburn, AL: Auburn University.
- Hurley, G. C., & Prowell, B. (2005). *Evaluation of Aspha-min Zeolite for use in Warm-Mix Asphalt NCAT Report 05-04*. Auburn, AL: National Center for Asphalt Technology.
- Hurley, G., & Prowell, B. (2005). *Evaluation of Evotherm for use in Warm-Mix Asphalt. Report No. NCAT Report 06-02*. Auburn, AL: National Center for Asphalt Technology.
- Hurley, G., & Prowell, B. (2005). *Evaluation of Sasobit Zeolite for use in Warm-Mix Asphalt. Report No.: NCAT Report 05-06*. Auburn, AL: National Center for Asphalt Technology.
- Iowa Department of Transportation. (2008, October). *Construction Manual Specifications Section 2303.03 D*. Retrieved February 10, 2009, from http://www.erl.dot.state.ia.us/Oct_2008/CM/frames.htm

- Johnston, A., Da Silva, M., Soleymani, H., & Yeung, C. (2006, May). An Early Evaluation of the Initial Canadian Experience with Warm Asphalt Mix. *2006 Annual General Conference of the Canadian Society for Civil Engineering*.
- Jones, W. (2004, Fall). *Warm Mix Asphalt Pavements: Technology of the Future*. (A. Institute, Producer) Retrieved February 16, 2009, from http://www.asphaltinstitute.org/Upload/2004_Fall_Mag_Warm_Mix_Asphalt_Pavements.pdf
- Kristjansdottir, O. (2006). *Warm Mix Asphalt for Cold Weather Paving. M.Sc. Thesis*. Retrieved March 16, 2009, from University of Washington: <http://www.wsdot.wa.gov/research/reports/fullreports/650.1.pdf>
- Kuennen, T. (2004, June). *Warm Mixes are a Hot Topic*. Retrieved March 6, 2009, from Better Roads: [http://betterroads.gcnpublishing.com/content/Issue-Story.45.0.html?&no_cache=1&tx_magissue_pi1\[pointer\]=0&tx_magissue_pi1\[mode\]=1&tx_magissue_pi1\[showUid\]=476](http://betterroads.gcnpublishing.com/content/Issue-Story.45.0.html?&no_cache=1&tx_magissue_pi1[pointer]=0&tx_magissue_pi1[mode]=1&tx_magissue_pi1[showUid]=476)
- Kvasnak, A., West, R., Moore, J., Nelson, J., Turner, P., & Tran, N. (2009). Case Study of Warm Mix Asphalt Moisture Susceptibility in Birmingham. *Transportation Research Board 88th Annual Meeting Compendium of Papers*. Washington, D.C.: Transportation Research Board of National Academies.
- Lee, D. (1980). *Treating Iowa's Marginal Aggregates and Soils by Foamix Process*. Ames: Iowa State University.
- Lee, S., Amirghani, S., Park, N., & Kim, K. (2008). *Characterization of Warm Mix Asphalt Binders Containing Artificially Long-Term Aged Binders*. Construction and Building Materials.
- Mallick, R., Bergendahl, J., & Pakula, M. (2009). A Laboratory Study on CO2 Emission Reductions Through the Use of Warm Mix Asphalt. *Transportation Research Board 88th Annual Meeting Compendium of Papers*. Washington, D.C.: Transportation Research Board of National Academies.
- MeadWestvaco. (2008). *Evotherm Case Studies*. Retrieved February 10, 2009, from MeadWestvaco: <http://www.meadwestvaco.com/PackagingSolutions/CaseStudies/CaseStudiesGeneralContent/MWV008465>
- MeadWestvaco. (2008, November 20). *MWV Specialty Chemicals, Ergon Asphalt & Emulsion, Inc., & Mathy Construction Company Sign License Agreement for Warm Mix Asphalt Technology*. Retrieved from MeadWestvaco: <http://www.meadwestvaco.com/mwv/groups/content/documents/document/mwv007942.pdf>
- Michael, L. (2007, October). Innovation to Implementation Warm Mix Asphalt. *AAPA 2007 Pavements Industry Conference*. Darling Harbour, Sydney, Australia.

- Middleton, B., & Forfyflow, R. (2009). An Evaluation of Warm Mix Asphalt Produced with the Double Barrel Green Process. *Transportation Research Board 88th Annual Meeting Compendium of Papers*. Washington, D.C.: Transportation Research Board of National Academies.
- Morgan, M., Peterson, B., Durham, S., & Surdahl, R. (2009). Advancing Innovative Materials Practice in Highway Construction. *Transportation Research Board 88th Annual Meeting Compendium of Papers. CD-ROM*. Washington, D.C.: Transportation Research Board of National Academies.
- Morrison, E. (2007). Retrieved March 16, 2009, from Flexible Pavements.org:
<http://www.flexiblepavements.org/Morrison.pdf>
- Muench, S., Anderson, J., & Söderlund, M. (2009). Greenroads: Development of a Sustainability Rating System for Roadways. *Transportation Research Board 88th Annual Meeting Compendium of Papers*. Washington, D.C.: Transportation Research Board of National Academies.
- Neitzke, B. (2007). *Warm Mix Asphalt: Yellowstone National Park*. Retrieved March 16, 2009, from http://76.12.53.242/submissions/44_20071227_Brad%20Neitzke.ppt
- Newcomb, D. (2007). *An Introduction to Warm-mix Asphalt*. Retrieved February 16, 2009, from http://fsl.hotmix.org/mbc/Introduction_to_Warm-mix_Aspphalt.pdf
- NOAA. (2008, June). *Climatological Data Iowa June 2008*. Retrieved June 10, 2010, from National Oceanic and Atmospheric Administration:
<http://www1.ncdc.noaa.gov/pub/orders/C36ACFEC-D5CA-1A41-C763-B51D83D0F396.pdf>
- NOAA. (2009, October). *Climatological Data Iowa October 2009*. Retrieved June 10, 2010, from National Oceanic and Atmospheric Administration:
<http://www1.ncdc.noaa.gov/pub/orders/EC81C549-F34E-C6C0-7804-53C8DBA494A5.pdf>
- NOAA. (2009, September). *Climatological Data Iowa September 2009*. Retrieved June 10, 2010, from National Oceanic and Atmospheric Administration:
<http://www1.ncdc.noaa.gov/pub/orders/5917E916-8AF6-F215-30B5-D688C6071AF6.pdf>
- Ott, L. (2001). *An introduction to statistical methods and data analysis. 5th Ed.* . Pacific Grove, CA: DAXBURY.
- Powers. (2007). *WMA Presentation*. Retrieved March 16, 2009, from Flexible Pavements:
<http://www.flexiblepavements.org/documents/PowersWMApresentation.pdf>
- Prowell, B., & Hurley, G. (2007, Spring). *Missouri Warm Mix Demonstration Project*. Retrieved March 16, 2009, from National Superpave News Volume 1, Issue #1:
http://www.eng.auburn.edu/center/ncat/ssc/newsletters/SSC_spring2007_Ntl.pdf

- Ramsey, F., & Schafer, D. (2002). *The Statistical Sleuth- A Course in Methods of Data Analysis*. Pacific Grove, CA: Daxbury.
- Rea, M. (2003, July). *New Technology Could Cool off 'Hot' in Hot Mix Asphalt*. Retrieved March 6, 2009, from Texas Construction: <http://texas.construction.com/features/archive/0307.hot.asp>
- Roberts, F., Engelbrecht, J., & Kennedy, T. (1984). *Evaluation of Recycled Mixtures Using Foamed Asphalt*. Transportation Research Board.
- Roberts, F., Kandhal, P., Lee, D., & Kennedy, T. (1996). *Hot Mix Asphalt Materials, Mixture Design, and Construction*. Lanham, MD.: National Asphalt Pavement Association Research and Education Foundation.
- Ruhl, R., Musanke, U., & Henseleit, R. (2006). *The German Bitumen Forum, An Alliance for Occupational Safety and Health*. Retrieved February 20, 2009, from <http://docserver.nrca.net/pdfs/technical/7855.pdf>
- SAS Institute Inc. (2008, March). *SAS for Windows Version 9.2 TS Level 2M2*. Cary, NC: SAS Institute Inc.
- Sasol Wax. (2003). *Sasobit Technology Applications: Frankfurt Airport, Main*. Retrieved March 16, 2009, from Sasol Wax: http://www.sasolwax.com/Frankfurt_Main__Germany-highlight-warm+mix+asphalt.html
- Sasol Wax. (2003). *Sasobit Technology Applications: Hamburg Fuhlsbuttel*. Retrieved March 16, 2009, from http://www.sasolwax.com/Hamburg_Fuhlsb%C3%BCttel
- Sasol Wax. (2004). *Sasobit Technology Applications: Berlin Schönefeld*. Retrieved March 16, 2009, from http://www.sasolwax.com/Berlin_Schönefeld__Germany.html
- Sasol Wax. (2006). *Sasol Wax: The United Kingdom*. Retrieved 16 3, 2009, from Sasol Wax: http://www.sasolwax.com/Sasobit_UK-highlight-sasobit.html
- Scherocman, J. (1996, August). *Compacting Hot-Mix Asphalt Pavements: Part 1*. Retrieved February 27, 2009, from Roads and Bridges: <http://www.roadsbridges.com/Compacting-Hot-Mix-Asphalt-Pavements-Part-I-article444>
- Tao, M., & Mallick, R. (2009). *An Evaluation of the Effects of Warm Mix Asphalt Additives on Workability and Mechanical Properties of Reclaimed Asphalt Pavement (RAP) Material. Transportation Research Board 88th Annual Meeting Compendium of Papers*. Washington D.C.: Transportation Research Board of National Academies.
- Transportation Research Board. (2007). *NCHRP 09-43: Mix Design Practices for Warm Mix Asphalt*. Retrieved March 1, 2009, from Transportation Research Board: <http://www.trb.org/TRBNet/ProjectDisplays.asp?ProjectID=977>

- Transportation Research Board. (2008). *NCHRP 09-47: Engineering Properties, Emissions, and Field Performance of Warm Mix Asphalt Technologies*. Retrieved March 1, 2009, from Transportation Research Board:
<http://www.trb.org/TRBNet/ProjectDisplay.asp?ProjectID=1625>
- U.S. Environmental Protection Agency. (2008, September 23). *Clean Air Interstate Rule: Iowa*. Retrieved February 27, 2009, from U.S. Environmental Protection Agency:
<http://www.epa.gov/interstateairquality/ia.html>
- U.S. Environmental Protection Agency. (2009, February). *Clean Air Interstate Rule*. Retrieved February 27, 2009, from U.S. Environmental Protection Agency:
<http://www.epa.gov/interstateairquality/>
- Ventura, A., Monéron, P., Jullien, A., Tamagny, P., Olard, F., & Zanvan, D. (2009). Environmental comparison at industrial scale of hot and half-warm mix asphalt manufacturing process. *Transportation Research Board 88th Annual Meeting Compendium of Papers*. Washington, D.C.: Transportation Research Board of National Academies.
- Wagner, H. (2007, October 8). *Warm Mix for Yellowstone*. Retrieved March 16, 2009, from Associated Construction Publications: <http://www.acppubs.com/article/CA6482887.html>
- Wei Goh, S., You, Z., & Van Dam, T. (2007). Laboratory Evaluation and Pavement Design for Warm Mix Asphalt. Ames, IA: Proceedings of the 2007 Mid-Continent Transportation Research Symposium.
- Wielinski, J., Hand, A., & Rausch, D. (2009). *Laboratory and Field Evaluations of Foamed Warm Mix Asphalt Projects*. Washington D.C.: Transportation Research Board of National Academies.
- Williams, M., Landel, R., & Ferry, J. (1955). The Temperature Dependence of Relaxation Mechanism in Amorphous Polymers and Other Glass-Liquids. *Journal of American Chemical Society*, Vol. 77, p. 370.
- Witczak, M. (2005). *NCHRP Report 547: Simple Performance Tests: Summary of Recommended Methods and Database*. Washington, D.C.: Transportation Research Board, National Highway Research Council.
- Witczak, M., Kaloush, K., Pellinen, T., El-Aasyouny, M., & Von Quintus, H. (2002). *NCHRP Report 465: Simple Performance Test for Superpave Mix Design*. National Cooperative Highway Research Program (NCHRP) .
- Xiao, F., Jordan, J., & Amirhanian, S. (2009). Laboratory Investigation of Moisture Damage in Warm Mix Asphalt Containing Moist Aggregate. *Transportation Research Board 88th Annual Meeting Compendium of Papers. CD-ROM*. Washington, D.C.: Transportation Research Board of National Academies.

Zettler, R. (2006, February). *Warm Mix Stands up to its Trial*. Retrieved February 17, 2009, from Better Roads Magazine: <http://obr.gcnpublishing.com/articles/feb06a.htm>

APPENDIX A: JOB MIX FORMULAS

WMA → 90-100°C Not workable
 Control → 135°C Light?

Form 956 ver. 6.5r

Iowa Department of Transportation
 Highway Division - Office of Materials
 HMA Gyratory Mix Design

County:	Polk	Project:	Commercial Pavement	Mix No.:	C-017
Mix Size (in.):	1/2	Contractor:	Des Moines Asphalt & Paving	Contract No.:	
Mix Type:	HMA IM	Design Life ESAL's:	1,000,000	Date Reported:	04/20/07
Intended Use:	Surface	Type A:	L-4	Project Location:	N/A

Job Mix Formula - Combined Gradation (Sieve Size in.)										
1"	3/4"	1/2"	3/8"	#4	#8	#16	#30	#50	#100	#200
Upper Tolerance										
100	100	100	97	75	56		28			6.3
100	100	96	90	68	51	36	24	11	6.2	4.3
100	100	89	83	61	46		20			2.3
Lower Tolerance										

Asphalt Binder Source and Grade: Bituminous Materials PG58-28 Special Testing Required for Binder Grade Determination

Gyratory Data					Number of Gyration	
% Asphalt Binder	5.40	5.56	5.90	6.40	N-Initial	7
Corrected Gmb @ N-Des.	2.354	2.355	2.257	2.382	N-Design	76
Max. Sp.Gr. (Gmm)	2.459	2.453	2.441	2.418	N-Max	117
% Gmm @ N-Initial	88.9	88.7	88.3	91.4	Gsb for Angularity	Method A
% Gmm @ N-Max	96.6	96.9	97.5	99.2		2.623
% Air Voids	4.3	4.0	3.4	1.5	Pba / %Abs Ratio	0.50
% VMA	14.6	14.7	15.0	14.5	Slope of Compaction	Curve
% VFA	70.8	72.8	77.0	89.7		14.9
Film Thickness	8.66	8.97	9.63	10.77	Mix Gmm Linearity	Good
Filler Bit. Ratio	0.94	0.91	0.85	0.76	Pb Range Check	1.00
Gsb	2.608	2.608	2.608	2.608	Specification Check	Comply
Gse	2.671	2.669	2.671	2.664	TSR Check	
Pbe	4.52	4.68	5.02	5.62		
Pba	0.93	0.90	0.93	0.83		
% New Asphalt Binder	71.8	72.7	74.3	76.5		
Asphalt Binder Sp.Gr. @ 25c	1.028	1.028	1.028	1.028		
% Water Abs	1.78	1.78	1.78	1.78		
S.A. m ² / Kg.	5.22	5.22	5.22	5.22		
% + 4 Type 4 Agg. Or Better	67.9	67.9	67.9	67.9		
% + 4 Type 2 or 3 Agg.	0.0	0.0	0.0	0.0		
Angularity-method A						
% Flat & Elongated	1.3	1.3	1.3	1.3		
Sand Equivalent	87	87	87	87		

Disposition: An asphalt content of 5.56% is recommended to start this project.
 Data shown in 5.56% column is interpolated from test data.
 The % ADD AC to start project is 4.0%

Comments:

Copies to: Des Moines Asphalt & P

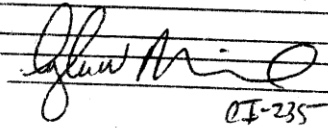
Mix Designer & Cert.#: Douglas Morton CI-235
 Signed:  CI-235

Field Mix 1 Job Mix Formula- WMA Additive is Evotherm 3G

9-9-09
 Form 956 ver. 7.0
 5.400 WMA
 9-9-09

6.2%
 6.8%
 5.8
 9.309
 9-9-09

FM2

Iowa Department of Transportation
 Highway Division - Office of Materials
 HMA Gyratory Mix Design

County : Floyd Project : NHSX-218-9(129)--3H-34 Mix No. : ABD9-2056R2
 Mix Size (in.) : 1/2 Type A Contractor : Mathy Contract No. : 34-2189-129
 Mix Type : HMA 10M L-2 Design Life ESAL's : 5,641,440 Date Reported : 09/01/09
 Intended Use : Surface Project Location : On US 218, Charles City Bypass

Aggregate	% in Mix	Source ID	Source Location	Bed	Gsb	%Abs	FAA
1/2" X 4 Quartzite	9.0%	AMN008	New Ulm Quartzite Quarry		2.620	0.72	45.0
1/2' ACC Stone	31.0%	A34008	Greene Limestone - Warnholtz	17 & 18	2.606	2.45	45.0
Man Sand	26.0%	A34008	Greene Limestone - Warnholtz	17 & 18	2.705	1.41	45.0
Concrete Sand	17.0%	A34516	Greene L.S. - Cedar Acres Resorts		2.606	0.76	38.0
RAP	17.0%	Hwy 218	*2RAP09-06 (4.63%)	**75%	2.635	1.65	42.4

Job Mix Formula - Combined Gradation (Sieve Size in.)

1"	3/4"	1/2"	3/8"	#4	#8	#16	#30	#50	#100	#200
Upper Tolerance										
100	100	100	94	72	53		24			6.7
100	100	95	87	65	48	32	20	8.8	5.8	4.7
100	100	88	80	58	43		16			2.7
Lower Tolerance										

Asphalt Binder Source and Grade: MIF @ LaCrosse PG 64-28
 Gyratory Data

	5.85	6.20	6.63	6.70	7.20	
% Asphalt Binder	5.85	6.20	6.63	6.70	7.20	Number of Gyriations
Corrected Gmb @ N-Des.	2.297	2.315	2.332	2.335	2.345	N-Initial
Max. Sp.Gr. (Gmm)	2.459	2.444	2.429	2.427	2.412	8
% Gmm @ N- Initial	85.3	87.3	88.3	88.4	89.6	N-Design
%Gmm @ N-Max	94.4	95.7	97.1	97.3	98.2	96
% Air Voids	6.6	5.3	4.0	3.8	2.8	N-Max
% VMA	18.0	17.7	17.4	17.4	17.5	152
% VFA	63.4	70.1	77.1	78.2	84.1	Gsb for Angularity
Film Thickness	10.31	11.12	11.97	12.11	13.02	Method A
Filler Bit. Ratio	0.92	0.85	0.79	0.78	0.73	2.649
Gsb	2.637	2.637	2.637	2.637	2.637	Pba / %Abs Ratio
Gsc	2.691	2.687	2.690	2.688	2.692	0.48
Pbe	5.11	5.52	5.94	6.01	6.46	Slope of Compaction
Pba	0.78	0.73	0.76	0.74	0.80	Curve
% New Asphalt Binder	87.2	88.0	88.8	89.0	89.8	14.5
Asphalt Binder Sp.Gr. @ 25c	1.031	1.031	1.031	1.031	1.031	Mix Gmm Linearity
% Water Abs	1.60	1.60	1.60	1.60	1.60	Excellent
S.A. m ² / Kg.	4.96	4.96	4.96	4.96	4.96	Pb Range Check
% + 4 Type 4 Agg. Or Better	80.5	80.5	80.5	80.5	80.5	1.35
% + 4 Type 2 or 3 Agg.	24.7	24.7	24.7	24.7	24.7	Specification Check
Angularity-method A	44	44	44	44	44	OUT Does Not Comply
% Flat & Elongated	1.3	1.3	1.3	1.3	1.3	TSR Check
Sand Equivalent	83	83	83	83	83	

Disposition : An asphalt content of 6.6% is recommended to start this project.
 Data shown in 6.63% column is interpolated from test data.
 The % ADD AC to start project is 5.9%
 Comments : Final acceptance based on plant produced HMA. **% binder in RAP, *** crushed particles in RAP.
 % VFA is within specifications.

Copies to : Mathy Britt RCE HMA Tech. L. Wolff
 Lab (2) File
 Mix Designer & Cert.# : John Jorgenson EC 186 Signed : Jon Kleven

Field Mix 2 Job Mix Formula- WMA Additive is Revix

Form 956 ver. 7.0

Iowa Department of Transportation

Highway Division - Office of Materials
HMA Gyratory Mix Design

FM 3 Gmm = 2.44

County : Cherokee Project : STP-143-1(4)-2C-18 Mix No. : ABD9-3030
 Mix Size (in.) : 1/2 Type A Contractor : Tri State Contract No. : 18-1431-004
 Mix Type : HMA 3M L-4 Design Life ESAL's : 3M Date Reported : 08/31/09
 Intended Use : Surface Project Location : Ia143 from Marcus N. to Ia10

Aggregate	% in Mix	Source ID	Source Location	Beds	Gsb	%Abs	FAA
#4x#20 CM	30.0%	ASD004	Concrete Materials		2.607	0.69	47.0
1/2" cr. Grav. Ash	24.0%	A72534	Hallett, Ashton Sievert		2.620	1.93	47.0
1/2" to #4MR	8.0%	ASD006	Myrl & Roy		2.621	0.80	47.0
3/4" scr. Grav.	10.0%	A72534	Hallett, Ashton Sievert		2.600	1.85	41.0
sand Ash	8.0%	A72534	Hallett, Ashton Sievert		2.624	1.15	41.0
RAP	20.0%	ABC9-32	Hwy 18, Sioux Co.		2.643	0.35	43.7

Job Mix Formula - Combined Gradation (Sieve Size in.)

1"	3/4"	1/2"	3/8"	#4	#8	#16	#30	#50	#100	#200
Upper Tolerance										
100	100	99	89	69	41		18			6.1
100	100	92	82	62	36	21	14	8.5	5.3	4.1
100	100	85	75	55	31		10			2.1
Lower Tolerance										

Asphalt Binder Source and Grade: **Jebro, Sioux City PG64-22**

	Gyratory Data				
	5.00	5.50	5.71	6.00	
% Asphalt Binder	5.00	5.50	5.71	6.00	<u>Number of Gyration</u>
Corrected Gmb @ N-Des.	2.310	2.353	2.360	2.369	
Max. Sp.Gr. (Gmm)	2.483	2.469	2.458	2.444	7
% Gmm @ N-Initial	84.6	86.4	87.0	87.9	N-Design
%Gmm @ N-Max	94.2	96.5	97.2	98.1	86
% Air Voids	7.0	4.7	4.0	3.1	N-Max
% VMA	16.2	15.1	15.0	15.0	134
% VFA	57.0	68.9	73.4	79.5	<u>Gsb for Angularity</u>
Film Thickness	9.77	10.77	11.41	12.26	<u>Method A</u>
Filler Bit. Ratio	1.00	0.91	0.86	0.80	2.612
Gsb	2.619	2.619	2.619	2.619	<u>Pba / %Abs Ratio</u>
Gse	2.682	2.688	2.683	2.679	0.87
Pbe	4.12	4.55	4.81	5.17	<u>Slope of Compaction</u>
Pba	0.92	1.01	0.94	0.88	<u>Curve</u>
% New Asphalt Binder	81.0	82.8	83.5	84.3	12.6
Asphalt Binder Sp.Gr. @ 25c	1.030	1.030	1.030	1.030	<u>Mix Gmm Linearity</u>
% Water Abs	1.08	1.08	1.08	1.08	Good
S.A. m ² / Kg.	4.22	4.22	4.22	4.22	<u>Pb Range Check</u>
% + 4 Type 4 Agg. Or Better	100.0	100.0	100.0	100.0	1.00
% + 4 Type 2 or 3 Agg.	93.4	93.4	93.4	93.4	<u>Specification Check</u>
Angularity-method A	44	44	44	44	Comply
% Flat & Elongated	1.7	1.7	1.7	1.7	<u>TSR Check</u>
Sand Equivalent	82	82	82	82	

Disposition : An asphalt content of 5.7% is recommended to start this project.
 Data shown in 5.71% column is interpolated from test data.
 The % ADD AC to start project is 4.8%

Comments :

Copies to : Tri State

Mix Designer & Cert.# :

T Huisman

CI-515

Signed :

Field Mix 3 Job Mix Formula- WMA Additive is Sasobit

Gmm = 2.5
FM4 - Johnston
Iowa Department of Transportation
 Highway Division-Office of Materials
 Proportion & Production Limits For Aggregates
Revised
Mix Design

Form 955 ver. 7.0

County: Polk Project No.: ESFM-CO77(168)-5S-77 Date: 05/01/09
 Project Location: _____ Mix Design No.: 1BD9-021Rev5
 Contract Mix Tonnage: _____ Course: Surface Mix Size (in.): 1/2
 Contractor: Des Moines Asphalt & Paving Mix Type: HMA 3M Design Life ESAL's: 3,000,000

Material	Ident #	% in Mix	Producer & Location	Type (A or B)	Friction Type	BeDs	Gsb	%Abs
1/2" cr. quartzite	ASD002	9.0%	Everest Dell Rapids, S.D.	A	2		2.647	0.29
3/8" chip	A85006	14.5%	M.M. Ames	A	4	47	2.669	0.78
man. sand	A85006	32.0%	M.M. Ames	A	4	47	2.679	0.80
sand	A77530	16.0%	Hallett, North Des Moines	A	4		2.658	0.66
3/4" chip	A85006	8.5%	M.M. Ames	A	4	47	2.675	0.79
RAP	RAP8-01	20.0%	Des Moines Asphalt				2.584	1.51

Type and Source of Asphalt Binder: PG64-22 Bituminous Materials

Material	Individual Aggregates Sieve Analysis - % Passing (Target)										
	1"	3/4"	1/2"	3/8"	#4	#8	#16	#30	#50	#100	#200
1/2" cr. quartzite	100	100	99	82	7.2	0.8	0.7	0.6	0.5	0.4	0.3
3/8" chip	100	100	100	95	30	4.0	2.0	1.8	1.2	1.1	1.0
man. sand	100	100	100	100	97	67	40	22	9.1	3.0	5.1
sand	100	100	100	100	96	86	67	40	10	10	0.4
3/4" chip	100	99	63	34	5.5	1.8	1.5	1.4	1.2	1.1	1.0
RAP	100	100	95	90	70	52	39	29	18	13	9.8

Preliminary Job Mix Formula Target Gradation											
Upper Tolerance	100	100	100	97	73	51		24			5.9
Comb Grading	100	100	96	90	66	46	32	20	8.4	3.9	3.9
Lower Tolerance	100	100	89	83	59	41		16			1.9
S.A. sq. m/kg	Total	4.43		+0.41	0.27	0.38	0.52	0.56	0.51	0.48	1.26

Sieve Size in.	Production Limits for Aggregates Approved by the Contractor & Producer											
	9.0% of mix 1/2" cr. quartzite		14.5% of mix 3/8" chip		32.0% of mix man. sand		16.0% of mix sand		8.5% of mix 3/4" chip		20.0% of mix RAP	
	Min	Max	Min	Max	Min	Max	Min	Max	Min	Max	Min	Max
1"	100.0	100.0	100.0	100.0	100.0	100.0	100.0	100.0	98.0	100.0		
3/4"	98.0	100.0	100.0	100.0	100.0	100.0	100.0	100.0	92.0	100.0		
1/2"	92.0	100.0	98.0	100.0	100.0	100.0	100.0	100.0	56.0	70.0		
3/8"	75.0	89.0	88.0	100.0	98.0	100.0	98.0	100.0	27.0	41.0		
#4	0.2	14.2	23.0	37.0	90.0	100.0	89.0	100.0	0.0	12.5		
#8	0.0	5.8	0.0	9.0	62.0	72.0	81.0	91.0	0.0	6.8		
#30	0.0	4.6	0.0	5.8	18.0	26.0	36.0	44.0	0.0	5.4		
#200	0.0	2.3	0.0	3.0	3.1	7.1	0.0	2.4	0.0	3.0		

Comments: _____
 Copies to: Des Moines Asphalt & Paving

The above target gradations and production limits have been discussed with and agreed to by an authorized representative of the aggregate producer.

Signed: _____
 Producer

Signed: _____
 Contractor

APPENDIX B: VOLUMETRICS

Highlighted blue lines indicate moisture conditioning

Table B-1: Field Mix 1 Dynamic Modulus Lab Compacted Samples

		#	Dry Weight (g)	Weight in Water (g)	SSD Weight (g)	G _{mb}	*G _{mm}	Pa (Percent Air Voids)
FM1: Dynamic Modulus Lab Compacted Samples	HMA	1	2681.7	1529.7	2689.4	2.31	2.46	5.96%
		2	2685.9	1536.6	2695.4	2.32	2.46	5.74%
		3	2681.9	1537.9	2694.2	2.32	2.46	5.68%
		4	2680.8	1537.7	2694.4	2.32	2.46	5.75%
		5	2679.8	1531.7	2688.4	2.32	2.46	5.78%
		6	2680.9	1534.0	2689.0	2.32	2.46	5.61%
		7	2680.8	1531.9	2689.4	2.32	2.46	5.81%
		8	2678.8	1532.3	2688.8	2.32	2.46	5.80%
		9	2687.4	1537.3	2695.0	2.32	2.46	5.60%
		10	2680.9	1531.9	2689.9	2.32	2.46	5.85%
	WMA	1	2685.7	1538.3	2695.9	2.32	2.46	5.65%
		2	2682.8	1536.0	2694.2	2.32	2.46	5.80%
		3	2684.8	1539.0	2698.5	2.32	2.46	5.84%
		4	2684.9	1542.9	2701.7	2.32	2.46	5.78%
		5	2684.5	1537.3	2695.8	2.32	2.46	5.77%
		6	2683.1	1538.7	2696.3	2.32	2.46	5.74%
		7	2684	1540.2	2696.1	2.32	2.46	5.57%
		8	2684	1540.8	2698.3	2.32	2.46	5.70%
		9	2684.7	1540.3	2696.1	2.32	2.46	5.54%
		10	2684.3	1544.4	2699.8	2.32	2.46	5.52%

Table B-2: Field Mix 1 ITS Laboratory Compacted Samples

		#	Dry Weight (g)	Weight in Water (g)	SSD Weight (g)	G _{mb}	*G _{mm}	Pa (Percent Air Voids)
Field Mix 1: ITS Lab Compacted Samples	HMA	1	1120.0	644.3	1122.6	2.34	2.46	4.77%
		2	1119.5	644.7	1123.3	2.34	2.46	4.88%
		3	1125.1	649.8	1129.1	2.35	2.46	4.54%
		4	1119.1	645.7	1123.0	2.34	2.46	4.65%
		5	1118.8	643.0	1123.2	2.33	2.46	5.25%
		6	1118.6	642.6	1121.6	2.34	2.46	5.03%
		7	1118.3	643.1	1121.0	2.34	2.46	4.84%
		8	1119.6	643.0	1123.2	2.33	2.46	5.18%
		9	1119.0	643.2	1122.3	2.34	2.46	5.02%
		10	1117.8	640.6	1120.2	2.33	2.46	5.22%
	WMA	1	1122.0	643.2	1124.2	2.33	2.46	5.14%
		2	1123.4	646.3	1125.6	2.34	2.46	4.68%
		3	1121.3	644.6	1125.1	2.33	2.46	5.10%
		4	1122.5	646.3	1125.5	2.34	2.46	4.74%
		5	1122.4	647.1	1126.6	2.34	2.46	4.81%
		6	1122.9	646.7	1126.3	2.34	2.46	4.79%
		7	1121.2	645.5	1124.5	2.34	2.46	4.81%
		8	1121.6	646.6	1124.7	2.35	2.46	4.60%
		9	1126.3	650.0	1129.7	2.35	2.46	4.52%
		10	1124.8	647.9	1127.0	2.35	2.46	4.52%

Table B-3: Field Mix 1 Dynamic Modulus Field Compacted Samples

		#	Dry Weight (g)	Weight in Water (g)	SSD Weight (g)	G_{mb}	* G_{mm}	Pa (Percent Air Voids)
		FM1: Dynamic Modulus Field Compacted Samples	HMA	1	2697.8	1538.4	2705.2	2.31
2	2698.2			1542.8	2707.6	2.32	2.46	5.80%
3	2693.8			1532.8	2700.7	2.31	2.46	6.20%
4	2692.4			1531.3	2698.5	2.31	2.46	6.19%
5	2688.8			1527.3	2696.4	2.30	2.46	6.47%
6	2690.9			1533.6	2701.3	2.30	2.46	6.29%
WMA	1		2714.7	1551.5	2720.1	2.32	2.46	5.53%
	2		2692.0	1533.2	2698.7	2.31	2.46	6.07%
	3		2740.0	1573.7	2743.9	2.34	2.46	4.78%
	4		2695.1	1539.6	2707.8	2.31	2.46	6.18%
	5		2714.1	1550.4	2719.2	2.32	2.46	5.57%
	6		2692.9	1529.5	2703.1	2.29	2.46	6.69%

Table B-4: Field Mix 2 Dynamic Modulus Laboratory Compacted Samples

	#	Dry Weight (g)	Weight in Water (g)	SSD Weight (g)	*G _{mm}	Pa (Percent Air Voids)	
FM2: Dynamic Modulus Laboratory Compacted Samples	HMA	1	2643.2	1499.3	2654.5	2.46	7.03%
		2	2646.7	1503.5	2656.3	2.46	6.71%
		3	2641.8	1493.8	2652.1	2.46	7.32%
		4	2640.9	1506.8	2658.6	2.46	6.83%
		5	2644.0	1506.3	2656.0	2.46	6.55%
		6	2641.0	1502.0	2651.9	2.46	6.68%
		7	2640.2	1496.8	2649.6	2.46	6.94%
		8	2639.1	1497.8	2652.2	2.46	7.11%
		9	2640.4	1502.1	2655.2	2.46	6.96%
		10	2647.0	1508.6	2662.0	2.46	6.75%
	WMA	1	2623.8	1484.3	2640.0	2.45	7.33%
		2	2628.7	1491.4	2645.9	2.45	7.06%
		3	2628.5	1490.9	2645.4	2.45	7.07%
		4	2629.2	1494.9	2648.6	2.45	6.98%
		5	2625.6	1489.8	2644.9	2.45	7.22%
		6	2627.7	1494.5	2647.8	2.45	7.00%
		7	2627.8	1499	2648.5	2.45	6.69%
		8	2627.2	1495.4	2648.2	2.45	6.98%
		9	2624.8	1492.6	2642.9	2.45	6.86%
		10	2629.1	1494.3	2648.2	2.45	7.00%

Table B-5: Field Mix 2 Indirect Tensile Strength Laboratory Compacted Samples

		#	Dry Weight (g)	Weight in Water (g)	SSD Weight (g)	G _{mm}	Pa (Percent Air Voids)
		FM2: Indirect Tensile Strength Laboratory Compacted Samples	HMA	1	1108.5	634.0	1112.2
2	1110.2			635.1	1113.1	2.46	5.59%
3	1100.1			627.0	1103.3	2.46	6.11%
4	1107.1			630.7	1110.2	2.46	6.14%
5	1111.0			637.6	1114.0	2.46	5.20%
6	1107.3			636.6	1110.5	2.46	5.02%
7	1108.2			635.2	1111.2	2.46	5.36%
8	1110.2			638.7	1113.1	2.46	4.87%
9	1109.9			637.4	1113.3	2.46	5.19%
10	1110.7			639.2	1115.6	2.46	5.23%
WMA	1		1125.5	647.7	1127.5	2.45	4.25%
	2		1126.3	649.6	1128.7	2.45	4.05%
	3		1125.1	647.2	1126.9	2.45	4.27%
	4		1124.5	649.2	1127.5	2.45	4.04%
	5		1126.1	646.7	1125.7	2.45	4.04%
	6		1126.4	650.1	1128.1	2.45	3.82%
	7		1125.3	648.2	1126.5	2.45	3.97%
	8		1124.7	646.8	1126.4	2.45	4.28%
	9		1126.4	649.7	1128.5	2.45	3.98%
	10		1124.5	648.5	1127	2.45	4.08%

Table B-6: Field Mix 2 Dynamic Modulus Field Compacted Samples

		#	Dry Weight (g)	Weight in Water (g)	SSD Weight (g)	*G _{mm}	Pa (Percent Air Voids)
		FM2: Dynamic Modulus Field Compacted Samples	HMA	1	2634.9	1498.4	2647.1
2	2638.7			1502.6	2653.4	2.46	6.79%
3	2647.0			1509.0	2659.8	2.46	6.50%
4	2651.3			1515.6	2667.1	2.46	6.40%
5	2639.2			1508.2	2657.2	2.46	6.63%
6	2650.5			1513.0	2661.0	2.46	6.15%
7	2642.2			1498.1	2647.8	2.46	6.58%
8	2646.5			1509.2	2654.8	2.46	6.09%
9	2646.5			1503.2	2653.9	2.46	6.51%
10	2645.0			1508.5	2657.2	2.46	6.40%
WMA	1		2645.5	1500.7	2661.0	2.45	6.94%
	2		2625.2	1486.5	2642.7	2.45	7.32%
	3		2632.7	1493.0	2649.5	2.45	7.08%
	4		2633.5	1494.0	2649.5	2.45	6.98%
	5		2625.6	1488.9	2644.4	2.45	7.25%
	6		2626.5	1496.1	2647.4	2.45	6.88%
	7		2631.4	1495	2648.3	2.45	6.87%
	8		2628.5	1491	2646.2	2.45	7.13%
	9		2627.5	1493.6	2647.4	2.45	7.05%
	10		2628.1	1491.9	2647.1	2.45	7.14%

Table B-7: Field Mix 2 Indirect Tensile Strength Field Compacted Samples

	#	Dry Weight (g)	Weight in Water (g)	SSD Weight (g)	*G _{mm}	Pa (Percent Air Voids)	
FM2: Indirect Tensile Strength Field Compacted Samples	HMA	1	1109.3	638.3	1112.0	2.46	4.81%
		2	1110.9	636.7	1113.4	2.46	5.27%
		3	1111.1	637.9	1113.8	2.46	5.09%
		4	1111.4	639.8	1114.9	2.46	4.91%
		5	1108.6	637.3	1112.9	2.46	5.25%
		6	1109.4	640.7	1113.9	2.46	4.70%
		7	1113.0	640.8	1114.7	2.46	4.53%
		8	1108.4	636.4	1110.9	2.46	5.04%
		9	1108.8	636.1	1110.7	2.46	5.03%
		10	1110.3	637.8	1112.5	2.46	4.92%
	WMA	1	1128.5	645.7	1133.2	2.45	5.52%
		2	1126.1	647.9	1129.3	2.45	4.52%
		3	1128.4	645.3	1132.2	2.45	5.41%
		4	1128.5	648.5	1130.9	2.45	4.52%
		5	1126.2	649.0	1128.6	2.45	4.15%
		6	1125.0	646.8	1127.0	2.45	4.38%
		7	1121.7	645.3	1124.4	2.45	4.44%
		8	1125.5	647.8	1127.7	2.45	4.27%
		9	1128.7	652	1130.8	2.45	3.78%
		10	1125.8	649.1	1128.3	2.45	4.11%

Table B-8: Field Mix 3 Dynamic Modulus Laboratory Compacted Samples

		#	Dry Weight (g)	Weight in Water (g)	SSD Weight (g)	G_{mb}	$*G_{mm}$	Pa (Percent Air Voids)
		FM3: Dynamic Modulus Laboratory Compacted Samples	HMA	1	2621.2	1488.9	2638.2	2.28
2	2620.6			1486.9	2636.4	2.28	2.44	6.57%
3	2618.5			1491.6	2642.7	2.27	2.44	6.77%
4	2619.1			1490.5	2638.3	2.28	2.44	6.48%
5	2620.7			1490.8	2638.9	2.28	2.44	6.45%
6	2621.8			1488.7	2640.9	2.28	2.44	6.74%
7	2619.2			1491.1	2639.2	2.28	2.44	6.50%
8	2616.6			1483.1	2634.1	2.27	2.44	6.83%
9	2622.5			1496.0	2641.0	2.29	2.44	6.13%
10	2623.7			1491.9	2641.7	2.28	2.44	6.48%
WMA	1		2618.2	1480.9	2633.4	2.27	2.44	6.90%
	2		2621.8	1484.5	2637.0	2.27	2.44	6.77%
	3		2619.2	1488.5	2636.3	2.28	2.44	6.48%
	4		2618.1	1485.3	2634.3	2.28	2.44	6.62%
	5		2619.7	1488.9	2637.3	2.28	2.44	6.51%
	6		2619.5	1489.2	2637.7	2.28	2.44	6.52%
	7		2617.8	1487.4	2634.6	2.28	2.44	6.48%
	8		2619.7	1488.7	2637.6	2.28	2.44	6.55%
	9		2619.3	1486.7	2636.1	2.28	2.44	6.60%
	10		2616.7	1487.4	2638.2	2.27	2.44	6.81%

Table B-9: Field Mix 3 Indirect Tensile Strength Laboratory Compacted Sample

		#	Dry Weight (g)	Weight in Water (g)	SSD Weight (g)	G_{mb}	* G_{mm}	Pa (Percent Air Voids)
		FM3: Indirect Tensile Strength Laboratory Compacted Samples	HMA	1	1102.6	629.2	1105.7	2.31
2	1101.7			628.6	1104.8	2.31	2.44	5.18%
3	1099.3			627.4	1103.1	2.31	2.44	5.29%
4	1100.0			629.4	1103.8	2.32	2.44	4.97%
5	1101.0			629.3	1104.3	2.32	2.44	5.00%
6	1101.2			629.8	1105.0	2.32	2.44	5.03%
7	1101.5			628.8	1105.5	2.31	2.44	5.30%
8	1100.7			629.6	1104.7	2.32	2.44	5.05%
9	1101.2			630.9	1105.0	2.32	2.44	4.81%
10	1099.8			628.3	1103.1	2.32	2.44	5.07%
WMA	1		1103.1	630.6	1105.8	2.32	2.44	4.86%
	2		1100.2	628.3	1104.4	2.31	2.44	5.29%
	3		1100.5	628.6	1104.5	2.31	2.44	5.23%
	4		1099.8	627.9	1104.1	2.31	2.44	5.35%
	5		1101.9	632.5	1107.8	2.32	2.44	4.99%
	6		1100.5	627.1	1104.1	2.31	2.44	5.45%
	7		1101.4	630	1106.4	2.31	2.44	5.25%
	8		1100.3	630.3	1106	2.31	2.44	5.20%
	9		1099.3	628.7	1103.5	2.32	2.44	5.11%
	10		1102.2	630	1106.8	2.31	2.44	5.26%

Table B-10: Field Mix 3: Dynamic Modulus Field Compacted Samples

		#	Dry Weight (g)	Weight in Water (g)	SSD Weight (g)	G _{mb}	*G _{mm}	Pa (Percent Air Voids)
		FM3: Dynamic Modulus Field Compacted Samples	HMA	1	2606.1	1471.0	2620.1	2.27
2	2609.5			1477.8	2627.9	2.27	2.44	7.01%
3	2605.3			1477.8	2628.6	2.26	2.44	7.22%
4	2610.0			1480.0	2628.8	2.27	2.44	6.89%
5	2607.9			1479.3	2630.1	2.27	2.44	7.12%
6	2604.1			1474.1	2623.9	2.26	2.44	7.18%
7	2622.5			1489.7	2639.5	2.28	2.44	6.52%
8	2605.1			1482.1	2631.3	2.27	2.44	7.10%
9	2607.2			1490.1	2636.1	2.28	2.44	6.76%
10	2613.8			1492.3	2638.6	2.28	2.44	6.55%
WMA	1		2617.8	1480.9	2629.8	2.28	2.44	6.62%
	2		2618.1	1482.6	2633.1	2.28	2.44	6.74%
	3		2605.6	1471.1	2620.4	2.27	2.44	7.09%
	4		2611.4	1484.7	2632.7	2.27	2.44	6.77%
	5		2606.2	1478.2	2625.3	2.27	2.44	6.89%
	6		2610.1	1480.7	2630.5	2.27	2.44	6.97%
	7		2610	1484.2	2630	2.28	2.44	6.64%
	8		2603	1475.8	2622.3	2.27	2.44	6.95%
	9		2611.8	1490.3	2636.5	2.28	2.44	6.61%
	10		2609.1	1488.1	2635.5	2.27	2.44	6.81%

Table B-11: Field Mix 3 Indirect Tensile Field Compacted Strength Samples

	#	Dry Weight (g)	Weight in Water (g)	SSD Weight (g)	G _{mb}	*G _{mm}	Pa (Percent Air Voids)	
FM3: Indirect Tensile Field Compacted Strength Samples	HMA	1	1089.2	619.5	1095.2	2.29	2.44	6.16%
		2	1109.6	634.2	1113.5	2.32	2.44	5.12%
		3	1088.8	618.2	1095.5	2.28	2.44	6.51%
		4	1085.5	616.9	1093.0	2.28	2.44	6.56%
		5	1091.4	617.9	1099.9	2.26	2.44	7.20%
		6	1088.5	613.9	1098.5	2.25	2.44	7.94%
		7	1087.0	608.2	1097.0	2.22	2.44	8.86%
		8	1092.0	622.0	1097.5	2.30	2.44	5.88%
		9	1091.0	621.8	1095.8	2.30	2.44	5.67%
		10	1090.6	622.6	1096.0	2.30	2.44	5.58%
	WMA	1	1088.7	617.8	1093.8	2.29	2.44	6.26%
		2	1088.3	619.0	1094.9	2.29	2.44	6.28%
		3	1083.1	616.2	1088.2	2.29	2.44	5.95%
		4	1091.4	621.3	1096.4	2.30	2.44	5.85%
		5	1089.0	621.4	1095.1	2.30	2.44	5.78%
		6	1087.5	619.1	1094.5	2.29	2.44	6.25%
		7	1089.9	620.5	1096.5	2.29	2.44	6.16%
		8	1088.8	622.2	1094.7	2.30	2.44	5.56%
		9	1093.1	631.6	1101	2.33	2.44	4.56%
		10	1100.8	630.7	1105	2.32	2.44	4.88%

Table B-12 Field Mix 4 Dynamic Modulus Laboratory Compacted Samples

	#	Dry Weight	Weight in Water	SSD Weight	G_{mb}	* G_{mm}	Pa (Percent Air Voids)	
		(g)	(g)	(g)				
FM4: Dynamic Modulus Laboratory Compacted Samples	HMA	1	2682.7	1532.6	2688.9	2.32	2.50	7.20%
		2	2683.9	1534.2	2690.0	2.32	2.50	7.12%
		3	2684.3	1534.6	2689.5	2.32	2.50	7.03%
		4	2682.7	1534.5	2689.2	2.32	2.50	7.07%
		5	2684.5	1535.6	2690.3	2.32	2.50	7.01%
		6	2685.0	1534.1	2690.4	2.32	2.50	7.12%
		7	2685.8	1537.6	2692.2	2.33	2.50	6.95%
		8	2684.5	1537.5	2692.1	2.33	2.50	7.00%
		9	2682.9	1534.7	2691.0	2.32	2.50	7.19%
		10	2683.9	1532.1	2689.3	2.32	2.50	7.23%
	WMA	1	2687.7	1541.2	2698.2	2.32	2.50	7.08%
		2	2686.7	1547.2	2701.6	2.33	2.50	6.91%
		3	2684.2	1542.2	2699.4	2.32	2.50	7.22%
		4	2689.5	1550.4	2703.5	2.33	2.50	6.70%
		5	2683.4	1547.1	2700.3	2.33	2.50	6.92%
		6	2686.0	1540.4	2696.1	2.32	2.50	7.03%
		7	2684.7	1548.6	2702	2.33	2.50	6.89%
		8	2683.9	1544.1	2696.7	2.33	2.50	6.86%
		9	2684.8	1541.7	2696	2.33	2.50	6.96%
		10	2683.9	1547.3	2700.2	2.33	2.50	6.88%

Table B-13: Field Mix 4 Indirect Tensile Strength Laboratory Compacted Samples

		#	Dry Weight (g)	Weight in Water (g)	SSD Weight (g)	G_{mb}	* G_{mm}	Pa (Percent Air Voids)
		FM4: Indirect Tensile Strength Laboratory Compacted Samples	HMA	1	1119.2	643.8	1120.8	2.35
2	1120.1			645.8	1120.9	2.36	2.50	5.70%
3	1117.8			644.0	1119.3	2.35	2.50	5.93%
4	1118.3			644.2	1119.7	2.35	2.50	5.93%
5	1118.8			643.5	1119.9	2.35	2.50	6.06%
6	1120.0			645.4	1121.5	2.35	2.50	5.90%
7	1119.3			645.8	1120.8	2.36	2.50	5.74%
8	1117.7			644.1	1120.0	2.35	2.50	6.06%
9	1119.3			646.2	1121.0	2.36	2.50	5.70%
10	1118.3			644.1	1120.3	2.35	2.50	6.06%
WMA	1		1119.2	644.5	1122.6	2.34	2.50	6.36%
	2		1118.3	644.2	1120.8	2.35	2.50	6.14%
	3		1119.2	645.2	1121.6	2.35	2.50	6.03%
	4		1118.7	645.2	1122.0	2.35	2.50	6.15%
	5		1120.2	646.6	1123.7	2.35	2.50	6.08%
	6		1119.1	646.3	1122.9	2.35	2.50	6.08%
	7		1119.2	645.2	1122.8	2.34	2.50	6.26%
	8		1119	645.1	1121.9	2.35	2.50	6.12%
	9		1119.9	646.5	1122.6	2.35	2.50	5.91%
	10		1119.3	647	1122.7	2.35	2.50	5.88%

Table B-14: Field Mix 4 Dynamic Modulus Field Compacted Samples

		#	Dry Weight (g)	Weight in Water (g)	SSD Weight (g)	G_{mb}	* G_{mm}	Pa (Percent Air Voids)
		FM4: Dynamic Modulus Field Compacted Samples	HMA	1	2686.9	1541.5	2698.5	2.32
2	2680.7			1538.9	2693.3	2.32	2.50	7.11%
3	2681.4			1538.0	2693.7	2.32	2.50	7.19%
4	2686.1			1542.6	2698.1	2.32	2.50	7.02%
5	2685.6			1541.1	2695.7	2.33	2.50	6.96%
6	2681.9			1535.1	2692.8	2.32	2.50	7.34%
7	2683.9			1538.4	2693.1	2.32	2.50	7.03%
8	2681.5			1536.0	2690.9	2.32	2.50	7.13%
9	2684.3			1542.1	2696.3	2.33	2.50	6.97%
10	2679.5			1536.7	2693.1	2.32	2.50	7.32%
WMA	1		2685.7	1545.7	2702.4	2.32	2.50	7.13%
	2		2687.1	1550.8	2708.5	2.32	2.50	7.16%
	3		2687.6	1550.9	2709.1	2.32	2.50	7.18%
	4		2686.0	1545.5	2705.5	2.32	2.50	7.38%
	5		2686.5	1546.4	2705.3	2.32	2.50	7.27%
	6		2683.9	1548.9	2704.0	2.32	2.50	7.06%

Table B-15: Field Mix 4 Indirect Tensile Strength Field Compacted Samples

	#	Dry Weight	Weight in Water	SSD Weight	G_{mb}	* G_{mm}	Pa (Percent Air Voids)	
		(g)	(g)	(g)				
FM4 : Indirect Tensile Strength Field Compacted Samples	HMA	1	1119.6	645.2	1123.6	2.34	2.50	6.39%
		2	1117.3	641.7	1119.8	2.34	2.50	6.52%
		3	1119.2	643.8	1123.0	2.34	2.50	6.58%
		4	1120.6	643.9	1123.3	2.34	2.50	6.50%
		5	1119.8	644.7	1122.1	2.35	2.50	6.18%
		6	1117.7	642.1	1120.4	2.34	2.50	6.53%
		7	1115.9	641.7	1119.1	2.34	2.50	6.50%
		8	1116.1	642.4	1119.7	2.34	2.50	6.47%
		9	1119.0	644.8	1122.3	2.34	2.50	6.26%
		10	1118.3	645.8	1123.7	2.34	2.50	6.40%
	WMA	1	1116.7	646.8	1121.6	2.35	2.50	5.92%
		2	1116.8	646.3	1121.1	2.35	2.50	5.91%
		3	1117.7	646.5	1122.6	2.35	2.50	6.10%
		4	1119.2	648.8	1123.2	2.36	2.50	5.63%
		5	1118.0	646.1	1124.1	2.34	2.50	6.44%
		6	1118.0	647.6	1123.5	2.35	2.50	6.03%

APPENDIX C: INDIRECT TENSILE STRENGTH AND TENSILE STRENGTH RATIO DATA

Table C-1: Field Mix 1 WMA Indirect Tensile Strength and Tensile Strength Ratio Data

Sample Identification	Moisture Conditioned Samples					Unconditioned Samples				
	FM1 W9 L	FM1 W8 L	FM1W4 L	FM1 W5 L	FM1 W3 L	FM1 W10 L	FM1 W2 L	FM1 W6 L	FM1 W7 L	FM1 W1 L
Diameter (D), mm	100	100	100	100	100	100	100	100	100	100
Thickness (t), mm	62.3	62.3	62.3	62.4	62.5	62.39	62.37	62.27	62.45	62.42
Dry Mass in Air (A), g	1124.8	1121.6	1122.5	1122.4	1121.3	1124.8	1123.4	1122.9	1121.2	1122
SSD Mass (B), g	1127	1124.7	1125.5	1126.6	1125.1	1127	1125.6	1126.3	1124.5	1124.2
Submerged Mass (C), g	647.9	646.6	646.3	647.1	644.3	647.9	646.3	646.7	645.5	643.2
Volume (E=B-C), cm ³	479.1	478.1	479.2	479.5	480.8	479.1	479.3	479.6	479	481
Bulk specific Gravity ($G_{mb} = A/E$)	2.35	2.35	2.34	2.34	2.33	2.35	2.34	2.34	2.34	2.33
Maximum Specific Gravity (G_{mm})	2.46	2.46	2.46	2.46	2.46	2.46	2.46	2.46	2.46	2.46
% Air Voids [$P_a = 100 (G_{mm} - G_{mb}) / G_{mm}$]	4.56	4.64	4.78	4.85	5.20	4.52	4.68	4.79	4.81	5.14
Volume of Air Voids ($V_a = P_a E / 100$), cm ³	21.86	22.17	22.90	23.24	24.99	21.68	22.45	22.95	23.04	24.72
Vacuum Saturation Conditions										
SSD Mass, g	1143.00	1139.30	1139.80	1140.70	1139.10	Not Applicable				
Volume of Absorbed Water, cm ³	16.70	17.70	17.30	18.30	17.80					
% Saturation	75.72	79.86	75.55	78.74	71.24					
Tensile Strength Calculations										
Failure Load, N	11,498	10,877	10,697	9,888	9,455	10,275	10,033	9,992	10,103	10,279
Dry Strength [$2000P/\pi tD$], kPa (psi)						1,048	1,024	1,021	1,030	1,048
Wet Strength [$2000P'/\pi t'D$] (psi)	1,174	1,112	1,093	1,009	964					
TSR (S_2/S_1)	1.12	1.09	1.07	0.98	0.92					
Average Strength	10,483					10,136				
Average TSR	1.03									

Table C-2: Field Mix 1 HMA Indirect Tensile Strength and Tensile Strength Ratio Data

Sample Identification	Moisture Conditioned Samples					Unconditioned Samples				
	FM1 H3 L	FM1 H1 L	FM1 H2 L	FM1 H6 L	FM1 H10 L	FM1 H4 L	FM1 H7 L	FM1 H9 L	FM1 H8 L	FM1 H5 L
Diameter (D), mm	100	100	100	100	100	100	100	100	100	100
Thickness (t), mm	62.5	62.5	62.4	62.4	62.4	62.4	62.4	62.3	62.4	62.4
Dry Mass in Air (A), g	1125.1	1120	1119.5	1118.6	1117.8	1119.1	1118.3	1119	1119.6	1118.8
SSD Mass (B), g	1129.1	1122.6	1123.3	1121.6	1120.2	1123	1121	1122.3	1123.2	1123.2
Submerged Mass (C), g	649.8	644.3	644.7	642.6	640.6	645.7	643.1	643.2	643	643
Volume (E=B-C), cm ³	479.3	478.3	478.6	479	479.6	477.3	477.9	479.1	480.2	480.2
Bulk specific Gravity ($G_{mb} = A/E$)	2.35	2.34	2.34	2.34	2.33	2.34	2.34	2.34	2.33	2.33
Maximum Specific Gravity (G_{mm})	2.46	2.46	2.46	2.46	2.46	2.46	2.46	2.46	2.46	2.46
% Air Voids [$P_a = 100 (G_{mm} - G_{mb}) / G_{mm}$]	4.58	4.81	4.91	5.07	5.26	4.65	4.84	5.02	5.18	5.25
Volume of Air Voids ($V_a = P_a E / 100$), cm ³	21.94	23.02	23.52	24.28	25.21	22.20	23.12	24.04	24.89	25.22
Vacuum Saturation Conditions										
SSD Mass, g	1141.30	1137.30	1136.70	1137.90	1136.60	Not Applicable				
Volume of Absorbed Water, cm ³	16.20	17.30	17.20	19.30	18.80					
% Saturation	73.83	75.17	73.13	79.47	74.57					
Tensile Strength Calculations										
Failure Load, N	15,422	13,976	13,844	11,851	11,105	14,293	10,371	10,692	10,670	14,379
Dry Strength [$2000P / \pi t D$], kPa (psi)						1,458	1,058	1,093	1,088	1,467
Wet Strength [2000P'/ $\pi t' D$] (psi)	1572.05	1423.58	1412.93	1209.97	1132.54					
TSR (S_2/S_1)	1.08	1.35	1.29	1.11	0.77					
Average Strength	13239.60					12,081				
Average TSR	1.12									

Table C-3: Field Mix 2 WMA Lab Compacted Indirect Tensile Strength and Tensile Strength Ratio Data

Sample Identification	Moisture Conditioned Samples					Unconditioned Samples				
	FM2 W6 L	FM2 W4 L	FM2 W2 L	FM2 W8 L	FM2 W1 L	FM2 W7 L	FM2 W9 L	FM2 W5 L	FM2 W3 L	FM2 W10 L
Diameter (D), mm	100	100	100	100	100	100	100	100	100	100
Thickness (t), mm	100.00	100.00	100.00	100.00	100.00	62.2	62.5	62.5	62.5	62.5
Dry Mass in Air (A), g	1126.4	1124.5	1126.3	1124.7	1124.5	1125.3	1126.4	1125	1125.1	1124.5
SSD Mass (B), g	1128.1	1127.5	1128.7	1126.4	1127	1126.5	1128.5	1127	1126.9	1127
Submerged Mass (C), g	650.1	649.2	649.6	646.8	648.5	648.2	649.7	646.7	647.2	648.5
Volume (E=B-C), cm ³	478	478.3	479.1	479.6	478.5	478.3	478.8	480.3	479.7	478.5
Bulk specific Gravity ($G_{mb} = A/E$)	2.36	2.35	2.35	2.35	2.35	2.35	2.35	2.34	2.35	2.35
Maximum Specific Gravity (G_{mm})	2.45	2.45	2.45	2.45	2.45	2.45	2.45	2.45	2.45	2.45
% Air Voids [$P_a = 100 (G_{mm} - G_{mb})/G_{mm}$]	3.82	4.04	4.05	4.28	4.08	3.97	3.98	4.40	4.27	4.08
Volume of Air Voids ($V_a = P_a E/100$), cm ³	18.24	19.32	19.39	20.54	19.52	18.99	19.04	21.12	20.48	19.52
Vacuum Saturation Conditions										
SSD Mass, g	1139.7	1139.9	1141.1	1140.2	1139.4	Not Applicable				
Volume of Absorbed Water, cm ³	13.3	15.4	14.8	15.5	14.9					
% Saturation	72.9	79.7	76.3	75.5	76.3					
Tensile Strength Calculations										
Failure Load, N	8559.00	7859.00	7450.00	8075.00	7460.00	9,399	9,478	8,774	8,170	8,876
Dry Strength [$2000P/\pi t^2 D$], kPa (psi)						962.71	965.78	894.14	832.46	904.05
Wet Strength [$2000P/\pi t^2 D$] (psi)	871.16	801.02	757.76	822.12	759.18					
TSR (S_2/S_1)	0.90	0.83	0.85	0.99	0.84					
Average Strength	7881					8939				
Average TSR	0.88									

Table C-4: Field Mix 2 HMA Lab Compacted Indirect Tensile Strength and Tensile Strength Ratio Data

	Moisture Conditioned Samples					Unconditioned Samples				
Sample Identification	FM2 H8 L	FM2 H9 L	FM2 H10 L	FM2 H2 L	FM2 H3 L	FM2 H6 L	FM2 H5 L	FM2 H7 L	FM2 H1 L	FM2 H4 L
Diameter (D), mm	100	100	100	100	100	100	100	100	100	100
Thickness (t), mm	100.00	100.00	100.00	100.00	100.00	62.4	62.4	62.6	62.5	62.6
Dry Mass in Air (A), g	1110.2	1109.9	1110.7	1110.2	1100.1	1107.3	1111	1108.2	1108.5	1107.1
SSD Mass (B), g	1113.1	1113.3	1115.6	1113.1	1103.3	1110.5	1114	1111.2	1112.2	1110.2
Submerged Mass (C), g	638.7	637.4	639.2	635.1	627	636.6	637.3	635.2	634	630.7
Volume (E=B-C), cm ³	474.4	475.9	476.4	478	476.3	473.9	476.7	476	478.2	479.5
Bulk specific Gravity ($G_{mb} = A/E$)	2.34	2.33	2.33	2.32	2.31	2.34	2.33	2.33	2.32	2.31
Maximum Specific Gravity (G_{mm})	2.46	2.46	2.46	2.46	2.46	2.46	2.46	2.46	2.46	2.46
% Air Voids [$P_a = 100 (G_{mm} - G_{mb}) / G_{mm}$]	4.87	5.19	5.23	5.59	6.11	5.02	5.26	5.36	5.77	6.14
Volume of Air Voids ($V_a = P_a E / 100$), cm ³	23.10	24.72	24.90	26.70	29.10	23.78	25.07	25.51	27.59	29.46
Vacuum Saturation Conditions										
SSD Mass, g	1128.10	1129.50	1129.40	1131.40	1123.10	Not Applicable				
Volume of Absorbed Water, cm ³	17.90	19.60	18.70	21.20	23.00					
% Saturation	77.49	79.28	75.11	79.40	79.02					
Tensile Strength Calculations										
Failure Load, N	7,753	7,436	7,707	7,034	6,894	8,382	8,508	7,887	7,784	7,127
Dry Strength [$2000P/\pi tD$], kPa (psi)						855	867	803	793	725
Wet Strength [2000P'/ $\pi t'D$] (psi)	789	756	785	713	702					
TSR (S_2/S_1)	0.92	0.87	0.98	0.90	0.97					
Average Strength	7365					7938				
Average TSR	0.93									

Table C-5: Field Mix 2 WMA Field Compacted Indirect Tensile Strength and Tensile Strength Ratio Data

Sample Identification	Moisture Conditioned Samples					Unconditioned Samples				
	FM2 W9 F	FM2 W5 F	FM2 W6 F	FM2 W4 F	FM2 W3 F	FM2 W10 F	FM2 W8 F	FM2 W7 F	FM2 W2 F	FM2 W1 F
Diameter (D), mm	100	100	100	100	100	100	100	100	100	100
Thickness (t), mm	62.4	62.3	62.4	62.9	63.1	62.5	62.4	62.4	62.6	63.7
Dry Mass in Air (A), g	1128.7	1126.2	1125	1128.5	1128.4	1125.8	1125.5	1121.7	1126.1	1128.5
SSD Mass (B), g	1130.8	1128.6	1127	1130.9	1132.2	1128.3	1127.7	1124.4	1129.3	1133.2
Submerged Mass (C), g	652	649	646.8	648.5	645.3	649.1	647.8	645.3	647.9	645.7
Volume (E=B-C), cm ³	478.8	479.6	480.2	482.4	486.9	479.2	479.9	479.1	481.4	487.5
Bulk specific Gravity ($G_{mb} = A/E$)	2.36	2.35	2.34	2.34	2.32	2.35	2.35	2.34	2.34	2.31
Maximum Specific Gravity (G_{mm})	2.45	2.45	2.45	2.45	2.45	2.45	2.45	2.45	2.45	2.45
% Air Voids [$P_a = 100 (G_{mm} - G_{mb})/G_{mm}$]	3.78	4.15	4.38	4.52	5.41	4.11	4.27	4.44	4.52	5.52
Volume of Air Voids ($V_a = P_a E/100$), cm ³	18.11	19.93	21.02	21.79	26.33	19.69	20.51	21.26	21.77	26.89
Vacuum Saturation Conditions										
SSD Mass, g	1142.20	1141.50	1141.50	1145.60	1148.70	Not Applicable				
Volume of Absorbed Water, cm ³	13.50	15.30	16.50	17.10	20.30					
% Saturation	74.56	76.78	78.51	78.48	77.10					
Tensile Strength Calculations										
Failure Load, N	7704.00	7617.00	6945.00	6243.00	6642.00	8,720	8,489	7,986	8,228	7,274
Dry Strength [2000P/πD], kPa (psi)						888.54	865.98	815.10	836.89	727.16
Wet Strength [2000P'/πt'D] (psi)	786.02	777.81	708.21	631.93	670.26					
TSR (S_2/S_1)	0.88	0.90	0.87	0.76	0.92					
Average Strength	7030					8139				
Average TSR	0.87									

Table C-6: Field Mix 2 HMA Field Compacted Indirect Tensile Strength and Tensile Strength Ratio Data

Sample Identification	Moisture Conditioned Samples					Unconditioned Samples				
	FM2 H7 F	FM2 H1 F	FM2 H10 F	FM2 H8 F	FM2 H5 F	FM2 H6 F	FM2 H4 F	FM2 H9 F	FM2 H3 F	FM2 H2 F
Diameter (D), mm	100	100	100	100	100	100	100	100	100	100
Thickness (t), mm	62.5	62.4	62.5	62.4	62.6	62.52	62.46	62.41	62.40	62.42
Dry Mass in Air (A), g	1113	1109.3	1110.3	1108.4	1108.6	1109.4	1111.4	1108.8	1111.1	1110.9
SSD Mass (B), g	1114.7	1112	1112.5	1110.9	1112.9	1113.9	1114.9	1110.7	1113.8	1113.4
Submerged Mass (C), g	640.8	638.3	637.8	636.4	637.3	640.7	639.8	636.1	637.9	636.7
Volume (E=B-C), cm ³	473.9	473.7	474.7	474.5	475.6	473.2	475.1	474.6	475.9	476.7
Bulk specific Gravity ($G_{mb} = A/E$)	2.35	2.34	2.34	2.34	2.33	2.34	2.34	2.34	2.33	2.33
Maximum Specific Gravity (G_{mm})	2.46	2.46	2.46	2.46	2.46	2.46	2.46	2.46	2.46	2.46
% Air Voids [$P_a = 100 (G_{mm} - G_{mb}) / G_{mm}$]	4.53	4.81	4.92	5.04	5.25	4.70	4.91	5.03	5.09	5.27
Volume of Air Voids ($V_a = P_a E / 100$), cm ³	21.46	22.77	23.36	23.93	24.95	22.22	23.31	23.87	24.23	25.11
Vacuum Saturation Conditions										
SSD Mass, g	1129.20	1127.10	1128.60	1127.50	1128.30	Not Applicable				
Volume of Absorbed Water, cm ³	16.20	17.80	18.30	19.10	19.70					
% Saturation	75.49	78.19	78.34	79.81	78.96					
Tensile Strength Calculations										
Failure Load, N	8119.00	6362.00	7721.00	7485.00	7506.00	7,422	7,242	7,853	7,022	6,944
Dry Strength [$2000P/\pi tD$], kPa (psi)						755.76	738.14	801.01	716.36	708.22
Wet Strength [2000P'/ $\pi t'D$] (psi)	826.77	648.62	786.37	763.35	763.78					
TSR (S_2/S_1)	1.09	0.88	0.98	1.07	1.08					
Average Strength	7439					7297				
Average TSR	1.02									

Table C-7: Field Mix 3 WMA Laboratory Compacted Indirect Tensile Strength and Tensile Strength Ratio Data

Sample Identification	Moisture Conditioned Samples					Unconditioned Samples				
	FM3 W1 L	FM3 W9 L	FM3 W3 L	FM3 W10 L	FM3 W4 L	FM3 W5 L	FM3 W8 L	FM3 W7 L	FM3 W2 L	FM3 W6 L
Diameter (D), mm	100	100	100	100	100	100	100	100	100	100
Thickness (t), mm	62.5	62.5	62.6	62.5	62.6	62.5	62.5	62.5	62.4	62.5
Dry Mass in Air (A), g	1103.1	1099.3	1100.5	1102.2	1099.8	1101.9	1100.3	1101.4	1100.2	1100.5
SSD Mass (B), g	1105.8	1103.5	1104.5	1106.8	1104.1	1107.8	1106	1106.4	1104.4	1104.1
Submerged Mass (C), g	630.6	628.7	628.6	630	627.9	632.5	630.3	630	628.3	627.1
Volume (E=B-C), cm ³	475.2	474.8	475.9	476.8	476.2	475.3	475.7	476.4	476.1	477
Bulk specific Gravity ($G_{mb} = A/E$)	2.32	2.32	2.31	2.31	2.31	2.32	2.31	2.31	2.31	2.31
Maximum Specific Gravity (G_{mm})	2.44	2.44	2.44	2.44	2.44	2.44	2.44	2.44	2.44	2.44
% Air Voids [$P_a = 100 (G_{mm} - G_{mb}) / G_{mm}$]	4.86	5.11	5.23	5.26	5.35	4.99	5.20	5.25	5.29	5.45
Volume of Air Voids ($V_a = P_a E / 100$), cm ³	23.11	24.27	24.88	25.08	25.46	23.70	24.76	25.01	25.20	25.98
Vacuum Saturation Conditions										
SSD Mass, g	1120.70	1117.10	1119.90	1122.10	1119.70	Not Applicable				
Volume of Absorbed Water, cm ³	17.60	17.80	19.40	19.90	19.90					
% Saturation	76.16	73.35	77.99	79.35	78.15					
Tensile Strength Calculations										
Failure Load, N	7500	7820	8246	7300	7714	8,118	8,659	8,466	8,318	8,750
Dry Strength [2000P/πtD], kPa (psi)						827.25	882.56	862.62	848.71	891.03
Wet Strength [2000P'/πt'D] (psi)	764.23	796.67	839.08	743.37	784.70					
TSR (S_2/S_1)	0.92	0.90	0.97	0.88	0.88					
Average Strength	7716					8,462				
Average TSR	0.91									

Table C-8: Field Mix 3 WMA Laboratory Compacted Indirect Tensile Strength and Tensile Strength Ratio Data

Sample Identification	Moisture Conditioned Samples					Unconditioned Samples				
	FM3 H9 L	FM3 H5 L	FM3 H8 L	FM3 H1 L	FM3 H3 L	FM3 H4 L	FM3 H6 L	FM3 H10 L	FM3 H2 L	FM3 H7 L
Diameter (D), mm	100	100	100	100	100	100	100	100	100	100
Thickness (t), mm	62.5	62.4	62.5	62.5	62.5	100.00	100.00	100.00	100.00	100.00
Dry Mass in Air (A), g	1101.2	1101	1100.7	1102.6	1101.5	1100	1101.2	1099.8	1101.7	1101.5
SSD Mass (B), g	1105	1104.3	1104.7	1105.7	1105.5	1103.8	1105	1103.1	1104.8	1105.5
Submerged Mass (C), g	630.9	629.3	629.6	629.2	628.8	629.4	629.8	628.3	628.6	628.8
Volume (E=B-C), cm ³	474.1	475	475.1	476.5	476.7	474.4	475.2	474.8	476.2	476.7
Bulk specific Gravity ($G_{mb} = A/E$)	2.32	2.32	2.32	2.31	2.31	2.32	2.32	2.32	2.31	2.31
Maximum Specific Gravity (G_{mm})	2.44	2.44	2.44	2.44	2.44	2.44	2.44	2.44	2.44	2.44
% Air Voids [$P_a = 100 (G_{mm} - G_{mb}) / G_{mm}$]	4.81	5.00	5.05	5.17	5.30	4.97	5.03	5.07	5.18	5.30
Volume of Air Voids ($V_a = P_a E / 100$), cm ³	22.79	23.77	23.99	24.61	25.27	23.58	23.89	24.06	24.68	25.27
Vacuum Saturation Conditions										
SSD Mass, g	1118.60	1119.10	1118.20	1121.70	1121.30	Not Applicable				
Volume of Absorbed Water, cm ³	17.40	18.10	17.50	19.10	19.80					
% Saturation	76.35	76.14	72.94	77.60	78.37					
Tensile Strength Calculations										
Failure Load, N	10,160	10,580	10,470	10,628	10,256	10,610	10,892	11,408	10,604	10,974
Dry Strength [$2000P/\pi t^2 D$], kPa (psi)						1,081	1,110	1,163	1,080	1,119
Wet Strength [$2000P/\pi t^2 D$] (psi)	1,035	1,079	1,066	1,082	1,045					
TSR (S_2/S_1)	0.96	0.97	0.92	1.00	0.93					
Average Strength	10,419					10,898				
Average TSR	0.96									

Table C-9: Field Mix 3 WMA Field Compacted Indirect Tensile Strength and Tensile Strength Ratio Data

Sample Identification	Moisture Conditioned Samples					Unconditioned Samples				
	FM3 W9 F	FM3 W8 F	FM3 W4 F	FM3 W7 F	FM3 W1 F	FM3 W10 F	FM3 W5 F	FM3 W3 F	FM3 W6 F	FM3 W2 F
Diameter (D), mm	100	100	100	100	100	100	100	100	100	100
Thickness (t), mm	62.5	62.6	62.6	62.5	62.6	62.4	62.3	62.4	62.5	62.5
Dry Mass in Air (A), g	1093.1	1088.8	1091.4	1089.9	1088.7	1100.8	1089	1083.1	1087.5	1088.3
SSD Mass (B), g	1101	1094.7	1096.4	1096.5	1093.8	1105	1095.1	1088.2	1094.5	1094.9
Submerged Mass (C), g	631.6	622.2	621.3	620.5	617.8	630.7	621.4	616.2	619.1	619
Volume (E=B-C), cm ³	469.4	472.5	475.1	476	476	474.3	473.7	472	475.4	475.9
Bulk specific Gravity ($G_{mb} = A/E$)	2.33	2.30	2.30	2.29	2.29	2.32	2.30	2.29	2.29	2.29
Maximum Specific Gravity (G_{mm})	2.44	2.44	2.44	2.44	2.44	2.44	2.44	2.44	2.44	2.44
% Air Voids [$Pa = 100 (G_{mm} - G_{mb})/G_{mm}$]	4.56	5.56	5.85	6.16	6.26	4.88	5.78	5.95	6.25	6.28
Volume of Air Voids ($Va = PaE/100$), cm ³	21.41	26.27	27.80	29.32	29.81	23.15	27.39	28.11	29.70	29.88
Vacuum Saturation Conditions										
SSD Mass, g	1109.90	1107.80	1113.60	1113.10	1111.50	Not Applicable				
Volume of Absorbed Water, cm ³	16.80	19.00	22.20	23.20	22.80					
% Saturation	78.47	72.32	79.84	79.13	76.48					
Tensile Strength Calculations										
Failure Load, N	6434.00	7494.00	6323.00	5876.00	6797.00	8,193	7,429	8,668	7,660	8,893
Dry Strength [$2000P/\pi tD$], kPa (psi)						836.00	758.61	884.00	780.45	906.17
Wet Strength [$2000P'/\pi t'D$] (psi)	655.15	761.55	643.51	598.27	691.23					
TSR (S_2/S_1)	0.78	1.00	0.73	0.77	0.76					
Average Strength	6585					8169				
Average TSR	0.81									

Table C-10: Field Mix 3 HMA Field Compacted Indirect Tensile Strength and Tensile Strength Ratio Data

	Moisture Conditioned Samples					Unconditioned Samples				
Sample Identification	FM3 H2 F	FM3 H9 F	FM3 H1 F	FM3 H4 F	FM3 H6 F	FM3 H10 F	FM3 H8 F	FM3 H3 F	FM3 H5 F	FM3 H7 F
Diameter (D), mm	100	100	100	100	100	100	100	100	100	100
Thickness (t), mm	62.5	62.5	62.5	62.5	64.4	100.00	100.00	100.00	100.00	100.00
Dry Mass in Air (A), g	1109.6	1091	1089.2	1085.5	1088.5	1090.6	1092	1088.8	1091.4	1087
SSD Mass (B), g	1113.5	1095.8	1095.2	1093	1098.5	1096	1097.5	1095.5	1099.9	1097
Submerged Mass (C), g	634.2	621.8	619.5	616.9	613.9	622.6	622	618.2	617.9	608.2
Volume (E=B-C), cm ³	479.3	474	475.7	476.1	484.6	473.4	475.5	477.3	482	488.8
Bulk specific Gravity ($G_{mb} = A/E$)	2.32	2.30	2.29	2.28	2.25	2.30	2.30	2.28	2.26	2.22
Maximum Specific Gravity (G_{mm})	2.44	2.44	2.44	2.44	2.44	2.44	2.44	2.44	2.44	2.44
% Air Voids [$P_a = 100 (G_{mm} - G_{mb}) / G_{mm}$]	5.12	5.67	6.16	6.56	7.94	5.58	5.88	6.51	7.20	8.86
Volume of Air Voids ($V_a = P_a E / 100$), cm ³	24.55	26.87	29.31	31.22	38.49	26.43	27.96	31.07	34.70	43.31
Vacuum Saturation Conditions										
SSD Mass, g	1128.10	1112.00	1112.30	1110.10	1119.10	Not Applicable				
Volume of Absorbed Water, cm ³	18.50	21.00	23.10	24.60	30.60					
% Saturation	75.37	78.16	78.82	78.79	79.49					
Tensile Strength Calculations										
Failure Load, N	9,549	9,719	9,761	11,274	9,393	10,490	10,468	10,708	10,265	9,234
Dry Strength [$2000P/\pi tD$], kPa (psi)						1,069	1,067	1,092	1,032	900
Wet Strength [2000P/πtD] (psi)	972	990	994	1,149	929					
TSR (S_2/S_1)	0.91	0.93	0.91	1.11	1.03					
Average Strength	9939					10233				
Average TSR	0.98									

Table C-11: Field Mix 4 WMA Lab Compacted Indirect Tensile Strength and Tensile Strength Ratio Data

Sample Identification	Moisture Conditioned Samples					Unconditioned Samples				
	FM4 W10 L	FM4 W3 L	FM4 W5 L	FM4 W2 L	FM4 W7 L	FM4 W9 L	FM4 W6 L	FM4 W8 L	FM4 W4 L	FM4 W1 L
Diameter (D), mm	100	100	100	100	100	100	100	100	100	100
Thickness (t), mm	62.4	62.5	62.5	62.5	62.5	62.3	62.3	62.4	62.4	62.4
Dry Mass in Air (A), g	1119.3	1119.2	1120.2	1118.3	1119.2	1119.9	1119.1	1119.0	1118.7	1119.2
SSD Mass (B), g	1122.7	1121.6	1123.7	1120.8	1122.8	1122.6	1122.9	1121.9	1122	1122.6
Submerged Mass (C), g	647	645.2	646.6	644.2	645.2	646.5	646.3	645.1	645.2	644.5
Volume (E=B-C), cm ³	475.7	476.4	477.1	476.6	477.6	476.1	476.6	476.8	476.8	478.1
Bulk specific Gravity ($G_{mb} = A/E$)	2.35	2.35	2.35	2.35	2.34	2.35	2.35	2.35	2.35	2.34
Maximum Specific Gravity (G_{mm})	2.50	2.50	2.50	2.50	2.50	2.50	2.50	2.50	2.50	2.50
% Air Voids [$Pa = 100 (G_{mm} - G_{mb})/G_{mm}$]	5.88	6.03	6.08	6.14	6.26	5.91	6.08	6.12	6.15	6.36
Volume of Air Voids ($Va = PaE/100$), cm ³	27.98	28.72	29.02	29.28	29.92	28.14	28.96	29.20	29.32	30.42
Vacuum Saturation Conditions										
SSD Mass, g	1142.10	1141.80	1141.30	1141.80	1142.60	Not Applicable				
Volume of Absorbed Water, cm ³	22.20	22.70	22.30	23.10	23.40					
% Saturation	79.34	79.04	76.84	78.89	78.21					
Tensile Strength Calculations										
Failure Load, N	9856.00	9917.00	11188.00	10755.00	9908.00	12,042	12,250	12,154	12,943	11,970
Dry Strength [$2000P/\pi t^2 D$], kPa (psi)						1229.67	1251.38	1240.18	1319.91	1220.43
Wet Strength [$2000P/\pi t^2 D$] (psi)	1005.00	1010.95	1138.99	1095.79	1009.28					
TSR (S_2/S_1)	0.82	0.81	0.92	0.83	0.83					
Average Strength	10324.80					12,272				
Average TSR						0.84				

Table C-12: Field Mix 4 HMA Laboratory Compacted Indirect Tensile Strength and Tensile Strength Ratio Data

	Moisture Conditioned Samples					Unconditioned Samples				
Sample Identification	FM4 H2 L	FM4 H7 L	FM4 H4 L	FM4 H8 L	FM4 H10 L	FM4 H9 L	FM4 H6 L	FM4 H3 L	FM4 H5 L	FM4 H1 L
Diameter (D), mm	100	100	100	100	100	100	100	100	100	100
Thickness (t), mm	62.4	62.4	62.3	62.3	62.3	62.28	62.57	62.30	62.32	62.49
Dry Mass in Air (A), g	1120.1	1119.3	1118.3	1117.7	1118.3	1119.3	1120	1117.8	1118.8	1119.2
SSD Mass (B), g	1120.9	1120.8	1119.7	1120	1120.3	1121	1121.5	1119.3	1119.9	1120.8
Submerged Mass (C), g	645.8	645.8	644.2	644.1	644.1	646.2	645.4	644	643.5	643.8
Volume (E=B-C), cm ³	475.1	475	475.5	475.9	476.2	474.8	476.1	475.3	476.4	477
Bulk specific Gravity ($G_{mb} = A/E$)	2.36	2.36	2.35	2.35	2.35	2.36	2.35	2.35	2.35	2.35
Maximum Specific Gravity (G_{mm})	2.50	2.50	2.50	2.50	2.50	2.50	2.50	2.50	2.50	2.50
% Air Voids [$P_a = 100 (G_{mm} - G_{mb}) / G_{mm}$]	5.70	5.74	5.93	6.06	6.06	5.70	5.90	5.93	6.06	6.15
Volume of Air Voids ($V_a = P_a E / 100$), cm ³	27.06	27.28	28.18	28.82	28.88	27.08	28.10	28.18	28.88	29.32
Vacuum Saturation Conditions										
SSD Mass, g	1138.40	1139.30	1137.90	1140.20	1140.70	Not Applicable				
Volume of Absorbed Water, cm ³	19.10	19.30	20.10	21.40	21.50					
% Saturation	70.58	70.75	71.33	74.25	74.45					
Tensile Strength Calculations										
Failure Load, N	11,787	12,130	11,493	11,509	11,362	12,860	12,659	12,886	12,810	12,492
Dry Strength [$2000P/\pi t D$], kPa (psi)						1,315	1,288	1,317	1,309	1,273
Wet Strength [2000P'/ $\pi t'D$] (psi)	1,202	1,238	1,175	1,176	1,162					
TSR (S_2/S_1)	0.91	0.96	0.89	0.90	0.91					
Average Strength	11,656					12,741				
Average TSR	0.92									

Table C-13: Field Mix 4 WMA Field Compacted Indirect Tensile Strength and Tensile Strength Ratio Data

Sample Identification	Moisture Conditioned Samples			Unconditioned Samples		
	FM4 W4 F	FM4 W1 F	FM4 W3 F	FM4 W2 F	FM4 W6 F	FM4 W5 F
Diameter (D), mm	100	100	100	100	100	100
Thickness (t), mm	62.5	62.4	62.4	62.5	62.3	62.4
Dry Mass in Air (A), g	1119.2	1116.7	1117.7	1116.8	1118	1118
SSD Mass (B), g	1123.2	1121.6	1122.6	1121.1	1123.5	1124.1
Submerged Mass (C), g	648.8	646.8	646.5	646.3	647.6	646.1
Volume (E=B-C), cm ³	474.4	474.8	476.1	474.8	475.9	478
Bulk specific Gravity ($G_{mb} = A/E$)	2.36	2.35	2.35	2.35	2.35	2.34
Maximum Specific Gravity (G_{mm})	2.50	2.50	2.50	2.50	2.50	2.50
% Air Voids [$Pa = 100 (G_{mm} - G_{mb})/G_{mm}$]	5.63	5.92	6.10	5.91	6.03	6.44
Volume of Air Voids ($Va = PaE/100$), cm ³	26.72	28.12	29.02	28.08	28.70	30.80
Vacuum Saturation Conditions						
SSD Mass, g	1137.50	1140.20	1139.80	Not Applicable		
Volume of Absorbed Water, cm ³	20.70	22.20	21.80			
% Saturation	77.47	78.95	75.12			
Tensile Strength Calculations						
Failure Load, N	11215.33	11068.33	10921.33	10,270	10,366	10,798
Dry Strength [$2000P'/\pi t^2D$], kPa (psi)				1046.82	1058.64	1100.99
Wet Strength [$2000P'/\pi t^2D$] (psi)	1142.08	1129.52	1114.22			
TSR (S_2/S_1)	1.09	1.07	1.01			
Average Strength	11068.33			10,478		
Average TSR	1.06					

Table C-14: Field Mix 4 HMA Field Compacted Indirect Tensile Strength and Tensile Strength Ratio Data

Sample Identification	Moisture Conditioned Samples					Unconditioned Samples				
	FM4 H5 F	FM4 H1 F	FM4 H8 F	FM4 H7 F	FM4 H6 F	FM4 H9 F	FM4 H10 F	FM4 H4 F	FM4 H2 F	FM4 H3 F
Diameter (D), mm	100	100	100	100	100	100	100	100	100	100
Thickness (t), mm	62.6	62.5	62.5	62.6	62.5	62.47	62.41	62.50	62.45	62.55
Dry Mass in Air (A), g	1119.8	1119.6	1116.1	1115.9	1117.7	1119	1118.3	1120.6	1117.3	1119.2
SSD Mass (B), g	1122.1	1123.6	1119.7	1119.1	1120.4	1122.3	1123.7	1123.3	1119.8	1123
Submerged Mass (C), g	644.7	645.2	642.4	641.7	642.1	644.8	645.8	643.9	641.7	643.8
Volume (E=B-C), cm ³	477.4	478.4	477.3	477.4	478.3	477.5	477.9	479.4	478.1	479.2
Bulk specific Gravity ($G_{mb} = A/E$)	2.35	2.34	2.34	2.34	2.34	2.34	2.34	2.34	2.34	2.34
Maximum Specific Gravity (G_{mm})	2.50	2.50	2.50	2.50	2.50	2.50	2.50	2.50	2.50	2.50
% Air Voids [$P_a = 100 (G_{mm} - G_{mb}) / G_{mm}$]	6.18	6.39	6.47	6.50	6.53	6.26	6.40	6.50	6.52	6.58
Volume of Air Voids ($V_a = P_a E / 100$), cm ³	29.48	30.56	30.86	31.04	31.22	29.90	30.58	31.16	31.18	31.52
Vacuum Saturation Conditions										
SSD Mass, g	1140.20	1140.50	1142.70	1141.80	1141.30	Not Applicable				
Volume of Absorbed Water, cm ³	21.20	22.20	22.10	24.50	22.10					
% Saturation	71.91	72.64	71.61	78.93	70.79					
Tensile Strength Calculations										
Failure Load, N	10,774	10,627	10,480	10,333	10,186	12,412	13,154	12,029	11,633	11,019
Dry Strength [$2000P/\pi tD$], kPa (psi)						1,265	1,342	1,225	1,186	1,121
Wet Strength [$2000P/\pi t'D$] (psi)	1,096	1,082	1,067	1,052	1,038					
TSR (S_2/S_1)	0.87	0.81	0.87	0.89	0.93					
Average Strength	10,480					12,049				
Average TSR	0.87									

APPENDIX D: DYNAMIC MODULUS VALUES

Table D-1 Field Mix 1 Dynamic Modulus Values (kPa)

Mix	Temp °C	Moisture Conditioned	25Hz	15Hz	10Hz	5Hz	3Hz	1Hz	0.5Hz	0.3Hz	0.1Hz
Hot Mix Field	4	Y	1.72E+07	1.59E+07	1.52E+07	1.42E+07	1.33E+07	1.16E+07	1.08E+07	1.01E+07	8.33E+06
Hot Mix Field	21	Y	7.82E+06	6.89E+06	6.37E+06	5.48E+06	4.55E+06	3.29E+06	2.82E+06	2.51E+06	1.69E+06
Hot Mix Field	37	Y	2.79E+06	2.38E+06	2.07E+06	1.64E+06	1.21E+06	8.48E+05	6.36E+05	5.33E+05	3.85E+05
Hot Mix Field	4	N	1.80E+07	1.72E+07	1.59E+07	1.50E+07	1.43E+07	1.23E+07	1.12E+07	1.06E+07	8.65E+06
Hot Mix Field	21	N	7.89E+06	7.06E+06	6.48E+06	5.58E+06	4.68E+06	3.57E+06	3.09E+06	2.70E+06	1.87E+06
Hot Mix Field	37	N	2.97E+06	2.47E+06	2.16E+06	1.72E+06	1.27E+06	8.81E+05	6.60E+05	5.52E+05	3.97E+05
Warm Mix Field	4	Y	1.46E+07	1.35E+07	1.27E+07	1.15E+07	1.06E+07	8.93E+06	7.95E+06	7.52E+06	5.96E+06
Warm Mix Field	21	Y	6.02E+06	5.34E+06	4.81E+06	4.10E+06	3.33E+06	2.49E+06	2.11E+06	1.77E+06	1.21E+06
Warm Mix Field	37	Y	1.95E+06	1.63E+06	1.43E+06	1.14E+06	8.33E+05	6.16E+05	4.55E+05	3.89E+05	2.95E+05
Warm Mix Field	4	N	1.75E+07	1.59E+07	1.62E+07	1.48E+07	1.38E+07	1.18E+07	1.08E+07	1.00E+07	8.12E+06
Warm Mix Field	21	N	7.62E+06	6.83E+06	6.25E+06	5.32E+06	4.05E+06	3.28E+06	2.79E+06	2.39E+06	1.70E+06
Warm Mix Field	37	N	2.64E+06	2.20E+06	1.92E+06	1.54E+06	1.09E+06	7.65E+05	5.74E+05	4.81E+05	3.49E+05
Hot Mix Lab	4	Y	1.72E+07	1.63E+07	1.55E+07	1.43E+07	1.36E+07	1.16E+07	1.07E+07	9.96E+06	8.19E+06
Hot Mix Lab	21	Y	7.74E+06	7.12E+06	6.55E+06	5.64E+06	4.66E+06	3.57E+06	2.98E+06	2.67E+06	1.83E+06
Hot Mix Lab	37	Y	2.63E+06	2.21E+06	1.95E+06	1.56E+06	1.15E+06	8.27E+05	6.30E+05	5.31E+05	3.87E+05
Hot Mix Lab	4	N	1.96E+07	1.83E+07	1.76E+07	1.66E+07	1.61E+07	1.38E+07	1.28E+07	1.19E+07	9.71E+06
Hot Mix Lab	21	N	9.24E+06	8.50E+06	7.80E+06	6.82E+06	5.84E+06	4.51E+06	3.91E+06	3.46E+06	2.46E+06
Hot Mix Lab	37	N	3.41E+06	2.84E+06	2.48E+06	1.97E+06	1.45E+06	1.02E+06	7.66E+05	6.33E+05	4.39E+05
Warm Mix Lab	4	Y	1.71E+07	1.53E+07	1.47E+07	1.36E+07	1.28E+07	1.06E+07	9.69E+06	9.11E+06	7.24E+06
Warm Mix Lab	21	Y	7.18E+06	6.37E+06	5.76E+06	4.89E+06	3.97E+06	3.01E+06	2.58E+06	2.21E+06	1.54E+06
Warm Mix Lab	37	Y	2.22E+06	1.85E+06	1.62E+06	1.30E+06	9.61E+05	6.93E+05	5.34E+05	4.57E+05	3.48E+05
Warm Mix Lab	4	N	1.83E+07	1.72E+07	1.65E+07	1.51E+07	1.42E+07	1.19E+07	1.09E+07	1.01E+07	8.03E+06
Warm Mix Lab	21	N	8.38E+06	7.52E+06	6.87E+06	5.84E+06	4.82E+06	3.63E+06	3.08E+06	2.65E+06	1.86E+06
Warm Mix Lab	37	N	2.76E+06	2.27E+06	1.97E+06	1.55E+06	1.15E+06	8.13E+05	6.16E+05	5.16E+05	3.76E+05

Table D-2 Field Mix 2 Dynamic Modulus Values (kPa)

Mix	Temp °C	Moisture Conditioned	25Hz	15Hz	10Hz	5Hz	3Hz	1Hz	0.5Hz	0.3Hz	0.1Hz
Hot Mix Field	4	Y	1.59E+07	1.45E+07	1.35E+07	1.23E+07	1.14E+07	9.35E+06	8.54E+06	7.80E+06	6.22E+06
Hot Mix Field	21	Y	6.80E+06	5.97E+06	5.40E+06	4.57E+06	3.72E+06	2.76E+06	2.32E+06	1.95E+06	1.42E+06
Hot Mix Field	37	Y	2.12E+06	1.75E+06	1.52E+06	1.24E+06	8.92E+05	6.77E+05	5.99E+05	5.20E+05	4.08E+05
Hot Mix Field	4	N	1.59E+07	1.43E+07	1.34E+07	1.21E+07	1.10E+07	9.10E+06	8.29E+06	7.52E+06	5.89E+06
Hot Mix Field	21	N	6.46E+06	5.57E+06	5.05E+06	4.21E+06	3.47E+06	2.53E+06	2.08E+06	1.77E+06	1.24E+06
Hot Mix Field	37	N	2.12E+06	1.75E+06	1.52E+06	1.25E+06	8.91E+05	6.78E+05	5.52E+05	4.93E+05	3.42E+05
Warm Mix Field	4	Y	1.43E+07	1.28E+07	1.20E+07	1.09E+07	9.95E+06	8.26E+06	7.26E+06	6.76E+06	5.28E+06
Warm Mix Field	21	Y	5.32E+06	4.67E+06	4.21E+06	3.54E+06	2.89E+06	2.12E+06	1.82E+06	1.45E+06	1.04E+06
Warm Mix Field	37	Y	1.94E+06	1.61E+06	1.39E+06	1.15E+06	8.31E+05	6.29E+05	5.43E+05	4.94E+05	3.75E+05
Warm Mix Field	4	N	1.64E+07	1.47E+07	1.39E+07	1.26E+07	1.14E+07	9.71E+06	8.88E+06	8.07E+06	6.42E+06
Warm Mix Field	21	N	6.88E+06	6.02E+06	5.41E+06	4.54E+06	3.70E+06	2.72E+06	2.30E+06	1.94E+06	1.53E+06
Warm Mix Field	37	N	2.17E+06	1.79E+06	1.56E+06	1.28E+06	9.11E+05	6.67E+05	5.40E+05	5.02E+05	3.96E+05
Hot Mix Lab	4	Y	1.55E+07	1.38E+07	1.29E+07	1.18E+07	1.07E+07	8.92E+06	8.15E+06	7.42E+06	5.88E+06
Hot Mix Lab	21	Y	5.78E+06	5.26E+06	4.81E+06	4.06E+06	3.31E+06	2.42E+06	2.04E+06	1.74E+06	1.25E+06
Hot Mix Lab	37	Y	2.08E+06	1.75E+06	1.56E+06	1.27E+06	9.45E+05	7.34E+05	6.16E+05	5.53E+05	4.01E+05
Hot Mix Lab	4	N	1.64E+07	1.49E+07	1.39E+07	1.26E+07	1.18E+07	9.64E+06	8.84E+06	8.03E+06	6.38E+06
Hot Mix Lab	21	N	6.67E+06	5.89E+06	5.30E+06	4.51E+06	3.65E+06	2.74E+06	2.27E+06	1.94E+06	1.36E+06
Hot Mix Lab	37	N	2.01E+06	1.65E+06	1.46E+06	1.18E+06	8.44E+05	6.63E+05	5.46E+05	5.46E+05	4.32E+05
Warm Mix Lab	4	Y	1.40E+07	1.26E+07	1.19E+07	1.08E+07	9.97E+06	8.19E+06	7.42E+06	6.76E+06	5.34E+06
Warm Mix Lab	21	Y	5.64E+06	4.98E+06	4.46E+06	3.73E+06	3.01E+06	2.19E+06	1.84E+06	1.57E+06	1.10E+06
Warm Mix Lab	37	Y	2.01E+06	1.69E+06	1.47E+06	1.21E+06	8.53E+05	6.60E+05	5.50E+05	4.87E+05	3.68E+05
Warm Mix Lab	4	N	1.53E+07	1.39E+07	1.30E+07	1.18E+07	1.09E+07	8.98E+06	8.08E+06	7.37E+06	5.76E+06
Warm Mix Lab	21	N	6.74E+06	5.78E+06	5.15E+06	4.27E+06	3.45E+06	2.50E+06	2.04E+06	1.76E+06	1.23E+06
Warm Mix Lab	37	N	1.86E+06	1.52E+06	1.39E+06	1.12E+06	8.13E+05	5.88E+05	5.02E+05	4.73E+05	2.87E+05

Table D-3 Field Mix 3 Dynamic Modulus Values (kPa)

Mix	Temp °C	Moisture Conditioned	25Hz	15Hz	10Hz	5Hz	3Hz	1Hz	0.5Hz	0.3Hz	0.1Hz
Hot Mix Field	4	Y	1.78E+07	1.60E+07	1.49E+07	1.38E+07	1.30E+07	1.07E+07	9.76E+06	8.96E+06	6.77E+06
Hot Mix Field	21	Y	6.98E+06	6.06E+06	5.39E+06	4.48E+06	3.54E+06	2.50E+06	2.07E+06	1.65E+06	1.00E+06
Hot Mix Field	37	Y	2.02E+06	1.62E+06	1.36E+06	1.03E+06	7.06E+05	4.72E+05	3.44E+05	2.78E+05	1.89E+05
Hot Mix Field	4	N	1.90E+07	1.83E+07	1.72E+07	1.57E+07	1.48E+07	1.21E+07	1.10E+07	1.03E+07	7.95E+06
Hot Mix Field	21	N	8.03E+06	7.07E+06	6.32E+06	5.25E+06	4.19E+06	2.97E+06	2.42E+06	1.93E+06	1.20E+06
Hot Mix Field	37	N	2.30E+06	1.82E+06	1.51E+06	1.15E+06	8.12E+05	5.07E+05	3.60E+05	3.56E+05	2.57E+05
Warm Mix Field	4	Y	1.67E+07	1.48E+07	1.40E+07	1.27E+07	1.19E+07	9.78E+06	8.65E+06	8.11E+06	6.09E+06
Warm Mix Field	21	Y	6.30E+06	5.48E+06	4.89E+06	4.06E+06	3.22E+06	2.27E+06	1.86E+06	1.49E+06	9.29E+05
Warm Mix Field	37	Y	2.06E+06	1.67E+06	1.40E+06	1.10E+06	7.82E+05	5.44E+05	3.85E+05	3.36E+05	2.28E+05
Warm Mix Field	4	N	1.85E+07	1.68E+07	1.55E+07	1.43E+07	1.33E+07	1.10E+07	9.76E+06	9.22E+06	6.94E+06
Warm Mix Field	21	N	7.30E+06	6.36E+06	5.63E+06	4.69E+06	3.79E+06	2.69E+06	2.20E+06	1.79E+06	1.14E+06
Warm Mix Field	37	N	2.14E+06	1.72E+06	1.47E+06	1.15E+06	8.42E+05	5.76E+05	4.81E+05	3.53E+05	2.75E+05
Hot Mix Lab	4	Y	1.90E+07	1.77E+07	1.67E+07	1.54E+07	1.47E+07	1.22E+07	1.12E+07	1.04E+07	8.14E+06
Hot Mix Lab	21	Y	8.00E+06	7.12E+06	6.43E+06	5.44E+06	4.17E+06	2.74E+06	2.68E+06	2.38E+06	1.26E+06
Hot Mix Lab	37	Y	2.57E+06	2.01E+06	1.71E+06	1.33E+06	9.79E+05	6.89E+05	6.06E+05	4.82E+05	4.05E+05
Hot Mix Lab	4	N	1.99E+07	1.87E+07	1.75E+07	1.58E+07	1.53E+07	1.26E+07	1.16E+07	1.07E+07	8.40E+06
Hot Mix Lab	21	N	8.28E+06	7.33E+06	6.61E+06	5.59E+06	4.17E+06	2.74E+06	2.68E+06	2.38E+06	1.26E+06
Hot Mix Lab	37	N	2.54E+06	2.05E+06	1.73E+06	1.30E+06	9.46E+05	6.47E+05	4.89E+05	4.26E+05	2.66E+05
Warm Mix Lab	4	Y	1.72E+07	1.56E+07	1.45E+07	1.30E+07	1.22E+07	9.84E+06	8.83E+06	8.20E+06	6.13E+06
Warm Mix Lab	21	Y	6.28E+06	5.50E+06	4.96E+06	4.12E+06	3.22E+06	2.36E+06	1.79E+06	1.57E+06	9.26E+05
Warm Mix Lab	37	Y	1.85E+06	1.49E+06	1.26E+06	9.69E+05	6.99E+05	4.55E+05	3.41E+05	2.86E+05	2.15E+05
Warm Mix Lab	4	N	1.94E+07	1.78E+07	1.67E+07	1.53E+07	1.51E+07	1.19E+07	1.10E+07	9.82E+06	7.87E+06
Warm Mix Lab	21	N	7.51E+06	6.55E+06	5.81E+06	4.92E+06	4.00E+06	2.85E+06	2.42E+06	1.85E+06	1.12E+06
Warm Mix Lab	37	N	2.18E+06	1.74E+06	1.47E+06	1.13E+06	7.48E+05	5.01E+05	3.70E+05	3.09E+05	2.46E+05

Table D-4 Field Mix 4 Dynamic Modulus Values (kPa)

Mix	Temp °C	Moisture Conditioned	25Hz	15Hz	10Hz	5Hz	3Hz	1Hz	0.5Hz	0.3Hz	0.1Hz
Hot Mix Field	4	Y	2.06E+07	2.01E+07	1.90E+07	1.75E+07	1.61E+07	1.41E+07	1.27E+07	1.22E+07	9.77E+06
Hot Mix Field	21	Y	1.00E+07	8.80E+06	8.00E+06	6.73E+06	5.54E+06	4.04E+06	3.52E+06	3.29E+06	2.08E+06
Hot Mix Field	37	Y	3.24E+06	2.68E+06	2.31E+06	1.81E+06	1.35E+06	8.72E+05	6.72E+05	5.65E+05	4.34E+05
Hot Mix Field	4	N	2.10E+07	2.00E+07	1.89E+07	1.74E+07	1.64E+07	1.43E+07	1.29E+07	1.24E+07	9.99E+06
Hot Mix Field	21	N	1.12E+07	9.93E+06	9.07E+06	7.80E+06	6.51E+06	4.94E+06	3.90E+06	3.58E+06	2.30E+06
Hot Mix Field	37	N	3.66E+06	2.97E+06	2.54E+06	1.98E+06	1.50E+06	1.02E+06	8.12E+05	6.90E+05	5.23E+05
Warm Mix Field	4	Y	2.02E+07	1.93E+07	1.77E+07	1.71E+07	1.67E+07	1.43E+07	1.32E+07	1.24E+07	1.01E+07
Warm Mix Field	21	Y	1.03E+07	9.22E+06	8.39E+06	7.24E+06	6.12E+06	4.61E+06	3.95E+06	3.22E+06	2.17E+06
Warm Mix Field	37	Y	3.65E+06	3.01E+06	2.57E+06	2.01E+06	1.49E+06	1.01E+06	7.86E+05	6.68E+05	5.22E+05
Warm Mix Field	4	N	2.25E+07	2.16E+07	2.04E+07	1.90E+07	1.81E+07	1.49E+07	1.43E+07	1.33E+07	1.09E+07
Warm Mix Field	21	N	1.12E+07	9.96E+06	8.95E+06	5.17E+06	6.57E+06	4.91E+06	4.14E+06	3.61E+06	2.42E+06
Warm Mix Field	37	N	3.69E+06	3.01E+06	2.56E+06	1.96E+06	1.38E+06	8.92E+05	7.15E+05	5.86E+05	4.07E+05
Hot Mix Lab	4	Y	1.95E+07	1.85E+07	1.75E+07	1.62E+07	1.56E+07	1.33E+07	1.23E+07	1.14E+07	9.41E+06
Hot Mix Lab	21	Y	9.15E+06	8.06E+06	7.36E+06	6.36E+06	5.27E+06	4.00E+06	3.43E+06	3.05E+06	2.08E+06
Hot Mix Lab	37	Y	3.19E+06	2.67E+06	2.34E+06	1.84E+06	1.34E+06	9.27E+05	7.18E+05	5.97E+05	4.32E+05
Hot Mix Lab	4	N	2.06E+07	1.96E+07	1.84E+07	1.74E+07	1.69E+07	1.44E+07	1.34E+07	1.24E+07	1.02E+07
Hot Mix Lab	21	N	9.85E+06	8.79E+06	8.05E+06	6.98E+06	6.00E+06	4.54E+06	3.90E+06	3.41E+06	2.34E+06
Hot Mix Lab	37	N	3.57E+06	2.98E+06	2.57E+06	2.02E+06	1.49E+06	1.00E+06	7.83E+05	6.78E+05	4.90E+05
Warm Mix Lab	4	Y	2.05E+07	1.97E+07	1.79E+07	1.66E+07	1.67E+07	1.36E+07	1.33E+07	1.24E+07	1.00E+07
Warm Mix Lab	4	N	2.40E+07	2.29E+07	2.15E+07	1.93E+07	1.96E+07	1.62E+07	1.55E+07	1.45E+07	1.17E+07
Warm Mix Lab	21	Y	1.09E+07	9.53E+06	8.71E+06	7.45E+06	6.30E+06	4.73E+06	3.72E+06	3.43E+06	2.24E+06
Warm Mix Lab	21	N	1.23E+07	1.08E+07	9.93E+06	8.64E+06	7.30E+06	5.55E+06	4.61E+06	4.39E+06	2.85E+06
Warm Mix Lab	37	Y	3.82E+06	3.19E+06	2.75E+06	2.15E+06	1.59E+06	1.07E+06	8.23E+05	6.87E+05	4.98E+05
Warm Mix Lab	37	N	4.19E+06	3.47E+06	2.96E+06	2.30E+06	1.70E+06	1.14E+06	8.73E+05	7.19E+05	5.17E+05

APPENDIX E- FLOW NUMBER RESULTS

(Blue means moisture conditioned sample and 10,000 cycles is the maximum)

Table E-1 Field Mix 1 Flow Number Values

		Field		Lab	
		Flow Number	Cycles to 3.0%	Flow Number	Cycles to 3.0%
HMA	1	1208	4495	1393	10000**
HMA	2	XX	XX	1833	10000**
HMA	3	2551	4596	1263	7941
HMA	4	1114	2744	2338	5610
HMA	5	2428	5863	1483	8282
HMA	6	1193	3851	1573	10000**
HMA	7	--	--	2143	9202
HMA	8	--	--	1979	3813
HMA	9	--	--	2078	6402
HMA	10	--	--	4503	5770
Average MC		1872	4224	1790	8742
Average NMC		1583	4367	2432	5907

		Field		Lab	
		Flow Number	Cycles to 3.0%	Flow Number	Cycles to 3.0%
WMA	1	1453	5999	XX	XX
WMA	2	1723	3393	883	2827
WMA	3	738	3671	963	5190
WMA	4	698	2282	1628	4235
WMA	5	898	3572	503	2481
WMA	6	558	1892	1918	4396
WMA	7	--	--	628	2181
WMA	8	--	--	1108	2919
WMA	9	--	--	1753	3148
WMA	10	--	--	1178	4499
Average MC		1358	4321	1566	4242
Average NMC		665	2615	860	2981

Table E-2 Field Mix 2 Flow Number Values

		Field		Lab	
		Flow Number	Cycles to 3.0%	Flow Number	Cycles to 3.0%
HMA	1	313	1013	403	1223
HMA	2	423	1257	468	1700
HMA	3	408	1007	308	1352
HMA	4	323	1176	443	1521
HMA	5	503	1233	498	1499
HMA	6	263	1298	358	1377
HMA	7	523	1659	338	1053
HMA	8	848	2768	523	1658
HMA	9	823	2543	593	1815
HMA	10	413	1674	433	1542
Average MC		520	1669	505	1639
Average NMC		448	1456	368	1309

		Field		Lab	
		Flow Number	Cycles to 3.0%	Flow Number	Cycles to 3.0%
WMA	1	338	1250	218	828
WMA	2	308	1146	308	1181
WMA	3	293	983	213	755
WMA	4	278	809	123	749
WMA	5	323	986	303	936
WMA	6	233	1071	148	645
WMA	7	408	1340	333	1050
WMA	8	303	1094	262	939
WMA	9	258	1015	273	818
WMA	10	213	918	313	1013
Average MC		326	1137	304	1024
Average NMC		265	985	195	759

Table E-3 Field Mix 3 Flow Number Values

		Field		Lab	
		Flow Number	Cycles to 3.0%	Flow Number	Cycles to 3.0%
HMA	1	498	1919	1018	2485
HMA	2	748	1763	1023	4014
HMA	3	533	1511	1463	4241
HMA	4	753	1971	803	2984
HMA	5	458	1452	1328	2335
HMA	6	578	1516	643	2764
HMA	7	713	2163	673	1627
HMA	8	603	1766	763	2586
HMA	9	573	1307	1578	9798
HMA	10	738	1798	1428	4445
Average MC		643	1703	1233	4825
Average NMC		596	1730	911	2631

		Field		Lab	
		Flow Number	Cycles to 3.0%	Flow Number	Cycles to 3.0%
WMA	1	718	2005	248	1284
WMA	2	573	1622	378	1402
WMA	3	498	1769	363	1605
WMA	4	488	1810	403	1698
WMA	5	458	1742	446	1787
WMA	6	528	1555	403	1654
WMA	7	513	1773	533	2188
WMA	8	1278	2702	453	1885
WMA	9	263	1484	468	1879
WMA	10	338	1481	338	1630
Average MC		450	1673	401	1721
Average NMC		681	1916	406	1681

Table E-4 Field Mix 4 Flow Number Values

		Field		Lab	
		Flow Number	Cycles to 3.0%	Flow Number	Cycles to 3.0%
HMA	1	1023	5250	1728	5587
HMA	2	728	3475	1768	3530
HMA	3	1713	3935	1148	4075
HMA	4	1423	6147	1103	7621
HMA	5	1358	6114	1118	8160
HMA	6	1548	4227	1028	6808
HMA	7	1053	4594	838	8862
HMA	8	973	4932	2283	5866
HMA	9	1428	4783	1053	6837
HMA	10	2193	5381	1283	6978
Average MC		1394	5565	1163	7408
Average NMC		1294	4203	1507	5457

		Field		Lab	
		Flow Number	Cycles to 3.0%	Flow Number	Cycles to 3.0%
WMA	1	1908	4829	1433	7695
WMA	2	1218	6507	1718	8320
WMA	3	978	4473	3293	4735
WMA	4	613	4056	2383	8328
WMA	5	2913	6543	1568	4823
WMA	6	3148	6079	1393	7345
WMA	7	--	--	2573	7429
WMA	8	--	--	2793	8862
WMA	9	--	--	1838	10000*
WMA	10	--	--	1688	10000*
Average MC		2426	6376	1812	8869
Average NMC		2426	6376	2324	6639

APPENDIX F: SAS OUTPUT DATA

Section F-1: Field Mix 1 ITS Statistical Analysis- Peak Loads

Class Level Information

Class	Levels	Values
mix	2	HMA WMA
mcond	2	Moisture Conditioned(MC) Not Moisture Conditioned(NMC)

Number of Observations Read 20
 Number of Observations Used 20

THREE-WAY ANOVA FOR FM1 ITS Samples

The GLM Procedure
 Dependent Variable: Peak Load

Source	DF	Sum of Squares	Mean Square	F Value	Pr > F
Model	3	31282815.60	10427605.20	5.23	0.0104
Error	16	31887540.40	1992971.28		
Corrected Total	19	63170356.00			

R-Square 0.495214 Coeff Var 12.29191 Root MSE 1411.726 Peak Load Mean 11485.00

Source	DF	Type I SS	Mean Square	F Value	Pr > F
mix	1	27626601.80	27626601.80	13.86	0.0018
mcond	1	2832033.80	2832033.80	1.42	0.2506
mix*mcond	1	824180.00	824180.00	0.41	0.5293

Source	DF	Type III SS	Mean Square	F Value	Pr > F
mix	1	27626601.80	27626601.80	13.86	0.0018
mcond	1	2832033.80	2832033.80	1.42	0.2506
mix*mcond	1	824180.00	824180.00	0.41	0.5293

Duncan's Multiple Range Test for Peak Load

NOTE: This test controls the Type I comparisonwise error rate, not the experimentwise error rate.

Alpha 0.05
 Error Degrees of Freedom 16
 Error Mean Square 1992971

Number of Means 2
 Critical Range 1338
 Means with the same letter are not significantly different.

Duncan Grouping

	Mean	N	mcond
A	11861.3	10	MC
A	11108.7	10	NMC

Duncan's Multiple Range Test for Peak Load

NOTE: This test controls the Type I comparisonwise error rate, not the experimentwise error rate.

Alpha 0.05
 Error Degrees of Freedom 16
 Error Mean Square 1992971

Number of Means 2
 Critical Range 1338
 Means with the same letter are not significantly different.

Duncan Grouping

	Mean	N	mix
A	12660.3	10	HMA
B	10309.7	10	WMA

RESIDUAL x PREDICTED VALUE PLOT

Plot of resid*predict. Legend: A = 1 obs, B = 2 obs, etc.

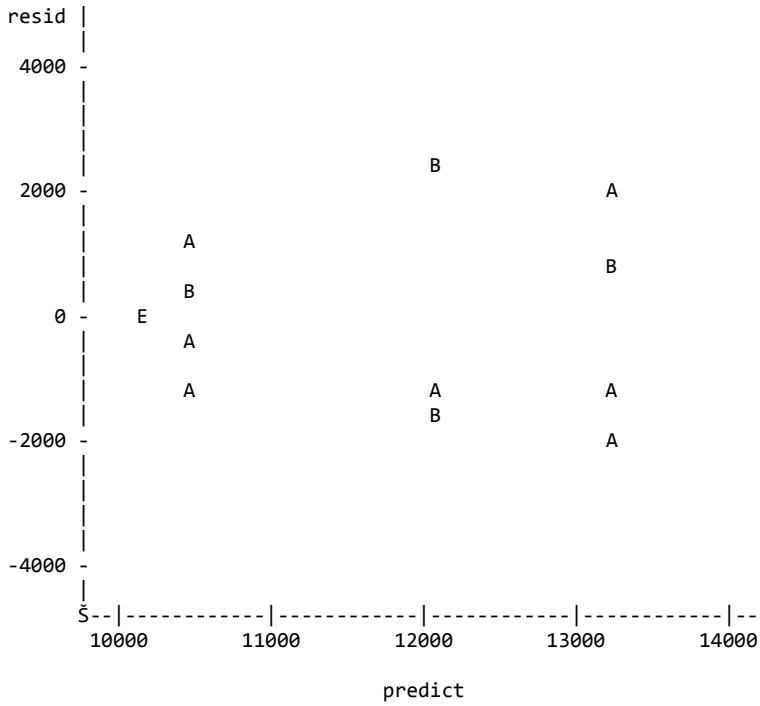

Normal Probability Plot

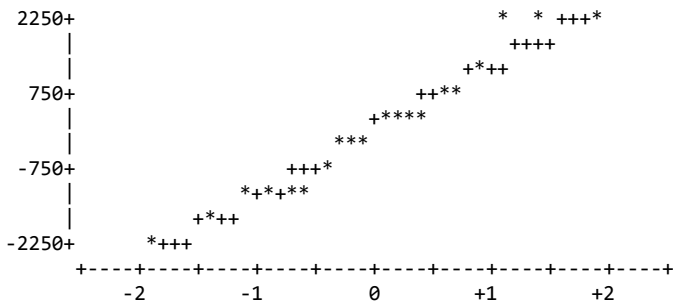

Tukey's Studentized Range (HSD) Test for Peak Load

NOTE: This test controls the Type I experimentwise error rate, but it generally has a higher Type II error rate than REGWQ.

Alpha	0.05
Error Degrees of Freedom	16
Error Mean Square	1992971
Critical Value of Studentized Range	4.04609
Minimum Significant Difference	2554.5

Means with the same letter are not significantly different.

Tukey Grouping

	Mean	N	cell
	A	13239.6	5 HMA Moisture Conditioned
B	A	12081.0	5 HMA Not Moisture Conditioned
B		10483.0	5 WMA Moisture Conditioned
B		10136.4	5 WMA Not Moisture Conditioned

Section F-2: Field Mix 2 ITS Statistical Analysis- Peak Loads

Class Level Information

Class	Levels	Values
mix	2	HMA WMA
comp	2	field lab
mcond	2	Moisture Conditioned Not Moisture Conditioned

Number of Observations Read 40
 Number of Observations Used 40

THREE-WAY ANOVA FOR FM2 ITS Samples

Dependent Variable: Peak Load

Source	DF	Sum of Squares	Mean Square	F Value	Pr > F
Model	7	12937474.80	1848210.69	6.68	<.0001
Error	32	8847578.80	276486.84		
Corrected Total	39	21785053.60			

R-Square 0.593869
 Coeff Var 6.781801
 Root MSE 525.8202
 Peak Load Mean 7753.400

Source	DF	Type I SS	Mean Square	F Value	Pr > F
mix	1	2381440.000	2381440.000	8.61	0.0061
comp	1	3073593.600	3073593.600	11.12	0.0022
mix*comp	1	733326.400	733326.400	2.65	0.1132
mcond	1	4221100.900	4221100.900	15.27	0.0005
mix*mcond	1	1886164.900	1886164.900	6.82	0.0136
comp*mcond	1	275892.100	275892.100	1.00	0.3253
mix*comp*mcond	1	365956.900	365956.900	1.32	0.2585

Source	DF	Type III SS	Mean Square	F Value	Pr > F
mix	1	2381440.000	2381440.000	8.61	0.0061
comp	1	3073593.600	3073593.600	11.12	0.0022
mix*comp	1	733326.400	733326.400	2.65	0.1132
mcond	1	4221100.900	4221100.900	15.27	0.0005
mix*mcond	1	1886164.900	1886164.900	6.82	0.0136
comp*mcond	1	275892.100	275892.100	1.00	0.3253
mix*comp*mcond	1	365956.900	365956.900	1.32	0.2585

Duncan's Multiple Range Test for Peak Load

NOTE: This test controls the Type I comparisonwise error rate, not the experimentwise error rate.

Alpha 0.01
 Error Degrees of Freedom 32
 Error Mean Square 276486.8

Number of Means 2
 Critical Range 455.4

Means with the same letter are not significantly different.

Duncan Grouping

	Mean	N	comp
A	8030.6	20	lab compacted
B	7476.2	20	field compacted

Duncan's Multiple Range Test for Peak Load

NOTE: This test controls the Type I comparisonwise error rate, not the experimentwise error rate.

Alpha 0.05
 Error Degrees of Freedom 32
 Error Mean Square 276486.8

Number of Means 2
 Critical Range 338.7

Means with the same letter are not significantly different.

Duncan Grouping

	Mean	N	mcond
A	8078.3	20	Not Moisture Conditioned
B	7428.6	20	Moisture Conditioned

RESIDUAL x PREDICTED VALUE PLOT

Legend: A = 1 obs, B = 2 obs, etc.

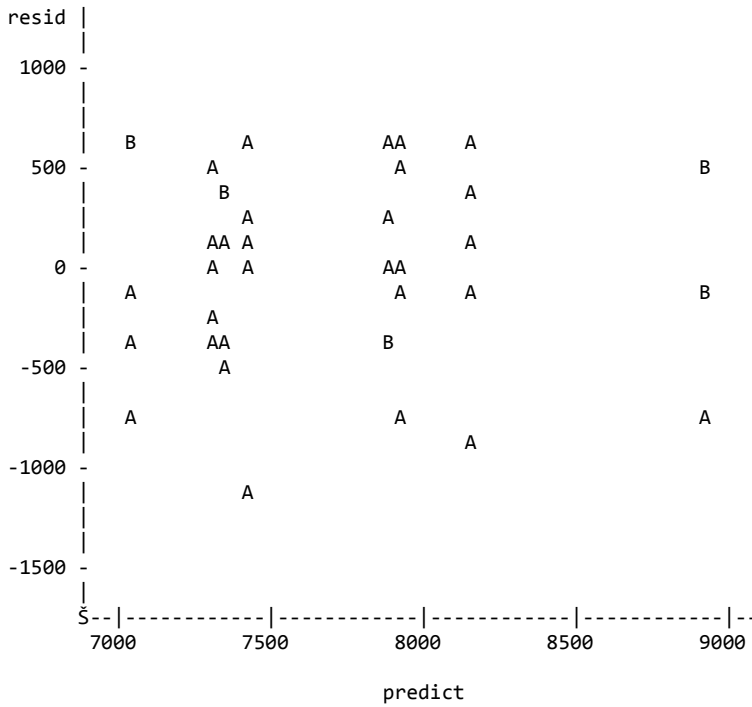

Normal Probability Plot

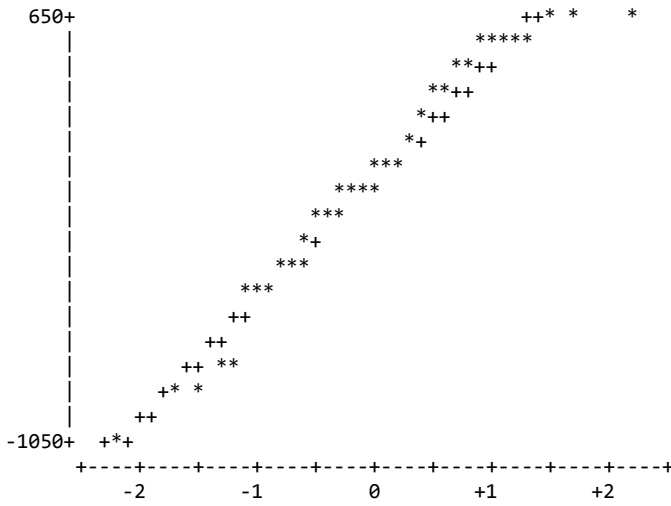

Duncan's Multiple Range Test for Peak Load

NOTE: This test controls the Type I comparisonwise error rate, not the experimentwise error rate.

Alpha 0.05
 Error Degrees of Freedom 32
 Error Mean Square 276486.8

Number of Means	2	3	4	5	6	7	8
Critical Range	677.4	712.0	734.4	750.5	762.7	772.2	779.9

Means with the same letter are not significantly different.

Duncan Grouping		Mean	N	cell	
	A	8939.4	5	Lab WMA NMC	
	B	8139.4	5	Field WMA NMC	
C	B	7937.6	5	Lab HMA NMC	
C	B	7880.6	5	Lab WMA MC	
C	B	D	7438.6	5	Field HMA MC
C	D	7364.8	5	Lab HMA MC	
C	D	7296.6	5	Field HMA NMC	
C	D	7030.2	5	Field WMA MC	

Tukey's Studentized Range (HSD) Test for Peak Load

NOTE: This test controls the Type I experimentwise error rate, but it generally has a higher Type II error rate than REGWQ.

Alpha 0.05
 Error Degrees of Freedom 32
 Error Mean Square 276486.8
 Critical Value of Studentized Range 4.58106
 Minimum Significant Difference 1077.3

Means with the same letter are not significantly different.

Tukey			
Grouping	Mean	N	cell
A	8939.4	5	Lab__WMA_NMC
A			
B	8139.4	5	Field_WMA_NMC
B	A	C	7937.6
			5
			Lab__HMA_NMC
B	A	C	7880.6
			5
			Lab__WMA_MC
B	C		7438.6
			5
			Field_HMA_MC
B	C		7364.8
			5
			Lab__HMA_MC
B	C		7296.6
			5
			Field_HMA_NMC
	C		7030.2
			5
			Field_WMA_MC

Section F-3: Field Mix 3 ITS Statistical Analysis Output- Peak Load

Class Level Information

Class	Levels	Values
mix	2	HMA WMA
comp	2	field lab
mcond	2	Moisture Conditioned Not Moisture Conditioned

Number of Observations Read 40
 Number of Observations Used 40

THREE-WAY ANOVA FOR FM3 ITS Samples

Dependent Variable: Peak Load

Source	DF	Sum of Squares	Mean Square	F Value	Pr > F
Model	7	82282478.38	11754639.77	46.57	<.0001
Error	32	8077649.60	252426.55		
Corrected Total	39	90360127.98			

R-Square 0.910606 Coeff Var 5.550061 Root MSE 502.4207 Peak Load Mean 9052.525

Source	DF	Type I SS	Mean Square	F Value	Pr > F
mix	1	69656405.63	69656405.63	275.95	<.0001
comp	1	4124850.62	4124850.62	16.34	0.0003
mix*comp	1	49210.22	49210.22	0.19	0.6618
mcond	1	6016329.22	6016329.22	23.83	<.0001
mix*mcond	1	1515934.22	1515934.22	6.01	0.0199
comp*mcond	1	266179.23	266179.23	1.05	0.3122
mix*comp*mcond	1	653569.23	653569.23	2.59	0.1174

Source	DF	Type III SS	Mean Square	F Value	Pr > F
mix	1	69656405.63	69656405.63	275.95	<.0001
comp	1	4124850.62	4124850.62	16.34	0.0003
mix*comp	1	49210.22	49210.22	0.19	0.6618
mcond	1	6016329.22	6016329.22	23.83	<.0001
mix*mcond	1	1515934.22	1515934.22	6.01	0.0199
comp*mcond	1	266179.23	266179.23	1.05	0.3122
mix*comp*mcond	1	653569.23	653569.23	2.59	0.1174

Duncan's Multiple Range Test for Peak Load

NOTE: This test controls the Type I comparisonwise error rate, not the experimentwise error rate.

Alpha 0.01
 Error Degrees of Freedom 32
 Error Mean Square 252426.5

Number of Means 2
 Critical Range 435.1

Means with the same letter are not significantly different.

Duncan Grouping

	Mean	N	comp
A	9373.7	20	lab compacted
B	8731.4	20	field compacted

Duncan's Multiple Range Test for Peak Load

NOTE: This test controls the Type I comparisonwise error rate, not the experimentwise error rate.

Alpha 0.05
 Error Degrees of Freedom 32
 Error Mean Square 252426.5
 Number of Means 2
 Critical Range 323.6

Means with the same letter are not significantly different.

Duncan Grouping

	Mean	N	mcond
A	9440.4	20	Not Moisture Conditioning
B	8664.7	20	Moisture Conditioning

RESIDUAL x PREDICTED VALUE PLOT

Plot of resid*predict. Legend: A = 1 obs, B = 2 obs, etc.

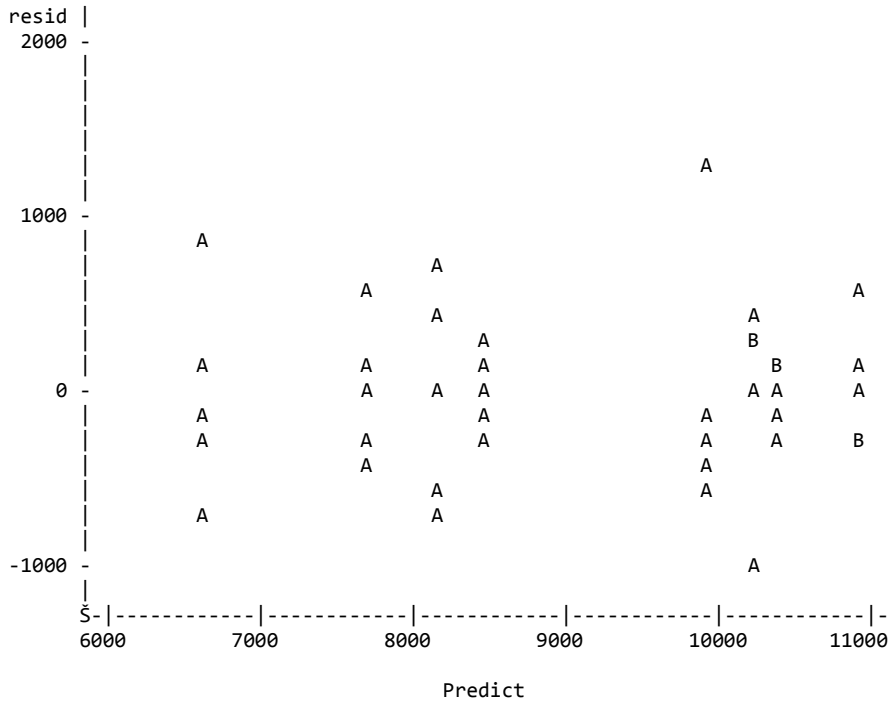

Normal Probability Plot

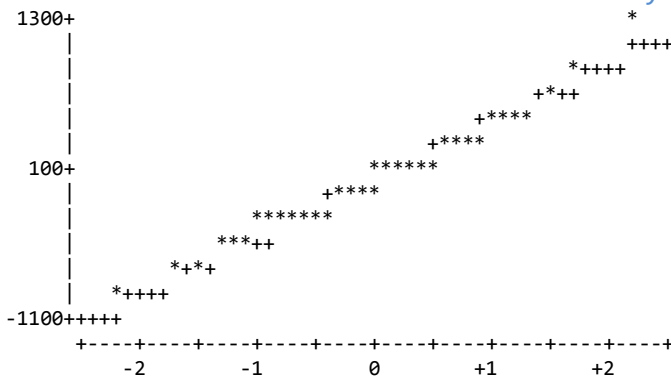

Duncan's Multiple Range Test for Peak Load

NOTE: This test controls the Type I comparisonwise error rate, not the experimentwise error rate.

Alpha 0.05
 Error Degrees of Freedom 32
 Error Mean Square 252426.5

Number of Means	2	3	4	5	6	7	8
Critical Range	647.3	680.3	701.8	717.1	728.7	737.9	745.2

Means with the same letter are not significantly different.

Duncan Grouping

	Mean	N	cell
B A	10897.6	5	lab HMA Not Moisture Conditioned
B A	10418.8	5	lab HMA Moisture Conditioned
B A	10233.0	5	field HMA Not Moisture Conditioned
B	9939.2	5	field HMA Moisture Conditioned
D C	8462.2	5	lab WMA Not Moisture Conditioned
D C	8168.6	5	field WMA Not Moisture Conditioned
D	7716.0	5	lab WMA Moisture Conditioned
E	6584.8	5	field WMA Moisture Conditioned

Tukey's Studentized Range (HSD) Test for Peak Load

NOTE: This test controls the Type I experimentwise error rate, but it generally has a higher Type II error rate than REGWQ.

Alpha 0.05
 Error Degrees of Freedom 32
 Error Mean Square 252426.5
 Critical Value of Studentized Range 4.58106
 Minimum Significant Difference 1029.3

Means with the same letter are not significantly different.

Tukey Grouping

	Mean	N	cell
A	10897.6	5	lab HMA Not Moisture Conditioned
A	10418.8	5	lab HMA Moisture Conditioned
A	10233.0	5	field HMA Not Moisture Conditioned
A	9939.2	5	field HMA Moisture Conditioned
B	8462.2	5	lab WMA Not Moisture Conditioned
B	8168.6	5	field WMA Not Moisture Conditioned
B	7716.0	5	lab WMA Moisture Conditioned
C	6584.8	5	field WMA Moisture Conditioned

Section F-4: Field Mix 4 ITS Statistical Analysis Output– Peak Load

Class Level Information

Class	Levels	Values
mix	2	HMA WMA
comp	2	field lab
mcond	2	Moisture Conditioned Not Moisture Conditioned

Number of Observations Read 36
 Number of Observations Used 36

THREE-WAY ANOVA FOR FM4 ITS Samples

Dependent Variable: Peak Load

Source	DF	Sum of Squares	Mean Square	F Value	Pr > F
Model	7	28027893.14	4003984.73	20.06	<.0001
Error	28	5588258.07	199580.65		
Corrected Total	35	33616151.21			

R-Square 0.833763 Coeff Var 3.901140 Root MSE 446.7445 Peak Load Mean 11451.64

Source	DF	Type I SS	Mean Square	F Value	Pr > F
mix	1	3533448.10	3533448.10	17.70	0.0002
comp	1	5037843.93	5037843.93	25.24	<.0001
mix*comp	1	358213.93	358213.93	1.79	0.1911
mcond	1	12525700.69	12525700.69	62.76	<.0001
mix*mcond	1	244319.20	244319.20	1.22	0.2780
comp*mcond	1	1438166.64	1438166.64	7.21	0.0121
mix*comp*mcond	1	4890200.65	4890200.65	24.50	<.0001

Source	DF	Type III SS	Mean Square	F Value	Pr > F
mix	1	4153688.373	4153688.373	20.81	<.0001
comp	1	4562459.798	4562459.798	22.86	<.0001
mix*comp	1	358213.928	358213.928	1.79	0.1911
mcond	1	8618120.558	8618120.558	43.18	<.0001
mix*mcond	1	901850.545	901850.545	4.52	0.0425
comp*mcond	1	2258549.335	2258549.335	11.32	0.0022
mix*comp*mcond	1	4890200.648	4890200.648	24.50	<.0001

Duncan's Multiple Range Test for Peak Load

NOTE: This test controls the Type I comparisonwise error rate, not the experimentwise error rate.

Alpha 0.01
 Error Degrees of Freedom 28
 Error Mean Square 199580.6
 Harmonic Mean of Cell Sizes 17.77778

NOTE: Cell sizes are not equal.

Number of Means 2
 Critical Range 414.1

Means with the same letter are not significantly different.

Duncan Grouping

	Mean	N	comp
A	11748.6	20	Clab
B	11080.5	16	Cfield

Duncan's Multiple Range Test for Peak Load

NOTE: This test controls the Type I comparisonwise error rate, not the experimentwise error rate.

Alpha 0.05
 Error Degrees of Freedom 28
 Error Mean Square 199580.6

Number of Means 2
 Critical Range 305.0

Means with the same letter are not significantly different.

Duncan Grouping

	Mean	N	mcond
A	12041.5	18	NMC
B	10861.8	18	MC

RESIDUAL x PREDICTED VALUE PLOT

Plot of resid*predict. Legend: A = 1 obs, B = 2 obs, etc.

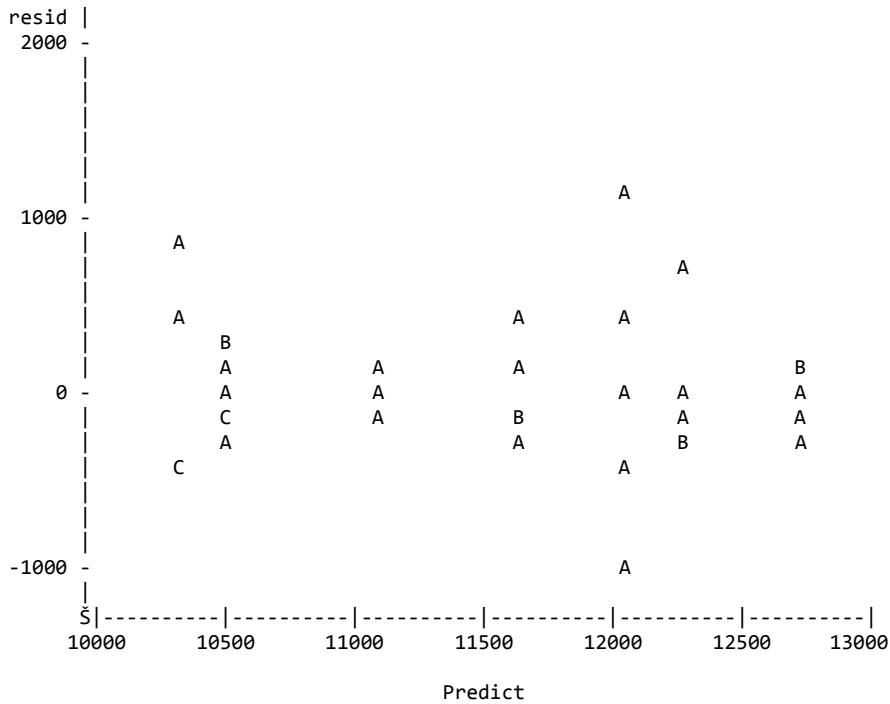

Normal Probability Plot

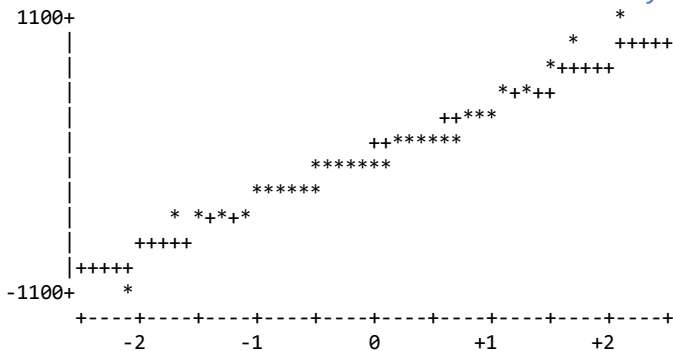

Duncan's Multiple Range Test for Peak Load

NOTE: This test controls the Type I comparisonwise error rate, not the experimentwise error rate.

Alpha 0.05
 Error Degrees of Freedom 28
 Error Mean Square 199580.6
 Harmonic Mean of Cell Sizes 4.285714

NOTE: Cell sizes are not equal.

Number of Means	2	3	4	5	6	7	8
Critical Range	625.1	656.9	677.4	692.0	702.9	711.5	718.4

Means with the same letter are not significantly different.

Duncan Grouping

	Mean	N	cell
A	12741.4	5	lab HMA Not Moisture Conditioned
B A	12271.8	5	lab WMA Not Moisture Conditioned
B	12049.4	5	field HMA Not Moisture Conditioned
B C	11656.3	5	lab HMA Moisture Conditioned
D C	11068.3	3	field WMA Moisture Conditioned
D E	10480.3	5	field HMA Moisture Conditioned
D E	10478.0	3	field WMA Not Moisture Conditioned
E	10324.8	5	lab WMA Moisture Conditioned

Section F-5: Field Mix 1 Dynamic Modulus Statistical Analysis Output

Class Level Information

Class	Levels	Values
mix	2	MHMA MWMA
comp	2	Cfield Clab
mcond	2	inMC iiMC
fre	9	fa fb fc fd fe ff fg fi fj
temp	3	tx ty tz

Number of Observations Read	864
Number of Observations Used	864

Five-WAY ANOVA FOR FM3 Dynamic Modulus Samples

Dependent Variable: SQRT(E*)

Source	DF	Sum of Squares	Mean Square	F Value	Pr > F
Model	215	1077334599	5010859	406.17	<.0001
Error	648	7994242	12337		
Corrected Total	863	1085328841			

R-Square	0.992634
Coeff Var	4.913300
Root MSE	111.0711
SQRT(E*) Mean	2260.622

Source	DF	Type I SS	Mean Square	F Value	Pr > F
mix	1	6076743.8	6076743.8	492.57	<.0001
comp	1	2399557.4	2399557.4	194.50	<.0001
mix*comp	1	76266.3	76266.3	6.18	0.0132
mcond	1	6062662.8	6062662.8	491.43	<.0001
mix*mcond	1	23343.8	23343.8	1.89	0.1694
comp*mcond	1	61417.7	61417.7	4.98	0.0260
mix*comp*mcond	1	825077.8	825077.8	66.88	<.0001
temp	2	905842463.6	452921231.8	36713.0	<.0001
mix*temp	2	262660.4	131330.2	10.65	<.0001
comp*temp	2	647266.9	323633.5	26.23	<.0001
mix*comp*temp	2	135907.9	67954.0	5.51	0.0042
mcond*temp	2	700519.0	350259.5	28.39	<.0001
mix*mcond*temp	2	20754.4	10377.2	0.84	0.4317
comp*mcond*temp	2	17184.1	8592.0	0.70	0.4987
mix*comp*mcond*temp	2	40842.9	20421.5	1.66	0.1918
fre	8	149925934.9	18740741.9	1519.09	<.0001
mix*fre	8	16011.8	2001.5	0.16	0.9955
comp*fre	8	17616.1	2202.0	0.18	0.9938
mix*comp*fre	8	4795.8	599.5	0.05	0.9999
mcond*fre	8	128622.3	16077.8	1.30	0.2387
mix*mcond*fre	8	23013.3	2876.7	0.23	0.9847
comp*mcond*fre	8	2285.8	285.7	0.02	1.0000
mix*comp*mcond*fre	8	15225.9	1903.2	0.15	0.9962
fre*temp	16	3556100.4	222256.3	18.02	<.0001
mix*fre*temp	16	301497.6	18843.6	1.53	0.0842
comp*fre*temp	16	17138.7	1071.2	0.09	1.0000
mix*comp*fre*temp	16	13192.3	824.5	0.07	1.0000
mcond*fre*temp	16	54418.9	3401.2	0.28	0.9979
mix*mcond*fre*temp	16	18918.8	1182.4	0.10	1.0000
comp*mcond*fre*temp	16	11128.3	695.5	0.06	1.0000
mix*comp*mcond*fre*temp	16	36029.5	2251.8	0.18	0.9999

Dependent Variable: SQRT(E*)

Source	DF	Type III SS	Mean Square	F Value	Pr > F
mix	1	6031291.3	6031291.3	488.89	<.0001
comp	1	2399557.4	2399557.4	194.50	<.0001
mix*comp	1	76266.3	76266.3	6.18	0.0132
mcond	1	5392168.9	5392168.9	437.08	<.0001
mix*mcond	1	140639.8	140639.8	11.40	0.0008
comp*mcond	1	61417.7	61417.7	4.98	0.0260
mix*comp*mcond	1	825077.8	825077.8	66.88	<.0001
temp	2	838922895.3	419461447.7	34000.8	<.0001
mix*temp	2	332840.2	166420.1	13.49	<.0001
comp*temp	2	647266.9	323633.5	26.23	<.0001
mix*comp*temp	2	135907.9	67954.0	5.51	0.0042
mcond*temp	2	629330.5	314665.3	25.51	<.0001
mix*mcond*temp	2	30886.8	15443.4	1.25	0.2867
comp*mcond*temp	2	17184.1	8592.0	0.70	0.4987
mix*comp*mcond*temp	2	40842.9	20421.5	1.66	0.1918
fre	8	139958134.5	17494766.8	1418.10	<.0001
mix*fre	8	13441.8	1680.2	0.14	0.9976
comp*fre	8	17616.1	2202.0	0.18	0.9938
mix*comp*fre	8	4795.8	599.5	0.05	0.9999
mcond*fre	8	115659.4	14457.4	1.17	0.3136
mix*mcond*fre	8	26843.1	3355.4	0.27	0.9749
comp*mcond*fre	8	2285.8	285.7	0.02	1.0000
mix*comp*mcond*fre	8	15225.9	1903.2	0.15	0.9962
fre*temp	16	3264448.1	204028.0	16.54	<.0001
mix*fre*temp	16	283568.7	17723.0	1.44	0.1184
comp*fre*temp	16	17138.7	1071.2	0.09	1.0000
mix*comp*fre*temp	16	13192.3	824.5	0.07	1.0000
mcond*fre*temp	16	45124.7	2820.3	0.23	0.9993
mix*mcond*fre*temp	16	17919.4	1120.0	0.09	1.0000
comp*mcond*fre*temp	16	11128.3	695.5	0.06	1.0000
mix*com*mco*fre*temp	16	36029.5	2251.8	0.18	0.9999

Duncan's Multiple Range Test for SQRT(E*)

NOTE: This test controls the Type I comparisonwise error rate, not the experimentwise error rate.

Alpha	0.01
Error Degrees of Freedom	648
Error Mean Square	12336.79
Harmonic Mean of Cell Sizes	405

NOTE: Cell sizes are not equal.

Number of Means	2
Critical Range	20.16

Means with the same letter are not significantly different.

Duncan Grouping

	Mean	N	comp
A	2301.443	540	lab
B	2192.586	324	field

Duncan's Multiple Range Test for SQRT(E*)

NOTE: This test controls the Type I comparisonwise error rate, not the experimentwise error rate.

Alpha	0.05
Error Degrees of Freedom	648
Error Mean Square	12336.79
Number of Means	2
Critical Range	14.84

Means with the same letter are not significantly different.

Duncan Grouping	Mean	N	mcond
-----------------	------	---	-------

A 2344.389 432 Not Moisture Conditioned
 B 2176.854 432 Moisture Conditioned
 Duncan's Multiple Range Test for SQRT(E*)

NOTE: This test controls the Type I comparisonwise error rate, not the experimentwise error rate.

Alpha 0.05
 Error Degrees of Freedom 648
 Error Mean Square 12336.79
 Harmonic Mean of Cell Sizes 405

NOTE: Cell sizes are not equal.

Number of Means 2
 Critical Range 15.33

Means with the same letter are not significantly different.

Duncan Grouping

	Mean	N	comp
A	2301.443	540	lab
B	2192.586	324	field

Duncan's Multiple Range Test for SQRT(E*)

NOTE: This test controls the Type I comparisonwise error rate, not the experimentwise error rate.

Alpha 0.05
 Error Degrees of Freedom 648
 Error Mean Square 12336.79

Number of Means 2
 Critical Range 14.84

Means with the same letter are not significantly different.

Duncan Grouping

	Mean	N	mix
A	2344.486	432	MHMA
B	2176.757	432	MWMA

Duncan's Multiple Range Test for SQRT(E*)

NOTE: This test controls the Type I comparisonwise error rate, not the experimentwise error rate.

Alpha 0.05
 Error Degrees of Freedom 648
 Error Mean Square 12336.79

Number of Means	2	3	4	5	6	7	8	9
Critical Range	31.48	33.14	34.26	35.08	35.72	36.24	36.68	37.06

Means with the same letter are not significantly different.

Duncan Grouping

	Mean	N	fre
A	2868.96	96	fa
B	2722.94	96	fb
C	2621.50	96	fc
D	2459.92	96	fd
E	2296.13	96	fe
F	2050.56	96	ff
G	1915.25	96	fg
H	1819.74	96	fi
I	1590.60	96	fj

Duncan's Multiple Range Test for SQRT(E*)

NOTE: This test controls the Type I comparisonwise error rate, not the experimentwise error rate.

Alpha 0.05
 Error Degrees of Freedom 648
 Error Mean Square 12336.79

Number of Means 2 3
 Critical Range 18.18 19.14

Means with the same letter are not significantly different.

Duncan Grouping

	Mean	N	temp
A	3583.493	288	tx
B	2109.236	288	ty
C	1089.135	288	tz

RESIDUAL x PREDICTED VALUE PLOT

Legend: A = 1 obs, B = 2 obs, etc.

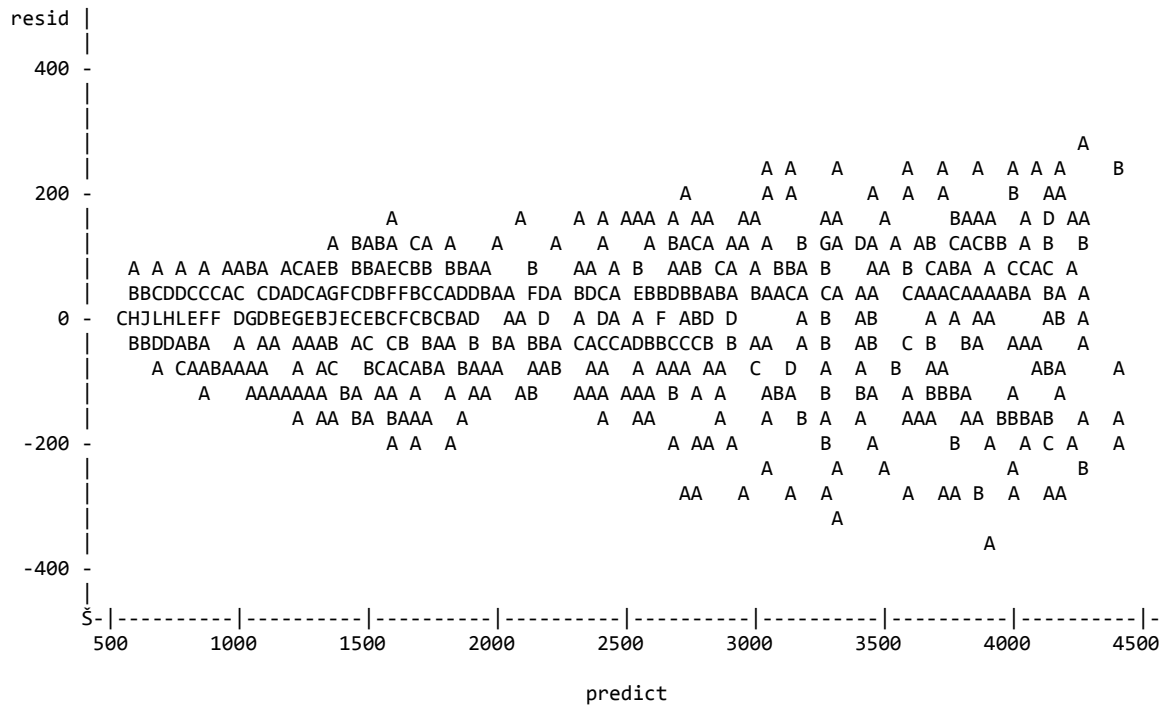

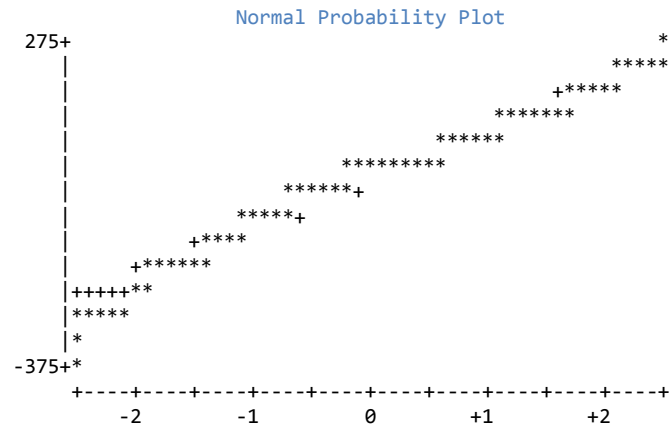

Section F-6: Field Mix 2 Dynamic Modulus Statistical Analysis Output

Class Level Information (Coding Translation)		
Class	Levels	Values
mix	2	MHMA MWMA (HMA WMA)
comp	2	Cfield Clab (field lab)
mcond	2	iNMC iiMC (Not Moisture Conditioned / Moisture conditioned)
fre Hz.)	9	fa fb fc fd fe ff fg fi fj (Frequencies: 25, 15, 10, 5, 3, 1, 0.5, 0.3, 0.1)
temp	3	tx ty tz (4, 21, 37 C)

Number of Observations Read 1080
Number of Observations Used 1080

Five-WAY ANOVA FOR FM4 Dynamic Modulus Samples

Dependent Variable: SQRT(E*)

Source	DF	Sum of Squares	Mean Square	F Value	Pr > F
Model	215	1112395139	5173931	460.25	<.0001
Error	864	9712782	11242		
Corrected Total	1079	1122107921			

R-Square	Coeff Var	Root MSE	SQRT(E*) Mean
0.991344	5.274478	106.0266	2010.182

Source	DF	Type I SS	Mean Square	F Value	Pr > F
mix	1	1015250.7	1015250.7	90.31	<.0001
comp	1	197722.0	197722.0	17.59	<.0001
mix*comp	1	8961.4	8961.4	0.80	0.3722
mcond	1	925236.4	925236.4	82.30	<.0001
mix*mcond	1	1051377.6	1051377.6	93.53	<.0001
comp*mcond	1	680.0	680.0	0.06	0.8058
mix*comp*mcond	1	597982.0	597982.0	53.19	<.0001
temp	2	920420241.0	460210120.5	40938.0	<.0001
mix*temp	2	191625.0	95812.5	8.52	0.0002
comp*temp	2	8363.8	4181.9	0.37	0.6895
mix*comp*temp	2	133609.7	66804.8	5.94	0.0027
mcond*temp	2	941204.7	470602.4	41.86	<.0001
mix*mcond*temp	2	267819.8	133909.9	11.91	<.0001
comp*mcond*temp	2	57717.3	28858.6	2.57	0.0773
mix*comp*mcond*temp	2	147992.0	73996.0	6.58	0.0015
fre	8	176316184.6	22039523.1	1960.52	<.0001
mix*fre	8	28472.6	3559.1	0.32	0.9599
comp*fre	8	7124.1	890.5	0.08	0.9997
mix*comp*fre	8	8192.7	1024.1	0.09	0.9994
mcond*fre	8	159435.8	19929.5	1.77	0.0788
mix*mcond*fre	8	15248.7	1906.1	0.17	0.9948
comp*mcond*fre	8	9857.1	1232.1	0.11	0.9989
mix*comp*mcond*fre	8	21757.3	2719.7	0.24	0.9828
fre*temp	16	9613237.4	600827.3	53.45	<.0001
mix*fre*temp	16	27494.0	1718.4	0.15	1.0000
comp*fre*temp	16	36432.1	2277.0	0.20	0.9997
mix*comp*fre*temp	16	15860.3	991.3	0.09	1.0000
mcond*fre*temp	16	72444.2	4527.8	0.40	0.9821
mix*mcond*fre*temp	16	9983.2	624.0	0.06	1.0000
comp*mcond*fre*temp	16	39592.4	2474.5	0.22	0.9995
mix*com*mco*fre*temp	16	48039.1	3002.4	0.27	0.9983

Dependent Variable: SQRT(E*)

Source	DF	Type III SS	Mean Square	F Value	Pr > F
mix	1	1015250.7	1015250.7	90.31	<.0001
comp	1	197722.0	197722.0	17.59	<.0001
mix*comp	1	8961.4	8961.4	0.80	0.3722
mcond	1	925236.4	925236.4	82.30	<.0001
mix*mcond	1	1051377.6	1051377.6	93.53	<.0001
comp*mcond	1	680.0	680.0	0.06	0.8058
mix*comp*mcond	1	597982.0	597982.0	53.19	<.0001
temp	2	920420241.0	460210120.5	40938.0	<.0001
mix*temp	2	191625.0	95812.5	8.52	0.0002
comp*temp	2	8363.8	4181.9	0.37	0.6895
mix*comp*temp	2	133609.6	66804.8	5.94	0.0027
mcond*temp	2	941204.7	470602.4	41.86	<.0001
mix*mcond*temp	2	267819.8	133909.9	11.91	<.0001
comp*mcond*temp	2	57717.3	28858.6	2.57	0.0773
mix*comp*mcond*temp	2	147992.0	73996.0	6.58	0.0015
fre	8	176316184.6	22039523.1	1960.52	<.0001
mix*fre	8	28472.6	3559.1	0.32	0.9599
comp*fre	8	7124.1	890.5	0.08	0.9997
mix*comp*fre	8	8192.7	1024.1	0.09	0.9994
mcond*fre	8	159435.8	19929.5	1.77	0.0788
mix*mcond*fre	8	15248.7	1906.1	0.17	0.9948
comp*mcond*fre	8	9857.1	1232.1	0.11	0.9989
mix*comp*mcond*fre	8	21757.3	2719.7	0.24	0.9828
fre*temp	16	9613237.4	600827.3	53.45	<.0001
mix*fre*temp	16	27494.0	1718.4	0.15	1.0000
comp*fre*temp	16	36432.1	2277.0	0.20	0.9997
mix*comp*fre*temp	16	15860.3	991.3	0.09	1.0000
mcond*fre*temp	16	72444.2	4527.8	0.40	0.9821
mix*mcond*fre*temp	16	9983.2	624.0	0.06	1.0000
comp*mcond*fre*temp	16	39592.4	2474.5	0.22	0.9995
mix*com*mco*fre*temp	16	48039.1	3002.4	0.27	0.9983

Duncan's Multiple Range Test for SQRT(E*)

Alpha 0.01
 Error Degrees of Freedom 864
 Error Mean Square 11241.65

Number of Means 2
 Critical Range 16.66

Means with the same letter are not significantly different.

Duncan Grouping

	Mean	N	comp
A	2023.713	540	field
B	1996.652	540	lab

Duncan's Multiple Range Test for SQRT(E*)

NOTE: This test controls the Type I comparisonwise error rate, not the experimentwise error rate.

Alpha 0.05
 Error Degrees of Freedom 864
 Error Mean Square 11241.65

Number of Means 2
 Critical Range 12.66

Means with the same letter are not significantly different.

Duncan Grouping

	Mean	N	mcond
A	2039.452	540	Not Moisture Conditioned
B	1980.913	540	Moisture Conditioned

Duncan's Multiple Range Test for SQRT(E*)

NOTE: This test controls the Type I comparisonwise error rate, not the experimentwise error rate.

Alpha 0.05
 Error Degrees of Freedom 864
 Error Mean Square 11241.65

Number of Means 2
 Critical Range 12.66

Means with the same letter are not significantly different.

Duncan Grouping

	Mean	N	comp
A	2023.713	540	field
B	1996.652	540	lab

Duncan's Multiple Range Test for SQRT(E*)

NOTE: This test controls the Type I comparisonwise error rate, not the experimentwise error rate.

Alpha 0.05
 Error Degrees of Freedom 864
 Error Mean Square 11241.65

Number of Means 2
 Critical Range 12.66

Means with the same letter are not significantly different.

Duncan Grouping

	Mean	N	mix
A	2040.843	540	HMA
B	1979.522	540	WMA

Duncan's Multiple Range Test for SQRT(E*)

NOTE: This test controls the Type I comparisonwise error rate, not the experimentwise error rate.

Alpha 0.05
 Error Degrees of Freedom 864
 Error Mean Square 11241.65
 Number of Means 2 3 4 5 6 7 8 9
 Critical Range 26.87 28.29 29.24 29.94 30.49 30.94 31.31 31.63

Means with the same letter are not significantly different.

Duncan Grouping

	Mean	N	fre
A	2622.46	120	fa
B	2461.68	120	fb
C	2352.83	120	fc
D	2195.11	120	fd
E	2025.22	120	fe
F	1797.14	120	ff
G	1677.28	120	fg
H	1580.67	120	fi
I	1379.27	120	fj

Duncan's Multiple Range Test for SQRT(E*)

NOTE: This test controls the Type I comparisonwise error rate, not the experimentwise error rate.

Alpha 0.05
 Error Degrees of Freedom 864
 Error Mean Square 11241.65
 Number of Means 2 3
 Critical Range 15.51 16.33

Means with the same letter are not significantly different.

Duncan Grouping

	Mean	N	temp
A	3223.533	360	tx
B	1820.875	360	ty
C	986.139	360	tz

RESIDUAL x PREDICTED VALUE PLOT

Legend: A = 1 obs, B = 2 obs, etc.

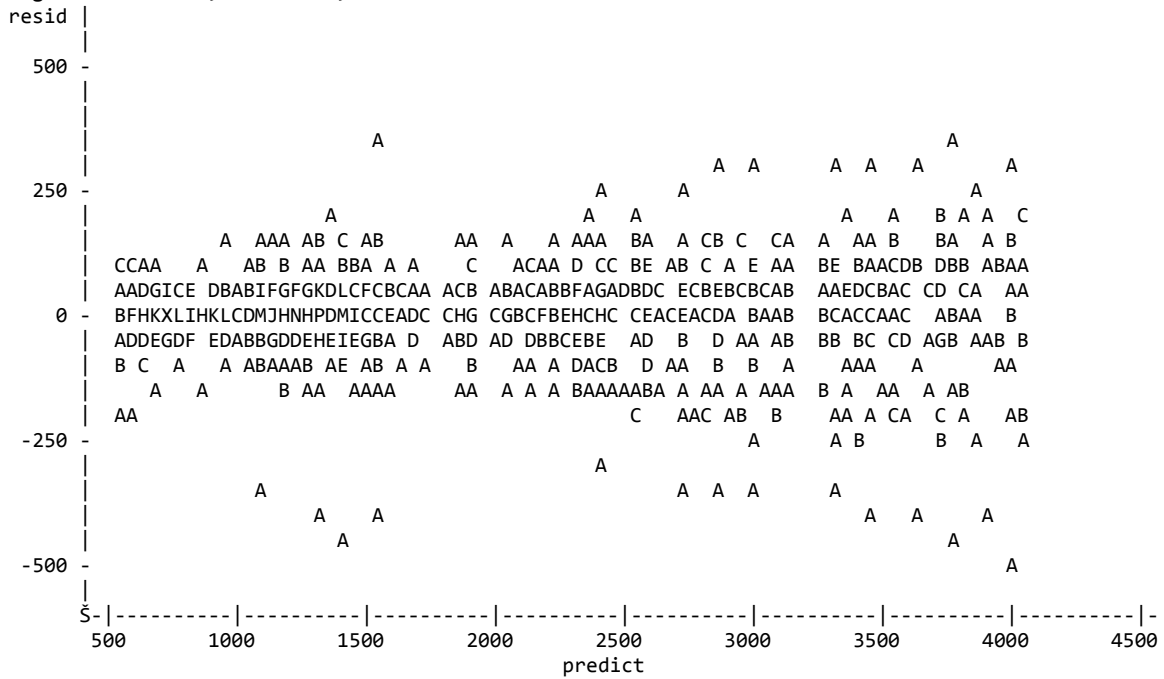

Normal Probability Plot

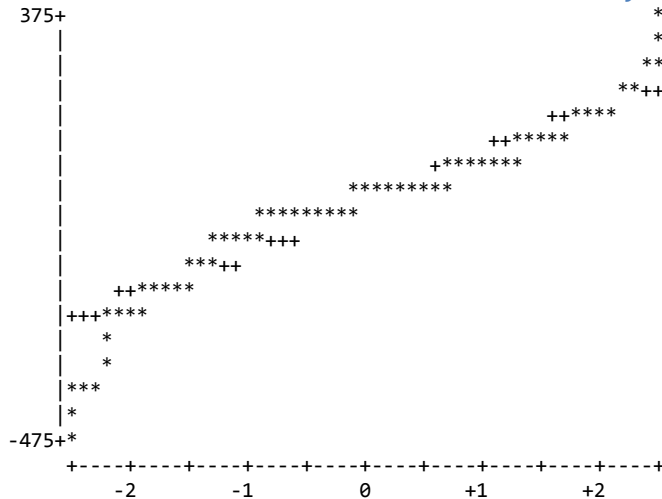

Section F-7: Field Mix 3 Statistical Analysis Output

Class	Levels	Values	Class Level Information (Coding Translation)
mix	2	MHMA MWMA	(HMA WMA)
comp	2	Cfield Clab	(field lab)
mcond	2	iNMC iiMC	(Not Moisture Conditioned / Moisture conditioned)
fre	9	fa fb fc fd fe ff fg fi fj	(Frequencies: 25, 15, 10, 5, 3, 1, 0.5, 0.3, 0.1 Hz.)
temp	3	tx ty tz	(4, 21, 37 C)

Number of Observations Read 1080
 Number of Observations Used 1080

Five-WAY ANOVA FOR FM3 Dynamic Modulus Samples

Dependent Variable: SQRT(E*)

Source	DF	Sum of Squares	Mean Square	F Value	Pr > F
Model	215	1505651330	7003029	522.49	<.0001
Error	864	11580244	13403		
Corrected Total	1079	1517231574			

R-Square 0.992368 Coeff Var 5.385027 Root MSE 115.7716 SQRT(E*) Mean 2149.880

Source	DF	Type I SS	Mean Square	F Value	Pr > F
mix	1	4891633	4891633	364.96	<.0001
comp	1	1550413	1550413	115.68	<.0001
mix*comp	1	922370	922370	68.82	<.0001
mcond	1	3612270	3612270	269.51	<.0001
mix*mcond	1	289625	289625	21.61	<.0001
comp*mcond	1	108601	108601	8.10	0.0045
mix*comp*mcond	1	532800	532800	39.75	<.0001
temp	2	1260712878	630356439	47030.8	<.0001
mix*temp	2	972755	486377	36.29	<.0001
comp*temp	2	181086	90543	6.76	0.0012
mix*comp*temp	2	77897	38949	2.91	0.0552
mcond*temp	2	1274327	637164	47.54	<.0001
mix*mcond*temp	2	44733	22366	1.67	0.1891
comp*mcond*temp	2	3914	1957	0.15	0.8642
mix*comp*mcond*temp	2	27986	13993	1.04	0.3525
fre	8	218858220	27357277	2041.12	<.0001
mix*fre	8	48593	6074	0.45	0.8888
comp*fre	8	10584	1323	0.10	0.9993
mix*comp*fre	8	10838	1355	0.10	0.9992
mcond*fre	8	107181	13398	1.00	0.4347
mix*mcond*fre	8	14517	1815	0.14	0.9976
comp*mcond*fre	8	21409	2676	0.20	0.9909
mix*comp*mcond*fre	8	7796	975	0.07	0.9998
fre*temp	16	11059319	691207	51.57	<.0001
mix*fre*temp	16	139260	8704	0.65	0.8443
comp*fre*temp	16	27549	1722	0.13	1.0000
mix*comp*fre*temp	16	24491	1531	0.11	1.0000
mcond*fre*temp	16	31232	1952	0.15	1.0000
mix*mcond*fre*temp	16	28314	1770	0.13	1.0000
comp*mcond*fre*temp	16	32693	2043	0.15	1.0000
mix*comp*mco*fre*temp	16	26047	1628	0.12	1.0000

Dependent Variable: SQR(E*)

Source	DF	Type III SS	Mean Square	F Value	Pr > F
mix	1	4891633	4891633	364.96	<.0001
comp	1	1550413	1550413	115.68	<.0001
mix*comp	1	922370	922370	68.82	<.0001
mcond	1	3612270	3612270	269.51	<.0001
mix*mcond	1	289625	289625	21.61	<.0001
comp*mcond	1	108601	108601	8.10	0.0045
mix*comp*mcond	1	532800	532800	39.75	<.0001
temp	2	1260712878	630356439	47030.8	<.0001
mix*temp	2	972755	486377	36.29	<.0001
comp*temp	2	181086	90543	6.76	0.0012
mix*comp*temp	2	77897	38949	2.91	0.0552
mcond*temp	2	1274327	637164	47.54	<.0001
mix*mcond*temp	2	44733	22366	1.67	0.1891
comp*mcond*temp	2	3914	1957	0.15	0.8642
mix*comp*mcond*temp	2	27986	13993	1.04	0.3525
fre	8	218858220	27357277	2041.12	<.0001
mix*fre	8	48593	6074	0.45	0.8888
comp*fre	8	10584	1323	0.10	0.9993
mix*comp*fre	8	10838	1355	0.10	0.9992
mcond*fre	8	107181	13398	1.00	0.4347
mix*mcond*fre	8	14517	1815	0.14	0.9976
comp*mcond*fre	8	21409	2676	0.20	0.9909
mix*comp*mcond*fre	8	7796	975	0.07	0.9998
fre*temp	16	11059319	691207	51.57	<.0001
mix*fre*temp	16	139260	8704	0.65	0.8443
comp*fre*temp	16	27549	1722	0.13	1.0000
mix*comp*fre*temp	16	24491	1531	0.11	1.0000
mcond*fre*temp	16	31232	1952	0.15	1.0000
mix*mcond*fre*temp	16	28314	1770	0.13	1.0000
comp*mcond*fre*temp	16	32693	2043	0.15	1.0000
mix*com*mco*fre*temp	16	26047	1628	0.12	1.0000

Duncan's Multiple Range Test for SQR(E*)

NOTE: This test controls the Type I comparisonwise error rate, not the experimentwise error rate.

Alpha	0.01
Error Degrees of Freedom	864
Error Mean Square	13403.06

Number of Means	2
Critical Range	18.19

Means with the same letter are not significantly different.

Duncan Grouping

	Mean	N	comp
A	2187.769	540	lab
B	2111.991	540	field

Duncan's Multiple Range Test for SQR(E*)

NOTE: This test controls the Type I comparisonwise error rate, not the experimentwise error rate.

Alpha	0.05
Error Degrees of Freedom	864
Error Mean Square	13403.06

Number of Means	2
Critical Range	13.83

Means with the same letter are not significantly different.

Duncan Grouping

	Mean	N	mcond
A	2207.713	540	Not Moisture Conditioned
B	2092.046	540	Moisture Conditioned

Duncan's Multiple Range Test for SQRT(E*)

NOTE: This test controls the Type I comparisonwise error rate, not the experimentwise error rate.

Alpha	0.05
Error Degrees of Freedom	864
Error Mean Square	13403.06

Number of Means	2
Critical Range	13.83

Means with the same letter are not significantly different.

Duncan Grouping

	Mean	N	comp
A	2187.769	540	lab
B	2111.991	540	field

Duncan's Multiple Range Test for SQRT(E*)

NOTE: This test controls the Type I comparisonwise error rate, not the experimentwise error rate.

Alpha	0.05
Error Degrees of Freedom	864
Error Mean Square	13403.06

Number of Means	2
Critical Range	13.83

Means with the same letter are not significantly different.

Duncan Grouping

	Mean	N	mix
A	2217.180	540	HMA
B	2082.580	540	WMA

Duncan's Multiple Range Test for SQRT(E*)

NOTE: This test controls the Type I comparisonwise error rate, not the experimentwise error rate.

Alpha	0.05							
Error Degrees of Freedom	864							
Error Mean Square	13403.06							
Number of Means	2	3	4	5	6	7	8	9
Critical Range	29.33	30.88	31.92	32.69	33.29	33.78	34.19	34.54

Means with the same letter are not significantly different.

Duncan Grouping

	Mean	N	fre
A	2819.68	120	fa
B	2653.62	120	fb
C	2530.79	120	fc
D	2354.12	120	fd
E	2184.64	120	fe
F	1917.73	120	ff
G	1780.73	120	fg
H	1681.61	120	fi
I	1426.02	120	fj

Duncan's Multiple Range Test for $\sqrt{E^*}$

NOTE: This test controls the Type I comparisonwise error rate, not the experimentwise error rate.

Alpha 0.05
 Error Degrees of Freedom 864
 Error Mean Square 13403.06

Number of Means 2 3
 Critical Range 16.94 17.83
 Means with the same letter are not significantly different.

Duncan Grouping

	Mean	N	temp
A	3569.967	360	tx
B	1928.206	360	ty
C	951.467	360	tz

RESIDUAL x PREDICTED VALUE PLOT

Plot of resid*predict. Legend: A = 1 obs, B = 2 obs, etc.

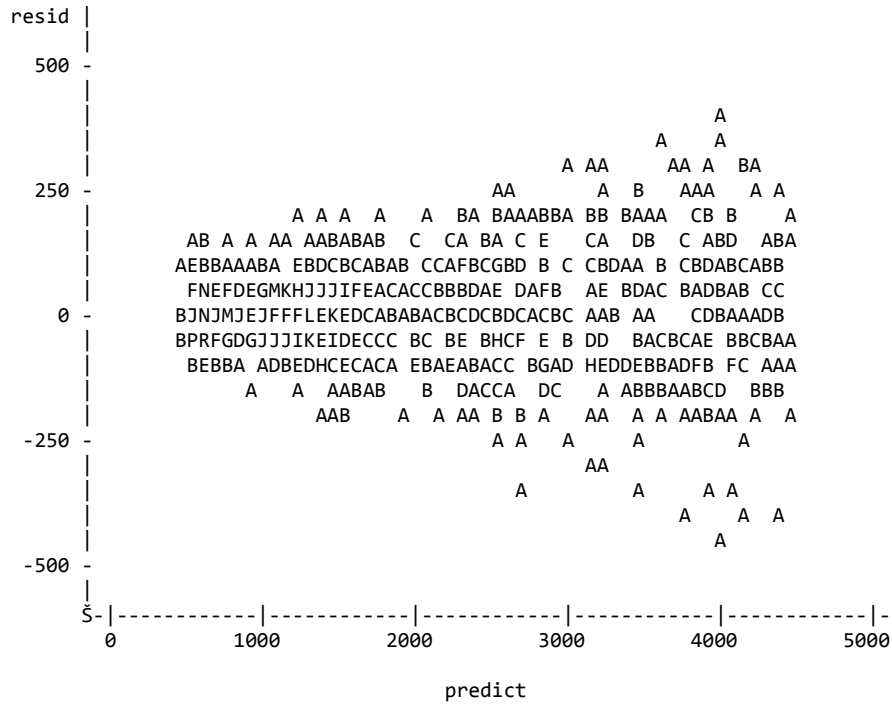

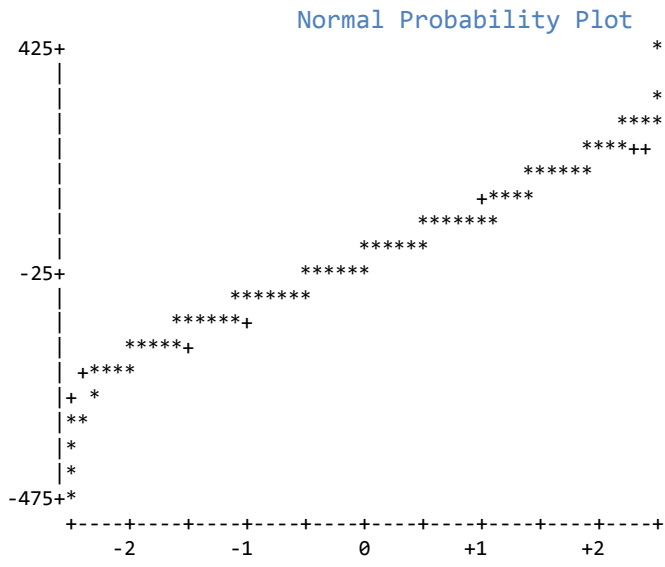

Section F-8: Field Mix 4 Dynamic Modulus Statistical Analysis Output

Class Level Information (Coding Translation)		
Class	Levels	Values
mix	2	MHMA MWMA (HMA WMA)
comp	2	Cfield Clab (field lab)
mcond	2	iNMC iiMC (Not Moisture Conditioned / Moisture conditioned)
fre (Hz.)	9	fa fb fc fd fe ff fg fi fj (Frequencies: 25, 15, 10, 5, 3, 1, 0.5, 0.3, 0.1)
temp	3	tx ty tz (4, 21, 37 C)

Number of Observations Read 971
 Number of Observations Used 971

Five-WAY ANOVA FOR FM4 Dynamic Modulus Samples

Dependent Variable: SQRT(E*)

Source	DF	Sum of Squares	Mean Square	F Value	Pr > F
Model	215	1452247463	6754639	664.23	<.0001
Error	755	7677637	10169		
Corrected Total	970	1459925101			

R-Square 0.994741
 Coeff Var 3.939880
 Root MSE 100.8417
 SQRT(E*) Mean 2559.513

Source	DF	Type I SS	Mean Square	F Value	Pr > F
mix	1	3249873	3249873	319.58	<.0001
comp	1	4709	4709	0.46	0.4964
mix*comp	1	1017906	1017906	100.10	<.0001
mcond	1	3356027	3356027	330.02	<.0001
mix*mcond	1	140236	140236	13.79	0.0002
comp*mcond	1	194105	194105	19.09	<.0001
mix*comp*mcond	1	133330	133330	13.11	0.0003
temp	2	1224001219	612000610	60182.6	<.0001
mix*temp	2	363814	181907	17.89	<.0001
comp*temp	2	77543	38771	3.81	0.0225
mix*comp*temp	2	122153	61076	6.01	0.0026
mcond*temp	2	703358	351679	34.58	<.0001
mix*mcond*temp	2	706170	353085	34.72	<.0001
comp*mcond*temp	2	129344	64672	6.36	0.0018
mix*comp*mcond*temp	2	51727	25864	2.54	0.0793
fre	8	212068612	26508576	2606.79	<.0001
mix*fre	8	139377	17422	1.71	0.0917
comp*fre	8	43506	5438	0.53	0.8307
mix*comp*fre	8	96502	12063	1.19	0.3044
mcond*fre	8	95010	11876	1.17	0.3158
mix*mcond*fre	8	46777	5847	0.57	0.7989
comp*mcond*fre	8	6341	793	0.08	0.9997
mix*comp*mcond*fre	8	8705	1088	0.11	0.9990
fre*temp	16	5143158	321447	31.61	<.0001
mix*fre*temp	16	132885	8305	0.82	0.6672
comp*fre*temp	16	79684	4980	0.49	0.9527
mix*comp*fre*temp	16	51941	3246	0.32	0.9950
mcond*fre*temp	16	20197	1262	0.12	1.0000
mix*mcond*fre*temp	16	42769	2673	0.26	0.9984
comp*mcond*fre*temp	16	10217	639	0.06	1.0000
mix*com*mco*fre*temp	16	10269	642	0.06	1.0000

The GLM Procedure

Dependent Variable: SQRT(E*)

Source	DF	Type III SS	Mean Square	F Value	Pr > F
mix	1	2635974	2635974	259.22	<.0001
comp	1	41692	41692	4.10	0.0432
mix*comp	1	997454	997454	98.09	<.0001
mcond	1	2982445	2982445	293.29	<.0001
mix*mcond	1	71464	71464	7.03	0.0082
comp*mcond	1	231014	231014	22.72	<.0001
mix*comp*mcond	1	127489	127489	12.54	0.0004
temp	2	1169909935	584954967	57523.0	<.0001
mix*temp	2	354636	177318	17.44	<.0001
comp*temp	2	58967	29483	2.90	0.0557
mix*comp*temp	2	110115	55058	5.41	0.0046
mcond*temp	2	765389	382695	37.63	<.0001
mix*mcond*temp	2	640590	320295	31.50	<.0001
comp*mcond*temp	2	113561	56780	5.58	0.0039
mix*comp*mcond*temp	2	44485	22243	2.19	0.1129
fre	8	202465629	25308204	2488.75	<.0001
mix*fre	8	119486	14936	1.47	0.1648
comp*fre	8	30374	3797	0.37	0.9348
mix*comp*fre	8	97108	12139	1.19	0.2998
mcond*fre	8	112449	14056	1.38	0.2005
mix*mcond*fre	8	53304	6663	0.66	0.7312
comp*mcond*fre	8	7847	981	0.10	0.9993
mix*comp*mcond*fre	8	9142	1143	0.11	0.9988
fre*temp	16	4910161	306885	30.18	<.0001
mix*fre*temp	16	116241	7265	0.71	0.7809
comp*fre*temp	16	69991	4374	0.43	0.9749
mix*comp*fre*temp	16	52124	3258	0.32	0.9949
mcond*fre*temp	16	18253	1141	0.11	1.0000
mix*mcond*fre*temp	16	45565	2848	0.28	0.9977
comp*mcond*fre*temp	16	10892	681	0.07	1.0000
mix*com*mco*fre*temp	16	10269	642	0.06	1.0000

Duncan's Multiple Range Test for SQRT(E*)

NOTE: This test controls the Type I comparisonwise error rate, not the experimentwise error rate.

Alpha 0.05
 Error Degrees of Freedom 755
 Error Mean Square 10169.06
 Harmonic Mean of Cell Sizes 485.4995

NOTE: Cell sizes are not equal.

Number of Means 2
 Critical Range 12.71

Means with the same letter are not significantly different.

Duncan Grouping

	Mean	N	mcond
A	2618.348	485	Not Moisture Conditioned
B	2500.798	486	Moisture Conditioned

Duncan's Multiple Range Test for SQRT(E*)

NOTE: This test controls the Type I comparisonwise error rate, not the experimentwise error rate.

Alpha 0.05
 Error Degrees of Freedom 755
 Error Mean Square 10169.06
 Harmonic Mean of Cell Sizes 479.3821
 NOTE: Cell sizes are not equal.
 Number of Means 2
 Critical Range 12.79

Means with the same letter are not significantly different.

Duncan Grouping

	Mean	N	comp
A	2568.000	540	lab
B	2548.879	431	field

Duncan's Multiple Range Test for SQRT(E*)

NOTE: This test controls the Type I comparisonwise error rate, not the experimentwise error rate.

Alpha 0.05
 Error Degrees of Freedom 755
 Error Mean Square 10169.06
 Harmonic Mean of Cell Sizes 479.3821

NOTE: Cell sizes are not equal.

Number of Means 2
 Critical Range 12.79

Means with the same letter are not significantly different.

Duncan Grouping

	Mean	N	mix
A	2624.269	431	WMA
B	2507.828	540	HMA

Duncan's Multiple Range Test for SQRT(E*)

NOTE: This test controls the Type I comparisonwise error rate, not the experimentwise error rate.

Alpha 0.05
 Error Degrees of Freedom 755
 Error Mean Square 10169.06
 Harmonic Mean of Cell Sizes 107.888
 NOTE: Cell sizes are not equal.
 Number of Means 2 3 4 5 6 7 8 9
 Critical Range 26.95 28.38 29.33 30.03 30.59 31.03 31.41 31.73

Means with the same letter are not significantly different.

Duncan Grouping

	Mean	N	fre
A	3246.09	108	fa
B	3091.35	108	fb
C	2955.25	108	fc
D	2768.61	107	fd
E	2603.51	108	fe
F	2313.26	108	ff
G	2173.44	108	fg
H	2080.70	108	fi
I	1805.33	108	fj

Duncan's Multiple Range Test for SQRT(E*)

NOTE: This test controls the Type I comparisonwise error rate, not the experimentwise error rate.

Alpha 0.05
 Error Degrees of Freedom 755
 Error Mean Square 10169.06
 Harmonic Mean of Cell Sizes 323.666

NOTE: Cell sizes are not equal.

Number of Means 2 3
 Critical Range 15.56 16.38
 Means with the same letter are not significantly different.

Duncan Grouping

	Mean	N	temp
A	3989.380	324	tx
B	2440.449	323	ty
C	1248.343	324	tz

RESIDUAL x PREDICTED VALUE PLOT

Legend: A = 1 obs, B = 2 obs, etc.

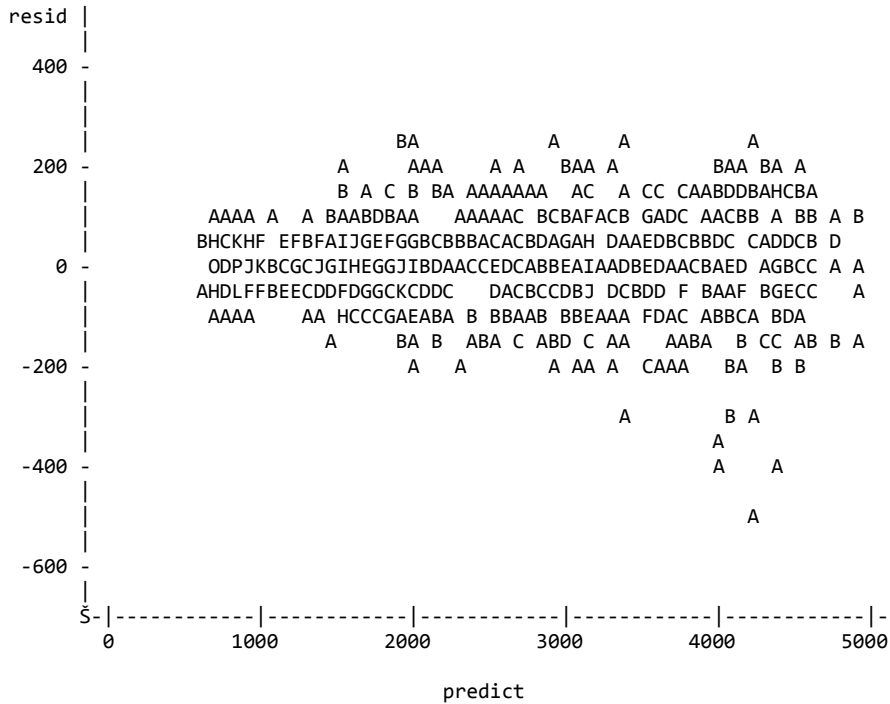

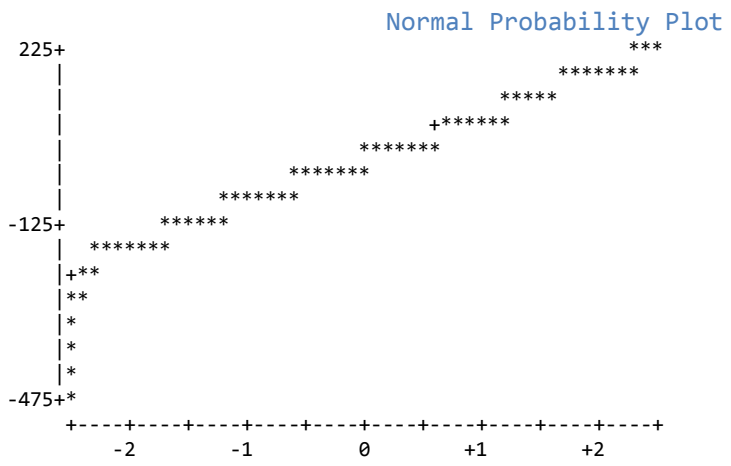

Section F-9: Field Mix 1 Flow Number Statistical Analysis Output

Class Level Information		
Class	Levels	Values
mix	2	HMA WMA
comp	2	field lab
mcond	2	Moisture Conditioned Not Moisture Conditioned

Number of Observations Read 30
 Number of Observations Used 30

THREE-WAY ANOVA FOR FM1 Flow Number

Dependent Variable: Flow Number

Source	DF	Sum of Squares	Mean Square	F Value	Pr > F
Model	1	5166750.00	5166750.00	10.75	0.0028
Error	28	13453562.67	480484.38		
Corrected Total	29	18620312.67			

R-Square 0.277479 Coeff Var 45.49353 Root MSE 693.1698 Flow Number Mean 1523.667

Source	DF	Type I SS	Mean Square	F Value	Pr > F
mix	1	5166750.000	5166750.000	10.75	0.0028

Source	DF	Type III SS	Mean Square	F Value	Pr > F
mix	1	5166750.000	5166750.000	10.75	0.0028

Duncan's Multiple Range Test for Flow Number

NOTE: This test controls the Type I comparisonwise error rate, not the experimentwise error rate.

Alpha 0.05
 Error Degrees of Freedom 28
 Error Mean Square 480484.4

Number of Means 2
 Critical Range 518.5

Means with the same letter are not significantly different.

Duncan Grouping

	Mean	N	mix
A	1938.7	15	MHMA
B	1108.7	15	MWMA

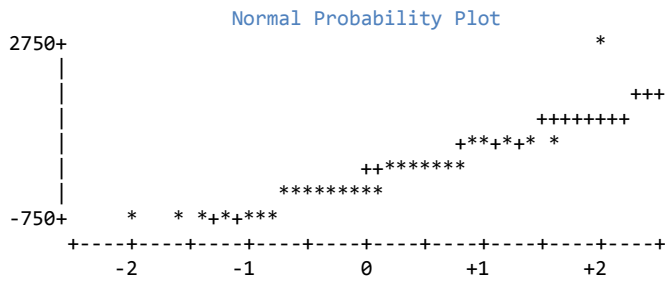
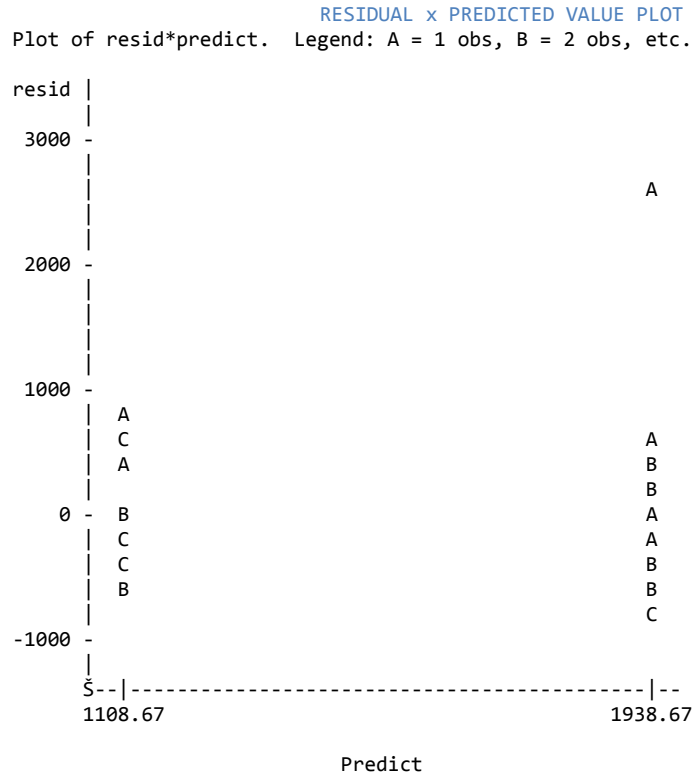

Duncan's Multiple Range Test for Flow Number

NOTE: This test controls the Type I comparisonwise error rate, not the experimentwise error rate.

Alpha 0.05
 Error Degrees of Freedom 22
 Error Mean Square 436564
 Harmonic Mean of Cell Sizes 3.404255

NOTE: Cell sizes are not equal.

Number of Means	2	3	4	5	6	7	8
Critical Range	1050	1103	1136	1160	1178	1191	1202

Means with the same letter are not significantly different.

Duncan		Mean	N	cell
Grouping				
B	A	2432.2	5	lab HMA Npt Moisture Conditioned
B	A	1872.0	2	field HMA _ Moisture Conditioned
B	A C	1685.0	5	lab_ HMA_ Moisture Conditioned
B	A C	1583.3	3	field HMA Not Moisture Conditioned
B	A C	1565.5	4	lab_ WMA_ Moisture Conditioned
B	A C	1358.0	3	field WMA Moisture Conditioned
B	C	860.0	5	lab WMA Not Moisture Conditioned
B	C	664.7	3	field WMA Not Moisture Conditioned

Tukey's Studentized Range (HSD) Test for Flow Number

NOTE: This test controls the Type I experimentwise error rate, but it generally has a higher Type II error rate than REGWQ.

Alpha 0.05
 Error Degrees of Freedom 22
 Error Mean Square 436564
 Critical Value of Studentized Range 4.72167
 Minimum Significant Difference 1690.9
 Harmonic Mean of Cell Sizes 3.404255

NOTE: Cell sizes are not equal.

Means with the same letter are not significantly different.

Tukey		Mean	N	cell
Grouping				
B	A	2432.2	5	lab HMA Not Moisture Conditioned
B	A	1872.0	2	field_HMA_ Moisture Conditioned
B	A	1685.0	5	lab HMA Moisture Conditioned
B	A	1583.3	3	field HMA Not Moisture Conditioned
B	A	1565.5	4	lab WMA Moisture Conditioned
B	A	1358.0	3	field WMA Moisture Conditioned
B	A	860.0	5	lab WMA Not Moisture Conditioned
B		664.7	3	field_WMA Not Moisture Conditioned

Section F-10: Field Mix 1 Cycles to 3% Strain Statistical Analysis

Class Level Information		
Class	Levels	Values
mix	2	HMA WMA
comp	2	field lab
mcond	2	Moisture Conditioned Not Moisture Conditioned

Number of Observations Read 30
 Number of Observations Used 30

THREE-WAY ANOVA FOR FM1 Cycles to 3% Strain

The GLM Procedure
 Dependent Variable: Cycles to 3% Strain

Source	DF	Sum of Squares	Mean Square	F Value	Pr > F
Model	7	148821627.3	21260232.5	16.98	<.0001
Error	22	27540764.1	1251852.9		
Corrected Total	29	176362391.5			

R-Square 0.843840 Coeff Var 22.20347 Root MSE 1118.862 Cycles to 3% Strain Mean 5039.133

Source	DF	Type I SS	Mean Square	F Value	Pr > F
mix	1	70429105.20	70429105.20	56.26	<.0001
comp	1	19205001.23	19205001.23	15.34	0.0007
mix*comp	1	19162240.65	19162240.65	15.31	0.0007
mcond	1	26855690.77	26855690.77	21.45	0.0001
mix*comp*mcond	3	13169589.49	4389863.16	3.51	0.0323

Source	DF	Type III SS	Mean Square	F Value	Pr > F
mix	1	41333128.24	41333128.24	33.02	<.0001
comp	1	21328776.20	21328776.20	17.04	0.0004
mix*comp	1	18231863.56	18231863.56	14.56	0.0009
mcond	1	17392768.61	17392768.61	13.89	0.0012
mix*comp*mcond	3	13169589.49	4389863.16	3.51	0.0323

Duncan's Multiple Range Test for Cycles to 3% Strain

NOTE: This test controls the Type I comparisonwise error rate, not the experimentwise error rate.

Alpha 0.05
 Error Degrees of Freedom 22
 Error Mean Square 1251853
 Harmonic Mean of Cell Sizes 13.93333

NOTE: Cell sizes are not equal.

Number of Means 2
 Critical Range 879.1

Means with the same letter are not significantly different.

Duncan Grouping

	Mean	N	comp
A	5727.1	19	lab
B	3850.8	11	field

Duncan's Multiple Range Test for Cycles to 3% Strain

NOTE: This test controls the Type I comparisonwise error rate, not the experimentwise error rate.

Alpha 0.05
 Error Degrees of Freedom 22
 Error Mean Square 1251853
 Harmonic Mean of Cell Sizes 14.93333

NOTE: Cell sizes are not equal.

Number of Means 2
 Critical Range 849.2

Means with the same letter are not significantly different.

Duncan Grouping

	Mean	N	mcond
A	6127.4	14	Moisture Conditioned
B	4086.9	16	Not Moisture Conditioned

Duncan's Multiple Range Test for Cycles to 3% Strain

NOTE: This test controls the Type I comparisonwise error rate, not the experimentwise error rate.

Alpha 0.05
 Error Degrees of Freedom 22
 Error Mean Square 1251853

Number of Means 2
 Critical Range 847.3

Means with the same letter are not significantly different.

Duncan Grouping

	Mean	N	mix
A	6571.3	15	HMA
B	3506.9	15	WMA

RESIDUAL x PREDICTED VALUE PLOT

Plot of resid*predict. Legend: A = 1 obs, B = 2 obs, etc.

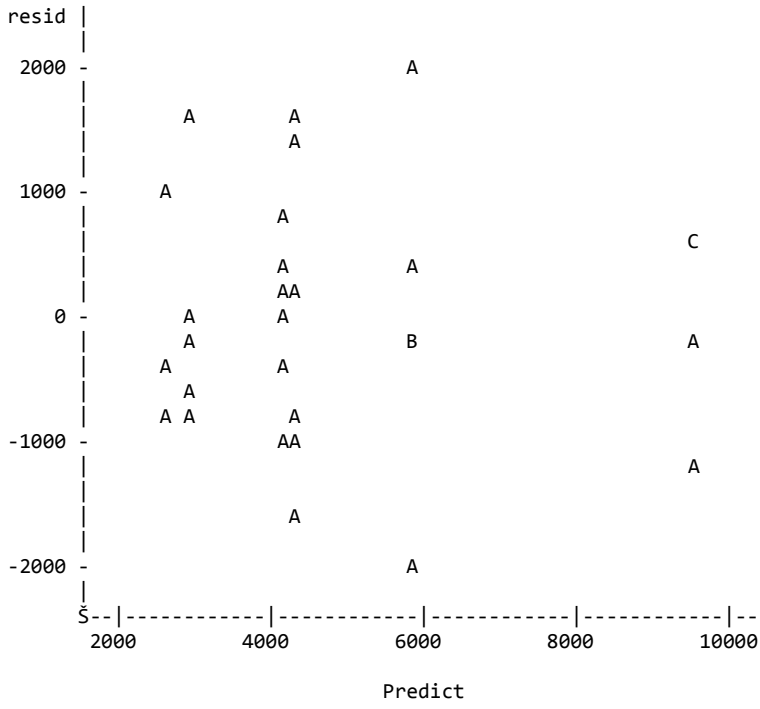

Normal Probability Plot

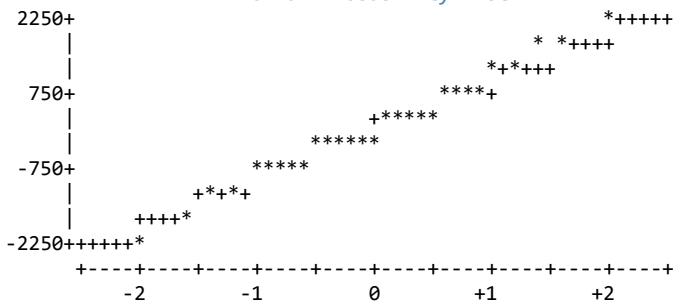

Duncan's Multiple Range Test for Cycles to 3% Strain

NOTE: This test controls the Type I comparisonwise error rate, not the experimentwise error rate.

Alpha 0.05
 Error Degrees of Freedom 22
 Error Mean Square 1251853
 Harmonic Mean of Cell Sizes 3.404255
 NOTE: Cell sizes are not equal.
 Number of Means 2 3 4 5 6 7 8
 Critical Range 1779 1867 1924 1964 1994 2017 2035

Means with the same letter are not significantly different.

Duncan Grouping

	Mean	N	cell
A	9496.8	5	lab HMA Moisture Conditioned
B	5907.2	5	lab HMA_Not Moisture Conditioned
C	4367.3	3	field_HMA Not Moisture Conditioned
C	4321.3	3	field WMA Moisture Conditioned
C	4224.0	2	field HMA Moisture Conditioned
C	4222.0	4	lab WMA Moisture Conditioned
C	2981.4	5	lab WMA Not Moisture Conditioned
C	2615.0	3	field WMA_Not Moisture Conditioned

Tukey's Studentized Range (HSD) Test for Cycles to 3% Strain

NOTE: This test controls the Type I experimentwise error rate, but it generally has a higher Type II error rate than REGWQ.

Alpha 0.05
 Error Degrees of Freedom 22
 Error Mean Square 1251853
 Critical Value of Studentized Range 4.72167
 Minimum Significant Difference 2863.3
 Harmonic Mean of Cell Sizes 3.404255

NOTE: Cell sizes are not equal.

Means with the same letter are not significantly different.

Tukey Grouping

	Mean	N	cell
A	9496.8	5	lab HMA Moisture Conditioned
B	5907.2	5	lab HMA Not Moisture Conditioned
C	4367.3	3	field HMA Not Moisture Conditioned
C	4321.3	3	field WMA_ Moisture Conditioned
C	4224.0	2	field HMA_ Moisture Conditioned
C	4222.0	4	lab WMA Moisture Conditioned
C	2981.4	5	lab WMA Not Moisture Conditioned
C	2615.0	3	field WMA Not Moisture Conditioned

Section F-11: Field Mix 2 Flow number Statistical Analysis Output

Class Level Information

Class	Levels	Values
mix	2	HMA WMA
comp	2	field lab
mcond	2	Moisture Conditioned Not Moisture Conditioned

Number of Observations Read 40
 Number of Observations Used 40

THREE-WAY ANOVA FOR FM2 Flow Number

Dependent Variable: Flow Number

Source	DF	Sum of Squares	Mean Square	F Value	Pr > F
Model	2	442369.3000	221184.6500	18.40	<.0001
Error	37	444857.8000	12023.1838		
Corrected Total	39	887227.1000			

R-Square 0.498598 Coeff Var 29.93047 Root MSE 109.6503 Flow Number Mean 366.3500

Source	DF	Type I SS	Mean Square	F Value	Pr > F
mix	1	352688.4000	352688.4000	29.33	<.0001
mcond	1	89680.9000	89680.9000	7.46	0.0096

Source	DF	Type III SS	Mean Square	F Value	Pr > F
mix	1	352688.4000	352688.4000	29.33	<.0001
mcond	1	89680.9000	89680.9000	7.46	0.0096

Duncan's Multiple Range Test for Flow Number

NOTE: This test controls the Type I comparisonwise error rate, not the experimentwise error rate.

Alpha 0.05
 Error Degrees of Freedom 37
 Error Mean Square 12023.18

Number of Means 2
 Critical Range 70.26

Means with the same letter are not significantly different.

Duncan Grouping

	Mean	N	mcond
A	413.70	20	Moisture Conditioned
B	319.00	20	Not Moisture Conditioned

Duncan's Multiple Range Test for Flow Number

NOTE: This test controls the Type I comparisonwise error rate, not the experimentwise error rate.

Alpha 0.05
 Error Degrees of Freedom 37
 Error Mean Square 12023.18

Number of Means 2
 Critical Range 70.26

Means with the same letter are not significantly different.

Duncan Grouping

	Mean	N	mix
A	460.25	20	HMA
B	272.45	20	WMA

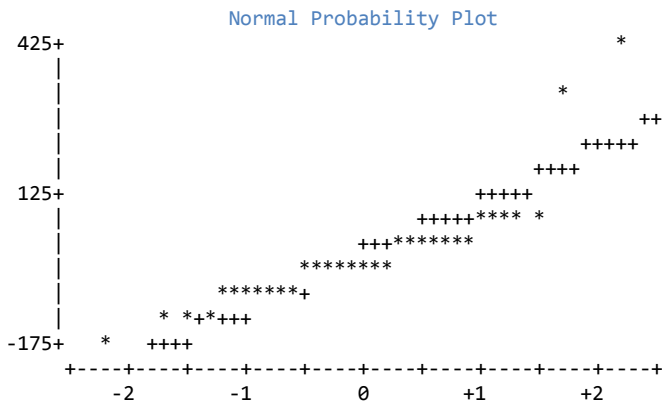
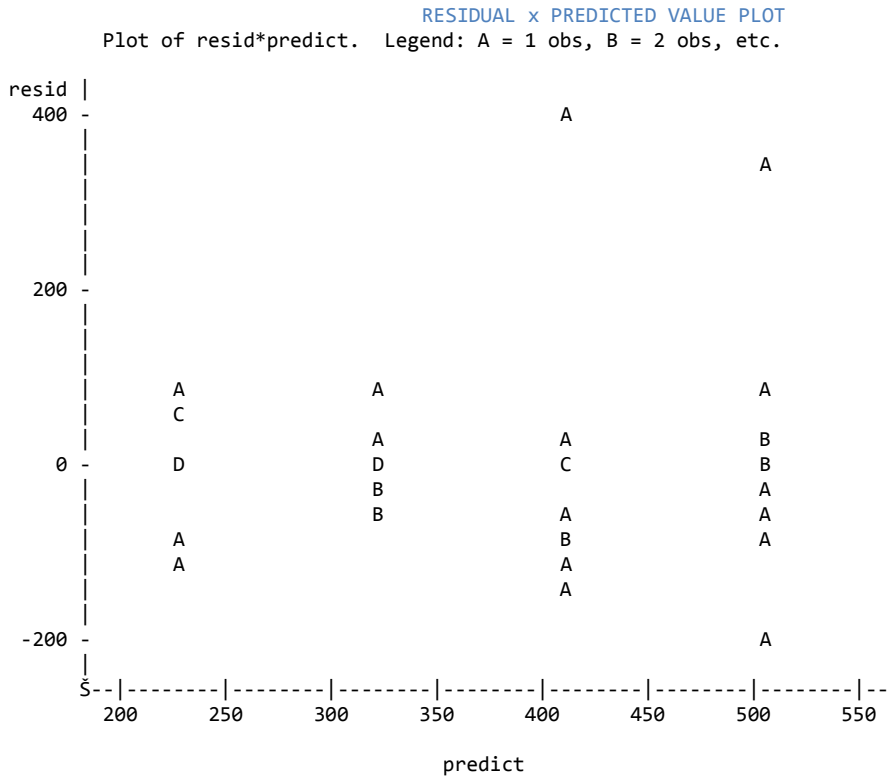

Duncan's Multiple Range Test for Flow Number

NOTE: This test controls the Type I comparisonwise error rate, not the experimentwise error rate.

Alpha 0.05
 Error Degrees of Freedom 32
 Error Mean Square 12932.9

Number of Means	2	3	4	5	6	7	8
Critical Range	146.5	154.0	158.8	162.3	165.0	167.0	168.7

Means with the same letter are not significantly different.

Duncan Grouping	Mean	N	cell
A	520.00	5	field HMA Moisture Conditioned
A	505.00	5	lab HMA Moisture Conditioned
B	448.00	5	field HMA Not Moisture Conditioned
B	368.00	5	lab HMA Not Moisture Conditioned
B	326.00	5	field WMA Moisture Conditioned
B	303.80	5	lab WMA Moisture Conditioned
D	265.00	5	field WMA Not Moisture Conditioned
D	195.00	5	lab WMA Not Moisture Conditioned

Tukey's Studentized Range (HSD) Test for Flow Number

NOTE: This test controls the Type I experimentwise error rate, but it generally has a higher Type II error rate than REGWQ.

Alpha 0.05
 Error Degrees of Freedom 32
 Error Mean Square 12932.9
 Critical Value of Studentized Range 4.58106
 Minimum Significant Difference 232.99

Means with the same letter are not significantly different.

Tukey Grouping	Mean	N	cell
A	520.00	5	field HMA Moisture Conditioned
A	505.00	5	lab HMA Moisture Conditioned
B	448.00	5	field HMA Not Moisture Conditioned
B	368.00	5	lab HMA Not Moisture Conditioned
B	326.00	5	field WMA Moisture Conditioned
B	303.80	5	lab WMA Moisture Conditioned
B	265.00	5	field WMA Not Moisture Conditioned
B	195.00	5	lab WMA Not Moisture Conditioned

Section F-12: Field Mix 2 Cycles to 3% Strain Statistical Analysis Output

Class Level Information

Class	Levels	Values
mix	2	HMA WMA
comp	2	field lab
mcond	2	Moisture Conditioned Not Moisture Co9nditioned

Number of Observations Read 40
Number of Observations Used 40

THREE-WAY ANOVA FOR FM2 Cycles to 3% Strain

The GLM Procedure
Dependent Variable: Cycles to 3% Strain

Source	DF	Sum of Squares	Mean Square	F Value	Pr > F
Model	2	3513285.000	1756642.500	16.22	<.0001
Error	37	4007180.100	108302.165		
Corrected Total	39	7520465.100			

R-Square	Coeff Var	Root MSE	Cycles to 3% Strain Mean
0.467163	26.38337	329.0929	1247.350

Source	DF	Type I SS	Mean Square	F Value	Pr > F
mix	1	2938724.100	2938724.100	27.13	<.0001
mcond	1	574560.900	574560.900	5.31	0.0270

Source	DF	Type III SS	Mean Square	F Value	Pr > F
mix	1	2938724.100	2938724.100	27.13	<.0001
mcond	1	574560.900	574560.900	5.31	0.0270

Duncan's Multiple Range Test for Cycles to 3% Strain
NOTE: This test controls the Type I comparisonwise error rate, not the experimentwise error rate.

Alpha	0.05
Error Degrees of Freedom	37
Error Mean Square	108302.2

Number of Means	2
Critical Range	210.9

Means with the same letter are not significantly different.

Duncan Grouping

	Mean	N	mcond
A	1367.2	20	Moisture Conditioned
B	1127.5	20	Not Moisture Conditioned

Duncan's Multiple Range Test for Cycles to 3% Strain
NOTE: This test controls the Type I comparisonwise error rate, not the experimentwise error rate.

Alpha	0.05
Error Degrees of Freedom	37
Error Mean Square	108302.2

Number of Means	2
Critical Range	210.9

Means with the same letter are not significantly different.

Duncan Grouping

	Mean	N	mix
A	1518.4	20	HMA
B	976.3	20	WMA

RESIDUAL x PREDICTED VALUE PLOT

Plot of resid*predict. Legend: A = 1 obs, B = 2 obs, etc.

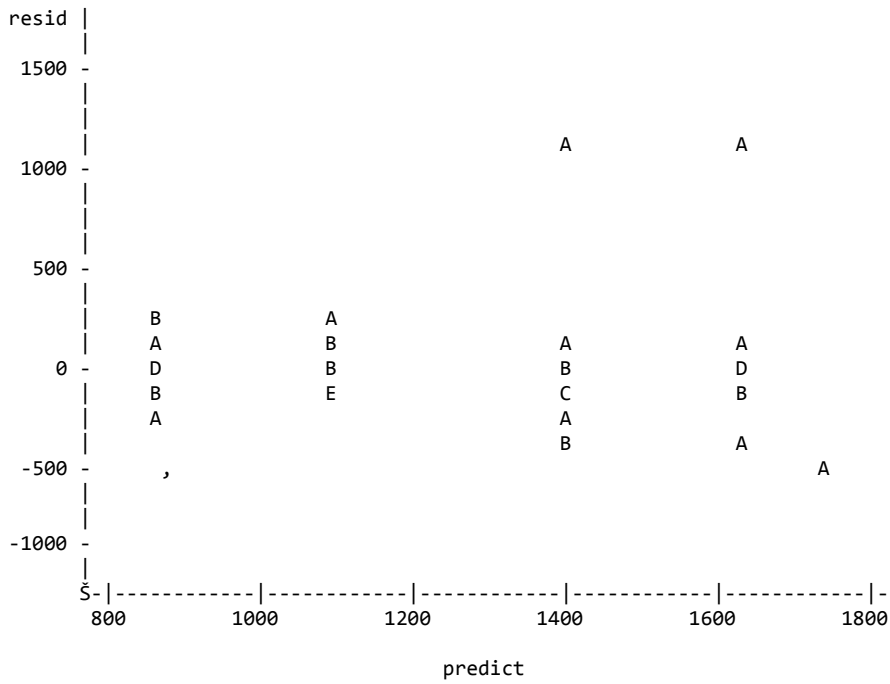

Normal Probability Plot

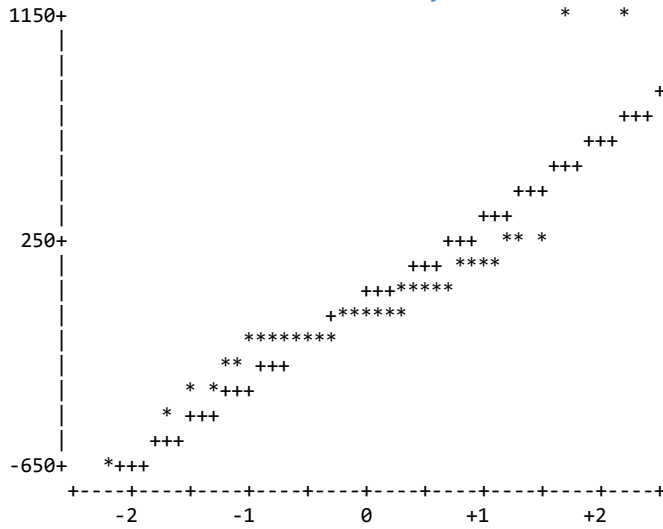

Duncan's Multiple Range Test for Cycles to 3% Strain

NOTE: This test controls the Type I comparisonwise error rate, not the experimentwise error rate.

Alpha 0.05
 Error Degrees of Freedom 32
 Error Mean Square 118151

Number of Means	2	3	4	5	6	7	8
Critical Range	442.8	465.4	480.1	490.6	498.6	504.8	509.9

Means with the same letter are not significantly different.

Duncan Grouping

	Mean	N	cell
A	1669.4	5	field HMA Moisture Conditioned
A	1638.6	5	lab HMA Moisture Conditioned
B	1456.2	5	field HMA Not Moisture Conditioned
B	1309.4	5	lab HMA Not Moisture Conditioned
B	1137.0	5	field WMA Moisture Conditioned
B	1023.8	5	lab WMA Moisture Conditioned
B	985.4	5	field WMA Not Moisture Conditioned
C	759.0	5	lab WMA Not Moisture Conditioned

Tukey's Studentized Range (HSD) Test for Cycles to 3% Strain

NOTE: This test controls the Type I experimentwise error rate, but it generally has a higher Type II error rate than REGWQ.

Alpha 0.05
 Error Degrees of Freedom 32
 Error Mean Square 118151
 Critical Value of Studentized Range 4.58106
 Minimum Significant Difference 704.21

Means with the same letter are not significantly different.

Tukey Grouping

	Mean	N	cell
A	1669.4	5	field HMA Moisture Conditioned
A	1638.6	5	lab HMA Moisture Conditioned
B	1456.2	5	field HMA Not Moisture Conditioned
B	1309.4	5	lab HMA Not Moisture Conditioned
B	1137.0	5	field WMA Moisture Conditioned
B	1023.8	5	lab WMA Moisture Conditioned
B	985.4	5	field WMA Not Moisture Conditioned
B	759.0	5	lab WMA Not Moisture Conditioned

Section F-13: Field Mix 3 Flow Number Statistical Analysis Output

Class Level Information		
Class	Levels	Values
mix	2	HMA WMA
comp	2	field lab
mcond	2	Moisture Conditioned Not Moisture Conditioned

Number of Observations Read 40
 Number of Observations Used 40

THREE-WAY ANOVA FOR FM3 Flow Number

Dependent Variable: Flow Number

Source	DF	Sum of Squares	Mean Square	F Value	Pr > F
Model	3	2461063.675	820354.558	14.89	<.0001
Error	36	1983653.100	55101.475		
Corrected Total	39	4444716.775			

R-Square 0.553705 Coeff Var 35.29482 Root MSE 234.7370 Flow Number Mean 665.0750

Source	DF	Type I SS	Mean Square	F Value	Pr > F
mix	1	1305738.225	1305738.225	23.70	<.0001
mix*comp	2	1155325.450	577662.725	10.48	0.0003

Source	DF	Type III SS	Mean Square	F Value	Pr > F
mix	1	1305738.225	1305738.225	23.70	<.0001
mix*comp	2	1155325.450	577662.725	10.48	0.0003

Duncan's Multiple Range Test for Flow Number

NOTE: This test controls the Type I comparisonwise error rate, not the experimentwise error rate.

Alpha 0.05
 Error Degrees of Freedom 36
 Error Mean Square 55101.47

Number of Means 2
 Critical Range 150.5

Means with the same letter are not significantly different.

Duncan Grouping

	Mean	N	mix
A	845.75	20	HMA
B	484.40	20	WMA

RESIDUAL x PREDICTED VALUE PLOT

Plot of resid*predict. Legend: A = 1 obs, B = 2 obs, etc.

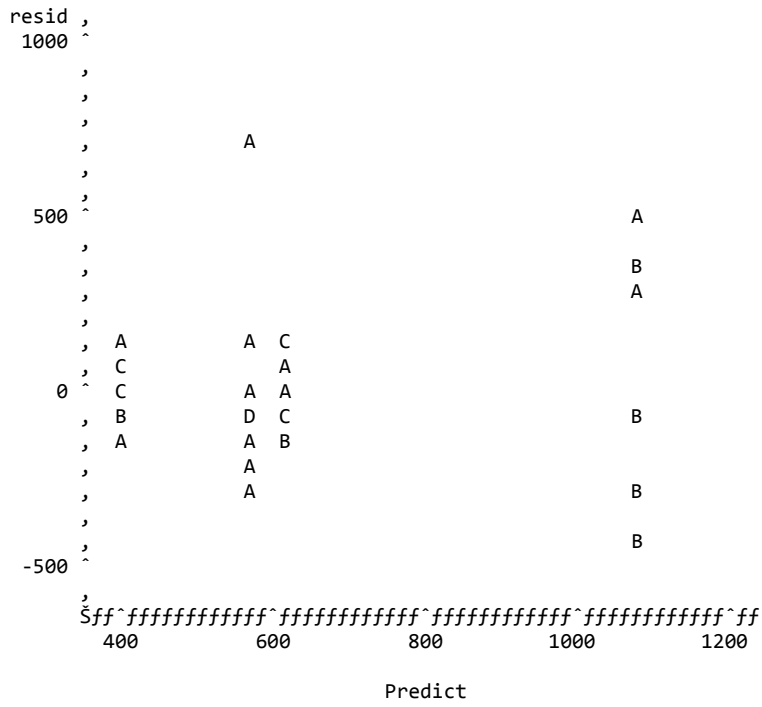

Normal Probability Plot

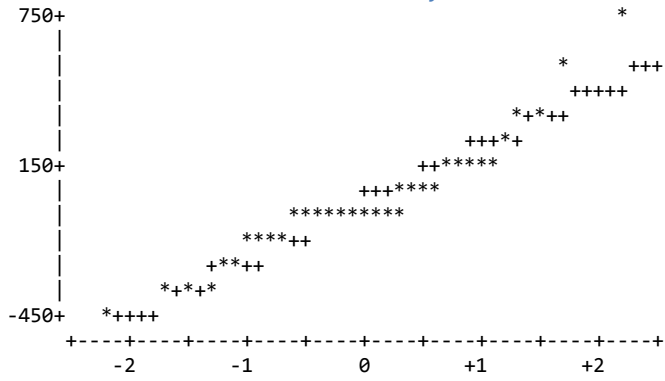

Duncan's Multiple Range Test for Flow Number

NOTE: This test controls the Type I comparisonwise error rate, not the experimentwise error rate.

Alpha 0.05
 Error Degrees of Freedom 32
 Error Mean Square 49545.16

Number of Means	2	3	4	5	6	7	8
Critical Range	286.8	301.4	310.9	317.7	322.9	326.9	330.2

Means with the same letter are not significantly different.

Duncan Grouping

	Mean	N	cell
A	1233.0	5	lab HMA Moisture Conditioned
B	911.0	5	lab HMA Not Moisture Conditioned
C B	681.0	5	field WMA Not Moisture Conditioned
C B	643.0	5	field HMA Moisture Conditioned
C	596.0	5	field HMA Not Moisture Conditioned
C	450.0	5	field WMA Moisture Conditioned
C	406.0	5	lab WMA Not Moisture Conditioned
C	400.6	5	lab WMA Moisture Conditioned

Tukey's Studentized Range (HSD) Test for Flow Number

NOTE: This test controls the Type I experimentwise error rate, but it generally has a higher Type II error rate than REGWQ.

Alpha 0.05
 Error Degrees of Freedom 32
 Error Mean Square 49545.16
 Critical Value of Studentized Range 4.58106
 Minimum Significant Difference 456.02

Means with the same letter are not significantly different.

Tukey Grouping

	Mean	N	cell
A	1233.0	5	lab HMA Moisture Conditioned
B A	911.0	5	lab HMA Not Moisture Conditioned
B C	681.0	5	field WMA Not Moisture Conditioned
B C	643.0	5	field HMA Moisture Conditioned
B C	596.0	5	field HMA Not Moisture Conditioned
C	450.0	5	field WMA Moisture Conditioned
C	406.0	5	lab WMA Not Moisture Conditioned
C	400.6	5	lab WMA Moisture Conditioned

Section F-14: Field Mix 3 Cycles to 3% Strain Statistical Analysis Output

Class Level Information

Class	Levels	Values
mix	2	HMA WMA
comp	2	field lab
mcond	2	Moisture Conditioned Not Moisture Conditioned

Number of Observations Read 40
 Number of Observations Used 40

THREE-WAY ANOVA FOR FM3 Cycles to 3% Strain

Dependent Variable: Cycles to 3% Strain

Source	DF	Sum of Squares	Mean Square	F Value	Pr > F
Model	3	29766479.00	9922159.67	7.04	0.0008
Error	36	50770777.00	1410299.36		
Corrected Total	39	80537256.00			

R-Square 0.369599 Coeff Var 53.13469 Root MSE 1187.560 Cycles to 3% Strain Mean 2235.000

Source	DF	Type I SS	Mean Square	F Value	Pr > F
mix	1	9496502.50	9496502.50	6.73	0.0136
comp	1	9198728.10	9198728.10	6.52	0.0150
mix*comp	1	11071248.40	11071248.40	7.85	0.0081

Source	DF	Type III SS	Mean Square	F Value	Pr > F
mix	1	9496502.50	9496502.50	6.73	0.0136
comp	1	9198728.10	9198728.10	6.52	0.0150
mix*comp	1	11071248.40	11071248.40	7.85	0.0081

Duncan's Multiple Range Test for Cycles to 3% Strain

NOTE: This test controls the Type I comparisonwise error rate, not the experimentwise error rate.

Alpha 0.05
 Error Degrees of Freedom 36
 Error Mean Square 1410299

Number of Means 2
 Critical Range 761.6

Means with the same letter are not significantly different.

Duncan Grouping

	Mean	N	comp
A	2714.6	20	lab
B	1755.5	20	field

Duncan's Multiple Range Test for Cycles to 3% Strain

NOTE: This test controls the Type I comparisonwise error rate, not the experimentwise error rate.

Alpha 0.05
 Error Degrees of Freedom 36
 Error Mean Square 1410299

Number of Means 2
 Critical Range 761.6

Means with the same letter are not significantly different.

Duncan Grouping

	Mean	N	mix
A	2722.3	20	HMA
B	1747.8	20	WMA

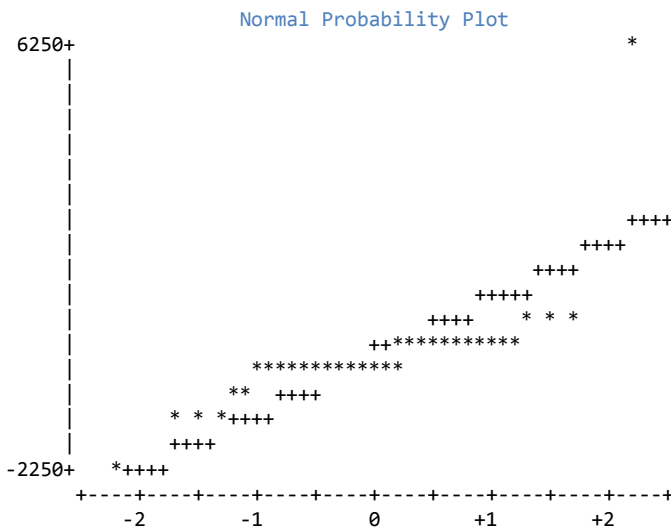
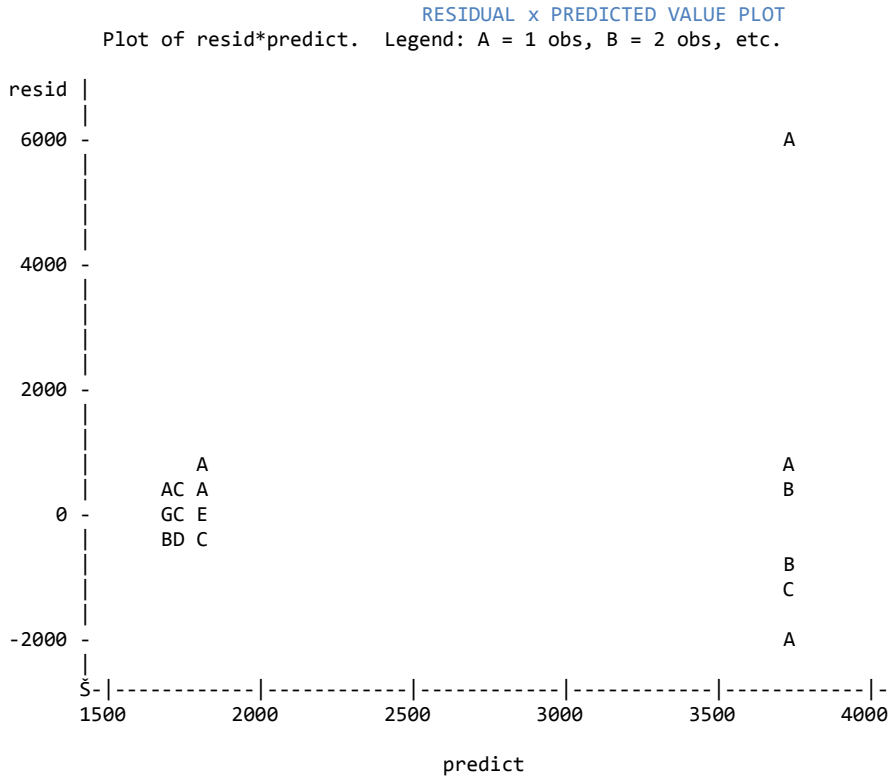

Duncan's Multiple Range Test for Cycles to 3% Strain

NOTE: This test controls the Type I comparisonwise error rate, not the experimentwise error rate.

Alpha 0.05
 Error Degrees of Freedom 32
 Error Mean Square 1205659

Number of Means	2	3	4	5	6	7	8
Critical Range	1415	1487	1534	1567	1593	1613	1629

Means with the same letter are not significantly different.

Duncan Grouping

	Mean	N	cell				
A	4825.0	5	lab	HMA	Moisture	Conditioned	
B	2630.8	5	lab	HMA	Not Moisture	Conditioned	
B	1915.8	5	field	WMA	Not Moisture	Conditioned	
B	1730.2	5	field	HMA	Not Moisture	Conditioned	
B	1721.0	5	lab	WMA	Moisture	Conditioned	
B	1703.0	5	field	HMA	Moisture	Conditioned	
B	1681.4	5	lab	WMA	Not Moisture	Conditioned	
B	1672.8	5	field	WMA	Moisture	Conditioned	

Tukey's Studentized Range (HSD) Test for Cycles to 3% Strain

NOTE: This test controls the Type I experimentwise error rate, but it generally has a higher Type II error rate than REGWQ

Alpha 0.05
 Error Degrees of Freedom 32
 Error Mean Square 1205659
 Critical Value of Studentized Range 4.58106
 Minimum Significant Difference 2249.5

Means with the same letter are not significantly different.

Tukey Grouping

	Mean	N	cell				
A	4825.0	5	lab	HMA	Moisture	Conditioned	
B A	2630.8	5	lab	HMA	Not Moisture	Conditioned	
B	1915.8	5	field	WMA	Not Moisture	Conditioned	
B	1730.2	5	field	HMA	Not Moisture	Conditioned	
B	1721.0	5	lab	WMA	Moisture	Conditioned	
B	1703.0	5	field	HMA	Moisture	Conditioned	
B	1681.4	5	lab	WMA	Not Moisture	Conditioned	
B	1672.8	5	field	WMA	Moisture	Conditioned	

Section F-15: Field Mix 4 Flow Number Statistical Analysis Output

Class Level Information		
Class	Levels	Values
mix	2	HMA WMA
comp	2	field lab
mcond	2	Moisture Conditioned Not Moisture Conditioned

Number of Observations Read 36
 Number of Observations Used 36

THREE-WAY ANOVA FOR FM4 Flow Number					
Dependent Variable: Flow Number					
Source	DF	Sum of Squares	Mean Square	F Value	Pr > F
Model	1	3490301.25	3490301.25	9.13	0.0047
Error	34	12994048.75	382177.90		
Corrected Total	35	16484350.00			

R-Square 0.211734 Coeff Var 38.20800 Root MSE 618.2054 Flow Number Mean 1618.000

Source	DF	Type I SS	Mean Square	F Value	Pr > F
mix	1	3490301.250	3490301.250	9.13	0.0047

Source	DF	Type III SS	Mean Square	F Value	Pr > F
mix	1	3490301.250	3490301.250	9.13	0.0047

Duncan's Multiple Range Test for Flow Number

NOTE: This test controls the Type I comparisonwise error rate, not the experimentwise error rate.

Alpha 0.05
 Error Degrees of Freedom 34
 Error Mean Square 382177.9
 Harmonic Mean of Cell Sizes 17.77778

NOTE: Cell sizes are not equal.

Number of Means 2
 Critical Range 421.4

Means with the same letter are not significantly different.

Duncan Grouping

	Mean	N	mix
A	1966.1	16	WMA
B	1339.5	20	HMA

Duncan's Multiple Range Test for Flow Number

NOTE: This test controls the Type I comparisonwise error rate, not the experimentwise error rate.

Alpha 0.05
 Error Degrees of Freedom 28
 Error Mean Square 334260.1
 Harmonic Mean of Cell Sizes 4.285714

NOTE: Cell sizes are not equal.

Number of Means	2	3	4	5	6	7	8
Critical Range	809.0	850.1	876.6	895.5	909.7	920.8	929.7

Means with the same letter are not significantly different.

Duncan		Mean	N	cell
Grouping				
	A	2426.3	3	field WMA Moisture Conditioned
B	A	2324.0	5	lab WMA Not Moisture Conditioned
B	A C	1812.0	5	lab WMA Moisture Conditioned
B	C	1507.0	5	lab HMA Not Moisture Conditioned
	C	1394.0	5	field HMA Moisture Conditioned
	C	1294.0	5	field HMA Not Moisture Conditioned
	C	1166.3	3	field WMA Not Moisture Conditioned
	C	1163.0	5	lab HMA Moisture Conditioned

Section F-16: Field Mix 4 Cycles to 3% Strain Statistical Analysis Output

Class Level Information

Class	Levels	Values
mix	2	HMA WMA
comp	2	field lab
mcond	2	Moisture Conditioned Not Moisture Conditioned

Number of Observations Read 36
 Number of Observations Used 36

THREE-WAY ANOVA FOR FM4 Cycles to 3% Strain

Dependent Variable: Cycles to 3% Strain

Source	DF	Sum of Squares	Mean Square	F Value	Pr > F
Model	3	75506545.7	25168848.6	20.68	<.0001
Error	32	38953412.8	1217294.2		
Corrected Total	35	114459958.6			

R-Square 0.659677 Coeff Var 17.79645 Root MSE 1103.311 Cycles to 3% Strain Mean 6199.611

Source	DF	Type I SS	Mean Square	F Value	Pr > F
mix	1	13195542.76	13195542.76	10.84	0.0024
comp	1	31170882.86	31170882.86	25.61	<.0001
mcond	1	31140120.11	31140120.11	25.58	<.0001

Source	DF	Type III SS	Mean Square	F Value	Pr > F
mix	1	8445938.44	8445938.44	6.94	0.0129
comp	1	31170882.86	31170882.86	25.61	<.0001
mcond	1	31140120.11	31140120.11	25.58	<.0001

Duncan's Multiple Range Test for Cycles to 3% Strain

NOTE: This test controls the Type I comparisonwise error rate, not the experimentwise error rate.

Alpha 0.05
 Error Degrees of Freedom 32
 Error Mean Square 1217294
 Harmonic Mean of Cell Sizes 17.77778

NOTE: Cell sizes are not equal.

Number of Means 2
 Critical Range 753.8

Means with the same letter are not significantly different.

Duncan Grouping

	Mean	N	comp
A	7093.1	20	lab
B	5082.8	16	field

Duncan's Multiple Range Test for Cycles to 3% Strain

NOTE: This test controls the Type I comparisonwise error rate, not the experimentwise error rate.

Alpha 0.05
 Error Degrees of Freedom 32
 Error Mean Square 1217294

Number of Means 2
 Critical Range 749.1

Means with the same letter are not significantly different.

Duncan Grouping

	Mean	N	mcond
A	7129.7	18	Moisture Conditioned
B	5269.6	18	Not Moisture Conditioned

Duncan's Multiple Range Test for Cycles to 3% Strain

NOTE: This test controls the Type I comparisonwise error rate, not the experimentwise error rate.

Alpha 0.05
 Error Degrees of Freedom 32
 Error Mean Square 1217294
 Harmonic Mean of Cell Sizes 17.77778

NOTE: Cell sizes are not equal.

Number of Means 2
 Critical Range 753.8

Means with the same letter are not significantly different.

Duncan Grouping

	Mean	N	mix
A	6876.5	16	WMA
B	5658.1	20	HMA

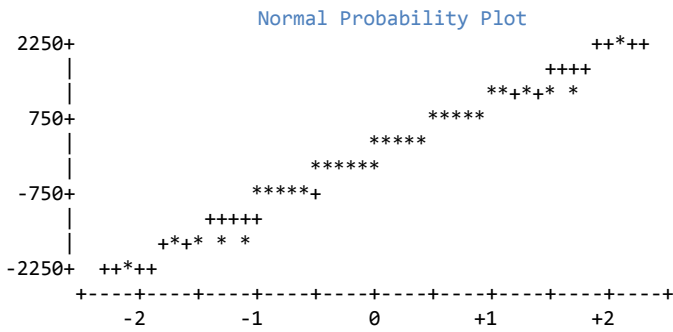
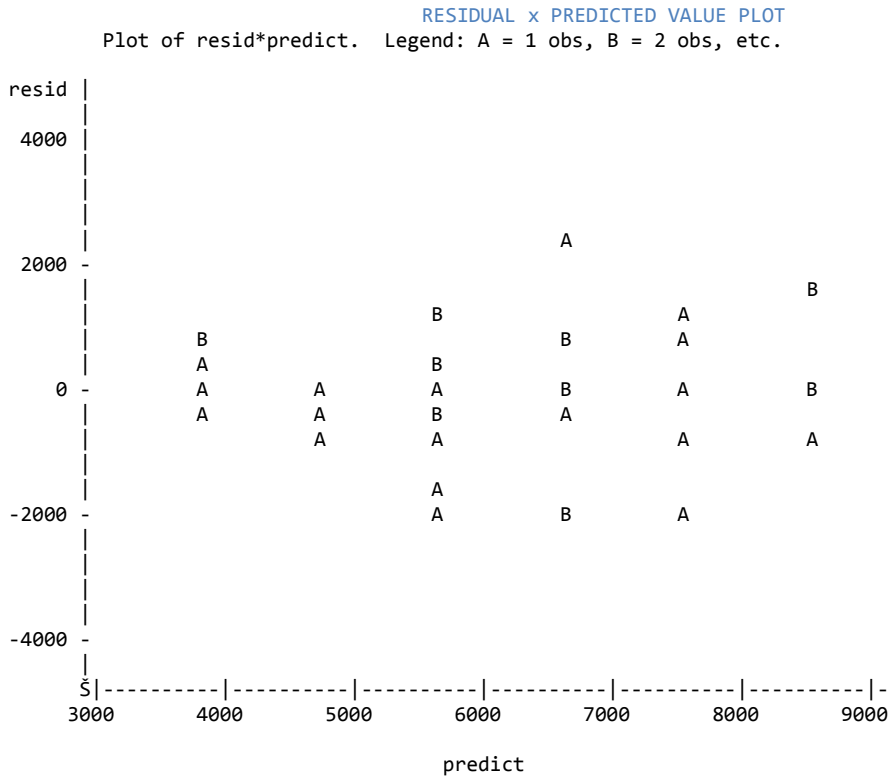

Duncan's Multiple Range Test for Cycles to 3% Strain

NOTE: This test controls the Type I comparisonwise error rate, not the experimentwise error rate.

Alpha 0.05
 Error Degrees of Freedom 28
 Error Mean Square 1308058
 Harmonic Mean of Cell Sizes 4.285714

NOTE: Cell sizes are not equal.

Number of Means	2	3	4	5	6	7	8
Critical Range	1600	1682	1734	1771	1800	1822	1839

Means with the same letter are not significantly different.

Duncan Grouping

	Mean	N	cell
A	8868.6	5	lab WMA Moisture Conditioned
B A	7407.6	5	lab HMA Moisture Conditioned
B C	6638.8	5	lab WMA Not Moisture Conditioned
B C	6376.3	3	field WMA Moisture Conditioned
D C	5564.8	5	field HMA Moisture Conditioned
D C	5457.2	5	lab HMA Not Moisture Conditioned
D	4452.7	3	field WMA Not Moisture Conditioned
D	4202.8	5	field HMA Not Moisture Conditioned

Tukey's Studentized Range (HSD) Test for Cycles to 3% Strain

NOTE: This test controls the Type I experimentwise error rate, but it generally has a higher Type II error rate than REGWQ.

Alpha 0.05
 Error Degrees of Freedom 28
 Error Mean Square 1308058
 Critical Value of Studentized Range 4.62479
 Minimum Significant Difference 2555
 Harmonic Mean of Cell Sizes 4.285714

NOTE: Cell sizes are not equal.

Means with the same letter are not significantly different.

Tukey Grouping

	Mean	N	cell
A	8868.6	5	lab WMA Moisture Conditioned
B A	7407.6	5	lab HMA Moisture Conditioned
B A C	6638.8	5	lab WMA Not Moisture Conditioned
B A C	6376.3	3	field WMA Moisture Conditioned
B C	5564.8	5	field HMA Moisture Conditioned
B C	5457.2	5	lab HMA Not Moisture Conditioned
C	4452.7	3	field WMA Not Moisture Conditioned
C	4202.8	5	field HMA Not Moisture Conditioned