

1-1-2013

Prediction of the Performance of a Flexible Footing on a Stone-Column Modified Subgrade

Justin Callahan

University of South Florida, jgcallah@mail.usf.edu

Follow this and additional works at: <http://scholarcommons.usf.edu/etd>



Part of the [Civil Engineering Commons](#)

Scholar Commons Citation

Callahan, Justin, "Prediction of the Performance of a Flexible Footing on a Stone-Column Modified Subgrade" (2013). *Graduate Theses and Dissertations*.

<http://scholarcommons.usf.edu/etd/4450>

This Thesis is brought to you for free and open access by the Graduate School at Scholar Commons. It has been accepted for inclusion in Graduate Theses and Dissertations by an authorized administrator of Scholar Commons. For more information, please contact scholarcommons@usf.edu.

Prediction of the Performance of a Flexible Footing on a Stone-Column
Modified Subgrade

by

Justin Callahan

A thesis submitted in partial fulfillment
of the requirements for the degree of
Master of Science in Civil Engineering
Department of Civil and Environmental Engineering
College of Engineering
University of South Florida

Major Professor: Manjriker Gunaratne, Ph.D.
Daniel Simkins, Ph.D.
Andres Tejada, Ph.D.

Date of Approval:
March 25, 2013

Keywords: Ground Modification, Unit Cell, Hardening Soil Model, Settlement,
Reduction Factors

Copyright © 2013, Justin Callahan

Table of Contents

List of Tables	ii
List of Figures.....	iii
Abstract.....	v
Chapter 1: Background of Ground Modification	1
Chapter 2: System Modeling	5
2.1 Foundation Modeling.....	5
2.1.1 Plate Theory	5
2.1.2 Boundary Conditions	8
2.2 Soil Model	9
2.2.1 Hardening Soil Model	10
2.2.2 Stone-Column Unit Cell	10
2.2.3 Soil Model Implementation	13
2.3 Programing.....	15
Chapter 3: Program Verification and Outputs.....	18
3.1 Verifications.....	18
3.2 Program Outputs.....	22
Chapter 4: Results of the Analysis.....	23
4.1 Settlement Reduction Factors	24
4.2 Modification of Structural Parameters.....	30
Chapter 5: Conclusion	38
References.....	39

List of Tables

Table 1 Finite Difference Stencils for in the X Direction	15
Table 2 Shear-Rotation Finite Difference Stencils in the Y Direction	16
Table 3 Moment-Curvature Finite Difference Stencils in the Y Direction	16
Table 4 Moment-Curvature Finite Difference Stencils in the X Direction	16
Table 5 Load-Deflection Finite Difference Stencils	17

List of Figures

Figure 1 Diagram of a Unit Cell	1
Figure 2 (a) An Unmodified Soil System on the Left and a Stone-Column Modified System on the Right (b) Plan of Stone Column Layout.....	3
Figure 3 An Infinitesimal Plate Element Showing All the Loads and Moments Acting on It.....	6
Figure 4 Torsion Couples Acting on an Infinitesimal Section.....	9
Figure 5 Flow Chart Depicting the Iterative Method for Hardening Soil Model.....	14
Figure 6 Program Prediction for Shear Distribution for Rigid Foundation with Point Load	19
Figure 7 Program Prediction for Moment Distribution for Rigid Footing with Point Load	20
Figure 8 (a) Program Predicted Deflection versus (b) Expected Deflections for a Simply Supported Uniformly Loaded Plate.....	21
Figure 9 Layout of Foundation Used to Create Design Charts	23
Figure 10 Variation of Replacement Ratio versus Settlement Reduction Factor with (a) Subgrade Oedometric Modulus, (b) Slab Thickness, (c) Footing Contact Pressure, and (d) Width of Foundation	24
Figure 11 Replacement Ratio versus Settlement Reduction Factor Considering All Parameters.....	27
Figure 12 Replacement Ratio versus Differential Settlement Reduction Factor Varying with (a) Subgrade Oedometric Modulus, (b) Slab Thickness, (c) Footing Contact Pressure, and (d) Width of Foundation	28
Figure 13 Replacement Ratio versus Differential Settlement Reduction Factor Considering All Parameters	30

Figure 14 Replacement Ratio versus Moment Modification Factor Varying with (a) Subgrade Oedometric Modulus, (b) Slab Thickness, (c) Footing Contact Pressure, and (d) Width of Foundation	32
Figure 15 Replacement Ratio versus Moment Modification Factor Considering All Parameters.....	34
Figure 16 Replacement Ratio versus Shear Modification Factor Varying with (a) Subgrade Oedometric Modulus, (b) Slab Thickness, (c) Footing Contact Pressure, and (d) Width of Foundation	35
Figure 17 Replacement Ratio versus Shear Modification Factor Considering All Parameters.....	37

Abstract

When foundations are designed on weak clay layers, it is a common practice to modify the subgrade by installing stone columns. Currently used methods for determining the level of ground modification, represented by the percentage of soil replaced (replacement ratio), assume a rigid foundation. These analytical methods provide the designer with the potential settlement reduction based on the compressibility parameters of the subgrade and the replacement ratio. The deficiencies of these methods are the assumption of rigidity of the foundation and the consideration of the settlement reduction as the only design criterion. Furthermore, they do not consider the effects that ground modification has on differential settlement, moments, and shear forces within the slab.

In order to determine the effects of ground modification on the overall performance of a flexible foundation, a computer program was formulated which compares a multitude of design parameters of the modified subgrade to those of the unmodified subgrade to determine the impact of ground modification. By performing this investigation, correlations were found between the replacement ratio and the settlement reduction factors. Similarly, correlations were also found between the ratio of the length of the foundation to the radius of relative stiffness, and the moments and shear

forces generated within the slab. The use of the findings of this thesis would allow the design to make more informed decisions when designing foundations on modified subgrade resulting in safer and more economical designs.

Chapter 1: Background of Ground Modification

When a building foundation is designed on soft clay layers, limiting its immediate settlement and consolidation is an important design consideration. A common method used to reduce potential foundation settlement is the use of stone columns to transform the subsurface clay layer into a composite layer. The objective of this research was to investigate the effects of the use of stone columns on the performance of the modified foundation system with respect to settlement reduction and structural design criteria. The current method for the design of a foundation on a stone-column modified subgrade is to either run a finite-element model of the entire system or to use one of the many analytical methods available in order to determine the settlement reduction.

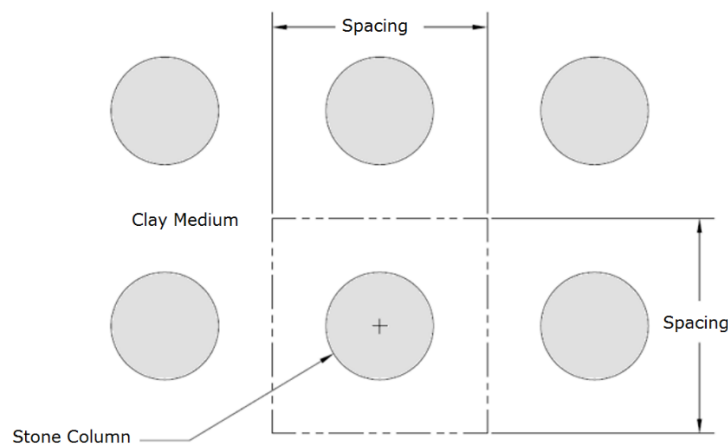

Figure 1 Diagram of a Unit Cell

Several methods are available to calculate the settlement reduction of a stone-column stabilized ground. Many of the original methods, like the work done by Aboshi (1), Balaam (2), and Shahu (3), assumed that the stone-column and the surrounding material behave elastically. When using the elastic approach, it has been found that the ratio of the stress in the soil and the stress in the column is approximately equal to the ratio of the oedometric moduli of the soil and column, where the oedometric modulus is the constrained elastic modulus under vertical deformation only. However, Barksdale and Bachus (4) later found that this ratio greatly overestimates the ratio of stresses and therefore overestimates the performance of the stone-column system.

A subsequent presented by Balaam and Booker (5) showed that the stone-column is not an elastic region, but rather a region in a triaxial state that could yield with no yielding in the soil. Methods created by Priebe (6), Impe and De Beer (7), and Impe and Madhav (8) consider the stone column to be in a plastic state and a triaxial condition. Impe and Madhav (8) later expanded their method and showed that the previous assumption that the stone column does not change its volume is invalid, but it dilates when loaded.

The method incorporated in this research is developed by Pulko and Majes (9) in 2006, which uses the Rowe's stress-dilatancy theory (10) in the calculations of the settlement reduction. Although the Pulko and Majes (9) method properly predicts the deflection, the drawbacks of the current analytical method are that it assumes a uniform load as well as a rigid

foundation on a single unit cell (Figure 1) which is assumed to represent the entire foundation system due to the assumption of rigidity.

The deficiencies of the current analytical methods are that they only provide the engineer with the effects the ground modification have on settlement reduction and fail to include the structural effects. However, the installation of stone columns (Figure 2) is expected to affect the differential settlement, moments, and shear forces generated within the footing. In order to quantify the overall changes in the performance of the foundation due to ground modification, a computer program which has the abilities to analyze a slab on grade and predict the improvements in terms of moments, shear forces, settlement, and differential settlement was designed. By knowing the overall effect the ground modification will have on a foundation, engineers would be able to plan the ground modification to achieve a safe and economical foundation design.

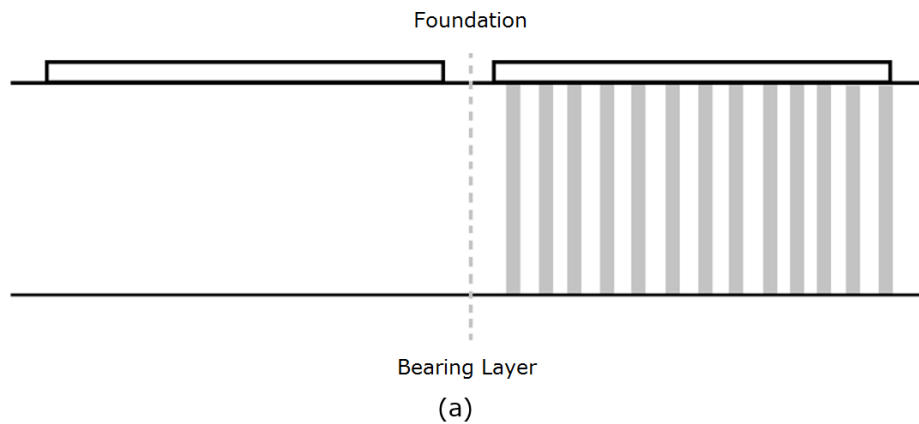

Figure 2 (a) An Unmodified Soil System on the Left and a Stone-Column Modified System on the Right (b) Plan of Stone Column Layout

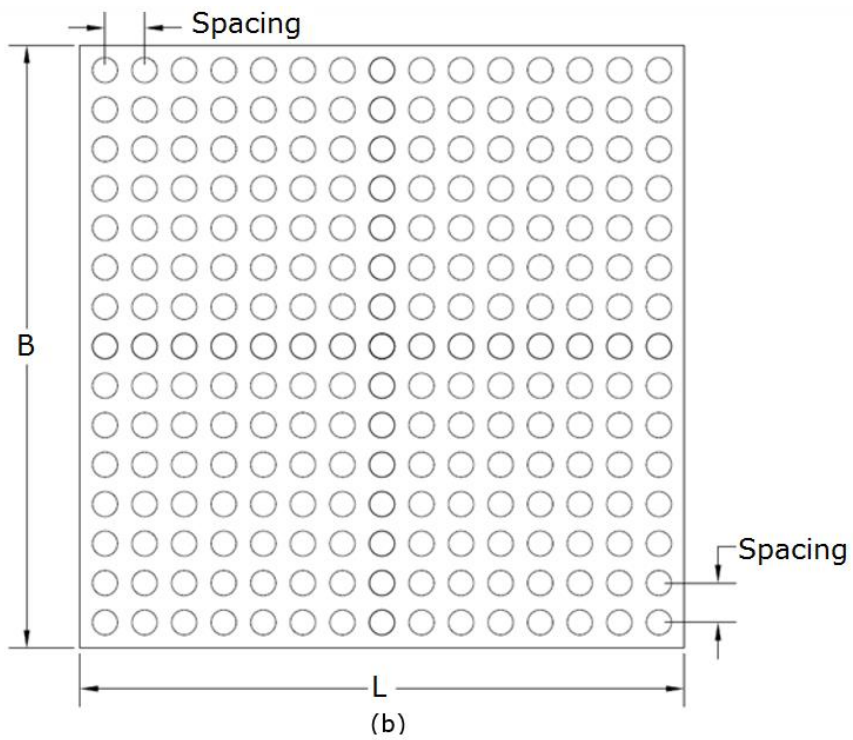

Figure 2 (Continued)

Chapter 2: System Modeling

2.1 Foundation Modeling

To investigate the performance of a ground modified foundation, the system must first be modeled. In this thesis, it was modeled as a slab on a modified Winkler foundation. Specifically, the foundation was modeled using the differential equation governing the bending of a plate supported by a nonlinear elastic foundation (equation 11) using a combination of a hardening soil model and the concept of a unit cell with respect to the performance of a stone-column modified ground.

2.1.1 Plate Theory

The differential equation governing the bending of a loaded plate can be derived by first considering an infinitesimal element, (dx, dy) , which is subjected to a uniform load, $p(x, y)$. The equilibrium state shown in Figure 3 shows the forces and moments per unit length. The first step is to consider equilibrium of the plate by summing forces in the z direction.

$$p(x, y)dxdy - Q_x dy + \left(Q_x + \frac{\partial Q_x}{\partial x} dx \right) dy - Q_y dx + \left(Q_y + \frac{\partial Q_y}{\partial y} dy \right) dx = 0 \quad (1)$$

$$p(x, y)dxdy + \left(\frac{\partial Q_x}{\partial x} dx \right) dy + \left(\frac{\partial Q_y}{\partial y} dy \right) dx = 0 \quad (2)$$

$$p(x,y) + \left(\frac{\partial Q_x}{\partial x}\right) + \left(\frac{\partial Q_y}{\partial y}\right) = 0 \quad (3)$$

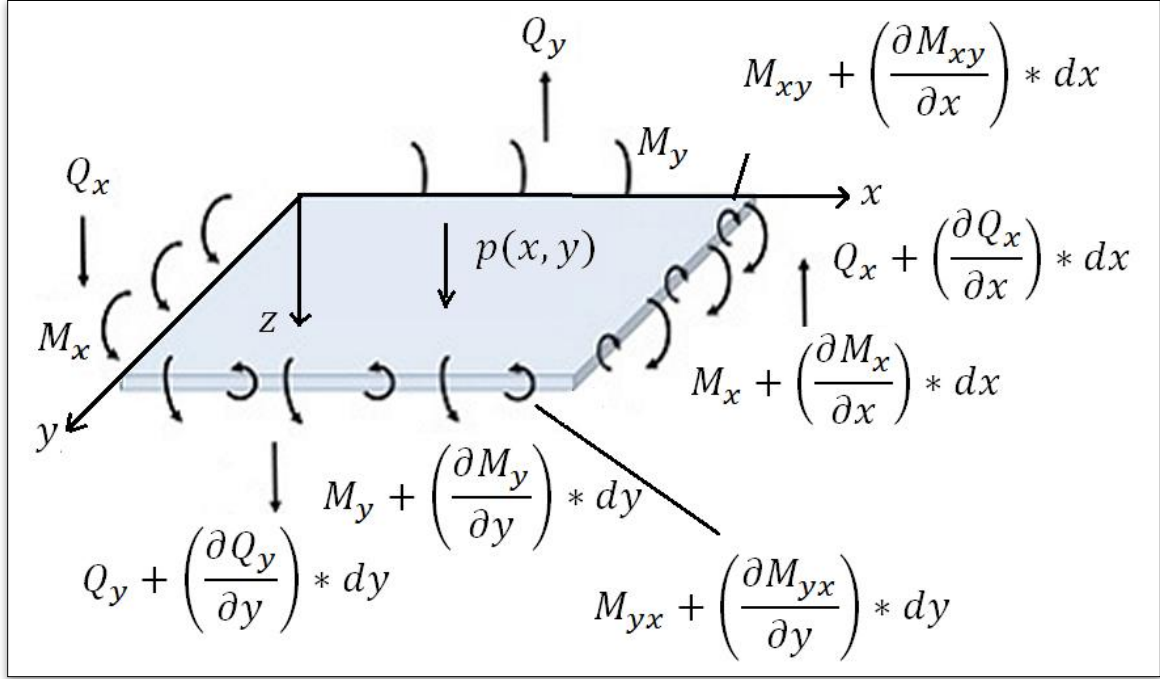

Figure 3 An Infinitesimal Plate Element Showing All the Loads and Moments Acting on It

The next step is to sum moments about the x axis and y axis respectively. Summing moments about the x axis gives equation (4). This can be reduced further to equation (6).

$$M_y dx - \frac{\left(Q_x + \frac{\partial Q_x}{\partial x} dx\right) dy dy}{2} - \frac{Q_x dy dy}{2} + \left(Q_y + \frac{\partial Q_y}{\partial y} dy\right) dx dy + M_y dx - \left(M_y + \frac{\partial M_y}{\partial y} dy\right) dx + \left(M_{xy} + \frac{\partial M_{xy}}{\partial x} dx\right) dy + M_{xy} dy + \frac{p dx dy dy}{2} = 0 \quad (4)$$

$$Q_y + \frac{\partial M_{xy}}{\partial x} - \frac{M_y}{\partial y} + \left(\frac{\partial Q_y}{\partial y} + \frac{\partial Q_x}{2\partial x} + \frac{1}{2}p\right) dy = 0 \quad (5)$$

$$\frac{\partial Q_y}{\partial y} = \frac{\partial^2 M_y}{\partial y^2} - \frac{\partial^2 M_{xy}}{\partial x \partial y} \quad (6)$$

The final equation of equilibrium comes from summing moments about the y-axis. When deriving the following equation it was assumed that $M_{xy} = M_{yx}$ due to the principle of complementary shear. This derivation follows the same procedure as summing moments about the x-axis and produces the following:

$$\frac{\partial Q_x}{\partial x} = \frac{\partial^2 M_x}{\partial x^2} - \frac{\partial^2 M_{xy}}{\partial x \partial y} \quad (7)$$

Substituting equation (6) and equation (7) into equation (3) gives:

$$p(x, y) + \frac{\partial^2 M_x}{\partial x^2} - 2 \frac{\partial^2 M_{xy}}{\partial x \partial y} + \frac{\partial^2 M_y}{\partial y^2} = 0 \quad (8)$$

The moment terms in equation (8) can also be expressed in terms of the changes in deflection. The relationship between moments and deflections are summarized in the matrix form in equation (9), where D is the flexural rigidity of the plate and ω is the deflection.

$$\begin{bmatrix} M_x \\ M_y \\ M_{xy} \end{bmatrix} = -D * \begin{bmatrix} 1 & \mu & 0 \\ \mu & 1 & 0 \\ 0 & 0 & u - 1 \end{bmatrix} * \begin{bmatrix} \frac{\partial^2 \omega}{\partial x^2} \\ \frac{\partial^2 \omega}{\partial y^2} \\ \frac{\partial^2 \omega}{\partial x \partial y} \end{bmatrix} \quad (9)$$

By substituting the moment-deflection relationship, equation (8) can be rewritten as

$$D \left[\frac{\partial^4 \omega}{\partial x^4} + 2 \frac{\partial^4 \omega}{\partial x^2 \partial y^2} + \frac{\partial^4 \omega}{\partial y^4} \right] = p(x, y) \quad (10)$$

which is the differential equation governing the deflection of a Kirchhoff-Love plate. In order to use equation (10) for a slab on grade, the load must be reduced by a soil reaction force, R . The reaction force is a function of the oedometric modulus and the deflection of the soil. Thus,

$$D \left[\frac{\partial^4 \omega}{\partial x^4} + 2 \frac{\partial^4 \omega}{\partial x^2 \partial y^2} + \frac{\partial^4 \omega}{\partial y^4} \right] = p(x, y) - R(x, y, E_{oed}(x, y), \omega(x, y)) \quad (11)$$

2.1.2 Boundary Conditions

In the case of a free edge boundary, the shear and the moment on the boundary are both equal to zero. From equation (9), the following relationships can be derived.

$$M_x = -D * \left(\frac{\partial^2 \omega}{\partial x^2} + \mu \frac{\partial^2 \omega}{\partial y^2} \right) = 0 \quad (12)$$

$$M_y = -D * \left(\mu \frac{\partial^2 \omega}{\partial x^2} + \frac{\partial^2 \omega}{\partial y^2} \right) = 0 \quad (13)$$

In order to set the shear equal to zero, one must first understand what creates shear on the boundary of the plate. From the infinitesimal section shown in Figure 3, it can be seen that Q represents the developed shear force. However, it has been shown that the torsional moment, M_{xy} can be thought of as a series of couples acting on an infinitesimal section (Figure 4) (11). Therefore the total shear force, V_y , acting on the boundary of the plate can be expressed by equation (14) as:

$$V_y = \left(Q_y - \frac{\partial M_{xy}}{\partial x} \right) \quad (14)$$

$$V_y = \left(Q_y + \frac{\partial}{\partial x} \left(D(\mu - 1) \frac{\partial^2 \omega}{\partial x \partial y} \right) \right) \quad (15)$$

$$V_y = Q_y + D(\mu - 1) \frac{\partial^3 \omega}{\partial y \partial x^2} \quad (16)$$

$$Q_y = \frac{\partial M_y}{\partial y} = \frac{\partial}{\partial y} \left(-D * \left(\mu \frac{\partial^2 \omega}{\partial x^2} + \frac{\partial^2 \omega}{\partial y^2} \right) \right) = -D * \left(\frac{\partial^3 \omega}{\partial y^3} + \mu \frac{\partial^3 \omega}{\partial x^2 \partial y} \right) \quad (17)$$

$$\therefore V_y = -D \left(\frac{\partial^3 \omega}{\partial y^3} + (2 - \mu) \frac{\partial^3 \omega}{\partial x \partial y^2} \right) \quad (18)$$

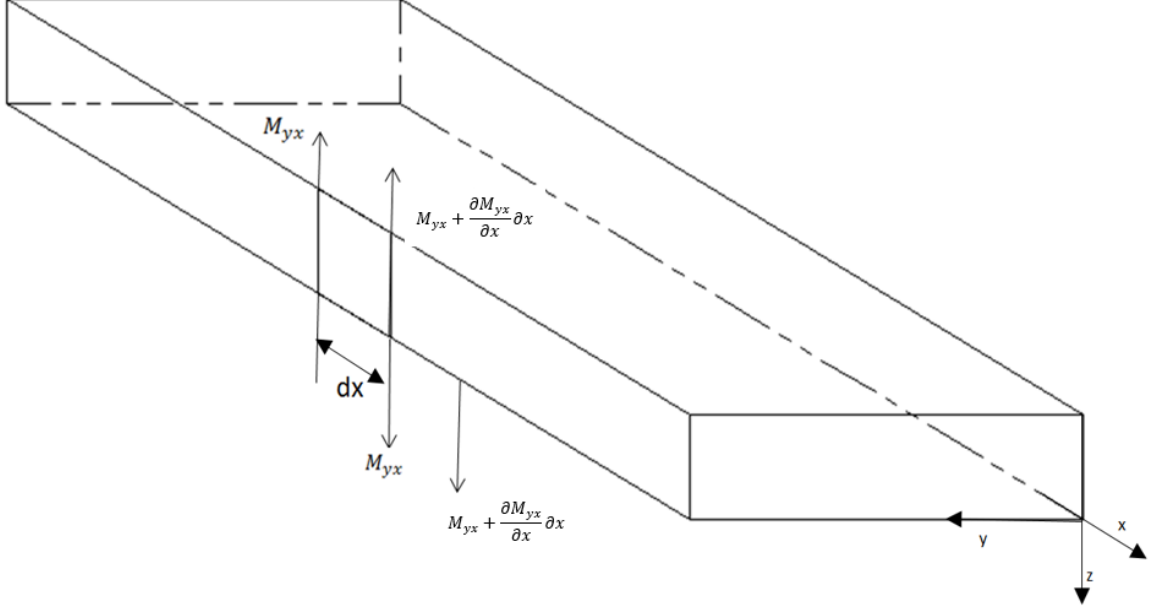

Figure 4 Torsion Couples Acting on an Infinitesimal Section

Alternatively, the shear force on the x face can also be expressed as:

$$V_x = -D \left(\frac{\partial^3 \omega}{\partial x^3} + (2 - \mu) \frac{\partial^3 \omega}{\partial x \partial y^2} \right) \quad (19)$$

2.2 Soil Model

The analysis of the substructure soil consists of two different stages. The first stage is pre-modification where the soil is homogenous and does not include stone columns. The analysis of this case uses the oedometric modulus of the soil, a requirement of the hardening soil model, to determine the subgrade modulus. The subgrade modulus is defined as the pressure per unit deflection of the soil. In the second stage, after the installation of the stone columns, a mixture of the hardening soil model and the unit-cell stone

column theory (Section 2.2.2) is used to determine the subgrade moduli of the soil and the column.

2.2.1 Hardening Soil Model

A feature of the hardening soil model is that it is formulated on the basis of the theory of plasticity. The model assumes that the soil yields and behaves plastically under the applied loading level. The strains in the hardening soil model are calculated using a stress dependent oedometric modulus. In soils, the stress-strain relationship is typically nonlinear. The following equation has been used to account for the logarithmic stress dependency of the strain (12).

$$E_{oed} = E_{oed}^{ref} \left(\frac{\sigma_3 + c * \cot(\phi)}{\sigma^{ref} + c * \cot(\phi)} \right)^m \quad (20)$$

where m is a variable used to define the shape of the stress-strain curve, σ_3 is the minor principal stress, c is the cohesion, E_{oed} is the oedometric modulus, ϕ is the angle of internal friction, and σ^{ref} refers to the minor principal stress in the soil at the reference stress level (from a triaxial test performed with a confining pressure of 100 kPa). This equation is only valid for the primary loading of the soil and should not be considered for cyclic loading or unloading.

2.2.2 Stone-Column Unit Cell

When a stone column is installed in the ground, its strength would be determined by the confining soil. The computer program developed in this research uses the method developed by B. Pulko and B. Majes (9) in order to determine the subgrade modulus of the modified soil. The above analytical

method is based on the yielding of granular material in the stone column governed by the Rowe's dilatancy theory (10). This method, like many other methods available for stone-column evaluations, is based on the unit-cell concept which assumes the stone columns to be end bearing columns laid out in a grid of uniform spacing (Figure 2).

The analysis starts with the consideration of a single unit cell (Figure 1). The first term that needs to be calculated is the area replaced by the column. The replacement ratio, A_R , is defined in equation (21) as the area of the stone column divided by the area of the unit cell.

$$A_R = \frac{0.25 * \pi * D^2}{Spacing^2} \quad (21)$$

In the analysis, it is assumed that the dense stone in the column reaches its peak resistance and then begins to dilate. It is assumed that a uniform load, or stress, is applied to the unit cell upon which the stone-column and surrounding soil will undergo equal vertical deformations. Because this method is based on the assumption of columns resting on a rigid bearing layer, the strains can be expressed in equations (22) – (23).

$$\epsilon_z = \frac{u}{H} \quad (22)$$

$$\epsilon_r = -\frac{u_r}{r_c} \quad (23)$$

$$\epsilon_{vd} = \epsilon_z + 2\epsilon_r \quad (24)$$

where H is the height of the stone column, u is the vertical deflection, u_r is the radial deflection, and r_c is the radius of the column.

By using the Rowe's stress dilatancy theory, the angle of dilatancy, ψ , can be expressed as

$$\sin \psi = \frac{(\sin(\phi) - \sin(\phi_v))}{1 - \sin(\phi) \sin(\phi_v)} \quad (25)$$

where ϕ is the peak angle of internal friction from the triaxial shear test and ϕ_v is the angle of internal friction under constant volume conditions.

For equilibrium, the lateral normal stresses along the soil-column interface must equal each other. By setting the lateral stresses and deflections on both sides of the soil-column interface equal, it is possible to develop five equations where the five unknowns are u_z , u_r , σ_r , σ_{zc} (*vertical column stress*), and σ_{zs} (*vertical soil stress*). Therefore, the following expressions for the representative subgrade moduli can be developed by dividing the corresponding stresses by the deflections.

$$k_{s,s} = \frac{\left(\frac{2 \left(\frac{\mu}{1-\mu} \right) A_r}{1 - A_r} K_\psi + 2 \right) * E_{oed}}{2 * H} \quad (26)$$

$$k_{s,c} = \frac{K_{pc} \left(\frac{1 - 2 \frac{\mu}{1-\mu} + A_r}{(1 - A_r)(1 - \mu)} K_\psi + 2 * \frac{\mu}{1 - \mu} \right) * E_{oed}}{2 * H} \quad (27)$$

where μ is the Poisson's ratio of the soil, E_{oed} is the oedometric modulus as defined in the hardening soil model as recommended by Raithel and Kempfert (13), and K_{pc} and K_ψ are defined as:

$$K_{pc} = \frac{1 + \sin(\phi)}{1 - \sin(\phi)} \quad (28)$$

$$K_{\psi} = \frac{1 + \sin(\psi)}{1 - \sin(\psi)} \quad (29)$$

2.2.3 Soil Model Implementation

In order to apply the theory described in Section 2.2.2, several assumptions had to be made. Pulko and Majes's (9) theory for the analysis of stone-columns in a clay medium assumes the foundation to be rigid and therefore produce equal deflections at every location. Because the deflection of the foundation does not vary much within the unit-cell under the foundation, it is possible to apply Pulko and Majes (9) method to a system of unit-cells under a flexible footing. In order to expand Pulko and Majes (9) method, the foundation was split into a grid of unit cells to which the equations to determine the subgrade moduli can be applied independently.

Since the soil hardening model requires the stress level of the soil to be considered in determining the elastic modulus of the soil, the initial stress of the soil is assumed to be equal to the total structural load divided by the total area of the footing. Then, during the ensuing computations, the actual stresses are calculated within the entire foundation and the oedometric modulus is updated while adjusting the subgrade modulus accordingly. This process is repeated until the subgrade moduli value converges to those corresponding to the actual stresses, and the final solution is obtained. The entire process is summarized in Figure 5.

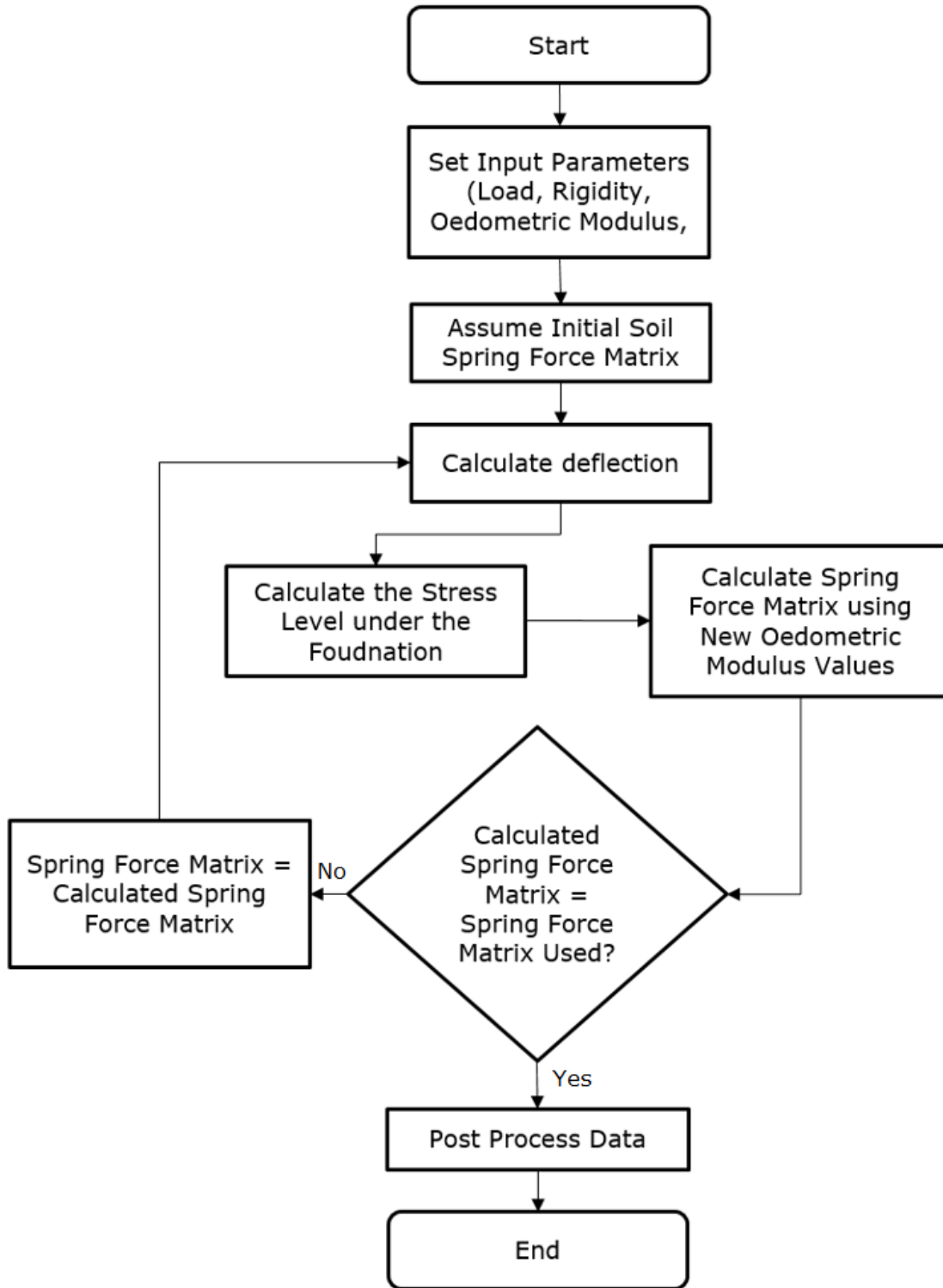

Figure 5 Flow Chart Depicting the Iterative Method for Hardening Soil Model

2.3 Programing

The differential equations governing the bending of a plate (equation (11)) were programmed using the finite difference (FD) method. Due to the use of the finite difference method, it is important to add fictitious nodes in order to be able to apply the FD equations at the boundary. It can be seen that the total number of fictitious nodes required is equal to $4n + 4m$ where n and m are the number of nodes in the x and y directions respectively. This can be accomplished by using a combination of the finite difference stencils shown in Table 1 through Table 5. In the Tables 1 - 5, the boxed cell in the difference stencil represents node (i, j) with positive i being downward and j being to the right (14), h is the node spacing, and μ is the Poisson's ratio.

Table 1 Finite Difference Stencils for in the X Direction

Shear-Rotation Equations (x Direction)						
Difference Stencils						Error
1)	$(2 - \mu)$	$-4(2 - \mu)$	$3(2 - \mu)$			$O(h^2)$
	$-1-2(2 - \mu)$	$2+8(2 - \mu)$	$-6(2 - \mu)$	-2	1	
	$(2 - \mu)$	$-4(2 - \mu)$	$3(2 - \mu)$			
2)			$3(2 - \mu)$	$-4(2 - \mu)$	$(2 - \mu)$	
	1	-2	$-6(2 - \mu)$	$2+8(2 - \mu)$	$-1-2(2 - \mu)$	
			$3(2 - \mu)$	$-4(2 - \mu)$	$(2 - \mu)$	

Table 2 Shear-Rotation Finite Difference Stencils in the Y Direction

Shear-Rotation Equations (y Direction)				
Difference Stencils			Error	
1)	(2 - μ)	-1-2(2 - μ)	(2 - μ)	O(h ²)
	-4(2 - μ)	2+8(2 - μ)	-4(2 - μ)	
3(2 - μ)	-6(2 - μ)	3(2 - μ)		
	-2			
	1			
	1			
2)		-2		
	3(2 - μ)	-6(2 - μ)	3(2 - μ)	
	-4(2 - μ)	2+8(2 - μ)	-4(2 - μ)	
	(2 - μ)	-1-2(2 - μ)	(2 - μ)	

Table 3 Moment-Curvature Finite Difference Stencils in the Y Direction

Moment-Curvature Equations (y Direction)			
Difference Stencil			Error
	1		O(h ²)
μ	-2(1+ μ)	μ	
	1		

Table 4 Moment-Curvature Finite Difference Stencils in the X Direction

Moment-Curvature Equations (x Direction)			
Difference Stencil			Error
	μ		O(h ²)
1	-2(1+ μ)	1	
	μ		

Table 5 Load-Deflection Finite Difference Stencils

Load-Deflection Equations		
Difference Stencil		Error
1)	<pre> 1 -4 1 -4 20 -24 17 -4 -24 50 -40 10 17 -40 32 -8 -4 10 -8 2 </pre>	$O(h^2)$
2)	<pre> -4 10 -8 2 17 -40 32 -8 -24 50 -40 10 1 -4 20 -24 17 -4 -4 1 </pre>	
3)	<pre> -4 -4 17 -24 20 -4 1 10 -40 50 -24 -8 32 -40 17 2 -8 10 -4 </pre>	
4)	<pre> 2 -8 10 -4 -8 32 -40 17 10 -40 50 -24 -4 17 -24 20 -4 1 -4 1 </pre>	
5)	<pre> 1 2 -8 2 1 -8 20 -8 1 2 -8 2 1 </pre>	

Chapter 3: Program Verification and Outputs

In order to investigate the effects that ground modification has on the performance of a foundation system, it was first verified that the program provides the correct results. Two different outputs of the program were verified. They are the deflections and the moments and shear, which are functions of the deflection. The program is capable of producing 3-D plots of the moment, shear, and deflection distributions as well as the corresponding critical values and the differential settlement.

3.1 Verifications

To ensure that the program provides correct results, it has been verified using multiple methods. Two of the verifications are shown below with the first verification being of a rigid foundation with a single point load, 20 kip, applied at the center. For this verification, the elastic modulus of the foundation was increased so that it was within the range for rigid foundation behavior as expressed by the following relationship (15).

$$\left(\frac{3 * k_s}{E * h^3}\right)^{0.25} L < \frac{\pi}{4} \quad (30)$$

In the case of a slab on uniform subgrade, the distributed reaction is equal to the load divided by the length and the corresponding shear and moment diagrams are shown in Figure 6 and Figure 7 respectively. The

maximum values of shear and moment which occur at the center of the foundation can be expressed as follows:

$$V_{max} = \frac{1}{2}P \quad (31)$$

$$M_{max} = \frac{L * P}{8} \quad (32)$$

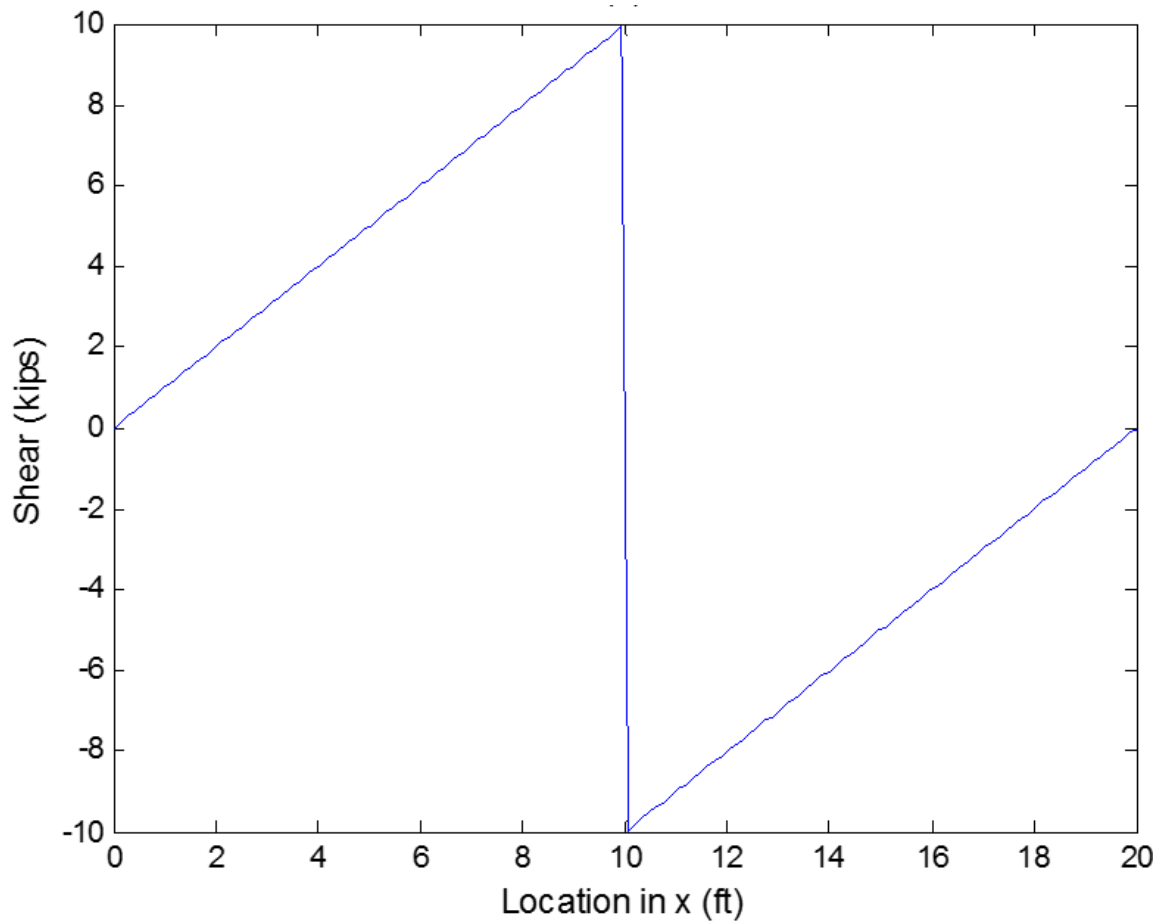

Figure 6 Program Prediction for Shear Distribution for Rigid Foundation with Point Load

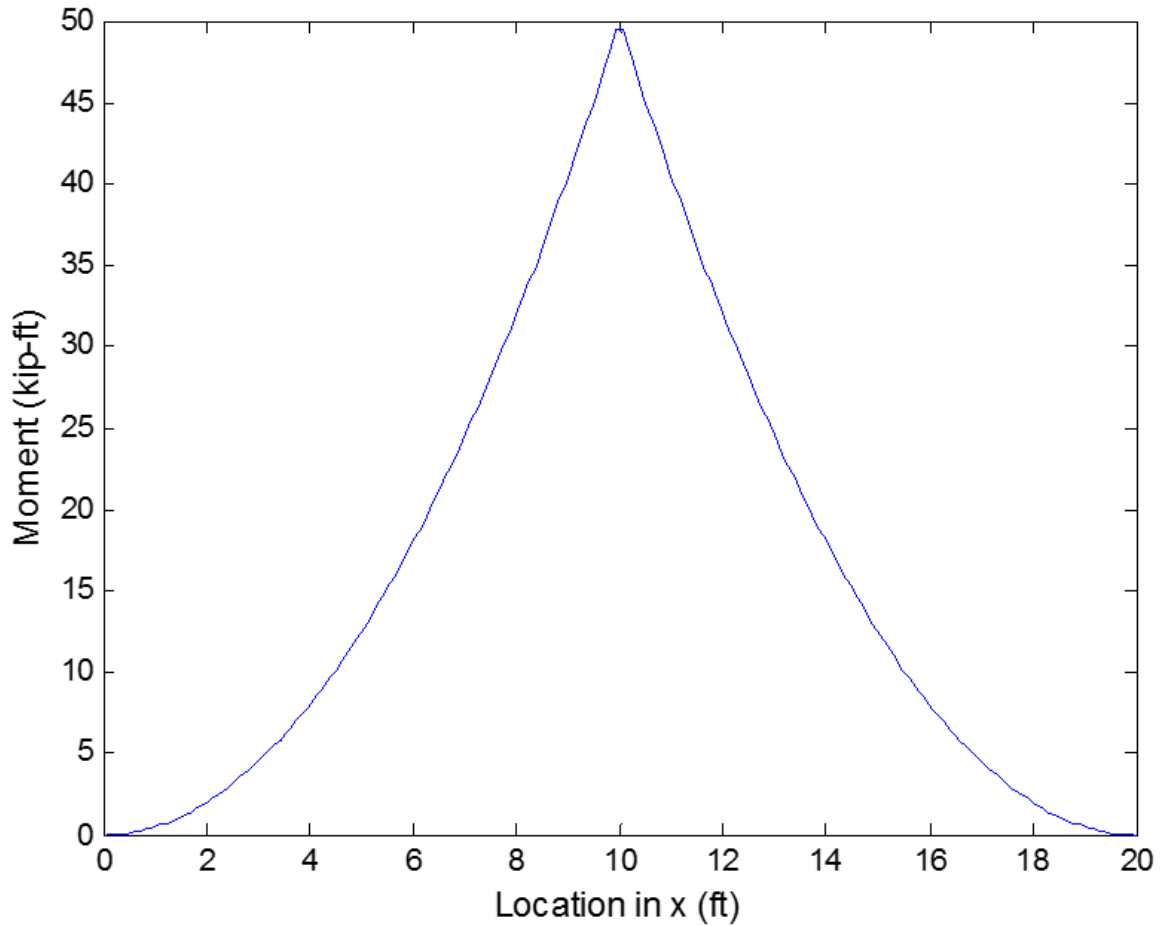

Figure 7 Program Prediction for Moment Distribution for Rigid Footing with Point Load

Another verification performed was that of the bending of a uniformly-loaded simply-supported plate. In this case the closed-form solution for the deflection is

$$w(x, y) = \sum_{m=1}^{\infty} \sum_{n=1}^{\infty} \frac{16 * q_o}{(2m - 1)(2n - 1)\pi^6 * D} \left(\frac{(2m - 1)^2}{a^2} + \frac{(2n - 1)^2}{b^2} \right)^{-2} \sin \left((2m - 1) \frac{\pi x}{a} \right) \sin \left((2n - 1) \frac{\pi y}{b} \right) \quad (33)$$

where a and b are the lengths in the x and y directions.

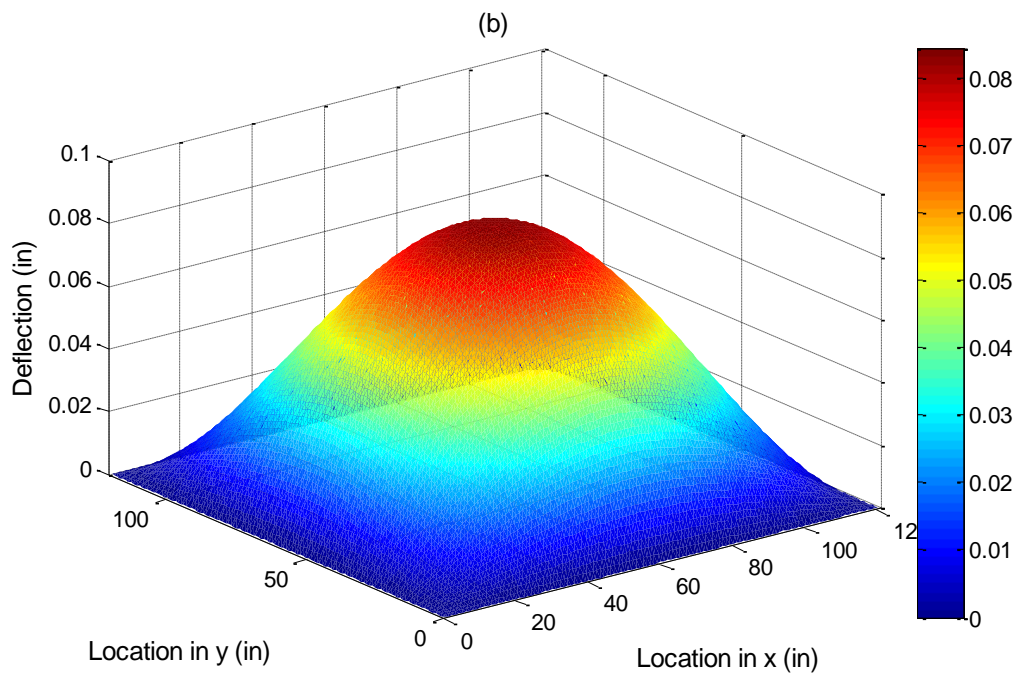
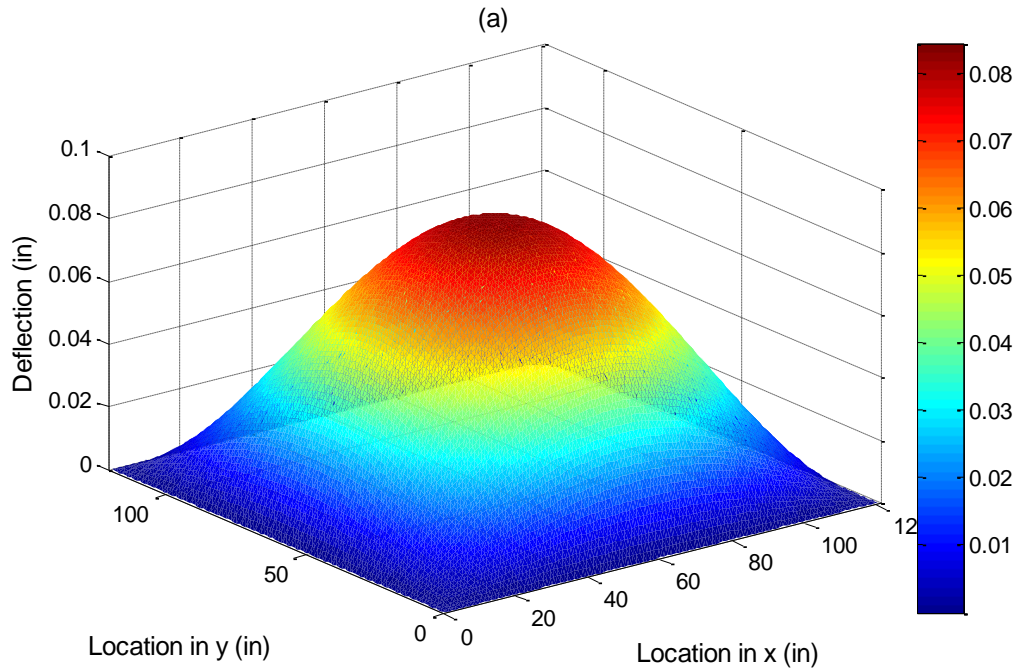

Figure 8 (a) Program Predicted Deflection versus (b) Expected Deflections for a Simply Supported Uniformly Loaded Plate

In this verification, the maximum difference between the expected distribution (Figure 8 (b)) and the predicted distribution (Figure 8 (a)) was

equal to 0.00075714 percent. From these two verifications it can be seen that the developed program calculates both the deflection as well as the moment and shear value within the slab correctly.

3.2 Program Outputs

The developed computer program has many outputs that can be split into two categories, (1) soil parameters and (2) structural parameters, which can then be used in order to determine the benefits of ground modification. The geotechnical benefits include the reduction of the maximum settlement and differential settlement. On the other hand, structural benefits include the reduction of the magnitudes of moments and shear. The effects of ground modification are determined by determining the ratio of the modified parameter to the corresponding unmodified parameter. This enables one to find the expected reductions in maximum moment, shear, settlement, and differential settlement due to any desired level of ground modification. Although the only data presented in the thesis are the modification factors, the program is also capable of providing the moment and shear distributions within the foundation.

Chapter 4: Results of the Analysis

The results of this research are presented as the effects ground modification on the reduction of moment, shear, differential settlement, and settlement of the foundation. Easy-to-use charts have been created to allow the designer to determine a starting level of ground modification in order to support the structure, by visualizing the effects of the envisioned level of modification on the structure. To model this effect, a foundation which supports a specific loading, where the corner columns carry a quarter of the center columns and the edge columns carry half of the center column was used (Figure 9). By modifying the footing parameters and soil modification level, the specific effects of ground modification were predicted.

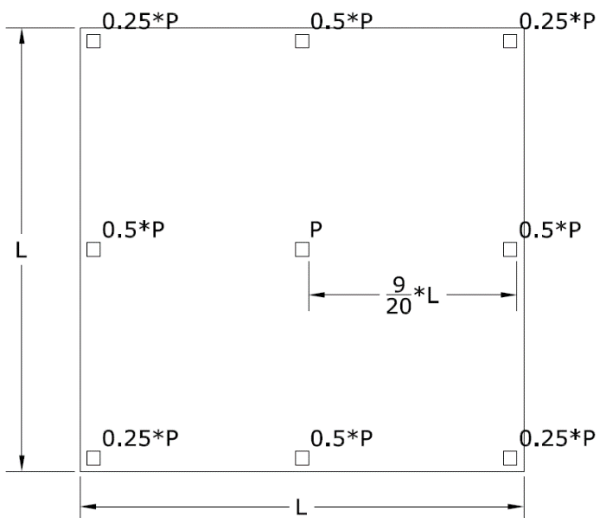

Figure 9 Layout of Foundation Used to Create Design Charts

4.1 Settlement Reduction Factors

The settlement reduction due to ground modification has been explored in Section 2.2.2 for a rigid raft with a uniform load. When applying the above methods to a flexible footing, it is important to investigate which parameters affect the settlement reduction. In the investigation, the settlement reduction was defined as β . Multiple cases were run where the rigidity (thickness), the size of the footing, the load (contact pressure on the footing), and the base oedometric modulus of the subgrade soil were changed so that the effects these parameters have on β could be evaluated.

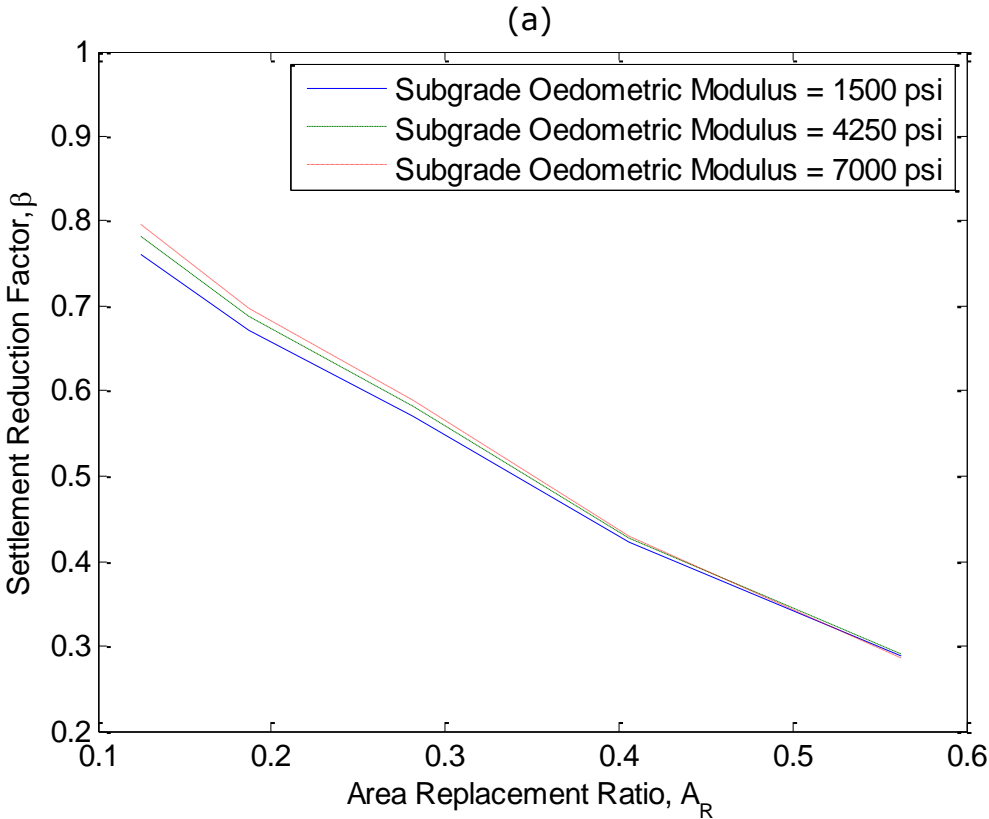

Figure 10 Variation of Replacement Ratio versus Settlement Reduction Factor with (a) Subgrade Oedometric Modulus, (b) Slab Thickness, (c) Footing Contact Pressure, and (d) Width of Foundation

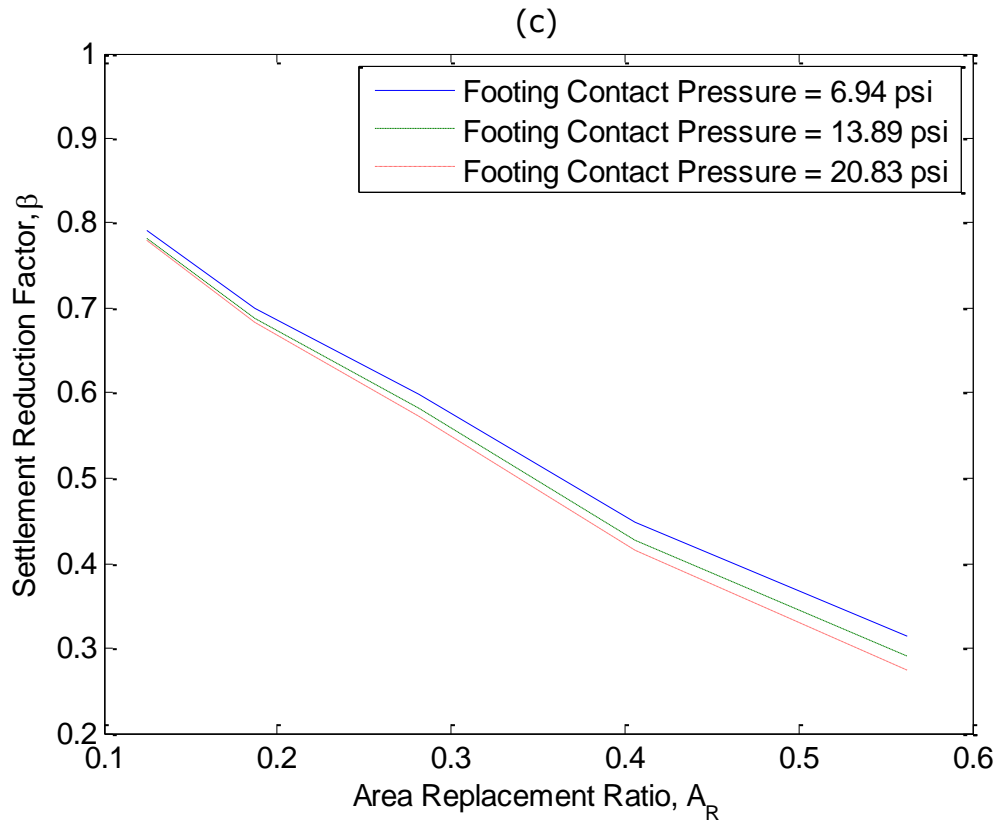
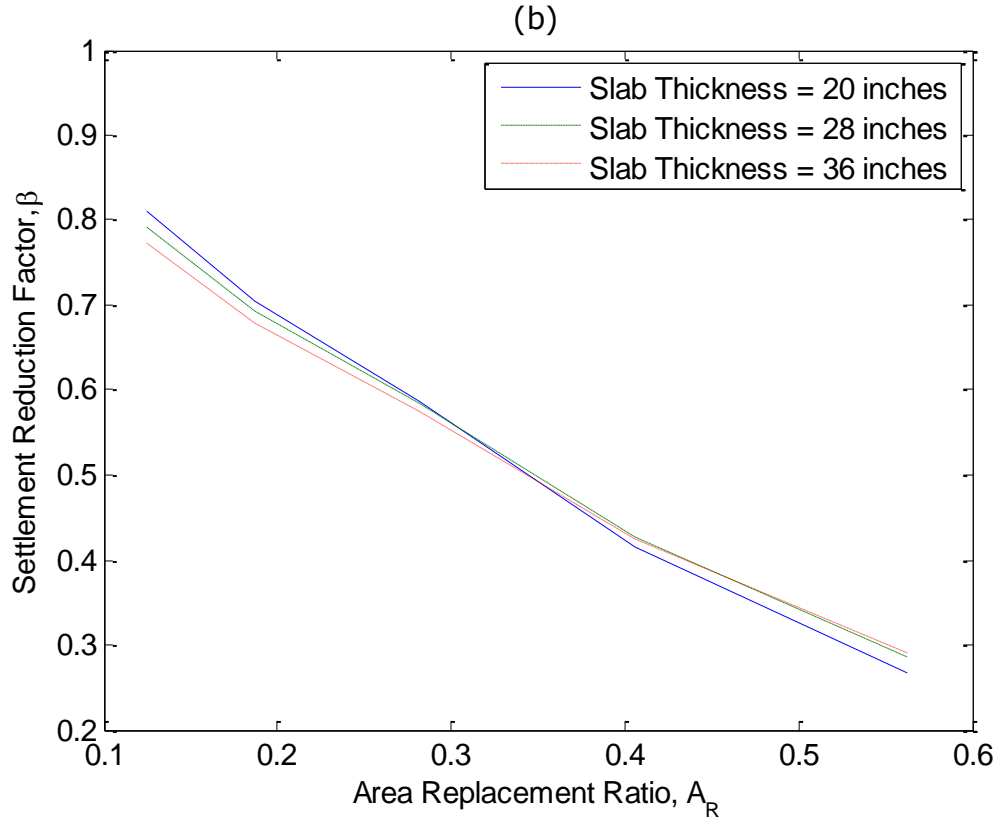

Figure 10 (Continued)

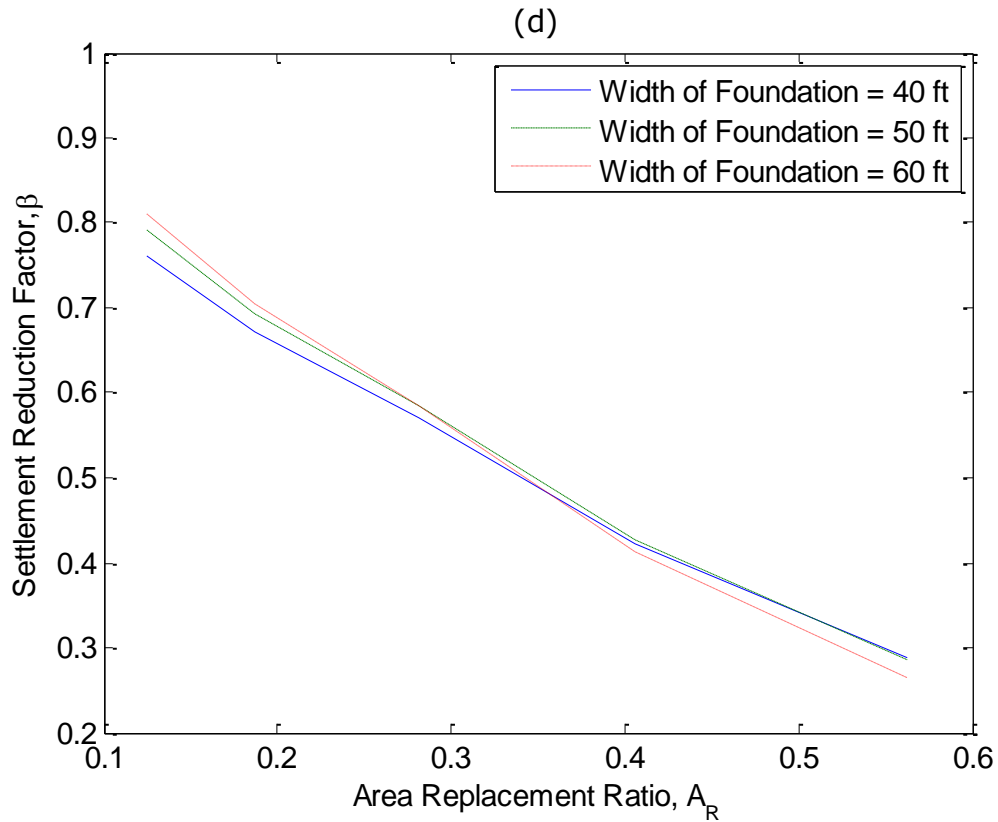

Figure 10 (Continued)

It can be seen in Figure 10 that the effects of the load contact pressure, oedometric modulus, thickness, and size have very little effect on the settlement reduction generated by ground modification. Due to the similarity of the above curves, all of the data points were used to develop a curve with a 95% prediction interval (Figure 11) to allow the designer to determine the desired level of ground modification, prior to footing design.

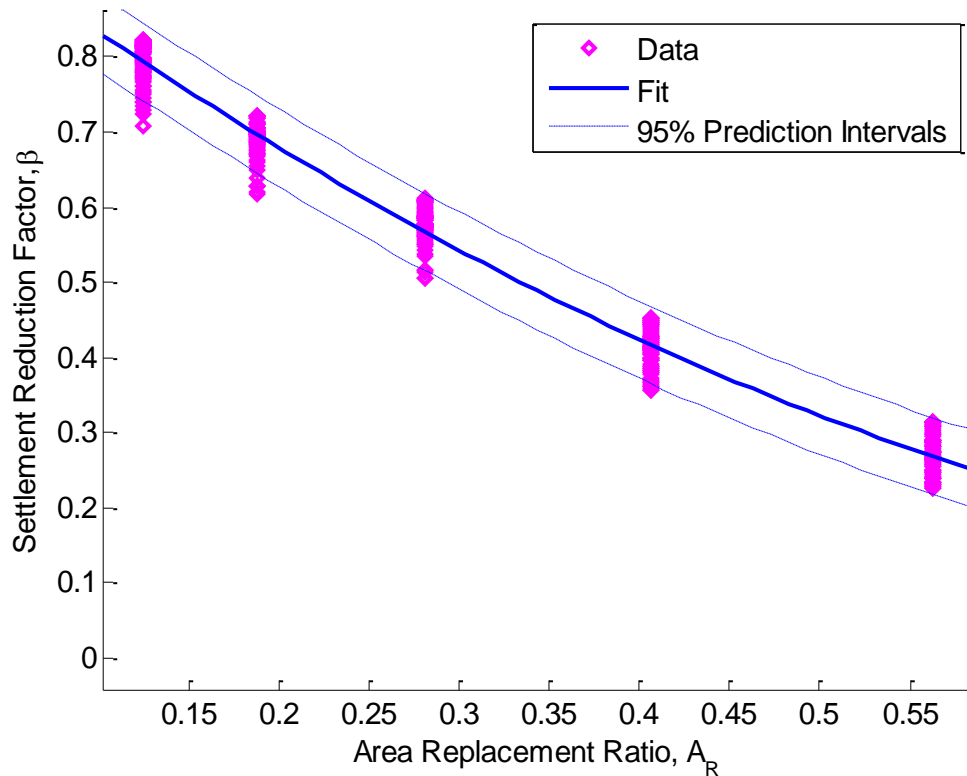

Figure 11 Replacement Ratio versus Settlement Reduction Factor Considering All Parameters

The second soil modification parameter investigated is the differential settlement reduction. Differential settlement is an indicator of the performance of the foundation system with respect to structural cracking. In the investigation, the differential settlement reduction was defined as α . This investigation was also conducted in the same way as that of the settlement reduction, where multiple tributary parameters were varied while keeping the others constant. It can be seen in Figure 12 that the effect of tributary parameters on the differential settlement is a slightly more significant than in the case of the maximum settlement.

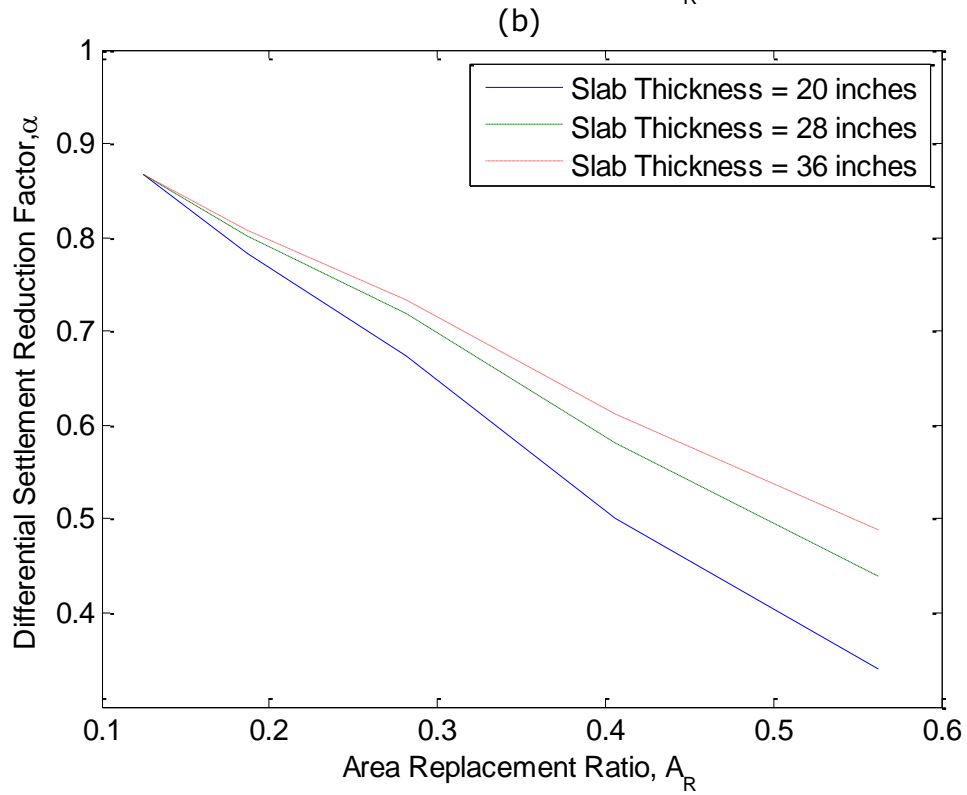
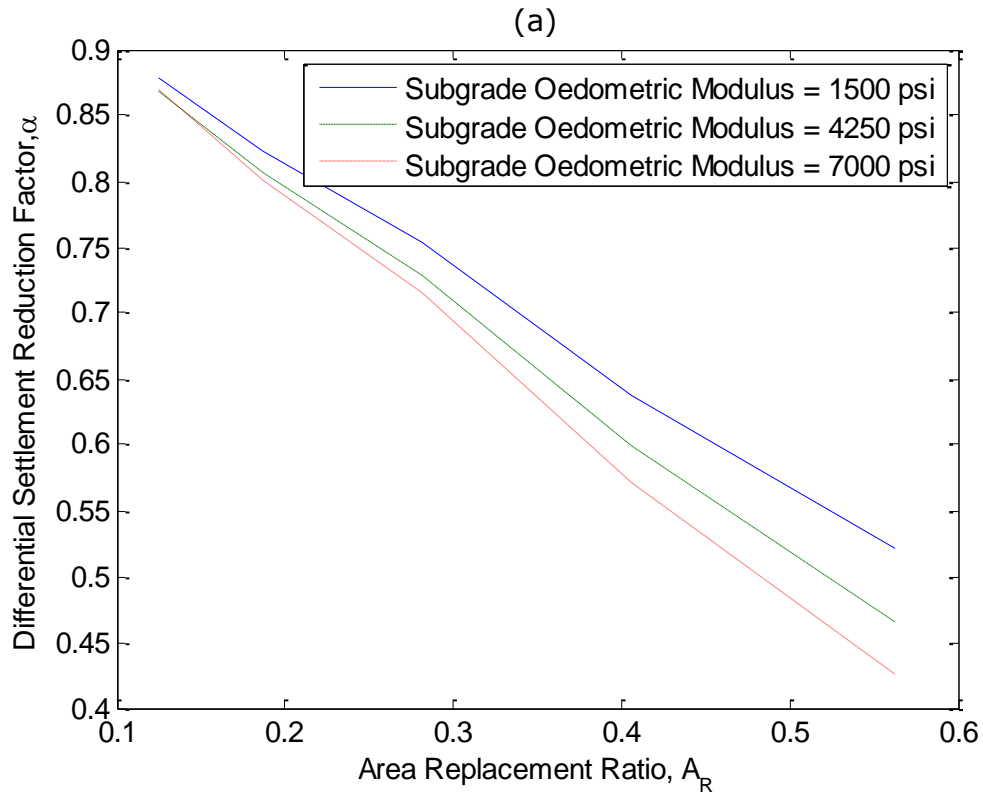

Figure 12 Replacement Ratio versus Differential Settlement Reduction Factor Varying with (a) Subgrade Oedometric Modulus, (b) Slab Thickness, (c) Footing Contact Pressure, and (d) Width of Foundation

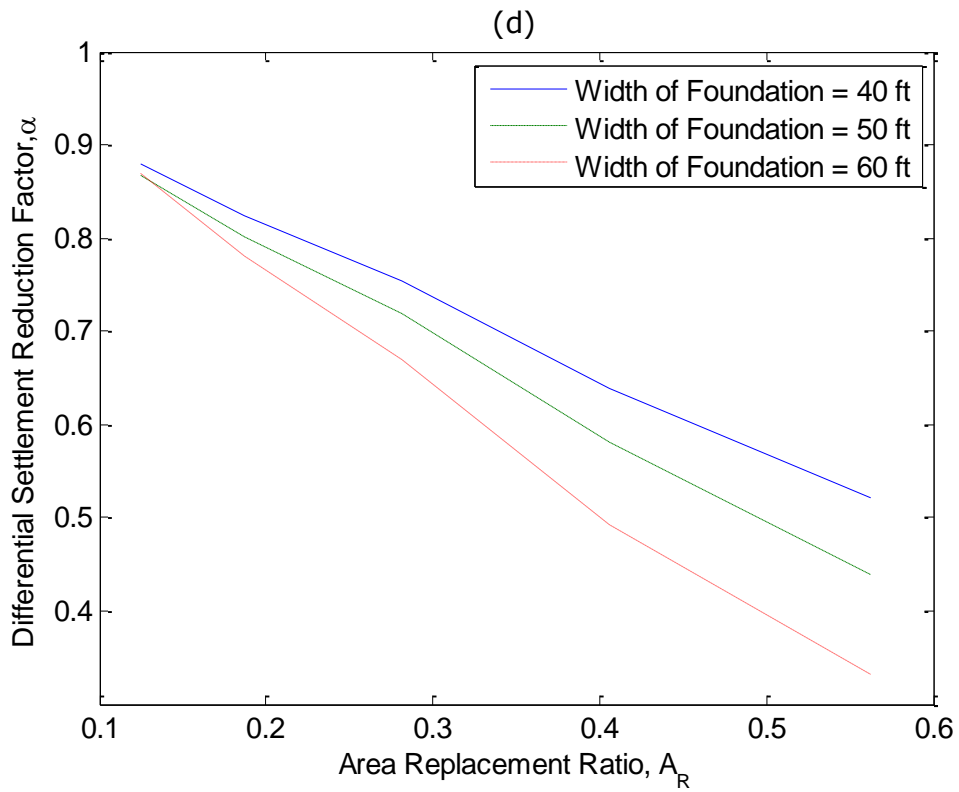
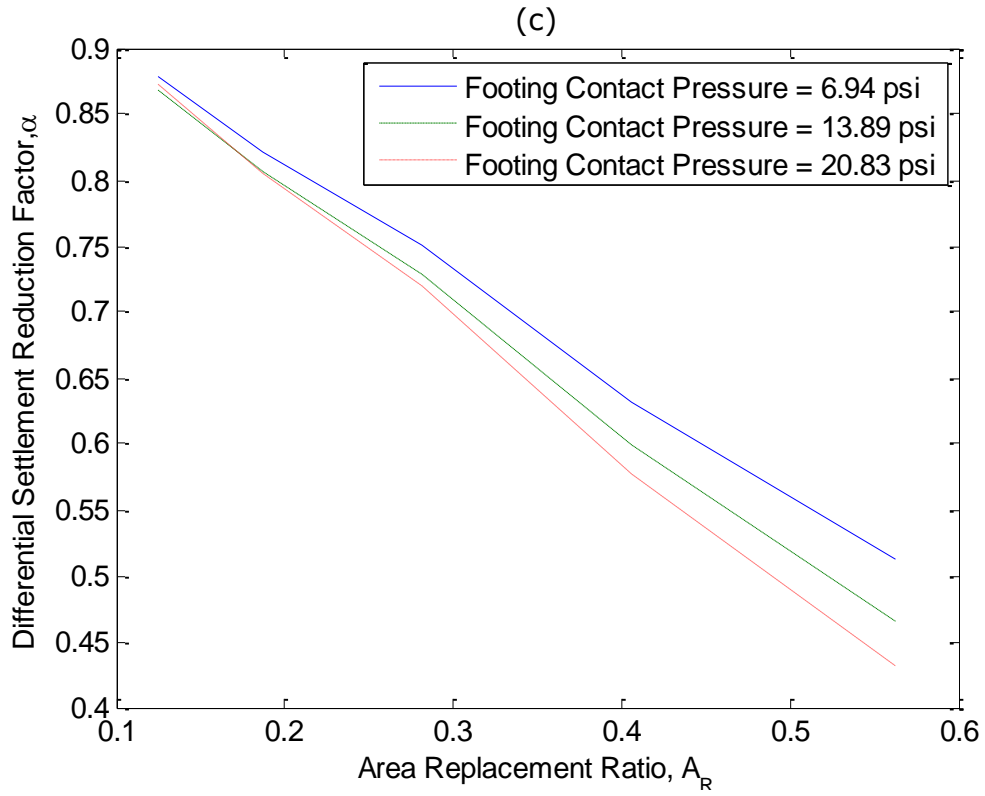

Figure 12 (Continued)

As in the case of the settlement reduction factor, β , a curve was fitted to the data points with a 95% prediction interval (Figure 13) to display the combined effects of all the parameters on the factor α .

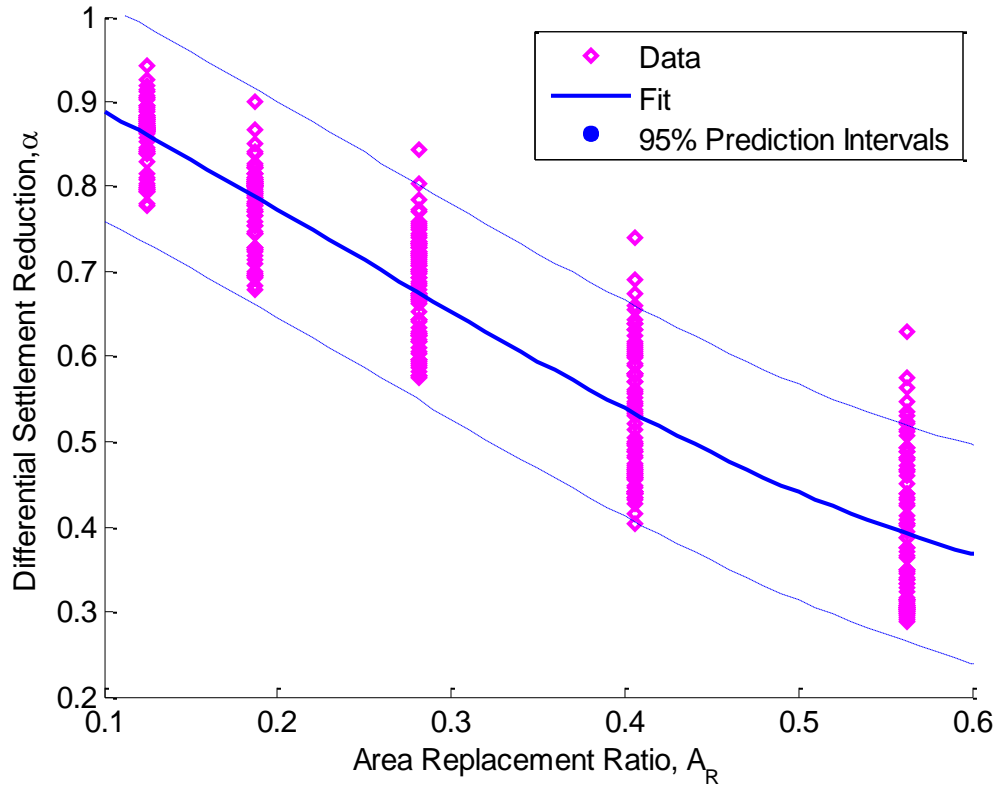

Figure 13 Replacement Ratio versus Differential Settlement Reduction Factor Considering All Parameters

4.2 Modification of Structural Parameters

Although most tributary parameters do not have a significant effect on the settlement reduction factors, the same factors are expected to have a more pronounced effect on the moments generated in the foundation due to the complexities of the soil-structure interaction. In this investigation, the moment modification factor, M , is defined as the ratio of the maximum moment in the modified case to the maximum moment in the unmodified case. In Figure 14, the moment modification factor, M , is plotted against the

replacement ratio for multiple contact pressures, length of the foundation, slab thickness, and the base oedometric moduli of the foundation soil. It is seen from Figure 14 that they produce confounding effects on the moment modification factor making it difficult to predict the individual effects.

Due to the confounding nature of the effects of the tributary parameters on the moment modification factor, M , the x-axis was modified to be the ratio of the length, in the direction of interest, to the radius of relative stiffness defined as follows (16):

$$l = \sqrt[4]{\frac{D}{k}} \quad (1)$$

where k is the equivalent subgrade modulus defined as

$$k = (1 - A_r) * k_{s,s} + A_r * k_{s,c} \quad (1)$$

The benefit of using this ratio compared to the replacement ratio is that it incorporates the effects of all of the relevant tributary parameters. It can be seen in Figure 15 that the above method of data representation brings out a stronger correlation for the moment modification factor, M , compared to Figure 14. The author believes that this correlation could be improved further by changing the length ratio to a ratio that includes the loading.

Similarly, this process was also performed for the shear forces generated within the foundation slab and the shear modification factor, V , is defined as the ratio of the maximum shear in the modified case to the maximum shear in the unmodified case. In this investigation, the shear modification, V , represents the maximum shear force generated on a unit width and does not represent a direct reduction in one-way or two-way

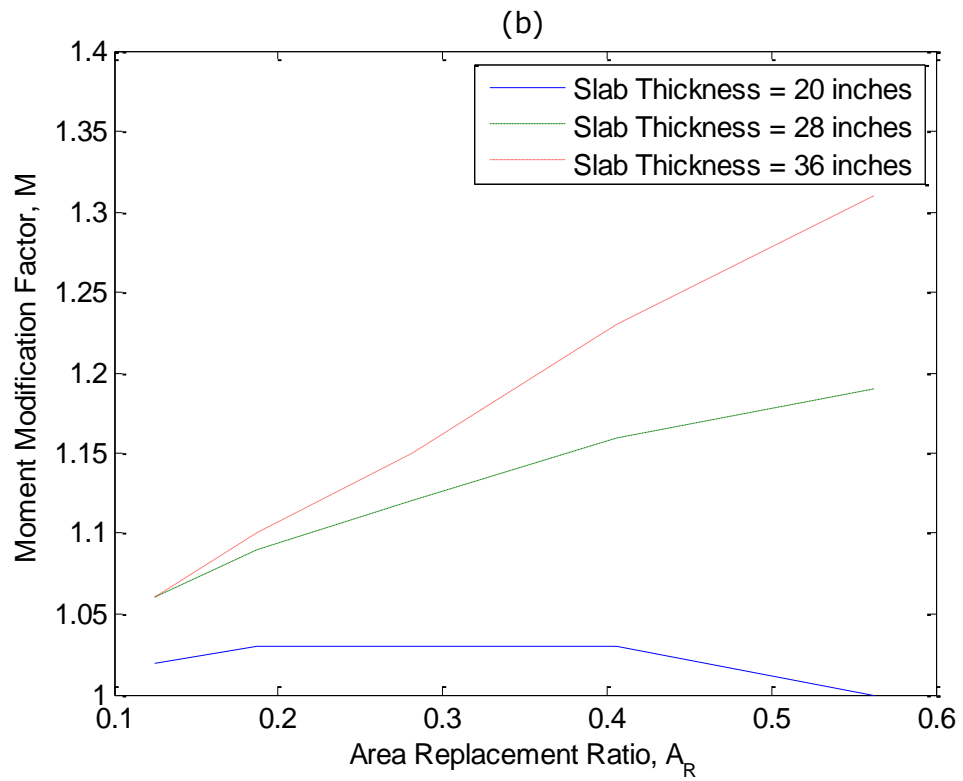
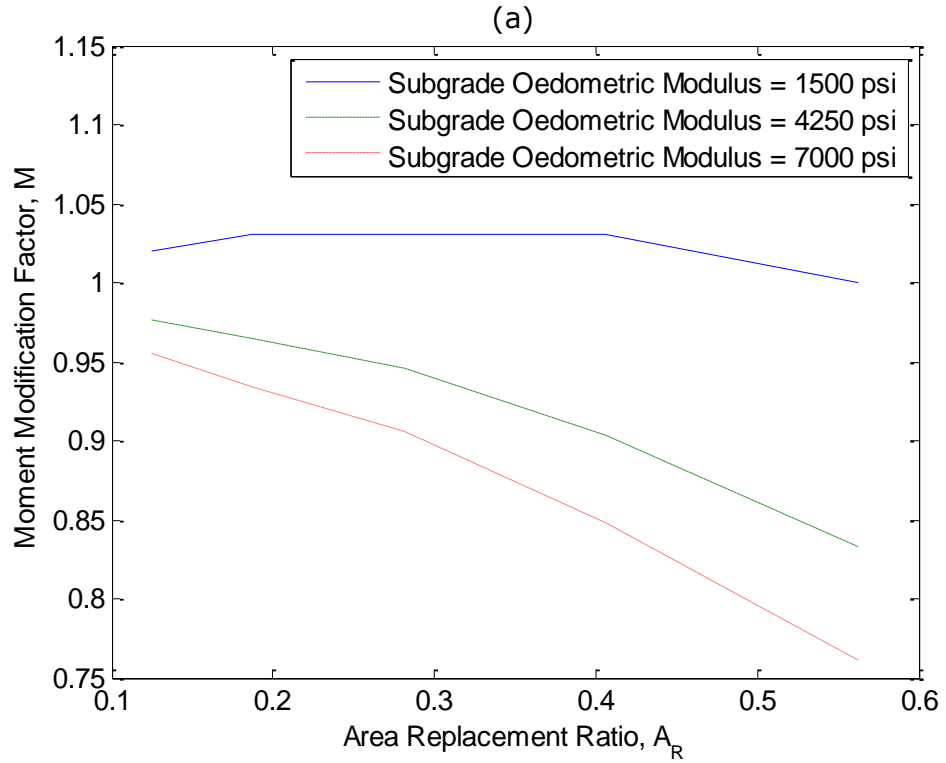

Figure 14 Replacement Ratio versus Moment Modification Factor Varying with (a) Subgrade Oedometric Modulus, (b) Slab Thickness, (c) Footing Contact Pressure, and (d) Width of Foundation

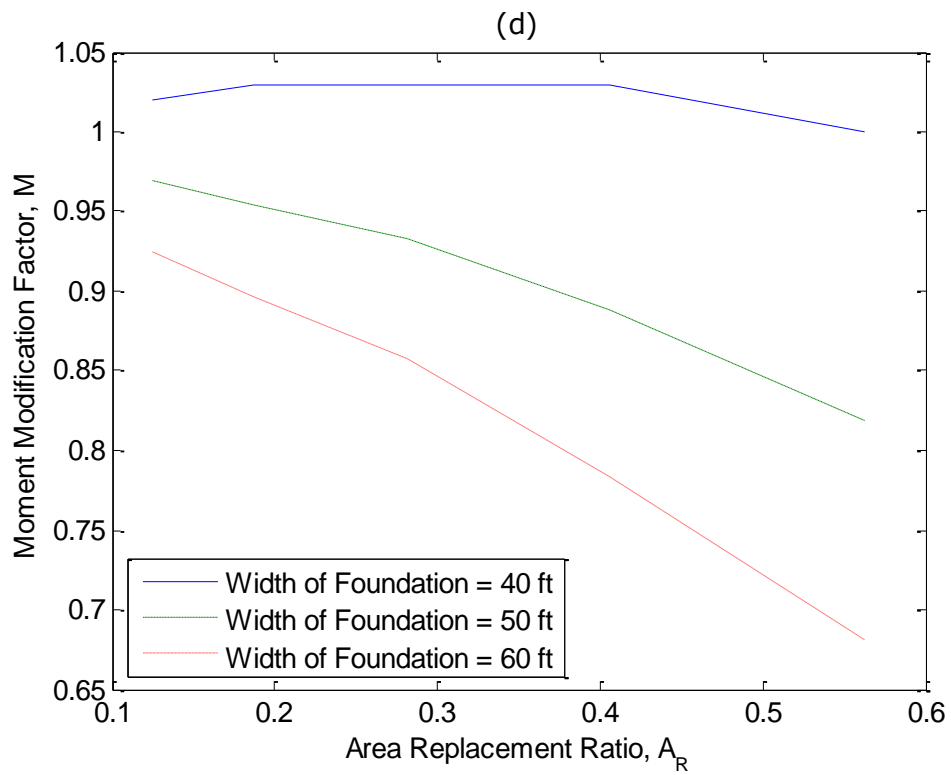
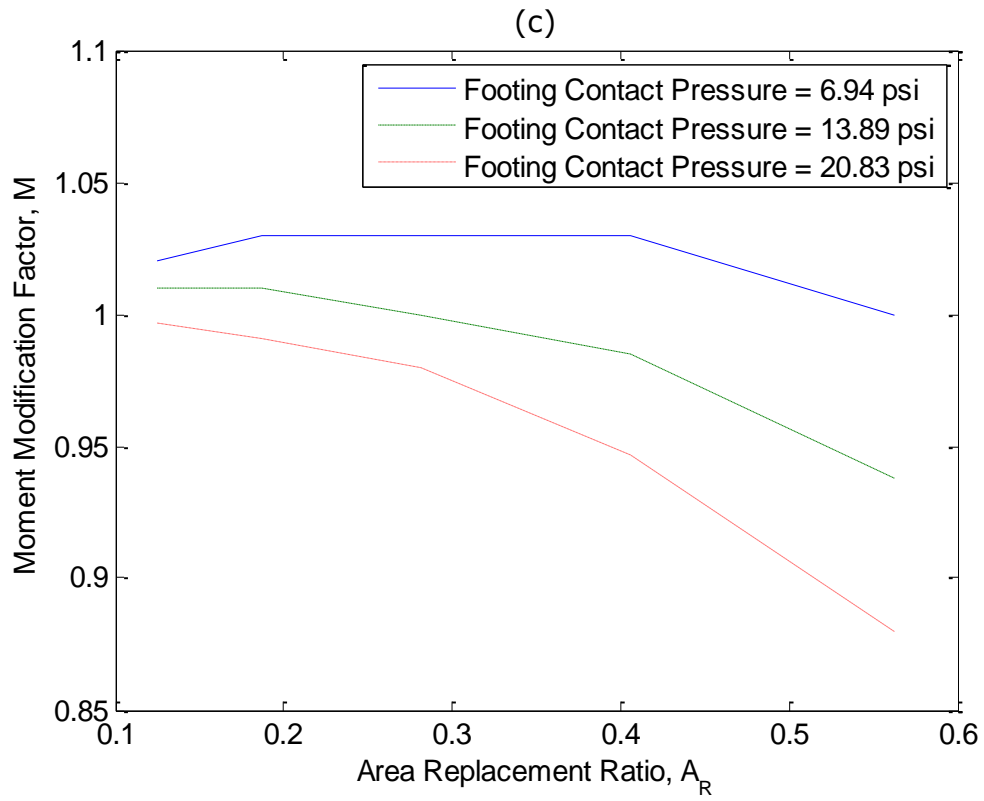

Figure 14 (Continued)

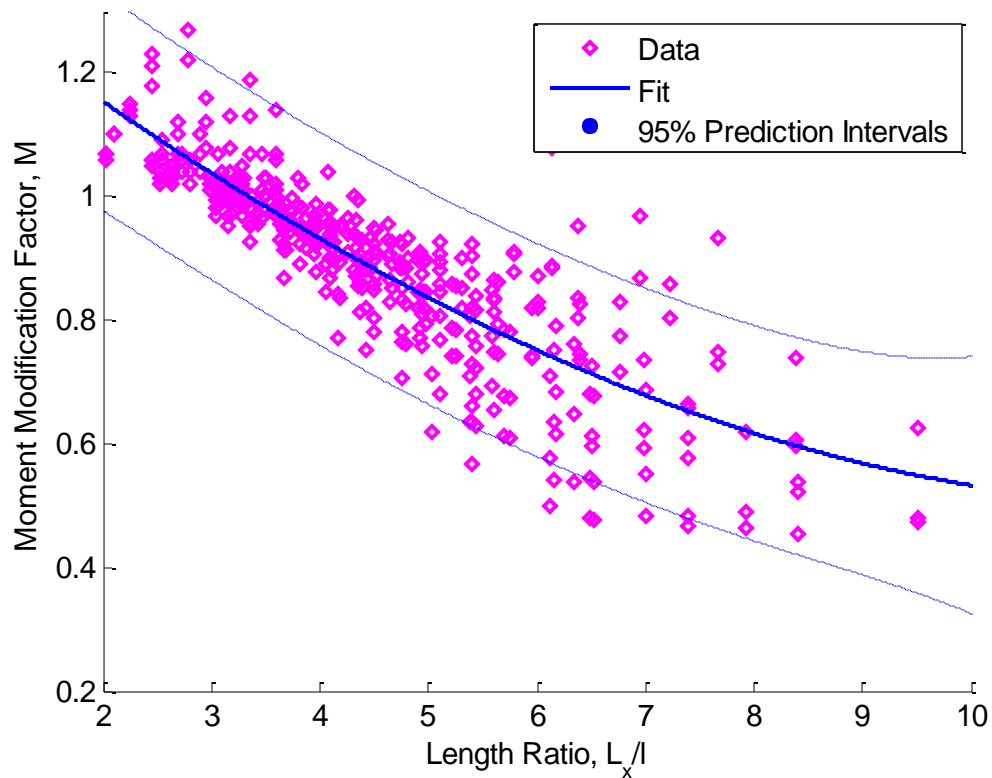

Figure 15 Replacement Ratio versus Moment Modification Factor Considering All Parameters shear. Figure 16 depicts how all of the tributary parameters affect the maximum shear force generated in the foundation slab. As in the case of the moment modification factor, these plots were modified using the length ratio, and all of the points within a 95% prediction interval over the line of best fit are plotted (Figure 17).

Although the 95% prediction interval seen in Figure 17 is wider than that in Figure 15, it provides a stronger correlation of the shear modification factor with the relevant tributary factors. It can be seen that when the length ratio is relatively small, the shear modification is almost non-existent and that the shear reduction becomes significant only when the length ratio increases above a value of about 4.

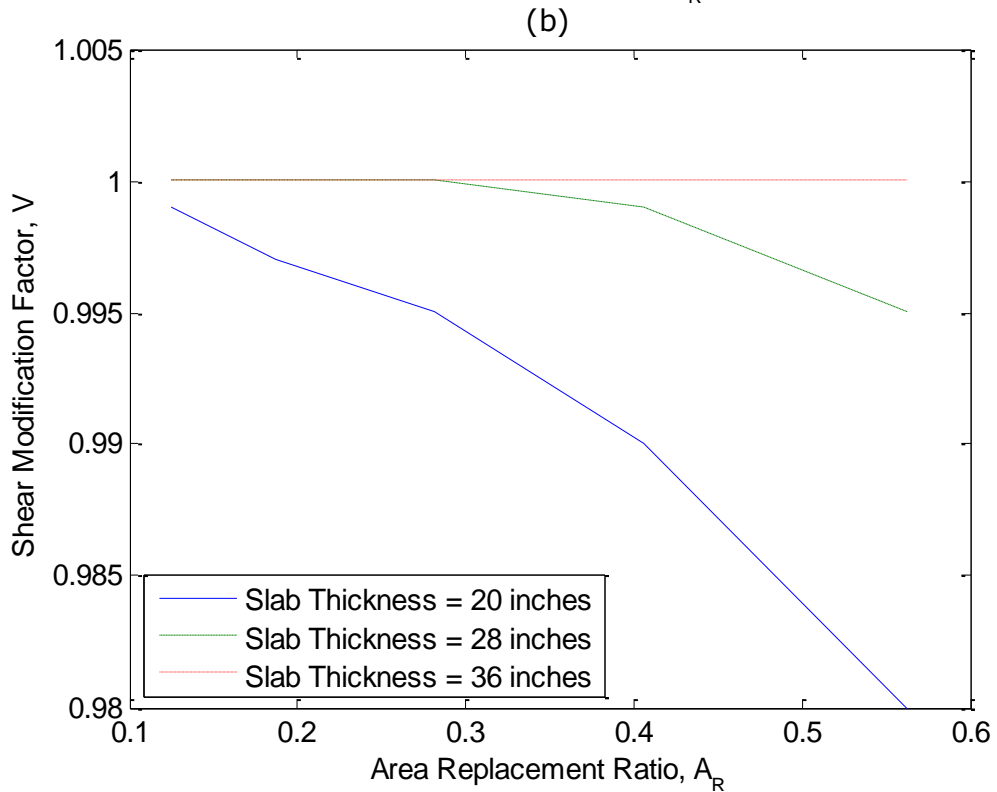
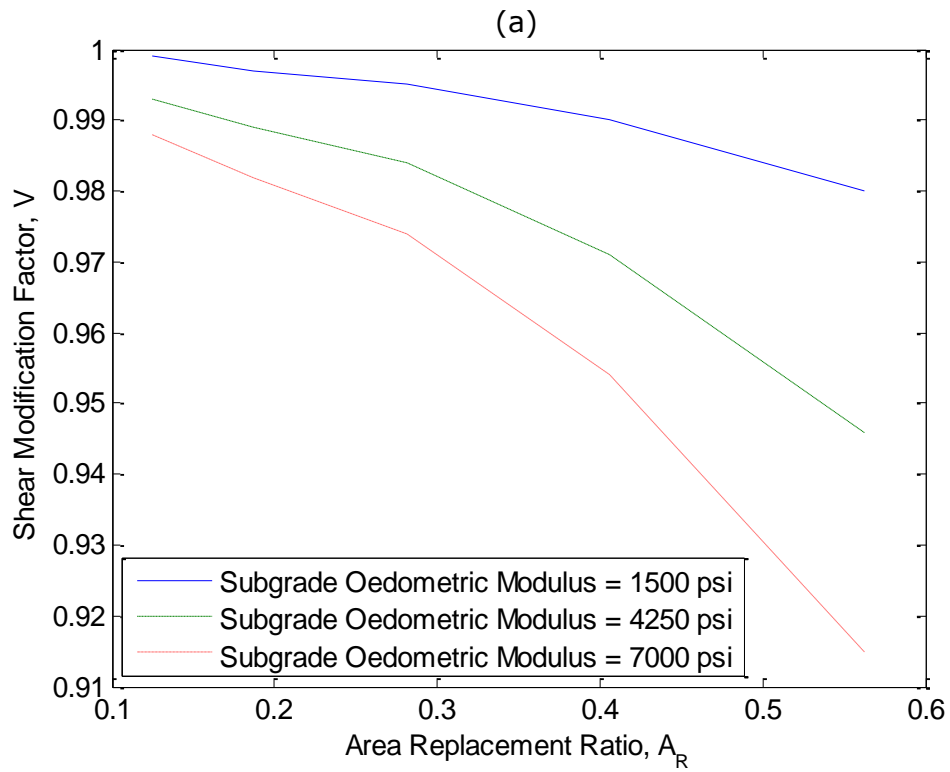

Figure 16 Replacement Ratio versus Shear Modification Factor Varying with (a) Subgrade Oedometric Modulus, (b) Slab Thickness, (c) Footing Contact Pressure, and (d) Width of Foundation

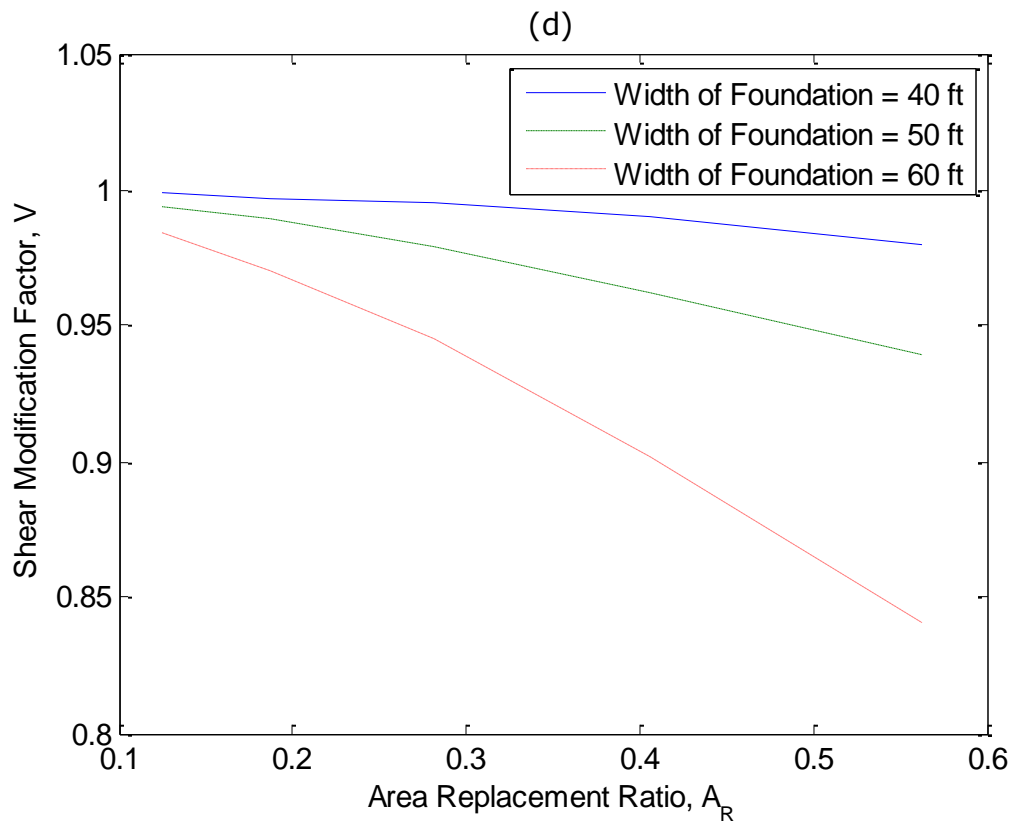
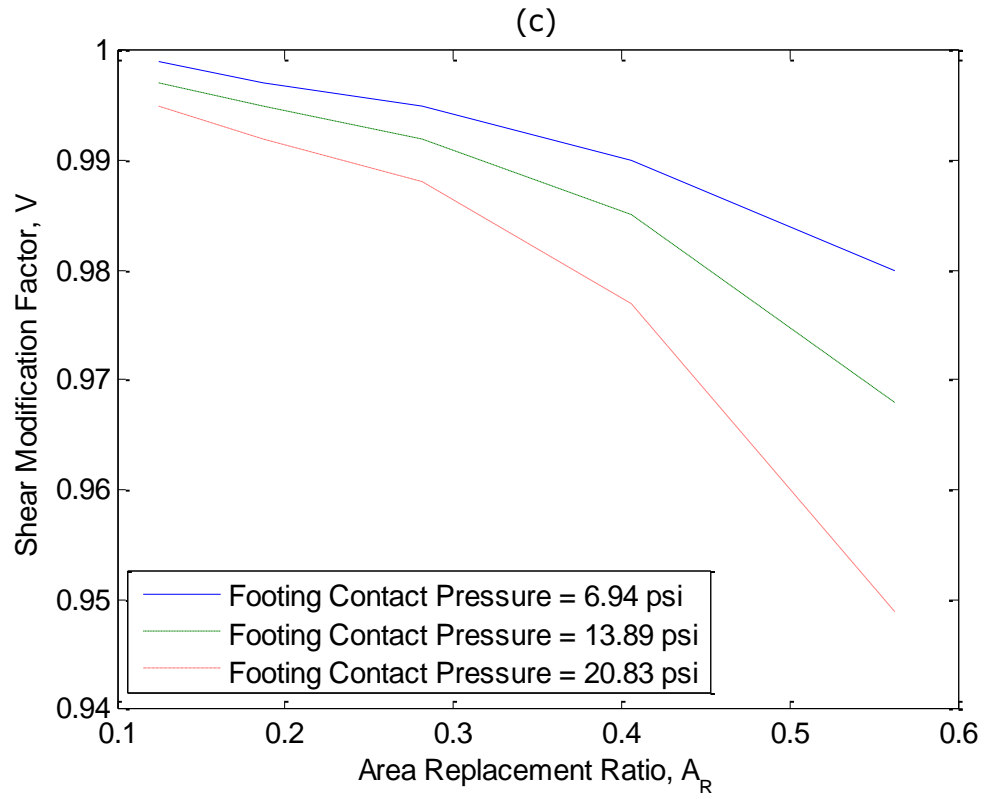

Figure 16 (Continued)

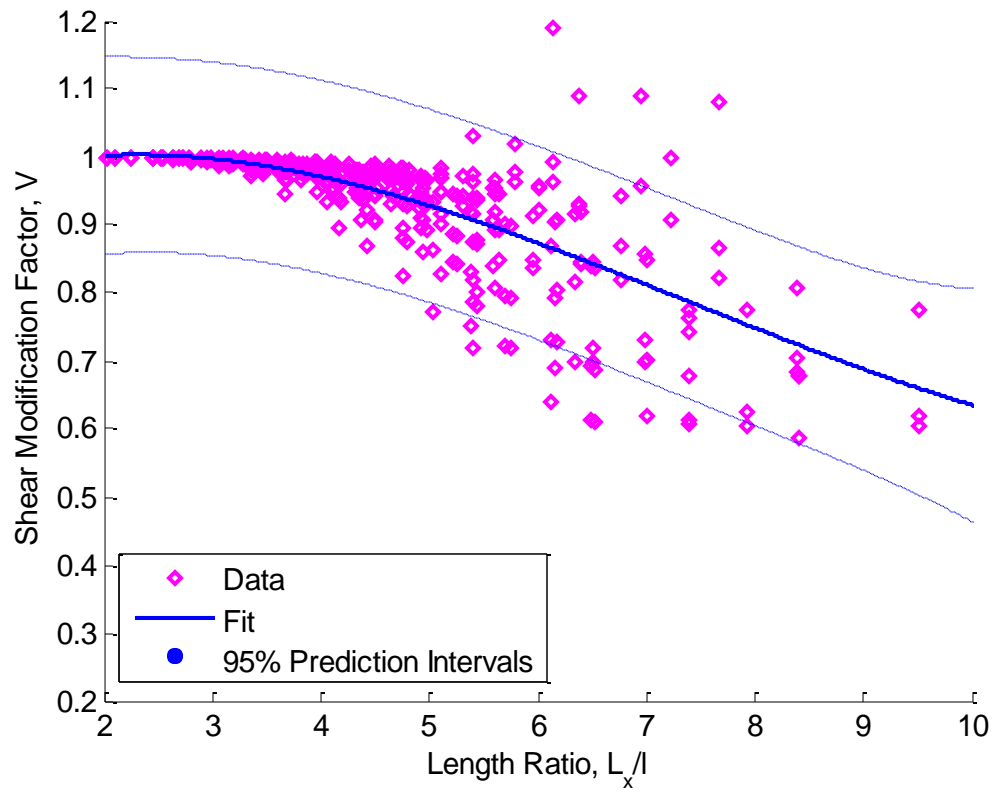

Figure 17 Replacement Ratio versus Shear Modification Factor Considering All Parameters

Chapter 5: Conclusion

In this thesis work, slab design on linear elastic subgrades was modified to incorporate nonlinear elastic subgrade characteristics and non-homogeneity in the stone-column modified subgrades. Slab foundation design information that would be useful in ground modification was developed by expanding previous analytical methods for the design of rigid footings, to include flexible footings as well. Plots were developed to correlate the extents of potential settlement reduction, moment modification, and shear modification to the level of ground modification. The benefits of using these plots are that they allow the structural and foundation designers to have an improved understanding of the effects that ground modification would have on conventional foundation designs, thus providing increased safety, decreased costs, and more efficient designs.

References

1. *The compozer - a method to improve characteristics of soft clay by inclusion of large diameter sand columns.* Aboshi, H., et al. Paris : E.N.P.C., 1979. Proceedings of International Conference on Soil Reinforcement - Reinforced Earth and Other Tichniques. pp. 211-216.
2. *Analysis of rigid rafts supported by granular piles.* Balaam, N.P. and Booker, J.R. 1981, International Journal for Numerical and Analytical Methods in Geomechanics, 5, pp. 379-403.
3. *Analysis of soft ground reinforced by non-homogeneous granular pile-mat system.* Shahu, T.F., Hayashi, S. and Madhav, M.R. 2000, Lowland Technology International, 2, pp. 71-82.
4. Barksdale, R.D. and Bachus, R.C. *Design and construction of stone columns. Report No. FHWA/RD-83/026.* Washington D.C. : Federal Highway Administration, Office of Engineering and Highway Operations, Research and Development, 1983.
5. *Effects of stone columns yield on settlement of rigid foundations in stabilized clay.* Balaam, N.P. and Booker, J.R. 1985, International Journal for Numerical and Analytical Methods in Geomechanics, 9, pp. 331-351.
6. *Abschätzung des Setzungsverhaltens eines durch Stopfverdichtung verbesserten Baurgrundes.* Priebe, H. 1976, Dis Bautechnik, pp. 160-162.
7. *Improvement of settlement behaviour of soft layers by means of stone columns.* Impe, W.F. and De Beer, E. Helsinki : s.n., 1983. Proceedings of 8th European Conference of Soil Mechanics and Foundation Engineering. Vol. 1, pp. 309-312.
8. *Analysis and settlement of dilating stone column reinforced soil.* Impe, W.F. and Madhav, M.R. 1992, Osterreichische Ingenieur und Architekten Zeitschrift, pp. 114-121.
9. *Analytical Method for the Analysis of Stone-Columns According to the Rowe Dilatancy Theory.* Pulko, B and Majes, B. 2006, Acta Geotechnica Slovenica, pp. 37-45.

10. *The stress-dilatancy relation for static equilibrium of an assembly of particles in contact.* Rowe, P.W. 1962. Proceedings of Royal Society, 269A. pp. 500-527.
11. Jawad, Maan H. *Theory and Design of Plate and Shell Structures.* New York : Chapman & Hall, 1994.
12. *The hardening soil model: Formulation and verification.* Schanz, T., Vermeer, P.A. and Bonnier, P.G. Amsterdam : Proceedings of the International Symposium Beyond 2000 in Computational Geotechnics, 1999.
13. *Calculation models for dam foundation with geotextile coated sand columns.* Raithel, M. and Kempfert, H.G. Melbourne : Proceeding of the International Conference on Geotechnical & Geological Engineering, 2000.
14. Chapra, S. and Canala, R. *Numerical Methods for Engineers with Personal Computer Applications.* Ann Arbor : McGraw Hill, 1984.
15. Gunaratne, Manjriker. *The Foundation Engineering Handbook.* Boca Raton : Taylor & Francis, 2006.
16. Huang, Y. *Pavement Analysis and Design.* Upper Saddle River : Pearson Education, 2004. 0-12-142473-4.