



2008

AGING AND SLEEP STAGE EFFECTS ON ENTROPY OF ELECTROENCEPHALOGRAPH SIGNALS

Swetha Vennelaganti

University of Kentucky, swetha.v@uky.edu

Recommended Citation

Vennelaganti, Swetha, "AGING AND SLEEP STAGE EFFECTS ON ENTROPY OF ELECTROENCEPHALOGRAPH SIGNALS" (2008). *University of Kentucky Master's Theses*. 553.
http://uknowledge.uky.edu/gradschool_theses/553

This Thesis is brought to you for free and open access by the Graduate School at UKnowledge. It has been accepted for inclusion in University of Kentucky Master's Theses by an authorized administrator of UKnowledge. For more information, please contact UKnowledge@sv.uky.edu.

ABSTRACT OF THESIS

AGING AND SLEEP STAGE EFFECTS ON ENTROPY OF ELECTROENCEPHALOGRAM SIGNALS

The aging brain is characterized by alteration in synaptic contacts, which leads to decline of motor and cognitive functions. These changes are reflected in the age related shifts in power spectrum of electroencephalogram (EEG) signals in both wakefulness and sleep. Various non-linear measures have been used to obtain more insights from EEG analysis compared to the conventional spectral analysis. In our study we used Sample Entropy to quantify regularity of the EEG signal. Because elderly subjects arouse from sleep more often than younger subjects, we hypothesized that Entropy of EEG signals from elderly subjects would be higher than that from middle aged subjects, within a sleep stage. We also hypothesized that the entropy increases during and following an arousal and does not return to background levels immediately after an arousal. Our results show that Sample Entropy varies systematically with sleep state in healthy middle-aged and elderly female subjects, reflecting the changing regularity in the EEG. Sample Entropy is significantly higher in elderly in sleep Stage 2 and REM, suggesting that in these two sleep stages the cortical state is closer to wake than in middle-aged women. Sample Entropy is higher in post-arousal compared to the pre-arousal and stays high for a 30 sec period.

Key Words: EEG Regularity, Sample Entropy, Sleep stages, EOG removal, MMSE filter

Swetha Vennelaganti

08-14-2008

AGING AND SLEEP STAGE EFFECTS ON ENTROPY OF
ELECTROENCEPHALOGRAPH SIGNALS

By

SWETHA VENNELAGANTI

Dr. Eugene Bruce
Director of Thesis

Dr. Abhijit Patwardhan
Director of Graduate Studies

08-14-2008
Date

RULES FOR THE USE OF THESES

Unpublished theses submitted for the Master's degree and deposited in the University of Kentucky Library are as a rule open for inspection, but are to be used only with due regard to the rights of the authors. Bibliographical references may be noted, but quotations or summaries of parts may be published only with the permission of the author, and with the usual scholarly acknowledgments.

Extensive copying or publication of the thesis in whole or in part also requires the consent of the Dean of the Graduate School of the University of Kentucky.

THESIS

Swetha Vennelaganti

The Graduate School
University of Kentucky

2008

AGING AND SLEEP STAGE EFFECTS ON ENTROPY OF
ELECTROENCEPHALOGRAPH SIGNALS

THESIS

A thesis submitted in partial fulfillment of the
requirements for the degree of
Master of Science in Biomedical Engineering
College of Engineering
Center for Biomedical Engineering
at the University of Kentucky

By
Swetha Vennelaganti
Lexington, Kentucky
Director: Dr. Eugene N. Bruce, Professor of Biomedical Engineering
Lexington, Kentucky
2008

ACKNOWLEDGEMENTS

I would like to thank my adviser, Dr. Eugene Bruce for giving me the opportunity to work on such wonderful project. This work would not have been possible without his constant support and guidance.

I am grateful to Dr. Peggy Bruce for helping me throughout, especially with the selection of subjects and the analyzable data segments.

I would like to thank my thesis committee members: Dr. Abhijit Patwardhan and Dr. Guoqiang Yu for their valuable inputs that helped me deliver a better finished product.

I am thankful to my friends and family for believing in me and for extending their constant support.

Finally, I would like to thank Kentucky Science and Engineering Foundation for funding this project.

TABLE OF CONTENTS

Acknowledgement	iii
List of Tables	vi
List of Figures	vii
List of Files	ix
Chapter 1: Introduction	1
1.1 EEG analysis techniques	2
1.2 Entropy.....	3
1.3 Hypotheses.....	3
Chapter 2: Background	6
2.1 Physiology of Sleep	6
2.2 Sleep Deficiency	7
2.3 Sleep Studies	7
2.4 Basics of the Electroencephalogram	8
2.5 EEG Analysis	8
Chapter 3: Methods	12
3.1 Subjects	12
3.2 Data	13
3.2.1 Sleep Stage Study	13
3.2.2 Arousal Study	13
3.3 Signal Analysis	14
3.3.1 Sleep Stage Study	14
3.3.1.1 EOG contamination	14
3.3.1.2 Sample Entropy calculation	16
3.3.1.3 Power Spectral Analysis	17
3.3.1.4 Statistical Analysis	18
3.3.2 Arousal Study	18
3.3.2.1 Sample Entropy Calculation	19
3.3.2.2 Power Spectral Analysis	19
3.3.2.3 Statistical Analysis	20

Chapter 4: Results	29
4.1 Sample Entropy and Sleep Stages	29
4.2 Arousal Study	30
Chapter 5: Discussions	53
5.1 Methodological Issues	53
5.2 Interpretation of Results	55
Chapter 6: Conclusions, implications and future directions	62

LIST OF TABLES

TABLE 3.2: Number of arousals chosen for sample entropy calculation	21
TABLE 3.3: Number of arousals chosen for power calculation	21
TABLE 4.1: Mean (+/- S.D.) Sample Entropy values in 20 middle aged subjects	33
TABLE 4.2: Mean (+/- S.D.) Sample Entropy values in 20 elderly subjects	33
TABLE 4.3: Mean (+/- S.D.) power values of 9 sec segments for middle aged subjects	34
TABLE 4.3 (continued)	35
TABLE 4.4: Mean (+/- S.D.) power values of 9 sec segments for elderly subjects	36
TABLE 4.4 (continued)	37
TABLE 4.5: Mean (+/- S.D.) Sample Entropy values of 10 sec segments for middle aged and elderly subjects	38

LIST OF FIGURES

FIGURE 1.1: Electroencephalogram signal in different sleep stages	5
FIGURE 2.1: All night Sleep Cycle of a normal, healthy subject	10
FIGURE 2.2: A 20 sec polysomnogram recording of a middle aged subject.....	11
FIGURE 3.1: Protocol for selection of an arousal segment for	22
Sample Entropy calculation	
FIGURE 3.2: Scheme for removing EOG contamination from EEG signal	22
FIGURE 3.3 Plot of Coherence vs. Frequency	23
FIGURE 3.4 Example of an impulse response of an MMSE filter	24
FIGURE 3.5: Figure illustrating the calculation of conditional probability	25
FIGURE 3.6: EEG spectral power for an SHHS-marked arousal in	26
different frequency bands	
FIGURE 3.7: Identification of an arousal; the green arrow indicates an	27
arousal identified by our method	
FIGURE 3.8: EEG spectral power for an arousal in different frequency bands	28
FIGURE 4.1: 30-second records of EEG signals in different sleep	39
stages after removal of EOG contamination	
FIGURE 4.2: Sample Entropy values in sleep stages: Wake, Stage 1,.....	40
Stage 2, Stage 3 and REM from an overnight polysomnogram	
of one middle aged subject	
FIGURE 4.3: Mean Sample Entropy values in various sleep stages	41
for all 20 middle aged subjects	
FIGURE 4.4: Difference in Sample Entropy values between subsequent	42
sleep stages for all 20 middle aged subjects	
FIGURE 4.5: Mean Sample Entropy values in various sleep stages for	43
all 20 elderly subjects	
FIGURE 4.6: Differences in Sample Entropy values between subsequent	44
sleep stages for all 20 elderly subjects	
FIGURE 4.7: Mean Sample Entropy values in various sleep stages for	45
all 20 middle aged and 20 elderly subjects	

FIGURE 4.8: Relative power values in different frequency bands in Wake Stage	46
FIGURE 4.9: Relative power values in different frequency bands in Stage 2	47
FIGURE 4.10: Relative power values in different frequency bands in Stage 3	48
FIGURE 4.11: Relative power values in different frequency bands in stage	49
FIGURE 4.12: Percent difference from overall mean in Delta power during	50
pre- and post-arousal	
FIGURE 4.13: Percent difference from overall mean in Theta power	50
FIGURE 4.14: Percent difference from overall mean in Alpha power	51
FIGURE 4.15: Percent difference from overall mean in Sigma power	51
FIGURE 4.16: Percent difference from overall mean in Beta power	52
FIGURE 4.17: Percent difference from overall mean in Sample Entropy	52
FIGURE 5.1: Power Spectrum of a raw EEG signal showing most	60
of the power is concentrated below 25Hz	
FIGURE 5.2: Power Spectrum of a raw EOG signal showing most	61
of the power is concentrated below 3Hz	

LIST OF FILES

1. Thesis-final.pdf

CHAPTER 1: INTRODUCTION

The Electroencephalogram (EEG), which is a recording of the patterns of electrical activity of the cerebral cortex, allows us to understand better the function of the brain in both the awake and sleep states. It is the only non-invasive and inexpensive imaging technology that can be used to evaluate sleep quality [1]. When a person is awake, brain patterns are highly desynchronous. The awake brain produces alpha and beta rhythms, which are high frequency waves with low amplitude. Alpha waves range between 8.0 and 12.0 Hz and beta waves have a frequency of ≥ 14.0 Hz. EEG in sleep Stage 1 is dominated by theta activity, which is slower in frequency and greater in amplitude compared to Wake Stage. Theta waves have a frequency range between 4.0 to 8.0 Hz. Stage 2 has theta waves interspersed by sleep spindles, which are characterized by a transient increase in frequency, and K complexes, which are characterized by a transient decrease in frequency and an increase in amplitude. Stages 3 and 4 are dominated by delta activity, which falls in the range of 4.0 Hz and below. Delta rhythm is the highest in amplitude and comprises the slowest waves. The EEG in rapid eye movement (REM) stage looks very similar to that in the Wake Stage, containing mostly a combination of alpha and beta waves. The EEG recordings in different sleep stages from one of the subjects are shown in Figure (1.1).

With aging, the beta power was shown to increase, along with decreases in sigma, delta and theta band powers in almost all sleep stages [2]. In contrast, younger subjects were shown to have higher power at low frequencies. Carrier et al. also suggested that there may be an association between increase in age and attenuation of homeostatic sleep pressure, which in turn could lead to an increase in cortical activation state during sleep [2].

The EEG signal is highly irregular and its regularity varies not only among different sleep stages, but also within a sleep stage. We define the varying degree of EEG regularity as the complexity of the EEG signal. This signal is extremely complex, since the EEG is generated as a superposition of weakly correlated dynamical systems. These temporal variations can provide insights into differences between diseased and normal states and hence may be used as biomarkers that are predictive of a trend towards an

abnormal state. The temporal variations, which include frequency of arousals, have been employed by other researchers as biomarkers for underlying disease process [3].

An EEG arousal as defined by the American Sleep Disorders Association (ASDA) is “an abrupt shift in EEG frequency, which may include theta, alpha and/or frequencies greater than 16Hz, but not spindles.” and is subjected to certain rules and conditions which are given in reference 4 [4]. Though arousals are intrinsic components of physiological sleep [5], an increase in the frequency of arousals is associated with sleep disorders and with aging [2, 6, 7]. Frequent arousals also tend to occur in patients with upper airway disease [8]. Also of concern, the increase in nocturnal blood pressure in sleep apnea/hypopnea syndrome and in periodic limb movement disorder is related to arousals [5]. The arousal index, i.e., the number of arousals per hour, is widely used in the literature as an indicator of severity of a sleep disorder and is sometimes used to make decisions on treatments. However, there is considerable variability in scoring arousals, even by experienced observers [9]. The Sleep Heart Health Study (SHHS) [33] scorers achieved poor-to-moderate agreement in identifying arousals for inter-scorer reliability and inter-scorer agreement was greater for sleep stage scoring than for arousal identifications, as it is sometimes difficult to discern the occurrence of an abrupt increase in EEG frequency from the background EEG activity [10].

1.1 EEG analysis techniques

Power spectral analysis is the traditional linear measure of the EEG signal. Various linear and non-linear measures have been studied for sleep staging. It was observed that non-linear measures were better at discriminating sleep stages I and II and that spectral measures were better at discriminating sleep stages I, III and IV [11]. The EEG analysis done on all night recording focused on individual frequency bands and the patterns they followed in normal and patient populations [1, 12, 13, 14]. These analyses show the distribution of high frequency and low frequency components in the REM and non-REM sleep stages. However, these power distributions could not differentiate all non-REM and REM sleep stages. As Sample Entropy is calculated on the entire signal and not on any specific frequency band of the signal, the analysis we propose gives a

consolidated picture without losing information from any frequency band. It strikes a balance between the sleep promoting mechanism (the delta region) and the arousal promoting mechanism (alpha and beta regions). Hence, our first goal was to assess sleep staging and determine whether the results of our analysis are consistent with the Rechtschaffen and Kales sleep staging [15].

1.2 Entropy

Entropy is a measure of randomness or unpredictability in a system containing information. In our analysis, we use Entropy to quantify “regularity” or “complexity” of the EEG signal. Entropy is the negative logarithmic probability of occurrence of an event. A high Entropy value commonly corresponds to randomness, while a low value corresponds to predictability. Predictability corresponds to regularity. In our study, we use Sample Entropy to quantify this regularity.

Approximate Entropy (ApEn) is a measure of the logarithmic likelihood that a set of data points close for m observations remain close when $m+1$ data point is added. The calculation of ApEn is briefly described by S.M. Pincus et al [16]. ApEn of the EEG signals has been shown to change with aging and neurodegenerative diseases like Alzheimer’s disease [16, 17]. ApEn calculation is associated with a bias as it includes self matches. This bias made ApEn dependent on record length and it also lacks relative consistency [18]. These limitations led to the development of Sample Entropy (SaEn) which does not take into account the self matches, thereby eliminating the bias involved in ApEn calculation.

1.3 Hypotheses:

- (i) The regularity of the EEG signal varies throughout the night. As entropy is a measure of randomness of the signal, we use a particular measure of entropy called Sample Entropy to quantify the regularity of the EEG signal. We hypothesize that the Sample Entropy values of EEG signals in healthy middle aged and elderly female subjects are highly correlated with sleep stages.

- (ii) The regularity of the EEG signal varies with sleep stage, as there are large shifts in the power spectrum from one sleep stage to another. The regularity of the EEG signal increases visually as we move from Wake (highly irregular) to sleep Stage 1 to sleep Stage 2 until Stage 4 (highly regular). Another way of looking at it would be that the regularity of the EEG signal increases with the shifts in power spectrum towards a lower frequency range. With aging, it has been shown that there are shifts in the power spectrum towards the higher frequency range [2] i.e., with aging, the regularity of the EEG signal decreases. The entropy value of a highly regular signal is very low and similarly, entropy of a highly irregular signal is very high. Hence, we hypothesize that the Sample Entropy values of the elderly are higher than those of the middle aged female subjects within a sleep stage.
- (iii) An arousal is marked by an abrupt increase in theta, alpha and/or beta frequencies. Arousals are almost always preceded by delta bursts, which cause a decrease in the Sample Entropy. Hence, we hypothesize that Sample Entropy in the middle aged and elderly subjects is lower before than that after an arousal and that this difference increases with age.

In order to test these hypotheses, two studies of EEG signals were conducted. In the first, we analyzed SaEn and power spectral density of the first sleep epoch in 20 middle aged and 20 elderly subjects. In the second, arousals occurring during Stage 3 were analyzed in 20 middle aged and 20 elderly subjects. SaEn and power before and after the arousal were compared.

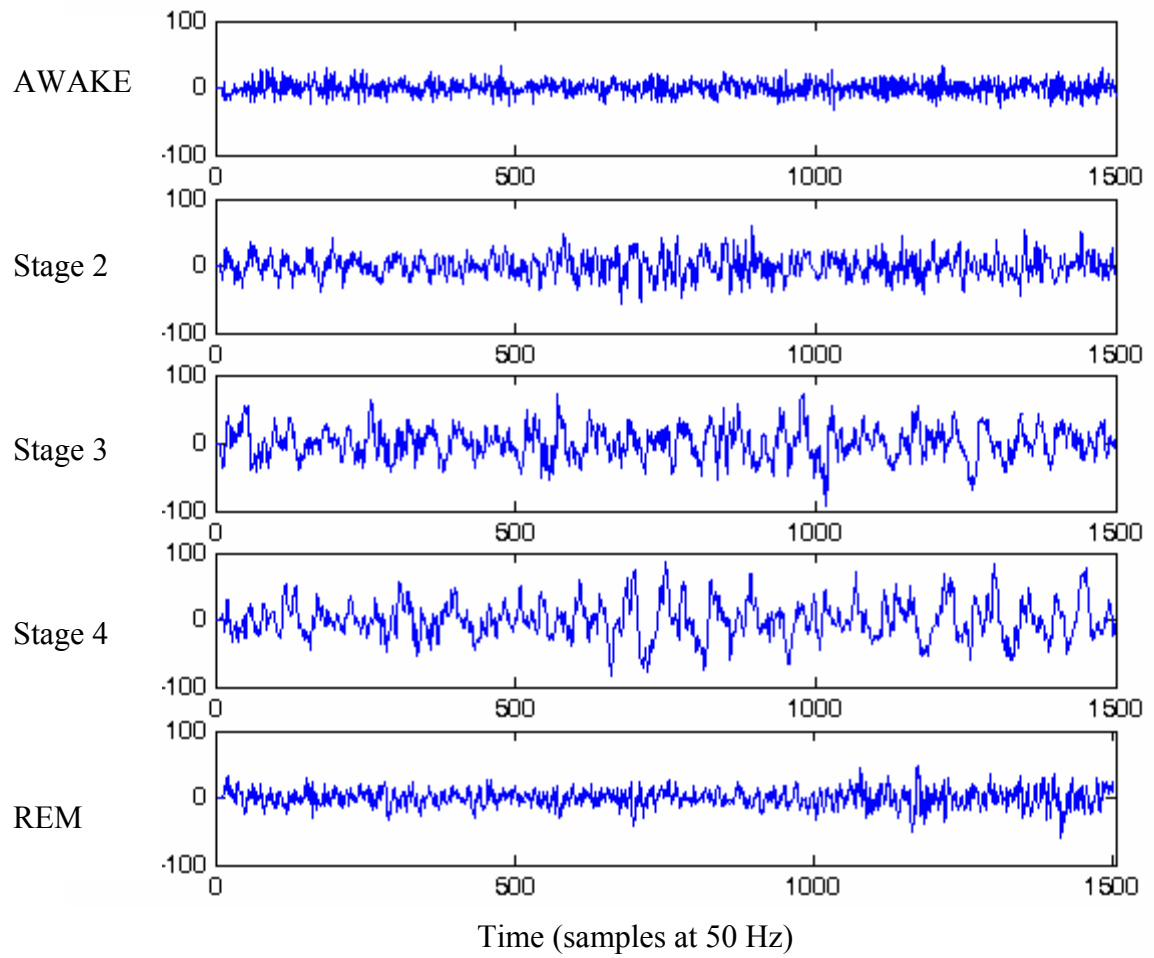

FIGURE 1.1: Electroencephalogram signal in different sleep stages. From this figure, it is evident that the regularity of the EEG signal varies with sleep stage.

CHAPTER 2: BACKGROUND

2.1 Physiology of Sleep

The most common notion people usually have about sleep is that we sleep only to rest our tired bodies. Some neuroscientists argue that at least one vital function of sleep is bound with learning and memory. Sleep loss makes you more reckless, more emotionally fragile, less able to concentrate and almost certainly more vulnerable to infection [50]. “Sleep is an actively induced, highly organized brain state” marked by these four qualities:

1. Reduced motor activity
2. Lowered response to sensory stimulation
3. Adoption of stereotypic postures such as lying down with the eyes closed, and
4. Easy reversibility (compared to coma, stupor, hibernation, etc.) [19]

Sleepers are not in a single stage through out the night, but they pass through five sleep stages: Stage 1, Stage 2, Stage 3, Stage 4 and rapid eye movement (REM) stage. The sleep Stage 1, Stage 2, Stage 3 and Stage 4 are the non-REM (NREM) sleep stages and sleep consists of alternating cycles of REM and NREM stages. A normal subject’s sleep cycle would look similar to the diagram shown in Figure (1.1).

Stage 1 is the lightest sleep stage, during which the eyes move slowly and muscle activity slows and the person can be easily awakened. The EEG is dominated by the alpha and beta rhythms. As a person enters Stage 2, the brain’s EEG activity becomes slower and is dominated by theta waves and there are no more eye movements. In Stage 3, slow delta waves with the occasional bursts of smaller, faster waves are common. Stage 4 is primarily characterized by delta waves. Stages 3 and 4 are the deep sleep stages. It is very difficult to wake a person from deep sleep. REM is marked by jerky eye movements, irregular and shallow breathing and temporarily paralyzed limb muscles. It is in this sleep stage that most of the dreams occur [25].

2.2 Sleep Deficiency

Sleep deficiency implies a decrease in either quality or quantity of sleep. Though the amount of sleep required varies from person to person, adequate sleep is essential for good mental and physical health. In a “Sleep in America” poll conducted by the National Sleep Foundation in 2002, approximately 32 million people have fallen asleep while driving. Sleep deficit leads to micro-sleep periods, which are brief moments of sleep, and it takes only a couple of seconds of micro-sleep while driving a car at 60 miles an hour to drift completely out of a lane. These brief lapses in attention could result in very serious accidents [20].

Sleep deprivation or sleep debt has been shown to impair the immune function in humans [21]. Sleep disordered breathing reduces the oxygen saturation, which could lead to an arousal, causing sleep fragmentation. Sleep fragmentation is characterized by repeated interruptions in sleep and is one of the determinants of daytime sleepiness [22]. Sleep deficit could alter the levels of hormones leptin and ghrelin which could increase hunger and appetite, leading to overeating and weight gain. It was also observed that when healthy young adults were subjected to recurrent partial sleep restriction, they showed marked alterations in glucose metabolism including decreased glucose tolerance and insulin sensitivity, resulting in type 2 diabetes [23]. It has been indicated that sleep loss could put the body in a high state of alert and as the body produces inflammatory markers, there are risks of adverse cardiovascular events [24].

2.3 Sleep Studies

Sleep studies involve recording various biophysiological signals of the subject during sleep and is known as polysomnography. It is a multi-parametric test that monitors function of the brain, heart, and lungs, as well as muscle activity. Some of the common signals measured are the Electroencephalogram (EEG), Electrocardiogram (EKG), Electrooculogram (EOG), Electromyogram (EMG), oxygen saturation, respiratory effort, and heart rate. The polysomnography helps in diagnosing sleep disorders like sleep

apnea, narcolepsy, restless leg syndrome, etc. Figure (2.2) shows the polysomnogram of a middle aged subject from the Sleep Heart Health Studies (SHHS) database.

2.4 Basics of the Electroencephalogram

An Electroencephalogram (EEG) is a recording of the electrical activity of the brain from electrodes placed on the scalp. It basically measures the summated activity of the postsynaptic potentials of thousands of neurons that have similar spatial orientation. These postsynaptic potentials are classified as excitatory or inhibitory and originate from the impulses arriving at the cortical neurons from other nearby neurons. The scalp EEG has a very wide frequency range and wide spatial distributions which are highly dependent on the state of brain function. Hence, the regularity of the EEG varies during different sleep stages. The EEG activity during sleep is mainly regulated by the thalamus, cortex and Pons. The thalamus consists of a pair of large oval masses of gray matter deeply situated in the forebrain and located on either side of the midline. It relays information to the cerebral cortex that is received from diverse brain regions and contributes to the regulation of autonomic activities and maintenance of consciousness. The thalamus blocks sensory information going to the cortex when the person is asleep [25]. The cerebral cortex is the outer rim of gray matter of the cerebrum. It plays a key role in memory, attention, perceptual awareness, thought, language and consciousness [26]. The Pons is a structure located on the brain stem. It relays sensory information between cerebellum and cerebrum and helps in relaying other messages in the brain, controls arousals and regulates respiration [27].

2.5 EEG Analysis

The conventional analysis of human sleep follows a set of pre-defined rules for sleep staging by visual inspection of the polysomnograms [15]. However, visual scoring by the R & K method is subject to both inter- and intra-scorer variability [28] and the arbitrarily defined thresholds to separate the sleep stages make it even more difficult to achieve accuracy [29]. Numerous attempts have been made to identify better methods to

analyze sleep. Power spectral analysis has been used for studying all-night EEG oscillations [12], effects of sleep deprivation on sleep stages [30], and EEG changes in patients with sleep apnea syndrome [31]. The period amplitude analysis [51] was used for sleep staging and studying gender differences, but it failed to show significant gender differences [14, 32]. Delta power and spectral edge have been used to monitor sleep cycles and the depth of anesthesia [48]. Fell et al. compared the performance of eight EEG measures for sleep stage discrimination. They included both linear and non-linear measures: relative delta power, spectral edge, spectral entropy, first spectral moment, stochastic time domain based measure entropy measure of amplitudes, correlation dimension, largest Lyapunov exponent and approximated Kolmogorof entropy. They concluded that the correlation dimension and Lyapunov exponent were better at discriminating stages 1 and 2, while the spectral measures were better at discriminating Stage 2 and slow wave sleep (stages 3 and 4 combined). Hence, no single measure could discriminate the sleep stages accurately [11].

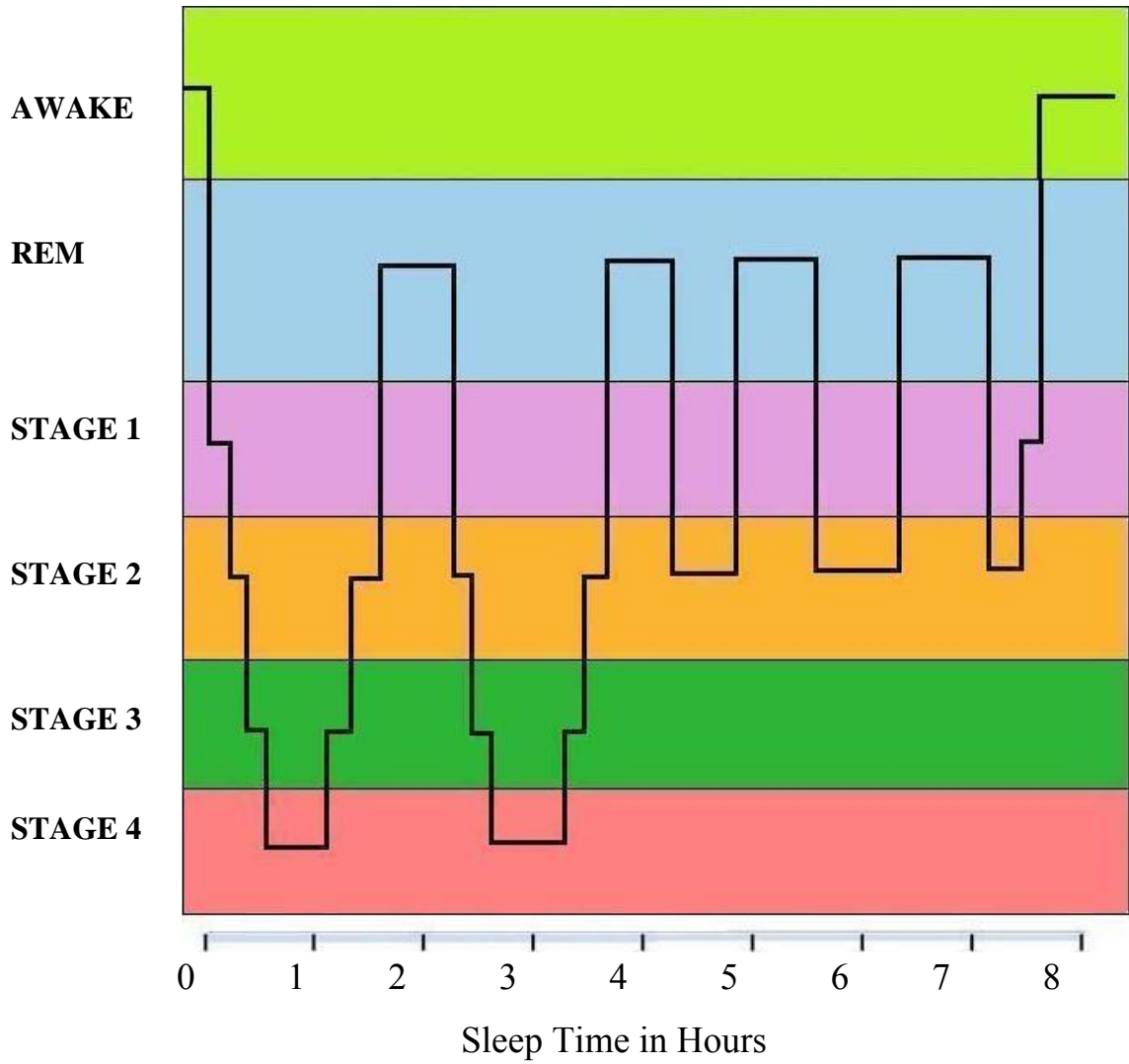

FIGURE 2.1: All night Sleep Cycle of a normal, healthy subject

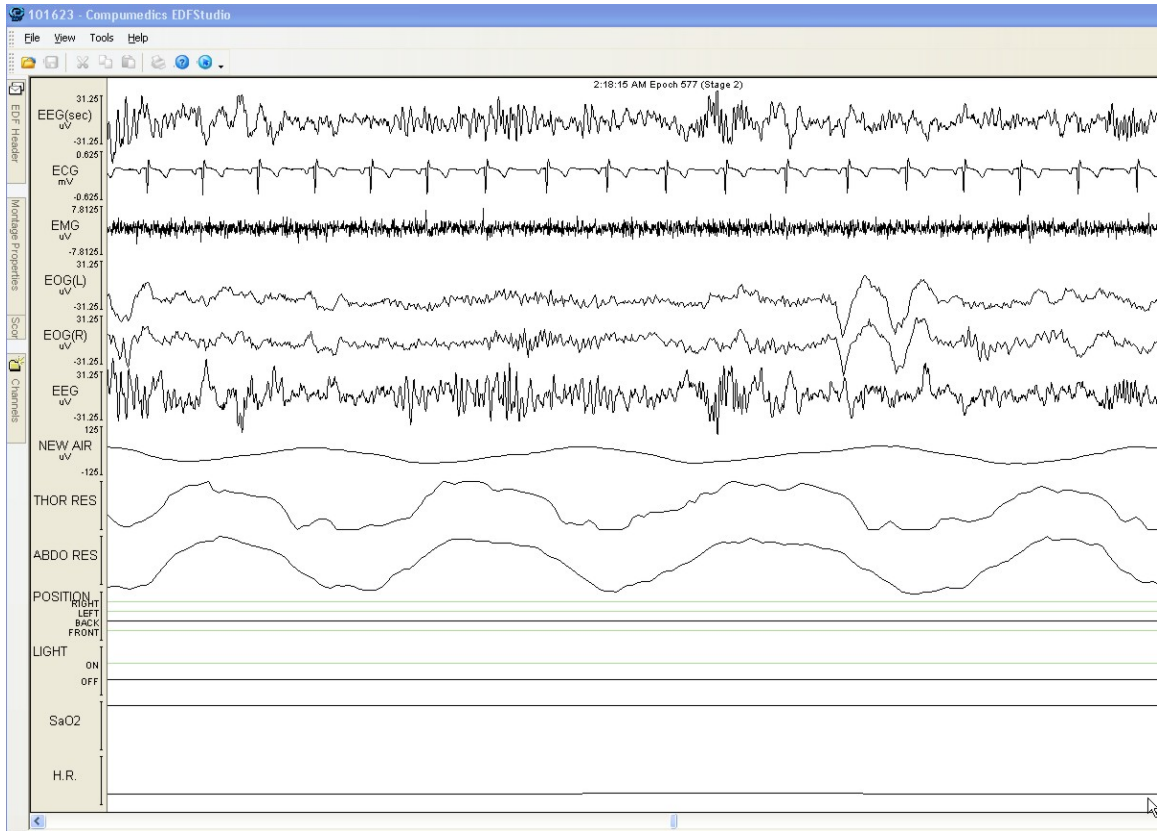

FIGURE 2.2: A 20 sec polysomnogram recording of a middle aged subject

CHAPTER 3: METHODS

In this chapter, the data and the analysis used for the study on sleep stage and the arousal study are discussed. The EOG removal was first performed on the data before calculating the Sample Entropy. A detailed description of the EOG removal filter is given in this chapter. Power spectral analysis was also carried out on the data. Because of the difficulty in identification of arousals, a novel method was proposed for the same. To verify the statistical significance of the results, a test of analysis of variance was performed.

3.1 Subjects

The overnight polysomnographs of subjects used in this study were obtained from the NIH sponsored Sleep Heart Health Study (SHHS). The SHHS study includes approximately 6,400 subjects and the polysomnographs were obtained at participants' home [33]. The montage includes two electroencephalograms (EEG), two electrooculograms (EOG), electrocardiogram (EKG), heart rate, chin electromyogram (EMG), oximetry, chest wall and abdominal movement, nasal/oral airflow, and body position. Sleep staging was done on 30 sec records based on Rechtschaffen and Kales guidelines [15], by the SHHS technicians. The data set we chose consists of Caucasian women from two age groups, middle aged (42 – 50 years) and elderly (71 – 86 years). Twenty subjects were chosen from each age group, with the mean age of middle aged women being 47.2 ± 2 years and the mean age of elderly women being 78.4 ± 3.8 years. These subjects were selected after a careful study of their medical history to make certain that they were not suffering from sleep disordered breathing and were not on any medication that would interfere with sleep. They were not current smokers and their BMI were ≤ 30 .

3.2 Data

The polysomnogram channels used for the analysis are the C3A2 EEG cerebral montage and the left EOG signal. The EEG records that are free from EMG or EKG artifacts were chosen by visual inspection. Also, the segments with breathing abnormalities or with low oxygen saturation values (lower than 90%) were avoided.

3.2.1 Sleep Stage Study

Simultaneous 30 sec EEG and EOG records were selected from the 20 middle aged and 20 elderly subjects, avoiding segments where an arousal occurred for ≤ 15 sec before or after the selected segment. The EEG signal was sampled at 125Hz and the EOG at 50 Hz. The original EEG and EOG signals were aligned in time and the alignment was maintained after sub-sampling. For each subject, we aimed to extract six 30 sec records from each of the stages: Wake, Stage 2, Stage 3 and REM. The data were extracted only from the first sleep cycle, i.e., until the end of first REM stage. The number of 30 sec segments analyzed for Sample Entropy calculation is 925. The mean numbers of 30 sec segments analyzed per subject in middle age are: Wake = 5.8, Stage 2 = 6.0, Stage 3 = 5.7, and REM = 5.6, and those in elderly subjects are: Wake = 5.9, Stage 2 = 6.0, Stage 3 = 6.0 and REM = 5.4. Apart from Sample Entropy, spectral power was estimated for randomly chosen subjects (8 in the middle aged and 8 in the elderly group).

3.2.2 Arousal Study

For this study, data segments of 1 min were taken both before and after the arousal, leaving a window of 1 sec between the arousal and the segments chosen for analysis. The protocol for selection of an arousal segment is shown in Figure (3.1). When 1 min data was inextricable, a 30 sec segment was extracted. Sample Entropy was calculated on these segments for all 30 sec, 15 sec and 10 sec periods, while spectral power was estimated for all 30 sec, 15sec and 9 sec periods. The segments chosen for

analysis are only from stage 3 and are not restricted to the first sleep cycle, but taken from all sleep cycles. Stage 3 was chosen because of high inter- and intra-scorer reliability for scoring arousals in this stage [28]. The number of segments chosen for Sample Entropy calculation and spectral power estimation for elderly and middle aged subjects are summarized in tables 3.1 and 3.2.

3.3 Signal Analysis

The EEG and EOG signals were extracted into MATLAB from the overnight polysomnogram records. As the two signals were sampled at different frequencies, the EEG signal was first up-sampled to 250Hz by repeating every sample and then sub-sampled to 50 Hz by selecting every fifth sample, to bring both the EEG and EOG to same sampling frequency. Both EEG and EOG signals were then low-pass filtered using a Hamming window based finite impulse response filter with 24.25 Hz as cutoff frequency to remove unwanted/noise components.

3.3.1 Sleep Stage Study

The analysis was first done on the 20 middle aged subjects and then on the elderly. The segments with movement artifacts, EMG and EKG contamination were not selected for the analysis. The EOG signal is the major contaminant of the EEG signal.

3.3.1.1 EOG contamination

The EEG signal was sometimes highly contaminated by the EOG signal, the EOG signal having power concentrated below 3Hz. The eye forms an electric dipole, where cornea is positive and retina is negative. EOG is an electric signal that is produced when the electric field around the eye changes because of eye movement. This signal propagates across the scalp and hence is picked up by the EEG leads as contamination. Though various methods have been developed to remove the EOG contamination [34, 35], it has not previously been done prior to entropy calculation [36, 17]. The signal

components of EEG and EOG below 3.125 Hz were obtained by wavelet decomposition using Daubechies (order 4) filter and from now on are referred to as EEGF and EOGF. The wavelet decomposition was done primarily to reduce the amount of EEG signal being removed, which has relevant information, outside the EOG dominant range. Also, the EEG components below 3.125Hz can be added back to the components above 3.125Hz after the EOG removal. Using EOGF as input an optimal noise removal filter was designed, whose output is the correlated EEOF signal. Figure (3.2) shows the Minimum Mean Squared Error (MMSE) filter design [49].

The filter is designed using the following relation:

$$F=R^{-1}g$$

where, F is a column matrix consisting of filter coefficients of length, say, p

R is the autocorrelation matrix of EEGF calculated for p+1 lags

g is the cross correlation vector between EEGF and EOGF calculated for p+1 lags

The elements in R and g are computed by generating convolution matrix and are normalized by dividing by the total number of elements in the input signal. Proper filter design depends on the filter length chosen. It is based on the following factors:

1. Coherence between EOGF and filtered EEG
2. Filter impulse response
3. Magnitude and Phase in the 0-3 Hz range

The example of a coherence plot is shown in Figure (3.3). The blue line in this plot represents the coherence between EOGF and EEGF, the green line represents the coherence between EEGF and the correlated EOGF, and the red line represents the coherence between EOGF and the optimally filtered EEGF. The correlated EOGF is the EOG contamination signal that is removed from the EEGF, and filtered EEGF is the optimally filtered output obtained by subtracting the correlated EOGF. Coherence between two signals tells us how well the signals correspond to one another at each frequency. Its value ranges between 0 and 1. A value of 0 implies there is no temporal correlation between the two signals and a value of 1 implies maximum correlation between the two signals. For every segment, the filtering process was repeated until we achieved a low coherence value at all frequencies below 3 Hz.

The desired length of the impulse response of the filter is achieved when the filter coefficient values decrease and come close to zero, with an increase in the number of coefficients. The filter lengths usually varied between 10 and 48. Figure (3.4) shows the example of an impulse response plot for which the number of coefficients is 30.

The focus of the frequency response of the filter, again, is in the 0-3 Hz range. One expects a decrease in gain of the signal with increase in frequency along with increasing phase shift.

Once the EOG contamination was removed, the optimally filtered EEGF signal was added back to the EEG signal components above 3.125 Hz to obtain an EEG signal free from EOG artifacts for further analysis.

3.3.1.2 Sample Entropy Calculation

Sample Entropy, SampEn(m, r, N), as defined by Richman et al. is the negative natural logarithm of the conditional probability that two sequences similar for m points remain similar at the next point, where self matches are not included in the probability calculations. Its calculation is as follows [18]:

For a time series of N points,

$\{u(j): 1 \leq j \leq N\}$ form $N-m-1$ vectors, $x_m(i)$ for $\{i: 1 \leq i \leq N-m+1\}$

where $x_m(i) = \{u(i+k): 0 \leq k \leq m-1\}$ is the vector of m data points $u(i)$ to $u(i+m-1)$

m is the length of the sequences to be compared.

The distance between two such vectors is the maximum difference between corresponding elements of the two vectors and is defined as:

$$d[x(i), x(j)] = \max \{ | u(i+k) - u(j+k) | : 0 \leq k \leq m-1 \}$$

$x(i)$ is the template vector and $x(j)$ is the conditional vector, as we calculate the conditional probability of $d[x_m(i), x_m(j)]$ being less than a tolerance width, r.

Now, $B_i^m(r) = [\text{number of times } x_m(i) \text{ within } r \text{ of } x_m(j)] * (N-m+1)^{-1}$

$$A_i^m(r) = [\text{number of times } x_{m+1}(i) \text{ within } x_{m+1}(j)] * (N-m)^{-1}$$

Sample Entropy is computed as follows:

$$\text{SampEn}(m, r, N) = - (N-m)^{-1} \ln \left[\sum_i^{N-m} A_i^m(r) / B_i^m(r) \right]$$

Figure (3.5) illustrates the calculation of the conditional probability of the conditional vector, falling within a tolerance width of the template vector. Here, $m=1$ is used for the illustration. The blue dots represent a part of the EEG signal sampled at 50 Hz. The sample highlighted by the red circle represents the template vector, $x(16)$ and the samples highlighted by black circles represent the conditional vectors, $x(20)$ and $x(44)$. The magenta lines represent the tolerance width of the template vector, which is $x(16) \pm 20\%$ of the standard deviation of x . Now we calculate the number of conditional vectors that fall within these limits for the template vector $x(16)$, from which we calculate the probability of one point matches. By taking $m=2$ and $m=3$, we calculate the probabilities of two point matches and three point matches. Sample Entropy is the negative natural logarithm of the ratio of the probability of three point matches to the probability of two point matches.

The parameters chosen for the Sample Entropy calculation, $SpEn(m,r,N)$ are the length of the vector for Sample Entropy calculation, m and the tolerance width, r . N is the number of data points, which is 1500 for a 30 sec record. Increasing the value of r or decreasing the value of m increase the number of matches. Values of 1 or 2 for m and $0.1 - 0.25$ times the standard deviation for r have been used in previous physiological studies [17, 36, 37]. We chose r to be 0.2 times the standard deviation of the EOG-free EEG signal and m to be 2 for calculating the Sample Entropy. By choosing the r value as a percentage of the standard deviation of the signal, data with different amplitude ranges can be compared.

3.3.1.3 Power Spectral Analysis

Power of the EEG signal was calculated for 16 subjects (8 from each age group) in different frequency bands, defined as very low frequency region (0-0.5 Hz), delta region (0.667 – 3.833 Hz), theta region (4 – 7.833 Hz), alpha region (8 – 11.833 Hz) and beta region (12 – 20 Hz). The spectral power was estimated for the 30 sec records using Welch's periodogram method by taking 6 sec sub-segments with half overlap. Relative

power in each region is given by the ratio of absolute power in the respective region to the total power.

3.3.1.4 Statistical Analysis

The mean (\pm standard deviation) Sample Entropy values were computed in each of the Wake, Stage 2, Stage 3 and REM sleep stages within each age group. A two-factor analysis of variance (ANOVA) was used to test the differences ($p < 0.05$) between these mean Sample Entropy values with sleep stages and age. The differences between the mean Sample Entropy values with age were also assessed for all the four sleep stages. This was followed by a Tukey post-hoc test, which includes a correction for multiple comparisons.

The two factor ANOVA was used again to assess the changes in power values in each of the alpha, beta, theta, and delta bands with age and sleep stage. This analysis again was followed by the Tukey post-hoc test.

3.3.2 Arousal Study

The Sample Entropy was calculated for 22 arousals in middle aged and the power analysis was done for 32 arousals in the same subjects. In the elderly subjects, Sample Entropy was calculated for 29 arousals and the power analysis was done for 37 arousals. Initially when we calculated Sample Entropy for more than 20 arousals, we did not find any pattern in those values. When we did the spectral analysis of these segments, we realized that some of the arousals marked by the SHHS scorers do not meet the ASDA criteria of arousals. Figure (3.6) shows an example of spectral analysis of a segment and the black lines mark the arousal indicated by the SHHS scorers. It is apparent from the figure that there is no increase in any of the alpha, beta or theta powers which should identify the arousal [4]. For some arousals, the start and stop time were not marked accurately.

We devised a method to choose arousals that met our criteria from the SHHS marked arousals. Because an arousal is defined as an abrupt increase in alpha (8-12 Hz), beta (16-24Hz) or theta (4-8 Hz) bands, the logarithmic power in these three bands was

added in the segment to be analyzed. We redefined the beta band, as the sleep spindles occur in 12- 16 Hz range and they do not mark arousals. The power signal that we used to identify an arousal is as follows:

$$\text{Power signal} = 10 * (\log(\text{alpha power}) + \log(\text{beta power}) + \log(\text{theta power}))$$

We identified the start and stop times of arousal when the power signal crosses a baseline which marks power doubling. The baseline was marked by first calculating the mean of the power signal for the minute preceding the arousal marked by SHHS and then adding 6 dB to it. When the power signal exceeded the threshold for 3 or more sec and less than 15 sec, the peak was identified as an arousal. The irregular black dashed line in Figure (3.7) is the power signal and the solid red line indicates the power signal passed through a median filter. The magenta line is the baseline for power signal. The green arrow shows the arousal identified by this method. Though there are other peaks that cross the baseline, they are not marked as arousals as they do not last for 3 sec. Figure (3.8) shows the spectral analysis of the arousal shown in Figure (3.7), where the increase in alpha and beta powers are apparent. Hence, SHHS arousal for which the power signal crossed 6 dB threshold was chosen for our analysis.

3.3.2.1 Sample Entropy Calculation

The Sample Entropy was calculated as described in section 3.3.12 for the pre- and post-arousal segments (of lengths 10, 15, or 30 sec) identified by our method and after the EOG removal was done as described in section 3.3.1.1.

3.3.2.2 Power Spectral Analysis

Power was calculated in different frequency bands, defined as delta region (0.5–4.0 Hz), theta region (4.0 – 8.0 Hz), alpha region (8.0 – 12.0 Hz), sigma region (12.0 – 16.0 Hz) and beta region (16 – 24 Hz) by taking the square of the moving averager of the EEG signal. A 3 sec window was used for the moving averager. The power was estimated during the 9 sec, 15 sec and 30 sec intervals for the same records on which Sample Entropy was previously calculated.

3.3.2.3 Statistical Analysis

A one-factor (age) analysis of variance (ANOVA) with repeated measures followed by a post-hoc test was used to test the differences ($p < 0.05$) between the Sample Entropy values in consecutive 10 sec records. The differences between the Sample Entropy values with age were also assessed. The one factor ANOVA with repeated measures followed by post-hoc test was used again to assess the changes in power values in each of the alpha, sigma, beta, theta, and delta bands with age.

TABLE 3.2: Number of arousals chosen for sample entropy calculation

AGE Group	Number of subjects	30 sec	15 sec	10 sec
Middle Aged	14	19	21	22
Elderly	16	28	29	29

TABLE 3.3: Number of arousals chosen for power calculation

AGE Group	Number of subjects	30 sec	15 sec	10 sec
Middle Aged	14	30	31	32
Elderly	16	35	35	35

Pre arousal 2 (30, 15, 10 sec)	Pre arousal 1 (30, 15, 10 sec)	1sec	Arousal	1sec	Post arousal 1 (30, 15, 10 sec)	Post arousal 2 (30, 15, 10 sec)
-----------------------------------	-----------------------------------	------	---------	------	------------------------------------	------------------------------------

FIGURE 3.1: Protocol for selection of an arousal segment for Sample Entropy calculation

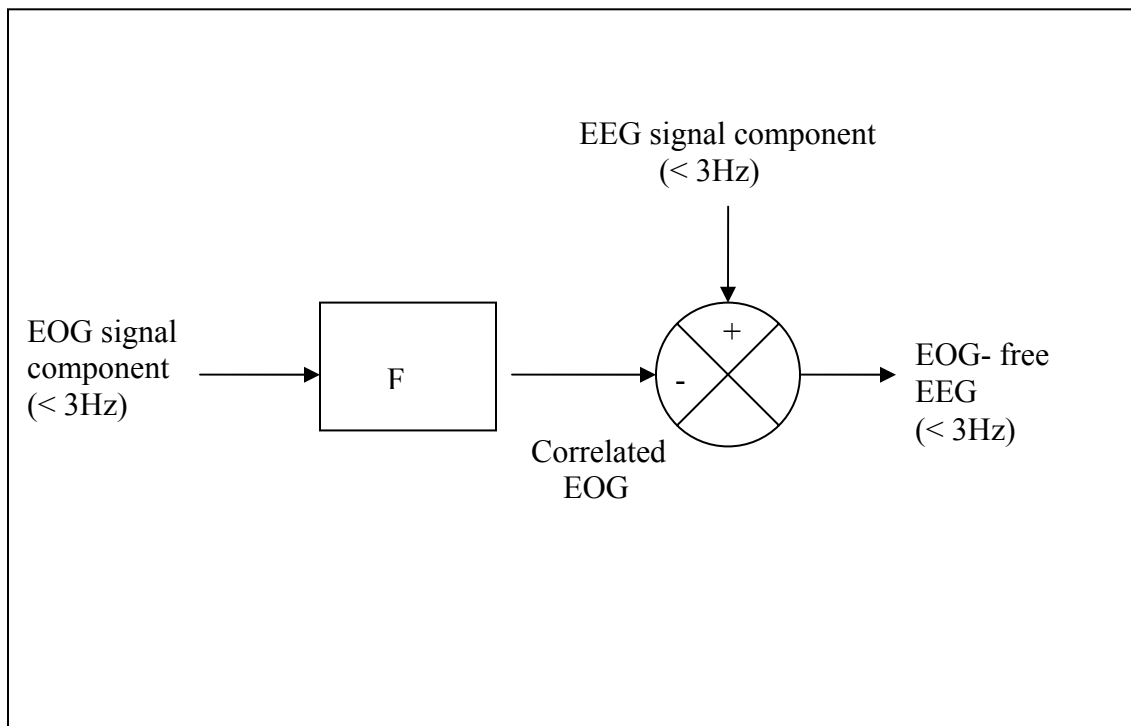

FIGURE 3.2: Scheme for removing EOG contamination from EEG signal.

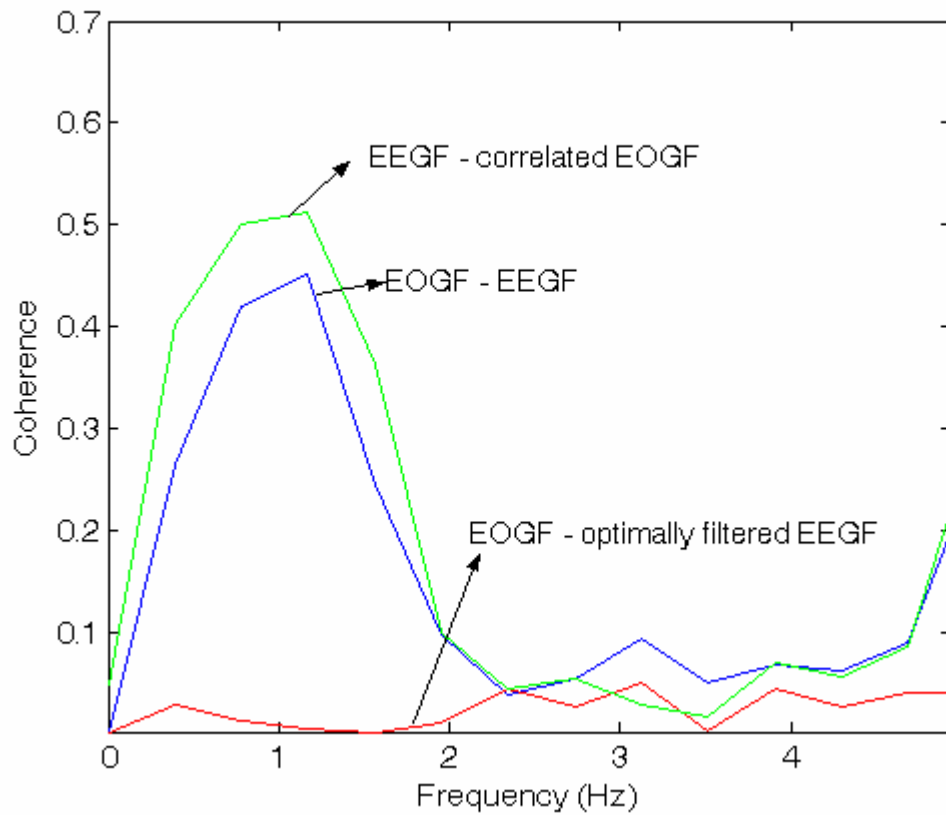

FIGURE 3.3 Plot of Coherence vs. Frequency. The blue line is the coherence between the EEG and EOG signals below 3 Hz. The red line in the figure is the coherence between the EEG and EOG signals below 3 Hz after the EEG signal is free from the EOG contamination.

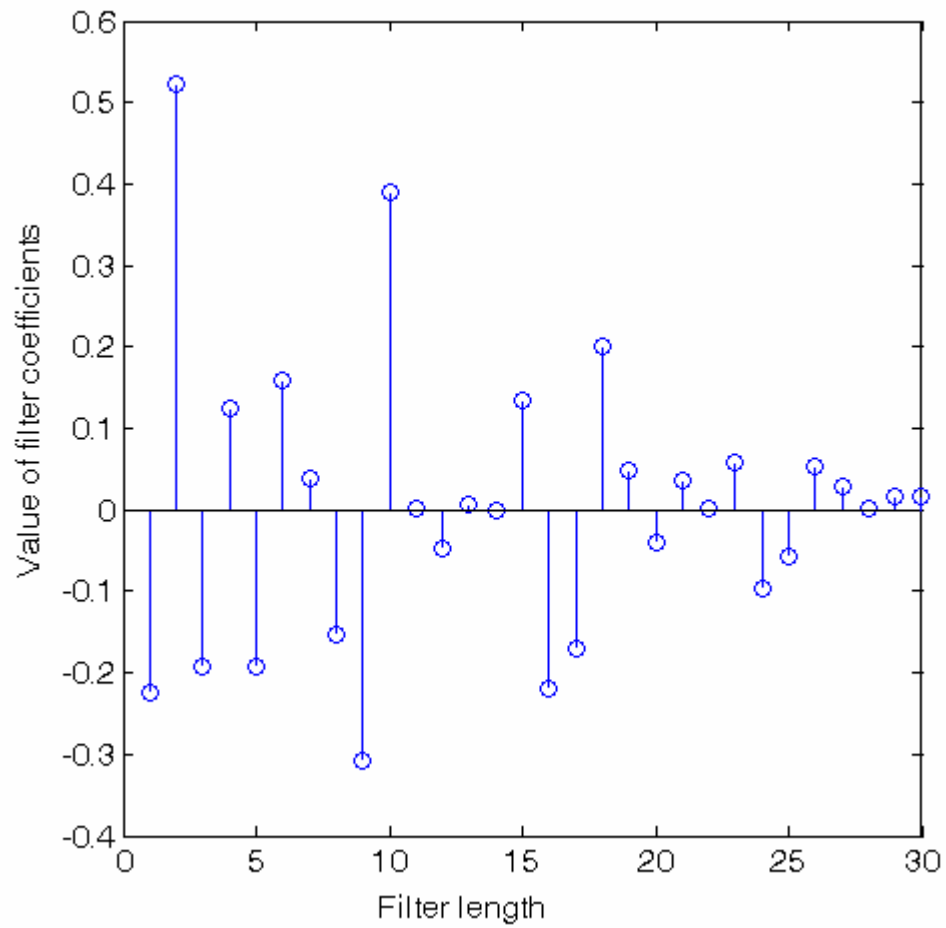

FIGURE 3.4 Example of an impulse response of an MMSE filter. The desired length of the impulse response of the filter is achieved when the filter coefficient values decrease and come close to zero, with increase of number of coefficients.

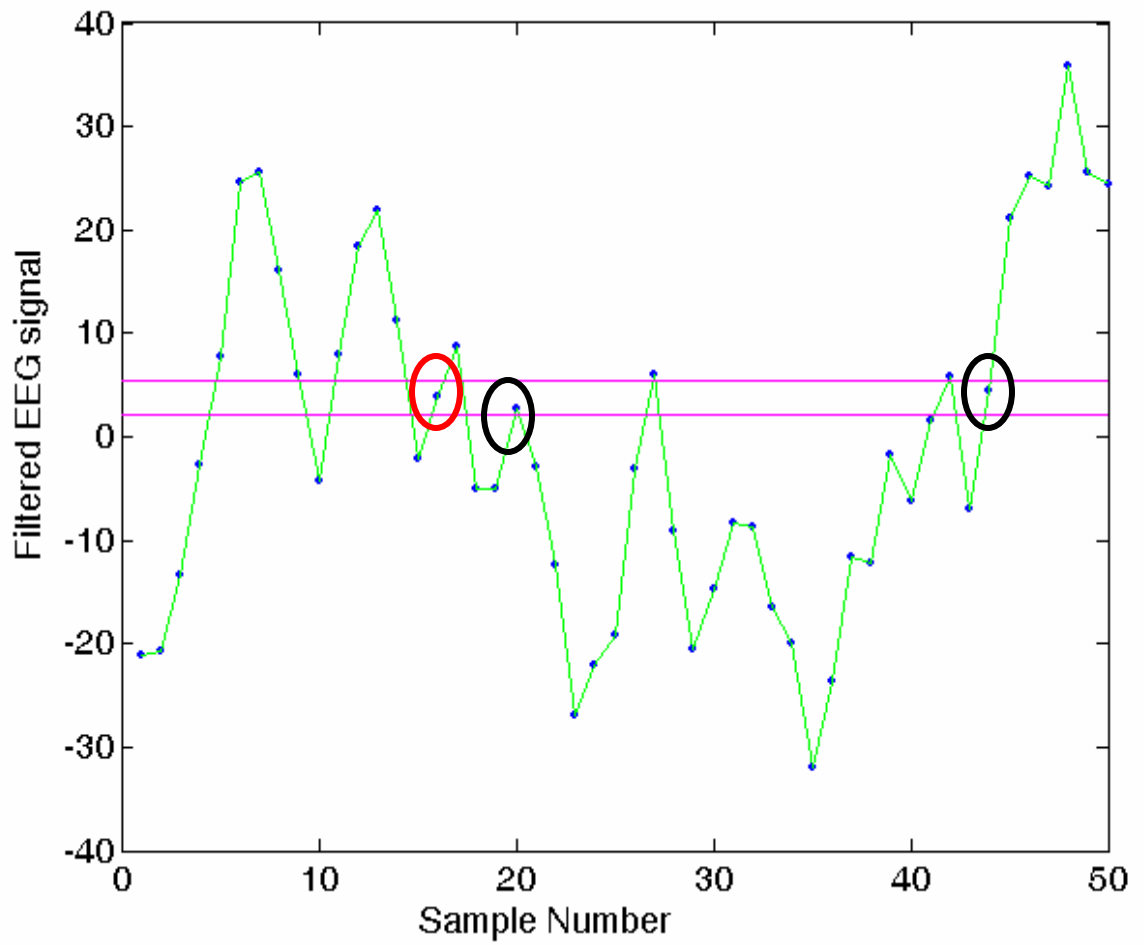

FIGURE 3.5: Figure illustrating the calculation of conditional probability

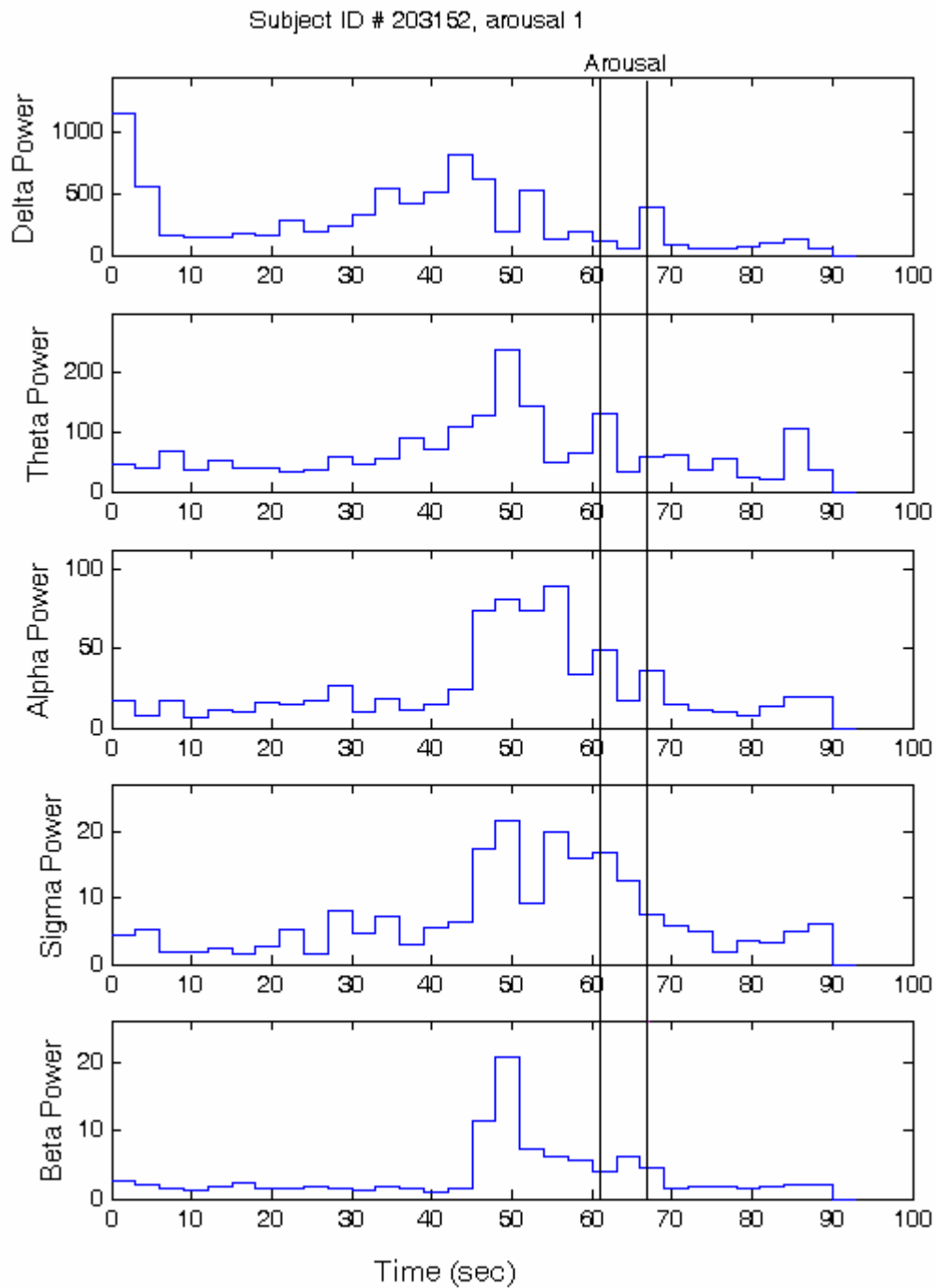

FIGURE 3.6: EEG spectral power for an SHHS-marked arousal in different frequency bands. This “arousal” does not meet the ASDA criteria.

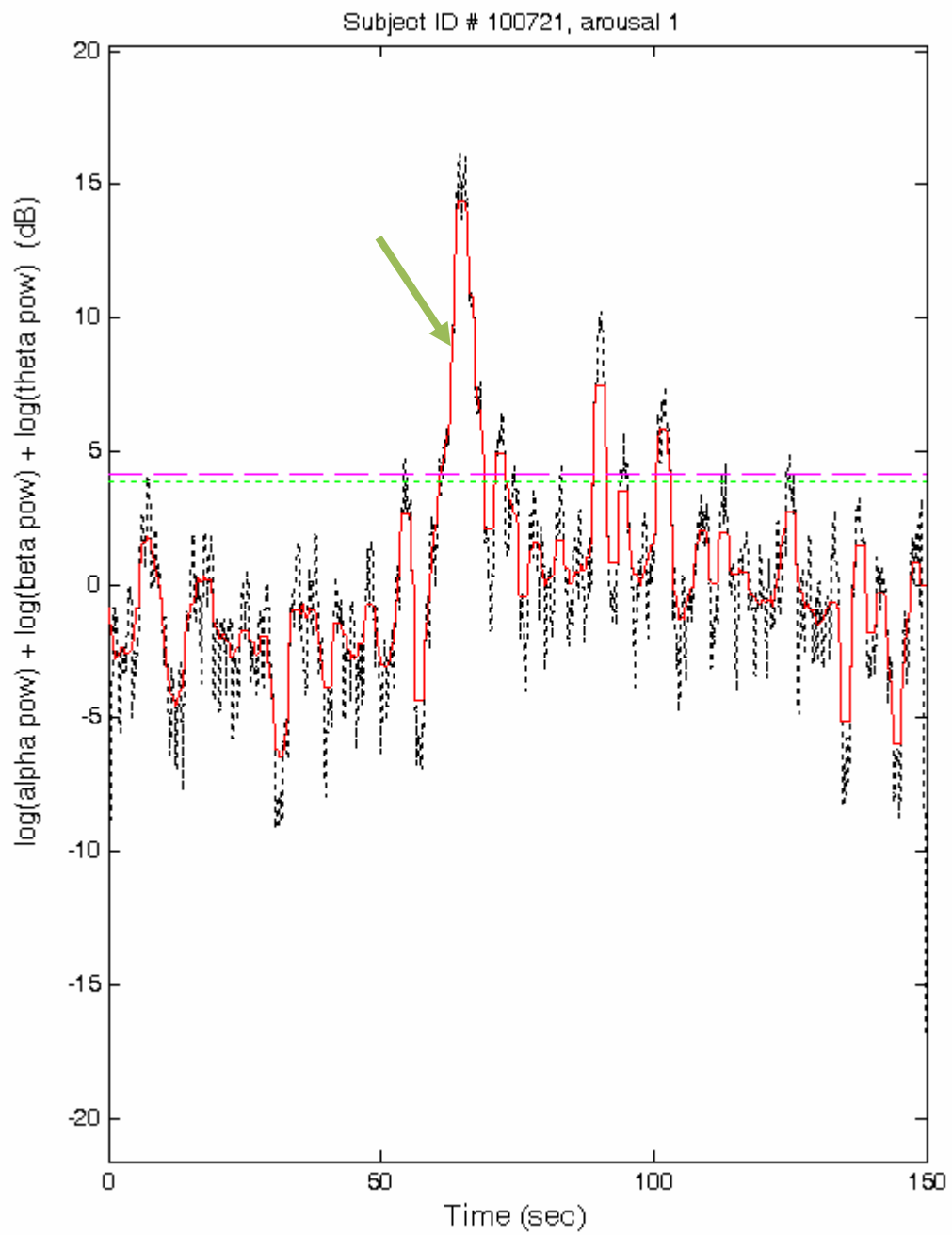

FIGURE 3.7: Identification of an arousal; the green arrow indicates an arousal identified by our method.

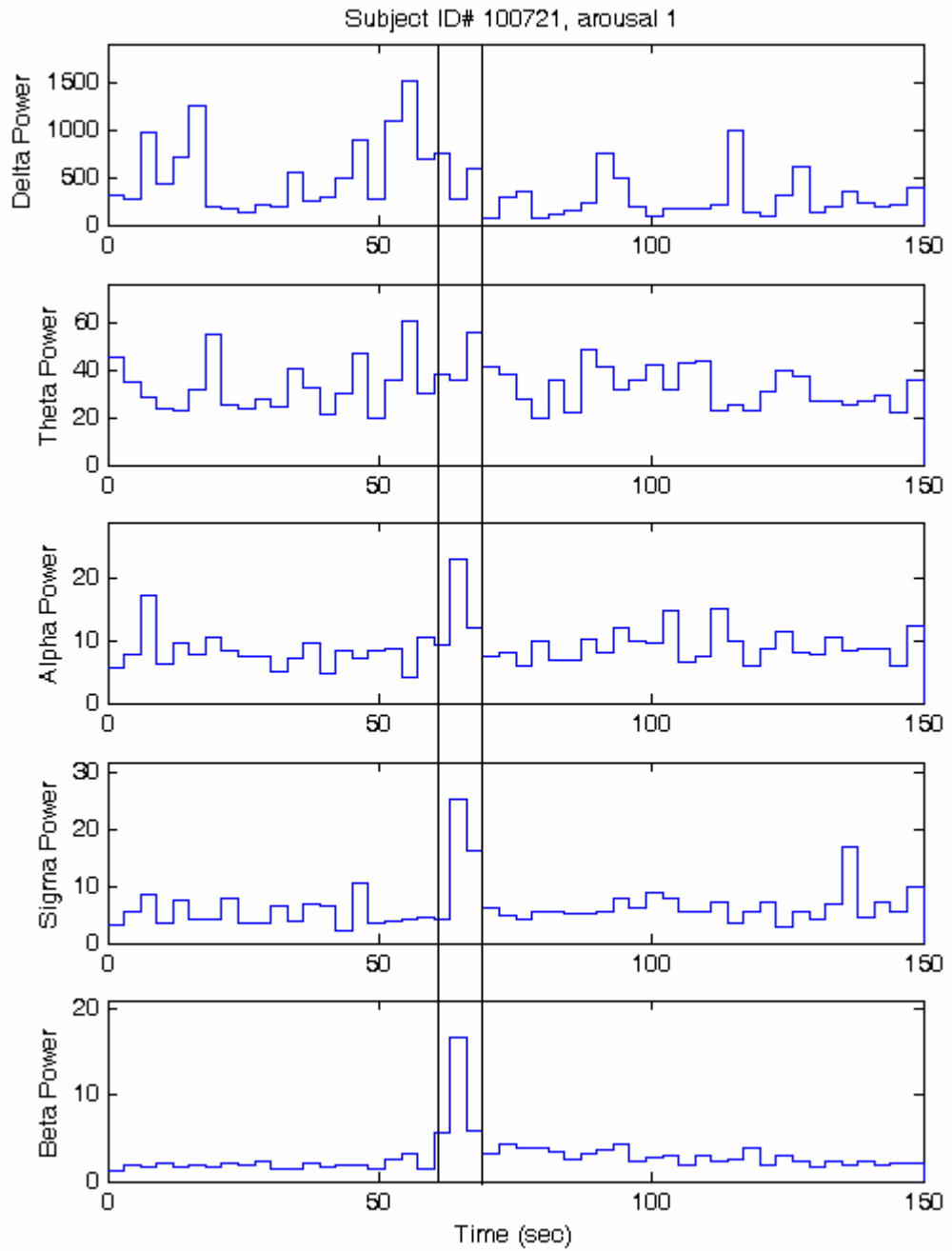

FIGURE 3.8: EEG spectral power for an arousal in different frequency bands. This “arousal” is the same arousal shown in Figure 3.7.

CHAPTER 4: RESULTS

4.1 Sample Entropy and Sleep Stages

Figure 4.1 shows examples (from one subject) of the varying regularity of the EEG signal during sleep stages Wake, Stage 2, Stage 3, Stage 4 and REM and the corresponding Sample Entropy values indicated by SaEn for a 30 sec EEG record. This figure shows that EEG is highly irregular in Wake Stage and hence its Sample Entropy value is higher. In Stage 2, EEG regularity increases and the SaEn value decreases. As the regularity of signal increases from Stage 2 to Stage 3 and from Stage 3 to Stage 4, the entropy value decreases further. In REM, the EEG becomes irregular and hence its entropy again increases, but is still less than the entropy of Wake Stage. Figure 4.2 illustrates examples from another subject that this trend is consistent during Wake, Stage 1, Stage 2, Stage 3 and REM in a middle aged subject. Each vertical bar in this figure represents a Sample Entropy value calculated for a 30 sec period. The sleep stages, during which these SaEn values are calculated, are shown on x-axis.

The mean Sample Entropy values are calculated for six 30 sec periods in each of the four sleep stages (Wake, Stage 2, Stage 3 and REM) in every subject. These values are presented for the 20 middle aged subjects in Figure 4.3 and for 20 elderly subjects in Figure 4.5. Table 1 and table 2 present the mean Sample Entropy values of the 20 middle aged and 20 elderly subjects, respectively, in all four sleep stages.

ANOVA of SaEn values was conducted for Wake, Stage 2, Stage 3 and REM in both middle aged and elderly subjects. The Wake mean SaEn values are significantly higher than the Stage 2 and Stage 3 mean SaEn values ($p < 0.0001$), Stage 2 mean SaEn values are significantly higher than mean Stage 3 SaEn values ($p < 0.0001$) and the REM mean SaEn values are significantly higher than those of Stage 2 ($p < 0.0001$) and Stage 3 ($p < 0.0001$) and significantly lower than those of Wake ($p < 0.0001$) in middle aged and elderly subjects.

The difference in mean Sample Entropy values among the four sleep stages: Wake, Stage 2, Stage 3 and REM in middle aged and elderly subjects are presented in Figure 4.4 and Figure 4.6, respectively. The W-S2 category on x-axis indicates the Stage 2 Sample Entropy values subtracted from the Wake stage Sample Entropy values.

Similarly, the other categories show the differences between subsequent sleep stages as indicated. Each figure shows that Wake SaEn values are higher than those of Stage 2 in each of the 20 middle aged subjects as well as in each of the 20 elderly subjects. Similarly, Stage 2 SaEn values are higher than Stage 3 SaEn, and REM SaEn values are higher than Stage 3 SaEn values. The Wake SaEn values are higher than the REM SaEn values in middle aged subjects, however this difference is not as consistent in the elderly. In 18 out of 20 elderly, the Wake SaEn values are higher than the REM SaEn values. As six 30 sec EEG segments in Stage 1 and Stage 4 could not be found in all the subjects, these stages are excluded.

The mean SaEn values in middle aged and elderly subjects were compared during Wake, Stage 2, Stage 3 and REM. The comparison between the two age groups during the four sleep stages is presented in Figure 4.7. The mean SaEn values in both age groups are found to be significantly different between the age groups only in Stage 2 ($p < 0.029$) and REM ($p = 0.001$).

The mean relative delta, theta, alpha and beta power values were compared between middle aged and elderly in Wake, Stage 2, Stage 3 and REM. The relative mean power values in four bands were compared in Wake Stage (Figure 4.8), in Stage 2 (Figure 4.9), in Stage 3 (Figure 4.10) and in REM (Figure 4.11). The relative mean delta power values are significantly higher in middle aged compared to the elderly subjects in Wake ($p = 0.001$), Stage 2 ($p < 0.0001$), Stage 3 ($p = 0.026$) and REM ($p < 0.0001$). Relative mean beta power values are significantly lower in middle aged than in elderly subjects in Stage 2 ($p = 0.045$) and REM ($p = 0.006$) and relative mean alpha power is also lower in middle aged than in elderly subjects in Stage 2 ($p = 0.045$) and REM ($p = 0.006$).

4.2 Arousal Study

The absolute power values in each of the delta, theta, alpha, sigma and beta bands were calculated for six 9 sec intervals during pre-arousal and post-arousal. The mean power values for 32 arousals in 14 middle aged and 37 arousals in 16 elderly subjects in each frequency band are presented in table 3 and table 4 respectively. The percent difference from overall mean power (average of all 12 pre- and post-arousal segments)

was calculated for each of the 9 sec segments and these values are shown in Figures 4.12-4.16 for middle aged and elderly subjects. In both age groups there is a small increase in delta activity from the mean value (Figure 4.12) in pre-arousal segments and there is a large increase in delta activity (delta bursts) right before the arousal. In the first four post-arousal segments, the delta power is lower than the overall mean in middle aged and in elderly. The theta activity (Figure 4.13) also increases above its overall mean before the arousal. The post-arousal theta activity decreases below mean in most of the segments in both age groups. Though there is small increase above the overall mean initially in middle aged subjects, the theta power values are much lower than the mean later on. In elderly, the theta power is below the mean in first three post-arousal segments to the same extent. The alpha activity (Figure 4.14) in pre-arousal segments is slightly above the mean and it is below the mean for the first three post-arousal records in both age groups. The pattern of sigma activity (Figure 4.15) is similar to that of alpha activity, i.e., it is slightly above the mean before arousal and then it is much below the mean after the arousal. The beta power (Figure 4.16) is lower than its overall mean during pre-arousal periods and increased during the post-arousal records. There is large increase from the record right before the arousal to the record right after the arousal in both age groups.

The mean Sample Entropy values were calculated for six 10 sec pre-arousal and six 10 sec post-arousal periods in each age group during Stage 3. These arousals are the ones for which power was calculated and included all arousals for which the SaEn calculations were possible. The mean Sample Entropy values for 22 arousals in 14 middle aged and 29 arousals in 13 elderly subjects are presented in table 5. A percent difference of mean Sample Entropy values from the average of all 12 pre- and post-arousal segments (overall mean) were calculated for each of the 10 sec segments and are shown in Figure 4.17 for middle aged and elderly subjects. The Sample Entropy increases above the mean during the post-arousal segments and the percent difference from mean is almost the same for the first three post-arousal segments in both age groups.

One factor ANOVA was performed on each of SaEn, delta power, theta power, alpha power, sigma power, and beta power in both middle aged and elderly subjects using repeated measures analysis. The post-hoc test showed a significant difference between the delta power values of sixth pre-arousal segment and first post-arousal segment

($p < 0.01$), and between the fifth and sixth pre-arousal segments ($p < 0.01$). Significant difference was found between the theta power values of first and second post-arousal segments ($p = 0.007$), and between third and fourth post-arousal segments ($p = 0.021$). Significant difference was also found between the sigma power values of fourth and fifth pre-arousal segments ($p = 0.045$), and between sixth pre-arousal and first post-arousal segment ($p < 0.001$), and between third and fourth post-arousal segments ($p = 0.015$). Also, beta power values are significantly different between first and second pre-arousal segments ($p = 0.037$), and between sixth pre-arousal and first post-arousal segments ($p = 0.002$). The SaEn values are significantly different between sixth pre-arousal segment and first post-segment ($p = 0.018$). Though delta, sigma and beta powers showed significant differences between sixth pre-arousal (segment right before the arousal) and the first post-arousal (segment right after the arousal) segments, they showed significant differences between a few other consecutive 9 sec segments too. Sample Entropy takes into account the variations in all frequency bands and gives a unified measure. During pre-arousal segments, the power in delta and theta bands is higher than their group's overall mean value and the power in beta is lower than their overall mean. Because the low frequency activity is greater than the mean and high frequency activity is below the mean (though there is small increase in alpha and sigma activity at times), the Sample Entropy values are lower before the arousal. Similarly, the SaEn values increase above their group's overall mean in the post-arousal segments because the low frequency activity is below the mean and the high frequency activity is above the mean. The ANOVA did not result in significant differences of SaEn between the two age groups.

TABLE 4.1: Mean (+/- S.D.) Sample Entropy values in 20 middle aged subjects

SLEEP STAGE	WAKE	STAGE 2	STAGE 3	REM
SAMPLE ENTROPY	1.985±0.125	1.601±0.120	1.388±0.139	1.772±0.103

TABLE 4.2: Mean (+/- S.D.) Sample Entropy values in 20 elderly subjects

SLEEP STAGE	WAKE	STAGE 2	STAGE 3	REM
SAMPLE ENTROPY	1.977±0.130	1.652±0.108	1.357±0.148	1.842±0.094

TABLE 4.3: Mean (+/- S.D.) power values of 9 sec segments for middle aged subjects

Arousal Segment	Mean Power				
	Delta (*10 ³)	Theta (*10 ²)	Alpha (*10 ¹)	Sigma (*10 ¹)	Beta
Pre Arousal-1	133.6 ±93.2	111.9 ±49.57	610.3 ±433.1	161.8 ±99.97	373.3 ±190.2
Pre Arousal-2	142.6 ±122	116.3 ±51.87	563.5 ±290.1	166.9 ±112.9	375.6 ±148.4
Pre Arousal-3	114.4 ±68.5	117.6 ±79.39	570.9 ±443.3	141.9 ±75.54	393.8 ±201.3
Pre Arousal-4	132.4 ±94.1	113.3 ±49.44	522.7 ±291.3	156.7 ±73.89	374.9 ±194.5
Pre Arousal-5	101.2 ±50.1	109.3 ±55.6	598.5 ±403.4	167.4 ±90.16	354.0 ±136.5
Pre Arousal-6	181.9 ±103	118.5 ±40.04	587.7 ±439.5	173.1 ±84.99	409.7 ±199.4
AROUSAL					

TABLE 4.3 (continued)

Arousal Segment	Mean Power				
	Delta (*10 ²)	Theta (*10 ²)	Alpha (*10 ¹)	Sigma (*10 ¹)	Beta
Post Arousal-1	951.5 ±822	111.8 ±58.99	480.3 ±307.9	113.8 ±60.54	465.4 ±260.2
Post Arousal-2	737.5 ±881	823.2 ±34.86	410.7 ±249.3	107.8 ±47.54	420.5 ±266.2
Post Arousal-3	720.7 ±563	935.6 ±38.52	495.5 ±33.66	132.0 ±60.26	401.2 ±196.8
Post Arousal-4	860.4 ±669	1105 ±54.42	590.9 ±375.2	188.5 ±97.81	416.6 ±248.6
Post Arousal-5	1233 ±1086	1148 ±63.63	660.2 ±396.4	208.5 ±120.7	567.6 ±615.9
Post Arousal-6	913.2 ±635.9	1176 ±57.09	638.3 ±573.6	187.5 ±141.9	438.0 ±227.5

TABLE 4.4: Mean (+/- S.D.) power values of 9 sec segments for elderly subjects

Arousal Segment	Mean Power				
	Delta (*10 ³)	Theta (*10 ²)	Alpha (*10 ¹)	Sigma (*10 ¹)	Beta
Pre Arousal-1	119.9 ± 92	138.3 ± 61.73	509.7 ± 259.4	161.4 ± 92.47	537.1 ± 323.9
Pre Arousal-2	111.9 ± 71.53	142.9 ± 55.17	515.0 ± 291.3	159.5 ± 85.68	477.2 ± 216.4
Pre Arousal-3	113.3 ± 69.84	148.4 ± 70.02	496.9 ± 300.1	171.4 ± 97.07	483.7 ± 233.5
Pre Arousal-4	120.4 ± 61.63	140.6 ± 58.23	520.7 ± 267.3	176.4 ± 135.2	545.7 ± 526.3
Pre Arousal-5	103.6 ± 43.06	136.7 ± 71.52	482.7 ± 228.3	143.3 ± 67.12	478.2 ± 271.3
Pre Arousal-6	153.7 ± 70.34	142.1 ± 61.02	487.7 ± 240.8	147.4 ± 64.44	480.1 ± 174.5
AROUSAL					

TABLE 4.4 (continued)

Arousal Segment	Mean Power				
	Delta (*10 ²)	Theta (*10 ²)	Alpha (*10 ¹)	Sigma (*10 ¹)	Beta
Post Arousal-1	883.7 ±624.4	137.3±57.98	488.2 ± 288.5	143.3 ± 70.34	629.5 ± 313.15
Post Arousal-2	812.1 ±653.7	134.2±51.86	436.2 ± 186.9	141.5 ± 69.86	547.1 ± 242.66
Post Arousal-3	959.4 ±653.6	134.5±46.19	468.6 ± 255.9	158.8 ± 130.9	600.3 ± 505.8
Post Arousal-4	942.3 ±968.5	128.0±56.05	467.2 ± 222.2	166.9 ± 91.75	508.8 ± 225
Post Arousal-5	103.3 ±666.3	156.0±62.78	881.8 ± 256.9	120.9 ± 102.8	544.1 ± 263.6
Post Arousal-6	123.3 ±837.7	152.2±68.79	591.2 ± 387.9	199.6 ± 164.9	544.4 ± 238.7

TABLE 4.5: Mean (+/- S.D.) Sample Entropy values of 10 sec segments for middle aged and elderly subjects

Arousal Segment	Middle Aged Subjects	Elderly Subjects
Pre Arousal-1	1.342 ± 0.1759	1.421 ± 0.2282
Pre Arousal-2	1.295 ± 0.2301	1.375 ± 0.1667
Pre Arousal-3	1.318 ± 0.1524	1.426 ± 0.1859
Pre Arousal-4	1.429 ± 0.2408	1.341 ± 0.1836
Pre Arousal-5	1.385 ± 0.2695	1.362 ± 0.1597
Pre Arousal-6	1.359 ± 0.2247	1.332 ± 0.1669
AROUSAL		
Post Arousal-1	1.444 ± 0.2178	1.456 ± 0.2085
Post Arousal-2	1.436 ± 0.2974	1.448 ± 0.1592
Post Arousal-3	1.457 ± 0.1968	1.454 ± 0.1986
Post Arousal-4	1.411 ± 0.2214	1.449 ± 0.1793
Post Arousal-5	1.489 ± 0.2068	1.390 ± 0.1761
Post Arousal-6	1.521 ± 0.1547	1.366 ± 0.2002

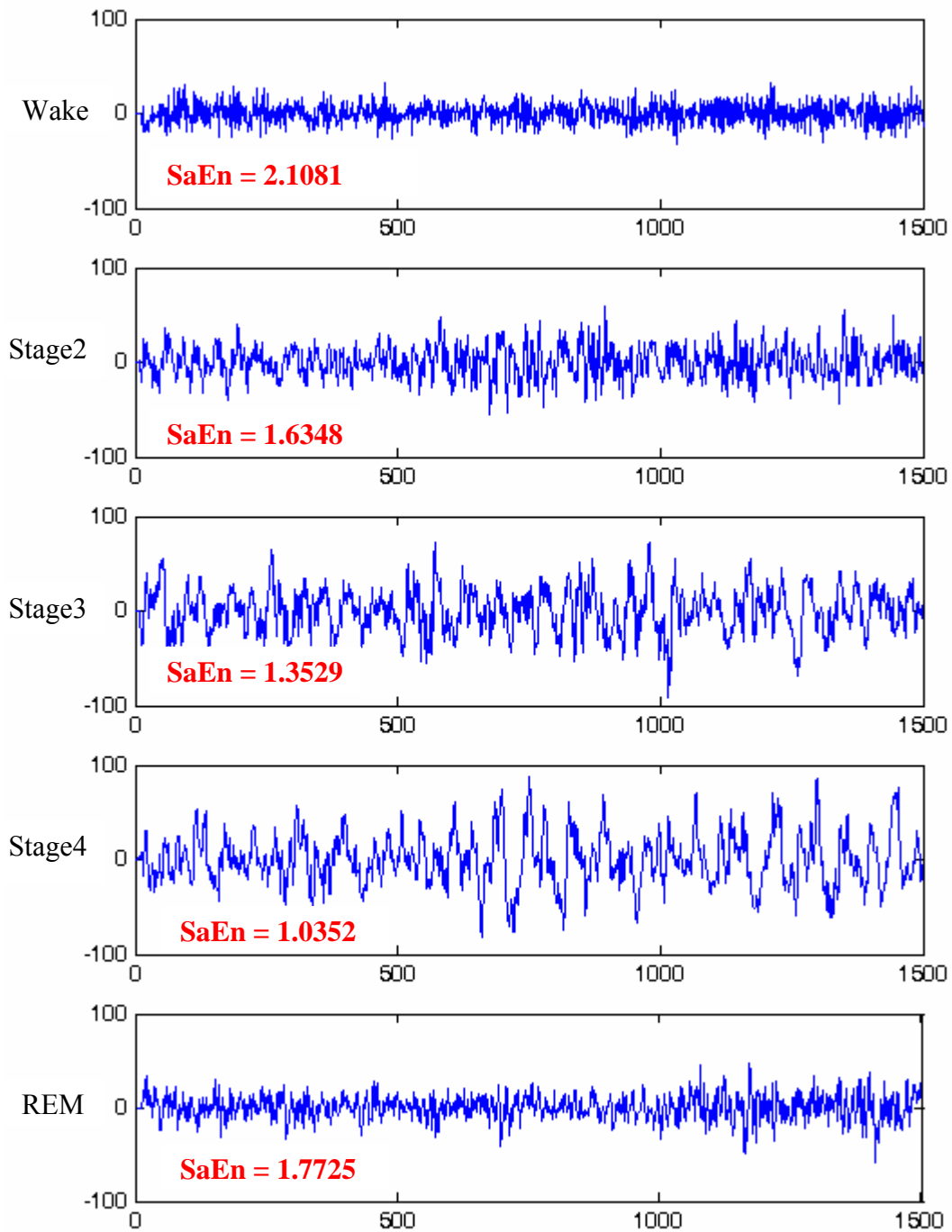

FIGURE 4.1: 30-second records of EEG signals in different sleep stages after removal of EOG contamination. The corresponding sample entropy values are indicated in red as SaEn, calculated over a 30 sec period from an overnight polysomnogram of one middle aged subject

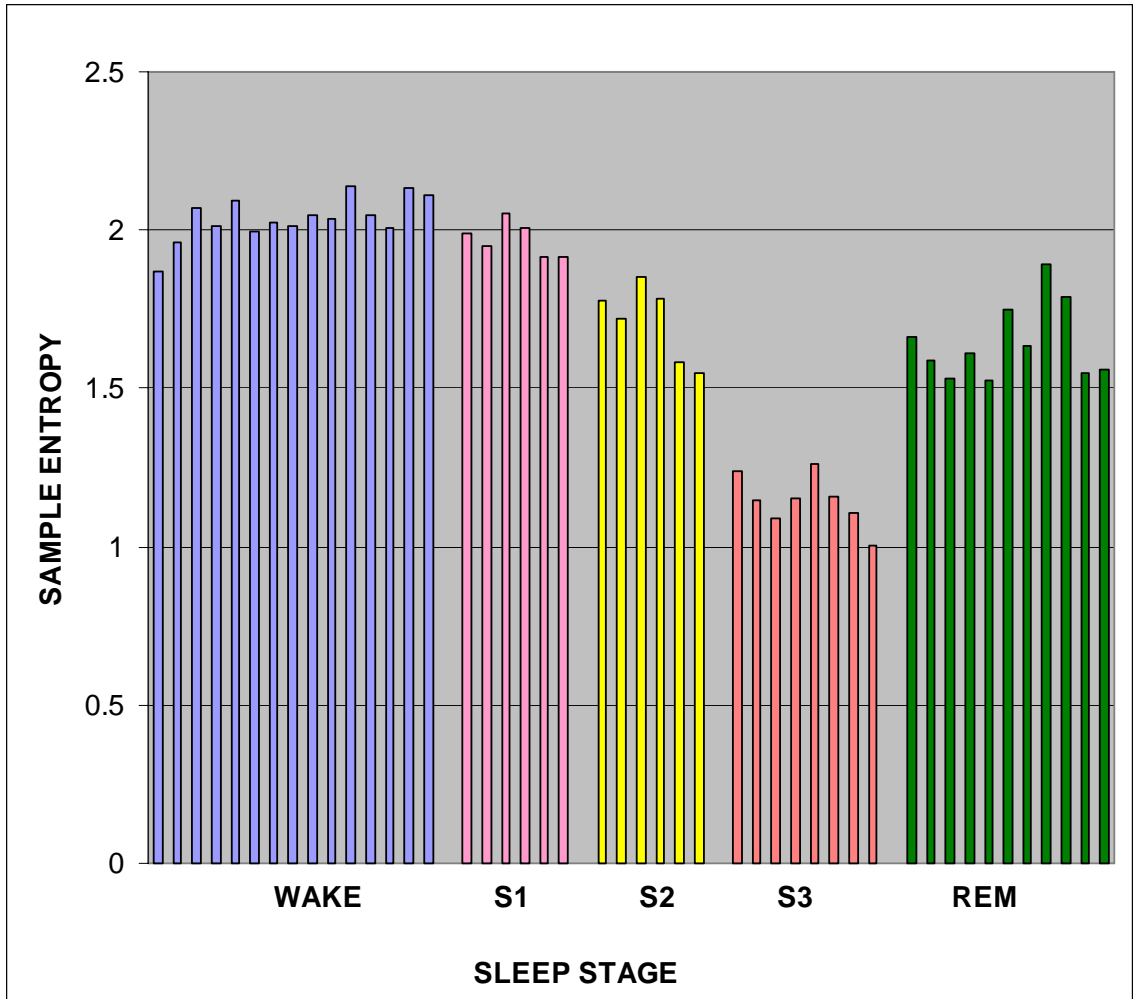

FIGURE 4.2: Sample Entropy values in sleep stages: Wake, Stage 1, Stage 2, Stage 3 and REM from an overnight polysomnogram of one middle aged subject. Each vertical line corresponds to Sample Entropy calculated during a 30-sec period in the indicated sleep stages as shown on x-axis.

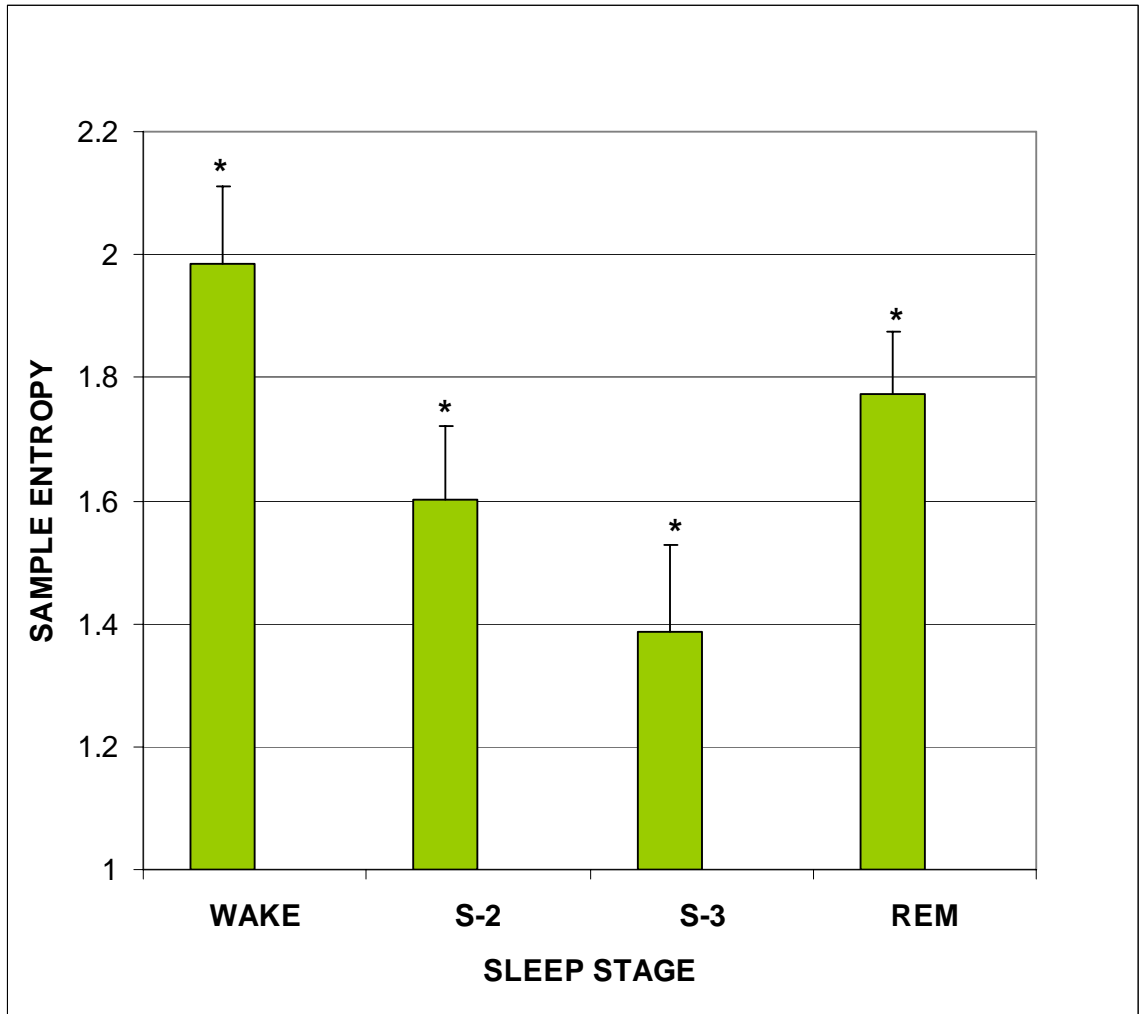

FIGURE 4.3: Mean Sample Entropy values in various sleep stages for all 20 middle aged subjects. * = significantly different from other sleep stages ($p < 0.0001$).

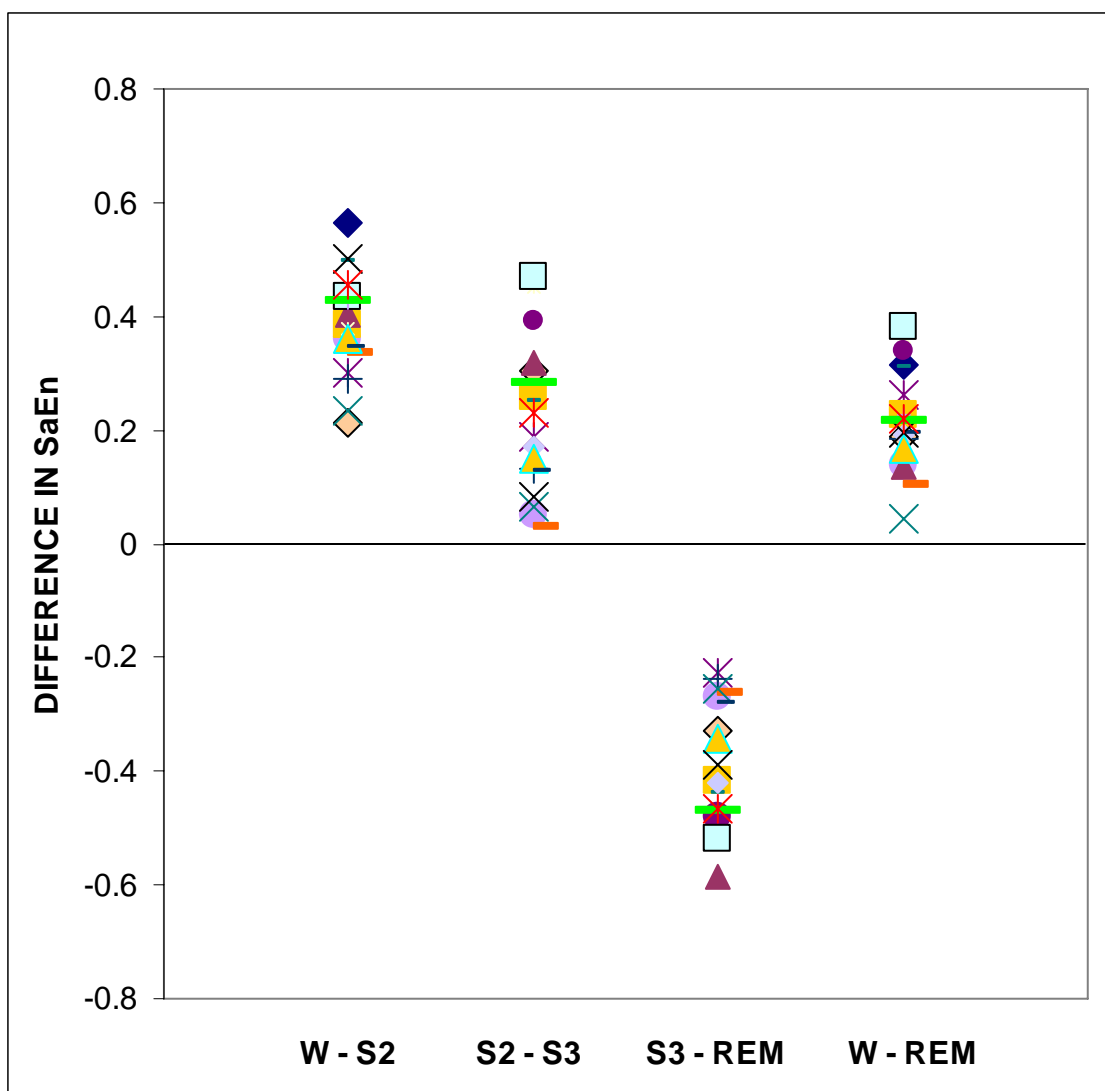

FIGURE 4.4: Difference in Sample Entropy values between subsequent sleep stages for all 20 middle aged subjects. W-S2 stands for Stage 2 Sample Entropy values (SaEn) subtracted from Wake SaEn, S2 – S3 stands for Stage 2 SaEn minus the Stage 3 SaEn, S3-REM implies Stage 3 SaEn minus REM SaEn and W-REM indicates Wake SaEn minus the REM SaEn. Each symbol stands for the difference in SaEn for one subject.

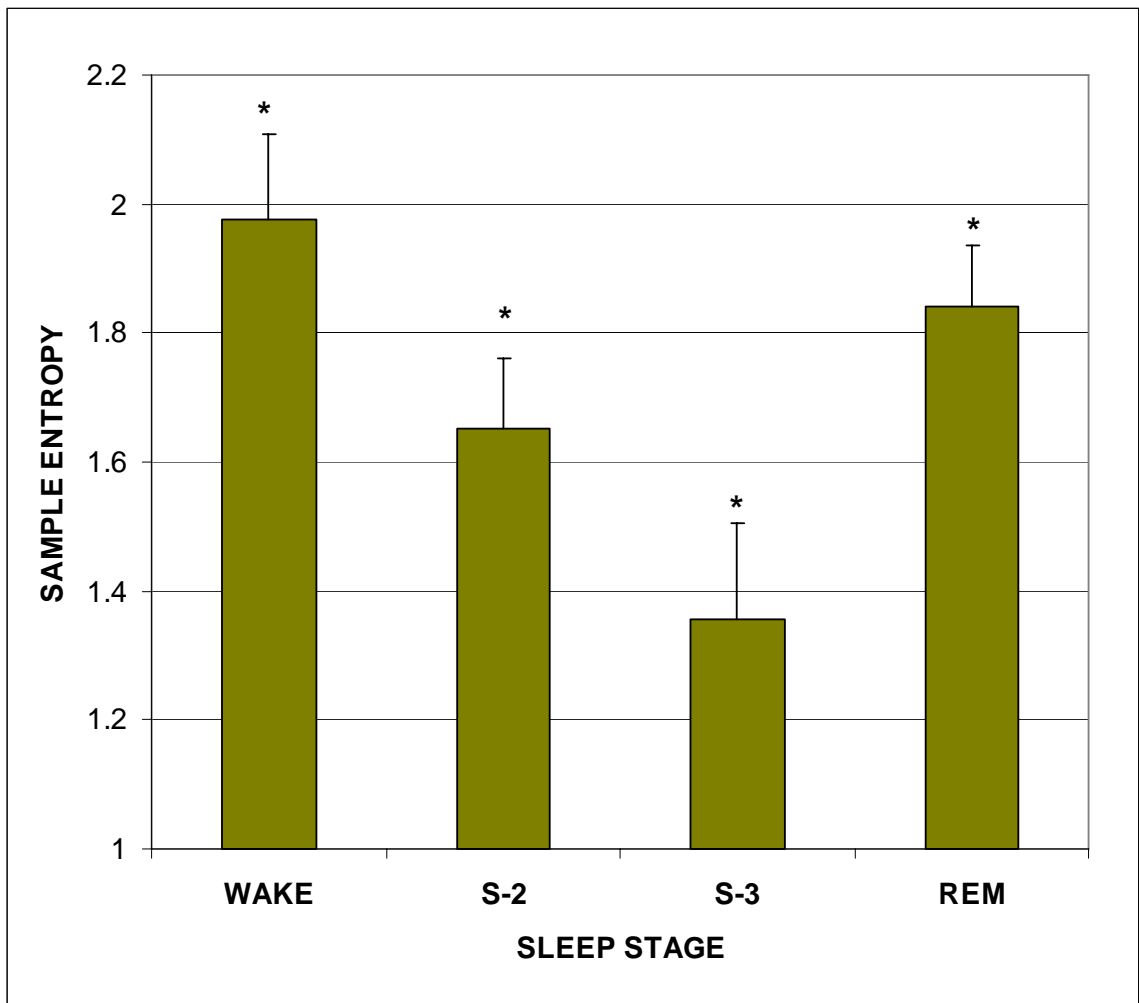

FIGURE 4.5: Mean Sample Entropy values in various sleep stages for all 20 elderly subjects. * = significantly different from other sleep stages ($p < 0.0001$).

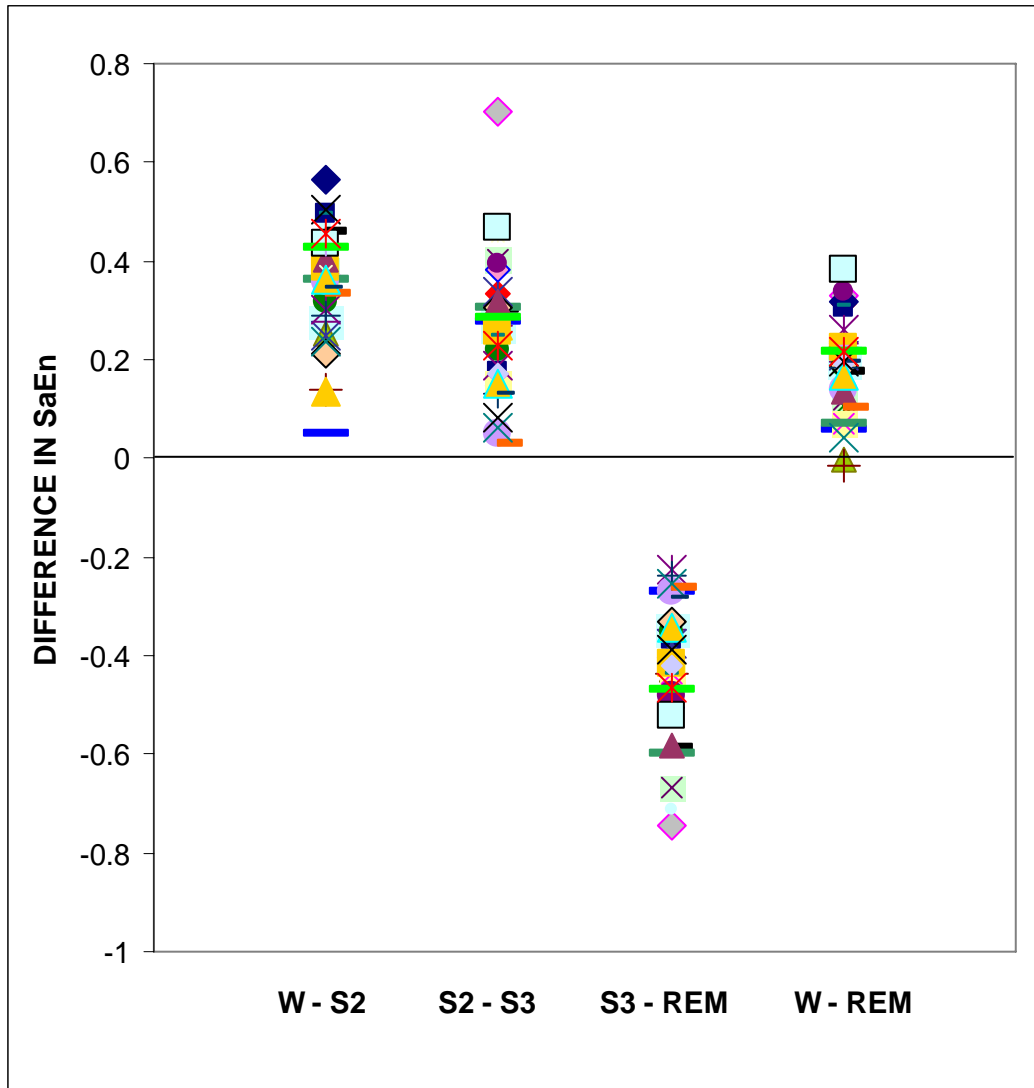

FIGURE 4.6: Differences in Sample Entropy values between subsequent sleep stages for all 20 elderly subjects. W-S2 stands for Stage 2 Sample Entropy values (SaEn) subtracted from Wake SaEn, S2 – S3 stands for Stage 2 SaEn minus the Stage 3 SaEn, S3-REM implies Stage 3 SaEn minus REM SaEn and W-REM indicates Wake SaEn minus the REM SaEn. Each symbol stands for the difference in SaEn for one subject.

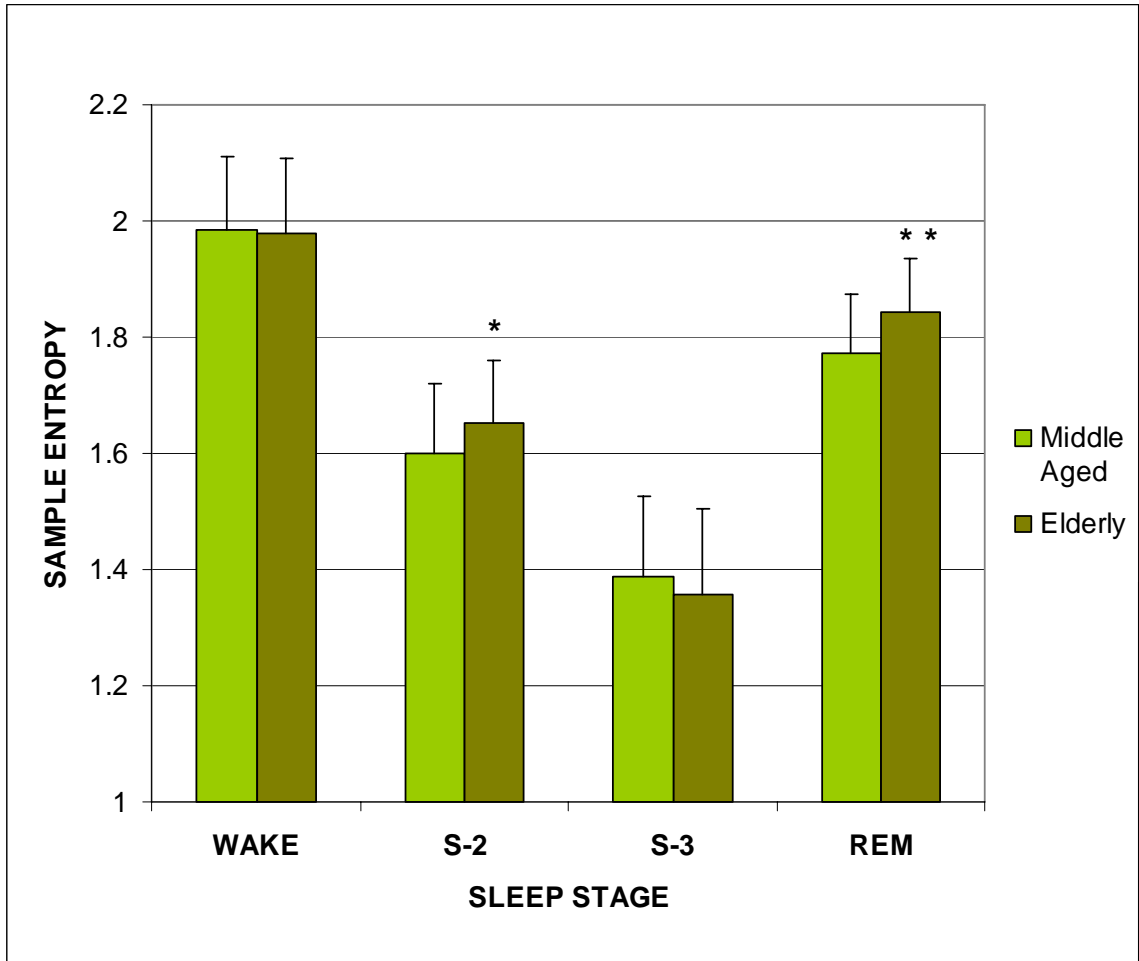

FIGURE 4.7: Mean Sample Entropy values in various sleep stages for all 20 middle aged and 20 elderly subjects. Middle aged Sample Entropy values are significantly different from elderly Sample Entropy values in Stage 2 and REM. * = significant difference between age groups ($p < 0.029$), ** = significant difference between age groups ($p = 0.001$)

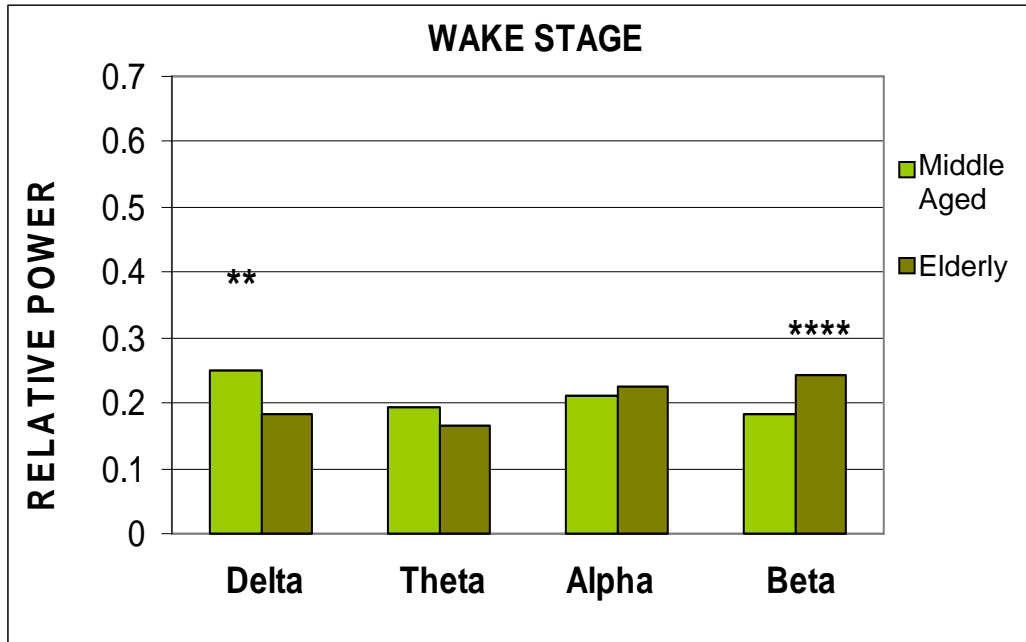

FIGURE 4.8: Relative power values in different frequency bands in Wake Stage. The middle aged relative power in delta and beta bands is significantly different from that of the elderly subjects in eight subjects. ** = significant difference between age groups ($p=0.006$), **** = significant difference between age groups ($p<0.0001$)

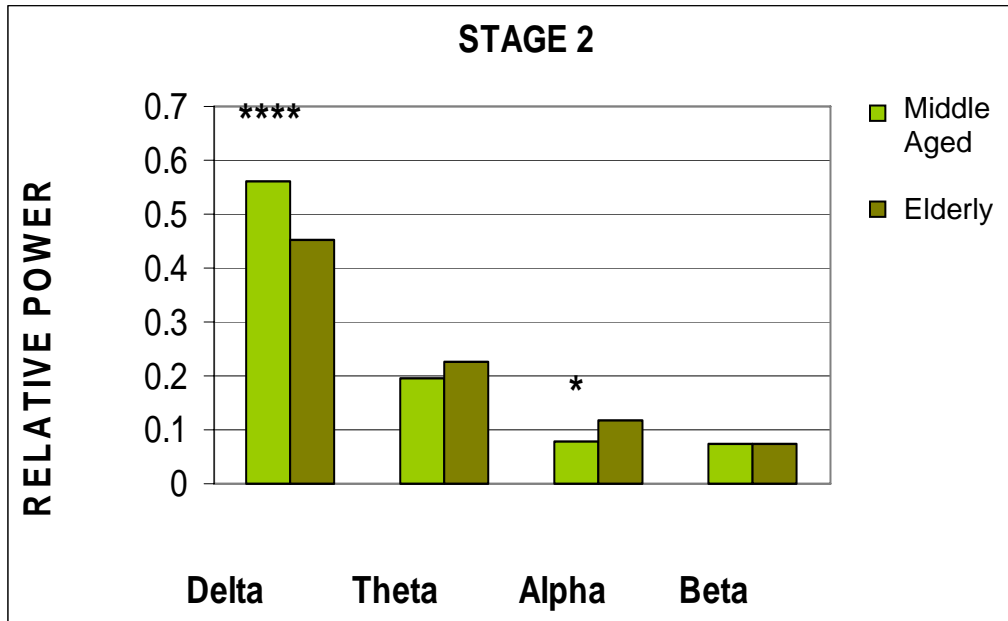

FIGURE 4.9: Relative power values in different frequency bands in Stage 2. The middle aged relative power in delta and beta bands is significantly different from that of the elderly subjects in eight subjects. * = significant difference between age groups ($p=0.045$), **** = significant difference between age groups ($p<0.0001$)

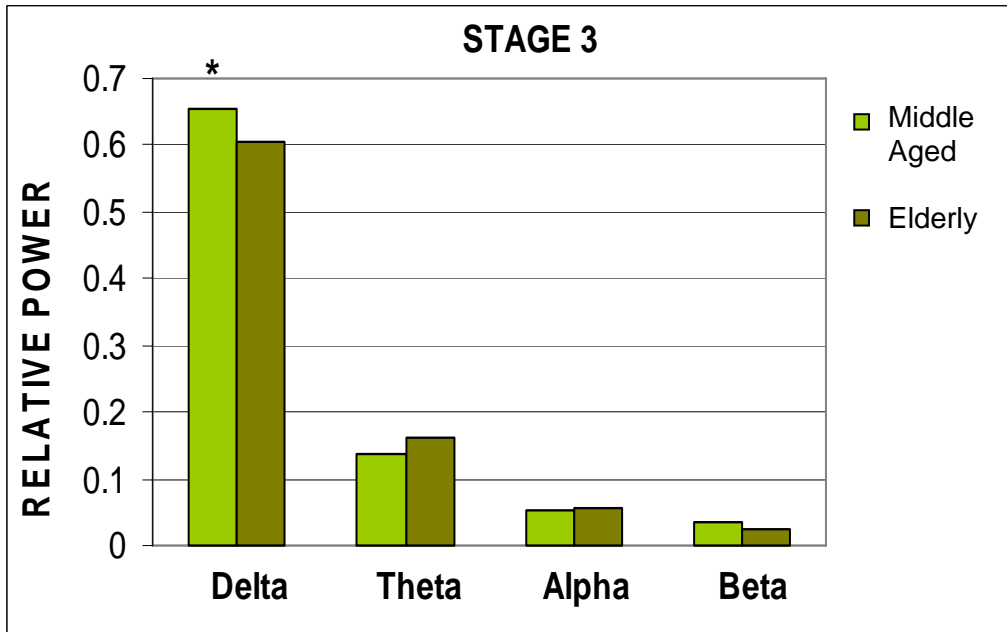

FIGURE 4.10: Relative power values in different frequency bands in Stage 3. The middle aged relative power in delta and beta bands is significantly different from that of the elderly subjects in eight subjects. * = significant difference between age groups (p=0.045)

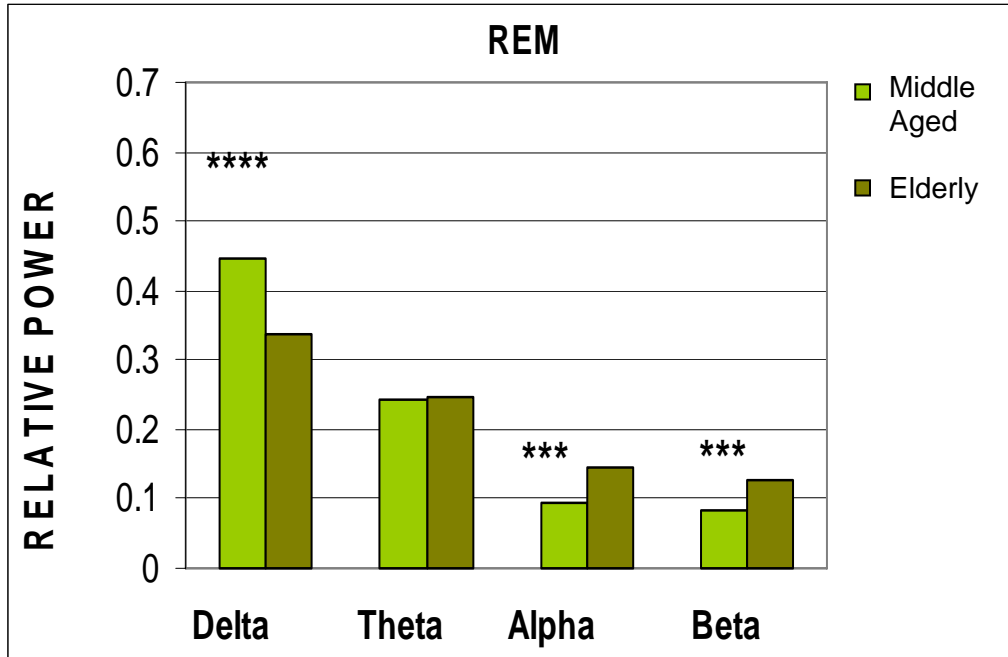

FIGURE 4.11: Relative power values in different frequency bands in stage. The middle aged relative power in delta and beta bands is significantly different from that of the elderly subjects in eight subjects. *** = significant difference between age groups ($p < 0.001$), **** = significant difference between age groups ($p < 0.0001$)

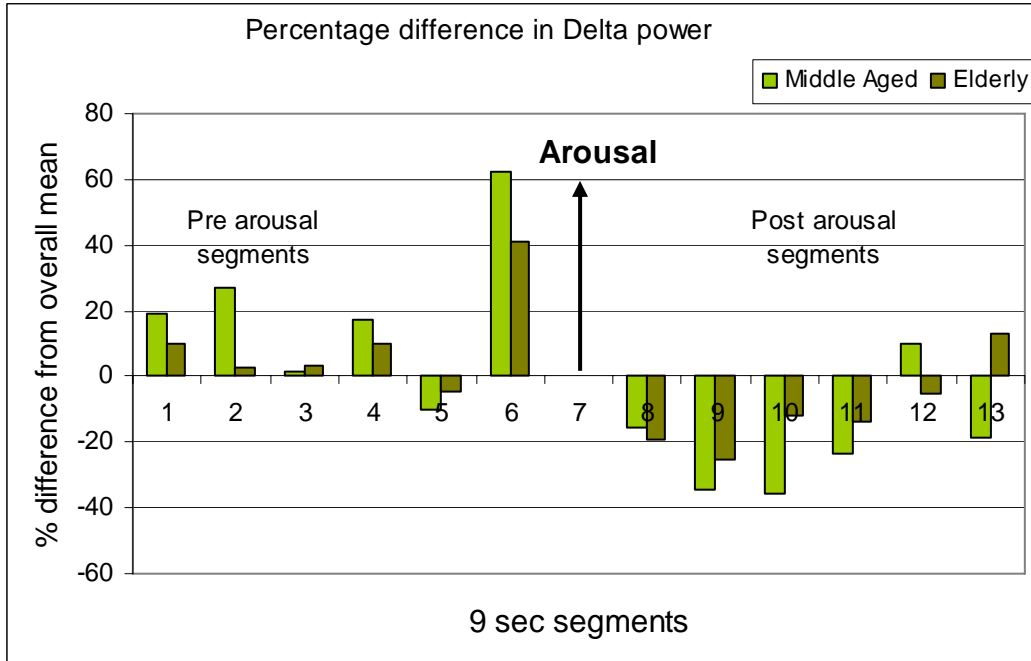

FIGURE 4.12: Percent difference from overall mean in Delta power during pre- and post-arousal.

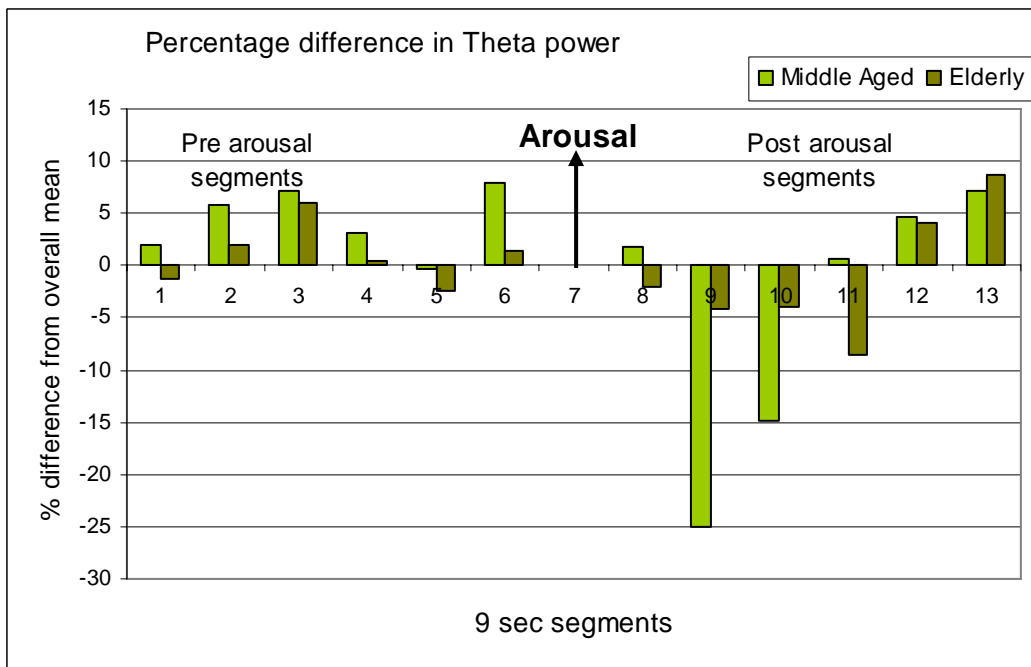

FIGURE 4.13: Percent difference from overall mean in Theta power

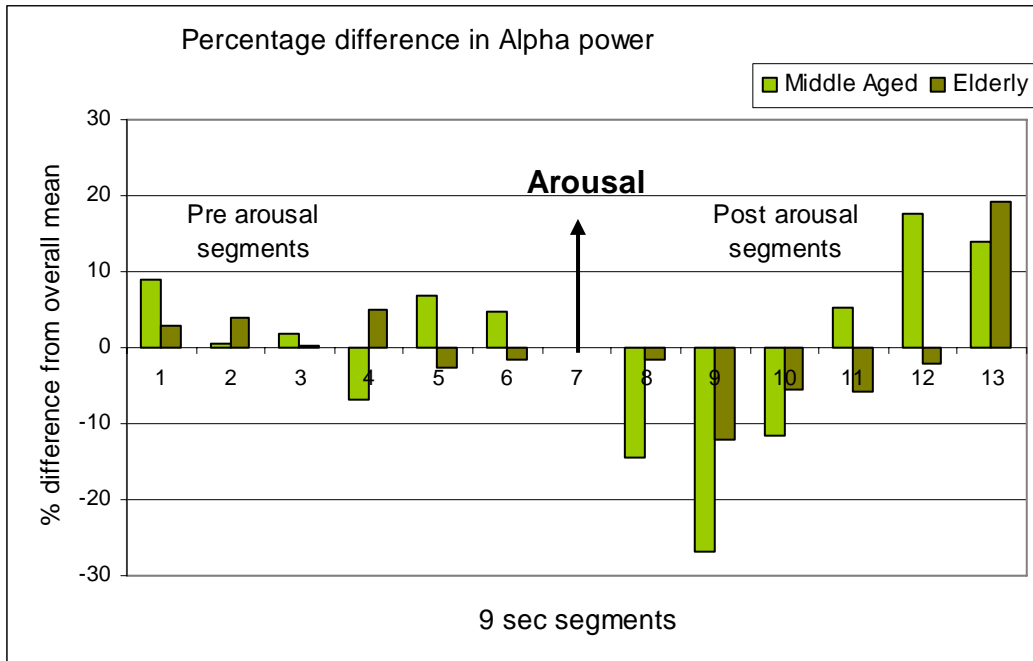

FIGURE 4.14: Percent difference from overall mean in Alpha power

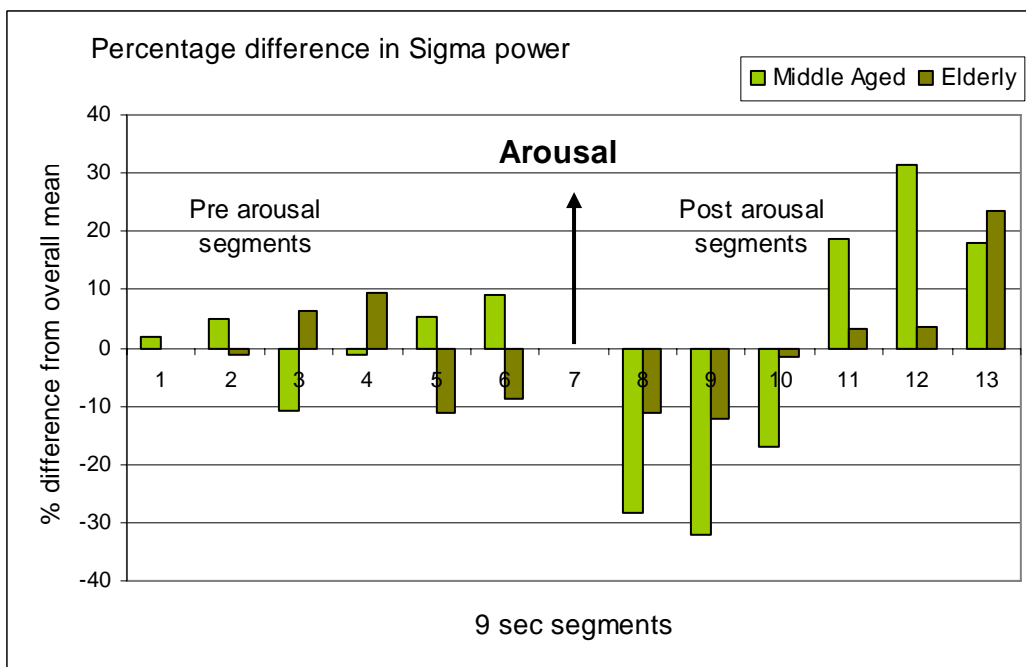

FIGURE 4.15: Percent difference from overall mean in Sigma power

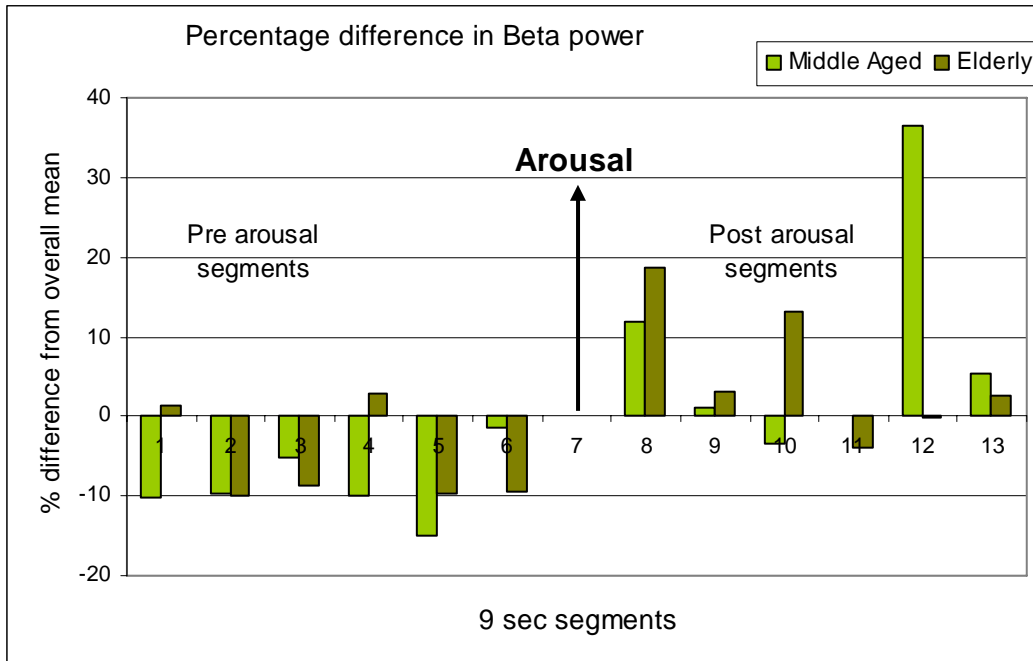

FIGURE 4.16: Percent difference from overall mean in Beta power

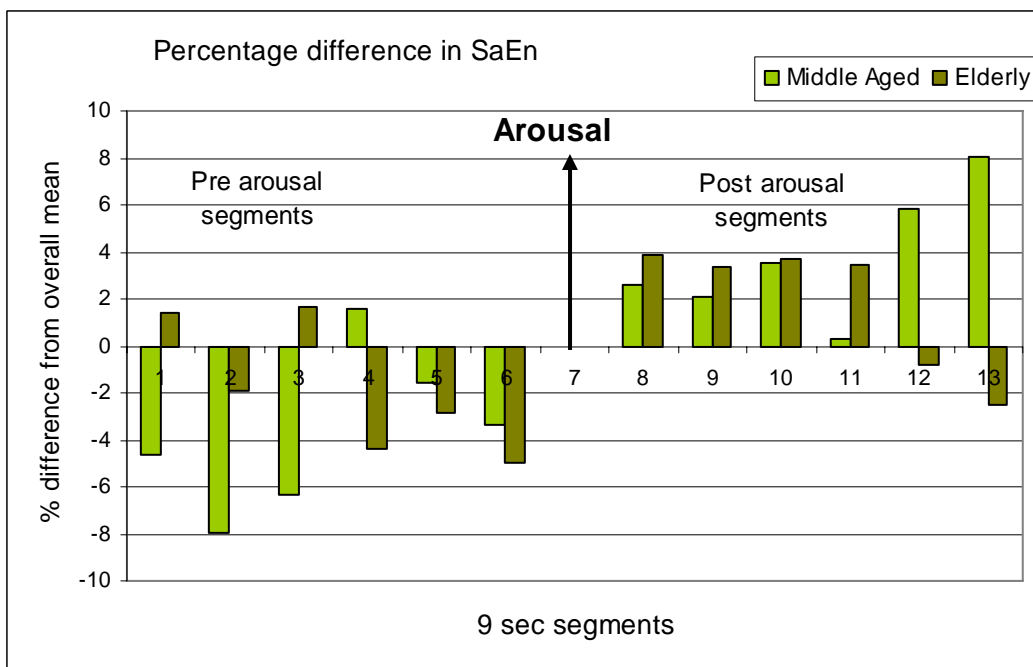

FIGURE 4.17: Percent difference from overall mean in Sample Entropy

CHAPTER 5: DISCUSSION

This chapter includes the methodological issues of our study and the interpretation of the results. It mainly deals with how and why Sample Entropy changes during different sleep stages in general and in two different age groups and during arousals. We try to address the critical issue of whether Sample Entropy conveys information not available from spectral analysis.

5.1 Methodological Issues

Sleep is a continuous process, with the sleepers passing from Wake to Stage 1 and then to Stage 2, Stage 3, Stage 4 and REM. This pattern of sleep stages is repeated throughout the night, although not every person goes through all the sleep stages. Stage 1 and Stage 4 were not included in the study because of the lack of a sufficient amount of these stages in some of the 40 subjects, although some data were discarded because of complications in EOG removal. In the elderly, it was observed that only a few subjects go into the deepest sleep stage, Stage 4. Though the values are not shown, the Stage 1 SaEn values calculated for a few subjects are closest to those of REM and fall between those of Wake and Stage 2. Also, the Stage 4 values are smaller than the Stage 3 SaEn values, following the consistent pattern of an initial high SaEn value for Wake and then a continuous decrease from Wake to Stage 1, Stage 1 to Stage 2 to Stage 3 to Stage 4 and finally an increase in SaEn in REM.

Topographical differences have been shown in different EEG bands during the first 30 min of sleep with the EEG power exhibiting an antero-posterior gradient in different bands [38]. However, our study includes the EEG signal from only a central derivation, as central leads are the only available leads in SHHS studies. With change in frequency distribution of EEG power, the Sample Entropy would also change. Though the entropy variations in other leads were not explored, the results from a single lead are likely to be representative. Blessy Mathew has shown that the Sample Entropy values calculated from the O1A2 lead followed the systematic patterns similar to the Sample

Entropy values calculated from the C3A2 lead [39]. Also, it has been recommended that only central or occipital EEG derivations should be used for scoring arousals [4].

Sleep staging is usually done in 30 sec or 20 sec intervals [15]. Though the values are not shown, entropy has been calculated in our study for segments as short as 6 sec. Because the variability of SaEn for these segments was too high, it was difficult to draw meaningful conclusions from their analysis. On the other hand, a long record could be insensitive to subtle changes in the EEG regularity. Since the sleep staging done by SHHS scorers was in 30 sec intervals, we chose 30 sec records for our analysis.

In contrast to our study, the EEG signal above 25Hz has been included in the beta region in some studies [40, 41]. The cut off frequency of the low pass filter is 24.25Hz, thereby attenuating any signal beyond this frequency. Since the EOG sampling frequency is 50Hz, the EEG signal had to be sub-sampled to 50 Hz, forcing the cut off frequency to be ~25Hz. However, the power was concentrated below 20 Hz in most of the cases (Figure 5.1).

During the EOG removal process, both EOG and EEG signals were decomposed to obtain the signal components below 3.125Hz. These components were used to remove the EOG contamination as its power is concentrated below 3Hz (Figure 5.2). The EOG contamination above 3Hz, however small it may be, was still present in the EEG signal. While there was EOG contamination in the EEG signal, there could be EEG contamination in the EOG signal. In such case, it is difficult to achieve optimum filtering because of the bidirectional contamination. This situation usually led to very large filter lengths and such data were discarded. The optimal filter had to be designed for each data record because of two reasons: firstly, the filter properties may change because of the physiological conditions. Secondly, the input to the filter contains noise, which varies for every segment because the cross-contamination between the EOG and EEG recordings depends on the sleep stage. Hence, a constant number of filter coefficients could not be used for all data segments and they varied from 10 to 48.

The identification of arousals has low inter-scorer reliability and a new method was developed to overcome this limitation. Arousals are defined as an abrupt shift in EEG frequency, which may include theta, alpha and/or frequencies greater than 16Hz but not spindles [4]. It is not uncommon that scorers cannot achieve high reliability on

arousal scoring, let alone the start and stop timing of an arousal [10]. Some of the arousals scored by the SHHS scorers did not have any increase in their alpha, beta or theta power when a power spectral analysis was done (Figure 3.6). Only those SHHS scored arousals that showed power doubling were selected for our analysis.

5.2 Interpretation of Results

The long-term goal of our study is to develop an EEG measure that can discriminate abnormalities between the normal and aged brain. Studies indicated that there is considerable change in the EEG power spectrum of the abnormal brain [42]. Early stages of dementia are associated with an increase in theta activity, while later stages are associated with an increase in delta activity, often accompanied by decreases in alpha and beta frequencies [43]. The slower frequencies were reported to decline across REM periods in subjects with clinical depression [13]. We developed a method that can track changes in the varying frequencies of an EEG signal, based on the regularity of the signal. Sleep stage discrimination is the basic test for any EEG measure's capability of discriminating the EEG regularity. The application of non-linear methods was believed to be more useful for understanding the EEG complexities [36]. Non-linear parameters like correlation dimension, fractal dimension, largest Lyapunov exponent, approximate entropy, Hurst exponent, phase space plots and recurrence plots were used to analyze sleep data [36]. The variation in approximate entropy is very similar to our results, except that the approximate entropy was reported to be higher in Stage 2 compared to Stage 1. Also, the consistency of entropy values within the subjects was not addressed. Because of the bias in this measure [18], Sample Entropy was developed. However, EOG removal was not done prior to the calculation of any of these measures. Another entropy measure called Tsallis entropy, which is a measure of the probability distribution of the amplitude of a time series, was also used to study the sleep stage changes [39]. It was reported that the changes in Tsallis entropy values were not as consistent as the Sample Entropy values.

Though various measures (spectral edge, spectral entropy, correlation dimension, largest Lyapunov exponent, first spectral moment) for EEG signal analysis were applied previously, a significant level in discrimination of the four sleep stages was not achieved by any single linear or non-linear measure [11]. In contrast, the Sample Entropy of the EEG signal is shown in our study to correlate strongly with the sleep stages (Wake, Stage 2, Stage 3 and REM) in both elderly (Figure 4.6) and middle aged (Figure 4.4) groups. The qualitative difference in the Sample Entropy values between different sleep stages was evident even in individual subjects (Figures 4.3 and 4.5). We feel that the greater sensitivity of our method is due to the removal of EOG contamination prior to the calculation of the Sample Entropy of the signal [39].

The Sample Entropy tracks changes in the regularity of the EEG signal from one sleep state to another. As the EEG in Wake is highly irregular, the Sample Entropy assumes a high value and as we go through stages 2, 3 and 4, the Sample Entropy value decreases with the increasing regularity of the signal. The EEG signal in REM is again desynchronous, very similar to that during Wake, and hence the entropy again increases. Though the Sample Entropy values are significantly different between the sleep stages, there are slight variations within a sleep stage for individual subjects (Figure 4.2). This finding may suggest a possibility of much finer sub-sleep stages than the conventional R & K sleep stages.

As a person moves from Wake to Stage 1, Stage 1 to Stage 2 and then to slow wave sleep, there is a decrease in the high frequency components of the EEG, along with an increase in the low frequency components. The Sample Entropy reflects these changes in the power spectrum as a unified measure. Multiple linear regression analysis of SaEn on relative beta, theta and delta bands across both age groups and all four sleep stages showed a significant positive correlation between SaEn and relative beta power ($p < 0.0001$), and between SaEn and relative theta power ($p < 0.006$). Significant negative correlation was found between SaEn and relative delta power ($p < 0.0001$). The beta band is thought of as an indicator of a higher arousal level in sleep while delta is an indicator of a sleep-promoting factor [40, 41]. In the presence of beta frequency components, the Sample Entropy goes up and it comes down with an increase in delta frequency components. Hence, Sample Entropy can be thought of as a balance between sleep-

promoting and arousal-promoting mechanisms as it is negatively correlated with relative delta power and positively correlated with relative beta power.

Decreased low frequency activity and increased involuntary arousals are the hallmarks of aging [44]. The spectral power is higher at low frequencies and the power is lower at high frequencies for younger subjects. With increase in age, there is a gradual decrease in the delta, theta and sigma bands along with an increase in beta power [2]. This may reflect a shift of the sleep state in elderly towards a more awake cortical state. Sample Entropy showed significant differences between the middle aged and elderly groups in Stage 2 and REM (Figure 4.7). The entropy values are higher in elderly compared to middle aged subjects in these two sleep stages. Power spectral analysis on the segments that were used for entropy calculations revealed that the relative delta power is higher in middle aged subjects compared to the elderly and relative beta and/or relative alpha power is higher in elderly compared to middle aged subjects (Figures 4.8 – 4.11).

This part of the discussion is about why we need a new measure for arousal scoring and how Sample Entropy is used to study the arousals. The associations between sleep disorder, sleep fragmentation and other physiological process have been studied for many years [3]. Arousals have been associated with a significant increase in mean arterial blood pressure in studies conducted to study the cardiovascular response to arousal from sleep under controlled conditions [45]. In hemodialysis patients, a higher frequency of arousals was reported [46]. In our study, we put an additional power doubling criterion on the arousals marked by SHHS scorers so that there are no false arousals. Figure 3.6 shows an example of an arousal which has increases in alpha, beta and/or theta band power values. The ASDA rules define an arousal as an abrupt increase in frequency, but provide no quantitative measure. Hence, there is high inter-scorer variability and reduced accuracy in arousal scoring. In our method, log power was taken to compensate for the varying ranges of power for varying sleep stages. As an arousal is defined as an increase in alpha, beta, and/or theta powers, the log of these power values are added. A 6 dB increase of log-power value from the baseline marks an arousal (Figure 3.7).

The Sample Entropy was calculated for 30 sec, 15 sec and 10 sec segments. The 30 sec segments are too large to track the subtle changes that could occur near the arousal. Though the comparisons are not shown, the 10 sec SaEn values are better at tracking the EEG regularity before and after the arousal than the 15 or 30 sec SaEn values. Results from the statistical analysis showed that there is a significant difference between the segments that are immediately before and after the arousal for Sample Entropy values, in addition to delta, theta, and beta power values. This shows that the brain is still in a higher cortical arousal state (higher SaEn values, table 4) in the post-arousal period. The power values also showed significant differences between other segments (ANOVA results from section 4.2). The mean beta and delta power values were significantly different between the segments right before and right after the arousal. When compared to the pre-arousal levels, mean beta power is higher after the arousal and mean delta power is lower, which could mean that the arousal-promoting factor is high and sleep-promoting factor is lower even after the arousal. The beta and delta mean power values do not change much for at least 30 sec after the arousal. This may make it easy for the next arousal to occur, increasing the arousal frequency. This could also mean that the quality of sleep is reduced because the subject does not go back to a deeper sleep stage (which has lower Sample Entropy value) immediately.

The percent increase of mean SaEn values from the overall mean (Figures 4.17, 4.23) show that there is not much change in the entropy values for 30 sec in the post-arousal region. This implies that the brain is still in a higher cortical state for 30 sec after the arousal, without going back to the background level. Though this may seem like a small time duration, the chances for another arousal in succession are high because the EEG is already in a higher cortical state. Multiple arousals further worsen the sleep fragmentation, leading to daytime sleepiness [47]. It is, however, surprising to find no significant differences between the age groups. This could be because of the fact that many entries were deleted by SYSTAT as there were some missing cases during the pre-arousal segments and/or post-arousal segments. Hence, many arousals could not be analyzed. These results, however, are preliminary results and more arousals have to be analyzed for the future studies.

In conclusion, the Sample Entropy tracks the changes in power spectrum in different sleep stages and provides a unified measure for sleep staging. Sample Entropy might be an indicator of the finer sub-sleep stages than the conventional R&K sleep stages. Also, Sample Entropy can be thought of as a balance between sleep-promoting and arousal-promoting mechanisms. Hence, we can speculate that the Sample Entropy consolidates the changes from different frequency bands and serves as a single measure that can provide valuable information that is not evident from the spectral analysis alone.

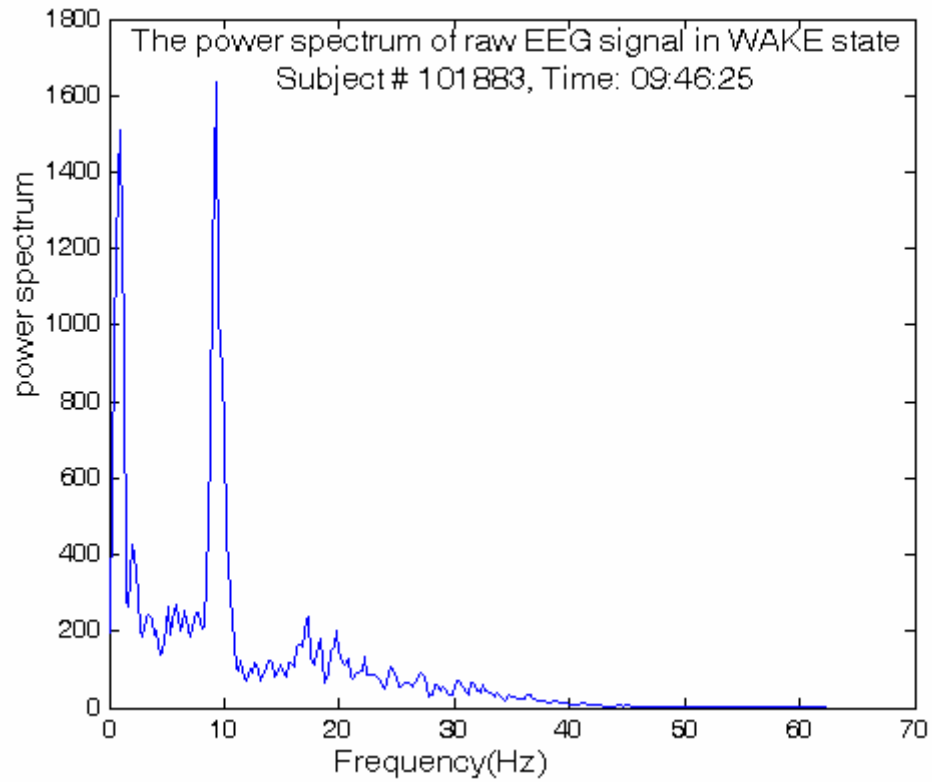

FIGURE 5.1: Power Spectrum of a raw EEG signal showing most of the power is concentrated below 25Hz. Note: This case (i.e., Wake EEG) represents the sleep state with greatest power at frequencies >20Hz.

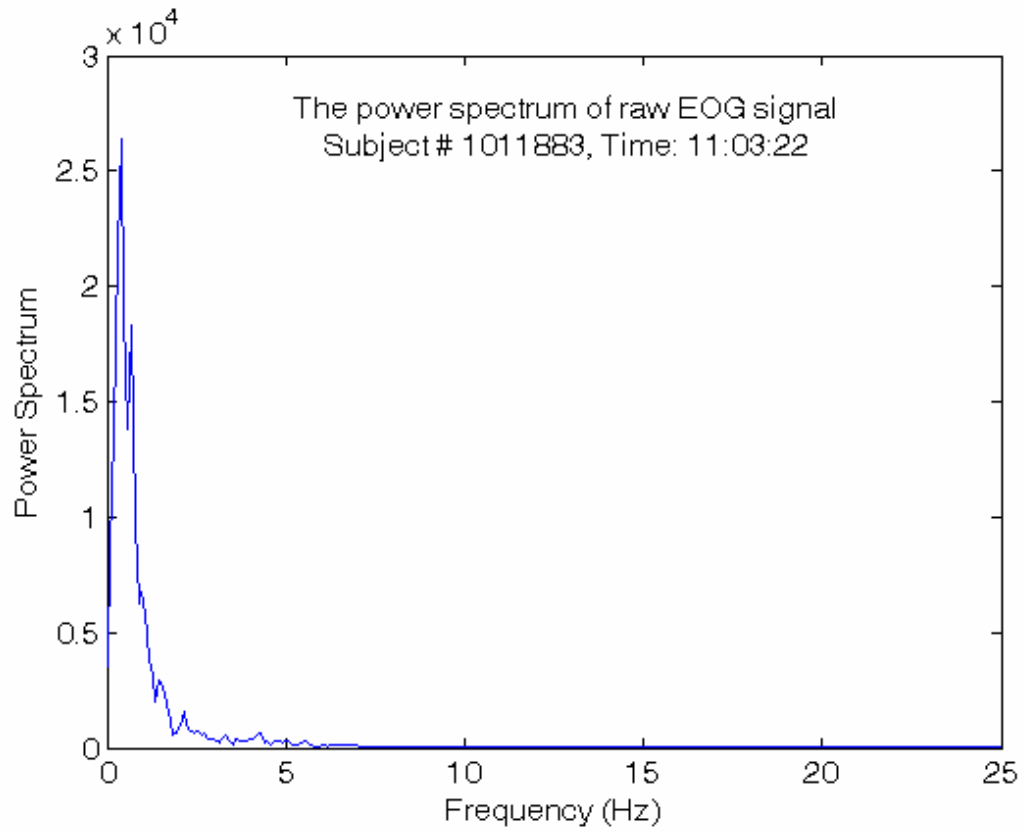

FIGURE 5.2: Power Spectrum of a raw EOG signal showing most of the power is concentrated below 3Hz.

CHAPTER 6: CONCLUSIONS, IMPLICATIONS, AND FUTURE DIRECTIONS

1. Sample Entropy tracks changes in the EEG regularity and it highly correlates with R & K sleep staging.
2. Sample Entropy differs between sleep stages in healthy middle aged and elderly women.
3. The differences between Sample Entropy values for successive sleep stages are highly consistent for each of 20 middle-aged and 20 elderly subjects.
4. Sample Entropy is significantly higher in elderly in Stage 2 and REM, suggesting that in these two sleep stages the elderly are closer to Wake state than middle aged women.
5. Sample Entropy in the post-arousal 9 sec record immediately after the arousal is significantly different from the Sample Entropy value in the pre-arousal 9 sec record right before the arousal.
6. Sample Entropy value is higher in the post-arousal period and does not change much for a 30 sec period.

Sample Entropy tracks changes in the regularity of the EEG signal during Wake and different sleep stages. We think that it highly correlates with sleep stages, in part, because of the EOG removal process. Sample Entropy can be thought of as an integrative measure of the various changes in power spectrum of the EEG signal in different sleep stages. Significant differences are found between Sample Entropy values of Wake, Stage 2, Stage 3 and REM. We speculate that the Sample Entropy measure, along with a measure of the EMG activity could be used in an algorithm for automated sleep staging, with appropriate training of the algorithm. Though Sample Entropy values are highly consistent within a sleep stage, there are slight variations in the entropy values. This might be indicative of sleep sub-stages apart from the R&K defined sleep stages. In addition to the variations in EEG during different sleep stages, Sample Entropy showed significant differences between the middle aged and elderly age groups. It signifies the fact that Sample Entropy could track the changes in the regularity in the EEG signal that are caused due to aging. Sample Entropy showed significant differences between the

post-arousal and pre-arousal 9 sec interval Sample Entropy values. The Sample Entropy values suggest that the EEG is in a higher cortical arousal state even after the end of an arousal and remains in a higher cortical state for at least 30 sec after an arousal. As the EEG does not go back from the higher cortical state immediately after an arousal, it increases the possibility for another arousal occurring in succession. Successive arousals lead to sleep fragmentation, thereby leading to daytime sleepiness and in addition decreasing the sleep quality.

FUTURE DIRECTIONS:

Having seen the pattern of EEG in middle aged (40-50 yrs) and elderly (70-80 yrs) subjects, studying Sample Entropy variation in young adults (20-30 yrs) would be a valuable addition. The Sample Entropy in the younger subjects could be lower than those of the middle aged subjects with much larger differences between young adults and middle aged subjects than the differences between middle aged and elderly.

The Sample Entropy calculations were done only during the first sleep cycle. Studies have shown that the spectral variations are different for sleep cycles in the later half of the sleep. Sample Entropy can be used to study variations in sleep quality during different sleep cycles. If the deterioration of sleep quality in the elderly is more pronounced in later sleep cycles, studying the first sleep cycle would not be sufficient.

For the arousal study, only sleep Stage 3 was considered because of the higher inter-scorer reliability. Now that we have devised a method to identify the arousals, the arousal study in other sleep stages should be further explored. It would be interesting to know if the patterns followed by arousal-promoting and sleep-promoting factors are similar for arousals in other sleep stages. If there are significant differences, the arousals should be grouped separately to mark the severity of sleep deterioration. This might provide more accurate associations between arousals and apneas, neurodegenerative disorders, etc. Another important factor associated with severity of sleep deterioration is the occurrence of multiple arousals. In our study, we included only isolated arousals. Studying multiple arousals (arousals in quick succession) provides more information on

sleep fragmentation and, in general, about poor sleep quality in people with a high arousal index.

Sample Entropy is shown to track the regularity of the EEG. Hence, it is a powerful measure that can be used to study changes in the temporal variations of EEGs of subjects with neurodegenerative diseases (e.g., in Alzheimer's patients). Neurodegeneration sets in long before the symptoms could be diagnosed. As neurodegenerative diseases are also associated with memory and dementia, studying the EEG regularity using Sample Entropy during different mental tasks might be helpful in early diagnosis of the disease.

REFERENCES:

1. Athena Akrami, Soroosh Solhjoo, Ali Motie-Nasrabadi, Mohammad-Reza Hashemi-Golpayegani, EEG – Based mental task classification: Linear and non-linear classification of movement imagery, Proceedings of 2005 IEEE, Engineering in medicine and biology 27th annual conference, September 1-4,2005
2. Julie Carrier, Stephanie Land, Daniel J. Busysse, David J. Kupfer, and Timothy H. Monk, The effects of age and gender on sleep EEG power spectral density in the middle years of life (ages 20–60 years old), *Psychophysiology*, 38 (2001), 232–242.
3. Reza Jamasebi, Susan Redline, Sanjay R Patel, Kenneth A. Loparo, Entropy-based Measures of EEG Arousals as Biomarkers for Sleep Dynamics: Applications to Hypertension, *sleep* 31(07) 935-943
4. EEG arousals: scoring rules and examples: a preliminary report from the Sleep Disorders Atlas Task Force of the American Sleep Disorders Association. *Sleep* 1992;15:173-84.
5. R.Mathur, N.J. Douglas, Frequency of EEG arousals from nocturnal sleep in normal subjects, *Sleep* 18(1995) 330-333
6. C. Guilleminault, R. Stoohs, A. Clerk, M. Cetel, P. Maistros, A cause of excessive sleepiness: the upper airway resistance syndrome, *Chest* 104 (1993) 781-787
7. L. Rosental, T. Roehrs, Y. Sicklesteel, F. Zorick, R. Wittig, T. Roth, Periodic leg movements during sleep, *Sleep* 7 (1984) 326-330
8. Strollo PJJ, sanders MH, Significance and treatment of nonapneic snoring, *Sleep*, 1993; 16:403-408.
9. Drinnan MJ, Murray A, Griffiths CJ, Gibson GJ, Interobserver variability in recognizing arousal in respiratory sleep disorders, *AM J RESPIR CRIT CARE MED* 1998; 158:358-362.
10. Coralyn W. Whitney, Daniel J. Gottlieb, Susan Redline, Robert G. Norman, Russel R. Dodge, Eyal Shahar, Susan Surovec, and F. Javier Nieto, Reliability of scoring respiratory disturbance indices and sleep staging, *Sleep* 21(7),1998

11. J. Fell, Roschke J, Mann K, Schaffner C, Discrimination of Sleep stages: a comparison between spectral and nonlinear EEG measures, *Electroencephalogr. Clin. Neurophysiol*, vol. 98, pp. 401-410, 1996
12. Sunao Uchida, Tom Maloney, and Irwin Feinberg, Beta (20 – 28 Hz) and Delta (0.3 – 3 Hz) EEGs oscillate reciprocally across NREM and REM sleep, *Sleep* 15(4):352-358;
13. Marcus P. Liscombe, Robert F. Hoffmann, Madhukar H. Trivedi, Marc K. Parker, A. John Rush, Roseanne Armitage, Quantitative EEG amplitude across REM sleep periods in depression: preliminary report , *J Psychiatry Neurosci* 2002;27(1):40-6
14. Roseanne Armitage, The distribution of EEG frequencies in REM and NREM sleep stages in healthy young adults, *Sleep*, 18(5): 334-341
15. A. Rechtschaffen and A. Kales, *A Manual of Standardized Terminology, Techniques and Scoring Sleep Stage of Human Subjects*, Washington D.C., Pub. Hth, Service U.S. Gov. Printing Off., 1968.
16. Steven M. Pincus, Ary L. Goldberger, Physiological time-series analysis: what does regularity quantify?, *Am. J. Physiol.* 266 (Heart Circ. Physiol. 35): H1643-H1656, 1994.
17. Daniel Abasolo, R. Hornero, P. Espino, J. Poza, C. I. Sanchez, R. de la Rosa, Analysis of regularity in EEG background activity of Alzheimer's disease patients with Approximate Entropy, *Clinical Neurophysiology* 116(2005) 1826-1834
18. J. Richman, J. R. Moorman, Physiological time series analysis using approximate entropy and sample entropy, *Am. J. Physiol. Heart Circ Physiol.*, vol. 278, H2039-H2049, 2000.
19. Rechtschaffen, A., & Siegel, J.M. (2000). *Sleep and dreaming. Principles of Neuroscience* (4th ed.). 936-947.
20. Allen J. Blaivas, Rajeshri Patel, Kenneth Antigua, David Hom and Hormoz Ashtyani, Quantifying microsleep to assess sleepiness, *Chest* 128 (4): 380S. (2005)
21. John D., Catherine T. MacArthur, Research Network on Socioeconomic Status and Health, [online] 25th July 1999, <http://www.macses.ucsf.edu/Research/Allostatic/notebook/sleep.html>.
22. Stepanski EJ, Sleep fragmentation and daytime sleepiness, *Sleep*. 2002 May 1; 25(3):268-76

23. Karine Spiegel, Kristen Knutson, Rachel Leproult, Esra Tasali, and Eve Van Cauter, Sleep loss: a novel risk factor for insulin resistance and Type 2 diabetes, *J Appl Physiol.* 2005 Nov;99(5):2008-19
24. James E. Gangwisch, [online] April 4, 2006, <<http://www.sciencedaily.com/releases/2006/04/060403230551.htm>>
25. Gerard J. Tortora, Sandra Reynolds Grabowski, Principles of anatomy and physiology, pp.517-519, Edition 10th, John Wiley & Sons.
26. [Online] 16 July 2008, <http://en.wikipedia.org/wiki/Cerebral_cortex>
27. [Online] 22 June 2008, <<http://en.wikipedia.org/wiki/Pons>>
28. Michael J. Drinnan, Alan Murray, Clive J. Griffiths, and G. John Gibson, Interobserver variability in recognizing arousal in respiratory sleep disorders, *AM J RESPIR CRIT MED* 1998; 158:358-362
29. James Pardey, Stephen Roberts, Lionel Tarassenko, and John Stradling, A new approach to the analysis of the human sleep/wakefulness continuum, *J. Sleep Res.* (1996) 5, 201-210)
30. Borbely A, Baumann F, Brandeis D, Strauch I, Lehmann D, Sleep deprivation: effects on sleep stages and EEG power density in man, *Electroencephalogr Clin Neurophysiol* 1981;51:483-93
31. F. Morisson, G. Lavigne, D. Petit, T. Nielsen, J. Malo, J. Montplaisir, Spectral analysis of wakefulness and REM sleep EEG in patients with sleep apnoea syndrome, *Eur Respir J* 1998; 11:1135–1140.
32. Dijk D-J, Beersma DGM, Bloem GM, Sex differences in the sleep EEG of young adults: visual scoring and spectral analysis, *Sleep* 1989; 12:500-7.
33. [Online] 12 Oct 2007, <<http://www.jhucct.com/shhs/>>
34. P. He, G. Wilson, C. Russell, Removal of ocular artifacts from electroencephalogram by adaptive filtering, *Medical & Biological Engineering & Computing*, vol. 42, pp-407-412, 2004.
35. T. Jung, S. Makeig, M. Westerfield, J. Townsend, E. Courchesne, T. J. Sejnowski, Removal of eye activity artifacts from visual event-related potentials in normal and clinical subjects, *Clinical Neuro.*, vol. 111, pp-1745-1758, 2000.

36. R. Acharya, O. Faust, N. Kannathal, T. Chua, S. Laxminarayan, Non-linear analysis of EEG signals at various sleep stages, *Comp. Methods and Pgm. Biomed.*, vol. 80, pp-37-45, 2005
37. S. M. Pincus, Assessing Serial Irregularity and Its implications for Health, *Ann. NY Acad Sci.*, vol. 954, pp-245-267, 2001
38. Michele Ferrara, Luigi De Gennaro, Giuseppe Curcio, Riccardo Cristiani, Mario Bertini, Regional differences of the temporal EEG dynamics during the first 30 min of human sleep, *Neuroscience Research* 44 (2002) 83_/89.
39. Blessy Anu Mathew, Entropy of Electroencephalogram (EEG) signals changes with sleep state, Master's thesis, University of Kentucky, Biomedical Engineering, 2006.
40. Sunao Uchida, Tom Maloney, Irwin Feinberg, Sigma (12-16 Hz) and beta (20-28 Hz) EEG discriminate NREM and REM sleep, *Brain Research* 659 (1994) 243-248.
41. María Corsi-Cabrera, Miguel Angel Guevara, Yolanda Del Río-Portilla MC, Consuelo Arce, and Yolanda Villanueva-Hernández, EEG Bands During Wakefulness, Slow-Wave and Paradoxical Sleep as a Result Of Principal Component Analysis in Man, *SLEEP*, Vol. 23, No. 6, 2000
42. Czigler B, Csikos D, Hidasi Z, Anna Gaal Z, Csibri E, Kiss E, Salacz P, Molnar M, Quantitative EEG in early Alzheimer's disease patients - power spectrum and complexity features, *Int J Psychophysiol.* 2008 Apr;68(1):75-80.
43. Verner Knott, Erich Mohr, Colleen Mahoney, Vadim Ilivitsky, Quantitative electroencephalography in Alzheimer's disease: comparison with a control group, population norms and mental status, *J Psychiatry Neurosci* 2001; 26(2):106-16
44. Cajochen C, Munch M, Knoblauch V, Blatter K, Wirz-Justice A, Age-related changes in the circadian and homeostatic regulation of human sleep, *Chronobiol Int.* 2006; 23(1-2):461-74.
45. O'Driscoll, Denise M., Guy E. Meadows, Douglas R. Corfield, Anita K. Simonds, and Mary J. Morrell, Cardiovascular response to arousal from sleep under controlled conditions of central and peripheral chemoreceptor stimulation in humans, *J Appl Physiol* 96: 865-870, 2004.

46. Mark L. Unruh, Mark H. Sanders, Susan Redline, Beth M. Piraino, Jason G. Umans, Terese C. Hammond, Imran Sharief, Naresh M. Punjabi, and Anne B. Newman, Sleep Apnea in Patients on Conventional Thrice-Weekly Hemodialysis: Comparison with Matched Controls from the Sleep Heart Health Study, *J Am Soc Nephrol* 17: 3503–3509, 2006.
47. Fabrizio De Carli, Lino Nobili, Paola Gelcich, Franco Ferrillo, A method for the automatic detection of arousals during sleep, *Sleep*, vol.22, No5, 1999.
48. R. Armitage and H.P. Roffwarg, Distribution of period-analyzed delta activity during sleep. *Sleep* 16 (1993), pp. 762–763
49. P. M. Clarkson, *Optimal and Adaptive Signal Processing*. pp. 89-98, CRC Press, Ann Arbor, 1993.
50. The New York Times, [online] October 23 2007, http://www.nytimes.com/2007/10/23/health/23memo.html?_r=3&8dpc&oref=slogin&oref=slogin&oref=slogin
51. Sunao Uchida, Irwin Feinberg, Jonathan D. March, Yoshikata Atsumi, Tom Maloney, A comparison of period amplitude analysis and FFT power spectral analysis of all-night human sleep EEG, *Physiology & Behavior*, Vol. 67, No. 1, pp. 121–131, 1999.

VITA

Date and place of birth:

- 05-20-1985, Hyderabad, INDIA

Educational institutions attended and degrees already awarded:

- B. Tech., Bachelors in Electronics and Instrumentation Engineering, Jawaharlal Nehru Technological University, AP,INDIA

Professional positions held:

- Research Assistant, Computational Physiology Laboratory, University of Kentucky

Typed name of student on final copy

- Swetha Vennelaganti