



2017

SEGMENT-BASED RELIABILITY ASSESSMENT FOR WATER DISTRIBUTION NETWORKS

Erika Hernandez Hernandez

University of Kentucky, ehernandez@uky.edu

Digital Object Identifier: <https://doi.org/10.13023/ETD.2017.431>

[Click here to let us know how access to this document benefits you.](#)

Recommended Citation

Hernandez Hernandez, Erika, "SEGMENT-BASED RELIABILITY ASSESSMENT FOR WATER DISTRIBUTION NETWORKS" (2017). *Theses and Dissertations--Civil Engineering*. 59.
https://uknowledge.uky.edu/ce_etds/59

This Master's Thesis is brought to you for free and open access by the Civil Engineering at UKnowledge. It has been accepted for inclusion in Theses and Dissertations--Civil Engineering by an authorized administrator of UKnowledge. For more information, please contact UKnowledge@lsv.uky.edu.

STUDENT AGREEMENT:

I represent that my thesis or dissertation and abstract are my original work. Proper attribution has been given to all outside sources. I understand that I am solely responsible for obtaining any needed copyright permissions. I have obtained needed written permission statement(s) from the owner(s) of each third-party copyrighted matter to be included in my work, allowing electronic distribution (if such use is not permitted by the fair use doctrine) which will be submitted to UKnowledge as Additional File.

I hereby grant to The University of Kentucky and its agents the irrevocable, non-exclusive, and royalty-free license to archive and make accessible my work in whole or in part in all forms of media, now or hereafter known. I agree that the document mentioned above may be made available immediately for worldwide access unless an embargo applies.

I retain all other ownership rights to the copyright of my work. I also retain the right to use in future works (such as articles or books) all or part of my work. I understand that I am free to register the copyright to my work.

REVIEW, APPROVAL AND ACCEPTANCE

The document mentioned above has been reviewed and accepted by the student's advisor, on behalf of the advisory committee, and by the Director of Graduate Studies (DGS), on behalf of the program; we verify that this is the final, approved version of the student's thesis including all changes required by the advisory committee. The undersigned agree to abide by the statements above.

Erika Hernandez Hernandez, Student

Dr. Lindell Ormsbee, Major Professor

Dr. Y. T. Wang, Director of Graduate Studies

SEGMENT-BASED RELIABILITY ASSESSMENT FOR WATER
DISTRIBUTION NETWORKS

THESIS

A thesis submitted in partial fulfillment of the
requirements for the degree of Master of Science
in Civil Engineering in the College of Engineering
at the University of Kentucky

By

Erika Hernandez Hernandez

Lexington, Kentucky

Director: Dr. Lindell Ormsbee, Director Kentucky Water Resources Research
Institute

Lexington, Kentucky

2017

Copyright© Erika Hernandez Hernandez 2017

ABSTRACT OF THESIS

SEGMENT-BASED RELIABILITY ASSESSMENT FOR WATER DISTRIBUTION NETWORKS

In recent years, water utilities have placed a greater emphasis on the reliability and resilience of their water distribution networks. This focus has increased due to the continuing aging of such infrastructure and the potential threat of natural or man-made disruptions. As a result, water utilities continue to look for ways to evaluate the resiliency of their systems with a goal of identifying critical elements that need to be reinforced or replaced. The simulation of pipe breaks in water reliability studies is traditionally modeled as the loss of a single pipe element. This assumes that each pipe has an isolation valve on both ends of the pipe that can be readily located and operated under emergency conditions. This is seldom the case. The proposed methodology takes into account that multiple pipes may be impacted during a single failure as a result of the necessity to close multiple isolation valves in order to isolate the “segment” of pipes necessary to contain the leak.

This document presents a simple graphical metric for use in evaluating the performance of a system in response to a pipe failure. The metrics are applied to three different water distribution systems in an attempt to illustrate the fact that different pipe segments may impact system performance in different ways. This information is critical for use by system managers in deciding which segments to prioritize for upgrades or replacement.

KEYWORDS: Reliability, Water Distribution Networks, Segment, Valve, Model
Database

Erika Hernandez Hernandez

Author

August 25, 2017

Date

SEGMENT-BASED RELIABILITY ASSESSMENT FOR WATER
DISTRIBUTION NETWORKS

By

Erika Hernandez Hernandez

Lindell Ormsbee

Director of Thesis

Y.T.Wang

Director of Graduate Studies

August 25, 2017

Date

To my grandparents.

ACKNOWLEDGEMENTS

In first place I would like to extend my sincerest gratitude to my advisor Dr. Lindell Ormsbee for his guidance, support, and advice throughout this process. Without his thoughtful questions and patient revisions this work wouldn't be possible. I would also like to thank Dr. Scott Yost for his encouragement and willingness to always discuss any issue at hand.

I would like to acknowledge the faculty at the University of Kentucky including Dr. Lindell Ormsbee, Dr. Y.T. Wang, Dr. James Fox, Dr. Scott Yost, and Dr. Kelly Pennell, who have helped me expand my knowledge and showed me the joy that can be found in being an engineer.

Finally, I would like to thank my family for their unwavering support and reassurance. They have made the journey more memorable.

TABLE OF CONTENTS

ACKNOWLEDGEMENTS	iii
LIST OF TABLES	vi
LIST OF FIGURES	vii
1. INTRODUCTION	1
1.1. Background	1
1.2. Research Task Description	2
1.3. Objectives of Research	4
1.4. Contents of Thesis.....	5
2. WATER DISTRIBUTION NETWORKS	6
2.1. Hydraulic Network Equations.....	8
2.2. Water Distribution Systems Modeling.....	9
2.3. Extended Periods Simulations (EPS).....	11
2.4. EPANET	12
3. LITERATURE REVIEW	14
3.1. Resilience.....	18
3.2. Robustness	20
3.3. Redundancy.....	23
3.4. Reliability.....	27
4. WATER DISTRIBUTION SYSTEM RESEARCH DATABASE	36
4.1. Database Development	36
4.2. Kentucky Model Development	37
4.2.1. Model Creation	37
4.2.2. Additional Modifications	40
4.2.3. Classification Methodology	42
5. METHODOLOGY	44
5.1. Segment-Based Analysis	44
5.1.1. Segment Identification	46
5.1.2. Loss of Nodal Connectivity as Measured by Reduction in Total Demand..	48
.....	48
5.1.3. Loss of Pressure Dependent Demands.....	52
5.1.4. Increase of Water Age	55
5.2. EPANET Toolkit	57
5.3. Analysis Sequence	58

6.	RESULTS	60
6.1.	Database Systems.....	60
6.2.	Reliability Assessment Results and Discussion.....	61
6.2.1.	Hanoi System Results	66
6.2.2.	Federally Owned Water Main (FOWM) Results.....	69
6.2.3.	ANYTOWN System Results	73
6.2.4.	General Discussion	76
6.2.5.	Composite Metric.....	77
6.2.6.	Composite Metric Results.....	78
7.	SUMMARY and CONCLUSIONS	81
7.1.	Summary	81
7.2.	Conclusions.....	82
7.3.	Potential Applications.....	82
7.4.	Limitations	83
7.5.	Future Research	83
APPENDIX A.	Contents of Water Distribution Database for Research Applications.	85
APPENDIX B.	Network Plots with Node IDs and Tabulated Segment Components	89
APPENDIX C.	Network Plots Color Coded by Segment	96
APPENDIX D.	Additional Information for Segments Identified.....	100
APPENDIX E.	Composite Metric Results for the Test Networks.	104
APPENDIX F.	MATLAB® Code	106
REFERENCES	117
VITA	125

LIST OF TABLES

Table 3-1 Resiliency metrics	22
Table 3-2 Redundancy metrics	26
Table 3-3 Definition of reliability (from multiple sources)	28
Table 3-4 Reliability metrics	35
Table 6-1 Performance metrics and segment information for Hanoi	68
Table 6-2 Performance metrics and segment information for FOWM.....	72
Table 6-3 Performance metrics and segment information for ANYTOWN.....	75
Table 6-4 Summary of critical segments for test networks	76
Table 6-5 Critical segments by network using a composite metric	78
Table 6-6 Composite metric average by test network	80

LIST OF FIGURES

Figure 1-1 Predicted break rate per mile per year with age (Clark and Thurnau 2011) 2	
Figure 2-1 Functional components of a water utility. (Cullinane 1989).....8	
Figure 2-2 Data flow diagram for EPANET’s solver (Rossman 2000)..... 13	
Figure 3-1 Types of failure and water distributions systems reliability. Adapted (Gheisi, Forsyth et al. 2016) 15	
Figure 3-2 Relation between Reliability, Robustness, Resilience, and Redundancy .. 16	
Figure 4-1 Model development flowchart (Jolly, Lothes et al. 2014)38	
Figure 4-2 Examples of typical classifications for Water Distribution Systems42	
Figure 4-3 Classification Algorithm (Hoagland, Schal et al. 2015, Hoagland 2016)..43	
Figure 5-1 Illustration of arc node diagram for link-node system diagram.45	
Figure 5-2 Segment Identification Algorithm.....47	
Figure 5-3 ‘Check Node’ function for Segment Identification.....49	
Figure 5-4 Illustration of the typical representation of a pipe breakage in a water distribution system50	
Figure 5-5 Illustration of the affected segment and unintended isolations for a pipe break.....50	
Figure 5-6 Effect on pressure independent demand. (a) Before failure, (b) After segment failure.51	
Figure 5-7 Pressure Dependent Demand function53	
Figure 5-8 Device Sequence (Sayyed, Gupta et al. 2014, Pacchin, Alvisi et al. 2017)54	
Figure 5-9 Effect on Pressure Dependent Demand after segment failure.55	
Figure 5-10 Effect on water age. (a) Before failure, (b) After segment failure.56	
Figure 5-11 Reliability Assessment Model.....57	
Figure 5-12 Performance histogram representing loss nodal connectivity measured as the reduction in demand.....58	
Figure 5-13 Example of how the software can be used to identify possible upgrades to increase reliability in a water distribution system.....59	
Figure 6-1 Active valve representation in KYPIPE (left) and EPANET (right)61	
Figure 6-2 Hanoi network with color coded segments63	
Figure 6-3 FOWM network with color coded segments64	

Figure 6-4 ANYTOWN network with color coded segments	65
Figure 6-5 Performance Metrics for the Hanoi network by segment (a) Fraction of original demand affected considering Pressure Independent Demand (b) Fraction of original demand affected considering Pressure Dependent Demand ($P_{\min}=20$ psi), (c) Fraction of original demand affected considering Pressure Dependent Demand ($P_{\min}=40$ psi) (d) Fraction of original weighted water age increased.....	67
Figure 6-6 Hanoi network with highlighted critical segments.....	68
Figure 6-7 Performance Metrics for the FOWM network by segment (a) Fraction of original demand affected considering loss of connectivity (b) Fraction of original demand affected considering Pressure Dependent Demand ($P_{\min}=20$ psi), (c) Fraction of original demand affected considering Pressure Dependent Demand ($P_{\min}=40$ psi) (d) Fraction of original weighted water age increased	71
Figure 6-8 FOWM network with highlighted critical segments.....	72
Figure 6-9 Performance Metrics for the ANYTOWN network by segment (a) Fraction of original demand affected considering Pressure Independent Demand (b) Fraction of original demand affected considering Pressure Dependent Demand ($P_{\min}=20$ psi), (c) Fraction of original demand affected considering Pressure Dependent Demand ($P_{\min}=40$ psi) (d) Fraction of original weighted water age increased.....	74
Figure 6-10 ANYTOWN network with highlighted critical segments.....	75
Figure 6-11 Composite metric (left axis) and number of isolation valves (right axis, and symbolized with blue circular marks) by segment.	79

1. INTRODUCTION

1.1. Background

Over two decades ago the American Water Works Association (2012) declared that the time for the replacement and rebuilding of water and wastewater infrastructure was steadily approaching, and significant investments would be required. A substantial portion of the water infrastructure in the country, as many of other public assets built over 50 years ago, are now reaching the end of their useful life; which combined with rapid growth and changes in demographics have placed water distribution pipe networks at a state that requires revitalization (AWWA 2012).

The continuing aging infrastructure along with the growing threat of natural and man-made disruptions have led water utilities to place a greater emphasis on developing better strategies to minimize the impact on the system users when a failure event occurs (i.e., improve the reliability of the system). Utilities in charge of operating and maintaining the distribution systems must address this concern with limited resources, while maintaining acceptable levels of service, managing risk, and considering the possible socio-economic impact on the community.

Usually the design and expansion of water distribution systems has involved large capital investments and conventionally least-cost approaches have been used to define the system configuration. This process typically leads to a design solution that may guarantee the minimum cost, but frequently does not include a reliability component for the system.

In general, water distribution systems are considered fairly reliable when compared to other infrastructure networks, given the fact that the useful life of the distribution network components can very well span from 40 to a 100 years (Mays 2000). However, given the vast areas typically served by such systems and the large number of system components involved, WDS are still particularly susceptible to multiple malfunctions during their lifetime. Pipe breakages can be related to age and diameter of the pipe (Figure 1-1). Previous research has revealed that the probability of pipe failure increases as the pipes age and diameters decrease (Kettler and Goulter 1985, Pelletier, Mailhot et al. 2003, Clark and Thurnau 2011). Changes in pressure and in demand have also been linked to pump and pipe failures. Other causes of pump failure include: the mechanical components of the pumps (bearing, seals, lubrication in the pump) which are affected

by fatigue and wear, and situations when pumping stations may be put out of service by an electric outage (Karassik, Messina et al. 2001). Thus, while failure events can be expected to occur during the lifetime of the water distribution systems, it is advantageous to develop strategies that can minimize their impact.

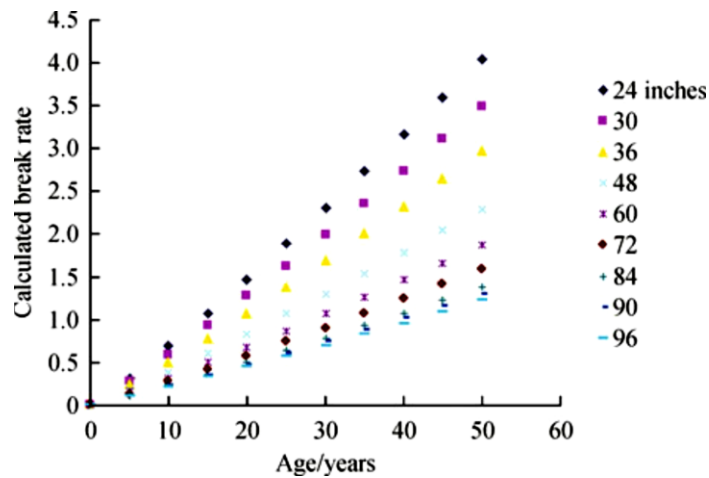

Figure 1-1 Predicted break rate per mile per year with age (Clark and Thurnau 2011)

In addition, it should be recognized that most water distribution systems in fact serve two major purposes: 1) supply of potable water for safe consumption, and 2) supply of water for fire suppression. In most cases, the associated fire demand will be the determining factor in selecting the size of pipes in a water distributions system. In the case of an event involving a disaster, the latter function of the system may in fact be the most critical and if incapacitated could lead to a much greater impact than that associated with the original event. The likelihood of failure of an element of the network, and its impact on the system is a tangible concern. Thus, utilities look for ways to evaluate the resiliency of their systems with a goal of identifying critical elements that need to be reinforced or replaced.

1.2. Research Task Description

Despite recent research into technologies used to assess and decrease the vulnerability of water distribution systems to chemical and biological threats (Ali S. Khan 2001, Gleick 2006), the physical infrastructure remains one of the most vulnerable components of the total system and the one that is most likely to be subject to disruption.

Water distribution systems are generally considered reliable when they have the ability to perform their function (i.e., deliver water at adequate pressure and quality to

the user), particularly during critical circumstances. Reliability can be improved in numerous ways, and multiple approaches have been proposed throughout the years (Goulter and Coals 1986, Goulter and Coals 1986, Goulter 1987, Su, Mays et al. 1987, Goulter and Bouchart 1990, Ormsbee and Kessler 1990, Fujiwara and Tung 1991, Gupta and Bhave 1996, Khomsi, Walters et al. 1996, Prasad and Park 2004). Most of these approaches typically include designing the water distribution systems with sufficient redundancies so that the system can still meet its operational objectives even if the network loses key components.

In developing methodologies for improving system reliability, some type of quantifiable metric is necessary. Once developed, the metric can then be evaluated under different failure scenarios such as: broken pipes, pump failures, power outages, valve failures, etc. Different strategies for improving the system reliability can then be evaluated using the same metric as a basis for selecting the least cost strategy for a given system. In the current research, the focus will be limited to a consideration of pipe failures, although the general methodology can be expanded to other component failures as well.

Little attention has been devoted to the multi-aspect nature of reliability in water distribution systems (Gheisi, Forsyth et al. 2016), and previous research has often fell short in characterizing the total effect of a broken link in a distribution network. The proposed method intends to address these aspects using a combination of performance metrics, and considering the location of isolation valves in the analysis.

Historically, most researchers have modeled pipe failure events by assuming that each failed pipe can be immediately isolated from the rest of the network (Morgan and Goulter 1985, Jowitt and Xu 1993, Khomsi, Walters et al. 1996, Ostfeld, Kogan et al. 2001, Gheisi and Naser 2014, Gupta, Kakwani et al. 2015), thus limiting the impact of the failure to a single pipe. This assumes that each pipe has an isolation valve on both ends of the pipe that can be readily located and operated under emergency conditions (Walski 1993). This is seldom the case.

The proposed methodology will include the actual valve locations when determining the spatial extent of the impact of a single pipe failure. Thus, the loss of a particular pipe segment may ultimately lead to several pipes being taken out of service.

The smallest section of the network that can be enclosed by the surrounding isolation valves is called a *segment* (Walski 1993). It should be recognized that when a segment is taken out of service, this may result in the loss of service to those customers connect to those pipes as well as other customers whose service has now been isolated by the isolation of the original pipe segment. The performance of the network should then be estimated using a reliability metric that quantifies the loss of this segment as well as any additional segments that are further isolated from the system. This research will quantify system performance using three different metrics: loss of water supply due to loss of nodal connectivity (either directly or indirectly), loss of water supply due to a decrease in supply pressure, and an increase in water age. A fourth composite metric will also be examined as a way to better capture the complexities of the network interactions.

The proposed performance metrics will be evaluated using a simplified assessment tool that has been developed using the EPANET hydraulic engine and the associated toolkit. The objective of the developed software is to provide a simple tool that can be used by small water distribution systems operators to perform reliability assessments of their systems which can then be used to prioritize maintenance and expansion efforts.

1.3. Objectives of Research

This research has four objectives. The first objective is to review different performance metrics for use in evaluating network reliability and then to select a set for use in this study. The second objective is to develop a reliability assessment methodology that incorporates the selected performance metrics. The third objective is to develop a computer algorithm for use in performing a reliability assessment that incorporates the reliability metrics. The algorithm will be developed using EPANET and the associated EPANET toolkit (Rossman 1999). The fourth objective is to apply the algorithm to three water distribution systems that have been repeatedly analyzed in the public literature. These systems include: 1) the Hanoi water distribution system (Fujiwara and Khang 1990), 2) the federally owned water main (FOWM) system (Chase, Ormsbee et al. 1988), and 3) the ANYTOWN system (Walski, Brill et al. 1987). The results of these applications will then be examined for general observations or practical applications.

1.4. Contents of Thesis

The thesis is divided into the following chapters.

1. Introduction: this chapter provides background information on the need for reliability research in water distribution systems.
2. Water distribution systems: this chapter provides an overview on water distribution system, and the modeling process.
3. Literature review: this chapter reviews previous research on the topic of reliability as applied to water distribution systems. This includes a review of different reliability metrics as well as strategies for applying such metrics.
4. Water Distribution Systems Research Database: this chapter reviews the creation, content, and application of the online Kentucky Water Distribution System Reaction database. It also summarizes the topological methodology used to classify the water distribution systems contained in the database.
5. Methodology: this chapter presents the proposed reliability metrics and the procedure for performing a reliability assessment. The MATLAB® algorithms and functions used as part of the algorithm are summarized in Appendix E.
6. Results: this chapter presents the results from the application of the developed methodology to several different water distribution systems reported in literature.
7. Summary and Conclusions: this chapter provides a summary of the findings of the research along with conclusions and recommendations for future research.

Appendix A, this section contains details of the Water Distribution Systems Database for Research Purposes

Appendix B, this section contains the network plots and tabulated components of the network segments (nodes and links)

Appendix C, this section contains the network plots identifying the segments.

Appendix D, this section contains additional information on the segments identified.

Appendix E, this section contains the assessment results using the composite metric.

Appendix F, this section contains the functions and algorithms written in MATLAB used to perform the analysis

2. WATER DISTRIBUTION NETWORKS

Water is an essential element to human life, and as such the access to it has been a concern to human populations since ancient times. The use of one of the first closed systems using terracotta pipes to transport water for human consumption can be traced back as far as 3500 years ago in Knossos (Crete). Other examples of early water supply systems are the water tunnels (sinnōr) built in Palestine and Syria around 1200 BC and artificial underground channels (qanāts or kanāts) built in Persia around 750 BC. Similar systems have also been discovered in Saudi Arabia, Pakistan, Iran, Oman, Egypt, and in Yemen (Biswas 1985). The availability of water supply has been a concern since the early human settlements were established and it still continues to be a pressing issue for society today (Swamee and Sharma 2008).

A water distribution network is typically composed of a series of links that are joined together by junction nodes for the purposes of distributing water to customers. The distribution system will typically have one or more supply points or nodes along with a combination of pumps, reservoirs, tanks, valves and hydrants. (Gunawan, Schultmann et al. 2017). In this context a link is understood as a conduit that transports water from one place to another (pipes are links with commercially available diameters), and a node is where two or more links meet. For modeling purposes, nodes can be characterized as source nodes (a node which supplies water to the network from an external source), demand nodes (a node from which water is withdrawn) and intermediate nodes (Bhave 2003, Bhave and Gupta 2006). Although technically the water to customers is typically supplied through individual service connection piping that runs from a pipe in a street (through a residential or commercial water meter) to a home or business, most water distribution models will approximate this reality by lumping half of the demands along a street at one junction node and the other half at the other junction node. Theoretically, the demands through each service connection (or at each junction) will be dependent upon the difference between the supply pressure at the service connection (or junction node) and the discharge pressure (typically atmospheric pressure) at the point of discharge (e.g. faucet or fire hydrant). Thus, as the supply pressure decreases, the demand or water supplied through the service connection will decrease (Wagner, Shamir et al. 1988). While this can be hydraulically modeled, most water distribution models are formulated based on an assumption that the demands (or amount of water supplied) will remain constant as long as there is an

adequate supply pressure (Walski, Blakley et al. 2017). Thus, the results from the model are assumed to be reliable (i.e. the demands can be adequately supplied) as long as all the pressures are above some stated threshold (e.g. 20 for fire flow demands, 40 psi for peak hour demands). In this study, reliability metrics will be developed that incorporate pressure dependent demands.

Water supply systems are managed, constructed, operated and maintain by both private and public water utilities. The concerns of these utilities and the water distribution system can be characterized under six major functional components (Figure 2-1): source development, raw water transmission, raw water storage, treatment, finished water storage, finished water distribution and subcomponents (Mays 2000). During the design and operational processes the concern for reliability is present for all functional objectives. With the multitude of interconnected systems and components, a system disruption caused by the failure of a water distribution system is unavoidable. These disruptions have a negative impact on safety, economic security, public health, and social wellbeing (Gunawan, Schultmann et al. 2017). Thus, the systems will eventually encounter competing objectives between minimizing the cost (energy from pump operation, disruptions) and maximizing the reliability (Mays 2000). This research will focus on the impact of individual pipe failures on system reliability as exacerbated by the impact of the loss of additional pipes as a consequence of the lack of adequate isolation valves.

In order to fulfill its function, the water distribution should be designed so that the final configuration will satisfy the minimal nodal pressure and the required flow (Swamee and Sharma 2008). With increasing network sizes and the complexity of growing water distribution networks, such analyses cannot be completed by hand. As a result, computer simulation models have been developed. Such models can be used to analyze capital improvements, locate and size specific components, develop pump scheduling, turnover analysis, energy optimization, water quality analysis, fire-flow studies and vulnerability/ reliability studies (Mays 2000). This study will employ a water distribution model (i.e. EPANET) in evaluating the developed reliability metrics.

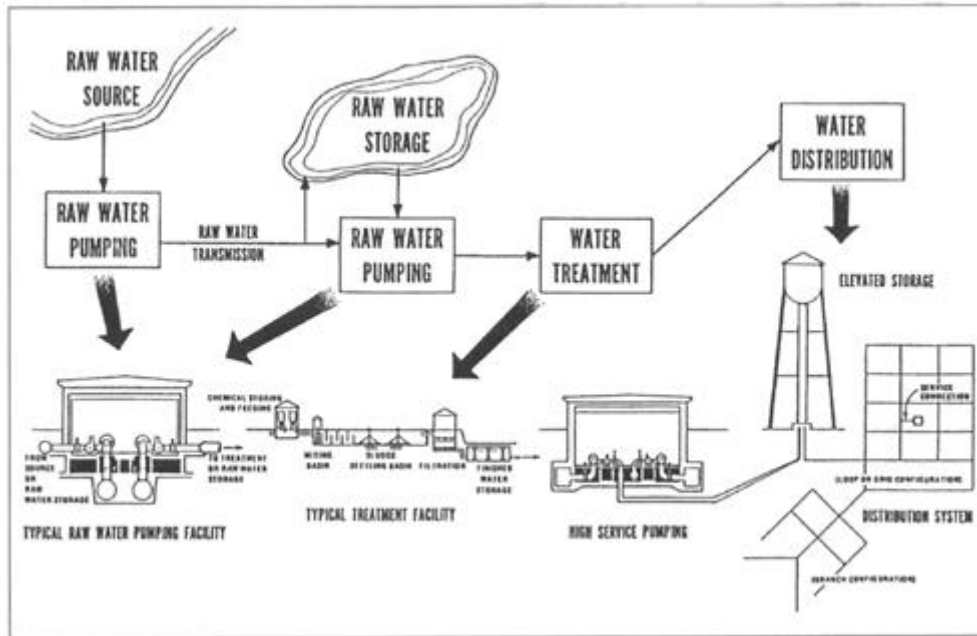

Figure 2-1 Functional components of a water utility. (Cullinane 1989)

2.1. Hydraulic Network Equations

The flow in a network under steady state can be mathematically described using the principles of mass and energy conservation. The fundamental equations used to describe the behavior of a network are presented in this section.

The flows and pressures in a water distribution system can be determined by solving two sets of conservation of mass and conservation of energy equations. The conservation of mass for a junction can be expressed as equation .

$$\sum_i Q_{ij} - \sum_k Q_{jk} = D_j \quad (2-1)$$

Where Q_{ij} is the flow in the link connecting i and j , it is positive when flow goes from i to j ; similarly with Q_{jk} . D_j Is the demand at node j .

For the hydraulic heads (pressure can be later derived after considering elevation), the principle of conservation of energy is used to write an expression as,

$$H_i - H_j = aQ_{ij}|Q_{ij}^{b-1}| \quad (2-2)$$

Where H_i = the hydrostatic head at the upstream end of a pipe and H_j = the hydrostatic head at the downstream end of a pipe, and a and b are coefficients that are dependent upon the equation used to characterize friction loss through a pipe. When the Hazen-

Williams equation is used for calculating headloss, $a = \frac{10.69L}{C^{1.85}d^{4.87}}$ (L is the pipe length [m], d is the pipe diameter [m] and C is a roughness coefficient), $b = 1.85$. If the Darcy-Weisbach equation is used for calculating headloss, then $a = \frac{8fL}{g\pi^2d^5}$ and $b = 2$.

A more general expression for the conservation of energy along the path between any pair of nodes i and j , along pipe l can be expressed as:

$$H_i - H_j = \sum_{all\ l \in\ path\ i-j} a Q_l |Q_l^{b-1}| \quad (2-3)$$

In a closed loop, one which begins and ends in the same node (i.e. $i = j$), the net energy loss is zero.

$$H_i - H_j = 0 \quad (2-4)$$

In the case of a path between two points with known total energy ΔE (e.g., reservoirs, tanks) can be expressed as:

$$H_i - H_j = \Delta E \quad (2-5)$$

Several different algorithms have been proposed for solving these equations, ranging from the Hardy Cross Method (Cross 1936), to the most recent method proposed by Todini and Pilati (1988). In each case the nonlinear energy equations are approximated by a set of algebraic equations (i.e. a first order Taylor Series approximation) which are then solved either simultaneously or one at a time in terms of nodal heads or pipe or path adjustment factors (Wood 1981, Boulos, Lansey et al. 2006). These methods are discussed in more detail in the following section.

2.2. Water Distribution Systems Modeling

The traditional water distribution network analysis problem involves a determination of pressures and flows in the pipe network in response to a given set of pressure or hydraulic grade boundary conditions (e.g. at tanks, reservoirs, and pump stations) and an associated set of discharge demands (typically expressed as average values and assigned at junction nodes) (Boulos, Lansey et al. 2006, AWWA 2011). The network problem and its hydraulic or water quality behavior can be explored using different numerical analysis techniques. However, the first methods for solving the associated conservation of mass and conservation of energy equations were proposed by Hardy Cross in 1936 (Cross 1936). The two methods proposed by Cross are typically

referred to as the “Single Loop Method” or the “Single Node Method” in which the conservation of energy equations are expressed in terms of a flow adjustment factor for each loop in the system or the conservation of mass equations are expressed in terms of a head adjustment factor for each node in the system. The resulting set of equations (i.e. L = number of loops for the Single Loop Method or N = number of junction nodes for the Single Node Method) are then solved iteratively one at a time and in repeated succession until the adjustment factors converge to a balanced solution. In comparing these methods, Rayes and Wood found that while both methods may fail to converge for larger and more complex systems, the Single Loop Method is generally more numerically stable than the Single Node Method (Wood and Rayes 1981).

Although somewhat tedious, small networks can be solved by hand using either the Single Loop Method or the Single Node Method, but as network problems increased in size and complexity the use of computer-aided models became a necessity. This need served as a catalyst for more computationally efficient methods such as the Simultaneous Node Method (Martin and Peters 1963, Shamir and Howard 1968), the Loop Method (Epp and Fowler 1970, Jeppson 1976), the Simultaneous Pipe Method (Wood and Charles 1972, Jeppson 1976) and the Simultaneous Network Method (Todini and Pilati 1988)

The development of such solution algorithms, and the growing computational power have fostered the appearance of several commercial software packages during the last several decades, including KYPIPE and EPANET (actually available for free from the USEPA).

With the increased availability of several software packages, the remaining challenge facing most water engineers is how to use such computer models. A set of suggested steps for users includes (Walski 1983, Mays 2000):

1. Define the kind of question the model should address.
 - Would a simulation or an optimization approach be required?
 - Should a steady-state or an unsteady- state model be used?
2. Select the software package. Possible considerations include: ease of operation, data input format, compatibility with other platforms, method for handling pumps and valves, output format.

3. Define the components that would be included and collect information to characterize them. For instance: as-built diagrams, maps, and water use.
4. Determine the water usage for the analysis period.
5. Cross check and code data into the required input format
6. Check how the network is operated during the analysis period, collect calibration data
7. Calibrate the model against field observation
8. Run model, answer the question intended for the model

As with other models, the quality of the network analysis is dependent on the quality of the input data. One of the common difficulties encountered by modelers is how to accurately characterize demand. The available data for demand is generally limited by accuracy and extent of the available metering data. Thus, more information is needed on loading variations in time, space and by different types of users; how these would compare from one network to another; and what is the likelihood of experiencing extreme events (AWWA 1974). Furthermore, the question of demand can become increasingly complicated as forecasting is also considered.

The demands placed in a water distribution system are a major factor in defining the behavior of the system. Recognizing that the information on water consumption may not be as rigorous as desired, most modelers can develop an initial model scenario using estimates. The common methods to estimate demand include: defining water usage by land use, usage by counting buildings, usage by meter routes or assigning meters to nodes in the network. The rates estimates can then be adjusted to reflect seasonal and daily variations during the analysis period (Mays 2000, AWWA 2011).

2.3. Extended Periods Simulations (EPS)

In order to perform a water quality analysis some type of extended period hydraulic simulation is required (EPS). The extended period simulation will reflect the changes in customer demand and other boundary conditions for the system (e.g. water tank levels, pump discharge pressures, etc.). In performing an extended period simulation of a water distribution system, the modeler sets the initial boundary conditions along with an incremental time step. The computer model is then used to perform a steady state simulation using the initial boundary conditions. The flows and pressures that result from this simulation are used along with the incremental time step to forecast the

boundary conditions at the end of the time increment. The computer model is then run with these new boundary conditions, forecasts are then made, new boundary conditions are established and additional simulations are run until the entire simulation period has been analyzed. In most cases, the tank levels at the end of an incremental simulation period can be forecast using a simple Eulerian approximation, where for each storage tank (S) the change in storage can be expressed as,

$$\frac{dV_t}{dt} = Q_s \quad (2-6)$$

And

$$H_S = E_S + h(V_S) \quad (2-7)$$

Where V_S is the volume in the storage tank, t is the time, Q_S can be the inflow (positive) or outflow (negative), H_S is the head in the tank, E_S is the elevation of the tank and V_S is the tank water level as a function of the tank volume.

Once the extended period hydraulic simulation is completed, the flows in each link at time step can be used as inputs for the water quality analysis.

2.4. EPANET

EPANET is a public domain water distribution system modeling package developed by the U.S. Environmental Protection Agency Division of Water Supply and Water (Rossman 2000). The package can perform steady state and extended period simulations for hydraulic and water quality behavior in pressurized pipe networks. While the program first appeared in 1993, the current official version was released in 2008 (i.e., 2.00.12) and can be downloaded through the USEPA website (EPA 2017).

A network solver module and a graphical user interface (GUI) form the EPANET package. The solver program can be executed independently using a text file as an input while the results file can be saved as a text file or a binary report file. The input processing, hydraulic analysis, water quality analysis, equation solver and the report generator are separated into modules (Figure 2-2) which facilitates potential modifications to the features of the program and computations.

In an effort to allow developers to customize EPANET to better fit their needs, a Programmer's Toolkit (Rossman 1999) has been developed that provides a library of routines which contain the different functions and algorithms of the network solver.

These routines can be “called” from other software programs that can be used to: open a network file; read and modify the network and the associated operating parameters; run simulations; and set-up the results in a specified format. In this work the toolkit will be used to create a custom routine to assist in a reliability analysis of water distribution networks.

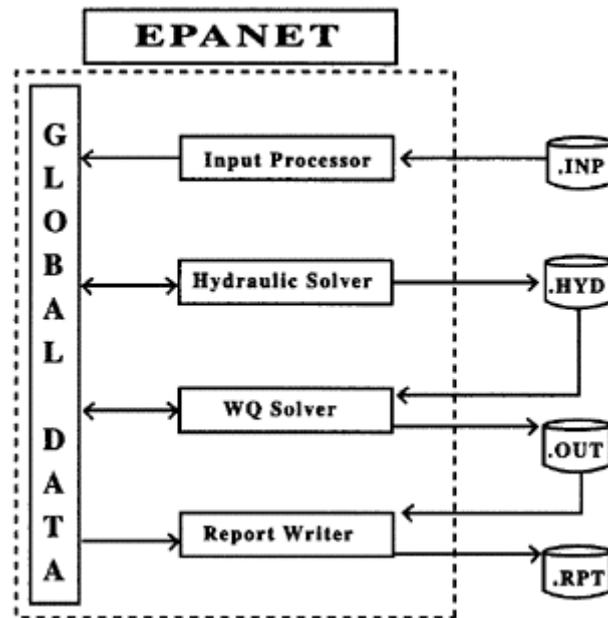

Figure 2-2 Data flow diagram for EPANET's solver (Rossman 2000)

3. LITERATURE REVIEW

Water distribution systems face a multitude of factors that could result in a failure event (i.e. not providing enough water at an adequate pressure and quality to meet the demands of the communities they serve). Some of the usual aspects considered by the systems include (Bhave 2003):

- Hydrologic: Related to the availability of water at a required quality and in a sufficient amount during a specified period of time (i.e. the design life of the system).
- Demand: The estimated demand for the design period will depend on the population forecast and the demand per capita. However, population forecasts can be uncertain due to unplanned growth and changes in zoning.
- Economic: Interest rates, the cost of power, and inflation influence the selection of alternative system designs or the pursuit of alternative operational strategies, and these may experience unexpected variations over the life of the system.
- Mechanical: The rate of failure and repair times of pipes, pumps, valves and other components will affect the operation of the system.
- Hydraulic: The reduced carrying capacity of aging of pipes, inaccurate measures of pressure and flow, and failing to consider the effects of simplifying assumptions used to generate hydraulic models (demand lumped at the neighboring junction nodes and skeletonized networks)
- Operational: Lack of maintenance, poor operation of valves, contamination at joints, and leaks.
- Catastrophic Event: Multiple pipe breaks can be the result of below freezing temperatures, earthquakes, fires, reservoir collapse or other catastrophic events.

Over the last few decades systems have sought to move beyond strictly complying with regulations, and providing a more reliable service to its users. The factors mentioned above will influence the ability of the systems to deliver the required water for a given system and could contribute to a network failure. A distribution system can have different failure modes, but at its essence it can be considered as any circumstance associated with a physical impact to the network; or where the pressure, flow or both fall below the requirement at a node. This definition could be extended to include water quality. The failure modes are usually grouped under two classifications: performance (network metrics fall below a specific design requirement) or component failure (an individual component is taken out of service). Possible causes and how these failures may relate to each other are presented in Figure 3-1. For instance, mechanical failures can be caused by aging pipes, corrosion, and natural disasters. Although mechanical failures are associated with the loss and repair of the physical components of the networks, they may also lead to failures in the system connectively or the hydraulic or

water quality performance of the system. In this study we will focus on failure events that result from the loss of physical components (i.e., pipes, pumps, valves) as we seek to determine the associated impacts on network connectivity, hydraulic performance, and water quality performance as we evaluate their effect on system reliability

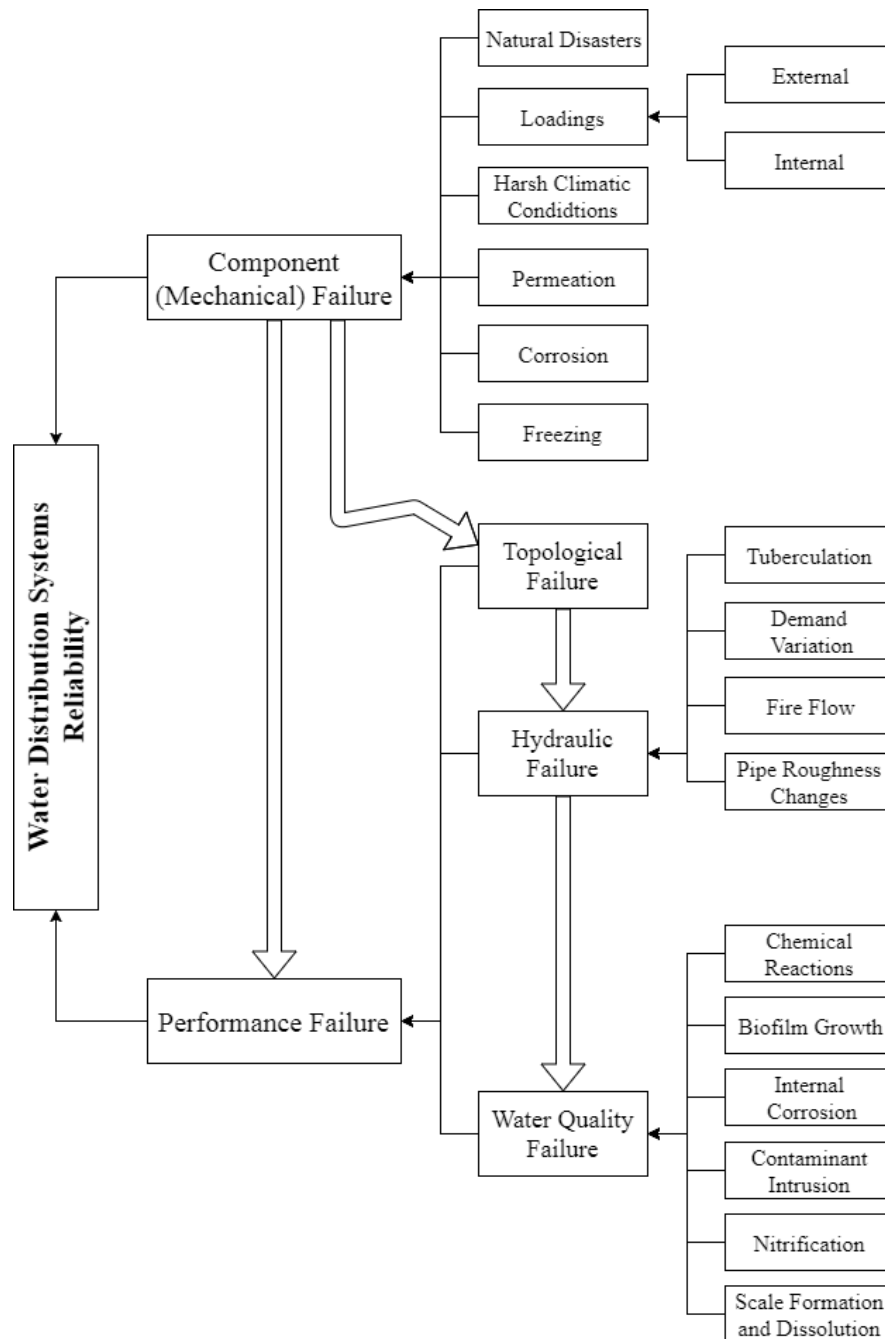

Figure 3-1 Types of failure and water distributions systems reliability. Adapted (Gheisi, Forsyth et al. 2016)

Reliability is a term commonly used to describe the probability that a system will be able to deliver flow at an adequate pressure and water quality during a given period of time and under a specific loading condition. Typically, the reliability of a system

will be evaluated under a critical stress condition, such as a fire. The term reliability is frequently used along with and sometimes interchangeably with the terms resilience, robustness, and redundancy. For the purposes of this study, these terms will be defined as follows and related as described in Figure 3-2.

Reliability – the ability of a system to maintain a specific level of performance over a specified period of time.

Robustness – a measure of how much or many component failures a system can experience before it violates a specific level of performance.

Resilience – a continuous measure of how much time it takes to restore a level of performance once it has been violated.

Redundancy – a discrete measure of the number of alternative paths (e.g. pipes) or components (e.g. pumps) that exist in a water distribution system sufficient to maintain a specific level of performance.

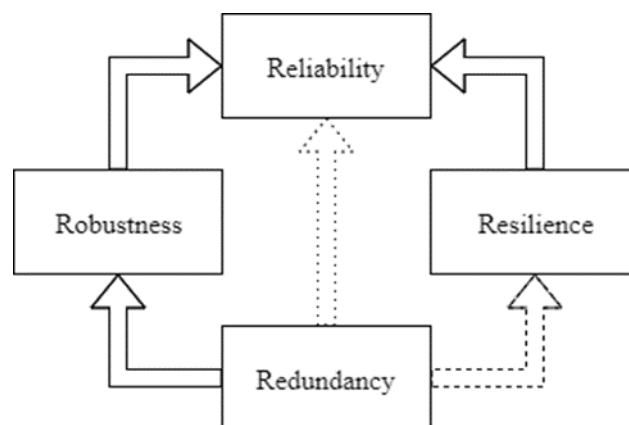

Figure 3-2 Relation between Reliability, Robustness, Resilience, and Redundancy

Using these definitions, a redundant system would also increase the robustness, since it provides duplicate network paths or components thereby increasing the capacity of the system to sustain service under multiple failures. A redundant network will also facilitate resiliency, since the effect on the system once failure occurs will be minimized which should decrease the repair time required to reestablish normal operating conditions. A redundant system could also provide increased resilience in possibly decreasing the “down” time of the system. Similarly, through the increase of robustness and resilience the reliability of the network would be increased. In this case reliability should be favored, since the system would be able to withstand more strenuous conditions and recover more rapidly whenever failure occurs.

The proposed approach aims to reflect the reliability of the network through a simplified process. Where, instead of an explicit measure of reliability (using the probability of failure for all network components), alternative performance metrics can be used to address the resilience, robustness and redundancy of the pipe network structure; which will in turn provide an implicit measure of the reliability of the system.

The interest in reliability of network infrastructure requires a description of the performance of the system. The performance indicators traditionally included for network analysis in water distribution have been adapted from graph theory, electrical engineering, and other fields. Additionally, other performance metrics that have been considered include cost, water quality, and water pressure. These performance indicators or metrics can then be used in the development of implicit measures of reliability, resilience, robustness, and redundancy.

In general, most metrics can be divided into two types: structural and functional. *Structural* metrics rely on the layout of the network to quantify its performance. These metrics are also known as topological and usually employ concepts from graph theory to calculate the indices (Gunawan, Schultmann et al. 2017). On the other hand, the *functional* metrics use the hydraulic state of the water distribution network under a given operating scenario. These metrics typically include: flow, demand, nodal pressure and water quality (Gheisi, Forsyth et al. 2016).

Other metrics that have been used to measure network performance are the generated greenhouse emissions from the operation of the system (Marchi, Salomons et al. 2014), the extent of a contamination event (Murray, Haxton et al. 2010), the volume of supply contaminated, the time to detect the contamination event (Murray, Grayman et al. 2009), the health effects on the population derived from the contamination event (EPA 2014), and social welfare.

Additionally, there are multiple approaches to estimate these performance metrics. The methods used to calculate them can be identified as: analytical, simulation-based, and heuristic. The analytical approaches solve for the performance metric under a stringent set of conditions using directly the demands of the network, and its layout. Metrics based on graph theory, topology, and probability are typically identified as analytical. In a simulation-based approach, different scenarios are used to observe the behavior of the network, which produce different requirements for the network. This

approach will usually consider performance metrics using hydraulic solvers, Monte Carlo simulations, and similar methods.

Heuristic or surrogate-based methods borrow principles from graph theory and hydraulics. The heuristic approaches focus on reflecting changes in reliability but do not measure it precisely (Mays 2000). In previous reviews, the heuristic metrics have been divided in three types: entropy-based, energy/power-based and hybrid surrogate measures (Gheisi, Forsyth et al. 2016).

The following sections will explore some of the definitions for the system properties (resilience, robustness, redundancy, and reliability) presented in literature, as well as the performance metrics used to quantify them.

3.1. Resilience

The term resilience has been used in multitude of contexts, including: psychology, biology, economics, material and environmental sciences. In the case of civil engineering it has been defined as the ability of a system to recover (“bounce back” or return to a satisfactory state) after a significant disturbance (Reed, Kapur et al. 2009, Zhuang, Lansey et al. 2013).

The focus of resiliency is to find ways to reduce the recovery time of a system after an often temporary failure event, and then reduce the probability of experiencing a similar disruption in the future (Reed, Kapur et al. 2009, Cuadra, Salcedo-Sanz et al. 2015).

Several researchers have proposed metrics for use in measuring resilience (Todini 2000, Prasad and Park 2004, Jayaram and Srinivasan 2008). These are summarized in Table 3.1 and discussed in the following paragraphs.

Todini (2000) first proposed the use of a resiliency index (I_r) which is calculated using the concept of “power”. In this context power was defined as the product of the specific weight of water (γ), discharge (Q), and head (H). The resiliency index is then calculated as the excess power that can be delivered to each node in a water distribution system compared to the total available power in the network (obtained from the summation of the power estimates for all reservoirs in the network). Incorporating a resiliency index in the design process for new water distribution systems explicitly considers allocating excess power (typically through surplus head) to the network. The

surplus power allows the delivery of adequate flow at the required pressure in case of failure or a demand increase (Todini 2000).

In later years, other researchers modified the resiliency index by trying to make improvements (Baños, Reca et al. 2011). For example, Todini's resiliency index considers the surplus head at each of the nodes, but doesn't consider the impact of having an adequate number loops in the network (Prasad and Park 2004). As a result, Prasad and Park introduced the network resilience index (NI_r), which considers both the excess "power" and the presence of reliable loops (pipes connected to a node with similar diameter and flow distribution). Using the network resiliency index as part of the formulation for a design algorithm favors allocating excess head at the nodes through the use of uniform diameter pipes connected to it.

Another modified version of Todini's index, i.e. the modified resiliency index (MI_r), was proposed by Jayaram and Srinivasan (2008) to address inaccuracies in networks with multiple sources. In single source networks, Todini's index is proportional to the surplus power at the demand nodes, since the total available power provided by the reservoir will remain constant. However, when multiple sources are present, the one with higher hydraulic grade will be favored and will deliver a higher fraction of flow to the system. The combination of an elevated head and an increased discharge from one of the sources could drive down the value of the resiliency index even when there is surplus head at the demand nodes. Thus, the modified resiliency index (MI_r) is defined as the amount of surplus "power" available at the demand nodes expressed as the percentage of the minimum "power" required at all the demand nodes. In this way, the modified resiliency index will always be proportional to the surplus head at the demand nodes even in a network with multiple sources (Jayaram and Srinivasan 2008).

All three of these resiliency indices (I_r , NI_r , MI_r) have been used by multiple researchers in the design of water distribution systems (Farmani, Walters et al. 2005, Reca, Martínez et al. 2008, Suribabu 2017). However, Todini's resiliency index and the subsequent modifications by Prasad and Park (2004) and Jayaram and Srinivasan (2008) only consider the total excess "power" (the global excess of pressure in the network) and fail to address the impact of the location of the failure event in the network. This means that an increase of demand near the source will be treated the same way as a demand in a remote section of the network (Baños, Reca et al. 2011).

Overlooking the importance of the location leads can lead to a lack of recognition of critical points where a failure or over-demand could lead to pressure heads below the minimum required in some areas of the system. More recent formulations (Herrera, Abraham et al. 2016) have tried to address this shortcoming by considering the different effects that each node and link would have in the network if that component were to fail. They introduce a resiliency index (I_{GT}) which is applied at a nodal level to account for the potential energy loss associated with the path between the node and its water source.

Additional resiliency metrics have attempted to measure resiliency using a combination of indices (Raad, Sinske et al. 2010, Cimellaro, Tinebra et al. 2016). Others have focused on comparing the supply that can be delivered before and after the failure event (Reed, Kapur et al. 2009). The resilience index defined by Cimellaro, Tinebra et al. (2016) is defined as the product of three performance indices: the number of users experiencing supply shortage in the system, the water levels experienced in the tank, and water quality (i.e. concentration of contaminants, residual concentration of chlorine, etc.). This resilience index has been used to evaluate recovery plans, since it considers the functionality of the network after a disruption and the expected recovery time for the system. The researchers accomplished this by evaluating the performance indices during a control time which includes a period of failure, a defined repair time for the components, and a period of recovery (the time required for the performance level to return at what was observed before failure).

In contrast, Reed, Kapur et al. (2009) adapted a metric used from the electrical industry which is based on the concepts of “fragility” and “quality”. In this case fragility refers to the number of users that would lose service, and quality is calculated using the demand that could be delivered in the system before and after the failure event (e.g. hurricanes, earthquakes).

3.2. Robustness

Unlike resilience, robustness doesn't explicitly include the recovery time after a failure condition. Robustness is generally defined as the ability of a system to continue to operate at satisfactory level conditions while under strenuous circumstances (Zhuang, Lansey et al. 2013). This would mean a robust network is more able to avoid a failure event or tolerate malfunctions under an emergency condition.

Researchers (Yazdani and Jeffrey 2011, Yazdani and Jeffrey 2012) have used topology principles to evaluate the robustness of a network. These topology-based approaches also include concepts from graph theory since robustness is typically assessed using a network layout. In graph-based metrics the network is modeled using a graph of the nodes and links or matrices. Different metrics can be derived from an evaluation of the eigenvalues and eigenvectors of the network adjacency matrix (representing the connected links and nodes), and the network Laplacian matrix (a matrix representation of a graph). Each of these matrices are constructed using connectivity data derived from the topology of the water distribution system. Yazdani and Jeffrey (2011), (2012) have used “algebraic connectivity” (Wasserman and Faust 1994, Estrada 2006) and the “spectral gap” (Fiedler 1973) to quantify the robustness of a network. These graph-based metrics have been linked to robustness since they are correlated to the maximum number of faults a network can tolerate and continue to operate.

The algebraic connectivity (λ_2) is defined as the second smallest eigenvalue of the normalized Laplacian matrix of a network (i.e. the sparsest approximation of the graph). Higher values of the algebraic connectivity in a network represents systems which require more components taken out service of the network to cause a disconnection. On the other hand, the spectral gap (Δ) is defined as the difference between the first and second eigenvalues of the adjacency matrix. A large value of the spectral gap for a network represent a well-connected structure where more removed (failed) nodes and links could be tolerated.

Table 3-1 Resiliency metrics

Reference	Metric	Description	
Todini, 2000	$I_r = \frac{\sum_{i=1}^{n_n} q_i^* (h_i - h_i^*)}{\sum_{k=1}^{n_k} Q_k H_k + \sum_{j=1}^{n_p} (P_j/\gamma) - \sum_{i=1}^{n_n} q_i^* h_i^*}$	<p>I_r = Resilience Index q_i = Flow at node i h_i = Head at node i H_k = Head for reservoir k Q_k = Discharge for reservoir k γ = Specific Weight</p> <p>P_j = Power introduced into the network by the j^{th} pump and n_p the number of pump n_k = Number of reservoirs n_n = Number of nodes $*$ Indicates the minimum required</p>	Relates redundancy to the excess power (discharge*head*water specific weight) that can be delivered to each node when compared to the maximum power that would be dissipated internally in order to satisfy the constraints in terms of demand and head at the nodes.
Prasad and Park, 2004	$I_N = \frac{\sum_{j=1}^{n_n} C_j Q_j (H_j - H_j^l)}{\sum_{k=1}^{n_r} Q_k H_k + \sum_{l=1}^{n_p} (P_l/\gamma) - \sum_{j=1}^{n_n} Q_j H_j^l}$	<p>Q_j = Discharge for node j Q_k = Discharge for reservoir k H_k = Head for reservoir k H_j = Head for node j P_j = Power introduced by pump l</p> <p>C_j = Uniformity coefficient for node j D_i = Diameter for pipe i $D_i = \frac{\sum_{j=1}^{n_{pj}} D_j}{npj \times \max\{D_i\}}$ npj = Number of pipes connected to node j</p>	The resilience index at each node j is given a weight of C_j based on the uniformity in diameter of pipes connected to it. The network resilience index seeks to include the importance of loops.
Jayaram and Srinivasan, 2008	$MI_r = \frac{\sum_{i=1}^{n_n} Q_j^{req} (H_j - H_{min j})}{\sum_{i=1}^{n_n} Q_j^{req} H_{min j}} \times 100$	<p>MI_r = Modified Resilience Index n_n = Number of nodes Q_j^{req} = Required discharge for node j H_j^{req} = Required head for node j</p> <p>Q_j = Discharge for node j H_j = Head for node j</p>	Defined as the amount of surplus power (discharge*head*water specific weight) available at the demand nodes as a percentage of the sum of the minimum required power at the demand nodes. The metric intends to better reflect redundancy for networks with multiple sources.
Reed et al., 2009	$R = \frac{\int_{t_1}^{t_2} Q(t) dt}{(t_2 - t_1)}$	<p>R = Resilience $Q(t)$ = Demand supplied at time t after the event t_1 and t_2 = Endpoints of interval under consideration</p>	The method proposed evaluates the resilience of infrastructure networks under natural hazards (e.g., earthquakes, and hurricanes) by comparing the demand supplied before and after the event.
Herrera et al., 2016	$I_{GR}(i) = \sum_{s=1}^S \left(\frac{1}{K} \sum_{k=1}^K \frac{1}{r(k,s)} \right)$	<p>K = number of routes from the source and node S = Total number of sources in the network $r(k,s)$ = Surrogate measure of energy loss associated the k^{th} path for source s M = number of pipes in pipe k D_m = Diameter of pipe m L_m = Length of pipe m</p> <p>$r(k) = \sum_{m=1}^M f(m) \frac{L_m}{D_m}$ $f(m)$ = friction factor for pipe m</p>	The metric uses the potential energy loss associated with each path connecting a node and its water source to estimate resilience.
Cimellaro et al., 2016	$R=R1*R2*R3$	<p>$R_i = \int_0^{T_{LC}} \frac{F_i(t)}{T_{LC}} dt \quad i = 1,2,3$ T_{LC} = Control time $F_1(t) = 1 - \frac{\sum_i n_{p,s}^i}{n_{Tot}}$ $n_{p,s}^i$ = number of users at each node that suffer insufficient pressure n_{Tot} = total number of users within the distribution system</p> <p>$F_2(t) = \begin{cases} \frac{h(t)}{h_{Reserve}} & h \leq h_{Reserve} \\ 1 & h > h_{Reserve} \end{cases}$ $h(t)$ = water level at time t $F_3(t) = \frac{Q(t)}{Q^*}$ Q^* = Water quality index before event $Q(t)$ = Water quality index after event</p>	A resilience index (R) proposed by Cimellaro et al. (2016) for earthquake events summarizes the performance of a network by combining three indices, the demand (R1), the capacity (R2), and the water quality aspects of the network (R3).

Vulnerability often accompanies the description of robustness, particularly when electrical networks are considered, and is defined as its opposite state. Both vulnerability and robustness are used to determine if a network has a high or low degree of reliability, since the level of robustness of a network (or lack of it) will reflect the degree to which it is affected under abnormal conditions and the extent of the consequences of the perturbation experienced (Cuadra, Salcedo-Sanz et al. 2015).

3.3. Redundancy

In water distribution networks, redundancy has been defined as the existence of alternative and independent pathways between the source and demand nodes through which water can travel when the main path is taken out of service (Goulter 1988). The existence of these paths is controlled by the topology of the network. As a result, redundancy has been closely linked to the configuration of the system. This relation between the network layout and redundancy has been used to justify the use of graph theory procedures to estimate this performance indicator (Goulter 1988, Jacobs and Goulter 1988).

Yazdani and Jeffrey (2012) have proposed the use of a clustering coefficient and a meshedness coefficient to assess redundancy. Both metrics quantify the organizational properties of the network based on its structure. Multiple expressions for the clustering coefficient have been proposed (Wasserman and Faust 1994, Onnela, Saramaki et al. 2005), but they all seek to identify the number of triangles (two nodes connected to a third node that are also connected to each other) in the network. The density of these triangular loops is used to measure how the junctions are linked (Yazdani and Jeffrey 2012).

Alternatively, the meshedness coefficient characterizes the status of loops in the network using a ratio of the numbers of loops actually present in the configuration and the maximum possible number of loops. The coefficient can take values between zero and one, where a meshedness coefficient of zero resembles a tree structure and a value of one represent graphs entirely formed with three link loops (Buhl, Gautrais et al. 2006). The clustering coefficient and the meshedness coefficient identify the prevalence of loops in a network. However, the clustering coefficient only considers triangular loops and the meshedness coefficient assumes all links only intersect at their endpoints. The latter assumption is not strictly the case in real distribution systems, but since only

relatively a small number of intersecting pipes don't match their endpoints it is considered an acceptable approximation. Both coefficients have shortcomings, but when used together they can begin to capture the level of redundancy of a network (Yazdani and Jeffrey 2012).

Given that a truly redundant network would have enough residual capacity to maintain the flow requirements if a component fails, redundancy is often seen as an indicator of reliability (Goulter 1988, Awumah, Goulter et al. 1991). A direct correlation between reliability and redundancy is often suggested, where increasing the redundancy of a network will also improve the reliability. This practice often allows one to estimate reliability using redundancy metrics. This type of approach has been incorporated in optimal design methodologies to improve reliability. For instance, by requiring the existence of at least two independent paths to each node from a given source (by using spanning trees) and by guaranteeing the ability of each path to supply the required demand at the lowest cost (Ormsbee and Kessler 1990).

Another early example of a redundancy metric has been proposed by Awumah, Goulter et al. (1991). The researchers use the definition of entropy proposed by Shannon (1948) to suggest an expression for network redundancy. This measure is exclusively based on flow. Although the researchers acknowledge the importance of pressures they emphasize that pressures “are not as important as flow itself” (Awumah, Goulter et al. 1991). This redundancy metric is based on the ratio between the flow delivered by each link to a node and the total flow to the node. The redundancy metric calculated using this formulation will have a higher value if the flows delivered to each node are more equally distributed among the connected links. When this metric is included as part of the design process, the equal distribution of flow amongst the pipes is favored and the effect of a single failing pipe is reduced.

Singh and Oh (2015) have also proposed a redundancy metric based on the concept of entropy. However, in their application the redundancy metric uses the entropy definition by Tsallis (1988). The new metric proposed can be calculated to address network redundancy by using two approaches: one which considers the ratio of the flow delivered by a link to the node and the total flow to the node, and a second approach based on the ratio between the flow delivered by each link to a node and the total flow of the network. In both cases the network redundancy will be higher when

the number of loops increases and distribution of flow to each node is equal (Singh and Oh 2015). The sample networks used to test the redundancy metric based on Tsallis' entropy were also used to calculate the redundancy metric based on Shannon's entropy. The researchers compared the results from this new metric to the result of the metric derived from Shannon's entropy (1948) and they found an almost 1-to-1 relationship between both entropy based indices.

Unlike Awumah, Goulter et al. (1991), Kalungi and Tanyimboh (2003) recognized the pressure dependency of flow in a distribution system by considering pressure dependent modeling. In the methodology proposed by these researchers the flow delivered to a node will vary depending on the pressure head at each location. This methodology continues to consider the flow delivered at the node, but the required demand is now made dependent upon the actual pressure delivered to the node. This metric also attempts to include the probability of a link failure. This is accomplished by including the product of the probability of failed components and the available flows if such components were to fail and using this value as part of the formulation to define reliability. This product can be interpreted as the expected supply. The researchers proceed to define their redundancy metric as the expected fraction of the network demand that is met following a component failure (i.e. pipe breakage, elements taken out service, or maintenance) in the system. Theoretically, the metric can take on values between zero and one, where a value of one would indicate a system that has more redundancies (spare components, oversized pipes, and additional pathways from the source to all demand nodes).

A summary of the metric referenced in this section and additional literature is provided in Table 3-2.

Table 3-2 Redundancy metrics

Reference	Metric	Description	
Cuadra et al., 2015; Gunawan et al., 2017	$C_i = \frac{2M_i}{k_i(k_i - 1)}$	<p>$M_i =$ number of links that exist between k_i nodes $k_i =$ number of links incident to node i $C_i =$ Clustering coefficient</p>	The clustering coefficient reflects the number of triangles in a network, each triangle is formed by two nodes connected to a third node that are also connected to each other.
Buhl et al., 2006	$M = \frac{m - n + 1}{2n - 5}$	<p>$M =$ Meshedness coefficient $m =$ number of edges $n =$ number of nodes</p>	The meshedness coefficient characterizes the status of loops in the network using a ratio between the loops present in a network and the maximum possible number.
Awumah et al., 1991	$S_j = - \sum_{i=1}^{n(j)} \left(\frac{q_{ij}}{Q_j} \right) \ln \left(\frac{q_{ij}}{Q_j} \right)$	<p>$S_j =$ Redundancy at node j $q_{ij} =$ flow carried by link between node i and j $Q_j =$ Total flow at node j $n_j =$ Number of links incident to node j</p>	Entropy based measure. The metric favors equal distribution of flow, reducing the impact of each failing pipe
Sing and Oh, 2015	$S_j = \frac{K}{m-1} \left\{ \sum_{i=1}^{n(j)} \left[\left(\frac{q_{ij}}{Q_j} \right) - \left(\frac{q_{ij}}{Q_j} \right)^m \right] \right\}$	<p>$S_j =$ Entropic measure of redundancy at node j $m =$ entropy index $n(j) =$ Number of links incident to node j $Q_j =$ Total flow at node j $q_{ij} =$ flow carried by link between node i and j $K =$ Positive constant (usually one)</p>	Entropy based measure. The metric favors equal distribution of flow.
Kalungi & Tanyimboh, 2003	$T = \frac{R - r(0)p(0)}{1 - p(0)}$	$R = \frac{1}{Q^{NL}} \left(p(0)Q(0) + \sum_{l=1}^{NL} p(l)Q(l) + \sum_{l=1}^{NL-1} \sum_{m=l+1}^{NL-1} p(l,m)Q(l,m) \right) + \frac{1}{2} \left(1 - p(0) - \sum_{l=1}^{NL} p(l) + \sum_{l=1}^{NL-1} \sum_{m=l+1}^{NL-1} p(l,m) \right)$ <p> $p(l) =$ probability that only link l is unavailable $p(l,m) =$ probability that link l and m are unavailable $Q(0) =$ outflow when zero components are unavailable $Q(l) =$ outflow when link l is unavailable $Q(l,m) =$ outflow when link l and m are unavailable $NL =$ number of links $r(0) =$ ratio of available flow to the required $p(0) =$ probability that no link is unavailable $a_l =$ probability a link l is available $p(0) = \prod_{l=1}^{NL} a_l$ </p>	The metric combines the results of a hydraulic simulation with the probability a links will be available in the network. The redundancy (T) takes a value between 0 (tree like system) and 1 (graph formed by triangular loops).
Dueñas-Osorio, Craig, Goodno, & Bostrom, 2007	$R_{Rv} = \frac{1}{(S - 1)^2} \sum I(v,j)$	<p>$S =$ graph order, $S > 1$ - in graphs where every node has a link to every node $I(v,j) =$ number of node independent paths between nodes v and j</p>	Originally intended for a power network, but has been adapted to other critical infrastructures. $R_R = 0$ indicates a fragment graph (the nodes are not connected to each other), $R_R = 1$ every node has a link to every node.

3.4. Reliability

A universally accepted definition of reliability has not been established, and multiple authors have presented slightly different definitions of the concept throughout the years (Table 3-3**Error! Not a valid bookmark self-reference.**). However, a definition of reliability frequently reported in the literature describes it as: the probability of a system performing its mission within the established limits for a period of time in a specified environment (Mays 2000). Others have defined reliability using three different concepts: the probability that a system operates in a satisfactory state, the probability that no failure occurs within a fixed period of time, and as one minus the risk or the probability of failure (Hashimoto, Stedinger et al. 1982). An element that these definitions have in common is the use of probability.

Including the probability of failure or the probability that an element will continue to be operational increases the difficulty in computing reliability analytically, since it would require an extensive analysis of the probability of failure of a considerable number of elements in a network. Thus, estimating the reliability of a network becomes a balancing act between the relevance or usefulness of a metric and the difficulty of its computation (Wagner, Shamir et al. 1988).

Similarly to the case of robustness, vulnerability is often included when reliability is considered. However, reliability and vulnerability should not be regarded as direct opposites. Reliability approaches consider the probability of an element in a critical infrastructure to be operational at any given time, while vulnerability focuses on the potential of disrupting the elements of the systems or degrading them to a point where their performance is diminished. Considering these definitions, a vulnerable system may still be a reliable one (Murray and Grubestic 2007).

There is no comprehensive and computationally practical method to assess reliability and the need for an explicit measure of reliability continues to exist. Additionally, the available measures of probabilistic reliability become increasingly difficult to calculate as the system size and complexity increases. Wagner, Shamir et al. (1988) have suggested as possible alternatives: the simplification of the network, the use of non-probability based methods or the use of more sophisticated computational methods. Despite such limitations, several researchers have attempted to develop different methods for measuring or assessing reliability (Wagner, Shamir et al. 1988,

Wagner, Shamir et al. 1988, Mays 2000, Bhave 2003, Gheisi, Forsyth et al. 2016, Gunawan, Schultmann et al. 2017). These efforts are summarized in this section.

Table 3-3 Definition of reliability (from multiple sources)

Term	Definition	Reference
Reliability	Probability that a system will perform its mission within specified limits for a given period of time in a specified environment	Gupta and Bhave (1994)
	Length of time that a system can be expected to perform without failure	Mays (2000)
	Any measure of the system's ability to satisfy the requirements placed on it	Mays (2000)
	The ability of the system to provide service with an acceptable level of interruption in spite of abnormal conditions	Cullinane et al. (1992)
	The ability of a water distribution system to meet the demands that are placed on it where such demands are specified in terms of (1) the flows to be supplied (total volume and flow rate); and (2) the range of pressures at which those flows must be provided.	Goulter (1995)
	Refers to the probability that a given element remains functional at any given time	Murray and Grubestic (2007)
	The probability that a system is in a satisfactory state, the probability that no failure occurs within a fixed period of time, reliability is one minus risk.	Hashimoto et al. (1982)

Two of the earliest analytical methods to estimate reliability were concerned with calculating the measures of reachability and connectivity in a network. The reachability of a specified demand node is related to the situation where the node is connected to at least one source. On the other hand, connectivity is related to the situation where every demand node is connected to at least one source (Wagner, Shamir et al. 1988). The concept of connectivity and reachability provides a method to check for the unreliability of a network caused by poor network interconnections or very

unreliable links (as measured the probabilities of their failures). However, neither metric is easily calculated for some networks and the exact probability of failure of a given link may be difficult to calculate (Wagner, Shamir et al. 1988, Mays 2000).

Beginning in the late 70s, many researchers began investigating the application least-cost optimization algorithms to the problem of network design. Although most of the approaches considered relatively simple systems that could be incorporated into standard optimization formulations such as linear programming, some researchers began to investigate the linkage of nonlinear optimizers with network simulation algorithms (Ormsbee 1979). Unfortunately, due to computational restrictions very few applications considered the issue of network reliability in their design and optimization formulations. Nonetheless, researchers recognized the importance of more reliable systems had been overlooked and incorporated reliability considerations as part of their design methodologies. An initial solution to the lack of reliability parameters were two alternative approaches based on the concepts of node isolation and goal programming (Goulter and Coals 1986).

The node isolation approach considers the probability that all links connected to a node will fail, effectively isolating that node from the rest of the network. An acceptable design under this approach will keep the probability of isolation of each node under a certain value. In case the node acceptable node isolation probability is exceed, an alternative design must be considered in which the probability of failure of the links must be reduced.

In contrast, the goal programming approach attempts to set the reliabilities (probability a pipe remains operational during the design period) of each link that feed a common node as close as possible to each other while continuing to satisfy the hydraulic constraints (e.g. minimum pressure). In solutions using this approach links are forced to have similar characteristics. This forced condition may cause violations of the hydraulic constraints. In such cases additional capacity can be added to individual links through the use of explicit weight factors that can be adjusted to satisfy the hydraulic constraints.

As more computational resources became available the use of a hydraulic simulation as part of the reliability assessment continued to increase. Morgan and Goulter (1985) proposed a design approach for new systems and the expansion of

existing systems using a hydraulic solver. The method does not use a reliability metric; but a series of iterations are performed by varying the demand pattern at the nodes, as well as the location and number of broken links. The approach uses a linear programming model to select the component sizes, followed by the use of the hydraulic solver to check if the flows and pressures are adequate. If the configuration fails the components are resized, otherwise a new failure scenario is evaluated.

Another design approach was suggested by Su, Mays et al. (1987) using a cut-set approach where reliability is defined as the probability of satisfying the hydraulic constraints (flow, and adequate pressure). A simulation model is used to define the minimum cut-sets, where each set is a group of components that when taken out of service induce a system failure. However, the individual cut-sets are constructed so that the failure of a single element in the set does not result in a system failure. Their model examines the impact of a simulated pipe break by the closing one or several links through simulation and calculates the reliability using the probability of failure of the pipes and the minimum cut sets.

Because of the large computational burden of the minimal cut-set approach, Jacobs and Goulter (1991) suggested dividing the reliability problem in two parts: first, identifying the probability that a given number of pipes fail simultaneously; second, determining the probability that the removal of a given number of pipes will cause system failure. The first probability could be estimated using leak data from the city of interest, the second could be derived through a simulation analysis. Using this approach the researchers were able to reduce the number of failure conditions that would have to be investigated.

Also using hydraulic simulation, Bao and Mays (1990) propose a joint reliability metric accounting for mechanical and hydraulic failure where failure occurs when demand nodes receive insufficient flow rate and/or inadequate pressure head. The simulation model generates a random value for the demand at each node and the roughness coefficient at each pipe (Monte Carlo simulation). A hydraulic network simulator (i.e. KYPIPE) was used to solve for the pressure and flow rate. The hydraulic simulator always assumes that the demand is satisfied, because of this the nodal reliability compares the supplied head to the minimum pressure head required. Formally, the nodal reliability is defined as the joint probability of flow rate and

pressure being satisfied at the nodes. Although the nodal reliability is thought as a fairly comprehensive measure, the researchers suggest three additional network reliability metrics which include: the minimum nodal reliability, the arithmetic mean of the nodal reliabilities of the network, and the weighted average of nodal reliability. The authors identify the preferred method to guarantee head requirement at the nodes as the geometric mean of node reliability. Unfortunately, this method doesn't include a distinction between critical and noncritical events (Mays 2000).

Goulter and Bouchart (1990) chose to use the *probability of no node failure* as the reliability parameter to measure system performance in their network design framework. The probability of no node failure combines the probability of the node not being isolated from the source (based on the probability of pipe failures), and the probability that the demand at the node doesn't exceed the design values. However, their approach does not explicitly evaluate hydraulic performance. Improvements in the reliability of the network will be reflected by a decrease in the probability of no node failure.

Regrettably, methods that explicitly considered reliability through component failure probabilities were often computationally intensive and were frequently not able to handle all aspects of reliability simultaneously (Goulter and Bouchart 1990). Thus, they were usually regarded as an approach to gain insights on the network design rather than a method for use in optimizing the design of a water distribution system (Goulter and Coals 1986, Mays 2000).

Other researchers have included a different definition of reliability which allows the system performance to be calculated using an optimization model. For instance, if one measures system reliability as the ratio of the expected minimum deficit in system demand to the total system demand, then reliability can be measures as (Fujiwara and De Silva 1990).

$$R = 1 - \frac{\text{Expected minimum shortfall in flow}}{\text{Total demand}} \quad (3-1)$$

Additional metrics have also been explored. In the work by Duan and Mays (1990) a modified frequency and duration analysis approach is used in determining the reliability of the pumping systems. In this case, both the hydraulic and mechanical

failure are considered for the pumps - not the network. Eight different reliability parameter metrics are derived from this methodology: failure probability, failure frequency, cycle time, expected duration of failure, expected unserved demand of a failure, expected number of failures, expected total duration of failures, and expected total unserved demand. Although this analysis considers storage tank levels, hydraulic and mechanical failure conditions for pumps, it does not include nodal reliability or mechanical failure of the network (Duan and Mays 1990, Mays 2000)

Bouchart and Goulter (1991) were one of the first researchers to consider valves in their research, not as an element susceptible to failure but as an element for use in increasing the reliability of the network. Using a similar definition of reliability as proposed by Duan and Mays (1990) they measured reliability as the expected total volume deficit associated with each failure. Unlike the previous methods, this approach did not consider demands to be lumped at the junction nodes, but spatially distributed along the links. In this design approach (Bouchart and Goulter 1991) the reliability of the network could be improved by adding valves (reducing the network wide effect), or by adjusting the system demands. Other options previously considered by researchers to improve reliability usually included increasing the pipe size (Fujiwara and Tung 1991).

Other approaches have attempted to integrate hydraulic and mechanical failures (Cullinane, Lansey et al. 1992). One of these procedures introduces the concept of availability as the means to address the reliability of a network in an optimization algorithm. In this case, hydraulic availability is defined as the ability of a system to provide an acceptable level of service under abnormal conditions, and is calculated as the percentage of time the demand required can be supplied with an acceptable pressure head (Cullinane, Lansey et al. 1992). The procedure uses extended period simulation, and unlike previous methods, incorporates the probability of failure of: piping, storage and pumping stations. The critical nodes are identified as the areas with lowest pressure in the simulation, that is, those that will cause a higher economic impact or those that pose a threat to public health (Cullinane, Lansey et al. 1992).

Park and Liebman (1993) have also considered the importance of adequate pressure in their approach. However, unlike other methods that reduce the flows when the pressure head is found to be below the minimum pressure, this method seeks to

modify the design of the network until the minimum pressures are satisfied. This approach seeks to represent the severity of a system failure to a single index called the supply shortage. Once low pressures are artificially removed, the reliability in this method is evaluated by considering the expected supply shortage. This metric (expected shortage) combines the shortage experienced by the failure of a single pipe and the probability of failure of the element.

Similarly Jowitt and Xu (1993) consider supply shortfall and adequate pressure constraints in their reliability assessment approach. In this case the dependency of flow on pressure is considered by incorporating a head dependent demand function. Theoretically, the network could be evaluated using the simulation model for every link failure in the system. However, Jowitt and Xu (1993) use the simulation from the network before failure to estimate the shortages during an abnormal condition (e.g., pipe break).

Gupta and Bhawe (1994) proposed a technique termed “nodal flow analysis” (NFA) to determine the available nodal flow considering the minimum required pressure head. This approach allows the consideration of three flow conditions: adequate flow node (the available head is above the minimum), partial flow node (the available head is equal to the minimum) and no flow node (the available head is below the minimum). The reliability assessment evaluates the behavior of the network under different states (i.e., different demand patterns, and combinations of failing pipes or pumps), comparing the available flow obtained from the NFA to the required value. The reliability is quantified by combining three proposed reliability factors: a node-reliability factor (ratio of the total available outflow volume at a node to the desired outflow), a volume-reliability factor (ratio of the total available outflow volume of the entire network to the required outflow), and a network-reliability factor (combines volume-reliability factor with a time and node factor).

A series of authors have continued to propose performance metrics that adopt concepts from graph theory. These are usually labeled as structural metrics (Gunawan, Schultmann et al. 2017) and are based on the network layout. Examples of this type of reliability metric include: connectivity loss (Albert, Albert et al. 2004), serviceability ratio (Adachi and Ellingwood 2008), and centrality measures (Cadini, Zio et al. 2010). These metrics were originally intended to evaluate electrical grids, but have been

adapted for water distribution systems (Fragiadakis, Christodoulou et al. 2013). A summary of the metrics is included at the closing of this section.

More recent approaches that incorporate optimization formulations tend to address reliability in terms of relative changes instead of absolute measurement. These techniques typically use heuristic or surrogate performance metrics, and they often rely on other system properties to evaluate reliability (e.g., redundancy, resiliency, and robustness) or have use a combination of metrics (Raad, Sinske et al. 2010). Examples of metrics used as reliability indicators include: the resilience index (Todini 2000), the modified resilience index (Jayaram and Srinivasan 2008), the network resilience index (Prasad and Park 2004), the minimum surplus head index(Prasad and Park 2004), the minimum surplus head index (Farmani, Walters et al. 2005) and the energy efficiency index (Dziedzic and Karney 2015). Several of these metrics have been reviewed in previous sections or are summarized in the Table 3-4.

Table 3-4 Reliability metrics

Reference	Metric	Description	Description	
O. Fujiwara & De Silva, 1990	$R = 1 - \frac{\text{Expected minimum shortfall in flow}}{\text{Total demand}}$		Defines the system reliability as the ratio of the expected demand to the total demand	
Gupta & Bhawe, 1994	$R_{nw} = R_v F_t F_n$	R_{nw} = Network reliability factor R_{nj} = Node reliability factor $R_{nj} = \frac{\sum_s q_{js}^{avl} t_s}{\sum_s q_{js}^{req} t_s}$ for all nodes j $F_n = \left[\prod_{j=1}^J R_{nj} \right]^{1/J}$ $F_t = \frac{\sum_s \sum_j a_{js} t_s}{JT}$ $R_v = \frac{\sum_s \sum_j q_{js}^{avl} t_s}{\sum_s \sum_j q_{js}^{req} t_s}$	$a_{js} = \begin{cases} 1 & \frac{q_{js}^{avl}}{q_{js}^{req}} \geq \text{Acceptable value defined} \\ 0 & \frac{q_{js}^{avl}}{q_{js}^{req}} < \text{Acceptable value defined} \end{cases}$ T = period of analysis ($\sum t_s$) j = total number of demand nodes R_v = Volume reliability factor t_s = time duration of a state (same for all nodes) q^{req} = required discharge rate q^{avl} = available discharge rate s = state subscript j = node subscript	The reliability metric proposed is based on a node-reliability factor, volume-reliability factor, and network reliability-reliability factor. This approach considers demands and the minimum head requirements (the head available at the node determines the discharge)
Albert, Albert, & Nakarado, 2004; Poljanšek, Bono, & Gutiérrez, 2012; Fragiadakis, Christodoulou, & Vamvatsikos, 2013	$CL = 1 - \left(\frac{N_{s,j}^{dam}}{N_{s,j}^{orig}} \right)$	$N_{s,j}^{orig}$ = number of sources connected to node j before failure $N_{s,j}^{dam}$ = number of sources connected to node j after failure $()$ = average of demand nodes j	Connectivity Loss (CL) measures the average reduction in the ability of the demand nodes to receive flow from the source. More reliable networks would be able to provide pathways from the source to most of the nodes after failure	
Adachi & Ellingwood, 2008; Fragiadakis et al., 2013	$SR = \frac{\sum_j \omega_j X_j}{\sum_j \omega_j}$	ω_j = weighting factor for node j $X_j = 1$ or 0 (node accessible to a source or not accessible) N = number of nodes	Serviceability Ratio (SR) was adapted for water distribution systems. SR is related to the number of nodes that can still receive supply from at least one of the sources after failure.	
Cadini et al., 2010	$RE = \frac{1}{N(N-1)} \sum \frac{1}{d^{ij^r}}$	N = number of nodes d^{ij^r} = shortest path between nodes i and j	Originally used for electrical networks. The metric uses the existing paths between nodes to define reliability. Higher values of RE reflect well connected nodes.	
Dziedzic & Karney, 2015	$PI = \left[\prod_{m=1}^M P_m \right]^{\frac{1}{M}}$	PI = Performance index M = number of performance metrics n = number of nodes Q_{req} = Flow required $Q_{del p}$ = Flow delivered despite a pipe break t = time step $h + 1$ = number of time steps s = number of scenarios i = scenario (normal or failure) E_{del} = Energy delivered to node E_{sup} = Total energy supplied by pumps, tanks, gravitational flow * indicates a failure condition $Reliability = \sum_{i=1}^s \sum_{t=0}^h \frac{E_{del t,i}}{E_{sup t,i}} (h+1)s$ $Vulnerability = \min(E_{del t,i} / E_{sup t,i})$ $Connectivity = \min(Q_{del p} / Q_{req})$ $Resilience = \sum_{i=1}^{s^*} \sum_{t=0}^{h^*} \frac{E_{del t^*,i^*}}{(h^*+1)s^*}$	The energy-efficiency-based index is an aggregated metric taking the geometric average of the proposed performance metrics for: reliability, resilience, vulnerability and connectivity. PI ranges from 0 to 1, where 1 is the best possible performance	

4. WATER DISTRIBUTION SYSTEM RESEARCH DATABASE

4.1. Database Development

Since the late 1960s, a handful of systems have been repeatedly used by the water distribution research community to test and compare water distribution analysis and optimization algorithms. (Jolly, Lothes et al. 2014). Some of the systems most commonly used include: the New York Tunnel System (Schaake and Lai 1969); the Two Loop system (Alperovits and Shamir 1977); ANYTOWN, U.S.A (Walski, Brill et al. 1987); the Hanoi, Vietnam network (Fujiwara and Khang 1990); and EPANET's "Net 2" and "Net3" (Rossman 2000), which are typically used when water quality questions are considered.

More recent additions to this growing database of systems has included "Network 1" and Network 2" (Ostfeld, Uber et al. 2008); "Exnet" a hypothetical network proposed by the University of Exeter (Farmani, Savic et al. 2004); and C-Town (Ostfeld, Salomons et al. 2012). Other models produced directly for research purposes include the Texas A&M "Micropolis" and "Mesopolis" (Brumbelow, Torres et al. 2007); and a virtual model that generate water distribution networks (Möderl, Sitzenfrie et al. 2011).

While many of these systems have been used as means of comparison for different algorithms, most of these systems if not completely hypothetical are highly skeletonized versions of real systems (Jolly, Lothes et al. 2013) . This may present a challenge when evaluating the characteristics and true performance of an algorithm, since certain algorithms may exploit the specific layout of a network. Additionally, significant aspects of the behavior may be lost when a skeletonized network is used. While skeletonized networks can reduce computation time, the advent of newer computers has largely eliminated the need for such approximations. As a result, larger more realistic systems may now be considered for such applications and thus provide a better means of comparison between algorithms (Jolly, Lothes et al. 2013, Hernandez, Hoagland et al. 2016).

Efforts to obtain systems that represent real distribution networks have increased in the last decade. One of these efforts is a database developed using actual systems in the state of Kentucky. Initially 12 different networks were selected from several small and medium systems in the state (Jolly, Lothes et al. 2014). The systems

were selected based on average demand (i.e. 1MGD to 3MGD), the topology of the system; and number of tanks, pumps, and reservoirs. For security purposes, the systems were modified to obscure the identities of the actual systems. The initial set of 12 systems, was later expanded to 15 models (Schal 2013), which were later updated to provide more realistic demands and system configurations (Hoagland, Schal et al. 2015, Hernandez, Hoagland et al. 2016). Eventually, two larger calibrated models were also added to the Kentucky Distribution Systems Database set.

In a continued effort to provide a set of systems that can be used for benchmarking purposes, the ASCE Task Committee on Research Databases for Water Distribution Systems was formed in 2013. This task committee has facilitated the identification and collection of a diverse library of water distribution network files along with descriptive narratives of the systems. The database includes several well-known systems (e.g. the New York Tunnel, the Hanoi system, among others), the Kentucky state set, web based network generators, and network files submitted by members of the committee. Each submission included the following information: an EPANET compatible file, a narrative summary of the history and physical characteristics of the system including a summary of the system attributes. In addition, information on two automatic network generators (WDS-Designer and Dyna VIBe-Web) were also included. Currently the database is maintained by students and staff associated with the Kentucky Water Resources Research Institute at the University of Kentucky.

The models used in this study are part of the research database. A summary of the status of the overall database is provided in Table A-1 included in APPENDIX A. The current database is freely accessible from the following website: <http://www.uky.edu/WDST>. Contact information for each of the contributors is also available on the website.

4.2. Kentucky Model Development

4.2.1. Model Creation

The database of water distribution models contains the contributions of several researchers. The largest number of systems in the database is from systems in Kentucky. The initial contribution to the Kentucky data set was made by Jolly, Lothes et al. (2014), followed by the addition of several systems by (Schal 2013). This set was later

expanded and edited by Hoagland, Schal et al. (2015) and then used to explore a new classification methodology for water distribution systems. This is the set that is included in the current Water Distribution Database Research Applications (Hernandez, Hoagland et al. 2016).

Basic topological data for each of the water distribution systems from Kentucky was obtained through the Kentucky Infrastructure Authority (KIA) and their Water Resources Information System (WRIS). The WRIS contains information on the spatial distribution of the lines, water mains, storage tanks, pumps and reservoirs. The data for each system is available as a shapefile which can be downloaded from the internet and then evaluated using GIS software like ArcMap (ESRI 2010). In developing the database, the information for the entire state was obtained, and the systems were then later separated into different files based on the individual communities that are identified in the attribute table. Individual data files were then created using a GIS import feature in available in KYPIPE. Nodal elevations for each node were then imported into KYPIPE using files generated from ArcMap which were obtained by using the spatial coordinates of each node and digital elevation maps. Once this information is integrated, the resulting data file can be saved or exported as an EPANET file (i.e. *.inp). The basic steps used in creating a network data file are summarized in Figure 4-1.

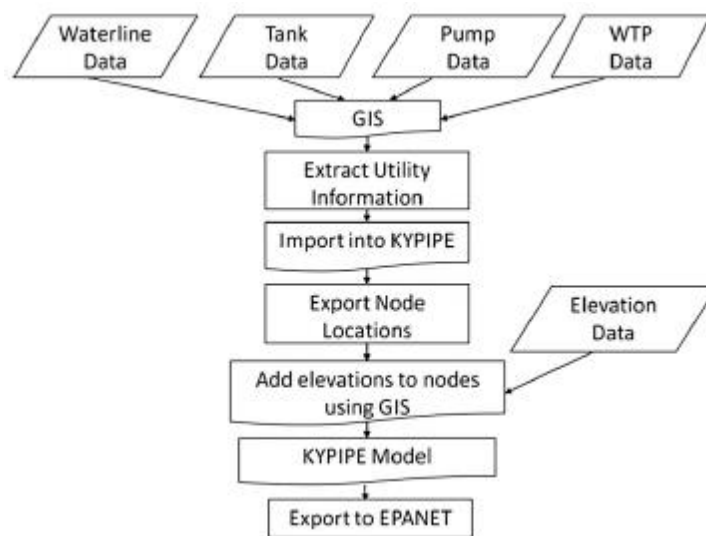

Figure 4-1 Model development flowchart (Jolly, Lothes et al. 2014)

The transition from shapefiles to a hydraulic model was made using a built-in conversion tool in the commercially available hydraulic modeling package KYPIPE. The GIS files were used as an input, and the conversion tool translates the spatial information and attributes assigned to the pipes, reservoirs, pumps and tanks of each network. In order to allow all the components to be converted successfully, each shapefile is defined as an element (i.e., water line, pumps, tanks, etc.) and the attributes of the GIS file are matched to attributes in the hydraulic model (e.g., diameter, or date of installation). This steps guarantees that the elements created match the data compiled by the KIA.

The junctions of the model were created by the intersection of two or more pipes once the GIS files were converted into elements for the KYPIPE hydraulic model. The junctions play a particularly important role in defining the hydraulic behavior, since the demand and elevation are assigned at these points. Currently, the KIA database does not contain data on either of these attributes. Instead, this information must be added once the shapefiles are converted into a network file. Assigning elevation to the nodes can be done using a digital elevation model (DEM), but the processing should be done in a GIS software (ArcGIS). Assigning demands to individual junction nodes can be done manually, using the hydraulic network files and wither the KYIPPE or EPANET graphical user interface. KYPIPE does have an option which allows the assignment of approximate nodal demands automatically as a function of the total system demand and the diameters of the pipes associated with each junction node (i.e. larger demands are assigned to junction nodes connected by larger diameter pipes).

The conversion tool that transformed the shapefiles into elements of the hydraulic model in KYPIPE also has an export function. Thus, the junction nodes can be exported into a shapefile that combined with a DEM can be used to obtain their elevation. Once the junction nodes are successfully exported back to ArcGIS, the DEM model is added. In developing the current database, a DEM with a spatial resolution of 10 meters by 10 meters was used to represent the ground area covered by the models. Each pixel in the DEM contains elevation data which can be extracted and assigned to each of the junction nodes using the “Extract Value to Point” tool in ArcMap (ESRI 2010) or an equivalent. Although the DEM files consist of ground elevation, pipes are typically buried 3 to 6 feet below. The user can make a manual adjustment to each of these elevations or use the ground elevation as an acceptable approximation. Once the

elevation data has been assigned to each junction it can be copied back into the KYPIPE hydraulic model. A final step in the file creation process is the conversion of the KYPIPE data file to an EPANET format since this package is freely available and is used by most researchers (Hoagland 2016).

The process at this point yields a hydraulic model with reservoirs, tanks, pumps, pipes and junctions. The elevation data for the nodes has been added but there are additional modifications that should be made to complete the model. The additional steps required before performing any hydraulic simulations are presented in the following section.

4.2.2. Additional Modifications

The conversion process may produce some connectivity errors that should be checked before the model is ready for hydraulic analysis. These are topological errors that may be created during the process of converting the shapefiles to pipe network files. In some cases the conversion process can result in pipes being completely disconnected from the rest of the network or disconnected from a nearby junction node or from an adjacent pipe segment. Unfortunately, some of these errors may not be visible when looking at the general network schematic but may only be seen when one “zooms in” or magnifies that portion of the network.

A built in “Connectivity Check” tool in KYPIPE can help facilitate this process. The tool can help identify such disconnected pipes so that a manual correction can be made. This is accomplished by specifying a spatial tolerance or distance between segments which the program will now recognize as “close enough” to constitute an actual physical connection (Hoagland 2016).

Currently, the KIA database does not contain roughness data for each pipe. As a result, this data must be entered manually for each pipe or entered once for the whole network using a global roughness factor. Pipe roughness can be characterized using either the Hazen-Williams roughness equation or the Darcy-Weisbach roughness equation. In either case, estimates of the associated roughness parameters (e.g. C or e) can be assigned as a function of pipe material and age. Ideally, these values should be adjusted through a more formal process of model calibration that requires the collection

of field data. For the purpose of this study, C factors of 100 were assumed for all the pipes in each network.

The hydraulic behavior of the network is directly linked to the demands, and the demand pattern of the system. The demand can be estimated using meter data, where utilities attach flow meter to the service connection to determine and bill the amount of water consumed by each customer. The meter data can be grouped and assigned to a neighboring node. Since the meter data was not available, the average daily demand for each system reported by KIA was used to assign the nodal demands.

In constructing the current database, the average daily demand was distributed across the available demand nodes using a weighted method based on pipe size. Junctions with larger incident pipes were assigned a larger fraction of the total demand, and junctions with smaller pipes leading to them were assigned a smaller fraction. This weighted demand distribution can be executed using the “Automatic Demand Distribution” tool in KYPIPE, where the weighting parameters for the demand fractions assigned can be adjusted. This distribution is close to what would be expected in a real system, except in the case of large transmission lines. However, in this study the approximation was considered acceptable (Schal 2013, Hoagland 2016).

Hydraulic models are generally set-up to perform steady-state and extended period simulations. With the current modifications, the model can be used for steady-state simulations; yet for extended period simulations a more representative behavior of the fluctuations in demand over the analysis period is required. For instance, in a typical community the demands during the nighttime are lower since most of the population is sleeping. In addition to fluctuations during the day, the demand will also vary over the week. Typical daily and weekly demand patterns for a particular system can be developed from direct observation, or approximated using average patterns obtained from the literature (AWWA 2011).

Once nodal demands have been assigned across the network, additional elevation and grade data associated with pumps, reservoirs, and tanks must then be assigned. Initial estimates of these data were obtained using WRIS system and then entered manually into the associated network file. These initial grades were then modified to insure that the resulting system pressures were within an acceptable operating range (i.e. 40 psi to 150 psi) (Hoagland 2016).

4.2.3. Classification Methodology

Water distribution systems have been typically classified according to their physical layout (i.e. grid, branched and looped networks) (AWWA 2011). In practice water distribution system rarely fit exclusively into a single category (see Figure 4-2).

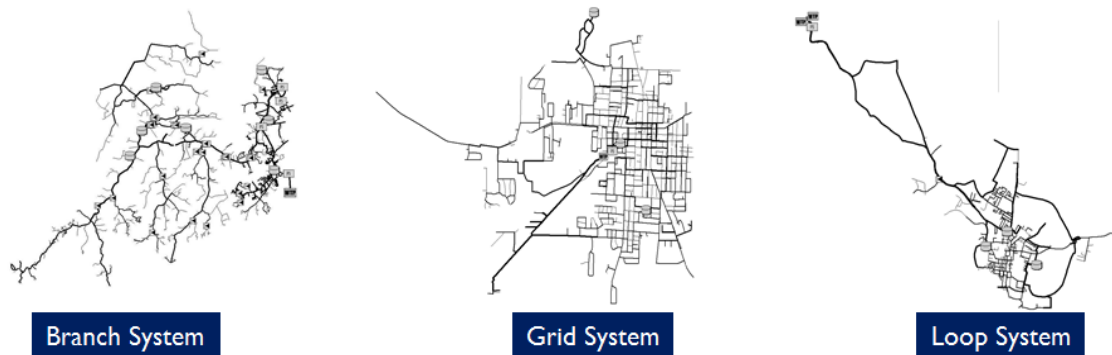

Figure 4-2 Examples of typical classifications for Water Distribution Systems

A branch network, also known as a tree network, is considered a water distribution network with no loops (Bhave and Gupta 2006, Swamee and Sharma 2008). Such networks are frequently encountered in rural distribution systems. A typical example of this network is a radial network, where several distribution lines span from the source, on a line connected to the source. The junctions are connected by a supply link upstream and one or more distribution links downstream. Thus, the direction of the flow in a single source branched system tends to be uni-directional (Bhave and Gupta 2006).

A network can be considered “looped” when the majority of the pipes are part of larger loops of pipes, typically involving five or more pipe segments. From a reliability standpoint, looped networks are typically preferred since they may provide an alternative path of flow if one or more pipes in another loop are taken out of service. In a looped system the direction of flow in a pipe may change based on changes in demand patterns (Bhave and Gupta 2006, Swamee and Sharma 2008).

Grid systems have a distribution similar to a checker board, composed of a grid of small loops connected to arterial pipes which feed the network from a central main, or connect the grid from side to side (Jolly, Lothes et al. 2014).

In the past, such water classifications have generally been based on a visual or subjective basis. However, as water distribution systems expand in response to changing population distributions and new developments, then what might have started as a branched system may evolve into a grid-like or and looped configuration, increasing the difficulty to classify the system.

A more objective method of system classification has recently been proposed by Hoagland and Ormsbee (2015) and is illustrated in Figure 4-3. To facilitate the topological classification of the network, a classification routine was developed that can use as input either a KYPIPE or EPANET file. The algorithm then processes and sorts the network topology data to then facilitate the calculation of several geometric indices that are then used to in a decision tree in order to arrive at a final classification (Hoagland, Schal et al. 2015).

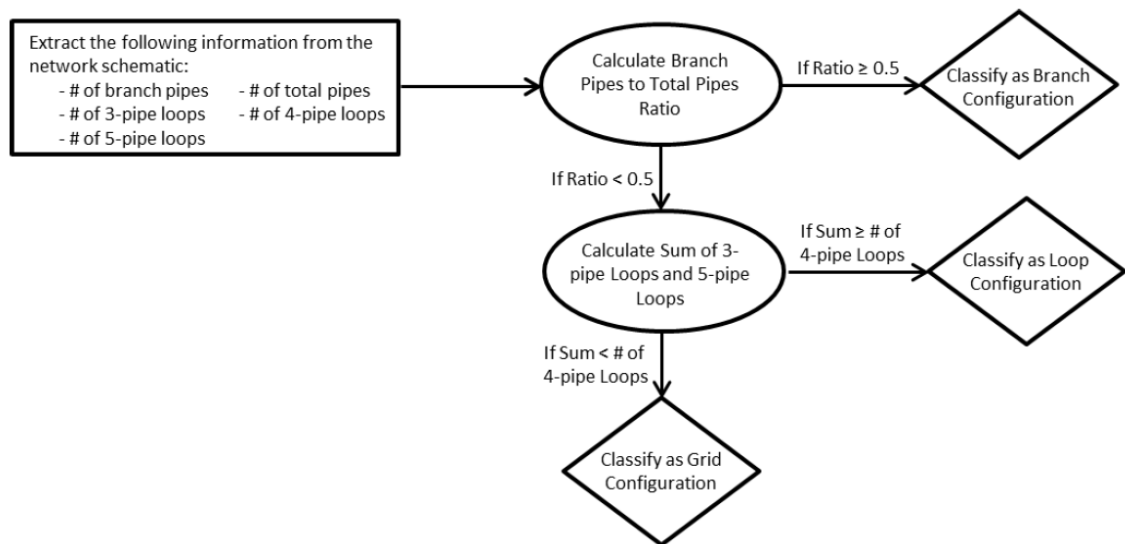

Figure 4-3 Classification Algorithm (Hoagland, Schal et al. 2015, Hoagland 2016)

The classification algorithm was automatized using a KYPIPE file and a Visual Basic based Pipe Loop Density tool (Hoagland 2016), however the classification decision tree can also be applied manually from an examination of the actual distribution network. By classifying the water distribution systems in the Kentucky Database into one of three dominant topologies, the user is provided with a more refined dataset for use in evaluating and comparing the efficiency of different analysis and optimization algorithms.

5. METHODOLOGY

5.1. Segment-Based Analysis

While the failure of pipe segments can be reduced, it is unlikely they will ever be eliminated, at least not with the current available technology. As a result, system disturbances can be expected to occur on numerous occasions over the life of a water distribution system. Thus, an interim solution to help to improve system resilience and reliability will typically focus on ways to make sure the outage can be confined to a small portion of the system thereby affecting the least number of costumers. One of the primary keys to limiting the impact of such breakages when they do occur is to insure that the system has an adequate number of isolation valves (Mays 2000).

Researchers (Bao and Mays 1990, Park and Liebman 1993, Gupta and Bhave 1994) have considered failure scenarios by reducing the affected area to a single pipe or link. However, the impact of a pipe breakage is not reduced to a single element in an actual system; but the area isolated by the valves closed to contain the damage. Therefore, vulnerability and reliability analysis should be implemented on the basis of the areas that can be isolated by the surrounding valves instead of using single pipes (Walski 1993, Li and Kao 2008). Walski first introduced the term “network or pipe segment” to describe the set of pipes that is included in the set that are isolated due to the closing of the isolation valves needed to isolate a single pipe break. (Walski 1993)

Historically, the placement of valves has followed general rules of thumb such as locating at least three valves at cross-sections and two valves at each T-intersection (Mays 2000). The Ten States Standards has the following design recommendation, “Valves should be located at not more than 500 foot intervals in commercial districts and at not more than one block or 800 foot intervals in other districts. Where systems serve widely scattered customers and where future development is not expected, the valve spacing should not exceed one mile.” (GLUMRB 2012). While most systems tend to have acceptable valve coverage any possible deficiencies can be identified when performing a segment based reliability analysis.

Walski (1993) has advocated for the use of segments in the evaluation of system reliability. However, since most network topology characterizations do not reflect the effect of valve locations or the existence of these segments, Walski suggested an alternative topology using an arc node representation where valves are represented as

arcs and segments as nodes (Figure 5-1). By graphing the segments as nodes and the valves as arcs, one can readily identify the critical segments (segments that provide the only path to a section of the system), the number of valves required to isolate a segment (number of arcs at each node) and the effects on the supply from the failure of any one segment.

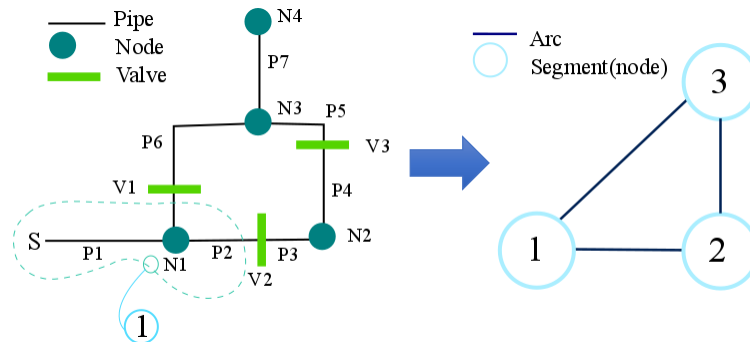

Figure 5-1 Illustration of arc node diagram for link-node system diagram.

Given that the number of valves required to isolate a section can be readily identified, the use of an arc segment topology facilitates defining the proper number and location of valves. An adequate valve configuration provides enough information to isolate the smallest possible segments while avoiding additional costs and operational constraints from an overwhelming number of valves (Walski 2006). The use of a segmentation analysis considers the true available pathways in case of a pipe failure since recognizing the location of the valves in the system allows the identification of the section of the network that is actually taken out of service.

Multiple researchers (Giustolisi, Berardi et al. 2014, Gupta, Baby et al. 2014, Liu, Walski et al. 2017) have acknowledged the importance of adequate valve placing in a system as an approach to increase reliability. Consequently, segment-based vulnerability analysis has been employed increasingly in the last decade (Kao and Li 2007, Li and Kao 2008, Berardi, Ugarelli et al. 2014, Giustolisi, Berardi et al. 2014).

Li and Kao (2008) use information about the topology of the water distribution systems to identify segments using an algorithm that systematically examines each node and pipe. The elements connected to an arbitrary node are first identified and stored and if one of the components is a valve it is marked as a boundary for the segment. The connected nodes and pipes are then stored as a new segment and identified as being “visited”. Then, the process is repeated using a new unvisited node until the entire

network is examined. Once the segments have been identified the computer program uses an algorithm based on the articulation point identification method (Li and Kao 2008) to detect the critical segments, or the segments that block the water supply downstream. The vulnerability of the system is then evaluated by simulating successive failures of the segments. After a segment is closed, the amount of water provided to each node is compared to the required demand at the node. The water supplied during the failure event is calculated using a pressure dependent formula proposed by Gupta and Bhave (1996). The segment model is then used to identify those segments that should be prioritized for rehabilitation and maintenance.

Loganathan and Jun (2007) also depart from the traditional link node representation by employing a segment approach to reliability assessment. Their segment-based analysis not only considers the failure of a link, but it also includes the possibility of a node failure or other elements (e.g. Pumps, fittings). Unlike Li and Kao (2008), their identification algorithm uses a series of matrices to represent how pipes, junction nodes and valves are connected. The segments are identified through a column and row search performed on a matrix representing valve deficiency. This valve deficiency matrix is constructed based on a node-pipe incidence matrix and a valve location matrix. Once the segments are identified, the required isolation valves, nodes, and pipes associated with each new segment are listed. The unintended isolations in the network can then be identified using an algorithm which explores all adjacent elements for each node, or through an arc node graphic representation of the original network.

In the proposed method, the segments identified in the network will be used to simulate failure scenarios. In each case, a segment is taken out of service and the behavior of the network is evaluated. In the following sections the procedure used to identify the segments of the network, and the performance metrics used are introduced.

5.1.1. Segment Identification

The proposed algorithm uses the connectivity matrix proposed by Loganathan and Jun (2007) and the depth first search algorithm used by Li and Kao (2008).

The program begins by creating a connectivity matrix containing the nodes and links organized by an index number. The index is the number used to represent each element in the hydraulic engine. In most cases, it will usually be the same as the label shown in the graphical user interface. The rows of the matrix correspond to the nodes

and the columns to the links. The matrix is populated by ones and zeroes, where a one indicates that a link and a node are connected. Each link is then examined and if it contains a valve then the node associated with that link is considered a boundary element. Each column is then checked to create a list of the links that are connected to that node thereby producing a list with the indices of all incident links.

The program then starts at one of the network nodes. If the node is not marked as checked it is listed as part of a new segment. A special function called ‘check node’ is then executed. This function performs a recursive calculation that will check every pipe listed as incident to that node and check the node connected on the other end of that link. The node connected at the other end of the pipe can now be either: 1) a node that has already been checked, 2) a node that has yet to be checked, 3) an end node, or 4) a node marked as a boundary (linked to a valve). If the node has already been checked, the algorithm moves on to the next link and node. If it is an end node it is marked as such and is added to the list of nodes of the segment. Once this classification has been performed the function moves on to next element. Once again, if the element is listed as a boundary, then an associated valve is added to the list of valves for that segment. If an unchecked node is encountered it is also added to the list of nodes for the present segment and the elements connected to that node are then checked and assigned a node type: a boundary node, an end node, an unchecked node, or a node that has already been visited. The pipes checked in the processes of moving from node to node

are added to the list of pipes assigned to the segment. This process is then followed until there are no more uncheck nodes that can be reached starting from the original

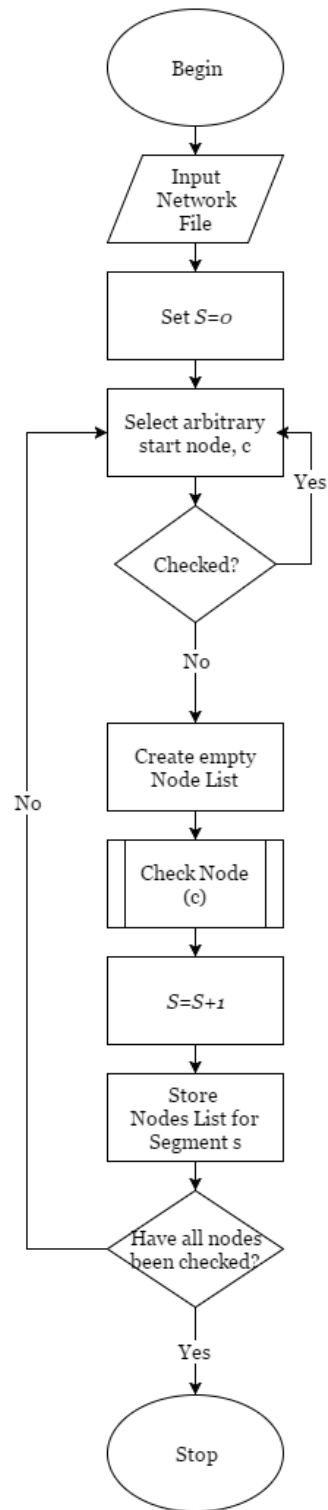

Figure 5-2 Segment Identification Algorithm

node without exploring locations beyond the boundary elements found. At this point a new segment list is created and the function ‘check node’ is executed again departing from a new unchecked node. Once all the nodes have been checked, the lists of segments will then be stored in an array with the links, nodes and enclosing isolation valves assigned to each of the segments. This procedure is summarized in Figure 5-2. A flowchart of the ‘check node’ function is provided in Figure 5-3.

The proposed method now uses the list of segments to evaluate how the system will behave whenever a segment is taken out of service as the result of a component failure within the segment or maintenance/replacement operations. To quantify the performance of the system in response to such failure events, three different performance metrics are proposed. These are discussed in more detail in the following sections.

5.1.2. Loss of Nodal Connectivity as Measured by Reduction in Total Demand

This metric will reflect the volume shortage experienced by the network when a segment is taken out of service with the assumption that the demands at each node are fixed and not affected by nodal pressures. Instead of considering the shortage produced by a single pipe which can be misleading (Figure 5-4), the area that can be isolated by the available valves (segment) will now be used since this provides a more accurate estimate (Figure 5-5).

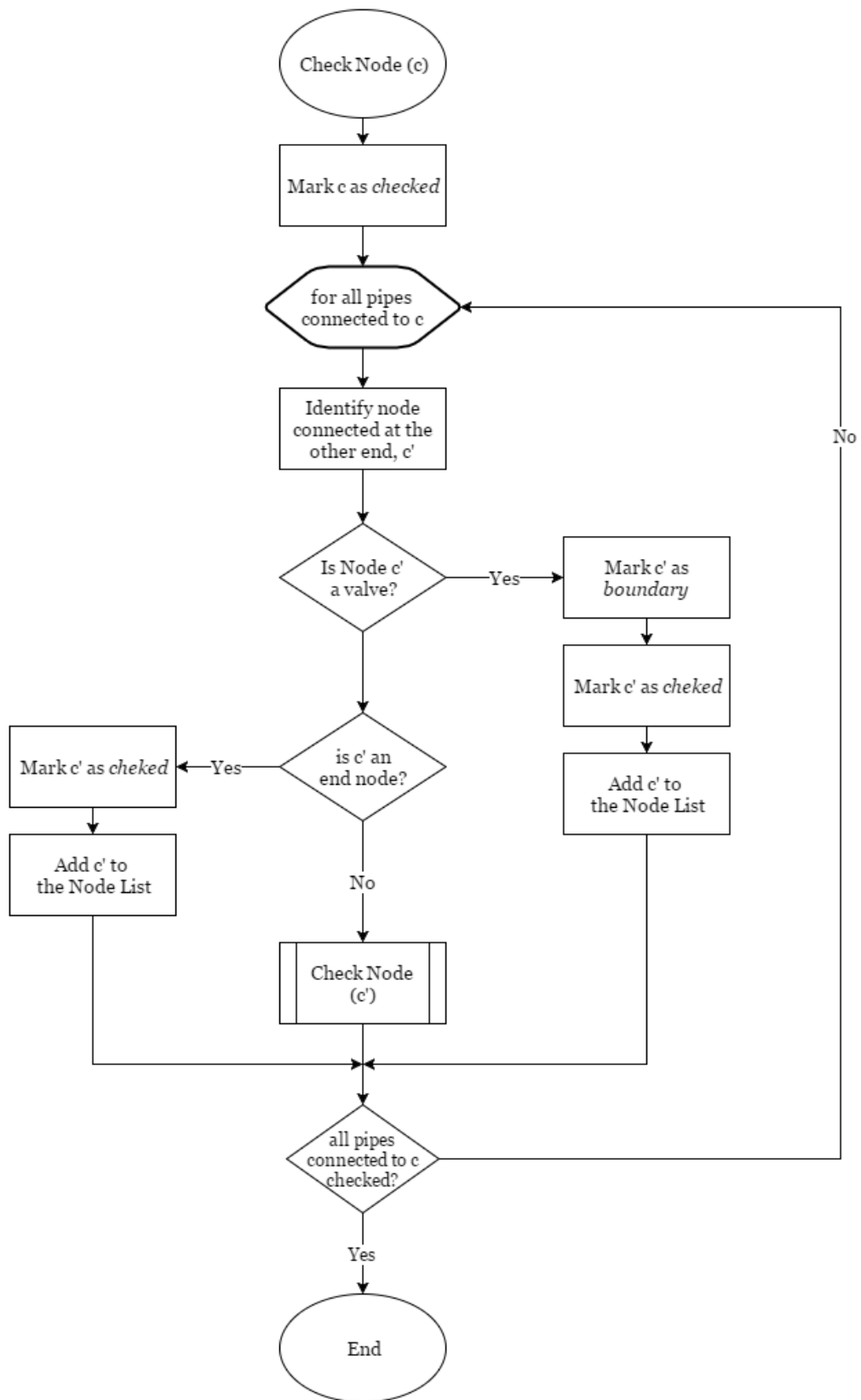

Figure 5-3 'Check Node' function for Segment Identification

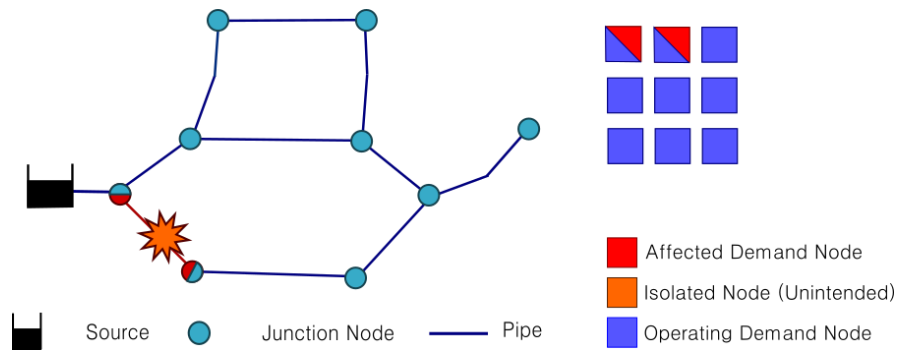

Figure 5-4 Illustration of the typical representation of a pipe breakage in a water distribution system

In this case, once a segment is closed, the users located in that section will be completely shut off from service if no other alternative source is present inside the enclosed area. However, some other sections surrounding the segment that was first closed may be also cut off from the source, effectively leaving those areas without service as well. These latter segments are considered unintended isolations (these nodes are indicated with orange nodes and blocks). The proposed performance metric will consider the shortage in volume delivered (Figure 5-6), accounting for the segment taken out of service and any unintended isolations.

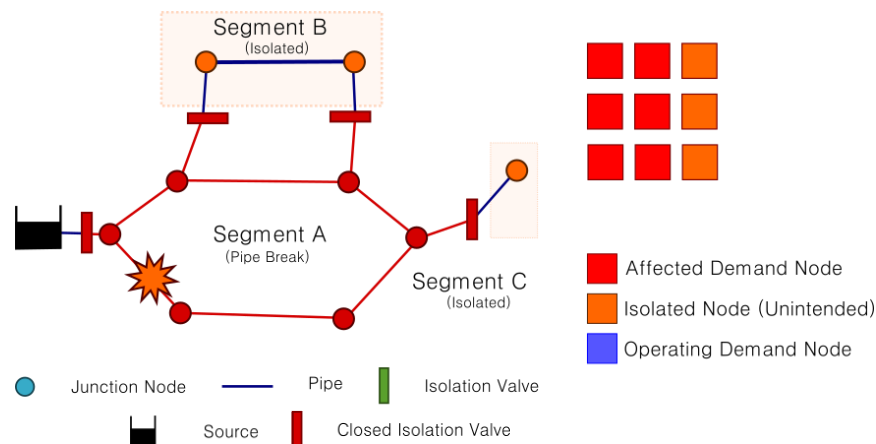

Figure 5-5 Illustration of the affected segment and unintended isolations for a pipe break

The procedure to determine this loss of demand starts with identifying how the segments are connected to each other. The first step is to define the list of incident segments. Using the array with the segment information created in segment identification step the valves that enclose each segment are compared. Those segments that have common valves are listed as incident since they connected to each other by

that common element. Once the list of incident segment is completed for each section, the information is added to the existing array with the segment data.

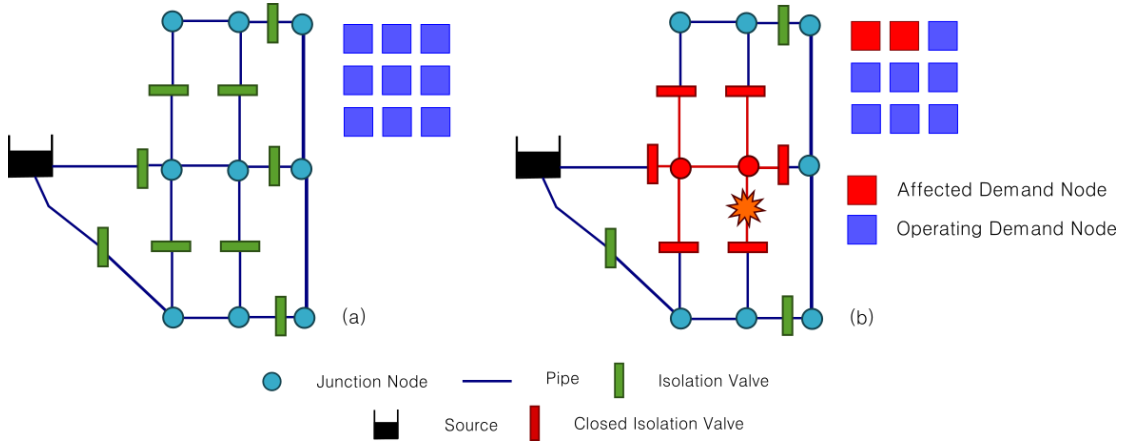

Figure 5-6 Effect on pressure independent demand. (a) Before failure, (b) After segment failure.

The shortage associated with each failed segment (both primary and secondary) can be expressed as the ratio of the demand remaining after the segment closure to the total original demand as follows,

$$\text{Loss of Pressure Connectivity}_s (\%) = \left(\frac{Q_{All} - Q_R}{Q_{All}} \right) * 100 = \left(\frac{Q_s}{Q_{All}} \right) * 100 \quad (5-1)$$

$$Q_{All} = \sum_{i=1}^n Q_i \quad (5-2)$$

Where, n is the total number of demand nodes in the network, Q_i is the demand at node i , Q_{All} is the total demand for the network, Q_R is the demand that can be fulfilled when the segment s has failed, and Q_s is the shortage experienced in the network as the result of the shut-off for segment s and any unintended isolations. This performance metric is calculated for all identified segments.

The shortage volume can be defined by checking the demands assigned to the demand nodes of the failing segments and unintended isolation during the analysis period, or by comparing the demand driven simulation from before and after failure. Alternatively, the number of affected users could also be determined.

The hydraulic impact of the segment failure can be used to address the reliability of the network. The shortage in the volume delivered created by a failing segment will

vary depending on its location and layout. Comparing the volume delivered before and after a segment failure provides a way to assess the loss of performance in terms of the demands that would remain unfulfilled. High shortages associated with a single segment can be interpreted as an added vulnerability associated with that segment, a lack of installed redundancies in the network, or a network that requires further reliability considerations to minimize the effect on the users.

As we have seen, the fraction of the total system demand that may be eliminated as a result of an isolated segment (from both primary and secondary isolations) can be readily determined by simply summing the demands associated with each of the isolated nodes. However, this assessment may underestimate the impact of such isolations to the rest of the system as a result of the reduction of system pressures which can also impact demands. This impact can be quantified by either simply identifying the number of nodes with lower pressures, or by actually calculating the reduction in delivered flows that result from such pressure reductions. Since the latter approach would be more accurate, this approach is used in this research.

5.1.3. Loss of Pressure Dependent Demands

Several methods have been proposed to simulate network conditions using a head flow relationship at the nodes. Using the concept of nodal availability the following relationship can be expressed mathematically as (Goulter and Coals 1986, Su, Mays et al. 1987),

$$q_j^{avl} = q_j^{req}, \text{ if } H_j^{avl} \geq H_j^{min} \quad (5-3)$$

$$q_j^{avl} = 0, \text{ if } H_j^{avl} < H_j^{min} \quad (5-4)$$

Where for node j , q_j^{avl} is the flow available, q_j^{req} required design flow, H_j^{avl} available nodal head, and H_j^{min} is the required head.

Other researchers have defined the flow in terms of residual heads ($H_j^{avl} - H_j^{min}$). However, most of these approaches were not adequate for reliability purposes since they disregarded the possibility of partial flow or did not set an upper limit to the flow allowing flows above the required limit (Gupta and Bhave 1996).

Bhave (1981) first attempted to include both flows and heads simultaneously (including partial flows) through the following proposed equations:

$$q_j^{avl} = q_j^{req} , \text{if } H_j^{avl} \geq H_j^{min} \quad (5-5)$$

$$0 < q_j^{avl} < q_j^{req} , \text{if } H_j^{avl} = H_j^{min} \quad (5-6)$$

$$q_j^{avl} = 0 , \text{if } H_j^{avl} \leq H_j^{min} \quad (5-7)$$

This expression approaches more closely what will happen in an actual system since the flow delivered at the nodes is be linked to the available pressure. In general, this formulation can be expanded to include variable demand targets as follows (Pacchin, Alvisi et al. 2016),

$$q_j^{avl} = q_j^{req} , \text{if } H_j^{avl} \geq H_j^{des} \quad (5-8)$$

$$\propto q_j^{req} , \text{if } H_j^{min} < H_j^{avl} < H_j^{des} \quad (5-9)$$

$$q_j^{avl} = 0 , \text{if } H_j^{avl} \leq H_j^{min} \quad (5-10)$$

Where \propto is a coefficient that modulates the flow. Other formulations for pressure dependent demands have been proposed by (Wagner, Shamir et al. 1988, Tucciarelli, Criminisi et al. 1999).

$$q = q_j^{req} * \left(\frac{H_j^{avl} - H_j^{min}}{H_j^{des} - H_j^{min}} \right)^\gamma \quad (5-11)$$

$$q = q_j^{req} * \sin^2 \left(\frac{H_j^{avl} - H_j^{min}}{H_j^{des} - H_j^{min}} \right) \quad (5-12)$$

In the method suggested by Wagner (1988) γ typically takes a value of 0.5, providing a parabolic relationship (Figure 5-7) between head and flow (Gupta and Bhave 1996).

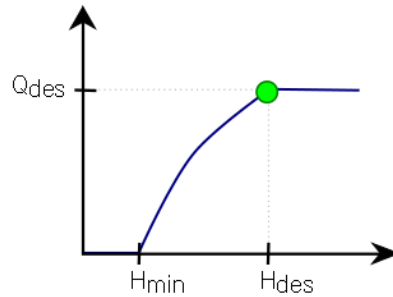

Figure 5-7 Pressure Dependent Demand function

In order to perform a pressure dependent simulation, the typical approach is to set up an iterative simulation. In an iterative process a set of simulated supplies at the nodes are used as the demands for the next iteration until the simulated supply and the demand are within a defined tolerance (Li and Kao 2008). However, other methods take advantage of an existing demand driven hydraulic simulation model to create equivalent results to a pressure dependent demand model. This can be achieved by making a series of modifications to the network by adding a sequence of devices and running a single steady state simulation. The elements used typically include: a reservoir, an emitter, a flow control valve, a pressure reducing valve, and a check valve to prevent flow reversal (Pacchin, Alvisi et al. 2017). The method used in this research uses the function proposed by Wagner et al. (1988) by relating it to the equation of flow through an emitter (Sayyed, Gupta et al. 2014). The generalized equation for nodal flow can now be expressed as:

$$q_j^{avl} = C_d * (H_j^{avl} - H_j^{min})^\gamma \quad (5-13)$$

Where C_d and γ are the emitter coefficient and exponent. Rearranging for a similar form to (5-11)

$$C_d = q_j^{avl} / (H_j^{avl} - H_j^{min})^\gamma \quad (5-14)$$

The sequence of devices for use in simulating this function includes a flow control valve, a junction node, a reach with a check valve (CV) and an emitter at each demand node j . To simulate the pressure dependent supply, the demand at the original node is set to zero while the flow control valve (FCV) is fixed to the original demand value (q_j^{req}). The junction and the emitter are set to an elevation $Z_e = Z_j + H^{min}$ (where Z_j is the ground elevation and H^{min} is the minimum allowable pressure expressed in terms of feet). The coefficient for the emitter is defined as $C_d = q_j^{req} / (H_j^{des} - H_j^{min})^\gamma$, and the exponent $\gamma = 0.5$ (or $\gamma = 2/3$) (Sayyed, Gupta et al. 2014, Pacchin, Alvisi et al. 2017). With this string of elements, the flow control valve will prevent the flow from exceeding the required demand and the check valve will prevent flow reversal from the emitter to the node (see Figure 5-8)

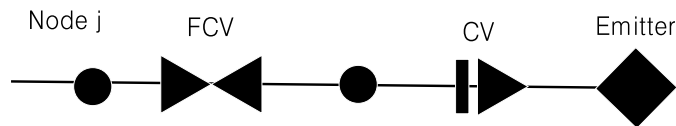

Figure 5-8 Device Sequence (Sayyed, Gupta et al. 2014, Pacchin, Alvisi et al. 2017)

Once the behavior of the pressures has been linked to the delivered flows, the effects of each segment failure in the demands across the network can be represented as the shortage in demand under a failure (Figure 5-9).

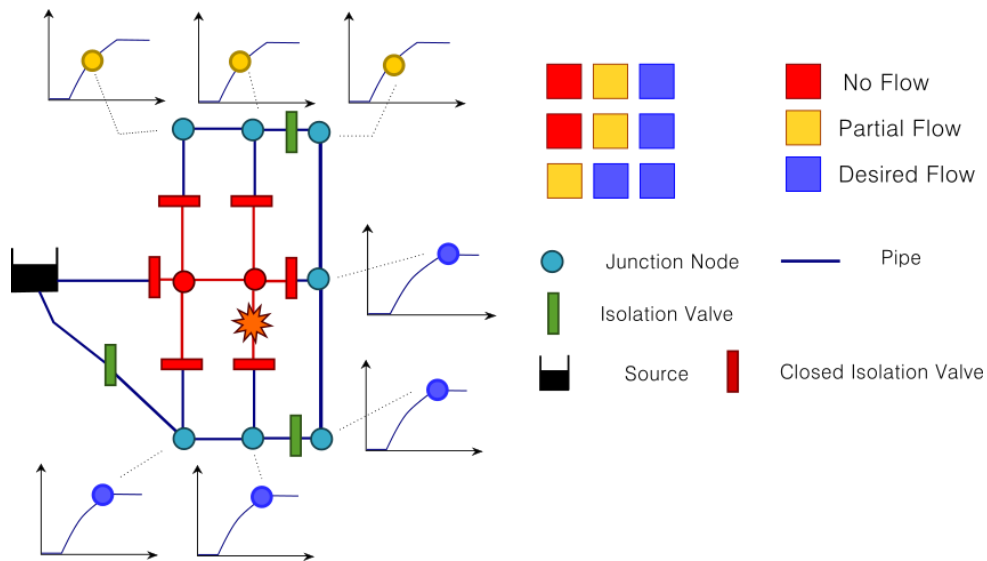

Figure 5-9 Effect on Pressure Dependent Demand after segment failure.

The shortage experienced under failure can be compared to the fully operating network to obtain a performance metric that could be expressed as a ratio or percentage. Mathematically,

$$\begin{aligned}
 \text{Loss of Pressure Dependent Demand}_s(\%) &= \left(\frac{Q_0 - Q_f^{PD}}{Q_0} \right) * 100 \\
 &= \left(\frac{Q_s^{PD}}{Q_0} \right) * 100
 \end{aligned}
 \tag{5-15}$$

Where Q_0 is the total demand supplied before failure, Q_f^{PD} is the demand supplied once failure occurs, and Q_s^{PD} is the shortage in demand experience as consequence of the failure of segment s (now including the eliminated nodes and the impaired nodes both caused from the segment isolation).

5.1.4. Increase of Water Age

In previous vulnerability and reliability assessments, water quality has not been explicitly included. However, previous studies have shown that water quality can be negatively impacted by the isolation of pipe segments, since it will typically take longer for the water to reach the consumer, thereby raising the likelihood of the loss or reduction of residual disinfection levels in the water distribution system.

Water quality performance can be assessed using several different metrics, including water age, chlorine residuals, etc. Since many of the water quality processes in a water distribution system are non-conservative, an accurate characterization may require additional sophisticated software. In order to simplify the assessment process, this research will only consider water age, which can frequently serve as an adequate surrogate for disinfection (Murray, Grayman et al. 2009).

The proposed water age metric used in this study is summarized as:

$$Effect\ on\ Water\ Quality(\%) = \left(\frac{\sum_1^n Q_i^{(s)} * A_i^{(j)} - \sum_1^n Q_i^{(0)} * A_i^{(s)}}{\sum_1^n Q_i^{(0)} * A_i^{(0)}} \right) * 100 \quad (5-16)$$

Where Q_i^0 =Estimated supply for node i (no failing segments), Q_i^s =Estimated supply for node i, with the closure of segment s, A_i^0 =Water age for node i (no failing segments) and A_i^s =Water age supply for node i, with the closure of segment s.

The performance metric considers an increase in water age as a negative effect on the behavior of the system, since higher water age will normally indicate a more stagnant system. Since the performance metric uses an increase in the average water age weighted by demand to evaluate the network behavior, this metric can be expressed as a ratio or the percentage increase in water age once a segment has failed when compared to the water age of the system before a breakage. A possible illustration of the results of such a metric are shown in Figure 5-10.

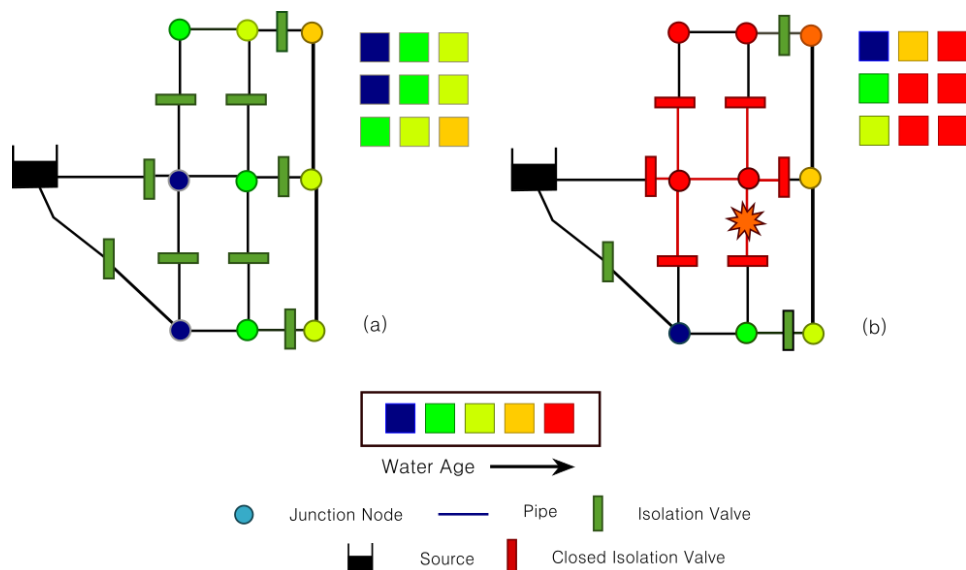

Figure 5-10 Effect on water age. (a) Before failure, (b) After segment failure.

5.2. EPANET Toolkit

All three performance metrics can be estimated using a customized version of EPANET (Rossman 2000). For this research, EPANET was customized using the EPANET programmer's toolkit which is composed of a dynamic link library (DLL) of functions. The toolkit is coded in an open-source version of MATLAB (OpenWaterAnalytics 2016). It was originally created by the KIOS Research Center for Intelligent Systems and Networks of the University of Cyprus (2013). Operating within the MATLAB environment (MathWorks 2015) it provides a programming interface for EPANET. A flowchart of the general assessment model is provided in Figure 5-11.

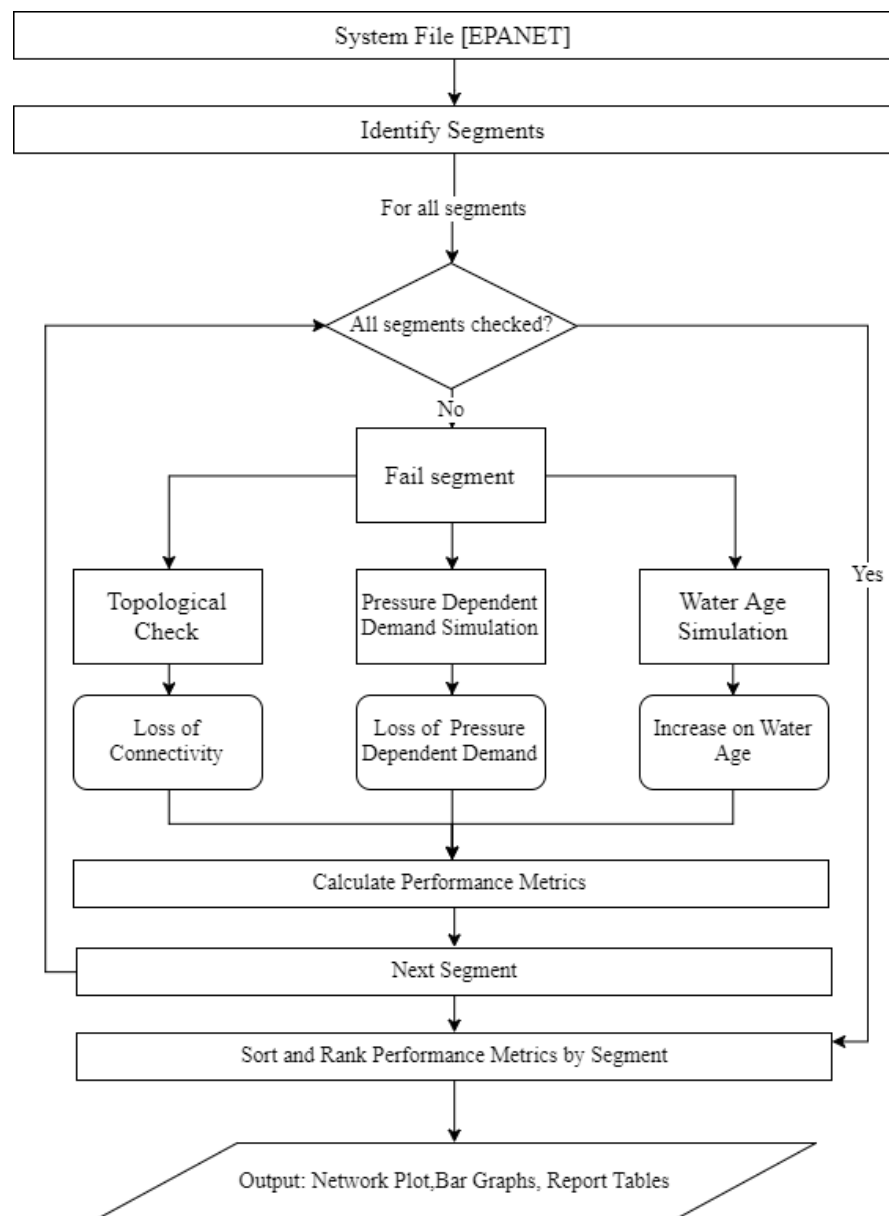

Figure 5-11 Reliability Assessment Model

5.3. Analysis Sequence

Once the data for the network has been assembled, the assessment process proceeds in the following sequence:

1. Assemble a compatible data file (including valve information) and identify the existing segments.
2. Perform a reliability assessment of the system. Three different levels of reliability are then examined: 1) Loss of Connectivity, 2) Loss of Pressure Dependent Demand, and 3) an Increase in Water Age.
3. Once the assessment is completed the assessment can be evaluated using tabulated results or histogram plots as shown in Figure 5-12. Critical pipe clusters and segments with the highest impact can then be identified and illustrated on map of the system. Once the segments are identified, they can be ranked using the estimated impact on the network performance (performance reduction metrics).

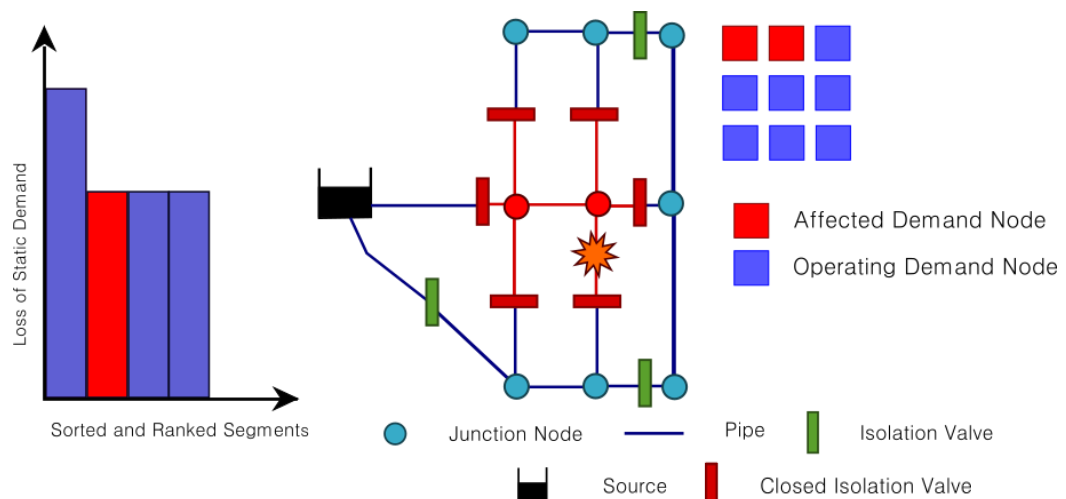

Figure 5-12 Performance histogram representing loss nodal connectivity measured as the reduction in demand

Once the reliability of the system is identified, individual pipe clusters can be examined (highlighting the location of the clusters on a graphical schematic of the distribution system with an underlying background map) for possible system upgrades (Figure 5-13). Such upgrades may include the addition of new isolation valves, booster pump stations, chlorine stations, parallel pipes or an increase in size of a new pipe. An iterative process can then be followed to achieve a desired level of reliability.

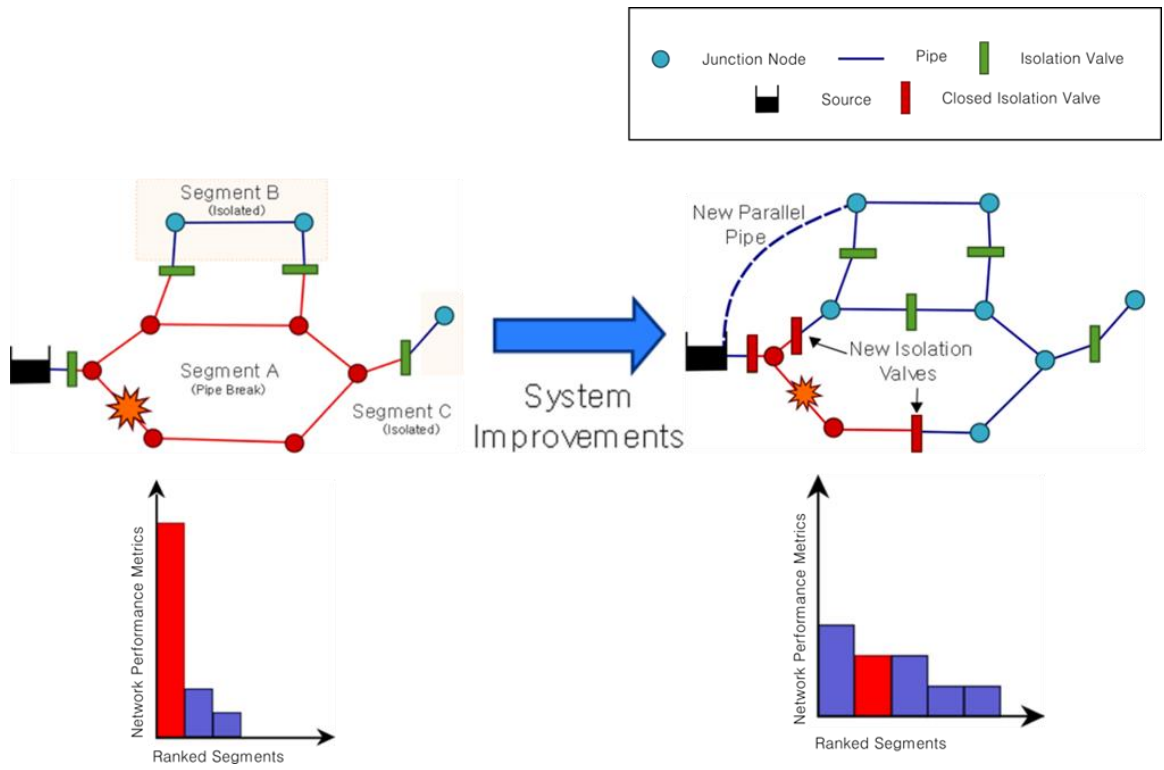

Figure 5-13 Example of how the software can be used to identify possible upgrades to increase reliability in a water distribution system

6. RESULTS

6.1. Database Systems

The developed assessment methodology was investigated using three common test systems: 1) the Hanoi water distribution system (Fujiwara and Khang 1990), 2) the Federally Owned Water Main (FOWM) system (Chase, Ormsbee et al. 1988), and 3) the ANYTOWN system (Walski, Brill et al. 1987). The Hanoi system and the FOWM are skeletonized versions of real distribution networks, while ANYTOWN is an artificial system created to test optimization algorithms. These systems are familiar to researchers in the field and have been used repeatedly to test optimization algorithms and design methods (Eiger, Shamir et al. 1994, Farmani, Walters et al. 2005, Wu and Walski 2005, Gupta, Kakwani et al. 2015)

In order to apply the assessment methodology, the associated network files must contain all of the operational isolation valves. Unfortunately, this type of data has not been collected in the past and is not available for any of the network systems in the Kentucky Database including the three systems selected for application. As a result, the data files had to be modified in order to apply the methodology. In this case isolation valves were added to each system consistent with a reasonable expectation of where the valves might be located.

For this application, the three network models used were downloaded from the database website (<http://www.uky.edu/WDST/database.html>) as KYPIPE compatible files). Each of these files was then edited. The modifications made to the data files included: the addition of valves, changes in the reservoir grade (for Hanoi and the FOWM), elimination of intermediate nodes, and exporting the file as an EPANET compatible network model.

The contents of the data files were modified using KYPIPE since the process to add valves was simple, and it didn't change the geometry of the existing network. However, when creating the valves in KYPIPE, it is important to designate the valves as "Active Valves" since other types of valves will not be exported to the EPANET compatible file. Once the valves have been added, any intermediate nodes (used by KYPIPE to represent the spatial curvature of any pipes) need to be eliminated. If a network contains intermediate junction nodes it will generate errors in the EPANET network file. An important difference to consider when the network models are being

transferred between KYPIPE and EPANET is that they manage the valves and pumps differently. In KYPIPE they are node elements, while in EPANET a valve or a pump is assigned as a link. Therefore, each valve or pump exported will be shown in the EPANET file as a new link and two junction nodes (Figure 6-1).

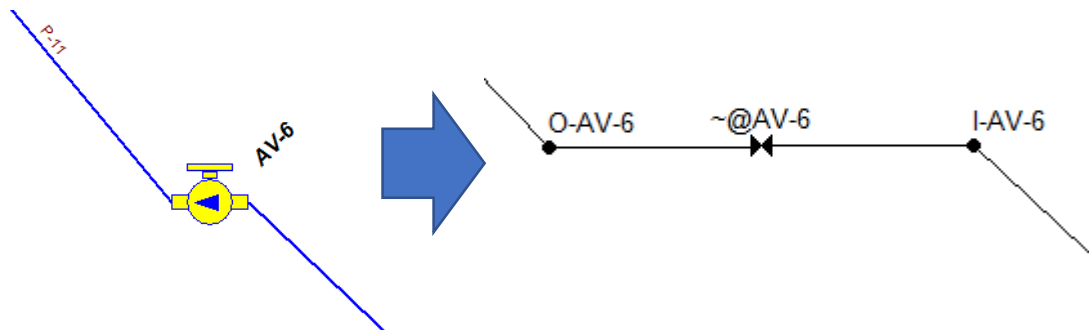

Figure 6-1 Active valve representation in KYPIPE (left) and EPANET (right)

6.2. Reliability Assessment Results and Discussion

Using the EPANET compatible network files, the first step is to identify the segments in the system. The segment identification routine stores in an array each of the sections of the network that can be isolated using the available valves. The elements that belong to each segment (e.g., pipes, junctions, reservoirs, tanks) are tabulated (see APPENDIX B) so that the network can be plotted using a different color for each segment. Examples of plots color coded by segment are presented for each of the three systems in Figures 6-2 through 6-4. These color coded plots are also provided in APPENDIX C.

The reservoirs and tanks in a system were assigned to the different segments. In case the system is operating with a single source, the reliability assessment will not evaluate the failure case for the segment containing the only source of the network (e.g. Hanoi, FOWM). Instead, this segment is assumed to continue to be operational, since loss of the segment containing the source would result in the loss of service to the entire network,

Any pumps in the system (e.g. ANYTOWN) are considered to act as valves. Since valves are typically placed in the suction and outlet side of pumps to protect them from surges, regulate flow, and are used during shut off or start up; an assumption was made that the pumps served as constant head boundary conditions for the associated segments.

The information associated with the segments identified for each of the networks was used to generate failure scenarios. Each network was evaluated for two different conditions (normal and failure) for the three performance metrics. The performance metrics included: percent of supply shortage checking for connectivity to the source, the percent of supply shortage assuming pressure dependent demands, and percent increase in water age. For the purposes of the pressure dependent demands a minimum value of 20 psi was used for fire flow conditions. A minimum value of 40 psi was used to emulate peak-hour demand settings (AWWA 2011).

Once the algorithm is executed for each system and each loading condition, the associated performance metrics are then calculated. The results are sorted and graphed in a histogram with the segment failures that most negatively affect the performance of the network plotted first. The segment that most negatively affects the performance of the network is referred to as a critical segment. The graphs, tabulated results, and additional information for all networks can be found in APPENDIX A through APPENDIX D.

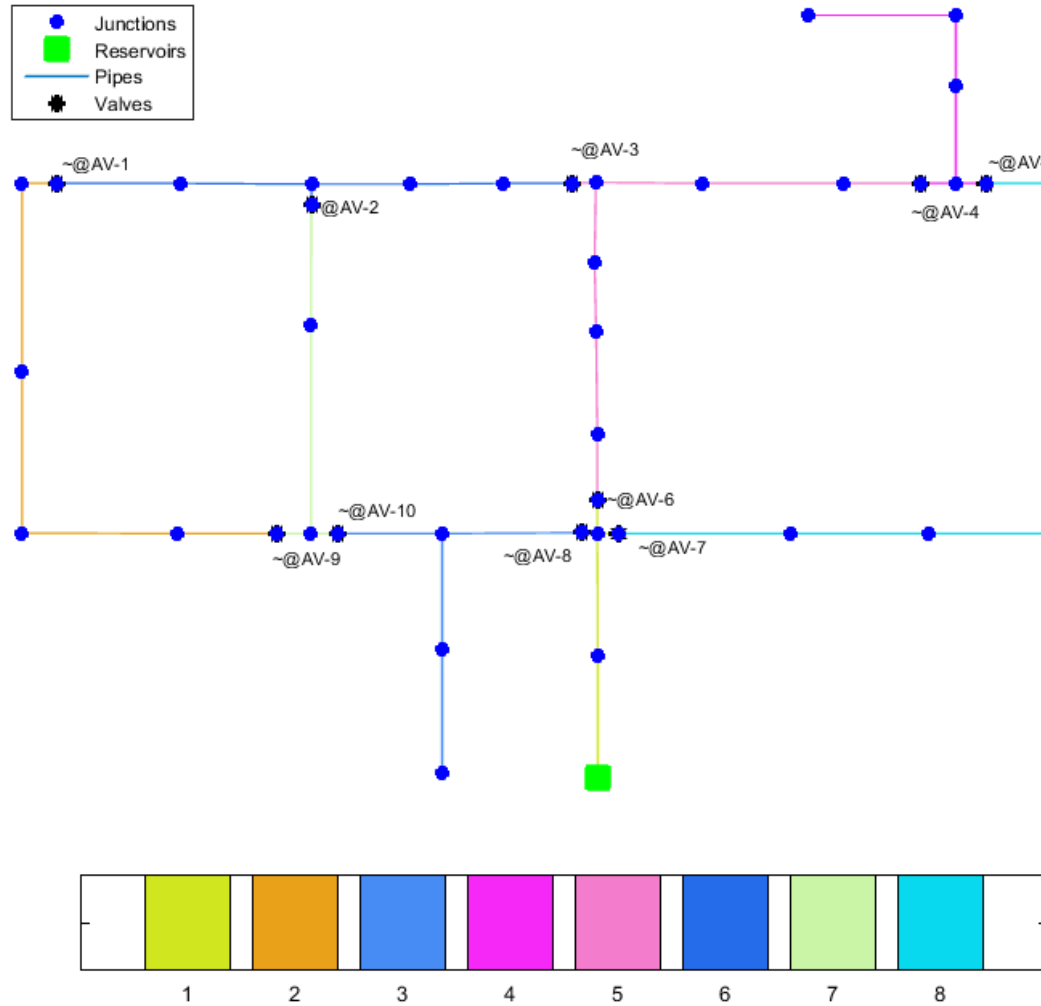

Figure 6-2 Hanoi network with color coded segments

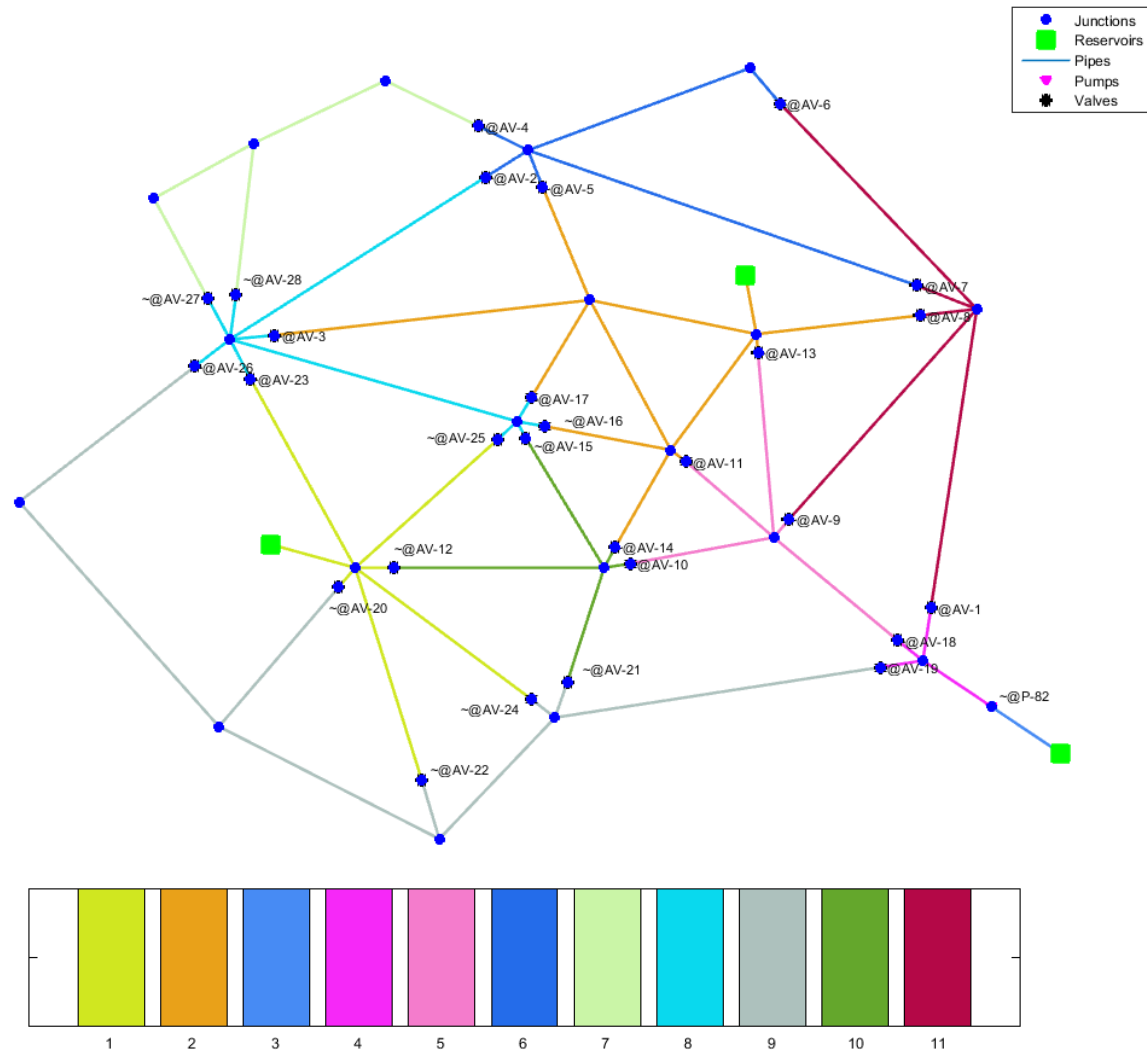

Figure 6-4 ANYTOWN network with color coded segments

6.2.1. Hanoi System Results

The Hanoi system is based on the planned trunk network of Hanoi, Vietnam. There are 34 pipes with a total length just under 39 km (24 mi). The pipe diameters range in sizes between 12 and 40 inches and the total demand of the system is 126.5 MGD. The grade of the reservoir is modified from that of the network model in the research database to guarantee pressures over 40 psi under normal operating conditions (no failing segments).

Loss of Connectivity When the independent pressure demand metric is used for the Hanoi system (see Figure 6-5, and Table 6-1) segment 8 is identified as the critical segment. The demand assigned to the junction nodes in this segment are the highest for the network. Therefore, the loss of this segment will create the largest shortage of supply.

Increase of Water Age The surrogate water quality parameter considered is the weighted water age, and the performance metric compares this parameter under normal and failure conditions. In the case of Hanoi the highest increase in the weighted water age is 7% and it is produced when segment 3 fails. Since isolating segment 3 changes the layout of the network increasing, the travel time of the supply to the segments on the left side of segment 3 increases producing the rise.

Loss of Pressure Dependent Demand As discussed previously, the pressure dependent demand metric was evaluated using two different minimum pressures: 20 psi and 40 psi. For both minimum pressure settings the segment that produces the most negative effect on the behavior of the network is segment 8.

The performance metric scores for the Hanoi system indicate the loss of segment 8 would cause the most detrimental effect on the network performance when the supply shortage (loss of connectivity and pressure dependent conditions) is considered. While the failure of segment 3 would produce the most negative effect on the weighted water age of the system (Figure 6-6).

The performance metric values for the loss of pressure dependent and connectivity are three or more times higher than the increase in the weighted water age of the system. This means during a failure a significant increase in water age may not be experienced, but the discharge delivered to the network will probably fall

significantly below the required volume. Therefore, the Hanoi system may perform better when water age is considered instead of hydraulic function parameters.

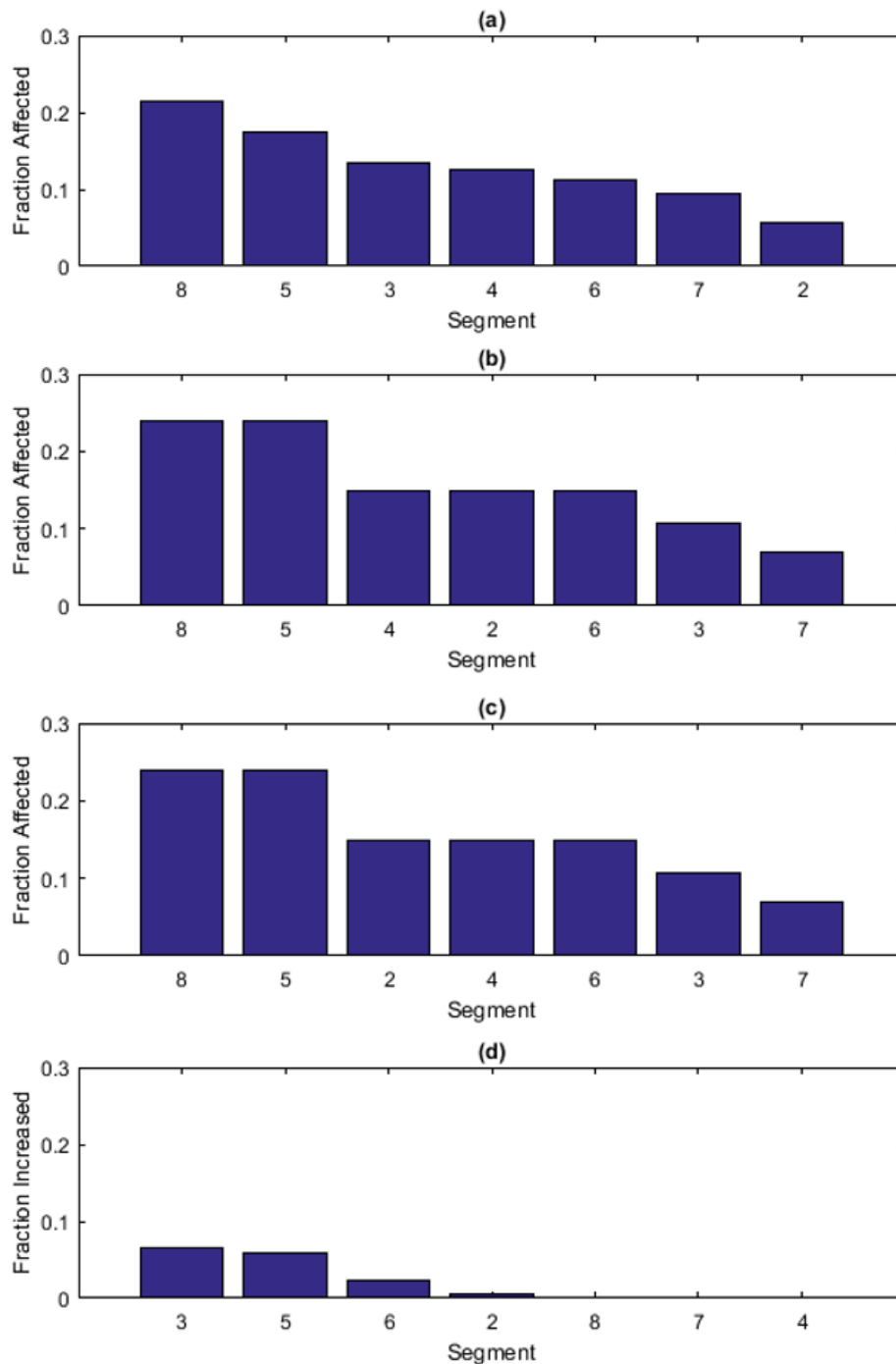

Figure 6-5 Performance Metrics for the Hanoi network by segment (a) Fraction of original demand affected considering Pressure Independent Demand (b) Fraction of original demand affected considering Pressure Dependent Demand ($P_{min}=20$ psi), (c) Fraction of original demand affected considering Pressure Dependent Demand ($P_{min}=40$ psi) (d) Fraction of original weighted water age increased

Table 6-1 Performance metrics and segment information for Hanoi

Segment	Total Segment Length [m]	Sources in Segment	Valves*	Loss of Connectivity (%)	Loss of Pressure Dependent Demand [20 psi] (%)	Loss of Pressure Dependent Demand [40 psi] (%)	Effect on Water Age (%)
1	1924.84	1	3	-	-	-	-
2	5062.58	0	2	6%	15%	15%	-
3	6062.1	0	2	13%	11%	11%	7%
4	6128.9	0	2	13%	15%	15%	-
5	7344.82	0	3	17%	24%	24%	6%
6	3520.24	0	3	11%	15%	15%	2%
7	3253.99	0	3	9%	7%	7%	-
8	6122.52	0	2	21%	24%	24%	-

*Valves required to isolate the segment

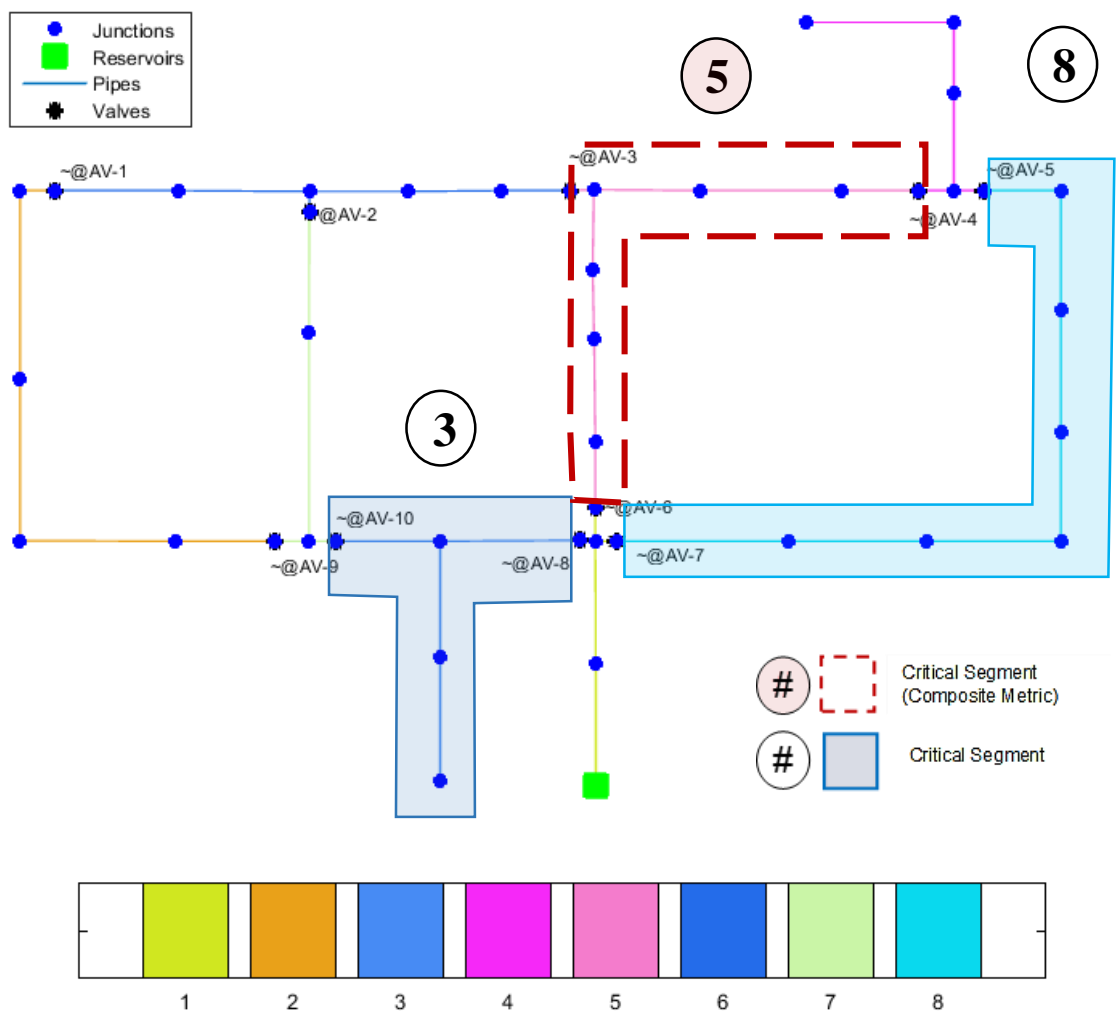

Figure 6-6 Hanoi network with highlighted critical segments

6.2.2. Federally Owned Water Main (FOWM) Results

The Federally Owned Water Main (FOWM) distribution system serves Federal facilities in the north of Arlington County, Virginia. It provides water supply to the Pentagon, Washington National Airport, the Navy Annex, Arlington National Cemetery, and Fort Myer. The supply for the system is provided by Washington, DC (represented in the hydraulic model using a reservoir) through two lines crossing the Potomac River. The system is represented using 37 pipes with a total length of 9.5 mi. The pipe diameters range in sizes between 4 and 32 inches and the total demand of the system is 3.2 MGD.

The grade of the reservoir is raised from that of the original network model in the research database to guarantee pressures over 40 psi under normal operating conditions (no failing segments).

Loss of Connectivity When the independent pressure demand metric is used for the FOWM system (see Figure 6-8 and Table 6-2) segment 10 can be considered the critical segment. Segment 10 in the FOWM is where the National Airport is located. Losing this segment isolates the consumer with the highest demand requirement, in the area served by this system, from the source.

Loss of Pressure Dependent Demand The loss of dependent pressure demand metric was evaluated using two different minimum pressures: 20 psi and 40 psi. When using 20 psi as the required minimum pressure, segment produced the most negative effect when failed. However, when 40 psi is used as the minimum pressure requirement, the critical segment is number 4.

Increase of Water Age Segment 10 is the critical segment when water age is considered.

The highest scores observed in the metrics reflecting the highest detriment in performance are those associated with the failure of segment 4 and segment 10 (Figure 6-8). The shortages experienced are different under the two pressure settings considered. When the network is operating under normal conditions the pressure at all nodes in the network is above 40 psi.

Using the minimum pressure as 20 psi, the critical segment is still the one with the greatest fraction of the total required demand (segment 10). Additionally, the system

pressures under a failure of segment 10 don't fall too far below the minimum required. Therefore, similar behaviors to those observed for the pressure independent demands scenarios are presented for the first four to five highest ranked segments.

On the other hand, when the minimum pressure is increased (40 psi) the pressure delivered at the nodes falls further below the new minimum. . The closure of segment 4 changes the network layout driving up the frictional losses and decreasing the pressure across the system. This intensifies the shortages beyond the initial failed segment since the demand delivered is pressure dependent.

Similarly to Hanoi, for the FOWM the detriment in performance during abnormal conditions is higher for the hydraulic parameters (pressure dependent and pressure independent demand) than the experienced effect on water age.

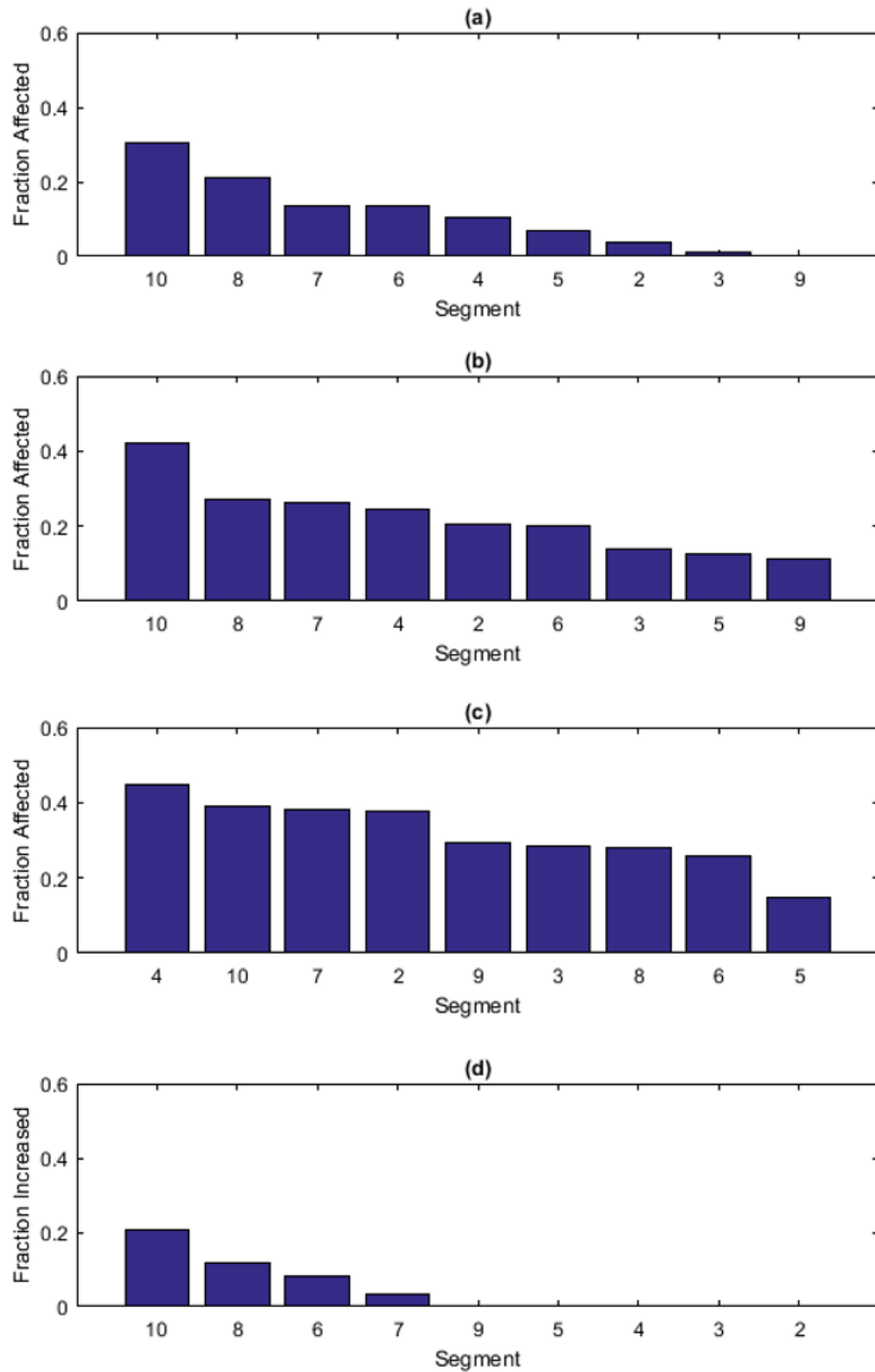

Figure 6-7 Performance Metrics for the FOWM network by segment (a) Fraction of original demand affected considering loss of connectivity (b) Fraction of original demand affected considering Pressure Dependent Demand ($P_{\min}=20$ psi), (c) Fraction of original demand affected considering Pressure Dependent Demand ($P_{\min}=40$ psi) (d) Fraction of original weighted water age increased

Table 6-2 Performance metrics and segment information for FOWM

Segment	Total Segment Length [ft]	Sources in Segment	Valves*	Loss of Connectivity [GPM]	Loss of Pressure Dependent Demand [20 psi] (%)	Loss of Pressure Dependent Demand [40 psi] (%)	Effect on Water Age (%)
1	2317	1	2	-	-	-	-
2	5114.23	0	3	4%	20%	38%	-
3	11159.97	0	4	1%	14%	29%	-
4	1936.04	0	4	10%	24%	45%	-
5	6632.49	0	3	7%	13%	15%	-
6	3174.33	0	4	14%	20%	26%	8%
7	2477.36	0	3	14%	26%	38%	3%
8	7381.17	0	3	21%	27%	28%	12%
9	5880.13	0	2	0%	11%	29%	-
10	4191.77	0	2	30%	42%	39%	21%

*Valves required to isolate the segment

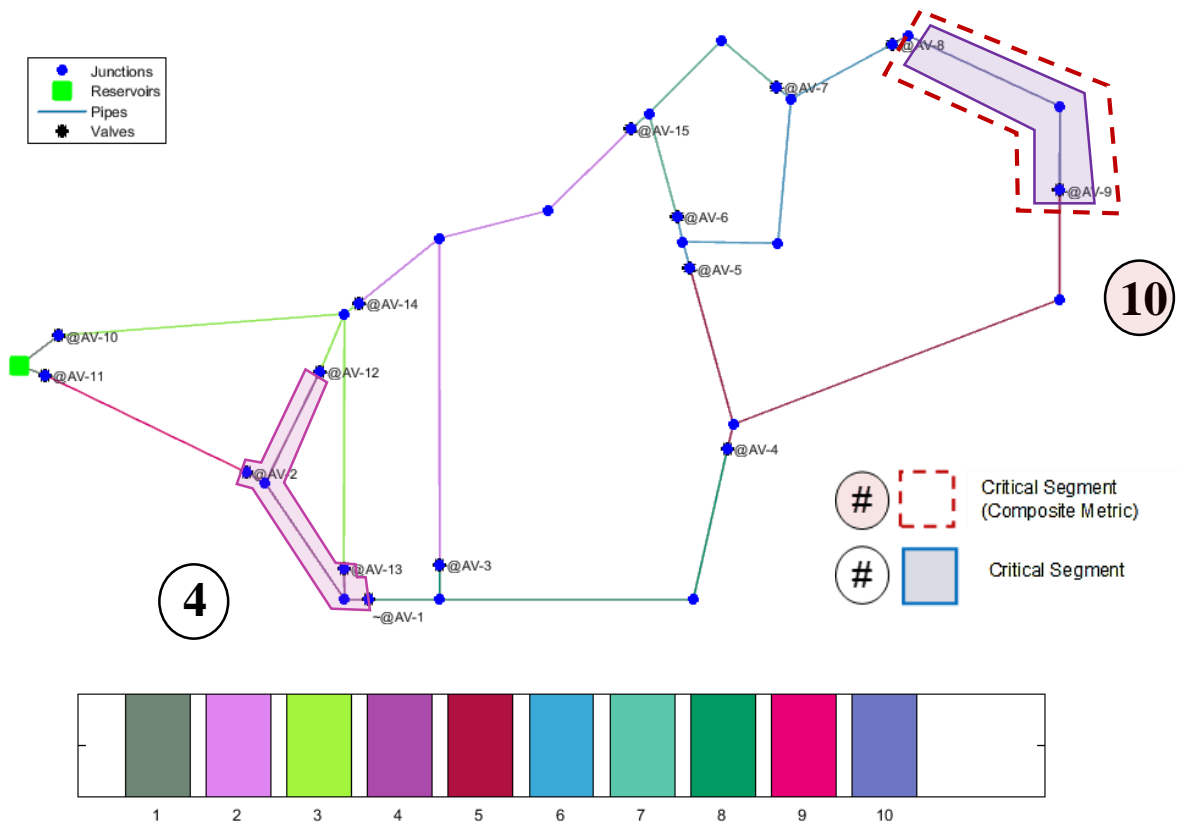

Figure 6-8 FOWM network with highlighted critical segments

6.2.3. ANYTOWN System Results

This water distribution system is created for a hypothetical community. In this distribution system water is taken from the river (represented as a reservoir in the hydraulic model) and pumped into the network. This system was part of the Battle of The Networks, where the participants were faced with the selection of new pipes, pumps, tanks, and pipes that met the minimum pressure requirements at minimum cost.

ANYTOWN consists of 80 pipes just under 22 miles, with an average system demand of 11 MGD.

Loss of Connectivity: When the independent pressure demand metric is used segment 2 is identified as the critical segment (See Figure 6-7 and Table 6-3). Unlike the other two test networks, the ANYTOWN distribution system has multiple sources which may help alleviate the shortages experienced. If segment 2 is taken out of service one of these sources is compromised. Additionally, several junction nodes with high demand requirements are included in this segment. The negative effect on the overall performance of the network if segment 2 fails can be linked to these two factors: inability to use one of the reservoirs, and the magnitude of the demand requirements allocated to the section and can no longer be fulfilled.

Loss of Pressure Dependent Demand: The segment that is identified as critical for a minimum pressure setting of 20 psi and for a minimum pressure of 40 psi is segment 2. In this case some drops in pressure are experienced during abnormal conditions, but the behavior of the system is similar to the one observed when the Loss of Connectivity was considered.

Increase of Water Age: The segment that produces the most significant increase in water age is segment 2. As it was the case for the Loss of Connectivity the additional source can no longer be used. Additionally, the change in layout increases some travel times

The largest detriment in performance is produced when the parameters for water quality are checked (i.e. water age), and the values of the remaining performance metrics (i.e. loss of demand) for their respective critical segments are within a small margin. Unlike the critical segments identified for Hanoi and the FOWM, all the critical

segments based on the individual performance metrics correspond to the same location, segment 2 (Figure 6-8).

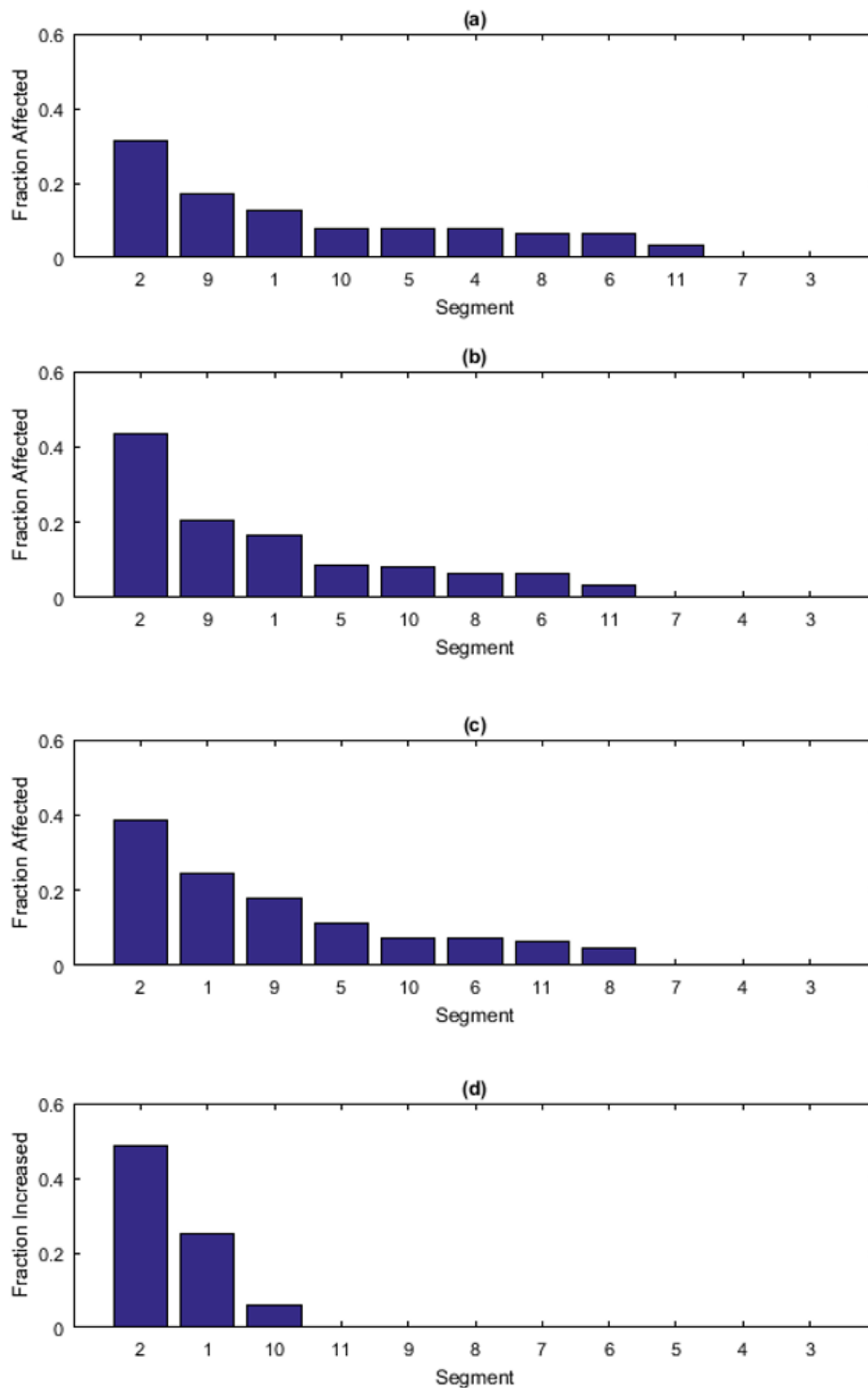

Figure 6-9 Performance Metrics for the ANYTOWN network by segment (a) Fraction of original demand affected considering Pressure Independent Demand (b) Fraction of original demand affected considering Pressure Dependent Demand ($P_{\min}=20$ psi), (c) Fraction of original demand affected considering Pressure Dependent Demand ($P_{\min}=40$ psi) (d) Fraction of original weighted water age increased

Table 6-3 Performance metrics and segment information for ANYTOWN

Segment	Total Segment Length [ft]	Sources in Segment	Valves*	Loss of Connectivity [GPM]	Loss of Pressure Dependent Demand [20 psi] (%)	Loss of Pressure Dependent Demand [40 psi] (%)	Effect on Water Age (%)
1	2287.22	1	6	13%	17%	24%	25%
2	4931	1	8	31%	43%	39%	49%
3	0.1	1	1	0%	0%	0%	-
4	5218.15	0	4	8%	0%	0%	-
5	12250.7	0	5	8%	9%	11%	-
6	5149.41	0	5	6%	7%	7%	-
7	24774.01	0	3	0%	0%	0%	-
8	16559.26	0	10	6%	7%	5%	-
9	23290.57	0	6	17%	20%	18%	-
10	1692.88	0	5	8%	8%	7%	6%
11	19246.86	0	5	3%	3%	6%	-

*Valves required to isolate the segment

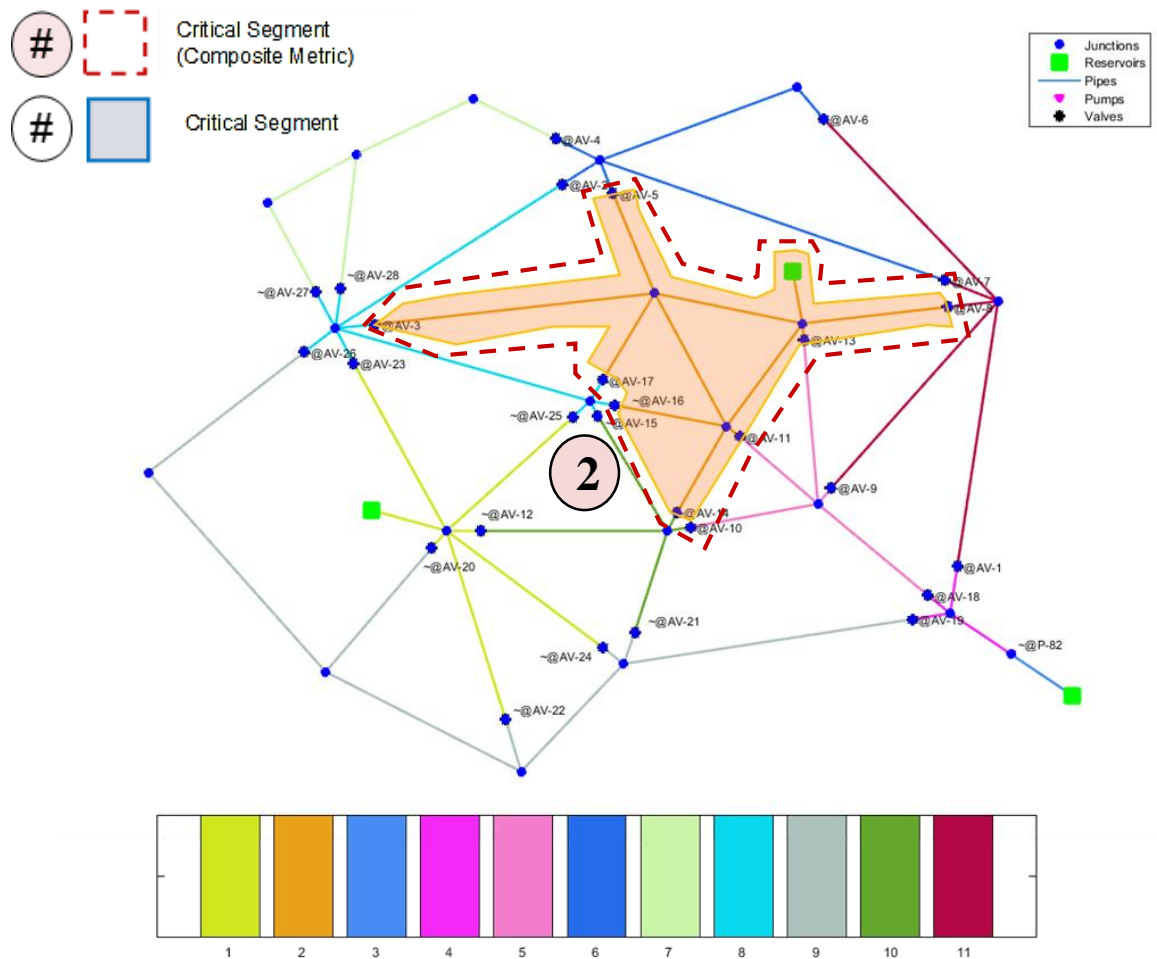

Figure 6-10 ANYTOWN network with highlighted critical segments

6.2.4. General Discussion

As we have seen, one way to evaluate the behavior of a system during failure is by using a set of three different performance metrics. This can be done by comparing the magnitude and distribution of the results from evaluating the metrics for loss of demand (both pressure independent and pressure dependent demand) and the effect on water quality (water age). Using the Hanoi system as an example (see Figure 6-5) the values of all demand performance metrics are below 25% and under 10% for the water quality parameter. Thus for this system, the primary concern associated with a pipe failure would be the impact on hydraulic performance, since the water quality of the rest of the system is minimally impacted. Therefore, the user applying the analysis method could conclude that the Hanoi network would be more vulnerable to hydraulic shortcomings (e.g. supply delivered below required) than water age related issues (i.e. stagnant water).

Comparisons can be made between networks using the individual performance metrics and the corresponding critical segment for each of the networks (**Error! Reference source not found.**). For instance, the critical segment performance metrics for loss of demand and the effect on water age are lower for the Hanoi network when compared to the FOWM, and ANYTOWN. This indicates that for any individual metric, the worst possible segment failure in the Hanoi system will produce the smallest detriment in performance relative to the normal operating conditions out of the test networks considered.

Table 6-4 Summary of critical segments for test networks

System	N.Valves per Segment (max)	N.Valves per Segment (min)	Water Age	Critical Segment		
				PID	PDD (20 psi)	PDD (40 psi)
Hanoi	3	2	3	8	8	8
FOWM	4	2	10	10	10	4
ANYTOWN	10	1	2	2	2	2

**Loss of Connectivity (PID), Loss of Pressure Dependent Demand (PDD)*

For the three systems considered, the performance results for the critical segments of the Hanoi system were the lowest. This may not be the case if other performance metrics are considered. As the number of systems evaluated increases and the best performing systems vary across metrics, a comprehensive measure of network

performance on case of segment failure would be useful. Therefore, a combination of the three performance metrics is suggested for this purpose.

6.2.5. Composite Metric

By using a single composite metric that combines the individual performance metrics together, one may be able to better capture the combined effect of a segment failure in the network. Theoretically, such a metric should provide a better indicator to compare the reliability of different distribution systems. This aggregate index (a composite metric) will be estimated using the mean of the scores obtained by each segment for: The Loss of Connectivity, the Loss of Pressure Dependent Demand, and the Increase of Water Age.

Use of a composite metric allows for additional types of performance evaluations between systems. Possible approaches include: comparing the scores of the critical segments, using the average of all the composite metrics of the entire system, using the average of a defined number of segments, the area below the curve, among others. This section will briefly examined the use of the scores of the critical segment and the use of the average score for all segments as means of comparison.

A low score for the composite metric followed by decreasing or uniform values reflects a network that can sustain the failure event and continue to perform better during failure. On the contrary, considerably high scores in the composite performance metric across all segments indicate that any given segment closure will produce a significant detriment to the performance of the network.

The use of the critical segment to compare reliability levels between networks is rooted in the idea that a more reliable network will present a lower value of the combined index for the highest ranked (critical) segment since the remaining scores will be lower. If an average of the composite metric for all segments is used, lower values will indicate more reliable performance.

As a result, the networks were also evaluated with an aggregate or composite index that is based on the arithmetic average of the three individual metrics. Other studies (Dziedzic and Karney 2014, Dziedzic and Karney 2015) have used the geometric mean to produce an aggregate metric. However, this approach is avoided in the current assessment since a particular segment failure can produce a fragmentation

that doesn't produce an increase in the average water age (e.g. a failure that near the source that isolates the rest of the network) but still affects the delivered demand. In this case (i.e. with no increase in the average water age in the fragmented network that remains operational) if a geometric average were used, it will cancel out the remaining scores producing a composite score of zero. This value would misrepresent the impact of the network since the performance metrics for loss of connectivity might not be zero.

Mathematically for each segment s , the composite metric can be expressed as,

$$\left(\text{Loss of Connectivity}_s + \text{Effect on Water Age} + \text{Loss of Pressure Dependent Demand}_{s,k} \right) / M \quad (6-1)$$

Where k is the pressure setting considered and M is the number of performance metrics used to calculate the composite metric.

6.2.6. Composite Metric Results

In order to evaluate the efficiency of the proposed composite metric, it was calculated for the all the test networks (Hanoi, FOWM, and ANYTOWN). The results can be graphed ordering the segments from the highest observed score to the lowest (see Figure 6-11). The number of valves required to isolate each segment can also be added as a reference as shown. The critical segments for each test network when the composite metric is considered are summarized in **Error! Reference source not found.**

Table 6-5 Critical segments by network using a composite metric

System	Critical Segment – Composite Metric (%)
Hanoi	5 - (18%)
FOWM	10 - (33%)
ANYTOWN	2 - (41%)

Observe that the histogram for the Hanoi network (Figure 6-11) presents significantly lower values of the composite metric when compared to those of the FOWM and ANYTOWN. Nonetheless, note the critical segment (**Error! Reference source not found.** and **Error! Reference source not found.**) for the composite metric (segment 5) is different from the critical segment from each of the individual

performance metrics (segment 8). Although both scores are close, the effect on water quality from segment 8 is lower driving the composite score of segment 5 ahead. In this case the difference between the aggregated index of both segments is small (one percentage point). However, in other systems this might not be the case. Therefore, prioritizing repairs and improvements based on the composite metric could ultimately provide a comprehensive improvement instead of an exclusively hydraulic or water quality based one.

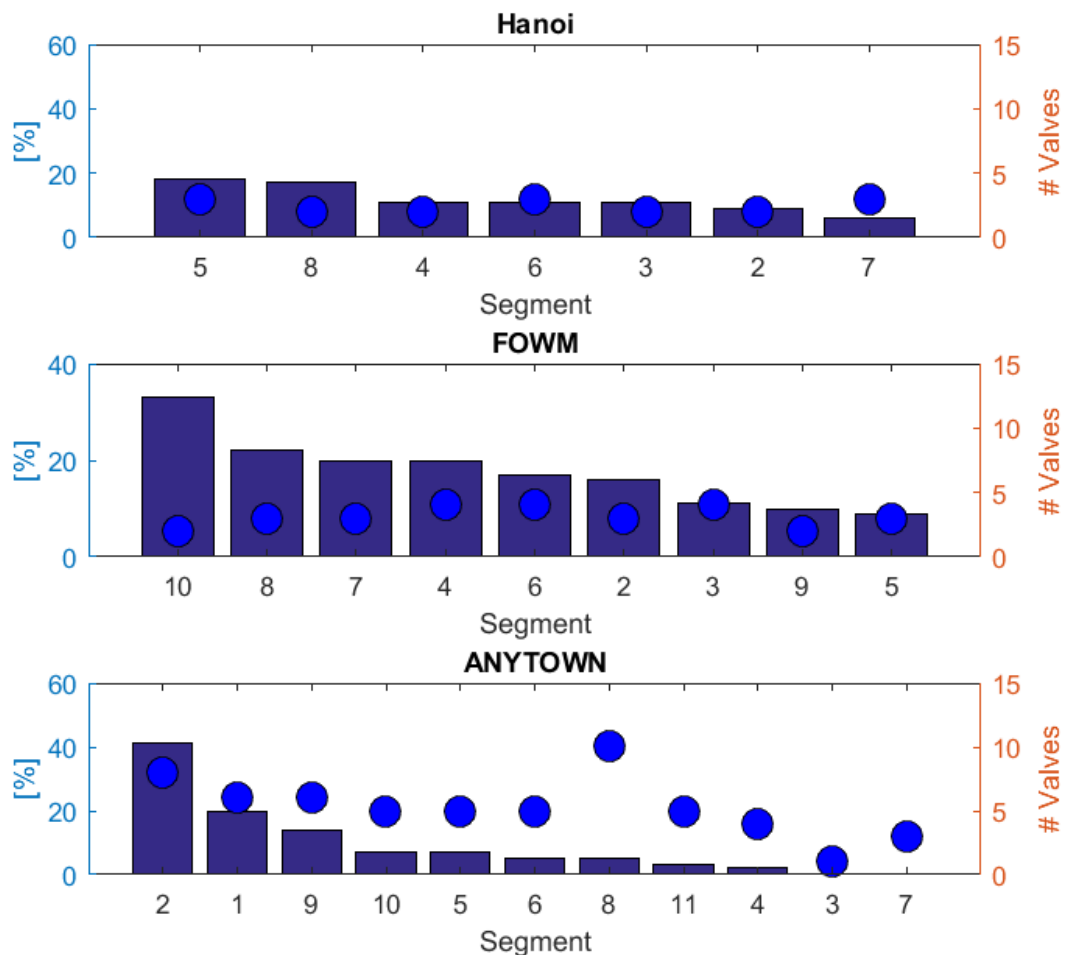

Figure 6-11 Composite metric (left axis) and number of isolation valves (right axis, and symbolized with blue circular marks) by segment.

Making comparisons on the basis of the critical segment (using the composite metric) Hanoi would be the most reliable network. Not only does the Hanoi contain the lowest metric values, but it also contains the lowest number of valves required to isolate each segment (i.e. either 2 or 3). In contrast to as system like ANYTOWN, the Hanoi

system should allow the operator to easily find and maintain these isolation valves. As communities grow, access points to the isolation valves are frequently paved over, or the location of new and old valves might have not ever been recorded. When the number of valves required to isolate a segment grows the possibility that one of these valves cannot not be reached or even located also increases.

After the Hanoi system, the next most reliable network appears to be the FOWM system with ANYTOWN being the least most reliable system. This is mainly influenced by the poor metric associated with its most critical segment. However, some of the values for the composite metric in some segments of ANYTOWN (e.g. 4, 3, and 7) are below those observed in the other systems. In part this is due to the fact that some of the segments in ANYTOWN (i.e. 7 and 3) did not contain junction nodes with any demands. Nonetheless, this observation raises the question if other forms of a composite metric might be more appropriate in capturing the effect of a steep decrease in the values of the composite metric which is then followed almost immediately by segments with much smaller scores.

In contrast, if the networks were compared only using the average metric (Table 6-6) then the most reliable network for the all the systems would in fact be ANYTOWN, followed by the FOWM, and Hanoi. This then raises the question of how to most effectively use the composite metric.

Table 6-6 Composite metric average by test network

System	Mean Composite Metric (%)
Hanoi	13%
FOWM	17%
Anytown	9%

7. SUMMARY and CONCLUSIONS

7.1. Summary

This research effort was initiated in order to achieve four research objectives. These are summarized below.

The first objective was to review different performance metrics for use in evaluating network reliability and then to select a set for use in this study. The review of other performance metrics and uses is achieved through the Literature Review chapter, and the set of metrics selected are presented in the Methodology chapter. The set of metrics ultimately used in this study included: loss of connectivity, loss of pressure depended demand, and water age weighted by demand. A composite metric based on the mean of the three individual metrics was also included.

The second objective was to develop a reliability assessment methodology that incorporates the selected performance metrics. The assessment proposed consists in examining the behavior of the network during abnormal conditions. Each of the abnormal conditions is defined as the failure of a segment which could be caused by the mechanical failure of any of its components. Finally, the behavior of the network is quantified using the performance metrics selected and comparing the normal and failure condition performance for each of the segments.

The third objective was to develop a computer algorithm for use in performing a reliability assessment that incorporates the reliability metrics. The algorithm was developed using EPANET and the associated EPANET toolkit (Rossman 1999). The routine developed is presented as part of APPENDIX F. It includes: the process of segment identification, the evaluation of the performance metric for normal and abnormal condition, the computation of a metric by segment, and the production of outputs for the user to interpret.

The fourth objective was to apply the algorithm to three water distribution systems that have been repeatedly analyzed in the public literature. These systems include: 1) the Hanoi water distribution system (Fujiwara and Khang 1990), 2) the federally owned water main (FOWM) system (Chase, Ormsbee et al. 1988), and 3) the ANYTOWN system (Walski, Brill et al. 1987). The results from the application of the assessment to the test networks using the routine developed are presented in chapter six where general observations are also discussed.

7.2. Conclusions

The metrics proposed in this document could be used to perform the qualitative assessment of the distribution network (loss of connectivity, loss of pressure dependent demand, and water age weighted by demand). They address a spectrum of items considered in the operation of water distribution systems, and as such they could be adaptable to the priorities and needs for each system (e.g. water quality, connectivity, among others).

An assessment where multiple metrics are used allow to reveal different aspects of reliability reveal different nature of the system. However, this may also make comparisons between different distribution systems more difficult.

A comparison of the results yielded by the proposed metrics on a larger set of systems of diverse layouts could help unveil any existing trends or correlations between system layouts (i.e. grid, loop, branch) and performance indicators.

A composite metric was used seeking to reflect in a single score the multiple facets of the system performance. All metrics were weighted equally in this case, but different weights could be used to fit the preferences of the user while adjusting the importance of the indicators. The composite metric was intended as a comprehensive indicator of the performance of the water distribution network and as a way to facilitate comparisons among different water distribution system layouts.

Although the composite metric serves as a single point of comparison it also poses a new challenge: the method of comparison. Two methods were considered in this occasion (arithmetic mean and most critical segment score), nonetheless other methods should be explored to determine the best approach.

7.3. Potential Applications

Identification of the overall reliability of a system is an implicit function of asset management. Water distribution systems contain several different assets including: treatment plants, tanks, pump, pipes, and valves among others that are required to maintain the system operational. Understanding the risk of an asset being taken out of service allows a utility to plan for contingencies and preventive strategies. However, in the normal process of asset management, only a limited amount of funding is available each year from which to finance system improvements.

For small systems, the proposed methodology could be used to help identify those critical segments of the network that could cause the largest detrimental impact on system performance in the event of a component failure. Upgrading such segments using either new valves or pipe could reduce the associated impacts of component failures, thereby producing more resilient and reliable systems.

7.4. Limitations

Despite the successful development and evaluation of four different performance metrics, and the development of a methodology for use in their application, the research has identified several potential limitations of the research, which also provide some guidance for future research

The most significant limitation of this study is the lack of available network models with valve information. The network models available in the Water Distribution Systems Research Database include hypothetical, skeletonized, and real models. However, none of the systems have the actual valve location.

While the assumed valve locations can be used to test the principles of the reliability assessment, real valve distributions are needed to fully take advantage of the insights that can be obtained from the proposed assessment method. A more extensive group of network models with valve locations that represent real distribution systems should be used in the future to examine if any correlations could be established between network type, number of sources, location of the source and performance scores (based on individual metrics, or the combined score).

Finally, using a composite performance metric allows the user to compare network modifications, or different distribution systems and identify which one might have a higher level or lower level of reliability than the other. However, in a sense, this assessment is still qualitative since the influences of the topological differences between the systems (e.g. grid, loop, and branch) is still not explicitly considered or directly incorporated into the composite metric.

7.5. Future Research

This research has revealed that different insights can be gathered from using the three metrics considered. It is likely that different insights may be obtained by using other metrics, especially when considering a composite metric. As a result, additional metrics should be investigated.

As previously indicated, the current research was limited due to the lack of the availability of water distribution systems with actual valve locations. Future research should seek to apply to proposed methodology on systems with real valve locations. Also, an attempt should be made to obtain a sufficiently large database to allow for an investigation of the impact of the overall topologic classification of the system (e.g. branch systems, grid systems, loop systems), on the resulting reliability metrics. It is possible that such an analysis might reveal general guidelines for valve placement or general reliability ranges that are based on the type of system configuration. Such insights could be useful to design engineers in the development more reliable systems.

The proposed methodology can also be expanded to include the probability of valve failure or inoperability. If a valve cannot be located or closed, then the initial affected area will expand beyond its original boundaries until a set of operable valves can finally located and used to isolate the section. The consideration of the probability of valve failure may be used in conjunction with a set of performance metrics to provide a more accurate estimate of the expected behavior of the system in response to a component failure.

Finally, since the appropriate number and exact location of the isolation valves is a key factor to the reliability of the system. Therefore, a method to optimize the placement of additional valves in a water distribution systems would be a useful in developing more reliable water distribution systems.

APPENDIX A. Contents of Water Distribution Database for Research
Applications.

The systems that are included in the database are enumerated in Table A-1. The contents available through the website (<http://www.uky.edu/WDST/database.html>) are indicated. For each system the table indicates if there is a narrative description available (“X”) or if there is a description available from a different source (“Link”). The files available could be EPANET or KYPIPE compatible, most can be download directly from the website (“X”) for a number of the systems and web-based applications an external link is provided (“Web”). The systems that appear as “Listed” under the Website column are not accessible through the website, but can be requested contacting the administrators using the following email address *wds@engr.uky.edu*.

Table A-1 List of Systems, contributors and available data for the Water Distribution Database for Research Applications

System	Contributor	Narrative	EPANET	KYPIPE	Website
KY1	Ormsbee/Hoagland		X	X	Listed
KY 2	Ormsbee/Hoagland	X	X	X	X
KY 3	Ormsbee/Hoagland	X	X	X	X
KY 4	Ormsbee/Hoagland	X	X	X	X
KY 5	Ormsbee/Hoagland	X	X	X	X
KY 6	Ormsbee/Hoagland	X	X	X	X
KY 7	Ormsbee/Hoagland	X	X	X	X
KY 8	Ormsbee/Hoagland	X	X	X	X
KY 9	Ormsbee/Hoagland	X	X	X	X
KY 10	Ormsbee/Hoagland	X	X	X	X
KY 11	Ormsbee/Hoagland	X	X	X	X
KY 12	Ormsbee/Hoagland	X	X	X	X
KY 13	Ormsbee/Hoagland	X	X	X	X
KY 14	Ormsbee/Hoagland	X	X	X	X
KY 15	Ormsbee/Hoagland	X	X	X	X
KY 16	Ormsbee/Hoagland		X		X
KY 17 - calibrated model	Ormsbee/Hoagland			X	Listed
KY 18 - calibrated model	Ormsbee/Hoagland			X	Listed
FOWM - Federally Owned Water Main System	Ormsbee/Hoagland		X	X	Listed
Cherry Hills/Brushy Plains, New Haven, CT (Net 2)	Low Rossman	Link	X		X
North Marin Water District, Novato, CA (Net 3)	Low Rossman		X		X
Bellingham, WA (Dakin Yew Zone)	Dominic Boccelli		X		X

Fairfield, CA (Rancho Solano Zone 3)	Dominic Boccelli		X	X
North Penn Water Authority System	Dominic Boccelli		X	X
Harrisburg, PA (Oberlin)	Dominic Boccelli		X	X
New York Tunnel System	Graeme Dandy	X	X	X
Hanoi System	Graeme Dandy	X	X	X
Toms River, New Jersey	Morris Maslia			Listed
2 Loop System	Alperovits & Shamir			Listed
KYPIPE System	Don Wood			Listed
Any-town System	Tom Walski	Link	X	X
Battle of the Water Sensor Networks	Avi Ostfeld	Link	X	X
Battle of the Calibration Networks System	Avi Ostfeld	Link	X	X
Micropolis	Texas A&M Univ.	Link	web	X
Mesopolis	Texas A&M Univ.	Link	web	X
WSS_set_2280	Mair and Sitzenfrei	Link	web	X
DynaVIBe-Web	Mair and Sitzenfrei	X	web	X
WDS-Designer	Mair and Sitzenfrei	X	web	X
Exnet System	Exeter University	Link	web	X
Modified New York Tunnels	Graeme Dandy	X	X	X
Jilin Network	Graeme Dandy	X	X	X
Rural Network	Graeme Dandy	X	X	X
Extended Hanoi	Graeme Dandy		X	X
Fosspoly1	Graeme Dandy	X	X	X
ZJ Network	Graeme Dandy		X	X
Balerma	Graeme Dandy	X	X	X

KL Network	Graeme Dandy	X	X	X
E-Town	WDSA 2016		X	Listed

APPENDIX B. Network Plots with Node IDs and Tabulated Segment
Components

This section presents the network plots for each of the test networks (Hanoi, FOWM, and ANYTOWN) labeled with the node IDs. Additionally, two tables indicating the nodes and links that belong to each of the identified segments in the test networks are presented.

- HANOI

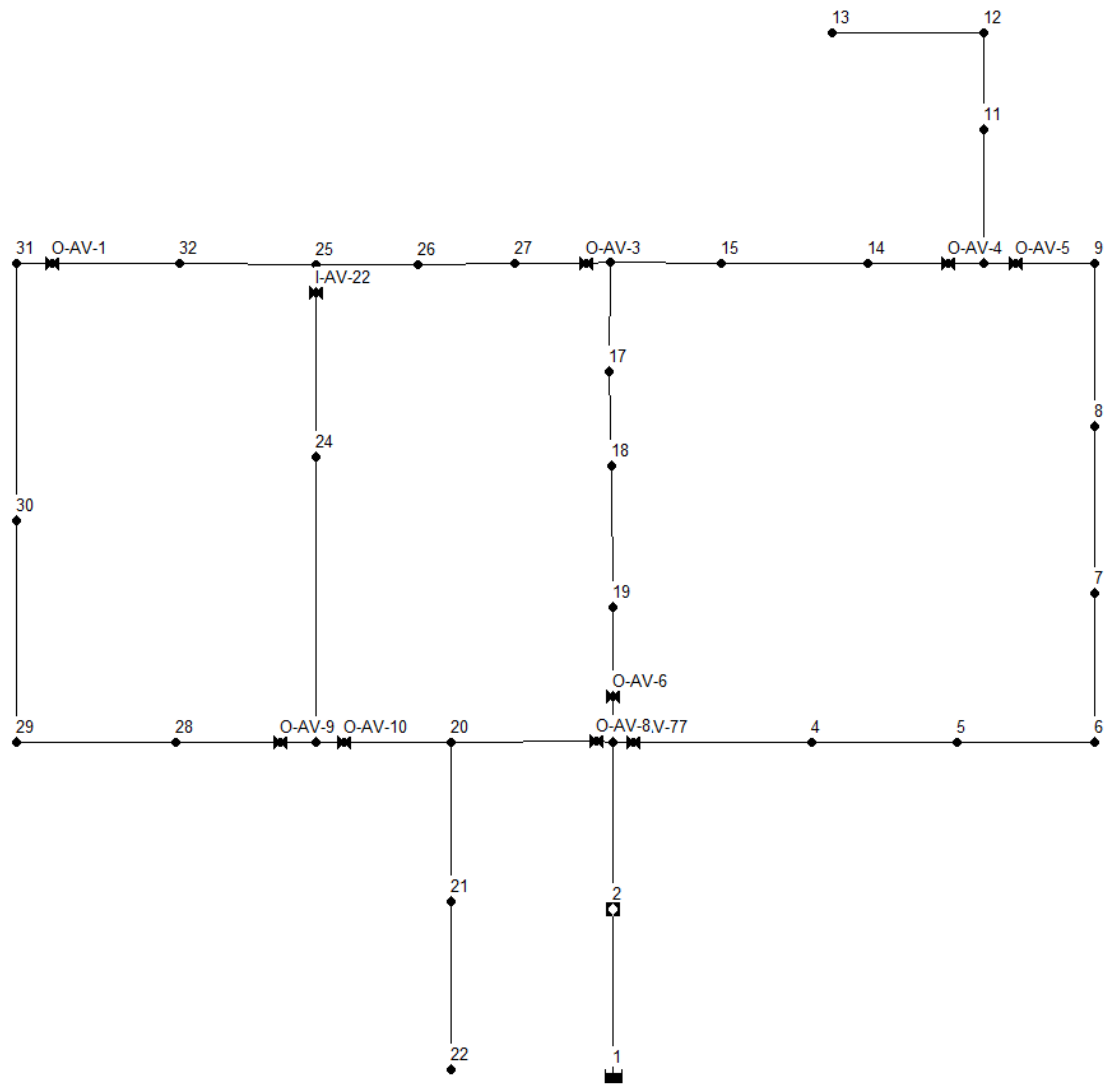

Figure B-1 Hanoi network with node IDs

Table B-1 Hanoi, nodes by segment

Segment	Node ID								
1	'1'	'2'	'3'	'I-AV-7'	'I-AV-8'	'O-AV-6'			
2	'O-AV-9'	'28'	'29'	'30'	'31'	'O-AV-1'			
3	'O-AV-8'	'20'	'21'	'22'	'I-AV-10'				
4	'O-AV-5'	'10'	'11'	'12'	'13'	'I-AV-4'			
5	'O-AV-4'	'14'	'15'	'16'	'17'	'18'	'19'	'I-AV-6'	'I-AV-3'
6	'O-AV-3'	'27'	'26'	'25'	'32'	'I-AV-1'	'O-AV-2'		
7	'I-AV-2'	'24'	'23'	'I-AV-9'	'O-AV-10'				
8	'O-AV-7'	'4'	'5'	'6'	'7'	'8'	'9'	'I-AV-5'	

Table B-2 Hanoi, pipes by segment

Segment	Pipe ID							
1	'1'	'2'	'3'	'20'	'P-40'			
2	'30'	'31'	'32'	'P-35'	'P-43'			
3	'21'	'22'	'23'	'P-42'				
4	'10'	'11'	'12'	'13'	'P-39'			
5	'14'	'15'	'16'	'17'	'18'	'19'	'28'	'P-38'
6	'26'	'27'	'33'	'34'	'P-36'	'P-37'		
7	'24'	'25'	'29'	'P-44'				
8	'4'	'5'	'6'	'7'	'8'	'9'	'P-41'	

Table B-4 FOWM, pipes by segment

Segment	Pipe ID					
1	P-1'	P-22'				
2	P-10'	P-11'	P-19'	P-37'		
3	P-14'	P-32'	P-35'	P-36'		
4	P-2'	P-12'	P-13'	P-24'	P-34'	
5	P-4'	P-15'	P-16'	P-26'		
6	P-5'	P-6'	P-17'	P-18'	P-21'	P-27'
7	P-7'	P-8'	P-28'	P-29'		
8	P-3'	P-9'	P-23'	P-25'		
9	P-33'					
10	P-20'	P-30'	P-31'			

- ANYTOWN

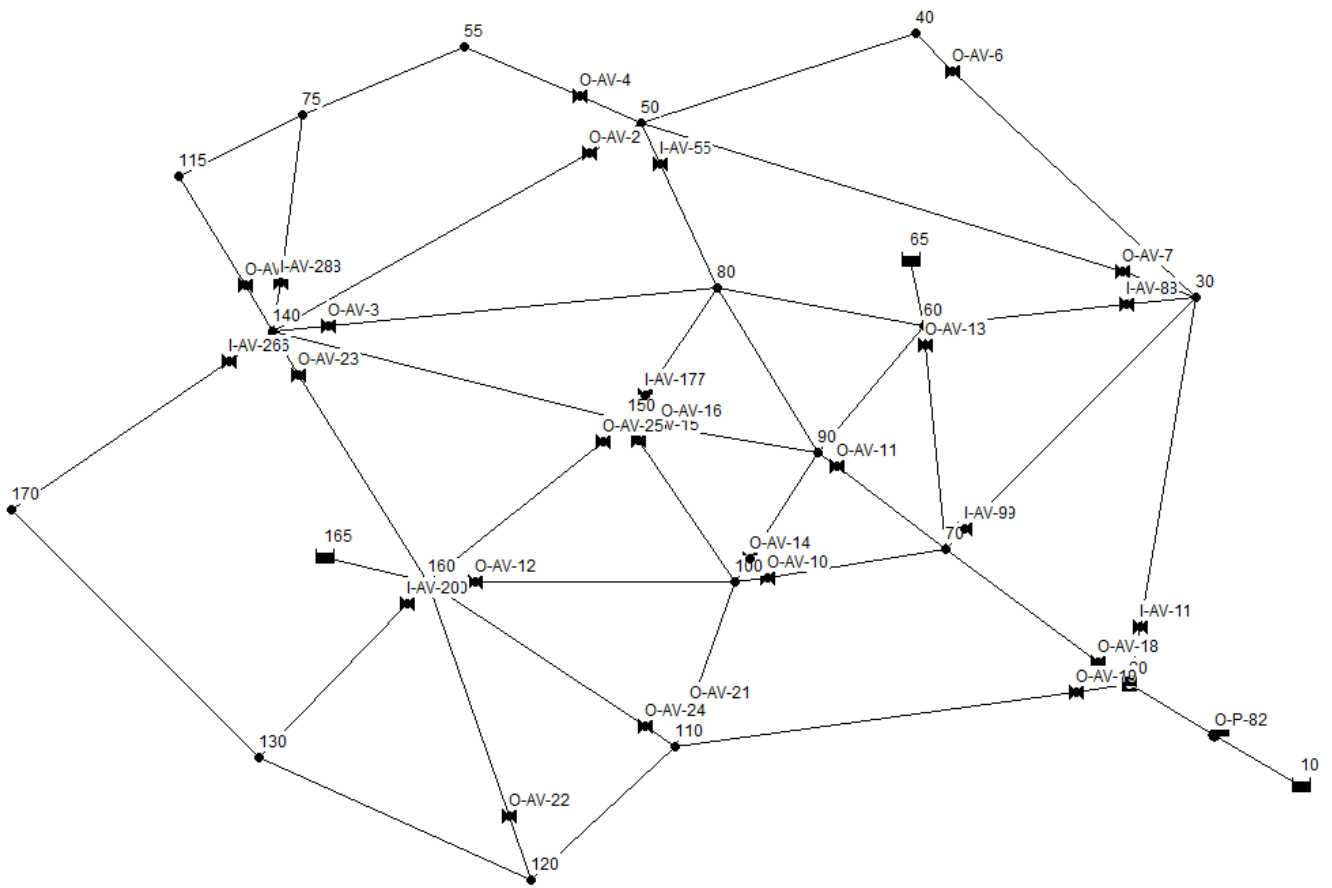

Figure B-3 ANYTOWN network with node IDs

Table B-5 ANYTOWN, nodes by segment

Segment	Node ID							
1	'165'	'160'	'I-AV-23'	'O-AV-12'	'O-AV-20'	'O-AV-22'	'O-AV-24'	'O-AV-25'
2	'65'	'60'	'90'	'80'	'I-AV-3'	'O-AV-17'	'O-AV-5'	'I-AV-16'
	'I-AV-14'	'O-AV-11'	'I-AV-8'	'O-AV-13'				
3	10'	'I-P-82'						
4	'O-P-82'	'20'	'I-AV-18'	'I-AV-1'	'I-AV-19'			
5	'I-AV-9'	'70'	'I-AV-10'	'I-AV-11'	'I-AV-13'	'O-AV-18'		
6	'O-AV-7'	'50'	'40'	'O-AV-6'	'I-AV-5'	'I-AV-2'	'I-AV-4'	
7	'O-AV-4'	'55'	'75'	'115'	'O-AV-27'	'O-AV-28'		
8	'O-AV-3'	'140'	'150'	'I-AV-17'	'I-AV-25'	'O-AV-15'	'O-AV-16'	'I-AV-27'
	'I-AV-28'	'O-AV-2'	'O-AV-23'	'O-AV-26'				
9	'I-AV-26'	'170'	'130'	'120'	'110'	'I-AV-24'	'O-AV-19'	'O-AV-21'
	'I-AV-22'	'I-AV-20'						
10	'O-AV-14'	'100'	'I-AV-15'	'I-AV-12'	'I-AV-21'	'O-AV-10'		
11	'O-AV-9'	'30'	'I-AV-6'	'I-AV-7'	'O-AV-1'	'O-AV-8'		

Table B-6 ANYTOWN, pipes by segment

Segment	Pipe ID							
1	'62'	'80'	'P-23'	'P-39'	'P-43'	'P-47'	'P-49'	
2	'16'	'18'	'20'	'22'	'24'	'30'	'40'	'78'
	'P-21'	'P-25'	'P-33'	'P-9'				
3	'P-82'							
4	'2'	'4'	'6'	'D_P-82'				
5	'8'	'10'	'12'	'14'	'P-35'			
6	36'	'38'	'66'	'74'	'P-11'	'P-13'		
7	'72'	'76'	'P-53'	'P-55'	'P-7'			
8	28'	'42'	'44'	'68'	'70'	'P-29'	'P-3'	'P-31'
	'P-45'	'P-5'	'P-51'					
9	'50'	'52'	'54'	'56'	'58'	'60'	'64'	'P-37'
	'P-41'							
10	26'	'46'	'48'	'P-19'	'P-27'			
11	'32'	'34'	'P-1'	'P-15'	'P-17'			

APPENDIX C. Network Plots Color Coded by Segment

This section presents the plots for each of the test networks (Hanoi, FOWM, and Hanoi) color coded by segment. Each network is accompanied by a legend indicating the components in the upper left (Hanoi, FOWM) or right (ANYTOWN) corner. The only elements labeled are the active valves since the closest junction nodes usually overlap over the symbol representing the valves. Each segment can be identified with a number and a color, a bar at the bottom of each graph is presented for this purpose. The number used to identify each segment are maintained throughout the document.

- HANOI

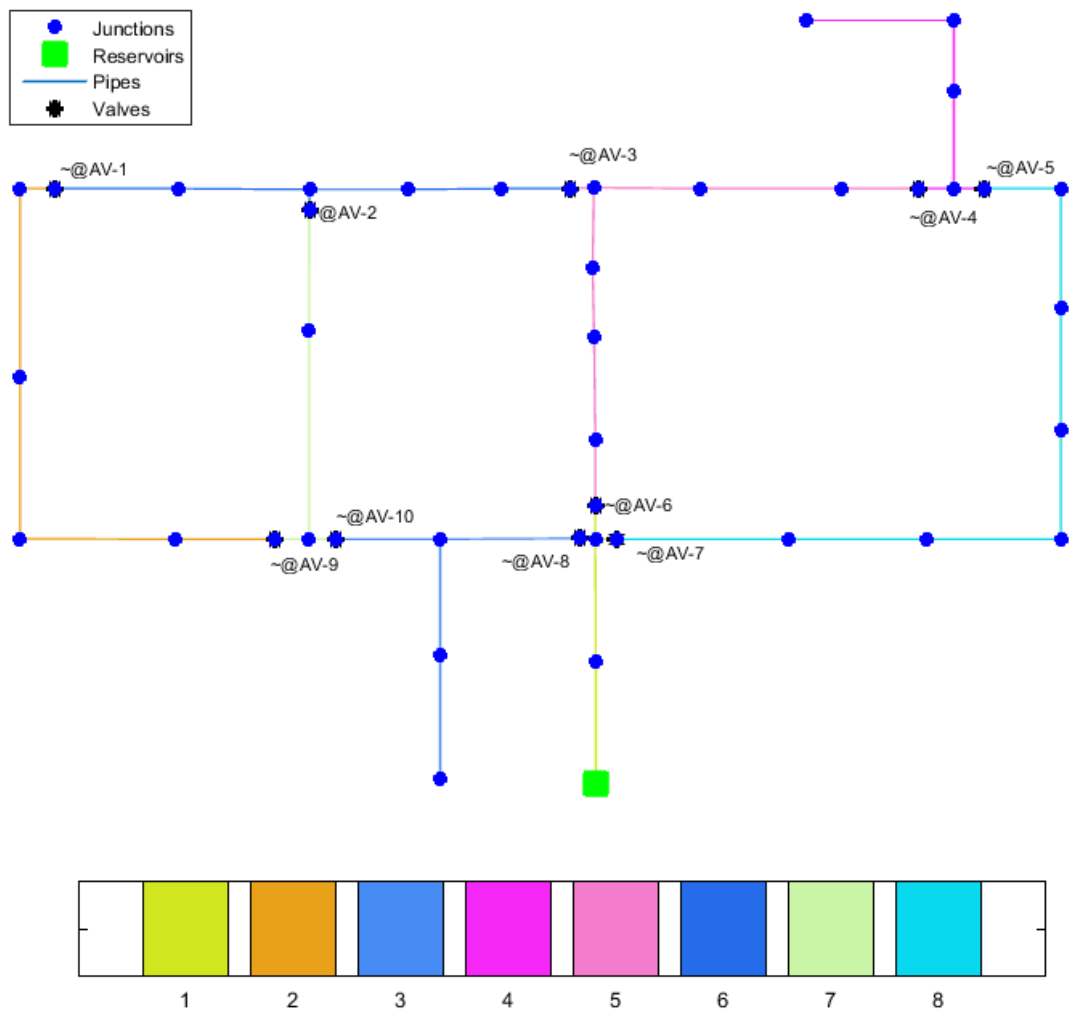

Figure C-1 Hanoi network with color coded segments

▪ FEDERALLY OWNED WATER MAIN (FOWM)

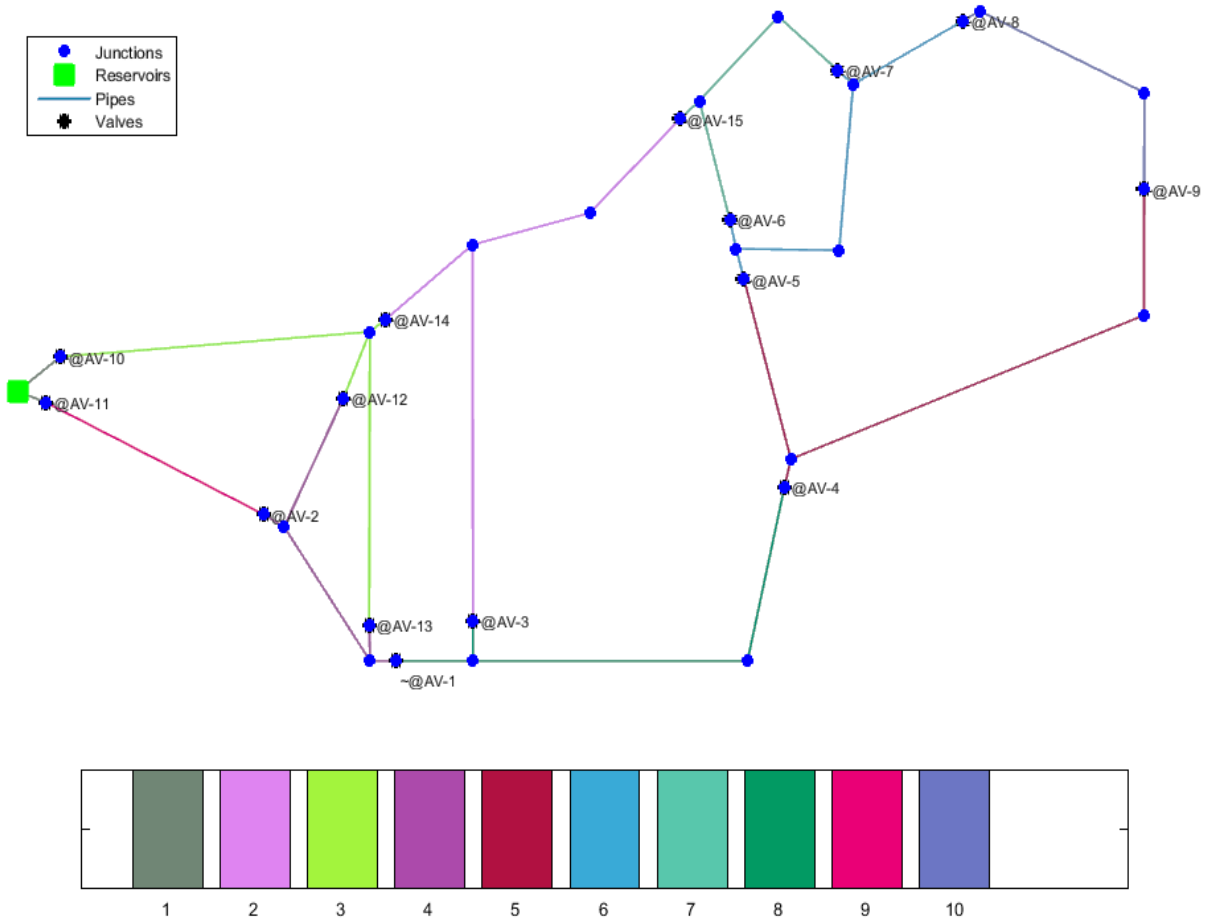

Figure C-2 FOWM with color coded segments

■ ANYTOWN

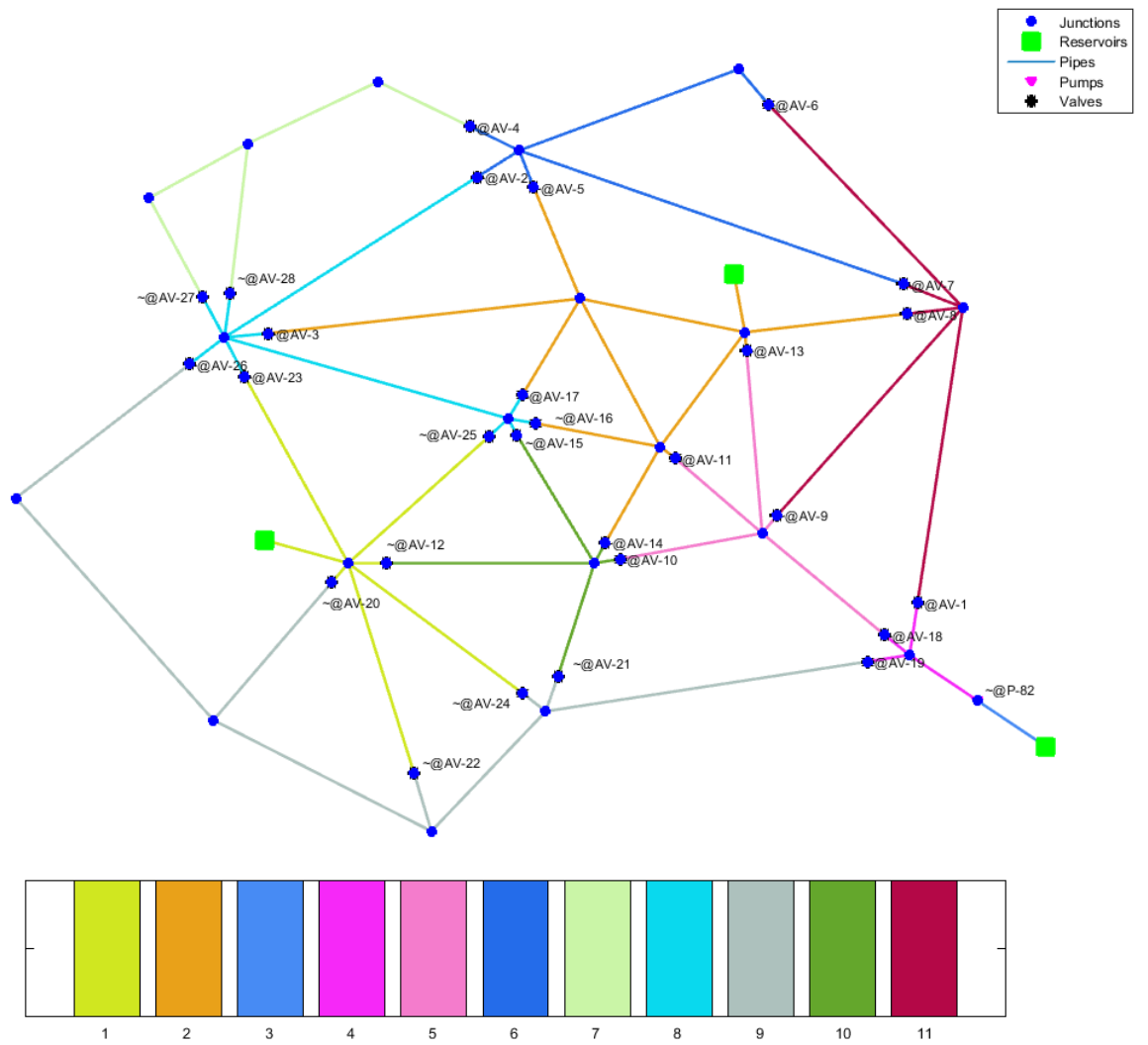

Figure C-3 ANYTOWN network with color coded segments

APPENDIX D. Additional Information for Segments Identified

This section presents additional information on segments of the test networks (Hanoi, FOWM, and ANYTOWN). For each network the following results are reported:

- Bar plots reporting the demand as flow rate affected when Pressure Independent Demand is considered (Figure D-1, Figure D-3, Figure D-5)
- Bar plots reporting the length of each segment identified in linear units (ft. or m.) (Figure D-2, Figure D-4, and Figure D-6)

▪ HANOI

(

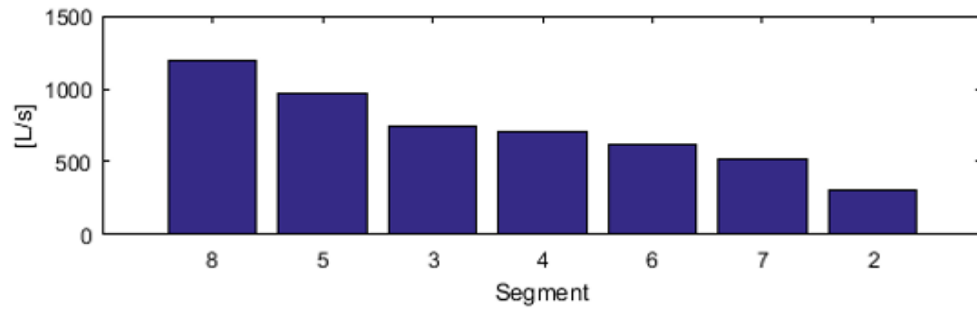

Figure D-1 Affected demand for Hanoi network expressed as flow rate when Pressure Independent Demand is considered

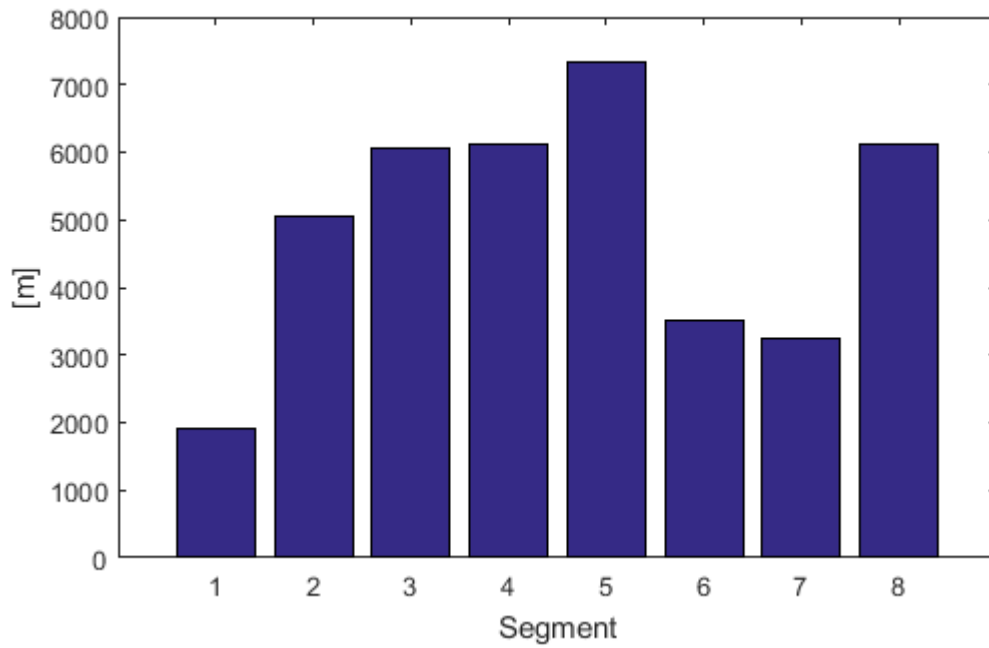

Figure D-2 Hanoi network, length of segments

- FEDERALLY OWNED WATER MAIN (FOWM)

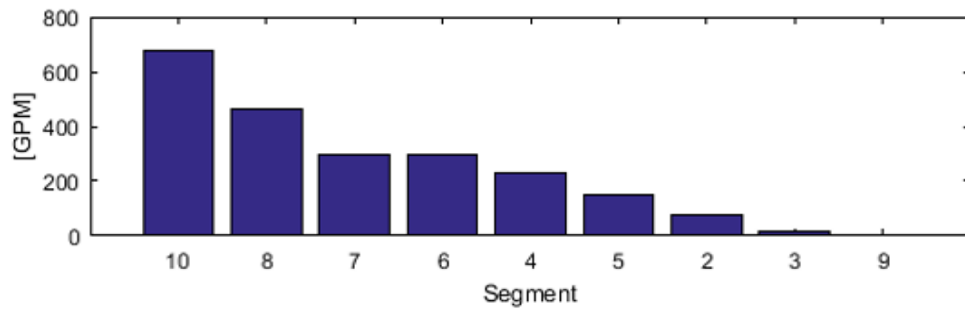

Figure D-3 Affected demand for FOWM network expressed as flow rate when Pressure Independent Demand is considered

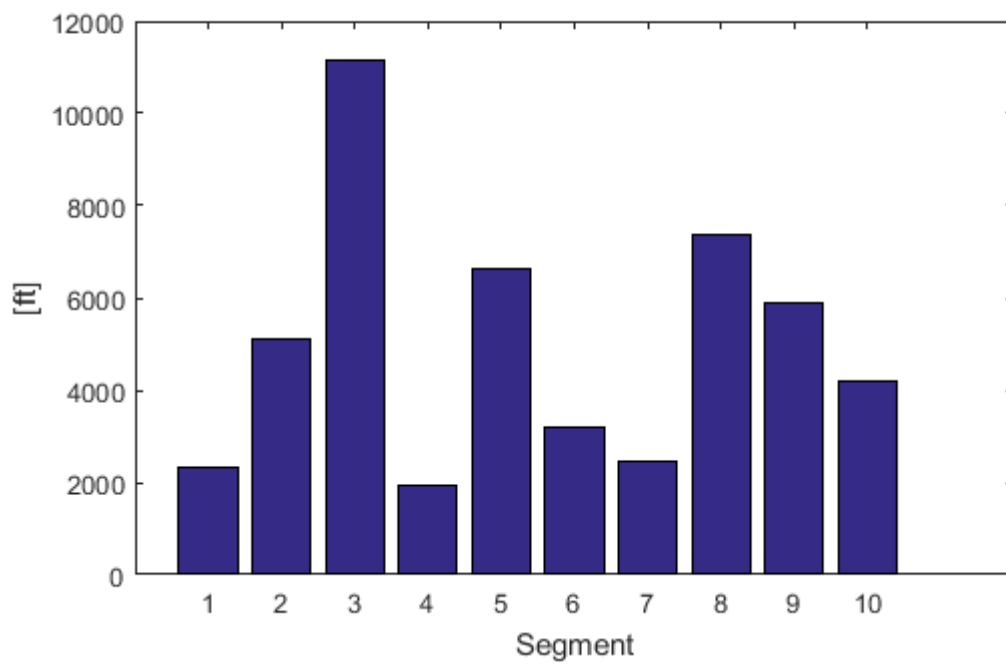

Figure D-4 FOWM, Length of segments

- ANYTOWN

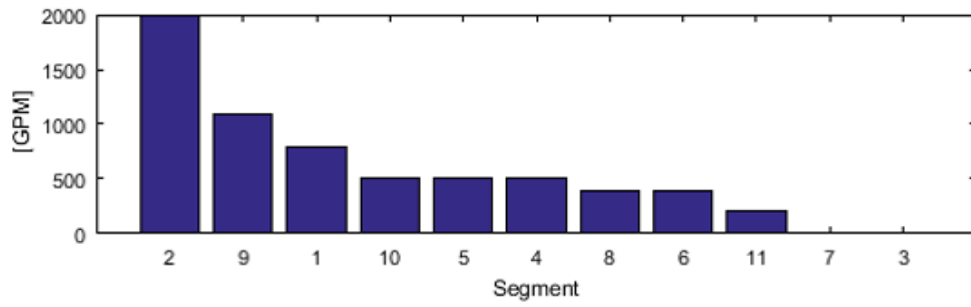

Figure D-5 Affected demand for anytown network expressed as flow rate when Pressure Independent Demand is considered

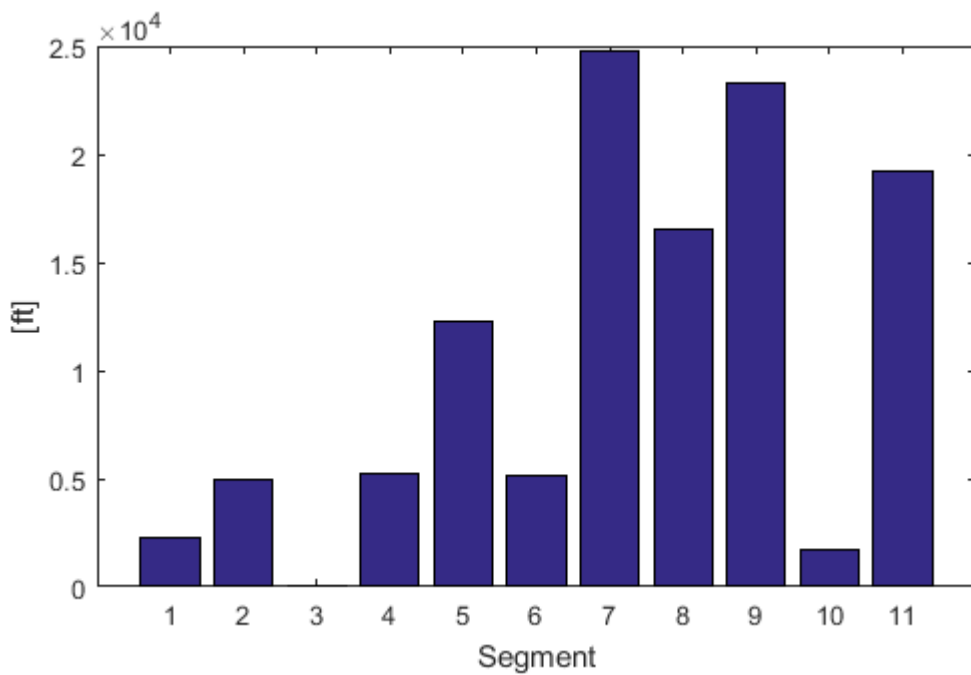

Figure D-6 ANYTOWN, Length of segments

APPENDIX E. Composite Metric Results for the Test Networks.

This section contains the results of the composite metric obtained for each of the test networks (Hanoi, FOWM, and ANYTOWN). The results for each test network are listed by segments and expressed as a percentage. This metric combines the results from the performance metrics addressing: the loss of connectivity, loss of pressure dependent demand, and effect on water quality.

Table E-1 Hanoi network, composite metric

Segment	Composite Metric (%)
1	-
2	9%
3	11%
4	11%
5	18%
6	11%
7	6%
8	17%

Table E-2 FOWM network, composite metric

Segment	Composite Metric (%)
1	-
2	16%
3	11%
4	20%
5	9%
6	17%
7	20%
8	22%
9	10%
10	33%

Table E-3 ANYTOWN network, composite metric

Segment	Composite Metric (%)
1	20%
2	41%
3	0%
4	2%
5	7%
6	5%
7	0%
8	5%
9	14%
10	7%
11	3%

APPENDIX F. MATLAB® Code

This section presents the functions and algorithms written in MATLAB used to perform the reliability assessment.

MATLAB® Code

Legend:

Green Text = Comments

Black text = variables, values, and operators

Blue text = statement begin or end

- Segment Identification, Hydraulic and Water Quality simulations.

This section presents the functions used to identify the segments in the provided network. Once the segments have been identified the performance indicators for the loss of connectivity and effect on water quality are evaluated.

The output for this function includes a plot of the network color coded by segment, a partial report of the metrics evaluated at this point, and the tables enumerating the components (junction, pipes, tanks, reservoirs) by segments

```
function [out,out2]=Segmentation2
%Opens the EPANET input file, identifies the segments. Creates a copy
for each
%segment. Then modifies each of the copies to match the segment
analyzed.
%The network is plotted with the identified segments, and the
performance
%metrics for Loss of Pressure independent demand and Water Age are
estimated

%Open file and identify segments (write original file name in the
routine
%file)
%The name change needs to be done in this routine and in segmentation
%routine

%Output variables: out- summation of demand losses, out2- segment
%information (nodes, links lengths, by ID and by Index)

%This function identifies the segments in the network
[Segment]=SegmentID2;

%Make copies
name='noname2';

[ output,s ]=segmentCopy( name,Segment );
%

oldinname=[name, '.inp'];
out2=Segment;

for i=1:1:s
%     if i==3
%     else
j=num2str(i);
inpname=[name, '_',j, 'C.inp'];
removed=modifyCopy( inpname,Segment,i );
```

```

    rem(i).NodeID=removed;
    demandLoss = StaticDemand(name,removed );
    static(i).demandLoss=demandLoss;
    out=static;
%   end
end
%Get base demand total
[ TotalDemand ] = getSumBaseDemand( oldinpname );

%Water Quality checks
OgAge=WaterQuality( oldinpname,0 );

for i=1:1:s

    j=num2str(i);
    WQname=[name,'_',j,'C.inp'];

    Age(i)=WaterQuality( WQname,i );
    WQeffect(i)=(Age(i)-OgAge)./OgAge;

end

WQeffect2=WQeffect;
WQeffect(find(WQeffect<0))=0;

%Set new figure for bar chart and table
figure;

%Bar chart for deficiency in supply
Loss=extractfield(out,'demandLoss');
LossP=Loss;
label=(1:s);
graphloss=[label' Loss'];
graphloss=sortrows(graphloss,2);
graphloss=flipud(graphloss);
ticklabel=num2cell(graphloss(:,1));

subplot(4,1,1);
demand=bar(graphloss(:,2));
set(gca,'XTickLabel',ticklabel);

%Loss as a percentage
LossP=LossP./TotalDemand;

%Bar chart for demand for loss of connectivity as percentage
label=(1:s);
graphlossP=[label' LossP'];
graphlossP=sortrows(graphlossP,2);
graphlossP=flipud(graphlossP);
ticklabel=num2cell(graphlossP(:,1));

subplot(4,1,2);
demand=bar(graphlossP(:,2));

```



```

set(gca, 'XTickLabel', ticklabel);

%Store results in out matrix
for i=1:1:s
    static(i).age=Age(i);
    static(i).WQe=WQeffect(i);
    static(i).DemandLoss=LossP(i);
end
out=static;

%Add a new Figure for effect on water quality
label=(1:s);
graphWQ=[label' WQeffect'];
graphWQ=sortrows(graphWQ,2);
graphWQ=flipud(graphWQ);
ticklabel=num2cell(graphWQ(:,1));

subplot(4,1,3);
demand=bar(graphWQ(:,2));
set(gca, 'XTickLabel', ticklabel);

%Add table
source=extractfield(out2, 'source');
source=source';
Length=extractfield(out2, 'LinksL');
Length=Length';
label=label';
Loss=Loss';
SDemand=LossP';
WQp=WQeffect2';
d=[label, Loss, Length, source, SDemand, WQp];

t=uitable('Data', d);

t.Position(3:4) = t.Extent(3:4);
t.ColumnFormat=({'short' 'bank' 'bank' 'short' 'bank'
'bank'}(Dziedzic and Karney 2014));
t.ColumnName={'Segment', 'Demand Loss', 'Length
Segment', 'Source', 'Pressure independent demand Loss', 'Effect on
Age'};

%Add Plot of Network
pipeID=extractfield(out2, 'LinksID');

PlotColor(oldinname, pipeID);
end

function [Segment]=SegmentID2(msxfn, inpf, rptfn)
% This function takes a defined network and identifies the number of
% segments, including nodes and pipes
% Valves are represented as shorter links, this definition can be
changed
% Change the name of the input network within the first lines of this

```

```

% function
% Make sure start node for c is not assigned to a valve otherwise the
% segments would be consistent but the boundaries would be shifted
%Structure adapted from the EPANET example.m file included with the
Matlab toolkit
%=====
global EN_CONSTANT
global MSX_CONSTANT

%Change names in this section to match
if nargin < 2
    msxfn = 'noname2.msx'
end;
if nargin < 1
    inpfm = 'noname2.inp'
end;
if nargin < 3
    [pathstr, name, ext] = fileparts(msxfn);
    rptfn = [name, '.rpt'];
end;
[pathstr, name, ext] = fileparts(msxfn);
hydrfn = [name, '.hyd'];

%open hydraulic network
[errcode] = ENopen(inpfm, rptfn, '');

%[errcode,from,to] = ENgetalllinknodes()
[errcode,from,to] = ENgetalllinknodes();

%Set the total number of links(2)
[errcode, count] = ENgetcount(2);
countlinks=count;

[nnodes,ntanks,nlinks,npats,ncurves,ncontrols,errcode] =
ENgetnetsize();
nnodes;
for i=1:1:count

    [errcod,id] = ENgetlinkid(i);
    a=id;
    % fprintf(linkfile, '%3.0f %s \r\n',[i,a]);
    [errcode, value] = ENgetlinkvalue(i, 1);
    L=value;
    % fprintf(pipefile, '%3.0f %6.2f \r\n',[i,L]);

end

%Set the total number of nodes(0)
[errcode, count] = ENgetcount(0);
countnodes=count;

%Build matrix from text files
[ Indice, ID]=textread('linkiID.txt','%f %f');
[Length]=textread('pipeValue.txt','%f %f');
[nodei nodef]=textread('LinkFromTo.txt','%f %f');

```

```

%Build matrix representation of system, index numbers are used for
nodes
%and pipes. The columns of the matrix are the links while the rows of
the
%system are the nodes

A=zeros(nnodes,nlinks);

for i=1:nnodes
    Nodes(i).boundary=0;
end

for l=1:1:nlinks
    ni=from(l);
    nf=to(l);
    A(ni,l)=1;
    A(nf,l)=1;
    %Get length and assign values to the link structure
    [errcode, length] = ENgetlinkvalue(l,1);
    Links(l).Length=length;
    Links(l).node1=ni;
    Links(l).node2=nf;
    if length<=0.1
        Nodes(ni).boundary=1;
        Nodes(nf).boundary=1;
        Nodes(ni).valve=1;
        Nodes(nf).valve=1;
        Links(l).valve=1;
    else
        Links(l).valve=0;
    end
end

end

nsource=0;

for k=1:1:nnodes
    pipelist=[];
    for l=1:1:nlinks
        if A(k,l)==1
            pipelist=[pipelist,l];
        end
    end
    Nodes(k).pipes=pipelist;
    check(k)=0;
    [errcode, type] = ENgetnodetype(k);
    if type==0
        %junction
        Nodes(k).source=0;
    else
        %tank or reservoir
        Nodes(k).source=1;
        nsource=nsource+1;
    end
end

end

% %%Check how nodes are stored in the structure
% T = struct2table(Nodes)

```

```

s=0;
for c=nnodes:-1:1

    if check(c)==1

    else
        s=s+1;
        [SegmentNodes,Segmentboundary,SegmentEnd,SegmentLinks,
check]=checknode( c, Links, Nodes,check, [], [], [], []);
        Segment(s).Nodes=SegmentNodes;
        Segment(s).boundary=Segmentboundary;
        Segment(s).End=SegmentEnd;
        Segment(s).Links=unique(SegmentLinks);

        segnodes=size(SegmentNodes,2);
        Segment(s).source=0;
        for m=1:1:segnodes
            if Nodes(SegmentNodes(m)).source==1;
                Segment(s).source=1;
            end
        end
    end

end

end

for i=1:nnodes
    Nodes(i).check=check(1,i);
End

for i=1:s
    nodesID=[];
    LinksID=[];
    boundaryID=[];
    tnodes=size(Segment(i).Nodes,2);
    LinksLength=0;
    for j=1:tnodes
        [errcode,id] = ENgetnodeid(Segment(i).Nodes(j));
        nodesID=[nodesID,{id}];
    end
    Segment(i).NodesID=nodesID;
    tpipes=size(Segment(i).Links,2);
    for j=1:tpipes
        [errcode,id] = ENgetlinkid(Segment(i).Links(j));
        LinksID=[LinksID,{id}];
        [errcode, Length] = ENgetlinkvalue(Segment(i).Links(j), 1);
        LinksLength=LinksLength+Length;
    end
    Segment(i).LinksID=LinksID;
    Segment(i).LinksL=LinksLength;
    tboundary=size(Segment(i).boundary,2);
    for j=1:tboundary
        [errcode,id] = ENgetnodeid(Segment(i).boundary(j));
        boundaryID=[boundaryID,{id}];
    end
    Segment(i).boundaryID=boundaryID;
end

%Define how segments are conected

```

```

% Set the index of the valves that isolate the segment

for k=1:s
    valveID=[];
    nvalves=size(Segment(k).boundary,2);
    for j=1:nvalves
        nodeIndex=Segment(k).boundary(j);
        Segment(k).valveIndex(j)=Nodes(nodeIndex).valve;
    end

    for m=1:nvalves
        [errcode,id] = ENgetlinkid(Segment(k).valveIndex(m));
        valveID=[valveID,{id}];
    end
    Segment(k).valveID=valveID;

end

%Define incident segments

for k=1:s
    Segment(k).Incident=[];
    for j=1:s
        sharedvalves=[];
        if j==k
            %Skip
        else
            sharedvalves=intersect(Segment(k).valveIndex,Segment(j).valveIndex);
            if size(sharedvalves,2)==0
                %no shared valves
            else
                Segment(k).Incident=[Segment(k).Incident,j];
            end
        end
    end
end

%Check for segments that would be isolated from the source at each
%segment

if nsource>0
    if nsource==1
        end
    end
ENclose();

ENMatlabCleanup();
MSXMatlabCleanup();

```

- Pressure Dependent Simulation, and Performance Metric

The performance metric for loss of pressure dependent demand is evaluated.

The function PressureString adds the components to allow a pressured pendant simulation.

The function PDDmodS evaluates the loss of pressure dependent demand and recalls the results for the other performance metrics.

The output for this function includes the bar graphs for all performance metrics.

```
function [output] = PDDmodS( s,name,out,out2 )
%Perform the pressure dependent module of the assessment
%Use only name without extension for input
%check the name in this section for the original file

%name='noname';
inpname=[name, '.inp'];

%Check original supply and pressure dependent algorithm

[ t,t2,JuncID,JuncCount,OGsupply ] = NewHyd( inpname );

%Verify Supply at a condition without failure
[ OGsupply ] = PressureString(t,inpname );

%Check sources
Source=[out2.source];
sourceN=find(Source==1);
if size(sourceN,2)==1
disp('Segment with single source removed');
skipSource=sourceN;
else
disp('verify segments with sources');
skipSource=0;
end

for i=1:1:s
    %disp(i)
    j=num2str(i);
    Pname=[name, '_',j, 'C.inp'];
    %Skip if it is the only source, check files
    if i==skipSource
        [supply]=0;
    else
        [ supply ] = PressureString(t,Pname );
    end

    out(i).PDDLoss=supply;
    PDDp=(OGsupply-supply)/supply;
    if PDDp<0
        PDDp=0;
    end
    out(i).PDDper=PDDp;
end
```

```

    %Add number of valves
    A=[out2(i).valveIndex];
    out(i).valveN=size(A,2);
end

%Save results for output
output=out;

%Set new figure for bar chart
figure;

%Bar chart for pressure independent demand

Metric1=extractfield(out,'demandLoss');
Per1=Metric1;
label=(1:s);
graphloss=[label' Metric1'];
% graphloss(sourceN,:)=[]; %Remove single source segment from graph
graphloss=sortrows(graphloss,2);
graphloss=flipud(graphloss);
ticklabel=num2cell(graphloss(:,1));

subplot(4,1,1);
demand=bar(graphloss(:,2));
set(gca,'XTickLabel',ticklabel);

%Bar chart for pressure independent demand Percentage

Metric4=extractfield(out,'DemandLoss');
Per4=Metric4;
label=(1:s);
graphloss2=[label' Metric4'];
% graphloss2(sourceN,:)=[]; %Remove single source segment from graph
graphloss2=sortrows(graphloss2,2);
graphloss2=flipud(graphloss2);
ticklabel=num2cell(graphloss2(:,1));

subplot(4,1,2);
demand=bar(graphloss2(:,2));
set(gca,'XTickLabel',ticklabel);

%Bar chart for water quality

Metric2=extractfield(out,'WQe');
Per2=Metric2;
label=(1:s);
graphWQ=[label' Metric2'];
% graphWQ(sourceN,:)=[]; %Remove single source segment from graph
graphWQ=sortrows(graphWQ,2);
graphWQ=flipud(graphWQ);
ticklabel=num2cell(graphWQ(:,1));

```

```

subplot(4,1,3);
demand=bar(graphWQ(:,2));
set(gca,'XTickLabel',ticklabel);

%Bar chart for pressure dependent

Metric3=extractfield(out,'PDDper');
Per3=Metric3;
label=(1:s);
graphPDD=[label' Metric3'];
% graphPDD(sourceN,:)=[]; %Remove single source segment from graph
graphPDD=sortrows(graphPDD,2);
graphPDD=flipud(graphPDD);
ticklabel=num2cell(graphPDD(:,1));

subplot(4,1,4);
demand=bar(graphPDD(:,2));
set(gca,'XTickLabel',ticklabel);

%Add table
figure;

%Add table

source=extractfield(out2,'source');
source=source';
Length=extractfield(out2,'LinksL');
Length=Length';
label=(1:1:s);
label=label';
LossP=extractfield(out,'DemandLoss');
WQp=extractfield(out,'WQe');
PDD=extractfield(out,'PDDper');
valves=extractfield(out,'valveN');
d=[label,Length,source,LossP,WQp,PDD,valves];

t=uitable('Data',d);

t.Position(3:4) = t.Extent(3:4);
t.ColumnFormat=({'short' 'bank' 'short' 'bank' 'bank' 'bank'
'bank'});
t.ColumnName={'Segment','Length Segment','Source','Pressure
independent demand Loss', 'Effect on Age','Pressure
Dep.Shortage','Valves'};

end

```

REFERENCES

- Adachi, T. and B. R. Ellingwood (2008). "Serviceability of earthquake-damaged water systems: Effects of electrical power availability and power backup systems on system vulnerability." Reliability Engineering & System Safety **93**(1): 78-88.
- Albert, R., I. Albert and G. L. Nakarado (2004). "Structural vulnerability of the North American power grid." Phys Rev E Stat Nonlin Soft Matter Phys **69**(2 Pt 2): 025103.
- Ali S. Khan, D. L. S., Dennis D. Juraneck and Ali S. Kahn (2001). "Precautions against Biological and Chemical Terrorism Directed at Food and Water Supplies." Public Health Reports **116**(1): 3-14.
- Alperovits, E. and U. Shamir (1977). "Design of optimal water distribution systems." Water Resources Research **13**(6).
- Awumah, K., I. Goulter and S. K. Bhatt (1991). "ENTROPY-BASED REDUNDANCY MEASURE IN WATER-DISTRIBUTION NETWORKS." Journal of Hydraulic Engineering **117**(5).
- AWWA (1974). "Water-Distribution Research and Applied Development Needs." Journal - American Water Works Association **66**(6): 385-390.
- AWWA (2011). Computer Modeling of Water Distribution Systems. Denver, UNITED STATES, American Water Works Assoc.
- AWWA (2011). Water distribution operator training handbook. Water distribution operator training handbook, AWWA.
- AWWA (2012). Buried No Longer, AWWA.
- Baños, R., J. Reça, J. Martínez, C. Gil and A. L. Márquez (2011). "Resilience Indexes for Water Distribution Network Design: A Performance Analysis Under Demand Uncertainty." Water Resources Management **25**(10): 2351-2366.
- Bao, Y. and L. Mays (1990). "Hydraulic reliability analysis of water distribution systems." J. Hydr. Engrg. **116**: 1119.
- Bao, Y. and L. W. Mays (1990). "Model for Water Distribution System Reliability." Journal of Hydraulic Engineering **116**(9): 1119-1137.
- Berardi, L., R. Ugarelli, J. Røstum and O. Giustolisi (2014). "Assessing mechanical vulnerability in water distribution networks under multiple failures." Water Resources Research **50**(3): 2586-2599.
- Bhave, P. R. (2003). Optimal Design of Water Distribution Networks, Narosa Publishing House.
- Bhave, P. R. and R. Gupta (2006). Analysis of Water Distribution Networks, Narosa Publishing House.
- Biswas, A. K. (1985). "Ancient urban water supply systems." GeoJournal **11**(3): 207-213.
- Bouchart, F. and I. Goulter (1991). "Reliability Improvements in Design of Water Distribution Networks Recognizing Valve Location." Water Resources Research **27**(12): 3029-3040.
- Boulos, P. F., K. E. Lansey and B. Karney (2006). NETWORK HYDRAULICS. Comprehensive Water Distribution Systems Analysis Handbook for Engineers and Planners. M. Soft.
- Brumbelow, K., J. Torres, S. Guikema, E. Bristow and L. Kanta (2007). Virtual cities for water distribution and infrastructure system research. World environmental and water resources congress 2007: Restoring our natural habitat.
- Buhl, J., J. Gautrais, N. Reeves, R. V. Solé, S. Valverde, P. Kuntz and G. Theraulaz (2006). "Topological patterns in street networks of self-organized urban settlements." The European Physical Journal B **49**(4): 513-522.

Cadini, F., E. Zio and C. A. Petrescu (2010). "Optimal expansion of an existing electrical power transmission network by multi-objective genetic algorithms." Reliability Engineering & System Safety **95**(3): 173-181.

Chase, D. V., L. Ormsbee and T. M. Walski (1988). "Technical Report EL-88-18: Reliability of the Federally Owned Water Main System." US Army Engineer Waterways Experiment Station, Vicksburg, MS.

Cimellaro, G. P., A. Tinebra, C. Renschler and M. Fragiadakis (2016). "New Resilience Index for Urban Water Distribution Networks." Journal of Structural Engineering **142**(8): C4015014.

Clark, R. M. and R. C. Thurnau (2011). "Evaluating the risk of water distribution system failure: A shared frailty model." Front. Earth Sci. **5**(4): 400-405.

Cross, H. (1936). Analysis of flow in networks of conduits or conductors. Urbana Champaign, University of Illinois

Cuadra, L., S. Salcedo-Sanz, J. Del Ser, S. Jiménez-Fernández and Z. Geem (2015). "A Critical Review of Robustness in Power Grids Using Complex Networks Concepts." Energies **8**(9): 9211-9265.

Cullinane, M. J. (1989). Methodologies for the evaluation of Water Distribution System Reliability/Availability. Ph. D. dissertation, University of Texas at Austin.

Cullinane, M. J., K. E. Lansey and L. W. Mays (1992). "Optimization-Availability-Based Design of Water-Distribution Networks." Journal of Hydraulic Engineering **118**(3): 420-441.

Duan, N. and L. Mays (1990). "Reliability Analysis of Pumping Systems." Journal of Hydraulic Engineering **116**(2).

Dziedzic, R. M. and B. W. Karney (2014). "Water Distribution System Performance Metrics." Procedia Engineering **89**: 363-369.

Dziedzic, R. M. and B. W. Karney (2015). "Performance Index for Water Distribution Networks under Multiple Loading Conditions." Journal of Water Resources Planning and Management **142**(1).

Eiger, G., U. Shamir and A. Ben-Tal (1994). "Optimal design of water distribution networks." Water Resources Research **30**(9): 2637-2646.

EPA (2014). Water Security Toolkit User Manual: Version 1.1.

EPA. (2017). "Water Research EPANET." Retrieved 07/20/2017, 2017, from <https://www.epa.gov/water-research/epanet>.

Epp, R. and A. G. Fowler (1970). "Efficient code for steady-state flows in networks." Journal of the hydraulics division **96**(1): 43-56.

ESRI (2010). ArcGIS Desktop: Release 10. E. S. R. Institute. Redlands, CA.

Estrada, E. (2006). "Network robustness to targeted attacks. The interplay of expansibility and degree distribution." The European Physical Journal B **52**(4): 563-574.

Farmani, R., D. A. Savic and G. A. Walters (2004). "Exnet benchmark problem for multi-objective optimization of large water systems." Modelling and control for participatory planning and managing water systems.

Farmani, R., G. A. Walters and D. A. Savic (2005). "Trade-off between Total Cost and Reliability for Anytown Water Distribution Network." Journal of Water Resources Planning and Management **131**(3).

Fiedler, M. (1973). "Algebraic connectivity of graphs." Czechoslovak Mathematical Journal **23**(2): 298-305.

Frangiadakis, M., S. E. Christodoulou and D. Vamvatsikos (2013). "Reliability Assessment of Urban Water Distribution Networks Under Seismic Loads." Water Resources Management **27**(10): 3739-3764.

Fujiwara, O. and A. U. De Silva (1990). "Algorithm for reliability-based optimal design of water networks." Journal of Environmental Engineering **116**(3).

Fujiwara, O. and D. B. Khang (1990). "A two-phase decomposition method for optimal design of looped water distribution networks." Water resources research **26**(4): 539-549.

Fujiwara, O. and H. Tung (1991). "Reliability improvement for water distribution networks through increasing pipe size." Water Resources Research **27**(7).

Gheisi, A., M. Forsyth and G. Naser (2016). "Water Distribution Systems Reliability: A Review of Research Literature." Journal of Water Resources Planning and Management **142**(11): 04016047.

Gheisi, A. and G. Naser (2014). "Water Distribution System Reliability Under Simultaneous Multicomponent Failure Scenario." Journal - American Water Works Association **106**: E319-E327.

Giustolisi, O., L. Berardi and D. Laucelli (2014). "Optimal Water Distribution Network Design Accounting for Valve Shutdowns." Journal of Water Resources Planning and Management **140**(3): 277-287.

Gleick, P. H. (2006). "Water and terrorism." Water Policy **8**(6): 481.

GLUMRB (2012). Recommended Standards for Water Works. T. G. L.-U. M. R. B. o. S. a. P. P. H. a. E. M. .

Goulter, I. (1987). "Current and future use of systems analysis in water distribution network design." Civil Engineering Systems **4**(4).

Goulter, I. (1988). "Measures of Inherent Redundancy." Journal of Information & Optimization Sciences **9**(3): 363-390.

Goulter, I. and F. Bouchart (1990). "Reliability-Constrained Pipe Network Model." Journal of Hydraulic Engineering **116**(2).

Goulter, I. and A. Coals (1986). "Quantitative Approaches to Reliability Assessment in Pipe Networks " Journal of Transportation Engineering **112**(3).

Goulter, I. and A. Coals (1986). "Quantitative approaches to reliability assessment in pipe networks." J. Transp. Engrg. **112**: 287.

Gunawan, I., F. Schultmann and S. Ashkan Zarghami (2017). "The four Rs performance indicators of water distribution networks: A review of research literature." International Journal of Quality & Reliability Management **34**(5): 720-732.

Gupta, R., A. Baby, P. V. Arya and L. Ormsbee (2014). "Upgrading Reliability of Water Distribution Networks Recognizing Valve Locations." Procedia Engineering **89**: 370-377.

Gupta, R. and P. R. Bhave (1994). "Reliability Analysis of Water Distribution Systems." Journal of Environmental Engineering **120**(2): 447-461.

Gupta, R. and P. R. Bhave (1996). "Comparison of Methods for Predicting Deficient-Network Performance." Journal of Water Resources Planning and Management **122**(3): 214-217.

Gupta, R. and P. R. Bhave (1996). "Reliability-Based Design of Water-Distribution Systems." Journal of Environmental Engineering **122**(1): 51-54.

Gupta, R., N. Kakwani and L. Ormsbee (2015). "Optimal Upgrading of Water Distribution Network Redundancy." Journal of Water Resources Planning and Management **141**(1): 04014043.

Hashimoto, T., J. R. Stedinger and D. P. Loucks (1982). "Reliability, Resiliency, and Vulnerability Criteria For Water Resource System Performance Evaluation." Water Resources Research **18**(1): 14-20.

Hernandez, E., S. Hoagland and L. Ormsbee (2016). Water Distribution Database for Research Applications. World Environmental and Water Resources Congress, West Palm Beach, Florida.

Herrera, M., E. Abraham and I. Stoianov (2016). "A Graph-Theoretic Framework for Assessing the Resilience of Sectorised Water Distribution Networks." Water Resources Management **30**(5): 1685-1699.

Hoagland, S. (2016). TRANSIENT-BASED RISK ANALYSIS OF WATER DISTRIBUTION SYSTEMS, University of Kentucky.

Hoagland, S., S. Schal, L. Ormsbee and S. Bryson (2015). Classification of Water Distribution Systems for Research Applications. World Environmental and Water Resources Congress, Austin, Texas.

Jacobs, P. and I. Goulter (1988). "Evaluation of methods for decomposition of water distribution networks for reliability analysis." Civil engineering systems **5**(2): 58-64.

Jacobs, P. and I. Goulter (1991). "Estimation of Maximum Cut-Set Size for Water Network Failure." Journal of Water Resources Planning and Management **117**(5): 588-605.

Jayaram, N. and K. Srinivasan (2008). "Performance-based optimal design and rehabilitation of water distribution networks using life cycle costing." Water Resources Research **44**(1).

Jeppson, R. W. (1976). "Analysis of flow in pipe networks."

Jolly, M. D., A. D. Lothes, L. Sebastian Bryson and L. Ormsbee (2013). "Research database of water distribution system models." Journal of Water Resources Planning and Management **140**(4): 410-416.

Jolly, M. D., A. D. Lothes, L. Sebastian Bryson and L. Ormsbee (2014). "Research Database of Water Distribution System Models." Journal of Water Resources Planning and Management **140**(4): 410-416.

Jowitt, P. W. and C. Xu (1993). "Predicting Pipe Failure Effects in Water Distribution Networks." Journal of Water Resources Planning and Management **119**(1).

Kalungi, P. and T. T. Tanyimboh (2003). "Redundancy model for water distribution systems." Reliability Engineering & System Safety **82**(3): 275-286.

Kao, J.-J. and P.-H. Li (2007). "A segment-based optimization model for water pipeline replacement." Journal - American Water Works Association **99**(7): 83-95.

Karassik, I. J., J. P. Messina, P. Cooper and C. C. Heald (2001). Pump Handbook, McGraw-hill.

Kettler, A. J. and I. Goulter (1985). "An analysis of pipe brakage in urban water distribution networks." Canadian Journal of Civil Engineering **12**(2): 286-293.

Khomsy, D., G. A. Walters, A. R. D. Thorley and D. Ouazar (1996). "RELIABILITY TESTER FOR WATER-DISTRIBUTION NETWORKS." JOURNAL OF COMPUTING IN CIVIL ENGINEERING **10**(1).

KIOS Research and Innovation Center of Excellence, K. (2013, 2016). "KIOS-Research/EPANET-Matlab-Toolkit." 2017, from <https://libraries.io/github/KIOS-Research/EPANET-Matlab-Toolkit>.

Li, P.-H. and J.-J. Kao (2008). "Segment-based vulnerability analysis system for a water distribution network." Civil Engineering and Environmental Systems **25**(1): 41-58.

Liu, H., T. Walski, G. Fu and C. Zhang (2017). "Failure Impact Analysis of Isolation Valves in a Water Distribution Network." Journal of Water Resources Planning and Management **143**(7): 04017019.

Loganathan, G. V. and H. Jun (2007). "Valve-Controlled Segments in Water Distribution Systems." Journal of Water Resources Planning and Management **133**(2): 145-155.

Marchi, A., E. Salomons, A. Ostfeld, Z. Kapelan, A. R. Simpson, A. C. Zecchin, H. R. Maier, Z. Y. Wu, S. M. Elsayed, Y. Song, T. Walski, C. Stokes, W. Wu, G. C. Dandy, S. Alvisi, E. Creaco, M. Franchini, J. Saldarriaga, D. Páez, D. Hernández, J. Bohórquez, R. Bent, C. Coffrin, D. Judi, T. McPherson, P. van Hentenryck, J. P. Matos, A. J. Monteiro, N. Matias, D. G. Yoo, H. M. Lee, J. H. Kim, P. L. Iglesias-Rey, F. J. Martínez-Solano, D. Mora-Meliá, J. V. Ribelles-Aguilar, M. Guidolin, G. Fu, P. Reed, Q. Wang, H. Liu, K. McClymont, M. Johns, E. Keedwell, V. Kandiah, M. N. Jasper, K. Drake, E. Shafiee, M. A. Barandouzi, A. D. Berglund, D. Brill, G. Mahinthakumar, R. Ranjithan, E. M. Zechman, M. S. Morley, C. Tricarico, G. de Marinis, B. A. Tolson, A. Khedr and M. Asadzadeh (2014). "Battle of the Water Networks II." Journal of Water Resources Planning and Management **140**(7).

Martin, D. W. and G. Peters (1963). "the application of newton's method to network analysis by digital computer." Journal of the institute of water engineers **17**: 115-129.

MathWorks (2015). MATLAB R2015b. Natick, MA.

Mays, L. (2000). MAINTENANCE AND REHABILITATION/ REPLACEMENT. Water Distribution System Handbook, McGraw-Hill Professional.

Mays, L. W. (2000). COMPUTER MODELS/EPANET. Water Distribution System Handbook, McGraw-Hill Professional.

Mays, L. W. (2000). INTRODUCTION. Water Distribution System Handbook, McGraw-Hill Professional.

Mays, L. W. (2000). RELIABILITY ANALYSIS FOR DESIGN. Water Distribution System Handbook, McGraw-Hill Professional.

Möderl, M., R. Sitzenfrei, T. Fetz, E. Fleischhacker and W. Rauch (2011). "Systematic generation of virtual networks for water supply." Water Resources Research **47**(2).

Morgan, D. R. and I. Goulter (1985). "Optimal Urban Water Distribution Design." Water Resources Research **21**(5): 642-652.

Murray, A. and T. Grubestic (2007). Critical Infrastructure Reliability and Vulnerability, Springer Berlin Heidelberg

Murray, R., W. Grayman, D. Savic, R. Farmani, J. Boxall and C. Maksimovic (2009). Effects of DMA redesign on water distribution system performance. Proceedings of the Tenth International Conference on Computing and Control in the Water Industry.

Murray, R., T. Haxton, R. Janke, W. E. Hart, J. Berry and C. Phillips (2010). "Sensor network design for drinking water contamination warning systems: A compendium of research results and case studies using the TEVA-SPOT software." National Homeland Security Research Center, US ENVIRONMENTAL PROTECTION AGENCY, CINCINNATI, OH, USA.

Onnela, J. P., J. Saramaki, J. Kertesz and K. Kaski (2005). "Intensity and coherence of motifs in weighted complex networks." Phys Rev E Stat Nonlin Soft Matter Phys **71**(6 Pt 2): 065103.

OpenWaterAnalytics. (2016). "EPANET-Matlab-Toolkit." Retrieved 7/18/2017, 2017, from <https://github.com/OpenWaterAnalytics/EPANET-Matlab-Toolkit>.

Ormsbee, L. and A. Kessler (1990). "Optimal Upgrading of Hydraulic-Network Reliability." Journal of Water Resources Planning and Management **116**(6).

Ostfeld, A., D. Kogan and U. Shamir (2001). "Reliability simulation of water distribution systems – single and multiquality." Urban Water **4**(1): 53-61.

Ostfeld, A., E. Salomons, L. Ormsbee, J. G. Uber, C. M. Bros, P. Kalungi, R. Burd, B. Zazula-Coetzee, T. Belrain, D. Kang, K. Lansley, H. Shen, E. McBean, Z. Y. Wu, T. Walski, S. Alvisi, M. Franchini, J. P. Johnson, S. R. Ghimire, B. D. Barkdoll, T. Koppel, A. Vassiljev, J. H. Kim, G. Chung, D. G. Yoo, K. Diao, Y. Zhou, J. Li, Z. Liu, K. Chang, J. Gao, S. Qu, Y. Yuan, T. D. Prasad, D. Laucelli, L. S. V. Lyroudia, Z. Kapelan,

D. Savic, L. Berardi, G. Barbaro, O. Giustolisi, M. Asadzadeh, B. A. Tolson and R. McKillop (2012). "Battle of the Water Calibration Networks." Journal of Water Resources Planning and Management **138**(5): 523-532.

Ostfeld, A., J. G. Uber, E. Salomons, J. W. Berry, W. E. Hart, C. A. Phillips, J.-P. Watson, G. Dorini, P. Jonkergouw and Z. Kapelan (2008). "The battle of the water sensor networks (BWSN): A design challenge for engineers and algorithms." Journal of Water Resources Planning and Management **134**(6): 556-568.

Pacchin, E., S. Alvisi and M. Franchini (2016). "Analysis of Non-Iterative Methods and Proposal of a New One for Pressure-Driven Snapshot Simulations with EPANET." Water Resources Management **31**(1): 75-91.

Pacchin, E., S. Alvisi and M. Franchini (2017). "A New Non-iterative Method for Pressure-driven Snapshot Simulations with EPANET." Procedia Engineering **186**: 135-142.

Park, H. and J. C. Liebman (1993). "Redundancy-Constrained Minimum Design of Water-Distribution Nets." Journal of Water Resources Planning and Management **119**(1).

Pelletier, G., A. Mailhot and J.-P. Villeneuve (2003). "Modeling Water Pipe Breaks—Three Case Studies." JOURNAL OF WATER RESOURCES PLANNING AND MANAGEMENT **129**(2).

Prasad, T. D. and N.-S. Park (2004). "Multiobjective Genetic Algorithms for Design of Water Distribution Networks." Journal of Water Resources Planning and Management **130**(1).

Raad, D. N., A. N. Sinske and J. H. van Vuuren (2010). "Comparison of four reliability surrogate measures for water distribution systems design." Water Resources Research **46**(5).

Reca, J., J. Martínez, R. Baños and C. Gil (2008). "Optimal Design of Gravity-Fed Looped Water Distribution Networks Considering the Resilience Index." Journal of Water Resources Planning and Management **134**(3): 234-238.

Reed, D. A., K. C. Kapur and R. D. Christie (2009). "Methodology for Assessing the Resilience of Networked Infrastructure." IEEE Systems Journal **3**(2): 174-180.

Rossman, L. A. (1999). The EPANET Programmer's Toolkit for Analysis of Water Distribution Systems. 29th Annual Water Resources Planning and Management Conference.

Rossman, L. A. (2000). "Epanet 2 users manual, us environmental protection agency." Water Supply and Water Resources Division, National Risk Management Research Laboratory, Cincinnati, OH **45268**.

Rossman, L. A. (2000). EPANET Programmer's Toolkit.

Sayyed, M. A. H. A., R. Gupta and T. T. Tanyimboh (2014). "Modelling Pressure Deficient Water Distribution Networks in EPANET." Procedia Engineering **89**: 626-631.

Schaake, J. C. and F. H. Lai (1969). Linear programming and dynamic programming application to water distribution network design. Cambridge, Mass., M.I.T. Hydrodynamics Laboratory.

Schal, S. (2013). WATER QUALITY SENSOR PLACEMENT GUIDANCE FOR SMALL WATER DISTRIBUTION SYSTEMS, University of Kentucky.

Shamir, U. Y. and C. D. Howard (1968). "Water distribution systems analysis." Journal of the Hydraulics Division **94**(1): 219-234.

Shannon, C. E. (1948). "A mathematical theory of communication." Mobile computing and communications review **5**(1).

Singh, V. P. and J. Oh (2015). "A Tsallis entropy-based redundancy measure for water distribution networks." Physica A: Statistical Mechanics and its Applications **421**: 360-376.

Su, Y.-C., L. W. Mays, N. Duan and K. E. Lansey (1987). "Reliability-Based Optimization Model for Water Distribution Systems." Journal of Hydraulic Engineering **114**(12).

Su, Y., L. Mays, N. Duan and K. Lansey (1987). "Reliability based optimization for water distribution systems." J. Hydr. Engrg. **113**: 589.

Suribabu, C. R. (2017). "Resilience-based optimal design of water distribution network." Applied Water Science.

Swamee, P. K. and A. K. Sharma (2008). Design of Water Supply Pipe Networks, John Wiley and Sons.

Todini, E. (2000). "Looped water distribution networks design using a resilience index based heuristic approach." Urban Water **2**(2): 115-122.

Todini, E. and S. Pilati (1988). A gradient algorithm for the analysis of pipe networks.

Tsallis, C. (1988). "Possible Generalization of Boltzmann-Gibbs Statistics." Journal of Statistical Physics **52**.

Tucciarelli, T., A. Criminisi and D. Termini (1999). "Leak analysis in pipeline systems by means of optimal valve regulation." Journal of Hydraulic Engineering **125**(3): 277-285.

Wagner, J. M., U. Shamir and D. Marks (1988). "Water distribution reliability: Simulation methods." J. Water Resour. Plng. and Mgmt. **114**: 276.

Wagner, J. M., U. Shamir and D. H. Marks (1988). "Water Distribution Reliability: Analytical Methods." Journal of Water Resources Planning and Management **114**(3): 253-275.

Wagner, J. M., U. Shamir and D. H. Marks (1988). "Water Distribution Reliability: Simulation Methods." Journal of Water Resources Planning and Management **114**(3): 276-294.

Walski, T. (1983). "Using water distribution system models." Journal - American Water Works Association **75**(2): 58-63.

Walski, T., D. Blakley, M. Evans and B. Whitman (2017). "Verifying Pressure Dependent Demand Modeling." Procedia Engineering **186**: 364-371.

Walski, T., E. Brill, J. Gessler, I. Goulter, R. Jeppson, K. Lansey, H. L. Lee, J. Liebman, L. Mays, D. Morgan and L. Ormsbee (1987). "Battle of the network models: Epilogue." J. Water Resour. Planning and Mgmt. **113**: 191.

Walski, T. M. (1993). "Water distribution valve topology for reliability analysis." Reliability Engineering & System Safety **42**(1): 21-27.

Walski, T. M. (2006). "How many isolation valves are needed in a water distribution system?"

Walski, T. M., E. D. Brill, J. Gessler, I. C. Goulter, R. M. Jeppson, K. Lansey, H. L. Lee, J. C. Liebman, L. Mays, D. R. Morgan and L. Ormsbee (1987). "Battle of the Network Models: Epilogue." Journal of Water Resources Planning and Management **113**(2): 191-203.

Wasserman, S. and K. Faust (1994). Social network analysis: Methods and applications, Cambridge university press.

Wood, D. J. (1981). Algorithms for Pipe Network Analysis and Their Reliability, University of Kentucky Water Resources Research Institute.

Wood, D. J. and C. O. Charles (1972). "Hydraulic network analysis using linear theory." Journal of the Hydraulics division **98**(7): 1157-1170.

- Wood, D. J. and A. Rayes (1981). "Reliability of algorithms for pipe network analysis." Journal of the Hydraulics Division **107**(10): 1145-1161.
- Wu, Z. Y. and T. M. Walski (2005). "Self-Adaptive Penalty Approach Compared with Other Constraint-Handling Techniques for Pipeline Optimization." Journal of Water Resources Planning and Management **131**(3): 181-192.
- Yazdani, A. and P. Jeffrey (2011). "Complex network analysis of water distribution systems." Chaos **21**(1): 016111.
- Yazdani, A. and P. Jeffrey (2012). "Applying Network Theory to Quantify the Redundancy and Structural Robustness of Water Distribution Systems." Journal of Water Resources Planning and Management **138**(2): 153-161.
- Zhuang, B., K. Lansey and D. Kang (2013). "Resilience/Availability Analysis of Municipal Water Distribution System Incorporating Adaptive Pump Operation." Journal of Hydraulic Engineering **139**(5): 527-537.

VITA

Erika Hernandez Hernandez

Place of Birth: Medellin, Colombia

Education: B.S. Civil Engineering, University of New Mexico, 2015

Engineering in Training, State of New Mexico, 2015

Publications: Hernandez, Erika, and Lindell Ormsbee. "Segment Based Reliability Assessment for Water Distribution Systems under Multiple Failure States." *World Environmental and Water Resources Congress 2017*.

Hernandez, Erika, and Lindell Ormsbee. "Segment-Based Reliability Assessment for Water Distribution Systems." Poster at *Water Professionals Conference, Lexington 2017*.

Hernandez, Erika, and Lindell Ormsbee. "Segment Based Assessment for Water Distribution Systems." Poster at *Kentucky Water Resources Annual Symposium 2017*.

Hernandez, Erika, and Lindell Ormsbee. "Segment Based Reliability Analysis." *13th Cincinnati Area Water Distribution Systems Symposium 2016*.

Hernandez, Erika, and Lindell Ormsbee. "Segment-based Reliability Assessment for Water Distribution Systems." *Water Distribution Systems Analysis (WDSA) 2016*.

Hernandez, E., Hoagland, S., & Ormsbee, L. "Water Distribution Database for Research Applications". *World Environmental and Water Resources Congress, 2016, West Palm Beach, Florida*.