

11-6-2015

# Grief Experience among Family Caregivers following Traumatic Brain Injury: The Role of Survivor Personality Change, Perceived Social Support, and Meaning Reconstruction

Bruce A. King  
*University of Windsor*

Follow this and additional works at: <https://scholar.uwindsor.ca/etd>

---

## Recommended Citation

King, Bruce A., "Grief Experience among Family Caregivers following Traumatic Brain Injury: The Role of Survivor Personality Change, Perceived Social Support, and Meaning Reconstruction" (2015). *Electronic Theses and Dissertations*. 5525.  
<https://scholar.uwindsor.ca/etd/5525>

This online database contains the full-text of PhD dissertations and Masters' theses of University of Windsor students from 1954 forward. These documents are made available for personal study and research purposes only, in accordance with the Canadian Copyright Act and the Creative Commons license—CC BY-NC-ND (Attribution, Non-Commercial, No Derivative Works). Under this license, works must always be attributed to the copyright holder (original author), cannot be used for any commercial purposes, and may not be altered. Any other use would require the permission of the copyright holder. Students may inquire about withdrawing their dissertation and/or thesis from this database. For additional inquiries, please contact the repository administrator via email ([scholarship@uwindsor.ca](mailto:scholarship@uwindsor.ca)) or by telephone at 519-253-3000ext. 3208.

GRIEF EXPERIENCE AMONG FAMILY CAREGIVERS FOLLOWING  
TRAUMATIC BRAIN INJURY: THE ROLE OF SURVIVOR PERSONALITY  
CHANGE, PERCEIVED SOCIAL SUPPORT, AND MEANING RECONSTRUCTION

by

Bruce A. King

A Dissertation  
Submitted to the Faculty of Graduate Studies  
through the Department of Psychology  
in Partial Fulfillment of the Requirements for  
the Degree of Doctor of Philosophy at the  
University of Windsor

Windsor, Ontario, Canada

2015

© 2015 Bruce A. King

Grief Experience among Family Caregivers following Traumatic Brain Injury: The Role of Survivor Personality Change, Perceived Social Support, and Meaning Reconstruction

by

Bruce A. King

APPROVED BY:

---

C. Davis, External Examiner  
Carleton University

---

C. Tindale, Outside Department Reader  
Philosophy

---

C. Abeare  
Department of Psychology

---

R. Hanks  
Department of Psychology

---

L. Buchanan, Advisor  
Department of Psychology

July 24, 2015

## AUTHOR'S DECLARATION OF ORIGINALITY

I hereby certify that I am the sole author of this thesis and that no part of this thesis has been published or submitted for publication.

I certify that, to the best of my knowledge, my thesis does not infringe upon anyone's copyright nor violate any proprietary rights and that any ideas, techniques, quotations, or any other material from the work of other people included in my thesis, published or otherwise, are fully acknowledged in accordance with the standard referencing practices. Furthermore, to the extent that I have included copyrighted material that surpasses the bounds of fair dealing within the meaning of the Canada Copyright Act, I certify that I have obtained a written permission from the copyright owner(s) to include such material(s) in my thesis and have included copies of such copyright clearances to my appendix.

I declare that this is a true copy of my thesis, including any final revisions, as approved by my thesis committee and the Graduate Studies office, and that this thesis has not been submitted for a higher degree to any other University or Institution.

## ABSTRACT

Although multiple aspects of psychological adjustment among individuals who provide care for a relative with traumatic brain injury (TBI) have been extensively investigated, research activity with respect to potential loss and attendant grief experience in this population has been largely circumscribed. The current project aimed to address this lacuna by investigating both the extent and predictors of grief reaction in a cross-sectional sample of 123 TBI family caregivers. The influence on grief experience of three factors in particular – viz., caregiver perceived change in the personality of the TBI survivor, caregiver perceived social support, and family member meaning reconstruction following TBI-induced loss – was identified as a research focus. The relationships between carer grief experience and other indices of caregiver adjustment were also explored. Outcome measures included the Marwit-Meuser Caregiver Grief Inventory - Acquired Brain Injury Revised, Center for Epidemiologic Studies Depression Scale, Zarit Burden Interview - Short Form, and the Satisfaction with Life Scale. Results indicated that, after accounting for control variables, perceived TBI survivor personality change and perceived social support predicted caregiver grief. Only one form of meaning reconstruction, benefit-finding, emerged as a unique grief predictor. Time since survivor injury was not associated with grief scores. The impact of perceived survivor personality change on grief level was moderated by benefit-finding operating in interaction with perceived social support. Consistent with expectation, carer grief was observed to mediate the relationship between perceived personality change and both caregiver depressive symptoms and life satisfaction. These findings suggest that grief experience is likely a highly salient component of the adjustment process among many TBI family

caregivers, and may operate as a factor that contributes to other key aspects of caregiver outcome. The results also highlight the potential role of benefit-finding and social support as protective factors with regard to grief among TBI family caregivers, and suggest the utility of the development and evaluation of grief-specific interventions for this population. With respect to the latter, services that aid family caregivers in finding something of meaningful benefit in their grief experience and promote supportive social networks may prove especially constructive.

## DEDICATION

This work is dedicated to my late father, Alan King, and to all those persons who have suffered a traumatic brain injury and their family members.

### Small words

I shall not forget how the news came.

The symphonies may play out but it all feels the same.

As I count the seconds and the diminished thirds,

You are forever gone and I am left with but small words.

Small words to try to capture a life,

My heart lined up as if on the edge of a knife.

How do I write the feeling of time spent at coastal night,

With you reading to us by soft bedside light?

And yet the letters are chosen and together strung.

The horses have been stabled and the church bell rung.

And these small words are all that remain

To tell of you and I and that narrow English country lane.

Bruce King

## ACKNOWLEDGEMENTS

First and foremost I would like to thank my advisor, Dr. Lori Buchanan. Her unwavering support, guidance, and patience have been invaluable. I am deeply grateful and feel most fortunate to have had her as a true mentor over the course of my doctoral studies. I would also like to express my gratitude to my committee members, Dr. Chris Abeare, Dr. Robin Hanks, and Dr. Chris Tindale, for their time and thoughtful contributions that have helped shape this project. Dr. Hanks' kind assistance during the initial design of the investigation was much appreciated.

Obviously, this study would not have been possible without the family caregivers who participated. I am extremely thankful to these individuals for so graciously giving their time and for their willingness to share their experiences. A further debt of gratitude is owed to the staff of the community brain injury organizations who helped with recruitment efforts. On a broader note, I would like to take this opportunity to acknowledge the immense contribution of such organizations in providing a wide range of much needed long-term services to both individuals with brain injury and their family members.

I am most grateful to my family, and friends on both sides of the Atlantic, for their support and encouragement over the years. A special thank you is extended to Karey, Ange, and Ivy, whose love and understanding have helped to buoy me over rough waters. I would also like to thank Dr. Rosanne Hardy in particular for her friendship, as well as her longstanding support of both my research and clinical endeavours. Finally, I thank my wonderful partner, Brandon, for his companionship and many kindnesses, which have helped me navigate the final stages of this journey.



## TABLE OF CONTENTS

DECLARATION OF ORIGINALITY	iii
ABSTRACT	iv
DEDICATION	vi
ACKNOWLEDGEMENTS	vii
LIST OF TABLES	xi
LIST OF FIGURES	xii
CHAPTER	
1. INTRODUCTION	1
2. LITERATURE REVIEW	
The Pathophysiology of TBI	5
Closed versus Penetrating Head Injury	5
Closed Head Injury	5
Penetrating Head Injury	7
Primary and Secondary Brain Injury	9
Focal versus Diffuse Damage	11
Classification of TBI Severity	11
The Epidemiology of TBI	15
TBI Outcome	18
Cognitive Outcome	18
Cognitive Sequelae of Penetrating Head Injury	19
Cognitive Sequelae of Closed Head Injury	21
Moderate to Severe TBI	21
Mild TBI	23
Emotional and Behavioural Outcome	25
Family Impact of TBI	33
Factors Influencing Family Outcome	43
Loss and Grief	50
Traditional Grief Models	53
Freud: The Work of Grief	53
The Attachment Perspective and the Ascension of Phasic Theories	55
Objections to Traditional Accounts: Grief Work, Linearity, & Time-Bound Resolution	60
Common Ground: Meaning-Making in the Face of Loss	65
Two Construals of Meaning: Making Sense and Finding Benefits	69
The Role of Social Support in Grief	81

Grief and Depression: Distinct Phenomena	82
Loss Experience and Grief amongst TBI Family Members	84
The Emotion Regulation Model: An Opportunity for Integration	88
The Nature of Familial Loss and Grief following TBI	91
Disenfranchised Grief and Ambiguous Loss	92
Chronic Sorrow and Nonfinite Loss	97
Extant Studies of Loss and Grief among TBI Family Caregivers	101
A Potentially Key Aspect of Loss: Personality Change Revisited	104
Aims and Hypotheses	108
3. METHOD	
Participants	117
Measures	117
Demographic and Injury Information Questionnaire	118
Predictor Variables	119
Perceived Care Recipient Personality System Change	119
Social Provision Scale	120
Meaning Reconstruction	121
Perceived Changes in Care Recipient Cognitive Functioning and Physical Independence	122
Caregiver Outcome	123
Marwit-Meuser Caregiver Grief Inventory – ABI Revised	123
Center for Epidemiologic Studies Depression Scale	124
Zarit Burden Interview – Short Form	125
Satisfaction with Life Scale	126
Control Variables	127
Preinjury Relationship Quality	127
Preinjury History of Depressive Symptomatology	128
Positive and Negative Affect Schedule	128
Procedure	129
Data Analysis	131
4. RESULTS	135
Demographic and Injury Characteristics	135
Relation between Caregiver Grief and Caregiver Demographic and Control Variables	137
Correlates of Caregiver Grief: Key Variables of Interest	139
Prediction of Caregiver Grief	141
Relationships between Caregiver Grief and other Indices of Caregiver Outcome	142
Moderation of the Effect of Perceived Personality System Change (PPSC) on Caregiver Grief by Benefit-Finding	144
Moderated Moderation Analysis	150
Mediation Analysis 1: Grief as a Mediator of the Relationship between PPSC and Depressive Symptoms	156
Moderated Mediation Analysis 1	159

Mediation Analysis 2: Grief as a Mediator of the Relationship between PPSC and Life Satisfaction	164
Moderated Mediation Analysis 2	166
Clinical Significance of Caregiver Outcome Findings	170
5. DISCUSSION	178
Clinical Significance of Outcome Data	197
Further Clinical Implications and Directions for Future Research	200
Conclusion	219
REFERENCES	221
APPENDIX A	268
APPENDIX B	279
APPENDIX C	290
APPENDIX D	292
APPENDIX E	317
VITA AUCTORIS	319

## LIST OF TABLES

Table 1:	Representative Schema of Phasal Theories of Grief	59
Table 2:	Descriptive Statistics: Demographic Characteristics	136
Table 3:	Descriptive Statistics: Control, Predictor, and Outcome Variables	137
Table 4:	Summary of Study Hypotheses	138
Table 5:	Bivariate Correlations	140
Table 6:	Hierachical Multiple Regression Analysis: Caregiver Grief	142
Table 7:	Regression Results for Model 1: Moderation of the Relationship between PPSC and Grief by Benefit-Finding	145
Table 8:	Conditional Effects of PPSC on Grief at Levels of Benefit-Finding	146
Table 9:	Regression Results for Model 2: Moderation of the Relationship between PPSC and Grief by Social Support	151
Table 10:	Regression Results for Model 3: Moderation of the Relationship between PPSC and Grief by Benefit-Finding and Social Support	152
Table 11:	Conditional Effects of PPSC and Benefit-Finding Interaction on Grief at Levels of Social Support	153
Table 12:	Regression Results for Model 4. Grief as a Mediator of the Relationship between PPSC and Depressive Symptoms	158
Table 13:	Slope Estimates for the Conditional Indirect Effects of PPSC on Depressive Symptoms through Grief moderated by Benefit-finding at Levels of Social Support	162
Table 14:	Regression Results for Model 6. Grief as a Mediator of the Relationship between PPSC and Life Satisfaction	166
Table 15:	Slope Estimates for the Conditional Indirect Effects of PPSC on Life Satisfaction through Grief Moderated by Benefit-Finding at Levels of Social Support	168
Table 16:	Frequency Statistics of MM-CGI HSL Scale Average Item Scores	172

## LIST OF FIGURES

Figure 1: Emotion regulation model as applied to family member TBI loss and grief experience	89
Figure 2: Conceptual (panel A) and statistical path (panel B) diagrams for simple moderation analysis (Model 1)	145
Figure 3: Moderation of the effect of PPSC on grief by level of benefit-finding	147
Figure 4: Johnson-Neyman region of significance for the conditional effect of PPSC at values of benefit-finding	149
Figure 5: Conceptual (panel A) and statistical path (panel B) diagrams for moderated moderation analysis (Model 3)	151
Figure 6: The conditional effect of PPSC on grief as a function of benefit-finding and social support	154
Figure 7: Johnson-Neyman region of significance for the conditional effect of the PPSC $\times$ benefit-finding interaction on grief at values of social support	155
Figure 8: Combined conceptual and statistical diagram for Model 4 showing path coefficients for simple mediation analysis on caregiver depressive symptoms	158
Figure 9: Conceptual (panel A) and statistical path (panel B) diagrams for moderated mediation analysis 1, outcome = CES-D (Model 5)	159
Figure 10: A visual representation of the conditional indirect effects of PPSC on depressive symptoms as a function of level of benefit-finding and social support	163
Figure 11: Combined conceptual and statistical diagrams for Model 6 showing path coefficients for simple mediation analysis of caregiver life satisfaction	165
Figure 12: Conceptual (panel A) and statistical path (panel B) diagrams for moderated mediation analysis 2, outcome = SWLS (Model 7)	167
Figure 13: A visual representation of the conditional indirect effects of PPSC on life satisfaction as a function of level of benefit-finding and social support	169

Figure 14: Receiver operating characteristic curve for MM-CGI HSL *T* score as an index measure predicting CES-D caseness

175

## CHAPTER 1

## INTRODUCTION

*Traumatic brain injury* (TBI) is defined as “damage to brain tissue caused by external mechanical force as evidenced by: loss of consciousness due to brain trauma, posttraumatic amnesia, skull fracture, or objective neurological findings attributed to TBI on physical examination or mental status examination” (Harrison-Felix, Newton, Hall, & Kreutzer, 1996, p. 2). Invariably, the high incidence and prevalence rates of TBI feature in the introductory passages of publications pertaining to this health domain as a key component in the rationale for basic science, clinical investigation, and intervention. Indeed, the number of individuals sustaining such injury is substantial; for 1990 the worldwide annual incidence of TBI severe enough to warrant medical attention or result in death was conservatively estimated to be over 9.5 million (Murray & Lopez, 1996). However, focus upon epidemiological magnitude in this context seems misguided, at least in certain respects, as lived experience and an ever-growing body of literature indicate that the personal neuropsychological and psychosocial impact of TBI secondary to its varied cognitive, behavioural, and affective sequelae is potentially so profound that if but a handful of individuals suffered such an injury that alone would arguably be just cause for scientific and clinical endeavour.

Over the last four decades, research has been largely unequivocal in demonstrating that TBI has a substantial negative effect not only on the injured person but also upon family members, especially those fulfilling the role of primary caregiver (e.g., Kreutzer, Gervasio, & Camplair, 1994; Lezak, 1978, 1986, 1988; McCullagh, Brigstocke, Donaldson, & Kalra, 2005; Oddy, Humphrey, & Uttley, 1978a; Panting &

Merry, 1972; Perlesz, Kinsella, & Crowe, 2000). In addition to disruption in family emotional interaction, roles, and communication following injury (e.g., Gan & Schuller, 2002; Testa, Malec, Moessner, & Brown, 2006), studies have found clinically significant levels of psychological distress, including depression and anxiety, in approximately one fourth to greater than one third of TBI family members (e.g., Kreutzer et al., 2009; Oddy et al., 1978a; Ponsford & Schönberger, 2010). Increased general stress (e.g., Chwalisz, 2006), lowered physical health status (e.g., Oddy et al., 1978a), and decreased quality of life (e.g., Norup, Siert, & Lykke Mortensen, 2010) have also been documented among this population. Other indices of negative family impact have included decreased social adjustment (e.g., Livingston, 1987) and reduced marital satisfaction and longevity (e.g., Liss & Willer, 1990; Wood & Yurdakul, 1997).

Despite this longstanding recognition and, in many respects thorough, subsequent investigation of the deleterious consequences of TBI for family members, a critical aspect of family reaction to TBI has been largely neglected by healthcare professionals: Facing the loss of a normally-functioning loved one following TBI would predictably evoke a grieving process for individual family members, including the primary caregiver. While several authors have proposed models of general family adjustment following TBI that acknowledge the presence of grief (Henry, Knipper, & Golden, 1985; Kosciulek, McCubbin, & McCubbin, 1993; Gardner, 1973; Williams, 1991), and a handful of clinicians have identified the importance of addressing the grieving process amongst family members in therapeutic settings (Grovesman & Brown, 1985; Klonoff, 2014; Klonoff & Koberstein, 2010; Lezak, 1978, 1986, 1988; Muir & Haffey, 1984), to the author's knowledge only three quantitative studies to date (Marwit & Kaye, 2006; Teel,



1993; Zinner, Ball, Stutts, & Philput, 1997) have empirically investigated grief reactions among the relatives of TBI survivors. It is believed that this relative lack of professional attention is reflective, in part, of a general societal failure to recognise the losses suffered, and the subsequent grief experienced, by TBI family members. Indeed, Doka (1989) has identified the grief experience of relatives of survivors of TBI as a key form of what he terms *disenfranchised grief*, that is, grief that follows a loss that is not or cannot be openly acknowledged, publicly mourned, or socially supported. Thus, as clinical experience is testament to, for many relatives the burden of grief is carried alone, without meaningful social recognition or support from the professional healthcare community.

The current project sought to address the outlined lacuna by investigating both the extent and predictors of grief reaction among family caregivers of individuals who have sustained a TBI. Guided by theory and research findings in the fields of both general TBI family adjustment and loss and bereavement, the influence on grief experience of three factors in particular – viz., caregiver perceived change in the personality of the TBI survivor, caregiver perceived social support, and family member meaning reconstruction following TBI-induced loss – were identified as a research focus. The relationships between TBI-related caregiver grief experience and other indices of caregiver adjustment, including depressive symptomatology and life satisfaction, were also explored.

As a robust body of research has demonstrated the important role played by family caregivers in the promotion of successful TBI survivor outcome in several domains, including emotional and psychosocial adjustment, functional recovery, and treatment adherence (e.g., Leach, Frank, Bouman, & Farmer, 1994; Sander et al., 2002; Taylor et al., 1995; Vangel, Rapport, & Hanks, 2011; Ylvisaker et al., 2005), it is

anticipated that the findings of the current study will help to lay the foundation for improved TBI educational and intervention support services that will not only meet key emotional needs of family caregivers but will also serve to enhance the functioning of the person with injury.

## CHAPTER 2

## LITERATURE REVIEW

## The Pathophysiology of TBI

Postmortem studies (e.g., Adams, Gennarelli, & Graham, 1983), animal models (e.g., Dietrich, Alonso, & Halley, 1994), and neuroimaging investigations (e.g., Kraus et al., 2007) have greatly advanced our understanding of the nature of TBI pathology and the mechanisms by which brain damage occurs in head injury.<sup>1</sup> It is now recognised that the neuropathology of TBI consists of multiple forms including gross overt damage to brain tissue as well as disruption of brain function at a cellular level (Yeates, 2010) with the total injury resulting from trauma depending not only on the direct mechanical damage but also the complex interactive series of pathological biochemical and genetic cascades that follow. Several conceptual approaches have been employed to classify the pathologies associated with TBI: closed versus penetrating head injury; primary versus secondary damage; and focal versus diffuse lesions.

*Closed versus Penetrating Head Injury*

Closed and penetrating head injury represent two broad classes of TBI, the characteristics of which differ with respect to the underlying primary injury mechanics and certain aspects of pathophysiology.

*Closed Head Injury*

In *closed head injury* brain damage is brought about by the mechanisms of either static or dynamic loading (Gennarelli, 1990) with the skull remaining unpenetrated.

---

<sup>1</sup> It is important to note that the terms brain injury and head injury are not synonymous. The human brain is relatively well protected, encased in the skull, surrounded by three layers of meninges (the pia mater, arachnoid, and dura mater), and suspended within cerebrospinal fluid. Thus, a person may sustain a head injury via trauma without her or his brain sustaining damage (Reitan & Wolfson, 2000).

Static loading occurs when forces are applied to the head in a gradual and slow manner. This uncommon mechanism is in operation when the head experiences a slow squeezing effect between opposing forces. Dynamic loading occurs in instances in which the brain is subjected to rapid acceleration/deceleration forces and is the more common mechanical input causing closed head injury (as in motor vehicle accidents, for example). Dynamic loading may be subdivided into two types – impulsive and impact. Impulsive dynamic loading takes place when the head is set into motion rapidly or when the moving head is brought to a sudden stop without being struck, resulting in inertial forces that injure the brain. Impact loading, the more frequent form of dynamic loading, occurs when a blunt object strikes the head (or vice versa) and typically leads to brain damage secondary to a combination of contact and inertial forces (Gennarelli, 1990; Morales et al., 2005). Both contact and inertial loading cause proximal tissue injury through strain (i.e., tissue deformation), with three forms of strain having been identified on the basis of the direction of the force applied – tensile (pulling apart), compressive (pushing together), and shear (parallel deforming). Both brain parenchyma and vascular tissue have very low tolerance to tensile and shear strain (Gennarelli, 1990; Katz, 1992).

Contact injuries result from the impact of the head with another object (i.e., when the head strikes an object or is hit) and reflect, as the term suggests, contact phenomena alone. Contact effects that occur locally at or near the site of impact include the majority of linear and depressed skull fractures, coup contusions, and epidural hematomas. Contact effects remote from the impact site arise due to skull distortion and shock waves, and include vault fractures, basilar skull fractures, and contra-coup and intermediary contusions (Gennarelli, 1990).

Inertial brain injuries are commonly referred to as acceleration injuries as they occur due to violent head motion. Structural inertial tissue damage arises from one of two mechanisms. First, acceleration injury can occur as a result of differential movement of the brain and skull, with inertia leading to the former lagging slightly behind the motion of the latter. This creates strain at the surface of the brain as it moves relative to the skull and dura and may cause subdural veins to tear. The inertial forces established with acceleration in combination with deceleration (i.e., head impact or abrupt change in the direction of head movement) may also cause the brain to come into compressive contact with one or more surfaces of the skull (Gennarelli, 1990; Reitan & Wolfson, 2000). The frontal poles, orbitofrontal cortex and anterior temporal lobes are particularly vulnerable to this effect given the bony protuberances of the anterior portion of the skull against which they can abrade (Ricker, 2010). Movement of the brain away from the skull can also create regions of low pressure which may lead to sufficient tensile strain to cause contusion. The second inertial injury mechanism is the production of strain directly within the parenchyma and vascular tissue of the brain itself. This mechanism is thought to cause diffuse axonal injury, petechial hemorrhages, and the majority of intermediate contusions (Gennarelli, 1990).

#### *Penetrating Head Injury*

The essential feature of *penetrating head injury* is, as the term suggests, penetration of the skull and dura with subsequent passage into the brain parenchyma by some form of object (Williamson, Scott, & Adams, 1996). Gunshot wounds to the head are the leading cause of penetrating head injury (Lezak, Howieson, Loring, Hannay, & Fischer, 2004). In the case of puncture wounds and low-velocity projectiles primary

brain damage may be largely concentrated in the path of the infiltrating object, with the tract of destruction related to the diameter of the missile. However, as the velocity and mass of the object increases the amount of kinetic energy transferred from the missile to brain tissue rises with the probability of less localised injury increasing markedly (Swan & Swan, 1980, Trask & Narayan, 1996). Two major sources of injury induced by high-velocity missiles as they traverse the brain have been identified. First, juxta-missile pressure, that is, high pressure in front of and at right angles to the missile head, results in the immediate and permanent injury cavity along the missile track (Carey, Sarna, Farrell, & Happel, 1989). Second, pressure waves from the dissipation of kinetic energy from the tumbling round into surrounding tissue induce a large temporary ellipsoid-shaped cavity behind the bullet. This temporary cavity, which is several times larger than the permanent missile tract, collapses upon itself only to re-expand in progressively smaller undulating wave-like patterns. Each cycle of temporary expansion and collapse compresses adjacent brain tissue and is considered to cause the majority of injury remote to the missile track (Carey et al. 1989; Williams et al., 2005). This can include shear-like distal axonal injury, epidural and subdural hematomas, and parenchymal contusions (Esposito & Walker, 2009; Williams et al., 2005).

Intracerebral haemorrhage is an immediate and frequently observed sequela of penetrating head injury. In addition to contributing to ischemia-induced infarction, evidence suggests that such haemorrhage may play a significant role in pathogenic cellular cascades, including apoptotic cell death (e.g., Levy, Streifler, Panet, Melamed, & Offen, 2002). Clinical reports indicate that limiting intracerebral haemorrhage in patients with penetrating head injuries favourably influences outcome and recovery (e.g. Giese et

al., 2002). Subarachnoid haemorrhage occurs in 31 to 78 percent of penetrating head injury cases with its presence shown to correlate significantly with mortality (Esposito & Walker, 2009).

Further brain damage in penetrating head injury may result from infection, raised intracranial pressure, and cerebral oedema (Koestler & Keshavarz, 2001). Infectious complications may take the form of cerebral abscess, meningitis, or ventriculitis (Aarabi et al., 1998), and occur in 1 to 5 percent of those cases treated with broad spectrum antibiotics (Benzel, Day, & Kesterton, 1991). Traumatic aneurysms and arteriovenous fistulas are the most common vascular complications observed following this form of head injury (Esposito & Walker, 2009).

#### *Primary and Secondary Brain Injury*

Although the forces initiating TBI generally take less than 100 milliseconds to occur and induce immediate neurological damage, other pathophysiological events are initiated that are much more prolonged and progressive in nature (Greve & Zink, 2009). The framework of primary and secondary brain injury was established to capture the developmental sequence of TBI neuropathology in terms of temporal relationship to the initial insult. *Primary brain damage* encompasses the direct, nonreversible biomechanical effects of the injury and occurs immediately at the time of traumatic force application. Primary injuries include perforating and penetrating wounds, skull fracture, contusions and lacerations, haemorrhage, diffuse axonal injury (select aspects), and other brain damage caused principally by movement of the brain within the skull and represented by lesions to the cranial nerves, the hypothalamus, and pituitary gland. *Secondary brain damage* results from physiological and biomolecular responses that are

delayed in nature, developing at least a small amount of time after the initial mechanical injury. Secondary forms of pathology include raised intracranial pressure, oedema and brain swelling, hypoxic-ischemic damage, haematoma, infectious complications, reactive axonal changes, and delayed pathogenic neurochemical and metabolic cascades contributing to necrotic and apoptotic cell death (Anderson, Northam, Hendy, & Wrennall, 2001; Graham, Adams, Nicoll, Maxwell, & Gennarelli, 1995; Reitan & Wolfson, 2000; Raghupathi, 2004; Yeates, 2010).<sup>2</sup>

Given their delayed onset and progression over hours to days or months after the initial trauma, the mechanisms underlying secondary damage following TBI are potentially amenable to postinjury therapeutic intervention (Morales et al., 2005). This coupled with the capacity of secondary injury mechanisms to significantly impact the overall extent of damage and in turn outcome, has led to focus in TBI medical management being placed on prevention or reduction of such mechanisms (Gennarelli & Graham, 2005; Yeates, 2010). While progress has been made in the management of certain secondary effects (e.g., mass lesions, increased intracranial pressure, and infection) (Hartl & Ghajar, 2005; Esposito & Walker, 2009), attempts at targeted therapeutic pharmacological intervention to attenuate cellular damage have been largely unsuccessful (Shimizu, Fulp, Royo, & McIntosh, 2005). Despite promising findings in a number of animal TBI models, to date, all phase III human clinical trials evaluating

---

<sup>2</sup> *Necrotic cell death* results from acute cellular injury secondary to environmental perturbations with subsequent uncontrolled release of inflammatory cellular contents. In turn, it is often associated with extensive damage to surrounding tissue. *Apoptosis* is a term used to refer to programmed cell death. Here the cell is an active participant in its own demise with apoptosis being described as akin to 'cellular suicide.' As a genetically determined process, apoptosis occurs during normal cell turnover and tissue homeostasis, embryogenesis, maintenance of immune tolerance, and development of the nervous system, without eliciting harmful inflammation (Elmore, 2007; Fink & Cookson, 2005). However, apoptotic cell death can also be triggered by pathological events such as the intra- and extracellular disturbances effected by TBI. Please see Raghupathi (2004) and Yakovlev and Faden (2004) for reviews of cell death mechanisms following TBI.



pharmaceutical compounds have failed to show robust and significant effects on posttraumatic outcome (Morales et al., 2005).

### *Focal versus Diffuse Damage*

A further classification of TBI has been developed based on clinical and neuroradiological data demonstrating that brain pathology following head trauma can be focal or diffuse in nature (Gennarelli & Graham, 2005). *Focal damage* typically involves contusion and/or mass lesion formation and is characterised by macroscopic injury that is largely limited within a local, clearly circumscribed area within direct vicinity of the mechanical impact to the head (Gennarelli, 1990; Povlishock & Katz, 2005). In contrast, *diffuse brain injury* results primarily from tissue strain secondary to inertial forces and is generally associated with widespread neurological dysfunction, usually in the absence of macroscopic structural lesions (Gennarelli, 1990; Smith, Meaney, & Shull, 2003). In both focal and diffuse TBI both necrotic and apoptotic cell death cascades have been identified. Detailed discussion of major forms of focal and diffuse injury types, including traumatic axonal injury, may be found in Appendix A.

### Classification of TBI Severity

The initial extent of damage, the degree of acute disruption of brain physiology, and, in turn, clinical presentation of TBI varies greatly across individuals, with classification of injury severity an important predictor of both short- and, to a lesser extent, long-term outcome (Corrigan et al. 2010, Roebuck-Spencer & Sherer, 2008).

The most commonly used measure of TBI severity is the *Glasgow Coma Scale* (GCS; Teasdale & Jennett, 1974), a metric designed to assess depth of coma in the acute period following injury by determining the individual's responsiveness level in eye

opening, verbal communication, and motor movement. Scores range from 3 to 15, with higher scores indicating greater level of consciousness. Patients with post-resuscitation scores of 3 to 8 are classified as having had *severe* injuries, scores from 9 to 12 are considered to indicate injuries of *moderate* severity, and scores between 13 and 15 are classified as representative of *mild* TBI (Levin & Eisenberg, 1991).

Duration of *loss of consciousness* or the time taken to return to a responsive state is another common TBI severity index. Ability to follow simple commands, provision of yes/no responses reliably through words or gestures, production of intelligible verbalizations, or other purposeful behaviours are typically used as indicators of a patient's return to a conscious state (Roebuck-Spencer & Sherer, 2008). The U.S. Departments of Veteran's Affairs and of Defence have advanced a classification system for this metric (Management of mTBI Working Group, 2009) in which an interval of  $\leq 30$  minutes loss of consciousness duration represents a mild injury, an interval greater than 30 minutes and up to 24 hours a moderate injury, and  $> 24$  hours a severe injury. It should be noted, however, that cutpoints used across studies for this indicator are inconsistent (Roebuck-Spencer & Sherer, 2008).

TBI severity is also frequently classified on the basis of duration of *posttraumatic amnesia*. This refers to a state following TBI in which the patient is responsive, but acutely confused, disoriented, and unable to form and retain new memories (Russell, 1932; Sherer, Nakase-Thompson, Yablon, & Gontkovsky, 2005). While memory disturbance is often a hallmark of this early phase of recovery recent researchers have noted the similarity of this state to delirium and consequently have argued that it may be more accurately characterised by the term *posttraumatic confusional state* (Nakase-

Thompson, Sherer, Yablon, Nick, & Trzepacz, 2004; Stuss et al., 1999).<sup>3</sup> One widely used criteria set classifies a period of posttraumatic confusion of less than 1 hour as representative of mild TBI, a period of 1 to 24 hours as indicative of moderate TBI, a period of 1 to 7 days as reflecting a severe injury, and a period of posttraumatic confusion exceeding 7 days as representative of very severe brain trauma (Russell & Smith, 1961).

While numerous studies have found GCS scores, duration of loss of consciousness, and length of posttraumatic confusion to be predictive of both acute outcomes and various aspects of long-term functioning following TBI, the latter including employment, neuropsychological outcome, and personal independence (e.g., Dikmen & Machamer, 1995; Dikmen, Ross, Machamer, & Temkin, 1995; Dikman, Temkin, Machamer, Holubkov, Fraser, & Winn, 1994; Ellenber, Levin, & Saydjari, 1996), current classification of TBI severity is not without flaws. First, there exist no universally accepted criteria for determining TBI severity, with independent use of the aforementioned common indices resulting in sometimes incongruent severity level classifications within a given patient (Sherer, Struchen, Nakase-Thompson & Yablon, 2005). Second, the boundaries between the nominal categories of severity have not been fully delineated. In a move to begin to address this, the U.S. Centers for Disease Control and Prevention convened an expert panel, which devised a consensus-based operational definition for mild TBI: “an injury to the head ... that results in 1 or more of the following: any period of confusion, disorientation, or impaired consciousness; any dysfunction of memory around the time of injury; loss of consciousness lasting less than

---

<sup>3</sup> A confusional state can be defined as a transient organic mental syndrome with acute onset characterized by a global impairment of cognitive functions with a concurrent disturbance of consciousness, attentional abnormalities, reduced or increased psychomotor activity, and a disrupted sleep/wake cycle (Stuss et al., 1999).

30 minutes; or the onset of observed signs or symptoms of neurological or neuropsychological dysfunction” (CDC, 2003, p.16). Distinctions between moderate and severe TBI, however, have yet to be clearly defined. Third, in certain instances of penetrating head injury, particular non-missile forms (i.e., those caused by penetrating objects with an impact velocity less than 100 m/s), significant alteration of consciousness often does not occur despite severe brain damage (Alafaci et al., 2010). Thus, clinical severity measures such as GCS score and loss of consciousness duration in such cases do not accurately reflect the extent of underlying neuropathology. Finally, it is important to note that clinical manifestation and outcomes of patients within the same TBI severity category can vary greatly (Dikman et al., 1995; Williams, Levin, & Eisenberg, 1990), suggesting a classification system more sensitive to intra-category variation is required. Steps toward such a system have been made with respect to mild TBI classification, with a more precise sub-classification method being derived that incorporates evaluation of pathoanatomic features in addition to neurological observation: Individuals with GCS scores between 13 and 15 are subdivided into complicated or uncomplicated mild TBI depending on the presence or absence, respectively, of positive findings on neuroimaging (Hsiang, Yeung, Ashley, & Poon, 1997; Williams et al., 1990). Confirming the utility of such an approach, several investigations have found those patients classified as having complicated mild TBI to have less favourable outcomes than those with uncomplicated mild TBI (e.g., Borgaro, Prigatano, Kwasnica, & Rexer, 2003; Dikmen, Machamer, Powell, & Temkin, 2003). A similar multidimensional pathoanatomic classification system has recently been proposed for all forms of TBI under study in clinical trials (Saatman et al., 2008). Within this new approach assessment of injury severity would

consider not only clinical effects evident on presentation (e.g., GCS and neurologic exam) but also include pathoanatomic injury type, lesion distribution (e.g., extent and location of injury measured using a radiologic grading scheme), and possibly physiological effects (e.g., biomarker analysis).

### The Epidemiology of TBI

Information pertaining to the occurrence of TBI is of importance as it allows for the identification of at risk populations and hazardous exposure circumstances, and, concurrently, facilitates appropriate planning and monitoring of both prevention and treatment measures (Canadian Institute for Health Information [CIHI], 2006; Kraus & McArthur, 1999). Although the worldwide *incidence* (the number of new cases during a given period) and *prevalence* (the number of all cases at a point in time) of TBI is not known, available data indicate that TBI represents a leading cause of mortality and disability throughout the world (Murray & Lopez, 1997), with higher rates observed in developing countries (Corrigan, Selassie, & Orman, 2010).

In the United States approximately 275,000 individuals are admitted to hospital for nonfatal TBI each year. A further 1.365 million TBI cases are estimated to be treated and released from an emergency department and 52,000 persons die annually (Faul, Xu, Wald, & Coronado, 2010). The overall annual U.S. incidence of TBI is estimated to be 576.8 per 100,000 population (Faul et al., 2010).<sup>4</sup> Of hospitalized cases, 19 percent are classified as severe, 21 percent as moderate, and 52 percent as mild (Thurman, Coronado,

---

<sup>4</sup> This estimate includes TBI incidence per 100,000 population for emergency department visits (403), acute hospital discharges (85), and fatal instances (18; Corrigan et al., 2010). It is to be noted that estimates of TBI incidence and prevalence are by nature conservative given that (a) many individuals who sustain less severe injuries may never seek medical attention following injury and therefore are not reflected in the medical data sets that form the foundation for epidemiological investigation, and (b) the estimates do not reflect persons with TBI treated outside of civilian hospitals.

& Selassie, 2007). It is notable that U.S. mortality following TBI has been significantly lowered from approximately 50 percent of hospitalised cases in the late 1970s to 17 percent in 2003 (Jennett et al., 1977; Rutland-Brown, Langlois, Thomas, & Xi, 2006). This reduction, attributable to the development of improved protocol-driven medical management and related technological advances (Greve & Zink, 2009), translates into a greater proportion of individuals returning home with significant TBI-related long-term *disability*.<sup>5</sup> In 2003, an estimated 124,000 hospitalized American TBI survivors (43.3%) experienced related disability one year post injury (Selassie, Zaloshnja, Langlois, Miller, Jones, & Steiner, 2003). The prevalence of TBI in the United States civilian population in 2005 was an estimated 1.1 percent; this translates to 3.17 million persons living with a TBI-related disability (Zaloshnja, Miller, Langlois, & Selassie, 2008).

According to the Canadian Institute for Health Information, in 2003-2004, 16,811 Canadians required hospitalization as a result of TBI (CIHI, 2006). This equates to an annual incidence of approximately 53 per 100,000 population.<sup>6</sup> In this year, 1,368 TBI related deaths were recorded, representing 8 percent of Canadian TBI hospital admissions (CIHI, 2006). On the basis of review of emergency department and family physician health records, Ryu and colleagues (Ryu, Feinstein, Colantonio, Streiner, & Dawson, 2009) calculated the incidence rate of mild TBI in Ontario to be between 493 and 653 per 100,000 population. Reliable TBI prevalence data for the Canadian population is not available at this time.

---

<sup>5</sup> Disability in this context is generally broadly defined to include inability or substantial difficulty performing activities of daily living, having postinjury symptoms that compromise the individual's capacity to complete daily tasks/pursue goals, and poor scores on standardized cognitive and mental health measures (Corrigan et al., 2010).

<sup>6</sup> It is important to note that this figure only represents the frequency of TBI cases that required hospitalization; TBI-related emergency department visits were not included in the study data set.

Major risk factors identified for TBI include age, gender, socioeconomic status, and alcohol consumption. U.S. studies of TBI occurrence have consistently found that children younger than age 4, persons 15 to 19 years old, and adults aged 75 and older have the highest incidence rates (Faul et al., 2010; Langlois, Rutland-Brown, & Thomas, 2006). Analysis of Canadian hospital admission records for TBI in 2003-2004 found a bimodal distribution with respect to age, with the highest incidences being among children and youth aged 19 years or younger and among persons 60 years and older (CIHI, 2006). Incidence reports in both the U.S. and Canada indicate that traumatic brain injuries are far more frequent among men than women, with rate ratios ranging from 1.4 to 2.8 (CIHI, 2006; Faul et al., 2010; Kraus & Chu, 2005). It is postulated that the higher rates for men may reflect greater male propensity toward risk-taking behaviour and/or involvement in high-risk activities; Injuries from motor vehicle accidents, contact sports, and interpersonal violence are all more common among men, who also show a higher rate of alcohol abuse (Kraus & McArthur, 1999). Socioeconomic status has also been suggested as a possible risk factor for TBI in the U.S., with several studies having found annual incidence rates to be highest in families at the lowest income levels (e.g., Kraus, Fife, Ramstein, Conroy, & Cox, 1986; Sosin et al., 1996). Finally, a positive association between blood alcohol concentration and risk of TBI has been observed in the U.S. (Kraus & McArthur, 1999). In one study 56 percent of adults with a brain injury diagnosis who were tested had a positive blood alcohol level; blood alcohol concentration was positively associated with degree of neurological impairment and with hospitalization length (Kraus, Morgenstern, Fife, Conroy, & Nourjah, 1989).

With respect to aetiology, in the United States each year from 2002 through 2006 falls were the most frequent exposure to energy transfer associated with TBI, accounting for 35 percent of cases. Other leading external causes were motor vehicle/traffic accidents (17 percent), struck by/against events (16 percent), and assaults (10 percent; Faul et al., 2010).<sup>7</sup> Falls accounted for approximately 50 percent of TBI hospital admissions in Canada in 2003-2004, followed by motor vehicle accidents (36 percent), and assault (10 percent; CIHI, 2006). In North America fall-related TBI rates are highest among children below the age of 5 and the elderly (60 years and over), while motor vehicle accidents are the leading cause of TBI for both teenagers and young adults (CIHI, 2006; Faul et al., 2010; Kraus & Chu, 2005; Langlois et al., 2006).

#### TBI Outcome

In this section cognitive outcome following TBI will be broadly reviewed. Focus will subsequently be placed upon those sequelae of TBI most consistently identified in prior research as predictive of family member emotional distress and adjustment, viz., primary and secondary/reactive psychiatric disorders and neurobehavioural and affective disturbance. Given the potentially highly deleterious impact of such sequelae on survivor interpersonal functioning they may, in turn, be of particular relevance to family caregiver experience of loss and grief. Personality change secondary to TBI will be discussed within this context.

#### *Cognitive Outcome*

A large body of evidence has demonstrated TBI to be associated with numerous cognitive difficulties (e.g., Draper & Ponsford, 2008). The magnitude of cognitive

---

<sup>7</sup> In this study, struck by/against events were defined as those in which a person was struck unintentionally by another person or an object, such as falling debris or a ball in sports, or in which someone struck against an object, such as a wall or another person.



impairment, however, varies greatly across individuals. A number of factors contribute to this heterogeneity of cognitive outcome, including survivor premorbid level of functioning, and type and severity of injury (Novack, Bush, Meythaler, & Canupp, 2001; Roebuck-Spencer & Sherer, 2008). Degree of persistent cognitive impairment is greater with increased initial injury severity. This was most effectively demonstrated by Dikmen and colleagues who found a clear dose-response relationship between TBI severity (assessed by length of coma, specifically time to follow commands) and level of performance on a comprehensive battery of neuropsychological measures at 1-year postinjury (Dikmen, Machamer, Winn, & Temkin, 1995). Performances of the subgroup of TBI survivors with the mildest form of injury, defined as time to follow commands less than 1 hour, were comparable to those of trauma control subjects. Significant differences compared with controls began to be observed with increasing TBI severity on measures of episodic memory, processing speed, and problem solving.

#### *Cognitive Sequelae of Penetrating Head Injury*

Penetrating head injury often produces a relatively focal brain lesion with associated cognitive deficits specific to the lateralization and region of the brain affected. For instance, a penetrating wound of the left hemisphere can result in a relatively circumscribed impairment of language and verbal memory with relative preservation of visuospatial skills with mild to no loss of consciousness (Dikmen, Corrigan, Levin, Machamer, Stiers, & Weisskopf, 2009; Williamson et al., 1996). Although such focal effects are typically more pronounced it should be noted, however, that patterns of diffuse cognitive impairment are also observed in more severe cases of penetrating injury

(Lezak et al., 2004), with larger lesions associated with more general deficits (Grafman, Salazar, Weingartner, Vance, & Amin, 1986).

Multiple studies conducted predominantly among military personnel have consistently observed long-term decline in several cognitive domains after penetrating brain injury as compared with appropriate controls. For example, Grafman et al. (1988) studied 263 Vietnam War veterans who had suffered a penetrating head injury and 64 uninjured controls who served in Vietnam during the same time period as those with brain injury, with follow-up assessment completed 12-15 years postinjury. No significant differences existed between the groups in age, education, or preinjury Armed Forces Qualification Test (AFQT) percentile scores. The AFQT is composed of four subtests (vocabulary knowledge, arithmetic word problems, object-function matching, and mental imagery box construction) and yields an overall score similar to an intelligence quotient. Results clearly indicated that those veterans with brain injury showed greater diminution in performance over time on the AFQT than did the controls, with total brain volume loss significantly predicting reduction in AFQT total score from before to after injury. When subtest scores were analysed lesion location accounted for a greater part of performance variance. For instance, poorer visual-spatial subtask performance was associated with right hemisphere lesions.

Other studies conducted with penetrating head injury military cohorts have demonstrated exacerbated decline in general intelligence at 36-39 years postinjury (Raymont, Greathouse, Reding, Lipsky, Salazar, & Grafman, 2008), and have showed long-term impairments in spatial orientation (Weinstein, Semmes, Ghent, & Teuber, 1956), facial discrimination (Grafman, Salazaar, Weingartner, & Amin, 1986), sustained

attention, verbal learning, and visual memory (Schwab et al., 1993), reasoning and arithmetic (Salazar et al., 1986), and problem solving (Grafman, Jonas, & Salazaar, 1990).

Survivors of penetrating forms of TBI typically display relatively rapid cognitive gains in the first year postinjury with further improvement slow and comparably minimal. Significant early gains are often observed in the domains of language and visuoconstruction while sensory deficits invariably persist unchanged indefinitely (Lezak et al., 2004).

### *Cognitive Sequelae of Closed Head Injury*

#### *Moderate to severe TBI.*

Studies of individuals with moderate to severe closed head injury have also consistently observed significant, long-term cognitive deficits. Although considerable variation in degree and precise profile of cognitive impairment has been found across persons (Dikmen et al., 1995; Kreutzer, Gordon, Rosenthal, & Marwitz, 1993), a relatively distinct pattern of persistent deficits following moderate to severe blunt TBI is frequently reported with impairments in the domains of attention, information processing speed, executive function, and learning and memory most commonly observed (Draper & Ponsford, 2008; Levin et al., 1990; Millis et al., 2001; Novack, Anderson, Bush, Meythaler, & Canupp, 2000; Ponsford, Oliver, & Curran, 1995; Sigurdardottir et al., 2015). Persistent aphasia syndromes, dyspraxia, or visual perceptual difficulties are uncommon but may occur in persons with focal injuries (Roebuck-Spencer & Sherer, 2008). To date, two studies have examined long-term cognitive performance in individuals with moderate to severe closed head injury with concurrent testing of

appropriate controls. Lannoo et al. (1998) assessed 85 consecutive patients with moderate to severe TBI (GCS score of 3–12) who were admitted to an intensive care unit and compared their cognitive function with that of 32 trauma patient controls. Six months postinjury those with TBI performed significantly worse than did the control group on most measures of attention, information processing, reaction time, memory and learning, mental flexibility, and verbal fluency. Tate and colleagues (Tate, Fenelon, Manning, & Hunter, 1991) studied a consecutive series of 87 persons with severe closed TBI (average posttraumatic amnesia length of 11.6 weeks) and compared their cognitive function with that of sibling controls 6 years after trauma. Seventy percent of the individuals with TBI demonstrated clinically significant impairments, and the group with TBI was more impaired than the control group in all domains. Learning and memory problems were the most common in persons with TBI (56.5% vs. 5% of controls). The least common problems among the TBI survivors were difficulties in orientation, visual perception, praxis, and language (16.5% and 2.5% of controls). Slowed information processing was seen in 34.1% of the TBI group and 2.5% of controls. Eleven percent of TBI survivors demonstrated a generalized pattern of impairment with deficient performance in all areas assessed.

With respect to neuropsychological recovery, research suggests significant improvements in several cognitive domains (particularly memory) in the first year following moderate to severe closed head injury with more accelerated recovery occurring in the first 5 to 6 months (Christensen et al., 2008; Dikmen, Machamer, Temkin, & McLean, 1990; Kersel, Marsh, Havill, & Sleigh, 2001; Levin et al., 1990; Novack et al., 2000). Improvement of cognitive functioning beyond 1-year postinjury is

more case-specific and dependent on severity of injury. For example, in a longitudinal investigation of moderate to severe TBI survivors at 1-month, 1-year, and 2-years postinjury, Dikmen et al. (1990) found a significant improvement in cognitive functioning in the first year postinjury, with only modest recovery of cognitive functions in the second year. Moreover, a high prevalence of cognitive difficulties persisted at 2-year follow-up with a significant association between length of coma and level of cognitive impairment. Millis and colleagues (2001) evaluated cognitive recovery among a cohort of persons with predominately moderate to severe closed head injury at 1-year and 5-years postinjury. Considerable variability in recovery over time was observed across subjects at 5-year follow-up. Using a criterion of reliable change on 2 or more of the 12 tasks administered as indicating significant improvement or deterioration from 1 to 5 years, 22% of survivors displayed improvement, 15% declined, and 63% remained unchanged with respect to neuropsychological performance. Improvement was most commonly observed on measures of cognitive speed, visuoconstruction, and verbal memory.

#### *Mild TBI.*

Several meta-analyses and prospective investigations of the cognitive sequelae of mild TBI have found impairments most commonly in the domains of attention, information processing speed, verbal fluency, and learning and memory in the first few days following injury, with a largely favourable course of neuropsychological recovery over a period of days to weeks, with no evidence of permanent deficits on neuropsychological assessment by 3 months postinjury when compared with healthy controls (Belanger, Curtiss, Demery, Lenowitz, & Vanderploeg, 2005; Binder, Rohling,

& Larrabee, 1997; Dikmen, Mclean, & Temkin, 1986; Heitger et al., 2006; Levin et al., 1987; Schretlen & Shapiro, 2003). It should be noted, however, that group data and meta-analysis results can obscure small sub-group and/or individual effects. Thus, a sub-group of individuals with residual cognitive impairment following mild TBI could exist and be concealed by group inferential statistical analyses (Iverson, 2010). In turn, one cannot state unequivocally on the basis of research findings to date that mild TBI does not cause long-term cognitive impairment. However, data available indicates that the majority of persons who sustain a mild TBI should be expected to experience substantial cognitive recovery (Dikmen et al., 2009; Iverson, 2010).

Studies of individuals with complicated mild TBI (as defined by a GCS score ranging from 13-15 and the presence of an intracranial lesion) suggest that patients in this group not only demonstrate more significant cognitive impairments than those with uncomplicated mild TBI at 1 and 3 months postinjury (Borgaro, Prigatano, Kwasnica, & Rexer, 2003; Williams et al., 1990) but also display long-term cognitive outcomes similar to those in persons who have sustained a TBI in the moderate range of severity (Kashluba, Hanks, Casey, & Millis, 2008). Kashluba et al. (2008) found performances on only 3 of 9 neuropsychological measures to differentiate a group of patients with complicated mild TBI from a patient group with moderate TBI. Descriptive analysis of levels of impairment based on normative data effectively nullified these group differences. Importantly, despite improvement across cognitive domains, the complicated mild TBI group still exhibited some degree of impairment at 1 year postinjury on measures of information processing speed, problem solving, cognitive flexibility, and verbal learning and recall.

In summary, the long-term cognitive sequelae of TBI studied to date vary according to pathoanatomic injury type and injury severity as assessed by clinical indices. There is sufficient evidence for long-term cognitive deficits across multiple domains associated with penetrating head injury. Factors that modify this association include volume of brain tissue lost and brain region affected. With respect to closed head injury, data suggest a clear dose-response relationship between injury severity and severity and pervasiveness of long-term cognitive impairments. Cognitive status following uncomplicated mild TBI is expected to return to baseline levels by 3 months postinjury in the majority of cases. However, there is insufficient evidence to conclude definitively that no impairments in cognition are associated with uncomplicated mild TBI. In comparison, moderate and severe blunt TBI leads to more pronounced and widespread cognitive impairment. Significant gains in neuropsychological performance occur within the first year following moderate to severe closed and penetrating head injury with further recovery variable but modest at best. Resolution of cognitive sequelae in such cases is far from complete with long-term cognitive disability common. Evidence to date suggests that cognitive outcome in complicated mild TBI parallels that observed in moderate closed head injury.

#### *Emotional and Behavioural Outcome*

Numerous studies have documented a wide range of often significant emotional and neurobehavioural difficulties in cases of penetrating and mild to severe closed head injury. These sequelae have been observed to have long-term functional impact for TBI survivors, often persisting after certain cognitive and physical symptoms resolve (Koponen et al. 2002; Malia, Powell, & Torode, 1995), and have consistently been found

to be the most robust associate of family member distress (e.g., Brooks et al., 1986; Ergh et al., 2002; Prigatano, Borgaro, Baker, & Wethe, 2005).

It is important to note that in most instances the aetiology of affective and behavioural disturbance following TBI, including psychiatric disorder, remains to a certain extent indeterminate. Such disturbances may be viewed as resulting from TBI in that they would likely not have been exhibited if the person had not suffered the injury. However, any disturbance may arise from (a) the pathophysiological effects of brain injury (e.g., damage to a component of the neurobiological substrate that mediates emotional and motivational processing), (b) a generalized psychological response to the trauma, distress, and disability resulting from injury (i.e., a secondary or reactive response reflecting problematic adjustment which may be strongly influenced by premorbid characteristics and postinjury psychosocial variables), or (c) a dynamic interplay of these factors (Prigatano, 1999; Rogers & Read, 2007; Wood, 2001).

With respect to psychiatric outcome, increased incidence of several forms of both DSM-based Axis I and II forms of disorder have been observed in TBI populations. van Reekum and colleagues (van Reekum, Cohen, & Wong, 2000) and Rogers and Reed (2007) have both conducted evidence-based reviews of post-TBI Axis I psychiatric disorders, applying several criteria to establish causation. These include (1) consistent demonstration of a strong association between the proposed causative agent and the outcome, (2) identification of a biologic gradient, such that greater severity of the causative agent produces poorer outcome, (3) demonstration of an appropriate temporal sequence (i.e., the causative agent comes first in time), and (4) establishing a biological and theoretical rationale for the casual chain.



van Reekum et al. (2000) observed *major depression* in 44% of TBI cases across ten studies, which represented an increase in prevalence relative to the general community population by a factor of 7.5. Evidence to support a biological gradient was insufficient, findings concerning the temporal sequence of illness onset were mixed, and, while left frontal cortex and noradrenergic and serotonergic neurotransmitter system abnormalities were identified as potential correlates, the majority of studies recognised that understanding of the biological mechanisms involved in major depression post-TBI remains limited. Rogers and Reed (2007) reviewed a further 13 studies of major depression following TBI published subsequent to the van Reekum et al. report. Major depression was diagnosed in 24.5% of cases and was found to be associated with poorer functional outcome and reduced social integration. Temporal pattern of onset was variable, with some patients meeting criteria at discharge from hospital while others were first diagnosed at 3-, 6-, 12-months or even years postinjury (Rogers & Read, 2007). Although prefrontal dysfunction has been identified as a potential causal factor, given the lack of consistent predictive power of injury-related variables, several authors have proposed the aetiology of major depression post-TBI to be multifactorial, with the disorder attributed to both injury-induced neuropathology and difficulty adjusting to postinjury disability (Pagulayan, Hoffman, Temkin, Machamer, & Dikmen, 2008; Rogers & Read, 2007).

Findings regarding increased risk of *bipolar affective disorder* (BPAD) among TBI survivors are inconsistent. In their review of 6 studies van Reekum et al. (2000) found BPAD to be diagnosed in 4.2% of patients, a prevalence rate 5.3-times higher than the general community population. Data regarding a biological gradient was considered

mixed. In contrast, evidence for the appropriate temporal sequence was considered strong and neuroradiologic evidence for a biological rationale involving right hemisphere subcortical or limbic atrophy reviewed.

However, Silver and colleagues (Silver, Kramer, Greenwald, & Weissman, 2001) reported a BPAD diagnosis among only 1.6% of TBI patients, which did not differ significantly from the prevalence rate of a non-injured control population. This coupled with the finding of a majority of persons with mild TBI and BPAD comorbidity reporting onset of symptoms prior to brain injury (Sagduyu, 2002), led Rogers and Read (2007) to contend that individuals with TBI are not at an increased risk for BPAD and questioned the extant evidence for a correct temporal causative sequence.

With respect to *generalized anxiety disorder* (GAD), both reviews concluded persons with TBI to be at greater risk but neither found consistent support for a biological gradient or rationale. The van Reekum et al. (2000) report found GAD prevalence to be 9.1% across five studies over a maximum of 7.5 years, which represented a 2.3-fold increase relative to the general population. Evidence for a temporal relationship was consistently positive. GAD was diagnosed in 24.5% of TBI survivors across a further three investigations reviewed by Roger and Read (2007). In one of these studies, comorbid GAD or major depression, was found to impact negatively upon recovery and was associated with poor outcome among 80 individuals with mild TBI (38% with a positive neuroradiologic exam) (Mooney & Speed, 2001).

*Posttraumatic stress disorder* (PTSD) was reported in 14.1% of TBI survivors across the six studies reviewed by van Reekum et al. (2000), a 5.8-times greater risk relative to that observed in the general population. Data pertinent to the other causative

criteria was not available. Roger and Read (2007) identified a further six studies reporting on the prevalence of PTSD following TBI with 16.5% of survivors meeting diagnostic criteria and evidence for the appropriate temporal sequence consistent. Persons with mild to severe TBI have been found to develop PTSD (Levin et al., 2001), with no reliable support of a biological gradient demonstrated. Although a plausible model for a direct pathophysiological contribution to the disorder has been proposed (i.e., TBI-related damage affecting the hypothalamic-pituitary-adrenal axis), it is more parsimonious to view PTSD post-TBI as primarily reflective of a generalized reaction to the inherently traumatic nature of the injury (Levin et al., 2001; Roger & Read, 2007). Both the van Reekum et al. (2000) and Roger and Read (2007) reviews also found elevated levels of *panic disorder* and *obsessive compulsive disorder* following TBI relative to general community lifetime prevalence rates.

Research investigating the diagnosis of Axis II disorders following TBI has been more limited. Hibbard et al. (2000) investigated the frequency of *personality disorder* (PD) among 100 individuals who were on average 7.5 years post mild to severe TBI. An almost three-fold increase in PDs following injury (24% pre and 66% post) was observed. The occurrence of PD was independent of injury severity. Among individuals with a premorbid history of Axis II disorder, the most common PDs diagnosed were borderline (28%), avoidant (26%), obsessive-compulsive (24%), and paranoid (17%). In a retrospective study of 60 Finns with mild to severe TBI, Koponen et al. (2002) diagnosed 23% of participants with a PD, noting this figure to be markedly higher than available European population prevalence rates of 5.9 to 13.5%. A distinct disinhibited organic personality syndrome was also identified among 15% of this sample (Koponen et al.,

2002), which was subsequently associated with frontal lesions on structural brain imaging (Koponen et al., 2006).

In summary, psychiatric disorders have been observed consistently at an elevated rate following TBI, negatively impacting other aspects of the recovery process and psychosocial outcome, even in mild cases. With respect to Axis I syndromes, survivors appear to be particularly susceptible to major depression, GAD, and PTSD (Mooney & Speed, 2001; Roger & Read, 2007; van Reekum et al., 2000). Although paucity of data preclude the formulation of a definitive account of the aetiological underpinnings of such psychiatric disturbance, available findings suggest a causative model in which direct injury-related pathophysiological damage and cerebral dysfunction interacts with both secondary negative psychological responses to injury and its panoply of associated adverse sequelae/consequences, and with environmental-social-economic factors (Hibbard et al., 2000; Roger & Reed, 2007; Ruocco, Swirsky-Sacchetti, & Choca, 2007).

In addition to specific psychiatric disorders, a host of other problematic affective, motivational, and behavioural disturbances have been associated with TBI. A consistent theoretical organizational framework of these phenomena has yet to be developed. A common approach, however, has been to group observed changes into two spheres along a spectrum of *positive* or *active* versus *negative* or *passive* symptoms (Crowe, 2008). For example, following a comprehensive review of the pertinent clinical literature, Prigatano (1992) included the following within the active group of observed disturbances: irritability, agitation, belligerence, anger, abrupt and unexpected acts of violence (episodic dyscontrol), impulsiveness, impatience, restlessness, inappropriate social responses, emotional lability, increased sensitivity to noise or distress, anxiety,

suspiciousness, delusional phenomena, paranoia, and mania or manic-like states. Passive symptoms reported included asponaneity, loss of interest in the environment, loss of drive or initiative, tiring easily, depressed mood, and lack of insight or awareness of limitations. Prigatano (1992) also identified two common syndromes, one termed *helplessness*, characterised by the need for continuous supervision and cueing in order to accomplish goals, and another termed *childishness* featuring self-centred behaviour, insensitivity to others, verbal expansiveness, and exuberance or euphoric behaviour. With respect to the latter, Lezak (1988) highlights that TBI survivors exhibiting this childlike egocentricity appear to have “lost the capacity to imbue others with self-hood, to understand other persons as subjects in their own right” (p.114). In turn, she notes that the ability to empathise with others and recognize others’ emotions and needs is typically greatly diminished if not lost altogether in these individuals.

With respect to the biological substrate of such disturbances following TBI, collectively termed *neurobehavioural disability* (Woods, 2001), damage and disruption of the frontal lobes and their extensive cortical and subcortical circuitry is most commonly implicated (e.g., Alexander & Stuss, 2000; Damasio, 1998; Jahanshahi & Frith, 1998; Mesulam, 2002, Tranel, 2002). In turn, a number of models tentatively connecting lesions to certain frontal systems with particular emotional and behavioural TBI sequelae have been proposed. For example, Fuster (1989, 2001, 2003) has characterised *disorders of control* (i.e., those resulting in impulsiveness and affective reactivity) as due to impaired inhibitory control mechanisms secondary to lesions of the orbital prefrontal cortex, and *disorders of drive and motivation* as arising due to inability to temporally integrate information and subsequently initiate and execute new goal

directed behaviours secondary to damage to the medial and dorsolateral aspects of the prefrontal cortex and its connections. Similarly, Cummings (Cummings, 1995; Tekin & Cummings, 2002) has described three major frontal-subcortical circuit syndromes: Patients with dorsolateral prefrontal circuit dysfunction are typically concrete and perseverative, and often display disorganised behaviour. In the orbitofrontal syndrome the circuit connecting the frontal monitoring systems to the limbic system is disrupted resulting in individuals who are irritable, prone to explosive aggressive outbursts, and who may lack empathy and interpersonal sensitivity. Finally, in the anterior cingulate syndrome associated dysfunction is considered to reflect decreased motivation, with apathy and diminished initiative (Tekin & Cummings, 2002).<sup>8</sup>

Numerous early and contemporary theorists and researchers in the field of TBI have come to conceive the above reviewed behavioural and affective changes exhibited by survivors of such injury, including psychiatric disturbance, as constituting a form of *personality change* (e.g., Brooks et al., 1986; Crowe, 2008; Hall et al., 1994; Lezak, 1978; Richardson, 2000; Obonsawin et al., 2007; Prigatano, 1999; Stuss, Gow, & Hetherington, 1992; Wood, 2001). In recent years, a small number of researchers who have adopted a *dispositional* approach to personality have questioned the applicability of this term in the context of TBI (Kurtz, Putnam, & Stone, 1998; Malec, Brown, & Moessner, 2004; Rush, Malec, Brown, & Moessner, 2006). In line with the five-factor model (e.g., McCrae & Costa, 1987, 1997), these authors have constricted their understanding of the construct of personality to the five *traits* (i.e., enduring nomothetic behavioural tendencies) of Neuroticism, Extraversion, Openness, Agreeableness, and

---

<sup>8</sup> A growing body of recent experimental evidence suggests that the medial frontal cortex, including the anterior cingulate region, plays a critical role in value judgements, the mental concept of the subjective self or personal entity, and related aspects of self-control (for review, please see Seitz, Franz, and Azari, 2009).

Conscientiousness. On the basis of a lack of significant change in TBI survivor and significant other retrospective ratings of these traits from pre- to postinjury (e.g., Kurtz et al., 1998; Malec et al., 2004; cf. Tate, 2003), Rush et al. (2006) have come to label the term personality change a “misnomer” in cases of TBI.

However, viewing the behavioural and emotional changes exhibited by survivors of TBI as a form of personality change is entirely congruent with the *processing* conceptualization of the construct of personality. In this framework personality is far more broadly conceived; it is not defined in terms of mean between-person differences on psycho-lexical dimensions but rather construed as an organized system of mediating units (e.g., encodings, expectancies, goals, motives) and cognitive-affective processes, conscious and unconscious, that interacts with the situation the person experiences (e.g., Mischel & Shoda, 2008). Such a processing understanding of personality is evident in the definitions of the construct proffered by those who recognise personality change as a valid entity among survivors of TBI. Stuss et al. (1992), for example, define personality as “the sum of characteristics or qualities that make an individual a unique self” (p. 350). They note that personality “includes mood, affect, drive, and other psychological functions such as self-reflectiveness” and that it represents “a dynamic balance between internal drive, needs, and desires, ... and [regulatory] internal and external forces” (*ibid.*).

#### Family Impact of TBI

The negative impact of TBI on both individual family member psychosocial and physical subjective well-being and overall family functioning has been well documented in the literature and has received growing attention over the last three decades. In addition to facing the above reviewed significant cognitive, emotional, and behavioural

changes exhibited by their injured relative, family members of TBI survivors are also invariably abruptly thrust into the role of primary long-term caregiver for their loved one following hospital discharge, and, in turn, often experience curtailment of multiple aspects of their social and vocational activities.

Four studies conducted in the 1970s were instrumental in first alerting healthcare professionals to the wider impact of TBI on family members as they attempt to adjust to both the traumatic nature of the injury itself, adjust to injury-induced changes in their relative, and assume the responsibility of providing daily functional assistance and emotional support as caregivers (Panting & Merry, 1972; Romano, 1974; Thomsen 1974; Rosenbaum & Najenson, 1976). Panting and Merry (1972), in studying long-term rehabilitation among 30 Britons with severe TBI, concluded on the basis of follow-up family interviews that the survivor's injury resulted in "great strain on all relatives" (p. 35). They found that 61 percent of family members had received supportive treatment in the form of tranquilizers or sleeping pills, whereas none had reportedly required such medications prior to the injury. These authors, in turn, were among the first to call for improved family support following TBI, suggesting provision to family members of more detailed prognostic information and counselling services. Romano (1974) reported clinical observations of families of 13 severe TBI survivors with whom she had extended contact in the capacity of a social worker. She reported significant denial of survivor neurobehavioural and affective disturbance among family members during the acute phase of recovery, and argued that this adversely affected survivor rehabilitation and family adjustment. Thomsen (1974) conducted a follow-up investigation of long-term outcome among 50 individuals with severe TBI and their relatives. At structured



interview family members reported neuropsychological sequelae, in particular “changes in personality”, but not physical disability, to be the greatest source of emotional distress. In the fourth seminal study, Rosenbaum and Najenson (1976) investigated spouse reports of depressive symptomatology and changes in family life following TBI. They surveyed wives of 10 Israeli military veterans with severe TBI, 6 veterans with spinal cord injury, and 14 non-injured veterans. At 1 year postinjury the wives of the TBI survivors were found to endorse significantly higher levels of depressive symptoms and adverse changes in family life than wives of men in the two control groups.

Subsequent more thorough and systematic investigation of family reaction to TBI was spearheaded by independent longitudinal studies conducted by two groups of British researchers, one based in Glasgow and the other in London. In the first set of Glasgow studies, McKinley and colleagues interviewed close relatives of 55 men with severe head injury (PTA greater than 48 hours) at 3, 6, and 12 months (McKinley, Brooks, Bond, Martinage, & Marshall, 1981), and 5 years postinjury (23% participant attrition; Brooks, Campsie, Symington, Beattie, & McKinley, 1986), with further follow-up at 7 years when the sample was increased by a further 92 relative-survivor dyads (Brooks, Campsie, Symington, Beattie, & McKinley, 1987). Derived from early work with family caregivers of individuals with chronic mental illness, McKinley et al. distinguished between objective and subjective burden. *Objective burden* was defined as observable changes in the survivor’s cognitive, emotional, behavioural, and physical functioning as perceived by the family member. The term *subjective burden* was used to refer to the psychological strain or stress which the relative suffers and attributes to these changes (McKinley et al, 1981). At each of the five follow-up points, subjective burden in family

members was assessed by a 7-point rating scale of the degree of “strain” experienced as a result of perceived changes in their relative with TBI. At 3 months postinjury 69 percent of family members reported a medium to high level of strain with this proportion gradually increasing over time. At 6 and 12 month follow-up, 73 and 75 percent of relatives reported a medium to high level of strain, respectively (McKinley et al, 1981). At 5 years postinjury, the proportion of family members experiencing this level of strain had increased to 89 percent (Brooks et al., 1986) and remained above 85 percent at 7 year follow-up (Brooks et al., 1987).

In addition to investigating general family member stress experienced in response to TBI sequelae, the Glasgow group also assessed psychiatric outcome and social functioning among relatives of 35 persons who had sustained a severe closed head injury (Livingston, Brooks, & Bond, 1985a). At 3, 6, and 12 months postinjury on standardized assessment measures approximately a quarter and a third of family members reported clinically significant levels of depressive symptomatology and anxiety, respectively. With respect to social adjustment, results suggested gradual development of difficulties between 3 and 6 months postinjury with deterioration of marital functioning being the most prominent. Trends toward poorer social adjustment in a number of other domains, including family functioning, work, and parenting, were also observed in comparison to community norms.

London-based Oddy and colleagues investigated TBI impact on spouses and parents of persons with severe TBI over a 7 year period (Oddy, Coughlan, Tylerman, & Jenkins, 1985; Oddy, Humphrey, & Uttley, 1978a, 1978b). At 6 and 12 months postinjury more than half of 54 relatives reported at interview that they were

experiencing significant stress as a result of the TBI. Forty percent of family members identified the major source of stress to be some aspect of the survivor's condition, such as poorly controlled behaviour or fear of epilepsy. Utilizing the Wakefield Depression Inventory (Snaith, Ahmed, Mehta, & Hamilton, 1971), at 1 month after trauma 39 percent of significant others were identified as "depressed", dropping off to approximately 25 percent at 6 and 12 months postinjury (Oddy et al., 1978a). At 7 year follow-up 23 relatives were assessed. Of these 17 percent reported levels of depressive symptoms or anxiety high enough to warrant clinical attention (Oddy et al., 1985).

In line with the early work of the Glasgow group and Oddy et al., more recent cross-sectional and longitudinal studies using standardised measures with larger sample sizes have continued to document increased incidence of clinically significant levels of *psychological distress* among TBI family members, in particular depressive symptomatology and anxiety, up to 7 years postinjury, with incidence estimates ranging from 19 to 77 percent (Douglas & Spellacy, 2000; Ergh et al., 2002; Gillen, Tennen, Affleck, & Steinpreis, 1998; Knight, Devereux, & Godfrey, 1998; Kreutzer, Gervasio, & Camplair, 1994a; Kreutzer et al. 2009; Linn, Allen, & Willer, 1994; Mintz, Van Horn, & Levine, 1995; Norup, Siert, & Lykke Mortensen, 2010; Ponsford & Schönberger, 2010; Perlesz, Kinsella, & Crowe, 2000; Rivera, Elliott, Berry, Grant, & Oswald, 2007).<sup>9</sup> For example, Gillen and colleagues (Gillen et al., 1998) investigated the prevalence of major depressive disorder and depressive symptomatology among 59 female family caregivers (39 mothers and 20 spouses) of individuals with moderate to severe TBI. Average time from injury to study participation was 18.5 months. At initial assessment, using a

---

<sup>9</sup> As a benchmark, 12-month prevalence rates of mood and anxiety disorders in the general U.S. population are 9.5 and 18.1 percent, respectively (Kessler, Chiu, Demler, Merikangas, & Walters, 2005).

structured diagnostic interview, 47 percent of the relatives met criteria for a DSM-III-R diagnosis of major depression. At 6 month follow-up, 43 percent of family members were diagnosed as depressed. Of those who met criteria for major depressive disorder at the time of initial assessment, 65 percent remained depressed, with five new cases emerging. Over the course of the study, 66 percent of participants experienced at least one depressive episode. Level of depressive symptomatology was also assessed via the depression subscale of the SCL 90-R. Interestingly, the use of a conservative “caseness” cutoff score on the SCL 90-R depression subscale (T score  $\geq 70$ ) with diagnostic interview depression diagnosis serving as the criterion yielded perfect specificity but low sensitivity (21 percent and 16 percent agreement at initial assessment and follow-up, respectively). Thus a large number of relatives who met criteria for major depressive disorder at interview were found to not exceed the critical cutoff on the SCL 90-R. In a large scale study, Ponsford and Schönberger (2010) assessed emotional functioning of family members of persons with predominantly moderate to severe TBI at 2 and 5 years postinjury. Of the 301 relatives who participated at 2 year follow-up, 27 and 47 percent displayed clinically significant levels of depressive symptoms and anxiety, respectively, on the Hospital Anxiety and Depression Scale. At 5 year follow-up, at which time 266 TBI family members participated (98 from the original cohort), a nonsignificant trend towards a lower, but still high, number of relatives with clinically significant depressive symptoms (19 percent) and anxiety (35 percent) was observed.<sup>10</sup>

---

<sup>10</sup> Variability in psychological distress prevalence findings among family members may be attributable to methodologic factors. Typically lower rates of distress have been observed in larger, prospective samples (e.g., Kreutzer et al., 2009).

With respect to further investigation of *burden* among relatives of persons with TBI, a key problem within the field has been the lack of a consensual definition of the construct. As can be seen in the work of McKinley and colleagues, for example, the term *burden* has at various times been used interchangeably with “strain”, “stress”, and “emotional distress.” In an attempt to provide a more well-defined theoretical framework in which to study relative burden and TBI family outcome in general, Chwalisz (1992, 1996) proposed the application of Lazarus and Folkman’s (1984, 1987) transaction model of stress to the study of family reaction following TBI. According to the transactional theory, stress is determined by the outcome of: (a) a primary appraisal in which the individual comes to identify a situation as involving harm or loss, threat, and/or challenge; and (b) a secondary appraisal that entails an evaluation of what might and can be done to manage the situation (i.e., an evaluation of available coping resources). Thus, *stress* can be defined as the degree to which the individual appraises a situation as endangering her or his well-being (e.g., harmful), and/or as taxing or exceeding her or his perceived coping resources. Within this stress-coping paradigm, Chwalisz (1992, 1996) proposed that TBI family member burden be defined as *perceived stress*. In other words, it was contended that burden is experienced by relatives of persons with TBI when the effects of the injury are appraised to be harmful and to exceed the family member’s ability to cope. Although Chwalisz’s work made an important contribution in terms of both linking TBI family member adjustment to stress process theory and subsequently identifying stress appraisal as a potential mediator of health-related outcomes, the author’s equating of burden to the broad construct of stress (regardless of source) can be viewed as a further muddying of the conceptual waters. Burden is traditionally defined

as “a responsibility or duty” and as “something that is difficult to bear, either emotionally or physically” (American Heritage Dictionary of the English Language, 1969). Other researcher’s in the field have been able to conceptualize family member burden experience following TBI in a manner that retains these unique traditional semantic elements of the construct and at the same time places it within the transaction stress-coping model. This has been achieved by focusing upon family member burden within the context of caregiving. Based upon work investigating appraisals of caregiving among caregivers of the elderly (Lawton, Kleban, Moss, Rovine, & Glicksman, 1989), *perceived burden* among TBI family members has been defined as the subjective perceptions by the relative of negative personal experience (including emotional distress, demoralization, poor physical health, feelings of loss of control, and social isolation) that is attributed directly to caregiving (Chronister & Chan, 2006; Chronister, Chan, Sasson-Gelman, & Chiu, 2010; Hanks, Rapport, & Vangel, 2007). This definition, although broad in terms of outcomes included, has the advantage of allowing for the assessment of family member negative appraisal (i.e., family member stress) directly related to the caregiving role; as such it effectively distinguishes burden as a distinct stress construct and is the conceptualization of burden that will be employed in the current investigation. For purposes of clarity, the term *perceived caregiving burden* will be used in the current text.

Several recent studies have documented high levels of perceived caregiving burden among relatives of TBI survivors at up to 15 years postinjury (Allen, Linn, Gutierrez, & Willer, 1994; Hanks et al., 2007; Manskow et al., 2014; Marsh, Kersel, Havill, & Sliagh, 1998; Minnes, Graffi, Nolte, Carlson, & Harrick, 2000;). Hanks and colleagues (2007), for example, in an investigation of caregiving appraisal after TBI

among 60 caregivers (86 percent of whom were relatives of the survivor) found approximately 89 percent of participants reported dissatisfaction with respect to perceived burden of caregiving.

Following the surge of research interest in the adjustment of individual family members to TBI (typically the primary caregiver), studies began to investigate the impact of TBI upon the family unit as a system. According to family systems theory, all members of a family are interconnected, and, in turn, a change in one part of the system results in change for the entire system. Thus, it would be expected that potentially all members of a family and various aspects of overall family functioning would be negatively effected by TBI (Maitz & Sachs, 1995; Zarski, DePompei, & Zook, 1988). A study conducted by Kozloff (1987) was seminal as one of the first to treat the family as a whole as the primary unit of study. Using a social network analysis framework, Kozloff observed that as time postinjury increases, the TBI survivor's social network decreases in size with "multiplex" relationships within the family increasing; i.e., family members were found to serve more and more roles and responsibilities within the relationship with the survivor as contact and support from outside the family was lost. Importantly, the study identified a pattern of increasing social isolation over time for not only the TBI survivor but also the family as a whole within the context of significant maladaptive intrafamilial role change. Subsequent research investigating family functioning after TBI has continued to document a number of adverse effects, including diminished family cohesion (Maitz, 1991), decreased marital satisfaction and longevity (Gosling & Oddy, 1999; Kravetz et al., 1995; Peters, Stambrook, Moore, & Esses, 1990; Wood & Yurdakul, 1997), disrupted family role performance (Anderson et al., 2009; Gan, Campbell,

Gemeinhardt, & McFadden, 2006; Gan & Schuller, 2002; Kreutzer et al., 1994a), reduced family emotional involvement and poor affective expression (Gan et al., 2006; Gan & Schuller, 2002; Kreutzer et al., 1994a; Peters, Stambrook, & Moore, 1990), impaired family communication (Gan et al., 2006; Gan & Schuller, 2002; Kreutzer et al., 1994a), and disrupted general family functioning (Anderson et al., 2009; Ergh, Rapport, Coleman, & Hanks, 2002; Gan & Schuller, 2002; Kreutzer et al., 1994a). Other problems observed among TBI families include significant financial strain (Hall et al., 1994; Jacobs, 1988; McMordie & Barker, 1988) and increased incidences of alcohol dependence and need for mental health services (Hall et al., 1994).

In the last decade, within the domain of individual family member impact following TBI, researchers have come to investigate another aspect of family caregiver subjective well-being, viz., *life satisfaction*. Subjective well-being has been conceptualised as consisting of three components: positive affective appraisal, negative affective appraisal, and life satisfaction. The balance between positive and negative affective appraisal is considered to be reflected in an individual's level of happiness, the emotional aspect of subjective well-being (Dijkers, 1999; Lucas, Diener, & Suh, 1996). Life satisfaction, in contrast, represents a person's subjective cognitive assessment of their overall satisfaction with their current life status in relation to self-defined standards or expectations of what they would like their life to be (Dijkers, 1999). Research suggests that although not independent of state negative or positive affectivity, life satisfaction is a distinct component of subjective well-being and provides unique information in this regard (Pavot & Diener, 1993).<sup>11</sup>

---

<sup>11</sup> Life satisfaction is closely related to the construct of *quality of life*. Although a consensual definition has remained elusive, quality of life may be broadly defined as an individual's subjective appraisal of their



Several studies have observed high levels of life dissatisfaction among family caregivers of persons with TBI (Ergh et al., 2003; Kolakowsky-Hayner, Miner, & Kreutzer, 2001; Livingston et al., 2010). In a recent longitudinal multi-centre study of 336 individuals caring for family members with TBI, Livingston et al. (2010) found family caregivers reported significantly lower life satisfaction relative to comparison samples of healthy adults without caregiver responsibilities. At one- and two-year follow-up, 39 and 41 percent of family members reported life dissatisfaction, respectively.

#### *Factors Influencing Family Outcome*

Although there is clear and mounting evidence that TBI often has a profound negative impact on the injured person's family, it is also pertinent to note that not all relatives and families are affected to the same degree and there are some who appear to adjust relatively well (Adams, 1996; Camplair, Kreutzer, & Doherty, 1990; Machamer, Temkin, & Dikmen, 2002; Perlesz, Kinsella, & Crowe, 1999). In an attempt to identify the factors underlying the observed variability in familial response and adjustment, research has increasingly been focused upon identifying potential predictors of individual family member outcome and family system functioning. Injury-related variables of interest have included injury severity, time since injury, and injury sequelae. In the majority of studies, indices of severity of injury, such as GCS score or length of loss of consciousness, have not been found to be associated with family outcome (Allen et al., 1994; Ergh et al., 2002; Ergh et al., 2003; Gervasio & Kreutzer, 1997; Gillen et al., 1998; Groom, Shaw, O'Connor, Howard, & Pickens, 1998; Hall et al., 1994; Kreutzer,

---

overall well-being as it relates to their emotional state, physical functioning, psychosocial attitudes, environment, or a combination thereof (Aaronson, 1988; WHOQOL Group, 1998).

Gervasio, & Camplair, 1994b; Kreutzer et al., 2009; Linn et al., 1994; Oddy et al., 1978a; Ponsford, Olver, Ponsford, & Nelms, 2003). The general lack of a strong relationship between injury severity ratings and family adjustment may reflect the fact that the former is only a gross predictor of residual survivor disability. As noted by Camplair et al. (1990), the absence of significant correlations may also be a partial function of the homogeneity of most research samples with respect to injury severity; most studies of family outcome following TBI have samples predominantly or exclusively comprised of index family members with severe forms of injury. In one of the few studies with better representation of mild TBI, Livingston et al. (1985b) found significantly higher levels of anxiety, stress, and impaired psychosocial role functioning among relatives of severe TBI survivors compared to family members of persons with mild brain injury. A handful of investigations have also observed injury severity to be associated with family adjustment following severe TBI: Brooks et al. (1986) observed significantly longer periods of posttraumatic amnesia among survivors of relatives reporting higher levels of TBI-related stress at five-year follow-up, while Douglas and Spellacy (1996) reported length of posttraumatic amnesia to be a unique predictor of variance in family functioning.

While time may afford family members the opportunity to adjust to the negative changes brought about by TBI, the effects of distress, associated caregiving burden, and disrupted family interactions may also accumulate. Research on the influence of time since injury on family adjustment has yielded equivocal findings. Some researchers have found increases in individual family member distress and family unit dysfunction over time (Brooks et al., 1986; Wood & Yurdakul, 1997), especially in cases in which social support is inadequate (Ergh et al., 2002), two studies have observed an inverse

relationship between family outcome and time postinjury (Groom et al., 1998; Sander, High, Hannay, & Sherer, 1997), while several investigations have found no evidence of change over time (Gillen et al., 1998; Gervasio & Kreutzer, 1997; Kreutzer et al., 2009; Linn et al., 1994). Differences in family adjustment measurement and range of time since injury among TBI survivors sampled have been identified as possible factors underlying inconsistent results (Ergh et al., 2002).

With respect to injury sequelae, family member perceived neurobehavioural and affective disturbance in TBI survivors, often termed personality change, has consistently emerged as the strongest predictor of both individual family member outcome and family functioning (Allen et al., 1994; Brooks et al., 1986; Ergh et al., 2002; Ergh et al., 2003; Groom et al., 1998; Knight et al., 1998; Kreutzer et al., 1994b; Marsh et al., 1998; McKinlay et al., 1981; Oddy et al., 1978a; Thomsen, 1984; Wells et al., 2005). Ergh and colleagues (Ergh et al., 2002), for example, in a study evaluating the relative influence of a host of factors on family outcome following TBI, including injury severity, time since injury, survivor awareness of deficit, survivor neuropsychological functioning, and caregiver perceived social support, found caregiver reported neurobehavioural and emotional functioning of the person with injury to contribute the most unique variance (18 percent) to the prediction of family member psychological distress.

Survivor cognitive impairments have been found to be moderately related to family outcome in several studies (Anderson et al., 2002; Ergh et al., 2002; Gillen et al., 1999; Machamer et al., 2002; Wells et al., 2005). In particular, cognitive changes, both subjectively reported by relatives and objectively assessed, have been found to be associated with family member depressive symptomatology (Kreutzer et al., 1994b;

Ponsford & Schönberger, 2010). It should be noted, however, that some studies have failed to observe a relationship between TBI cognitive sequelae and family outcome (Gan et al., 2006; Linn et al., 1994). Investigations of the relationship between physical disability following TBI and family adjustment have produced disparate findings: while some have found survivor physical impairment to be predictive of distress and burden among relatives (Chan, 2007; Kreutzer et al., 1994b; Marsh et al., 1998), others have observed no relationship (Allen et al., 1994; Brooks et al., 1986; Hanks et al., 2007; Linn et al., 1994; McKinley et al., 1981).

A number of family member characteristics have also been identified as potential predictors of relative adjustment. These include kin relationship to the TBI survivor, preinjury psychiatric history, and perceived social support. With respect to kinship, several authors have postulated that posttrauma changes may have a more negative impact on spouses than parents, because parents are more likely to have the benefit of a partner to provide emotional support and share the burden of care. Parents may also perform more effectively as caregivers as they are viewed as returning to more familiar roles (Gervasio & Kreutzer, 1997; Perlesz et al., 1999; Willer, Allen, Liss, & Zicht, 1991). Although this hypothesis has frequently been advanced in the literature, results of empirical inquiry into the role of kin relationship have been conflicting. Some studies have found spouses to report higher levels of psychological distress than parents (Gervasio & Kreutzer, 1997; Hall et al., 1994; Kreutzer et al., 1994a; Perlesz et al., 2000, Thomsen, 1974), one group of researchers observed higher levels of depressive symptoms among parents relative to spouses (Douglas & Spellacy, 2000), while others have reported kinship to be unrelated to family member outcome (Allen et al., 1994;

Brooks et al., 1987; Gillen et al., 1998; Knight et al., 1998; Kreutzer et al., 2009; Livingston et al., 1985a, 1985b; Machamer et al., 2002).

Although only a handful of studies have investigated the influence of family member psychiatric history predating care recipient injury, extant findings strongly suggest that family members who have had psychologic difficulties in the past may be more vulnerable to the impact of injury and may display poorer postinjury adjustment (Livingston et al., 1987; Gillen et al., 1998; Sander et al., 2003, Davis et al., 2009). In their convenience sample of 59 female TBI caregivers, Gillen et al. (1998) found that 40 percent had experienced depression prior to the injury. Of those participants who met criteria for major depression on average 18 months postinjury, 69 percent had experienced a preinjury depressive episode. In discriminant function analyses, history of depression emerged as the only significant predictor of current depression at both initial assessment and six-month follow-up. Davis and colleagues (Davis et al., 2009) investigated potential predictors of 114 family caregivers of individuals with moderate to severe TBI. After accounting for other relevant variables, including caregiver demographics and level of survivor functioning, caregiver psychiatric history was identified as a significant risk factor for postinjury general psychological distress.

A robust body of research indicates that social support plays a significant protective role with respect to the adverse effects of stress on both physical and mental health outcomes in a number of life situations (e.g., Cobb, 1976; Cohen & Wills, 1985; Cutrona, 1984, 1989; Kojima et al., 2007; Reinhardt, Boerner, & Horowitz, 2006; Sarason, Sarason, Potter, & Antoni, 1985). According to transactional stress theory (Lazarus & Folkman, 1984), such support, as with other coping resources, may intervene

at two points in the stress-outcome process: First, social support, as a perceived personal coping resource, may mediate or directly influence the link between the potentially stressful event and the stress reaction by preventing or reducing the intensity of a stress appraisal response. Second, social support, as a moderating or “buffer” variable, may intervene between the experience of stress and the onset of negative outcome by reducing or eliminating the negative affective reaction, or by altering maladaptive behavioural responses (Cohen & Wills, 1985; Chwalisz, 1992).<sup>12</sup>

Social support researchers highlight the distinction between *received/enacted* and *perceived* support. Whereas received social support involves actual helping behaviours provided to an individual by others, perceived social support reflects a person’s cognitive appraisal of her or his reliable social connections (Barrera, 1986). Notably, several investigations have observed perceived social support to be more closely associated with health outcomes than enacted support (Barrera, 1986; Kaul & Lakey, 2003; Reinhardt, Boerner, & Horowitz, 2006).

On the basis of the above findings, several theorists, operating within the transactional model of stress, have hypothesized family member perceived social support to both directly affect and moderate the impact of TBI on individual relative’s well-being and family functioning (Chwalisz, 1992; Godfrey, Knight, & Partridge, 1996; Kosciulek, McCubbin, & McCubbin, 1993). Subsequent research efforts have largely supported this postulate. Ergh and colleagues (Ergh et al., 2002, 2003) found perceived social support to both directly predict levels of TBI caregiver psychological distress and life

---

<sup>12</sup> In general, a *mediator* may be defined as a third variable that explains the relation between a predictor and an outcome. In other words, a mediator represents a generative or causal mechanism through which an independent variable influences an outcome (Baron & Kenny, 1986). A moderator is a variable that alters the strength or direction of the relation between a predictor and an outcome (*ibid.*).

satisfaction, as well as moderate the influence of certain injury sequelae, but not others, on outcome. Low perceived social support was directly linked to increased caregiver psychological distress (Ergh et al., 2002) and decreased life satisfaction (Ergh et al., 2003). Among caregivers reporting the lowest levels of perceived support, care recipient impaired executive functioning and unawareness of deficit were positively related to caregiver psychological distress (Ergh et al., 2002) and inversely related to life satisfaction (Ergh et al., 2003). In contrast, these survivor characteristics showed no relationship to adjustment among those caregivers with moderate to high levels of perceived social support. Social support was found not to buffer the negative impact of care recipient neurobehavioural and affective problems on caregiver outcome. Across all levels of support, increased neurobehavioural and affective disturbance was associated with increased psychological distress (Ergh et al., 2002) and adversely affected life satisfaction (Ergh et al., 2003). Ergh et al. (2002) also observed a direct and beneficial effect of perceived social support on family functioning: family functioning improved consistently as support increased. In line with the findings of Ergh and her associates, a number of other studies have demonstrated perceived social support to both directly predict and/or moderate caregiver burden (Chronister & Chan, 2006; Davis et al., 2009; Hanks et al., 2007; Manskow et al., 2014), general psychological distress (Chwalisz, 1996), depressive symptoms (Harris et al., 2001), quality of life (Chronister & Chan, 2006; Chronister et al., 2010), and family functioning (Douglas & Spellacy, 1996) following TBI.

## Loss and Grief

*Grief* may be conceptualised as a complex molar experience that ensues following appraisal of significant loss (Averill, 1968; Bonanno, 2001). The term acts as a broad rubric that encompasses both the emotional, cognitive, and behavioural reactions to loss, as well as the normal psychological process of adjustment to loss. While some theorists conceptualise grief as ensuing only after the loss of a significant other through death (e.g., Bonanno & Kaltman, 1999; Stroebe, Hansson, Stroebe, & Schut, 2001), many others use the term more inclusively to refer to the natural psychological experience accompanying the loss of anything imbued with personal significance/value and subjective meaning (e.g., Engel, 1961; Freud, 1917/1957; Harvey & Weber, 1998; Marris, 1974; McCabe, 2003; Murray, 2001; Parkes, 1971, 1972b; Rando, 1993; Shneidman, 1974; Trolley, 1993-1994). Engel (1961) for example, defined grief as “the characteristic response to the loss of a valued object, be it a loved person, a cherished possession, a job, status, home, country, an ideal, [or] a part of the body” (p. 18). Shneidman (1974) defined a *partial death* as any loss of an important aspect of one’s life, noting “[s]uch endings short of death ... often involve mourning and grief as intense as the mourning caused by death itself, and as appropriate” (p. 119). Similarly, Harvey (2000) posits that a grief reaction may arise secondary to any form of *major loss*, defining the latter as “the reduction in symbolic or physical resources in which a person is emotionally invested” (p. 3). Indeed, the process and characteristics of grief have been both theorized and observed to be similar across death and several non-death loss events (Archer & Rhodes, 1993, 1995; Bloom-Feshbach & Bloom-Feshbach, 1987; Parkes, 1972b; Rando, 1993; Raphael, 1983). Thus, at least elements of models of grief derived



to explain loss of a significant other to death have the potential to be usefully applied to inform our understanding of possible grief responses among family members of persons with TBI.

Although the inclusive view of grief is adopted here, given the socially relational nature of the construction of the self (Mead, 1934), it is recognised that the intensity of grief experience may be, in certain respects, of greater magnitude or potentially qualitatively different following the deprivation of relationships and bonds secondary to interpersonal forms of loss. Indeed, Harvey (2002) contends that our greatest deprivations are social losses – “losses of interaction, companionship, love, compassion, and the human touch” (p. 4). He argues that the dialectic between grief and interpersonal connection is seen vividly in the literature on close relationships: Although close relationships have the capacity to yield some of our greatest moments of joy and satisfaction in living, they also bring us many of our greatest experiences of major loss and attendant grief (Harvey, 2001). To date, however, possible differences in grief reaction following different types of loss event have yet to be systematically investigated to any great extent, with the majority of empirical studies that inform our understanding of grief having examined reactions to death (Walsh-Burke, 2006, Weiss, 1998).

With respect to the affective content of grief, although a wide array of emotions have been identified, including anger, anxiety, and guilt, sadness or *sorrow*, i.e., a deep intense protracted form of sadness, has been highlighted as an essential element by numerous theorists (Bowlby, 1977; Clayton, Desmaris, & Winokur, 1968; Parkes, 1975, Rubin, 1989) and is arguably the affective state most central to the experience of grief: As noted, by definition, major loss operates as the catalyst of grief, and in emotion theory

sadness is considered the primary emotional response elicited by an appraisal of loss (e.g., Greenberg, Rice, & Elliot, 1993; Lazarus, 1999). Here etymology and phenomenology unsurprisingly, though pleasingly, overlap: The word “grief” derives from the Latin *gravis*, “heavy, burdensome”, from which also derives the word “gravity” (Hollis, 1996); Greenberg and Paivio (1997) describe the unique characteristic of the experience of sadness as its heaviness, the feeling of being “weighed down” (p. 164).

Constructs closely related to grief are those of bereavement and mourning. The term *bereavement* is used to denote the objective situation of having lost someone significant to death (Stroebe et al., 2001). *Mourning* is sometimes used interchangeably with the term grief. Such usage is commonly followed by researchers and clinicians adhering to the psychoanalytic tradition, with a focus on the intrapsychic process of adjustment to loss (e.g., Bowlby, 1980; Rando, 1984). In line with Stroebe and colleagues (Stroebe, Hansson, Schut, & Stroebe, 2008), mourning is considered here to refer to social expressions or acts expressive of grief that are influenced and shaped by the beliefs, dominant discourses, mores, and subsequent practices within a particular society or cultural group. In the present context, this definition of mourning is extended to apply to grief not only secondary to bereavement, but also to that stemming from non-death loss experience.<sup>13</sup>

Following review of key aspects of several dominant modernist/traditional theories of grief, contemporary criticisms of these models will be discussed, with attention subsequently turned to the recent growing consensus across theoretical frameworks regarding the centrality of meaning-making in the process of adjustment to loss. Prior to

---

<sup>13</sup> For a review of contrasts across culture in beliefs surrounding death, and in mourning customs and rituals see Parkes, Laungani, and Young (1997).

subsequently considering the potential nature of loss and grief reaction within the context of a TBI within the family, the impact of social support on grief experience as well as the relationship between depression and grief will also be addressed.

### *Traditional Grief Models*

#### *Freud: The Work of Grief*

The phenomenological experience of grief and mourning rites following bereavement feature in our earliest recorded stories and myths. For example, several tablets of the *Epic of Gilgamesh* (Anonymous, ca. 2000 B.C.E./1989) are devoted almost entirely to detailed description of the protagonist's grief, his "sadness deep within", and the related existential turmoil effected by the loss of his friend, Enkidu. In the *Iliad* (Homer, ca. 800 B.C.E./1998) the "grief infinite" of Achilles for Patroclus and the sorrow of Hector's parents are central features of the narrative. With respect to academic treatment, in addition to providing meticulous descriptions of the expressions associated with grief in both man and a number of apes, Darwin (1872/2009) introduced arguably the first partial theoretical account of grief, noting a transition from "an acute paroxysm of grief" in which self-control is overwhelmed, to "despair or deep sorrow" following acceptance of the irrevocable nature of loss to death. However, it was not until the writings of Freud that it was asked, as an issue for deliberate examination, what psychological processes lead from loss to grief and how it is that grief may potentially come to abate (Weiss, 1998). Thus, as noted by Bonanno (2001), much of the considerable body of theoretical and empirical literature that has subsequently been generated in the past century to describe the nature of grief and the methods by which people may best cope with loss owes a debt to the work of Freud.

Although Freud addressed the phenomenon of grief in several earlier publications, including *Totem and Taboo* (1915/1958), his theory of grief took fullest form, and laid the foundation for what Hagman (2001) terms the standard psychoanalytic bereavement model, in the paper *Mourning and Melancholia* (1917/1957). Written before Freud had fully developed his structural model of the psyche, this work conceptualized grief within the framework of what is known as Freud's thermodynamic metapsychology (Aragno, 2007). Here Freud envisioned psychological processes operating in terms of a limited amount of psychic energy which could be released or withheld, with interpersonal bonds made and unmade through the investment and retraction of *libidinal cathexes*, i.e., through the investment and withdrawal of *libido*, the psychic energy linked with the sexual instinct, to and from objects. Thus Freud (1917/1957) viewed the "work of mourning" (p. 127) as accepting the reality that the loved object, i.e., the significant other, no longer exists with subsequent *decathexis*, i.e., the retraction of all emotional bonds from the deceased. This process is seen as characterized by a struggle between the intrinsic inertia of previous libidinal investment and reality's dictate for libidinal withdrawal: The bereaved is repeatedly confronted by the discrepancy between the wish to continue to invest libido in the deceased as an object of instinctual gratification and the awareness that it is no longer possible to do so as the object no longer exists. Consequently, the relinquishing of one's bond with the deceased can only be achieved gradually over an extended period of time as the reality of the permanence of the loss of the loved one is slowly accepted after an initial period of denial. Freud (1926/1959) later argued that the extreme pain of grief results from the accumulation of previously invested libido within the mind. Recovery, therefore, involves *recathexis* – a redirection of the

energy previously attached to the mental representations of the lost person toward new individuals and commitments, thereby releasing painful “psychic pressure” and renewing opportunities for pleasure in life.

Divested of its jargon, Freud’s conceptualization of grief contains a number of important features which have been highly influential in shaping subsequent theorizing regarding the nature of grief and how individuals adjust to loss, both within and outside the psychoanalytic tradition (Archer, 1999; Bradbury, 2001; Stroebe et al., 2008).

Foremost among these is the notion of “the work of mourning”, from which arose a focus upon the importance of *grief work* (Lindemann, 1944) in healthy adaptation to loss.

Lindemann (1944) defined grief work as three tasks, emancipation from bondage to the deceased, readjustment to the environment in which the deceased is missing, and the formation of new relationships. Broadly conceived, the grief work position holds that adjustment to bereavement can be achieved via a process of actively confronting and “working through” (i.e., acknowledging, reviewing, revising, and expressing) thoughts and negative emotions associated with the loss with a view to giving up one’s bond to the deceased (Shaver & Tancredy, 2001; Stroebe & Schut, 2001).

#### *The Attachment Perspective and the Ascension of Phasic Theories*

Deriving originally from a psychodynamic concern with the impact of temporary separation of young children from their parents, attachment theory ultimately came to include a focus on the significant psychosocial transitions occasioned by the permanent separation from a loved one through death (Bowlby, 1961, 1980). The central tenet of attachment theory (Bowlby, 1969, 1973, 1980) is that humans, like many of their primate and mammalian relatives, possess an innate psychobiological system, the *attachment*

*system*, that motivates them instinctively to seek proximity to significant others, termed *attachment figures*, in times of need in order to protect themselves from threats and alleviate distress. During the course of healthy development attachment behaviour leads infants and children to become emotionally attached or bonded to their primary attachment figures, typically their parents. Once this occurs they display a clear preference for these figures and become distressed when separated from them. In a complimentary way adults usually become emotionally invested in the children who are attached to them. Notably, Bowlby (1980) viewed the attachment system as active throughout an individual's life. Thus people of all ages are capable of forming attachment bonds with a variety of close relationship partners, including siblings, friends, and romantic partners. Each attachment figure in a person's life comes to be seen as a safe haven in times of need and a secure base, with separation from such a figure resulting in feelings of distress. According to Bowlby (1973) attainment of proximity to an attachment figure in times of perceived threat results in feelings of relief and a sense of security – a sense that the world is generally a safe place, that attachment figures are supportive when needed, and that it is possible to explore the environment confidently and to engage rewardingly with other people (Mikulincer & Shaver, 2008).

Within the attachment model, adult grief following bereavement is viewed as an extreme form of *separation distress*, with similarities drawn to the experience of infants and young children separated from their primary caregivers: the permanent loss of an attachment figure is a devastating event that triggers intense and pervasive distress as the bereaved cannot imagine regaining a sense of security, support, protection, and love in the absence of the deceased and the attachment bond they provided (Bowlby, 1969,

1980). Drawing upon several interview-based studies of spousal bereavement, Bowlby (1961, 1980) proposed that following the loss of an attachment figure bereaved adults typically proceed through a succession of four phases of grief. The first stage is one of *numbness*, characterized by feelings of being “stunned” and of apprehension, with varying degrees of denial of the loss usually present. The second phase of *yearning and searching for the lost figure* begins as the bereaved starts to slowly register the reality of the loss. Recognition that death has occurred leads to painful pangs of intense pining or yearning for the loved one. At the same time, Bowlby (1961, 1980) contends that the bereaved may at some level be in a state of disbelief regarding the reality of the death and in turn experiences an urge to search for and recover the lost person. Anger is a common feature of the second stage. With respect to this emotion, Bowlby (1980) notes that anger is typically adaptive when separation is temporary; “it then helps overcome obstacles to reunion with the lost person; and, after reunion is achieved, to express reproach towards whomever seemed responsible for the separation makes it less likely that a separation will occur again” (p. 91). Thus, he argues there to be “good biological reasons for every separation to be responded to ... with aggressive behaviour; irretrievable loss is statistically so unusual that it is not taken into account” (p. 91). In this evolutionary framework anger is therefore seen as an understandable though Sisyphean effort by the bereaved to restore the severed bond. Anger is also aroused by the repeated disappointment of the fruitless search for restoration. Alongside this Bowlby (1980) also notes the experience of “deep and pervasive sadness”, a reaction elicited by a coexisting recognition of the likely permanence of the loss. In the penultimate stage of *disorganization and despair* searching attempts to recover the deceased are given up and

the bereaved comes to recognise that “old patterns of thinking, feeling, and acting” have become redundant and must be relinquished. Bowlby (1980) notes that in this phase it is almost inevitable that the bereaved will at times “despair that anything can be salvaged and, as a result, fall into depression and apathy” (p. 94). However, he proposes that this stage will soon start to alternate with a transition to the final phase of *greater or less degree of reorganization*. This involves a “redefinition of self and situation” that is both painful and critical: it is painful in part as it requires giving up finally all hope that what is lost can be regained; it is critical as only when such redefinition is achieved can the bereaved plan for the future and reengage with life.

The redefinition of self and situation entails “reshaping internal representations.” (p. 94). Here Bowlby (1980) is referring to a key component of his conceptualization of the cognitive processes underlying the grief reaction. When confronted with information that portends loss, the individual processes the information in reference to preexisting representational cognitive models of the world and of the self (Bowlby, 1980). These *working models* are constructed over the course of early development and, in turn, are so ingrained that they largely operate automatically and are resistant to change (Bowlby, 1973). Thus, the revising of these models forced by permanent loss is by nature a slow and arduous undertaking. Despite the irreversible nature of the loss and its implications, the tendency is to avoid certain information and rely on old models of the world. To avoid the overwhelming nature of the unwelcome information, the task of redefinition proceeds in fits and starts. Following the initial numbing phase, a period of verification similar to Freud’s (1917/1957) account of “reality testing” occurs. According to Bowlby



(1980), the oscillation between reverting to established models and revision accounts for some of the fluctuation in emotions experienced in the grieving process.

The phases of grief as suggested by Bowlby are depicted in Table 1. As can be seen, several other theorists have proposed phasal conceptualizations of the grief process with stages that tend to overlap and follow a parallel course; each articulates a pathway through grief that typically begins with a sense of numbness or disbelief and – after proceeding through intermediate stages that commonly include deep sadness and some form of angry protest – ultimately ends with acceptance of the loss (Averill, 1968; Engel, 1961, 1964; Kübler-Ross, 1969; Kübler-Ross & Kessler, 2005; Lindemann, 1944; Parkes, 1971, 1987; Rando, 1984, 1993; Sanders 1989).

**Table 1**  
*Representative Schema of Phasal Theories of Grief (Adapted from McCabe, 2003)*

<i>Theorist</i>	<i>Stage or Phase</i>					
Bowlby (1980)	Numbness	Yearning and Searching		Disorganization and Despair	Greater or less degree of Reorganization	
Lindemann (1944)	Shock and Disbelief	Acute Mourning			Resolution	
Engel (1961, 1964)	Shock and Disbelief	Developing Awareness	Restitution	Resolving the loss	Idealization	Outcome
Averill (1968)	Shock	Despair			Recovery	
Kübler-Ross (1969)	Denial	Anger	Bargaining	Depression	Acceptance	
Parkes (1971)	Numbness	Searching and Pining		Depression	Recovery	
Parkes (1987)	Numbness	Yearning and Searching		Disorganization and Despair	Reorganization	
Rando (1984, 1993)	Avoidance	Confrontation			Reestablishment	
Sanders (1989)	Shock	Awareness of Loss		Conservation-Withdrawal	Healing	Renewal

Bowlby's phase theory came to dominate thinking about the course of grief for more than three decades from the time of its initial publication in 1961 (Weiss, 2008) and has been taught as a core component of bereavement curricula in medical schools and nursing programmes (Downe-Wamboldt & Tamlyn, 1997). Moreover, the stage models have gained significant, and with each new iteration seemingly growing, traction in Western dominant cultural discourses and have strongly influenced the layperson understanding of grief. Indeed, Doka (2007) argues that in the West these models have come to transcend the realms of professional practice and academic theory to become a part of the general public's grieving culture. As a result, Miller and Omarzu (1998) contend that grief has come to be seen by many as a time-limited state that demands a stagic progression toward recovery in order for it to be considered normal or "healthy." The popularity of this modernist framework notwithstanding, as discussed in the next section, the view of grief as proceeding along a series of predictable stages has been subject to recent theoretical debate and criticism.

*Objections to Traditional Accounts: Grief Work, Linearity, & Time-Bound Resolution*

As noted above, the grief work perspective suggests that individuals experiencing loss need to actively process the loss event and that attempts to deny the implications of the loss, or block feelings or thoughts about it and their expression, will ultimately be unproductive (Rando, 1984), and in some instances harmful (Marris, 1958). Although the importance of grief work has been widely endorsed in the bereavement literature for most of the latter half of the twentieth century (e.g., Bowlby, 1980; Deutsch, 1937; Rando, 1984; Worden, 1991), more recently several authors (e.g., Bonanno & Kaltman, 1999; Rubin, 1999; Shackleton, 1984; Wortman & Silver, 1989) have come to contend

that it has yet to receive convincing empirical support and in turn have spoken of a resultant “theoretical vacuum” in bereavement studies (Bonanno & Kaltman, 1999). Indeed, findings regarding the benefits of various aspects of grief work with respect to adjustment have been mixed (for reviews, see Archer, 2008 and Wortman & Silver, 2001). However, it should be noted that empirical evaluation of the grief work hypothesis appears to have been confounded by a diversity in, and at times poor, operationalization of the construct (Stroebe & Schut, 2001; Weiss, 1998), as well as selected outcome variables in some investigations tapping only a restricted element of grief experience (e.g., depression). Thus, despite criticisms, several theorists (e.g., Weiss, 1998; Field, 2008; Stroebe & Schut, 2001) continue to recognise the grief work concept as a powerful analytic tool for understanding how at least some individuals come to terms with loss, although, at the same time calling for refinements in its definition and acknowledging alternate pathways of adjustment (Stroebe, Hansson, Schut, & Stroebe, 2008).

One contemporary refinement in the conceptualization of grief work relates to the purported necessity of decathexis or complete relinquishment of bonds to the lost loved one. Originating with Freud (1917/1957), this view continued to be influential for many years with advocates maintaining that if attachments are not broken down, the bereaved will be unable to invest energy in new relationships and pursuits (e.g., Rando, 1984; Raphael, 1983; Worden, 1982). More recent findings, however, indicate that continued relationships or connections to the deceased are in fact common (e.g., Silverman & Nickman, 1996; Zisook & Shuchter, 1993), and in many instances may be adaptive (e.g., Field, Gao, & Paderna, 2005).

It is important to note here that Bowlby, although identified in error as a ‘relinquishment’ theorist by some (e.g., Balk, 1996; Silverman & Klass, 1996), argued for a reorganization of attachment bonds with the deceased and not complete detachment as the outcome of successful adaptation to bereavement (Fraley & Shaver, 1999). Bowlby (1980) recognised that for many a healthy maintenance of an internal imaginal relationship with the deceased was possible so long as the permanence of loss was accepted. In extension of Bowlby’s position, contemporary attachment theorists argue that through internalization of the deceased in mental representation it is possible to establish what is termed *psychological proximity* while acknowledging the irrevocability of the loss. Thus, the bereaved can make use of the deceased as a safe haven in evoking an internal image of her or his comforting presence when under duress. Similarly, the deceased can function as a secure base for the bereaved, for example, operating as a significant reference point when making important autonomy-promoting decisions (Field et al., 2005). Such continuing connections with the deceased may therefore provide solace and support to the bereaved (Klass, Silverman, & Nickman, 1996). Nonetheless, as Fraley and Shaver (1999) emphasize, studies also indicate that for a significant minority of survivors, ongoing bonds with deceased may not always be adaptive or comforting. Clearly, further research into the nature of continuing bonds and their relationship to adjustment to loss is required (for further discussion see Stroebe, Hansson, Schut, & Stroebe, 2008b).<sup>14</sup>

---

<sup>14</sup> Although not formally revising his theoretical account of grief, it appears that Freud acknowledged that full severance of ties may not be possible and that grief, in some senses, is inconsolable. Six years after losing his grandson and on the anniversary of his daughter’s death, he wrote in reply to his friend Ludwig Binswanger, who had recently lost a son:

Although we know that after such a loss the acute stage of mourning will subside, we also know we shall remain inconsolable and will never find a substitute. No matter what may fill the gap, if it be filled

The phasic models of grief outlined above have come under criticism on several grounds. For example, Wortman and colleagues (Wortman, Silver, & Kessler, 1993) maintained that the stage models severely understate the extent to which individuals differ in their emotional experience following loss and found no empirical support in a review of extant bereavement literature or in their own longitudinal data for an invariable universally experienced sequence of stages. In a similar vein, Archer (1999) concluded that longitudinal studies of the course of grief in response to death suggest that the process of adjustment over time is much more a mixture of affective and cognitive reactions that wax and wane in relation to external events and may be delayed or prolonged for a variety of reasons. Thus the stage metaphor with its discrete intervals implies far more intercorrelation of the various expressions of grief than is observed empirically (Weiss, 2008). Moreover, McCabe (2003) notes although some stage theorists provide caveats regarding flexibility, regression, and oscillation in responses, the use of the phase metaphor results in an overall hierarchical structure which results in a linear time-limited conceptualization of the grief process that is ultimately incommensurate with the experience of actual grievers and encourages inappropriate expectations of the course of grieving.

A further criticism levelled against the stage models is that they have promoted the view that the optimal goal or natural endpoint of the grief process is full recovery or resolution (e.g., Wortman & Silver, 1989). Here it is important to be cognizant, however, that several of the stage theorists themselves either did not conceive of or explicitly rejected such an outcome as feasible. Bowlby (1980) labelled his final phase one of

---

completely, it nevertheless remains something else. And actually, this is how it should be; it is the only way of perpetuating that love which we do not want to relinquish. (Freud, 1929/1975, p. 386).

“greater or less degree of reorganization”, a cumbersome but purposeful title suggesting adaptation rather than recovery from loss, and recognition that much may remain unresolved. Rando (1993), another stage proponent, argues that terms like “recovery” and “resolution” are not applicable to most losses as they imply a form of once-and-for-all closure that typically does not occur. Nonetheless, a related critique of the stage theories remains that they establish the expectation among professionals and laypeople alike of a terminal phase of grieving that is to be reached within an ‘appropriate’ amount of time. Research data indicate, however, that a significant minority of bereaved continue to experience distressing symptoms, painful memories, and reduced well-being for periods of such length (e.g., 30 years; for review see Wortman & Silver, 2001) so as to render the notion of a circumscribed definitive endpoint to grief in some senses arbitrary (McCabe, 2003; cf. Bonanno & Kaltman, 2001).

Within contemporary loss and bereavement literature there are now signs of a consensus that the temporal course of grief and its manifestations are more likely to reflect a considerably diverse array of trajectories, rather than stages or phases (Stroebe et al., 2008b). However, Weiss (2008) notes that although there is great individual variation in the sequencing and even the experience of affective states, there may still be some validity to the idea of a progression in grief states and that acknowledging this makes it easier to think about the changes in grieving that are often observed with the passage of time. In this regard, he argues that the stage theories may be considered as Weberian *ideal types*, insofar as they operate as conceptual devices that provide a tentative framework for theory and expectations.

In closing, although available longitudinal evidence suggests that for many the intensity of grief following bereavement lessens with time (Bonanno & Kaltman, 2001), it can be cogently argued that a recognition of distinct individual trajectories of grief provides a richer and more detailed view of the construct (e.g., Schulz, Boerner, & Hebert, 2008), with recent studies providing at best limited support for stage models (Holland & Neimeyer, 2010; Maciejewski, Zhang, Block &, Prigerson, 2007). Moreover, stage-based grief conceptualizations do not adequately capture the long-term reactions to cumulative loss (Zupanick, 1994) or to losses involved in situations of chronic adversity such as disability, infertility, chronic illness (Teel, 1991), or indeed TBI.

*Common Ground: Meaning-Making in the Face of Loss*

In the wake of the critique of the modernist grief frameworks a “new wave” of grief theories has emerged (Neimeyer, 1998a). Broadly, these feature in common relational psychology and constructivist paradigmatic influences, appreciation of the grief experience as intrinsically unique and varied with a rejection of a Procrustean, universal, uniform, normative, stage-bound view of grieving, and a greater focus upon the cognitive processes entailed in and the potentially personally transformative nature of adjustment to, rather than recovery from, major loss. In these models it is maintained that the outward manifestations of distress associated with grieving are best conceptualised in terms of the struggle of the individual to accommodate to the changed intra- and interpersonal reality effected by loss. Stated succinctly, grieving is reconstrued as an active process of relearning the self, and relearning the world (Attig, 1996). In consequence, *meaning-making* or *meaning reconstruction* has come to be recognized as being of central importance in the process of adaptation to loss (Currier, Holland, &

Neimeyer, 2009; Harvey, 2001; Neimeyer, 1998a, 2001b; Neimeyer & Sands, 2014). Strikingly, despite marked differences in other domains of grief conceptualization, emphasis on the key role of finding or making meaning following loss is present across a wide range of current theoretical perspectives and clinical therapeutic approaches, including those originating in response to addressing trauma (Janoff-Bulman, 1989; 1992), constructivist/narrative grief therapy (e.g., Neimeyer, 2001a, 2005; Neimeyer, Burke, Mackay, & Van Dyke Stringer, 2010), and contemporary stress-coping (Folkman, 2001), psychoanalytic (e.g., Aragno, 2006; Baker, 2001; Hagman, 2001), cognitive-behavioural (Boelen, 2006; Boelen, van den Hout, & van den Bout, 2006), and integrative (Stroebe & Schut, 2001; Bonanno & Kaltman, 1999) bereavement models.

In his seminal *Man's Search for Meaning*, Frankl (1946/1984) asserted that people are driven by a core psychological need to find or create meaning in their lives. Moreover, he argued that the ascription of meaning and specific acts to achieve meaning can significantly bolster the human capacity to face and transcend even the worst of life situations, allaying pain and potentially transforming suffering into personal achievement. In this regard he quotes Nietzsche: "He who has a *why* to live for can bear almost any *how*" (p. 126, emphasis in original). Frankl's position regarding the critical importance of finding meaning, particularly at times of adversity, has greatly influenced theorizing in psychology regarding how people adapt to severe stressors, and has been applied to numerous forms of human distress, including the experience of bereavement and non-death loss.

On the basis of work with victims of trauma, Janoff-Bulman and colleagues (e.g., Janoff-Bulman, 1992; Janoff-Bulman & Berg, 1998) have provided insight into why



meaning reconstruction following adverse life events, including those involving loss, is a key component of subsequent adjustment.<sup>15</sup> Janoff-Bulman (1992) maintains that at the very core of our cognitive-emotional system are *working models* or *assumptive worlds* that have developed over years of experience, guide our behaviour, and provide us with a sense of safety and relative invulnerability. Three assumptions postulated to be central to these models are that we are worthy individuals (good, decent, capable), the world of the people and events in which we operate is benevolent, and that the world ‘makes sense’ – we believe that the relationship between ourselves and the world is neither random nor unpredictable, but meaningful (Janoff-Bulman & Frantz, 1997).

From the viewpoint of our fundamental assumptions, a world is ‘meaningful’ if there is a contingency between people and their outcomes. In other words, the relationship between people and what happens to them ‘makes sense’, or can be understood. Paralleling scientific phenomena being considered comprehensible if they fit certain accepted physical laws or theories of events, outcomes in our daily lives are deemed to make sense if they fit certain accepted social laws or theories. In Western culture, our most widely received theories employed to account for person-outcome contingencies are those of justice and control. Justice accounts for the contingency via consideration of the individual’s character and moral attributes: Adopting Lerner’s (1980)

---

<sup>15</sup> A traumatic event is defined by the American Psychiatric Association (2000) as an extreme stressor that “involves actual or threatened death or serious injury...; or learning about unexpected or violent death, serious harm, or threat of death or injury experienced by a family member or other close associate” (p. 463), and evokes a response of fear, helplessness, or horror. Bereavement, in turn, is often considered a potential form of trauma (e.g., Janoff-Bulman & Frantz, 1997). The relationship between loss and trauma has not been clearly delineated: Some authors use the terms loss and trauma interchangeably (e.g., Thompson, 1998), while others define traumatic loss as following a violent, unexpected, or untimely death (e.g., Currier, Holland, & Neimeyer, 2006). Harvey (2001) contends that trauma results secondary to any “unusual and great loss” (p. 839), including non-death forms. Broadly conceived, trauma may be defined as psychological injury, usually resulting from an extremely stressful or life-threatening situation (Stroebe, Schut, & Stroebe, 1998).

just world theory, Janoff-Bulman (1992) argues we believe that justice will prevail and people get what they deserve. Thus a good person should be protected from misfortune. Negative events are not random occurrences but are most likely to strike those who are morally questionable; personal outcomes are essentially considered to be appropriate punishments and rewards (Janoff-Bulman & Frantz, 1997). Person-outcome contingencies are also understood by attending to people's actions and behaviours; by assuming we can behaviourally control our outcomes (a form of fundamental attribution error), we can explain misfortune by attributing it to individual failure to take the necessary precautions: for example, car accidents happen to those who do not stay alert while driving, diseases befall those who do not eat right or exercise sufficiently, *et cetera* (Janoff-Bulman & Frantz, 1997; Janoff-Bulman & Berg, 1998). Thus, together, our assumptions of a worthy self, and a benevolent, meaningful world afford us great comfort as our social environment is rendered predictable, ordered, and benign; as long as we are 'good' people who engage in the 'right' behaviours we will be safe and secure.

Traumatic events such as major loss can undermine or even shatter these core assumptions, forcing victims to recognise that their taken for granted models of self and the world that had provided psychological stability, security, and meaningful coherence are at best inaccurate reflections of a now threatening reality. Therefore, it is argued, adjustment and reduction of pain and distress following trauma and loss hinges to a great degree upon the re-establishment or reconstruction of meaning as the victim actively attempts to assimilate or accommodate the disruption into their assumptive world and

restore a sense of order, security, and predictability (Bonanno & Kaltman, 1999; Janoff-Bulman, 1992; Janoff-Bulman & Berg, 1998; Neimeyer, 2001b; Thompson, 1998).<sup>16</sup>

*Two Construals of Meaning: Making Sense and Finding Benefits*

Having been approached from a myriad of different theoretical perspectives, the rubric of meaning reconstruction in the aftermath of loss or trauma encompasses multiple overlapping subconstructs, with a definitive definition of the term *meaning* remaining elusive (for review, see Park, 2010). Indeed, it has been argued that the very imprecision of the concept of meaning as expounded by its original proponent Frankl (1946/1984) has restricted scientific study of the phenomenon (e.g., Reker, 1994). However, more recently, researchers, including those investigating grief reactions, have made increasingly clear distinctions between two construals of meaning: *sense-making* or *meaning-as-comprehensibility*, and *benefit-finding* or *meaning-as-significance* (e.g., Affleck & Tennen, 1996; Davis, Nolen-Hoeksema, & Larson, 1998; Janoff-Bulman & Frantz, 1997).

Within the context of bereavement, meaning-as-comprehensibility (Janoff-Bulman & Frantz, 1997), later termed sense-making by Davis et al. (1998), refers to attempting to develop an explanation for the loss, that is, to achieve a subjective sense of understanding of the loss. One way in which this may be achieved is to *assimilate* the painful experience of the loss and its implications into one's existing global meaning schemas or assumptive world. One factor that has been proposed to potentially influence people's capacity to make sense of loss in this manner is religious or spiritual belief (Dull & Skokan, 1995). Belief in an afterlife, invoking the "inscrutability of God" (a view that

---

<sup>16</sup> Evidence for disruption of assumptive worldviews or global meaning structures secondary to bereavement has been found by several independent research investigations (e.g., Schwartzberg & Janoff-Bulman, 1991; Matthews & Marwit, 2004).

entails a willingness to accept adverse events as they are God's will), or spiritual-religious beliefs more generally may mitigate the senselessness of loss by providing a conceptual framework in which the loss is rendered comprehensible, at least in a spiritual sense. Support for this position comes from a study by McIntosh and colleagues (McIntosh, Silver, & Wortman, 1993) who observed stronger religious beliefs to be related to parents' ability to make sense of the loss of a child to sudden death syndrome (see also Pargament, Ensing, Falgout, & Olsen, 1990). Other types of sense-making via assimilation involve attempting to discover or impose some person-outcome contingency for the loss that can be reconciled with one's primary assumptions (Janoff-Bulman, 1992; Janoff-Bulman & Frantz, 1997). This may take the form of behavioural self- or other-blame. For instance, assuming some degree of personal responsibility for the event's occurrence or attributing the loss to the behaviours of the deceased (e.g., smoking for several years prior to the onset of lung cancer) may make the loss more understandable (Davis et al., 1998; Janoff-Bulman & Frantz, 1997).

An alternative strategy to assimilation for making sense of loss is revision of one's assumptive world, or worldview (Janoff-Bulman, 1992). For example, one can make sense of loss by adopting a new philosophical stance recognising the intrinsic fragility or brevity of life, or by acknowledging that sometimes bad things do indeed happen to good people. Such *accommodation* of the loss via worldview revision, however, is obviously by nature both more arduous and distressing an undertaking and, in turn, is only attempted when the data of loss cannot be successfully assimilated (Janoff-Bulman, 1992).

Meaning-as-significance (Janoff-Bulman & Frantz, 1997) or benefit-finding (Davis et al., 1998) refers to the paradoxical ability of victims of loss or trauma to uncover a ‘silver lining’ in the personal or social consequences of their adversity. Benefits commonly identified following loss include transformative growth of character, gains in perspective, revisions in life philosophy, enhanced empathy, and improved relationships with other people (e.g., Davis et al., 1998; Harvey & Weber, 1998; Lehman et al., 1993). These mirror closely the types of benefit reported by persons coping with other adversities (e.g., McMillen, Smith, & Fisher, 1997), and are reflected partially in the related construct of *posttraumatic growth* (Tedeschi & Calhoun, 1996, 2004).<sup>17</sup> Here concern with meaning comes to centre on questions of value and significance, with the primary meaning-related issue for the individual being not whether the world makes sense, but rather whether her or his life is meaningful – whether it is of value (Janoff-Bulman, 1992; Janoff-Bulman & Frantz, 1997). Focus in this construal of meaning is also placed on the person’s appraisal of the significance of the loss/adversity with respect to her or his sense of life goals and purpose; finding meaning in this context entails reasserting a sense of purpose and control through development of new goals and, in some instances, a new, perhaps ‘wiser’, sense of self and a new direction in life (Harvey, 2002; Thompson & Janigian, 1988).

With respect to finding meaning-as-significance, Janoff-Bulman (1992) contends that trauma and loss can serve as catalysts for a re-evaluation of the individual’s life. Meaning-making takes place via a process of becoming cognizant of or creating significance and worth in one’s daily existence. She proposes that adversity affords

---

<sup>17</sup> Posttraumatic growth is broadly defined as “positive psychological change experienced as a result of the struggle with highly challenging life circumstances” (Tedeschi & Calhoun, 2004, p.1).

people the opportunity to move past life's superficial elements and reconsider what is important. Generally, this involves a newfound appreciation of their lives or at least aspects of their lives, and a consequent reordering of priorities (Janoff-Bullman, 1992). Here it is promulgated that it is the awareness of the inherent fragility and finiteness of the human condition afforded by the experience of loss or trauma that provides the impetus for seeking value: As life or important aspects of it can be lost at any time, it cannot be taken for granted; because negative events can befall us when least expected, people must make choices and decide what matters. Our choices subsequently become the basis of our goals, actions, and commitments (e.g., devoting time and energy to select aspects of one's life), which, in turn provide a foundation for meaning, fulfillment, and potential growth (Janoff-Bullman & Berg, 1998; Janoff-Bulman & Frantz, 1997).

It is within the construal of meaning-as-significance, particularly as envisioned by Janoff-Bulman and her colleagues, that echoes of Frankl's (1946/1984) position can be resonantly heard: He asserted that finding personal meaning hinges on tapping the human potential to creatively turn adversity into something positive or constructive; individual-specific meaning may be found in the lived moment by deriving from the adverse situation that cannot be changed "the opportunity to change oneself for the better ... and deriving from life's transitoriness an incentive to take responsible action" (p. 162).

Several other cognitive theorists also recognize the importance of meaning-making via benefit-finding in adjusting to loss. For example, Taylor (1983), in her cognitive adaptation model, suggests that individuals cope with severe negative events such as loss by considering the positive implications or benefits of the event for one's life. Such benefit-finding she argues, in addition to mitigating certain negative aspects of

the experience, allows for maintenance of personal themes of mastery, continued care for and about others, and personal growth in the face of disturbing events. From a constructivist perspective, finding benefits following loss is seen as a critical means of building new positive meaning structures and a progressive reconstruction of one's self-narrative which not only incorporate but in some cases are founded upon the 'raw materials' offered by the loss (Gillies & Neimeyer, 2006; Neimeyer, Baldwin, & Gillies, 2006).

Empirical support for the relevance of the meaning reconstruction processes of sense-making and benefit-finding as predictors of bereavement outcome is accumulating as a result of several converging research programmes. In a longitudinal study of 205 individuals who had lost a family member to death following a long illness, Davis et al. (1998) found that making sense of the loss was associated with less distress but only at 6 months postloss, whereas finding something positive in the experience, while also predictive of adjustment at the 6 month postloss assessment, was most strongly associated with better adjustment at interviews conducted 13 and 18 months following bereavement. No relationship between being able to make sense of the loss and reporting finding benefits was observed. These data were interpreted as providing support for sense-making and benefit-finding as representing two distinct processes playing largely independent roles in adjustment to bereavement, with the latter viewed as having a more ameliorative effect in the long term. Similar findings were reported by Murphy and colleagues (Murphy, Johnson, & Lohan, 2003), who, in a 5-year longitudinal investigation of 138 parents who had lost their children to a violent death, observed a shift over time in the focus of meaning-making efforts from attempting to comprehend

the death to endowing the experience with significance. Benefit-finding was considered a better ongoing means of coping that strengthens adjustment over time vis-à-vis sense-making. Holland and coworkers (Holland, Currier, & Neimeyer, 2006) attempted to replicate the findings of Davis et al. (1998) in a cross-sectional study of 1,022 university students who had lost a family member or friend in the previous two years with a measure of *complicated grief* as the outcome variable.<sup>18</sup> Like Davis et al. (1998), they observed both making sense of the death and finding something positive in the experience of loss to both have a salutary role in adjustment to bereavement. However, they did not find evidence of a shift in the impact of sense-making and benefit-finding, with time since loss bearing no relation to any other variables investigated. Moreover, sense-making emerged as the more robust predictor of outcome. Benefit-finding interacted with sense-making, with the most favourable adaptation to bereavement associated with high attribution of sense to the loss, in the presence of low perceived benefit. This profile was interpreted to reflect “altruistic acceptance” or the ability to place the loss into a broader spiritual or secular frame of intelligibility (i.e., assimilation into one’s worldview) but without an implication of personal gain. The highest level of complicated grief distress was observed in those who were unable to make sense of their loss or find benefits. Those who reported high degrees of meaning-as-significance,

---

<sup>18</sup> Complicated grief may be broadly defined as “a clinically significant deviation from the cultural norm in either (a) the time course or intensity of specific or general symptoms of grief and/or (b) the level of impairment in social, occupational, or other important areas of functioning” (Stroebe et al., 2008a, p. 7). Following a strident movement to establish complicated grief secondary to bereavement as a new category of mental disorder, a form of complicated grief with a focus on grief symptoms that persist for at least 12 months (6 months in children) after the death, *Persistent Complex Bereavement Disorder*, has been identified in the DSM-V as a condition for further study and possible inclusion in future editions of the DSM (American Psychiatric Association, 2013). Treatment of the merits of the creation of a complicated grief diagnosis is beyond the scope of this paper. For comprehensive review of arguments both for and against the proposal and relevant empirical findings, please see Shear et al. (2011), Prigerson, Vanderwerker, and Maciejewski (2008), Rubin, Malkinson, and Witztum (2008), and Bonanno et al. (2007).



whether in the presence of absence of sense-making, were intermediate in their adjustment.

Several studies have investigated the relationship between sense-making and adjustment following violent or sudden, unexpected, “off-time” loss. Davis and colleagues (Davis, Wortman, Lehman, & Silver, 2000) reviewed data from an 18-month longitudinal study of 124 parents coping with the loss of their baby to sudden infant death syndrome (Downey, Silver, & Wortman, 1990), and a cross-sectional study of 93 adults who had lost their spouse or child in a MVA which had occurred 4 to 7 years prior (Lehman, Wortman, & Williams, 1987). They found that less than half of the respondents in each of these samples reported finding any sense in their loss, even more than a year after the event; a markedly lower proportion compared to the 68 percent of participants reporting having made sense of their loss at 13-month follow-up in the Davis et al. (1998) study. Furthermore, those participants in both studies who continued in an unsuccessful quest to construct a sense of understanding experienced considerable pain about their inability to comprehend the loss, and also exhibited greater psychological distress on standardised measures than did those who never pursued existential questions in the first place or those people who searched for meaning and were able to find it. On the basis of these findings and those of Davis et al. (1998), it has been argued that (a) sense-making may be particularly difficult following traumatic loss (i.e., loss that is violent or unexpected), and (b) sense-making may only aid psychological adjustment if achieved relatively soon after bereavement as reports of making sense of loss at later

follow-up periods in longitudinal studies have not been found to be associated with reductions in distress (Davis et al., 2000; Davis, 2001).<sup>19</sup>

Currier and colleagues (2006) also view violent loss as posing greater challenges to sense-making efforts, contending that such bereavement is more difficult to reconcile with existing global meaning systems or assumptive worldviews given its less “normative” nature. Subsequent difficulties in making sense of the loss are, in turn, hypothesized to lead to greater complications in grieving. In support of this position Currier et al. (2006), using data from the same sample as Holland et al. (2006), demonstrated sense-making to fully mediate the effect of losing a loved one violently (by homicide, suicide, and accident) versus non-violently (through ‘natural’ deaths) on complicated grief symptoms, when age, gender, and closeness to the deceased were controlled.

Keesee, Currier, and Neimeyer (2008) examined the relative contribution of several risk factors, including violent death, as well as both sense-making and benefit-finding to normative and complicated grief severity among 157 bereaved parents. In line with the findings of Holland et al. (2006), sense-making emerged as the most salient predictor of normative and complicated grief symptoms. Consistent with the data of Davis et al. (2000), those parents who struggled to comprehend their loss reported the highest levels of grief severity. Benefit-finding predicted lower intensity of complicated but not normative grief. As with Holland et al. (2006), sense-making and benefit-finding displayed a positive correlation with one another. Contrary to this earlier study, however,

---

<sup>19</sup> Interestingly, Davis (2001) has subsequently argued that those who only made sense of their loss at later follow-up periods in the Davis et al. (1998) study did not obtain reprieve from distress as qualitative analysis suggests that this sense-making had to be achieved via worldview revision, the more difficult and painful act relative to sense-making via assimilation, which appeared to be the strategy adopted by those bereaved who reported having made sense of the death at the 6 month postloss interview.

both were positively correlated with length of bereavement, suggesting that parents who had more time to adjust had a greater likelihood of making sense and finding benefit in their loss experience. In accordance with the results of Currier et al. (2006), parents who had lost a child to a violent death reported making significantly less sense of the loss and demonstrated higher levels of complicated and normative grief compared to parents who lost a child to a non-violent form of death.

More recently, Lichtenthal and colleagues (Lichtenthal, Currier, Neimeyer, & Keesee, 2010) sought to expand upon the findings of Keesee et al. (2008) by exploring via qualitative analysis narrative data provided to open-ended items assessing sense-making and benefit-finding in the same bereaved parents sample. Association of meaning-making themes with grief severity was also examined via regression analysis. Less severe symptoms of both normative and complicated grief were predicted by a greater number of ways parents made sense of their loss and a larger number of benefits identified.

In summary, available data suggest that both sense-making and benefit-finding have the potential to be salutary with respect to adjustment following bereavement. However, findings regarding the relative importance of each meaning-making process in this regard and their relationship to the passage of time are mixed. As observed, some studies suggest a greater ameliorative role for making sense of loss. This may be the case particularly in instances of violent death. Other investigations, in contrast, appear to underscore the importance of finding something positive in one's experience of loss in order to achieve more favourable adjustment in the long term. This is concordant with the theoretical position of Janoff-Bullman and colleagues (e.g., Janoff-Bullman & Berg,

1998) who suggest that better adaptation to loss is likely if the victim is able to shift from an initial concern with making sense of the event to a focus on finding some gain or value in the experience for one's life.

Beyond differences in study design (i.e., longitudinal versus cross-sectional), a number of further potential reasons for the divergent findings reported above can be identified. First, there is the use of different outcome measures; a composite distress measure in the Davis et al. (1998) study versus measures of normative and complicated grief by Holland et al. (2006) and Keesee and colleagues (2008). Differences in the nature of the relationship lost and age of participant are also potential confounds.<sup>20</sup> For example, relative to the sample of Davis et al. (1998), a greater proportion of participants in the Holland et al. (2006) study lost secondary relationships (e.g., extended family members or friends) versus primary relationships (e.g., parents, children), with participants in the latter investigation also being markedly younger. Finally, qualitative data suggest that the phrasing of the measure employed to assess benefit-finding may impact results pertaining to this variable. In both the Holland et al. (2006) and Keesee et al. (2008) studies, where benefit-finding was observed to be a weaker predictor than sense-making, a number of participants took offense to being asked if they found “benefit” in their loss. In contrast, this response was not observed in the Davis et al. (1998) investigation, where benefit-finding was assessed by asking participants “Have

---

<sup>20</sup> Age appears to be a potential determinant of reaction to bereavement, with elderly persons observed in some studies to experience less intense grief relative to younger adults. It is postulated that this may be due to bereavement in old age being seldom unexpected or untimely; older individuals are believed to be potentially “better prepared for the losses that are an increasing occurrence in old age” (Parkes, 2001, p. 36). It should be noted, however, that numerous investigations have not found age effects (for review, see Archer, 1999).

you found anything positive in this experience?” after providing some examples of meaning-as-significance reported by others in the wake of bereavement.

To the author’s knowledge the role of sense-making and benefit-finding in adjustment to non-death forms of loss has yet to be systematically investigated. However, there is a growing body of evidence for the adaptive significance of benefit-finding with respect to mental health outcomes secondary to a wide array of negative life events (e.g., Carver & Antoni, 2004; Cassidy, 2013; Frazier, Conlon, & Glaser, 2001; Holland, Currier, Coleman, & Neimeyer, 2010; Thompson, 1991; for reviews see Helgeson, Reynolds, & Tomich, 2006, and Zoellner & Maercker, 2006) which arguably could be conceptualised as involving both recognition of and adjustment to loss.

Before moving on to consider the relationship between social support and grief, it is important to note that, although not readily acknowledged in the ‘new wave’ grief models or their associated literature, meaning reconstruction, or at least the precursors thereof, was also recognized as critical to adjustment following bereavement by a number of the early grief theorists. For Parkes, grief arises from an “awareness of a discrepancy between the world that is and the world that should be” (1988, p. 54). In describing the latter, Parkes employed the term *assumptive world*. Similar to Janoff-Bullman’s understanding, representing an individual’s unique reality, the assumptive world consists of the strongly held set of assumptions and preconceptions about the world and the self (Parkes, 1975). Parkes (1971, 1975) employed this concept to explain why grief responses are observed following not only bereavement but also other forms of significant loss: Loss and, in turn, grief occur whenever there is an unwelcome major change in a person’s life which forces one to relinquish established assumptions or

expectations held about the world and self. Drawing on his own study of patients requiring limb amputation, his work with the bereaved, and on Fried's (1962) study of individuals grieving a lost home, Parkes argued that all loss experiences involve a painful but also a principal adaptive process of assumptive world revision, of revising old identities and ways of understanding the world, "of making real inside the self events which have already occurred in reality outside" (1972b, p. 344). Similarly, Bowlby (1980), although not overtly referring to meaning-making, also arguably recognised the importance of adjusting global meaning structures in response to loss. Following Parkes (1972b), he noted the need for "reshaping of internal representational models", and described this aspect of adjustment to bereavement as the "act upon which all else turns" (Bowlby, 1980, p. 94).

Marris (1974) viewed grief as a response that is evoked not only by death but by any event that effects a profoundly disruptive loss of meaning. For him grieving and the assimilation of loss was therefore fundamentally a process of meaning reconstruction. He placed focus less upon the loss of an object and more on the associated collapse of the *structure of meanings* (a concept equivalent to Bowlby's internal models and Parke's assumptive world) dependent upon it. Thus, Marris (1974) argued that any change that contradicts assumptions about one's world of experience disrupts one's ability to organize one's life in a meaningful way and can be termed a loss. Grief represents, in part the struggle to retrieve this sense of meaning. For Marris (1974), favourable adjustment in grief depends on restoring a sense that that which has been lost "can still give meaning to the present" (p. 149). In the case of bereavement, for example, the core

meanings of the relationship with the lost individual are abstracted to become a set of purposes or ideals in the present (Marris, 1974).

### *The Role of Social Support in Grief*

As noted above, several studies have demonstrated perceived social support to be an important determinant of psychological distress in many difficult life circumstances (e.g., Cobb, 1976; Reinhardt et al., 2006), and, indeed, a moderator of mental health outcomes among TBI caregivers (e.g., Ergh et al., 2002; Sander et al., 1997). With respect to the relationship between perceived social support and grief outcome following bereavement, theoretical models offer discordant predictions and findings have been inconsistent. In applications of transactional stress theory to bereavement (e.g., Ogrodniczuk, Joyce, & Piper, 2003), it is argued that social support may enable the bereaved to appraise the loss as an event that she or he can cope with, thereby reducing vulnerability to the impact of death loss. Stroebe and colleagues (Stroebe, Stroebe, Abakoumkin, & Schut, 1996; Stroebe, Zech, Stroebe, & Abakoumkin, 2005), also working within the stress process theory framework, contend that perceived social support can further serve to “buffer” against the deleterious effects of bereavement by, at least partially, alleviating the loss of instrumental, validation, and emotional support experienced immediately following the death of a loved one. Stroebe et al. (2005) argue further that perceived social support may serve to facilitate more favourable coping efforts and thereby aid adjustment. In contrast, attachment theorists (Bowlby, 1969; Weiss, 1973; 2001) propose that supportive family and friends fundamentally cannot compensate for the loss of a significant attachment figure. Bowlby (1969) argued that the lost attachment figure was uniquely able to foster feelings of emotional security and well-

being and that other people could not take over this function. Thus, in the attachment model of loss, the impact of grief, characterised by a core sense of emotional isolation (Weiss, 1973), cannot be lessened by an individual's other sources of social support. Indeed, in this view, it is the loss of a particular attachment figure not the loss of a role occupant that gives rise to the sorrow and despair of grief (Weiss, 2001). At the empirical level, while some studies have found perceived social support to predict more favourable grief adjustment following bereavement (e.g., Engler & Lasker, 2000; Hansen, Vaughan, Cavanaugh, Connell, & Sikkema, 2009; Thornton, 1998), other investigators have failed to find associations between reported levels of social support and post-death grief outcome (e.g., Mahan, 2007; Murphy, Chung, & Johnson, 2002). The small number of studies that have investigated the impact of perceived social support upon grief experience in non-death situations have not observed a relationship between the two variables (Marwit, Chibnall, Dougherty, Jenkins, & Shawgo, 2008; McCaskill, 1997; Teel, 1993).

#### *Grief and Depression: Distinct Phenomena*

Numerous theorists, while acknowledging partial isomorphy with respect to certain characteristics, contend that grief and depression form two distinctive and distinguishable syndromes (e.g., Freud, 1917/1957; Prigerson, Vanderwerker, & Maciejewski, 2008; Stroebe & Stroebe, 1987; Weiss, 1998). Several key differences have been delineated. First, grief lacks the persistent, severe, distorted, and negative perceptions of self, and the related maladaptive internal generation of shame, that are considered pathognomonic of depression (Greenberg & Paivio, 1997; Rando, 1993). In this regard, Weiss (1998, 2001) notes that while sadness is common to both conditions



the self-reproach and core alienation from self that characterizes depression is absent from grief.<sup>21</sup> A further key distinction drawn between depression and grief by Weiss (2008) is that in the case of the latter a single circumscribed event, the return of that which has been lost (were it possible), would restore well-being. Relatedly, yearning or pining for the lost object has been identified as an emotional response central and unique to grief experience (Stroebe, Abakoumkin, & Stroebe, 2010; Weiss, 1998).

While asserting that grief and depression are distinct entities, many bereavement theorists recognise depressive symptoms to be a common but transient component of the normal grief process that arises as the individual confronts the reality of the loss (e.g., Parkes, 1971; Bowlby, 1980; Rando, 1984, 1993). In addition, however, if the grieving process is complicated or arrested in some manner clinical depression may result. Possible sources of complication identified include ambiguous or unresolved feelings toward the individual lost (Freud, 1917/1957; Greenberg & Paivio, 1997), prolonged psychological protest against the reality of the loss (Bowlby, 1980; Prigerson et al., 2008), and interrupted experience of primary sadness following loss (Greenberg & Paivio, 1997).

Notably, researchers investigating emotional adjustment among family members of persons with cancer (Williamson & Shaffer, 1996, 1998) and among relatives of individuals with dementia (Meuser, Marwit, & Sanders, 2004; Walker & Pomeroy, 1996) have independently proposed that non-death loss and subsequent grief experience within

---

<sup>21</sup> Lowered self-esteem is not an uncommon consequence of major loss. However, the damage to self-esteem in depression is considered to be of much greater intensity, more global in nature, and stems, in part, from a depression-specific unrealistic sense of worthlessness, inadequacy, and guilt (American Psychiatric Association, 2013; Rando, 1993).

the context of caregiving should be considered a potential causal factor contributing to depression and other mental health outcomes among these populations.

*Loss Experience and Grief amongst TBI Family Members*

Relative to the substantial and burgeoning body of literature on the impact of TBI on the family, caregiver experience of loss and subsequent grief following TBI has received only cursory attention. To date only one quantitative psychological study has examined the extent of grief response among TBI family members (Zinner et al., 1997). This relative dearth of consideration is indeed surprising as several theorists highlighted the potential importance of substantial loss and grief reactions among this population during the early stages of empirical inquiry into TBI family adjustment.

Over thirty years ago, in a seminal paper enumerating the various forms of familial impact of TBI, although not discussing the phenomena in any great detail, Lezak (1978) identified both grief and sorrow as natural responses among spouses who perceived significant characterological change in their partners. Muir and Haffey (1984), adopting Shneidman's (1974) term, argued that TBI leads to *partial deaths*, losses of significance for both the TBI survivor and their family members. These losses were noted to range from minor coordination difficulties "to the other end of the spectrum, where the individual as was experienced by others ... ceases to exist" (p. 252). The partial deaths effected by TBI were postulated to result in a unique pattern of grieving, termed *mobile mourning*: Although this grief reaction contained elements common to grief subsequent to bereavement it was noted to be characterized by a pervasive sense of uncertainty and, in turn, much more disorganised vis-à-vis the stage-based formulation of adjustment following death-loss dominant at the time (e.g. Bowlby,

1980). Although each grieving process following TBI was recognised as differing across family systems, common themes identified in mobile mourning included a search for certainty of recovery, related oscillations between hope and despair, feelings of anger, breakdowns of relationships within the family, and learned helplessness (Muir & Haffey, 1984). In addition to this theoretical formulation of the nature of grief following TBI, Muir and Haffey (1984) argued that neuropsychological assessment and intervention, both in the form of cognitive remediation efforts and psychotherapeutic work, had a critical role to play in facilitating both TBI survivors and their family members through the grieving process.

Several models of family adjustment following TBI advanced in the latter half of the 1980s also came to delineate grief and mourning as core components (Groverman & Brown, 1985; Henry, Knippa, & Golden, 1985; Lezak, 1986; Spanbock, 1987; for a critical review, see Rape, Bush, & Slavin, 1992). For example, Lezak (1986), with a focus upon the neurobehavioural and affective TBI sequelae perceived as characterological change, describes a period of active mourning by family members in cases of severe injury following recognition of the irrevocable nature of the losses suffered. This stage is seen as a key aspect to favourable long-term adjustment. Interestingly, in line with current recognition of the importance of meaning reconstruction in adaptation to loss, Lezak (1986) identifies “rebuilding a life with new meanings” (p. 247) as a central goal of the grieving process in this context.

In light of the above, one is left to ask how familial experience of loss and grief in the wake of TBI, an event recognised in early literature not only as psychologically traumatic but potentially replete with a host of losses for the family system, including

profound interpersonal deprivations, came to subsequently be largely neglected in TBI family outcome research in the last two decades? A number of potential factors may be delineated. First, as will be discussed in greater detail below, loss and related grief experience in non-death situations such as TBI are often *disenfranchised* (Doka, 1989, 2008) in that they are not recognised or are marginalised by society in general. Second, the dominant theoretical framework adopted in recent years by researchers investigating family member adjustment to TBI has been the stress-appraisal-coping paradigm of Lazarus and Folkman (1984). Although Lazarus and Folkman (1984) identify appraisals of loss as a basic component within their primary definition of the stress process – “stress appraisals include harm/loss, threat, and challenge” (p. 32) – and even contend “the most damaging life events [to be] those in which central and extensive commitments are *lost*” (p. 32, emphasis added), with the exception of a single passing reference to grief work in the context of a discussion of denial as a maladaptive coping strategy (p. 134), the phenomenon of grief is not mentioned and grief experience as an outcome of stress appraisal is simply not addressed within the original formulation of cognitive stress theory. In turn, it is not surprising that subsequent conceptualizations of family member adjustment to TBI within the transactional stress model have come to focus upon appraisals of harm, threat of harm, or challenge, at the exclusion of appraisals of loss (e.g., Godfrey et al., 1996; Kosciulek et al., 1993). Thus grief in the context of TBI secondary to loss experience has not been recognised as the latter is no longer acknowledged as a precipitant of a stress reaction within contemporary applications of the transactional stress model.

In addition to this basic exclusion of the phenomenon of loss from the stress construct, several researchers of TBI family outcome who have employed the stress-appraisal-coping model as a theoretical framework have either (a) postulated perceived stress related to the injury (e.g., Chwalisz, 1992, 1996) or stress secondary to appraisals of the caregiving role (e.g., Chronister & Chan, 2006) to mediate other important family member mental health outcomes; or (b) have come to equate stress to distinct constructs such as depression, anxiety, and low self-esteem (e.g., Chronister et al., 2010; Godfrey et al., 1996; Harris et al., 2001). These trends, together with the resulting focus on stress and appraisals of caregiving as key family member outcome variables of interest, have arguably occurred at the expense of consideration of other important aspects of caregiver affective experience and alternate potential catalysts for caregiver distress, and have involved the unfortunate condensing of a range of caregiver emotional reactions into the nebulous construct of stress. Moreover, the general failure among TBI family impact research to identify different and distinct forms of family member emotional experience as potential responses to loss has led to further conceptual slippage with affective grief reactions among relatives, including those of sadness and anger, when observed, often being equated to depression (e.g., Douglas & Spellacy, 2000; Kreutzer et al., 1994b). For example, Douglas and Spellacy (2000) note that many of their family caregiver participants displayed “a chronic sadness” which they subsequently termed “persistence of depressive symptoms” (p. 83). No mention of loss or of potential grief is made.

*The Emotion Regulation Model: An Opportunity for Integration*

The application of the traditional transactional model of stress and coping (Lazarus & Folkman, 1984) to bereavement experience has faced criticism on similar grounds to those outlined above (e.g., Hooyman & Kramer, 2006; Stroebe & Schut, 2001). Shaver and Tancredy (2001) contend:

If the primary goal is to understand a particular person's grief reactions, it may be misleading to reduce everything to "stress and coping". Being angry and being lonely, for example, seem sufficiently different to warrant distinctions more precise than "stress versus nonstress." (p. 66)

Shaver and Tancredy (2001), in turn, have advanced a model of grief outcome using contemporary emotion theory as a conceptual framework. This approach allows for exploration and understanding of individual emotions and related action tendencies in response to loss, and views coping efforts not as constituting a separate process but rather incorporates coping as a standard component of emotion elicitation and regulation. Indeed, Lazarus (1999) in his revised model of stress and coping highlights the need for integrating emotion into his framework, identifies emotion as the superordinate construct, and notes:

[T]he idea of stress is much simpler than that of emotions ... stress tells us very little about the details of a previous struggle to adapt. Emotion conversely, includes as least 15 different varieties, greatly increasing the richness of what can be said about a person's adaptational struggle ... If we know what it means to experience each emotion – that is the dramatic plot of each – then knowing the emotion being experienced provides a ready understanding of how it was brought

about. This provides the advantage of substantial clinical insight about the dynamics of that person’s adaptational life. (pp. 33-34)

Thus, rather than adopting the original transactional stress model of Lazarus and Folkman (1984), on the basis of the work of Shaver and Tancredy (2001) and Lazarus’ (1999) revised emotion theory, the present author proposes that loss and subsequent grief experience among family members of persons with TBI is better conceptualized within the *emotion regulation model* depicted in Figure 1. This model is based on both theoretical considerations and research findings (e.g., Frijda, 2008; Lazarus, 1999), individual accounts of emotional experience (Fischer, Shaver, & Carnochan, 1990), and can incorporate both the individual’s worldviews and the potentially mollifying influence

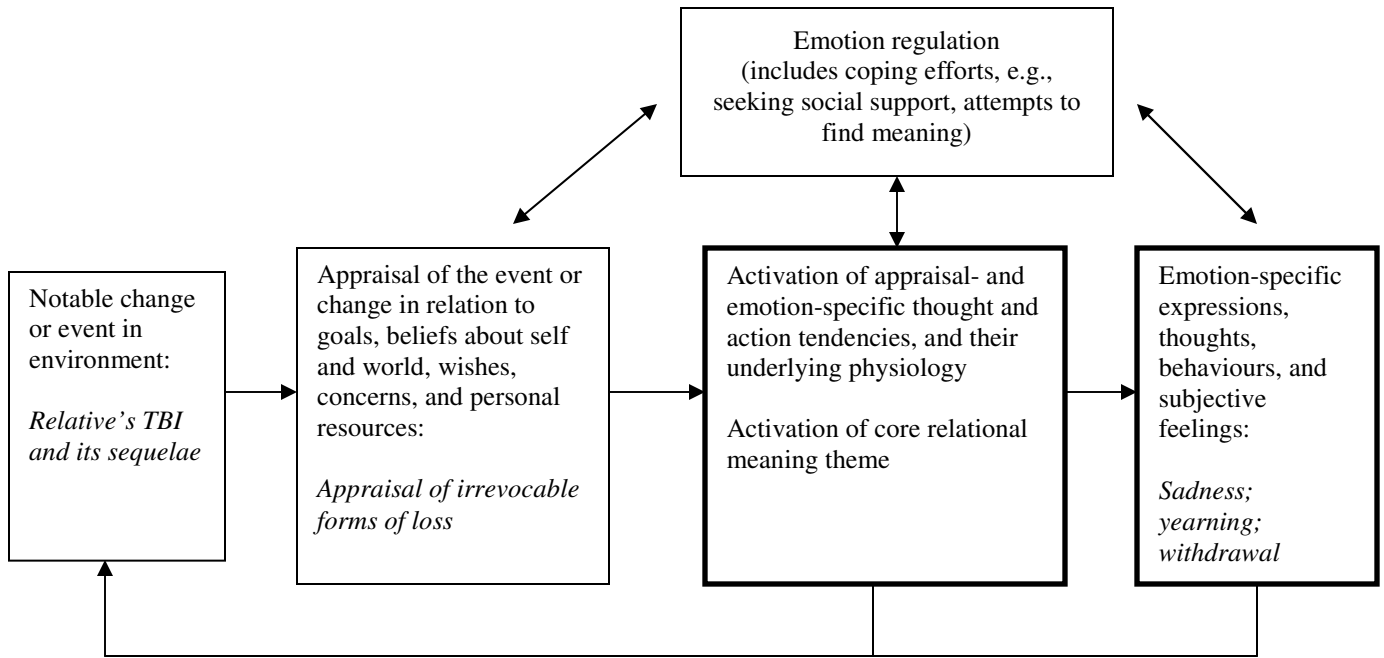

*Figure 1.* Emotion regulation model as applied to postulated family member TBI loss and grief experience. Here appraisal of loss is depicted as triggering the subjective emotional experience of sadness and yearning. The components in heavy outline indicate what is meant informally by the everyday term emotion. Emotions, when recognised as notable changes/events, can themselves become the objects of subsequent emotions (e.g., guilt with respect to ‘unwarranted’ sadness). This appraisal of emotions is indicated by the return arrow along the bottom of the figure. Adapted from Shaver and Tancredy (2001), and Lazarus (1999).

of meaning-making efforts in grief adjustment. As can be seen at the extreme left-hand side of the figure, activation of an emotion is contingent upon a perceived change in the environment, particularly an unexpected or personally significant change; as applied here, a relative sustaining a TBI. Such change is automatically, and often unconsciously, appraised with respect to the perceiver's needs, goals, beliefs about the self and the world, wishes, concerns, and personal resources. The particular emotion or emotions that emerge depend on the specific pattern of appraisals that are activated and can be viewed as an organised, functional set of thought and action tendencies, and the related physiology (Frijda, 2008; Gross & Barrett, 2011). Each emotion is determined in part by the synthesis of appraisals of the personal meaning of the event to the individual – what Lazarus (1999) terms a *core relational theme*. As depicted in Figure 1, the initial event of and ongoing consequences brought about by a loved one suffering a TBI may result in appraisal of potentially irrevocable forms of loss, and activation of the core emotional theme leading to sadness and its related expressions, thoughts, and behaviours.<sup>22</sup>

The emotion regulation component in the model represents recognition that emotion generation gives rise to a coordinated yet malleable multi-system response to the ongoing person-environment interaction (Gross & Barnett, 2011); thus emotions and their related behaviours can be modified. For example, one may change one's appraisals in a manner that alters the situation's personal and, in turn, emotional significance or impact. In the situation of potential loss experience elicited by a loved one's TBI, such reappraisal, for example, by means of the meaning-making processes discussed above, may alter the family member's affective adjustment. Shaver and Tancredy (2001)

---

<sup>22</sup> Obviously, other affective components of grief, such as anger at perceived wrongful separation, and their related action tendencies can also be accommodated by the model.



observe that emotion regulation may be conceptualised as roughly equivalent to what other investigators term coping. However, rather than viewing it as a separate process in the proposed model it is included as a normal part of the dynamic phenomenon of emotion elicitation and modification.

Thus to summarize, working within this emotion regulation framework, while integrating central tenets from traditional and contemporary grief models, as well as emotion theory, grief is conceptualized herein as both the psychological reaction and the active process of adjustment/adaptation to appraisal of an irrevocable loss of something imbued with great personal significance, meaning, and value. This, in turn, activates the core relational emotion theme of loss – that of deep sadness or sorrow. Thus, in line with the conceptualization of the grief construct advanced by several theorists and clinicians (e.g., Bowlby, 1977, 1980; Darwin, 1872/2009; Marwit & Meuser, 2002; Rubin, 1989), an intense sadness is considered the central affective component of grief. As a natural corollary of this, a strong yearning or longing for that which has been lost but can never be restored is also considered a core feature of grief experience. Finally, reconstruction of meaning, through attempts to attain a subjective sense of understanding of the loss suffered and/or to creatively transform the adversity and pain of loss into a catalyst for discovery of positive gains (e.g., greater/revised appreciation of what is of value in the individual's life and/or positive personal growth), is viewed as a key factor in the process of adaptation to loss.

#### *The Nature of Familial Loss and Grief following TBI*

Four constructs and their related theoretical frameworks that have emerged relatively recently in the loss and grief literature, viz., disenfranchised grief, ambiguous

loss, chronic sorrow, and nonfinite loss, may be particularly useful in aiding the conceptualization of grief experience of family members of TBI survivors. In addition to taking the first important step of acknowledging the existence of loss and grief reactions in this specific population, each suggest that aspects of the grieving process in this context may be particularly difficult given the specific nature of the losses generated by brain injury. At the same time, they also highlight the potential pitfalls of applying in uncritical fashion grief paradigms developed largely specific to bereavement to non-death loss.

*Disenfranchised grief and ambiguous loss.*

Doka (1989, 2002, 2008) defines *disenfranchised grief* as a grief that results when an individual experiences a significant loss which is or cannot be openly acknowledged, socially validated, or publicly mourned. Although the person is experiencing a grief reaction, there is no social recognition of the person's right to grieve. The individual is not afforded the "rights" or the "grieving role" that would lay claim to social sympathy and support or compassionate compensations such as time off work or diminishment of social responsibilities. In advancing the concept of disenfranchised grief, Doka (1989, 2008) noted the existence of prescriptive normative standards in each society (i.e., in constructivist-narrative terminology, dominant hegemonic cultural discourses) which establish expectations and govern behaviour, emotions, and cognition. A component of these standards are what Doka (1989, 2008) terms *grieving rules*. These specify "what losses one grieves, how one grieves them, who legitimately can grieve the loss, and how and to whom others respond with sympathy and support (Doka, 2008, p. 225). These standards manifest not only in folkways, or informally expected behaviours, but also are

codified as laws. For instance, these standards are evidenced in company policies that extend bereavement leave to certain individuals as well as laws that define who has control of the deceased's body or funeral rituals. When one's personal experience of loss is discordant with society's grieving rules aspects of or one's grief in its entirety may be disenfranchised (Doka, 1989, 2008).

Doka (1989) identified three broad reasons for grief being disenfranchised: Either the relationship between the deceased and the bereaved is not socially recognised or sanctioned; the griever is not socially recognised as capable of grief (e.g., young children, individuals with intellectual disabilities); or the loss itself is not socially defined as significant or goes publicly unacknowledged. It is this last form of disenfranchisement that is applicable to family members of persons with TBI. In discussing forms of disenfranchised grief in which the loss itself is not socially validated, Doka (1989) introduces the concept of *psychosocial death*, defined as a situation "in which the persona of someone has changed so significantly, through mental illness, *organic brain syndromes*, or even significant personal transformation ... , that significant others perceive the person as he or she previously existed as dead" (p. 6, emphasis added). In such cases Doka (2002, 2004) notes that family members may experience a profound sense of loss that cannot be publicly acknowledged as the person is still physically alive.

The disenfranchisement of grief has been identified as a factor that complicates adjustment to loss (Corr, 2002, Doka, 1989, 2008; Meuser, Marwit, & Sanders, 2004; Rando, 1993). Doka (1989, 2008) notes that while disenfranchised grief is by nature more inherently problematic than grief secondary to socially recognised forms of loss, paradoxically those who experience the former are also denied or receive minimal

sources of support to facilitate mourning. In the case of psychosocial loss, such as that potentially following TBI, it is argued that grief experience may be exacerbated or adjustment disrupted as the circumstances and nature of the loss itself intensify what can be problematic feelings such as guilt and anger (Doka & Aber, 1989). For example, family caregivers may feel guilt with respect to responding in intemperate ways, under chronic levels of stress, to aberrant undesirable behaviour on the part of the TBI survivor when they understand such behaviour to be beyond the survivor's volitional control (Doka & Aber, 1989). Similarly, significant others may also experience guilt with respect to negative feelings they may come to harbour toward the care recipient (Lezak, 1978), or over use of respite care, or consideration of institutionalization (Doka & Aber, 1989). Anger following psychosocial loss may be directed toward healthcare professionals or other family members who are perceived to be unsympathetic or unhelpful, toward the TBI survivor, or at an unresponsive society. Family caregiver feelings toward the care recipient that may also complicate the grief process in cases of psychosocial loss include a deep sense of abandonment and resentment secondary to unmet companionship or sexual needs (Doka & Aber, 1989).

Doka and Aber (2002) also contend that the very nature of psychosocial loss may exclude the possibility of favourable grief outcome as formulated in dominant bereavement-based models of adjustment. In particular they note the incompatibility of family caregiver loss and grief experience following a psychosocial death with Worden's (1991) four critical tasks of grief work: accepting the reality of the death; experiencing the pain of grief; adjusting to life without the deceased; and withdrawing emotional energy from the lost person and reinvesting it in others. With respect to the first

injunction, Doka and Aber (2002) note that the continued physical presence of the survivor, his/her largely unchanged physical appearance, as well as the sudden and often poorly understood cause of psychosocial death, all render recognition of the reality of the loss difficult. The nature of psychosocial loss also obviously complicates other aspects of grief work. Doka and Aber (2002) argue that given both the demands of the provision of care and the fact that a relationship, although different, nonetheless continues between the caregiver and the care recipient, neither the time nor the intra/interpersonal environment exists for gradual review of one's past relationship and subsequent processing of emergent feelings with a view toward emotional decathexis and formation of new relationships. Rather, "[g]rieving is held in a state of partial suspension" (Doka & Aber, 1989, p. 193)

To compound the above, in all forms of disenfranchised grief, but particularly in cases of psychosocial loss, many of the factors that may potentially facilitate the grieving process are absent (Doka, 1989, 2008). Funeral rituals have long been considered as aiding personal articulation of grief – "[E]xpressing its impulses in symbolic acts, containing them in a recognised period of social withdrawal, these rites and gestures of remembrance ... help to incorporate the meaning of the [lost] relationship in the continuing stream of life" (Marris, 1974, p. 152). With no physical death to mourn, such rituals do not exist for those who have suffered a psychosocial loss. Moreover, as the loss event itself is not socially acknowledged, there exists no recognised role in which the individual can assert the right to mourn and thus receive support (Doka, 2008). Therefore, should family members of persons with TBI experience such psychosocial loss secondary to injury-induced characterological change they may not be afforded the

opportunity to verbalise the loss or receive expressions of sympathy and support, either in the context of their natural social environments or within the healthcare system.

Here it is important to be cognizant of the intrapsychic dimension of disenfranchised grief. Societal grieving rules when internalized can become standards by which we assess and judge the legitimacy of our own grief reactions (Kauffman, 2002). Thus, in the context of a society that does not to any significant degree acknowledge psychosocial loss nor legitimise its pain and accordant grief, a family caregiver of a person with TBI may experience shame and guilt over feelings of grief stemming from the experience of having lost aspects of their loved one, a loved one who still stands before them and is still very much a part of their life. Indeed such feelings may be deemed inappropriate, found threatening, or potentially viewed as incompatible with the love and respect that is still felt for the individual's son, brother, or life partner. In turn, the family caregiver may come to disenfranchise their own grief reaction. In this way both societal and self-imposed disenfranchisement may come to limit the TBI family caregiver's ability to acknowledge, experience, and adapt to their loss.

Boss (1999, 2004, 2006) recognises TBI as a form of *ambiguous loss*. Ambiguous loss is defined as an unclear loss that is inherently indeterminate, with two major types identified. In the first type, people are perceived by family members to be physically absent but psychologically present; here a loved one is physically lost but remains psychologically present as there is no definitive evidence of death. Examples of this form include kidnapped children and soldiers missing in action. Ambiguous loss can also result when a significant other is physically present but perceived to be partially or completely psychologically absent (Boss, 2006; Boss & Yeats, 2014). The changes in

personality following TBI as perceived by family members is considered to constitute such a form of ambiguous loss (Boss, 1999, 2006).

Boss (1999, 2006) contends that ambiguous loss automatically complicates the grieving process; as the loss is not clearly defined and is characterized by uncertainty it defies closure. Citing psychoanalytic formulations of complicated grief as arising from an inability to deattach from the lost object, Boss (1999, 2006) notes that ambiguous loss arising from the perceived psychological absence but physical presence of a loved one is by its very nature irresolvable: it is the external situation, over which the individual has no control, that renders relinquishing that which has been lost impossible. In addition to resulting in the arrestment of the grief process (Boss, 1999), ambiguous loss and the related confusion are also postulated to add another dimension of distress: alongside the universal pain of loss the inability to resolve the source of the loss together with the uncanny coexistence of the known and the unknown (in the case of TBI, the survivor is perceived simultaneously as both familiar and eerily unfamiliar to the family member) is viewed as causing a unique form of traumatic anxiety (Boss, 2006; Feigelson, 1993).

*Chronic sorrow and nonfinite loss.*

The term *chronic sorrow* was introduced by Olshansky (1962) to describe the recurring episodes of profound sadness experienced by parents of children born with cognitive disabilities. This sadness was characterized as a normal response to an ongoing loss situation that persisted throughout the lives of the parents. A small number of studies conducted in the 1980s further documented the existence of chronic sorrow among parents of children with various identified cognitive and physical disabilities (for

review, see Burke, Eakes, & Hainsworth, 1999). Several investigators subsequently suggested that the continued presence of the child with a disability served as a constant reminder of the loss of the expected “perfect” child, which, in turn, rendered grief resolution impossible (e.g., Blacher, 1984; Wikler, Wasow, Hatfield, 1981). More recent studies, conducted almost exclusively by members of the Nursing Consortium for Research on Chronic Sorrow (NCRCS), have found chronic sorrow, assessed via structured interview, to be common among family caregivers of adult individuals with chronic adverse conditions, including multiple sclerosis (Hainsworth, 1995), chronic mental illness (Eakes, 1995), and Parkinson’s disease (Lindgren, 1996). Eakes and colleagues (Eakes, Burke, & Hainsworth, 1999) also reported observing chronic sorrow among a majority of a sample of bereaved persons. In light of this, a revised view of the construct has been advanced with chronic sorrow defined as periodic recurrence of permanent, pervasive sadness, or other grief-related feelings associated with an ongoing disparity between the current and idealised reality resulting from a significant loss (Eakes et al., 1999; Eakes, 2009). This reformulation of the construct is problematic in that it removes the requirement of an ongoing loss experience (Eakes, 2009), which is arguably the *sine qua non* component of chronic sorrow. As noted by Roos (2002), the concept of chronic sorrow does not apply in situations in which the source or object of the loss does not persist. Indeed, Roos (2002) contends “[t]o expand the definition further is to lose the meaningfulness of the concept ..., both as originally postulated ... and in its expanded application” (p. 45).

Like Roos (2002), Bruce and Schultz (2001) recognise TBI as a potential source of ongoing or *nonfinite loss* and related persistent grief for family members, noting that in



such cases the relative is “confronted with a painful and constant interplay of what was and what is” (p. 8). Bruce and Schultz (2001) describe nonfinite losses as continuous, insidious, often not fully recognised, accruing significance over time, and contingent upon the lack of synchrony between reality and one’s hopes, wishes, ideals, dreams, and expectations. Notably, these authors argue that reliance upon theoretical grief models developed largely in response to bereavement can lead to a failure to recognise the nonfinite nature of many non-death losses, and consequently unrealistic expectations with respect to adjustment. For instance, they argue that when erroneously treated as a discrete event (in TBI, the time of the accident, for example), a loss nonfinite in nature comes to be viewed as an entity distinct from the process that precedes or follows it. Thus from a traditional grief perspective, it is often assumed that the individual absorbs the implications of a loss *in toto* at a particular point in time; failure to do so may then be deemed pathological. Such an approach does not appreciate that nonfinite loss is by definition unfinished (Bruce & Schultz, 2001). In the case of TBI, there is often no doubt great uncertainty among the survivor and his/her family members with respect to what has been lost, what will be regained, and what has been lost irrevocably. Indeed, appreciation of various privations is likely to only coalesce over time, with related oscillations between hope and grieving. Moreover, as documented in the chronic sorrow family caregiver literature, recognition of new losses for TBI family caregivers may emerge with the unfolding of the processes of human growth and development. For example new disparities between reality and expectations may lead to recurrent grief reactions as personal and family developmental milestones are reached but are unachievable. In this regard, Bruce and Schultz (2001) contend, that for many facing

nonfinite loss, “the falling away or relinquishment of dreams [embedded in normative developmental trajectories] is a cause for continuing grief” (p. 9).

Bruce and Schultz (2001) also observe that the nature of nonfinite loss in situations such as TBI is often likely to complicate the grieving process. For instance, with respect to the tasks of grief work, mirroring in many ways the position of Doka (Doka, 1989; Doka & Aber, 2002), they argue that facing the pain of grief will likely be suspended or undermined in a context where constant physical and emotional energy must be devoted to meet caregiving demands, and question the possibility of withdrawing emotional bonds from a loved one who lives on.

Regarding Bowlby’s (1980) model of grief adjustment, it is noted that the critical act of giving up searching attempts for what has been lost may be difficult, if not impossible, in cases of nonfinite loss as it is often characterized by ambiguity and uncertainty: In a context of rehabilitation, surgery, and drugs which may fuel hopes and aspirations, searching behaviour may come to organise itself around alternative aspects of the loss that might be perceived as reclaimable, or aspects or abilities not yet verified as lost. In addition, Bruce and Schultz (2001) contend that as the particularities of deprivation in nonfinite loss only reveal themselves over time, the alignment of Bowlby’s (1980) working models of self and the world to the emerging situation has no recourse but to remain imperfect: “The individual oscillates within a context of possibilities diminishing and possibilities lost” (p. 25).

Importantly, meaning reconstruction is recognised as a crucial factor in adjustment to nonfinite loss. In this regard, meaning is viewed as being abstracted from the adversity and loss, and takes the form of identifying positive changes effected in the

self and the development of new goals. This process, akin to benefit-finding or establishing meaning-as-significance, is viewed as providing a renewed sense of purpose and control which can help to mollify, to some extent, the impact of and threat posed to identity by the ongoing loss (Bruce & Schultz, 2001).

*Extant Studies of Loss and Grief among TBI Family Caregivers*

As noted, investigation of appraisals of loss and experience of grief among relatives of persons with TBI has been limited. A handful of small-scale qualitative studies investigating the general experience of parents of young children and teenagers with TBI have noted the presence of significant grief in their analysis of interview transcripts (Clark, Stedman, & Margison, 2008; Good, 2003; Singer & Nixon, 1996). For example, in her phenomenological study of the lived experience of three mothers of children with TBI ranging in age from 6 to 13 years at time of injury, Good (2003) observed that all participants displayed recurrent grief reactions:

As each new growth milestone arose along the continuum of their child's development, a new awareness also arose of the extent of their child's lost potential. This became a source of chronic sorrow ebbing and flowing with each newly presented developmental task (p. 78).

Although Good (2003) does not use the term, review of participant responses by the current author also suggest a nonfinite nature to their loss experience.

Further insight into the nature and types of loss experienced by family members of individuals with TBI is provided by a reanalysis of qualitative data by Chwalisz (1998). At the end of a questionnaire from a larger quantitative study of family member burden (defined as perceived stress) (Chwalisz, 1996) participants were given the

instruction, “if you wish to share anything else, feel free to write on the rest of this page.” Chwalisz and Stark-Wroblewski (1996) subsequently conducted a typological content analysis of the resultant essay data provided by 27 (26 female) of the 135 spousal TBI caregiver participants of the larger study. Although experience of loss was noted grief experience was not identified and all content themes delineated were ultimately conceptualised as an expression of burden. In a subsequent publication, however, Chwalisz (1998) reanalysed the spousal essay data with a specific focus on loss. A major theme that emerged was labelled *loss of consortium*. This was conceived of as containing two categories of loss: First *personal and emotional losses*, reflecting loss of the survivor’s premorbid personality and lost emotional and sexual aspects of the relationship; and second, *supportive and tangible losses*, reflecting the loss of pragmatic and financial forms of support. Other themes of loss identified included loss of purpose, a lost sense of security, loss of core aspects of the self, loss of physical health, loss of personal freedom, loss of family support and friends, and the loss of dreams (Chwalisz, 1998).

With respect to quantitative research, two investigations have explored grief experience among relatives of persons with *acquired brain injury* (ABI). ABI refers to damage to the brain which occurs after birth and is not related to a congenital disorder or degenerative disease. The damage may be caused traumatically, resulting in a TBI, or via an internal process or pathology. Non-traumatic causes of ABI include anoxia, brain tumours, and stroke (Toronto ABI Network, 2011). Teel (1993) documented evidence of grief reactions and the presence of chronic sorrow among 31 family members (58% parents) of individuals with ABI. She described this group as including persons with TBI

and stroke. However, no further details regarding ABI group composition were provided and no separate analyses were conducted by ABI subtype. Marwit and Kaye (2006) observed elevated levels of grief among 28 family caregivers of persons with ABI. Thirty-five percent of care-recipients had sustained a TBI. No separate statistical analyses were performed for the TBI subgroup and the small overall sample size excluded investigation of potential predictors of grief reaction via regression analysis.

In the only quantitative study to date to explore the extent of grief in a sample comprised exclusively of TBI caregivers, Zinner and colleagues (Zinner et al., 1997) asked mothers of 102 adolescents and young adults who had suffered a TBI (90 percent of moderate to severe severity) within the last three years to complete a modified non-death loss form of the Grief Experience Inventory (GEI). As the GEI does not provide a summary score of grief intensity, analyses were conducted using 13 subscales. Notably, none of these assess sadness or yearning secondary to loss. Zinner et al. (1997) observed significantly higher elevations among the TBI mother group relative to another non-death loss sample<sup>23</sup> on the despair (a measure of hopelessness), social isolation, loss of control, and loss of vigor (a measure of physical strength) scales. With respect to potential predictors of grief experience, with the exception of guilt, which was particularly intense during the earliest and latest time periods studied, time since injury was not associated with GEI scale scores. Injury severity, defined as reported length of coma, was also found to be unrelated to maternal grief response. Ratings of the present level of functioning of survivors was observed to influence maternal grief patterns, with mothers of low functioning children expressing greater anger, loss of control, and increased sleep

---

<sup>23</sup> This was comprised of divorced and separated women, adults who had placed their parents in a long-term care facility, and parents of children with developmental disability (Sanders, Mauger, & Strong, 1975).

disturbance relative to mothers of children with higher levels of functioning. This finding was interpreted within the framework of burden: “Thus, the grief process seems to parallel the ‘objective burden’ that Brooks (1984) views as a major aspect of the psychosocial burden placed on families” (Zinner et al., 1997, p. 442). The presence or absence of a husband in the home did not impact maternal grief responses.

*A Potentially Key Aspect of Loss: Personality Change Revisited*

As noted, the various neurobehavioural and affective sequelae of TBI are invariably labelled within the literature as personality change, with the appropriateness of this term questioned by some who argue that such effects should not be uncritically equated with changes in normal personality traits (Kurtz et al., 1998; Rush et al., 2006). With respect to the emotional adjustment and outcome of family members of TBI survivors, including their potential appraisals of loss and subsequent grief experience, what ultimately is of consequence is the perception of said relatives. Theoretical disputes regarding the definition of the construct of personality aside, early research findings of two thirds or more of relatives responding in the affirmative when asked if the TBI survivor had “changed in personality” (Brooks & McKinley, 1983; Brooks et al., 1986), more recent qualitative data provided by family members across several studies (e.g., Chwalisz, 1998; Good, 2003), as well as the published autobiographical accounts of relatives (e.g., Crimmins, 2000; Kramer, 1991; Beaver, 1991) suggest that many do indeed perceive significant alteration in the basic psychological constitution of the survivor secondary to the injury. Moreover, in line with the work of Doka (1989, 2008) and the nonfinite loss framework reviewed above (e.g., Bruce & Schultz, 2001; Roos, 2002), several of the available qualitative descriptions written by family members also

provide preliminary evidence of such perceived change constituting a form of psychosocial death resulting in a chronic form of grief. For example, a participant in a quantitative study provided the following unsolicited spontaneous comment:

I write this to show you how this is ongoing grief and despair ... The closer you get to seeing what they won't get back, the worse the grief, until you bury the "old" person and start getting to know the "new one" (Zinner et al., 1997, p. 445).

In an attempt to both capture this seemingly more fundamental perceived alteration in the self of the TBI survivor by their family members, and address the "superficial" and "plastic" critiques levelled against now dominant trait models of personality (i.e., where the construct of personality is viewed as providing a purely descriptive rather than explanatory/casual framework and/or is considered highly malleable across situations), the dynamic processing conceptualization of personality as postulated by Mischel and Shoda (1995) will be adopted here.

Traditionally, personality psychology has been devoted to understanding the dispositional characteristics of the individual that are presumed to be invariant across context and situation. However, multiple studies over the course of a century demonstrated individual behaviour to vary greatly from situation to situation. This seeming incongruence between empirical findings and core assumptions of personality theory came to be termed the "personality paradox" and led many to question the nature and locus of consistency in personality (Mischel & Shoda, 1995; Mischel, Shoda, Mendoza-Denton, 2002).

Subsequent research has found that concealed within the apparently random variation of behaviour across situations is a pattern that is indeed stable and distinctive

for each individual: While the behaviour itself varies, there is stability in how each person's behaviour varies from one situation to another (see Mischel et al., 2002 for review). To provide a conception of personality that could account for not only the overall average differences between people but also the stable and unique patterns of intraindividual variability across situations, Mischel and Shoda developed the *cognitive-affective personality system* (CAPS) theory (Mischel & Shoda, 1995, 1998, 2008).

Within the CAPS model personality is not conceptualised merely as a collection of attributes or fixed points on a set of psycholexical dimensions, but rather as a coherent organization of mental-emotional representations, termed *cognitive-affective units*, that interact within a network of relationships and constraints to form a parallel and distributed processing system operating at multiple levels of awareness. Activation or inhibition of a select pattern of cognitive-affective units results in particular behaviours. Importantly the units of the personality system are broadly conceived and include the individual's encodings or construals of the self, people, events and situations; expectations and beliefs about the world, about outcomes for behaviour, and about self-efficacy; emotion schemas and affective responses (including physiological reactions); goals, values, desired affective states, and life projects; as well as individual competencies and self-regulatory plans (Mischel & Shoda, 1995, 1998, 2008).

Individual differences in personality in the CAPS approach are considered to arise both from differences in the chronic accessibility of cognitive-affective units, that is, the ease with which the units become activated, and from the distinctive organization of relationships between them within each person. The latter determines how the units change in their salience, or activation, over time and in relation to varying situations. It is



this organization that is postulated to form the basic stable structure of personality and underlies the individual's characteristic distinctiveness. The units and their network of interrelations that constitute the personality system and mediate behaviour emerge over the course of development and are viewed as the product of the individual's social learning history, culture, genetics, and biological history. The CAPS system interacts continuously and dynamically with the external world in a reciprocal manner: The distinctive behaviours generated by the mediating units of the personality system in response to a particular situation influence the situations the individual subsequently encounters and that, in turn, influence the person (Mischel & Shoda, 1995, 1998, 2008; Mischel et al., 2002).<sup>24</sup>

The present author proposes that the basic components and organization of the personality system as conceptualised by Mischel and Shoda (1995, 1998, 2008) may be fundamentally altered by TBI as a function of both (a) direct damage to the biological substrate subserving the various forms of cognitive-affective unit and their interconnection, and (b) the chain of psychological processes of adjustment triggered by experience of the injury and its various consequences and implications. Thus, in line with the CAPS model, for the purposes of the current investigation the neurobehavioural and emotional changes effected by TBI as appraised by family members will be termed *perceived personality system change*. This term will be used interchangeably with

---

<sup>24</sup> A notable empirical finding with respect to the CAPS personality framework of relevance to the current study comes from an investigation of the nature of person perception. Idson and Mischel (2001) observed lay person perceptions of others to go beyond unelaborated trait descriptions and include inference of cognitive-affective mediating variables – such as construals, expectancies, and goals – only in cases in which the target individual being described played an important role in their lives. This finding was interpreted as suggesting that while trait terms may be sufficient for perceptions of the personalities of nonsignificant others, individuals are guided by an intuitive CAPS approach when considering people who are familiar and significant, with the incorporation of cognitive-affective mediating factors being critical to people's mental representations of their significant others (Idson & Mischel, 2001).

*perceived characterological change*. Such change is considered to represent a significant interpersonal form of irrevocable loss, and subsequently is viewed as potentially the most important catalyst for grief experience among TBI relatives.

#### Aims and Hypotheses

On the basis of the foregoing review, the current author contends that conceptualization of the familial impact of TBI in terms of loss and subsequent grief experience – drawing on insights gained from a number of related theoretical frameworks including bereavement and contemporary loss models, as well as trauma and emotion theory – may add greatly to our understanding of the potential causes and nature of family member psychological distress and adjustment in the wake of a TBI. However, as seen, research activity with respect to this potentially highly salient aspect of family member experience has been largely circumscribed. Moreover, the most relevant empirical study to date, that of Zinner et al. (1997), despite making a significant contribution to the field, does, however, have a number of limitations. The first set of these undermine the generalizability of Zinner et al's (1997) findings and may have occluded potential associations with the selected predictors of outcome: First, only mothers of TBI survivors were assessed; and second, time elapsed since injury was confined to a range of 3 to 36 months. Most importantly, Zinner et al's (1997) selected grief measure did not assay what many consider to be the core or definitive elements of grief experience, viz. sadness and longing secondary to loss. Therefore, the current investigation sought to expand upon the findings of Zinner et al. (1997) by exploring loss experience and grief reaction among family members of TBI survivors across a wider

range of kin relationship, with no upper limit restriction placed upon time since injury, while utilizing a grief instrument that assessed both sadness and yearning.

Possible predictors as well as factors potentially moderating TBI-related grief were also systematically examined. As discussed, characterological change in TBI survivors as perceived by relatives has been found to be the most reliable and strongest predictor of several forms of family member emotional adjustment and family functioning (e.g., Kreutzer et al., 1994). In addition, several theorists have suggested characterological change or “change in the psychological essence ... or the self” (Doka & Aber, 1989, p. 189) of TBI survivors to be the principal catalyst for an appraisal of significant loss and, in turn, grief reaction among the family caregivers of such persons. Limited qualitative data also suggest that perceived change in the core psychological makeup of the TBI survivor constitutes the most painful form of loss for many relatives (e.g., Chwalisz, 1998; Good, 2003; Feigelson, 1993). To date, however, the relationship between perceived personality system or characterological change and grief in this population has yet to be empirically explored.<sup>25</sup> Therefore investigation of this potential association has been identified as a research focus. Operating within the broad framework of the psychology of loss and informed by both traditional and more contemporary inclusive formulations of grief as outlined above, this characterological change is believed to constitute a partial psychosocial death, and in turn, is considered to reflect appraisal of a critical form of interpersonal loss, including the loss of an attachment bond. Perceived personality system change is also hypothesized to lead to

---

<sup>25</sup> Although Zinner et al. (1997) did investigate the relationship between present general functioning of TBI survivors and maternal grief response, the measure employed was neither designed nor conceived of as a measure of characterological change: The General Functioning Rating Scale, as the name suggests, provided a single score of broad current survivor functioning across a number of domains, including physical functioning. Moreover, no premorbid estimates of functioning were obtained.

potential secondary symbolic losses, such as the losses associated with role changes within the relationship, and the loss of dreams, hopes, and aspirations for the future. Therefore this particular TBI sequela of family member perceived personality change was expected to be associated with greater familial caregiver grief (*Hypothesis 1a*), predicting unique variance in the latter (*Hypothesis 1b*), after statistically controlling for the influence of potential confound variables, including global response set and the quality of the premorbid relationship between the family caregiver and survivor.

As noted, perceived social support has been documented by a large body of research to be associated with reduced psychological distress and improved general well-being in a diverse array of populations (e.g., Reinhardt et al., 2006, Sarason et al., 1985), and has been observed to be a significant predictor of mental health outcomes among TBI caregivers (e.g., Chronister et al., 2010), moderating the impact of certain TBI sequelae on adjustment (Ergh et al., 2002, 2003). However, investigation of the influence of perceived social support with respect to outcome in bereaved populations has yielded equivocal results (for review, see Stroebe et al., 2005). With respect to non-death forms of loss, the few studies conducted to date have not revealed an inverse relationship between perceived social support and grief outcome (e.g., Marwit et al., 2008). Extrapolation of stress-coping based models of the role of perceived social support in bereavement (e.g., Ogrodniczuk et al., 2003), would suggest that perception of adequate social support among TBI caregivers may serve to bolster their appraisal of personal coping resources and partially alleviate certain losses following the injury of their relative. However, in line with the position advanced by attachment theorists (e.g., Bowlby, 1969; Weiss, 2001), TBI caregivers were anticipated to likely experience non-

death losses of unique forms that entail deprivation of interpersonal connection and communion which result in voids that cannot be filled and related grief experience that cannot be effectively ameliorated/mollified by social support. Therefore, perceived social support was predicted to display at most a relatively weak inverse relationship with caregiver grief (*Hypothesis 2a*) and was not expected to be a unique predictor of this outcome variable (*Hypothesis 2b*).

A persistent and urgent need for meaning has been observed by researchers studying reactions among individuals experiencing a wide spectrum of adverse life events, including bereavement and various predicaments arguably involving non-death forms of loss (e.g., Bulman & Wortman, 1977; Burgess & Holmstrom, 1979; McIntosh et al., 1993; Thompson, 1991). Subsequently, meaning-making / meaning reconstruction has been highlighted across a number of fields and interdisciplinary theoretical frameworks as a potentially critical component in the process of adjustment to bereavement and major loss in general. As TBI is conceptualised herein to precipitate the experience of potentially profound and, in many cases, traumatic intra- and interpersonal losses for the family members of the individual injured – losses that may come to undermine core assumptions about the world and self – the meaning reconstruction processes of sense-making and benefit-finding were identified as factors that may play an important role in the adjustment of relatives. Therefore more successful sense-making and benefit-finding efforts on the part of family caregivers with respect to their experience of their relative's injury were expected to be associated with lower grief levels (*Hypothesis 3a*), with both forms of meaning construction emerging as a unique predictor of family member grief reaction (*Hypothesis 3b*). Moreover, if sense-making and

benefit-finding were each found to be a protective variable accounting for unique variance in grief level, these meaning-making processes were anticipated to moderate, i.e., buffer, the influence of perceived personality system change on caregiver grief (*Hypothesis 3c*). Specifically, the positive relation between perceived characterological change and grief would be stronger among those caregivers who reported lower levels of sense-making or benefit-finding and weaker among those more successful in their meaning reconstruction efforts.

As the investigation was in part exploratory in nature, the potential influence upon caregiver grief experience of several other factors was also examined. These included the care recipient/injury characteristics of time since injury and decline in certain domains of cognitive functioning and in physical independence as perceived by family members, as well as the caregiver characteristics of age, gender, and kin relationship to the TBI survivor.

With respect to the potential influence of time, as discussed, numerous orthodox theoretical grief models propose a progression toward grief resolution or a more or less stable final stage of adjustment with the passage of time following a death loss (e.g., Parkes & Weiss, 1983, Rando, 1984, Worden, 1982). In addition, models of family functioning following TBI predict improved family adjustment over time, with successful “working through” of grief reactions, (e.g., Lezak, 1986; Spanbock, 1987). However, other theorists, such as those who postulate the losses and grief experience entailed in TBI to complicate the grieving process as a function of their disenfranchised, ambiguous, and nonfinite nature (e.g., Boss, 1999; Bruce & Schultz, 2001; Doka, 1989; Muir & Haffey, 1984), together with qualitative research findings (e.g., Collings, 2008; Good,

2003) and clinical experience, suggest that favourable integration of or adjustment to loss may be a particularly difficult process, and in turn may be delayed or ultimately unachievable, for many family members of TBI survivors. Indeed, to the extent that such losses are recurrent or nonfinite, a chronic grief trajectory may be the most probable among this population. Therefore, time elapsed since injury was not expected to show a significant negative relationship with caregiver grief (*Hypothesis 4*).

As losses that are social in nature have been identified as deprivations that are likely to elicit the strongest grief reactions (e.g., Harvey, 2002), caregiver perceived declines secondary to TBI in four domains of survivor cognitive functioning that play critical roles in interpersonal interaction - viz., receptive and expressive language, emotion identification, and theory of mind capacity - were postulated to constitute highly salient forms of interpersonal loss for family members. In turn, perceived declines in these domains were anticipated to be associated with higher levels of caregiver grief (*Hypothesis 5a*) and to potentially account for unique variance in the prediction of grief level (*Hypothesis 5b*). To clarify, theory of mind refers to the capacity to infer the thoughts, goals, intentions, and motives of other people; i.e., the ability to make inferences about the mental states of others (Milders, Ietswaart, Crawford, & Currie, 2006). Both theory of mind and emotion identification have been identified as key forms of social cognition. They are delineated as such because both processes contribute significantly to effective functioning within a social context (Couture, Penn, & Roberts, 2006). In contrast, perceived functional decline in TBI survivor memory, a cognitive domain arguably less central to basic social interaction and maintenance of interpersonal

relationships, was not expected to display a strong association with grief (*Hypothesis 6*).<sup>26</sup> A significant relationship between perceived decline in the survivor's physical ability to independently provide self-care and familial grief experience was also not anticipated (*Hypothesis 7*).

With respect to the caregiver characteristics of age, gender, and kin relationship to TBI survivor, there is either insufficient data or the relevant findings from the TBI family outcome and bereavement literatures are equivocal, rendering predictions regarding their potential influence upon family member grief experience with a reasonable degree of assuredness difficult.

In order, in part, to better situate the current results regarding caregiver grief experience in the larger body of research investigating TBI family member adjustment, caregiver levels of depressive symptomatology, caregiving burden, and life satisfaction were also assessed, with the relationships between these more widely studied family member outcome variables and caregiver grief explored. A modest positive relationship was expected between grief and depressive symptomatology, reflecting their status as related but distinct psychological phenomena (*Hypothesis 8*). Greater family member grief was also anticipated to be associated with higher levels of perceived caregiving burden (*Hypothesis 9*). An inverse relationship between caregiver grief and life satisfaction was expected (*Hypothesis 10*). Associations between these additional caregiver outcome variables and the protective factors of perceived social support and meaning reconstruction were also of interest. Concordant with extant TBI family

---

<sup>26</sup> It is acknowledged that extreme compromise in an individual's autobiographical memory to the extent that sense of self is significantly degraded, such as that observed in late stage Alzheimer's disease, would constitute an interpersonal loss for family members. However, in TBI deficits in this form of memory function are typically far less severe (Bauer, Grande, & Valenstein, 2003; Piolino, Desgranges, Manning, North, Jokic, & Eustache, 2006; Richardson, 2000).



outcome research (e.g., Davis et al., 2009; Chwalisz, 1996), perceived social support was anticipated to be associated in the current study with reduced levels of both depressive symptoms (*Hypothesis 11*) and perceived caregiving burden (*Hypothesis 12*), and higher caregiver life satisfaction (*Hypothesis 13*). More successful sense-making and benefit-finding efforts on the part of caregivers with respect to their experience of their relative's injury were also expected to be associated with more favourable scores of depressive symptoms (*Hypothesis 14*), burden (*Hypothesis 15*), and life satisfaction (*Hypothesis 16*).

A further aim of the research project was to test the postulate that non-death loss and grief experience may operate as a causal factor contributing to level of depression and other aspects of well-being among family caregivers – a position originally advanced by authors in the fields of cancer and dementia caregiver outcome (e.g., Meuser et al, 2004; Williamson & Shaffer, 1996, 1998). In turn, the prediction that reported TBI caregiver grief would mediate the relationship between perceived personality system change and (i) caregiver depressive symptomatology (*Hypothesis 17*), and (ii) caregiver life satisfaction (*Hypothesis 18*) was assessed.

Finally, in order to combine the hypothesis of moderation of the impact of perceived personality change on caregiver grief by level of meaning reconstruction achieved (i.e., Hypothesis 3c above) with each mediation hypothesis just proposed, two moderated mediation hypotheses were developed: It was predicted that the role of caregiver grief as a mediator of the two caregiver outcomes of depressive symptoms and life satisfaction would be conditional on the extent of meaning reconstruction. Specifically, the indirect effect of perceived personality change on both caregiver depressive symptomatology and life satisfaction through caregiver grief experience was

anticipated to be larger for those family members reporting relatively lower levels of meaning reconstruction (*Hypothesis 19* and *Hypothesis 20*, respectively).

## CHAPTER 3

### METHOD

#### Participants

The study sample consisted of 123 family caregivers of persons who had sustained a TBI at least 3 months prior to caregiver participation. In order to be eligible to participate, caregivers had to be at least 18 years of age, must have known the TBI survivor for at least 6 months prior to their injury, had to be actively involved in the care-recipient's life by providing emotional and/or practical support, and must have had no history of neurological disorder. Exclusion criteria included caring for a TBI survivor with a history positive for (a) a developmental disability, (b) a physical disability acquired prior to her/his TBI, and/or (c) a neurological condition other than TBI. Sample demographic and injury-related information is presented in the Results chapter (see pp. 135-136).

#### Measures

Each participant completed an online questionnaire set, comprised of the following: (1) a demographic and injury information questionnaire; (2) the Neuropsychology Behavior and Affect Profile (Nelson, Satz, & D'Elia, 1994); (3) the Social Provision Scale (Cutrona & Russell, 1987); (4) measures of meaning reconstruction adapted from Davis et al. (1998) and Keesee et al. (2008); (5) the ABI revision of the Marwit-Meuser Caregiver Grief Inventory (Marwit & Kaye, 2006); (6) the Center for Epidemiologic Studies Depression Scale (Radloff, 1977); (7) the Zarit Burden Interview – Short Form (Bédard et al., 2001); (8) the Satisfaction with Life Scale (Diener, Emmons, Larsen & Griffin, 1985); (9) a measure of premorbid caregiver-TBI survivor

relationship quality developed for the current investigation; and (11) the Positive and Negative Affect Schedule (Watson, Clark, & Tellegen, 1988). Individual measures are presented in Appendix B; given copyright protection, the Neuropsychology Behavior and Affect Profile is not included.

In addition, participants were asked to provide free-form written responses to describe in their own words, first, their experience of loss and grief secondary to their family member's TBI, and second, the extent to which they had been able to make sense of and find something positive in, or resulting from, their experience of their relative's TBI and its consequences. This qualitative data is to be analysed in a separate study.

#### *Demographic and Injury Information Questionnaire*

This questionnaire obtained (a) caregiver and care recipient demographic information (including age, gender, education level, and kin relationship); (b) information pertaining to caregiver psychiatric history; (c) information regarding the TBI (including cause, time since injury, and severity of injury); and (d) caregiver perceived Likert-type scale ratings of decline in (i) TBI survivor functioning in select cognitive domains, and (ii) TBI survivor level of physical independence (see more detailed item description below).

TBI severity was classified on the basis of caregiver report of duration of loss of consciousness (LOC). The following classification system for this metric was employed: an interval of  $\leq 30$  minutes LOC duration was categorized as a mild injury, an interval of  $> 30$  minutes up to 24 hours a moderate injury, and  $> 24$  hours a severe injury (VA/DoD Management of mTBI Working Group, 2009).

### *Predictor Variables*

#### *Perceived Care Recipient Personality System Change*

As noted, caregivers of individuals with TBI often report marked changes in the personality of the survivor as a result of the injury, citing disturbance in both affect and behaviour in this regard (Brooks, 1988; Brooks & McKinley, 1983; Prigatano, 1992, 1999). Perceived postinjury personality system change was assessed via the Neuropsychology Behavior and Affect Profile (NBAP; Nelson et al., 1994). The NBAP is a 106-item measure designed to assess changes in neurobehavioural and emotional functioning following brain damage. Items are worded in an agree/disagree format, which are scored 1 and 0 respectively. The NBAP has five scales designed to reflect five behavioural and emotional components of personality disturbance commonly observed following brain injury: *Indifference* (lack of awareness or denial of impairment; apathy; unresponsiveness to environment), *Inappropriateness* (inappropriate, bizarre, or unusual behaviour), *Pragnosia* (deficits in the pragmatics of communication), *Depression* (depressive symptomatology including dysphoric mood and withdrawal), and *Mania* (elevated, expansive, or irritable mood; sustained energy and high levels of activity).<sup>27</sup> The instrument requires respondents to rate aspects of behavioural and affective functioning both prior to and post brain injury. This allows for assessment of the degree of change from premorbid levels (Nelson et al., 1994). Both observer- and self-report versions are available; the former was used in the present study. As the Mania subscale

---

<sup>27</sup> *Pragmatics* may be defined as knowledge and successful application of the social rules that underlie a language so as to achieve effective communication appropriate to the social context (Martin & McDonald, 2003; Matlin, 2003). Pragmatic language skills include understanding and conveying intentions, utilization of context to infer the meaning of an utterance, the ability to adhere to the needs of a conversational partner, and discourse management skills (Landra 2005; Loukusa & Moilanen, 2009). See Martin and McDonald (2003) for a review of pragmatic deficits observed among persons with TBI.

of the NBAP has not been found to discriminate between persons with TBI and age-matched controls, and has not been observed to be associated with TBI caregiver distress (Groom, Shaw, O'Connor, Howard, & Pickens, 1998), this subscale was not employed in the current investigation. A total change score for the 42 items of the remaining four scales was computed, with higher scores indicating higher levels of perceived change (possible range zero to 42).

Several studies have been conducted to examine the content validity, internal consistency, stability over time, and discriminant validity of the NBAP in different patient populations, including TBI (Nelson, Drebing, Satz, & Uchiyama, 1998; Nelson, Mitrushina, Satz, Sowa, & Cohen, 1993; Nelson et al., 1989). Acceptable internal consistency reliability estimates have been demonstrated across the subscales (.66 to .82) and for the composite score (.88; Ergh et al., 2002; Nelson et al., 1989; Nelson et al., 1993). In the present study, the internal reliability estimate for the composite change score was .86.

#### *Social Provision Scale (SPS)*

Level of perceived caregiver social support was measured using the original form of the SPS (Cutrona & Russell, 1987).<sup>28</sup> The SPS is a 12-item self-report inventory that requires respondents to indicate the level of social support that they receive from their current relationships on a 5-point Likert-type scale, with response alternatives ranging from *strongly disagree* (1) to *strongly agree* (5). The range of possible scores is 12 (low perceived social support) to 60 (high perceived social support). The SPS was developed to assess the six forms of social support or provision derived from relationships as described by Weiss (1973, 1974): *guidance* (support in the form of information or

---

<sup>28</sup> A 24-item version of the scale has also been developed (Cutrona & Russell, 1987).

advice), *reliable alliance* (the assurance that others can be counted on for tangible assistance), *reassurance of worth* (recognition by others of one's competence, skills, and value), *opportunity for nurturance* (the sense that others rely upon one for their well-being), *social integration* (the sense of belonging to a group that shares similar interests, concerns, and recreational activities), and *attachment* (emotional closeness from which one derives a sense of security). It is important to note that a caregiver's perception of social support stemming from their relative with TBI may be substantially altered as a direct function of the injury (for example, as discussed, a caregiver may experience significant loss of attachment). In order to avoid this confound, participants were instructed to exclude the social support they perceive to be provided by their family member with TBI when completing the SPS.

When administered to a sample of 505 undergraduate and graduate students, the Cronbach alpha coefficient for the SPS total score was .84 (Russell, Cutrona, Rose, & Yurko, 1984). Adequate internal consistency reliability has also been found in caregivers of persons with TBI (alpha coefficient = .78; Ergh et al., 2003). For the current study sample, the SPS alpha coefficient was .85.

### *Meaning Reconstruction*

Meaning-making efforts were assessed via items addressing the two construals of meaning identified by Janoff-Bulman and Frantz (1997) and Davis et al. (1998), sense-making and benefit-finding. Sense-making was measured by the question "To what extent have you been able to make sense of your family member's brain injury and its consequences?" Sense made was rated on an ordinal 9-point Likert-type scale with anchor points of 1 (*no sense*) to 9 (*a great deal of sense*). Following a short paragraph

noting that sometimes individuals are able to find some positive aspect in their experience of adversity and loss, with examples provided, benefit-finding was assessed by the question “To what extent have you been able to find anything positive in or as a result of your experience of your family member’s brain injury and its consequences?”. Degree of benefit-finding was rated on an ordinal 9-point Likert-type scale with anchor points of 1 (*nothing positive found*) to 9 (*significant positive consequence/s or growth experience found*). These questions correspond closely to the single item measures that other researchers have used to assess these construals of meaning for quantitative analyses and that have been found to be of considerable utility in predicting grief outcomes following bereavement (e.g., Davis et al., 1998; Currier et al. 2006; Keesee et al., 2008; McIntosh et al., 1993).

*Perceived Changes in Care Recipient Cognitive Functioning and Physical Independence*

Caregiver perception of decline in survivor functioning secondary to injury in the domains of expressive and receptive language, cognitive empathic capacity, theory of mind, memory, and physical capacity to independently engage in self-care were assessed by single-item ordinal 9-point Likert-type scales with response options ranging from 1 (*no decline*) to 9 (*extreme decline*). Caregiver perceived rather than objectively measured alterations in care recipient functioning have been postulated to have greater bearing on caregiver adjustment. With respect to grief in particular, what a caregiver believes to be true about the care recipient’s level of impairment arguably drives her or his grief reaction to a greater extent than the actual impairment status, as an individual’s grief response is, by definition, contingent upon her or his perception of loss (Marwit & Meuser, 2002).



*Caregiver Outcome**Marwit-Meuser Caregiver Grief Inventory – ABI Revised (MM-CGI – AR)*

Caregiver grief was assessed via the Heartfelt Sadness and Longing scale of the acquired brain injury (ABI) revision of the Marwit-Meuser Caregiver Grief Inventory (MM-CGI – AR; Marwit & Kaye, 2006). The MM-CGI is a 50-item self-report measure scored on a 5-point Likert-type scale ranging from *strongly disagree* (1) to *strongly agree* (5). The MM-CGI was initially developed and psychometrically evaluated with independent samples of dementia caregivers (Meuser & Marwit, 2001; Marwit & Meuser, 2002). Three subscales were delineated: *Personal Sacrifice Burden*, *Worry and Felt Isolation*, and *Heartfelt Sadness and Longing* (Marwit & Meuser, 2002). The Personal Sacrifice Burden scale measures individual losses in the caregiver's present life related to the caregiving role itself, such as loss of personal freedom, loss of sleep, compromised health, and loss of energy. The Worry and Felt Isolation factor assesses both caregiver uncertainty and anxiety regarding the future and their capacity to cope, and caregiver experience of losing connections with, and support from, others. The Heartfelt Sadness and Longing scale is designed to assess the emotional reactions to caregiver experience of loss secondary to their family member's illness/injury (e.g., abject sadness, yearning for what was, anger, feelings of powerlessness and hopelessness, and unwillingness to accept the current reality). Marwit and Meuser (2002) identify this factor as the most closely related to traditional concepts of grief, that is, "one's personal, internal, emotional reactions to actual or impending loss" (p. 759). The possible range of scores on this 15-item scale is 15 to 75, with higher scores indicative of higher levels of grief.

When administered to an independent dementia family caregiver sample, the MM-CGI total grief score and factor scores demonstrated high internal consistency reliability (.83-.96) and the factors demonstrated divergent and convergent validity when correlated with standardized measures of relevant constructs, including depressive symptomatology, caregiving burden, and perceived social support (Marwit & Meuser, 2002). In a study with family caregivers of individuals with ABI, Marwit & Kaye (2006) demonstrated highly similar psychometric and validity properties, supporting both the internal consistency reliability of an ABI-modified version of the MM-CGI and its factors (.90-.96), and the relative independence of each factor within a brain injury population.<sup>29</sup> In the present investigation, Chronbach`s alpha for the Heartfelt Sadness and Longing scale was .93.

*Center for Epidemiologic Studies Depression Scale (CES-D)*

The CES-D (Radloff, 1977) is a 20-item scale designed to measure current level of depressive symptomatology, with emphasis on the affective component, depressed mood. Respondents rate the frequency of symptoms over the previous week. Responses are recorded along a 4-point Likert-type scale ranging from *rarely or none of the time* (0) to *most or all of the time* (3). The possible range of scores is zero to 60, with higher scores indicating more depressive symptoms. The standard cutoff score for clinically relevant depressive symptoms among adult community samples is 16 (Radloff & Teri, 1986), with scores of 16 to 26 and scores of 27 or more considered indicative of mild and moderate to severe depressive symptomatology, respectively (Zich, Attkisson, & Greenfield, 1990).

---

<sup>29</sup> Only minor modifications were required to adapt the scale to the ABI caregiver population: In four instances, the word ‘disease’ was replaced with either ‘brain injury’ or ‘injury’ (Marwit & Kaye, 2006).

High degrees of internal consistency for the CES-D total score have been demonstrated across age, gender, and ethnicity in community, psychiatric, and medical samples with Cronbach alpha coefficients ranging from .85 to .90 (e.g., Radloff, 1977; Roberts, 1980; Thombs et al., 2005). A meta-analysis of reliability of the CES-D among caregiver respondents found an average Cronbach's alpha of .88 (O'Rourke, 2004). Criterion validity for the CES-D has been established in several studies investigating the sensitivity and specificity of the measure relative to depression spectrum disorder diagnosis on clinical interview using DSM-III-R and DSM-IV criteria (e.g., Beekman, Deeg, Van Limbeek, Braam, De Vries, & Van Tilburg, 1997; Haringsma et al., 2004; Vázquez, Blanco, & López, 2007). The internal reliability coefficient for the present sample was .92.

#### *Zarit Burden Interview – Short Form (ZBI-S)*

In line with the conceptualization of perceived caregiving burden discussed above, Zarit and colleagues developed the Zarit Burden Interview (ZBI; Zarit, Orr, & Zarit, 1985; Zarit, Reever, & Bach-Peterson, 1980) to assess the negative impact of the provision of care upon caregiver emotional health, physical health, social life, and financial status as perceived by the caregiver (Zarit, Todd, & Zarit, 1986). Subjective or perceived caregiving burden was assessed in the current study via the ZBI-S (Bédard et al., 2001), an abbreviated version of the ZBI. The ZBI-S is a 12-item measure that requires respondents to rate their perceived level of caregiving burden in terms of frequency of stress experiences secondary to care provision along a 5-point Likert-type scale. Response options range from *never* (0) to *nearly always* (4), yielding a range of possible scores of zero to 88, with higher total scores reflecting greater burden.

In large-scale informal caregiver samples, the ZBI-S has demonstrated acceptable internal consistency reliability with alpha coefficients ranging from .85 (O'Rourke & Tuokko, 2003) to .88 (Bédard et al., 2001). The internal reliability coefficient for the ZBI in the current study was .89.

*Satisfaction with Life Scale (SWLS)*

Caregiver life satisfaction, or quality of life, was assessed using the SWLS (Diener, Emmons, Larsen & Griffin, 1985), a self-report measure that requires respondents to indicate their level of agreement with five life satisfaction statements on a 7-point Likert-type scale from *strongly disagree* (1) to *strongly agree* (7). The possible range of SWLS scores is 5 (low satisfaction) to 35 (high satisfaction). Diener et al. (1985) adopt the following definition of life satisfaction: “a global assessment of a person’s quality of life according to *his [her]* chosen criteria” (Shin & Johnson, 1978, p. 478, emphasis added). Consequently, the SWLS, unlike other quality of life scales, contains items that are global rather than specific in nature, leaving respondents free to weight various domains of their life in terms of their own values, in arriving at an overall judgment of life quality (Pavot & Diener, 1993a).

In the original validation sample of undergraduate students, the Cronbach’s alpha for the SWLS was .87 (Diener et al., 1985). Internal consistency of the scale among a sample of TBI caregivers was adequate (alpha coefficient = .72; Ergh et al., 2003). In the current study, internal reliability was high (alpha coefficient = .92). Classification of the percent of study participants exceeding a normative cutoff was based on data from Pavot and Diener (1993b) using a *T* score of less than 40 (i.e., a score more than one standard deviation below the normative sample mean).

### *Control Variables*

#### *Preinjury Relationship Quality*

To the extent that TBI results in family member appraisal of loss of aspects of their relationship with the TBI survivor, it was anticipated that premorbid caregiver-care recipient relationship quality would influence said appraisal and, in turn, level of caregiver grief experience. Therefore quality of the dyadic relationship prior to injury was assessed so that it could be controlled for as necessary in statistical analyses of potential grief predictor variables.

Extant measures of relationship quality ask for ratings of current relationships and invariably are designed with individuals in romantic dyads in mind (e.g., Norton, 1983; Spanier, 1976). Thus a new five-item scale was developed to assess quality of the caregiver-care recipient relationship prior to injury onset (see Appendix B). Following review of several existing instruments (Relationship Assessment Scale, Hendrick, 1988; Quality of Relationships Inventory, Pierce, Sarason, & Sarason, 1991; Intimacy Scale, Walker & Thompson, 1983; and the Mutual Communal Behaviors Scale, Williamson & Schulz, 1995), items were designed to measure core aspects of the construct of relationship quality including the extent to which the relationship was perceived to be favourable/good, mutually supportive, characterized by emotional closeness or intimacy, characterized by positive roles, and satisfying. Participants were asked to indicate their level of agreement with each of the five preinjury relationship quality statements on an 8-point Likert-type scale ranging from *strongly disagree* (1) to *strongly agree* (8). The possible range of scores for this measure is 5 to 40 with higher scores indicating better

perceived premorbid relationship quality. The internal consistency reliability for the scale was high (alpha coefficient = .94).

*Preinjury History of Depressive Symptomatology*

Extrapolating from findings regarding the impact of premorbid psychiatric history on other forms of psychological distress among TBI family caregivers (e.g., Davis et al., 2009; Gillen et al., 1998), prior history of depressive symptomatology may represent a preinjury risk factor for poorer adjustment to potential TBI-related loss experience among family members. Therefore a positive prior history in this regard may be related to higher levels of family member grief. In turn, preinjury history of depressive symptoms was assessed so that this factor could be controlled for as necessary in statistical analyses of potential grief predictor variables. The operationalization of this variable was based upon core components of DSM-IV-TR (American Psychiatric Association, 2000) criteria for a depressive episode: “Prior to you family member’s TBI, did you ever have a time in your life lasting two weeks or more when most of the day, nearly every day, you felt depressed (e.g., sad or empty); or when you lost interest in most things like work, hobbies, or things you usually liked to do for fun?”

*Positive and Negative Affect Schedule (PANAS)*

In order to control for the potential influence of a global response set secondary to individual differences in trait affectivity, caregiver positive affectivity was assessed via the PANAS (Watson, Clark, & Tellegen, 1988). The version of the PANAS employed requires respondents to rate the extent to which they generally experience 20 different affective states (10 are positive, 10 are negative) using a 5-point Likert-type scale ranging from *very slightly* (1) to *extremely* (5), generating estimates of both positive and negative affectivity (possible Positive Affect score range: 10 to 50). In the original validation

sample, internal consistency estimates were high for both positive affectivity (alpha coefficient range: .86-.90) and negative affectivity (alpha coefficient range: .84-.87), with demonstrable convergent and divergent validity for both constructs (Watson, Clark, & Tellegan, 1988). The Positive Affect scale internal consistency estimate for the current sample was .89.

### Procedure

The study procedures, including informed consent, were approved by the University of Windsor Research Ethics Board. Caregivers were recruited from a number of brain injury support organizations, including provincial and county/city affiliates of the Brain Injury Association of Canada (BIAC), state and county/city affiliates of the Brain Injury Association of America (BIAA), state affiliates of the United States Brain Injury Alliance (USBIA), and branches of Headway in both the United Kingdom and South Africa (see Appendix C for a list of participating organizations). Following approval from organization boards of directors and/or executive administrators, study recruitment materials were distributed via brain injury caregiver support group leaders and by organization emails to registered members. Recruitment materials were also included in organization newsletters and physically placed in organization support centres. All recruitment materials included a brief description of the nature of the research, inclusion criteria, anticipated time commitment, information regarding reimbursement for participation (an electronic gift certificate), and instructions to TBI caregivers interested in participation to contact the primary investigator via email. Following a screening procedure conducted via email to confirm all inclusion criteria were met, a follow-up email containing a URL link to the online questionnaire and a unique randomly generated

code to access the questionnaire was sent by the primary investigator to each eligible family TBI caregiver. Individuals who agreed to participate after accessing the questionnaire completed an electronic informed consent procedure approved by the University of Windsor Research Ethics Board. Following completion of the questionnaire, caregivers were asked to create and enter an alpha-numeric study completion code. After this code was entered and questionnaire responses submitted, participants were automatically redirected to a gift card selection page located on a separate URL. Here participants were requested to submit their study completion code together with their e-mail addresses and gift card selection in order to receive an electronic gift certificate for their time and contribution within 7 days of data submission. Participants were subsequently automatically redirected to an online debriefing form and a resource list for persons with TBI and their family members developed by the primary investigator. The debriefing form contained a brief review of research regarding adjustment outcomes and related psychological distress among family members of persons with TBI, and encouraged participants to seek counselling services if they were experiencing distress and felt they were in need of support. The resource list (please see Appendix D) included the contact details of agencies and organizations that provide counselling and other support services or referrals to such services, as well as the contact details of brain injury support organizations for each country in which recruitment took place. The resource page also provided a list of publications designed to help caregivers better understand TBI and aid adjustment to the issues that may arise from it. Associated publication URL links were provided as applicable. Of a total of 138 eligible TBI family caregivers who were provided study access codes, 14 (10.1%) subsequently either opted



not to participate or did not complete the questionnaire. Twenty-two individuals who expressed interest in participation were declined entry into the study as they did not meet all inclusion criteria; 16 of these were providing care for a person with a non-traumatic form of acquired brain injury, three were caregivers of a friend with TBI, two were providing care for a survivor with a pre-TBI history of another neurological condition, and one caregiver only established a relationship with their relative after the TBI was sustained.

### Data Analysis

Following data screening procedures for entry errors and removal of one participant's questionnaire response set given a lack of response for all 24 items of a measurement scale, a missing data analysis was conducted. Little's MCAR test indicated that the pattern of missing values for the remaining 123 questionnaire response sets was not dependent on the observed data ( $p > .05$ ), i.e., that data missing completely at random may be inferred (Tabachnick & Fidell, 2007). Using deterministic regression imputation with an added error component, 138 data points (0.41% of the total data set) were imputed. All variables were screened for violations of assumptions associated with multivariate analyses. Results of this evaluation revealed the distributions of annual household income, time since injury, caregiver perceived decline in receptive language, and CESD scores to be positively skewed. The distributions of preinjury relationship quality, caregiver perceived decline in memory, and SPS scores were negatively skewed. A square root transformation was used on annual income, receptive language decline, memory decline, CESD, and SPS scores. Logarithmic transformations were applied to time since injury and preinjury relationship quality data. For negatively skewed

measures the transformation was performed following reversal with a subsequent second reflection of scores. Normality tests demonstrated these procedures to be effective (Tabachnick & Fidell, 2007). For purposes of interpretation, the untransformed values are used when reporting descriptive statistics, whereas the transformed scores were entered into statistical analyses. For participants residing outside the United States annual household income was converted to U.S. dollars using 2012 *purchasing power parity conversion factors* for private consumption (World Bank, 2013).<sup>30</sup>

No univariate outliers ( $z > 3.0$ ), multivariate outliers (Mahalanobis distance  $p < .001$ ), or influential observations (Cook's distance  $> 1$ ) were identified. Examination of plots of standardized residuals versus predicted values did not suggest any violations of assumptions of normality, linearity, or homoscedasticity. Obtained variance inflation factor, tolerance, conditioning index, and variance proportion values were well below recommended levels for variable exclusion and suggested the absence of multicollinearity (Stevens, 2002; Tabachnick & Fidell, 2007). To ensure adequate power and to minimise the potential for overfitting models, a conservative n-to-k (cases to variables) ratio of at least 9:1 was maintained in all multivariate analyses (Tabachnick & Fidell, 2007). Alpha level was set at .05.

Descriptive statistics for all relevant variables were calculated to describe the characteristics of the study population. Before examination of zero-order Pearson correlations to assess proposed associations between the core predictor variables of interest and caregiver grief experience, relationships between family member grief and

---

<sup>30</sup> A purchasing power parity conversion factor is the number of units of a country's currency required to buy the same amounts of goods and services in the domestic market as a U.S. dollar would buy in the United States. A conversion factor for private consumption is calculated to reflect household final consumption expenditure.

caregiver demographic variables of interest and control variables were evaluated by ANOVA and correlation analysis for categorical and continuous variables, respectively.

Subsequently, a further five sets of primary analyses were conducted. First, an ordinary least-squares (OLS) hierarchical multiple regression analysis was performed to determine the direct influence on family caregiver grief of the key variables of interest of perceived personality system change, perceived social support, and meaning reconstruction. To be controlled statistically, preinjury control and demographic variables significantly associated with family member grief in univariate analyses were entered in the first block of the model. In addition to personality system change, social support, and meaning reconstruction indices, injury-related variables demonstrated to be significantly related to grief outcome in correlation analysis were entered in the second block. Beta weights, squared semipartial correlations, and change in  $R^2$  value at the second step were examined to assess the significance of each predictor, the unique, non-overlapping variance in caregiver grief accounted for by each predictor, and the amount of variance in grief accounted for by the full model sans control and demographic variables, respectively.

Second, the relationships between caregiver grief and the more commonly investigated family member outcome variables of depressive symptomatology, caregiving burden, and life satisfaction were assessed via correlation analysis. Bivariate correlations between these additional outcome variables and the protective factors of perceived social support and meaning reconstruction were also investigated.

Moderation and mediation analyses were conducted using methods described and associated computational tools developed by Hayes and colleagues (Hayes, 2013; Hayes

& Matthews, 2009; Preacher & Hayes, 2004, 2008; Preacher, Rucker, & Hayes, 2007). These progressed in a series of steps, the details of which are described further in the results section. First, to assess if the effect of perceived personality system change on grief level was moderated by meaning reconstruction efforts a moderated OLS regression analysis was performed (Aiken & West, 1991; Hayes & Matthews, 2009). To test mediation hypotheses, the effect of perceived characterological change on (i) caregiver depressive symptoms and (ii) caregiver life satisfaction, both directly and indirectly through caregiver grief experience, was assessed using an OLS regression-based path analytic approach (Preacher & Hayes, 2004, 2008). Moderation and mediation results were then combined to form two moderated mediation models with conditional indirect effects estimated using conditional process analysis (Hayes, 2013; Preacher et al., 2007).

Clinical significance and/or relative magnitude/frequency of caregiver depressive symptomatology, life satisfaction, and grief were also evaluated, with comparisons made of the current sample statistics to normative data and to results observed among other family caregiver populations administered the MM-CGI, as available. The suitability of a MM-CGI HSL scale cut-score proposed by Marwit and Meuser (2002) to identify caregivers at risk of poorer adjustment within the current population was also assayed. Independent *t*, Mann-Whitney, and chi-square tests were used to examine differences between TBI caregivers with HSL scores above and below the proposed grief cutoff. Finally, a receiver operating characteristic analysis of the sensitivity and specificity of the proposed HSL cut-score was conducted with clinically significant depressive symptomatology used as the criterion.

## CHAPTER 4

## RESULTS

Descriptive statistics for demographic information and for the control, predictor, and outcome variables are presented in Table 2 and Table 3, respectively. For ease of reference, study hypotheses are presented in Table 4.

*Demographic and Injury Characteristics*

Participants ranged in age from 19 to 83 years old ( $M = 51.44$ ,  $SD = 12.98$ ). The sample was comprised of 105 women (85.4%) and 18 men (14.6%). The kinship of the caregivers to the persons with injury included 53 parents (43.1%), 41 spouses/romantic partners (33.3%), 14 children (11.4%), 13 siblings (10.6%), one grandmother, and one aunt. Level of education ranged from 9 to 22 years ( $M = 14.82$ ,  $SD = 2.32$ ). Forty caregivers resided in the United States (32.5%), 38 in the United Kingdom (30.9%), 32 in Canada (26%), and 13 in South Africa (10.6%). Participants identified themselves as Caucasian (97.6%), Asian (1.6%), and African American (.8%). Annual household income in U.S. dollars ranged from \$9,000 to \$208,000 ( $M = \$65,168$ ,  $SD = \$41,707$ ). Married persons (69.1%) constituted the majority of the caregivers.

Sixty-five percent of TBI care recipients were male ( $n = 80$ ). TBI survivors ranged in age from 9 to 76 years old ( $M = 41.0$ ,  $SD = 15.37$ ), with the majority identified as Caucasian (94.3%). Care recipient level of education ranged from 5 to 21 years ( $M = 13.36$ ,  $SD = 2.56$ ). Vehicular accidents were the primary cause of TBI (67.5%), followed by falls (20.3%), assault (5.7%), and sports injuries (4.1%). Injury severity was classified per caregiver report of length of loss of consciousness. Seventy-eight percent of care-recipients had sustained severe injuries ( $n = 96$ ), 18.7% moderate injuries ( $n = 23$ ), and

3.3% mild injuries (n = 4). Average time since injury was 10.45 years (SD = 9.33), with a range of 6 months to 44 years.

Table 2  
*Descriptive Statistics: Demographic characteristics*

Variable	Caregiver					Care Recipient				
	n	%	M	SD	Range	n	%	M	SD	Range
Age			51.44	12.98	19-83			41.0	15.36	9-76
Sex										
Female	105	85.4				43	35.0			
Male	18	14.6				80	65.0			
Kinship to survivor										
Parent	53	43.1								
Spouse/Partner	41	33.3								
Child	14	11.4								
Sibling	13	10.6								
Other	2	1.6								
Years of education			14.82	2.32	9-22			13.36	2.56	5-21
Country of residence										
United States	40	32.5								
United Kingdom	38	30.9								
Canada	32	26								
South Africa	13	10.6								
Race/ethnicity										
Caucasian	120	97.6				116	94.3			
Asian	2	1.6				2	1.6			
African American	1	0.8				1	0.8			
Hispanic						2	1.6			
Native American						1	0.8			
Turkish Cypriot						1	0.8			
Household income per annum (USD)†			65168	41707	9000-208000					
Marital status										
Single	12	9.8								
Married	85	69.1								
Living with partner	5	4.1								
Divorced	14	11.4								
Separated	1	0.8								
Widowed	6	4.9								

Note. † For participants residing outside the United States income was converted to U.S. dollars using 2012 purchasing power parity conversion factors for private consumption (World Bank, 2013).

Table 3  
*Descriptive Statistics: Control, Predictor, and Outcome Variables*

Variable	n	%	M	SD	Range
Preinjury relationship quality			34.04	6.73	10-40
Preinjury depressive symptoms					
No	101	82.1			
Yes	22	17.9			
PANAS Positive Affect			33.57	7.57	13-49
PPSC			21.84	7.84	4-42
SPS			45.48	7.78	22-60
Sense-making			5.83	2.59	1-9
Benefit-finding			5.08	2.67	1-9
Receptive language <sup>†</sup>			3.76	2.42	1-9
Expressive language <sup>†</sup>			5.02	2.76	1-9
Emotion identification <sup>†</sup>			5.42	2.43	1-9
Theory of mind <sup>†</sup>			6.35	2.20	1-9
Memory <sup>†</sup>			6.97	1.92	1-9
Physical self-care <sup>†</sup>			5.59	2.68	1-9
MM-CGI HSL			47.07	13.04	17-72
CES-D			17.03	11.69	0-47
ZBI-S			23.32	9.16	5-46
SWLS			18.38	8.14	5-35

*Note.* PANAS = Positive and Negative Affect Scale; PPSC = perceived personality system change (NBAP composite change score); SPS = Social Provisions Scale; MM-CGI HSL = Marwit-Meuser Caregiver Grief Inventory Heartfelt Sadness and Longing; CES-D = Center for Epidemiologic Studies Depression Scale; ZBI-S = Zarit Burden Interview – Short Form; SWLS = Satisfaction with Life Scale.

<sup>†</sup> perceived caregiver decline in respective domain.

#### *Relation between Caregiver Grief and Caregiver Demographic and Control Variables*

Neither caregiver gender ( $F_{1, 121} = .05, p = .820$ ) nor kin relationship to the survivor (grouped as parent, spouse, or other;  $F_{2, 120} = .856, p = .427$ ) was related to grief experience. Of the continuous caregiver demographic variables assessed, i.e., age, education level, and annual household income (adjusted to reflect purchase power parity), only annual household income was negatively correlated with caregiver grief ( $r = -.19, p = .039$ ). Subsequent analyses controlled for this variable as appropriate.

Table 4  
*Summary of Study Hypotheses*

Hypothesis
1a. Perceived survivor personality change will display a positive correlation with caregiver grief.
1b. Perceived survivor personality change will be a unique positive predictor of grief.
2a. Perceived social support will show at most a weak negative correlation with grief.
2b. Perceived social support will not be a unique predictor of grief.
3a. Both sense-making and benefit-finding will display a negative correlation with grief.
3b. Sense-making and benefit-finding will each be a unique negative predictor of grief.
3c. Both sense-making and benefit-finding will moderate the impact of perceived personality change on grief. Specifically the positive relation between perceived characterological change and grief will be stronger among caregivers who report lower levels of each form of meaning-making.
4. Time since injury will not display a negative correlation with grief.
5a. Perceived declines in survivor receptive and expressive language, emotion identification, as well as theory of mind capacity will display positive correlations with grief.
5b. Perceived declines in the cognitive domains indicated in H5a will be unique positive predictors of grief.
6. Perceived decline in survivor memory functioning will not be correlated with grief.
7. Perceived decline in survivor physical ability to independently provide self-care will not be correlated with grief.
8. Caregiver grief will display a modest positive correlation with carer depressive symptomatology.
9. Caregiver grief will be positively correlated with perceived caregiving burden.
10. Caregiver grief will be negatively correlated with carer life satisfaction.
11. Perceived social support will display a negative correlation with depressive symptoms.
12. Perceived social support will be negatively correlated with caregiving burden.
13. Perceived social support will be positively correlated with life satisfaction.
14. Both sense-making and benefit-finding will display a negative correlation with depressive symptoms.
15. Sense-making and benefit-finding will each be inversely correlated with caregiving burden.
16. Both meaning-making processes will be positively correlated with life satisfaction.
17. Caregiver grief will mediate the relationship between perceived personality change and carer depressive symptomatology.
18. Caregiver grief will mediate the relationship between perceived characterological change and carer satisfaction with life.
19. The mediated effect proposed in H17 will be conditional on the extent of meaning-making. Specifically, the indirect effect of perceived personality change on depressive symptom level through grief will be larger for those caregivers reporting lower levels of meaning reconstruction.
20. The mediated effect anticipated in H18 will be conditional on the extent of meaning-making. Specifically, the indirect effect of perceived personality change on life satisfaction through grief will be greater for those caregivers reporting lower levels of meaning reconstruction.



With regard to the proposed control variables, as anticipated PANAS Positive Affect (PA), measured to operate as a control for the potential confound of global response set, was negatively correlated with grief experience ( $r = -.52, p < .001$ ). Also as expected, preinjury quality of the survivor-caregiver relationship ( $r = .184, p = .042$ ) and caregiver history positive for experience of depressive symptoms prior to the TBI ( $F_{1, 121} = 4.30, p = .040$ ) were both associated with higher grief scores.

*Correlates of Caregiver Grief: Key Variables of Interest*

As shown in Table 5, in line with expectation, perceived personality system change (PPSC; NBAP composite change score) displayed a strong positive relationship with grief experience ( $r = .50, p < .001$ ) (Hypothesis 1a). Contrary to Hypothesis 2a, a moderate negative relationship was observed between perceived social support (SPS) and grief level ( $r = -.38, p < .001$ ). In line with Hypothesis 3a, sense-making ( $r = -.33, p < .001$ ) and benefit-finding ( $r = -.57, p < .001$ ) showed moderate and large inverse relationships, respectively, with grief. Time since survivor injury, as predicted, was not associated with caregiver grief scores (Hypothesis 4). As anticipated, perceived decline in survivor receptive language ( $r = .36, p < .001$ ), expressive language ( $r = .35, p < .001$ ), emotion identification ( $r = .35, p < .001$ ), and theory of mind capacity ( $r = .32, p < .001$ ) displayed modest positive relationships with grief (Hypothesis 5a). In contrast, perceived decline in care-recipient memory function was not associated with higher grief levels (Hypothesis 6). Hypothesis 7 was not supported; although small, a positive relation between perceived decline in survivor physical capacity for independent self-care and caregiver grief was observed ( $r = .18, p < .05$ ).

Table 5  
Bivariate Correlations

	1	2	3	4	5	6	7	8	9	10	11	12
1. MM-CGI HSL												
2. PPSC	.50***											
3. SPS	-.38***	-.27**										
4. Sense-making	-.33***	-.12	.06									
5. Benefit-finding	-.57***	-.32***	.23*	.38***								
6. Time since injury	-.02	.12	-.01	-.02	.08							
7. Receptive language <sup>†</sup>	.36***	.35***	-.08	-.31**	-.23*	.01						
8. Expressive language <sup>†</sup>	.35***	.21**	-.14	-.25**	-.22*	.10	.59***					
9. Emotion identification <sup>†</sup>	.35***	.54***	-.15	-.19*	-.29**	.12	.39***	.40***				
10. Theory of mind <sup>†</sup>	.32***	.44***	-.13	-.13	-.21*	.15	.43***	.43***	.73***			
11. Memory <sup>†</sup>	.09	.35***	-.04	-.05	-.04	.21*	.39***	.26**	.33***	.47***		
12. Physical self-care <sup>†</sup>	.18*	.20*	-.07	-.07	-.07	.17	.24**	.46***	.25**	.25**	.15	

Note. MM-CGI HSL = Marwit-Meuser Caregiver Grief Inventory Heartfelt Sadness and Longing; PPSC = perceived personality system change (NBAP composite change score); SPS = Social Provisions Scale.

<sup>†</sup> perceived caregiver decline in respective domain.

\* $p < .05$  \*\* $p < .01$  \*\*\* $p < .001$ .

*Prediction of Caregiver Grief*

Table 6 presents the results of the hierarchical regression analysis, which examined predictors of grief experience. In the first step, the control variables of preinjury relationship quality, premorbid history of depressive symptoms, and PANAS PA were entered into the model together with annual household income. This block accounted for 30% of the variance in caregiver grief ( $R^2 = .30$ ,  $F_{4, 118} = 12.91$ ,  $p < .001$ ). In the second step, perceived characterological change (NBAP change score), perceived social support (SPS), sense-making, benefit-finding, perceived decline in survivor linguistic functioning (composite score of decline in receptive and expressive language ability), perceived decline in survivor social cognition (composite score of decline in emotion identification and ToM capacity), and perceived decline in care-recipient physical self-care accounted for an additional 27% of variance ( $R^2_{\text{change}} = .27$ ,  $F_{\text{change } 7, 111} = 9.78$ ,  $p < .001$ ). Thus, the full model accounted for 57% of variance in caregiver grief ( $R^2 = .57$ ,  $F_{11, 111} = 13.36$ ,  $p < .001$ ).

As anticipated, perceived personality system change was a significant individual predictor of grief level in the final model ( $\beta = .25$ ,  $p = .002$ ), accounting for 4% of unique, non-overlapping variance in grief experience ( $sr^2 = .04$ ) (Hypothesis 1b). Contrary to Hypothesis 2b, formulated within the attachment grief framework, perceived social support also emerged as a significant predictor ( $\beta = -.15$ ,  $p = .041$ ), contributing 2% unique variance to the overall regression outcome ( $sr^2 = .02$ ). Hypothesis 3b was partially supported; of the two meaning-making processes assessed, only benefit-finding was found to be a significant predictor in the full model ( $\beta = -.29$ ,  $p < .001$ ), accounting for 6% of unique variance in caregiver grief ( $sr^2 = .06$ ).

Table 6  
*Hierarchical Multiple Regression Analysis: Caregiver Grief*

Variable	$R^2$	$F$	df	$b$	$\beta$	$p$	$sr^2$	$R^2_{\text{change}}$	Sig. $F_{\text{change}}$
<i>Block 1</i>	.30	12.91	4, 118			.000			
Preinjury relationship quality				2.32	.08	.238	.01		
Preinjury depressive symp.				5.01	.15	.025	.02		
PANAS PA				-.33	-.19	.016	.02		
Annual household income				-.00	-.01	.933	.00		
<i>Block 2</i>	.57	13.36	11, 111			.000		.27	.000
PPSC				.41	.25	.002	.04		
SPS				-1.84	-.15	.041	.02		
Sense-making				-.60	-.12	.095	.01		
Benefit-finding				-1.40	-.29	.000	.06		
Language decline				.34	.12	.132	.01		
Social cognition decline				.03	.01	.901	.00		
Physical self-care decline				.19	.04	.587	.00		

*Note.* PANAS PA = PANAS Positive Affect; PPSC = perceived personality system change; SPS = Social Provisions Scale.

Contrary to Hypothesis 5b, caregiver perceived decline in care-recipient linguistic functioning ( $\beta = .12, p = .132$ ) and social cognition ( $\beta = .01, p = .901$ ) were not significant individual predictors of grief. Perceived decline in survivor capacity for independent physical self-care also did not contribute uniquely to grief prediction in the full model ( $\beta = .04, p = .587$ ). Caregiver preinjury history of depressive symptoms was a significant predictor in the final model ( $\beta = .15, p = .025$ ), accounting for 2% of unique variance in grief scores.

#### *Relationships between Caregiver Grief and other Indices of Caregiver Outcome*

Caregiver depressive symptomatology (CES-D) scores showed a positive relationship with caregiver grief ( $r = .71, p < .001$ ). This association was slightly larger than anticipated (Hypothesis 8) but is similar in magnitude to that observed in other caregiver studies in which the MM-CGI was used (e.g., Marwit et al., 2008). As

expected, caregiver grief was also strongly associated with higher levels of perceived caregiving burden (ZBI-S;  $r = .65, p < .001$ ) (Hypothesis 9).<sup>31</sup> In line with Hypothesis 10, a strong inverse relationship was found between grief scores and family member life satisfaction (SWLS;  $r = -.59, p < .001$ ).

Concordant with expectation, a higher degree of caregiver perceived social support was associated with lower levels of depressive symptoms ( $r = -.43, p < .001$ ) and perceived caregiving burden ( $r = -.38, p < .001$ ), and higher life satisfaction ( $r = .51, p < .001$ ) (Hypotheses 11 - 13). Both sense-making and benefit-finding, as predicted, showed inverse associations with caregiver depressive symptomatology (Hypothesis 14). As observed in the case of caregiver grief, benefit-finding was found to have a greater ameliorative impact on depressive symptoms ( $r = -.49, p < .001$ ) compared to the more modest negative relation found for sense-making ( $r = -.20; p < .05$ ). Hypothesis 15 was partially supported; only benefit-finding was associated with lower perceived caregiving burden, with a moderate inverse relation observed ( $r = -.40, p < .001$ ). With respect to Hypothesis 16, while more successful efforts in both forms of meaning reconstruction were associated with higher life satisfaction, a stronger relationship was again found for benefit-finding ( $r = .45, p < .001$ ) vis-à-vis sense-making ( $r = .20, p < .05$ ).

---

<sup>31</sup> As noted, perceived caregiving burden is defined as the subjective perceptions by the caregiver of negative personal experience (including emotional distress, demoralization, and poor physical health) that is attributed directly to caregiving.

*Moderation of the Effect of Perceived Personality System Change on Caregiver Grief by Benefit-Finding*

A core aim of the investigation was to assess whether the meaning-making processes under consideration moderate the effect of perceived personality system change (PPSC) on family member grief experience (Hypothesis 3c). As sense-making was not a unique predictor of caregiver grief, only benefit-finding was subject to moderation analysis. This was achieved by estimation of an OLS regression moderation model (Model 1) predicting grief from PPSC, benefit-finding, and their product, with the preinjury and demographic control variables of PANAS PA, preinjury relationship quality, preinjury history of depressive symptoms, and annual household income included as covariates:

$$\text{Caregiver grief} = \text{constant} + a_1(\text{PPSC}) + a_2(\text{benefit-finding}) + a_3(\text{PPSC} \times \text{benefit-finding}) + \text{covariates} + \text{error} \quad (1)^{32}$$

Model 1 is depicted as a conceptual and statistical path diagram in panels A and B, respectively, in Figure 2. The results of the regression analysis are presented in Table 7. Most pertinent is the coefficient for the interaction, which is positive and significant ( $a_3 = .09, p = .027$ ). Thus, as predicted by Hypothesis 3c, the effect of perceived characterological change on caregiver grief was dependent on level of benefit-finding.

---

<sup>32</sup> Though not mathematically necessary, perceived personality change and benefit-finding scores were mean centred prior to the computation of the product term so as to render regression coefficients for these variables that would be interpretable within the range of the data.

The interaction accounted for 2% of unique variance in grief level ( $R^2_{\text{change}} = .02$ ,  $F_{\text{change } 1, 115} = 5.01$ ,  $p = .027$ ).<sup>33</sup>

To further understand the nature of this moderation, conditional effects of PPSC on grief were estimated using the traditional “pick-a-point” approach (Preacher, Curran, & Bauer, 2006; Hayes & Matthews, 2009), with the sample mean, and plus one standard deviation from the mean, and minus one standard deviation from the mean, representing

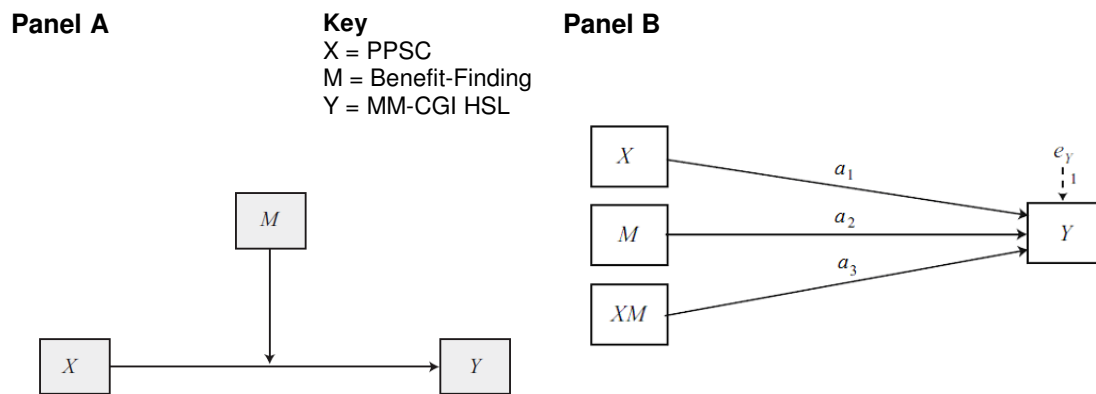

Figure 2. Conceptual (panel A) and statistical path (panel B) diagrams for simple moderation analysis (Model 1).

Table 7  
 Regression Results for Model 1: Moderation of the Relationship between PPSC and Grief by Benefit-Finding

Variable	$R^2$	$F$	df	Coeff.	SE	$p$
	.54	19.21	7, 115			.000
PPSC				.47	.12	.000
BF				-1.76	.36	.000
PPSC × BF				.09	.04	.027

Note. PPSC = perceived personality system change; BF = benefit-finding. PANAS PA, preinjury relationship quality, preinjury history of depressive symptoms, and annual household income were included as covariates, but their coefficients are not presented here. Unstandardized effects are reported as these are the standard metric in conditional path analysis.

<sup>33</sup> Simultaneous variable entry was employed to build the regression model.  $R^2_{\text{change}}$  was computed using the formula  $t_{b3}^2(1 - R^2) / df_{\text{residual}}$ .

“moderate,” “high,” and “low” levels of benefit-finding, respectively. As can be seen in Table 8, PPSC was positively related to caregiver grief at moderate and high ( $p < .001$ ), but not at low ( $p = .176$ ) levels of benefit-finding, with the effect increasing in size as benefit-finding increased. Thus, Hypothesis 3c was supported in part; although evidence of moderation was found a stronger relationship between perceived characterological change and grief was predicted among caregivers reporting lower rather than higher levels of meaning reconstruction.

Examination of the simple slopes for the conditional effects depicted in Figure 3 shows that the unanticipated finding of a relationship between PPSC and grief only at moderate and high levels of benefit-finding emerged as a result of grief levels being uniformly high at all levels of perceived characterological change among those caregivers reporting low benefit-finding. In other words, benefit-finding had a protective effect only for those family members who achieved moderate to high degrees of this form of meaning reconstruction; for these caregivers decreases in PPSC resulted in statistically significant decreases in grief. In contrast, in the low benefit-finding condition no association emerged between perceived characterological change and grief as the

Table 8  
*Conditional Effects of PPSC on Grief at Levels of Benefit-Finding*

Benefit-finding	Point estimate	SE	p	95% CI Limit	
				Lower	Upper
Low (- 1 SD; 2.40)	.23	.17	.176	-.11	.57
Moderate (Mean; 5.08)	.47	.12	.000	.23	.70
High (+ 1 SD, 7.75)	.70	.15	.000	.41	.99

*Note.* Benefit-finding values reported are before mean centering. Unstandardized effects are reported.



latter was high irrespective of the extent of PPSC. At this level of benefit-finding even low levels of interpersonal loss experience in the form of PPSC led to relatively high levels of grief. Figure 3 also shows that at all levels of PPSC the high level of benefit-finding was associated with the lowest levels of caregiver grief, with the unexpected increase in the strength of the PPSC and grief relationship observed secondary to the protective effect of benefit-finding being greatest at low levels of perceived characterological change.

Although the “pick-a-point” approach is a broadly useful interpretational tool, it has an important limitation: it requires essentially arbitrary values of the moderator to be selected with different choices in this regard potentially leading to different claims (Bauer & Curran, 2005). Therefore the interaction between PPSC and benefit-finding was probed further using the Johnson-Neyman technique (Bauer & Curran, 2005; Preacher et

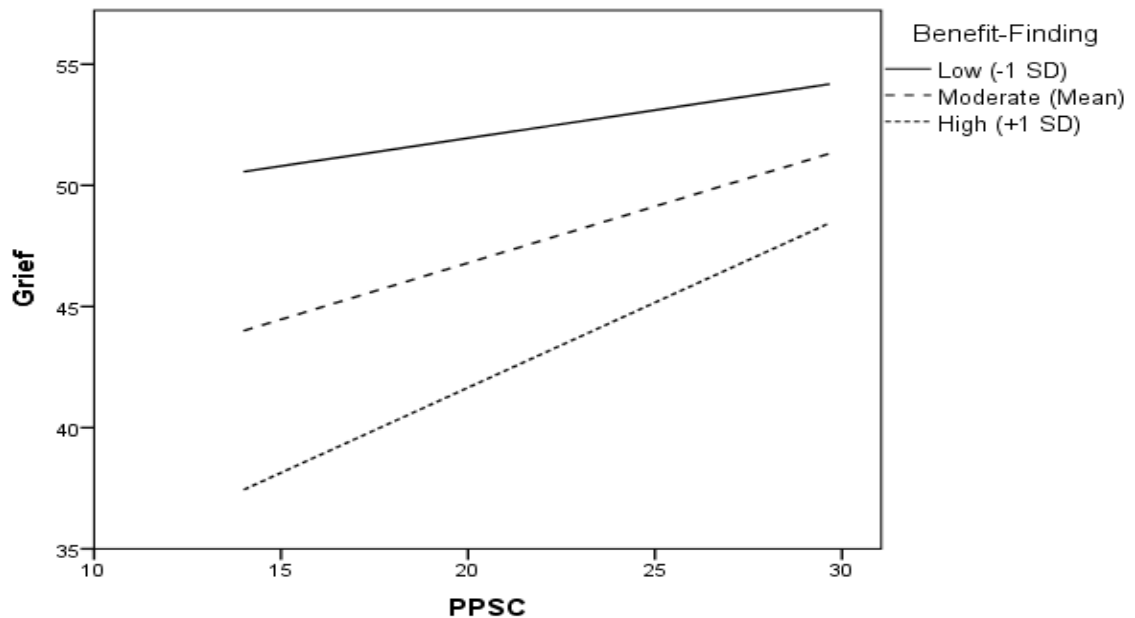

Figure 3. Moderation of the effect of PPSC on grief by level of benefit-finding.

al., 2006). This procedure mathematically derives the *region/s of significance* for the conditional effect of the predictor, i.e., the values within the range of the moderator in which the association between the predictor and outcome is statistically different from zero.<sup>34</sup> Figure 4 plots the conditional effect of PPSC on caregiver grief across the distribution of benefit-finding as well as the upper and lower bounds of a 95 percent confidence interval (the dashed lines) for the effect (note. the parameter estimates from Model 1 define the slope of the point estimate:  $a_1 + a_3 \times \text{benefit-finding} = .47 + .09 \times \text{benefit-finding}$ ; Aiken & West, 1991; Hayes & Matthews, 2009). The points at which the confidence interval is wholly below or above zero define the region of significance. As can be seen, the benefit-finding value defining the region of significance is 3.15 with 34 percent of observed scores in the sample falling below this value. Thus, benefit-finding had a protective effect with respect to the impact of PPSC on grief for those caregivers above the 34<sup>th</sup> percentile of this form of meaning reconstruction; at lower levels of benefit-finding, as noted, caregivers reported grief levels that were uniformly high regardless of the magnitude of interpersonal loss experience in the form of perceived characterological change.

---

<sup>34</sup> The Johnson-Neyman approach may be seen as a refinement/extension of simple slopes analysis in that it affords greater precision and sensitivity: It allows one to directly identify points in the range of the moderator variable where the effect of the predictor on the outcome transitions from being statistically significant to nonsignificant by finding the value of the moderator variable for which the ratio of the conditional effect to its standard error is equal to the critical *t* score.

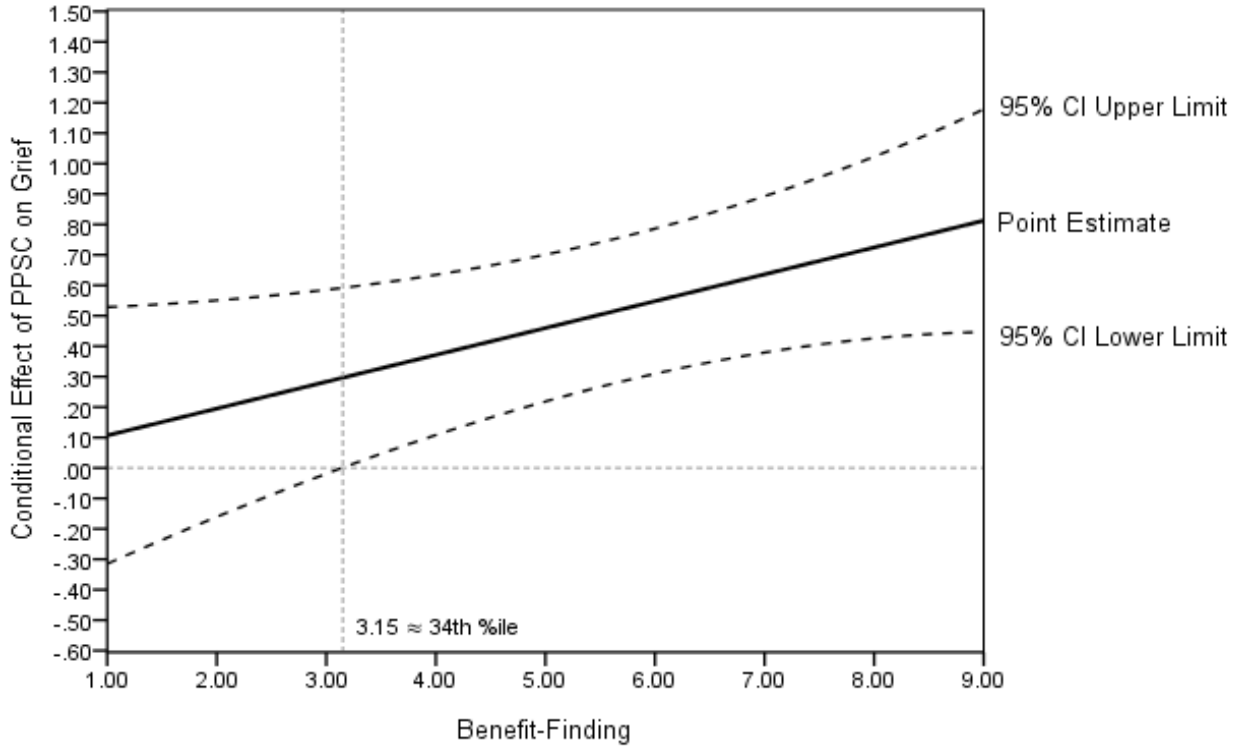

Figure 4. Johnson-Neyman region of significance for the conditional effect of PPSC at values of benefit-finding.

*Moderated Moderation Analysis*

As perceived social support was found to be a unique predictor of caregiver grief experience, the possibility of social support moderating the relationship between PPSC and grief level, both independently (a simple moderation model, Model 2) and in interaction with benefit-finding (a moderated moderation model, Model 3), was assessed:

$$\text{Caregiver grief} = \text{constant} + a_1(\text{PPSC}) + a_2(\text{social support}) + a_3(\text{PPSC} \times \text{social support}) \\ + \text{covariates} + \text{error} \quad (2)$$

$$\text{Caregiver grief} = \text{constant} + a_1(\text{PPSC}) + a_2(\text{benefit-finding}) + a_3(\text{social support}) \\ + a_4(\text{PPSC} \times \text{benefit-finding}) + a_5(\text{PPSC} \times \text{social support}) \\ + a_6(\text{benefit-finding} \times \text{social support}) + a_7(\text{PPSC} \times \text{benefit-finding} \times \text{social support}) \\ + \text{covariates} + \text{error} \quad (3)$$

Model 3 is depicted as a conceptual and a statistical path diagram in Figure 5.

Although social support was not found to be an independent moderator of the association between PPSC and grief (two-way interaction term  $p = .120$ ; see Table 9), results of the moderated moderation analysis yielded a significant three-way interaction between PPSC, benefit-finding, and social support ( $p = .016$ ; see Table 10). This term contributed significantly to the explained variance in caregiver grief, after accounting for all two-way interactions, each of their simple effects, and the four control variables ( $R^2_{\text{change}} = .02$ ,  $F_{\text{change } 1, 111} = 5.99$ ,  $p = .016$ ).

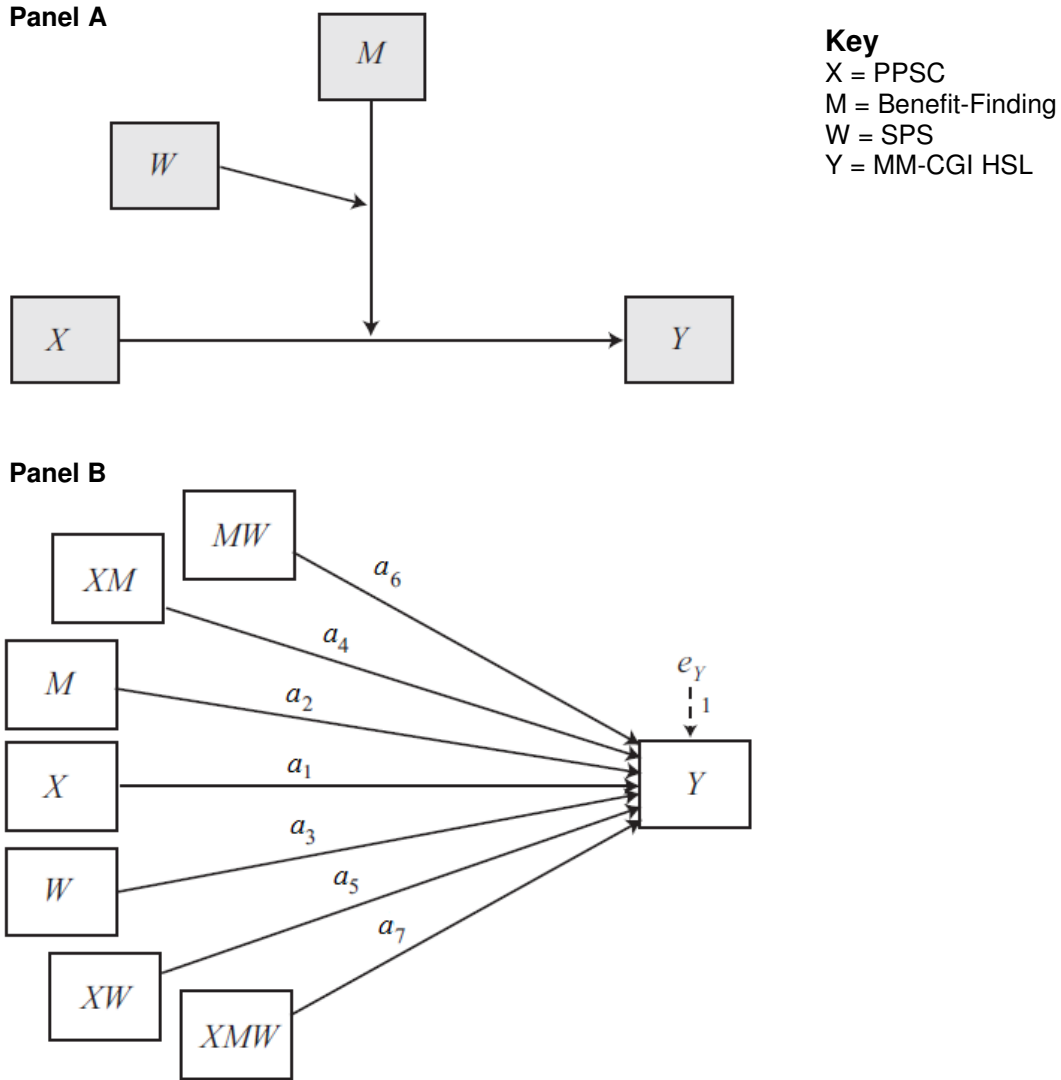

Figure 5. Conceptual (panel A) and statistical path (panel B) diagrams for moderated moderation analysis (Model 3).

Table 9  
 Regression Results for Model 2: Moderation of the Relationship between PPSC and Grief by Social Support

Variable	$R^2$	$F$	df	Coeff.	SE	$p$
	.46	13.73	7, 115			.000
PPSC				.57	.13	.000
SPS				-2.25	.99	.025
PPSC $\times$ SPS				.16	.10	.120

Note. PPSC = perceived personality system change; SPS = Social Provision Scale. PANAS PA, preinjury relationship quality, preinjury history of depressive symptoms, and annual household income were included as covariates. Regression coefficients are unstandardized.

Table 10  
*Regression Results for Model 3: Moderation of the Relationship between PPSC and Grief by Benefit-Finding and Social Support*

Variable	<i>R</i> <sup>2</sup>	<i>F</i>	<i>df</i>	Coeff.	<i>SE</i>	<i>p</i>
	.58	13.97	11, 111			.000
PPSC				.55	.12	.000
BF				-1.75	.35	.000
SPS				-2.13	.96	.028
PPSC × BF				.08	.04	.059
PPSC × SPS				.10	.11	.351
BF × SPS				.45	.32	.173
PPSC × BF × SPS				-.09	.04	.016

*Note.* PPSC = perceived personality system change; BF = benefit-finding; SPS = Social Provision Scale. PANAS PA, preinjury relationship quality, preinjury history of depressive symptoms, and annual household income were included as covariates. Regression coefficients are unstandardized.

As noted above, the simple moderation analysis (Model 1) indicated that only among those caregivers at moderate to high levels of benefit-finding does a decrease in PPSC result in a significant decrease in grief. Among caregivers reporting low levels of benefit-finding grief experience is uniformly high, with decreases in PPSC not resulting in significantly lower grief such that there is an absence of an association between perceived characterological change and grief level. This finding is qualified by the moderated moderation analysis; examination of the conditional effects at low (-1 SD), moderate (mean), and high (+1 SD) levels of perceived social support reported in Table 11 shows that the moderation of the relationship between PPSC and grief by benefit-finding is only significant among those caregivers attesting to low levels of social support (point estimate = .17,  $p = .003$ ). Moreover, as perceived social support increases the conditional effect of the PPSC and benefit-finding interaction on grief falls in size, indicating the salutary/buffering effect of social support. As reflected in the simple slopes depicted in Figure 6, at higher levels of social support (mean, + 1 SD) benefit-

finding is no longer a moderator of the PPSC effect (i.e., the gradients of the slopes are not significantly different) as grief levels are no longer uniformly high at the low benefit-finding level: Less efficacious meaning reconstruction efforts in the form of benefit-finding are associated with high levels of grief independent of severity of loss experience only when perceived social support is also low.

More specifically, as indicated by the Johnson-Neyman analysis (see Figure 7), when social support is at or above the 49<sup>th</sup> percentile value (i.e., 3.40; an untransformed SPS score of 46.22) the effect of PPSC on grief is no longer moderated by benefit-finding, i.e., a higher level of PPSC is required to produce higher grief levels among all benefit-finding levels, including among those family members least successful in meaning-as-significance reconstruction efforts. This analysis of the interaction of the protective effects of benefit-finding and social support suggests that increases in social support are particularly ameliorative for those caregivers reporting relatively low levels of benefit-finding and low levels of PPSC.<sup>35</sup>

Table 11  
*Conditional Effects of PPSC and Benefit-Finding Interaction on Grief at Levels of Social Support*

SPS	Point estimate	SE	p	95% CI Limit	
				Lower	Upper
Low (- 1 SD; 37.70)	.17	.06	.003	.057	.280
Moderate (Mean; 45.48)	.08	.04	.059	-.003	.165
High (+ 1 SD, 53.26)	-.01	.05	.896	-.116	.102

*Note.* SPS = Social Provision Scale.

SPS values reported are before mean centering. Unstandardized effects are reported.

<sup>35</sup> This interpretation is more readily apparent visually when probing the three-way interaction by analysis of the simple slopes of the PPSC × social support two-way interaction at different levels of benefit-finding. The results of this analysis are presented in Appendix E. This alternate probing approach is also informative in that it shows that at the high (+1 SD) level of benefit-finding, although the overall conditional effect is not significant, the pattern of the simple slopes changes such that the impact of PPSC on grief levels falls as social support increases.

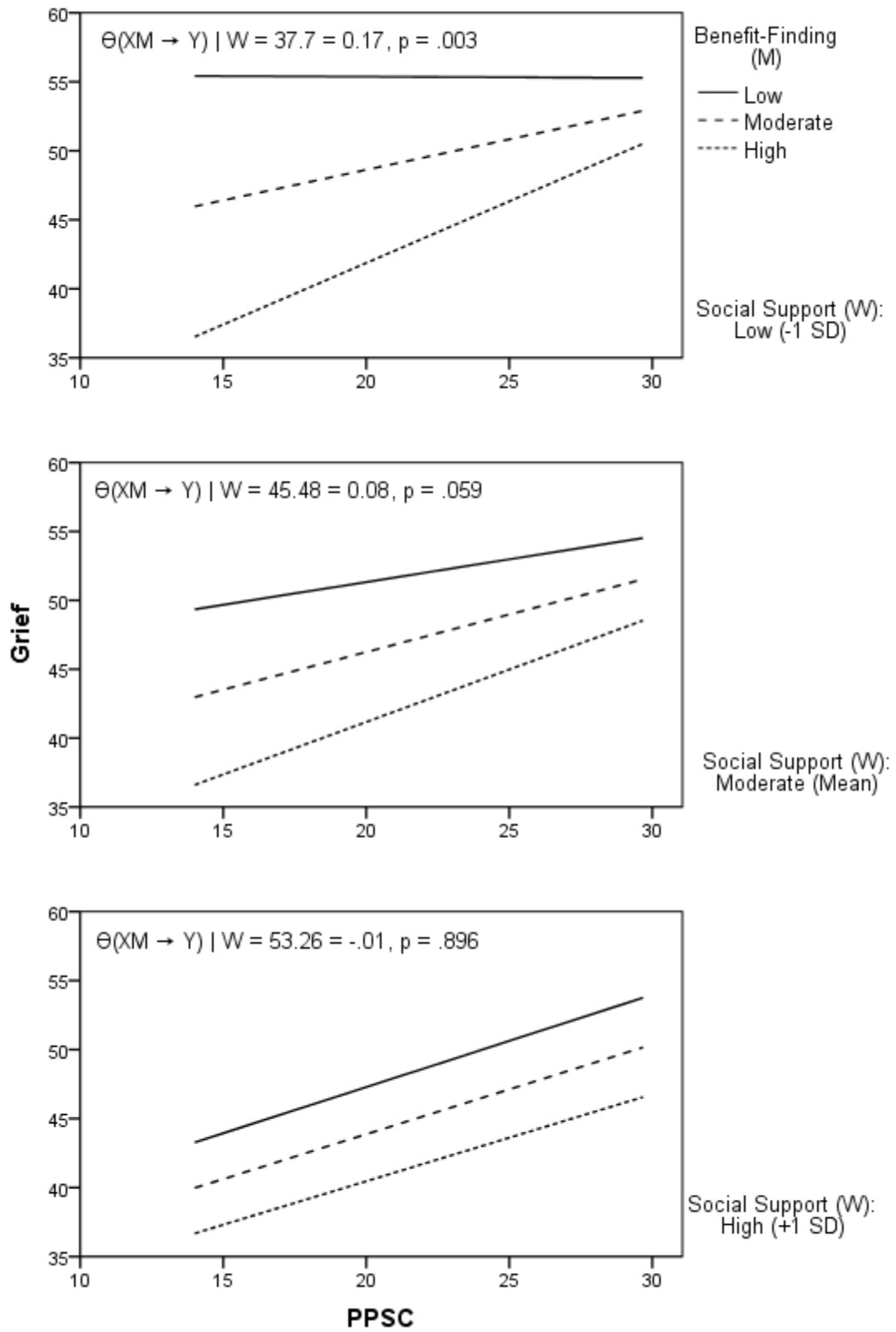

Figure 6. The conditional effect of PPSC on grief as a function of benefit-finding and social support.



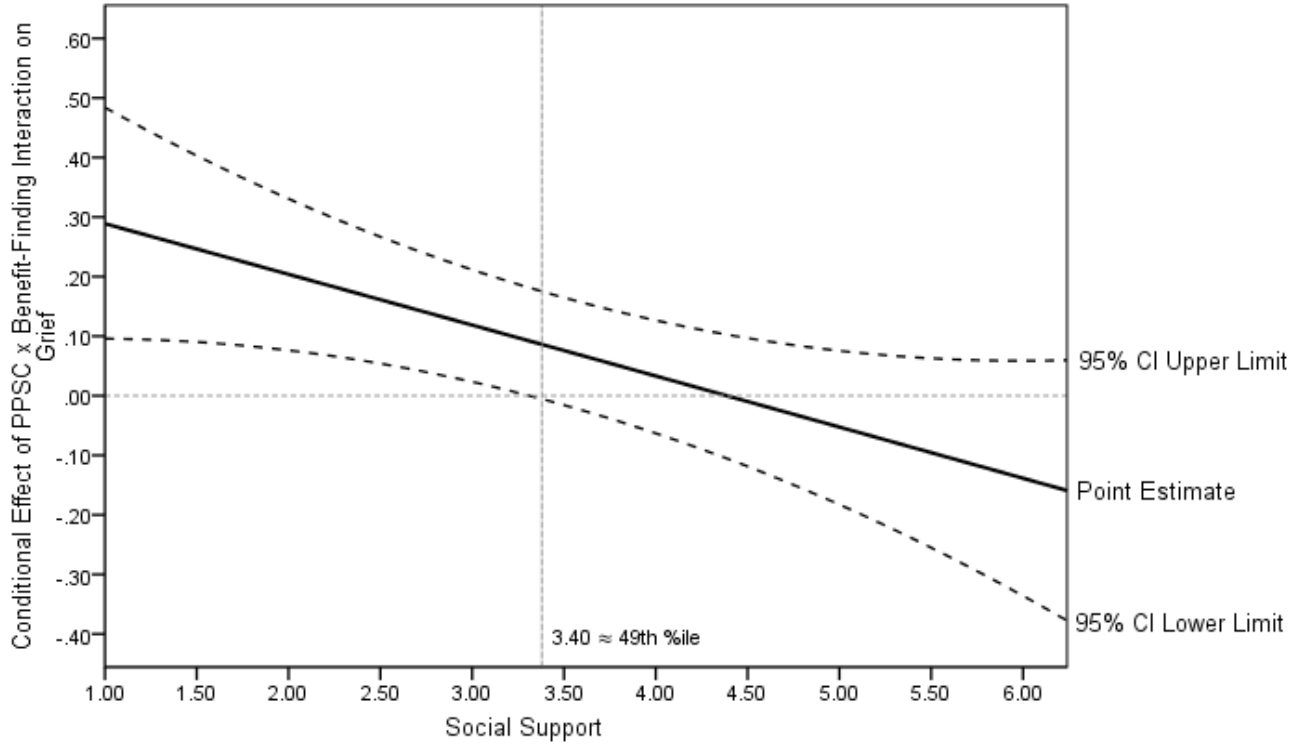

Figure 7. Johnson-Neyman region of significance for the conditional effect of the PPSC × benefit-finding interaction on grief at values of social support.

*Mediation Analysis 1: Grief as a Mediator of the Relationship between PPSC and Depressive Symptoms*

As noted, researchers studying emotional adjustment among family members of persons with cancer (Williamson & Shaffer, 1998) and among relatives of individuals with dementia (Meuser et al., 2004; Walker & Pomeroy, 1996) have postulated that non-death loss and subsequent grief experience within the context of caregiving may be a potential causal factor contributing to depression and other mental health outcomes among these populations. In order to assess if this proposal holds among family caregivers of persons with TBI, a simple mediation model (Model 4) was developed to test if perceived characterological change affects caregiver depressive symptoms indirectly through caregiver grief (Hypothesis 17). Model 4 is presented in a combined conceptual and statistical diagram in Figure 8.

The following regression models were estimated to derive the total and direct effects, and the indirect effect through grief, of PPSC on caregiver depressive symptoms (CES-D):

$$\text{Depressive symptoms} = \text{constant} + c(\text{PPSC}) + \text{covariates} + \text{error} \quad (4.1)$$

$$\text{Grief} = \text{constant} + a(\text{PPSC}) + \text{covariates} + \text{error} \quad (4.2)$$

$$\text{Depressive symptoms} = \text{constant} + c'(\text{PPSC}) + b(\text{grief}) + \text{covariates} + \text{error} \quad (4.3)$$

As all four control variables, viz., Positive Affect, preinjury relationship quality, preinjury history of depressive symptoms, and annual household income, were also significantly correlated with CES-D scores, all were included as covariates in the mediation analyses. As can be seen in the Model 4.1 results in Table 12 and path *c* in Figure 8, the total effect of perceived characterological change on caregiver depressive

symptomatology level was positive and significant with higher levels of PPSC leading to increases in reported symptoms ( $c = .06, p < .001$ ). Also, as can be seen in the Model 4.2 results in Table 12 and path  $a$  in Figure 8, as already demonstrated, higher levels of PPSC were associated with higher levels of grief ( $a = .63, p < .001$ ). In line with expectation, grief was a significant positive predictor of depressive symptomatology ( $b = .05, p < .001$ ; see Model 4.3 in Table 12, path  $b$  in Figure 8). The direct effect of PPSC on depressive symptoms (see Model 4.3 in Table 12, path  $c'$  in Figure 8) was smaller than the total effect but remained significant ( $c' = .03, p = .019$ ).

Most relevant to the mediation hypothesis was the estimate of the indirect effect of PPSC on depressive symptomatology, quantified as the product of the regression coefficient estimating grief from PPSC (path  $a$  in Figure 8) and the coefficient estimating depressive symptoms from grief while controlling for PPSC (path  $b$  in Figure 8). A bias-corrected bootstrap confidence interval (CI) for the product of these paths that does not include zero provides evidence of a significant indirect effect (Preacher & Hayes, 2004, 2008). In line with Hypothesis 17, using the PROCESS procedure (Hayes, 2013) with 10,000 bootstrap samples revealed a significant positive indirect effect of PPSC on depressive symptoms through caregiver grief (point estimate = .03, 95% bootstrap CI = .018 to .051).<sup>36</sup> The indirect effect size, estimated using the  $R^2_{\text{med}}$  statistic (Fairchild et

---

<sup>36</sup> The bootstrapping approach, such as that implemented in PROCESS, is an increasingly favoured method to testing mediation models relative to the highly familiar Baron and Kenny (1986) *causal steps* approach and the related Sobel test on both logical grounds (e.g., Preacher & Hayes, 2004), as well as for its increased sensitivity to detecting true indirect effects (e.g., Hayes, 2013; MacKinnon, Lookwood, Hoffman, West, & Sheets, 2002). Bootstrapping generates a sampling distribution for the indirect effect ( $ab$ ) empirically by repeatedly estimating the indirect effect after sampling from the existing data set with replacement and estimating the model in each resample. The estimates of the indirect effect are then used to generate confidence intervals for the purpose of inference. As this approach does not incorrectly assume the sampling distribution of the statistic to be normal it is more valid and powerful than the Sobel test. In this particular instance the bootstrap-based inference and Sobel test provide consistent results ( $z = 3.71, p = .0002$ ).

al., 2009), fell within the small to medium range, accounting for 7% unique variance in depressive symptoms ( $R^2_{med} = .07$ ). Given that 64% of the variance in CESD scores was accounted for by Model 4.3 ( $R^2 = .64$ ), 10% ( $.07/.64$ ) of explained variance was attributable to the mediated effect.

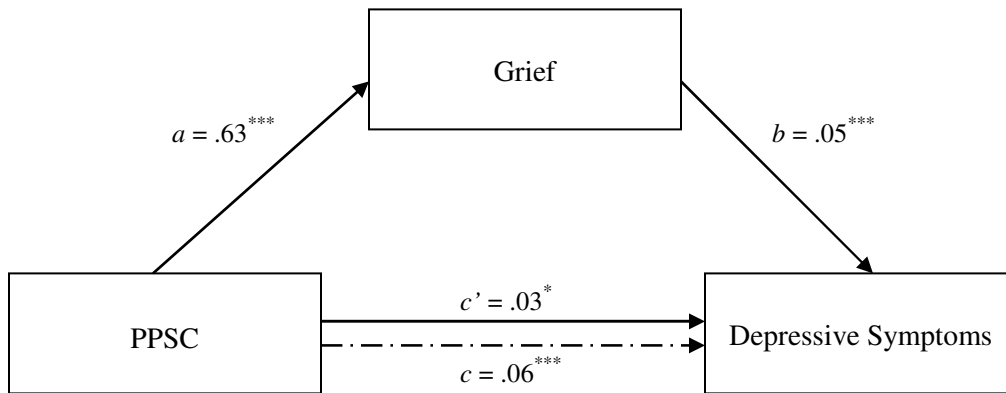

Figure 8. Combined conceptual and statistical diagram for Model 4 showing path coefficients for simple mediation analysis on caregiver depressive symptoms.

Note. Dotted line denotes effect of PPSC on depressive symptoms when grief is not included as a mediator. Unstandardized regression coefficients are reported. Covariates are not represented. \*  $p < .05$  \*\*\*  $p < .001$ .

Table 12

Regression Results for Model 4. Grief as a Mediator of the Relationship between PPSC and Depressive Symptoms

Outcome →	Depressive Symptoms (CESD)						Grief (MM-CGI HSL)		
	Model 4.1			Model 4.3			Model 4.2		
	Coeff.	SE	p	Coeff.	SE	p	Coeff.	SE	p
PPSC	.06	.01	.000	.03	.01	.019	.63	.13	.000
MM-CGI HSL				.05	.01	.000			
$R^2$	.53			.64			.42		

Note. CESD = Center for Epidemiologic Studies Depression Scale; MM-CGI HSL = Marwit-Meuser Caregiver Grief Inventory Heartfelt Sadness and Longing; PPSC = perceived personality system change. PANAS PA, preinjury relationship quality, preinjury history of depressive symptoms, and annual household income were included as covariates. Regression coefficients are unstandardized.

*Moderated Mediation Analysis 1*

As demonstrated in the moderated moderation analysis (Model 3), the PPSC → grief path component (i.e., path *a*) in the mediation model just described (Model 4) is moderated by the interaction of caregiver perceived social support and level of benefit-finding; in other words, the mediation is moderated. Models 3 and 4 are incorporated into the conditional process analysis Model 5 to form a *moderated mediation* model. Conceptual and statistical diagrams of Model 5 are presented in Figure 9.

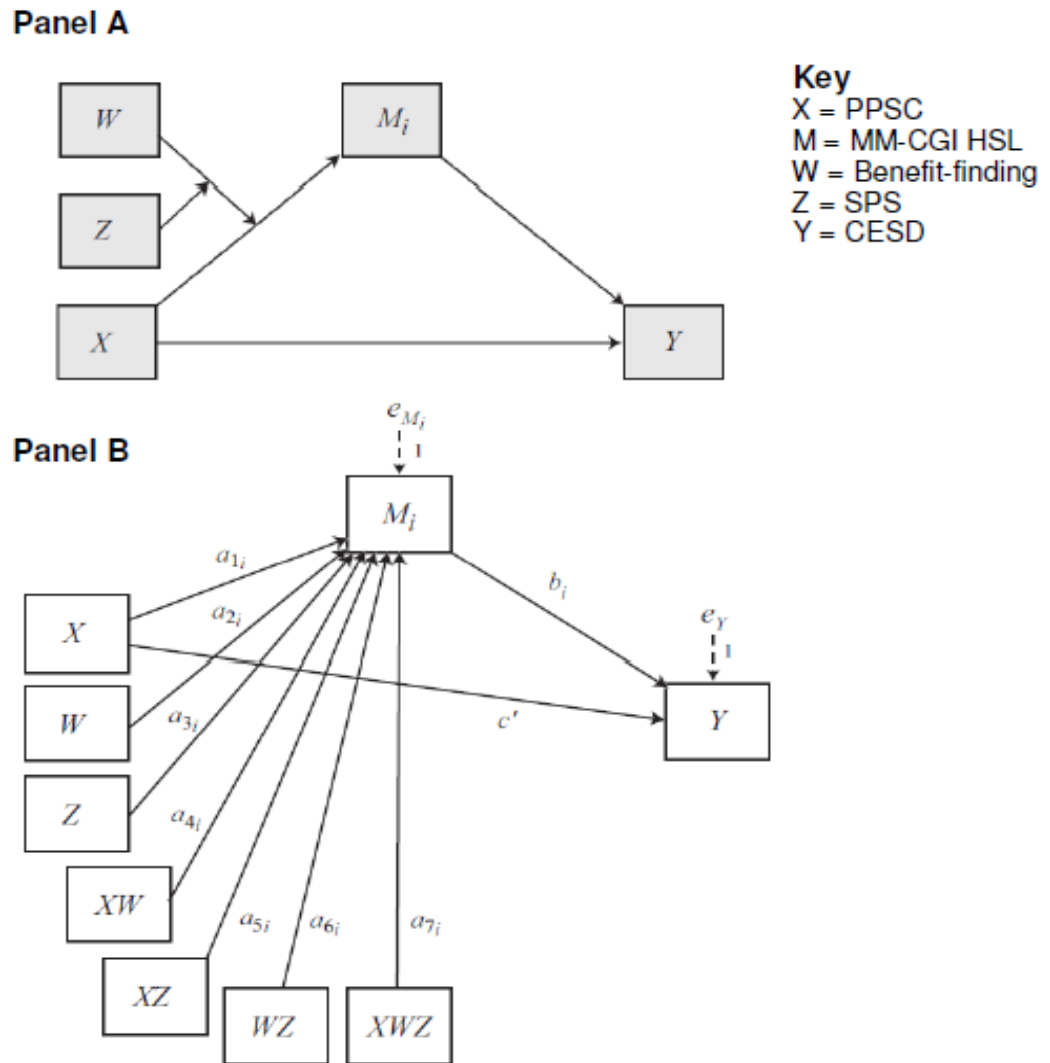

Figure 9. Conceptual (panel A) and statistical path (panel B) diagrams for moderated mediation analysis 1, outcome = CES-D (Model 5).

As discussed by Preacher, Rucker, and Hayes (2007), the preferred inferential method for a model of this form is estimation and testing, using a bootstrap confidence interval, of the slope of the line linking the *conditional indirect effects* to values of the moderator. Specifically, if a 95% CI for the point estimate of the slope does not contain zero then moderated mediation can be said to be present. In the case of moderated mediation with two interactive moderators, the primary moderator may only moderate the mediation at certain levels of the second moderator. Therefore, estimation and testing of the conditional indirect effect of the two-way interaction term between the predictor and the primary moderator at different levels of the secondary moderator is required. In the specific model under consideration this entailed estimation and testing of the conditional indirect effect of the PPSC  $\times$  benefit-finding interaction at different levels of social support. In turn, for Model 5, employing 10,000 bootstrap estimates, 95% CIs were constructed for the slope of the indirect effect of PPSC on caregiver depressive symptoms through grief moderated by benefit-finding at the mean as well as a standard deviation above and below the mean of social support to represent, as before, moderate, high, and low levels of the second moderator, respectively.<sup>37</sup>

This approach analytically combines estimates from Model Equations 3 (p. 150) and 4.3 (p. 156). The conditional indirect effect of PPSC on depressive symptomatology through caregiver grief experience is the product of the conditional effect of PPSC on grief as a function of benefit-finding and social support ( $a_1 + a_4\text{benefit-finding} + a_5\text{social support} + a_7\text{benefit-finding} \times \text{social support}$ ; from Equation 3) and the effect of grief on

---

<sup>37</sup> This provided a test of whether the indirect effects of PPSC on depressive symptoms through grief conditioned on benefit-finding level are significantly different from each other at the three levels of social support.

depression controlling for PPSC ( $b$  in Equation 4.3). Using the notation from Figure 9, the conditional indirect effect can therefore be expressed as:

$$(a_1 + a_4W + a_5Z + a_7WZ)b \quad (5.1)$$

With  $Z$  (i.e., social support) held constant, the difference between two points on the slope of the conditional indirect effect is:

$$\begin{aligned} &(a_1 + a_4w_1 + a_5Z + a_7w_1Z)b - (a_1 + a_4w_2 + a_5Z + a_7w_2Z)b \\ &= a_4b + a_7Zb (w_1 - w_2) \end{aligned} \quad (5.2)$$

In turn, using 10,000 saved bootstrap estimate sets of the parameters of Model 5, 10,000 estimates of the slope of the conditional indirect effect (i.e., function  $a_4b + a_7Zb$  from Equation 5.2) were calculated and 95% CIs constructed for the three levels of social support indicated above.

As can be seen in Table 13 and Figure 10 the conditional indirect effect of PPSC on depressive symptomatology displayed a significant positive relationship with benefit-finding only at the low (-1 SD) level of social support (.01, 95% CI: .002 to .016). At the moderate (mean) and high (+1 SD) social support levels, consistent with the results for Model 3, no relationship is observed as benefit-finding is no longer a moderator of the PPSC  $\rightarrow$  Grief path component in Model 5 (i.e., path  $a_1$  in Figure 9). In other words, at moderate and high social support levels the association between PPSC and grief does not vary significantly across the benefit-finding score continuum, and, consequently, the indirect effect of PPSC on depressive symptoms through grief is not moderated at these levels. Notably, as can be seen in Figure 10, at higher levels of benefit-finding the conditional indirect effect decreases as social support increases.<sup>38</sup>

---

<sup>38</sup> At the moderate (i.e., mean) level of social support the test of moderated mediation approaches significance as the lower CI limit is just above below zero; this is consistent with the moderated moderation

Thus Hypothesis 19 was only partially supported: although evidence for moderated mediation was found, the conditional indirect effect of PPSC on caregiver depressive symptoms through grief was larger for family members reporting relatively higher (rather than lower) meaning-as-significance scores and low levels of social support. As noted in the moderated moderation analysis, this unexpected pattern resulted as a function of high levels of grief independent of the magnitude of PPSC only at low levels of benefit-finding and low to just below the mean level of perceived social support.

Table 13  
*Slope Estimates for the Conditional Indirect Effects of PPSC on Depressive Symptoms through Grief moderated by Benefit-finding at Levels of Social Support*

SPS	Point estimate	95% bootstrap CI limit	
		Lower	Upper
Low (- 1 SD; 37.70)	.010	.002	.016
Moderate (Mean; 45.48)	.004	-.001	.009
High (+ 1 SD, 53.26)	-.0004	-.006	.005

*Note.* SPS = Social Provision Scale.

SPS values reported are before mean centering.

A CI that does not contain zero indicates the presence of moderated mediation, i.e., moderation of the indirect effect by benefit-finding.

---

analysis finding of the conditional effect of the PPSC and benefit-finding interaction on grief approaching significance at the moderate social support level.



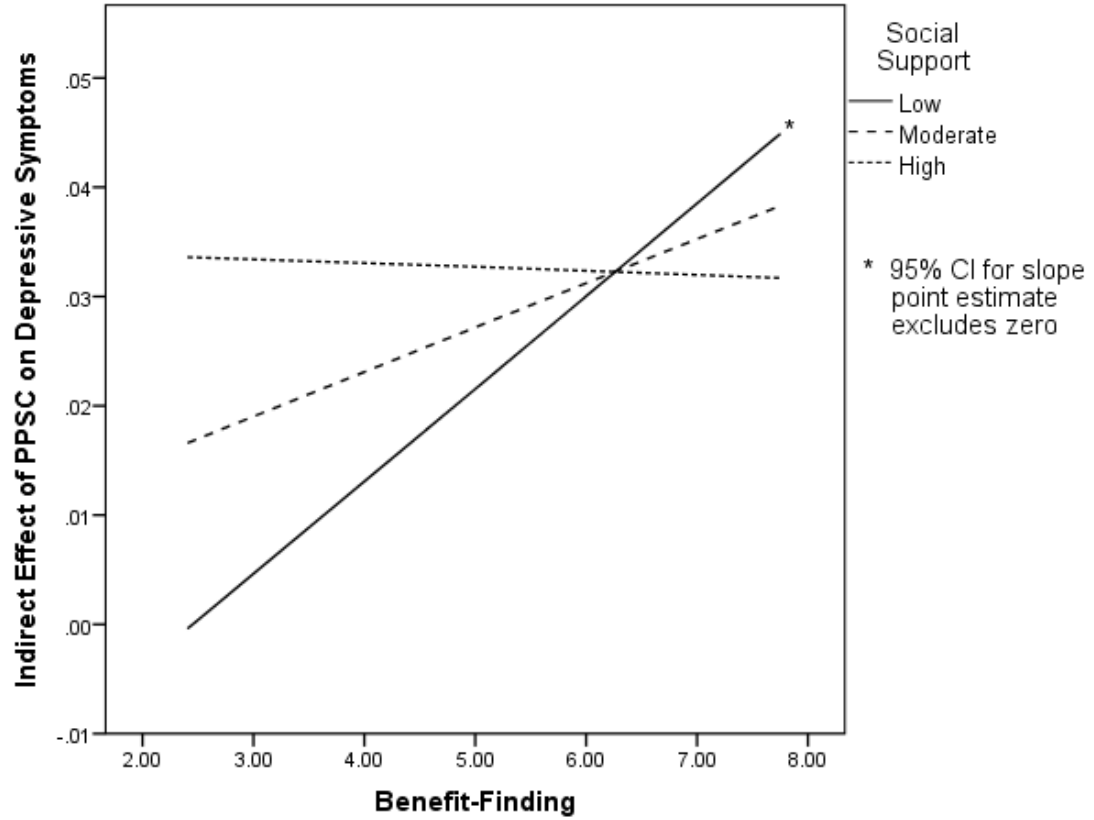

Figure 10. A visual representation of the conditional indirect effects of PPSC on depressive symptoms as a function of level of benefit-finding and social support.

*Mediation Analysis 2: Grief as a Mediator of the Relationship between PPSC and Life Satisfaction*

The postulate that caregiver grief experience may operate as an intermediary causal link between TBI sequelae and reduced family member life satisfaction (Hypothesis 18) was tested in a second simple mediation model (Model 6). The combined conceptual and statistical diagram for this model can be found in Figure 11.

Three regression models were estimated to derive the total and direct effects, and the indirect effect through grief, of PPSC on caregiver life satisfaction (SWLS):

$$\text{Life satisfaction} = \text{constant} + c(\text{PPSC}) + \text{covariates} + \text{error} \quad (6.1)$$

$$\text{Grief} = \text{constant} + a(\text{PPSC}) + \text{covariates} + \text{error} \quad (6.2)$$

$$\text{Life satisfaction} = \text{constant} + c'(\text{PPSC}) + b(\text{grief}) + \text{covariates} + \text{error} \quad (6.3)$$

Covariates consisted of the four control variables previously described. As shown in Model 6.1 in Table 14 and path  $c$  in Figure 11, the total effect of perceived characterological change on level of caregiver life satisfaction was, in line with expectation, negative and significant with higher levels of PPSC resulting in reduced life satisfaction ( $c = -.24, p < .01$ ). As before, a positive relationship between level of PPSC and caregiver grief experience was observed ( $a = .63, p < .001$ ; see Model 6.2. in Table 14. and path  $a$  in Figure 11). Also congruent with prediction, higher grief levels had an adverse impact on life satisfaction ( $b = -.23, p < .001$ ; see Model 6.3 in Table 14, path  $b$  in Figure 11). The direct effect of PPSC on life satisfaction (see Model 6.3 in Table 14, path  $c'$  in Figure 11) was not significant with grief included as a mediator ( $c' = -.09, p = .300$ ).

The estimate of the indirect effect of PPSC on life satisfaction, quantified as the product of the coefficient estimating grief from PPSC (path *a* in Figure 11) and the coefficient estimating life satisfaction from grief while controlling for PPSC (path *b* in Figure 11) is of primary concern. In line with Hypothesis 18, application of the PROCESS procedure (Hayes, 2013) with 10,000 bootstrap samples demonstrated a significant negative indirect effect of PPSC on life satisfaction through the mediator of grief (point estimate =  $-.15$ , 95% bias-corrected bootstrap CI =  $-.26$  to  $-.07$ ).<sup>39</sup> The indirect effect size fell within the small to moderate range, accounting for 4% unique variance in caregiver life satisfaction ( $R^2_{\text{med}} = .04$ ), with 9% ( $R^2_{\text{med}}/R^2 = .04/.44$ ) of the total variance explained by Model 6.3 attributable to this effect.

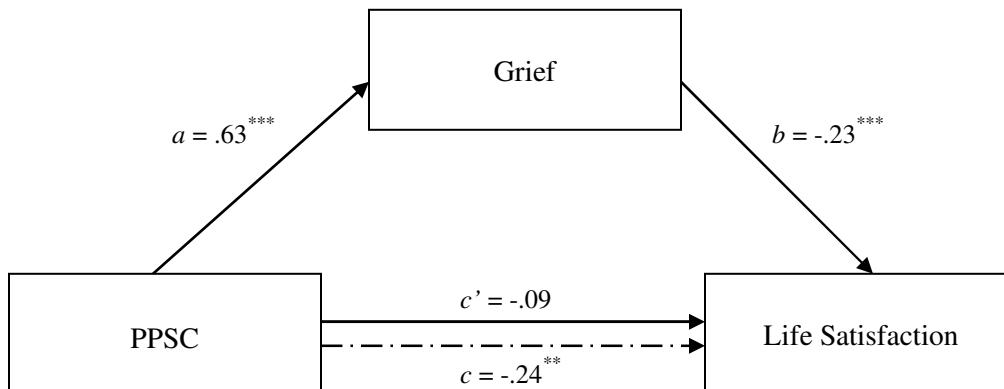

*Figure 11.* Combined conceptual and statistical diagrams for Model 6 showing path coefficients for simple mediation analysis of caregiver life satisfaction.

*Note.* The dotted line denotes the effect of PPSC on life satisfaction when grief is not included as a mediator. Unstandardized regression coefficients are reported. Covariates are not represented.

\*\*  $p < .01$  \*\*\*  $p < .001$ .

<sup>39</sup> The less powerful Sobel test yielded a result congruent with the bootstrap-based inference ( $z = -3.10$ ,  $p = .002$ ).

Table 14  
*Regression Results for Model 6. Grief as a Mediator of the Relationship between PPSC and Life Satisfaction*

Outcome →	Life Satisfaction (SWLS)						Grief (MM-CGI HSL)		
	Model 6.1			Model 6.3			Model 6.2		
	Coeff.	SE	<i>p</i>	Coeff.	SE	<i>p</i>	Coeff.	SE	<i>p</i>
PPSC	-.24	.08	.006	-.09	.09	.300	.63	.13	.000
MM-CGI HSL				-.23	.06	.000			
<i>R</i> <sup>2</sup>	.36		.000	.44		.000	.42		.000

*Note.* SWLS = Satisfaction with Life Scale; MM-CGI HSL = Marwit-Meuser Caregiver Grief Inventory Heartfelt Sadness and Longing Scale; PPSC = perceived personality system change. PANAS PA, preinjury relationship quality, preinjury history of depressive symptoms, and annual household income were included as covariates. Regression coefficients are unstandardized.

### *Moderated Mediation Analysis 2*

The moderated moderation analysis presented in Model 3 and the model of grief operating as a mediator between perceived characterological change and caregiver life satisfaction (Model 6) were combined to form a second moderated mediation model, Model 7. Conceptual and statistical path diagrams for this model are presented in Figure 12.

Replicating the procedure employed earlier, to empirically assay the proposed moderated mediation the conditional indirect effect of the PPSC x benefit-finding interaction on family member life satisfaction at different levels of the second moderator, perceived social support, was estimated and tested. Ten thousand bootstrap estimates were used to construct 95% CIs for the slope of the indirect effect of PPSC on caregiver life satisfaction through grief as moderated by benefit-finding at the mean as well as a standard deviation above and below the mean of social support to represent, as before, moderate, high, and low levels of the second moderator, respectively.

Panel A

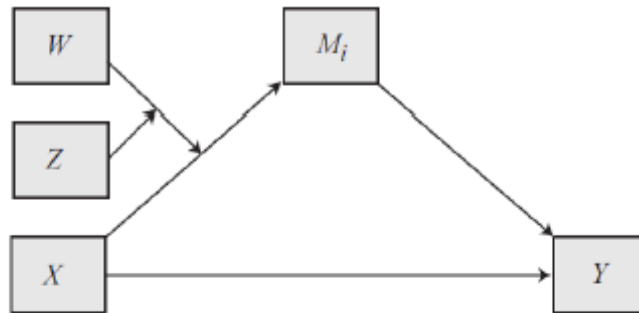

**Key**  
 X = PPSC  
 M = MM-CGI HSL  
 W = Benefit-finding  
 Z = SPS  
 Y = SWLS

Panel B

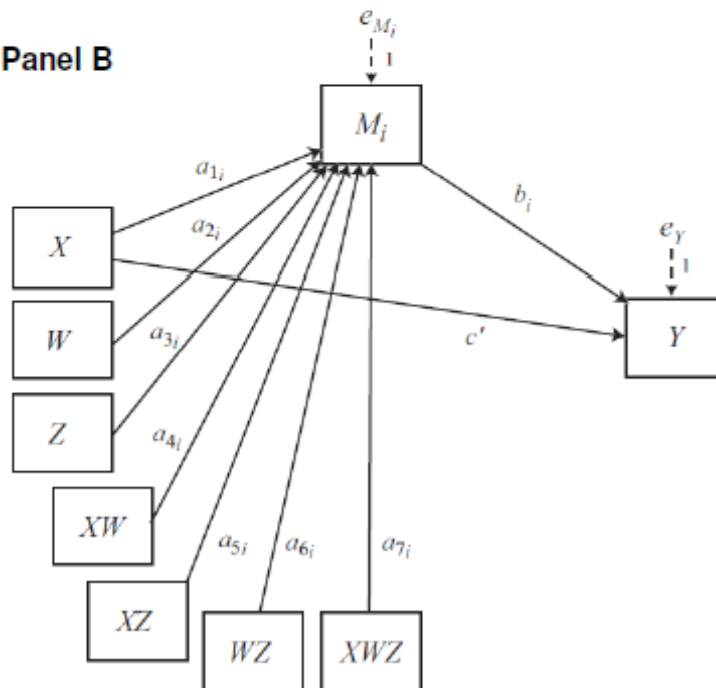

Figure 12. Conceptual (panel A) and statistical path (panel B) diagrams for moderated mediation analysis 2, outcome = SWLS (Model 7).

In Model 7 the conditional indirect effect of PPSC on life satisfaction is the product of the conditional effect of PPSC on grief as a function of benefit-finding and social support ( $a_1 + a_4$ benefit-finding +  $a_5$ social support +  $a_7$ benefit-finding  $\times$  social support; from Equation 3) and the effect of grief on life satisfaction controlling for PPSC

(*b* in Equation 6.3). Employing the notation from Figure 12, the conditional indirect effect is expressed as:

$$(a_1 + a_4W + a_5Z + a_7WZ)b \quad (7.1)$$

With *Z* (social support) held constant, the difference between two points on the slope of the conditional indirect effect is:

$$(a_1 + a_4w_1 + a_5Z + a_7w_1Z)b - (a_1 + a_4w_2 + a_5Z + a_7w_2Z)b \\ = a_4b + a_7Zb (w_1 - w_2) \quad (7.2)$$

The point estimates and 95% bootstrap CIs for the slope of the conditional indirect effect on life satisfaction, i.e., function  $a_4b + a_7Zb$  from Equation 7.2, at high, moderate, and low levels of social support are presented in Table 15.

As shown in Table 15 and Figure 13, the conditional indirect effect of perceived characterological change on caregiver life satisfaction displayed a significant negative relationship with benefit-finding only at the low (-1 SD) level of social support (-.0391, 95% CI: -.0735 to -.0089). As one would anticipate given the results of the moderated moderation analysis, and mirroring the pattern observed in the first moderated mediation

Table 15  
*Slope Estimates for the Conditional Indirect Effects of PPSC on Life Satisfaction through Grief Moderated by Benefit-Finding at Levels of Social Support*

SPS	Point estimate	95% bootstrap CI limit	
		Lower	Upper
Low (- 1 SD; 37.70)	-.039	-.074	-.009
Moderate (Mean; 45.48)	-.019	-.043	.001
High (+ 1 SD, 53.26)	.002	-.025	.028

*Note.* SPS = Social Provision Scale.  
SPS values reported are before mean centering.  
A CI that does not contain zero indicates the presence of moderated mediation, i.e., moderation of the indirect effect by benefit-finding.

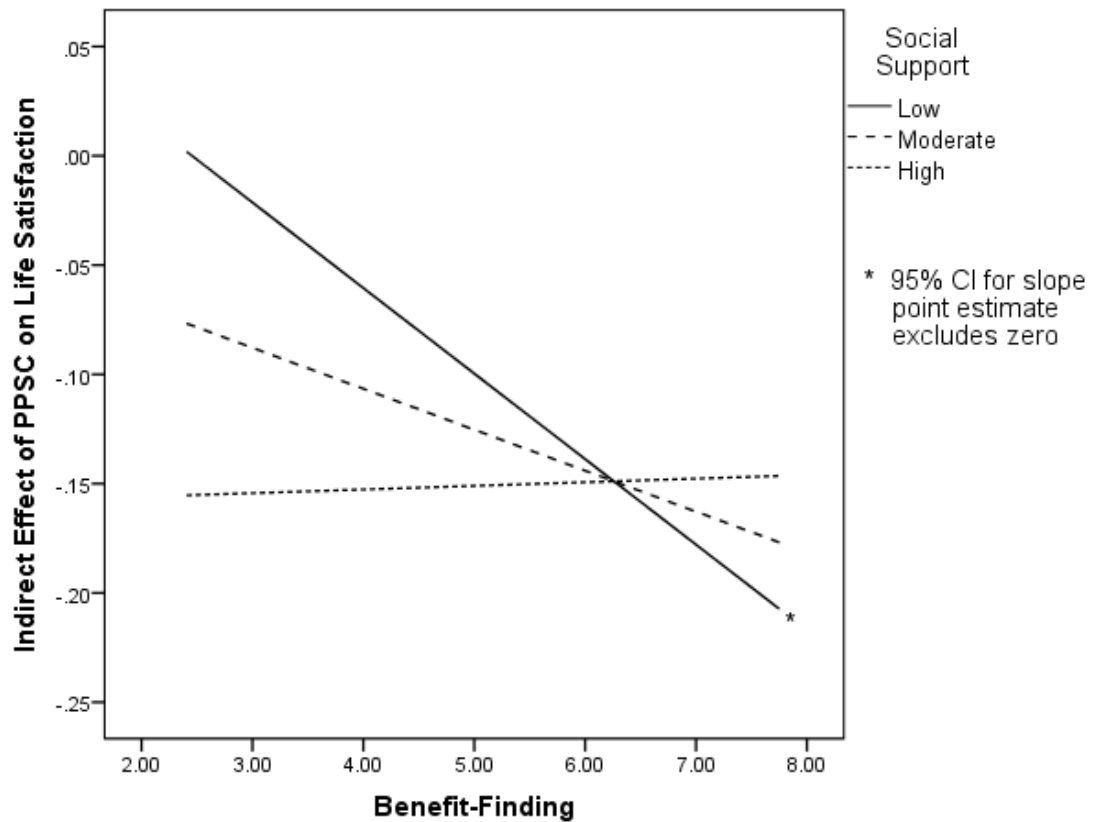

Figure 13. A visual representation of the conditional indirect effects of PPSC on life satisfaction as a function of level of benefit-finding and social support.

analysis where the outcome was depressive symptoms, at moderate (mean) and high (+1 SD) levels of social support, no relationship was observed as benefit-finding was no longer operating as a moderator of the PPSC  $\rightarrow$  Grief path component (i.e., of path  $a_1$  in Figure 12, Panel B). At moderate and high social support levels the association between PPSC and grief does not vary significantly across the benefit-finding score continuum, and, in turn, the indirect effect of PPSC on life satisfaction through grief is not moderated at these levels. Although the slope is not significant, it is noted that the conditional

indirect effect decreases in magnitude as benefit-finding increases at the high social support level.<sup>40</sup>

In sum, Model 7 provided evidence congruent with Hypothesis 20 in part. While moderated mediation was observed, the negative conditional indirect effect of PPSC on family member life satisfaction through grief was larger for those participants reporting relatively higher (rather than lower) benefit-finding when perceived social support was low. As noted earlier, this unanticipated result was observed secondary to grief levels being uniformly elevated across the PPSC continuum at low levels of benefit-finding in combination with low to just below moderate (i.e., below the 49<sup>th</sup> percentile) levels of perceived social support. Thus, in the low social support condition, when benefit-finding is low a unit increase in PPSC has no appreciable impact on caregiver grief level, and, in turn, a nonsignificant indirect effect on life satisfaction. In contrast, at higher levels of benefit-finding a unit increase in PPSC does result in an increase in grief experience, and in consequence leads to a larger negative indirect impact on life satisfaction.

#### *Clinical Significance of Caregiver Outcome Findings*

With regard to depressive symptoms, 47.2% of caregivers ( $n = 58$ ) had CES-D scores at or exceeding the standard cut-score of 16, a marker for possible depression. Approximately a quarter of the sample (24.4%,  $n = 30$ ) had CES-D scores within the range considered indicative of mild depressive symptoms (i.e., 16-26) and 22.8% ( $n = 28$ ) had scores in the moderate to severe range (i.e.,  $\geq 27$ ). The mean participant CES-D score (17.0,  $SD = 11.7$ ) was substantially higher than that documented by Levine (2013)

---

<sup>40</sup> At the moderate (i.e., mean) level of social support it can be seen that the test of moderated mediation approaches significance as the upper CI limit is just above zero; this is consistent with the moderated moderation analysis finding of the conditional effect of the PPSC and benefit-finding interaction on grief approaching significance at this social support level.



in a large nonclinical community sample (9.8,  $SD = 9.3$ ,  $n = 8,858$ ; Welch  $t_{124} = 6.80$ ,  $p < .001$ ).

Based on data from Pavot and Diener (1993b), in the present study 48.8% of family caregivers ( $n = 60$ ) had life satisfaction scores more than one standard deviation below the normative mean (i.e., a  $T$  score  $< 40$ ); 22% of participants ( $n = 27$ ) had life satisfaction scores more than two standard deviations below the mean (i.e., a  $T$  score  $< 30$ ). Using interpretative guidelines for the SWLS (Pavot & Diener, 1993a), 17.9% ( $n = 22$ ) and 18.7% ( $n = 23$ ) of caregivers were dissatisfied and very dissatisfied with their life, respectively. Conversely, 16.3% ( $n = 20$ ) and 5.7% ( $n = 7$ ) of participants were satisfied and very satisfied with their life, respectively. The mean SWLS score for the sample (18.4,  $SD = 8.1$ ) was lower than that observed by Pavot and Deiner (1993a) in a normative nonclinical sample (23.7,  $SD = 6.4$ ,  $n = 244$ ; Welch  $t_{200} = 6.33$ ,  $p < .001$ ), and corresponds to an average item endorsement indicating “neither agree nor disagree” to “slightly disagree” (3.68,  $SD = 1.6$ ) regarding the positive statements about life satisfaction.

The mean level of grief reported on the MM-CGI HSL scale in the present sample (47.1,  $SD = 13.0$ ) is very similar to mean grief levels observed on the same measure among family caregivers of persons with dementia (48.2,  $SD = 11.1$ ; Marwit & Meuser, 2002) and relatives of individuals with acquired brain injury (53.1,  $SD = 13.1$ ; Marwit & Kaye, 2006). Review of frequency statistics of average item endorsement levels for the MM-CGI HSL scale provided in Table 16 shows that 58.6% ( $n = 72$ ) of the current sample displayed an average item score indicating agreement regarding statements of grief experience within the context of being a caregiver for a family member with a TBI;

Table 16  
 Frequency Statistics of MM-CGI HSL Scale Average Item Scores

Average item score	HSL score	<i>n</i>	%
≤ 2 ( <i>disagree</i> )	≤ 30	13	10.6
> 2 ( <i>disagree</i> ) but < 3 ( <i>somewhat agree</i> )	31 to 44	38	30.9
3 ( <i>somewhat agree</i> ) to 4 ( <i>agree</i> ), inclusive	45 to 60	52	42.3
> 4 ( <i>agree</i> )	≥ 61	20	16.3

42.3% (*n* = 52) had an average item score of between 3 (indicating *somewhat agree*) and 4 (*agree*), inclusive, with a further 16.3% (*n* = 20) displaying an average item endorsement above 4. Only 10.6% (*n* = 13) of participants had an average item score at or below 2 (*disagree*).

Clinically significant levels of caregiver grief following non-death loss have not been definitively established. However, Marwit and Meuser (2002) suggest that MM-CGI HSL scores exceeding one standard deviation above the original validation sample mean, i.e., *T* scores above 60, “may indicate a need for formal intervention or support assistance to enhance coping” (p. 763). Indeed, the present study findings of (i) higher MM-CGI HSL scores being associated with higher levels of depressive symptomatology and reduced life satisfaction, and (ii) evidence in support of the position that grief may operate to mediate the relationship between TBI sequelae and these two caregiver mental health outcomes, suggest that consideration is warranted of high caregiver grief experience as a potential marker of / risk factor for poorer overall psychological adjustment among this population.

In the current sample, 18.7% (*n* = 23) of caregivers had grief *T* scores exceeding 60. Independent *t*, Mann-Whitney, and chi-square tests were employed to examine differences between this group of caregivers reporting relatively high levels of grief experience and those with HSL scores below the Marwit and Meuser (2002) proposed

cutoff ( $T \leq 60$ ,  $n = 100$ ). Caregivers with grief  $T$  scores above 60 reported higher levels of depressive symptomatology ( $t_{121} = -5.82$ ,  $p < .001$ ) and lower life satisfaction (Mann-Whitney  $U = 488$ ,  $z = -4.30$ ,  $p < .001$ ). Caregivers within this group were more likely to be experiencing depressive symptoms within the clinically significant range (82.6%) than were caregivers with grief scores below the cutoff (39%;  $\chi^2 = 14.27$ ,  $df = 1$ , 2-tailed  $p < .001$ ; odds ratio = 7.43). Participants with HSL  $T$  scores exceeding 60 were also more likely to have SWLS scores within the dissatisfied to very dissatisfied range (69.6% to 29%;  $\chi^2 = 13.26$ ,  $df = 1$ , 2-tailed  $p < .001$ ; odds ratio = 5.59)

Notably, those caregivers above Marwit and Meuser's (2002) proposed grief cutoff score who fell within the clinically significant range on the CES-D represented only 32.8% of the overall number of participants with a CES-D score above the clinical cutoff. Indeed, 39% of caregivers below the proposed grief cutoff score had CES-D scores suggestive of clinically significant depressive symptomatology. This suggests that a lower MM-CGI HSL cutoff score may be required in this population to increase sensitivity with respect to those TBI family caregivers potentially at risk for depression, poorer overall psychological adjustment, and in need of professional support.

To explore this possibility further, a receiver operating characteristic (ROC) analysis was conducted to establish the accuracy of the grief cut-score proposed by Marwit and Meuser (2002) with regard to identification of TBI family caregivers at risk for depression. A CES-D score equal to or above the standard cutoff of 16, i.e., equal to or exceeding the score considered indicative of clinically significant depressive symptoms, was used as the target/criterion variable.

ROC analysis evaluates the trade-off between specificity versus sensitivity across a range of values on the index measure, in this instance the MM-CGI HSL, with respect to its ability to predict a dichotomous outcome (Florkowski, 2008; Youngstrom, 2014), here a CES-D score equal to/above or below the clinical cutoff. *Specificity* refers to the accuracy of the index measure for persons that do not have the target condition. Its complement is the *false positive / false alarm rate*, or how often individuals that do not have the target condition would incorrectly score positive on the index measure. Specificity plus the false positive rate always sum to 1. *Sensitivity* describes the accuracy of the index measure among those who do have target condition – it refers to the proportion of participants who have the target condition who test positive on the index measure, i.e., the proportion of true positives. While it is possible to achieve perfect sensitivity by identifying all individuals under study as having the condition, this would also result in a 100% false positive rate and specificity of 0%. Conversely, perfect specificity can be attained by not identifying any cases; of course, this strategy also yields a sensitivity of 0%, as none of the cases positive for the criterion condition would be identified. Ideally, there would be a cutpoint on the index measure that would separate those who meet the target condition from those who do not (Florkowski, 2008; Youngstrom, 2014).

The ROC curve in Figure 14 visually summarizes the trade-off between decrement in sensitivity (i.e., the true positive rate) and false alarm reduction (i.e., improving specificity) vis-à-vis CES-D caseness as the MM-CGI HSL *T* score cutpoint becomes more stringent. A perfectly discriminating index measure would reach the top left corner, including 100% sensitivity and 0% false positives on the curve. The diagonal

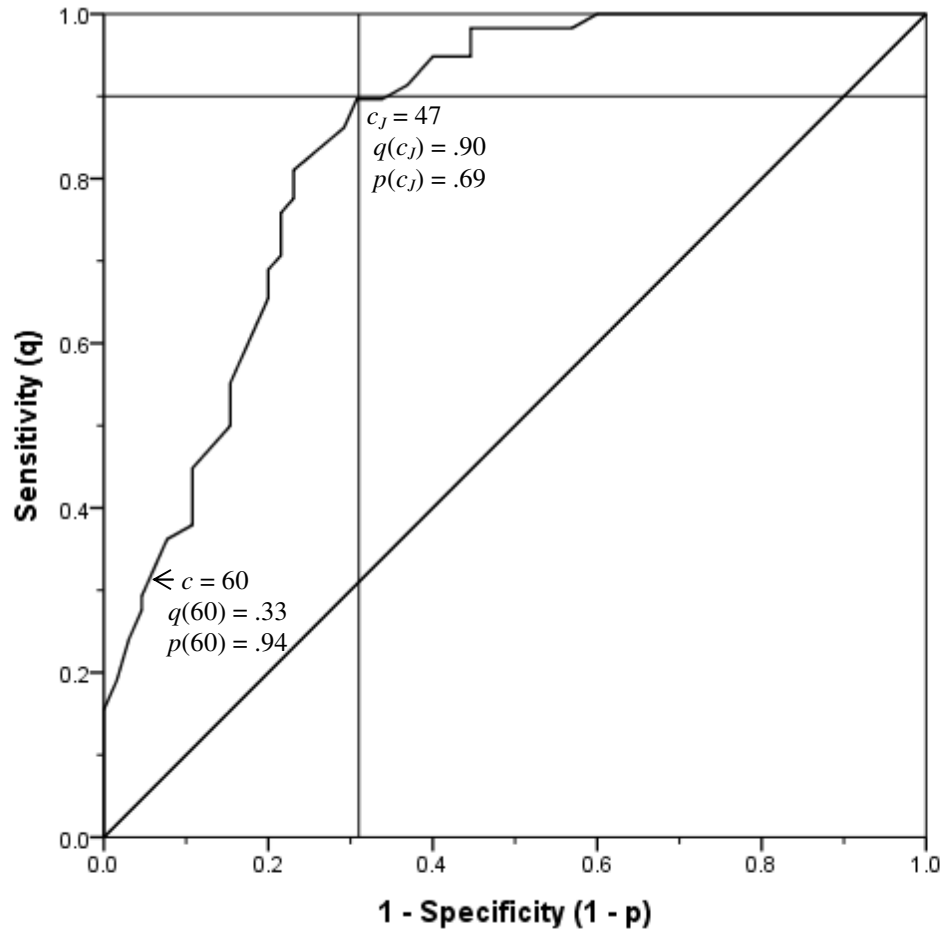

Figure 14. Receiver operating characteristic curve for MM-CGI HSL  $T$  score as an index measure predicting CES-D caseness. The intersection of the internal vertical and horizontal lines indicate the optimal cutpoint as identified by the Youden index,  $c_j$ .

line represents chance performance. Visually, the closer the ROC curve comes to the top left corner, and the further it is from the random ROC line on the diagonal, the better the job it performs discriminating the target condition (Streiner & Cairney, 2007; Youngstrom, 2014). This is reflected in the *area under the curve* (AUC) statistic, an indicator of the overall accuracy of the index measure. Here, the AUC can be interpreted as the probability that a randomly selected participant with a CES-D score equal to or above 16 would have a higher score on the grief measure than a randomly selected participant with a CES-D score below 16. The AUC statistic for the HSL index measure

is significant and favourably large, with the null hypothesis of .50 not contained within the 95% confidence interval ( $AUC = .848$ ,  $SE = .034$ ,  $p < .001$ , 95%  $CI$ : .780 to .916). Benchmarks for gauging AUCs suggest that values  $\geq .90$  are “excellent,”  $\geq .80$  “good,”  $\geq .70$  “fair,” and  $< .70$  “poor.” These are appropriate for engineering and certain biomedical applications, but are considered less representative in the context of mental health indicators where the AUC is typically more constrained by the reliability and validity of the target condition / criterion measure. In practice, many of the best-performing index measures in clinical psychology display AUC estimates in the .70 to .80 range (Youngstrom, 2014).

With regard to establishing the optimal cutpoint on the predictor measure in ROC analysis, i.e., the cutpoint that classifies the most people correctly and the fewest incorrectly, a method commonly recommended is calculation of the Youden index,  $J$  (Kumar & Indrayan, 2011; Perkins & Schisterman, 2006). The Youden index is defined as follows:

$$\begin{aligned}
 J &= \max \{q(c) + p(c) - 1\} \\
 &= \max \{q(c) - (1 - p(c))\} \quad (8)
 \end{aligned}$$

In equation 8,  $q(c)$  denotes the sensitivity and  $p(c)$  denotes the specificity of the predictor for a given cutpoint  $c$ ;  $c_J$  denotes the cutpoint corresponding to  $J$ . On a ROC curve,  $J$  is the maximum vertical distance from the curve to the chance line (the positive diagonal in Figure 14), making  $c_J$  the optimal cutpoint. The intuitive interpretation of the Youden index is that  $J$  is the point on the curve farthest from chance (Perkins & Schisterman, 2006). As can be seen in Figure 14, calculation of the distance to the diagonal for each point on the ROC curve identified an HSL  $T$  score of 47 as the optimal

cutpoint ( $c_J = 47$ ;  $J = .59$ ). Sensitivity,  $q(c_J)$ , and specificity,  $p(c_J)$ , at this cut-score were .90 (false negative rate = .10) and .69 (false positive rate = .31), respectively. In contrast, application of the cutpoint proposed by Marwit and Meuser (2002), an HSL  $T$  score of 60, results in sensitivity,  $q(60)$ , and specificity,  $p(60)$ , of .33 (false negative rate = .67) and .94 (false positive rate = .06).

The higher level of sensitivity versus specificity of the grief  $T$  score cutpoint identified via use of the Youden index in comparison to the cutpoint advanced by Marwit and Meuser (2002) is arguably preferable in this context as the goal is to examine the potential of the grief measure to operate as a screener for those TBI family caregivers who may be at risk of depression. Indeed, in such circumstances a greater premium is typically placed on sensitivity in order to avoid missing positive cases (Youngstrom, 2014). Moreover, the overall correct classification rate,  $q(c) + p(c)$ , is 1.59 for  $c_J$  and 1.27 for  $c = 60$ , out of a possible 2. In other words, correct classification increases from 63.5% to 79.5% by shifting from the Marwit and Meuser (2002) proposed grief cut-score to the cutpoint identified by application of the Youden index.

## CHAPTER 5

## DISCUSSION

In line with expectation, the findings of the current study provide evidence that grief experience is likely a highly important component of the adjustment process among many family members of persons who have sustained a TBI. This is in accord with the observations of several small-scale qualitative investigations (Clark et al., 2008; Good, 2003; Singer & Nixon, 1996), as well as the results of the only other quantitative method study of grief reaction among relatives of TBI survivors, that conducted by Zinner and colleagues (Zinner et al., 1997). The present investigation is considered to represent an extension of the Zinner et al. (1997) study in several important respects. These include measurement of critical components of grief experience not assayed by Zinner et al. (1997), viz., sadness and longing secondary to loss, documenting grief among relatives with a wide array of kin relationship to the survivor, as opposed to only maternal caregivers, assessment at points beyond the Zinner et al. (1997) upper limit restriction on time since injury of three years, as well as delineation of additional predictors of caregiver grief, including potential protective factors. Furthermore, the current study also explored the possibility that grief experience operates as a causal factor that contributes to other key aspects of TBI family caregiver outcome, including depression and overall satisfaction with life.

As predicted, change in TBI survivor personality as perceived by the family caregiver, in the form of TBI-induced neurobehavioural and emotional change, displayed a strong positive association with grief experience. Moreover, perceived personality change secondary to TBI emerged as one of the two strongest predictors of unique



variance in grief. This finding is congruent with the hypothesis, formulated within the context of the emotion regulation grief model advanced earlier (pp. 89-91), that perceived change in TBI survivor personality represents a key catalyst for caregiver appraisal of a profound form of irrevocable interpersonal loss, and subsequent grief reaction. As noted by Harvey (2001), such interpersonal or social losses, i.e., “losses of interaction, companionship, love, [and] compassion” (p. 4), are considered to induce some of the strongest forms of grief experience.

On the basis of clinical work and social observation, the theoretical models of Doka (e.g., Doka, 1989, 2004; Doka & Aber, 2002) and of Boss (e.g., 1999, 2006) postulate characterological change following brain injury as a non-death form of loss that results in significant grief. In the context of discussion of grief experience that is disenfranchised secondary to a loss not being socially recognized, Doka (1989) advanced the construct of psychosocial death, and noted this to lead to strong grief reactions. He described a psychosocial death as occurring when “the persona of someone has changed so significantly, through mental illness, [or] organic brain syndromes . . . , that significant others perceive the person as he or she previously existed as dead” (p. 6). Boss (1999, 2006) formulated that personality change following TBI as perceived by relatives constitutes a form of ambiguous loss in which a significant other is physically present but perceived to be partially or completely psychologically absent. In a similar vein, Lezak (1978, 1986, 1988) and Muir and Haffey (1984), on the basis of their psychotherapeutic interactions with TBI family caregivers, proposed change in TBI survivor personality to be a central factor resulting in family member grief, with the latter complicated by a loss experience that is uncertain in nature and not recognized by others. The present finding

of perceived personality change secondary to TBI as a significant predictor of family caregiver grief represents the first empirical support from a quantitative study for the seminal formulations of Doka (1989, 2004), Boss (1999, 2006), Lezak (1978, 1986, 1988), and Muir and Haffey (1984) vis-à-vis characterological change as a non-death form of loss that operates as an important precipitant of grief experience in the wake of a relative's TBI.

The current data are also consistent with prior research which has observed personality change in TBI survivors, manifest as caregiver perceived alteration or disturbance in survivor neurobehavioural and affective functioning, to be a highly reliable, and in a number of studies the strongest, predictor of several other indices of family adjustment, including family member psychological distress (e.g., Brooks et al., 1986; Ergh et al., 2002; Kreutzer et al., 1994b), depressive symptomatology (e.g., Oddy et al., 1978a), anxiety (Ponsford & Schönberger, 2010), perceived caregiving burden (e.g., Allen et al., 1994), and life satisfaction (e.g., Ergh et al., 2003, Wells et al, 1995), as well as family system functioning (Douglas & Spellacy, 1996; Groom et al., 1998).

Perceived personality change emerging as one of the strongest independent predictors of grief in the regression analysis was echoed in the content of many of the free-form caregiver descriptions of loss and grief experience collected from the current sample for a separate qualitative method study. In these narratives, participants often highlighted perceived characterological change as a primary form of loss and cause of their grief. Indeed, in line with Doka's (1989) construct of psychosocial death, several participant narratives attested to loss in the form of personality change of such magnitude that their relative as they knew them was described as having been lost in entirety,

emerging from injury as a completely different person. For instance, a participant whose husband was injured four years prior stated:

The loss I feel is the loss of the person I knew before the MVA. He isn't there anymore. This person I am married to has a very different personality. Gone is the person with a great sense of humor ... Gone is the caring thoughtful person who was concerned about how I felt ... I grieve the husband I lost. (P98, wife)<sup>41</sup>

The following is a small selection of further illustrative examples of the role of personality change in caregiver loss and grief experience as reflected in participant narratives:

When my daughter had her accident she died that day and a new young lady was born ... The grief is simply grieving the loss of a person. She is not the same person so we had to come to terms with the new young lady and embrace her and let the old girl go. That has taken a lot of time and we are still grieving her and the life she had and the life we thought she would have. (P35, mother)

I felt that I had lost my child. Yes Ollie was alive but I didn't know this person that had come home. Although it is 5 years later and he has made a remarkable recovery he is not the same person. He still is very rigid and his personality is very different. I just feel an incredible sadness about what could have been! (P62, mother)

I have lost the man I married and he has been replaced with a child. He is not the same man but a different one. It is like having a changeling. (P8, wife)

Even after 19 years grief creeps up on me unbidden ... Most of all I grieve because this is not the daughter who was born to us. We have had to learn to love and get used to a totally different person with a totally different and sometimes unlikeable personality. (P58, mother)

I feel like I lost my son Daniel. This Daniel has a totally different personality ... I live with a different son now. He is different in all the good ways (more sociable, family oriented and outgoing) but I still mourn my old Daniel. I'll never know what he could have been. (P59, mother)

Attachment models of bereavement (e.g., Bowlby 1969; Weiss, 1973; 2001)

contend that social support cannot lessen the intensity of grief experience as the lost

---

<sup>41</sup> Participant narrative quotations are indexed by participant number; names of relatives, when present, have been changed. Open-ended response data are being used here for illustrative purposes only. As noted, a full qualitative analysis of participant narratives will be conducted in a future investigation.

attachment figure is considered a unique, and, in turn, irreplaceable source of emotional security and well-being. Empirical study of the influence of perceived social support on outcome among bereaved populations has produced mixed findings (for review, see Stroebe et al., 2005), while the small number of investigations exploring grief reactions secondary to non-death forms of loss, including acquired brain injury sustained by a family member, have not observed any relationship between perceived social support and grief outcome (Marwit et al., 2008; McCaskill, 1997; Teel, 1993). Therefore, perceived social support was hypothesized to display at most a weak negative relationship with caregiver grief in the current sample, and was not anticipated to contribute uniquely to the prediction of variance in grief level. Contrary to expectation, however, a modest inverse correlation was found between caregiver perceived social support and grief experience, with social support emerging as a unique predictor of grief in regression analysis.

These findings speak to the potential value of the application of stress-coping based formulations of the role of social support in adaptation to loss (e.g., Ogrodniczuk et al., 2003); here it is proposed that perception of adequate social support may operate to bolster appraisal of personal coping resources and partially alleviate the adverse impact of loss. The emotion regulation model of grief reaction adapted by the current author from the work of Shaver and Tancredy (2001) incorporates elements of Lazarus' (1999) revised stress-coping theory, and views the emotional experience of grief as a malleable, ongoing response to the person-environment interaction. Operating within this model, the finding of a robust negative relationship between social support and grief suggests perception of adequate social support from others following a family member suffering a

TBI, while not fully able to compensate for the potential partial or full loss of an attachment figure, nonetheless serves to alleviate at least some of the associated loss of instrumental, validation, and emotional support. Subsequently, perceived social support is likely to enhance favourable emotion regulation over time by bolstering both the caregiver's perception of their coping capacity and engagement in coping efforts. In turn, this dynamic reduces the adverse emotional impact of the caregiver's loss appraisal secondary to their relative's TBI, leading to better grief outcome.

The observation of perceived social support operating as a protective factor with regard to grief experience is broadly consistent with the relatively large body of existing research that has demonstrated higher levels of perceived social support among TBI family members to be associated with more positive adjustment in several other domains of psychological well-being. Specifically, higher perceived social support has been found to be related to lower caregiver burden (e.g., Davis et al., 2009), general psychological distress (e.g., Ergh et al., 2002), and depressive symptoms (Harris et al., 2001), higher life satisfaction/quality of life (e.g., Chronister et al., 2010), as well as better overall family functioning (e.g., Douglas & Spellacy, 1996). A similar pattern was observed in the current sample, with higher levels of caregiver perceived social support found to be associated with lower perceived caregiving burden, lower levels of depressive symptomatology, and higher life satisfaction scores.

Hypotheses regarding the potential protective effects of meaning reconstruction processes vis-à-vis TBI caregiver grief experience were partially supported. While both sense-making and benefit-finding efforts by participants with regard to their experience of their family member's TBI were observed to be associated with lower grief levels,

only benefit-finding was found to be a unique predictor of grief. Benefit-finding emerging as the more powerful protective factor among TBI caregivers with respect to grief is congruent with the postulate advanced by Bruce and Schultz (2001) that in the case of nonfinite loss, such as that experienced by family members of TBI survivors, abstracting meaning by seeking to identify positive consequences or benefits associated with the loss experience constitutes a critical component of more favourable adjustment. This finding in the current sample, where the average reported time since survivor injury was 10.5 years with 72 percent of participants providing care for a relative who sustained their TBI at least 5 years prior, is also congruent with the observation of benefit-finding having a more ameliorative effect than sense-making at later time periods in longitudinal studies investigating the impact of meaning reconstruction on general distress and grief outcomes among bereaved individuals (Davis et al., 1998; Murphy et al., 2003). Indeed, as previously noted, Janoff-Bulman and colleagues, in their germinal formulation of meaning-as-comprehensibility and meaning-as-significance argue that the latter meaning reconstruction process is likely to play a more important role with regard to favourable adaptation to loss in the long term (Janoff-Bulman & Berg, 1998; Janoff-Bulman & Frantz, 1997). These authors contend that following attempts to make sense of a loss or trauma within the context of belief systems and related sociocultural discourses with regard to notions such as justice, control over life events, and person-outcome contingencies, meaning-making efforts naturally shift over time to questions regarding value and significance. The primary meaning-related concern for the individual is no longer one of sense-making, but instead whether their life is meaningful – whether it is of value: It is argued that the experience of loss or trauma ultimately leads to a re-

evaluation of one's life and what is important. The search for meaning "out there" in the form of making sense of the world becomes less central as meaning-making efforts shift to a process of establishing significance and purpose in one's daily life as a creative agent constructing something positive and of personal worth out of adversity. A greater awareness of human fragility and transience effected by the experience of loss or trauma acts as a catalyst for seeking value. With the knowledge that life or critical aspects of it can be lost at any moment comes appreciation that it cannot be taken for granted; with awareness that adverse events can occur when least expected, the person must determine for themselves what matters, what gives purpose to their existence, and make choices accordingly (Janoff-Bulman & Frantz, 1997). While we do not have full control over what happens in terms of life's outcomes, we have control over our attitude toward suffering, and meaningful control over our choices and what is important to us in our lives (Frankl, 1946/1984). Thus, one's attitude in the face of adversity and one's choices become the foundation for actions and commitments, thereby providing a source of personal meaning, purpose, fulfillment, self-esteem, and potential growth. Moreover, the loss experience provides a powerful touchstone, a point of contrast with which to compare aspects of the individual's daily lived experience. Subsequently aspects of the person's life that were previously underappreciated or future experience that may have been undervalued in the absence of the loss experience and associated reframing of worldview are seen as positive, enjoyable, and worthy of investment (Janoff-Bulman & Berg, 1998; Janoff-Bulman & Frantz, 1997).

In accord with the current result of more successful benefit-finding efforts being predictive of lower TBI caregiver grief level, studies investigating adjustment to a diverse

number of other non-death forms of loss and trauma have also found this type of meaning-making to be associated with more favourable psychological outcome (e.g., Carver & Antoni, 2004; Cassidy, 2013; McMillen et al., 1997; Schok, Kleber, & Lensvelt-Mulders, 2010; Siegel & Schrimshaw, 2007). Further support for the position that benefit-finding may play a greater role in promoting adjustment with the passage of time is provided by a meta-analytic review conducted by Helgeson et al. (2006) of the effect of benefit-finding on several health indices among samples of people adjusting to a variety of adverse events, including bereavement. These authors observed benefit-finding to be more strongly related to reduced depressive symptoms and greater positive well-being among those studies where the average time since stressor onset was greater than two years. Congruent with Janoff-Bulman and colleagues' conceptualization of meaning-as-significance (e.g., Janoff-Bulman & Berg, 1998), several investigations in this research domain have also found discovery of unsought benefits to often involve a greater appreciation of life and reordering of priorities, as life, or at least elements of it, is now regarded as inherently more valuable (e.g., Collins, Taylor, & Skokan, 1990; Davis et al., 1998; Joseph, Williams, & Yule, 1993; Schok et al., 2010). In a recent qualitative investigation of meaning reconstruction and grief reaction among bereaved parents, Lichtenthal et al. (2010) identified heightened appreciation of life as one of the three most common themes of benefit-finding present in parent narratives.

The observation of benefit-finding but not sense-making operating as a predictor of grief is at odds with the results of certain cross-sectional studies which have investigated the role of these two construals of meaning among bereaved populations. Some of the studies conducted by Neimeyer and his colleagues have found sense-making



rather than benefit-finding to be a stronger predictor of normative and complicated grief (Holland et al., 2006; Keesee et al., 2008). Of note, however, sense-making has not consistently emerged as a grief predictor among bereaved samples. For example, Coleman and Neimeyer (2010) observed neither concurrent nor subsequent grief to be predicted by sense-making in a longitudinal study assessing outcome among bereaved older adults at 6, 18, and 48 months post-loss.

Interestingly, when comparing the role of the two meaning-making processes under consideration in aiding adjustment to distress, Holland and colleagues (Holland, Currier, Coleman, & Neimeyer, 2010) observed a different pattern of associations between a group of bereaved college students and a sample of college students dealing with a stressful non-death life event: In correlation analyses benefit-finding but not sense-making was associated with better outcome on several indices in the general distress cohort; the opposite pattern of associations was found in the bereaved sample with only sense-making displaying favourable relationships with adjustment measures. The current findings together with those of Holland et al. (2010) suggest that benefit-finding may play a larger role in adjustment to non-death forms of adverse life experience. Further research on the impact of these two construals of meaning on outcomes in the face of different kinds of stressors is indicated. In particular, it would likely prove both theoretically and clinically informative to explore, using prospective, longitudinal designs, whether the role of benefit-finding and sense-making differs across different forms of loss experience. One key factor to examine here may be a temporal aspect of the loss: Losses that occur at a single point in time (such as some forms of bereavement) may elicit a different process of integration into meaning structures than those that are

extended over time, such as the nonfinite losses postulated to be effected by TBI. In addition, the discovery of unsought benefits from loss may be a process that takes longer to initiate/complete vis-à-vis sense-making. Another aspect of loss worthy of consideration in future investigations is the relative degree to which the loss is experienced as unexpected or traumatic; it has been suggested that losses that result from sudden and violent causes are likely to be more challenging to make sense of compared to losses secondary to less traumatic events (e.g., Currier et al., 2006; Davis et al., 1998). Preliminary support for this position was found by Holland et al. (2010), who observed that participants in their bereaved subsample who lost a relative by unanticipated and violent means (i.e., accident, suicide, or homicide) displayed much lower meaning-as-comprehensibility scores compared with those who lost a loved one to natural causes.

Affirming Frankl's (1946/1984) contention that the human capacity to find meaning in the face of adversity is a key component to maintenance of mental health and positive adaptation, the meaning-making processes under investigation were found to not only be associated with lower grief levels but also more favourable adjustment with respect to other indices of caregiver outcome. Both sense-making and benefit-finding were observed in the present sample to be associated with lower levels of depressive symptoms and higher life satisfaction, with stronger relationships found for benefit-finding. Finding something positive in their experience of their family member's injury was the only construal of meaning that was associated with lower perceived caregiving burden for participants.

In keeping with expectation, time since survivor injury was observed to have no association with caregiver grief level. This finding provides empirical support for the

position of those theorists who contend that the grieving process following a family member sustaining a TBI is likely to be complicated and protracted, with an absence of full resolution of grief over time, given the disenfranchised, ambiguous, and, in particular, nonfinite nature of the losses experienced (Boss, 1999; Bruce & Schultz, 2001; Doka, 1989; Muir & Haffey, 1984; Roos, 2002). The observation of no reduction in grief level over time suggests revision is likely required to models of family functioning following TBI which delineate successful “working through” of grief reactions with the passage of time as a normative expectation (e.g., Groveman & Brown, 1985; Lezak, 1986; Spanbock, 1987). Congruent with observations from an investigation of the phenomenological experience of three parents of children who sustained a TBI (Good, 2003), as well as available published autobiographical family member accounts (e.g., Beaver, 1991; Kramer, 1991), several narratives written by participants from the current sample when asked to describe their grief experience secondary to their relative’s TBI also suggest a chronic grief trajectory may be common among this population. Evident in these narratives, collected for the aforementioned separate qualitative investigation, were links between ongoing grief and perceived personality change with associated ambiguous loss. A small illustrative selection of this qualitative data is presented here to provide examples in this regard at different time points post injury, with emphasis added by the present author:

I feel like my son died that night and no matter what happens I feel I will never get over it. I occasionally see shades of him, they soon go. I have often thought it would have been kinder for everyone, especially him, if he had not survived as *there is no end to the grief – it stays as a constant open wound.* (P81, mother; time since injury: 3 years 6 months)

*It is living grief, a loss of no closure.* As a caregiver and mother of a survivor, it is an indescribable loss. There are no words to express the deepness of grief that

never leaves ... the loss of the person you used to have, the constant hurt of seeing your son struggle every day is exhausting. Unless you live the daily ongoing experience, you definitely do not understand. (P18; time since injury: 5 years 2 months)

I grieve for the loss of my sweet lovable daughter ... I drive the three hours to her house and weep the entire ride home. I have had to pull over on the side of the road many many times to cry for the loss of my child ... I love her but my sadness consumes me sometimes. (P97, mother; time since injury: 14 years 6 months)

Yes I do feel a huge amount of grief because of his injury. He has changed from the person he was before and is hugely dependent on me. *Even though it is now many years on it is always there.* You put it to the back of your mind and don't dare to think about it too much. Sometimes I only feel that way slightly but if I am tired or ill, then it feels like a huge cloak that is enveloping me, suffocating me. I can physically feel it descend on my shoulders. (P53, wife; time since injury: 19 years 5 months)

The finding of no relationship between time since injury and grief level is also congruent with the body of theoretical and empirical literature in the field of bereavement which has challenged stage models of grief that propose grief following death unfolds in predictable patterns over time. Bereavement research has demonstrated the amount of time that has elapsed since a loss through death is a relatively weak predictor of grief outcome, with several studies failing to observe time accounting for unique variance in complicated grief symptoms (e.g., Holland et al., 2006; Keesee et al., 2008) and a number of divergent grief trajectories over time having been identified (Bonanno & Kaltman, 2001; Bonanno, Wortman, & Nesse, 2004). Accordingly, the contemporary models of grief in the context of bereavement that have largely replaced phasic models have shifted the focus from time since loss to meaning reconstruction and other coping mechanisms (e.g., Neimeyer, 2001; Gillies & Neimeyer, 2006; Stroebe et al., 2001).

In keeping with expectation, caregiver perceived declines in four domains of survivor cognitive functioning considered critical to effective social interaction and

maintenance of interpersonal relationships – viz., receptive and expressive language, emotion identification, and theory of mind capacity – were modestly associated with higher caregiver grief levels in correlation analysis. In turn, the current study provides preliminary evidence for the position that diminished functioning among TBI survivors in these specific cognitive domains may represent important sources of social loss experience among caregivers. As predicted, perceived decline in survivor memory functioning, a cognitive domain viewed as less pivotal to basic interpersonal dynamics, was found to be unrelated to caregiver grief experience. Composite indices of perceived decline in survivor linguistic functioning (a composite of decline in receptive and expressive language) and in survivor social cognition (a composite of decline in emotion identification and theory of mind capacity) did not contribute uniquely to the prediction of grief.

As anticipated, caregiver history positive for experience of depressive symptomatology prior to survivor injury was observed to be associated with higher grief levels. Said history also accounted for unique variance in grief scores in the full regression model. This finding is consistent with previous research in the field which has found TBI family caregiver psychiatric history predating care recipient injury to predict postinjury depression diagnosis (Gillen et al., 1998) and general psychological distress (Davis et al., 2009). This observation, in turn, further underscores the importance of consideration of preinjury mental health difficulties as a risk factor for poorer adjustment among this population: Family TBI caregivers should be screened regarding their prior psychiatric histories early after injury to aid rehabilitation professionals in identifying

caregivers who may be at risk for developing distress, including potentially protracted grief experience, in the post-acute period.

Further evidence for the role of benefit-finding as a potential protective factor vis-à-vis TBI-related caregiver grief reaction was obtained via moderation analysis. Benefit-finding was observed to moderate the relationship between perceived survivor personality change and grief level: For caregivers reporting moderate to high levels of this form of meaning-making (above the 34<sup>th</sup> percentile) decreases in the level of perceived characterological change were associated with decreases in grief. In contrast, those participants reporting low levels of benefit-finding experienced uniformly high grief levels across the range of perceived personality change. The subsequent moderated moderation analysis qualified these findings and demonstrated the salutary effect of perceived social support with regard to grief outcome when operating in tandem with benefit-finding. Less successful meaning-making efforts in the form of low levels of benefit-finding were observed to be linked to high grief scores independent of the extent of perceived change in the survivor's personality only when social support was also low (below the 49<sup>th</sup> percentile). It is postulated that those caregivers reporting the combination of low benefit-finding and low perceived social support may represent a group of individuals with low *resilience*. For such persons even low levels of interpersonal loss experience in the form of relatively small appraised changes in survivor personality may lead to high levels of grief, as two factors that operate to aid favourable emotion regulation, and, in turn, confer resilience – viz., the capacity to find positives in adversity and supportive social connections – are largely absent.

As is the case with many latent psychological constructs, the definition and operationalization of resilience has been characterized by a significant lack of agreement (Fletcher & Sarker, 2013). In an attempt to address the need for concept clarification, Windle (2011), utilizing the methods of systematic review, concept analysis, and stakeholder consultation, has proposed the following definition of resilience:

[T]he process of effectively negotiating, adapting to, or managing significant sources of stress or trauma. Assets and resources within the individual, their life and environment facilitate this capacity for adaptation and ‘bouncing back’ in the face of adversity. Across the life course, the experience of resilience will vary. (p. 163)

This definition is adopted here as it conceptualises resilience as a dynamic multidimensional person-environment phenomenon that is likely to vary temporally and contextually, and incorporates the role of developmental history/prior experience. Thus, it moves beyond static trait models of the construct to view resilience as a process emerging from the dynamic interaction of both protective person level variables and sociocontextual/environmental factors (Pangallo, Zibarras, Lewis, & Flaxmam, 2015).<sup>42</sup>

Benefit-finding or meaning-as-significance has been identified as an individual level protective factor that is likely to bolster resilience in the face of loss (e.g., Hooghe & Neimeyer, 2013). Indeed, Boss (2006, 2011) contends this form of meaning-making to be central to resilience in the face of ambiguous loss secondary to psychological absence. Preliminary evidence supporting the role of benefit-finding in promoting resilience in the context of different forms of adversity has been provided by a relatively small number of

---

<sup>42</sup> Some authors distinguish person level protective factors as *assets*, while protective factors external to the individual are termed *resources*.

studies which have demonstrated positive relationships between benefit-finding and resilience measures in several populations, including, child caregivers (Cassidy, Giles, & McLaughlin, 2014), war veterans (Schok et al., 2010), and adult cancer caregivers (Cassidy, 2013). At the same time, social support is widely recognized as a key environmental protective factor that, when available, confers resilience (e.g., Atkinson, Martin, & Rankin, 2009; American Psychological Association, 2009; Bonanno & Diminich, 2013, Wilks & Croom, 2008), with a large body of empirical support in this regard having accrued (for reviews see Rutter, 2013, and Stewart & Yuen, 2011). Notably, Boss (2006, 2011) also considers social support to play a key role in building resilience among persons experiencing ambiguous loss and its attendant grief. Thus, the present observation of low benefit-finding and low perceived social support as the only condition in which caregiver grief levels were uniformly high irrespective of extent of appraised characterological change in the TBI survivor is in accord with extant theory and findings in the field of psychological resilience, and lends support to Boss' (2006, 2011) proposition that these two factors operate to aid positive adaptation within the context of ambiguous loss and associated nonfinite grief.

The moderated moderation analysis, in addition, indicated that the interplay of benefit-finding and perceived social support helped to confer what Luthar (1993) terms a "protective reactive" pattern of resiliency factor effects such that the interactive ameliorative impact of these variables with regard to grief outcome was greatest when adversity/loss, in the form of perceived personality change, was lower. Thus, the current findings suggest there are limits to the buffering effects of benefit-finding and social support with respect to caregiver grief, with the protective value of these factors observed



to diminish as perceived change in survivor personality increased. Interestingly, Windle and colleagues (Windle, Woods, & Markland, 2010) observed a similar pattern within the context of another form of chronic loss experience: A resilience factor buffered the adverse effects on subjective well-being of chronic illness – expressly conceptualized by Windle et al. (2010) as a loss experience – to a greater extent when illness severity was lower.

With regard to more common indices of TBI family member outcome, in accord with expectation and the results of other non-TBI caregiver studies in which the MM-CGI has been employed (Meuser & Marwit, 2001; Marwit et al., 2008; Marwit & Kaye, 2008), caregiver grief was associated with higher levels of both depressive symptomatology and perceived caregiving burden. In addition, higher grief scores were related to lower levels of caregiver life satisfaction.

Importantly, caregiver grief was found to mediate the relationship between perceived survivor personality change and both caregiver depressive symptoms and life satisfaction, with small to medium indirect effects observed. Thus, the current findings provide preliminary evidence that grief experience may play a causal role in the development of depression and lower life satisfaction among TBI caregivers. These results, in turn, provide prefatory empirical support for the position, originally advanced by investigators in the fields of cancer and dementia caregiver research, that grief in response to non-death loss (especially that which is interpersonal in nature) operates as a central causal factor contributing to depression and other aspects of psychological adjustment among family caregivers (Meuser et al., 2004; Walker & Pomeroy, 1996; Williamson & Shaffer, 1996, 1998). Combining the moderation and mediation models in

conditional path analyses demonstrated that the indirect effect of perceived personality change on both caregiver depressive symptoms and life satisfaction via grief was moderated by benefit-finding only at low levels of perceived social support. The moderated mediation analyses, in addition, provided further evidence of the interactive protective impact of meaning-as-significance and social support as the conditional indirect effect of perceived characterological change through grief on carer depressive symptoms and satisfaction with life fell in magnitude with increases in social support only at high levels of benefit-finding.

The results implicating TBI caregiver grief experience as a potential mediating link between TBI-induced survivor personality change and caregiver depression also provides support for components of both Boss' (1999, 2006) model of ambiguous loss and Roos' (2002) formulation of chronic sorrow. On the basis of her clinical work, Boss (1999, 2006) contends that ambiguous loss in the form of persistent psychological absence with physical presence secondary to brain injury related characterological change complicates the grieving process and, in turn, commonly results in the development of depression: It is argued that the inherent inability to resolve the source of the loss, together with the indeterminate, uncanny nature of the loss (the loved one is perceived as simultaneously present and absent, familiar yet unfamiliar) leads to arrested grieving, extreme and chronic stress that may overwhelm and immobilize coping efforts, hopelessness, and subsequent depression. Similarly Roos (2002), while noting chronic sorrow – a nonfinite form of grief in response to an ongoing 'living' loss – to be distinct from depressive and other psychiatric disorders, argues that individuals experiencing such sorrow, including family members of TBI survivors, in addition to experiencing

chronic stress in the form of nonfinite loss, have an increased susceptibility and reactivity to additional stressors. In turn, there is an increased likelihood that the latter will precipitate pathological conditions, including major depressive disorder.

#### Clinical Significance of Outcome Data

With regard to depressive symptom prevalence, the proportion of participants in the present study exceeding the CES-D clinical cut-score, 47 percent, is markedly higher than the 15 to 21 percent observed in large US community samples (Eaton & Kessler, 1981; Levine, 2013). This elevated frequency of depressive symptomatology in the current sample – approximately 24 and 23 percent in the mild and moderate to severe range, respectively – is broadly consistent with the majority of the existing TBI caregiver findings. For example, Gillen et al. (1998) found 43 percent of their sample of family caregivers met criteria for a DSM-III-R diagnosis of major depressive disorder as assayed via diagnostic interview. Rivera and colleagues (2007) reported 48 percent of caregiver participants had CES-D scores that met the criteria for risk of depression. Similarly, Mintz et al. (1995) found 52 percent of TBI relatives scoring above the clinical cutpoint on the Beck Depression Inventory. Lower prevalence rates of depressive symptoms have been observed by Kreutzer et al. (2009), and Ponsford and Schönberger (2010); 19 percent of each of their samples were above the clinical cutoff on the Depression subscales of the BSI-18 and the HADS, respectively.<sup>43</sup> These lower prevalence levels may reflect differential sensitivity of the measurement scales employed across the studies and/or differences in targeted recruitment populations. With regard to the latter, it has been argued that recruitment of community samples may be more likely to draw

---

<sup>43</sup> Ponsford and Schönberger (2010) reported clinically significant depressive symptom prevalence of 19% at 5-years postinjury, a decline from a prevalence rate of 27% at 2-year follow-up. In the current sample time since injury was not correlated with depressive symptoms.

distressed participants in comparison to recruitment conducted as a component of hospital follow-up procedures, as done by Kreutzer et al. (2009) and Ponsford and Schönberger (2010). However, it is noted that the sample of Gillen et al. (1998) was also recruited via contact of all persons on hospital TBI patient lists that met other study inclusion criteria.

Divergence in exact symptomatology prevalence rates across investigations notwithstanding, the findings of the current project, together with those of prior studies, suggest higher prevalence of depression among TBI family caregivers is likely relative to the general population; 12-month national prevalence estimates of major depressive disorder in Canada, the US, and the UK range from 2 to 12 percent (Halliwell, Main, & Richardson, 2007; Kessler et al., 2005; Langlois et al., 2012).

In the current investigation a substantial number of TBI family caregivers (37 percent) reported dissatisfaction with life. Additionally, participants displayed significantly lower life satisfaction relative to a normative sample of healthy adults. These findings are largely congruent with the results of past studies that have assessed this important aspect of subjective well-being. In previous investigations, the proportion of family caregivers reporting life dissatisfaction has ranged from 27 to 41 percent (Ergh et al., 2003; Kolakowsky-Hayner et al., 2001; Livingstone et al., 2010). However, it is also important to note that, in line with the position advanced by Perlesz et al. (1999), in addition to providing evidence of the adverse impact of TBI on life satisfaction among family members, the present results suggest that a subgroup of this population display relatively positive adjustment with respect to this outcome variable: 22 percent of the sample reported being satisfied with their lives.

The mean grief level observed in the current study is of similar magnitude to mean scores achieved on the same caregiver grief scale by family members of individuals with dementia (Marwit & Meuser, 2002) and relatives of persons with acquired brain injury (Marwit & Kaye, 2006). Definitively establishing the prevalence of grief reaction in the present sample on the basis of available data is not possible as there is no cutpoint on the MM-CGI HSL scale indicating the absence versus presence of grief. However, review of the frequencies of average item scores for this scale does suggest grief experience in a majority of caregivers: 59 percent of participants had average item scores indicating agreement with statements assessing grief secondary to a family member's TBI. Further insight into the extent to which grief is a salient aspect of TBI caregiver adjustment is also provided by preliminary analysis of participant written narratives collected for the aforementioned qualitative study. In response to an item requesting participants to describe, if applicable, grief secondary to their relative's injury, only four participants (3.3 percent) wrote of not having experienced grief; the remaining 119 caregivers provided narratives affirming their experience of TBI-induced grief.

The developers of the MM-CGI (Marwit & Meuser, 2002) have argued that HSL scale scores more than one standard deviation above the validation sample mean may be of clinical relevance, potentially indicating a need for intervention to aid coping. Indeed, the present study findings of (i) higher HSL scores being associated with higher levels of depressive symptomatology and reduced life satisfaction, and (ii) evidence in support of the position that grief may operate to mediate the relationship between TBI sequelae and these two caregiver mental health outcomes, suggest that consideration is warranted of

high caregiver grief experience as a potential marker of / risk factor for poorer overall psychological adjustment among this population.

Although Marwit and Meuser's (2002) proposed grief cutoff *T* score of 60 was found to successfully identify a group of participants more likely to be experiencing clinically significant levels of depressive symptomatology and decreased life satisfaction, a sizeable proportion of the sample subgroup with grief scores below the proposed cutpoint (39 percent) was observed to display depressive symptom levels within the clinically significant range. Subsequent ROC analysis indicated that the sensitivity of the HSL scale, as well as its overall accuracy, with regard to identification of those TBI caregivers who may be at risk of depression, increased markedly by shifting the grief cutpoint downward from that proposed by Marwit and Meuser (2002) to a *T* score of 47. The latter equates to a raw HSL score of 45, a figure just below the mean grief score of the current sample. Further investigation of the potential of the MM-CGI HSL scale to operate as a screener for those TBI family caregivers at risk of depression, ideally with use of a longitudinal design and major or persistent depressive disorder identified by diagnostic interview, is indicated.

#### Further Clinical Implications and Directions for Future Research

The results of the current investigation add to a small but growing body of research that suggests loss and consequent grief experience is likely a highly salient component of the process of family member adjustment to a loved one suffering a TBI. Moreover, the present findings provide initial support for the position that grief may operate as a broader psychological conditioning factor with contributions to other important elements of family TBI caregiver outcome, including depression and life

satisfaction. In turn, it is suggested here that inclusion of grief in both the conceptualization and assessment of caregiver adjustment would provide a more comprehensive understanding of the impact of TBI on family members, and, subsequently, valuable insight with regard to the development and evaluation of clinical interventions for this generally underserved population.

With respect to assessment of TBI family caregiver outcome, Carlozzi et al. (2015) have cogently argued for the development of new measurement instruments that are designed to capture quality of life issues unique to TBI caregivers, with a view to incorporate such population-specific tools into the state-of-the-art computer administered Patient Reported Outcomes Measurement Information System (PROMIS). Notably, Carlozzi and colleagues (2015), via thematic analysis of transcripts from caregiver focus groups, identified “feelings of loss” as a prominent domain of TBI caregiver quality of life not captured by PROMIS or existing caregiver measures. These researchers, in turn, suggested development of a measure of this domain is required. Although Carlozzi et al. (2015), while delineating a wide range of other emotional health concerns, do not make any mention of grief, the present author proposes that the “feelings of loss” consistently identified among their sample are likely to reflect, at least in part, caregiver grief experience. Thus, the brain injury version of the Marwit-Meuser caregiver grief inventory (Marwit & Kaye, 2006) may represent a good candidate instrument for review in future research for incorporation into the PROMIS assessment framework. As a natural corollary, it is also suggested here that caregiver grief be strongly considered for inclusion as an additional emotional health domain in a revised version of Carlozzi et al.’s (2015) conceptual model of factors related to TBI caregiver quality of life. This addition

would arguably aid the Carlozzi et al. (2015) model to more fully meet its remit as a guide to development of a comprehensive patient-reported outcome measurement system specific to this carer population.

The present findings also suggest interventions designed to specifically target loss and grief experience among family TBI caregivers may be indicated to aid adjustment and foster resilience. Before moving to a discussion of such interventions, it is important to note certain limitations of the current study. First, the cross-sectional design limits definitive temporal and causal inferences regarding the relationships between the variables under consideration. Second, the relative homogeneity of the sample along certain dimensions restricts the generalization of results. Despite considerable geographic diversity, the vast majority of participants were Caucasian. In addition, as with most studies in the area, the sample consisted predominantly of female caregivers. Future studies are required to replicate and build upon the present findings with utilization of longitudinal designs as well as recruitment procedures that will yield greater representation of various racial/ethnic groups and male caregivers. Longitudinal investigations will be particularly helpful with regard to examining the relationship between the passage of time and grief experience, as well as assaying the role of risk and protective factors identified in the present study in shaping grief outcome over time. Further investigation of the relationship between grief and other more common indices of caregiver adjustment is also indicated. In this regard, it is noted that mediation analyses in the context of a cross-sectional design cannot demonstrate causation. In turn, future longitudinal studies are required to investigate the potential causal pathways between grief and other forms of caregiver outcome, including depression and life satisfaction.



Given the current observations of caregiver grief intensity being unrelated to time since injury, and perceived personality change secondary to TBI predicting grief level, interventions delineated by Boss (1999, 2006) and Roos (2002) to address the unique aspects of chronic grief in response to nonfinite, ambiguous loss may be of benefit to TBI caregivers. Indeed, characterological change in a relative following brain injury is identified by both of these clinicians as a central source of ongoing loss experience and subsequent persistent grief (e.g., Boss, Roos, & Harris, 2011). Core therapeutic guidelines advanced by Boss and Roos (Boss, 1999, 2006; Boss et al., 2011; Roos, 2002) vis-à-vis supporting persons experiencing chronic grief are briefly outlined here. First recognizing and naming nonfinite losses and associated grief, alongside introduction of the concepts of ambiguous loss, chronic sorrow, and disenfranchised grief, can be seen to represent an important initial step in validating and normalizing the client's experience, laying the foundation for further intervention. Promotion of revision of the client's attachment to the survivor is considered to be a further key therapeutic task. Here a dialectic of very gradually relinquishing the family member as they were prior to the injury – a process that also involves slowly letting go of hopes for full restoration of that which has been lost – is facilitated, alongside cultivation of a “letting in” and embracing of the survivor as they exist postinjury. Thus, grieving of that which has been irretrievably lost, including aspirations for the future, is empathically supported, while building a stronger connection to and an acceptance of the survivor as they are postinjury is cultivated. The latter incorporates facilitating appreciation of those aspects of the survivor and of the client's relationship to the survivor that have not been lost. Other interventions suggested by Boss and Roos (Boss, 2006; Boss et al., 2011; Roos, 2002)

include cognitive-behavioural, Gestalt, experiential, and narrative therapy techniques to aid affect modulation, address symptoms of trauma should they be present, moderate the need for mastery in the face of external factors beyond personal control, and assist reconstruction of the client's relational sense of self in order to take into account the changes effected by the loss, including changes in familial roles.

It is important to note that although the intervention programs delineated by Boss and Roos (Boss, 2006; Boss et al., 2011; Roos, 2002) have strong theoretical foundations and are grounded in clinical experience, controlled studies of the efficacy of the interventions proposed in TBI family caregiver samples are required in order to help ensure evidence-based practice. Longitudinal qualitative studies focusing upon the nuances of TBI caregiver loss and grief experience in the wake of a relative's injury are also indicated to establish further the extent to which such experience is concordant with the ambiguous loss and chronic sorrow models which posit a complicated, protracted grieving process.

In her review of resilience research, Windle (2011) notes that for those experiencing chronic forms of adversity, mental health difficulties could be averted "providing that the individual is able to draw on a range of resources within themselves and their immediate environment, and that the wider environment is supportive" (p. 165). In accord with this position, the results of the current project suggest that for TBI family caregivers, interventions aimed at facilitating the discovery of benefits in their experience of loss and adversity secondary to their relative's injury, in combination with efforts to increase availability of / strengthen social support networks, are two possible ways in which healthcare professionals and support organizations can work toward bolstering

resilience in this population vis-à-vis potentially chronic and complicated grief reactions that may adversely impact broader psychological adjustment.

With regard to structuring interventions to help foster meaning-as-significance among grieving TBI family members, the constructivist meaning-oriented grief treatment model developed by Neimeyer for bereaved individuals may be a valuable source of guidance (for reviews see Neimeyer, 2001, 2006; Neimeyer, Burke, Mackay, & van Dyke Stringer, 2010; and Neimeyer & Burke, 2015). From this perspective profound loss challenges the coherence of an individual's *self-narrative*, defined as “an overarching cognitive-affective-behavioural structure that organizes the ‘micro-narratives’ of everyday life into a ‘macro-narrative’ that consolidates our self-understanding, establishes our characteristic range of emotions and goals, and guides our performance on the stage of the social world” (Neimeyer, 2006, p. 43). People are viewed as cognitively and neurobiologically ‘wired’ to make sense of life in storied form, and to integrate autobiographical events into self-narrative schemas that impart order and meaning to experience, and ultimately a stable sense of coherence in identity across time. Complications in grief are considered to arise when the implications of a loss significantly disorganize the congruence of the individual's self-narrative or invalidate its thematic substructure to such an extent that the person is forced to accommodate their narrative to adequately take into account present realities, and encounters difficulties in this process. In such circumstances the individual faces a protracted, painful search for meaning in their loss experience which is often unsuccessful (Neimeyer, 2006; Neimeyer & Sands, 2011; Shear, Boelen, & Neimeyer, 2011). The thrust of Neimeyer's (2001, 2006) constructivist grief therapy is therefore helping the client integrate the loss into

their self-narrative with concurrent fostering of meaning reconstruction efforts in the form of both sense-making and benefit-finding (Neimeyer et al., 2010).

Two key meaning-making strategies employed in Neimeyer's grief treatment model (Neimeyer et al., 2010; Shear et al., 2011) that could be considered for adaptation in working with TBI family caregivers are *narrative retelling* and *directed therapeutic writing*. Retelling of the narrative of loss in a safe therapeutic environment is viewed as offering a measure of social validation for the account, and serves to redress societal empathic failure, particularly when losses are non-normative. As with exposure-based therapies for other types of traumatic event, re-narration of the loss, including focusing on the hardest aspects of the experience and "staying with" them until the associated images and meanings can be held with less anguish, promotes mastery of difficult material and helps counteract overreliance on avoidance coping.<sup>44</sup> Importantly, narrative retelling is employed to help identify aspects of the loss and grief experience for which further meaning-based processing is required, and as a subsequent vehicle to promote sense-making and/or benefit-finding (Neimeyer et al., 2010; Neimeyer, 2012)

Research suggests that expressive writing regarding grief experience is more likely to aid adaptation to loss when participants are specifically directed to attempt to engage in meaning-making processes through their writing (Lichtenthal & Neimeyer, 2012). Lichtenthal and Cruess (2010) conducted a control trial to assess the efficacy of meaning-oriented directed writing intervention following bereavement. Randomizing participants to one of four conditions – emotional disclosure (ED), sense-making (SM), benefit-finding (BF), or a control condition (CC) – they requested that they write for

---

<sup>44</sup> This form of intervention is a central element of demonstrably efficacious treatments for complicated grief (Shear, Frank, Houck, & Reynolds, 2005).

three, 20-minute sessions over the course of a week about either their deepest thoughts and emotions related to their loss (ED), making sense of the event by exploring its causes, place in their lives, and level of congruence with their pre-existing worldviews (SM), any positive changes that came about as a result of their loss experience (BF), or simply the room in which they were seated (CC). Writing about the loss experience with a focus on meaning-making was found to be more effective in reducing both complicated grief and depressive symptoms than writing about a neutral topic. Symptom reduction increased in magnitude over the three-month follow-up period. In line with the current observation of benefit-finding emerging as the strongest predictor of TBI caregiver grief, the benefit-finding writing intervention was found to be especially salubrious, with treatment effects most pronounced in participants assigned to this condition. Future studies are required to establish the efficacy of adapted forms of narrative retelling and guided therapeutic writing with a focus on fostering benefit-finding, as well as other meaning-as-significance interventions, vis-à-vis more favourable family caregiver adjustment to TBI-induced loss. Here it is important to indicate that any meaning-making interventions are to be implemented cautiously. In this regard, interventions should be conducted in such a manner that the client's pain and suffering is fully acknowledged and validated in advance. Further research is required to establish the particular conditions under which the promotion of benefit-finding is likely to be helpful to TBI caregivers, including optimum timing.

An aspect of meaning-making not assessed in the current investigation but in need of study among family TBI caregivers is the active process of searching for meaning in the form of sense-making. Findings with regard to the impact of this component of

meaning-making upon adjustment among persons facing loss and chronic adversity have resulted in an important caveat being advanced with respect to its promotion in a therapeutic context: On the basis of findings that (a) a sizeable minority of persons who have experienced loss or adversity do not search for meaning in the form of understanding but still display favourable adjustment, and (b) associations between frequent unresolved searching for meaning-as-comprehensibility and higher levels of distress, Davis and colleagues (Davis & Morgan, 2008; Davis & Novoa, 2013) note that it may be misguided to actively encourage individuals who would not otherwise search for meaning in the form of sense-making to do so. In this regard, in congruence with the position advanced by both Davis and Morgan (2008) and Janoff-Bulman and Frantz (1997), it may be helpful to shift the focus of meaning-making efforts from sense-making to benefit-finding among those TBI family caregivers who have searched unsuccessfully for meaning-as-comprehensibility.

In addition, further research is required to establish whether a subgroup of those TBI caregivers who display positive adjustment profiles do not search to make sense of their experience of loss and adversity. It is likely that a key factor in determining whether a person searches for this form of meaning is the extent to which their core meaning systems are challenged by loss/adversity, which, in turn, may be an important determinant of resilience. For example, Davis et al. (2000) have postulated that living under generally adverse life conditions over time (e.g., chronic exposure to crime, poverty, and limited opportunity) may foster a worldview such as “major stressors are a part of life, and are not generally controllable” (p. 514). Such a worldview may confer resilience in allowing persons to incorporate major loss or trauma without becoming

intensely distressed or searching for sense. Similarly, Holland et al. (2006) have advanced that resilient grievers – those who show only minimal symptomatology to loss and quickly re-establish their psychosocial functioning and equilibrium (Bonanno, 2004) – are likely to possess pre-loss meaning systems that are able to readily assimilate the loss event and thereby negate the need for sense-making. Future studies of family TBI caregiver adjustment may wish to investigate the possibility that chronic experience of preinjury adversity, which may be more prevalent among persons of lower socioeconomic background, is a factor leading to a lower need to search for meaning-as-comprehensibility post injury, and subsequently more resilient outcomes.

A related area for further research in this population is exploration of the potential role of acceptance with respect to caregiver outcomes. The ability to come to accept adversity, or at least aspects of it, is likely closely connected to the capacity of existing worldviews to assimilate negative experience and one's relative need to engage in sense-making efforts. Higher degrees of acceptance of tinnitus, for example, have been found to be associated with reduced frequency of searching for meaning in the form of asking "Why me?", and lower levels of depressive symptoms (Davis & Morgan, 2008).

As noted by Davis and Novoa (2013), our understanding of the adaptive significance of meaning-making processes in the context of adversity and loss would also be improved by assessing the impact of within-person change in searching for and finding meaning on outcomes. Thus longitudinal studies that assay not only differences between those TBI family caregivers who search and/or find meaning and those who do not but also the effects that changes in meaning over time (both finding and losing) have on grief and other indices of caregiver outcome are indicated.

A further goal for future research exploring the role of meaning reconstruction processes in the promotion of TBI caregiver adjustment is delineation of the *types* of benefit found, and investigation of their potentially varying relationship with outcome. As a first step in this regard, analysis of caregiver narratives of perceived positive consequences secondary to their relative's TBI obtained from the current sample is planned to identify different themes of meaning-as-significance and their relative frequency with comparisons made to the forms of benefit-finding most commonly observed among individuals who have experienced other forms of loss and adversity, including bereavement.<sup>45</sup> Here it is important to note that, based in part on research of meaning-making among a group of bereaved persons who lost a family member in a mine explosion (Davis et al., 2007), Davis (2008) have suggested that distinctions may be drawn between three proposed categories of benefit, which, in turn, are likely to have different implications for adjustment and well-being: First, minor benefits are considered temporary in nature, incidental to loss or adversity, and do not require effortful processing to be found. Second, posttraumatic growth involves significant and sustained positive changes in major commitments, life goals, or life purpose that are reflected in the individual's actions and identity, and is contingent upon disruption of core models of the world and/or the self, with subsequent effortful processing of the meaning of the loss and/or trauma experience.<sup>46</sup> The third form of benefit proposed by Davis (2008) is

---

<sup>45</sup> Qualitative analysis by multiple coders of prominent sense-making themes in open-ended response data provided by the present sample is also planned.

<sup>46</sup> This represents a narrowing of the conceptualization of posttraumatic growth. As indicated earlier, such growth is often more broadly defined as "positive psychological change experienced as a result of the struggle with highly challenging life circumstances" (Tedeschi & Calhoun, 2004, p.1). It is important to note here that resilience and posttraumatic growth are distinct constructs. Resilience refers to the extent to which a person is able to maintain or re-establish their pre-adversity state of psychological functioning. Posttraumatic growth, as reflected in the latter half of the term, involves positive changes in an individual in response to adversity that extend beyond prior levels of functioning (Clay, Knibbs, & Joseph, 2009).



increased *insight*. This refers to development of a permanent deeper understanding of the self as a result of effortful reflection regarding the nature of the self that is induced by loss experience or other suffering. Support for the position that some types of benefit are more likely than others to play a role in favourable adjustment in the wake of adversity is provided by a study by Lichtenthal et al. (2010). In this investigation changes in life priorities and/or roles emerged as the only one of twelve forms of benefit-finding identified among a bereaved sample to consistently predict levels of normative and complicated grief, as well as prolonged grief disorder caseness.

Future study of the potential of adapted therapeutic interventions from the strength-based *Acceptance and Commitment Therapy* (ACT) model (Hayes, Strosahl, & Wilson, 1999; Hayes, Pistorello, & Levin, 2012) to aid adjustment among TBI family caregivers may also be warranted. In addition to possibly helping to foster a flexible stance toward negative cognitive and emotional experience, including that related to loss, such interventions, when cautiously and judiciously implemented, may assist caregivers in benefit-finding efforts by supporting not only identification but also concerted action toward achievement of value-directed goals. It is important to note, however, that systematic assessment of the appropriateness and efficacy of ACT model components within the specific context of grief experience, and in working with TBI family caregivers in particular is indicated. Evidence for the need of such evaluation and application of ACT interventions in a manner highly sympathetic to and accommodating of the unique challenges faced by the population under consideration is provided by a recent clinical study conducted by Williams and colleagues (Williams, Vaughan, Huws, & Hastings, 2014). In this qualitative investigation the impact of an ACT group

intervention program upon five spousal caregivers of persons with an acquired brain injury was observed to be mixed. Techniques designed to reduce experiential avoidance of painful emotional experience were reported by several participants to have caused distress. In this regard, Williams et al. (2014) note that future ACT interventions with brain injury caregivers need to be respectful of the potential utility of coping styles involving emotional avoidance developed by individuals within the specific context of long-standing chronic stress and daily caregiving demands.

The current results suggest interventions designed to increase both perceived and actual social support for TBI family caregivers will likely prove beneficial in relation to grief adjustment. In addition to provision of psychoeducation regarding the importance of seeking and obtaining adequate social support, healthcare professionals should directly facilitate caregiver access to and use of pertinent community resources, including respite care and support groups. Mobilizing family and public healthcare resources to provide respite care services would likely afford caregivers more time to seek and engage in social contexts, with subsequent opportunities to develop new supportive relationships (Ergh et al., 2003). Limited evidence for positive effects of respite care on carer well-being has been observed among dementia caregivers (McNally, Ben-Shlomo, & Newman, 1999) with further research of the potential benefits, including possible increases in social support, of such services among TBI caregivers required (Smeets, van Heugten, Geboers, Visser-Meily, & Schepers, 2012).

Family TBI caregiver support groups are likely to provide social ties that may help to buffer against the deleterious effects of TBI-induced loss and grief. Such groups have the potential to operate as a source of contact with similar others who can provide

empathy and an experienced ‘sounding board’, which, in turn, may help to counteract hopelessness. In addition, supportive contact with others who have experienced similar loss and adversity may help caregivers realize they are not alone in their struggles which may aid coping efforts. Moreover, there is evidence that a sense of a shared social identity, such as that likely promoted by participation in carer support groups, operates as a psychological basis that increases the likelihood of individuals being receptive to and benefiting from social support (Haslam, O'Brien, Jetten, Vormedal, & Penna, 2005).

Peer-to-peer mentoring may be another form of intervention with potential to provide an additional source of social succour to TBI family caregivers. However, research evaluating peer mentoring programs in this population is limited, with the available data suggesting minimal to no favourable impact on caregiver perceived social support or community integration (Hanks, Rapport, Wertheimer, & Koviak, 2012; Hibbard et al., 2002).

Within the context of discussion of the role of benefit-finding and social support in aiding adjustment to loss and grief experience among TBI family members it behooves one to be cognizant that meaning-making following loss does not occur only at the level of the individual but is also a social process situated in broader familial, cultural, linguistic, and political frameworks/systems (e.g., Neimeyer, Klass, & Dennis, 2014). Consequently, interventions designed to increase social support for TBI family caregivers may provide greater opportunities and resources for meaning reconstruction at the interpersonal level.

As indicated earlier, both benefit-finding and social support are identified by Boss (2006) as central to resiliency among persons who experience ambiguous loss and

associated nonfinite grief. Subsequently facilitation of both of these factors is included as a key component of her therapeutic model. Boss (2006) also acknowledges the social aspect of meaning-making processes, and argues that the efficacy of narrative therapy methods designed to encourage finding meaning in the form of personal significance is likely increased when employed within supportive group or family settings.

Notably, citing qualitative research and personal clinical experience, Klonoff (2014) has come to recognize grief as an important element of the adjustment process among relatives of individuals with acquired brain injury (ABI). Thus, in a recent reformulation and elaboration of her *Family Experiential Model (FEM) of Recovery* after brain injury and associated treatment model, Klonoff (2014) has incorporated interventions specifically targeting loss and grief among family members. These are predominantly based on the interventions developed by Boss (2006) and Roos (2002) to address nonfinite grief as described above. In turn, in addition to empathic validation of ongoing loss and grief experience, narrative, psychoeducational, and experiential techniques to engender adjustment of meaning schemas, finding meaning-as-significance, an empowered resolve to reengage with life, and social reintegration are included in the model. The clinical contribution of Klonoff's (2014) FEM treatment framework with regard to aiding family member adjustment to grief secondary to a relative's brain injury is highly substantial, and is in accord with a number of the findings of the current study. However, empirical investigation of the efficacy of the model as a whole as well as several of its constituent interventions, particularly those formulated to address grief adjustment, is strongly indicated.

Importantly, Klonoff's (2014) treatment model includes a group therapy format designed to provide long-term support for ABI family caregivers and other relatives, with several components focusing on loss and grief experience. The present findings along with those of extant studies (e.g., Gan, Gargarob, Brandysc, Gerberd & Boschene, 2010; Ponsford & Schönberger, 2010) strongly suggest that professional assistance to aid psychological adjustment among TBI family members needs to extend well beyond the inpatient rehabilitation period. To this end future study is required to investigate whether Klonoff's (2014) group treatment model, incorporating interventions targeting loss and grief reactions, could serve as a template for family caregiver support groups run as a collaborative endeavour between community-based brain injury organizations and appropriately trained healthcare professionals (e.g., clinical psychologists, neuropsychologists), with the latter operating as group leaders/facilitators with the capacity to make referrals for individualized treatment as indicated. Pilot investigations of the efficacy of such groups vis-à-vis family caregiver grief and other aspects of psychological well-being would be a first step in this regard.

A manualized family therapy intervention for adults with an ABI and their family members, termed the *Brain Injury Family Intervention* (BIFI), has been developed by Kreutzer and colleagues (Kreutzer et al., 2009; Kreutzer, Stejskal, Godwin, Powell, & Arango-Lasprilla, 2010; Kreutzer & Taylor, 2004). Although loss experience is addressed in this intervention model, it is done so in a largely cursory manner, and grief is not directly addressed in the implementation manual or supporting materials. This may partially be a function of the format of the intervention: The person with injury and his/her family members are seen together for therapy. While this approach is

advantageous in many respects, the presence of the survivor may make discussion by family members of highly sensitive material, such as loss and grief secondary to changes in the survivor's personality, extremely difficult. A revised version of the BIFI for adolescents with an ABI and their relatives, the BIFI-A, does include a brief discussion of grief secondary to ABI as a subcomponent of one therapy session (Gan, Gargaro, & Kreutzer, 2010; Gan, Gargaro, Kreutzer, Boschen, & Wright, 2010). However, the theoretical and empirical underpinnings of this intervention are not described in the BIFI-A literature or manual. Moreover, coping strategies outlined to address "change and loss" are given in unelaborated point form with many not directly related to grief adjustment (e.g., "Take one step at a time, set goals for each day").

Although some evidence of participant benefit for both the BIFI and BIFI-A has been observed in the form of high session helpfulness ratings (Kreutzer et al., 2010; Gan et al., 2010), the BIFI was found to have no impact on ABI family caregiver psychological distress or life satisfaction (Kreutzer et al., 2009; Stejskal, 2008). Further systematic investigation of the clinical utility of the adult and adolescent versions of the BIFI with larger TBI samples, wait-list control groups, and more comprehensive assessment of participant outcomes is indicated. Revision of BIFI components designed to address loss and grief may also be needed to more accurately represent both this aspect of adjustment as well as appropriate grief-specific interventions as more empirically-derived data in this domain become available. However, it is important to note that, as alluded to above, the format of this intervention model is considered likely to preclude full discussion of family member loss and grief experience given the presence of the

individual with injury. Indeed, such discussion may very well be contraindicated given its high potential to have an adverse psychological impact on the survivor.

Perceived change in the personality of a loved one with TBI was conceptualized in the current study to effect family caregiver appraisal of a critical form of interpersonal loss. Further research is warranted to identify other types of family loss experience secondary to TBI and their potential relationships to family member adjustment. An analysis of qualitative data provided by 27 spouse TBI caregivers by Chwalisz (1998) identified a number of salient themes of loss. These included lost emotional, supportive, and sexual aspects of the spouse-survivor relationship, which Chwalisz (1998) attributed, in part, to loss of the care recipient's premorbid personality. Other major forms of loss delineated were loss of purpose, loss of aspects of caregiver identity, loss of personal freedom and sense of control, loss of friendships and family support, and loss of dreams.

Future analysis of narrative accounts from the present sample is planned to further our understanding of different forms of loss experience among a larger group of relatives with a range of kinship relationship to the TBI survivor. Here a focus will be placed on distinguishing between inter- and intrapersonal losses effected by the TBI. With regard to potential loss of caregiver identity it is noted that this likely reflects an interplay of the inter- and intrapsychic types of deprivation, as the interpersonal ramifications of significant TBI-induced personality change in a loved one can come to undermine core aspects of the caregiver's self-construct. It is believed that this dynamic may largely mirror the adverse impact on family member identity following bereavement. Within this context Neimeyer (1998b) maintains that the loss of a loved one can lead to "profound shifts in our sense of who we are, as whole facets of our past that were shared

with the [individual lost] slip away from us forever, if only because no one else will occupy the unique position in relation to us necessary to call them forth” (p. 90). In turn, Neimeyer’s (2001, 2006) constructivist model of grief intervention may again provide useful guidance here as it entails aiding positive identity change in the face of loss, with a focus on helping the individual develop a new coherent and affirming self-narrative that incorporates the loss.

The results of the current study suggest that the conceptualization of familial loss and grief post TBI requires movement away from linear stage-based grief models. Rather, as noted above, a more flexible framework incorporating the adapted emotion regulation model of grief advanced by the present author, as well as drawing on the theoretical formulations of adjustment to disenfranchised and nonfinite forms of loss (Bruce & Schultz, 2001; Boss, 2006, 2011; Doka, 1989; Roos, 2002) is indicated. The *dual process model* (DPM; Stroebe & Schut, 1999, 2001, 2010) represents a further conceptual account of reaction to loss that is likely to be helpful in this regard. Designed to address criticisms of phasic grief models, the DPM posits a dynamic non-linear interplay of grief coping processes, recognizes variability in outcome, incorporates meaning reconstruction, and can accommodate more chronic grief trajectories. Within this model adaptive grief adjustment requires oscillation between two forms of coping processes. *Loss-oriented coping* entails concentration on, appraising of, and processing of interpersonal loss experience, with associated active mourning and working through of negative affect. In *restoration-oriented coping* focus shifts to attending to secondary consequences of the loss. This includes adjusting worldviews to incorporate the loss, as well as positive reappraisals, and pursuit of new goals and new relationships. Thus, the



DPM suggests that the individual needs to ‘dose’ their exposure to the pain of loss, acknowledging the need for relief from active mourning and the need to attend to other demands. In addition, the oscillation component of the model allows for consideration of the potential advantage of a degree of avoidance in the process of adjusting to loss; here limited periodic orientation away from the negative emotional experience of grief serves not only a protective function against potentially overwhelming feelings but also enables hope affirming re-engagement with life. Future research is required to assess the applicability of an adapted form of the DPM as a further constructive heuristic to guide understanding of grief adjustment among TBI family members.

### Conclusion

The current project data suggest that the psychology of loss and grief represents a valuable but hitherto largely neglected theoretical lens through which to better comprehend central aspects of an individual’s adjustment process in the wake of a relative sustaining a TBI. Indeed, inclusion of a focus on loss and grief in our conceptualization of TBI family caregiver adaptation arguably provides a far richer appreciation of caregiver lived experience and the nature of the stressors they are trying to overcome. The present results, together with a small but important corpus of both existing qualitative research and clinical knowledge, suggest being a family TBI caregiver is not just about fulfilling the often exhausting, stressful, and isolating caregiver role. It also involves a potential litany of often profound losses, including for many the relational, irrevocable, and nonfinite loss of their loved one’s preinjury personality. These deprivations, in turn, may occasion an ongoing grief process that goes largely unacknowledged by others, defies definitive closure, and likely adversely impacts other

facets and determinants of a family member's well-being and functioning. It is hoped that this enriched understanding of TBI family caregiver experience will help to inform further empirical inquiry and, pivotally, the development and implementation of specific interventions to aid family members in their navigation of and adjustment to grief. In this regard, services that assist relatives in finding something of meaningful personal value in their grief experience and facilitate supportive social connections may prove to be of particular benefit.

## REFERENCES

- Aaronson, N. K. (1988). Quality of life: What is it? How should it be measured? *Oncology*, 2, 69–74.
- Aarabi, B., Alden, T. D., Chestnut, R. M., et al. (2001). Guidelines for the management of penetrating brain injury. *Journal of Trauma*, 51(Suppl.), 1-86.
- Adams, J. H., Graham, D. I., & Gennarelli, T. A. (1983). Head injury in man and experimental animals: Neuropathology. *Acta Neurochirurgica*, 32(Suppl.), 15-30.
- Adams, N. (1996). Positive outcomes in families following traumatic brain injury (TBI). *Australian and New Zealand Journal of Family Therapy*, 17, 75-84.
- Affleck, G., & Tennen, H. (1996). Construing benefits from adversity: Adaptational significance and dispositional underpinnings. *Journal of Personality*, 64, 899-922.
- Alafaci, C., Caruso, G., Caffo, M., Adorno, A. A., Cafarella, D., Salpietro, F. M., et al. (2010). Penetrating head injury by a stone: Case report and review of the literature. *Clinical Neurology and Neurosurgery*, 112, 813-816
- Alexander, M. P., & Stuss, D. T. (2000). Disorders of frontal lobe functioning. *Seminars in Neurology*, 20, 427-437.
- Allen, K., Linn, R. T., Gutierrez, H., & Willer, B. S. (1994). Family burden following traumatic brain injury. *Rehabilitation Psychology*, 39, 29-48.
- The American Heritage dictionary of the English language*. (1969). New York: American Heritage.
- American Psychiatric Association (2000). *Diagnostic and statistical manual of mental disorders* (4<sup>th</sup> ed., text revision). Washington, DC: Author.
- American Psychiatric Association (2013). *Diagnostic and statistical manual of mental disorders* (5<sup>th</sup> ed.). Washington, DC: American Psychiatric Publishing.
- American Psychological Association (2009). *The road to resilience*. Retrieved February 19, 2015, from <http://www.apa.org/helpcenter/road-resilience.aspx>
- Anderson, V., Northam, E., Hendy, J., & Wrennall, J. (2001). *Developmental neuropsychology: A clinical approach*. Hove, England: Psychology Press.
- Anderson, M. I., Paramenter, T. R., & Mok, M. (2002). The relationship between neurobehavioral problems of severe traumatic brain injury (TBI), family functioning and psychological well-being of the spouse/caregiver: Path model analysis. *Brain Injury*, 16, 743-757.
- Anderson, M. I., Simpson, G. K., Morey, P. J., Mok, M. M. C., Gosling, T. J., & Gillett, L. E. (2009). Differential pathways of psychological distress in spouses vs. parents of people

with severe traumatic brain injury (TBI): Multi-group analysis. *Brain Injury*, 23, 931-943.

- Anonymous (1989). *The epic of Gilgamesh* (M. G. Kovacs, Trans.). Stanford: Stanford University Press. (Original work produced ca. 2000 B.C.E.).
- Aragno, A. (2007). Transforming mourning: A new psychoanalytic perspective. In B. Willock, L. C. Bohm, & R. C. Curtis (Eds.), *On deaths and endings: Psychoanalysts' reflections on finality, transformations and new beginnings* (pp. 21-41). New York: Routledge.
- Archer, J. (1999). *The nature of grief: The evolution and psychology of reactions to loss*. London: Routledge.
- Archer, J. (2008). Theories of grief: Past, present, and future perspectives. In M. S. Stroebe, R. O. Hansson, H. Schut, & W. Stroebe (Eds.), *Handbook of bereavement research and practice: Advances in theory and intervention* (pp. 45-65). Washington, DC: American Psychological Association.
- Archer, J., & Rhodes, V. (1993). The grief process and job loss: A cross-sectional study. *British Journal of Psychology*, 84, 395.
- Archer, J., & Rhodes, V. (1995). A longitudinal study of job loss in relation to the grief process. *Journal of Community & Applied Social Psychology*, 5(3), 183-188.
- Atkinson, P. A., Martin, C. R., & Rankin, J. (2009). Resilience revisited. *Journal of Psychiatric and Mental Health Nursing*, 16, 137-145.
- Attig, T. (1996). *How we grieve: Relearning the world*. New York: Oxford University Press.
- Averill, J. R. (1968). Grief: Its nature and significance. *Psychological Bulletin*, 70, 721-748.
- Baker, J. E. (2001). Mourning and the transformation of object relationships: Evidence for the persistence of internal attachments. *Psychoanalytic Psychology*, 18, 55-73.
- Balk, D. E. (1996). Attachment and the reactions of bereaved college students: A longitudinal study. In D. Klass, P. R. Silverman, & S. L. Nickman (Eds.), *Continuing bonds: New understandings of grief* (pp.311-328). Washington, DC: Taylor & Francis.
- Baron, R. M., & Kenny, D. A. (1986). The moderator–mediator variable distinction in social psychological research: Conceptual, strategic, and statistical considerations. *Journal of Personality and Social Psychology*, 51, 1173-1182.
- Barrera, M. Jr. (1986). Distinctions between social support concepts, measures, and models. *American Journal of Community Psychology*, 14, 413-445.
- Beekman, A. T. F., Deeg, D. J. H., Van Limbeek, J., Braam, A. W., De Vries, M. Z., & Van Tilburg, W. (1997). Brief communication: Criterion validity of the center for

- epidemiologic studies depression scale (CES-D): Results from a community-based sample of older subjects in the Netherlands. *Psychological Medicine*, 27, 231-235.
- Bédard, M., Molloy, D. W., Squire, L., Dubois, S., Lever, J. A., & O'Donnell, M. (2001). The Zarit Burden Interview: A new short version and screening version. *The Gerontologist*, 41, 652-657.
- Belanger, H. G., Curtiss, G., Demery, J. A., Lebowitz, B. K., & Vanderploeg, R. D. (2005). Factors moderating neuropsychological outcomes following mild traumatic brain injury: A meta-analysis. *Journal of the International Neuropsychological Society*, 11, 215-227.
- Benzel, E. C., Day, W. T., & Kesterson, L. (1991). Civilian craniocerebral gunshot wounds. *Neurosurgery*, 29, 67-72
- Biggins, N. A. (2002). *Long-term caregiving of aphasic stroke survivors: The lived experience*. Unpublished doctoral dissertation, Walden University, Minnesota.
- Binder, L. M., Rohling, M. L., & Larrabee, G. J. (1997). A review of mild head trauma: Part I. Meta-analytic review of neuropsychological studies. *Journal of Clinical and Experimental Neuropsychology*, 19, 421-431.
- Blacher, J. (1984). Attachment and severely handicapped children: Implications for intervention. *Journal of Developmental and Behavioral Pediatrics*, 5, 178-183.
- Bloom-Feshbach, J., & Bloom-Feshbach, S. (1987). *The psychology of separation and loss: Perspectives on development, life transitions, and clinical practice*. San Francisco: Jossey-Bass.
- Boelen, P. A. (2006). Cognitive-behavioural therapy for complicated grief: Theoretical underpinnings and case descriptions. *Journal of Loss and Trauma*, 11, 1-30.
- Boelen, P. A., van den Hout, M. A., & van den Bout, J. (2006). A cognitive-behavioral conceptualization of complicated grief. *Clinical Psychology: Science and Practice*, 13, 109-128.
- Bonanno, G. A. (2001). Grief and emotion: A social-functional perspective. In M. S. Stroebe, R. O. Hansson, W. Stroebe, & H. Schut (Eds.), *Handbook of bereavement research: Consequences, coping, and care* (pp. 493-515). Washington, DC: American Psychological Association.
- Bonanno, G. A. (2004). Loss, trauma and human resilience. *American Psychologist*, 59, 20-28.
- Bonanno, G. A., & Diminich, E. D. (2013). Annual research review: Positive adjustment to adversity – trajectories of minimal-impact resilience and emergent resilience. *Journal of Child Psychology and Psychiatry*, 54, 378-401.

- Bonanno, G. A., & Kaltman, S. (1999). Toward an integrative perspective on bereavement. *Psychological Bulletin, 125*, 760-776.
- Bonanno, G. A., & Kaltman, S. (2001). The varieties of grief experience. *Clinical Psychology Review, 21*, 705-734.
- Bonanno, G. A., Wortman, C. B., & Nesse, R. M. (2004). Prospective patterns of resilience and maladjustment during widowhood. *Psychology and Aging, 19*, 260-271.
- Bonanno, G. A., Neria, Y., Mancini, A., Coifman, K. G., Litz, B., & Insel, B. (2007). Is there more to complicated grief than depression and posttraumatic stress disorder? A test of incremental validity. *The Journal of Abnormal Psychology, 116*, 342-351.
- Borgaro, S. R., Prigatano, G. P., Kwasnica, C., & Rexer, J. L. (2003). Cognitive and affective sequelae in complicated and uncomplicated mild traumatic brain injury. *Brain Injury, 17*, 189-198.
- Boss, P. (1999). *Ambiguous Loss: Learning to live with unresolved grief*. Cambridge, MA: Harvard University Press.
- Boss, P. (2004). Ambiguous loss. In F. Walsh, & M. McGoldrick (Eds.), *Living beyond loss: Death in the family* (2<sup>nd</sup> ed.) (pp. 237-246). New York: W. W. Norton & Co.
- Boss, P. (2006). *Loss, trauma, and resilience: Therapeutic work with ambiguous loss*. New York: W. W. Norton & Co.
- Boss, P. (2007). Ambiguous loss theory: Challenges for scholars and practitioners. *Family Relations: An Interdisciplinary Journal of Applied Family Studies, 56*, 105-111.
- Boss, P. (2011). *Loving someone who has dementia: How to find hope while coping with stress and grief*. San Francisco: Jossey-Bass.
- Boss, P., & Yeats, J. R. (2014). Ambiguous loss: A complicated type of grief when loved ones disappear. *Bereavement Care, 33*, 63-69.
- Bostock, L., Sheikh, A., & Barton, S. (2009). Posttraumatic growth and optimism in health-related trauma: A systematic review. *Journal of Clinical Psychology in Medical Settings, 16*, 281-296.
- Bowlby, J. (1961). Processes of mourning. *International Journal of Psychoanalysis, 69*, 975-989.
- Bowlby, J. (1977). The making and breaking of affectional bonds: I. Aetiology and psychopathology in the light of attachment theory. *British Journal of Psychiatry, 130*, 201-210.
- Bowlby, J. (1969). *Attachment and loss. Vol. 1: Attachment*. New York: Basic Books.
- Bowlby, J. (1973). *Attachment and loss. Vol. 2: Separation: Anxiety and anger*. New York: Basic Books.

- Bowlby, J. (1980). *Attachment and loss. Vol. 3: Loss: Sadness and depression*. New York: Basic Books.
- Brooks, D. N. (1984). Head injury and the family. In D. N. Brooks (Ed.), *Closed head injury: Psychological, social, and family consequences* (pp. 123-147). Oxford: Oxford University Press.
- Brooks, D. N. (1991). The head-injured family. *Journal of Clinical and Experimental Neuropsychology*, 13, 155-188.
- Brooks, D. N. & McKinlay, W. (1983). Personality and behavioral differences after severe head injury—a relative's view. *Journal of Neurology, Neurosurgery, and Psychiatry*, 46, 336-344.
- Brooks, N. (1988). Personality change after severe head injury. *Acta Neurochirurgica (Supplementary)*, 44, 59-64.
- Brooks, N., Campsie, L., Symington, C. Beattie, A., & McKinlay, W. (1986). The five year outcome of severe blunt head injury: A relative's view. *Journal of Neurology, Neurosurgery, and Psychiatry*, 49, 764-770.
- Brooks, N., Campsie, L., Symington, C. Beattie, A., & McKinlay, W. (1987). The effects of severe head injury on patient and relative within seven years of injury. *Journal of Head Trauma and Rehabilitation*, 2, 1-13.
- Bruce, E. J., & Schultz, C. L. (2001). *Nonfinite loss and grief: A psychoeducational approach*. Baltimore, MD: Paul H. Brookes.
- Buki, A., Siman, R., Trojanowski, J. Q., & Povlishock, J. T. (1999). The role of calpail-mediated spectrin proteolysis in traumatically induced axonal injury. *Journal of Neuropathology & Experimental Neurology*, 58, 365-375.
- Bulman, R. J., & Wortman, C. B. (1977). Attributions of blame and coping in the "real world": Severe accident victims react to their lot. *Journal of Personality and Social Psychology*, 35, 351-363.
- Burgess, A. W., & Holmstrom, L. L. (1979). Adaptive strategies and recovery from rape. *The American Journal of Psychiatry*, 136, 1278-1282.
- Burke, M. L., Eakes, G. G., & Hainsworth, M. A. (1999). Milestones of chronic sorrow: Perspectives of chronically ill and bereaved persons and family caregivers. *Journal of Family Nursing*, 5, 374-387.
- Camplair, P. S., Kreutzer, J. S., & Doherty, K. R. (1990). Family outcome following adult traumatic brain injury: A critical review of the literature. In J. S. Kreutzer & P. Wehman

- (Eds.), *Community integration following traumatic brain injury* (pp. 207-222). New York: Paul H. Brookes.
- Canadian Institute of Health Information (CIHI, 2006). *Head injuries in Canada: A decade of change (1994-1995 to 2003-2004)*. Retrieved March 14, 2009, from [http://secure.cihi.ca/cihiweb/products/ntr\\_head\\_injuries\\_2006\\_e.pdf](http://secure.cihi.ca/cihiweb/products/ntr_head_injuries_2006_e.pdf)
- Carey, M. E., Sarna, G.S., Farrell, J. B., & Happel, L. T. (1989). Experimental missile wound to the brain. *Journal of Neurosurgery*, *71*, 754-764.
- Carver, C. S., & Antoni, M. H. (2004). Finding benefit in breast cancer during the year after diagnosis predicts better adjustment 5 to 8 years after diagnosis. *Health Psychology*, *23*, 595-598.
- Carver, C. S., Schreier, M., & Weintraub, J. K. (1989). Assessing coping strategies: A theoretically based approach. *Journal of Personality and Social Psychology*, *36*, 267-283.
- Cassidy, T. (2013). Benefit finding through caring: The cancer caregiver experience. *Psychology & Health*, *28*, 250-266.
- Cassidy, T., Giles, M., & McLaughlin, M. (2014). Benefit finding and resilience in child caregivers. *British Journal of Health Psychology*, *19*, 606-618.
- Centers for Disease Control and Prevention National Center for Injury Prevention and Control (2003). *Report to congress on mild traumatic brain injury in the United States: Steps to prevent a serious public health problem*. Atlanta, GA: Centers for Disease Control and Prevention.
- Chan, J. J. (2007). Carers' perspective on respite for persons with acquired brain injury. *International Journal of Rehabilitation Research*, *30*, 137-146.
- Christensen, B. K., Colella, B., Inness, E., Hebert, D., Monette, G., Bayley, M., et al. (2008). Recovery of cognitive function after traumatic brain injury: A multilevel modelling analysis of Canadian outcomes. *Archives of Physical Medicine and Rehabilitation*, *89*, S3-S15.
- Chronister, J., & Chan, F. (2006). A stress process model of caregiving for individuals with traumatic brain injury. *Rehabilitation Psychology*, *51*, 190-201.
- Chronister, J., Chan, F., Sasson-Gelman, E., & Chiu, C. (2010). The association of stress-coping variables to quality of life among caregivers of individuals with traumatic brain injury. *NeuroRehabilitation*, *27*, 49-62.
- Chwalisz, K. (1992). Perceived stress and caregiver burden after brain injury: A theoretical integration. *Rehabilitation Psychology*, *37*, 189-203.



- Chwalisz, K. (1996). The perceived stress model of caregiver burden: Evidence from spouses of persons with brain injuries. *Rehabilitation Psychology, 41*, 91-114.
- Chwalisz, K. (1998). Brain Injury: A tapestry of loss. In J. H. Harvey (Ed.), *Perspectives on loss: A sourcebook* (pp. 189-200). New York: Routledge.
- Chwalisz, K., & Stark-Wroblewski, K. (1996). The subjective experience of spouse caregivers of persons with brain injuries: A qualitative analysis. *Applied Neuropsychology, 3*, 28-40.
- Cobb, S. (1976). Social support as a moderator of life stress. *Psychosomatic Medicine, 38*, 300-314.
- Cohen, J. (1988). *Statistical power analysis for the behavioral sciences* (2<sup>nd</sup> ed.). Hillsdale, NJ: Lawrence Erlbaum Associates.
- Cohen, S., & Wills, T. A. (1985). Stress, social support, and the buffering hypothesis. *Psychological Bulletin, 98*, 310-357.
- Coleman, R. A., & Neimeyer, R. A. (2010). Measuring meaning: Searching for and making sense of spousal loss in late-life. *Death Studies, 34*, 804.
- Collings, C. (2008). That's not my child anymore! Parental grief after acquired brain injury: Incidence, Nature, and Longevity. *British Journal of Social Work, 38*, 1499-1517.
- Collins, R. L., Taylor, S. E., & Skokan, L. A. (1990). A better world or a shattered vision: Changes in life perspectives following victimization. *Social Cognition, 8*, 263-285.
- Corr, C. A. (2002). Revisiting the concept of disenfranchised grief. In K. J. Doka (Ed.), *Disenfranchised grief: New directions, challenges, and strategies for practice* (p. 39-60). Champaign, IL: Research Press.
- Corrigan, J. D., Selassie, A. W., & Orman, J. A. (2010). The Epidemiology of Traumatic Brain Injury. *Journal of Head Trauma Rehabilitation, 25*, 72-80.
- Couture, S. M., Penn, D. L., & Roberts, D. L. (2006). The functional significance of social cognition in schizophrenia: A review. *Schizophrenia Bulletin, 32*, S1, S44-S63.
- Clark, V.A., Aneshensel, C.S., Frerichs, R.R., & Morgan, T.M. (1981). Analysis of effects of sex and age in response to items on the CES-D scale. *Psychiatric Research, 5*, 171-181.
- Clayton, P., Desmaris, L., & Winokur, G. (1968). A study of normal bereavement. *American Journal of Psychiatry, 125*, 168-178.
- Crowe, S. F. (2008). *The behavioural and emotional complications of traumatic brain injury*. Philadelphia, PA: Taylor & Francis.
- Cummings, J. L. (1995). Anatomic and behavioral aspects of frontal-subcortical circuits. *Annals of the New York Academy of Sciences, 769*, 1-13.

- Currier, J. M., Holland, J. M., & Neimeyer, R. A. (2006). Sense-making, grief, and the experience of violent loss: Toward a mediational model. *Death Studies, 30*, 403-428.
- Currier, J. M., Holland, J. M., & Neimeyer, R. A. (2009). Assumptive worldviews and problematic reactions to bereavement. *Journal of Loss and Trauma, 14*, 181-195.
- Cutrona, C. E. (1984). Social support and stress in the transition to parenthood. *Journal of Abnormal Psychology, 93*, 378-390.
- Cutrona, C. E. (1989). Ratings of social support by adolescents and adult informants: Degree of correspondence and prediction of depressive symptoms. *Journal of Personality and Social Psychology, 57*, 723-730.
- Cutrona C. E., & Russell, D. (1987). The provisions of social relationships and adaptation stress. In W. H. Jones & D. Periman (Eds.), *Advances in Personal Relationships. Vol. 1* (pp. 37-68). Greenwich, CT: JAI Press.
- Damasio, A. (1998). The somatic marker hypothesis and the possible functions of the prefrontal cortex. In A. C. Roberts, T. W. Robbins, & L. Weiskrantz (Eds.), *The prefrontal cortex: Executive and cognitive functions* (pp. 36-50). New York: Oxford University Press.
- Darwin, C. (2009). *The expression of the emotions in man and animals*. New York: Penguin Classics. (Original work published 1872).
- Davis, C. G. (2001). The tormented and the transformed: Understanding responses to loss and trauma. In R. A. Neimeyer (Ed.), *Meaning reconstruction & the experience of loss* (pp. 137-156). Washington, DC: American Psychological Association.
- Davis, C. G. (2008). Redefining goals and redefining self: A closer look at posttraumatic growth following loss. In M. S. Stroebe, R. O. Hansson, H. Schut, & W. Stroebe (Eds.), *Handbook of bereavement research and practice: Advances in theory and intervention* (pp. 309-326). Washington, DC: American Psychological Association.
- Davis, C. G., Harasymchuk, C., & Wohl, M. J. (2012). Finding meaning in a traumatic loss: A families approach. *Journal of Traumatic Stress, 25*, 142-149.
- Davis, C. G., & Morgan, M. S. (2008). Finding meaning, perceiving growth, and acceptance of tinnitus. *Rehabilitation Psychology, 53*, 128-138.
- Davis, C. G., Nolen-Hoeksema, S., & Larson, J. (1998). Making sense of loss and benefiting from the experience: Two construals of meaning. *Journal of Personality and Social Psychology, 75*, 561-574.
- Davis, C. G., & Novoa, D. C. (2013). Meaning-making following spinal cord injury: Individual differences and within-person change. *Rehabilitation Psychology, 58*, 166-177.

- Davis, C. G., Wohl, M. J., & Verberg, N. (2007). Profiles of posttraumatic growth following an unjust loss. *Death Studies, 31*, 693-712.
- Davis, C. G., Wortman, C. B., Lehman, D. R., & Silver, R. C. (2000). Searching for meaning in loss: Are clinical assumptions correct? *Death Studies, 24*, 497-540.
- Davis, L. C., Sander, A. M., Struchen, M. A., Sherer, M., Nakase-Richardson, R., Malec, J. F., et al. (2009). Medical and psychosocial predictors of caregiver distress and perceived burden following traumatic brain injury. *The Journal of Head Trauma Rehabilitation, 24*, 145-154.
- Derogatis, L. R. (1977). *Symptom Checklist-90 – R (SCL-90 – R): Administration, scoring, and procedures manual I*. Baltimore, MD: Clinical Psychometric Research.
- Derogatis, L. R. (1993). *Brief Symptom Inventory (BSI): Administration, scoring, and procedures manual* (3rd ed.). Minneapolis, MN: Pearson.
- Derogatis, L. R. (1994). *Symptom Checklist-90 – R (SCL-90 – R): Administration, scoring, and procedures manual* (3rd ed.). Minneapolis, MN: Pearson.
- Derogatis, L. R. (2001). *Brief Symptom Inventory (BSI) 18: Administration, scoring, and procedures manual*. Minneapolis, MN: Pearson.
- Derogatis, L. R., Lipman, R. S., Rickels, K., Uhlenhuth, E. H., & Covi, L. (1974). The Hopkins Symptom Checklist (HSCL): A measure of primary symptom dimensions. In P. Pichot (Ed.), *Psychological measurements in psychopharmacology*. (pp.79-111). Basel, Switzerland: Karger.
- Derogatis, L. R., & Spencer, P. (1982). *Brief Symptom Inventory (BSI): Administration, scoring, and procedures manual I*. Baltimore, MD: Clinical Psychometric Research.
- Deutsch, H. (1937). Absence of grief. *The Psychoanalytic Quarterly, 6*, 12-22.
- Diener, E., Emmons, R. A., Larsen, R. J., & Griffin, S. (1985). The Satisfaction with Life Scale. *Journal of Personality Assessment, 49*, 71-75.
- Diener, E., Suh, E.M., Lucas, R.E., & Smith, H.L. (1999). Subjective well-being: Three decades of progress. *Psychological Bulletin, 125*, 276–302.
- Dietrich, W. D., Alonso, O., & Halley, M. (1994). Early microvascular and neuronal consequences of traumatic brain injury: A light and electron microscopic study in rats. *Journal of Neurotrauma, 11*, 289-301.
- Dijkers, M. (1999). Measuring quality of life: methodological issues. *American Journal of Physical Medicine and Rehabilitation, 78*, 286–300.
- Dikmen, S., & Machamer, J. (1995). Neurobehavioural outcomes and their determinants. *Journal of Head Trauma Rehabilitation, 10*, 74-86.

- Dikmen, S.S., Machamer, J. E., Powell, J. M., & Temkin, N.R. (2003). Outcome at 3 to 5 years after moderate to severe traumatic brain injury. *Archives of Physical Medicine and Rehabilitation*, 84, 1449-1457.
- Dikmen, S., Corrigan, J. D., Levin, H. S., Machamer, J., Stiers, W., & Weisskopf, M. G. (2009). Cognitive outcome following traumatic brain injury. *Journal of Head Trauma Rehabilitation*, 24, 430-438.
- Dikmen, S., Machamer, J., Temkin, N., & McLean, A. (1990). Neuropsychological recovery in patients with moderate to severe head injury: 2 year follow-up. *Journal of Clinical and Experimental Neuropsychology*, 12, 507-519.
- Dikmen, S.S., Machamer, J. E., Winn, H.R., & Temkin, N.R. (1995). Neuropsychological outcome at 1-year post head injury. *Neuropsychology*, 9, 80-90.
- Dikmen, S. S., McLean, A., & Temkin, N. (1986). Neuropsychological and psychosocial consequences of minor head injury. *Journal of Neurology, Neurosurgery, and Psychiatry*, 49, 1227-1232.
- Dikmen, S., Ross, B. L., Machamer, J. E., & Temkin, N. R. (1995). One year psychosocial outcome in head injury. *Journal of the International Neuropsychological Society*, 1, 67-77.
- Dikmen, S., Temkin, N. R., Machamer, J. E., Holubkov, A. L., Fraser, R. T., & Winn, H. R. (1994). Employment following traumatic head injuries. *Archives of Neurology*, 51, 177-186.
- Doka, K. J. (1989). Disenfranchised grief. In K. J. Doka (Ed.), *Disenfranchised grief: Recognizing hidden sorrow* (pp. 3-23). New York: Lexington Books
- Doka, K. J. (2002). Introduction. In K. J. Doka (Ed.), *Disenfranchised grief: New directions, challenges, and strategies for practice* (p. 5-22). Champaign, IL: Research Press.
- Doka, K. J. (2007). Challenging the paradigm: New understandings of grief. In K. J. Doka (Ed.), *Living with grief: Before and after the death* (p. 87-102). Washington, DC: Hospice Foundation of America.
- Doka, K. J. (2008). Disenfranchised grief in historical and cultural perspective. In M. S. Stroebe, R. O. Hansson, H. Schut, & W. Stroebe (Eds.), *Handbook of bereavement research and practice: Advances in theory and intervention* (pp. 223-240). Washington, DC: American Psychological Association.
- Doka, K. J., & Aber, R. (1989). Psychosocial loss and grief. In K. J. Doka (Ed.), *Disenfranchised grief: Recognizing hidden sorrow* (pp. 187-198). New York: Lexington Books

- Doka, K. J., & Aber, R. (2002). Psychosocial loss and grief. In K. J. Doka (Ed.), *Disenfranchised grief: New directions, challenges, and strategies for practice* (p. 217-232). Champaign, IL: Research Press.
- Douglas, J. M., & Spellacy, F. J. (1996). Indicators of long-term family functioning following severe traumatic brain injury in adults. *Brain Injury, 10*, 819-840.
- Douglas, J. M., & Spellacy, F. J. (2000). Correlates of depression in adults with severe traumatic brain injury and their carers. *Brain Injury, 14*(1), 71-88.
- Downe-Wamboldt, B., & Tamlyn, D. (1997). An international survey of death education trends in faculties of nursing and medicine. *Death Studies, 21*, 177-188.
- Downey, G., Silver, R. C., & Wortman, C. B. (1990). Reconsidering the attribution-adjustment relation following a major negative event: Coping with the loss of a child. *Journal of Personality and Social Psychology, 59*, 925-940.
- Draper, K., & Ponsford, J. (2008). Cognitive functioning ten years following traumatic brain injury and rehabilitation. *Neuropsychology, 22*, 618-625.
- Dull, V. T., & Skokan, L. A. (1995). A cognitive model of religion's influence on health. *The Journal of Social Issues, 51*, 49-64.
- Eakes, G. G. (2009). Chronic sorrow. In S. J. Peterson, & T. S. Bredow (Eds.), *Middle Range Theories: Application to nursing research* (2<sup>nd</sup> ed.) (pp. 149-159). New York: Wolters Kluwer.
- Eakes, G. G., Burke, M. L., & Hainsworth, M. A. (1999). Chronic sorrow: The lived experience of bereaved individuals. *Illness, Crises, and Loss, 7*, 172-182.
- Eakes, G. G. (1995). Chronic sorrow: The lived experience of parents of chronically mentally ill individuals. *Archives of Psychiatric Nursing, 9*, 77-84.
- Eaton W. W., & Kessler, L. G. (1981) Rates of symptoms of depression in a national sample. *American Journal of Epidemiology, 114*, 528-538
- Ellenberg, J. H., Levin, H. S., & Saydjari, C. (1996). Posttraumatic amnesia as a predictor of outcome after severe closed head injury. Prospective assessment. *Archives of Neurology, 53*, 782-791.
- Elmore, S. (2007). Apoptosis: A review of programmed cell death. *Toxicologic Pathology, 35*, 495-516.
- Engel, G. L. (1961). Is grief a disease? A challenge for medical research. *Psychosomatic Medicine, 23*, 18-22.
- Engel, G. L. (1964). Grief and grieving. *The American Journal of Nursing, 64*, 93-98.

- Engler A. J., & Lasker, J. N. (2000). Predictors of Maternal Grief in the Year after a Newborn Death. *Illness, Crisis & Loss*, 8, 227-243
- Ergh, T. C., Hanks, R. A., Rapport, L. J., & Coleman, R. D. (2003). Social support moderates caregiver life satisfaction following traumatic brain injury. *Journal of Clinical and Experimental Neuropsychology*, 25(8), 1090-1101.
- Ergh, T. C., Rapport, L. J., Coleman, R. D., & Hanks, R. A. (2002). Predictors of caregiver and family functioning following traumatic brain injury: Social support moderates caregiver distress. *The Journal of Head Trauma Rehabilitation*, 17(2), 155-174.
- Esposito, D. P., & Walker, J. B. (2009). Contemporary management of penetrating brain injury. *Neurosurgery Quarterly*, 19, 249-254.
- Faul M., Xu L., Wald M. M., & Coronado V. G. (2010). *Traumatic Brain Injury in the United States: Emergency Department Visits, Hospitalizations and Deaths 2002–2006*. Atlanta (GA): Centers for Disease Control and Prevention, National Center for Injury Prevention and Control. Retrieved November 17, 2010, from [http://www.cdc.gov/traumaticbraininjury/pdf/blue\\_book.pdf](http://www.cdc.gov/traumaticbraininjury/pdf/blue_book.pdf).
- Feigelson, C. (1993). Personality death, object loss, and the uncanny. *The International Journal of Psychoanalysis*, 74, 331-345.
- Field, N. P. (2008). Whether to relinquish or maintain a bond with the deceased. In M. S. Stroebe, R. O. Hansson, H. Schut, & W. Stroebe (Eds.), *Handbook of bereavement research and practice: Advances in theory and intervention* (pp. 87-112). Washington, DC: American Psychological Association.
- Field, N. P., Gao, B., & Paderna, L. (2005). Continuing bonds in bereavement: An attachment theory based perspective. *Death Studies*, 29, 277-299.
- Fink, S. L. & Cookson, B. T. (2005). Apoptosis, pyroptosis, and necrosis: Mechanistic description of dead and dying eukaryotic cells. *Infection and Immunity*, 73, 1907-1916.
- Fischer, K. W., Shaver, P. R., & Carnochan, P. (1990). How emotions develop and how they organise development. *Cognition and Emotion*, 4, 81-127.
- Fletcher, D., & Sarkar, M. (2013). Psychological resilience: A review and critique of definitions, concepts, and theory. *European Psychologist*, 18, 12-23.
- Florkowski, C. M. (2013). Sensitivity, specificity, receiver-operating characteristic curves and likelihood ratios: Communicating the performance of diagnostic tests. *Clinical Biochemistry Review*, 29(Suppl. 1), 83-87.
- Florian, V., & Katz, S. (1991). The other victims of traumatic brain injury: Consequences for family members. *Neuropsychology*, 5, 267-279.

- Frijda, N. H. (2008). The psychologists' point of view. In M. Lewis, J. M. Haviland-Jones, L. Feldman Barrett (Eds.), *Handbook of emotions* (3<sup>rd</sup> ed.) (68-87). New York: Guilford Press.
- Folkman, S. (2001). Revised coping theory and the process of bereavement. In M. S. Stroebe, R. O. Hansson, W. Stroebe, & H. Schut (Eds.), *Handbook of bereavement research: Consequences, coping, and care* (pp. 563-584). Washington, DC: American Psychological Association.
- Fraley, R. C., & Shaver, P. R. (1999). Loss and bereavement: Attachment theory and recent controversies concerning "grief work" and the nature of detachment. In J. Cassidy & P. R. Shaver (Eds.), *Handbook of attachment: Theory, research, and clinical applications* (pp. 735-759). New York: Guilford Press.
- Frankl, V. E. (1984). *Man's search for meaning*. New York: Pocket Books. (Original work published 1946).
- Frazier, P., Conlon, A., & Glaser, T. (2001). Positive and negative life changes following sexual assault. *Journal of Consulting and Clinical Psychology, 69*, 1048-1055.
- Frazier, P. A., Tix, A. P., & Barron, K. E. (2004). Testing moderator and mediator effects in counseling psychology research. *Journal of Counseling Psychology, 51*, 115-134.
- Freud, S. (1957). Mourning and melancholia. In J. Rickman (Ed.), *A general selection of the works of Sigmund Freud* (pp. 124-140). New York: Liveright Publishing. (Original work published 1917)
- Freud, S. (1958). Totem and taboo. In J. Strachey (Ed. and Trans.), *The standard edition of the complete psychological works of Sigmund Freud* (Vol. 13, pp. 1-163). London: Hogarth Press. (Original work published 1915)
- Freud, S. (1959). Inhibition, symptoms, and anxiety. In J. Strachey (Ed. and Trans.), *The standard edition of the complete psychological works of Sigmund Freud* (Vol. 20, pp. 77-175). London: Hogarth Press. (Original work published 1926)
- Freud, S. (1975). Letter to Binswanger. In E. L. Freud (Ed.), T. Stern, & J. Stern (Trans.), *Letters of Sigmund Freud* (p. 386). New York: Basic Books. (Original work published 1929)
- Fried, M. (1962). Grieving for a lost home. In L. J. Duhl (Ed.), *The environment of the metropolis*. New York: Basic Books.
- Fuster, J. M. (1989). *The prefrontal cortex: Anatomy, physiology, and neuropsychology of the frontal lobe* (2<sup>nd</sup> ed.). New York: Raven Press.
- Fuster, J. M. (2001). The prefrontal cortex – An update: Time is of the essence. *Neuron, 30*, 319–333.

- Fuster, J. M. (2003). *Cortex and mind: Unifying cognition*. New York: Oxford University Press.
- Gan, C., Campbell, K. A., Gemeinhardt, M., & McFadden, G. T. (2006). Predictors of family system functioning after brain injury. *Brain Injury, 20*, 587-600.
- Gan, C., Gargaro, J., Brandysc, C., Gerberd, G., & Boschene, K. (2010). Family caregivers' needs after brain injury: A synthesis of perspectives from caregivers, programs, and researchers. *NeuroRehabilitation, 27*, 5-18.
- Gan, C., Gargaro, J., & Kreutzer, J. S. (2010). *The Brain Injury Family Intervention – Adolescent Version manual*. Toronto: Holland Bloorview Kids Rehabilitation Hospital.
- Gan, C., Gargaro, J., Kreutzer, J. S., Boschen, K. A., & Wright, F. V. (2010). Development and preliminary evaluation of a structured family system intervention for adolescents with brain injury and their families. *Brain Injury, 24*, 651-663.
- Gan, C., & Schuller, R. (2002). Family system outcome following acquired brain injury: Clinical and research perspectives. *Brain Injury, 16*, 311-322.
- Gardner, R. A. (1973). *The family book about minimal brain dysfunction*. New York: Jason Aronson.
- Gennarelli, T. A. (1990). Mechanisms of cerebral concussion, contusion, and other effects of head injury. In J. R. Youmans (Ed.), *Neurological surgery* (pp. 1953-1964). Philadelphia: Saunders.
- Gennarelli, T. A., & Graham, D. I. (2005). Neuropathology. In J. M. Silver, T. W. McAllister, & S. C. Yudofsky (Eds.), *Textbook of traumatic brain injury* (pp. 27-50). Arlington, VA: American Psychiatric Publishing.
- Gervasio, A. H., & Kreutzer, J. S. (1997). Kinship and family members' psychological distress after traumatic brain injury: A large sample study. *Journal of Head Trauma Rehabilitation, 72*(3), 14-26.
- Gillen, R., Tennen, H., Affleck, G., & Steinpreis, R. (1998). Distress, depressive symptoms, and depressive disorder among caregivers of patients with brain injury. *Journal of Head Trauma Rehabilitation, 13*, 31.
- Gillies, J., & Neimeyer, R. A. (2006). Loss, grief, and the search for significance: Toward a model of meaning reconstruction in bereavement. *Journal of Constructivist Psychology, 19*, 31-65.
- Giese, A., Koops, E., Lohmann, F., Westphal, M., & Puschel, K. (2002). Head injury by gunshots from blank cartridges. *Surgical Neurology, 57*, 268-277.



- Godfrey, H. P. D., Knight, R. G., & Partridge, F. M. (1996). Emotional adjustment following traumatic brain injury: A stress-appraisal-coping formulation. *Journal of Head Trauma Rehabilitation, 77*(6), 29-40.
- Good, S. R. (2003). A phenomenological study of the experience of parents of children with acquired brain injury: A family challenge. Unpublished doctoral dissertation, Saybrook Graduate School, San Francisco, CA.
- Gosling, J., & Oddy, M. (1999). Rearranged marriages: Marital relationships after head injury. *Brain Injury, 13*, 785-796.
- Grafman J., Jonas, B. S., Martin, A., Salazar, A. M., Weingartner, H., Ludlow, M. A., et al. (1988). Intellectual function following penetrating head injury in Vietnam veterans. *Brain, 111*, 169–184.
- Grafman J., Jonas, B., & Salazar, A. (1990). Wisconsin Card Sorting Test performance based on location and size of neuroanatomical lesion in Vietnam veterans with penetrating head injury. *Perceptual and Motor Skills, 71*, 1120–1122.
- Grafman, J., Salazar, A. M., Weingartner, H., & Amin, D. (1986). Face memory and discrimination: an analysis of the persistent effects of penetrating brain wounds. *International Journal of Neuroscience, 29*, 125–139.
- Grafman, J., Salazar, A. M., Weingartner, H., Vance, S., & Amin, D. (1986). The relationship of brain tissue loss volume and lesion location to cognitive deficit. *Journal of Neuroscience, 6*, 301-307.
- Graham, D. I., & Gennarelli, T. A. (2000). Pathology of brain damage after head injury. In P. R. Cooper, & J. G. Golfinos (Eds.), *Head injury* (pp.133-153). New York: McGraw-Hill.
- Graham, D. I., Adams, J. H., Nicoll, J. A., Maxwell, W. L., & Gennarelli, T. A. (1995). The nature, distribution and causes of traumatic brain injury. *Brain Pathology, 5*, 397-406.
- Greenberg, L. S., & Paivio, S. C. (1997). *Working with emotions in psychotherapy*. New York: Guilford Press.
- Greenberg, L. S., Rice, L. N., & Elliot, R. (1993). *Facilitating emotional change: The moment-by-moment process*. New York: Guilford Press.
- Greve, M. W., & Zink, B. J. (2009). Pathophysiology of Traumatic Brain Injury. *Mount Sinai Journal of Medicine, 76*, 97-104.
- Groom, K. N., Shaw, T. G., O'Connor, M. E., Howard, N. I., & Pickens, A. (1998). Neurobehavioral symptoms and family functioning in traumatically brain-injured adults. *Archives of Clinical Neuropsychology, 13*, 695-711.

- Gross, J. J., & Barrett, L. F. (2011). Emotion generation and emotion regulation: One or two depends on your point of view. *Emotion Review*, 3, 8-16.
- Groveman A., & Brown, E. (1985). Family therapy with closed head injured patients: Utilizing Kubler-Ross' model. *Family Systems Medicine*, 3, 440-446.
- Hagman, G. (2001). Beyond decahexis: Toward a new psychoanalytic understanding and treatment of mourning. In R. A. Neimeyer (Ed.), *Meaning reconstruction & the experience of loss* (pp. 13-31). Washington, DC: American Psychological Association.
- Hainsworth, M. A. M. (1995). Helping spouses with chronic sorrow related to multiple sclerosis. *Journal of Gerontological Nursing*, 21, 29-33.
- Hall, K. H., Karzmark, P., Stevens, M., Englander, J., O'Hare, P., & Wright, J. (1994). Family stressors in traumatic brain injury: A two year follow-up. *Archives of Physical Medicine and Rehabilitation*, 75, 876-884.
- Halliwell, E., Main, L., & Richardson, C. (2007). *The fundamental facts: The latest facts and figures on mental health*. Retrieved May 10, 2014, from <http://www.mentalhealth.org.uk/publications/fundamental-facts>
- Hanks, R. A., Rapport, L. J., & Vangel, S. (2007). Caregiving appraisal after traumatic brain injury: The effects of functional status, coping style, social support and family functioning. *NeuroRehabilitation*, 22, 43-52.
- Hanks, R. A., Rapport, L. J., Wertheimer, J., & Koviak, C. (2012). Randomized controlled trial of peer mentoring for individuals with traumatic brain injury and their significant others. *Archives of Physical Medicine and Rehabilitation*, 93, 1297-1304.
- Hansen, N. B., Vaughan, E. L., Cavanaugh, C. E., Connell, C. M., & Sikkema, K. J. (2009). Health-related quality of life in bereaved HIV-positive adults: Relationships between HIV symptoms, grief, social support, and axis II indication. *Health Psychology*, 28, 249-257.
- Haringsma, R., Engels, G. I., Beekman, A. T. F., & Spinhoven, P. (2004). The criterion validity of the center for epidemiological studies depression scale (CES-D) in a sample of self-referred elders with depressive symptomatology. *International Journal of Geriatric Psychiatry*, 19(6), 558-563.
- Harris, J. K. J., Godfrey, H. P. D., Partridge, F. M., & Knight, R. G. (2001). Caregiver depression following traumatic brain injury (TBI): A consequence of adverse effects on family members? *Brain Injury*, 15, 223-238.

- Harrison-Felix, C., Newton, C. N., Hall, K. M., & Kreutzer, J. S. (1996). Descriptive findings from the Traumatic Brain Injury Model Systems National Database. *Journal of Head Trauma and Rehabilitation, 11*, 1-14.
- Hartl, R., & Ghajar, J. (2005). Neurosurgical interventions. In J. M. Silver, T. W. McAllister, & S. C. Yudofsky (Eds.), *Textbook of traumatic brain injury* (pp. 51-58). Arlington, VA: American Psychiatric Publishing.
- Harvey, J. H., & Weber, A. L. (1998). Why there must be a psychology of loss. In J. H. Harvey (Ed.), *Perspectives on loss: A sourcebook* (pp. 319-330). New York: Routledge.
- Harvey, J. H. (2000). *Give sorrow words: Perspectives on loss and trauma*. Philadelphia: Brunner/Mazel.
- Harvey, J. H. (2001). The psychology of loss as a lens to a positive psychology. *American Behavioral Scientist, 44*, 838-853.
- Harvey, J. H. (2002). *Perspectives on loss and trauma: Assaults on the self*. Thousand Oaks, CA: Sage.
- Haslam, S. A., O'Brien, A., Jetten, J., Vormedal, K., & Penna, S. (2005). Taking the strain: Social identity, social support, and the experience of stress. *The British Journal of Social Psychology, 44*, 355-370.
- Hayes, A. F. (2009). Beyond Baron and Kenny: Statistical mediation analysis in the new millennium. *Communication Monographs, 76*, 408-420.
- Hayes, S., Pistorello, J., & Levin, M. (2012). Acceptance and Commitment Therapy as a unified model of behavior change. *The Counseling Psychologist, 40*, 976-1002.
- Hayes, S. C., Strosahl, K. D., & Wilson, K. G. (1999). *Acceptance and Commitment Therapy: An experiential approach to behavior change*. New York: Guilford.
- Heitger, M. H., Jones, R. D., Dalrymple-Alford, J. C., Frampton, C. M., Ardagh, M. W., & Anderson, T. J. (2006). Motor deficits and recovery during the first year following mild closed head injury. *Brain Injury, 20*, 807-824.
- Helgeson, V. S., Reynolds, K. A., & Tomich, P. L. (2006). A meta-analytic review of benefit-finding and growth. *Journal of Consulting and Clinical Psychology, 74*, 797-816.
- Hendrick, S. S. (1988). A generic measure of relationship satisfaction. *Journal of Marriage and the Family, 50*, 93-98.
- Henry, P. H., Knippa, J., & Golden, C. J. (1985). A systems model for therapy with brain-injured adults and their families. *Family Systems Medicine, 3*, 427-439.

- Hertzog, C., van Alstine, J., Usala, P. D., Hultsch, D. F., & Dixon, R. (1990). Measurement properties of the Center for Epidemiological Studies Depression Scale (CES-D) in older populations. *Psychological Assessment, 2*, 64-72.
- Hibbard, M. R., Bogdany, J., Uysal, S., Kepler, K., Silver, J. M., Gordon, W. A., et al. (2000). Axis II psychopathology in individuals with traumatic brain injury. *Brain Injury, 14*, 45-61.
- Hibbard, M. R., Cantor J., Charatz H., Rosenthal, R., Ashman, T., Gundersan, N. et al. (2002). Peer support in the community: Initial findings of a mentoring program for individuals with traumatic brain injury and their families. *Journal of Head Trauma Rehabilitation, 17*, 112-131.
- Himmelfarb, S., & Murrell, S. A. (1983). Reliability and validity of five mental health scales in older persons. *Journal of Gerontology, 38*, 333-339.
- Holland, J. M., Currier, J. M., Coleman, R. A., & Neimeyer, R. A. (2010). The Integration of Stressful Life Experiences Scale (ISLES): Development and initial validation of a new measure. *International Journal of Stress Management, 17*, 325-352.
- Holland, J. M., Currier, J. M., & Neimeyer, R. A. (2006). Meaning reconstruction in the first two years of bereavement: The role of sense-making and benefit-finding. *Omega: Journal of Death and Dying, 53*, 175-191.
- Holland, J. M., & Neimeyer, R. A. (2010). An examination of stage theory of grief among individuals bereaved by natural and violent causes: A meaning orientated contribution. *Omega: Journal of Death and Dying, 61*, 103-120.
- Hollis, J. (1996). *Swamplands of the soul: New life in dismal places*. Toronto: Inner City Books.
- Hooghe, A., & Neimeyer, R. A. (2013). Family resilience in the wake of loss: A meaning-oriented contribution. In D. S. Becvar (Ed.), *Handbook of family resilience* (pp. 269-284). New York: Springer.
- Hooyman, N. R., & Kramer, B. J. (2006). *Living through loss: Interventions across the life span*. New York: Columbia University Press.
- Homer (1998). *The Iliad* (R. Fagles, Trans.). New York: Penguin. (Original work produced ca. 800 B.C.E.).
- Howell, D. C. (2002). *Statistical methods for psychology* (5<sup>th</sup> ed.). Pacific Grove, CA: Duxbury.
- Hsiang, J. N. K., Yeung, T., Ashley, L. M., & Poon, W. S. (1997). High-risk mild head injury. *Journal of Neurosurgery, 87*, 234-238.

- Idson, L. C., & Mischel, W. (2001). The personality of familiar and significant people: The lay perceiver as a social-cognitive theorist. *Journal of Personality and Social Psychology*, *80*, 585-596.
- Iverson, G. L. (2010). Mild traumatic brain injury meta-analyses can obscure individual differences. *Brain Injury*, *24*, 1246-1255.
- Iwata, A., Stys, P. K., Wolf, J. A., Chen, X., Taylor, A. G., Meaney, D. F., & Smith, D. H. (2004). Traumatic axonal injury induces proteolytic cleavage of the voltage-gated sodium channels modulated by tetrodotoxin and protease inhibitors. *Journal of Neuroscience*, *24*, 4605-4613.
- Jacobs, H. E. (1988). The Los Angeles head injury survey: Procedures and initial findings. *Archives of Physical Medicine and Rehabilitation*, *69*, 425-431.
- Jahanshahi, M., & Frith, C. D. (1998). Willed action and its impairments. *Cognitive Neuropsychology*, *15*, 483-533.
- Janoff-Bulman, R. (1989). Assumptive worlds and the stress of traumatic events: Applications of the schema construct. *Social Cognition*, *7*, 113-136.
- Janoff-Bulman, R. (1992). *Shattered assumptions: Toward a new psychology of trauma*. New York: Free Press.
- Janoff-Bulman, R., & Berg, M. (1998). Disillusionment and the creation of values: From traumatic losses to existential gains. In J. H. Harvey (Ed.), *Perspectives on loss: A sourcebook* (pp. 35-48). New York: Routledge.
- Janoff-Bulman, R., & Frantz, C. M. (1997). The impact of trauma on meaning: From meaningless world to meaningful life. In M. J. Power & C. R. Brewin (Eds.), *The transformation of meaning in psychological therapies: Integrating theory and practice* (pp. 91-106). Hoboken, NJ: John Wiley & Sons.
- Jennett, B., Teasdale, G., Galbraith, S., Pickard, J., Grant, H., Braakman, R., et al. (1977). Severe head injuries in three countries. *Journal of Neurology, Neurosurgery and Psychiatry*, *40*, 291-298. doi:10.1136/jnnp.40.3.291
- Jones-Webb, R.J., & Snowden, L.R. (1993). Symptoms of depression among blacks and whites. *American Journal of Public Health*, *83*, 240-244.
- Joseph, S., Williams, R., & Yule, W. (1993). Changes in outlook following disaster: The preliminary development of a measure to assess positive and negative responses. *Journal of Traumatic Stress*, *6*, 271-279.

- Kashluba, S., Hanks, R. A., Casey, J. E., & Millis, S. R. (2008). Neuropsychologic and functional outcome after complicated mild traumatic brain injury. *Archives of Physical Medicine Rehabilitation, 89*, 904-911.
- Katz, D. I. (1992). Neuropathology and neurobehavioral recovery from closed head injury. *The Journal of Head Trauma Rehabilitation, 7*, 1-15.
- Kauffman, J. (2002). The psychology of disenfranchised grief: Liberation, shame, and self-disenfranchisement. In K. J. Doka (Ed.), *Disenfranchised grief: New directions, challenges, and strategies for practice* (p. 61-78). Champaign, IL: Research Press.
- Kaul, M., & Lakey, B. (2003). Where is the support in perceived support? The role of generic relationship satisfaction and enacted support in perceived support's relation to low distress. *Journal of Social and Clinical Psychology, 22*, 59-78.
- Keesee, N. J., Currier, J. M., & Neimeyer, R. A. (2008). Predictors of grief following the death of one's child: The contribution of finding meaning. *Journal of Clinical Psychology, 64*, 1145-1163.
- Kernan, W. D., & Lepore, S. J. (2009). Searching for and making meaning after breast cancer: Prevalence, patterns, and negative affect. *Social Science & Medicine, 68*, 1176-1182.
- Kersel, D. A., Marsh, N. V., Havill, J. H., & Sleight, J. W. (2001). Neuropsychological functioning during the year following severe traumatic brain injury. *Brain Injury, 15*, 283-296.
- Kessler, R. C., Chiu, W. T., Demler, O., Merikangas, K. R., & Walters, E. E. (2005). Prevalence, severity, and comorbidity of 12-month DSM-IV disorders in the national comorbidity survey replication. *Archives of General Psychiatry, 62*, 617-627.
- Klass, D., Silverman, P. R., & Nickman, S. L. (Eds.) (1996) *Continuing bonds: New understandings of grief*. Washington, DC: Taylor & Francis.
- Klonoff, P. S. (2014). *Psychotherapy for families after brain injury*. New York: Springer.
- Klonoff, P. S., & Koberstein, E. J. (2010). Family life. In P. S. Klonoff (Ed.), *Psychotherapy after brain injury: Principles and techniques* (pp. 150-170). New York: Guilford Press.
- Knight, R. G., Devereux, R., & Godfrey, H. P. D. (1998). Caring for a family member with a traumatic brain injury. *Brain Injury, 12*, 467-481.
- Knight, R. G., Williams, S., McGee, R., & Olan, S. (1997). Psychometric properties of the Center for Epidemiologic Studies Depression Scale (CES-D) in a sample of women in middle life. *Behavioral Research and Therapy, 35*, 373-380.
- Koestler, J., & Keshavarz, R. (2001). Penetrating head injury in children: A case report and review of the literature. *The Journal of Emergency Medicine, 21*, 145-150.

- Kojima, M., Hayano, J., Tokudome, S., Suzuki, S., Ibuki, K., Tomizawa, H., et al. (2007). Independent associations of alexithymia and social support with depression in hemodialysis patients. *Journal of Psychosomatic Research, 63*, 349-356.
- Kolakowsky-Hayner, S., Miner, K. D., & Kreutzer, J. S. (2001). Long-term life quality and family needs after traumatic brain injury. *The Journal of Head Trauma Rehabilitation, 16*, 374-384.
- Koponen, S., Taiminen, T., Kurki, T., Portin, R., Isoniemi, H., Himanen, L., et al. (2006). MRI findings and axis I and II psychiatric disorders after traumatic brain injury: A 30-year retrospective follow-up study. *Psychiatry Research: Neuroimaging, 146*, 263-270.
- Koponen, S., Taiminen, T., Portin, R., Himanen, L., Isoniemi, H., Heinonen, H., et al. (2002). Axis I and II psychiatric disorders after traumatic brain injury: A 30-year follow-up study. *The American Journal of Psychiatry, 159*, 1315-1321.
- Kosciulek, J. F., McCubbin, M. A., & McCubbin, H. I. (1993). A theoretical framework for family adaptation to head injury. *Journal of Rehabilitation, 59*, 40-45.
- Kozloff, R. (1987). Networks of social support and the outcome from severe head injury. *The Journal of Head Trauma Rehabilitation, 2*, 14-23.
- Kraus, J. M., & Chu, L. D. (2005). Epidemiology. In J. M. Silver, T. M. McAllister, & S. C. Yudofsky. (Eds.), *Textbook of traumatic brain injury* (pp. 3-26). Washington, DC: American Psychiatric Publishing.
- Kraus, J. F., Fife, D., Ramstein, K., Conroy, C., & Cox. (1986). The relationship of family income to the incidence, external causes, and outcomes of serious brain injury, San Diego County, California. *American Journal of Public Health, 76*, 1345-1347.
- Kraus, J. F., & McArthur, D. L. (1999). Incidence and prevalence of, and costs associated with traumatic brain injury. In M. Rosenthal, E. R. Griffith, J. S. Kreutzer, & B. Pentland (Eds.), *Rehabilitation of the adult and child with traumatic brain injury* (3rd ed., pp. 3-18). Philadelphia, PA: F. A. Davis.
- Kraus, J. F., Morgenstern, H., Fife, D., Conroy, C., & Nourjah, P. (1989). Blood alcohol tests, prevalence of involvement, and outcomes following brain injury. *American Journal of Public Health, 79*, 294-299.
- Kraus, M. F., Susmaras, T., Cahughlin, B. P., Walker, C. J., Sweeney, J. A., & Little, D. M., et al. (2007). White matter integrity and cognition in chronic traumatic brain injury: A diffusion tensor imaging study. *Brain, 130*, 2508-2519.
- Kravetz, S., Gross, Y., Weiler, B., Ben-Yakar, M., Tadir, M., & Stern, M. J. (1995). Self-concept, marital vulnerability and brain damage. *Brain Injury, 9*, 131-139.

- Kreutzer, J. S., Gervasio, A. H., & Camplair, P. S. (1994a). Primary caregiver's psychological status and family functioning after traumatic brain injury. *Brain Injury*, 8, 197-210.
- Kreutzer, J. S., Gervasio, A. H., & Camplair, P. S. (1994b). Patient correlates of caregivers' distress and family functioning. *Brain Injury*, 8, 211-230.
- Kreutzer, J. S., Gordon, W. A., Rosenthal, M., & Marwitz, J. (1993). Neuropsychological characteristics of patients with brain injury: preliminary findings from a multicenter investigation. *Journal of Head Trauma Rehabilitation*, 8, 47-59.
- Kreutzer, J. S., Rapport, L. J., Marwitz, J. H., Harrison-Felix, C., Hart, T., Glenn, M., & Hammond, F. (2009). Caregivers' well-being after traumatic brain injury: A multicenter prospective investigation. *Archives of Physical Medicine and Rehabilitation*, 90, 939-946.
- Kreutzer, J. S., Stejskal, T. M., Godwin, E. G., Powell, V. D., & Arango-Lasprilla, J. C. (2010). A mixed methods evaluation of the Brain Injury Family Intervention. *NeuroRehabilitation*, 27, 19-29.
- Kreutzer, J. S., Stejskal, T. M., Ketchum, J. M., Marwitz, J. H., Taylor, L. A., & Menzel, J. C. (2009). A preliminary investigation of the brain injury family intervention: Impact on family members. *Brain Injury*, 23(6), 535-547.
- Kreutzer, J. S., & Taylor, L. (2004). *Brain Injury Family Intervention implementation manual*. Richmond, VA: National Resource Center for Traumatic Brain Injury.
- Kübler-Ross, E. (1969). *On death and dying*. New York: Macmillan.
- Kübler-Ross, E., & Kessler, D. (2005). *On grief and grieving: Finding the meaning of grief through the five stages of loss*. New York: Scribner.
- Kumar, R., & Indrayan, A. (2011). Receiver operating characteristic curve analysis for medical researchers. *Indian Pediatrics*, 48, 277-287.
- Kurtz, J. E., Putnam, S. H., & Stone, C. (1998). Stability of normal personality traits after traumatic brain injury. *The Journal of Head Trauma Rehabilitation*, 13, 1-14.
- Kushner, D. (1998). Mild traumatic brain injury: toward understanding manifestations and treatment. *Archives of Internal Medicine*, 158, 1616-1624.
- Landra, R. J. (2005). Assessment of social communication skills in preschoolers. *Mental Retardation and Developmental Disabilities*, 11, 247-252.



- Langlois, J. A., Rutland-Brown W., & Thomas, K. E. (2006). *Traumatic brain injury in the United States: Emergency department visits, hospitalizations, and deaths*. Atlanta, GA: Centers for Disease Control and Prevention, National Center for Injury Prevention and Control. Retrieved January 12, 2009, from [http://www.cdc.gov/ncipc/pubres/TBI\\_in\\_US\\_04/TBI%20in%20the%20US\\_Jan\\_2006.pdf](http://www.cdc.gov/ncipc/pubres/TBI_in_US_04/TBI%20in%20the%20US_Jan_2006.pdf).
- Lannoo, E., Colardyn, F., Vandekerckhove, T., De Deyne, C., De Soete, G., & Jannes C. (1998). Subjective complaints versus neuropsychological test performance after moderate to severe head injury. *Acta Neurochirurgica (Wien)*, *140*, 245–253.
- Lawton, M. P., Kleban, M. H., Moss, M., Rovine, M., & Glicksman, A. (1989). Measuring caregiving appraisal. *Journal of Gerontology*, *44*, 61–71.
- Lazarus, R. S. (1999). *Stress and emotion: A new synthesis*. New York: Springer.
- Lazarus, R. S., & Folkman, S. (1984). *Stress, appraisal, and coping*. New York: Springer Publishing.
- Lazarus, R. S., & Folkman, S. (1987). Transactional theory and research on emotions and coping. *European Journal of Personality*, *1*, 141-169.
- Leach, L. R., Frank, R. G., Bouman, D. E., & Farmer, J. (1994). Family functioning, social support and depression after traumatic brain injury. *Brain Injury*, *8*, 599-606.
- Leatham, J., Heath, E., & Woolley, C. (1996). Relatives perceptions of role change, social support, and stress after traumatic brain injury. *Brain Injury*, *10*, 27-38.
- Lehman, D. R., Davis, C. G., DeLongis, A., Wortman, C. B., Bluck, S., Mandel, D., & Ellard, J. H. (1993). Positive and negative life changes following bereavement and their relations to adjustment. *Journal of Social and Clinical Psychology*, *12*, 90-112.
- Lehman, D. R., Wortman, C. B., & Williams, A. F. (1987). Long-term effects of losing a spouse or child in a motor vehicle crash. *Journal of Personality and Social Psychology*, *52*, 218-231.
- Lerner, M. J. (1980). *The belief in a just world: A fundamental delusion*. New York: Plenum.
- Levin, H. S., Brown, S. A., Song, J. X., McCauley, S. R., Boake, C., Contant, C. F., et al. (2001). Depression and posttraumatic stress disorder at three months after mild to moderate traumatic brain injury. *Journal of Clinical and Experimental Neuropsychology*, *23*, 754-769.
- Levin, H. S., & Eisenberg, H. M. (1991). Management of head injury. Neurobehavioural outcome. *Neurosurgery Clinics of North America*, *2*, 457-472.

- Levin, H. S., Gary, H., Eisenberg, H. M., Ruff, R. M., Barth, J., Kreutzer, J., et al. (1990). Neurobehavioral outcome 1 year after severe head injury. *Journal of Neurosurgery*, *73*, 699-709.
- Levin, H. S., Mattis, S., Ruff, R. M., Eisenberg, H. M., Marshall, L. F., Tabbador, K., et al. (1987). Neurobehavioral outcome of minor head injury: A three centre study. *Journal of Neurosurgery*, *66*, 234-243.
- Levine, S. (2013). Evaluating the seven-item Center for Epidemiologic Studies Depression Scale Short-Form: A longitudinal US community study. *Social Psychiatry and Psychiatric Epidemiology*, *48*, 1519-1526.
- Levy, Y. S., Streifler, J. Y., Panet, H., Melamed, E., & Offen, D. (2002). Hemin-induced apoptosis in PC12 and neuroblastoma cells: implications for local neuronal death associated with intracerebral hemorrhage. *Neurotoxicity Research*, *4*, 609-616.
- Lezak, M. D. (1978). Living with the characterologically altered brain injured patient. *Journal of Clinical Psychiatry*, *39*, 592-598.
- Lezak, M. D. (1986). Psychological implications of traumatic brain damage for the patient's family. *Rehabilitation Psychology*, *31*(4), 241-250.
- Lezak, M. D. (1988). Brain damage is a family affair. *Journal of Clinical and Experimental Neuropsychology*, *10*(1), 111-123.
- Lezak, M. D. (1995). *Neuropsychological assessment* (3<sup>rd</sup> ed.). New York: Oxford University Press.
- Lezak, M. D., Howieson, D. B., Loring, D. W., Hannay, H. J., & Fischer, J. S. (2004). *Neuropsychological assessment* (4<sup>th</sup> ed.). New York: Oxford University Press.
- Lichtenthal, W. G., & Cruess, D. G. (2010). Effects of directed written disclosure on grief and distress symptoms among bereaved individuals. *Death Studies*, *34*, 475-499.
- Lichtenthal, W. G., Currier, J. M., Neimeyer, R. A., & Keesee, N. J. (2010). Sense and significance: A mixed methods examination of meaning-making after the loss of one's child. *Journal of Clinical Psychology*, *66*, 791-812.
- Lindemann, E. (1944). Symptomatology and management of acute grief. *American Journal of Psychiatry*, *101*, 141-148.
- Lindgren, C. L. (1996). Chronic sorrow in persons with parkinson's and their spouses. *Scholarly Inquiry for Nursing Practice*, *10*, 351-366.
- Linn, R. T., Allen, K., & Wilier, B. S. (1994). Affective symptoms in the chronic stage of traumatic brain injury: A study of married couples. *Brain Injury*, *8*, 135-147.

- Liss, M., & Willer, B. (1990). Traumatic brain injury and marital relationships: A literature review. *International Journal Rehabilitation Research*, *13*, 309-320.
- Livingston, L. A., Kennedy, R. E., Marwitz, J. H., Arango-Lasprilla, J., Rapport, L. J., Bushnik, T., & Gary, K. W. (2010). Predictors of family caregivers' life satisfaction after traumatic brain injury at one and two years post-injury: A longitudinal multi-center investigation. *NeuroRehabilitation*, *27*, 73-81.
- Livingston, M. G. (1987). Head injury: the relatives' response. *Brain Injury*, *1*, 33-39.
- Livingston, M. G., Brooks, D. N., & Bond, M. R. (1985a). Patient outcomes in the year following severe head injury and relatives psychiatric and social functioning. *Journal of Neurology, Neurosurgery, and Psychiatry*, *48*, 876-881.
- Livingston, M. G., Brooks, D. N., & Bond, M. R. (1985b). Three months after severe head injury: Psychiatric and social impact on relatives. *Journal of Neurology, Neurosurgery and Psychiatry*, *48*, 870-875.
- Loukusa, S., & Moilanen, I. (2009). Pragmatic inference abilities in individuals with asperger syndrome or high-functioning autism. A review. *Research in Autism Spectrum Disorders*, *3*, 890-904.
- Lucas, R.E., Diener, E., & Suh, E. (1996). Discriminant validity of well-being measures. *Journal of Personality and Social Psychology*, *71*, 616-628.
- Luthar, S. S. (1993). Methodological and conceptual issues in research on childhood resilience. *Journal of Child Psychology and Psychiatry*, *34*, 441-453.
- Lyness, J. M., Noel, T. K., Cox, C., King, D. A., Conwell, Y., & Caine, E. D. (1997). Screening for depression in elderly primary care patients. *Archives of Internal Medicine*, *157*, 449-454.
- Maciejewski, P. K., Zhang, B., Block, S. D., & Prigerson, H. G. (2007). An empirical examination of the stage theory of grief. *Journal of the American Medical Association*, *297*, 716-723.
- Machamer, J., Temkin, N., & Dikmen, S. (2002). Significant other burden and factors related to it in traumatic brain injury. *Journal of Clinical and Experimental Neuropsychology*, *24*, 420-433.
- Mahan, R. B. (2007). *Assessing the moderating role of social support in adjustment to bereavement in an elderly sample: A structural equation modeling causal analysis*. Unpublished doctoral dissertation, Pacific Graduate School of Psychology, Palo Alto, CA.

- Maitz, E. A. (1991). Family systems theory applied to head injury. In J. M. Williams & T. Kay (Eds.), *Head injury: A family matter* (pp. 65-80). Baltimore: Paul H. Brookes.
- Maitz, E. A., & Sachs, P. R. (1995). Treating families of individuals with traumatic brain injury from a family systems perspective. *The Journal of Head Trauma Rehabilitation, 10*, 1-11.
- Malec, J. F., Brown, A. W., & Moessner, A. M. (2004). Personality factors and injury severity in the prediction of early and late traumatic brain injury outcomes. *Rehabilitation Psychology, 49*, 55-61.
- Malia, K., Powell, G., & Torode, S. (1995). Personality and psychosocial function after brain injury. *Brain Injury, 9*, 697-712.
- Malkinson, R. (2001). Cognitive-behavioral therapy of grief: A review and application. *Research on Social Work Practice, 11*, 671-698.
- Manskow, U. S., Sigurdardottir, S., Røe, C., Anđelic, N., Skandsen, T., Damsgård, E., et al. (2014). Factors affecting caregiver burden 1 year after severe traumatic brain injury: A prospective nationwide multicenter study. *Journal of Head Trauma Rehabilitation, 34*, 1-13.
- Marris, P. (1958). *Widows and their families*. London: Routledge and Kegan Paul.
- Marris, P. (1974). *Loss and change*. New York: Random House.
- Marsh, N. V., Kersel, D. A., Havill, J. H., & Sliagh, W. (1998). Caregiver burden at one year following severe traumatic brain injury. *Brain Injury, 12*, 1045-1059.
- Marwit, S. J., Chibnall, J. T., Dougherty, R., Jenkins, C., & Shawgo, J. (2008). Assessing pre-death grief in cancer caregivers using the Marwit-Meuser Caregiver Grief Inventory (MM-CGI). *Psycho-Oncology, 17*, 300-303.
- Marwit, S. J., & Kaye, P. N. (2006). Measuring grief in caregivers of persons with acquired brain injury. *Brain Injury, 20*, 1419-1429.
- Marwit, S. J., & Meuser, T. M. (2002). Development and initial validation of an inventory to assess grief in caregivers of persons with alzheimer's disease. *The Gerontologist, 42*, 751-765.
- Matthews, L. T., & Marwit, S. J. (2004). Complicated grief and the trend toward cognitive-behavioral therapy. *Death Studies, 28*, 849-863.
- McArthur, D. L., Chute, D. J., & Villablanca, J. P. (2004). Moderate and severe traumatic brain injury: Epidemiologic, imaging and neuropathologic perspectives. *Brain Pathology, 14*, 185-194.

- McCabe, M. (2003). *The paradox of loss: Toward a relational theory of grief*. Westport, CT: Praeger.
- McCaskill, J. W. (1997). *Maternal grief reactions to their children's birth defects: Factors influencing grief resolution*. Unpublished doctoral dissertation, Wayne State University, Detroit, MI.
- McCrae, R. R., & Costa, P. T. (1987) Validation of the five-factor model of personality across instruments and observers. *Journal of Personality and Social Psychology*, 52, 81-90.
- McCrae, R. R., & Costa, P. T. (1997) Personality trait structure as a human universal. *American Psychologist*, 52, 509-516.
- McCullagh, E., Brigstocke, G., Donaldson, N., & Kalra, L. (2005). Determinants of caregiving burden and quality of life in caregivers of stroke patients. *Stroke*, 36, 2181-2186.
- McIntosh, D. N., Silver, R. C., & Wortman, C. B. (1993). Religion's role in adjustment to a negative life event: Coping with the loss of a child. *Journal of Personality and Social Psychology*, 65, 812-821.
- McKinlay, W. W., Brooks, D. N., Bond, M. R., Matinaga, D. P. & Marshall, M. M. (1981). The short-term outcome of severe blunt head injury as reported by relatives of the injured persons. *Journal of Neurology, Neurosurgery, and Psychiatry*, 44, 527-533.
- McNally, S., Ben-Shlomo, Y., & Newman, S. (1999). The effects of respite care on informal carers' well-being: A systematic review. *Disability & Rehabilitation*, 21, 1-14.
- McMillen, J. C., Smith, E. M., & Fischer, R. H. (1997). Perceived benefit and mental health after three types of disaster. *Journal of Consulting and Clinical Psychology*, 65, 733-739
- McMordie, W. R., & Barker, S. (1988). The financial trauma of head injury. *Brain Injury*, 2, 357-364.
- Mead, G. H. (1934). *Mind, self, and society: from the standpoint of a social behaviourist*. University of Chicago Press: Chicago.
- Meuser, T. M., & Marwit, S. J. (2001). A comprehensive, stage-sensitive model of grief in dementia caregiving. *Gerontologist*, 41, 658-670.
- Meuser T. M., Marwit, S. J., & Sanders, S. (2004). Assessing grief in family caregivers. In K. Doka (Ed.), *Living with grief: Alzheimer's Disease*, (pp. 169-196). Hospice Foundation of America: Washington, DC, 2005; 169-196.
- Mesulam, M. M. (2002). The human frontal lobes: Transcending the default mode through contingent encoding. In D. T. Stuss & R. Knight (Eds.), *Principles of frontal lobes function* (pp. 8–30). New York: Oxford University Press.

- Meythaler, J. M., Peduzzi, J. D., Eleftheriou, E., & Novack, T. A. (2001). Current concepts: diffuse axonal injury - associated traumatic brain injury. *Archives of Physical Medicine and Rehabilitation, 82*, 1461-1471.
- Mikulincer, M., & Shaver, P. R. (2008). An attachment perspective on bereavement. In M. S. Stroebe, R. O. Hansson, H. Schut, & W. Stroebe (Eds.), *Handbook of bereavement research and practice: Advances in theory and intervention* (pp. 87-112). Washington, DC: American Psychological Association.
- Milders, M., Ietswaart, M., Crawford, J. R., & Currie, D. (2006). Impairments in Theory of Mind shortly after traumatic brain injury and at 1-year follow-up. *Neuropsychology, 20*, 400-408.
- Miller, E. D., & Omarzu, J. (1998). New directions in loss research. In J. H. Harvey (Ed.), *Perspectives on loss: A sourcebook* (pp. 3-20). New York: Routledge.
- Millis, S. R., Rosenthal, M., Novack, T. A., Sherer, M., Nick, T. G., Kreutzer, J. S., et al. (2001). Long-term neuropsychological outcome after traumatic brain injury. *Journal of Head Trauma Rehabilitation, 16*, 343-355.
- Minnes, P., Graffi, S., Nolte, M. L., Carlson, P., & Harrick, L. (2000). Coping and stress in canadian family caregivers of persons with traumatic brain injuries. *Brain Injury, 14*, 737-748.
- Mintz, M. C, Van Horn, K. R., & Levine, L. J. (1995). Developmental models of social cognition in assessing the role of family stress in relatives' predictions following traumatic brain injury. *Brain Injury, 9*, 173-186.
- Mischel, W., & Shoda, Y. (1995). A cognitive-affective system theory of personality: Reconceptualizing situations, dispositions, dynamics, and invariance in personality structure. *Psychological Review, 102*, 246-268.
- Mischel, W., & Shoda, Y. (1998). Reconciling processing dynamics and personality dispositions. *Annual Review of Psychology, 49*, 229-258.
- Mischel, W., & Shoda, Y. (2008). Toward a unified theory of personality: Integrating dispositions and processing dynamics within the cognitive-affective processing system. In O. P. John, R. W. Robins, & L. A. Pervin (Eds.), *Handbook of personality psychology: Theory and research* (3rd ed.) (pp. 208-241). New York: Guilford Press.
- Mischel, W., Shoda, Y., & Mendoza-Denton, R. (2002). Situation-behavior profiles as a locus of consistency in personality. *Current Directions in Psychological Science, 11*, 50-54.
- Mooney, G., & Speed, J. (2001). The association between mild traumatic brain injury and psychiatric conditions. *Brain Injury, 15*, 865-877.

- Morales, D. M., Marklund, N., Lebold, D., Thompson, H. J., Pitkanen, A., Maxwell, W. L., et al. (2005). Experimental models of traumatic brain injury: do we really need to build a better mousetrap? *Neuroscience*, *136*, 971-989.
- Muir, C. A., & Haffey, W. J. (1984). Psychological and neuropsychological interventions in the mobile mourning process. In B. A. Edelstein and E. T. Couture (Eds.), *Behavioral assessment and rehabilitation of the traumatically brain damaged*. New York, NY: Plenum Publishing.
- Murphy, S. A., Chung, I., & Johnson, L. C. (2002). Patterns of mental distress following the violent death of a child and predictors of change over time. *Research in Nursing & Health*, *25*, 425-437
- Murphy, S. A., Johnson, L. C., & Lohan, J. (2003). Finding meaning in a child's violent death: A five-year prospective analysis of parents' personal narratives and empirical data. *Death Studies*, *27*, 381-404.
- Murray, J. A. (2001). Loss as a universal concept: A review of the literature to identify common aspects of loss in adverse situations. *Journal of Loss and Trauma*, *6*, 219-241.
- Murray, C. J. L., & Lopez, A. D. (1997). Alternative projections of mortality and disability by cause 1990–2020: Global Burden of Disease Study. *The Lancet*. 1997; 349(9064):1498–1504.
- Nakase-Thompson, R., Sherer, M., Yablon, S. A., Nick, T. G., & Trzepacz, P. T. (2004). Acute confusion following traumatic brain injury. *Brain Injury*, *18*, 131-142.
- Neimeyer, R. A. (1998a). Can there be a psychology of loss? In J. H. Harvey (Ed.), *Perspectives on loss: A sourcebook* (pp. 331-342). New York: Routledge.
- Neimeyer, R. A. (1998b). *Lessons of loss: A guide to coping*. Boston: McGraw-Hill.
- Neimeyer, R. A. (2001a). The language of loss: Grief therapy as a process of meaning reconstruction. In R. A. Neimeyer (Ed.), *Meaning reconstruction & the experience of loss* (pp. 261-292). Washington, DC: American Psychological Association.
- Neimeyer, R. A. (2001b). Meaning reconstruction and loss. In R. A. Neimeyer (Ed.), *Meaning reconstruction & the experience of loss* (pp. 1-13). Washington, DC: American Psychological Association.
- Neimeyer, R. A. (2005). Complicated grief and the quest for meaning: A constructivist contribution. *Omega: Journal of Death and Dying*, *52*, 37-52.
- Neimeyer, R. A. (2006). Re-storying loss: Fostering growth in the posttraumatic narrative. In L. Calhoun, & R. Tedeschi (Eds.), *Handbook of posttraumatic growth: Research and practice* (pp. 227-252). New York: Springer.

- Neimeyer, R. A. (2012). From stage follower to stage manager: Contemporary directions in bereavement care. In K. J. Doka & A. S. Tucci (Eds.), *Beyond Kübler Ross: New perspectives on death, dying and grief* (pp. 129-150). Washington, DC: Hospice Foundation of America.
- Neimeyer, R. A., Baldwin, S. A., & Gillies, J. (2006). Continuing bonds and reconstructing meaning: Mitigating complications in bereavement. *Death Studies, 30*, 715-738.
- Neimeyer, R. A., Burke, L. A., Mackay, M. M., & van Dyke Stringer, J. (2010). Grief therapy and the reconstruction of meaning: From principles to practice. *Journal of Contemporary Psychotherapy, 40*(2), 73-73-83.
- Neimeyer, R. A., Klass, D., & Dennis, M. R. (2014). A social constructivist account of grief: Loss and the narration of meaning. *Death Studies, 38*, 485-498.
- Neimeyer, R. A., Prigerson, H. G., & Davies, B. (2002). Mourning and meaning. *American Behavioral Scientist, 46*, 235-251.
- Nelson, L. D., Drebing, C., Satz, P., & Uchiyama, C. (1998). Personality change in head trauma: A validity study of the neuropsychology behavior and affect profile. *Archives of Clinical Neuropsychology, 13*(6), 549-560.
- Nelson, L. D., Mitrushina, M., Satz, P., Sowa, M., & Cohen, S. (1993). Cross-validation of the neuropsychology behavior and affect profile in stroke patients. *Psychological Assessment, 5*(3), 374-376.
- Nelson, L., Satz, P., & D'Elia, L. F. (1994). *Neuropsychology Behavior and Affect Profile*. Palo Alto, CA: Mind Garden.
- Nelson, L., Satz, P., Mitrushina, M., van Gorp, W., Cicchetti, D., Lewis, R., & van Lancker, D. (1989). Development and validation of the Neuropsychology Behavior and Affect Profile. *Psychological Assessment: A Journal of Consulting and Clinical Psychology, 1*, 266-272.
- Norton, R. (1983). Measuring marital quality: A critical look at the dependent variable. *Journal of Marriage and the Family, 45*, 141-151.
- Norup, A., Siert, L., & Lykke Mortensen, E. (2010). Emotional distress and quality of life in relatives of patients with severe brain injury: The first month after injury. *Brain Injury, 24*(2):81-88.
- Novack, T. A., Anderson, A. L., Bush, B. A., Meythaler, J. M., & Canupp, K. (2000). Cognitive and functional recovery at 6 and 12 months post-TBI. *Brain Injury, 14*, 987-996.



- Novack, T. A., Bush, B. A., Meythaler, J. M., & Canupp, K. (2001). Outcome after traumatic brain injury: Pathway analysis of contributions from premorbid, injury severity, and recovery variables. *Archives of Physical Medicine and Rehabilitation, 82*, 300-305.
- Obonsawin, M. C., Jefferis, S., Lowe, R., Crawford, J. R., Fernandes, J., Holland, L., et al. (2007). A model of personality change after traumatic brain injury and the development of the brain injury personality scales. *Journal of Neurology, Neurosurgery and Psychiatry, 78*, 1239-1247.
- Oddy, M., Coughlan, T., Tyerman, A., & Jenkins, D. (1985). Social adjustment after closed head injury: A further follow-up seven years after injury. *Journal of Neurology, Neurosurgery and Psychiatry, 48*, 564-568.
- Oddy, M., Humphrey, M., & Uttley, D. (1978a) Stresses upon the relatives of head-injured patients. *British Journal of Psychiatry, 133*, 507-513.
- Oddy, M., Humphrey, M., & Uttley, D. (1978b). Subjective impairment and social recovery after closed head injury. *Journal of Neurology, Neurosurgery, and Psychiatry, 41*, 611-616.
- Ogrodniczuk, J. S., Joyce, A. S., & Piper, W. E. (2003). Changes in perceived social support after group therapy for complicated grief. *Journal of Nervous and Mental Disease, 191*, 524-530.
- Olshansky, S. (1962). Chronic sorrow: A response to having a mentally defective child. *Social Casework, 43*, 190-193.
- O'Rourke, N. (2004). Reliability generalization of responses by care providers to the center for epidemiologic studies-depression scale. *Educational and Psychological Measurement, 64*, 973-990.
- O'Rourke, N., & Tuokko, H. A. (2003). Psychometric properties of an abridged version of the Zarit Burden Interview within a representative Canadian caregiver sample. *The Gerontologist, 43*, 121-127.
- Pagulayan, K. F., Hoffman, J. M., Temkin, N. R., Machamer, J. E., & Dikmen, S. S. (2008). Functional limitations and depression after traumatic brain injury: Examination of the temporal relationship. *Archives of Physical Medicine and Rehabilitation, 89*, 1887-1892.
- Pangallo, A., Zibarras, L., Lewis, R., & Flaxman, P. (2015). Resilience through the lens of interactionism: A systematic review. *Psychological Assessment, 27*, 1-20.
- Panting, A., & Merry, P. H. (1972). The long-term rehabilitation of severe head injuries with particular reference to the need for social and medical support for the patient's family. *Rehabilitation, 38*, 33-37.

- Pargament, K. I., Ensing, D. S., Falgout, K., & Olsen, H. (1990). God help me: I. religious coping efforts as predictors of the outcomes to significant negative life events. *American Journal of Community Psychology, 18*, 793-824.
- Park, C. L. (2010). Making sense of the meaning literature: An integrative review of meaning-making and its effects on adjustment to stressful life events. *Psychological Bulletin, 136*, 257-301.
- Parkes, C. M. (1971). Psycho-social transitions: A field for study. *Social Science and Medicine, 5*, 101-115.
- Parkes, C. M. (1972a). *Bereavement: Studies of grief in adult life*. New York: International Universities Press.
- Parkes, C. M. (1972b). Components of the reaction to loss of a limb, spouse or home. *Journal of Psychosomatic Research, 16*, 343-349.
- Parkes, C. M. (1975). What becomes of redundant world models? A contribution to the study of adaptation to change. *The British Journal of Medical Psychology, 48*, 131-137.
- Parkes, C. M. (1987). *Bereavement: Studies of grief in adult life* (2<sup>nd</sup> ed.). Madison, CT: International Universities Press.
- Parkes, C. M. (1988). Bereavement as a psychosocial transition: Processes of adaptation to change. *Journal of Social Issues, 44*, 53-65.
- Parkes, C. M. (2001). A historical overview of the scientific study of bereavement. In M. S. Stroebe, R. O. Hansson, W. Stroebe, & H. Schut (Eds.), *Handbook of bereavement research: Consequences, coping, and care* (pp. 25-47). Washington, DC: American Psychological Association.
- Parkes, C. M., Laungani, P., & Young, B. (Eds.). (1997). *Death and bereavement across cultures*. New York: Routledge.
- Parkes, C. M., & Weiss, R. S. (1983). *Recovery from bereavement*. New York: Basic Books.
- Pavot, W., & Diener, E. (1993). Review of the satisfaction with life scale. *Psychological Assessment, 5*, 164-172.
- Perkins, N. J., & Schisterman, E. F. (2006). The inconsistency of “optimal” cutpoints obtained using two criteria based on the receiver operating characteristic curve. *American journal of Epidemiology, 163*, 670-675.
- Perlesz, A., Kinsella, G., & Crowe, S. (1999). Impact of traumatic brain injury on the family: A critical review. *Rehabilitation Psychology, 44*, 6-35.

- Perlesz, A., Kinsella, G., & Crowe, S. (2000). Psychological distress and family satisfaction following traumatic brain injury: Injured individuals and their primary, secondary, and tertiary caregivers. *Journal of Head Trauma Rehabilitation, 15*, 909-929.
- Peters, L. C., Stambrook, M., Moore, A. D., & Esses, L. (1990). Psychosocial sequelae of closed head injury: Effects on the marital relationship. *Brain Injury, 4*, 39-47.
- Pierce, G. R., Sarason, I. G., & Sarason, B. R. (1991). General and relationship-based perceptions of social support: Are two constructs better than one? *Journal of Personality and Social Psychology, 61*(6), 1028-1028-1039.
- Ponsford, J. L., Oliver, J. H., & Curran, C. (1995). A profile of outcome: 2 years after traumatic brain injury. *Brain Injury, 9*, 1-10.
- Ponsford, J., Olver, J., Ponsford, M., & Nelms, R. (2003). Long-term adjustment of families following traumatic brain injury where comprehensive rehabilitation has been provided. *Brain Injury, 17*, 453-468.
- Ponsford, J., & Schönberger, M. (2010). Family functioning and emotional state two and five years after traumatic brain injury. *Journal of the International Neuropsychological Society, 16*, 306-317.
- Povlishock, J. T., & Christman, C. W. (1995). The pathobiology of traumatically induced axonal injury in animals and humans: A review of current thoughts. *Journal of Neurotrauma, 12*, 555-564.
- Povlishock, J. T., & Katz, D. I. (2005). Update of neuropathology and neurological recovery after traumatic brain injury. *Journal of Head Trauma Rehabilitation, 20*, 76-94.
- Preacher, K. J., Curran, P. J., & Bauer, D. J. (2006). Computational tools for probing interactions in multiple linear regression, multilevel modeling, and latent curve analysis. *Journal of Educational and Behavioral Statistics, 31*, 437-448.
- Preacher, K. J., & Hayes, A. F. (2004). SPSS and SAS procedures for estimating indirect effects in simple mediation models. *Behavior Research Methods, Instruments & Computers, 36*, 717-731.
- Preacher, K. J., & Hayes, A. F. (2008). Asymptotic and resampling strategies for assessing and comparing indirect effects in multiple mediator models. *Behavior Research Methods, 40*, 879-891.
- Prigatano, G. (1992). Personality disturbances associated with traumatic brain injury. *Journal of Consulting and Clinical Psychology, 60*, 360-368.
- Prigatano, G. P. (1999). *Principles of neuropsychological rehabilitation*. New York: Oxford University Press.

- Prigatano, G. P., Borgaro, S., Baker, J., & Wethe, J. (2005). Awareness and distress after traumatic brain injury: A relative's perspective. *The Journal of Head Trauma Rehabilitation, 20*, 359-367.
- Prigerson, H. G., Vanderwerker, L. C., & Maciejewski, P. K. (2008). A case for inclusion of Prolonged Grief Disorder in DSM-IV. In M. S. Stroebe, R. O. Hansson, H. Schut, & W. Stroebe (Eds.), *Handbook of bereavement research and practice: Advances in theory and intervention* (pp. 163-186). Washington, DC: American Psychological Association.
- Qureshi, N. H., & Harsh, G. (2009, November 10). Skull fracture. *eMedicine from WebMD*, Article 248108. Retrieved December 14, 2009, from <http://emedicine.medscape.com/article/248108-overview>
- Radloff, L. S. (1977). The CES-D scale: a self-report depression scale for research in the general population. *Applied Psychological Measurement, 1*, 385-401.
- Radloff, L. S. & Teri, L. (1986). Use of the CES-D with older adults. *Clinical Gerontologist, 5*, 119-136.
- Raghupathi, R. R. (2004). Cell death mechanisms following traumatic brain injury. *Brain Pathology, 14*, 215-222.
- Rando, T. A. (1984). *Grief, dying, and death: Clinical interventions for caregivers*. Champaign, IL: Research Press.
- Rando, T. A. (1993). *Treatment of complicated mourning*. Champaign, IL: Research Press.
- Raphael, B. (1983). *The anatomy of bereavement*. New York: Basic Books.
- Raymont, V., Greathouse, A., Reding, K., Lipsky, R., Salazar, A., & Grafman, J. (2008). Demographic, structural and genetic predictors of late cognitive decline after penetrating head injury. *Brain., 131*, 543-558.
- Recklitis, C. J., Parsons, S. K., Shih, M-C., Mertens, A., Robison, L. L., & Zeltzer, L. (2006). Factor structure of the Brief Symptom Inventory—18 in adult survivors of childhood cancer: Results from the Childhood Cancer Survivor Study. *Psychological Assessment, 18*, 22-32.
- Reinhardt, J. P., Boerner, K., & Horowitz, A. (2006). Good to have but not to use: Differential impact of perceived and received support on well-being. *Journal of Social and Personal Relationships, 23*, 117-129.
- Reitan, R. M., & Wolfson, D. (2000). *Mild head injury: Intellectual, cognitive, and emotional consequences*. Tucson, Arizona: Neuropsychology Press.
- Reker, G. T. (1994). Logotherapy and logotherapy: Challenges, opportunities, and some empirical findings. *International Forum for Logotherapy, 17*, 47-55.

- Richardson, J. T. E. (2000). *Clinical and neuropsychological aspects of closed head injury* (2nd ed.). New York, NY, US: Psychology Press.
- Ricker, J. H. (2010). Traumatic brain injury in adults. In J. H. Ricker, R. G. Frank, M. Rosenthal, & B. Caplan (Eds.), *Handbook of rehabilitation psychology* (2<sup>nd</sup> ed) (pp. 43-62). Washington, DC: American Psychological Association.
- Rimel, R. W., Giordani, B., Barth, J. T., & Jane, J. A. (1982). Moderate head injury: Completing the clinical spectrum of brain trauma. *Neurosurgery*, *11*, 344-351.
- Roberts, R.E. (1980). Reliability of the CES-D scale in different ethnic contexts. *Psychiatry Research*, *2*, 125-134.
- Roberts, R.E., & Vernon, S.W. (1983). The Center for Epidemiologic Studies-Depression Scale: Its use in a community sample. *American Journal of Psychiatry*, *140*(1), 41-46.
- Roberts, R. E., Vernon, S. W., & Rhoades, H. M. (1989). Effects of language and ethnic status on reliability and validity of the Center for Epidemiologic Studies-Depression Scale with psychiatric patients. *The Journal of Nervous and Mental Disease*, *177*, 581-592.
- Roebuck-Spencer, T., & Sherer, M. (2008). Moderate and severe traumatic brain injury. In J. E. Morgan and J. H. Ricker (Eds.), *Textbook of Clinical Neuropsychology* (pp. 411-429). New York: Taylor & Francis.
- Rogers, J. M., & Read, C. A. (2007). Psychiatric comorbidity following traumatic brain injury. *Brain Injury*, *21*, 1321-1333.
- Romano, M. D. (1974). Family response to traumatic head injury. *Scandinavian Journal of Rehabilitation Medicine*, *6*, 1-4.
- Roos, S. R. (2002). *Chronic sorrow: A living loss*. New York: Routledge.
- Rosenbaum, M., & Najenson, T. (1976). Changes in life patterns and symptoms of low mood as reported by wives of severely brain-injured soldiers. *Journal of Consulting and Clinical Psychology*, *44*, 881-888.
- Royo, N. C., Shimizu, S., Schouten, J. W., Stover, J. F., & McIntosh, T. K. (2003). Pharmacology of traumatic brain injury. *Current Opinion in Pharmacology*, *3*, 27-32.
- Rubin, S. S. (1989). Death of the future?: An outcome study of bereaved parents in Israel. *Omega*, *20*, 323-323-339.
- Rubin, S. S. (1999). The two-track model of bereavement: Overview, retrospect, and prospect. *Death Studies*, *23*, 681-714.
- Rubin, S. S., Malkinson, R., & Witztum, E. (2008). Clinical aspects of a DSM complicated grief diagnosis: Challenges, Dilemmas, and Opportunities. In M. S. Stroebe, R. O. Hansson, H. Schut, & W. Stroebe (Eds.), *Handbook of bereavement research and practice: Advances*

- in theory and intervention* (pp. 187-206). Washington, DC: American Psychological Association.
- Ruocco, A. C., Swirsky-Sacchetti, T., & Choca, J. P. (2007). Assessing personality and psychopathology after traumatic brain injury with the millon clinical multi-axial inventory-III. *Brain Injury, 21*, 1233-1244.
- Rush, B. K., Malec, J. F., Brown, A. W., & Moessner, A. M. (2006). Personality and functional outcome following traumatic brain injury. *Rehabilitation Psychology, 51*, 257-264.
- Russell, W. R. (1932). Cerebral involvement in head injury. A study on the examination of two hundred cases. *Brain, 55*, 549-603.
- Russell, W. R., & Smith, A. (1961). Post-traumatic amnesia in closed head injury. *Archives of Neurology, 5*, 4-17.
- Russell, D., Altmaier, E., & Van Velzen, D. (1987). Job-related stress, social support, and burnout among classroom teachers. *Journal of Applied Psychology, 72*, 269-274.
- Russell, D., Cutrona, C.E., Rose, J., & Yurko, K. (1984). Social and emotional loneliness: An examination of Weiss's typology of loneliness. *Journal of Personality and Social Psychology, 46*, 1313-1321.
- Rutland-Brown W., Langlois, J. A., Thomas, K. E., & Xi, Y. L. (2006). Incidence of traumatic brain injury in the United States, 2003. *Journal of Head Trauma Rehabilitation, 21*, 544-548.
- Rutter, M. (2013). Annual research review: Resilience - clinical implications. *Journal of Child Psychology and Psychiatry, 54*, 474-487.
- Ryu, W. H. A., Feinstein, A., Colantonio, A., Streiner, D. L., & Dawson, D. R. (2009). Early identification and incidence of mild TBI in Ontario. *Canadian Journal of Neurological Sciences, 36*, 429-435.
- Saatman, K. E., Duhaime, A. C., Bullock, R., Maas, A. I., Valadka, A., & Manley, G. T. (2008). Classification of traumatic brain injury for targeted therapies. *Journal of Neurotrauma, 25*, 719-738.
- Sagduyu, K. (2002). Association of mild traumatic brain injury with bipolar disorder. *Journal of Clinical Psychiatry, 63*, 594.
- Salazar A. M., Grafman J., Schlesselman S., et al. (1986). Penetrating war injuries of the basal forebrain: neurology and cognition. *Neurology, 36*, 459-465.
- Sander, A. M., High, W. M., Hannay, H. J., & Sherer, M. (1997). Predictors of psychological health in caregivers of patients with closed head injury. *Brain Injury; 11*, 235-249.

- Sander, A. M., Carosselli, J. S., High, W. M., Becker, A., Ness, L., & Scheibel, R. S. (2002). Relationship of family functioning to progress in a post-acute rehabilitation programme following traumatic brain injury. *Brain Injury, 16*, 649-657.
- Sander, A. M., Sherer, M., Malec, J. F., High, W. M., Thompson, R. N., Moessner, A. M., et al. (2003). Preinjury emotional and family functioning in caregivers of persons with traumatic brain injury. *Archives of Physical Medicine and Rehabilitation, 84*, 197-203.
- Sanders, C. (1989). *Grief: The mourning after*. New York: Wiley.
- Sanders, C. M., Mauger, P. A., & Strong, P. N. (1985). *A manual for the Grief Experience Inventory*. Palo Alto, CA: Consulting Psychologists Press.
- Sarason, I. G., Sarason, B. R., Potter, E. H., & Antoni, M. H. (1985). Life events, social support, and illness. *Psychosomatic Medicine, 47*, 156-163.
- Schok, M. L., Kleber, R. J., & Lensvelt-Mulders, G. J. (2010). A model of resilience and meaning after military deployment: Personal resources in making sense of war and peacekeeping experiences. *Aging & Mental Health, 14*, 328-338.
- Schretlen, D. J. & Shapiro, A. M. (2003). A quantitative review of the effects of traumatic brain injury on cognitive functioning. *International Review of Psychiatry, 15*, 341-349.
- Schulz, R., Boerner, K., & Hebert, R. S. (2008). Caregiving and bereavement. In M. S. Stroebe, R. O. Hansson, H. Schut, & W. Stroebe (Eds.), *Handbook of bereavement research and practice: Advances in theory and intervention* (pp. 265-286). Washington, DC: American Psychological Association.
- Schwab, K., Grafman, J., Salazaar, A. M., & Kraft, J. (1993). Residual impairments and work status 15 years after penetrating head injury: Report from the Vietnam Head Injury Study. *Neurology, 43*, 95-103.
- Sears, S. R., Stanton, A. L., & Danoff-Burg, S. (2003). The yellow brick road and the emerald city: Benefit finding, positive reappraisal coping, and posttraumatic growth in women with early-stage breast cancer. *Health Psychology, 22*, 487-497.
- Seitz, R., Franz, M., & Azari, N. P. (2009). Value judgments and self-control of action: The role of the medial frontal cortex. *Brain Research Reviews, 60*, 368-378.
- Selassie, A. W., Zaloshnja, E., Langlois, J. A., Miller, T., Jones, P., & Steiner, C. (2003). Incidence of long-term disability following traumatic brain injury hospitalization in the United States. *Journal of Head Trauma Rehabilitation, 23*(2), 123-131.
- Shackleton, C. H. (1984). The psychology of grief: A review. *Advances in Behaviour Research & Therapy, 6*, 153-205.

- Shaver, P. R., & Tancredy, C. M. (2001). Emotion, attachment, and bereavement: A conceptual commentary. In M. S. Stroebe, R. O. Hansson, W. Stroebe, & H. Schut (Eds.), *Handbook of bereavement research: Consequences, coping, and care* (pp. 63-88). Washington, DC: American Psychological Association.
- Shear, M. K., Simon, N. M., Wall, M. M., Zisook, S., Neimeyer, R. A., Duan, N., et al. (2011). Complicated grief and related bereavement issues for DSM-5. *Depression and Anxiety*, 28, 103-117.
- Sherer, M., Nakase-Thompson, R., Yablon, S. A., & Gontkovsky, S. T. (2005). Multidimensional assessment of acute confusion after traumatic brain injury. *Archives of Physical Medicine and Rehabilitation*, 86, 896-904.
- Sherer, M., Struchen, M. A., Nakase-Thompson, R., & Yablon, S. A. (2005). Comparison of indices of severity of traumatic brain injury. *Journal of the International Neuropsychological Society*, 11, 48.
- Shin, D. C., & Johnson, D. M. (1978). Avowed happiness as an overall assessment of the quality of life. *Social Indicators Research*, 5, 475-492.
- Shimizu, S., Fulp, C. T., Royo, N. C., & McIntosh, T. K. (2005). Pharmacotherapy of prevention. In J. M. Silver, T. W. McAllister, & S. C. Yudofsky (Eds.), *Textbook of traumatic brain injury* (pp. 699-726). Arlington, VA: American Psychiatric Publishing.
- Shneidman, E. S. (1974). *Deaths of man*. Baltimore: Penguin Books.
- Shrout, P. E., & Bolger, N. (2002). Mediation in experimental and nonexperimental studies: New procedures and recommendations. *Psychological Methods*, 7, 422-445.
- Siegel, K., & Schrimshaw, E. W. (2007). The stress moderating role of benefit finding on psychological distress and well-being among women living with HIV/AIDS. *AIDS and Behavior*, 11, 421-433.
- Sigurdardottir, S., Andelic, N., Wehling, E., Røe, C., Anke, A., Skandsen, T., et al. (2015). Neuropsychological functioning in a national cohort of severe traumatic brain injury: Demographic and acute injury-related predictors. *Journal of Head Trauma Rehabilitation*, 30, E1-E12.
- Silver, J. M., Kramer, R., Greenwald, S., & Weissman, M. (2001). The association between head injuries and psychiatric disorders: Findings from the new haven NIMH epidemiologic catchment area study. *Brain Injury*, 15, 935-945.
- Silverman, P. R., & Klass, D. (1996). Introduction: What's the problem?. In D. Klass, P. R. Silverman, & S. L. Nickman (Eds.), *Continuing bonds: New understandings of grief* (pp. 3-30). Washington, DC: Taylor & Francis.



- Silverman, P. R., & Nickman, S. L. (1996). Children's construction of their dead parents. In D. Klass, P. R. Silverman, & S. L. Nickman (Eds.), *Continuing bonds: New understandings of grief* (pp. 73-86). Washington, DC: Taylor & Francis.
- Singer, G., & Nixon, C. (1996). A report on the concerns of parents of children with ABI. In G. Singer, A. Glang, & J. Williams (Eds.), *Children with acquired brain injury* (pp. 23-52). Baltimore, MD: Paul H. Brookes.
- Smeets, S. M., van Heugten, C. M., Geboers, J. F., Visser-Meily, J. M., & Schepers, V. P. (2012). Respite care after acquired brain injury: The well-being of caregivers and patients. *Archives of Physical Medicine and Rehabilitation*, *93*, 834-841.
- Smith, D. H., Meaney, D. F., & Shull, W. H. (2003). Diffuse axonal injury in head trauma. *The Journal of Head Trauma Rehabilitation*, *18*, 307-316.
- Snaith, R. P., Ahmed, S. N., Mehta, S., & Hamilton, M. (1971). Assessment of the severity of primary depressive illness: Wakefield self-assessment depression inventory. *Psychological Medicine: A Journal of Research in Psychiatry and the Allied Sciences*, *1*(2), 143-149.
- Sosin, D. M., Sniezek, J. E., & Thurman, D. J. (1996). Incidence of mild and moderate brain injury in the United States, 1991. *Brain Injury*, *10*, 47-54.
- Spanbock, P. (1987). Understanding head injury from a family's perspective. *Cognitive Rehabilitation*, *5*, 12-14.
- Spanier, G. B. (1976). Measuring dyadic adjustment: New scales for assessing the quality of marriage and similar dyads. *Journal of Marriage and the Family*, *38*, 15-25
- Stejskal, T. M. (2008). *Evaluating an evidence-based intervention for families and survivors after traumatic brain injury: The Brain Injury Family Intervention*. Unpublished doctoral dissertation, University of Maryland.
- Stevens, J. P. (2002). *Applied multivariate statistics for the social sciences* (4<sup>th</sup> ed). Mahwah, NJ: Lawrence Erlbaum.
- Stewart, D. E., & Yuen, T. (2011). A systematic review of resilience in the physically ill. *Psychosomatics*, *52*, 199-209.
- Strauss, A., & Corbin, J. (1990). *Basics of qualitative research: Grounded theory procedures and techniques*. Thousand Oaks, CA: Sage.
- Streiner, D., & Cairney, J. (2007). What's under the ROC: An introduction to receiver operating characteristic curves. *Canadian Journal of Psychiatry*, *52*, 121-128.
- Stroebe, M., & Schut, H. (1999). The dual process model of coping with bereavement: Rationale and description. *Death Studies*, *23*, 197-224.

- Stroebe, M., Schut, H., & Stroebe, W. (1998). Trauma and grief: A comparative analysis. In J. H. Harvey (Ed.), *Perspectives on loss: A sourcebook* (pp. 81-98). New York: Routledge.
- Stroebe, M. S., Hansson, R. O., Stroebe, W., & Schut, H. (2001). Introduction: Concepts and issues in contemporary research on bereavement. In M. S. Stroebe, R. O. Hansson, W. Stroebe, & H. Schut (Eds.), *Handbook of bereavement research: Consequences, coping, and care* (pp. 3-22). Washington, DC: American Psychological Association.
- Stroebe, M. S., Hansson, R. O., Schut, H., & Stroebe, W. (2008a). Bereavement research: Contemporary perspectives. In M. S. Stroebe, R. O. Hansson, H. Schut, & W. Stroebe (Eds.), *Handbook of bereavement research and practice: Advances in theory and intervention* (pp. 3-26). Washington, DC: American Psychological Association.
- Stroebe, M. S., Hansson, R. O., Schut, H., & Stroebe, W. (2008b). Bereavement research: 21<sup>st</sup>-Century prospects. In M. S. Stroebe, R. O. Hansson, H. Schut, & W. Stroebe (Eds.), *Handbook of bereavement research and practice: Advances in theory and intervention* (pp. 577-603). Washington, DC: American Psychological Association.
- Stroebe, M. S., & Schut, H. (2001). Models of coping with bereavement: A review. In M. S. Stroebe, R. O. Hansson, W. Stroebe, & H. Schut (Eds.), *Handbook of bereavement research: Consequences, coping, and care* (pp. 375-404). Washington, DC: American Psychological Association.
- Stroebe, W., & Stroebe, M. S. (1987). *Bereavement and health: The psychological and physical consequences of partner loss*. New York: Cambridge University Press.
- Stroebe, W., Stroebe, M. S., & Abakoumkin, G. (2010). Beyond depression: Yearning for the loss of a loved one. *Omega*, *61*, 85-101
- Stroebe, W., Stroebe, M. S., Abakoumkin, G., & Schut, H. (1996). The role of loneliness and social support in adjustment to loss: A test of attachment versus stress theory. *Journal of Personality and Social Psychology*, *70*, 1241-1249.
- Stroebe, W., Zech, E., Stroebe, M. S., & Abakoumkin, G. (2005). Does social support help in bereavement? *Journal of Social and Clinical Psychology*, *24*, 1030-1050.
- Stuss, D. T., Binns, M. A., Carruth, F. G., Levine, B., Brandys, C. E., Moulton, R. J., Snow, W. G., & Swartz, M. L. (1999). The acute period of recovery from traumatic brain injury: Posttraumatic amnesia or posttraumatic confusional state? *Journal of Neurosurgery*, *90*, 635-643.
- Stuss, D. T., Gow, C. A., & Hetherington, C. R. (1992). "No longer gage": Frontal lobe dysfunction and emotional changes. *Journal of Consulting and Clinical Psychology*, *60*, 349-359.

- Stys, P. K., Waxman, S. G., & Ransom, B. R. (1991). Reverse operation of the  $\text{Na}^+$ - $\text{Ca}^{2+}$  exchanger mediates  $\text{Ca}^{2+}$  influx during anoxia in mammalian CNS white matter. *Annals of the New York Academy of Sciences*, 639, 328-332.
- Swan, K. G., & Swan, R. C. (1980). *Gunshot wounds: Pathophysiology management*. Littlejohn, MA: PSG Publishing.
- Schwartzberg, S. S., & Janoff-Bulman, R. (1991). Grief and the search for meaning: Exploring the assumptive worlds of bereaved college students. *Journal of Social and Clinical Psychology*, 10, 270-288.
- Tabachnick, B. G., & Fidell, L. S. (2007). *Using Multivariate Statistics* (5<sup>th</sup> ed.). New York, NY: Pearson Education.
- Tate, R. L. (2003). Impact of preinjury factors on outcome after severe traumatic brain injury: Does post-traumatic personality change represent an exacerbation of premorbid traits? *Neuropsychological Rehabilitation*, 13, 43-64.
- Tate, R. L., Fenelon, B., Manning, M. L., & Hunter, M. (1991). Patterns of neuropsychological impairment after severe blunt head injury. *Journal of Nervous and Mental Disease*, 179, 117-126.
- Taylor, S. E. (1983). Adjusting to threatening events. A theory of cognitive adaptation. *American Psychologist*, 38, 1161-1173.
- Taylor, H., Drotar, D., Wade, S., Yeates, K., Stancin, T., & Klein, S. (1995). Recovery from traumatic brain injury in children: The importance of the family. In S. H. Broman & M. E. Michel (Eds.), *Traumatic head injury in children* (pp. 188-216). New York: Oxford University Press.
- Teasdale, G., & Jennet, B. (1974). Assessment of coma and impaired consciousness: A practical scale. *Lancet*, 2, 81-84.
- Tedeschi, R. G., & Calhoun, L. G. (1996). The posttraumatic growth inventory: Measuring the positive legacy of trauma. *Journal of Traumatic Stress*, 9, 455-471.
- Tedeschi, R. G., & Calhoun, L. G. (2004). Posttraumatic growth: Conceptual foundations and empirical evidence. *Psychological Inquiry*, 15(1), 1-18.
- Teel, C. S. (1991). Chronic sorrow: Analysis of a concept. *Journal of Advanced Nursing*, 16, 1311-1319.
- Teel, C. S. H. (1993). *Grief, recurrent sorrow, and depression among caregivers and bereaved*. Unpublished doctoral dissertation, University of Arizona.
- Tekin, S., & Cummings, J. L. (2002). Frontal-subcortical neuronal circuits and clinical neuropsychiatry: An update. *Journal of Psychosomatic Research*, 53(2), 647-654.

- Testa, J. A., Malec, J. F., Moessner, A. M., & Brown, A. W. (2006). Predicting family functioning after TBI. Impact of neurobehavioral factors. *Journal of Head Trauma and Rehabilitation, 3*, 236-247.
- Thombs, B. D., Hudson, M., Schieir, O., Taillefer, S. S., Baron, M., & the Canadian Scleroderma Research Group. (2008). Reliability and validity of the Center for Epidemiologic Studies Depression Scale in patients with systemic sclerosis. *Arthritis & Rheumatism, 59*, 438–443.
- Thompson, S. C. (1991). The search for meaning following a stroke. *Basic and Applied Social Psychology, 12*, 81-96.
- Thompson, S. C. (1998). Blockades to finding meaning and control. In J. H. Harvey (Ed.), *Perspectives on loss: A sourcebook* (pp. 21-34). New York: Routledge.
- Thompson, S. C., & Janigian, A. S. (1988). Life schemes: A framework for understanding the search for meaning. *Journal of Social and Clinical Psychology, 7*, 260-280.
- Thomsen, I. V. (1974). The patient with severe head injury and his family. *Scandinavian Journal of Rehabilitation Medicine, 6*, 180-183.
- Thomsen, I. V. (1984). Late outcome of very severe blunt head trauma: A 10-15 year second follow-up. *Journal of Neurology, Neurosurgery and Psychiatry, 47*, 260-268.
- Thomsen, I. V. (1992). Late psychosocial outcome in severe traumatic brain injury. *Scandinavian Journal of Rehabilitation Medicine, Supplement, 26*, 142-152.
- Thornton, J. C. B. (1997). The hospice widow and grief resolution: Perceived marital satisfaction and social support as factors influencing bereavement. Unpublished doctoral dissertation, Barry University, Miami Shores, FA.
- Thurman, D. J., Alverson, C., Dunn, K. A., Guerrero, J., & Sniezek, J. E. (1999). Traumatic brain injury in the united states: A public health perspective. *The Journal of Head Trauma Rehabilitation, 14*(6), 602-615.
- Thurman, D. J., Coronado, V., & Selassie, A. (2007). The epidemiology of TBI: implications for public health. In N. D. Zasler, D. I. Katz, & R. D. Zafonte (Eds.). *Brain Injury Medicine*. New York: Demos Medical Publishing.
- Toronto ABI Network (2011). Definition of acquired brain injury. Retrieved, February 11, 2011, from <http://www.abinetwork.ca/definition.htm>.
- Tranel, D. (2002). Emotion, decision making, and the ventromedial prefrontal cortex. In D. T. Stuss & R. Knight (Eds.), *Principles of frontal lobes function* (pp. 338–353). New York: Oxford University Press.

- Trask, T. W., & Narayan, R. K. (1996). Civilian penetrating head injury. In R. K. Narayan et al. (Eds.), *Neurotrauma* (pp. 869-890). New York: McGraw-Hill.
- Trolley, B. C. (1993-1994). Abridge between traumatic life events and losses by death. *Omega*, 28, 285-300.
- van Reekum, R., Cohen, T., & Wong, J. (2000). Can traumatic brain injury cause psychiatric disorders? *The Journal of Neuropsychiatry and Clinical Neurosciences*, 12, 316-327.
- Vangel, S. J., Rapport, L. J., & Hanks, R. A. (2011). Effects of family and caregiver psychosocial functioning on outcomes in persons with traumatic brain injury. *The Journal of Head Trauma Rehabilitation*, 26, 20-29.
- Vázquez, F. L., Blanco, V., & López, M. (2007). An adaptation of the center for epidemiologic studies depression scale for use in non-psychiatric spanish populations. *Psychiatry Research*, 149, 247-252.
- Walker, R. J., & Pomeroy, E. C. (1996). Depression or grief? the experience of caregivers of people with dementia. *Health and Social Work*, 21, 247-254.
- Walker, A. J., & Thompson, L. (1983). Intimacy and intergenerational aid and contact among mothers and daughters. *Journal of Marriage and the Family*, 45, 841-849.
- Walsh-Burke, K. (2006). *Grief and loss: Theories and skills for helping professionals*. Boston: Pearson.
- Watson, D., Clark, L. A., & Tellegen, A. (1988). Development and validation of brief measures of Positive and Negative Affect: The PANAS Scales. *Journal of Personality and Social Psychology*, 54, 1063-1070.
- Weddell, R. A., & Leggett, J. A. (2006). Factors triggering relatives' judgements of personality change after traumatic brain injury. *Brain Injury*, 20, 1221-1234
- Weinstein S., Semmes, J., Ghent, L., & Teuber, H. L. (1956). Spatial orientation in man after cerebral injury, II: analysis according to concomitant defects. *Journal of Psychology*, 42, 249-263.
- Weiss, R. S. (Ed.) (1973). *Loneliness: The experience of emotional and social isolation*. Cambridge, MA: MIT Press.
- Weiss, R. (1974). The provisions of social relationships. In Z. Rubin (Ed.), *Doing unto others* (pp. 17-26). Englewood Cliffs, NJ: Prentice Hall.
- Weiss, R. S. (1998). Issues in the study of loss and grief. In J. H. Harvey (Ed.), *Perspectives on loss: A sourcebook* (pp. 343-352). New York: Routledge.

- Weiss, R. (2001). Grief, bonds, and relationships. In M. S. Stroebe, R. O. Hansson, W. Stroebe, & H. Schut (Eds.), *Handbook of bereavement research: Consequences, coping, and care* (pp. 47-62). Washington, DC: American Psychological Association.
- Weiss, R. S. (2008). The nature and causes of grief. In M. S. Stroebe, R. O. Hansson, H. Schut, & W. Stroebe (Eds.), *Handbook of bereavement research and practice: Advances in theory and intervention* (pp. 29-44). Washington, DC: American Psychological Association.
- Weissman, M. M. (1987). Advances in psychiatric epidemiology: Rates and risks for major depressive disorder. *American Journal of Public Health, 77*, 445-451.
- Wells, R., Dywan, J., & Dumas, J. (2005). Life satisfaction and distress in family caregivers as related to specific behavioural changes after traumatic brain injury. *Brain Injury, 19*, 1105-1115.
- WHOQOL Group. (1998). Development of the World Health Organization WHOQOL-BREF Quality of Life Assessment. *Psychological Medicine, 28*, 551-558.
- Wikler, L., Wasow, M., & Hatfield, E. (1981). Chronic sorrow revisited: Parent vs. professional depiction of the adjustment of parents of mentally retarded children. *American Journal of Orthopsychiatry, 51*, 63-70.
- Wilks, S. E., & Croom, B. (2008). Perceived stress and resilience in Alzheimer's disease caregivers: Testing moderation and mediation models of social support. *Aging & Mental Illness, 12*(3), 357-365.
- Willer, B. S., Allen, K. M., Liss, M., & Zicht, M. S. (1991). Problems and coping strategies of individuals with traumatic brain injury and their spouses. *Archives of Physical Medicine and Rehabilitation, 72*, 460-464.
- Williams, J. M. (1991). Family reaction to head injury. In J. M. Williamsn, & T. Kay (Eds.), *Head Injury: A family matter* (pp. 81-99). Baltimore: Paul H. Brookes.
- Williams, A. J., Hartings, J. A., Lu, X. -C. M., Rolli, M. L., Dave, J. R., & Tortella, F. C. (2005). Characterization of a new rat model of penetrating ballistic brain injury. *Journal of Neurotrauma, 22*, 313-331.
- Williams, D. H., Levin, H. S., & Eisenberg, H. M. (1990). Mild head injury classification. *Neurosurgery, 27*, 422-428.
- Williams, J., Vaughan, F., Huws, J., & Hastings, R. (2014). Brain injury spousal caregivers' experiences of an acceptance and commitment therapy (ACT) group. *Social Care and Neurodisability, 5*(1), 29-40.

- Williamson, G. M., & Shaffer, D. R. (1996). Interpersonal loss in the context of family caregiving: Implications of communal relationships theory. *Journal of personal and interpersonal loss, 1*, 249-274.
- Williamson, G. M., & Shaffer, D. R. (1998). Implications of communal relationships theory for understanding loss among family caregivers. In J. H. Harvey (Ed.), *Perspectives on loss: A sourcebook* (pp. 173-188). New York: Routledge.
- Williamson, D. J. G., Scott, J. G., & Adams, R. L. (1996). Traumatic brain injury. In R. L. Adams, O. A. Parsons, J. L. Culbertson, & S. J. Nixon (Eds.), *Neuropsychology for clinical practice: Etiology, assessment, and treatment of common neurological disorders* (pp. 9-64). Washington, DC: American Psychological Association.
- Williams, D. H., Levin, H. S., & Eisenberg, H. M. (1990). Mild head injury classification. *Neurosurgery, 27*, 422-428.
- Windle, G. (2011). What is resilience? A review and concept analysis. *Reviews in Clinical Gerontology, 21*, 152-169.
- Windle, G., Woods, R., & Markland, D. (2010). Living with ill-health in older age: The role of a resilient personality. *Journal of Happiness Studies, 11*, 763-777.
- Wolf, J. A., Stys, P. K., Lusardi, T., Meaney, D., & Smith, D. H. (2001). Traumatic axonal injury induces calcium influx modulated by tetrodotoxin-sensitive sodium channels. *Journal of Neuroscience, 21*, 1923-1930.
- Wood, R. L. (2001). Understanding neurobehavioural disability. In R. L. Wood, & T. M. McMillan (Eds.), *Neurobehavioural disability and social handicap following traumatic brain injury* (pp. 3-27). Hove, East Sussex: Psychology Press.
- Wood, R. L., & Yurkadul, L. K. (1997). Change in relationship status following traumatic brain injury. *Brain Injury, 7*, 491-502.
- Worden, J. W. (1982). *Grief counselling and grief therapy: A handbook for the mental health practitioner*. New York: Springer.
- Worden, J. W. (1991). *Grief counseling and grief therapy: A handbook for the mental health practitioner (2nd ed.)*. New York: Springer.
- Wortman, C. B., & Silver, R. C. (1989). The myths of coping with loss. *Journal of Consulting and Clinical Psychology, 57*, 349-357.
- Wortman, C. B., & Silver, R. C. (2001). The myths of coping with loss revisited. In M. S. Stroebe, R. O. Hansson, W. Stroebe, & H. Schut (Eds.), *Handbook of bereavement research: Consequences, coping, and care* (pp. 405-430). Washington, DC: American Psychological Association.

- Wortman, C. B., Silver, R. C., & Kessler, R. C. (1993). The meaning of loss and adjustment to bereavement. In M. S. Stroebe, W. Stroebe, & R. O. Hansson (Eds.) *Handbook of bereavement: Theory, research, and intervention* (pp. 349-366). New York: Cambridge University Press.
- Yeates, K. O. (2010). Traumatic brain injury. In K. O. Yeates, M. D. Ris, H. G. Taylor, & B. F. Pennington (Eds.). *Pediatric neuropsychology: Research, theory, and practice* (2nd ed.) (pp. 112-146). New York: Guilford Press.
- Yakovlev, A. G., & Faden, A. I. (2004). Mechanisms of neural cell death: Implications for development of neuroprotective treatment strategies. *NeuroRx: The Journal of the American Society for Experimental NeuroTherapeutics*, 1, 5-16.
- Ylvisaker, M., Adelson, P. D., Braga, L. W., Burnett, S. M., Glang, A., Feeney, T., Moore, W., Rumney, P., & Todis, B. Rehabilitation and ongoing support after pediatric TBI: Twenty years of progress. *Journal of Head Trauma Rehabilitation*, 20, 95-109
- Youngstrom, E. A. (2014). A primer on receiver operating characteristic analysis and diagnostic efficiency statistics for pediatric psychology: We are ready to ROC. *Journal of Pediatric Psychology*, 39, 204-221.
- Zabora, J., BrintzenhofeSzoc, K., Jacobsen, P., Curbow, B., Piantadosi, S., Hooker, C., Owens, A., & Derogatis, L. R. (2001). A new psychosocial screening instrument for use with cancer patients. *Psychosomatics*, 42, 241-246.
- Zaloshnja E., Miller, T., Langlois, J. A., & Selassie, A. W. (2008). Prevalence of long-term disability from traumatic brain injury in the civilian population of the United States, 2005. *Journal of Head Trauma Rehabilitation*, 23(6), 394-400.
- Zarit, S. H., Reever, K. E., & Bach-Peterson, J. (1980). Relatives of the impaired elderly: Correlates of feelings of burden. *The Gerontologist*, 20, 649-655.
- Zarit, S. H., Orr, N. K., & Zarit, J. M. (1985). *The hidden victims of Alzheimer's disease: Families under stress*. New York: New York University Press.
- Zarit, S. H., Todd, P. A., & Zarit, J. M. (1986). Subjective burden of husbands and wives as caregivers: A longitudinal study. *The Gerontologist*, 26, 260-266.
- Zarski, J. J., DePompei, R., & Zook, A. (1988). Traumatic head injury: Dimensions of family responsiveness. *The Journal of Head Trauma Rehabilitation*, 3, 31-41.
- Zich, J. M., Attkisson, C. C., & Greenfield, T. K. (1990). Screening for depression in primary care clinics: The CES-D and the BDI. *International Journal of Psychiatry in Medicine*, 20, 259-277.



- Zinner, E. S., Ball, J. D., Stutts, M. L., & Philput, C. (1997). Grief reactions of mothers of adolescents and young adults with traumatic brain injury. *Archives of Clinical Neuropsychology, 12*, 435-447.
- Zisook, S., & Shuchter, S. R. (1993). Uncomplicated bereavement. *Journal of Clinical Psychiatry, 54*(10), 365-365-372.
- Zoellner, T., & Maercker, A. (2006). Posttraumatic growth in clinical psychology--A critical review and introduction of a two component model. *Clinical Psychology Review, 26*, 626-653.
- Zupanick, C. E. (1994). Adult children of dysfunctional families: Treatment from a disenfranchised grief perspective. *Death Studies, 18*, 183-195.

## APPENDIX A

*Focal and Diffuse Damage Subtypes in TBI**Focal Injury*

Predominant forms of focal lesion in TBI include skull fracture, brain contusions and lacerations, and intracranial haematomas.

*Skull fracture.*

In general, frequency of skull fracture increases with brain injury severity, with the former strongly associated with intracranial haematoma (Gennarelli & Graham, 2005; Graham & Gennarelli, 2000). However, skull fracture may occur in the absence of extensive neuropathology. For example, a crush head injury may lead to significant fractures of the skull but little underlying brain damage. As a corollary, severe brain injury may be present in the absence of skull fracture, with skull fracture absent in approximately 20 percent of fatal TBI cases (Gennarelli & Graham, 2005). The nature of the fracture deformity is a function of the mass, velocity, and shape of the object striking the skull as well as the thickness of the skull at the site of impact (Morales et al., 2005).

Two major types of skull fracture have been identified: linear and depressed. Linear fractures result entirely from the contact effects of a hard impacting object of intermediate size striking the skull. Simple linear fractures represent the most common form of skull fracture and involve the vault of the skull in the majority of cases (Gennarelli, 1990). These are typically of little significance. However, if the fracture runs through a vascular channel, venous sinus groove, or a suture it may lead to epidural haematoma, venous sinus thrombosis and occlusion, or sutural diastasis, respectively (Qureshi & Harsh, 2009). Basilar skull fracture is a linear fracture located at the base of

the skull and arises as a function of direct impact to the skull base or energy transmission from facial or mandibular impact (Gennarelli, 1990). Dural tears and cranial nerve damage are common complications (Qureshi & Harsh, 2009).

Depressed skull fractures occur when the contact forces applied to the head are greater or more focused in nature (due to higher object velocity or smaller impact surface) and, in turn, exceed the maximum threshold of skull elasticity, thereby leading to skull perforation (Gennarelli, 1990). In addition to brain contusion and/or laceration from contact forces and depressed bone segments at the site of impact, depressed skull fractures may lead to infection and seizure development (Qureshi & Harsh, 2009).

#### *Contusions.*

Contusions involve localised areas of haemorrhage, oedema, and tissue damage within the gray matter or at gray-white matter interface zones, and over time form regions of scarring and retraction (Katz, 1992; Povlishock et al., 2005). Necrotic and apoptotic neuronal death have been documented in contusional and pericontusional domains (Povlishock et al., 2005). Contusions have a characteristic distribution, occurring typically at locations where the brain surface comes into contact with the bony protuberances of the skull. Thus, they occur commonly at the poles and inferior surfaces of the frontal lobes, the poles and inferior and lateral aspects of the temporal lobes, and above and below the operculum of the Sylvian fissures (Graham et al., 1995). In severe cases, a hematoma may develop within the affected gyrus with bleeding into the subdural compartment if laceration of the pia mater and arachnoid membranes has occurred (Gennarelli & Graham, 2005).

A number of different contusion types have been identified. Coup contusions result from tissue strain secondary to local bending of the skull that exceeds the tolerances of the underlying pial, vascular, and cortical brain tissue (Gennarelli, 1990). They occur directly under the site of impact and are associated with skull fracture (Reitan & Wolfson, 2000). Damage is more severe at the crests of gyri relative to the sulci but often extends into the subcortical white matter (Graham et al., 1995). Contrecoup contusions are typically defined as those contusions that occur in brain tissue diametrically opposite the point of contact. They occur secondary to inertial effects: Movement of the brain toward the impact site leads to the development of tensile strains at area typically opposite the impact location. Notably, contrecoup contusions may occur in the absence of impact as the critical mechanism underlying their formation is acceleration/deceleration. Moreover, given the complexity of head motions in TBI and inner skull surface irregularities, such contusions are often not exactly opposite the point of impact (Gennarelli, 1990). Intermediary contusions represent focal bleeding at sites within the brain that are not adjacent to the skull. They are believed to arise secondary to inertial brain motion or impact-generated stress waves. In the case of the latter, brain tissue is forced against or pulled away from relatively immobile adjacent structures (e.g., the falx, the tentorium) leading to focal compressive or tensile strain, respectively (Gennarelli, 1990). Herniation contusions result when medial components of the temporal lobes are forced against the tentorium or the cerebellar tonsils against the foramen magnum at the time of injury (Graham & Gennarelli, 2000). This form typically occurs in association with missile wounds (Reitan & Wolfson, 2000).

*Intracranial haematoma.*

Intracranial haematoma is a common form of localized brain damage, especially in individuals who suffer a skull fracture. Two broad forms are identified: extradural (epidural) haematoma and intradural haematoma. Extradural haematoma usually results from haemorrhage from a meningeal artery with blood collecting to form an ovoid mass between the skull and the dura. As the haematoma develops, it gradually strips the dura from the skull and may progressively distort underlying brain tissue (Graham & Gennarelli, 2000).

Intradural haematoma is subdivided into subdural haematoma, subarachnoid haematoma, intracerebral haematoma, and “burst” lobe. The majority of subdural haematomas arise secondary to rupture of veins that bridge the subdural space in the parasagittal region (Graham et al., 1995). Rupture of subdural veins is typically caused by accelerations/decelerations of the head that result in high strain rate loading (Gennarelli, 1990). Therefore, subdural haematoma is more common in individuals who fall, where the period of deceleration is usually short, as opposed to persons involved in MVAs where strain rates are lower (Graham & Gennarelli, 2000). The majority of cases of subdural haematoma lead to compressive mass lesions and are associated with significant brain damage (Gennarelli & Graham, 2005). Subarachnoid haemorrhage is observed in most instances of severe closed TBI with a thin layer of blood clot present over the inferior and lateral regions of the frontal and temporal lobes. In approximately 10 to 15 percent of cases, the collection of blood is of sufficient size to form a subarachnoid haematoma (Gennarelli & Graham, 2005). Potential complications of subarachnoid haematoma include vasospasm (constriction of the cerebral vasculature),

with possible secondary ischemia and infarction, and acute obstructive hydrocephalus (Esposito & Walker, 2009; Gennarelli & Graham, 2005). Intracerebral haematomas are commonly associated with large cortical contusions. They occur with the greatest frequency in the temporal and frontal lobes and in many cases may be considered as contusions in which larger, deeper blood vessels have been ruptured at the time of injury. Less commonly, they may be seen in the cerebellum (Graham et al., 1995). Impact-induced concentrated stress waves or tissue strain deep within the brain secondary to inertial forces may lead to smaller intracerebral haematomas that are not associated with contusion. These are considered to potentially represent a forme fruste of tissue tear haemorrhages that occur in combination with diffuse axonal injury (see below; Gennarelli, 1990). Burst lobe is a term used to describe an intracerebral haematoma that is continuous with a subdural haematoma. This phenomenon is observed most commonly in the frontal and temporal lobes and is presumed to arise due to laceration of surface brain tissue (Gennarelli & Graham, 2005).

### *Diffuse Injury*

Diffuse brain injuries occur primarily from tissue distortion or tissue shear caused by acceleration/deceleration forces that are commonly produced at the time of injury in motor vehicle accidents and, less commonly, falls and assaults (Morales et al., 2005; Smith, Meaney, & Shull, 2003). As noted by Gennarelli and Graham (2005), although damage of this type is often widely distributed and in some cases diffuse, the term *diffuse brain injury* may be considered in certain respects a misnomer as in the majority of cases the pathology is multifocal. Four main forms of diffuse or multifocal pathology have

been delineated: traumatic axonal injury, hypoxic-ischemic damage, diffuse vascular injury, brain swelling, and brain damage due to raised intracranial pressure.

*Traumatic axonal injury.*

Traumatic axonal injury (TAI) is considered the most common and important pathology in all forms of TBI (Kushner, 1998; Smith et al., 2003), representing the primary mechanism of injury in 40-50% of cases requiring hospitalization (Meythaler, Peduzzi, Eleftheriou, & Novack, 2001). The pattern of axonal damage is typically multifocal in nature, distributed throughout the deep and subcortical white matter, and is most commonly observed in midline structures including the corpus callosum and brainstem (Smith et al., 2003). TAI is hypothesized to be the principal pathological substrate underlying a continuum of neurological deficit from mild to severe TBI in CHI cases (Gennarelli & Graham, 2005), with the extent of TAI considered a pivotal determinant of the degree of posttraumatic cognitive impairment and disability (Morales et al., 2005). TAI within the brainstem has been identified as playing an important role in the induction of coma (Smith et al., 2003), and a positive association between TAI severity and duration of phases of neurological recovery demonstrated (Povlishock & Katz, 2005).

Previously, it was postulated that the dynamic shear, tensile, and compressive tissue strains induced by rotational acceleration of the brain led to widespread immediate tearing and disconnection of axons. However, more recent findings suggest that such primary axotomy of mechanical cause is not the norm, occurring only in severe cases of injury. Rather, it is now believed that the majority of posttraumatic axonal pathologies evolve progressively over an extended time course (hours to months) and involve a series

of deleterious physiologic cascades that ultimately result in the compromise of the axonal cytoarchitecture and, in turn, detachment of axons from downstream targets (secondary axotomy; Iwata et al., 2004; Povlishock & Christman, 1995; Povlishock & Katz, 2005; Wolf, Stys, Lusardi, Meaney, & Smith, 2001). On the basis of animal models, it is suggested that the physical stretch of axons at the time of injury results in damage to the axolemma. This alteration in membrane structure allows for the influx of normally excluded extracellular ions into the axon (Gennarelli & Graham, 2005; Povlishock & Katz, 2005). In particular, it is believed that mechanical deformation of axonal sodium channels may lead to the massive entry of sodium which in turn triggers significant calcium influx (Wolf et al., 2001; Stys, Waxman, & Ransom, 1991). The increased intracellular calcium levels are believed to subsequently activate proteolysis (protein degradation), thereby further damaging the cytoskeleton (Buki, Siman, Trojanowski, & Povlishock, 1999). Protein accumulation secondary to disrupted axoplasmic transport kinetics leads to focal swelling of the axon over hours to days. Thereafter, from days to months postinjury progressive disorganization of the axonal architecture and mitochondrial failure results in axon disconnection with the pathological signature feature of bulb formation at the terminal end of the axon, formerly referred to as 'retraction balls' or 'terminal clubbing' (Smith et al., 2003).

As noted by Povlishock and Katz (2005), a significant late-stage consequence of TAI is downstream deafferentation/denervation. Following secondary axotomy, several months postinjury the distal portion of the axon, now disconnected from its sustaining cell body, undergoes Wallerian degeneration. This includes breakdown of the myelin sheath, axon cylinder, and downstream boutons with resultant denervation of target sites



(Povlishock & Christman, 1995; Povlishock & Katz, 2005). Importantly, it is believed that the amount of deafferentation substantially exceeds the number of axons that can be identified by morphological means as damaged. Thus, it is postulated that downstream denervation is a far more widespread phenomenon than previously thought and is considered to contribute significantly to TAI-associated morbidity (Povlishock & Katz, 2005).

*Hypoxic-ischemic damage.*

Diffuse hypoxic-ischemic injury (HII) is typically associated with cardiovascular or respiratory compromise (Katz, 1992). It is one of the most common forms of pathology in both closed and penetrating TBI (Greve & Zink, 2009; McArthur et al., 2004), and has been observed at autopsy in up to 90 percent of fatal cases (Graham et al., 1995). Characteristic distributions of diffuse HII include diffuse cortical neuronal loss (laminar necrosis), ‘patchy’ infarctions in the border regions between vascular territories, and multifocal lesions within structures particularly susceptible to hypoxia, e.g., the basal ganglia and hippocampi (Katz, 1992). A number of different mechanisms may lead to post-TBI cerebral blood flow (CBF) reduction and ultimately to cerebral ischemia and infarction. These include distortion and stretching of brain vessels secondary to mechanical displacement of brain structures (e.g., midline shift or herniation due to intracranial mass lesion), vasospasm of circle of Willis<sup>47</sup> blood vessels, arterial hypotension in association with multiple injuries, and posttraumatic perturbation of small blood vessels (Gennarelli & Graham, 2005).

---

<sup>47</sup> The circle of Willis is the joining area of several arteries at the base of the brain. Here the internal carotid arteries branch into smaller arteries that supply oxygenated blood to over 80% of the cerebrum.

*Diffuse vascular injury.*

Diffuse or multifocal vascular injury is a form of acute brain injury that is characterized by multiple, small haemorrhages that occur most frequently in the white matter of the temporal and frontal lobes, in and adjacent to the thalamus, and in the brain stem. This pathology is seen in individuals who suffer severe closed TBI (most commonly in MVAs) and typically die within 24 hours following injury. The pathogenesis of this type of injury is not fully understood but is believed to be due to significant acceleration/deceleration forces leading to tearing of small blood vessels throughout the brain (Gennarelli & Graham, 2005; Graham et al., 1995).

*Brain swelling.*

Swelling of the brain is a common complication in TBI. It may take the form of oedema, in which brain water content is increased, and/or cerebral hyperemia and engorgement of the vascular bed, in which cerebral blood volume is raised (congestive brain swelling; Gennarelli & Graham 2005). Two types of oedema occur commonly in TBI: vasogenic and cytotoxic. Vasogenic oedema results from traumatic damage to capillaries, arteries, and veins with subsequent breakdown of the blood-brain barrier leading to influx of excess water from the systemic bloodstream into extracellular space. Cytotoxic oedema is characterised by accumulation of intracellular fluid within neurons and glia due to metabolic failure of affected cells to regulate their ionic gradients and, in turn, their water balance (Greve & Zink, 2009; Reitan & Wolfson, 2000). Related disruption in cell membrane function and ion transport can ultimately lead to failure of ATP production and subsequent cell death. Cytotoxic oedema, if widespread, can result in increased intracranial pressure (see below), restricted blood flow, and ischemia (Greve

& Zink, 2009). Cerebral oedema can develop shortly after TBI and continue for weeks, but in most cases the process reaches its zenith between one and eight days post injury and then gradually subsides (Gennarelli & Graham, 2005; Reitan & Wolfson, 2000).

Brain swelling may be focal or diffuse in nature. Localized vasogenic oedema occurs most commonly in association with circumscribed cerebral contusions. Swelling of one cerebral hemisphere is most commonly observed following evacuation of an ipsilateral subdural haematoma. Here the mass effect of the haematoma is believed to result in compromise of the blood-brain barrier of the surrounding vascular bed and, in turn, lead to diffuse vasogenic oedema. Swelling of both cerebral hemispheres tends to be restricted to children and adolescents; it is postulated to arise secondary to extensive vasodilation and subsequent vasogenic oedema (Gennarelli & Graham, 2005). Diffuse oedema involving the entire brain is also common in PHI (Reitan & Wolfson, 2000).

*Damage due to raised intracranial pressure.*

Volume increase within the rigid skull cavity secondary to the mass effects of contusion, intracranial haematoma, and/or brain swelling frequently leads to elevated intracranial pressure (ICP) following both closed and penetrating TBI (Graham & Gennarelli, 2000; Esposito & Walker, 2009). Intracranial hypertension is defined as an ICP greater than 20 mm Hg. ICP in excess of 40 mm Hg results in impairment of brain electrical activity and neurological dysfunction, with further ICP elevation compromising autoregulation of cerebral circulation and, in turn, cerebral perfusion. ICP greater than 60 mm Hg is typically fatal: Unrelieved increases in ICP lead to extensive tissue deformation, shift of midline structures, herniation, and secondary damage to the upper

brainstem. This mechanism is the most common cause of death in TBI, being present in approximately 75 percent of fatal cases (Gennarelli & Graham, 2005).

## APPENDIX B

*Rating Scales for Caregiver Perceived Decline in Survivor Functioning**Instructions*

TBI can result in decline or worsening of functioning in a number of areas, including aspects of thinking and behaviour. For each item below, using the scale provided, please indicate the amount of decline you believe has occurred in your family member's functioning as a result of the TBI. For example, in the case of item 1, if you believe your relative's ability to understand spoken language has declined a moderate amount due to their injury you would select 7.

Please note that any number on the scale may be selected as they represent continuums of decline. For instance, if you believe the decline has been more than mild but not as large as moderate, you would select 6.

1. Please indicate the extent of decline as a result of the TBI in your family member's ability to understand spoken language:

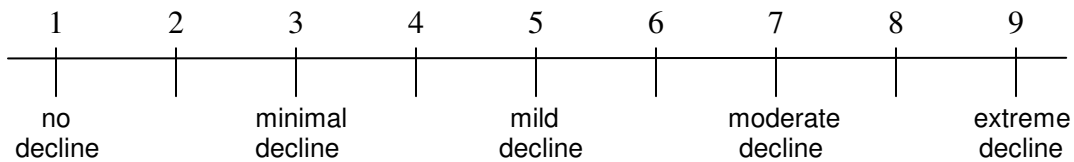

2. Please indicate the extent of decline as a result of the TBI in your family member's ability to effectively communicate by means of spoken language:

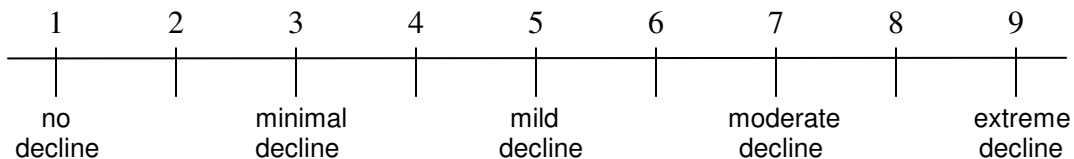

3. Please indicate the extent of decline as a result of the TBI in your family member's ability to identify the emotions of other people:

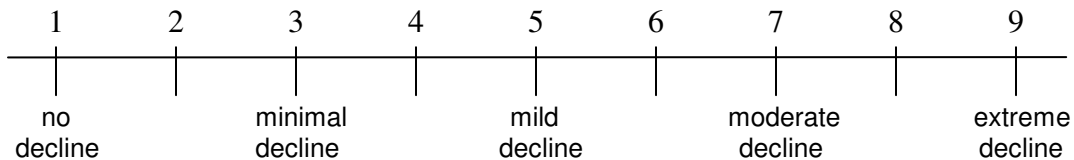

4. Please indicate the extent of decline as a result of the TBI in your family member's ability to identify the thoughts, goals, intentions, and motives of others (i.e., their ability to work out for themselves the probable contents of other people's minds):

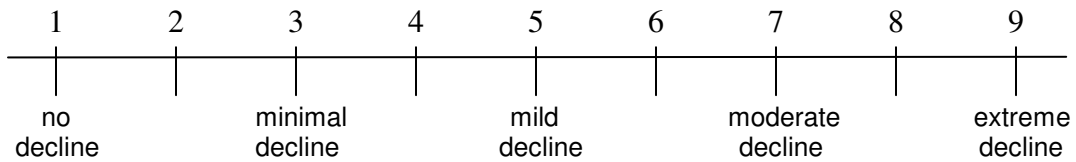

5. Please indicate the extent of decline as a result of the TBI in your family member's memory functioning:

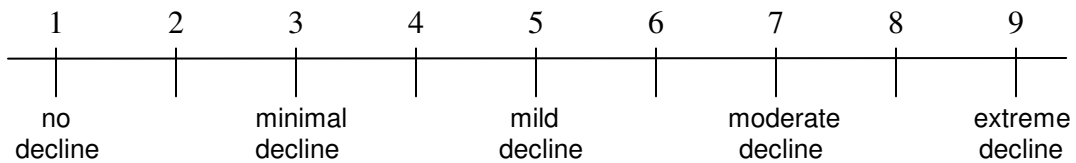

6. Please indicate the extent of decline as a result of the TBI in your family member's overall physical ability to independently provide self-care:

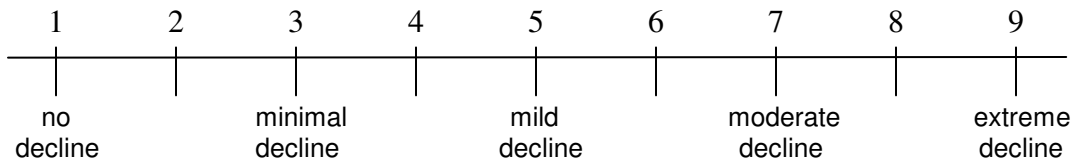

*Social Provision Scale (SPS)**Instructions*

In completing this section, please think about your current relationships with family members (excluding your relationship with your relative who sustained the TBI), friends, co-workers, community members, and so on. Using the scale provided, please indicate how much you agree with each statement by typing a number from 1 to 5 in the box beside that statement (for example, 5 = strongly agree).

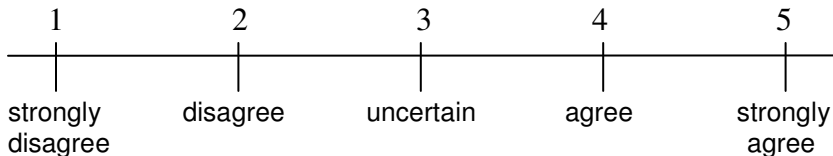

- 1 There are people I can depend on to help me if I really need it.
- 2 There is no one I can turn to for guidance in times of stress.
- 3 There are people who enjoy the same social activities I do.
- 4 I feel personally responsible for the well-being of another person.
- 5 I do not think other people respect my skills and abilities.
- 6 If something went wrong, no one would come to my assistance.
- 7 I have close relationships that provide me with a sense of emotional security and well-being
- 8 I have relationships where my competence and skill are recognized.
- 9 There is no one who shares my interests and concerns.
- 10 There is no one who really relies on me for their well-being.
- 11 There is a trustworthy person I could turn to for advice if I were having problems.
- 12 I lack a feeling of intimacy with another person.

Adapted from Cutrona & Russell (1987)

*Meaning Reconstruction*

**Instructions**

Please read each question carefully and indicate your response using the scales provided. Please note that any number along the scale may be selected as they represent continuums.

1. To what extent have you been able to make sense of your family member’s brain injury and its consequences? For example, if you have been able to make no sense of the injury and its effects you would select response 1.

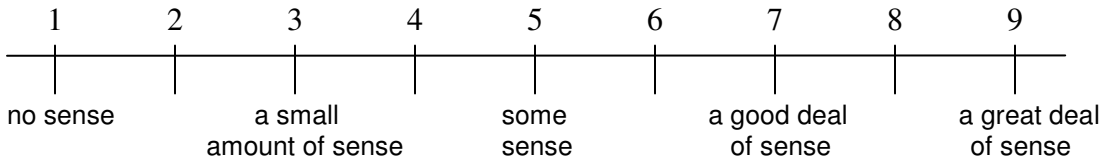

2. After or while facing highly distressing or traumatic circumstances or events in life sometimes people are able to find or identify some positive aspect in, or consequence of, their experience of adversity and/or loss. Examples of this include people reporting improved relationships with others, gains in perspective, development of new life goals, or personal growth such as increased compassion for others. To what extent have you been able to find anything positive in or as a result of your experience of your family member’s brain injury and its consequences?

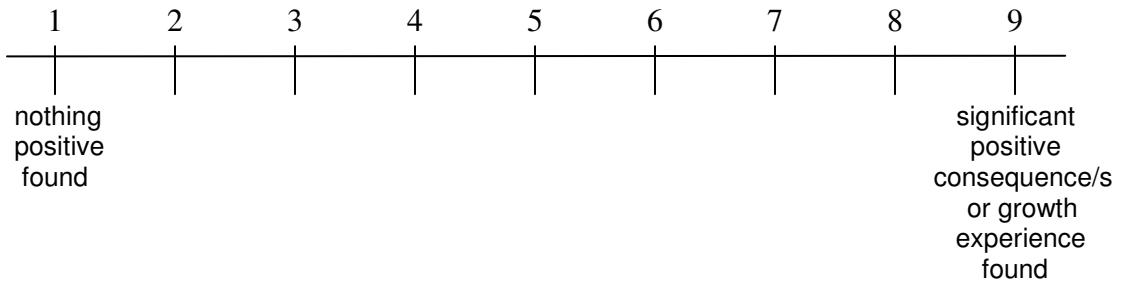

Adapted from Davis, Nolen-Hoeksema, & Larson (1998) and Keesee, Currier, & Neimeyer (2008)



*Marwit-Meuser Caregiver Grief Inventory – ABI revised (MM-CGI – AR)**Instructions*

Please read each statement carefully, then decide how much you agree or disagree with what is said. Circle a number 1–5 to the right using the answer key below (for example, 5 = strongly agree). When answering each item please think about your experience as a caregiver for your family member who has suffered the brain injury. It is important that you respond to all items.

**ANSWER KEY**

1 = Strongly Disagree // 2 = Disagree // 3 = Somewhat Agree // 4 = Agree // 5 = Strongly Agree

1	I've had to give up a great deal to be a caregiver.	1	2	3	4	5
2	I miss so many of the activities we used to share.	1	2	3	4	5
3	I feel I am losing my freedom.	1	2	3	4	5
4	My physical health has declined from the stress of being a caregiver.	1	2	3	4	5
5	I have nobody to communicate with.	1	2	3	4	5
6	I don't know what is happening. I feel confused and unsure.	1	2	3	4	5
7	I carry a lot of stress as a caregiver.	1	2	3	4	5
8	I receive enough emotional support from others.	1	2	3	4	5
9	I have this empty, sick feeling knowing that the person I provide care for 'has changed'.	1	2	3	4	5
10	I feel anxious and scared.	1	2	3	4	5
11	My personal life has changed a great deal.	1	2	3	4	5
12	I spend a lot of time worrying about the bad things to come.	1	2	3	4	5
13	Brain injury is like a double loss ... I've lost the closeness with the person I provide care for, and connectedness with my family.	1	2	3	4	5
14	I feel terrific sadness.	1	2	3	4	5
15	This situation is totally unacceptable in my heart.	1	2	3	4	5
16	My friends simply don't understand what I'm going through.	1	2	3	4	5
17	I feel this constant sense of responsibility and it just never leaves.	1	2	3	4	5
18	I long for what was, what we had and shared in the past.	1	2	3	4	5
19	I could deal with other serious disabilities better than with this.	1	2	3	4	5
20	I can't feel free in this situation.	1	2	3	4	5
21	I'm having trouble sleeping.	1	2	3	4	5
22	I'm at peace with myself and my situation in life.	1	2	3	4	5
23	It's a life change and I know we'll get through it.	1	2	3	4	5

24	My extended family has no idea what I go through in caring for her/him.	1	2	3	4	5
25	I feel so frustrated that I often tune her/him out.	1	2	3	4	5
26	I am always worrying.	1	2	3	4	5
27	I'm angry at the brain injury for robbing me of so much.	1	2	3	4	5
28	This is requiring more emotional energy and determination than I ever expected.	1	2	3	4	5
29	I will be tied up with this for who knows how long.	1	2	3	4	5
30	It hurts to help her/him with a task and realize that she/he 'has changed'.	1	2	3	4	5
31	I feel very sad about what this brain injury has done.	1	2	3	4	5
32	I feel severe depression.	1	2	3	4	5
33	I lay awake most nights worrying about what's happening and how I'll manage tomorrow.	1	2	3	4	5
34	The people closest to me do not understand what I'm going through.	1	2	3	4	5
35	His/her death will bring me renewed personal freedom to live my life.	1	2	3	4	5
36	I feel powerless.	1	2	3	4	5
37	It's frightening because you know doctors can't cure the injury, so things only get worse.	1	2	3	4	5
38	I've lost other people close to me, but the losses I'm experiencing now are much more troubling.	1	2	3	4	5
39	Independence is what I've lost ... I don't have the freedom to go and do what I want.	1	2	3	4	5
40	I've had to make some drastic changes in my life as a result of becoming a caregiver.	1	2	3	4	5
41	I wish I had an hour or two to myself each day to pursue personal interests.	1	2	3	4	5
42	I'm stuck in this caregiving world and there's nothing I can do about it.	1	2	3	4	5
43	I can't contain my sadness about all that's happening.	1	2	3	4	5
44	What upsets me most is what I've had to give up.	1	2	3	4	5
45	I'm managing pretty well overall.	1	2	3	4	5
46	I think I'm denying the full implications of this for my life.	1	2	3	4	5
47	I get excellent support from members of my family.	1	2	3	4	5
48	I've had a hard time accepting what is happening.	1	2	3	4	5
49	The demands on me are growing faster than I ever expected.	1	2	3	4	5
50	I wish this was all a dream and I could wake up back in my old life.	1	2	3	4	5

Adapted from Marwit & Kaye (2006)

*Center for Epidemiologic Studies Depression Scale (CES-D)*

*Instructions.* Below is a list of the ways you might have felt or behaved during the past week. Using the answer key provided, please select the number next to each item that best reflects how frequently each was experienced in the past 7 days.

*Answer Key:* 0 = Rarely or none of the time (less than 1 day)  
 1 = Some or a little of the time (1-2 days)  
 2 = Occasionally or a moderate amount of time (3-4 days)  
 3 = Most or all of the time (5-7 days)

		Rarely or none of the time (less than 1 day)	Some or a little of the time (1-2 days)	Occasionally or a moderate amount of time (3-4 days)	Most or all of the time (5-7 days)
	During the past week:				
1	I was bothered by things that usually don't bother me.	0	1	2	3
2	I did not feel like eating; my appetite was poor.	0	1	2	3
3	I felt that I could not shake off the blues even with help from my family or friends.	0	1	2	3
4	I felt I that I was just as good as other people.	0	1	2	3
5	I had trouble keeping my mind on what I was doing.	0	1	2	3
6	I felt depressed.	0	1	2	3
7	I felt that everything I did was an effort.	0	1	2	3
8	I felt hopeful about the future.	0	1	2	3
9	I thought my life had been a failure.	0	1	2	3
10	I felt fearful.	0	1	2	3
11	My sleep was restless.	0	1	2	3
12	I was happy.	0	1	2	3
13	I talked less than usual.	0	1	2	3
14	I felt lonely.	0	1	2	3
15	People were unfriendly.	0	1	2	3
16	I enjoyed life.	0	1	2	3
17	I had crying spells.	0	1	2	3
18	I felt sad.	0	1	2	3
19	I felt that people dislike me.	0	1	2	3
20	I could not get "going."	0	1	2	3

Adapted from Radloff (1977)

*Zarit Burden Interview – Short Form (ZBI-S)**Instructions*

The following questions reflect how people sometimes feel when taking care of another person. Please indicate how often you experience each feeling listed by selecting the appropriate number (for example, 4 = nearly always).

		Never	Rarely	Sometimes	Quite Frequently	Nearly Always
1	Do you feel that because of the time you spend with your relative that you don't have enough time for yourself?	0	1	2	3	4
2	Do you feel stressed between caring for your relative and trying to meet other responsibilities for your family or work?	0	1	2	3	4
3	Do you feel angry when you are around your relative?	0	1	2	3	4
4	Do you feel that your relative currently affects your relationship with other family member or friends in a negative way?	0	1	2	3	4
5	Do you feel strained when you are around your relative?	0	1	2	3	4
6	Do you feel that your health has suffered because of your involvement with your relative?	0	1	2	3	4
7	Do you feel that you don't have as much privacy as you would like because of your relative?	0	1	2	3	4
8	Do you feel that your social life has suffered because you are caring for your relative?	0	1	2	3	4
9	Do you feel that you have lost control of your life since your relative's injury?	0	1	2	3	4
10	Do you feel uncertain about what to do about your relative?	0	1	2	3	4
11	Do you feel you should be doing more for your relative?	0	1	2	3	4
12	Do you feel you could do a better job in caring for your relative?	0	1	2	3	4

Adapted from Bédard, Molloy, Squire, Dubois, Lever, & O'Donnell (2001)

*Satisfaction with Life Scale (SWLS)**Instructions*

Using the scale provided, please indicate how much you agree with each statement by typing a number from 1 to 7 in the box beside that statement (for example, 7 = strongly agree).

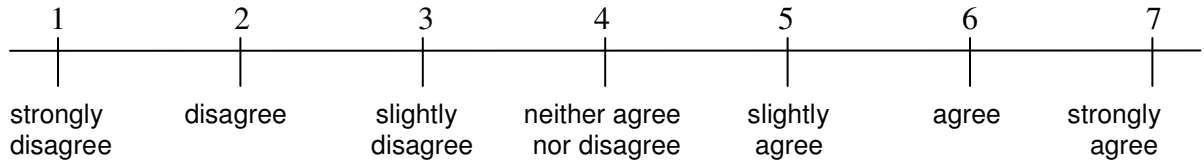

- 1 In most ways my life is close to my ideal.
- 2 The conditions of my life are excellent.
- 3 I am satisfied with my life.
- 4 So far I have gotten the important things I want in my life.
- 5 If I could live my life over, I would change almost nothing.

Adapted from Diener, Emmons, Larsen & Griffin (1985)

*Preinjury Relationship Quality Scale**Instructions*

Using the scale provided, please indicate how much you agree with each statement by typing a number from 1 to 8 in the box beside that statement (for example, 8 = strongly agree). The family member referred to in each item is your relative who suffered the TBI.

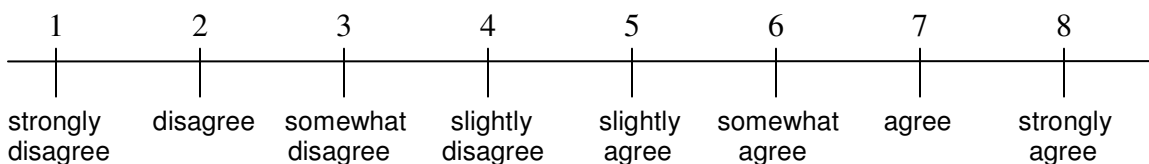

1	My family member and I had a very good personal relationship before the injury.	
2	My family member and I were very close (i.e., were very involved in each other's lives at an emotional level) before the injury.	
3	My family member and I each played a positive role in each other's lives before the injury.	
4	The relationship that existed between myself and my family member before the injury was mutually supportive in that we both were attentive to each other's needs and well-being.	
5	In general, I was very satisfied with my relationship with my family member before the injury.	

*Positive and Negative Affect Schedule (PANAS)**Instructions*

This measure consists of a number of words that describe different feelings and emotions. Please read each item and then type the appropriate number in the space next to that word. Indicate to what extent you generally feel this way, that is, how you feel on the average. Use the following scale to record your answers:

1	2	3	4	5
very slightly or not at all	a little	moderately	quite a bit	extremely
_____	_____	_____	_____	_____
	interested			irritable
_____	_____	_____	_____	_____
	distressed			alert
_____	_____	_____	_____	_____
	excited			ashamed
_____	_____	_____	_____	_____
	upset			inspired
_____	_____	_____	_____	_____
	strong			nervous
_____	_____	_____	_____	_____
	guilty			determined
_____	_____	_____	_____	_____
	scared			attentive
_____	_____	_____	_____	_____
	hostile			jittery
_____	_____	_____	_____	_____
	enthusiastic			active
_____	_____	_____	_____	_____
	proud			afraid

Adapted from Watson, Clark, & Tellegen (1988)

## APPENDIX C

*Participating Organizations**Canada*

Brain Injury Association of Canada  
 Brain Injury Association of London and Region  
 Brain Injury Association of North Bay and Area  
 Brain Injury Association of Nova Scotia  
 Brain Injury Association of Ottawa Valley  
 Brain Injury Association of Peel and Halton  
 Brain Injury Association Peterborough Region / Four Counties Brain Injury Association  
 Brain Injury Association of Waterloo/Wellington  
 Brain Injury Association of Toronto  
 Brain Injury Association of Winsor/Essex  
 Brain Injury Association of York Region  
 Manitoba Brain Injury Association  
 Ontario Brain Injury Association  
 Saskatchewan Brain Injury Association  
 Southern Alberta Brain Injury Society

*United States*

Alaska Brain Injury Network  
 Brain Injury Alliance of Arizona  
 Brain Injury Alliance of Colorado  
 Brain Injury Alliance of Connecticut  
 Brain Injury Alliance of Iowa  
 Brain Injury Alliance of Kentucky  
 Brain Injury Alliance of New Jersey  
 Brain Injury Alliance of Oregon  
 Brain Injury Alliance of Utah  
 Brain Injury Alliance of West Virginia  
 Brain Injury Association of America  
 Brain Injury Association of Georgia  
 Brain Injury Association of Indiana  
 Brain Injury Association of Kansas  
 Brain Injury Association of Maryland  
 Brain Injury Association of Massachusetts  
 Brain Injury Association of Michigan  
 Brain Injury Association of Nebraska  
 Brain Injury Association of North Carolina  
 Brain Injury Association of North Dakota  
 Brain Injury Association of Rhode Island  
 Brain Injury Association of Vermont  
 Brain Injury Association of Washington, D.C.  
 Headstrong Seattle  
 National Association of Head Injury Administrators



Texas Brain Injury Alliance  
United States Brain Injury Alliance

*United Kingdom*

Headway UK: The Brain Injury Association  
Headway Blackburn with Darwen  
Headway Bedford  
Headway Belfast  
Headway Bradford  
Headway Bristol  
Headway Cambridgeshire  
Headway Conwy and Denbighshire – Conwy and Sir Ddinbych  
Headway Dorset  
Headway Durham and Chester-le-Street  
Headway East Lothian  
Headway Ennisrone  
Headway Essex  
Headway Fife  
Headway Gateshead and South Tynside  
Headway Glasgow  
Headway Guernsey  
Headway Highland  
Headway Hull and East Riding  
Headway Leicester, Leicestershire and Rutland  
Headway Lincolnshire  
Headway Luton  
Headway Milton Keynes  
Headway Neath Port Talbot  
Headway North East  
Headway Northhampton  
Headway North West London  
Headway Plymouth  
Headway Somerset  
Headway South Bucks  
Headway South Lanarkshire  
Headway South West London  
Headway North Staffordshire  
Headway Tynedale  
Headway Wearside  
Headway West Suffolk  
Headway West Sussex  
Headway Yorkshire and Humberside

*South Africa*

Headway Gauteng: National Head Injury Association  
Headway Natal: KwaZulu-Natal Head Injury Association

## APPENDIX D

*Resource List for Persons with Traumatic Brain Injury and their Family Members***Contents**

- Mental Health and Counselling Services
  - Canada
  - South Africa
  - United Kingdom
  - United States
- Brain Injury Support Organizations
  - Canada
  - South Africa
  - United Kingdom
  - United States
- Traumatic Brain Injury and Caregiver Online Resources

***Mental Health and Counselling Services******Canada***

If you are experiencing psychological distress and feel that you are in need of support we strongly encourage you to seek counselling services. The following agencies/organizations in your area may be contacted for referral to or provision of counselling services:

**CANADA - ALL REGIONS****The Canadian Register of Health Service Providers in Psychology (CRHSPP)**

<http://www.crhspp.ca/findlist.php>

- Provides a free online directory for finding a psychologist in Canada: <http://www.crhspp.ca/findlist.php>.

The CRHSPP website states that all psychologists listed "are certified, registered or licensed in the province/territory/state where they provide psychological health services, except in the case of the Yukon", which does not have a statute regulating psychology.

**The Canadian Mental Health Association**

<http://www.cmha.ca>

- From CMHA website: A nation-wide, voluntary organization, the Canadian Mental Health Association (CMHA) promotes the mental health of all and supports the resilience and recovery of people experiencing mental illness. A range of specialized mental health programs and services are offered by CMHA offices across the country, tailored to the needs and available resources of those communities where they are based.
- Services include an information and referral service.
- To find the CMHA location nearest you click [here](#).

**ALBERTA****Alberta Health Services Mental Health Helpline**

1-877-303-2642 (toll free)

<http://www.albertahealthservices.ca/services.asp?pid=service&rid=6810>

- From website: Staffed 24/7 by health professionals, the Mental Health Help Line provides: crisis intervention; information on Mental Health programs and services; and referral to other agencies where appropriate. This confidential, anonymous service is provided by Health Link Alberta and is available to all Albertans.

**The Psychologists' Association of Alberta (PAA) Referral Service**

1-888-424-0297 (toll free)

[http://www.psychologistsassociation.ab.ca/site/Referral\\_Service-Public\\_Info](http://www.psychologistsassociation.ab.ca/site/Referral_Service-Public_Info)

- The Psychologists' Association of Alberta provides a free service to help you locate qualified psychologists in your community. (from PAA website)
- Toll-free telephone referral service: 1-888-424-0297 anywhere in Alberta
- Online referral search: [http://www.psychologistsassociation.ab.ca/site/doctor\\_search\\_agreement](http://www.psychologistsassociation.ab.ca/site/doctor_search_agreement)

## BRITISH COLUMBIA

### BC Mental Health Information Line

310-6789 (toll free)

<http://www.heretohelp.bc.ca/connect/community-resources>

- From HeretoHelp website: Please phone the Distress Line Network at 310-6789 if you wish to speak to a trained volunteer specialist for support or referrals related to mental health (do not enter 604, 250 or 778 area codes). This is a free call. This service is available 24 hours a day, with no wait or busy signal.
- HeretoHelp is a project of the BC Partners for Mental Health and Addictions Information. BC Partners work is funded by BC Mental Health and Addiction Services, an agency of the Provincial Health Services Authority.

### British Columbia Psychological Association (BCPA) Referral Service

604-730-0522 or 1-800-730-0522

<http://www.psychologists.bc.ca/drupal/content/find-help>

- From BCPA website: The BC Psychological Association offers free access to the **Referral Service**, a listing of Registered Psychologists and Registered Psychological Associates in your area. You can search by location, area of concern, therapy method, and other criteria.

If you are unable to access the information online, you can also call us at 604-730-0522 or at 1-800-730-0522 from Monday to Friday, 9:30 AM to 4:30 PM.

## MANITOBA

### Manitoba Health - Mental Health and Spiritual Health Care

<http://www.gov.mb.ca/health/mh/crisis.html>

Klinik Crisis Counselling Program:

From Klinik Community Healthcare website ([www.klinik.mb.ca/counsel-crisis.htm](http://www.klinik.mb.ca/counsel-crisis.htm)):

- Manitoba Suicide Line - 24 Hours 1-877-435-7170
- Crisis Line - 24 Hour Crisis Line 786-8686
- Toll free 1-888-322-3019 TTY 784-4097

- Manitoba Farm & Rural Support Services Stress Line: 1-866-367-3276
- Manitoba Farm & Rural Support Services Online counselling:  
www.ruralsupport.ca

**What is the Crisis Program?** The Crisis Program operates the crisis phone line that offers confidential counselling, support and referral. Counsellors are there to help improve the quality of life of our callers and to prevent suicides.

**When does it operate?** The Crisis Line and Manitoba Suicide Line operates 24 hours a day, 7 days a week.

**What is a crisis?** A crisis is a time in your life when you feel like you can't cope.

**Who can call the Crisis Line?** Anyone who wants to discuss a problem can call. You do not have to be in crisis or suicidal to call. The Crisis Line is open to anyone who needs help.

People call to talk about: Depression, Anxiety, Loss, Separation, Family and relationship problems, Grief, Self-esteem, Suicide, Substance abuse, Life changes, Feelings of shame, failure, guilt or helplessness.

### **Manitoba Psychological Society (MPS)**

<http://www.mps.ca>

- Online Referral Directory: <http://www.mps.ca/Referral.aspx>

From MPS website: This is a list of clinicians who are members of MPS. MPS provides this service as a way for you to find psychologists who are located near you and who provide the services you want. You may select by the specialty areas associated with your concerns.

- Referrals to Psychologists within the Public Health Care System: <http://www.mps.ca/Referral.aspx>

From MPS website: Referrals to, or inquiries about, services from clinical psychologists in the public health care system can be made by accessing the Department of Clinical Health Psychology Central Intake Line at: (204) 787-7424.

---

## NEW BRUNSWICK

### Government of New Brunswick (GNB) Community Mental Health Centres - Acute Services

<http://www.gnb.ca/0055/cmhcs-e.asp>

- From GNB website:

The objectives of Acute Services are:

- To provide screening, assessment, 24-hour crisis intervention, short-term therapy, prevention, consultation and service delivery coordination.
- To direct clients to the mental health programs and/or community services appropriate to their needs.
- Please go to the following website to find a GNB Community Mental Health Centre in your area:<http://www.gnb.ca/0055/mental-health-e.asp>

### Chimo Helpline

1-800-667-5005 (toll free)

<http://www.chimohelpline.ca>

- From Chimo website: Chimo is a provincial crisis phone line, that is accessible 24hrs a day, 365 days a year to all residents of New Brunswick.

**Our Mission Statement:** "To serve New Brunswick by providing a competent level of crisis intervention, referrals and vital information in a caring, confidential manner."

**We are committed to helping with any issue:** Thoughts of suicide, Emotional stress, Employment, Accommodations, General Information, Loneliness, Divorce/Separation, Senior Resources.

### College of Psychologists of New Brunswick (CPNB) - Psychologist Search Tool

[http://www.cpnb.ca/en/psychology\\_finding.aspx](http://www.cpnb.ca/en/psychology_finding.aspx)

- From CPNB website: This search tool allows you to obtain the list of the licensed psychologists (in New Brunswick) including the region of the province in which they practice.

## NEWFOUNDLAND AND LABRADOR

### **Newfoundland and Labrador Department of Health and Community Services - Mental Health Crisis Line**

1-888-737-4668 (toll free; 24hrs)

<http://www.health.gov.nl.ca/health/findhealthservices/helplines.html>

- Offers free confidential counselling, support, and referral.

### **Association of Psychology in Newfoundland and Labrador - Psychologist Search Tool**

<http://www.nlpsych.ca/FindAPsychologyProvider.aspx>

- A search tool that provides the contact details of psychologists practicing in your area. Allows you to select areas of practice associated with your concerns.

## NORTHWEST TERRITORIES

### **Northwest Territories Department of Health and Social Services: NWT Helpline**

1-800-661-0844 (toll free) or (867) 920-2121

<http://www.nwthelpline.ca>

You can call this number if you are having personal problems. This line provides information, support, and referral services. You can call between 7:00 p.m. and 11:00 p.m. any night of the week. Your call will be completely confidential, which means no one will know that you have called and talked about your personal problems.

### **Northwest Territories Department of Health and Social Services: NWT Community Counselling Programs**

[http://www.hlthss.gov.nt.ca/english/services/addictions/contact\\_us.htm](http://www.hlthss.gov.nt.ca/english/services/addictions/contact_us.htm)

- From website:
  - Community Counselling Programs:
  - provide communities with support and counselling in the area of addiction, mental health and family violence;

- provide referrals for additional programs and services as required (e.g. addiction treatment programs); and
- provide prevention and education initiatives around addiction, mental health and family violence issues, e.g. educating teachers and students in the schools about addictions, working closely with the Community Health Representatives (CHRs) in prevention/promotion activities related to healthy lifestyle choices.
- [Click here for contact information](#)
- Community Counselling Programs provide assessment and referral services to appropriate treatment programs when required.

## NOVA SCOTIA

**Capital District Mental Health Mobile Crisis Team** (Provides confidential phone support in addition to in person services if requested)

902-429-8167

1-888-429-8167 (toll free, 24hrs)

<http://www.cdha.nshealth.ca/mental-health-program/programs-services/mental-health-mobile-crisis-team>

- From website:

The Mental Health Mobile Crisis Team (MHMCT) provides intervention and short term crisis management for children, youth and adults experiencing a mental health crisis. We offer telephone intervention throughout the Capital District and mobile response in areas served by Halifax Regional Police including Halifax, Dartmouth and Bedford. Our support is confidential, non-judgmental and respectful.

- The MHMCT may respond in person to callers within Halifax Regional Municipality only, but answer phone calls province wide. Counselling and referrals are provided by phone.
- Brochure: <http://www.cdha.nshealth.ca/system/files/sites/100/documents/mobile-crisis-team-2007.pdf>

## Association of Psychologists of Nova Scotia - Psychologist Search Tool

<http://www.apns.ca/findapsych.html>



- A search tool that provides the contact details of psychologists practicing in your area. Allows you to select areas of practice associated with your concerns.

### **Government of Nova Scotia Mental Health Services**

[http://www.gov.ns.ca/health/mhs/find\\_help.asp](http://www.gov.ns.ca/health/mhs/find_help.asp)

- Contact details for mental health services and supports across the province.

## **NUNAVUT**

### **Government of Nunavut Department of Health and Social Services - Mental Health Services** Kamatsiaqtut Help Line: (867) 979-3333 or toll free at (800) 265-3333

<http://www.hss.gov.nu.ca/en/Your%20Health%20MHA.aspx>

- Provides mental health help line (see above) and mental health information.

## **ONTARIO**

### **Ontario Mental Health Helpline** (funded by the Government of Ontario)

1-866-531-2600 (24/7; toll free)

<http://www.mentalhealthhelpline.ca/>

- Provides information about counselling and support services in communities across Ontario. Service is free, confidential, and anonymous.
- Website contains educational material on various forms of mental health problems.

### **Ontario Psychological Association Referral Service**

1-800-268-0069 (Monday to Friday, 10:00 am to 3:30 pm)

<http://www.psych.on.ca/index.asp?id1=56>

- The Ontario Psychological Association offers a free referral service to registered psychologists in the province via phone (1-800-268-0069; Monday to Friday, 10:00 am to 3:30 pm.) and via their website.

**PRINCE EDWARD ISLAND (PEI)****Government of PEI Community Mental Health System - Island Helpline**

1-800-218-2885 (toll free; 24hr)

<http://www.healthpei.ca/index.php3?number=1020501&lang=E>

- From Health PEI website: Island Helpline is a 24 hour, bilingual, toll free, confidential and anonymous telephone service available to all Islanders. Island Helpline is operated by staff who are trained to listen and help callers generate solutions to problems. Island Helpline provides information, support or help in a crisis.

**Government of PEI Community Mental Health System**

<http://www.healthpei.ca/mentalhealth>

- From Health PEI website: The Community Mental Health system offers: professional assessment; consultation; treatment; crisis intervention; medication; monitoring; outreach; and on-going support for persons with mild to moderate mental health problems.
- Website (see above) contains locations and contact details of local mental health offices.

**QUEBEC****Revivre: Quebec Anxiety, Depressive and Bipolar Disorders Support Association - Support, Information and Referral Hotline (bilingual)**

<http://revivre.org/hot-line.php>

Montreal area: (514) REVIVRE [738-4873]

Toll free: 1 866 REVIVRE [738-4873]

Hotline hours: 9 am to 9 pm, Monday through Friday

- From website: Plays a preventive role with people suffering directly or indirectly from anxiety, depression or bipolar disorders. This includes people who have not been diagnosed with one of the above, but are experiencing some of the signs and symptoms.

Workers and volunteers trained in active listening pay close attention to the distress experienced by individuals suffering from any of the above and by their loved ones. The hotline volunteers also answer questions regarding the disorders and, if necessary, refer the questions to specialists.

### **Ordre des Psychologues du Québec Referral Service**

<http://www.ordrepsy.qc.ca/en/public/trouver-un-professionnel/index.sn>

- From website: The Order referral service will help you find a psychologist working in the private sector by region and/or by the type of problem you are experiencing.

The Order also offers this service over the phone, from Monday to Friday between 8:30 a.m. and 4:30 p.m. You can access this service by dialling 514-738-1223 or our toll free number at 1-800-561-1223

---

## **SASKATCHEWAN**

### **The Saskatchewan College of Psychologists Referral Service**

<http://www.skcp.ca/regionalmap.htm>

- Service: Searchable database provides names and contact details of psychologists throughout the province of Saskatchewan.

### **Government of Saskatchewan Adult Community Mental Health Services**

<http://www.health.gov.sk.ca/adult-community-services>

From website:

- *Services offered by health regions:* Direct and indirect clinical and counselling services are available for adults in Saskatchewan.
- *Direct Services* include diagnosis and treatment of a wide variety of mental health problems as well as counselling and support for community clients.
- *Indirect Services* take the form of consultation and support to other agencies.
- Adult services available through health regions' mental health clinics include: Intake/assessment/referral; Crisis intervention; Individual counselling; Marital counselling (with distress); Family violence treatment; Family violence support; Sexual assault/sexual abuse support; Promotion/prevention/education (Not all services are available in every region)

- Mental Health and Addictions Contact List
- RHA contact list and phone numbers.

**Government of Saskatchewan HealthLine**

1-877-800-0002 (24hrs, 7 days per week)

<http://www.health.gov.sk.ca/healthline>

From website:

- **What is HealthLine?**

HealthLine is a confidential, 24-hour health information and support telephone line, staffed by Registered Nurses, Registered Psychiatric Nurses and Social Workers. The professionals who work at HealthLine are experienced and specially trained to help you make decisions about your health care options. They can help you decide whether to treat your own symptoms, go to a clinic, see your primary health care provider, or access emergency medical care, if necessary.

HealthLine is available to anyone in the province, free of charge.

HealthLine is not for emergency situations. Call 9-1-1 if you are experiencing a medical emergency.

- **How does HealthLine work?**

When you call HealthLine, you have the option to speak with a Registered Nurse or a mental health and addictions professional. If you choose to speak with a Registered Nurse, the nurse will assess your symptoms and provide you with the most appropriate health support or information.

If you choose to speak to a mental health and addictions professional, you will be able to discuss your concerns in a safe, caring, and confidential manner with a Registered Psychiatric Nurse or Social Worker. They may help you with crisis counseling, strategies to help you manage your situation, or provide information about resources in your community.

---

**YUKON****Government of Yukon Mental Health Services**

(867) 667-8346

Outside Whitehorse within Yukon: 1-800-661-0408, local 8346.

[http://www.hss.gov.yk.ca/mental\\_health.php](http://www.hss.gov.yk.ca/mental_health.php)

From website:

- Mental Health Services is a community mental health clinic offering assessment, individual and group therapy, supportive counselling and referral services for a wide range of emotional and behavioural problems and mental illnesses. Mental health professionals work to provide assistance in managing depression, anxiety, schizophrenia, and bipolar disorders.

Requests for marital counselling, parenting skills and substance abuse counselling are likely to be referred to other agencies specializing in services for these problems.

Mental Health Services also provides funding to Yukon Family Services Association (a community counselling agency.)

Counsellors/therapists from Mental Health Services and Yukon Family Services travel to the communities outside of Whitehorse on a regular basis to provide services.

Services are confidential.

***Mental Health and Counselling Services******South Africa***

If you are experiencing psychological distress and feel that you are in need of support we strongly encourage you to seek counselling services. The following agencies/organizations in your area may be contacted for referral to or provision of counselling services:

## **SOUTH AFRICA - ALL REGIONS**

### **LifeLine South Africa**

National Counselling Line: 0861-322-322

<http://www.lifeline.org.za/work.php.html>

- Provides free, confidential telephone counselling and a range of other services. Not-for-profit organisation.
- The contact details for provincial and city LifeLine centres can be found here: <http://www.lifeline.org.za/contactus.php.html>

### **South African Government Mental Health Information Line**

0800 567 567

<http://www.doh.gov.za/show.php?id=1672>

### **South African Government National Crisis Line**

0861 322 322 (24hr)

<http://www.info.gov.za/issues/hotline/index.htm>

- From website:

24 hour telephonic counselling service dealing with all forms of abuse, HIV/AIDS, bereavement, suicide and eating disorders.

## ***Mental Health and Counselling Services***

### ***United Kingdom***

If you are experiencing psychological distress and feel that you are in need of support we strongly encourage you to seek counselling services. The following agencies/organizations in your area may be contacted for referral to or provision of counselling services:

## **UNITED KINGDOM - ALL REGIONS**

### **National Health Service: Mental Health Service Directory**

<http://www.nhs.uk/livewell/mentalhealth/Pages/Mentalhealthhome.aspx>

- Online directory allows you to find addresses, phone numbers and websites for mental health services and support (including psychological therapy services) near you:  
<http://www.nhs.uk/servicedirectories/Pages/ServiceSearchAdditional.aspx?ServiceType=Mentalhealth>
- Information regarding how to access mental health services within the NHS can be found here:  
<http://www.nhs.uk/NHSEngland/AboutNHSservices/mentalhealthservices/Pages/Accessingmentalhealthservices.aspx>

### **Samaritans Emotional Support Service**

08457 90 90 90 (for cost of a local call)

<http://www.samaritans.org/>

- From website:

Samaritans is a confidential emotional support service for anyone in the UK and Ireland.

The service is available 24 hours a day for people who are experiencing feelings of distress or despair, including those which may lead to suicide.

Volunteers offer support by responding to phone calls, emails and letters. Alternatively people can drop in to a branch to have a face to face meeting.

Across the UK you can call Samaritans on 08457 90 90 90 for the price of a local call. In the Republic of Ireland call 1850 60 90 90.

You can also email Samaritans at [jo@samaritans.org](mailto:jo@samaritans.org) or write to Chris, PO Box 9090, Stirling, FK8 2SA.

- You may locate a local branch here:  
[http://www.samaritans.org/talk\\_to\\_someone/find\\_my\\_local\\_branch.aspx](http://www.samaritans.org/talk_to_someone/find_my_local_branch.aspx)

### **British Psychological Society: Directory of Chartered Psychologists**

<http://www.bps.org.uk/bpslegacy/dcp>

- A free online directory that allows you to search for the contact details of chartered UK psychologists in your area.

- See also the British Psychological Society Register of Psychologists Specializing in Psychotherapy: <http://www.bps.org.uk/psychology-public/find-psychologist/psychotherapy-register/find-chartered-psychologist-specialising->

## ***Mental Health and Counseling Services***

### ***United States***

If you are experiencing psychological distress and feel that you are in need of support we strongly encourage you to seek counseling services. The following agencies/organizations in your area may be contacted for referral to or provision of counseling services:

#### **UNITED STATES - ALL REGIONS**

##### **Substance Abuse and Mental Health Services Administration (SAMHSA): Mental Health Services Locator and Helpline**

<http://store.samhsa.gov/mhlocator>

- From website:

This Locator provides you with comprehensive information about mental health services and resources and is useful for professionals, consumers and their families, and the public. You may also access the underlying facility location information here.

If you, or someone you know, is in suicidal crisis or emotional distress please call **1-800-273-TALK (8255)** or if medical help is immediately needed please call 911.

##### **American Psychological Association: Psychologist Locator Service**

<http://locator.apa.org>

- From website:

The Psychologist Locator makes it easy for you to find practicing psychologists in your local area. Psychologists are trained to help people deal effectively with many of life's problems and can help improve physical and mental health for you and your family. The Psychologist Locator lets you consider many factors in searching for psychologists, including their areas of specialization, gender, insurance accepted, languages spoken and much more.

---



## ***Brain Injury Support Organizations***

### ***Canada***

#### **Brain Injury Association of Canada (BIAC)**

<http://biac-aclc.ca/>

1-866-977-2492 (toll free)

- From website:

Our mandate is to improve the quality of life for all Canadians affected by acquired brain injury and promote its prevention. As well, BIAC is dedicated to facilitate post-trauma research, education and advocacy in partnership with national, provincial/territorial and regional associations and other stakeholders.

BIAC is incorporated as a national charitable organization under the Canada Corporations Act and Canada Revenue Agency

- **Links to brain injury associations in your area** can be found on the left-hand side of the BIAC homepage under the title "Provincial Associations": <http://biac-aclc.ca/en/>

### ***South Africa***

#### **Headway - Gauteng: National Head Injuries Association**

<http://www.headway-gauteng.org/>

011 442 5722

- From website:

The vast majority of our injured members have sustained a traumatic brain injury (TBI) as a result of a motor vehicle accident, sporting accident or personal assault. We also assist survivors of other acquired brain injuries (ABI) for example, stroke (CVA).

All our injured members have led a full life up until they sustained a life changing brain injury which could include permanent changes to physical, cognitive, emotional and or behavioural processes.

We provide the following services:

- **A family support group** consisting of hundreds of families from a diverse range of cultural and socio-economic backgrounds. Each family has someone dear to them who has sustained a brain injury.
- **A counselling service** and a small telephone call centre which provides one-on-one counselling to families.
- **A friendship group** which takes place twice a month.
- **A holistic fully inclusive activity/therapy day programme** at all our branches which provides our injured members with a structured, productive day where stimulating and enjoyable activities and social skills can be practiced, under the supervision of fully trained therapists, ably assisted by a team of volunteers from the community.

### **Headway - Natal: KwaZulu-Natal Head Injuries Association**

<http://www.headway.org.za/>

031 266 2709

- From website:

Headway-Natal is a non-profit organisation assisting survivors of acquired brain injury which can be caused by strokes, near drowning, motor and cycle accidents, assaults and even infections such as meningitis and encephalitis. We also provide assistance for their families and carers.

### ***United Kingdom***

#### **Headway: The Brain Injury Association**

<http://www.headway.org.uk/home.aspx>

Free helpline: 0808 800 2244

- From website:

Headway is a charity set up to give help and support to people affected by brain injury. It does this in a number of ways:

#### **Locally**

A network of local Groups and Branches throughout the UK and Channel Islands offers a wide range of services, including rehabilitation programmes, carer support, social re-

integration, community outreach and respite care. The services available will vary, depending on local needs and resources.

### **Nationally**

Headway UK provides support to the local Groups and Branches and helps to deliver high quality services through guidance on policies, procedures, standards and training. Additionally:

- The Headway Helpline provides information, advises on sources of support, finds local rehabilitation services and offers a listening ear to those experiencing problems
- We publish a range of booklets containing information about aspects of brain injury that will be helpful to those directly affected, plus professionals, employers and members of the public
- We promote understanding of brain injury and its effects
- We lobby for better support and resources to be made available by statutory health and social care providers
- We campaign for measures that will reduce the number of brain injuries

To find Headway services in your area please follow this link: <http://www.headway.org.uk/in-your-area.aspx>

**The United Kingdom Acquired Brain Injury Forum** (UK membership organization and charity)

<http://www.ukabif.org.uk/>

Tel: 0845 608 0788

- From website:

The United Kingdom Acquired Brain Injury Forum (UKABIF) is a membership organisation and charity which aims to promote the understanding of all aspects of acquired brain injury. The organisation was established in 1998 by a coalition of organisations working in the field of acquired brain injury who wished to improve awareness of ABI through education and information.

There are regional ABI groups throughout the UK. UKABIF works with these groups to set common aims, encourage sharing of information and practice and co-ordinate group work. For further information: <http://www.ukabif.org.uk/regional-groups>

## ***United States***

### **Brain Injury Association of America (BIAA)**

<http://www.biausa.org/>

703-761-0750

- From website:

The Brain Injury Association of America (BIAA) is the voice of brain injury. We are dedicated to increasing access to quality health care and raising awareness and understanding of brain injury through advocacy, education and research. With a nationwide network of state affiliates, local chapters and support groups, we provide help, hope and healing for individuals who live with brain injury, their families and the professionals who serve them.

- To find a BIAA affiliate in your state please follow this link: <http://www.biausa.org/state-affiliates.htm>
- The BIAA National Directory of Brain Injury Services can be found here: <https://secure.biausa.org/OnlineDirectory/Directory/Default.aspx>

This contains information for:

- Facilities and community-based services
- Brain Injury Specialists
- State Brain Injury Associations
- Support Groups

### **United States Brain Injury Alliance (USBIA)**

[usbia.org/](http://usbia.org/)

- From website:

The mission of the United States Brain Injury Alliance is to engage the community in preventing brain injury and improving lives.

- State USBIA members include:
  - Arkansas. The Brain Injury Alliance of Arkansas - [bia-ar.org/](http://bia-ar.org/)
  - Colorado. The Brain Injury Alliance of Colorado - [biacolorado.org/](http://biacolorado.org/)
  - Connecticut. The Brain Injury Alliance of Connecticut - [biact.homestead.com/](http://biact.homestead.com/)
  - Idaho. The Brain Injury Alliance of Idaho - [www.biaid.org/](http://www.biaid.org/)

- Iowa. The Brain Injury Alliance of Iowa - [www.biaia.org/](http://www.biaia.org/)
- Kentucky. The Brain Injury Alliance of Kentucky - [www.biak.us/](http://www.biak.us/)
- Minnesota. The Minnesota Brain Injury Alliance - [www.braininjurymn.org/](http://www.braininjurymn.org/)
- New Jersey. The Brain Injury Alliance of New Jersey - [bianj.org/](http://bianj.org/)
- New Mexico. The Brain Injury Alliance of New Mexico - [www.braininjurynm.org/](http://www.braininjurynm.org/)
- Oregon. The Brain Injury Alliance of Oregon - [www.biaoregon.org/](http://www.biaoregon.org/)
- Utah. The Brain Injury Alliance of Utah - [www.biau.org/](http://www.biau.org/)
- Wyoming. The Brain Injury Alliance of Wyoming - [www.wybia.org/](http://www.wybia.org/)

### ***Traumatic Brain Injury and Caregiver Online Resources***

Please note that while some of the sites and materials below contain country- or area-specific information they also contain general information that will likely prove a helpful resource regardless of your location. Unless indicated, all online resources are available free of charge.

#### **Ontario Brain Injury Association (OBIA) Online Resource Centre**

<http://www.obia.ca/index.php/resources/brain-injury-articles>

- The OBIA is building an extensive resource of brain injury articles. These include articles on education, health, family and friends, survivor and family adjustment, and treatment.

#### **Brain Injury Association of America Resources**

<http://www.biausa.org/living-with-brain-injury.htm>

- Information about brain injury, its effects, recovery and adjustment, caring for someone with a brain injury, resources.

#### **Headway UK Brain Injury Information Page**

<http://www.headway.org.uk/About-Brain-Injury.aspx>

- Information about brain injury, its effects, recovery and adjustment, caring for someone with a brain injury, resources, and relevant publications.
- Caregiver or carer resources: <http://www.headway.org.uk/caring.aspx>

### Virginia Commonwealth University National Resource Center for Traumatic Brain Injury

<http://www.tbinrc.com/>

- Contains free articles on TBI, links to relevant resources, and sells publications including guides to help foster better adjustment and wellbeing among survivors of TBI and among family members.
- Free articles on TBI and adjustment: <http://www.tbinrc.com/articles>
  - These include:

Managing Stress Effectively after TBI, Part

1: [http://www.tbinrc.com/Websites/vcunrc/Images/Vol%20\\_1\\_Stress%20Pt\\_1.pdf](http://www.tbinrc.com/Websites/vcunrc/Images/Vol%20_1_Stress%20Pt_1.pdf)

Managing Stress Effectively after TBI, Part

2: [http://www.tbinrc.com/Websites/vcunrc/Images/Vol%20\\_2%20Stress%20part%202.pdf](http://www.tbinrc.com/Websites/vcunrc/Images/Vol%20_2%20Stress%20part%202.pdf)

- Books designed to aid survivor and family adjustment are available for purchase: <http://www.tbinrc.com/the-practical-idea-series1>

Titles include:

- Getting better after brain injury: A guide for survivors
- Getting better after brain injury: A guide for families, friends and caregivers
- Recovering relationships after brain injury

Description from website:

Loss of good relationships may be one of the greatest casualties of traumatic brain injury. Many survivors describe feeling lonely, isolated, and misunderstood. Old friends often disappear and family members may seem distant or unsupportive.

This essential 35-page guide helps survivors and family members understand how brain injury changes roles, relationships, emotions, and communication. Relationships with friends, family members, co-workers, and acquaintances are covered.

**Traumatic Brain Injury Survival Guide** by Dr. Glen Johnson, *Clinical Neuropsychologist*

<http://www.tbiguide.com/>

- Free online book written specifically for survivors of TBI and their family members.

**The Perspectives Network**

<http://www.tbi.org/>

- From website:

The Perspectives Network, Inc.'s primary focus is positive communication between persons with brain injury, family members/caregivers/friends of persons with brain injury, those many professionals who treat persons with brain injury and community members in order to create positive changes and enhance public awareness and knowledge of acquired/traumatic brain injury.

- Contains an archive of TBI-related articles for survivors and family members, a list of relevant books, a FAQ section, and links to other resources.

**Family Caregiver Alliance (FCA) National Center on Caregiving** (U.S. nonprofit organization)

<http://www.caregiver.org/>

- From website:

FCA is a public voice for caregivers. Our pioneering programs - information, education, services, research, and advocacy - support and sustain the important work of families caring for loved ones with chronic, disabling health conditions.

- Provides information and advice for caregivers ([http://www.caregiver.org/caregiver/jsp/content\\_node.jsp?nodeid=344](http://www.caregiver.org/caregiver/jsp/content_node.jsp?nodeid=344)) and factsheets and publications (<http://www.caregiver.org/caregiver/jsp/publications.jsp?nodeid=345>).

Topics covered include:

- Taking Care of You: Self-Care for Family Caregivers

[http://www.caregiver.org/caregiver/jsp/content\\_node.jsp?nodeid=847](http://www.caregiver.org/caregiver/jsp/content_node.jsp?nodeid=847)

- Coping with Behavior Problems after Head Injury

[http://www.caregiver.org/caregiver/jsp/content\\_node.jsp?nodeid=396](http://www.caregiver.org/caregiver/jsp/content_node.jsp?nodeid=396)

- Caregiving and Ambiguous Loss

[http://www.caregiver.org/caregiver/jsp/content\\_node.jsp?nodeid=2185](http://www.caregiver.org/caregiver/jsp/content_node.jsp?nodeid=2185)

- Caregiving for Adults with Cognitive or Memory Impairments

[http://www.caregiver.org/caregiver/jsp/content\\_node.jsp?nodeid=392](http://www.caregiver.org/caregiver/jsp/content_node.jsp?nodeid=392)

### **United Kingdom National Health Service Carers Direct**

<http://www.nhs.uk/carersdirect/Pages/CarersDirectHome.aspx>

- Information, advice, and support for caregivers.
- Includes guides to maintaining caregiver wellbeing:  
<http://www.nhs.uk/CarersDirect/yourself/Pages/Yourownwellbeinghome.aspx>

### **Carers UK (UK charity)**

Tel. 020 7378 4999

<http://www.carersuk.org/>

- From website:

Carers UK is a charity set up to help the millions of people who care for family or friends. We provide information and advice about caring alongside practical and emotional support for carers. Carers UK also campaigns to make life better for carers and influences policy makers, employers and service providers, to help them improve carers' lives.



**The Carers Federation** (UK organization)

Tel. 01159 629 310

<http://www.carersfederation.co.uk/>

- From website:

The Carers Federation is dedicated to supporting carers of all ages and the people they look after. It is now a diverse organisation offering a wide range of services to individuals and the wider community.

We currently offer:

- Young carer support
- Adult carer support
- Black and ethnic minority carer support
- Drug and alcohol misuse support
- Counselling
- Local Involvement Networks (LINKs)
- Independent Complaints Advocacy Service (ICAS)
- Research
- Mentoring

**Carers Trust** (UK charity)

Tel. 0844 800 4361

<http://www.carers.org/>

- From website:

**Who are we?**

Carers Trust is a new charity which was formed by the merger of The Princess Royal Trust for Carers and Crossroads Care in April 2012.

Carers Trust works to improve support, services and recognition for anyone living with the challenges of caring, unpaid, for a family member or friend who is ill, frail, disabled or has mental health or addiction problems. With our Network Partners, we aim to ensure that information, advice and practical support are available to all carers across the UK.

Note: In Scotland, we will be keeping the name The Princess Royal Trust for Carers, as this was what our Network Partners in Scotland wanted.

[Find out more about our Scotland office](#)

[Find out more about our Wales office](#)

**What do we do?**

Together with our Network Partners, we provide access to desperately-needed breaks, information and advice, education, training and employment opportunities. Our Network Partners benefit from the provision of grants, advice documents and reports to improve carers' services. We give carers and young carers avenues to speak to someone and make their voices heard, offline via our carers' services and young carers' schemes and online via our interactive websites.

*Carers website:* [www.carers.org](http://www.carers.org)

*Young carers website:* [www.youngcarers.net](http://www.youngcarers.net)

**The United Kingdom Acquired Brain Injury Forum** (UK membership organization and charity)

Tel. 0845 608 0788

<http://www.ukabif.org.uk/>

- From website:

The United Kingdom Acquired Brain Injury Forum (UKABIF) is a membership organisation and charity which aims to promote the understanding of all aspects of acquired brain injury. The organisation was established in 1998 by a coalition of organisations working in the field of acquired brain injury who wished to improve awareness of ABI through education and information.

There are regional ABI groups throughout the UK. UKABIF works with these groups to set common aims, encourage sharing of information and practice and co-ordinate group work. For further information: <http://www.ukabif.org.uk/regional-groups>

***Disclaimer***

The University of Windsor and the authors of this document cannot and, in turn, do not provide any warranties related to the information contained in or resulting services from the organizations and materials listed in the Resource List. Links to other sites are provided for information only -- they do not constitute endorsements of those other sites.

Use of the Resource List is voluntary and will not result in any liability against the University of Windsor or the authors of this document. In no event shall the University of Windsor or the authors of this document be liable for damages to any user of the Resource List for use of any of the services provided by the organizations listed or for use of any of the information contained in the Resource List, or for any other damages which may occur.

APPENDIX E

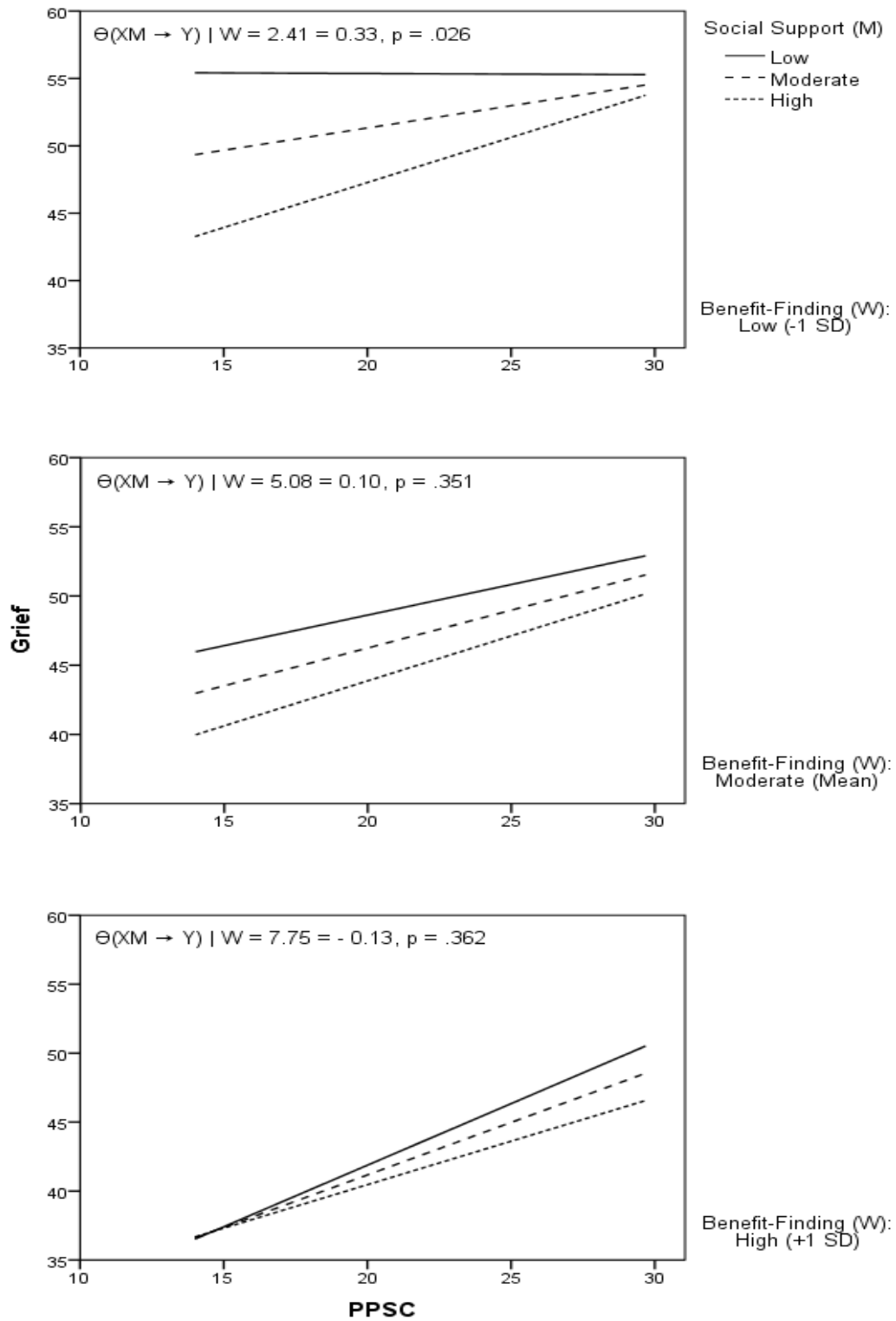

Figure E1. The conditional effect of perceived personality system change (PPSC) on grief as a function of social support and benefit-finding.

Table E1  
*Conditional Effects of PPSC and Social Support Interaction on Grief at Levels of Benefit-Finding*

Benefit-Finding	Point estimate	SE	p	95% CI Limit	
				Lower	Upper
Low (- 1 SD; 2.41)	.33	.15	.026	.041	.620
Moderate (Mean; 5.08)	.10	.11	.351	-.113	.316
High (+ 1 SD, 7.75)	-.13	.13	.362	-.405	.149

*Note.* Benefit-finding values reported are before mean centering. Unstandardized effects are reported.

VITA AUCTORIS

NAME: Bruce Andrew King

PLACE OF BIRTH: Salisbury, Zimbabwe

YEAR OF BIRTH: 1980

EDUCATION: Sherborne School, Dorset, England  
1997

St. Charles College, KwaZulu-Natal, South Africa  
1998

University of Natal, KwaZulu-Natal, South Africa  
1999-2001 B.Sc.  
2001-2002 B.Sc. Hons.

University of Windsor, Ontario, Canada  
2004-2006 M.A.