

Spring 1-1-2016

# Evaluating Admission Practices as Potential Barriers to Creating Equitable Access to Undergraduate Engineering Education

Beth Ann Myers

University of Colorado at Boulder, [beth.myers@colorado.edu](mailto:beth.myers@colorado.edu)

Follow this and additional works at: [https://scholar.colorado.edu/cven\\_gradetds](https://scholar.colorado.edu/cven_gradetds)



Part of the [Engineering Commons](#), and the [Higher Education Commons](#)

---

## Recommended Citation

Myers, Beth Ann, "Evaluating Admission Practices as Potential Barriers to Creating Equitable Access to Undergraduate Engineering Education" (2016). *Civil Engineering Graduate Theses & Dissertations*. 27.  
[https://scholar.colorado.edu/cven\\_gradetds/27](https://scholar.colorado.edu/cven_gradetds/27)

This Dissertation is brought to you for free and open access by Civil, Environmental, and Architectural Engineering at CU Scholar. It has been accepted for inclusion in Civil Engineering Graduate Theses & Dissertations by an authorized administrator of CU Scholar. For more information, please contact [cuscholaradmin@colorado.edu](mailto:cuscholaradmin@colorado.edu).

EVALUATING ADMISSION PRACTICES AS POTENTIAL BARRIERS TO CREATING  
EQUITABLE ACCESS TO UNDERGRADUATE ENGINEERING EDUCATION

by

BETH ANN MYERS

B.A., University of Colorado, 2006

M.E., University of Colorado, 2011

A thesis submitted to the  
Faculty of the Graduate School of the  
University of Colorado in partial fulfillment  
of the requirement for the degree of  
Doctor of Philosophy  
Department of Civil Engineering  
2016

This thesis entitled:  
Evaluating Admission Practices as Potential Barriers to Creating Equitable Access to  
Undergraduate Engineering Education  
written by Beth Ann Myers  
has been approved for the Department of Civil Engineering

---

Angela R. Bielefeldt

---

Jacquelyn F. Sullivan

Date \_\_\_\_\_

The final copy of this thesis has been examined by the signatories, and we find that both the content and the form meet acceptable presentation standards of scholarly work in the above mentioned discipline.

IRB protocol # 11-0651

IACUC protocol # N/A

*Myers, Beth Ann (Ph.D., Civil Engineering)*

## Evaluating Admission Practices as Potential Barriers to Creating Equitable Access to Undergraduate Engineering Education

Thesis directed by Professor Angela Bielefeldt

To create a more competitive and creative engineering workforce, breakthroughs in how we attract and educate more diverse engineers are mandated. Despite a programmatic focus on increasing the representation of women and minorities in engineering during the last few decades, no single solution has been identified and is probably not realistic. But a systems approach, including changes in policy and practice, should be possible. Thus, a thorough understanding of the current climate of engineering admissions policy and practice is a necessity.

This research focused on evaluating ways current engineering admission practices and policies could be changed to broaden the pathways into engineering college for students from underrepresented backgrounds and for the *next-tier* of potential students, subsequently expanding the diversity of the engineering student population.

We hypothesized that engineering colleges' overreliance on standardized test scores in the admissions process denies admissions to diverse students capable of successfully becoming engineers. Using large datasets including more than a million students, engineering admission practices related to these test score values were evaluated.

Diversity in engineering can be expanded, with data-supported confidence in engineering graduation rates, if engineering colleges aggressively admit more next-tier students who boast top high school performance—within the top quartile of high school grade point average of admitted students—yet have much lower standardized test scores (SAT or ACT) than typical at the institution.

Engineering education admissions practices' overreliance on standardized test scores also led to a hypothesis that the pool of qualified students from backgrounds historically underrepresented in engineering was being limited by test score thresholds. A national and single-state investigation found that, using the current metric of standardized test scores and their associated values used for admission decisions, it is impossible to reach racial and ethnic parity in engineering education. Thus, our evidence suggests that engineering colleges need to take bold admission steps such as becoming test score optional, and alternatively relying much more heavily on students' four-year high school academic track records.

Changes in admission policies and practices related to engineering colleges' use of standardized test scores could significantly change who gains access to undergraduate engineering.

## ACKNOWLEDGEMENTS

This research is based upon work supported, in part, by the National Science Foundation under grant number EEC 1160264. Any opinions, findings, and conclusions or recommendations expressed in this material are those of the author(s) and do not necessarily reflect the views of the National Science Foundation.

I would like to thank my committee members Angela Bielefeldt, Jacquelyn Sullivan, Jeffrey Luftig, Amy Javernick-Will and Fernando Rosario-Ortiz for their helpful feedback and suggestions, and the grant co-PIs Beverly Louie, Kevin O'Connor and Daria Kotys-Schwartz. Added thanks to research colleague Denise W. Carlson for her insights and critique.

I would also like to thank Matt Ohland and Russell Long for their help accessing the MIDFIELD database. Thanks to the American Society for Engineering Education, ACT and The College Board for providing raw data for analysis.

## CONTENTS

<b>CHAPTER 1—INTRODUCTION.....</b>	<b>1</b>
<i>Standardized Tests and Their History .....</i>	<i>2</i>
<i>Test Optional .....</i>	<i>4</i>
<i>Preliminary Findings.....</i>	<i>5</i>
<i>Is the engineering admission “arms race” necessary? .....</i>	<i>9</i>
<i>Specific Research Questions.....</i>	<i>9</i>
<i>Research Question 1.....</i>	<i>9</i>
<i>Research Question 2.....</i>	<i>9</i>
<i>Research Question 3.....</i>	<i>9</i>
<b>CHAPTER 2—TOP HIGH SCHOOL GRADE POINT AVERAGES .....</b>	<b>11</b>
<i>Introduction.....</i>	<i>12</i>
<i>Literature Review .....</i>	<i>16</i>
<i>Research Framework.....</i>	<i>18</i>
<i>Research Questions .....</i>	<i>19</i>
<i>Research Design/Methods .....</i>	<i>21</i>
<i>Findings.....</i>	<i>28</i>
<i>Results and Discussion.....</i>	<i>35</i>
<i>Limitations.....</i>	<i>39</i>
<i>Implications .....</i>	<i>41</i>
<i>Acknowledgments .....</i>	<i>42</i>
<i>Chapter 2 Appendix.....</i>	<i>43</i>
<b>CHAPTER 3—CRITICAL THRESHOLD.....</b>	<b>44</b>

<i>Research Question 2</i> .....	44
<i>Methods</i> .....	45
<i>Overview of Analysis Plan</i> .....	48
<i>Underrepresented Minority Categorization</i> .....	48
<i>T-Test HSGPA and Higher Test Score by URM2</i> .....	49
<i>Exhaustive CHAID</i> .....	50
<i>Results</i> .....	52
<i>Return to Research Question 1</i> .....	64
<i>Conclusion</i> .....	67
<b>CHAPTER 4—QUANTIFYING THE POOL OF UNDERREPRESENTED MINORITY STUDENTS FOR ENGINEERING STUDIES</b> .....	<b>68</b>
<i>Research Question 3</i> .....	68
<i>Engineering Interest</i> .....	68
<i>Admission Variables</i> .....	70
<i>Method and Results</i> .....	71
<i>ACT and SAT Overlap</i> .....	78
<i>Research Filter Criteria</i> .....	79
<i>Example Parity Calculation</i> .....	80
<i>Example ACT and SAT Overlap Calculations</i> .....	82
<i>Pool Calculations and Graphs</i> .....	83
<i>Colorado Case Study</i> .....	98
<i>Limitations</i> .....	103
<i>Conclusion</i> .....	104
<b>CHAPTER 5—SUMMARY AND OVERARCHING CONCLUSIONS</b> .....	<b>106</b>

**BIBLIOGRAPHY..... 113**

**APPENDIX ..... 120**



## LIST OF TABLES

<b>Table 1.</b> Engineering colleges' entry class metrics over the last decade. ....	8
<b>Table 2.</b> Six-year engineering graduation rates, by demographic, across all institutions. ....	29
<b>Table 3.</b> Six-year institution graduation rates, by demographic, across all institutions. ....	30
<b>Table 4.</b> Six-year engineering graduation rates by demographic and institution profile. ....	33
<b>Table 5.</b> Summary of graduation rates and percentages of URM and female students. ....	39
<b>Table 6.</b> Engineering graduation rates calculated within institution for each group. ....	43
<b>Table 7.</b> Engineering entry class metrics for the 2012 cohort by institution type. ....	45
<b>Table 8.</b> Engineering six-year graduation rates by race and ethnicity by institution. ....	47
<b>Table 9.</b> High school grade point averages by institution (on a five-point scale). ....	48
<b>Table 10.</b> T-test for URM2 HSGPA and standardized test score. ....	50
<b>Table 11.</b> Summary of 11 institution model for engineering six-year graduation rate of URM2. ....	55
<b>Table 12.</b> URM2 Exhaustive CHAID model summary, risk and classification results. ....	57
<b>Table 13.</b> HSGPA cutoffs by institution with associated engineering graduation rates. ....	58
<b>Table 14.</b> Non-URM exhaustive CHAID summary for test score anomaly. ....	64
<b>Table 15.</b> High school senior engineering interest among 2012 national cohort. ....	69
<b>Table 16.</b> ASEE engineering college selected entry class metric distributions by year. ....	73
<b>Table 17.</b> Engineering entry class metrics for the 2012 cohort by institution type. ....	74
<b>Table 18.</b> Math 25 <sup>th</sup> percentile concordant scores for 2012 first-year engineering cohort. ....	74
<b>Table 19.</b> Weighted average of 2012 entering engineering class. ....	75
<b>Table 20.</b> 2012 U.S. high school completers, college and engineering enrollments by race/ethnicity. ....	76
<b>Table 21.</b> 2012 Cohort ACT and SAT underrepresented minority student test takers. ....	78

<b>Table 22.</b> ACT and SAT overlap in submitted scores to the CU College of Engineering and Applied Science for the 2012 cohort. ....	79
<b>Table 23.</b> ACT initial filter variables and criteria provided by admission decision-makers. ....	80
<b>Table 24.</b> Engineering enrollment and number needed for representation by race/ethnicity. ....	82
<b>Table 25.</b> Students of color needed for parity representation by race or ethnicity. ....	82
<b>Table 26.</b> Students needed for representation from each test by race/ethnicity with interest multiplier.....	91
<b>Table 27.</b> Colorado 2012 high school class and postsecondary enrollment.....	98
<b>Table 28.</b> Colorado enrollment of full-time first-year engineering undergraduates in 2012. ....	99
<b>Table 29.</b> Undergraduate engineering standardized test score 25 <sup>th</sup> percentiles and percent of class in top quarter of high school class. ....	100
<b>Table 30.</b> Colorado high school graduates who meet the 25 <sup>th</sup> percentile using ACT only. ....	101
<b>Table 31.</b> Colorado high school graduates that meet the 25 <sup>th</sup> percentile using ACT and high school rank.....	102
<b>Table 32.</b> Institutions with engineering degrees that have deemphasized test scores. (FairTest; The National Center for Fair and Open Testing, 2016) .....	120
<b>Table 33.</b> Research Question 1: Top and bottom decile and quintile values by institution. ....	124
<b>Table 34.</b> Old SAT to ACT before February 2005 concordance chart. (ACT and SAT, 2008)	125
<b>Table 35.</b> Additional independent samples t-test statistical output.....	126
<b>Table 36.</b> SAT initial filter variables and criteria.....	139
<b>Table 37.</b> Initial filter criteria calculation, engineering enrollment and number needed for representation by race/ethnicity. ....	140
<b>Table 38.</b> ACT filter criteria with widened planned major and occupation.....	140

**Table 39.** ACT expanded filter, major and occupation removed. .... 140

**Table 40.** ACT and SAT expanded filter with all engineering interest filters removed. .... 141

**Table 41.** ACT and SAT expanded filter with AP, advanced and honors course requirements removed..... 142

**Table 42.** ACT and SAT expanded filter with math requirement lowered to three years. .... 143

**Table 43.** ACT and SAT expanded filter with physics course requirement removed. .... 144

**Table 44.** ACT and SAT expanded filter with higher math course requirement removed. .... 145

**Table 45.** ACT and SAT expanded filter with algebra II course requirement removed. .... 146

**Table 46.** ACT and SAT expanded filter with minimum science grade requirement removed. 147

**Table 47.** ACT and SAT expanded filter with minimum math grade requirement removed. ... 148

**Table 48.** ACT and SAT expanded filter with math and science years requirement removed. . 149

**Table 49.** ACT and SAT expanded filter with all filters removed except standardized test score and HSGPA..... 150

**Table 50.** ACT and SAT expanded filter, only standardized test scores. .... 151

## LIST OF FIGURES

<b>Figure 1.</b> Exhaustive CHAID tree for URM2 students, continued on next page.....	53
<b>Figure 2.</b> Exhaustive CHAID tree model, risk and classification results for institution 1.....	60
<b>Figure 3.</b> Exhaustive CHAID tree model, risk and classification results for institution 10.....	62
<b>Figure 4.</b> 2012 U.S. cohort ACT Math scores by race/ethnicity (initial most-restrictive filter)..	84
<b>Figure 5.</b> 2012 U.S. cohort ACT Math scores by race/ethnicity-expanded major and occupation filters. ....	85
<b>Figure 6.</b> 2012 U.S. cohort ACT Math scores by race/ethnicity, with major and occupation filters removed.....	86
<b>Figure 7.</b> 2012 U.S. cohort ACT Math scores by race/ethnicity, with engineering-interest filters removed.....	87
<b>Figure 8.</b> 2012 U.S. cohort ACT Math scores by race/ethnicity with all filters removed. ....	89
<b>Figure 9.</b> 2012 U.S. cohort ACT Math scores by race/ethnicity with all filters removed (zoomed). ....	90
<b>Figure 10.</b> ACT Math and ACT Composite cross-tabulation for Black/African American students. ....	93
<b>Figure 11.</b> ACT Math and ACT Composite cross-tabulation for American Indian/Alaska Native students. ....	94
<b>Figure 12.</b> ACT Math and ACT Composite cross-tabulation for Hispanic/Latino students.....	95
<b>Figure 13.</b> ACT Math and ACT Composite cross-tabulation for Native Hawaiian/Other Pacific Islander students.....	96
<b>Figure 14.</b> ACT Math and ACT Composite cross-tabulation for Two or More Races students.	97
<b>Figure 15.</b> MIDFIELD database institutions.....	123

**Figure 16.** Exhaustive CHAID tree model, typical URM definition model (2 pages). ..... 127

**Figure 17.** Exhaustive CHAID tree model, risk and classification results for institution 2..... 129

**Figure 18.** Exhaustive CHAID tree model, risk and classification results for institution 3..... 130

**Figure 19.** Exhaustive CHAID tree model, risk and classification results for institution 4..... 131

**Figure 20.** Exhaustive CHAID tree model, risk and classification results for institution 5..... 132

**Figure 21.** Exhaustive CHAID tree model, risk and classification results for institution 6..... 133

**Figure 22.** Exhaustive CHAID tree model, risk and classification results for institution 7..... 134

**Figure 23.** Exhaustive CHAID tree model, risk and classification results for institution 8..... 135

**Figure 24.** Exhaustive CHAID tree model, risk and classification results for institution 9..... 136

**Figure 25.** Exhaustive CHAID tree model, risk and classification results for institution 11..... 137

**Figure 26.** U.S. locations where the SAT and ACT dominate. Edited from Saget, 2013..... 138

## *CHAPTER I—Introduction*

To create a more competitive and creative engineering workforce, breakthroughs in how we attract and educate more diverse engineers must be found. During the last 10 years, 81% of all U.S. undergraduate engineering degrees were awarded to men, and 80% to Caucasian and Asian Americans while, according to the U.S. Census, they only represented 51% and 62% of the total college-aged population in 2010. (American Society for Engineering Education, 1998-2015; U.S. Department of Commerce, 2010)

Many of the programs—typically created between 1970 and 2000—that work at attracting more diverse students into engineering and increasing student persistence to graduation are minority engineering programs (MEPs) and women in engineering programs (WIEPs). Summer bridge programs are another widely disseminated approach to increasing student retention and persistence. Even with the support of these programs, the percentage of engineering bachelor's degrees earned by women in 2014 was 19.9%, up from the most recent years but just slightly above the 19.5% in 2005 a decade earlier. Students of color have historically been underrepresented in engineering and continue to be represented much lower than at parity in the population. Hispanic students earned 10.1% of U.S. bachelor's degrees in engineering in 2014, yet represented 20.7% of the U.S. college-aged population; Black or African American earned 3.5% (versus 14.8% in population), American Indian 0.4% (versus 0.9%), Hawaiian/Pacific Islander 0.3% (not disaggregated) and Two or More Races 1.9% (versus 2.4%) (American Society for Engineering Education, 1998-2015), all much lower than in the U.S. population. (U.S. Department of Commerce, 2010)

Despite all this programmatic focus on increasing the representation of women and minorities in engineering during the last few decades, no single solution has been identified, and is probably not realistic. But a systems approach, including changes in policy and practice, should be possible. Thus, a thorough understanding of the current climate of engineering admissions policy and practice is required.

This research focuses on evaluating ways current engineering admission practices and policies could be changed to broaden the pathways into engineering college for students from underrepresented backgrounds and for the next-tier of potential students—subsequently expanding the diversity of the engineering student population. Next-tier students are those just below “making the cut” for acceptance to a given engineering college based on its admission requirements. These students are deemed to have high potential and probability for success in engineering if a pathway for entry can be identified.

#### *Standardized Tests and Their History*

The ACT, which was originally an abbreviation of American College Testing, is a standardized test created in 1959 to assess college readiness as well as measure high school achievement and college admission in the U.S. ACT was created as a competitor to the College Board’s Scholastic Aptitude Test, now known as SAT. In 2011, ACT surpassed SAT in the total number of test takers for that cohort with 1,666,017 ACT takers versus 1,664,479 SAT takers. (ACT, Inc., 2012) Students typically take the ACT and SAT tests during the spring of their junior years, however, cohorts are defined by graduation year and include all students in a graduating cohort regardless of when they took the test. More students from the Midwest and Rocky Mountain regions take the ACT, while more students living along the West and East Coasts of the U.S. take the SAT (as shown in **Figure 26** in the APPENDIX). (Saget, 2013)

Based on the results of multiple-choice answers, ACT scores are integers that can range from 1 to 36 for a composite score and each of four subject tests in English, reading, mathematics, and science. The composite score is the average of the four subject tests rounded to the nearest whole number. An optional writing section is not factored into the composite score. ACT has defined college-readiness benchmark scores of 18 for English, 22 for mathematics, 22 for reading, and 23 for science. (ACT, Inc., 2015) ACT lists average composite scores typically accepted at different types of institutions as: highly selective 27-30, selective 25-27, traditional 22-24, liberal 18-21, and open 17-20. (ACT, Inc)

The SAT, developed by The College Board and currently operated by Educational Testing Service, was introduced in 1926 and has changed names and scoring many times since then. It is also a standardized test to assess students' college aptitudes, however it has historically not been aligned with high school curriculum or standards. In early offerings, test takers were commonly those students who ended up applying to select, prestigious institutions. Over the years, the number and demographics of students taking the SAT has grown dramatically. (Lemann, 2000)

Currently, SAT scores can range from 200 to 800 for each of three major sections: critical reading, mathematics and writing. Possible total scores range from 600 to 2400, a sum of test results from the three 800-point test sections. An additional essay score is also included. The SAT Total score was historically maxed at 1600, however, in 2005 it changed to a maximum of 2400, the maximum will be changed back to 1600 in 2016 with additional subscores and cross-test scores provided. (The College Board, 2016)

The stated intention of standardized tests such as the SAT and ACT is to predict students' potential for college success; the tests are not intended to measure current knowledge or academic achievement, but to predict first-year college grades. (ACT Inc, 2008) However,



research published by the College Board shows that students' high school grades and class ranks are better predictors of first-year college grades than students' SAT scores. (Morgan, 1989; Korbin, Patterson, Shaw, Mattern, & Barbuti, 2008)

Currently, secondary and post-secondary educators are questioning whether standardized test scores predict grades beyond the first year through to obtaining college degrees. (Mattern, Patterson, & Wyatt, 2013; Kobrin & Michel, 2006) Thirty-seven different studies have shown consistent gender bias in standardized tests, with a typical finding that women's college grades are under-predicted by the SAT standardized test. (Young & Korbin, 2001) In particular, Steinberg and Wainer and found that males score 35 points higher on SAT Math than females who earn the same grades in the same college math courses. (Steinberg & Wainer, 1991) Also, various studies have found no common pattern to the results for validity and prediction of SAT for different racial/ethnic minority groups. (Young & Korbin, 2001) And yet, standardized test scores are heavily used for admissions decisions by the nation's engineering colleges. (Myers & Sullivan, 2014)

### *Test Optional*

While a huge movement expanded the use of standardized tests after the first and second World Wars and through the 20<sup>th</sup> century, in the 21<sup>st</sup> century a growing movement in the U.S. is advocating that colleges and universities move away from requiring standardized test scores for admission decisions. The National Center for Fair and Open Testing tracks schools that are "test optional, test flexible or de-emphasize the use of standardized test by making admission decisions about substantial numbers of applicants who recently graduated from U.S. high schools without using the SAT or ACT." (FairTest; The National Center for Fair and Open Testing, 2016) More than 850 institutions are now listed in their database. The higher education

institutions vary in whether standardized test scores are accepted at all or required in some situations or for some students. For example, some use standardized test scores for placement and advising, others require the scores for out-of-state applicants, when a minimum GPA and/or class rank are not met, or for particular programs.

The National Center for Fair and Open Testing argues that the schools that have gone test optional are pleased with their results because incoming classes become more diverse without any loss in academic quality, promoting equity and excellence. The lessons learned from test score-optional schools include increases in diversity because otherwise qualified minority, low-income, first-generation, female, and other underrepresented students apply at higher rates when test scores are not required. This attracts more students who are academically capable to apply for admission to these schools. (FairTest; The National Center for Fair and Open Testing, 2016)

Of the 367 institutions downloaded from ASEE for 2014 undergraduate enrollment, 80 (22%) are test optional, test flexible or have deemphasized the use of standardized test scores in some way. However, the vast majority of those, 56 (70%) still required SAT/ACT, but consider it when a minimum GPA and/or class rank is not met, or are institutions at which SAT/ACT are required for some but not all programs (potentially engineering still requires the scores). Only 17 (5% of total) institutions are listed as fully test optional and offer engineering undergraduate degrees. For the list of schools that offer undergraduate engineering degrees that have deemphasized test scores in some way, see **Table 32** in the APPENDIX.

### *Preliminary Findings*

The three research questions presented in this thesis were formulated based on the preliminary outcomes from studies of the Engineering GoldShirt Program at the University of Colorado Boulder. The Engineering GoldShirt Program was modeled after athletic redshirting in which

players postpone their periods of athletic eligibility to between their second and fifth years of undergraduate study. They still attend classes as students and are on the team practicing during the first year, but are preparing for subsequent years. Similarly, the Engineering GoldShirt Program supports motivated and talented students who need additional preparation and support to be successful in the undergraduate engineering curriculum. This turns the undergraduate engineering degree into a five-year program. Multiple conference presentations for the American Society for Engineering Education have summarized the Engineering GoldShirt Program.

(Milford, et al., 2010; Ennis, Milford, Sullivan, Myers, & Knight, 2011; Sullivan, et al., 2015)

This preliminary research was crucial in helping define the research questions related to defining next-tier students and the potential pool of qualified students.

The variables selected in all three research questions were chosen as the result of preliminary survey findings that are discussed in length in Myers & Sullivan, 2014. In August 2013, an online survey was sent to admissions decision-makers at U.S. “high research-active” universities with engineering programs. The survey contained 16 questions about specific engineering admission practices and policies, soliciting both rating and ranking of variables used in engineering admission decisions. Respondents were also asked about their roles and responsibilities in the engineering admission process to ensure responses were from decision-makers.

Survey results showed that a variety of factors are used to determine engineering admission eligibility. But—unsurprisingly—when asked to rate the importance of variables in the admissions process, the ubiquitous key factors for at least 74% of the respondents were high school grade point average; math and comprehensive standardized test scores; physics, calculus and chemistry high school track record; and the quality of the high school course load.

Next, respondents were asked to further differentiate amongst their top variables by ranking their “extremely important” variables *in order of importance*. The four variables ranked highest most frequently were: high school grade point average, math standardized test score, comprehensive standardized test score, and the quality of the high school course load. Notably, students’ track records in calculus, physics and chemistry were ranked a bit lower than the overall quality of the high school course load. And, it is noteworthy that standardized test scores were prioritized as two of the top three admissions variables.

Another survey question inquiring about median admission criteria found an ACT median math range of 23-34 among responding institutions, with an average of 29.5—a level only achieved by 6% of all U.S. ACT test takers in 2013! (ACT, Inc., 2015) Likewise, the SAT Math score of 689 indicated as the average median score among survey respondents was achieved by only 8% of all SAT test takers in 2013. (The College Board, 2015) These results suggest the math standardized test score is a significant gatekeeper for access to engineering education, already narrowing the pool of “qualified” future engineers to far less than 10% of all test takers. Embedded in this pool limitation is the unstated assumption and hubris that enough “qualified” high school students exist that engineering can meet its societal needs by trying to interest (and subsequently attract) enough, and diverse enough at that, students among the remaining 6-8% of students.

Thus, the rationale for using high school grade point averages and standardized test scores throughout all three research questions investigated in this work became clear. Additionally, the variables rated and ranked highly were used to quantify the pool of potential underrepresented minority engineering-admissible students.

At our own institution, the high school grade point average and standardized test scores needed for admission to our engineering college continue to creep up year after year. Entering class 25<sup>th</sup>

and 75<sup>th</sup> percentile standardized test score metrics and the percentage of students that were in the top quartile of their high school classes can be used as proxies for what is necessary for admission at a particular institution. For the last 10 years, at the ~200 institutions that provided the information to the American Society for Engineering Education, the percentage of students in the top quartile of their high school classes has hovered around 69%. (American Society for Engineering Education, 1998-2015) However, the standardized test score 25<sup>th</sup> and 75<sup>th</sup> percentiles have increased at these institutions, as shown in **Table 1**. The 25<sup>th</sup> percentile ACT score averages have increased more, 2.5 and 2.6 points, which is more than the 0.7 and 1.2 point increases for the 75<sup>th</sup> percentile average ACT scores. (American Society for Engineering Education, 1998-2015)

**Table 1.** Engineering colleges' entry class metrics over the last decade.

Year	Percent in Top Quartile HS class	Avg ACT Math 75%ile	Avg ACT Math 25%ile	Avg ACT Comp 75%ile	Avg ACT Comp 25%ile
2005	66.4	29.7	22.9	28.6	22.5
2006	68.5	29.7	23.4	28.7	23.2
2007	68.7	29.4	23.8	28.6	23.1
2008	68.5	29.9	24.0	29.0	23.5
2009	69.0	30.2	24.0	29.3	23.5
2010	70.0	30.2	24.6	29.4	24.0
2011	69.5	30.5	25.0	29.6	24.4
2012	69.6	30.5	25.1	29.6	24.5
2013	69.2	30.3	25.5	29.6	24.8
2014	68.6	30.4	25.5	29.8	25.0

These test score increases could be related to many factors that may not even be the same at each institution. At our own institution, increases were related to the growth in demand for engineering education and increases in the profile of students applying to our institution. Another related factor could be the impact institutions believe their entry class metrics and percentage of declined students play into their national rankings and selectivity categorization.

Is the engineering admission “arms race” necessary? This preliminary research has prompted overarching questions that challenge our nation’s approach to engineering admissions criteria. Is it ordained that engineering must be ultra-exclusive, eliminating all but the very brightest 18-year-olds from admission to engineering futures? Alternatively, might strong high school students in the top quartile among standardized test takers be *well-enough* educated to become an excellent engineering workforce? Must the admissions sieve really have such small pores? Further research is warranted to answer these questions. The results in this dissertation sets the stage for further research in this area.

### *Specific Research Questions*

**Research Question 1:** Is the prediction of success—defined as graduating with an engineering degree within six years—for incoming first-time, first-year engineering students with high grade point averages (HSGPAs) from high school and low ACT/SAT scores different than for students with low HSGPAs and high ACT/SAT scores? Does this differ by higher education institution? By ethnicity? By gender?

**Research Question 2:** Is there a critical threshold for HSGPA and SAT/ACT that accurately predicts URM student success (defined as six-years to graduation) in engineering? Does the threshold vary by higher education institution?

**Research Question 3:** How large is the pool of potential underrepresented minority undergraduate engineering students based on today’s typical admissions criteria?

The first research question, found in Chapter 2, was written in the format appropriate for publication in the *Journal of Engineering Education* and had been submitted for review. It has its own standalone background and literature review section. Additional tables are provided in the APPENDIX of this dissertation that were not included in the submitted manuscript. The second

research question, found in Chapter 3, follows the first and is written as follow-on research, without additional background or literature review. The third research question, found in Chapter 4, relies on the background and literature presented in the first question, with some additions.

## CHAPTER 2—Top High School Grade Point Averages

### Broaden Participation of Next-Tier Students Using Top High School Grade Point Averages<sup>1</sup>

#### *Abstract*

**Background**—To educate enough engineers to meet demand and propel our nation’s competitiveness through an engineering workforce reflective of our nation’s diversity, we must increasingly engage and capitalize on the contributions of people from backgrounds underrepresented in engineering—especially women and minorities.

**Purpose**—This study focuses on broadening pathways into engineering for next-tier students, expanding both the diversity and size of the engineering student population. Next-tier students are defined as those just below “making the cut” for acceptance to an engineering college based on its admission policies. We hypothesized that engineering colleges’ overreliance on standardized test scores in the admissions process inadvertently denies admissions to diverse students capable of becoming successful engineers.

**Design/Method**—Using the Multiple-Institution Database for Investigating Engineering Longitudinal Development (MIDFIELD) database of 226,221 engineering students, six-year graduation rates were analyzed for students with top quintile high school grade point averages and bottom quintile ACT/SAT scores, compared to students with bottom quintile GPAs and top quintile ACT/SAT scores.

---

<sup>1</sup> Submitted to the *Journal of Engineering Education* with authors: Beth A. Myers, Jacquelyn F. Sullivan, Angela R. Bielefeldt, Beverly Louie and Jeffrey Luftig, all associated with the University of Colorado Boulder



Results—Across a wide range of engineering colleges, students with top quintile high school GPAs but bottom quintile standardized test scores—a population wherein female and students from communities of color are overrepresented—have significantly higher six-year engineering graduation rates than students with top quintile test scores and bottom quintile GPAs.

*Conclusion.* Diversity in the engineering workforce can be expanded, with data-supported confidence, if engineering colleges aggressively admit more next-tier students who boast top high school performance yet have much lower standardized test scores than institutional averages.

Keywords—broadening participation, enrollment, gender, underrepresented students, admission policy and practice

### *Introduction*

The goal of this research is to identify new and realistic access pathways into and through engineering education for students from underrepresented populations, including women and historically underrepresented minority (URM) students from communities of color. The MIDFIELD dataset was used to support this quantitative research, providing an in-depth look into access variables and subsequent student success across 11 different institutions during a 20-year period (institutions shown in **Figure 15** in APPENDIX). Gaining insight into how high school GPA and ACT/SAT test scores—the two widely used variables that play the most significant role in engineering admissions—predict successful engineering graduation at the

undergraduate level may help change practices and policies that negatively impact the number and types of students admitted to the nation's engineering colleges.

To educate the number of engineers necessary to meet demand and propel our nation's competitiveness, as well as to continuously populate an engineering workforce reflective of the our nation's rich diversity, we must engage people from backgrounds historically underrepresented in engineering—especially women and minorities. Compelling drivers for increasing the number and diversity of engineers have been promoted by the National Academy of Engineering (NAE) (National Academy of Engineering; Committee on Diversity in the Engineering Workforce, 2002), the National Science Foundation (NSF) and the current U.S. president (Obama, Speech on Economy, 2009; Obama, The White House, 2013); however, the representation of women and people from communities of color, typically underrepresented in engineering, has not increased significantly in the last decade. Former NAE President William Wulf noted that "...for the United States to remain competitive in a global technological society, the country as a whole must take serious steps to ensure that we have a diverse, well trained, multicultural workforce." (National Academy of Engineering; Committee on Diversity in the Engineering Workforce, 2002)

Despite these national calls to action, little has changed in who the nation's engineering colleges graduate: predominantly majority men. Increasingly missing are students from those populations that grew the most on college campuses during the last two decades: women and minority men (U.S. Department of Education, Institute of Education Sciences, National Center for Education Statistics, 2015) who represent 19.6% and 10.5% of U.S. engineering bachelor's degrees earned in 2014. (American Society for Engineering Education, 1998-2015)

The number of U.S. engineering jobs is projected to increase in all engineering disciplines during the next decade; many disciplines are projected to grow faster than other labor sectors. (U.S. Department of Labor, 2015) While the number of undergraduate engineering degrees awarded in the U.S. fell dramatically from 77,572 in 1985 to a low of 59,214 in 2001, it is thankfully again on the rise with a high of 99,173 in 2014. (U.S. Department of Education, n.d.; National Science Foundation, 2014; American Society for Engineering Education, 1998-2015)

Yet, only 4.5% of all U.S. undergraduate degrees awarded across all disciplines in 2011 were in engineering—and outrageously, only 1.5% of all women graduating with bachelor's degrees are doing so in engineering disciplines. By comparison, 31% of all degrees awarded in China, 17% across Asia and 12% across Europe in 2010 were in engineering. (National Science Foundation, 2014) To better compete globally, the U.S. must expand the number and types of its citizens educated as engineers, which requires broadening participation to capture the creativity and passions of all our youth.

Progress towards this noble goal has been sluggish; during the last 10 years, 81% of all undergraduate engineering degrees were awarded to men, and 80% to Caucasian and Asian Americans while, according to the U.S. Census, they only represented 51% and 62% of the total college-aged population in 2010. (American Society for Engineering Education, 1998-2015; U.S. Department of Commerce, 2010) Clearly, engineering education's practices must change if we are to engage the other half of our nation's college-age youth.

To create a more competitive and creative engineering workforce, we need breakthroughs in how we attract and educate more diverse engineers. This is especially crucial given the changing demographics in our nation: between 2000 and 2010, the U.S. Hispanic/Latino population grew by 43%, versus a 5% increase in people who are not Hispanic/Latino; and the Hispanic

population is projected to keep growing. (U.S. Department of Commerce, 2010) Yet, despite a programmatic focus on increasing the representation of women and minorities in engineering during the last few decades, no single solution has been identified and is probably not realistic. But a systems approach, based on historical results and including evidence-driven changes in policy and practice, should be possible. Thus, a thorough understanding of the current climate of engineering admissions policies and practices across the range of MIDFIELD institutions was deemed a necessary starting point.

This research focuses on how to broaden the pathways into engineering college for students from underrepresented backgrounds and for the next-tier of potential students, subsequently expanding the diversity of the engineering student population. Next-tier students are those just below “making the cut” for acceptance to a given engineering college based on its admission requirements. These students are deemed to have high potential and probability for success in engineering if a pathway for their admissions and educational success could be identified. We found that at our own institution, URM students were historically admitted to engineering at a rate lower than their majority peers (51% for URM versus 64% overall admit rate from 2005-2009), primarily due to their pre-college course selections and lower scores on standardized ACT/SAT tests.

Our strategy for looking at admission policies and practices, and how they impact underrepresented student access to and through engineering, is derived from years of analysis and experience that led to significant change in our own institution’s student population.

When exploring myriad avenues to broaden participation, to our surprise we found that current applicants with the same high school academic profile as previous students who had successfully graduated from our engineering college a few years prior were no longer being admitted due to

their pre-admission standardized test scores. In an environment in which the NAE and NSF were beseeching engineering colleges to broaden participation, this finding seemed both out of synch with the times, and unsupported by evidence of what it takes to succeed in engineering. So, while our college's increasingly rigorous standardized test scores did not impact the total number of students being admitted to our college, it was having an impact on who was being admitted. This finding led us to explore what the outcome would be if we admitted those students with "next-tier" standardized test scores.

### *Literature Review*

The engineering admissions process is often conducted exclusively by offices of admissions with little or no direct input from their engineering colleges. And, many admission processes are considered "holistic," taking into account myriad performance variables. While this provides flexibility in making decisions, it also makes the process less transparent. (Holloway & Reed-Rhoads, 2008)

Purdue University found its admissions process a barrier for women to study engineering because of gender schemas and institutional bias (Holloway, Reed, Imbrie, & Reid, 2014) with significant gender differences in the metrics used for admission. Researchers concluded that the reasons might be that only the highest ability women are encouraged and/or self-select to apply to engineering, while men apply across a wider range of ability; women are held to a higher standard; and/or the institution's admissions counselors weighted standardized test scores more heavily than high school performance (females outperform their male counterparts on the latter). (Holloway & Reed-Rhoads, 2008; Holloway, Reed, Imbrie, & Reid, 2014) When the institutional bias was realized and processes were put in place to mitigate bias, the ratio of

women admitted to Purdue engineering markedly increased from 20% in its 2009 freshman class to 32% in 2015. (American Society for Engineering Education, 1998-2015)

The stated intention of standardized tests such as the SAT and ACT is to predict students' potential for college success; the tests are not intended to measure current knowledge or academic achievement, but to predict first-year college grades. (ACT Inc, 2008) However, research published by the College Board, who administers the SAT, shows that students' high school grades and class ranks are better predictors of first-year college grades than students' SAT scores. (Morgan, 1989; Korbin, Patterson, Shaw, Mattern, & Barbuti, 2008)

More recently, secondary and post-secondary educators question whether standardized test scores predict grades beyond the first year through to obtaining college degrees. (Mattern, Patterson, & Wyatt, 2013; Kobrin & Michel, 2006) Thirty-seven different studies have shown consistent gender bias in standardized tests, with a typical finding that women's college grades are under-predicted by the SAT standardized test. (Young & Korbin, 2001) In particular, Steinberg and Wainer and found that males score 35 points higher on SAT Math than females who earn the same grades in the same college math courses. (Steinberg & Wainer, 1991) Also, various studies have found no common pattern to the results for validity and prediction of SAT for different racial/ethnic minority groups. (Young & Korbin, 2001) And yet, standardized test scores are heavily used for admissions decisions by the nation's engineering colleges. (Myers & Sullivan, 2014)

Regarding the predictive validity of ACT scores, ACT itself has acknowledged that if an institution wants its admission criteria to reflect students' final college GPAs, then ACT scores should carry lesser weight in the admission process than high school grades. (ACT Inc, 2008)

Veenstra, Dey, & Herrin included a summary of eight research studies related to engineering academic success. Across all these studies, high school GPA or class rank was consistently a significant predictor of college GPA. They also found that predicting success of engineering students (as assessed by first-year GPA) is different than predicting success of general college students. Their findings revealed that ACT and SAT were each predictive of engineering student first-year GPA, but it was found that excellent high school preparation in math and science and confidence in math and computer abilities are more important for predicting first-year GPA success than ACT or SAT scores. (Veenstra, Dey, & Herrin, 2008)

To explain the various psychosocial factors related to academics and graduation outcomes of engineering students who participated in a specific math course, Bourne, Klingbeil and Ciarallo classified individual student ACT and GPA score combinations into four quadrants based on above and below the institutional averages. Students with high GPA and low ACT were categorized as “support seekers,” with researchers theorizing that this group of students outperform their academic talent through demonstrating a high degree of discipline, determination and goal orientation. Students with low GPA and high ACT scores were categorized as “purpose seekers,” theorizing that this group of students is generally unmotivated and may lack the discipline and commitment necessary to be successful in college. (Bourne, Klingbeil, & Ciarallo, 2014)

### *Research Framework*

In August 2013, an online survey regarding their admission policies and practices was sent to admissions decision-makers at 98 U.S. “high research-active” universities with engineering programs, in an effort to explore differences between what an institution’s online resources specify about their admissions priorities, and what their actual practices may be. Survey results

from 42 institutions indicate that institutions use a variety of factors to determine engineering admission eligibility. However, unsurprisingly, the pervasive three key factors were high school grade point average, and both math and comprehensive standardized test scores.

The four admissions variables ranked highest most frequently by those respondents who indicated multiple “extremely important” variables were: high school grade point average, math standardized test score, comprehensive standardized test score, and the quality of the high school course load. (Myers & Sullivan, 2014) Regardless of whether these factors are the best predictors of success, they are the ones most used in policies and practices that impact engineering admission decisions, and thus merit further investigation from a broadening participation perspective.

### *Research Questions*

**Research Question 1:** Are success rates for incoming first-time, first-year engineering students with top high school grade point averages (HSGPA) and bottom ACT/SAT scores statistically and meaningfully different than for students with bottom HSGPA and top ACT/SAT scores?

For this research question, the following terms were defined:

- Success: graduating within six years with an engineering bachelor’s degree
- Top: highest quintile
- Bottom: lowest quintile

Research Question 1 was based first on anecdotal observations, and subsequently on statistical results, which showed that this success rate phenomenon was true for engineering students at our own institution.



Quantitative analysis of 10 cohorts found that students who were near the top of their high school classes (earning impressive high school grade point averages) appeared to have the motivation and grit necessary to succeed in our engineering college regardless of their lower test scores, which while low for admission to our engineering college were near the campus average. And, those with less-than-stellar high school grades but who had outstanding test scores might have the acumen to succeed but may lack the determination and grit to stick through to the end.

It would not be surprising that a student's four-year high school track record would be a better predictor than standardized test scores of the student's long-term success to graduation in engineering college. However, admissions policies still put great emphasis on the standardized test scores—having the effect of making higher test scores serve as a gateway to an engineering education, even with evidence to the contrary.

Thus, we began to think more broadly: if different access patterns emerge from analysis of the MIDFIELD dataset, might engineering's "one size fits all" admissions practices be inadvertently denying admission to high potential students—especially those whose engagement in engineering has historically been underrepresented?

**Research Question 2:** Are six-year engineering graduation rates statistically and meaningfully different based upon the ethnicity and gender of the students within the groups defined above?

**Research Question 3:** Are six-year engineering graduation rates statistically and meaningfully different among groups of mission-equivalent institutions of higher education within the groups defined above?

*Research Design/Methods*

Data from the Multiple-Institution Database for Investigating Engineering Longitudinal Development (MIDFIELD) (Ohland, Zhang, Thorndyke, & Anderson, 2004) were analyzed. MIDFIELD includes 20 years of student record data at the 11 institutions; it contains records for the 204,413 students who ever declared engineering as a major from 1988 through 2009. The MIDFIELD schools comprise 11 public institutions in the U.S. whose size and diversity help make the research results generalizable to all engineering students at large public universities. The MIDFIELD institutions include four of the 10 largest U.S. engineering programs in terms of undergraduate enrollment, resulting in a study population that includes 10.5% of all engineering graduates of U.S. engineering programs.

Before filtering the data for purposes of our study, the MIDFIELD 1988-2009 cohorts include more than 41,000 female engineering students, or 20% of students in the study population—slightly higher than the national average of undergraduate enrollment in engineering during this time period. Likewise, Black students are noticeably overrepresented in the MIDFIELD dataset at 16.8% of the students (compared to enrollment percentages nationally of 5.9% in 2009): partner institutions graduate 20% of all U.S. Black engineering B.S. degree recipients each year, reflected in the MIDFIELD dataset that includes two Historically Black Colleges and Universities (HBCUs) and four of the top 10 producers of Black engineering graduates during the database time period. While the percentage of Hispanic students in MIDFIELD is low at 4%, it is not unrepresentative of U.S. engineering programs at large (that saw single digit enrollment percentages of Hispanic students during this time period). (Multiple-Institution Database for Investigating Engineering Longitudinal Development, n.d.)

Our approach to address the research questions was a quantitative analysis using a database with student demographics, high school grade point averages, pre-admission standardized test scores and the longitudinal engineering graduation record for individual students. The first stage of the work was preparation of the dataset by selecting the appropriate variables from a much larger set, and then filtering the records for those engineering students who met conditions for evaluation. These conditions include: students that have enough data to reveal a six-year graduation result; students had a high school grade point average; and students had a standardized test score, either SAT and/or ACT, on record. These conditions reduced the number of students in the research dataset to 90,892.

A demographic variable for underrepresented minority (URM) was created that includes anyone identified as “B,” “H” or “I” in the MIDFIELD database, the categories used to describe the ethnic groups to which individuals belong, identify with, or belong in the eyes of the community; they do not denote scientific definitions of anthropological origins. For this study, an individual person may be counted in only one group. A = Asian, B = Black/African American, H = Hispanic, I = Native American, N = International, W = White, X = Other/Unknown.” (Multiple-Institution Database for Investigating Engineering Longitudinal Development, n.d.)

The next stage was the calculation and recording of the percentile rank for each HSGPA and test score for each student, calculated within each of the institutions included in this study.

Calculating percentile ranks within institution was necessary because the variability across institutions (particularly in HSGPA) was large. Also, some institutions used a five-point scale for HSGPA while others used a four-point scale.

While ACT and SAT standardized test scores could have been pooled and calculated across all institutions, we concluded that the variability in the institutions’ student profiles warranted

within institution calculation. For example, the ACT twentieth percentile ranged from scores of 17 to 26 (out of 36) at the 11 institutions studied. Similarly, the SAT Math component twentieth percentile ranged from 460 to 610 (out of 800), a 150-point range across institutions.

The third stage of the analysis included removing the records of students who had conflicting variables in their profiles. For example, a student who had a top ACT and bottom SAT score, or vice versa, would be removed since it was not clear how each institution's admission review would assess these students. This reduced the number of students in the dataset slightly to 89,325. Post filtering we found 19,078 or 21% females, 8,768 or 10% Black, 2,627 or 3% Hispanic and 320 or 0.4% Native American. We elected to keep ACT and SAT scores independent to see if differences arose between the two measures; however, the results in this paper focus on students who were top or bottom in either or both measures as long as the scores were not conflicting. Also, at one institution the ACT scores were removed from analysis because they were deemed unreliable.

Quintile Comparative Performance—Individual student records were defined as having a top HSGPA, ACT, SAT Math, SAT Verbal or SAT Total if they fell in the top quintile of all student records from the same institution. Similarly, students were defined as having bottom HSGPA, ACT, SAT Math, SAT Verbal or SAT Total if they fell in the lowest quintile. Initially the top and bottom deciles were also investigated; however, due to small numbers of students who were defined as having both top HSGPA and bottom test scores at many of the institutions, we moved to using the top and bottom twentieth percentile, quintiles, for all subsequent analyses.

Six-year graduation rates are used as a standard metric by the U.S. Department of Education as a requirement of the 1990 Student Right-to-Know Act, which directed postsecondary institutions to report the percentage of students that complete their programs within 150% of the normal time

for completion (that is, within six years for students pursuing a bachelor's degree). The Integrated Postsecondary Education Data System (IPEDS) helps institutions respond to this requirement. (National Center for Education Statistics, n.d.) Because of this standard, six-year graduation rates are widely used in higher education and are typically the cited benchmark; therefore, this research used six-year graduation rates as the metric to define graduation success.

As with many of the analyses performed for cohort data, the issue of whether statistical significance and associated statistical tests of significance can be applied to these data is worth pondering. Classical statistical theory dictates that inferential statistical tests be conducted on data that represent a random sample or subgroup of the research population of interest. Since we used the entire cohort at each institution (N rather than n) for these analyses, these data cannot be argued to represent a random sample in time. However, many researchers would argue that the cohort, even taken in its entirety, might be interpreted as representing a random sample of cohorts through time (NTx); and that given this interpretation, inferential statistics may be applied. If the reader is determined to employ the former interpretation, then any observed difference in the descriptive statistics represents a true difference (although it still may not be an important difference, practically speaking). If the reader interprets the data utilizing the latter interpretation of random sampling theory, then the tests of significance presented can assist in determining whether the observed differences are indeed consequential, or simply due to sampling error (chance). For the purposes of this study, even if this latter interpretation is employed by the reader, the statistical differences, correlations, or associations identified should be interpreted as relational rather than causal in nature.

Statistical tests of significance as employed in the analysis of the data in this study indicate whether an observed difference may have occurred due to sampling error (chance or random

variation), or whether the difference is real. Having said that, finding a statistically significant difference does not by definition imply that the observed difference is **important**. All statistical tests of significance are accompanied by statistical measures associated with the importance of the difference; often expressed (for continuous data sets) as a percentage of explained variability, as with (for example)  $r^2$  and  $\omega^2$ . However, similar indices are available for all measurement scales. For crosstabulation tables of size  $2 \times 2$ , following the use of Fisher's Exact test (assuming a statistically significant difference is found), the calculation of phi ( $\phi$ ) presents a measure of importance for the observed difference.

It should be noted that, due to sample size variation, these statistical measures of importance can reveal results that are spurious, despite the p-values calculated for the statistical tests of significance. For example, at samples sizes of 100,000, proportions of (again, for example) of 3% and 3.2%, compared for two independent groups would yield a 2-tailed p-value of 0.010 for Fisher's Exact test, but a  $\phi$  of only 0.006 (possible values of phi range from 0 to 1). While the difference might be statistically significant, it would likely, under these circumstances, not be considered statistically important. Nor would the difference, especially for the type of study described in this article, be considered functionally important; or meaningful.

This last observation is critical, because when sample sizes are very small, it is possible to find a significance level of 0.000 when comparing two proportions, accompanied by a  $\phi$  of (for example) 0.4; yet with an observed difference in proportions might be 40% (e.g., 20% versus 60%). In cases such as these, it is important to remember that in this study, the differences are calculated for the entire cohort analyzed. Therefore, any difference is a true difference, because we are using subgroups of a research population rather than random samples. Evaluation of

functionally and statistically meaningful differences are provided in the interpretations of the observed differences identified throughout this study.

Once student records were assigned quintiles within each institution, the proportion of students that graduated within six years from engineering were compared from the two groups being researched. The Fisher exact test (Fisher, 1945) was used to compare the proportions using a contingency 2 x 2 table for each group. The Fisher exact test is used when a comparison of the independence of the relative proportions of two nominal variables is sought. Fisher's exact test is more accurate than the chi-squared test when the expected numbers are small. (Yates, 1984) Since certain populations of students are small—particularly when looking at the URM graduation rate within institution—it was concluded that the Fisher exact test would be preferable to a chi-squared test.

The assumptions for the Fisher exact test are that the sample is composed of independent observations, meaning the value of one observation does not affect the value of other observations, and that the marginal totals of the observed table are fixed. Having fixed marginal totals means that each student is classified into only one category of the row variable and one category of the column variable, which holds true in our research because students are either in one group or the other and are categorized as graduated from engineering in six years or not. Conversely, a common source of non-independence is that observations are close together in time or space, which is not the case with our data.

Both the assumptions of independent observations and marginal totals are met in our research dataset. A maximum type I error of  $\alpha = 5\%$  was used; therefore, we consider a statistically significant difference if a p-value of less than 0.05 is calculated. If this is the case, we have sufficient statistical evidence to infer that the students with top HSGPA and bottom standardized

test scores have different six-year engineering graduation rates than students with bottom quintile HSGPA and top quintile test scores.

The phi coefficient of association statistic was also calculated to help determine the importance of any statistically significant differences. The phi coefficient ranges between -1 and 1 for 2 x 2 tables with 0.7 to 1.0 representing a strong positive association and -1.0 to -0.7 representing a strong negative association. The findings also inform the discussion of whether any observed differences are seen as important to policies and practices that could serve to broaden participation in engineering education.

After assigning students to quintiles within institutions, all students within the two groups being studied were combined using the institution-specific quintiles and then equivalent quintiles were compared. While engineering graduation rates were calculated within institution for each group (see **Table 6** in Chapter 2 Appendix for detail), the pooled overall results are presented here.

Also, graduation rates based on the top and bottom quintiles for each standardized test and test category were assessed, however, the findings presented here are based on unique students who had any test score that was defined as top or bottom based on the quintile ranks. While quintile comparative performance was pooled, actual quintile values for test scores and HSGPA across institutions should not be associated with one another because they vary significantly.

Individual institutions are not identified, but the profiles of each of the 11 institutions included in the study were created for research purposes so that mission-similar institutions could be pooled for analysis and reporting purposes. Because we think it is more relevant for policy makers and educational leaders to evaluate these research results in the context of institutions similar to their own, we peered into the data by institution size, undergraduate engineering program ranking,



research activity level and the percentage of the total student body in engineering. Thus, we report “pooled category” results at various types of institutions as well.

### *Findings*

When the students with HSGPA in the top quintile coupled with bottom quintile test scores are pooled from all 11 institutions, we find that they have a significantly higher six-year graduation rate, 51%, compared to their peers who, with 36% six-year graduation rate, entered engineering college with the bottom quintile HSGPA and top quintile test scores ( $p = 0.000$ ,  $\phi = 0.150$ ). This holds true for underrepresented minority students (50% versus 26%,  $p = 0.000$ ,  $\phi = 0.225$ ) and females (54% versus 31%,  $p = 0.000$ ,  $\phi = 0.191$ ), see **Table 2**. For comparison, the overall engineering graduation rate for all students in the dataset, across all comparative quintile performance groups, is 49%. The graduation rate for all students not part of the two comparative quintile subgroups studied is 50%.

It is also worth noting that underrepresented minority students are overrepresented among the top HSGPA + bottom test score students in the dataset (28% versus 13% in the dataset) and underrepresented in the bottom HSGPA + top quintile test score group (9% versus 13% in the dataset).

This finding also held true for female students—who made up 36% of top HSGPA + bottom test score students in MIDFIELD (overrepresented), but underrepresented at only 9% of students entering engineering with bottom HSGPA + top test scores—even though they comprised 21% of the study dataset, as shown in **Table 2**.

A question worth pondering then, is: what are the demographic variables describing the majority of students in the bottom HSGPA + top test score subgroup in the study? Although comprising 70% of students in the study dataset, majority males accounted for only 49% of top HSGPA +

bottom test score students, but 84% of bottom HSGPA + top test score students. Thus, majority men are represented in drastically different rates among the two groups, further highlighting that the engineering admission system may be optimized for majority male students, turning a blind eye to their poorer high school track records in favor of high scores on standardized admissions tests—with no evidence that this test score bias actually produces engineers for the workforce.

**Table 2.** Six-year engineering graduation rates, by demographic, across all institutions.

	Top Quintile HSGPA + Bottom Quintile Test Score		Bottom Quintile HSGPA + Top Quintile Test Score		Fisher Exact	
	N	Grad Rate	N	Grad Rate	p-value	phi
All	3140	51%	4296	36%	0.000*	0.150
URM	878	50%	376	26%	0.000*	0.225
Female	1137	54%	372	31%	0.000*	0.191

\*  $p < 0.05$ , significant difference

For comparison purposes, the engineering graduation rates for all students studied in this dataset are presented in **Table 3**. For all students in the dataset, across the 11 institutions, the six-year engineering graduation rate is 49%, and it is 42% and 50% for URM and female populations, respectively.

A large number of students matriculate into engineering but change majors and earn non-engineering degrees within the same institutions. Since many institutions use the overall institution graduation rate metric, we also looked at the six-year institutional graduation rates for students within the comparative quintile performance groups, as shown in **Table 3**. The “Add’l” column shows the additional percentage of students who graduated within six years from non-engineering degrees at the same institutions and the Overall column gives the overall six-year institution graduation rate. Within each demographic group, the top quintile HSGPA + bottom

quintile test score group had statistically significantly higher overall institutional graduation rates than bottom quintile HSGPA + top quintile test score group.

**Table 3.** Six-year institution graduation rates, by demographic, across all institutions.

	All Students			Top Quintile HSGPA + Bottom Quintile Test Score			Bottom Quintile HSGPA + Top Quintile Test Score		
	N	Eng Grad	Overall	Eng Grad	Add'l	Overall	Eng Grad	Add'l	Overall
All	89325	49%	67%	51%	18%	69%*	36%	16%	52%
URM	11715	42%	57%	50%	16%	65%*	26%	15%	40%
Female	19078	50%	72%	54%	19%	73%*	31%	27%	59%

\* Statistically significantly higher than bottom quintile HSGPA + top quintile test score, all p-values = 0.000,  $\phi$  = 0.171, 0.234, 0.131

Institutions were also categorized using research activity level, undergraduate engineering program ranking, institution size and the engineering percentage of the student body. For research activity, each of the 11 institutions' Basic Carnegie Classification<sup>TM</sup> (The Carnegie Classification of Institutions of Higher Education) was used. Seven of the 11 institutions are considered research universities with very high research activity (RU/VH) and the other four are either research universities with high research activity (RU/H) or doctoral/research universities (DRU). When the quintile pairings are applied, similar trends emerge for the RU/VH and non-RU/VH institutions, with statistically significantly higher graduation rates for the top quintile HSGPA + bottom quintile test score students versus the bottom quintile HSGPA + top quintile test score students (49% vs. 40%,  $p = 0.000$ ,  $\phi = 0.090$ ; 59% vs. 29%,  $p=0.000$ ,  $\phi = 0.339$ ).

A significant difference in six-year engineering graduation rates is not found for the URM populations at the RU/VH institutions (40% vs. 35%,  $p = 0.299$ ) but is found when comparing female students in the two groups (50% vs. 38%,  $p = 0.003$ ,  $\phi = 0.091$ ), favoring the top quintile HSGPA + bottom quintile test score student group, as shown in .

Using the U.S. News & World Report *Best Undergraduate Engineering Program Rankings* for institutions at which doctoral degrees are awarded (U.S. News & World Report), the student data were pooled among those with rankings above and below 50. Rankings were considered for the five-year period between 2011 and 2016; while some shifts occurred, using the <50 and >50 approach meant that no schools changed groups. Six of the MIDFIELD schools were top 50 ranked.

Using this “ranking” pooling method, we found statistically significantly higher graduation rates for top HSGPA + bottom test score students than for bottom HSGPA + top test score within both ranking groups (52% vs. 40% at top 50 ranked,  $p = 0.000$ ,  $\phi = 0.117$ ; 48% vs. 26% at the institutions not ranked in the top 50,  $p = 0.000$ ,  $\phi = 0.361$ ). At the six top 50 ranked institutions in the study, a significant graduation rate difference is not found among URM students within the two groups (44% vs 36%,  $p = 0.112$ ), but is found in the five institutions not ranked in the top 50 (57% vs. 19%,  $p = 0.000$ ,  $\phi = 0.358$ ). For female students, as shown in , a significant graduation rate difference is found at both institution types (52% vs. 39% at top 50 ranked,  $p = 0.000$ ,  $\phi = 0.111$ ; 57% vs. 21% at the institutions not ranked in the top 50,  $p = 0.000$ ,  $\phi = 0.331$ ).

Institution size was categorized using the Carnegie Classification (The Carnegie Classification of Institutions of Higher Education) student population values for the entire institution (including engineering and non-engineering students) from the 2008-10 timeframe, which overlaps the last cohort of data in the MIDFIELD database. When categorizing institutions as either greater or less than 20,000 students, the MIDFIELD dataset includes eight and three institutions, respectively. The same trend was found, with statistically significantly higher graduation rates for the top quintile HSGPA + bottom quintile test score students overall (49% vs. 40%,  $p = 0.000$ ,  $\phi = 0.095$ ; 60% vs. 25%,  $p = 0.000$ ,  $\phi = 0.341$ ) and for females (50% vs 38%,  $p = 0.002$ ,

$\phi = 0.095$ ; 66% vs. 20%,  $p = 0.000$ ,  $\phi = 0.438$ ). However, no significant difference was found for URM populations in the larger institutions (40% vs. 35%,  $p = 0.262$ ), but a significant difference was found within the smaller institutions (64% vs. 19%,  $p = 0.000$ ,  $\phi = 0.434$ ), as shown in **Table 4**.

Lastly, the engineering percentage of the student body was calculated for each institution during the same time by employing the Carnegie student population values and engineering enrollment numbers published by the American Society for Engineering Education (American Society for Engineering Education, 1998-2015). For comparison, two approximately equal groupings were formed: six institutions had >20% engineering students, while five had fewer than 20%.

Significantly higher six-year engineering graduation rates for students with the top quintile HSGPA + bottom quintile test scores are seen for both types of institutions and within each demographic group studied, as shown in **Table 4**.

Of note is that for all cells in which the proportion differences were not found to be statistically significant, the N for the bottom quintile HSGPA + top quintile test score was fewer than 170 students.

Think impact; in an overwhelming number of cases, a functionally important and highly meaningful difference of greater than a 10% higher six-year graduation rate was found for the top quintile HSGPA + bottom quintile test score group compared to the bottom quintile HSGPA + top test score group. Given the over-representation of women and minority students in the former group, finding evidence that lower test scores were not predictive of their success in graduating with an engineering degree in six years could have huge impact on who is admitted to the hallowed halls of engineering colleges.

**Table 4.** Six-year engineering graduation rates by demographic and institution profile.

	All					Underrepresented Minority					Female				
	Top Quintile HSGPA	Bottom Quintile HSGPA	+ Fisher Exact p-value	$\phi$	$\Delta$	Top Quintile HSGPA	Bottom Quintile HSGPA	+ Fisher Exact p-value	$\phi$	$\Delta$	Top Quintile HSGPA	Bottom Quintile HSGPA	+ Fisher Exact p-value	$\phi$	$\Delta$
All	51%	36%	0.000*	0.150	<u>15%</u>	50%	26%	0.000*	0.225	<u>24%</u>	54%	31%	0.000*	0.191	<u>22%</u>
RU/VH (N=7)	49%	40%	0.000*	0.090	9%	40%	35%	0.299		5%	50%	38%	0.003*	0.091	<u>11%</u>
Non RU/VH (N=4)	59%	25%	0.000*	<b>0.339</b>	<u>34%</u>	64%	19%	0.000*	<b>0.429</b>	<u>45%</u>	66%	20%	0.000*	<b>0.435</b>	<u>46%</u>
Ranked Top 50 (N=6)	52%	40%	0.000*	0.117	<u>12%</u>	44%	36%	0.112		8%	52%	39%	0.000*	0.111	<u>13%</u>
Not Ranked Top 50 (N=5)	48%	26%	0.000*	<b>0.361</b>	<u>23%</u>	57%	19%	0.000*	<b>0.358</b>	<u>38%</u>	57%	21%	0.000*	<b>0.331</b>	<u>36%</u>
Size >20k (N=8)	49%	40%	0.000*	0.095	9%	40%	35%	0.262		5%	50%	38%	0.002*	0.095	<u>12%</u>
Size <20k (N=3)	60%	25%	0.000*	<b>0.341</b>	<u>35%</u>	64%	19%	0.000*	<b>0.434</b>	<u>46%</u>	66%	20%	0.000*	<b>0.438</b>	<u>46%</u>
Eng >20% (N=6)	56%	36%	0.000*	0.189	<u>20%</u>	43%	27%	0.000*	0.177	<u>17%</u>	54%	32%	0.000*	0.209	<u>22%</u>
Eng <20% (N=5)	47%	36%	0.000*	0.107	<u>11%</u>	55%	23%	0.000*	0.245	<u>32%</u>	53%	32%	0.000*	0.147	<u>21%</u>

\* p < 0.05, significant difference

\*\* Cells highlighted in yellow indicate statistically important differences.

\*\*\* Underlined values indicate functionally important (highly meaningful) differences.

Another finding is that even though only 7,436 of the 89,325 students in the study fell into the top/bottom HSGPA and test score combination quintile groups, more of those admitted engineering students (4,296) were found in the bottom quintile HSGPA + top quintile test score group than the converse (3,140). Are more students given the benefit of the doubt in engineering admission if they have top test scores, than if they have a stellar high school track record? This was true at our institution, which had a long tradition of admitting students with top test scores in spite of their non-stellar high school track records. It is unclear whether this finding across multiple institutions is the result of admission policies, implicit bias in their “unwritten” implementation, and/or the pool of students who applied to the 11 engineering colleges. Admission policies and/or practices do appear to vary in acceptance of students with lower test scores in that four of the 11 institutions had larger numbers of students in the top quintile HSGPA + bottom quintile test score category, as was true for the institutions that had less than 20% of their student bodies studying engineering. As an engineering student body grows proportionally, does an institution’s preference for admission of students with higher test scores grow too? If so, is this intentional? Is it strategic?

At the institutional level, bias towards top test scores versus top HSGPA appears to be unwarranted, in that significantly higher engineering graduation rates by the top quintile HSGPA + bottom test scores group held true at eight of the 11 institutions studied. At two of the other institutions, the graduation rate between the groups was equal and one was an outlier, with higher graduation rates among the bottom HSGPA + top test score students. Something appears to be different at these three institutions: even though they had some of the highest ratios of students in the top quintile HSGPA + bottom test score group, they do not see higher graduation rates for students with that profile.

*Results and Discussion*

The findings presented have enormous implications for engineering admission policies and practices. Significantly higher rates of graduation from engineering have been demonstrated by students with the combination of top quintile HSGPA/bottom quintile test scores than the reverse—the group in which significantly higher percentages of women and URM students are also found. We cannot in any good conscience espouse a commitment to broadening participation in engineering while differentially biasing admission to those students who achieve high standardized test scores—namely majority men—in spite of the evidence that lower test scores coupled with very strong high school academic track records are better predictors of both success to graduation and equity in access for women and students of color.

If we espouse broadening participation but limit admission to engineering to students who benefitted by strong reliance on the use of standardized test scores, predominantly majority male students, we are not addressing the potential success nor creating equity in access to students with stellar high school performances. Nor are we benefiting either the growing population of students from demographics (e.g., women or students of color) who are underrepresented in the engineering profession. With extensive research showing that diverse groups of people enhance design and research teams, workplaces, schools and societies (Page, 2008; Wilde, 2011; Freeman & Huang, 2015; Phillips, 2014), the engineering profession and preceding engineering education, would both be enhanced if participation was broadened.

Educators and admission decision-makers anguish over the varying quality of pre-college education that students receive. And, with the huge increase in the number of students earning weighted grade point averages from taking honors, advanced, IB and AP courses, debate ensues about how comparable high school grade point averages really are across high schools. Some



argue that a 4.0 GPA on a 4.0 scale is “better” than earning a 4.0 on a 5.0 scale, as that means students have earned all A grades during high school—deemed more accomplished than earning a 4.0 GPA using weighted B grades. Using a standardized test, like ACT or SAT, may serve as a university’s convenient proxy for which students they perceive to be academically “prepared” for college study irrespective of these high school grade questions. And, the variability in grading, access to quality education and pre-college learning quality may have nudged engineering admission teams to rely more heavily on the standardized test measures; however, the results of this investigation show that prospective next-tier engineering students with robust high school grade point averages similar to the top 20% of an institution’s historic cohorts should be considered for admission, even if they have test scores that are low relative to the institution’s historic admission profile.

In practice, the top quintile high school GPA for students at an engineering college might be 4.0 – 5.0, depending on the scale used. As this research demonstrates, relying on the grade point average metric—which demonstrates student performance results over the entire four years of high school—instead of standardized test scores, provides more opportunity for female and underrepresented minority students to be admitted to engineering, with a high degree of evidence-based confidence that they will succeed.

In addition, standardized tests are high-stakes exams, instances in which research indicates that stereotype threat may impact outcomes of both women and underrepresented minority students, particularly in math. (Aronson, Quinn, & Spencer, 1998) Thus, the heavy weighting of standardized test scores for engineering admission is particularly onerous for underrepresented minority students who score lower than majority students in all subject areas. (The College Board, 2015; ACT, Inc., 2015)

As stated before, 37 different studies have shown consistent gender bias in standardized tests, with a typical finding that women's college grades are under-predicted by the SAT standardized test. (Young & Korbin, 2001) In particular, Steinberg and Wainer found that males score 35 points higher on SAT Math than females who earn the same grades in the same college math courses. (Steinberg & Wainer, 1991) Also, various studies have found no common pattern to the results for validity and prediction of SAT for different racial/ethnic minority groups. (Young & Korbin, 2001) Regarding the predictive validity of ACT scores, ACT itself has acknowledged that if an institution wants its admission criteria to reflect students' final college GPAs, then ACT scores should carry lesser weight in the admission process than high school grades. (ACT Inc, 2008)

Our results are clear: students with top quintile high school grade point averages and bottom quintile standardized test scores have statistically significantly higher six-year engineering graduation rates than students with top quintile test scores and bottom quintile high school grade point averages. This holds true for female and underrepresented minority students, who are overrepresented in the former group—and whom engineering colleges have increasingly invested larger and larger amount of resources to groom and recruit. Yet, these same institutions have not admitted women and underrepresented minority students—who took the initiative to both prepare themselves academically (as represented by their HSGPAs) and demonstrate sufficient interest in the engineering profession to apply to engineering colleges—because their standardized test scores were deemed to be too low.

This research shows that one of many pathways institutions should immediately pursue to broaden participation in engineering is to open a now-obvious conduit for students with top quintile HSGPA even when their standardized test scores are quite low compared to the

institutional standard. Success in engineering can be increased if more focus is placed on admitting these high-potential, next-tier students rather than those with top standardized test scores in the presence of bottom high school grade point averages.

This is when the difficult truth conversation begins. This research demonstrates that educational quality (here, defined by success through to graduation in engineering within six years) and increasing diversity in the engineering student population can and should go hand in hand. The benefit of changing admission practices to “standardly” admit students with top quintile HSGPA + bottom quintile test scores is clear for broadening participation in engineering. A secondary benefit to the institution, as demonstrated by this research, is strong persistence to graduation among these students.

To be sure, the engineering and total institutional graduation rates are highest if an institution only admits the top quintile HSGPA + top quintile test score students, but very few institutions have a strong enough applicant pool to only admit these students. Equally important—and of particular concern for public institutions—to consider is equity in access to an engineering education: the top quintile HSGPA + top test score group is comprised of 28% female and only 5% URM students, whereas the successful (as defined by graduating in engineering) top quintile HSGPA + bottom quintile test score group is comprised of a much more representative 36% female and 28% URM students. Thus, the opportunity for engineering colleges to broaden participation by differentially admitting students whose application profile is top quintile HSGPA + bottom quintile test score is huge, bolstered by confidence that these students will graduate and strengthen the engineering workforce.

**Table 5** shows that institutions could have a much more diverse cohort and maximize graduation rates by differentially admitting students with top quintile HSGPA + bottom quintile test scores

versus the historical approach of admitting (mostly majority male) students in the bottom quartile HSGPA + top quartile test score group, whose graduation rate from engineering is an unimpressive 36%.

Through the lens of broadening participation, a fresh look at an institution's admission practices may be in order, given the findings of this study that women and URM students are overrepresented among students with top high school performance coupled with bottom standardized test scores, and that if admitted, achieve strong six-year graduation rates from engineering colleges.

**Table 5.** Summary of graduation rates and percentages of URM and female students.

	Eng Grad Rate	Total Institution Grad Rate	% URM	% Female
All	49%	67%	13%	21%
Top Q HSGPA + Bottom Q test	51%	69%	28%	36%
Top Q HSGPA + Top Q test	64%	78%	5%	28%
Bottom Q HSGPA + Top Q test	36%	52%	9%	9%
Bottom Q HSGPA + Bottom Q test	37%	57%	23%	15%

### *Limitations*

A limitation of this study is that only 11 institutions are included in the analysis, and while their sizes and diversity help make the results generalizable to engineering students at large public universities, they are similar to each other in many ways. All the institutions are public, research universities with high or very high research activity or are doctoral/research universities. None are small, private or liberal arts college settings. While this is a limitation of the results, the types of institutions included in this study graduate the majority of the nation's engineering bachelors' recipients each year.

Further, the applicability of this research may be limited to institutions with limited or selective admissions criteria, and thus might have no application at “open admissions” or “open enrollment” institutions.

Another study limitation is that even when the historic data from the 11 MIDFIELD institutions were pooled together, the dataset still contained small numbers of URM students in the bottom HSGPA + top test score category, in some instances fewer than 170 students. These small population sizes may lack the power necessary to realize statistical differences, even when a meaningful difference may exist. Consideration that so few URM students were found in this population of admitted engineering students may reveal yet another subtle (but potentially impactful) admissions bias previously unreported in engineering education literature.

A limitation of the findings is also that the size of the pool of students who could have been admitted if the institution’s policy were to admit top HSGPA students regardless of their test scores is unknown. Are students with this profile less represented in the dataset because they were less likely to be admitted? Or, do fewer students fall into this category, and therefore fewer apply to engineering colleges? Experience at our own institution showed that while students with this admission profile did apply to engineering, they tended to be declined admission. Informed by early institutional-level research, recent changes in our engineering admission practices (including admitting this profile of student) has resulted in drastic increases in the representation of URM and female students in our first-year engineering cohorts. And, based on this study, we expect this “next-tier” of student to be just as successful as their majority male engineering peers.

Another limitation of this study is that even though the comparative quintile performance was determined within institution, admission policies and practices may have varied through time, causing changes in who would fall into different quintiles.

### *Implications*

Systems are pervasive in engineering; why not also in engineering education? Realizing that an important problem engineering colleges nationwide are solving for is broadening participation, we encourage policy and admissions decision makers to have a *bias to action*. The research results presented here should bolster institutions to admit next-tier engineering students who would not likely be accepted with today's broadly applied, test score heavy, admission practices—but who, evidence shows, have high potential and probability for success in engineering if provided access pathways. Understanding the landscape surrounding underrepresented student entry to engineering college is the first-step in identifying more equitable admissions policies and practices, with the goal of populating a creative engineering workforce representative of our nation's rich diversity of ideas, perspectives, experiences and people.

Some might fear that implementing changes to engineering admission policies or practices to be more inclusive of high-performing students with low test scores might poorly influence their institutional rankings. While implementing a strategy similar to the one proposed herein at our own institution over the last few years, we have not seen a decrease in our overall average standardized test scores, but have seen a drastic change in the representation of female and URM students in our engineering college. We hope to push this even further in the future through expanding the profile of students we welcome for admission, convinced that this is good for our engineering students and faculty, the engineering profession and our nation. Ultimately, organizations get what they measure; perhaps one day positive evidence of broadening participation will be accounted for in college rankings.

The results of this analysis, specific to engineering students, augment the test optional admission practice now employed at several highly selective and Ivy League institutions. While our own institution is nowhere near ready to go test optional, making changes that will expand the admission rate of next-tier engineering applicants is happening.

The next step in this research is to investigate whether minimum threshold values of HSGPA and standardized test scores exist that predict successful graduation from engineering. Knowing if these thresholds exist and what they are, coupled with which next-tier students have the best likelihood of success in engineering, can help further broaden participation in engineering.

#### *Acknowledgments*

This material is based upon work supported, in part, by the National Science Foundation under grant number EEC 1160264. This article is part of the first author's dissertation research, and we thank the committee members Amy Javernick-Will and Fernando Rosario-Ortiz for their helpful feedback and suggestions, and grant co-PIs Kevin O'Connor and Daria Kotys-Schwartz. We also thank Matt Ohland and Russell Long for their help accessing the MIDFIELD database.

## Chapter 2 Appendix

**Table 6.** Engineering graduation rates calculated within institution for each group.

Institution	All			URM			Female		
	Top Quintile HSGPA	Low Quintile HSGPA	Fisher Exact p-value	Top Quintile HSGPA	Low Quintile HSGPA	Fisher Exact p-value	Top Quintile HSGPA	Low Quintile HSGPA	Fisher Exact p-value
	+ Low Quintile Test Score	+ Top Quintile Test Score		+ Low Quintile Test Score	+ Top Quintile Test Score		+ Low Quintile Test Score	+ Top Quintile Test Score	
A	58%	41%	0.000*	69%	44%	0.074	58%	33%	0.023*
B	19%	38%	0.080	29%	35%	0.782	26%	40%	0.905
C	17%	36%	0.000*	18%	18%	1.000	17%	33%	0.371
D	38%	39%	0.643	30%	57%	0.018*	34%	40%	0.724
E	71%	45%	0.000*	70%	28%	0.004*	76%	45%	0.002*
F	68%	41%	0.000*	55%	48%	0.617	61%	50%	0.293
G	68%	4%	0.000*	71%	3%	0.000*	71%	10%	0.000*
H	58%	40%	0.001*	50%	31%	0.343	49%	25%	0.066
I	56%	26%	0.001*	63%	100%	N/A	56%	20%	0.469
J	88%	26%	0.000*	N/A	24%	N/A	80%	20%	0.000*
K	43%	38%	0.049*	30%	15%	0.225	39%	38%	0.986
All	51%	36%	0.000*	50%	26%	0.000*	54%	31%	0.000*

\*  $p < 0.05$ , significant difference, one instance is found to be significant in which low quintile HSGPA + top quintile test score students have a higher engineering graduation rate, institution C for all students



*CHAPTER 3—Critical Threshold*

**Research Question 2:** Is there a critical threshold for high school GPA and SAT/ACT that accurately predicts URM student success (defined as six-years to graduation) in engineering? Does the threshold vary by higher education institution?

This research question is a follow-on to the previous work and relies on the same background. In addition, **Table 7** displays the entry class metrics for students at various types of engineering institutions for the fall 2012 entry cohort at all engineering colleges across the U.S. that provided their data to the American Society for Engineering Education. (American Society for Engineering Education, 1998-2015) These specific entry metrics, which can be used as a proxy for admission requirements, are lower for Historically Black Colleges and Universities and Hispanic Serving Institutions than for other engineering colleges (for the ACT Math 25<sup>th</sup> percentile, Wilcoxon-Mann-Whitney HBCU vs. All,  $p=0.007$ , HSI vs. All,  $p=0.000$ , the difference in the two medians is significant and could not have come from a single population with the same median value). It is interesting to note that the ACT Math 25<sup>th</sup> and 75<sup>th</sup> percentile values are maxed out at a score of 36 in at least one of the engineering colleges. This means that the vast majority of the students at that institution had perfect ACT Math scores.

**Table 7.** Engineering entry class metrics for the 2012 cohort by institution type.

Institution Type		ACT Math 25%ile	ACT Math 75%ile	SAT Math 25%ile	SAT Math 75%ile	Percent Top Quartile HS class
HBCU (N=6)	Minimum	16	23	420	555	42
	Median	20	26	483	630	64
	Maximum	26	30	600	770	80
HSI or >30% Hispanic (N=12)	Minimum	11	26	200	570	21
	Median	22	28	535	650	59
	Maximum	25	36	570	800	100
All U.S. Engineering (198-205)	Minimum	9	14	200	520	11
	Median	25	30	600	695	70
	Maximum	36	36	760	800	100

Now that the evidence is clear that students with bottom quartile standardized test scores, when combined with top quartile high school grade point averages, are successful (as measured by six-year engineering graduation), the next question is whether *a minimum test score and high school grade point average* exist that predict success for underrepresented students, and if so, what values are above and below the threshold. We investigated whether the data supports using a singular combined threshold using both high school grade point average (HSGPA) and standardized test scores, or whether the data suggests using another model for predicting success in engineering as measured by a six-year engineering graduation rate.

### *Methods*

For this investigation, the same MIDFIELD database was used, however, all the standardized test scores were converted to SAT values using the pre-2005 version of the ACT-to-SAT concordance table, reproduced in **Table 34** the APPENDIX. (ACT and SAT, 2008) In the MIDFIELD database, the only ACT score variable provided is ACT Composite; therefore, all SATs were also converted to a total score—with a maximum of 1600 (sum of SAT Verbal and SAT Math, MIDFIELD data timeframe before SAT switched to separate Critical Reading and

Writing scores with a maximum of 2400). For students with two SAT values after the conversion, the higher score was used.

Next, all high school grade point averages were converted to a 5.0 scale. Our rationale is that only five of the 11 institutions had maximum high school grade point averages less than 5.0; thus, converting to a 5.0 scale conserved data resolution among the six institutions using the wider 5.0 scale. It is not clear how each institution tracked the high school grade point average initially; a 4.0 at one school might be comparable to either a 5.0 or a 4.0 at another.

Unfortunately this is a limitation of the MIDFIELD dataset. For example, at our own institution, a student who attended a high school that offered AP, advanced or honors courses that were graded on a 5.0 scale could have an average grade point higher than 4.0. As an example, let's assume a student earned As in every one of his or her courses, including those weighted on the 5.0 scale. That high school grade point average could be quite a bit higher than 4.0, however, in our student database we input a maximum of 4.0. Assume another student at the same school took the exact same course load and earned Bs in every weighted course. This second student could still earn a 4.0 and would appear the same in our system. Yet a third student who attended a school with no 5.0-weighted courses could also get a 4.0 grade point average if s/he earned all As across his/her transcript. Each of these three students might have had different experiences and outcomes from the courses they took, however, in our system, in which a 4.0 is the GPA maximum, they would appear the same. Other institutions use a different approach for tracking high school grade point averages, using the maximum value the high school reports on the student transcript. Unfortunately, we do not know the method used at each of the 11 MIDFIELD institutions; however, the two data changes allow comparison across and within all 11 institutions with the same variable and variable scales.

For this investigation, the dataset includes 89,296 students from 11 institutions, including two Historically Black Colleges/Universities. The breakdown of students in the dataset by race and ethnicity is 79% White, 8% Black/African American, 6% Asian, 3% Hispanic and 0.4% Native American. The dataset also has 1.5% international students and 1.1% other/unknown race or ethnicity. This represents 7,456 Black/African American, 2,635 Hispanic and 320 Native American students, for a total of 10,411 underrepresented minority students. **Table 8** shows the engineering six-year graduation rates by race and ethnicity at each of the 11 MIDFIELD institutions; **Table 9** shows the high school grade point average minimums, overall averages, average for URM students and maximum GPA at each institution. In the tables, the fields without data represent counts of 10 or fewer students, which was deemed too few to calculate a graduation rate by group.

**Table 8.** Engineering six-year graduation rates by race and ethnicity by institution.

Institution	Overall	Black or African American	Hispanic or Latino	Native American
1	43%	34%	38%	29%
2	36%	36%		
3	28%	27%	22%	25%
4	59%	51%	60%	67%
5	28%	32%		
6	49%	34%	57%	33%
7	56%	45%	52%	39%
8	39%	37%	35%	
9	55%	47%	46%	38%
10	42%	26%	44%	53%
11	42%	27%	36%	53%
Total	48%	35%	46%	39%

**Table 9.** High school grade point averages by institution (on a five-point scale).

Institution	Minimum HSGPA	URM Average HSGPA	Non-URM Average HSGPA	p-value	Max HSGPA
1	1.36	3.14	3.31*	0.000	5.00
2	1.00	3.60	3.44	0.399	5.00
3	1.00	3.48	3.79*	0.000	5.00
4	2.09	4.40	4.53*	0.000	5.00
5	1.10	3.08	3.08	0.933	5.00
6	1.82	3.46	3.67*	0.000	5.00
7	1.25	4.12	4.27*	0.000	5.00
8	1.82	3.36	3.44	0.125	5.00
9	1.73	4.39	4.50*	0.000	5.00
10	1.00	3.39	3.83*	0.000	5.00
11	1.63	4.29	4.45*	0.000	5.00
Total	1.00	3.70	4.10*	0.000	5.00

\* Indicates significant difference between URM average HSGPA and Non-URM HSGPA within the institution or across all institutions. Significant differences in HSGPA between institutions was also found.

#### *Overview of Analysis Plan*

Creating a six-year predictive graduation algorithm was investigated by generating sequential analyses—strategically adding and filtering out selected independent variables at each step.

Models were created based on Exhaustive CHAID, CRT and QUEST algorithms (details below).

The goal was to ascertain whether common thresholds of high school grade point average and standardized test score values exist across the various institutions that could predict engineering graduation success for underrepresented minority students.

#### *Underrepresented Minority Categorization*

We undertook creating a predictive algorithm to calculate the probability of an *individual* underrepresented minority student graduating from engineering in six (or fewer) years. For the data analysis to create such a predictive model, an initial category of “underrepresented minority” (URM) was created using a societal definition of underrepresentation in engineering based on race/ethnicity that included Black/African American (B), Hispanic (H) and Native

American (I). During the initial iteration of trees (method explained below), it appeared that the predictive ability of the variables to detect differences in engineering graduation rates among students from various racial/cultural backgrounds was masked by the created URM category. In particular, analysis found that the two Historically Black College/Universities (HBCUs) kept both appearing and being grouped together, and being separate from other institutions. Thinking differently about the institution-specific cultural situations at the two HBCUs, we investigated to see if the admissions predictive model would be improved if a new URM2 category was created that took an institution's dominant racial/ethnic population into consideration. Subsequently, at the two HBCU institutions, Black/African American students (greater than 80% of population at each) were *not* considered *underrepresented* (URM)—but all other ethnic and racial groups were within the new URM2 category including White and Asian American. This changed the total number of URM students being investigated from 10,411 to 8,664. While this approach does not conform to the widely used definition of underrepresented minority, it was postulated that Black/African American students experienced dominant (or majority) representation *within* the HBCU institutions that may be orthogonal to what URM students typically experience in White majority institutions. Following that logic, we explored to see if a more robust predictive admissions model might result. Implications for this change in perspective and data aggregation will be discussed further. This group is 31% female, 64% Black or African American, 30% Hispanic or Latino, 4% Native American, 1.2% White, 0.1% Asian and 0.3% International.

#### *T-Test HSGPA and Higher Test Score by URM2*

Before creating any models, the first analysis performed was a t-test for HSGPA and Highest Test Score by the re-categorized URM2 groups (**Table 10**). We found sufficient statistical evidence to infer that the mean HSGPA of 4.09 for non-URM students was higher than the mean

of 3.76 for URM2 students. In addition, we could infer that the Highest SAT Total test score mean of 1226 for (80,632) non-URM students was greater than the mean of 1117 for the (8,664) URM2 students in this dataset. Recall that the 80,632 students that are not URM2 includes Asian, International, White and Other or Unknown for the nine predominately majority-serving institutions and also Black or African American students from the two HBCUs. These findings supported that we would be justified in looking for a different model of HSGPA and Highest Test Score for URM2 students.

**Table 10.** T-test for URM2 HSGPA and standardized test score.

Group Statistics						
	URM2	N	Mean	Standard Deviation	Standard Error Mean	Sig (2-tailed)
HSGPA 5.0	N	80632	4.0865	.69260	.00244	0.000
	Y	8664	3.7565	.79817	.00858	
Highest Test Score	N	80632	1225.62	143.052	.504	0.000
	Y	8664	1117.37	155.874	1.675	

#### *Exhaustive CHAID*

The Exhaustive CHAID (CHi-squared Automatic Interaction Detection) method, originally proposed by Biggs et al. (1991), was performed iteratively using SPSS 23 to determine which predictor variables to use as well as to help define various threshold values. The dependent or target variable for this analysis was the binary (yes/no) engineering six-year graduation outcome. The predictor variables investigated were high school grade point average (converted to a 5.0 scale), highest SAT Total test score value (either converted from ACT Composite or original SAT Total), institution, ethnicity (using the same categories as the previous MIDFIELD investigation, A, B, H, I, N, W, and X), gender, and whether their ethnicity is categorized as underrepresented.

Exhaustive CHAID consists of three recurrent steps: merging, splitting and stopping.

**Merging.** The merging step uses an exhaustive search procedure that merges two categories iteratively, merging similar pairs until only a single pair remains. During our merging, each non-significant predictor variable category was merged, and the adjusted p-value was created. The Bonferroni adjustment uses a multiplier that is the sum of the number of possible ways of merging two categories at each iteration, with a maximum of 10 intervals. The p-values are calculated based on the data type of the dependent variable; if it is nominal, as is the case in this investigation, the null hypothesis of independence using observed frequencies to calculate Pearson chi-squared is used. Each final category after merging results in a child node on the tree. In our investigation, a child node includes predictor variable groups that have statistically similar graduation rates to each other but is different than all other child node groups in that level of the tree. The Chi-Square Pearson converge value of 0.001 was used with 100 maximum iterations.

**Splitting.** In the next step of Exhaustive CHAID analysis—splitting—the predictor variable with the smallest adjusted p-value is split into child nodes. If no predictor variable has a p-value less than or equal to the defined alpha-level, the node is considered a terminal node. We used an alpha-level of 0.05.

**Stopping.** Next, in the stopping step the software checks to see if the growing tree should be stopped based on various user-specified parameters or if the node becomes pure, which means it has identical values for each predictor variable. We indicated minimum parent nodes sizes of 100 individuals and minimum child node sizes of 50. Of note, these minimum node sizes could limit tree creation and identification of differences for groups with small numbers, such as Native American students. This iterative process of merging, splitting and stopping is repeated until the tree growth is fully stopped. (Biggs, de Ville, & Suen, 1991; IBM, 2013)



CRT (Classification and Regression Trees) and QUEST (Quick, Unbiased, Efficient, Statistical Tree) were also created using the same variables and settings to see which would create the best predictive model. The biggest differences between Exhaustive CHAID and CRT/QUEST is that CRT and QUEST are algorithms that produce binary trees that use univariate splits creating two (and no more than two) child nodes repeatedly. These models were compared to the Exhaustive CHAID models as explained below.

After various tree models are created, the predicted and observed classifications are considered to see how well the model has predicted the observed outcome. The overall percentage the model predicted correctly is compared across the various models to determine the best. As a result of the iterative process of creating trees from Exhaustive CHAID, CRT and QUEST, the predictor variables are included in a linear regression model.

### *Results*

Of all the created predictive models that spanned all 11 institutions, the HSGPA converted to the 5.0 scale was the most influential in predicting six-year engineering graduation. The next influential variable in predicting six-year engineering graduation was the higher education institution or ethnicity, both for URM2 and non-URM students—a finding that disappointingly suggests that the best predictive admissions model is specific to an individual institution, not an across-institutional model that we had hoped could be developed from the 11-school MIDFIELD dataset. The example tree provided in **Figure 1** shows the breakdown for URM2 students; this information is also summarized in **Table 11**.

Figure 1. Exhaustive CHAID tree for URM2 students, continued on next page.

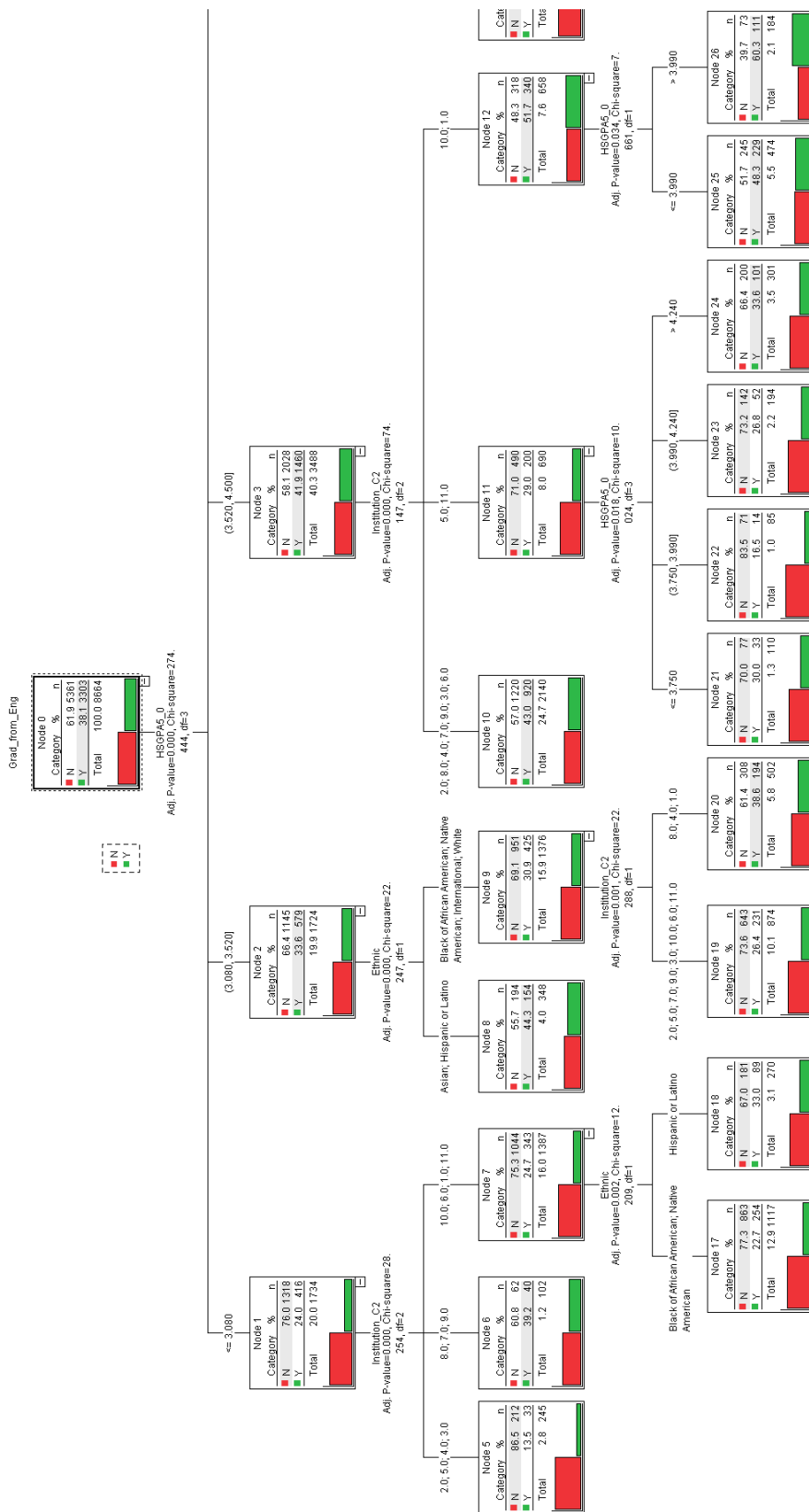

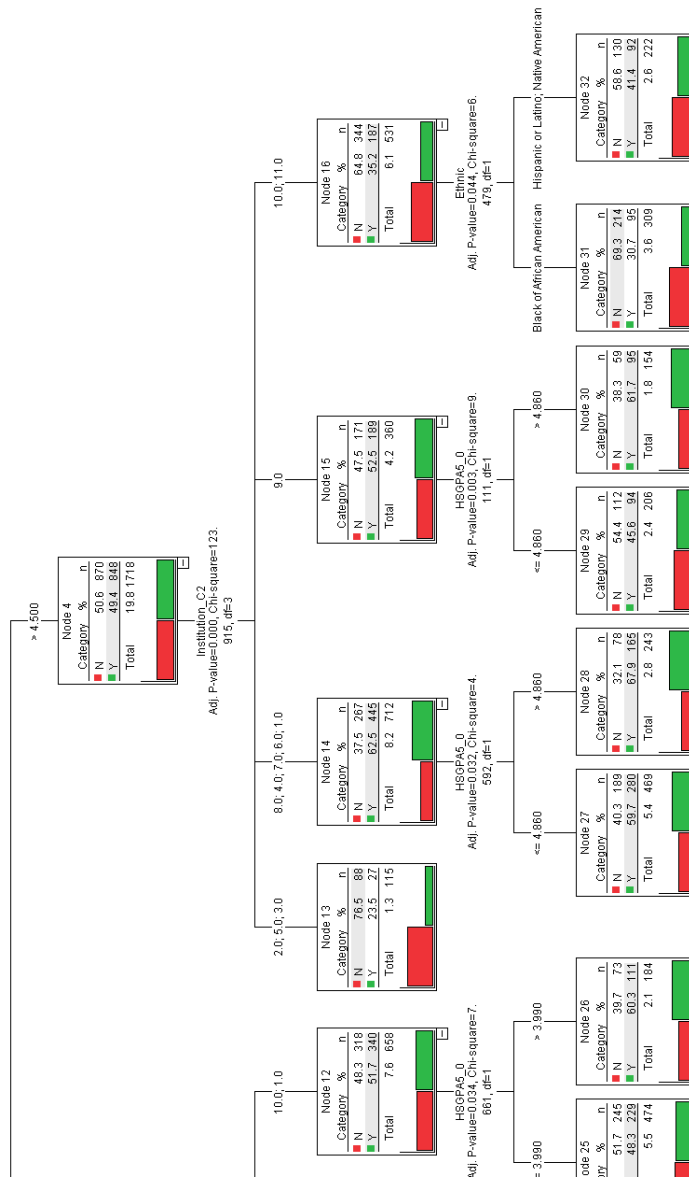

**Table 11.** Summary of 11 institution model for engineering six-year graduation rate of URM2.

Tree Level 1	HSGPA <=3.08 24%	HSGPA (3.08-3.52] 34%	HSGPA (3.52-4.50] 42%	HSGPA >4.5 49%
Tree Level 2	Institution 4 @ 14% 4 @ 25% 3 @ 39% R	Asian, Hisp 44% Black, NA, Intl, White 31% I	Institution 7 @ 43% 2 @ 29% G1 2 @ 52% G2	Institution 3 @ 24% 2 @ 35% R 5 @ 63% G1 1 @ 53% G2
Tree Level 3	R = Race/Ethnicity Hisp 33% Black NA 22.7%	I = Institution 8 @ 26% 3 @ 39%	G1 = HSGPA <=3.75 30% (3.75,3.99] 17% (3.99,4.24] 27% >4.24 34%  G2 = HSGPA <=3.99 48% >3.99 60%	R = Race/Ethnicity Black 31% Hisp, NA 41%  G1 = HSGPA <=4.86 60% >4.86 68%  G2 = HSGPA <=4.86 46% >4.86 62%

This tree shows that for the 8,664 underrepresented minority students (URM2) included in the model, 38.1% (3303) graduated from engineering in six-years. The HSGPA converted to the 5.0 scale is the most influential in predicting this graduation outcome, with an adjusted p-value of 0.000, chi-square of 274.444 with 3 degrees of freedom. The HSGPA has four nodes corresponding to HSGPA ranges less than or equal to 3.08, greater than 3.08 to 3.52, greater than 3.52 to 4.50 and greater than 4.50 on the 5-point scale. Of note, all following tree models and subsequent tables use interval notation in which using a parenthesis means a value is not included and a bracketed value is included in the range.

For the URM2 students in the lower GPA range (less than or equal to 3.08), a significantly lower 24% six-year graduation rate exists, varying from 13.5% to 39.2% depending on higher education institution. And within four institutions, we see that Hispanic or Latino students graduated from engineering at a statistically higher rate of 33% versus 22.7% for their Black or

African American and Native American peers at those same institutions. Looking at the HSGPA range of greater than 3.08 to 3.52, we find a graduation rate of 33.6% for this group (higher than the 24% graduation rate in the lower HSGPA group).

The next predictor variable for this group is ethnicity (versus institution in the previous, lower HSGPA group), in which institution is not a predictor variable for Asian and Hispanic or Latino students within this HSGPA range. It is also interesting to note that when institution is a predictor variable, the institutions grouped together within this HSGPA range are not the same as the institutions grouped together in the lower HSGPA range of less than 3.08.

For the remaining two HSGPA ranges greater than 3.52, we again see groupings by higher education institution but no consistent pattern emerges in which institutions are similar. For these ranges, we also see that within certain—but not all—higher education institutions, the HSGPAs are further broken down to create the best predictive model. Recall that gender was included as a potential predictor variable, but it never came out as a predictor of six-year engineering graduation for this group.

Using the model with the same dataset results in 57.3% correct prediction of the engineering six-year graduation outcome, with 74.9% correctly predicting those that did graduate and 46.5% correctly predicting those that did not graduate—as shown in **Table 12**.

**Table 12.** URM2 Exhaustive CHAID model summary, risk and classification results.

Model Summary		
Specifications	Growing method	Exhaustive CHAID
	Dependent variable	Graduated from engineering
	Independent variables	HighestTestScore, HSGPA5.0, ethnicity, gender, institution
	Validation	None
	Maximum tree depth	3
	Minimum cases in parent node	100
	Minimum cases in child node	50
Results	Independent variables included	HSGPA5.0, institution, ethnicity
	Number of nodes	33
	Number of terminal nodes	21
	Depth	3

Risk	
Estimate	Std. Error
.522	.007

Classification			
Observed	Predicted		
	1 N	2 Y	Percent Correct
1 N	2491	2870	46.5%
2 Y	828	2475	74.9%
Overall Percentage	38.3%	61.7%	57.3%
Growing method: Exhaustive CHAID			
Dependent variable: Graduated from engineering			

The model for the typical definition of URM students is provided in **Figure 16** in the APPENDIX. The model for the typical definition of URM students only accurately predicts 27.1% of the observed URM students that graduated from engineering in six-years.

Next, individual institutions were investigated separately to see if those with similar outcomes could be grouped together. For this step, we went back to investigating all underrepresented minority students at the two HBCUs using the first definition. The same dependent (six-year graduation from engineering) and independent (standardized test score, HSGPA converted to the 5.0 scale, race or ethnicity, and gender) variables were investigated within institution. In eight of

the 11 institutions, high school grade point average was found to be the most influential predictor variable. In one institution it was ethnicity, and in another it was standardized test score. And one institution did not result in any predictor variables from the independent variables included.

Gender was not found to be a predictive factor in any of the 11 institutions for underrepresented minority students. It was found that at institutions where HSGPA was the most influential variable that predicted six-year engineering graduation, differences still existed in the category cutoffs for HSGPA, as shown in **Table 13**. Two examples of individual institution trees are shown in **Figure 2** and **Figure 3** (the remaining nine institution-only models can be found in **Figure 17 – Figure 25** in the APPENDIX).

**Table 13.** HSGPA cutoffs by institution with associated engineering graduation rates.

Institution	Branch 1	Branch 2	Branch 3	Branch 4	Branch 5
1	$\leq 2.790$ 17.4%	(2.79, 3.11] 27.2%	(3.11, 3.50] 39.6%	$> 3.50$ 55.7%	
2	$\leq 3.30$ 24.2%	(3.30, 3.98] 45.9%	(3.98, 4.37] 63.9%	(4.37, 4.97] 47.9%	$> 4.97$ 24.6%
3	$\leq 2.97$ 11.9%	(2.97, 3.70] 28.0%	(3.70, 4.75] 48.9%	$> 4.75$ 21.9%	
4	$\leq 4.31$ 42.4%	(4.31, 4.68] 51.8%	(4.68, 4.94] 64.7%	$> 4.94$ 77.5%	
5	$\leq 2.97$ 19.6%	(2.97, 3.06] 37.1%	(3.06, 3.19] 19.0%	(3.19, 3.62] 39.0%	$> 3.62$ 60.6%
6	$\leq 3.10$ 24.4%	(3.10, 3.68] 32.4%	(3.68, 3.99] 42.4%	$> 3.99$ 58.5%	
7	$\leq 4.30$ 40.9%	$> 4.30$ 58.3%			
8	N/A				
9	$\leq 4.45$ 41.7%	(4.45, 4.58] 26.9%	(4.58, 4.70] 41.0%	(4.70, 4.99] 53.8%	$> 4.99$ 67.7%
10 – within test scores (920, 1180]	$\leq 3.40$ 27.8%	(3.40, 4.10] 48.5%	$> 4.10$ 33.1%		
11 – for Black or African American	$\leq 4.00$ 20.2%	$> 4.00$ 31.5%			
Model across All Institutions	$\leq 3.08$ 24.0%	(3.08, 3.52] 33.6%	(3.52, 4.50] 41.9%	$> 4.50$ 49.4%	

**Figure 2** includes the Exhaustive CHAID model with engineering six-year graduation outcome as the dependent variable, specifically filtered for only underrepresented minority students at institution 1. Node 0 shows that of the 1,437 underrepresented minority students within this institution, 498 (34.7%) graduated from engineering within six years. The remaining 939 (65.3%) did not graduate from engineering in that timeframe. For those 1,437 URM students, HSGPA is the best predictor of the graduation outcome from the variables being investigated (HSGPA, highest test score, gender and ethnicity) with an adjusted p-value of 0.000, chi-square of 109.589 and 3 degrees of freedom. For the 288 students with a HSGPA less than or equal to 2.79, the graduation rate drops to 17.4%. For the 430 students with a HSGPA greater than 2.79 but equal to or less than 3.11, we find a statistically higher graduation rate of 27.2%. For the 432 students with HSGPAs greater than 3.11 but equal to or less than 3.5, the graduation rate is 39.6%, and for students with HSGPAs higher than 3.50, the engineering graduation rate is 55.7%. Thus, using the predictive model for this institution only correctly predicts 61.4% overall.



**Figure 2.** Exhaustive CHAID tree model, risk and classification results for institution 1.

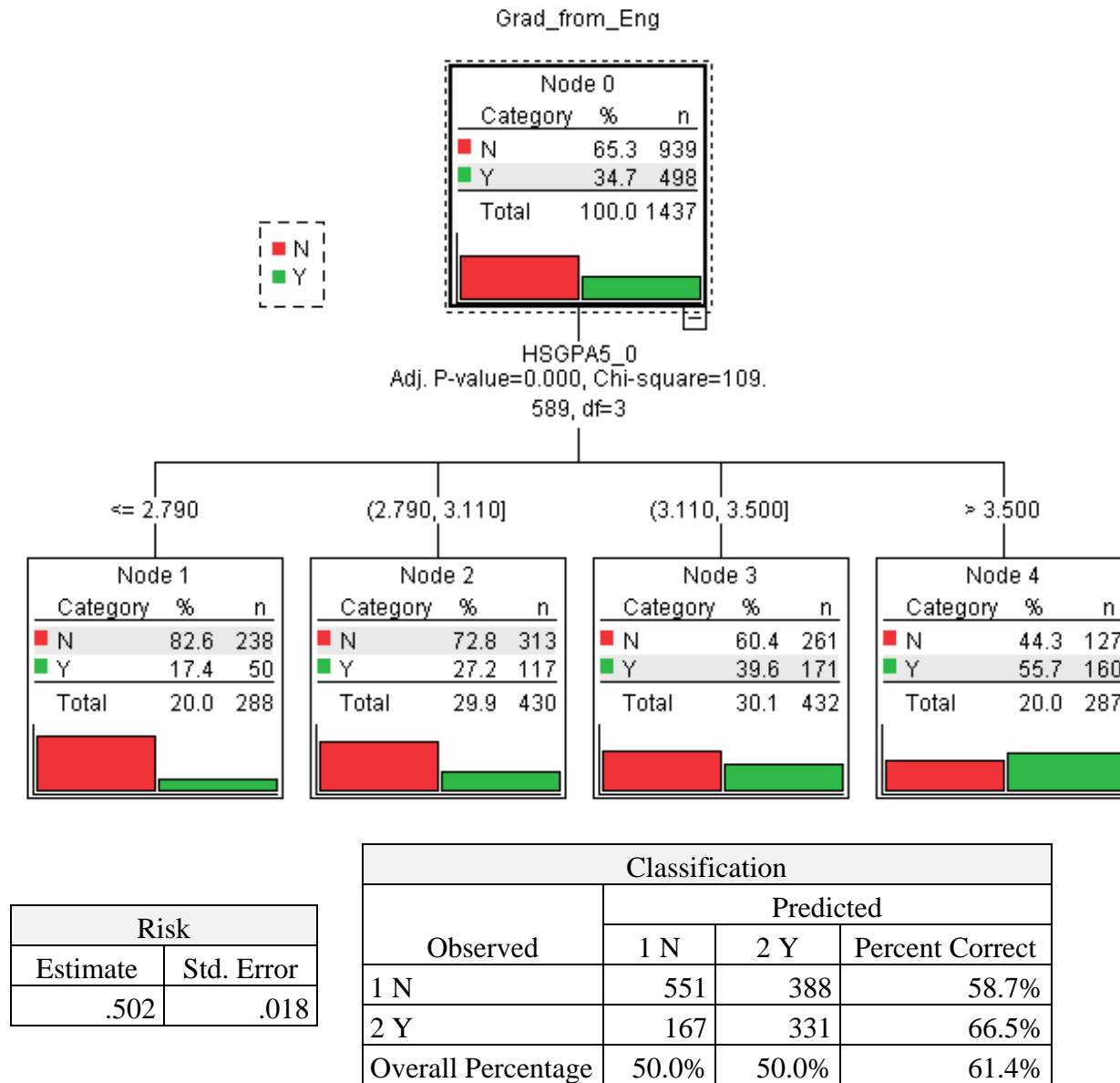

Institution 10 is unique because it is the only one at which the highest standardized test score came out as the *most* predictive of six-year engineering graduation outcomes, adjusted p-value 0.000, chi-square 72.236 with three degrees of freedom. As shown in **Figure 3**, 1,338 underrepresented minority students are included with 36.2% (484) graduating from engineering. Highest test score is split into four groups. Those with test score values of less than or equal to

920 (144 students) have an engineering graduation rate of 12.5%. Those with scores greater than 920 but equal to or less than 1,180 (731 students) have an engineering graduation rate of 33.5%, however, this node split further based on HSGPA. For the students in the test range (920, 1180] that also had HSGPA of 3.4 or less (439 students), the graduation rate was 27.8%. This node split again on the race/ethnicity variable with the 201 Hispanic or Latino students having a higher graduation rate of 33.8% and the 238 Black or African American and Native American students having a graduation rate of 22.7%. Moving back up and across the tree rather than down the current branch, the 171 students with HSGPA greater than 3.4 but less than or equal to 4.1 had a graduation rate of 48.5%. Oddly, the 121 students with the highest HSGPAs (greater than 4.1) within this test score range had a *lower* graduation rate, 33.1%, than the previous group. The 312 students with test scores greater than 1,180 but less than or equal to 1,290 had an engineering graduation rate of 43.3%. This node also split by race/ethnicity, with the 77 Black or African American students within this test score range having a 24.7% graduation rate and the 235 Hispanic or Latino and Native American students having a graduation rate of 49.4%. The highest test score range of greater than 1,290 had 151 underrepresented minority students included; they had a graduation rate of 57.0%. This model for institution 10 correctly predicts the six-year engineering graduation outcome of 59.9% overall. This second example contrasts the simple example of institution 1 and shows how different the models are for individual institutions, and how complex an overall model would be if one were to create a model for all institutions.

**Figure 3.** Exhaustive CHAID tree model, risk and classification results for institution 10.

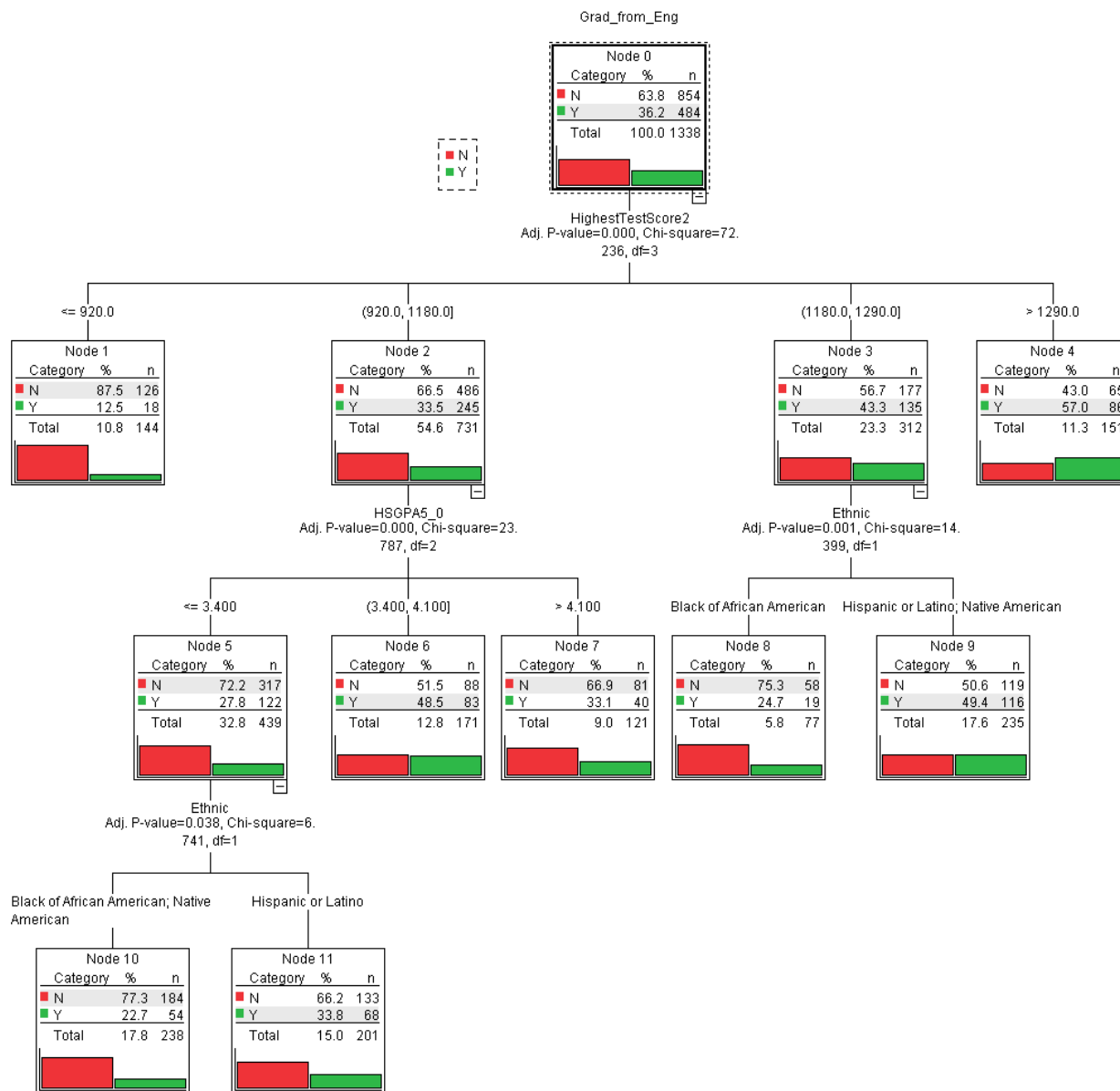

Risk	
Estimate	Std. Error
.499	.018

Classification			
Observed	Predicted		
	1 N	2 Y	Percent Correct
1 N	449	405	52.6%
2 Y	131	353	72.9%
Overall Percentage	43.3%	56.7%	59.9%

**Weighting for Prediction**—Some of these models are not weighted in a way that makes the predicted outcomes favorable (i.e., the model for institution 7 predicts all students as graduating and does not predict any of the non-graduates), however, since the goal was not to create individual models for each institution, we moved to the next step instead of adjusting weighting on the individual models.

**Adjusting HSGPA**—Next, we investigated whether adjusting the HSGPA variable to account for the wide variation across institutions, using the HSGPA percentile within institution to compare across institutions, would allow grouping of those with similar trends in independent predictor variables. For example, institutions 1 and 3 both had HSGPA as their only predictor variable, but had differences in their HSGPA cutoffs for grouping.

While their 80<sup>th</sup> percentiles for HSGPA were 3.50 and 4.79, the predicted graduation rates were 55.9% and 22.6%, not permitting the creation of a useful combined model because the graduation rates did not consistently increase with increasing HSGPA at both institutions. And, institution 3 had an *inverse* relationship; students with the top HSGPAs had the lowest engineering graduation rates. These results indicate that something else is going on that cannot be predicted with the MIDFIELD variables included in this research study.

**Not about Test Score**—When looking at the overall model across all institutions, the standardized test score was not found to be a significant predictor of engineering six-year graduation for underrepresented minority students (using the URM2 definition). However, standardized test score was found to be a significant predictor for non-underrepresented minority students and in the model created that included all students (after high school grade point average and institution). This in itself is interesting since standardized test scores are widely used in the admission decision process under the guise that they predict success for all students. This

might infer that they predict success to graduation in engineering for the majority students who have historically populated engineering colleges, but not for underrepresented minority students, who increasingly populate engineering colleges as the nation's youth population becomes more diverse.

Bottom Line—Standardized test score was the most significant predictor in only one of the 11 institutions when modeled separately and in three others after high school grade point average. In seven of the 11 institutions, test score was not found to be a significant predictor of six-year engineering graduation for underrepresented minority students.

#### *Return to Research Question 1*

An interesting finding at one institution may support the findings of the previous research question. At institution 5, it was found that underrepresented minority students with high school grade point averages in the lowest grouping for that institution (less than or equal to 2.97 on the 5.0 scale), but who also had higher test scores—greater than 1,030—had a lower graduation rate (10.4%) than similar students in the same grade point average range with the lower test scores (equal to or less than 1,030, 28.1%). This situation was also found for seven different institutions in the model for non-URM students; details are summarized in **Table 14**.

**Table 14.** Non-URM exhaustive CHAID summary for test score anomaly.

HSGPA Range & Group Order	Number of Institutions	Standardized Test Scores	Six-Year Engineering Graduation Rate
<=3.1 1 of 10 groupings	3	<=1030	51.6%
		(1030, 1290]	42.6%
		>1290	31.5%
(3.1, 3.46] 2 of 10 groupings	4 (2 same as above)	<=1100	45.5%
		(1100,1400]	41.7%
		>1400	35.9%
(4.37,4.57] 7 of 10 groupings	3 (1 same as above)	<=1100	47.8%
		(1100,1400]	41.1%
		>1400	31.8%

In seven of the 11 institutions, an anomaly was found in which statistically significantly increased test scores did not equate with increased graduation rate from engineering in certain HSGPA ranges. Two of the three instances were found in the lowest HSGPA groups. In every instance in which standardized test score is a predictor variable with HSGPA greater than 4.57 on the 5.0 scale, the graduation rates increased with increasing test score (the expected outcome).

Limitations—Many of the limitations of this research question are similar to the first question. Again, only 11 institutions were included in the analysis, and while their sizes and diversity help make the results generalizable to engineering students at large public universities, the institutions are similar to each other in many ways. All the institutions are public, research universities with high or very high research activity, or are doctoral/research universities. None are small, private or liberal arts college settings. Of the 11 institutions, nine are in the South while one is in the West, one Midwest and none are in the North (using the regional university definition used by U.S. News and World Report). While these are limitations of the results, the types of institutions included in this study graduate the majority of the nation's engineering bachelor's degree recipients each year.

Another study limitation is that even when the historic data from the 11 MIDFIELD institutions were pooled together, the dataset still contained small numbers of URM students in some categories or at some institutions. These small population sizes may lack the power necessary to realize statistical differences, even when a meaningful difference may exist. About 20% of the Black or African American students in the dataset were enrolled in two HBCUs that offer different surroundings than the majority-serving institutions, however, none of the schools studied were Hispanic Serving Institutions.

While this research focused on women and students from racial and ethnic backgrounds typically underrepresented in engineering, no focus was made on international or non-domestic students. Since this study concentrated on high school grade point averages and standardized test scores that are common in the U.S., many international students were filtered out because they lacked these variables in their admission records. In addition to the lack of consistent variables common to domestic students, a concern also exists about widespread cheating among students from certain countries or regions (Redden, 2015; Krantz & Meyers, 2016; Chen & Schultz, 2015); therefore, the engineering success of international students is best investigated separately.

Another limitation of the second research question (which impacts the first question as well) is that admission policies and practices may have varied through time even within institution. Related to this is high school grade point average inflation over time and grade non-equivalence (Godfrey, 2011-2); this research did not investigate grade inflation; however, if grades uniformly inflate, we expect that HSGPA would still be a good predictor of engineering success until the vast majority of engineering-bound students have maximum grade point averages. However, high school grade inflation and changes in admission practices could impact the high school grade point average threshold values found for success to graduation in engineering.

Also, when students near the bottom of the test score or high school GPA ranges were admitted and enrolled at an institution, we do not know what other factors were considered or impacted their admission and enrollment decisions. Such unknown factors could play a major role in predicting success to graduation in engineering.

Further, the applicability of this research may be limited to institutions with limited or selective admissions criteria, and thus might have no application at “open admissions” or “open enrollment” institutions. The findings are also limited to undergraduate study.

### *Conclusion*

In the predictive models created that spanned all 11 institutions, the HSGPA converted to the 5.0 scale was the most influential in predicting six-year engineering graduation; however, the next influential variable in predicting six-year engineering graduation was the higher education institution or ethnicity. This finding suggests that the best predictive admissions model would be specific to an individual institution, not an across-institutional model. While this answers the second part of the research question, it means that HSGPA and test score critical thresholds should not be modeled *across* institutions. When institutions with similar predictive models were considered for comparison, it was found that their differences made grouping them unreasonable. Clearly, more is happening within institutions that cannot be modeled by the independent variables investigated in this research, and which drive admission to engineering (HSGPA, standardized test score, gender and ethnicity). A better understanding of the admissions profile of each institution might help determine what other factors are at play. Other potential factors that come to mind are financial aid, first-generation college-attendance and socioeconomic status. Interestingly, some anomalies were found in this investigation that point to the findings from the previous research question that found top standardized test scores do not always predict higher engineering graduation outcomes.



*CHAPTER 4—Quantifying the Pool of Underrepresented Minority Students  
for Engineering Studies*

**Research Question 3:** How large is the pool of potential underrepresented minority undergraduate engineering students based on typical admissions criteria?

A widely held belief exists among engineering educators and policy-makers that if pre-college student *interest* in engineering were broadly increased, the population of students pursuing a collegiate engineering education would be more diverse. (My College Options and STEMconnector, 2012) However, after years of working in engineering admissions, a more probable hypothesis emerged that the pool of engineering-eligible students that come from communities of color is smaller than might be expected. To reach *parity* in representation with national, college-bound, high school graduates, engineering colleges would need to markedly change admission practices regarding the use of standardized test scores.

*Engineering Interest*

In 2012, a report drawn from an annual survey of 5.5 million high school students regarding their interest in STEM (science, technology, engineering and mathematics), including disaggregation for engineering-specific interest (My College Options and STEMconnector, 2012), provided insights into future engineering enrollment possibilities. While 28% of high school ninth-graders declare an interest in STEM, 57% of them lose interest by the time they graduate from high school—a time during which fewer students become interested in STEM. Of the 2012 graduating cohort, only 24.8% of high school seniors indicated an interest in STEM, with 45.8% of those indicating a specific interest in engineering. Thus, about 11% of the 2012 total cohort indicated

an interest in engineering, with vast differences across gender: 23% of males indicated interest in engineering versus only 3% for females. The differences across race and ethnicity were much smaller (see **Table 15**).

**Table 15.** High school senior engineering interest among 2012 national cohort.

	STEM Interest	Engineering Interest (% of STEM)	Overall Engineering Interest
Male	40%	59%	23%
Female	15%	18%	3%
American Indian	30%	51%	15%
Asian	33%	44%	14%
African American	23%	45%	10%
Hispanic	25%	51%	13%
White	27%	46%	13%
2012 Cohort	25%	46%	11%

Interest in engineering steadily declines throughout high school: in 2012, while 11% of college-bound high school seniors expressed *interest* in engineering, only 6.2% of first-year students from that cohort who subsequently enrolled in college did so in engineering (American Society for Engineering Education, 1998-2015; National Center for Education Statistics, 2012) and 4.6% of bachelor's degrees earned that year were from engineering (National Center for Education Statistics, n.d.).

Looking at the engineering enrollment challenge from another perspective, among the 2012 ACT cohort (typically students take the test as high school juniors), 7% of test takers indicated an interest in majoring in engineering and an additional 1% in engineering technology (ACT, Inc., 2012). That same year, 9% of SAT takers (again, typically taken in 11<sup>th</sup> grade) indicated their intent to major in engineering in college, with an additional 2% in engineering technology (The College Board, 2012).

### *Admission Variables*

As discussed previously, the admissions variables used in this research were identified in a 2013 survey of engineering admission decision-makers that asked about the admission practices and policies applied to their 2012 cohorts. (Myers & Sullivan, 2014) The key factors rated and ranked by 42 survey respondents were high school grade point average; math and comprehensive standardized test scores; physics, calculus and chemistry high school track record; and the quality of the high school course load.

Only 18 decision-maker survey respondents provided minimum high school grade point average values and test scores for engineering admission to their institutions. The minimum high school grade point averages varied from no minimum to 3.8 (on a 4.0 scale). An even smaller number of responses (12) were obtained for the minimum ACT scores accepted by engineering colleges: minimum composite scores varied between 21 and 30, and for math the minimum range was 22 to 30. So, while we knew these two variables were crucial to the admission decision for prospective engineering students, we did not know what values to use as minimums in our research investigation.

Many factors go into the admission decision for each student and schools perform holistic reviews that extend beyond a few quantitative variables; thus, many universities do not *prescribe* and hold firm to minimum GPA values and standardized test metrics. This was found to be true in the MIDFIELD dataset, with minimum GPAs across 11 institutions ranging from 1.00 to 2.88 and minimum ACT scores ranging from 11 to 16. However, the same quantitative variables—GPAs and standardized test scores—were reported as the most important for the vast majority of the 42 admissions survey respondents. As a secondary check of admission decision variables, the State of College Admission Report prepared by National Association for College Admission

Counseling (NACAC) also found that the most important factors in the college admission decision (not engineering specific) are grades in preparatory courses, strength of curriculum, admission test scores and grades in all courses. (Clinedinst, 2015)

Since our research survey and the NACAC survey did not reveal robust minimum values for the admissions variables rated and ranked as the most important in the admission decision process, we relied on the use of an engineering common data source—the American Society for Engineering Education (ASEE) College Profiles. (American Society for Engineering Education, 1998-2015) Most engineering colleges provide annual data to ASEE on their incoming first-year class, including their 25<sup>th</sup> percentile standardized test scores from ACT and SAT. Using the 25<sup>th</sup> percentile test score values from the robust ASEE data source in conjunction with other high school variables appears to be a solid approach for quantifying how large the pool of potential engineering student from backgrounds underrepresented in engineering might be.

#### *Method and Results*

The ASEE Data Mining Tool was used to download the 2011, 2012 and 2013 cohort data (2012 is also the year aligned with the survey results), including data from nearly 200 engineering colleges. The particular metrics of interest for this research are the number of new undergraduate engineering applicants that were enrolled in the fall; their 25<sup>th</sup> percentile SAT Math, SAT Total, ACT Math and ACT Composite scores; and the percentage of entering students that were ranked in the top quarter of their high school classes (see **Table 16**). While additional data is sometimes available in the National Center for Education Statistics (NCES) Common Dataset, it is not disaggregated for engineering students; therefore, the ASEE data was preferable for this study. A handful of values were removed due to being outside possible ranges (e.g., ACT scores greater than 36).

The ACT college readiness assessment and SAT are different tests that measure similar but different and distinct constructs; therefore, scores from one test cannot be considered equivalent to the other. However, ACT and the College Board (who administers the SAT) have studied the relationship between their tests and provide a concordance table as a guideline for comparing scores. (ACT and SAT, 2008) The 25<sup>th</sup> percentile ACT and SAT Math scores were compared to see if the data provided by engineering colleges was consistent across the two tests. However, the SAT Total and ACT composite scores were not compared because it appears that some engineering colleges provided to ASEE SAT Total scores for Critical Reading + Math (max 1600) while others provided the SAT score for Critical Reading + Math + Writing (max 2400).

As shown in **Table 18**, the ACT Math score ranges provided are wider than the SAT Math ranges. For example, the math 25<sup>th</sup> percentile ACT scores have a wider range (lower minimum and higher maximum) than the provided SAT Math 25<sup>th</sup> percentile scores. And, the lowest quartile of ACT Math scores was 23 (concordant to an SAT score of 530), compared to the actual SAT Math score of 560 (concordant to an ACT Math score of 25). Conversely, the maximum 25<sup>th</sup> percentile ACT Math score was 36 (concordant to an SAT Math score of 800), compared to the actual SAT Math score of 760 (concordant to an ACT Math of 33). Interesting in itself is that a school reported a perfect ACT Math score for its school's 25<sup>th</sup> percentile, which means that 75% of its students had perfect scores. While this may have been an error, multiple prestigious engineering colleges list a score of 34 as their 25<sup>th</sup> percentile ACT Math scores for their entry classes.

**Table 16.** ASEE engineering college selected entry class metric distributions by year.

		2011		2012		2013	
ACT Math 25%ile	Minimum	N=182	11	N=198	9	N=200	14
	Q1		23		23		24
	Median		25		25		25
	Q3		27		27		27
	Max		34		36		36
SAT Math 25%ile	Minimum	N=204	200	N=205	200	N=209	330
	Q1		550		560		550
	Median		592.5		600		590
	Q3		640		640		640
	Max		760		760		800
ACT Comp 25%ile	Minimum	N=203	6	N=213	6	N=217	13
	Q1		22		22		23
	Median		24		24		24
	Q3		27		27		27
	Max		34		35		35
SAT Total 25%ile	Minimum	N=178	400	N=183	400	N=183	720
	Q1		1100		1090		1080
	Median		1200		1200		1210
	Q3		1600		1560		1660
	Max		2170		2400		2350
Percent Top 25% in HS Graduating Class	Minimum	N=205	7	N=205	11	N=198	14
	Q1		54		53		53.22
	Median		69		70		68.50
	Q3		89.8		90.75		90.03
	Max		100		100		100
# Enrolled into Engineering Majors	Minimum	N=264	3	N=260	9	N=264	1
	Q1		167.25		187.75		189.50
	Median		349		382		395
	Q3		599.50		630.5		661
	Max		2397		2481		3736

**Table 17.** Engineering entry class metrics for the 2012 cohort by institution type.

Institution Type		ACT Math 25%ile	ACT Math 75%ile	SAT Math 25%ile	SAT Math 75%ile	Percent Top Quartile HS class
HBCU (N=6)	Minimum	16	23	420	555	42
	Median	20	26	483	630	64
	Maximum	26	30	600	770	80
HSI or >30% Hispanic (N=12)	Minimum	11	26	200	570	21
	Median	22	28	535	650	59
	Maximum	25	36	570	800	100
All U.S. Engineering (198-205)	Minimum	9	14	200	520	11
	Median	25	30	600	695	70
	Maximum	36	36	760	800	100

**Table 18.** Math 25<sup>th</sup> percentile concordant scores for 2012 first-year engineering cohort.

		Original ACT	Converted SAT	Original SAT	Converted ACT
Math 25%ile	Minimum	9	*N/A	200	*N/A
	Q1	23	530	560	25
	Median	25	570	600	26
	Q3	27	610	640	29
	Max	36	800	760	33

\* The ACT and SAT concordance tables do not include values below 11 for ACT or 310 for SAT single score.

When we weight the 25<sup>th</sup> percentile test score values based on first-year engineering enrollments at each of the ~200 institutions that provided entry class metrics to ASEE, we find higher average test scores across the institutions because, on average, larger engineering colleges report higher test scores for their 25<sup>th</sup> percentiles (see **Table 19**). And, the 25<sup>th</sup> percentile scores were also weighted based on first-year engineering enrollments of students from racial and ethnic backgrounds underrepresented in engineering. Included were four group descriptors: Black or African American, Hispanic or Latino, Native American, and Native Hawaiian or Other Pacific Islander. Not included for this weighting were: Asian, White, Nonresident Alien also known as International, Not Reported and Two or More Race students.

**Table 19.** Weighted average of 2012 entering engineering class.

25 <sup>th</sup> Percentile	Enrollment Weighted Average	URM Student Weighted Average
ACT Math	26.1	24.6
SAT Math	608	578
ACT Comp	25.5	24.1

For comparison, the weighted average ACT Math of 26.1 is concordant to an SAT score range of 590-600. The weighted average SAT Math of 608 is concordant to an ACT Math score of 27. Again, the SAT Total is not reliable because it appears institutions reported two different score values.

As shown in **Table 20**, in 2012, 3.2 million U.S. students completed high school, among which 697K (22%) identified as Hispanic and 413K (13%) as Black. That cohort went to college in roughly the same percentages: 2.1 million students enrolled in college, among which 490K (23%) identified as Hispanic and 233 K (11%) as Black. (National Center for Education Statistics, 2015) But the nation's engineering colleges did not attract nearly as diverse of a cohort from those students: of the 132 K students enrolled as first-time engineering students, only 11% identified as Hispanic, 6% as Black, 0.4% as Native American or Alaskan Native, and 0.2% as Pacific Islander. (American Society for Engineering Education, 1998-2015)

From a different data source we find 32 K (1.0%) students who identified as American Indian or Alaskan Native earned high school diplomas in 2012. (National Center for Education Statistics, 2012) The Asian and Pacific Islander group was aggregated together so the underrepresented Native Hawaiian or Other Pacific Islanders could not be disaggregated. However, according to the U.S. Census, 0.2% of the population identifies as Native Hawaiian and Other Pacific Islander, while 2.9% identify as Two or More Races. (U.S. Department of Commerce, 2010)



**Table 20.** 2012 U.S. high school completers, college and engineering enrollments by race/ethnicity.

2012 Cohort	Number	Percent of Total	Group Representation
High school completers	3,203,000	81% graduation rate*	
Black or African American	413,000	68%*	12.9%
Hispanic or Latino	697,000	76%*	21.8%
*Native American or Alaskan Native	32,423	68%*	1.0%
Enrolled in college at large	2,121,000	66.2% of completers	
Black or African American	233,000	56.4%	11.0%
Hispanic or Latino	490,000	70.3%	23.1%
Enrolled in engineering	130,671	6.2% of enrolled	
Black or African American	8,178	3.5%	6.3%
Hispanic or Latino	12,898	2.6%	9.9%
Native American or Alaskan Native	544		0.4%
Native Hawaiian or Other Pacific Islander	262		0.2%
Two or More Races	4188		3.2%

Data from NCES, 2015 and \*from NCES 2012 CCD data source, engineering enrollments from ASEE Profiles excludes students from Puerto Rico since not included elsewhere.

It is expected that the U.S. will see increased numbers and percentages of Hispanic or Latino students graduating from high school in the next few years, with a continued trend of increases in the Hispanic or Latino population over time. (Western Interstate Commission for Higher Education, 2013; Colby & Ortman, 2015)

Data Acquisition from ACT and SAT—Although time consuming, student-level data was obtained from both ACT and The College Board (who administers the SAT) for the U.S. 2012 cohort. The ACT College Readiness Assessment provided the graduating class file for all students (except those from Illinois) who tested under standard or extended time conditions and who achieved college-reportable composite scores during a three-year period, which included the 2012 cohort. Only the most recent test record was provided for students who tested more than once. Thus, we received data for 1,579,519 of the 1,666,017 students from the 2012 cohort who took the ACT.

The types of information provided by ACT included select fields from the Interest Inventory, Student Profile and the High School Course and Grade Information sections. Example fields are graduation year, gender, ACT scores, state, admissions and enrollment information, educational plans, interests and needs, financial aid, student background including racial/ethnic background, factors influencing college choice, high school extracurricular activities, out-of-class accomplishments, and interest inventory percentile ranks for science, arts, social service, business contact, business operations, and technical interests. The racial/ethnic backgrounds provided by ACT include: Black/African American, American Indian/Alaska Native, White, Hispanic/Latino, Asian, Native Hawaiian/Other Pacific Islander, Two or More Races, and Prefer Not to Respond.

Taking a different approach, the College Board (SAT) would only provide a random *sample* of student level data from 100,000 of the 1,664,479 students in the 2012 cohort who took the SAT. The racial/ethnic categories provided for SAT test takers include: American Indian or Alaska Native; Black or African American; Hispanic; White; Other; a summary group for Asian, Asian-American, and Pacific Islander; and No Response. The College Board/SAT does not provide a category of Two or More Races. In the 2010 U.S. Census, 18% of all people who chose two or more races were White and Asian, neither of which would be considered underrepresented minorities (URM) in our engineering study. However, the remaining 82% would be considered URM. (Jones & Bullock, 2012) At our own institution, 25% of the 2012 applicants to the College of Engineering and Applied Science who chose two or more races were Asian and White, while 75% were from underrepresented minority backgrounds. For this reason, the Two or More Races group was included in our analysis, but all pool projection numbers were adjusted by 82%.

**Table 21.** 2012 Cohort ACT and SAT underrepresented minority student test takers.

Ethnicity or Race	ACT Takers	SAT Takers	ACT File Provided	SAT File Provided
Black/African American	222,237 (13.3%)	217,656 (13.1%)	209,986 (13.4%)	15,107 (15.1%)
American Indian/Alaska Native	13,523 (0.8%)	9,716 (0.6%)	13,265 (0.8%)	589 (0.6%)
Hispanic/Latino	234,456 (14.1%)	272,633 (16.4%)	216,881 (13.8%)	17,709 (17.7%)
Native Hawaiian/Other Pacific Islander	4,545 (0.3%)		4,305 (0.3%)	
Two or More Races	55,500 (3.3%)		53,111 (3.4%)	
Total	1,666,017	1,664,479	1,579,519	100,000

Geographic regional differences exist in the number of students who take one or both tests, with the ACT dominating in Midwestern states while students in the coastal regions are more inclined to take the SAT (see **Figure 26** in the APPENDIX). (Saget, 2013) Both Delaware and Maine had contracts for all students to take the SAT in 2012 (The College Board, 2012) while the ACT was contracted in 2012 for all students to take the ACT in Colorado, Illinois, Kentucky, Louisiana, Michigan, Mississippi, North Dakota, Tennessee and Wyoming. (ACT, Inc., 2012) Results from students who took the state contracted test in Illinois were not included in the dataset.

The bulk of analysis for this study was done using ACT data due to its higher completeness and fewer resulting concerns associated with it being nationally representative. Initial analyses included information for both ACT and SAT filters, however, after further consideration, the SAT analyses have only been included in **Table 40 – Table 50** in the APPENDIX.

#### *ACT and SAT Overlap*

The National Center for Education Statistics contends that 54% of *graduates* from the 2011-2012 high school cohort took the SAT while 49.1% took the ACT test. (National Center for Education Statistics, 2012) and (National Center for Education Statistics, 2012) Similarly, the Integrated

Postsecondary Education Data System (IPEDS) shows that 52.8% of first-year students submitted SAT scores when applying to college that year and 57.6% submitted ACT scores. (National Center for Education Statistics, 2016) However, no definitive way exists to ascertain the overlap between students who take both the ACT and SAT tests. Significant overlap appears to exist in California, “with 85% of students who took the SAT also taking the ACT and 86% of ACT takers also taking the SAT.” (Maitre, 2014) Another source shows that for the top 50 U.S. News & World Report-ranked universities, a weighted average of 19% of admitted students reported both ACT and SAT scores. (Vasavada, 2011) And, at an elite sample of schools, the percentage of first-time freshman submitting both scores ranged between 20-45%. (Saget, 2013)

At our own majority White, high-SES institution, 36% of engineering applicants in 2012 submitted both ACT and SAT scores. In Colorado the same year, we saw 17% of graduates taking the SAT and, as an ACT-contracted state, close to 100% taking the ACT.

**Table 22.** ACT and SAT overlap in submitted scores to the CU College of Engineering and Applied Science for the 2012 cohort.

	Applicants		Admits		Enrolled	
SAT Only	679	24%	542	22%	111	13%
ACT Only	1130	40%	987	40%	403	49%
Both ACT and SAT	1004	36%	912	37%	324	39%
Total	2813		2441		838	

### *Research Filter Criteria*

To quantify the number of underrepresented students who might be admissible to engineering colleges using current admission standards practiced across the nation, we started by filtering the student data records based on the variables provided by ACT and The College Board. The first filter we investigated mirrors what admission decision-makers listed in their survey responses as the most important variables in their decisions to admit to engineering colleges. (Myers & Sullivan, 2014) These variables, and their associated filter criteria, are listed in **Table 23**. The

initial criteria shown are based on the survey responses, but also come from years working in engineering admissions. These criteria are what our own institution would expect of students applying and being admissible for our program, so this became the first, and most restrictive filter we investigated. The initial filter used for the SAT variables can be found in **Table 36** in the APPENDIX.

**Table 23.** ACT initial filter variables and criteria provided by admission decision-makers.

Variable	Initial Criteria
ACT Mathematics	Graphed by score
ACT Composite	Score $\geq 22$
High school grade point average	(A- to A) 3.5-4.0 or higher
High school class rank	Top quarter
Type of high school	Exclude other (e.g., GED)
Years certain subjects studied	
Math	$\geq 4$ years or more
Science	$\geq$ Three years
Advanced placement, accelerated, or honors courses	
Mathematics	Yes
Natural Sciences	Yes
High school course completion	
Algebra 2	Completed or plan to take
Calculus OR Trigonometry OR Other math beyond Algebra 2	Completed or plan to take
Physics	Completed or plan to take
High school course grades	
Mathematics (all courses)	Exclude D AND F
Natural sciences (all courses)	Exclude D AND F
Interest	
Planned college major	Engineering
First choice of occupation	Engineering
Interest inventory	
Science	Percentile rank $> 49$
Technology	Percentile rank $> 49$

#### *Example Parity Calculation*

For each race or ethnic group, a value was calculated of how many students would have been needed to be enrolled in engineering in 2012 to have national parity. The values presented in

**Table 20** were used for the calculations for both high school completers and those enrolled in college. Example calculations for the Hispanic or Latino students:

$$\text{Needed for parity} = \frac{\text{Hispanic or Latino completers}}{\text{Total completers}} \times \text{Enrolled in engineering total}$$

$$\text{Needed for parity} = \frac{697,000}{3,203,000} \times 130,671 = 28,435$$

*Needed for parity*

$$= \frac{\text{Hispanic or Latino enrolled in college}}{\text{Total enrolled in college}} \times \text{Enrolled in engineering total}$$

$$\text{Needed for parity} = \frac{490,000}{2,121,000} \times 130,671 = 30,188$$

*Way Short of Reaching Parity*—If engineering education accomplished its goal to achieve parity in racial or ethnic representation by students of color as compared to the 2012 cohort of high school completers and those graduates who enrolled in college, we would have seen 28,435-30,188 Hispanic or Latino students, 14,355-16,849 Black or African American students and 1,323 American Indian or Alaska Native students enrolled in engineering college that year. But, engineering’s broadening participation and equity results fell short, as only 12,898 Hispanic or Latino (45% of parity), 8,178 Black or African American (57%), 544 American Indian or Alaskan Native (41%), 262 Native Hawaiian or Other Pacific Islander and 4,188 students identifying as Two or More Races did enroll in the nation’s engineering colleges that year. See **Table 24** for details.

**Table 24.** Engineering enrollment and number needed for representation by race/ethnicity.

Racial/Ethnic Background	Needed for Parity in Representation		First-Years Enrolled in Engineering	Compared to High School Completers
	High school completers	Enrolled in college		
Hispanic / Latino	28,435	30,188	12,898	45%
Black / African American	16,849	14,355	8,178	49%
American Indian/Alaska Native	1,323	-	544	41%
Native Hawaiian/Other Pacific Islander	-	-	262	-
Two or More Races	-	-	4,188	-

- Native Hawaiian and Other Pacific Islander and Two or More Races are not included in the data source on high school completers or those enrolled in college

#### *Example ACT and SAT Overlap Calculations*

As shown earlier, in 2012, SAT and ACT had similar numbers of test takers: 1,666,017 students took ACT and 1,664,479 took the SAT. If we were to assume no overlap in test takers, we could assume that half of the pool of prospective engineering students could come from ACT and half from SAT. But, taking into consideration the probable overlap in test takers (i.e., students who took both tests), can calculate a range of students needed from each test population to meet parity for the number of students of color to achieve representation nationally, as shown in **Table 25**.

**Table 25.** Students of color needed for parity representation by race or ethnicity.

Racial/Ethnic Background	Overlap = 0%	Overlap = 20%	Overlap = 50%	Overlap = 80%
Hispanic / Latino	14,218-15,094	17,061-18,113	21,326 - 22,641	25,592-27,169
Black / African American	7,178-8,425	8,613-10,109	10,766 - 12,637	12,920-15,164
American Indian/Alaska Native	662	794	992	1,191
Native Hawaiian/Other Pacific Islander	131	157	197	236
Two or More	1895	2274	2843	3411

*Pool Calculations and Graphs*

Using the filter criteria from **Table 23**, we see in **Figure 4** that at every ACT Math score range, the test score filter is too restrictive, resulting in a pool of students of color far short of reaching racial or ethnic parity among the students enrolled as 2012 first-years in engineering colleges in—even if no overlap existed with SAT takers (which of course is not the case). The range of students of color needed to achieve the parity goal is not even shown on the graph! Of note, American Indian or Alaska Native is hidden behind the Native Hawaiian and Other Pacific Islander line. Also, the total URM as a percentage-of-parity dotted line is graphed using the secondary y-axis and is a sum of the total URM students divided by the total necessary for representation, assuming a 20% ACT and SAT overlap and no interest adjustment. For example, at an ACT Math score of 25, which was the median found across the institutions that provided entry metrics to ASEE, we could achieve 5.5% of URM parity and at the first quartile value of ACT Math 23 the pool increases 9% to 6.1% of parity (again with no accounting for engineering interest).



**Figure 4.** 2012 U.S. cohort ACT Math scores by race/ethnicity (initial most-restrictive filter).

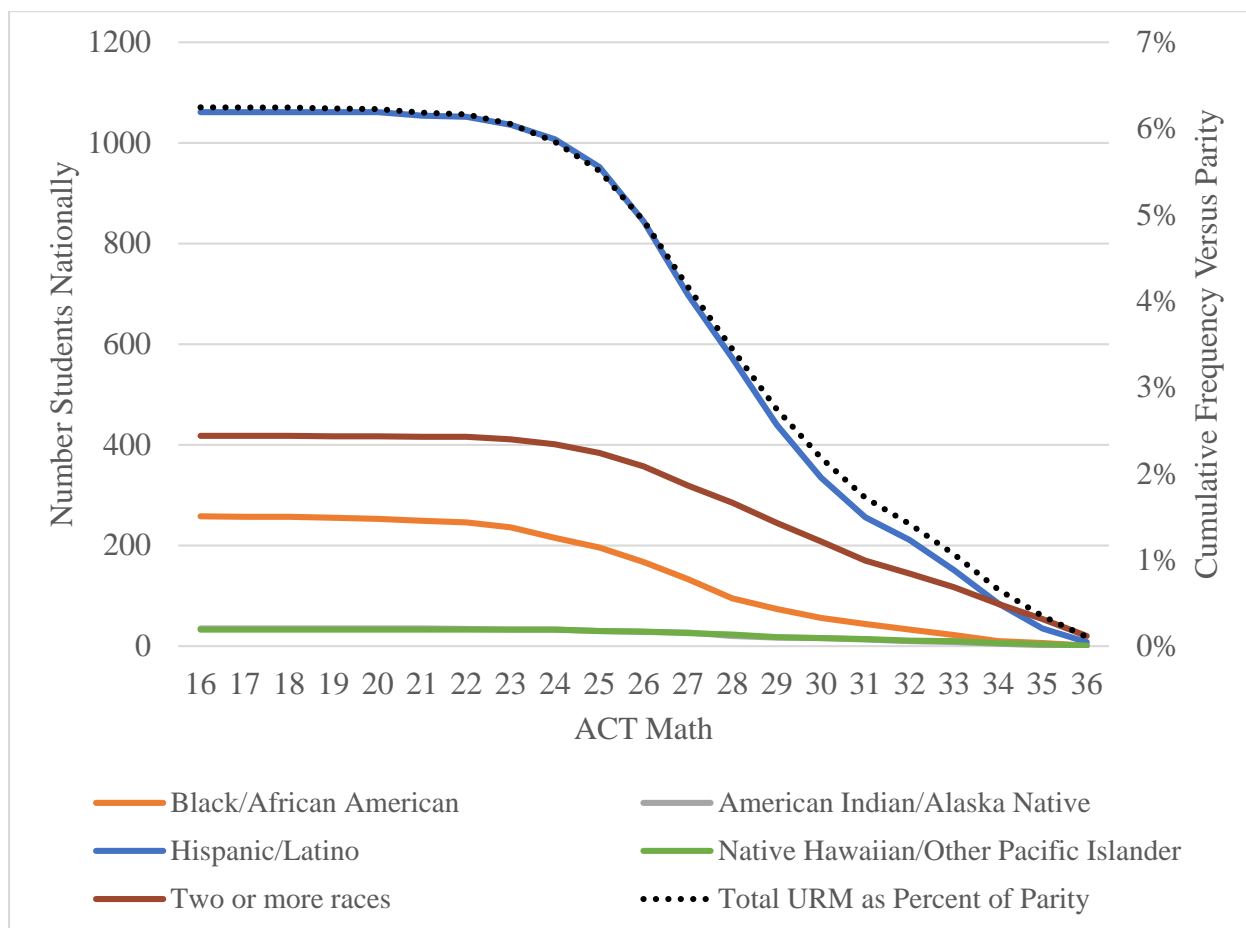

*Pool Forecast #2*—Next, an expanded filter for ACT test takers was used to widened students’ planned major and occupation to include engineering technology for either. Again, this filter is too restrictive to yield a pool of students remotely near racial/ethnic parity with the population of students graduating from high school, as shown in **Figure 5**. In short, with the stated constraints in the forecast, the population of engineering admissions-ready students of color is still way too small, even after expanding the majors and occupation options to include engineering technology. Given that our future engineering applicants must be found within the population of high school graduates, we have a choice: either become sanguine that racial and ethnic parity is not within the range of possibility, or change our admissions filters to find creative pathways to engineering for today’s graduates. Engineers are problem solvers; it’s what we do. And, we

know how to design within constraints. It is clear that engineering education needs to get much more creative to create an effective engineering education for our nation's youth who hail from all walks of life. It is not prudent to give up on creating access to an engineering future for the largest growing segment of our nation's population. We must face the constraints with more determination to find solutions that work to create multiple pathways to an engineering future for all people within our borders.

**Figure 5.** 2012 U.S. cohort ACT Math scores by race/ethnicity-expanded major and occupation filters.

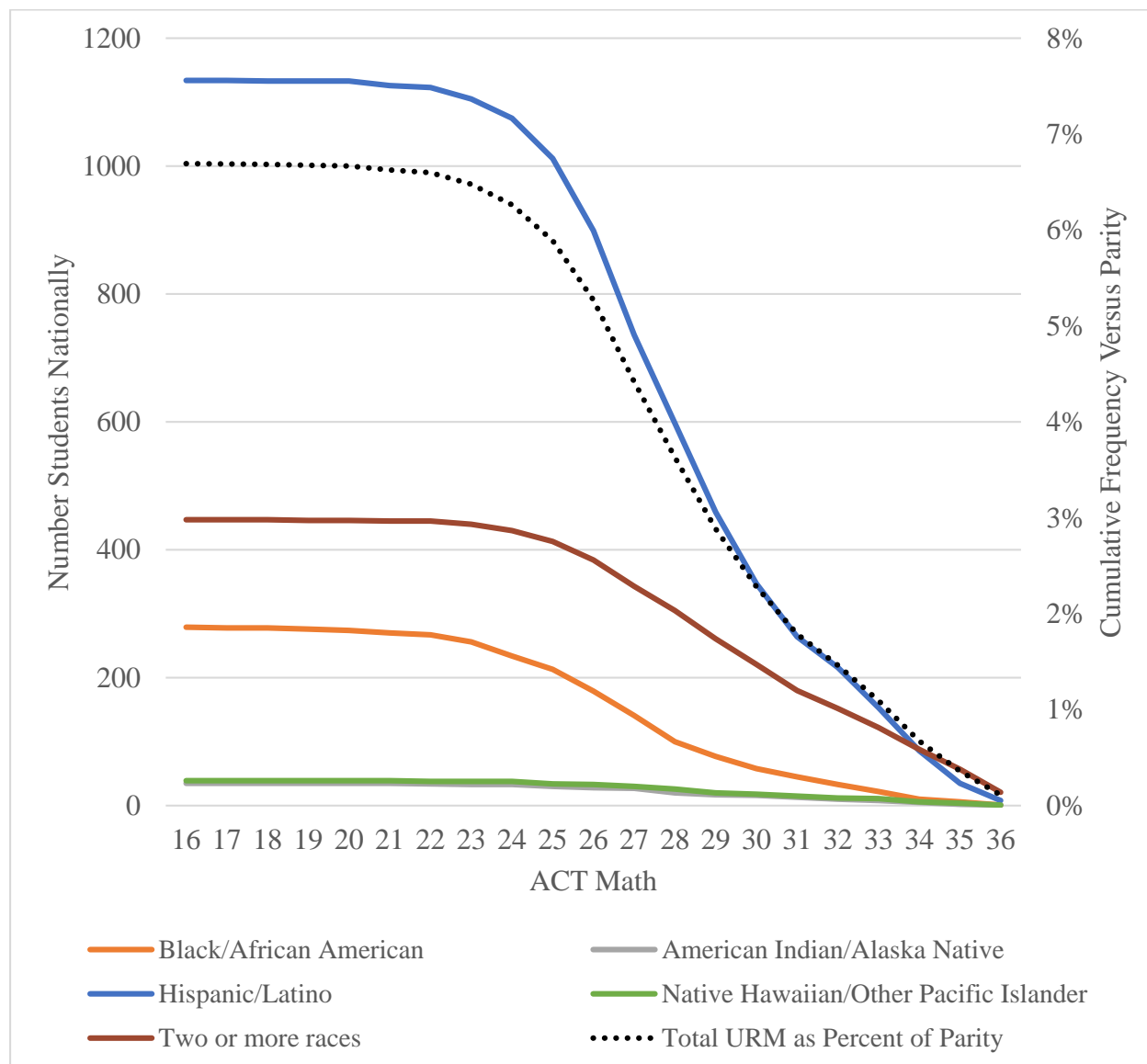

If major and occupation filters are removed altogether from the ACT takers while keeping the interest percentiles in science and technology at or above 50%, we see increased numbers of students (see **Figure 6**), but it is still very small compared to what would be needed for parity representation.

**Figure 6.** 2012 U.S. cohort ACT Math scores by race/ethnicity, with major and occupation filters removed.

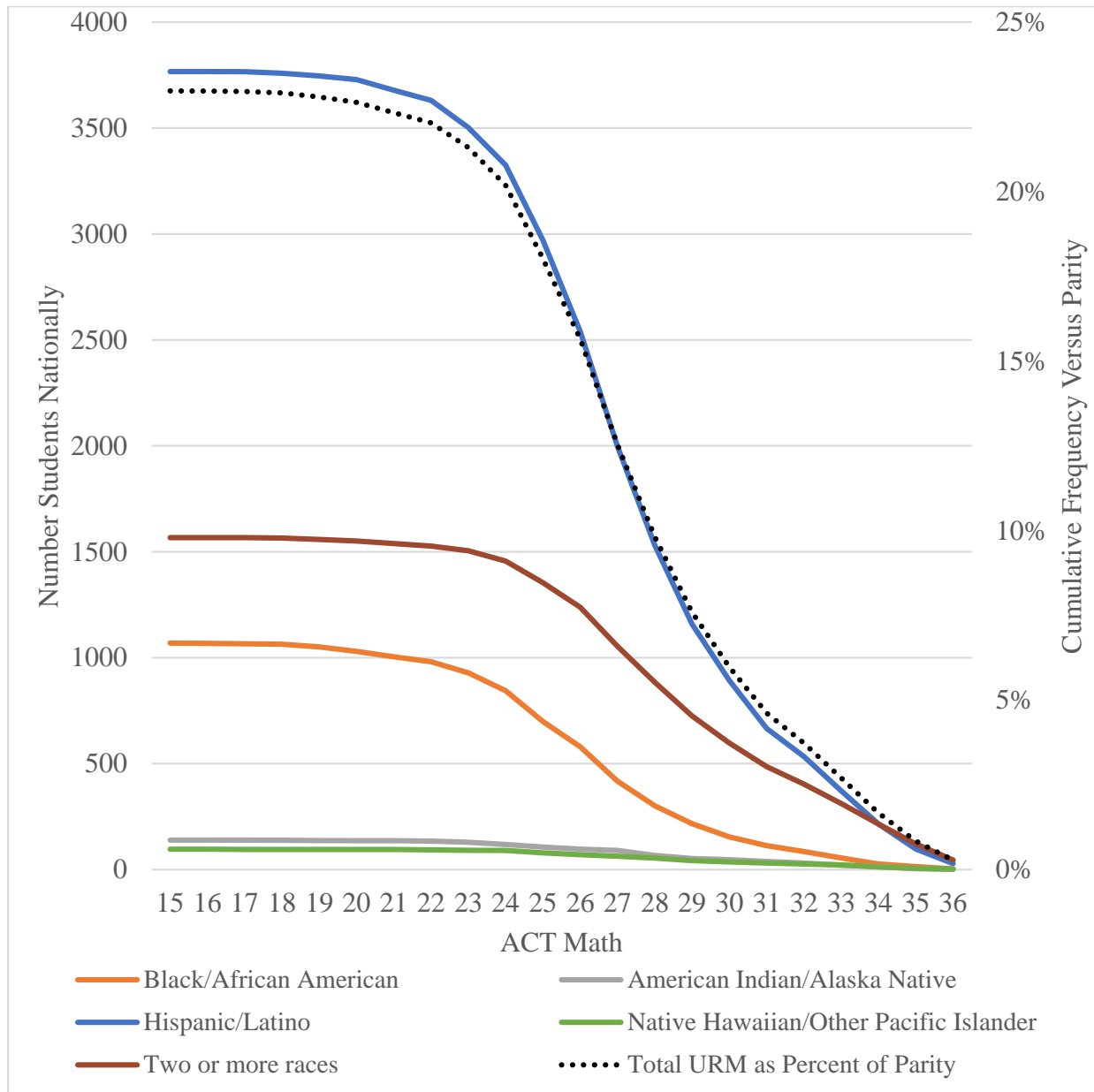

*Pool Forecast #3*—If all *interest* filters are removed from the model and only the standardized test scores and high school performance variables are included, the population of students of color within the constraints is expanded, but not *yet* to the level that would result in engineering college parity (see **Figure 7**). Again looking at ACT Math median of 25, we could reach 44% of URM parity if all test takers chose to pursue engineering. Thus, to adequately increase the pool of underrepresented students to reach parity, we cannot only rely on increasing *interest* in engineering among high school youth, we must also make policy changes that result in different admission *practices* regarding high school performance and standardized test scores.

**Figure 7.** 2012 U.S. cohort ACT Math scores by race/ethnicity, with engineering-interest filters removed.

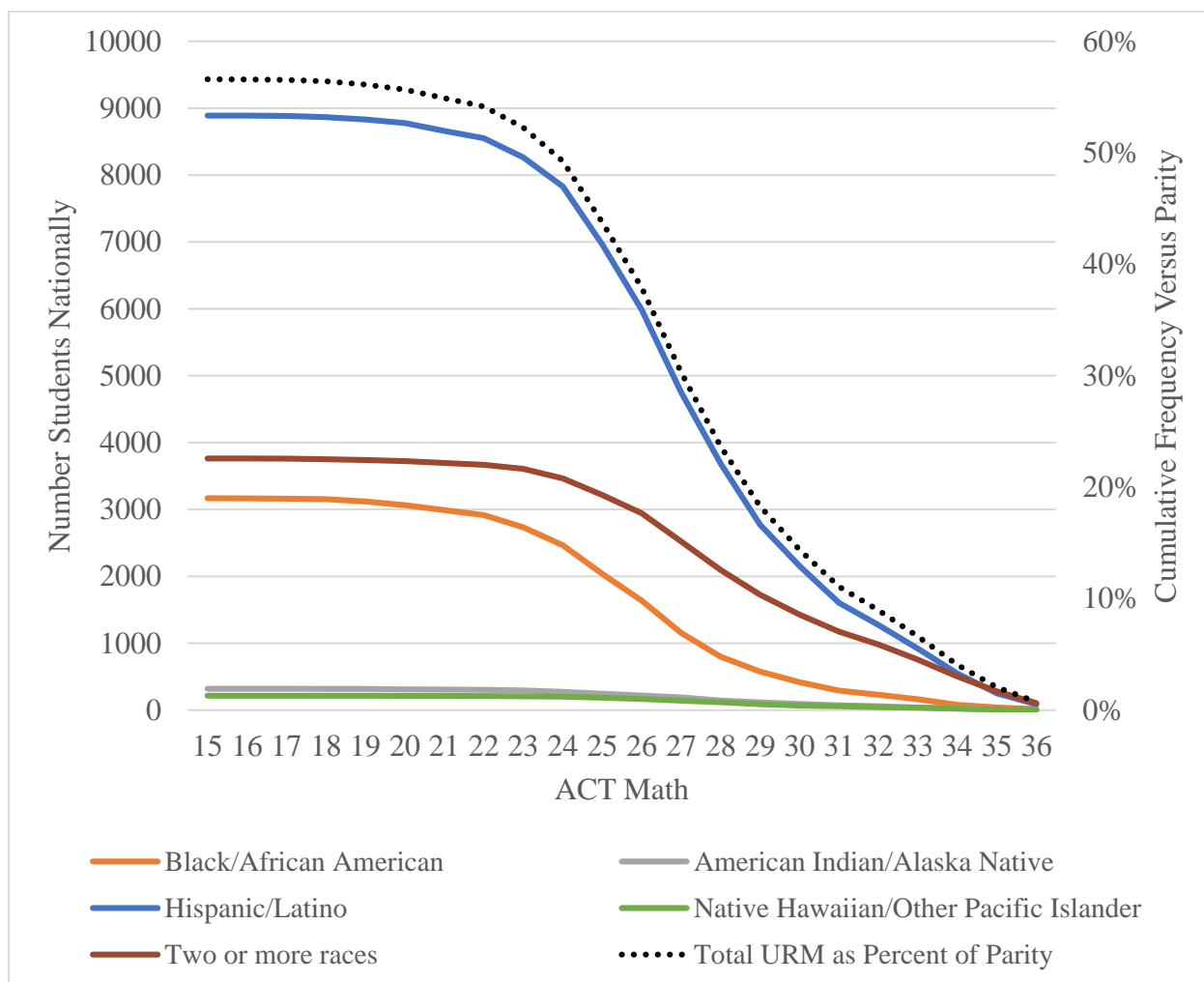

Additional filter examples are provided in the APPENDIX.

*Pool Forecasts without Academic Filters*—Next, the pool of potential students of color without any filters and looking only at ACT Math as the variable of interest is presented in **Figure 8**. The dotted black line shows the cumulative frequency of URM students at the percentage of parity. The dashed black line accounts for engineering interest. So, we see that at the median ACT Math score of 25 we could reach URM parity IF every student chose to pursue an engineering degree in college. Since that is unreasonable and not the goal of higher education, the more reasonable investigation is the dashed black line that takes into consideration that, at most, 11% of students may have an interest in engineering. At the median ACT Math score of 25, we could reach 26% of URM parity and at the lowest quartile of ACT Math 23 we could reach 45% of parity. To achieve 100% parity accounting for 11% interest, we would need to admit students down to an ACT Math score of 17.

**Figure 8.** 2012 U.S. cohort ACT Math scores by race/ethnicity with all filters removed.

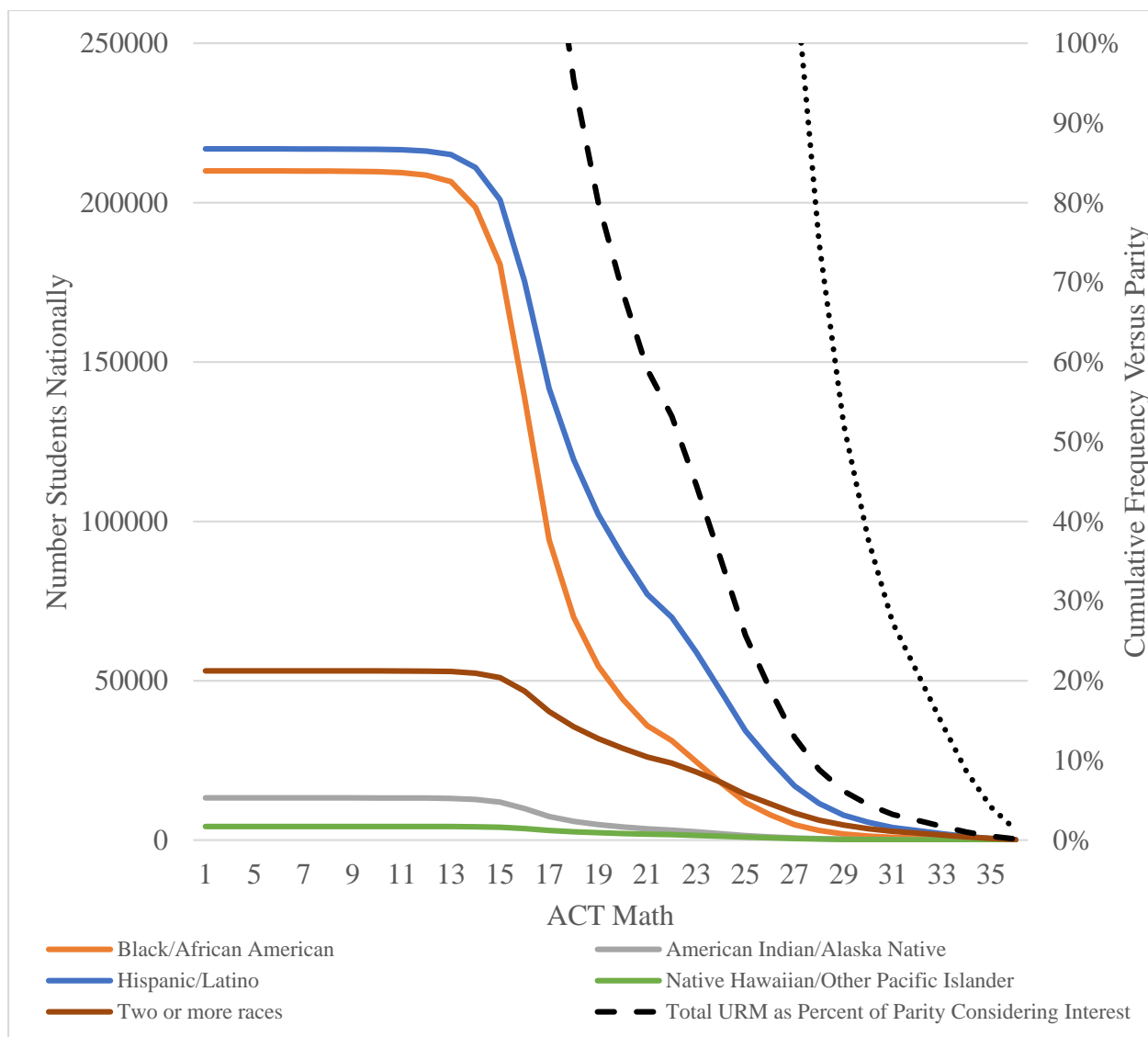

Recall from **Table 25** that assuming 20% overlap in ACT and SAT takers would require ~31K students of color enrolling in engineering in 2012 to reach engineering parity with that year's high school graduating class. Disaggregating the 31K students by racial/ethnic demographics reveals 18K Hispanic/Latino, 10K Black/African American, 794 American Indian/Alaska Native, 157 Native Hawaiian/Other Pacific Islander and 2,274 students identifying as Two or More Races.

**Figure 9.** 2012 U.S. cohort ACT Math scores by race/ethnicity with all filters removed (zoomed).

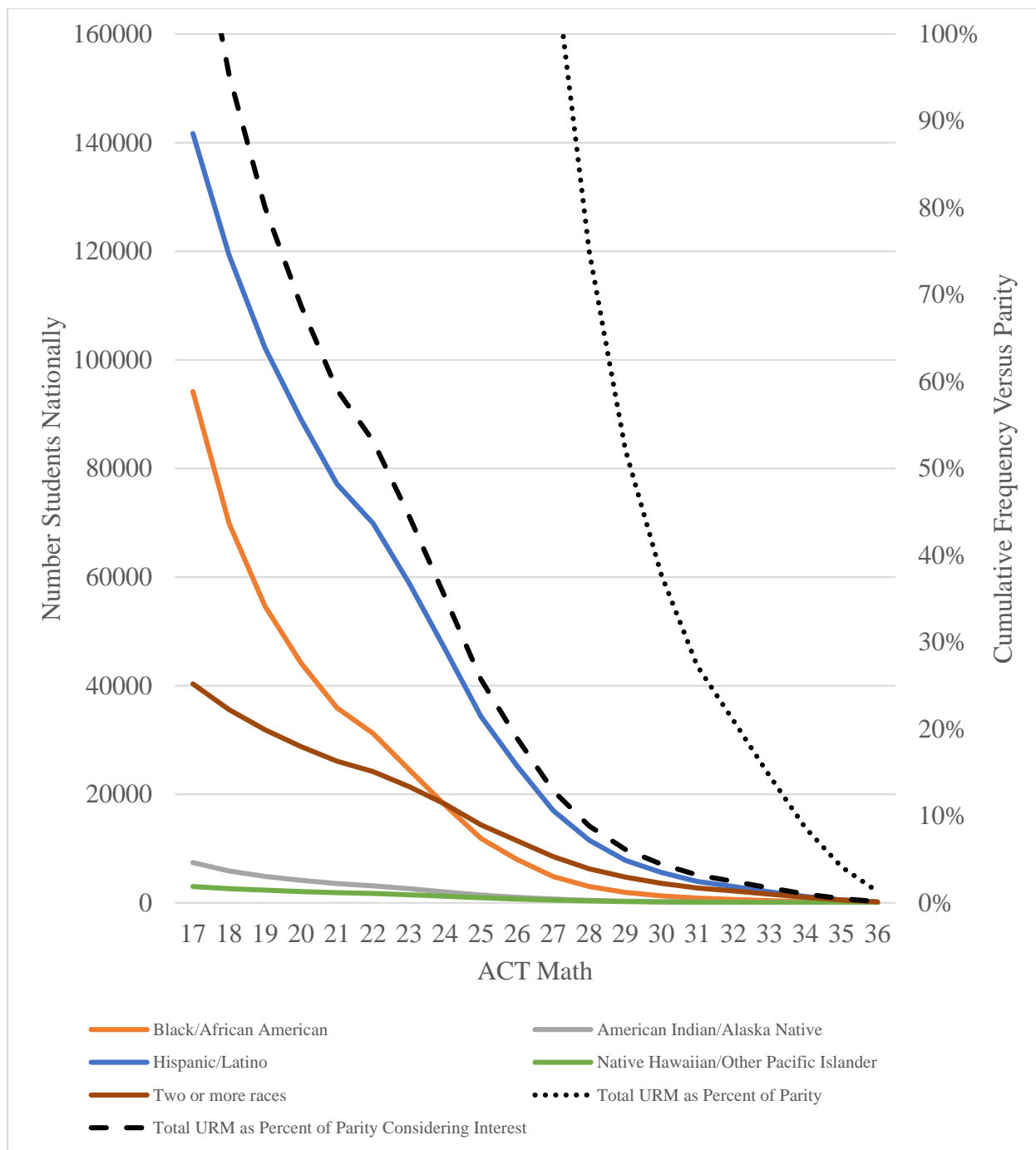

Looking deeper, to achieve this engineering enrollment for Black or African American students, would require that *every* Black student in the nation with an ACT Math score above 25 attend engineering college. Yes, to be *interested* in engineering, to *apply* to engineering, to be *admitted*

to engineering, and to *enroll* in engineering—which is totally unrealistic. Bear in mind that only about 11% of all high school seniors in the 2012 U.S. cohort had an interest in engineering: 13% for Hispanic/Latino, 10% for Black/African American and 15% for American Indian/Alaska Native students. (My College Options and STEMconnector, 2012)

Thus, interest in engineering among high school students was next taken into account in order to realistically refine the forecast for the number of students of color necessary to meet parity representation in engineering education. The black dashed line in **Figure 9** shows that to get the cumulative sum of underrepresented students we expect are necessary, using best-case interest levels, to reach parity in engineering enrollment, again, would require considering students with ACT Math down to a score of 17. Of note, the interest levels used above are higher than those indicated by ACT and SAT takers (7% and 9%) (ACT, Inc., 2012; The College Board, 2012).

Even if no overlap existed between ACT and SAT takers (and we assume a 20-80% overlap exists), not enough Hispanic or Latino, Black or African American, and American Indian/Alaska Native students with ACT or SAT scores at the 25<sup>th</sup> percentile range are admitted at U.S. engineering colleges to enable for representation consistent with students enrolled in college.

**Table 26.** Students needed for representation from each test by race/ethnicity with interest multiplier.

Racial/Ethnic Background	ACT/SAT Overlap = 0%	ACT/SAT Overlap = 20%	ACT/SAT Overlap = 50%	ACT/SAT Overlap = 80%
Hispanic / Latino	109,365- 116,108	131,238- 139,329	164,048- 174,162	196,856- 208,994
Black / African American	71,775- 84,245	86,130- 101,094	107,663- 126,368	129,195- 151,641
American Indian/Alaska Native	4410	5292	6615	7938
Native Hawaiian/Other Pacific Islander	1191	1429	1786	2144
Two or More	17,227	20,673	25,841	31,009



Another way of looking at the pool of potential engineering students is a cross-tabulation of ACT Math and ACT Composite scores. The following tables (**Tables 10-14**) are filtered to include all students across the nation with high school grade point averages greater than 3.4 on a 4.0 scale. Each cross-tabulation table includes one race or ethnic group. This representation of the data enables comparison of the impact of differentiating ACT Math and ACT Composite scores for admission decisions. As seen in **Figure 10**, the most common ACT Math and ACT Composite combination for Black or African American students is ACT Math 16 and ACT Composite 17. The most common combination for American Indian or Alaska Native students is ACT Math 23 and ACT Composite 22 (**Figure 11**). For Hispanic students it is ACT Math 24 and ACT Composite 23 (**Figure 12**); for Native Hawaiian and Other Pacific Islander it is ACT Math 26 and ACT Composite 25 (**Figure 13**). Lastly, for Two or More Races, we see ACT Math of 24 and ACT Composite 24 (**Figure 14**).

Density Comparison—The most common ACT Math and Composite combination for 1,099 Hispanic and Latino students with high school grade point averages greater than 3.4 (on a 4.0 scale) is ACT Math 24 and ACT Composite 23. To sum to the same number of students at the high end of the ACT Math scale, we would need to include every Hispanic or Latino student who scored 34-36 to reach more than 1,000 students (1,016). This means that one cell of the table is equivalent to three entire columns. Another comparison, 6,393 of these Hispanic or Latino students scored 24 on the ACT Math, and 6,265 scored between 29 and 36 on ACT Math. One math score, i.e., one column, is equivalent to the same number of students in the top eight math scores, or columns, in the table. This shows that student test scores are many-fold denser in lower ranges that are outside the typical 25<sup>th</sup> percentile for engineering entry classes.

**Figure 10.** ACT Math and ACT Composite cross-tabulation for Black/African American students.

		Number of Black/African American Students (2012 cohort)																																			
		ACTMath																																			Total
		4	5	6	7	8	9	10	11	12	13	14	15	16	17	18	19	20	21	22	23	24	25	26	27	28	29	30	31	32	33	34	35	36			
ACT Composite	6																																			1	
	7						1																														4
	8														1																						3
	9																																				14
	10																																				42
	11																																				148
	12																																				337
	13																																				686
	14																																				1077
	15																																				1574
	16																																				2126
	17																																				2651
	18																																				3077
	19																																				3377
	20																																				3512
	21																																				3311
	22																																				3043
	23																																				2602
	24																																				2185
	25																																				1793
	26																																				1392
	27																																				1085
	28																																				834
	29																																				611
	30																																				398
	31																																				257
	32																																				160
	33																																				90
	34																																				43
	35																																				43
	36																																				4
			1	2	3	10	16	80	269	698	2382	4312	3625	3232	2584	2427	1484	2401	2732	2961	2023	1858	1176	736	459	292	184	168	164	100	50	18	36447				





**Figure 13.** ACT Math and ACT Composite cross-tabulation for Native Hawaiian/Other Pacific Islander students.

		Number of Native Hawaiian/Other Pacific Islander Students (2012 cohort)																																			
		ACTMath																																			
ACT Composite		4	6	7	8	9	10	11	12	13	14	15	16	17	18	19	20	21	22	23	24	25	26	27	28	29	30	31	32	33	34	35	36				
		12										1	2																							3	
	13								1		2	3	4																						11		
	14								1		4	7	5	1					1																19		
	15									1	1	5	9	9	1	3	1																		30		
	16											3	11	6	3	2	2	1	1																29		
	17									1		2	13	10	8	5	4	1	3	2															50		
	18										1	3	11	11	12	13	7	3	3	8	2	1													75		
	19											2	7	19	14	19	20	3	5	3	4	1													97		
	20											1	3	5	8	10	12	12	17	13	7	4	2	1											95		
	21											1	2	6	10	10	9	12	10	11	12	2	1				1								87		
	22											1	3	7	9	11	5	13	24	19	16	11	3				1		1						125		
	23											1	2	5	1	1	4	10	23	24	24	24	16	8	3	2									125		
	24											1	2	5	1	2	1	5	18	16	26	21	11	10	1										120		
	25											1	2	3	1	5	5	15	17	15	31	11	3	3	4										110		
	26											1	2	3	1	2	5	14	14	25	18	13	7	3	2										109		
	27											1	2	2	1	1	2	7	9	9	13	16	8	3	3	2									76		
	28											1	1	1	1	1	1	5	12	13	18	10	3	3	3	1	2	1							77		
	29											1	1	1	1	1	1	4	6	8	8	5	8	5	8	5	1	2							48		
	30											1	1	1	1	1	2	4	4	10	5	1	3	5	1	3	5	3	1	1	1	1	1	1	40		
	31											1	3	11	12	13	7	5	6	7	5	2	4	6	8	1	1	4	1	1	1	1	1	41			
	32											1	3	11	12	13	7	5	2	4	6	8	1	1	4	1	1	4	1	1	1	1	1	41			
	33											2	7	19	14	19	20	3	5	3	4	1														16	
	34											2	7	19	14	19	20	3	5	3	4	1														16	
	35											2	7	19	14	19	20	3	5	3	4	1														6	
	36											2	7	19	14	19	20	3	5	3	4	1														6	
												2	2	8	27	68	69	67	78	73	46	81	124	123	130	138	91	89	56	25	28	29	24	22	14	6	1420

Figure 14. ACT Math and ACT Composite cross-tabulation for Two or More Races students.

		Number of Two or More Race Students (2012 cohort)																																					
		ACTMath																																					
		4	6	7	8	9	10	11	12	13	14	15	16	17	18	19	20	21	22	23	24	25	26	27	28	29	30	31	32	33	34	35	36						
ACT Composite	9									1																									1				
	10										1																									1			
	11							1			2	3	3			1																					10		
	12							1	3		4	4	11	3	3																						29		
	13							1	1		6	8	23	16	7		1	1																			64		
	14							1	1	2	3	11	30	24	15	3	1	2																			92		
	15										9	8	38	52	29	22	2	5	1	3	2																171		
	16										2	8	49	99	46	37	20	13	3	6	2																285		
	17									1	2	6	47	107	102	47	28	19	13	11	6	4															394		
	18											4	41	137	99	66	49	32	30	15	7	3	1														615		
	19											4	27	98	129	148	97	86	48	52	38	18	6	2	1			1									755		
	20											1	19	98	138	157	135	111	83	110	95	62	23	12	3	2											1050		
	21												13	72	97	128	143	160	113	150	166	132	60	35	5	3											1277		
	22											2	5	29	57	75	101	125	104	177	239	230	139	97	37	12	1	2										1432	
	23											1	2	15	26	43	80	96	93	172	229	282	227	148	73	25	11	6	1	1								1531	
	24													7	11	30	47	68	65	140	222	323	238	231	140	65	23	11	1	1	1	1	1	1	2		1626		
	25												1	6	6	19	29	42	54	87	174	277	275	276	204	104	50	24	12	5	3	1	1	1		1650			
	26												1		3	6	15	20	24	64	127	207	229	291	228	148	80	44	18	11	15	8			1539				
	27														1	4	6	10	9	27	84	151	192	265	245	203	116	65	39	21	31	4	2	2	1477				
	28														1	1	2	4	6	16	45	98	133	217	212	157	129	95	67	39	30	16	5	2	1275				
	29															1	1	2	2	5	13	53	73	162	177	166	145	98	68	59	41	26	14	4	1109				
	30																		2	4	7	39	103	153	117	126	102	57	68	75	32	21	4	910					
	31																		1	5	13	38	75	86	75	86	94	99	82	103	88	53	22	14	773				
	32																			1	3	6	27	39	60	69	59	85	93	72	51	20	585						
	33																																				408		
	34																												4	4	10	29	62	74	67	33	283		
	35																																					146	
	36																																						19508
			2	3	7	30	61	310	757	808	820	774	813	650	1052	1462	1857	1653	1884	1587	1137	860	657	447	473	516	410	313	165	19508									

### Colorado Case Study

To address the impact of the unknown overlap in ACT- and SAT-taking trends, a single-state case study is provided for Colorado. Colorado is a bit unique in that essentially all high school students in the state took the ACT in 2012. And, the state has a limited number of engineering colleges. Thus this single-state case study illustrates how standardized test scores impact the pool of eligible students of color versus the reality of high school preparation and engineering college student interest and demand within the state.

The 2012 Colorado high school graduating class was 52,012 students, of which 57% (29,625) enrolled in postsecondary study immediately following graduation. Class characteristics of the cohort can be seen in **Table 27**. The dataset used for the case study includes 51,696 student ACT results from the Colorado 2012 high school class (>99% of graduates). (Colorado Department of Higher Education, 2014)

**Table 27.** Colorado 2012 high school class and postsecondary enrollment.

	# Graduates	% High School Class	% College-Going Students	Enrollment Rate	Total College Enrollment	% Stayed In Colorado for College	# Stayed In Colorado for College
American Indian or Alaskan Native	476	0.9	0.6	40.3	192	31.2	149
Asian	1,660	3.2	4.0	71.1	1,181	57.5	955
African-American	2,597	5.0	4.6	52.4	1,362	41.5	1,078
Hawaiian/Pacific Islander	111	0.2	0.2	57.7	64	50.5	56
Hispanic	13,147	25.3	18.4	41.6	5,464	36.7	4,825
Two or More Races	1,315	2.5	2.7	61.8	813	48.2	634
White (not Hispanic)	32,706	62.9	69.4	62.8	20,549	47.2	15,437
Free Reduced Lunch / Low-SES	14,066	27.0	19.7	41.4	5,824	36.4	5,120
Total	52,012			57.0	29,625		23,133

In 2012, across the state of Colorado, the enrollment of first-time, full-time undergraduate students studying engineering was 2,676 within seven institutions, as shown in **Table 28**. This table excludes the U.S. Air Force Academy and Colorado Technical University because their admissions process is very different from all other institutions considered.

**Table 28.** Colorado enrollment of full-time first-year engineering undergraduates in 2012.

School	Black or African American	Native American	Hispanic	Native Hawaiian	Two or More Races	URM *	% URM*	No. Enrolled	Needed for Parity Representation	
									CO HS Graduate URM (33.5%)	CO in-state college-going URM (28.7%)
UCCS	1	12	3	0	9	23	17	140	47	40
CSU-Pueblo	6	28	0	0	1	35	42	82	27	23
UCD	2	11	0	0	2	15	29	51	17	15
DU	1	10	1	0	3	15	19	80	27	23
CSU	5	47	0	0	20	68	11	596	199	171
CSM	11	67	1	1	54	123	13	949	318	272
CU-Boulder	8	77	3	0	25	109	14	778	260	223
Total	34	252	8	1	114	387	14	2,676	896	767

UCCS=University of Colorado Colorado Springs; CSU-Pueblo=Colorado State University-Pueblo; UCD=University of Colorado Denver; DU=University of Denver; CSU=Colorado State University; CSM=Colorado School of Mines; CU-Boulder=University of Colorado Boulder

\*Assumes 82% of Two or More Races are URM students based on 2012 census data

These seven institutions range from 65-90% Colorado residents within their various study bodies. (Division of Research, Planning and Performance, 2012) Most Colorado high school graduates in 2012 attended college in their home state: 78% of those who enrolled in college stayed in Colorado for their studies. (Colorado Department of Higher Education, 2014)

As shown in **Table 29**, undergraduate standardized test score 25<sup>th</sup> percentiles for the 2012 cohort were obtained from the American Society for Engineering Education for six of the Colorado



universities that enrolled students in engineering degree programs that year. (American Society for Engineering Education, 1998-2015) The University of Colorado Colorado Springs did not provide to ASEE information on its incoming class. As can be seen, the entry class metrics that are used as a proxy for admission requirements, vary greatly across the institutions offering engineering degrees in the state of Colorado with the University of Colorado Boulder and Colorado School of Mines having the highest 25<sup>th</sup> percentiles for test scores.

**Table 29.** Undergraduate engineering standardized test score 25<sup>th</sup> percentiles and percent of class in top quarter of high school class.

Colorado School	ACT Math	Composite	SAT Math	SAT Verbal	SAT Combined	Percent in Top Quartile
UCCS	-	-	-	-	-	-
CSU-Pueblo	18	19	-	-	-	32
UCD	22	20	580	535	1,110	91
DU	26	24	610	500	-	24
CSU	26	25	600	540	1,140	70
CSM	27	27	630	570	-	91
CU-Boulder	28	27	630	570	1,210	88

As shown in **Table 29**, undergraduate standardized test score 25<sup>th</sup> percentiles for the 2012 cohort were obtained from the American Society for Engineering Education for six of the Colorado universities that enrolled students in engineering degree programs that year. (American Society for Engineering Education, 1998-2015) The University of Colorado Colorado Springs did not provide to ASEE information on its incoming class. As can be seen, the entry class metrics that are used as a proxy for admission requirements vary greatly across the institutions offering engineering degrees in the state of Colorado with the University of Colorado Boulder and Colorado School of Mines having the highest 25<sup>th</sup> percentiles for test scores.

If the ACT results for Colorado students is used as a filter for admission to engineering, and meeting or exceeding the 25<sup>th</sup> percentile for ACT Math and ACT Composite are constraints, we find the pool of eligible students of color drastically reduced (see **Table 30**).

**Table 30.** Colorado high school graduates who meet the 25<sup>th</sup> percentile using ACT only.

School	ACT Math	Composite	Black or African American	Native American	Hispanic	Native Hawaiian	Two or More Races	Total URM* Pool in CO	URM Needed for Parity Representation, CO HS Graduates
CSU-Pueblo	18	19	576	121	4068	87	1231	5861	27
UCD	22	20	334	77	2416	59	869	3599	17
DU	26	24	90	23	712	23	376	1156	27
CSU	26	25	84	23	631	22	352	1049	199
CSM	27	27	46	13	353	15	231	616	318
CU-Boulder	28	27	29	9	272	14	229	512	260

\*Assumes 82% of Two or More Races are URM based on 2012 census data

When looking at only the ACT Math and ACT Composite score variables as constraints, we already see extremely limited numbers of students of color who meet the 25<sup>th</sup> percentile for more selective engineering colleges like the Colorado School of Mines and University of Colorado Boulder. Using these admissions metrics, it would be impossible for these two schools to achieve ethnic parity with the state's college-going population for Black/African American students. And, entirely unrealistically, it would require *every* eligible Hispanic student who meets these constraints to choose to study engineering at one of these two schools. Furthermore, to reach parity would require all of these Hispanic students to have chosen to attend college in the first place, and attend in Colorado. Remembering that 78% of Colorado students who went on to college stayed in Colorado for their studies, any forecast that assumes 100% of any student

population cohort goes to college in Colorado is based on unrealistic assumptions. Thus, to summarize, for engineering colleges to meet racial/ethnic parity in Colorado, the most selective schools would need to either change their admission metrics or be more successful than they are recruiting students of color from outside the state of Colorado—which is clearly not a solution that helps meet national needs by creating more *capacity* for engineering-admissible students of color.

In addition, this already-unrealistic forecast only considers ACT test score variables as constraints. But, four of the Colorado engineering colleges typically have incoming classes in which the vast majority of students are in the top 25% of their high school classes. When the forecast is rerun with filters that include students in the top quartile of their high school classes, we see an even more restricted pool (as shown in **Table 31**). Also shown is the number of underrepresented minority students that meet the criteria multiplied by 11% to adjust for engineering interest, recall this is the most optimistic engineering interest value found.

**Table 31.** Colorado high school graduates that meet the 25<sup>th</sup> percentile using ACT and high school rank.

School	ACT Math	Composite	Black or African American	Native American	Hispanic	Native Hawaiian	Two or More Races	Total URM* Pool	Total URM* Pool Assuming 11% Engineering Interest	Needed for Parity Representation, CO HS Graduates
UCD	22	20	151	34	1041	28	395	1578	174	17
CSU	26	25	56	13	410	16	219	675	74	199
CSM	27	27	33	8	256	12	159	439	48	318
CU-Boulder	28	27	22	5	198	11	130	343	38	260

\*Assumes 82% of Two or More Races are URM based on 2012 census data

This single-state investigation shows that the pool of eligible students of color is smaller than what would be required to come even close to meeting parity with regard to ethnicity as compared to the 2012 state population of college-going high school completers. Since Colorado's engineering colleges cannot, at any reasonable scale, effect the standardized test score performance of their state's high school students, their only option—if they are to broadly serve all the peoples of the state—is to drastically change their reliance on standardized test scores as a barrier to access. The above analysis, at both the national level, and brought down to the state level through one case study, demonstrates that equity to access in engineering education is indeed an issue.

#### *Limitations*

One limitation of this research is quantifying the overlap between SAT and ACT test takers. While various sources have published overlap ranges between 19-85%, the actual overlap is unknown and might vary drastically based on the student profile.

Another limitation is that we do not know the minimum test score of accepted students at each engineering degree-granting institution or exactly which, and to what extent, specific variables are used in the admission decision.

Thirdly, regional variations in demographics and student performance could impact the actual number of potential students available to pursue engineering at any given engineering college. Each institution would need to analyze where its students come from and its local environment to fully assess the pool of potential underrepresented students that might consider studying engineering at its institution.

College choice preferences such as location, institution type and size, cost of attendance, financial aid need, campus and community cultural norms, and other factors are important to

students. Such factors were not considered for these national and Colorado case studies. For a more accurate depiction, these factors would need to be included in the analysis.

Another limitation is that the ACT and SAT variables beyond test scores are self-identified and not confirmed. While we believe these self-identified variables to be highly reliable, they have not been verified.

### *Conclusion*

Unrealistic Expectations—Fostering student interest in engineering to the extent that it leads more, and more diverse, students to pursue engineering as their chosen undergraduate major is key to increasing the number of underrepresented students who enroll in engineering colleges. The larger, and perhaps more problematic issue for the engineering profession is that far too few students meet the stringent academic standards expected by engineering colleges to be able to achieve regional and national race and ethnic parity in engineering education. Meeting parity with regard to race and ethnicity would require a drastic change in admission policy and practice through reduced reliance on standardized test scores. The single-state Colorado case study demonstrates that it would be impossible, regardless of interest, for the largest engineering colleges in the state to meet racial and ethnic representation through the continued use of today's standardized test scores and high school performance "filters." It has been shown that standardized test scores are not the best predictors of success in engineering education; therefore, putting so much weight on these barriers is damaging to the goal of diversifying the engineering profession. Employing today's "weed out" practices is doing just that: denying equity in access to an engineering education to students from all populations in our diverse nation. Today's engineering education system is optimized for access by majority students, and that by and large

is who attends our nation's colleges. If we are to diversify our nation's engineering colleges, we must find more creative access pathways to do so.

### *CHAPTER 5—Summary and Overarching Conclusions*

The first research investigation looked at the six-year engineering graduation rate of incoming first-time, first-year engineering students with high grade point averages (HSGPAs) from high school and low standardized test scores, and compared it to the engineering graduation rate for students with low HSGPAs and high standardized test scores. It was found that for engineering students attending the 11 institutions for which we have MIDFIELD data, students with top quintile high school GPAs but bottom quintile standardized test scores—a population in which female and students from communities of color were overrepresented—had significantly higher six-year engineering graduation rates than students with top quintile test scores and bottom quintile GPAs. Therefore, diversity in engineering could be expanded if engineering colleges aggressively admit more students who boast top high school performance yet have much lower standardized test scores than institutional averages.

The next step in this research was to investigate whether minimum threshold values of HSGPA and standardized test scores exist that predicted successful graduation from engineering for students from racial and ethnic groups underrepresented in engineering. In the predictive models created that spanned all 11 institutions, the HSGPA converted to the 5.0 scale was the most influential in predicting six-year engineering graduation; however, the next influential variable in predicting six-year engineering graduation was either the higher education institution itself or ethnicity. This finding suggests that the best predictive admissions model would be specific to an

individual institution, and (disappointingly) not be an across-institutional model. And, that HSGPA and test score critical thresholds should not be modeled *across* institutions.

Last, the pool of potential underrepresented minority undergraduate engineering students based on today's typical admissions criteria across engineering colleges was investigated. It was found that fostering student interest in engineering is key to increasing the number of underrepresented students who enroll in engineering colleges; however, the larger and perhaps more problematic issue is that not enough students exist who meet the stringent academic standards expected by engineering colleges to achieve race and ethnic parity in engineering education—even if *all* of them were interested in engineering.

Limitations—Many of the limitations of the research for the first two questions are common to both. These include the fact that only 11 engineering institutions were included in the analysis, and while their sizes and student diversity help make the results generalizable to engineering students at other large public universities, the 11 MIDFIELD institutions are similar to each other in many ways. All the institutions are public, research universities with high or very high research activity, or are doctoral/research universities. None are small, private or liberal arts college settings. Of the 11 institutions, nine are in the South while one is in the West, and one in the Midwest; none are in the North (using the regional university definition used by U.S. News and World Report). While these are limitations of the results, the types of public institutions included in this study graduate the majority of the nation's engineering bachelor's degree recipients each year.

Another study limitation is that even when the historic data from the 11 MIDFIELD institutions were pooled together, the dataset still contained small numbers of URM students in some



categories or at some institutions. These small population sizes may lack the power necessary to realize statistical differences, even when a meaningful difference may exist. About 20% of the Black or African American students in the dataset were enrolled in two HBCUs that offer different surroundings than the other nine majority-serving institutions. And, because the MIDFIELD dataset was employed for the analysis, none of the schools studied were Hispanic Serving Institutions.

This research focused on women and students from racial and ethnic backgrounds typically underrepresented in U.S. engineering colleges; no focus was made on international or non-domestic engineering students. Since this study concentrated on high school grade point averages and standardized test scores that are commonly used for admission to college in the U.S., many of the international students were filtered out of the dataset because they lacked these variables in their admission records. In addition to the lack of consistent variables common to domestic students, a concern also exists about widespread cheating among students from certain countries or regions (Redden, 2015; Krantz & Meyers, 2016; Chen & Schultz, 2015); therefore, the engineering persistence and success of international students should be investigated separately.

A limitation of the findings is also that the size of the pool of students who could have been admitted if the institution's policy were to admit top HSGPA students regardless of their test scores is unknown. Are students with this profile less represented in the dataset because they were less likely to be admitted? Or, do fewer students fall into this category, and therefore fewer apply to engineering colleges?

Another limitation of the first research question is that even though the comparative quintile performance was determined *within* institution, admission policies and practices may have varied

through time, causing changes in who would fall into different quintiles. Related to this is high school grade point average inflation over time and grade non-equivalence (Godfrey, 2011-2), this research did not investigate grade inflation, however, if grades uniformly inflate we expect that HSGPA would still be a good predictor of engineering success until the vast majority of engineering-bound students had maximum grade point averages.

Also, when students near the bottom of the test score or high school GPA ranges were admitted and enrolled at an institution, we do not know what other factors were considered or impacted their admission and enrollment decisions. These unknown factors could play a major role in predicting success to graduation in engineering.

The applicability of this research may be limited to institutions with limited or selective admissions criteria, and thus might have little relevance at “open admissions” or “open enrollment” institutions. The findings are also limited to undergraduate study.

Another limitation of trying to quantify a national pool of students and comparing it to parity is the unknown overlap between SAT and ACT test takers. While various sources have published overlap ranges between 19-85%, the actual overlap is unclear and could vary drastically based on the student profile.

Another limitation is that we do not know the minimum test score of accepted students at each engineering degree-granting institution or exactly which, and to what extent, specific variables are used in the admission decision. We relied on the 25<sup>th</sup> percentile entry metric as a proxy for minimum admission criteria. Related, it appears that some engineering colleges reported spurious data to ASEE for their entry class values; while extreme values would not impact the median, some of the maximum and minimum values may not be valid. Values outside the

possible ranges were removed but those within the range were included even if it seemed unlikely they were valid.

Regional variations in demographics and student performance could impact the actual number of potential students available to pursue engineering at any given engineering college. Each institution would need to analyze where its students come from and its local environment to fully assess the pool of potential underrepresented students that might consider studying engineering at its institution.

College choice preferences such as location, institution type and size, cost of attendance, financial aid need, campus and community cultural norms, and other factors are important to students. Such factors were not considered for these national and Colorado case studies. For a more accurate depiction, these factors would need to be included in the analysis.

Another study limitation is that the ACT and SAT variables beyond test scores are self-identified and not confirmed. While we believe these self-identified variables to be highly reliable, they have not been verified.

**Next Steps and Further Research**—While the motivation for this research was not to support test optional admission practices, the research results warrant serious consideration by engineering colleges of exploring test optional admission practices in order to achieve break-through results in *broadening access* to engineering for students of color. It would be strategically significant to study the six-year engineering graduation rate and student population composition for a few cohorts of students immediately prior to becoming test optional, and then a few cohorts after becoming test optional to see if any significant differences appear in the graduation outcomes and diversity of students who were not selected using standardized test scores. This research

suggests that individual engineering colleges should examine their own institutional outcomes to see if standardized test scores are really improving their ability to predict success for underrepresented students in their colleges, or if the test score requirements are more overwhelmingly limiting access to the students they admit (and over time, those who apply). The mere use of standardized tests in the admission process may deter potential applicants who would make suitable engineering students. Therefore, individual engineering colleges would be wise to determine if standardized tests have any predictive validity in their institutions, and if so, determine if this validity holds true for their underrepresented students. If they do not, perhaps deemphasizing (or eliminating) test scores is an appropriate step.

Another potential area of study is how the documented grade inflation occurring at the high school level (Godfrey, 2011-2) impacts the predictive ability of the high school grade point average as a predictor of engineering graduation. If high school grade point average continues to rise among all students applying to certain institutions, at some point it becomes a constant. If that is the case, what other factors should be used to predict success for underrepresented students?

Investigations about who applies to engineering colleges and why could be revealing, for example, do the institutions' published metrics impact who applies to a college? Do mostly students who meet published criteria or metrics apply (self-eliminating) or do students across the spectrum apply? And does this vary by institution? If an institution changes the metrics it tracks and publishes, does that change who applies? Our own engineering college found that very few women applied who did not meet the lower end of the standardized test scores we published, while men with *much* lower test scores applied.

This study focused on the impact of standardized test scores on undergraduate admission to engineering colleges; further study would be warranted to explore whether standardized test score requirements (such as the GRE) have the same impact on graduate admissions in engineering. Similar concerns have been voiced about the GRE as the SAT/ACT: that it does not predict the most successful students and limits STEM diversity. (Miller & Stassun, 2014) However, GRE recently revised its test and has procedures in place to minimize potential bias against particular cultural/ethnic groups. (ETS GRE, 2014) Some prestigious programs no longer require GREs, such as, the NSF GRFP (in previous years, it counted the GRE to varying degrees in evaluating intellectual merit). (National Science Foundation, 2016)

**Summary Conclusion**—Across multiple research investigations it was found that standardized test scores have limited ability to predict when underrepresented minority students will be successful in undergraduate engineering programs. And, requiring high standardized test scores drastically limits access to the number of students of color who can pursue an engineering education. If we accept that a plethora of little-understood bias and cultural experiences lead to these quite different test score outcomes and yet we continue as a community to insist on using test scores for engineering admission, the numbers do not support expanding diversity in engineering education. However, if evidence-driven differentiation of test scores in the admission process or moving away from test score reliance becomes both conceivable and operational, then we have hope to reach parity in engineering admissions.

## BIBLIOGRAPHY

- ACT and SAT. (2008, June). *ACT-SAT Concordance Study: June 2008*. Retrieved from ACT-SAT Concordance: A Tool for Comparing Scores: <http://www.act.org/aap/concordance/pdf/reference.pdf>
- ACT Inc. (2008). *ACT Research*. Retrieved from The Relative Predictive Validity of ACT Scores and High School Grades in Making College Admission Decisions: <https://www.act.org/research/policymakers/pdf/PredictiveValidity.pdf>
- ACT, Inc. (n.d.). *Research and Policy Issues - Information Brief; Interpreting ACT Assessment Scores: College Admissions*. Retrieved from <http://www.act.org/research/researchers/briefs/2002-1.html#UItAIYq5fw>
- ACT, Inc. (2012). *2012 ACT National and State Scores*. Retrieved from Average Scores by State: <https://www.act.org/newsroom/data/2012/states.html>
- ACT, Inc. (2015). *ACT Profile Report - National*. Iowa City, IA: ACT, Inc.
- American Society for Engineering Education. (1998-2015). *Engineering College Profiles & Statistics Book*. Washington, DC: ASEE. Retrieved from [http://www.asee.org/papers-and-publications/publications/college-profiles#The\\_Profiles\\_and\\_Data\\_Book](http://www.asee.org/papers-and-publications/publications/college-profiles#The_Profiles_and_Data_Book)
- Aronson, J., Quinn, D. M., & Spencer, S. J. (1998). Stereotype Threat and the Academic Underperformance of Minorities and Women. In J. K. Swim, & C. Stangor (Eds.), *Prejudice: The Target's Perspective* (pp. 83-103). San Diego, CA: Academic Press.
- Biggs, D., de Ville, B., & Suen, E. (1991). A method of choosing multiway partitions for classification and decision trees. *Journal of Applied Statistics*, 18, 49-62.
- Bourne, A., Klingbeil, N., & Ciarallo, F. (2014). Developing the Academic Performance-Commitment Matrix: How Measures of Objective Academic Performance Can Do More Than Predict College Success. Indianapolis, IN: American Society for Engineering Education. Retrieved from <https://peer.asee.org/20296>
- Chen, T.-P., & Schultz, A. (2015, June 5). *The Wall Street Journal*. Retrieved from Cheating Concerns in Asia Cloud SAT Testing: <http://www.wsj.com/articles/cheating-concerns-in-asia-cloud-sat-testing-1433549895>
- Clinedinst, M. (2015). *State of College Admission*. Arlington, VA: National Association for College Admission Counseling. Retrieved from [http://www.nxtbook.com/ygsreprints/NACAC/2014SoCA\\_nxtbk/#/28](http://www.nxtbook.com/ygsreprints/NACAC/2014SoCA_nxtbk/#/28)
- Colby, S. L., & Ortman, J. M. (2015). *Projections of the Size and Composition of the U.S. Population: 2014 to 2060*. Washington, DC: U.S. Department of Commerce, Census Bureau. Retrieved from <http://www.census.gov/content/dam/Census/library/publications/2015/demo/p25-1143.pdf>

- Colorado Department of Higher Education. (2014). *2014 Legislative Report on the Postsecondary Progress and Success of High School Graduates*. Denver, CO: Colorado Department of Higher Education. Retrieved from [http://higher.ed.colorado.gov/Publications/Reports/Legislative/PostSecondary/2014\\_Postsecondary\\_Progress\\_rel20140505.pdf](http://higher.ed.colorado.gov/Publications/Reports/Legislative/PostSecondary/2014_Postsecondary_Progress_rel20140505.pdf)
- Division of Research, Planning and Performance. (2012). *Enrollments by Institution, Residency Fall Terms 2010-2012*. Denver, CO: Colorado Department of Higher Education. Retrieved from [http://higher.ed.colorado.gov/Publications/Reports/Enrollment/FY2013/20102012\\_Enrollment\\_Summary\\_byInst.pdf](http://higher.ed.colorado.gov/Publications/Reports/Enrollment/FY2013/20102012_Enrollment_Summary_byInst.pdf)
- Ennis, T. D., Milford, J. B., Sullivan, J. F., Myers, B. A., & Knight, D. (2011). GoldShirt Transitional Program: First-Year Results and Lessons Learned on Creating Engineering Capacity and Expanding Diversity. *2011 Annual Conference & Exposition* (pp. 22.754.1 - 22.754.15). Vancouver, BC: American Society for Engineering Education. Retrieved from <https://peer.asee.org/18035>
- ETS GRE. (2014). *A Snapshot of the Individuals Who Took the GRE revised General Test*. Retrieved from [https://www.ets.org/s/gre/pdf/snapshot\\_test\\_taker\\_data\\_2014.pdf](https://www.ets.org/s/gre/pdf/snapshot_test_taker_data_2014.pdf)
- FairTest; The National Center for Fair and Open Testing. (2016, Spring). *FairTest*. Retrieved from 850+ Colleges and Universities That Do Not Use SAT/ACT Scores to Admit Substantial Numbers of Students Into Bachelor Degree Programs: <http://www.fairtest.org/university/optional>
- Fisher. (1945). A New Test for 2 x 2 Tables. *Nature*, 156(3961), 388. doi:10.1038/156388a0
- Freeman, R. B., & Huang, W. (2015, February). Collaborating with People Like Me: Ethnic Co-Authorship within the United States. In S. Turner, W. Kerr, & Journal of Labor Economics (Ed.), *U.S. High-Skilled Immigration in the Global Economy* (pp. 289-318). Chicago, IL: University of Chicago Press. doi:10.3386/w19905
- Godfrey, K. E. (2011-2). *Investigating Grade Inflation and Non-Equivalence*. College Board. Retrieved from <https://research.collegeboard.org/sites/default/files/publications/2012/7/researchreport-2011-2-investigating-grade-inflation-non-equivalence.pdf>
- Holloway, B. M., & Reed-Rhoads, T. (2008). Between Recruiting and Retention: A Study of Admissions Practices and Their Impact on Women in Engineering. *ASEE Global Colloquium on Engineering Education*. Cape Town, South Africa.
- Holloway, B. M., Imbrie, P., & Reed-Rhoads, T. (2011). A holistic review of gender differences in engineering admissions and early retention. *ICWES 15: The 15th International Conference for Women Engineers and Scientists*, (pp. 54-63). Australia.

- Holloway, B. M., Reed, T., Imbrie, P., & Reid, K. (2014, April). Research-Informed Policy Change: A Retrospective on Engineering Admissions. *Journal of Engineering Education*, 103(2), 274-301.
- IBM. (2013). *IBM Knowledge Center*. Retrieved from SPSS Statistics 22.0.0 > Algorithms > TREE Algorithms . CHAID and Exhaustive CHAID Algorithms: [http://www-01.ibm.com/support/knowledgecenter/SSLVMB\\_22.0.0/com.ibm.spss.statistics.algorithms/alg\\_tree-chaid.htm](http://www-01.ibm.com/support/knowledgecenter/SSLVMB_22.0.0/com.ibm.spss.statistics.algorithms/alg_tree-chaid.htm)
- Jones, N. A., & Bullock, J. (2012). *The Two or More Races Population: 2010*. Census Bureau. U.S. Department of Commerce.
- Kobrin, J. L., & Michel, R. S. (2006). *The SAT As a Predictor of Different Levels of College Performance*. New York, NY: The College Board. Retrieved from <http://research.collegeboard.org/publications/content/2012/05/sat-predictor-different-levels-college-performance>
- Korbin, J. L., Patterson, B. F., Shaw, E. J., Mattern, K. D., & Barbuti, S. M. (2008). *Validity of the SAT for Predicting First-Year College Grade Point Average*. New York, NY: The College Board. Retrieved from <http://research.collegeboard.org/sites/default/files/publications/2012/7/researchreport-2008-5-validity-sat-predicting-first-year-college-grade-point-average.pdf>
- Krantz, L., & Meyers, J. (2016, January 19). *Boston Globe*. Retrieved from Fight to Find Cheats Takes Schools Around the World: <https://www.bostonglobe.com/metro/2016/01/19/chinese-students-hungry-attend-universities-caught-fraudulent-application-process/gpRB06mqBVAsxZ6eAbFKCJ/story.html>
- Lemann, N. (2000). *The Big Test-The Secret History of the American Meritocracy*. New York, NY: Macmillian, Farrar, Straus and Giroux. doi:ISBN10: 0374527512
- Maitre, M. (2014, June 17). *EdSource: Highlighting Strategies for Student Success*. Retrieved from Evaluation shows number of students not taking SAT, ACT or AP exams: <http://edsources.org/2014/evaluation-shows-number-of-students-not-taking-sat-act-or-ap/63320>
- Mattern, K. D., Patterson, B. F., & Wyatt, J. N. (2013). *How Useful Are Traditional Admission Measures in Predicting Graduation Within Four Years?* New York, NY: The College Board. Retrieved from <http://research.collegeboard.org/sites/default/files/publications/2013/9/researchreport-2013-1-how-useful-traditional-measures-graduation.pdf>
- Milford, J., Scarritt, A., Myers, B., Ennis, T., Sieber, D., Sullivan, J., & Knight, D. (2010). Goldshirt Transitional Program: Creating Engineering Capacity And Expanding Diversity Through A Performance Enhancing Year. *2010 Annual Conference & Exposition* (pp.



- 15.627.1 - 15.627.16). Louisville, KY: American Society for Engineering Education. Retrieved from <https://peer.asee.org/15886>
- Miller, C., & Stassun, K. (2014, June 11). A test that fails. *Nature*, *510*, 303-304. doi:10.1038/nj7504-303a
- Morgan, R. (1989). *Analyses of the Predictive Validity of the SAT and High School Grades From 1976 to 1985*. New York, NY: The College Board. Retrieved from <http://research.collegeboard.org/publications/content/2012/05/analysis-predictive-validity-sat-and-high-school-grades-1976-1985>
- Multiple-Institution Database for Investigating Engineering Longitudinal Development*. (n.d.). Retrieved April 2014, from Project Summary: <https://engineering.purdue.edu/MIDFIELD/Summary.htm>
- My College Options and STEMconnector. (2012). *Where are the STEM Students? What are their Career Interests? Where are the STEM Jobs?* Lee's Summit, MO and Washington, DC: My College Options & STEMconnector.
- Myers, B. A., & Sullivan, J. F. (2014). Beginning to Quantify the Pool of Engineering-Eligible Prospective Students through a Survey of Access Practices. *2014 ASEE Annual Conference* (pp. 24.224.1 - 24.224.13). Indianapolis, IN: American Society for Engineering Education. Retrieved from <https://peer.asee.org/20115>
- National Academy of Engineering; Committee on Diversity in the Engineering Workforce. (2002). *Diversity in Engineering: Managing the Workforce of the Future*. Washington DC: National Academies Press. Retrieved from [http://www.nap.edu/catalog.php?record\\_id=10377](http://www.nap.edu/catalog.php?record_id=10377)
- National Center for Education Statistics. (2012, December). *Digest of Education Statistics*. Retrieved from Table 174. SAT mean scores of college-bound seniors and percentage of graduates taking SAT, by state: Selected years, 1995-96 through 2011-12: [http://nces.ed.gov/programs/digest/d12/tables/dt12\\_174.asp](http://nces.ed.gov/programs/digest/d12/tables/dt12_174.asp)
- National Center for Education Statistics. (2012, September). *Digest of Education Statistics*. Retrieved from Table 175. ACT score averages and standard deviations, by sex and race/ethnicity, and percentage of ACT test takers, by selected composite score ranges and planned fields of study: Selected years, 1995 through 2012: [http://nces.ed.gov/programs/digest/d12/tables/dt12\\_175.asp](http://nces.ed.gov/programs/digest/d12/tables/dt12_175.asp)
- National Center for Education Statistics. (2012). *NCES Common Core of Data State Dropout and Graduation Rate Data File*. U.S. Department of Education.
- National Center for Education Statistics. (2015, May). *Digest of Education Statistics*. Retrieved from Table 504.10. Labor force status of 2011, 2012, and 2013 high school completers, by college enrollment status, sex, and race/ethnicity: October 2011, 2012, and 2013: [https://nces.ed.gov/programs/digest/d14/tables/dt14\\_504.10.asp](https://nces.ed.gov/programs/digest/d14/tables/dt14_504.10.asp)

- National Center for Education Statistics. (2016, February 20). *IPEDS Data Center*. Retrieved from <https://nces.ed.gov/ipeds/datacenter/Default.aspx>
- National Center for Education Statistics. (n.d.). *Integrated Postsecondary Education Data System*. Retrieved April 2014, from Student Right-to-Know Act: <http://nces.ed.gov/Ipedsglossary/index.asp?id=625>
- National Science Foundation. (2014). *National Center for Science and Engineering Statistics*. Retrieved from Science and Engineering Indicators 2014: <http://www.nsf.gov/statistics/seind14/>
- National Science Foundation. (2016). *NSF Graduate Research Fellowship Program*. Retrieved from <https://www.nsfgrfp.org/applicants/faqs>
- Obama, B. H. (2009, April 14). Speech on Economy. *Call for Engineers*. Washington, D.C.: YouTube. Retrieved from <http://www.youtube.com/watch?v=Zvj5EJgSSVU>
- Obama, B. H. (2013, April). *The White House*. Retrieved from Education for K-12 Students: <http://www.whitehouse.gov/issues/education/k-12/educate-innovate>
- Ohland, M. W., Zhang, G., Thorndyke, B., & Anderson, T. (2004). The creation of the Multiple-Institution Database for Investigating Engineering Longitudinal Development (MIDFIELD). Salt Lake City, UT: American Society for Engineering Education. Retrieved from <https://engineering.purdue.edu/MIDFIELD/user/image/e.3.38.the-creation-of-the-multiple-institution-database-for-investigating-engineering-longitudinal-development-28midfield29.pdf>
- Page, S. E. (2008). *The Difference: How the Power of Diversity Creates Better Groups, Firms, Schools and Societies*. Princeton, NJ: Princeton University Press.
- Phillips, K. W. (2014, October 1). How Diversity Makes Us Smarter. *Scientific American*. Retrieved from <http://www.scientificamerican.com/article/how-diversity-makes-us-smarter/>
- Redden, E. (2015, July 9). *Inside Higher Ed*. Retrieved from In China, No Choice But to Cheat?: <https://www.insidehighered.com/news/2015/07/09/admissions-process-broken-chinese-students>
- Saget, B. (2013, August 1). Where the SAT and ACT Dominate. *The New York Times*. Retrieved from [http://www.nytimes.com/interactive/2013/08/04/education/edlife/where-the-sat-and-act-dominate.html?\\_r=0](http://www.nytimes.com/interactive/2013/08/04/education/edlife/where-the-sat-and-act-dominate.html?_r=0)
- Steele, C., & Aronson, J. (1995). Stereotype Threat and the Intellectual Test Performance of African-Americans. *Journal of Personality and Social Psychology*, 69, 797.
- Steinberg, L. S., & Wainer, H. (1991). *Sex Differences in Performance on the Mathematics Section of the Scholastic Aptitude Test: A Bidirectional Validity Study*. Princeton, NJ:

- Educational Testing Service. Retrieved from [http://www.ets.org/research/policy\\_research\\_reports/publications/report/1991/hxgl](http://www.ets.org/research/policy_research_reports/publications/report/1991/hxgl)
- Sullivan, J. F., Myers, B. A., O'Connor, K., Peck, F. A., Ennis, T. D., Stites, N. A., . . . Kotys-Schwartz, D. A. (2015). Continuously Improving a Diversity-Bolstering System through Integrating Quantitative and Qualitative Engineering GoldShirt Program Facets. *2015 ASEE Annual Conference and Exposition* (pp. 26.405.1 - 26.405.12). Seattle, WA: American Society for Engineering Education. doi:10.18260/p.23744
- The Carnegie Classification of Institutions of Higher Education. (n.d.). About Carnegie Classification. Retrieved from <http://carnegieclassifications.iu.edu/>
- The College Board. (2012). *The SAT Report on College & Career Readiness: 2012*. New York, NY: The College Board. Retrieved from <http://media.collegeboard.com/homeOrg/content/pdf/sat-report-college-career-readiness-2012.pdf>
- The College Board. (2015). *SAT Data Tables-Critical Reading, Mathematics and Writing Percentile Ranks by Gender and Ethnic Groups*. New York: The College Board.
- The College Board. (2016, March 19). *SAT Suite of Assessments*. Retrieved from New Score Structure: <https://collegereadiness.collegeboard.org/educators/higher-ed/scoring-changes/new-score-structure>
- U.S. Department of Commerce. (2010). *U.S. Census Bureau*. Retrieved from Census.gov: <http://www.census.gov>
- U.S. Department of Education. (n.d.). *National Center for Education Statistics*. Retrieved from Digest of Education Statistics.
- U.S. Department of Education, Institute of Education Sciences, National Center for Education Statistics. (2015). Digest of Education Statistics and Fast Facts. Retrieved from <http://nces.ed.gov/fastfacts/display.asp?id=372>
- U.S. Department of Labor. (2015, November 4). *Bureau of Labor Statistics*. Retrieved October 3, 2013, from Occupational Outlook Handbook 2014-2015 edition: <http://www.bls.gov/ooh/>
- U.S. News & World Report. (n.d.). Best Undergraduate Engineering Program Rankings. Retrieved April 2016, from <http://premium.usnews.com/best-colleges/rankings/engineering-doctorate>
- Vasavada, N. P. (2011). *Ivy+ Admission Analytics for the Fox Parent; Intelligence, Strategy and Decision Rules for Breaching the Ivory Citadels*. Navendu P. Vasavada. Retrieved from <https://books.google.com/books?id=Ct6qkwnSYa8C>
- Veenstra, C. P., Dey, E. L., & Herrin, G. D. (2008). Is Modeling of Freshman Engineering Success Different from Modeling of Non-Engineering Success? *Journal of Engineering Education*, 467-479.

- Western Interstate Commission for Higher Education. (2013). *Knocking at the College Door: Projections of High School Graduates by Sex and for Major Metropolitan Areas*. Boulder, CO: Western Interstate Commission for Higher Education. Retrieved from <http://www.wiche.edu/info/knocking-8th/supplement/KnockingOct13Full.pdf>
- Wilde, D. (2011, January). Personalities into teams. *IEEE Engineering Management Review*, 39(1), 20-24. doi:10.1109/EMR.2011.5729969
- Yates, F. (1984). Tests of Significance for 2 x 2 Contingency Tables. (R. S. Society, Ed.) *Journal of the Royal Statistical Society*, 147(3), 426-463. Retrieved from <http://www.jstor.org/stable/2981577>
- Young, J. W., & Korbin, J. L. (2001). *Differential Validity, Differential Prediction, and College Admission Testing: A Comprehensive Review and Analysis*. New York, NY: The College Board. Retrieved from <http://ec2-184-73-88-202.compute-1.amazonaws.com/sites/default/files/publications/2012/7/researchreport-2001-6-differential-validity-prediction-college-admission-testing-review.pdf>

## APPENDIX

**Table 32.** Institutions with engineering degrees that have deemphasized test scores.  
(FairTest; The National Center for Fair and Open Testing, 2016)

Engineering Institution	State	Test Optional or Limited or Flexible?
Arizona State University	AZ	Yes (3)
Baker College	MI	Yes
California Maritime Academy	CA	Yes (3)
California Polytechnic State University	CA	Yes (3)
California State Polytechnic University-Pomona	CA	Yes (3)
California State University-Chico	CA	Yes (3)
California State University-East Bay	CA	Yes (3)
California State University-Fresno	CA	Yes (3)
California State University-Fullerton	CA	Yes (3)
California State University-Long Beach	CA	Yes (3)
California State University-Los Angeles	CA	Yes (3)
California State University-Northridge	CA	Yes (3)
California State University-Sacramento	CA	Yes (3)
Colorado Technical University	CO	Yes
Embry Riddle Aeronautical University-Daytona Beach	FL	Yes
Embry Riddle Aeronautical University-Prescott	AZ	Yes
Fairfield University	CT	Yes
Ferris State University	MI	Yes (3)
George Mason University	VA	Yes (3)
Hofstra University	NY	Yes (4)
Humboldt State University	CA	Yes (3)
Kansas State University	KS	Yes (2)
Lamar University	TX	Yes (1,3)
Louisiana State University	LA	Yes (1,3,4)
Loyola University Maryland	MD	Yes
McNeese State University	LA	Yes
Merrimack College	MA	Yes
Minnesota State University-Mankato	MN	Yes (1,3)
Montana State University	MT	Yes (1,3)
Northern Arizona University	AZ	Yes
Norwich University	VT	Yes (4)
Oakland University	MI	Yes (1)
Oklahoma State University	OK	Yes (1)

Engineering Institution	State	Test Optional or Limited or Flexible?
Old Dominion University	VA	Yes (3)
Oregon Institute of Technology	OR	Yes (1,3)
Portland State University	OR	Yes (3)
Prairie View A&M University	TX	Yes (1,3)
Robert Morris University	PA	Yes
Roger Williams University	RI	Yes
Rowan University	NJ	Yes (3)
San Francisco State University	CA	Yes (3)
San Jose State University	CA	Yes (3)
Smith College	MA	Yes
South Dakota School of Mines and Technology	SD	Yes (1,3)
South Dakota State University	SD	Yes (3)
Southern University and A&M College	LA	Yes (2,3)
Temple University	PA	Yes
Texas A&M University	TX	Yes (3)
Texas A&M University - Kingsville	TX	Yes (3)
Texas Tech University	TX	Yes (3)
The University of Mississippi	MS	Yes (1,3)
The University of Texas at Arlington	TX	Yes (3)
The University of Texas at Dallas	TX	Yes (3)
The University of Texas at El Paso	TX	Yes (3)
The University of Texas at San Antonio	TX	Yes (3)
The University of Texas at Tyler	TX	Yes (3)
Trinity College	CT	Yes
Union College	NY	Yes (4)
University of Alaska Fairbanks	AK	Yes (1,3)
University of Arizona	AZ	Yes
University of Central Oklahoma	OK	Yes (3)
University of Delaware	DE	Yes (2)
University of Houston	TX	Yes (3)
University of Idaho	ID	Yes (3)
University of Kansas	KS	Yes (2,3,4)
University of Louisiana at Lafayette	LA	Yes (2,3)
University of Massachusetts Lowell	MA	Yes
University of Nebraska-Lincoln	NE	Yes (3)
University of Nevada-Las Vegas	NV	Yes (1)

Engineering Institution	State	Test Optional or Limited or Flexible?
University of Nevada-Reno	NV	Yes (1,3)
University of New Orleans	LA	Yes (2,3)
University of North Texas	TX	Yes (3)
University of Rochester	NY	Yes (5)
Virginia Commonwealth University	VA	Yes (3,4)
Walla Walla University	WA	Yes (1)
Washington State University	WA	Yes (3)
West Virginia University Institute of Technology	WV	Yes (1,3)
Western New England University	MA	Yes
Wichita State University	KS	Yes (2,3)
Worcester Polytechnic Institute	MA	Yes

*Test Optional or Limited or Flexible Key (details about universities' test score usage):*

- 1 SAT/ACT used only for placement and/or academic advising
- 2 SAT/ACT required only from out-of-state applicants
- 3 SAT/ACT may be required but considered only when minimum GPA and/or class rank is not met
- 4 SAT/ACT required for some programs
- 5 Test Flexible: SAT/ACT not required if other college level exams specified by school, such as SAT Subject Test, Advanced Placement or Int'l Baccalaureate, submitted; contact school for details
- 6 Placement test or school-specific admissions exam score required if not submitting SAT/ACT
- 7 Admission/Eligibility Index calculated with 3.5 GPA and combined SAT Critical Reading plus Math score of 400

Figure 15. MIDFIELD database institutions.

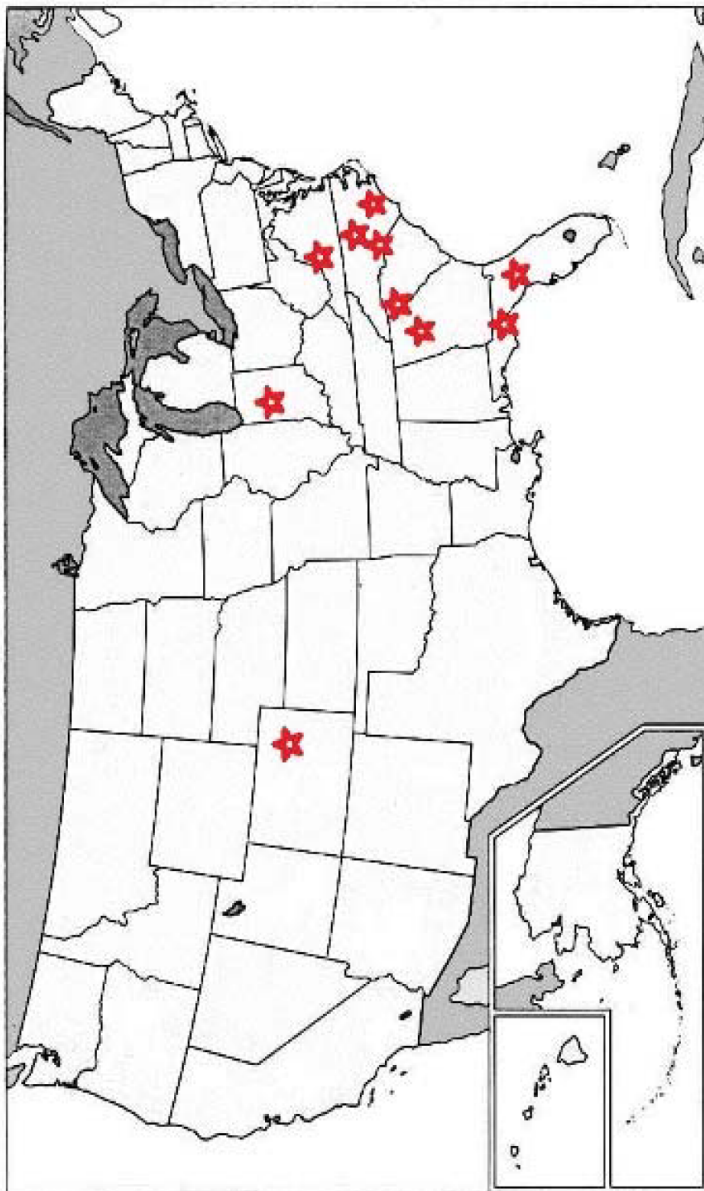

School	Location	Overall Inst. Data		USNWR Ranking	Engineering Bachelor's Degrees Awarded 2011			Engineering College Specific Stats 2011		
		Univ Size	Control		Total	% to Women	% to URM	Total	% Women	% URM
Georgia Tech	Atlanta, Georgia	20,941	Public	5	1716	22.6%	11.5%	396	14.6%	7.6%
Purdue University	West Lafayette, Indiana	39,637	Public	9	1394	19.4%	4.1%	315	15.6%	8.9%
Virginia Tech	Blacksburg, Virginia	30,936	Public	15	1270	17.0%	6.4%	331	11.8%	8.2%
North Carolina State	Raleigh, North Carolina	34,376	Public	27	1268	15.9%	9.1%	328	11.6%	4.6%
University of Florida	Gainesville, Florida	49,589	Public	27	962	19.3%	23.7%	264	11.4%	6.8%
University of Colorado	Boulder, Colorado	30,417	Public	34	581	19.8%	6.9%	148	18.9%	6.8%
Clemson University	Clemson, South Carolina	19,914	Public	66	624	18.6%	7.7%	192	13.5%	6.3%
UNC Charlotte	Charlotte, North Carolina	25,277	Public	82	273	7.3%	9.9%	77	9.1%	6.5%
Florida A&M	Tallahassee, Florida	52,401	Public	115	263	19.0%	27.4%	73	12.3%	23.3%
Florida State	Tallahassee, Florida	52,401	Public	130	169	30.8%	82.2%	77	13.0%	27.3%
North Carolina A&T	Greensboro, North Carolina	10,881	Public							



**Table 33.** Research Question 1: Top and bottom decile and quintile values by institution.

Institution	ACT_10%	ACT_20%	ACT_80%	ACT_90%	HSGPA_10%	HSGPA_20%	HSGPA_80%	HSGPA_90%	SAT_M_10%	SAT_M_20%	SAT_M_80%	SAT_M_90%	SAT_V_10%	SAT_V_20%	SAT_V_80%	SAT_V_90%	SAT_10%	SAT_20%	SAT_80%	SAT_90%
A	23	24	30	31	3.13	3.33	3.98	4.00	560	590	700	730	460	500	640	680	1040	1110	1320	1380
B	17	18	26	28	2.58	2.90	4.10	4.80	430	470	620	660	370	410	570	620	830	890	1170	1250
C	20	21	28	29	2.75	3.00	4.40	5.00	510	550	670	710	420	460	600	640	950	1010	1240	1300
D	21	24	30	31	2.99	3.30	4.30	5.00	540	580	710	740	440	480	650	690	1010	1090	1340	1400
E	24	26	31	32	3.23	3.41	3.97	4.00	580	610	730	760	520	560	680	710	1130	1190	1390	1440
F	22	23	29	31	2.78	3.00	3.89	4.00	540	570	700	740	430	470	620	670	1000	1070	1300	1370
G					2.50	2.75	3.56	3.78	430	460	580	610	410	440	550	590	910	950	1070	1130
H	21	22	29	30	3.13	3.36	4.17	4.42	520	560	690	720	430	460	610	660	980	1040	1280	1350
I	20	21	26	28	2.87	3.08	3.91	4.06	490	520	630	660	430	460	590	620	950	1000	1200	1260
J	14	17	28	30	2.32	2.49	3.77	4.28	400	500	690	770	440	480	590	630	920	1040	1250	1320
K	22	24	29	31	3.10	3.30	3.90	4.00	550	590	700	730	450	490	630	670	1030	1100	1310	1370

**Table 34.** Old SAT to ACT before February 2005 concordance chart. (ACT and SAT, 2008)

SAT Composite (V+M) Score	ACT Composite Score
1600	36
1580	35
1550	34
1490	33
1450	32
1410	31
1360	30
1330	29
1290	28
1250	27
1210	26
1180	25
1140	24
1100	23
1060	22
1030	21
1000	20
960	19
920	18
870	17
820	16
770	15
740	14
720	13
700	12
660	11

**Table 35.** Additional independent samples t-test statistical output.

		Levene's Test for Equality of Variances		T-Test for Equality of Means						
		F	Sig.	t	df	Sig. (2-tailed)	Mean Difference	Std. Error Difference	95% confidence interval of the difference	
									Lower	Upper
HSGPA 5.0	Equal variances assumed	274.188	.000	41.479	89294	.000	.32993	.00795	.31434	.34552
	Equal variances not assumed			37.007	10114.391	.000	.32993	.00892	.31245	.34740
Highest Test Score	Equal variances assumed	177.833	.000	66.331	89294	.000	108.249	1.632	105.050	111.447
	Equal variances not assumed			61.901	10292.918	.000	108.249	1.749	104.821	111.676

Figure 16. Exhaustive CHAID tree model, typical URM definition model (2 pages).

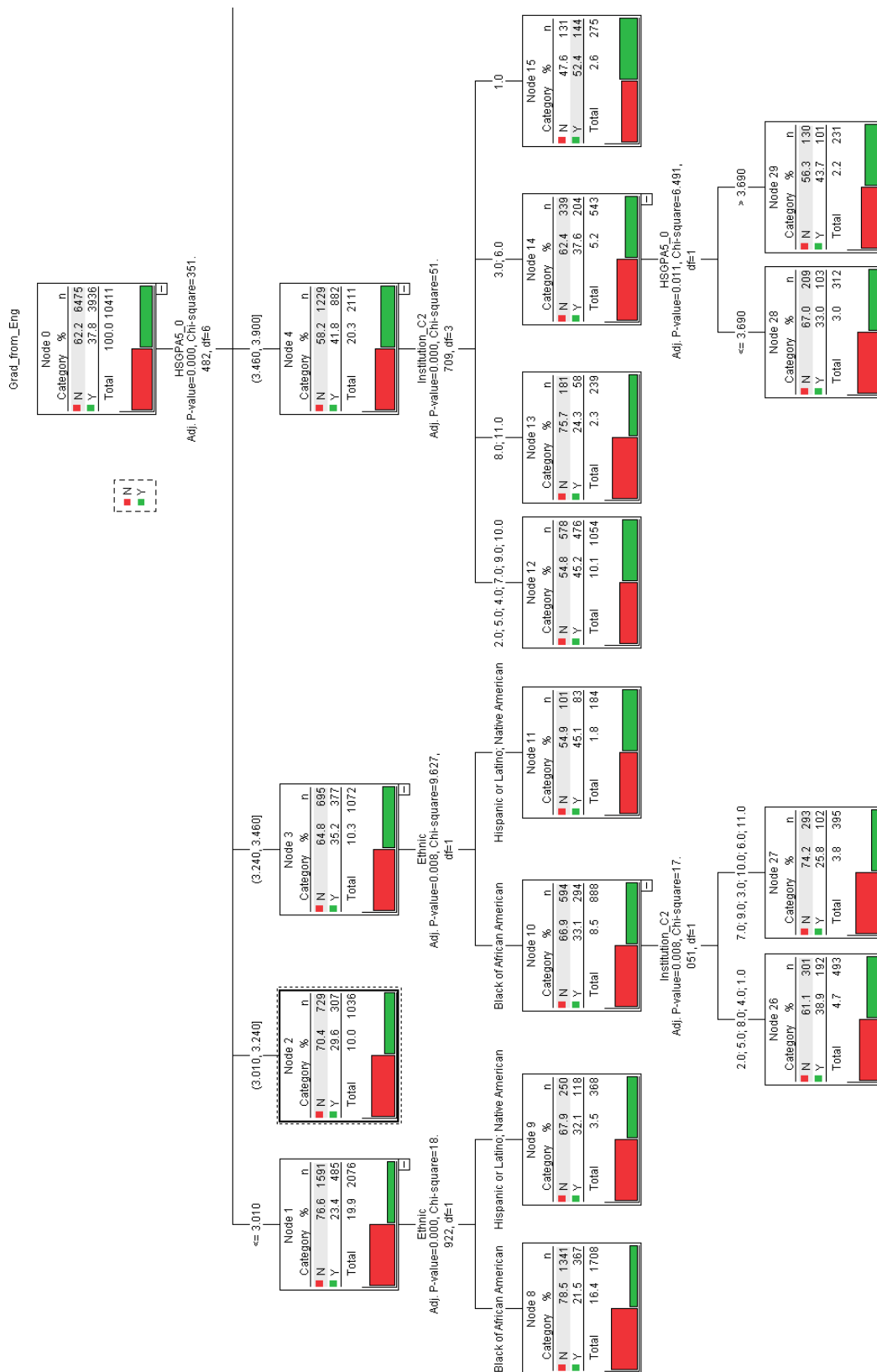

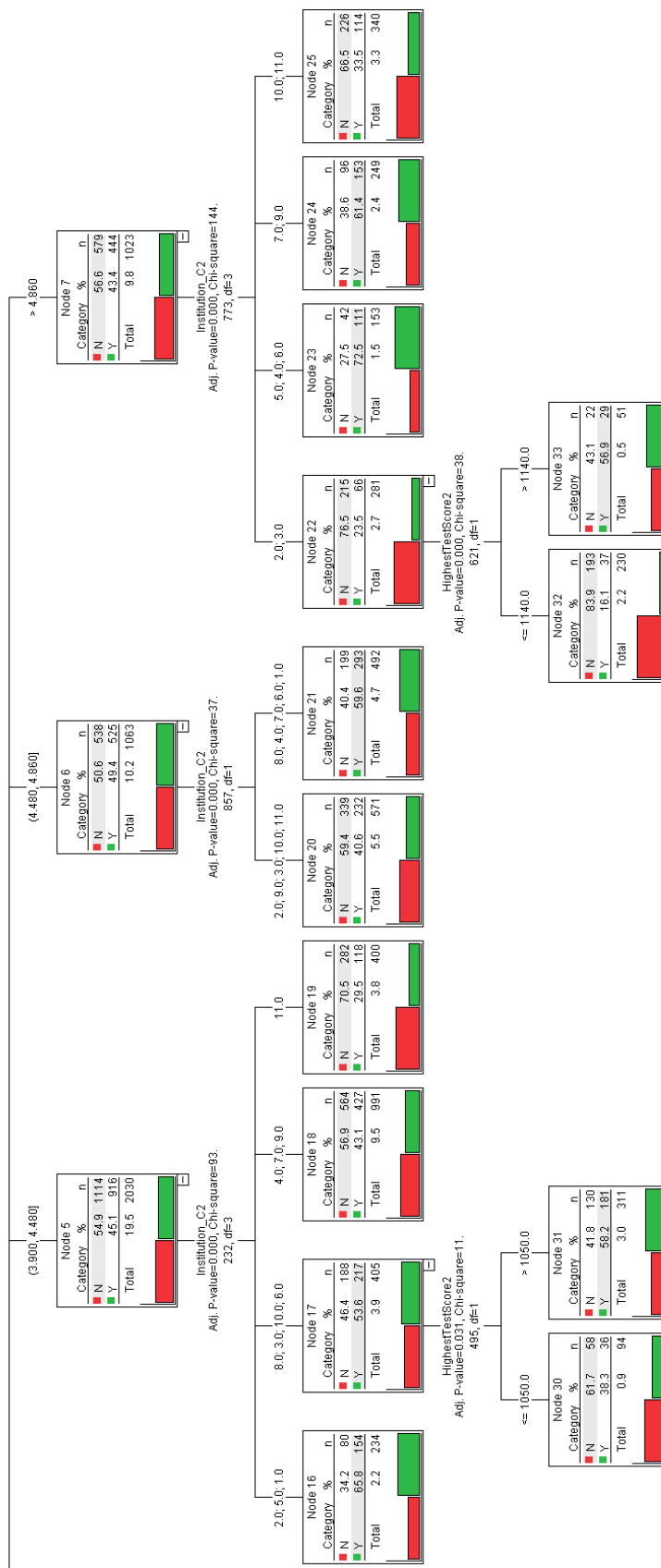
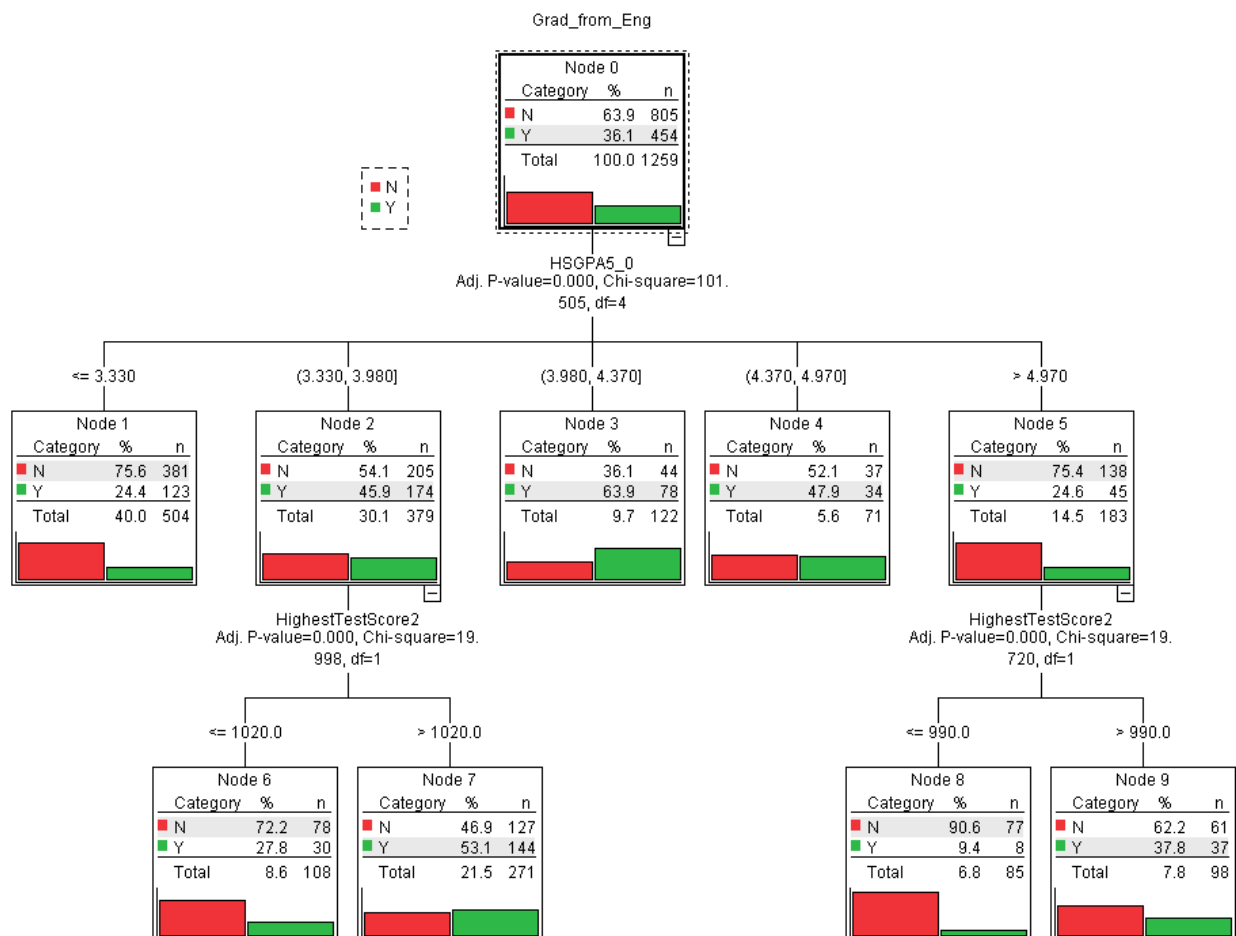

Figure 17. Exhaustive CHAID tree model, risk and classification results for institution 2.



Risk	
Estimate	Std. Error
.469	.020

Classification			
Observed	Predicted		
	1 N	2 Y	Percent Correct
1 N	536	269	66.6%
2 Y	161	293	64.5%
Overall Percentage	55.4%	44.6%	65.8%

**Figure 18.** Exhaustive CHAID tree model, risk and classification results for institution 3.

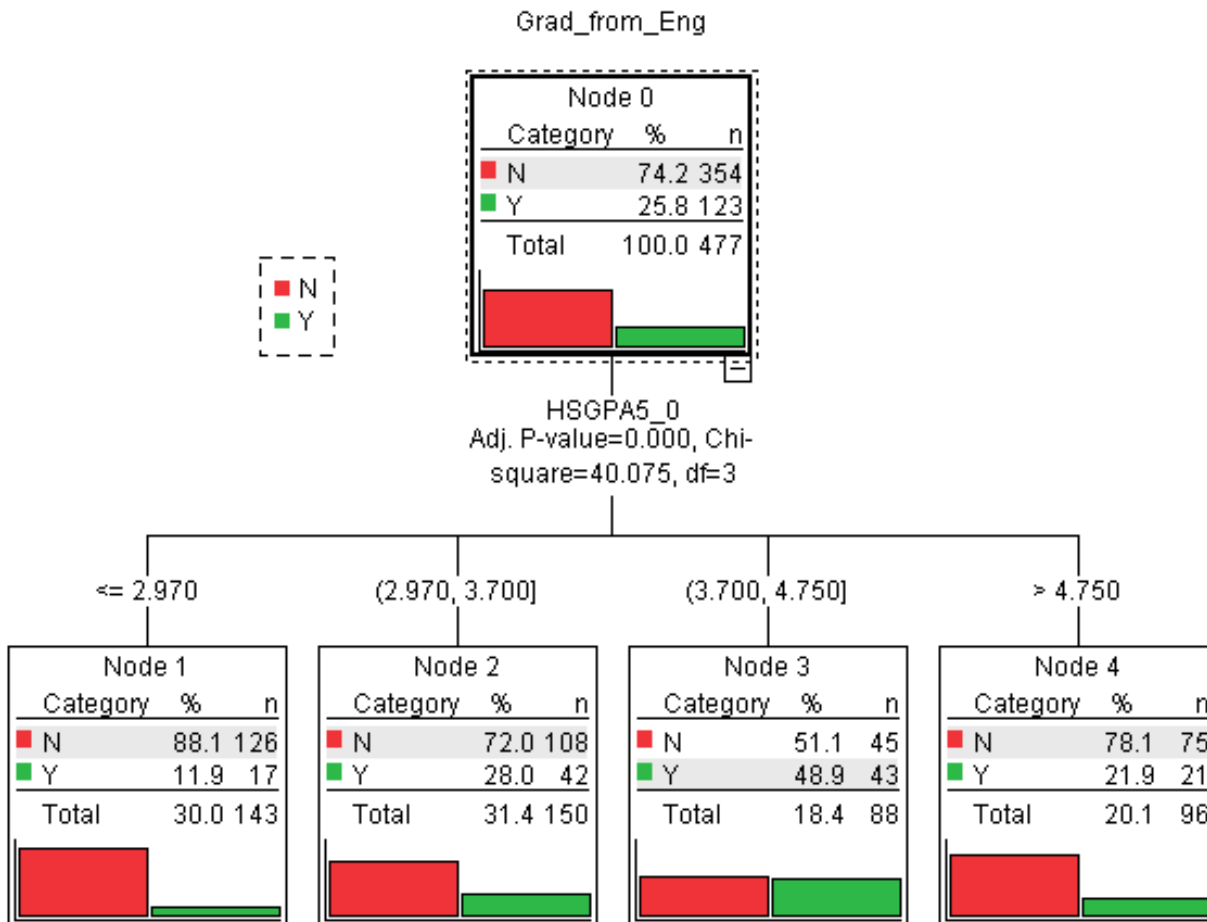

Risk	
Estimate	Std. Error
.430	.035

Classification			
Observed	Predicted		
	1 N	2 Y	Percent Correct
1 N	309	45	87.3%
2 Y	80	43	35.0%
Overall Percentage	81.6%	18.4%	73.8%

**Figure 19.** Exhaustive CHAID tree model, risk and classification results for institution 4.

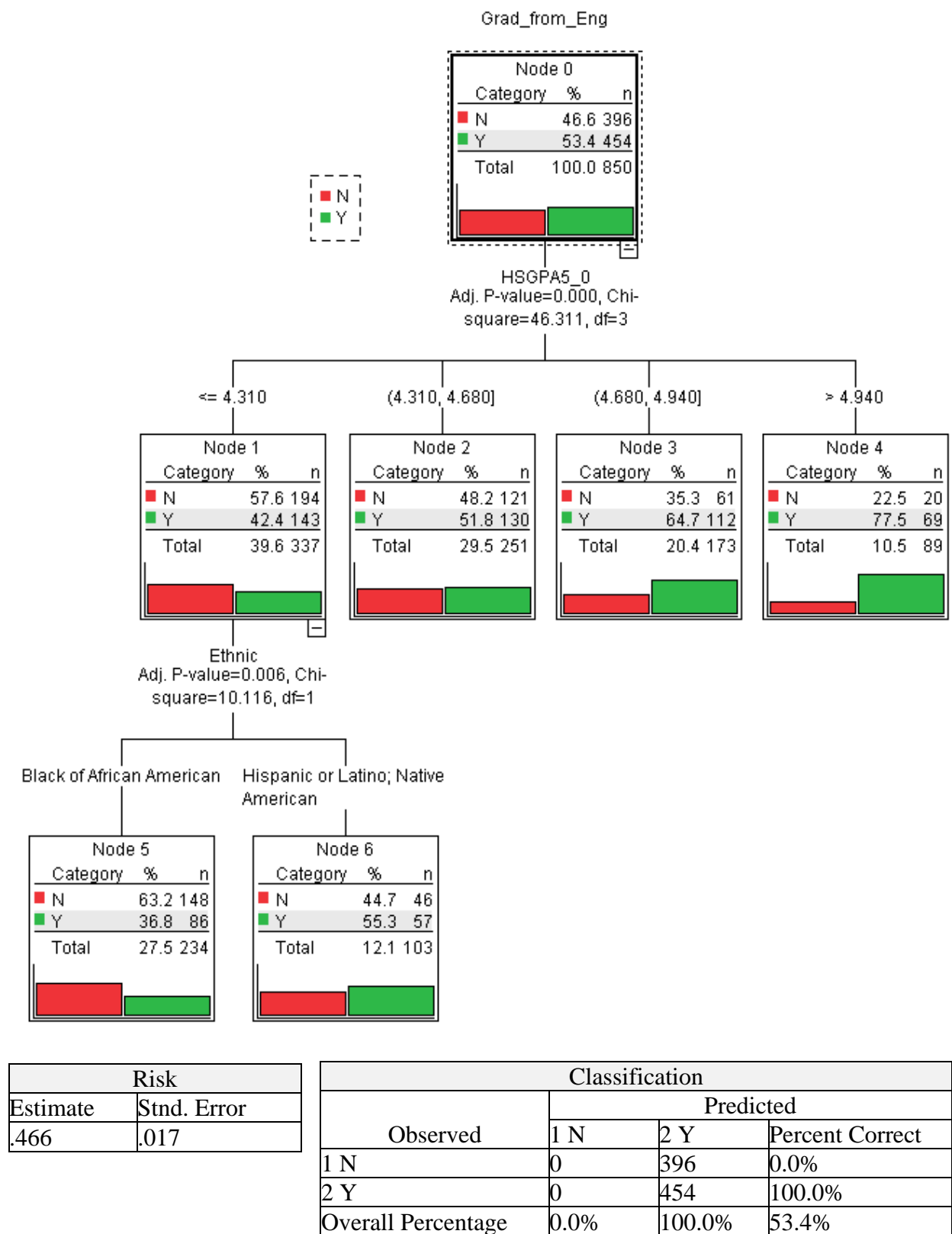



**Figure 20.** Exhaustive CHAID tree model, risk and classification results for institution 5.

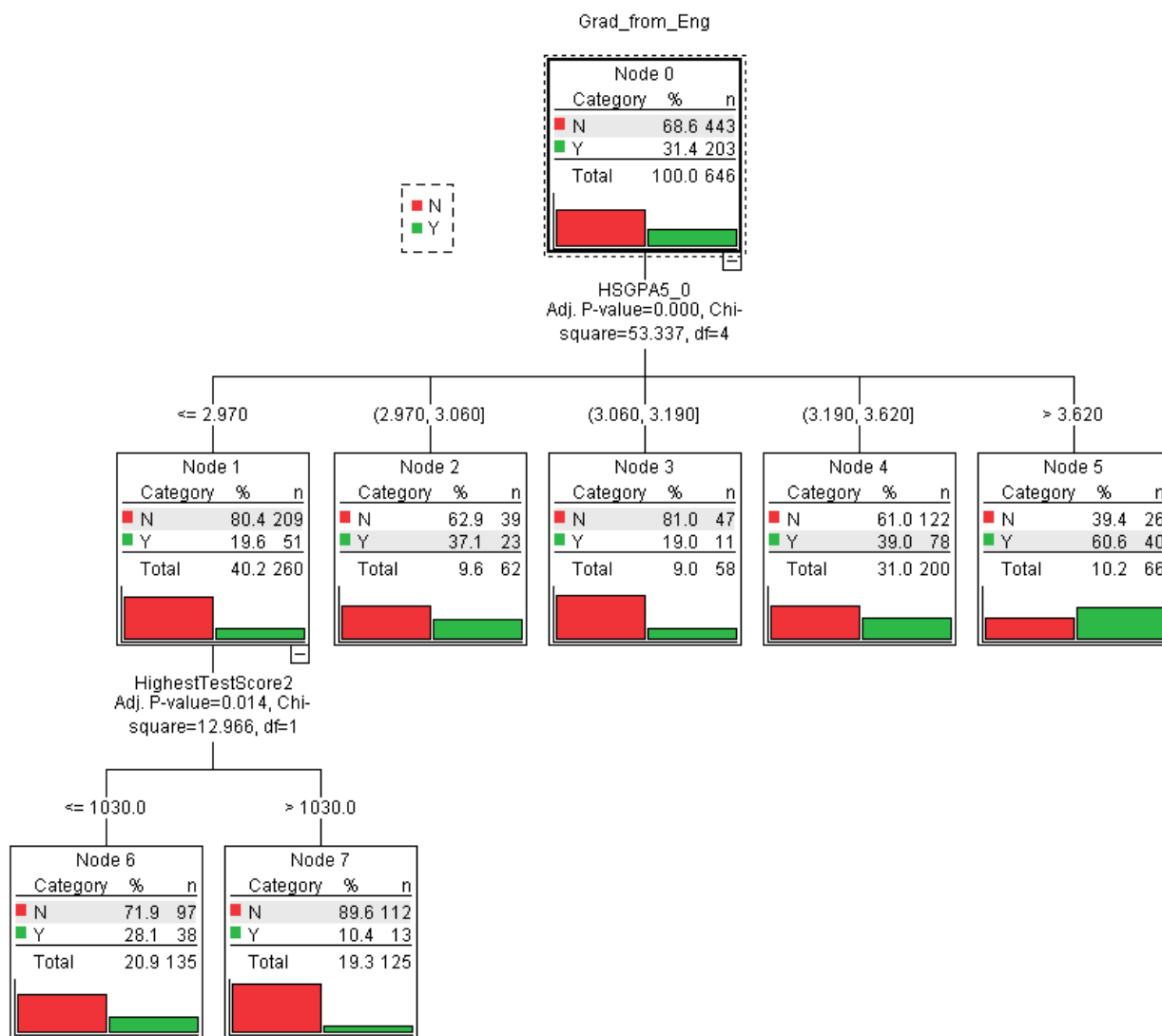

Risk	
Estimate	Std. Error
.481	.026

Classification			
Observed	Predicted		
	1 N	2 Y	Percent Correct
1 N	256	187	57.8%
2 Y	62	141	69.5%
Overall Percentage	49.2%	50.8%	61.5%

**Figure 21.** Exhaustive CHAID tree model, risk and classification results for institution 6.

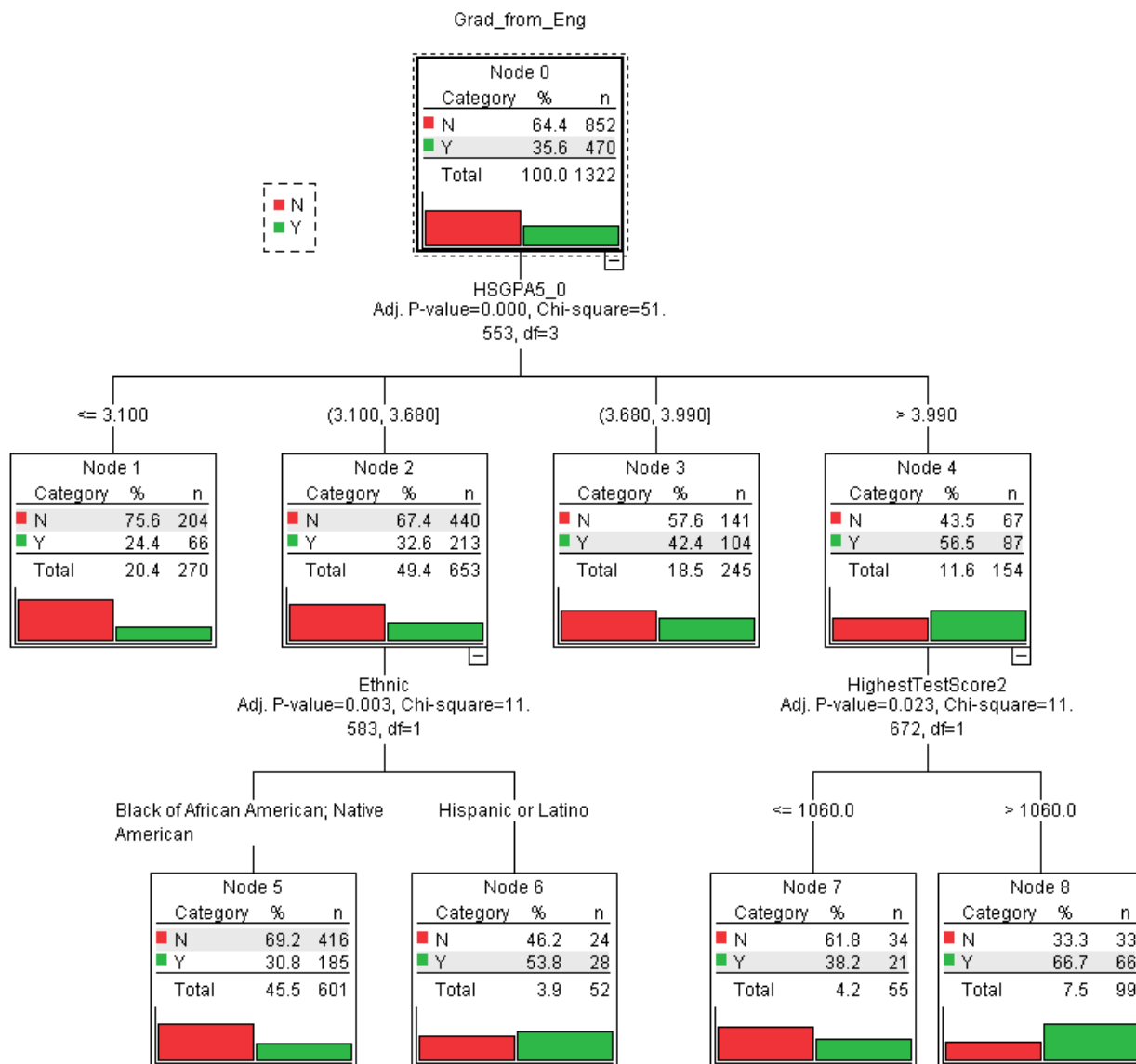

Risk	
Estimate	Std. Error
.555	.022

Classification			
Observed	Predicted		
	1 N	2 Y	Percent Correct
1 N	620	232	72.8%
2 Y	251	219	46.6%
Overall Percentage	65.9%	34.1%	63.5%

**Figure 22.** Exhaustive CHAID tree model, risk and classification results for institution 7.

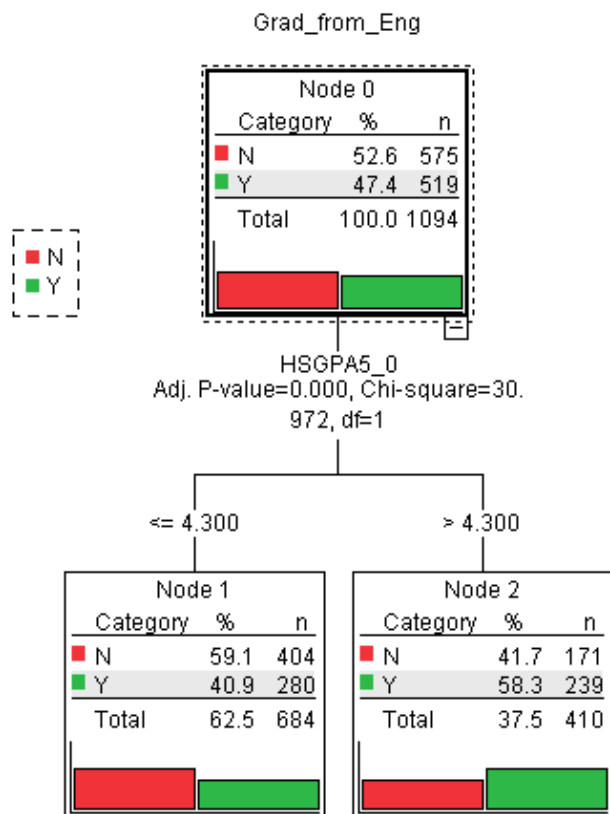

Risk	
Estimate	Std. Error
.526	.015

Classification				
		Predicted		
Observed		1 N	2 Y	Percent Correct
1 N		0	575	0.0%
2 Y		0	519	100.0%
Overall Percentage		0.0%	100.0%	47.4%

**Figure 23.** Exhaustive CHAID tree model, risk and classification results for institution 8.

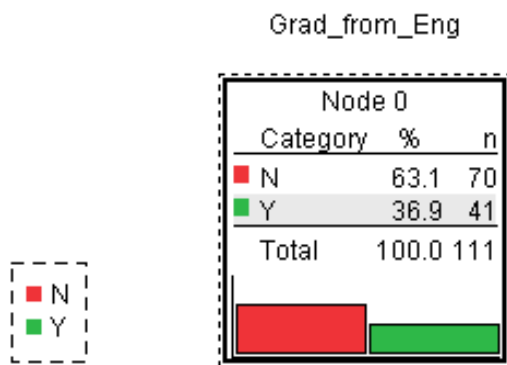

Risk	
Estimate	Std. Error
.631	.046

Classification			
Observed	Predicted		Percent Correct
	1 N	2 Y	
1 N	0	70	0.0%
2 Y	0	41	100.0%
Overall Percentage	0.0%	100.0%	36.9%

**Figure 24.** Exhaustive CHAID tree model, risk and classification results for institution 9.

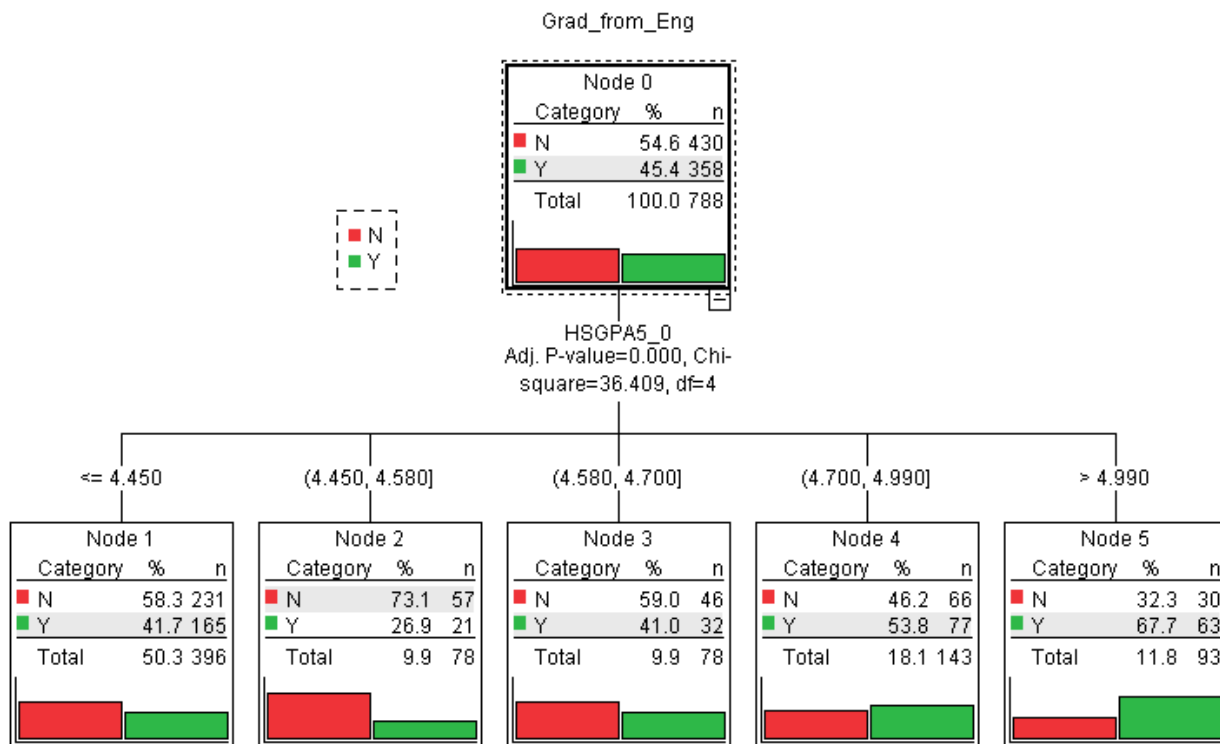

Risk	
Estimate	Std. Error
.527	.020

Classification			
Observed	Predicted		
	1 N	2 Y	Percent Correct
1 N	57	373	13.3%
2 Y	21	337	94.1%
Overall Percentage	9.9%	90.1%	50.0%

**Figure 25.** Exhaustive CHAID tree model, risk and classification results for institution 11.

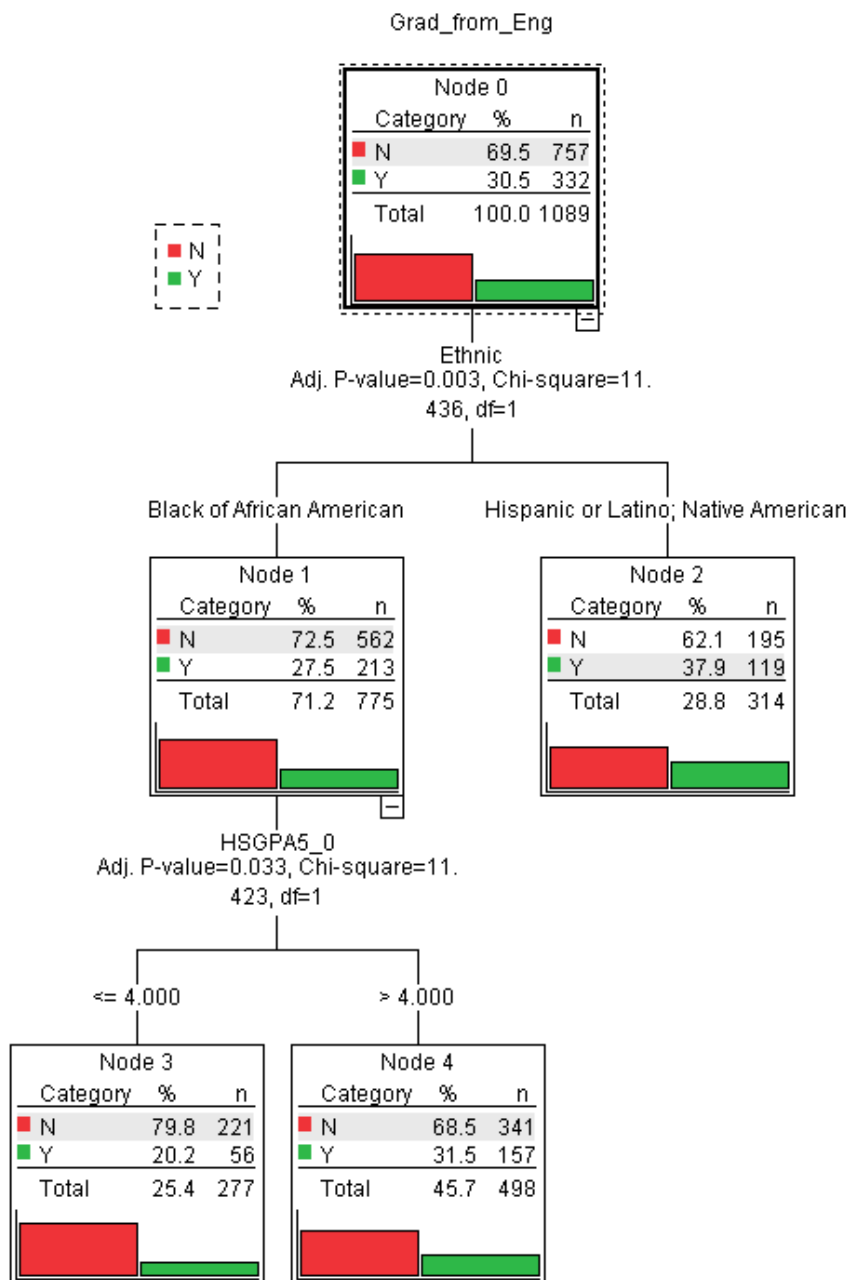

Risk	
Estimate	Std. Error
.570	.024

Classification			
Observed	Predicted		
	1 N	2 Y	Percent Correct
1 N	562	195	74.2%
2 Y	213	119	35.8%
Overall Percentage	71.2%	28.8%	62.5%

**Figure 26.** U.S. locations where the SAT and ACT dominate. Edited from Saget, 2013.

Green shading on map denotes where more students took the SAT than the ACT, blue shading on the map denotes states where more students took the ACT than the SAT.

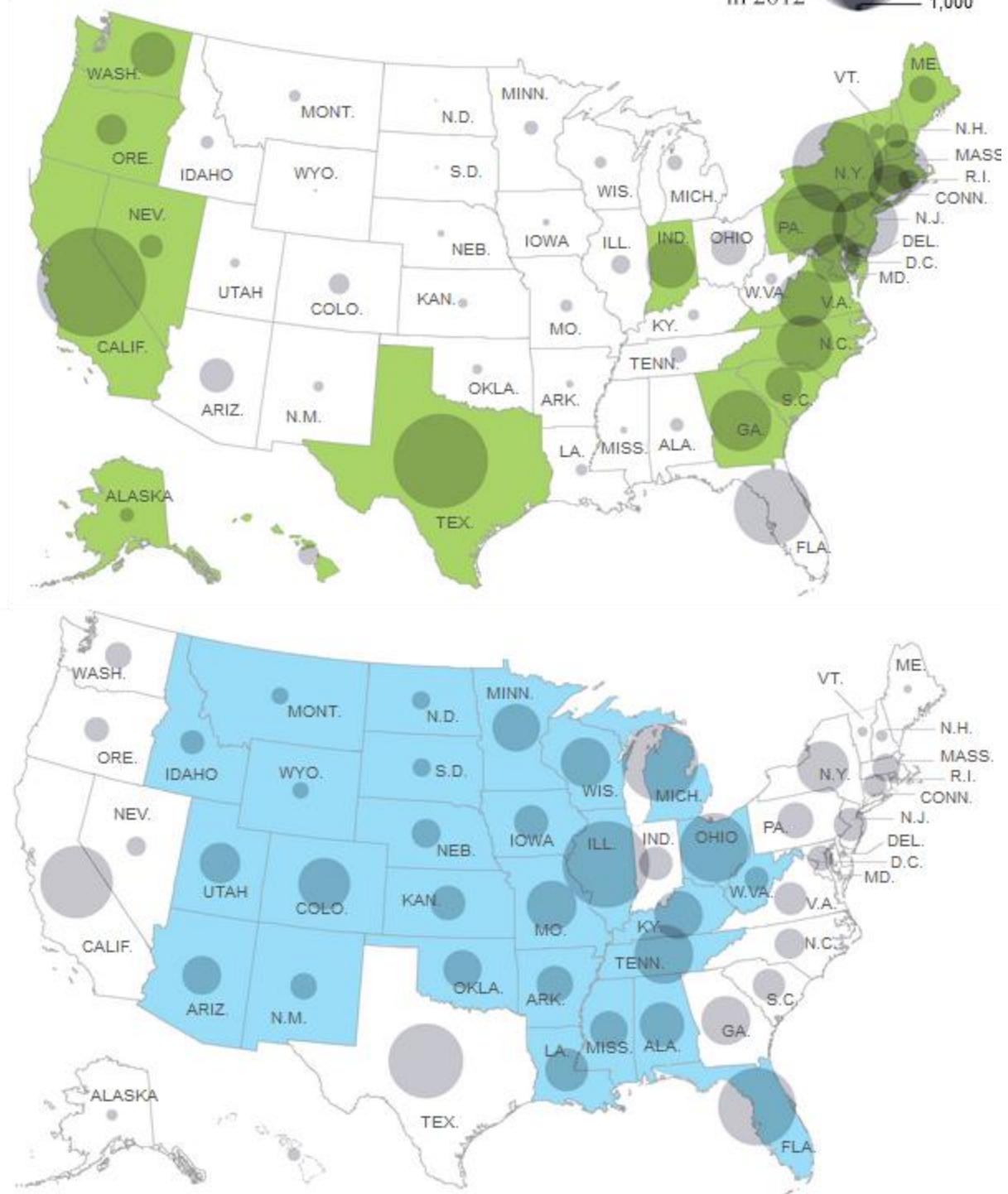

**Table 36.** SAT initial filter variables and criteria.

Variable	Initial Criteria
SAT Mathematics	Score $\geq 600$ , $\geq 570$ , $\geq 550$
SAT Total	Score $\geq 1200$ , $\geq 1150$ , $\geq 1110$
High school grade point average	(A- to A+) 3.7-4.3
High school class rank	Top 20%
Years certain subjects studied	
Math	$\geq 4$ years or more
Science	$\geq$ Three years
Advanced placement, accelerated, or honors courses	
Mathematics	Yes
Natural Sciences	Yes
High school course completion	
Algebra	2 or more years
Calculus OR Trigonometry OR Precalculus	At least $\frac{1}{2}$ year
Physics	At least $\frac{1}{2}$ year
Average grade	
Natural Sciences	Exclude C or Fair and below
Mathematics	Exclude C or Fair and below
Interest	
Planned college major, including 1-4 <sup>th</sup> alternates	Engineering

Using the filters above, the pool of underrepresented minority students that took the ACT test results in 697 from a Hispanic/Latino racial/ethnic background, 132 Black/African American, 25 American Indian/Alaskan Native, 20 Native Hawaiian/Other Pacific Islander and 301 Two or More Races. For SAT takers, the number filtered from the 100,000 sample by race/ethnicity was multiplied by the percentage representation in the population. This resulted in an estimated pool of 631 from Hispanic/Latino racial/ethnic backgrounds, 173 Black/African American and no American Indian/Alaskan Native students found for this filter in the SAT taker sample. Assuming an overlap of ACT and SAT takers between 19-80%, this means the filters are overly constrictive.



**Table 37.** Initial filter criteria calculation, engineering enrollment and number needed for representation by race/ethnicity.

Racial / Ethnic Background	Pool from ACT Math $\geq 24$	Pool from SAT Math $\geq 550$	Actual First-Years Enrolled in Engineering	Needed for Representation	
				<i>High school completers</i>	<i>Enrolled in college</i>
Hispanic / Latino	697	631	14,105	28,749	30,464
Black / African American	132	173	8,178	17,012	14,507
American Indian / Alaska Native	25	0	544	1,319	
Native Hawaiian/Other Pacific Islander	20		262		
Two or More Races	301		4,188		

**Table 38.** ACT filter criteria with widened planned major and occupation.

Racial / Ethnic Background	Pool from ACT Math $\geq 24$
Hispanic / Latino	919
Black / African American	192
American Indian / Alaska Native	30
Native Hawaiian / Other Pacific Islander	32
Two or More Races	402

**Table 39.** ACT expanded filter, major and occupation removed.

Racial / Ethnic Background	Pool from ACT Math $\geq 24$
Hispanic / Latino	2828
Black / African American	698
American Indian / Alaska Native	109
Native Hawaiian / Other Pacific Islander	78
Two or More Races	2098

**Table 40.** ACT and SAT expanded filter with all engineering interest filters removed.

Racial / Ethnic Background	Pool from ACT Math $\geq 24$	Pool from SAT Math $\geq 550$	Actual First-Years Enrolled in Engineering	Needed for Representation	
				<i>High school completers</i>	<i>Enrolled in college</i>
Hispanic / Latino	6722	1955	12,898	28,749	30,464
Black / African American	2036	778	8,178	17,012	14,507
American Indian / Alaska Native	255	81	544	1,319	
Native Hawaiian/Other Pacific Islander	177		262		
Two or More	3245		4,118		

Presented next is a series of tables that show how the pool of potential engineering students increases with ever decreasing academic admission requirements.

**Table 41.** ACT and SAT expanded filter with AP, advanced and honors course requirements removed.

Racial / Ethnic Background	Pool from ACT Math ≥ 24	Pool from SAT Math ≥ 550
Hispanic / Latino	8374	4034
Black / African American	2491	1743
American Indian / Alaska Native	346	132
Native Hawaiian / Other Pacific Islander	221	
Two or More	4079	

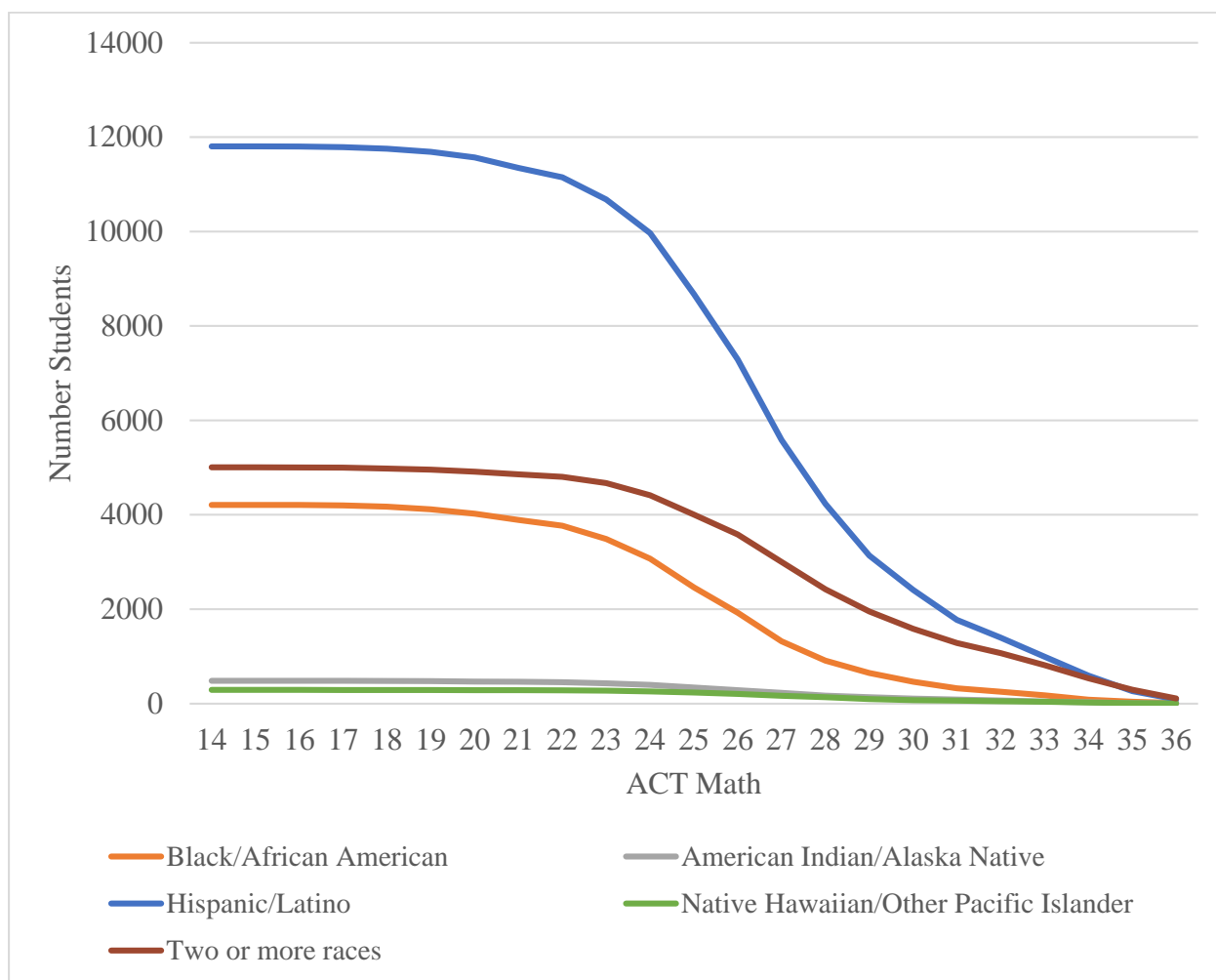

**Table 42.** ACT and SAT expanded filter with math requirement lowered to three years.

Racial / Ethnic Background	Pool from ACT Math ≥ 24	Pool from SAT Math ≥ 550
Hispanic / Latino	8868	4295
Black / African American	2720	1844
American Indian / Alaska Native	373	132
Native Hawaiian / Other Pacific Islander	238	
Two or More	4309	

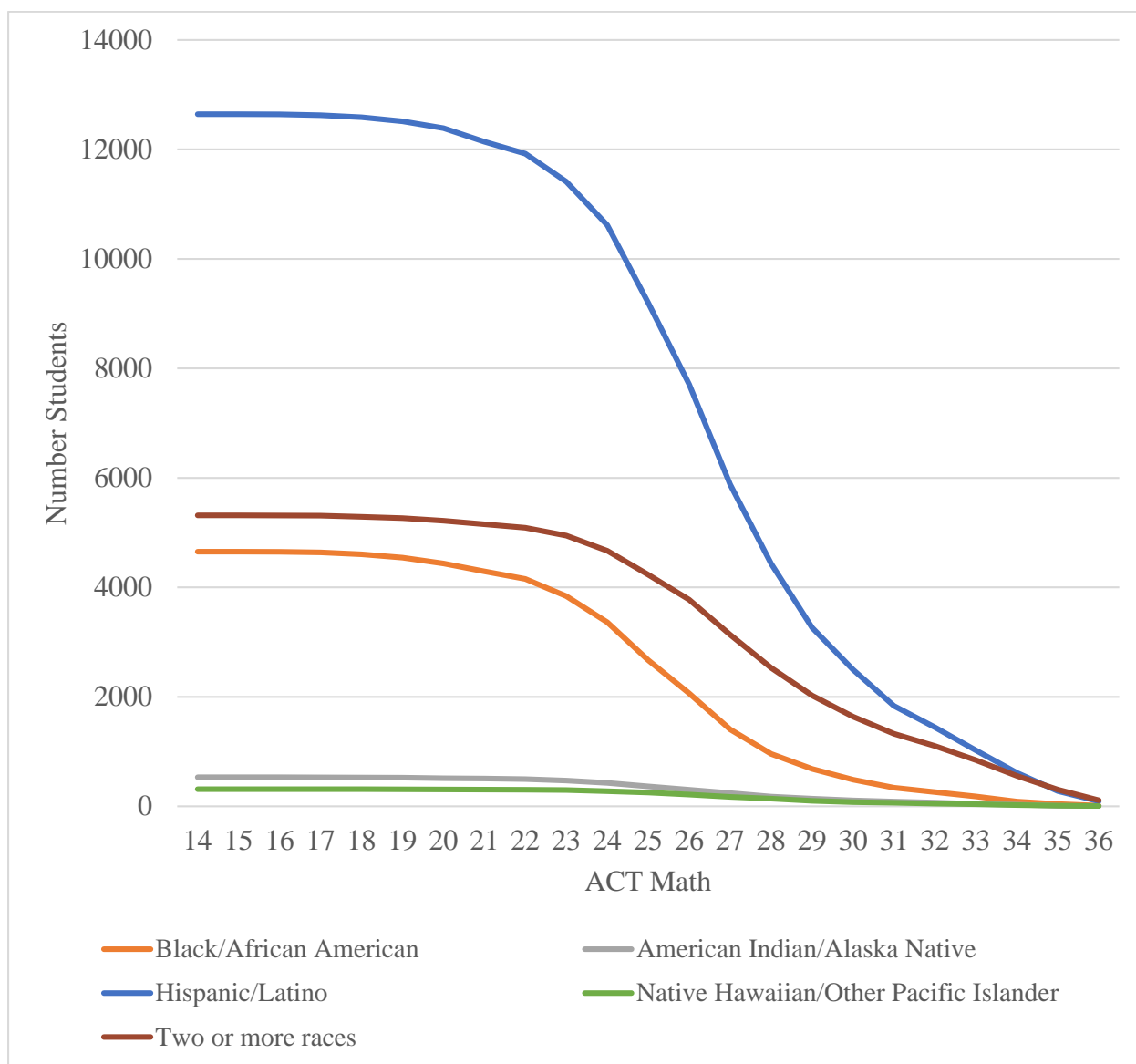

**Table 43.** ACT and SAT expanded filter with physics course requirement removed.

Racial / Ethnic Background	Pool from ACT Math $\geq 24$	Pool from SAT Math $\geq 550$
Hispanic / Latino	10439	4880
Black / African American	3319	2132
American Indian / Alaska Native	468	165
Native Hawaiian / Other Pacific Islander	280	
Two or More	8137	

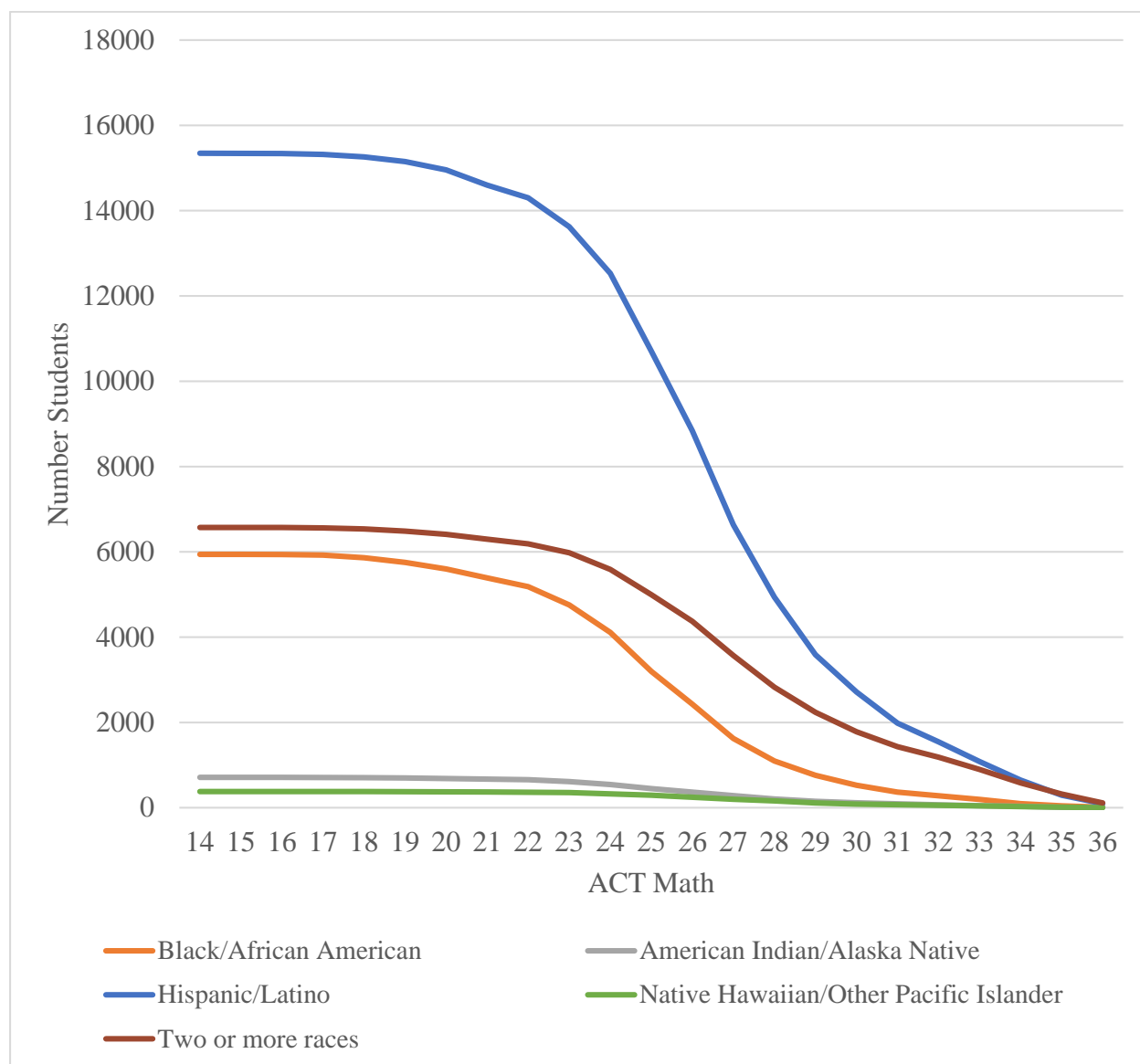

**Table 44.** ACT and SAT expanded filter with higher math course requirement removed.

Racial / Ethnic Background	Pool from ACT Math $\geq 24$	Pool from SAT Math $\geq 550$
Hispanic / Latino	10500	5465
Black / African American	3338	2464
American Indian / Alaska Native	473	214
Native Hawaiian / Other Pacific Islander	280	
Two or More	8166	

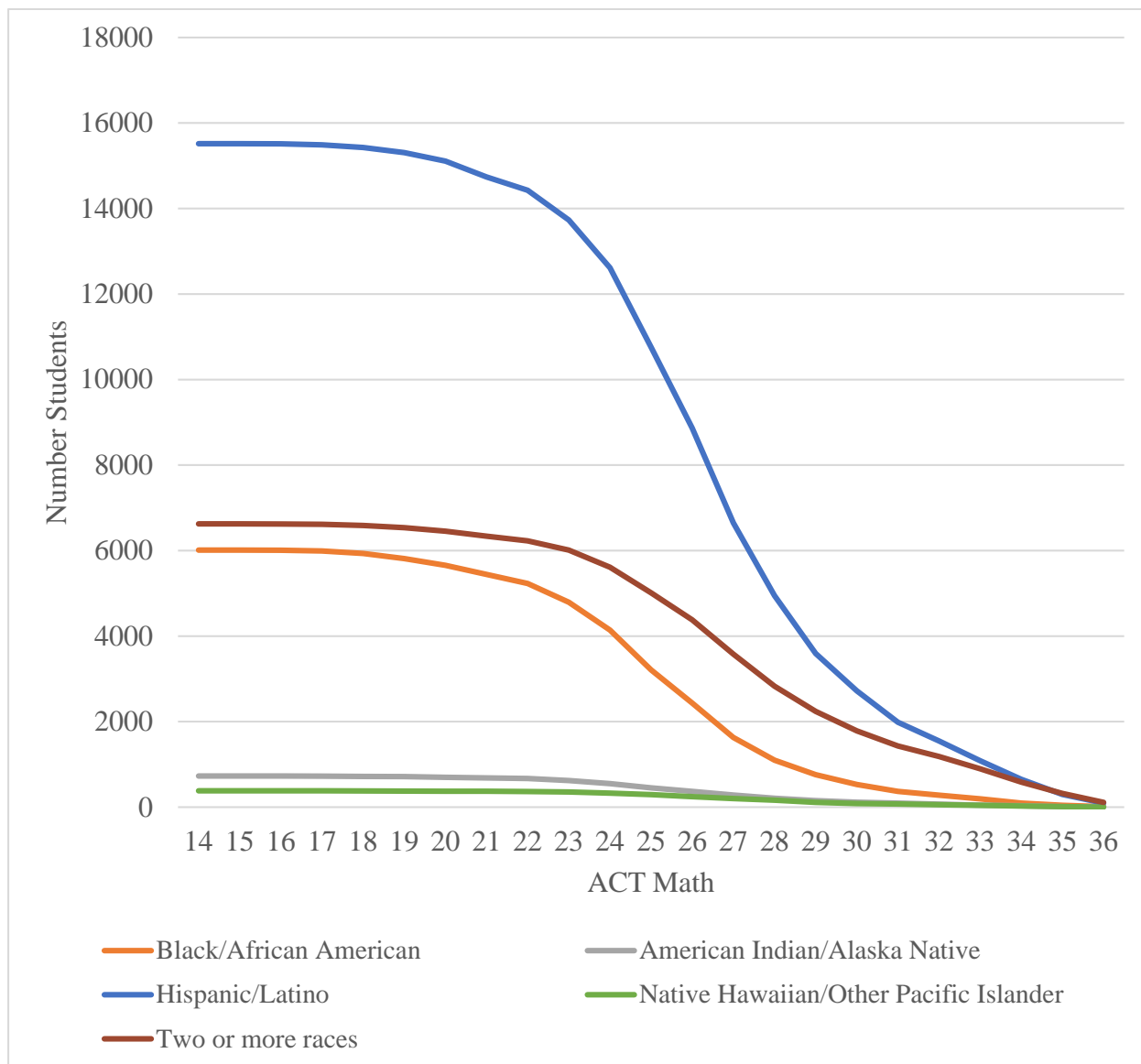

**Table 45.** ACT and SAT expanded filter with algebra II course requirement removed.

Racial / Ethnic Background	Pool from ACT Math ≥ 24	Pool from SAT Math ≥ 550
Hispanic / Latino	10601	18859
Black / African American	3377	7795
American Indian / Alaska Native	476	841
Native Hawaiian / Other Pacific Islander	283	
Two or More	8255	

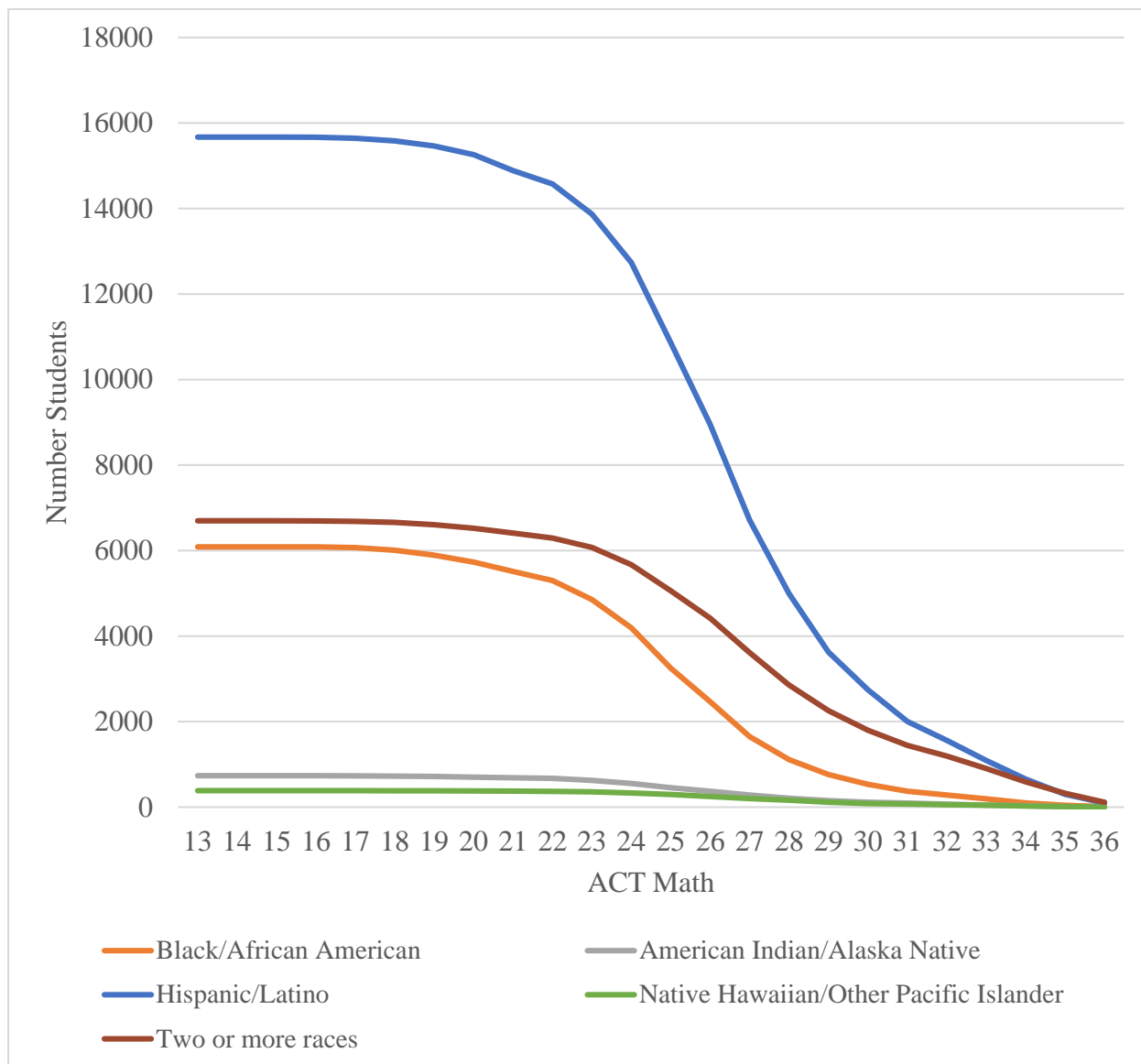

**Table 46.** ACT and SAT expanded filter with minimum science grade requirement removed.

Racial/Ethnic Background	Pool from ACT Math ≥ 24	Pool from SAT Math ≥ 550
Hispanic / Latino	10616	18982
Black / African American	3383	7852
American Indian / Alaska Native	477	841
Native Hawaiian / Other Pacific Islander	283	
Two or More	8259	

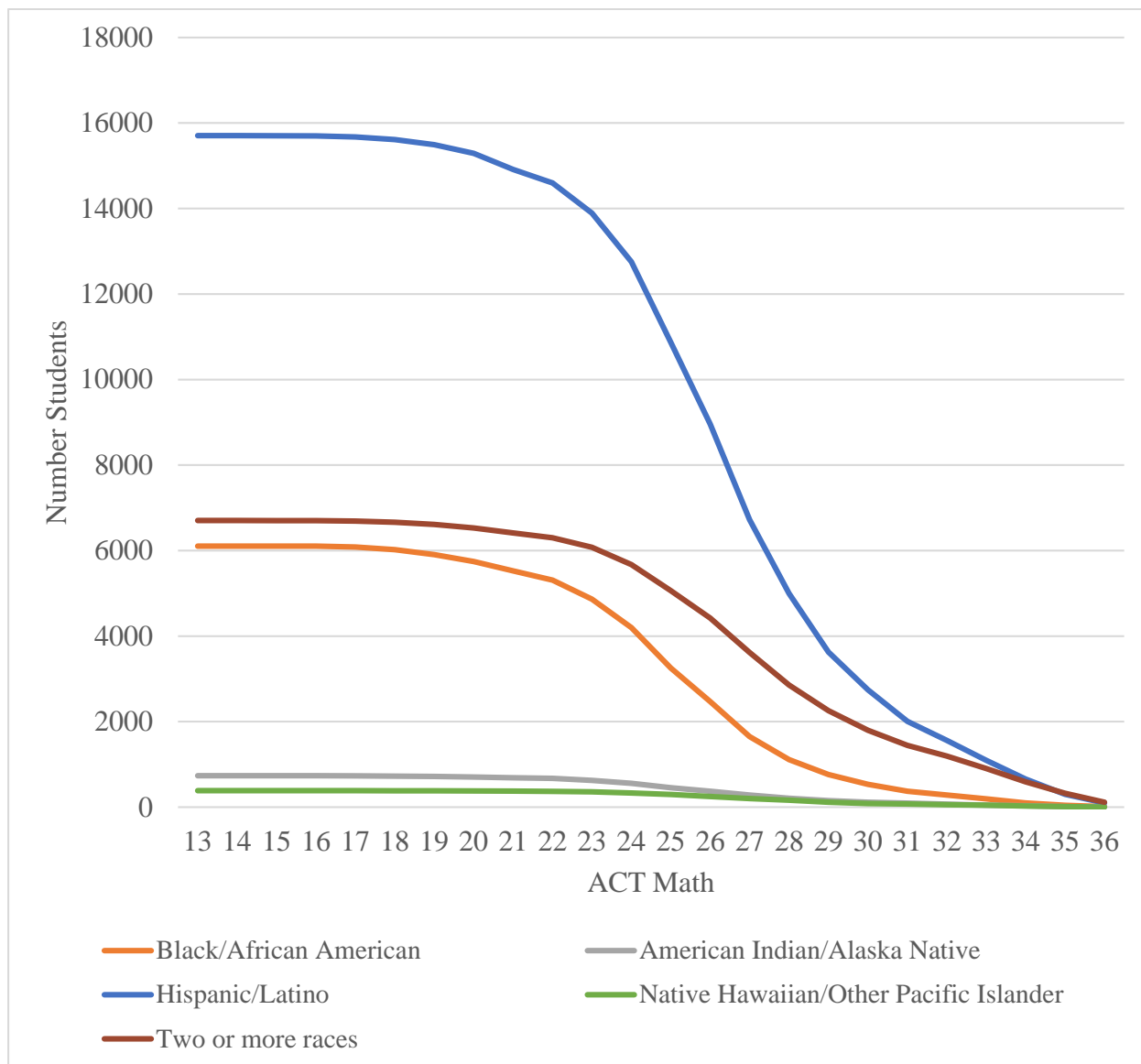



**Table 47.** ACT and SAT expanded filter with minimum math grade requirement removed.

Racial / Ethnic Background	Pool from ACT Math ≥ 24	Pool from SAT Math ≥ 550
Hispanic / Latino	10651	19229
Black / African American	3401	8011
American Indian / Alaska Native	477	858
Native Hawaiian / Other Pacific Islander	285	
Two or More	8279	

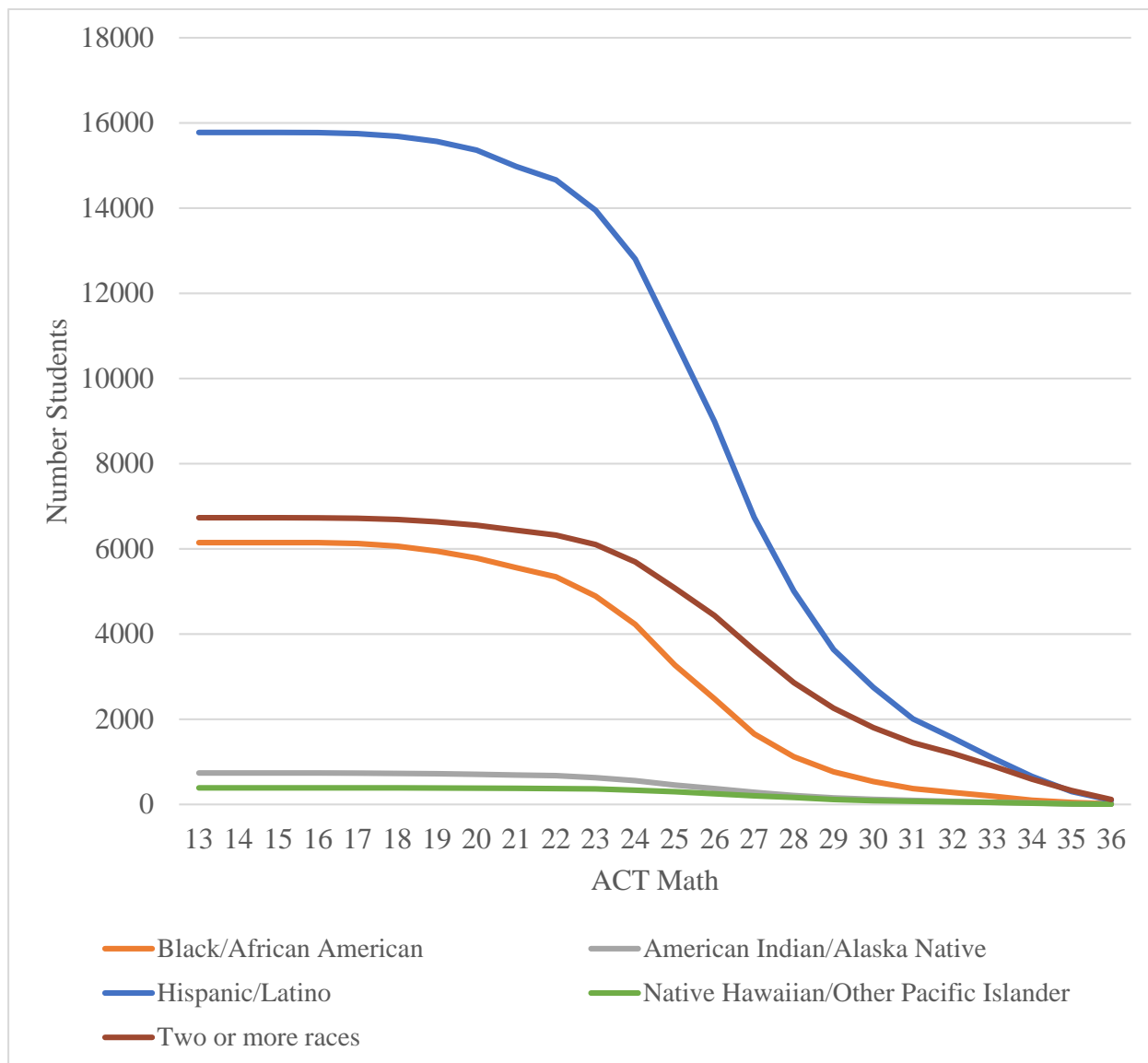

**Table 48.** ACT and SAT expanded filter with math and science years requirement removed.

Racial / Ethnic Background	Pool from ACT Math ≥ 24	Pool from SAT Math ≥ 550
Hispanic / Latino	17498	23878
Black / African American	5623	9840
American Indian / Alaska Native	872	1089
Native Hawaiian / Other Pacific Islander	464	
Two or More	8476	

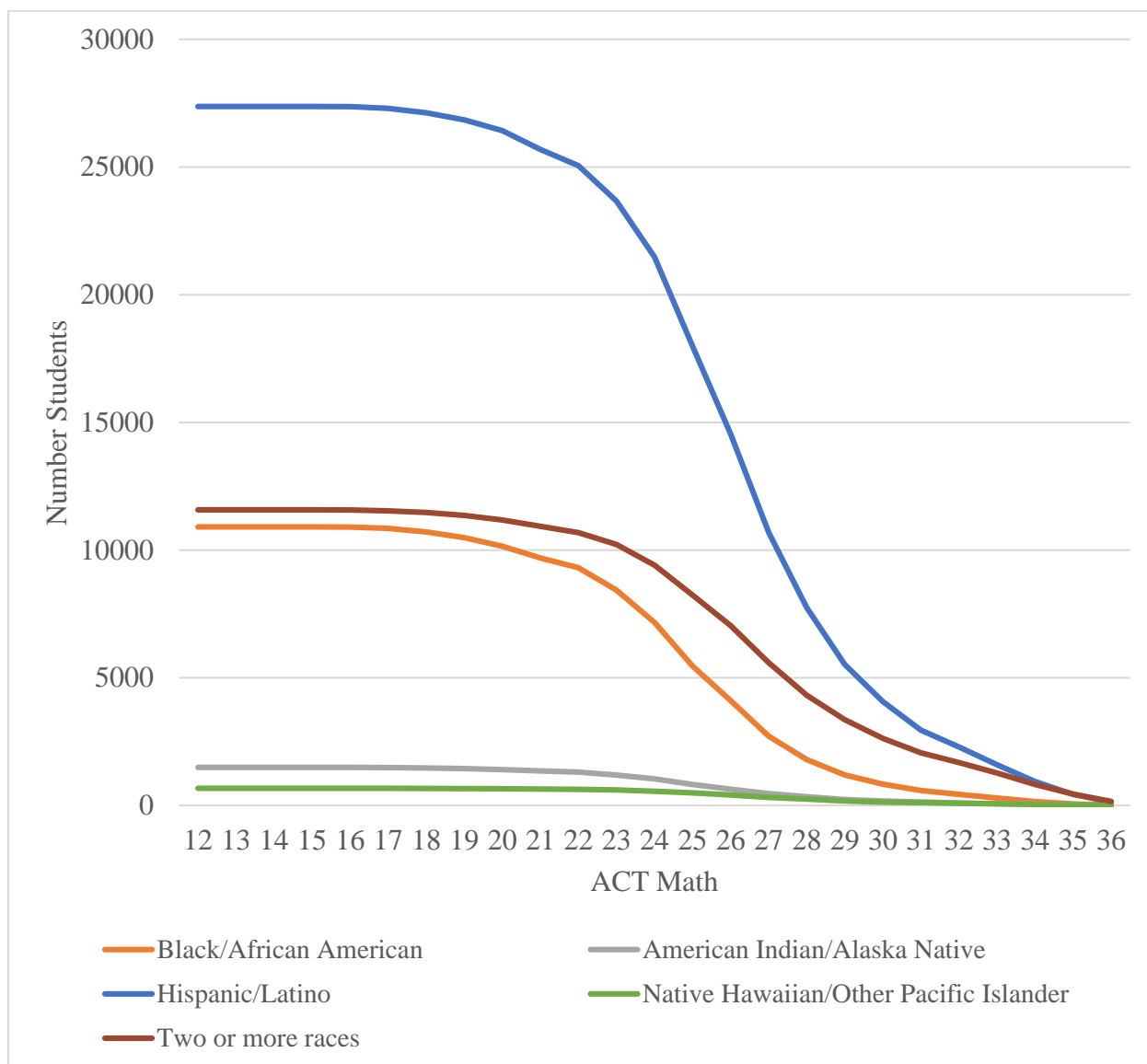

**Table 49.** ACT and SAT expanded filter with all filters removed except standardized test score and HSGPA.

Racial / Ethnic Background	Pool from ACT Math $\geq 24$	Pool from SAT Math $\geq 550$
Hispanic / Latino	21528	25417
Black / African American	7044	10863
American Indian / Alaska Native	1001	1188
Native Hawaiian / Other Pacific Islander	595	
Two or More	15732	

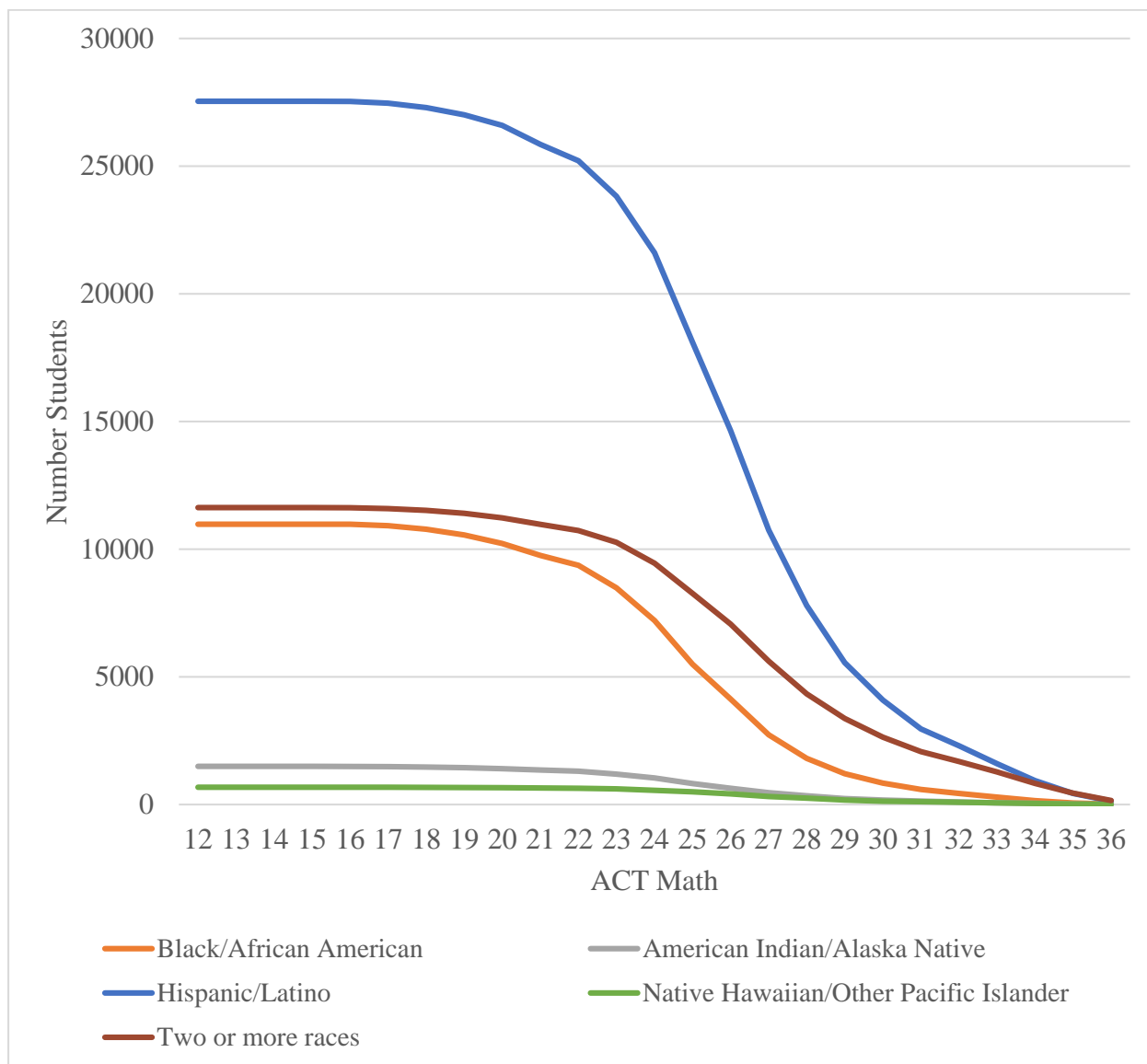

**Table 50.** ACT and SAT expanded filter, only standardized test scores.

Racial/Ethnic Background	Pool from ACT Math + Comp $\geq 24$	Pool from ACT Math + Comp $\geq 25$	Pool from ACT Math + Comp $\geq 26$	Pool from ACT Math + Comp $\geq 27$	Pool from SAT Math + Comp $\geq 550/1110$	Pool from SAT Math + Comp $\geq 570/1140$	Pool from SAT Math + Comp $\geq 590/1180$	Pool from SAT Math + Comp $\geq 610/1220$
Hispanic / Latino	30750	22140	15739	10689	31375	25965	18274	12024
Black / African American	10962	7185	4706	2837	14033	11022	7737	4913
American Indian / Alaska Native	1396	969	693	469	1468	1221	792	511
Native Hawaiian / Other Pacific Islander	827	617	468	331				
Two or More	23050	11249	15440	12001				

