

January 2012

Improving the Throughput and Reliability of Wireless Sensor Networks with Application to Wireless Body Area Networks

Gabriel Arrobo

University of South Florida, garrobo@mail.usf.edu

Follow this and additional works at: <http://scholarcommons.usf.edu/etd>

 Part of the [Electrical and Computer Engineering Commons](#)

Scholar Commons Citation

Arrobo, Gabriel, "Improving the Throughput and Reliability of Wireless Sensor Networks with Application to Wireless Body Area Networks" (2012). *Graduate Theses and Dissertations*.

<http://scholarcommons.usf.edu/etd/4279>

This Dissertation is brought to you for free and open access by the Graduate School at Scholar Commons. It has been accepted for inclusion in Graduate Theses and Dissertations by an authorized administrator of Scholar Commons. For more information, please contact scholarcommons@usf.edu.

Improving the Throughput and Reliability of Wireless Sensor Networks
with Application to Wireless Body Area Networks

by

Gabriel Arrobo

A dissertation submitted in partial fulfillment
of the requirements for the degree of
Doctor of Philosophy
Department of Electrical Engineering
College of Engineering
University of South Florida

Major Professor: Richard D. Gitlin, Sc.D.
Huseyin Arslan, Ph.D.
Ravi Sankar, Ph.D.
Miguel Labrador, Ph.D.
Zygmunt Haas, Ph.D.

Date of Approval:
November 2, 2012

Keywords: *In Vivo* Communications, Real-time Traffic, Network Coding,
Diversity Coding, OFDM

Copyright © 2012, Gabriel Arrobo

DEDICATION

To my beloved wife, Carolina, who supported me each step of the way; my son, Gabriel, who is my motivation to give and be amongst the best; my parents, who have taught me invaluable lessons; and God who presents me challenging opportunities to grow personally and professionally.

ACKNOWLEDGMENTS

I would like to express my deepest appreciation to my advisor Dr. Richard D. Gitlin, who I also consider my mentor, for his invaluable guidance, support, patience, encouragement, and life teachings. I will internalize all he has taught me in my future life, because it is something that will help me to achieve even greater objectives. I am also grateful to Dr. Huseyin Arslan, Dr. Ravi Sankar, Dr. Miguel Labrador and Dr. Zygmunt Haas for being part of my doctoral committee, and for the knowledge that I acquired when interacting with them.

I am thankful to my friends and colleagues at the *In vivo* Wireless Information Networking (*i*WINLAB) Laboratory. Also, my sincere thanks to all the staff at the Department of Electrical Engineering at USF for their kindness and valued assistance.

My deepest gratitude to my wife Carolina and my darling son Gabriel for their love, support and company. Finally, I thank God for giving me the opportunity to keep growing and improving myself, with the ultimate goal of better serve the society.

TABLE OF CONTENTS

LIST OF TABLES	v
LIST OF FIGURES	vi
ABSTRACT.....	xi
CHAPTER 1. INTRODUCTION	1
1.1 Wireless Sensor Networks and Wireless Body Area Networks	1
1.2 Insights and Constraints in Wireless Sensor Networks and Body Area Networks.....	3
1.3 Research Motivation	6
1.4 Contributions and Organization of this Dissertation.....	9
CHAPTER 2. LITERATURE REVIEW	13
2.1 Introduction.....	13
2.2 Error Detection Techniques	13
2.2.1 Parity.....	14
2.2.2 Checksum.....	14
2.2.3 Cyclic Redundancy Check.....	14
2.3 Error Correction Techniques	14
2.3.1 Forward Error Correction (at the bit level)	15
2.3.1.1 Linear Block Codes	15
2.3.1.2 Convolutional Codes	16
2.3.2 Hybrid Techniques.....	16
2.3.2.1 Simple Hybrid ARQ:	17
2.3.2.2 Hybrid ARQ with Soft Combining.....	17
2.3.3 Forward Error Correction Techniques at the Packet Level.....	18
2.4 Diversity Coding.....	18
2.5 Network Coding.....	25
2.5.1 Network Coding Approaches.....	27
2.5.2 Applications of Network Coding.....	31
2.5.2.1 Wireless Broadcast Networks.....	31
2.5.2.2 Peer to Peer File Sharing System.....	32
2.5.2.3 Network Security Applications.....	32
2.6 Concluding Remarks.....	33
CHAPTER 3. COOPERATIVE NETWORK CODING FOR WIRELESS SENSOR NETWORKS	34
3.1 Introduction.....	34
3.2 Cooperative Network Coding	36
3.3 Simulation Scenario and Results for Wireless <i>Ad Hoc</i> Networks	44
3.3.1 Effect of the Number of Original Packets on the Performance of Cooperative Network Coding.....	44

3.3.2	Effect of the Probability of Link Error on the Performance of Cooperative Network Coding.....	46
3.3.3	Effect of the Connectivity on the Performance of Cooperative Network Coding	48
3.3.4	Effect of the Number of Clusters on the Performance of Cooperative Network Coding	51
3.4	Concluding Remarks.....	55
CHAPTER 4. LINK LEVEL RETRANSMISSIONS FOR COOPERATIVE NETWORK CODING AND COOPERATIVE DIVERSITY CODING		57
4.1	Introduction.....	57
4.2	Effect of Retransmission from the Last Cluster.....	60
4.3	Cooperative Network Coding Optimization – Selective Retransmissions to Minimize Energy Consumption.....	65
4.4	Simulation Scenario for Wireless <i>Ad hoc</i> Networks.....	72
4.4.1	Cooperative Network Coding with Retransmission from the Last Cluster	73
4.4.2	Cooperative Diversity Coding and Cooperative Network Coding Optimization - Minimizing Energy Consumption.....	74
4.5	Concluding Remarks.....	81
4.5.1	Cooperative Network Coding with Retransmissions	81
4.5.2	Cooperative Diversity Coding and Cooperative Network Coding Optimization - Minimizing Energy Consumption.....	82
CHAPTER 5. IMPROVING THE PERFORMANCE OF SINGLE SOURCE – SINGLE DESTINATION WIRELESS BODY AREA NETWORKS VIA COOPERATIVE NETWORK CODING		83
5.1	Introduction and Motivation	83
5.2	Literature Review	85
5.3	Extant Wireless Body Area Networks	86
5.4	Network Coding in Wireless Body Area Networks.....	88
5.5	Cooperative Network Coding in Wireless Body Area Networks Model.....	89
5.5.1	Network Coding at the Source Node	90
5.5.2	Operations at the Relay Nodes.....	91
5.5.3	Operations at the Destination Node	91
5.6	Simulation Results and Discussion.....	92
5.7	Concluding Remarks.....	98
CHAPTER 6. IMPROVING THE PERFORMANCE OF WIRELESS BODY AREA NETWORKS THROUGH TEMPORAL DIVERSITY CODING		99
6.1	Introduction and Motivation	99
6.2	Literature Review	100
6.3	System Model	100
6.4	Temporal Diversity Coding for Increasing the Performance of <i>In Vivo</i> Wireless Communications	101
6.5	Simulation Results and Discussion.....	105
6.6	Concluding Remarks.....	109

CHAPTER 7. IMPROVING THE PERFORMANCE OF WIRELESS BODY AREA NETWORKS FOR MULTIPLE SOURCE – MULTIPLE RECEIVERS.....	111
7.1 Introduction and Motivation	111
7.2 Literature Review	112
7.3 Cooperative Network Coding for Multiple Source – Multiple Destination.....	114
7.4 Simulation Results and Discussion.....	116
7.5 Concluding Remarks.....	119
 CHAPTER 8. IMPROVING THE RELIABILITY OF <i>IN VIVO</i> VIDEO WIRELESS COMMUNICATIONS	120
8.1 Introduction.....	120
8.2 Orthogonal Frequency Division Multiplexing.....	121
8.3 Diversity Coding - Orthogonal Frequency Division Multiplexing.....	124
8.4 Preliminary Results.....	127
8.5 Concluding Remarks.....	129
 CHAPTER 9. DC–OFDM FOR IMPROVING THE RELIABILITY OF VEHICULAR COMMUNICATIONS	130
9.1 Introduction.....	130
9.2 Literature Review	131
9.2.1 Wireless Access in Vehicular Environments	131
9.2.2 Orthogonal Frequency Division Multiplexing.....	133
9.2.3 Diversity Coding.....	138
9.3 Related Work – Network Coding for OFDM-Based Systems.....	138
9.3.1 Network Coding in the MAC Layer	138
9.3.2 Network Coding in the PHY Layer	140
9.3.2.1 Rate Diverse Network Coding.....	140
9.3.2.2 CodePlay.....	142
9.3.3 Performance Evaluation of PHY Layer Network Coding Techniques	142
9.4 Diversity Coded Orthogonal Frequency Division Multiplexing.....	145
9.4.1 System Model	146
9.4.2 Operation of Diversity Coding – OFDM.....	151
9.5 Results.....	155
9.6 Concluding Remarks.....	158
 CHAPTER 10. CONCLUSION AND FUTURE DIRECTIONS.....	160
10.1 Main Contributions and Conclusions.....	161
10.1.1 Cooperative Network Coding for Improving the Performance of Wireless Sensor Networks.....	161
10.1.2 Link-level Retransmissions for Cooperative Network Coding Architectures	162
10.1.3 Cooperative Network Coding for Improving the Performance of Wireless Body Area Networks	163
10.1.4 Temporal Diversity Coding for Improving the Performance of Wireless Body Area Networks	164
10.1.5 Diversity Coding for Orthogonal Frequency Division Multiplexing (OFDM-based) Systems	165
10.2 Future Directions	165
 REFERENCES	167

APPENDICES 174
 Appendix A Copyright and Permissions..... 175
ABOUT THE AUTHOR END PAGE

LIST OF TABLES

Table 1-1 Comparison of our approaches for wireless sensor networks	10
Table 1-2 Comparison of our approaches for wireless body area networks	11
Table 3-1 System parameters [22]	39
Table 4-1 Minimum number of transmitted packets M' and probability of linear independency of the transmitted packets	68
Table 4-2 CNC performance for probability of link error of 0.10, connectivity among the nodes equal to 6, and 11 combination packets	76
Table 4-3 CDC performance for probability of link error of 0.10, connectivity among the nodes equal to 8, and 11 combination packets	76
Table 4-4 CNC performance for probability of link error of 0.05, connectivity among the nodes equal to 6, and 11 combination packets	78
Table 4-5 CDC performance for probability of link error of 0.05, connectivity among the nodes equal to 6, and 11 combination packets	78
Table 8-1 Diversity Coding as a function of the modulation scheme	126
Table 9-1 Diversity Coding as a function of the modulation scheme for IEEE 802.11p.....	149
Table 10-1 Comparison between Diversity Coding and Network Coding	161

LIST OF FIGURES

Figure 1.1 Wireless sensor network.....	2
Figure 1.2 A wireless body area network and its possible communication links [8], © 2010 IEEE	3
Figure 1.3 Communication links for a wireless body area network ---WBAN	6
Figure 1.4 Trocar port used for surgical tools and placement of the MARVEL Camera Module in the abdominal wall [38]	8
Figure 2.1 1 for N Diversity Coding system [13].....	19
Figure 2.2 Point-to-point system with M for N Diversity Coding [13].....	24
Figure 2.3 Multipoint-to-point Diversity Coding [13].....	24
Figure 2.4 Multipoint-to-multipoint Diversity Coding [13]	25
Figure 2.5 Butterfly topology (Network Coding)	26
Figure 2.6 Traditional network approach (No Network Coding)	27
Figure 2.7 Network Coding packet format	29
Figure 2.8 Wireless Network Coding (WNC) topology	30
Figure 3.1 The multihop network model	34
Figure 3.2 Probability of successful reception of a packet vs. the number of hops	35
Figure 3.3 Cooperative Network Coding model.....	37
Figure 3.4 Node's Network Coding operation.....	41
Figure 3.5 The connectivity of Cooperative Network Coding.....	42
Figure 3.6 Probability of successful reception at the destination vs. number of nodes per cluster n as a function of the number of original packets and connectivity, the probability of link error p is 10^{-1}	45
Figure 3.7 Probability of successful reception at the destination vs. number of nodes per cluster n as a function of the probability of link error p for a connectivity $r = 8$	47

Figure 3.8 Probability of successful reception at the destination vs. number of nodes per cluster n as a function of the connectivity r_{ij} for $r_s=m=10$, the probability of link error p is 0.1	49
Figure 3.9 Probability of successful reception at the destination vs. number of nodes per cluster n as a function of the connectivity r_{ij} for $r_s=m=10$, the probability of link error p is 0.25.....	49
Figure 3.10 Comparison of probability of successful reception at the destination for probability of link error p is 0.1, r_s equal m (10) and r_s equal n for different values of connectivity.....	50
Figure 3.11 Comparison of probability of successful reception at the destination for probability of link error p is 0.25, r_s equal m (10) and r_s equal n for different values of connectivity.....	50
Figure 3.12 Effect of connectivity between nodes in the last cluster and the destination node for the probability of link error p of 0.1	51
Figure 3.13 Probability of successful reception at the destination vs. number of clusters K for connectivity $r_s=r_{ij}=4$, the probability of link error p is 0.1 and different number of nodes per cluster.....	53
Figure 3.14 Probability of successful reception at the destination vs. number of clusters K for connectivity $r_{ij}=4$, the probability of link error p is 0.25 and different number of nodes per cluster	53
Figure 3.15 Probability of successful reception at the destination vs. number of clusters K for connectivity $r_{ij}=8$, the probability of link error is 0.1 and different number of nodes per cluster	54
Figure 3.16 Probability of successful reception at the destination vs. number of clusters K for connectivity $r_{ij}=8$, the probability of link error p is 0.25 and different number of nodes per cluster	54
Figure 4.1 The throughput vs. number of nodes per cluster n of Cooperative Network Coding (with $r_s=r_{ij}=10$) and of Multihop Packet Network	59
Figure 4.2 Probability V_K that a node in the cluster K correctly receives at least one coded packet vs. number of nodes in a cluster n for different values of connectivity r and for $p = 0.1$	60
Figure 4.3 The probability of successful reception P_s vs. number of nodes in a cluster n for a number of values of connectivity r and for $p = 0.1$	61
Figure 4.4 Probability V_K that a node in the cluster K correctly receives at least one coded packet vs. number of nodes in a cluster n for different values of connectivity r and for $p = 0.25$	61
Figure 4.5 The probability of successful reception P_s vs. number of nodes in a cluster n for a number of values of connectivity r and for $p = 0.25$	62

Figure 4.6 Link-layer retransmission model	63
Figure 4.7 Probability of successful reception P_s vs. number of nodes n in a cluster for $p = 0.1$	73
Figure 4.8 Probability of successful reception P_s vs. number of nodes n in a cluster for $p = 0.25$	74
Figure 4.9 CNC and CDC performance for probability of link error equal to p , connectivity equal to r and $m = m' = 10$ coded packets.....	75
Figure 4.10 CNC performance for probability of link error equal to 0.10, connectivity equal to 6 and $m = 10$ original packets.....	78
Figure 4.11 CNC and CDC performance vs. the number of nodes per cluster for probability of link error equal to 0.05, connectivity equal to r and $m = 10$ original packets.....	79
Figure 5.1 (a) Placement of the MARVEL Camera Module in the abdominal wall, and (b) Two MARVEL CMs are inside of a porcine abdominal cavity [38].....	83
Figure 5.2 Possible communication links for body area networking [68], © 2010 IEEE.....	84
Figure 5.3 Network topology in [71]	86
Figure 5.4 Network topology in [72]	86
Figure 5.5 Cooperative Network Coding for wireless body area network.....	90
Figure 5.6 Probability of successful reception as a function of the E_b/N_0 for U and UC systems with modulation 4-PSK.....	94
Figure 5.7 Probability of successful reception as a function of the E_b/N_0 for NC systems with modulation 4-PSK	94
Figure 5.8 Probability of successful reception as a function of the E_b/N_0 for CNC systems with modulation 4-PSK	95
Figure 5.9 Probability of successful reception at the destination as a function of the E_b/N_0 for UC $m = 10$ and for CNC with different number of coded packets with modulation 4-PSK	96
Figure 5.10 Probability of successful reception at the destination as a function of the E_b/N_0 for UC $m = 10$ and for CNC with different number of coded packets with modulation 16-QAM	96
Figure 5.11 Probability of successful reception at the destination as a function of the number of coded packets for CNC.....	97
Figure 5.12 Probability of successful reception at the destination as a function of the E_b/N_0 for U, UC, NC, and CNC systems with modulation 4-PSK	97

Figure 6.1 System with 1 <i>for</i> N Diversity Coding [13].....	100
Figure 6.2 Temporal Diversity Coding: System model for two relay paths	101
Figure 6.3 Temporal Diversity Coding: Network topology	102
Figure 6.4 Probability of successfully receiving information vs. E_b/N_0 for an uncoded ($U - 1$) and Temporal Diversity Coding ($TDC - 1$) schemes.....	106
Figure 6.5 Efficiency vs. E_b/N_0 for an uncoded (U) and Temporal Diversity Coding (TDC) schemes for a two-path system.....	107
Figure 6.6 Utilization vs. E_b/N_0 for an uncoded (U) and Temporal Diversity Coding (TDC) schemes for a two-path system.....	108
Figure 6.7 Efficiency vs. Utilization for an uncoded (U) and Temporal Diversity Coding (TDC) schemes for a two-path system.....	108
Figure 6.8 Probability of success comparison for Temporal Diversity Coding $TDC - 2$ and the other 3 schemes $U - 1, U - 2, TDC - 1$	109
Figure 7.1 Wireless Body Area Network.....	111
Figure 7.2 Cooperative Network Coding for Wireless Body Area Networks	114
Figure 7.3 Cooperative Network Coding model for WBANs.....	116
Figure 7.4 Throughput vs. probability of link error for two relays ($R=2$) and different numbers of transmitted packets per source (m') and per relay (r_i)	117
Figure 7.5 Throughput vs. probability of link error as a function of the number of relays	118
Figure 7.6 Throughput vs. probability of link error as a function of the number of relays and the number of sinks.....	118
Figure 8.1 Overview of Diversity Coding OFDM.....	120
Figure 8.2 Comparison between single carrier transmission and OFDM.....	122
Figure 8.3 System with 1 – <i>for</i> – N DC–OFDM <i>in vivo</i> communication links.....	124
Figure 8.4 Schematic to implement DC–OFDM <i>in vivo</i> communication links	127
Figure 8.5 Performance of 3 – <i>for</i> – N DC – OFDM system for an OFDM-QPSK.....	127
Figure 8.6 Performance of M – <i>for</i> – N DC – OFDM system for an OFDM-QPSK with probability of link error equal to 10^{-2}	128
Figure 8.7 Performance of M – <i>for</i> – N DC – OFDM system for an OFDM-QPSK as a function of the E_b/N_0	129
Figure 9.1 Protocol Data Unit (PPDU) frame format [79].....	132

Figure 9.2 OFDM block diagram.....	134
Figure 9.3 (a) Non-WNC multihop system and (b) WCN multihop system [82].....	139
Figure 9.4 Rate diverse Network Coding [88].....	141
Figure 9.5 DC–OFDM communication system	145
Figure 9.6 System with 1 – <i>for</i> – <i>N</i> DC–OFDM communication links (Transmitter)	146
Figure 9.7 System with 1 – <i>for</i> – <i>N</i> DC–OFDM communication links (Receiver).....	147
Figure 9.8 DC – OFDM block diagram	150
Figure 9.9 <i>M</i> – <i>for</i> – <i>N</i> DC – OFDM communication links	151
Figure 9.10 Performance of a 1 – <i>for</i> – <i>N</i> DC – OFDM system as a function of the number of subcarriers	156
Figure 9.11 Performance of a <i>M</i> – <i>for</i> – <i>N</i> DC – OFDM system for a probability of link error p_{ser} of 10^{-3}	156
Figure 9.12 Performance of a <i>M</i> – <i>for</i> – <i>N</i> DC – OFDM system for a probability of link error p_{ser} of 10^{-1}	157
Figure 9.13 Performance of 1 – <i>for</i> – <i>N</i> DC – OFDM system for an OFDM-QPSK in a multi-path channel for various relative speeds	158

ABSTRACT

This dissertation will present several novel techniques that use cooperation and diversity to improve the performance of multihop Wireless Sensor Networks, as measured by throughput, delay, and reliability, beyond what is achievable with conventional error control technology.

We will investigate the applicability of these new technologies to Wireless Body Area Networks (WBANs) an important emerging class of wireless sensor networks. WBANs, which promise significant improvement in the reliability of monitoring and treating people's health, comprise a number of sensors and actuators that may either be implanted *in vivo* or mounted on the surface of the human body, and which are capable of wireless communication to one or more external nodes that are in close proximity to the human body. Our focus in this research is on enhancing the performance of WBANs, especially for emerging real-time *in vivo* traffic such as streaming real-time video during surgery. Because of the nature of this time-sensitive application, retransmissions may not be possible.

Furthermore, achieving minimal energy consumption, with the required level of reliability is critical for the proper functioning of many wireless sensor and body area networks. Additionally, regardless of the traffic characteristics, the techniques we introduce strive to realize reliable wireless sensor networks using (occasionally) unreliable components (wireless sensor nodes).

To improve the performance of wireless sensor networks, we introduce a novel technology *Cooperative Network Coding*, a technology that synergistically integrates the prior art of Network Coding with Cooperative Communications. With the additional goal of further minimizing the energy consumed by the network, another novel technology *Cooperative Diversity Coding* was introduced and is used to create protection packets at the source node. For

representative applications, optimized *Cooperative Diversity Coding* or *Cooperative Network Coding* achieves $\geq 25\%$ energy savings compared to the baseline *Cooperative Network Coding* scheme. *Cooperative Diversity Coding* requires less computational complexity at the source node compared to *Cooperative Network Coding*.

To improve the performance and increase the robustness and reliability of WBANs, two efficient feedforward error-control technologies, *Cooperative Network Coding* (CDC) and *Temporal Diversity Coding* (TDC), are proposed. *Temporal Diversity Coding* applies Diversity Coding in time to improve the WBAN's performance. By implementing this novel technique, it is possible to achieve significant improvement ($\sim 50\%$) in throughput compared to extant WBANs. An example of an implementation of *in vivo* real-time application, where TDC can improve the communications performance, is the MARVEL (Miniature Anchored Robotic Videoscope for Expedited Laparoscopy) research platform developed at USF.

The MARVEL research platform requires high bit rates (~ 100 Mbps) for high-definition transmission. Orthogonal Frequency Division Multiplexing (OFDM), a widely used technology in fourth generation wireless networks (4G) that achieves high transmission rates over dispersive channels by transmitting serial information through multiple parallel carriers. Combining *Diversity Coding* with OFDM (DC-OFDM) promises high reliability communications while preserving high transmission rates. Most of the carriers transport original information while the remaining (few) carriers transport diversity coded (protection) information.

The impact of DC-OFDM can extend far beyond *in vivo* video medical devices and other special purpose wireless systems and may find significant application in a broad range of *ex vivo* wireless systems, such as LTE, 802.11, 802.16.

CHAPTER 1. INTRODUCTION

In the 21st century, wireless networks will forever alter how people access information and will facilitate integration of the physical world with the Internet. According to the Wireless World Research Forum (WWRF), seven trillion wireless devices will serve seven billion people by 2020 [1], where all these devices are part of the internet. Wireless technology is rapidly migrating from communications to a multitude of embedded real-world applications (Cyber Physical Systems). On average, there will be 1000 wireless devices per person in 2020. However, this does not necessarily mean that each person will own 1000 wireless devices because most of the communications will be machine-to-machine communications including sensor related communication [2]. An example of such an application is automated meter reading where sensor nodes automatically and periodically (e.g. monthly) read, for example, the water meter or electric meter at home and transmit that data to a processing center. Another such application is surveillance or reconnaissance tasks in the military that exploit the rapid deployment of many wireless sensor nodes. Also, wireless sensor and actuator nodes¹ can be installed on or in the soldier's body to continuously monitor vital signs, and possibly initiate the actuation of node on or in the human body when needed, during action in the battlefield.

1.1 Wireless Sensor Networks and Wireless Body Area Networks

A wireless sensor network (WSN) is a network formed by a large number of low-power and low-complexity wireless nodes that can sense a variable parameter from the physical environment and transmit the collected data to a sink (or possibly multiple sinks), typically, through multiple hops as depicted in Figure 1.1. In addition, wireless sensor networks can have actuators that are nodes that execute actions in the physical environment. Because of their

¹ Sensors are devices used to monitor signals from a physical environment, and actuators are devices that “act” on the physical environment.

inherent functionality, the actuators have higher complexity than the sensors. The main desired features of this type of network are [3]:

- Robustness,
- Scalability,
- Self-organization,
- Extended lifetime,
- Low cost and size

Wireless sensor networks can be used for different applications, ranging from military applications such as enemy intrusion detection and home automation [4].

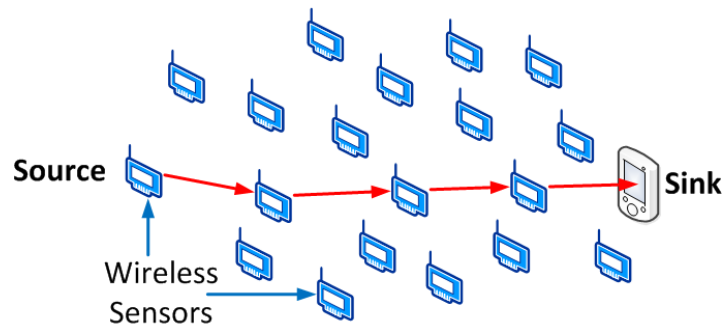

Figure 1.1 Wireless sensor network

Wireless Body Area Networks (WBANs) are a special purpose wireless sensor networks that are receiving considerable attention because they can provide ubiquitous real-time monitoring of human physiology [5], [6]. A WBAN is a network formed by low-power devices that are located on, in or around the human body and are used to monitor physiological signals and motion [7], as shown in Figure 1.2. WBANs can be used in several applications such as healthcare, fitness, gaming and entertainment, military, etc. Among the most impactful applications is in healthcare, where the WBANs could lead to proactive monitoring and treatment of a personal health. Healthcare applications have attracted researchers' attention because of the increasingly aging population that is prone to age-related diseases and who could often benefit from continuous monitoring of physiological signals [6]. The use of WBANs may enable

ubiquitous “on line” healthcare and could lead to proactive, and even remote, diagnostic of diseases in an early stage. Moreover, a WBAN may contain an actuator, which, based on measurements and settings, can automatically release medicine or other agents. An example is an actuator to supply insulin to a patient with diabetes that is triggered when the level of sugar exceeds a certain level. Additionally, WBANs can provide health monitoring without interfering the patient’s everyday activities.

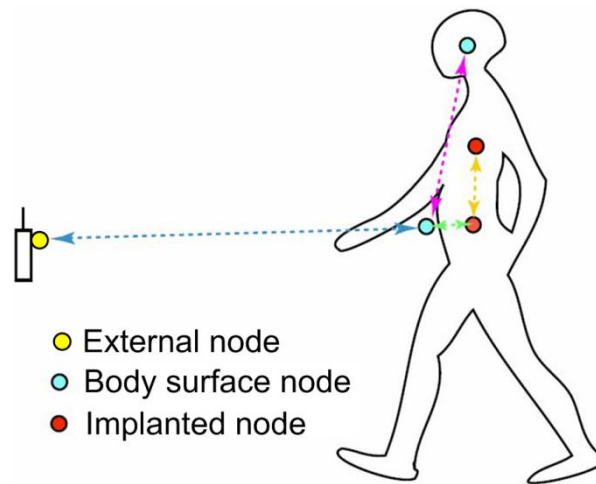

Figure 1.2 A wireless body area network and its possible communication links [8], © 2010 IEEE

Figure 1.2 shows the communication links proposed by the IEEE 802.15.4 TG6 in their channel model document [8], where the information from the implanted or on body surface nodes is sent to an on-body surface node and this node can forward the information to an external node. Notice that typically these are two-hop, store-and-forward packet networks, where a relay assists the sensor nodes by forwarding the sensors’ data towards the external node. The external node can be connected to other networks, e.g. the Internet, to reach the destination node, where the information is processed and stored.

1.2 Insights and Constraints in Wireless Sensor Networks and Body Area Networks

While wireless sensor nodes are inexpensive, they have limitations in complexity, power consumption, and communication capabilities [9]. Moreover, because of their simplicity and how they are deployed, these devices are unreliable. Additionally, since these nodes are battery-

powered, there is a trade-off between transmission/processing power and operational lifetime, especially for nodes deployed in inaccessible environments such as the jungle or embedded in infrastructures such as bridges, where it is very difficult to replace them in case of failure. Another main parameter in wireless sensor networks is the traffic characteristics (e.g. real-time or non-real-time). For non-real-time traffic, reliable transmission can be achieved by error detection and retransmission techniques, such as automatic repeat request (ARQ). However, for real-time traffic, well-known feedforward techniques such as forward error correction (FEC) at the bit level [10–12], or relatively new feedforward techniques such as Diversity Coding (DC) [13–15] and Network Coding (NC) [16–23] at the packet level are more appropriate. Regardless of the traffic characteristics, the above techniques strive to realize reliable wireless (sensor) networks using occasionally unreliable components (wireless links and nodes).

In past few years there has been considerable research in Network Coding to address the need for a simple and efficient method of broadcasting packetized information over a lossy wireless medium that improves upon the traditional method retransmission of errored or lost packets. Traditionally, information transmission is accomplished by forwarding, or routing, the data generated from the transmitting node through the intermediate nodes to the destination node. For example if node A and B want to communicate with each other through node X , A sends a packet p_1 to X and X forwards p_1 to B . When B wants to transmit a packet p_2 , B sends p_2 to X and then X forwards p_2 to A . This method requires 4 transmissions for message transfer between A and B . In the case of multihop networks, this method increases the number of transmissions needed for the message transfer between the two nodes resulting in increased congestion and reduced throughput. Also, if one of the transmitted packets is lost in the intermediate nodes, the data needs to be retransmitted from the source node. However, with Network Coding, the intermediate nodes combine the received packets, create coded packets and send these coded packets towards the destination. The received coded packets are then decoded to recover the original data. As with the previous example, if A and B wants to communicate, A sends packet p_1

to X and B sends packet p_2 to X . Now, X upon receiving both packets p_1 and p_2 , it XORs the received packets and sends the XORed packet to both A and B . By correctly receiving this XORed packet, A and B can recover each other's packet by XORing the received packet with its own (transmitted) packet. In this way, the number of transmissions between A and B is reduced to 3 instead of 4 as in previous case. Because fewer transmissions are required, the throughput increases. This method also increases the reliability of the network. These features are attractive to increase the performance of different type of networks, especially for those who transport real-time traffic and where with high reliability is required because, for example, a wireless body area network (WBAN) that is monitoring the vital signs of a person, who is in chronic conditions or emergency situations, must provide high reliability.

Wireless body area networks, similar to the wireless sensor networks, have certain characteristics/requirements such as low-complexity nodes, limited transmission and processing power, reduced latency, high reliability, mobility, and operating in a highly lossy and dispersive radio frequency (RF) channel [24], [25]. In addition to these challenges, wireless body area nodes, especially *in vivo* nodes, have a form factor constraint that make WBANs unique when compared to other networks. The sensor nodes are restricted in complexity and processing power because of their size and battery limitations. Their transmission power is limited to avoid hazardous RF radiation to the human body, as well as to extend the node's battery lifetime. Moreover, the WBANs must transmit at low power to protect the patients against harmful health effects associated with the radiofrequency (RF) emissions. Thus, the specific absorption rate (SAR) should be low [26]. SAR is the rate at which the RF energy is absorbed by a body volume or mass and has units of watts per kilogram (W/Kg). Due to this limitation on the specific absorption rate, it is not possible to increase the transmission power beyond a certain level to overcome the transmission loss or errors of the packets. The radio channel is continuously changing because the dielectric characteristics of the human tissues and organs are themselves in continuous variation, due to the movements of the body such as arms, legs, and the movement of

internal fluids such as blood, which make the channel time varying. Because of these channel variations, it is a challenge to realize a WBAN with reliable communications among the nodes [27].

Furthermore, for real-time applications where the caregiver, or decision device, needs to receive information about the patient's health on a continuous basis, such as *in vivo* video monitoring, the WBANs should provide, among other characteristics, reliable communications that are relatively insensitive to link or node failures [28]. However, patient mobility increases the probability of packet loss, and it is preferred that the packet error rate should be kept less than 1% [29].

1.3 Research Motivation

The editors of the National Academy of Engineering's publication *The Bridge* write that "...Health care delivery today is in turmoil. Despite rapid advances in medical procedures and the understanding of diseases and their treatment, the efficiency, safety, and cost-effectiveness of the delivery of health care have not kept pace" [30].

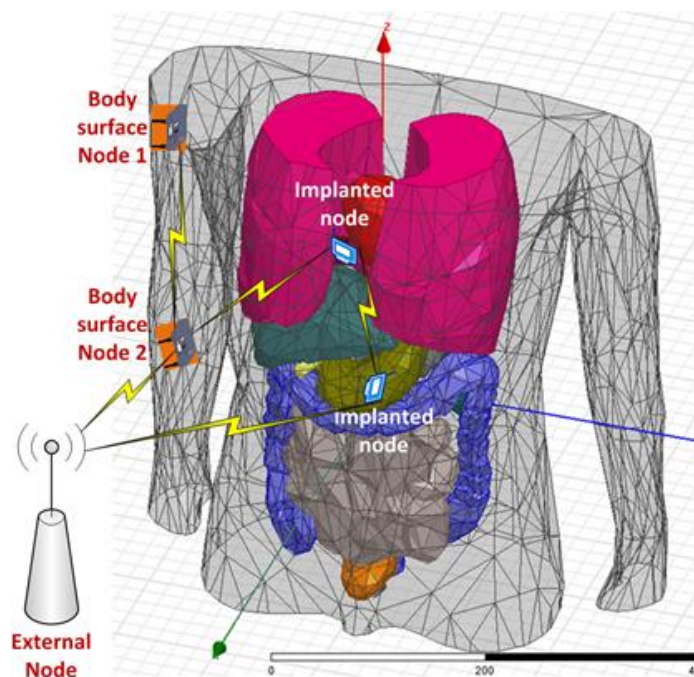

Figure 1.3 Communication links for a wireless body area network ---WBAN

Certainly, one critical element for improving the delivery of advanced health care is the application of technologies that can effectively monitor patient health and/or allow medical professionals to administer procedures with increased efficiency and reduced invasion. For the patient, a reduction in the invasiveness of the procedure means less pain/trauma to the body, less scarring, reduction in healthcare costs, faster recovery, decreased risk of developing complications after surgery and the opportunity to return to regular daily routines faster.

One possible application of technology in health care delivery that is gaining increased attention in the research community is the use of wireless technology to allow communication among near-body, on-body, or even *in vivo* sensors and actuators. For example, one interesting concept is the use of a smart phone equipped with the proper application software to manage the flow of data between a host of biomedical sensors and/or actuators and a central server that can monitor the data and possibly specify sensor or actuator changes in response to the relayed observations, as shown in Figure 1.3. Such a capability, enhanced perhaps by using a relay device or multiple relay devices for improved communication, could allow adaptive drug delivery rates that are based on observed body chemistry, appliance (canes, artificial limbs or organs) responses to monitored physical stresses, or manipulation of *in vivo* sensors and actuators. Furthermore, allowing reception of high-quality video from implanted nodes or swallowed camera pills [31–37] could assist not only in disease diagnosis but also in minimally invasive surgeries (MIS). To utilize and network devices like the MARVEL (Miniature Anchored Robotic Videoscope for Expedited Laparoscopy) [38] research platform at USF, which is a wireless controlled and communication *in vivo* camera module, will need a highly reliable communication system. It is expected that the novel communication techniques presented in this dissertation, will create a paradigm shift in minimally invasive surgery (MIS) by freeing trocar ports currently used for laparoscopes be used by other surgical instruments, as shown in Figure 1.4.



Figure 1.4 Trocar port used for surgical tools and placement of the MARVEL Camera Module in the abdominal wall [38]

In summary, WBANs must satisfy stringent technical requirements, particularly, when the network is monitoring life-saving related signals, such as indicators of a heart attack. WBANs face several design challenges including that they are expected to:

- Be extremely reliable by avoiding single points of failure and provide self-healing capabilities if nodes or links are not operating properly,
- Transmit at low power to extend the network's lifetime and preclude any harmful effects in the human body, and
- Allow enhanced throughput when communicating via the dynamic and challenging *in vivo* wireless channel. A frequent constraint is that it is often neither possible nor desirable to retransmit the sensor data. With these challenges in mind, the aim of the research reported in this dissertation is to explore novel approaches for improving the throughput and reliability of wireless sensor networks, with direct application to Wireless Body Area Networks.

1.4 Contributions and Organization of this Dissertation

The contributions presented in this dissertation are directed to improving the throughput and reliability of wireless sensor networks with application to wireless body area networks are the following:

- *Cooperative Network Coding and Cooperative Diversity Coding with retransmissions* [39], [40]. Building upon the pioneering work of Haas in Cooperative Network Coding (CNC) [22], the probability of successful reception at the destination for CNC has been mathematically characterized and a novel technique that combines CNC and link-level retransmissions has been investigated. Further, a novel technique, which is based on CNC with retransmissions, uses Diversity Coding to create the coded packets at the source has been proposed and investigated. We refer to this technique as *Cooperative Diversity Coding (CDC)*. CNC and CDC with retransmissions significantly improve the performance of wireless sensor networks, while minimizing the consumed energy for the overall network. Moreover, CDC provides further energy savings at the source node compared to CNC because of its simplicity to code the packets at the source node.
- *Cooperative Network Coding and Time Diversity Coding for wireless body area networks* [41–44]. With CNC for multihop wireless sensor network [22] as point of departure and recognizing that main difference between a wireless sensor network and a wireless body area network is the number of hops and knowledge of the topology, we propose Cooperative Network Coding and Temporal Diversity Coding for wireless body area network applications. It is demonstrated in this dissertation that Cooperative Network Coding (CNC) and Time Diversity Coding (TDC) improve the performance of wireless body area networks by about 50% in terms of the probability of successful reception of a message at the destination. TDC has the additional advantage of lower computational complexity and lower delay.

- *Diversity Coding – Orthogonal Division Frequency Multiplexing* [45]. Implementing Diversity Coding in OFDM-based systems provides reliable communication that is quite tolerant of link failures, since the data and protection lines are transmitted via multiple sub-channels. Moreover, only adding one protection line (subcarrier), DC–OFDM provides significant performance improvement. Note that DC–OFDM is also well suited for mobile communications because this type of communications often has (raw) high symbol error rates.

The tables shown below compare the proposed approaches for wireless sensor networks and wireless body area networks. Since in a wireless sensor network, typically, the information will be transmitted through multiple hops, and because of the unknown topology the nodes (relays) will re-encode the received packets, while in a wireless body area network, the information can be either forwarded or re-encoded/forwarded because the topology is known and there are generally two hops between the source and destination nodes.

Table 1-1 Comparison of our approaches for wireless sensor networks

Characteristic	Cooperative Diversity Coding	Cooperative Network Coding
Basic idea	Both schemes introduce redundant packets	
Error correction	Both schemes are feed-forward error-correction techniques	
Network topology	Unknown	
Coding coefficients at the source	Known [Given by: $\beta_{ij} = \alpha^{(i-1)(j-1)}$, α is a primitive element of a $GF(2^q)$]	Randomly chosen [From a $GF(2^q)$]
Coded information (at the source)	Only the protection packets are coded	All the packets are coded
Coding coefficients at the nodes	Randomly chosen [From a $GF(2^q)$]	
Energy to transmit the packets	Both approaches require the same energy	
Energy at the source node	Less energy	More energy
Complexity at the source node	Less complex	More complex

Table 1-2 Comparison of our approaches for wireless body area networks

Characteristic	Temporal Diversity Coding	Cooperative Network Coding
Basic idea	Both schemes introduce redundant packets	
Error correction	Both schemes are feed-forward error-correction techniques	
Network topology	Known	
Coding coefficients at the source	Known [Given by: $\beta_{ij} = \alpha^{(i-1)(j-1)}$, α is a primitive element of a $GF(2^q)$]	Randomly chosen [From a $GF(2^q)$]
Coded information (at the source)	Only the protection packets are coded	All the packets are coded
Relay nodes	Only forwards correctly received packets	Only forwards correctly received packets or re-encode correctly received packets and transmit them to the destination
Performance	Lower performance	Higher performance (when the relays re-encode the packets)
Delay	Lower delay	Higher delay
Energy	Less energy	More energy
Complexity	Less complex	More complex

The dissertation is organized as follows:

- CHAPTER 2 presents a literature review of the error correction techniques, which are the standard approaches for improving the reliability and throughput of networks. Well known techniques such as Automatic Repeat reQuest (ARQ) and channel coding are briefly summarized. Also, relatively new error correction techniques such as Network Coding and Diversity Coding, which are the basis for the novel techniques used throughout this dissertation, are explained.
- CHAPTER 3 describes a thorough analysis of Cooperative Network Coding.

- Our approaches to improving the performance of wireless sensor networks using Network Coding and/or Diversity Coding and cooperation with retransmissions, while minimizing energy consumption is presented in CHAPTER 4.
- CHAPTER 5 describes a novel Cooperative Network Coding approach to reliable single source – single destination wireless body area networks.
- A new approach to apply Diversity Coding in wireless body area networks, Temporal Diversity Coding, is described in CHAPTER 6.
- CHAPTER 7 describes novel Cooperative Network Coding approaches to reliable multiple source – multiple receivers wireless body area networks.
- A novel technique Diversity Coding - Orthogonal Frequency Division Multiplexing (DC-OFDM) is shown to improve the reliability of *in vivo* video wireless devices and is presented in CHAPTER 8.
- CHAPTER 9 describes the performance of Diversity Coding - Orthogonal Frequency Division Multiplexing (DC-OFDM) in a vehicular environment to demonstrate its broader impact to a wide range of networks. Finally,
- CHAPTER 10 summarizes the research contributions in this dissertation (Chapters 3 to 9), along with recommendations for future work.

CHAPTER 2. LITERATURE REVIEW

2.1 Introduction

The aim of wireless communication systems is to reliably transport data from one node to another under certain conditions. In unreliable communication channels, transmission errors are very likely because of the channel impairments, e.g. noise. Errors can occur in different forms such as isolated single bit error caused by thermal noise or burst errors because of deep fades on wireless channels. To make a transmission over these channels reliable, error detection and correction techniques are implemented. These error detection and correction techniques can be done in a systematic and non-systematic manner. In a systematic manner, the original message is not encoded. The parity bits, which are derived from the data bits, are attached to the original data and transmitted. In non-systematic scheme the original message is encoded and transmitted. For wireline channels, where the errors are less likely, error detection techniques could be sufficient. But for wireless channels, where the error rate is very high, error correction techniques are required.

This dissertation is focused on error correction techniques at packet level. That is, Diversity Coding [13] and Network Coding [16] are emphasized and investigated in this document. A summary of error detection and error correction techniques is presented below:

2.2 Error Detection Techniques

Error detection techniques [11] work by adding redundant bits to the data and detecting the error caused during the transmission from the transmitter to the receiver. There are three different schemes for error detection: Parity, Checksum, and Cyclic Redundancy Check (CRC).

2.2.1 Parity

In this technique, a single bit called the parity bit is added to the original data. The parity bit value is chosen in such a way to make the number of 1 bit in the codeword to be even or odd. This technique has the capacity to detect single bit error because its minimum Hamming distance is 2. When the errors are in burst, this scheme is unreliable. The reliability can be improved by using interleaving techniques in the presence of burst errors.

2.2.2 Checksum

A group of parity bits or check bits are called checksum. They are represented as the compliment of modulo arithmetic sum of the codeword. Checksum is placed at the end of the message and transmitted. In the receiver, the errors are detected by summing the received codeword. If the output is 0, there is no error. Otherwise, error is detected. This is very simple and efficient method of error detection but the problem with this method is that it does not detect errors when the message is swapped or when the 0 data is added or deleted in the message.

2.2.3 Cyclic Redundancy Check

Cyclic Redundancy Check (CRC) is also known as polynomial code because m bit frames are represented as coefficients of polynomial ranging from X^{m-1} to X^0 . The sender and receiver know the generator polynomial $g(x)$ that has a degree denoted by r . With r check bits, CRC can detect burst errors of length less than or equal to r bits. Even though, CRC requires more calculations, it is easy to implement in hardware and is widely used.

2.3 Error Correction Techniques

These techniques allow reconstructing the original (source) information at the destination/receiver when errors had been introduced during transmission over unreliable channels. Error correction can be performed either in a feedforward manner, by adding extra bits to the original information, or in a feedback manner, by retransmitting the packets that are in error. Feedforward techniques are preferred for real-time applications because extra information is already transmitted and, ideally, no retransmission of the information is required. However,

since the communications channel is not deterministic, there will be times that the extra information will not be needed because no errors occur. In these cases, feedback techniques such as retransmissions are preferred.

Feedforward error correction techniques can be implemented at packet, byte or bit levels, while feedback error correction techniques, Automatic Repeat request (ARQ), are typically implemented at packet (frame) level.

2.3.1 Forward Error Correction (at the bit level)

Error correction codes or Forward error correction codes [10–12], [46], [47] use parity bits (redundancy bits) for each block of the message so that the receiver can recover the original data. Since this is a feedforward technique, it does not request retransmission and is well-suited for one-way communication systems like broadcasting and real-time applications where retransmissions are not suitable. There are two main error correction codes groups: linear block codes and convolution codes.

2.3.1.1 Linear Block Codes

In the linear block codes, the check/parity bits are formed as a linear function (XOR) of data bits. The most widely used linear block code is Reed Solomon (RS) codes [12]. They are widely used to correct burst errors. So they work on blocks rather than bits. The RS coder reads D input message samples and writes n coded output samples where $n = 2^m - 1$ and m is the number of bits per symbol. The parity symbols are $C = n - D$ and the coding rate R is $\frac{D}{D+C}$.

The number of errors that the coder can correct is given by:

$$t = \left\lfloor \frac{n - D + 1}{2} \right\rfloor = \left\lfloor \frac{C + 1}{2} \right\rfloor \quad (2-1)$$

The C parity symbols are calculated in the Galois Field 2^m . Given a message sequence $k(x)$ in the form of polynomial whose coefficients are taken from the finite field with 2^m elements, then the codeword is constructed as $n(x) = k(x)g(x)$, where $g(x)$ is the generator polynomial of the code. The received codeword is compared with the transmitted codeword. The

received codeword has an error polynomial $e(x)$ along with the transmitted code word, i.e. $r(x) = e(x) + n(x)$. So, to identify the error value y_k and location of error x_k , syndromes S_j are used. Syndromes can be represented as sum of product of y_k and x_k for $j = \{1, 2, \dots, n - k\}$. If the syndrome is not equal to zero then there is error. Thus, the roots of error location polynomial indicate the position of error and the error is corrected.

2.3.1.2 Convolutional Codes

This code is good for handling isolated errors. They work on bit by bit basis. The output bit is based on the current and previous input bits. The constraint length tells the number of previous bits the output should depend upon. The encoder has shift registers to encode the m information bits to n coded bits at code rate of $\frac{m}{n}$ based on constraint length k .

The output is generated as XOR sum of inputs and internal states. The decoding is done using Viterbi algorithm which considers the input sequence with fewer errors as most likely to be the original message.

2.3.2 Hybrid Techniques

Hybrid ARQ [48], [49] is error correction mechanism that combines both ARQ and Forward error correction coding (FEC). They are mainly used in high-speed downlink and uplink packet access (HSDPA/HSUPA). FEC is used for correcting certain amount of errors using redundancy bits, while ARQ is used for correcting errors that cannot be corrected by FEC using retransmissions. Hybrid ARQ combines these two methods and outperforms ordinary ARQ method in poor signal conditions. In the standard ARQ scheme, the redundancy bits (parity bits) in the form of error detection codes are added to the message bits and then transmitted.

While in hybrid ARQ, the message bits are encoded using FEC and parity bits are either added to the encoded bits before transmission or sent separately when error is detected in the receiver. The hybrid ARQ can be explained in two ways. One is simple hybrid ARQ and the other is hybrid ARQ with soft combining.

2.3.2.1 Simple Hybrid ARQ:

They are of two types: Type I and Type II hybrid ARQ.

- *Type I HARQ*: The FEC redundant bits and error detection in the form of parity bits are added to the message bits before transmitting the data. The FEC encoded bits are first decoded at the receiver and the transmission errors are corrected at good channel conditions. When channel quality is poor, and when the errors cannot be corrected, it discards the packet and the receiver requests for new retransmission of erroneous data until the correct data is received. Type I is not efficient when the channel quality is good since there is channel capacity loss in transmission of FEC along with message bits. This is because FEC has more redundant bits than the message bit length.
- *Type II HARQ*: In this method, the message bits are first transmitted with error detecting parity bits. In the receiver if there is no error in transmission then the FEC bits are not sent. If there is error in transmission then the FEC bits are sent along with error detection. If there is transmission error, error correction is done by combining the two received information bits. Type II HARQ does not suffer from capacity loss under good signal conditions since FEC is not transmitted with message bits. This method also has good sensitivity under poor signal conditions.

2.3.2.2 Hybrid ARQ with Soft Combining

The incorrectly received data blocks in the receiver are not discarded. They are combined with retransmitted data block to get enough information for correct decoding. This is called Hybrid ARQ with soft combining [50]. The two main soft combining methods are Chase combining and Incremental redundancy.

- *Chase combining*: The coded data that is sent during the first transmission is sent repeatedly during the retransmissions. So, the retransmitted data contains the same data bits and parity bits as the original transmitted data. The receiver decodes the

information by combining the received bits with retransmitted bits using Maximum ratio combining.

- *Incremental redundancy*: This method does not have the same retransmission information as original transmitted message. For the same set of information bits, multiple set of coded bits are generated. Thus every retransmission uses coded bit set (relevant to the information bits) that are different from previous transmission by puncturing. The receiver decodes on each retransmission by gaining some extra information.

2.3.3 Forward Error Correction Techniques at the Packet Level

Diversity Coding and Network Coding are two feed-forward error correction techniques at packet level and are the main techniques investigated throughout this dissertation to improve the reliability of wireless sensor networks with emphasis on wireless body area networks. The following two sections describe in detail the advantages of these techniques and how they work.

2.4 Diversity Coding

Diversity Coding (DC) [13–15] is a feed-forward spatial diversity technology that enables near instant self-healing and fault-tolerance in the presence of wireless link failures. The protection paths (c_i) carry information that is the combination of the uncoded data lines (d_i). Figure 2.1 shows a Diversity Coding system that uses a spatial parity check code for a point-to-point system with N data lines and 1 protection line. If any of the data lines fail (e.g. d_3), through the protection line (c_i), the destination (receiver) can recover the information of the data line that was lost (d_3) by taking the mod 2 sum of all of the received signals. This model can be generalized to a M -for- N Diversity Coding system as shown in [13].

A network is transparently self-healed when any combination of N links survive among M diverse links. This technique is very efficient without the necessity of having the packets reroute in other directions.

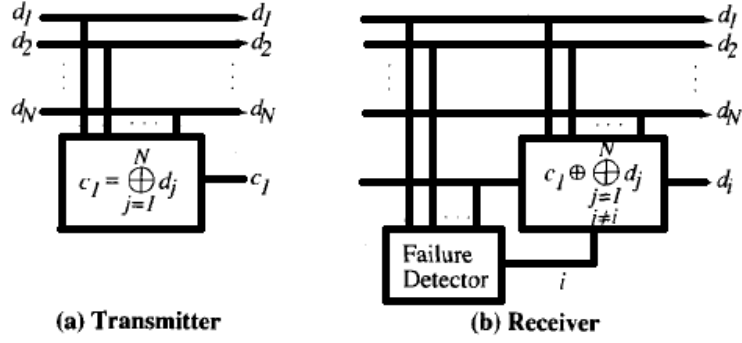

Figure 2.1 1 for N Diversity Coding system [13]

Assuming there are N links in the network, d_j to be the information carrying bits in the binary form and there is an extra line present to protect the network from fading or other failures.

$$c_1 = d_1 \oplus d_2 \oplus \dots \oplus d_N \quad (2-2)$$

$$c_1 = \bigoplus_{j=1}^N d_j \quad (2-3)$$

where \oplus represents the XOR function and the extra line $N + 1$ carries the checksum c_1 . If any one of the lines between 1 and N fails, then the receiver detects the line/channel with failure and obtains \hat{d}_i :

$$\hat{d}_i = c_1 \oplus \bigoplus_{\substack{j=1 \\ j \neq i}}^N d_j \quad (2-4)$$

According to Eq. (2-4), the estimated unknown variable \hat{d}_i can be calculated from the logical XOR function performed on all the d_j variables from 1 to N , except d_i . After expanding c_1 (2-3), it is easy to obtain the information of the failed i^{th} line as $d_j \oplus d_j = 0$ and $\hat{d}_i = d_i$.

$$\hat{d}_i = \bigoplus_{j=1}^N d_j \oplus \bigoplus_{\substack{j=1 \\ j \neq i}}^N d_j \quad (2-5)$$

Expanding Eq. (2-5), we have:

$$\hat{d}_i = (d_1 \oplus \dots \oplus d_i \oplus \dots \oplus d_N) \oplus (d_1 \oplus \dots \oplus d_{i-1} \oplus d_{i+1} \oplus \dots \oplus d_N) \quad (2-6)$$

Given that $d_j \oplus d_j = 0$, Eq. (2-6) becomes:

$$\hat{d}_i = d_i \quad (2-7)$$

By using just one extra line, the lost information in the failed link can be recovered instantaneously without rerouting or providing a feedback channel to the transmitter.

Assuming that the probability of link error (p_i) is the same for all the links ($p = p_i, \forall i$), the probability of successfully receive the correct information through at least any x links, out of the N data lines plus 1 protection line ($N + 1$), is calculated as:

$$P_S = Prob(x) \quad (2-8)$$

$$P_S = \sum_{t=1}^{N-1} \left(\left(\frac{\prod_{i=1}^t i}{(N+1)^t} \right) \binom{N+1}{t} (1-p)^t (p)^{N+1-t} \right) + \sum_{t=N}^{N+1} \left(\binom{N+1}{t} (1-p)^t (p)^{N+1-t} \right) \quad (2-9)$$

Rewriting Eq. (2-9), we have that the probability of successful reception at the destination is calculated as:

$$P_S = \sum_{t=1}^{N-1} \left(\left(\frac{\prod_{i=N+2-t}^N i}{(N+1)^{t-1}} \right) (1-p)^t (p)^{N+1-t} \right) + \sum_{t=N}^{N+1} \left(\binom{N+1}{t} (1-p)^t (p)^{N+1-t} \right) \quad (2-10)$$

However, since the region of interest is when the information has been correctly received through at least N links, Eq. (2-10) is reduced to:

$$P_S = \sum_{t=N}^{N+1} \left(\binom{N+1}{t} (1-p)^t (p)^{N+1-t} \right) \quad (2-11)$$

Because the first term of P_S is the probability of correctly received the information of at least one link and at most $N - 1$ links is zero. That is,

$$\sum_{t=1}^{N-1} \left(\left(\frac{\prod_{i=N+2-t}^N i}{(N+1)^{t-1}} \right) (1-p)^t (p)^{N+1-t} \right) = 0 \quad (2-12)$$

As shown in Figure 2.1 and Eq. (2-3), each link can carry as few as one bit to implement a 1 *for N* Diversity Coding system because with one bit we can calculate Galois Field of up to two elements $\{0, 1\}$, $GF(2^1)$. In other words, the number of bits per link limits the number of protection links. That is, the larger the number of bits to be transmitted by each link, the larger the number of protection links that can be implemented. This is because the number of protection links is limited to the Galois Field $[GF(2^q)]$ size q to calculate the information that is transmitted through the protection links.

This concept can be extended to multiple line failures and also to recover lost packets in packet-based networks. The delay in a network changes whenever there is a link failure and when recovery is needed, otherwise, the delay in a normal operating network is constant. The delay occurs because the system contains different links, each having different lengths, with each link causing delay based on the distance between source node and destination node.

For a $M - \text{for} - N$ Diversity Coding system, the coded information is calculated as [13]

$$c_i = \sum_{j=1}^N \beta_{ij} d_j \quad i \in \{1, 2, \dots, M\} \quad (2-13)$$

where c_i and d_j are protection (diversity coded) and data (uncoded) packets, respectively. The β coefficients are given by:

$$\beta_{ij} = \alpha^{(i-1)(j-1)} \quad (2-14)$$

where α is a primitive element of a Galois Field $GF(2^q)$, $i = \{1, 2, \dots, M\}$ and $j = \{1, 2, \dots, N\}$.

The total number of transmitted packets is equal to the number of data packets plus the number of protection packets ($N + M$), where the number of protection packets is typically less than the number of data packets ($M \leq N$). We define the DC code rate as the number of data lines (subcarriers) to the number of data plus protection lines (subcarriers) ratio:

$$DC \text{ code rate} = \frac{N}{N + M} \quad (2-15)$$

We can calculate the number of protection lines as a function of the data lines and DC code rates as:

$$M = \frac{(1 - DC \text{ code rate})N}{DC \text{ code rate}} \quad (2-16)$$

At the receiver, the coefficients of the data and protection lines form the following matrix, which depends on the information that was correctly received at the destination:

$$\beta' = \begin{bmatrix} 1 & 0 & 0 & \dots & 0 \\ 0 & 1 & 0 & \dots & 0 \\ 0 & 0 & 1 & \dots & 0 \\ \vdots & \vdots & \vdots & \ddots & \vdots \\ 0 & 0 & 0 & \dots & 1 \\ 1 & 1 & 1 & \dots & 1 \\ 1 & \alpha & \alpha^2 & \dots & \alpha^N \\ 1 & \alpha^2 & \alpha^4 & \dots & \alpha^{2N} \\ \vdots & \vdots & \vdots & \ddots & \vdots \\ 1 & \alpha^{(M-1)} & \alpha^{(M-1)2} & \dots & \alpha^{(M-1)N} \end{bmatrix} \quad (2-17)$$

The receiver, by using the β' matrix coefficients, a $(N + M)$ -by- N matrix, can find the transmitted data by recovering the lost information in the data lines through the protection lines. That is, the receiver uses only N rows out of the $N + M$ rows from the β'_N matrix coefficients to recover the information of the data lines:

$$\beta'_N \mathbf{x} = \mathbf{b}_N \quad (2-18)$$

The receiver preferably uses as many indexes of the data lines as possible to faster decode the information that is lost during transmission. If no data line is lost during transmission, no decoding process is needed at the receiver and the information transmitted through the protection lines is discarded. \mathbf{x} is the vector formed by the data lines:

$$\mathbf{x} = \begin{bmatrix} d_1 \\ d_2 \\ \vdots \\ d_N \end{bmatrix} \quad (2-19)$$

and \mathbf{b}_N is the vector formed by the correctly received information at the destination with the same indexes as the β'_N matrix.

The receiver can recover the lost information transmitted through the data lines by performing Gaussian elimination to the β coefficients (protection lines). This is a fast process because some of the row elements of the coefficients matrix are already in the row canonical form.

Assuming that the probability of link error (p_i) is the same for all the links ($p = p_i, \forall i$) the probability of successfully receiving the correct information through at least any N links, out of the N data lines plus M protection lines, is calculated as:

$$P_S = Prob(x \geq N) \quad (2-20)$$

$$P_S = \sum_{t=N}^{N+M} \binom{N+M}{t} (1-p)^t (p)^{N+M-t} \quad (2-21)$$

However, since the assumption that all the links have the same probability of link error may be unrealistic because each link can experience different channel effects. A general formula to calculate the probability of successfully receiving the correct information through at least any N links, out of the N data lines plus M protection lines is:

$$P_S = Prob(x \geq N) \quad (2-22)$$

$$P_S = \sum_{t=N}^{N+M} \left[\sum_{\vec{a} \in A} \left(\prod_{i \in a_1} p_i \prod_{j \in a_0} (1-p_j) \right) \right] \quad (2-23)$$

where:

- A is a set of $N + M$ binary sequences of all the 2^{N+M} possible combinations. A binary sequence can contain either 0 or 1, where “1” means that the transmission was successful and “0” otherwise. The number of 1-s in A is t and the number of 0-s is $(N + M - t)$; so there are $\binom{N+M}{t}$ such sequences. Thus,

$$\|A\| = \binom{N+M}{t} \quad (2-24)$$

- \vec{a} is a particular sequence from the set A , a_0 is a set of all indices j of \vec{a} such that $a(j) = 0$, and a_1 is a set of all indices i of \vec{a} such that $a(i) = 1$. Thus,

$$\|a_0\| + \|a_1\| = N + M \quad (2-25)$$

- p_i is the probability that the information transmitted through subcarrier i is correctly received at the destination.

The expected number of correctly received information packets (\mathbb{E}) can be calculated as in Network Coding as:

$$\mathbb{E} = N * P_s \quad (2-26)$$

Diversity Coding can be applied to different network topologies, where the topology is known. For example, Figs. 2.2 – 2.4 below show different network topologies for DC, where \mathbf{c} denotes the vector of diversity coded bits:

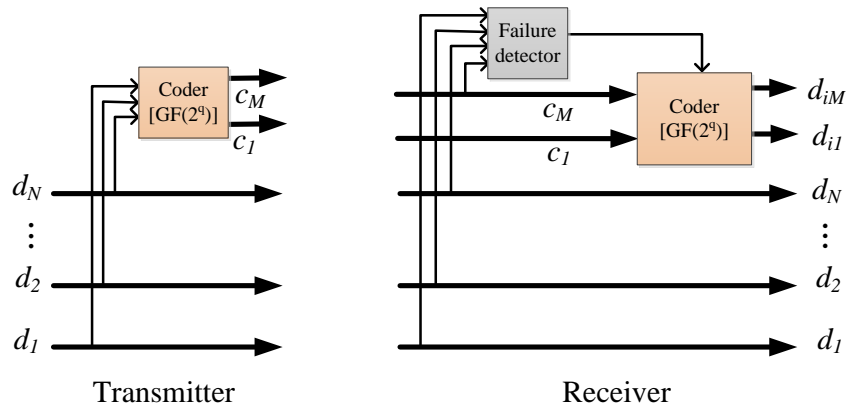

Figure 2.2 Point-to-point system with M for N Diversity Coding [13]

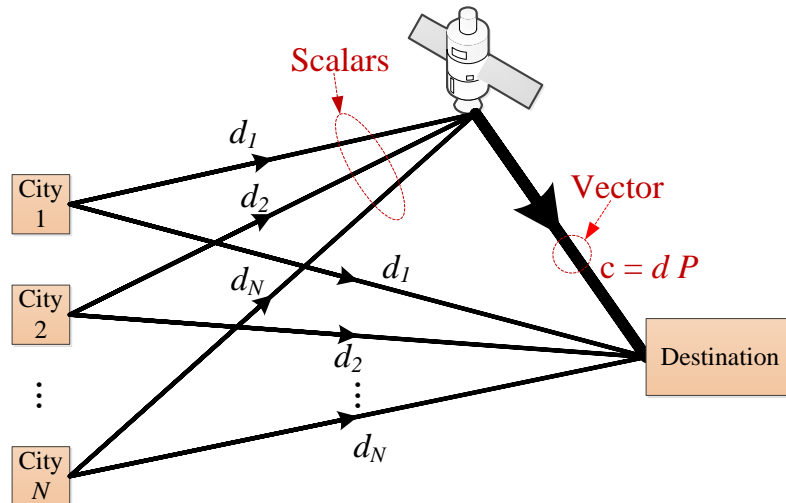

Figure 2.3 Multipoint-to-point Diversity Coding [13]

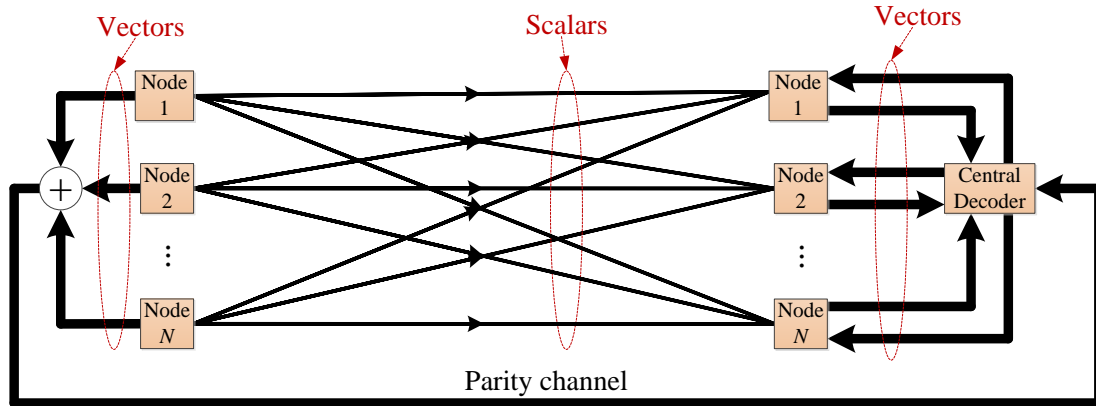

Figure 2.4 Multipoint-to-multipoint Diversity Coding [13]

In Multipoint-to-Multipoint Diversity Coding, the protection paths from each source form a vector that carries the protection information of all the sources. At the destinations, a central decoder receives input (data lines) from the destination nodes. Based on the input from the receivers and with the aid of the parity (protection) vector, the data that was lost during the transmission can be recovered.

There has been considerable research on Network Coding (NC) [16], which is related to Diversity Coding, to improve the performance of different type of networks. These approaches are applied at packet, symbol or signal levels.

2.5 Network Coding

Network Coding [16], an extensively studied technique, achieves throughput gain by using spatial path diversity and by combining independent (or partially independent) pieces of information in intermediate network nodes. In one implementation of Network Coding, the network nodes select random coefficients. The random coefficients are then transmitted in the packet header. Reference [51] shows that Network Coding can also be used to improve network reliability, and, in particular, for recovering from failures [13]. Additionally, Network Coding helps to decrease the complexity of routing, because it is sent the same linear combination of sources' information through all the links. Therefore, there is not needed complex formulation for routing the packets. Another advantage of Network Coding is that it increases security, since the

information transmitted through the links is a random linear combination of packets that are received via different input links and it is less likely that a single node will receive sufficient information to decode all the source information.

It has been shown that Network Coding also improves throughput in “noisy,” or lossy, networks [19], [22], [43], [52], [53]. However, in all of these network architectures, coded (parity) packets have to be transmitted to overcome wireless channel impairments. This increases network reliability at the expense of increasing the transmitted number of packets.

The most relevant advantages of Network Coding are:

- It increases network capacity for multicast networks where many nodes simultaneously receive the same information from a single transmission. Thus, each node receives the information at a maximum rate possible. In other words, Network Coding helps in sharing the available network bandwidth efficiently,
- It offers higher throughput for both multicast and unicast networks,
- By linearly combining the packets, Network Coding increases the robustness of the network and minimizes the delay,
- It reduces the number of transmissions in a wireless network, and
- It helps to reduce the congestion in wired networks.

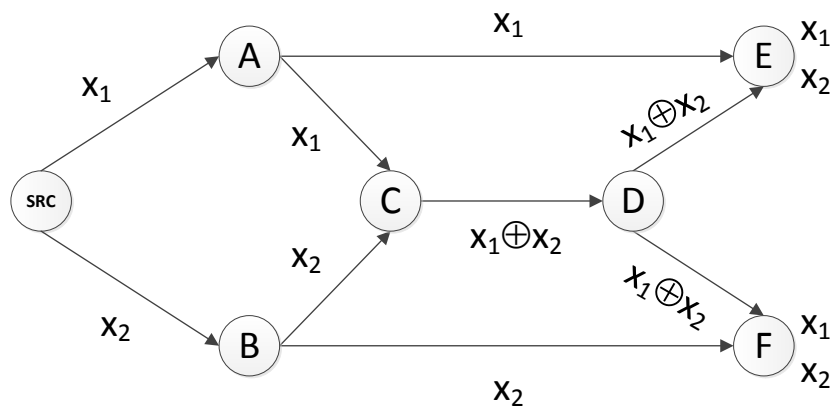

Figure 2.5 Butterfly topology (Network Coding)

A typical example of the usefulness of Network Coding is shown in Figure 2.5, where the links are considered error-free. The source *SRC* transmits the messages, x_1 and x_2 . The node *C* receives those two messages, creates a message that is a linear combination of x_1 and x_2 and transmits this single message to the node *E*. At the destination nodes, *D* receives the message x_1 from *A* and *F* receives the message x_2 from *B*. Additionally, the two destinations receive the linear combination of the two messages, $x_1 \oplus x_2$ through *E*. Therefore, each destination can retrieve the original two messages, x_1 and x_2 . As opposed to networks without coding, the middle link could only transmit one of the two messages, x_1 and x_2 , resulting a bottleneck of the network the link between nodes *C* and *D* as is in Figure 2.6.

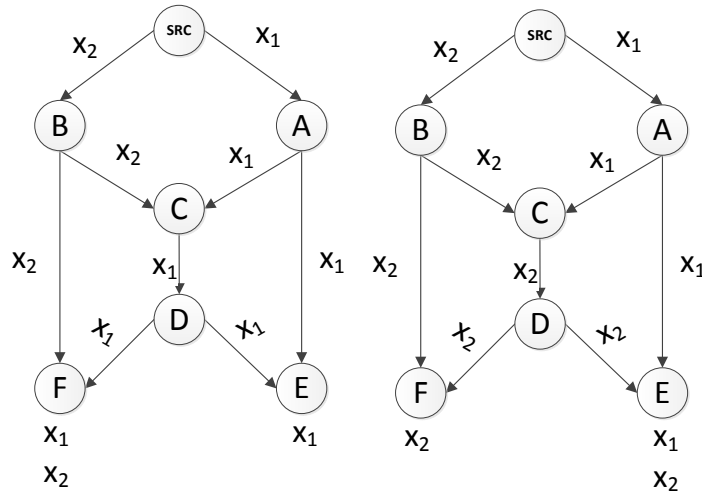

Figure 2.6 Traditional network approach (No Network Coding)

2.5.1 Network Coding Approaches

Network Coding can be done in different ways. Each Network Coding approach has its own advantages and disadvantages. The usage of any Network Coding approach is therefore mainly dependent on the applications and types of networks. The first approach is linear Network Coding [23], [54], where one or many outgoing packets are generated by linear combination of original or coded incoming packets. These linear combination operations such as addition and multiplication are done over finite fields. Consider that the incoming packets are x_1, x_2, \dots, x_n . Their associated Galois Field coefficients (coding coefficients) are given as $g_{i1}, g_{i2}, \dots, g_{in}, \forall i$.

The encoded data (packet), which is a linear combination of incoming packets and coding coefficients, is given as:

$$y_i = \sum_{j=1}^n g_{ij}x_j \quad i \in \{1, 2, \dots, m\} \quad (2-27)$$

The encoded packets are transferred along with y_i and g_{ij} , where y_i is the information vector and g_i is the encoding vector. At the destination node, the number of received packets should be greater than or equal to the number of original transmitted packets for the destination node to be able to decode the original information. The decoding is done by storing the information received in a matrix format and then performing Gaussian elimination to recover the original information x_j . The major drawback of linear Network Coding is that there is packet delay because the decoding process is done in blocks of packets (number of original packets). Moreover, this method requires central controller to manage the generation of the coding coefficients. This method is not well suited for wireless networks where the nodes are constantly moving.

Another method is partial Network Coding with opportunistic routing [55], where the source node separates the information into n blocks and each block has k packets. In this method, the source codes (combines) the packets from the same block using random coefficients and forwards the coded packet along with a *forwarding list* in the packet header. The *forwarding list* contains the list of all nodes that need to forward the packets. This list is generated based on the calculated cost metric between the source and destination. The destination node, upon receiving the coded packets, retrieves the information by decoding the encoded packet and sends the ACK to the sender. The sender transmits the next block after receiving the ACK. The main drawback of this method is that it requires coordination among the nodes.

Another Network Coding approach is opportunistic Network Coding [55]. In this method, based on the status of queue at a node, the decision to code the packet or not is taken. If the queue

is high, the packet is transmitted without coding. If queue is low, the packet is coded and transmitted. This method was proposed to solve the issue with the delay involved in coding and decoding the packets in Network Coding schemes.

The most widely use Network Coding approach is random linear Network Coding (RLNC) [56], a decentralized approach, where the nodes use random coding coefficients to create the coded packets. The centralized approaches of Network Coding are not feasible to implement on wireless networks where the nodes are mobile. Because of the dynamic nature of the nodes' paths and unknown network topology, a distributed approach is appropriate. Upon receiving the encoded packets, each node uses its own randomly chosen coding coefficients to generate a new coded packet. A (randomly) coded packet contains information of all the source packets and is calculated as the sum of the products of each of the N original packets with a random coefficient c_{il} :

$$y_i = \sum_{j=1}^N c_{ij}x_j \quad i = 1,2, \dots, M \quad (2-28)$$

where y_i and x_j are the coded and original packets, respectively, M is the number of coded packets and at least equal to the number of original packets ($M \geq N$). The coefficients c_{il} are randomly chosen from a Galois Field $GF(2^q)$, where the $GF(2^q)$ elements are $\{0, 1, 2, \dots, 2^q - 1\}$, and all the operations in (2-28) are performed over a Galois Field $GF(2^q)$.



Figure 2.7 Network Coding packet format

The random coefficients $\{c_{il}\}$ comprise the encoding vector and are embedded into the coded packet's header, as shown in Figure 2.7. The coded packet will also include a cyclic

redundancy check (CRC, error detecting) field, so that packets in error can be identified. The generator ID field (Gen ID) is used to identify combination packets from different sources.

As long as the destination receives at least m original packets, it is able to recover the original information; otherwise, the received packets are discarded. The decoding could be performed through block decoding or earliest decoding, the latter being preferred because of its smaller decoding delay [17].

In a point-to-point architecture with a probability p of link error, the probability of successful reception, P_s , can be calculated as:

$$P_s = P(i \geq N) \quad (2-29)$$

$$P_s = \sum_{i=N}^{N+M} \binom{N+M}{i} (1-p)^i p^{N+M-i} \quad (2-30)$$

The expected number of correctly received information packets (\mathbb{E}) can be calculated as the product of the number of original packets and the probability of successful reception,

$$\mathbb{E} = N \cdot P_s \quad (2-31)$$

For wireless networks, the typical network topology is shown in Figure 2.8 [21], where, by using Network Coding, nodes A and B only need 3 time slots to interchange 2 packets (α and β), as shown in Figure 2.8 (b), where $\chi = \alpha \oplus \beta$. Classic networks need 4 time slots to interchange 2 packets (α and β), as shown in Figure 2.8 (a).

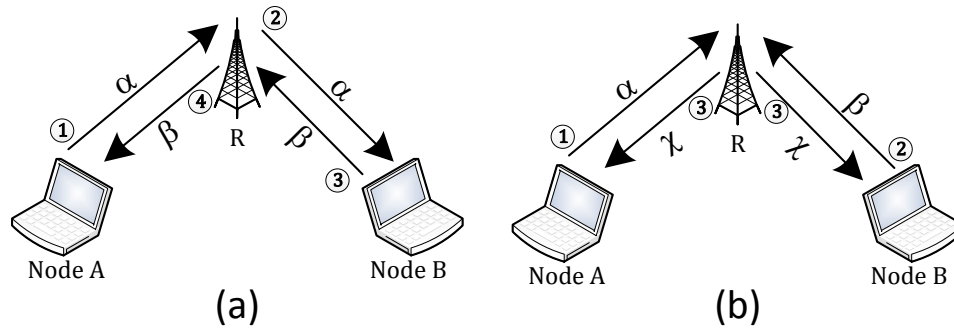

Figure 2.8 Wireless Network Coding (WNC) topology

In this method, also known as Wireless Network Coding (WNC), the Network Coding operations are performed at the MAC layer to improve the quality of the communication. With this Network Coding method, node A transmits α to intermediate node R (relay) during time slot T_1 . Then, node B transmits β to node R during time T_2 . After that, node R creates χ by combining the packets received from nodes A and B , α and β , respectively. Then, node R transmits χ to nodes A and B during time T_3 . By receiving χ , node A can decode β and node B can decode α .

A technique to improve the performance of WNC is to use diversity. This approach takes advantage of the broadcasting nature of the wireless medium. Because of this property of the wireless medium, the packet sent by node A to node R is also received by node B . But, the signal is weak because of the longer distance from node A . This weak signal is called the overreach signal. Node B stores this overreach signal α in its memory during time slot T_1 . When node B transmits β to node R , node A can also receive a overreach signal and stores it (β) in its memory during time slot T_2 . During the time slot T_3 , nodes A and B receive χ . Node B decodes α by combining the received packet ($\chi=\alpha\oplus\beta$) with its own packet (β), which is stored in its memory, and obtains $\hat{\alpha}$,

$$\hat{\alpha} = \chi \oplus \beta = (\alpha \oplus \beta) \oplus \beta \quad (2-32)$$

The extracted $\hat{\alpha}$ is diversity combined with the stored overreach signal α and the receiver (node B) can make a better decision about the received signal α . Because of the diversity combining, the communication quality is improved.

2.5.2 Applications of Network Coding

Network Coding can be used to improve the communications performance in different applications. The most widely used applications are:

2.5.2.1 Wireless Broadcast Networks

Wireless systems generally broadcast information in multiple frequency channels and follow the multihop pattern that tends to overcrowd the available frequency bandwidth. This

results in interference due to increase in the number of wireless devices used today. A system with multiple hops reduces the resultant throughput of the system that is not desired. Wireless Network Coding (WNC) helps a multihop system use fewer transmissions, in contrast to a multihop system that does not use WNC.

The WNC scheme is typically a MAC layer oriented scheme where a relay node combines (network code) packets from both the nodes A and B. As shown in Figure 2.8(b), both A and B transmit their packet to the relay R which stores the packets and performs an XOR operation on the packets and sends the resultant output to A and B. Since A and B know the packet they transmitted, they decode the XORed output and obtain the necessary information. Instead of sending the packets through four transmissions (time slots) to reach both A and B (Figure 2.8(a)), using wireless Network Coding reduces it to three transmissions. This improves the throughput of the system and the bandwidth. Also, the WNC scheme is found to have high efficiency and very low packet transmission loss compared to traditional schemes.

2.5.2.2 Peer to Peer File Sharing System

The avalanche project from Microsoft [57–59] is one application that uses Network Coding for peer to peer file distribution. When the file is large, the server splits the large file into smaller blocks and sends them to the nodes. The peer nodes download the blocks of file from the server and exchange the blocks among each other. In avalanche, the blocks are coded using RLNC and then sent to the nodes. The peer nodes decode these blocks and also exchange these RLNC blocks among themselves. By this method, the download time is reduced because the block transmission between nodes is minimized.

2.5.2.3 Network Security Applications

With the use of Network Coding, the original packets are coded using random coefficients and transmitted, preferable through multiple paths/routes. As a result, there is protection against eavesdropper since the packets obtained by the eavesdropper do not provide any information about the original packets transmitted [20].

2.6 Concluding Remarks

Error detection and error correction techniques enable reliable communication over unreliable channels by adding extra bits. Error detection techniques allow detecting errors in the original information at the receiver while error correction techniques allow correcting errors in the original information at the receiver. Error correction can be applied at bit (codeword) or packet level and can be feedforward such as Reed-Solomon codes and Diversity Coding or feedback such as retransmissions (ARQ). With feedforward error correction techniques, extra information is transmitted along with the original information. The extra information is useful when the channel introduces errors into the original information. However, if the channel performs in good conditions and no errors are introduced into the original information, the extra information is wasted.

Diversity Coding and Network Coding are the error correction techniques used in the work presented in this dissertation to improve the network performance of wireless sensor and wireless body area networks. The advantage of Diversity Coding and Network Coding over the forward error correction at bit level is that enable near-instant self-healing and fault-tolerance in the presence of link and node failures using spatial diversity to transmit information through different paths (links). A mathematical analysis for Diversity Coding and Network Coding is presented to shown the coding process and performance analysis. Forward error correction techniques at bit level have the capability of correcting a finite number of errors and when the link completely fails, it is not possible to recover the original information.

In multicast transmissions, Network Coding and Diversity Coding perform better than in unicast transmissions, as is shown in the Butterfly diagram, Figure 2.5. Network Coding and Diversity Coding also achieve capacity gain in many-to-many transmissions. The many-to-many topology is similar to the Butterfly diagram, but the difference is instead of one source transmitting many packets there are many sources transmitting only one packet.

CHAPTER 3. COOPERATIVE NETWORK CODING FOR WIRELESS SENSOR NETWORKS

3.1 Introduction

In multi-hop wireless packet networks, such as sensor networks, a path (a sequence of nodes between the source and the destination) is chosen and then packets are forwarded, or routed, along the path, as is shown in Figure 3.1. Because of the multiple hops that a packet generally takes to reach its destination, the probability of successful reception at the destination in a multihop network is generally lower than the probability of successful reception in a single hop, as shown in Figure 3.2.

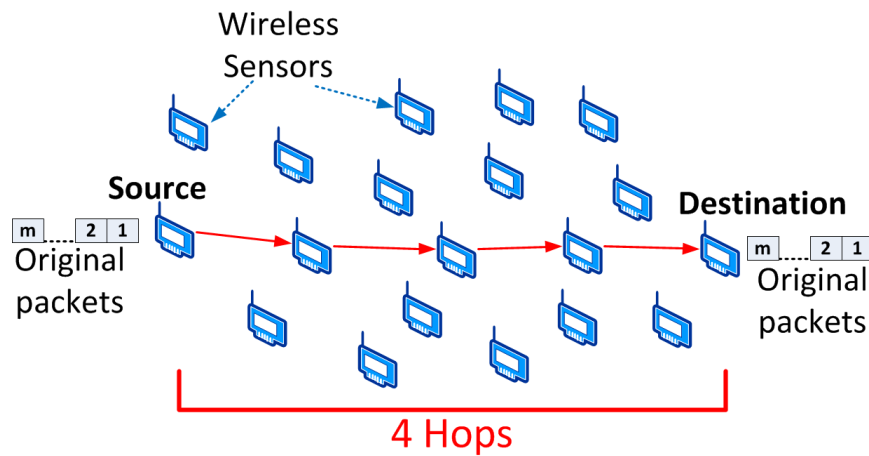

Figure 3.1 The multihop network model

To overcome the link-level packet loss and to avoid significant end-to-end throughput degradation, networks often use link-level retransmissions. Moreover, if any packet is “lost” during the transmission, that specific packet is retransmitted from the source node. However, there is no guarantee that the retransmitted packet can be correctly received by the destination node.

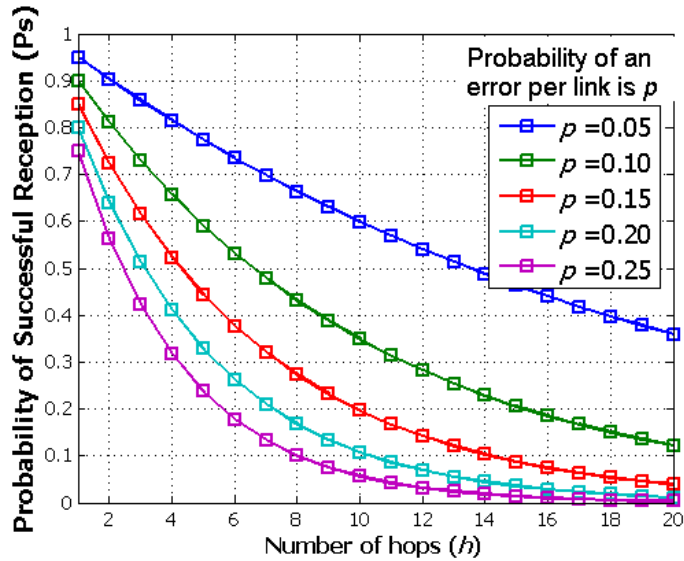

Figure 3.2 Probability of successful reception of a packet vs. the number of hops

To improve the probability of successful reception and the expected number of correctly received and decoded information packets at the destination in multihop networks, the authors in [22] presented a novel technology known as Cooperative Network Coding that synergistically integrates Network Coding with Cooperative Communications to produce enhanced network reliability and security features, and which improves throughput, primarily by reducing the probability of packet loss, for a large class of networks, including wireless sensor networks, satellite networks, and selected military networks. The analysis of the performance of Cooperative Network Coding was evaluated without either link-level feedback or retransmissions.

Cooperative Communications [60] is a well-known technique that improves the reliability of wireless links where the receiver obtains signals from multiple relays and by properly combining this data, the receiver can make more reliable decisions about the transmitted information. In effect, cooperative communication allows single-receiver devices to obtain some of the advantages of Multiple-Input-Multiple-Output (MIMO) systems [61]. As shown in [61] and [62], MIMO systems can transmit higher bit rates than Single-Input-Single-Output (SISO) systems with the same transmission power and under the same bit-error rate channel conditions.

In conventional multihop networks, a path selection mechanism is needed to transmit the packets from the source node to the destination node, and if any packet is errored or lost during transmission (does not reach the destination), that specific packet has to be retransmitted from the source. Figure 3.1 shows the multihop network model for a 4-hop communication network, where each of the nodes receives a packet from the previous node and forwards it to the next node towards the destination.

Due to the lack of cooperation and/or path diversity, classic multihop networks are more susceptible to packet loss than point-to-point networks. That is, as the number of hops increases, the probability that a packet transmitted by the source is correctly received at the destination, P_s , exponentially decreases and is given by the probability that a packet is correctly received at each hop $(1 - p_i)$ to the number of hops h , where p_i is the probability of link error of link i .

$$P_s = \prod_{i=1}^h (1 - p_i) \quad (3-1)$$

Thus, the probability of successfully receiving a packet in a multihop network is lower than the probability of successfully receiving a packet of a single hop network. The information redundancy in Cooperative Network Coding improves reliability, when some coded packets are in error, since it is very likely that other network paths have provided the sufficient number of combinations for the destination node to recover the original packets.

3.2 Cooperative Network Coding

Cooperative Network Coding [22] synergistically combines Cooperative Communications with packet coding via Network Coding, where the latter is typically implemented based on linear operations over a Galois Field to improve network performance by providing high throughput and overcoming packet losses. Cooperative Communications (CC) [60] is a technique that allows single-antenna devices to share their antennas and thus enjoy some of the benefits of multiple-antenna systems. Cooperative Communications exploits the broadcast nature of wireless communications, i.e. single transmissions can be received by a number of

cooperating nodes and those cooperative nodes transmit the data to the destination. This technique improves the reliability of wireless links because the receiver processes data from multiple relays and by properly combining this data, the receiver can make more reliable decisions about the transmitted information. Network Coding (NC) [16], which is a feedforward technique at the packet level, increases the network's throughput by combining received packets, at intermediate nodes. As long as the destination receives a sufficient number of innovative (linearly independent) coded packets, the original (source) packets may be properly decoded. On the other hand, when not enough linear independent packets have been received, all the received packets are, in effect, wasted because the original information cannot be recovered.

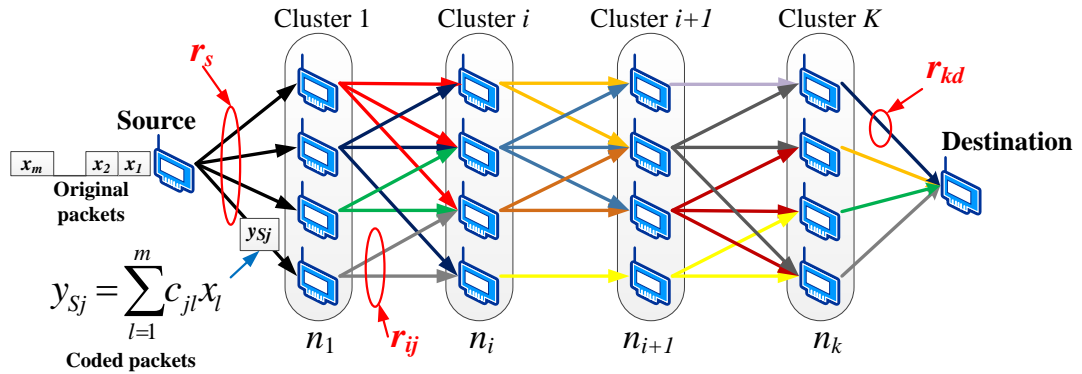

Figure 3.3 Cooperative Network Coding model

With Cooperative Network Coding, before the source transmits the information to the destination, the nodes that are in the source-destination route/path recruit other nodes that are geographically close, and can hear the transmissions of the other nodes in the cluster, on the path from the source to the destination to form clusters [22], [63]. Since the clusters can continuously change because some nodes can move away from the cluster or be disabled and other nodes can be incorporated to the cluster, Cooperative Network Coding incorporates the functions of route determination, creation and control of the clusters, and cluster-to-cluster transmission. As opposed to traditional multihop networks, in Cooperative Network Coding nodes on a path (from

a source to a destination) are replaced by clusters of nodes (Figure 3.3), which are in geographically close proximity to each other.

Nodes in a cluster receive coded packets from nodes of the prior cluster, create new coded packets (one new coded packet per each node), and transmit the coded packets to the nodes in the next cluster. Packets are created without cooperation from the other nodes in the cluster. That is, the nodes create the packets independently. Of course, the goal is to forward as many independent coded packets as possible. We refer to a coded packet as being “innovative,” if it is linearly independent of all the other coded packets already transmitted by the nodes of the same cluster. The diagram of the network architecture is shown in Figure 3.3, where there are K clusters and the i^{th} cluster contains n_i nodes. The overall objective is for the destination node to be able to correctly reproduce the original packets.

Since m is the number of original packets in a block sent by the source node, thus, m is the minimal number of (independent) combinations that the destination needs to receive to be able to recover all the m original packets. Therefore, the source node creates m' (where $m' \geq m$) network coded packets from a block of m original packets. The original packets are combined via operations in a Galois Field $GF(2^q)$, using Eq. (2–28), as follows:

$$y_{sj} = \sum_{l=1}^m c_{jl}x_l , \quad j \in \{1, 2, \dots, m'\} \quad (3-2)$$

where y_{sj} and x_l are the coded packets and original packets, respectively and the coefficients c_{jl} are randomly chosen from $GF(2^q)$ [56]. The coding operation in (3–2) is performed symbol-by-symbol (depending on the GF size) to create the bits in the coded packet. The c_{jl} coefficients are embedded in the packet’s header. In each cluster, the c_{jl} coefficients are multiplied by random coefficients and the result of the multiplication is embedded in the packet’s header that is transmitted to the nodes in the next cluster.

Depending upon the degree of connectivity between the nodes in the first cluster and the source node, each node in cluster 1 can correctly receive up to m' coded packets if there are no transmission losses or errors. However, because of the probability of link error, some of coded packets may not be received. Table 3-1 describes the system parameters for Cooperative Network Coding.

Table 3-1 System parameters [22]

Parameter	Description
n_i	Number of nodes in the cluster i
K	Number of clusters between the source and the destination
r_{ij}	Number of nodes in the cluster $i + 1$ that are connected with node (i, j)
r_s	Number of nodes in the cluster 1 that are connected with the source node
$p_{(i,j)(i+1,l)}$	Probability of link error between node (i, j) and node $(i + 1, l)$
m	Number of original packets in a block (i.e., block size)
m'	Number of coded packets transmitted by the source node

The probability V_{1j} that a node in the first cluster can hear at least a coded packet from the source node is given by [22]:

$$V_{1j} = 1 - \left[1 - \frac{r_s \times (1 - p_{s(1,j)})}{n_i} \right]^{m'} \quad (3-3)$$

The probability of link error between node (i, j) and node $(i + 1, l)$ depends on the transmission power, channel conditions, modulation scheme, and packet length, among other factors. That is, for systems without any channel coding (forward error correction at the bit level), the probability of an errored packet on a link between node (i, j) and node $(i + 1, l)$ is given by:

$$p_{(i,j)(i+1,l)} = 1 - \left(1 - p_{b(i,j)(i+1,l)} \right)^L \quad (3-4)$$

where $p_{b(i,j)(i+1,l)}$ is the average bit error probability a link between node (i, j) and node $(i + 1, l)$, and L is the packet length in bits.

When a channel coding technique is used (e.g. Reed-Solomon code), the probability of link error between node (i, j) and node $(i + 1, l)$ is given by:

$$p_{(i,j)(i+1,l)} = 1 - \prod_{r=1}^x p_{c_r} \quad (3-5)$$

$$p_{c_r} = \sum_{v=0}^t \binom{D_r + C_r}{v} (p_{b(i,j)(i+1,l)})^v (p_{b(i,j)(i+1,l)})^{D_r + C_r - v} \quad (3-6)$$

where $p_{b(i,j)(i+1,l)}$ is the average bit error probability a link between node (i, j) and node $(i + 1, l)$, t is the error correction capability of the channel coding technique (i.e., t is the number of errors that can be corrected), D_r is number of information bits that are coded through the channel coding technique, C_r is number of parity bits used by the channel coding technique (e.g. Reed-Solomon code) to protect the information bits, p_{c_r} is average probability that a received frame of length $D_r + C_r$ was correctly decoded (i.e., the received frame has at most t bit errors), x is the number of transmitted frames per packet, and L is the packet length in bits. Extant systems, e.g. IEEE802.11a, use only one channel coding technique (convolutional coding) but use adaptive coding rates during transmission ($1/2, 2/3, 3/4$) to accommodate “noisy” channels. Therefore, (3-5) becomes:

$$p_{(i,j)(i+1,l)} = 1 - (p_{c_r})^{\lfloor \frac{L}{D} \rfloor} \quad (3-7)$$

In general, the average bit error probability p_b for $M - PSK$ and $M - QAM$ in an additive white Gaussian noise (AWGN) channel can be calculated using the following two formulas given in [64]:

$$p_{b_{M-PSK}} \cong \frac{2}{\max(\log_2 M, 2)} \sum_{i=1}^{\max(\frac{M}{4}, 1)} Q \left(\sqrt{\frac{2E_b \log_2 M}{N_0}} \sin \frac{(2i-1)\pi}{M} \right) \quad (3-8)$$

$$p_{b_{M-QAM}} \cong 4 \left(\frac{\sqrt{M} - 1}{\sqrt{M} \log_2 M} \right) \sum_{i=1}^{\sqrt{M}/2} Q \left((2i - 1) \sqrt{\frac{3E_b \log_2 M}{N_0(M - 1)}} \right) \quad (3-9)$$

where M is the modulation order, $M = 2^x$, $x \in \{1, 2, 3, 4, \dots\}$, and E_b/N_0 is the energy per bit to noise power spectral density ratio. Note that the probability of link error depends on the transmission power, channel conditions, modulation scheme, packet length, among other factors, as shown in the previous equations (3-4) – (3-9).

By combining the received packets, each node in cluster 1 creates a new coded packet and transmits it to the next cluster. In general, node j in the cluster i creates and transmits to nodes in cluster $i + 1$ a coded packet from the received coded packets as follows:

$$y_{ij} = \sum_{l=1}^{m_j} c_{ijl} y_{i-1,l}, \quad j \in \{1, 2, \dots, n_i\} \quad (3-10)$$

where y_{ij} and $y_{i-1,l}$ are the transmitted coded packets and received coded packets, respectively, m_j is the number of coded packets received by node j in cluster i from nodes in cluster $i - 1$ and the coefficients c_{ijl} are randomly chosen from $GF(2^q)$.

Each node in a cluster (2 through K) acts as a MISO (Multiple Input, Single Output) node by receiving multiple coded packets and transmitting one new coded packet, as shown in Figure 3.4.

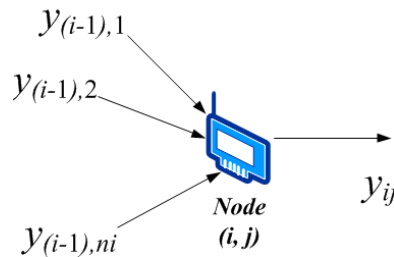

Figure 3.4 Node's Network Coding operation

The number of coded packets received M by node (i, j) depends on the connectivity of the network, which is denoted as r_{ij} , as shown in Table 3-1. Cooperative Network Coding considers

three metrics of connectivity. The first metric of connectivity is the number of nodes in the 1st cluster that are connected with the source node, r_s , which can vary from the number of original packets (m) to the number of nodes in the 1st cluster (n_1).

For example, in Figure 3.5, r_s is equal to 4. The second metric of connectivity is the number of nodes in cluster ($i + 1$) that are connected with node (i, j), r_{ij} , which can vary from 2, because r_{ij} should be at least 2 to implement cooperation among the nodes, to the number of nodes in cluster ($i + 1$). For example, in Figure 3.5, r_{i3} is equal to 5. And, the last metric of connectivity is whether the node j in the last cluster is connected to the destination, r_{Kj} , which could be either 0 or 1. For example, in Figure 3.5, r_{K1} is 0 and r_{K2} is 1. In general, the connectivity's metrics can take the following values:

$$r_s \in [m, m + 1, \dots, n_1 - 1, n_1] \quad (3-11)$$

$$r_{ij} \in [2, 3, \dots, n_{i+1} - 1, n_{i+1}] \quad (3-12)$$

$$r_{Kj} \in [0, 1] \quad (3-13)$$

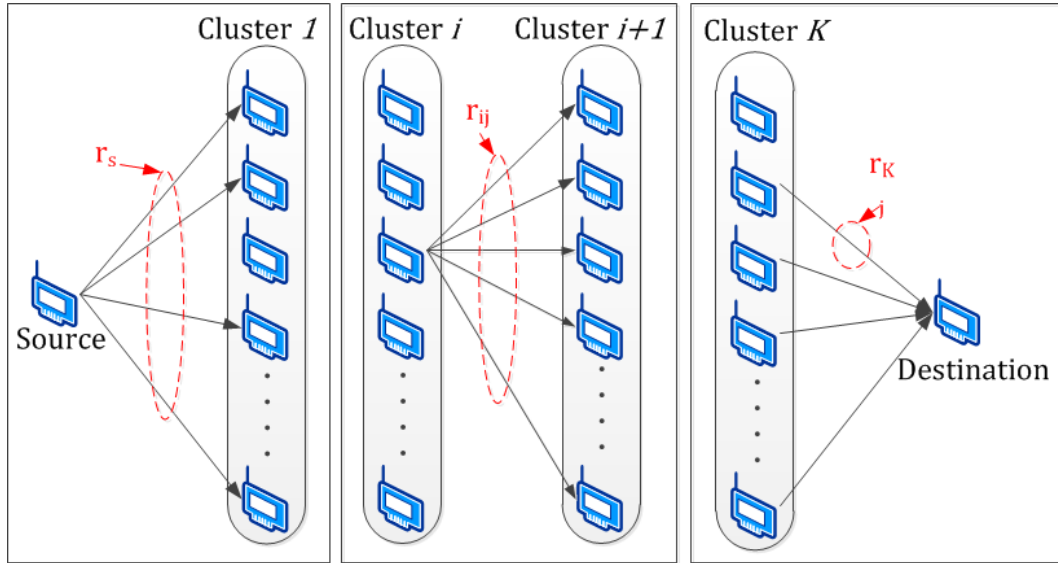

Figure 3.5 The connectivity of Cooperative Network Coding

The probability V_{ij} that a node in cluster i^{th} can correctly receive at least a coded packet from nodes in cluster $(i - 1)^{th}$ is calculated as [22]:

$$V_{ij} = 1 - \prod_{t=1}^{n_{i-1}} \left[1 - \frac{V_{(i-1)t} \times r_{(i-1)t} \times (1 - p_{(i-1,t)(l,j)})}{n_i} \right] \quad (3-14)$$

At the destination, the destination node needs to receive at least m coded packets from nodes in cluster K to be able to recover the original information. Decoding could either be done by block decoding or Gaussian elimination [19] applied to the matrix formed by the packet headers c_{Kij} to determine the original packets $\{x_i\}$:

$$\begin{pmatrix} c_{K11} & c_{K12} & \cdots & c_{K1m} \\ c_{K21} & c_{K22} & \cdots & c_{K2m} \\ \vdots & \vdots & \ddots & \vdots \\ c_{Km1} & c_{Km2} & \cdots & c_{Kmm} \end{pmatrix} \begin{pmatrix} x_1 \\ x_2 \\ \vdots \\ x_m \end{pmatrix} = \begin{pmatrix} y_{K1} \\ y_{K2} \\ \vdots \\ y_{Km} \end{pmatrix} \quad (3-15)$$

The probability of successful reception, P_s , is given in [39] and is calculated as the sum of the combinations of successful reception of the links between nodes in the cluster K and the destination node P_{di} :

$$P_s = \text{Prob}(x \geq m) \quad (3-16)$$

$$P_s = \sum_{t=m}^{n_K} \left[\sum_{\vec{a} \in A} \left(\prod_{i \in a_1} P_{di} \cdot \prod_{j \in a_0} (1 - P_{dj}) \right) \right] \quad (3-17)$$

$$P_{di} = V_{Ki} r_{Ki} (1 - p_{(K,i)d}) \quad (3-18)$$

Where:

- A is a set of n_K binary sequences of all the 2^{n_K} possible combinations. A binary sequence can contain either 0 or 1, where “1” means that the transmission was successful and “0” otherwise. The number of 1-s in A is t and the number of 0-s is $(n_K - t)$; so there are $\binom{n_K}{t}$ such sequences. Thus,

$$\|A\| = \binom{n_K}{t} \quad (3-19)$$

- \vec{a} is a particular sequence from the set A , a_0 is a set of all indices j of \vec{a} such that $a(j) = 0$, and a_1 is a set of all indices i of \vec{a} such that $a(i) = 1$. Thus

$$\|a_0\| + \|a_1\| = n_K \quad (3-20)$$

- P_{di} is the probability that a combination packet, transmitted from node i in the cluster K , is correctly received by the destination node,
- V_{Ki} is the probability that node i in the cluster K receives at least a combination packet from nodes of the cluster $K - 1$,
- r_{Ki} is the connectivity between node i in the cluster K and the destination node. This parameter could be either 1 or 0,
- $p_{(K,i)d}$ is the probability of link error between node i in the cluster K and the destination node.

The expected number of correctly received and decoded packets (information packets) at the destination (\mathbb{E}) is given by:

$$\mathbb{E} = m \cdot P_s \quad (3-21)$$

3.3 Simulation Scenario and Results for Wireless *Ad Hoc* Networks

In the following two sections, we present the general rules of design such as the Network Coding rate (number of original packets to the number of coded packets ratio), probability of link error, among others to achieve performance improvement through *Cooperative Network Coding* in wireless sensor networks.

3.3.1 Effect of the Number of Original Packets on the Performance of Cooperative Network Coding

In this section we discuss various scenarios of the number of original packets and its effect on the performance of Cooperative Network Coding.

We considered the following assumptions:

- The number of coded packets is at least equal to the number of original packets ($m' \geq m$),
- All the clusters have the same number of nodes $n = n_i$,
- The number of coded packets (m') is equal to the number of nodes per cluster (n),

- There are 5 clusters between the source and destination nodes ($K = 5$),
- The connectivity between node j in cluster i and the nodes in cluster $i + 1$ is the same for all the nodes between cluster 1 and cluster K and is equal to the number of nodes in cluster 1 connected to the source ($r = r_s = r_{ij}$),
- The destination nodes is connected to all the nodes in the last cluster ($r_{Kj} = 1, \forall j$),
- The probability of link error is the same for all the links ($p = p_{(i,j)(i+1,l)}$).

Figure 3.8 shows the probability of successful reception at the destination vs. the number of nodes per cluster for different numbers of original packets for a probability of link error equal to 10^{-1} . Approximately, full throughput is achieved when the code rate for Network Coding is about $2/3$ over a broad range of the number of transmitted packets. That is, the number of transmitted packets (coded packets) is about 1.5 times the number of original packets.

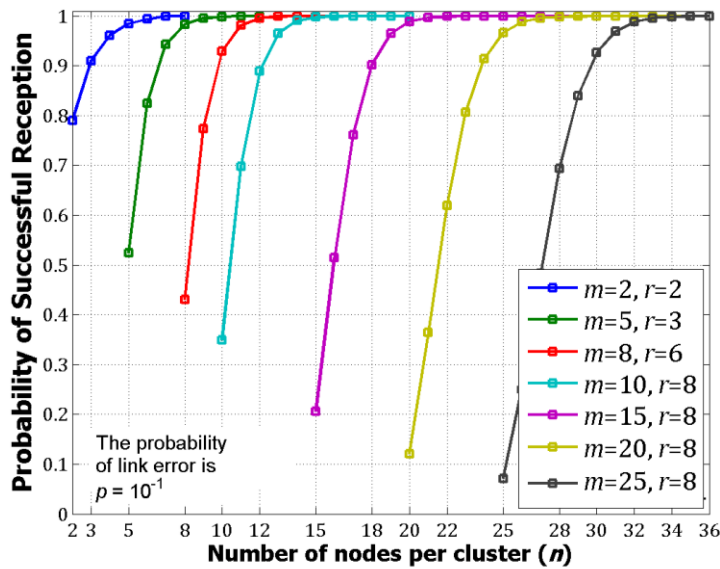

Figure 3.6 Probability of successful reception at the destination vs. number of nodes per cluster (n) as a function of the number of original packets and connectivity, the probability of link error (p) is 10^{-1}

Additionally, we can see that the probability of successful reception at the destination is higher when the number of original packets is lower. For example, when the number of original packets is 2, the probability of successfully receiving the 2 original packets at the destination is

about 80%, while the probability of successfully receiving the 15 original packets at the destination, when the number of original packets is 15, is about 20%. Therefore, it is recommended to keep the number of original packets (m) small to increase the probability of successfully decoding the information at the destination (P_s) and also this reduces the decoding processing time because the destination node needs to receive at least m linearly independent coded packet to recover the original information.

3.3.2 Effect of the Probability of Link Error on the Performance of Cooperative Network Coding

In this section we discuss the effect of the probability of link error on the performance of Cooperative Network Coding.

We considered the following assumptions:

- The number of original packets m is 10,
- All the clusters have the same number of nodes $n = n_i$,
- The number of coded packets (m') is equal to the number of nodes per cluster (n),
- There are 5 clusters between the source and destination nodes ($K = 5$),
- The connectivity between node j in cluster i and the nodes in cluster $i + 1$ is the same for all the nodes between cluster 1 and cluster K and is equal to the number of nodes in cluster 1 connected to the source ($r = r_s = r_{ij}$),
- The destination nodes is connected to all the nodes in the last cluster ($r_{Kj} = 1, \forall j$),
- The probability of link error is the same for all the links ($p = p_{(i,j)(i+1,l)}$).

Figure 3.7 shows the probability of successful reception at the destination vs. the number of nodes per cluster for different values of probability of link error. As we can see in this figure, the probability of link error has direct influence in the probability of successful reception at the destination. That is, for low probabilities of link error (e.g., $p \leq 10^{-4}$), no extra information (redundancy) would be required to correctly receive the block of information at the destination.

However, since CNC uses random linear network coding to create the coded packets, complete linear independency among the packets is not guaranteed. Therefore, it is recommended to transmit at least one extra coded packet ($m' = m + 1$) to overcome the issue with the linear independency among the coded packets.

Additionally, by transmitting at least one extra coded packet ($m' = m + 1$), it is possible to overcome any node failure. If any node fails, the cluster size is reduced and the number of linear independent packets depends on the number of nodes transmitting coded packets because each node transmits only one coded packet. For example, if cluster i has m' nodes and only m coded packets are transmitted ($m' = m = n_i$) and at least one node in cluster i fails, then it is not possible to recover the original information at the destination because the system loses the linear independency of the packets ($rank < m$) and no original information can be recovered.

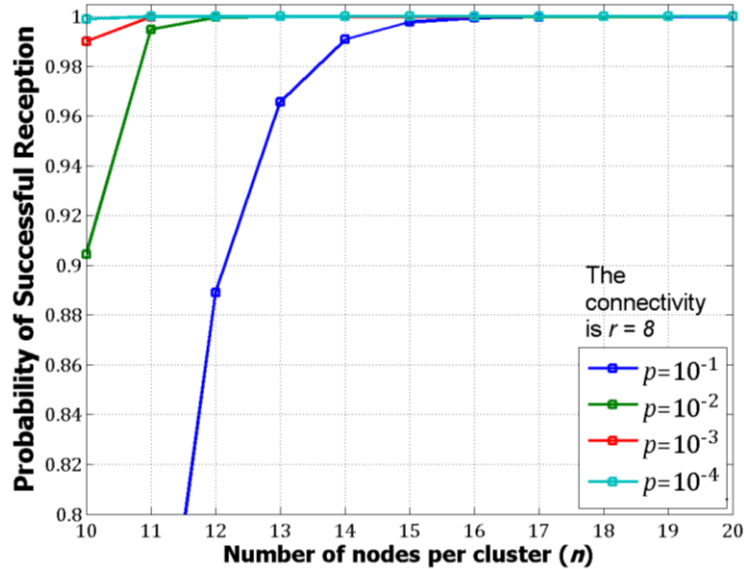

Figure 3.7 Probability of successful reception at the destination vs. number of nodes per cluster (n) as a function of the probability of link error (p) for a connectivity $r = 8$

In the following subsections, we present the results of the effect of the connectivity on the performance of Cooperative Network Coding [65] and the effect of the number of clusters between the source and destination nodes on the performance of Cooperative Network Coding

[66] for a different range of parameters. The results presented in this section were obtained through simulations by running 10,000 experiments and averaging the results.

3.3.3 Effect of the Connectivity on the Performance of Cooperative Network Coding

In this section we discuss various scenarios of the connectivity and its effect on the performance of Cooperative Network Coding. The different scenarios for the connectivity indicate whether a significant improvement in the expected number of correctly received and decoded information packets at the destination node is achieved varying the connectivity among the nodes or no improvement at all. We considered the following assumptions:

- The number of original packets m is 10,
- All the clusters have the same number of nodes $n = n_i$,
- There are 3 clusters between the source and destination nodes ($K = 3$),
- The number of nodes in cluster 1 connected to the source is equal to the number of original packets ($r_s = m = 10$),
- The connectivity between node j in cluster i and the nodes in cluster $i + 1$ is the same for all the nodes between cluster 1 and cluster K ($r = r_{ij}$),
- The destination nodes is connected to all the nodes in the last cluster ($r_{Kj} = 1, \forall j$),
- The probability of link error is the same for all the links ($p = p_{(i,j)(i+1,l)}$).

Figure 3.8 and Figure 3.9 show the probability of successful reception at the destination vs. the number of nodes per cluster for different values of connectivity and probability of link error of 0.1 and 0.25, respectively. As we can see in these figures, the gain in probability of successful reception at the destination is minimum compared to the increase of cooperation among the nodes for values of connectivity greater than 4. Therefore, we concentrate our work on investigating the effect of the connectivity on the performance of Cooperative Network Coding for connectivity values r equal 2, 3 and 4, where $r = 4$ is the optimal value for the connectivity of the nodes between two adjacent clusters (r_{ij}).

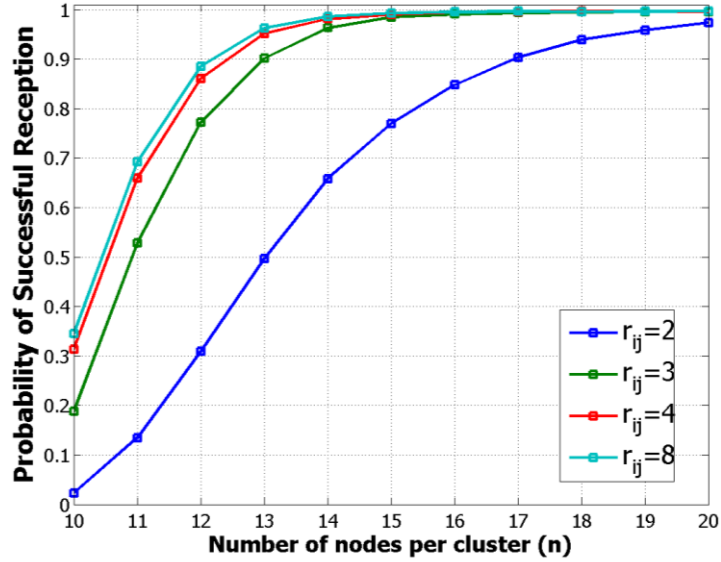

Figure 3.8 Probability of successful reception at the destination vs. number of nodes per cluster (n) as a function of the connectivity r_{ij} for $r_s=m=10$, the probability of link error (p) is 0.1

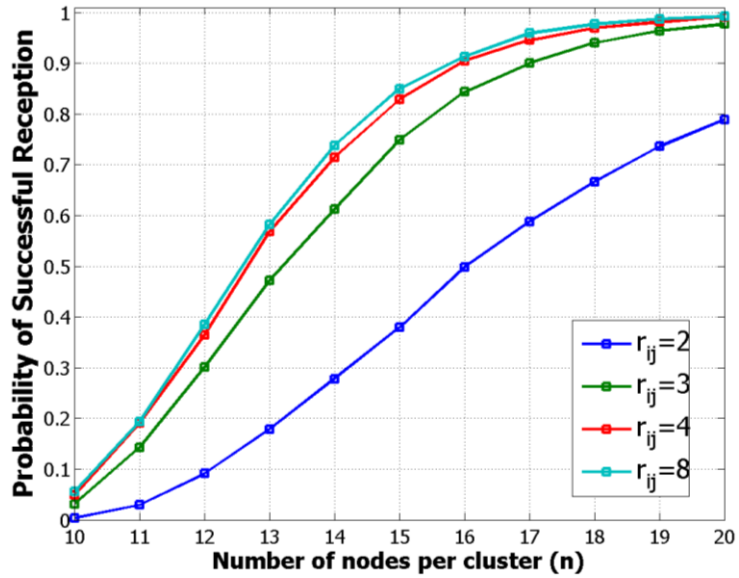

Figure 3.9 Probability of successful reception at the destination vs. number of nodes per cluster (n) as a function of the connectivity r_{ij} for $r_s=m=10$, the probability of link error (p) is 0.25

A comparison of the effect of the connectivity between the source and nodes in the first cluster, r_s , is presented in Figure 3.10 and Figure 3.11. As is shown, increasing the connectivity r_s provides a marginal improvement on the performance for connectivity values between nodes in cluster $i + 1$ and the node (i, j) , r_{ij} , is greater or equal than 3.

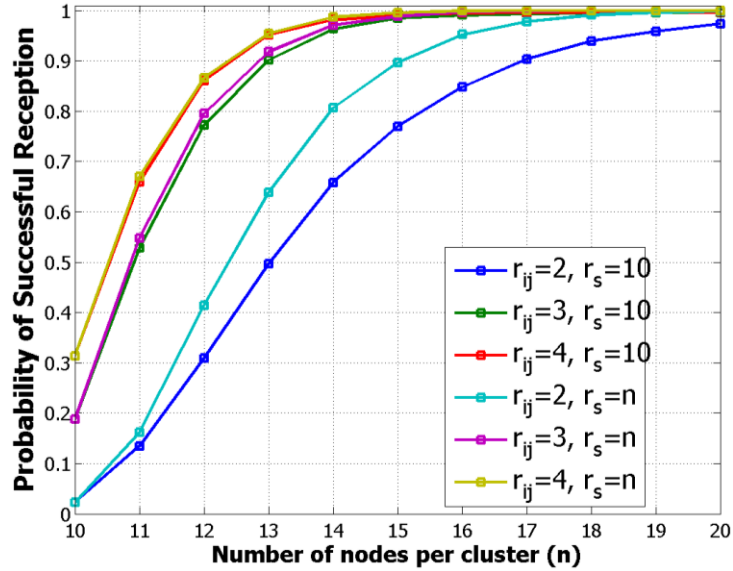

Figure 3.10 Comparison of probability of successful reception at the destination for probability of link error (p) is 0.1, r_s equal m (10) and r_s equal n for different values of connectivity

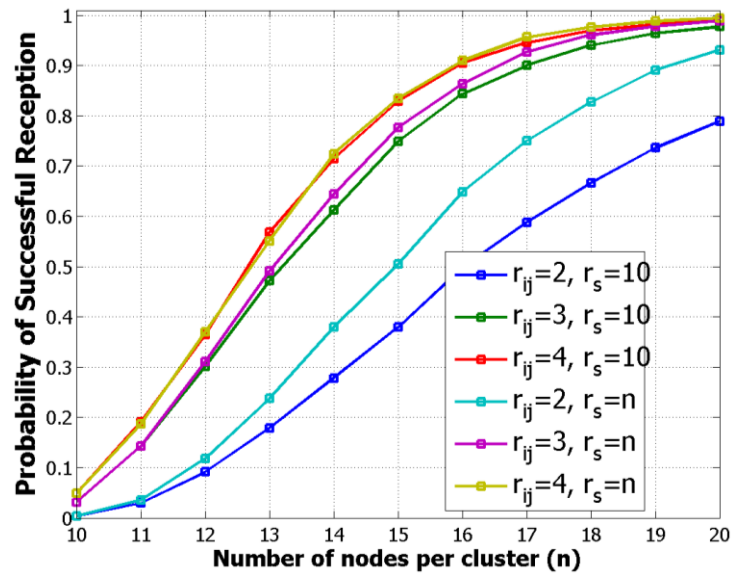

Figure 3.11 Comparison of probability of successful reception at the destination for probability of link error (p) is 0.25, r_s equal m (10) and r_s equal n for different values of connectivity

When the connectivity between nodes in cluster $i + 1$ and the node (i, j) is 2, we can obtain a significant increase of the performance of Cooperative Network Coding by connecting all the nodes in the first cluster to the source node.

Figure 3.12 shows the effect of the connectivity between nodes in the last cluster and the destination node. The connectivity r_{Kj} impacts the performance of Cooperative Network Coding, because when one node in the last cluster is disconnected from the destination, the performance of Cooperative Network Coding for a cluster size n is the same as the performance for a cluster size $n - 1$ when all the nodes in the last cluster are connected to the destination. This connectivity is directly related to a node failure, because if a node in the last cluster fails, for any reason, its connectivity to the destination is set to be 0. A failure of a node in any cluster between the first and the penultimate cluster has little or no effect on the connectivity, so it does not affect the performance of the network.

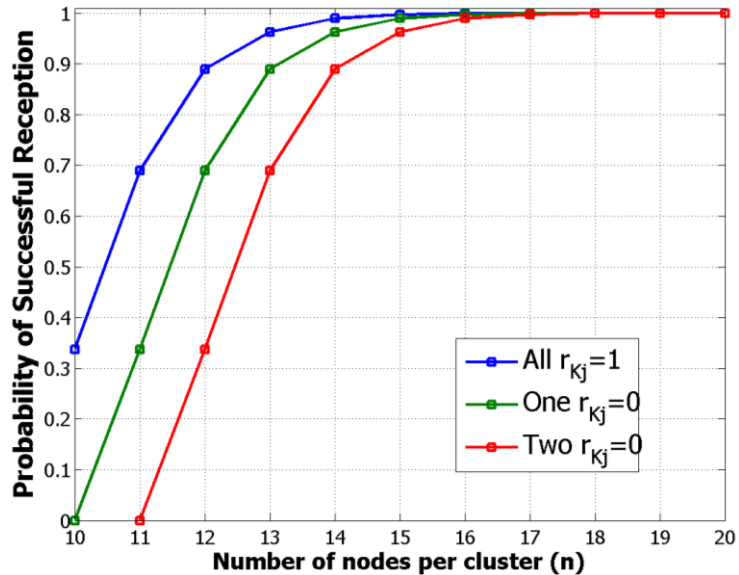

Figure 3.12 Effect of connectivity between nodes in the last cluster and the destination node for the probability of link error (p) of 0.1

3.3.4 Effect of the Number of Clusters on the Performance of Cooperative Network Coding

In this section we present a number of scenarios to analyze the effect of the number of clusters / hops K on the performance of Cooperative Network Coding. The different scenarios indicate whether the probability of successful reception at the destination is decreasing as the number of cluster increases or there is no degradation at all.

The results were obtained through simulations by running 10,000 experiments and averaging the results. Additionally, similar to [22] and [39], we assumed that:

- 10 original packets are transmitted, $m = 10$;
- The number of nodes per cluster is the same for all the clusters, $n = n_i$;
- All the nodes, including the source node, have the same connectivity value, $r = r_s = r_{ij}$;
- All the links have the same probability of link error, $p = p_{(i,j)(i+1,l)}$.

As it was recommended in [22] and [65], by setting the connectivity to 8 and 4, respectively, it is possible to achieve the highest performance of Cooperative Network Coding. Thus, we consider the level of cooperation (connectivity) to 4 and 8 to find out the effect of the number of clusters between the source and destination nodes.

In Figure 3.13 and Figure 3.14, we can see that the probability of successful reception at the destination in Cooperative Network Coding does not vary significantly for cluster size, n , greater or equal than 13 nodes, regardless the probability of link error. For cluster size smaller than 13 nodes, we can see that the throughput decreases when the number of clusters increases. However, this decrease of the performance is not that significant as in a multihop network, which does not take advantage of cooperation among the nodes.

In Figure 3.13, we can see that to achieve the optimal probability of successful reception at the destination, when all the m original packets can be decoded, the cluster size should be at least 14 nodes per cluster when the probability of link error is 0.1. Also, from Figure 3.14, we can see that because the probability of link error is relatively high, the cluster size should be increased to values beyond 15 nodes per cluster to obtain a probability of successful reception at the destination close to 1. That is, all the original packets can be recovered.

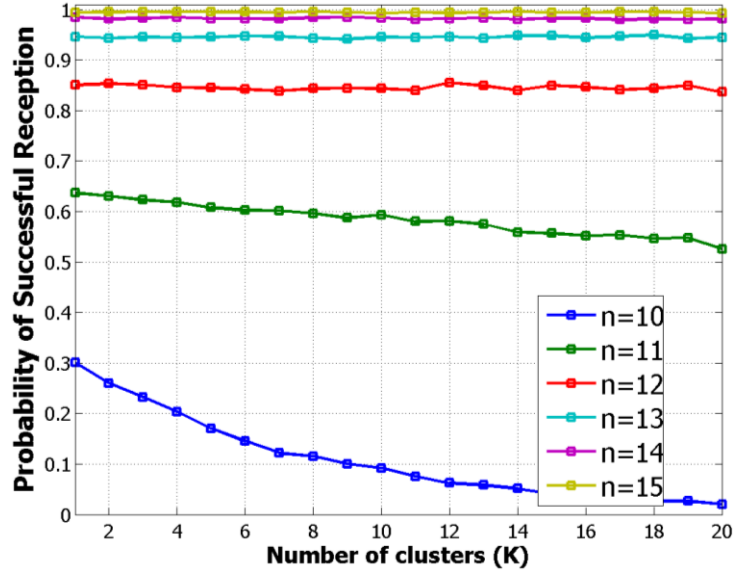

Figure 3.13 Probability of successful reception at the destination vs. number of clusters (K) for connectivity $r_s=r_j=4$, the probability of link error (p) is 0.1 and different number of nodes per cluster

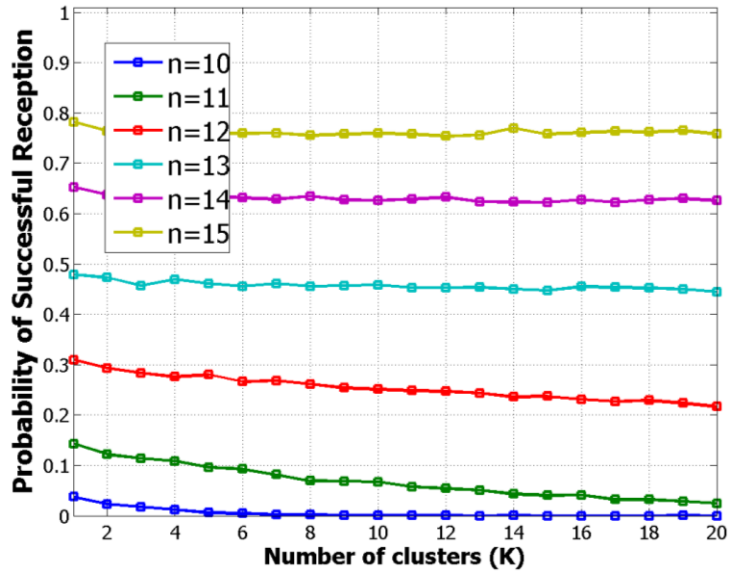

Figure 3.14 Probability of successful reception at the destination vs. number of clusters (K) for connectivity $r_j=4$, the probability of link error (p) is 0.25 and different number of nodes per cluster

Figure 3.15 and Figure 3.16 show that because of the degree of cooperation among the nodes (connectivity r), the Cooperative Network Coding performance is not sensitive to the number of hops, regardless the probability of link error. Similarly, when the connectivity is 4, for

small probabilities of link error, the appropriate cluster size is at least 14 nodes per cluster and for higher probabilities of link error, the cluster size be beyond 15 nodes per cluster.

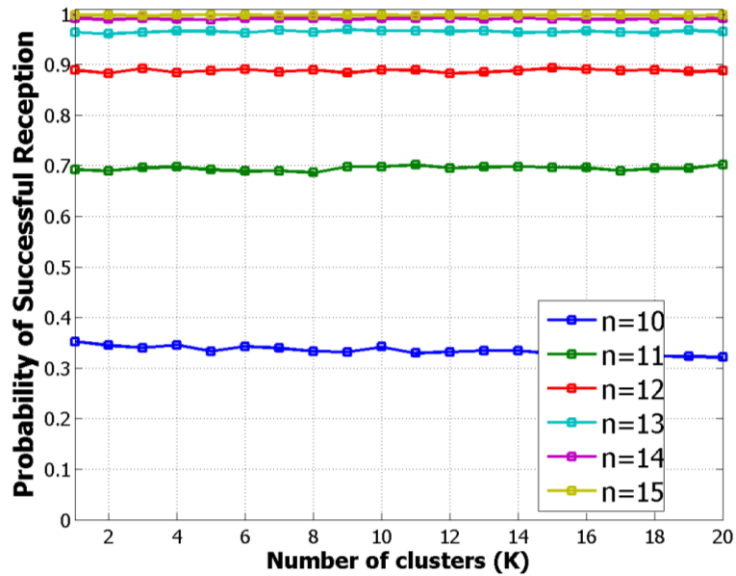

Figure 3.15 Probability of successful reception at the destination vs. number of clusters (K) for connectivity $r_{ij}=8$, the probability of link error is 0.1 and different number of nodes per cluster

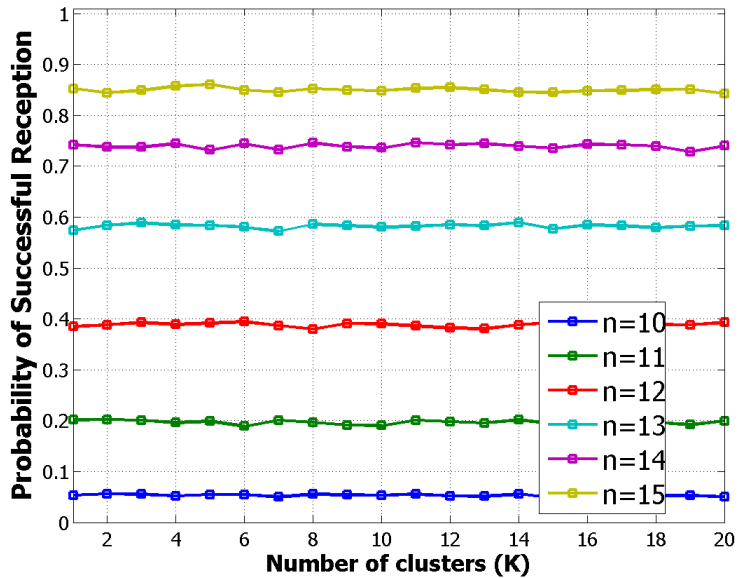

Figure 3.16 Probability of successful reception at the destination vs. number of clusters (K) for connectivity $r_{ij}=8$, the probability of link error (p) is 0.25 and different number of nodes per cluster

As we can see in Figure 3.14 and Figure 3.16, the probability of successful reception at the destination does not significantly vary with the number clusters/hops. However, the expected

number of correctly received and decoded packets is not optimal since the source node is transmitting 10 original packets and, in average, less than 9 packets are being received (decoded) at the destination node. Thus, we should increase the number of nodes per cluster n to increase the throughput and combat the high probability of link error $p = 0.25$.

Additionally, this characteristic of lack of sensitivity to the number of clusters K is seeing in Cooperative Communications with link-level retransmission, where the link-level retransmission is implemented between the nodes in the last cluster and the destination node.

3.4 Concluding Remarks

Our study in this chapter focused on analyzing the effect of the connectivity on the performance of Cooperative Network Coding. Also, we study the effect of the number of clusters between the source and destination nodes on the performance of Cooperative Network Coding for a different range of parameters.

Based on the range of parameters we have investigated, Cooperative Network Coding achieves its optimal performance when r_s is equal to m , r_{ij} is 4 and r_{Kj} is 1 for all the j 's. Any increase of the connectivity, r_s and r_{ij} , offers just marginal gain in the probability of successful reception at the destination and introduces unnecessary redundant traffic in the network. In other words, Cooperative Network Coding achieves its optimal performance, under the assumption that the probability of link error is the same for all the links ($p = p_{(i,j)(i+1,l)}, \forall i, j, l$), when the number of nodes in the first cluster connected to the source node is equal to the number of original packets (data packets), 4 nodes in cluster i are connected to node $(i - 1, j)$, and all the nodes in the last cluster (cluster K) are connected to the destination node.

For connectivity r_{ij} equal to 2 and r_{Kj} equal to 1 for all the j 's and, by setting the connectivity r_s equal to the number of nodes per cluster m , Cooperative Network Coding can achieve an increase of the probability of successful reception at the destination of about 34% and 37% for probabilities of link error of 0.1 and 0.25, respectively.

The connectivity r_{Kj} has a direct effect on the performance of Cooperative Network Coding because if the destination is disconnected from one of the nodes in the last cluster, the network performance is reduced and the probability of successful reception at the destination for a cluster size n is equal to the throughput of a cluster size $n - 1$.

As opposed to multihop *ad-hoc* networks, where the outage probability exponentially increases with the number of hops, Cooperative Network Coding provides a very low outage probability that is not very sensitive to the number of hops when the system parameters are properly set. We can observe this characteristic of invariability in the probability of successful reception at the destination when the cluster size is at least 14 nodes per cluster for any number of hops K .

In conclusion, the optimal value of connectivity for Cooperative Network Coding to deliver the largest expected number of correctly received and decoded information packets is achieved by having at least m nodes in the 1st cluster connected to the source ($r_s = m$), the destination node connected to all the nodes in the last cluster and r_{ij} equal to 4. However, if the goal is to minimize the number of Network Coding operations per node, due to the constraints of processing capability that certain wireless sensor nodes have, an alternative would be to improve the network performance by connecting all the nodes in the first cluster to the source and connecting only two nodes of cluster $(i + 1)$ to the node (i, j) . Moreover, the probability of successful reception at the destination of Cooperative Network Coding is almost invariant to the number of hops between the source and the destination nodes independently of the probability of link error for connectivity values greater or equal to 4.

CHAPTER 4. LINK LEVEL RETRANSMISSIONS FOR COOPERATIVE NETWORK CODING AND COOPERATIVE DIVERSITY CODING

4.1 Introduction

Due to the channel impairments, some packets transmitted from the source to the destination node are errored or lost. So, to overcome packet errors and/or loss, communication systems make the use of retransmissions to increase the probability of successful delivery of a message. The retransmissions can be done end-to-end or link-by-link. In end-to-end retransmissions, the destination node acknowledges (ACK) the reception of a packet and if the transmitted packet or the ACK is errored or lost, the source node retransmits the packet. This operation is performed in the transport layer (e.g. TCP protocol). In link-by-link retransmissions, a transmitted packet is acknowledged on a link basis. That is, the source transmits a packet to the next node that is in the path towards the destination. Then, the node acknowledges the packet to the source. If the packet is errored or lost, the source retransmits the packet. If not, the node sends the packet to the following node in the path to the destination and the following node acknowledges successful reception of the packet. If the packet is errored or lost, the packet is retransmitted. This process continues until the penultimate node in the path sends the packet to the destination node and waits for the acknowledgement. If the packet is errored or lost, the penultimate node retransmits the packets. Link-by-link retransmission is implemented at link layer and Automatic Repeat reQuest (ARQ) [11], [46] error detection and retransmission is used. This error-control method uses two types of frames: frames (data), and acknowledgements (ACK). The transmitter sends one or many frames, the receiver runs an error-detection algorithm on the received data to verify that the frames are error-free and, if an error is detected in a frame, the receiver requests the transmitter for retransmission of the erroneous frame(s) by sending a

NACK (negative ACK) frame indicating the last correctly received frame. This feedback process continues until no error is detected. In multihop communication, link-by-link retransmission provides higher reliability compared to the end-to-end retransmission. However, the main drawback of this approach, when compared to a feed-forward approach, is its latency because of retransmissions and also requires buffers and timers. As a result of the retransmissions, the load on the network can be very high, especially under bad channel conditions, and the capacity is reduced because of need for a reverse channel.

Considering the advantages and disadvantages of these two approaches, a mixed (combination of forward error correction at packet level and retransmissions) approach to error control is presented in this chapter with the aim of optimizing the performance of multihop wireless networks that use Cooperative Network Coding. In [22], the authors analyzed the performance of Cooperative Network Coding, without link-level feedback and retransmissions. In this chapter, we extend the work done in [22] by analyzing the effect of link-level feedback (i.e., packet retransmission) on Cooperative Network Coding. Link-level feedback is implemented when an insufficient number of combination packets is received at the destination node, so that the destination cannot reproduce the original packets transmitted by the source. To compare the performance of Cooperative Network Coding with and without link-layer feedback, we rely on two metrics: the expected number of correctly received packets and the probability of recovery of the source information at the destination.

In [22], the authors determined the appropriate values of the system's parameters to achieve an optimal performance of the network under the following assumptions:

- There is no link-level feedback.
- The number of original packets m is 10.
- All the clusters have the same number of nodes $n = n_i$

- The connectivity between node j in the cluster i and nodes in the cluster $i + 1$ is denoted as r_{ij} and, furthermore, $r = r_s = r_{ij}$.
- All the links have the same characteristics, i.e., $p = p_{(i,j)(i+1,l)}$, such that $1 \leq i \leq K - 1$, $1 \leq j \leq n_i$, and $1 \leq l \leq n_{i+1}$. Although this assumption may not be realistic in some network scenarios, it considerably simplifies the analysis and evaluation.

Figure 4.1 shows the probability of successful reception at the destination vs. the number of nodes per cluster (n) for the Cooperative Network Coding and the Multihop Packet networks, demonstrating the significant improvement of the former scheme. (For the Multihop Packet network case, a single path between the source and the destination is chosen and packets are forwarded along the path.) The results in this figure were calculated for the probability of link error $p = 0.1$.

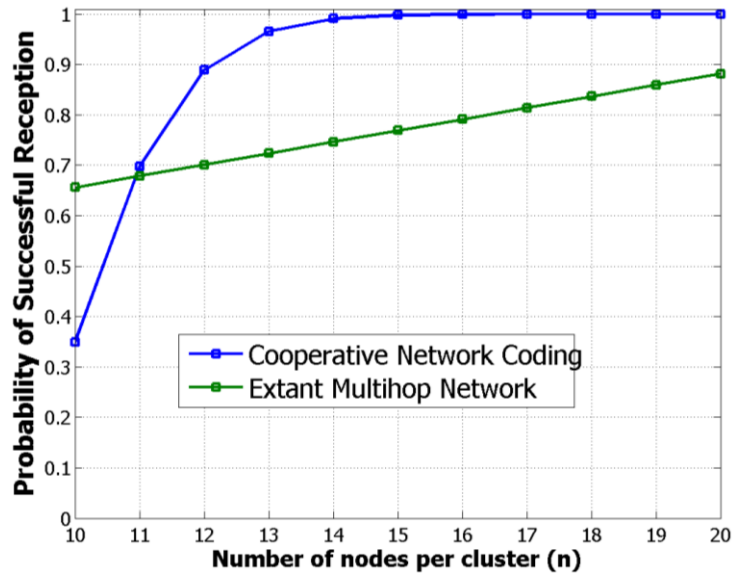

Figure 4.1 The throughput vs. number of nodes per cluster (n) of Cooperative Network Coding (with $r_s=r_{ij}=10$) and of Multihop Packet Network

Generally speaking, in packet networks, reliability can be improved via channel coding and/or retransmission schemes, both of which increase the load on the network, or from a different viewpoint, decrease the amount of useful information. When a link fails, increased reliability could be achieved by rerouting the packets along an alternative route. In contrast,

Cooperative Network Coding increases reliability by applying redundancy across the spatial domain, so that when some packets are erroneous or even completely lost, it is quite likely that the other network paths can provide sufficient information for the destination node to recover the transmitted packets. Therefore, Cooperative Network Coding can guard against failures of links or nodes without the need for end-to-end retransmissions.

4.2 Effect of Retransmission from the Last Cluster

We begin by examining, the probability of successfully decoding of a message by the destination, P_s , and the probability V_K that at least one combination packet is correctly received by a node in the cluster K . Using the assumptions made in [22], the parameter V_K , calculated with (3–14), is equal for all the nodes in the cluster K . Results for V_K and P_s are shown in Figure 4.2 and Figure 4.3.

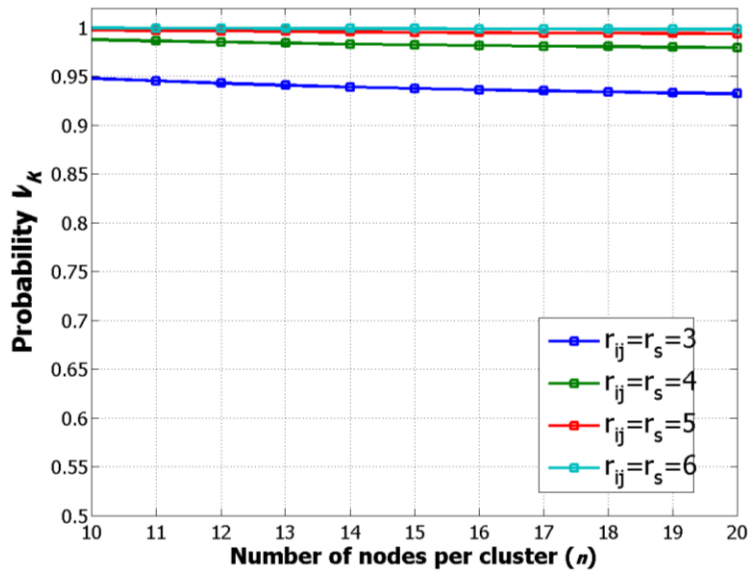

Figure 4.2 Probability V_K that a node in the cluster K correctly receives at least one coded packet vs. number of nodes in a cluster (n) for different values of connectivity r and for $p = 0.1$

Figure 4.2 demonstrates that, for the assumed network parameters, connectivity values r greater than 3, the probability that at least one combination packet is correctly received by a node in the cluster K is close to 1, independently of the number of nodes in a cluster. However, as is shown in Figure 4.3, the probability that the destination node can decode the original message is

much lower than V_K for a cluster size smaller than 13 nodes. In other words, as might be expected, the performance of the links between nodes in the last cluster (the K^{th} cluster) and the destination node significantly affects the network's performance.

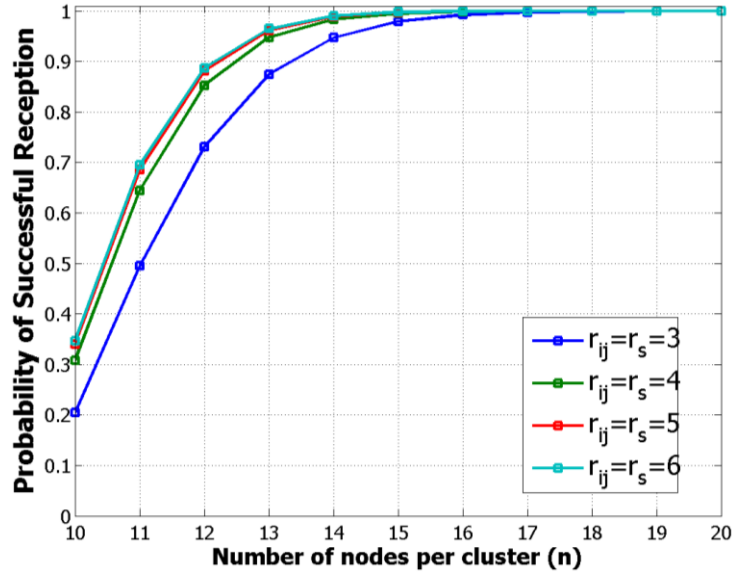

Figure 4.3 The probability of successful reception P_s vs. number of nodes in a cluster (n) for a number of values of connectivity (r) and for $p = 0.1$

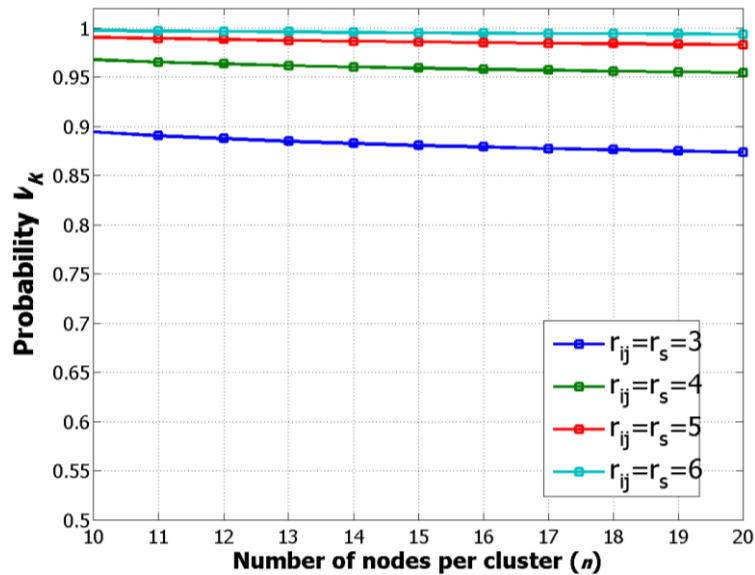

Figure 4.4 Probability V_K that a node in the cluster K correctly receives at least one coded packet vs. number of nodes in a cluster (n) for different values of connectivity r and for $p = 0.25$

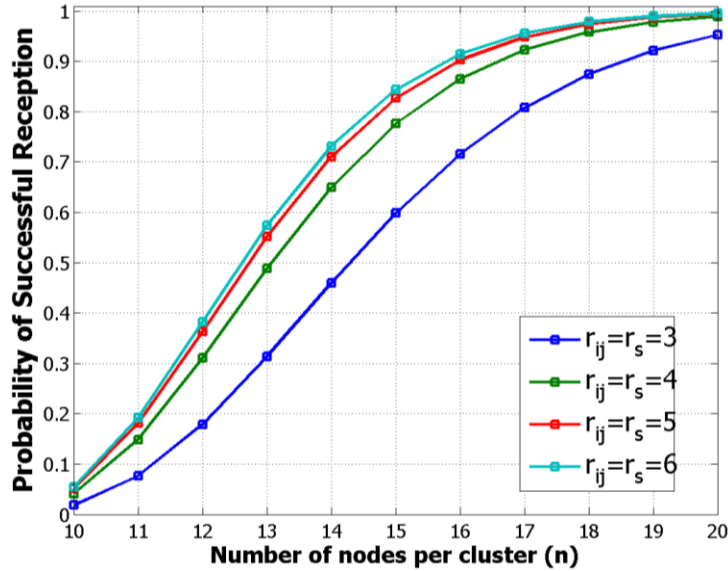

Figure 4.5 The probability of successful reception P_s vs. number of nodes in a cluster (n) for a number of values of connectivity (r) and for $p = 0.25$

Similar results, depicted in Figure 4.4 and Figure 4.5, were obtained for the probability of link error $p = 0.25$. Thus, even when the probability of link error (p) increases to 0.25, the probability that at least one combination packet is correctly received by a node in the cluster K is still close to 1 for values of r greater than 3. However, the probability P_s that the destination node can decode the original message is significantly affected when the number of nodes in a cluster is less than 16 nodes.

Additionally, the probability of successful reception P_s decreases when not all the nodes in the cluster K are connected to the destination node. For example, if three nodes of the cluster K are disconnected from the destination, we need the cluster K to be of size of at least 13 nodes to achieve the same performance as with a cluster size of 10 when all the nodes are connected to the destination node.

Since the probability V_K that at least one coded packet is correctly received by a node in the cluster K is already close to 1, it is intuitively clear that link-layer retransmissions would be of benefit only in the last hop; i.e., on the links from nodes in the cluster K to the destination node. This is an important observation, as only the feedback from the destination node to nodes in the

last cluster (the K^{th} cluster) suffices, without the need for retransmission from the source node to the destination node (end-to-end retransmission).

If the destination node receives less than m correct coded packets, the destination node is unable to recover the original information. Therefore, the destination node stores the received coded packets and requests new coded packets to be retransmitted from the K^{th} cluster, in which case, every node of the K^{th} cluster transmits a new coded packet. Successful reception occurs if the total number of correctly received packets in the original transmission and in the retransmissions equals or exceeds m . (The destination node will request such a retransmission any time that it receives at least one, but less than m coded packets.)

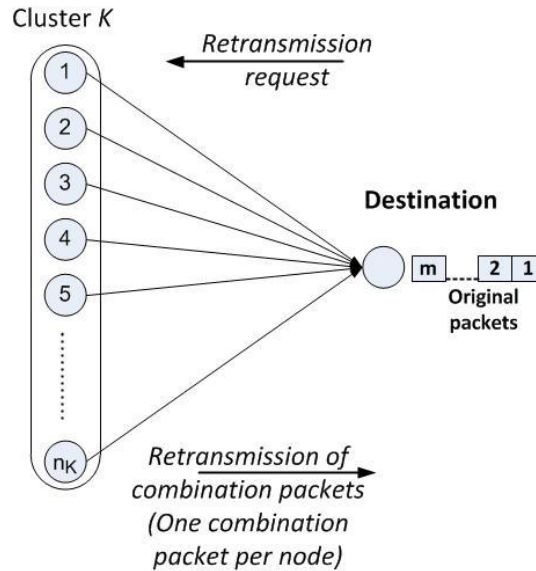

Figure 4.6 Link-layer retransmission model

In this context, link-level feedback means that the destination asks for retransmission from nodes in the last cluster (the K^{th} cluster). In the analysis, we account for packet loss in the retransmissions, as well as for the retransmission requests. The diagram of the link-layer retransmission scheme between nodes in the cluster K and the destination node is shown in Figure 4.6.

The probability that the destination node requests retransmission, denoted by P_r , is given by:

$$P_r = Prob(1 \leq t \leq m - 1) \quad (4-1)$$

$$P_r = \sum_{t=1}^{m-1} \left[\sum_{\vec{a} \in A} \left(\prod_{i \in a_1} \cdot \prod_{j \in a_0} P_{di}(1 - P_{dj}) \right) \right] \quad (4-2)$$

The number of coded packets received at the destination node is represented by t and the indices \vec{a}, a_0, a_1, i, j are as defined in (3-17).

The probability that the node i in the cluster K correctly receives the retransmission request from the destination node (P_{Ki}) is given by:

$$P_{Ki} = (1 - BER_i)^L \quad (4-3)$$

where BER is the probability of a bit being in error over this link. However, since the retransmission request packet would be typically small (a few bytes) relative to a coded (data) packet, its probability of link error can be considered negligible compared to the probability of link error of a coded packet (p_{ij}). Thus, the probability that a retransmitted coded packet is successfully received at the destination, denoted as P_{ret}, P_{2nd} is given by:

$$P_{reti} = V_{Ki} r_{Ki} (1 - p_{(K,i)d}) \quad (4-4)$$

$$P_{reti} = P_{di}, \quad 1 \leq i \leq n_K \quad (4-5)$$

After the second transmission, the destination node receives, in the best case, up to n_K packets in the first transmission and up to n_K packets in the retransmission (the second transmission).

The formula for the probability of successful reception with link-level retransmission PS_f is given by:

$$PS_f = \sum_{t=m}^{2n_K} \left[\sum_{\vec{a} \in A} \left(\prod_{i \in a_1} \cdot \prod_{j \in a_0} P_{di}(1 - P_{dj}) \right) \right] \quad (4-6)$$

under the following conditions:

- A is a set of $2n_K$ binary sequence of all the 2^{2n_K} possible combinations. A binary sequence can contain either 0 or 1, where “1” means that the transmission was successful and “0” otherwise. The number of 1’s in A is t and the number of 0’s is $(2n_K - t)$; so there are $\binom{2n_K}{t}$ such sequences.
- \vec{a} is a particular sequence from the set A , a_0 is a set of all indices j of \vec{a} such that $a(j) = 0$ and a_1 is a set of all indices i of \vec{a} such that $a(i) = 1$. Thus,

$$\|a_0\| + \|a_1\| = 2n_K \quad (4-7)$$

- P_{di} is the probability that a coded packet, transmitted from node i in the cluster K , is correctly received by the destination node.

In section 4.4.1 we evaluate the performance of Cooperative Network Coding with link-level retransmission and compare to the results obtained in [22].

4.3 Cooperative Network Coding Optimization – Selective Retransmissions to Minimize Energy Consumption

Achieving minimal energy consumption, with the required level of reliability is critical for the proper functioning of many wireless sensor and body area networks. In this section we will address this challenge for advanced network architectures including *Cooperative Network Coding* (CNC) [22] that was introduced in CHAPTER 3.

It has been shown that NC also improves throughput in “noisy,” or lossy, networks [18], [19], [22], [43], [52], [53]. However, in all of these network architectures, coded (parity) packets have to be transmitted to overcome wireless channel impairments. This increases network reliability at the expense of increasing the transmitted energy. We will address the design tradeoffs in optimizing the use of error control and retransmissions to optimize performance based on a statistical study because it goes beyond finding averages, as is the case when mathematical analysis is used. Moreover, finding the distribution is a challenging nonlinear

problem and does not lend itself to analysis beyond averages. An example of this is the study of the skewness, a measure of the asymmetry of a distribution, which is explained in detail later in this chapter.

For CNC systems, as long as, the destination receives a sufficient number of error-free, innovative (linearly independent) coded packets, the original (source) packets may be properly recovered at the destination. There are two ways to implement NC; the first is through a centralized scheme, where the coding coefficients are assigned to the nodes by a central node. Complete linearly independency of the coded packets can be achieved with this methodology; however, the network topology needs to be known by all the nodes. The second method, which is known as Random Linear Network Coding (RLNC) [56], is to implement NC through a decentralized scheme where each node randomly chooses the coding coefficients.

In [22], the authors study the performance of this scheme in terms of probability of successful reception at the destination and the expected number of correctly received information packets at the destination. Through a mathematical analysis, the authors concluded that the number of nodes per cluster should be 15, when the number of original packets is 10. That is a Network Coding rate of $2/3$. Also, they found that the optimal connectivity of the nodes should be 8 and that the expected number of correctly received information packets at the destination of this scheme is invariant with the number of hops (clusters). The authors compared this scheme with other three schemes:

- No-cooperation and no-Network Coding
- Cooperation and no-Network Coding; and
- No-cooperation and Network Coding.

The effect of link-level feedback and retransmissions on the performance of *Cooperative Network Coding*, presented in the previous section, was analyzed in [39]. We found that by having retransmissions only in the last cluster (cluster K), the performance of *Cooperative*

Network Coding can be improved when the number of nodes per cluster is low ($m \approx n_i$ for $\forall i$).

The analysis considers that all the nodes in the last cluster retransmit.

In this section, a mathematical analysis of the energy required to code packets and the minimum number of coded packets that to be transmitted for Cooperative Network Coding is presented. Further, a mathematical analysis of the energy required to code packets through Cooperative Diversity Coding is studied and a comparison of these two techniques, in terms of energy required to code packet is presented.

The energy required to network code a packet, (2–28), is calculated as:

$$E_{NC} = mE_{LFSR} + \frac{L}{q}(mE_{MUL} + (m - 1)E_{ADD}) \quad (4-8)$$

where E_{LFSR} is the energy required to generate the random coefficients using linear feedback shift register (LFSR), L is the packet length in bits, E_{MUL} is the energy require to multiply a random coefficient and the packet (portion of the packet that depends on the Galois Field size) and E_{ADD} is the energy required to add the results of two multiplication processes. Since with Network Coding, all the packets are coded, the energy required for each node to code m' packets is:

$$E_{NODE_{NC}} = m'E_{NC} \quad (4-9)$$

$$E_{NODE_{NC}} = m' \left(mE_{LFSR} + \frac{L}{q}(mE_{MUL} + (m - 1)E_{ADD}) \right) \quad (4-10)$$

In Network Coding, the linear independency of the coded packets is a function of the field size. Thus, the expected number of transmitted packets until transmitting m linearly independent coded packets, when using *RLNC*, can be calculated as [67]:

$$M' = \sum_{l=1}^m \frac{1}{1 - \left(\frac{1}{2^q}\right)^l} \quad (4-11)$$

A typical field size is $GF(2^8)$, whose elements are $\{0, 1, \dots, 255\}$, because each element can be represented by one byte (8 bits). From (4-11), we can calculate the average probability p_l of the m' coded packets being linearly independent:

$$p_l = \frac{m}{m'} \quad (4-12)$$

In Table 4-1 we present the minimum number of transmitted coded packets, m' , needed to achieve m linearly independent packets for a field size equal to 8. Also, we calculate, p_l , the probability of linear independency of the transmitted combination packets. As we can see with *RLNC*, the source node needs to transmit a number of coded packets m' that is at least the smallest integer not less than M' .

$$m' = [M'] = \left\lceil \sum_{l=1}^m \frac{1}{1 - \left(\frac{1}{2^q}\right)^l} \right\rceil \quad (4-13)$$

Table 4-1 Minimum number of transmitted packets (M') and probability of linear independency of the transmitted packets

Metric	Minimum number of transmitted packets and probability of their linear independency			
	$m = 2$	$m = 5$	$m = 10$	$m = 20$
m'	3	6	11	21
p_l	99.8035%	99.9213%	99.9606%	99.9803%

Depending upon the degree of connectivity between the nodes in the first cluster and the source node, each node in cluster 1 can correctly receive, on average, up to $\frac{m r_s}{m}$ coded packets if there are no transmission losses or errors, where r_s is the number of nodes in cluster one that are connected to the source node (we assume that the r_s nodes connected to the source node are uniformly distributed for each transmission of a coded packet). When there are no losses or errors, all the packets are received. However, the total number of received packets

depends on the connectivity between the source node and the nodes in the first cluster. For example, if the connectivity r_s is 2, then only 2 out of the n_1 nodes in cluster 1 can receive each packet. However, because of the channel characteristics (probability of link error), some of coded packets may not be received or received with errors. By combining the received packets, each node in cluster 1 creates a new coded packet and transmits it to the next cluster. In general, node j in the cluster i creates and transmits to nodes in cluster $i + 1$ a coded packet from the received coded packets.

At the destination, the destination node needs to receive at least m linearly independent coded packets from nodes in cluster K to be able to recover the original information. Decoding could be done by block decoding or Gaussian elimination [19] applied to the matrix formed by the packets header to determine the original packets $\{x_l\}$.

In order to realize our goal of achieving minimal energy consumption, with the required level of reliability, we study the effect of the linear independency of the coded packets for multihop wireless networks and we propose a method to selectively retransmit coded packets from the last cluster where the combination packets have full rank. That is, since each node in a cluster transmits only one coded packet and all the nodes in a cluster cooperate to transmit linear independent coded packets, full rank in a cluster is achieved when at least m linear independent packets are transmitted from the n_i nodes in cluster i , where $m \leq n_i$. The nodes in cluster i cooperate by receiving coded packets from the previous cluster (cluster $i - 1$), combining those received packets and creating a new coded packet.

By using this selectivity of the retransmitted packets, we can minimize the average energy consumed by each node and the energy required by the source node to create and transmit combination packets. In case that the destination receives less than the minimum number of linearly independent coded packets, selective retransmission from the last cluster that has full rank (at least m linearly independent coded packets) can be made to avoid any retransmission

from the source node. This feature of *Cooperative Network Coding* is very useful for multihop networks.

When the destination node receives less than m linear independent packets, it sends a message to the previous clusters by using the initial route that was established between source and destination nodes before the transmission began. The nodes that are part of this route and were in charge of recruiting other nodes to create the clusters keep track of the number of linearly independent packets (rank) that were transmitted by the nodes in their own clusters. Thus, when the retransmission message from the destination node is received by the node in the last cluster with full rank (m linearly independent packets), this node forwards the retransmission request to the nodes in its cluster. Based on this retransmission request, the nodes in this cluster create a new coded packet and retransmit.

With the aim of further minimizing the energy consumed by the source due to coding operations; we also study the performance of cooperative Diversity Coding (CDC). Cooperative Diversity Coding [40] operates similarly as to Cooperative Network Coding, but the difference is in the method of how the source node chooses the coding coefficients. The source uses Diversity Coding [13], which is an efficient technique to code packets. For CNC, the source creates coded packets by randomly choosing the coding coefficients and for CDC, the source creates the protection packets by using known coefficients from the Vandermonde matrix. Note that the source node does not need to know the topology of the network because Diversity Coding is used only at the source node (to reduce the energy consumed by the source node to create the coded packets). The intermediate nodes use Network Coding to code the packets. By randomly choosing the coefficients, linearly independency of the combination packets is not guaranteed as we can see in Table 4-1. Moreover, the linearly independence of the coded packets depends on the Galois field size. The higher the field size the higher is the probability of linear independence of the combination packets; we can verify this using (4–11). On the other hand, by selecting known coefficients from a Vandermonde matrix, it is guaranteed that all coded packets will be linearly

independent at the source. Moreover, since the coefficients are known, the computational complexity is reduced because the Vandermonde matrix coefficients are stored in the sensor memory. Also, no extra circuitry is needed (e.g. shift registers) as is the case for RLNC. The simplicity of using Vandermonde matrix coefficients was implemented in Diversity Coding [13], a forerunner of Network Coding. With the aim of minimize the energy required to code the packets in multihop scenarios, the nodes could choose the coding coefficients from the Vandermonde matrix. However, the nodes need to keep track of the coding coefficients (a row from the Vandermonde matrix) to be able to properly decode the packets at the destination.

In Diversity Coding, the coding coefficients (β_{ij}) are calculated using (2-14). Thus, the source uses the β_{ij} coefficients to calculate the coded packets (2-13):

$$y_{sj} = \sum_{l=1}^m \beta_{jl} x_l \quad j \in \{1, 2, \dots, m'\} \quad (4-14)$$

Note that with CDC the coded packets lose their linear independency at the clusters, because the nodes in a cluster still use random Network Coding to create the new coded packets. The main advantage of CDC over CNC is that the source saves computation energy by creating coded packets using known coding coefficients (not random coefficients), which are stored in the node's memory. Also, with CDC, only the additional (protection) packets are coded and the original information is transmitted uncoded. That is, the energy required to code a packet using Diversity Coding is calculated as:

$$E_{DC} = \frac{L}{q} (mE_{MUL} + (m-1)E_{ADD}) \quad (4-15)$$

where L is the packet length in bits, E_{MUL} is the energy require to multiply a random coefficient and the packet (portion of the packet that depends on the Galois field size) and E_{ADD} is the energy required to add the results of two multiplication processes. Since with Diversity Coding, only the protection packets are coded, the energy required for the source node to code m' packets is:

$$E_{NODE_{DC}} = (m' - m)E_{DC} \quad (4-16)$$

$$E_{NODE_{DC}} = (m' - m) \frac{L}{q} (mE_{MUL} + (m - 1)E_{ADD}) \quad (4-17)$$

As we can see from equations (4-10) and (4-17), the source node requires less energy when using Diversity Coding to create coded packets ($E_{SOURCE_{DC}}$). That is given in (4-18):

$$E_{SOURCE_{DC}} = E_{SOURCE_{NC}} - m'mE_{LFSR} - m \frac{L}{q} (mE_{MUL} + (m - 1)E_{ADD}) \quad (4-18)$$

where the second term on the right hand side of (4-18) is the energy savings for using known coding coefficients and the third term on the right hand side of (4-18) is the energy savings achieved for coding only the protection packets.

We can express the total number of transmitted packets in the network with CDC or CNC as:

$$E_{TOTAL} = m' + \prod_{i=1}^K n_i \quad (4-19)$$

4.4 Simulation Scenario for Wireless *Ad hoc* Networks

In this section, we present the results for Cooperative Network Coding with a retransmission for all the nodes in the last cluster and simulation results and a statistical analysis of the simulations for Cooperative Network Coding and Cooperative Diversity Coding with retransmission from the last cluster that has full rank (at least m linearly independent packets) with the aim of minimizing the energy required to transmit a block of information by minimizing the number of transmitted packets.

The parameters for the analyses and simulations of Cooperative Network Coding and Cooperative Diversity Coding are similar to the parameters used in [22]:

- The number of original packets m is 10.
- All the clusters have the same number of nodes $n = n_i$

- The connectivity between node j in the cluster i and nodes in the cluster $i + 1$ is denoted as r_{ij} and, furthermore, $r = r_s = r_{ij}$.
- All the links have the same characteristics, i.e., $p = p_{(i,j)(i+1,l)}$, such that $1 \leq i \leq K - 1$, $1 \leq j \leq n_i$, and $1 \leq l \leq n_{i+1}$. This assumption may be unrealistic but it simplifies the study.

4.4.1 Cooperative Network Coding with Retransmission from the Last Cluster

In our evaluations, we compared the probability of successful reception of Cooperative Network Coding with and without link-level retransmission. Cooperative Network Coding with link-level retransmission is evaluated considering the number of original packets $m = 10$, (as in [22]), the cluster size n of up to 20 nodes per cluster and there are 3 clusters between the source and destination nodes ($K = 3$). In particular, we assumed that the probabilities of error of all the links are equal.

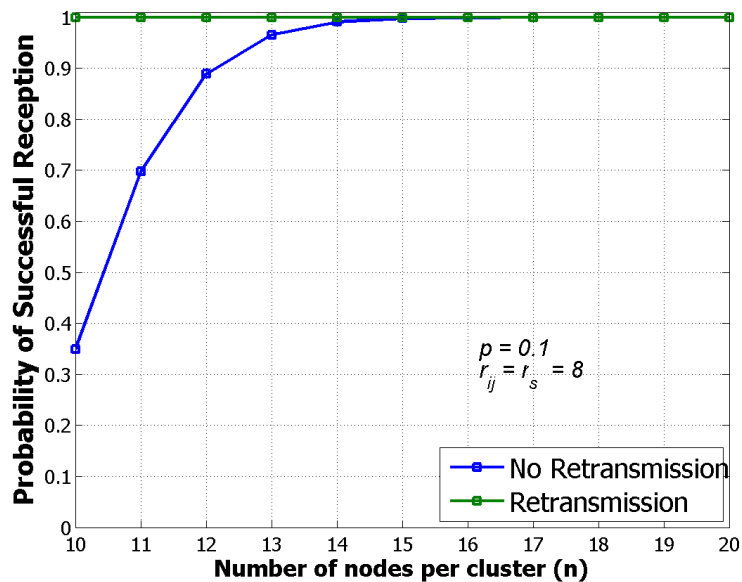

Figure 4.7 Probability of successful reception P_s vs. number of nodes n in a cluster for $p = 0.1$

As we can see in Figure 4.7 and Figure 4.8, Cooperative Network Coding with link-level retransmission implemented between the last cluster (the K^{th} cluster) and the destination node has better performance than Cooperative Network Coding without link-level retransmission. This

is intuitively clear, since the destination node can receive more coded packets with link-level retransmission.

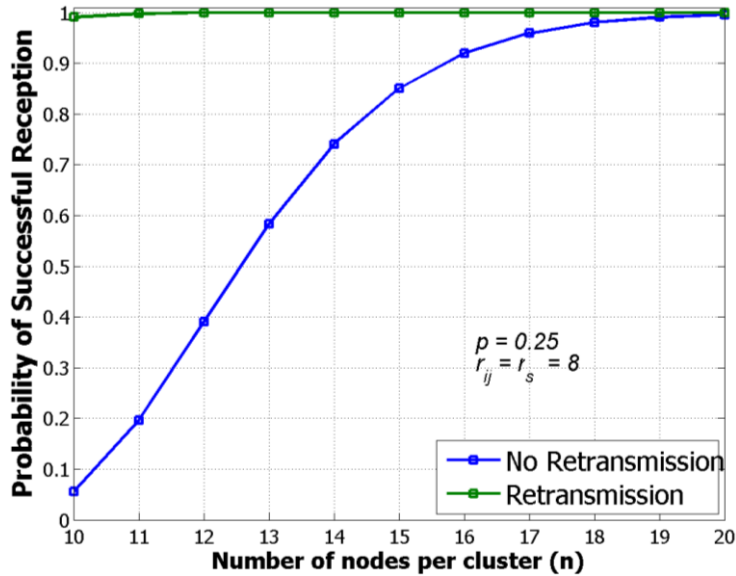

Figure 4.8 Probability of successful reception P_s vs. number of nodes n in a cluster for $p = 0.25$

4.4.2 Cooperative Diversity Coding and Cooperative Network Coding Optimization - Minimizing Energy Consumption

In this chapter, more precisely in section 4.3, we proposed a method to minimize the energy consumption for Cooperative Network Coding and Cooperative Diversity Coding systems. We have simulated the effect of different parameters, such as: number of coded packets, coding coefficients at the source by using random coefficients or Vandermonde matrix coefficients, linear independency of the packets at each cluster (rank) to minimize the average energy consumed by the network while optimizing the network's performance.

The results presented in the figures and tables below were obtained through simulations by running 1,000 experiments. An experiment is considered successful when the sink was able to decode the information from the source. Additionally, we assumed that the network consists of 20 clusters ($K = 20$). Also, we assumed that the probability of link error is the same for all the links. Note that the probability of link error depends on the transmission power, channel conditions,

modulation scheme, packet length, among other factors. We performed the Network Coding operations over a Galois field $GF(2^8)$ with packets size of 100 bytes.

As shown in Figure 4.9, the source needs to transmit at least $m + 1$ combination packets otherwise the source needs to make a retransmission with very high probability. This is because the links between the source and the nodes in the first cluster are error prone. In other words, when the number of combination packets is equal to the number of information packets, regardless of the connectivity among the nodes and the probability of link error ($p_{(s)(1,j)} \neq 0$), it is not possible to have full rank (at least m linearly independent packets) with high probability in the first cluster.

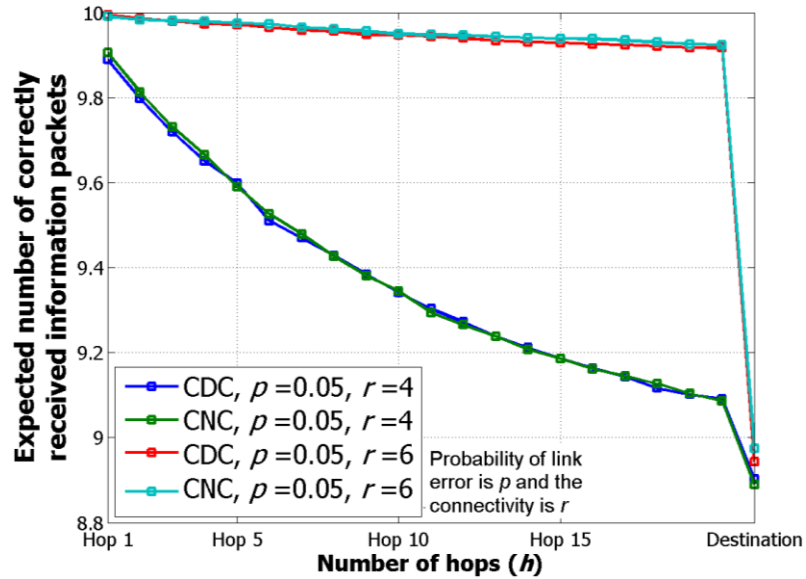

Figure 4.9 CNC and CDC performance for probability of link error equal to p , connectivity equal to r and $m = m' = 10$ coded packets

Table 4-2 and Table 4-3 show the linear independency of the packets at each cluster for CNC and CDC for different connectivity parameters and probability of link error of 0.10, given that the source node transmitted 11 combination packets. Based on the statistical analysis, we can see that there is, on average, no need for a retransmission from the source node because clusters 4 and 11, respectively, have full rank and the retransmission can be made from those clusters.

Table 4-2 CNC performance for probability of link error of 0.10, connectivity among the nodes equal to 6, and 11 combination packets

		Descriptive Statistics											
		hop 1	hop 2	hop 3	hop 4	hop 5	hop 6	...	hop 17	hop 18	hop 19	hop 20	Destination
N	Statistic	1000	1000	1000	1000	1000	1000	...	1000	1000	1000	1000	1000
Range	Statistic	0	0	0	0	1	1	...	1	1	1	1	5
Minimum	Statistic	10	10	10	10	9	9	...	9	9	9	9	5
Maximum	Statistic	10	10	10	10	10	10	...	10	10	10	10	10
Mean	Statistic	10.00	10.00	10.00	10.00	10.00	10.00	...	10.00	10.00	10.00	10.00	9.54
	Std. Error	.000	.000	.000	.000	.001	.001001	.001	.001	.001	0.025
Std. Deviation	Statistic	.000	.000	.000	.000	.032	.032032	.032	.032	.032	0.798
	Variance	.000	.000	.000	.000	.001	.001001	.001	.001	.001	0.637
Skewness	Statistic	-.31.623	-.31.623	...	-.31.623	-.31.623	-.31.623	-.31.623	-1.884
	Std. Error077	.077077	.077	.077	.077	0.077

Table 4-3 CDC performance for probability of link error of 0.10, connectivity among the nodes equal to 8, and 11 combination packets

		Descriptive Statistics											
		hop 1	hop 2	hop 3	...	hop 9	hop 10	hop 11	hop 12	...	hop 19	hop 20	Destination
N	Statistic	1000	1000	1000	...	1000	1000	1000	1000	...	1000	1000	1000
Range	Statistic	0	0	0	...	0	0	0	1	...	1	1	3
Minimum	Statistic	10	10	10	...	10	10	10	9	...	9	9	7
Maximum	Statistic	10	10	10	...	10	10	10	10	...	10	10	10
Mean	Statistic	10.00	10.00	10.00	...	10.00	10.00	10.00	10.00	...	10.00	10.00	9.60
	Std. Error	.000	.000	.000000	.000	.000	.001001	.001	.022
Std. Deviation	Statistic	.000	.000	.000000	.000	.000	.032032	.032	.696
	Variance	.000	.000	.000000	.000	.000	.001001	.001	.485
Skewness	Statistic	-.31.623	...	-.31.623	-.31.623	-1.730
	Std. Error077077	.077	.077

Figure 4.10 along with Table 4-4 and Table 4-5 show the most general case where full rank, that is at least m linearly independent correct packets, is achieved at a sufficient number of nodes including the last cluster, and a selective retransmission has to be made by the nodes in the last cluster for the destination to be able to decode the source's information. Figure 4.10 shows the expected number of information packets decoded at the destination as a function of the number of coded packets. As noted, the source node should transmit at least $m + 1$ coded packets to avoid retransmissions. Table 4-4 presents the results for Cooperative Network Coding given that the probability of link error is 0.10, the connectivity among the nodes is 8 and the number of combination packets transmitted by the source is 11. In the worst case 5 nodes in the last cluster need to retransmit a coded packet. A similar situation is shown in Table 4-5 but since the probability of link error is lower than in Table 4-4, only 2 nodes in the last cluster need to retransmit. Considering these two examples, we can see that only 11 coded packets should be

transmitted by each cluster (one coded packet per node) plus one retransmission (5 and 2 coded packets, respectively) from the last cluster (cluster 20) for the destination to be able to reliably decode the m original packets.

Moreover, all the tables (Table 4-2 – Table 4-5) show that the skewness, a measure of the asymmetry of a probability distribution, is negative, which means that most of the values of the probability distribution lie to the right of the mean. For example, in Table 4-4 and Table 4-5, the mean at the destination node is 9.88, which means that all the 10 original packets were recovered in an average of 98.8% of the simulations. Also, Table 4-4 and Table 4-5 show, through the skewness, that most of the values lie to the right of the 98.8%. In other words, the 10 original packets are recovered most of the time. This characteristic is omitted in mathematical analyses that consider only averages values.

Comparing with [22], where 15 combination packets should be transmitted to achieve full throughput, our approach, which selectively retransmits coded packets from the last cluster that has full rank (m linearly independent packets), reduces by 26% the energy consumed by the network. That is, the source node transmits 15 coded packets to the nodes in the first cluster. Then, the nodes in a cluster (15 nodes per cluster), transmits one coded packet to the nodes in the next cluster, and so on. So, we can calculate the number of transmitted packets to achieve full throughput at the destination by using (15), which is 315 packets for a 21-hop network. Using our approach, we only need to transmit 233 packets (Table 4-5) to achieve full throughput at the destination node. Moreover, since each node is receiving fewer packets, the energy required to create a new coded packet is reduced. In addition, as shown in (14), extra energy savings for the overall network are achieved when CDC is used at the source node.

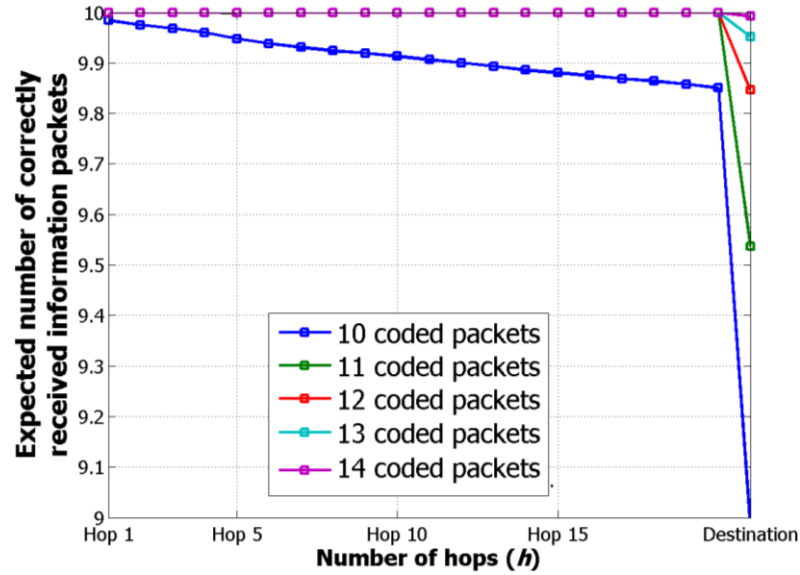

Figure 4.10 CNC performance for probability of link error equal to 0.10, connectivity equal to 6 and $m = 10$ original packets

Table 4-4 CNC performance for probability of link error of 0.05, connectivity among the nodes equal to 6, and 11 combination packets

		Descriptive Statistics											
		hop 1	hop 2	hop 3	...	hop 14	hop 15	hop 16	hop 17	hop 18	hop 19	hop 20	Destination
N	Statistic	1000	1000	1000	...	1000	1000	1000	1000	1000	1000	1000	1000
Range	Statistic	0	0	0	...	0	0	0	0	0	0	0	3
Minimum	Statistic	10	10	10	...	10	10	10	10	10	10	10	7
Maximum	Statistic	10	10	10	...	10	10	10	10	10	10	10	10
Mean	Statistic	10.00	10.00	10.00	...	10.00	10.00	10.00	10.00	10.00	10.00	10.00	9.88
	Std. Error	.000	.000	.000000	.000	.000	.000	.000	.000	.000	.012
Std. Deviation	Statistic	.000	.000	.000000	.000	.000	.000	.000	.000	.000	.394
Variance	Statistic	.000	.000	.000000	.000	.000	.000	.000	.000	.000	.155
Skewness	Statistic	-3.794
	Std. Error077

Table 4-5 CDC performance for probability of link error of 0.05, connectivity among the nodes equal to 6, and 11 combination packets

		Descriptive Statistics											
		hop 1	hop 2	hop 3	...	hop 14	hop 15	hop 16	hop 17	hop 18	hop 19	hop 20	Destination
N	Statistic	1000	1000	1000	...	1000	1000	1000	1000	1000	1000	1000	1000
Range	Statistic	0	0	0	...	0	0	0	0	0	0	0	2
Minimum	Statistic	10	10	10	...	10	10	10	10	10	10	10	8
Maximum	Statistic	10	10	10	...	10	10	10	10	10	10	10	10
Mean	Statistic	10.00	10.00	10.00	...	10.00	10.00	10.00	10.00	10.00	10.00	10.00	9.88
	Std. Error	.000	.000	.000000	.000	.000	.000	.000	.000	.000	.012
Std. Deviation	Statistic	.000	.000	.000000	.000	.000	.000	.000	.000	.000	.368
Variance	Statistic	.000	.000	.000000	.000	.000	.000	.000	.000	.000	.135
Skewness	Statistic	-3.298
	Std. Error077

Figure 4.11 shows the performance of CNC and CDC vs. the number of nodes per cluster. As it was expected, the performance of these two approaches increases when the number of nodes per cluster increases because there are more nodes in each cluster transmitting combination packets. However, increasing the number of nodes per cluster is not a preferred option because of the extra energy that is spent by the entire network. A better option is to retransmit from the last cluster, where the system still has full rank (linear independency of the combination packets).

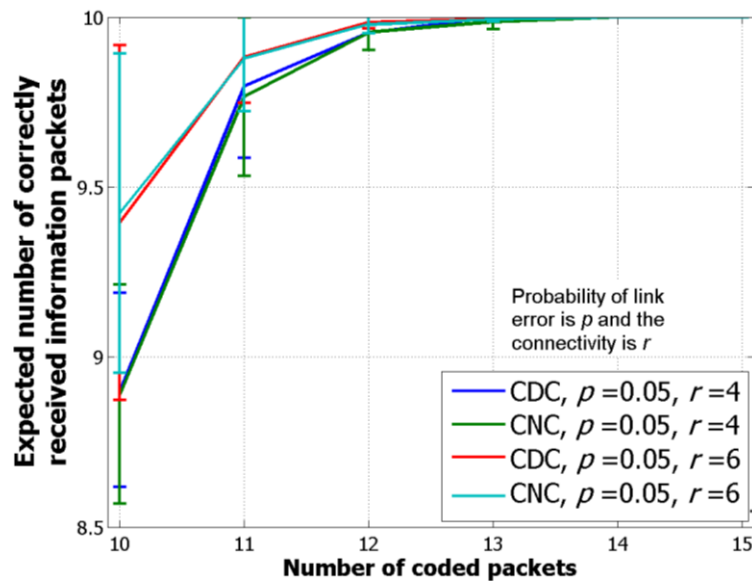

Figure 4.11 CNC and CDC performance vs. the number of nodes per cluster for probability of link error equal to 0.05, connectivity equal to r and $m = 10$ original packets

We determined the full rank of the coding coefficients (linear independency among the packets) is lost in the first hop about ~98.5% - 99.9% of the time, depending on the connectivity among the nodes, the number of nodes per cluster, and the probability of link error. However, for 10 original data packets, and independently of the number of hops and the connectivity among the nodes, the probability of successful reception at destination is essentially unity when 14 and 16 coded packets are transmitted for a probability of link error of 0.05 and 0.10, respectively. That is, a coding overhead of 40% for a probability of link transmission loss of 0.05 and 60% coding overhead for a probability of link transmission loss 0.10 will achieve full throughput. However,

with the aim of minimizing the energy consumed by the nodes in transmitting coded packets, the source need only transmit about 10% - 30% coded packets and utilize retransmission by the nodes in the last cluster that has full rank (100% linear independency among the packets) to minimize energy utilization. Our statistical analysis has shown that most of the retransmissions are only required at the last cluster. In this way we optimize the energy consumed by each node and minimize the energy consumed by the source node. Moreover, we minimize the delay introduced by the retransmissions because no retransmission is done from the source node.

Since these are random events, minimum energy consumption can be achieved in practice by the nodes listening to the transmitted coded packets from their own cluster and calculating the rank of the system. Note that the nodes that form a cluster are geographically close to each other and they can hear each other's packets with high probability. For example, if there are n nodes in cluster i and assuming that the node 1 transmits first and node n transmits last, node 2 can check whether its coded packet is linear independent with the coded packet already transmitted by node 1. If the packet is not linearly independent, node 2 can discard that packet and create a new coded packet and transmit it. Then node 3 creates a coded packet from the received packets and checks whether this packet is linearly independent with the previous transmitted packets (packet from node 1 and 2). If its packet is not linearly independent, it creates a new coded packet and transmits it. This process continues until node n creates its own packet from the coded packets received from the previous cluster and checks the rank of the packets already transmitted by the other $n - 1$ nodes and its own packet. If there are not enough linearly independent packets (i.e. less than m linearly independent packets), node n requests retransmission from the nodes in the previous cluster (cluster $i - 1$).

In summary the above approach of selective retransmissions will minimize both the energy consumed by the network and the delay, while achieving the desired throughput.

4.5 Concluding Remarks

4.5.1 Cooperative Network Coding with Retransmissions

Our study in this chapter focused on analyzing the effect of link-level retransmission on the performance of Cooperative Network Coding [39]. Based on the range of parameters we have investigated, Cooperative Networking with link-level retransmission offers significant performance improvement in sparse wireless sensor networks, that is when the cluster size n and the connectivity of the network r are small.

By implementing link-level retransmission in Cooperative Networking, the probability of successful reception P_s can be increased from 0.05 without link-level retransmissions to close to 1 with link-level retransmissions, when the number of nodes per cluster n is equal to the number of original packets m ($n = m = 10$) and the probability of link error p is 0.25.

For cluster sizes n of less than 15 nodes per cluster and the connectivity of nodes r less than 8, link-level retransmissions offers a significant improvement in the probability of successful reception P_s from values in the range (0.05 to 0.35) with no link-level retransmissions, to values greater than 0.95 with link-level retransmissions.

Moreover, when not all the nodes in the cluster K are connected to the destination node, link-layer retransmission can help to increase the network's performance without increasing the cluster size.

Also, we observe that link-layer retransmissions on other than the last hop will not produce significant improvement in the performance of Cooperative Networking, since the probability that a node in the cluster K correctly receives at least one combination packet, V_K , is already close to 1. In fact, implementation of link-layer retransmissions on other than the last hop would be counter-productive, because of the unnecessary consumption of network resources and the introduction of extraneous traffic in the network.

In conclusion, Cooperative Networking with link-level retransmission results in larger probability of successful reception together with increased throughput when there are small clusters, when the connectivity of the network is small ($n \leq 15, r \leq 6$), and when the probability of link error is large ($p \geq 0.2$). These conditions are representative sparse sensor networks.

4.5.2 Cooperative Diversity Coding and Cooperative Network Coding Optimization - Minimizing Energy Consumption

Our approach of selective retransmissions [40] minimizes the energy consumed by multihop wireless packet networks that use Cooperative Network Coding (CNC) or a novel variant Cooperative Diversity Coding (CDC). By optimizing and balancing the use of forward error control, error detection, and retransmissions at packet level in such networks we can both minimize the energy consumption and network latency.

The energy savings obtained by using our approaches (CNC and CDC) are about 26% compared to the baseline CNC approach. Our approaches attain energy savings by making selective retransmissions from the last cluster that has full rank (at least m' linear independent packets), which is typically the last cluster. Further, our CDC approach further reduces the energy and complexity of the source node to create coded packets.

CHAPTER 5. IMPROVING THE PERFORMANCE OF SINGLE SOURCE – SINGLE DESTINATION WIRELESS BODY AREA NETWORKS VIA COOPERATIVE NETWORK CODING

5.1 Introduction and Motivation

As it was described in CHAPTER 1, a wireless body area network (WBAN) is a communication network formed by a collection of low-power devices, such as wireless sensors, that are located on, in or around the human body and are used to monitor physiological signals and motion for medical, personal entertainment and other applications [7]. Recently, WBANs have attracted attention for healthcare applications since it is now possible to monitor several vital physiological signs such as blood pressure, glucose level, and pulse oximetry (the oxygen saturation of arterial blood) among others, without restricting patient's mobility. Moreover, *in vivo* real-time monitoring, such as capsule endoscopy and video/medical imaging [6], can be performed. An example of *in vivo* real-time monitoring is the Miniature Anchored Robotic Videoscope for Expedited Laparoscopy (MARVEL) platform (Figure 5.1) that, with its camera module (CM), wirelessly transmits high definition (HD) video [38].

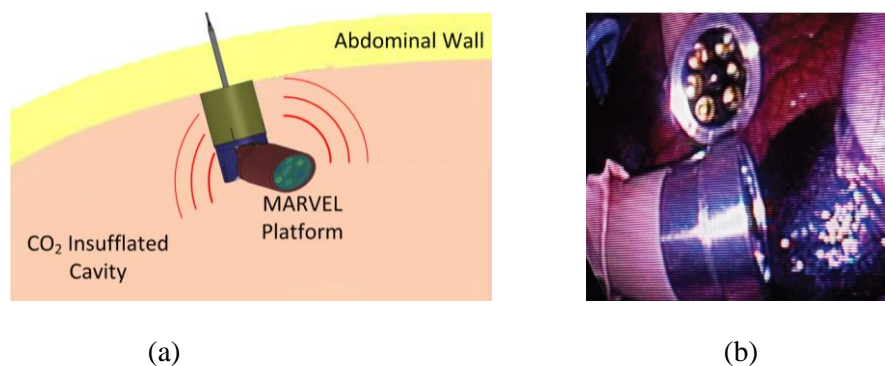

Figure 5.1 (a) Placement of the MARVEL Camera Module in the abdominal wall, and (b) Two MARVEL CMs are inside of a porcine abdominal cavity [38]

These time-sensitive applications generally use a two-hop topology (Implanted node – Body surface node – External node) [68], as shown in Figure 5.3, and for some (real-time) applications, such as video, retransmissions are generally not possible and the reliability of the of communications is generally not possible or preferred. Moreover, the throughput is often reduced because the tissues and organs within the human body affect the signal propagation from the *in vivo* sensor to the destination/gateway [69]. Hao and Foster [27] reviewed wireless body sensor networks for health-monitoring applications. Besides describing the different technologies used in body area networks, the authors included the hardware architecture of a body sensor transceiver and also included in their work measurements of electric field distribution inside and outside a human body.

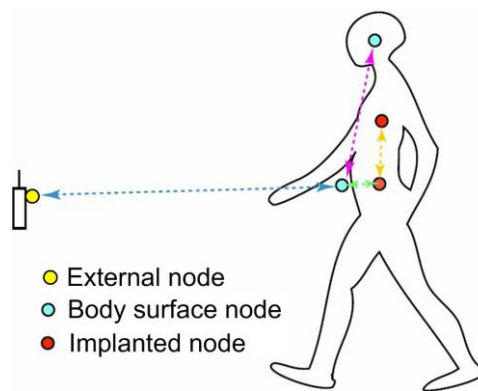

Figure 5.2 Possible communication links for body area networking [68], © 2010 IEEE

In [6] and [29], the authors surveyed enabling technologies for wireless body area networks and discussed the characteristics that distinguish body area networks from wireless sensor networks, i.e. architecture, density, data rate, latency and mobility. Two main applications of wireless body area networks were analyzed: healthcare, where the body area network monitors vital signals, and human-computer interaction and entertainment where the keyboard, mouse, and touch screen are replaced by wireless body area network devices that are capable of recognizing human movements, activities and actions.

In this chapter, we apply Cooperative Network Coding to design Wireless Body Area Networks for increased reliability and probability of successful reception at the destination improvement, while avoiding single points of failure. This approach expand upon the analysis done in [22] and [39], presented in the previous chapters, and provides higher reliability compared to other schemes, since it is highly probable that, due to the spatial diversity of routes/paths, the destination receives a sufficient number of packets to be able to decode the original information. Consequently, Cooperative Network Coding offers robust protection against failures of links and/or nodes.

5.2 Literature Review

Due to the importance of the data that are acquired by the sensors, particularly for real-time applications, it is important that WBANs provide high reliability by avoiding single points of node or link failures. In this chapter, we apply the *Cooperative Network Coding* (CNC) model presented in CHAPTER 3 and [22], and consider the situation where the source (e.g. implant node) transmits coded packets to a cluster of a few relay nodes (e.g. body surface nodes) that either create new coded packets from the received packets and transmit them to the destination node or just forward to the destination the correctly received packets, and the destination (e.g. external node) decodes the information. The relays act as multiple-input-multiple-output (MIMO [70]) nodes, to increase the network's reliability while providing increased throughput.

There are a few papers where Network Coding is applied to WBANs. In [71] and [72], the sources transmit uncoded packets to two relays. The relays (body surface nodes) XOR some of the received packets in groups of two packets and forward the coded packets to the monitoring station (external node). The rest of the received packets are forwarded uncoded to the monitoring station, Figure 5.3 and Figure 5.4. In these approaches other sensors also transmit information, and the relays can combine packets from different sources and take advantage of Network Coding. If the other sensors are not transmitting, the source's packet is transmitted uncoded from the relays to the destination to avoid significant delays by waiting for packets from other

sources/sensors to arrive and network code them. Our approach improves reliability by using Network Coding (by combining packets from the same source) to protect all packets from the source to the destination. Moreover, in our approach the sensors operate independently of each other and a MAC protocol schedules transmissions to avoid/minimize collisions.

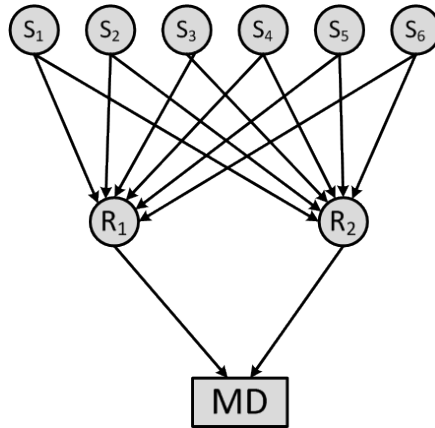

Figure 5.3 Network topology in [71]

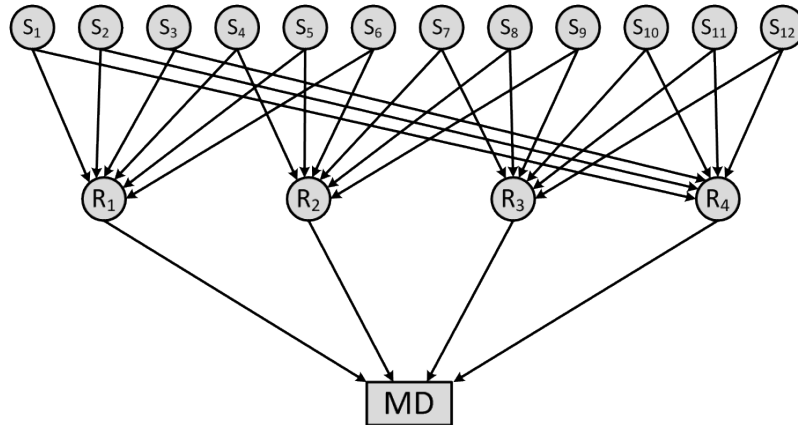

Figure 5.4 Network topology in [72]

5.3 Extant Wireless Body Area Networks

Extant wireless body area networks do not take advantage of either cooperation or Network Coding, as shown in Figure 5.2. However, they can use well-known channel coding techniques such as convolutional codes [11], Reed-Solomon codes [12] or other channel coding technique [10] along with interleaving with the aim that the number of errors per transmission is at most equal to the error correction capability of the channel coding technique.

We first consider the wireless body area networking topology proposed by the IEEE-802.15 TG6 [68], where there is only one relay transmitting coded packets to the destination from the source node, and for comparison purposes no channel coding techniques will be included in this study to analyze any of the techniques presented throughout this chapter. However, channel coding will improve all approaches and is synergistic with Cooperative Network Coding. Therefore, assuming independent errors, the probability P_{SR} that an information packet transmitted from the source (S) to the relay is lost is given by:

$$P_{SR} = 1 - (1 - p_{b_{SR}})^L \quad (5-1)$$

where $p_{b_{SR}}$ is the average bit error probability of the link between the source and the relay, and L is the packet length in bits. In general, the average bit error probability p_b for $M - PSK$ and $M - QAM$ in an additive white Gaussian noise (AWGN) channel can be calculated using (5-2) or (5-3), which were also presented in (3-8) and (3-9) [64], respectively

$$p_{b_{M-PSK}} \cong \frac{2}{\max(\log_2 M, 2)} \sum_{i=1}^{\max(\frac{M}{4}, 1)} Q \left(\sqrt{\frac{2E_b \log_2 M}{N_0}} \sin \frac{(2i-1)\pi}{M} \right) \quad (5-2)$$

$$p_{b_{M-QAM}} \cong 4 \left(\frac{\sqrt{M} - 1}{\sqrt{M} \log_2 M} \right) \sum_{i=1}^{\sqrt{M}/2} Q \left((2i-1) \sqrt{\frac{3E_b \log_2 M}{N_0(M-1)}} \right) \quad (5-3)$$

where M is the modulation order and E_b/N_0 is the energy per bit to noise power spectral density ratio.

The probability P_{RD} that a coded packet transmitted from the relay (R) to the destination is lost is calculated using (5-1):

$$P_{RD} = 1 - (1 - p_{b_{RD}})^L \quad (5-4)$$

where $p_{b_{RD}}$ is the average bit error probability of the link between the relay and the destination and, as it was mentioned before, is calculated using (5-2) or (5-3).

Thus, the probability of successful reception at the destination is given by:

$$P_S = (1 - P_{SR})(1 - P_{RD}) \quad (5-5)$$

$$P_S = (1 - p_{b_{SR}})^L (1 - p_{b_{RD}})^L \quad (5-6)$$

When the network uses several relays to transmit the source information towards the destination (cooperative communication [73]), the probability of successful reception at the destination improves and is given by:

$$P_S = 1 - \prod_{i=1}^K (1 - P_{SR_i})(1 - P_{R_iD}) \quad (5-7)$$

where K is the total number of relays that help to forward the information towards the destination.

5.4 Network Coding in Wireless Body Area Networks

In this section, we study the effects of Network Coding in the wireless body area networking topology proposed by the IEEE-802.15 TG6 [68], where there is only one relay transmitting coded packets to the destination from the source node. First, the source node creates m' coded packets from a block of information of m packets using (2-28). Then, the relay can receive up to m' error-free packets. However, because of the channel impairments, errors are introduced in the packets. The relay, with the help of a cyclic redundancy check (CRC) algorithm, determines which packets are error free, and forwards to the destination only the correctly received coded packets. The probability P_{SR} that a coded packet transmitted from the source (S) to the relay is lost is given by (5-1):

$$P_{SR} = 1 - (1 - p_{b_{SR}})^L \quad (5-8)$$

where $p_{b_{SR}}$ is the average bit error probability of the link between the source and the relay, and can be calculated using (5-2) or (5-3). L is the packet length in bits, including the header with the Network Coding coefficients.

The probability P_{RD} that a coded packet transmitted from the relay (R) to the destination is lost is calculated using (5-1):

$$P_{RD} = 1 - (1 - p_{b_{RD}})^L \quad (5-9)$$

where $p_{b_{RD}}$ is the average bit error probability of the link between the relay and the destination and is calculated using (5-2) or (5-3), and L is the packet length in bits, including the header with the Network Coding coefficients.

At the destination, the probability that the destination node receives at least m linear independent packets (probability of successfully decoding the block of information, P_S) depends on the operations performed at the relay. That is, if the relay just forwards the correctly received packets, the probability of successful reception at the destination, P_S , is given by:

$$P_S = P(x \geq m) \quad (5-10)$$

$$P_S = \sum_{t=m}^{m'} \binom{m'}{t} [(1 - P_{SR})(1 - P_{RD})]^t [1 - (1 - P_{SR})(1 - P_{RD})]^{m'-t} \quad (5-11)$$

However, if the relay creates new coded packets from the correctly received packets, the relay can create as many linear independent coded packets as the number of correctly received linear independent coded packets the probability of successful reception at the destination, P_S , is given by:

$$P_S = P(x \geq m) \quad (5-12)$$

$$P_S = \sum_{t=m}^i \binom{i}{t} (1 - P_{RD})^t P_{RD}^{i-t} \binom{m'}{i} (1 - P_{SR})^i P_{SR}^{m'-i} \quad (5-13)$$

In the following section, we discuss using Cooperative Network Coding to improve the reliability of WBANs in the presence of node or links failures.

5.5 Cooperative Network Coding in Wireless Body Area Networks Model

Cooperative Network Coding was originally presented as a one source – multiple clusters of many relays – one destination model [22]. In this chapter, we consider CNC for one source, a

single cluster of a few relays, and one destination, as is the case of the proposed communication links for wireless body area networks where the sensors transmit their information through two hops to a receiving device (destination) via relays [68].

Figure 5.5 shows a general scheme of Cooperative Network Coding where several sensors/sources transmit information to the destination via 2 relays. In this model, we avoid single points of failure by having multiple relays and thus, multiple paths for the information to reach the destination. The sensors have access to the wireless medium via a MAC protocol, such as TDMA (time division multiple access) or RTS/CTS (Request to Send/Clear to Send), that assigns one or many timeslots for transmitting to each sensor.

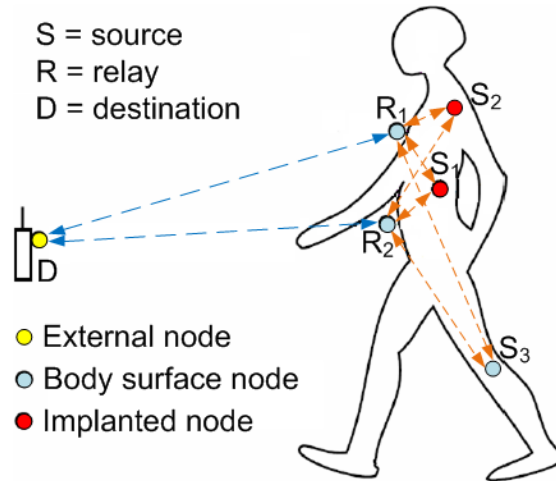

Figure 5.5 Cooperative Network Coding for wireless body area network

5.5.1 Network Coding at the Source Node

By using the encoding of (2–28), each source creates m' coded packets from a block of information (m packets) and transmits those coded packets to the relays. The probability P_{SR_j} that a coded packet transmitted from the source (S) to relay j (R_j) is lost is given by (5–1):

$$P_{SR_j} = 1 - \left(1 - p_{b_{SR_j}}\right)^L, \quad j \in \{1, 2, 3, \dots, K\} \quad (5-14)$$

where $p_{b_{SR_j}}$ is the average bit error probability of the link between source and relay j , and L is the packet length in bits, including the coding coefficients that are embedded in the

packet's header. The average bit error probability p_b is calculated using (5-2) or (5-3), depending on the modulation technique. The number of relays (j) should be kept low because of practical and physical constraints.

5.5.2 Operations at the Relay Nodes

The relays act as MIMO (Multiple-Input-Multiple-Output) devices by receiving multiple coded packets from the source and transmitting multiple coded packets to the destination. From the received packets, the relay nodes check the cyclic redundancy check (CRC) of each packet and, as it was mentioned in the previous section, can either:

- Forward to the destination only the packets that have no errors, or
- Create new combination packets from the received packets using (3-10) and transmit those new coded packets to the destination.

The probability $P_{R_j,D}$ that a coded packet transmitted from relay j to the destination (D) is lost is calculated the same way as in (5-4).

When the relays only forward the correctly received coded packets (Option 1), the probability P_{C_j} that the destination node correctly receives a coded packet through relay j is calculated as:

$$P_{C_j} = (1 - p_{b_{SR_j}})(1 - p_{b_{R_j,D}}), \quad j \in \{1, 2, \dots, K\} \quad (5-15)$$

5.5.3 Operations at the Destination Node

Successful reception occurs if at least m linear independent coded packets are received by the destination. Thus, the probability of successful reception P_S at the destination is given by:

$$P_S = 1 - \left[\sum_{i+j=0}^{m-1} P\{x = i, y = j\} + \sum_{\substack{i+j \geq m \\ i, j < m \\ \text{rank}(\text{header}) < m}} P\{x = i, y = j\} \right] \quad (5-16)$$

where $P\{x = i, y = j\}$ is a bivariate binomial distribution and is given by [74]:

$$P\{x = i, y = j\} = \sum_{k=\max(0, i+j-m')}^{\min(i, j)} \frac{m!}{k!(i-k)!(j-k)!(m'-i-j+k)!} \pi_{11}^k \pi_{12}^{i-k} \pi_{21}^{j-k} \pi_{22}^{m'-i-j+k} \quad (5-17)$$

and

$$\pi_{11} = P_{C_1} P_{C_2} \quad (5-18)$$

$$\pi_{12} = P_{C_1} (1 - P_{C_2}) \quad (5-19)$$

$$\pi_{21} = (1 - P_{C_1}) P_{C_2} \quad (5-20)$$

$$\pi_{22} = (1 - P_{C_1})(1 - P_{C_2}) \quad (5-21)$$

The probability of successful reception P_S at the destination is a function of the number of received linear independent packets given that the relays, combined, receive at least m linear independent packets. The expected number of correctly received information (original) packets is calculated as the product of the number of original packets and the probability of successful reception at the destination,

$$\mathbb{E} = m \cdot P_S \quad (5-22)$$

When there are multiple relay nodes forwarding multiple coded packets (e.g. K relays, $K > 2$), the probability of successful reception P_S at the destination can be characterized as a K -multinomial distribution [75]. However, if there are K relays ($K \geq m$) transmitting only one coded packet towards the destination, the probability of successful reception can be mathematically characterized using (3-17) [39].

We present, in the following section, the evaluation and simulation results for a range of parameters for the network, such as: number of coded packets, number of relays, modulation scheme, and energy per bit to noise power spectral density ratio.

5.6 Simulation Results and Discussion

In this section, we discuss the performance of a WBAN that uses CNC to realize a highly reliable network which provides high probability of successful reception at the destination and

avoids single points of failure compared to extant wireless body area technologies that do not take advantage of cooperation and/or Network Coding. We have analyzed the effect of different parameters, such as: number of coded packets, number of cooperative relays, modulation technique and average energy per bit, to optimize the network's probability of successful reception of a message (block of information) at the destination. Moreover, we have compared our approach [CNC] to existing WBANs that do not use cooperation or Network Coding ("uncoded" system [U]), to WBANs that use cooperation but not Network Coding [UC], and to WBANs that use Network Coding but not cooperation [NC]. [U] and [UC] systems were described in section 5.3 and the [NC] system was presented in section 5.4.

The results presented below were obtained through simulations with the MATLAB communications toolbox (modulation, channel, and Galois field operations) by running 1,000 experiments and averaging the results. With CNC or NC, successful transmission occurs when the destination receives a sufficient number of correct packets to be able to successfully decode the information from the source. Additionally, we assumed that the source has a block of information of 10 packets, the energy per bit to noise power spectral density ratio is the same for all the links and the channel is additive white Gaussian noise (AWGN). We performed the Network Coding operations over a Galois field $GF(2^8)$ with packets size of 100 bytes. The packets include cyclic redundancy check (CRC) so the receiver can detect which packets have been correctly received and discard the packets that have errors. For CNC and NC, the packet length is 110 bytes, which includes: data, Network Coding random coefficients (1 byte per original packet) and CRC. No bit error correction capability (channel coding) has been used in the packets. Note that the probability of link error will decrease when an error correction technique at bit level is used. Also note that if we use FEC at bit level, we would be "over protecting" the system, in the sense that we would be using double error correction. Thus, the effective throughput will be considerably reduced.

First, we start validating our mathematical analysis by comparing it with our simulation results. As we can see in Figure 5.6, Figure 5.7, and Figure 5.8, our analysis closely matches with the simulation results for all four systems (U, UC, NC, and CNC).

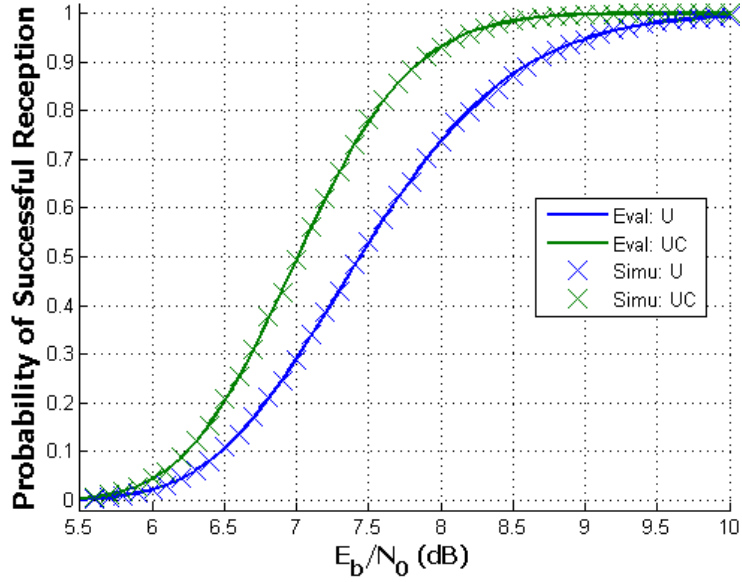

Figure 5.6 Probability of successful reception as a function of the E_b/N_0 for U and UC systems with modulation 4-PSK

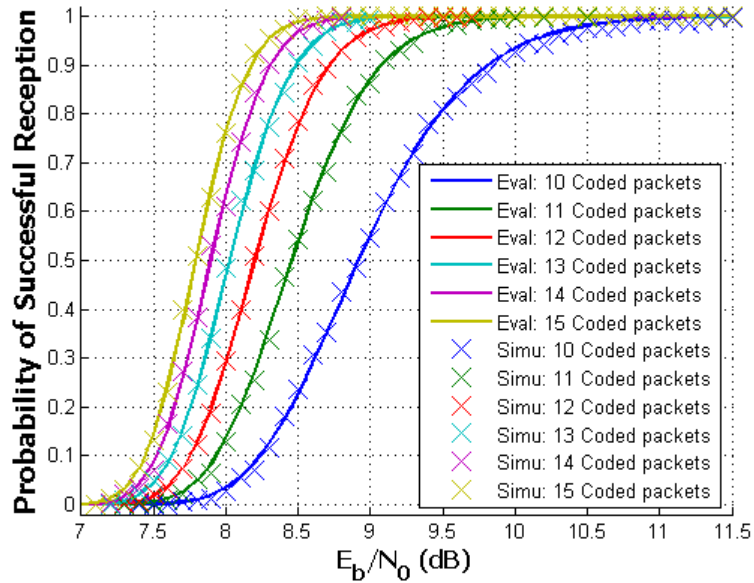

Figure 5.7 Probability of successful reception as a function of the E_b/N_0 for NC systems with modulation 4-PSK

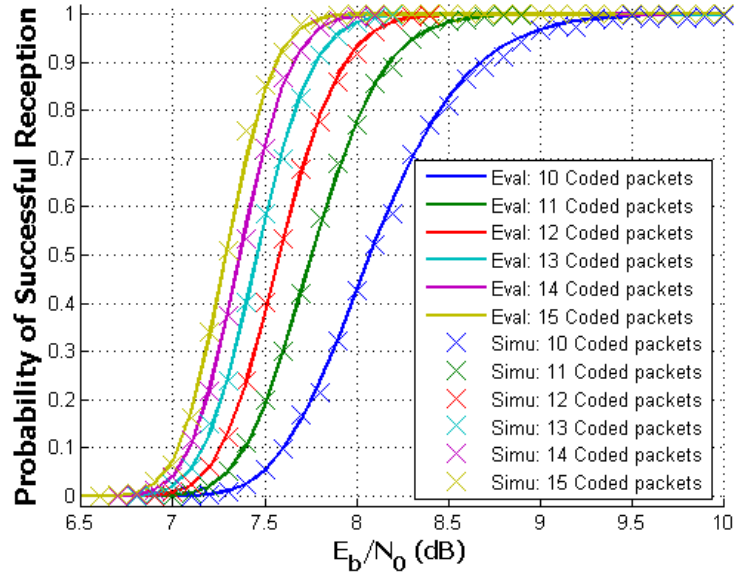

Figure 5.8 Probability of successful reception as a function of the E_b/N_0 for CNC systems with modulation 4-PSK

Probability of successful reception at the destination as a function of the E_b/N_0 for a cooperative uncoded system [UC] (m packets) and Cooperative Network Coding [CNC] for different number of coded packets (m') is shown in Figure 5.9 and Figure 5.10. As shown, a cooperative uncoded system [UC] of m packets outperforms the Cooperative Network Coding system of m coded packets independently of the E_b/N_0 and the modulation scheme. This should be intuitively clear since any errors will render the networking coding ineffective because at least m coded packets has to be received for the destination be able to decode the entire message. If less than m coded packets are received, those packets are wasted because it is not possible to recover any information from them, unless a retransmission is scheduled. This characteristic also holds when comparing non-cooperative uncoded [U] and Network Coding [NC] systems. Thus, the Cooperative Network Coding approach should always transmit at least $m + 1$ coded packets to have better performance than an uncoded [U] system. Also, note that Figure 5.10 is similar to Figure 5.9 but shifted to the right because of the performance of the modulation scheme (16-QAM and 4-PSK, respectively).

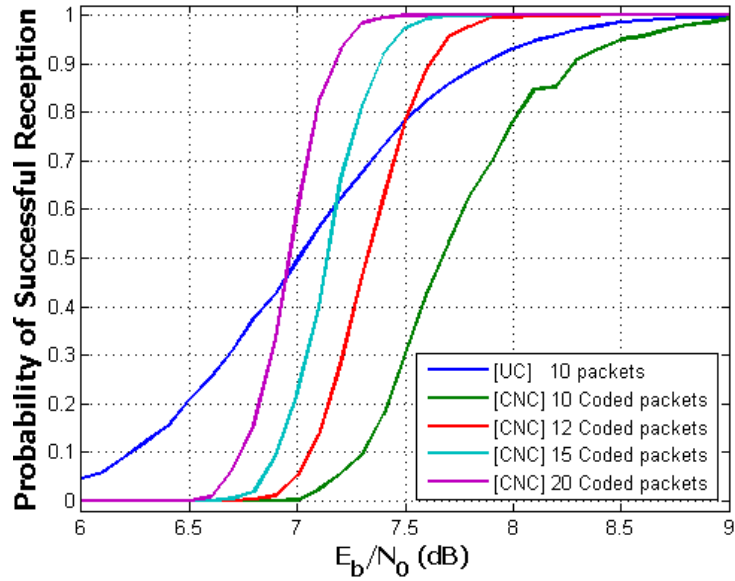

Figure 5.9 Probability of successful reception at the destination as a function of the E_b/N_0 for UC ($m = 10$) and for CNC with different number of coded packets with modulation 4-PSK

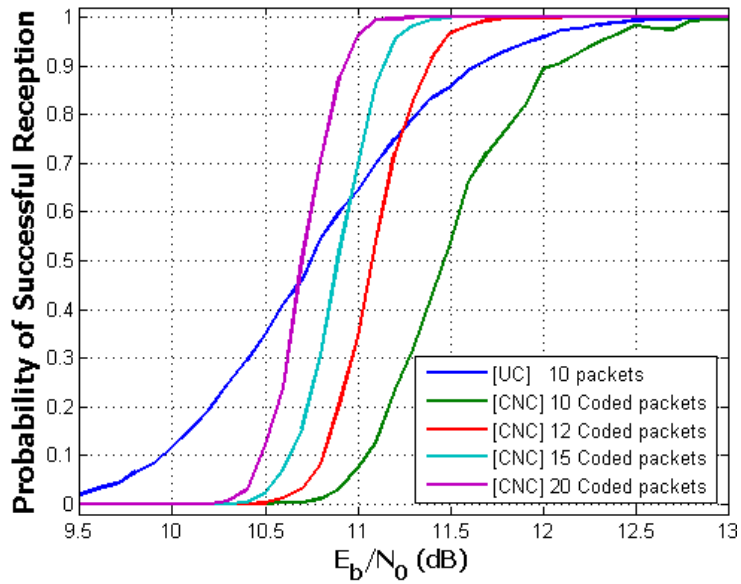

Figure 5.10 Probability of successful reception at the destination as a function of the E_b/N_0 for UC ($m = 10$) and for CNC with different number of coded packets with modulation 16-QAM

In Figure 5.11, we can see the variation of the throughput as a function of the number of coded packets for 4-PSK. As expected, we observe that the number of coded packets required for adequate performance is inversely proportional to the energy per bit to noise power spectral density ratio (E_b/N_0).

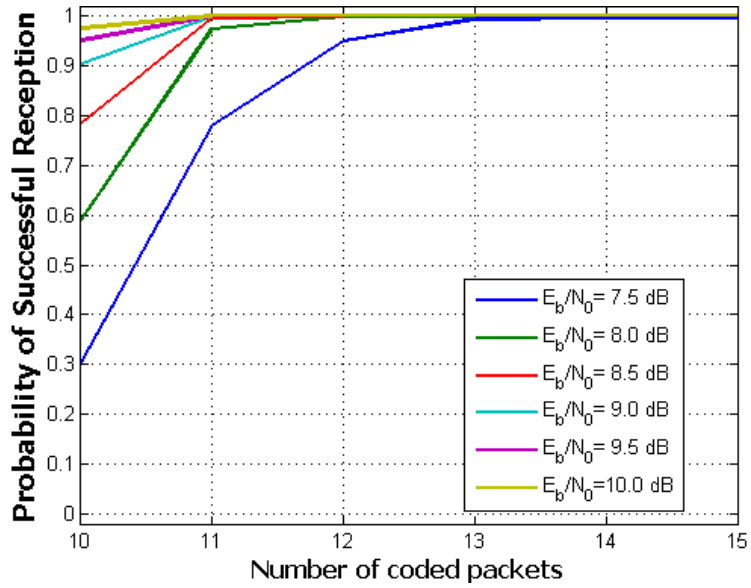

Figure 5.11 Probability of successful reception at the destination as a function of the number of coded packets for CNC

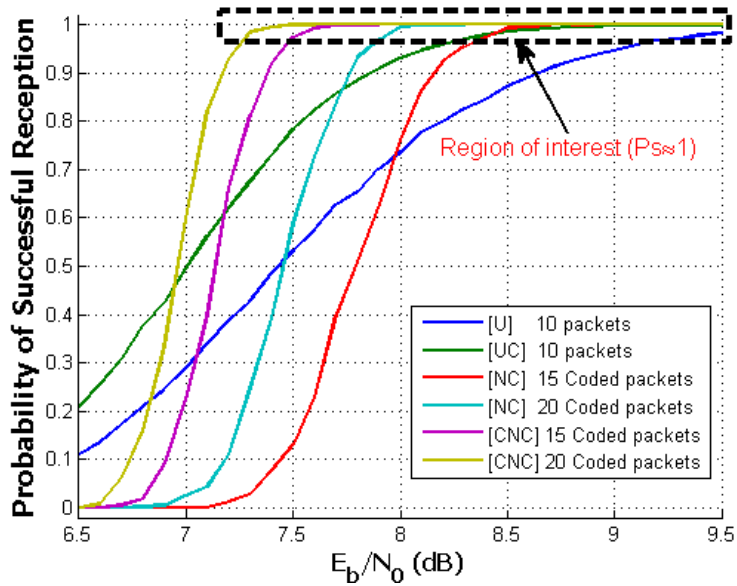

Figure 5.12 Probability of successful reception at the destination as a function of the E_b/N_0 for U, UC, NC, and CNC systems with modulation 4-PSK

Figure 5.12 shows the probability of successful reception at the destination as a function of the E_b/N_0 for U (non cooperative uncoded), UC (cooperative uncoded), NC (non Cooperative Network Coding), and CNC (Cooperative Network Coding) systems. Notice that Cooperative Network Coding offers the highest performance; i.e. Cooperative Network Coding requires lower energy per bit than the other schemes. For instance $[CNC]$ requires about 3.5 dB less than $[U]$ and

about 1.5 dB less than [UC] to achieve optimal performance ($P_s \approx 1$). Also note that Network Coding [NC] offers better performance than uncoded cooperation [UC] in terms of probability of successful reception at the destination. However, [NC] does not provide spatial diversity, as is the case for [UC], to overcome link or node failures.

5.7 Concluding Remarks

In this chapter, we proposed and present a WBAN communication network based on Cooperative Network Coding that provides improved probability of successful reception at the destination and transparent self-healing and fault-tolerance. Since, real-time applications for wireless body area networks are sensitive to packet loss, Cooperative Network Coding offers an attractive solution to combat packet loss and improve the probability of success to recover the information at the destination while transmitting at relatively low powers. Also, by implementing Cooperative Network Coding in a wireless body area network, we can avoid single points of failure and provide a more reliable network that is quite tolerant of node or link failures, since the information is transmitted via multiple relays.

In conclusion, under typical operating conditions, Cooperative Network Coding enables increased probability of successful reception at the destination, and thus higher expected number of correctly received and decoded packets at the destination, and improved network reliability because of the cooperation of the relays in transmitting coded packets through multiple paths.

CHAPTER 6. IMPROVING THE PERFORMANCE OF WIRELESS BODY AREA NETWORKS THROUGH TEMPORAL DIVERSITY CODING

6.1 Introduction and Motivation

In this chapter we discuss and analyze the application and effect of Diversity Coding [13] on the performance of WBANs, and propose Temporal Diversity Coding (*TDC*) [44], a novel technique that applies Diversity Coding in time and uses multiple paths to enhance the performance of WBANs, especially for emerging real-time *in vivo* applications such as:

- Streaming real-time video during surgery, and
- Measurement-response applications requiring feedback on small time-scale, such as cardio-feedback applications, where the remote control system needs to react to fast changes in the biological/physiological parameters and actuate an *in vivo* mechanism.

For this type of *in vivo* applications, since retransmissions are not very useful, the throughput and network reliability must be maximized, while the complexity and energy consumption should be kept low. An example of an implementation for *in vivo* real-time application, where *TDC* can improve the communications performance, is the MARVEL (Miniature Anchored Robotic Videoscope for Expedited Laparoscopy) [38] research platform at USF (Figure 5.1), which is a device that decreases the surgical-tool bottleneck experienced by surgeons in state-of-the art Laparoscopic Endoscopic Single-Site (LESS) procedures for minimally invasive abdominal surgery (MIS).

The very attractive feature of Diversity Coding is its feed-forward architecture that transmits data packets and coded packets over spatially distinct paths, to improve network performance by providing high throughput, overcoming packet losses and minimizing the delay.

6.2 Literature Review

Diversity Coding [13], introduced in CHAPTER 2, is an established feedforward spatial diversity technology that enables near-instant self-healing and fault-tolerance in the presence of link and node failures. The protection paths (c_i) carry information that is the combination of the uncoded data lines (d_j), as shown in Figure 6.1.

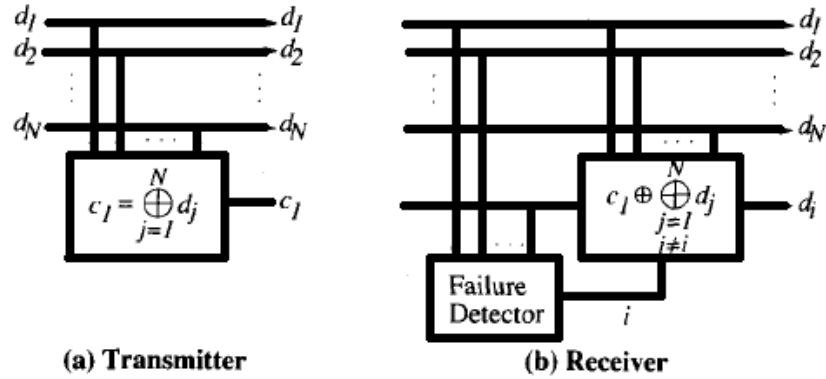

Figure 6.1 System with 1 for N Diversity Coding [13]

Figure 6.1 shows the Diversity Coding system that uses a spatial parity check code for a point-to-point system with N data lines ($j = 1, 2, \dots, N$) and 1 protection line ($i = 1$). If any of the data lines fail (e.g. d_5), the failure detector detects the problem (e.g. loss of signal) and informs the receiver about the failure on d_5 . The destination (receiver), through the protection line (c_1), can recover the information of the data line that was lost (d_5) by taking the mod 2 sum of all of the received signals ($\hat{d}_5 = d_1 \oplus d_2 \oplus \dots \oplus d_N \oplus c_1$). This model can be generalized as a M -for- N Diversity Coding system as shown in CHAPTER 2. As we will show later in this chapter, Diversity Coding may also be used to provide time diversity.

The Temporal Diversity Coding concept, introduced in this chapter, applies the mathematical analysis presented in CHAPTER 2.

6.3 System Model

The system model, as depicted in Figure 6.2, applies Diversity Coding, only in the time domain and transmits the packets through multiple paths (given that the number of paths is less

than the number of transmitted packets) with the aim of enhancing the throughput and reliability of real-time *in vivo* applications like medical imaging and capsule endoscope and increasing the energy efficiency of transmitting a message, while minimizing the delay. Since coding is applied at the packet level, Diversity Coding provides time diversity instead of spatial diversity as in [13]. Reliability is increased by using multiple relays (paths). Because of the complexity and energy constraints of these *in vivo* sensors, the reliability should be maximized while the sensor's energy to transmit the message should be minimized [27]. Temporal Diversity Coding promises improvement in these two parameters, as well as improved reliability in the presence of link and node failures. The throughput (expected number of correctly received information packets) is calculated as the sum of all received packets that add information at the destination. Additionally, Diversity Coding is a feed-forward technology where protection packets are transmitted and no retransmission is required for the destination to be able to decode the information.

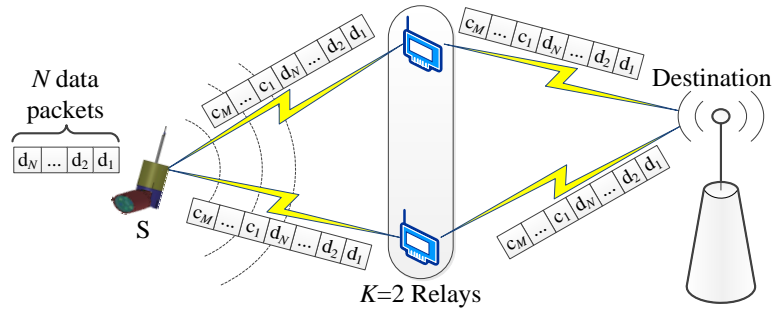

Figure 6.2 Temporal Diversity Coding: System model for two relay paths

6.4 Temporal Diversity Coding for Increasing the Performance of *In Vivo* Wireless Communications

Without some form of coding, if a sensor, incurs a packet loss, the throughput is always reduced. Moreover, because of the real-time nature of these applications, retransmission is not a preferred option. There are two simple ways to try and overcome the effects of packet loss. The first is using multiple paths, so the (same) information is transmitted to the destination through different nodes (links), and the second is by transmitting additional (extra) redundant packets, from the source, that are copies of the original (uncoded) packets. However, since there is no *a*

priori knowledge about which packets will be lost during the transmission, there is no guarantee that these “extra” packets will be able to increase the reliability at the destination. As with classical communications, a coded scheme, such as Diversity Coding, applied to the additional (extra) packets could be beneficial.

With this in mind, we take as a frame of reference, the WBAN topology proposed by the IEEE P802.15 Working Group in [68], and we investigate the proposed Temporal Diversity Coding (*TDC – 2*) model of Figure 6.3, where “2” represents the number of relays that help to transmit the source packets towards the destination. Each sensor transmits independently, but may use the same relays.

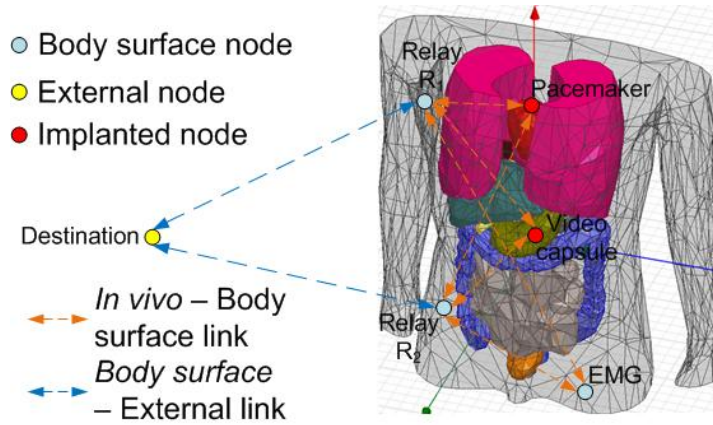

Figure 6.3 Temporal Diversity Coding: Network topology

In *TDC – K*, the source node (e.g. an implanted node) has a block of information (e.g. N data packets) to transmit to the destination through the K relays. So, the source (S) starts to transmit the N data packets to the R_k relays², where $k \in \{1, 2, \dots, K\}$, and simultaneously uses those data packets to create M protection packets that are transmitted to the relays after the N data packets have been transmitted. The c_i protection packets are created using (2–13):

$$c_i = \sum_{j=1}^N \beta_{ij} d_j \quad i \in \{1, 2, \dots, M\} \quad (6-1)$$

² Because of physical and practical constraints, K should be kept low.

where c_i and d_j are protection (diversity coded) and data (uncoded) packets, respectively. The β coefficients are given by:

$$\beta_{ij} = \alpha^{(i-1)(j-1)} \quad (6-2)$$

where α is a primitive element of a Galois Field $GF(2^q)$ and

$$i = \{1, 2, \dots, M\} \quad (6-3)$$

$$j = \{1, 2, \dots, N\} \quad (6-4)$$

The matrix representation of the β coefficients is presented below:

$$\beta_{ij} = \begin{pmatrix} 1 & 1 & 1 & \dots & 1 \\ 1 & \alpha & \alpha^2 & \dots & \alpha^N \\ 1 & \alpha^2 & \alpha^4 & \dots & \alpha^{2N} \\ 1 & \vdots & \vdots & \ddots & \vdots \\ 1 & \alpha^{(M-1)} & \alpha^{(M-1)2} & \dots & \alpha^{(M-1)N} \end{pmatrix} \quad (6-5)$$

Notice that (6-5) represents the Discrete Fourier Transform matrix on a Galois Field with respect to the primitive element α . Also, notice that for the system presented in Figure 6.1 (System with 1 for N Diversity Coding), $\beta_{1j} = 1, \forall j$.

The computational complexity needed to create the protection packets is low since the β coefficients (6-2) are known by the source and destination nodes, and no randomness is required for choosing the coefficients (as is the case in Random Linear Network Coding [56]). Moreover, the length of the protection packets is the same as the data packets and no extra information such as the β coefficients needs to be included in the packet's header. However, it is necessary to include a sequence number in the identification field (packet header) for the destination to assemble the packets into the block of information.

The R_k relays regenerate the received signal and transmit to the destination only the data and protection packets that have no errors. The packets include a cyclic redundancy check (CRC) to detect bit errors in a packet, and a packet with errors is discarded. Diversity Coding operations, such as decoding and/or encoding, are not performed at the relays. However, the relays detect and calculate the CRC to determine which packets are in error and then discarded.

To assemble the original information, the destination (D) receives data and protection packets from the R_k relays and checks which packets have no errors. The number of correctly received data and protection packets depends on the probability of link error (p_{SR_k}) between source S and relay R_k and the probability of link error (p_{R_kD}) between the relay R_k and the destination node D . The probability of link error p is a function of the transmission power, channel conditions, modulation scheme, and packet's length.

The destination can correctly receive \tilde{N} ($\tilde{N} \leq N$) and \tilde{M} ($\tilde{M} \leq M$) data and protection packets, respectively. The destination needs to correctly receive at least N data and/or protection packets, where $N \leq \tilde{N} + \tilde{M}$, to be able to decode the entire block of information (N), otherwise only \tilde{N} information packets can be recovered. That is, the useful information is given by:

$$I = \begin{cases} N & N \leq \tilde{N} + \tilde{M} \\ \tilde{N} & o. w. \end{cases} \quad (6-6)$$

Since the destination can receive data and protection packets, and the protection packets can provide information if and only if $N \leq \tilde{N} + \tilde{M}$, there would be cases where correctly received protection packets provide no information because not enough packets have been correctly received and it is not possible to decode them. So, we define another metric, called *utilization*, to find the percentage of useful information that can be recovered from the correctly received packets. The utilization can be calculated as:

$$\rho = \frac{I}{\tilde{N} + \tilde{M}} \quad (6-7)$$

Notice that the Temporal Diversity Coding model includes redundancy at the packet level but not at the bit level (error-correction / channel coding) to avoid any extra complexity in the sensor where the computational resources are limited or are preferred to keep low to avoid additional energy consumption. However, error-detection (CRC) is required in each packet to discard the packets with errors.

In the following section, the simulation results for a range of parameters for the network, such as: number of coded packets, number of relays, modulation, and energy per bit to noise power spectral density ratio are presented.

6.5 Simulation Results and Discussion

The results presented here were obtained through simulations from 1,000 trials and averaging the output of the simulations. We used the MATLAB communications toolbox for the modulation schemes³ (4-PSK and 16-QAM), the additive white Gaussian noise channel model (AWGN), and the Galois Field operations in our simulations. The topologies presented in Figure 5.2 and Figure 6.3 (single path and multiple paths topologies, respectively) were considered for comparing network performance. We assumed that the source node transmits blocks of information of 10 packets ($N = 10$) and the Diversity Coding operations were performed over a Galois Field $GF(2^8)$. Also, we are assuming that all the links have the same average performance (E_b/N_0).

We compare the performance of Temporal Diversity Coding ($TDC - 2$) with other communication modes:

- The single path uncoded model where the information is transmitted uncoded and with the assistance of only one relay. The information is transmitted from the source node (e.g. implant) to the destination (e.g. external node) via a relay (e.g. body surface node), as is shown in Figure 5.2. We refer to this model as " $U - 1$ ";
- The single path Diversity Coded model where the source uses Diversity Coding to code the packets (as explained in section 6.2), and transmits the data (uncoded) and protection (coded) packets to the destination via a relay, as is shown in Figure 5.2. We refer to this model as " $TDC - 1$ "; and
- The multiple relay paths uncoded model is where the source transmits its information (uncoded) to the destination through spatially different paths with the help of two

³ In the figures, 4-PSK is the default modulation scheme, unless otherwise is stated.

relays as is shown in Figure 6.2. No information is coded in this scheme. We refer to this model as “ $U - 2$ ”, where 2 is the number of relays that help to transmit the information towards the destination.

First, we compare the performance for a single path topology as is the case in Figure 5.2, where the source node transmits its information to the destination through a relay. In Figure 6.4, we show the probability of successfully receiving useful information as a function of the energy per bit to noise power spectral density (E_b/N_0) for the uncoded scheme (U) and Temporal Diversity Coding scheme ($TDC - 1$). For the $TDC - 1$ scheme 1, 2, 5, or 10 protection packets have been transmitted in addition to the 10 data packets ($N + M$) where $N = 10$ and $M = \{1, 2, 5, 10\}$.

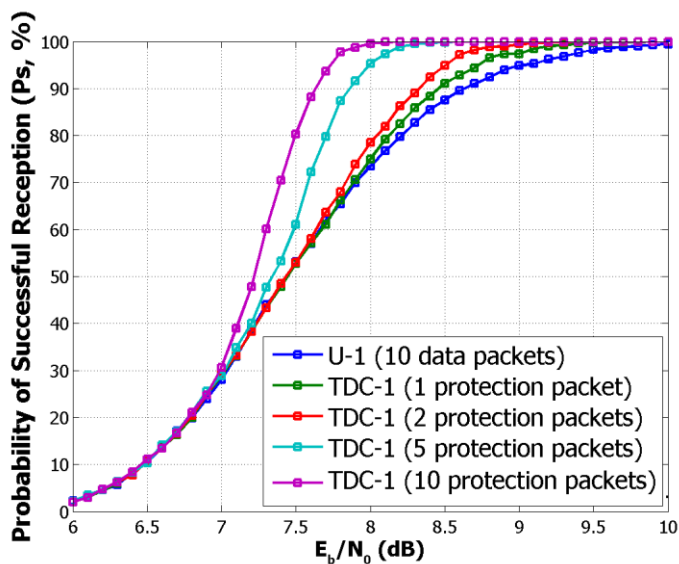

Figure 6.4 Probability of successfully receiving information vs. E_b/N_0 for an uncoded ($U - 1$) and Temporal Diversity Coding ($TDC - 1$) schemes

As we can see in Figure 6.4, for 1/2 and 2/3 DC code rates⁴, the $TDC - 1$ scheme considerably improves (decreases) the E_b/N_0 from about 2.9 and 2.6 dB, respectively, to correctly receive the entire block of information. In other words, the energy per bit can be decreased to approximately half to receive the entire block of information. Similar results

⁴ We define the “DC code rate” as the number of data packets to the number of transmitted packets ratio, [$DC\ code\ rate = N/(N + M)$].

(curves) are obtained when 16-QAM is used. However, the curves are shifted to the right because of the increased E_b/N_0 required for higher order modulations.

Figure 6.5 shows the performance, in terms of efficiency, of $U - 2$ and $TDC - 2$ schemes. As we can see, the efficiency of both schemes ($U - 2$ and $TDC - 2$) increases with the energy per bit to noise power spectral density (E_b/N_0). However, for E_b/N_0 higher of certain value, the efficiency for $TDC - 2$ maintains constant. For example, for energy per bit to noise power spectral density ratio of 7.4 dB or higher, $TDC - 2$ achieves its maximum efficiency (50%). For the $U - 2$ scheme, 100% efficiency can be achieved because all the packets transmitted by the source contain information (data packets). However, the $U - 2$ scheme requires larger E_b/N_0 than $TDC - 2$ to improve the performance of the system.

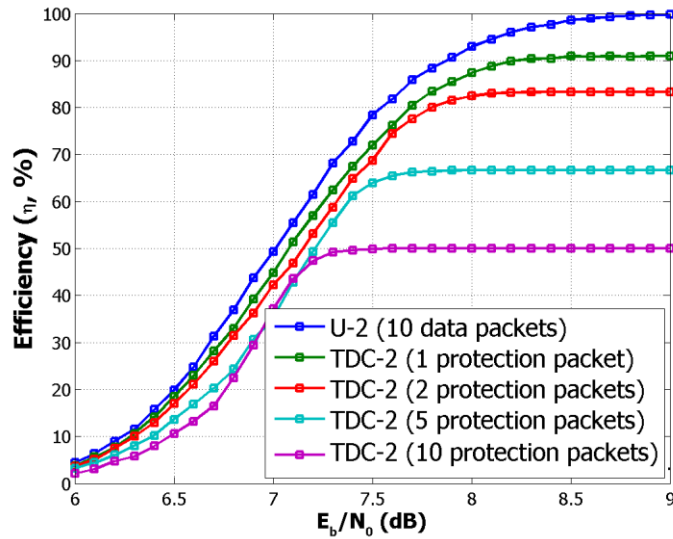

Figure 6.5 Efficiency vs. E_b/N_0 for an uncoded (U) and Temporal Diversity Coding (TDC) schemes for a two-path system

Utilization, which is the ratio of the number of useful information to the number of correctly received packets, as a function of the energy per bit to noise power spectral density (E_b/N_0) is shown in Figure 6.6. As we can see, the utilization increases with the E_b/N_0 , reaches a peak and then decreases with higher values of E_b/N_0 . That is, depending on the number of transmitted data and protection packets, there is an optimal value of E_b/N_0 where the correctly

received packets are used to recover the original information. For instance, $TDC - 2 \frac{1}{2}$ and $TDC - 2 \frac{2}{3}$ reach their maximum utilization (ρ) when $E_b/N_0 = 7.2 \text{ dB}$ and 7.4 dB , respectively.

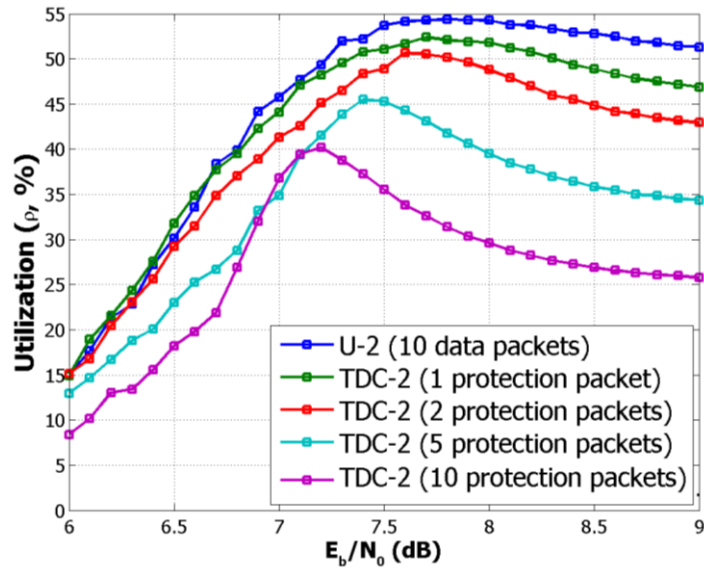

Figure 6.6 Utilization vs. E_b/N_0 for an uncoded (U) and Temporal Diversity Coding (TDC) schemes for a two-path system

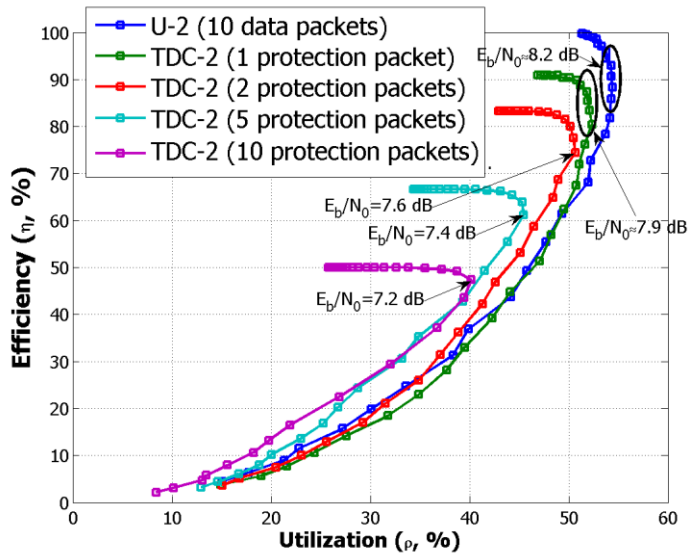

Figure 6.7 Efficiency vs. Utilization for an uncoded (U) and Temporal Diversity Coding (TDC) schemes for a two-path system

Figure 6.7 shows the performance, in terms of efficiency and utilization, of $U - 2$ and $TDC - 2$ schemes. As we can see, the efficiency of both schemes ($U - 2$ and $TDC - 2$) increases with the energy per bit to noise power spectral density (E_b/N_0).

Figure 6.8 shows the performance comparison of the 4 schemes ($U - 1$, $U - 2$, $TDC - 1$, $TDC - 2$) as a function of the E_b/N_0 . Cooperative Diversity Coding outperforms the other three schemes. $TDC - 2$ requires about 3.6 dB less E_b/N_0 than the single path uncoded scheme to receive the entire message. In other words, with the same E_b/N_0 , e.g. 7.6 dB, $TDC - 2$ (10 protection packets) outperforms $U - 1$, $U - 2$, and $TDC - 1$ (10 protection packets) by 43%, 18%, and 12%, respectively. As expected, we can see in Fig. 8 that there are regions where $TDC - 1$ outperforms $U - 2$. That is the case when the E_b/N_0 is greater than 7.5 dB. Therefore, it is preferred to use Temporal Diversity Coding ($TDC - 1$) instead of two paths ($U - 2$).

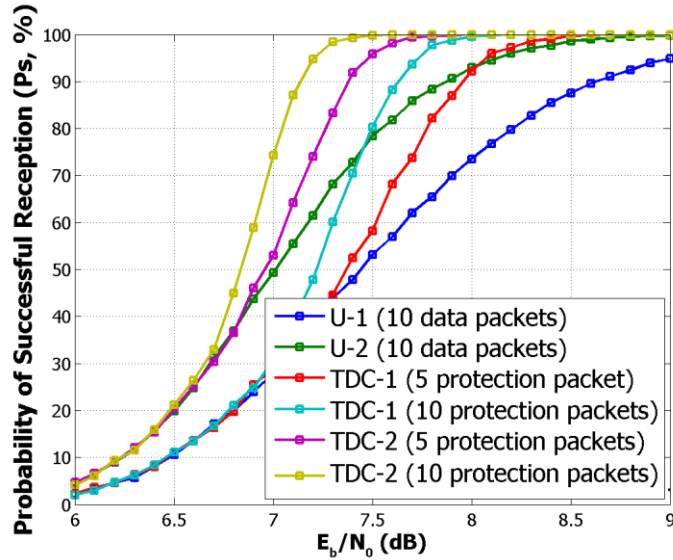

Figure 6.8 Probability of success comparison for Temporal Diversity Coding ($TDC - 2$) and the other 3 schemes ($U - 1$, $U - 2$, $TDC - 1$)

6.6 Concluding Remarks

In this chapter, we proposed and analyzed Temporal Diversity Coding ($TDC - K$) [44], a novel technique that applies Diversity Coding in time through K spatially independent paths to

achieve improved network performance by increasing the network's reliability and minimizing the delay.

For E_b/N_0 equal to 7.6 dB, where $TDC - 2$ achieves full throughput and maximum efficiency at a $\frac{1}{2}$ DC code rate, we can see that transmitting the packets through multiple paths about 12% improvement in throughput is achieved, Temporal Diversity Coding - 1 ($\frac{1}{2}$ DC code rate) provides about 18% improvement in throughput, and the combination of these two techniques [$TDC - 2$ ($\frac{1}{2}$ DC code rate)] provides a 43% improvement in throughput.

Wireless body area networks (WBANs) are an attractive application for Temporal Network Coding because of the low complexity, limited power, and high reliability that this type of networks should provide, especially in real-time applications such as capsule endoscopy and video/medical imaging where retransmissions are not a good alternative.

Temporal Diversity Coding has:

- Low extra complexity, compared to CNC because the Diversity Coding coefficients are already stored in the source (implant) and destination (external) nodes;
- Limited power consumption because lower energy per bit to noise spectral ratio is required to recover the entire message;
- High reliability because of the use of a cooperative relay that helps to transmit the packets from the source to the destination node; and
- Real-time transmission because the source node transmits the data packets as soon as they are in the queue and simultaneously creates the protection packets (using the data packets) that are transmitted after the data packets.

CHAPTER 7. IMPROVING THE PERFORMANCE OF WIRELESS BODY AREA NETWORKS FOR MULTIPLE SOURCE – MULTIPLE RECEIVERS

7.1 Introduction and Motivation

To increase the network's throughput and reliability in the presence of packet errors or losses and avoid single points of node or link failures, we extend Cooperative Network Coding (CNC) as proposed in [22] to networks where there are many sources, many relay nodes and many sinks/destinations. The relays and sinks act as multiple-input-multiple-output (MIMO) nodes. A relay is a wireless node that helps to transmit the received packets towards the destination, and a sink is a node with high processing capability that receives the packets transmitted by the relays. There is communication, via wired or wireless communications, among the sinks to combine the received packets and decode the information.

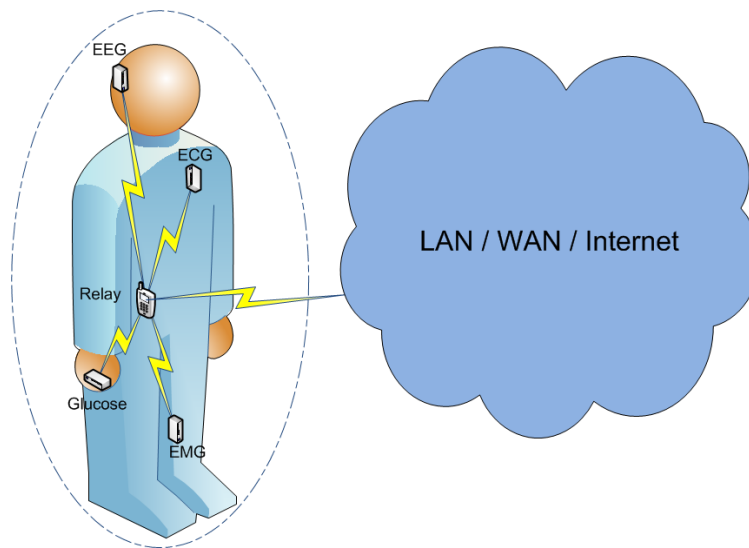

Figure 7.1 Wireless Body Area Network

The very attractive feature of Cooperative Network Coding is that it synergistically combines Cooperative Communications and Network Coding, in a feed-forward architecture that

creates combination packets of the source information and transmits these over spatially distinct paths, to improve network performance by providing high throughput and overcoming packet losses.

7.2 Literature Review

Network Coding [16] is a networking technology that achieves capacity gain by combining the packets received at intermediate nodes and transmitting a linearly independent coded packet that contains information about all the original (source) packets. A coded packet is obtained by multiplying each of the m original packets with a random coefficient and then the results are summed:

$$y_i = \sum_{l=1}^m c_{il}x_l, \quad i = 1, 2, \dots, m' \quad (7-1)$$

where y_i and x_l are the combination, also known as coded, packets and original packets, respectively, $m' (\geq m)$ is the number of coded packets, the coefficients c_{il} are randomly chosen from a Galois Field $GF(2^q)$ and all the operations are performed over a Galois Field $GF(2^q)$, where the $GF(2^q)$ elements are $\{0, 1, 2, \dots, 2^q - 1\}$. The random coefficients $\{c_{il}\}$ are embedded into the packet's header.

Intermediate nodes create new coded packets from the correctly received coded packets

$$y_{ij} = \sum_{l=1}^{m_j} c_{ijl}y_{i-1,l}, \quad j = 1, 2, \dots, n_i \quad (7-2)$$

where y_{ij} and $y_{i-1,l}$ are the transmitted coded packets and correctly received coded packets, respectively, n_i is the number of nodes in cluster i , m_j is the number of coded packets received by node j in cluster i from nodes in the previous cluster $(i - 1)$ and the coefficients c_{ijl} are randomly chosen from $GF(2^q)$.

Cooperative Communications [60] is a communications technology that improves the reliability of wireless links because the receiver obtains data from multiple relays and by properly combining this data, the receiver can make more reliable decisions about the transmitted information. In effect, cooperative communication allows single-receiver devices to obtain the considerable advantages of Multiple-Input-Multiple-Output (MIMO) systems [61].

A Multiple-Input-Multiple-Output (MIMO) system is a system that uses multiple transmitters and multiple receivers to improve communication performance. Traditionally, a transmitter and receiver, with multiple antennas are viewed as a MIMO system. However, because small-size devices form a WBAN, it is often not possible to implement more than one antenna for each network device. Thus, cooperation among the sources and among the relays, as in a MIMO system, is preferred. Due to the multiple links between the transmitter and receiver nodes, and the cooperation between the receiver nodes, the probability that at least one receiver node correctly receives the message is greatly increased because, in MIMO systems, the probability that all the links fail at the same instant is very low.

A few papers have considered the use of Network Coding for wireless body area networks. In [72] and [71], the authors demonstrated that by using Network Coding in wireless body area networks, a network throughput gain is achieved or the packet loss rate is reduced. The sources transmit ‘uncoded’ packets to the relays and the relays code the received packets via Network Coding and transmit the ‘coded’ packets to the destination. However, a drawback of this approach is that the sources are not taking advantage of Network Coding because only the relays code the packets.

Due to the importance of the data that are acquired by the sensors for real-time applications, it is important that WBANs provide high reliability by avoiding single points of node or link failures. Here, we apply the Cooperative Network Coding (CNC) model presented in [22] and consider the situation where the source (e.g. implant node) transmits coded packets to a cluster of a few relay nodes (e.g. body surface nodes) that either create new coded packets from

the received packets and transmit them to the destination node or just forward to the destination the correctly received packets, and the destination (e.g. external node) decodes the information. The relays act as multiple-input-multiple-output (MIMO [70]) nodes, to increase the network's reliability while providing increased throughput.

7.3 Cooperative Network Coding for Multiple Source – Multiple Destination

In this chapter, we consider using Cooperative Network Coding for a multiple source – multiple destination network, as is the case for wireless body area networks, where there may be several sensors (i.e., sources) that, for example, *in vivo* video, measure heart rate, blood pressure, oxygen level, motion sensors and transmit this information to a receiving devices (sinks) through relays. Through a highly reliable background, wired or wireless, communication, the sinks combine the received packets, decode the information and send it to servers. The model presented in [22] is the point of departure for our analysis.

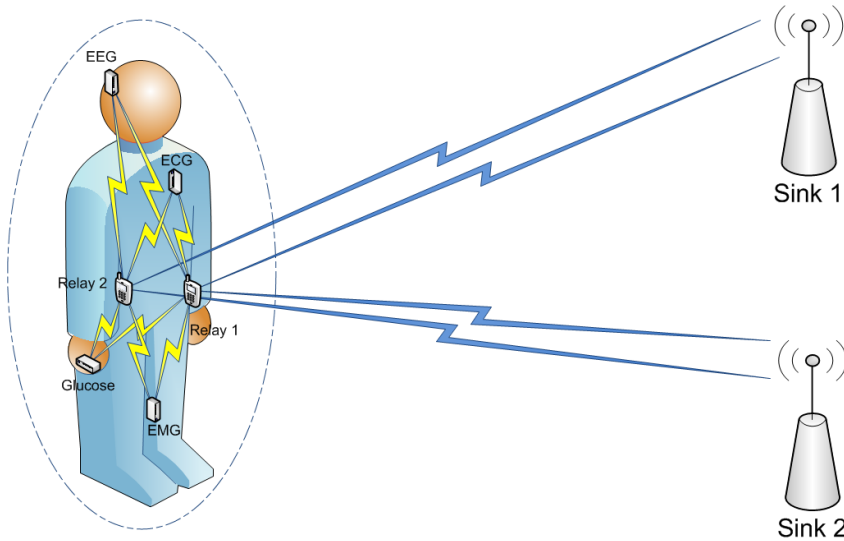

Figure 7.2 Cooperative Network Coding for Wireless Body Area Networks

Figure 7.2 shows an example network that uses Cooperative Network Coding where 4 sensors/sources transmit information to 2 sinks via 2 relays. Each source transmits independently and a MAC protocol, such as TDMA, controls the access to the channel. In this model, we avoid

single points of failure by having multiple relays and, thus, provide multiple paths to transmit a message.

As discussed above, with CNC each source creates m'_s coded packets by using (7-1), where i is the index of each source node, $s = \{1, 2, \dots, N\}$. The combination packets are transmitted to the R relays and assuming that no packet is lost during transmission, each relay can receive r_r coded packets from the N sources:

$$r_r = \sum_{s=1}^N m'_s \quad (7-3)$$

Then, by using (7-2), the relays create new coded packets, from the received coded packets, by combining packets only from the same source. That is, relay 1 creates coded packets of the received packets from source 1 and transmits those packets to the sinks; next, relay 1 creates coded packets of the received packets from source 2 and transmits those packets to the sinks, and so on. Therefore, the minimum number of coded packets that each relay should create for each source is given by the smallest integer greater than or equal to the ratio of original packets (m_s) to the number of relays (R):

$$r_{t_{min}} = \left\lceil \frac{m_s}{R} \right\rceil \quad (7-4)$$

When one or more relays fail, $r_{t_{min}}$ must be increased so that the available relays can receive, create and transmit the appropriate number of coded packets for the sinks to be able to decode the information of all the sources. In the case of a relay failure, a background mechanism communicates the failure among the other relays. The relays then compensate by transmitting more coded packets to the sinks, so it is able to decode the original information.

Recall that the sinks, in the aggregate, need to receive at least m_i linearly independent coded packets for each source to be able to decode the original information of all the sources. Figure 7.3 shows our proposed WBAN system that uses CNC with N sources, one cluster of R

relays and S sinks. This architecture avoids single point node failures because of the multiple relays and (cooperating) sinks.

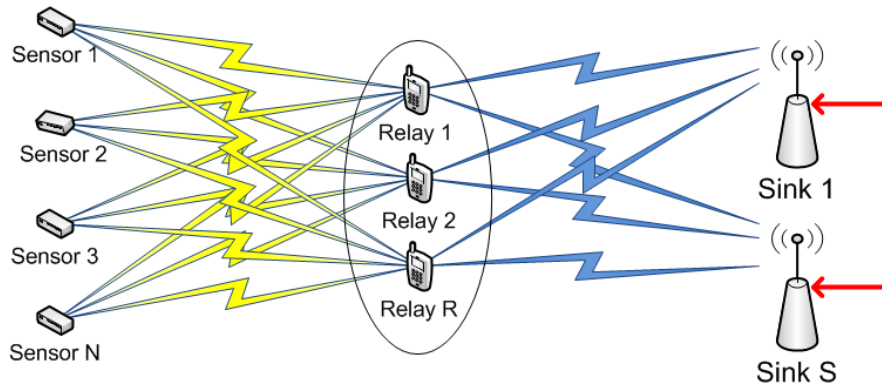

Figure 7.3 Cooperative Network Coding model for WBANs

The above example can be generalized to a multihop network of $(K + 1)$ hops by having K cluster of relays, between the sources and the sinks, helping to transmit the coded packets towards the destination node.

7.4 Simulation Results and Discussion

We have analyzed the effect of different parameters, such as number of transmitted packets by the sources and number of transmitted packets by the relays, number of relays, as well as number of sinks, in order to optimize the network throughput (expected number of correctly received information packets) for different probabilities of link error. Using the cyclic redundancy check (CRC), the receiver can determine if the packet is correctly received.

An experiment is considered successful when, after the sinks interchange the received packets, at least one sink can correctly decode the information of all the sources. The interchange process by the sinks of the received packets is performed through highly reliable communication links (no packet is lost during this process). Therefore, all the sinks will have each other's packets. Additionally, we assumed that the network consists of 5 sources, each source has a block of information of 10 packets ($m_s = m = 10$) and the probability of link error is the same for all

the links. The Network Coding operations were performed over a Galois field $GF(2^8)$ with packets size of 100 bytes.

Figure 7.4 shows throughput, in terms of expected number of correctly received packets, as a function of the probability of link error for different numbers of transmitted packets per source (m') and per relay (r_t) when the network has two relays. Note that m and m' are the number of original and coded packets, respectively; r_t is the number of packets that a relay creates and transmits by each source; and $r_{t_{min}}$ is the minimum number of combination packets that a relay needs to create and transmit to the sinks. As expected, the network offers higher throughput for a given link error as the number of extra packets increases.

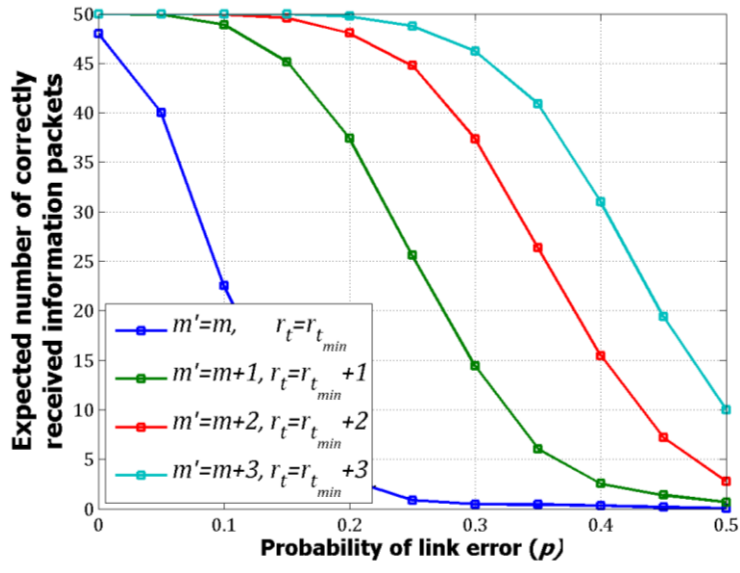

Figure 7.4 Throughput vs. probability of link error for two relays ($R=2$) and different numbers of transmitted packets per source (m') and per relay (r_t)

Figure 7.5 shows the throughput vs. the probability of link error for different numbers of relays given that the number of combination packets transmitted by each source and by each relay are $m + 1$ and $r_{t_{min}} + 1$, respectively. As we can see, increasing the number of relays results in increasing the throughput of the network.

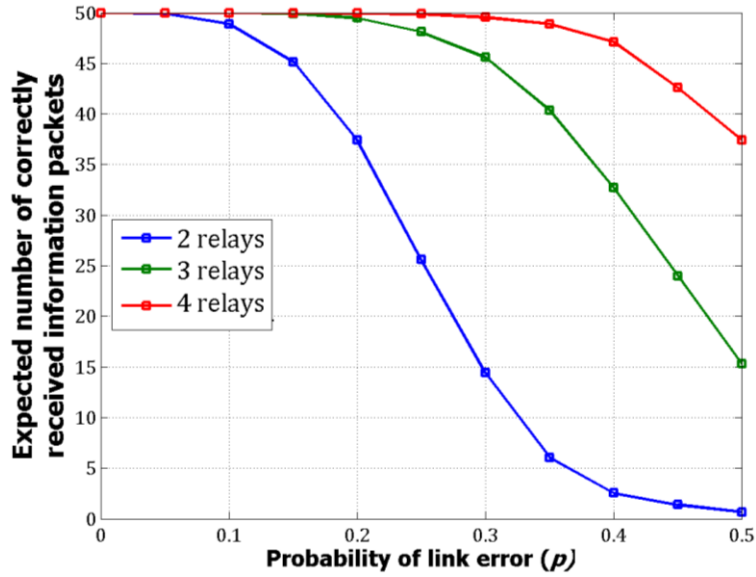

Figure 7.5 Throughput vs. probability of link error as a function of the number of relays

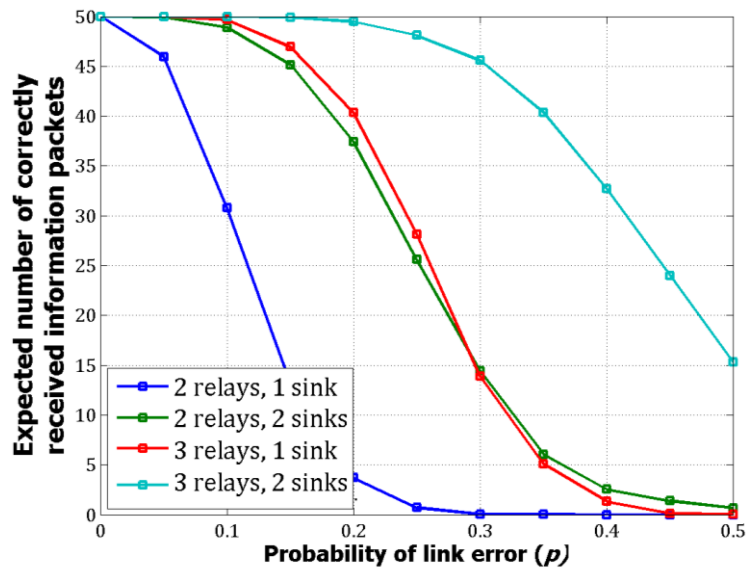

Figure 7.6 Throughput vs. probability of link error as a function of the number of relays and the number of sinks

Figure 7.6 shows a comparison of throughput using Cooperative Network Coding with multiple sinks for different probabilities of link error. Cooperative Network Coding with a single sink is plotted in dashed lines and Cooperative Network Coding with two sinks is shown in solid lines. It is clear that Cooperative Network Coding with two sinks significantly outperforms

Cooperative Network Coding with a single sink because of the multiple paths between the relays and the sinks.

7.5 Concluding Remarks

In this chapter, we proposed and evaluated the performance of a highly reliable wireless body area network that uses Cooperative Network Coding combined with multiple-input-multiple-output cooperative techniques at the sinks to achieve high throughput and avoid single points of failure compared to extant wireless body area technologies. Since, real-time applications for wireless body area network are sensitive to packet loss; Cooperative Network Coding offers an attractive solution against packet loss and improved probability of successfully recovering the information at the sink/destination. Cooperative Network Coding in a wireless body area network avoids single points of failure and provides a more reliable network.

In conclusion, Cooperative Network Coding with multiple sinks enables substantially increased throughput and network reliability in Wireless Body Area Networks.

CHAPTER 8. IMPROVING THE RELIABILITY OF *IN VIVO* VIDEO WIRELESS COMMUNICATIONS

8.1 Introduction

There are key technical challenges to the efficient use of the *in vivo* RF spectrum for access to embedded medical devices, especially for real-time traffic such as video streaming applications, which require high transmission data rates. Our target application is the MARVEL camera module [38], [76], which transmits real-time video from the abdominal cavity. For this application we need to provide high data transmission rate with maintaining adequate reliability levels. This is why we explore Orthogonal Frequency Division Multiplexing (OFDM) to realize high data rates and apply Diversity Coding across subcarriers. Diversity Coding can improve the reliability of the OFDM-based communication because retransmissions are not a good alternative for this real-time traffic application.

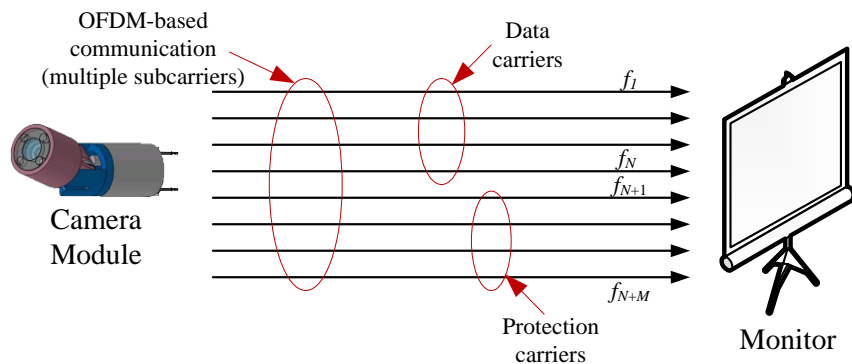

Figure 8.1 Overview of Diversity Coding OFDM

Using Diversity Coding, we intend to enhance the performance and increase the reliability of these point-to-point OFDM wireless connections by transmitting data in some set of subcarriers and protection data (redundant information) through another subset of carriers. Figure

8.1 shows an overview of the implementation of Diversity Coding in OFDM-based systems. As we can see the number of data and protection carriers should be at most equal to the number of OFDM subcarriers.

While there has been significant recent work on the potential performance of wireless body area networks (WBANs) by the IEEE P802.15 TG6 Wireless Body Area Network (WBAN) channel model [68], there is far less research on communicating information across the boundary of the body (i.e. between *in vivo* and on-body or other external devices). Naturally, such communication poses significant difficulties. First, for radio frequency (RF) communication, the body is relatively lossy, making the establishment of links with high signal-to-noise ratio (SNR) and therefore high data rates challenging. Also, because the dielectric parameters of internal tissues depend on the operating frequency and a typical end-to-end propagation path consists of multiple components associated with many types of tissues, it can be difficult to couple electromagnetic fields efficiently into or out of the body.

8.2 Orthogonal Frequency Division Multiplexing

Orthogonal Frequency Division Multiplexing (OFDM) [77] is a widely used technology in fourth generation wireless network (4G) that achieves high transmission rates over dispersive channels by transmitting serial information through multiple parallel carriers. The transmission bandwidth is divided into many narrow sub-channels, which are transmitted in parallel, such that the fading each channel experiences is flat.

Instead of modulating a digital information stream on one carrier waveform (as in QAM), in OFDM the information stream is broken into many lower-data rate streams that are transmitted in parallel. The parallel data transmission scheme in OFDM reduces the effect of multipath fading and makes the use of complex equalizers unnecessary. OFDM is derived from the fact that the digital data is sent using many carriers, each of a different frequency and these sub-carriers will overlap but are orthogonal to each other, and hence Orthogonal Frequency Division Multiplexing OFDM is an effective technique to transmit wideband signals. $M - QAM$ and $M - PSK$ signals,

where M is the modulation order, may be used within each subchannel to realize data rate appropriate for that subchannel.

Figure 8.2 shows a comparison in time and frequency domain between single carrier and OFDM systems. As we can see there, when there are multipath fading effects, OFDM provides enhanced performance compared to single carrier systems for wideband transmissions because each subcarrier in OFDM experiences flat fading.

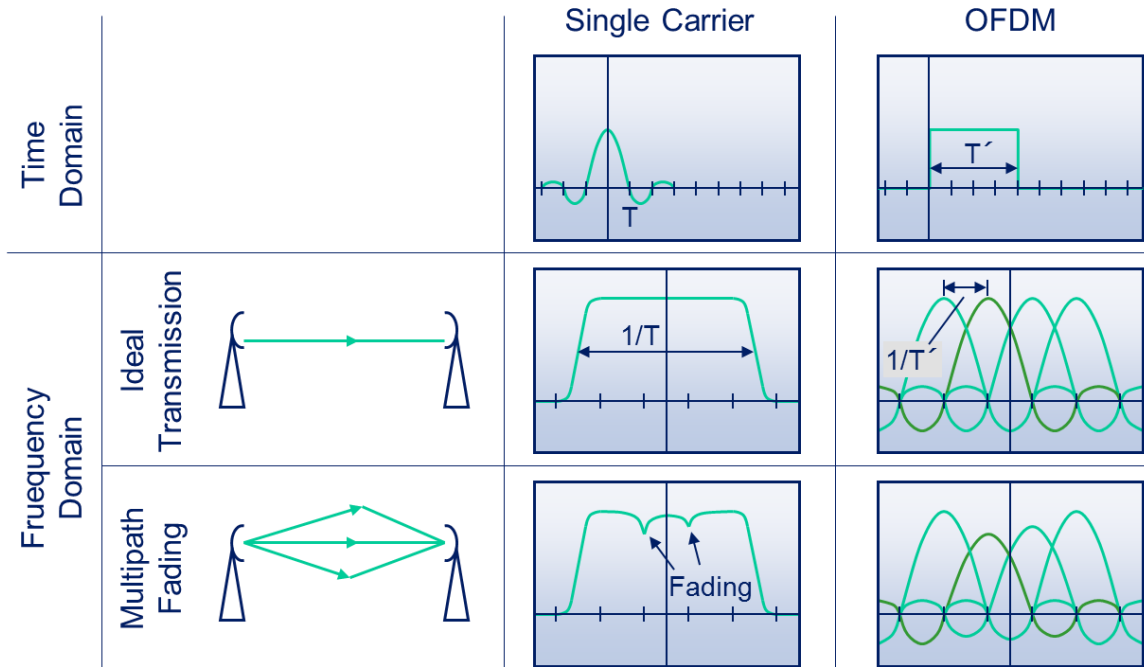

Figure 8.2 Comparison between single carrier transmission and OFDM

The OFDM signal can be expressed as:

$$s(t) = \sum_{k=0}^{N-1} X_k e^{\frac{j2\pi kt}{T}}, \quad t \equiv [0, T) \quad (8-1)$$

where $\{X_k\}$ are the data symbols, N is the number of subcarriers and T is the OFDM symbol duration. The orthogonality condition is given by:

$$\int_0^T e^{\frac{j2\pi k_1 t}{T}} e^{\frac{j2\pi k_2 t}{T}} dt = \delta_{k_1 k_2} \quad (8-2)$$

where $\delta_{k_1 k_2}$ is the Kronecker delta function. This function has the following values:

$$\delta_{k_1 k_2} = \begin{cases} 1, & \text{if } k_1 = k_2 \\ 0, & \text{o.w.} \end{cases} \quad (8-3)$$

The probability of symbol error for a QPSK modulated OFDM signal under an AWGN channel is given by [78]:

$$p_s(\gamma) = 2Q(\sqrt{2\gamma}) - Q^2(\sqrt{2\gamma}) \quad (8-4)$$

If we consider a Rayleigh distributed channel, (8-4) becomes [78]:

$$p_s(\bar{\gamma}) = \frac{3}{4} - \sqrt{\frac{\bar{\gamma}}{1+\bar{\gamma}}} \left(1 - \frac{1}{\pi} \tan^{-1} \sqrt{\frac{\bar{\gamma}}{1+\bar{\gamma}}} \right) \quad (8-5)$$

where:

$$\bar{\gamma} = \frac{E_b}{\left(\frac{\pi f_d}{\Delta f}\right)^2 \frac{E_b}{3} + N_0} \quad (8-6)$$

$$f_d = \frac{v f_c}{c} \quad (8-7)$$

$$\Delta f = \frac{1}{T} \quad (8-8)$$

where f_d is the maximum Doppler shift, v is the relative speed between the transmitter and receiver, f_c is the carrier frequency and c is the speed of light. The total bandwidth is calculated as the product between the number of subcarriers (N) and the subcarrier spacing (Δf).

Assuming that all subcarriers experience independent channel conditions and that the probability of symbol error is the same for all subcarriers, the probability of having η symbol errors in an OFDM symbol is calculated by the probability mass function of the binomial distribution:

$$P(\eta) = \binom{N}{\eta} (1 - p_s(\bar{\gamma}))^{N-\eta} (p_s(\bar{\gamma}))^\eta \quad (8-9)$$

The probability of having no symbol errors in an OFDM symbol can be calculated as:

$$P(\eta = 0) = (1 - p_s(\bar{\gamma}))^N \quad (8-10)$$

8.3 Diversity Coding - Orthogonal Frequency Division Multiplexing

Combining Diversity Coding with Orthogonal Frequency Division Multiplexing (DC-OFDM) promises high reliability communications while preserving high transmission rates. This is achieved by transmitting coded information across the OFDM carriers (spatial protection). That is, most of the carriers transport original information while the remaining (few) carriers transport coded information. The coded information is the result of the combination of the original information as in Diversity Coding. As shown in Figure 8.3, if any of the carriers that transport data ($d_0, d_1, \text{ up to } d_{N-2}$) is lost because of a fade or because of the number of errors in a carrier is bigger than the error correction capability of the forward error correction code (FEC), the information from the lost carrier can be recovered from the (received) protection carriers (d_{N-1} for this simple example). That is, if any carrier, that has data, is in a fade, the information of that OFDM carrier can be recovered from the protection data received through other carriers. This novel technique of applying coding across carriers differs from the traditional coded OFDM where channel coding techniques, such as convolutional codes, Reed-Solomon codes, are used to combat noise floor.

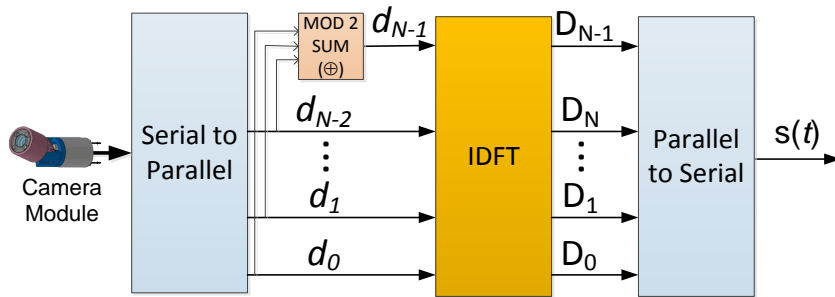

Figure 8.3 System with 1 – for – N DC-OFDM *in vivo* communication links

The protection information (c_i) that is transmitted through the protection carriers is calculated as (2–13):

$$c_i = \sum_{j=1}^N \beta_{ij} d_j \quad i \in \{1, 2, \dots, M\} \quad (8-11)$$

where d_j is data (uncoded) information. The β coefficients are given by:

$$\beta_{ij} = \alpha^{(i-1)(j-1)} \quad (8-12)$$

where α is a primitive element of a Galois Field $GF(2^q)$, $i = \{1, 2, \dots, M\}$ and $j = \{1, 2, \dots, N\}$.

As mentioned in Section 8.1, the total number of data plus protection lines (subcarriers) should be at most equal to the FFT size because the number of subcarriers is limited to the FFT size:

$$N + M \leq FFT_{size} \quad (8-13)$$

The probability of successfully receiving the correct information through at least any N links, out of the N data lines plus M protection lines can be calculated as [39]:

$$P_S = Prob(x \geq N) \quad (8-14)$$

$$P_S = \sum_{t=N}^{N+M} \left[\sum_{\vec{a} \in A} \left(\prod_{i \in a_1} p_i \cdot \prod_{j \in a_0} (1 - p_j) \right) \right] \quad (8-15)$$

Where:

- A is a set of $N + M$ binary sequences of all the 2^{N+M} possible combinations. A binary sequence can contain either 0 or 1, where “1” means that the transmission was successful and “0” otherwise. The number of 1-s in A is t and the number of 0-s is $(N + M - t)$; so there are $\binom{N + M}{t}$ such sequences. Thus,

$$\|A\| = \binom{N + M}{t} \quad (8-16)$$

- \vec{a} is a particular sequence from the set A , a_0 is a set of all indices j of \vec{a} such that $a(j) = 0$, and a_1 is a set of all indices i of \vec{a} such that $a(i) = 1$. Thus,

$$\|a_0\| + \|a_1\| = N + M \quad (8-17)$$

- p_i is the probability that the information transmitted through subcarrier i is correctly received at the destination.

The following section presents our results for our DC-OFDM scheme for different parameters as the number of data and protection lines, DC code rates, among others.

Equation (8-15) can be reduced to the cumulative distribution function of a binomial distribution when the probability of link error (p_i) for each subcarrier is the same for all the links (subcarriers) ($p = p_i, \forall i$). Therefore, the probability of successfully receiving the correct information through at least any N links, out of the N data lines plus M protection lines, is calculated as:

$$P_S = Prob(x \geq N) \quad (8-18)$$

$$P_S = \sum_{t=N}^{N+M} \binom{N+M}{t} (1-p)^t (p)^{N+M-t} \quad (8-19)$$

Note that the probability of link error is equal to the probability of symbol error.

If we apply Diversity Coding based on the modulation scheme (assuming that all subcarriers use the same modulation scheme), the maximum number of protection subcarriers that can be created depends on the number of bits used by each modulation. Table 8-1 shows the maximum number of protection subcarriers that can be created.

Table 8-1 Diversity Coding as a function of the modulation scheme

Modulation	Coded bits per subcarrier (N_{BPSC})	Max Rank GF(2^{bits})
BPSK	1	1
QPSK	2	3
16 QAM	4	15
64 QAM	6	24

We intend to test this technique on a FPGA-based development kit. The implementation structure is shown in Figure 8.4

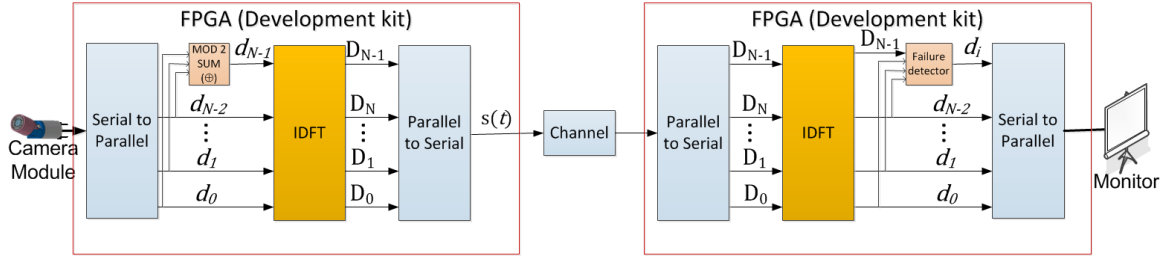

Figure 8.4 Schematic to implement DC-OFDM *in vivo* communication links

In the following section, we present results that compare the performance between OFDM systems that do not use Diversity Coding and systems that use Diversity Coding.

8.4 Preliminary Results

In this section, we show the results of the performance of Diversity Coding on OFDM-based systems. We have studied several scenarios such as the effect of the number of data carrier, the number of protection carriers, and the probability of link error (probability of symbol error).

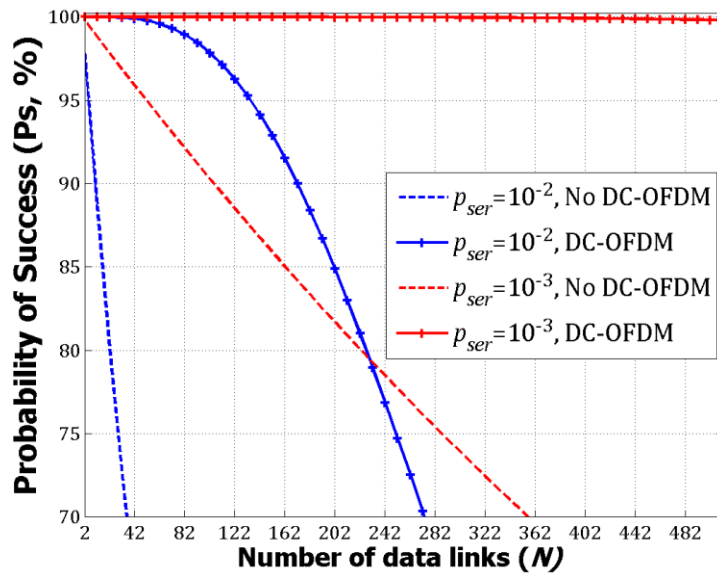

Figure 8.5 Performance of 3 – for – N DC – OFDM system for an OFDM-QPSK

The performance of a M – for – N DC – OFDM system as a function of the number of data carriers for an OFDM-QPSK modulated system is shown in Figure 8.5. As we can see, DC-OFDM provides significant performance improvement for OFDM-based communications. The results shown below are for an OFDM-QPSK system that uses the maximum number of

protection links that can be implemented with a QPSK modulation. In other words, it uses 3 protection carriers (*3-for-N DC-OFDM*).

Figure 8.6 shows the performance of DC-OFDM as a function of the number of data link for different number of protection links. We can see in Figure 8.6 that for a probability of symbol error of 10^{-2} and 48 data links, *3-for-N DC-OFDM* provides a performance improvement of about 40% compared to an OFDM system that does not use Diversity Coding. Moreover, by only using one protection link in a 48 data link OFDM system, a performance improvement of about 30% can be achieved.

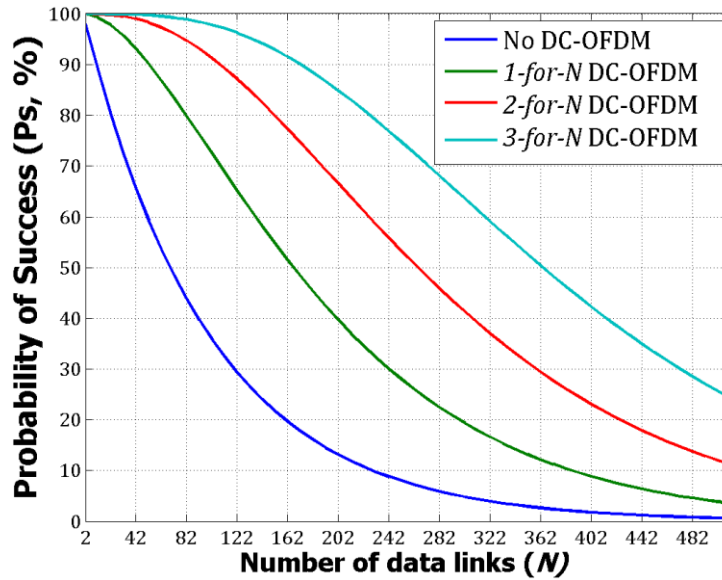

Figure 8.6 Performance of *M-for-N DC-OFDM* system for an OFDM-QPSK with probability of link error equal to 10^{-2}

The probability of successful reception for *M-for-N DC-OFDM* system vs. the energy per bit to noise power spectral density ratio (E_b/N_0) for an OFDM-QPSK modulated system is shown in Figure 8.7. As we can see, *3-for-N DC-OFDM* achieves full throughput when the energy per bit is about 16 dB ($E_b/N_0 = 16dB$), while OFDM without Diversity Coding requires about 35 dB to achieve the same performance.

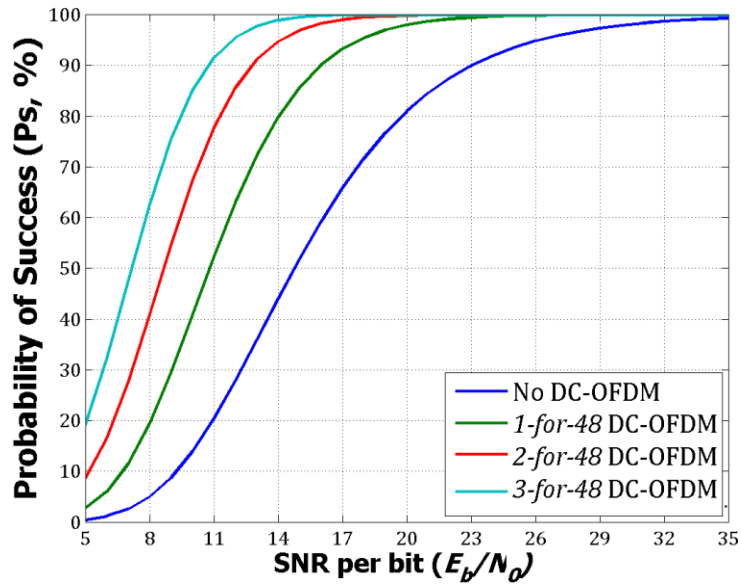

Figure 8.7 Performance of $M - for - N$ DC - OFDM system for an OFDM-QPSK as a function of the E_b/N_0

8.5 Concluding Remarks

Diversity Coding – OFDM maximizes the probability of successful reception and increases the reliability of OFDM-based systems through Diversity Coding. DC-OFDM seems to be a good technology to improve the reliability and performance of real-time *in vivo* video transmission where high data rates and reliability are required. Moreover, DC-OFDM significantly improves the performance of OFDM-based Networks in terms of expected number of correctly received symbols.

For example, 3 – for – N DC-OFDM achieves up to 40% performance gain, compared to systems that do not use DC-OFDM for an OFDM-QPSK modulated system with a probability of link error (probability of symbol error) of 10^{-2} . From another viewpoint, 3 – for – N DC-OFDM requires up to 19 dB less energy per bit to achieve the same performance as a system that does not use DC-OFDM.

CHAPTER 9. DC-OFDM FOR IMPROVING THE RELIABILITY OF VEHICULAR COMMUNICATIONS

9.1 Introduction

Vehicular communications play an important role in vehicle safety and transportation efficiency. The objective of vehicular communication is to ensure vehicle safety for the drivers and passengers and to reduce time and fuel consumption, among other services. A few of the primary applications envisioned for vehicular networks are emergency notifications for automotive safety, notification and prevention of vehicles during collision, location-based information and vehicle tracking services, high-speed tolling, real-time traffic updates and Internet access with multimedia streaming.

For short and medium range communications, WAVE/IEEE 802.11p standards-based systems have been devised using the WLAN technologies in these systems. These systems have acceptable transmission range and power, although, they are limited in terms of coverage distance. WAVE systems are complex as the vehicular environment is dynamic. Therefore, it is important to maintain a stable and reliable wireless connection for a significant period of time. Moreover, Wireless Access in Vehicular Environments (WAVE), which is a wireless scheme that provides vehicle-to-vehicle communication and vehicle-to-infrastructure communication, has as its primary application in providing emergency safety measures for vehicles.

IEEE 802.11p uses Orthogonal Frequency Division Multiplexing (OFDM) [77] to transmit information. OFDM is a widely used technology in fourth generation wireless networks (4G) and 802.11a/g/n WLANs that achieve high transmission rates over dispersive channels by transmitting serial information through multiple parallel carriers. The transmission bandwidth is

divided into many narrow sub-channels, which are transmitted in parallel, such that the fading each channel experiences is flat.

Many applications need to be communicated in a timely manner, so reliability of these networks is a concern. To overcome these issues, the novel idea of employing Diversity Coding [13] across OFDM subchannels is proposed. Diversity coded OFDM-based systems [45] are capable of achieving better spectrum efficiency with excellent transmission rates, improved throughput, perform better during multipath fading and retrieve lost information easily without the need of retransmission or feedback from the transmitter when compared to other similar schemes employed in VANETs (Vehicular Ad-Hoc Networks). Using Diversity Coding, reliable information can be transmitted especially for time-critical applications even when a reliable infrastructure is available.

9.2 Literature Review

9.2.1 Wireless Access in Vehicular Environments

WAVE is a combination of both IEEE 802.11p and IEEE 1609.x working in the DSRC (Dedicated Short Range Communications) band (75 MHz bandwidth operating between 5.85 GHz and 5.925 GHz) specifically for both the PHY and the MAC layers. IEEE 1609 is a higher layer standard based on the IEEE 802.11p.

The IEEE 802.11p standard PHY layer is similar to the 802.11a standard, but with specific features matched to the communication requirements between vehicles or between a vehicle and the infrastructure in current vehicular environments. The key points that drove the 802.11p standard are the relative speed (distances) between the vehicles, the maximum possible coverage distance (~1000 meter radius), varying multipath channel effects in multiple environments and most importantly, the reliability and the security of the message broadcasted in the network. The 5.85 – 5.925 GHz band was chosen to minimize the interference and overcrowding present in the operating bandwidth of 802.11a WLANs. The 75 MHz bandwidth of 802.11p is divided into seven 10MHz channels each with a 5 MHz margin at the lower end. Since

the channel bandwidth is halved (as compared to 802.11a channel bandwidth of 20 MHz), the data rates, carrier spacing and other parameters will also be halved. The carrier spacing is reduced from 0.3125 MHz to 0.15625 MHz and the symbol duration is doubled to 8 μ s. While doubling the symbol duration helps prevent Inter-Symbol Interference, and it also helps in reducing the effects of the multipath channel in rural, urban and sub-urban environments under study.

The structure and frame format of 802.11p is the same as that of 802.11a with the PHY layer having two sub layers: Physical Layer Convergence Protocol (PLCP) to communicate with the MAC layer and the Physical Medium Dependent (PMD) to transmit and receive the data units between two stations via the wireless medium. The Protocol Data Unit (PPDU) frame format including the PLCP header is illustrated below:

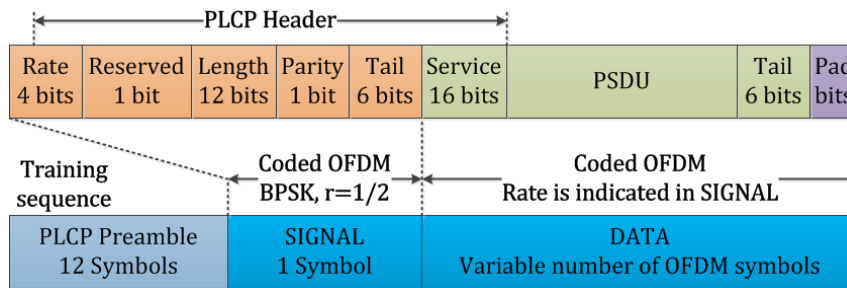

Figure 9.1 Protocol Data Unit (PPDU) frame format [79]

The entire data (OFDM signal) consists of 16 bits for Service field, up to 1500 bytes for the PLCP service data unit (PSDU), 6 Tail bits and padded bits. The PSDU unit contains the actual data bits generated from the MAC layer. The maximum PSDU length for 802.11 is 4095 bytes although in reality it does not go beyond 1500 bytes, even in high-speed scenarios. The tail bits are usually zero bits used to return the state of encoder to “zero”. The padded bits are units to include additional information but are generally zeros. The greater the number of padded bits, the lower the amount of information is transmitted, which is not desirable. The default number of padded bits required is two, as all other fields with respect to the OFDM data symbols are multiples of 2. For 3 Mbps, the number of uncoded bits in the OFDM symbol will be 24 bits. To these 24 uncoded bits, the additional padded bits can be 2, 10 or 18 bits, excluding the default 2

bits. Similarly for 27 Mbps (216 uncoded bits), the number of padded bits (apart from the default 2 bits) will be between 0 and 26 bits [80]. The service bits are used in the synchronization of the scrambler and the descrambler in the 802.11p transmitter/receiver architecture. The PLCP header is the main unit that has all the information about the type of modulation technique used (BPSK, QPSK, 16 QAM and 64 QAM) and the different coding rates ($\frac{1}{2}$, $\frac{2}{3}$, $\frac{3}{4}$). The 4 bits in “RATE” specify the modulation technique, coding rate and data rate for the transmission. The “LENGTH” carries information about the number of data octets in the PSDU unit, and the “tail bits” are usually zero entities.

The preamble section of the frame format consists of 12 symbols – ten Short Training Symbols (STS) and two Long Training Symbols (LTS). This section is 32 μ s long, twice compared to the preamble length of 802.11a structure. The functions of STS and LTS are the same as 802.11a. STS and LTS help in automatic gain control, detection of the signal and frequency subcarrier estimation as well as channel estimation.

9.2.2 Orthogonal Frequency Division Multiplexing

The OFDM block diagram, as shown in Figure 9.2, consists of the data that comes from the upper layers, which is the data to be transmitted (source data). The data from upper layers comes in the form of bits, which is then sent to the scrambler. The scrambler shuffles the data sequence with the help of a pseudo random sequence generator to reduce the chances of error probability at the receiver. The data is punctured in order to increase the data rate and/or the coding rate, but it is also responsible for decreasing the bit error rate (BER) performance of the signal by improving system performance and its flexibility. The minimum transmission rate for 802.11p is 3 Mbps for BPSK modulation with $\frac{1}{2}$ coding rate up to a maximum of 27 Mbps for 64 QAM with $\frac{3}{4}$ coding rate (Table 9-1). This data is then interleaved, a process of spacing out all the data sequences in order to protect the information from forming burst errors during severe channel fading. The interleaved data is then modulated (mapped) according to the desired technique.

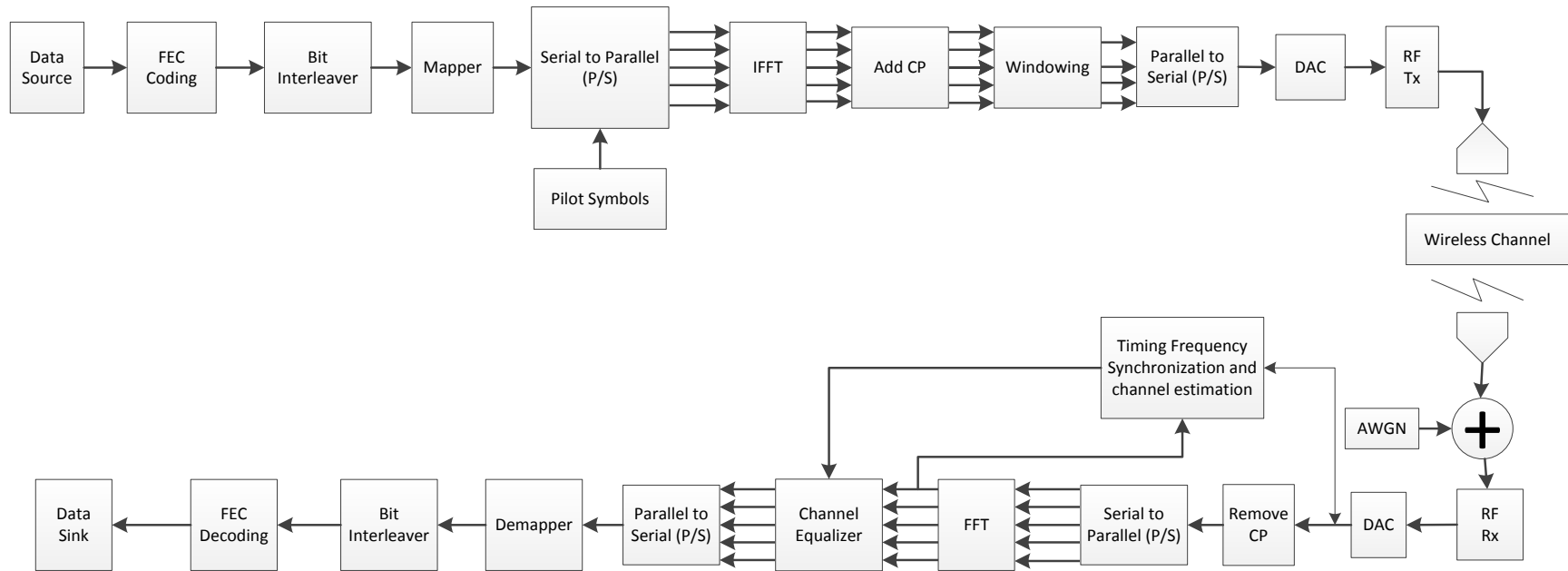

Figure 9.2 OFDM block diagram

Similar to the 802.11a architecture, the 802.11p has a total of 64 carriers, each occupying 0.15625 MHz. The 64 carriers are divided into 48 subcarriers carrying the data, 4 pilot carriers to make the signal robust against frequency offset and the remaining 12 null subcarriers. The data bits are then converted to symbols that contain a value (integer and/or complex) and occupy their respective positions in the constellation. The subcarriers subjected to IFFT (Inverse Fourier Transform) convert from the frequency domain to the time domain. The output of the IFFT process is the OFDM symbol. To this symbol, guard intervals (GI) are added to prevent the symbol from Inter-Symbol Interference (ISI) and Inter-Carrier Interference (ICI). ICI causes loss of orthogonality and frequency offset and can be mitigated by windowing to smooth out the transitions between the symbols. The guard interval (TG11) of 802.11p is twice that of 802.11a and this is better in reducing the effects of ISI and mitigating the effects of the multipath channel. The guard interval for OFDM in 802.11a is 0.8 μ s seems to be sufficient for the suburban environment; however there are chances of the multipath channel subjected to additional (excess) delay in the rural, urban and highway-based environments. In such cases, the channel model becomes very difficult to be estimated due to the rapidly changing environment. For high-speed scenarios, the channel is difficult to predict and there is an increase in the Doppler shift, which in turn degrades the quality of the signal and increases the Bit Error Rate (BER). The choice of having a longer guard interval is a tradeoff between the bandwidth of the data and the reliability as longer GI reduces the throughput of the channel. In the case of 802.11p standard, the guard interval is observed to be longer than the maximum excess delay in all the environments.

The bit error rate of an OFDM-based system for $M - QAM$ modulation scheme in AWGN and Rayleigh channels, respectively, are given by [81]:

$$P_e = \frac{2(M-1)}{M \log_2 M} Q \left(\sqrt{\frac{E_b}{N_0} \frac{6 \log_2 M}{M^2 - 1}} \right) \quad (9-1)$$

$$P_e = \frac{M-1}{M \log_2 M} \left(1 - \sqrt{\frac{\frac{E_b}{N_0} 3 \log_2 M}{(M^2-1)}} \right) \quad (9-2)$$

where M is the order of the modulation scheme and E_b/N_0 is the energy per bit to noise power spectral density ratio. The symbol error probability (P_{ser}) for a M-QAM and M-PSK modulated OFDM signals under an AWGN channel are given by [64]:

$$P_{ser} = 4 \left(1 - \frac{1}{\sqrt{M}} \right) Q \left(\sqrt{\frac{E_s}{N_0} \frac{3}{(M-1)}} \right) - 4 \left(1 - \frac{1}{\sqrt{M}} \right)^2 Q^2 \left(\sqrt{\frac{E_s}{N_0} \frac{3}{(M-1)}} \right) \quad (9-3)$$

$$P_{ser} = \frac{1}{\pi} \int_0^{\frac{(M-1)\pi}{M}} e^{-\left(\frac{E_s}{N_0} \frac{\sin^2 \frac{\pi}{M}}{\sin^2 \theta} \right)} d\theta \quad (9-4)$$

If we assume that the channel is an ideal linear time-invariant frequency non-dispersive AWGN channel, the receiver sees the OFDM signal as a group of parallel AWGN channels with equal SNR that has a similar performance as a single carrier system. That is, the average symbol error probability for an OFDM symbol is equal to the symbol error probability of a subcarrier.

$$P_{ser} = P_{serOFDM} = \frac{1}{N} \sum_{i=1}^N P_{serSubCarrier_i} \quad (9-5)$$

Since $P_{serSubCarrier_i} = P_{serSubCarrier}$, $\forall i$, then

$$P_{ser} = P_{serSubCarrier} \quad (9-6)$$

However, the OFDM signal has a lower SNR compared to the single carrier signal due to the cyclic prefix.

When a multipath channel is assumed (e.g. Rayleigh distributed), the symbol error probability for a QPSK modulated OFDM signal can be calculated as [78]:

$$P_{ser} = \frac{3}{4} - \sqrt{\frac{\bar{\gamma}}{1 + \bar{\gamma}}} \left(1 - \frac{1}{\pi} \tan^{-1} \sqrt{\frac{\bar{\gamma}}{1 + \bar{\gamma}}} \right) \quad (9-7)$$

where:

$$\bar{\gamma} = \frac{E_b}{\frac{\pi^2 f_d^2}{3\Delta f^2} E_b + N_0} \quad (9-8)$$

f_d is the maximum Doppler shift ($f_d = \frac{vf_c}{c}$), Δf is the subcarrier spacing, v is the relative speed between transmitter and receiver, and, c is the speed of wave (typically the speed of light in the vacuum).

The probability of having δ symbol errors in an OFDM symbol can be calculated using the Binomial probability mass function:

$$P_\delta = \binom{n}{\delta} (1 - P_{ser})^{n-\delta} P_{ser}^\delta \quad (9-9)$$

And the probability of having no symbol errors ($\delta = 0$) in an OFDM symbol can be calculated using Eq. (9-9):

$$P_{\delta=0} = (1 - P_{ser})^n \quad (9-10)$$

The probability of symbol error of a coded OFDM system, using block coding (n, k, t), is given by [78]:

$$P_{ser_{coded}} = \frac{1}{n} \sum_{\delta=t+1}^n \delta P_\delta \quad (9-11)$$

By implementing Diversity Coding in vehicular communications that use OFDM-based technologies, such as IEEE 802.11p systems, the bandwidth is utilized in an efficient manner, the reliability of the communication is improved and lost information can be recovered in different vehicular communication scenarios. For real-time traffic applications, such as emergency response, link failures cannot be acceptable as the applications are delay sensible. Both feedback and rerouting add to the delay and it is preferable to use Diversity Coding technique, a spatial diversity technique, to recover the lost information.

9.2.3 Diversity Coding

Diversity Coding (*DC*) [13–15] is a feed-forward spatial diversity technology that enables near instant self-healing and fault-tolerance in the presence of wireless link failures. We use the mathematical analysis developed in CHAPTER 2 to study the performance of our proposed approach.

9.3 Related Work – Network Coding for OFDM-Based Systems

Network coding, which is an enhancement of Diversity Coding, is a concept where packets are combined and transmitted through different nodes or locations. The aim of Network Coding is to reduce the number of packet retransmission and thereby improve system bandwidth and throughput.

There are two different Network Coding techniques widely used at different levels (symbol level and packet level) applicable to both PHY and MAC layers in IEEE 802.11p (WAVE) systems.

9.3.1 Network Coding in the MAC Layer

Wireless systems generally broadcast information in multiple frequency channels and follow the multihop pattern that tends to overcrowd the available frequency bandwidth. This results in interference due to increase in the number of wireless devices used today. A system with multiple hops reduces the resultant throughput of the system that is not desired. Wireless Network Coding (WNC) helps a multihop system use fewer transmissions, in contrast to a multihop system that does not use WNC.

The WNC scheme is typically a MAC layer oriented scheme based on the proposed method of sending acknowledgment (ACK) packets from both the nodes A and B for OFDM based systems. This technique complies with the IEEE 802.11a (WLAN) standard. As shown in Figure 9.3(b), both A and B transmit their packet to the relay R that stores these packets and performs an XOR operation on the packets and sends the resultant output to A and B. Since A and B know the packet they transmitted, they decode the XORed output and obtain the necessary

information. Instead of sending the packets through four transmissions (time slots) to reach both A and B (Figure 9.3(a)), using wireless Network Coding reduces it to three transmissions. This improves the throughput of the system and the bandwidth.

Nodes A and B send their ACK packets in the form of direct and delayed signals and the relay R demodulates them as one ACK packet. Generally, the OFDM technique has some subcarriers that have redundant information that is useful in letting the relay know if A and B have sent their respective ACK packets. This scheme makes use of CSMA/CA mechanism which checks for the availability of the channel and sends the ACK packets during every transmission opportunity.

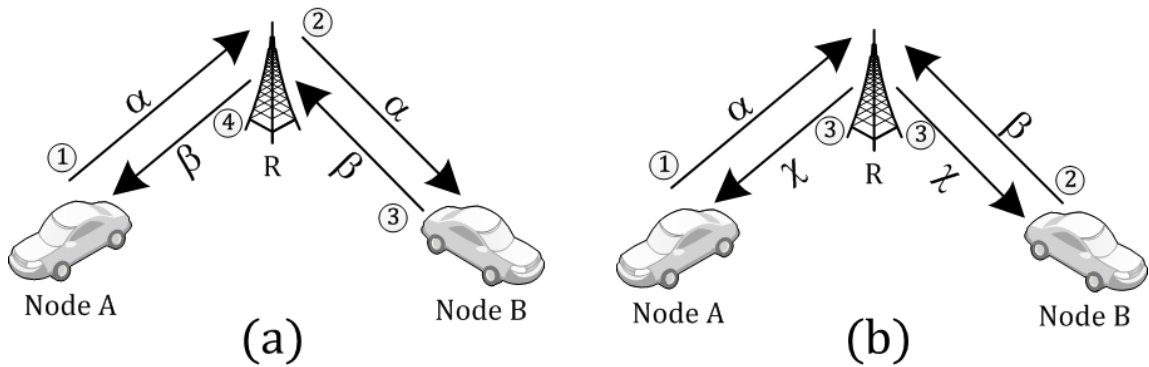

Figure 9.3 (a) Non-WNC multihop system and (b) WCN multihop system [82]

According to this scheme, in order to receive an ACK packet simultaneously without collision, scrambler initial state synchronization (SISS) and acknowledgement identification (AI) are used. The relay node identifies the ACK packets as direct and delayed signals although they have the same scrambler initial state (SIS) for both A and B and have the same modulated ACK packet. With the help of SISS, the relay demodulates the ACK packet as one packet. But the relay does not know which node has sent the ACK packet. This issue is solved using AI. Both A and B are assigned to different Zero subcarriers (ZS) and the relay will be able to identify the node that has transmitted the ACK packet depending on the ZS. If the relay does not receive the ACK packet from the particular node, then it will retransmit the XORed packet. Thus the relay node

can discriminate between the nodes based on the nulls in the spectrum resulting in higher MAC throughput.

The WNC scheme is found to have high efficiency and very low packet transmission loss compared to traditional schemes. TCP throughput is observed to increase by 3.4 Mbps at 25 dB SNR and has much better packet loss rate (PLR) performance which ensures high reliability than in conventional systems [82].

9.3.2 Network Coding in the PHY Layer

In the PHY layer, symbol level Network Coding is a predominant method and there are different approaches used in vehicular to vehicular (V2V) and vehicular to infrastructure (V2I) communications [83–87]. Vehicular communications are point-to-point communications with an infrastructure such as roadside units. However, in reality, most of the communications take place in *Ad-Hoc* network mode (Vehicular *Ad-Hoc* Network, VANET) with the help of relays. The vehicles adopt the *Ad-Hoc* network mode in situations when there is no availability of roadside units in the particular area of interest.

There are several approaches that implement Network Coding in the PHY layer. A few of them are:

9.3.2.1 Rate Diverse Network Coding

The idea of combining modulation techniques with the conventional Network Coding scheme in the physical layer as Rate diverse Network Coding (RDNC) [88] was proposed for IEEE 802.11a/g networks to demodulate the signal received at different nodes according to their respective channel types.

As shown in Figure 9.4, using BPSK modulation node *A* sends two packets to the relay node and node *B* sends only one packet to the relay. The relay codes both packets from node *A* with one packet from node *B* and transmits it to node *B* using QPSK modulation.

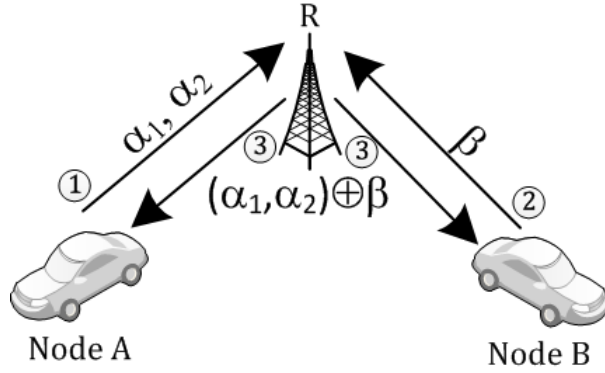

Figure 9.4 Rate diverse Network Coding [88]

Since QPSK has 2 bits per symbol, the modulated packet will be able to pair with the two BPSK packets. In the case of node *B*, the demodulation process is simple and it is able to retrieve node *A*'s packets from its own packet:

$$((\alpha_1, \alpha_2) \oplus \beta) \oplus \beta \rightarrow (\alpha_1, \alpha_2) \quad (9-12)$$

where (α_1, α_2) is the concatenated output of the packets transmitted to the relay by node *A*.

On the other side, node *A* cannot demodulate the QPSK modulated packet and hence it uses its known information (α_1) and (α_2) to decode β with the help of a BPSK-like modulation technique. That is, since $(\alpha_1, \alpha_2) \oplus \beta$ is the coded packet (concatenated) transmitted from *R* to node *A*, where for every bit of α (BPSK modulation) there are two bits of β (QPSK modulation), the α bits are already known by node *A*, so it only needs to demodulate the second bit from $(\alpha_1, \alpha_2) \oplus \beta$ through BPSK demodulation.

Compared to the conventional Network Coding scheme, RDNC is found to have better throughput and coding gain.

In the physical layer, RDNC is performed such that the receiver will be aware of the encoded bits by subjecting them to channel coding in order to obtain the RDNC decoded packets. Depending on the decoding ability of the receivers, the original packets can be recovered. To the

encoded packet, the header is added and sent to the receiver. The receiver will use the header, PLCP, Nexthop and Packetfield information to identify its destination.

This scheme is still valid even if the packets to be XORed do not have the same bits. Among the coding rates that comply with the IEEE 802.11a standard, RDNC uses $\frac{3}{4}$ coding rate as it is capable of carrying more information than the other rates. Therefore, it is limited to 9 Mbps (BPSK), 18 Mbps (QPSK) and 36 Mbps (16 QAM). When different symbols carrying different bits and modulation techniques are sent, there is a problem in combining these into one single packet and then sending it to the destination nodes. BPSK is the preferred modulation method in conventional systems but it is inefficient modulation techniques for higher quality links.

9.3.2.2 CodePlay

CodePlay [89] is a symbol level Network Coding (SLNC) technique proposed for live multimedia streaming service in vehicular communications (VANETs). SLNC is a type of Network Coding applied to a smaller group of consecutive bits within a packet. Live multimedia streaming (LMS) service is used for real-time applications such as live video streaming which is useful for intelligent navigation and also for non-real time applications like video on-demand. LMS is generally employed in conventional wired or wireless networks where the link is stable and reliable. When the LMS scheme is used in VANETs, it will lead to severe packet loss due to the varying effects of the channel and the bandwidth utilization is inefficient. The objectives of this scheme are:

- Better utilization of the bandwidth,
- Reliable service delivery ensuring all near-by users have the same delays, and
- Providing smooth playback having a high and stable streaming rate.

9.3.3 Performance Evaluation of PHY Layer Network Coding Techniques

The RDNC scheme has the disadvantage of using a low-order modulation method for high quality links. To overcome this, a new scheme of high quality links having their own

individual modulation rate is used to receive their coded packets. This prevents the use of lower order modulation method for high quality links while the lower quality links make use of the previous transmission to demodulate the high rate coded packets. The coding gain is almost 250% better than the other methods used in [88] making the RDNC scheme very robust.

The performance of ZCR is better than the traditional retransmission scheme as it gives better throughput and simulation results show this scheme to have 670% higher median throughput gain than the conventional method. The difficulty in using RDNC is the quality of the link used for broadcasting the information and the usage of higher coding rate leads to some amount of degradation in the performance of the decoding process. The performance of RDNC in the classic “Alice-Bob topology” [21] is found to have more uncoded packets than other schemes used for comparison in [88]. RDNC uses three packets in every coding, causing lesser coding opportunities to be created and results in more than 30% of the packets to be transmitted in uncoded manner.

CodePlay was implemented for both sparse and dense VANET conditions and the performance of SLNC CodePlay was compared to that of PLNC CodePlay [89]. The comparison was based on the factors: Initial buffering delay, skip ratio (fraction of generations skipped due to incomplete reception before playback time over all the generations that are played [89]) and the source rate. In highly dense highways, the performance of SLNC and PLNC was compared for two-AP and single-AP condition. Both performed better in two-AP than single-AP. But the skip ratio for SLNC was as low as 8% whereas for PLNC, it was as high as 24%. In two-AP condition, the packet losses are compensated as the packets are sent in both the directions and smooth playback is ensured.

Simulations were performed for sparse VANET condition by varying initial buffering delay and the source rates accordingly [89]. In the cases considered, SLNC was found to be more stable than PLNC. The CodePlay +SLNC scheme outperforms PLNC for source rates not greater than 30KB/s and for initial buffering delay of 16s and 24s [89]. In dense VANET conditions, the

performance of SLNC is better than PLNC although the skip ratios are high with low buffering values when compared to sparse VANETs. In the dense VANET case, if all vehicles request for different LMS content at the same time, this will lead to frequent playback skips which would affect the performance. Using OLRR gives better results than LRR scheme and the skip ratio is found to reduce to 6% from 20%. Also, this scheme is more suitable for SLNC and reliable for long distance transmissions.

The idea behind the implementation of CodePlay is to provide smooth and reliable playback along with high streaming rates. LMS services with high source rates can be difficult and might require better infrastructure but feasible. This scheme is also applicable to sparse VANETs with decent buffering delay and source rate no greater than 30 KB/s in order to ensure stable, smooth and reliable playback.

Physical Layer Network Coding scheme in WAVE system helps in sending the information in fewer transmissions and also in retrieving the original information sent by one of the transmitters in a two-node (as discussed above) or in a multi-node network. In order to perform this scheme in WAVE, the PHY layer specifications of IEEE 802.11p need to be known and the working of OFDM in the physical layer needs to be understood.

However, the main difference between these schemes and our approach is that they are typically applied to two hop communication through a relay and for multicasting, where it has been proven that Network Coding provides throughput gain [19], [21], [56], [67], [90], [91]. Our approach focuses on point-to-point communications and takes advantage of the spatial (frequency) transmission of the information when using Orthogonal Frequency Division Multiplexing. Moreover, our approach can be used by itself, or it can be used along with any other forward error correction technique at bit level such as convolutional codes or Reed-Solomon codes.

9.4 Diversity Coded Orthogonal Frequency Division Multiplexing

Orthogonal Frequency Division Multiplexing (OFDM) [77], [92] is a well-known technology used for 4G and 802.11 systems to achieve high data rates by transmitting the information through several orthogonal subcarriers such as IEEE 802.11p that provides wireless access in vehicular environments. DC-OFDM is a novel coding technique, which can be applied to 802.11p networks, and operates at the symbol level to transmit information through orthogonal frequencies, to enhance the performance and increase the reliability of the communication. DC-OFDM increases the reliability of these point-to-point OFDM wireless connections by transmitting data in some set of subcarriers and protection data (redundant, or coded, information) through another subset of carriers.

DC-OFDM is based on the observation that in OFDM communications the information is transmitted through orthogonal frequencies (parallel channels) and each subchannel can experience different channel effects. The DC-OFDM communication is shown in Figure 9.5.

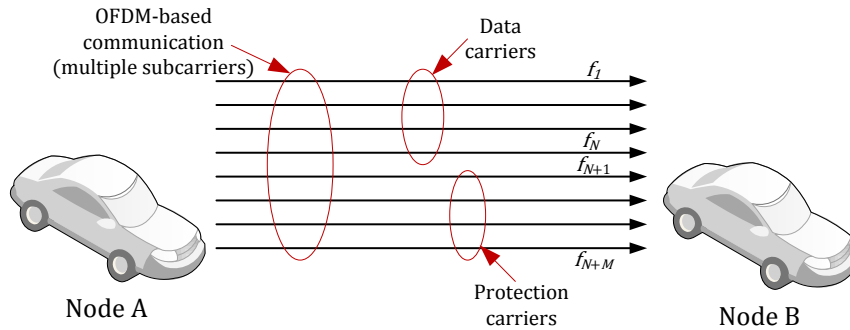

Figure 9.5 DC-OFDM communication system

This novel technique of applying coding across OFDM carriers differs from the traditional coded OFDM where channel coding techniques, such as convolutional codes, Reed-Solomon codes, in combination with interleaving, are used in each subcarrier channel in the time domain.

9.4.1 System Model

Combining Diversity Coding with OFDM promises high reliability in vehicular, and other, communications while preserving high transmission rates. This is achieved by transmitting coded information across the OFDM carriers. That is, most of the carriers transport original information while the remaining (few) carriers transport coded information. The coded information is the result of the combination of the original information as in Diversity Coding. As shown in Figure 9.6, if any of the carriers that transport data ($d_1, d_2, \text{ up to } d_N$) is lost because of a fade or because of the number of errors in a carrier exceeds the error correction capability of the forward error correction code (FEC), the information from the lost carrier can be recovered from the (received) protection carriers (c_1 for this simple example).

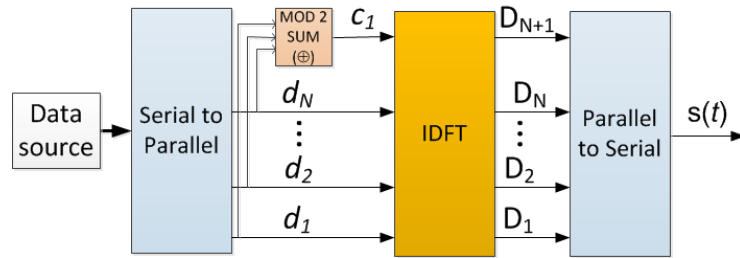

Figure 9.6 System with 1 – for – N DC-OFDM communication links (Transmitter)

The information transported by the protection subcarrier c_1 , as shown in Figure 9.6, is calculated using (2-3). That is:

$$c_1 = \bigoplus_{j=0}^N d_j \quad (9-13)$$

At the receiver, the decoding process is carried out using Eq. (2-5). If there is no failure in the data lines (data subcarriers), the information transmitted through the protection subcarrier is discarded. However, if there is a link failure in any of the data subcarriers, a failure detection algorithm detects the failure and informs the receiver which data subcarrier should be omitted and the information of the data subcarrier with failure is recovered with the information provided by

the protection subcarrier. That is, if the information of the data subcarrier d_i is lost or corrupted, it can be recovered using c_i , as shown in Figure 9.7.

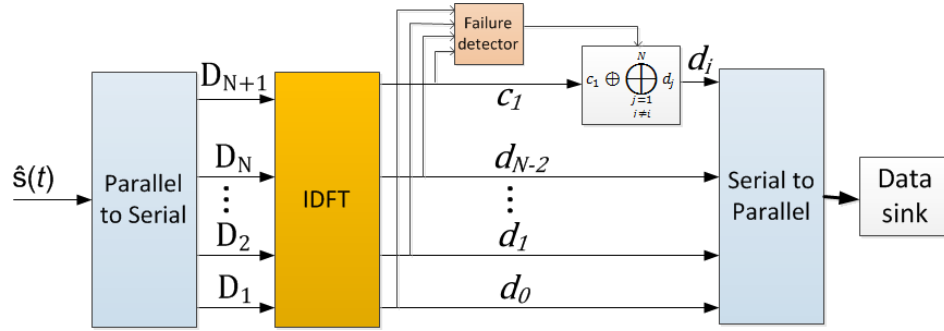

Figure 9.7 System with 1 – for – N DC–OFDM communication links (Receiver)

From Eq. (2–5), we have:

$$\hat{d}_i = \bigoplus_{j=1}^N d_j \oplus \bigoplus_{\substack{j=1 \\ j \neq i}}^N d_j \quad (9-14)$$

Expanding Eq. (9–14), we have:

$$\hat{d}_i = (d_1 \oplus \dots \oplus d_i \oplus \dots \oplus d_N) \oplus (d_1 \oplus \dots \oplus d_{i-1} \oplus d_{i+1} \oplus \dots \oplus d_N) \quad (9-15)$$

Given that $d_j \oplus d_j = 0$, Eq. (9–15) becomes:

$$\hat{d}_i = d_i \quad (9-16)$$

By using just one subcarrier to transmit the coded information, the lost information in the failed link can be instantaneously recovered.

Assuming that the probability of link error (p_i) is the same for all the links/subcarriers ($p = p_i, \forall i$) the probability of successfully receive the correct information through at least any x links, out of the N data lines plus 1 protection line ($N + 1$), is calculated as:

$$Ps = Prob(x) \quad (9-17)$$

$$P_S = \sum_{t=1}^{N-1} \left(\left(\frac{\prod_{i=1}^t i}{(N+1)^t} \right) \binom{N+1}{t} (1-p)^t (p)^{N+1-t} \right) + \sum_{t=N}^{N+1} \left(\binom{N+1}{t} (1-p)^t (p)^{N+1-t} \right) \quad (9-18)$$

Rewriting Eq. (9-18), we have that the probability of successful reception at the destination is calculated as:

$$P_S = \sum_{t=1}^{N-1} \left(\left(\frac{\prod_{i=N+2-t}^N i}{(N+1)^{t-1}} \right) (1-p)^t (p)^{N+1-t} \right) + \sum_{t=N}^{N+1} \left(\binom{N+1}{t} (1-p)^t (p)^{N+1-t} \right) \quad (9-19)$$

However, since the region of interest is when the information has been correctly received through at least N links, Eq. (9-19) is reduced to:

$$P_S = Prob(x \geq N) \quad (9-20)$$

$$P_S = \sum_{t=N}^{N+1} \left(\binom{N+1}{t} (1-p)^t (p)^{N+1-t} \right) \quad (9-21)$$

As shown in Figure 9.6, each link can carry as few as one bit to implement a 1 for N Diversity Coding system, because with one bit we can calculate a Galois Field of up to two elements $\{0, 1\}$, $GF(2^1)$. In other words, the number of protection links is limited by the number of bits per link. That is, the larger the number of bits to be transmitted by each link, the larger the number of protection links that can be implemented. This is because the number of protection links (subcarriers) is limited to the Galois Field $[GF(2^q)]$ size q to calculate the information that is transmitted through the protection links. If we would like to relate the number of protection links and the modulation schemes in an OFDM system directly, we can see that only high order modulation schemes can be used with Diversity Coding because of Diversity Coding spatial transmission characteristic. Table 9-1 shows the parameters for a Diversity Coding OFDM-based system that take into account the IEEE 802.11p standard. That is, the number of subcarriers is 48, the number of data bits per OFDM symbol depends on the modulation scheme, and the code rate

depends on the data rate. As we mentioned before, a maximum of one protection subcarrier can be created for a BPSK modulation scheme, a maximum of 3 protection links can be created for QPSK modulation scheme, 15 protection subcarriers can be created for 16 QAM, and 24 protection links can be created for 64 QAM. In other words, only 16 QAM $\frac{3}{4}$, 64 QAM $\frac{2}{3}$, and 64 QAM $\frac{3}{4}$ would be suitable to directly create the spatial protection through Diversity Coding while maintaining the same structure as the IEEE 802.11p standard.

The probability of successful reception at the destination for Diversity Coding – OFDM-based systems that use 16 QAM $\frac{3}{4}$, 64 QAM $\frac{2}{3}$, or 64 QAM $\frac{3}{4}$ modulation schemes can be calculated using eq. (9–21).

Table 9-1 Diversity Coding as a function of the modulation scheme for IEEE 802.11p

Modulation	Code Rate (R)	Coded bits per subcarrier (N_{BPSK})	Data rate (Mbps)	Carriers with data	Max Rank $GF(2^{\text{bits}})$	Max total carriers
BPSK	$\frac{1}{2}$	1	3	24	1	25
	$\frac{3}{4}$	1	4.5	36	1	37
QPSK	$\frac{1}{2}$	2	6	24	3	27
	$\frac{3}{4}$	2	9	36	3	39
16 QAM	$\frac{1}{2}$	4	12	24	15	39
	$\frac{3}{4}$	4	18	36	15	51
64 QAM	$\frac{2}{3}$	6	24	32	24	56
	$\frac{3}{4}$	6	27	36	24	60

Nevertheless, since we are interested in studying the effects of Diversity Coding in OFDM-based schemes, regardless of the modulation scheme and FFT size, in the following subsection, we present how Diversity Coding works for any modulation scheme and FFT size.

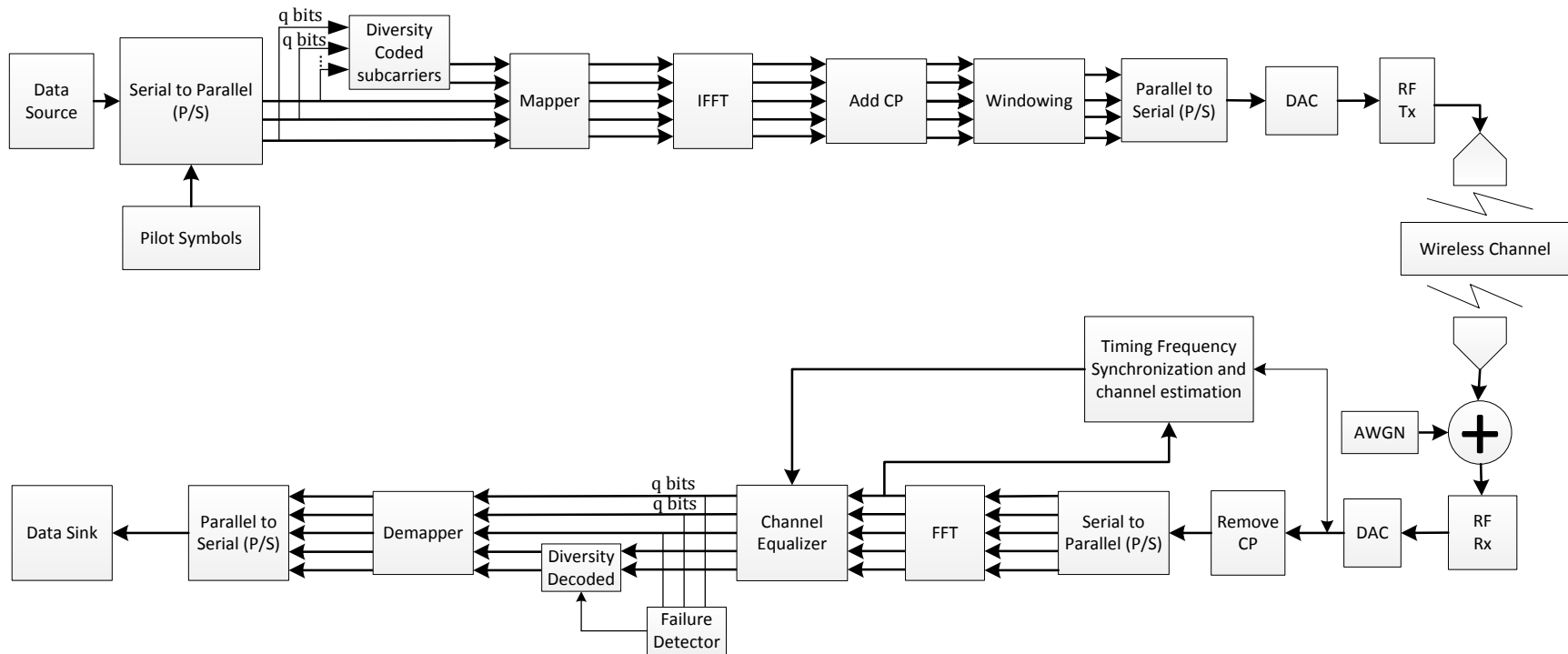

Figure 9.8 DC – OFDM block diagram

9.4.2 Operation of Diversity Coding – OFDM

Diversity Coding, which is a spatial feed-forward error correction technique, is well suited to work on OFDM-based systems because the protection “lines” can be transmitted through some of the subcarriers. Since the number of protection subcarriers depends on the Galois Field size q , we first assign q bits per subcarrier in the serial to parallel conversion, as shown in Figure 9.8.

The number of bits to be transmitted per subcarrier is calculated based on the number of data and protection subcarriers, N and M , respectively and is given by [13]:

$$q \geq \lceil \log_2(N + M + 1) \rceil \quad (9-22)$$

The total number of data plus protection lines (subcarriers) should be at most equal to the FFT size because the number of subcarriers is limited to the FFT size:

$$N + M \leq FFT_{size} \quad (9-23)$$

The protection information that is transmitted through some of the OFDM subcarriers is calculated using Eq. (2-13):

$$c_i = \sum_{j=1}^N \beta_{ij} d_j \quad i \in \{1, 2, \dots, M\} \quad (9-24)$$

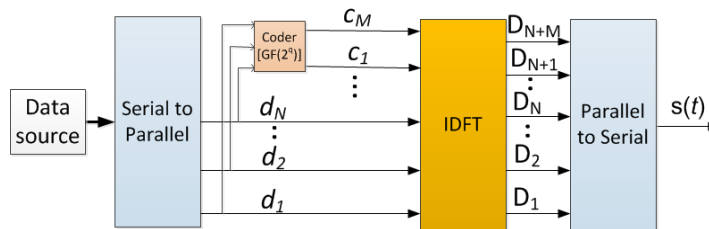

Figure 9.9 M – for – N DC – OFDM communication links

Figure 9.9 shows the Diversity Coding at the source node, where each subcarrier carries a symbol of q bits. Moreover, the information transmitted through each subcarrier (data or protection subcarrier) is predetermined and known by the transmitter and receiver. That is, the subcarrier index (location) is predefined for each subcarrier to transport either data or protection information.

Since the information transmitted through the data lines (subcarriers) is uncoded, the coding coefficients of the data lines form an identity matrix of size N (I_N) as shown below:

$$\text{Subcarrier}_j \left\{ \begin{array}{c} \text{Data line}_j \\ \left[\begin{array}{cccc} 1 & 0 & 0 & \dots & 0 \\ 0 & 1 & 0 & \dots & 0 \\ 0 & 0 & 1 & \dots & 0 \\ \vdots & \vdots & \vdots & \ddots & \vdots \\ 0 & 0 & 0 & \dots & 1 \end{array} \right] \end{array} \right. \quad (9-25)$$

where $j \in \{1, 2, \dots, N\}$. The coefficients of the protection lines are formed by the β_{ij} coefficients matrix, as shown in Eq. (2-14):

$$\text{Subcarrier}_{i+N} \left\{ \begin{array}{c} \text{Protection line}_{i+N} \\ \left[\begin{array}{cccc} 1 & 1 & \dots & 1 \\ 1 & \alpha & \dots & \alpha^N \\ 1 & \alpha^2 & \dots & \alpha^{2N} \\ 1 & \vdots & \ddots & \vdots \\ 1 & \alpha^{(M-1)} & \dots & \alpha^{(M-1)N} \end{array} \right] \end{array} \right. \quad (9-26)$$

The assignment of the data and protection lines to each subcarrier is predefined to minimize the computational complexity in both transmitter and receiver. The assignment can be sequential, where the data lines $\{1, 2, \dots, N\}$ can be assigned to the N first subcarriers and the protection lines $\{1, 2, \dots, M\}$ can be assigned to the next M subcarriers $\{N + 1, N + 2, \dots, N + M\}$, or it can be interleaved, where for example, the first data line is assigned to the first subcarrier, the first protection lines is assigned to the second subcarrier, the second data line is assigned to the third subcarrier, and so on. This will depend on the diversity code (DC) rate. The DC code rate is calculated as:

$$\text{DC code rate} = \frac{N}{N + M} \quad (9-27)$$

We can calculate the number of protection lines as a function of the data lines and DC code rates as:

$$M = \frac{(1 - \text{DC code rate})N}{\text{DC code rate}} \quad (9-28)$$

At the receiver, the coefficients of the data and protection lines form the following matrix, which depends on the information that was correctly received at the destination:

$$\boldsymbol{\beta}' = \begin{bmatrix} 1 & 0 & 0 & \cdots & 0 \\ 0 & 1 & 0 & \cdots & 0 \\ 0 & 0 & 1 & \cdots & 0 \\ \vdots & \vdots & \vdots & \ddots & \vdots \\ 0 & 0 & 0 & \cdots & 1 \\ 1 & 1 & 1 & \cdots & 1 \\ 1 & \alpha & \alpha^2 & \cdots & \alpha^N \\ 1 & \alpha^2 & \alpha^4 & \cdots & \alpha^{2N} \\ \vdots & \vdots & \vdots & \ddots & \vdots \\ 1 & \alpha^{(M-1)} & \alpha^{(M-1)2} & \cdots & \alpha^{(M-1)N} \end{bmatrix} \quad (9-29)$$

The receiver, by using the $\boldsymbol{\beta}'$ matrix coefficients, a $(N + M)$ -by- N matrix, can find the transmitted data by recovering the lost information in the data lines through the protection lines. That is, the receiver uses only N rows out of the $N + M$ rows from the $\boldsymbol{\beta}'_N$ matrix coefficients to recover the information of the data lines:

$$\boldsymbol{\beta}'_N \mathbf{x} = \mathbf{b}_N \quad (9-30)$$

The receiver preferably uses as many indexes of the data lines as possible to faster decode the information that is lost during transmission. In other words, the receiver uses as many elements of the identity matrix, Eq. (9-25), as the implementation will allow. If no data line is lost during transmission, no decoding process is needed at the receiver and the information transmitted through the protection lines is discarded. The vector formed by the data lines \mathbf{x} is:

$$\mathbf{x} = \begin{bmatrix} d_1 \\ d_2 \\ \vdots \\ d_N \end{bmatrix} \quad (9-31)$$

and \mathbf{b}_N is the vector formed by the correctly received information at the destination with the same indexes as the $\boldsymbol{\beta}'_N$ matrix.

The receiver can recover the lost information transmitted through the data lines by performing Gaussian elimination of the $\boldsymbol{\beta}$ coefficients (protection lines). This is a fast process because some of the row elements of the coefficients matrix are already in the row canonical form.

Assuming that the probability of link error (p_i) is the same for all the links ($p = p_i, \forall i$) the probability of successfully receiving the correct information through at least any N links, out of the N data lines plus M protection lines, is calculated as:

$$P_S = Prob(x \geq N) \quad (9-32)$$

$$P_S = \sum_{t=N}^{N+M} \binom{N+M}{t} (1-p)^t (p)^{N+M-t} \quad (9-33)$$

However, the assumption that all the links have the same probability of link error may be unrealistic, because in an OFDM system each subcarrier can experience different channel effects. A general formula to calculate the probability of successfully receiving the correct information through at least any N links, out of the N data lines plus M protection lines is:

$$P_S = Prob(x \geq N) \quad (9-34)$$

$$P_S = \sum_{t=N}^{N+M} \left[\sum_{\vec{a} \in A} \left(\prod_{i \in a_1} p_i \prod_{j \in a_0} (1-p_j) \right) \right] \quad (9-35)$$

Where:

- A is a set of $N + M$ binary sequences of all the 2^{N+M} possible combinations. A binary sequence can contain either 0 or 1, where “1” means that the transmission was successful and “0” otherwise. The number of 1-s in A is t and the number of 0-s is $(N + M - t)$; so there are $\binom{N+M}{t}$ such sequences. Thus,

$$\|A\| = \binom{N+M}{t} \quad (9-36)$$

- \vec{a} is a particular sequence from the set A , a_0 is a set of all indices j of \vec{a} such that $a(j) = 0$, and a_1 is a set of all indices i of \vec{a} such that $a(i) = 1$. Thus,

$$\|a_0\| + \|a_1\| = N + M \quad (9-37)$$

- p_i is the probability that the information transmitted through subcarrier i is correctly received at the destination.

The following section presents our results for our DC–OFDM scheme for different parameters as the number of data and protection lines, DC code rates, among others.

9.5 Results

In this section, we discuss the performance of Diversity Coding – Orthogonal Frequency Division Multiplexing (DC–OFDM) as measured by the probability of successful reception at the destination. We have analyzed the effect of different parameters, such as: number of data links, number of coded (protection) links, modulation technique and DC code rate, to optimize the communication’s probability of successful reception of an OFDM symbol at the receiver. Moreover, we have compared our approach (DC–OFDM) to existing OFDM-based systems, such as IEEE 802.11p, that do not use coding in the spatial domain (across sub-channels). Extant OFDM-based systems were described in subsection 9.2.2 and the DC–OFDM approach was presented in Section 9.4.

First, we start comparing the performance of 1 *for* N DC–OFDM system to extant OFDM systems that do not use Diversity Coding (no DC). Figure 9.10 shows the probability of successfully receiving at the destination the information of N data links (subcarriers) as a function of the symbol error rate per subcarrier ($p_{ser_i} = p_{ser}, \forall i$). That is, we use Eq. (9–10) and Eq. (9–24) for this comparison. We have also validated these equations through simulations. As we can see in Figure 9.10, by only adding one subcarrier to transmit coded information, that is the combination of the information transmitted through the data links, we can achieve a significant performance improvement (probability of correctly receiving the information), as the number of data links increases. The performance improvement is more pronounced for high symbol error rates ($p_{ser} \geq 10^{-3}$). Moreover, Diversity Coding provides excellent performance when a data link fails, e.g. d_i fails ($p_{ser_i} = 1$).

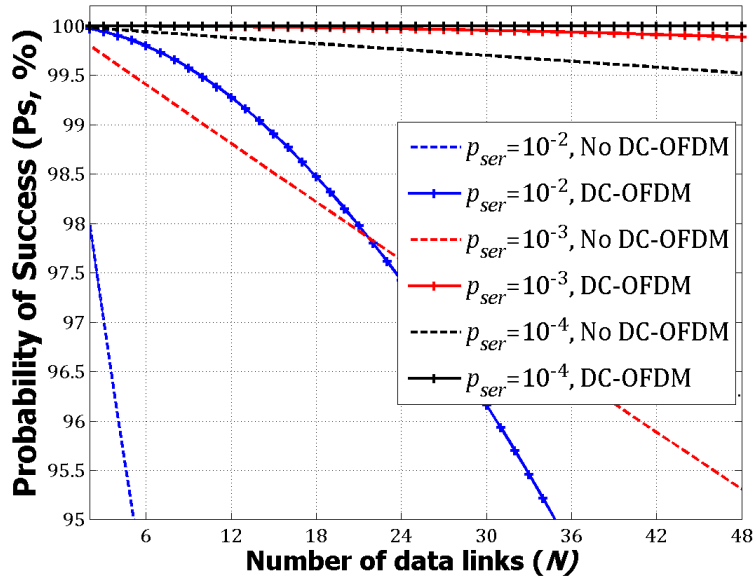

Figure 9.10 Performance of a 1 – for – N DC – OFDM system as a function of the number of subcarriers

Figure 9.11 and Figure 9.12 show the performance of DC – OFDM as a function of the number of data link for different, typical, code rates. As we can see in Figure 9.11, $\frac{1}{2}$, $\frac{2}{3}$ and $\frac{3}{4}$ code rates achieve the maximum throughput performance because the symbol error probability (p_{ser}) is very small.

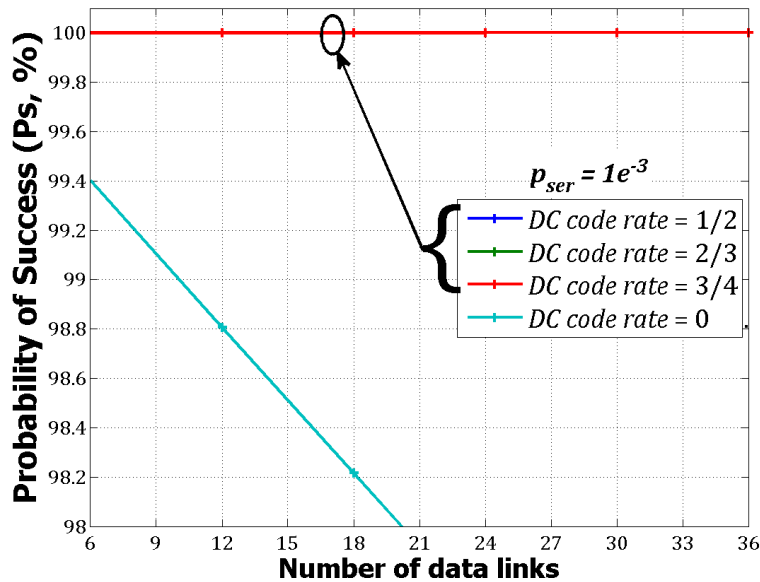

Figure 9.11 Performance of a M – for – N DC – OFDM system for a probability of link error p_{ser} of 10^{-3}

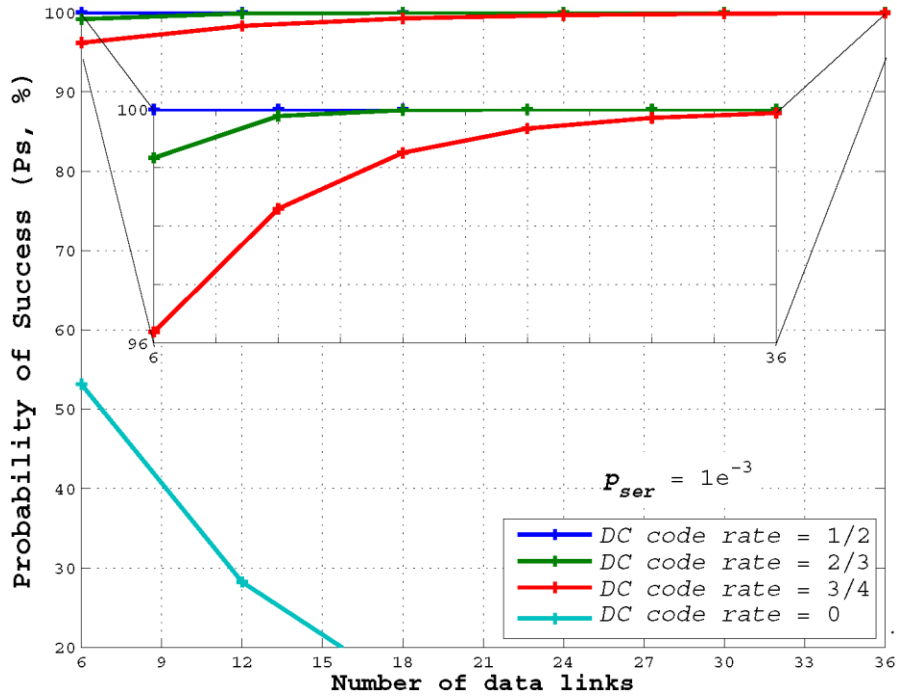

Figure 9.12 Performance of a $M - for - N$ DC – OFDM system for a probability of link error p_{ser} of 10^{-3}

For higher symbol error probabilities, as shown in Figure 9.12, DC code rate of $1/2$ provides the highest probability of successful reception at the receiver. That is, the probability of correctly receiving the information through at least N data and/or protection lines (subcarriers). For typical symbol error probabilities ($p_{ser} \approx 10^{-5}$), low DC code rates are enough to achieve the best performance. Or from another viewpoint, we can reduce the energy per symbol (or energy per bit, E_b/N_0) and increase the DC code rate to achieve a 100% of probability of successful reception.

The performance of a $1 - for - N$ DC – OFDM system for OFDM-QPSK modulated in a multi-path channel for various relative speeds between transmitter and receiver vehicles (expressed as the maximum Doppler shift (f_d) and the subcarrier spacing Δf ratio) is shown in Figure 9.13. As we can see, DC-OFDM provides performance improvement for communications between stationary terminals/vehicles ($f_d = 0$). By implementing $1 - for - N$ DC – OFDM, it is possible to reduce the energy per bit by about 10 dB and achieve similar performance than a

system that does not use DC-OFDM. Moreover, when the relative speed between transmitter and receiver vehicles is high, the symbol error rate per subcarrier is also high. Therefore, by adding an extra subcarrier to transmit protection data, we can significantly increase the performance of the communication. Note that when the relative speed is high, it is not possible to significantly reduce the symbol error rate by increasing the energy per bit (E_b/N_0).

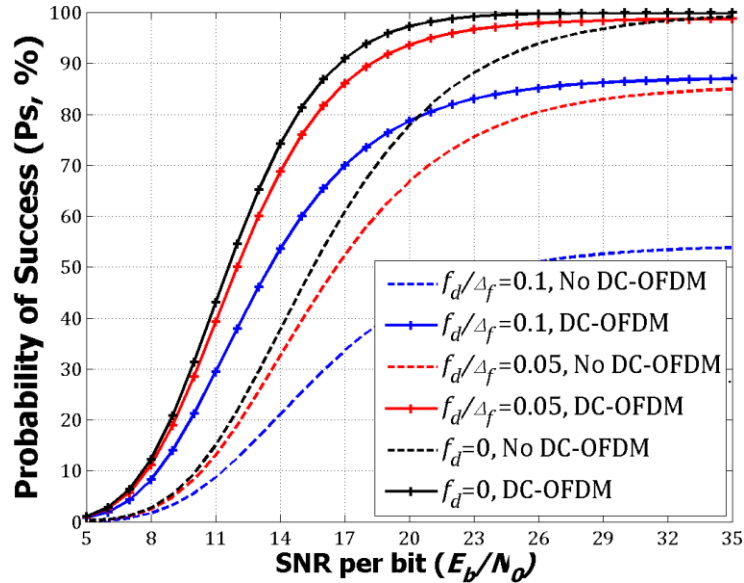

Figure 9.13 Performance of 1 – for – N DC – OFDM system for an OFDM-QPSK in a multi-path channel for various relative speeds

9.6 Concluding Remarks

In this chapter, we proposed a Diversity Coding orthogonal frequency division multiplexing (DC-OFDM) scheme that applies Diversity Coding to OFDM-based systems such as IEEE 802.11p for vehicular environments and provides improved probability of successful reception at the receiver and transparent self-healing and fault-tolerance. Diversity Coding is well suited for OFDM-based systems because of its spatial diversity nature (parallel links). DC-OFDM provides the best performance when the probability of link error is high or when a link (sub-channel) fails. Also, by implementing Diversity Coding in OFDM-based systems, we can provide reliable communication that is quite tolerant of link failures, since data and protection lines are transmitted via multiple sub-channels. Moreover, only adding one protection line

(subcarrier), DC-OFDM provides significant performance improvement. Note that DC-OFDM is also well suited for mobile communications because this type of communications often has (raw) high symbol error rates.

In conclusion, under typical operating conditions, DC-OFDM enables increased probability of successful reception at the receiver, thus, increasing the reliability of communications between vehicles.

CHAPTER 10. CONCLUSION AND FUTURE DIRECTIONS

Wireless networks will forever alter how people access information and will facilitate integration of the physical world with the Internet. Wireless technology is rapidly migrating from communications to a multitude of embedded real-world applications. A current example is surveillance in the military, which exploits the rapid deployment of many wireless sensor nodes. One of the main desired features of this type of network is robustness while minimizing the energy consumption.

In the recent years, Wireless Body Area Networks (WBANs), communication networks of low-power wireless sensors or devices located on, in, or around the human body that provides ubiquitous real-time monitoring and / or actuation, have gained interest in medical applications for prevention and early detection of medical problems that may need attention, as well as for assisting surgeons in minimally invasive surgeries (MIS) as the MARVEL camera module for real-time video streaming.

Since wireless high-definition video over the *in vivo* communications channel requires high bit rates, Orthogonal Frequency Division Multiplexing (OFDM), a widely used technology in fourth generation wireless network (4G), is studied. By applying Diversity Coding through orthogonal subcarriers (OFDM), high reliability communications while preserving high transmission rates is achieved.

The technologies that we use to improve the performance of wireless sensor and wireless body area networks are based on Network Coding and Diversity Coding. Table 10-1 shows a comparison between Diversity Coding and Network Coding. As per this table, Diversity Coding is more suited to improve the performance of Wireless Body Area Networks because of its low complexity and low energy required to code the packets.

Table 10-1 Comparison between Diversity Coding and Network Coding

Characteristic	Diversity Coding (DC)	Network Coding
Basic idea	Both schemes introduce redundant packets/symbols/links that carry the coded information	
Error correction	Both schemes are feed-forward error-correction techniques	
Coding coefficients	Known [Given by: $\beta_{ij} = \alpha^{(i-1)(j-1)}$, α is a primitive element of a $GF(2^q)$]	Randomly chosen [From a $GF(2^q)$]
Network topology	Known	Unknown
Coded information	Only the protection packets are coded	All the packets are coded
Energy	Less energy	More energy
Complexity	Less complex	More complex

10.1 Main Contributions and Conclusions

The main contributions in this dissertation are described below:

10.1.1 Cooperative Network Coding for Improving the Performance of Wireless Sensor Networks

We analyzed the effect of the connectivity on the performance of Cooperative Network Coding [65]. Based on the range of parameters we investigated, Cooperative Network Coding achieves its optimal performance when r_s is equal to m , r_{ij} is 4 and r_{Kj} is 1 for all the j 's. Any increase of the connectivity, r_s and r_{ij} , provides only marginal gain in throughput and introduces unnecessary redundant traffic in the network. For connectivity r_{ij} equal to 2 and r_{Kj} equal to 1 for all the j 's and, by setting the connectivity r_s equal to the number of nodes per cluster m , Cooperative Network Coding can achieve an increase of throughput of about 34% and 37% for probabilities of transmission loss of a link of 0.1 and 0.25, respectively. The connectivity r_{Kj} has a direct effect on the performance of Cooperative Network Coding because if the destination is disconnected from one of the nodes in the last cluster, the network performance is reduced and the throughput for a cluster size n is equal to the throughput of a cluster size $n - 1$.

Further, we studied the effect of the number of clusters between the source and destination nodes on the performance of Cooperative Network Coding for a different range of parameters [66]. As opposed to multihop *ad-hoc* networks, where the outage probability exponentially increases with the number of hops, Cooperative Network Coding provides a very low outage probability that is not very sensitive to the number of hops when the system parameters are properly set. We can observe this characteristic of invariability in the throughput when the cluster size is at least 14 nodes per cluster for any number of hops K . Generally, the throughput of Cooperative Network Coding is almost invariant to the number of hops between the source and the destination nodes independently of the probability of transmission loss for connectivity values greater or equal to 4.

10.1.2 Link-level Retransmissions for Cooperative Network Coding Architectures

Cooperative Network Coding with link-level retransmission in the last cluster [39] results in increased probability of successful reception together with increased throughput when there are small clusters, when the connectivity of the network is small ($n \leq 15$, $r \leq 6$), and when the probability of transmission loss is large ($p \geq 0.2$). These conditions are representative sparse sensor networks. By implementing link-level retransmission in Cooperative Network Coding, the probability of successful reception P_s can be increased from 0.05 without link-level retransmissions to close to 1 with link-level retransmissions, when the number of nodes per cluster n is equal to the number of original packets m ($n = m = 10$) and the probability of transmission loss p is 0.25. For cluster sizes n of less than 15 nodes per cluster and the connectivity of nodes r less than 8, link-level retransmissions offers a significant improvement in the probability of successful reception P_s from values in the range (0.05 to 0.35) with no link-level retransmissions, to values greater than 0.95 with link-level retransmissions. Moreover, when not all the nodes in the cluster K are connected to the destination node, link-layer retransmission can help to increase the network's performance without increasing the cluster size.

To further improve the performance of Cooperative Network Coding architectures with link-level retransmissions, we presented an approach of selective retransmissions that minimizes the energy consumed by multihop wireless packet networks that use Cooperative Network Coding (CNC) or a novel variant Cooperative Diversity Coding (CDC) [40]. By optimizing and balancing the use of forward error control, error detection, and retransmissions at packet level in such networks we can both minimize the energy consumption and network latency. The energy savings obtained by our approaches (CNC and CDC) are about 26% compared to the baseline CNC approach. Further, our CDC approach further reduces the energy and complexity of the source node to create coded packets.

10.1.3 Cooperative Network Coding for Improving the Performance of Wireless Body Area Networks

We discussed the ability of Cooperative Network Coding [CNC] to increase the reliability, provide transparent self-healing, and enhance the expected number of correctly received and decoded packets at the destination of WBANs while transmitting at low power. Because of the real-time nature of many medical applications and the fact that many sensors can only transmit, error detection and retransmission (i.e., ARQ) is not a preferred option. We proposed a WBAN communication network based on Cooperative Network Coding that provides improved probability of successful reception at the destination and transparent self-healing and fault-tolerance [41]. For representative systems, we determine the optimal parameter values to achieve the highest throughput and reduce the required energy per bit. As opposed to systems that are unprotected against node or link failures, for WBANs with Cooperative Network Coding, it is quite likely that the packets needed to recover the original information are available through different paths to the sink and (therefore) enable a substantial throughput gain. Our approach [CNC] requires about 3.5 dB less energy per bit than extant WBAN systems that do not use cooperation or Network Coding. Moreover, we have shown that Network Coding [NC] provides better performance than an uncoded cooperation system [UC], but at expense of decreasing the

network reliability because of the single path between source and destination. Under typical operating conditions, Cooperative Network Coding enables increased probability of successful reception at the destination, and thus higher expected number of correctly received and decoded packets at the destination, and improved network reliability because of the cooperation of the relays in transmitting coded packets through multiple paths.

10.1.4 Temporal Diversity Coding for Improving the Performance of Wireless Body Area Networks

We proposed the Temporal Diversity Coding (*TDC – K*) scheme, a novel technique that utilizes Diversity Coding in time through K spatially independent paths to achieve improved network performance by increasing the network's reliability and minimizing the delay. Wireless body area networks (WBANs) are an attractive application for Temporal Network Coding because of the requirement for low complexity, limited power, and high reliability for this type of network in real-time applications such as capsule endoscopy and video/medical imaging, where retransmissions are not a good alternative. We demonstrated that by implementing this novel technique, we can achieve significant improvement (~50%) in throughput compared to extant WBANs. The Temporal Diversity Coding scheme features: low complexity because the Diversity Coding coefficients are implicitly known to the source and destination nodes; limited power consumption because smaller E_b/N_0 is required to recover the entire message; better reliability because of the use of a cooperative relays that help to transmit the packets from the source to the destination node; and real-time transmission because of the reduced complexity of the scheme, allowing processing on low-power nodes.

Temporal Diversity Coding requires less complexity and computational power, but is limited in that the relays cannot combine packets (they just forward the packets). On the other hand, Cooperative Network Coding requires more complexity and computational power than TDC but the relays can combine the received packets and create new combination packets. This process adds “some” linear independency among the packets. However, Temporal Diversity

Coding allows “almost” real-time transmission because while the data packets are being transmitted, the protection packets are being created. So, after the last data packet is transmitted, the protection packets are immediately transmitted. For Cooperative Network Coding, the source needs to have the block of information (e.g. m packets) to be able to create the m' coded packets, where $m' \geq m$. And after that, it transmits the coded packets.

10.1.5 Diversity Coding for Orthogonal Frequency Division Multiplexing (OFDM-based) Systems

We proposed a Diversity Coding orthogonal frequency division multiplexing (DC-OFDM) scheme [45] that applies Diversity Coding to OFDM-based systems to provide improved probability of successful reception at the receiver and transparent self-healing and fault-tolerance. Diversity Coding is well suited for OFDM-based systems because of its spatial diversity nature (parallel links). DC-OFDM provides the best performance when the probability of link error is high or when a link (sub-channel) fails. Also, by implementing Diversity Coding in OFDM-based systems, we can provide reliable communication that is quite tolerant of link failures, since data and protection lines are transmitted via multiple sub-channels. Moreover, only adding one protection line (subcarrier), DC-OFDM provides significant performance improvement. Note that DC-OFDM is also well suited for mobile communications because this type of communications has high symbol error probability. Under typical operating conditions, DC-OFDM enables increased probability of successful reception at the receiver, thus, increasing the reliability of communications between vehicles by transmitting data and protection information through parallel subcarriers.

10.2 Future Directions

Beyond what has been presented throughout this dissertation, there are topics that can be further explored. For example:

- Analyzing and simulating the performance and dynamic effects of link-level retransmissions on Cooperative Network Coding (CNC) when the links or nodes fail.

- Optimizing the performance of Cooperative Diversity Coding (CDC) while minimizing the energy consumed by the network, including the energy consumed by the nodes in checking the rank in a cluster.
- Studying the performance of a pseudo-random approach based on Cooperative Network Coding. Where the nodes, instead of randomly choosing the coding coefficients, select the coding coefficients from a given row from the Vandermonde matrix.
- Analyzing the performance of Cooperative Network Coding (CNC) for WBANs when there are many relays transmitting many coded packets.
- Analyzing the benefits of combining Temporal Diversity Coding (*TDC*) and Spatial Diversity Coding.
- Studying the most effective method to detect symbol errors in DC-OFDM.
- Exploring the performance of CDC, TDC and DC-OFDM over *in vivo* wireless channels.

REFERENCES

- [1] K. David, D. Dixit, and N. Jefferies, “2020 Vision,” *Vehicular Technology Magazine, IEEE*, vol. 5, no. 3, pp. 22–29, 2010.
- [2] Lene Sørensen and Knud Erik Skouby, “User scenarios 2020 - a worldwide wireless future.” Wireless World Research Forum, Sep-2012.
- [3] Roberto Verdone, Davide Dardari, Gianluca Mazzini, and Andrea Conti, *Wireless sensor and actuator networks: technologies, analysis and design*. Amsterdam; Boston: Elsevier/Academic Press, 2008.
- [4] K. Sohraby, D. Minoli, and T. Znati, *Wireless sensor networks : technology, protocols, and applications*. Hoboken,N.J.: John Wiley & Sons, 2007.
- [5] S. Ullah, H. Higgins, B. Braem, B. Latre, C. Blondia, I. Moerman, S. Saleem, Z. Rahman, and K. S. Kwak, “A Comprehensive Survey of Wireless Body Area Networks,” *Journal of Medical Systems*, Aug. 2010.
- [6] M. Patel and Jianfeng Wang, “Applications, challenges, and prospective in emerging body area networking technologies,” *Wireless Communications, IEEE DOI - 10.1109/MWC.2010.5416354*, vol. 17, no. 1, pp. 80–88, 2010.
- [7] “IEEE 802.15 WPAN™ Task Group 6 (TG6) Body Area Networks.” [Online]. Available: <http://www.ieee802.org/15/pub/TG6.html>. [Accessed: 15-Sep-2011].
- [8] IEEE P802.15 Working Group for Wireless Personal Area Networks (WPANs), “Channel Model for Body Area Network (BAN).” IEEE P802.15 Wireless Personal Area Networks, 2010.
- [9] M. A. Labrador and P. M. Wightman, *Topology control in wireless sensor networks with a companion simulation tool for teaching and research*. Springer, 2009.
- [10] C. Lee, *Error-control block codes for communications engineers*. Artech House, Boston, 2000.
- [11] A. S. Tanenbaum and D. Wetherall, *Computer networks*. Boston: Pearson Prentice Hall, 2011.
- [12] Stephen B. Wicker and Vijay Bhargava, Eds., *Reed-Solomon codes and their applications*. New York: IEEE Press, 1994.
- [13] E. Ayanoglu, Chih-Lin I, R. D. Gitlin, and J. E. Mazo, “Diversity coding for transparent self-healing and fault-tolerant communication networks,” *IEEE Transactions on Communications*, vol. 41, no. 11, pp. 1677–1686, 1993.

- [14] E. Ayanoglu, Chih-Lin I, R. D. Gitlin, and J. E. Mazo, "Diversity coding: using error control for self-healing in communication networks," in *Proceedings of Ninth Annual Joint Conference of the IEEE Computer and Communication Societies. "The Multiple Facets of Integration"*, INFOCOM '90, 1990, pp. 95–104 vol.1.
- [15] Chih-Lin I, E. Ayanoglu, R. D. Gitlin, and J. E. Mazo, "Transparent self-healing communication networks via diversity coding," in *IEEE International Conference on Communications, 1990. ICC '90, Including Supercomm Technical Sessions. SUPERCMM/ICC '90*, 1990, pp. 509–514 vol.2.
- [16] R. Ahlswede, Ning Cai, S.-Y. R. Li, and R. W. Yeung, "Network information flow," *Information Theory, IEEE Transactions on*, vol. 46, no. 4, pp. 1204–1216, 2000.
- [17] P. A. Chou and Yunnan Wu, "Network Coding for the Internet and Wireless Networks," *Signal Processing Magazine, IEEE DOI - 10.1109/MSP.2007.904818*, vol. 24, no. 5, pp. 77–85, 2007.
- [18] S. Yang and R. Koetter, "Network Coding over a Noisy Relay: a Belief Propagation Approach," *CoRR*, vol. abs/cs/0701062, 2007.
- [19] C. Fragouli, D. Katabi, A. Markopoulou, M. Medard, and H. Rahul, "Wireless Network Coding: Opportunities & Challenges," in *Military Communications Conference, 2007. MILCOM 2007. IEEE*, 2007, pp. 1–8.
- [20] L. Lima, M. Medard, and J. Barros, "Random Linear Network Coding: A free cipher?," in *Information Theory, 2007. ISIT 2007. IEEE International Symposium on*, 2007, pp. 546–550.
- [21] S. Katti, H. Rahul, Wenjun Hu, D. Katabi, M. Medard, and J. Crowcroft, "XORs in the Air: Practical Wireless Network Coding," *Networking, IEEE/ACM Transactions on*, vol. 16, no. 3, pp. 497–510, 2008.
- [22] Z. J. Haas and Tuan-Che Chen, "Cluster-based cooperative communication with network coding in wireless networks," in *MILITARY COMMUNICATIONS CONFERENCE, 2010 - MILCOM 2010*, 2010, pp. 2082–2089.
- [23] A. Sprintson, "Network Coding and Its Applications in Communication Networks," in *Algorithms for Next Generation Networks*, G. Cormode and M. Thottan, Eds. London: Springer London, 2010, pp. 343–372.
- [24] M. Chen, S. Gonzalez, A. Vasilakos, H. Cao, and V. C. M. Leung, "Body Area Networks: A Survey," *Mobile Networks and Applications*, vol. 16, pp. 171–193, Aug. 2010.
- [25] B. Latré, B. Braem, I. Moerman, C. Blondia, and P. Demeester, "A survey on wireless body area networks," *Wireless Networks*, vol. 17, pp. 1–18, Nov. 2010.
- [26] "IEEE Standard for Safety Levels With Respect to Human Exposure to Radio Frequency Electromagnetic Fields, 3 kHz to 300 GHz." 2006.
- [27] Y. Hao and R. Foster, "Wireless body sensor networks for health-monitoring applications," *Physiological Measurement*, vol. 29, pp. R27–R56, Nov. 2008.

- [28] H. Alemdar and C. Ersoy, "Wireless sensor networks for healthcare: A survey," *Computer Networks*, vol. 54, no. 15, pp. 2688–2710, Oct. 2010.
- [29] Huasong Cao, V. Leung, C. Chow, and H. Chan, "Enabling technologies for wireless body area networks: A survey and outlook," *Communications Magazine, IEEE*, vol. 47, no. 12, pp. 84–93, 2009.
- [30] W. Dale Compton and Proctor P. Reid, "Engineering and the Health Care Delivery System (editorial)," *The Bridge*, vol. 38, no. 1, pp. 3–5, Spring-2008.
- [31] "Healthcare: PillCam, Video Capsule Endoscopy, Esophageal Endoscopy - Given Imaging." [Online]. Available: <http://www.givenimaging.com/en-us/healthcareprofessionals/Products/Pages/PillCamSB.aspx>. [Accessed: 22-Nov-2011].
- [32] "Capsule Endoscopes - Endo Capsule redefining capsule endoscopy." [Online]. Available: http://www.olympusamerica.com/msg_section/msg_endoscopy_capsulescopes.asp. [Accessed: 22-Nov-2011].
- [33] C.-Y. Li, B.-L. Zhang, C.-X. Chen, and Y.-M. Li, "OMOM capsule endoscopy in diagnosis of small bowel disease," *J Zhejiang Univ Sci B*, vol. 9, no. 11, pp. 857–862, Nov. 2008.
- [34] W. A. Qureshi, "Current and future applications of the capsule camera," *Nat Rev Drug Discov*, vol. 3, no. 5, pp. 447–450, May 2004.
- [35] C. Kovac, "'Video pill' may supplement standard endoscopy," *BMJ*, vol. 323, no. 7309, p. 358, Aug. 2001.
- [36] F. Li, J. A. Leighton, and V. K. Sharma, "Capsule endoscopy in the evaluation of obscure gastrointestinal bleeding: a comprehensive review," *Gastroenterol Hepatol (N Y)*, vol. 3, no. 10, pp. 777–785, Oct. 2007.
- [37] A. Koulaouzidis and S. Douglas, "Capsule endoscopy in clinical practice: concise up-to-date overview," *Clin Exp Gastroenterol*, vol. 2, pp. 111–116, 2009.
- [38] C. A. Castro, S. Smith, A. Alqassis, T. Ketterl, Yu Sun, S. Ross, A. Rosemurgy, P. P. Savage, and R. D. Gitlin, "MARVEL: A Wireless Miniature Anchored Robotic Videoscope for Expedited Laparoscopy," in *IEEE International Conference on Robotics and Automation (ICRA), 2012*, 2012, pp. 1–6.
- [39] G. E. Arrobo, R. D. Gitlin, and Z. J. Haas, "Effect of link-level feedback and retransmissions on the performance of cooperative networking," in *Wireless Communications and Networking Conference (WCNC), 2011 IEEE*, 2011, pp. 1131–1136.
- [40] G. E. Arrobo and R. D. Gitlin, "Minimizing Energy Consumption for Cooperative Network and Diversity Coding Sensor Networks," in *Accepted to 4th Latin-American Conference on Communications (LATINCOM 2012)*, 2012, pp. 1–6.
- [41] G. E. Arrobo and R. D. Gitlin, "Cooperative Network Coding in Wireless Body Area Networks for Improved Performance," *Submitted to EURASIP Journal on Advances in Signal Processing*, pp. 1–19, 2012.

- [42] G. E. Arrobo and R. D. Gitlin, “New approaches to reliable wireless body area networks,” in *IEEE International Conference on Microwaves, Communications, Antennas and Electronics Systems (COMCAS 2011)*, Tel Aviv, Israel, 2011, pp. 1–6.
- [43] G. E. Arrobo and R. D. Gitlin, “Improving the reliability of wireless body area networks,” in *Engineering in Medicine and Biology Society, EMBC, 2011 Annual International Conference of the IEEE*, 2011, pp. 2192–2195.
- [44] G. E. Arrobo, Z. J. Haas, and R. D. Gitlin, “Temporal Diversity Coding for Improving the Performance of Wireless Body Area Networks,” in *Accepted to the 7th International Conference on Body Area Networks*, Oslo, Norway, 2012, pp. 1–4.
- [45] G. E. Arrobo and R. D. Gitlin, “Improving the Performance of OFDM-based Vehicular Systems through Diversity Coding,” *Submitted to Journal of Communications and Networks*, pp. 1–10, 2013.
- [46] H. Liu, H. Ma, M. El Zarki, and S. Gupta, “Error control schemes for networks: An overview,” *Mobile Networks and Applications*, vol. 2, no. 2, pp. 167–182, 1997.
- [47] A. Goldsmith, *Wireless Communications*. New York, NY, USA: Cambridge University Press, 2005.
- [48] H. O. Burton and D. D. Sullivan, “Errors and error control,” *Proceedings of the IEEE*, vol. 60, no. 11, pp. 1293 – 1301, Nov. 1972.
- [49] E. Y. Roher and R. L. Pickholtz, “An analysis of the effectiveness of hybrid transmission schemes,” *IBM J. Res. Dev.*, vol. 14, no. 4, pp. 426–433, Jul. 1970.
- [50] E. Dahlman, *3G Evolution: HSPA and LTE for Mobile Broadband*. Academic Press, 2008.
- [51] Jia-Qi Jin, T. Ho, and H. Viswanathan, “Comparison of Network Coding and Non-Network Coding Schemes for Multi-hop Wireless Networks,” in *Information Theory, 2006 IEEE International Symposium on*, 2006, pp. 197–201.
- [52] D. S. Lun, M. Medard, and R. Koetter, “Network Coding for Efficient Wireless Unicast,” in *Communications, 2006 International Zurich Seminar on*, 2006, pp. 74–77.
- [53] S. Yang and R. Koetter, “Network Coding over a Noisy Relay: a Belief Propagation Approach,” in *Information Theory, 2007. ISIT 2007. IEEE International Symposium on*, 2007, pp. 801–804.
- [54] C. Fragouli, J.-Y. Le Boudec, and J. Widmer, “Network coding: an instant primer,” *SIGCOMM Comput. Commun. Rev.*, vol. 36, no. 1, pp. 63–68, Jan. 2006.
- [55] J. Bhatia, A. Patel, and Z. Narmawala, “Review on variants of network coding in wireless ad-hoc networks,” in *2011 Nirma University International Conference on Engineering*, Ahmedabad, Gujarat, India, 2011, pp. 1–6.
- [56] T. Ho, M. Medard, R. Koetter, D. R. Karger, M. Effros, Jun Shi, and B. Leong, “A Random Linear Network Coding Approach to Multicast,” *Information Theory, IEEE Transactions on*, vol. 52, no. 10, pp. 4413–4430, 2006.

- [57] C. Gkantsidis and P. R. Rodriguez, "Network coding for large scale content distribution," in *Proceedings IEEE INFOCOM 2005. 24th Annual Joint Conference of the IEEE Computer and Communications Societies*, 2005, vol. 4, pp. 2235 – 2245 vol. 4.
- [58] C. Gkantsidis, J. Miller, and P. Rodriguez, "Anatomy of a P2P Content Distribution system with Network Coding," in *IPTPS'06*, 2006, pp. 1–6.
- [59] C. Gkantsidis, J. Miller, and P. Rodriguez, "Comprehensive view of a live network coding P2P system," in *Proceedings of the 6th ACM SIGCOMM conference on Internet measurement*, New York, NY, USA, 2006, pp. 177–188.
- [60] A. Sendonaris, E. Erkip, and B. Aazhang, "User cooperation diversity-part I: system description," *IEEE Transactions on Communications*, vol. 51, pp. 1927–1938, Nov. 2003.
- [61] A. Nosratinia, T. E. Hunter, and A. Hedayat, "Cooperative communication in wireless networks," *Communications Magazine, IEEE*, vol. 42, no. 10, pp. 74–80, 2004.
- [62] Shuguang Cui, A. J. Goldsmith, and A. Bahai, "Energy-efficiency of MIMO and cooperative MIMO techniques in sensor networks," *Selected Areas in Communications, IEEE Journal on*, vol. 22, no. 6, pp. 1089–1098, 2004.
- [63] M. Elhawary and Z. J. Haas, "Energy-Efficient Protocol for Cooperative Networks," *Networking, IEEE/ACM Transactions on*, vol. 19, no. 2, pp. 561–574, 2011.
- [64] M. K. Simon and M.-S. Alouini, *Digital communication over fading channels*. Hoboken, N.J.: Wiley-Interscience, 2005.
- [65] G. E. Arrobo and R. D. Gitlin, "Effect of the connectivity on the performance of Cooperative Network Coding," in *Wireless and Microwave Technology Conference (WAMICON), 2011 IEEE 12th Annual*, 2011, pp. 1–4.
- [66] G. E. Arrobo and R. D. Gitlin, "Effect of the number of clusters on the performance of Cooperative Network Coding," in *Wireless Telecommunications Symposium (WTS), 2011*, 2011, pp. 1–4.
- [67] G. Angelopoulos, M. Medard, and A. P. Chandrakasan, "Energy-aware hardware implementation of network coding," in *Proceedings of the IFIP TC 6th international conference on Networking*, Valencia, Spain, 2011, pp. 137–144.
- [68] IEEE P802.15 Working Group for Wireless Personal Area Networks (WPANs), "Channel Model for Body Area Network (BAN)."
- [69] T. P. Ketterl, G. E. Arrobo, A. Sahin, T. J. Tillman, H. Arslan, and R. D. Gitlin, "In vivo wireless communication channels," in *Wireless and Microwave Technology Conference (WAMICON), 2012 IEEE 13th Annual*, 2012, pp. 1–3.
- [70] Ezio Biglieri, Robert Calderbank, Anthony Constantinides, Andrea Goldsmith, Arogyaswami Paulraj, and H. Vincent Poor, *MIMO wireless communications*. Cambridge University Press, 2007.

- [71] S. Marinkovic and E. Popovici, "Network Coding for Efficient Error Recovery in Wireless Sensor Networks for Medical Applications," in *Emerging Network Intelligence, 2009 First International Conference on*, 2009, pp. 15–20.
- [72] A. Taparugssanagorn, F. Ono, and R. Kohno, "Network coding for non-invasive Wireless Body Area Networks," in *Personal, Indoor and Mobile Radio Communications Workshops (PIMRC Workshops), 2010 IEEE 21st International Symposium on*, 2010, pp. 134–138.
- [73] K. J. R. Liu, A. K. Sadek, W. Su, and A. Kwasinski, *Cooperative Communications and Networking*. Cambridge: Cambridge University Press, 2008.
- [74] A. W. Marshall and I. Olkin, "A Family of Bivariate Distributions Generated by the Bivariate Bernoulli Distribution," *Journal of the American Statistical Association*, vol. 80, no. 390, p. 332, Jun. 1985.
- [75] J. E. Mosimann, "On the Compound Multinomial Distribution, the Multivariate β -Distribution, and Correlations Among Proportions," *Biometrika*, vol. 49, no. 1/2, pp. 65–82, Jun. 1962.
- [76] A. Alqassis, T. P. Ketterl, C. A. Castro, R. D. Gitlin, S. Ross, Yu Sun, and A. Rosemurgy, "MARVEL In Vivo Wireless System," *National Academy of Inventors: Journal of Technology and Innovation*, 2012.
- [77] H. Liu, *OFDM-based broadband wireless networks: design and optimization*. Hoboken N.J.: Wiley-Interscience, 2005.
- [78] M. Engels, "Wireless OFDM Systems - How to Make Them Work?" Springer - Verlag.
- [79] "IEEE Standard for Information technology--Telecommunications and information exchange between systems Local and metropolitan area networks--Specific requirements Part 11: Wireless LAN Medium Access Control (MAC) and Physical Layer (PHY) Specifications." 29-Mar-2012.
- [80] J. B. Kenney, "Standards and Regulations," in *VANET*, John Wiley & Sons, Ltd, 2009, pp. 365–429.
- [81] Y. S. Cho, *MIMO-OFDM wireless communications with MATLAB*. Singapore; Hoboken, NJ: IEEE Press : J. Wiley & Sons (Asia), 2010.
- [82] N. Otsuki and T. Sugiyama, "A New ACK Packet Transmission Scheme for Wireless Network Coding Systems Based on IEEE802.11a," in *Vehicular Technology Conference (VTC Spring), 2011 IEEE 73rd*, 2011, pp. 1–5.
- [83] S. Ahmed and S. S. Kanhere, "VANETCODE: network coding to enhance cooperative downloading in vehicular ad-hoc networks," in *Proceedings of the international conference on Wireless communications and mobile computing*, New York, NY, 2006, pp. 527–532.
- [84] U. Lee, J.-S. Park, J. Yeh, G. Pau, and M. Gerla, "Code torrent: content distribution using network coding in VANET," in *Proceedings of the 1st international workshop on Decentralized resource sharing in mobile computing and networking*, New York, NY, USA, 2006, pp. 1–5.

- [85] J.-S. Park, U. Lee, S. Y. Oh, M. Gerla, and D. S. Lun, "Emergency related video streaming in VANET using network coding," in *Proceedings of the 3rd international workshop on Vehicular ad hoc networks*, New York, NY, USA, 2006, pp. 102–103.
- [86] S.-H. Lee, U. Lee, K.-W. Lee, and M. Gerla, "Content Distribution in VANETs Using Network Coding: The Effect of Disk I/O and Processing O/H," in *5th Annual IEEE Communications Society Conference on Sensor, Mesh and Ad Hoc Communications and Networks, 2008. SECON '08*, 2008, pp. 117–125.
- [87] M. Li, Z. Yang, and W. Lou, "CodeOn: Cooperative Popular Content Distribution for Vehicular Networks using Symbol Level Network Coding," *IEEE Journal on Selected Areas in Communications*, vol. 29, no. 1, pp. 223–235, Jan. 2011.
- [88] S. Yun and H. Kim, "Rate diverse network coding: breaking the broadcast bottleneck," in *Proceedings of the eleventh ACM international symposium on Mobile ad hoc networking and computing*, Chicago, Illinois, USA, 2010, pp. 221–230.
- [89] Z. Yang, M. Li, and W. Lou, "CodePlay: Live multimedia streaming in VANETs using symbol-level network coding," in *Proceedings of the The 18th IEEE International Conference on Network Protocols*, 2010, pp. 223–232.
- [90] Hang Su and Xi Zhang, "Characterizing the throughput gain of network coding in wireless ad hoc networks," in *Military Communications Conference, 2008. MILCOM 2008. IEEE*, 2008, pp. 1–7.
- [91] A. Keshavarz-Haddadt and R. Riedi, "Bounds on the Benefit of Network Coding: Throughput and Energy Saving in Wireless Networks," in *INFOCOM 2008. The 27th Conference on Computer Communications. IEEE*, 2008, pp. 376–384.
- [92] Y. Li, *Orthogonal frequency division multiplexing for wireless communications*. New York :: Springer Science Business Media,, 2006.

APPENDICES

Appendix A Copyright and Permissions

© 2011 IEEE. Reprinted, with permission, from Gabriel E. Arrobo, Richard D. Gitlin, and Zygmunt J. Haas, “Effect of link-level feedback and retransmissions on the performance of cooperative networking,” IEEE Wireless Communications and Networking Conference (WCNC), March 2011.

© 2011 IEEE. Reprinted, with permission, from Gabriel E. Arrobo, and Richard D. Gitlin, “Effect of the number of clusters on the performance of Cooperative Network Coding,” IEEE Wireless Telecommunications Symposium (WTS), April 2011.

© 2011 IEEE. Reprinted, with permission, from Gabriel E. Arrobo, and Richard D. Gitlin, “Improving the reliability of wireless body area networks,” IEEE Wireless and Microwave Technology Conference (WAMICON), April 2011.

© 2011 IEEE. Reprinted, with permission, from Gabriel E. Arrobo, and Richard D. Gitlin, “Effect of the connectivity on the performance of Cooperative Network Coding,” IEEE Engineering in Medicine and Biology Society (EMBC), August 2011.

© 2011 IEEE. Reprinted, with permission, from Gabriel E. Arrobo, and Richard D. Gitlin, “New approaches to reliable wireless body area networks,” IEEE Microwaves, Communications, Antennas and Electronics Systems (COMCAS), November 2011.

© 2012 IEEE. Reprinted, with permission, from Thomas P. Ketterl, Gabriel E. Arrobo, Alphan Sahin, Thomas J. Tillman, Huseyin Arslan, and Richard D. Gitlin, “*In vivo* wireless communication channels,” IEEE Wireless and Microwave Technology Conference (WAMICON), April 2012.

© ACM, 2012. This is the author’s version of the work. It is posted here by permission of ACM for your personal use. Not for redistribution. The definitive version will be published in BodyNets, 2012.

ABOUT THE AUTHOR

Gabriel Arrobo received his Engineering degree (CUM LAUDE) in Electronics and Telecommunications (5-year degree) from the Escuela Politécnica Nacional, in Quito, Ecuador in 2004 and the Engineering Diploma in Inter-networking (1-year graduate studies) from the Escuela Politécnica Nacional, in Quito, Ecuador in 2006. He received his Master of Business Administration, Concentration in strategy and enterprise policy from the Instituto Tecnológico de Estudios Superiores de Monterrey, Toluca, Mexico in 2008. Gabriel was with the “Corporación Nacional de Telecomunicaciones” (formerly ANDINATEL), a telecommunications service provider, where he held various jobs positions ranging from staff engineer to manager. In 2010, he received his Master of Sciences in Electrical Engineering from the University of South Florida, in Tampa, Florida, where he is currently pursuing his Doctor of Philosophy in Electrical Engineering. His research interests include performance of wireless sensor networks with emphasis on wireless body area networks, where reliability is one of the key performance metrics.