

10-28-2010

Mutual Elements and Substrate Effect Analysis on Patch Antenna Arrays

Matthew J. Wallace
University of South Florida

Follow this and additional works at: <http://scholarcommons.usf.edu/etd>

 Part of the [American Studies Commons](#)

Scholar Commons Citation

Wallace, Matthew J., "Mutual Elements and Substrate Effect Analysis on Patch Antenna Arrays" (2010). *Graduate Theses and Dissertations*.
<http://scholarcommons.usf.edu/etd/3702>

This Thesis is brought to you for free and open access by the Graduate School at Scholar Commons. It has been accepted for inclusion in Graduate Theses and Dissertations by an authorized administrator of Scholar Commons. For more information, please contact scholarcommons@usf.edu.

Mutual Elements and Substrate Effect Analysis on Patch Antenna Arrays

by

Matthew J. Wallace

A thesis submitted in partial fulfillment
of the requirements for the degree of
Master of Science in Electrical Engineering
Department of Electrical Engineering
College of Engineering
University of South Florida

Co-Major Professor: Ravi Sankar, Ph.D.
Co-Major Professor: Kenneth Buckle, Ph.D.
Paris H. Wiley, Ph.D.

Date of Approval
October 28, 2010

Keywords: Beamwidth, Bandwidth, Modeling, Range, RADAR

Copyright ©2010 Matthew J. Wallace

ACKNOWLEDGEMENTS

I would like to express my sincere gratitude to my co-major professors Drs. R. Sankar and K. Buckle for their belief in me, and the guidance and support throughout the entire project. My deepest thanks to Global Technical Systems for trusting me with their antenna design which assisted in choosing a thesis topic.

Many thanks go to my close friends for the moral support they provided. Last but not least I would like to the Drs. Kimon Valavanis, Sanil Segul, and my entire family for believing in me and their motivational tactics not only through my thesis, but throughout my entire academic career.

TABLE OF CONTENTS

LIST OF FIGURES	iii
ABSTRACT.....	v
CHAPTER 1 INTRODUCTION	1
1.1 Movement towards Patch Antennas.....	2
1.2 Antenna Basics.....	4
1.2.1 Antenna Beamwidth.....	4
1.2.2 Antenna Gain	5
1.2.3 Antenna Bandwidth	6
1.2.4 Impedance (VSWR).....	7
1.3 Patch Antenna Characteristics	9
1.3.1 Efficiency, Bandwidth, and Quality Factor	9
1.3.2 Patch Shapes	10
1.3.3 Feed Networks	11
1.4 Research Motivation and Thesis Outline	12
CHAPTER 2 APPLICATION AND DESIGN.....	14
2.1 RADAR Basics	14
2.1.1 RADAR Equation	14
2.1.2 Pulse Compression.....	14
2.1.3 Doppler Shifting.....	15
2.1.4 Matched Filter.....	16
2.1.5 SAR/PPI/MTI	17
2.2 RADAR Design	17
2.3 Antenna Design.....	18
2.3.1 Antenna Substrate Selection	18
2.3.2 Initial Design Approach.....	20
2.3.3 Element Size and Spacing.....	21
2.3.4 Antenna Feed Method.....	22
CHAPTER 3 ANTENNA MODELING AND PROTOTYPING	24
3.1 Antenna Modeling Software	24
3.1.1 Ansoft HFSS	24
3.1.2 Agilent Advanced Design Software (ADS).....	25
3.1.3 Agilent Genesys	25
3.2 Modeling Software of Choice.....	26
3.3 Results of Modeling.....	27
3.4 Antenna Manufacturing	29

CHAPTER 4 ANTENNA TESTING AND COMPARISON	30
4.1 Antenna Test Ranges	30
4.1.1 Outside Test Range	31
4.1.2 Near Field Test Chamber	32
4.1.3 Compact Antenna Test Range (CATR)	33
4.1.4 Far Field Antenna Test Range	34
4.2 Test Method and Range Chosen	34
4.3 Antenna Testing Results	37
4.3.1 Test 1	38
4.3.2 Test 2	40
4.3.3 Test 3	41
4.4 Comparison Between Prototype and Simulation	43
 CHAPTER 5 CONCLUSION AND FUTURE WORK	 46
5.1 Conclusions	46
5.2 Future Work	47
 REFERENCES	 48
 ABOUT THE AUTHOR	 End Page

LIST OF FIGURES

Figure 1. Slotted Waveguide Antenna	3
Figure 2. Fractal Geometry	11
Figure 3. Two Examples of Microstrip Patch Antenna Array Feed Networks.....	12
Figure 4. Rogers RO3730 Substrate Datasheet.....	20
Figure 5. Full Prototyped Antenna Array	22
Figure 6. Single Antenna Board Design	23
Figure 7. Simulation Photograph of the Three Patches Under Investigation	27
Figure 8. Azimuth Beam Simulation of the Three Patches Under Investigation.....	28
Figure 9. Elevation Beam Simulation of the Three Patches Under Investigation	28
Figure 10. Characterization of Antenna Chamber	35
Figure 11. Antenna Chamber Computer Software	36
Figure 12. Azimuth Beam Measurement of Patch Antenna	37
Figure 13. Elevation Beam Measurement of Patch Antenna.....	38
Figure 14. Measured Azimuth Graph of Patch 1	38
Figure 15. Measured Elevation Beam of Patch 1	39
Figure 16. Measured Azimuth Beam of Patch 2.....	40
Figure 17. Measured Elevation Beam of Patch 2	41
Figure 18. Measured Azimuth Beam of Patch 3.....	42
Figure 19. Measured Elevation Beam of Patch 3	42

Figure 20. Simulation and Measured Azimuth Beam Comparison	43
Figure 21. Simulation and Measured Elevation Beam Comparison.....	45

ABSTRACT

There have been many different technology advancements with the invention of solid state electronics, leading to the digital era which has changed the way users employ electronic circuits. Antennas are no different; however, they are still analog devices. With the advancements in technology, antennas are being fabricated on much higher frequencies and with greater bandwidths, all while trying to keep size and weight to a minimum. Centimeter and millimeter wave technologies have evolved for many different radio frequency (RF) applications. Microstrip patch antennas have been developed, as wire and tubular antenna elements are difficult to fabricate with the tolerances required at micro-wavelengths. Microstrip patch antennas are continuously being improved. These types of antennas are great for embedded or conformal applications where size and weight are of the essence and the ease of manufacturing elements to tight tolerances is important. One of the greatest benefits of patch antennas is the ease in creating an array. Many simulation programs have been created to assist in the design of patch antennas and arrays. However, there are still discrepancies between simulated results and actual measurements.

This research will focus on these differences. It begins with a literature research of patch antenna design, followed by an assessment of simulation programs used for patch antenna design. The resulting antenna design was realized by the fabrication of an antenna from the Genesys software. Laboratory measurements of the real-world antenna are then compared to the theoretical antenna characteristics. This process is used to

illustrate deficiencies in the software models and likely improvements that need to be made.

CHAPTER 1

INTRODUCTION

The development of antennas has been part of electrical design since the discovery of electricity. Mr. Benjamin Franklin experimented with lightning striking his kite which was attached to a metal key, so that he could prove lightning was electricity. The kite wire, acting as a probe of the natural electric fields during a storm was essentially an antenna.

An antenna is a device that converts electromagnetic radiation flowing through free space into electricity flowing in a transmission line or wire. In Mr. Franklin's case, it was electricity flowing into a metal key. As more electrical discoveries were made, wireless electric communication was discovered. As the wireless communications means became more popular, the required bandwidths for high speed data transfer were not available at the lower frequencies employed. This led to research and development into techniques necessary to generate ever increasing operating frequencies. As frequencies increase, the wavelength decreases. Since antenna size is strongly influenced by the wavelength, the physical antenna size decreases as well. Once development began in the centi / milli-meter wavelengths, wire antennas were no longer practical due to fabrication tolerances required. Size and weight is often a concern during the antenna development process. When microstrip technology was introduced to fabricate printed circuit boards at higher frequencies, it was naturally employed by antenna designers to create reproducible, high precision antenna arrays. The demand for wireless communications applications has

grown faster than others, such as passive direction finding and RADAR. Many parameters are well understood in microwave microstrip antenna array design, although overcoming real-world effects in antenna design is still viewed as an art.

1.1 Movement towards Patch Antennas

Microstrip antennas are commonly referred to patch antennas. If the antenna consists of multiple patch antennas, it is referred to as a patch array. This terminology will be employed throughout the rest of this document.

Patch antennas have made a large impact in the last few years of technology development. With the advancements in transmitter and receiver design using frequencies in the Gigahertz (GHz) range, wire antennas have become impractical. With wavelengths measured in centimeters and millimeters even a slight error in antenna length can be very detrimental to the intended properties. Reflector or directional antennas are used extensively for communications. High directional gain tends to require physically large antennas making them impractical to be used on cellular phones or other small devices. “Skin effect” also tends to make wire elements lossy at these frequencies.

Transmission lines suffer from the same effects. To avoid signal loss when connecting various devices, waveguides are used rather than other conductive transmission mechanisms. Antenna designers have developed antennas using waveguides to reduce the complexity of properly illuminating the reflector dish. Furthermore, waveguide antennas are extremely difficult to manufacture and are often costly. As seen in Figure 1, waveguide antennas have holes or slots in the waveguide to allow the signal to radiate in free space. The size and shape of these holes determine the radiating frequency,

bandwidth, and polarization [1]. The number and spacing of holes creates the beamwidth associated with the antennas radiation pattern [1]. The most significant design issues associated with waveguide antennas pertains to the overall weight and cost of manufacturing.

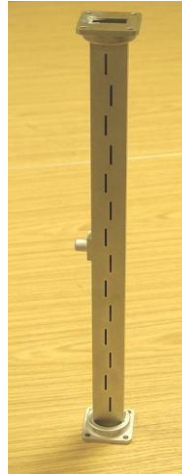

Figure 1. Slotted Waveguide Antenna

Patch antennas are created from high frequency laminate circuit material rather than rolled or sheet metal employed in waveguide antennas. In general, these materials have a much lower cost per unit size than both waveguide and reflector antennas. These laminates are extremely easy for an electronic board manufacturer to produce. Patch antennas hold the same tolerances as RF board designs, which is a major benefit when compared to using wire or tubular antennas. These are all significant advantages in manufacturing. Additionally, the patch antenna has many benefits pertaining to operational use as well.

Due to patch antennas being created out of circuit board material, they may be fabricated to be small and light weight. Such antennas naturally operate on high frequencies. These features make the patch antenna an ideal design option for many different applications,

such as antennas in palm size radios, cellular telephones, global positioning system (GPS) antennas and the like. These antennas are extremely versatile and may be mounted on automobiles, aircraft and sea vessels. If patch antennas are much smaller, lighter weight, cheaper to manufacture, why are the reflector and waveguide antennas still used?

As with any engineering problem, there are always tradeoffs in antenna design and application. Patch antennas are certainly not out of the ordinary. Patch antennas have their own set of design characteristics. However, when size and weight are the main attributes in a design requirement, the antenna designer has to accept the limiting characteristics.

1.2 Antenna Basics

With every antenna design, there are certain parameters the design should optimize.

Antennas parameters are usually specified with reference to the transmit function. This reference is perfectly acceptable since transmit and receive have a reciprocity attribute in antennas for aspects other than the antenna's tolerance to peak powers. This section will provide background knowledge of key antenna parameters.

1.2.1 Antenna Beamwidth

One of the most important parameters in antenna design is called the half-power beamwidth (HPBW), usually known as beamwidth. Beamwidth is the radiation area the antenna will illuminate during either transmit or receive (Balanis). It is a 3-dimensional (3-D) pattern that can be broken into two 2-D patterns; azimuth and elevation. The azimuth beam represents the X axis and the Y axis in Cartesian, or R axis and ϕ axis in the spherical coordinate system (Balanis). The elevation beam represents the Y axis and

Z axis in Cartesian, or ϕ axis and θ axis in the spherical coordinate system (Balanis). Improving one of these characteristics usually degrades the other. Depending on the application, antenna requirements may favor specific characteristics in one direction at the expense of the other. For example, RADAR antenna systems typically require a finer beam in azimuth than in elevation.

Radiation patterns all around the antenna are of concern to the antenna designer. Most antennas have a major lobe, and multiple side lobes, including lobes that face the opposite direction the antenna is pointed, known as the back lobe (Balanis). Sidelobe levels are of great concern when extracting position information from the signal. High sidelobe levels can create a phenomenon known as aliasing in the Signal Processing world [2], [3]. A ratio is referenced between the front and the back lobes. This ratio tells the antenna designer how much power can be radiated in the opposite direction (Balanis). Ideally this ratio is 0, meaning no power is radiating in the back, unless otherwise required. Bandwidth is one of the main contributing factors of antenna gain as well. Higher directional gain is attained by focusing the energy in a single direction leading to very narrow beamwidths and high point accuracy requirements.

1.2.2 Antenna Gain

Certain antennas are known to provide very high effective gain to the radiated signal during transmitting or receiving. The antenna gain is compared to the signal produced by an isotropic antenna. Also known as a point source, isotropic antennas radiate the same energy strength in all directions equally (Balanis). When referring to antenna gain, it is the ratio of radiation intensity (Power radiated per unit area) in a certain direction as compared to an isotropic radiator. This ratio is usually written in a logarithmic form of

dBi, or decibel with respect to an isotropic antenna. An antenna's directivity can also be compared to a dipole, which is written dBd. A dipole is not an isotropic antenna, and a dipole has its own gain when compared to an isotropic antenna. A dipole antenna has 2.15 dB of gain in its maximum lobe when compared to an isotropic antenna [3]. This means 0 dBd equals 2.15 dBi, so when designing an antenna it is important to ensure the correct gain/directivity value is being considered.

1.2.3 Antenna Bandwidth

In the transmit mode, an antenna acts as a transducer to change electron flow into electromagnetic waves launched into free space. As electrons flow into and out of the antenna, time varying magnetic and electric fields are created around the antenna element. Since the electrons do not normally leave the antenna conductor, a stable solution to the Maxwell's equations has zero current (electron flow) at the antenna end points [1]. This is characterized by the antenna being an electrical half-wavelength at the design frequency. In real-world conditions, an electrical half-wavelength is not necessarily identical to a physical half-wavelength. "Launching" the electromagnetic wave into space is similar to an oscillator creating a sinusoidal wave through a wire.

An antenna's bandwidth is the range of frequencies that the antenna will effectively allow electromagnetic radiation to occur. Different antenna types have common bandwidth characteristics, which are usually referenced as a percentage of the natural operating frequency [1]. This is often determined through the antenna's impedance characteristics as the operating frequency is varied. There are techniques to increase the bandwidth (or maintain the antenna's operating impedance), although there are always tradeoffs associated with such methods. The bandwidth and size of an antenna are generally

conflicting characteristics [4]. Normally the improvement of one of these characteristics will degrade the other [4], [5]. Designers have developed design methods to minimize the degradation of these characteristics, although the result is often more complex fabrication which leads to higher cost antennas.

1.2.4 Impedance (VSWR)

The impedance of an antenna is an extremely important characteristic. When discussing an antenna's impedance, it is referred to as the impedance that the antenna needs to provide in order to match the rest of the Radio Frequency (RF) system. In order to transfer the maximum power, the antenna must present the same impedance as the transmission line feeding radio frequency power to the antenna. Typically RF systems are designed to have a characteristic impedance of 50 ohms (Ω). The characteristic impedance of free space is the square root of the magnetic permeability divided by the electric permittivity ($\sqrt{[\mu_0 / \epsilon_0]}$) which equals $120\pi\Omega$ or 377Ω , so having a 50Ω antenna does not necessarily achieve max power transfer to free space [5]. Why wouldn't the impedance of antennas and their associated feed systems be designed to have a characteristic impedance of 377Ω ? The standard was selected to be 50Ω after a tradeoff study was completed [5]. The 50Ω standard was selected because it is a good compromise between power handling and low loss of the electromagnetic signal for a coaxial cable with an air dielectric [5]. When dealing with impedance, antenna designers typically focus on a parameter called Voltage Standing Wave Ratio (VSWR).

$$VSWR = \frac{V_{\max}}{V_{\min}} = \frac{1 + \rho}{1 - \rho} \quad (1)$$

$$\Gamma = \frac{Z_L - Z_S}{Z_L + Z_S} \quad (2)$$

Where V_{\max} is the maximum voltage, V_{\min} is the minimum voltage, ρ is the reflection coefficient ($\rho = \Gamma$), Z_L is the load impedance, and Z_S is the source impedance. This compares the output of a system to the input of another system, such as the output of the power amplifier to the input of the antenna [1]. This ratio a comparison of the reflection coefficient of the antenna, defined by the source impedance (Z_S) and the load impedance (Z_L) [6]. Using the VSWR formula above, when the VSWR is said to be 1:1.5 with a characteristic impedance of 50Ω , it is calculated that the load impedance (antenna impedance) is 75Ω . For radio frequency systems, impedance is the same as index of refraction is for optical systems (electromagnetic frequencies at extremely short wavelengths that follow quantum rather than bulk properties). As such, if the electromagnetic wave comes in contact with an abrupt change in the index of refraction, or impedance, some of the energy will propagate into the new medium and part will be reflected back along the incoming path [6]. This process is called reflection. Clearly, the lower the reflection the more power is delivered to the antenna. Since this reflected power must be absorbed in some fashion (normally turned into heat) by the earlier stage, antenna designers typically design an antenna to have a VSWR of 1:2 or less.

1.3 Patch Antenna Characteristics

When designing an antenna certain requirements will often dictate a particular antenna design. A high frequency design limits many antenna choices; although, when trying to minimize the size and weight of the antenna, the designs are restricted even more. This leads to using waveguide and patch designs. As the real-world design specifications are based around economics, the economics of manufacturing and reliability has shown patch antennas to be a better choice than waveguide antenna designs. This is due to their relatively inexpensive manufacturing cost, unlike the manufacturing of waveguides. There are two major contributing costs to the manufacturing of patch antennas. They are the price of the substrate used in the design and the number of times the machine needs to re-tool.

1.3.1 Efficiency, Bandwidth, and Quality Factor

With patch antennas, the efficiency, bandwidth, and quality factor are all interrelated. There is always a tradeoff between each of these factors to arrive at an optimized patch antenna design [7]. The total quality factor consists of many elements.

$$\frac{1}{Q_t} = \frac{1}{Q_{\text{rad}}} + \frac{1}{Q_c} + \frac{1}{Q_d} + \frac{1}{Q_{\text{sw}}} \quad (3)$$

In the equation above, Q_{rad} takes into account the radiation losses, Q_c is the factor due to conduction (resistive) losses, Q_d is due to dielectric losses, and Q_{sw} is due to surface waves [1]. Essentially these quality factors are strongly influenced by the substrate characteristics, frequency, height of substrate, and size of the patch.

The bandwidth of the patch antenna is very closely related to the quality factor of the antenna; actually the fractional bandwidth is inversely proportional to the total quality factor of the antenna.

$$\frac{\Delta f}{f_0} = \frac{VSWR - 1}{Q_t \sqrt{VSWR}} \quad (4)$$

The equation above calculates the fractional bandwidth with respect to the acceptable impedance mismatch of the antenna and the quality factor [1]. Efficiency is calculated from the quality factor as well.

$$e_{cdsw} = \frac{1/Q_{rad}}{1/Q_t} = \frac{Q_t}{Q_{rad}} \quad (5)$$

As shown above, the radiated efficiency of the antenna is determined by the total quality factor divided by the radiated quality factor, or in simpler terms, the power radiated over the input power [1].

1.3.2 Patch Shapes

The shape of the patch can vary drastically. The goal of any patch antenna is to create a radiating device at a particular frequency or frequencies, which produces a radiating pattern and impedance characteristics that fits the design criteria. Patches can have either a very broad beam, or narrowed by putting them into an array [8]. Typically patches are rectangular or circular, although more complex designs are being created, such as triangular and fractals. Fractal antennas (shown in Figure 2) are based on fractal geometry, and provide a very broad band of resonating frequencies [9]. Fractal antennas

are difficult to manufacture when using wire, ensuring all bends are at the correct point, etc. Being able to create a circuit board design in a simulator and then producing the drill file for the manufacturer relieves many of the manufacturing difficulties in realizing a working antenna.

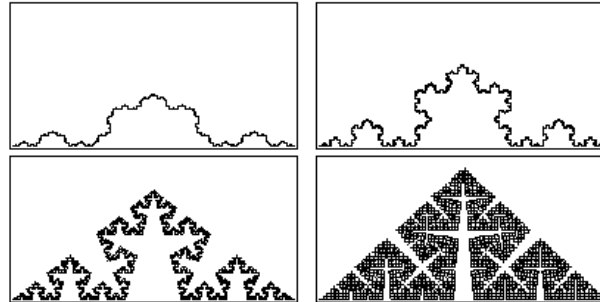

Figure 2. Fractal Geometry

1.3.3 Feed Networks

With patch antennas, feed networks are a very important part of the overall antenna design. A basic patch has four popular ways of feeding the signal into the patch; microstrip line, coaxial probe, proximity coupling and aperture coupled [1]. Feeding the patch with a microstrip is the easiest method to ensure the antenna will provide a 50Ω load impedance. Probe feeding is a bit more difficult, as a hole has to be drilled through the patch in the precise place to obtain 50Ω . At higher frequencies, the hole creates capacitance, while the probe introduces inductance [6]. Matching the probe to the hole can be achieved using more complex (hence expensive) simulation software packages, but is typically achieved in the real-world by trial and error. Aperture coupling and proximity feed techniques are the most challenging. For them, the feed line is basically an antenna radiating to the patch antenna which in turn radiates the signal [8]. This

method is an alternative way to increase the bandwidth on the patch, although the technique does introduce signal loss when transferred from the transmission line to the patch. Feeding an array of patch antennas introduces additional complexity as shown in Figure 3.

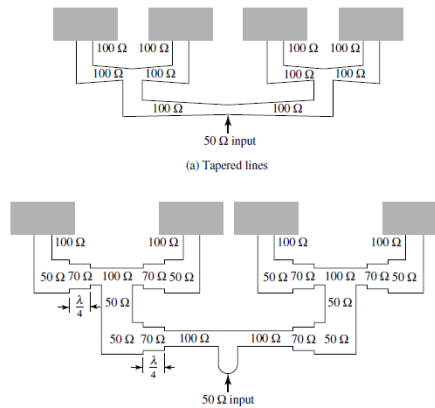

Figure 3. Two Examples of Microstrip Patch Antenna Array Feed Networks

1.4 Research Motivation and Thesis Outline

The motivation for this research project was developed while designing an antenna array for an airborne RADAR application. The antenna requirements were well defined. However, even though the total effect of the array was well understood, the antenna modeling and simulation program did not account for the surrounding substrate. When individual patches were excited, the simulation model showed the surrounding elements did not have an effect on the radiating patch. These results started to raise the question whether there is really an interaction effect that could degrade the antenna’s beam pattern. A patch antenna is created to be measured and compared to the simulation, to show how the simulation program can assist in the design and where the design is still considered an art.

This thesis is organized as follows; chapter two will discuss background theory on RADAR systems, and will define the requirements of the antenna array for the particular RADAR system. Chapter three discusses modeling software, the results from the modeling, and the manufacturing process of patch antennas. Chapter four leads into the process of measuring antenna patterns, the results of the measured beam pattern, and the comparison between the simulation patterns and the measured beam patterns. Chapter five will summarize the overall thesis research work and provide areas of improvement and areas where further study is needed.

CHAPTER 2

APPLICATION AND DESIGN

2.1 RADAR Basics

2.1.1 RADAR Equation

The radar equation is the most important guiding equation when building RADARs. This equation determines all the principal parameters that are needed to calculate a RADARs performance. This equation, as seen, calculates the maximum detection distance from the target given certain parameters [10].

$$R_{\max} = \left[\frac{P_t G A_e \sigma}{(4\pi)^2 S_{\min}} \right]^{1/4} \quad (6)$$

The parameters that are included are the transmitting power (P_t), the combined gain of the transmitting and receiving antenna(s) (G), the receiving antenna area aperture (A_e), the minimum detectable signal level (S_{\min}), and the radar resolution or cross-sectional area (σ) [10]. Each of the parameters can be optimized depending on the radar system requirements.

2.1.2 Pulse Compression

Theoretical radars are capable of transmitting infinitely short pulses. With an infinitely short pulse, pulse duration does not allow a large amount of radiated energy. The range of the radar system and return signal strength from the target is dependent on the total

radiated energy. When the peak power required from the short-pulse needed for high range resolution cannot be achieved via practical transmitters, pulse-compression techniques are employed to increase the average energy that illuminates the target [10]. Pulse compression utilizes a long pulse, while the transmitting signal frequencies are varied. These variations are typically from the low end of the selected bandwidth to the high end of the operating bandwidth [10]. This allows for an extremely short pulse on a particular frequency while producing a large amount of total radiating power. Upon receiving the signal, correlation between the transmitted signal and the received signal is compared in the frequency domain to extract precise target range information.

Pulse compression has many attributes. It can be used to increase range resolution, range accuracy, clutter reduction, glint reduction, multipath resolution, minimum range detections, target classification and Doppler tolerances [10]. This technique was discovered during the early developments of radar systems, although it was an extremely costly feature. With the development of digital signal processing, pulse compression is now much easier to introduce into the system [10]. The new “HD” marine radars have implemented pulse compression into their radar system by employing modern signal processing techniques. The marine radar transmitter and antennas all utilize the same basic components as their non-HD radar systems keeping them cost-effective.

2.1.3 Doppler Shifting

When a radio wave transmitted at a specific wavelength is reflected from a moving target, the wavelength of the reflected signal is modified. A target moving away from the transmitter effectively stretches the wave, this lowering the frequency of the return signal. The opposite occurs when the target moves towards the transmitter. Doppler processing

compares the change in frequency from the receive signal to the transmitted signal [10].

This technique assists in discerning moving targets from stationary targets and also provides the velocity towards or away from the radar. This technique is a necessity in high-quality air-surveillance radars that operate with clutter. Typically, clutter is generated by the ground which is stationary and thus has no Doppler effects [10].

Doppler radars can be used in a pulsed radar system. A stable coherent oscillator is typically used as the reference signal for the comparison. This coherent oscillator must preserve the phase of the transmitted signal otherwise errors are introduced into the system as phase errors may be interpreted as frequency shifts by the radar [10]. In higher frequency radar systems, the up-conversion and down-conversion mixing circuits must be extremely stable as well. This mixing product is generally satisfied with using the same precision oscillator for both mixing purposes.

2.1.4 Matched Filter

The matched filter concept is used in the design of nearly every radar receiver. A matched filter is a network whose frequency-response maximizes the output peak signal-to-mean power ratio [10]. If the filter is too wide, extra noise is introduced into the system. If the filter is too narrow, the noise energy is reduced along with part of the signal energy. These are examples of an unmatched filter. The matched filter correlates a known signal with the unknown received signal, which creates an optimal linear filter for maximizing the signal-to-noise ratio in the presence of noise [10]. When a RADAR employs pulse compression, a matched filter, and Doppler processing, the system can detect and track targets accurately and that have a small cross-sectional area.

2.1.5 SAR/PPI/MTI

SAR, synthetic aperture RADAR, is a form of RADAR which uses the relative motion between the radar and the target of interest to achieve high target spatial resolution. To obtain high resolution in the cross-range dimension, the target's relative motion is used to synthesize the very narrow beam-width effect of a large antenna aperture [10]. The other way to increase the cross range resolution of a SAR antenna is by using a physically large antenna with a narrow beam. Mechanical and electrical tolerances limit the maximum size and thus the minimum beam-width of the antenna, as well as the target cross-sectional area at a given distance [10]. A PPI or planned position indicator RADAR system is only interested in the position of the target which allows for a larger beam on the antenna. An MTI or moving target indicator RADAR system utilizes both Doppler and PPI modes to discern moving targets from stationary clutter [10]. The PPI mode is often utilized during target search. Once a target has been identified, SAR mode is used to increase the resolution and extract an image of the target for identification.

2.2 RADAR Design

The proposed RADAR was designed to operate in the X-Band frequency range (8 GHz to 12 GHz). The principal reason for selecting this operating frequency band was to comply with international laws regulating spectrum allocations. This particular allocation allows the use of ground and airborne radar systems. The specified center frequency would be 9.41 GHz. Furthermore, to meet range resolution requirements, at least 200 MHz of bandwidth, with an objective bandwidth of 500 MHz would be needed. The radar cross-sectional area of the defined target is 10 square meters. The radar is designed to be integrated onto an aircraft with an operational objective of finding maritime vessels at sea

in sea clutter. The antenna was required to fit within a space of 13 inches wide, 12 inches high, and a 5 inch depth for mounting in the nose of the aircraft. Additionally, the antenna could not weigh more than 5 lbs.

To meet the required spatial location requirements, the azimuth beamwidth must be $4.9^\circ \pm 0.2^\circ$, while the elevation beamwidth had to be $5.3^\circ \pm 0.2^\circ$. To minimize false targets, the antenna had to produce maximum sidelobe levels of -13 dB from the main lobe without an element taper. An element taper would be implemented to reduce the azimuth maximum sidelobe level to less than -20 dB from the main lobe, while keeping the azimuth beamwidth of $5.2^\circ \pm 0.2^\circ$ with the implemented taper.

Additional design considerations included the need during synthetic aperture RADAR (SAR) mode to use the entire antenna aperture. During planned positioned indicating (PPI) mode, the radar would employ monopulse beam sharpening to further narrow the effective antenna beamwidth while meeting the design objectives described above.

2.3 Antenna Design

This antenna design will be part of an overall RADAR system with given beamwidth requirements stated above in section 2.2. Due to the size and weight constraints, a patch antenna array was chosen. The first design parameter when creating a patch antenna is to select the substrate the patches will be created from, as these parameters affect the rest of the design.

2.3.1 Antenna Substrate Selection

The antenna substrate defines certain radiating properties. Typically a signal is fed into a piece of metal and is separated from the ground connection by air. Patch antennas operate

the same way, although the radiating metal patch is separated from the ground connection by the substrate. The lower the dielectric constant of the substrate is, ideally 1 or the same as air, the more efficiently the patch antenna will create and launch an electromagnetic wave [11]. Also, the further away the radiating patch is from the ground connection the easier it is to maintain desired radiating characteristics [11]. Depending on the power to be radiated from the patch, the metal thickness can impact the design parameters. All materials resist the flow of electrons to some degree. For high power systems, the patch antenna material must be able to absorb the heat generated by Ohmic losses in the material without distorting the design or melting the materials.

Many substrates were analyzed before the selection of substrate material known as Rogers RO3730 was selected. Rogers RO3730 was tested at 23°C at 10 GHz. The dielectric constant is a mere 3.00 with only ± 0.06 tolerance during manufacturing. The dissipation factor of the metal, δ , is 0.0016. The 0.060" (60 thousandths of an inch or mil) substrate thickness was selected. Only 1 oz rolled copper is offered for this form factor, which will satisfy the power requirements for the application. These substrate parameters are of most concern, although other factors are of interest, such as the flexural strength, thermal expansion coefficient, thermal conductivity, moisture absorption, etc, which are all shown in the characteristic datasheet (Figure 4) provided by Rogers below.

Property	Typical Value	Direction	Units	Condition	Test Method
Dielectric Constant, ϵ_r	3.00 ± 0.06	Z		10 GHz/23°C	IPC-TM-2.5.5.5
Dissipation Factor, δ	0.0016 0.0013	Z		10 GHz/23°C 2.5GHz/23°C	IPC-TM-650, 2.5.5.5
Volume Resistivity	10 ⁷		MΩ•cm	COND A	IPC-TM-650, 2.5.17.1
Surface Resistivity	10 ⁷		MΩ	COND A	IPC-TM-650, 2.5.17.1
Flexural Strength	9 8	X Y	MPa (kpsi)		IPC-TM-650, 2.4.4
Dimensional Stability	0.02 0.03	X Y	mm/m (mils/inch)		IPC-TM-650, 2.4.39A
Coefficient of Thermal Expansion	11	X	ppm/°C		IPC-TM-650, 2.1.41
	12	Y			
	65	Z			
PIM	<-154*		dBc		
Td	500		°C TGA		ASTM D3850
Thermal Coefficient of ϵ_r - TcDK	-22		ppm/°C	-50°C to +150°C	
Thermal Conductivity	0.45		W/m/°K	D24/23	IPC-TM-650 2.6.2.1
Moisture Absorption	0.04		%	D48/50	ASTM D570
Specific Gravity	2.1		gm/cm ³	23°C	ASTM D792
Copper Peel Strength	1.8 (10.5)		N/mm (pli)	10 sec. 550°F Solder Float	IPC-TM-650 2.4.8
Flammability	V-0 pending				UL94
Lead-Free Process Compatible	YES				

*as tested on similar constructions in development.

Thickness	Panel Sizes	Standard Claddings
0.030" (0.762mm), 0.060" (1.524mm)	24"X18" (610mm X 457mm) 24"X54" (610mm X 1.37m)	1 oz. Rolled Copper foil

Figure 4. Rogers RO3730 Substrate Datasheet

2.3.2 Initial Design Approach

After the selection of the substrate, the size and beam requirements guided the design approach. The initial concept of the RADAR system was for each antenna element to have their own power amplifier, so the radiated power would be combined in the far-field to achieve the effective radiated power requirement.

With this approach, a design initiative was set to achieve the optimum number of elements that will fit within the specified volume and meet the antenna performance constraints. The first step was creating a single patch antenna to resonate at 9.41 GHz

with a 500 MHz bandwidth. Linear polarization is a must in RADAR applications, as if the signal was sent using right-handed circular polarization; the return signal would be received as left-handed circular polarized [10]. Cross-polarization would either require having two antenna systems or result in a significant reduction in signal strength received from the target. Horizontal polarization was selected to reduce unwanted ground effects that would be present from a vertical polarization signal.

This antenna was also expected to accommodate monopulse beam sharpening. This design parameter turned out to assist in the physical design of the antenna during the analysis of the feed method.

2.3.3 Element Size and Spacing

Starting with a quarter wavelength, which at the operating frequency is 312 thousandths of an inch (mil) or 0.797 cm, the patch was created using an antenna modeling software. After the first simulation, the radiating frequencies were higher than expected, so the patch dimensions were slightly enlarged. After optimization, it was determined the patch dimensions needed to be 318 mil by 318 mil (8.1 cm by 8.1 cm).

Given this size of a patch, an array could be formed by employing more patch antennas and still fit in the allowed volume. Patches were added in the azimuth direction until the specified beam requirement of 4° was met. After final optimization, it was determined 16 elements in the azimuth direction with a center-on-center spacing of 0.8125 inches (2 cm). The same method was applied in the elevation direction, until the beam requirement of 5.3° was achieved. After optimization it was determined 16 elements could be placed in the elevation direction with a center-on-center spacing of 0.75" (1.9 cm). This creates a

256 element antenna array shown in figure 5, with a total size of 13 inches by 12 inches, which falls at the maximum width and height specifications respectively.

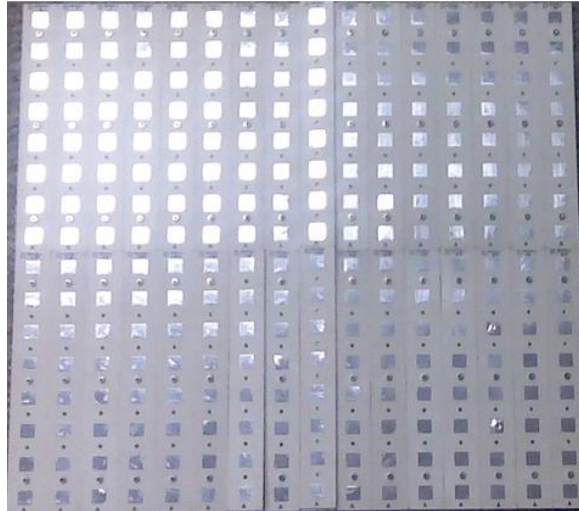

Figure 5. Full Prototyped Antenna Array

2.3.4 Antenna Feed Method

Since the antenna's width and height are at the maximum allowable, feeding the elements would have to be through the antenna board, also known as probe feeding as described earlier. Another aspect of design that needed to be considered was to take into account the process of combining all these signals into one feed for the receiver. This is where the process of monopulse beam sharpening comes into play. Monopulse beam sharpening effectively splits the antenna and compares the sum of the signals of the antenna and the difference of the signals of the antenna [6]. This antenna will be split into halves both in the azimuth and elevation directions, which essentially creates four, 8 element by 8 element sub-arrays or quadrants of the physical antenna.

The feed combiner design is an 8 by 1 Wilkinson combiner/splitter networks, combining all elements in the azimuth direction. This will leave 8 outputs per quadrant. Another 8

by 1 Wilkinson combiner/splitter network is used to provide one output per quadrant, allowing for monopulse beam sharpening network to be attached. The 8 by 1 Wilkinson combiner/splitter networks needed to be the same size as one 8 by 1 element antenna board. Knowing the feed network and element spacing helped define the size of the antenna boards, which will have 8 elements on each board, and 8 boards will create a sub-array or quadrant.

The size and placement of the via hole (or impedance matching hole) through the patch affects the input impedance into the antenna [1]. After running several simulations, the via hole diameter size was optimized and forecast to be .020" (20 mils or .5 mm), with the hole placement in the center of the patch and .094 inches (94 mils or 2.4 mm) from the vertical right side of the patch, as shown in the figure 6 below.

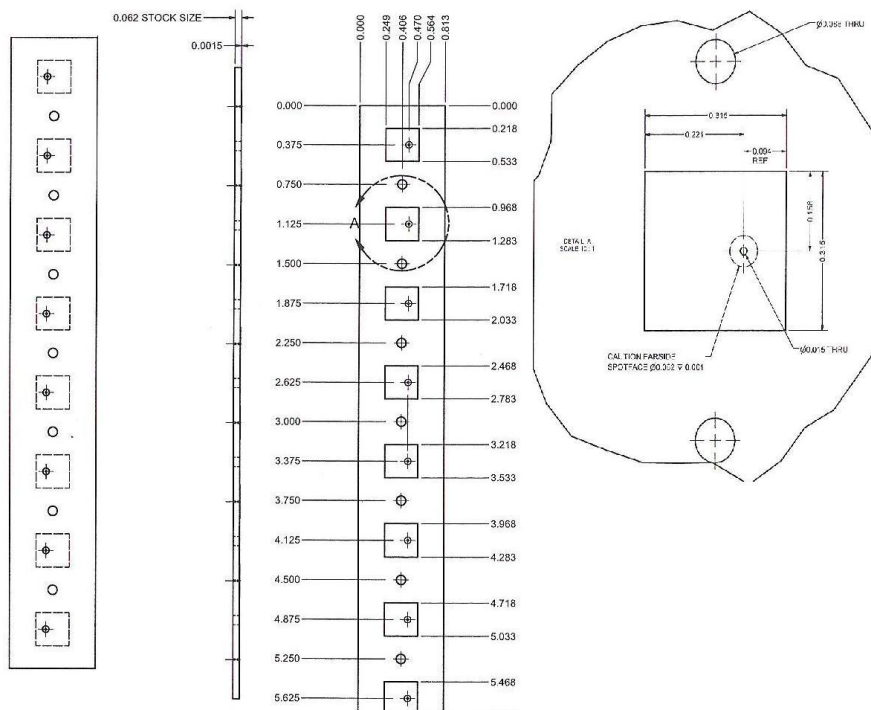

Figure 6. Single Antenna Board Design

CHAPTER 3

ANTENNA MODELING AND PROTOTYPING

3.1 Antenna Modeling Software

There are many software programs available to assist in the design of antenna design and modeling. Some programs offer free downloads available from the Internet which were developed by amateur radio operators. These programs typically model in the high frequency (HF) to Very High Frequency (VHF) ranges. There are other programs that are used for the development in the microwave frequencies. These programs usually have some associated costs, whether it is included in text books or commercial products backed by companies with legions of engineers charged with creating accurate models. One of the most well known antenna modeling software products is published by Ansoft and known as HFSS.

3.1.1 Ansoft HFSS

Ansoft HFSS is a very extensive antenna modeling software program. This program utilizes three-dimensional (3-D) modeling defined by the finite elements method (FEM). The FEM utilizes a more powerful and versatile numerical technique for handling problems involving complex geometries and inhomogeneous mediums [12]. The FEM digitizes the 3-D problem into a finite number of two dimensional (2-D) sub-regions to analyze the voltage potential in each element [12]. The elements are then assembled together to produce the overall effect. There are two methods used to combine the sub-regions, the iteration method and the band matrix method. Each method has its own error

attributes [12]. Ansoft HFSS software utilizes these methods internally, and selects the best method for the application. The greatest benefit to using HFSS is the 3-D modeling capability especially when utilizing probe, proximity, or aperture coupling antenna feed methods.

3.1.2 Agilent Advanced Design Software (ADS)

Agilent is well known in the electronic industry for their test equipment, especially for the RF test equipment such as signal generators, oscilloscopes, spectrum analyzers, vector network analyzers, and the like. Agilent started creating modeling software specifically for RF. This software package is well known to RF engineers as it is one of the most used and well developed programs. This software package also accommodates antenna modeling in the software suite. Many design comparisons have been made between Agilent's ADS and Ansoft's HFSS, as ADS utilizes the method of moment's method for calculation. The method of moments is a 2-D modeling technique. Essentially the method of moment's process takes moments by multiplying with the appropriate weighing functions and integrating them [12]. Method of moments sets up a partial differential equation which is solved by Green's function [12]. When dealing with 3-D, the mathematical computations for method of moments become extensive. However, for many RF cases only planar conditions are needed. Throughout a literature search, multiple sources showed minimal differences between ADS and HFSS during their patch antenna modeling.

3.1.3 Agilent Genesys

The Genesys software package is comparable to Agilent's ADS, although it has fewer capabilities to offer which results in a less expensive purchase price for the software. The

Genesys software package was originally developed by Eaglewear. In 2005, Agilent purchased the rights from Eaglewear. This is a contributing factor to the low cost, as Agilent's had no additional development costs beyond the price of the buyout. Agilent has refined the software package to have similar interfaces as the more robust ADS. Genesys utilizes the same method of moment's calculation as ADS.

3.2 Modeling Software of Choice

The modeling software chosen was Agilent Genesys, as this package was easily accessible. An AutoCAD model of the antenna was imported into the Genesys layout schematic where the top metal and via were defined. Genesys' library holds many different substrates, although the Rogers RO3730 substrate was not found in the library of the 2009 edition of Genesys. Genesys has an option to add substrate parameters, so the dielectric constant, magnetic constant, loss tangent (dissipation factor), resistivity, metal thickness in thousandths of an inch, metal roughness in thousands of an inch, and substrate thickness were all entered from the Rogers RO3730 substrate datasheet shown above.

Genesys' electromagnetic simulation (called Momentum or method of moments simulator) parameters were defined such as the frequency range to be analyzed, number of points, input port impedance, etc. Momentum has a far-field option which allows the individual beam patterns of an array to be characterized, which is the case for this design. The far-field radiation can be calculated in three dimensions, conic cut, principle plane cut, or the normal E and H plane cut. Since the concern of this thesis is how does the surrounding substrate and antenna elements affect the E and H fields (azimuth and elevation), the E and H plane cut was selected.

3.3 Results of Modeling

Once the simulation was setup, one element (shown in figure 7) was energized at a time, and the azimuth (E-field) beams were compared, as well as the elevation (H-field) beams were compared.

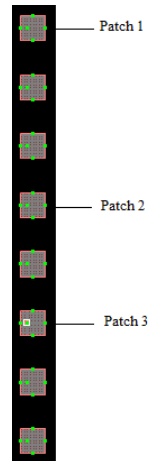

Figure 7. Simulation Photograph of the Three Patches Under Investigation

Figure 8 shows the patches under investigation to compare against measured beamwidth results. It shows the beamwidths of each patch plotted on the same graph for the ease of comparison.

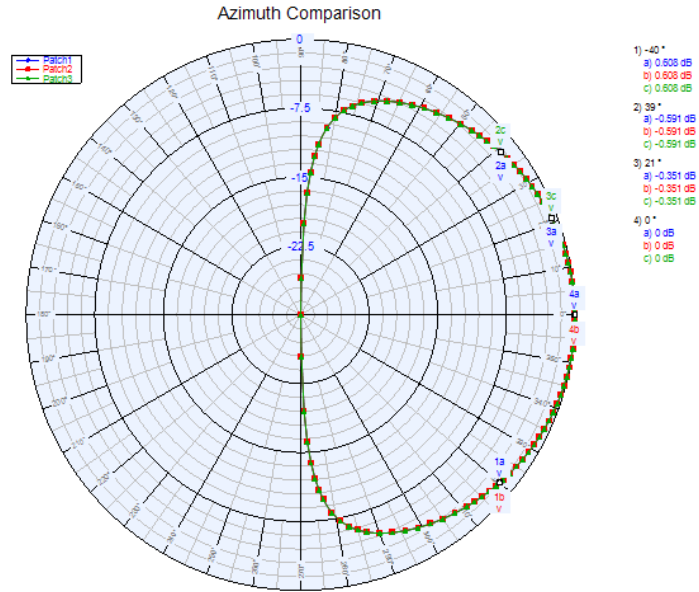

Figure 8. Azimuth Beam Simulation of the Three Patches Under Investigation

As shown from the plot in Figure 8, the beamwidth plots from each individual patch antenna are exactly the same. Given the azimuth radiation beams for each patch align on each other; the elevation beam was expected to show the same result (Figure 9).

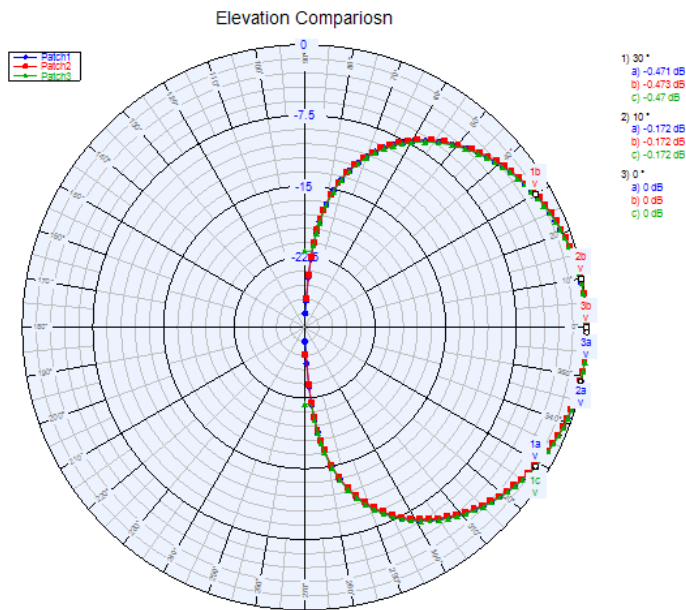

Figure 9. Elevation Beam Simulation of the Three Patches Under Investigation

After running the elevation simulation on each patch, the beams were plotted on one graph shown in Figure 9. In this simulation, each patch was exactly the same in dimension, and had the same size via hole positioned in the same place, therefore it was expected to have all the beams line up on each other. Will this occur once these patches are manufactured, with the etching tolerances and added substrate? The measured beams of the same patches can be found in chapter 4.

3.4 Antenna Manufacturing

Patch antennas are fabricated out of board material with rolled copper on either side, in this case Rogers RO3730. Typically the antenna board design is constructed in a software program that outputs a Gerber drill file. This file is imported into the board manufactures' acid wash machine and the machine creates the board as defined by the Gerber file.

Most board manufactures will convert an AutoCAD file of the board design into a Gerber file, as machine tolerances have to be included in the Gerber file otherwise the board will not turn out as designed. The board manufacture can also apply a protective coating to the board to help minimize corrosion and other environmental effects. This is a great feature for patch antennas to increase the longevity of the antenna.

CHAPTER 4

ANTENNA TESTING AND COMPARISON

4.1 Antenna Test Ranges

Testing of antenna systems can be extremely difficult and costly. Antennas are relatively hard to characterize as the flow of electrons create electromagnetic energy in free space, and the electrons cannot be seen by the “naked” eye. Test instruments have been developed to determine the signal strength exhibited by the antenna. To analyze energy coupled into free space, a receiving or sense antenna is required. To test antennas, there has to be a transmitting antenna and a receiving antenna. The device under test can be either transmit or receive, as antennas have reciprocity relationship (their characteristics are the same whether emitting a signal or capturing one). Throughout the rest of this document, the antenna being tested will be referred to as either Device Under Test (DUT) or the receive antenna.

A typical antenna test will have a DUT as the receive antenna and a transmitting antenna with well known characteristics, both operating on the desired frequency. Typically low signals levels are used as the test conditions minimize perturbations to the propagated signal. Furthermore, the signal strength attained by the receive antenna is at a certain frequency is compared to the angular position referenced from the transmitting signal. The ability to use low signals strengths allows either a low power signal generator or a vector network analyzer (VNA) to be used as the signal source. The transmit antenna is usually set to a fixed position, while the receive antenna is mounted on a rotating

platform to allow angular sweeping [1]. A spectrum analyzer can be used to monitor and record signal strength throughout the angular sweep. There are a few major problems that lie within this test setup. The distance between the two antennas is important to consider in order that the signal act as they do in free space. This means the antenna must appear to be operating either in the near-field (or Fresnel) range, or the far-field range [1]. The receive signal test results will consist of relative signal strength versus azimuth direction. In the near field, this is used to produce a pattern of both the transmitting and receive antenna patterns. Therefore to extract only the DUT deconvolution of the transmitting antenna pattern is performed [1]. The more accurate the known antenna (transmitting) pattern is, the more accurate the overall testing (received antenna pattern) will be. Furthermore, any obstacles that are in the path, must be known as an electromagnetic (EM) signal will bounce off an obstacle and could bounce into one of the receive antenna's side lobes providing a false pattern. Antenna testing is performed either outside or on inside test ranges which include the near field range, compact test range, or the far field range.

4.1.1 Outside Test Range

The outside test range is typically the easiest to setup, although the hardest to have accurate results, due to interference from unwanted objects in the test path [1]. An outdoor range will accommodate any size of antenna at most all frequencies. They typically operate in the far field range, as the distance between the two antennas can be enlarged as necessary. Interference is the greatest concern in outdoor ranges. Using a spectrum analyzer and broadband antenna such as a dipole or horn can be used to identify any spurious frequencies that may interfere with the testing. Although birds can cause

interference as they can fly through the signal transmissions and cause reflections their effects can be mitigated by slowly rotating the test antenna. Other objects, such as buildings and trees, are major contributing factors to reflections. These can be minimized through the proper choice of range location and clearing of the range. The hardest parameter to account for is the ground reflections [1]. This can be accommodated by raising the antenna into the far field range from the ground, but could be extremely costly depending on the wavelength and thus platform height the antenna must rest on.

4.1.2 Near Field Test Chamber

The near field range test chamber tests the antenna within its near field range defined by the equation 7 below, where R is the distance of the outer boundary of the region, D is largest dimension of the antenna, and λ is the wavelength of the signal.

$$R < 0.62\sqrt{D^3/\lambda} \quad (7)$$

This type of test range is very useful for the lower frequencies which have longer wavelengths. There are significant costs associated with the building of these chambers. All walls, ceiling and floor must be lined with foam absorber [1]. Foam absorber is created out of specialized foam absorber materials that essentially trap the radiating signal and minimizes the reflections. Foam absorbers are relatively expensive, as a typically 4 sqft absorber is approximately \$400 [13]. Also, foam absorbers are optimized in a certain frequency range, the greater the range (more broadband) the higher the cost [13]. This limits the operating frequencies that the range can be used for testing. Once the range is built, it still has to be characterized, as the foam absorbers are not perfect and

only attenuated signals so there are still reflections that would affect the accuracy of the test model.

This chamber sounds rather complicated, although there is another major cost associated with the near field range. The test results from antenna testing need to be presented as far field results, as most antennas are designed to operate in the far field range. In order to convert from the near field into the far field, each parameter has to be passed through a fast Fourier transform (FFT) algorithm [1]. Depending on the resolution required for the testing, this FFT algorithm is very processing intensive. Some complex antenna designs require the use of supercomputers for the processing speeds needed, which come at a large expense.

4.1.3 Compact Antenna Test Range (CATR)

A compact antenna test range is another type of testing range which is approximately the same size as the near field range. This range differs from the near field range, as the heavy processing power for the FFTs is not involved. This range uses multiple mirrors as reflectors in strategic places [1]. The purpose of these reflectors is to put the radiating signal into a planar waveform as the signal would appear in the far field [1]. These ranges are just as costly as the setup and characterization of the antenna test range is much more critical. The transmitted signal must reflect off of at least two mirrors before the wave is in a planar form. The chamber again is covered with foam absorber to reduce the unwanted reflections.

4.1.4 Far Field Antenna Test Range

The far field antenna test range is the easiest to setup and characterize. As this range has the same operations as the outdoor range, although this range is setup inside a closed chamber which eliminates many of the interference that is a product of an outdoor range. The cost of the range is the foam absorber. The foam absorber is the same as is used in the CATR and near field ranges, although the sheer size due to placing the antenna in its far field drives the cost. The chamber costs can be decreased when operating higher frequencies, since the signals have smaller wavelengths, which correlate with a smaller far field range, shown in the formula below. Unless antenna measurements are made fairly often, many companies will utilize outdoor testing, or will outsource the testing.

$$R > 0.62\sqrt{D^3/\lambda} \quad (8)$$

4.2 Test Method and Range Chosen

After researching antenna test ranges, it was found that there are multiple companies that rent their chambers to help subsidize the cost of development and maintenance of their antenna test ranges. Many test ranges can be found for frequencies around 6 GHz and below, as this is where most of the microwave work is focused. Rental chambers typically range from \$1500 - \$3500 per an 8 hour shift depending on complexity [14]. For a basic antenna such as the patch proposed, it was estimated the test range would take about 2 shifts in order to test the basic parameters of an antenna, azimuth and elevation beam pattern, cross-polarization, gain, efficiency, etc.

For a student researcher preparing a master's thesis with a very limited budget, hiring out the testing was not the best choice. The University of South Florida has an antenna

testing range that will accommodate testing up to 13 GHz. The anechoic chamber is approximately an 8ft cube lined with foam absorber on all walls and ceiling. An initial test was performed on the chamber using two horn antennas to ensure the anechoic chamber would perform the needed measurements. Figure 10 below shows the horn configuration and the anechoic chamber setup.

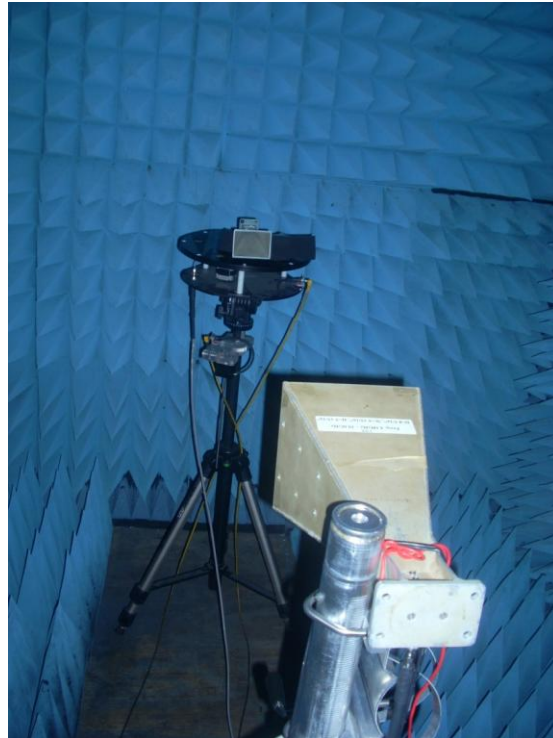

Figure 10. Characterization of Antenna Chamber

The closer horn antenna was the transmitting antenna being fed a signal from a Hewlett Packard 8719D Vector Network Analyzer. This Vector Network Analyzer (VNA) has an operating range from 50 MHz to 13.5 GHz. The horn antenna measurements were swept between the frequencies of 8 GHz to 10 GHz. The second horn was the receiving antenna or the device under test (DUT). The DUT is mounted to a motorized antenna positioned, that rotates in 2° increments. A software controlled program rotates the positioner, then

takes a measurement and saves/plots the data in a graphical user interface on a computer utilizing a GPIB connection.

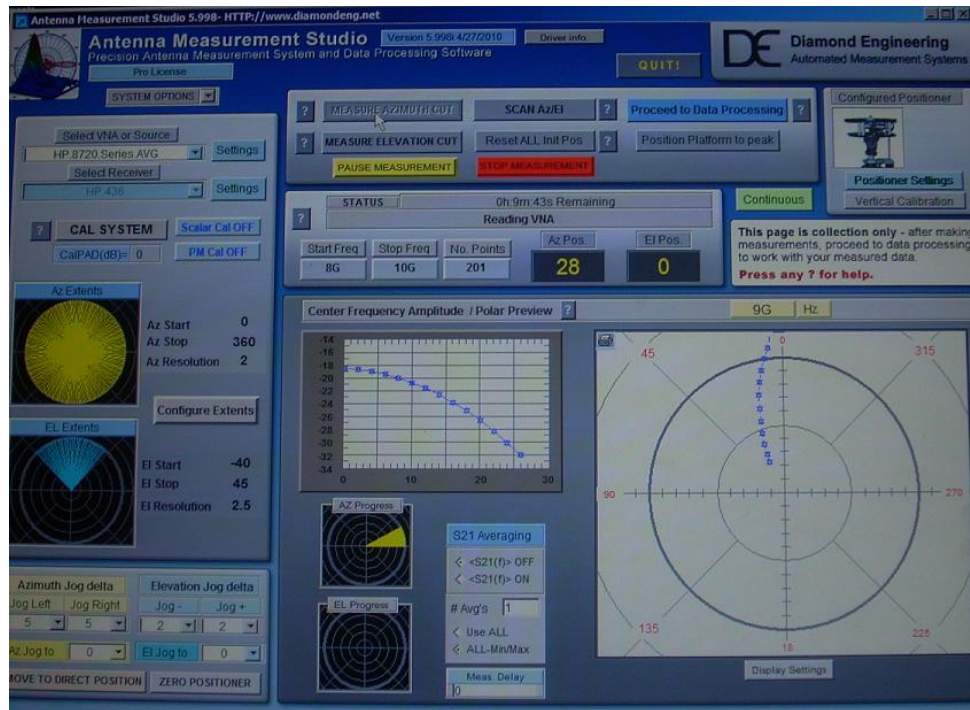

Figure 11. Antenna Chamber Computer Software

As seen in Figure 11 above, the GUI is called Antenna Measurement Studio provided by Diamond Engineering. Each measurement taken is updated into the GUI so the tester can tell if any unexpected measurements occur. This software also deconvolutes the transmitting antenna from the entire signal, to only show the beam of the DUT. The data is plotted at only one frequency, typically the maximum radiation frequency, although when saving the data, particular frequencies can be selected. The software saves the radiation pattern in a vector form and keeps the vector information in a comma-separated value (csv) file. This allows the data to be imported into either Matlab or Excel to manipulate the data and plot the characteristics. In this case, the data is imported into

Matlab, where the vector was normalized, converted into decibels, and plotted against the angular position of the antenna on a logarithmic polar graph.

4.3 Antenna Testing Results

Throughout these tests a horn antenna was excited and the first patch beam was measured from 0° to 360° in 2° increments. The output power level at the VNA was +10 dBm or 10 milliwatts. The transmit and receive antennas were placed 5 ft from each other, or 48 wavelengths away, which places the antennas into their far field ranges. While measuring the azimuth or electric field plane, the patch antenna was in a vertical position as shown in Figure 12 below. While measuring the elevation or magnetic field plane, the patch antenna was in a horizontal position as shown in figure 13.

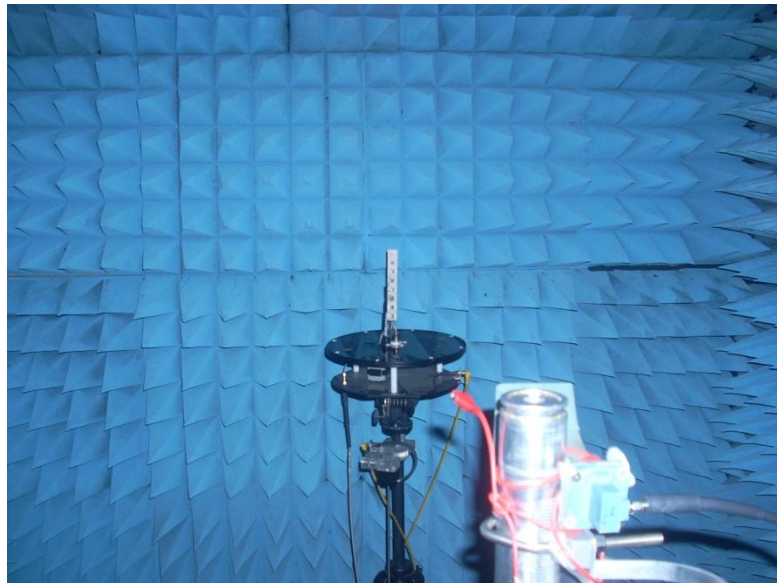

Figure 12. Azimuth Beam Measurement of Patch Antenna

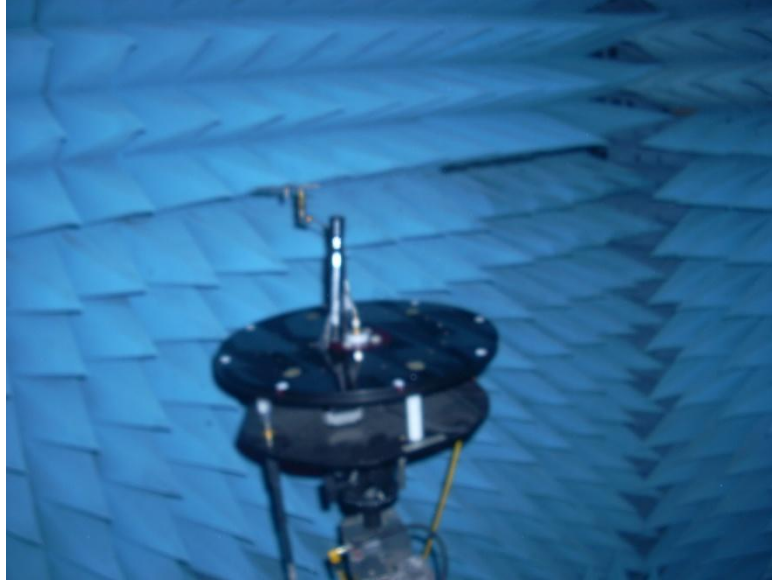

Figure 13. Elevation Beam Measurement of Patch Antenna

4.3.1 Test 1

The first test setup measured the beam on the patch closest to the edge of the antenna.

Figure 14 shows the measured azimuth field, while Figure 15 shows the measured elevation field.

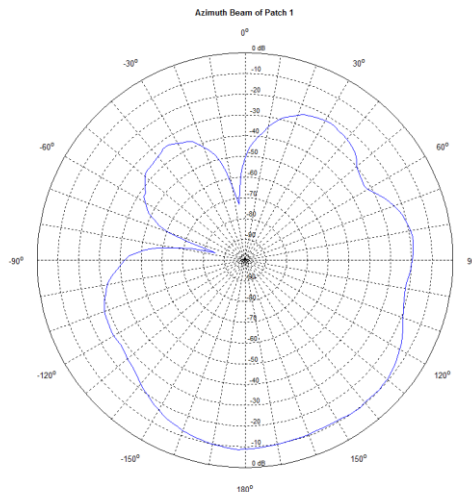

Figure 14. Measured Azimuth Graph of Patch 1

Analyzing the azimuth beam of Patch 1, it is noticed that the beam is wide as simulated, but a defined back lobe appears. Having defined sidelobes and back lobes degrade the antenna efficiency, as power is lost in these lobes. These lobes can be beneficial in some antenna applications such as jamming scenarios, although in RADAR applications, the energy should be directed in the main lobe.

Analyzing the Figure 15, the measured elevation pattern of Patch 1, it is shown the patch is almost Omni-directional. Nulls appear when the signal approaches the polarization type, in this case horizontal. One side of the measured pattern seems to have interference; this is most likely caused by adjacent patches.

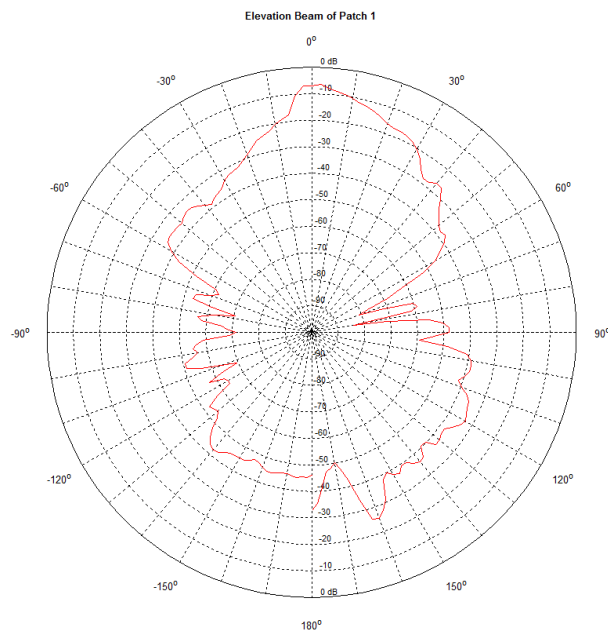

Figure 15. Measured Elevation Beam of Patch 1

4.3.2 Test 2

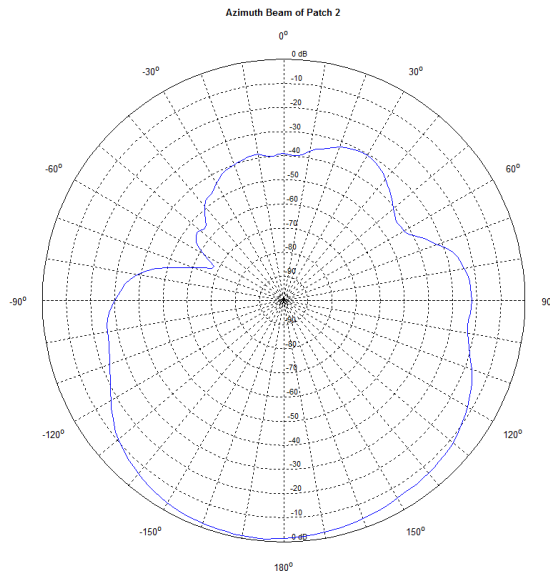

Figure 16. Measured Azimuth Beam of Patch 2

The azimuth beam shown in Figure 16 above is of tested Patch 2. This patch resides in the middle of the antenna, with the largest amount of substrate and other patch elements surrounding. Again this pattern shows a large back lobe in the pattern. This patch has a larger angular back lobe than Patch 1.

Figure 17 below shows the measured pattern of the elevation beam on Patch 2. This elevation pattern has many more nulls than Patch 1. From visual inspection, there is a greater amount of solder between the feed pin and the metal patch, than Patch 1.

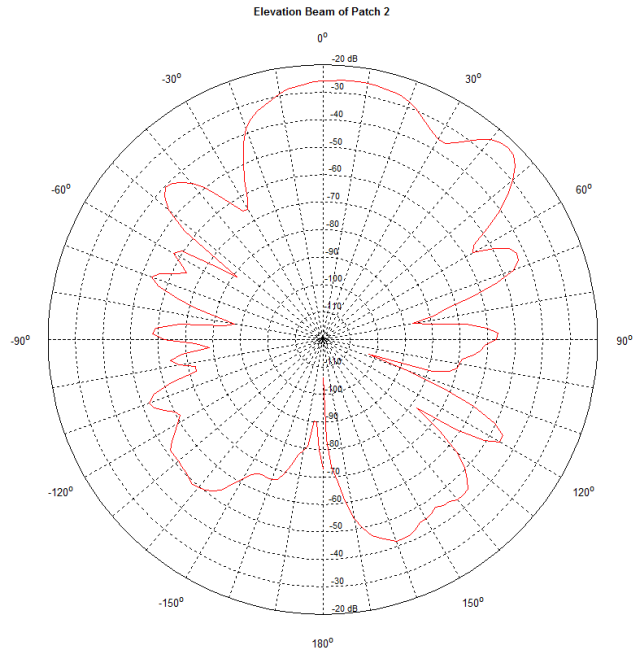

Figure 17. Measured Elevation Beam of Patch 2

4.3.3 Test 3

The last test setup measured the beam on the patch in the between the two extremes, the edge and the middle of the antenna. Figure 18 shows the measured azimuth field, while Figure 19 shows the measured elevation field.

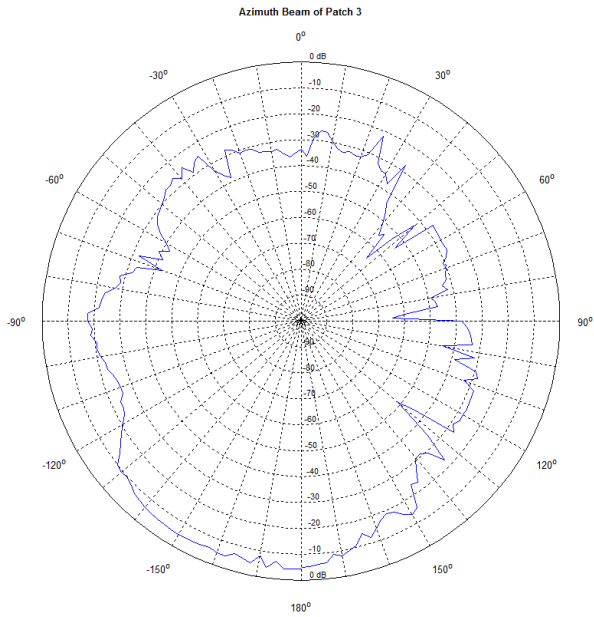

Figure 18. Measured Azimuth Beam of Patch 3

If the data in this measurement was smoothed, this plot would take form of the same beam as Patch 1, although the plot would be rotated approximately 100°.

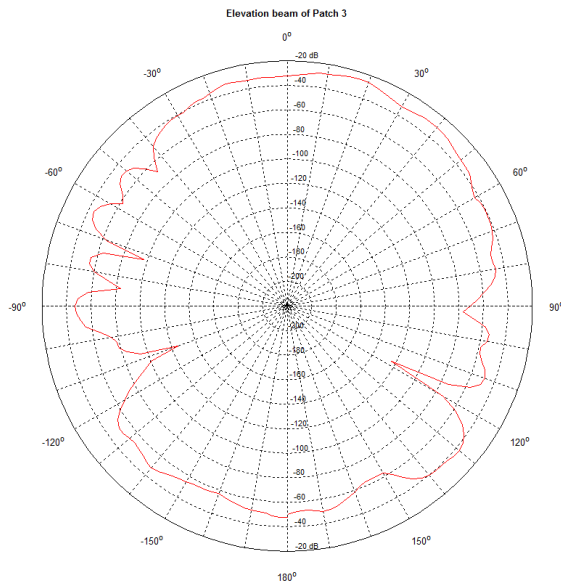

Figure 19. Measured Elevation Beam of Patch 3

Again the measured elevation beam pattern takes on closely the same pattern as Patch 1. The major nulls are a bit offset from the horizontal poles as shown in Patch 1. After inspection of the patch antenna, it is noticed there is about triple the amount of solder attaching the feed pin to the metal patch. It is apparent that the amount of solder, and solder voids, do affect the radiating characteristics.

4.4 Comparison Between Prototype and Simulation

After simulating the patch antennas utilizing Genesys, and performing actual test, it was quickly realized there is a difference between simulation and real life. Comparison plots have been created and placed side by side in Figure 20. Each will be discussed in greater detail.

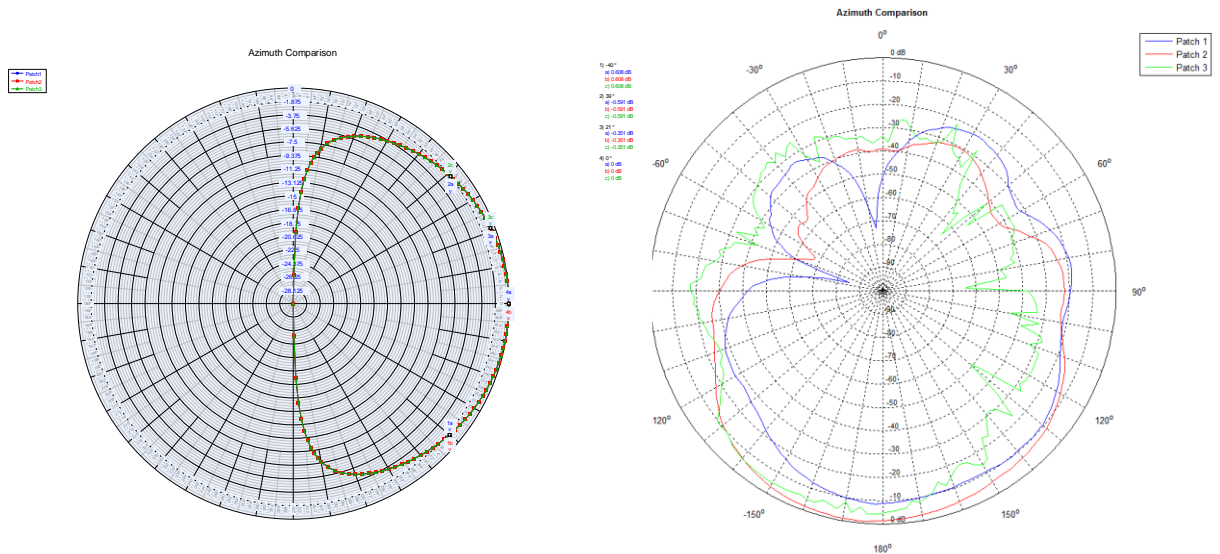

Figure 20. Simulation and Measured Azimuth Beam Comparison

The plot above on the left shows the simulation results of all patches on the same graph. Each patch is exactly the same in any position on the antenna. It also shows there are no

back lobes. The measured beams on the right of Figure 20 shows back lobes are introduced, and the patch radiations are related but not identical. The introduction of back lobes is due to the effects of the substrate and ground connection.

The simulation program creates the substrate underneath the metal patch only, where as in the measured prototype antenna, the substrate borders the metal patch which helps in the physical design to ensure proper spacing between elements. Since the simulation assumes the substrate is only under the metal patch, the program also assumes a perfect ground is surrounding the patch, which will reflect the signal, and pushing the signal forward. Having a better ground surrounding the antenna would decrease the back lobe level, creating higher gain of the antenna.

From the measured antenna patterns, the first two patches have similar antenna patterns. It seems from patch 1, that having less substrate around creates a more defined back lobe, whereas patch 2 is centered in the antenna having the most amount of surrounding substrate. Patch 3 seems to have other phenomenon during the measurement. Soldering flux had to be used on Patch 3 in order to get the solder to stick to the patch and the feed pin. After further inspection, it appears there is some bubbling in the patch metal itself.

While comparing the elevation beams, it is noticed in the measured beam, the patches are almost Omni-directional, with two nulls located horizontally. These nulls are created due to the patch being horizontally polarized, having the signal resonate at $\pm 90^\circ$. It also seems as the signal approaches $\pm 90^\circ$, other nulls are created. This phenomenon is most likely due to the other patches surrounding the radiating patch, especially depending on the height of the solder joint from the patch metal to the feed pin.

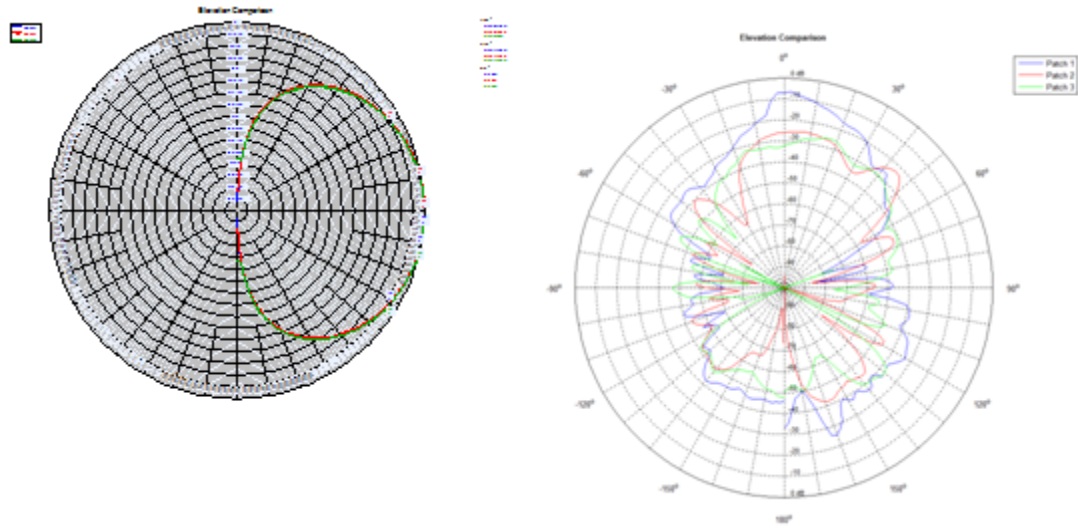

Figure 21. Simulation and Measured Elevation Beam Comparison

CHAPTER 5

CONCLUSION AND FUTURE WORK

5.1 Conclusions

With the continuing requirements for decreasing the size and weight of antenna systems while still increasing bandwidth and gain characteristics, patch antenna arrays will continue to be developed and used extensively. Patch antenna arrays are well understood as a total system, but when broken down, many characteristics are assumed and modeled from test results. The patch to patch comparison on a patch array presented in this thesis attempted to help understand surrounding element interactions. This problem was analyzed utilizing both software simulation tools and measurements from a fieldable antenna array for a PPI/SAR RADAR system. It was shown that software simulators compare each antenna element to an ideal ground, while actual patch arrays have substrate surrounding the element. This research also showed how solder joints and the application of excessive heat during the soldering process can change an antenna element pattern, which cannot be modeled in many of the commercial software packages. The measured antenna pattern results were compared to the simulated antenna patterns. The extra nulls in the pattern correlation, especially in the H-Field, shows that extra material from surrounding elements and solder joints has large effects on the radiating element pattern.

5.2 Future Work

The antenna comparison proposed in this thesis introduces additional investigations that might be followed. In order to determine how the surrounding substrate corrupts the radiating signal, the tested antenna could be redesigned to reduce the amount of surrounding substrate while keeping the same element spacing. This research was focused on a probe fed antenna array, where many variables are introduced from the feed method. A microstrip fed antenna could be used which would reduce added variables. If these test results yield differences from the modeling software, the board layout in the software could encompass more of a mechanical CAD interface to create a more accurate simulation model.

REFERENCES

1. Balanis, Constatine A. *Antenna Theory*. s.l. : Hamilton Printing, 1982.
2. Oppenheim, Alan and Schafer, Ronald. *Discrete-Time Signal Processing*. 3. Upper Saddle River : Pearson Higher Education, Inc., 1999.
3. League, American Radio Relay and Straw, R. Dean. *The ARRL Antenna Book*. s.l. : American Radio Relay League, 2007.
4. *High Gain Microstrip Patch Antenna*. Islam, Mohammad, Misran, Norbahiah and Shakib, Mohammed. 2009, *European Journal of Scientific Research*, pp. 187-193.
5. Microwaves 101. [Online] january 13, 2009. [Cited: May 8, 2010.] <http://www.microwaves101.com/encyclopedia/why50ohms.cfm>.
6. Pozar, David. *Microwave Engineering*. 3rd. New York : John Wiley and Sons Inc., 2005.
7. *Design Analysis of a Slotted Microstrip Antenna for Wireless Communication*. Islam, Mohammad, Misran, Norbahiah and Shakib, Mohammed, and Yatim, Baharudin. 2009, *World of Academy of Science, Engineering and Technology*, pp. 448 - 450.
8. Hazdra, Pavel, Mazanek, Milos and Cermak, Jiri. Wideband Rectangular Microstrip Patch Antenna Using L-Probe Feeding System. *Radio Engineering*. September 2007, Vol. 16, 3, pp. 37-41.
9. Hazdra, Pavel and Mazanek, Milos. *Microstrip Patch Antenna with Fractal Boundary: Design, Simulation and Results*. Deaprtment of Electromagnetic Field, Czech Technical University in Prague. p. 4, Technical Paper.
10. Skolnik, Merrill I. *Introduction to RADAR Systems*. s.l. : McGraw-Hill, 1980.
11. Gupta, Vibha Rani and Gupta, Nisha. *Gain and Bandwidth Enhancement in Compact Microstrip Antenna*. Birla Institute of Technology. Ranchi : s.n. p. 4, Technical Paper.
12. Sadiku, Matthew. *Numerical Techniques in Electromagnetics*. 3rd. Boca Raton : CRC Press, 2009.
13. Electronics, DJM. EMI Filters and RF Shielding Products. [Online] [Cited: July 18, 2010.] <http://www.djmelectronics.com/rf-absorber.html>.

14. Millitech. Antenna Testing Services. [Online] [Cited: August 23, 2010.]
http://www.millitech.com/pdfs/Antenna_Testing_Services.pdf.

ABOUT THE AUTHOR

Matthew Wallace moved from the Washington, D.C. metropolitan area to Saint Petersburg, Florida in 2001. He attended high school at Admiral Farragut Academy, and graduated from the University of South Florida with a Bachelors of Science in Electrical Engineering in 2009. His career began as an intern for Eagan, McAllister Associates in 2002, followed by part time work with SAIC and L-3 Communications. A full time career was started at Global Technical Systems and recently joined Espial Services Inc. His work experience includes electronics assembly, electronics bench technician, training and troubleshooting with satellite communication systems, and leading to RF Engineering designing RADAR antennas. He presently provides programmatic and technical support to the Science and Technology directorate at United States Special Operations Command.