

2008

Assessing the effectiveness of the response to instruction model for english language learners by utilizing a non-language-based intervention

Chisato Komatsu

Louisiana State University and Agricultural and Mechanical College

Follow this and additional works at: https://digitalcommons.lsu.edu/gradschool_dissertations



Part of the [Psychology Commons](#)

Recommended Citation

Komatsu, Chisato, "Assessing the effectiveness of the response to instruction model for english language learners by utilizing a non-language-based intervention" (2008). *LSU Doctoral Dissertations*. 2908.
https://digitalcommons.lsu.edu/gradschool_dissertations/2908

This Dissertation is brought to you for free and open access by the Graduate School at LSU Digital Commons. It has been accepted for inclusion in LSU Doctoral Dissertations by an authorized graduate school editor of LSU Digital Commons. For more information, please contact gradetd@lsu.edu.

ASSESSING THE EFFECTIVENESS OF THE
RESPONSE TO INSTRUCTION MODEL FOR ENGLISH LANGUAGE LEARNERS
BY UTILIZING A NON-LANGUAGE-BASED INTERVENTION

A Dissertation

Submitted to the Graduate Faculty of the
Louisiana State University and
Agricultural and Mechanical College
in partial fulfillment of the
requirements for the degree of
Doctor of Philosophy

in

The Department of Psychology

by
Chisato Komatsu
B.A., The University of Texas at Austin, 2001
M.A., Louisiana State University, 2004
December 2008

DEDICATION

I would like to dedicate this dissertation to my mother, Chikako Komatsu. My mother had passed away while I was in my third year of graduate program at LSU. Through her perseverance, courage, and love, I had learned never to give up in accomplishing my goals in life. I miss you deeply, and this degree is for you.

ACKNOWLEDGEMENTS

I would like to thank Dr. George H. Noell and Dr. Kristin Gansle for their guidance and support in the preparation of this document. I would also like to thank Dr. Frank Gresham, Dr. Mary Lou Kelly, Dr. Jeffrey Tiger, and Dr. Doris Carver for being members of my dissertation committee. I thank Dr. Joseph Witt for conceptualization of the idea to design the study. I would like to thank all of the individuals who had aided me in data collection. Finally, I would like to thank my father, Hisanori Komatsu, and my sister, Kanako Komatsu, for their constant support, understanding, and love.

TABLE OF CONTENTS

Dedication.....	ii
Acknowledgements.....	iii
List of Tables.....	vi
List of Figures.....	vii
Abstract.....	viii
Introduction.....	1
Review of Literature.....	4
IQ-achievement Discrepancy Model.....	4
Assessment for English Language Learners.....	7
Non-language Laden Assessment Approaches.....	7
Nonverbal Intelligence and Ability Measures.....	10
Advantages and Limitations of Nonverval Measures.....	12
Response to Intervention (RTI).....	14
General Benefits of RTI Approach.....	17
Literature Pertaining to RTI.....	18
Applicability of RTI Approach on ELLs.....	20
Rationale for the Current Study.....	23
Intervention for Students with Language Issues.....	24
Constant Time Delay (CTD).....	24
Paired Associate Task.....	27
Purpose of the Study.....	28
Research Questions.....	29
Method.....	30
Participants and Setting.....	30
Design of the Study.....	31
Predictor Variables.....	31
Outcome Variables.....	32
Computerized Constant Time Delay Procedure.....	32
Procedure.....	33
Data Collector Training.....	33
Student Paired Associate Training Sessions.....	33
Probe Sessions.....	35
Inter-observer Agreement and Treatment Integrity.....	36
Results.....	38
Participants.....	38
Mastery Criterion.....	38

Discussion.....	52
References.....	62
Appendix A. Sample CTD Prompts from the Intervention Powerpoint Screen.....	72
Appendix B. Data Sheet Utilized During the Computer-based CTD.....	73
Vita.....	74

LIST OF TABLES

1. Distribution of Grade and Age Placement for the Population Groups.....	39
2. Percentage of Students Who Met Mastery Criterion During Constant Time Delay Sessions.....	41
3. Mean Ordinary Least Squares Slopes for Each Population Group.....	42
4. Mean Number of Correct Responses by Session for English Language Learners.....	44
5. Mean Number of Correct Responses by Session for Native English Speakers....	44
6. Mean Number of Correct Responses by Session for Participants with Mental Retardation.....	45

LIST OF FIGURES

1. Distribution of the Number of Sessions Required to Reach Mastery Criterion in Computerized Constant Time Delay Procedure for English Language Learner group.....40

2. Distribution of the Number of Sessions Required to Reach Mastery Criterion in Computerized Constant Time Delay Procedure for Native English speaker group.....40

3. Distribution of the Number of Sessions Required to Reach Mastery Criterion in Computerized Constant Time Delay Procedure for Students with Mental Retardation Group.....41

4. Mean Correct Responses per Session for Responders.....47

5. Mean Correct Responses per Session for Non-responders.....48

6. Mean Correct Responses per Session for Ambiguous Responders.....49

ABSTRACT

The purpose of the current investigation was to examine the use of the Response to Intervention (RTI) model for English Language learners (ELLs) by using a computerized constant time delay procedure (CTD) that de-emphasized the use of language. Forty-five ELLs, 22 native English speakers, and five students with a diagnosis of mild mental retardation participated in the study. A computer-administered CTD procedure was utilized for paired associate tasks. The study found differences and patterns in students' performances that could be used to differentiate responders and non-responders to intervention. An interesting finding was that once the students were divided into groups based on their performance, there was no difference found between the population groups (i.e., ELLs, native English speakers, and students with mental retardation). By assessing the students' responses to intervention with a non-language-based intervention, the study provided useful information for the establishment of a non-discriminative, efficient, and practical approach for assessment with ELLs.

INTRODUCTION

There are approximately 4.6 million students identified as learners of English as an additional language (EAL) who attended pre-kindergarten through grade 12 in 2000–2001 in the United States educational system. This group represents 9.3% of the total public school enrollment (Kindler, 2002). This population has increased approximately 101% since the 1989–1990 school year, and researchers predict that the trend will continue for at least the next two decades (Thomas & Collier, 2002).

Learners of English as an additional language (EAL), limited English proficient (LEP), and English language learners (ELLs) are a few of numerous terms that describe these students who are learning English as a second language (ESL) (Echevarria & Graves, 2003; Kindler, 2002; Northwest Regional Educational Library, 2003; Valdez-Pierce, 2003). A quick scan of the literature in this area would indicate that the term English language learners (ELL) may be gaining favor in the field and will therefore be used throughout this document. There is a growing body of literature which suggests that a large proportion of ELLs are inappropriately assessed and placed in special education (Echevarria & Graves, 2003; Linan-Thompson, Vaughn, Hickman-Davis, & Kouzekanani, 2003). Given that almost one in ten students in U.S. schools is not a native English speaker, effective approaches for their assessment are critical for ensuring that they have access to instructional programs that meet their learning needs. There is, however, a dearth of research on effective assessment or interventions for ELLs who struggle in school (Linan-Thompson et al., 2003; McNamara & Hollinger, 2003). Development of assessment procedures that accurately identify ELLs who are in need of additional services, including special education, is essential.

In the United States, most states utilize standardized tests to measure students' academic performance. An increasing number of students in U.S. schools is from families whose dominant language is not English (Thomas & Collier, 2002); increasingly large proportions of students who take these standardized tests are ELLs. When academic skills are assessed with these measures, many ELLs fail to meet minimum expectations (Linan-Thompson et al., 2003), and are likely to be classified as eligible for special education services with a diagnosis of a specific learning disability (LD) (Case & Taylor, 2005). For ELLs, there is an alternative hypothesis to sub-average intelligence or learning disabilities for low test scores. That is, students may have low scores because of a lack of language proficiency which interferes with their capacity to understand and respond to test questions. Cummins (1984) stresses that inappropriate assessment approaches can lead to inaccurate identification of ELLs' needs, improper program placement, insufficient monitoring of student progress, and long-term failure of school programs. Furthermore, the Individuals with Disabilities Education Act (IDEA, 2004) specifically states that every ELL must be assessed at least once a year utilizing an English proficiency test under the federal legislation for Title III (Language Instruction for Limited English Proficient and Immigrant Students) of the No Child Left Behind Act (U.S. Department of Education, 2001). Several standardized assessments (e.g., Stanford Achievement Test (SAT9) and Iowa Test of Basic Skills (ITBS)) are being administered to evaluate ELLs' language proficiency (Echevarria & Graves, 2003; Kindler, 2002; Valdez-Pierce; 2003). Knowledge of lack of language proficiency, however, does not prevent ELLs from being assessed by individuals with no knowledge of their native language and with measures with doubtful applicability to their native language.

For both legal and ethical reasons, the development of assessment procedures that accurately identify ELLs who are in need of additional services, including special education, is essential. Valdez-Pierce (2003) recommended that educators proceed with care in making program placements, especially those to special education, based on the results of these assessments. The goal of the current study is to design a method that can be used during disability classification procedures and special education eligibility determination that would rule out lack of language proficiency as a possible explanation for poor academic performance for ELLs.

REVIEW OF LITERATURE

Historically, standardized tests are utilized to measure students' academic performance in the United States. These tests have been and are used in an attempt to answer a critical question: which students have a learning disability (LD) or mental retardation (MR) and therefore are entitled to special education and related services. Diagnosis of LD is typically an inference made by professionals based on scores from ability and achievement tests (Valdez-Pierce, 2003). In the case of LD, determination of eligibility criteria has been a highly ambiguous and controversial issue (Furlong & Yanagida, 1985; Vaughn & Fuchs, 2003; Ysseldyke, Algozzine, Shinn, & McGue, 2001). The controversy is due to the use of the IQ-achievement discrepancy, a procedure that is frequently used to identify students with LD (Vaughn & Fuchs, 2003).

IQ-achievement Discrepancy Model

Establishing acceptable criteria for LD identification historically has been a controversial issue. The foremost reason for the controversy about identification is the use of the IQ-achievement discrepancy. IQ-achievement discrepancy is not required by federal law, but is a frequently used procedure by local education agencies across the nation (Vaughn & Fuchs, 2003). The underlying assumption in the identification of LD is that IQ-achievement discrepancy is a valid indicator of the presence of a specific learning disability. That is, academic performance of students who demonstrated an unexpected discrepancy between their ability and achievement (i.e., discrepant underachievers) differs from that of students who demonstrated no such discrepancies (i.e., nondiscrepant underachievers such as students with MR). In other words, students with average ability or IQ scores are expected to perform academically or achieve in the average range.

Students whose achievement is significantly below that range are considered to have an unexpected difference (Kavale & Forness, 2000).

Several lines of research, however, have revealed that nondiscrepant and discrepant low achievers are not meaningfully different in domains of achievement, behavior, and processes related to reading (Fuchs, Fuchs, Mathes, & Lipsey, 2000; Stanovich & Siegel, 1994; Stuebing et al., 2002; Torgesen & Burgess, 1998). Reading has been a primary focus for research on the subject matter because 1) reading has been an area in which most students with LD demonstrate significant difficulty (Lerner, 1989), and 2) is an essential fundamental skill for students' outcomes (Resetar, Noell, & Pellegrin, 2006). Additionally, the discrepancy approach does not provide information which is useful for making instructional decisions (Fuchs & Fuchs, 1997; Gresham & Witt, 1997; Vellutino, Scanlon, & Lyon, 2000).

Aside from the fact that the academic performance of discrepant and nondiscrepant low achievers do not differ, other assumptions of the IQ-achievement discrepancy model of LD identification are not empirically supported. For example, the degree of discrepancy is not substantially related to the severity of the student's LD (Stanovich & Siegel, 1994), or how much remediation a student with LD appears to need seems to have no relationship to the magnitude of the IQ-achievement discrepancy. Furthermore, the magnitude of the discrepancy does not indicate the best or most appropriate instructional methods for students with LD (Elliott & Fuchs, 1997; Fletcher et al., 1998; Gresham, 2002). Several empirical studies provide evidence that the IQ-achievement discrepancy is not a valid marker for the presence of LD (Fletcher et al., 1994; Vellutino, Scanlon, & Lyon, 2000).

In addition, use of the IQ-achievement discrepancy model may even harm students who are identified this way. For example, some National Institute for Child Health and Development (NICHD) studies caution that using IQ-achievement discrepancies to identify LD delays treatment to these students beyond the time when interventions are most effective (see National Association of State Directors of Special Education, 2005). The practice is often referred to as a “wait to fail” model, where the use of psychometrics properties of the standard tests often prevent students from receiving the additional help including special education until they are age 9 or older (Vaughn & Fuchs, 2003). As a result, reconceptualization and redefinition of LD has been called for by many writers in the field (e.g., Fletcher et al., 1994; Gresham 2002; Vaughn & Fuchs, 2003; Vellutino, Scanlon, & Lyon, 2000; see also Bradley, Danielson, & Hallahan, 2002).

Fundamentally, the assumptions underlying the IQ-achievement discrepancy model have not been supported, even for students who are tested in their native English (Stanovich & Siegel, 1994; Fletcher et al., 1998). Furthermore, the results of such assessments provide no useful information for instructional planning, monitoring of student progress, or for intervention design (Fletcher et al., 1998). Given the flaws inherent in the model, it is unlikely that it would provide more accurate or more informative results for students who are tested in English when it is not the language in which they are most comfortable or fluent and likely therefore to provide the most accurate information for diagnostic purposes. Clearly, there is a need to further examine and refine our understanding of the extent to which low achieving students who are identified with LD under IDEA are different from low achieving students who are not

given that label. In addition, the relationship of these groups of students to ELLs with and without LD should be further investigated to determine whether these groups show evidence of differences in academic performance that can be used to provide more effective services for low achievement across the board.

Assessment for English Language Learners

Non-language Laden Assessment Approaches. Given the relationship between language and academic achievement (Case & Taylor, 2005), the common solution to the problem of appropriate academic assessment and finding the “true” learning potential of ELLs has been the development of non-language laden assessment approaches (Heflinger, Cook & Thackrey, 1987). There are several types of measures that use non-language assessment as an eligibility criterion for ELLs. First, a number of public school systems suggest a neurological examination or evaluation for ELL students who have been referred for evaluation (Chandler, 1984). If indications of neurological problems were apparent, the student would be placed in the Other Health Impaired category under the IDEA eligibility criteria (Chandler). The important limitation of this approach is that a neurological examination provides no other information concerning the student that would either be useful for diagnosis of the twelve other IDEA eligibility criteria, or for determination of intervention or instructional design.

Another non-language assessment approach that has been widely used is the System of Multicultural Pluralistic Assessment (SOMPA; Mercer & Lewis, 1977). As described in the Ninth Mental Measurement Yearbook, it is designed “...as a comprehensive system for assessing the level at which children function in cognitive abilities, perceptual motor abilities, and adaptive behavior” (Mitchell, 1985). The

SOMPA was designed to be responsive to the mandates of PL 94-142 (Education for All Handicapped Children Act of 1975), that is, to assess the educational needs of children five to 11 years of age in a racially and culturally non-discriminatory manner. Based on the premise that cultural, linguistic, and health factors must be taken into account when assessing a child's performance, the SOMPA estimates academic potential by taking into consideration the child's background and experience (Mitchell).

The SOMPA consists of three components: medical, social systems, and pluralistic. The medical component focuses on the presence or absence of organic pathology which consists of six measures (i.e., sensory motor coordination, perceptual and neurological factors, health history, nutritional or developmental problems, vision, and auditory acuity). The social systems component, which utilizes the Adaptive Behavior Inventory for Children (ABIC) or the Wechsler Intelligence Scale for Children (WISC-R), inquires with questions regarding how the student's behavior conforms to the social norms of the various social groups in which the child participates. The pluralistic component is the third component of the SOMPA and is distinctive to this assessment. This component derives a student's estimated learning potential (ELP) score, which takes into account the student's ethnic, cultural and socioeconomic background. Test results are to be interpreted by a psychologist or a trained assessment team. Separate norms are provided for African-American, Caucasian, and Hispanic children.

There is a study that supported the content validity of this assessment procedure. Talley (1979) examined SOMPA's three components as well as educational placement information and profile characterization utilizing two standardization samples and found that the SOMPA assists professionals in making nonbiased placement decisions for both

Anglo and Hispanic students. Despite this characterization of the SOMPA by Talley, however, the assessment also has a number of drawbacks. First, although the authors of the SOMPA describe the assessment as a comprehensive system for assessing the *educational* needs of children in a racially and culturally non-discriminatory manner, none of the three components of the SOMPA (i.e., medical, social systems, and pluralistic components) takes into account the academic performance of a student. Rueda, Figueroa, Cardoza, and Mercer (1985) reported a study utilizing the SOMPA in an attempt to examine the performance of limited-English proficient Hispanic students on a battery of psychometric instruments designed to appropriately assess linguistic minority students. Forty-four typically developing students, 45 students with LD, and 39 elementary school students with mild mental retardation participated in the study. Results indicated that in general, the patterns of scores on the instruments were in the expected directions as the diagnostic classifications assigned to the students in the school setting. The assessment approach, however, revealed no information on what needed to be taught and which method should be utilized during intervention. In other words, the SOMPA provided very little information beyond the traditional eligibility assessment (Rueda et al.).

Another pitfall of the assessment as Chandler (1984) stated, is that the SOMPA is difficult to use, time consuming, and expensive in terms of personnel costs. Most public schools, therefore, have elected not to administer the social and pluralistic components which are the heart of the SOMPA assessment (Chandler, 1984). Jirsa (1983) also criticized the SOMPA, stressing that the philosophical basis of the assessment is not considered helpful or useful in the assessment process because it creates an artificial separation of populations. An assessment procedure that is more time and cost efficient

and that places its focus on academic performance would serve as a better alternative for this assessment.

Nonverbal Intelligence and Ability Measures. Other non-language-based assessment approaches that have been used are nonverbal intelligence measures. Verbal language is used by neither examiner nor examinee during these assessments. One measure that falls under the category is the Test of Nonverbal Intelligence, Third Edition (TONI-3; Brown, Sherbenou, & Johnsen, 1997). The TONI-3 is a norm-referenced test which was developed to assess aptitude, intelligence, abstract reasoning, and problem solving in a completely language-free manner (Plake & Impara, 2001). It was designed to assess individuals between six and 89 years of age and is advertised as particularly well suited for individuals who are known to have disorders such as learning disabilities, speech problems and specific academic deficits. The format also accommodates the needs of individuals who do not read or write English well, due to disability or lack of exposure to the English language (Brown, Sherbenou, & Johnsen). Alternate form reliability estimate ranges from .74 to .95, test-retest reliability estimate ranges from .89 to .94, and interrater reliability is .99 (Plake, & Impara, 2001). Criterion-related validity with the Wechsler Intelligence Scale for Children-Revised (WISC-R; Wechsler, 1974) Performance and Verbal Scales were reported. The correlation coefficients between the WISC-R Performance Scale and Forms A and B were .56 and .58, respectively. The correlation coefficients between the WISC-R Verbal Scale were .59 and .53 for Forms A and B, respectively (Plake & Impara).

Another recent language-free measure of intelligence is called the Universal Nonverbal Intelligence Test (UNIT; Bracken, & McCallum, 1996). It was published in

1996 to meet the needs of educators and psychologists who must evaluate the intellectual functioning of children and adolescents between five and 18 years of age who cannot be assessed readily on a verbally-laden measure of intelligence (Plake & Impara, 2001). The UNIT was designed to provide a fair assessment of intelligence for individuals who have speech, language, or hearing impairments; different cultural or language backgrounds; or those who are verbally uncommunicative. The administration of the UNIT requires no receptive or expressive language for examiners or examinee. There are six subtests to the assessment: symbolic memory, objective memory, spatial memory, analogic reasoning, cube design and mazes. Of the six subtests, three assess short term memory (i.e., symbolic memory, objective memory, and spatial memory) and three assess reasoning (i.e., analogic reasoning, cube design, and mazes).

Additionally, three of the UNIT subtests are symbolic in nature. That is, these subtests are related to language but do not require receptive or expressive language from the examinee. The assessment yields a comprehensive Full Scale IQ as well as subscale and subtest standard scores. Correlations with the Woodcock-Johnson Cognitive Ability Scales are in the .60s (Plake & Impara, 2001). The UNIT may be administered in three forms: abbreviated battery, 10-15 minutes; standard battery, 30 minutes; extended battery, 45 minutes (Riverside Publishing, 2006). The assessment can be administered in a time efficient manner, which is an advantage the UNIT has compared to the SOMPA. Hooper and Mee Bell (2006) investigated the concurrent validity of the UNIT by evaluating the correlation coefficients with the Leiter International Performance Scale-Revised (Leiter-R; Roid & Miller, 1997). The researchers found that the correlation coefficients between the two measures ranged from .33 to .74, which were statistically

significant. Goldberg Edelson (2005) administered the UNIT and the TONI-3 to 35 individuals with Autism between the ages of four and 18 from Italy and the United States. The results revealed a significant correlation coefficients between the two ($r(35) = .56, p < .01$), indicating that the two measures are appeared to be measuring similar constructs.

Another non-language-based assessment instrument is called the Non-Verbal Ability Tests (NATs; Rowe, 1986). The NATs are ability tests which are designed to measure perceptual, conceptual, attention, and memory skills of students ages eight and over. The tests give a standardized measure of cognitive ability which is purported to be largely independent of students' language skills, and provide an objective indicator of individual students' potential which can help to establish appropriate academic expectations (Conoley & Impara, 1995). Test-retest reliability coefficients with a four-week interval were reported on four ethnic groups (i.e., English, Greek, Italian, and Turkish). The reliability coefficients ranged from .71 to .90. The average internal consistency estimates utilizing the Kuder-Richardson formula 20 was .81, with the range of .51 to .99. Further information regarding the description of the groups was not provided (Conoley, & Impara). Concurrent validity was reported by evaluating the NATs with the WISC-R (D. Weschler, 1974). The correlation coefficients ranged from .19 to .59, which were in the low to moderate range (Conoley, & Impara).

Advantages and Limitations of Nonverbal Measures. Aside from the obvious advantage of removing verbal language from assessment for students who are not fluent in that language, several advantages of nonverbal measures have been cited in the literature. These include 1) racially and culturally non-discriminatory manner of administration (McCallum & Bracken, 2005), 2) reduced oral or written language load

(Hooper, & Mee Bell, 2006), 3) suitable for individuals with certain deficits (e.g., learning disabilities, speech problems, and specific academic deficits) (Plake & Impara, 2001), and 4) reduced mean differences between monolingual and bilingual students (Brown, Sherbenou, & Johnsen, 1997).

Although the utilization of non-language-based assessments may seem an appealing means of determining eligibility for special education for ELLs, there are limitations in using these measures for this purpose. First, with the exception of the Non-verbal Ability Test, these measures either are or utilize intelligence tests. IQ scores have not been demonstrated particularly useful for diagnostic and classification purposes for students with mild learning problems (Gresham & Gansle, 1992; Forness, Keogh, MacMillan, Kavale, & Gresham, 1998); that is, they do not demonstrate utility for making differential diagnoses for students with mild problems (Vaughn & Fuchs, 2003; Ysseldyke, Algozzine, Shinn, & McGue, 2001). Further, they do not directly measure the most important variable in student achievement: academic performance. These types of assessment approaches, which purport to be free of language, still require inferences about achievement and ability to be made because they do not directly measure students' academic performance. An inference about how the student *would* perform academically is required based on the measure, which puts those who assess in the same position as when they used a verbal intelligence measure (Vaughn & Fuchs, 2003; Vaughn, Linan-Thompson, & Hickman, 2003).

It has also been argued that IQ tests have limited treatment utility; that is, they contribute little reliable information to the planning, implementation, and evaluation of instructional interventions for children and youth (Gresham, 2002; Gresham & Witt,

1997; Siegel, 1989). The authors therefore suggest replacing intelligence tests with assessment tools with established treatment utility (Gresham, 2002; Gresham & Witt, 1997).

Ideally, for an effective and useful assessment, the items must be tied to the student's curriculum (Shinn, 1989; Valdez-Pierce, 2003). When assessing children with language difficulties, it is first essential to evaluate whether the instruction being presented to the student matches the student's current skill level or behavioral repertoire (Richman et al., 2001). Once instructional and frustrational levels of curriculum have been determined for basic skills, it is important to address the issue of adequate instruction. Knowing whether the student has received adequate instruction and how that student might behave given adequate instruction would provide a great deal of information that could be used in remediating academic performance issues. If an assessment approach does not include an implementation of an empirically validated intervention, there is no means to rule out the possibility that the student never had an opportunity to learn the material in the past. That is, assessment approaches without empirically validated interventions require an inference about whether a student is a typically developing student.

Response to Intervention (RTI)

One increasingly common approach to disability identification and service delivery in U.S. schools is Response to Intervention (RTI). RTI is defined as the change in behavior or performance as a function of an intervention (Gresham, 1991). It is a more direct set of procedures that has evolved as an alternative to the test based approach in recent years (Gresham, 2002; Resetar, Noell, & Pellegrin, 2006; Vaughn, Linan-

Thompson, & Hickman-Davis, 2003). RTI has shifted the focus of responding to low student achievement from standardized test scores to more skills-based academic outcomes by implementing an empirically validated intervention and making an eligibility determination based on whether a student has or has not responded to the intervention. Determination of student eligibility based on this approach therefore is a low inference situation because the decision about whether a student *can* learn is based upon data about whether a student *does* (Vaughn & Fuchs, 2003). In other words, students who have received adequate instruction and responded to an intervention would not be considered to have a disability, while those who have received adequate instruction and not responded would be identified with a disability. The disability is assumed to be the reason why the student is not making progress in spite of quality instruction or intervention.

In response to the burgeoning literature providing evidence for the efficacy of the RTI approach (Fletcher et al., 1998; Speece & Case, 2001; Vaughn & Fuchs, 2003; Vaughn, Linan-Thompson, & Hickman-Davis, 2003), the Individuals with Disabilities Education Improvement Act of 2004 (IDEA) allows for, but does not mandate the use of, response-to-intervention (RTI) as an avenue available to schools and educators to identify students with LD. Given the increasing number of ELL population in the United States (Thomas & Collier, 2002) and exceedingly high number of ELLs who are identified as LD (Case & Taylor, 2005), application of RTI in identifying ELLs with disability appears practical.

The RTI approach as a means to identify LD has its foundation in a 1982 National Research Council study (see Heller, Holtzman, & Messick, 1982). RTI uses a

discrepancy-based approach between pre- and post-intervention levels of academic performance rather than between ability and achievement scores. The RTI approach to eligibility determination identifies students as having LD if their academic performances in relevant areas do not change in response to a validated intervention that has been implemented with integrity. An intervention is implemented to help distinguish between reading problems caused by cognitive deficits versus those caused by experiential deficits (i.e., poor or inadequate reading instruction) (Gresham, 2002). The proposition that “difficult to remediate” children can be considered LD and easily remediated children would not have LD would abandon the entire questionable process of calculating ability-achievement discrepancies (Fletcher et al., 2002).

RTI has been recognized as a valid way to identify students in need of additional services including special education. There is evidence that English speaking students who are at risk for placement in special education benefit from RTI models, especially in reading (Fletcher et al., 2002; Gresham, 2002; Linan-Thompson et al., 2003; National Reading Panel Report, 2000). For example, the state of Iowa has been using the RTI model for eligibility determination and service delivery for over a decade. There are two purposes to the state’s utilization of the RTI model. The first purpose is to identify appropriate and effective interventions that result in improved individual performance. The second purpose is to determine whether students require special education and related services (Iowa Department of Education, 2005). The determination of an eligibility decision for special education services relies on establishing the need for special education instructional support or related services, which leads directly to the provision of those services. In other words, those who need services are determined

eligible for services without the need for a specific disability diagnosis (Vaughn & Fuchs, 2003).

General Benefits of RTI Approach. There are a number of advantages of the RTI approach compared to the IQ-achievement approach. The first advantage is that RTI moves from a deficit model to a risk model for both identification and intervention on students with LD (Vaughn & Fuchs, 2003). In the RTI model, students are screened early in their school years (i.e., kindergarten or grade one), and highly effective instruction is delivered to the students who are identified as “at risk” for school failure. In the IQ-achievement discrepancy model, however, the focus is to identify underlying “processing deficits” and to develop interventions that would help overcome those deficits (Vaughn & Fuchs). Conceptualizing the identification and severity of disorders in terms of a student’s responsiveness to intervention takes the focus away from the within-child view of a problem (MacMillan & Speece, 1999).

The second advantage is that the utilization of the model reduces the bias that is inherent in the teacher referral process. Traditional screening procedures used by the public school system to identify students with LD often appear to be confusing, inconsistent, and highly reliant on information provided by teachers (Gresham, MacMillan, & Bocian, 1997). Typically, general education teachers apply their impression of local or classroom norms in deciding whether students’ academic performance is adequate. This inclination has been referred to in the literature as “teachers as imperfect tests” (Gerber & Semmel, 1984; Gresham, MacMillan, & Bocian, 1997; Gresham, Reschly, & Carey, 1987). In other words, the teacher’s impressions of student academic performance function as a test of whether that student’s performance is

similar or dissimilar to the rest of the students. The teacher makes a referral accordingly. Once the referral is made for a special education evaluation, testing and subsequent eligibility for special education services are likely (Algonzine, Yesseldyke, & McGue, 1995). In the RTI model however, the determination of eligibility for special education services does not rely primarily on teacher referral but on establishing both the presence of a disability and the need for special education instructional support based on the student's responsiveness to empirically validated intervention(s). It therefore minimizes the subjectivity inherent in the identification process.

Other advantages of RTI include early identification of and intervention for the problem rather than waiting for the student to have extreme difficulty learning that affects their achievement. The RTI model allows the identification of students as well as the remediation of their academic deficits early in their careers for both students with disabilities and for students without disabilities who are at risk for failure in school (Fuchs & Fuchs, 1997). Early identification is possible with the RTI model because at-risk students are identified on the basis of their level of performance, and empirically validated intervention is delivered promptly to evaluate their responsiveness (Fuchs, Fuchs, & Speece, 2002; Vaughn & Fuchs, 2003). Prompt identification and intervention implementation is unlikely with the IQ-achievement discrepancy model because the referrals are made by teachers after students demonstrate difficulty (Gresham, 2002).

Literature Pertaining to RTI. Due to the unresolved problems in the current system as well as the availability of improved practices based on RTI research, there is an increasing need for RTI-based reform. A number of research studies emphasize the need for prereferral intervention to evaluate a student's placement in special education (Baca

& Almanza, 1991; Gresham, 1991; McNamara & Hollinger, 2003). Resistance to a prereferral intervention is often seen as a need for special education placement because the child is not learning like a typical learner and shows evidence of needing intensive one-to-one instruction (Gresham, 1991).

In the RTI model, if a student responds to an empirically validated intervention, the student is deemed disability-free and is then returned to the original classroom environment. Vaughn, Linan-Thompson, and Hickman-Davis (2003) utilized RTI for students in second grade who were at risk for reading disabilities. Students who were at risk (i.e., eligibility for participation) were identified through 1) at-risk nomination criteria by classroom teaches based on the students' low level of reading performance, and 2) screening procedure utilizing the screening portion of the Texas Primary Reading Inventory (TPRI; Texas Education Agency, 1998). The identified 45 students participated in 10 weeks of supplemental, small-group reading instruction. Instructors used a series of criteria to determine whether the student would benefit from supplemental instruction. Preestablished criteria for completing the intervention were as follows: 1) minimum of five words read correctly out of eight on the screening portion of the TPRI, 2) 55 correct words read per minute on second-grade level Test of Oral Reading Fluency (TORF; Children's Educational Services Inc., 1987) with errors five or less, and 3) a score of 50 correct words read per minute on fluency progress monitoring sessions for minimum of three consecutive weeks (Vaughn et al.).

After the 10 weeks of intervention, students who met the criteria were returned to general education curriculum and no longer included in supplemental instruction, and the rest of the students were provided with another 10 weeks of intervention. The

intervention phases continued for 30 weeks, including only the students who did not respond to the previous phase of intervention in subsequent intervention phases. The results showed that almost equal numbers of students met criteria at the end of each phase. Ten, 14, and 10 students met the criteria after ten, 20, and 30 weeks of intervention sessions, respectively. Approximately 25% of the students who had participated in the study due to the at-risk level of their reading performances did not respond to any of the interventions and therefore were considered eligible for referral for special education. That is, approximately 75% of students who were considered at-risk by teacher nomination and the screening procedure in fact responded to the intervention and demonstrated growth. The study allowed for the distinction of a group of students who would require additional support (Vaughn et al., 2003). The push away from traditional practices and the pull toward alternatives is essential to the current consensus regarding RTI (Fletcher et al., 2002; Gresham, 2002; Reschly & Ysseldyke, 2002).

Applicability of RTI Approach on ELLs. Despite the movement of the field toward RTI, there is little research that describes its use with ELLs, and with good reason. In the RTI model, students would be identified as eligible for referral for special education evaluation only after demonstrating inadequate response to interventions that have been shown to be effective in the literature (Gresham, 2002; Vaughn, Mathes, Linan-Thompson & Francis, 2005). It has been eminently difficult to implement the RTI model with ELLs because various interventions have been shown to be effective for native speakers of English, but have yet to be tested with the ELL population (Linan-Thompson et al., 2003; Vaughn et al., 2005). When an intervention is delivered in English, an ELL student's failure to respond may be due to a lack of language proficiency

or to the presence of a disability; the root of the failure to respond remains largely ambiguous.

Despite the lack of research on the RTI model with the ELL population, there are several studies that have directly examined receptive language skills of native English speaking students as well as ELLs. Richman et al. (2001) conducted a study to directly measure students' receptive language skills by altering the receptive language requirement of directives. The study evaluated students' responses to brief hierarchical analyses to identify instructions that served as discriminative stimuli for accurate responding. Although the participating students' primary language was English, these students had receptive language or receptive vocabulary difficulties. In the first analysis, the students' accuracies of task completion under directives with varied complexity were measured. A distinct pattern of accurate task completion for each student was observed as the directives shifted from least to most complex in the hierarchy. That is, analysis was successful in identifying how complex a directive could be in order for a student to accurately follow the directives (Richman et al.). While the non-language laden assessment approaches discussed earlier in the document practiced no direct measure of students response, Richman et al. contributed to the literature by directly measuring the receptive language skills.

Based on the Richman et al. (2001) study, Komatsu and Witt (2006) conducted a similar study with Spanish-speaking ELLs, administering the assessment both in English and in Spanish. The purpose of the investigation was to determine if the experimental analysis of antecedent variables conducted in English and in Spanish would identify effective and ineffective instructions for response accuracy for Spanish speaking ELLs.

The study directly measured students' receptive language skills in two languages and compared the performances.

The study utilized three laminated poster boards with either 12 or 15 color-printed items. Some of the items included shapes in different colors, fruits, and animals. Students were verbally prompted to point to either one or three items illustrated on a laminated board. The required tasks for the student were to touch the correct items in the correct order as specified in each instruction. The instructions were arranged into a least to most complex hierarchy. There were five levels to the hierarchy, and students progressed to the next level in the hierarchy if they meet the preestablished criterion. The systematic delivery of the instructions identified the level of instruction complexity in which each student could comply with accuracy. The task was administered in English and Spanish, and the identified levels of the instruction complexity were compared between the two languages. It was expected that if a student's difficulty following instructions was due to a language disadvantage, the student's ability to discriminate the requirements of the task and performance in the conditions conducted in English would be poor. In addition, for students whose difficulty following instructions was due to a language disadvantage, the identified level of instruction a student can comply with accuracy between the two language conditions would be different. That is, these students would perform better in the conditions conducted in Spanish than in English.

Results demonstrated that the analysis successfully identified effective (i.e., instruction complexity in which a student complied with accuracy) and ineffective (i.e., instruction complexity in which a student failed to comply with accuracy) instruction and is a promising method for systematically identifying directives that control accurate

responding. The results supported the results obtained by Richman et al. (2001) by observing differential responses by students as instructions increased in its complexity. In addition, manipulation of directive complexity as conducted by Komatsu and Witt (2006) appears to be a relevant assessment for ELLs; it identifies how complex a directive can be for a student and reveals the performance difference between the student's dominant language (i.e., Spanish) and the non-dominant language (i.e., English). The addition of conditions in another language was innovative to this study and the results appeared promising as a methodology for providing information about the discrimination skills of ELLs across two languages.

Although the results of Komatsu and Witt's (2006) assessment provided useful information, the results may be insufficient in determining whether it is the complexity of the directive or the language in which the directive is issued that directly affects student responding to tasks. Special education identification, placement, and instruction decisions for students who are ELLs, therefore, require assessment procedures that directly measure their performance, include no verbal instruction, require no verbal response from students, include implementation of an intervention, and measure students' responses to intervention in order to more accurately evaluate the necessity of additional services to each student.

Rationale for the Current Study. Given that there is ample evidence supporting the usefulness of the RTI model for English speaking students but insufficient evidence on the applicability of this model to ELLs, more research is needed to determine the appropriate use of the RTI model for ELLs. An ideal study would use methods that deemphasize the use of language. Research attempting to distinguish whether a student

has a disability or the student merely lacks English language proficiency when instruction is delivered in English is scarce. It was speculated that by excluding an alternative explanation for their poor academic performance (i.e., lack of knowledge of the English language) through non-language-based, objective data regarding their learning, students who continued to experience extreme difficulty in spite of instruction would be more likely to demonstrate the characteristics of students with a disability. Those students are likely to be better served by identification and special education services than merely by additional intervention services. This investigation was designed to explore the validity of a RTI-based approach to explain why ELLs fail to demonstrate satisfactory academic skills at their schools.

Intervention for Students with Language Issues

One intervention procedure with extensive research support that can be implemented with no language is a constant time delay (CTD) procedure (Doyle, Wolery, Ault, & Gast, 1988). CTD has been successful in teaching a variety of skills requiring memorization to students with various disabilities as well as severity of disabilities (Koscinski & Gast, 1993). The procedure has been utilized successfully to teach students with LD (Stevens & Shuster, 1987), moderate mental retardation (Ault, Gast, & Wolery, 1988), autism (Ault, Wolery, Gast, Doyle, & Eizenstart, 1988), and developmental disabilities (Schoen & Sivil, 1989). It is a promising option for using with ELLs for the purposes of identifying responsiveness to instruction.

Constant Time Delay (CTD). CTD is an instructional procedure that provides for the systematic introduction of prompting and assistance. When using CTD, an instructional cue that will cause a correct student response, a controlling prompt, is faded

along a dimension of time. As a result, the student will emit the correct response when the controlling prompt is present and will not when the controlling prompt is absent (Walker, 2008). Initially, 0-s delay trials are presented in which the controlling prompt is provided immediately following the discriminative stimulus. Following these trials, the prompt is presented after a specified amount of time (Schuster, Stevens, & Doak, 1990). That is, the student will have the opportunity respond before the correct answer is provided. This interval remains constant throughout the remaining trials until criterion is achieved (Schuster, Morse, Ault, Doyle, Crawford, & Wolery, 1998). The student is provided with reinforcement contingent on his or her correct response, and successful performance and a low error rate is experienced (Schuster, Stevens, & Doak, 1990).

CTD and prompt fading are stimulus control procedures that have been used extensively in behavior change interventions for students with moderate to severe disabilities (Wolery, Ault & Doyle, 1992). A discriminative stimulus is a stimulus that signals that a response will be reinforced, only when the response is emitted in the presence of the stimulus (Cooper, Heron, & Heward, 1987). Furthermore, stimulus control is said to occur when behavior occurs more often in the presence of the discriminative stimulus than in its absence (Cooper et al.).

CTD instruction results in a low occurrence of student errors (usually less than 5%) (Koscinski & Gast, 1993), which are both positively related to the quality of treatment implementation or integrity (Hughes & Fredrick, 2006) and the rate at which students improve skills (Schuster et al., 1998). Hughes, Fredrick, and Keel (2002) demonstrated effectiveness of the CTD in teaching spelling to a 12-year-old student enrolled in a special education resource room for students with LD. The student

demonstrated his weakness in basic reading and writing skills. The CTD procedure included teaching 15 target words using 5-s time delay, 20 trials per session on average, for 4 days a week. During each session, the teacher said a word from the list, and the student was to spell the word on an index card within ten seconds after the presentation of the controlling prompt. The controlling prompt was a presentation of the word card with correct spelling. Contingent on the correct response, verbal praise was provided by the teacher. The results demonstrated that the student learned all 15 words and that using CTD procedure is an effective way to teach student with LD (Hughes et al.).

The effectiveness of the computer-assisted CTD procedure has also been demonstrated with students with disabilities. Hitchcock and Noonan (2000) utilized a computer-assisted CTD procedure to teach matching of shapes, colors, and numbers or letters to five preschool students who were three or four years old. All were identified as having a developmental delay. During the computer-assisted CTD procedure, a teacher presented a controlling prompt (e.g., laminated card with a picture of a triangle) and asked the student to click on the same item displayed on the computer screen. The results showed that students were able to successfully build early academic skills. The study compared the effectiveness of computer-assisted CTD procedure with teacher-assisted CTD procedure and found that computer-assisted CTD procedure was equally or superiorly effective relative to teacher-assisted CTD procedure (Hitchcock & Noonan).

In the same way that it would be necessary to remove language from the instruction through the use of a procedure such as CTD, a non-language laden activity would serve best to provide objective information regarding students' learning. The paired associate task is an excellent choice for this kind of research.

Paired Associate Task. The paired associate task is a fundamental building block of many types of learning (Meehan, 1999; Nakagawa, 2005; Pilgrim, Jackson, & Galizio, 2000), because students are asked to learn that two things are associated. Paired-associate learning involves the pairing of two items, a stimulus and a response. When learning a new stimulus with the paired associate task, a student must pair the stimulus itself with another stimulus. This form of learning is present in reading, for example, when a student learns to pair simple, familiar words with no obvious association between the two (e.g., plane-cake) (Camp & Dahlem, 1975; Weinstein & Rabinovitch, 1971). It has been demonstrated that paired associate learning can also be conducted nonverbally through studies with non-humans such as pigeons (Meehan, 1999) as well as rats (Nakagawa, 2005). Hunsaker, Thorup, Welch, and Kesner (2006) demonstrated the utility of paired associate tasks with rats. By delivering a reward contingent on selecting the correct location of food, the rats successfully learned correct pairings.

Braggio, Braggio, Lanier, Simpson, & Reisman (1979) incorporated a paired associate task into their study to identify a condition of task presentation that would most likely eliminate errors by students with LD. Twenty-four elementary school students 10 years of age or younger were presented with paired associate task, which consisted of eight pairs of a nonsense word (i.e., a consonant-vowel-consonant, e.g., KIR) and a noun (e.g., bear). During the instructional phase, the task was presented to the students, and students were then asked to respond. A posttest was administered at the end of the instructional phase. Results demonstrated that students with LD were able to learn the pairs utilizing paired associate task. The task has also been administered nonverbally (Furth & Youniss, 1964). Furth and Youniss administered a non-verbal paired associate

task to deaf students and hearing students between ages of six and 11. The pairs consisted of solidly colored rectangles (i.e., stimuli) and readily identifiable toys. Results indicated that students successfully learned the tasks, and no difference was observed between the performances of deaf and hearing students. As the literature supports its effectiveness for students with special needs, the paired associate task appears a suitable task to utilize in the current study.

In order to teach the paired associate task to ELLs, the intervention selected needed to possess specific characteristics. First, it needed to be a process which could be implemented relatively free of language to reduce the possible mean differences between native speakers of English and ELLs. Second, the intervention needed to exclude components that were taught in school prior to the current study. This was of particular importance because it is practical to speculate that ELLs with low English language proficiency had not been benefiting from instructions delivered in classrooms. The current study included non-verbal paired associate tasks employing abstract symbols for this reason.

Purpose of the Study

In order to implement a RTI process that was relatively language free, the target learning activity and the intervention for this study were carefully chosen. Ideally, what students would be expected to learn during the RTI process would be directly related to the type of learning students are normally asked to accomplish in schools, but would be as free from direct English language use as possible. It also needed to be a research-supported process. Constant time delay with paired associate learning seemed an obvious choice for the study. The current experiment evaluated the validity of the CTD procedure

with the paired associate task in order to gather preliminary evidence which would suggest its validity for the purpose of classification. In attempting to measure participants' response to intervention, a CTD procedure was utilized for paired associate tasks. In the intervention phases, a computer-administered nonverbal CTD procedure was implemented. The effectiveness of CTD procedures have been demonstrated by many researchers (Gast, Ault, Wolery, Doyle, & Belanger, 1988; McDonnell & Ferguson, 1989; Schuster, Stevens, & Doak, 1990). Generally, evaluation of CTD procedures is made based on the number of sessions required by the participant in order to reach whatever mastery criterion has been set (Schuster et al., 1998). The same evaluation procedures were adopted for this study.

Research Questions

The ultimate goal for the current investigation was to examine the effectiveness of methods (i.e., CTD) that can be utilized to gather preliminary evidence for determining whether ELLs are able to learn like typically developing English-speaking students do under similar conditions, which would rule out disability-based explanations for poor academic performance. Specifically, how do the performances of ELL students, typically academically performing, native English-speaking students, and students with mild Mental Retardation compare on a non-language laden paired associate task presented using CTD? Second, is it possible to define a group of responders and non-responders to intervention using these procedures? And third, how does the performance of responders and non-responders compare within diagnosed (ELL and MR) and non-diagnosed groups?

METHOD

Participants and Setting

Forty-five English language learners (ELLs) from two public elementary schools in the western United States participated in the study. Both schools served kindergarten through sixth grade, and students in first through fifth participated in the current study. Both schools are located in suburban areas, and both schools had 99% of the school population designated as economically disadvantaged. The total enrollment of students in the 2005-06 academic year was 617 in one school and 484 in the other. After securing permission from the school district, a parental permission form, which was written both in English and in Spanish, was sent home by the classroom teachers with all ELL students in the kindergarten through fifth grade. Of 102 permission forms given to the students, 66 students returned the form (65%). In order to examine the English proficiency of these ELLs, the Woodcock-Muñoz Language Survey (The Riverside Publishing Company, 2001) was administered. The survey assigns students to one of five proficiency levels depending on their language performance (i.e., 5. Advanced, 4. Fluent, 3. Limited, 2. Very Limited, and 1. Negligible). The inclusion criterion for the current study was determined prior to the administration of the survey, and students whose proficiency level with English was low, or level 1 or level 2, were included in the study. After the administration of the survey, 45 ELLs qualified to participate in the intervention sessions. None of the ELL participants was receiving compensatory educational services nor had been diagnosed as having a disabling condition at the time they participated in the study.

In addition to the ELLs, two other groups participated in the current study. The first group, native English speakers, included 22 American students who were native English speakers. The second group included five students with a diagnosis of mild mental retardation (MR). For the MR group, the experimenter had access to the students in one special education classroom in one school located in the western United States. The special education classroom teacher was requested to refer every student with a diagnosis of mild mental retardation, and referred five students, all of whom participated in the study. The performance of the ELLs was compared to that of the two groups. All of the participants except for those in the MR group were students who were receiving instruction in general education. All assessment sessions were conducted in a quiet area outside of the participants' classroom, in the library, or in a computer lab at the participants' school.

Design of the Study

This quasi-experimental study was designed to provide descriptive information regarding the performance of ELL students compared to students with mild mental retardation and native English-speaking non-disabled elementary school students using repeated measures. Their performance was compared using a standardized non-verbal paired-associate task using CTD.

Predictor Variables. The independent variable for the current study was the three population groups: ELLs, native English speakers, and students with a diagnosis of mental retardation. Once the mastery criterion was developed based on the performances of native English speakers and students with MR, three outcome groups: responders to

intervention, non-responders to intervention, and ambiguous responders served as another independent variable in the data analyses.

Outcome Variables. The outcome variables recorded were the number of correct responses in each probe session, the number of incorrect responses that were no-wait errors, and the number of responses that were non-responses. Although the stimulus presentation was completed automatically by the computer, the computer program did not record students' performances; students' responses were recorded manually by a graduate student who monitored each probe session. A correct response was defined as the participant correctly clicking the target stimulus within 5 s. A no-wait error was recorded if the participant clicked on the incorrect stimulus within 5 s. A no-response was defined as the participant failing to click on a stimulus during the 5 s.

Materials

Computerized Constant Time Delay Procedure. During all probe and training sessions, a computer with Microsoft PowerPoint 2003 was used. Each computer had a color monitor, sound capability, a USB drive, a keyboard, and a mouse.

Computer assisted constant time delay that was programmed with Microsoft PowerPoint was used. There were 20 trials of constant time delay probes per session. Training sessions started with a blank screen. A sample stimulus first appeared on the left side of computer screen after a 1-s delay. The sample stimulus was followed by two comparison stimuli (i.e., a correct stimulus and an incorrect stimulus), which would appear on the right side of the screen. The current investigation utilized a 5-s delay; after 5 s had elapsed since the appearance of the two comparison stimuli, the incorrect

stimulus disappeared from the screen, and the correct stimulus was emphasized by increasing its size by 200%.

In order to rule out an alternative explanation for poor performance due to lack of English proficiency or history of not benefitting from daily instruction, non-language-based, objective stimuli were utilized in the paired associate task. That is, students were required to learn to pair an abstract symbol with another abstract symbol. The abstract symbols were drawn from the AutoShape functions under the Toolbar options on Microsoft PowerPoint 2003. Please see Appendix A for copies of the screen shots used in the study.

Procedure

Data Collector Training. Three graduate students in school psychology participated as second data collectors. The author was the primary data collector in the majority of the sessions, and each data collector was trained in the scoring procedure as a secondary data collector. Each secondary data collector could serve as a primary data collector after obtaining two inter-observer agreements with the author of 90%.

Student Paired-associate Training Sessions. Each data collection session consisted of 20 trials. A training session was conducted prior to each probe session. During probe sessions a graduate student silently assisted the participant to seat him or herself in front of the computer and select the correct training program on Microsoft PowerPoint presentation from the menu of the computer program. If the participants did not independently put on the audio headphones, they were physically guided to put them on. The audio headphone was utilized solely for the participants to hear the buzzer (i.e., indication of incorrect responses). There were 20 trials of 5-s constant time delay

procedures per session. There were four stimulus pairs in a session, and each of the four stimulus pairs were presented five times in a randomly intermixed sequence.

At the beginning of each training session, the graduate student selected the training program from the menu on the computer screen. The first session of the first training condition utilized a 0-s CTD interval between the presentation of the two comparison stimuli and the presentation of the prompt. That is, the correct stimulus was emphasized and the incorrect stimulus disappeared from the screen immediately following the presentation of those stimuli. In order to be consistent with previous literature (Schuster et al., 1998), a 0-s CTD interval was utilized during the first session, and 5-s constant time delay procedure was used during all subsequent sessions within each training condition. After 5 s had elapsed since the appearance of the two comparison stimuli, the incorrect stimulus disappeared from the screen, and the correct stimulus was emphasized by increasing its size by 200%. Participants were allowed to click during and after (i.e., for a total of 3 s) the prompt described above.

Consequences were delivered contingent on students' correct and incorrect responses during the training sessions. Contingent on a participant's correct response, a smiley face 10cm by 10 cm in size, in color (i.e., yellow) emerged on a blank screen for two seconds. Contingent on an incorrect response (i.e., participant clicking on incorrect comparison stimulus), the incorrect stimulus faded from the screen over 3 s, and participants heard a buzzer for 1 s that indicated that the response was incorrect. If a participant did not make any response for 8 s (i.e., 5 s of stimulus presentation plus 3 s of visual prompt presentation), the computer screen automatically progressed to the following trial.

During a training session, four types of responses were possible: two correct responses (i.e., correct expectancies and correct waits) and two incorrect responses (i.e., no-wait errors and no-responses). Correct expectancies were defined as the participant correctly clicking the target stimulus within 5 s. Correct waits were defined as the participant correctly clicking the target stimulus within 3 s during and after the presentation of the visual prompt on the screen. Both correct responses resulted in a presentation of a smiley face on the screen for two seconds. A no-wait error was recorded if the participant clicked on the incorrect stimulus within the initial 5 s. A no-response was defined as the participant failing to click on a stimulus before, during and after the presentation of the prompt. A no-response resulted in an automatic progression to the following trial.

Probe Sessions. Each probe session consisted of 20 trials. Probe sessions were conducted each day for four days a week. The number of weeks and the total number of sessions varied depending on the participants' performances (i.e., the intervention was terminated when participants reached the mastery criterion). Probe sessions were conducted immediately following a training session each day. Participants remained seated in front of the computer after the training session; there was no assistance necessary by the graduate student collecting data. Each of the four stimulus pairs was presented 5 times in a randomly intermixed sequence. Probe sessions were operated in the same way as the training sessions except that there was no consequence delivered contingent on correct or incorrect responses. The program allowed a total of 5 s for the participant to click on either of the comparison stimuli. After the 5-s delay since the appearance of the two comparison stimuli, the computer screen automatically progressed

to the following trial. The form used during probe sessions for data collection is included in Appendix B.

During the probe sessions, three types of responses were possible: one correct response and two incorrect responses (i.e., no-wait errors and no-responses). A correct response was defined as the participant correctly clicking the target stimulus within 5 s. A no-wait error was recorded if the participant clicked on the incorrect stimulus within 5 s. A no-response was defined as the participant failing to click on a stimulus during the 5 s. Neither correct nor incorrect responses resulted in a consequence in the probe sessions.

Based on previous literature, the criterion for reaching mastery was defined as two consecutive sessions of 100% mastery (Edwards, Blackhurst, & Koorland, 1995; Schuster, Morse, Ault, Doyle, Crawford, & Wolery, 1998; Stevens & Schuster, 1988). Due to the exploratory nature of the study, the criteria for reaching mastery and determining which students responded to the intervention were determined subsequent to data collection and inspection of the distribution of outcome data.

Inter-observer Agreement and Treatment Integrity

Two independent data collectors scored approximately 17% of the probe sessions to determine the interobserver agreement of the constant time delay procedure. Interobserver reliability was calculated as the percentage agreement for individual items on the probes. The reliability was calculated by counting the number of agreements and number of disagreements for all attempted items, dividing the number of agreements by the number of agreements plus disagreements, and multiplying the resulting number by 100%. Average interobserver agreement for the assessments was 95.97% (85-100%).

Treatment integrity data were collected during approximately 20% of the probe sessions, and the average treatment integrity for the sessions was 99.12% (66.67-100%). Treatment integrity data were collected on the data collector procedure.

RESULTS

Participants

Three different groups of students: 45 ELLs, 22 English-speaking American students, and 5 students with mild mental retardation, participated in the study. The mean age of the students was 8.43 years. The distribution of grade placement for the different groups may be found in Table 1.

Mastery Criterion. The outcome distribution of the native English speaker group and the students with MD group were examined to determine the criterion for response to the current intervention (i.e., constant time delay procedure. Review of the data revealed that 4 of 5 participants with MD did not master the task and that the fifth required the full 10 trials to master the task. These data suggested that the task was sufficiently difficult that the students with known disabilities would not respond to instruction as provided. In contrast, 72.7% of the participants in the English speaker group reached mastery by session 5. Of the remaining students the majority never reached mastery. Based on this pattern of data, a responder was defined as a participant who reached mastery by session 5 and a non-responder was a participant who did not reach mastery.

Figures 1, 2, and 3 display the distribution for the outcome of the computerized constant time delay procedure for the native English speaker group, ELL group, and students with mental retardation group (MR), respectively. The number of students who reached and did not reach the mastery criterion in each probe session within 10 sessions is summarized in Table 2.

Table 1
Distribution of Grade and Age Placement for the Population Groups

	1 st Grade			2 nd Grade			3 rd Grade			4 th Grade			5 th Grade			6 th Grade		
	N	M	SD	N	M	SD	N	M	SD	N	M	SD	N	M	SD	N	M	SD
ELL	6	6.2	41	12	7.2	39	15	8.1	59	5	9.4	55	1	10		6	12	55
Native English Speaker				6	7.3	52	8	8.4	52	3	10	0	4	10	0	1	11	
MR	1	6		1	7				1	9			1	11		1	12	
Total	7	6.1	38	19	7.2	42	23	8.2	58	9	9.6	53	6	10	41	8	12	53

Note. N = the number of participants per described; M = the average number of trials correct per described;
SD; the standard deviation of the average number of trials correct per described

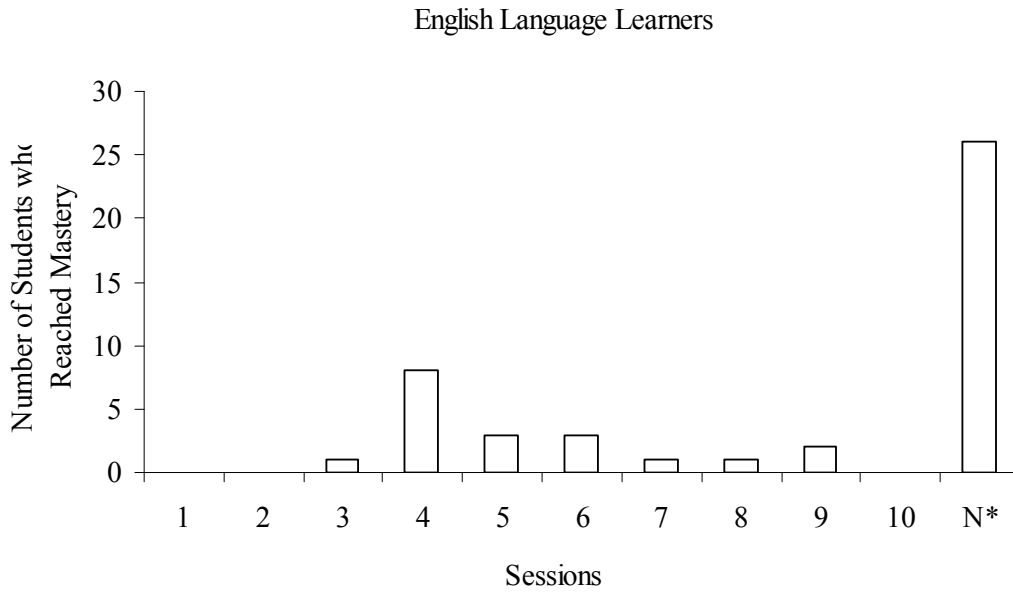

*N represents number of students who did not reach the mastery criterion within 10 sessions.

Figure 1. Distribution of the number of sessions required to reach mastery criterion in computerized constant time delay procedure for English Language Learner group.

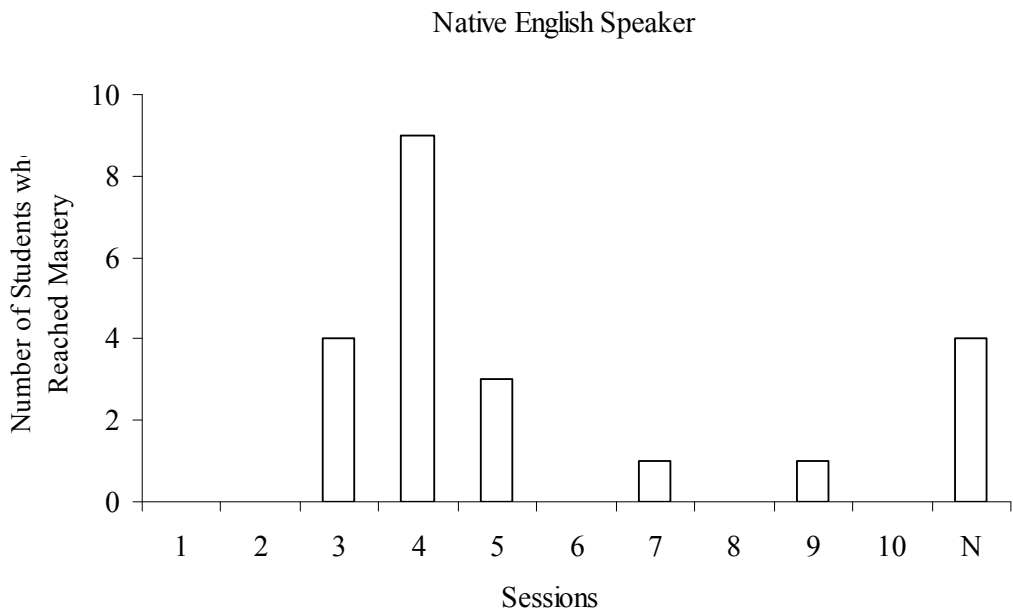

Note. N = number of students who did not reach the mastery criterion within 10 sessions.

Figure 2. Distribution of the number of sessions required to reach mastery criterion in computerized constant time delay procedure for native English speaker group.

Students with Mental Retardation

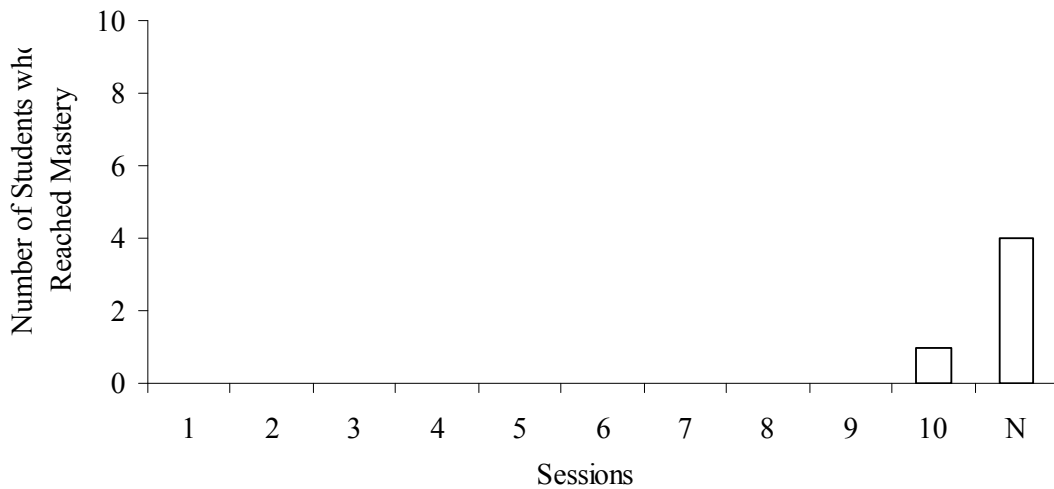

Note. N = number of students who did not reach the mastery criterion within 10 sessions.

Figure 3. Distribution of the number of sessions required to reach mastery criterion in computerized constant time delay procedure for students with MR group.

Table 2
Percentage of students who met mastery criterion during constant time-delay sessions

	1	2	3	4	5	6	7	8	9	10	N
ELL	0	0	2.2	17.8	6.7	6.7	2.2	2.2	4.4	0	57.8
Native English speakers	0	0	18.2	40.9	13.6	0	4.6	0	4.6	0	18.2
Mental Retardation	0	0	0	0	0	0	0	0	0	20	80

Note. N = percentage of students who did not reach the mastery criterion within 10 sessions.

For the native English speaking American student group, 18.2%, 40.9%, and 13.6% of the students in the group reached the mastery criterion (i.e., two consecutive sessions of 100% accuracy) on the 3rd, 4th, and 5th sessions, respectively. Seventy-three percent of the group (i.e., 16 students) therefore had reached the mastery criterion in five or fewer sessions. Four and six tenths percent of the students in the group (i.e., four students) did not reach the criterion within ten sessions. Nine and two tenths percent of

the students (i.e., two students) had ambiguous results; the students did reach criterion in less than 10 sessions (i.e., on 7th and 9th session); however, the response was not as rapid as the majority of the students in the group. For students in the MR group, one student (i.e., 20%) reached the mastery criterion on the 10th session, and the remaining four students (i.e., 80%) never met the criterion.

An analysis of variance (ANOVA) was conducted to examine if there was an overall difference between the slopes of the three population groups (i.e., ELL, native English speakers, and students with MD). Table 3 contains the mean slopes with standard deviations for the different groups. A one-way between subject analysis of variance on ordinary least squares slopes (OLS) for each student demonstrated that there was a significant difference between the groups ($F(2, 69) = 5.50, p < .01$). A follow-up Tukey test demonstrated that the slope of the native English speaker group ($M = 4.14$) was significantly larger than that of students with MD ($M = 1.09$) (Tukey's HSD = 3.04, $p < .05$). The native speakers' slope was also significantly larger than that of the ELLs ($M = 2.27$) (Tukey's HSD = 1.86, $p < .05$). There was no significant difference between ELLs and students with MD. Due to the nature of the current data collection procedure (i.e., discontinuing data collection after students reached mastery criterion), implementation of a repeated measures analysis of variance (RM-ANOVA) was precluded.

Table 3
Mean Ordinary Least Squares slopes for each population group

	Responder		Ambiguous		Non-responder		Total	
	Mean	SD	Mean	SD	Mean	SD	Mean	SD
ELL	3.95	1.1	2.11	.41	.60	.18	.34	

(Table 3 continued)

Native English Speaker	3.53	.98	1.83	.39	.03	.19	-.09	.49
Mental Retardation	_	_	1.18	.45	1.07	.15	1.1	.21
Total	3.71	1.0	1.71	.38	.59	.17	.29	.36

Based on the outcome distribution of the two groups (i.e., native English speakers and students with MD), the criterion for determining whether an ELL did or did not respond to the current intervention was determined. Students who had reached the mastery criterion in less than five sessions were considered responders, students who did not reach the criterion within ten probe sessions were considered non-responders, and students who did reach the mastery criterion but did do so between the sixth and tenth sessions were considered an ambiguous group. In addition to the fact that 73% of the native English speaking students reached the mastery criterion in five or fewer sessions, there were only two additional students from the native English speaking group who reached the mastery criterion by conducting the sessions for twice as long (i.e., ten sessions). This result was used to determine the break points. ELL students were then divided into one of the three outcome groups. Twelve students (26.7%) of the ELL group were considered responders, 26 students (57.8%) were placed in non-responders group, and 7 students (15.6%) fell in the ambiguous group. Tables 4, 5, and 6 summarize the descriptive data from the probe sessions across the three outcome groups (i.e., responders, non-responders, and the ambiguous group) for ELLs, native English speakers, and students with MD. The tables present the mean scores, the number of students in the group, and the standard deviations for each mean score.

Table 4
 Mean Number of Correct Responses by Session for English Language Learners

Sessions	Responder			Ambiguous			Non-responder		
	N	Mean*	SD	N	Mean*	SD	N	Mean*	SD
1	12	3.33	3.34	7	1.00	1.92	26	1.65	2.55
2	12	13.83	6.93	7	8.29	6.70	26	5.92	5.24
3	12	19.75	.45	7	13.29	6.05	26	6.96	4.89
4	11	20.00	.00	7	14.29	4.27	26	7.23	5.51
5	3	20.00	.00	7	16.57	5.47	26	7.77	4.95
6	0			7	17.86	4.41	26	8.19	4.82
7	0			4	19.25	.96	26	8.85	5.41
8	0			3	20.00	.00	26	8.42	5.02
9	0			2	20.00	.00	26	8.23	5.08
10	0			0			26	9.50	5.85

Note. Mean = the average number of trials correct per session for the described group.

Table 5
 Mean Number of Correct Responses by Session for Native English Speakers

Sessions	Responder			Ambiguous			Non-responder		
	N	Mean*	SD	N	Mean*	SD	N	Mean*	SD
1	16	5.00	4.37	2	4.50	2.12	4	7.25	5.19
2	16	14.75	5.43	2	8.50	9.19	4	12.25	2.36
3	16	19.31	1.85	2	13.00	7.07	4	10.00	2.94
4	12	20.00	.00	2	19.50	.71	4	9.75	3.20
5	3	20.00	.00	2	19.50	.71	4	13.25	5.38

(Table 5 continued)

6	0	2	19.50	.71	4	9.25	.96
7	0	2	19.50	.71	4	11.00	2.16
8	0	1	20.00		4	10.50	1.73
9	0	1	20.00		4	9.00	1.41
10	0	0			3	10.00	1.00

Note. Mean = the average number of trials correct per session for the described

Table 6
Mean Number of Correct Responses by Session for Participants with Mental Retardation

Sessions	Responder			Ambiguous			Non-responder		
	N	Mean*	SD	N	Mean*	SD	N	Mean*	SD
1	0			1	4.00		4	4.00	3.16
2	0			1	15.00		4	7.50	3.51
3	0			1	16.00		4	9.25	5.32
4	0			1	18.00		4	10.00	2.16
5	0			1	19.00		4	11.50	4.04
6	0			1	20.00		4	12.50	5.51
7	0			1	18.00		4	11.50	7.72
8	0			1	19.00		4	15.25	4.27
9	0			1	20.00		4	14.25	2.36
10	0			1	20.00		4	14.50	4.12

Note Mean = the average number of trials correct per session for the described.

Figures 4, 5, and 6 display the mean correct responses per session for responders, non-responders, and the ambiguous group, respectively. Each data point represents the

average number of correct responses per session, and each figure plots the mean scores of ELLs, native English speakers, and students with MD. For the responders group, the performances were similar between the ELLs and native English speakers. There was a great increase in the number of correct responses between the first and second sessions. From the third session, the students in the group performed with high accuracy. Compared to the performance of the responder group, the ambiguous group responded more gradually. For the non-responders group, no large increase was observed. From the figures, values of the ordinary least squares slopes were calculated and are presented in Table 3.

The values of the two groups in the responder group are above 3.5, and the values for non-responders are between 0 and just over 1, indicating more horizontal slopes. The slopes for the ambiguous group were in between those of the responder group and non-responder group, which is consistent with the visual inspection results from figures 4, 5, and 6.

After each population group (i.e., native English speaker, ELL, and students with MD) was divided into outcome groups (i.e., responder, non-responder, and ambiguous), differences between the OLS slopes within each outcome groups (i.e., responders, ambiguous, and non-responders) were conducted. For the ambiguous group and the non-responder group, the one-way ANOVAs were conducted, but because there were no responders among the students with MD, there were only two groups to compare within the responder group (i.e., ELL and native English speakers). A *t*-test was therefore conducted to examine the performance difference between the ELL and native English speaker groups.

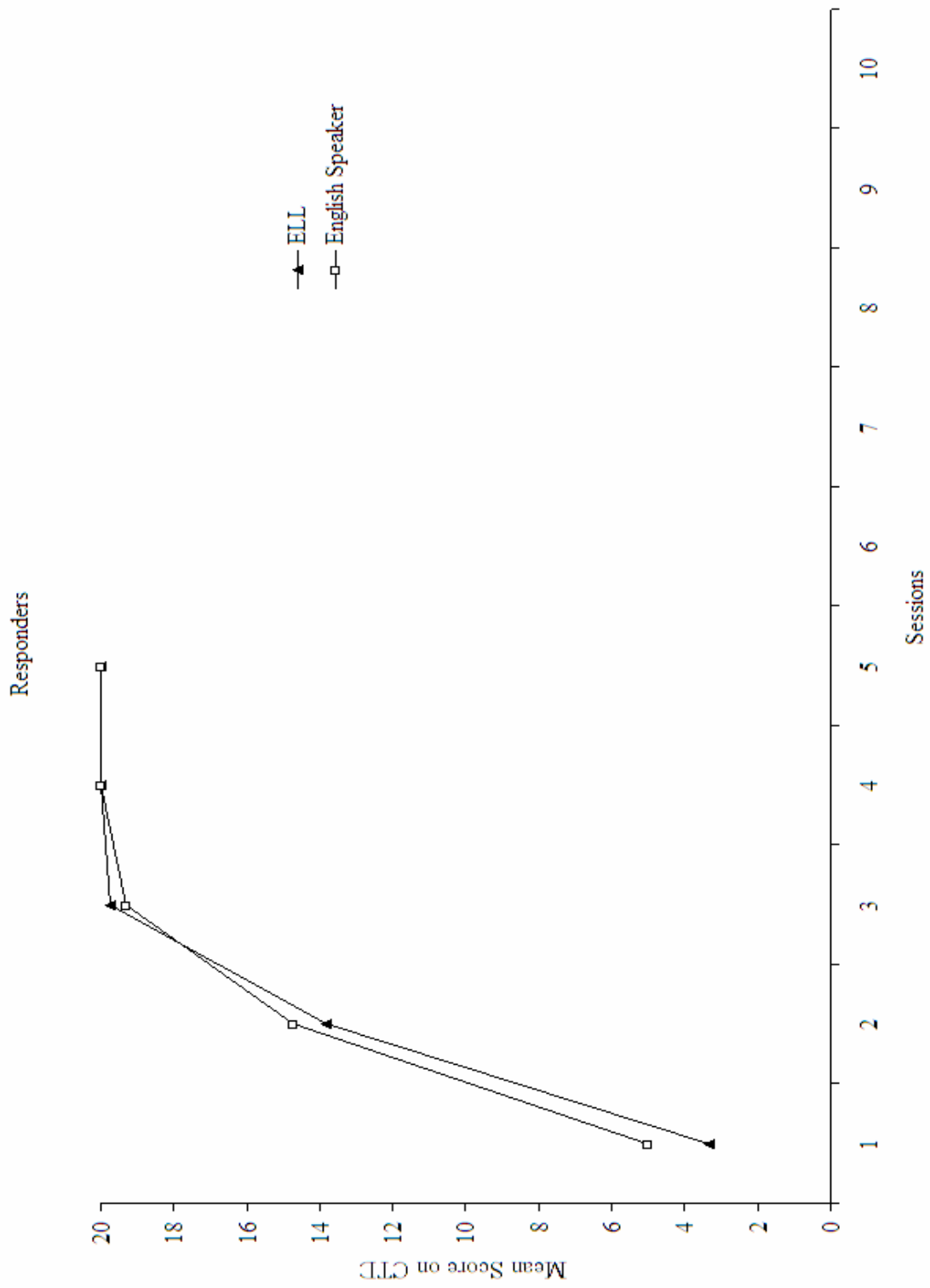

Figure 4. Mean Correct Responses per Session for Responders.

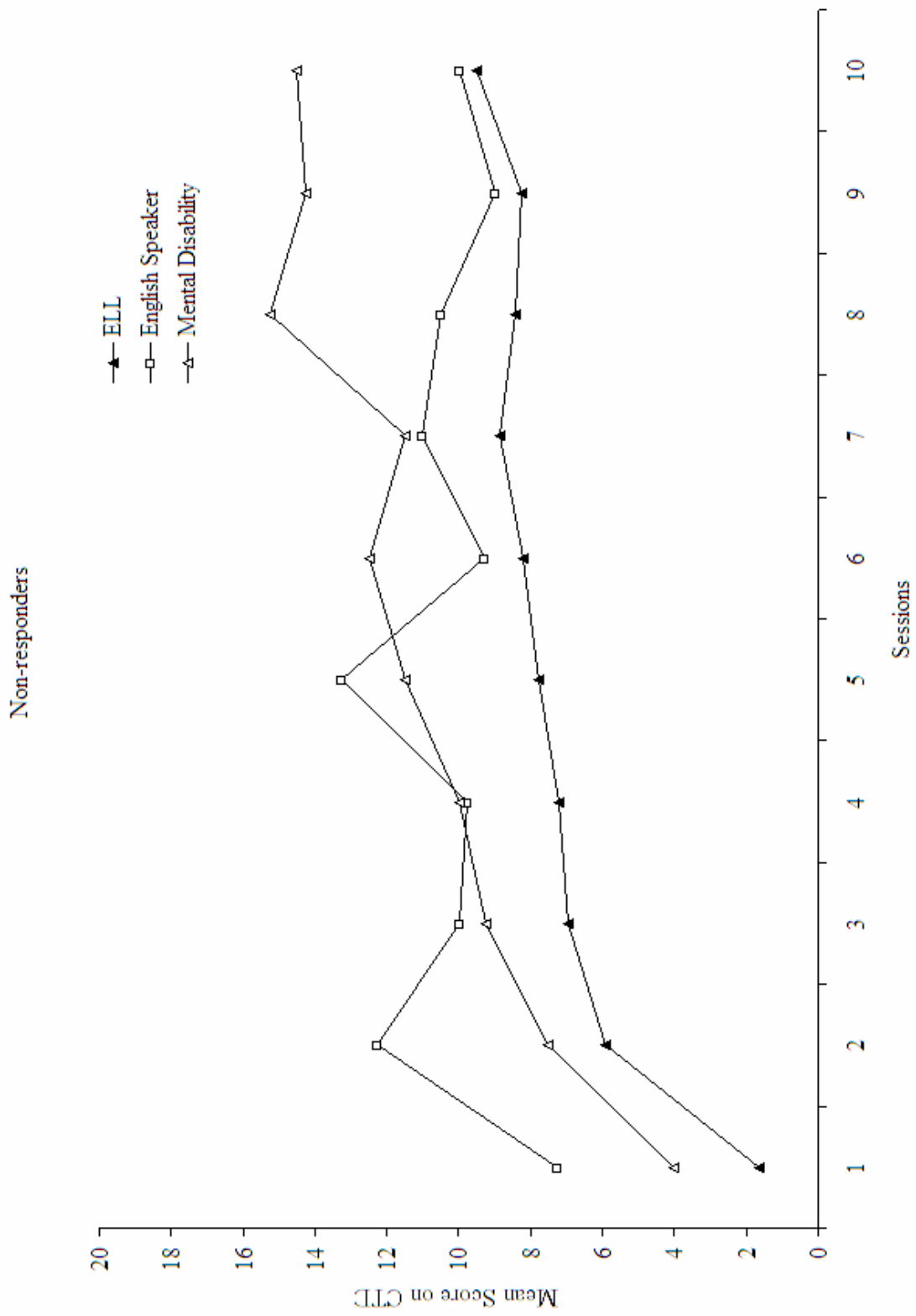

Figure 5. Mean Correct Responses Per Session for Non-responders.

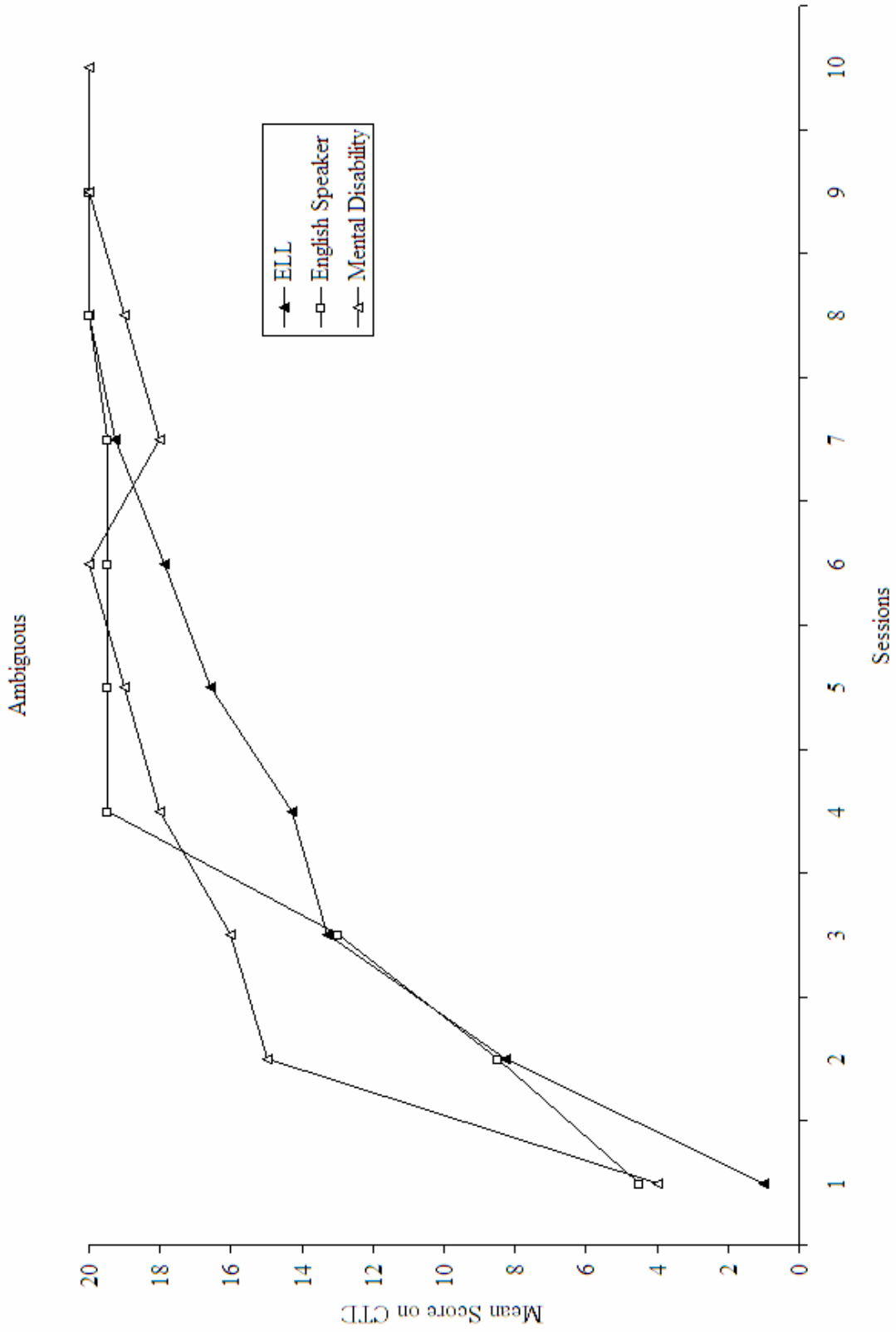

Figure 6. Mean Correct Responses per Session for Ambiguous Responders.

Results of the one-way between subject ANOVA on ordinary least squares slopes demonstrated that there was no significant difference between the three population groups within the non-responders group ($F(2, 31) = 2.84, p > .05$), nor was there a significant difference within the ambiguous group ($F(2, 7) = 1.97, p > .05$). A paired-samples t -test between the ELL and the Native speakers of English within the responders group demonstrated that there was no significant difference between the two population groups ($t(5) = 1.13, p > .05$).

A chi-square test of independence was conducted separately for the native English speaking group and the ELL group, native English speaking group and students with MD group, and for the students with MD group and ELL group for students who responded and those who did not respond. The ambiguous group was excluded from the analysis and the comparison was made only between the responders and non-responders group for the simplicity of interpretation; the percentages of the responders and non-responders relative to those in the analysis in each group changed as a result of the exclusion of the ambiguous responders. The percentage of native English speaking students who responded to the intervention was 80% (i.e., 16 responders out of 20 students total in the group); the percentage of ELLs who responded was 31.6% (i.e., 12 responders out of 38 students total in the group). The difference in percentage was significant ($\chi^2(1, N = 58) = 12.30, p < .001$). In addition, there was a significant difference in the percentages of native English speakers and students with mental retardation (0%) who had responded ($\chi^2(1, N = 24) = 9.60, p < .01$). Although there was no student with mental retardation who responded to the current intervention procedure, there was no significant difference between the mental retardation and ELL groups ($\chi^2(1, N = 42) = 1.77, p > .05$). This

absence of finding is most assuredly a result of low statistical power resulting from the small number of students with MD who participated in the study.

DISCUSSION

In 2000-2001, approximately 4.6 million students from pre-kindergarten through grade 12 who attended schools in the United States were identified as English Language Learners (ELLs). This number represents 9.3% of the total public school enrollment (Kindler, 2003). The ELL population has been increasing each year, and researchers predict the trend will continue for at least the next two decades (Thomas & Collier, 2003). Despite the growing number of students in this population, development of appropriate program placement procedures for ELLs that utilize appropriate assessment and intervention procedures has remained a challenge (Echevarria & Graves, 2003; Garcia, 2000; Gunn, Biglan, Smolkowsk, & Ary, 2000; Linan-Thomptson, Vaughn, Hickman-Davis, & Kouzekanani, 2003; Losardo and Notari-Syverson, 2001; Quiroga, Lemos-Britton, Mostafapuor, & Berninger, 2001; Valdez-Pierce, 2003).

Utilization of standardized tests in determining whether an ELL is entitled to additional services including special education is a high inference activity, and these scores make it commonly impractical to distinguish the ELL's poor English language competency from sub-average intelligence or learning disabilities (Valdez-Pierce, 2003). A mounting body of literature suggests that a large proportion of ELLs are unsuitably assessed and placed in special education (Echevarria & Graves, 2003; Linan-Thomptson, Vaughn, Hickman-Davis, & Kouzekanani, 2003), despite the protections against inappropriate evaluation afforded them by IDEA (2004). There is a need to evaluate an alternative hypothesis (i.e., lack of language proficiency) for poor academic performance by ELLs.

Response to intervention (RTI) has been receiving increasing attention as an alternative approach to the use of traditional standardized tests in determining which children are and are not eligible for special education services (Gresham, 2002; Gresham, VanDerHeyden & Witt, 2005; Vaughn & Fuchs, 2003). An eligibility decision for special education services that utilizes the RTI approach relies on students' responses to empirically validated interventions (Gresham, 2002; Vaughn, Mathes, Linan-Thompson & Francis, 2005). Despite the increasing nationwide recognition of RTI as a valid approach to identify English speaking students who are eligible for special education services (Fletcher et al., 2002; Gresham, 2002; Linan-Thompson et al., 2003; National Reading Panel Report, 2000), the applicability of the RTI model for ELLs is questionable because of the use of the English language in the interventions themselves. When an intervention is delivered in English, whether the ELL's lack of response is due to insufficient language proficiency or the effects of a disability remains largely ambiguous. Development and empirical evaluation of appropriate interventions with improved outcomes is necessary for the RTI model to be established as a suitable procedure for ELLs.

The present study was conducted in order to examine the use of the RTI model for ELLs by using a computerized constant time-delay procedure that would de-emphasize the use of language. The study found differences and patterns in students' performances that allowed responders and non-responders to be differentiated by those performances. By assessing the students' responses to intervention utilizing a non-language based intervention, this study demonstrated an assessment and intervention procedure for ELL students, in which the results ruled out lack of English proficiency as an explanation for

poor performance, and therefore was less ambiguous relative to traditional RTI procedures. Moreover, utilization of a computer-based intervention made possible an administration of stable, efficient, and least intrusive means of intervention as computer-based interventions have been proven to be an effective and efficient means of promoting performances of students in various populations (Hitchcock & Noonan, 2000; Kinney, Stevens, & Schuster, 1988; Koscinski & Gast, 1993; Schuster et al., 1998).

The comparison of performances was made between the population groups within each outcome group (i.e., responders, non-responders, and ambiguous group). Although there was a significant difference between the population groups as a whole, the analyses (i.e., one-way between subject ANOVA for the non-responders and the ambiguous group, and a paired-samples *t*-test for the responders group) on ordinary least squares slopes revealed that there was no significant difference between the population groups within any of the outcome groups. That is, once the population groups were divided based on their outcomes, there was no significant difference between the native English speakers, ELLs, and students with mental retardation. Another interesting result was found when setting the criterion to determine whether an ELL student did or did not respond to the current intervention. Approximately three quarters of the native English speakers (i.e., 73%) met the mastery criterion in or fewer than five sessions. Between the sixth and the tenth sessions, however, there were only two students who had reached the mastery criterion. Conducting the intervention sessions for twice as long (i.e., ten sessions) added very few students to the number who met the criterion, which had helped in establishing the decision line. Although eventually research and/or practice applications might provide far fewer than 10 sessions for assessment purposes, that would remain premature

at this time. Given how little is known about setting criteria for responders, providing sufficient sessions to assure that they are accurately identified will be critical.

By using a constant time-delay procedure, the current study was able to measure students' learning without verbal language and without previously instructed academic tasks. In attempting to measure participants' response to intervention, a CTD procedure was utilized for paired associate tasks. Delivering the paired-associate tasks via a computer-administered nonverbal CTD procedure, the present investigation was able to meet its ultimate goal of gathering preliminary evidence for determining whether an ELL was able to respond to intervention as do children without disabilities, which would rule out the possible disability explanation for poor academic performance. A sessions to mastery criterion is a widely used means of measuring proficiency in constant time-delay procedures (Schuster et al., 1998); by employing a sessions to mastery criterion as the dependent measure, a quantitative criterion could be defined for responsiveness to the intervention.

Furthermore, CTD procedures have been used extensively in behavior change interventions for students with moderate to severe disabilities (Koscinski & Gast, 1993; Wolery, Ault & Doyle, 1992), and utilizing an empirically validated procedure, the current study was able to minimize the subjectivity in drawing the conclusion of whether the student responds to intervention as in a typical RTI model through a use of an objective, low inference procedure. The inaccuracy of relying considerably on teacher referrals has been addressed in the literature (Gerber & Semmel, 1984; Gresham, MacMillan, & Bocian, 1997; Gresham, Reschly, & Carey, 1987). Consistent with the RTI

model, the results of the current study were not affected by teacher referral but relied on responsiveness to empirically validated intervention (i.e., constant time-delay procedure).

Drawing on the growing body of literature on the importance of appropriate assessment and placement of EL learners (Echevarria & Graves, 2003; Linan-Thompson, Vaughn, Hickman-Davis, & Kouzekanani, 2003; Valdez-Pierce, 2003), the current study expands the literature by addressing several problems of conducting traditional RTI on ELL students and investigating further the effects of academic instruction for these students. RTI models have been demonstrated as beneficial to English speaking students who are at risk for placement in special education (Fletcher et al., 2002; Linan-Thompson et al., 2003; National Reading Panel Report, 2000), but the model has yet to be empirically tested with the ELL population (Komatsu & Witt, 2006). In order to ensure that an alternative explanation for the ELL's poor academic performance (i.e., English language) is excluded, the current study expanded on the RTI assessment literature by examining procedures that required no verbal response from the student.

Komatsu and Witt (2006) were able to systematically identify instructions that controlled accurate responding and revealed the performance differences between the student's dominant language and the non-dominant language by directly measuring student performance. In addition to the direct measurement of student performance accomplished by Komatsu and Witt, the assessment procedure developed in the current study included no verbal instruction, required no verbal response from students, included implementation of an intervention, and obtained repeated measurement of students' responses to intervention in order to more accurately evaluate the necessity of additional services to each ELL.

Evaluation of the results of this study should be tempered by consideration of its limitations. First, data were collected only during the probe sessions. No data were collected during the training session each day. The primary data collector observed, however, that there were students who never reached criterion within ten sessions, but were selecting correct stimuli during the training sessions. A contingency was put in place during the training sessions but not during the probe sessions. That is, the CTD program delivered a positive consequence (i.e., presentation of a smiley face) contingent on a correct response and delivered a negative consequence (i.e., audio effect of buzzer) contingent on an incorrect response only during the training sessions. Some students performed accurately during the training sessions but did not do so during probe sessions. These students may have had adequate discrimination skills that were not correctly identified by the assessment. In fact, contrary to the prediction made from the presented results that these students may have poor discrimination skills, the students could have been more sensitive than other responders in discriminating contingencies.

Researchers have addressed the importance of motivational variables and differentiating skill deficits and performance deficits as a function of students' absence of behavior (Duhon et al., 2004; Gresham, 1981; Noell, Roane, VanDerHeyden, Whitmarsh, & Gatti, 2000). The distinction is based on the conceptual heuristic that the possibility that insufficient motivation is the reason for one's absence of behavior could be evaluated by delivering more a powerful reinforcer on the occurrence of target behavior than the occurrence of alternative behavior (Gresham, 1981). That is, students who acquire sufficient skills may engage in the behavior in certain contexts with powerful reinforcement but not in other contexts. Several researchers have conducted brief

experimental analyses and successfully identified students whose absence of behavior is due to students not acquiring skills necessary to complete the task (i.e., skill deficit) or lack of motivation (i.e., performance deficit) (Duhon, et al., 2004; Eckert, Ardoin, Daly, & Martens, 2002; Noell, Freeland, Witt, & Gansle, 2001).

The current study did not incorporate the motivational variable in the analysis. There is a possibility that the poor performance among students in the current study including students whose accurate responses were observed during the training sessions but not during the probe sessions were due to their performance deficits. That is, if the smiley face was not functioning as sufficient reinforcer that would mean that the student's poor performance was due to performance deficit. Hypotheses about students' poor performances can be developed through their responses to antecedent or consequent manipulations. It is therefore essential in future studies to appropriately identify effective reinforcers and integrate the component that would differentiate skill deficit from performance deficit.

Another potential limitation in the current study is that for students whose outcome level fell into the ambiguous group, it took them longer to discriminate. If the computer-based CTD procedure utilized in the current study used more antecedent stimuli to facilitate discrimination skills, the performances of these students in the ambiguous group might have been accelerated. In addition, having a sufficient number of participants to compare the performances of students in each grade would have provided valuable information. For example, if younger students tend to perform significantly poorer than older students, components of the intervention procedure (e.g., number of 0-s

time-delay sessions, number of stimulus pairs, length of time-delay, etc.) could be modified to better examine the performance of the students on discrimination skills.

An additional limitation that needs to be addressed is the inclusion criterion for the native English speakers and the ELLs. Results demonstrated that there was a larger number of ELLs who did not respond to the intervention as compared to the native English speakers. Although both native English speakers and ELLs participated in the current study and none had been referred for special education eligibility determination, several factors may have differentiated the groups other than their native languages. Prior to the implementation of the intervention, it was ascertained that the English proficiency level of the ELL participants was either level 1 (i.e., Negligible) or level 2 (i.e., Very Limited) on the Woodcock-Muñoz Language Survey (The Riverside Publishing Company, 2001). The current study, however, did not obtain information regarding the length of time the student had been in the United States nor regarding their familiarity with computers.

Given their low English proficiency levels, it can be speculated that little time had passed since these students moved to the United States. The ELLs may not have had enough time to become familiar with the computers. In addition, the school may not have had enough time to consider the potential need for their referral. More systematic selection of participants by collecting additional information including the length of the time the ELL had been in the country and familiarity with the computer is warranted in future studies. Concerning the selection of the native English speakers, no data were collected on their academic performance. Information regarding their academic skills

(e.g., reading fluency) would have specified the range of skills for the participants in the group and therefore would be a component worthy of incorporation in future studies.

In terms of the specific procedures utilized in the current study (i.e., CTD procedures), future research could investigate the differential effects of the various procedural details. For some non-responders in the current study, their performance might have improved if the tasks they were required to perform had been more apparent to them. In order to make the task more apparent to the students, the CTD procedure could be simplified by modifying the procedure in one or more of the following ways: increasing the number of 0-s time-delay sessions, conducting progressive time delay procedures instead of a constant time-delay procedure, extending the time delay to longer than 5 s, and/or presenting stronger discriminative stimuli at each trial. It is also possible that the consequences delivered contingent on students' performances (i.e., a smiley face and the audio effect of buzzer) might not have functioned effectively. Finding potent reinforcers that can be delivered through a computer screen to maintain the procedure's efficiency is another area of evaluation for future research.

The present study investigated the participants' response to intervention by means of implementing paired associate tasks utilizing a computer-administered nonverbal CTD procedure. Although the purpose of the current study was to develop an assessment/intervention procedure that is non-language based, connecting the results from the current study to academic tasks is needed. An extension of the study to compare the students' responsiveness to that of typically administered RTI procedures with empirically valid reading interventions would add interesting and useful information to

the literature. This would contribute to the establishment of a non-discriminative, efficient, and practical approach to be administered with ELLs.

In summary, the evidence collected during this study suggests that using a non-language-based intervention would provide practical information to the schools; however, the analysis may not be utilized in isolation, but as part of a more comprehensive assessment model. Vaughn and Fuchs (2003) proposed that in order for a special education classification to be considered valid, the procedure must 1) evaluate the quality of the general education program in which adequate learning would be expected, 2) judge the effectiveness of a special education program in producing substantial outcomes for students, and 3) evaluate the accuracy and meaningfulness of the assessment process utilized for identification of students who are in need of special education. This study was a preliminary step toward examining a method to help schools collect additional information about ELLs; however, the results from the current study alone do not tell us how this approach would work to determine special education eligibility. Research on comprehensive assessment and intervention procedures is warranted in the educational system for ELLs to fully benefit from the instruction delivered in schools.

REFERENCES

- Algozzine, B., Ysseldyke, J.E., & McGue, M. (1995). Differentiating low-achieving students: Thoughts and setting the record straight. *Learning Disabilities Research, 10*, 140-144.
- Ault, M.J., Gast, D.L., Wolery, M. (1988). Comparison of progressive and constant time-delay procedures in teaching community-sign word reading. *American Journal of Mental Retardation, 93*, 44-56.
- Ault, M.J., Wolery, M., Gast, D.L., & Doyle, P.M. (1988). Comparison of response prompting procedures in teaching numeral identification to autistic subjects. *Journal of Autism and Developmental Disorders, 18*, 627-636.
- Baca, L. & Almanza, E. (1991) *Language Minority Students with Disabilities* (pp.1-56). Reston, Virginia: Council for Exceptional Children.
- Bracken, B.A., & McCallum, R.S. (1996). *Universal Nonverbal Intelligence Test (UNIT)*. Rolling Meadows, IL: Riverside Publishing.
- Bradley, R., Danielson, L., & Hallahan, D. P. (2002). *Identification of learning disabilities: Research to practice*. Mahwah, NJ: Lawrence Erlbaum Associates.
- Braggio, J.T., Braggio, S.M., Lanier, J.H., Simpson, L., & Reisman, F.K. (1979). Optimal response modes influence the performance of learning disabled children on academic tasks. *Journal of Learning Disabilities, 12*, 374-378.
- Brown, L., Sherbenou, R.J., & Johnsen, S.K. (1997). *Test of Nonverbal Intelligence, Third Edition (TONI-3)*. Austin, TX: Pro-ed.
- California Department of Education. (2008). *California Standardized Testing and Reporting (STAR)*. Retrieved June 10, 2008, from <http://star.ede.ca.gov/star2006/Viewreport.asp>
- Camp, B.W., & Dahlem, N.W. (1975). Paired-associate and serial learning in retarded readers. *Journal of Educational Psychology, 67*, 385-390.
- Case, R.E., & Taylor, S.S. (2005). Language Difference or Learning Disability? *Clearing House, 78*, 127-130.
- Chandler, H.N. (1984). The bilingual special education interface: Issues in assessment. *Journal of Learning Disabilities, 17*, 629-630.
- Children's Educational Services, Inc. (1987). *Test of Oral Reading Fluency*. Minneapolis, MN: Author.

- Conoley, J.C., & Impara, J.C. (Eds.). (1995). *The twelfth mental measurements yearbook*. Lincoln, NE: Buros Institute of Mental Measurements.
- Cooper, J.O., Heron, T.E., & Heward, W.L. (1987). *Applied behavior analysis*. Columbus, OH: Merrill Publishing.
- Cummins, J. (1984). *Bilingualism and special education: Issues in assessment and pedagogy*. Clevedon, England: Multilingual Matters.
- Doyle, P.M., Wolery, M., Ault, M.J., & Gast, D.L. (1988). System of least prompts: A literature review of procedural parameters. *Journal of the Association for Persons with Severe Handicaps*, *13*, 28-40.
- Duhon, G. J., Noell, G. H., Witt, J. C., Freeland, J. T., Dufrene, B. A., & Gilbertson, D. N. (2004). Identifying academic skill and performance deficits: The experimental analysis of brief assessments of academic skills. *School Psychology Review*, *33*, 429-443.
- Echevarria, J., & Graves, A. (2003). *Sheltered content instruction: Teaching English-language learners with diverse abilities* (2nd ed.). Boston: Allyn and Bacon.
- Eckert, T. L., Ardoin, S. P., Daly, E. J. III., & Martens, B. K. (2002). Improving oral reading fluency: A brief experimental analysis of combining an antecedent intervention with consequences. *Journal of Applied Behavior Analysis*, *35*, 271-281.
- Education for All Handicapped Children (EHA) of 1975*. (1977). Public Law 94-142.
- Elliott, S.N., & Fuchs, L.S. (1997). The utility of curriculum-based measurement and performance assessment as alternatives to traditional intelligence and achievement tests. *School Psychology Review*, *26*, 224-233.
- Fletcher, J., Francis, D., Shaywitz, S.E., Lyon, G.R., Foorman, B.R., Steubing, K.K., et al. (1998). Intelligent testing and the discrepancy model for children with learning disabilities. *Learning Disabilities Research and Practice*, *13*(4), 186-203.
- Fletcher, J., Lyon, G.R., Barnes, M., Steubing, K.K., Francis, D.J., Olson, R.K., et al. (2002). Classification of learning disabilities: An evidence-based evaluation. In R. Bradley, L. Danielson, & D. Hallahan (Eds.), *Learning disabilities: Research to practice* (pp. 185-250). Mahwah, NJ: Lawrence Erlbaum.
- Fletcher, J., Shaywitz, S., Shankweiler, D., Katz, L., Liverman, I., Steubing, K., Francis, D., et al. (1994). Cognitive profiles of reading disability: Comparisons of discrepancy and low achievement definitions. *Journal of Educational Psychology*, *86*, 6-23.

- Forness, S.R., Keogh, B.K., MacMillan, D.L., Kavale, K.A., & Gresham, F.M. (1998). What is so special about IQ? The limited explanatory power of cognitive abilities in the real world of special education. *Remedial and Special Education, 19*, 315-322.
- Fuchs, L., & Fuchs, D. (1997). Use of curriculum-based measurement in identifying students with disabilities. *Focus on Exceptional Children, 30*, 1-16.
- Fuchs, D., Fuchs, L.S., Mathes, P.G., & Lipsey, M.W. (2000). Reading differences between low-achieving students with and without learning disabilities: A meta-analysis. In R. Gersten & S. Vaughn (Eds.), *Issues and research in special education* (pp. 81-104). Hillsdale, NJ: Erlbaum.
- Fuchs, L.S., Fuchs, D., & Speece, D.L. (2002). Treatment validity as a unifying construct for identifying learning disabilities. *Learning Disability Quarterly, 25*, 33-45.
- Furlong, M.J., & Yanagida, E. H. (1985). Psychometric factors affecting multidisciplinary team identification of learning disabled children. *Learning Disability Quarterly, 8*, 37-44.
- Furth, H.G., & Youniss, J. (1964). Color-object paired associate in deaf and hearing children with and without response competition. *Journal of Consulting Psychology, 28*, 224-227.
- Gast, D.L., Ault, M.J., Wolery, M., Doyle, P.M., & Belanger, S. (1988). Comparison of constant time delay and the system of least prompts in teaching sight word reading to students with moderate retardation. *Education and Training in Mental Retardation, 23*, 117-128.
- Gerber, M. & Semmel, M. (1984). Teacher as imperfect test: Reconceptualizing the referral process. *Educational Psychologist, 19* (2), 137 - 148.
- Gresham, F. M. (1981). Assessment of children's social skills. *Journal of School Psychology, 19*, 120-133.
- Gresham, F.M. (1991). Conceptualizing behavior disorders in terms of resistance to intervention. *School Psychology Review, 20*, 23-36.
- Gresham, F.M. (2002). Responsiveness to intervention: An alternative approach to the identification of learning disabilities. In R. Bradley, L. Danielson, & D. Hallahan (Eds.), *Learning disabilities: Research to practice* (pp. 467-519). Mahwah, NJ: Lawrence Erlbaum.
- Gresham, F.M., & Gansle, K.A. (1992). Misguided assumption of DSM-III-R: Implications for school psychological practice. *School Psychology Quarterly, 7*, 79-95.

- Gresham, F.M., MacMillan, D.L., & Bocian, K. (1996). Learning disabilities, low achievement, and mild mental retardation: More alike than different? *Journal of Learning Disabilities, 29*, 570-581.
- Gresham, F.M., Reschly, D.J., & Carey, M. (1987). Teachers as “tests”: Differential validity of teacher judgments in identifying students at-risk for learning difficulties. *School Psychology Review, 26*, 47-60.
- Gresham, F.M., VanderHeyden, A., & Witt, J.C. (2005). Response to intervention in the identification of learning disabilities: Empirical support and future challenges. Unpublished manuscript. Available online at [http://www.joewitt.org/Downloads/Response to Intervention MS Gresham Vanderheyden Witt.pdf](http://www.joewitt.org/Downloads/Response%20to%20Intervention%20MS%20Gresham%20Vanderheyden%20Witt.pdf) [page no longer active; link disabled post-publication]
- Gresham, F.M., & Witt, J.C. (1997). Utility of intelligence tests for treatment planning, classification, and placement decisions: Recent empirical findings and future directions. *School Psychology Quarterly, 12*, 249-267.
- Heflinger, C.A., Cook, V.J. & Thackrey, M. (1987). Identification of mental retardation by the SOMPA: Nondiscriminatory or nonexistent? *Journal of School Psychology, 25*, 177-183.
- Heller, K.A., Holtzman, W.H., & Messick, S. (Eds.) (1982). *Placing children in special education: A strategy for equity*. Washington, D.C.: National Academy Press.
- Hitchcock, C. H. & Noonan, M. J. (2000). Computer-assisted instruction of early academic skills. *Topics in Early Childhood Special Education, 20*, 145-158.
- Hooper, V.S., & Mee Bell, S. (2006). Concurrent validity of the Universal Nonverbal Intelligence Test and the Leiter International Performance Scale-Revised. *Psychology in the Schools, 43*, 143-148.
- Hoover, J.J., & Collier, C. (1991). Meeting the needs of culturally and linguistically diverse exceptional learners: Prereferral to mainstreaming. *Teacher Education and Special Education, 14*, 30-34.
- Hughes, T.A., & Fredrick, L.D. (2006). Teaching vocabulary with students with learning disabilities using classwide peer tutoring and constant time delay. *Journal of Behavioral Education, 15*, 1-23.
- Hughes, T.A., Fredrick, L.D., & Keel, M.C. (2002). Learning to effectively implement constant time delay procedures to teach spelling. *Learning Disability Quarterly, 25*, 209-220.
- Hunsaker, M.R., Thorup, J.A., Welch, T., & Kesner, R.P. (2006). The role of ca3 and ca1 in the acquisition of an object-trace-place paired-associate task. *Behavioral Neuroscience, 120*, 1252-1256.

- Individuals with Disabilities Education Improvement Act (2004). Public Law 108-446 (20 U.S.C. 1400 *et seq.*).
- Iowa Department of Education: RTI Model: Special education eligibility standards (February 2005). Available online at <http://www.state.ia.us/educate/ecese/cfcs/speced/doc/sees.pdf>
- Jirsa, J.E. (1983). The SOMPA: A brief examination of technical considerations, philosophical rationale, and implications for practice. *Journal of School Psychology, 21*(1), 13-21.
- Kavale, K. A., & Forness, S. R. (2000). History, rhetoric and reality: Analysis of the inclusion debate. *Remedial and Special Education, 21*, 279-296.
- Kindler, A.L. (2002). *Survey of the states' limited English proficient students and available educational programs and services: 2000–2001 summary report*. Washington, DC: U.S. Department of Education, Office of English Language Acquisition, Language Enhancement and Academic Achievement for Limited English Proficient Students.
- Kinney, P. G., Stevens, K. B., & Schuster, J. W. (1988). The effects of CAI and time delay: A systematic program for teaching spelling. *Journal of Special Education Technology, 9*, 61-72.
- Komatsu, C., & Witt, J.C. (2006). Assessing effects of directive complexity on accuracy of task completion in English language learners, *School Psychology Review, 35*, 552-567.
- Koscinski, S.T., & Gast, D.L. (1993). Constant time delay in teaching multiplication facts to students with learning disabilities. *Journal of Learning Disabilities, 26*(8), 533-567.
- Lerner, J.W. (2002). *Learning disabilities: Theories, diagnosis, and teaching strategies* (8th ed.). Boston: Houghton-Mifflin.
- Linan-Thompson, S., Vaughn, S., Hickman-Davis, P., & Kouzekanani, K. (2003). Effectiveness of supplemental reading instruction for second-grade English language learners with reading difficulties. *Elementary School Journal, 103*, 221-238.
- Lohman, D. (n.d.). The role of nonverbal ability tests in identifying academically gifted students: An aptitude perspective. Retrieved August 10, 2006, from The University of Iowa, Education Department Web site: <http://faculty.education.uiowa.edu/dlohman/ppt>

- Losardo, A., & Notari-Syverson, A. (2001). *Alternative approaches to assessing young children*. Baltimore, MD: Brookes Publishing.
- MacMillan, D.L., & Speece, D. (1999). Utility of current diagnostic categories for research and practice. In R. Gallimore, L. Hernheimer, D. MaMillan, D. Speece, & S. Vaughn (Eds.), *Developmental perspectives on children with high-incidence disabilities* (pp. 111-133). Mahwah, NJ: Lawrence Erlbaum.
- McCallum, R.S., & Bracken, B.A. (2005). The universal nonverbal intelligence test: A multidimensional measure of intelligence. In D. Flanagan & P. Harrison (Eds.), *Contemporary intellectual assessment* (pp. 425-440). New York: Guilford Press.
- McDonnell, J. & Ferguson, B. (1989). A comparison of time delay and decreasing prompt hierarchy strategies in teaching banking skills to students with moderate handicaps. *Journal of Applied Behavior Analysis*, 22, 85-91.
- McNamara, K., & Hollinger, C. (2003). Intervention-based assessment: Evaluation rates and eligibility findings. *Exceptional Children*, 69(2), 181-193.
- Meehan, E.F. (1999). Class-consistent differential reinforcement and stimulus class formation in pigeons. *Journal of the Experimental Analysis of Behavior*, 72, 97-115.
- Mercer, J.R., & Lewis, J.F. (1977). *System of Multicultural Pluralistic Assessment*. New York, NY: The Psychological Corporation.
- Mitchell, J.V., Jr. (Ed.). (1985). *The ninth mental measurements yearbook*. Lincoln, NE: Buros Institute of Mental Measurement. SOMPA Peason Testings (n.d.). *TONI-3: Test of Nonverbal Intelligence, Third Edition*. Retrieved August 10, 2006 from <http://ags.pearsonassessments.com>
- Nakagawa, E. (2005). Emergent, untrained stimulus relations in many-to-one matching-to-sample discriminations in rats. *Journal of the Experimental Analysis of Behavior*, 83, 185-195.
- National Association of State Directors of Special Education (2005). *Response to intervention: Policy considerations and implementation*. Alexandria, VA: Author.
- National Reading Panel (2000). *Report of the national reading panel. Teaching children to read: An evidence-based assessment of the scientific literature on reading and its implications for reading instruction*. (NIH Publication No. 00-4769). Washington, D.C.: U.S. Government Printing Office.

- Noell, G. H., Roane, H. S., VanDerHeyden, A. M., Whitmarsh, E. L., & Gatti, S. L. (2000). Programming for the generalization of communication to the classroom following assessment and training outside of the classroom. *School Psychology Review, 29*, 429-442.
- Noell, G. H., Freeland, J. T., Witt, J. C., & Gansle, K. A. (2001). Using brief assessment of identify effective interventions for individual students. *Journal of School Psychology, 39*, 335-355.
- Pilgrim, C., Jackson, J., & Galizio, M. (2000). Acquisition of arbitrary conditional discriminations by young normally developing children. *Journal of the Experimental Analysis of Behavior, 73*, 177-193.
- Plake, B.S., & Impara, J.C. (Eds.). (2001). *The fourteenth mental measurement yearbook*. Lincoln, NE Buros Institute of Mental Measurements. UNIT
- Reschly, D.J., & Ysseldyke, J. (2002). Paradigm shift: The past is not the future. In A. Thomas & J. Grimes (Eds.), *Best practices in school psychology-IV* (pp. 3-20). Bethesda, MD: National Association of School Psychologists.
- Resetar, J.L., Noell, G.H., & Pellegrin, A.L. (2006). Teaching parents to use research-supported systematic strategies to tutor their children in reading. *School Psychology Quarterly, 21*, 241-261.
- Richman, D. M., Wacker, D. P., Cooper-Brown, L. J., Kayser, K., Crosland, K., Stephens, T. J., et al. (2001). Stimulus characteristics within directives: Effects on accuracy of task completion. *Journal of Applied Behavior Analysis, 34*(3), 289- 312.
- Riverside Publishing (2006). Retrieved August 10, 2006, from <http://www.riverpub.com/products/unit/index.htmlrrect.com/intro.htm#doyou>
- Roid, G.H., & Miller, L.J. (1997). *Leiter International Performance Scale-Revised (Leiter-R)*. Wood Dale, IL: Stoelting Co..
- Rueda, R., Figueroa, R., Cardoza, D., & Mercer, J. (1985). *Performance of limited English proficient students on the WISC RM, SOMPA, and S KABC*. Office of Special Education Research, U.S. Department of Education.
- Schoen, S.F., & Sivil, E.O. (1989). A comparison of procedures in teaching self-help skills: Increasing assistance, time delay, and observational learning. *Journal of Autism and Developmental Disorders, 19*, 57-72.
- Schuster, J.W., Morse, T.E., Ault, M.J., Doyle, P.M., Crawford, M.R., & Wolery, M. (1998). Constant time delay with chained tasks: A review of the literature. *Education and Treatment of Children, 21*(1), 74-106.

- Schuster, J.W., Stevens, K.B., & Doak, P.K. (1990). Using time delay to teach word definitions. *The Journal of Special Education, 24*, 306-318.
- Schuster, J.W., Stevens, K.B., & Doak, P.K. (1990). Using constant time delay to teach word definitions. *The Journal of Special Education, 24*(3), 306-318.
- Shinn, M.R. (Ed.). (1989). *Curriculum-based measurement: Assessing special children*. New York: Gilford.
- Siegel, L. (1989). IQ is irrelevant to the definition of learning disabilities. *Journal of Learning Disabilities, 22*, 469-479.
- Snow, C., Burns, M.S., & Griffin, P. (Eds.) (1998). *Preventing reading difficulties in young children*. Washington, D.C.: National Academy Press.
- Speece, D.L., & Case, L.P. (2001). Classification in context: An alternative approach to identifying early reading disability. *Journal of Educational Psychology, 93*, 735-749.
- Stanovich, K., & Siegel, L. (1994). Phenotypic performance profile of children with reading disabilities: A regression-based test of the phonological-core-variable-difference model. *Journal of Educational Psychology, 86*, 24-53.
- Stevens, K.B., & Schuster, J.W. (1987). Effects of a constant time delay procedure on the written spelling performance of a learning disabled student. *Learning Disability Quarterly, 10*, 9-16.
- Stuebing, K., Fletcher, J., LeDoux, J., Lyon, G.R., Shaywitz, S., & Shaywitz, B. (2002). Validity of IQ-discrepancy classifications of reading disabilities: A meta-analysis. *American Educational Research Journal, 39*, 469-518.
- Talley, R.C. (1979). *Evaluating the effects of implementing the System of Multicultural Pluralistic Assessment*. Center for innovation in teaching the handicapped. Bureau of Education for the handicapped, Washington, DC.
- Texas Education Agency (1998). *Texas Primary Reading Inventory (TPRI)*. Austin, TX: McGraw-Hill.
- Thomas, W.P., & Collier, V.P. (2002). *A national study of school effectiveness for language minority students' long-term academic achievement*. Santa Cruz, CA: Center for Research on Education, Diversity & Excellence. Retrieved February 21, 2003, from www.crede.ucsc.edu/research/llaa/1.1_final.html

- Torgesen, J., & Burgess, S. (1998). Consistency of reading-related phonological processes throughout early childhood: Evidence from longitudinal-correlational and instructional studies. In J. Metsala & L. Ehri (Eds.), *Word recognition in beginning reading* (pp. 161-188). Hillsdale, NJ: Lawrence Erlbaum.
- U.S. Department of Education (1998). *To assure the free appropriate public education of all children with disabilities: Twentieth annual report to Congress on the implementation of the Individuals with Disabilities Education Act*. Washington, DC: U.S. Government Printing Office.
- U.S. Department of Education. (2001). *Language instruction for limited-English-proficient and immigrant students* (Title III of the No Child Left Behind Act of 2001, PL 107-110). Washington, DC: Author.
- U.S. Department of Health & Human Services. (2006). *Test de vocabulario en imagines Peabody (TVIP), 1986*. Retrieved January 10, 2006 from http://www.acf.hhs.gov/programs/opre/ehs/perf_measures/reports/resources_measuring
- Valdez-Pierce, L. (2003). *Assessing English Language Learners*. Washington, D. C.: National Education Association.
- Vaughn, S. & Fuchs, L.S. (2003). Redefining learning disabilities as inadequate response to instruction: The promise and potential problems. *Learning Disabilities Research & Practice, 18*(3), 137-146.
- Vaughn, S., Linan-Thompson, S., & Hickman-Davis, P. (2003). Response to instruction as a means of identifying students with reading/learning disabilities. *Exceptional Children, 69*, 391-409.
- Vaughn, S., Mathes, P.G., Linan-Thompson, S., & Francis, D.J. (2005). Teaching English language learners at risk for reading disabilities to read: Putting research into practice. *Learning Disabilities Research & Practice, 20*(1), 58-67.
- Vellutino, F.R., Scanlon, D., & Lyon, G.R. (2000). Differentiating between difficult-to-remediate and readily remediated poor readers: More evidence against IQ-achievement discrepancy of reading disability. *Journal of Learning Disabilities, 33*, 223-238.
- Walker, G. (2008). Constant and progressive time delay procedures for teaching children with autism: A literature review. *Journal of Autism and Developmental Disabilities, 38*, 261-275.
- Wechsler, D. (1974). *Wechsler Intelligence Scale for Children- Revised (WISC-R)*. New York, NY: The Psychological Corporation.

Weinstein, R. & Rabinovitch, M.S. (1971). Sentence structure and retention in good and poor readers. *Journal of Educational Psychology*, 62, 25-30.

Wolery, M., Ault, M.J., & Doyle, P.M. (1992). *Teaching students with moderate to severe disabilities*. New York: Longman.

Ysseldyke, J.E., Algozzine, B., Shinn, M.R., & McGue, M. (1982). Similarities and differences between low achievers and students classified learning disabled. *The Journal of Special Education*, 16, 73-85.

APPENDIX A

SAMPLE CTD PROMPTS FROM THE INTERVENTION POWERPOINT SCREEN

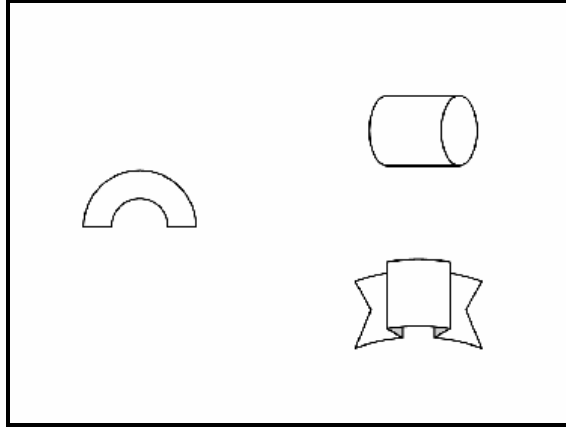

a. A sample stimulus and comparison stimuli that appear at the beginning of each trial

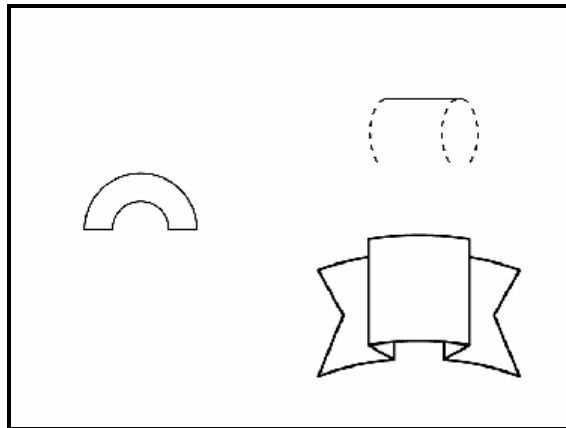

b. A correct comparison stimulus is emphasized and incorrect stimulus is fading away after the time delay during the training session

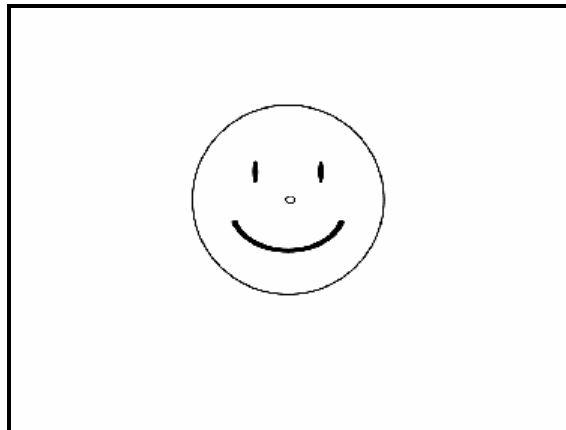

c. A smiley face that was delivered contingent on correct response

APPENDIX B

DATA SHEET UTILIZED DURING THE COMPUTER-BASED CTD

Student Name: _____ Grade: ____ Date: _____

Teacher Name: _____ Probe session #: _____

1.

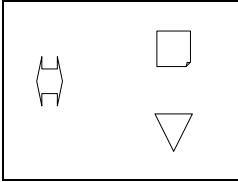

2.

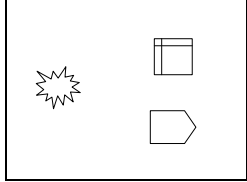

3.

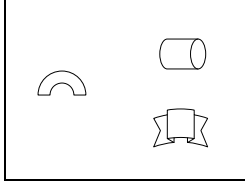

4.

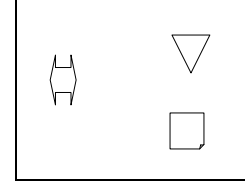

5.

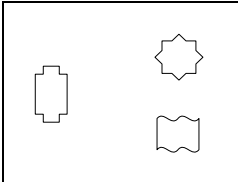

6.

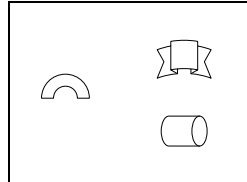

7.

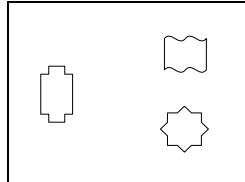

8.

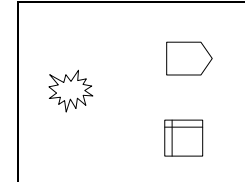

9.

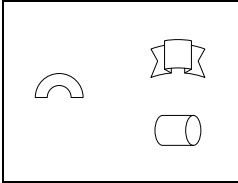

10.

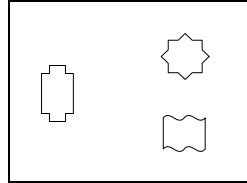

11.

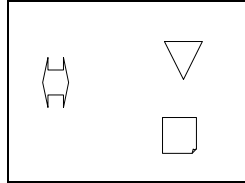

12.

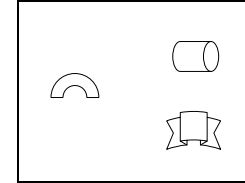

13.

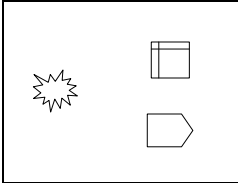

14.

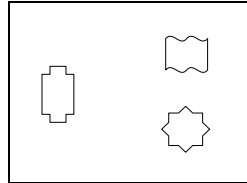

15.

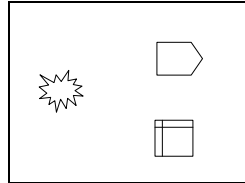

16.

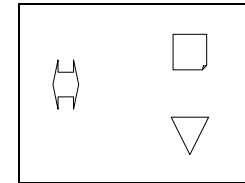

17.

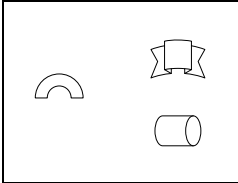

18.

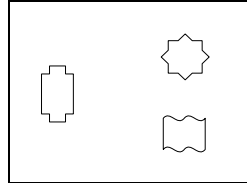

19.

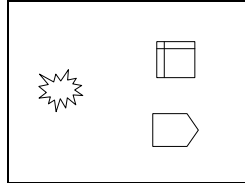

20.

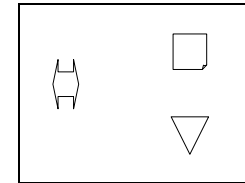

VITA

Chisato Komatsu is currently a graduate student in the school psychology Program at Louisiana State University. She received her Bachelor of Arts degree in psychology from the University of Texas at Austin in May 2001 and her Master of Arts degree in school psychology from Louisiana State University in December 2004. Chisato Komatsu is a candidate for the degree of Doctor of Philosophy in school psychology at Louisiana State University.