

Durham E-Theses

*Application of stochastic and evolutionary methods to
plan for the installation of energy storage in voltage
constrained LV networks*

CROSSLAND, ANDREW,FREDERICK

How to cite:

CROSSLAND, ANDREW,FREDERICK (2014) *Application of stochastic and evolutionary methods to plan for the installation of energy storage in voltage constrained LV networks*, Durham theses, Durham University. Available at Durham E-Theses Online: <http://etheses.dur.ac.uk/10819/>

Use policy



This work is licensed under a [Creative Commons Attribution Non-commercial No Derivatives 3.0 \(CC BY-NC-ND\)](https://creativecommons.org/licenses/by-nc-nd/3.0/)

Academic Support Office, Durham University, University Office, Old Elvet, Durham DH1 3HP
e-mail: e-theses.admin@dur.ac.uk Tel: +44 0191 334 6107
<http://etheses.dur.ac.uk>

Material Abstract

Energy storage is widely considered to be an important component of a decarbonised power system if large amounts of renewable generation are to provide reliable electricity. However, storage is a highly capital intensive asset and clear business cases are needed before storage can be widely deployed. A proposed business case is using storage to prevent overvoltage in low voltage (LV) distribution networks to enable residential photovoltaic systems.

Despite storage being widely considered for use in LV networks, there is little work comparing where storage might be installed in LV networks from the perspective of the owners of distribution networks (DNOs). This work addresses this in two ways. Firstly, a tool is developed to examine whether DNOs should support a free market for energy storage in which customers with PV purchase storage (e.g. battery systems) to improve their self-consumption. This reflects a recent policy in Germany. Secondly, a new (published) method is developed which considers how DNOs should purchase and locate storage to prevent overvoltage. Both tools use a snapshot approach by modelling the highest and lowest LV voltages.

On their own, these tools enable a DNO to determine the cost of energy storage for a particular LV network with a particular set of loads and with PV installed by a given set of customers. However, in order to predict and understand the future viability of energy storage it is valuable to apply the tools to a large number of LV networks under realistic future scenarios for growth of photovoltaics in the UK power system. Therefore, the work extracts over 9,000 LV network models containing over 40,000 LV feeders from a GIS map of cables provided by one of the UK's electricity distribution networks- Electricity North West.

Applying the proposed tools to these 9,000 network models, the work is able to provide projections for how much LV energy storage would be installed under different scenarios. The cost of doing so is compared to the existing method of preventing reinforcement- LV network reconductoring. This is a novel way of assessing the viability of LV energy storage against traditional approaches and allows the work to draw the following conclusions about the market for energy storage in LV distribution networks in the UK:

- Overvoltage as a result of PV could begin to occur in the next few years unless UK regulations for voltage levels are relaxed. There could be a large cost (hundreds of millions of pounds) to prevent this if the traditional approach of reconductoring is used.
- If overvoltage begins to occur, a free market for energy storage (randomly purchased by electricity consumers) cannot offer large benefits to DNOs in reducing the reinforcement cost unless this is properly controlled, located and/or widely installed by customers.
- Optimally located storage by the DNO can reduce overall reinforcement costs to mitigate overvoltage. This would enable more energy storage to balance renewable generation and present large savings to the power system. The exact topology of storage and the storage rating in each LV network could be determined using the tool proposed in this work.

Application of stochastic and evolutionary methods to plan for the installation of energy storage in voltage constrained LV networks

Mr Andrew Frederick Crossland MEng (Hons) MSc

Submitted for the degree of Doctor of Philosophy
School of Engineering and Computer Science
Durham University

September 2014

Supervised by

Dr Neal Wade

Dr Rob Dominy

Dr Chris Crabtree

Sponsored by

Electricity North West Limited

Scottish Power Distribution Networks

Declaration

No part of this thesis has been submitted elsewhere for any other degree or qualification. It is all my own work unless referenced to the contrary.

Statement of copyright

The copyright of this thesis rests with the author. No quotation from it should be published without the author's prior written consent and information derived from it should be acknowledged.

Acknowledgements

A number of people are due thanks and acknowledgements for supporting this thesis, but without the particular help of the supervision of Dr Neal Wade the work would have been impossible. Neal has been a constant support pastorally as well as technically and provided myself and my PhD researching colleagues with invaluable access to sponsors, conferences and his peers in the industry. Further, a few trips to Rwanda, Uganda and Kenya have been a welcome distraction to the core PhD research and have allowed us both to broaden our knowledge of this field.

The work has been generously supported by Electricity North West and Scottish Power. Particular thanks are extended to Darren Jones for providing good feedback on our work and his invaluable advice “don’t forget the pound sign”! Allen and TJ have also been great collaborators on this work on papers, conferences and over many coffees. I would also like to extend thanks to Dr Rob Dominy and Dr Christopher Crabtree for committing to providing supervision at a late stage and allowing me to remain with Durham University as well as the staff of the Energy CDT and Durham Energy Institute.

I would like to thank the family members who have put up with me at the various stages of the work: Mum, Dad, Nana, Grandad, James, Sally, Lorraine, Martin, Becky, Helen and the life mentored. Finally, I also thank Barbara Denz, Rukiya Sood, Helen Pinkney, Jonathan Allen, Jo Cantwell, Mark Collins, Meena Nayar, Daniel Raisen, James Keaveney, Charles Fletcher, Zara Cook Alex Hearnden, and Russell King who have gone out of their way to help over the three years. Love you all, and you are more than welcome to an electronic copy of the final version!

Table of contents

Material Abstract	i
Declaration	iii
Statement of copyright	iii
Acknowledgements	i
Table of contents.....	ii
List of Figures.....	vii
List of Tables	xvi
List of abbreviations	xviii
Glossary	xviii
Nomenclature	xix
Chapter 1 : Introduction to electricity networks	1
1 Distributed generation	3
2 Electrical energy storage.....	6
2.1 Energy storage regulation in the UK	9
3 Summary	10
Chapter 2 : Distributed generation in the LV network and the potential role for energy storage	12
1 Impacts of distributed generation on LV networks	12
1.1 Regulatory constraints in LV networks.....	13
1.2 Impacts of distributed generation on LV Networks	14
1.3 Increased demand in LV networks.....	18
1.4 Summary	19
2 Improving the hosting capacity for LV distributed generation	19
2.1 Summary	21
3 Energy storage in the LV distribution network	22
3.1 LV energy storage technologies and trials	24
3.2 Impacts of LV energy storage on the rest of the power system.....	27
3.3 Benefits of LV energy storage to network operators	28
3.4 Summary	30

4	Planning for LV energy storage.....	30
5	Conclusions.....	33
Chapter 3 : LV Network Modelling Considerations and Assumptions		34
1	Modelling decisions.....	34
1.1	Loads.....	36
1.2	Residential photovoltaics	37
2	Decoupling and MV voltage variation	40
3	Financial model.....	42
3.1	Cost of LV network reconductoring.....	42
3.2	LV energy storage cost	43
4	Conclusions.....	47
Chapter 4 : Preliminary Study of LV Distribution Networks		49
1	Case study networks.....	49
2	Measured parameters	51
2.1	Voltage and voltage unbalance.....	52
2.2	Power flow and fluctuation	53
2.3	Specific impacts of PV on case study networks.....	55
2.4	Outputs of data analysis.....	56
3	Projected future performance of case study networks.....	57
3.1	Headroom.....	59
3.2	Preliminary study of case study network MA	60
3.3	Locating energy storage within LV networks	61
4	Conclusions.....	63
Chapter 5 : Planning Tools for Distributed Generation and Energy Storage in LV Distribution Networks		64
1	Introduction.....	64
2	Effect of energy storage and determination of size.....	64
3	Stochastic method for determining voltage impacts of distributed generation and home energy storage.....	65
3.1	Assumptions.....	68

3.2	Application to case study LV networks	68
3.3	Summary	73
4	Heuristic for optimal location of energy storage in LV distribution networks to alleviate voltage problems	75
4.1	Heuristic planning tools	75
4.2	Genetic algorithm for wide area planning	76
4.3	Fitness calculation.....	79
4.4	Parameter selection	81
4.5	Application of heuristic	84
4.6	Summary	86
5	Conclusions.....	87
Chapter 6 : Network Model Creation Using a GIS Map		88
1	ENWL GIS system	89
1.1	Transformers and fuses	90
1.2	Feeder and service cables	91
1.3	Link boxes	92
1.4	Loads.....	92
1.5	Summary	93
2	Computational method for LV model creation.....	95
2.1	Methods for determining network properties.....	95
2.2	Description of computational method.....	102
3	Validation.....	107
3.1	Cable diameter sense check.....	107
3.2	Comparison to case study networks	107
3.3	Performance of algorithm across network area	110
4	Selection of representative networks	113
4.1	Selection criteria.....	113
4.2	Application of selection criteria.....	114
5	Calculation of the transformer voltage deviation.....	118
5.1	Model of the MV network	119

5.2	Derived rules for modelling large numbers of LV networks	120
6	Conclusions.....	122
Chapter 7 : Application of Planning Tools for Technical Results		123
1	Generation, demand and storage scenarios.....	123
1.1	Demand.....	123
1.2	PV installation.....	123
1.3	LV energy storage scenarios	124
1.4	Voltage headroom	124
1.5	Determination of the number of repeats for stochastic PV placement.....	125
2	Network condition with no energy storage (basecase)	127
2.1	Increase in peak demand.....	128
2.2	Sensitivity analysis	132
3	Comparison of energy storage scenarios	135
3.1	Selection of energy storage system on a single network.....	135
3.2	Analysis of all GIS networks.....	139
4	Conclusions.....	145
Chapter 8 : Business case for energy storage in LV networks		147
1	Basecase with no energy storage	147
2	Value of energy storage to the DNO	148
2.1	Stochastically located energy storage	148
2.2	Secondary transformer storage.....	149
2.3	Optimally located storage.....	149
3	Cost of energy storage	150
4	Net value of energy storage	152
4.1	Value of stochastically located storage	152
4.2	Net value of optimally located energy storage	154
4.3	Total reinforcement cost.....	155
4.4	Sensitivity analysis of reinforcement cost	156
5	Additional revenue from the power system	157
5.1	Power system.....	157

5.2 Home owner.....	158
6 Conclusions.....	159
Chapter 9 : Discussion and Conclusion	160
1 Preliminary study.....	160
2 Review of tools	160
2.1 Method for LV model extraction from GIS data.....	160
2.2 Stochastic tool	162
2.3 Optimisation tool	163
3 Storage types	164
3.1 Secondary transformer.....	164
3.2 Home storage.....	164
3.3 Three phase storage on the street.....	166
3.4 Conclusions.....	166
4 Control.....	167
5 Size of voltage problems.....	168
5.1 MV variation and measured data	168
6 Financial considerations.....	169
7 Alternatives to energy storage	170
8 Summary of discussion	171
9 Conclusion.....	172
Appendix	I
A DNO PV reference table	I
B Publication and training summary.....	III
C Control algorithm used in CIRED 2012 paper.....	VI
References.....	VII

List of Figures

Figure 1-1: Overview of the electrical power network including indicative voltage levels. Blue sections are transmission assets and green assets are distribution assets	1
Figure 1-2: Operating areas of the UK Electricity distribution network companies in April, 2014 (Electricity Networks Association 2014)	2
Figure 1-3: (a) Cumulative number and (b) installed capacity of renewable systems registered under the UK FiT (April 2010 - February 2014). PV is photovoltaics, CHP is micro combined heat and power and AD is anaerobic digestion (Department of Energy and Climate Change 2014e)	5
Figure 1-4: The number of PV systems per local authority installed in the UK, June 2013 (Department of Energy and Climate Change 2013)	6
Figure 1-5: Applications for ESS technologies for different autonomy period and power (Kaldellis & Zafirakis 2007)	7
Figure 1-6: Simplified diagram of the future power grid showing wind farms and storage alongside traditional power stations in the transmission network, co-generation of electricity, demand side response in manufacturing, increased data monitoring in data hubs and centres and PV and electric vehicles in residential networks (The Guardian 2011)	11
Figure 2-1: Traditional and future electricity system	12
Figure 2-2: Traditional residential LV distribution network with passive loads, no distributed generation and unidirectional power flow	13
Figure 2-3: Active LV network with residential PV systems causing reverse power flow	14
Figure 2-4: Voltage change over a single line segment (Masters 2002)	15
Figure 2-5: Overvoltage due to PV systems in a LV distribution network	15
Figure 2-6: Irradiance measured by the author on three different days on a residential property in Retford, Nottinghamshire as used in (Wang et al. 2013)	17
Figure 2-7: Number of residential heat pumps that are projected to be installed in the UK under high and low trajectories (National Grid Company 2011d)	18
Figure 2-8: Four scenarios for decarbonisation of car and van transport (Department of Energy and Climate Change 2011a)	18
Figure 2-9: Different locations/topologies for energy storage in LV distribution networks	22
Figure 2-10: Overview of home storage with respect to self-consumption for a system which includes (1) PV panels, (2) a control unit, (3) battery storage, (4) a grid supply and (5) a series of domestic electrical loads (adapted from (Energy Storage Journal 2013))	23
Figure 2-11: RedFlow battery used in Newington smart home trial	26

Figure 2-12: Components of the RIIO Model (Ofgem 2010c).....	29
Figure 3-1: Forecast for installed capacity of PV within the EWNL network. Data provided by Geraldine Bryson and Darren Jones of ENWL.....	39
Figure 3-2: Parameters used to define LV voltage variation.....	41
Figure 3-3: Decision tree for determining if reconductoring or energy storage is required to solve an overvoltage problem in an LV network.....	42
Figure 3-4: Charging and discharging efficiency losses in an energy storage system (self-discharge is assumed to be negligible).....	43
Figure 3-5: Capital, operating and replacement costs of different battery technologies	47
Figure 4-1: Areas covered by each LV network and location of PV systems presently installed within the case study networks	49
Figure 4-2: 11kV MV network associated with the case study networks.....	50
Figure 4-3: (a) Headroom used in the case study networks and (b) the voltage range at each of the MV busbars in the case study networks according to MV network modelling in OpenDSS at highest and lowest demands	51
Figure 4-4: From the measured data (a) Boxplot of the mean voltage across the three phases for all data points at each secondary transformer and (b) boxplot of voltages for all transformers after transients are removed	53
Figure 4-5: For 100 consecutive minutes in the measured data (a) Transient voltage dip identified across three phases in the data and (b) the voltage measurements in one of the networks with missing data shown as 0 p.u.....	53
Figure 4-6: Boxplots of (a) real and (b) reactive power through each LV residential transformer	54
Figure 4-7: From the measured data P-Q graph for networks with mostly residential loads.....	54
Figure 4-8: From the measured data real power and power factor for transformer DG on 29 th March 2012	55
Figure 4-9: From the measured data, boxplots of real power flows through (a) DG and through (b) LL at each hour of the day.....	55
Figure 4-10: Probability distribution of the mean voltage at transformer DG when the power flow through the transformer is between given values	56
Figure 4-11: (a) Voltage drop and (b) present and potential voltage rise on case study networks when modelled using OpenDSS	57
Figure 4-12: Reverse power flow in case study networks when all PV systems are at maximum power and loads are at minimum demand ADMD 3.6 kW PV	58

Figure 4-13: Range of voltages in each residential LV network with no DG or energy storage installed, where VT is the transformer deviation, ∇VLV is the LV voltage drop and VS is a 1% safety margin. The tap position is set to a notional level as the important parameter is the range of voltages experienced in the LV network as outlined in Chapter 3, Section 2..... 59

Figure 4-14: For three sizes of energy storage at the secondary transformer and 2% load growth (a) the peak power through transformer and (b) the highest voltage in the network 60

Figure 4-15: (a) Number of storage units installed by the heuristics and (b) the number of load flows used in each heuristic used in the CIRED 2013 paper (Crossland, Jones, et al. 2013b) . 62

Figure 5-1: Stochastic tool for determining the voltage rise in LV networks with different amounts of stochastically located PV and energy storage. n repeat runs of the tool are completed..... 67

Figure 5-2: Probability distribution of voltage rise with different percentages of south facing homes having rooftop PV systems installed. An arbitrary voltage rise limit is shown in the figure which highlights that a PV dispersion of 25% is unlikely to cause overvoltage whilst a 75% PV dispersion is practically certain to cause overvoltage. 69

Figure 5-3: (a) Mean and (b) standard deviation of voltage rise on when stochastic tool is applied to four of the case study networks with different PV dispersion levels and the no energy storage 69

Figure 5-4: Probability of a given voltage rise with (a) a PV dispersion level of 50% and no energy storage and (b) a PV and home energy storage dispersion level of 50% 70

Figure 5-5: Headroom in each residential LV network with different percentages of South facing homes having PV under the following scenarios with no energy storage at (a) a 99.7% confidence and (b) a 68.3% confidence..... 71

Figure 5-6: Voltage headroom under different amounts of PV and home energy storage with a 99.7% confidence..... 71

Figure 5-7: (Upper) Voltage rise in network MA under different PV and home storage dispersion levels. (Lower) The green region in the lower three figures shows where the network never has a voltage problem, the yellow region shows there the network might have a voltage problem depending on where PV and energy storage is located and in the red region a voltage problem will always occur. The solid horizontal black line shows the limit for voltage rise 73

Figure 5-8: Feasible locations for (a) home storage and (b) street storage 77

Figure 5-9: Overview of genetic algorithm implemented with the MATLAB Optimization Toolbox 78

Figure 5-10: An LV network with five feasible locations for home energy storage (labelled A-E) 79

Figure 5-11: Construction of a fixed penalty function for the problem of locating energy storage to prevent overvoltage in LV distribution networks	80
Figure 5-12: Construction of different fitness functions for the problem of locating energy storage to prevent overvoltage in LV distribution networks	80
Figure 5-13: Fitness of genetic algorithm with different penalty values, ρ , in the fitness function when applied to network MA	81
Figure 5-14: Three processes for generating new population in the MATLAB genetic algorithm	82
Figure 5-15: Comparison of selection methods based upon (a) the fitness of solutions and (b) the standard deviation of solutions	83
Figure 5-16: (a) Time (in seconds) to complete genetic algorithm and (b) average solution fitness with different population sizes and number of generations for a LV network.....	83
Figure 5-17: (a) Time (in seconds) to complete genetic algorithm and (b) average solution fitness with different population size and number of generations for a single LV network after all parameters have been optimised.....	84
Figure 5-18: Voltage rise in two residential LV networks before and after the heuristic is used to locate home energy storage at optimal locations within them. The black horizontal line indicates the maximum permitted voltage rise in each network.....	85
Figure 5-19: Number of energy storage installed by heuristic to mitigate overvoltage. Network A contains 360 loads (homes) and network B contains 348 loads (homes)	86
Figure 5-20: Cost of energy placing energy storage in networks to alleviate voltage constraints for two different LV distribution networks. The black horizontal line indicates the reinforcement cost. The green zone labelled A is where storage is always more affordable, the yellow zone labelled B is where storage might be more affordable and in the red zone storage is always more expensive than reconductoring.....	86
Figure 6-1: Section of ENWL network showing urban (red polygon) and rural (blue polygon) networks.....	89
Figure 6-2: (a) A typical LV transformer and associated equipment and (b) photograph of MV and LV cables in a secondary transformer substation	90
Figure 6-3: GIS image of transformers with (a) 10 LV feeders and (b) no LV feeders.....	90
Figure 6-4: Primary substation transformers in the ENWL GIS map.....	91
Figure 6-5: A typical section of a domestic LV network showing feeders, service cables and homes.....	91
Figure 6-6: (a) A typical LV link box and (b) a schematic of the connectivity of a link box.....	92

Figure 6-7: (a) Street light within GIS diagram and (b) the same street light visible on Google Street View	92
Figure 6-8: (a) Relationship between phase resistance and (b) reactance to the cross-sectional area of copper ENWL cables	96
Figure 6-9: Histogram of the cross section area of all cables in the ENWL distribution network (a) by percentage of cables and (b) scaled by the cable length	96
Figure 6-10: (a) An LV cable demarked by orange coloured vertices and (b) the same LV cable with additional vertices shown in green. A service cable is shown in blue with blue vertices. ...	97
Figure 6-11: (a) Histogram of the distance between vertices in LV cables, (b) percentage of cable sectors which are split into sub 1m sections versus different numbers of interpolation points (c) total memory requirement for different numbers of interpolation points and (d) time needed to calculate vectors for different numbers of interpolation points	97
Figure 6-12: Determination of the number of loads at each service cable	99
Figure 6-13: Area in network where load phase is (a) sequential and (b) not sequential. Phase labels are circled blue and the notation for phases is “R” for red, “BL” for blue and “W” or “Y” for yellow	100
Figure 6-14: A section of network where the length of street light cables is comparable to the length of load cables	100
Figure 6-15: (a) House with a South facing roof and PV panels, (b) house with a service cable within $\pm 45^\circ$ of South but which does not have a South facing roof and (c) house with a service cable which is oriented East-West but which does have a PV system.....	101
Figure 6-16: (a) Orientation of all of the service cables in the ENWL network relative to North-South and (b) measurement of the angle of service cables 1-4 relative to the North-South direction.....	102
Figure 6-17: Procedure for extracting data from MapInfo files for use in MATLAB	102
Figure 6-18: Flowchart showing procedure for automatic LV model creation from the GIS database.....	106
Figure 6-19: A GIS section where the ends of two different feeder cables are close together	107
Figure 6-20: Additional length of feeder cable on network BL	108
Figure 6-21: Automatically generated model for KC showing where the network correctly ends at a normally open linkbox (blue box) and at a cluster of connection points (red box).....	108
Figure 6-22: A node in network KC which connects 5 loads but where the GIS will only identify 1	109

Figure 6-23: Boxplots of the range of voltage drop on the manually and automatically created network models in the case study area.....	110
Figure 6-24: Pie chart of the percentage of (a) feeder and (b) service cables connected to the models.....	111
Figure 6-25: Map of connected (blue) and unconnected (red) feeder cables in the centre of Blackpool.....	112
Figure 6-26: (a) An isolated section of network which is has no obvious transformer in the GIS and (b) a cable section which is missing from the GIS map	112
Figure 6-27: (a) Reasons why cables are not connected according to a random sample of 50 cables and (b) the overall performance of the algorithm including the information from this sample.....	112
Figure 6-28: Fraction of networks that pass the selection criteria	114
Figure 6-29: (a) LV networks which have fewer than 50 loads and (b) a rural transformer serving a farm	114
Figure 6-30: Histogram of the feeder cable length in each network (a) before and (b) after selection criteria area applied	115
Figure 6-31: Histogram of the number of feeders in each network (a) before and (b) after selection criteria	115
Figure 6-32: Histogram of the voltage drop in each LV network (a) before and (b) after the selection criteria area applied with each load set to 1 kW.....	116
Figure 6-33: Map of cables included in network models in Salford (shown as red). The majority of these are in the residential areas around the central industrial area (i.e. outside the yellow polygon).....	116
Figure 6-34: Probability density function of (a) the number of loads and (b) the PV dispersion level per transformer after the section criteria are applied.....	117
Figure 6-35: (a) Voltage variation at each secondary transformer in Figure 4-2 with a PV dispersion level of 100% in (a) one network at a time and (b) aggregated effect if all suitable homes in all of the LV networks install PV.....	119
Figure 6-36: (a) Increase in transformer voltage for all case study networks at different dispersion levels with 2.5 kW PV and a minimum demand of 0.2 kW and (b) the gradient of the graph of transformer voltage increase against dispersion level for different PV ratings on the upper and lower feeder	120
Figure 7-1: Forecast for future PV integration in residential networks (total dispersion level across entire ENWL network)	124

Figure 7-2: Deviation in reconductoring cost under extreme clustering scenario and different overall PV dispersion levels across the ENWL network 126

Figure 7-3: Boxplots of (a) the voltage rise and (b) the reconductoring cost of each LV feeder when the PV dispersion level is 50% the storage dispersion level is 0% and PV systems of 3.6 kW are installed..... 126

Figure 7-4: Boxplots of (a) the voltage rise and (b) the reconductoring cost of each LV feeder when the PV dispersion level is 50% the storage dispersion level is 50% and PV systems of 3.6 kW are installed..... 127

Figure 7-5: (a) Number of LV feeders in ENWL residential LV networks which will violate voltage constraints and (b) the number of PV systems in problematic feeders according to the four forecasts for PV dispersion level..... 127

Figure 7-6: Histogram of total voltage deviation (MV plus LV voltage deviation) with a PV dispersion level of 36% and a safety margin, V_S , of 0.005 p.u. 128

Figure 7-7: (a) Percentage of feeders which need to be reconductoring and (b) the reconductoring cost under different load growth scenarios and no voltage rise..... 128

Figure 7-8: Probability of a voltage problem when the peak load is 10% and 20% higher than it is presently. Feeders are sorted according to their length..... 129

Figure 7-9: Number of LV feeders with voltage problems under the FiT PV integration scenario with different percentage growths in peak demand per year 129

Figure 7-10: For different PV dispersion levels (a) the percentage of networks with and without overvoltage in the ENWL network and (b) the PV capacity which is constrained and not constrained by voltage problems in LV networks. 130

Figure 7-11: Percentage of feeders which have overvoltage when they are sorted by the total length of cable within each feeder 131

Figure 7-12: Number of problematic LV feeders (feeders with overvoltage) (a) if the networks are stochastically assigned to different MV feeders (b) if the safety margin is changed (c) if the demand during the worst voltage rise condition is changed (d) if the PV capacity is changed and (f) if the PV is stochastically determined using the probability distribution shown in (e). A PV dispersion level of 36% is used throughout with no energy storage..... 134

Figure 7-13: Performance of an LV network with five energy storage scenarios 1. storage at the secondary transformer 2. storage randomly installed by customers with PV. 3. storage randomly installed by any customers. 4. storage installed in customer homes with the location optimised by the DNO and 5. three phase energy storage on the street. Voltage profiles with and without storage are shown on the left for each scenario which includes the highest LV and MV voltages. Red lines are the voltage before energy storage and blue the voltage after storage is installed. The upper right figure shows the reduction in voltage rise, the middle right shows the required

storage rating and the lower right figure shows the number of storage units that are installed. The PV location is the same in all of the figures.	137
Figure 7-14: Comparison of stochastic and optimised storage location within an LV network. The original worst case voltage within the network when all PV systems are installed and generating and maximum power is shown in red. The worst voltage rise after storage is installed is shown in blue. The locations of energy storage are shown as blue bars on the figures. All storage units have the same power rating as the PV and are single phase. This figure only shows the LV voltage rise component as opposed to the transformer and LV voltage rise shown in Figure 7-13.	138
Figure 7-15: Number of problematic LV feeders if present PV install rate continues with and without energy storage installed at secondary transformers	139
Figure 7-16: Number of problematic LV feeders when energy storage is installed with different dispersion levels under the FiT scenario	140
Figure 7-17: Number of problematic feeders with different amounts of stochastically applied home storage and storage at the secondary transformer in (a) 2030 and (b) 2050	140
Figure 7-18: Installed energy storage under the FiT PV scenario	141
Figure 7-19: (a) Histogram of the number of home storage units placed in each problematic feeder with a 34% PV dispersion level and (b) number of home storage systems installed with optimal location using the genetic algorithm compared to a free market under the FiT scenario	142
Figure 7-20: (a) Histogram of the number of street storage units placed in each problematic feeder with a 34% PV dispersion level and (b) number of storage systems installed with home, street and a stochastic storage installation	142
Figure 7-21: For the FiT scenario in 2030 (a) the number of storage systems installed in the networks under different scenarios and (b) the total rating of installed storage	143
Figure 7-22: For all of the networks, (a) the number of phases which experience a voltage problem and (b) the worst case voltage unbalance factor with a PV dispersion level of 34% .	143
Figure 7-23: Number of energy storage units installed with 5 kW optimally located street storage compared to 25 kW street storage and optimally located home storage.....	144
Figure 7-24: Histogram of the voltage headroom in previously problematic networks after (a) 25 kW street storage and (b) 5 kW home storage is installed	144
Figure 8-1: Expected reconductoring costs for ENWL under each of the PV installation scenarios with no energy storage installed in their networks with (a) a 0.01 p.u. safety margin and (b) no safety margin	148

Figure 8-2: Expected reconductoring costs for ENWL under each of the PV installation scenarios with energy storage stochastically installed by customers in their homes	149
Figure 8-3: Expected reconductoring costs for ENWL under the FIT PV installation scenarios with energy storage stochastically installed by customers in their homes compared to secondary transformer storage	149
Figure 8-4: Number of energy storage units installed under different PV and storage take up scenarios	151
Figure 8-5: Cumulative cost of installing energy storage under different stochastic and optimally located storage scenarios	152
Figure 8-6: Value of each energy storage system to the DNO if it is stochastically installed in the network compared to a (discounted) home storage system cost	153
Figure 8-7: Percentage of networks where overvoltage is solved with storage if either home or street storage is selected	154
Figure 8-8: Comparison of optimally located home and street storage in terms of the percentage of feeders where home or street storage is cheaper for different PV dispersion levels	155
Figure 8-9: Total cost of network reinforcement to alleviate overvoltage under the FIT PV scenario where (a) the DNO meets all of the storage cost and (b) the DNO subsidises stochastically located home storage	156
Figure 8-10: For different reconductoring costs (a) the total reinforcement costs (storage and reconductoring) and (b) the percentage of networks where optimally located home storage is chosen under the FIT PV scenario.....	157
Figure 9-1: Present and future UK energy storage projects including targets on the right (Electricity Storage Network 2014)	167

List of Tables

Table 1-1: Technical challenges to the power network infrastructure for transition to a low-carbon electricity system (Energy Research Partnership 2010)	4
Table 1-2: List of LCNF projects which include distributed energy storage (Ofgem 2014a)	8
Table 1-3: Summary of services and benefits that energy storage can achieve across power system (Akhil et al. 2013).....	9
Table 2-1: Overview of technologies used in a selection of grid connected RES and CES projects.....	27
Table 3-1: Example of a 8 bus LV network including secondary transformer, 11kV voltage source and a number of low voltage (230V) cables, loads and PV systems as defined in OpenDSS models in this network. LV voltages are measured relative to the secondary transformer LV busbar at A.....	35
Table 3-2: Maximum and minimum household demands used by different sources.....	37
Table 3-3: Summary of cost parameters.....	45
Table 3-4: Technology specific decentralised energy storage cost parameters.....	46
Table 3-5: Final cost parameters of different battery types	46
Table 4-1: Properties of the case study networks.....	49
Table 4-2: Summary of parameters from measured data.....	57
Table 4-3: Dispersion level required for transformer ratings to be exceeded under reverse power flow in the three most problematic case study LV networks	59
Table 5-1: Confidence intervals for voltage rise.....	69
Table 5-2: Voltage rise regions in Figure 5-7.....	72
Table 5-3: Default and selected parameters for genetic algorithm in MATLAB Optimisation Toolbox.....	84
Table 6-1: Manual determination of the number of loads connected to each service cable from GIS representation of the ENWL network.....	94
Table 6-2: Probability distribution of the number of loads connected to each service cable in case study LV networks	99
Table 6-3: Parameters used to describe each section of LV feeder cable which makes up the LV model.....	103
Table 6-4: Table of number of ways, number of loads, potential number of PV systems and network length compared to the manually created network models.....	109
Table 6-5: Parameters used to identify feasible urban residential networks	114

Table 6-6: Summary of selected networks for further analysis 117

Table 6-7: Derived constants for upper and lower MV feeder 121

Table 7-1: Installed PV capacity and annual generation under three scenarios for DNOs to permit PV installation 131

Table 8-1: Cost of home and street storage under the financial model described in Chapter 3 150

Table 8-2: Comparison between distributed storage cases in this study to existing pumped hydro resources (data on the latter is taken from (Wilson et al. 2010) and (SSE 2014)) 158

Table 8-3: Benefit through increased self-consumption of PV for homeowners under different tariffs in addition to the Feed-in-Tariff 158

List of abbreviations

CAES	Compressed air energy storage
CES	Community energy storage
CSV	Comma separated value file type
ENWL	Electricity North West Limited
EPRI	Electric Power Research Institute
EV	Electric Vehicle
GIS	Geographic Information System
HP	Heat pump
LCNF	Low Carbon Networks Fund
LV	Low voltage, associated with the low voltage (400V) network in this thesis
MV	Medium voltage, associated in this thesis with networks operating above 400V.
Ofgem	Office of gas and electricity markets
OLTC	On-load tap changer
PV	Photovoltaic (solar photovoltaic module)
RES	Residential energy storage
SMUD	Sacramento Municipal Utility District
SP	Scottish Power
SSE	Scottish and Southern Energy

Glossary

Centroids	Geometric centre of a GIS component
MATLAB	Modelling software for efficient matrix calculation
Metadata	Extra data to describe components in the GIS database
OpenDSS	Open source distribution system simulator produced by EPRI
Shapefile	Format for describing geographical data
Upstream	Cables or components which are electrically closer to the transformer, i.e. those which, in traditional networks would be the sending end.

Nomenclature

English

A	Cross-sectional area of the conductor of a LV cable [m^2]
C	Future cash flow to be discounted using net present value calculations [£]
C_C	Capacity cost of an energy storage system [£/kWh]
C_{CAP}	Capital cost of an energy storage system [£]
C_{ES}	Cost to install and purchase an energy storage system for an LV network [£]
C_I	Install cost for an energy storage system [£/system]
C_{kW}	Cost of an energy storage system per unit of power installed [£/kW]
C_L	Cost of roundtrip efficiency losses of an energy storage system to a DNO as a result of additional network losses per year [£/year] C_P Power cost of an energy storage system [£/kW]
C_{LI}	Ofgem cost of losses (loss incentive) as charged to DNOs [£/kWh]
C_M	Fixed annual maintenance cost of operating an energy storage system [£/kW/year]
C_P	Power cost of an energy storage system [£/kW]
C_R	Cost to reconnector a feeder of an LV network [£/m]
C_{RP}	Replacement cost of an energy store [£]
C'_L	Present value of total cost of losses over lifetime of an energy storage system [£]
C'_M	Present value of total maintenance cost over lifetime of an energy storage system [£]
C'_{RP}	Present value of total replacement cost over lifetime of an energy storage system [£]
d	Discount rate used in net present value calculations [%]
D	Maximum allowable depth of discharge of an energy storage system [%]
E_L	Total annual energy throughput for an energy storage system [kWh/year]
i	Inflation rate used in net present value calculations [%]
L	Length of cable in an LV feeder [m]
n	Number of stochastic placements of PV and energy storage in a network [no unit]

NPV	Net present value of future value C [£]
N_c	Number of times that an energy storage system is cycled per year [cycles/year]
N_{ES}	Number of energy storage systems installed in a residential LV network
N_H	Number of homes in a residential LV network
$N_{H,PV}$	Number of homes in a residential LV network where rooftop solar photovoltaics can feasibly be installed
N_{PV}	Number of homes in a residential LV network with rooftop solar photovoltaics
p	Dispersion level of PV in a network [%]
P	Real power flow through a line segment [W]
P_{ES}	Rated power of an energy storage unit [kW]
P_H	Real power demand of a home [kW]
P_{PV}	Rated (maximum) power of a solar photovoltaic system [kWp]
P_T	Rated power of secondary transformer [kW]
q	Dispersion level of home energy storage in a network [%]
Q	Reactive power flow through a line segment [VAR]
r	Maximum reverse power flow across secondary transformer as an index of the transformer rating [kW/kW]
R	Known resistance of a line segment [Ω or p.u.]
R_0	Calculated resistance of an LV cable of cross-sectional area A [Ω]
s	Number of selected values from n values [no unit]
t	Storage time: total time that energy storage system can charge or discharge at the rated power [hours]
VUF	Voltage unbalance factor [%]
V_1, V_2	Voltage at ends 1 and 2 of a line segment [V or p.u.]
V_a, V_b, V_c	Voltage of phase a , b and c respectively [V or p.u.]
$\overline{V_{abc}}$	Average phase voltage [V or p.u.]
V_{dev}	Difference between total voltage deviation in an LV network and the regulatory limit for voltage deviation [V]
$V_{i,n}$	Voltage at node/busbar i in LV network n [V or p.u.]
V_s	Safety margin between modelled voltage deviation and regulatory voltage deviation in an LV network [p.u.]

$V_{T,n}$	Voltage at LV busbar of secondary transformer of LV network n [V or p.u.]
$V_{T,n}^{max}$	Highest voltage at secondary transformer LV busbar serving network n [V or p.u.]
$V_{T,n}^{min}$	Lowest voltage at secondary transformer LV busbar serving network n [V or p.u.]
ΔV^+	Voltage rise over a line segment [V or p.u.]
ΔV^-	Voltage drop over a line segment [V or p.u.]
$\Delta V_{LV,n}^+$	Maximum voltage rise across LV network n at time of minimum load at peak generation [V or p.u.]
$\Delta V_{LV,n}^-$	Maximum voltage drop across LV network n at time of maximum load [V or p.u.]
\bar{x}_n	Mean voltage rise for network n , for a given PV dispersion level, p , and storage dispersion level, q [V or p.u.]
x_1, x_2	Latitude of end points of a section of LV cable
X	Known reactance of a line segment [Ω or p.u.]
X_0	Calculated reactance of an LV cable of cross-sectional area A [Ω]
y	Years until future cash flow, C , occurs [year]
y_1, y_2	Longitude of end points of a section of LV cable
<u>Greek</u>	
α_n	Total deviation of voltages at LV busbar of secondary transformer n without any distributed generation or energy storage [V or p.u.]
β_n	Incremental deviation of voltages at LV busbar of secondary transformer n with additional PV and energy storage installed [V or p.u.]
η	Round trip efficiency of an energy storage system [%]
θ	Voltage phase angle [units]
ρ	Penalty per unit of voltage deviation used to calculate fitness of an energy storage solution for an LV network [£/V]
σ_n	Standard deviation of voltage rise for network n , for a given PV dispersion level, p , and storage dispersion level, q [V or p.u.]
ϕ	Angle of a LV service cable relative to the North-South line [degrees]

Chapter 1: Introduction to electricity networks

The UK electricity networks are designed to deliver controllable and centralised generation to distributed and uncontrollable loads. The transmission network carries the bulk movement of power at very high voltage between power stations and load centres through approximately 23,000 km of lines. Over 1,500 grid-supply transformers link the transmission and distribution networks (National Grid Company 2011a). These distribution networks connect customers at all voltage levels to transmission (Shaw et al. 2010) (Harrison 1999). Overall, Great Britain has a distribution network of approximately 910,000km of lines and cables and 690,000 substations (Electricity North West Limited 2011; Western Power Distribution 2011; UK Power Networks 2011; Scottish Power 2011; Scottish and Southern Energy 2011; Central Networks 2011). An overview of the system is shown in Figure 1-1 with the transmission system in blue and the distribution system in green.

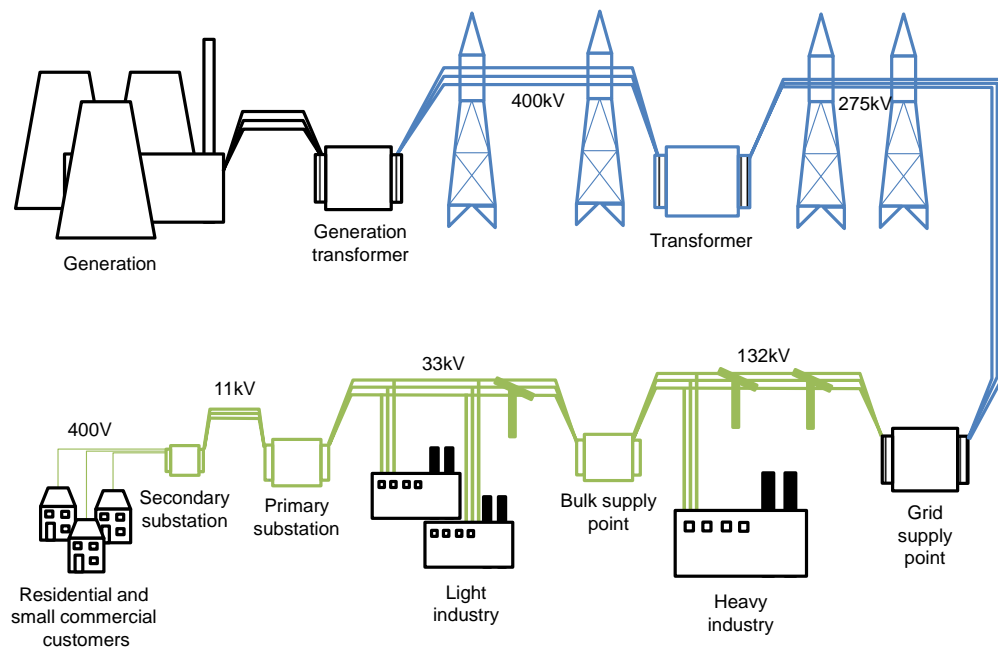

Figure 1-1: Overview of the electrical power network including indicative voltage levels. Blue sections are transmission assets and green assets are distribution assets

The electricity industry comprises a number of separate companies, overseen by The Office of Gas and Electricity Markets (Ofgem). As the regulator, Ofgem must protect customer interests by ensuring competition, investment and the development of a more environmentally sustainable system (Department of Energy and Climate Change 2009b; Ofgem 2011a). This is done through a number of financial incentives.

Generation companies are responsible for producing electricity which is sold on the wholesale market. The cost of generation accounts for 63% of the final customer bill (Ofgem 2011b). Supply companies buy the generated electricity which they sell to consumers on the retail market (HM Treasury & Department of Energy and Climate Change 2010; Ofgem 2005).

National Grid (National Grid Company 2014) operates the Great Britain transmission system and ensures a balance between the supply of electricity and electrical demand (National Grid Company 2011a). The transmission network itself is owned by three regulated regional monopolies: National Grid, Scottish Power Transmission Limited and Scottish Hydro-Electric Transmission Limited (Ofgem 2011c).

Distribution Network Operators (DNOs) own and make money from the distribution system. As of April 2014, six companies operate the fourteen distribution networks in Great Britain (Figure 1-2). The revenue that DNOs receive is regulated by Ofgem because each has a regional monopoly on electrical power distribution (Ofgem 2010a).

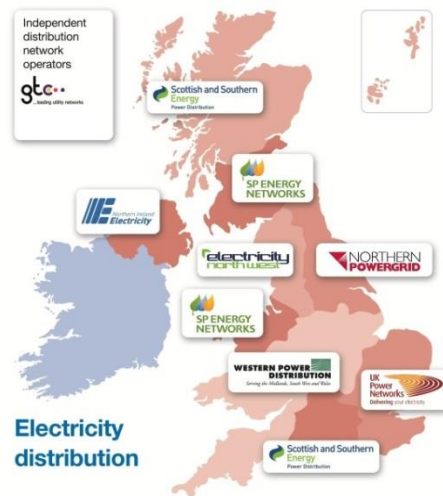

Figure 1-2: Operating areas of the UK Electricity distribution network companies in April, 2014
(Electricity Networks Association 2014)

The existing UK electrical power system is experiencing fundamental change. In 2010, most of the UK's electricity was supplied by fossil fuel power stations supplemented by nuclear, interconnectors and renewables. In the late 20th Century, there were a number of energy supply challenges due to problems such as miner's strikes, fuel blockades and falling British gas production (Parliamentary Office of Science and Technology 2004), (Department of Energy and Climate Change et al. 2011). In response to this and given environmental concerns, the Government is diversifying supply and to increase the amount of locally and sustainable sourced energy (Department of Energy and Climate Change 2011b; Department of Trade and Industry 2007).

Under the Climate Change Act, the UK will reduce carbon dioxide emissions to 80% below 1990 levels by 2050 (Climate Change Act 2008). The electricity sector contributes 35% of all greenhouse gas and 34% of all carbon dioxide emissions in the UK (Department of Energy and Climate Change 2014b) and the Committee on Climate Change recommends reducing average carbon dioxide emissions in the power industry from 540 gCO₂eq/kWh in 2008 to 50 gCO₂eq/kWh by 2050 (Committee on Climate Change 2010). Accordingly, the UK is set to install 29 GW of renewable generation capacity to meet 15% of the country's energy needs by

2020 (Department of Energy and Climate Change 2011c). These changes to generation are compounded by electrification of heating and transport sectors (Energy Research Partnership 2011; Department of Energy and Climate Change 2012c) and a rising population (Roberts 2008). In the future, electricity will supply nearly all of the UK's final energy, up from a third in 2012.

To decarbonise, the generation mix in the UK will have to change. This will likely require some combination of new nuclear and other low-carbon generation (Wilson et al. 2010; Denholm & Hand 2011). A number of pathways to achieve this are proposed (Department of Energy and Climate Change 2011a; Energy Research Partnership 2011). Under all future scenarios, there is expected to be increase in renewables embedded in distribution networks. This is called distributed generation (DG).

1 Distributed generation

In the UK, certain distributed generation technologies are subsidised using a Feed-in-Tariff (FiT). Subsidised technologies include wind, solar PV, anaerobic digestion, combined heat and power and hydro (Ofgem 2014c). This was legislated in April 2010 in part to encourage the development of small scale, low carbon electricity generation (National Grid Company 2011b; Department of Energy and Climate Change 2009a). The cost of the FiT is shared among suppliers according to market share (Department of Energy and Climate Change 2012a) and ultimately adds to the customer bill. Through this market mechanism, the Government is encouraging the expansion of DG to help meet renewable integration targets (Department of Energy and Climate Change 2009c).

A number of technologies are already connected to distribution networks (Ofgem 2014b) and as more and more DG is installed, it will present a number of challenges across the power system (as summarised in Table 1-1). These include large scale integration of renewables with inflexible generation, impacts of distributed generation on the distribution network, ensuring existing infrastructure will continue to operate, engaging with customers and meeting new demand. It is important to study and understand these challenges if companies are to ensure that the future power network will function correctly and cost-effectively.

Table 1-1: Technical challenges to the power network infrastructure for transition to a low-carbon electricity system (Energy Research Partnership 2010)¹

System Level Issue	Technical Challenges
Large Scale Intermittent renewables and inflexible generation resources	System security: Large scale penetration of intermittent renewables with limited capacity value requires back-up (generation, responsive demand or storage). System balancing with inflexible plus intermittent generation resources presents an additional challenge. System flexibility will be required from non-traditional sources (storage and demand response). Challenges also arise from minimum demand periods when there may be excess (uncontrollable) generation on the system.
	Ancillary services: System management from intermittent renewable resources
	Fault management: Mitigating network faults caused by renewables. Generation availability post-fault
	Network access: Timely connection of renewables
	Offshore networks: Building new networks to reach resources offshore (e.g. Wind & marine). Connecting to onshore grid (connections at distribution level, linking on- and off-shore systems etc.). Extending connections to mainland Europe
Distributed Generation	System security: DG not visible to system operator. Uncontrollable resource.
	Ancillary services: Use of DG resources for system management (small scale, limited availability, intermittent etc)
	Fault management: Mitigating/minimising network faults/problems caused by DG
	System operation: Bi-directional flows, over stressed network (larger flow, exceeding design ratings) increased requirement for automation of operation at distribution level
Customer Engagement	Transparency in service provision: Increased customer involvement required, networks will need to be able to provide transparency in operation, customers need to see the cost and value of their actions in network terms.
	Interaction with other networks: Involvement of new communications systems, linking heat, transport, gas etc.
	Data handling and data protection: Managing large volumes of granular real time data (and control signals) passing in both directions from consumer to network. Dealing with data protection, data security and new network vulnerabilities.
Existing Infrastructure	Optimising existing networks: Increase capacity of existing networks, losses reduction, infrastructure life extension, reducing CO ₂ footprint, flexible use of networks, minimising use of SF ₆ as an insulant
	Interaction with other networks: E.g. gas, carbon, hydrogen, biogas, Local heat
New Electricity Demand	System reliability: Accommodating more demand from new sectors and responding to changing patterns of energy use (e.g. implication of altered diurnal or seasonal variations) increasing the capacity of the network. Issue at both transmission and distribution level.
	Ancillary services: Using new resources on the demand side for system management

¹ Note that that only the smallest units DG are not visible to the system operator.

In order to be commercially viable, on-shore wind turbines need to be connected to the medium voltage or higher voltage networks. Off-shore wind turbines are connected to the highest voltage networks, particularly the transmission network. Anaerobic digesters are built at sites where suitable fuel can be found such as at farms or sewage works. There are few examples of small scale hydro in the UK as there are few locations where new hydro can be installed. High capacity photovoltaics (PV) are installed on farms and industrial premises.

In addition to these forms of generation, a large number of people have purchased small (0-4 kWp) rooftop PV systems. For homeowners, residential PV can reduce their consumption of grid electricity and gas during the day, reduce their energy bill as well as gaining revenue from the FiT (Yong et al. 2012). In Figure 1-3 it can be seen that, as of February 2014, around 450,000 small PV systems have been installed across in the UK. These are almost exclusively installed in low voltage (LV) power networks. As the most widely installed technology, the impact of larger amounts of PV on the LV networks presents a pertinent research focus. These impacts can be negative and cause problems for network operators. Where PV is identified to cause problems with the network, the DNO is legislated to meet the cost of mitigation. This is traditionally achieved using new cables (called reconductoring). However this is expensive and there is interest in alternative methods. One technology to alleviate these constraints is distributed electrical energy storage. The concept of distributed energy storage is now introduced.

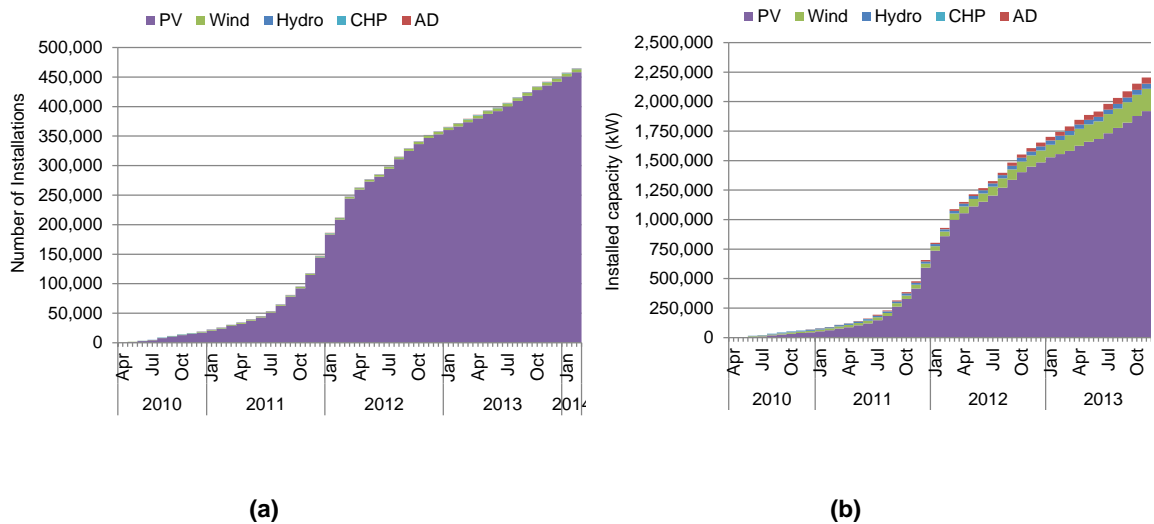

Figure 1-3: (a) Cumulative number and (b) installed capacity of renewable systems registered under the UK FiT (April 2010 - February 2014). PV is photovoltaics, CHP is micro combined heat and power and AD is anaerobic digestion (Department of Energy and Climate Change 2014e)

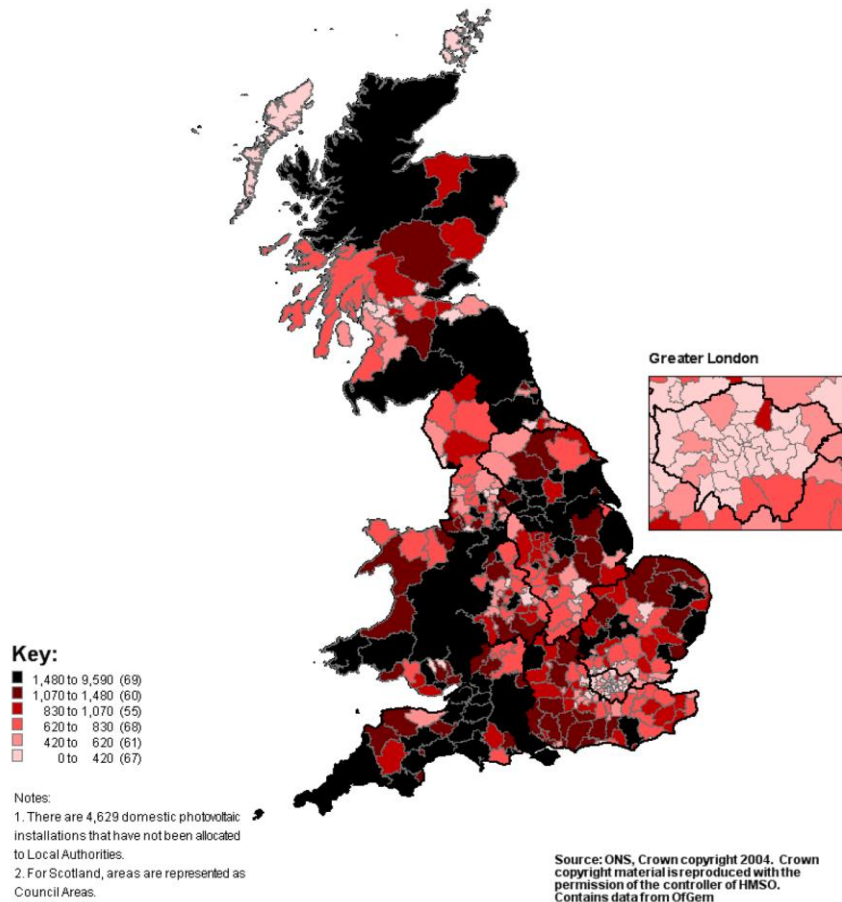

Figure 1-4: The number of PV systems per local authority installed in the UK, June 2013
 (Department of Energy and Climate Change 2013)

2 Electrical energy storage

Wind and solar power systems are inherently uncontrollable, in that the amount of energy produced depends on meteorological conditions. In an electricity system which needs to balance supply and demand, it is widely anticipated that energy storage will be required to enable renewables to provide reliable power. Electrical energy storage is an umbrella term for a range of technologies which allow energy to be captured and subsequently used at a later time. Reviews and comparisons of different electrical energy storage technologies and applications can be found in (Beaudin et al. 2010; Chen et al. 2009; Dell & Rand 2001; Díaz-González et al. 2012; Divya & Østergaard 2009; EPRI 2010; Evans et al. 2012; Eyer & Corey 2010; Ferreira et al. 2013; Hadjipaschalis et al. 2009; Hall & Bain 2008; Ibrahim et al. 2008; Rahman et al. 2011; Roberts & Sandberg 2011; Ter-Gazarian 1994; Van den Bossche et al. 2006). By reviewing these it is determined that energy storage can be broadly split into three main technology groups. These are represented diagrammatically in Figure 1-5.

Large scale energy storage includes pumped hydro and compressed air for megawatt to gigawatt transmission level applications. Pumped hydro storage requires two reservoirs of water. During charging, water is pumped from the lower to upper reservoir. During discharge,

the water in the upper reservoir is released through turbines into the lower reservoir. In compressed air energy storage, charging is completed using a compressor to pressurise air in some form of container (usually a large underground cavern). During discharge, this pressure is released through a turbine to generate electricity. Both pumped hydro and compressed air storage are restricted geographically as to where they can be deployed.

Distributed storage includes electrochemical and flow batteries. Electrochemical batteries (lead acid, lithium ion, sodium sulphur etc.) have low energy density, high maintenance costs, short life and potentially toxic chemicals after life. This has limited their application. However, they offer long storage durations, are scalable and can be located in most parts of the power system (especially compared to pumped hydro and compressed air) and are widely seen as a storage technology which will be installed to offer services to the power system.

Short term storage includes flywheels, (super) capacitors and superconducting magnetic energy storage (SMES). Such storage systems have high round-trip efficiencies (up to 95%), can provide large amounts of power in a very short response time and have long cycle lives. However, they have very high capacity costs (£/kWh). Capacitors and flywheels also have high self-discharge making them unsuitable for economical storage of energy for long periods of time. These technologies are therefore used or proposed for short power quality applications such as reducing transient voltage rise and drop (particularly for industrial customers with sensitive equipment), ride through of short power cuts, bridging power between different supplies, reactive power support and as a “spinning” reserve.

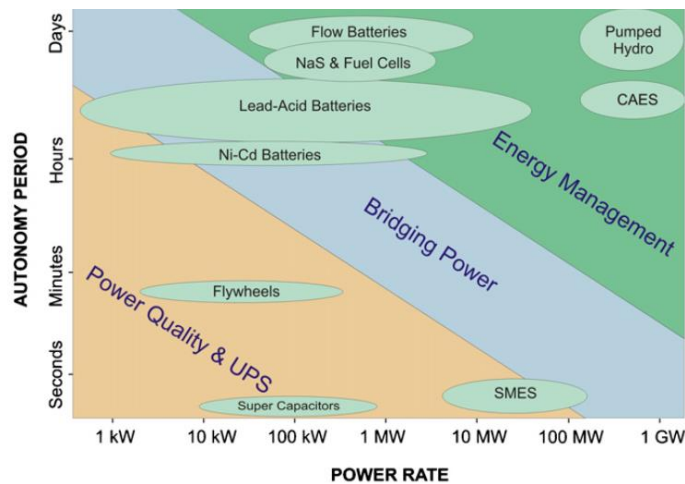

Figure 1-5: Applications for ESS technologies for different autonomy period and power (Kaldellis & Zafirakis 2007)

Presently, nearly all grid storage is pumped hydro (EPRI 2010). Two compressed air energy storage installations exist, the first installed in Germany in 1978 and the second in Alabama, USA in 1991 (Schaber et al. 2004). Some smaller storage facilities exist as technology demonstrations or for specialist applications such as flywheels for frequency regulation in New York (Strbac et al. 2012) and a Ni-Cd battery demonstration plant in Fairbanks, Alaska to prevent customer disruptions (McDowall 2005). The largest medium of rechargeable energy

storage in the UK is pumped-hydro which has a capacity of 17.6 GWh and provides around 1.1% of electricity demand (Mackay 2008). This provides fast responding balancing services and has led to a proven and understood business case for transmission level storage.

In response to the large scale integration of renewables, the market for UK energy storage is changing. Indeed, energy storage was recognised by Chancellor George Osborne as a key technology for larger renewable generation capacity (Shankleman 2012). Ofgem also recognise this and support a number of distributed storage projects with DNOs as listed in Table 1-2.

Table 1-2: List of LCNF projects which include distributed energy storage (Ofgem 2014a)

Project title	DNO	Project scope
1MW Battery, Shetland (SSET1001)	Scottish and Southern Energy	A 1MWe battery at Lerwick Power station used in conjunction with demand-side response to manage local network constraints (reducing peak demand, providing demand capacity, reducing renewable generation curtailment, reduce fuel consumption in power station, provision of ancillary services)
Orkney Energy Storage Park (SSET1007, SSET1009)	Scottish and Southern Energy	Use storage to reduce renewable curtailment, defer network reinforcement and find other revenue such as short term operating reserve and electricity price arbitrage
Low Voltage Network Connected Energy Storage (SSET1008)	Scottish and Southern Energy	Connection of three single phase 25kW/25kWh lithium ion batteries and demonstration of peak shaving, voltage management and safe connection to an LV network.
Demonstrating the benefits of short-term discharge energy storage on an 11kV distribution network (UKPNT1001)	UK Power Networks	Use of a 200kWh, 1 hour discharge battery to support a primary substation with distributed generation attached.
Customer led network revolution	Northern Powergrid	Includes storage projects as part of a wider project looking at how future networks and customers will perform and act.
Smarter Network Storage	UK Power Networks	Use of a 6MW/10MWh battery to manage thermal constraints on a primary substation and to trial methods of using storage to provide and earn revenue from other services to the power system.
BRISTOL	Western Power Distribution	Investigation of battery storage with PV in homes and schools to provide battery and network benefits – includes a tariff incentive to reduce peak energy consumption.

Storage can provide benefits across the power system as summarised in Table 1-3 and (KEMA 2012; Mohd et al. 2008; Moore & Douglas 2006; Wade et al. 2010; Walawalkar & Apt 2008). Presently, most storage operates in services 1 and 2, the vast majority of which is pumped hydro. However, building more pumped hydro is problematic in the UK due to a limited number of feasible locations. There is a consequent interest in using energy storage in the distribution network where further revenue might be available. Storage designed to support distribution infrastructure (point 4) can participate in the other services identified in this figure if it is correctly controlled and aggregated.

Table 1-3: Summary of services and benefits that energy storage can achieve across power system
(Akhil et al. 2013)

Service	Benefit	Description
1 Bulk energy	Energy time shift (arbitrage)	Purchasing and storage energy when the price is low and selling back when prices are high. This includes storing energy that would otherwise be curtailed
	Supply capacity	Reducing the need for new generating capacity by using storage to meet peak demands.
2 Ancillary	Regulation	Primarily this is the use of storage to manage frequency fluctuations and to bridge momentary fluctuations in generation and load.
	Spinning, non-spinning and supplemental reserves	Reserve capacity if a generation supply becomes unavailable.
	Voltage support	Displacing reactive power sources to maintain voltage within specified limits
	Black start	A strategic reserve of energy to energise the power system and help bring power stations online.
	Other uses	Load following, short term frequency response
3 Transmission infrastructure	Upgrade deferral	Relieving transmission system assets by strategically reducing peak demands
	Congestion relief	Providing energy to a local area when this cannot be met without overloading the transmission system
4 Distribution infrastructure	Upgrade deferral and voltage support	Deferring upgrades of the distribution network where load growth or changing generation/demands cause problems with peak loading or voltage
5 Customer energy management	Power quality	Protection of on-site loads from short term power quality events such as voltage spikes, voltage dips, frequency changes, harmonics and interruptions.
	Reliability	Supporting local loads in the event of power cuts
	Retail energy time shift	Reduce customer costs by purchasing and storing off-peak electricity to use during peak periods.
	Demand charge management	Reduce the peak demand to avoid peak demand charges.

2.1 Energy storage regulation in the UK

Energy storage integration in the UK faces a number of challenges as outlined below (source (Anuta et al. 2014)):

- Negative perceptions about energy storage after a pilot flow cell battery trial was stopped due to technical difficulties
- No specific regulation for energy storage which is considered a generator under licence conditions. This means that transmission and distribution network operators are restricted to smaller storage devices.
- Robust transmission and distribution networks so viability of storage is limited to small areas with specific issues

- No incentive for investing in energy storage such as Renewable Obligation Certificates (ROCs) or a Feed in Tariff.
- Storage is not considered to be an asset for DNOs and so they cannot recover investment costs for storage as a regulated asset.
- Wholesale price volatility is uncertain so the commercial success of using storage for electricity price arbitrage is difficult to predict

The need to reform the electricity market to enable storage is recognised by Government (Department of Energy and Climate Change 2010). The capacity mechanism (which rewards system actors for providing capacity) is one mechanism which can be structured to reward storage- the first auction for capacity will take place in December 2014 (Department of Energy and Climate Change 2014d). Storage is permitted to participate within this.

However, regardless of the design of the capacity market, there needs to be a clear mechanism by which savings that storage offers to the distribution network (for example preventing or deferring upgrades) are available to the owner of the storage. Otherwise, storage will not add as much value (or reduce costs) as it otherwise would in the power system.

3 Summary

The power grid of the future (see Figure 1-6) will be fundamentally different to the one presently operated in the UK. The requirements for greater energy security, reduced greenhouse gas emissions and decarbonisation of transport/heat do not just present issues with future supply of electricity: there are also going to be challenges using the UK electricity network to deliver electricity from new points of generation to points of consumption. Whatever the generation mix, the network must retain sufficient capacity to meet the peak demands; provide highly reliable delivery; and provide stable voltage quality (Willis & Scott 2000). As a consequence, there are expected to be a number of challenges in future distribution networks and particularly for DNOs. To overcome these, there is interest in the use of energy storage in the distribution system.

Chapter 2 presents a background literature review into the properties of the LV distribution network, the expected impacts of distributed generation on this and the proposed benefits of using distributed energy storage in response. This establishes a particular interest in voltage control and uncertainties about which energy storage topologies are most beneficial to DNOs.

Chapter 3 describes how LV distribution networks are modelled including a definition of loads, PV and the causes of voltage variation. This includes the establishment of a financial model.

Chapter 4 is a preliminary study into a set of case study LV networks. This includes analysis of measured network data and the results of work used in conference papers on the subject of planning for LV network storage. This also shows the need for planning tools.

Chapter 5 describes planning tools to investigate LV energy storage under uncertainty about where PV will be installed. A stochastic tool is presented to allow uncertainty about storage

location to be investigated. This is followed by a proposed heuristic approach to optimise the location of storage. The latter has been published in the International Journal of Electrical Power and Energy Systems.

Chapter 6 shows how models of over 9,000 power networks have been derived from a GIS map of the ENWL distribution network. The use of these network models with the planning tools defined in Chapter 5 allows a high level technical and financial analysis of the ENWL network. Chapters 7 and 8 present these technical and financial results to determine what energy storage can offer to DNOs and how much money this can save.

The results from this work are discussed and conclusions are summarised in Chapter 9.

The work has a particular focus on the UK power system especially that in the North West of the UK where a project sponsor, Electricity North West Limited (ENWL), operates a distribution network and has provided data to make study possible.

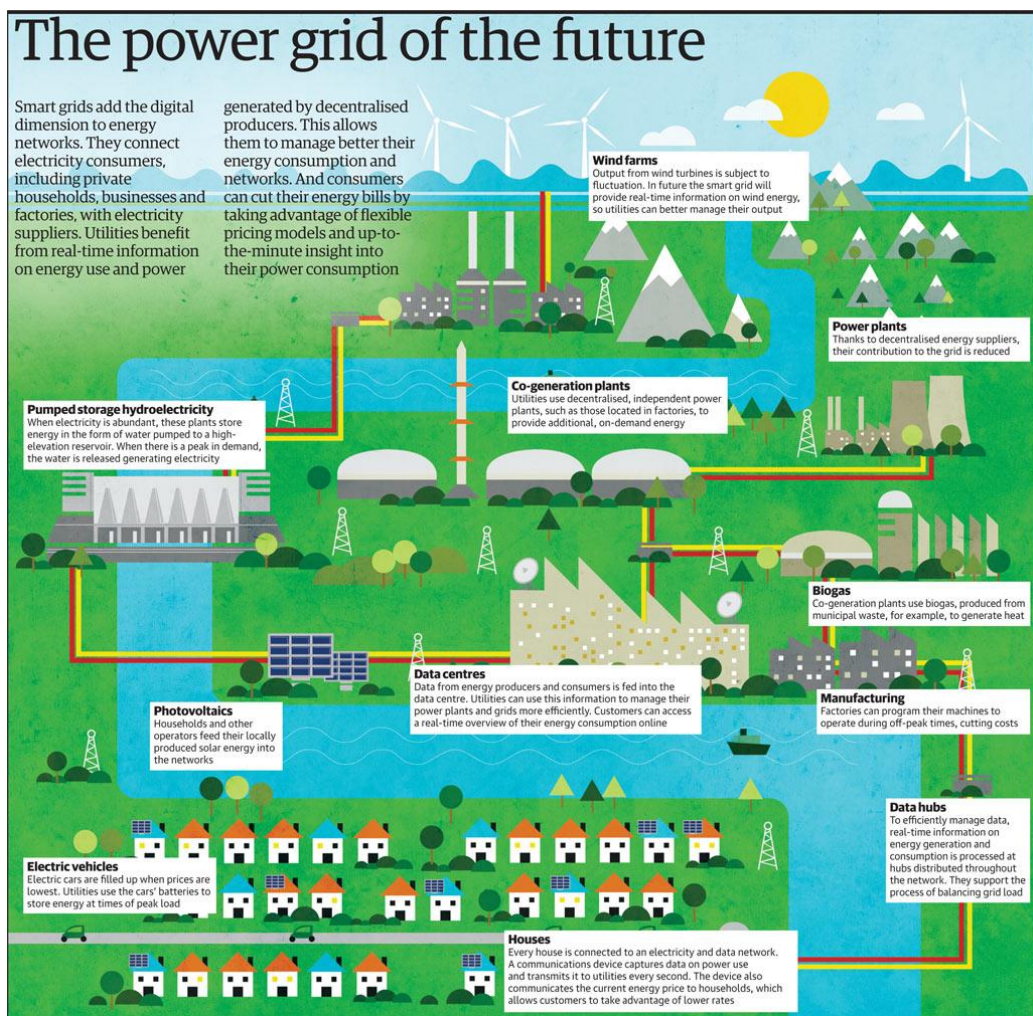

Figure 1-6: Simplified diagram of the future power grid showing wind farms and storage alongside traditional power stations in the transmission network, co-generation of electricity, demand side response in manufacturing, increased data monitoring in data hubs and centres and PV and electric vehicles in residential networks (The Guardian 2011)

Chapter 2: Distributed generation in the LV network and the potential role for energy storage

The electricity system was originally designed to transfer power from large central generation to demand. In the future, there is wide consensus that there will be increasing amounts of generation in the distribution system as shown in Figure 2-1. As a result, DNOs need to develop new ways of predicting the power flows and to establish how their expensive assets¹ will behave in the future. This chapter first reviews the expected impacts of changing power flows on the LV distribution network followed by a consideration of how mitigation measures, particularly energy storage, might be used to provide better management of a future power distribution system.

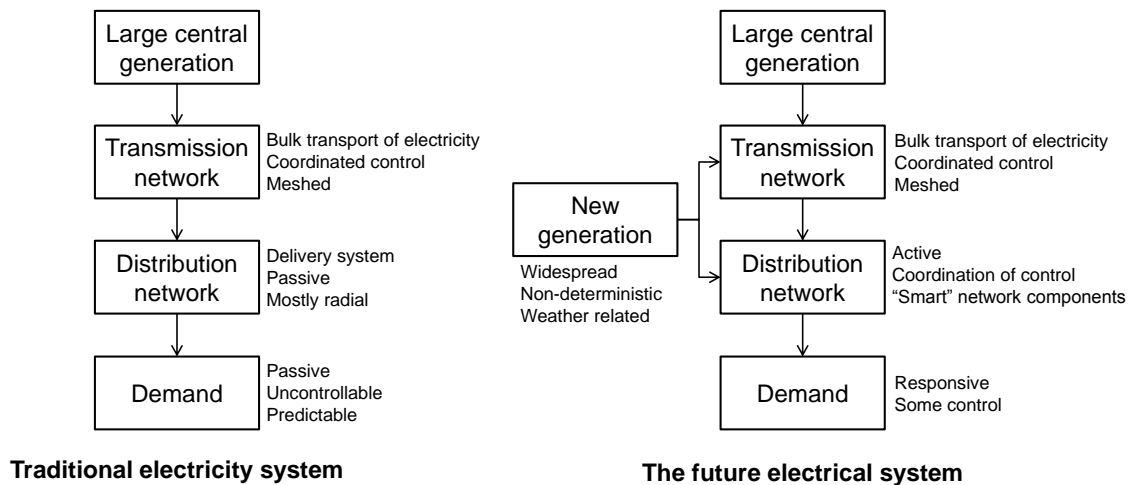

Figure 2-1: Traditional and future electricity system

1 Impacts of distributed generation on LV networks

As established in Chapter 1, photovoltaics are expected to be the most widely installed form of distributed generation in the LV network. These will turn such networks from being passive to active. A simplified diagram of a “passive” LV power network without PV is shown in Figure 2-2. The major components of this network are:

- The secondary transformer which reduces the voltage of the medium voltage (MV^2) network (which generally operates below 33 kV (Electricity North West Limited 2011)) to that of the 400V LV network. These are usually set to a fixed voltage ratio.
- Loads, which are shown in the figure to be homes, but can be commercial, community, or (small) industrial customers with low voltage supplies.
- Over/underground LV feeder cables which connect loads to the secondary transformer.

¹ DNOs operate highly capital intensive distribution assets such as cables, switchgear and transformers. As discussed in Chapter 6 these have a replacement value of the order of billions of pounds and as discussed in Chapter 8 there is a significant potential cost in ensuring distribution networks are suitable for enabling a low carbon power system in the UK

² Here, MV refers to any network section with a nominal voltage above 400V.

In a passive LV network the power flow is unidirectional from the high voltage to the low voltage network and the voltage decreases from the secondary transformer to the end of each cable as indicated by the arrow in Figure 2-2. The performance of these networks is managed by a number of technical constraints and regulations.

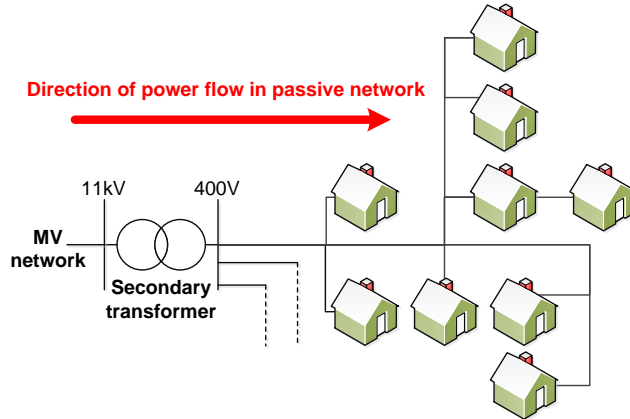

Figure 2-2: Traditional residential LV distribution network with passive loads, no distributed generation and unidirectional power flow

1.1 Regulatory constraints in LV networks

1.1.1 Frequency

The frequency of the UK electricity network must be kept within $50 \pm 1\%$ Hz (HMSO 2002). This is managed by the supply and demand balance of the whole system.

1.1.2 Steady state voltage

The magnitude of the supply voltage in the LV network is 230V between phase and neutral in 4 wire systems or between each phase in 3 wire systems. Static voltages can affect the performance of appliances and electrical equipment connected to the network and will change with different loading conditions (Passey et al. 2011). This variation must not be 10% above or 6% below this value (HMSO 2002). Overvoltage occurs if the upper steady state voltage limit (1.1 p.u.) is violated. Undervoltage occurs if the voltage falls below the lower limit (0.94 p.u.). Regulations state that the 95% of the 10 minute mean rms voltages in a week should be within these limits, and absolutely no overvoltage is allowed (i.e. some undervoltage is permitted up to -15%) (British Standards Institution 2007)

1.1.3 Voltage unbalance

The difference between the voltage amplitude and/or angle in each phase, is called the voltage unbalance. Eq. 2-1 is used to calculate the voltage unbalance factor, VUF , where V_a , V_b and V_c are the three individual phase voltages and $\overline{V_{abc}}$ is the average of the three phase voltages (Energy Networks Association 1990). Unbalance must be below 1.3% in LV networks, although continuous unbalance of up to 2% is allowed for up to one minute (Parmar 2011).

$$VUF = \frac{\max(V_a - \overline{V_{abc}}, V_b - \overline{V_{abc}}, V_c - \overline{V_{abc}})}{\overline{V_{abc}}} \times 100\% \quad \text{Eq. 2-1}$$

1.1.4 Thermal constraints

Thermal constraints are a maximum current carrying capacity for a cable, transformer or other network component. If this current capacity is violated then there is a risk that the conductor will overheat and damage itself or the surrounding equipment/insulation. LV networks are designed so that the current under the highest demand will not exceed the thermal limits (Bertini et al. 2011).

1.1.5 Other constraints

Other regulations include fault levels, harmonics, protection and other power quality factors. These are not addressed in this work as it is considered that voltage and thermal issues are the predominant problems associated with PV in residential LV networks.

1.2 Impacts of distributed generation on LV Networks

There are a number of regulatory constraints on LV networks which need to be maintained by the network companies. The specific impacts of PV on these constraints are now discussed.

A simplified diagram of an “active” LV power network with large amounts of residential, rooftop photovoltaics is shown in Figure 2-3. In this network, it can no longer be assumed that power will only flow into each house since the PV generation might exceed local demand. Current might flow back into the network and, potentially, across the secondary transformer from the LV to MV side. This is called reverse power flow. Reverse power flow can cause the thermal constraints in the network to be violated if this increases the peak current flow along the cables. As is now explained, it also increases voltages in the network.

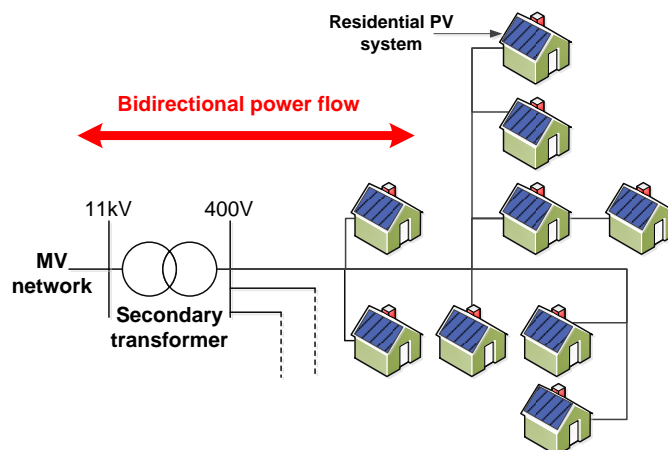

Figure 2-3: Active LV network with residential PV systems causing reverse power flow

Eq. 2-2 shows that the potential difference across a line segment (Figure 2-4) is related to the real, P , and reactive, Q , power flow and the cable resistance, R , and reactance, X . Under normal power flow (from left to right) the voltage at V_1 will be lower than that at V_2 . The difference between these voltages is the cable voltage drop, ΔV^- . This is largest when the power flows are largest. If the voltage drop is sufficient to cause regulatory limits to be violated, this is termed undervoltage.

Under reverse power flow, it can be seen in Eq. 2-2 that the voltage at V_1 will be higher than that at V_2 since the real/reactive power is negative. This is termed the voltage rise, ΔV^+ and is calculated using Eq. 2-3. If the voltage rise is sufficient to violate the upper voltage limit (as shown in Figure 2-5) then this is called overvoltage.

$$\Delta V^- = V_2 - V_1 \approx \frac{RP + XQ}{V_2} \tag{Eq. 2-2}$$

$$\text{If } V_2 \geq V_1$$

$$\Delta V^+ = V_1 - V_2$$

$$\text{If } V_2 < V_1$$

Eq. 2-3

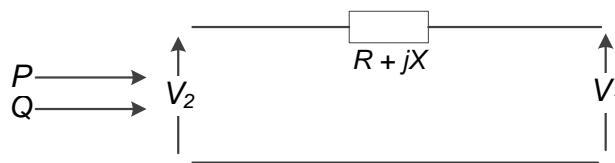

Figure 2-4: Voltage change over a single line segment (Masters 2002)

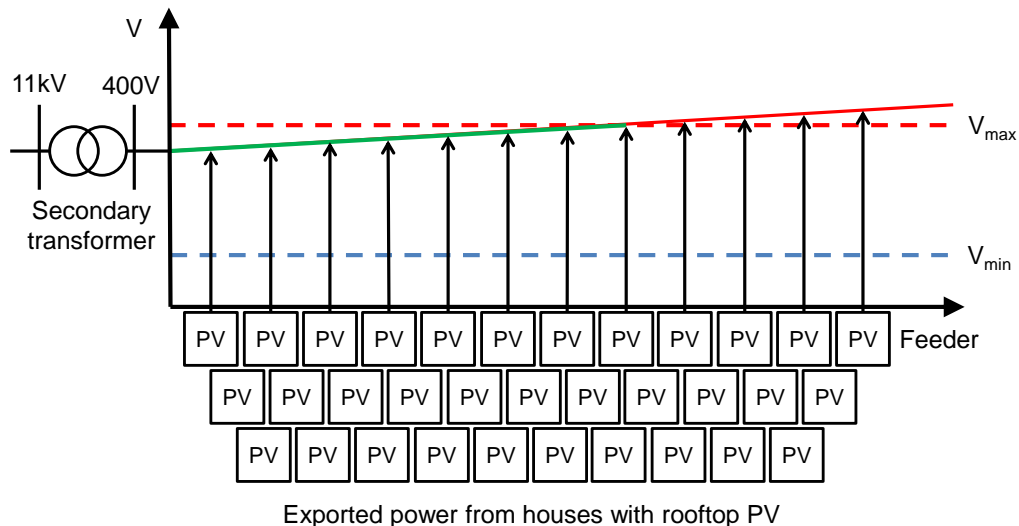

Figure 2-5: Overvoltage due to PV systems in a LV distribution network

Overvoltage is a widely studied impact of residential PV (along with other distributed generation technologies) and is considered to be one of the major problems for LV distribution networks alongside the exceeding of power flow limits (Demirok et al. 2011; Canova et al. 2009). Although other technologies might also cause LV overvoltage (e.g. wind (Chalise et al. 2013)) PV is the most widely installed technology in the LV network (Figure 1-3). An overview of overvoltage associated with PV can be found in (Masters 2002) and the publication year of the article (2002) shows that overvoltage is a long held concern with this form of distributed generation. Voltage rise from PV is most likely to be worst in the middle of the day when generation is highest and demand is lowest (Ali et al. 2012; Alam et al. 2013). However, this can change depending on local meteorological conditions and electricity demand. Voltage rise is only a problem if this causes overvoltage (Masoum et al. 2012) and can sometimes be beneficial in mitigating undervoltage in the middle of the day. This means that, in terms of

voltage, it may be considered that PV is most suitable for power systems when the PV generation coincides with heavy load. Such conditions are typical in areas with significant use of air-conditioning.

The configuration of the network and its components can also affect how severe voltage rise is. It is commonly considered that rural networks are more likely than urban networks to have overvoltage problems (Canova et al. 2009). This is because the voltage rise and drop on long, high impedance rural conductors is generally much larger. However, it is not right to say that overvoltage is exclusive to such networks. As discussed in (Gonzalez et al. 2012), overvoltage can occur in some, but not all urban and semi-urban power networks. Further, different networks will be affected by different amounts (number of units, capacity etc.) of PV. This indicates that, when assessing the impact of PV across a large distribution network, it is not valid to assume that all networks will be affected or that the amount of PV that will cause a problem can be easily determined. In (M Thomson & Infield 2007), an increasing amount of PV on a real UK distribution network is modelled and this shows that voltage constraints are violated when there is a large amount of PV. However, the study is limited in that it is only completed on one network and does not explicitly consider that different PV locations can change the voltage rise. (Papaioannou & Purvins 2014) presents a method for determining the maximum size that a single DG unit can be to keep a LV feeder within voltage limits. This is useful if the new location of DG is known, but not necessarily appropriate if the network operator cannot categorically determine where the next DG system will be installed. This is because the magnitude of the voltage rise relates to both the size and location of the DG (Conti et al. 2003).

None of the overvoltage studies discussed here enable network operators to calculate the voltage rise given this uncertainty about where DG will be located. This is particularly problematic for UK DNOs who cannot prevent (nor accurately predict) where residential photovoltaics will be installed since, under UK regulation, DNOs cannot refuse installation of residential PV. Further, residential PV is bought in a free market and so it is difficult to determine where it will be installed. Such stochastic work is completed to calculate losses in (González-Longatt 2007). This is discussed in (Navarro et al. 2013) where the uncertain location of PV is studied on two feeders. Here, high resolution load profiles are used to find the most extreme (highest/lowest generation/demand) events and therefore study the most extreme (highest) voltages. The work is limited to PV and only a few feeders.

The causes of voltage unbalance are classed as structural (due to differing impedances of cables and equipment across the phases) and functional (because of uneven placement of single phase generation or loading on cables) (Singh et al. 2007). The impact of PV on voltage unbalance, is studied in (Shahnian et al. 2011) through a stochastic (Monte Carlo) analysis of residential LV networks with randomly determined PV rating, location and number of systems. The unbalance is found to be worse when PV with a higher rating is located at the end of feeders as these nodes are most sensitive to voltage changes.

Voltage fluctuation as a result of residential PV is considered by (Woyte et al. 2006). These are undesirable for customers as they can cause fluctuating brightness of lights for example. Such fluctuation is classed as a power quality problem and is caused by changes in the PV output by clouds or shading. These fluctuations in irradiance can be significant as shown in Figure 2-6.

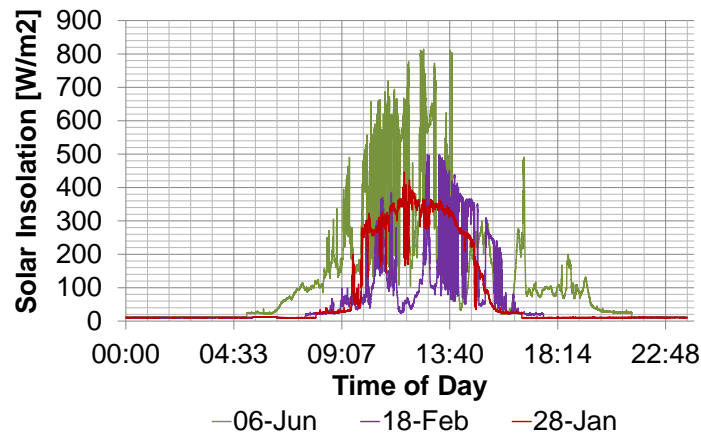

Figure 2-6: Irradiance measured by the author on three different days on a residential property in Retford, Nottinghamshire as used in (Wang et al. 2013)

A limiting factor on the amount of PV that can be installed in LV networks is the injection of harmonic currents (Latheef et al. 2006; Papaioannou et al. 2008). For example, in a study of the impact of harmonics on a network in Croatia, limits are violated with the most extreme installation of PV in the network (on all homes) (Fekete et al. 2012). Harmonics can disturb or damage sensitive equipment, distort the supply voltage, overload equipment and resonate with power factor correction capacitors (Jegathesan & Jerome 2011). Harmonics themselves are injected by the switching characteristics of the inverter and so much work is being completed to reduce this harmonic injection. This means that harmonic reduction may be, to some degree, mitigated by changed inverter design (Passey et al. 2011) for example through Harmonics Elimination Pulse-Width Modulation (Moeed Amjad & Salam 2014).

Losses are the mismatch between the energy generated and the energy measured within the system. Technical losses are those caused by the physical properties of the system such as energy lost across the line impedance, while non-technical losses are other losses such as theft or inaccurate metering (Fritz & Russ 2002). Distributed generation will affect these technical losses because they change the magnitude and direction of the power flow. As more demand is met with local generation, power flows in the distribution network will generally decrease which can decrease overall losses. However, as the amount of distributed generation increases, there will be increasing amounts of reverse power flow and losses will increase (Costa & Matos 2009). This is found in a Monte Carlo based study (Delfanti et al. 2013) where DG is installed in a network with random size, location and type, and through modelling of a Japanese distribution network (González-Longatt 2007). Work in (Kashem et al. 2006) considers the optimal operating point, size and location of distributed generation to minimise losses.

1.3 Increased demand in LV networks

Electricity is not the only industry which needs decarbonising in order to meet UK climate change goals. In 2013, provisional figures showed that electricity supply accounted for 38.4% of CO₂ emissions, with transport and residential heating accounting for 41.6% (Department of Energy and Climate Change 2014c). These two sectors will need to be decarbonised in order for the UK to meet its emission reduction targets. Accordingly, the Government expects these loads to be increasingly met using a low carbon electricity system. Provision of domestic heat is expected to be widely achieved using heat pumps since these have much lower energy demand than resistive heating (Department of Energy and Climate Change 2012c). A trajectory for the increase in the number of heat pumps installed in the UK is shown in Figure 2-7. Pathways for decarbonisation of car and van transport are shown in Figure 2-8 and it can be seen that there is expected to be an increase in electric vehicles being used in the UK. If demand from these devices is sufficiently aggregated, they can increase peak demands which can overload cables and transformers and also cause voltage to drop below limits (Mancarella et al. 2011; Papadopoulos et al. 2009).

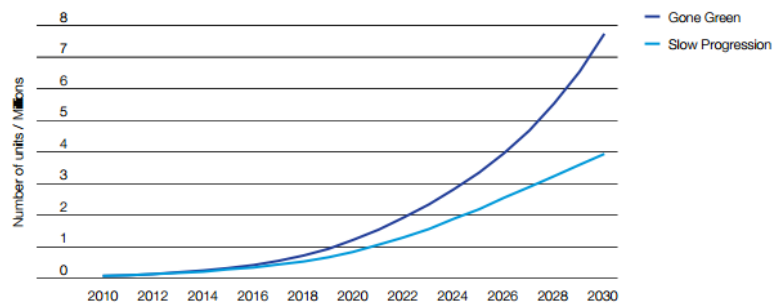

Figure 2-7: Number of residential heat pumps that are projected to be installed in the UK under high and low trajectories (National Grid Company 2011d)

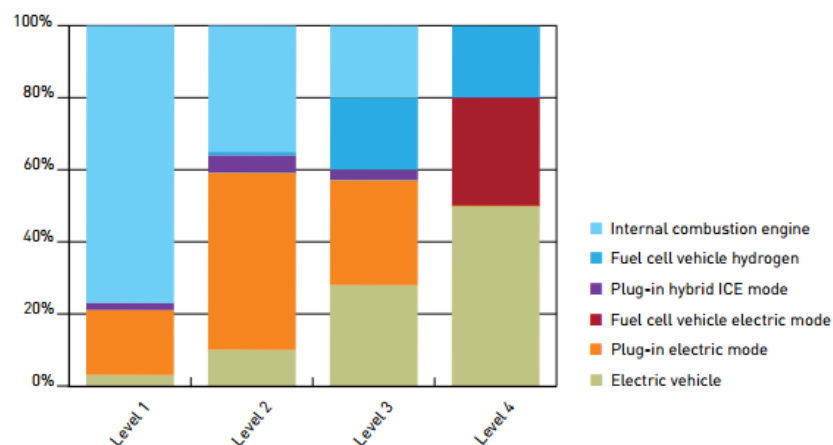

Figure 2-8: Four scenarios for decarbonisation of car and van transport (Department of Energy and Climate Change 2011a)

1.4 Summary

Residential photovoltaics are the most prevalent distributed generation technology in the UK LV network. Although such distributed energy units have benefits to their owners, they can present problems for network operators. As a result of the changing direction and magnitude of the power flow, these might cause a number of issues to occur in LV networks (Papathanassiou 2007; Caire et al. 2002; Passey et al. 2011):

- Voltage imbalance (different voltages on each phase) can occur if significant amounts of single phase DG are installed on one phase. This can damage three phase transformers, generators and loads.
- Reverse power flow and voltage rise as a consequence of loads exporting power rather than importing it which can break thermal and static voltage limits.
- Short term fluctuations in generator output which can cause voltage deviations which commonly manifest as flickering lights.
- Injection of harmonics by PV inverters can damage equipment or change the way that they perform (for example, TVs might flicker).
- Changes in the way that losses occur.

Overvoltage and reverse power flow are widely seen to be the major impact of PV on the LV network and limit the amount of generation that can be installed. Other issues such as harmonics, voltage fluctuation and voltage unbalance are also important. However, voltage rise and reverse power flow are fundamental parameters if energy is to be injected into the LV network. As such, these need to be mitigated to allow wide spread integration of PV in the distribution system.

2 Improving the hosting capacity for LV distributed generation

To prevent overvoltage, the DNO can reduce the primary or secondary transformer voltage, use reactive power control, install auto transformers to adjust the voltage along a line or replace cables with those of a lower resistance (Masters 2002). In LV networks, the transformer voltage can only be lowered if this does not cause undervoltage at times of high demand. Absorbing reactive power has limited effect due to the low X/R ratio of UK LV networks. Cable reconfiguration is also possible (Zidan & El-Saadany 2013), although there is no guarantee that there is enough flexibility (space to physically install cables or correctly positioned normally open points (link boxes) for reconfiguration) in a given network to achieve this. Lowering the network impedance through cable replacement reduces the voltage rise and drop (Passey et al. 2011). However, this is both expensive and not innovative, which the DNOs have a regulatory incentive to be (see section 3.3). The DNO would also want to consider alternative technologies if they provide lower cost ways of managing their distribution networks within regulatory limits. Auto-transformers may be installed along the feeder if there is physical space in the network (Zhang et al. 2013) but this requires very frequent switching due to solar

fluctuation, which can reduce the life of these components (Mokhtari et al. 2013). Flexible AC Transmission Systems, such as static synchronous compensators, use reactive power for voltage management (Rao et al. 2000). However, due to the low X/R ratio, these are not very effective for LV voltage control (Clement-Nyns et al. 2011). For network operators to show innovation, they need to consider alternative technologies which prevent overvoltage. An important class of technologies are active power devices which either reduce the generated power or intelligently absorb power as needed by the network. These work because, as shown in Eq. 2-2, if the power flows are reduced, so is the voltage rise.

Curtailement is the reduction of real or reactive power from the generator and can be used to avoid overvoltage (Ghassem et al. 2013). This is studied for an urban, residential Danish network using reactive power in (Demirok et al. 2011). However, reactive power is insufficient in LV networks with a low X/R ratio (Ballanti et al. 2013). Therefore, in the UK, active power curtailment is likely to be required (Madureira & Peças Lopes 2009), particularly if feeders have a large amount of PV installed (Ueda et al. 2008). PV inverters already have active power curtailment in response to voltage. Although this curtailment prevents overvoltage, it leads to reduced renewable energy generation which is very undesirable for PV system owners as they lose revenue. Further, in practical networks, the voltage is higher at the ends of feeders and so some systems are curtailed more than others. Curtailing active power can be more evenly spread across a fleet of PV systems in a network by changing the droop coefficients of the inverters. This causes higher overall energy curtailment (Tonkoski & Lopes 2011). Overall, these factors mean that curtailment is undesirable in a future low carbon network. Demand side response (DSR) and energy storage are two alternative active technologies. Rather than curtailing the energy, they shift the time at which energy is used in LV feeder and thus can reduce reverse power flows.

DSR does this by changing the time that equipment is used or by adjusting the power consumption of devices. This can be achieved through changing customer behaviour and/or automated control of loads (Pina et al. 2011). As studied in (Papaioannou et al. 2013), customers might be encouraged to shift demand to increase the load on the network and therefore reduce or eliminate the overvoltage. Sensitivity analysis in (Papaioannou et al. 2013) shows that this is most effective when customers at the end of feeders are encouraged to shift load because they have a larger impact on network voltages. However, this is not desirable if the energy market needs to treat all customers equally. A coordinated control for such demand response is shown in (Mokhtari et al. 2013) which considers critical and non-critical customer loads. Overall, if demand side response is to be widely installed it requires both compliance from customers and sufficient amounts of controllable loads in the network and may therefore not always be suitable. A good review of the barriers to DSR is presented in (Balta-Ozkan et al. 2013) including the customers being unconvinced that changing behaviour will reduce bills, the high cost of smart home appliances, technical and aesthetic suitability of older housing stock,

privacy and data security and difficulties in actually being flexible with demand. These present major uncertainties to DNOs about how flexible and responsive DSR can be.

Conversely, distributed energy storage is a controllable device which allows power to be imported or exported as needed by the network. This can be used to achieve active power control in LV networks, and is potentially more flexible than DSR in that it can be more easily controlled to prevent network problems. At the outset of this research, storage was only located in LV networks with unique characteristics such as islands where storage is economically used to offset expensive diesel generators. However, there have recently been a number of LV energy storage products, trials and installations (see Table 2-1) and a growing market for distributed energy storage products for homeowners. This includes incentives in Germany for homes with small scale PV to install energy storage and improve integration of PV in the power system which has resulted in an extra 4000 small scale storage systems (CleanTechnica 2014; KfW 2013). Despite this, distributed energy storage is sometimes overlooked in high level studies of the energy storage industry. For example it does not gain much prominence in a recent IEA review of the industry (IEA 2014). Widespread deployment of distributed battery storage is considered hampered by energy density, power performance, lifetime and costs in this report. However, as a growing and innovative method for alleviating LV network problems it is worth investigating if a technical and economic case will exist in the future.

2.1 Summary

Any alternative mitigation must be more affordable than traditional reinforcement as well as other technologies in a cost driven industry. Energy storage is potentially more flexible than demand side response in reducing curtailment. However, this will only be installed if there is a proven financial case. A more detailed overview of LV energy storage and the benefits it provides is now performed to identify further research questions.

3 Energy storage in the LV distribution network

In the literature and through considering energy storage trials (see Table 2-1, page 27), it is determined that LV energy storage can be installed in customer premises (homes), on the street or at the secondary transformer. This is summarised in Figure 2-9. These are now discussed to identify gaps in research.

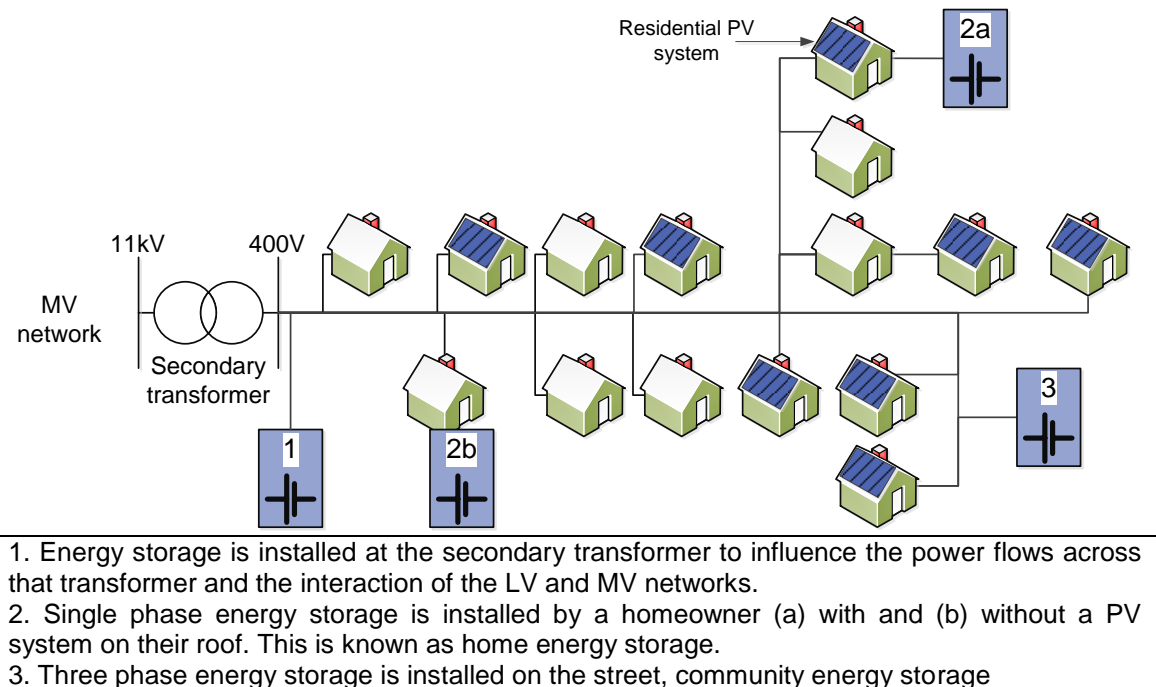

Figure 2-9: Different locations/topologies for energy storage in LV distribution networks

Energy storage installed in customer homes helps to enable customers to become active members of the power system (Moneta et al. 2007) and can offer benefits in reducing consumers bills through absorbing excess PV, providing power backup and purchasing off-peak electricity to support loads during peak times (Toledo et al. 2010; Johnson et al. 2011). One company, Moixa Energy, aims to put energy storage in 10% of UK homes by 2020 (Solar Power Portal 2014). In Germany, a subsidy promotes home energy storage and report in 2014 found that over two thirds of German solar installers offer battery backup options (RENewEconomy 2014). A case study of storage with PV in California and New York for residential and commercial customers is presented in (Hoff et al. 2005). These residential customers are considered to be interested in using storage for emergency backup whilst commercial customers also use it for reducing their electricity bill by reducing export of PV to the grid. Depending on the location, there is shown to be a financial benefit for both.

Control of home storage is discussed in (Ahlert & van Dinther 2009). This considers the optimisation of the charge-discharge profile and performs a sensitivity analysis on the impact of efficiency, cycle life and costs on the overall benefit to consumers. Essentially, home storage controlled for customer benefits will reduce the reverse power flow of PV into the network if it effectively absorbs the mismatch between generation and demand. Such home energy storage

can also be used with demand side response in a smart home (Figure 2-10) however it can increase total self-consumption of energy generated by the homes rooftop PV because of the inherent charging-discharging losses in storage (Castillo-Cagigal et al. 2011). The combination of distributed storage with generation and smart control of domestic loads is studied in (Atzeni et al. 2013) with a particular focus on a day-ahead optimisation of each user's demand and storage. The benefits are shown to be a reduced overall electricity unit cost and a lower peak electricity demand. Further, combining storage with DG can allow areas of the network to operate as a microgrid in islanded operation in the event of loss of the main grid connection (Mao et al. 2010).

Methods for sizing storage systems (capacity and rating) from the perspective of the home owner are available, such as in (Jenkins et al. 2008). Similarly, (Kahrobaee & Asgarpour 2013) presents a method using Monte Carlo and particle swarm optimisation for determining the size of a wind-battery system for a smart home. (Mulder et al. 2010) present another method which considers that the storage size will be different for different homes. The storage is rated the same as the PV system to be able to absorb all of the generation when local demand is near zero.

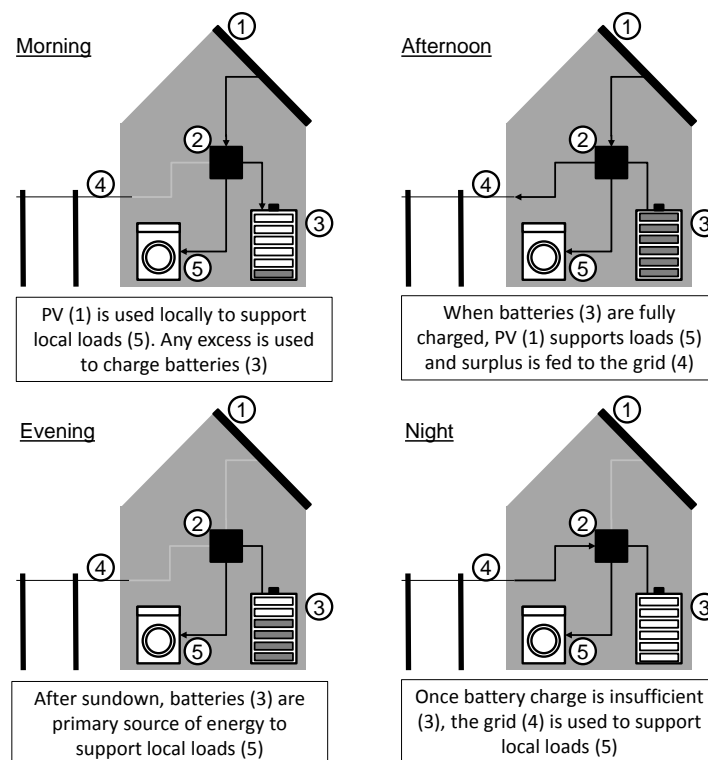

Figure 2-10: Overview of home storage with respect to self-consumption for a system which includes (1) PV panels, (2) a control unit, (3) battery storage, (4) a grid supply and (5) a series of domestic electrical loads (adapted from (Energy Storage Journal 2013))

For DNOs, energy storage can control the power injection of solar PV into the grid to minimise the impact of PV on the power system (Zahedi 2011) and can therefore address the problems of over and under voltage, reverse power flow, harmonics, voltage fluctuation and voltage unbalance in distribution networks (Zahedi 2011; Schoenung & Burns 1996; Chua et al. 2012). For example, smart control of multiple storage units is presented in (Marra et al. 2014) for overvoltage prevention (the most immediate impact of PV on LV networks). These benefits are additional to those which can be achieved with transmission level storage (Brandao et al. 2011). However, there is little study which quantifies these benefits and how many LV voltage problems DNOs might face in their networks. Some studies have looked at how to optimally place storage to relieve voltage constraints, such as the simple voltage based heuristic used in (Marra et al. 2012). However, these simplistic approaches do not find an optimal location for the storage, and more work is needed in this field. Coordinated control of the storage with the OLTC of the primary transformer is considered in (Liu et al. 2012). This is designed to reduce the number of tap changes and to enable the tap changer to work when there is reverse power flow. (Alam et al. 2013; Alam et al. 2012) considers the location of storage directly with PV in low voltage (LV) distribution networks. The work particularly focuses on the control of the storage to reduce voltage fluctuation, to keep voltage within regulatory limits, to reduce reverse power flow and reduce evening peak demand. The work demonstrates that energy storage at the home can influence a wide variety of network problems but does not provide an indication of the economic value of the storage to the network. Storage in the customer home is studied in (Sugihara et al. 2013), specifically looking at how a network operator can subsidise the storage owner for providing voltage regulation in their networks. This is achieved for customers with high demand with DNOs paying for the reactive power capability of the storage inverter. In networks with a low X/R ratio, such as in the residential LV networks in the UK, real power is much more effective for voltage control (Eq. 2-2).

In addition to the home, storage can be located in the street or at the secondary transformer. Secondary transformer storage mostly influences the MV network voltage and power flows. This can be used to influence the LV voltage as discussed in (Anuta et al. 2012). Street storage, commonly called community storage, can achieve similar benefits to home storage but is typically owned by the network operator. Several trials of this exist as discussed in the next section. If there is to be a market for network operators to install such systems, and to decide where to install these systems, then the size of voltage problems in LV networks needs to be determined along with the impact of these technologies on fixing the problems. An overview of rules for connecting and operating storage to LV networks is given in (VDE 2013).

3.1 LV energy storage technologies and trials

If predictions for the large future market for energy storage are correct, then there will need to be a large amount of technical innovation in storage technology. This is evident through both Government level innovation funding for technology trials (Ofgem 2014a; Department of Energy and Climate Change 2014a), high level recognition of the role of storage (Department of Energy

and Climate Change 2011b) and numerous news articles discussing new systems (e.g. (BBC [Online] 2014a; Energy Storage Industry News 2014; PV Tech 2014; Energy Storage Journal 2014)). Advances in battery technology have focused on improved power and energy density (power or energy per unit weight or volume) and aging for automotive applications where this is an important parameter in this market e.g. (Takami et al. 2013; Barré et al. 2013). Improvements in life, cost and reliability are also expected to be important for the power system (BBC [Online] 2014d; BBC [Online] 2014c; BBC [Online] 2012; The Guardian 2010; The Guardian 2014b; The Guardian 2013; BBC [Online] 2011; BBC [Online] 2014b). A suitable approach is needed for changes in technology and costs to be evaluated.

A comparison of the technology choices for home storage is performed in (Nair & Garimella 2010) and it is felt that a reduction of capital costs will be important to establish this market. Here, it is stated batteries are most likely to be deployed because they are the most financially viable means for providing several hours of storage in LV networks. Voltage fluctuations can exist in time frames of seconds to up to an hour. As shown using wavelet decomposition in (Woyte et al. 2006), short fluctuations can be managed using supercapacitors and SMES. Batteries are more suitable for slower voltage fluctuation because they cannot sustain large numbers of charge cycles. Therefore, in (Zahedi 2011), batteries and supercapacitors are combined with a solar PV system. Here, the battery provides steady state voltage control while the capacitor handles shorter term voltage fluctuations. Unbalanced control of the power electronic conversion unit of the energy storage can also address harmonics and voltage unbalance (Han et al. 2006), including that caused by PV (Chua et al. 2012).

A number of battery energy storage projects have been installed, a sample of which is shown in Table 2-1. The SMUD storage project investigated how residential energy storage can reduce peak demand through load shifting. Fifteen 5kW/7.7kWh residential energy storage units and three 30kW/34kWh community energy storage units were installed in a neighbourhood containing a high amount of solar PV. As reported at the ESA Annual Conference 2013, the utility had little problem getting residents to support the idea as they were a particularly environmentally conscious community. A number of units had to be taken offline during the trial due to problems with the equipment; however the storage was shown to be useful in output smoothing. These home energy storage units also allowed home energy bill reduction with the time of use rates applied in California (Green Tech Media 2012)

A smart home trial was conducted between July 2010 and February 2012 to demonstrate the use of energy storage with a fuel cell, an electric vehicle and PV in Newington, Australia. The use of energy storage (a 10 kWh RedFlow R510 ZnBr flow battery (Figure 2-11)) was able to reduce net import of energy from the grid, but was of insufficient capacity to fully charge the EV and thus there was import of power from the grid 8% of the time. There was still export to the grid of PV energy which occurred 39% of the time.

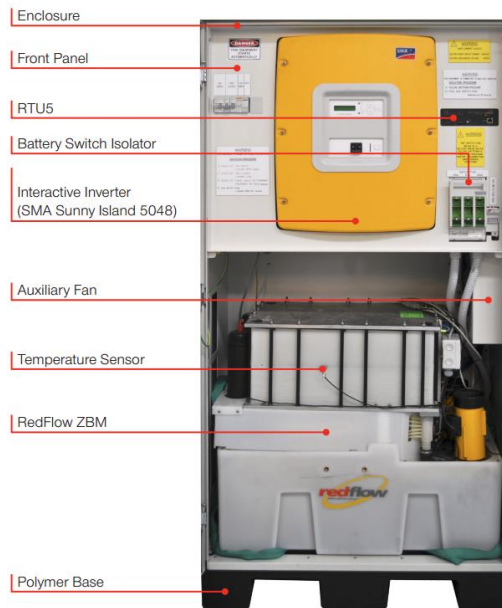

Figure 2-11: RedFlow battery used in Newington smart home trial

The BRISTOL energy storage is a second tier LCNF project run by Western Power Distribution in the UK. The storage is deployed to demonstrate how domestic, school and office energy storage can be used in conjunction with time of use rates to prevent network upgrades as a result of PV installations. Thirty homes will have a 2 kW/4.8 kWh battery storage and a DC lighting, computer and heat pump circuit installed. Larger storage units will be installed in schools and an office. The batteries were due to be installed in 2013. (Western Power Distribution 2014)

As part of a wider project to demonstrate zero-carbon homes in Slough, SSE is deploying three 25kWh batteries within an LV network. These will be used to measure their impact on the LV network in mitigating the effects of PV and preventing network reinforcement (S&C Electric Company 2013).

A specific type of energy storage/demand side response is the smart charging (or discharging) of electric vehicle batteries to provide network benefits. This is achieved by changing the charging rate or providing power to the grid as required and requested by the power system. The impacts of this are widely studied such as in (Clement-Nyns et al. 2011) where vehicles can help to provide local peak power, load levelling, voltage regulation in low voltage networks. This does require a sufficient numbers of vehicles to be available (i.e. connected to the charger) and to be sufficiently controlled to provide the benefits. When aggregated, fleets of electric vehicles can also provide other ancillary services such as load balancing (Tomić & Kempton 2007). The IEA assumes that 25% of the electricity requirement from EVs will be controllable (IEA 2014).

Table 2-1: Overview of technologies used in a selection of grid connected RES and CES projects

Project	Country	Type	Storage type	Power	Capacity	Storage time [hours]
SMUD storage (DOE Global Energy Storage Database 2014b)	USA	RES	Lithium-ion	5 kW	7.7 kWh	1.54
		CES	Lithium-ion	30 kW	34 kWh	1.13
Columbus, Ohio energy storage with American Electric Power (Thomas 2010)	USA	CES	Lithium-ion	25 kVA	75 kWh	3.00
Newington smart home (DOE Global Energy Storage Database 2014a)	Australia	RES	ZnBr flow battery	4 kWh	10 kWh	2.50
BRISTOL (Western Power Distribution 2014)	UK	RES	Lead acid	2 kWh	4.8 kWh	2.40
Zero carbon homes (Southern Electric Power Distribution 2011)	UK	CES	Lithium-ion	25 kW	25 kWh	1.00
NTVV	UK	RES	Lithium-ion	10 kW	10 kWh	1.00
	UK	CES	Lithium-ion	25 kW	25 kWh	1.00

Further to the electrical energy storage technologies previously described there are also proposals for the storage of thermal energy in LV networks. (Peterson 2011) is an example of such work, which considers that electricity is stored as heat and that heat is then used to generate electricity during discharge (no notion of scale is given). An alternative approach is to store thermal energy for subsequent use to provide a thermal capability. This is studied on a macro scale model in (Arce et al. 2011), showing that the wide adoption of thermal storage in homes and businesses will reduce demand for fossil fuels and use heat that would otherwise be wasted. Although not studied by the authors, a derived benefit to the distribution network of this storage could be the reduced peak demands of electricity to generate heat. This is discussed in (Arteconi et al. 2012) where thermal storage is used to allow conversion of electricity to heat/cold at times of off-peak demand and for electrical heating/cooling systems to be turned off during periods of peak demand. This form of demand side response can therefore affect and potentially benefit the distribution system. In residential networks, this can be achieved using hot water tanks (Department of Energy and Climate Change 2012c), phase change materials (Campos-Celador et al. 2014) and underground tanks (Inalli et al. 1997) amongst other means. Effectively, such storage allows for generation of heat to be shifted to when it is needed.

3.2 Impacts of LV energy storage on the rest of the power system

On a system level, reliability and power balancing becomes more challenging as more and more renewable generation is added to the electrical system (Denholm & Hand 2011; Denholm & Margolis 2007). In response, there remains a focus on large scale energy storage connected to the transmission network with studies looking at pumped hydro (Deane et al. 2010; Tuohy & O'Malley 2011) and compressed air energy storage (Kim et al. 2012; Safaei & Keith 2014) along

with more unusual designs such as subsea air bags (Pimm et al. 2014). Pumped hydro for example is considered to be economical in Ireland to reduce wind curtailment, assuming poor forecasting, when wind provides more than 50% of generation (Tuohy & O'Malley 2011).

National Grid already recognises that distributed storage, through an aggregator, could provide similar benefits for transmission and balancing system operators (Etheridge 2014) and there are some examples of studies which look at alternative ways of providing the services provided by large energy storage. When considering the power system as a whole, battery banks can be used for load frequency control (Aditya 2001) and for reducing curtailment of wind (particularly in systems with inflexible generation) (Black & Strbac 2006). Methods such as that discussed in (Perez et al. 2010) could be used to determine how much firm capacity distributed storage can provide. For providing ancillary services, (Kazempour et al. 2009) compare pumped storage to battery storage through a self-scheduling optimisation and find that the emerging (battery) technology is less profitable and needs external financial support to succeed. This is because the battery has a higher capital cost and shorter lifetime. Studies for demand side response show how it can help to manage the balancing of system demand and generation, particularly in a grid with a high degree of non-deterministic generation, however a communication infrastructure needs to be built which adds to the system complexity (Strbac 2008).

By accruing additional revenue from providing benefits in the transmission network, distributed storage may be cost competitive in the future, particularly given the problems associated with integration of distributed generation. However, the financial and regulatory benefits that LV storage can offer DNOs need to be summarised. An overview of this is now given.

3.3 Benefits of LV energy storage to network operators

3.3.1 Regulation

In order to build a low carbon power system, it is estimated that £32billion needs to be invested in the UK gas and electricity networks by 2020. This doubles the rate of investment seen over the previous twenty years and will increase the value of the networks by 75% (Ofgem 2010c). A number of financial mechanisms have been introduced to encourage this. The revenue that DNOs earned was originally regulated using an RPI-X price control mechanism. This took the retail prices index (RPI) and subtracted an efficiency factor (X) to give the maximum amount that each DNO could increase its prices by every year (National Grid Company 2011c). The advantage to DNOs was reduced commercial risks in recovering investments (Shaw et al. 2010). Since privatisation of the electricity industry, the RPI-X helped to encourage an investment of over £35billion and reduced network costs. However, this was not deemed suitable given the large amounts of DG expected in the future system. Therefore, Ofgem will introduce a new regulatory framework by April 2015 to encourage DNOs "to play a full roll in the delivery of sustainable energy". This scheme will be called RIIO (Revenue = Incentives + Innovation + Outputs) and under it, revenue will be awarded based on measures such as customer satisfaction and environmental impact. An overview of RIIO is shown in Figure 2-12.

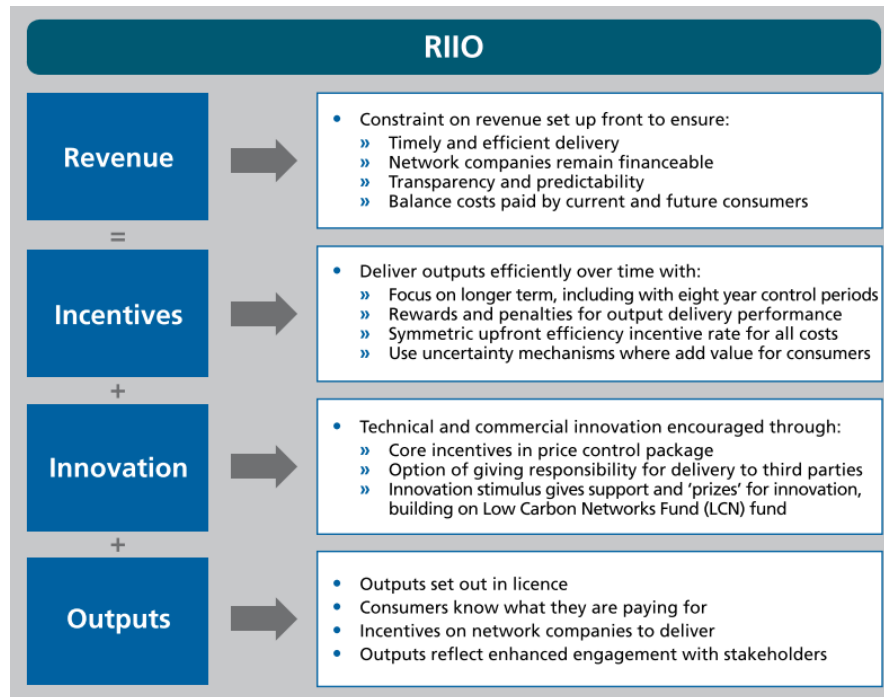

Figure 2-12: Components of the RIIO Model (Ofgem 2010c)

The RIIO pricing structure is supported by The Low Carbon Network Fund. This was established by Ofgem in 2010 to support projects which help distribution networks work better with much more distributed, low-carbon generation. The fund is worth up to £500m over five years (Ofgem 2010b). Tier One projects are designed to allow DNOs to recover spending on small scale projects and has previously funded storage. Tier Two funding is for flagship projects such as smart metering. Ofgem also encourages DNOs to reduce losses through the loss incentive. Under DCPR5, this incentive is £60/MWh pre-tax. Losses are measured as the difference between units entering and units leaving the distribution network (Ofgem 2009).

3.3.2 Asset management and upgrade deferral

Although energy storage can offer a number of technical benefits in helping maintaining LV network regulations, according to (Brandao et al. 2011), there are few examples of storage in LV networks because DNOs have traditionally prioritised protection of higher voltage levels where failures are more expensive to fix and can affect more customers. It is important to remember that storage will only be installed where the cost benefit is clear to DNOs. As such, it is important to quantify how distributed storage can accrue financial benefits in the LV system. In the LV network, the two main financial benefits are in avoiding cable reconductoring and avoiding replacing the secondary transformer. A financial model for assessing upgrade deferral is found in (Eyer 2009). Here, the cost of replacing an asset (avoided cost) is compared to the energy storage cost for a particular problem. A similar formulation was used by the author in (Anuta et al. 2012) to defer upgrade of LV network cables and transformers to fund a storage installation. A practical project in the UK is investigating how a fixed energy storage installation can protect a primary transformer by reducing peak power flows (UK Power Networks 2013).

Reduced capital cost is the common method for improving the profitability/affordability of storage projects (Hittinger et al. 2012). Storage profitability can also be improved through aggregation of benefits and many authors feel that energy storage will only be commercially viable if this can be achieved (Grünwald et al. 2012), (Gyuk et al. 2005).

3.4 Summary

There are a number of ways in which energy storage can be installed to provide voltage and thermal support to LV networks as shown in Figure 2-9 and DNOs are incentivised to show innovation on their networks. LV networks are an emerging location for installing energy storage because it offers benefits to home owners, the distribution network operator and (potentially) to the wider power system under wide integration of PV.

- Storage might be purchased by homeowners in a free market. However, as with installation of PV, this might not be in the correct or optimal location to offer services to the DNO.
- Energy storage might be installed by the network operator in homes, on the street or at the secondary transformer.

Given that energy storage can provide a number of benefits to the LV network and the lack of proven business cases, an understanding needs to be developed about how to best locate the storage in these networks. Due to a low number of energy storage projects within LV networks, the overall benefits are unclear and there is a lack of quantification of the benefits that storage might offer. Storage is not treated as a regulated asset by DNOs and they have never previously been encouraged to install it. Further, storage is an inherently expensive asset. Therefore, a competitive analysis between storage and traditional reinforcement needs to be developed to understand if storage is commercially viable for DNOs. If this can be completed, direction can be provided to industry about energy storage in LV networks. To achieve this, planning tools need to be built to simulate the different storage integration scenarios.

4 Planning for LV energy storage

Energy storage planning problems fall into a number of categories. They can look at the determination of control algorithms, energy storage location, the power and capacity of the energy storage (sizing) for a particular problem or the technology choice. There is much literature surrounding the control of energy storage in LV networks and batteries are widely accepted to be an appropriate technology. Correctly choosing the location is critical for a DNO since this has a key impact on the costs of storage and network reinforcement. For example, if storage is randomly purchased by homeowners to increase PV self-consumption, this might not be placed at the optimum location. As such it is important to establish planning tools for this from the perspective of DNOs.

A method for locating, sizing and determining the power factor of both dispatchable and non-dispatchable DG units for loss reduction is presented in (Hung et al. 2014). A similar study is also completed by the authors for locating capacitors and community energy storage for loss reduction although there is no consideration of cost (Hung & Mithulananthan 2011). Problems of sizing and siting energy storage alongside small scale dispatchable generation and non-dispatchable renewable generation can be found in the area of micro or island grids. These have been long recognised, such as in (Kottick & Blau 1993). Kadellis is an author of many articles in this field such as (Kaldellis 2008; Kaldellis et al. 2009; Kaldellis & Zafirakis 2007; Kapsali & Kaldellis 2010). Here the storage needs to be correctly designed to help balance consumer demand with the hourly, daily and season variation in wind and solar generation whilst considering the constraints of the power distribution system. The high cost of island systems presents a much more favourable economic case for energy storage.

Within a smart grid, (Carpinelli et al. 2013) considers the problem of locating energy storage and capacitors and finds that traditional internal and external revenue sources (loss reduction, price arbitrage and reactive power support) are insufficient when compared to the cost of operating energy storage and that capital grants or specific tariffs may be one way to help finance more storage. Locating capacitors in power networks, the so called “capacitor placement problem” is widely studied in literature. Here, the optimal placement, size, control and type of capacitors within a network are considered to provide benefits such as improved voltage regulation, releasing of capacity and reduced losses. A good background to this problem (Boone & Chiang 1993) introduces the use of a genetic algorithm to this field.

Energy storage control and sizing is considered in (Tant et al. 2013) for reducing voltage deviation, peak power and annual cost. Here it is considered that a single energy store is used at a predetermined location, but the authors do not provide a heuristic for determining this or consider that multiple storage units might be appropriate. Some study has focussed on the location of storage to alleviate voltage problems, but this focusses on technical considerations rather than cost such as in (Nick et al. 2012).

(Leou 2011) present a model for determining the capacity and control of energy storage at a substation for price arbitrage, reduced transmission access cost and upgrade deferral. The authors particularly focus on a vanadium redox flow battery as being economically and technically viable for a large system at this location in the network. A study of just arbitrage is considered for energy storage in the PJM area in the USA (Sioshansi et al. 2009) and it is concluded that although there is revenue to be gained, this depends on the location of the storage, the electricity prices and requires short term prediction of energy prices. It is also noted that large scale deployment of energy storage in a network will reduce peak prices and raise off-peak prices and so reduce the available arbitrage revenue (Walawalkar et al. 2007).

In addition to studies of energy storage, the problem of placing and sizing of distributed generation is complex with large numbers of unknowns. Therefore heuristic methods need to be

used. (Afzalan et al. 2012) use a hybrid particle swarm and honey bee mating heuristic to locate DG in a power network to reduce voltage deviation and reduce the power losses in the network. (Ahmadigorji et al. 2009) consider a dynamic programming method to solve an optimisation problem for locating distributed generation. The implementation considers fixed sizes of diesel generators and micro turbines and determines the best location for these to reduce the costs of losses and power purchasing and to improve reliability. The optimisation compares the benefits to the cost of the distributed generation. (Manjunatha Sharma et al. 2008) use a genetic algorithm with optimal power flow. (Gandomkar et al. 2005) use a genetic algorithm with simulated annealing to place wind turbines, PV, micro turbines and storage in an IEEE test network (IEEE Distribution Test Feeder Working Group 2012) to minimise energy losses. The algorithm is useful because it is able to search and compare a wide number of solutions. Further, as is also shown in a paper by the author of this work, the combination of a genetic algorithm with simulated annealing can produce solutions of a better fitness with fewer iterations (Crossland et al. 2014).

It can be seen that although there are many tools for locating storage, there is no focus on locating within LV networks from the perspective of the DNO. Developing and applying such tools can provide information for decision making by the DNO (and other system stakeholders) about storage in the LV distribution network.

5 Conclusions

UK electricity supply will be expanded and decarbonised over the next 30 years in response to concerns about climate change and energy security. This will lead to a wide installation of new generation including a large number of residential photovoltaics. Over 450,000 PV arrays have been installed in the UK at the time of writing and this market is forecast to continue growing. Although PV contributes to electricity decarbonisation, it fundamentally changes the operation of LV networks. Power can no longer be considered to be unidirectional and networks can no longer to be considered to be passive. This might cause technical constraints (particularly voltage) in LV networks to be violated, which will require expensive mitigation solutions. This cost will ultimately be met by the customer bill.

Distributed energy storage is one form of mitigation. Within the reviewed literature there are many studies looking at the benefits of distributed energy storage to customers and to the power companies. However, there is a question about the case for the deployment of many small energy storage systems within the power system. There is also little understanding of how much energy storage is required by DNOs under realistic future scenarios and about where and how the storage is best located (Figure 2-9) in LV networks to fix problems. In a cost-driven industry, LV storage will only be deployed if the business case is clear. This remains unproven.

In a future power system, it might be feasible that consumers could purchase energy storage systems to help improve their PV self-consumption- as is already happening in Germany. The benefit of this is unproven from the perspective of DNOs. Indeed, it is not easy for DNOs to own energy storage as they are not treated as regulated power system assets. Ultimately, there needs to be a clear case for energy storage and a study of its benefits to assess whether it is a practical solution for enabling more renewable generation.

To determine this, new methods will be developed to understand how to locate storage. These will represent scenarios where LV storage is installed within LV networks at locations determined by the DNO or alternatively by electricity consumers in a free market. If installed by a DNO, there is also a question of where in the network it will be installed to achieve the most benefit for the least cost. If installed by customers in a free market, a method needs to be developed which reflects that storage will be located randomly in the system. For both of these scenarios, new tools are presented in Chapter 5.

In order to understand inform the debate about what energy storage in LV networks can practically achieve, these methods are applied across a large number of representative and realistic LV network models. These are derived in Chapter 6. Such a wide study of LV networks has not been found in literature and presents the chance to understand the technical and financial implications of PV and energy storage in the LV network.

Before this can take place, it is important to establish modelling assumptions and a preliminary study as described in Chapter 3 and Chapter 4.

Chapter 3: LV Network Modelling Considerations and Assumptions

Assumptions

1 Modelling decisions

Traditional assessment of LV networks is completed using generation and demand data applied to models of the networks (Ali et al. 2012; Eisenreich et al. 2010) in one of two ways:

- Time series studies of the performance of networks over seconds, hours, days, months or years using representative load and generation profiles. In relevance to energy storage, time series studies are used to determine the capacity of storage or to test control algorithms.
- Single time step models use singular network conditions. Typically these will consider the worst case network conditions such as the voltages in the network when demand is highest. For studies of energy storage, these studies allow the charging or discharging power of to fix any problems to be determined.

Voltages, power flows, losses and other network parameters are typically investigated using LV network modelling software. A number of different software packages exist for modelling power networks such as IPSA (IPSA 2014) and PSCAD (Manitoba HVDC Research Centre 2014). In this work, OpenDSS (EPRI 2013) is selected because it can be easily integrated with MATLAB (MathWorks 2013) for developing heuristics and modelling different network scenarios and because OpenDSS allows 4-wire simulation of networks. Within OpenDSS, models are constructed using a series of text files. In this work, LV networks are constructed according to the following specification to allow all customer connections and the all of the LV cables to be included in each network model as described below and as shown in Table 3-1:

- The LV network starts at the secondary transformer. The primary coil of this is connected to a fixed voltage source (slack bus). Every feeder connected to each secondary transformer is included in the model. LV voltages are measured relative to the low voltage bus of this transformer (bus A in Table 3-1) to negate effects from the transformer voltage drop. A tap changer is placed on the high voltage busbar (primary coil) to enable the DNO to raise or lower the voltage level in the LV network. This is fixed, in that it does not change automatically in response to network conditions unlike those on the primary substation transformers. Secondary transformers are rated up to 1500 kVA in the ENWL network (see Chapter 6, section 4).
- The LV network is split into individual cable sections between splits in the cable (junctions) and customer connection points. LV network cables are often capacitive in the UK since they are underground in density residential areas.

- Customers are connected at customer connection points. Each of these is modelled to allow analysis of the impact of generation and loads at each of these locations to be assessed. This work considers residential customers in particular because, as discussed in Chapter 6, these present interesting challenges due to small scale PV. Residential customers generally have a peak demand in the evening with a baseload powering fridges and freezers and other small electronic equipment.
- Every customer connection point, cable junction and busbar is included in the model as an individual load. At each busbar, the number and phase of loads are recorded.
- The number of PV systems that can be connected at each busbar is recorded noting that South facing homes are most likely to install PV.

This fully detailed model is necessary to enable the effect on the network of each PV system and load to be assessed. In order to complete analyses, suitable methods for representing loads, generation and network components need to be established.

Table 3-1: Example of a 8 bus LV network including secondary transformer, 11kV voltage source and a number of low voltage (230V) cables, loads and PV systems as defined in OpenDSS models in this network. LV voltages are measured relative to the secondary transformer LV busbar at A

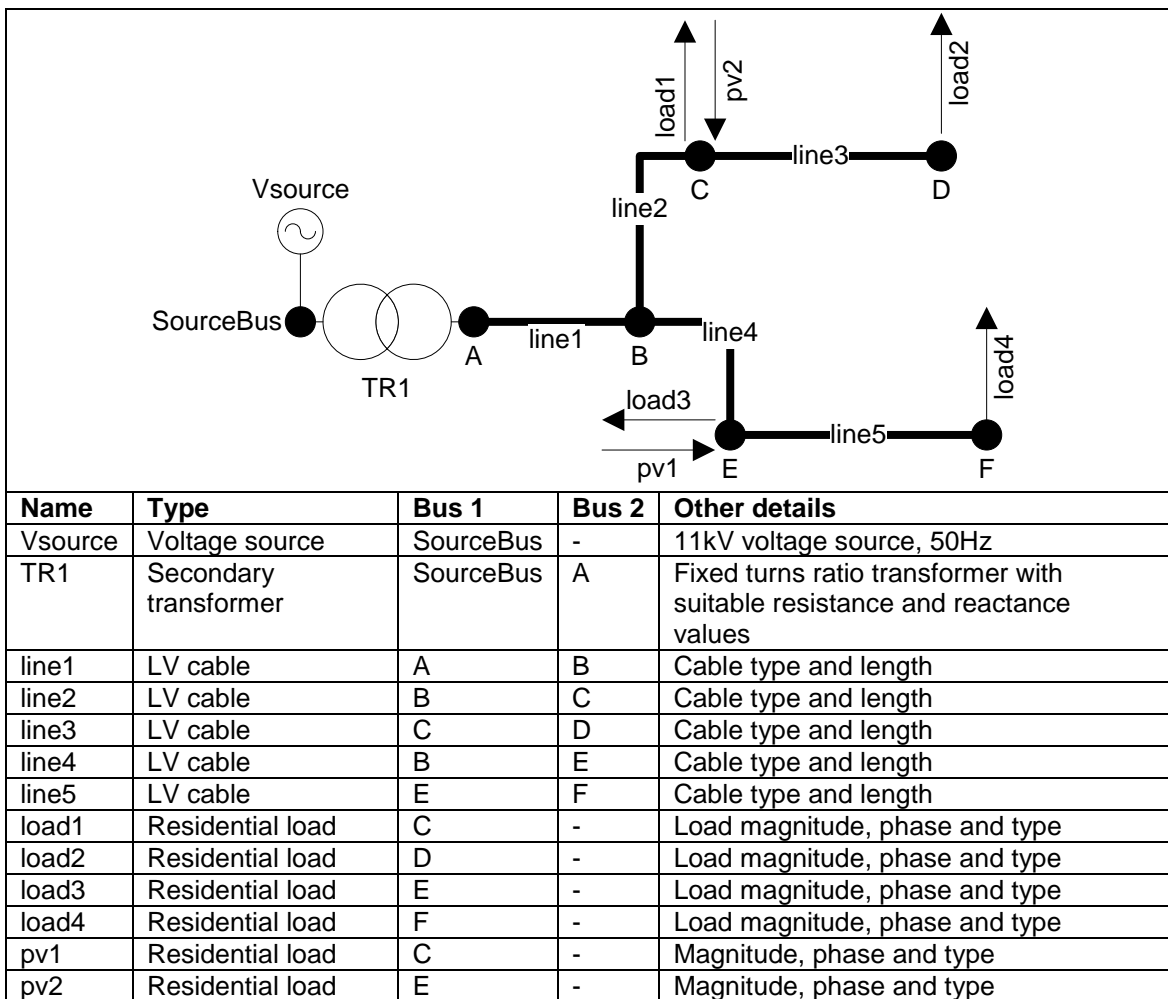

1.1 Loads

The current and therefore power that is drawn by loads is dependent on the network voltage. This is because most residential loads are resistive and according to Ohm's Law the power and current is proportional to the input voltage. However loads such as kettles draw a specific amount of energy to heat a finite volume of water over a few minutes. These can be considered to draw a specific power which is independent of the voltage (Herman & Gaunt 2008). As stated in (Herman & Gaunt 2008), it is appropriate to consider residential loads as having constant power since this best represents the mixed loads in this scenario.

For single time step studies of networks in their highest and lowest voltage condition the maximum and minimum demand needs to be established. Although each dwelling in a residential network will have a high maximum demand, the time that this occurs is not coincident between dwellings on a particular feeder (McQueen et al. 2004). As the number of dwellings increases, the net maximum demand reduces to an asymptotic value (Richardson et al. 2010). Similar trends are true for the minimum demand. There are a number of ways of determining the maximum and minimum demand of each load after diversity:

- Demand profiles such as (RMDS 2014; Hemdan & Kurrat 2011) applied with a diversity factor if necessary.
- Synthesised demand profiles using some form of heuristic. This can be done using a combination of individual appliances, social and technical factors as described in (Paatero & Lund 2006; Yao & Steemers 2005; Richardson et al. 2010; Stokes et al. 2004) or by using a probability distribution with mean and standard deviations (Jardini et al. 2000).
- Measured data such as that described provided in section 1 of this chapter. The network operator has also stated that they consider the maximum demand in their residential networks to be 1 kW or 1.4 kW, depending on the demographics of the networks customers¹.

Such values have been provided in previous studies of power networks and by network operators. A summary of these is given in Table 3-2. Given the importance of geographical context the ENWL figures are selected: an ADMD of 1.4 kW is applied in the network models unless this causes lower voltage limits to be violated (as is the case for networks MA and FC) where a 1 kW is applied. A minimum demand of 0.142 kW is applied in the daytime (this is taken from measured data as described in Chapter 4, Section 1). The DNO can use other minimum demands if required as more data becomes available, but this is deemed to be a

¹ As discussed in later chapters (particularly Chapter 5), tools in this paper are designed to be flexible to allow for different demand figures to be implemented by network operators. This is particularly important if operating and planning decisions are to be made increasingly from measured data as the distribution network becomes increasingly instrumented (see Figure 1-6).

realistic and acceptable value for this work. It is noted that the ENWL figures are similar to those of other sources. Demand does vary during the day, and this can be assessed using time series data, however, for this work it is acceptable to use single time-step studies to determine the worst operating conditions in the network. When applying the tools presented in Chapter 5 to the large number of LV network models described in Chapter 6, it can be seen that such an assumption is important to allow an evaluation of the case for LV energy storage within a reasonable computation time. This is also discussed in Chapter 9, Section 2.

Table 3-2: Maximum and minimum household demands used by different sources

Source	Quoted maximum demand [kW/kVA]	Quoted minimum daytime demand [kW/kVA]
Western Power Distribution (Western Power Distribution 2005)	0.5 + 0.25 x number of bedrooms	0.4
UKPN (UKPN 2014)	1.2-3.1	Not given
IEA (IEA 2002b)	1.2	0.133
Electricity Association (Papadopoulos et al. 2009)	1.3	0.16
Papaioannou (Papaioannou & Purvins 2014)	Not given	0.2 at power factor 0.7 (just a residential refrigerator)
ENWL	1.0 or 1.4	0.142 (according to measured data, see Chapter 4, Section 1)

1.2 Residential photovoltaics

To assess residential photovoltaics, it is necessary to establish how they are to be modelled within a power flow study, how to define how much PV is in a network and what PV system ratings (kW) are installed. Under the UK FIT, small scale PV are under 4 kW (Department of Energy and Climate Change 2013). Photovoltaics are constant power generators with an output which under normal operating conditions can be considered to be independent voltage at the busbar to which is connected. The power factor of PV is generally very close to unity in accordance with the performance of standard inverters and this value is adopted in wider academic practise such as (Canova et al. 2009), but they can operate within the range 0.95 lagging to 0.95 leading in accordance to Engineering Recommendation G83 (Energy Networks Association 2012). Although practically overvoltage protection in the PV inverter will cause the PV to disconnect in the event of overvoltage, this feature is disabled in OpenDSS modelling to ensure that the full range of network voltages is visible in the studies.

1.2.1 Definition of the amount of PV

In order to study the impact of this PV on LV networks, and the potential role for energy storage, it is important to establish how to define and describe amount of photovoltaics in residential power networks. A simple way of achieving this would be to state the installed capacity (kW) of photovoltaics in each network. However, this does not describe how much distributed generation is installed relative to the size of the network.

A common metric which is used is the “PV penetration”, although a number of slightly different definitions of this are used. In (IEA 2002a; Canova et al. 2009), PV power penetration is defined as the total rated power of PV divided by the rated (maximum) power of the distribution system. This approach is useful in that it provides a numeric link between demand and generation but it does not reflect the relative amount of power between the DG and the network at the worst voltage rise condition (i.e. when demand is lowest). (González-Longatt 2007) uses the PV power penetration and also provide an additional metric termed the “dispersion level” which is the ratio of the number of homes where there is DG to the number of homes in the low voltage network. The latter is useful in that it provides details of the extent to which the DG is spread in the network. In (M Thomson & Infield 2007), the term penetration is used to define the percentage of homes which have PV in a residential network. This is analogous to the definition of “dispersion level” in (González-Longatt 2007), but with penetration defined as homes as opposed to nodes. This is an important distinction, since a node (customer connection point) in (González-Longatt 2007) could feasibly have two or more homes connected to it. In (Widén et al. 2010), the penetration level is the ratio between the total DG power and the number of loads with units of kW per home. Considering the approaches taken in the literature, the dispersion level is selected as the most appropriate way for describing the amount of PV in a network. Generally, only South facing homes will be suitable for PV in the Northern Hemisphere since these will have the largest generation. This is defined as follows:

The PV dispersion level, p , of an individual network or feeder is calculated as the total number of PV systems, N_{PV} , divided by the total number of domestic loads (customers) where a PV system can be installed, $N_{H,PV}$, as shown in Eq. 3-1. This is analogous the probability that a customer will install rooftop PV.

$$p = \frac{N_{PV}}{N_{H,PV}} \quad \text{Eq. 3-1}$$

It is also necessary for this work to define the amount of energy storage, notably home energy storage, in an LV network. Therefore the following definition is used to define the home storage dispersion level:

The home energy storage dispersion level, q , of an individual network or feeder is calculated as the total number of home energy storage systems, N_{ES} , divided by the total number of domestic loads (customers) where a PV system is installed, N_{PV} , as shown in Eq. 3-2. This is analogous the probability that a home with PV will purchase and install a home energy storage system.

$$q = \frac{N_{ES}}{N_{PV}} \quad \text{Eq. 3-2}$$

1.2.2 PV installation scenarios

As discussed in Chapter 2, a large number of small, domestic PV systems are installed in the UK. A map of the distribution of PV by local authority in Q3 2013 is shown in Figure 1-4. This represents around 2.5GW of installed capacity across the UK. DECC forecast that there will be 10GW of solar PV installed in the UK by 2020, although the Minister of State for Energy and Climate Change believes that 20GW is possible. This is eight times the installed capacity in August 2013 (Department of Energy and Climate Change 2013).

Three scenarios (called DNO1, DNO2 and DNO3) were provided by ENWL to describe their forecast for the expansion of PV within their network. The DNO predicts that PV will grow quickly up to 2020. By 2020, there is expected to be between 400 and 880 MW of PV installed before the install rate will slow. In fact, the DNO predicts under two scenarios that the rate of install under the FiT will be exceeded until 2020. The DNO forecast is also supplemented with an additional scenario that the average install rate of PV under the FiT continues unchanged. The average install rate from 29th January 2012 to 23rd February 2014 is 2,163 PV systems per week¹ (Department of Energy and Climate Change 2014e). Given that ENWL has 8.14% of the UK customers (Consumer Focus 2010), this equates to an additional 176 systems per week in the ENWL licence area. These scenarios are shown in Figure 3-1 in terms of installed capacity.

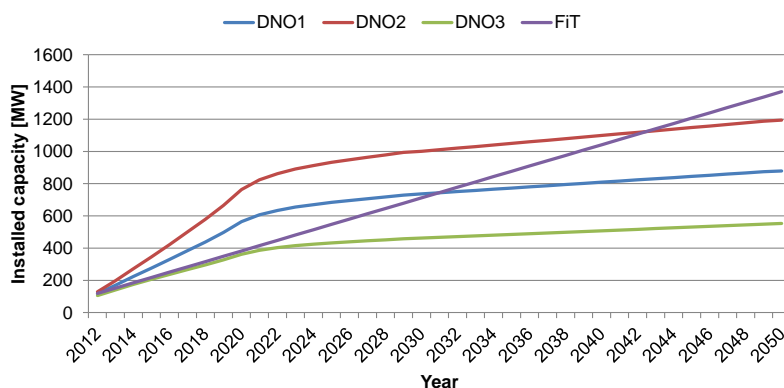

Figure 3-1: Forecast for installed capacity of PV within the ENWL network. Data provided by Geraldine Bryson and Darren Jones of ENWL.

1.2.3 PV output power

PV generation is predictable in that it is known to inject power into the network during daylight hours. The injected power is greatest when the solar irradiance is greatest which occurs during the middle of the day in the summer. The maximum power from the PV is also a function of the size of the installed PV system. The UK feed-in-tariff supports domestic systems of up to 4 kW with the highest tariff. As established in Chapter 2, Section 1.2, the DNO has no control over where PV is installed and there has been an uneven dispersion level of PV across the local authorities in the UK. The rating of PV systems is also limited by the available roof area for panels on each home. ENWL have stated that the average size in their network is 3.6 kW.

¹ Excluding weeks where install rate is higher than 10,000/week before changes in FIT tariff

2 Decoupling and MV voltage variation

The distribution network was originally designed to deliver power in one direction from higher to lower voltage levels. As a result of the current flowing along the line resistance, there is also a reduction in voltage, ΔV^- , along the MV and LV cables and lines. UK regulations state that the voltage at any customer connection point in an MV network must be within the range 0.94 p.u. to 1.06 p.u. Voltages in an LV network must not be greater than 1.1 p.u. or less than 0.94 p.u. (HMSO 2002)- although voltage drops are permitted if they occur no more than 5% of the time in a week when 10 minute values are considered (British Standards Institution 2007). Networks are designed to maintain voltage limits under unidirectional (passive) power flow where voltage reduces along a line.

To regulate the voltage in the network, the DNO generally uses on-load tap changers (OLTC) at grid supply points, bulk supply points and primary substations (Murray Thomson & Infield 2007). These transformers automatically change their turns ratios in response to the changing load conditions. As a result of this (and the changing network power flows), voltages in the MV network are dynamic. Secondary transformers usually have a fixed, pre-set tap position. The DNO will set this tap to the position which does not cause the upper voltage limit to be violated whilst minimising the chance of undervoltage in the LV network. To do so, they consider the expected voltages at the MV side of each secondary transformer. The maximum and minimum voltage at secondary transformer LV busbar n are denoted $V_{T,n}^{max}$ and $V_{T,n}^{min}$ respectively.

Secondary transformers reduce the MV network voltage to each LV network and therefore the voltage in an LV network is affected by that at the secondary transformer. For passive LV networks, the voltage will always decrease along a particular line segment. According to Eq. 2-2, the largest voltage drop in a network will occur when the loading in the network is highest. The voltage drop in LV network n is denoted $\Delta V_{LV,n}^-$ and is calculated as the difference between the transformer voltage and the lowest voltage in the network. The DNO needs to ensure that $V_{T,n}^{max}$, $V_{T,n}^{min}$ and all points within each LV network are within the regulatory voltage limits. As such, Eq. 3-3 and Eq. 3-4 must hold true. Here, a safety margin, V_S , is included. This reflects a margin that the DNO might choose to allow for extra voltage rise and to allow for the discrete nature of the tap positions of the secondary transformer.

$$1.1 \geq V_{T,n}^{max} + V_S \quad \text{Eq. 3-3}$$

$$0.94 \leq V_{T,n}^{min} - \Delta V_{LV,n}^- - V_S \quad \text{Eq. 3-4}$$

Where:

$$\Delta V_{LV,n}^- > 0$$

$$V_S > 0$$

The addition of DG in the LV networks changes the assumptions previously presented. Due to the possibility for power flows in both directions along feeder cables, the voltage in the MV and LV networks can increase along the lines i.e. if P and/or Q in Eq. 2-2, are negative then V_1 might be larger than V_2 . In the LV networks, this means that voltage rise, $\Delta V_{LV,n}^+$, becomes important. This is the difference between the highest voltage in the LV network and the voltage at the transformer and calculated using Eq. 3-5, where $V_{i,n}$ is the voltage at each busbar, i , in LV network, n .

$$\Delta V_{LV,n}^+ = \max(V_{i,n} - V_{T,n}, 0) \tag{Eq. 3-5}$$

The highest voltage at the secondary transformer LV busbar, $V_{T,n}^{max}$, may also increase due to changing power flow through the secondary transformer. This can be impacted by distributed generation in either of the LV or MV networks. Thus, Eq. 3-3 is rewritten as shown in Eq. 3-6. Combining this new inequality with Eq. 3-4, the maximum allowable voltage rise in an LV network (the LV network headroom) can be derived as shown in Eq. 3-7.

$$1.1 \geq V_{T,n}^{max} + \Delta V_{LV,n}^+ + V_S \tag{Eq. 3-6}$$

$$\Delta V_{LV,n}^+ \geq 0.16 - (V_{T,n}^{max} - V_{T,n}^{min}) - \Delta V_{LV,n}^- - 2V_S \tag{Eq. 3-7}$$

In summary, DNOs now need to consider maximum voltage at each secondary transformer as well as the worst case voltage rise in LV networks. In the event of inequality Eq. 3-7 being violated then the DNO needs to reinforce the given LV network which presents additional costs to their business. The parameters in these equations are also shown in Figure 3-2.

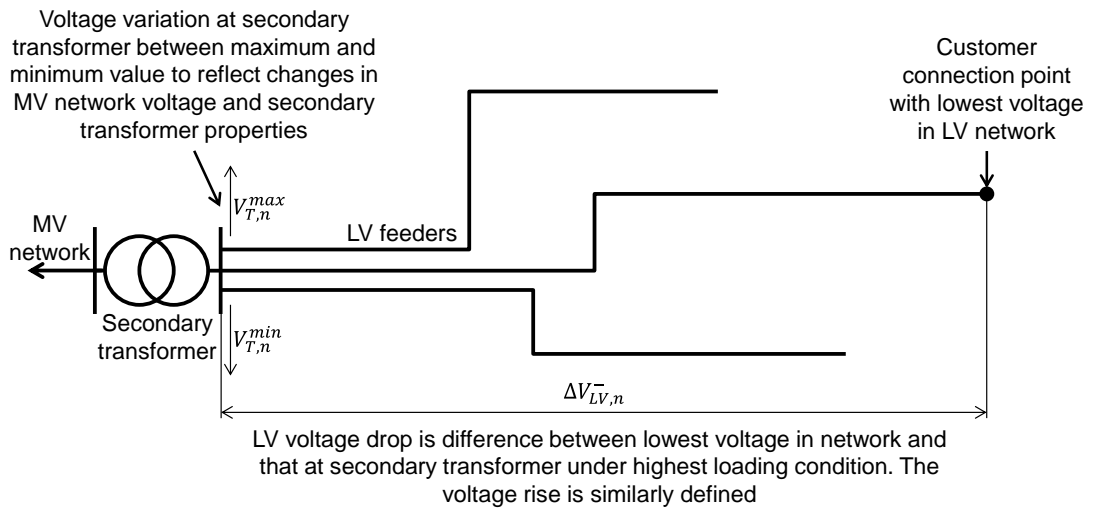

Figure 3-2: Parameters used to define LV voltage variation

In reality, the LV voltage will be further constrained since each secondary transformer has a finite number (usually 5) discrete tap positions. This means that output voltage can be changed in discrete not continuous steps. Because of this, a safety margin which considers the resolution of the tap positions is required. If no safety margin is included, then the DNO will accept a higher risk of some over or under voltage in the most extreme network conditions. To reflect this, a safety margin is included in this technical work.

3 Financial model

In order to determine the quality (from a DNO, policy and whole system perspective) of the solutions generated by planning tools developed in Chapter 4, a suitable financial model needs to be defined. It was established in the literature review that decisions are made on cost and so storage will only be installed if it is the cheapest option. Therefore, a decision tree for determining what action a DNO will take in response to a voltage problem can be developed (Figure 3-3). The reductoring and storage costs are now described.

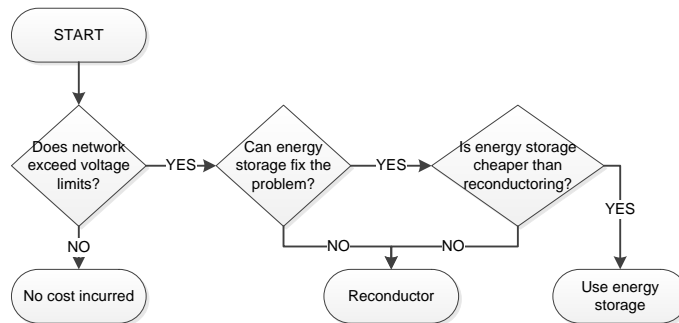

Figure 3-3: Decision tree for determining if reductoring or energy storage is required to solve an overvoltage problem in an LV network

3.1 Cost of LV network reductoring

Through discussion with ENWL it is known that to alleviate voltage problems they would traditionally reductor the LV feeder cables and that they are interested in relating the work here to the reductoring cost. Practically, this involves increasing the cable conductor area. The cost of purchasing and installing feeder cable was provided by ENWL at a fixed £80/m. This value was used in (Crossland, Jones, et al. 2013b; Crossland, Jones, et al. 2013a) and assumes an entire feeder is reductored in the event of a voltage problem. It is appropriate to use the cost figures provided by the DNO of the system being investigated, even though other costs have been used in literature such as in (Zhang et al. 2013). Because the LV voltage deviation is independent between each feeder, it can be assumed that the decision to reductor is taken on a feeder by feeder basis. As such, the cost to reductor each feeder, C_R , is the length of the cable in the feeder, L , multiplied by the fixed £80/m cost (as shown in Eq. 3-8).

$$C_R = 80L$$

Eq. 3-8

3.2 LV energy storage cost

(Schoenung & Hassenzahl 2003) provides a widely accepted cost formulation for energy storage systems which is adapted for use in this work. This produces a cost per kW for energy storage accounting for capital, operating and replacement costs (resale values are not included because the resale market for batteries in 10 years is very difficult to accurately predict). Such a per unit cost is useful as it can be easily scaled to different energy storage sizes and allows quick comparison of different energy storage technologies.

Derivation of the capital, operating and replacement costs are now described. Unless otherwise stated, parameters have been taken from (Schoenung & Hassenzahl 2003) or the updated cost figures in (Schoenung 2011) for a long duration storage system performing a cycle per day for 250 days per year.

3.2.1 Capital cost

The capital cost of each storage unit, C_{CAP} , can be expressed as the sum of the power conversion system and the energy store as shown in Eq. 3-9. The cost of the power conversion system is the rating, C_p , multiplied by the installed power of each unit, P_{ES} . The capacity cost is the cost per kWh for the storage system, C_c , multiplied by the capacity. The capacity itself is calculated as the storage rating multiplied by the number of hours that it is assumed to operate at full power, t . The capacity of the energy store depends on the maximum depth of discharge of the storage, D , and the round trip charging efficiency, η . As shown in Figure 3-4, the losses in the energy storage power conversion can be considered to reduce the amount of capacity required in the energy store. Conversely, the depth of discharge will increase the capacity required. It is assumed that the CAPEX is met up front.

$$C_{CAP} = C_p P_{ES} + C_c \left(\frac{P_{ES} t \sqrt{\eta}}{D} \right) \quad \text{Eq. 3-9}$$

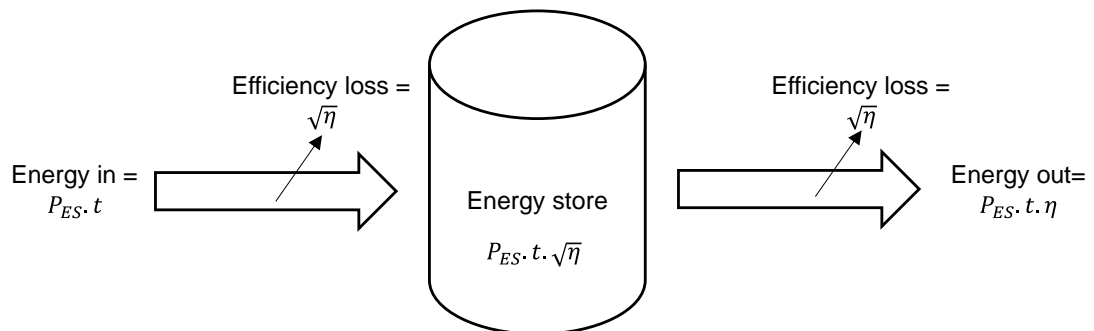

Figure 3-4: Charging and discharging efficiency losses in an energy storage system (self-discharge is assumed to be negligible)

3.2.2 Operating and replacement costs

Operating costs relate to maintenance and energy costs for an energy storage system. In the case of battery energy storage in distribution networks, the maintenance costs should be low if the systems are correctly designed. Therefore a fixed maintenance cost, C_M , of £1.50/kW/year is used as in (Schoenung & Hassenzahl 2003).

There is also an operating cost, C_L , related to the energy lost in charging and discharging the energy storage due to the system efficiency. For a DNO, this will increase the losses in their network and therefore increase the overall loss incentive payments. The energy loss, E_L , is defined as the total energy consumed (the product of the storage time, the number of annual cycles, N_c and the depth of discharge) multiplied by the efficiency loss as shown in Eq. 3-10 (this is an upper limit of the energy consumption as it assumes each cycle discharges the energy storage to the maximum depth of discharge). This is multiplied by the Ofgem loss incentive, C_{LI} to give the total cost of efficiency loss, C_L (Eq. 3-11). Parasitic energy loss (also known as self-discharge) for most batteries chemistries is very low (0.1-0.6% of charge lost per day) and is therefore not included (Evans et al. 2012)

$$E_L = tDN_c(1 - \eta) \quad \text{Eq. 3-10}$$

$$C_L = C_{LI} \cdot E_L \quad \text{Eq. 3-11}$$

Batteries need replacing after a fixed number of cycles (cycle life) or after a number of years (asset life) depending which comes first. The replacement cost, C_{RP} , is the cost of the system capacity (Eq. 3-12) discounted to the year in which replacement is required.

$$C_{RP} = C_C \left(\frac{P_{ES} t \sqrt{\eta}}{D} \right) \quad \text{Eq. 3-12}$$

3.2.3 Discount factors

Replacement and operating costs are annualised to give a net present value (NPV) and therefore need to be discounted. This is done using a standard net present value calculation of a future cash flow. Eq. 3-13 shows how a such a future cash flow, C , is discounted using inflation, i , and discount, d , rates for a year y . These rates have been selected with the DNO and are taken as 4% and 6% respectively. Capital costs are discounted using an annual DNO capital charge, A , of 7%.

$$NPV = \frac{C}{(1 + i - d)^y} \quad \text{Eq. 3-13}$$

The cost of an energy storage system, C_{ES} , is the sum of the discounted capital, operating and replacement costs as shown in Eq. 3-14 for discounted replacement, C'_{RP} , maintenance, C'_M and losses C'_L . This is normalised per kW installed i.e. has units of £/kW

$$C_{kW} = \frac{C_{CAP} + C'_{RP} + C'_M + C'_L}{P_{ES}} \quad \text{Eq. 3-14}$$

3.2.4 Final cost calculation

Table 3-3 summarises all of the general parameters used to determine the costs of energy storage in distribution networks. In the literature review a number of different home and community energy storage systems were identified (Table 2-1). These units are rated with power of the same order of the local PV system, and have storage capacities of between 1 and 2.5 times greater than the system rating. In this work 2.5 hour storage is therefore selected in line with these practically applied systems. An 80% maximum depth of discharge is selected in line with industry practice.

Four technologies from (Schoenung & Hassenzahl 2003) are chosen for comparison as the most suitable for distributed storage after considering a review of suitable technologies in literature and by considering technologies used in trial systems. Two varieties of lead acid batteries represent the most mature battery technology for this application, zinc bromine is chosen as a representative flow battery technology as used by RedFlow (see Figure 2-11) and lithium ion is a widely accepted future technology. Cost and technical parameters for these technologies are summarised A summary of the cost per kW of different storage technologies is given in Table 3-5. Operating costs for all of the devices are small since this is just the annual energy lost across the storage inefficiency. Capital and replacement costs are found to be the most important parameters (see Figure 3-5). The lowest cost technology is found to be lead acid with carbon enhanced electrodes. Lithium ion batteries have a larger capital cost, but a lower replacement cost because these batteries need replacing much less frequently. Many market analysts expect the capital cost of lithium ion batteries to reduce in line with improvements in this technology e.g. (The Guardian 2014a).

Table 3-4.

Table 3-3: Summary of cost parameters

Parameter	Symbol	Value
Storage time [hrs.]	t	2.5
Operating days per year	N	200
Project life [years]	-	10
Depth of discharge [%]	D	80%
Inflation rate	i	4%
Discount rate	d	6%
Electricity cost [£/kWh]	C_{LI}	0.06
Fixed maintenance cost [£/kW]	C_M	1.50

A summary of the cost per kW of different storage technologies is given in Table 3-5. Operating costs for all of the devices are small since this is just the annual energy lost across the storage inefficiency. Capital and replacement costs are found to be the most important parameters (see Figure 3-5). The lowest cost technology is found to be lead acid with carbon enhanced electrodes. Lithium ion batteries have a larger capital cost, but a lower replacement cost because these batteries need replacing much less frequently. Many market analysts expect the capital cost of lithium ion batteries to reduce in line with improvements in this technology e.g. (The Guardian 2014a).

Table 3-4: Technology specific decentralised energy storage cost parameters

Storage technology	Advanced lead-acid battery	Lead acid battery with carbon-enhanced electrodes	Zinc bromine battery	Lithium ion battery
Power cost, C_p [£/kW]	267	267	267	267
Energy cost, C_c [£/kWh]	220	220	267	400
Round trip efficiency, η [%]	80%	75%	70%	85%
Cycles	2,000	20,000	3,000	4,000
Asset life	5	10	8	10

The costs in Table 3-5 are higher than those in (Schoenung 2011) mostly due to the higher inflation rate and lower discount factor provided by ENWL even though a storage time of 4 hours is used in the comparative work from Schoenung. The comparative work uses a number of proprietary figures which makes it impossible to build a completely comparable model. Operating and replacement costs will be affected by different operating cycles as was explored by the authors in (Anuta et al. 2013; Crossland, Anuta, et al. 2013). The costs calculated using the given parameters are considered to be indicative and are therefore taken forward in later analysis. Using this formulation, it would be easy to incorporate other cost models if required.

Table 3-5: Final cost parameters of different battery types

Storage technology	Advanced lead-acid battery	Lead acid battery with carbon-enhanced electrodes	Zinc bromine battery	Lithium ion battery
Cost [£/kW]	2,150	1,433	1,739	2,425
Cost [£/kW] in (Schoenung 2011)	1,893	1,345	1,679	1,933

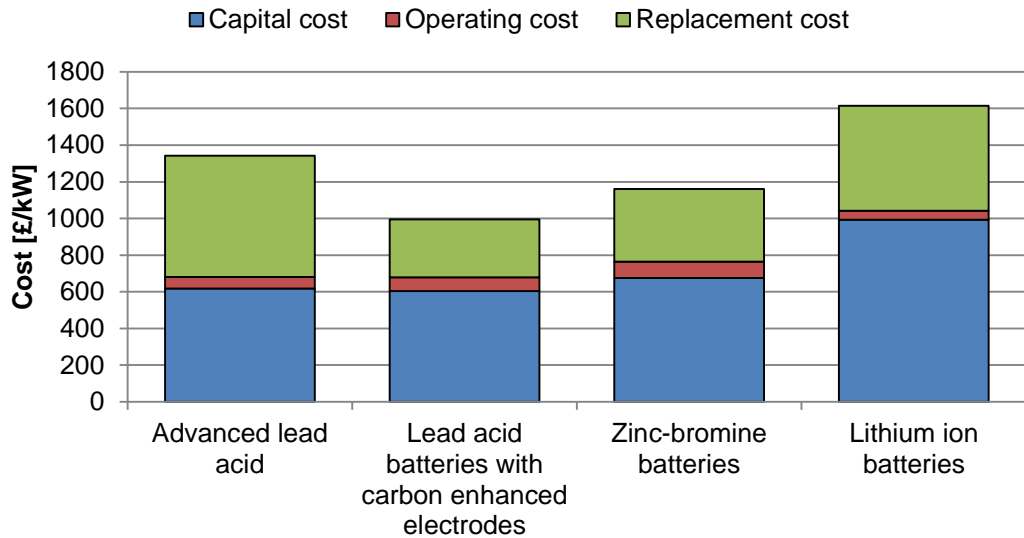

Figure 3-5: Capital, operating and replacement costs of different battery technologies

Apart from the cost of the storage system, there is also a cost associated with installation of a storage unit. This is called the install cost, C_I . In published work by the author, home storage was considered to have an install cost of £400 per system and community storage a cost of £8,000 per system (Crossland et al. 2014). The higher community storage cost reflects the need to carry out civil works (digging) in order to access underground LV cables. This means, that a storage system of rating P kW will have a cost, C_{ES} , as calculated in Eq. 3-15.

$$C_{ES} = C_I + P_{ES}C_{kW} \quad \text{Eq. 3-15}$$

4 Conclusions

This chapter has described the modelling techniques used for LV network analysis. This includes technical assessment of LV network voltages and power flows given changes in the voltage at a secondary transformer using a detailed OpenDSS model which includes every customer connection point. These detailed models are needed to allow full stochastic locationing of PV with the LV networks and to avoid having to develop a process to simplify the GIS derived network models in Chapter 6. However, this does impact computational time as much more effort is needed to perform load flow calculations.

In addition to the LV modelling techniques described, a method has been developed for decoupling the LV and MV network voltages. This allows a MV voltage variation to be included when determining the headroom for voltage rise and drop at LV. The decoupling is in part an estimated approach in that it assumes direct correlation between the highest and lowest MV voltages with the highest and lowest LV voltages. It also does not reflect the discrete nature of secondary transformer tap positions. To overcome this, it is recommended at this stage to study extreme voltage levels (very high generation, very low demand for voltage rise and no generation and very high demand for voltage drop) as well as the possible inclusion of a safety margin to give DNOs the highest confidence that voltage levels will be not be violated.

A financial model is described allowing the discounted cost of energy storage and reconductoring to be calculated and compared. The model is designed to allow energy storage costs to be calculated from the energy storage rating. In this, the storage capacity is expressed as a storage time rather than an energy rating in kWh. This has been done deliberately given the snapshot nature of the experiments discussed in later chapters. As is subsequently discussed, it would take a large amount of computational effort and design of control algorithms to derive accurate storage capacities when studying a large number of LV networks. This means that the final cost calculations may be altered by a better understanding of the storage capacity required to manage LV voltages. For example, on-going work by the author with a colleague is looking at how coordinated control can be used to provide greater storage reliability and robustness, but the cost implications and financial benefits of this are not studied.

The techniques are applied to case study networks in Chapter 4 to investigate energy storage planning decisions in LV networks.

Chapter 4: Preliminary Study of LV Distribution Networks

1 Case study networks

At the outset of the work, the industrial sponsor of this research project (ENWL) identified residential LV networks in Stockport (Figure 4-1) which have a particularly large amount of PV installed. A summary of the properties of these networks is given in Table 4-1 and the 11 kV MV network connecting the networks is shown in Figure 4-2. Overall, these networks have 1.4 MW of PV installed with a potential for 4.4 MW of PV (assuming each system is 3.6 kW:- the average system size across the ENWL network). One of the networks (DG) presently has PV on more than 50% of homes. An ENWL study has highlighted network MA as a being potentially problematic in terms of overvoltage after installation of PV. No concerns were highlighted with the other networks at present, but regardless a study of all of these networks has been performed to check this. This section details how LV networks such as these can be modelled and analysed from the perspective of the impact of PV on voltage as described in section 3 of this chapter.

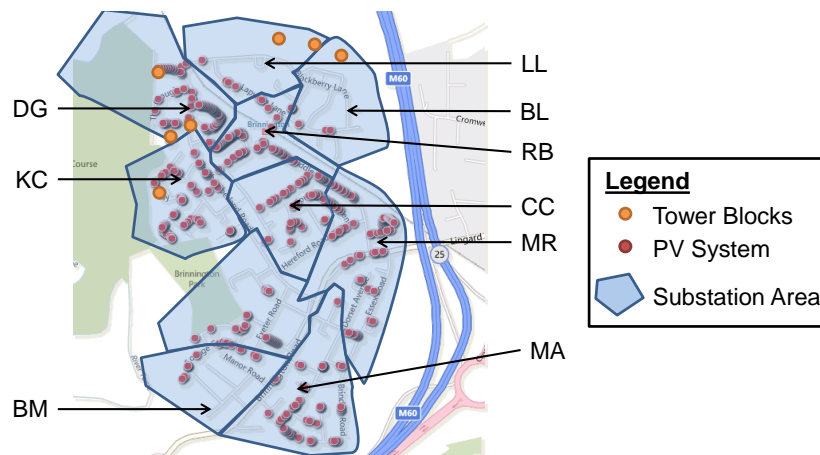

Figure 4-1: Areas covered by each LV network and location of PV systems presently installed within the case study networks

Table 4-1: Properties of the case study networks

Network name	BL	BM	CC	DG	KC	LL	MA	MR	RB
Transformer rating [kVA]	300	500	500	750	500	315	500	1000	300
Number of feeders	5	5	7	4	7	5	4	6	4
Number of domestic loads	194	171	270	195	296	208	380	335	185
Installed PV systems	2	10	47	99	58	6	53	65	43
Present PV dispersion level, p [%]	1%	6%	17%	51%	20%	3%	14%	19%	23%
Potential number PV systems	94	111	133	112	140	115	247	150	114
Potential PV dispersion level p [%]	48%	65%	49%	57%	47%	55%	65%	45%	62%
ADMD [kW]	1.4	1.4	1.4	1.4	1.4	1.4	1.0	1.0	1.4

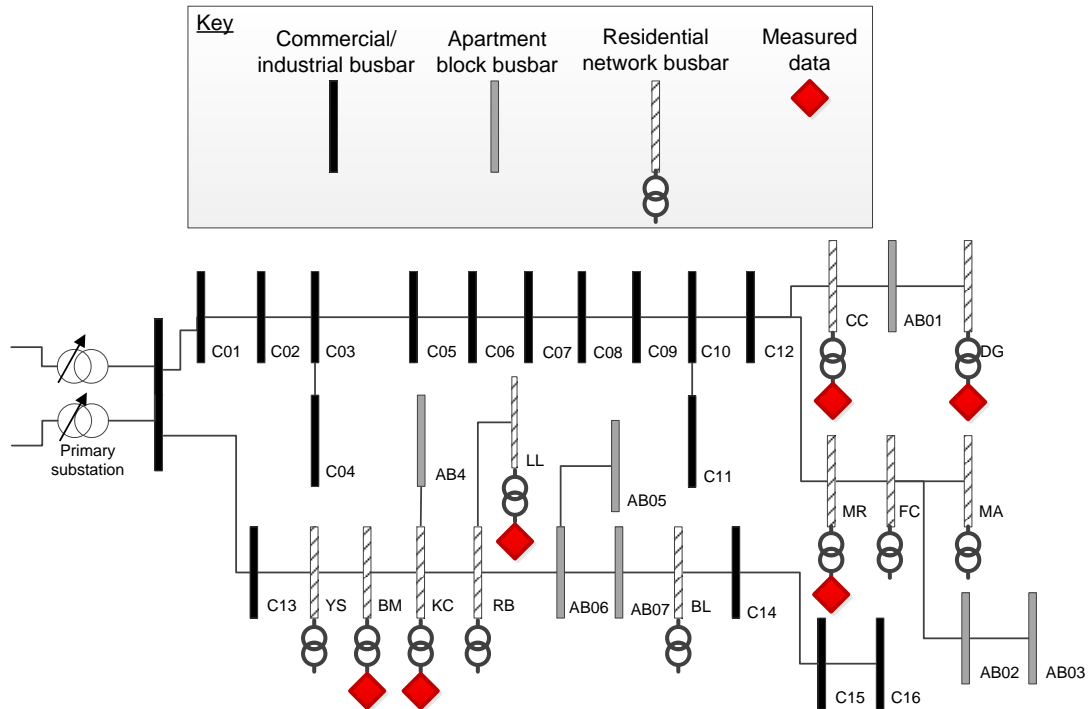

Figure 4-2: 11kV MV network associated with the case study networks

The performance of these case study networks (with no PV) is now presented using the decoupling of the MV and LV voltages (Eq. 3-7) described in Chapter 3, section 2. MV and LV networks are modelled separately to allow different network models to be maintained and modelled separately. This also helps with validation of each network model. The MV network variation is calculated using an OpenDSS model of the network shown in Figure 4-2 with loads set at their highest and lowest demand. This gives the variation at the LV bus of the secondary transformer of each case study network, as shown in Figure 4-3(b). Voltage drops in the LV networks are calculated using OpenDSS with residential loads set to their maximum demand.

The headroom for additional voltage rise or drop in these networks can be seen as the difference between the top of the stacked bar for the network and 0.16 p.u in Figure 4-3(a). Network MR is most constrained having 0.030 p.u. of headroom, whilst network BL has the most amount of headroom. All experience similar MV variation as seen in Figure 4-3(b) but the largest component of the voltage variation in all of the networks is the LV component as seen in Figure 4-3(a). This is because this voltage component considers the voltage difference across the entire length of and LV network feeder as opposed to that at just one node in a relatively strong MV network.

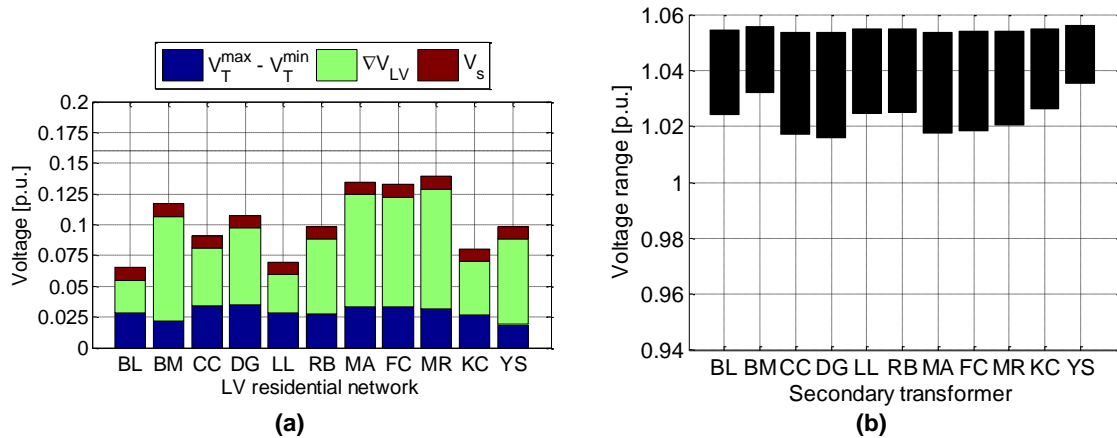

Figure 4-3: (a) Headroom used in the case study networks and (b) the voltage range at each of the MV busbars in the case study networks according to MV network modelling in OpenDSS at highest and lowest demands

2 Measured parameters

In December 2011, ENWL installed network monitoring equipment into the fuse boxes of six of the case study secondary transformers (see Figure 4-2) to help them understand the effects of the relatively high concentration of PV within these LV networks. The data provides measurements from networks BM, CC, DG, KC, LL and MR. Feeders BM, CC, DG, KC and LL primarily serve residential loads with varying amounts of residential PV systems. DG has a particularly high amount of PV and the data for this network provides the most information about the impact of PV on the LV networks. Network MR serves some commercial properties and has a large export of reactive power. The number of loads and PV systems connected to these is given in Table 4-2 alongside the results derived from analysis of the measured data. The monitors provided 11,886,628 individual data points, with each containing, for each phase, the following parameters at a one minute resolution:

- Mean, minimum and maximum bus-neutral voltage;
- Mean, minimum and maximum feeder current;
- Mean real, reactive and apparent power;

There are significant amounts of missing data points within the data set. Information is available less than 21% of the time on secondary transformers BM, CC, DG, LL and MR. Transformer KC has valid points for 66% of the year. For only 29 minutes is data available for all of the feeders at the same time. A summary of the data is now presented including analysis of voltage, voltage unbalance, real and reactive power. Some conclusions are reached about the impact of PV and then network parameters are calculated for application in subsequent work in subsequent chapters.

2.1 Voltage and voltage unbalance

Figure 4-4(a) shows boxplots of the voltages measured at each transformer. As shown, each has a different mean voltage. This is due to the relative position along the MV network (Figure 4-2) and the tap setting of the secondary transformer. ENWL have stated that, as a general rule, transformers are set at the highest or second highest voltage tap position to prevent voltage drop in networks with no distributed generation. However, the tap may be decreased if the DNO is concerned about overvoltage due to PV.

The voltage deviation is large, but closer analysis of the data shows that some of the most extreme voltages are transient voltage spikes. This is shown in Figure 4-5(a) where there is a transient voltage drop. These transients do not last long and do not represent steady state conditions. Also, looking at the data it is possible that these could be measurement errors in the experimental equipment used to produce this measured data. Therefore the transients are removed. To remove the transients, a 5 minute moving average of the valid data is calculated. This leaves the underlying, steady state voltage.

Figure 4-5(b) highlights the large amounts of missing data and lack of continual measurements. The black columns at the bottom of (a) shows where data points exist (where there is no data a straight line is interpolated).

Boxplots of the voltages without transients is shown in Figure 4-4(b). It can be seen that the voltage range is reduced to less than 0.04 p.u. It also can be seen that the voltage ranges are very similar. This is strong evidence that the secondary transformer voltage follows the MV network.

The voltage unbalance factor at each secondary transformer was calculated using Eq. 2-1. For 99.986% of the time steps studied, the networks are within regulatory VUF limits. However, BM, CC, DG and KC have voltage unbalance of more than 2% with the longest excursion lasting 2 minutes.

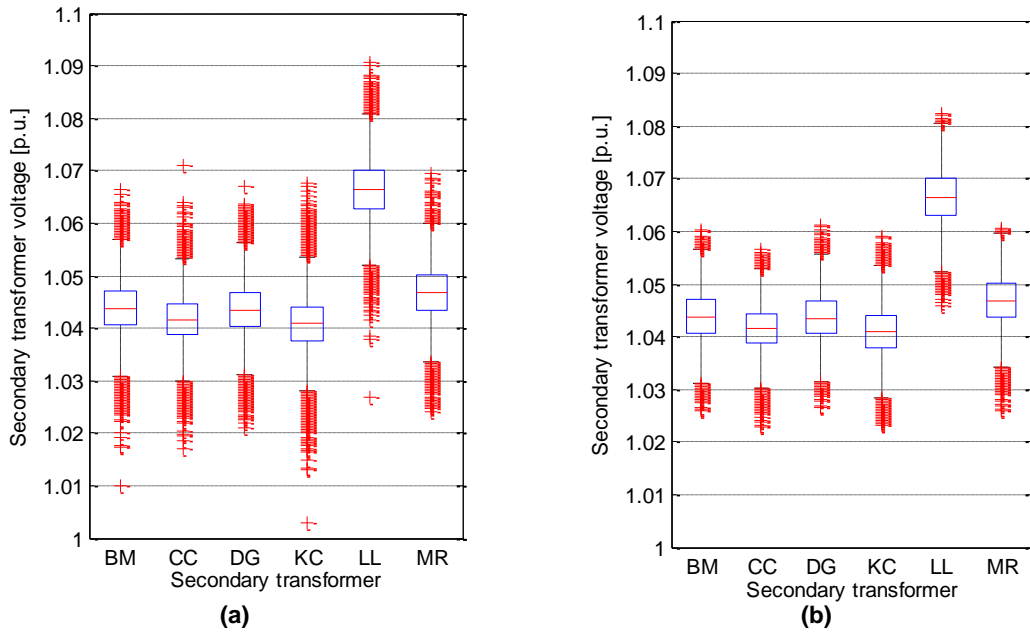

Figure 4-4: From the measured data (a) Boxplot of the mean voltage across the three phases for all data points at each secondary transformer and (b) boxplot of voltages for all transformers after transients are removed

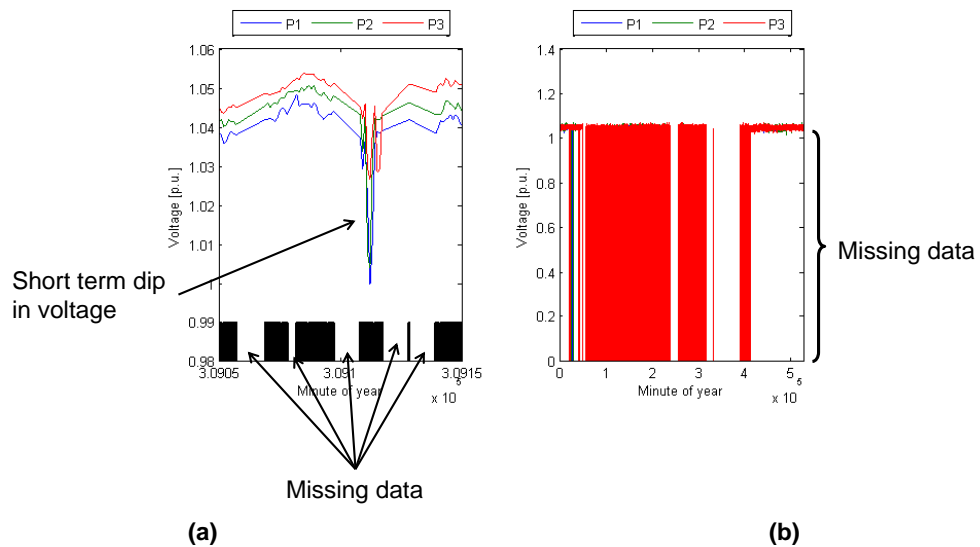

Figure 4-5: For 100 consecutive minutes in the measured data (a) Transient voltage dip identified across three phases in the data and (b) the voltage measurements in one of the networks with missing data shown as 0 p.u.

2.2 Power flow and fluctuation

Figure 4-6(a) shows boxplots of the powers through the secondary transformers which primarily serve residential loads. There is no trend between the real powers to the number of loads in each network. This is to be expected given the limited amount of data. For example, the data for LL represents less than 5% of a year leading to a large interquartile range in the boxplot for this transformer. High real power export is seen for network DG due to the high PV dispersion level.

Figure 4-6(b) shows boxplots of the reactive power through each of the transformers. It can be seen that, for the majority of the time, the networks import reactive power. The reactive power is very low in these networks compared to the real power, which indicates a low number of reactive power devices and/or a low correlation between when devices that consume/export reactive power (e.g. washing machines) are used. There is a small amount of reactive power export which indicates some capacitive load. This may be due to the capacitance of the underground cable, although the precise reasons are unclear. There is very high reactive power export on network DG and again the reasons are unclear but there is a large farm connected to this network as well as large amounts of PV. Besides, the export of real power as a result of the PV might be affecting the reactive power readings on the KelVAtек measuring system. As shown in the P-Q graphs (Figure 4-7), the real and reactive power components generally follow each other. The exception is network DG which has significant amounts of reactive power export across the real power range (around 33% of data points have reactive power export).

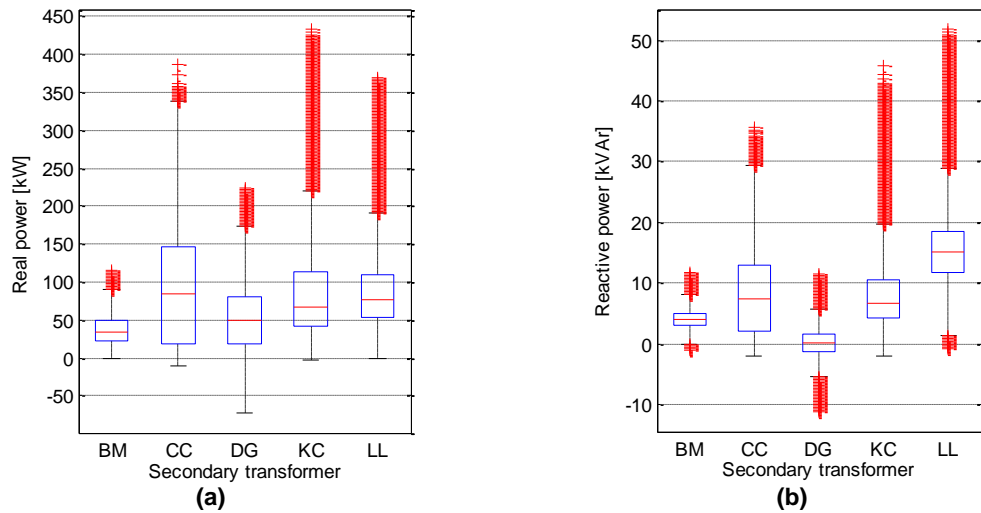

Figure 4-6: Boxplots of (a) real and (b) reactive power through each LV residential transformer

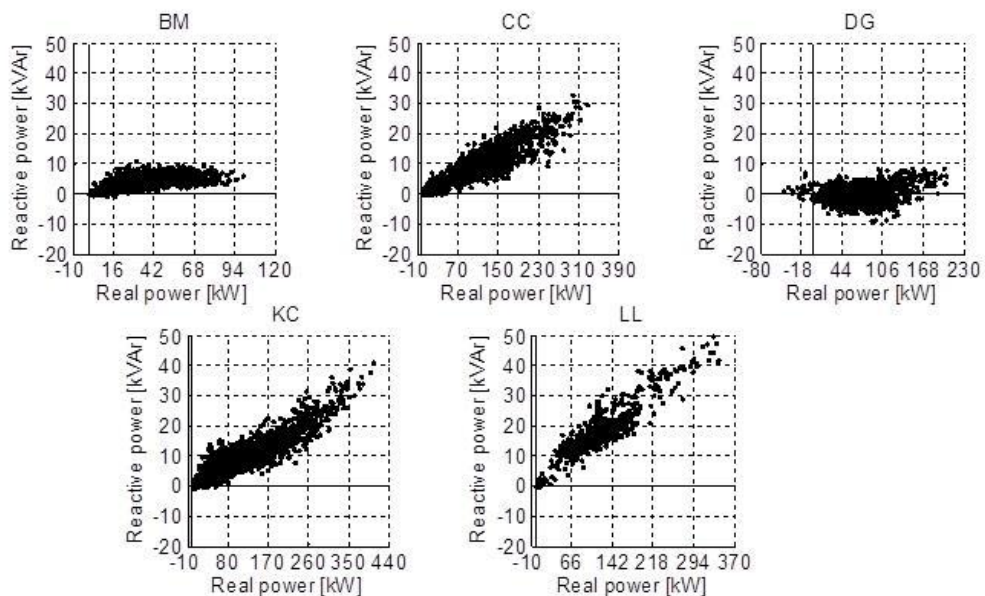

Figure 4-7: From the measured data P-Q graph for networks with mostly residential loads

2.3 Specific impacts of PV on case study networks

The most obvious impact of PV generation on the network is reverse power flow when the generation exceeds demand. As shown in Figure 4-6, networks CC, DG and KC experience reverse power flow but this does not exceed the thermal limits of the transformer. Figure 4-8 shows the real power and power factor through transformer DG on 29th March 2012. It can be seen that the PV reverses the power factor when its output exceeds demand. This is because the PV only provides real power (which is being exported), whilst reactive power is still being imported into the network.

Figure 4-9 shows boxplots of the hourly power flow through transformers with (a) high and (b) low amounts of PV. It can be seen that reverse power flow does not occur every day. This is due to the differing irradiance levels on different days and at different times of the day. As shown in Figure 4-8, there is a fluctuation in the power factor as the real and reactive power changes.

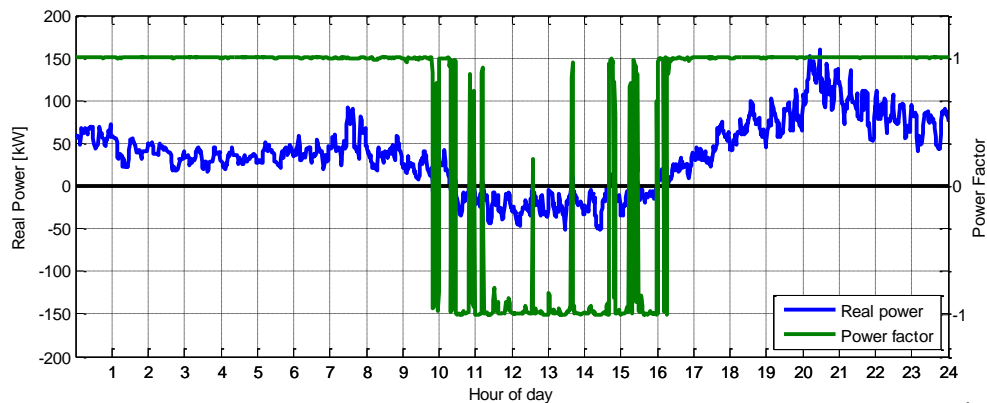

Figure 4-8: From the measured data real power and power factor for transformer DG on 29th March 2012

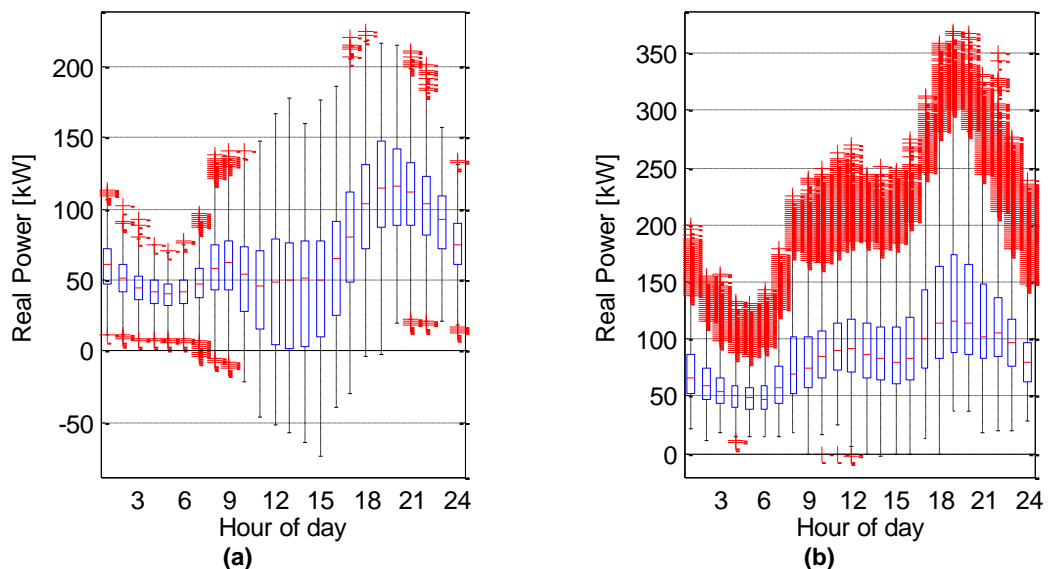

Figure 4-9: From the measured data, boxplots of real power flows through (a) DG and through (b) LL at each hour of the day

A further impact of the PV is that of voltage rise within the LV network. The measured data is recorded at the secondary transformer, where the voltage rise will be much lower. Figure 4-10 shows normal distributions of the voltages with different powers. The top chart shows the voltage when the power is reversed, and the bottom figure that with the highest forward (passive) power flows. It can be seen that the voltage is slightly lower when the power flows are higher. Because this effect is very small, it can be said that energy storage at a secondary transformer will have little effect for voltage control within an LV network. Measurements within the LV network would be more useful in investigating LV voltage rise.

2.4 Outputs of data analysis

Table 4-2 shows a summary of the findings from the measured data. Due to the limited quantity of data from the other secondary transformers, findings from KC are considered to be most valid.

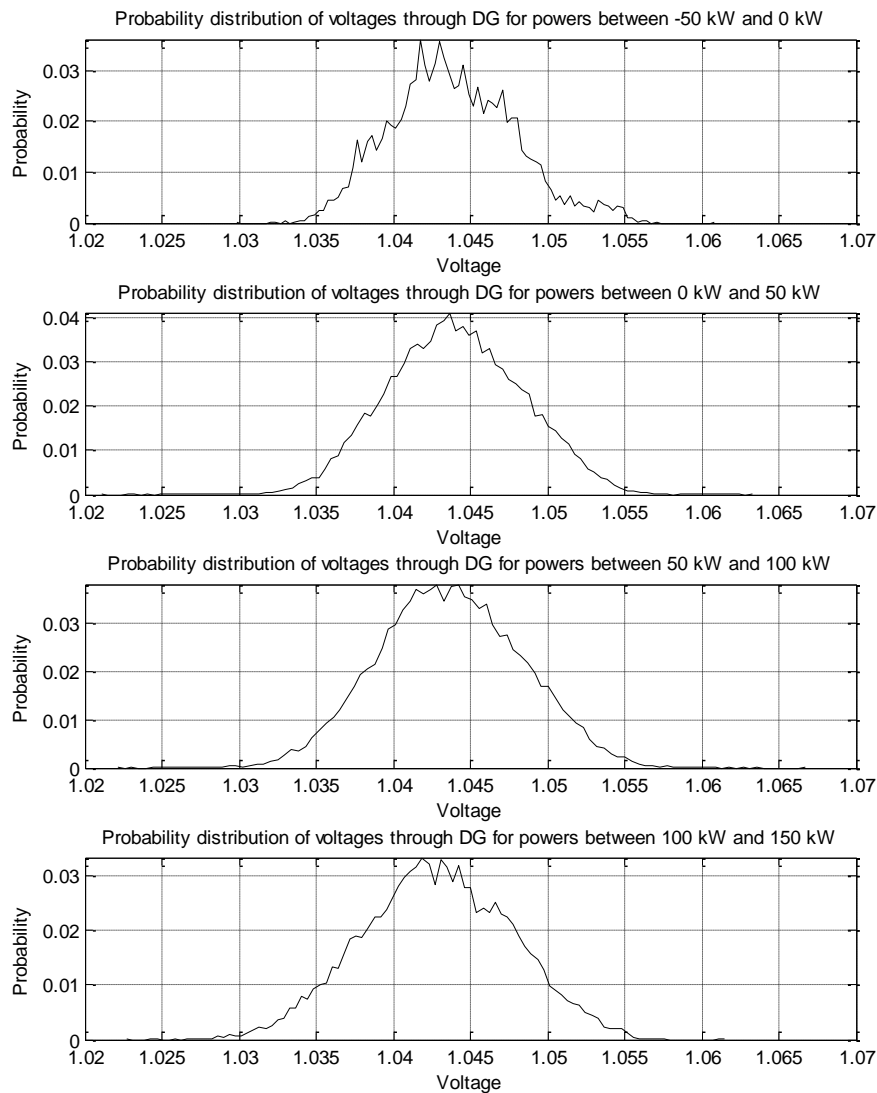

Figure 4-10: Probability distribution of the mean voltage at transformer DG when the power flow through the transformer is between given values

Table 4-2: Summary of parameters from measured data

Substation	BM	CC	DG	KC	LL	MR	Mean
Mean power factor ¹	0.991	0.992	0.998	0.994	0.981	0.992	0.991
Min. power factor ¹	0.856	0.888	0.925	0.928	0.757	0.606	0.826
Max. VUF [%]	3.070%	2.310%	2.037%	1.921%	1.443%	1.579%	2.060%
Mean VUF [%]	0.176%	0.248%	0.298%	0.334%	0.164%	0.236%	0.243%
Mean voltage [p.u.]	1.044	1.042	1.044	1.041	1.066	1.049	1.048
Voltage range [p.u.]	0.056	0.054	0.046	0.065	0.064	0.045	0.055
Voltage range after transients removed [p.u.]	0.034	0.034	0.035	0.036	0.037	0.035	0.035

3 Projected future performance of case study networks

The measured data allows consideration of the voltage variation at the secondary transformer. However, as shown by the study of the case study networks in section 1, the variation within each LV network is important and must be considered. Due to a lack of measured data in this project, this is done through modelling using OpenDSS and the procedures described in Chapter 3, section 1.

The voltage rise and drop in all of the case study networks is shown in Figure 4-11. The worst case LV voltage drop is calculated by setting all loads in a model of each network to the ADMD. No PV systems are included here. To calculate the voltage rise, loads are set to 0.142 kW (see Table 3-2)) and 3.6 kW PV systems are installed on either:

1. All of the homes which presently have PV to give the present worst voltage rise
2. All of the south facing roofs in each network to give the worst potential voltage rise.

It can be seen that the voltage in MA is most problematic given the large voltage rise and voltage drop on one of the feeders in the network. The remaining networks will see decreased voltage headroom, but this will not exceed the regulatory limits.

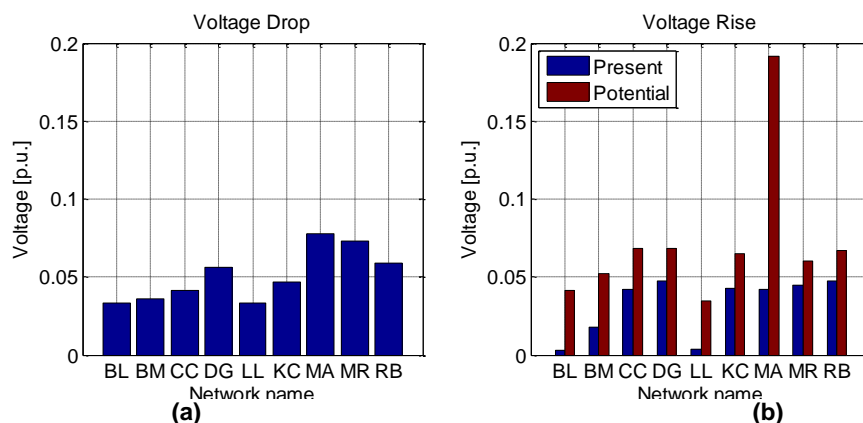

Figure 4-11: (a) Voltage drop and (b) present and potential voltage rise on case study networks when modelled using OpenDSS

¹ Between 8pm and 4am when no PV is active in the network

The highest expected reverse power flow through a secondary transformer can be estimated using the difference between the total demand (the number of homes, N_H , multiplied by their demand, P_H) in the LV network and the total generation (the product of the number of homes with PV, N_{PV} , and the rating of the PV systems, P_{PV}). This is shown in Eq. 4-1, with the reverse power flow calculated as an index of the transformer rating, P_T .

$$r = \frac{P_H N_H - P_{PV} N_{PV}}{P_T} \quad \text{Eq. 4-1}$$

Figure 4-12 shows the highest expected peak reverse power flow across the secondary transformers if 100% of the South facing homes have PV installed. This is shown for two different PV ratings (2.5 kW, 3 kW and 3.6 kW). The worst voltage reverse power flow occurs when demand is minimum (0.142 kW) and PV is at maximum output. It can be seen that the reverse power flow in network MA is expected to exceed limits if 2.5 kW PV is installed, whilst network LL, MA and RB are expected to exceed limits if 3 kW PV is installed.

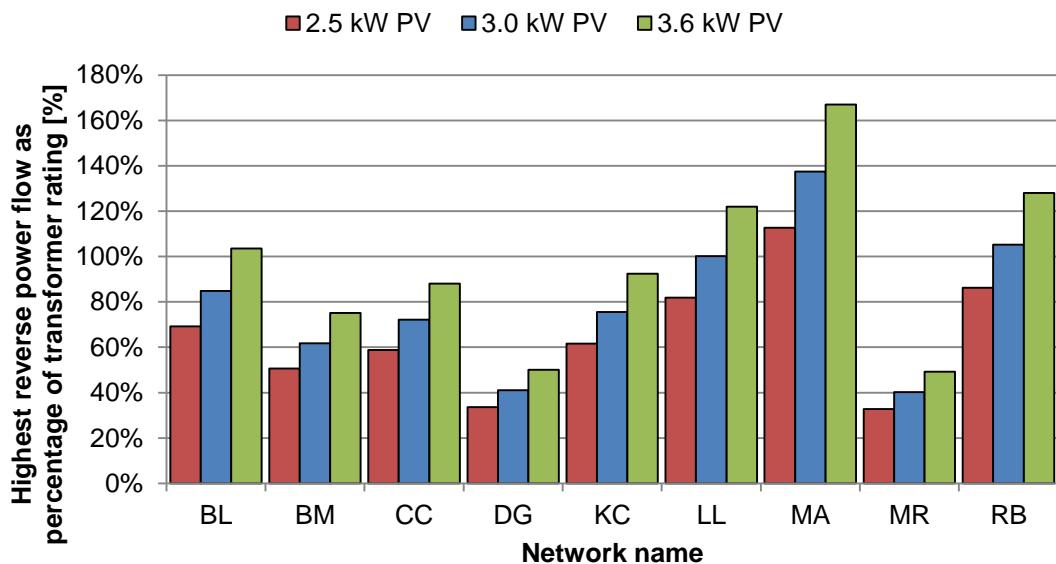

Figure 4-12: Reverse power flow in case study networks when all PV systems are at maximum power and loads are at minimum demand ADMD 3.6 kW PV

Of further interest is the number of installed PV systems which will cause the networks to exceed reverse power flow limits. This can be calculated through rearranging Eq. 4-1 with $r = 1$. Table 4-3 shows the dispersion level needed to cause reverse power flow limits to be exceeded. This transformer rating is only exceeded with a large number ($\geq 75\%$) of homes having PV due to the fact that power networks are generally designed to consider some long term load growth.

Table 4-3: Dispersion level required for transformer ratings to be exceeded under reverse power flow in the three most problematic case study LV networks

Network	2.5 kW PV	3 kW PV
MA	90%	75%
LL	> 100%	100%
RB	> 100%	95%

3.1 Headroom

Headroom is the additional voltage deviation that can be experienced in an LV network before voltage limits are violated. The existing headroom in the case study LV networks can be determined by considering the networks with no PV including MV deviations calculated from an OpenDSS model of the MV network shown in Figure 4-2. The headroom for voltage rise (which can be found using Eq. 3-7) is shown as the unused voltage range for each network in Figure 4-13. It can be seen that MR, FC and MA are the most constrained due to large voltage drops within each LV network. In all of the networks, the deviation in each LV network is much higher than deviation at each transformer, which indicates that the voltage levels are most constrained by the LV networks. This is due to the fact that the voltage drop ($\Delta V_{LV,n}^-$) term accounts for the whole LV network whilst the V_T^{max} and V_T^{min} account for just one node of the MV network. This latter point is important since it means that LV networks are most likely to be constrained by the voltage deviation within them as opposed to that as a result of the voltage deviation in the MV network. This is particularly true on larger LV networks (i.e. urban residential networks connecting large numbers of customers with long feeder cables) since these will have much larger LV deviations.

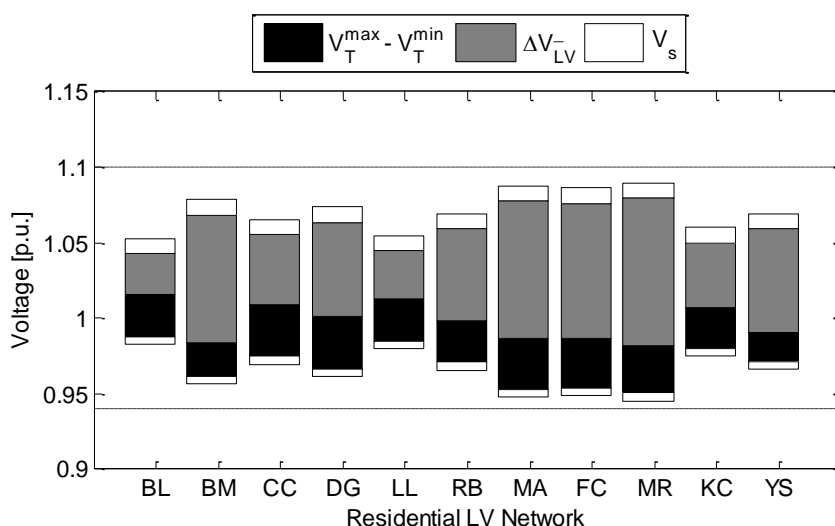

Figure 4-13: Range of voltages in each residential LV network with no DG or energy storage installed, where V_T is the transformer deviation, ΔV_{LV} is the LV voltage drop and V_s is a 1% safety margin. The tap position is set to a notional level as the important parameter is the range of voltages experienced in the LV network as outlined in Chapter 3, Section 2

3.2 Preliminary study of case study network MA

This work can also be found in:

Anuta, O., Crossland, A. F., Jones, D., & Wade, N. (2012). Regulatory and Financial Hurdles for the Installation of Energy Storage in UK Distribution Networks. In CIRED Workshop. Lisbon. (Anuta et al. 2012).

A preliminary study was carried out into the impact of PV and load growth on electrical losses, peak power flow, thermal limits, reverse power flow and voltage. Technical, financial and regulatory findings were presented at the CIRED 2012 workshop (Anuta et al. 2012). The study used a bespoke temporal model of network MA to which hourly demand (RMDS 2014) and generation (NREL 2011) profiles were applied. The study was conducted over ten years with two representative annual uniform load growth scenarios of 0.04% and 2% and the addition of 20 PV systems each year. Energy storage, located at the secondary transformer, was evaluated for its ability to reduce losses, reverse power flow, peak power and voltage rise. Two energy storage capacities of capacity 250 kWh and 500 kWh are considered. A flowchart showing the control algorithm is given in Appendix C. The main conclusions from the work were as follows:

- ❖ Load growth of 2% caused the peak power flow to exceed the transformer thermal limits after 9 years. The energy storage was easily able to prevent thermal limits being exceeded due to its high rating (Figure 4-14(a)). However, the benefit of not replacing the secondary transformer (~£8,000) was much less than the energy storage cost.
- ❖ Losses were reduced using the energy storage but the revenue from this was of the order of several hundred pounds per annum which was very much less than the cost of the storage.
- ❖ The LV network cables needed replacing due to overvoltage in the networks. The storage was able to defer the year in which overvoltage occurred. This had the largest financial benefit to the DNO.

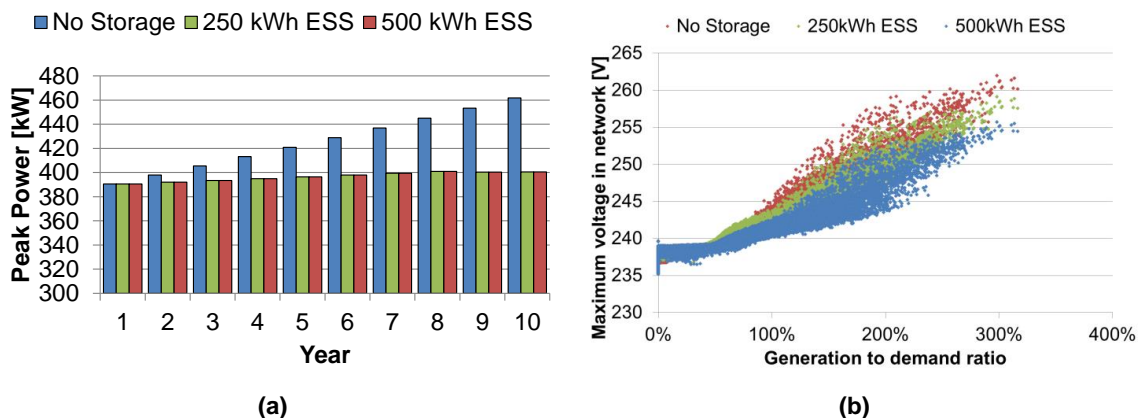

Figure 4-14: For three sizes of energy storage at the secondary transformer and 2% load growth (a) the peak power through transformer and (b) the highest voltage in the network

3.3 Locating energy storage within LV networks

This work is detailed in:

Crossland, A., Jones, D., & Wade, N. (2013). Energy Storage/Demand Side Response in LV Networks: Design of Cost Based Planning Tools for Network Operators. In 22nd International Conference on Electricity Distribution (CIRED). Stockholm. (Crossland, Jones, et al. 2013a).

Energy storage at the secondary transformer was shown in 3.2 to be able to reduce voltage rise and reverse power flow and prevent peak power flow from overloading the transformer. However, it is noted that by locating energy storage within an LV network, it is possible to locate the storage closer to where a voltage problem occurs whilst still being able to manage peak and reverse power flow. Doing so will reduce the reverse power flow through the LV network cables and therefore, potentially, reduce the voltage rise in the networks as shown by considering Eq. 2-2.

This will improve the financial case if it is shown to further reduce or eliminate overvoltage, prevent the need for cable replacement and/or use less storage. However, correctly determining the location for energy storage is difficult because number of questions need to be answered:

1. How big should each energy storage unit be?
2. Where units should be placed?
3. How many units are required?

This is a complex problem to solve. For example, in a network with 200 homes, there are 64 million ways of locating four energy storage units within it. In (Crossland, Jones, et al. 2013a) a comparison was made between different cost based planning tools for locating energy storage within LV networks to mitigate the voltage problem. Specifically, two deterministic planning tools were compared with a stochastic tool. The tools determine where to locate storage within a LV network with a high PV dispersion level and which will violate regulatory voltage limits when generation is highest and demand is lowest:

- ❖ **Heuristic 1:** Energy storage is first located at the node with the highest voltage. If this does not solve the voltage problem, then it is located at the node with the next highest voltage. This process is repeated until the voltage problem is solved.
- ❖ **Heuristic 2:** Energy storage is located at the node with the highest voltage sensitivity factor relative to where the voltage problem occurs. This is repeated until the voltage problem is solved.
- ❖ **Heuristic 3:** A genetic algorithm (see Chapter 5, Section 4) is used to determine the optimum configuration of energy storage devices in the network which solve the voltage problem for the lowest cost. Such an algorithm could also be adapted to look at thermal protection, loss reduction and other parameters using a multi-objective formulation.

Studies are carried out using the worst case network conditions i.e. with the network in the highest voltage rise condition (the lowest demand and highest generation) to determine the amount of power needed to fix the voltage problem. The performance of these three heuristics is shown in Figure 4-15 when applied to both network MA and to the IEEE LV test network (IEEE Distribution Test Feeder Working Group 2012). Two scenarios are considered, 3 kW single phase energy storage located in customer homes and 15 kW three phase energy storage located on the street. In this single time step study, the home storage absorbs all of the generation from local load whilst the street storage reduces reverse power flows in the network. It can be seen that the genetic algorithm (heuristic 3) produces solutions with the lowest capital cost. This is because it is able to search the entire problem space (locations for energy storage) and intelligently determine the best solution. This comes at a computation cost of a larger number of load flow calculations as shown in Figure 4-15(b). The large impact that storage location and size has on its ability to solve a problem was also subsequently found in (Hashemi et al. 2014).

For both of the networks studied, the three phase street storage produces solutions with a higher CAPEX than single phase storage in the home. This is because home storage can be located on the same phase as where the voltage problem occurs and so use all of its available power and energy capability to directly address the voltage problem. This is particularly important given that the voltage problems were not found to be the same across the phases in either of the LV networks studied.

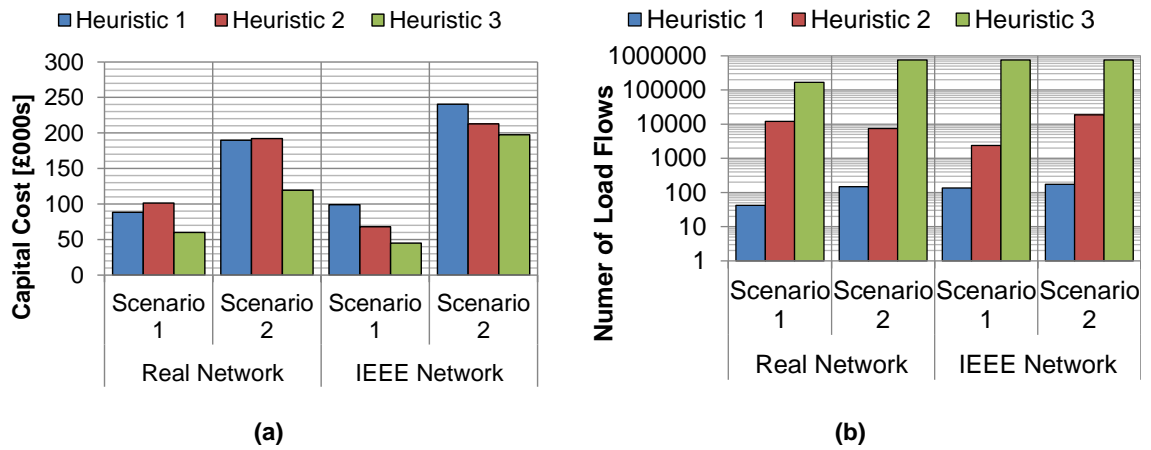

Figure 4-15: (a) Number of storage units installed by the heuristics and (b) the number of load flows used in each heuristic used in the CIRED 2013 paper (Crossland, Jones, et al. 2013b)

4 Conclusions

In this preliminary work, reverse power flow and overvoltage were found to be a problem in some but not all of the case study networks; as was predicted in the literature review. Energy storage was investigated to reduce this impact. At the secondary transformer, storage could solve reverse power flow, but could not eliminate overvoltage because it did not affect the LV network voltage rise. However, storage within the networks could prevent overvoltage and improve the integration of PV. This is because it could be located closer to the voltage problem. This establishes and underpins further work in investigating how energy storage can be installed within LV networks and how this can practically be achieved by DNOs. A literature review will be performed to establish methods for investigating this problem.

Of the network studied, not all are expected to have voltage problems as a result of PV integration. This is an interesting finding and highlights the need for planning tools to identify problematic networks. It cannot be assumed that all networks will be.

Measured data has established modelling parameters and also showed that there will be some variation in the secondary transformer voltage as a result of reverse power flow and other variations in loading. Further, the measured data provides useful parameters for further study. However, monitoring equipment is not widely available across the ENWL secondary transformers and so it can only provide a limited amount of data in the study of a large number of LV networks. The measured data itself has proven to be extremely difficult to work with due to the difficult way in which the data is recorded and due to the large amounts of missing data. If measured data is to be used more widely, then the data reporting needs to be improved and it is recommended that manufacturers of modelling equipment look at better data processing. For example, of interest for this study is the range of voltages seen at the secondary transformer and these could be transmitted to the DNO on an hourly or daily basis whilst detailed voltage measurements at different time steps could be saved locally to be collected and analysed if needed at a later date.

Chapter 5: Planning Tools for Distributed Generation and Energy Storage in LV Distribution Networks

1 Introduction

In this chapter, two planning tools are proposed for DNOs to investigate energy storage in LV distribution networks. The first tool can be used to investigate how stochastically located energy storage (i.e. home storage bought in a free market by customers) can reduce the voltage rise caused by PV. For example, if there is a street of 10 houses with PV, the DNO cannot influence which houses might purchase home energy storage. This tool allows a DNO to determine how this uncertainty affects the probability of the storage eliminating voltage rise. This tool also calculates the voltage rise caused by PV if no storage is installed.

The second tool can be used to find the optimal locations for distributed home or street storage to reduce the voltage rise to within regulatory limits for a particular PV dispersion. This tool is a heuristic with the objective of installing the cheapest formulation of energy storage within an LV network to fix an overvoltage problem. As established in Chapter 2, no suitable tools were found for this.

Both tools recognise that DNOs cannot control where PV is located within their networks and by using them, it is possible for the DNO to assess:

1. The overall impact of rooftop, residential PV systems on existing networks on voltage rise.
2. The benefit of using home energy storage in reducing overvoltage problems caused by residential PV given uncertainty about where this will be installed
3. The optimum energy storage rating, type and location for reducing voltage rise problems in LV networks caused by residential PV.

2 Effect of energy storage and determination of size

To avoid the need to use time series data (which requires a large amount of additional computational effort: if hourly resolution data were used, this would require 8760 additional load flows and increase the time for the tools proposed in this chapter to analyse a full set of networks from days to weeks) a worst case single time step network condition is assessed. Here all loads are set to their minimum value and all generators (PV) are set to their maximum export power to give the highest possible voltage rise in each LV network. Once the network is in this condition, energy storage is charged to absorb reverse power flow and reduce the voltage rise. By setting all of the energy storage systems to their maximum charge rate, the ability of a particular configuration (location, power rating) of storage to reduce voltage rise can be measured. Therefore, different storage solutions can be compared on their ability to solve a particular voltage problem.

Storage energy capacity is determined by multiplying the total storage power by a storage time. This storage time will depend on the control objectives of the storage, and suitable values have been determined looking at existing systems as described in Chapter 3, Section 3.2. This suitable simplification allows the tools proposed here to be applied within a reasonable computational time to a large number of network models in Chapter 7 and Chapter 8.

3 Stochastic method for determining voltage impacts of distributed generation and home energy storage

This section describes the design of a probabilistic tool which considers PV and energy storage being stochastically located in power networks. The tool is similar to the Monte Carlo approaches used in (Kolenc et al. 2015; Shahnian et al. 2011; McQueen et al. 2004; Navarro et al. 2013) but applied specifically to the problem of overvoltage due to residential PV and adapted for assessment of randomly located energy storage, given that:

- PV can be sited at any of the valid nodes in an LV network (i.e. on south facing roofs). DNOs do not have control over where PV is sited in their LV networks
- Home energy storage is most likely to be installed by customers with PV to improve their self-consumption. If these are bought in a free market then the DNO does not have control over where this will be sited.
- The worst case for voltage rise is when the demand is lowest and the generation is at its peak.

An overview of the tool is shown in Figure 5-1. As shown, the tool loops over all the LV networks being studied. First, a full model of each LV network being studied is retrieved which includes each individual customer connection. To calculate the voltage drop, $\Delta V_{LV,n}^-$, all of the loads are set to their maximum value (ADMD) with no DG connected and a load flow is performed. The voltage rise in the LV network is then determined by randomly placing PV and energy storage at feasible locations in the network. This requires two parameters, p and q which describe:

- The probability that a home which is suitable for PV has this installed (PV dispersion level).
- The probability that a home with a PV system has energy storage (storage dispersion level).

The tool first randomly places domestic PV systems of a fixed rating (3.6 kW systems are used in Chapter 7 and Chapter 8) at each feasible location for PV with probability, p_n . Then, for each home with PV, a proportion q_n will also have a home energy storage system installed. Once the PV and energy storage units have been placed in the network, all loads are set to their minimum value, all of the PV at the maximum rated output and all energy storage units charge

at their maximum power. This creates the conditions for the highest voltage rise, ΔV_{LV} , given the particular location of PV and energy storage. A load flow is performed to determine the voltage rise. This process is repeated a number of times with different PV and energy storage locations. The process is repeated for each LV network to be analysed. If the PV rating is the same as the storage rating, then there is an assumption that the storage is always available to fully charge all of the PV power. In reality this might not be the case, for example if the storage is failed or if the control of the storage is ineffective. However, this does reflect a storage rating that is capable (if fully reliable and controlled effectively) of preventing overvoltage. To reflect unreliable storage control, or storage that is not fully available, a simplified approach would reduce the storage rating by a factor (e.g. 10%). This would require careful selection of appropriate parameters which is beyond the scope of this work and could be revealed through storage trials such as those outlined in Table 1-2, page 8. n repeats are completed of the heuristic with different randomly determined locations for PV and home energy storage.

The tool is implemented in a MATLAB (MathWorks 2013) script which interfaces with power flow analysis in OpenDSS (EPRI 2013) to calculate voltages. As a voltage study, power flows are of less interest here. However, the flexibility of using MATLAB with OpenDSS allows power flow analysis to be completed if necessary by adapting the proposed tools.

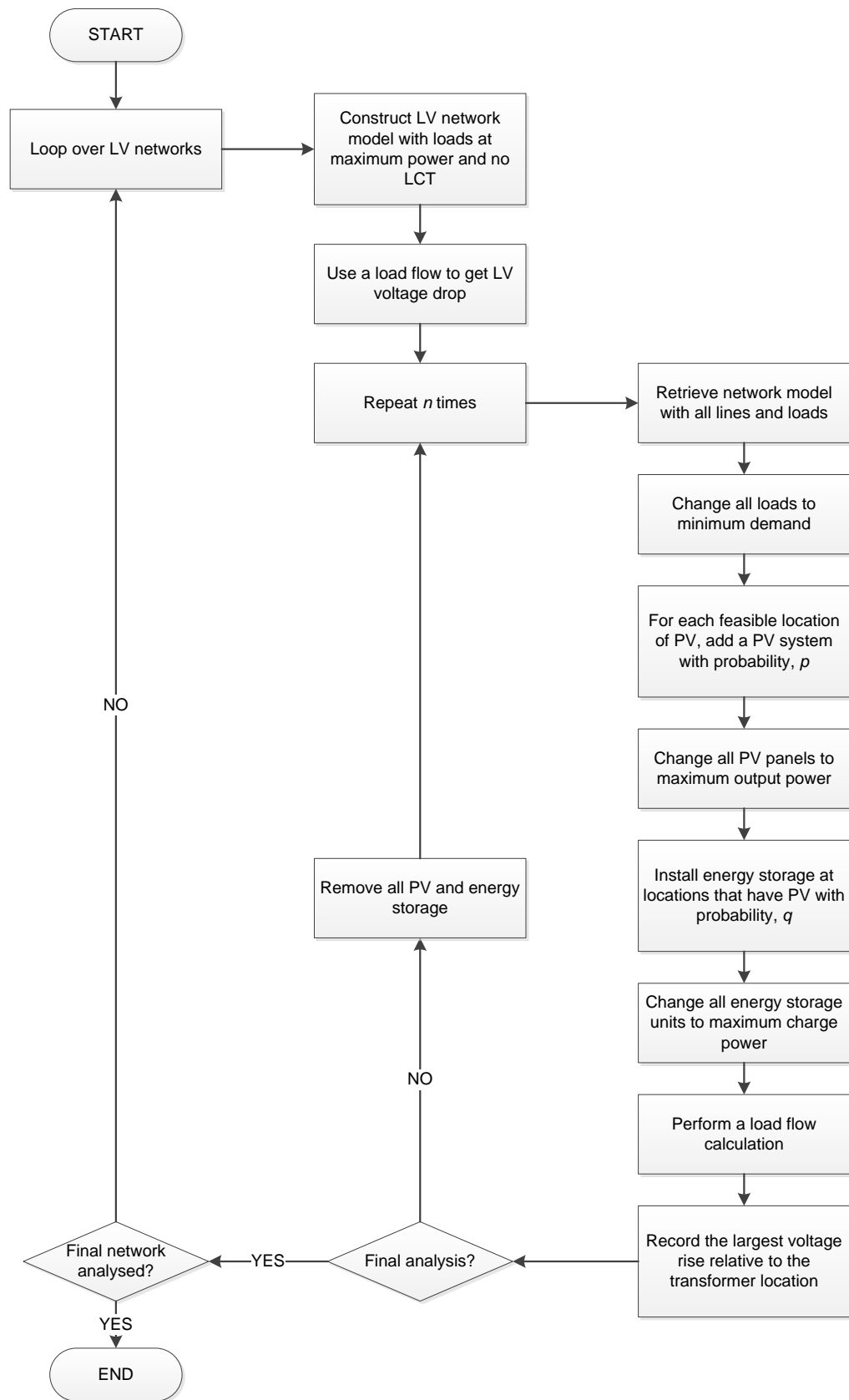

Figure 5-1: Stochastic tool for determining the voltage rise in LV networks with different amounts of stochastically located PV and energy storage. n repeat runs of the tool are completed

3.1 Assumptions

The stochastic tool makes a number of assumptions which are important to clarify:

- It assumes that all PV in a particular network has the same peak capacity. This is valid since it is likely that all properties on a feeder have similar roof area and therefore peak capacity. In the future, solar conversion efficiency of panels will improve and therefore it may be necessary to allow different PV ratings to be installed.
- It assumes that all PV systems will have peak output at the same time. Practically, this is not the case if the panels have different orientation and a study by Western Power Distribution found the PV diversity to be 81.1% (Shaddick 2011). This can be implemented by reducing the PV rating using a scaling factor of 0.811 and could be completed in future work.
- The tool assumes that home storage would only be installed in homes with PV. This is valid if it is assumed that to make storage profitable, owners benefit from increased self-consumption of PV.
- The probability that each home will install PV (p) or energy storage (q) is assumed to be the same for every LV network or every home: in reality, social factors influence this.

It is noted that although these assumptions are considered valid through discussion with the sponsoring companies (ENWL and SP) and through assessment of the market for residential storage by companies, consultancies and academics at numerous conferences (e.g. Energy Storage World Forum, London 2014), the tool can easily be adapted to represent some other assumptions. For example, feasible locations for home storage could be changed to include all homes within the network if it becomes profitable for homeowners without PV to own storage.

3.2 Application to case study LV networks

The proposed stochastic tool is applied to the case study networks. Figure 5-2 is a distribution of the voltage rise for three different PV dispersion levels on one of the case study networks. It can be seen that the voltage rise is normally distributed, as confirmed using the in One-sample Kolmogorov-Smirnov test MATLAB (MathWorks 2014c) which is a test of normality. This confirms that the voltage rise for a given PV dispersion level is does not have a single value because the exact locations of the PV within a network can be different but still achieve the same dispersion level. The normality of the voltage rise is important because this allows a probabilistic representation of the voltage rise, i.e. the voltage rise for a given amount of installed PV and energy storage on a given network, $\Delta V_{LV,n}^+$, can be considered to be normally distributed with mean \bar{x}_n and standard deviation, σ_n . These can be determined using N samples of the voltage rise using Eq. 5-1 and Eq. 5-2 and, for a given confidence level, upper bounds of the voltage rise caused by a given amount of installed PV can be estimated as determined in Table 5-1.

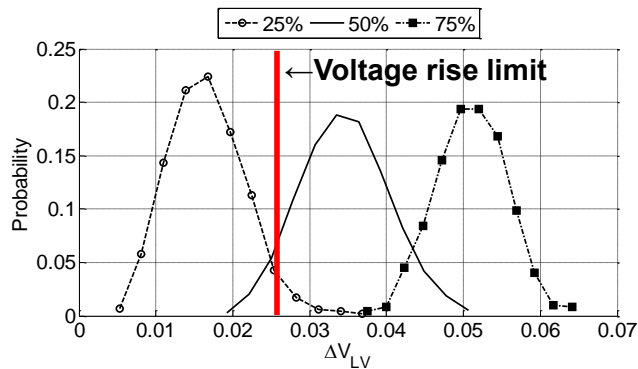

Figure 5-2: Probability distribution of voltage rise with different percentages of south facing homes having rooftop PV systems installed. An arbitrary voltage rise limit is shown in the figure which highlights that a PV dispersion of 25% is unlikely to cause overvoltage whilst a 75% PV dispersion is practically certain to cause overvoltage.

$$\bar{x}_n = \frac{\sum \Delta V_{LV,n}^+}{N} \quad \text{Eq. 5-1}$$

$$\sigma_n = \sqrt{\frac{1}{N-1} \sum (\Delta V_{LV,n}^+ - \bar{x}_n)^2} \quad \text{Eq. 5-2}$$

Table 5-1: Confidence intervals for voltage rise

Value	Confidence
$\Delta V_{LV,n}^+ < \bar{x}_n$	50.0%
$\Delta V_{LV,n}^+ < \bar{x}_n + \sigma_n$	68.3%
$\Delta V_{LV,n}^+ < \bar{x}_n + 2\sigma_n$	95.4%
$\Delta V_{LV,n}^+ < \bar{x}_n + 3\sigma_n$	99.7%

Figure 5-3 shows mean and standard deviation of voltage rise in four of the case study networks with no energy storage installed. It can be seen that the voltage rise increases as more PV is installed. The standard deviation will be zero when there is no PV or if the dispersion level is 1 since there is no variation in the location and rating of the PV. The standard deviation is highest when the dispersion level is 50%. This is because this dispersion level gives the greatest number of possible combinations for the PV as shown in Eq. 5-3, which is the number of ways of selecting s locations of PV from n possible locations (largest when $s = \frac{n}{2}$).

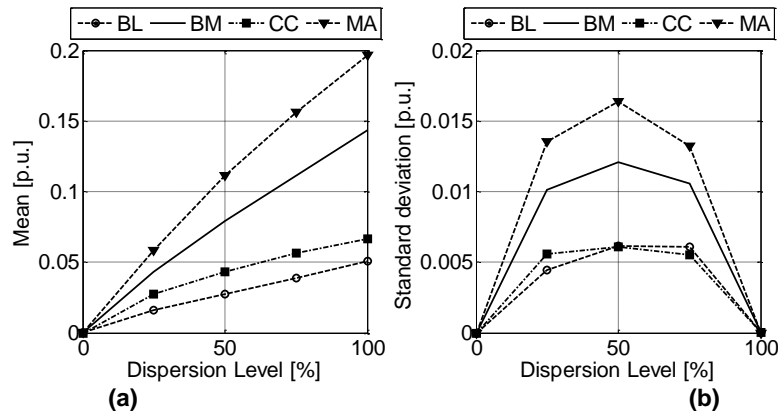

Figure 5-3: (a) Mean and (b) standard deviation of voltage rise on when stochastic tool is applied to four of the case study networks with different PV dispersion levels and the no energy storage

$${}^nC_s = \frac{n!}{s!(n-s)!} \quad \text{Eq. 5-3}$$

Figure 5-4 shows a distribution of the voltage rise in networks BL, BM, CC and MA with a PV dispersion level of 50% and (a) no energy storage and (b) energy storage in 50% of homes with PV. Although the same PV dispersion level is applied to the four sample networks, they have different mean and standard deviations for voltage rise. For example, network MA has the largest mean voltage rise as well as the largest standard deviation, whilst network BL has the smallest voltage rise and standard deviation. This suggests that some LV networks will be more constrained for voltage than others and that there is differing amounts of certainty for voltage rise between networks as was seen in the literature review. When energy storage is installed in the networks the voltage rise falls because there is less reverse power flow (as shown by the red arrow in Figure 5-4(b)).

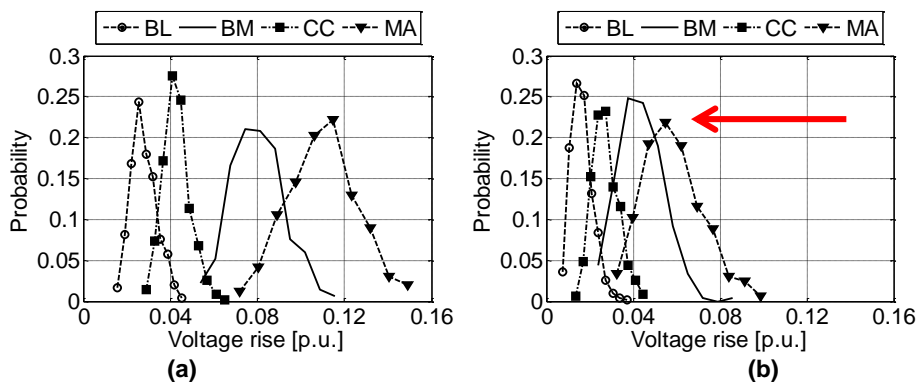

Figure 5-4: Probability of a given voltage rise with (a) a PV dispersion level of 50% and no energy storage and (b) a PV and home energy storage dispersion level of 50%

Figure 5-5(a) shows the headroom in all of the networks with different percentages of south facing homes having PV with a 99.7% confidence. It can be seen that there is a negative/zero headroom for MR, FC, MA, BM and RB depending on the amount of PV installed. For example, the tool shows that the DNO is 99.7% confident that the voltage headroom in network R05 will be more than 0.005 p.u. when PV is installed on 10% of the south facing homes. However, when 20% or more homes have PV, the DNO cannot be confident that the network will maintain voltage limits. Figure 5-5 (b) shows the same analysis, but with a 68.3% confidence. Here the DNO will expect more headroom in each network. For example, if the DNO is prepared to accept a 68.3% confidence, then they would also be prepared to accept PV on 60% of the homes in network RB as opposed to 40% before. It can also be seen that over half of the networks are not expected to have a voltage problem under any dispersion level. In reality, a DNO is unlikely to accept a confidence level of less than 99.7% (see Table 5-1) if they want to be sure that voltage levels in their LV networks are within limits and to reduce the chance of breaking regulations, however understanding confidence levels might be important if the DNO needs identify networks at most rise of overvoltage.

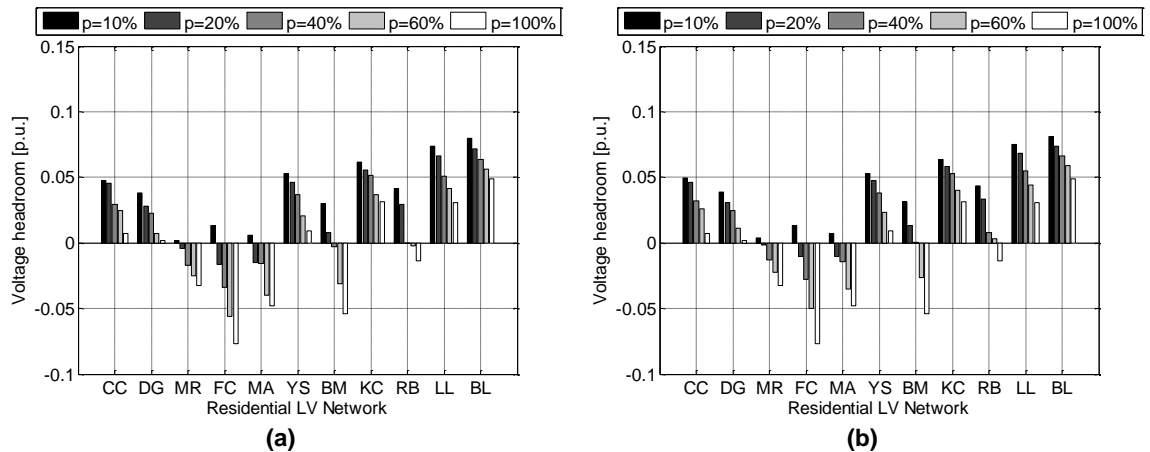

Figure 5-5: Headroom in each residential LV network with different percentages of South facing homes having PV under the following scenarios with no energy storage at (a) a 99.7% confidence and (b) a 68.3% confidence

The effect of different amounts of home energy storage on the voltage headroom is examined for the most constrained networks (FC and MA) in Figure 5-6. This is shown for different proportions, q , of homes having storage. If energy storage is located in every home with PV ($q = 100\%$) then, since none of the energy from each PV enters the distribution network, there are no voltage problems. For both networks, if all south facing homes have PV ($p = 100\%$), then between 60% and 80% (q) of the houses with PV need energy storage to prevent overvoltage if the DNO requires a 99.7% confidence. However, if the DNO is prepared to accept a lower confidence, then they would require less energy storage. As more PV is installed in the networks, the requirement for storage also increases. This is because, with more PV installed in the network, the voltage problem gets worse. Further, it becomes less likely that the storage is installed at homes with the largest impact on voltage. This finding would support a more controlled approach to determining where energy storage should be installed as the amount of PV installed in a network increases.

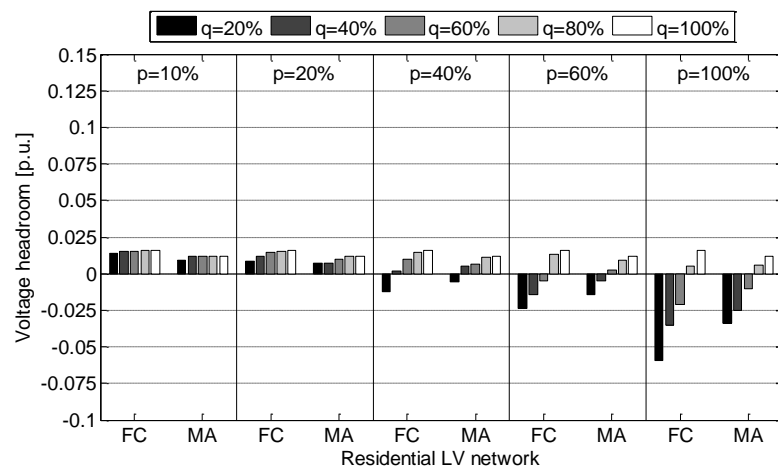

Figure 5-6: Voltage headroom under different amounts of PV and home energy storage with a 99.7% confidence

To demonstrate the uncertainty of the voltage rise in a single network, Figure 5-7 shows the application of the stochastic tool on the most constrained network (MA) with different PV dispersion levels (p) and storage dispersion levels (q). The top graph shows the application of the tool with p and q randomly determined using a uniform distribution from 0 to 1. As before, it is seen that the voltage rise is expected to be higher as the dispersion level increases and there is a degree of unpredictability in the voltage rise for a given dispersion level. The impact of home energy storage can also be seen because the highest storage dispersion levels (red) result in lower voltage rise than smaller storage dispersion levels (blue). Again, there is uncertainty about the actual voltage rise for a given PV and storage dispersion level.

The bottom three graphs in Figure 5-7 can be used to explain and interpret this uncertainty. The horizontal line represents the highest voltage rise that is permissible before overvoltage. In the green region (labelled A), whatever the dispersion level, the network does not violate the voltage limit. In the yellow region (labelled B) there is uncertainty about whether the voltage rise limit will be violated. In the red region (labelled C), the network is found to experience overvoltage. The PV dispersion levels of these regions are given in Table 5-2.

The bottom-left figure shows the voltage rise and dispersion level with no energy storage. It can be seen that overvoltage will not occur if the dispersion level is less than ~10% and will definitely occur when the dispersion level is greater than ~35%. The impact of energy storage is shown in the middle and far right figures. Here the storage dispersion level is 25% and 50% respectively. In both the figures, the green region is extended (from $p \sim 10\%$ to $p \sim 35\%$). This makes the network less likely to violate voltage limits for a given dispersion level. I.e. Energy storage, located with PV, reduces the probability that a network will experience overvoltage.

Table 5-2: Voltage rise regions in Figure 5-7

Storage dispersion level (q)	0%	25%	50%
A region - no overvoltage	$p = 0.0\% - 14.3\%$	$p = 0.0\% - 16.6\%$	$p = 0.0\% - 29.6\%$
B region - possibility of overvoltage	$p = 14.3\% - 34.0\%$	$p = 16.6\% - 51.5\%$	$p = 29.6\% - 63.9\%$
C region - definitely overvoltage	$p = 34.0\% - 100.0\%$	$p = 51.5\% - 100.0\%$	$p = 63.9\% - 100.0\%$

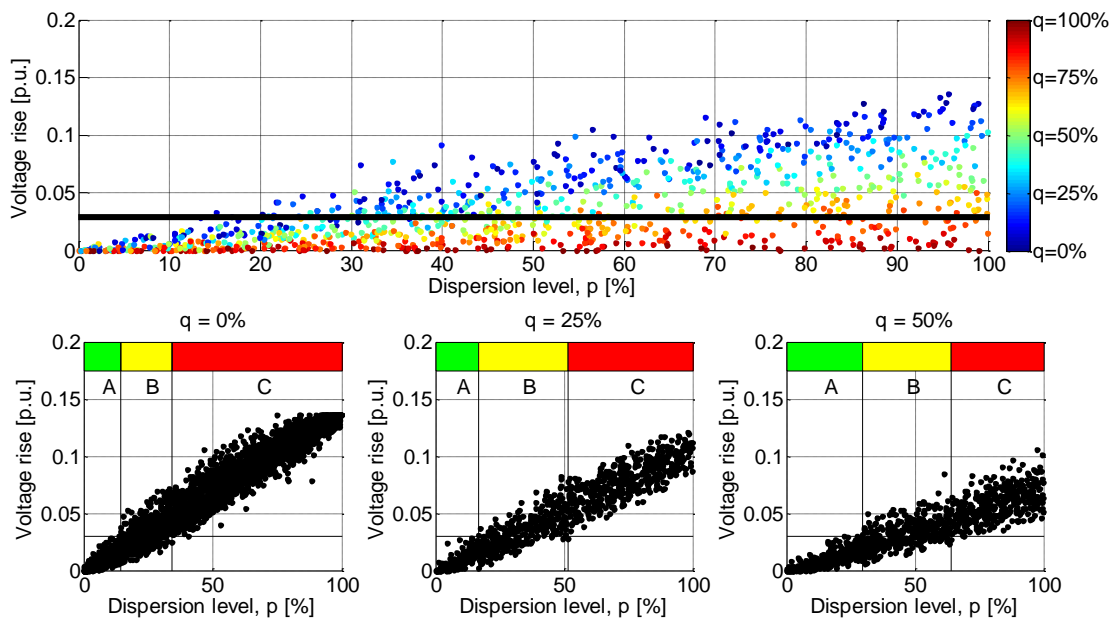

Figure 5-7: (Upper) Voltage rise in network MA under different PV and home storage dispersion levels. (Lower) The green region in the lower three figures shows where the network never has a voltage problem, the yellow region shows there the network might have a voltage problem depending on where PV and energy storage is located and in the red region a voltage problem will always occur. The solid horizontal black line shows the limit for voltage rise

3.3 Summary

A stochastic tool has been proposed which allows assessment of the impact of randomly placed PV and energy storage units on voltage. This takes a snapshot approach which places the network in the most extreme voltage rise and voltage drop condition to determine if networks will violate voltages as a result of PV or load growth. This tool is also used to determine if stochastically located energy storage can absorb sufficient power to remove the voltage problem at the worst voltage rise condition (assuming that the storage control algorithm is able to offer 100% storage availability to solve overvoltage). Applying the tool to case study networks, it is found that there is uncertainty about the amount of voltage rise that will be caused by a particular PV or storage dispersion level because of uncertainty about where these are located. This means that it is not always known if a particular dispersion level will cause overvoltage. The tool allows the DNO to determine a confidence that given dispersion levels will cause overvoltage. For each network, the DNO can therefore determine the number of PV systems which will cause overvoltage under different confidence intervals, maximum demands, minimum demands and PV ratings. If produced for all of their networks, this provides a mechanism for the DNO to identify networks which have violated or are close to voltage limits as more residential PV is added to their networks. An illustrative example of this is shown in the Appendix, Table A.

This planning tool is applicable if the DNO cannot determine the location of energy storage in customer homes in their LV network (e.g. if they are purchased by homeowners in a free market

similar to how PV is currently under the FiT). This leaves uncertainty about whether this storage can solve overvoltage.

It was found in preliminary study (Crossland, Jones, et al. 2013a) that it is more beneficial for a DNO to determine the optimal locations for the storage to reduce the voltage rise using fewer storage units. In order to do so, it is first recognised that locating energy storage in a network is a complex problem. For example, according to the theory of statistical combinations (Eq. 5-3), there are 9.055×10^{58} ways of locating 100 energy storage in a network with 200 nodes. A heuristic approach is therefore needed to search the problem space describing where energy storage can be located. This is investigated in the next section.

4 Heuristic for optimal location of energy storage in LV distribution networks to alleviate voltage problems

The design and application of this heuristic problem is also discussed in:

Crossland, A. F., Jones, D., & Wade, N. S. (2014). Planning the location and rating of distributed energy storage in LV networks using a genetic algorithm with simulated annealing. International Journal of Electrical Power and Energy Systems, 59, 103–110. doi:10.1016/j.ijepes.2014.02.001

This section describes a heuristic which, for a given set of feasible locations for energy storage in an LV network, determines the fewest number of energy storage units which can bring a network within voltage limits. Similar to the stochastic approach described in section 3, this takes a snapshot approach to determine the storage location and rating which is capable of solving an overvoltage problem in an LV network at the most extreme voltage rise condition. The objective of this tool is to determine the optimal location of energy storage at feasible locations in an LV network to (a) mitigate an overvoltage problem and (b) do so using the least amount of energy storage. The latter is important for the DNO to minimise their total energy storage cost whilst the former provides certainty over the energy storage being able to fix the overvoltage. An overview of relevant heuristics tools in power systems is now described, followed by a description of the tool which has been designed for use in exploring this problem.

4.1 Heuristic planning tools

There are a number of examples of the application of heuristic algorithms in network planning. Early applications include the “capacitor placement problem”, in which a heuristic is used to determine the location, type, number and/or size of capacitors in a distribution network to minimise costs, voltage problems and/or losses. As stated in Chapter 2, such capacitors provide minimal benefits to LV distribution networks in the UK due to the low X/R ratio. A number of established heuristics are used such as Tabu search (Huang et al. 1996) and genetic algorithm (Vargas & Jimenez-estevez 2011). Tabu is a local search and a genetic algorithm is global.

A number of papers consider heuristic approaches in the location, sizing or operation of energy storage in power networks. In (Chakraborty et al. 2009) a Tabu search approach is used for sizing energy storage by considering unit commitment. In (Huang et al. 2010), the authors use a genetic algorithm to locate superconducting magnetic energy storage to maximise the voltage stability index. In (Chang et al. 2009) a genetic algorithm is used to locate and size a single energy storage unit to achieve benefits in reducing loss, voltage deviation and costs. (Geth et al. 2010) use the multi-objective SPEA2 algorithm (Zitzler et al. 2001) to locate and size storage units in a 34 bus, 24 kV IEEE test network. Objectives include reduction of storage power and capacity, minimising the probability of voltage deviations, maximisation of arbitrage revenue and

minimisation of lost ancillary service opportunities. The heuristic used in (Geth et al. 2010) builds on work in (Alarcon-Rodriguez et al. 2008) where wind, PV and CHP units are located in a network in a distribution network using a genetic algorithm. In (Leou 2011), a genetic algorithm is used to size and determine the operation of energy storage to participate in electricity price arbitrage, defer investment and reduce transmission access costs. In (Gantz et al. 2012), a simulated annealing is used for locating energy storage in micro-grids and power networks for emergency backup. As discussed in (Ekren & Ekren 2010), the simulated annealing approach allows non-improving moves to be selected and therefore allows the algorithm to escape from local optima. In (Gandomkar et al. 2005), the genetic algorithm and simulated annealing approaches are combined to locate distributed generation for reducing losses. The combination of these approaches is shown to produce more effective results than the genetic algorithm on its own.

Although global and local search methods have been applied to distribution networks in literature, further consideration is needed into how their application can provide relevant results to DNOs in relation to distributed energy storage. This particularly applies in the area of LV network planning given uncertainty and a lack of control of the location of PV.

4.2 Genetic algorithm for wide area planning

Here, a suitable cost based method is proposed for finding the optimal location of energy storage in LV networks. This is implemented using the MATLAB Global Optimization Toolbox (MathWorks 2014b). It is preferable to use this toolbox since it removes the need to design, test and operate a bespoke heuristic. A genetic algorithm is selected because of its ability to provide a global search. This was also used in published work by the author (Crossland et al. 2014).

A genetic algorithm is an iterative heuristic optimisation method inspired by the theory of evolution. A population of candidate solutions to a problem are initially generated across the problem space with chromosomes which represent the characteristics of the solution. For this problem, a chromosome of each population member describes the location of multiple energy storage units at feasible locations within an LV network. The fitness of each population member is then evaluated against an objective function. Population members are subsequently combined to produce a new generation of solutions. The selection of population members to carry to the next generation is stochastic, but weighted towards solutions with a lowest fitness (this problem is represented as a minimisation problem as described in 4.3). This means that the new population should be, on average, closer to the optimal solution. The process is repeated for either a fixed number of generations, or until a convergence criterion is met. Through successive rounds, the genetic algorithm will converge to a population of fitter solutions.

Figure 5-9 shows an overview of the MATLAB script which enables the Optimization Toolbox to be used with energy storage locationing. The genetic algorithm parameters are first established (the selection of these is described in 4.3). The algorithm then loops over each of the networks that are being studied. PV is stochastically installed with a given dispersion level in the same manner as for the previous tool. The voltage headroom is determined and if there is a voltage problem the genetic algorithm is run. Feasible storage locations are given at this stage. These locations will change depending on what type of storage is being investigated:

- Feasible locations for home storage are all of the homes in the network with PV (labelled A-B in Figure 5-8(a))
- Feasible locations for street storage are all of the network nodes at the ends of cable sections (labelled A-E in Figure 5-8(b))

Once the algorithm is complete, the results are saved and the next network is analysed.

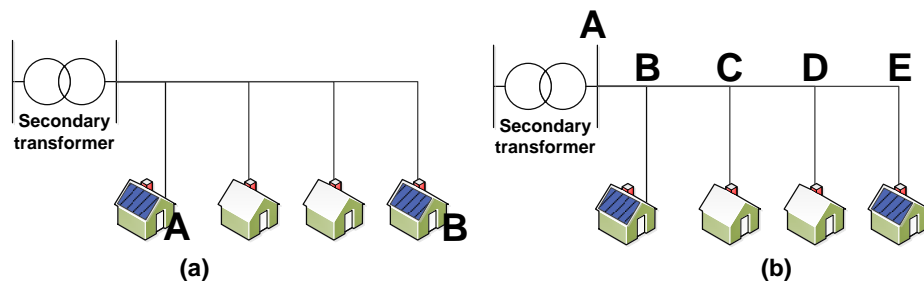

Figure 5-8: Feasible locations for (a) home storage and (b) street storage

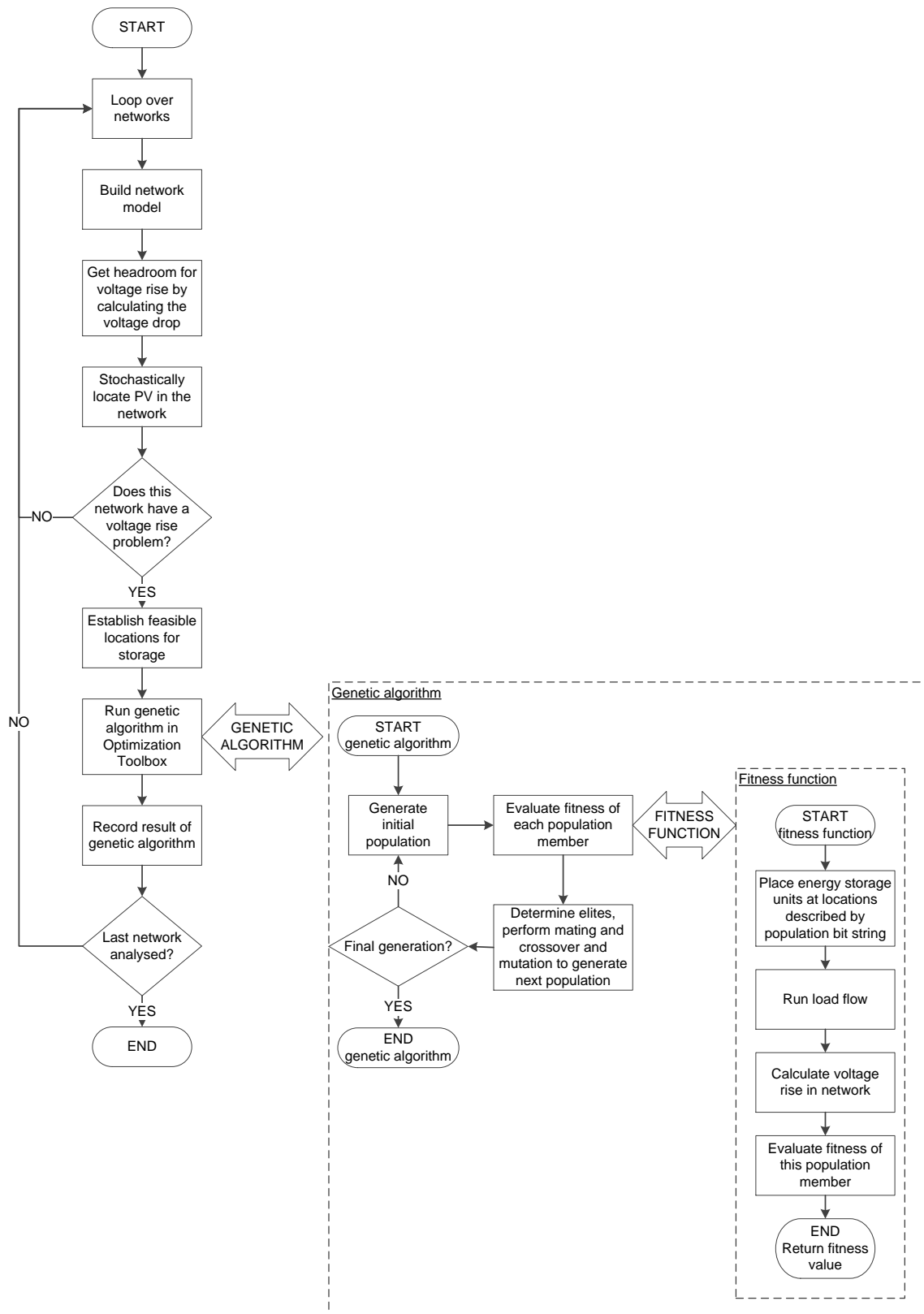

Figure 5-9: Overview of genetic algorithm implemented with the MATLAB Optimization Toolbox

Each population member describes where storage is installed using a binary array of bits. For example, the network shown in Figure 5-10 has five feasible storage locations A, B, C, D and E. Population members are therefore a 5 bit string with each bit representing a different feasible storage location. If the first bit is 1 then there is storage at position A. If the population member is 10010 then there are storage units at A and D. A MATLAB script interprets this binary number and places the relevant storage units in each LV network as required. Therefore, all feasible combinations of storage locations can be implemented within the genetic algorithm. By changing which locations are feasible, the algorithm can easily evaluate different storage technologies. For example, feasible locations could be locations for street storage, or all homes with PV, or all homes in the network. The fitness/utility of each population member is calculated as described in 4.3.

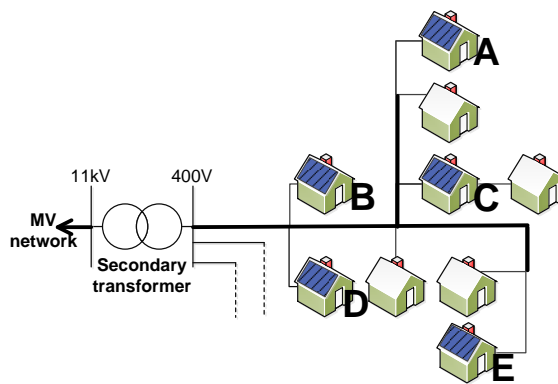

Figure 5-10: An LV network with five feasible locations for home energy storage (labelled A-E)

4.2.1 Simulated annealing

In the published work which establishes the problem of locating energy storage in an LV network (Crossland et al. 2014), simulated annealing was included in the genetic algorithm. This is shown to have some advantages in improving convergence and providing more optimal solutions in this paper on the problem of locating energy storage in LV networks. However, this has not been included in the thesis as doing so allows use of the standard MATLAB optimisation tools.

4.3 Fitness calculation

The fitness describes the utility of a particular set of energy storage locations (population member). The genetic algorithm tries to generate a population member with the lowest possible fitness (i.e. the method is a formulation of a minimisation problem). It is not appropriate to use the cost of energy storage for the fitness. This is because, as shown in Figure 5-11(a), this will converge to a solution with no storage. A penalty function is therefore needed to attribute a cost to network voltages being violated. A fixed penalty function is shown in Figure 5-11(b) and is combined with the storage cost in (c). It can be seen that although there is a penalty for violating the voltage limit, the genetic algorithm might still converge to a lower cost solution which does not solve the voltage.

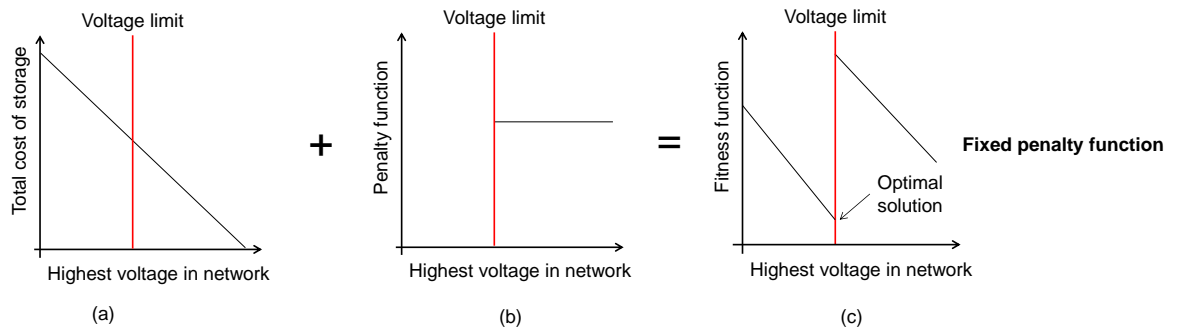

Figure 5-11: Construction of a fixed penalty function for the problem of locating energy storage to prevent overvoltage in LV distribution networks

A penalty function (Eq. 5-4) is therefore applied as shown in (Figure 5-12). The value of this penalty is proportional to the voltage deviation above regulatory limits, V_{dev} by the use of a penalty coefficient, ρ . The use of such a function is seen in the figure to always be minimal at the optimal solution.

$$\text{minimise } N_{ES} C_{ES} \begin{cases} 0 & \text{if voltage is within limits} \\ \rho \cdot V_{dev} & \text{if the voltage is outside the limits} \end{cases} \quad \text{Eq. 5-4}$$

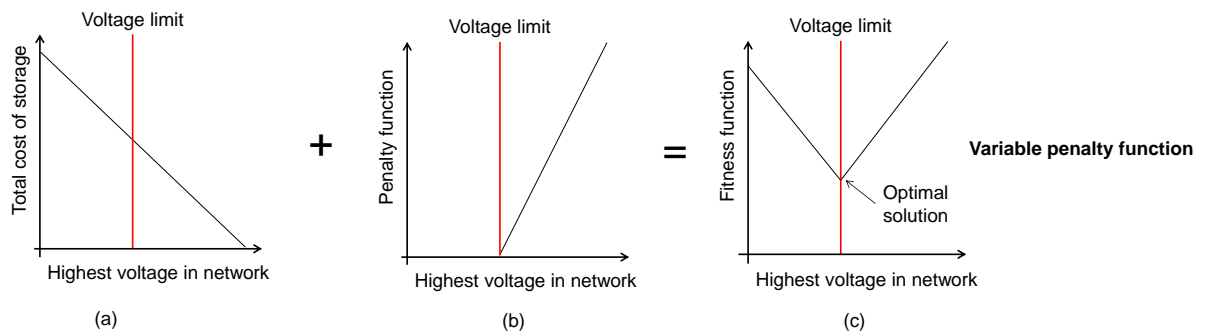

Figure 5-12: Construction of different fitness functions for the problem of locating energy storage to prevent overvoltage in LV distribution networks

The out of limits penalty, ρ , needs to be selected to ensure that the fitness function performs effectively. The selection of this is now described. Figure 5-13 shows the resulting fitness of a number of different home storage configurations in the network MA for different out of limits penalties. As shown in the top left figure, if there is no fitness function then the algorithm will converge to a solution with no storage (i.e. a cost of zero). A penalty function which is too small is shown in the top right figure. It can be seen that a number of solutions have as low a fitness as the best solution within voltage limits. The bottom left figure shows a fitness function which is selected to give an equal and opposite gradient either side of the voltage rise limit. The optimal solution here is within limits however, it is not hugely distinguished from neighbouring solutions. Therefore, as shown in the bottom right figure, a higher penalty is chosen to ensure that the optimal solution in terms of voltage also has the lowest fitness.

A higher penalty function of 150,000 is therefore used throughout this work. It is noted that a differing penalty function might produce more optimal energy storage locations, but given this analysis as long as the penalty function is high relative to the storage cost, then the cost of feasible solutions with no overvoltage will be found.

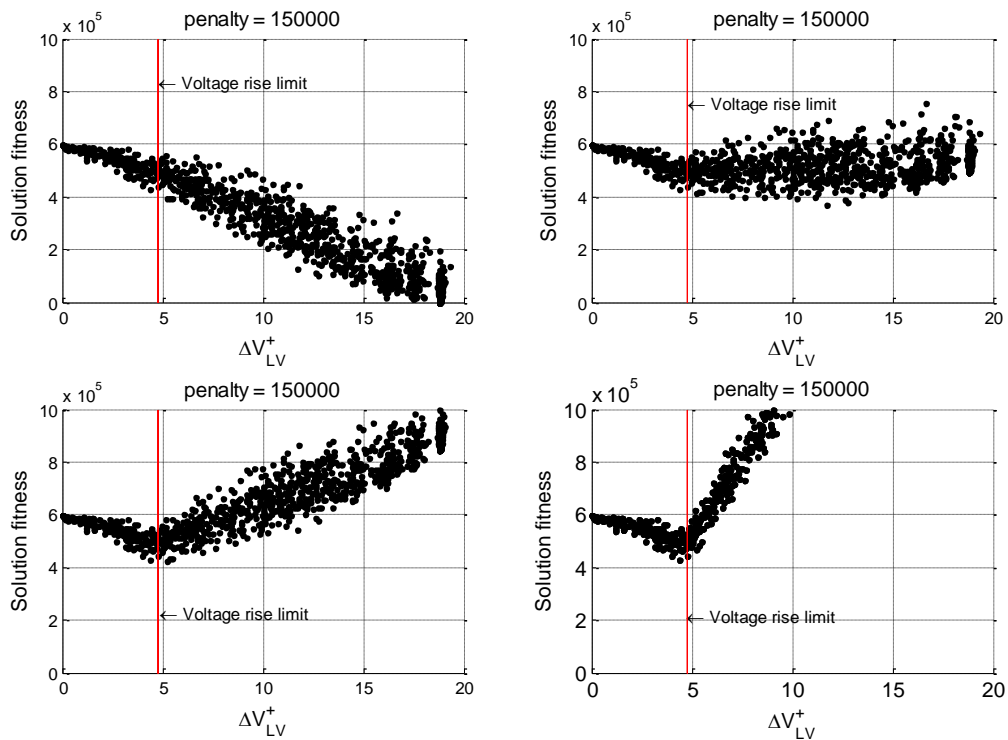

Figure 5-13: Fitness of genetic algorithm with different penalty values, ρ , in the fitness function when applied to network MA

4.4 Parameter selection

Several parameters influence the ability of the genetic algorithm to find an optimal solution. These need to be carefully selected to solve the energy storage location problem. To do so, the genetic algorithm is run on a sample network several thousand times with different parameters. The values of these parameters are compared based upon the length of time taken to perform the genetic algorithm, the average fitness of the optimal solution and the variation of the solutions.

4.4.1 Crossover type and number of elites

Elites, crossover and modification determine how parents from the previous generation are carried forward into the next generation. An overview of these is shown in Figure 5-14.

- A number of elite (lowest fitness) parents are taken forward to the new population without mating or crossover. It is found that an elite size of around 6% of the population is effective.

- Crossover determines how selected parents are combined to produce children. A number of crossover methods are available in the MATLAB Optimisation Toolbox for performing the crossover. A scattered crossover function is found to produce solutions with the lowest fitness. Here a random binary vector is produced. The child takes values from parent 1 or parent 2 depending on the setting of each bit in this random binary vector. This crossover function therefore takes a balanced look across the possible storage locations. The crossover fraction determines the percentage of the population to which crossover is applied. It is found that a crossover fraction of 80% produces solutions with the lowest fitness.
- Modification of population members (often called mutation) is a method for generating new children. This is a series of random changes to individual population members. Because these changes are stochastic and are not weighted to existing population members, modification will generate children which are more diverse than the original population. This allows the genetic algorithm to explore more of the search space. A mutation probability of 0.03 is chosen because this is found to have the lowest fitness and standard deviation.

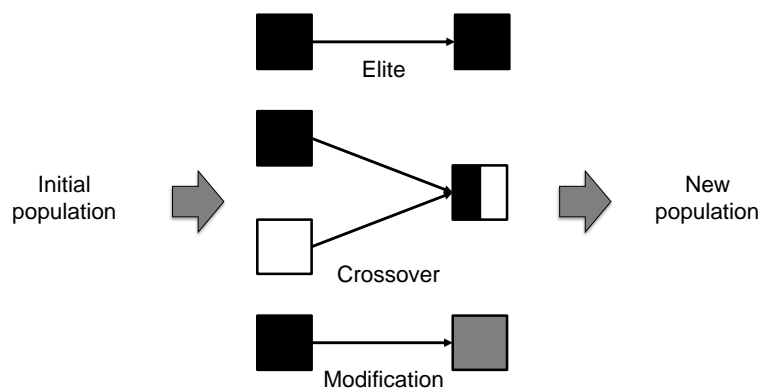

Figure 5-14: Three processes for generating new population in the MATLAB genetic algorithm

4.4.2 Crossover and mating selection method

A method is needed to determine which parents are selected for mating and crossover. Four methods are available in the MATLAB Optimization Toolbox: uniform, stochastic uniform, roulette wheel and tournament selection. Details of how these operate can be found in (MathWorks 2014a). It is found that these all take a similar time to complete but tournament selection is found to produce both the cheapest solutions and has the lowest standard deviation between solutions (Figure 5-15). However the differences between this and other selection methods are small.

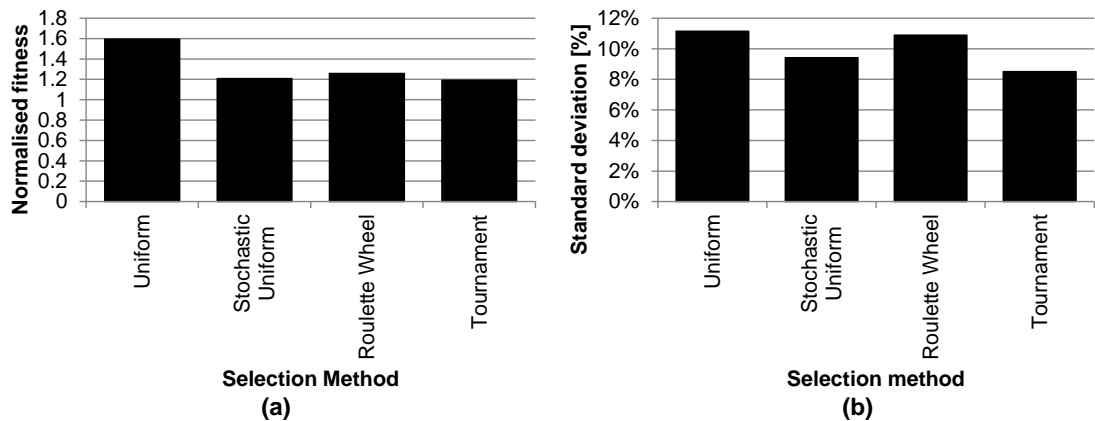

Figure 5-15: Comparison of selection methods based upon (a) the fitness of solutions and (b) the standard deviation of solutions

4.4.3 Population size and number of generations

The population size describes how many different parents are generated and included in each algorithm round. The number of generations describes the number of times that the algorithm is repeated until it is considered to have converged to the optimal solution. Figure 5-16(a) shows the length of time taken to analyse a network for different population sizes and number of generations. It can be seen that both are proportional to the computational time. As shown in Figure 5-16(b), as the population size and number of generations increases, the fitness of the solution decreases. It is found that increasing the population size reduces the deviation in solutions more than the number of generations. Therefore, the population size should be larger than the number of generations.

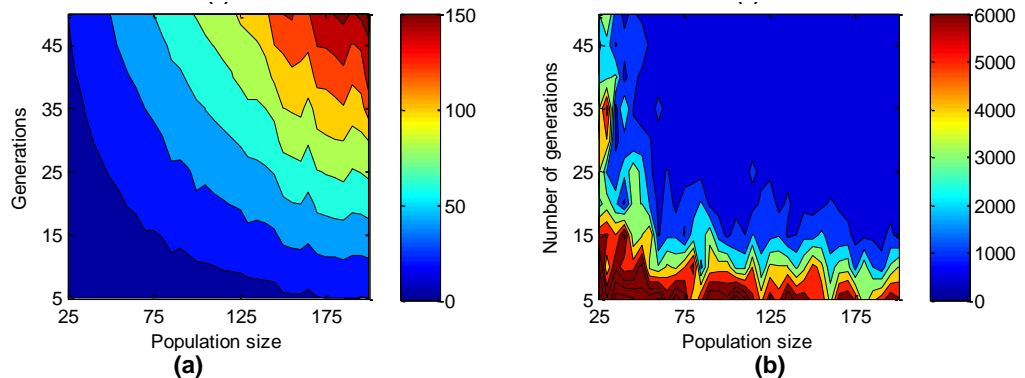

Figure 5-16: (a) Time (in seconds) to complete genetic algorithm and (b) average solution fitness with different population sizes and number of generations for a LV network

4.4.4 Chosen parameters

Based upon this analysis, parameters 1-5 in Table 5-3 are selected. These are applied within the genetic algorithm with randomly selected population size and generation counts and the time to complete the algorithm and average fitness value is plotted (Figure 5-17). It can be seen by comparing Figure 5-16 and Figure 5-17 that the time taken to complete each algorithm is not changed, however better fitness values can be achieved with less computational time by carefully selecting the parameters. Considering these figures, a population size of 60 is chosen

with 25 generations to give the greatest chance of finding a solution close to the optimal solution. This is important if a large number of optimisation methods are to be applied across a large number of network models within a reasonable computational time.

Table 5-3: Default and selected parameters for genetic algorithm in MATLAB Optimisation Toolbox

Parameter	Default value	Chosen value
1a Selection method	Roulette wheel	Tournament
1b Tournament size	n/a	4
2 Mutation probability	1%	0.03
3 Crossover type	Scattered crossover	Scattered crossover
4 Crossover fraction	80%	80%
5 Elite count	1	6% of population
6 Population size	25	60
7 Maximum number of generations	30	25

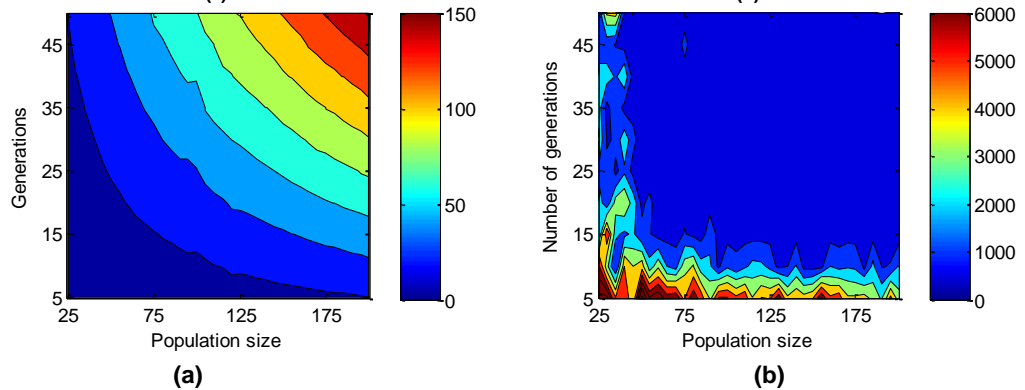

Figure 5-17: (a) Time (in seconds) to complete genetic algorithm and (b) average solution fitness with different population size and number of generations for a single LV network after all parameters have been optimised

4.5 Application of heuristic

In contrast to the stochastic tool, the genetic algorithm will bring the voltage rise within the overvoltage limit when working correctly. This is shown in Figure 5-18 for two different LV networks which have voltage rise limits of 9.21 V and 5.61 V respectively. Here, the genetic algorithm is used to locate 3.6 kW home storage in a network with different dispersion levels of 3.6 kW PV. 3.6 kW is chosen because it is the average installed value of PV in the EWNL network. A storage capacity of 2.5 hours is used as outlined in Table 3-3, page 45.

For both networks it can be seen that the voltage is nearly always maintained within limits. There are a small number of cases where the genetic algorithm does not solve the voltage problem, however the overvoltage is small and this will not have a significant impact on the cost of energy storage. It can be seen in this figure that the voltage rise with storage is sometimes a long way below the limit (up to 2.5 V). This is not necessarily because the heuristic is producing sub-optimal solutions with too many storage units because one storage unit could be located at a node with high voltage sensitivity.

The number of energy storage units which are installed is shown in Figure 5-19. As the PV dispersion level increases, it can be seen that more and more storage units are installed. For network A, no storage is needed until the PV dispersion level is above 42%. Network B requires storage when the PV dispersion level is less than 10%. For network B, very few storage units are needed below a 25% PV dispersion level. Network A requires much more storage once a voltage problem is found:- this is due to the lower voltage sensitivity of feasible storage locations in this network.

Since the genetic algorithm will always bring voltage within acceptable limits, the DNO is always confident that the energy storage will solve the voltage problem. A cost based approach can therefore be used with the genetic algorithm to compare the costs of energy storage to that of reconductoring. These are shown in Figure 5-20. In the green region (A), there is either no voltage problem or the energy storage solution is always cheaper than reconductoring. In the red region (C), regardless of the dispersion level, then energy storage is always more expensive. In the yellow region (B), there is uncertainty about whether mitigation is needed, if energy storage is less expensive than reconductoring or if reconductoring is the preferred option. This is because, as shown in Figure 5-18, there is a range of voltage rises within these dispersion levels and so there are different requirements for the amount of energy storage needed to solve the voltage problem.

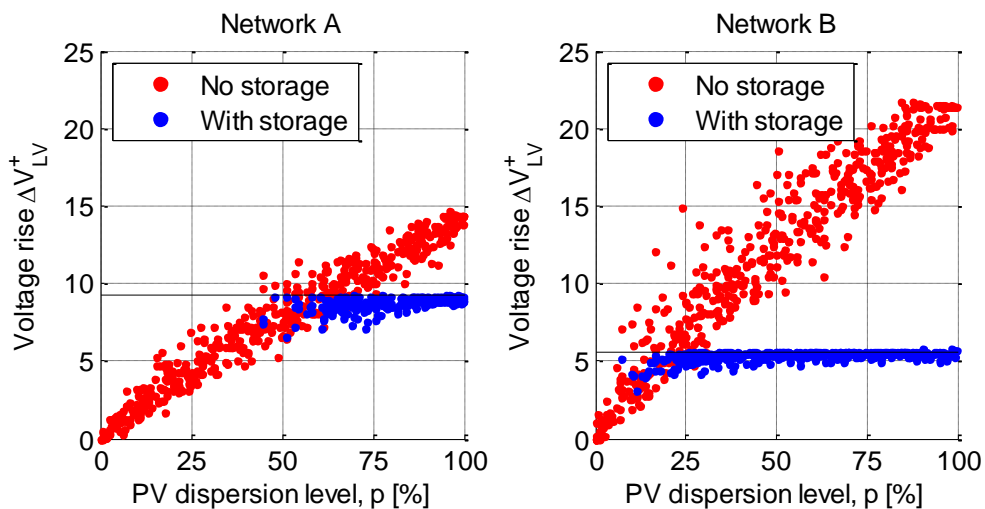

Figure 5-18: Voltage rise in two residential LV networks before and after the heuristic is used to locate home energy storage at optimal locations within them. The black horizontal line indicates the maximum permitted voltage rise in each network

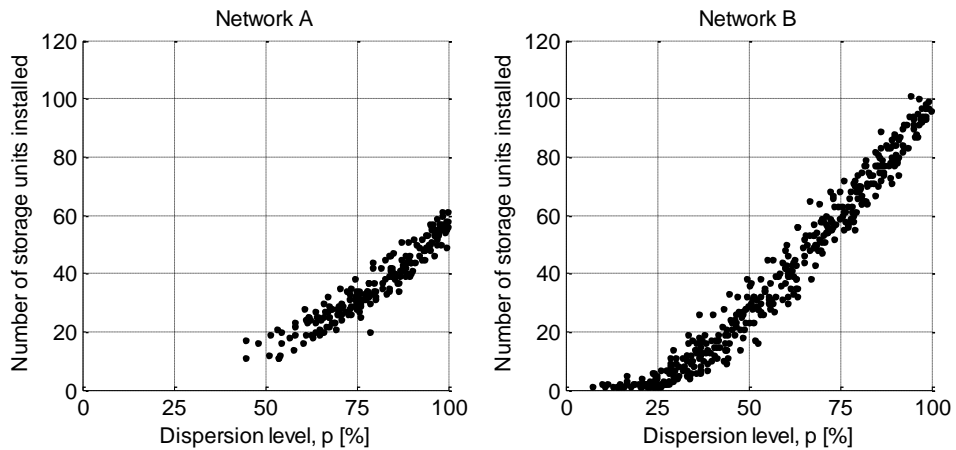

Figure 5-19: Number of energy storage installed by heuristic to mitigate overvoltage. Network A contains 360 loads (homes) and network B contains 348 loads (homes)

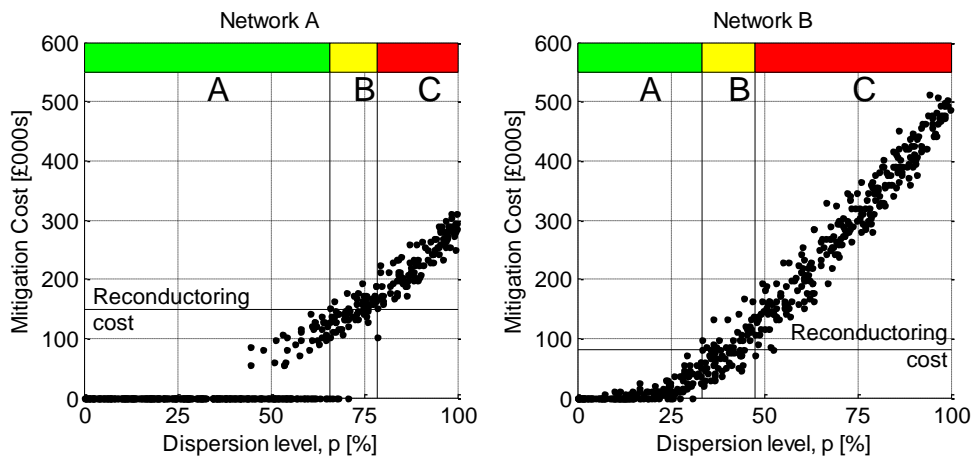

Figure 5-20: Cost of energy placing energy storage in networks to alleviate voltage constraints for two different LV distribution networks. The black horizontal line indicates the reinforcement cost. The green zone labelled A is where storage is always more affordable, the yellow zone labelled B is where storage might be more affordable and in the red zone storage is always more expensive than reconductoring

4.6 Summary

A heuristic tool has been presented to determine the lowest cost location for energy storage which brings an LV network voltage within limits. The tool is implemented in MATLAB and is shown to produce near optimal results on a number of LV networks. This level of optimisation is appropriate for subsequent comparison of stochastically and optimally located storage. The heuristic can be used for locating both home energy storage and street energy storage depending on where feasible locations for the storage are provided.

5 Conclusions

In this chapter, two planning tools for LV networks have been proposed, one of which has been established in published work (Crossland et al. 2014). The first planning tool allows an investigation of a wide number of LV networks given uncertainty about where both PV and energy storage will be located. Specifically, this investigates a scenario whereby energy storage is installed across the distribution network on a similar manner to photovoltaics under the feed-in-tariff i.e. customers will begin to adopt energy storage in their homes for improved utilisation of their photovoltaics and also to participate in electricity price arbitrage. The second (optimisation) tool investigates a different scenario whereby DNOs are able to specify the size and location of energy storage within the distribution network in response to being unable to control the location of photovoltaics.

These tools examine the most extreme (highest and lowest) voltages that will be experienced in an LV network to determine if voltage limits will be violated. The stochastic tool investigates if energy storage, at particular locations and of a particular rating, can eliminate overvoltage. The optimisation tool determines the minimum amount and location of energy storage of a particular rating to solve overvoltage. Both tools assume that storage is controlled in such a way as to always be available to charge at its rated power to absorb PV generation. This means that both tools only examine if a fleet of storage units have the potential to solve a voltage problem. The tools also only consider single time steps and therefore cannot be used to calculate the capacity of storage required to solve overvoltage. To do so would require much computational effort and design of suitable control algorithms (which themselves are difficult to determine and many different control regimes are proposed e.g. (Wang et al. 2013)). For this high level study, a fixed storage capacity (expressed as 2.5 hours) is used to reflect a realistic storage capacity without needing to provide a detailed capacity assessment.

These tools can be used to provide useful information about where and how energy storage can be viable for alleviating overvoltage as a result of PV in LV networks. To achieve this, a large number of representative network models are generated using a procedure described in Chapter 6. The tools described in this chapter are then applied to these network models in Chapter 7 and Chapter 8.

Chapter 6: Network Model Creation Using a GIS Map

Applying the planning tools to the case study networks demonstrates their potential on a small sample of networks. This is useful for validating the tools and for providing some technical results surrounding how energy storage should be implemented. However, given the infant nature of energy storage in LV networks, application of the tools to a larger number of networks would allow determination of potential cost savings from LV energy storage applied to all networks, not just the most problematic or on test feeders. This has benefits to DNOs as well as informing wider policy decisions about if and how energy storage should be installed in residential power networks. DNOs generally do not maintain models of their LV networks to be used for such load flow analysis. This is because these networks were originally designed under a fit and forget approach and there has been no need to regularly model these. If load flow analysis is required, the DNO will look at a Geographic Information System (GIS) map of the particular LV distribution network and build a bespoke network model. Such an approach is appropriate on a case by case basis but is time consuming and is prone to human error (it took a week to produce and validate the 9 case study networks). To produce a larger sample of network models, an alternative strategy is proposed here.

There are very few generic network models for LV networks, such as the IEEE LV test feeder (IEEE Distribution Test Feeder Working Group 2012). LV models could be automatically generated using a statistical approach such as in (Gan et al. 2011; Green et al. 1999). These methods can develop a large number of network models, but there is no guarantee that these are entirely representative of a particular DNO area. Scottish and Southern Energy trialled a computational procedure to extract network models from their GIS data. This was performed over a small section of network to investigate the impact of PV, electric vehicles and heat pumps (Scottish and Southern Energy Power Distribution 2013).

This chapter investigates whether a similar computational procedure can be used to extract a large number of LV network models from ENWL's GIS system. Then the tools described in Chapter 5 can be applied to these networks to quantify the expected impacts of PV and consequent market for low voltage energy storage. The results of these, described in Chapter 7 and Chapter 8, will have value to a number of stakeholders:

- The DNO in analysing large parts of their existing network under future scenarios. This is important because the “fit and forget” approach for LV is no longer appropriate (see Chapter 2). It also informs the value of other mitigation e.g. active LV switching.
- Customers or installers in understanding the technical implications and/or any costs incurred as a result a specific LCT installation on LV networks.
- Regulators and policy makers in understanding the long term technical and cost implications of LCT/decarbonisation policies.

A procedure for developing LV network models across the whole ENWL network is now described and validated.

1 ENWL GIS system

The ENWL distribution network, which covers the area between Cheshire in the South and Cumbria in the North, is mapped in a GIS database. This GIS map is not in a format by which network modelling can be completed. This database contains 36,997 transformers and 55,500 km of LV feeder and service cables. Transformers and cables cover both rural and urban areas. Some networks serve a small number of customers (as shown in the blue polygon in Figure 6-1), whilst others can serve a large number of urban customers (as highlighted in the red polygon in Figure 6-1). The following section describes how the LV networks are represented in the GIS database.

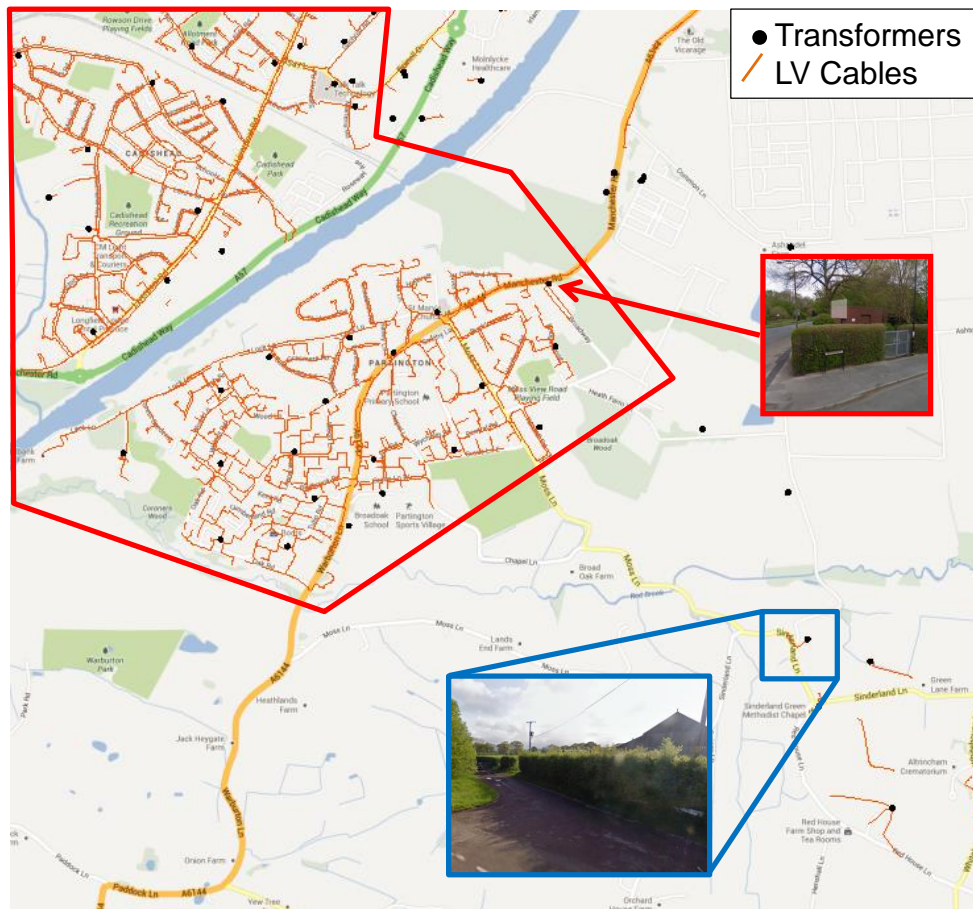

Figure 6-1: Section of ENWL network showing urban (red polygon) and rural (blue polygon) networks

1.1 Transformers and fuses

Each LV network has an MV/LV secondary transformer (Figure 6-2). This reduces the MV voltage to the LV level through fuses into a number of LV feeders. There can be a large number of feeders, e.g. the ten feeder transformer shown in Figure 6-3(a). Not all of the transformers in the GIS database are MV/LV, or have the fuse configuration previously described. These include pole mounted transformers such as the transformer highlighted in blue in Figure 6-1, transformers located in commercial premises as shown in Figure 6-3(b) and HV/MV transformers shown in Figure 6-4. Residential LV networks are distinguished by an arrangement of an LV busbar and LV fuseboards as shown in Figure 6-2.

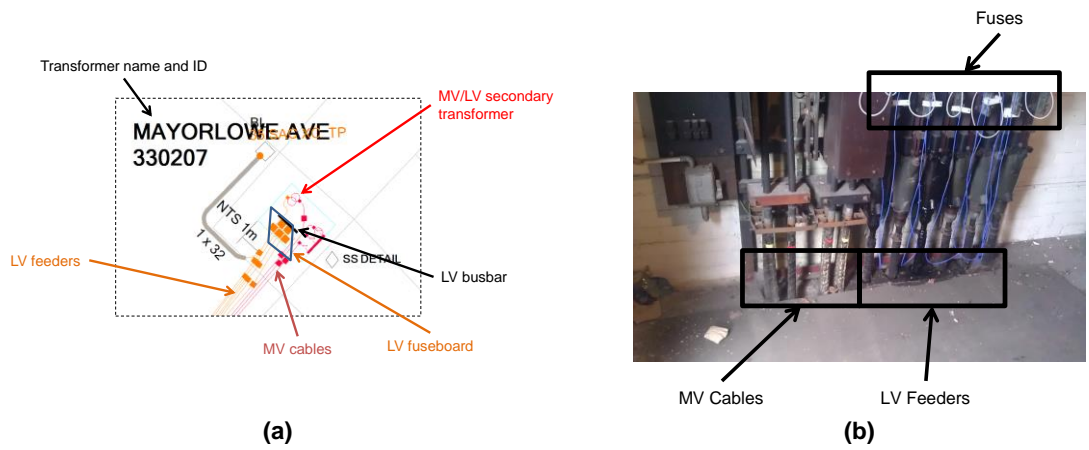

Figure 6-2: (a) A typical LV transformer and associated equipment and (b) photograph of MV and LV cables in a secondary transformer substation

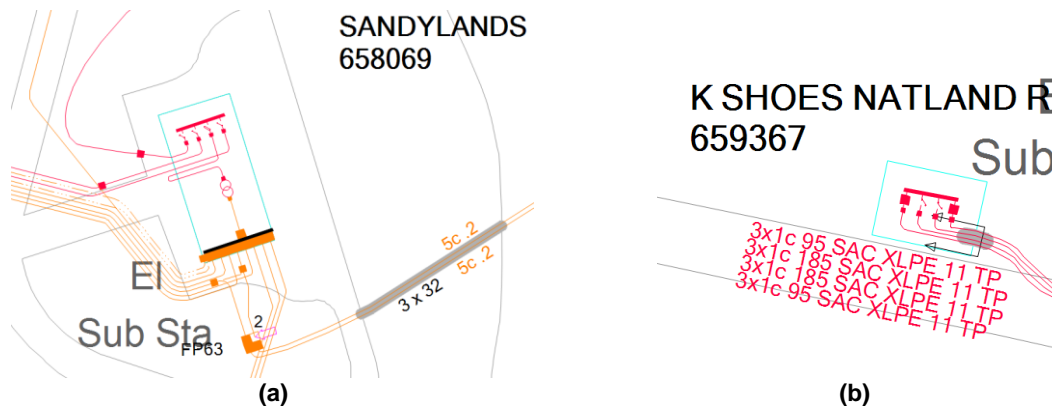

Figure 6-3: GIS image of transformers with (a) 10 LV feeders and (b) no LV feeders

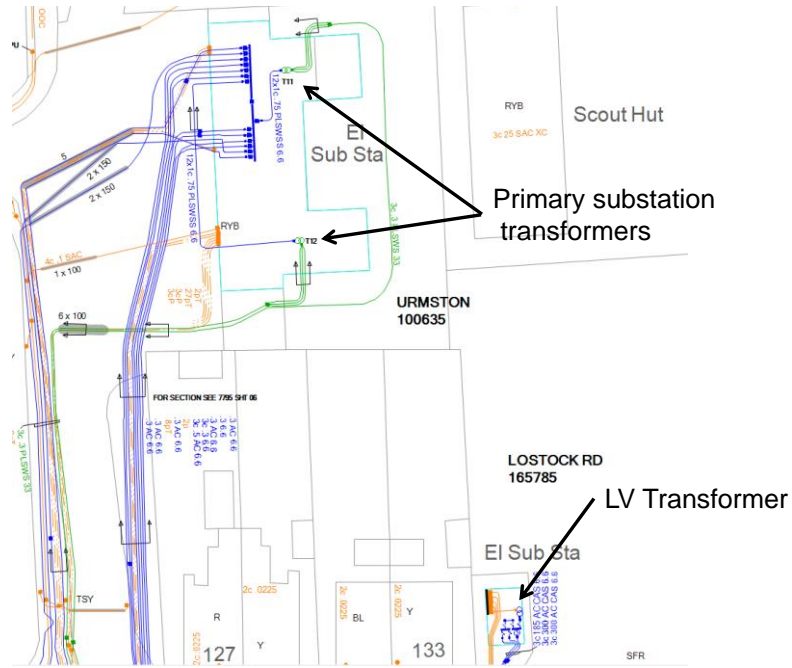

Figure 6-4: Primary substation transformers in the ENWL GIS map

1.2 Feeder and service cables

Feeder cables connect the loads/customers to the transformer. ENWL electricity policy document EPD283 states that each feeder can have no more than 200 customers (Electricity North West Limited 2013). The layout of cables within a section of domestic network is shown in Figure 6-5. Three phase, four wire feeder cables run along the road and the type of cable used is denoted by a label. Feeder cables are joined to each other by “cable connectors” which are displayed as square icons in the GIS diagram.

Service cables link the loads to feeder cables and can be one or three phase. Connections between feeder and service cables are also marked with square connectors as shown. These service cable connectors are described with different metadata to the feeder cable connectors in the GIS database, even though they are displayed with the same symbol in the map. This means that they can be easily distinguished from cable connectors in the database. The location of service cable connectors can be linked with the feeder cables, allowing a determination of how loads connect to feeders.

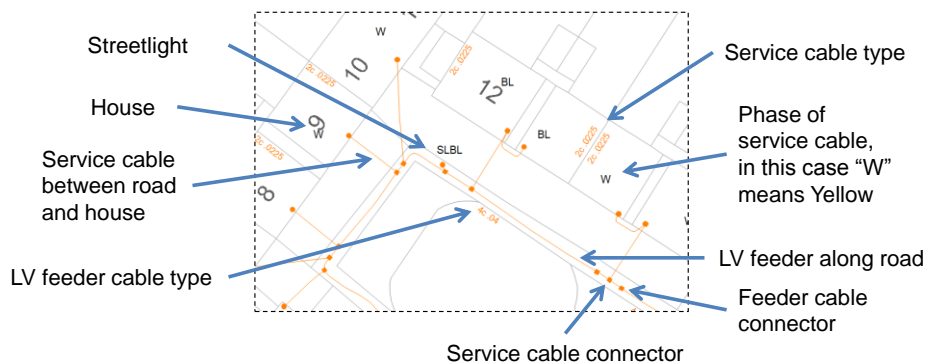

Figure 6-5: A typical section of a domestic LV network showing feeders, service cables and homes

1.3 Link boxes

Link boxes are used to connect sections of feeders and are used for network reconfiguration in the event of a fault or for maintenance. A link box is illustrated in Figure 6-6(a), where LV feeder 4 can be connected to feeder 1, 2 or 3 by the link box. The filled boxes indicate that feeder 4 is connected to feeder 2, and the arrow indicates that feeders 1 and 3 are normally open. A screenshot (Figure 6-6(b)) shows how this is represented in the GIS. Link boxes are usually manually operated through an access hatch at pavement level, although automatic network reconfiguration is being researched to achieve LV network automation. The connectivity of the link boxes is considered correct in the GIS.

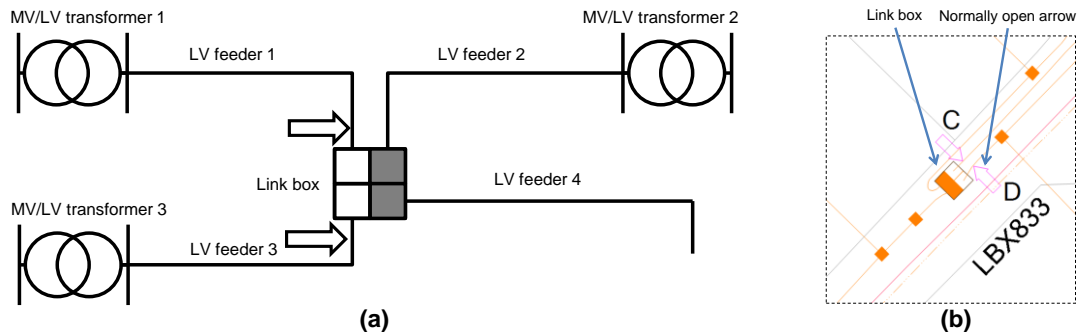

Figure 6-6: (a) A typical LV link box and (b) a schematic of the connectivity of a link box

1.4 Loads

Loads are connected to service cables. As shown in Table 6-1, each service cable can serve a number of loads. When using the GIS to manually make network models, the number of loads can be determined by looking at the house numbers or using supplementary map data such as Google Maps/Street View. In some parts of the GIS, the phase is given but this is not true across the entire database. Some service cables are used for street lights which are usually, but not always, labelled in with text of the form SL# where # denotes the phase that the light is connected to (Figure 6-7).

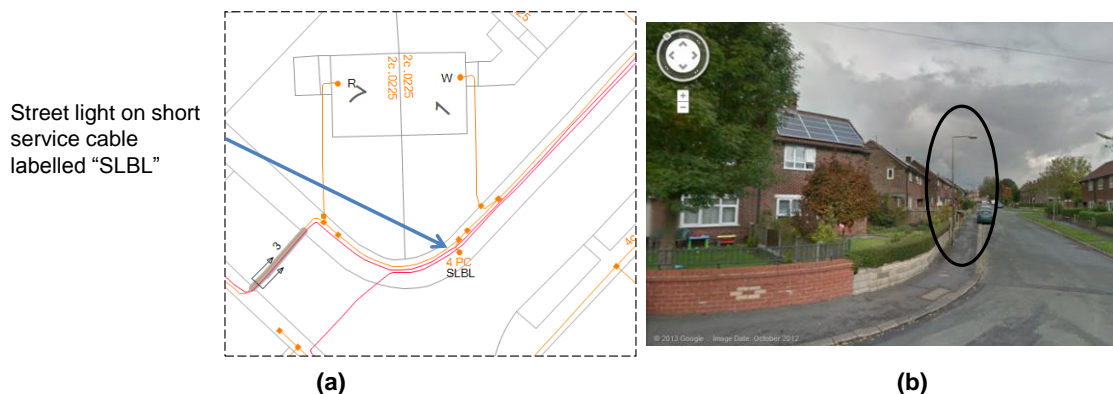



Figure 6-7: (a) Street light within GIS diagram and (b) the same street light visible on Google Street View

1.5 Summary

In Chapter 4 and Chapter 5 a manual method was used to extract network data from these GIS maps. This was time consuming and therefore impractical for generating large numbers of network models. The GIS data provides a digitised topology of the entire ENWL network, which, through an appropriate algorithm, can be used to automatically generate representative models. A suitable algorithm is now described.

Table 6-1: Manual determination of the number of loads connected to each service cable from GIS representation of the ENWL network

Loads per service cable	Representation in GIS	Street View image
(a) 1 load		
(b) 2 loads		
(c) 6 loads		
(d) No loads		
(e) Unknown number of loads (building site)		

2 Computational method for LV model creation

The computational method used to extract the LV network models from the GIS is now described. Firstly, the assumptions used to determine the properties of the networks are described. Then, the design of the computational procedure is presented in full.

2.1 Methods for determining network properties

2.1.1 Cable properties

There are 1,014,973 feeder cable lengths and 3,820 unique labels describing cable types in the GIS data. 98% of these labels include the cable diameter. The properties of only 55 underground cable types have been provided by ENWL and a mathematical approach is used to determine the properties of the remaining 3,765 cable types. For a given section of cable, the resistance is proportional to the resistivity and length of the conductor and inversely proportional to the conductor cross-sectional area, A (Hughes 1969). For an aluminium conductor, with resistivity $2.82 \times 10^{-8} \Omega/\text{m}$ at 20°C (Naidu & Kamakshaiah 1995), the resistance per unit length, R_0 , can be calculated as shown in Eq. 6-1, where the area is given in square millimetres. Figure 6-8(a) shows the resistance for different cross sectional areas of the 55 cable types provided by ENWL next to the result from applying Eq. 6-1. The equation provides a suitable predictor for the cable resistance when compared to the data provided by ENWL. This is important since properties of all ENWL cables have not been provided.

$$R_0 = \frac{28.2}{A} \quad \text{Eq. 6-1}$$

The reactance, X_0 , of an LV cable is dependent on a number of factors such as cable construction, insulation thickness and insulation material and cannot be calculated without further details about the cable. Since only the cable diameter is provided in the GIS data, an appropriate mathematical relationship is needed to estimate the reactance of the cables.

Figure 6-8(b) shows the reactance of the 55 ENWL cables. At small cross-sectional areas, the reactance generally decreases with the cross-sectional area. However, above an area of 100mm^2 the reactance has an average of $0.07 \Omega/\text{m}$. This implies that the cable insulation thickness and construction are similar for cables with conductors larger than 100mm^2 . Below this cross-sectional area, the mathematical expression in Eq. 6-2 is found to be suitable for calculating the reactance. The full equation for calculating the reactance is shown in Eq. 6-3. Based upon the information provided by ENWL this approach is deemed appropriate since there is only a slight deviation in the reactance of the cables. The reactance is also very much smaller than the resistance. Therefore, the impact of any error in the calculated reactance will be small.

$$X_0 = 0.1268A^{-0.126} \tag{Eq. 6-2}$$

$$X_0 = \begin{cases} 0.1268A^{-0.126} & \text{if } A < 100 \\ 0.07 & \text{otherwise} \end{cases} \tag{Eq. 6-3}$$

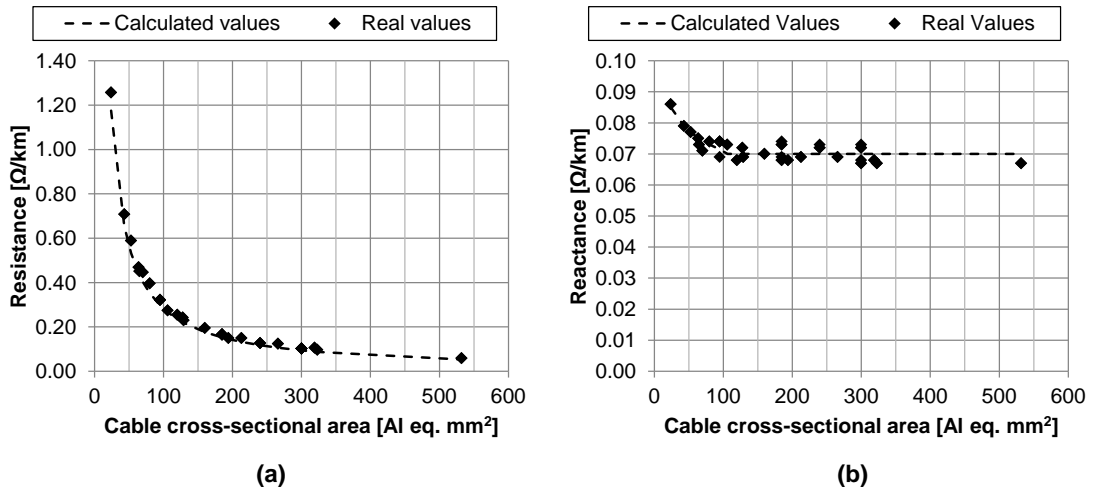

Figure 6-8: (a) Relationship between phase resistance and (b) reactance to the cross-sectional area of copper ENWL cables

A histogram of the cross-sectional area of all of the ENWL cable types is given in Figure 6-9. It can be seen that the highest proportion (18%) of the cables in the network have a cross-sectional area between 55mm² and 65mm². Therefore, for any label that does not contain information about the conductor size, it is assumed to be 60mm².

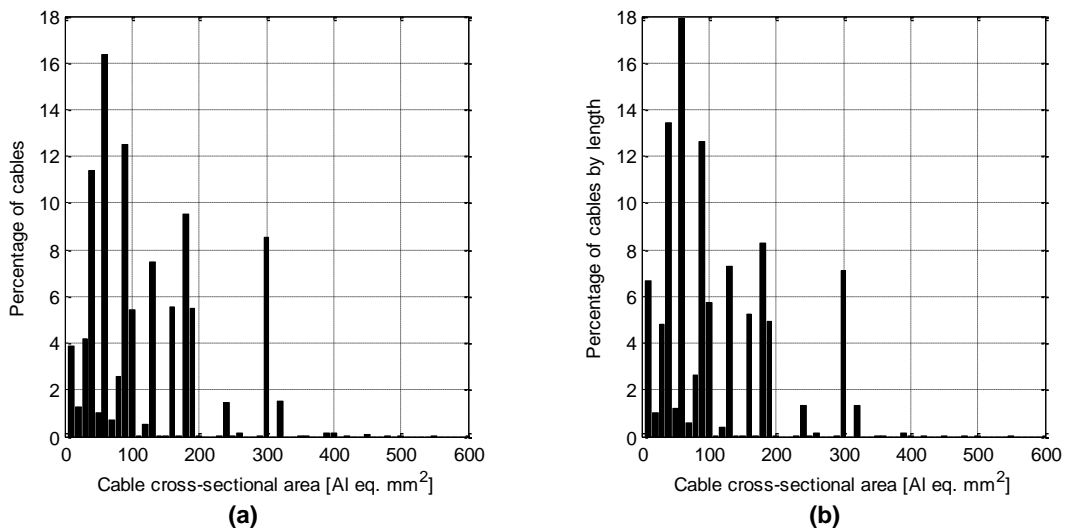

Figure 6-9: Histogram of the cross section area of all cables in the ENWL distribution network (a) by percentage of cables and (b) scaled by the cable length

2.1.2 Location of loads

Feeder and service cables are described as a series of vertices in the GIS shapefiles as shown in orange and blue in Figure 6-10. To associate service cables with LV feeders, it is necessary to increase the resolution of these vertices. For example, as shown in Figure 6-10(a), the vertex

at the end of the blue service cable BC is closest to vertex E on the wrong feeder cable. Therefore, each section of feeder cable is divided into a number of smaller sections as shown in green in Figure 6-10(b).

The number of additional vertices added is chosen as a compromise between accuracy and memory overhead. As shown in Figure 6-11(a), over 40% of the vertices are more than 1m apart and the furthest two vertices are 685m apart. Considering the memory requirement, accuracy and computational time shown in Figure 6-11, the number of evenly spaced interpolation points is set to 50 which mean that the vertices on 99.993% of cable sectors are less than 1m apart. The effect of this is shown in Figure 6-10(b), where the service cable is now closest to feeder cable AD at point F.

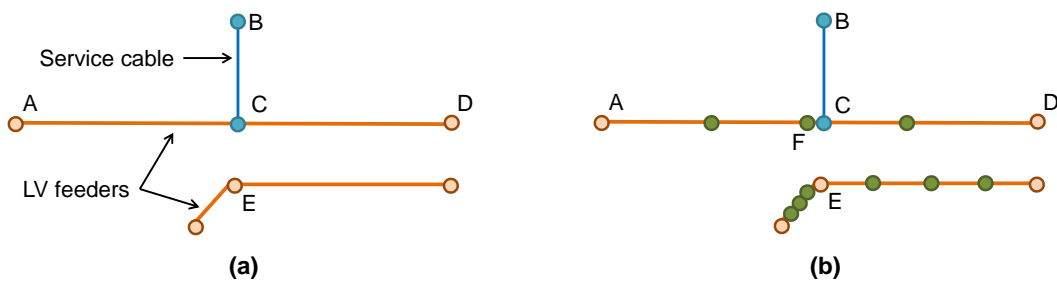

Figure 6-10: (a) An LV cable demarked by orange coloured vertices and (b) the same LV cable with additional vertices shown in green. A service cable is shown in blue with blue vertices.

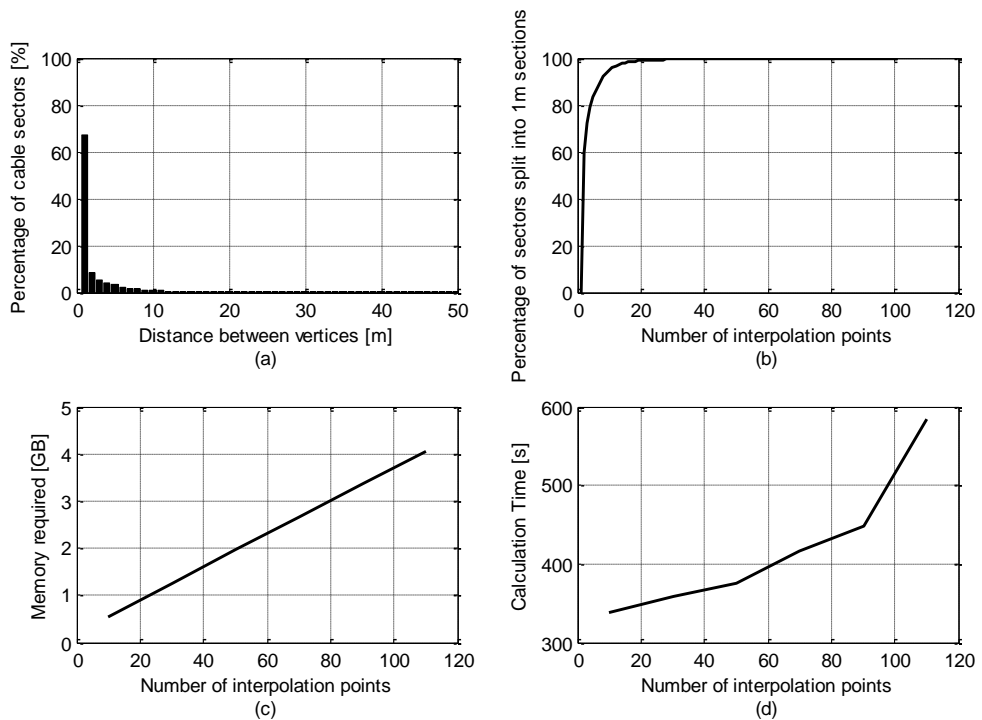

Figure 6-11: (a) Histogram of the distance between vertices in LV cables, (b) percentage of cable sectors which are split into sub 1m sections versus different numbers of interpolation points (c) total memory requirement for different numbers of interpolation points and (d) time needed to calculate vectors for different numbers of interpolation points

2.1.3 Number of domestic loads

In order to determine the number of loads connected to each service cable, three methods are considered:

1. A computational procedure which reads the house numbers/property size in the GIS map data combined with demographic (e.g. census, ordinance survey) data sets to estimate the number of loads at each location.
2. A probability distribution (Table 6-2), based upon the pilot study of 9 networks with 2,390 domestic loads is used to stochastically allocate loads to each service cable
3. The number of ends on each service cable (see Figure 6-12).

The first method is potentially very powerful for developing network models which reflect the social factors which influence network loading. However, this requires an entirely separate geographic dataset containing specific details about residences. It would also require new interpretation of the data such as street names and property types and an associated understanding of how demand relates factors such as property size, type and other social indicators. The aim of this study is simply to build representative models, and this level of complexity is therefore unnecessary. Given that the computational effort is already high, this method is rejected.

The second approach relies on a small and non-representative sample relative to the whole distribution network. The sample is based on a specific network area with particular demographics and house designs. Therefore, it would be inappropriate to use this across the whole network. The sample area could be widened, but this would lead to a probability distribution which represents the average network rather than using local network information inferred from the GIS. The second approach is therefore rejected.

The third approach is accepted since it is not unreasonably computationally difficult and also because, to some degree, it relies on local network topology. In this method, the number of loads attached to each service cable is determined by the number of “ends” on the cable (as shown in Figure 6-12). There are two major weaknesses with this approach. Firstly it is unable to distinguish single service cables which connect more than one property (for example, see Table 6-1 cases (c) and (d) and secondly it cannot distinguish between residential and commercial customers.

Therefore, the proposed GIS based network models are only suitable if the method is restricted to residential networks. For this to be reasonable, it is assumed that:

- Commercial customers which have a larger maximum demand than residential customers are generally serviced by their own dedicated transformers, such as in Figure 6-26(b)

- The majority of large commercial customers which do not have their own dedicated transformer are connected close to the LV transformer, or are connected by large diameter cables which have a low-voltage drop across them.
- Any other commercial customers have similar ADMD as residential customers and are able to install rooftop PV. Such customers can be analogous to residential loads.
- The case of multiple customers connected to a single service cable (Table 6-1(c)) is unusual and in this case the feeder cables are sufficiently large to maintain acceptable voltage drops.
- Service cables connected to no customers such as Table 6-1 (d) are rare.

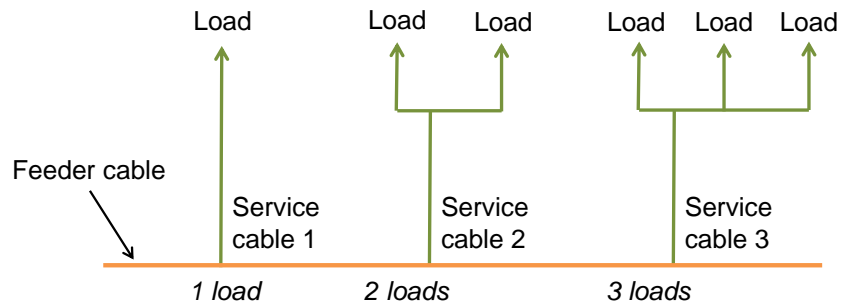

Figure 6-12: Determination of the number of loads at each service cable

Table 6-2: Probability distribution of the number of loads connected to each service cable in case study LV networks

Number of loads	1	2	3	4	5	6	7	8
Probability	0.670	0.259	0.027	0.028	0.002	0.012	0.001	0.002

2.1.4 Load phase

An assumption is made that the network is designed to be well balanced. Doing so is practically important to maximise the life of three phase network components such as the MV/LV transformer. To achieve this, network designers often sequentially change the phase of connected loads along the feeder cables. However, it has been noted in the GIS that this is not always the case, for example, see Figure 6-13(b). Therefore, the phase of each load is assigned stochastically using a uniform probability function i.e. each single phase load has an equal probability of being on phase 1, 2 or 3.

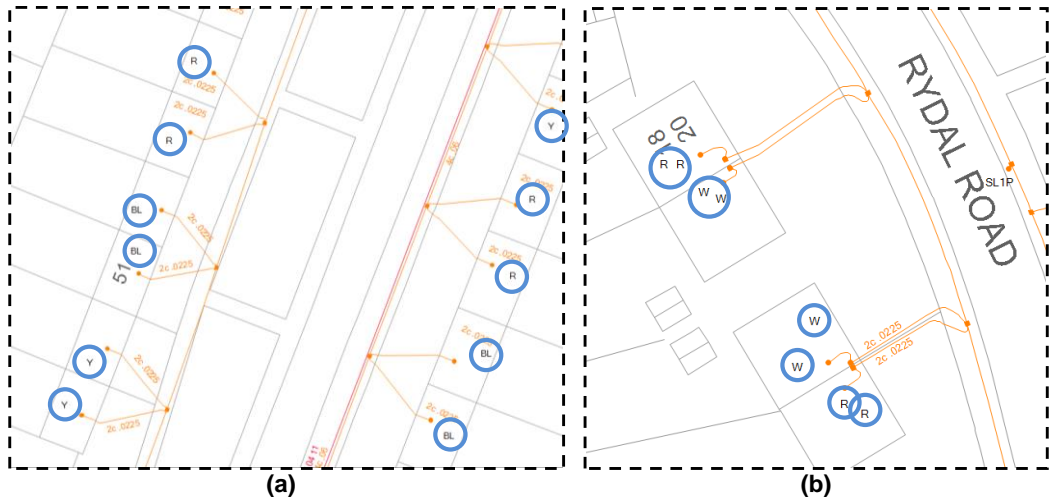

Figure 6-13: Area in network where load phase is (a) sequential and (b) not sequential. Phase labels are circled blue and the notation for phases is “R” for red, “BL” for blue and “W” or “Y” for yellow

2.1.5 Street lights

Some of the service cables connect to street lights. These lights increase the demand in the network, particularly in the winter. 512,394 of the 3,402,991 service cables in the DNO area are labelled as street lights. These are removed from the GIS data to reduce the computational burden. In a study of the impact of PV (which operate in the day and are at peak output in the summer), the location of street lights is not necessarily important in the model. These can be accounted by an increase in the residential demand.

Two methods were considered to identify and remove street lights. A simple method is to remove service cables which are shorter than a specific length but, as shown in Figure 6-14, there is a risk that discounting cables in this manner will result in some load cables being removed. Therefore, a procedure has been developed which associates each street light label with its closest service cable. This means that exactly the same number of service cables are removed as there are street lights.

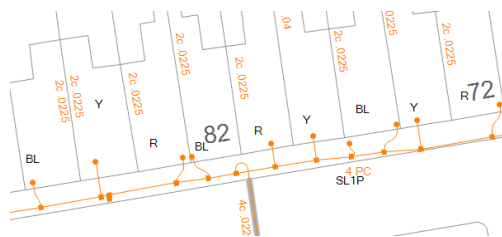

Figure 6-14: A section of network where the length of street light cables is comparable to the length of load cables

2.1.6 Roof orientation

In order to maximise the generation from a PV system in the UK, it should face south. The total generation decreases as the orientation is changed, and is minimal for panels facing North (Mondol et al. 2007). It is therefore desirable to include the orientation of homes in the network to be able to find realistic locations for rooftop PV. However, roof orientation is not explicitly contained in the GIS database.

It has been observed that the orientation of the service cable is a reliable proxy for roof orientation. This is because houses are typically aligned parallel to the street with their largest sloping roof at the front and back of the property. Since the feeder cable runs along the street and the service cable connects the house to the feeder, the service cable will generally be perpendicular to the front of a house. This is shown in Figure 6-15(a).

The orientation of service cables, ϕ , can be calculated using the coordinates of the cable end points (x_1, y_1) and (x_2, y_2) as shown in Eq. 6-4. A histogram of the orientation of the service cables relative to North/South is shown in Figure 6-16(a) using the angle measured according to the formulation in Figure 6-16(b). It is found that 49.8% of the service cables have an orientation in the range $\pm 45^\circ$.

$$\phi = \text{atan}\left(\frac{x_2 - x_1}{y_2 - y_1}\right) \quad \text{Eq. 6-4}$$

Figure 6-15(b) and Figure 6-15(c) show two ways in which this method may not be correct. In (b), the house is on a corner and the service cable connects to the gable end. In (c), the owner has decided to install PV on both east and west facing roofs. It has been observed that for the majority of occasions, such houses are not common in the GIS. However, by including the roof orientation in the network models East-West solar installations can be included in analysis if desired.

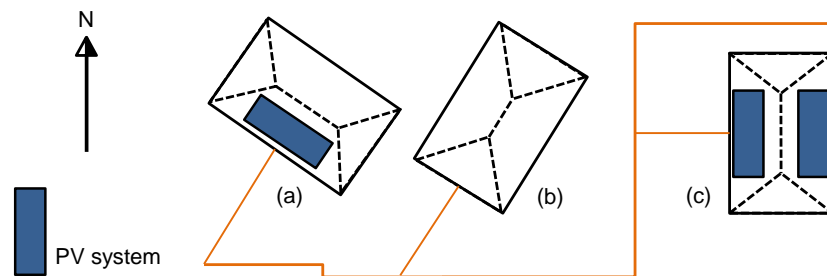

Figure 6-15: (a) House with a South facing roof and PV panels, (b) house with a service cable within $\pm 45^\circ$ of South but which does not have a South facing roof and (c) house with a service cable which is oriented East-West but which does have a PV system

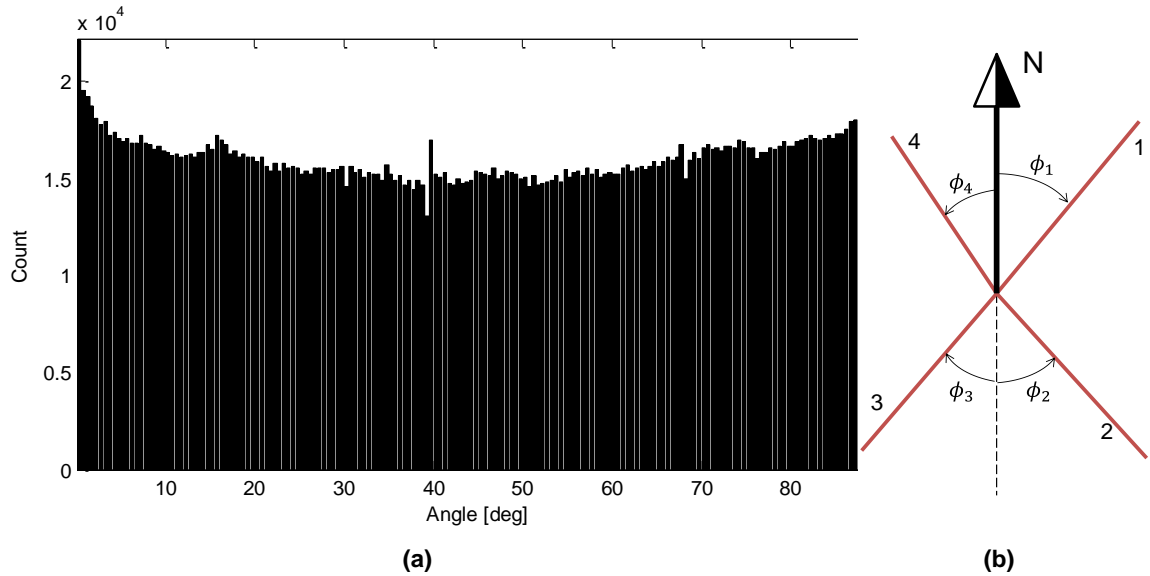

Figure 6-16: (a) Orientation of all of the service cables in the ENWL network relative to North-South and (b) measurement of the angle of service cables 1-4 relative to the North-South direction

2.1.7 Transformers

ENWL LV transformers range from 25 kVA to 1500 kVA. The transformer rating is not given in the GIS data and so, if required, this needs to be determined by calculating the expected peak demand in each LV network from the number of loads. As the research is only interested in the change in voltage in the LV networks, the tap position of each transformer does not need to be known or recorded (see Chapter 3 section 2 for how these voltages are determined).

2.2 Description of computational method

As shown in Figure 6-17, the GIS database is provided in a MapInfo (Pitney Bowes Software 2013) format which describes the entire ENWL HV and LV network in December 2011. This LV portion of this MapInfo data is extracted into shapefiles using Quantum GIS (QGIS 2013) which is subsequently imported into MATLAB for processing with custom algorithms. These algorithms for automatic creation of network consist of two parts:

1. Part I: a broad analysis of the GIS is completed to determine basic connectivity and properties of the network components. This is called data preparation
2. Part II: The individual network models are created. Performing analysis in this manner means that network models can be produced within a reasonable computational time.

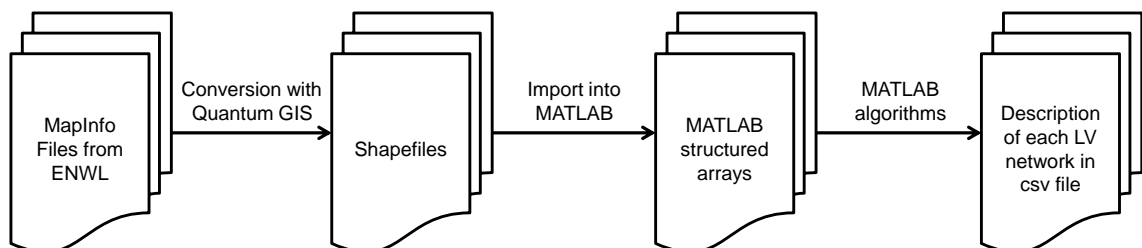

Figure 6-17: Procedure for extracting data from MapInfo files for use in MATLAB

2.2.1 Implementation

MATLAB is chosen to implement the proposed method because; it has useful inbuilt functions such as “pdist2” which is used for calculating the distance between two points; it is efficient for matrix calculations which are used throughout; it can read and interpret shapefiles; and inbuilt plotting tools can be used for validating the code.

2.2.2 Output file

Each LV network is described in a CSV file in which each row denotes a length of feeder cable in the network. Loads and generation are connected directly to the downstream end of each cable. The service cable can be omitted from the model description to save memory space and processing time if the inclusion of this is considered to have a negligible effect on the output of load flow analysis. The column headers from the CSV file are summarised in Table 6-3.

Table 6-3: Parameters used to describe each section of LV feeder cable which makes up the LV model

Parameter	Description
Line number	Identification number of line, sequential down the model table
Feeder number	Feeder to which the line belongs, as a number
Bus 1	ID of the busbar which is electrically closest to the transformer
Bus 2	ID of the busbar which is electrically furthest from the transformer
Number of loads	Number of loads connected to the downstream busbar
Potential number of PV	Number of PV systems that might be connected to the downstream busbar given the orientation of properties at that location
Service cable angle	Angle of the service cable relative to the north-south direction (see Figure 6-16(a))
Cable type	Type of feeder cable
Cable length	Length of cable segment in meters.
Load phase	Phase at which the load is connected if it is a single phase load

2.2.3 Part I: Preparation of data

The procedure for part I is shown in Figure 6-18(a) and has a number of distinct phases:

Data import and pre-processing

The GIS shapefiles describing the transformers, LV boards, linkways, feeder cables and service cables are imported into MATLAB. This includes a number of data descriptors which are not needed in the analysis and these are removed to reduce memory overhead. Matrices to describe the coordinates of the centroids of all of the network components are then created.

Transformers

The location of all of the transformers is compared to all of the LV busbars, linkways and fuseboards. If the transformer is located within 50m of the nearest LV busbar, linkway and fuseboards then these are associated with it and this is stored in the data structure.

Cables

The connector at the start and end of each cable is identified. This is done by calculating the distance between the cable ends and the connectors. The closest connector within a threshold is recorded. The cable type is determined by associating each cable type label with its nearest feeder cable. Vectors are created to describe the location of the vertices along each feeder cable (see 2.1.2). The length of cable between each of these vertices from the start of the cable is also recorded. To reduce computational overhead, cables, connectors and type labels are pre-clustered before this analysis is completed using a grid. This grid divides the entire ENWL network into 10km² regions meaning that the MATLAB code only tries to link cables to those close to each other and that the overall processing and memory overhead is lower.

Service cables

Service cables are used to determine the location and size of the loads in each network. The closest service cable to each street light label is first removed to exclude these from the network models as described in 2.1.5. Then, the number of loads at each service cable is calculated using the number of connecting service cables at each location as described in 2.1.3. Finally, the orientation of all of the service cable relative to the north-south direction is calculated using assumptions described in 2.1.6.

2.2.4 Part II: Produce network models

A flowchart of the procedure for part II is presented in Figure 6-18(b). The following steps are performed sequentially for each transformer:

1. Network components within 500m of each transformer are identified. This reduces the computational effort to determine the network topology since the MATLAB code only considers network components that are close to each other rather than having to load and analyse the entire network.
2. The feeder cable closest (within a threshold) to each LV fuseboard is identified.
3. Feeder cables in each way are identified. This is done by first identifying the connectors associated with feeder cables in the network and then adding new feeder cables associated with these connectors. This process is completed until no new feeder cables are found associated with any of the feeders.
4. Service cables whose ends are within 1m of the feeder cables are then added to the network model. Their respective position along each feeder cable and the cable angle is recorded.
5. The model is written to a CSV file by interpreting the previously calculated information.

2.2.5 Performance of the analysis tool

It takes a large amount of computational effort to produce all of the network models across the DNO area. On a 12 core, multi-threaded, 3.2 GHz, 64-bit PC with 16 GB of RAM it takes 19 minutes to load the shapefiles. The shapefiles themselves need 8 GB of RAM and the additional memory requirement for derived network parameters means that the algorithm requires over 15 GB of RAM. Part I of the analysis takes up to 4 hours and part II requires 12 hours. Since the algorithm is only designed to be run rarely (to generate an initial set of network models with periodic updates) this computational effort is acceptable.

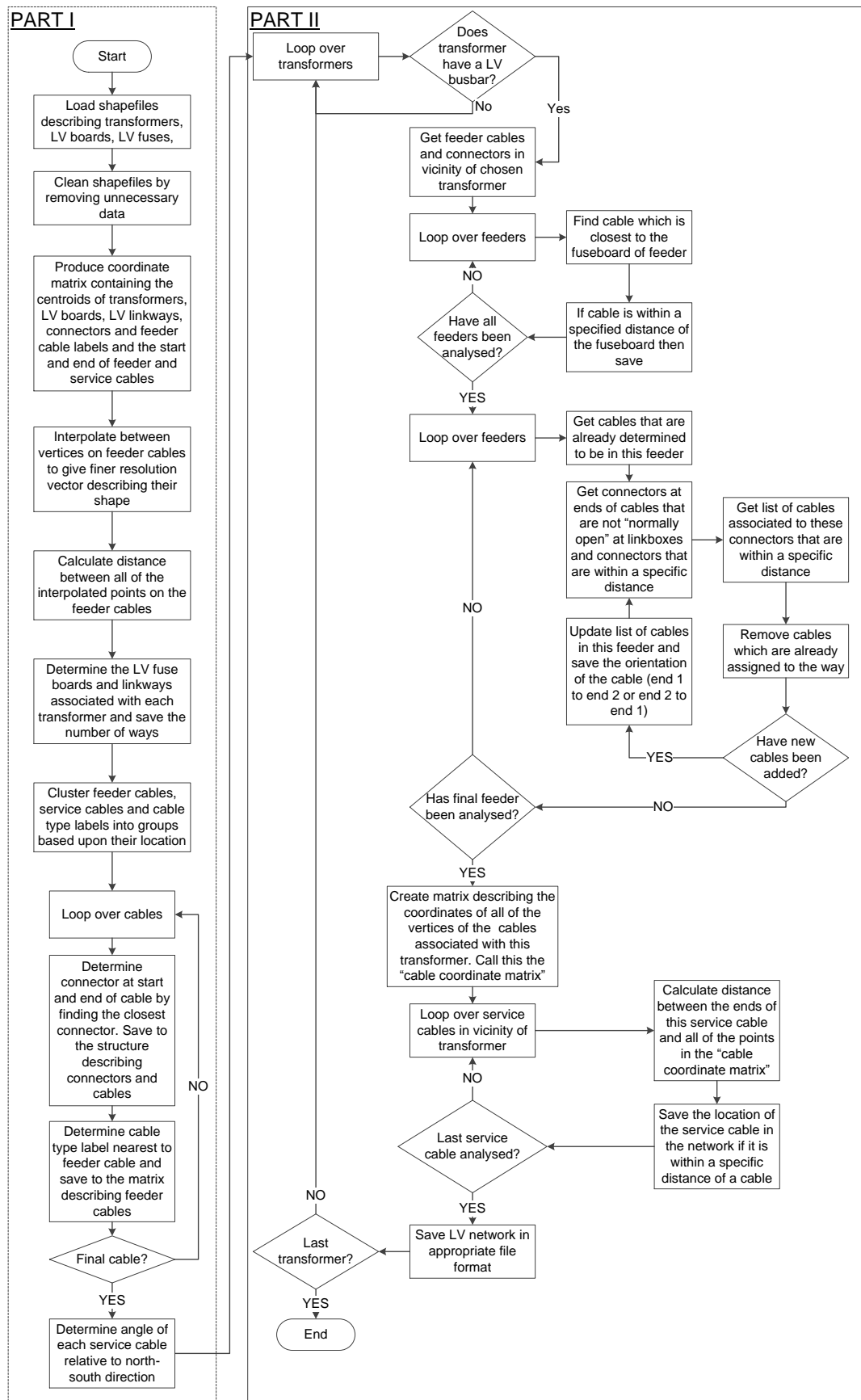

Figure 6-18: Flowchart showing procedure for automatic LV model creation from the GIS database

3 Validation

A number of validation criteria have been developed to ensure that a set of realistic residential LV network models are produced from the automatic procedure. These are now described.

3.1 Cable diameter sense check

When automatically generating the networks, there might be occasions where the model includes feeder cables from other networks. For example, if the ends of two feeder cables in different networks are close together (Figure 6-19) then the algorithm can link the two cables together. In the design of LV networks, the cables at the sending end of the feeder (i.e. those electrically closest to the transformer) carry larger currents. Under normal power flow, with no distributed generation, the current will decrease along the feeder as it serves local loads. As a result, LV network designers can reduce the cross sectional area, and therefore cost, of cables along the network whilst maintaining acceptable voltages and not overloading cables. Using this property of radial networks, downstream feeder cables which have a higher diameter than upstream cables are removed.

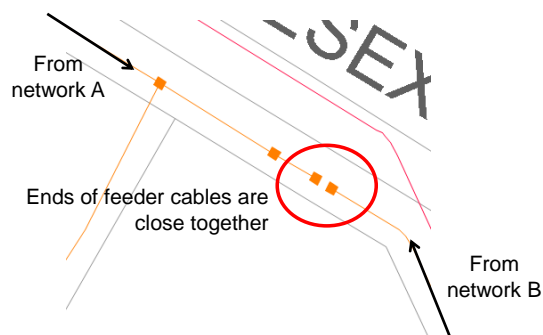

Figure 6-19: A GIS section where the ends of two different feeder cables are close together

3.2 Comparison to case study networks

3.2.1 Topology

The case study networks (Chapter 3) provide a dataset for comparison to the automatically created models. Table 6-4 shows a comparison between the number of feeders, loads, PV systems and length of the manually and automatically created network models. Here it can be seen that:

- The number of feeders on each network is correctly interpreted for all of the networks. A random sample of 50 further LV transformers across the ENWL network had the correct number of feeders assigned to them.
- The total length of feeder cables in the automatic networks is within 4% of all of the manually created networks. The small differences are due to human error when measuring cables on the GIS map and also the inclusion of additional feeder cable lengths (such as Figure 6-20). The total error of 33m across all of the sample networks

is slight and indicates no systematic error. Maps of the automatically created models have been compared to maps of the manually created networks and no differences are seen between the network topologies. This includes cable ends which are close together and normally open link boxes (see Figure 6-21).

- The automatic procedure generally overestimates the number of service cables and underestimates the number of loads connected to each network. This is to be expected since service cables do not always connect to homes: for example service cables to street lights are not always labelled. The number of loads is generally underestimated for this section of network since there are a significant number of single service cables which connected to more than one load. As discussed in 2.1.2, the proposed method cannot distinguish such properties. Network KC, for example, has at least 30 properties where the number of loads will be underestimated, such as that shown in Figure 6-22.



Figure 6-20: Additional length of feeder cable on network BL

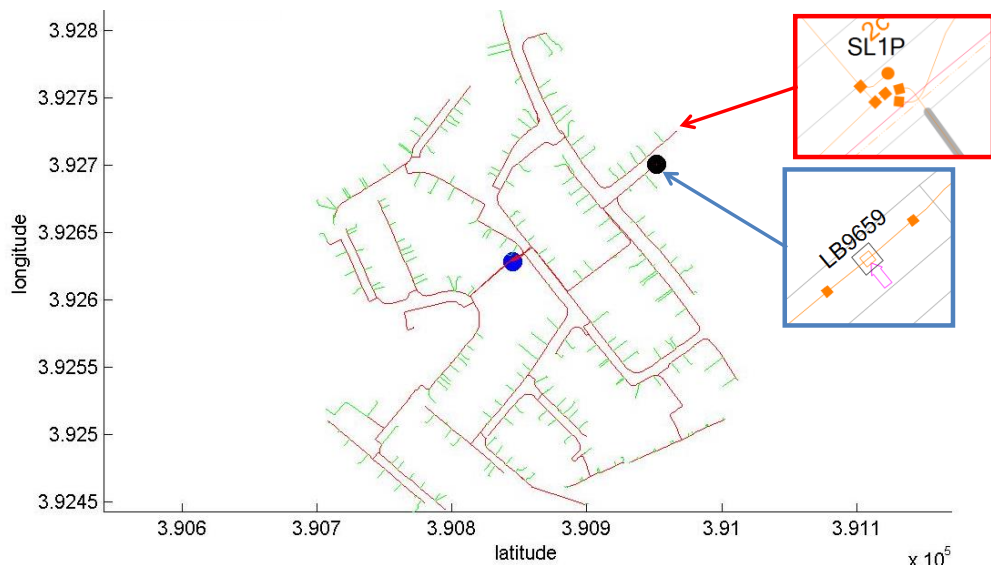

Figure 6-21: Automatically generated model for KC showing where the network correctly ends at a normally open linkbox (blue box) and at a cluster of connection points (red box)

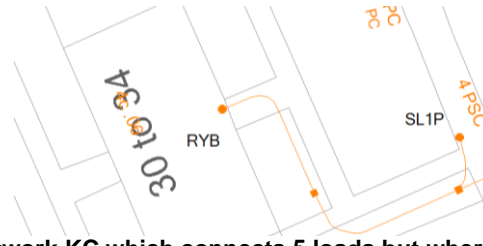

Figure 6-22: A node in network KC which connects 5 loads but where the GIS will only identify 1

Table 6-4: Table of number of ways, number of loads, potential number of PV systems and network length compared to the manually created network models

Network		BL	BM	CC	DG	KC	LL	MA	MR	RB	Total
Feeders	Manual	5	5	7	4	7	5	4	6	4	56
	Automatic	5	5	7	4	7	5	4	6	4	56
	Difference [%]	0%	0%	0%	0%	0%	0%	0%	0%	0%	0%
Loads	Manual	278	218	270	195	310	208	380	346	185	2390
	Automatic	250	204	308	193	268	169	348	395	172	2307
	Difference [%]	-10%	-6%	14%	-1%	-14%	-19%	-8%	14%	-7%	-3%
Service cables	Manual	196	169	214	140	192	130	267	271	112	1691
	Automatic	211	137	241	136	209	107	271	303	125	1740
	Difference [%]	8%	-19%	13%	-3%	9%	-18%	1%	12%	12%	3%
Feeder length [m]	Manual	2684	2342	3285	2564	3083	1626	3860	4329	1740	25513
	Automatic	2762	2319	3264	2540	3124	1562	3815	4275	1818	25480
	Difference [%]	3%	-1%	-1%	-1%	1%	-4%	-1%	-1%	4%	0%

3.2.2 Voltage characteristic

The voltage rise and drop in a network depends on the line resistance and reactance as well as the location of the loads. Therefore, the voltage profiles in the automatically and manually generated models should be consistent. Both are built in OpenDSS with each of the loads at 1 kW and no PV generation. The difference in the voltage between the secondary transformer and each customer connection point is then calculated. These are plotted in Figure 6-23. It can be seen that the voltages are broadly consistent between the automatically created models and the manually created models. Generally, the automatic models overestimate the voltage drop, but the difference is small enough for the automatic models to be considered representative of the networks.

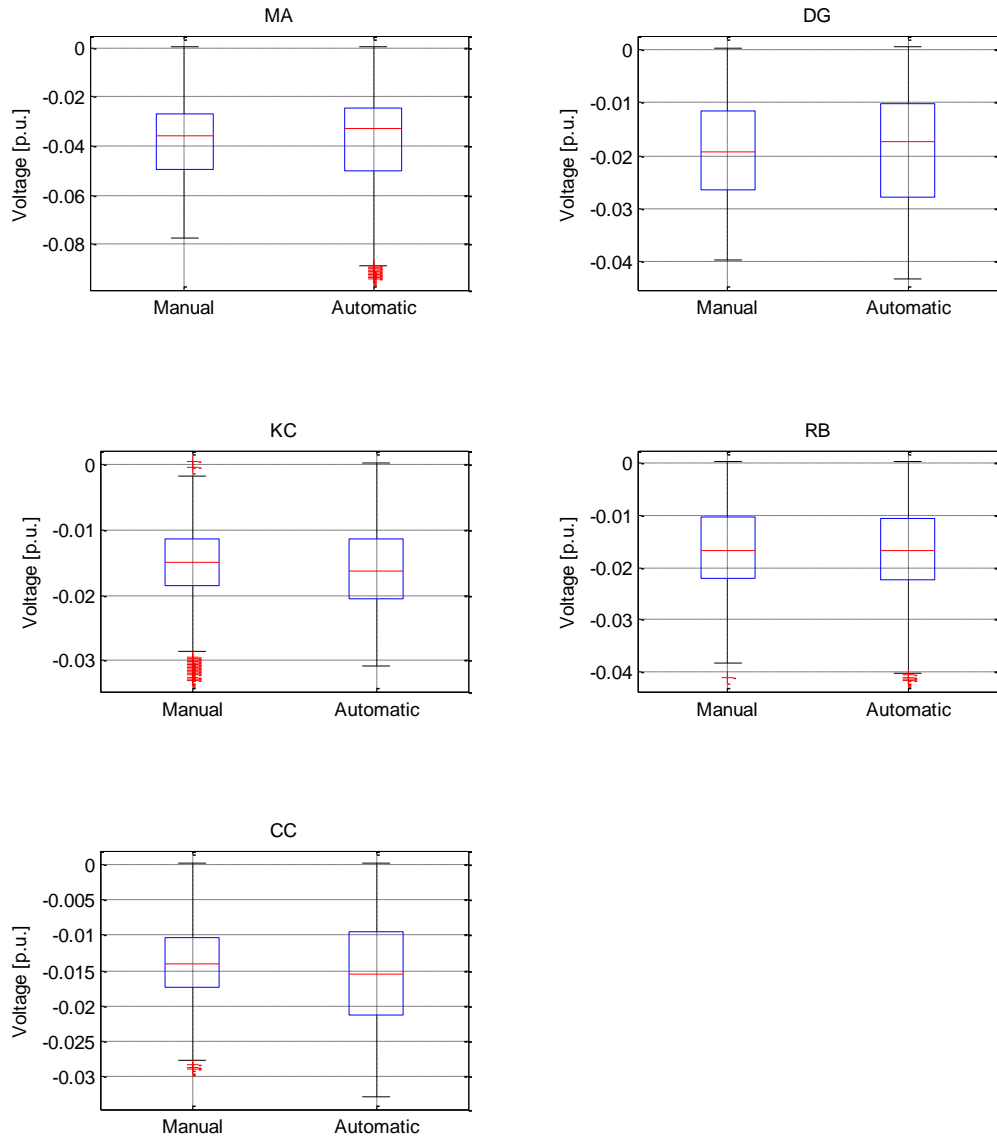

Figure 6-23: Boxplots of the range of voltage drop on the manually and automatically created network models in the case study area

3.3 Performance of algorithm across network area

Across the ENWL license area, the algorithm successfully connects 88% of the LV feeder and 89% of the service cables as shown in Figure 6-24. An analysis has been performed to determine the reasons why these cables are not connected. Figure 6-25 shows a map of the LV cables in the centre of Blackpool. Cables which have been successfully assigned to transformers are coloured blue and those which have not are coloured red. This figure can be used to summarise the main reasons why cables are not successfully connected.

- The cables on the left of the figure (*a1* and *a2*) which run along the seafront have ends which are not connected to any other part of the network. They are isolated according to

the GIS and it is therefore impossible to accurately determine their connectivity from the GIS. Such sections are also found in other areas of the network, e.g. Figure 6-26(a).

- The cables labelled *b* at the top of the figure are in an industrial/commercial area and have no LV fuseboard or busbar in the GIS diagram. As an industrial zone, these are not within the scope of this analysis which considers only residential networks.
- The cables labelled *c* should be associated with an LV transformer, but there is a missing section of cable close to the transformer. This is also seen in other parts of the network such as that shown in Figure 6-26(b). This is not a common occurrence and is not found in the survey of cables in Figure 6-27.
- The cables labelled *d* are beyond a normally open point and so are not included. In reality, this particular normally open point would be closed to allow these loads to be connected. This means that there is an error in the GIS diagram.

To understand the frequency of occurrence across the ENWL network, a random sample of 50 unused cable segments were identified and the reasons for unsuccessful connection were recorded. These results are summarised in Figure 6-27. It can be seen that the vast majority of unconnected cables (88%) are either isolated, beyond normally open points or in industrial areas. 12% of the unconnected cables (or 1.4% of all cables) are not successfully connected by the algorithm.

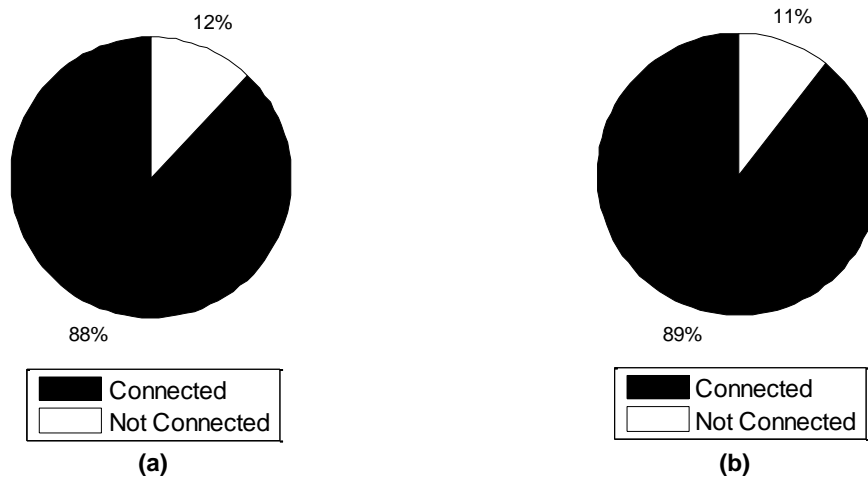

Figure 6-24: Pie chart of the percentage of (a) feeder and (b) service cables connected to the models

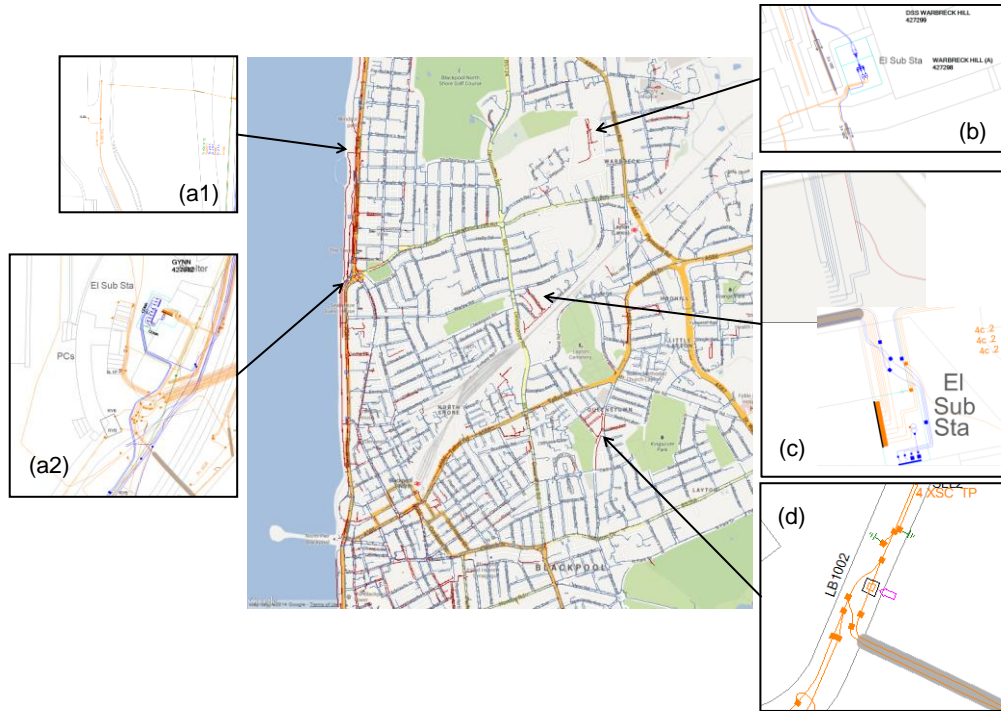

Figure 6-25: Map of connected (blue) and unconnected (red) feeder cables in the centre of Blackpool

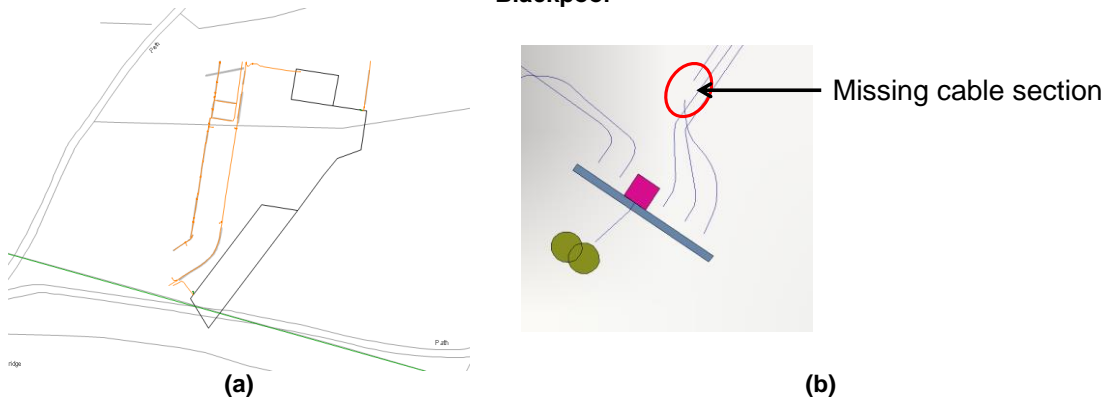

Figure 6-26: (a) An isolated section of network which has no obvious transformer in the GIS and (b) a cable section which is missing from the GIS map

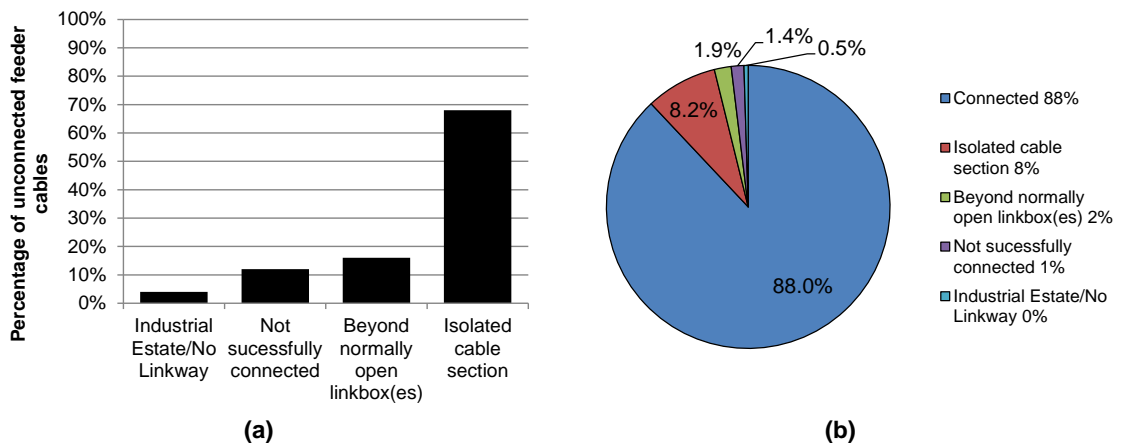

Figure 6-27: (a) Reasons why cables are not connected according to a random sample of 50 cables and (b) the overall performance of the algorithm including the information from this sample

4 Selection of representative networks

4.1 Selection criteria

The automatic procedure creates a network model for each transformer which has an LV fuse (28,642 networks). To identify the residential LV networks within this data set and to remove networks which are invalid due to mistakes in the automatic procedure or the GIS, a number of selection criteria have been developed. These are applied to the networks to produce a set of representative networks.

- ENWL design rules state that any feeder cannot contain more than 200 individual loads (Electricity North West Limited 2013). Network with more than 200 loads on a feeder are therefore not included.
- Commercial and industrial premises with a high peak demand have their own dedicated feeder or transformer. These are removed by only taking networks with more than 50 loads.
- The largest LV transformer that ENWL operate has a rating of 1500 kVA. Under an ADMD of 1 kW per load and a 20% margin for load growth, networks must have less than 1,200 loads.
- The longest distance between the most remote load and the transformer the case study networks is 575m. It is considered that a network feeder with a remote load more than 800m from the transformer is unrealistically long. Networks where this occurs are not included.
- Only networks with between 1 and 25 individual feeders are considered. If they are higher than 25, it is considered that the algorithm has added cables from an adjacent network.
- Networks containing less than 50m of feeder cable are likely to be either small rural networks, networks with minimal voltage rise or networks with incomplete models. Networks with more than 12,000m of LV cable are also consider unfeasible (equating to 480m per feeder)
- ENWL design rules state that the voltage drop in any network must not exceed 0.07 p.u. However, it has been found (see Chapter 4, Section 1) that the voltage drop on some of the case study networks already exceeds this. Therefore, a network is considered to have an unacceptable voltage drop if it is greater than the regulatory voltage range within a 2% safety margin at an ADMD of 1 kW and an MV voltage variation of 0.037 i.e. greater than $1.1 - 0.94 - 0.037 = 0.123$ p.u.

A summary of these design rules is provided in Table 6-5.

Table 6-5: Parameters used to identify feasible urban residential networks

Parameter	Minimum value	Maximum value
(a) Number of loads on most heavily loaded feeder	0	200
(b) Total number of loads	50	1,200
(c) Distance of most remote load from transformer [m]	10	800
(d) Total length of feeder cable in network [m]	50	12,000
(e) Number of feeders	1	25
(f) Voltage drop under maximum load [p.u.]	0	0.12

4.2 Application of selection criteria

Figure 6-28 shows the percentage of networks which meet the selection criteria. It can be seen that the majority of networks (more than 55%) are rejected because they have too few loads. A sample was taken of 50 of the networks which have less than 50 loads. As shown in Figure 6-29(a), more than 70% of these are farms or villages which are served by pole mounted transformers (for example, Figure 6-29(b)). The rest of the networks surveyed supplied commercial, industrial or other non-residential customers beyond the scope of this study. Approximately 50% of the networks have less than 10 loads on their most heavily loaded feeder. 99% of these networks are discounted because they have fewer than 50 loads and this criterion is effective in identifying more non-urban residential networks. As shown in Figure 6-28, more than 80% of the networks meet all of the other criteria.

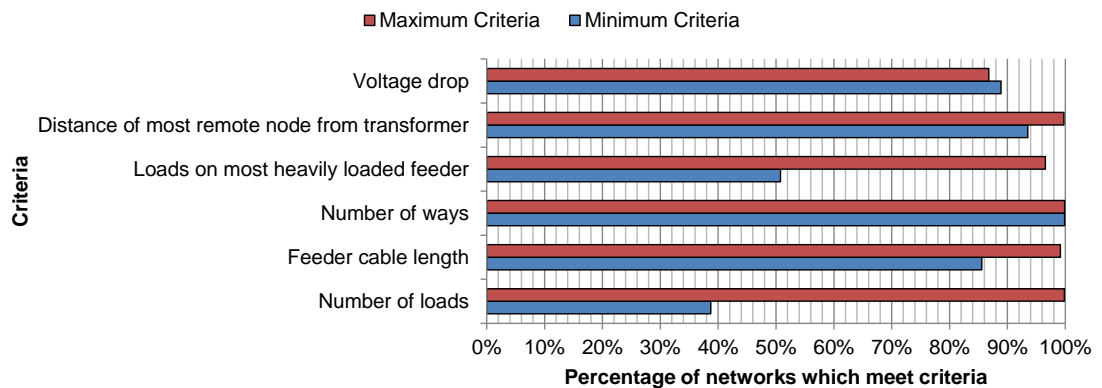

Figure 6-28: Fraction of networks that pass the selection criteria

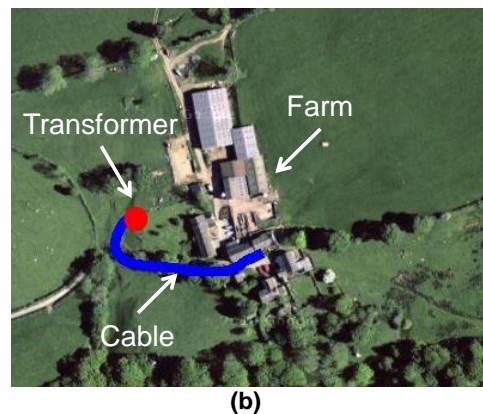
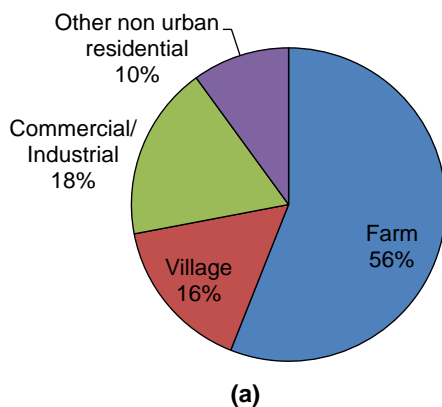

Figure 6-29: (a) LV networks which have fewer than 50 loads and (b) a rural transformer serving a farm

Figure 6-30 shows histograms of the lengths of the networks before and after the selection criteria are applied (with the smallest bin being a total length of 50m). It can be seen that the validation criteria removes the shortest networks. These networks are removed as a consequence of only selecting networks with more than 50 loads which are, generally, much longer than networks with fewer loads in dense residential areas.

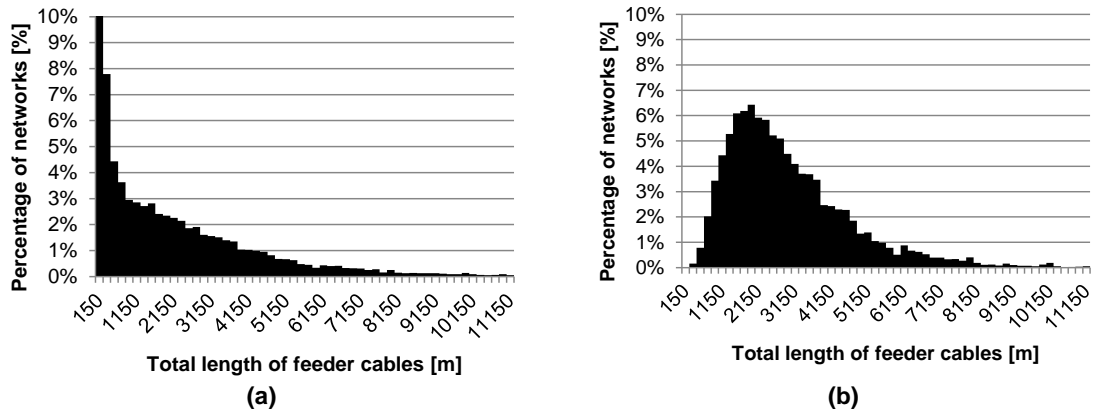

Figure 6-30: Histogram of the feeder cable length in each network (a) before and (b) after selection criteria area applied

Figure 6-31 is a histogram of the number of feeders in the LV networks before and after the selection criteria are applied. Here it can be seen that a large number of single feeder LV networks are removed. These networks are those with very few loads or of a short length which are removed by selection criteria (b) and (d), i.e. they are networks like those shown in Figure 6-29. A small number of single feeder networks remain in the data set. These meet the selection criteria.

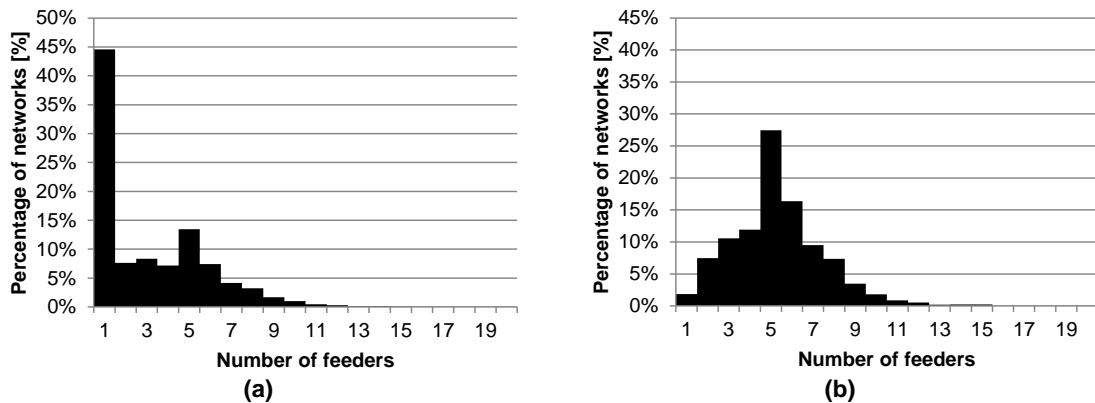

Figure 6-31: Histogram of the number of feeders in each network (a) before and (b) after selection criteria

Figure 6-32 is a histogram of the voltage drop in the networks before and after the selection criteria. Again it can be seen that the shortest networks, i.e. those with low impedance and few loads, are removed from the study even though a voltage drop of 0 p.u. is permitted in the selection criteria.

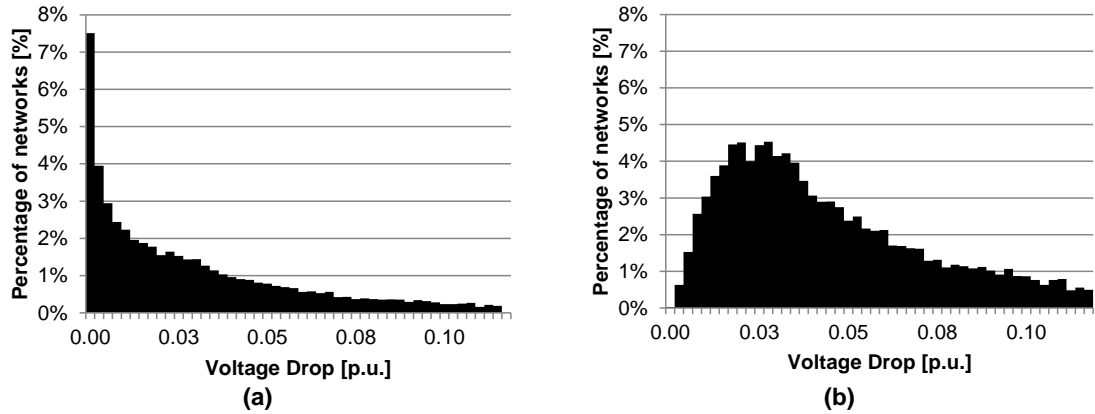

Figure 6-32: Histogram of the voltage drop in each LV network (a) before and (b) after the selection criteria area applied with each load set to 1 kW

A further representation of the effectiveness of the approach is shown in Figure 6-33. The red lines indicate cables which are included in the representative set of residential networks. It can be seen that the majority of cables in the industrial area in the centre of the figure are not included despite the large number of transformers. Surrounding the central area is a number of residential networks which are mostly included. It can be seen some networks are selected within the industrial area as shown by the yellow polygon in Figure 6-33. These networks are selected because they connect to a more than 50 small commercial or industrial units using the design rules described for residential LV networks. These networks should be allowed into the representative set of networks since these customers could still have PV or other LCT installed and are part of a complex LV network.

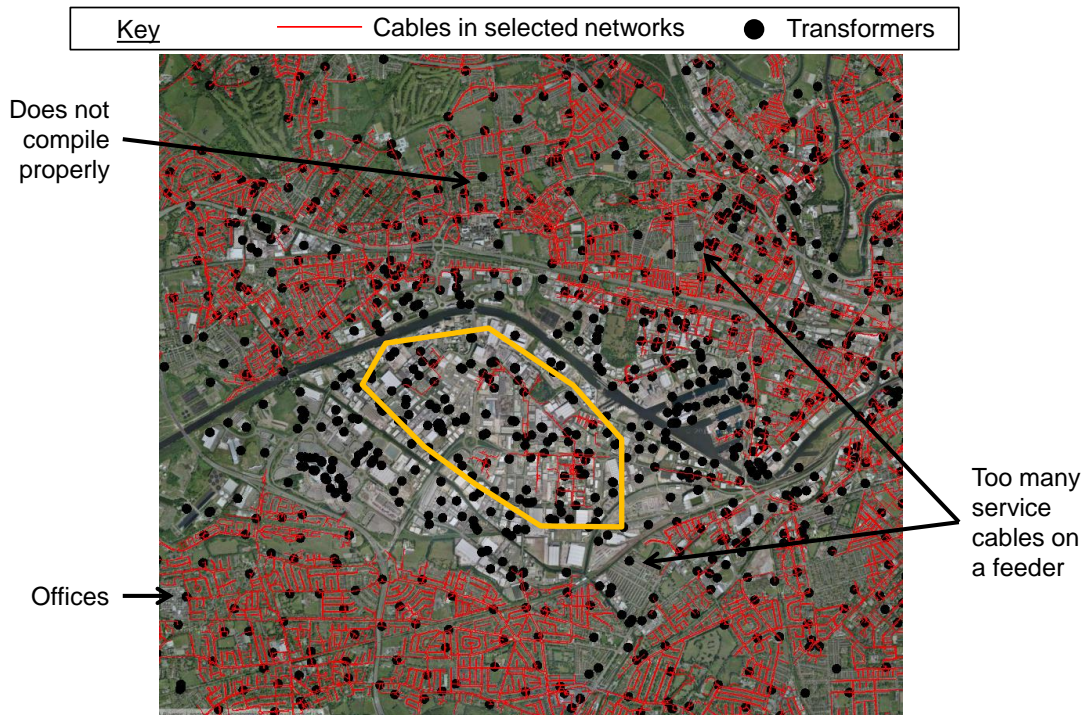

Figure 6-33: Map of cables included in network models in Salford (shown as red). The majority of these are in the residential areas around the central industrial area (i.e. outside the yellow polygon)

A summary of the selected networks is given in Table 6-6. The method is found to generate 9,163 network models which serve 1.67 million different residential properties. This comprises approximately 33% of the MV/LV transformers in the network and over 80% of the LV feeder cable in the ENWL licence area. A histogram of the number of loads and maximum PV dispersion level in the selected is given in Figure 6-34. It can be seen that the modal network is small, but there are many larger networks with more than 100 loads. The PV dispersion level is normally distributed as would be expected (50% of homes are South facing within $\pm 45^\circ$ but there are some clusters of houses which are not all suitable for PV). The biggest network has 845 loads: networks with more loads are removed by the validation criteria.

Table 6-6: Summary of selected networks for further analysis

Parameter	Value
Number of residential networks produced	9,163
Number of feeders in residential networks	43,816
Length of feeder cables in selected networks [km]	26,916
Number of customers in selected networks	1,666,030
Number of properties suitable for PV in selected networks (within $\pm 50^\circ$ of south)	910,366
Cost to replace cables in selected networks ¹ [£million]	£2,153.26

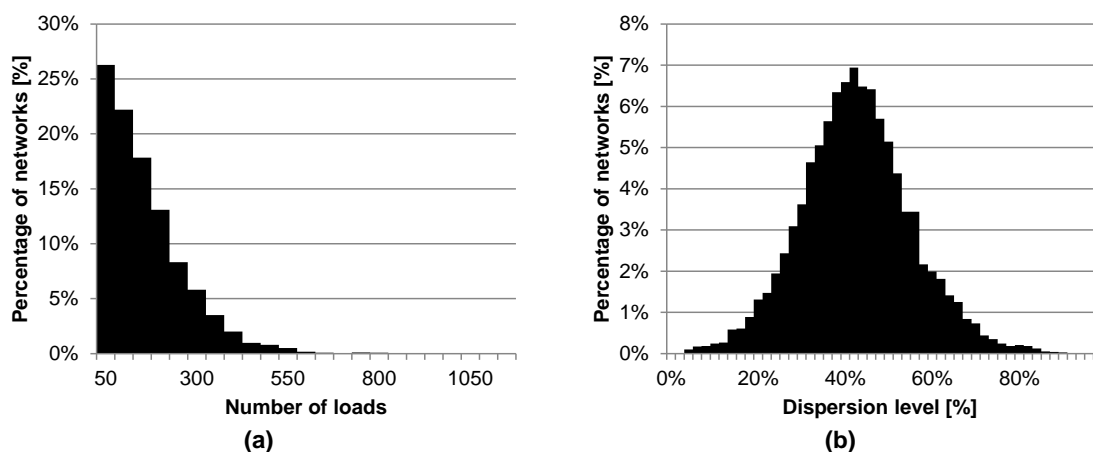

Figure 6-34: Probability density function of (a) the number of loads and (b) the PV dispersion level per transformer after the section criteria are applied

¹ Calculated using a reconductoring cost of £80/m as used in (Anuta et al. 2012)

5 Calculation of the transformer voltage deviation

As established in Chapter 3, Section 2, the transformer voltage variation, $V_T^{max} - V_T^{min}$, needs to be known to determine the voltage headroom in an LV network. Measured network data from the LV busbar of the secondary transformers is one of the options for providing this. However, this has a number of weaknesses which make it unsuitable for analysing the future performance of the LV networks derived from the GIS database:

- Network data monitoring is only available to the researchers from the case study networks and network monitoring devices have not been installed by the DNO across their secondary transformers.
- Measured data can only provide an indication of historical rather than future conditions, unless rules can be developed from the measured data about how voltages will change.
- High temporal resolution data sets of a long historical period and large amounts of statistical analysis of measured data is needed. For example, annual data sets can be used to provide the extreme conditions in a year, but over the life of a network more extreme network conditions may be experienced. This is not available from existing measured data.

The alternative to measured data is the use of representative MV network models derived from the GIS. In this chapter a large number of LV network models have been created, each of which will connect to a different MV network. It is however not possible to create MV models from the GIS data because these connect a number of commercial, industrial and residential customers with more complex demand characteristics which are not described in the GIS. However, it is possible to consider the MV network from the case study network to be representative of other MV networks in the ENWL distribution network. This is because:

- The dominating factor affecting the voltage level is deviation within the LV networks, i.e. $V_T^{max} - V_T^{min} \ll 2V_s + \nabla V_{LV} + \Delta V_{LV}$ as shown in Chapter 4, Section 3.1.
- The increase in voltage rise as a result of PV in LV networks is always linearly proportional to the dispersion level and power flow through the transformer as shown by the derivation of the voltage sensitivity factor (see Figure 6-35).

In order to meet these assumptions, the following rules are implemented:

- Only residential LV networks in urban areas are considered. Here, there is a low probability of large DG installations (such as wind farms) on the MV networks. This limits the change in voltage deviation at each secondary transformer to being mostly affected by small sized renewable generation in LV networks.
- The DNO will take remedial action if necessary to improve the MV voltage control as a result of reverse power flow. This voltage control cannot directly affect voltage rise over the LV cables. As such, it is assumed that the voltage deviation in the MV network no more than 20% larger than is already the case.

5.1 Model of the MV network

A full model of the MV network for the case study networks (Figure 4-2) was built in OpenDSS. Load flows were run at the highest and lowest loading to calculate the total transformer voltage variation (without PV) at each secondary transformer. Using the demand figures in Table 3-2, the maximum power consumed by the residential networks was calculated. The minimum demand per property is taken to be 0.142 kW as described in Chapter 3, Section 0. If the south facing homes in the residential networks have PV then the power flow at each secondary transformer will change. Specifically, the largest voltage at the transformer is expected to be higher due to reverse power flow into the MV network. This is analysed by calculating the power flow through each residential network with PV at maximum output and minimum demand.

The present performance of this MV network (with no PV installed) is shown in blue in Figure 6-35. This is of the same order as the measured network data from this network (see Chapter 4, Section 1). The effect of the addition of the PV is also shown in red. Figure 6-35(a) shows the change in voltage when PV is only installed in one of the networks, so for example the leftmost bar shows the rise in voltage at CC if PV is only installed on all of the south facing homes in network CC. Figure 6-35(b) shows the change in voltage when PV is installed in all of the residential networks.

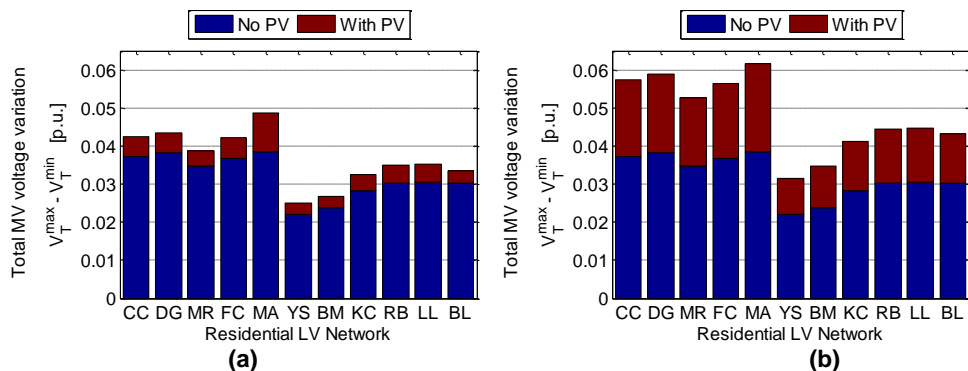

Figure 6-35: (a) Voltage variation at each secondary transformer in Figure 4-2 with a PV dispersion level of 100% in (a) one network at a time and (b) aggregated effect if all suitable homes in all of the LV networks install PV

Looking at these results, it can be seen that the addition of PV in the residential LV networks does increase the variation in transformer voltage. The variation is not the same between the networks due to the different cable properties and busbar locations in the MV network. It is found that the networks in the upper feeder of Figure 4-2 have a larger deviation because this is a longer feeder with more load. It can also be seen by comparing Figure 6-35(a) and (b) that the change in voltage is higher when all of the networks have PV. This is because there is more reverse power flow into the MV network. A further finding is that the voltage rise at the secondary transformers at the ends of the MV feeders does not increase dramatically more than that at busbars at the start of the feeder. This is because of the robust nature of the MV network

which serves a mixture of commercial and residential loads which do not inject power into the networks and so reduce the reverse power flow along the feeders.

The increase in the voltage at each residential transformer is shown in Figure 6-36(a) for different PV dispersion levels. It initially appears that the networks have very different voltage rise characteristics. However, the results can be grouped into those for networks on the upper feeder and lower MV feeder, as shown. The increased voltage for the upper and lower feeders at different dispersion levels, p , is found to be linear. Further, there is little impact on the voltage when the dispersion level is low. This is supported by findings in the measured data from the network (Chapter 2, Section 1). The gradient of this graph is proportional to the rating of the PV system as shown in Figure 6-36(b).

It is interesting that the results shown in this figure correlate with the network diagram shown in Figure 4-2. There is a clear distinction between networks on the upper feeder (CC, DG, MR, FC and MA) with those on the lower feeder (YS, BM, KC, RB, LL and BL). Those on the upper feeder all have a higher sensitivity to PV (greater voltage rise as a result of PV) as these are all located towards the end of the MV feeder. Those on the lower feeder have a lower sensitivity as they are located closer to the primary substation than the LV networks in the upper feeder

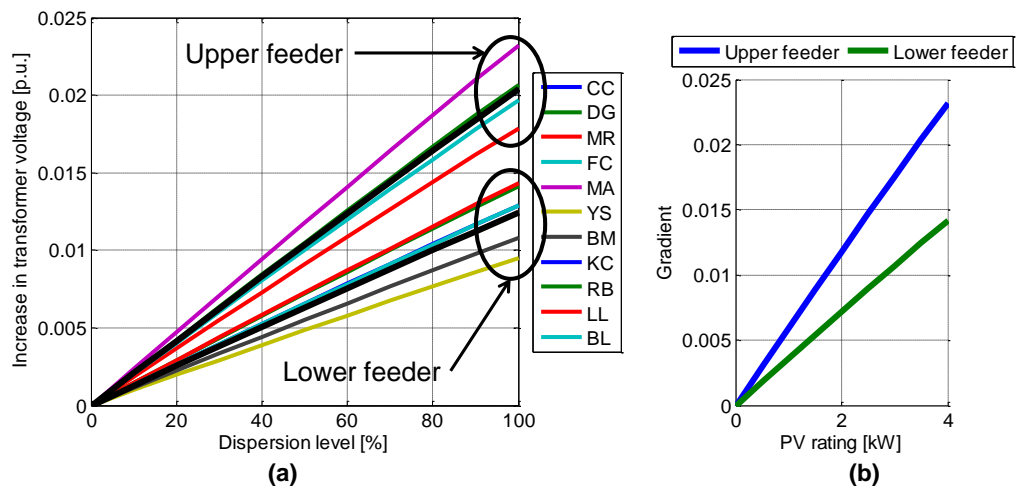

Figure 6-36: (a) Increase in transformer voltage for all case study networks at different dispersion levels with 2.5 kW PV and a minimum demand of 0.2 kW and (b) the gradient of the graph of transformer voltage increase against dispersion level for different PV ratings on the upper and lower feeder¹

5.2 Derived rules for modelling large numbers of LV networks

For studies of a large number of LV network models, it is assumed that the LV networks have an equal probability of being connected to the upper or lower feeder of the case study MV network. Given the trends found in this network, Eq. 6-5 and Eq. 6-6 are proposed to determine the voltage deviation at each transformer in the upper and lower feeder respectively. Here, the

¹ Note that higher minimum demand and lower installed PV power are used to represent a reduced diversity between many loads and generators across a large geographical area.

voltage deviation, $V_{T,n}^{max} - V_{T,n}^{min}$, is calculated using the voltage deviation with no PV, α , a gradient, β , the PV rating, P_{PV} and the PV dispersion level, p . Values for α and β are summarised in

Table 6-7.

$$V_{T,n}^{max} - V_{T,n}^{min} = \alpha_1 + p \cdot \beta_1 P_{PV} \quad \text{Eq. 6-5}$$

$$V_{T,n}^{max} - V_{T,n}^{min} = \alpha_2 + p \cdot \beta_2 P_{PV} \quad \text{Eq. 6-6}$$

Table 6-7: Derived constants for upper and lower MV feeder

MV Feeder	α [p.u.]	β [p.u./kW]
Upper feeder	0.037	0.006
Lower feeder	0.028	0.004

This approach has weaknesses, in that it does not account for MV networks which presently have voltage variations greater than 0.038 p.u. or for MV networks which are more largely impacted by PV within the LV networks. These are largely acceptable because the voltage deviation across the LV network will generally be much higher than at the secondary transformer. As a result of this, the analysis here can only assess the cost implications of reinforcing the LV network. There may be further costs to the DNO in reducing the MV variation to those similar to present values.

6 Conclusions

The GIS is able to provide a large number of representative models of LV residential distribution networks. These networks meet selection criteria that results in a set which have the characteristics of urban residential networks and are comparable to case study networks which themselves have been extensively scrutinised. It is important to note that the GIS database has limitations which restrict the precision of the network models:

1. The GIS database does not describe the present location of PV systems. Therefore, the LV models are suitable for determining the potential impact of PV under a suitable rule governing the orientation of the roof of a home.
2. It does not contain enough detail to accurately determine the type, size or number of loads connected by each service cable. Residential customers do have different load characteristics (for example economy 7 customers consume more than average and consumption is different in different regions (Department of Energy and Climate Change 2012b)). Such social factors are not available.
3. It has obviously not been possible to validate the tool against all of the ENWL network and there will be differences between the GIS models and the real ones. This can occur because of inconsistencies in the GIS data, the GIS data not representing the real situation in the distribution network and invalid assumptions in the method presented. It is assumed that, on average, these inconsistencies will average out and that an overall assessment of the value of energy storage and how energy storage should be installed in the LV network can be made.
4. The MV variation is assessed only using two feeders. This is because it was decided not to use the GIS procedure to develop MV networks. There may be scope for doing this in future work but as discussed in the chapter, this might be difficult.

Further to this, the tool takes an excessively large amount of computational effort to run which means that it cannot be used on a real time basis. This is not a problem as once the models are produced they could be edited or modified to reflect changes in the LV networks.

Within these limitations, network model creation from GIS can be considered to be successful for the needs of this work since it has generated over 9,000 LV network models which meet the validation criteria adopted in this work. Using these models, it is possible to evaluate the impact of PV and role for energy storage across the ENWL network area and to provide technical and financial information for a DNO. As such, the models can inform policy decisions surrounding how energy storage should be installed in LV networks to mitigate overvoltage and to further increase the amount of PV that can be installed by domestic customers. This work is completed using the tools described in Chapter 5. Chapter 7 describes the complete formulation of this study followed by technical results. Chapter 8 then draws financial results for DNO and policy based decision making using the financial model described in Chapter 3, section 3.

Chapter 7: Application of Planning Tools for Technical Results

In this chapter, the tools described in Chapter 5 are applied to the residential LV networks derived in Chapter 6 to determine the future impact of residential PV on LV voltage levels. In order to do this, future demand and generation scenarios are first established. The tools are then demonstrated on one of the case study networks to see how different energy storage topologies impact the voltage rise in an LV network. Then, the tools are used to determine what type or types of energy storage are best suited to prevent voltage problems across all of the GIS developed network models. Specifically, different scenarios for stochastically (randomly in the free market) and optimally locating LV energy storage are compared. These are evaluated on the resulting technical benefits of these to the DNO in terms of preventing overvoltage as a result of PV integration.

1 Generation, demand and storage scenarios

1.1 Demand

As described in Chapter 3, Section 1.1, ENWL consider the maximum demand of residential customers to be 1.4 kW or 1 kW depending on the customer type. A maximum demand of 1.4 kW is initially applied to each load in the LV network model. If this causes undervoltage, then a 1 kW maximum demand is applied to the loads. It is assumed that all customers on a feeder will have the same maximum demand after diversity since they are most likely to be of a similar demographic. A minimum demand of 0.142 kW is applied in the daytime (taken from the measured network data) which establishes the conditions which cause the highest voltage in the LV networks.

1.2 PV installation

ENWL have provided a forecast of how PV is expected to be installed in their network until 2050. This has been supplemented with a projection of the present rate at which PV is installed under the UK feed-in-tariff as described in Chapter 3, Section 1.2. In Chapter 6, 1,292,960 south facing homes were identified in the entire ENWL network (not just in the selected networks). By combining these two data sources future PV dispersion levels, p , have been established (Figure 7-1). Each PV is assumed to have a capacity of 3.6 kWp as this is the average size of PV installations in the ENWL network. It should be noted that a scenario with increased or decreased PV ratings is easy to incorporate in the modelling tools if required. This facility is used in a sensitivity analysis.

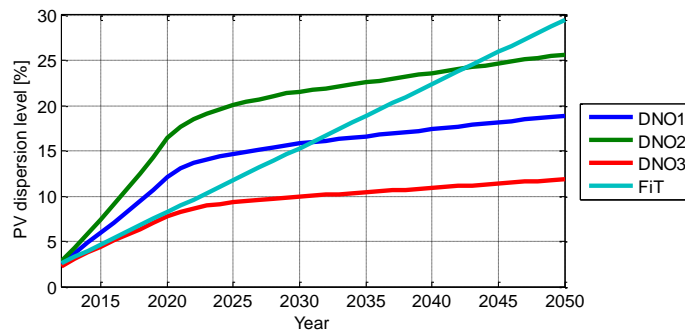

Figure 7-1: Forecast for future PV integration in residential networks (total dispersion level across entire ENWL network)

1.3 LV energy storage scenarios

Based upon the literature review (Chapter 2, Figure 2-9 page 22), the following future LV energy storage scenarios are compared.

1. Energy storage is located at the secondary transformer. Through intelligent charging and discharging, this eliminates any voltage rise at the secondary transformer as a result of reverse power flow from the LV to the MV network (see Chapter 4, Section 1). The power rating of storage needed to achieve this is the total capacity of PV in each LV network minus the minimum demand concurrent with peak generation.
2. Energy storage is located in customer homes. These are purchased by customers who have PV and who want to maximise their self-consumption. This storage is assumed to be bought in a free market and so the DNO cannot determine where they will be located (much the same as PV is today). Further, it is assumed that storage will always absorb all of the peak demand from the PV to maximise self-consumption and so has a rating of 3.6 kW and is single phase. The stochastic tool is used to determine the location of the storage. Storage dispersion levels between 0 and 100% are considered to explore the entire problem space.
3. The DNO determines which homes energy storage is installed in. The optimisation tool is used to find the location of these to minimise the capital, operating and replacement costs to the network operator whilst solving the voltage problem. These have a rating of 3.6 kW to fully absorb reverse power flow from the PV panels and are single phase.
4. Energy storage is located in the street by the DNO to alleviate voltage problems. Three phase 25kW CES (see Table 2-1) are selected using the optimisation tool.

1.4 Voltage headroom

The headroom for voltage rise, ΔV_{LV}^+ , in an LV network can be expressed as shown in Eq. 7-3. This is calculated when all PV systems in a network are at maximum output and each load consumes the minimum power. The maximum voltage drop, ΔV_{LV}^- , is calculated at the maximum demand with no generation equating to the evening peak.

It is assumed that the MV voltages are at their highest and lowest values when the LV network voltages are highest and lowest. Since the GIS has not been used to generate MV network

models for this study, assumed MV voltage ranges, V_T^{max} and V_T^{min} need to be applied. For this study, the MV voltage deviation is calculated using an empirical relationship detailed in Chapter 5. Each network is randomly assigned to one of the two feeders in the case study MV network. Eq. 7-3 is used to give the headroom for voltage rise in each LV feeder if safety margin, V_S , of 0.005 p.u. is used as shown in Eq. 7-1 - Eq. 7-3. This allows the total allowable voltage rise permitted in each LV network to maintain regulatory limits.

$$\Delta V_{LV,n}^+ \leq 0.16 - (V_T^{max} - V_T^{min}) - \Delta V_{LV,n}^- - 2V_S \quad \text{Eq. 7-1}$$

$$\Delta V_{LV,n}^+ \leq 0.16 - (V_T^{max} - V_T^{min}) - \Delta V_{LV,n}^- - 2 \cdot (0.005) \quad \text{Eq. 7-2}$$

$$\Delta V_{LV,n}^+ \leq 0.15 - (V_T^{max} - V_T^{min}) - \Delta V_{LV,n}^- \quad \text{Eq. 7-3}$$

1.5 Determination of the number of repeats for stochastic PV placement

The proposed tools (Chapter 5) assume that PV is stochastically installed in the ENWL network, i.e. regardless of location, the probability that a house will have a PV system is uniform across the entire ENWL network. In reality, social factors such as wealth, property size, government subsidies, local planning regulations etc. will influence these probabilities and lead to geographic clustering of PV panels (as is evident in the uneven distribution of PV across the UK between local authorities, Figure 1-4). Such social data could be accounted for in the stochastic tool through applying different dispersion levels to different feeders or sections of feeders. Calculating these probabilities for a large network study would also add a large degree of complexity and uncertainty which is difficult to account for over a large set of networks. However, it is hypothesised that, across a large set of test networks, there will be little variation in the overall effect of PV on the ENWL residential LV distribution networks, even if it is clustered. This is because a statistically large number of feeders are assessed.

To test this hypothesis, a study of all the networks derived from the ENWL GIS system has been completed under an extreme clustering scenario. Here, it is assumed any LV network that has PV, has it on every south facing home. This is achieved as follows. Firstly, a random LV network is selected and PV is placed on all the homes with south facing roofs. Then another network is selected and PV applied on all homes. This is repeated until the required number of PV systems is placed, i.e. a small number of networks have PV, but each has a PV dispersion level of 100%. A series of load flows are run to determine how many of the LV networks experience voltage and the reconductoring cost is calculated using the model described in Chapter 5, Section 4.6.

Figure 7-2 shows a probability distribution of the reconductoring cost when this extreme clustering scenario is performed 100 times for four different overall PV dispersion levels, p . It is seen for example that a 10% PV dispersion level is expected to cause a reconductoring cost in the range £59 -£74 million. In the study, it is found that the standard deviation of the reconductoring cost is just £4.25 million when the PV dispersion level is 50%.

The small variation in cost suggests that the assumption of a uniform probability that PV is installed on a south facing home is valid. This also indicates that there is a sufficiently large degree of independence between the geographical factors which influence where PV is installed and the voltage headroom in the LV networks when a whole DNO network study is performed.

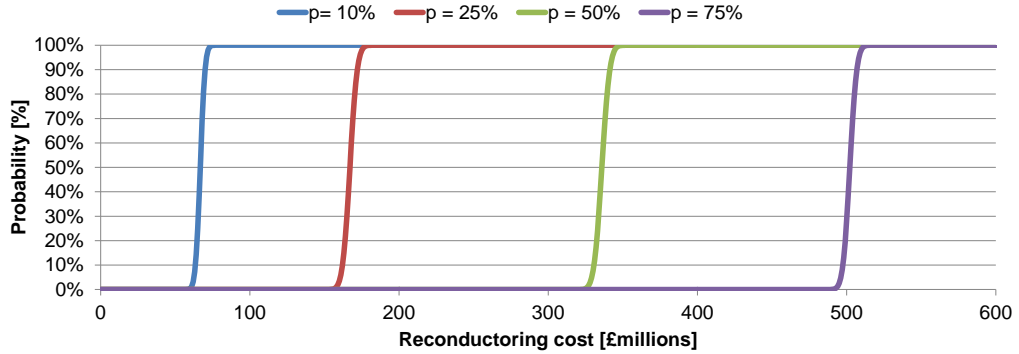

Figure 7-2: Deviation in reconstructing cost under extreme clustering scenario and different overall PV dispersion levels across the ENWL network

A further finding of the stochastic tool is that the voltage rise for a given network for a particular dispersion level is normally distributed (as shown in Figure 5-4). When a large number of networks are analysed, it is important to establish how this variability affects the overall reconstructing cost and how many samples are appropriate to determine meaningful results from the models. This is assessed by setting the dispersion level to 50% and recording the voltage rise in all of the LV networks. A 50% dispersion level is selected as this offers the most variability as discussed in Chapter 5, Section 3. Figure 7-3 shows boxplots for each of the 10 repeats of (a) the per unit voltage rise and (b) the reconstructing cost. It can be seen that the boxplots remain consistent in both figures. There are some extreme differences in the voltage rise, but these are outliers and overall the reconstructing cost does not change significantly. The outliers are the result of the probabilistic nature of the voltage rise with uncertain PV location with some networks having particularly high standard deviations or mean voltage rise (see Figure 5-4, page 70). Similar results are found with a 50% integration of PV and 50% storage integration (Figure 7-4). This shows that, over a large number of networks, it is valid to just run the stochastic tool once for each PV and storage dispersion level.

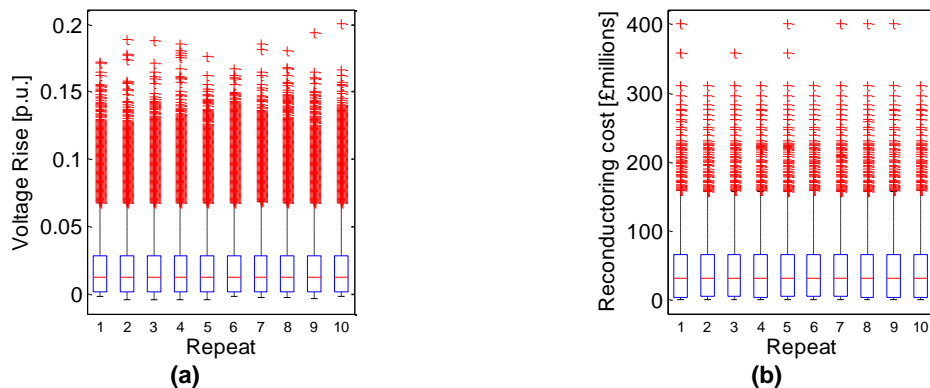

Figure 7-3: Boxplots of (a) the voltage rise and (b) the reconstructing cost of each LV feeder when the PV dispersion level is 50% the storage dispersion level is 0% and PV systems of 3.6 kW are installed

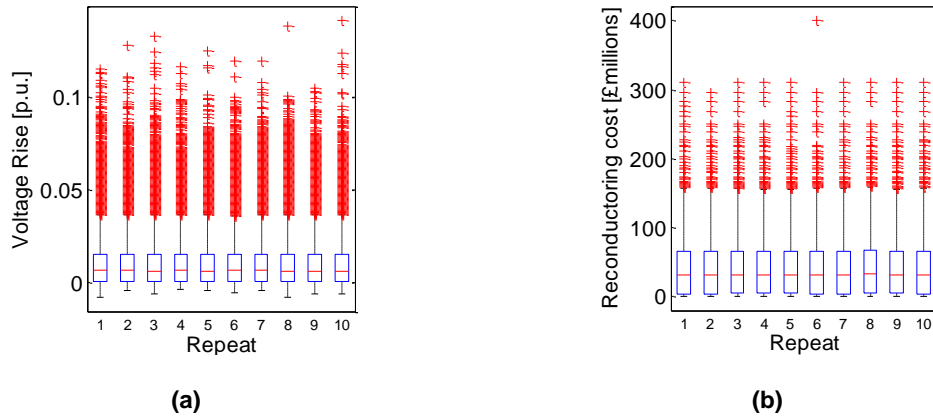

Figure 7-4: Boxplots of (a) the voltage rise and (b) the reconductoring cost of each LV feeder when the PV dispersion level is 50% the storage dispersion level is 50% and PV systems of 3.6 kW are installed

2 Network condition with no energy storage (basecase)

Since the validity of the stochastic placement of PV is established, the impact of PV without any energy storage or other mitigation can be investigated. This is completed using the stochastic tool repeatedly at the dispersion levels defined in Figure 7-1. Figure 7-5 shows the number of feeders (out of 43,816) which are expected to experience overvoltage under the various PV integration scenarios. It can be seen in Figure 7-5(a) that between 2012 and 2020, there is expected to be a significant increase in the number of LV networks which will experience overvoltage. Figure 7-5(b) shows the number of PV systems which experience overvoltage. Presently, less than 400 PV systems in the ENWL area are projected to experience overvoltage at some point in the year within the safety margin (Figure 7-5(b)). The inverters of these systems will switch off to prevent the statutory limits being exceeded.

According to all of the scenarios, the DNO will eventually begin to experience voltage problems on a number of feeders which will affect a significant number of customers and PV systems. Therefore, it is to be expected that overvoltage is an issue that will be a much more widespread problem in coming years as it is projected to affect up to 12% of all PV systems expected to be installed in these networks by 2050.

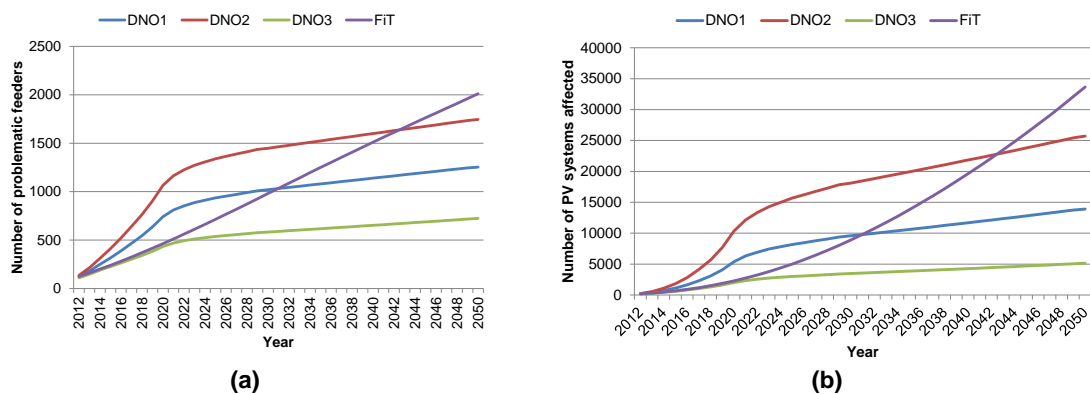

Figure 7-5: (a) Number of LV feeders in ENWL residential LV networks which will violate voltage constraints and (b) the number of PV systems in problematic feeders according to the four forecasts for PV dispersion level

Figure 7-6 shows a histogram of the total voltage deviation (LV and MV) in all of the GIS feeders with a 36% PV dispersion level. It can be seen that the majority of feeders will not have a voltage problem under the demand-generation conditions considered here. 13.3% of the feeders have a voltage problem. Although this may appear to be a small problem (when considering most networks will remain within voltage limits), these results present two problems for DNOs, firstly they need to identify which networks will experience problems and secondly, as shown in Chapter 8, the reinforcement cost to prevent overvoltage in these networks is high.

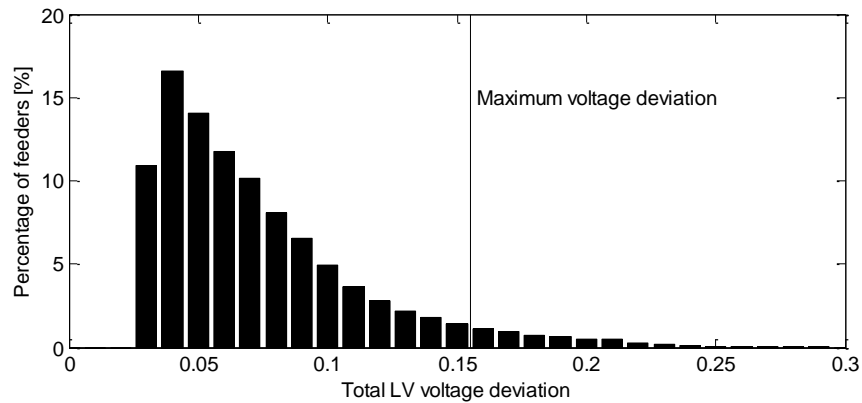

Figure 7-6: Histogram of total voltage deviation (MV plus LV voltage deviation) with a PV dispersion level of 36% and a safety margin, V_s , of 0.005 p.u.

2.1 Increase in peak demand

One potential consequence of increased low carbon technologies such as electric vehicles and heat pumps is an increase in the peak demand in the LV networks. This will increase the LV and MV voltage drops, V_T^{min} and ΔV_{LV}^- . As such, it is possible to provide an analysis of how this increased demand will affect the voltage headroom in the LV networks. To do so, a percentage load growth is applied which increases the maximum demand. The percentage of networks which experience a voltage problem and the cost of reconductoring these networks to alleviate voltage problems are shown in Figure 7-7(a) and (b) respectively when no PV is included. It can be seen that reconductoring is needed on a minority of networks, even if peak demand increases by 50%.

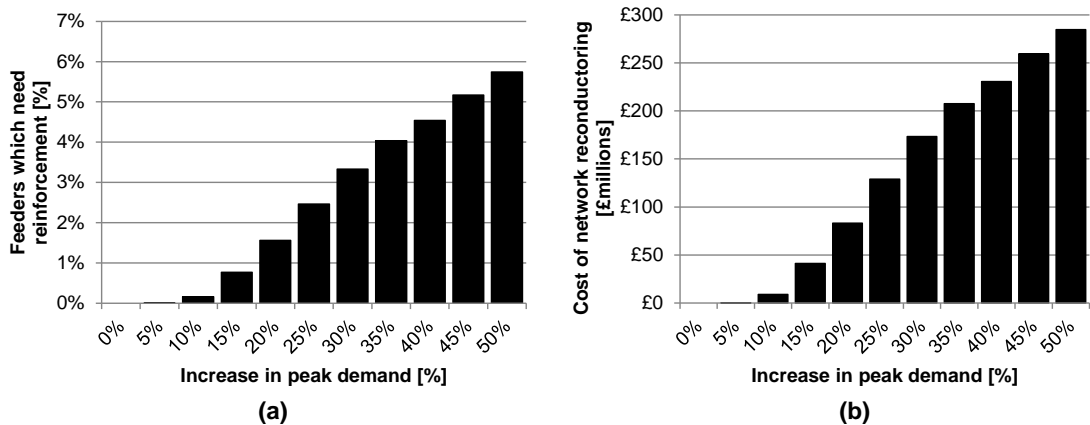

Figure 7-7: (a) Percentage of feeders which need to be reconductoring and (b) the reconductoring cost under different load growth scenarios and no voltage rise

Figure 7-8 shows the percentage of feeders (and number of customers) that have a voltage problem with the feeders sorted by their length. It can be seen that the longest feeders are more likely to have a voltage problem under peak load growth. This is because, as longer feeders, they have higher impedances and so according to Eq. 3-7 will have larger voltage drops for the same load. This is not an exclusive pattern since voltage problems are found (but to a lesser degree) on shorter feeders. These feeders either have higher impedance cable or have a higher number of loads connected per unit length so according to Eq. 3-7 have higher voltage drops.

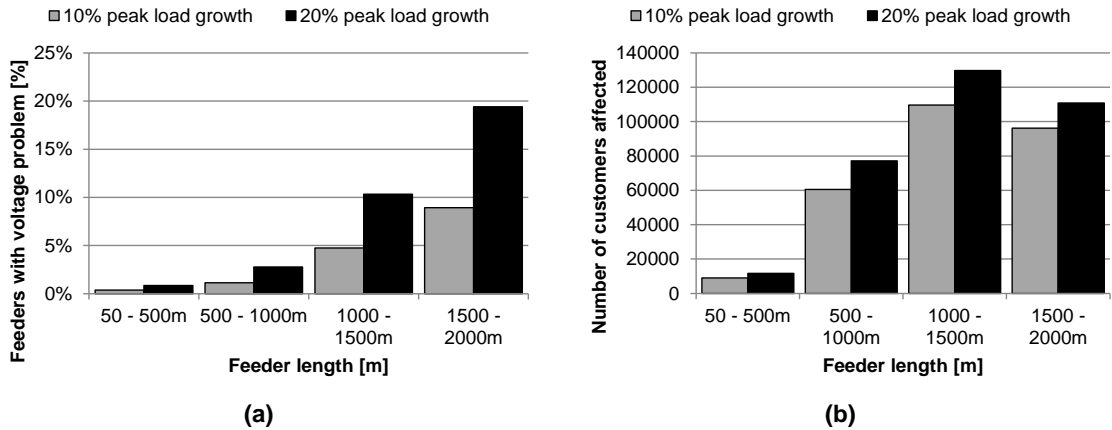

Figure 7-8: (a) Probability of a voltage problem and (b) the number of customers in feeders with voltage problems when the peak load is 10% and 20% higher than it is presently. Feeders are sorted according to their length

The compound effect of peak load growth and PV under the FiT scenario is shown in Figure 7-9 (the FiT scenario is chosen because it is the most extreme PV integration scenario). An annual load growth is applied which is assumed to increase the peak demand and therefore the LV voltage drop (ΔV_{LV}^-). A reference case with no peak load growth is also shown (blue). The two load growth scenarios are taken from (Anuta et al. 2012) and are shown here for illustrative purposes. It can be seen that the number of problematic feeders is not linear with the PV dispersion level. This means that over time the DNO will experience more and more problematic networks and that larger peak load growths have a disproportionate effect on the number of problematic networks. This means that DNOs have a large incentive for supporting peak load growth reduction (although they presently have no direct interaction with residential customers).

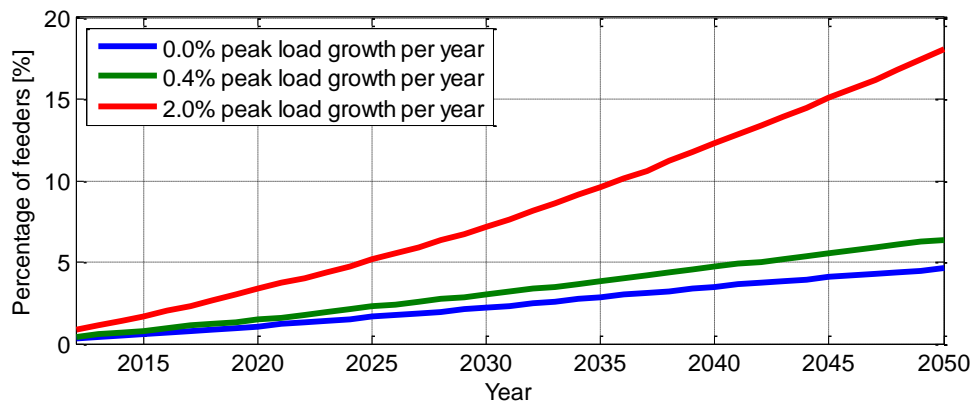

Figure 7-9: Number of LV feeders with voltage problems under the FiT PV integration scenario with different percentage growths in peak demand per year

The tools can now be applied with extreme PV dispersion levels of 10%, 25%, 50% and 100%. Here, the highest MV voltage at the secondary transformer cannot exceed 20% above the present value as it is considered that some form of MV reinforcement/voltage control is implemented. No load growth is included so the results of just PV growth can be investigated. Figure 7-10(a) shows the percentage of feeders which would need to be reconducted under these scenarios. It can be seen that, even under the most extreme dispersion level (100%), more than 80% of the feeders will not have a voltage problem. This means that, as the PV dispersion level increases, the market for mitigation measures to alleviate voltage constraints in LV networks is small in terms of number of problematic feeders. However, as shown in Figure 7-10(b), the number of constrained PV systems increases much more severely. With the most extreme dispersion level, over 40% of the installed PV systems will experience a voltage constraint. This is because, as shown in Figure 7-11, voltage problems occur on the longest feeders with the most number of loads and PV systems. This means that although the fraction of LV networks affected by voltage problems will be small, overvoltage could potentially affect a disproportionately large percentage of the number of installed PV systems and therefore curtail a large proportion of the PV in the UK power system.

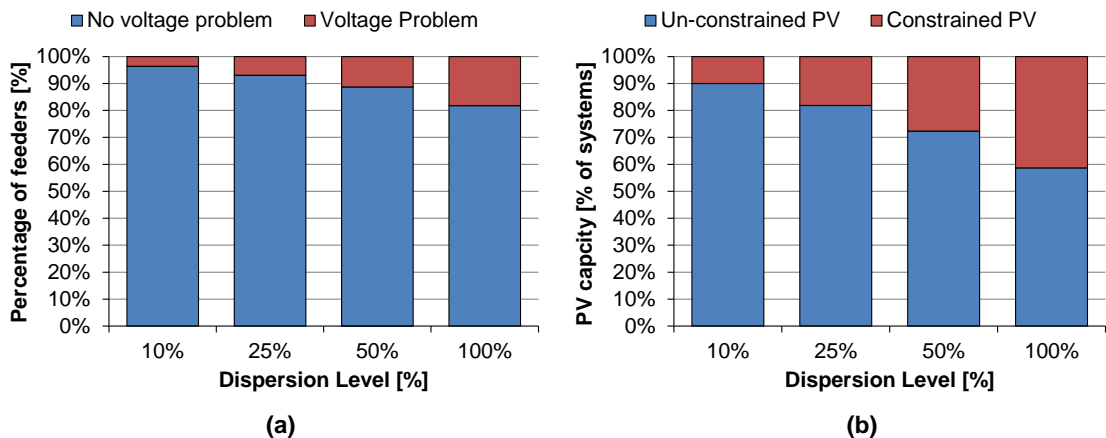

Figure 7-10: For different PV dispersion levels (a) the percentage of networks with and without overvoltage in the ENWL network and (b) the PV capacity which is constrained and not constrained by voltage problems in LV networks.

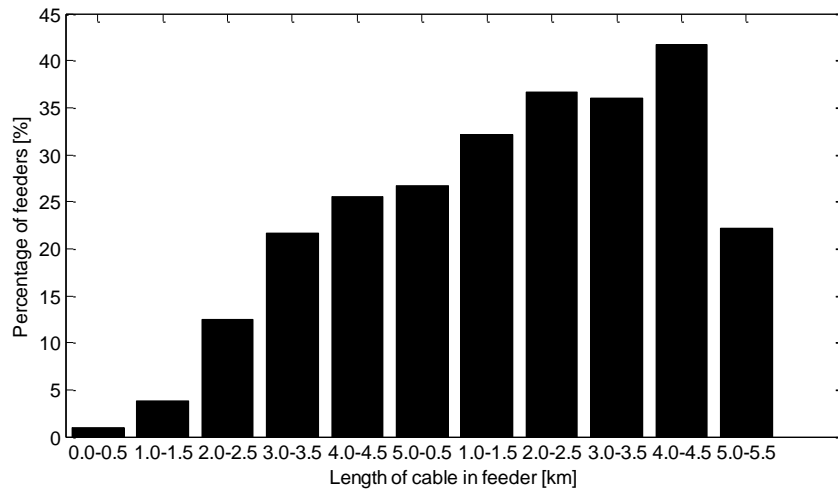

Figure 7-11: Percentage of feeders which have overvoltage when they are sorted by the total length of cable within each feeder

The DNO could avoid these voltage constraints without reinforcement if they did not have to accept ever residential PV system connected to the distribution network. This is illustrated using the tools to investigate three simple regulatory scenarios:

1. The DNO cannot prevent installation of PV in the network (as present regulation stipulates)
2. The DNO permits PV until any new system will cause overvoltage in a network
3. The DNO only permits PV to be installed in LV networks where there is no risk of overvoltage.

Table 7-1 summarises the installed capacity and annual generation under these three scenarios. Annual generation is determined by multiplying the number of PV systems by the expected annual generation from a 3.6 kWp PV system at a 30° inclination and facing due South which is installed in Manchester, UK (2,990 kWh/year (JRC 2014)). It can be seen that just within the ENWL area a large amount of PV can be installed without causing overvoltage. This suggests that a large amount of PV can be integrated without mitigation for overvoltage. However, under the present regulations, DNOs cannot refuse the installation of PV and therefore mitigation measures must be identified.

Table 7-1: Installed PV capacity and annual generation under three scenarios for DNOs to permit PV installation

DNO Rule	1	2	3
Installed PV Capacity [GW]	3.88	2.68	2.30
Annual generation [TWh]	3.19	2.20	1.89

2.2 Sensitivity analysis

A sensitivity analysis is now performed on the factors that affect overvoltage in the LV networks. Considering the equation for overvoltage (Eq. 3-7), these factors are the variation in transformer voltage, the DNO safety margin, the minimum load and the PV rating.

Figure 7-12(a) is a sensitivity analysis of how networks are assigned to the upper or lower MV feeders in the case study with a 36% PV dispersion level. This is performed for 10 different stochastic allocations of the GIS generated LV networks to the upper and lower feeders (labelled repeat 1-10 in the figure). These are compared to cases where all networks are assigned to just the lower or upper feeder. It can be seen that there is little variation between the different stochastic cases. This is because, on average, the impact of different MV networks evens out and because the variation in voltage is dominated by the LV voltage rise.

Figure 7-12(b) shows the impact of the safety margin on the number of problematic feeders. Negative safety margins are included which represent a scenario where the DNO would accept some overvoltage. By lowering the safety margin, fewer “problematic” feeders are found. The effect of the safety margin is significant, i.e. the difference between a 0.01 p.u. and 0.005 p.u. safety margin is 250 feeders (with a 36% dispersion level). To reduce their reconductoring cost, the DNO can reduce the safety margin. However, to do so the DNO would also need to be confident in their modelling assumptions and future peak demand and generation in their LV networks.

A sensitivity analysis of the impact of the minimum demand in the network during the worst voltage rise condition is shown in Figure 7-12(c). Here the stochastic tool is applied ten times for each minimum demand. Increasing the minimum demand is found to reduce the number of feeders with overvoltage because there is less reverse power flow into the network at each home with PV. In the definition of load parameters (Table 3-2), minimum demands in the range 0.1-0.2 kW were common. Increasing the minimum demand from 0.1 kW to 0.2 kW means that 500 fewer feeders are found to be problematic. The minimum demand of 0.142 kW applied in the results would be around half way between these two values and so an error of ± 250 feeders might be expected as a result of the demand figure used in these technical results. Interestingly, Western Power use a minimum demand of 0.4 kW (Table 3-2) which would reduce the number of problematic feeders that would be found.

There is little variability between the results when the same minimum demand is used. This is because, as shown in Figure 5-3, a dispersion level of 36% has a lower standard deviation. The highest variability would be expected with a PV and storage dispersion level of 50% (as discussed in Chapter 5, Section 3.2).

A sensitivity analysis of PV rating is shown in Figure 7-12(d). Here, the stochastic tool is applied to the networks with a dispersion level of 36% with different PV systems rating as shown on the x-axis. The PV rating is seen to be significant in changing the number of problematic feeders

since larger PV systems will inject more reverse power flow and therefore cause more voltage rise.

In practice, PV systems have ratings in the range 0-4 kW are installed under the lowest feed-in-tariff. The rating of each will depend on factors such as the size of the house roof, the panel efficiency and the investment costs. In the ENWL networks, these have an average rating of 3.6 kW and for the analysis shown in this chapter, each PV system has had a 3.6 kW rating. To assess whether it is credible to do this, another sensitivity analysis is performed whereby the rating of PV systems is randomly selected in the range 1-4 kW using the probability distribution shown in Figure 7-12(d). This distribution means that the average system size in the EWNL network is 3.6 kW, i.e. network A might have PV systems of 3.2 kW installed on 50 homes and network B might have PV systems of 4 kW installed on 50 homes meaning that on average, 3.6 kW PV systems are installed in the network. Figure 7-12(e) shows the number of problematic feeders in the GIS networks with a PV dispersion level of 36% for ten different stochastic PV rating allocations using this probability distribution. It can be seen that as long as the average PV size is 3.6 kW then the number of problematic feeders is relatively constant. Further, a similar number of feeders are found to have overvoltage as when all PV systems were assumed to be 3.6 kW.

In summary, the sensitivity analysis shows that the voltage constraints within the LV networks are impacted by a number of factors, and for studies of individual networks these need to be carefully considered. Further, it is found that the voltage constraints are most influenced by factors affecting the LV networks i.e. the PV rating, demand and the safety margin. The factors used in the subsequent analysis are chosen to be representative of the authors and DNOs understanding of the network conditions. It is found that the tools do not need to be repeated more than once when applied to all of the networks which were derived from the ENWL GIS system because there is little variability in the overall results.

An important limitation of the study is revealed by the sensitivity analysis. This is that it does not represent properties of demand and generation between individual networks. All networks are assumed to have the same PV rating, minimum/maximum demand and one of two secondary transformer voltage variations. This simplification is made due to a lack of available data, however it is recognised such data is important to improve the accuracy of the results. This data can be made available through further network measurement such as expansion of the KelVAtek data and smart meter data. As discussed in Chapter 9, Section 2.1 (page 160) this could provide real term information for the DNO to assess how close their LV networks are operating within the regulatory voltage limits and how best to reduce reinforcement costs. Such data is important also in financial forecasting, for example, updating the minimum demand based on real data which represents geographic distances will affect the number of problematic feeders as shown in Figure 7-12(c) and therefore affect the projected cost of reinforcement.

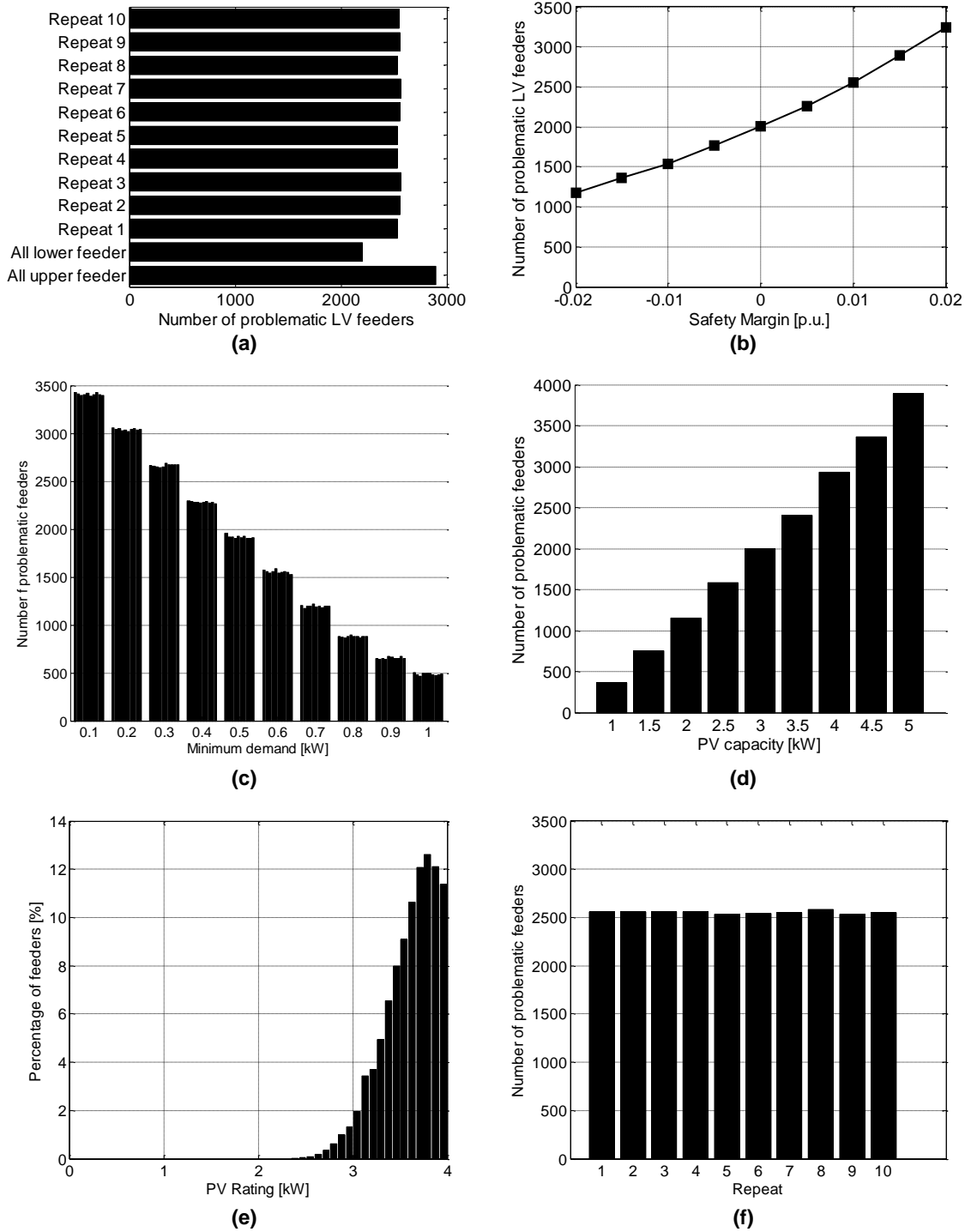

Figure 7-12: Number of problematic LV feeders (feeders with overvoltage) (a) if the networks are stochastically assigned to different MV feeders (b) if the safety margin is changed (c) if the demand during the worst voltage rise condition is changed (d) if the PV capacity is changed and (f) if the PV is stochastically determined using the probability distribution shown in (e). A PV dispersion level of 36% is used throughout with no energy storage.

3 Comparison of energy storage scenarios

As shown in Figure 2-9, there are different ways of installing energy storage in LV distribution networks. These storage scenarios are now compared to inform the DNO and other stakeholders about how LV energy storage is installed and the technical benefits it can bring. The tools are first used on one of the case study networks to show how much the different energy storage systems reduce the voltage rise. Then, the storage configurations (as outlined below) and are compared across all of the networks derived from GIS in Chapter 6 for their ability to solve overvoltage.

3.1 Selection of energy storage system on a single network

The planning tools are applied to one of the case study networks with different energy storage scenarios. These are compared for their ability to solve the overvoltage and for the amount of energy storage required to do so. Network MA is selected as this was highlighted by the DNO to be particularly problematic in terms of voltage and a model of MA produced from GIS is used. It is considered that PV has a rating of 3.6 kW, which is the average rating of PV within ENWL network. Home storage when combined with PV is set to the same rating to be able to absorb all of the reverse power flow. The results of applying energy storage scenarios to network MA are shown in Figure 7-13. This investigates the following 5 scenarios:

1. Energy storage located at the secondary transformer rated to absorb all reverse power flow
2. 3.6 kW, single phase home storage systems stochastically located within homes with PV
3. 3.6 kW, single phase home storage systems stochastically located in homes whether they have PV or not.
4. 3.6 kW, single phase home storage optimally located within the network at homes with PV
5. 25 kW, three phase street storage optimally located to eliminate overvoltage

The five charts on the left show, for each scenario, the highest voltage in the network before (red) and after (blue) energy storage is installed. The upper right bar chart shows the average reduction in voltage for the energy storage scenario. The middle right bar chart shows the total rating (kW) of storage in the network under each scenario and the lower right chart shows the number of storage units installed.

It can be seen that the storage at the secondary transformer has the least effect. This is because it only affects the voltage increase at the secondary transformer and so reduces the voltage across all of the feeders by a fixed amount (compare the red line to the blue line in the upper left figure). As shown in the upper and middle right figures, this uses the largest amount of storage to achieve the least improvement in voltage rise.

There is a different result between cases 2 and 3 i.e. when storage is randomly located in homes with PV or within any home in the network. It can be seen that if storage is located in any

home, then it reduces the voltage in all of the feeders (cases 2 and 3 on the left hand side of Figure 7-13). This is because the storage is less likely to be located on the same phase or in the same location as the PV which is causing the voltage rise. As the storage is applied stochastically with the same probability, cases 2 and 3 have different storage ratings and number of units (see the middle and lower right figures). Their random location means that the voltage rise is not proportional to the number of units and as discussed in Chapter 5, Section 3.2, the reduction in voltage rise is uncertain.

Cases 4 and 5 compare the optimal location of home and community storage. Both produce the highest voltage drops but the community storage requires more power to do so. This is because the community storage has to operate across three phases and so its power is not all used to solve the voltage problem. However, because power is balanced across the three phases, the community storage has a higher reduction in voltage and does so using fewer (high powered) units. Both of these storage solutions improve the voltage most within the problematic area of the network (between bus 50 and 95). This is because the storage is targeted to the busbars which affect the overvoltage the most (this can also be seen in Figure 7-14). There is some impact on the other feeders as the reverse power flow is reduced which reduces the voltage rise in the MV network.

This figure is an important validation of the stochastic and optimal approaches for locating storage since it clearly shows the reasons how the different storage configurations affect the LV network voltage.

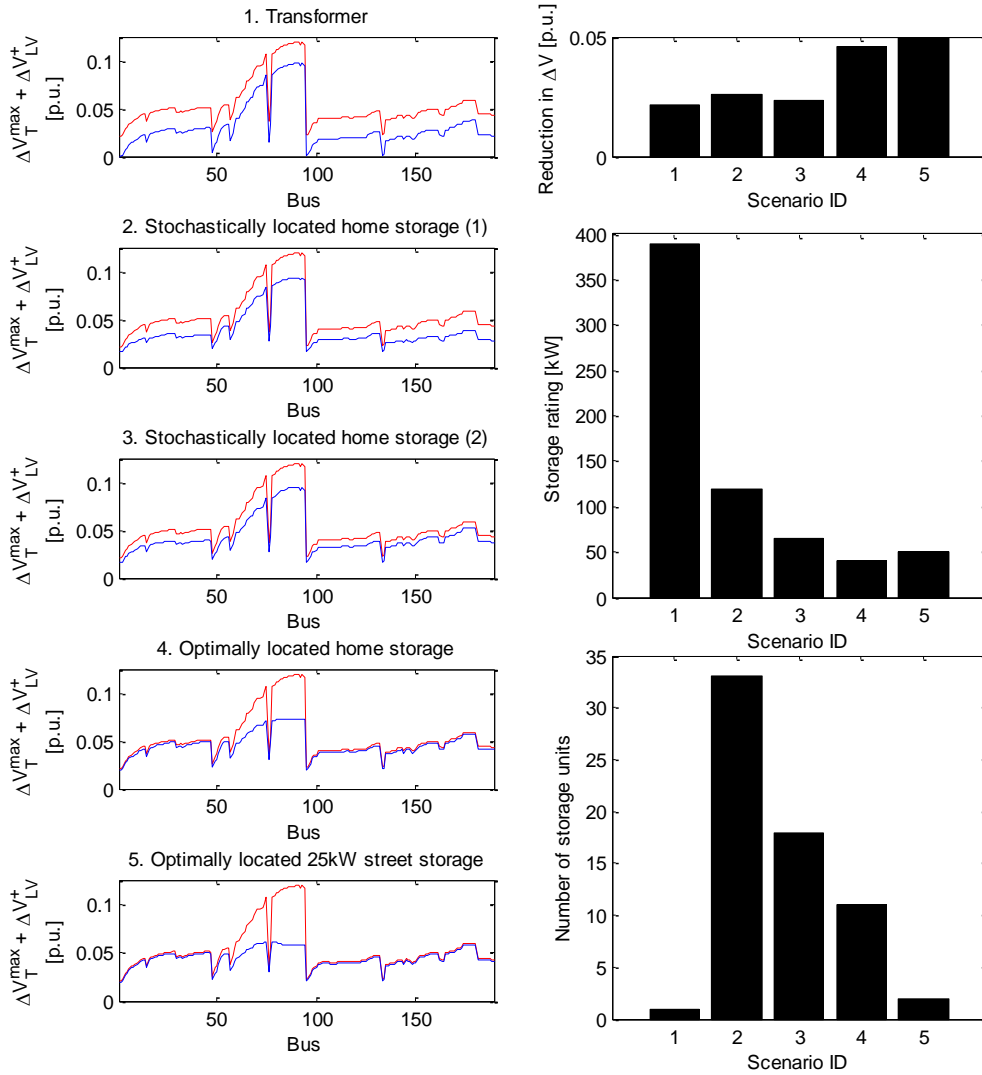

Figure 7-13: Performance of an LV network with five energy storage scenarios 1. storage at the secondary transformer 2. storage randomly installed by customers with PV. 3. storage randomly installed by any customers. 4. storage installed in customer homes with the location optimised by the DNO and 5. three phase energy storage on the street. Voltage profiles with and without storage are shown on the left for each scenario which includes the highest LV and MV voltages. Red lines are the voltage before energy storage and blue the voltage after storage is installed. The upper right figure shows the reduction in voltage rise, the middle right shows the required storage rating and the lower right figure shows the number of storage units that are installed. The PV location is the same in all of the figures.

Voltage profiles of the stochastic and optimised approaches for locating home storage are shown in Figure 7-14. The top two figures show the voltage in the network with the same PV configuration before and after home energy storage is stochastically installed for two runs of the tool. It can be seen in the circled area of the top figure that there is one particularly problematic feeder in this network. The blue bars at the bottom of each figure show which busbars that home energy storage has randomly been applied. By reducing the reverse power flow, the home storage reduces the worst case voltage rise in the network. The per-unit reduction in voltage is fairly consistent across the feeder since storage is stochastically installed across it. Due to the random nature of the storage installation, there is uncertainty about the amount of

storage that is installed with 32 units in the first simulation and 28 units in the second simulation. The former is shown to have a greater reduction in voltage.

The same network is then analysed using the genetic algorithm to optimally locate storage. This installs 28 home energy storage units, but causes over twice the reduction in voltage. This is because the genetic algorithm intelligently locates the energy storage within the problematic feeder (as shown). Further, this storage is located at nodes which have higher voltage sensitivity to the problem. It can be seen that more storage units are installed towards the end of the feeder where the VSF is higher. There remains some sub-optimal storage placement at bus 122 and 128 which highlights that the heuristic does not necessarily produce optimal solutions. This could be changed by running the optimisation for longer, but to do so would require additional computational effort which makes examination of a large number of GIS feeders impractical. The slight sub-optimality is accepted and noted that the optimisation tool, as configured for analysis of a large number of feeders will provide an upper limit of the amount of storage needed. As shown, despite this sub-optimality, optimally located energy storage still requires much fewer storage units that stochastically located energy storage.

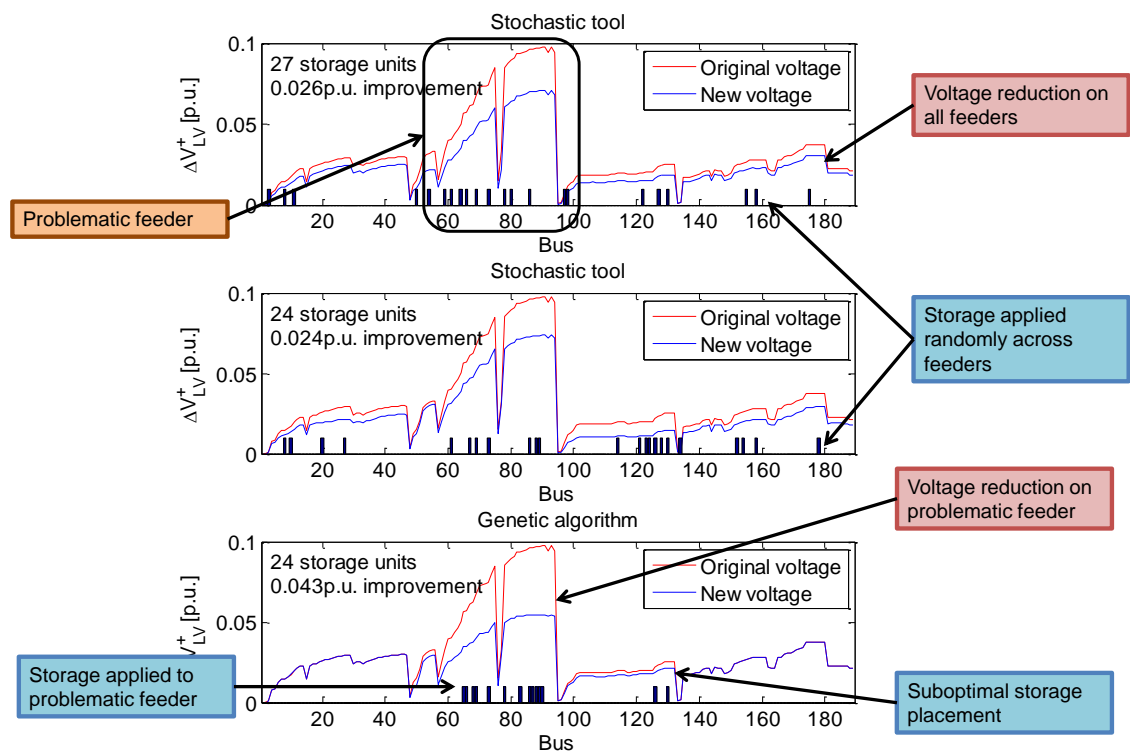

Figure 7-14: Comparison of stochastic and optimised storage location within an LV network. The original worst case voltage within the network when all PV systems are installed and generating and maximum power is shown in red. The worst voltage rise after storage is installed is shown in blue. The locations of energy storage are shown as blue bars on the figures. All storage units have the same power rating as the PV and are single phase. This figure only shows the LV voltage rise component as opposed to the transformer and LV voltage rise shown in Figure 7-13

3.2 Analysis of all GIS networks

3.2.1 Transformer storage

Figure 7-15 shows the number of LV feeders that are affected by overvoltage before and after secondary transformer storage is applied for the most extreme FiT PV scenario. This shows that this form of storage can reduce the number of problematic feeders. However, even if it is installed at every secondary transformer, it cannot prevent voltage problems in all of the LV networks. This is because there is sufficient voltage rise in the LV networks to cause overvoltage.

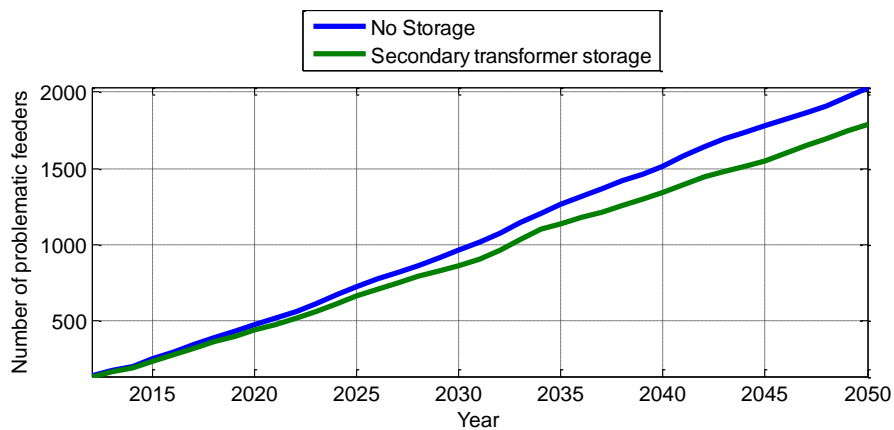

Figure 7-15: Number of problematic LV feeders if present PV install rate continues with and without energy storage installed at secondary transformers

3.2.2 Stochastically located home energy storage (under a free market)

The stochastic tool described in Chapter 5, Section 3 is applied to the residential network models to determine how much a free market for home energy storage can improve the voltage constraints. To do so, different home energy storage dispersion levels are applied across all of the networks. The impact of such stochastically located energy storage is shown in Figure 7-16 for the FiT PV scenario. It can be seen that it reduces the number of feeders which need to be reconducted. If more home storage is installed then the reduction in the number of feeders which need reconducting decreases further, i.e. if home storage is installed in 5% of the homes with PV in 2050, then 1820 feeders will need reconducting. However, if 15% of these homes have PV then around 1700 feeders will need reconducting due to overvoltage problems. This is because there is more storage in the networks and this storage is more likely to be located in a position which has a high enough voltage sensitivity to keep the network within regulatory limits.

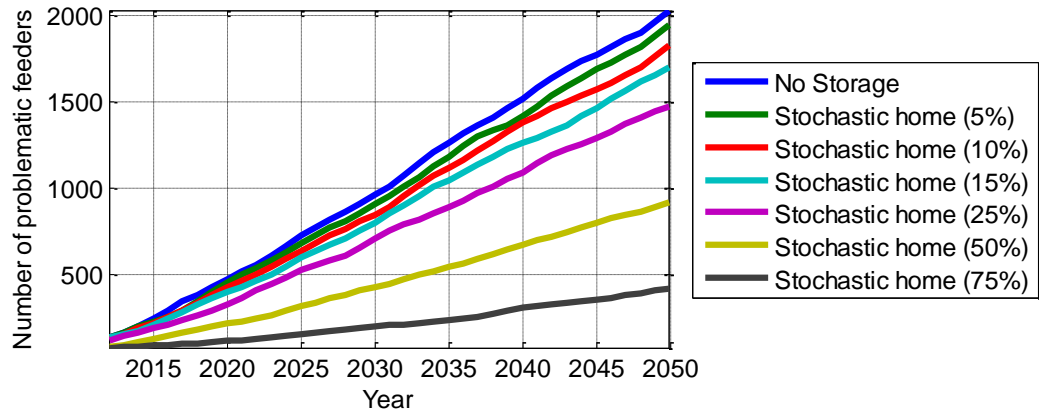

Figure 7-16: Number of problematic LV feeders when energy storage is installed with different dispersion levels under the FiT scenario

Comparing the effects of stochastically located home and storage at the transformer, it can be seen that home storage dispersion levels of around 15% are needed to improve upon transformer storage in terms of the number of feeders that will need reconductoring. This is also found for the other PV scenarios as shown in Figure 7-17. Furthermore, comparing Figure 7-17(a) and (b), it can be seen that the benefit in terms of number of problematic feeders for using transformer storage increases over time. In 2050, a storage dispersion level of 5% will require $1900 - 1750 = 150$ more feeders to be reinforced than transformer storage under the FiT PV scenario. In 2030, the difference is just 50 feeders.

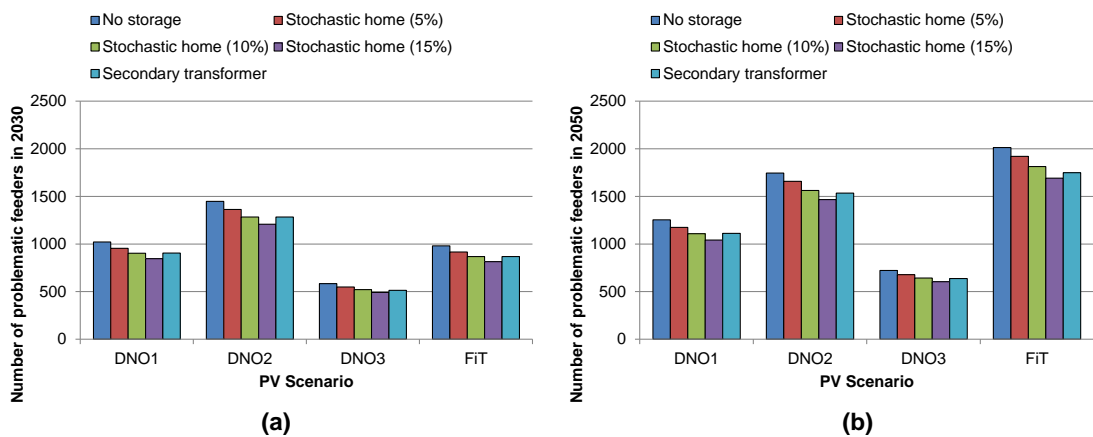

Figure 7-17: Number of problematic feeders with different amounts of stochastically applied home storage and storage at the secondary transformer in (a) 2030 and (b) 2050

Despite the benefit of transformer storage in terms of the reduced LV network reinforcement, storage at the transformer will be significantly more expensive to achieve similar benefits to storage in the LV network. This is because it can only influence the MV voltage levels. This means that, as shown by comparing Figure 7-16, Figure 7-17 and Figure 7-18, six times much energy storage would need to be installed for the same effect as storage stochastically located in 10% of homes with PV. Given that all cost is ultimately met by the customer through their

electricity bill, and that secondary transformer storage will be very much more expensive, the DNO would consider mechanisms to support stochastic home storage over installing transformer storage. However, in terms of storage provision, optimally located energy storage also needs to be considered.

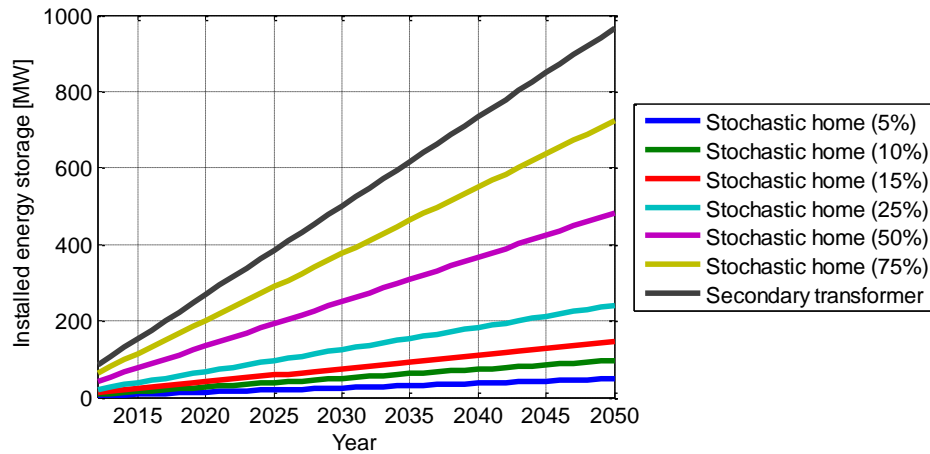

Figure 7-18: Installed energy storage under the FiT PV scenario

3.2.3 Optimally located energy storage

Storage with optimised location is studied using the genetic algorithm described in Chapter 5, Section 4. Here, storage units are considered feasible in the home (single phase units with the same 3.6 kW rating as the PV) or on the street (three phase units with a 25 kW rating like the zero carbon homes storage identified in Table 2-1).

The genetic algorithm is first used to optimally place home storage in the networks. This successfully eliminates the overvoltage all of the networks using between 1 and 69 storage units in each of the feeders which experience voltage rise (see Figure 7-19(a)). In the majority of networks, less than 10 storage units are needed (with a modal value of 1-2 storage units) reflecting that the disruption to customers in each feeder could be slight.

The number of storage units is compared between the stochastic home storage cases and the optimally located storage case in Figure 7-19(b) and it can be seen that until 2036 fewer optimally located storage systems are required than for the 5% stochastic case. This confirms the hypothesis that optimally located home storage can achieve greater voltage reduction using fewer storage units. This is because it can be directed towards more problematic areas of the LV network (i.e. it is only installed in feeders with a voltage problem) and is also installed at nodes with a greater impact on the voltage (i.e. nodes with a higher voltage sensitivity). Beyond 2036, more storage units are used, but unlike stochastic storage this always solves overvoltage.

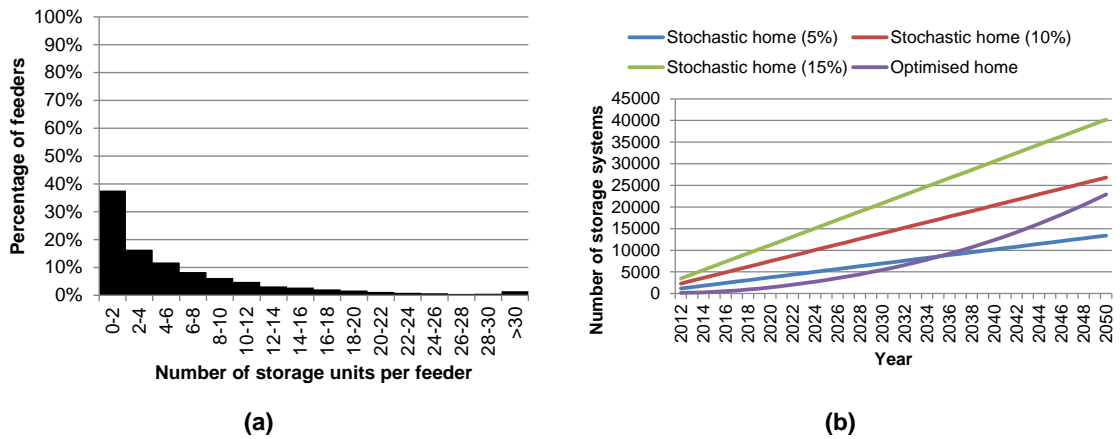

Figure 7-19: (a) Histogram of the number of home storage units placed in each problematic feeder with a 34% PV dispersion level and (b) number of home storage systems installed with optimal location using the genetic algorithm compared to a free market under the FiT scenario

The genetic algorithm is then used to optimally locate 25kW street storage systems in the LV networks. As shown in Figure 7-20(a), this typically locates one or two energy storage units in each network. One feeder has 15 storage units, but this can be considered to either be an outlier with a large number of high impedance branches or is a result of a sub-optimal placement of street storage.

Figure 7-20(b) shows the total number of storage systems placed in the LV networks for the FiT PV scenario for stochastic, home and street storage scenarios. It can be seen that much fewer street storage systems are installed. This is because they have a higher rating than home storage (3.6 kW versus 25 kW) and so each storage system has a higher impact on voltage. This can also be seen in the fact that problematic feeders have much fewer storage units installed (comparing Figure 7-20(a) to Figure 7-19(a)). This is because the storage units have a higher rating and so have a larger impact (per system) on the voltages across three phases. This scenario imagines 1-2 storage units on more than 68% of feeders which is a highly believable circumstance when considering similar storage projects (e.g. those in Chapter 2).

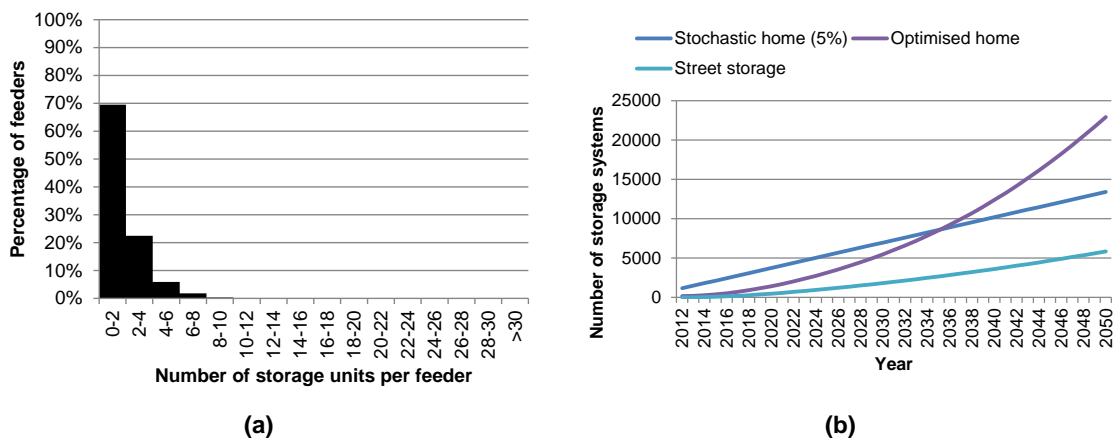

Figure 7-20: (a) Histogram of the number of street storage units placed in each problematic feeder with a 34% PV dispersion level and (b) number of storage systems installed with home, street and a stochastic storage installation

A comparison between the number of storage systems under the stochastic and optimised storage scenarios is shown in Figure 7-21(a) and it can be seen (as with the case study networks) that the street storage requires the fewest number of storage units. However, because the units have a higher rating, they will therefore have a greater installed amount of power and consequently capacity as shown in Figure 7-21(b). As a result of this, it is worth comparing the home and street storage on cost grounds. This is completed in Chapter 8.

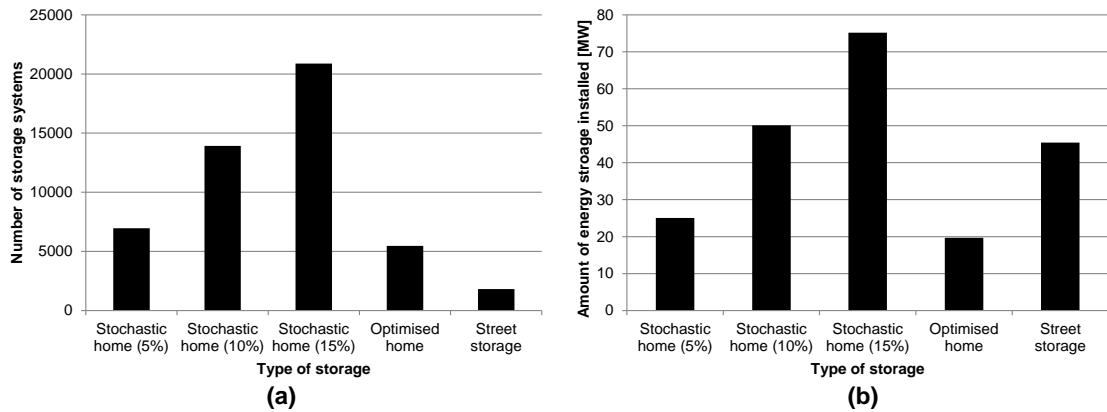

Figure 7-21: For the FiT scenario in 2030 (a) the number of storage systems installed in the networks under different scenarios and (b) the total rating of installed storage

The reason that the home storage is more effective per unit power can be explained using Figure 7-22. It can be seen in (a) that voltage problems do not occur on all phases in each feeder. There is some voltage unbalance (as shown in (b)) within the LV feeders due to the fact that LV networks are made up of a large number of single phase loads which are geographically separated along cables.

Optimised home storage is therefore better because it is located on the problematic phases where it has the greater impact on voltage as opposed to three phase street storage which uses its power across all three phases. It might be hypothesised that the street storage might be made more effective by making these single phase units or operate in an unbalanced manner. Alternatively, the size of street storage units might be reduced since, as shown in Figure 7-24, there is a large amount of headroom for voltage rise in the LV networks after a 25 kW storage system is included.

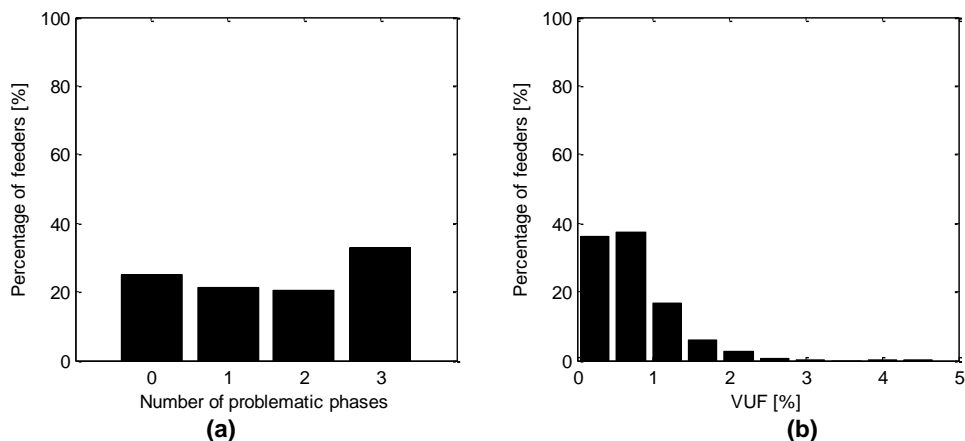

Figure 7-22: For all of the networks, (a) the number of phases which experience a voltage problem and (b) the worst case voltage unbalance factor with a PV dispersion level of 34%

To investigate this, the genetic algorithm is used to optimally locate 5 kW street storage in the networks. The number of installed units is shown in Figure 7-23 and it can be seen that, since each unit has a lower rating and therefore impact on the network, more energy storage units are installed than with 25 kW storage. Because these are three phase, they require more units than home storage, but the difference between 5 kW street storage and optimally located home storage is small. As shown in Figure 7-23, these are able to solve as many voltage problems as 25 kW storage with less headroom for voltage rise in the networks. By placing more units in the network, the install cost will be higher. However, the smaller units will be cheaper than 25 kW street storage. To determine the effect of this, a cost comparison is performed in Chapter 8.

Figure 7-24 shows the voltage headroom in the LV networks after energy storage is installed. Ideally there will be no headroom as the storage exactly solves the voltage problem without excess storage units (see Figure 5-13, page 81), however storage systems have discrete rating in this study and so tend to over solve the voltage problem. This headroom allows some extra PV systems to be installed in a network after storage has been installed without causing further voltage problems. As shown in Figure 7-24, 5 kW storage generally leaves less headroom and would be more vulnerable to overvoltage if additional PV systems are installed in a network.

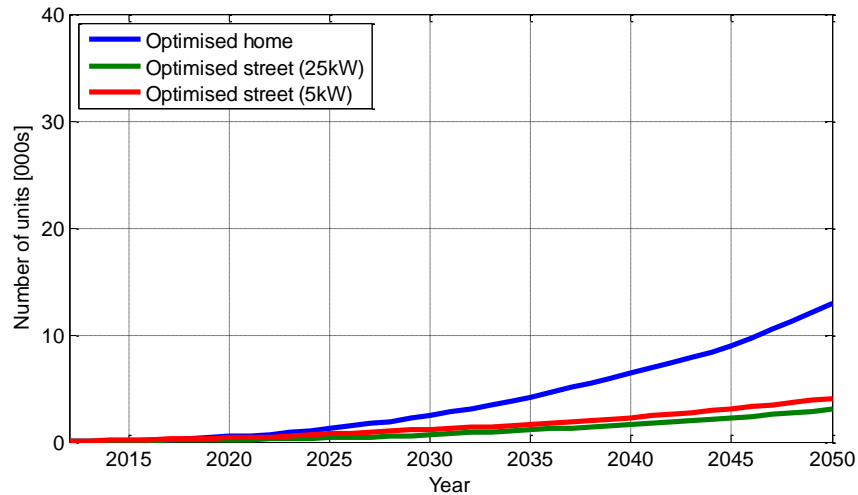

Figure 7-23: Number of energy storage units installed with 5 kW optimally located street storage compared to 25 kW street storage and optimally located home storage

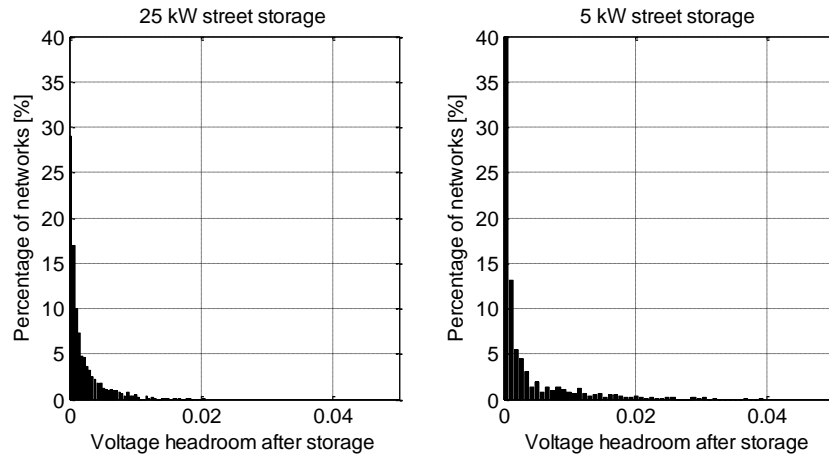

Figure 7-24: Histogram of the voltage headroom in previously problematic networks after (a) 25 kW street storage and (b) 5 kW home storage is installed

4 Conclusions

The technical results presented here show little variability between different runs of stochastic algorithms since the results are performed over a large number of feeders. However, the ENWL distribution network is shown to be sensitive to the safety margin, PV rating, minimum demand and, to a lesser extent, the MV variation as expected. This is important as it shows the importance of correctly choosing modelling parameters to identify and mitigate problematic networks. The technical results would benefit from a better understanding of localised demand as it is clear within the results that the maximum and minimum demand are important parameters. This data is not currently available, but could become so through the deployment of smart meters.

When the tools are applied to a large number of networks, it is found that overvoltage as a result of PV will affect an increasing and significant number of LV feeders. Not all networks will be affected, and so the DNO needs to develop ways to predict and identify problematic networks. This can be completed using the tools here. Improved understanding of household demand, PV ratings and secondary transformer voltage variation (particularly that linked to geographical information) should be fed into a model similar to the one used to accurately identify problematic networks. This can be achieved with increased LV network monitoring such as smart meters and secondary transformer voltage measurements.

Stochastically located energy storage is shown to have some benefit to the DNO in reducing the number of feeders with a voltage problem. However, this requires widespread integration to be effective in terms of reducing the number of problematic feeders. Optimally located energy storage is also considered. Home storage was initially found to be more effective than street storage technology (rated 25 kW) because it eliminates overvoltage in all of the feeders using less energy storage. 5 kW units are also investigated and found to be able to fix overvoltage and leave less headroom than the 25 kW storage. This is an advantage in that less storage is needed to fix overvoltage (which is cheaper), but means that there is less additional headroom to facilitate extra PV in a particular LV network after storage is installed by the DNO.

One area for further work is checking the optimality of solutions produced by the storage location heuristic. Some of the solutions for the 25 kW street storage for example have more than 6 storage units per feeder. This might be realistic for example in a feeder with a large number of branches close to the secondary transformer. However, this would be noted and checked by a DNO when proposing the location of storage in a network. On a single feeder, the optimisation tool would be repeated with a bigger population size and number of generations if it is felt the tool is producing sub-optimal results.

What is unclear in this analysis is whether competing technologies, such as demand side response can also offer similar benefits in mitigating overvoltage. The results here provide information if a certain power capacity (kW rating) is sufficient to reduce voltage rise to prevent overvoltage. Further study is needed on how a wider fleet of demand side response with much

more unpredictable availability than storage can also solve the overvoltage. This can be completed by adapting the approaches used in this work. E.g. the normal distributions in Chapter 5 for stochastically located energy storage provide probabilities that a given dispersion of DSR would be effective in mitigating overvoltage.

A final finding is the effect of increases in peak demand on networks in causing voltage drop. This is again found to affect a limited number of networks, but since these are the longest and most expensive feeders, the cost implications are high. If combined with voltage rise, this additional voltage drop will further constrain ENWL's LV networks.

In order to determine the best storage solution for a DNO, the costs of the different systems are now investigated and compared to determine what types of LV energy storage a DNO is likely to support i.e. the cost of energy storage needs to be compared to reconductoring to determine if it is feasible. This is completed in Chapter 8.

Chapter 8: Business case for energy storage in LV networks

A new and novel result of this work is to evaluate the commercial benefit to DNOs of using energy storage in avoiding LV network reconductoring. To determine if storage is beneficial when compared against reconductoring, the financial model described in Chapter 3, Section 3 is now applied to the technical results in Chapter 7. This begins by calculating the business-as-usual (reconductoring) cost for the DNO as more PV is installed in LV networks. By comparing this to the cost of energy storage to prevent overvoltage, different scenarios are compared to see the relative benefit for DNOs of LV energy storage. Financial values are discounted accounting for inflation, i , and discount rate, d , to discount a future cash flow, C , in year, y (see Eq. 8-1). Inflation and discount rates are taken from Table 3-3. This approach could be applied by DNOs to determine the benefits of storage in their system with any cost values.

$$NPV = \frac{C}{(1 + (i - d))^y} \quad \text{Eq. 8-1}$$

1 Basecase with no energy storage

Figure 8-1 shows the expected costs for reconductoring LV networks between 2012 and 2050 (a) with and (b) without a safety margin. This is determined by calculating the problematic feeders at the different PV dispersion levels as specified by the PV integration scenarios (Figure 7-1) assuming that the DNO will reconnector every feeder that experiences overvoltage and that the cost of doing so is the value of replacing all of the feeder cable. This means that the reconductoring costs shown in the figure are an upper limit as the DNO might be able to partially reconnector cables to fix overvoltage.

It can be seen that with a safety margin of 0.01 p.u. the DNO will currently need to reconnector some of their cables. Under the ENWL PV integration scenarios, the costs will accelerate between now and 2023 as large amounts of PV are installed. Under the highest PV integration scenario, ENWL are expected to accumulate £165 million worth of reconductoring costs by 2050. If the safety margin is reduced, then the reconductoring costs are reduced by around £50 million. Given the large financial saving in removing the safety margin which is found in this network it is unlikely that a DNO would operate the 0.01 p.u. margin used in the technical analysis. Therefore, the safety margin is removed from the financial analysis. This means that the DNO accepts a higher risk of overvoltage (PV curtailment) in the most extreme network conditions and that they run their LV networks closer to voltage limits. The decision to do so is a commercial one for the DNO, but given the huge cost avoided then it is expected that the DNO would do so.

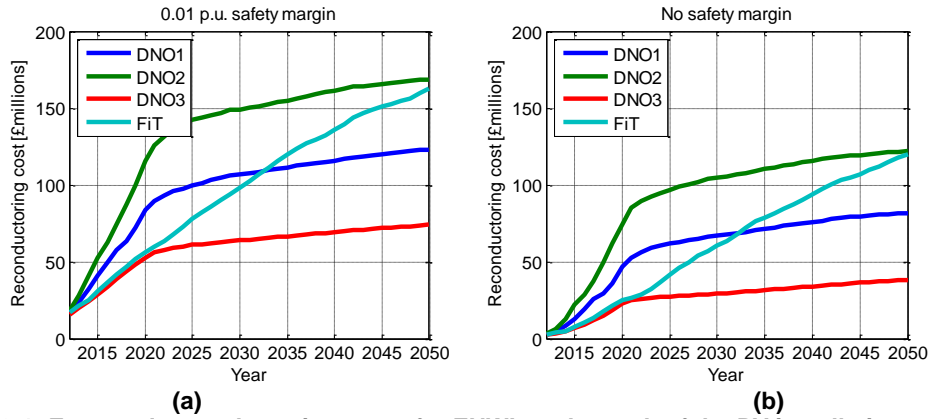

Figure 8-1: Expected reconductoring costs for ENWL under each of the PV installation scenarios with no energy storage installed in their networks with (a) a 0.01 p.u. safety margin and (b) no safety margin

2 Value of energy storage to the DNO

2.1 Stochastically located energy storage

A possible route by which energy storage will be added to the distribution network is through a free market for storage, installed by customers with PV panels. Figure 8-2 shows the expected reconductoring costs under this stochastically located energy storage scenario for the four different predictions for the installation of PV. It can be seen that the reconductoring cost is reduced because the stochastic storage reduces the number of networks which experience overvoltage. As expected, as more and more stochastic storage is installed, the number of networks with a voltage problem decreases and so does the cost. I.e. if home storage is installed in 75% of homes then the reconductoring cost will be around £15 million by 2050 and if it is installed in 5% of homes then the reconductoring will cost ENWL around £120 million. It can be seen that there is a large degree of uncertainty in the final bill to the DNO depending on the how much PV is installed by residential customers in the LV network. The cost is much higher under the FiT scenario because this predicts the highest amount of solar installed in the LV network. This cost is over twice that under the scenario DNO3 which is the lowest PV integration scenario.

For the three DNO scenarios, the market for storage improves most up to around 2023, before having a steady increase in savings. The reason for this is that, as networks contain more PV, they will violate voltage limits by more and so need more energy storage to reinforce them. This means that DNOs should begin investigating the benefits of LV energy storage now whilst the highest cost savings can be realised in comparison to reconductoring.

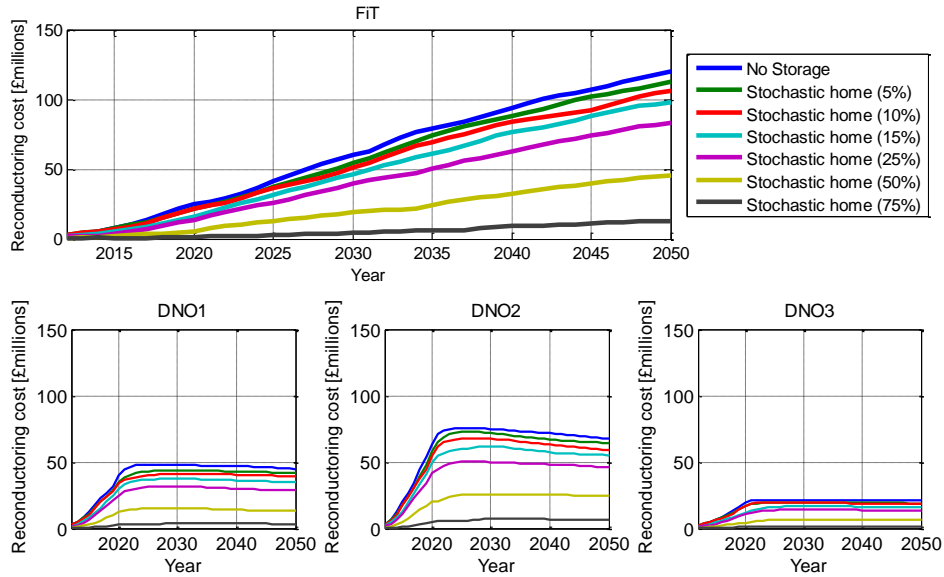

Figure 8-2: Expected reconductoring costs for ENWL under each of the PV installation scenarios with energy storage stochastically installed by customers in their homes

2.2 Secondary transformer storage

Figure 8-3 shows the total reconductoring costs if storage is located at the secondary transformer against two stochastic cases. Because this storage does not solve voltage problems and because it requires the largest investment in energy storage (Figure 7-18), secondary transformer storage is rejected as being uneconomical at fixing voltage problems in LV networks.

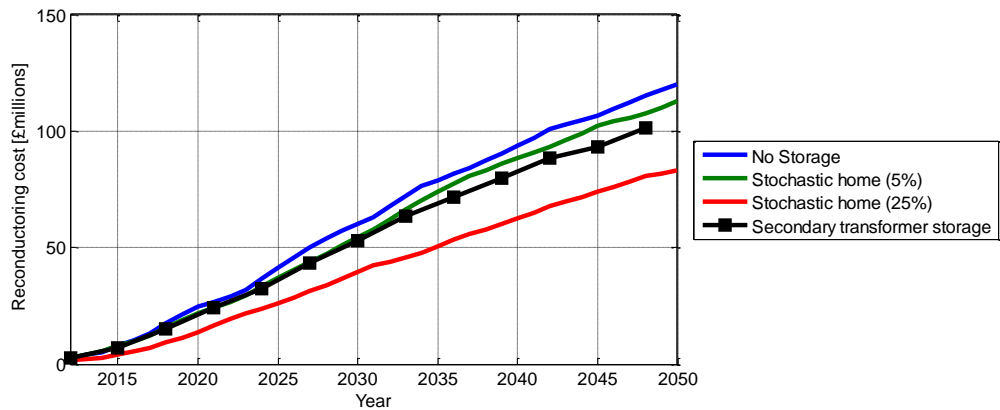

Figure 8-3: Expected reconductoring costs for ENWL under the FIT PV installation scenarios with energy storage stochastically installed by customers in their homes compared to secondary transformer storage

2.3 Optimally located storage

Optimally located energy storage, whether in the home or on the street, will always solve the voltage problem and will result in zero reconductoring cost. However, practically, a DNO will only use energy storage in a feeder if it is the cheapest solution or the solution with the biggest benefit for the DNO. Therefore the costs of the different stochastic and optimally located energy storage are now studied. A decision tree for selecting to reconductor or install energy storage is shown in Figure 3-3.

3 Cost of energy storage

The cost of energy storage is calculated by multiplying the number of energy storage units installed under each storage scenario by the cost of each unit. Under the cost model presented in Chapter 3, an estimate of the cost of installing energy storage can be derived. Here, the number of storage units installed is multiplied by the cost of storage per kW (Table 3-5) and the storage rating (3.6 kW for home storage and 5 or 25 kW for street storage). This gives a total cost per energy storage system as summarised in Table 8-1.

Table 8-1: Cost of home and street storage under the financial model described in Chapter 3

Storage type	Home storage	Street storage	Street storage
Rating [kW]	3.6	25	5
Install cost [£/system]	400	8000	8000
Cost of storage system [£/system]	5,188	35,825	7,165
Total cost [£/system]	5,558	43,825	15,165

Figure 8-4 shows the number of energy storage units installed in the network under the different stochastic and optimally located storage scenarios. It can be seen that the number of stochastically located units is proportional to the PV dispersion level since it is assumed that the stochastic energy storage market will target a fraction of homes with solar panels. These 3.6 kW systems (average rating of PV in the ENWL network) would have an installed capacity of between 12 and 150 MW by 2050, and therefore be comparable in scale to a small pumped hydro storage station. However, these will not fix all overvoltage problems.

Figure 8-4 also shows the number of optimally located storage units installed. These will fix all overvoltage problems. Under all forecasts, fewer optimally located units are placed in the network than under the stochastic cases. These also have the biggest benefit since these completely remove the need to reconductor the networks. In all cases, more optimally located home storage units are needed, followed by units in the street. More optimally located home storage is needed because these units have a lower rating. However, these are single phase with lower install costs. Two optimally located street storage cases are presented. More of the 5 kW street storage units are used because these, individually, have a lower rating and therefore less impact on voltage than the 25 kW units. However, the difference between the number of units is not proportional to the rating. This is because, as established in Chapter 7, the 25 kW units leave larger voltage headroom in each network. The heuristic can therefore install fewer 5 kW units in the network to bring it closer to the voltage limit.

The rate at which storage is installed relative to the PV dispersion level is best seen considering the FiT scenario (a linear increase in PV dispersion). As expected, the amount of stochastic storage installed is proportional to the PV however the amount of optimally located storage installed increases relative to the amount of PV. This is because of two compound effects. Firstly, as more PV is installed in the LV networks, more become problematic in terms of overvoltage. Secondly, the size of the overvoltage in problematic networks increases meaning that more storage units are needed in them. The consequence of this is that, the amount of

storage required will increase over time which will affect the value of storage as a means of mitigation measure to prevent overvoltage. If the reconductoring cost does not change, then it can be expected that it will become more favourable as a means of mitigation than storage. The DNO needs to consider the long term costs of using energy storage to reduce overvoltage e.g. is a network likely to have more PV installed and will this mean more storage is needed in the future?

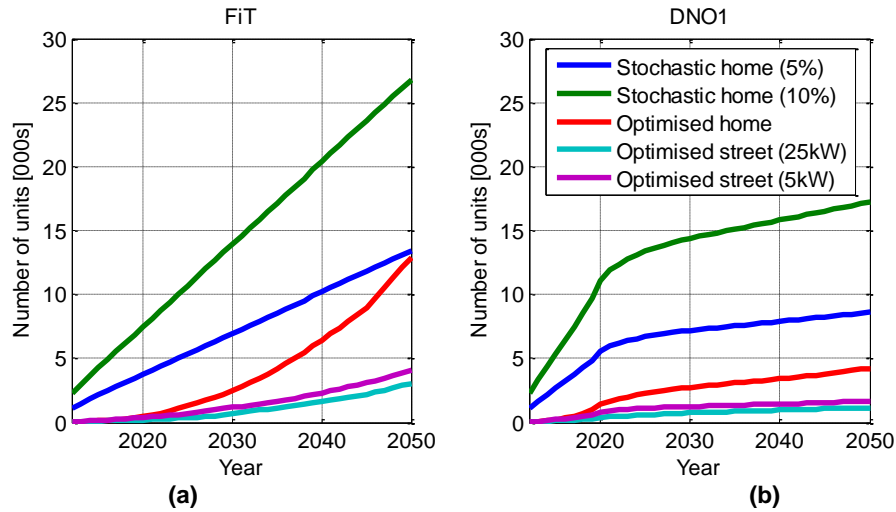

Figure 8-4: Number of energy storage units installed under different PV and storage take up scenarios

Figure 8-5 shows a comparison between the costs of stochastically located storage against optimally located storage. Optimally located storage is always cheaper than both stochastically located storage cases under the DNO1 and DNO3 PV integration scenarios. It is always cheaper than stochastically located storage in 10% of the homes. Because much fewer home storage units are required and because these avert all overvoltage, it can be concluded that, from an overall cost perspective, optimally located home storage is much better for the DNO.

Between the optimally located home and street storage, the costs of 5 kW street storage is comparable overall to home storage. 25 kW street storage is much more expensive than 5 kW storage because it has a higher rating. Although fewer 25 kW street storage units are needed, this is not proportional to the cost as previously established. These values result from the storage cost model described in Table 8-1, but the tools are adaptable to different installation and system costs.

The major advantage of this type of storage is that it offers grid services and reduces grid costs which would otherwise need to be met under present DNO voltage regulations. Therefore the investment in storage is partly offset by reduced grid costs. However, the costs of preventing overvoltage in networks are still large and, from a whole system view, it might be cheaper allow PV to be curtailed to prevent overvoltage and to avert any reinforcement costs in LV networks. A whole system cost benefit analysis of this should be completed and regulations determined, for example, a regulation for PV might be developed which means a PV system must not be curtailed for more than 95% of the time during the daytime and for no more than 30 minutes at a time.

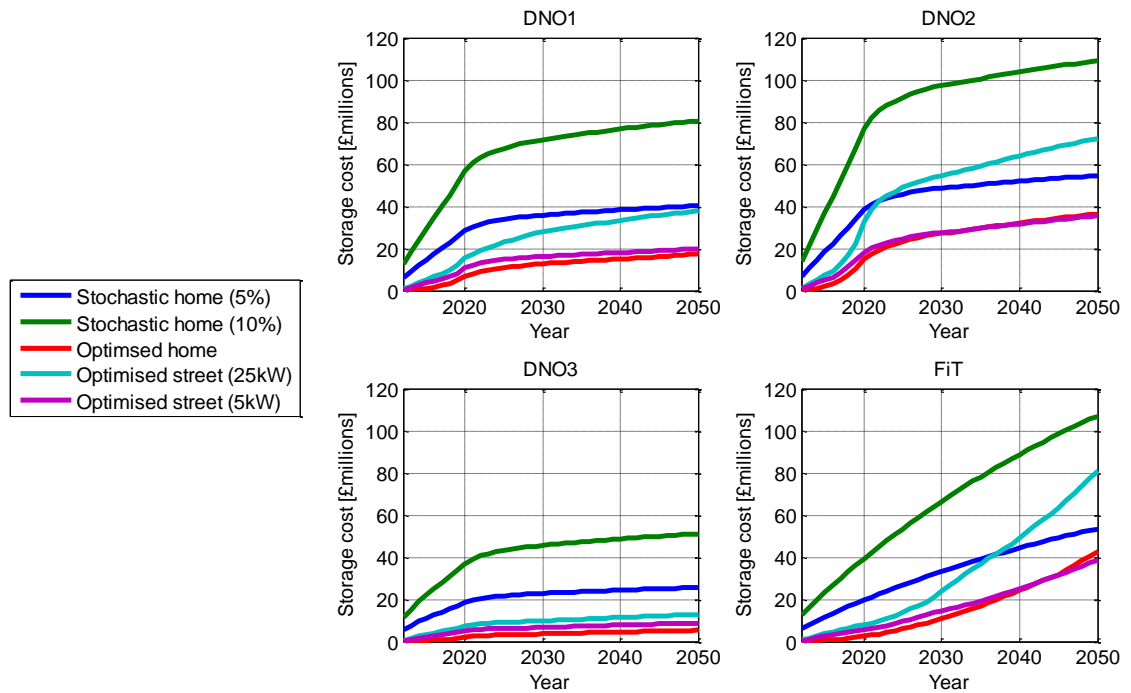

Figure 8-5: Cumulative cost of installing energy storage under different stochastic and optimally located storage scenarios

4 Net value of energy storage

4.1 Value of stochastically located storage

The value of energy storage to the DNO is the reduction in reconductoring cost. This value, (expressed as pounds per energy storage system) is shown in Figure 8-6 for stochastically located storage. It can be seen that stochastically located storage will increase in value initially as more and more LV networks experience overvoltage. This means that, as a power system, it is getting more favourable to subsidise stochastic storage now and in the future that value will decrease. The value of the storage decreases as the overvoltage becomes larger and the storage is less able to prevent the need to reconnector. The value of the stochastic storage decreases as more units are added the network. This is because:

- There is no value in adding extra units in networks where a lower storage dispersion level has already fixed the overvoltage.
- More storage is placed in networks which do not experience overvoltage since this is evenly distributed in the network.
- There is no guarantee that additional stochastically located energy storage will solve a voltage problem because its location in a network is not optimised.

It is found that the value that stochastically located energy storage offers to the DNO comprises a significant proportion of the storage system cost. This is because the moderate overvoltage problem at a small number of homes can be fixed cheaply using a small energy storage unit (rather than reconductoring). This is found to be the case in 23% of the networks with a 5% storage dispersion level and suggests that with slight overvoltage problems, energy storage is

cost competitive with reconductoring and should be considered as a solution for managing overvoltage in the future. This is the case where the DNO targets stochastically located storage at particularly problematic feeders.

Conversely, if stochastic storage is applied across the entire network, it is found that stochastic home storage is unprofitable for a DNO under present prices because it does not prevent all reconductoring. If the value of a stochastic storage to the DNO is passed on to the customer then more storage installations can be encouraged. This might be beneficial for the UK power system. This is because energy storage has multiple benefits to the power system for the reasons outlined in Table 1-3 and affordable ways of financing that storage need to be found. This research shows that if the DNO subsidised every stochastic located storage unit to no more than the value given in Figure 8-6, then the total cost for the power system in LV network reinforcement can be reduced whilst encouraging more storage in the network.

Since the value of stochastically located storage does not match that of the averted reconductoring costs, the DNO has a number of options if sufficient extra value to support the storage cannot be found:

- Stochastic storage should not be supported since this does not reduce overall costs in the distribution network.
- Or if the cost of storage decreases sufficiently then it should be installed and supported
- Or storage should be targeting at homes experiencing voltage problems where this is cheaper than reconductoring and where customers are willing to accept storage in their homes or planning permission can be achieved to install it on the street.

Either way, this research finds that stochastically located storage cannot offer a net financial benefit to the network in reducing the need to reductor LV networks.

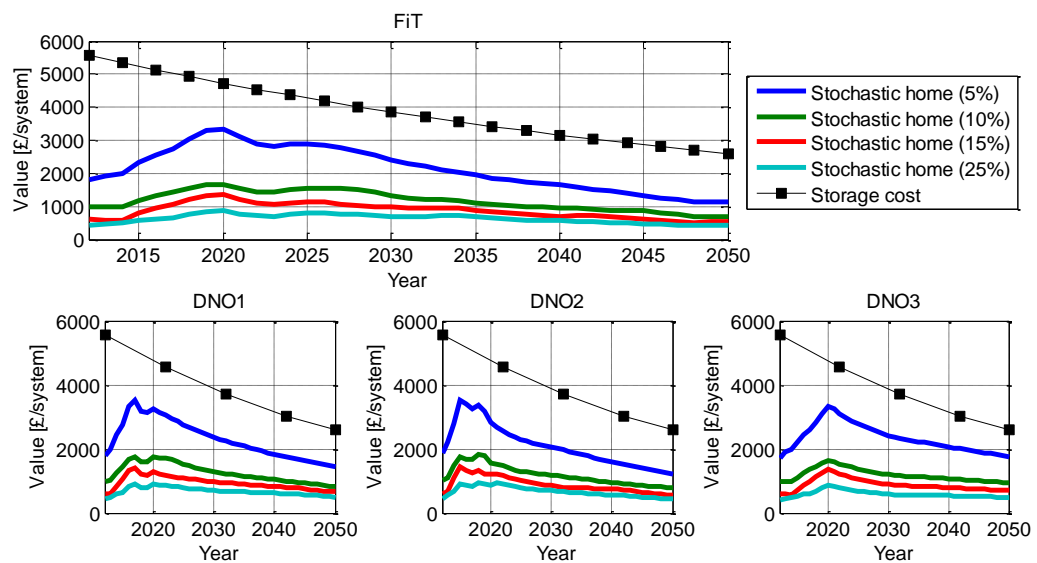

Figure 8-6: Value of each energy storage system to the DNO if it is stochastically installed in the network compared to a (discounted) home storage system cost

4.2 Net value of optimally located energy storage

Storage will only be installed by the DNO in a network if this is cheaper than reconductoring. Therefore, the cost of storage and reconductoring can be compared on a feeder by feeder basis. The results of this are shown in Figure 8-7. Here it can be seen that optimally located home storage is cheaper than reconductoring for more than 90% of the feeders studied within dispersion levels below 30% (the expected PV dispersion level across the ENWL network). Optimised street storage is also cost competitive with reconductoring on a number of feeders. It can be seen that as the dispersion level increases, a larger number of feeders will be reconnected. This is because, as shown in Figure 5-20, as the dispersion level increases so does the cost of the storage solution whilst the reconductoring cost is fixed.

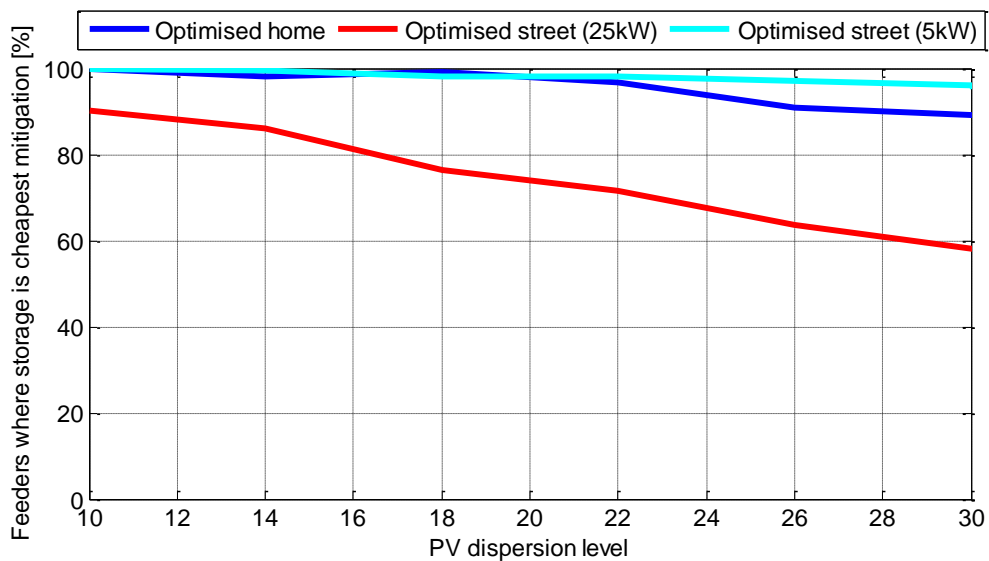

Figure 8-7: Percentage of networks where overvoltage is solved with storage if either home or street storage is selected

Figure 8-8 shows an examination of which storage technology is selected for a feeder when the cost of each is compared. It can be seen that under low PV dispersion levels, optimally located home storage is chosen more frequently. However, 5 kW storage is increasingly selected as the PV dispersion level increases because more and more phases become unbalanced. It is noted that 25 kW street storage is sometimes selected as the cheapest mitigation method. There are two reasons for this, firstly the tools do not directly compare the same PV configuration so the 25 kW storage might be solving a less severe voltage problem and secondly because the 25 kW storage, on these networks, can solve the problem with fewer units. The latter may be either suboptimal storage solutions produced by the heuristic or that the particular configuration of the storage problem particularly suits a 25 kW storage unit. The main conclusion to be drawn from this comparison is that the DNO should, on a feeder by feeder basis, use a heuristic to find a compare different energy storage locations and types. Such study can be completed using the tools in this paper with a variety of storage ratings and capacities and given uncertainty about where PV might be added to a network with already has overvoltage or has storage installed.

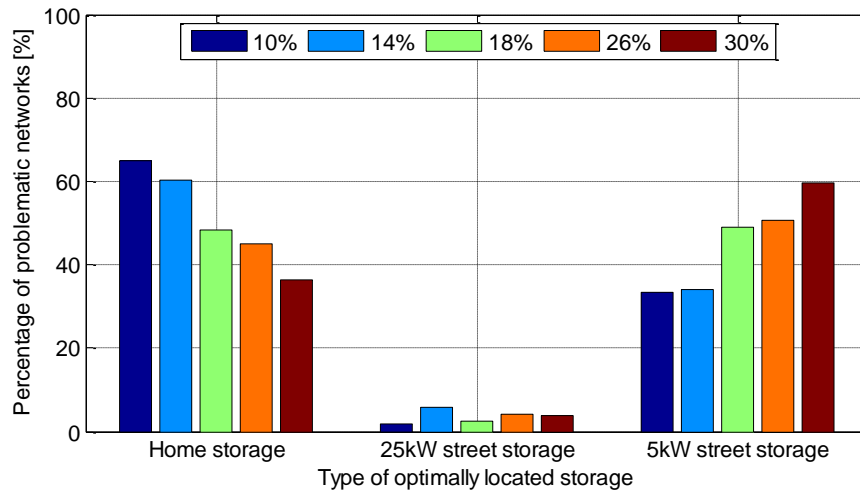

Figure 8-8: Comparison of optimally located home and street storage in terms of the percentage of feeders where home or street storage is cheaper for different PV dispersion levels

4.3 Total reinforcement cost

The total reinforcement cost for the entire LV residential network is the cost of reconductoring and installing energy storage. For a stochastic installation of storage, reconductoring is completed by the DNO in networks where the voltage problem is not solved even if storage is installed. For optimally located storage, storage is only installed where this is cheaper than reconductoring according to the financial model used.

The total cost of storage and reconductoring is shown in Figure 8-9(a). It can be seen that optimally located home storage is the cheapest option over optimally located street storage. Stochastic storage is more expensive than reconductoring since there is a cost to place this in all networks regardless of whether it is needed to avert overvoltage and because it does not always avert the need for reconductoring when it is installed.

In contrast to this, an alternative scenario is considered in Figure 8-9(b). Here, the DNO pays a subsidy of £500 (a lower bound on the value of stochastic storage in Figure 8-6) to every home owner who installs a battery system. This means that stochastic storage is now cheaper than reconductoring, but marginally so and optimally located home and street storage should be chosen.

Optimally located street and home storage offer savings to the DNO. Over the lifetime of PV uptake scenarios, it can be seen that the value of optimally located storage reduces relative to the reconductoring cost with no storage, i.e. in 2030, optimally located home storage can save over 70% of the cost to the DNO whilst by 2050 the saving is less than 65%. This is because, with more PV located in networks, more storage is required to fix overvoltage. The total benefit to the DNO might be reduced if other revenue streams are added to the storage, as discussed in section 5.

Generally, it can be concluded that optimally located energy storage can reduce distribution reinforcement costs by up to 70% whilst stochastically located storage will be more expensive

than reconductoring and should not be supported to achieve DNO cost savings. However, this scenario does enable more households to increase their self-consumption of PV (reducing consumer energy bills from the utility) and also adds more storage to the power system which is required to help decarbonise and balance non-deterministic generation.

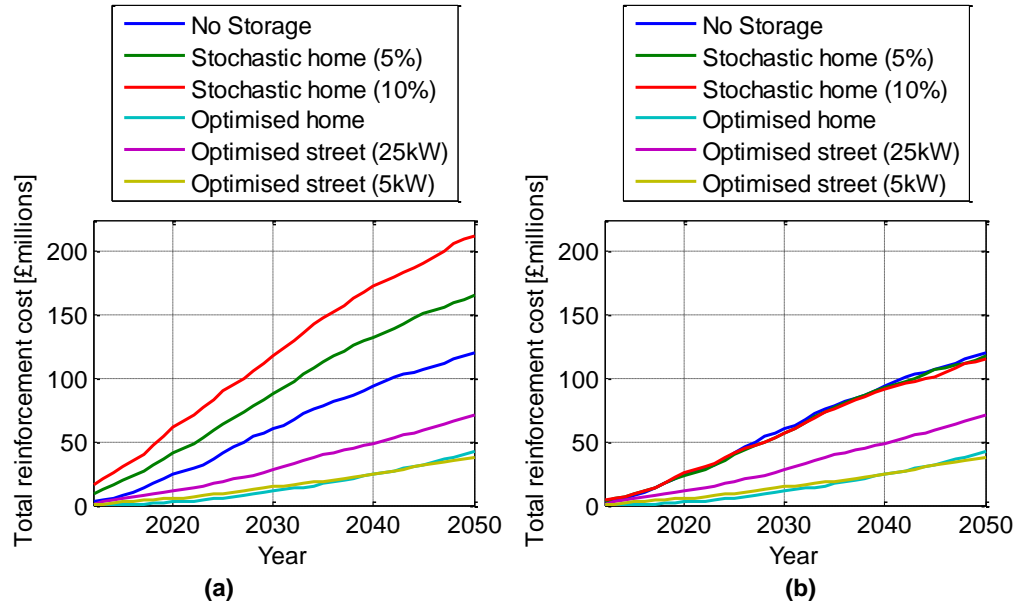

Figure 8-9: Total cost of network reinforcement to alleviate overvoltage under the FiT PV scenario where (a) the DNO meets all of the storage cost and (b) the DNO subsidises stochastically located home storage

4.4 Sensitivity analysis of reinforcement cost

Figure 8-10(a) shows the total reinforcement cost with optimally located energy storage if the cost of reconductoring changes. This is important because, under the financial model used (see Figure 3-3), energy storage is only installed by a DNO if it is cheaper than reconductoring. It can be seen that it takes a large reduction in the reconductoring cost for it to become more viable than energy storage in a significant number of networks. For example, if the reconductoring cost is reduced from £80/m to £20/m then the overall cost of mitigating overvoltage is reduced from £76 million to £46 million.

This is also reflected in Figure 8-10(b) which shows the percentage of networks where storage is cheaper than reconductoring to prevent overvoltage. This shows that if the reconductoring cost is reduced from £80/m to £20/m¹, then 50% of the feeders will still have storage installed. This shows that, according to these experiments, energy storage is generally cost competitive with reconductoring since the cost of reconductoring a feeder is generally of the order of several tens of thousands of pounds whereas a few storage units can be installed for much less to fix overvoltage. This can be seen by considering the number of storage systems needed to fix a problem in Figure 7-19.

¹ These are arbitrary figures for illustration

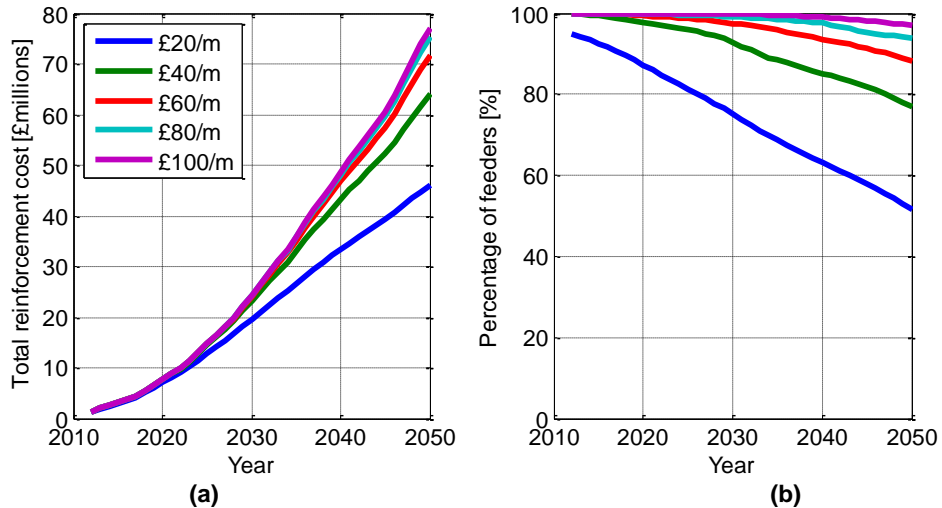

Figure 8-10: For different reconductoring costs (a) the total reinforcement costs (storage and reconductoring) and (b) the percentage of networks where optimally located home storage is chosen under the FIT PV scenario

5 Additional revenue from the power system

5.1 Power system

It might be expected that large integration of distributed energy storage can provide wider benefits to the power system if they are controlled in an aggregated manner. The total capacity and rating of the distributed storage systems proposed (2.5 hour batteries) in 2030 under the FiT scenario is shown in Table 8-2. The FiT scenario is shown because it represents the approximate mean PV integration according to the ENWL forecasts. The storage scenarios representative of just the EWNL licence area are compared to the existing pumped hydro storage systems. In terms of power, the 5% stochastic and optimally located storage is relatively large and comparable to the pumped storage if it is considered that this data represents one of the fourteen DNO license areas. The ratio between capacity and power of the batteries is much smaller than hydro (i.e. more power relative to the capacity provided) since the batteries are only designed here for 2.5 hours of operation. Distributed storage, across the UK, would be comparable in size to the Ffestiniog pumped storage station by 2030. If so, installers should consider, through future work, how their systems can be aggregated to provide wider benefits to the power system. On a local level, distributed storage can also provide benefits to the system in asset protection through peak shaving or in providing backup during outages.

Table 8-2: Comparison between distributed storage cases in this study to existing pumped hydro resources (data on the latter is taken from (Wilson et al. 2010) and (SSE 2014))

Name	Storage capacity (GWh)	Power output (MW)	Location	Technology
Ffestiniog	~1.3	360	Wales	Pumped hydro
Ben Cruachan	~10	440	Scotland	Pumped hydro
Foyers	~6.3	305	Scotland	Pumped hydro
Dinorwig	~10	1728	Wales	Pumped hydro
Choire Ghlais (proposed)	30	600	Scotland	Pumped hydro
Balmacaan (proposed)	60	300-600	Scotland	Pumped hydro
Stochastic storage, 2030 (5%)	~0.065	26	ENWL distribution network	Battery
Stochastic storage, 2030 (25%)	~0.315	126	ENWL distribution network	Battery
Optimally located home storage, 2030, FIT scenario	~0.050	20	ENWL distribution network	Battery
Optimally located street storage, 2030, FIT scenario	~0.120	48	ENWL distribution network	Battery

5.2 Home owner

This project considers a 3.6 kW/2.5 hour energy storage system costing around £6,000 over 10 years. Home storage located in under a free market has financial benefits to customers in terms of reducing their annual electricity bill by increasing self-consumption. Under the UK FIT structure, payment is received for what the panels generate regardless of whether this is consumed within the property or exported into the grid. To encourage export of energy, an export tariff of 4.50p/kWh applies. In homes without an export meter, this is assumed to be 50% of the generated energy. For a PV system in Manchester which exports 2,990 kWh/year, this totals £615 over ten years. If the home storage completely removes this then the export tariff would not be paid (assuming an export meter is fitted). However, the customer would gain from not consuming electricity from the grid. An assessment of the benefit of this to the customer over 10 years is shown in Table 8-3 for different customer tariffs. This assumes that the customer achieves 100% self-consumption and the far right column accounts for the loss of an export tariff. Comparing this value to the cost of storage and the benefit to the DNO in Figure 8-6, it can be seen that without either new revenue streams for home storage or reductions in storage price that it will remain uneconomical.

Table 8-3: Benefit through increased self-consumption of PV for homeowners under different tariffs in addition to the Feed-in-Tariff

Tariff [£/kWh]	Avoided electricity cost [£]	Discounted (NPV) benefit of self-consumption over export tariff over 10 years [£]
0.05	£684	£68
0.10	£1,367	£752
0.15	£2,051	£1,436

6 Conclusions

This analysis in this chapter shows that a DNO can expect a large cost to prevent overvoltage in their LV residential networks as a result of PV. Energy storage, through averting reconductoring, can offer value to the DNO. However, there is insufficient value in averting reconductoring for a DNO to fully support stochastically located energy storage across their entire network. For a DNO, this could justify a subsidy of such systems if the devices can also accumulate/aggregate multiple benefits to homeowners for example by providing ancillary services to the power system. This has already been trialled in Germany as discussed in Chapter 2, Section 2. This would improve the financial case for homeowners to install storage and therefore encourage adoption of storage in the UK network (which is strategically important). However, as discussed in 5.2, there appears to be little value in reduced utility bills by improving self-consumption from PV. This may mean that home storage is unlikely to be financially viable in the UK unless there are increases in electricity prices or reductions in the cost of storage. Further, this requires a much larger investment in storage which would mean, from a whole system perspective, stochastically located storage would add unreasonable cost if its only benefit is in mitigating overvoltage. A better solution might be to just install storage in homes where there is a voltage problem and this creates avenues for future work.

Optimally located home (one phase) and street (three phase) storage is also compared to reconductoring. There is shown to be value for both of these in the network as an alternative to reconductoring even if the reconductoring cost is lowered under a sensitivity analysis. The published heuristic tool provides a suitable method for comparing these two ways to adopt storage on an individual network and also to determine the cheapest storage rating which fixes a voltage problem.

It is found that the relative value of storage to reconductoring decreases as more PV is integrated. This is because more and more storage is needed but the cost of reconductoring does not change in the model used here. Further, the reconductoring model is simplistic in that an entire feeder is considered reconductored if there is a voltage problem. Although the DNO is happy with this assumption, this might not be the case practically if for example there is a slight voltage rise which can be prevented reconductoring a short length of cable.

A further challenge for DNOs is in how regulation allows them to recover investment in storage since although it is shown here to be a potential alternative to reconductoring it is not recognised as a regulated asset within the present UK regulatory system for DNOs. Indeed, since it can offer other benefits to the power system e.g. providing balancing or in capacity, it seems sensible that storage operators should be able to aggregate storage benefits to improve the investment case and therefore reduce the net cost of adapting the electricity network to enable low carbon generation.

The technical and financial results of this work, along with the methods, are now discussed in to enable conclusions about LV energy storage to be drawn.

Chapter 9: Discussion and Conclusion

This work has focussed on overvoltage associated with the integration of residential rooftop PV in LV distribution networks. This has been followed by a technical and financial comparison of the different configurations for energy storage which can address this problem across a large number of networks. The work was sponsored by Electricity North West and Scottish Power and a focus has been placed on the former network due to the availability of a GIS network map. DNOs have not needed any detailed modelled of their LV networks because these have, in the past, been passive and built to established design codes. With the move towards active networks, DNOs recognise the need to reassess their LV network assets.

This discussion summarises and reviews the methods developed to assess energy storage in future LV networks. This is followed by a discussion of the technical/financial results to enable conclusions to be drawn about residential PV integration and LV energy storage from the perspective of DNOs.

1 Preliminary study

At the start of the research project, ENWL selected 11 of their LV networks in Stockport which they are monitoring for voltage problems as a result of PV. Presently, these networks already have a high integration of rooftop PV and were modelled as part of a preliminary study presented at two CIRED conferences. Similar studies were shown to the researchers by external consultants. The preliminary study highlighted that the most valuable asset in LV networks is the feeder cable, which under present procedures and policies would be reconducted to alleviate an overvoltage problem. The preliminary studies found that overvoltage would occur in some but not all of the case study networks and that there is uncertainty about how large voltage rise will be for a given amount of PV. This latter point is important and drove the development of a stochastic planning approach which reflects uncertainty about where PV will be located in future power networks. In doing the preliminary study and building on the understanding of LV energy storage presented in Chapter 2, it was identified that there would be much value in applying planning tools to a large number of real network models to forecast the number of networks that will experience overvoltage in the future. In this work, a stochastic modelling and an optimisation approach have been developed for this purpose.

2 Review of tools

2.1 Method for LV model extraction from GIS data

A procedure has been designed for extracting network models from the GIS. This has allowed study of the case for energy storage over 9,163 representative residential LV networks containing 43,816 feeders. Residential networks were chosen because they are where large

amounts of PV will be installed in the future. They are also the most complex LV networks with the largest amount of value (they contain 88% of all of the ENWL LV feeder cable worth over £2.1 billion).

The use of GIS data for this problem is novel (only one other practical implementation of this in the UK has been found for a small network area (Scottish and Southern Energy Power Distribution 2013)) and presents opportunities for the DNO to carry out further analysis. Developing a procedure for extracting models was a substantial piece of work which took over 10 months of development time. The network models do have limitations and, as discussed below, would benefit from increased geographically located data such as recorded minimum and maximum demands at different locations and secondary transformer voltage variations. Loading the GIS map into MATLAB takes over 4 hours and the optimised code for creating the network models takes several days of computational analysis. To develop and improve the GIS LV network model extraction procedure, it is strongly recommended that the software designers first trial it on several small sections of network (say 100 square miles) before being used across the entire DNO licence area. However, the present networks can be used for further analysis.

Analysis of this set of network models has found that the DNO could be exposed to many millions of pounds in reconductoring costs and therefore there is huge value for DNOs in better understanding their LV networks. In the short term, these models can be used by DNOs to assess each particular LV network on a case by case basis. In the medium to long term, if linked to live GIS and PV data, the procedure for extracting and analysing networks could provide information about how close networks are to limits. This would be achieved by providing the PV dispersion that will cause voltage problems in each LV network with different confidence intervals (e.g. Figure 4-13). In the future, the network models generated for this work could be supplemented with additional data including information about load types taken from geographic or smart meter data (all were assumed to be residential in this study) and real PV ratings (all were assumed to be 3.6 kW in this study). The latter might be extracted by storing the roof size of properties alongside their orientation and, as shown in the sensitivity analysis, including lower PV ratings in some networks will reduce their voltage rise.

LV network models are only as up to date as the GIS map which itself has been found to contain errors. In recognition that errors with the procedure or GIS data can influence the results of the work, suitable selection criteria have been applied. Because the GIS procedure is inherently valuable (as discussed below) the DNO should invest in validation of the network models and the procedure produced in this work. The software used here is entirely adaptable for this to be achieved and shapefiles can be easily imported into most mapping software for comparison to the original GIS map.

There is confidence in the models since histograms of the network properties (Figure 6-30 - Figure 6-32) produce credible results and comparisons between the networks produced using

the GIS analysis to the actual GIS data have not found any significant errors. Shapefiles of the network models as well as the CSV files showing the networks will be provided to the DNO.

An alternative to modelling networks to identify voltage problems is to rely on customers to report them. As such, the DNO might not see any value in adding an expensive, automatic reporting system when they already have a system which responds to customer complains. However, as shown by this work, many thousands of PV systems will soon be constrained by overvoltage and this could leave a DNO inundated with service complaints in the medium term.

2.2 Stochastic tool

A stochastic tool has been developed to understand the impact of PV and home energy storage when there is uncertainty about where these will be located in the future. The tool is flexible and can easily be modified to include different demands and PV and energy storage ratings/dispersion levels. It is also adaptable in that it is not difficult to integrate individual demand, generation and storage parameters for each LV network or feeder. Such adaptability is important as DNOs gain more understanding of the demand and generation in their LV networks. It also allows DNOs to investigate and model different storage technologies e.g. proportional immersion heaters (Immersun 2014) may be installed by customers with PV to reduce their overall reverse power flow.

The stochastic tool can be used to identify problematic networks from a large number of network models. For macro level studies, the results are linked to the quality of the network models and the modelling assumptions and do not need to be completed many times to get meaningful results. This is because this work has found little variability between the number of problematic feeders under different allocations of PV and storage when considering the whole population of 40,000+ feeders extracted from the GIS data.

The stochastic tool can also be applied to individual networks. When repeated several times, the tool can give a DNO probabilistic confidence of the likelihood of overvoltage for different PV and storage configurations. For individual networks, a large number of repeat runs are completed with different PV and storage locations to give a normal distribution of the voltage rise.

Computationally, the stochastic tool can be operated within a sufficiently short amount of time (an analysis of all of the LV networks from Chapter 6 was completed for one set of demand and generation parameters in around 4 hours). Assessment of an individual network with thousands of different PV dispersion levels and configurations can be achieved in a time of the order of minutes. Improvements in computational efficiency would most easily be found by changing the file format used for representing the networks because loading and parsing these files takes a significant amount of the computational effort.

2.3 Optimisation tool

A major finding of the work is that distributed energy storage needs to be carefully located to maximise its impact for the lowest cost. This is because different nodes have different voltage sensitivity. Heuristic approaches can allow determination of these locations (as is performed here) and in the future they can be used to investigate different energy storage ratings, objective functions and control mechanisms. A genetic algorithm with simulated annealing for locating energy storage in power networks has been published in the International Journal of Electrical Power and Energy Systems. This contributes to an emerging field for optimisation of LV energy storage locations.

Because of the large number of load flows required to determine the fitness of different solutions, the genetic algorithm has a much longer computational time than the stochastic tool. Much work has gone into code optimisation to allow results to be gathered for the study of the GIS networks which has resulted in a computational time of approximately 3 days to study all of the GIS generated networks (this is a lengthy amount of time, but with correct assumptions would allow suitable long term planning decisions to be made for LV networks). For individual networks, the heuristic is entirely appropriate for study of different parameters because results for a single network can be obtained in times of the order of a few minutes.

On individual networks, there is uncertainty if a particular optimal storage solution will be cheaper than reconductoring for the same PV dispersion level (as shown in Figure 5-20). This is because different PV dispersion levels will cause different amounts of voltage rise and need more or less storage to fix a problem. As such, the heuristic can be used to determine the range of PV dispersion levels which are always solvable by optimally located storage.

The tool could be developed to provide more information for the DNO. Firstly it does not reflect how the optimal location of storage might change as more PV is added to a network. For example, a network with 50 PV systems might need 10 storage systems to solve an overvoltage problem. However, these might now not be best placed to solve overvoltage if a further 10 PV systems are added. Future work could consider adding an understanding of how future proof a given set of storage locations are and include this within the objective function. Doing this is complex as the DNO does not have control over the location of PV, and so confidence intervals would need to be included and investigated. Further, this might affect the choice of energy storage. In this work, optimally located home storage is found to be cheaper than street storage. However, it might be found that community storage, with fewer units offers more robustness. This might also affect the location of storage. For example, if it is located at the end of feeders it affects voltages all along it and so might be more robust for managing voltages with future increases the number of PV installations.

This work has made an assumption that all street storage that the DNO installs will be the same size. The heuristic tool could be adapted to include storage size within the population structure but the exploration of this presents a large amount of further work and consideration. For

example, the DNO might want to consider different sized units within an individual network. To implement this would naturally increase the size of the problem and therefore the computational effort required. Running the heuristic for street storage takes three days across six different PV dispersion levels. Each additional binary bit added to the population string effectively doubles the problem size. It was therefore deemed impractical to include different sized systems in this study.

For individual networks, the heuristic approach could be adapted to explore different street storage unit sizes which can be compared to home storage. Additional constraints could also be included such as a limit on the number of units installed in a network, a list of infeasible customer connection points (e.g. narrow streets, conservation areas), different control objectives, coordinated or distributed control etc.

3 Storage types

Different energy storage integration scenarios are investigated using the two tools comprising storage at the secondary transformer, stochastically located storage in the home and storage optimally located in homes or on the street.

3.1 Secondary transformer

One of the sponsoring DNOs have stated a preference to install storage at secondary transformers as they own the land near to these and because do not have capacity or experience installing technology into customer homes. Secondary transformer storage is found to be the least practical for LV overvoltage constraints because achieves the least benefit to LV networks for each kW of energy storage installed. It can offer benefits to the MV network by adjusting power flows, but these benefits can also be achieved using storage within the LV network if this has some form of direct or indirect centralised control.

3.2 Home storage

A free market for home storage was also investigated. Here, it was considered that customers in the UK (as is happening in Germany (CleanTechnica 2014; Forbes 2013)) will start purchasing batteries to improve their PV self-consumption. Similarly to PV, it is considered that DNOs would have no control over where these are located or be able to determine which customers would purchase them. In the future, reduced storage costs might mean that homeowners without PV might also find storage profitable through electricity price arbitrage, and/or through providing services to the whole system in renewables balancing, distribution network services, frequency regulation, backup, black start capacity, upgrade deferral, loss reduction, voltage regulation etc. This is not considered to be feasible in this work but could be included the future.

The results of this study show that, without widespread adoption, stochastically located home storage will only have a small benefit to the DNO in terms of the percentage of feeders where overvoltage is prevented because the location of the storage in each network is important. It

was considered that the DNO could pass on the financial benefit they derive by not reconductoring networks to customers with storage as a form of subsidy. To do so would encourage more storage in the power system which is widely considered to be important and to some extent reduces the overall mitigation cost that DNOs will face.

Despite still needing to reinforce many of the problematic networks, a major weakness with this approach is the burden of proof. For example, although modelling shows that voltage problems will be reduced by home storage, system owners might need to prove that they are actually offering benefits to the DNO. This is particularly important given the small margin between the original reconductoring cost, and the cost of a storage subsidy since the DNO needs to be confident that they will be saving money in the long term. A similar problem is encountered with the benefits of loss reduction. Distributed generation and storage can reduce power flows through HV, MV and LV cables which reduce the electrical losses and therefore DNO loss payments. However, due to the complex nature of power flows, changing demand, different voltage levels etc. it is incredibly difficult to quantify the loss reduction and then attribute that to each specific DG or storage unit.

The amount of money that a DNO could offer in terms of a subsidy does not cover the cost of storage system as shown by comparing the results in Figure 8-6 to the costs in Table 8-1. To improve this, either a larger subsidy needs to be offered, more value added or the cost of storage reduced. Media commentators have suggested that the latter will occur, e.g. falls in the cost of lithium ion batteries (Boston Consulting Group 2010). However, such reports should be treated with caution since the future is uncertain given that there is no mass market for electric vehicles and stationary battery energy storage at the time of writing. The DNO could direct a subsidy to homes which have more impact on the voltage problem. However, this might conflict with the need to treat all customers equally. If aggregated, home storage might earn extra revenue by providing ancillary services, but this would require a comprehensive and reliable control system, acceptance from the system operator, consideration of how different operating cycles might affect the battery life and a large amount of systems to be installed in the network (which may not occur for a number of years as shown in Table 8-2),

It might be considered that home storage marketed to a residential electricity customer will be designed to maximise self-consumption and so would always align with the DNOs requirement to minimise/eliminate reverse power flow. However, in reality, the most economically sized storage unit is unlikely to be one which achieves 100% self-consumption. By reducing the battery size, the homeowner reduces the capital and investment costs at the sacrifice of some energy export during the brightest summer days.

If the location of storage in homes is determined using the heuristic, it has been shown to be much more cost effective than reconductoring and stochastically located storage. However, this can only be achieved with the permission of the customer. This can of course be avoided by using community storage which does not require space in a customer's property.

3.3 Three phase storage on the street

In contrast to home storage, street storage could be built with control algorithms which are targeted towards a DNO objective of voltage control. Further, it is shown to be economical in many cases over reconductoring. Street storage itself might be favourable for DNOs in that it does not need to be located in customer homes. Doing so adds safety risks, requires acceptance from customers and also fundamentally changes the relationship between the DNO and homeowners. However, due to the need for more substantial civil engineering works (i.e. digging to reach underground cables), street storage is inherently more expensive to install. It may also be difficult to install such storage where there is limited space on the street or concerns of theft or damage.

Street storage is found to be more expensive than home storage if a 25 kW unit is always used on the networks. However, it is cheaper on some networks, which shows two things. Firstly, street storage is worthy of investigation by DNOs as one possible mitigation measure if they discover overvoltage in a feeder. Secondly, the DNO would want to consider different sizing for street storage which can solve overvoltage but for a lower rating. The latter can be performed through running the heuristic several times on a network with different energy storage ratings or by including energy storage rating selection in the optimisation. It is also assumed that street storage is three phase. Since overvoltage problems are commonly single phase (and therefore home storage is frequently selected), it is also worth investigating larger single phase units which are located on the networks.

3.4 Conclusions

The results of this work show that storage should be carefully located within an LV network using a heuristic method from the perspective of a DNOs (and ultimately the customers) overall cost. This is because it can achieve greater prevention of overvoltage, using fewer storage units and for a lower cost. On individual networks, heuristic methods should be used to compare different storage topologies (single or three phase street and home storage) of different ratings. This should be performed on a network by network or feeder by feeder basis since local constraints such as customer acceptance, geographical limitations, the nature of the voltage problem and the network configuration will all influence the choice of topology and storage type. This analysis can be performed quickly and efficiently on an individual LV network using the tools described in this thesis.

If installed across all of the 14 UK DNO licence areas, it is shown to be worth further study of LV energy storage (and the correct unit type and size for each feeder) as an alternative to reconductoring since this can help the UK to achieve greater storage integration whilst reducing overall reinforcement costs to allow more DG. This can make an important contribution to the Energy Storage Network's goal of 2000 MW of UK storage by 2020 (Figure 9-1). However, this will only be achieved regulation allows DNOs to install storage and the proposition will be improved if storage can earn revenue providing wider services to the power system.

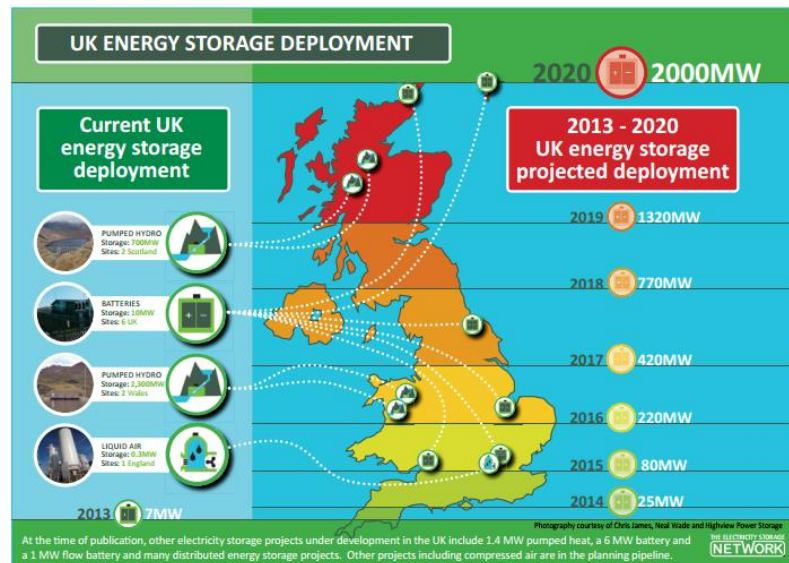

Figure 9-1: Present and future UK energy storage projects including targets on the right (Electricity Storage Network 2014)

4 Control

Storage in this work is assumed to fully absorb reverse power flow. This defines the control algorithm which is implemented. Such a control algorithm will maximise the self-consumption, however, for a DNO, absorbing all reverse power flow may not be required. Assessment should be carried out into whether the 2.5 hour storage system proposed here is actually too large or too small. This will depend on the control scheme objectives and irradiance and demand patterns. For example, energy storage could be specified to absorb all of the reverse power flow during the sunniest day of the year with the lowest demand. However, it may be more economical for a consumer to purchase a smaller battery which is cheaper but does not absorb all of the reverse power flow from their PV system. A DNO on the other hand might just want to absorb reverse power flow above a certain threshold since reducing the PV peak capacity (reverse power flow) can reduce the number of problematic feeders (Figure 7-12(d)). Regulation could also be changed to allow some overvoltage (practically curtailment of PV) to reduce overall costs to the power system whilst still allowing large amounts of distributed generation. This recognises that the case studied here is a very onerous one for the power system. Therefore, if the energy storage can reduce the reverse power flow from 3.6 kW to 1 kW then the number of problematic feeders can be reduced by up to seven times depending on the storage dispersion level. This lowers the cost of storage to a DNO if optimally located in the network. In terms of control, this might be achieved by using a charging control for the storage which is proportional to the local overvoltage (Wang et al. 2013).

5 Size of voltage problems

There are additional factors which may affect the case for storage. In the study of the ENWL residential LV networks derived in Chapter 6, it is found that the majority (<2000 of the 43,816 feeders studied) will not experience voltage problems as a result of PV and that the overvoltage in majority of the networks is slight. However, as shown, the cost implications for mitigating voltage constraints in the problematic feeders are high. A DNO must, in regulatory terms, mitigate for overvoltage this adds a huge cost to the power system. Since overvoltage in many networks was found to be small, problems may not occur for lengthy periods in a year (very few hours per year) and in these cases smaller energy storage or demand side response may be appropriate to reduce costs. The tools presented in Chapter 5 can be used to investigate these.

Voltage problems will become more common if there is an increase in peak demand. This has not been explicitly studied in this work, which focuses on integration of DG, but it could easily be incorporated into the tools with suitable understanding of how peak growth will change. This has been seen in the sensitivity analysis of the minimum demand shown in Figure 7-12(c) and the peak demand as shown in Figure 7-8. This would also require an understanding by the DNO of how energy storage would be used in such situations. For example, the DNO could continue the present practice of setting secondary transformers to not allow any undervoltage whilst using energy storage to manage overvoltage. This would be appropriate since practically, protection in inverters will prevent overvoltage in the event of storage units failing. To reduce the storage power rating, it could be used to solve under and over voltage through intelligent charging and discharging. This could potentially require a smaller (and cheaper storage unit) but if this increases the number of charge/discharge cycles then the battery cycle life will be reduced which increases the lifetime cost of a storage project. Storage could also be linked to a tap changing secondary transformer, as investigated in (Wang et al. 2014).

The work assumes that there is a continuous range of voltage taps at the secondary transformer which it is recognised not to be the case. It is difficult to know these tap positions as they also relate to where on the MV feeder the secondary transformer is placed. In future, the planning tools could be adapted to include modelled or measured secondary transformer tap positions. As discussed below the MV variation is also important in modelling the voltage change at the secondary transformer.

5.1 MV variation and measured data

Measured data was provided from the case study networks. These showed the voltage, current and power flows at the LV busbar of secondary transformers serving LV networks and allowed characterisation of networks with and without PV. The measured data showed the voltage variation at the secondary transformer in response to the LV and MV loading conditions. These voltage variations were used to validate an MV network model of the case study networks. A link between the reverse power flow and lower voltages was also found, but this was only slight.

Modelling has found LV voltage variation as a result of residential PV to be much more significant.

Although useful, the measured data was extremely difficult to work with: there were a large number of data points and significant amounts of missing data. The latter made it difficult to determine when in the day problems occur and made it impossible to derive absolute confidence in total voltage variation in the measured data. Analysing the data was extremely difficult computationally due to the volume of data and the impractical way in which it was formatted. For example, date and time information was in a bespoke text format and statistics for each phase were given on different lines of the data files. Much off-site processing was required on data which was transmitted over the cellular network. It would be much more useful for the system to locally calculate and then report parameters such as the voltage deviation, maximum and minimum power flows etc. at a lower resolution (hourly or daily) as this aggregated data was found to be more useful for the DNO. Such data has been used to validate the case study network analysis.

Without correctly calculating the changed voltages in the MV network, the DNO is at risk of either underestimating the voltage variation and therefore having overvoltage in their LV networks or overestimating the voltage variation, determining that there is a voltage problem in their LV networks and mistakenly incurring reinforcement costs. Wider integration of network monitoring equipment would enable voltage variation to be measured in networks without the need for MV modelling; if the suggested changes to the way the monitoring equipment reports data are carried out.

The case study network was used to generate two MV network feeders for use with the GIS models. Sensitivity analysis found that the stochastic allocation of LV networks to these feeders is unimportant, however it is recognised that practically the MV deviation will be different for different LV feeders depending on the MV network to which they are connected. These MV voltages may also be affected by integration of distributed generation at the MV level. This could be achieved using measured network data or accurate MV network models.

6 Financial considerations

A financial model has been presented for energy storage but it has been recognised in the literature review that the cost of energy storage will change as technological advances are made and if a wider market for electrical storage is generated. The energy storage is also compared to a simplistic reconductoring model where an entire feeder is recabled in the event of overvoltage. This model is widely used in literature, and has been accepted by the sponsoring DNO. It should be noted that the reconductoring cost is an upper limit and different reconductoring cost models have been explored (see Chapter 8, Section 4.4).

The tools presented here require realistic technical and financial parameters and the DNO feels that the ones used here are suitable for this study. However, when practically applying these

tools, DNOs need to carefully consider their acceptable safety margins, reconductoring costs and storage costs to determine the correct course of action. Recognising this, the tools are entirely adaptable to different costs and technical constraints, discount factors etc. This is important because, in the future, DNOs will, need to reassess the case for optimally and stochastically located energy storage in their networks as their LV networks begin to need reinforcement as a result of PV.

Legislation means that companies working in the different sections of the industry must act separately, even if they have the same parent organisation. For example, DNOs are not permitted to hold a license to supply consumers. A subsidy might be financially viable for the DNO to offer to customers, but this might conflict with these legal requirements.

Another major cost component to be considered for a DNO is that of designing, installing and managing energy storage. This also relates to the quality of the control mechanism. In the short term a simple time based charge/discharge control could be used which charges during the middle of the day at a rate proportional to the network voltage. However, in the future, this may be less effective at managing fleets of energy storage in power network as was investigated in work contributing to (Wang et al. 2013)

7 Alternatives to energy storage

The work here is completed as an energy storage study because it was decided to determine if there is a case for installing this in LV networks. To do so, suitable planning tools have been developed to allow DNOs to determine the cost of reconductoring their networks in the event of overvoltage and to subsequently investigate configurations for electrical energy storage as an alternative mitigation measure. However, other technologies which might be stochastically located in homes can be beneficial. For example, electric immersion heaters have a lower capital cost than battery storage and could be installed in homes with hot water tanks. However, this may not be the most efficient use of electrical energy, i.e. the roundtrip efficiency of converting solar irradiance to electricity and then to heat is much lower than the use of solar thermal generators. Further, if the hot water is not used then the heat energy is simply wasted. With panels generating reverse power flow, then the electrical energy is being used somewhere within the power system to support electrical loads and therefore can displace conventional generators.

Curtailement of PV is the major practical implication of overvoltage in LV networks. This is because inverters will turn off where there is overvoltage. Such automatic curtailment is obviously undesirable from an integration of renewable energy point of view as it reduces the amount of renewable energy that is generated. It also makes it harder to forecast PV output for the system operator. Additional knowledge of the amount of curtailment in each network would be obtained using annual demand and generation profiles or by looking for automatic reporting from inverters/PV control and monitoring systems. Such modelling would allow the DNO to

select networks with the worst voltage problems and those where the most curtailment will occur. This is important to allow the DNO to determine networks where curtailment is most extreme and where reconductoring should be directed. Further, the DNO could be given control about where PV is installed. This might allow significant amounts PV integration with minimal cost to the power system as shown in Table 7-1.

A relevant finding of the work is that the minimum demand, and the reverse power flow, has quite a significant effect on the need for reconductoring. The move towards higher efficiency equipment, such as fridges, with lower demand might make the reverse power flow more significant and therefore cause more voltage problems. Conversely, smart grids can allow shifting of flexible loads (electric vehicle charging, electrical heating) to where this provides voltage support:- projects looking at DNO control of vehicle charging include (My Electric Avenue 2014). The do-nothing approach is seen here to be likely to cause the most voltage problems in the future.

Another potential factor is the increase in peak demand as a result of electric vehicle charging and heat pumps. These may also increase the minimum demand and therefore reduce the reverse power flow depending on how they are controlled. Integration of these is expected to increase, but it will not necessarily be in conjunction with PV. There is a lot of uncertainty about how integration of these will impact LV networks, however if they do increase the peak demand they will further increase the LV and MV voltage deviation and cause more networks to violate voltage limits. Here, energy storage can be effective if it is used to discharge power back into the networks. Demand side response using load control cannot do this so would only be effective if it can be used to reduce the demand at peak.

8 Summary of discussion

The discussion has focussed on the tools and methods used, the decisions surrounding which type of energy storage should be used and factors which DNOs need to consider before committing to an investment in LV energy storage. It is first shown that the tools here are adaptable in that they can be used with a variety of parameters or easily adapted to include factors such as load growth, different constraints and demand/generation scenarios. The heuristic tool can also be expanded to include explicit comparison of different storage sizes and types (number of phases) and also to mix different types on the same feeder. This is important for DNOs to assess networks under different scenarios.

Different storage deployment strategies are discussed using a technical and financial comparison in Chapter 7 and Chapter 8 and also from the perspective of other DNO considerations such as proving benefits to the network and control objectives. DNOs could supplement this through trials or by assessing how other DNOs use storage. Regardless, the results do provide guidance and tools for DNOs to determine where and how to integrate storage in their networks to reduce overvoltage

A discussion surrounding the magnitude of the voltage problems is completed. This considers how the results are sensitive to demand, generator size, load growth, transformer tap settings and MV voltage variation. The DNO would address these factors when a problematic network is identified through network modelling, consideration of correct parameters local to the network under study and possibly through wider installation of network monitoring equipment.

Changes to the financial considerations may help or hinder the case for energy storage. This includes assessing the simplistic reconductoring model used in the work, building capacity within DNOs to manage energy storage, legislation which makes it difficult for DNOs to interact with customers and expected reduced costs of energy storage (e.g. a 50% reduction in battery costs are expected by 2020 in a recent article (The Guardian 2014a)).

Finally, alternative technologies to storage are discussed including curtailment and demand side response. Again, these would be considered on a network by network basis using time series analysis of the length of voltage problems. For example, a short demand side response might be effective, which itself might become more feasible if heat pumps and electric vehicles become more common. Some small amounts of curtailment may be beneficial from the perspective of whole system if this avoids the need for expensive mitigation in the short term or allows investments to be deferred.

9 Conclusion

A recent IMechE report says that energy storage, although vital to the power system, cannot be supported through conventional market mechanisms (IMechE 2014). This work has considered the particular case of energy storage in future LV networks (part of the power system which will have increasingly active power flows as a result of integration of large amounts of residential PV).

The work started by recognising that there is a lack of understanding about LV networks since they have always been considered by DNOs to be “fit and forget” assets, i.e. they were built with sufficient amounts of headroom and spare capacity to be able to deliver power without problems for many decades. Due to the integration of residential PV, this approach is no longer always valid. This work has shown that planning tools are required for these networks to determine voltage headrooms in future load and generation scenarios. These tools have reflected the uncertainty about where PV will be located. Applying the planning tools has shown that some, but not all, LV feeders will be problematic in terms of overvoltage in the future and that the tools can be used on a wide variety of networks to identify feeders of concern.

A large number of LV network models have been extracted for analysis with the planning tools using a GIS map. This is a new and novel method when applied with PV and energy storage. Using the tools on these networks has shown that there is a large potential exposure by DNOs to the cost of reconductoring their LV networks. This is of the order of hundreds of millions of pounds by 2050. This cost will be compounded if there is peak load growth, study of which is worthwhile in the future.

An alternative to network reconductoring is the use of energy storage in the LV networks to reduce voltage rise. DNOs can use tools described here to determine which type of storage to use and where to place it on a case by case basis. These allow investigation of both a stochastic (free) market for energy storage versus optimally located single and three phase storage of different ratings.

Through avoiding reconductoring, a benefit is found (in terms of cost saving) for DNOs from installing energy storage in LV networks. This benefit is shown to be highest when single or three phase energy storage is carefully located using a heuristic. The fact that storage can be installed in networks for a lower cost than reconductoring has been shown through detailed and published studies of case study networks as well as study of the ENWL residential LV network derived from the ENWL GIS system. This is a novel finding and is worthy of future investigation by DNOs as their LV networks approach or violate voltage limits. Indeed, there is a natural extension of DNOs looking to provide benefits for their MV network assets by aggregating energy storage located in LV networks.

In the future, DNOs should build on the work by creating models of their LV networks, determining how close they are to voltage limits and how much PV and load growth will breach voltage limits. When voltage problems are found, DNOs should look at whether optimally located energy storage (or a subsidy to encourage homeowners to install storage) can reduce these voltage problems and mitigate the need for reconductoring. If not, without changes or alternative reinforcement strategies for voltage control, the present for residential PV is shown to commit UK DNOs (and ultimately customers) to large costs to allow distributed generation in the LV network.

Appendix

A DNO PV reference table

Appendix

Table A-1: Illustrative table for DNO to determine the amount of PV systems installed in each LV network which will cause a voltage problem

Maximum demand [kW]		1.0								1.4							
Minimum demand [kW]		0.1				0.2				0.1				0.2			
PV rating [kW]		2	2.5	3	3.5	2	2.5	3	3.5	2	2.5	3	3.5	2	2.5	3	3.5
Network	MA	100	90	80	70	90	80	70	60	60	50	40	30	50	40	30	20
	BL	250	220	190	180	220	190	180	150	180	150	120
	CC	20
	DG	80
	...																

B Publication and training summary

Journal papers

Crossland, A. F., Jones, D., & Wade, N. S. (2014). Planning the location and rating of distributed energy storage in LV networks using a genetic algorithm with simulated annealing. *International Journal of Electrical Power and Energy Systems*, 59, 103–110. doi:10.1016/j.ijepes.2014.02.001

Journal papers (Under review/awaiting submission)

Crossland, A.F., Anuta, O.H., Wang, L., Jones, D., Wade, N.S. (2014) A stochastic method for determining the voltage constraints on PV and home energy storage using decoupled MV and LV voltages. *Electric Power Systems Research*

Wang, L., Liang, D.H., Crossland, A.F., Jones, D., Taylor, P.C., Wade, N.S. (2014) Coordinated Control of Multiple Energy Storage Units in a Low Voltage Distribution Network. *IEEE Transactions in Smart Grid*

Conferences

Presentations:

- | | |
|-------------|---|
| April, 2014 | Crossland, A. Improving Solar Penetration within a Residential Network and Overcoming Limiting Factors for DSOs, Energy Storage World Forum, London, UK |
| Sept, 2013 | Crossland, A. Energy Storage for a Low Carbon Future. Energy CDT Network @ Energy Futures Student Research Conference, London, UK |
| June, 2013 | Wang, L., Liang, D., Crossland, A., Wade, N., & Jones, D. Using a Smart Grid Laboratory to Investigate Battery Energy Storage to Mitigate the Effect of PV in Distribution Networks. <i>22nd International Conference on Electricity Distribution</i> . Stockholm, Sweden. |
| June, 2013 | Crossland, A., Jones, D., & Wade, N. Energy Storage/Demand Side Response in LV Networks: Design of Cost Based Planning Tools for Network Operators. <i>22nd International Conference on Electricity Distribution</i> . Stockholm, Sweden. |
| May, 2013 | Crossland, A., Anuta, O., & Wade, N. Assessing the impact of society and energy storage on the success of solar photovoltaic systems utilized for healthcare in rural Rwanda, <i>2013 International Conference on Alternative Energy in Developing Countries and Emerging Economies</i> . Bangkok, Thailand |
| May, 2013 | Anuta, O., Crossland, A., Wade, N., & Dargan, S. Techno-economic study on the performance of PV systems in schools and health centres in Rural Rwanda. <i>2013 International Conference on Alternative Energy in Developing Countries and Emerging Economies</i> . Bangkok, Thailand |

May, 2012 Anuta, O., Crossland, A., Jones, D., & Wade, N. Regulatory and Financial Hurdles for the Installation of Energy Storage in UK Distribution Networks. *CIREN Workshop*. Lisbon, Portugal.

Poster presentations:

May, 2013 Crossland, A. Energy Storage Research Projects at Durham University *Energy Storage Association Annual Meeting, 2013*, Santa Clara, CA, USA.

Other conferences attended

Mar, 2013 Energy Storage for Power Networks, 12th March 2013, IMechE, London

June, 2012 Energy Storage Forum, Rome, Italy

Nov, 2011 Energy Storage: a pragmatic approach, 3rd November 2011, IET, London.

Reports by sponsoring companies

May, 2014 Low Carbon Network Fund Project ENWT1001- The Smart Fuse

Reports to sponsoring companies

May, 2013 KelVAtek close down report

Apr, 2012 Dunton Green KelVAtek analysis

External training

June, 2013 Modern trends in planning for active distribution systems, CIREN 2013, Stockholm

This tutorial discussed how planning of distribution systems will need to change in response to low carbon technologies. Of particular interest was how more complex planning can provide cost savings for network operators.

May, 2013 Energy Storage Association Annual Conference Workshops

North American Energy Markets

Workshop provided an introduction to the US storage market including initiatives to support storage and a background of the different energy market areas and segments. There was a particular focus on transmission applications for storage in the frequency regulation ancillary market.

PV Energy Storage Integration

This workshop introduced the reasons why storage and PV are integrated and presented tools for financial and technical analysis of PV with storage systems. The workshop included case studies of a RES/CES project in California

Apr, 2013	MathWorks online training <u>MATLAB Fundamentals</u> Online training course into the basic Matlab commands and techniques and a 500kW grid-connected PV/storage system in New Mexico.
Apr, 2012	NATCOR: Heuristics and Approximation Algorithms A 4 day residential course completed at Nottingham University in April 2012 which introduced a number of heuristic algorithms, notably genetic algorithms and simulated annealing which are applied in this thesis. Learning was delivered through lectures and a lab session (www.natcor.ac.uk).
Mar, 2012	North West Enterprise School A 6 week course which included 6 days of residential training to develop enterprise skills. A business proposal was determined with a group of 5 other PhD students. Provided team working skills in particular.
<u>Internal training</u>	
May, 2013	ArcGIS - Introduction
Mar, 2012	Long Documents in Word
Mar, 2012	MS Access 2010 - Creating Your First Database
Feb, 2012	Introduction to NVivo

C Control algorithm used in CIRED 2012 paper

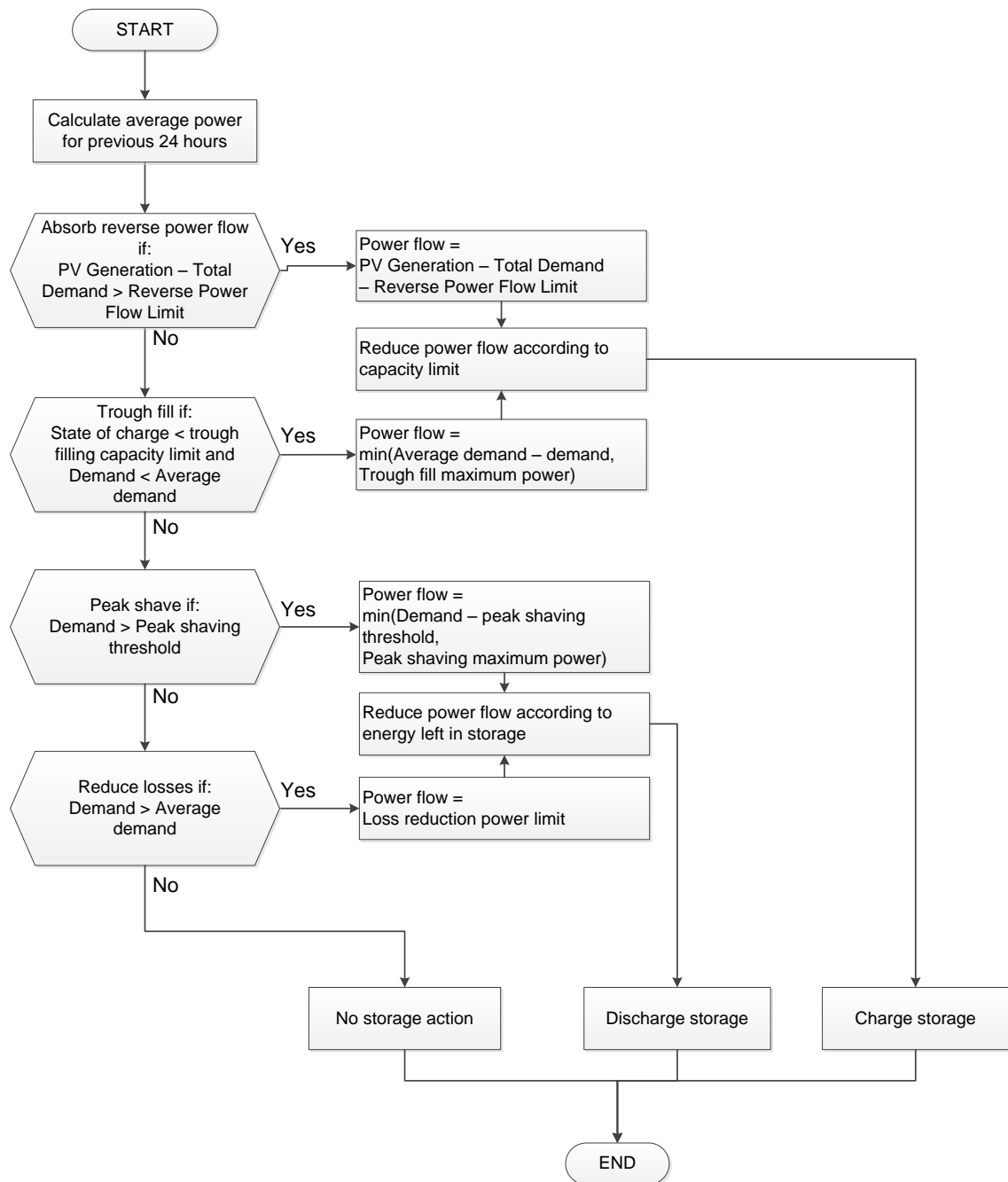

Figure A-1: Control algorithm used in CIRED 2012 paper (Anuta et al. 2012)

References

- Aditya, S., 2001. Battery energy storage for load frequency control of an interconnected power system. *Electric Power Systems Research*, 58(3), pp.179–185. Available at: <http://linkinghub.elsevier.com/retrieve/pii/S0378779601001298>.
- Afzalan, M., Taghikhani, M.A. & Sedighizadeh, M., 2012. Optimal DG placement and sizing with PSO&HBMO algorithms in radial distribution networks. In *Electrical Power Distribution Networks*. Tehran, Iran, pp. 1–6.
- Ahlert, K.-H. & van Dinther, C., 2009. Sensitivity analysis of the economic benefits from electricity storage at the end consumer level. In *2009 IEEE Bucharest PowerTech*. Bucharest, Romania: IEEE. Available at: <http://ieeexplore.ieee.org/lpdocs/epic03/wrapper.htm?arnumber=5282245>.
- Ahmadigorji, M. et al., 2009. Optimal DG Placement in Distribution systems Using Cost / Worth Analysis. *Engineering and Technology*, pp.746–753.
- Akhil, A.A. et al., 2013. DOE / EPRI 2013 Electricity Storage Handbook in Collaboration with NRECA. , (July).
- Alam, M.J.E., Muttaqi, K.M. & Sutanto, D., 2012. Distributed Energy Storage for Mitigation of Voltage-rise Impact caused by Rooftop Solar PV. In *Power and Energy Society General Meeting, 2012 IEEE*. San Diego, CA, pp. 1–8. Available at: http://ieeexplore.ieee.org/xpls/abs_all.jsp?arnumber=6345726&tag=1.
- Alam, M.J.E., Muttaqi, K.M. & Sutanto, D., 2013. Mitigation of Rooftop Solar PV Impacts and Evening Peak Support by Managing Available Capacity of Distributed Energy Storage Systems. *IEEE Transactions on Power Systems*, 28(4), pp.3874 – 3884.
- Alarcon-Rodriguez, A. et al., 2008. Multi-objective planning framework for stochastic and controllable distributed energy resources. *IET Renewable Power Generation*, 3(2), pp.227–238.
- Ali, S., Pearsall, N. & Putrus, G., 2012. Impact of High Penetration Level of Grid-Connected Photovoltaic Systems on the UK Low Voltage Distribution Network. In *International Conference on Renewable Energies and Power Quality*. Santiago de Compostela, Spain.
- Anuta, O. et al., 2012. Regulatory and financial hurdles for the installation of energy storage in UK distribution networks. In *CIREN 2012 Workshop: Integration of Renewables into the Distribution Grid*. IET, pp. 219–219.
- Anuta, O., Crossland, A. & Wade, N.S., 2013. Assessing the impact of society and energy storage on the success of solar photovoltaic systems utilized for healthcare in rural Rwanda. In *Alternative Energy in Developing Countries and Emerging Economies*. Bangkok, Thailand.
- Anuta, O.H. et al., 2014. An international review of the implications of regulatory and electricity market structures on the emergence of grid scale electricity storage. *Renewable and Sustainable Energy Reviews*, 38, pp.489–508. Available at:

<http://linkinghub.elsevier.com/retrieve/pii/S1364032114004432> [Accessed July 21, 2014].

Arce, P. et al., 2011. Overview of thermal energy storage (TES) potential energy savings and climate change mitigation in Spain and Europe. *Applied Energy*, 88(8), pp.2764–2774. Available at: <http://dx.doi.org/10.1016/j.apenergy.2011.01.067> [Accessed June 27, 2011].

Arteconi, A., Hewitt, N.J. & Polonara, F., 2012. State of the art of thermal storage for demand-side management. *Applied Energy*, 93, pp.371–389. Available at: <http://linkinghub.elsevier.com/retrieve/pii/S0306261911008415> [Accessed March 11, 2012].

Atzeni, I. et al., 2013. Demand-Side Management via Distributed Energy Generation and Storage Optimization. *IEEE Transactions on Smart Grid*, 4(2), pp.866–876. Available at: <http://ieeexplore.ieee.org/xpl/articleDetails.jsp?reload=true&arnumber=6297498>.

Ballanti, A. et al., 2013. Assessing the benefits of PV var absorption on the hosting capacity of LV feeders. In *IEEE PES ISGT Europe 2013*. IEEE, pp. 1–5. Available at: <https://www.escholar.manchester.ac.uk/uk-ac-man-scw:197001> [Accessed October 7, 2014].

Balta-Ozkan, N. et al., 2013. The development of smart homes market in the UK. *Energy*, 60, pp.361–372. Available at: <http://linkinghub.elsevier.com/retrieve/pii/S0360544213006798> [Accessed October 21, 2013].

Barré, A. et al., 2013. A review on lithium-ion battery ageing mechanisms and estimations for automotive applications. *Journal of Power Sources*, 241, pp.680–689. Available at: <http://www.sciencedirect.com/science/article/pii/S0378775313008185> [Accessed March 20, 2014].

BBC [Online], 2014a. BBC News - Building on the suburban dream. Available at: <http://www.bbc.co.uk/news/uk-26551219> [Accessed April 10, 2014].

BBC [Online], 2014b. BBC News - Building on the suburban dream.

BBC [Online], 2014c. BBC News - Cruachan hydro power station output “could double.” Available at: <http://www.bbc.co.uk/news/uk-scotland-glasgow-west-26124572> [Accessed April 10, 2014].

BBC [Online], 2011. BBC News - Formula 1 technology goes beyond the track. Available at: <http://www.bbc.co.uk/news/business-14046449> [Accessed April 10, 2014].

BBC [Online], 2012. BBC News - Liquid metal promise for future batteries. Available at: <http://www.bbc.co.uk/news/science-environment-20420557> [Accessed April 10, 2014].

-
- BBC [Online], 2014d. BBC News - Wind energy storage plan for Kilroot power station. Available at: <http://www.bbc.co.uk/news/uk-northern-ireland-26833713> [Accessed April 10, 2014].
- Beaudin, M. et al., 2010. Energy storage for mitigating the variability of renewable electricity sources: An updated review. *Energy for Sustainable Development*, 14(4), pp.302–314. Available at: <http://linkinghub.elsevier.com/retrieve/pii/S0973082610000566> [Accessed October 14, 2011].
- Bertini, D. et al., 2011. Hosting Capacity of Italian Distribution Networks. In *CIREN 21st International Conference on Electricity Distribution*. Frankfurt, Germany, pp. 6–9. Available at: http://www.cired.net/publications/cired2011/part1/papers/CIREN2011_0930_final.pdf.
- Black, M. & Strbac, G., 2006. Value of storage in providing balancing services for electricity generation systems with high wind penetration. *Journal of Power Sources*, 162(2), pp.949–953. Available at: <http://dx.doi.org/10.1016/j.jpowsour.2005.07.020> [Accessed March 18, 2014].
- Boone, G. & Chiang, H.-D., 1993. Optimal capacitor placement in distribution systems by genetic algorithm. *International Journal of Electrical Power & Energy Systems*, 15(3), pp.155–161. Available at: <http://linkinghub.elsevier.com/retrieve/pii/014206159390030Q>.
- Van den Bossche, P. et al., 2006. SUBAT: An assessment of sustainable battery technology. *Journal of Power Sources*, 162(2), pp.913–919. Available at: <http://linkinghub.elsevier.com/retrieve/pii/S0378775305008761> [Accessed March 7, 2012].
- Boston Consulting Group, 2010. *Focus Batteries for Electric Cars*, Available at: <http://www.bcg.com/documents/file36615.pdf>.
- Brandao, M., Johal, H. & Ion, L., 2011. Energy Storage for LV grid support in Australia. In *Innovative Smart Grid Technologies Asia (ISGT)*. pp. 1–8.
- British Standards Institution, 2007. *BS EN 50160:2007 Voltage characteristics of electricity supplied by public distribution networks*,
- Caire, R. et al., 2002. Impact Assessment of LV Distributed Generation on MV Distribution Network. In *IEEE Power Engineering Society Summer Meeting*. Saint Marin d’Heres, France, pp. 1423–1428.
- Campos-Celador, Á. et al., 2014. Design of a Finned Plate Latent Heat Thermal Energy Storage System for Domestic Applications. *Energy Procedia*, 48, pp.300–308. Available at: <http://www.sciencedirect.com/science/article/pii/S1876610214002975> [Accessed April 11, 2014].
- Canova, A. et al., 2009. Electrical Impact Of Photovoltaic Plant In Distributed Network. *IEEE Transactions on Industry Applications*, 45(1), pp.341–347.
-

-
- Carpinelli, G. et al., 2013. Optimal Integration of Distributed Energy Storage Devices in Smart Grids. *IEEE Transactions on Smart Grid*, pp.1–11. Available at: <http://ieeexplore.ieee.org/lpdocs/epic03/wrapper.htm?arnumber=6476054>.
- Castillo-Cagigal, M. et al., 2011. PV self-consumption optimization with storage and Active DSM for the residential sector. *Solar Energy*, 85(9), pp.2338–2348. Available at: <http://linkinghub.elsevier.com/retrieve/pii/S0038092X11002404> [Accessed August 11, 2012].
- Central Networks, 2011. Central Networks: About Us. Available at: <http://www.central-networks.co.uk/> [Accessed November 25, 2011].
- Chakraborty, S. et al., 2009. Determination methodology for optimising the energy storage size for power system. *IET Generation, Transmission & Distribution*, 3(11), p.987. Available at: <http://link.aip.org/link/IGTDAW/v3/i11/p987/s1&Agg=doi> [Accessed January 16, 2013].
- Chalise, S., Poudel, B.P. & Tonkoski, R., 2013. Overvoltages in LV rural feeders with high penetration of wind energy. In *2013 IEEE Power & Energy Society General Meeting*. IEEE, pp. 1–5. Available at: <http://ieeexplore.ieee.org/lpdocs/epic03/wrapper.htm?arnumber=6672971> [Accessed October 7, 2014].
- Chang, Y. et al., 2009. Lead-acid battery use in the development of renewable energy systems in China. *Journal of Power Sources*, 191(1), pp.176–183. Available at: <http://dx.doi.org/10.1016/j.jpowsour.2009.02.030> [Accessed February 13, 2012].
- Chen, H. et al., 2009. Progress in electrical energy storage system: A critical review. *Progress in Natural Science*, 19(3), pp.291–312. Available at: <http://dx.doi.org/10.1016/j.pnsc.2008.07.014> [Accessed July 4, 2011].
- Chua, K.H. et al., 2012. Energy Storage System for Mitigating Voltage Unbalance on Low-Voltage Networks With Photovoltaic Systems. *IEEE Transactions on Power Delivery*, 27(4), pp.1783–1790.
- CleanTechnica, 2014. Germany's Residential Battery Storage Subsidy A Success -- 4,000 New Systems In 1st Year. Available at: <http://cleantechnica.com/2014/05/18/germanys-residential-battery-storage-subsidy-success-4000-new-systems-1st-year/> [Accessed May 23, 2014].
- Clement-Nyns, K., Haesen, E. & Driesen, J., 2011. The impact of vehicle-to-grid on the distribution grid. *Electric Power Systems Research*, 81(1), pp.185–192. Available at: <http://dx.doi.org/10.1016/j.epsr.2010.08.007> [Accessed August 25, 2011].
- Climate Change Act, 2008. *HM Governmet*, London, UK.
- Committee on Climate Change, 2010. *The Fourth Carbon Budget*, London. Available at: <http://www.theccc.org.uk/reports/fourth-carbon-budget>.
- Consumer Focus, 2010. *Guaranteed Standards of electricity distribution*, London. Available at: <http://www.consumerfocus.org.uk/files/2011/12/Guaranteed-Standards-of-electricity-distribution.pdf>.
-

-
- Conti, S. et al., 2003. Integration of multiple PV units in urban power distribution systems. *Solar Energy*, 75(2), pp.87–94. Available at: <http://linkinghub.elsevier.com/retrieve/pii/S0038092X03002494> [Accessed November 2, 2011].
- Costa, P.M. & Matos, M.A., 2009. Avoided losses on LV networks as a result of microgeneration. *Electric Power Systems Research*, 79(4), pp.629–634. Available at: <http://linkinghub.elsevier.com/retrieve/pii/S0378779608002617> [Accessed October 22, 2013].
- Crossland, A., Anuta, O. & Wade, N.S., 2013. Can enhanced electrical storage unlock off-grid photovoltaic systems in rural Rwanda? Available at: Can enhanced electrical storage unlock off-grid photovoltaic systems in rural Rwanda? [Accessed July 20, 2012].
- Crossland, A., Jones, D. & Wade, N.S., 2013a. Energy Storage/Demand Side Response in LV Networks: Design of Cost Based Planning Tools for Network Operators. In *22nd International Conference on Electricity Distribution*. Stockholm.
- Crossland, A., Jones, D. & Wade, N.S., 2013b. Energy Storage/Demand Side Response in LV Networks: Design of Cost Based Planning Tools for Network Operators. In *22nd International Conference on Electricity Distribution*. Stockholm, Sweden.
- Crossland, A.F., Jones, D. & Wade, N.S., 2014. Planning the location and rating of distributed energy storage in LV networks using a genetic algorithm with simulated annealing. *International Journal of Electrical Power and Energy Systems*, 59, pp.103–110. Available at: <http://dx.doi.org/10.1016/j.ijepes.2014.02.001>.
- Deane, J.P., Ó Gallachóir, B.P. & McKeogh, E.J., 2010. Techno-economic review of existing and new pumped hydro energy storage plant. *Renewable and Sustainable Energy Reviews*, 14(4), pp.1293–1302. Available at: <http://linkinghub.elsevier.com/retrieve/pii/S1364032109002779> [Accessed July 25, 2011].
- Delfanti, M., Falabretti, D. & Merlo, M., 2013. Dispersed generation impact on distribution network losses. *Electric Power Systems Research*, 97, pp.10–18. Available at: <http://linkinghub.elsevier.com/retrieve/pii/S0378779612003513> [Accessed July 30, 2013].
- Dell, R. & Rand, D.A.J., 2001. Energy storage — a key technology for global energy sustainability. *Journal of Power Sources*, 100(1-2), pp.2–17. Available at: [http://dx.doi.org/10.1016/S0378-7753\(01\)00894-1](http://dx.doi.org/10.1016/S0378-7753(01)00894-1) [Accessed February 4, 2012].
- Demirok, E. et al., 2011. Local Reactive Power Control Methods for Overvoltage Prevention of Distributed Solar Inverters in Low-Voltage Grids. *IEEE Journal of Photovoltaics*, 1(2), pp.174–182.
- Denholm, P. & Hand, M., 2011. Grid flexibility and storage required to achieve very high penetration of variable renewable electricity. *Energy Policy*, 39(3), pp.1817–1830. Available at: <http://linkinghub.elsevier.com/retrieve/pii/S0301421511000292> [Accessed July 18, 2011].
-

- Denholm, P. & Margolis, R.M., 2007. Evaluating the limits of solar photovoltaics (PV) in electric power systems utilizing energy storage and other enabling technologies. *Energy Policy*, 35(9), pp.4424–4433. Available at: <http://linkinghub.elsevier.com/retrieve/pii/S030142150700095X>.
- Department of Energy and Climate Change, 2014a. £8 million boost for energy storage innovation - Press releases - GOV.UK. Available at: <https://www.gov.uk/government/news/8-million-boost-for-energy-storage-innovation> [Accessed April 11, 2014].
- Department of Energy and Climate Change, 2014b. *2012 UK Greenhouse Gas Emissions, Final Figures*, London, UK. Available at: <https://www.gov.uk/government/publications/final-uk-emissions-estimates>.
- Department of Energy and Climate Change, 2014c. *2013 UK Greenhouse Gas Emissions, Provisional Figures and 2012 UK Greenhouse Gas Emissions, Final Figures by Fuel Type and End-User*, London, UK. Available at: https://www.gov.uk/government/uploads/system/uploads/attachment_data/file/295968/20140327_2013_UK_Greenhouse_Gas_Emissions_Provisional_Figures.pdf [Accessed April 11, 2014].
- Department of Energy and Climate Change, 2011a. *2050 pathways analysis*, London. Available at: <http://www.decc.gov.uk/en/content/cms/tackling/2050/2050.aspx> [Accessed November 7, 2011].
- Department of Energy and Climate Change, 2009a. *Consultation on Renewable Electricity Financial Incentives*, London. Available at: http://www.decc.gov.uk/en/content/cms/consultations/elec_financial/elec_financial.aspx [Accessed November 25, 2011].
- Department of Energy and Climate Change et al., 2011. *Digest of UK energy statistics*, London. Available at: <https://www.gov.uk/government/collections/digest-of-uk-energy-statistics-dukes>.
- Department of Energy and Climate Change, 2010. *Electricity Market Reform*, London.
- Department of Energy and Climate Change, 2014d. Electricity Market Reform: Capacity Market design - News stories - GOV.UK. Available at: <https://www.gov.uk/government/news/electricity-market-reform-capacity-market-design> [Accessed October 9, 2014].
- Department of Energy and Climate Change, 2014e. Feed-in Tariff Statistics. Available at: <https://www.gov.uk/government/organisations/department-of-energy-climate-change/series/feed-in-tariff-statistics> [Accessed April 9, 2014].
- Department of Energy and Climate Change, 2012a. FiTs Implementation. Available at: http://www.decc.gov.uk/en/content/cms/meeting_energy/renewable_ener/feedin_tariff/implementation/implementation.aspx [Accessed March 12, 2012].
- Department of Energy and Climate Change, 2011b. *Planning our electric future: a White Paper for secure, affordable and low carbon electricity*, London. Available at:

http://www.decc.gov.uk/en/content/cms/legislation/white_papers/emr_wp_2011/emr_wp_2011.aspx.

Department of Energy and Climate Change, 2009b. *Smarter grids: the opportunity*, London. Available at: [http://www.decc.gov.uk/assets/decc/what we do/uk energy supply/futureelectricitynetworks/1_20091203163757_e_@@_smartergridsoportunity.pdf](http://www.decc.gov.uk/assets/decc/what_we_do/uk_energy_supply/futureelectricitynetworks/1_20091203163757_e_@@_smartergridsoportunity.pdf) [Accessed October 26, 2011].

Department of Energy and Climate Change, 2012b. *Sub-national electricity consumption and household analysis*, London, UK. Available at: https://www.gov.uk/government/uploads/system/uploads/attachment_data/file/65933/4782-subnat-electricity-cons-stats-article.pdf.

Department of Energy and Climate Change, 2012c. *The Future of Heating : A strategic framework for low carbon heat in the UK*, London. Available at: <http://www.decc.gov.uk/assets/decc/11/meeting-energy-demand/heat/4805-future-heating-strategic-framework.pdf>.

Department of Energy and Climate Change, 2009c. *The UK Renewable Energy Strategy*. Available at: <https://www.gov.uk/government/publications/the-uk-renewable-energy-strategy>.

Department of Energy and Climate Change, 2011c. *UK Renewable Energy Roadmap*, Available at: http://www.decc.gov.uk/en/content/cms/meeting_energy/renewable_ener/re_roadmap/re_roadmap.aspx.

Department of Energy and Climate Change, 2013. *UK Solar PV Strategy Part 1: Roadmap to a Brighter Future*, London,UK. Available at: https://www.gov.uk/government/uploads/system/uploads/attachment_data/file/249277/UK_Solar_PV_Strategy_Part_1_Roadmap_to_a_Brighter_Future_08.10.pdf.

Department of Trade and Industry, 2007. *Meeting the Energy Challenge: A White Paper on Energy*, London.

Díaz-González, F. et al., 2012. A review of energy storage technologies for wind power applications. *Renewable and Sustainable Energy Reviews*, 16(4), pp.2154–2171. Available at: <http://linkinghub.elsevier.com/retrieve/pii/S1364032112000305> [Accessed February 27, 2012].

Divya, K.C. & Østergaard, J., 2009. Battery energy storage technology for power systems—An overview. *Electric Power Systems Research*, 79(4), pp.511–520. Available at: <http://linkinghub.elsevier.com/retrieve/pii/S0378779608002642> [Accessed July 22, 2011].

DOE Global Energy Storage Database, 2014a. DOE Global Energy Storage Database Smart Grid, Smart City. Available at: <http://www.energystorageexchange.org/projects/57> [Accessed April 15, 2014].

DOE Global Energy Storage Database, 2014b. DOE Global Energy Storage Database SMUD PV & Smart Grid Pilot at Anatolia. Available at: <http://www.energystorageexchange.org/projects/284> [Accessed April 15, 2014].

- Eisenreich, M. et al., 2010. Integration of PV systems into low voltage networks using standard load profiles. In *International Conference of Renewable Energies and Power Quality*. Grenada, Spain.
- Ekren, O. & Ekren, B.Y., 2010. Size optimization of a PV/wind hybrid energy conversion system with battery storage using simulated annealing. *Applied Energy*, 87(2), pp.592–598. Available at: <http://linkinghub.elsevier.com/retrieve/pii/S0306261909002177> [Accessed October 19, 2012].
- Electricity Networks Association, 2014. ENA - Overview of DNOs. Available at: <http://www.4thintegrationconference.com/detailed.asp> [Accessed April 15, 2014].
- Electricity North West Limited, 2011. About Us. Available at: <http://www.enwl.co.uk/about-us> [Accessed November 25, 2011].
- Electricity North West Limited, 2013. Summary of Network Design Policies. Available at: <http://www.enwl.co.uk/about-us/long-term-development-statement/policies-and-technical-references/summary-of-network-design-policies> [Accessed September 23, 2013].
- Electricity Storage Network, 2014. *Development of electricity storage in the national interest*, Available at: <http://www.electricitystorage.co.uk/documents/140513ESNReportfinalweb.pdf>.
- Energy Networks Association, 2012. *Engineering Recommendation G83 Issue 2 (August 2012)*, London, UK.
- Energy Networks Association, 1990. *Engineering Recommendation P29: Planning Limits for Voltage Unbalance in the United Kingdom*, London.
- Energy Research Partnership, 2010. *Electricity Infrastructure*, London, UK. Available at: <http://www.energyresearchpartnership.org.uk/page12>.
- Energy Research Partnership, 2011. *The future role for energy storage in the UK Main Report*, Available at: <http://www.energyresearchpartnership.org.uk/tiki-index.php?page=page12>.
- Energy Storage Industry News, 2014. Energy Storage Industry News. Available at: <http://www.energystorageindustrynews.com/> [Accessed April 11, 2014].
- Energy Storage Journal, 2013. Bye Bye FIT Hello self- consumption. Available at: <http://energystoragejournal.com/bye-bye-fit-hello-self-consumption/> [Accessed April 10, 2014].
- Energy Storage Journal, 2014. Germany introduces subsidy for PV and storage systems. Available at: <http://energystoragejournal.com/germany-introduces-subsidy-for-pv-and-storage-systems/> [Accessed April 11, 2014].
- EPRI, 2010. *Electricity Energy Storage Technology Options*, Palo Alto, CA.
- EPRI, 2013. Simulation Tool - OpenDSS. Available at: <http://www.smartgrid.epri.com/SimulationTool.aspx> [Accessed October 24, 2013].
-

-
- Etheridge, A., 2014. Balancing and Markets Manager, Energy Strategy and Policy. In *Energy Storage World Forum, London*. London, UK.
- Evans, A., Strezov, V. & Evans, T.J., 2012. Assessment of utility energy storage options for increased renewable energy penetration. *Renewable and Sustainable Energy Reviews*, 16(6), pp.4141–4147. Available at: <http://linkinghub.elsevier.com/retrieve/pii/S1364032112002316> [Accessed May 7, 2012].
- Eyer, J., 2009. *Electric Utility Transmission and Distribution Upgrade Deferral Benefits from Modular Electricity Storage*, Albuquerque.
- Eyer, J. & Corey, G., 2010. *Energy Storage for the Electricity Grid: Benefits and Market Potential Assessment Guide A Study for the DOE Energy Storage Systems Program*, Albuquerque.
- Fekete, K., Klaic, Z. & Majdandzic, L., 2012. Expansion of the residential photovoltaic systems and its harmonic impact on the distribution grid. *Renewable Energy*, 43, pp.140–148. Available at: <http://linkinghub.elsevier.com/retrieve/pii/S0960148111006288> [Accessed October 22, 2013].
- Ferreira, H.L. et al., 2013. Characterisation of electrical energy storage technologies. *Energy*, 53, pp.288–298. Available at: <http://linkinghub.elsevier.com/retrieve/pii/S0360544213001515> [Accessed October 21, 2013].
- Forbes, 2013. Solar Energy Storage About To Take Off In Germany and California. Available at: <http://www.forbes.com/sites/justingerdes/2013/07/18/solar-energy-storage-about-to-take-off-in-germany-and-california/> [Accessed September 10, 2014].
- Fritz, J. & Russ, D.H., 2002. *Non-Technical Losses in Electrical Power Systems*. Ohio University.
- Gan, C.K. et al., 2011. Statistical appraisal of economic design strategies of LV distribution networks. *Electric Power Systems Research*, 81(7), pp.1363–1372. Available at: <http://www.sciencedirect.com/science/article/pii/S0378779611000368> [Accessed April 23, 2014].
- Gandomkar, M., Vakilian, M. & Ehsan, M., 2005. A combination of genetic algorithm and simulated annealing for optimal DG allocation in distribution networks. *Canadian Conference on Electrical and Computer Engineering, 2005.*, (May), pp.645–648. Available at: <http://ieeexplore.ieee.org/lpdocs/epic03/wrapper.htm?arnumber=1557013>.
- Gantz, J.M., Amin, S.M. & Giacomoni, A.M., 2012. Optimal Mix and Placement of Energy Storage Systems in Power Distribution Networks for Reduced Outage Costs. In *Energy Conversion Congress and Exposition*. Raleigh, NC, pp. 2447–2453. Available at: http://ieeexplore.ieee.org/xpl/articleDetails.jsp?tp=&arnumber=6342550&contentType=Conference+Publications&searchField%3DSearch_All%26queryText%3Dsimulated+annealing+energy+storage.
-

-
- Geth, F., Tant, J. & Haesen, E., 2010. Integration of Energy Storage in Distribution Grids. In *Power and Energy Society General Meeting*. Minneapolis, MN, pp. 1–6. Available at: http://ieeexplore.ieee.org/xpls/abs_all.jsp?arnumber=5590082&tag=1.
- Ghassem, M. et al., 2013. A New Voltage Support Approach for Distribution Networks. *IEEE Transactions on Smart Grid*.
- Gonzalez, C. et al., 2012. LV Distribution Network Feeders in Belgium and Power Quality Issues due to Increasing PV Penetration Levels. In *Innovative Smart Grid Technologies (ISGT), 2012*. Berlin, pp. 1–8.
- González-Longatt, F.M., 2007. Impact of Distributed Generation over Power Losses on Distribution System. In *9th International Conference, Electrical Power Quality and Utilisation*. Barcelona.
- Green, J.P., Smith, S.A. & Strbac, G., 1999. Evaluation of electricity distribution system design strategies. *IEE Proceedings - Generation, Transmission and Distribution*, 146(1), p.53. Available at: http://digital-library.theiet.org/content/journals/10.1049/ip-gtd_19990067 [Accessed April 23, 2014].
- Green Tech Media, 2012. The Numbers Behind Tesla and SolarCity's Home Energy Storage Play : Greentech Media. Available at: <http://www.greentechmedia.com/articles/read/the-numbers-behind-tesla-and-solarcitys-solar-home-energy-storage-play> [Accessed September 10, 2014].
- Grünewald, P.H. et al., 2012. The socio-technical transition of distributed electricity storage into future networks—System value and stakeholder views. *Energy Policy*. Available at: <http://linkinghub.elsevier.com/retrieve/pii/S0301421512006337> [Accessed August 27, 2012].
- Gyuk, I. et al., 2005. The United States of Storage. *IEEE Power and Energy Magazine*, (March/April), pp.31–39.
- Hadjipaschalis, I., Poullikkas, A. & Efthimiou, V., 2009. Overview of current and future energy storage technologies for electric power applications. *Renewable and Sustainable Energy Reviews*, 13(6-7), pp.1513–1522. Available at: <http://dx.doi.org/10.1016/j.rser.2008.09.028> [Accessed June 14, 2011].
- Hall, P.J. & Bain, E., 2008. Energy-storage technologies and electricity generation. *Energy Policy*, 36(12), pp.4352–4355. Available at: <http://dx.doi.org/10.1016/j.enpol.2008.09.037> [Accessed September 5, 2011].
- Han, B., Cho, B. & Sul, S., 2006. Unified power quality conditioner for compensating voltage interruption. *Journal of Electrical Engineering & Technology*, 1(4), pp.503–512. Available at: [http://pearlx.snu.ac.kr/Publication/Unified Power Quality Conditioner for compensating voltage interruption.pdf](http://pearlx.snu.ac.kr/Publication/Unified%20Power%20Quality%20Conditioner%20for%20compensating%20voltage%20interruption.pdf) [Accessed March 23, 2012].
- Harrison, J.A., 1999. *The Essence of Electric Power Systems* 1st ed., Harlow: Pearson Education Limited.
-

-
- Hashemi, S., Ostergaard, J. & Yang, G., 2014. A Scenario-Based Approach for Energy Storage Capacity Determination in LV Grids With High PV Penetration. *IEEE Transactions on Smart Grid*, 5(3), pp.1514–1522. Available at: <http://ieeexplore.ieee.org/lpdocs/epic03/wrapper.htm?arnumber=6782335>.
- Hemdan, N.G.A. & Kurrat, M., 2011. Interconnection of decentralized renewable resources into distribution grids: Implications and planning aspects. *Electric Power Systems Research*, 81(7), pp.1410–1423. Available at: <http://linkinghub.elsevier.com/retrieve/pii/S0378779611000502> [Accessed April 24, 2014].
- Herman, R. & Gaunt, C.T., 2008. A Practical Probabilistic Design Procedure for LV Residential Distribution Systems. *IEEE Transactions on Power Delivery*, 23(4), pp.2247–2254.
- Hittinger, E., Whitacre, J.F. & Apt, J., 2012. What properties of grid energy storage are most valuable? *Journal of Power Sources*, 206, pp.436–449. Available at: <http://linkinghub.elsevier.com/retrieve/pii/S0378775311024220> [Accessed March 9, 2012].
- HM Treasury & Department of Energy and Climate Change, 2010. *Energy Market Assessment*, London.
- HMSO, 2002. *The Electricity Safety, Quality and Continuity Regulations 2002*, UK: HMSO, no 2665. Available at: <http://www.legislation.gov.uk/ukxi/2002/2665/contents/made> [Accessed February 2, 2012].
- Hoff, T.E., Perez, R. & Margolis, R.M., 2005. Maximising the Value of Customer-Sited PV Systems Using Storage and Controls. In D. Y. Goswami, S. Vijayaraghavan, & R. Campbell-Howe, eds. *Proceedings of 2005 Solar World Congress*. Orlando, FL: International Solar Energy Society (ISES), p. 6.
- Huang, X., Zhang, G. & Xiao, L., 2010. Optimal Location of SMES for Improving Power System Voltage Stability. *IEEE Transactions on Applied Superconductivity*, 20(3), pp.1316–1319. Available at: <http://ieeexplore.ieee.org/lpdocs/epic03/wrapper.htm?arnumber=5444930>.
- Huang, Y., Yang, H.-T. & Huang, C.-L., 1996. Solving the Capacitor Placement Problem in a Radial Distribution System Using Tabu Search Approach. *IEEE Transactions on Power Systems*, 11(4), pp.1868–1873.
- Hughes, E., 1969. *Electrical Technology* 4th ed., Longmans, Green and Co. LTD.
- Hung, D.Q. & Mithulananthan, N., 2011. Community Energy Storage and Capacitor Allocation in Distribution Systems. In *21st Australasian Universities Power Engineering Conference (AUPEC)*, Brisbane, pp. 1–6.
- Hung, D.Q., Mithulananthan, N. & Lee, K.Y., 2014. Optimal placement of dispatchable and nondispatchable renewable DG units in distribution networks for minimizing energy loss. *International Journal of Electrical Power & Energy Systems*, 55, pp.179–186. Available at:
-

-
- <http://linkinghub.elsevier.com/retrieve/pii/S0142061513003803> [Accessed October 21, 2013].
- Ibrahim, H., Ilinca, A. & Perron, J., 2008. Energy storage systems—Characteristics and comparisons. *Renewable and Sustainable Energy Reviews*, 12(5), pp.1221–1250. Available at: <http://linkinghub.elsevier.com/retrieve/pii/S1364032107000238> [Accessed July 25, 2011].
- IEA, 2002a. *Impacts of power penetration from photovoltaic power systems in distribution networks*,
- IEA, 2002b. *Risk analysis of islanding of photovoltaic power systems within low voltage distribution networks*, Swindon.
- IEA, 2014. *Technology Roadmap: Energy Storage*, Paris, France.
- IEEE Distribution Test Feeder Working Group, 2012. Distribution Test Feeders. Available at: <http://ewh.ieee.org/soc/pes/dsacom/testfeeders/index.html> [Accessed April 10, 2014].
- IMechE, 2014. *Energy Storage: The Missing Link in the UK's Energy Commitments*, London. Available at: <http://www.imeche.org/docs/default-source/reports/imeche-energy-storage-report.pdf?sfvrsn=4>.
- Immersun, 2014. PV Water Heating, Solar Hot Water Switch and Controller Supplier. Available at: <http://www.immersun.co.uk/> [Accessed May 23, 2014].
- Inalli, M., Ünsal, M. & Tanyildizi, V., 1997. A computational model of a domestic solar heating system with underground spherical thermal storage. *Energy*, 22(12), pp.1163–1172. Available at: <http://www.sciencedirect.com/science/article/pii/S0360544297000492> [Accessed April 11, 2014].
- IPSA, 2014. Welcome to IPSA Power. Available at: <http://www.ipsa-power.com/> [Accessed August 25, 2014].
- Jardini, J.A. et al., 2000. Daily Load Profiles for Residential , Commercial and Industrial Low Voltage Consumers. *IEEE Transactions on Power Delivery*, 15(1), pp.375–380.
- Jegathesan, V. & Jerome, J., 2011. Elimination of lower order harmonics in Voltage Source Inverter feeding an induction motor drive using Evolutionary Algorithms. *Expert Systems with Applications*, 38(1), pp.692–699. Available at: <http://linkinghub.elsevier.com/retrieve/pii/S095741741000638X> [Accessed April 12, 2014].
- Jenkins, D.P., Fletcher, J. & Kane, D., 2008. Model for evaluating impact of battery storage on microgeneration systems in dwellings. *Energy Conversion and Management*, 49(8), pp.2413–2424. Available at: <http://dx.doi.org/10.1016/j.enconman.2008.01.011> [Accessed August 6, 2011].
- Johnson, M.P. et al., 2011. Energy peak shaving with local storage. *Sustainable Computing: Informatics and Systems*, 1(3), pp.177–188. Available at:
-

-
- <http://linkinghub.elsevier.com/retrieve/pii/S2210537911000357> [Accessed October 25, 2011].
- JRC, 2014. Photovoltaic Geographical Information System. Available at: <http://re.jrc.ec.europa.eu/pvgis/apps4/pvest.php> [Accessed March 5, 2014].
- Kahrobaee, S. & Asgarpoor, S., 2013. Optimum Sizing of Distributed Generation and Storage Capacity in Smart Households. *IEEE Transactions on Smart Grid*, 4(4), pp.1791–1801.
- Kaldellis, J.K., 2008. Integrated electrification solution for autonomous electrical networks on the basis of RES and energy storage configurations. *Energy Conversion and Management*, 49(12), pp.3708–3720. Available at: <http://dx.doi.org/10.1016/j.enconman.2008.06.034> [Accessed October 25, 2011].
- Kaldellis, J.K. & Zafirakis, D., 2007. Optimum energy storage techniques for the improvement of renewable energy sources-based electricity generation economic efficiency. *Energy*, 32(12), pp.2295–2305. Available at: <http://dx.doi.org/10.1016/j.energy.2007.07.009> [Accessed June 18, 2011].
- Kaldellis, J.K., Zafirakis, D. & Kavadias, K.A., 2009. Techno-economic comparison of energy storage systems for island autonomous electrical networks. *Renewable and Sustainable Energy Reviews*, 13(2), pp.378–392. Available at: <http://dx.doi.org/10.1016/j.rser.2007.11.002> [Accessed June 15, 2011].
- Kapsali, M. & Kaldellis, J.K., 2010. Combining hydro and variable wind power generation by means of pumped-storage under economically viable terms. *Applied Energy*, 87(11), pp.3475–3485. Available at: <http://dx.doi.org/10.1016/j.apenergy.2010.05.026> [Accessed October 31, 2011].
- Kashem, M.A., Negnevitsky, M. & Ledwich, G., 2006. Distributed Generation for Minimization of Power Losses in Distribution Systems. *IEEE Power Engineering Society General Meeting*, pp.1–8.
- Kazempour, S.J. et al., 2009. Electric energy storage systems in a market-based economy: Comparison of emerging and traditional technologies. *Renewable Energy*, 34(12), pp.2630–2639. Available at: <http://linkinghub.elsevier.com/retrieve/pii/S0960148109001906> [Accessed November 28, 2011].
- KEMA, 2012. *Market Evaluation for Energy Storage in the United States*, Fairfax, VA.
- KfW, 2013. KfW and Federal Environment Ministry launch programme to promote use of energy storage in solar PV installations. Available at: https://www.kfw.de/KfW-Group/Newsroom/Aktuelles/Pressemitteilungen/Pressemitteilungen-Details_107136.html [Accessed October 7, 2014].
- Kim, H.-M. et al., 2012. Exploring the concept of compressed air energy storage (CAES) in lined rock caverns at shallow depth: A modeling study of air tightness and energy balance. *Applied Energy*, 92, pp.653–667. Available at: <http://www.sciencedirect.com/science/article/pii/S0306261911004582> [Accessed April 10, 2014].
-

-
- Kolenc, M., Papič, I. & Blažič, B., 2015. Assessment of maximum distributed generation penetration levels in low voltage networks using a probabilistic approach. *International Journal of Electrical Power & Energy Systems*, 64, pp.505–515. Available at: <http://linkinghub.elsevier.com/retrieve/pii/S0142061514004980> [Accessed August 20, 2014].
- Kottick, D. & Blau, M., 1993. Operational and economic benefits of battery energy storage plants. *International Journal of Electrical Power & Energy Systems*, 15(6), pp.345–349. Available at: <http://linkinghub.elsevier.com/retrieve/pii/0142061593900025>.
- Latheef, A.A., Gosbell, V.J. & Smith, V., 2006. Harmonic Impact of Residential Type Photovoltaic Inverters on 11kV Distribution System. In *Australian Universities Power Engineering Conference*. Melbourne, Victoria. Available at: http://www.elec.uow.edu.au/iepqrc/content/papers/AUPEC/AUPEC06_3.pdf.
- Leou, R.-C., 2011. An economic analysis model for the energy storage system applied to a distribution substation. *International Journal of Electrical Power & Energy Systems*, 34(1), pp.132–137. Available at: <http://dx.doi.org/10.1016/j.ijepes.2011.09.016> [Accessed November 2, 2011].
- Liu, X., Aichhorn, A. & Liu, L., 2012. Coordinated Control of Distributed Energy Storage System With Tap Changer Transformers for Voltage Rise Mitigation Under High Photovoltaic Penetration. *IEEE Transactions on Smart Grid*, 3(2), pp.897–906.
- Mackay, D.J.C., 2008. *Sustainable Energy—Without the Hot Air*, Cambridge: UIT.
- Madureira, A.G. & Peças Lopes, J.A., 2009. Coordinated voltage support in distribution networks with distributed generation and microgrids. *IET Renewable Power Generation*, 3(4), p.439. Available at: <http://digital-library.theiet.org/content/journals/10.1049/iet-rpg.2008.0064> [Accessed October 21, 2013].
- Mancarella, P., Gan, C.K. & Strbac, G., 2011. Evaluation of the impact of electric heat pumps and distributed CHP on LV networks. In *IEEE PowerTech*. Trondheim, pp. 1–7. Available at: http://ieeexplore.ieee.org/xpls/abs_all.jsp?arnumber=6019297.
- Manitoba HVDC Research Centre, 2014. PSCAD Home. Available at: <https://hvdc.ca/pscad/> [Accessed August 25, 2014].
- Manjunatha Sharma, K., Vittal, K.P. & Seshagiri, P., 2008. A heuristic approach for Distributed Generation sources location and capacity evaluation in distribution systems. In *TENCON 2008 - 2008 IEEE Region 10 Conference*. Hyderabad, India: IEEE. Available at: <http://ieeexplore.ieee.org/lpdocs/epic03/wrapper.htm?arnumber=4766655>.
- Mao, B. et al., 2010. Dynamic modelling for distribution networks containing dispersed generations and energy storage devices. In *2010 International Conference on Power System Technology*. Hangzhou, China: IEEE. Available at: <http://ieeexplore.ieee.org/lpdocs/epic03/wrapper.htm?arnumber=5666158>.
-

-
- Marra, F. et al., 2014. A Decentralized Storage Strategy for Residential Feeders With Photovoltaics. *IEEE Transactions on Smart Grid*, 5(2), pp.974–981.
- Marra, F. et al., 2012. Energy Storage Options for Voltage Support in Low-Voltage Grids with High Penetration of Photovoltaic. In *3rd IEEE PES International Conference and Exhibition on Innovative Smart Grid Technologies (ISGT Europe)2*. Berlin, Germany.
- Masoum, A.S. et al., 2012. Impact of Rooftop PV Generation on Distribution Transformer and Voltage Profile of Residential and Commercial Networks. In *IEEE PES Innovative Smart Grid Technologies*. Washington DC, pp. 1–7.
- Masters, C.L., 2002. Voltage rise the big issue when connecting embedded generation to long 11 kV overhead lines. *Power Engineering Journal*, 16(1), pp.5–12. Available at: http://ieeexplore.ieee.org/xpls/abs_all.jsp?arnumber=990181.
- MathWorks, 2014a. How the Genetic Algorithm Works. Available at: <http://www.mathworks.co.uk/help/gads/how-the-genetic-algorithm-works.html#f6192> [Accessed May 7, 2014].
- MathWorks, 2013. MATLAB. Available at: <http://www.mathworks.co.uk/products/matlab/> [Accessed June 21, 2013].
- MathWorks, 2014b. MATLAB Global Optimization Toolbox. Available at: <http://www.mathworks.co.uk/products/global-optimization/> [Accessed February 21, 2014].
- MathWorks, 2014c. One-sample Kolmogorov-Smirnov test. Available at: <http://www.mathworks.co.uk/help/stats/kstest.html> [Accessed February 10, 2014].
- McDowall, J., 2005. Integrating energy storage with wind power in weak electricity grids. *Journal of Power Sources*, 162(2), pp.959–964. Available at: <http://dx.doi.org/10.1016/j.jpowsour.2005.06.034> [Accessed July 12, 2011].
- McQueen, D.H.O., Hyland, P.R. & Watson, S.J., 2004. Monte Carlo Simulation of Residential Electricity Demand for Forecasting Maximum Demand on Distribution Networks. *IEEE Transactions on Power Systems*, 19(3), pp.1685–1689. Available at: <http://ieeexplore.ieee.org/lpdocs/epic03/wrapper.htm?arnumber=1318709>.
- Moeed Amjad, A. & Salam, Z., 2014. A review of soft computing methods for harmonics elimination PWM for inverters in renewable energy conversion systems. *Renewable and Sustainable Energy Reviews*, 33, pp.141–153. Available at: <http://www.sciencedirect.com/science/article/pii/S1364032114001026> [Accessed April 10, 2014].
- Mohd, A. et al., 2008. Challenges in Integrating Distributed Energy Storage Systems into Future Smart Grid. In *International Symposium on Industrial Electronics*. pp. 1627–1632.
- Mokhtari, G. et al., 2013. Overvoltage prevention in LV smart grid using customer resources coordination. *Energy and Buildings*, 61, pp.387–395. Available at: <http://linkinghub.elsevier.com/retrieve/pii/S0378778813000911> [Accessed July 17, 2013].
-

- Mondol, J.D., Yohanis, Y.G. & Norton, B., 2007. The impact of array inclination and orientation on the performance of a grid-connected photovoltaic system. *Renewable Energy*, 32(1), pp.118–140. Available at: <http://linkinghub.elsevier.com/retrieve/pii/S0960148106001170> [Accessed October 31, 2013].
- Moneta, D. et al., 2007. New interactions between LV customers and the network : further possibilities for home automation functions. In *IEEE International Conference on Robotics and Automation*. pp. 2886–2891.
- Moore, T. & Douglas, J., 2006. Energy Storage: Big Opportunities on a Smaller Scale. Available at: http://mydocs.epri.com/docs/CorporateDocuments/EPRI_Journal/2006-Spring/1013289_storage.pdf.
- Mulder, G., Ridder, F. De & Six, D., 2010. Electricity storage for grid-connected household dwellings with PV panels. *Solar Energy*, 84(7), pp.1284–1293. Available at: <http://linkinghub.elsevier.com/retrieve/pii/S0038092X10001519> [Accessed August 27, 2012].
- My Electric Avenue, 2014. My Electric Avenue. Available at: <http://myelectricavenue.info/> [Accessed May 23, 2014].
- Naidu, M.S. & Kamakshaiah, S., 1995. *Introduction to Electrical Engineering*, McGraw-Hill Education (India) Pvt Limited.
- Nair, N.-K.C. & Garimella, N., 2010. Battery energy storage systems: Assessment for small-scale renewable energy integration. *Energy and Buildings*, 42(11), pp.2124–2130. Available at: <http://dx.doi.org/10.1016/j.enbuild.2010.07.002> [Accessed July 22, 2011].
- National Grid Company, 2011a. *2011 National Electricity Transmission System (NETS) Seven Year Statement*, Available at: <http://www.nationalgrid.com/uk/Electricity/SYS/current/>.
- National Grid Company, 2011b. *National Electricity Transmission System Seven Year Statement*,
- National Grid Company, 2011c. Regulatory environment – UK regulation - National Grid Annual Report and Accounts 2010/11. Available at: <http://www.nationalgrid.com/annualreports/2011/operating-and-financial-review/operating-environment/regulatory-environment.html> [Accessed December 13, 2011].
- National Grid Company, 2014. UK | National Grid. Available at: <http://www2.nationalgrid.com/uk/> [Accessed April 10, 2014].
- National Grid Company, 2011d. *UK Future Energy Scenarios*, Available at: http://www.nationalgrid.com/NR/rdonlyres/86C815F5-0EAD-46B5-A580-A0A516562B3E/50819/10312_1_NG_Futureenergyscenarios_WEB1.pdf [Accessed April 11, 2014].

- Navarro, A., Ochoa, L.F. & Randles, D., 2013. Monte Carlo-Based Assessment of PV Impacts on Real UK Low Voltage Networks. In *IEEE Power and Energy Society General Meeting*. Vancouver, BC, pp. 1–5.
- Nick, M., Hohmann, M. & Cherkaoui, R., 2012. On the Optimal Placement of Distributed Storage Systems for Voltage Control in Active Distribution Networks. In *3rd IEEE PES International Conference and Exhibition on Innovative Smart Grid Technologies (ISGT Europe)*. Berlin.
- NREL, 2011. A Performance Calculator for Grid-Connected PV Systems. Available at: redc.nrel.gov/solar/calculators/PVWATTS/version1/ [Accessed November 30, 2011].
- Ofgem, 2011a. About Us. Available at: <http://www.ofgem.gov.uk/AboutUs/Pages/AboutUsPage.aspx> [Accessed November 4, 2011].
- Ofgem, 2010a. *Electricity Distribution Price Control Review Final Proposals 144/09*, Available at: <https://www.ofgem.gov.uk/ofgem-publications/46746/fp1core-document-ss-final.pdf>.
- Ofgem, 2009. *Electricity Distribution Price Control Review Final Proposals 145/09*, London. Available at: <http://www.ofgem.gov.uk/Pages/MoreInformation.aspx?docid=348&refer=Networks/ElecDist/PriceCtrls/DPCR5> [Accessed February 1, 2012].
- Ofgem, 2010b. *Low Carbon Network Fund Factsheet*, Available at: <http://www.ofgem.gov.uk/Media/FactSheets/Documents1/LCNbro.pdf> [Accessed November 25, 2011].
- Ofgem, 2014a. Low Carbon Networks Fund | Ofgem. Available at: <https://www.ofgem.gov.uk/electricity/distribution-networks/network-innovation/low-carbon-networks-fund> [Accessed April 11, 2014].
- Ofgem, 2011b. *Ofgem Factsheet: Household energy bills explained*, Available at: <http://www.ofgem.gov.uk/Markets/Pages/Markets.aspx>.
- Ofgem, 2014b. *Renewables Obligation Annual Report 2012-13*, London, UK. Available at: <https://www.ofgem.gov.uk/ofgem-publications/86392/roannualreport2012-13final.pdf>.
- Ofgem, 2010c. *RfIO: A new way to regulate energy networks*, London. Available at: <http://www.ofgem.gov.uk/Networks/rpix20/Pages/RPIX20.aspx>.
- Ofgem, 2005. *Securing Britain's Electricity Supply*, Available at: <http://www.ofgem.gov.uk/Media/FactSheets/Documents1/5337-soselecupdatemay05.pdf>.
- Ofgem, 2014c. Tariff tables | Ofgem. Available at: <https://www.ofgem.gov.uk/environmental-programmes/feed-tariff-fit-scheme/tariff-tables> [Accessed April 15, 2014].

-
- Ofgem, 2011c. Transmission. Available at: <http://www.ofgem.gov.uk/Networks/Trans/Pages/trans.aspx> [Accessed November 25, 2011].
- Paatero, J. V. & Lund, P.D., 2006. A model for generating household electricity load profiles. *International Journal of Energy Research*, 30(5), pp.273–290. Available at: <http://doi.wiley.com/10.1002/er.1136> [Accessed August 3, 2011].
- Papadopoulos, P. et al., 2009. Distribution Networks with Electric Vehicles. In *Universities Power Engineering Conference*. Glasgow. Available at: http://ieeexplore.ieee.org/xpls/abs_all.jsp?arnumber=5429477.
- Papaioannou, I.T. et al., 2008. Harmonic Impact of Small Photovoltaic Systems Connected to the LV Distribution Network. In *5th International Conference on European Electricity Market, 2008. EEM 2008*. Lisbon.
- Papaioannou, I.T. & Purvins, A., 2014. A methodology to calculate maximum generation capacity in low voltage distribution feeders. *International Journal of Electrical Power & Energy Systems*, 57, pp.141–147. Available at: <http://linkinghub.elsevier.com/retrieve/pii/S014206151300505X> [Accessed January 12, 2014].
- Papaioannou, I.T., Purvins, A. & Tzimas, E., 2013. Demand shifting analysis at high penetration of distributed generation in low voltage grids. *International Journal of Electrical Power & Energy Systems*, 44(1), pp.540–546. Available at: <http://linkinghub.elsevier.com/retrieve/pii/S0142061512004140> [Accessed October 22, 2013].
- Papathanassiou, S.A., 2007. A technical evaluation framework for the connection of DG to the distribution network. *Electric Power Systems Research*, 77(1), pp.24–34. Available at: <http://linkinghub.elsevier.com/retrieve/pii/S0378779606000241> [Accessed April 2, 2014].
- Parliamentary Office of Science and Technology, 2004. *The Future of UK Gas Marketing: Impact on North Sea Producers*, Society of Petroleum Engineers. Available at: <http://www.spe.org/elibrary/servlet/spepreview?id=00023158>.
- Parmar, D., 2011. Impact of Unbalanced Penetration of Single Phase Grid Connected Photovoltaic Generators on Distribution Network. In *26th International Universities Power Engineering Conference*. Soest.
- Passey, R. et al., 2011. The potential impacts of grid-connected distributed generation and how to address them: A review of technical and non-technical factors. *Energy Policy*, 39(10), pp.6290–6280. Available at: <http://dx.doi.org/10.1016/j.enpol.2011.07.027> [Accessed July 29, 2011].
- Perez, R., Hoff, T.E. & Perez, M., 2010. Quantifying the Cost of High Photovoltaic Penetration. In *American Solar Energy Society Annual Conference*. Phoenix, AZ, pp. 1–8.
- Peterson, R.B., 2011. A concept for storing utility-scale electrical energy in the form of latent heat. *Energy*, 36(10), pp.6098–6109. Available at:
-

- <http://linkinghub.elsevier.com/retrieve/pii/S0360544211005330> [Accessed October 9, 2012].
- Pimm, A.J., Garvey, S.D. & de Jong, M., 2014. Design and testing of Energy Bags for underwater compressed air energy storage. *Energy*, 66, pp.496–508. Available at: <http://www.sciencedirect.com/science/article/pii/S0360544213010670> [Accessed March 21, 2014].
- Pina, A., Silva, C. & Ferrão, P., 2011. The impact of demand side management strategies in the penetration of renewable electricity. *Energy*, 41(1), pp.128–137. Available at: <http://linkinghub.elsevier.com/retrieve/pii/S0360544211003902> [Accessed April 4, 2012].
- Pitney Bowes Software, 2013. MapInfo. Available at: <http://www.mapinfo.com/> [Accessed October 31, 2013].
- PV Tech, 2014. Japan launches subsidies for lithium-ion battery storage - PV-Tech. Available at: http://www.pv-tech.org/news/japan_launches_subsidies_for_lithium_ion_battery_storage [Accessed April 11, 2014].
- QGIS, 2013. QGIS. Available at: <http://www.qgis.org/> [Accessed October 31, 2013].
- Rahman, F., Rehman, S. & Abdul-Majeed, M.A., 2011. Overview of energy storage systems for storing electricity from renewable energy sources in Saudi Arabia. *Renewable and Sustainable Energy Reviews*. Available at: <http://linkinghub.elsevier.com/retrieve/pii/S136403211100400X> [Accessed November 8, 2011].
- Rao, P., Crow, M.L. & Yang, Z., 2000. STATCOM control for power system voltage control applications. *IEEE Transactions on Power Delivery*, 15(4), pp.1311–1317. Available at: <http://ieeexplore.ieee.org/lpdocs/epic03/wrapper.htm?arnumber=891520>.
- RENewEconomy, 2014. Solar storage market tipped to boom in Germany : Renew Economy. Available at: <http://reneweconomy.com.au/2014/solar-storage-demand-tipped-boom-germany-15695> [Accessed April 10, 2014].
- Richardson, I. et al., 2010. Domestic electricity use: A high-resolution energy demand model. *Energy and Buildings*, 42(10), pp.1878–1887. Available at: <http://linkinghub.elsevier.com/retrieve/pii/S0378778810001854> [Accessed February 10, 2014].
- RMDS, 2014. Standard Load Profiles. Available at: www.rmdservice.com/guidance/standard_load_profiles.htm [Accessed November 5, 2011].
- Roberts, B.P. & Sandberg, C., 2011. The Role of Energy Storage in Development of Smart Grids. *Proceedings of the IEEE*, 99(6), pp.1139–1144. Available at: <http://ieeexplore.ieee.org/lpdocs/epic03/wrapper.htm?arnumber=5768106>.
- Roberts, S., 2008. Demographics, energy and our homes. *Energy Policy*, 36(12), pp.4630–4632. Available at:

- <http://linkinghub.elsevier.com/retrieve/pii/S0301421508004965> [Accessed July 18, 2014].
- S&C Electric Company, 2013. Solar Energy Storage: The Key to Installing Solar Generation on a 1940s Grid. Available at: <http://www.sandc.com/blogs/index.php/2013/04/solar-energy-storage-the-key-to-installing-solar-generation-on-a-1940s-grid/> [Accessed April 15, 2014].
- Safaei, H. & Keith, D.W., 2014. Compressed air energy storage with waste heat export: An Alberta case study. *Energy Conversion and Management*, 78, pp.114–124. Available at: <http://www.sciencedirect.com/science/article/pii/S019689041300678X> [Accessed March 25, 2014].
- Schaber, C., Mazza, P. & Hammerschlag, R., 2004. Utility-Scale Storage of Renewable Energy. *The Electricity Journal*, 17(6), pp.21–29.
- Schoenung, S.M., 2011. *Energy Storage Systems Cost Update*, Albuquerque, NM. Available at: prod.sandia.gov/techlib/access-control.cgi/2011/112730.pdf.
- Schoenung, S.M. & Burns, C., 1996. Utility Energy Storage Applications Studies. *IEEE Transactions of Energy Conversion*, 11(3), pp.658–665.
- Schoenung, S.M. & Hassenzahl, W. V, 2003. *Long- vs . Short-Term Energy Storage Technologies Analysis A Life-Cycle Cost Study*, Albuquerque, NM.
- Scottish and Southern Energy, 2011. Energy Networks: About Us: Introduction. Available at: <http://www.spenergynetworks.com/AboutUs/default.asp> [Accessed November 25, 2011].
- Scottish and Southern Energy Power Distribution, 2013. *LCNF Tier 1 Close Down Report Low Voltage Network Modelling and Analysis Environment Project ref . SSEPDT1005*,
- Scottish Power, 2011. Energy Networks: About Us: Introduction. Available at: <http://www.spenergynetworks.com/AboutUs/default.asp> [Accessed November 25, 2011].
- Shaddick, G., 2011. *LV Network Templates for a Low Carbon Future: Report on the use of proxy PV FiT meters to reflect local area Generation*,
- Shahnia, F. et al., 2011. Voltage imbalance analysis in residential low voltage distribution networks with rooftop PVs. *Electric Power Systems Research*, 81(9), pp.1805–1814. Available at: <http://linkinghub.elsevier.com/retrieve/pii/S0378779611001040> [Accessed June 2, 2013].
- Shankleman, J., 2012. George Osborne: make UK a world leader in energy storage. *The Guardian*. Available at: <http://www.theguardian.com/environment/2012/nov/09/george-osborne-uk-energy-storage> [Accessed April 9, 2014].

-
- Shaw, R., Attree, M. & Jackson, T., 2010. Developing electricity distribution networks and their regulation to support sustainable energy. *Energy Policy*, 38(10), pp.5927–5937. Available at: <http://dx.doi.org/10.1016/j.enpol.2010.05.046> [Accessed August 15, 2011].
- Singh, A.K., Singh, G.K. & Mitra, R., 2007. Some Observations on Definitions of Voltage Unbalance. In *2007 39th North American Power Symposium*. IEEE, pp. 473–479. Available at: http://ieeexplore.ieee.org/xpl/freeabs_all.jsp?arnumber=4402352 [Accessed November 29, 2011].
- Sioshansi, R. et al., 2009. Estimating the value of electricity storage in PJM: Arbitrage and some welfare effects. *Energy Economics*, 31(2), pp.269–277. Available at: <http://linkinghub.elsevier.com/retrieve/pii/S0140988308001631> [Accessed September 27, 2011].
- Solar Power Portal, 2014. Energy storage incentive “essential” for the UK. Available at: http://www.solarpowerportal.co.uk/news/energy_storage_incentive_essential_for_the_uk_2356 [Accessed April 11, 2014].
- Southern Electric Power Distribution, 2011. Low Carbon Networks Fund Full Submission Pro-Forma. Available at: <https://www.ofgem.gov.uk/ofgem-publications/46055/ntvvproformaappendices.pdf> [Accessed April 15, 2014].
- SSE, 2014. Coire glas hydro scheme. Available at: <http://sse.com/whatwedo/ourprojectsandassets/renewables/CoireGlas/> [Accessed May 21, 2014].
- Stokes, M., Rylatt, M. & Lomas, K., 2004. A simple model of domestic lighting demand. *Energy and Buildings*, 36(2), pp.103–116. Available at: <http://linkinghub.elsevier.com/retrieve/pii/S037877880300135X> [Accessed June 29, 2011].
- Strbac, G., 2008. Demand side management: Benefits and challenges. *Energy Policy*, 36(12), pp.4419–4426. Available at: <http://linkinghub.elsevier.com/retrieve/pii/S0301421508004606>.
- Strbac, G. et al., 2012. *Strategic Assessment of the Role and Value of Energy Storage Systems in the UK Low Carbon Energy Future Report for*, London.
- Sugihara, H. et al., 2013. Economic and Efficient Voltage Management Using Customer-Owned Energy Storage Systems in a Distribution Network With High Penetration of Photovoltaic Systems. *IEEE Transactions on Power Systems*, 28(1), pp.102–111.
- Takami, N. et al., 2013. High-power and long-life lithium-ion batteries using lithium titanium oxide anode for automotive and stationary power applications. *Journal of Power Sources*, 244, pp.469–475. Available at: <http://www.sciencedirect.com/science/article/pii/S0378775312017296> [Accessed March 19, 2014].
-

- Tant, J. et al., 2013. Multiobjective Battery Storage to Improve PV Integration in Residential Distribution Grids. *IEEE Transactions on Smart Grid*, 4(1), pp.182–191.
- Ter-Gazarian, A., 1994. *Energy Storage for Power Systems* 1st ed., London: Peter Peregrinus Ltd.
- The Guardian, 2014a. Big power out, solar in: UBS urges investors to join renewables revolution | Environment | theguardian.com. Available at: <http://www.theguardian.com/environment/2014/aug/27/ubs-investors-renewables-revolution> [Accessed September 10, 2014].
- The Guardian, 2014b. Cheap batteries will revolutionise the renewable energy market. Available at: <http://www.theguardian.com/commentisfree/2014/mar/09/cheap-batteries-renewable-energy-market-big-power-companies-wind-solar-power> [Accessed April 10, 2014].
- The Guardian, 2010. Giant gravel batteries could make renewable energy more reliable. Available at: <http://www.theguardian.com/environment/2010/apr/26/gravel-batteries-renewable-energy-storage> [Accessed April 10, 2014].
- The Guardian, 2011. The power grid of the future. Available at: <http://www.theguardian.com/smart-revolution/the-power-grid-of-the-future> [Accessed April 10, 2014].
- The Guardian, 2013. Trial run for biggest battery in Europe that could help power Britain. Available at: <http://www.theguardian.com/environment/2013/jul/29/biggest-battery-energy-technology-trial> [Accessed April 10, 2014].
- Thomas, P.R., 2010. American Electric Power's Community Energy Storage. In *EPRI 4th International Conference on Integration of Renewable and Distributed Energy Resources*. Albuquerque, NM. Available at: <http://www.4thintegrationconference.com/detailed.asp>.
- Thomson, M. & Infield, D.G., 2007. Impact of widespread photovoltaics generation on distribution systems. *IET Renewable Power Generation*, 1(1), pp.33–40.
- Thomson, M. & Infield, D.G., 2007. Network Power-Flow Analysis for a High Penetration of Distributed Generation. *IEEE Transactions on Power Systems*, 22(3), pp.1157–1162.
- Toledo, O.M., Oliveira Filho, D. & Diniz, A.S.A.C., 2010. Distributed photovoltaic generation and energy storage systems: A review. *Renewable and Sustainable Energy Reviews*, 14(1), pp.506–511. Available at: <http://linkinghub.elsevier.com/retrieve/pii/S136403210900207X> [Accessed October 11, 2012].
- Tomić, J. & Kempton, W., 2007. Using fleets of electric-drive vehicles for grid support. *Journal of Power Sources*, 168(2), pp.459–468. Available at: <http://linkinghub.elsevier.com/retrieve/pii/S0378775307005575> [Accessed October 11, 2012].

- Tonkoski, R. & Lopes, L.A.C., 2011. Impact of active power curtailment on overvoltage prevention and energy production of PV inverters connected to low voltage residential feeders. *Renewable Energy*, 36(12), pp.3566–3574. Available at: <http://linkinghub.elsevier.com/retrieve/pii/S096014811100259X> [Accessed May 30, 2013].
- Tuohy, A. & O'Malley, M., 2011. Pumped storage in systems with very high wind penetration. *Energy Policy*, 39(4), pp.1965–1974. Available at: <http://linkinghub.elsevier.com/retrieve/pii/S030142151100036X> [Accessed July 13, 2011].
- Ueda, Y. et al., 2008. Analysis Results of Output Power Loss Due to the Grid Voltage Rise in Grid-Connected Photovoltaic Power Generation Systems. *IEEE Transactions on Industrial Electronics*, 55(7), pp.2744–2751. Available at: <http://ieeexplore.ieee.org/lpdocs/epic03/wrapper.htm?arnumber=4510865>.
- UK Power Networks, 2011. About UK Power Networks. Available at: <http://www.ukpowernetworks.co.uk/products-services/networks/about-networks/index.shtml> [Accessed November 25, 2011].
- UK Power Networks, 2013. Pioneering energy storage project gets the green light at trial site. Available at: <http://www.ukpowernetworks.co.uk/internet/en/news-and-press/press-releases/Pioneering-energy-storage-project-gets-the-green-light-at-trial-site.html> [Accessed March 24, 2014].
- UKPN, 2014. *Design and Planning: Framework for underground networks in UK Power Networks*, London. Available at: http://library.ukpowernetworks.co.uk/library/en/g81/Miscellaneous/G81_Guidance/UKPN_G81_Design_Planning_Appendix_V1.0_KK_040711.pdf.
- Vargas, L.S. & Jimenez-estevez, G.A., 2011. Genetic Algorithms for the Capacitor Placement Problem in Distribution Networks. In *16th International Conference on Intelligent System Application to Power Systems (ISAP)*. Santiago, Chile. Available at: http://ieeexplore.ieee.org/xpls/abs_all.jsp?arnumber=6082187.
- VDE, 2013. *Connecting and operating storage units in low voltage networks*, Berlin, Germany. Available at: http://www.vde.com/en/fnn/Documents/FNN_Connecting-operating-storage-units-in-low-voltage-networks_2013-06.pdf.
- Wade, N.S. et al., 2010. Evaluating the benefits of an electrical energy storage system in a future smart grid. *Energy Policy*, 38(11), pp.7180–7188. Available at: <http://dx.doi.org/10.1016/j.enpol.2010.07.045> [Accessed August 5, 2011].
- Walawalkar, R. & Apt, J., 2008. *Market Analysis of Emerging Electric Energy Storage Systems*, Pittsburgh, PA. Available at: doe.
- Walawalkar, R., Apt, J. & Mancini, R., 2007. Economics of electric energy storage for energy arbitrage and regulation in New York. *Energy Policy*, 35(4), pp.2558–2568. Available at: <http://linkinghub.elsevier.com/retrieve/pii/S0301421506003545> [Accessed September 26, 2011].

- Wang, L. et al., 2013. Using a Smart Grid Laboratory to Investigate Battery Energy Storage to Mitigate the Effect of PV in Distribution Networks. In *22nd International Conference on Electricity Distribution*. Stockholm.
- Wang, P. et al., 2014. Integrating Electrical Energy Storage into Coordinated Voltage Control Schemes for Distribution Networks. *IEEE TRANSACTIONS ON SMART GRID*, 5(2), pp.1018–1032.
- Western Power Distribution, 2011. About Us. Available at: <http://www.westernpower.co.uk/About-WPD.aspx> [Accessed November 25, 2011].
- Western Power Distribution, 2005. *ENA Engineering Recommendation G81 Part 4 "Framework for design and planning, of industrial and commercial underground connected loads up to and including 11kV*, Available at: ENA Engineering Recommendation G81 Part 4 ?Framework for design and planning, of industrial and commercial underground connected loads up to and including 11kV.
- Western Power Distribution, 2014. Low Carbon Networks - So La Bristol. Available at: <http://www.westernpowerinnovation.co.uk/So-La-Bristol.aspx> [Accessed April 15, 2014].
- Widén, J. et al., 2010. Impacts of distributed photovoltaics on network voltages: Stochastic simulations of three Swedish low-voltage distribution grids. *Electric Power Systems Research*, 80(12), pp.1562–1571. Available at: <http://linkinghub.elsevier.com/retrieve/pii/S0378779610001707> [Accessed June 2, 2013].
- Willis, H.L. & Scott, W.G., 2000. *Distributed Power Generation Planning and Evaluation* 1st ed., New York, Basel: Marcel Dekker Inc.
- Wilson, I.A.G., McGregor, P.G. & Hall, P.J., 2010. Energy storage in the UK electrical network: Estimation of the scale and review of technology options. *Energy Policy*, 38(8), pp.4099–4106. Available at: <http://dx.doi.org/10.1016/j.enpol.2010.03.036> [Accessed June 21, 2011].
- Woyte, A. et al., 2006. Voltage Fluctuations on Distribution Level Introduced by Photovoltaic Systems. *IEEE Transactions on Energy Conversion*, 21(1), pp.202–209.
- Yao, R. & Steemers, K., 2005. A method of formulating energy load profile for domestic buildings in the UK. *Energy and Buildings*, 37(6), pp.663–671. Available at: <http://linkinghub.elsevier.com/retrieve/pii/S037877880400307X> [Accessed June 24, 2011].
- Yong, T., Wade, N.S. & Fragaki, K., 2012. *Harvesting solar energy for domestic buildings in the UK*. Durham University.
- Zahedi, A., 2011. Maximizing solar PV energy penetration using energy storage technology. *Renewable and Sustainable Energy Reviews*, 15(1), pp.866–870. Available at: <http://dx.doi.org/10.1016/j.rser.2010.09.011> [Accessed June 15, 2011].

- Zhang, Y. et al., 2013. Quantification of Low Voltage Network Reinforcement Costs : A Statistical Approach. *IEEE Transactions on Power Systems*, 28(2), pp.810–818.
- Zidan, A. & El-Saadany, E.F., 2013. Distribution system reconfiguration for energy loss reduction considering the variability of load and local renewable generation. *Energy*, 59, pp.698–707. Available at: <http://linkinghub.elsevier.com/retrieve/pii/S0360544213005604> [Accessed October 21, 2013].
- Zitzler, E., Laumanns, M. & Thiele, L., 2001. *SPEA2 : Improving the Strength Pareto Evolutionary Algorithm*, Zurich.