

8-2016

# OSEM : occupant-specific energy monitoring.

Anand S. Kulkarni  
*University of Louisville*

Follow this and additional works at: <https://ir.library.louisville.edu/etd>

Part of the [Electrical and Electronics Commons](#)

---

## Recommended Citation

Kulkarni, Anand S., "OSEM : occupant-specific energy monitoring." (2016). *Electronic Theses and Dissertations*. Paper 2511.  
<https://doi.org/10.18297/etd/2511>

This Doctoral Dissertation is brought to you for free and open access by ThinkIR: The University of Louisville's Institutional Repository. It has been accepted for inclusion in Electronic Theses and Dissertations by an authorized administrator of ThinkIR: The University of Louisville's Institutional Repository. This title appears here courtesy of the author, who has retained all other copyrights. For more information, please contact [thinkir@louisville.edu](mailto:thinkir@louisville.edu).

# OSEM: OCCUPANT-SPECIFIC ENERGY MONITORING

By

Anand S. Kulkarni

A Dissertation Submitted

to the Faculty of J. B. Speed School of Engineering

in Partial Fulfillment of Requirements

for the Degree of

Doctor of Philosophy in Electrical Engineering

Department of Electrical and Computer Engineering

J. B. Speed School

University of Louisville

Louisville, Kentucky

August 2016

Copyright© 2016 by Anand Sunil Kulkarni

All rights reserved



# OSEM: OCCUPANT-SPECIFIC ENERGY MONITORING

By

Anand S. Kulkarni

A Dissertation Approved

On June 6, 2016

By the following Dissertation Committee:

---

Dr. Karla C. Welch, ECE Department  
Dissertation Director

---

Dr. Cindy K. Harnett, ECE Department

---

Dr. Michael McIntyre, ECE Department

---

Dr. Lihui Bai,  
Industrial Engineering Department

## DEDICATION

This dissertation is dedicated to my dear family members and friends, who have been my moral support and shown their incessant love and patience. I owe this one to you all, as I could have never achieved this pinnacle in my career without your blessings and friendship.

## ACKNOWLEDGEMENTS

The completion and writing of my Ph.D. dissertation has been a long and wonderful journey. It has been one of the most significant academic challenges with an immensely rewarding experience. Without the support, patience and guidance of the following people I would not have achieved this milestone. I owe them my deepest gratitude.

With great pleasure and gratitude, I thank my mentor, Dr. Karla Welch, who has been inspirational and motivating through her wisdom, knowledge and commitment. She has been a great source of invaluable advice, constructive suggestions and encouragement.

I would also like to express my appreciation to my committee members, for their constructive comments and insights.

I thank my lab colleague, Nasser Saadatzi, for his help during different phases of my work.

Finally, I would like to thank my family for their unending support, and in particular, my wife Vaibhavi, for her love and understanding. She has been a constant source of support, encouragement, and has shown faith in me during the tough times in this journey.

## ABSTRACT

### OSEM: OCCUPANT-SPECIFIC ENERGY MONITORING

Anand Sunil Kulkarni

June 6, 2016

Electricity has become prevalent in modern day lives. Almost all the comforts people enjoy today, like home heating and cooling, indoor and outdoor lighting, computers, home and office appliances, depend on electricity. Moreover, the demand for electricity is increasing across the globe. The increasing demand for electricity and the increased awareness about carbon footprints have raised interest in the implementation of energy efficiency measures. A feasible remedy to conserve energy is to provide energy consumption feedback. This approach has suggested the possibility of considerable reduction in the energy consumption, which is in the range of 3.8% to 12%. Currently, research is ongoing to monitor energy consumption of individual appliances. However, various approaches studied so far are limited to group-level feedback. The limitation of this approach is that the occupant of a house/building is unaware of his/her energy consumption pattern and has no information regarding how his/her energy-related behavior is affecting the overall energy consumption of a house/building. Energy consumption of a house/building largely depends on the



energy-related behavior of individual occupants. Therefore, research in the area of individualized energy-usage feedback is essential.

The OSEM (Occupant-Specific Energy Monitoring) system presented in this work is capable of monitoring individualized energy usage. OSEM system uses the electromagnetic field (EMF) radiated by appliances as a signature for appliance identification. An EMF sensor was designed and fabricated to collect the EMF radiated by appliances. OSEM uses proximity sensing to confirm the energy-related activity. Once confirmed, this activity is attributed to the occupant who initiated it. Bluetooth Low Energy technology was used for proximity sensing. This OSEM system would provide a detailed energy consumption report of individual occupants, which would help the occupants understand their energy consumption patterns and in turn encourage them to undertake energy conservation measures.

## TABLE OF CONTENTS

DEDICATION	iii
ACKNOWLEDGEMENT	iv
ABSTRACT	v
LIST OF TABLES	xii
LIST OF FIGURES	xiii
1 INTRODUCTION	
1.1 Overview.....	1
1.2 Effectiveness of feedback on energy conservation.....	2
1.3 Group-level feedback vs. Individualized feedback.....	3
1.4 OSEM: Occupant-Specific Energy Monitoring .....	5
1.5 OSEM for creating energy-prediction models.....	6
2 RESEARCH TRENDS	
2.1 Current status of energy consumption feedback .....	9
2.2 Group-level energy monitoring .....	11
2.2.1 ILM systems .....	12
2.2.1.1 Outlet monitoring systems .....	13
2.2.1.2 Ambient sensing systems .....	14
2.2.2 NILM systems.....	15

2.2.2.1 Steady-state features.....	16
2.2.2.2 Transient-state features.....	19
2.3 Individualized energy monitoring .....	20
2.4 Indoor localization.....	22
2.5 Indoor localization techniques .....	23
2.5.1 Triangulation.....	24
2.5.2 Trilateration.....	24
2.5.2.1 Received Signal Strength (RSS)-based technique .....	25
2.5.2.2 Time measurement based techniques.....	25
2.5.2.2.1 Time of Arrival (TOA).....	25
2.5.2.2.2 Time Difference of Arrival (TDOA).....	26
2.5.2.2.3 Round-trip Time of Arrival (RTOA).....	26
2.5.3 Proximity.....	26
2.5.4 Fingerprinting.....	27
2.6 Technologies used for indoor localization.....	27
2.6.1 Infrared (IR) .....	27
2.6.2 Ultrasound .....	28
2.6.3 Radio-Frequency Identification (RFID) .....	30
2.6.4 Wireless Local Area Network (WLAN).....	30
<b>3 WEARABLE SENSOR FOR OSEM</b>	
3.1 EMF sensor .....	35
3.1.1 Theory of operation.....	35
3.1.2 Schematic of EMF sensor.....	38

3.2 Localization sensor .....	40
3.2.1 Schematic of localization sensor .....	40
3.3 Housing design .....	42
4 APPLIANCE CLASSIFICATION USING EMF SENSOR	
4.1 Appliances used for the study .....	44
4.2 ON/OFF model of appliances .....	44
4.3 Data collection procedure .....	45
4.4 DAQ device parameters .....	46
4.4.1 Sampling speed .....	46
4.4.2 Window sizing .....	46
4.5 Fast Fourier Transform (FFT) of collected data .....	47
4.6 Data visualization .....	49
4.7 Appliance classification .....	51
4.7.1 Classification using all features .....	52
4.7.2 Feature reduction .....	53
4.6.3 Feature selection .....	55
5 PROXIMITY SENSING USING BLUETOOTH LOW ENERGY	
5.1 Overview of Bluetooth Classic .....	58
5.2 Overview of Bluetooth Low Energy (BLE) .....	61
5.2.1 BLE architecture .....	62
5.2.1.1 Physical Layer .....	62
5.2.1.2 Link Layer .....	64
5.2.1.3 Host Controller Interface .....	65

5.2.1.4 Logical Link Control and Adaption Protocol .....	65
5.2.1.5 The Security Manager .....	65
5.2.1.6 Generic Attribute Profile .....	65
5.2.1.7 Generic Access Profile .....	65
5.2.2 New models in BLE .....	66
5.2.3 Parameter for localization .....	66
5.3 Hardware used for proximity sensing .....	67
5.3.1 BLE beacon nodes .....	68
5.3.2 BLE enabled mobile node .....	68
5.3.2.1 Programming of BLED112 .....	69
5.4 Proximity sensing .....	70
<b>6 OCCUPANT-SPECIFIC ENERGY MONITORING</b>	
6.1 Data and information flow .....	72
6.2 Block diagram .....	73
6.2.1 Wearable sensor for OSEM .....	73
6.2.2 Data Acquisition .....	74
6.2.3 Short-time Fourier Transform .....	74
6.2.4 Appliance Identification .....	74
6.2.5 Event Detection .....	74
6.2.6 Occupant-Specific Energy Attribution .....	75
6.3 Web application for OSEM .....	76
6.3.1 Architecture .....	76
6.3.2 User interface .....	77

6.3.3 Energy attribution model.....	78
6.4 MATLAB Profiling .....	79
6.5 Evaluation of OSEM .....	81
7 CONCLUSION AND FUTURE WORK	
7.1 Conclusion.....	85
7.2 Future work.....	86
REFERENCES .....	88
APPENDIX A.....	102
APPENDIX B .....	104
CURRICULUM VITAE .....	107

## LIST OF TABLES

I List of appliances.....	44
II Classification accuracy using all features .....	53
III Appliance-wise accuracy using all features .....	53
IV Classification accuracy after feature reduction.....	54
V Appliance-wise accuracy after feature reduction.....	55
VI Classification accuracy after FFS.....	56
VII Appliance-wise accuracy after FFS.....	56

## LIST OF FIGURES

1 Commercially-available energy monitoring products: (a) TED, (b) Wattson panel, (c) Neurio.....	10
2 Taxonomy of group-level appliance monitoring systems .....	12
3 Socket monitoring systems.....	13
4 Framework of NILM systems .....	15
5 Classification of localization techniques .....	23
6 Trilateration technique .....	24
7 (a) Active bat transmitter and (b) the receiver arrangement .....	29
8 Wearable sensor for OSEM.....	34
9 Wearable sensor with lid-off .....	34
10 Voltage and current waveforms for linear load .....	35
11 Voltage and current waveforms for non-linear load .....	36
12 Harmonic components of the current waveform .....	36
13 Frequency domain representation of harmonics.....	37
14 Schematic of EMF sensor.....	38
15 EMF sensor PCB designed with EagleCAD .....	40
16 Schematic of localization sensor .....	41
17 Localization sensor PCB designed with EagleCAD .....	41
18 NI USB 6361 DAQ device.....	43



19 ON/OFF model of an appliance .....	45
20 Data collection procedure .....	46
21 FFT of the fan .....	47
22 FFT of the incandescent lamp .....	47
23 FFT of the hair dryer .....	48
24 FFT of the compact fluorescent lamp .....	48
25 FFT of the blender .....	48
26 FFT of the fluorescent lamp .....	49
27 Projections of EMF signatures on first and second principle components .....	50
28 Projections of EMF signatures on second and third principle components .....	50
29 3D plot of first, second, and third principle components .....	51
30 Comparison of classification results .....	57
31 BLE protocol stack .....	64
32 BLE channel map [112], Green channels are used for advertising, Blue channels are used for data transmission and Gray channels are used by Wi-Fi .....	64
33 Estimote Beacon .....	68
34 BLED112 .....	69
35 Bluegiga Bluetooth Smart stack .....	70
36 Data and information flow .....	72
37 Block diagram of OSEM system .....	73

38 Client-Server architecture .....	76
39 User interface without events .....	78
40 User interface with few events .....	78
41 Screenshot of MATLAB profiling result .....	81
42 Assessment lab .....	82
43 Comparison of total energy consumption .....	83
44 Comparison of occupant-specific energy consumption .....	83
45 Appliance-wise comparison .....	84

# CHAPTER 1

## INTRODUCTION

### 1.1 Overview

Before electricity was discovered, people used oil and kerosene lamps for lighting, and wood to cook food and to keep their houses warm. Up until a few centuries ago, people had never imagined what modern conveniences would be possible with the rise in use of electricity. It was William Gilbert who coined the term “electric” after the Greek word amber (i.e., elektron) in 1600. However, it was the nineteenth century when “electricity” gained popularity. Electricity has now become prevalent in daily life. Almost all the comforts enjoyed today, like home heating and cooling, indoor and outdoor lighting, computers, home and office appliances, depend on electricity. Moreover, the demand for electricity is increasing across the globe. It is estimated that the worldwide energy requirement will increase by 53% by 2035 [1]. Most of the electricity generation is done using nonrenewable sources of energy. However, there are two main problems associated with these sources. First, nonrenewable fuels are limited and are depleting at a very fast rate. Hence, it is necessary to conserve them for future use. The second problem is the large-scale pollution caused by burning them. The increasing demand for electricity, increased awareness about carbon footprints, global warming, and ozone layer depletion, etc. have raised interest in

the implementation of energy efficiency measures [2]. The solution to the above problems would be the usage of renewable sources of energy. However, full utilization of renewable sources is still in its developing stages and is quite expensive at this moment. Until these reliable alternate sources are made profitable, there is an urgent need for reduction in the energy consumption and the associated environmental impacts.

The building sector accounts for a larger portion of energy consumption as compared to the industrial and transportation sectors, and has a greater potential for energy conservation [2, 3]. Residential and commercial buildings together consume 37 % of the primary energy (coal, oil, natural gas, wood, etc.) and 68 % of the electricity generated in the United States [4]. The smart grid [5] and home automation networks [6] have the potential to reduce a building's energy consumption. However, despite government and media efforts, the social and consumer acceptance is low [7].

## **1.2 Effectiveness of feedback on energy conservation**

Unlike other fuel sources like gasoline, wood, and coal; electricity cannot be seen by the naked eye. Electricity flows into homes seamlessly, meeting demands for cooking, heating, refrigeration, and entertainment. In daily life, while using various appliances, the users of electricity have a vague idea about their energy usage and about the contribution of each appliance towards the total energy consumption. The invisible nature of electricity makes its management and conservation difficult.

A viable solution to promote energy conservation is to provide feedback about the energy consumption [8-11]. Various types of feedback approaches have been studied including weekly, daily, and real-time energy consumption feedback. Studies on energy consumption feedback report reductions of 3.8% to 12% in the energy consumption [12].

### **1.3 Group-level feedback vs. Individualized feedback**

- **Group-level feedback:** Group-level feedback provides information about the energy consumption by a group of people in a house/building. The limitation of this approach is that the individual occupant of a house/building is unaware of his/her energy consumption pattern and has no information regarding how his/her energy-related behavior is affecting the overall energy consumption of a house/building.
- **Individualized feedback:** Individualized feedback can provide information about the energy consumption on an occupant level. With this approach, each occupant of a house/building will be aware of their energy-related behavior and their contribution towards the overall energy consumption of a house/building.

Researchers have compared the effectiveness of individualized feedback over group-level feedback. Two such studies and their results are briefly presented here.

A study conducted by Toner et al. [13] shows the impact on the behavior of individuals, when they are provided with comparisons of group-level and individual-level feedback. In this study, participants were asked to complete an

online survey to rate their environmentally relevant behaviors. They were provided with group and individual feedback, falsely skewed to report a moderately or highly negative environmental impact. A follow-up survey asked participants about their plans to change their behavior in near future, and it was observed that the participants expressed highest intention to behave in environmentally friendly ways, when their individual feedback was worse than their group feedback. Informing users on an individual level about their energy consumption, particularly when their consumption is overindulgent when compared to the group average, can motivate users to consider changes in their consumption of electricity.

Another study conducted by Midden et al. [14] investigates the effectiveness of individual feedback on energy consumption behavior, as compared to group feedback. The participants were asked to perform energy conservation tasks within a computer game. They received feedback about their energy consumption, in the form of a comparison of their individual performance to individual performances of others in the group as well as to their group's overall performance, at the end of each task. The results of the experiment indicated that individual comparative feedback encouraged participants to make energy-saving choices in the game. Results also indicated that group feedback only showed a behavioral effect when individual comparison feedback was also present. In conclusion, research indicates that forms of individual feedback are more effective than providing group-level feedback alone. By providing individual comparative feedback, people's sense of competition can be evoked. Also,

individual feedback can aid a person in connecting how his/her behavior impacts the overall energy consumption of a building. If a user is uninformed, there is often no change in the negative behavior. With more information, change is more likely to occur.

#### **1.4 OSEM: Occupant-Specific Energy Monitoring**

To date very little work has been done in the area of individualized energy-usage feedback. The few studies completed so far were based on behavioral intention rather than actual behavior. Researchers of those studies recommend testing the effects while measuring the users' actual behaviors. To provide researchers with a platform to use actual behaviors in their studies, the OSEM (Occupant-Specific Energy Monitoring) system which has an ability to provide occupant-specific energy-usage feedback is presented here.

OSEM makes use of electromagnetic field (EMF) radiated by appliances, as a signature for appliance identification. It uses a simple electromagnetic field sensor to collect radiated EMF data. The EMF pattern radiated by an appliance varies with the type of appliance. The characteristics of EMF radiated by an appliance are influenced by the amount and the frequency of power supplied to it, and the electromagnetic components inside it. The features extracted from the collected EMF data are used for appliance identification. OSEM uses proximity sensing to attribute the energy-related event to a particular occupant. This work utilizes and combines recent technological advances in the areas of (i) signal processing, (ii) data fusion, (iii) machine learning, and (iv) BLE programming; to create a tool that encourages electricity conservation.

## 1.5 OSEM for creating energy-prediction models

To encourage energy conservation, USGBC (US Green Building Council) introduced the LEED (Leadership in Energy and Environmental Design) building rating system. The LEED certified buildings (commonly referred to as “Green Buildings”) were expected to use less energy as compared to their less energy-efficient counterparts. However, most of the LEED certified buildings consume more energy than projected [14, 16].

The electricity consumption in any building depends significantly on the behavior of the inhabitants [17]. A common criticism of the energy predictive models is the absence of behavioral models [18-22]. It is also the reason for discrepancies between the expected and actual energy consumption of Green Buildings. Very little assessment is done after the buildings are constructed. Furthermore, post-construction, the energy consumption depends much upon how the users actually operate the building (e.g., setting thermostats; turning lights ON/OFF; installing space heaters, refrigerators, and additional computer equipment) [23]. It is imperative to study the energy consumption patterns of individual occupants in a building, to correctly predict the energy demand of a building as well as to determine the scope of energy conservation.

The remainder of this dissertation is organized in the following way:

**Chapter 2, Research Trends:** This chapter covers the current status of research on energy consumption feedback. Various group-level energy feedback approaches are discussed here. It also talks about the research conducted so far



in the area of individualized energy feedback systems. Later, various existing techniques and technologies for indoor localization are discussed.

**Chapter 3, Wearable Sensor for OSEM:** This chapter covers the operation of EMF sensor. It covers the schematic, PCB design, and housing design of the wearable sensor. The data collection and data processing equipment fit within a user's backpack, and the sensor is designed to be small enough to be worn on a user's lanyard. Future iterations of the design can reduce the size of the system further.

**Chapter 4, Appliance identification with EMF sensor:** This chapter covers the details of the DAQ parameters and data collection procedure. It also covers the data visualization with Principle Component Analysis (PCA) and the results of k-Nearest Neighbor (k-NN), Support Vector Machines (SVM), and Naïve Bayes classifier, when used with radiated EMF data.

**Chapter 5, Proximity sensing using Bluetooth Low Energy:** This chapter covers an overview of Bluetooth Classic and Bluetooth Low Energy. The details of the hardware used for proximity sensing are covered here. It also discusses the procedure used for proximity sensing.

**Chapter 6, Occupant-Specific Energy Monitoring:** This chapter covers the block diagram and the data flow of OSEM. It also covers the details of web application developed for OSEM. Results of MATLAB profiling are provided to show the capability of the system to work in real-time. The details of the evaluation procedure for OSEM and the results are covered here.

**Chapter 7, Conclusion and Future work:** This chapter covers the conclusion and future steps of the project.

## CHAPTER 2

### RESEARCH TRENDS

#### **2.1 Current status of energy consumption feedback**

At present, consumers of electricity receive indirect (after consumption) feedback about the amount of energy consumed by them, in the form of a monthly or yearly electricity bill. This electricity bill is calculated using traditional energy meters and provides information about the total electricity consumption, but it cannot segregate the energy consumed by each appliance. Kempton and Layne [24] compared electricity consumption to grocery shopping, where no individual item has a price tag and buyers only get the aggregate cost for their total shopping cart. When planning to reduce one's monthly grocery bill, a history of detailed receipts with the cost of each item can certainly be helpful. If consumers are to reduce their energy consumption, additional information at a finer level than monthly bills may have a potent impact.

Various in-home energy displays available in the market provide direct feedback (near real-time) of energy consumption. These products are usually installed in the building's main circuit breaker panel and use a current transformer to calculate the flow of energy. The data is wirelessly transmitted to the in-home panel, which displays the real-time energy consumption. Most of these products report on the home's total energy consumption, with no

disaggregation. Some of the products have a capability to provide circuit level disaggregation i.e., consumers can find out how much energy is being consumed in the kitchen, a bedroom, the family room, a bathroom, etc. The Energy Detective (TED) [25] and Wattson panel [26], shown in Figure 1(a) and (b), are examples of in-home energy displays. Neuroio (Figure 1(c)) [27], like TED and Wattson panel, is installed in the electrical panel. It provides flexibility to the user to monitor their energy usage from anywhere using iOS and Android apps. Allen et al. [28] conducted a research on TED to monitor its effectiveness. The results showed increased awareness about energy usage among the occupants but did not indicate any major energy savings. Although, some products of this category provide circuit level disaggregation, none of them provide appliance

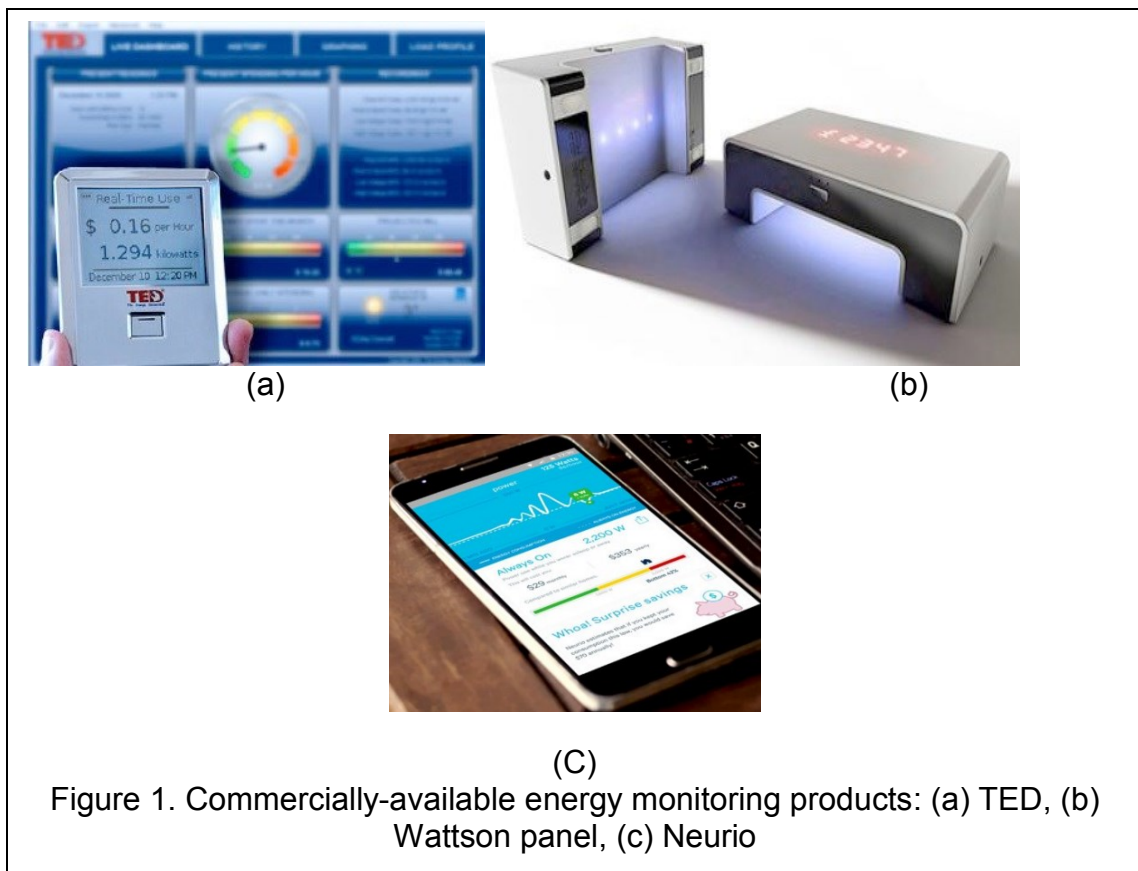

level energy consumption, individualized feedback, or comparative feedback of an individual's energy consumption to a group.

Once consumers receive accurate, timely, and detailed feedback about their energy usage, there are a wide variety of things they can do to reduce the amount of energy they consume [12]. Energy savings can be achieved by changing behavioral patterns and by investing in new energy-efficient appliances [29]. To provide detailed energy-usage feedback, it is necessary to monitor the energy consumption of each appliance. Researchers have been working on various approaches for monitoring energy consumption at the appliance level. However, approaches studied so far are limited to group-level feedback, i.e., the total amount of energy used by all the occupants in a house/building. The limitation of this approach is that an individual occupant is unaware of his/her energy consumption pattern and has no information regarding how his/her energy-related behavior is affecting the overall energy consumption. Provision of individual energy usage feedback can encourage individual occupants to conserve energy. However, the field of individualized energy usage feedback is not yet thoroughly explored.

## **2.2 Group-level energy monitoring**

Depending on the method of appliance monitoring, group-level energy monitoring systems can be divided into Intrusive Load Monitoring (ILM) and Non-Intrusive Load Monitoring (NILM). Figure 2 shows the taxonomy of a group-level appliance monitoring system. The details of Figure 2 are covered in Sections 2.2.1 and 2.2.2. ILM is a distributed load monitoring system and requires at least

one sensor per appliance for energy consumption measurement. It uses complex hardware and simple software for appliance monitoring. NILM is a single point sensing method which uses only one sensor per house/building. It uses simple hardware and complex algorithms to identify the energy consumption of individual appliances. NILM is less costly as compared to ILM, especially when it is used for large-scale deployments. Although both types of systems provide information on energy consumption, neither provides feedback on the level of an individual user's energy consumption.

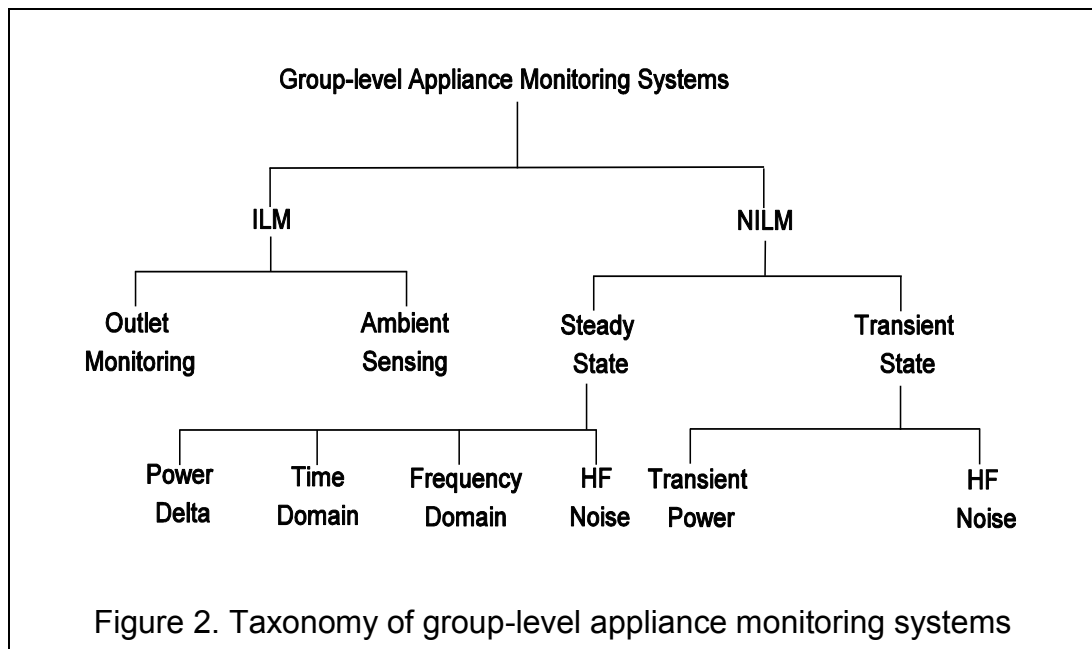

### 2.2.1 ILM systems

The ILM systems are very accurate in measuring appliance-specific energy consumption and are fairly straightforward to use. However, multiple units are required to monitor the energy consumption of each appliance in a room or a building. ILM systems can be divided into outlet monitoring systems and ambient sensing systems. Outlet monitoring systems monitor the energy consumption of the appliance(s) plugged into it. Ambient sensing systems use the ambient

signals emitted by the appliances while they are in operation. The hardware used for ambient sensing is very complex, as large numbers of sensors are required to monitor each appliance.

### 2.2.1.1 Outlet monitoring systems

Kill-A-Watt [30] (Figure 3(a)) is an ILM-based commercially available outlet monitoring system, which provides energy usage feedback for the appliance(s) plugged into it. The information about energy consumption of an appliance is displayed locally on the device but not shared with a centralized system. The burden is on the user to collect the data manually or to add a wireless collection system to each device before analyzing. Energy Optimizers Limited's Plogg (Figure 3(b)) [31] is a combination of a smart meter plug and a data logger. It uses ZigBee wireless technology and a metering chip. Plogg stores the measured electricity data and broadcasts this information wirelessly to a PC, an internet-linked Ethernet gateway, or a ZigBee installed smart meter.

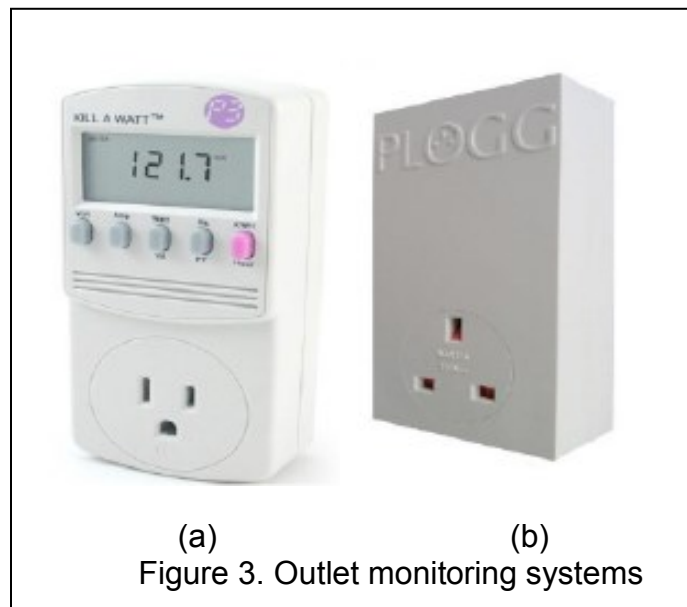

### **2.2.1.2 Ambient sensing systems**

The appliances emit measurable signals when they consume energy (e.g., light, sound, heat, magnetic field). The status of an appliance and its energy consumption can be monitored by placing temperature, light, sound, vibration, or magnetic sensors near that appliance. Rowe et al. [32] used an EMF sensor to detect the ON/OFF state of an appliance. A wireless EMF sensor was placed very close to the wires powering an appliance. The amplitude of EMF changes according to the state of an appliance. They used root mean square (RMS) value of EMF to detect the changes in the state of an appliance. Kim et al. [33], in Viridiscope, used the standard deviation of the magnetic field near an appliance to calculate its power consumption. They deployed light and acoustic sensors near each appliance to monitor their internal states. For example, a refrigerator has two components which draw power - a compressor and a door light. With these components, four power states are possible: only a compressor is ON, only a door light is ON, both are ON, both are OFF. A refrigerator's status can be monitored with a light-intensity sensor and a microphone, where a light sensor can detect the status of the door light and an acoustic sensor can detect the status of the compressor. Data from the indirect sensors was collected centrally using wireless nodes, and models were created to map the status of the indirect sensors to energy consumption of an appliance. Schoofs et al. [34] designed an automated data annotation system called ANNOT. It generates the database of the signature which can be used by an NILM system for appliance identification. They placed a Tyndall [35] wireless sensor mote near each appliance. A mote was equipped with a temperature, light, humidity, sound, and accelerometer



sensor. ACme [36] node was used to capture the current variations. A microcontroller was used to collect data from the sensor suite to make a decision about the state of an appliance. Once an event is detected, the system records time-domain features and stores them as a signature for that particular state of an appliance.

The advantage of this approach is that the appliances are monitored without installing in-line monitoring devices. However, ambient sensing is prone to noise. Also, the number of sensors and hence the hardware cost and complexity increases, with the increasing number of appliances.

### 2.2.2 NILM systems

In the 1980s, Hart [37] introduced the concept of NILM. A typical framework of NILM systems is shown in Figure 4. The data acquisition systems collect information about the total energy consumption of the entire house/building. These systems are installed on the main electrical panel of the house. The data acquisition speed depends on the type of features extracted

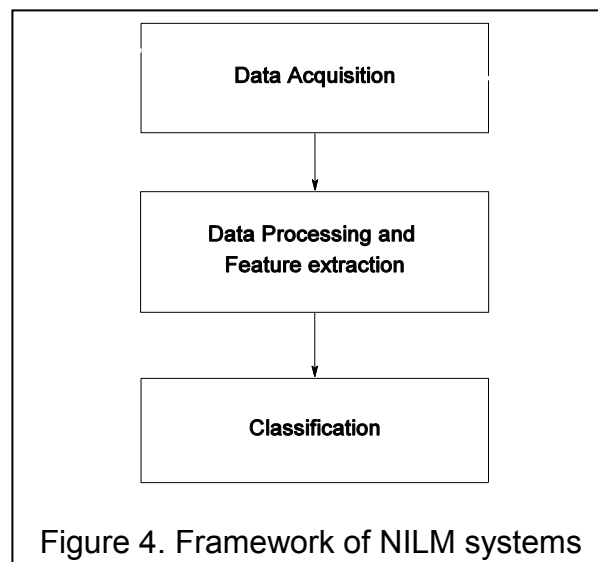

from it, and may vary from as low as 1 sample per second to several mega samples per second. The next step after sampling is data processing and feature extraction.

The extracted features for appliance identification can be mainly classified into two major categories, namely, steady-state features and transient state features (reference Figure 2). Classification algorithms use extracted features to identify individual appliances. Supervised machine learning techniques are commonly used for classification. In this section, various features used for appliance identification using NILM systems are reviewed.

#### **2.2.2.1 Steady-state features**

The steady-state features are collected when an appliance is in a steady operating state.

##### **a) Power Delta ( $\Delta P$ - $\Delta Q$ )**

The power consumption of each appliance is different and depends on the current required by that appliance. Real power ( $P$ ) and reactive power ( $Q$ ) can be used as signatures for appliance monitoring. Real power is the power consumed by an appliance during its operation. For a resistive appliance like a heater, the current and the voltage are in phase, and the total power consumed by the appliance is the real power. There will be no reactive power for a resistive appliance. However, for a reactive appliance, the voltage and the current are not in phase and the total power consumed is real and reactive power. The approaches under this section use changes in the real and reactive power as a

signature for appliances. The total power consumption is continuously monitored, and step changes in the power are matched with the appliance database.

Real power was used as a single feature by the researchers in [38, 39] to identify the appliances. High power appliances can be identified with this approach. However, this method fails for disaggregating appliances with similar power consumption as well as the appliances with low power consumption. Hart [37] uses step changes in the real and reactive power for appliance classification. Marchiori et al. [40] proposed a circuit level power measurement to detect smaller appliances. Only a few appliances are connected to each circuit which makes the identification easier. Marceau et al. [41] developed a load disaggregation algorithm which used the changes in power step and the average duration of an appliance's ON status, as a signature for appliance identification. All these approaches can identify the appliances with dissimilar power consumption but might fail when more than one appliance consumes the same amount of power [42].

#### **b) Time-domain features**

A combination of time domain features like real power, power factor, peak current, RMS current, peak voltage, and RMS voltage can generate a unique signature for each appliance. The voltage and current waveforms are continuously monitored at a single point, and changes in the time-domain features are matched with the database of profiled appliances. Ruzzelli et al. [43] used a similar approach in RECAP. Figueiredo et al. [44] used power factor in addition to real and reactive power for appliance identification.

### **c) Frequency-domain features**

In an AC power distribution system, harmonics are present when the electrical current waveform is distorted by non-linear loads. The generated harmonics are carried back to the power system and can be monitored at a single location. The harmonics can uniquely identify non-linear appliances [45, 46]. The harmonic signatures of the appliances can be added to the power delta and time-domain features, to improve the accuracy of appliance identification [47-49].

For OSEM system, the frequency domain features are used. However, in contrast to references [45-49] which uses harmonics transmitted back to an AC power distribution system, we focus on frequency domain features of the EMF radiated by the appliances.

### **d) High-frequency noise**

Appliances with switch mode power supplies (SMPS) generate high frequency (HF) electromagnetic interference (EMI) during their operation. These EMI signatures were used by Gupta et al. [50] for appliance identification. A plug-in module was designed which could be plugged into any ordinary outlet. Each appliance was profiled and a database was generated. The limitation of this approach is its ability to identify only the appliances with SMPS.

In OSEM, high-frequency noise is used for appliance identification. Gupta et al. have used EMI transmitted back to the power system. This approach used by Gupta cannot be used in OSEM system, as OSEM uses a mobile sensor which is to be carried by the user during daily activities. Hence, OSEM makes

use of radiated EMF as a signature for appliance identification and uses features at low and high frequencies together.

#### **2.2.2.2 Transient-state features**

Transient state signatures can uniquely identify the appliances and are less overlapping compared to the steady state appliance signatures.

##### **a) Transient power**

The power consumption immediately after turning ON an appliance has oscillating, ramping variations before settling at a steady state. These abrupt changes in the power can be used as features for appliance identification. Cole et al. [51] extended Hart's [37] work by adding a transient power feature to the algorithm which used only steady state power changes for appliance identification. They characterized the load being turned ON by three phases: an initial upward spike in power, slower changing variations, and a settled power level. They introduced 'edges' and 'slopes' as the features of an appliance, in addition to steady-state power draw. The features of the appliance power consumption were defined by edges, slopes, and steady-states. References [52, 53] use spectral envelopes of the current waveform to calculate the transient power. The spectral envelope is a vector of the first several coefficients of the short-time Fast Fourier Transform (FFT). They fit the current spectral envelope to the signature envelopes from the database.

OSEM uses a mobile sensor and hence cannot use transient power features, as it would require a sensor which is always connected to the power system.

## **b) High-frequency noise**

An abruptly switched mechanical/solid state electrical load produces broadband electrical noise, either in the form of a transient or a continuous noise which can be used as a signature for that load. Patel et al. [54] designed a plug-in module which records transient noise generated while operating mechanical switches. Individual appliances were profiled to generate a database and machine learning was used to match the appliances from the database to the incoming signature.

## **2.3 Individualized energy monitoring**

There is a paucity of research on individualized energy feedback systems. Two recent publications present the study of energy monitoring systems that provide individualized feedback to the users.

The first, by Murtagh et al. [55], aimed to investigate the effect of individual feedback on energy used at the work desk. The energy consumption of the appliances at each desk of 83 participants was monitored. All work desks had a desktop PC and a monitor, and half the desks had one or two additional devices like a docking station, a desk fan, an additional monitor, and/or a mobile phone charger. Each set of devices on a desk were routed through a single energy monitor, and the data from 83 energy monitors were collected on a server. The feedback was provided through a computer application which allowed users to monitor their energy use on an hourly, daily, and weekly basis. The results report a significant reduction in energy consumption (i.e., average kWh used) when compared to a 4-week baseline measurement. Energy consumption by the

appliances on the desk was attributed to an individual assigned to the work desk. Localization of individuals was not monitored. Although the work desk is likely to be under the control of an individual, this may not be true always. There are chances that individuals might use the appliances on a desk which is not assigned to them. Since all the electrical devices on the desk were routed through a single monitoring device, the system could not disaggregate the energy usage of individual appliances on the desk. Analysis of energy consumption per appliance could not be performed. Another limitation of this system is that it cannot attribute energy consumption of shared appliances to the individuals.

The second study, conducted by Coleman et al. [56], also monitored the appliances on work desks to provide individualized energy usage feedback. This study was completed by four users. Individual appliances on each desk were monitored with AlertMe's [57] wireless energy monitoring system. Data were collected from all the appliances on a smart hub at 1 min intervals. In contrast to [55], Coleman et al. included localization of users. Ekahau's [58] location tracking system was used to monitor each participant's movements throughout the study area to obtain their occupancy patterns. The location tracking system used Wi-Fi access points and wearable RFID badges to track individual participants. This system detected if the participant was at his/her desk, away from the desk but present in the office, or was not in the office at all. The electricity consumption and occupancy data for each participant was processed and analyzed manually, and the participants were given feedback a week later. One participant was

identified as having high potential to reduce energy use. After receiving feedback, this participant showed a significant reduction in kWh consumed. As a major constraint, the researchers acknowledged that the technologies used by them were time-consuming for providing feedback. This research area in general is lacking in available technologies for providing timely feedback to individuals. Testing the effectiveness of the feedback can take place after such technologies are developed.

Both the approaches discussed above utilize outlet monitoring systems. The outlet monitoring systems are not designed to work with appliances which do not have standard plugs, e.g., ceiling lights. Also, the number of outlet monitors, and hence the cost, would increase with the number of appliances being monitored.

## **2.4 Indoor localization**

In OSEM, we use an EMF sensor for appliance identification. The aim of OSEM is to provide individualized feedback to the occupants in a house/building. To do so, it is required to find out which occupant has initiated the energy-related event. This can be achieved by finding out which occupant is in proximity to the appliance which is being turned ON/OFF. For proximity sensing, an accurate localization system is required.

Global Positioning System (GPS) technology has made outdoor localization accessible. Since its introduction, various applications have emerged that affected many aspects of modern life [59]. It is now ubiquitous and can be found in car navigation systems, cell phones, wearable devices, etc. However,



GPS cannot be used for indoor localization because of the attenuation of signal due to the construction material used for walls and rooves of buildings [60, 61].

The need for indoor positioning systems is growing more diverse each year, driven by location-based services [62-65]. Applications of indoor positioning include navigation of malls and airports, locating items on shelves in warehouses, children's safety care systems, locating patients and doctors in the hospital, etc. [61, 66]. Currently, a lot of research is going on in the area of indoor localization. However, the success achieved so far is not as significant as that of outdoor localization [67].

Here, existing techniques and technologies which are being explored for designing of accurate indoor localization systems are reviewed.

## 2.5 Indoor localization techniques

Various techniques for indoor localization have been proposed [65, 68, 69]. Localization techniques can be classified into four categories: triangulation, trilateration, proximity, and fingerprinting, as shown in Figure 5. These techniques make use of technologies like RFID, WLAN, ultra-sound, infrared for indoor positioning.

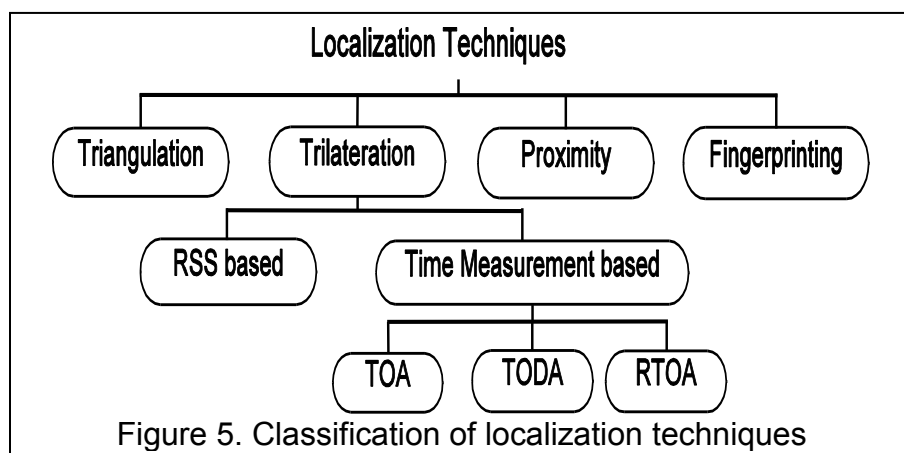

### 2.5.1 Triangulation

Triangulation uses properties of a triangle. Two reference nodes are placed at a known distance. The location of a mobile node is then determined by finding out the angles of a mobile node with respect to the fixed nodes and a known distance between reference nodes. Triangulation can be used for 2D as well as 3D positioning with two and three reference nodes respectively. Angle measurements can be accomplished with directional antennas or antenna arrays.

### 2.5.2 Trilateration

Similar to triangulation, trilateration also uses geometric properties of triangles and circles, except that it uses distances of a mobile node from a reference node instead of angles, for position estimation. As shown in Figure 6, at least three reference nodes are required for positioning using trilateration. The distance between a mobile node and a reference node can be considered as radii, with a reference node as the center. The position of the mobile node is where all three circles intersect.

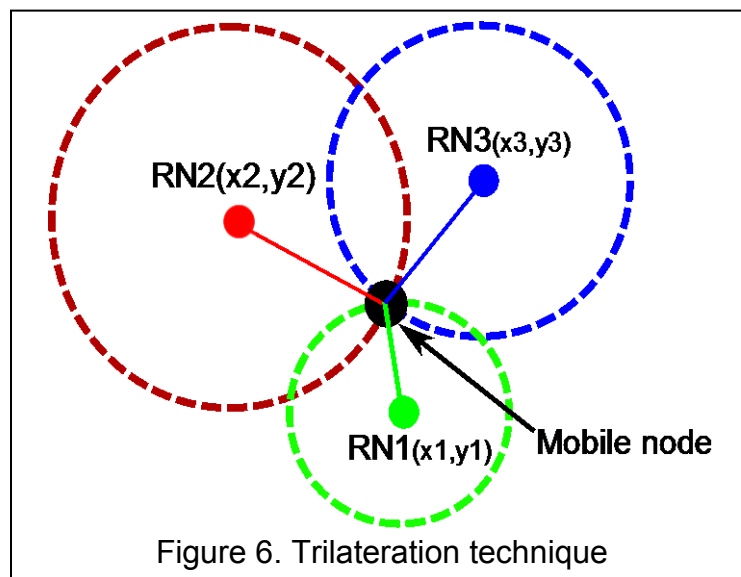

### **2.5.2.1 Received Signal Strength (RSS)-based technique**

Wireless signal's strength decreases with increasing distance. For free space in air, the received signal strength and the distance between the transmitter and the receiver have an inverse square relationship [70]. This path loss model can be utilized to find the distance between a transmitter and a receiver. However, in a typical real-world implementation, the path loss model is affected by many factors such as reflection, refraction, shadowing, multi-path fading, etc. [71]. To deal with these factors, the log-normal path loss model [72] has been used by researchers for RSS-based position estimation [73, 74].

### **2.5.2.2 Time measurement based techniques**

#### **2.5.2.2.1 Time of Arrival (TOA)**

The velocity of a signal for a given medium is always constant. For example, RF signals propagate with the speed of light in air. The time required for a signal to travel from the source to the receiver depends on the distance between them. If the velocity of a signal and time required for the signal to travel from the source to the receiver is known, then distance can be easily calculated. For example, if the source transmits signal at time "t1" with known velocity "v" and the receiver receives the signal at time "t2", then the distance between them is  $(t2-t1)*v$ .

The source transmits the signal along with the timestamp. When the receiver receives the signal, it calculates the time it took for the signal to travel. Localization using TOA requires clocks of the source and the receiver to be

synchronized with very high precision; otherwise, the estimated propagation time will have an inherent error.

#### **2.5.2.2.2 Time Difference of Arrival (TDOA)**

In this method, two signals with different propagation velocities are used. When two signals are received by the receiver, the time difference between arrivals of two signals can be measured and the actual time required for the signal to travel from source to receiver can be found out. With this approach, the synchronization of clocks of both the source and the receiver is not required. However, the requirement of using two different signals adds to hardware complexity.

#### **2.5.2.2.3 Round-trip Time of Arrival (RTOA)**

In this method, the source transmits a signal to the receiver. Upon receiving the signal, the receiver re-transmits that signal back to the original source. The total time required for the signal to reach back to the source is twice the propagation time, plus the processing time required for the receiver to re-transmit the signal. With this approach, the necessity of clock synchronization in the TOA method as well as the requirement to add additional hardware in the TDOA method can be avoided.

### **2.5.3 Proximity**

Proximity sensing approaches do not provide absolute location; their aim is to track the location of a mobile target with respect to some known location. The antennas required by this technique are equal to the number of known

locations where proximity sensing is required. When a mobile target is detected by an antenna, it is considered to be in proximity of that antenna. If the mobile target detects more than one antenna, it is considered to be in proximity of an antenna from which it receives the strongest signal.

#### **2.5.4 Fingerprinting**

The fingerprinting method avoids the requirement of distance or time calculation for localization. It usually defines a grid over the area where localization is to be performed. Various signal parameters like RSS and Link Quality (LQ) can be utilized for this approach. Fingerprinting consists of two phases: the offline phase (database creation) and the online phase. In the offline phase, the signal parameters received from all sources at each intersection point of the grid are measured, and a database of these recordings is created. For example, if RSSI is used as a signal parameter and four beacons are used, the fingerprint at each intersection point in the grid will have four RSSI values. The online phase is where the actual position estimation is done. In this phase, currently received signal parameters are compared with the recorded data, to find out the position of a mobile target in real-time.

### **2.6 Technologies used for indoor localization**

#### **2.6.1 Infrared (IR)**

Infrared (IR) is a type of electromagnetic radiation. Wavelength of IR radiation is between 1 mm to 750 nm. Infrared light is invisible to human eyes

and is used in cell phones, TV remotes, PDAs, etc. Researchers have also explored IR technology for indoor localization [75-77].

In these systems, IR receivers are placed at known locations. The IR source emits light, which is detected by the receivers. Depending upon the receiver which receives the IR light, the location of the mobile person can be determined. Active Badge [78] is one of the first IR-based positioning systems, developed by AT&T Cambridge. They designed wearable badges that can be worn anywhere on the body outside one's clothing. A badge emits a unique code every 15 seconds. A network of sensors was created to pick up the signal radiated by the badge. All the sensors were connected to the master station, which gathered the data from all the sensors. Depending on the sensor which received the signal and the unique code associated with the badge, the location of the badge and hence the person wearing the badge could be determined.

OPTOTRAK [79] and Firefly [80] are examples of commercially-available IR based motion tracking systems. IR-based systems provide reliable positioning accuracy. They are lightweight and are easy to be carried around by a person. However, the sensor network required for detecting the source needs wiring and can be expensive. IR-based systems also need line-of-sight for positioning, which is a major disadvantage of these systems [75].

### **2.6.2 Ultrasound**

Ultrasounds are high frequency sound waves which are beyond the audible frequency range of humans. Bats use ultrasound waves for navigation. In a medium (air in this case), a signal always travels with a constant velocity. If the

velocity of a signal is known, the distance between the transmitter and the receiver can be calculated with ease. Ultrasound based system uses trilateration

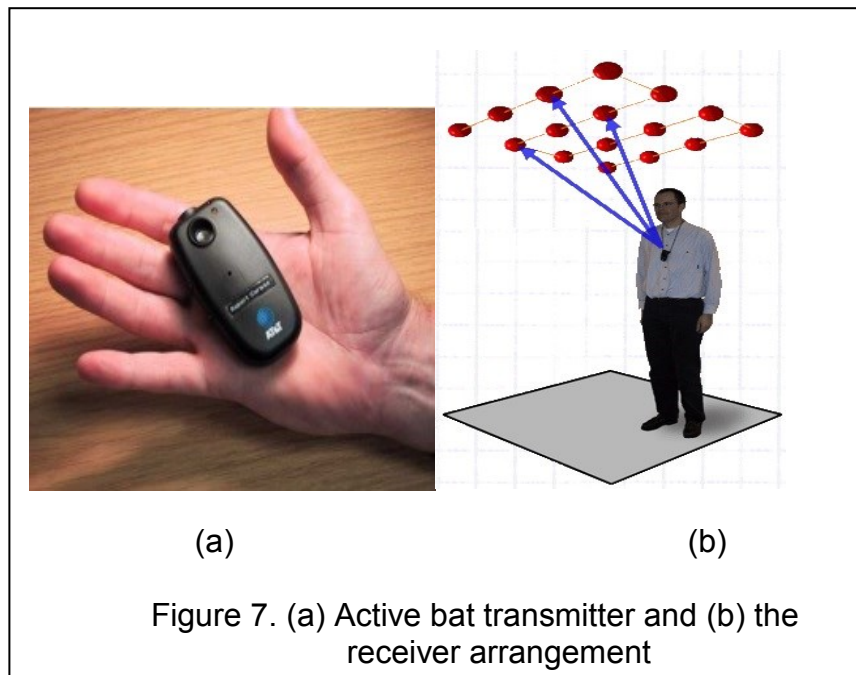

technique, where the distance from the known locations is calculated using time of flight to decide the location of a mobile target.

AT&T laboratories designed an 'Active Bat' [81] system. A bat, shown in Figure 7(a), is attached to an object to be located. It is small and can be easily carried around by a person. A square grid of receivers is located at the ceiling, as shown in Figure 7(b), and are connected by a high-speed network. A bat emits a short pulse of ultrasound, which is received by the receivers placed on the ceilings. By calculating the time required by the signal emitted from the bat to reach the receiver, the distance of the bat from the receiver can be calculated. Three known distances from the bat to the receiver are enough to locate the mobile object in 3D position. This system provides high positioning accuracy;

however, large numbers of receivers with sensitive alignment are required. Cricket [82], Dolphin [83, 84] are the examples of indoor positioning systems which also use ultrasound.

### **2.6.3 Radio-Frequency Identification (RFID)**

RFID technology has wide variety of applications [85] and researchers have explored it for indoor positioning [86-89]. RFID consists of two parts: RFID tag and a scanner. Data is transmitted from tags to the reader using RF (radio frequency) waves. RFID tags contain an integrated circuit for processing and storing data; and an antenna for transmitting and receiving the signals. Scanner receives the information transmitted by the RFID tag and processes it. RFID can be passive or active. Passive tags do not have battery and rely on inductive coupling. Energy generated in the passive tag because of inductive coupling from nearby RFID scanner is enough to transmit the information back to the scanner. Active tags are used where long range is required and they are powered by batteries.

RFID tag returns its serial number which can be used as location information. Indoor positioning with RFID is a type of proximity sensing and does not provide absolute position. The accuracy of localization increases with increase in density of tags.

### **2.6.4 Wireless Local Area Network (WLAN)**

Wireless local area network (WLAN) uses high-frequency radio waves for communication and allows multiple devices to communicate with each other



wirelessly in a particular area. It allows people to freely move around within the coverage area and remain connected to the internet. It is used widely in residential buildings, offices, hospitals, airports, university campuses, etc. Although WLAN systems are mainly used for communication between multiple devices, the RSSI (Received Signal Strength Indicator) of the access point can be used as a parameter to find the location of the device with respect to the access point. WLAN uses the available infrastructure and this proves to be an advantage for developing indoor localization system.

WLAN based localization systems can be grouped as: propagation-based and fingerprinting-based [89]. Propagation-based methods use a path loss model to convert the received signal strength to distance. Trilateration can be used to find the absolute location when three or more access points are available. References [90]-[92] uses propagation model with WLAN for indoor positioning. Propagation model is affected by various factors such as the structure of a building, environment etc., and hence it is not possible to find a universal model that would work in any condition. This issue can be addressed by fingerprinting-based methods. However, it adds a training phase, where a radio map is created by observing the RSSI at various locations and storing them together with the ground-truth locations. [90, 93-96] used fingerprinting approach for indoor positioning using WLAN.

Ekahau's Real-Time Location System [58] is a commercially available indoor positioning system that uses WLAN. It uses tags which can be attached to an object or a person to be located. The signals are collected centrally on the

RTLS location engine and the fingerprinting approach is used to provide real-time indoor positioning. This system is capable of providing sub-room level accuracy.

## CHAPTER 3

### WEARABLE SENSOR FOR OSEM

The aim of this project is to provide occupant-specific energy feedback in real-time. To do so, it is necessary to gather information about how each occupant is using energy. Further, to find out how each occupant is using energy, it is firstly required to monitor the real-time status of each appliance, and then integrate the instantaneous power (kW) over time to calculate the total energy consumed (kWh). Secondly, monitoring which of the occupants initiated the energy-related event is required, to attribute the energy usage to an individual occupant. This attribution is viable only if we design a sensor which is capable of detecting energy-related events, confirm the energy-related events using proximity sensing technique, and if it is small enough to be worn or carried around during day-to-day activities. Figure 8 is a picture of the wearable sensor which is designed and fabricated for OSEM system. The size of this sensor is 54 mm x 72 mm x 12 mm and weighs around 62 grams. Small form factor of the sensor allows it to be worn during day-to-day activities.

As shown in Figure 9, this wearable sensor consists of two PCBs. The circuit is split into two parts to avoid the interference from high-speed Bluetooth data lines. The PCB at the top collects localization information; whereas, one at

the bottom is the EMF sensor used for collecting the EMF radiated by the appliances.

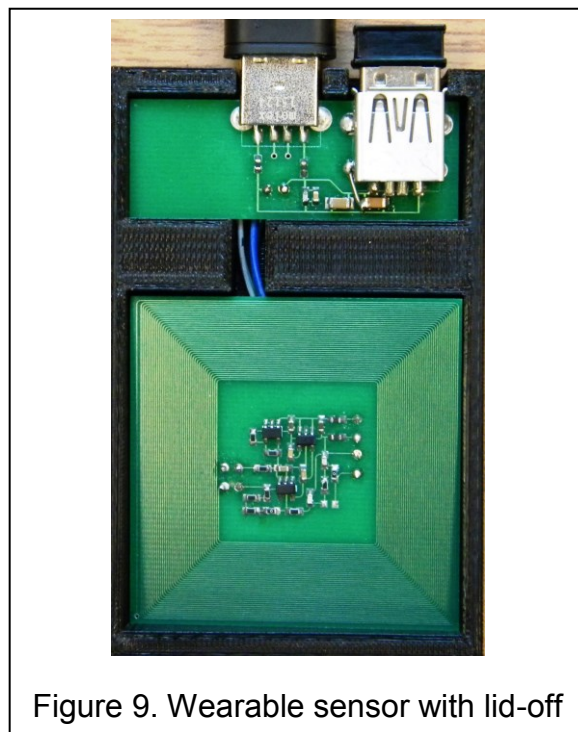
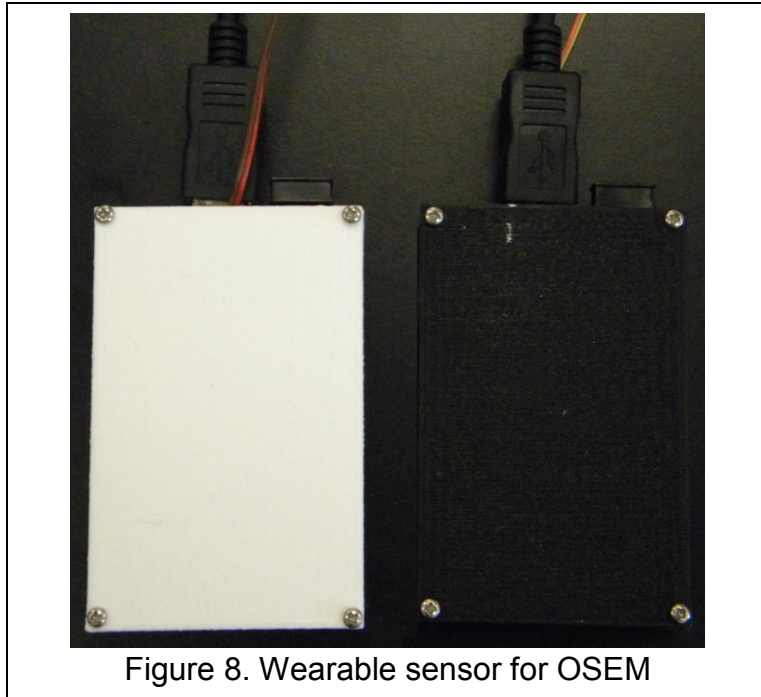

### 3.1 EMF sensor

#### 3.1.1 Theory of operation

EMFs consist of electric and magnetic fields and are radiated where electricity is produced or used. Electric fields are produced by electric charges or by changing magnetic fields; whereas magnetic fields are produced by the current flowing through a conductor, permanent magnets in electric motors, or by changing electric fields. The characteristics of EMFs radiated by an electrical device or an appliance are influenced by the amount and the frequency of power supplied to it, and the electromagnetic components inside it.

Power is supplied to home appliances at extremely low frequency (e.g., 60 Hz in the US). Therefore, low frequency EMF is omnipresent in the areas where there are electrical appliances. The electrical appliances are classified into linear and non-linear loads. An impedance of a linear load is constant to the applied voltage, resulting in the current waveform which follows the shape of the applied voltage waveform, as shown in Figure 10. A non-linear load, however, does not

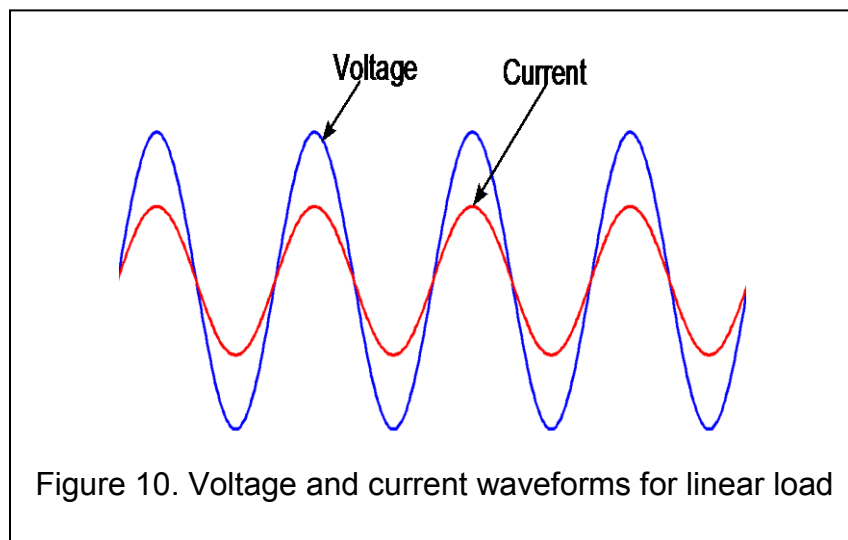

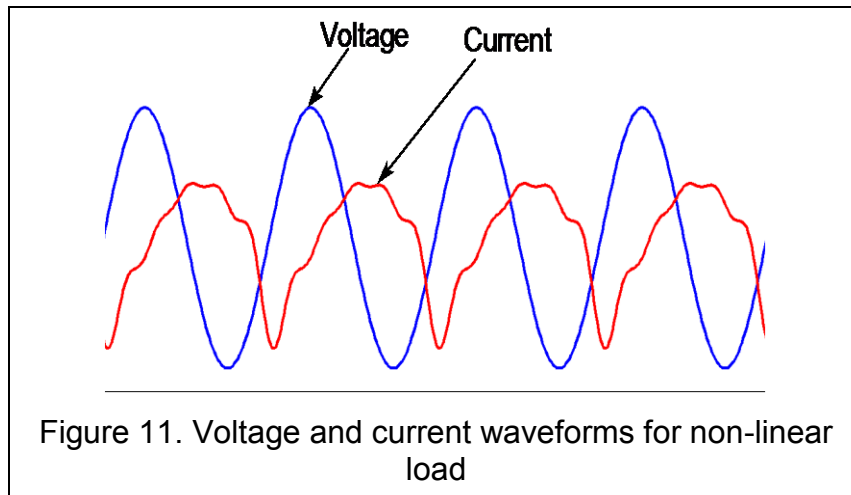

have constant impedance resulting in the current waveform which does not follow the voltage waveform, as shown in Figure 11, generating harmonics in the power system.

Harmonics, based on the Fourier series, can be described as a summation of sinusoidal waves which are integer multiples of the fundamental frequency. Figure 12 shows the harmonics present in the current waveform for non-linear loads shown above. When these harmonics are represented in the frequency domain, as shown in Figure 13, they provide useful information about the appliance.

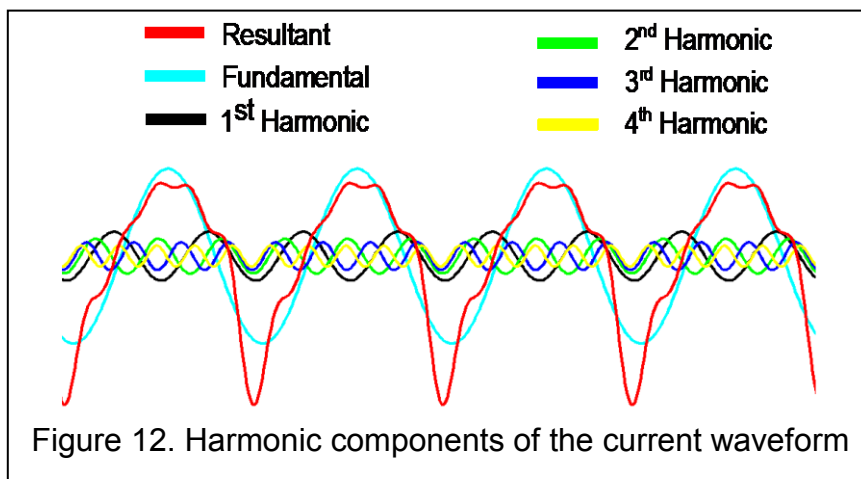

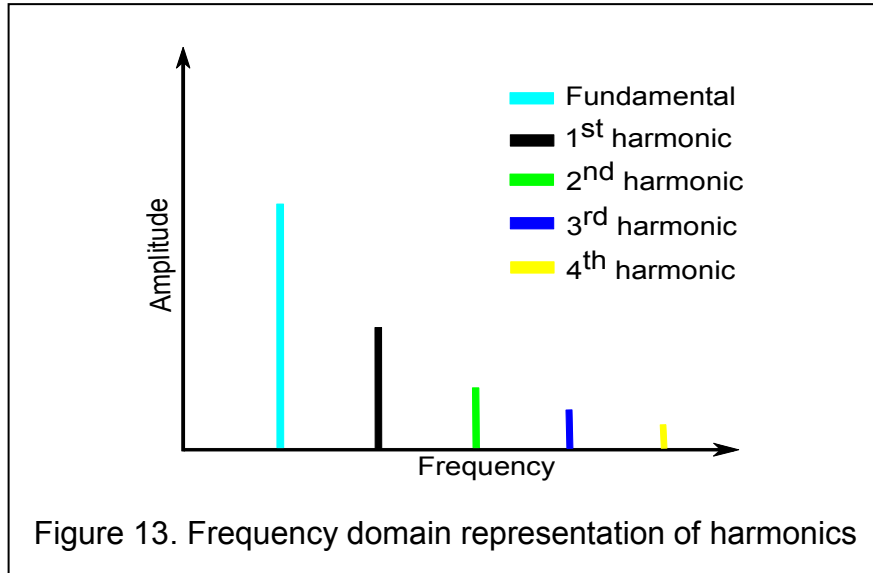

Each electric appliance has an EMF signature, i.e., a unique specific amplitude and frequency pattern of radiation, which we use for appliance identification. For example, a hair dryer's heating coil radiates an EMF at the frequency of 60 Hz, while the motor of a dryer's fan radiates an EMF at 60 Hz along with the harmonic frequency components (i.e., 120 Hz, 180 Hz and so on). Electromechanical loads like juicers, blenders, and hair dryers radiate EMFs with the frequency of 60 Hz and its harmonics. The appliances with SMPS radiate EMF with high frequency, typically in the range of tens to hundreds of kHz, depending upon the switching frequencies used by the manufacturers. The variable speed motors radiate EMF at frequencies that vary with motor speed. There has been a rapid increase in the number of non-linear devices being used at homes and in commercial buildings [97, 98].

### 3.1.2 Schematic of EMF sensor

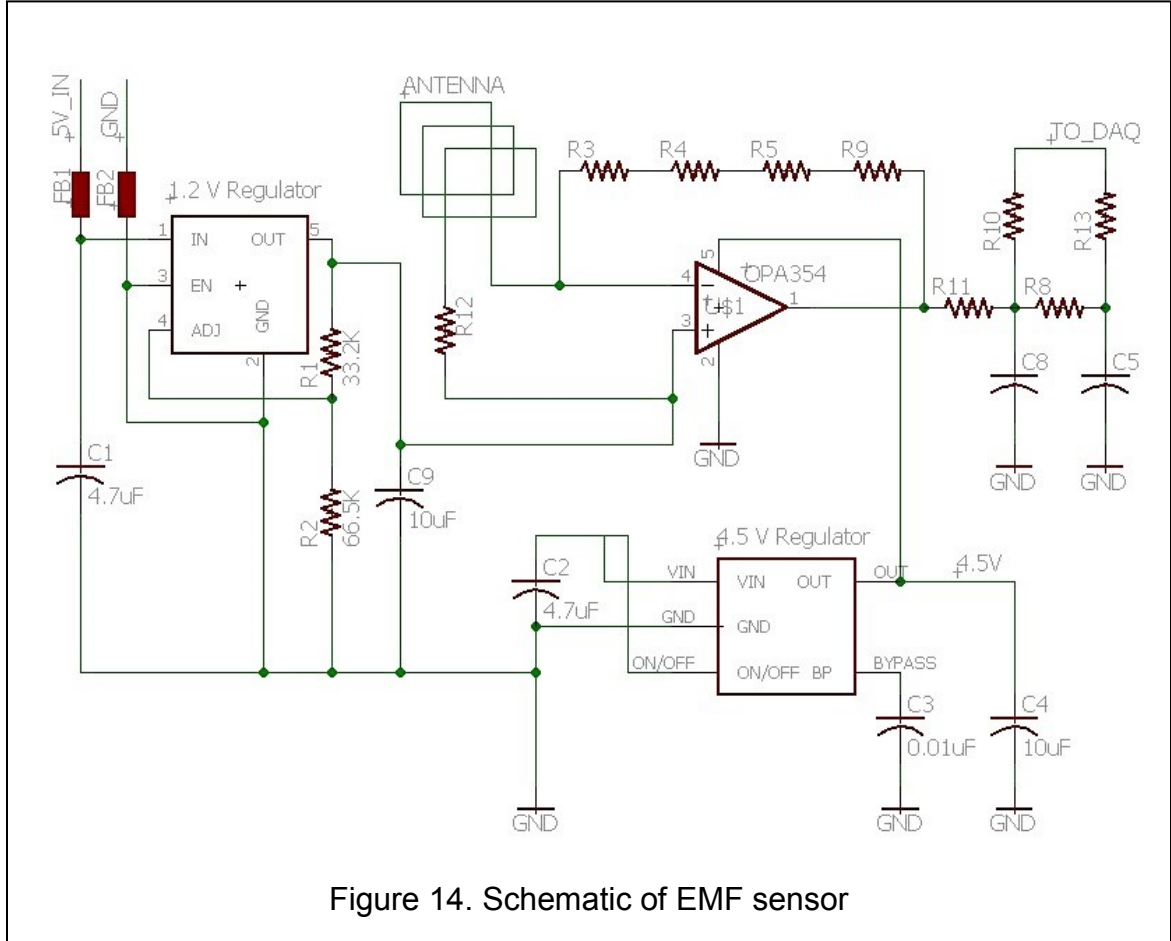

Figure 14. Schematic of EMF sensor

Figure 14 shows the schematic of the EMF sensor. The EMF sensor operates under the principle of Faraday's law of electromagnetic induction, meaning, the current is induced in a conductor in the changing magnetic field. When switched ON, the appliance starts radiating EMF in all directions. The antenna of the sensor perceives radiated EMF and a current is induced in it due to the changing magnetic fields. The current induced in the antenna is given as an input to the transimpedance amplifier, which converts current into voltage. The antenna is a PCB loop antenna and is laid around the transimpedance amplifier and the signal conditioning circuit. The antenna is printed on both sides



of the PCB to achieve maximum number of turns, while maintaining the small size of the PCB.

Bluetooth Low Energy (BLE) dongle used for proximity sensing needs to be connected to the USB, for power and data transmission. This available USB is used to power the EMF circuit as well. The USB supplies stable 5V, however, it is contaminated with high frequency noise generated by the computer. Ferrite beads were used on the incoming lines to suppress the noise coming from the USB. Ferrite bead is a passive electric component made from ferrite material that acts as impedance to high frequency signal, thus, attenuating high frequency noise.

OPA354, operational amplifier manufactured by Texas Instruments (TI) is used for transimpedance amplifier circuit. OPA354 is a voltage-feedback CMOS operational amplifier. It offers a wide bandwidth of 100MHz, high input impedance, and the quiescent current of only 4.9mA per channel. Also, it is available in SOT23-5 package, which has a very small footprint. The operational amplifier is powered with a regulated 4.5V power supply. LP2985, an ultra-low dropout linear (300mV) regulator, with SOT23-5 package from TI is used to obtain the regulated power supply. The need for dual power supply was avoided by introducing an offset of 1.5V into the transimpedance amplifier circuit. Another low-dropout adjustable regulator, TPS76201 from TI, was used to obtain the regulated 1.5V supply. The output of the op-amp is filtered with a pair of low pass filters before being sampled by the data acquisition device.

PCB designing was done with EagleCAD Light PCB designing software (Version 7.4). Figure 15 shows the board designed with EagleCAD. The size of the EMF sensor PCB is 50mm X 50mm.

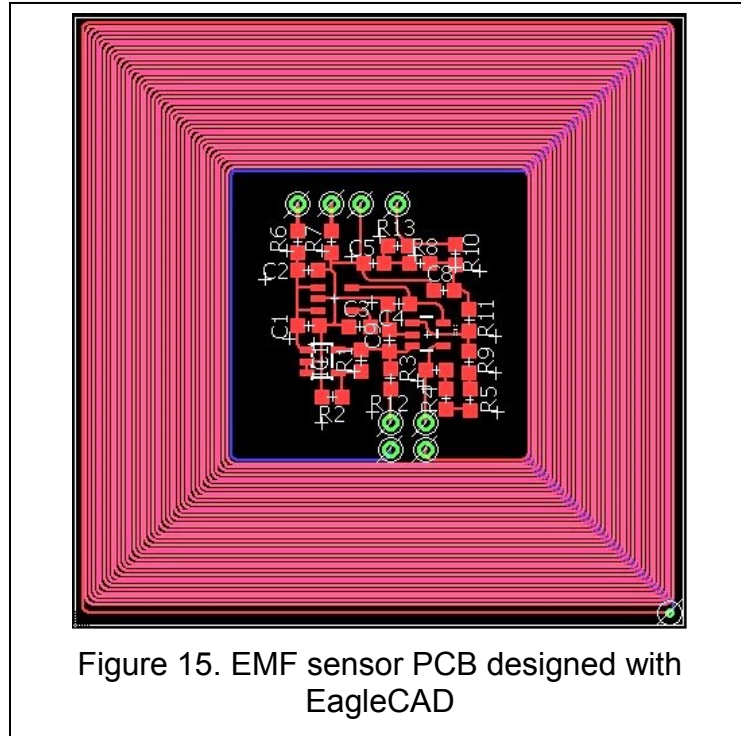

Figure 15. EMF sensor PCB designed with EagleCAD

### 3.2 Localization sensor

#### 3.2.1 Schematic of localization sensor

Figure 16 shows the schematic of the localization sensor. Localization sensor is used in the project for proximity sensing. Once the energy-related activity is detected by the EMF sensor, the localization sensor helps determine if the occupant is close enough to the appliance from where he/she can change the state of that appliance.

BLED112 dongle manufactured by BlueGiga is used as a receiver radio (the details of BLED112 and its programming are explained in Chapter 5). This

BLE dongle needs to be connected to the USB for power and communication. The USB extension cable is used to connect the laptop to the USB plug, which is soldered on the PCB. It serves two purposes. First, by adding a USB receptacle on the same PCB, a BLE dongle can be connected to it and can be fitted in the same housing as that of the EMF sensor. Second, the 5V supply coming from the computer is utilized, thus avoiding a separate power supply just for the EMF sensor.

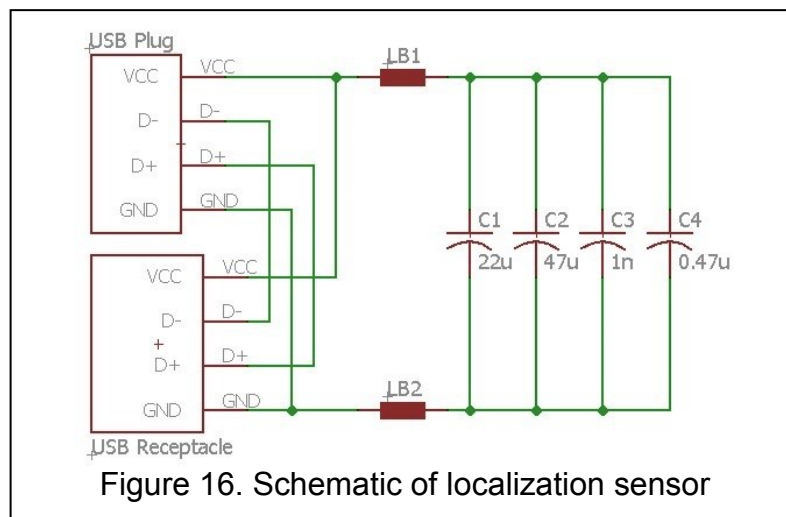

Ferrite beads were used to suppress the high frequency noise. Along with ferrite beads, series of decoupling capacitors are also used for additional filtering. The connection between two PCBs is done using a flexible ribbon cable. Figure 17 shows the PCB designed with EagleCAD software. The size of the localization sensor PCB is 50mm X 18mm.

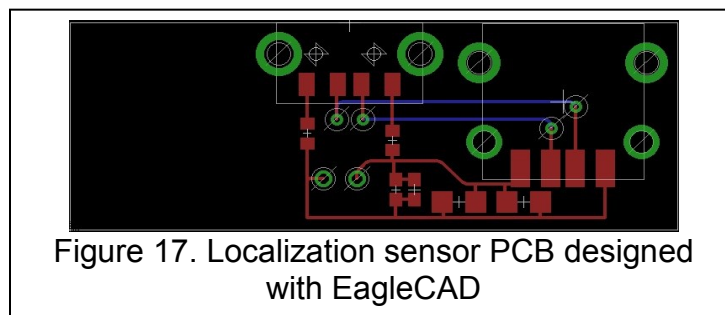

### **3.3 Housing design**

To accommodate the complete hardware of both the sensors, a 3D printer was used to print the housing. A 3D printing is the process of making three-dimensional solid objects from digital designs. The first step was to design the housing using the 3D CAD design software. SolidWorks, a 3D mechanical CAD software was used for the housing design. The housing was printed with PLA (poly lactic acid) material.

## CHAPTER 4

### APPLIANCE CLASSIFICATION USING EMF SENSOR

The previous chapter covers the design and fabrication of the wearable sensor. In this chapter, identification of appliances using the EMF sensor is discussed. The output of the EMF sensor is a time-varying analog voltage. National Instrument's USB 6361 data acquisition (DAQ) device (shown in Figure 11) was used to sample the output of the EMF sensor. USB 6361 is a high-speed DAQ device which offers a sampling speed up to 2MS/s with 16-bit resolution.



Figure 18. NI USB 6361 DAQ device

For this project, a supervised learning approach was used. A supervised learning is a type of machine learning approach that uses training datasets to

make predictions. The training data includes input data and the labels associated with the input data. A model is generated from the training dataset, which is then used to make predictions on the new data. To generate the training dataset, the samples of the EMF radiated by each appliance used in the study were collected.

#### 4.1 Appliances used for the study

Table I shows the details of the appliances used in this study. These are common appliances used in our daily lives and their selection for this study is based on the wide spectrum of operating frequencies they provide. These appliances were operated under the steady-state condition while collecting data.

Table I. List of appliances

No.	Appliance Name	Brand or Manufacturer	Wattage (W)
1	Fan	Wexford	35
2	Incandescent Lamp	Sylvania	60
3	Hair Dryer	Studio 35	1875
4	Compact Fluorescent Lamp	Longstar	13
5	Blender	Oster	450
6	Fluorescent Lamp	Philips	30

#### 4.2 ON/OFF model of appliances

Hart [37] divided the appliances into three different models; namely, ON/OFF model, Finite State Machine (FSM), and Continuously Variable Load. In this phase of OSEM, only the ON/OFF model of appliances as shown in Figure 19, is considered. This model allows the appliances to be either ON or OFF at any given time. This is a good model for most household appliances, such as a

toaster, a TV set, a light bulb, a blender, or a music system. However, it does not consider distinct ON states found in a lamp (low/medium/high), a hair dryer (low/high), or a washing machine (fill/ agitate/ spin).

The appliances where the user has to manually change the state of an appliance are considered (i.e., where the user needs to be close to the appliance while turning it ON/OFF). However, it is not necessary for the user to remain in close proximity after changing the state of the appliance.

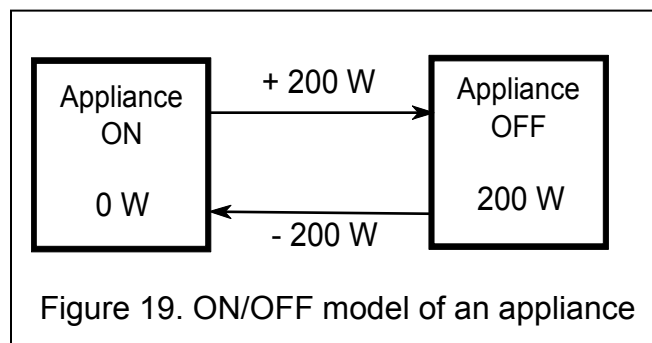

#### 4.3 Data collection procedure

The data was collected from three sides around the appliance at varying heights and distances. This was done to simulate a real scenario, where an occupant can approach the appliance from any side to turn it ON/OFF and the appliances are usually placed against the wall. The data was collected from 81 locations around the appliance. To take into account any temporal variations, 10 samples were collected at each location. The time series of the EMF magnitude was collected and this data was stored on a computer. Figure 20 shows a typical data collection procedure. Similar procedure was followed for each appliance in the study.



Figure 20. Data collection procedure

#### **4.4 DAQ device parameters**

##### **4.4.1 Sampling speed**

The sampling speed of 125 kS/s was used. This sampling speed allows to cover the appliances which radiate EMF with the frequency as high as 62.5 kHz.

##### **4.4.2 Window sizing**

A window size of 16,384 data points was used. Hence, the incoming time domain data was buffered as 16,384 data point vectors. Sampling speed of 125 kS/s and a window size of 16,384 data points would allow to scan the space around 8 times per second when working with real-time appliance identification.



#### 4.5 Fast Fourier Transform (FFT) of collected data

FFT was performed on each sample of the collected data, where each sample has 16,384 data points. Only the positive half of the frequency spectrum was considered as the spectrum of real-world signal is always symmetrical around 0 Hz. Hence, by removing the negative spectrum, redundant features could be avoided. Figures 21-26 show a sample FFT for each appliance.

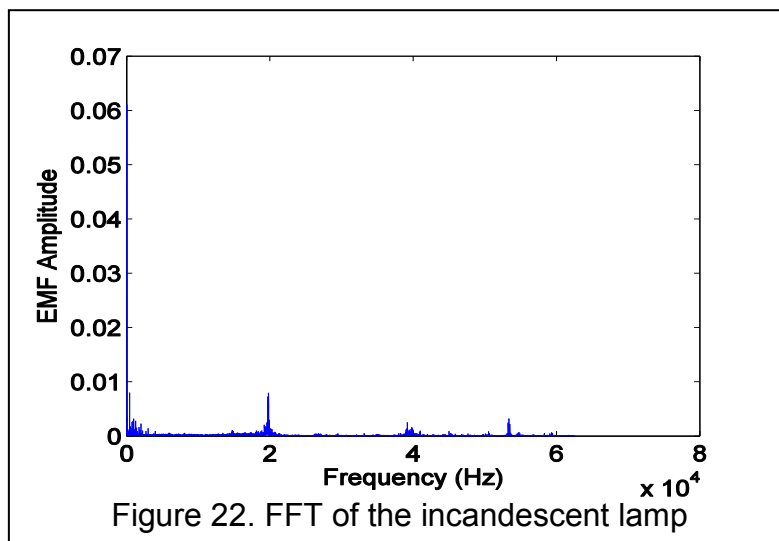
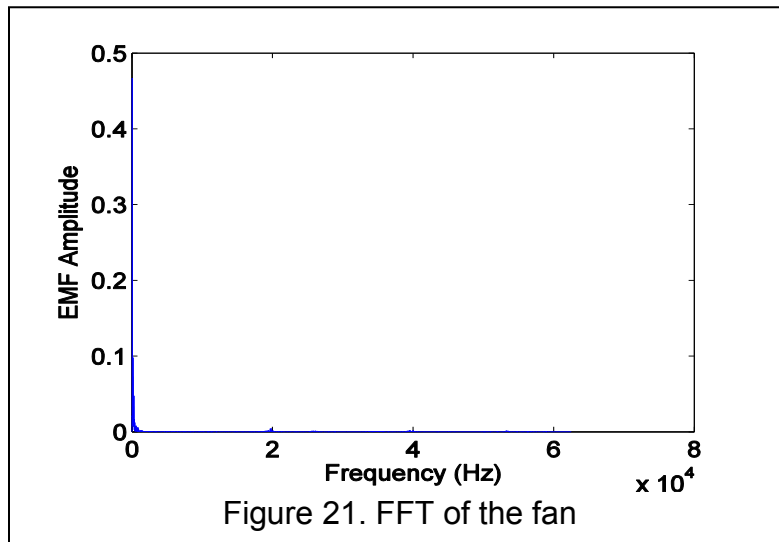

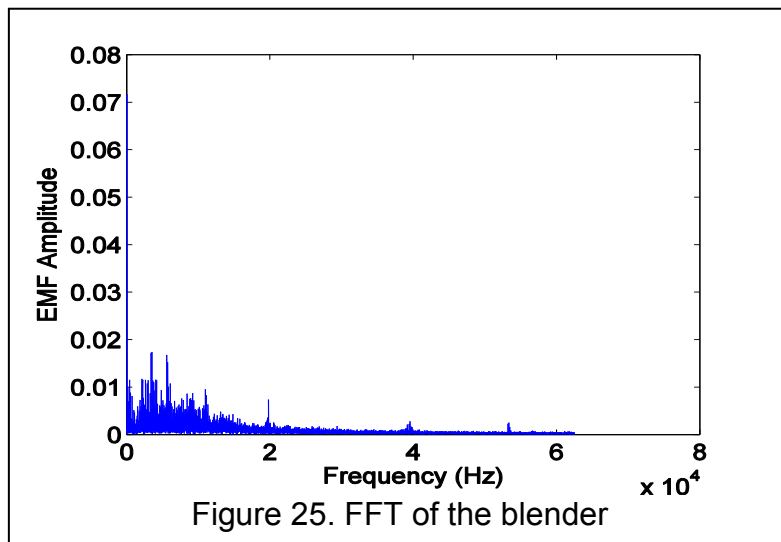
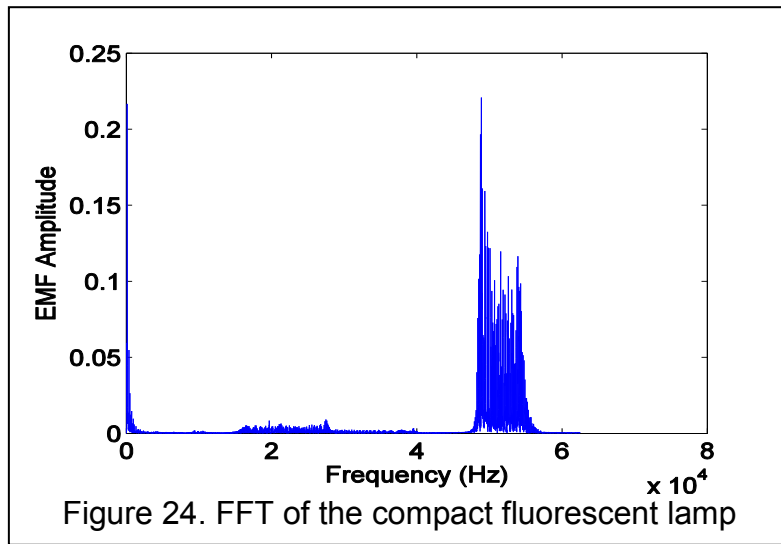
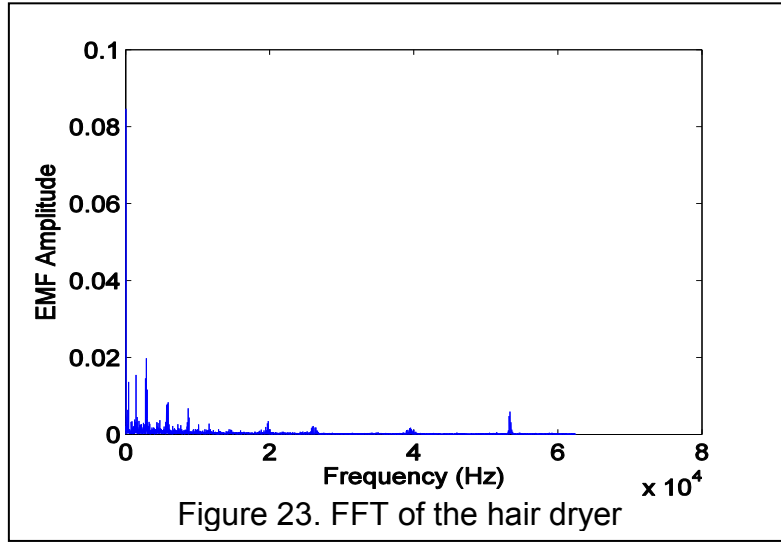

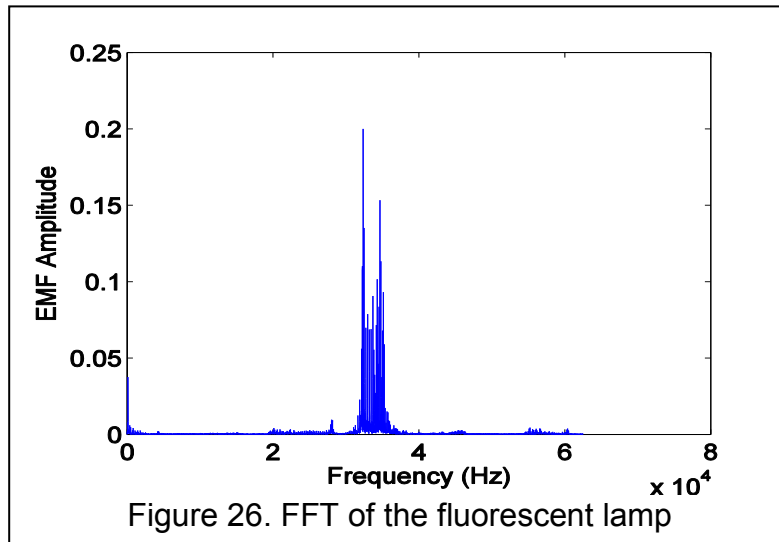

#### 4.6 Data visualization

The FFT data collected was high-dimensional. Even after ignoring the negative side spectrum, each data sample had 8192 features. Each feature represented the amplitude of the radiated EMF at a particular frequency. Principle Component Analysis (PCA) was used to reduce the dimensionality for visualization. PCA is a widely used technique for visualizing high-dimensional data [99]. PCA is a statistical procedure and uses orthogonal transformation [100]. It rotates the original space such that the first principle component has the largest variance in the new space. The next principle component is orthogonal to the first component and has the highest variance possible. First few principle components have most of the variance. First two or three principle components can be plotted against each other to visualize the data. Figure 27 shows the plot of first and second principle components and Figure 28 shows the plot of second

and third principle components. Figure 29 shows a 3D plot of first three components plotted against each other.

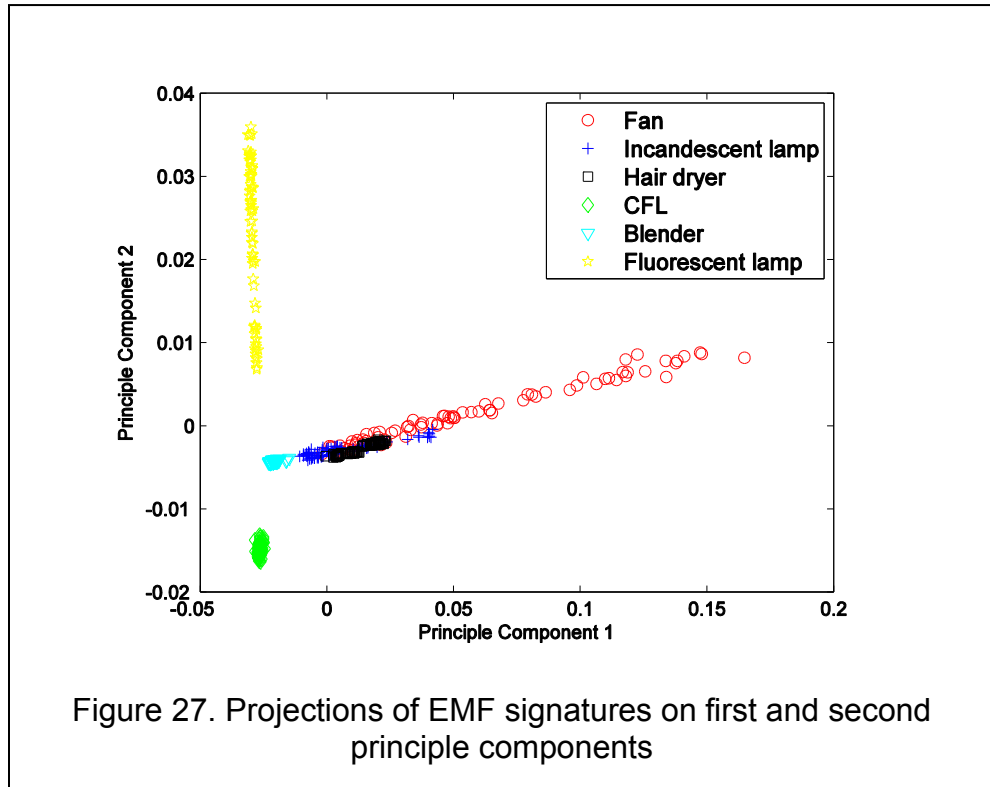

Figure 27. Projections of EMF signatures on first and second principle components

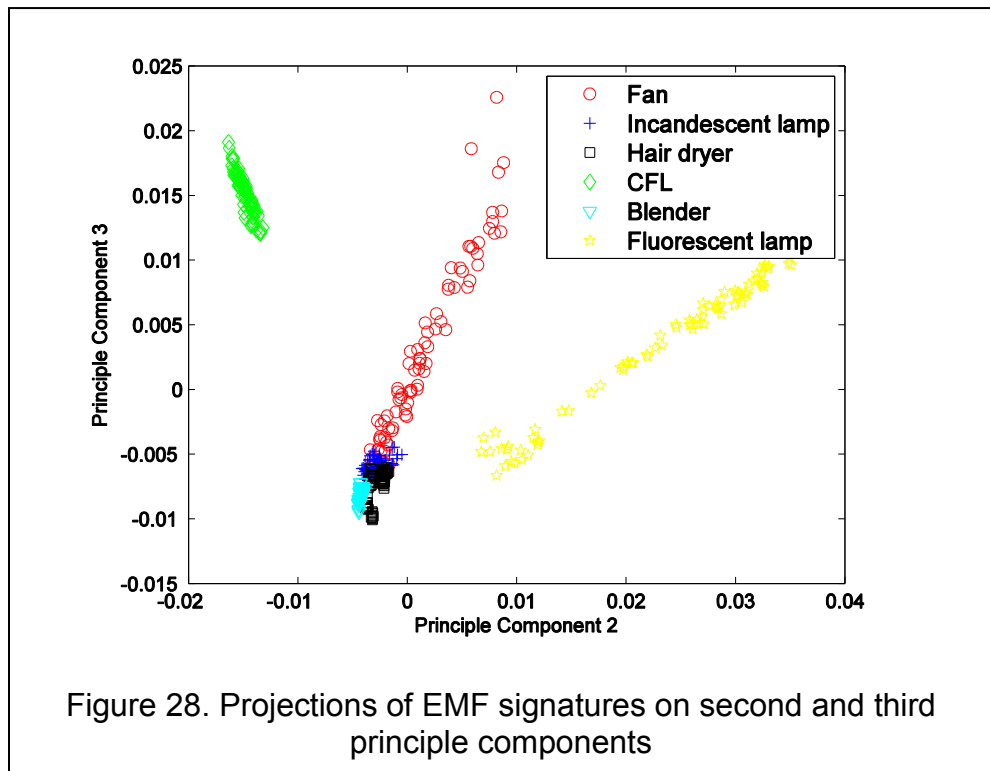
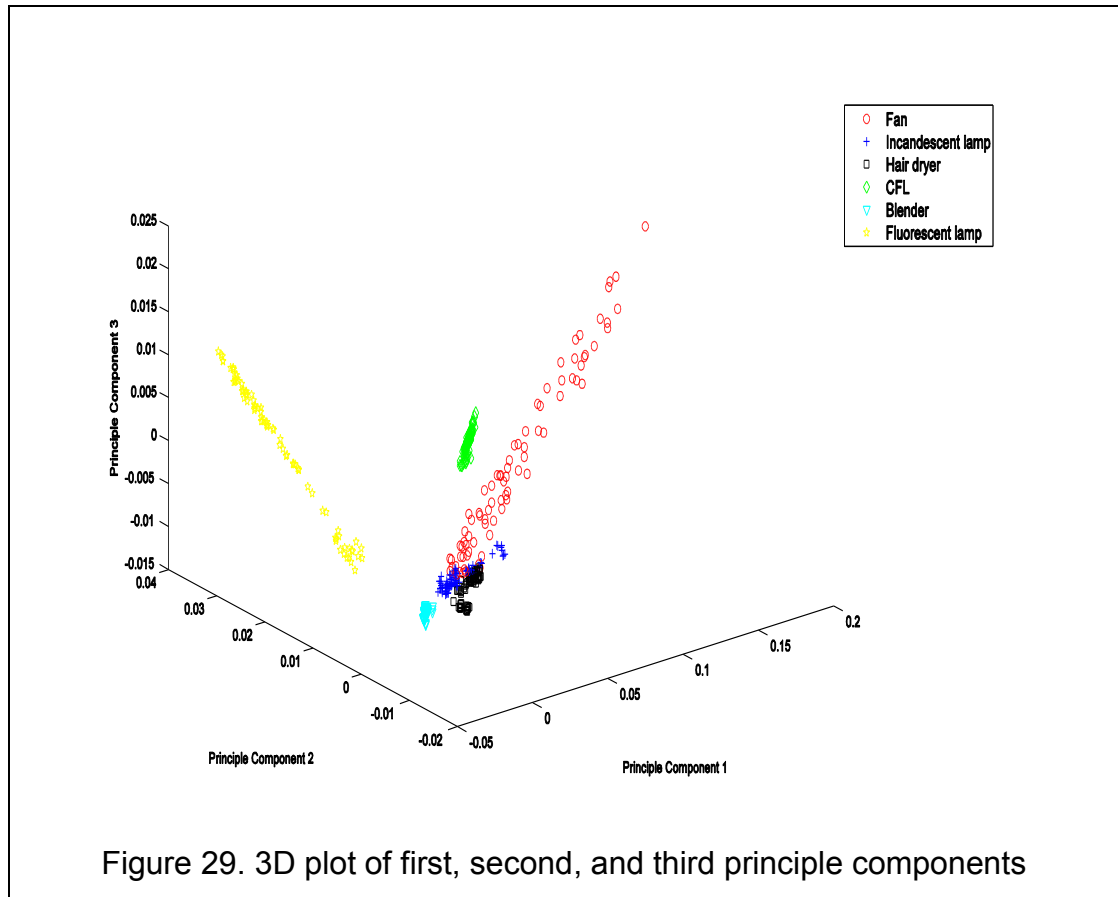

Figure 28. Projections of EMF signatures on second and third principle components



From the above plots, it is observed that the appliances formed clusters. First three principle components accounts for 85.3% of variance. Dimensionality can be reduced with PCA; however, PCA is a feature extraction method and uses all features to extract a set of new features. For OSEM system, this is not required. OSEM performs appliance identification in real-time. Hence, it is more sensible to remove unwanted features completely to reduce the computational cost.

#### 4.7 Appliance classification

The performances of k-NN, SVM, and Naïve Bayes classifiers for signature extraction and appliance identification were compared. k-NN is an

instance-based learning method and is among the simplest of all the machine learning algorithms. It uses the distance metric to identify the similarity between the test and the training instance. Euclidean distance metric was used in this study. Naïve Bayes classifier is a probabilistic classifier. It is based on the Bayes' theorem, with the assumption of independence between the predictors. Support Vector Machines pioneered by Vapnik [101], is widely used in machine learning and it delivers excellent performance in applications such as text recognition and image classification. SVM is a non-probabilistic, two class, linear classifier. It constructs a hyperplane in a high-dimensional space, which is then used for classification. Although SVM is a binary classifier, it can be used for multi-class classification using 'one versus one' and 'one versus all' approaches. In this work, 'one versus all' approach was used. MATLAB programming language was used to design classifiers and implement the feature selection method.

#### **4.7.1 Classification using all features**

Each sample collected had 16,384 data points in time domain. After performing FFT and considering single-sided spectrum, 8192 data points were obtained and these were used as a feature vector for appliance classification. Table II shows the mean of the classification accuracies obtained by performing 10-fold cross validation using k-NN, SVM, and Naïve Bayes classifiers. Table III shows appliance-wise classification accuracy. The percentage of correct classification was calculated by dividing the number of correct classifications by the size of the validation set.

Table II. Classification accuracy using all features

	k-NN	SVM	Naïve Bayes
Accuracy	98.56	96.40	89.45

Table III. Appliance-wise accuracy using all features

Appliance	Accuracy		
	k-NN	SVM	Naïve Bayes
Baseline	98.51	88.27	87.90
Fan	97.5	95.55	96.91
Incandescent Lamp	97.77	96.79	88.02
Hair Dryer	100	100	100
Compact Fluorescent Lamp	100	100	100
Blender	97.40	97.40	62.71
Fluorescent Lamp	100	100	100

#### 4.7.2 Feature reduction

Although good classification accuracy was obtained while using all the features, it is not possible to use all the features while performing real-time classification because of the computational cost. Wrapper techniques [102] can be used to select useful features, however, they are computationally intensive and do not scale up well to high-dimensional data. To use the wrapper technique, the complete frequency spectrum was divided into sections. This reduced the dimensionality, and the mean of each section was used as a feature.

After considering the positive half of the frequency spectrum, 8192 data points were obtained. To make a section, eight data points were combined together and a mean of those points was used to represent the amplitude of that

particular section. In the lower frequency range, harmonics are useful features and are present at frequencies which are integer multiples of fundamental frequency. In US, the fundamental frequency is 60 Hz and harmonics are present at 120 Hz, 180 Hz, 240 Hz and so on. With 8192 data points representing a frequency spectrum of 62.5 kHz, each point is 7.62 Hz apart. The points which are between harmonic frequencies are basically noise and do not add any useful information for appliance identification. Hence, if a frequency band of 60 Hz is combined, the dimensionality can be reduced without losing any useful information. In higher frequencies, the gap between useful features is more hence larger frequency bands can be combined. It was planned to use wrapper technique for feature selection. Hence, it was decided to make equal sized sections throughout the spectrum. With the feature selection process, only the useful features would be retained.

Table IV shows the mean of classification accuracies obtained by performing 10-fold cross validation, and table V shows the appliance-wise classification accuracies obtained using k-NN, SVM, and Naïve Bayes classifiers.

Table IV. Classification accuracy after feature reduction

	k-NN	SVM	Naïve Bayes
Accuracy	98.71	94.75	85.94



Table V. Appliance-wise accuracy after feature reduction

Appliance	Accuracy		
	k-NN	SVM	Naïve Bayes
Baseline	98.76	91.85	75.31
Fan	97.53	89.75	95.43
Incandescent Lamp	98.15	97.41	83.45
Hair Dryer	100	98.89	90
Compact Fluorescent Lamp	100	99.51	100
Blender	97.65	89.51	60.99
Fluorescent Lamp	100	100	100

#### 4.6.3 Feature selection

Feature selection plays a very important role in classification. By removing insignificant features, the computational cost can be reduced significantly. Feature selection can also reduce the noise and improve the classification accuracy. In this work, wrapper technique was used for feature selection. Wrapper techniques use classification algorithm to identify the optimal feature subset. Forward Feature Selection (FFS) was used for OSEM. FFS starts with an empty feature set and adds features that improve the classification accuracy.

Table VI shows the overall accuracy of each classifier and the total number of features selected after using FFS. Table VII shows the appliance-wise accuracy.

Table VI. Classification accuracy after FFS

	k-NN	SVM	Naïve Bayes
Accuracy	98.49	97.73	96.69
Number of features selected	15	17	14

Table VII. Appliance-wise accuracy after FFS

Appliance	Accuracy		
	k-NN	SVM	Naïve Bayes
Baseline	98.52	97.56	96.91
Fan	97.65	96.46	92.35
Incandescent Lamp	97.28	98.10	94.57
Hair Dryer	97.78	95.65	97.78
Compact Fluorescent Lamp	100	100	100
Blender	97.53	96.34	96.17
Fluorescent Lamp	100	100	100

The results showed that after performing FFS, the mean accuracies of SVM and Naïve Bayes improved, as compared to the accuracies when all the features were used. The feature subset obtained after FFS was very small for all the classifiers, which can significantly reduce the computational cost.

Figure 30 shows the comparison of accuracies with all the features used, after feature reduction, and after feature selection. Overall, k-NN classifier performed best, with only 15 features and a mean accuracy of 98.49 % after FFS.

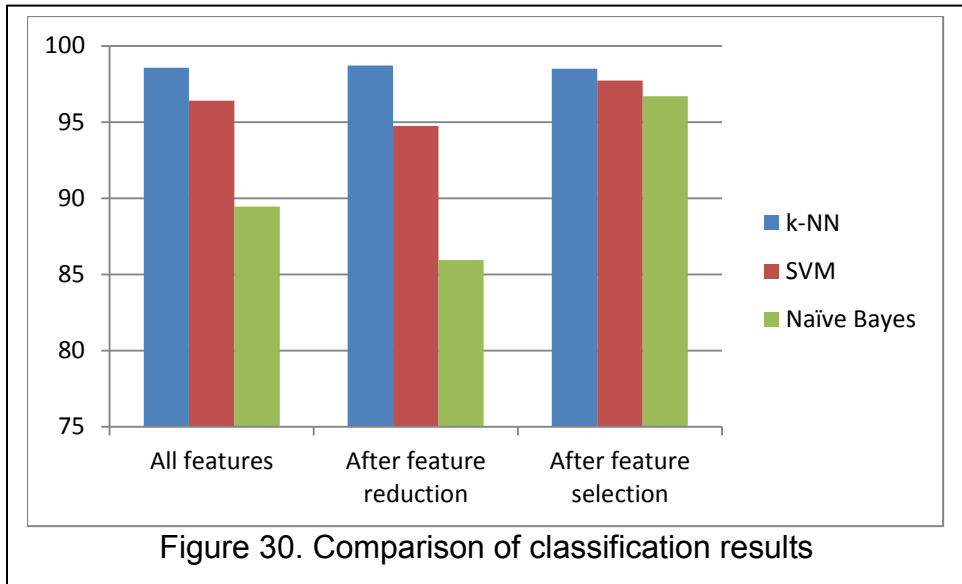

## CHAPTER 5

### PROXIMITY SENSING USING BLUETOOTH LOW ENERGY

#### 5.1 Overview of Bluetooth Classic

Bluetooth, named after the king of Denmark, Harald Blåtand, is the specification for a technology that enables short-range wireless communication. In 1994, Ericsson, a telecommunication company, realized the potential for global short-range wireless communication and started studying the low-power short-range communication solution [103]. The Bluetooth Special Interest Group (SIG), formed in 1998 by Ericsson, Intel, IBM, Nokia, and Toshiba, designed the specification. The first specification of Bluetooth standard was released by SIG in 1999 [104]. Since then, several versions of the specifications have been released. The specification outlines the requirements of a Bluetooth radio along with a set of communication protocols. The specification also covers various Bluetooth usage models known as 'profiles'. Profiles define how to use communication protocols when two Bluetooth enabled devices communicate with each other. Below are the examples of commonly used profiles:

- **Headset Profile (HSP):** This profile defines how a Bluetooth enabled headset should communicate with other Bluetooth enabled device.

- **File Transfer Profile (FTP):** FTP defines how files and folders can be browsed by two Bluetooth enabled devices. For example, a file transfer between two laptops, or an image transfer between a cell phone and a computer.
- **Advanced Audio Distribution Profile (A2DP):** A2DP defines how high-quality audio should be streamed. For example, playing songs from an iPod on Bluetooth enabled speakers.

The aim of Bluetooth technology was to replace the cables for short-range communication, such as those used for a keyboard, a mouse, and printers. As the technology matured, more and more new applications were developed, including music streaming, wireless printing etc. Bluetooth Basic Rate (BR) started with a data rate of 1 Mbps and reached 24 Mbps with Bluetooth version 3.0. The first Bluetooth enabled product hit the market in 2000, and today Bluetooth has become ubiquitous.

Bluetooth uses radio waves to communicate through air, similar to broadcasting of a radio or a television. It uses a frequency spectrum of 2400 MHz to 2483.5 MHz. This frequency spectrum comes under ISM (Industrial, Scientific, and Medical) band and can be used globally without license. Since ISM band is license-free, many other technologies including Wi-Fi also uses the same band. To avoid interference, Bluetooth uses Frequency Hopping Spread Spectrum (FHSS) for data transmission. In FHSS, the available frequency spectrum is divided into small channels. The data to be transmitted is divided into small packets. A single packet is transmitted on a particular channel and the next

packet is transmitted on some other channel. This way FHSS can reduce the RF interference. Also, if a packet fails to transmit because of interference, only one packet is lost and it can be retransmitted with a new channel.

According to the transmit power levels of the radio, Bluetooth specification defines three classes. Class 1 devices have a transmit power of 20 dBm (100mW) and theoretically can transmit up to 100 meters. Class 3 devices have the lowest transmit power of 0 dBm (1mW) and covers up to 1 meter. Class 2 devices can transmit up to a distance of 10 meters with the transmit power being 4 dBm (2.5mW) [105].

When two Bluetooth enabled devices want to communicate with each other, a pairing is always necessary. One of the devices takes the role of a 'master' and the other device acts as a 'slave'. Any device can take the role of a master or a slave. Usually, the master role is undertaken by the device which initiates the communication. A master governs the synchronization of all slaves, by determining the frequency hopping pattern. A master may communicate with maximum 7 slaves actively. The network formed by a master and its slave is called as 'piconet'. A device can be a part of more than one piconet. In that case, it is called as 'scatternet'. However, each piconet has only one master.

Although the aim of Bluetooth is to provide wireless communication between two devices, researchers have explored the possibility of using Bluetooth for indoor localization [63, 106-108]. Link Quality, Transmit Power Level (TPL), Received Signal Strength Indicator (RSSI) have been studied for providing the reference values for indoor positioning [109, 110]. Various indoor

localization techniques such as fingerprinting, trilateration, and cell based position can be used with LQ, TPL, and RSSI for indoor positioning.

- **Link Quality (LQ):** This parameter is available when two devices are in an active connection. LQ is an indication of the quality of the signal received at the receiver. LQ is an 8-bit unsigned integer. Its value ranges from 0-255, where 255 indicates the best quality. This number is calculated using average bit error rate and is updated continuously as the packets are received.
- **Transmit Power Level (TPL):** To conserve power, Bluetooth devices adjust the power depending on the distance between the transmitter and the receiver. If two communicating devices are far from each other, the transmit power is more. If these devices come close to each other, TPL is lowered to save the power. TPL is an 8-bit signed integer and can be used to find the distance between the transmitter and the receiver.
- **Received Signal Strength Indicator (RSSI):** RSSI indicates the strength of the signal received at the receiver. It is an 8-bit signed integer and its value varies from -127 to 20 dBm, where the larger number indicates stronger strength. This information can be obtained when two devices are in active connection or in inquiry mode.

## **5.2 Overview of Bluetooth Low Energy (BLE)**

Nokia, a communication company, recognized the need for an ultra-low-power short-range wireless communication and started working on the project named 'Wibree'. In June 2010, SIG and Nokia collaborated and Wibree became

a part of Bluetooth specification. It was introduced as version 4.0 of Bluetooth [111]. This version is known as Bluetooth Low Energy (also known as Bluetooth Smart). Although this version is complementary to the previous versions of Bluetooth Classic, it is a complete new technology. BLE (Bluetooth Low Energy) introduced a new architecture and is not backward compatible with Bluetooth Classic. Unlike Bluetooth Classic, which emphasized on increasing data rates, BLE (Bluetooth Low Energy) compromised on data rate and emphasized on ultra-low power consumption. Power consumption of BLE is so less that it's coin cell battery is expected to last for a few years. Due to its ultra-low power consumption feature, many new applications are now becoming possible.

### **5.2.1 BLE architecture**

BLE stack (Figure 31) consists of two parts: a controller and a host. The controller consists of a Physical Layer, a Link Layer, and a lower part of the Host Controller Interface. It also consists of Direct Test Mode. This allows testing of the Physical Layer directly by transmitting and receiving the test packets. The host consists of a software stack that defines the communication between two devices. The Application Layer makes use of the host and the Physical Layer, to enable any application. Various layers of the BLE stack are briefly discussed here.

#### **5.2.1.1 Physical Layer**

The Physical Layer consists of a radio and an antenna to transmit and receive the RF waves. Similar to Bluetooth Classic, BLE also uses 2.4 GHz ISM band and uses FHSS to avoid the interference from other technologies and



devices using the ISM band. The frequency spectrum of 2400 – 2483.5 MHz is divided into 40 channels of bandwidth 2 MHz each. The lowest and highest frequency used by the BLE is 2402 MHz and 2480 MHz respectively. Last 3.5 MHz is left as a band gap. There are two types of channels in BLE: data channels and advertising channels. Data channels are used when two devices have established a connection and are ready for data sharing. Devices use advertising channels to advertise that they are available and are ready for connection, for scanning and initiating the connections, and for broadcasting the data. Out of 40 channels, 3 channels are used for advertising and remaining 37 channels are used for data transfer. The selection of 3 advertising channels is wisely done to save power and avoid the interference from Wi-Fi channels 1, 6, and 11. Figure 32 shows the channel map used by BLE.

BLE radio uses Gaussian Frequency Shift Keying (GFSK) with a modulation index between 0.45 and 0.55. There are limitations on the maximum transmit powers in the ISM band. The BLE specification allows a maximum transmit power of +10 dBm and a minimum transmit power of -20 dBm. The required sensitivity of the receiver is specified as -70 dBm. The data transfer rate of the Physical Layer is 1Mbps.

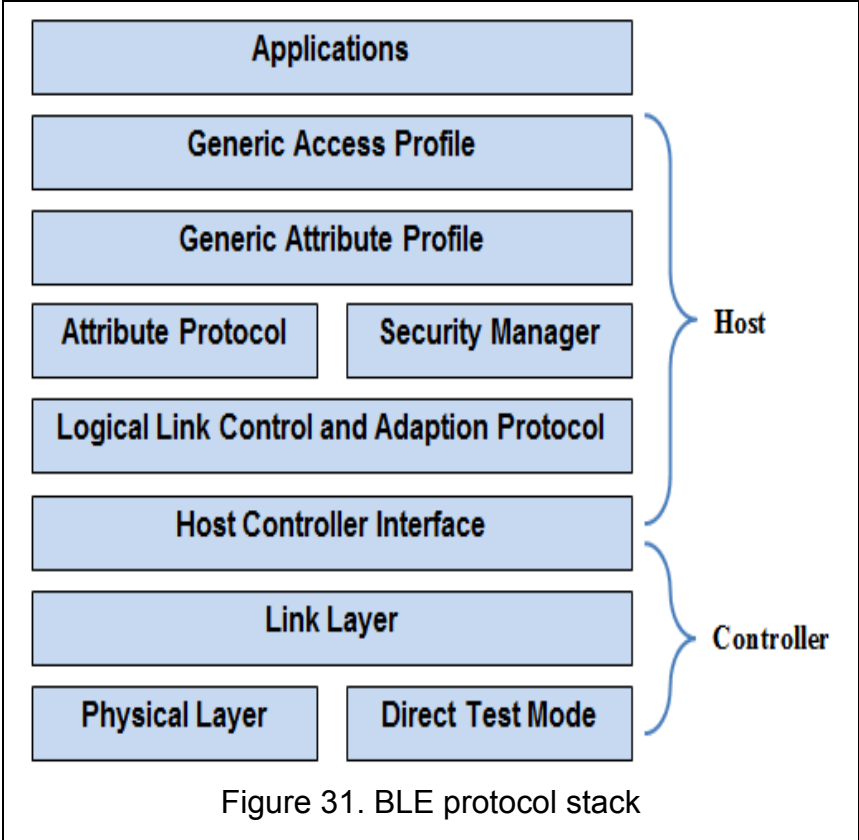

**5.2.1.2 Link Layer**

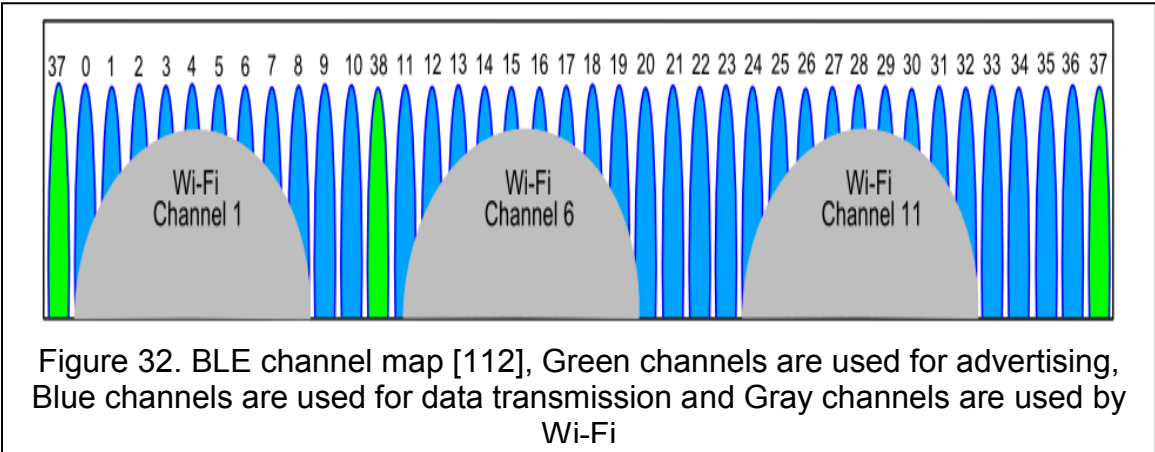

Link Layer defines five states of a device: Standby, Advertising, Scanning, Initiating, and Connection. It explains the process a device needs to follow to change the state. Link Layer is responsible for generating advertising and data packages. It also defines the procedure which two devices need to follow when

communicating with each other. Link Layer maintains a list of devices which are allowed for communication and ignores the data request and advertising information from other devices.

#### **5.2.1.3 Host Controller Interface**

This is an interface between the controller and the host. It sends commands to the controller and receives the events back.

#### **5.2.1.4 Logical Link Control and Adaption Protocol**

L2CAP is responsible for protocol multiplexing and data segmentation. Also, if the data packet is large, it chops it into smaller pieces before sending it to the controller. It combines the data packet before sending it to the upper layers.

#### **5.2.1.5 The Security Manager**

This protocol handles the pairing of two devices using authentication and authorization. It is responsible for key exchanging. BLE uses Advanced Encryption System (AES) and the key size is 128-bit.

#### **5.2.1.6 Generic Attribute Profile**

Attribute is a piece of information stored on a device. For example, a humidity sensor can have an attribute for humidity and an attribute for the physical location of the sensor. Attribute protocol defines a procedure to be followed when one device wants to access the attributes of other device.

#### **5.2.1.7 Generic Access Profile**

It defines the procedures related to the discovery and the connection of Bluetooth devices. GAP is also responsible for pairing of two devices.

### **5.2.2 New models in BLE**

Protocols and stack are very different in BLE as compared to Bluetooth Classic. BLE introduces new usage models, which allows the devices to communicate without being in active connection mode. The new usage models are built around the advertising model. In an advertising state, the BLE device transmits the advertising packets on advertising channels. Advertising state also allows 'broadcasting' using the advertising channels. On the receiver side, there are two modes: active and passive. If the receiver is actively scanning, it sends a request for more information to the transmitter to initiate the connection. In passive scanning, the receiver just listens to the advertisements and conveys the information to the upper layers. The BLE specification allows the selection of advertising intervals. Devices can send advertising events every 20 milliseconds to maximum of 10.28 seconds.

### **5.2.3 Parameter for localization**

Bluetooth Classic offered Link Quality, Transmit Power Level, and Received Signal Strength Indicator, which could be used as parameters for indoor positioning. Because of the change in the protocol and the stack, Link Quality and Transmit Power Strength are not available in BLE.

RSSI is still available in BLE. RSSI can be obtained while the devices are in connection and even during passive scanning. Also, RSSI has gained more popularity as the parameter in Bluetooth for indoor positioning. In Bluetooth Classic, the RSSI was available during a connection or in an inquiry mode, which was relatively a slow process. Smaller channel widths (1 MHz) of Bluetooth

cause fluctuations in the RSSI values and also cause fast fading [113]. The channel width in BLE (2 MHz) is double as compared to the channel width in Bluetooth Classic, and this should reduce the fluctuations in the RSSI. Easy accessibility of the RSSI during passive scanning makes it a really good parameter for indoor positioning.

Bluetooth has emerged as a viable choice for indoor localization because of its omnipresence. Bluetooth is already available in cellphones, laptops, PDAs, wearables, etc. The number of Bluetooth devices is expected to increase by a large number in future. With the increasing demand of Bluetooth technology, their prices per unit will certainly go down. Researchers are currently exploring Bluetooth for indoor localization and soon it might be used for indoor localization on a large scale.

### **5.3 Hardware used for proximity sensing**

Any indoor positioning system requires two basic components: Bluetooth LE nodes as beacons and a mobile node whose location needs to be monitored. Two types of architectures are possible for indoor localization. First, where the mobile node continuously broadcasts and BLE beacons acts as receivers. The information received by all the beacons is collected together on a server to make judgements about the position of the mobile node. Second, the BLE beacons acts as transmitters and the mobile node acts as a receiver. In this scenario, the mobile node needs to have a capacity to make the positioning calculations.

The second architecture was more suitable for the OSEM project, as it allowed collecting the localization information and the EMF data at a single

location, thus reducing complexity. Hence, BLE beacons were used for broadcasting and BLE enabled mobile node was used for passive scanning. Below are the details of the hardware used for this project.

### 5.3.1 BLE beacon nodes

BLE beacons from various manufacturers are available in the market today. Estimote's BLE beacons (shown in Figure 33) [114] were used because of its good reputation for transmitting reliable data, ease-of-use, and the availability of product support. Estimote's beacon contains a 32-bit ARM Cortex M0 CPU, and a 2.4 GHz radio using Bluetooth LE. An accelerometer and a temperature sensor are also included in the beacon housing. It uses a coin-cell battery (CR2477) to power the circuitry. Estimote has developed an iOS application, which can be used to change the transmit power and the advertising interval, without changing any code.

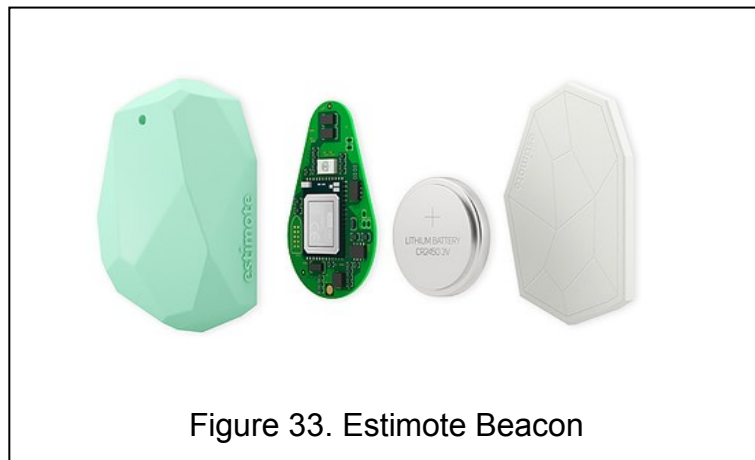

Figure 33. Estimote Beacon

### 5.3.2 BLE enabled mobile node

In the current state of OSEM, a laptop is used for computation so a mobile node that can be connected to the laptop was required. BLED112 (shown in

Figure 34), a BLE USB dongle, manufactured by Bluegiga [115] was used for this project. Here are some key features of BLED112:



- Bluetooth version 4.0
- USB host interface
- Integrated Bluetooth Smart stack
- Radio performance: Transmit power: 0dBm, Receiver Sensitivity: -93dBm
- Antenna: Integrated PCB antenna
- A programmable 8051 microcontroller

### 5.3.2.1 Programming of BLED112

BLED112 was programmed as a passive scanner. It listens to the packets transmitted by the BLE beacons and sends the information to the laptop. Bluegiga Bluetooth Smart stack (shown in Figure 35) consists of two parts: Bluetooth Smart stack and Bluetooth Smart Software Development Kit (SDK). Bluetooth Smart stack is a standard Bluetooth stack according to the BLE specification. The Bluegiga SDK allows the user to program BLED112. BLED112 can be programmed either by using an API (Application Program Interface) developed by Bluegiga (BGAPI) or by using a scripting language BGScript.

- BGAPI: BGAPI is a command, response, and event-based protocol which can be used over the USB interface. A library, BGLIB, is developed by Bluegiga in ANSI C for the easy implementation of BGAPI.
- BGScript: BGScript is a scripting language and allows the user to embed the applications into BLED112, without the need of an external MCU.

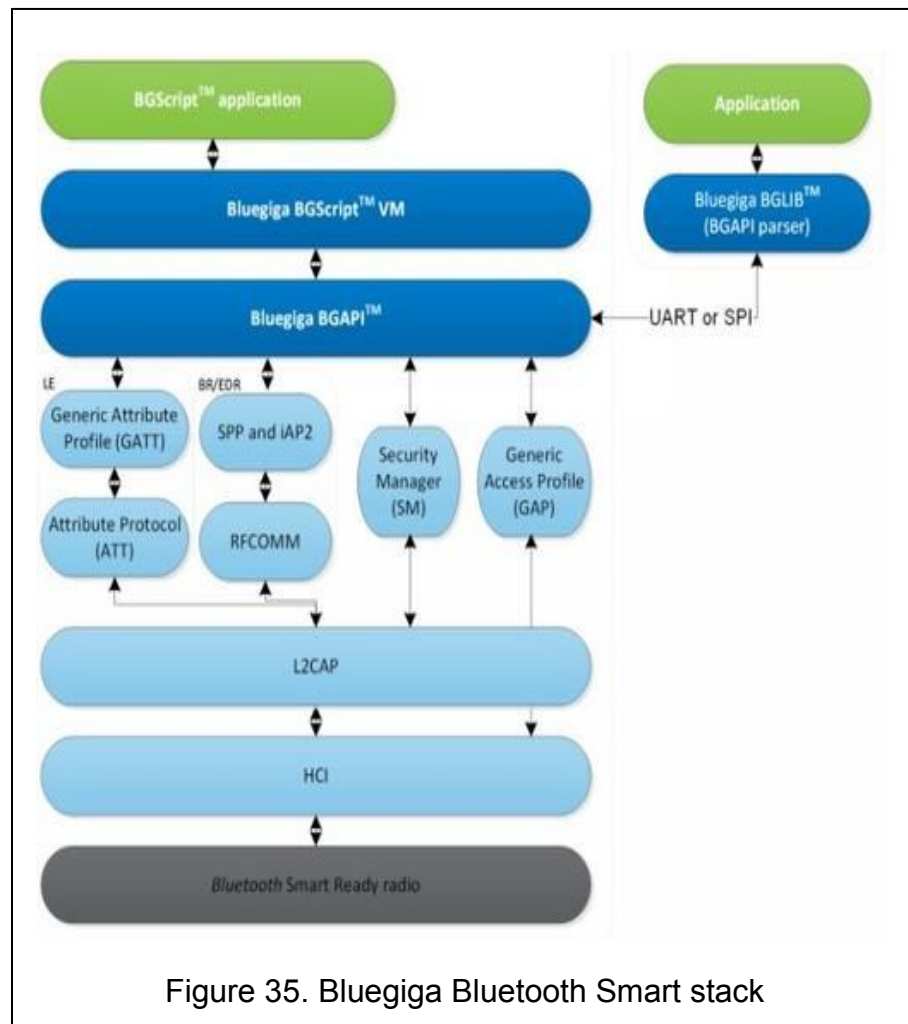

Figure 35. Bluegiga Bluetooth Smart stack

## 5.4 Proximity sensing

In OSEM system, an Estimote beacon was placed near each appliance under study. These beacons were programmed to broadcast the information with



an advertising interval of 100 milliseconds and the transmit power of 4 dBm. On the receiver side, BLED112 was programmed with BGScript. MATLAB's serial communication toolbox was used to collect the data from BLED112 USB dongle. The advertising packet includes a MAC address which identifies the beacon. Once the advertising packet is received, the beacon gets identified with its MAC address and an array associated with that particular beacon gets updated with the respective RSSI values.

When an occupant comes close to any of the transmitting beacons, the RSSI values become higher. Whenever, an appliance detection algorithm detects an event and wants to confirm the proximity of the occupant, the mean of the array of RSSI values is used. If the mean of the RSSI values is greater than the threshold value, then the occupant is considered to be in proximity to the appliance. Here, the threshold values were empirically determined. If the occupant is near the appliance, an event is confirmed.

## CHAPTER 6

### OCCUPANT-SPECIFIC ENERGY MONITORING

This chapter explains how appliance identification (done using an EMF sensor, covered in Chapter 4) and proximity sensing (using Bluetooth Low Energy, covered in Chapter 5) are combined together to make an Occupant-Specific Energy Monitoring system.

#### 6.1 Data and information flow

Figure 36 shows the data and information flow of OSEM system for two users. Each user is required to wear a sensor designed for OSEM. This wearable sensor includes an EMF sensor and a localization sensor (details are

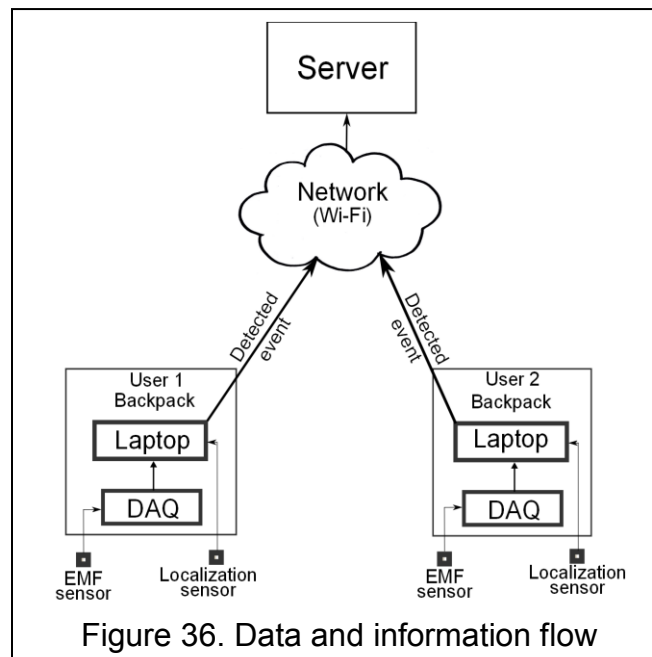

Figure 36. Data and information flow

covered in Chapter 3). The user is also required to carry a backpack containing a data acquisition system (DAQ) and a laptop.

The laptop carried by each user runs the programs required for data collection and processing, and acts as a client to transmit the useful information to the server. A web server is deployed on a PC and receives information from all the clients. The communication between the client and the server is done over the network via HTTP (Hypertext Transport Protocol).

## 6.2 Block diagram

Figure 37 shows the block diagram of the steps involved in the OSEM system. Short-time Fourier Transform, Appliance identification and a part of Event Detection blocks are realized using MATLAB software. The details of each block in the system are explained below:

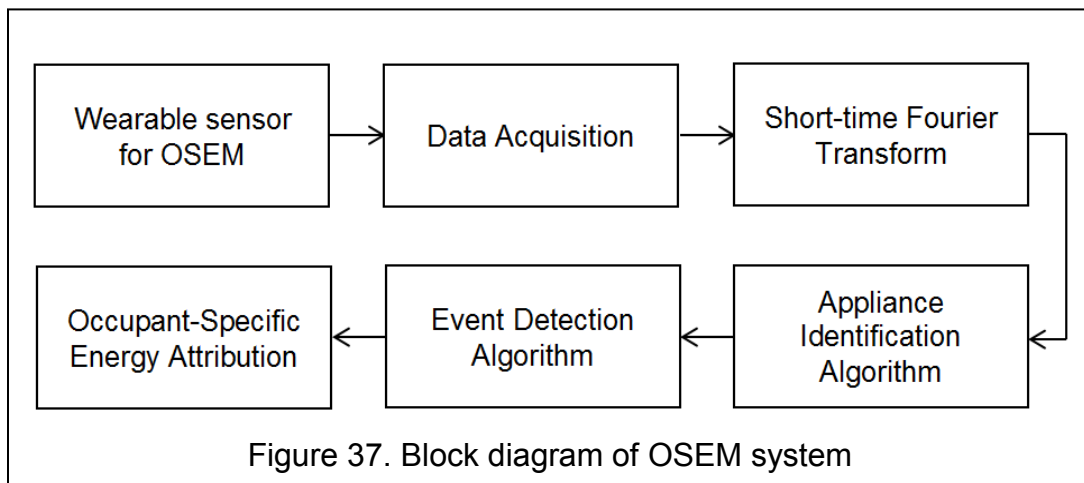

### 6.2.1 Wearable sensor for OSEM

As previously mentioned, the wearable sensor consists of an EMF sensor and a localization sensor. The antenna of the EMF sensor perceives the EMF radiated by appliances. The localization sensor (BLED112) receives the

advertising packets transmitted by the advertising beacons (Estimates). The localization information is fed to the laptop over the USB port.

### **6.2.2 Data Acquisition**

The time domain output of the EMF sensor is sampled and digitized using a data acquisition system (NI USB-6361) and the data is fed to the laptop over the USB port.

### **6.2.3 Short-time Fourier Transform**

The incoming data from DAQ is buffered as a vector whose length is determined by the window size (covered in 4.4.2). Fast Fourier Transform is performed on the data vector to convert it into the frequency domain. The frequency domain vector is fed as a feature vector to the appliance identification block.

### **6.2.4 Appliance Identification**

For OSEM project, supervised Machine Learning is used. The classifier model is trained and is stored on a laptop. This model takes feature vector as an input and provides the respective appliance name or baseline (when no appliances are ON) as an output. The output of the appliance identification block is given as an input to the event detection block.

### **6.2.5 Event Detection**

This block collects appliance names as input and sends confirmed events to the server. A counter is used, whose count increases only when same

appliance name is received consecutively. If the count reaches a predefined number, the program jumps to the next step of distance thresholding. However, if any other appliance name is received from the appliance identification algorithm before the counter reaches its predefined number, the counter resets and starts counting again. This helps reduce the false positives. The number of recurring appliance names required is the tradeoff between the false positives and the responsiveness of the system. A count of four is used as a threshold, as it gives a good balance between the responsiveness of the system and the false positives.

The localization sensor receives information about the distance between users and each appliance continuously. A moving average filter ( $m = 3$ ) was used to remove the noise. When the count reaches a predefined number, the program uses current distance between the user and the appliance. If the distance is less than the threshold, the event is confirmed and is transmitted to the server over the network.

Since OSEM is a real-time system, programs are written optimally to achieve maximum speed. The confirmed event is transmitted to the server using HTTP protocol and may add delays depending on the network speed. Java thread was used to make the event transmission step asynchronous and offload it from MATLAB's main thread.

#### **6.2.6 Occupant-Specific Energy Attribution**

All the confirmed events transmitted by the clients are received on a server. A web application is designed, which resides on a remote server. This

web application analyzes incoming events and attributes the energy related events to the individual user. The details of web application development are covered in the next section.

### 6.3 Web application for OSEM

#### 6.3.1 Architecture

A web application was developed in Java programming language, which handles incoming energy-related events from the user and attributes those events to the particular user who initiated it. Figure 38 shows the OSEM client-server architecture. Confirmed energy-related events are sent from MATLAB through Java thread to the server over the network. Information about the energy consumption can be accessed through a user interface.

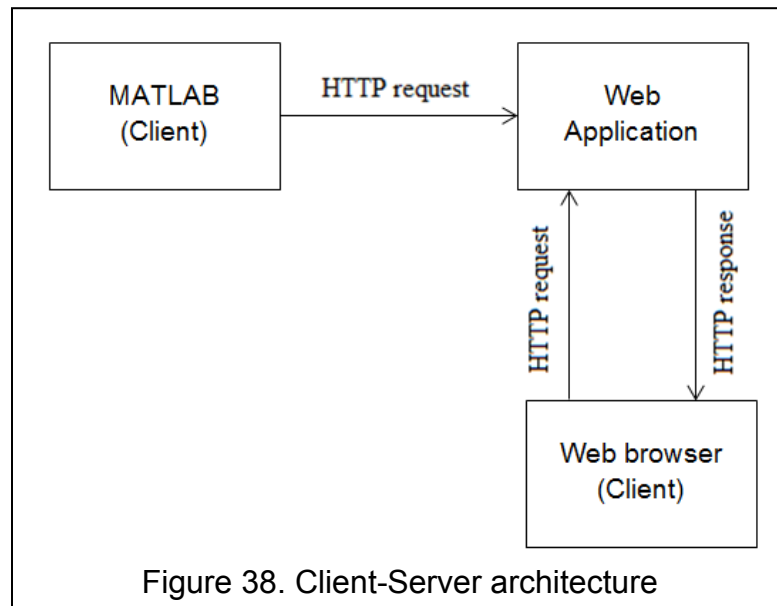

Web application is a program which resides on a remote server and can be accessed through a browser interface (e.g. Google Chrome, Mozilla Firefox etc.). To run a web application, a web server is required. Web server receives

HTTP request and responds back to the client with HTTP response over the network. The HTTP request is sent from a web browser, to which the web server responds in the form of a HTTP response.

Apache Tomcat was used as a webserver. Apache Tomcat is most widely used web server software and is maintained by Apache Software Foundation. It is fast, reliable and an open-source software. Version 8.0 of Apache Tomcat was used for this project. MySQL database management system was used to handle the incoming events from the MATLAB client. MySQL is most widely used and reliable open-source database management system. Web application for the OSEM project was developed in Eclipse IDE (Integrated Development Environment).

### **6.3.2 User interface**

Figure 39 and Figure 40 shows pictures of the user interface accessed from Google Chrome. Figure 39 shows the appearance of the user interface without any events and Figure 40 shows the appearance of user interface after few events have arrived.

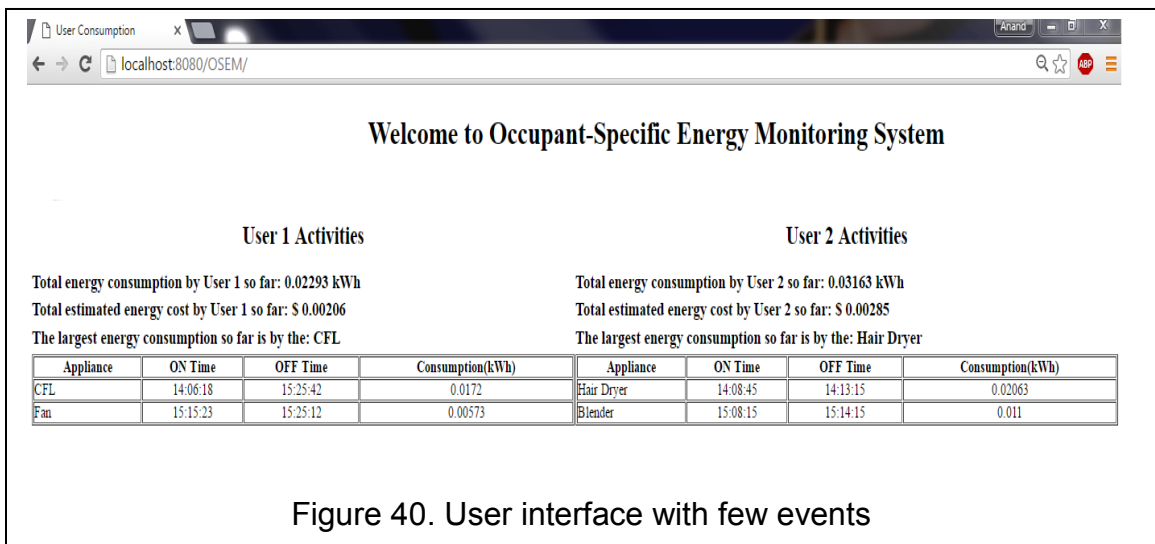
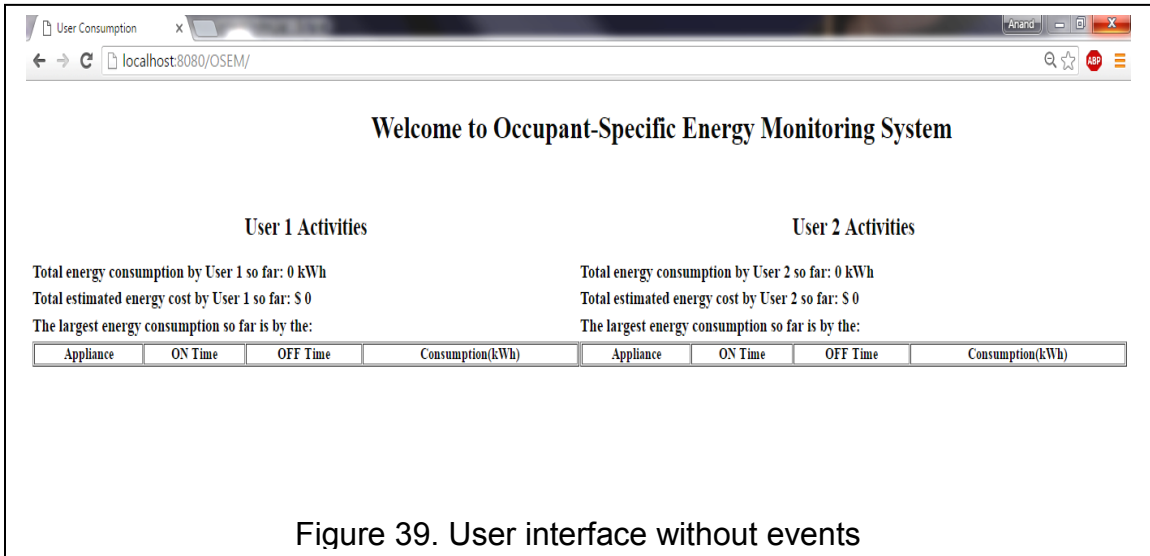

### 6.3.3 Energy attribution model

Energy attribution model is a part of web application and is responsible for calculation of energy consumption and its attribution. A database of all the appliances under study along with their wattage ratings is created. Kill-A-Watt was used to find out the wattage rating of each appliance. This database is used to calculate the energy consumption.



When a user turns an appliance ON or OFF, the programs running on the client laptop confirm the event and the confirmed event is then transmitted to the server. A confirmed energy-related event contains information about the user, the appliance name, and the ON/OFF time of the event.

When an ON event is received, the model fetches the user, appliance and time information from the received event, and attributes turning ON of that appliance to that particular user at that particular time. If a consecutive ON event of the same appliance is received, irrespective of the user; then that recurring event is ignored.

When an OFF event for a particular appliance is received, the model confirms if the appliance was previously ON, and attributes that OFF event to the user who had initiated the ON event. The time difference between the ON and OFF events for an appliance is calculated to find out the time period for which the appliance stayed in ON condition. The energy consumed by that appliance is then calculated using the wattage rating of that appliance from the database and the time period for which that appliance was ON.

All these ON/OFF events are displayed immediately on the user interface. The user interface also provides the information about the cost of energy consumed by the user so far. It also displays the name of the appliance which has consumed the highest amount of energy.

#### **6.4 MATLAB Profiling**

Data collection, processing and classification for OSEM are done using MATLAB software. Since OSEM is a real-time system, it is necessary to make

sure that the code is written in optimal way. MATLAB profiling is a great tool to track the execution time of the code.

NI DAQ is configured to sample EMF sensor with a sampling speed of 125 kS/s. A window size of 16,384 samples was selected. Once 16,384 samples are collected, buffered data is made available for further processing. With the sampling speed of 125 kS/s, data is available every 131 milliseconds for further processing. To design a real-time system, all the other computations needs to be done well within 131 milliseconds, so that MATLAB is always ready to handle next data when it is available.

Each time when data is available, it is first converted into frequency domain. Frequency domain vector is then divided into equal sections and the mean of each section is calculated to make feature vector of reduced size. This feature vector is fed to a machine learning classifier for appliance identification.

Figure 41 shows the profiling results for a one-minute long test. In one minute, the time domain data is available 457 times and all the previously mentioned calculations are performed 457 times on the incoming data. Results indicate that it took 6.897 seconds to perform the calculations 457 times i.e., each time it took 15 milliseconds. Out of 15 milliseconds, the appliance classification algorithm (k-NN) consumed 11 milliseconds on an average. Results show that all our computations are performed well before the next time domain data is available and that the system is capable of performing in real-time.

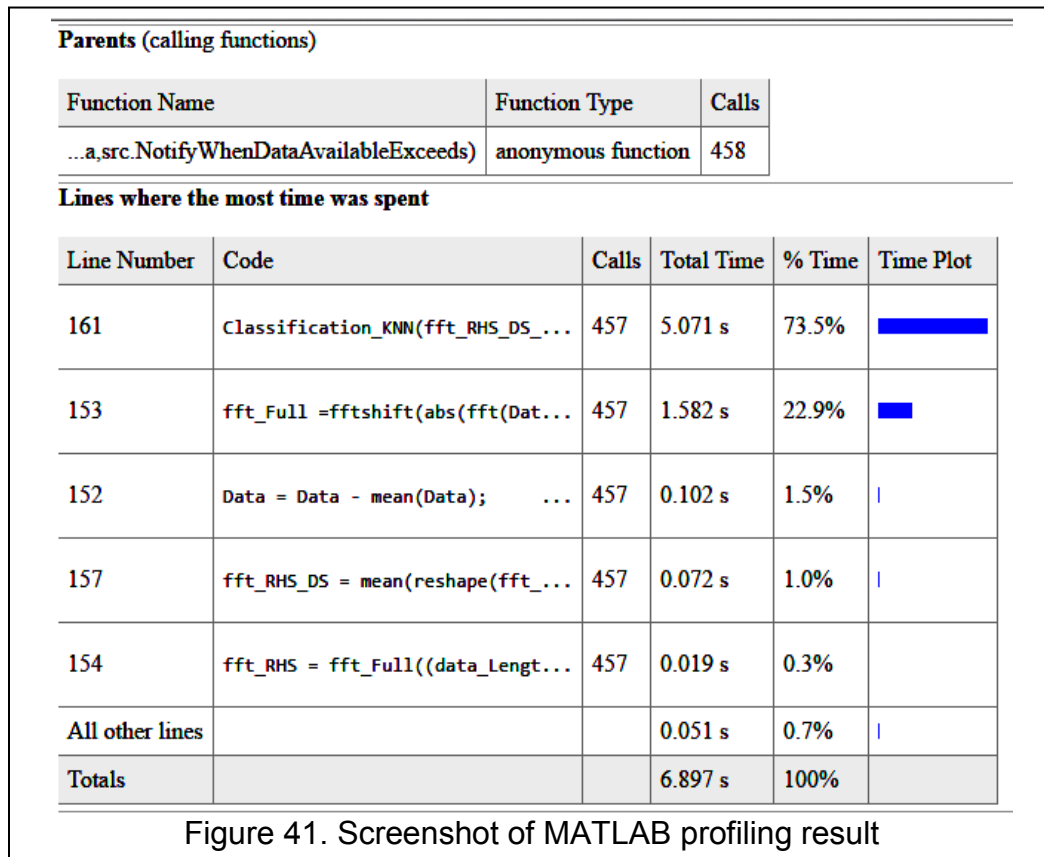

## 6.5 Evaluation of OSEM

The ‘Machine Learning and Interactions Lab’ at University of Louisville was used as an assessment lab. The assessment lab is generally occupied by students and researchers. Figure 42 shows the location of the appliances and Estimote beacons.

OSEM system provides the total energy consumed by each user. It also keeps track of the energy consumed by individual appliances. All this information is provided at the user interface, which can be accessed through any web browser. For performance evaluation, we compared the results of OSEM system to the results obtained by using Kill-A-Watt. Each appliance used for the

experiment was powered through a Kill-A-Watt. The kWh reading obtained from Kill-A-Watt was used as a ground truth for comparison.

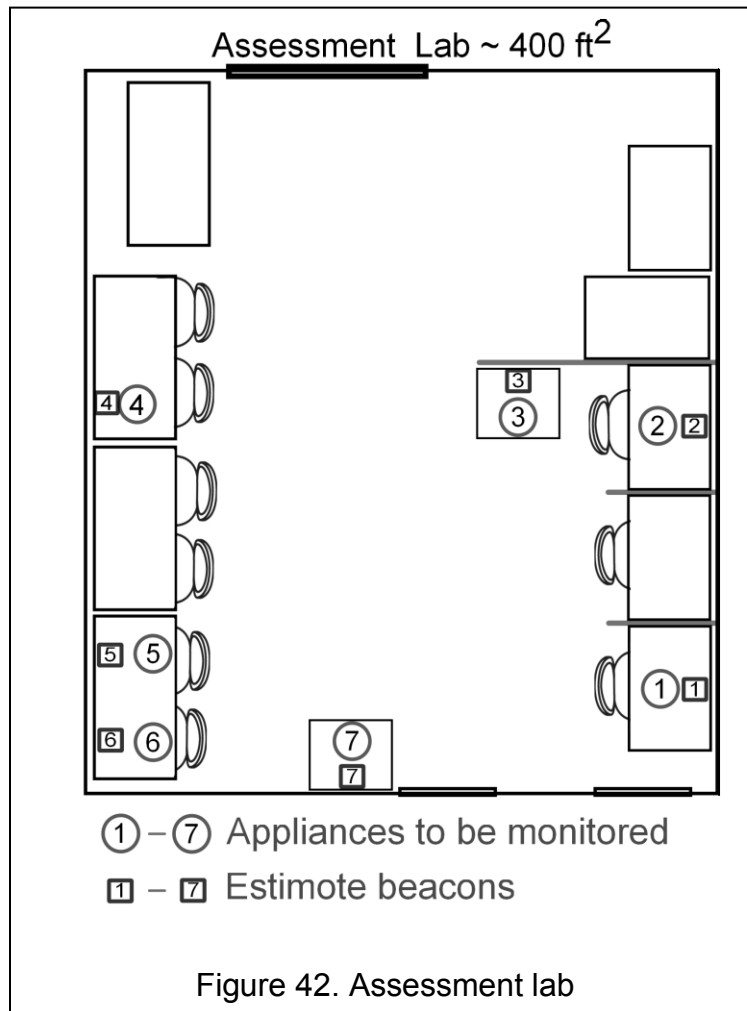

A test with two users was designed to simulate a real world scenario. The test lasted for approximately 47 minutes. The details of each step involved in the test are provided in Appendix A.

Figure 43 shows the comparison between the total energy consumption obtained by using a Kill-A-Watt and the OSEM system. A minor difference in the overall power consumption was noticed, which could be because of the resolution of Kill-A-Watt i.e., 0.01 kWh. Another reason could be the assumption

of constant power draw by each appliance, which might actually fluctuate slightly with time.

Overall, the OSEM system showed comparable results with Kill-A-Watt, having an actual difference of just 0.05 kWh over the entire test. Hence, it can be said that the OSEM system is capable of giving accurate energy consumption results.

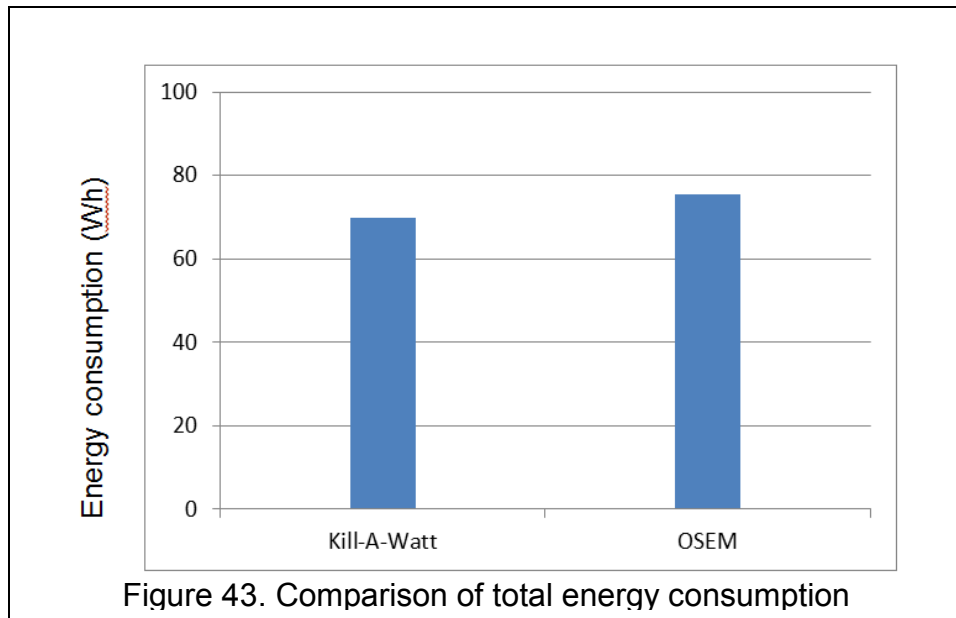
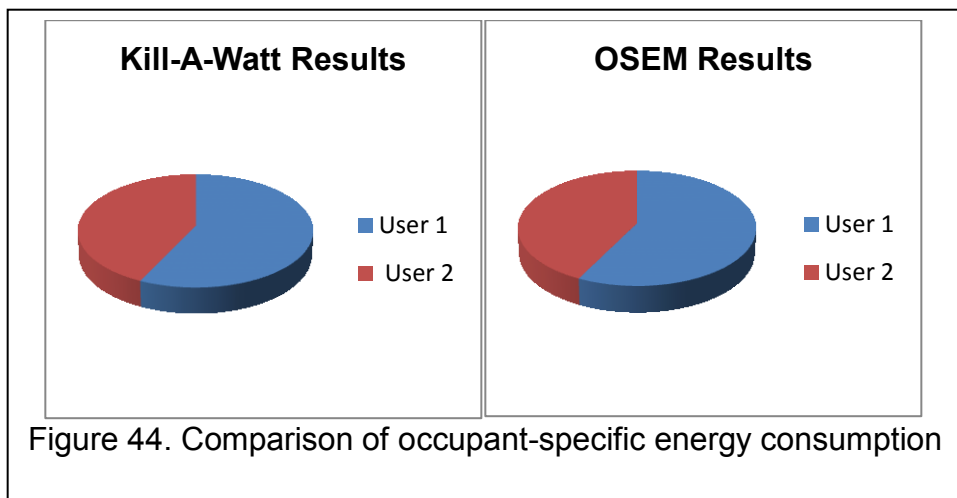
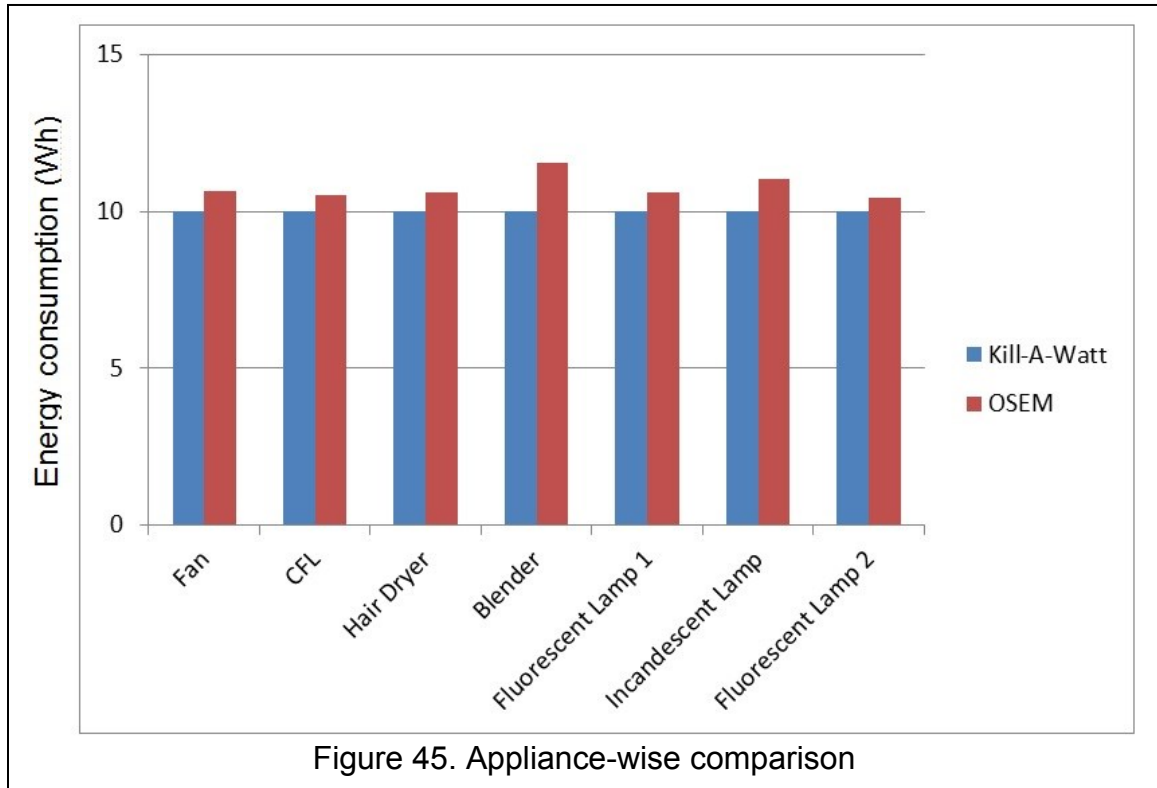

Figure 44 shows the comparison of occupant-specific energy consumption obtained by using Kill-A-Watt and OSEM system. It can be seen from the results



that both the systems showed similar results.

Figure 45 shows the comparison of appliance-specific energy consumption between Kill-A-Watt and OSEM system. As mentioned earlier, the slight difference between the energy consumption is because of the resolution of Kill-A-Watt and our assumption of constant power draw.



## CHAPTER 7 CONCLUSION AND FUTURE WORK

### 7.1 Conclusion

With time, the demand of electricity will increase and it is necessary to curb the energy usage to avoid various problems including pollution, global warming, and depletion of fossil fuels. Using renewable energy resources is the best remedy for this problem. However, until renewable resources are fully developed and made profitable; encouraging people to conserve energy by providing them with feedback about their energy usage, is an immediate and viable solution. Research has indicated that, once consumers receive accurate, timely, and detailed feedback about their energy usage, there are a wide variety of things they can do to reduce the amount of energy they consume. There are various products available in the market which provides energy consumption information of a house/building. Lot of research is being done on NILM systems which provide appliance-specific energy monitoring. Researchers have indicated that individualized feedback is more effective than group feedback. However, very less research has been done so far in the area of individualized energy monitoring.

The OSEM (Occupant-Specific Energy Monitoring) system presented here is capable of monitoring individualized energy usage. OSEM uses the EMF

radiated by appliances as a signature to identify the appliances. Bluetooth technology was used to find the proximity of a user to an appliance. A wearable sensor was designed and fabricated for OSEM, which has two parts: an EMF sensor, and a localization sensor. Web application was designed to collect energy-related events from all the users and attribute the events to the user who initiated it. Results show that the OSEM system is capable of functioning in real-time and individualized energy consumption information can be accessed from any standard web browser.

An individualized energy feedback system like OSEM can be used to study the energy-consumption patterns of the occupants in a house/building. OSEM can be employed in residential and commercial buildings to provide individualized energy-usage feedback. After a week-long or a month-long data analysis, it would provide a detailed energy consumption report of individual occupants. This report can then be used to generate behavioral models and help create better energy predictive models.

## **7.2 Future work**

The first extension of this work is to reduce the size of the hardware required to collect and process the data. In this version of OSEM, NI's DAQ was used for sampling the EMF sensor and a laptop was used to perform all the computations. Each user was required to carry a backpack with a DAQ and a laptop. However, it is not practical to use a DAQ and a laptop in our day-to-day lives. The size of the OSEM system can be reduced by building it around a small single board computer, which can perform all the computations. A data



acquisition circuit can be developed and interfaced with this computer. The current version of OSEM uses Bluetooth LE dongle as a mobile node. This node can be combined with the EMF sensor PCB to save space. By incorporating these changes, the hardware size can be reduced to a large extent, making it compact enough to be carried around during daily activities.

In this phase of OSEM, one Estimate beacon per appliance was used to find the proximity of the user to the appliance. However, it is not feasible to increase the number of beacons with the increasing number of appliances. To address this issue, other indoor localization techniques like trilateration or fingerprinting (discussed in Chapter 2) can be used; where the number of beacons is fixed irrespective of the number of appliances.

According to Bluetooth Low Energy specifications, the advertising interval can be set to 20 milliseconds i.e., 50 packets per second. However, the iOS application for programming Estimote beacons used in OSEM system, does not allow transmitting more than 10 packets per second. So, we recommend trying beacons with smaller advertising interval to improve the responsiveness of the system.

There is a great potential for efficiency gains by adding a suite of sensors to the OSEM system, and interfacing it with the building control infrastructure. For example, upon locating a user and receiving ambient lighting measurement in user's proximity, the building control center can adjust the lighting according to the user's preference and comfort. Also, where no users are detected, the lights can be dimmed or turned off.

## REFERENCES

- [1] "Use of Energy in the United States Explained," Energy Information Administration, 2009.
- [2] L. Pérez-Lombard, J. Ortiz, and C. Pout. "A review on buildings energy consumption information", *Energy and Buildings*, vol. 40, pp.394-398, 2008.
- [3] C. A. Balaras, K. Droutsas, A. A. Argiriou, and D. N. Asimakopoulos, "Potential for energy conservation in apartment buildings," *Energy and Buildings*, vol. 31, pp. 143-154, 2000.
- [4] The U.S. Green Building Council, "Building Momentum: National Trends and Prospects for High-Performance Green Buildings," based on the April 2002 Green Building Roundtable and prepared for the U.S. Senate Committee on Environment and Public Works, 2002.
- [5] S. Park, H. Kim, H. Moon, J. Heo, and S. Yoon, "Concurrent simulation platform for energy-aware smart metering systems," *IEEE transactions on Consumer Electronics*, vol. 56, pp. 1918-1926, 2010.
- [6] K. Balasubramanian and A. Cellatoglu, "Improvements in home automation strategies for designing apparatus for efficient smart home," *IEEE transactions on Consumer Electronics*, vol. 54, pp. 1681-1687, 2008.
- [7] S. Lipoff, "Home automation – the unrealized promise," *IEEE consumer Electronics Society Newsletter*, pp. 13-14, 2010.

- [8] S. Darby, "The effectiveness of feedback on energy consumption: A review for DEFRA of the literature on metering, billing and direct displays," Environmental Change Institute, University of Oxford, 2006.
- [9] C. Seligman and J. M. Darley, "Feedback as a means of decreasing residential energy consumption," *Journal of Applied Psychology*, vol. 62, pp. 363-368, 1977.
- [10] A. H. McMakin, E. L. Malone, and R. E. Lundgren, "Motivating residents to conserve energy without financial incentives," *Environment and Behavior*, pp. 848-863, 2002.
- [11] W. Abrahamse, L. Steg, C. Vlek, and T. Rothengatter, "A review of intervention studies aimed at household energy conservation," *Journal of Environmental Psychology*, vol. 25, pp. 273-291, 2005.
- [12] K. Ehrhardt-Martinez, K. A. Donnelly, and J. A. Laitner, "Advanced Metering Initiatives and Residential Feedback Programs: A Meta-Review for Household Electricity-Saving Opportunities," Report E105, ACEEE, 2010.
- [13] K. Toner, M. Gan, and M. R. Leary, "The impact of individual and group feedback on environmental intentions and self-beliefs," *Environment and Behavior*, vol. 46, pp. 24-45, 2014.
- [14] C. Midden, J. Ham, M. Kleppe, H. Kimura, and T. Nakajima, "Persuasive power in groups: The influence of group feedback and individual comparison feedback on energy consumption behavior," in *PERSUASIVE'11*, Columbus, OH, 2011.

- [15] G. R. Newsham, S. Mancini, and B. J. Birt, "Do LEED-certified buildings save energy ? yes, but...", *Energy and Buildings*, vol. 41, pp. 897-905, 2009.
- [16] J. H. Scofield, "Do LEED-certified buildings save energy? Not really...", *Energy and Buildings*, vol. 41, pp. 1386-1390, 2009.
- [17] A. H. McMakin, E. L. Malone, and R. E. Lundgren, "Motivating residents to conserve energy without financial incentives," *Environment and Behavior*, pp. 848-863, 2002.
- [18] C. M. Clevenger and J. Haymaker, "The impact of the building occupant on energy modeling simulations," in *Computing and Decision Making in Civil and Building Engineering*, Montreal, Canada, 2006.
- [19] E. M. Ryan and T. F. Sanquist, "Validation of building energy modeling tools under idealized and realistic conditions," *Energy and Buildings*, vol. 47, pp. 375-382, 2012.
- [20] W. F. V. Raaij and T. M. M. Verhallen, "A behavioral model of residential energy use," *Journal of Economic Psychology*, vol. 3, pp. 39-63, 1983.
- [21] C. F. Reinhart, "Lightswitch-2002: a model for manual and automated control of electric lighting and blinds," *Solar Energy*, vol. 77, pp. 15-28, 2004.
- [22] H. B. Rijal, P. Tuohy, M. A. Humphreys, J. F. Nicol, A. Samuel, and J. Clarke, "Using results from field surveys to predict the effect of open windows on thermal comfort and energy use in buildings," *Energy and Buildings*, vol. 39, pp. 823-836, 2007.
- [23] K. Janda, "Buildings don't use energy: people do," in *PLEA*, Quebec City, Canada, 2009.

- [24] W. Kempton and L. Layne, "The consumer's energy analysis environment," *Energy Policy*, vol. 22, pp. 857-866, 1994.
- [25] The Energy Detective, Retrieved February 25, 2016, from <http://www.theenergydetective.com/>.
- [26] Wattson, Retrieved February 25, 2016, from <http://smarthomeenergy.co.uk/wattson-energy-monitoring>.
- [27] Neurio, Retrieved February 25, 2016, from <http://neur.io/>
- [28] D. Allen and K. Janda, "The effects of household characteristics and energy use consciousness on the effectiveness of real-time energy use feedback: a pilot study," in *ACEEE summer study on energy efficiency in buildings*, Pacific Grove, CA, 2006.
- [29] T. Dietz, G. T. Gardner, J. Gilligan, P. C. Stern, and M. P. Vandenbergh, "Household actions can provide a behavioral wedge to rapidly reduce U.S. carbon emissions," in *National Academy of Sciences of USA*, 2009.
- [30] P3 International, Retrieved August 15, 2014, from <http://www.p3international.com>
- [31] S. Merrick, "ZigBee Smart Energy Makes Electric Outlets Smart: Plogg smart meter plug brings energy-saving wireless intelligence to homes and buildings," *Business Wire*, 2010.
- [32] A. Rowe, M. Berges, and R. Rajkumar, "Contactless Sensing of Appliance State Transitions through Variations in Electromagnetic Fields," in *Embedded Systems for Energy-Efficient Buildings*, Zurich, Switzerland, 2010.

- [33] Y. Kim, T. Schmid, Z. M. Charbiwala, and M. B. Srivastava, "ViridiScope: Design and implementation of a fine grained power monitoring system for homes," in UbiComp, Orlando, FL, pp. 245-254, 2009.
- [34] A. Schoofs, A. Guerrieri, D. T. Delaney, G. M. P. O'Hare, and A. G. Ruzzelli, "ANNOT: Automated electricity data annotation using wireless sensor networks," in Sensor Mesh and Ad Hoc Communications and Networks, Boston, MA, pp. 1-9, 2010.
- [35] Tyndall, Retrieved February 25, 2016, from <https://www.tyndall.ie/content/mote-layers>
- [36] X. Jiang, S. Dawson-Haggerty, P. Dutta, and D. Culler, "Design and implementation of a high-fidelity AC metering network," in IPSN, San Francisco, CA, pp. 253-264, 2009.
- [37] G. W. Hart, "Nonintrusive appliance load monitoring," in Proceedings of the IEEE, pp.1870-1891, 1992.
- [38] L. K. Norford and S. B. Leeb, "Non-intrusive electrical load monitoring in commercial buildings based on steady-state and transient load-detection algorithms," Energy and Buildings, vol. 24, pp. 51-64, 1996.
- [39] L. Farinaccio and R. Zmeureanu, "Using a pattern recognition approach to disaggregate the total electricity consumption in a house into the major end-uses," Energy and Buildings, vol. 30, pp. 245-259, 1999.
- [40] A. Marchiori, D. H. Q. Han, and L. Earle, "Circuit-Level Load Monitoring for Household Energy Management," Pervasive Computing, IEEE, vol. 10, pp. 40-48, 2011.

- [41] M. L. Marceau and R. Zmeureanu, "Nonintrusive load disaggregation computer program to estimate the energy consumption of major end uses in residential buildings, " *Energy Conservation and Management*, vol. 41, pp. 1389-1403, 2000.
- [42] C. Laughman, K. Lee, L. Norford, and P. Armstrong, " Power signature analysis," *IEEE Power & Energy Magazine*, pp. 56-63, 2003.
- [43] A. G. Ruzzelli, C. Nicolas, A. Schoofs, and G. M. P. O'Hare, "Real-Time Recognition and Profiling of Appliances through a Single Electricity Sensor," in *IEEE Sensor Mesh and Ad Hoc Communications and Networks*, Boston, MA, 2010.
- [44] M. Figueiredo, A. D. Almeida, and B. Ribeiro, "An Experimental Study on Electrical Signature Identification of non-intrusive load monitoring (NILM) systems," in *Adaptive and Natural Computing Algorithms*, Berlin, Germany, pp. 31-40, 2011.
- [45] D. Srinivasan, W. S. Ng, and A. C. Liew, "Neural-Network-Based Signature Recognition for Harmonic Source Identification," *IEEE Transactions of Power Delivery*, vol. 21, pp. 398-405, 2006.
- [46] S. Giri, M. Berges, and A. Rowe, "Towards automated appliance recognition using an EMF sensor in NILM platforms," *Advanced Engineering Informatics*, vol. 27, pp. 477-485, 2013.
- [47] A. Cole and A. Albicki, "Nonintrusive Identification of Electrical Loads in a Three-Phase Environment Based on Harmonic Content," in *Instrumentation and Measurement Technology Conference*, Baltimore, MD, 2000.

- [48] C. Laughman, K. Lee, R. Cox, S. Shaw, S. Leeb, L. Norford, "Power signature analysis," *IEEE power and energy magazine*, pp. 56-63, 2003.
- [49] J. Li, S. West, and G. Platt, "Power Decomposition Based on SVM Regression," in *International Conference on Modelling, Identification Control*, Wuhan, China, pp. 1195–1199, 2012.
- [50] S. Gupta, M. Reynolds, and S. Patel, "ElectriSense: Single point sensing using EMI for electrical event detection and classification in the home," in *UbiComp*, Copenhagen, Denmark, 2010.
- [51] A. I. Cole and A. Albicki, "Data Extraction for Effective Non-Intrusive Identification of Residential Power Loads," in *IEEE Instrumentation and Measurement*, St. Paul Minnesota, USA, pp. 812-815, 1998.
- [52] S. B. Leeb, S. R. Shaw, and J. L. Kirtley, "Transient Event Detection in Spectral Envelope Estimates for Nonintrusive Load Monitoring," *IEEE Transactions of Power Delivery*, 1995.
- [53] S. R. Shaw, S. B. Leeb, L. K. Norfold, and R. W. Cox, "Nonintrusive Load Monitoring and Diagnostics in Power Systems," *IEEE Transactions on Instrumentation and Measurement*, vol. 57, pp. 1445-1454, 2008.
- [54] S. N. Patel, T. Robertson, J. Kientz, M. Reynolds, and G. Abowd, "At the flick of a switch: Detecting and classifying unique electrical events on the residential power line," in *UbiComp*, Innsbruck, Austria, pp. 271-288, 2007.
- [55] N. Murtagh, M. Nati, W. R. Headley, B. Gatersleben, A. Gluhak, M. A. Imran, *et al.*, "Individual energy use and feedback in an office setting: A field trial," *Energy Policy*, vol. 62, pp. 717-728, 2013.



- [56] M. J. Coleman, K. N. Irvine, M. Lemon, and L. Shao, "Promoting behaviour change through personalized energy feedback in offices," *Building Research & Information*, vol. 41, pp. 637-651, 2013.
- [57] *Alertme*, Retrieved September 5, 2014, from [www.alertme.com](http://www.alertme.com).
- [58] *Ekahau*, Retrieved September 3, 2014, from [www.ekahau.com](http://www.ekahau.com).
- [59] F. Van Diggelen, "Indoor GPS theory & implementation," In IEEE Position Location and Navigation Symposium, pp. 240-247, 2002.
- [60] T. W. Christ, P.A. Godwin, and R.E. Lavigne, "A prison guard duress alarm location system," Proc. Of IEEE international carnahan conference on Security Technology, pp. 106-116, 1993.
- [61] D. Devanshi, S. Agrawal, and S. Singh, "Indoor localization based on bluetooth technology: A brief review," International journal on computer applications, vol. 97(8), pp. 31-33, 2014.
- [62] M. Vossiek, L. Wiebking, P. Gulden, J. Wieghardt, C. Hoffmann, and P. Heide, "Wireless Local Positioning," IEEE Microwave Mag., vol. 4(4), pp. 77-86, 2003.
- [63] Y. Wang, X. Jia, H.K. Lee, and G.Y. Li, "An indoors wireless positioning system based on wireless local area network infrastructure," Int. Symp. on Satellite Navigation Technology Including Mobile Positioning & Location Services, 2003.
- [64] H. Liu, H. Darabi, P. Banerjee, and J. Liu, "Survey of wireless indoor positioning techniques and systems", IEEE Transactions on Systems, Man,

- and Cybernetics, Part C: Applications and Reviews, vol. 37(6), pp. 1067-1080, 2007.
- [65] Y. Gu, A. Lo, and I. Niemegeers, "A survey of indoor positioning systems for wireless personal networks," IEEE Communications Surveys & Tutorials, vol. 11(6), pp. 13-32, 2009.
- [66] K. Takata, J. Ma, and B.O. Apduhan, "A dangerous location aware system for assisting kids safety care," in AINA'06, Vienna, Austria, 2006.
- [67] H. Wang, S. Sen, A. Algohary, M. Farid, M. Youssef, and R. R. Choudhury, "No need to war-drive: unsupervised indoor localization" in MobiSys 12, Lake District, UK, pp. 197-210, 2012.
- [68] J. Hightower and G. Borriello, "Location sensing techniques," IEEE Computer, vol. 34(8), pp 57-66, 2001.
- [69] C.C. Pu, C.H. Pu, and H. J. Lee., "Indoor location tracking using received signal strength indicator". INTECH Open Access Publisher, 2011.
- [70] Y. Wang, S. Shi, X. Yang, and A. Ma," Bluetooth indoor positioning using RSSI and least square estimation", Proc. of International conference on future computer and communication, Shanghai, China, 2010.
- [71] Q. Dong, and D. Walteneus, "Evaluation of the reliability of RSSI for indoor localization," In Wireless Communications in Unusual and Confined Areas (ICWCUCA), pp. 1-6, 2012.
- [72] T. S. Rappaport, "Wireless communications: principles and practice," vol. 2. New Jersey: Prentice Hall PTR, 1996.

- [73] O.S. Oguejiofor, V.N, Okorogu, A. Adewale, and B. O. Osuesu, "Outdoor localization system using RSSI measurement of wireless sensor network," International journal of innovative technology and exploring engineering, vol. 2(2), pp. 1-6 , 2013.
- [74] G. Ionescu, de la Osa C.M., and M. Deriaz, "Improving distance estimation in object localization with bluetooth low energy," in SENSORCOMM, pp. 44-50, 2014.
- [75] E. Aitenbichler and M. Mühlhäuser, "An IR local positioning system for smart items and devices," in ICDCSW'03, Providence, Rhode Island, USA, pp. 334-339, 2003.
- [76] J. Krejsa, and S. Vechet, "Infrared beacons based localization of mobile robot," Elektronika ir Elektrotechnika, vol. 117(1), pp. 17-22, 2012.
- [77] C. Lee, Y. Chang, G. Park, J. Ryu, S. Jeong, and S. Park, "Indoor Positioning System Based on Incident Angles of Infrared Emitters," in Industrial Electronics Society, Busan, Korea, 2004.
- [78] R. Want, A. Hopper, V. Falcao, and J. Gibbons, "The Active Badge Location System", ACM Trans. Information Systems, vol. 10(1), pp. 91-102, 1992.
- [79] R. States and E. Pappas, "Precision and repeatability of the Optotrak 3020 motion measurement system", J. Medical Engineering and Technology, vol. 30(1), pp. 1-16, 2006.
- [80] Cybernet Interactive, Firefly Motion Capture System,  
<http://www.cybernet.com/interactive/firefly/>
- [81] Active Bat, <http://www.cl.cam.ac.uk/research/dtg/attarchive/bat/>

- [82] N. Priyantha, A. Chakraborty, and H. Balakrishnan, "The cricket location-support system," in ACM Conference on Mobile Computing and Networking, 2000.
- [83] Y. Fukuju, M. Minami, H. Morikawa, and T. Aoyama, "Dolphin: An autonomous indoor positioning system in ubiquitous computing environment," in WSTFEUS, Hakodate, Hokkaido, Japan, pp. 53-56, 2003.
- [84] M. Minami, Y. Fukuju, K. Hirasawa, S. Yokoyama, M. Mizumachi, H. Morikawa, and T. Aoyama, "Dolphin: A practical approach for implementing a fully distributed indoor ultrasonic positioning system", in UbiComp, Nottingham, England, pp. 347–365, 2004.
- [85] L. Zhekun, R. Gadh, and B.S. Prabhu, "Applications of RFID technology and smart parts in manufacturing" in DETC'04, Salt lake city, Utah, USA, 2004.
- [86] J. Wang and D. Katabi, "Dude, Where's My Card? RFID Positioning That Works with Multipath and Non-Line of Sight," in SIGCOMM, Hong Kong, China, pp.51-62, 2013.
- [87] F. Manzoor and K. Menzel, "Indoor Localisation for Complex Building Designs using Passive RFID Technology," in proc. Of 2011 General Assembly and scientific symposium, pp. 1-4, 2011.
- [88] L.M. Ni, Y. Liu, Y.C. Lau, and A.P. Patil, "LANDMARC: Indoor location using active RFID," *Wireless Networks*, vol.10, pp. 701-710, 2004.
- [89] S. L. Ting, S. K. Kwok, A.H. Tsang, and G.T Ho, "The study on using passive RFID tages for indoor positioning," *International journal of engineering business management*, vol. 3(1), pp. 9-15, 2011.

- [90] M. Emery and M. K. Denko, "IEEE 802.11 WLAN based real-time location tracking in indoor and outdoor environments," in CCECE, Vancouver, BC, Canada, pp. 1062- 1065, 2007.
- [91] S. Mazuelas, A. Bahillo, R.M. Lorenzo, P. Fernandez, F.A. Lago, E. Garcia, J. Blas, and E.J. Abril, "Robust indoor positioning provided by real-time RSSI values in unmodified WLAN networks," IEEE journal of selected topics in signal processing, vol. 3(5), pp. 821-831, 2009.
- [92] J. Ma, X. Li, X. Tao, and J. Lu, "Cluster Filtered KNN:A WLAN-Based Indoor Positioning Scheme," in WoWMoM, Newport Beach, CA, USA, pp. 1-8, 2008.
- [93] K. Kaemarungsi and P. Krishnamurthy, "Modeling of indoor positioning systems based on location fingerprinting," in INFOCOMM'04, Hong Kong, China, vol. 2, pp. 1012-1022, 2004.
- [94] U. Grossmann, M. Schauch, and S. Hakobyan, "RSSI based WLAN Indoor Positioning with Personal Digital Assistants," in IDAACS, Dortmund, Germany, pp. 653-656, 2007.
- [95] C. Rohrig and F. Kunemund, "Mobile Robot Localization using WLAN Signal Strengths," in IDAACS, Dortmund, Germany, pp. 704-709, 2007.
- [96] P. Bahl and V.N. Padmanabhan, "RADAR: An in-building RF-based user location and tracking system," in INFOCOMM, Tel-Aviv, Israel, vol.2, pp. 775-784, 2000.
- [97] W. M. Grady and S. Santoso, "Understanding Power System Harmonics," IEEE Power Engineering Review, pp. 8-11, 2001.

- [98] C. W. Smith, "Power systems and harmonic factors," *Potentials*, IEEE, vol. 20, pp. 10-12, 2002.
- [99] A. Butte, "The use and analysis of microarray data," *Nature reviews drug discovery*, vol 1(12), pp. 951-960, 2002.
- [100] M. Ringnér, "What is principal component analysis?," *Nature biotechnology*, vol. 26(3), pp. 303-304, 2008.
- [101] V. Vapnik, "Statistical learning theory," Wiley, New York, 1998.
- [102] I. Guyon, and A. Elisseeff, "An introduction to variable and feature selection," *The Journal of Machine Learning Research*, vol. 3, pp. 1157-1182, 2003.
- [103] E. Ferro and F. Potorti, "Bluetooth and Wi-Fi wireless protocols: a survey and a comparison," *Wireless Communications*, vol. 12(1), pp. 12-26, 2005.
- [104] Bluetooth SIG, "Bluetooth Specifications V 1.0," 1999.
- [105] C. Bisdikian "An overview of the Bluetooth wireless technology," *IEEE Commun Magazine*, vol. 39(12), pp. 86-94, 2001.
- [106] Z. Jianyong, C. Zili, L. Haiyong, and L. Zhaohui, "RSSI based Bluetooth Low Energy indoor positioning," in *International conference on indoor positioning and indoor navigation*, Busan, Korea, 2014.
- [107] S. Feldmann, K. Kyamakya, A. Zapater, and Z. Lue, "An indoor Bluetooth-based positioning system: concept, Implementation and experimental evaluation," in *International conference on Wireless Networks*, pp. 109-113, 2003.

- [108] L. Pei, R. Chen, J. Liu, and T. Tenhunen, "Inquiry-Based Bluetooth Indoor Positioning via RSSI Probability Distributions," in SPACOMM, Athens, pp. 151-156, 2010.
- [109] A.K.M.M. Hossain, and S. Wee-Seng, "A comprehensive study of bluetooth signal parameters for localization," in PIMRC, Athens, pp. 1-5, 2007.
- [110] F. Subhan, H. Halabi, A. Rozyyev, and S.T. Bakush, "Analysis of Bluetooth signal parameters for indoor positioning systems," in ICCIS, Kuala Lumpur, Malaysia, pp. 784-789, 2012.
- [111] Bluetooth SIG. Bluetooth Specification Version 4.0, 06 2010.
- [112] R. Heydon, "Bluetooth low energy: the developer's handbook," Prentice Hall, 2012.
- [113] R. Faragher and R. Harle, "An Analysis of the Accuracy of Bluetooth Low Energy for Indoor Positioning Applications," in proceedings of 27th international technical meeting of the satellite division of the institute of navigation, 2014.
- [114] Estimote, Retrieved February 25, 2016, from <http://estimote.com/>
- [115] BLED112, Retrieved February 26, 2016, from <https://www.bluegiga.com/en-US/products/bled112-bluetooth-smart-dongle/>

## APPENDIX A

1. User 1 comes back from the gym and returns to the lab, turning *ON* the CFL. He/she leaves it in the *ON* condition and walks away.
2. Since he/she is feeling hot, he/she turns *ON* the Fan and stays in front of it for some time. He/she then moves away without turning it *OFF*.
3. He/she is exhausted and needs energy drink. So, he/she decides to make a smoothie for himself/herself and turns *ON* the Blender.
4. After making the smoothie he/she turns *OFF* the Blender.
5. He/she grabs his/her smoothie and reaches his/her desk to relax and read a book. He/she turns *ON* the Desk Lamp (Fluorescent Lamp (FL)) there.
6. After some time, User 2 arrives at the lab and turns *ON* the Incandescent Lamp.
7. He/she is feeling cold as he/she just came from outside, and it had started to drizzle. He/she notices that the Fan is *ON* so he/she turns it *OFF* immediately.
8. User 2 then uses the Hair Dryer (*ON* and *OFF*) to blow dry his/her hair.
9. User 1 is now done reading and turns *OFF* his/her Desk Lamp (FL). Then he/she leaves the lab for a meeting in another building.
10. User 2 turns *OFF* the Incandescent Lamp and approaches his/her own desk.



11. He/she opens his/her planner to make notes about his/her day and turns *ON* Desk Lamp (FL) at his/her desk (i.e., a different lamp than the FL at User 1's desk but the same type of appliance).
12. After User 2 is done making plans for his/her day, he/she switches *OFF* his/her Desk Lamp (FL).
13. He/she heads out for a class and notices that User 1 has left the CFL *ON*. He/she turns it *OFF* and walks out of the lab.

## APPENDIX B

A2DP	Advanced Audio Distribution Profile
AC	Alternating Current
AES	Advanced Encryption System
API	Application Program Interface
ARM	Advanced RISC Machines
BGAPI	Bluegiga Application Program Interface
BLE	Bluetooth Low Energy
BR	Basic Rate
CAD	Computer-Aided Design
CMOS	Complementary Metal Oxide Semiconductor
DAQ	Data Acquisition
EMF	Electromagnetic Field
EMI	Electromagnetic Interference
FFS	Forward Feature Selection
FFT	Fast Fourier Transform
FHSS	Frequency Hopping Spread Spectrum
FSM	Finite State Machine
FTP	File Transfer Profile
GAP	Generic Access Profile
GFSK	Gaussian Frequency Shift Keying

GPS	Global Positioning System
HF	High Frequency
HSP	Headset Profile
HTTP	Hypertext Transport Protocol
IDE	Integrated Development Environment
ILM	Intrusive Load Monitoring
iOS	iPhone Operating System (Apple, Inc.)
IR	Infrared
ISM	Industrial, Scientific, and Medical
k-NN	k-Nearest Neighbor
LEED	Leadership in Energy and Environmental Design
L2CAP	Logical Link Control and Adaption Protocol
LQ	Link Quality
MAC	Media Access Control
MCU	Microcontroller Unit
NI	National Instruments
NILM	Non-Intrusive Load Monitoring
OSEM	Occupant-Specific Energy Monitoring
PC	Personal Computer
PCA	Principle Component Analysis
PCB	Printed Circuit Board
PDA	Personal Digital Assistant
PLA	Poly Lactic Acid

RF	Radio Frequency
RFID	Radio-Frequency Identification
RMS	Root Mean Square
RSS	Received Signal Strength
RSSI	Received Signal Strength Indicator
RTLS	Real-Time Location System
RTOA	Round-trip Time of Arrival
SDK	Software Development Kit
SIG	Special Interest Group
SMPS	Switched Mode Power Supply
SVM	Support Vector Machines
TDOA	Time Difference of Arrival
TED	The Energy Detective
TI	Texas Instruments
TOA	Time of Arrival
TPL	Transmit Power Line
USB	Universal Serial Bus
USGBC	US Green Building Council
WLAN	Wireless Local Area Network

# CURRICULUM VITAE

Anand Sunil Kulkarni

Machine Learning and Interactions Lab

Department of Electrical and Computer Engineering

University of Louisville, Louisville, KY, 40292

Email: askulk02@louisville.edu

## **PROFESSIONAL SUMMARY**

- Prototyped a wireless device in the form factor of a 'wrist watch' for a NSF funded project, to monitor physiological signals which would be used for emotion mapping.
- Assisted in NIH funded project of designing a wearable computing device for monitoring daily activities and health of elderly people.
- Hands-on experience in PCB and sensor design, signal processing, machine learning, and data acquisition.
- Worked on indoor localization using Bluetooth Low Energy.
- Comprehensive knowledge of programming languages to communicate with hardware.
- Goal oriented, diligent team-player with effective communication skills.

- Particularly competent at multitasking and task prioritization based time management.

## **EDUCATION**

University of Louisville, Louisville, KY, USA	Aug. 2010 – May 2016
Ph.D. in Electrical and Computer Engineering	GPA: 3.77
University of Louisville, Louisville, KY, USA	Aug. 2007 - Dec. 2009
Master of Science in Electrical and Computer Engineering	GPA: 3.76
Bharti Vidyapeeth College of Engineering, Pune, India	July 2000 - June 2005
Bachelors in Electrical Engineering	First Class

## **TECHNICAL SKILLS**

**Programming:** MATLAB, Octave, Python, Processing, C, C++, VHDL, LabVIEW, Simulink, Arduino

**CAD Tools:** Solid Works, AutoCAD

**EDA Tools:** EagleCAD, OrCAD

## **PROFESSIONAL EXPERIENCE**

**Ph.D. Researcher** **Aug. 2010 – May 2016**

**University of Louisville, KY**

- Designed an electromagnetic field (EMF) sensor to collect radiated EMF signature from appliances, using National Instrument's DAQ.
- Used signal processing and machine learning to identify the appliance from radiated EMF.
- Programmed USB dongle using Bluetooth API and utilized Estimote beacons for indoor localization.

- Fused localization information and EMF sensor data to measure occupant-specific energy consumption.

**Electrical Engineering Intern**

**May 2015 - Aug. 2015**

**Gen Nine, Inc., Louisville, KY**

- Planned various phases involved in the NIH funded project of designing a wearable computing device.
- Prepared a preliminary list of components required for designing health and activity monitor for elderly people.
- Designed schematics and PCBs for pulse oximetry and motion sensors, tested fabricated PCBs.
- Designed a schematic and PCB to connect motion sensor to Variscite's DART-4460 SOM.
- Used Linux I2C tools to communicate between digital sensors and OMAP 4460 processor.

**Teaching Assistant**

**Aug. 2010 - Apr. 2013**

**University of Louisville, KY**

- ECE221 (Network Analysis Lab): Taught experiments about measuring instruments and measurement of network characteristics.
- ECE211 (Logic Design Lab): Taught design-oriented experiments on combinational and sequential logic circuits, using integrated circuit components.

**Research Assistant**

**Aug. 2007 - Dec. 2009**

**College of Business, University of Louisville, KY**

- Involved in research conducted by Dr. Rohan A. Christie-David, Professor of Finance.
- Gathered and processed data for research in finance, employing SAS.

### **Electrical Engineer**

**July 2005 - Sep. 2006**

### **ThyssenKrupp Industrial Solutions Private Limited, Pune, India**

- Performed electrical equipment sizing.
- Designed various electrical and lighting layouts.
- Utilized PDMS for 3D modeling of a plant.
- Designed medium and high voltage panels.
- Coordinated with vendors, clients and project sites.
- Inspected various electrical equipments including transformers and UPS (Unregulated power supply).

### **ACADEMIC PROJECTS**

#### **Ethernet Controller Interface**

- Designed an IP addressable I/O device to control multiple application devices.
- Used PCDEM.net2 board with PIC18F97J60 microcontroller.
- Designed a webpage and a LabVIEW interface for reading data from Ethernet Controller.

#### **555 timer IC Design**

- Designed and tested 555 timer IC using SPICE and L-Edit.

#### **Design of 10 bit Synchronous Counter**

- Designed a 10-bit counter and 4-bit input multiplier in VHDL.



- Tested counter design with Xilinx Spartan development board.

### **Microcontroller-based Differential Relay**

- Designed a prototype to demonstrate transformer protection in case of differential currents.
- Programmed Atmel 89C51 microcontroller to detect differential current and trip the circuit.
- Commissioned the prototype for educational purpose at the institute's laboratory.

### **PUBLICATIONS**

- "A Mobile EMF Sensor for Appliance Identification", IEEE SoutheastCon, Norfolk, VA, March, 2016.
- "EMF Signature for Appliance Classification", IEEE Sensors Journal, December, 2014.
- "Classifying Energy-Related Events using Electromagnetic Field Signatures", HCII 2013, Las Vegas, NV, July, 2013.
- "Modeling Human Behavior for Energy Usage Prediction", HCII 2011, Orlando, FL, July, 2011.
- "A Review of Energy Monitoring and Feedback Systems", IEEE SoutheastCon, Nashville, TN, March, 2011.

### **ACTIVITIES**

- Won 2nd prize for poster presentation at E-expo 2013.
- Elected Joint General Secretary for ASEE (Association of Students of Electrical Engineers).

- Won prize at National Level Paper Presentation Competition.