

RTO through ES control in multidimensional parameter space

by

Sonja Sredojev

Thesis submitted in total fulfilment of the requirements
of the degree of Master of Science

Department of Electrical and Electronic Engineering
The University of Melbourne

March 2011

Abstract

Optimization of industrial processes or behavior of any real-world system typically attracts a lot of attention among researchers. Many different approaches are suggested and many different algorithms designed and explored.

The work reported in this thesis is motivated by perturbation-based extremum seeking algorithm. This is a model-free or a so called "black-box" real time optimization technique that dates back in 1922. The main difference and may be the challenge is the way how the gradient is estimated. The algorithm uses periodic perturbation which is injected into the algorithm with intention to extract the information about the gradient. To deal with the model uncertainties and unknown disturbances it is assumed no information is available about the plant dynamics. Analytical structure of cost function is not known but its measurements are available. Structure of input-output correlation is used to find the necessary condition to force the gradient towards zero, and consequently output to the optimal set-point.

The research analyzes first order extremum seeking controller. Procedure for tuning the parameters is established and SPA stability proved in multidimensional parameter space. It is shown that proper tuning of parameters can guaranty stability beyond the local analysis. If properly tuned this parameters can considerably speed up the algorithm, enlarge the domain of attraction or increase the accuracy of the controller.

Declaration

This is to certify that

- (i) the thesis comprises only my original work towards the Master of Science in Engineering except where indicated in the Preface,
- (ii) due acknowledgement has been made in the text to all other material used
- (iii) the thesis is less than 50,000 words in length, exclusive of tables, maps, bibliographies and appendices as approved by RHD Committee

Signature _____

Date _____

Acknowledgements

I wish to express my deepest gratitude to my supervisor Iven Mareels for his limitless and direct support and guidance during these studies.

I would further like to extend my gratitude to the Australian Government for providing me with the scholarship that made my studies possible.

Contents

1	Introduction	10
1.1	Formulation of general optimization problem	11
1.2	Real-time optimization	12
1.3	Extremum seeking	16
1.4	Motivational examples	21
1.5	Simple extremum seeking algorithm	23
1.6	Outline of the thesis	27
2	Background	30
2.1	Lyapunov stability concepts	30
2.2	Comparison functions and Laypunov direct method	37
2.3	Asymptotic approximations and averaging	40
3	Extremum seeking controllers	41
3.1	Deterministic ESC	42
3.1.1	Sinusoidally perturbed ES	42
3.1.2	Analysis of sinusoidally perturbed ES algorithm with and without dynamics	46
3.1.3	Algorithm performance. Some extensions and modifications	52
3.1.4	Sliding mode ESC	57
3.1.5	RTO and model predictive control. Unified framework	58

3.1.6	Numerical approach. Nonlinear programming	59
3.2	Stochastic ESC	59
3.3	Examples of applications	62
4	p-dimensional parameter space	66
4.1	First order ESC. Problem formulation	66
4.2	Convergence analysis. SPA stability	68
4.3	Numerical results and discussion	77
5	Conclusions and future work	81
5.1	Contributions	81
5.2	Algorithm limitations	82
5.3	Discussion and future work	83
A	Appendix	84
A.1	Taylor Theorem. Taylor series	84
A.2	Lagrange Theorem	86

List of Figures

1.1	Summary of real-time optimization methods	14
1.2	Update directions for steepest descent	19
1.3	Combustion process in gas turbine	21
1.4	Higher order extremum seeking algorithm	23
1.5	Static curve	24
1.6	Performance of extremum seeking controller	25
2.1	Stable solution in Lyapunov sense	31
2.2	Stable solution in Lyapunov sense	32
2.3	The state portrait of the system of Example 2.1	34
2.4	Stable origin	34
2.5	Attractive origin	35
2.6	Exponentially stable origin	36
3.1	The effect of sinusoidal perturbation on cost function	44
3.2	Basic extremum seeking scheme for static mapping	47
3.3	ES scheme without dither signal	56
3.4	ES control using sliding mode	57
3.5	Block diagram for the anti-windup ESC	65
4.1	First order MISO extremum seeking algorithm	67

4.2	ES convergence for two dimensional parameter	78
4.3	Convergence speed comparison for two different frequencies	79
4.4	Algorithm performance for three- and five-dimensional parameter	79
4.5	Comparison of two performances	80
A.1	Geometrical meaning of Lagrange Theorem	88

Chapter 1

Introduction

Nonlinear optimal control problems are problems involving real world situations where the objectives are locating the minimum or maximum of the cost function, during, for example, the operation of some physical, social or, may be economic processes. Algorithms used to solve these problems are expected to satisfy the objectives.

The function may be given analytically or determined "experimentally". Noise and experimental error may, or may not be associated with this function. However, there may exist constraints equations which limit the arguments of the performance measure. The efficiency of available search techniques for computing the optimum is affected by certain global and local properties of functions. Generally, a function may or may not exhibit discontinuities. The best known search techniques are perhaps elementary gradients methods.

When the performance measure $f(\mathbf{x})$ is evaluated experimentally, there exist experimental errors from measurements and from noise in the physical system under study. Under such conditions, exact expressions are not obtainable for the function $f(\mathbf{x})$ or for the gradient of $f(\mathbf{x})$. It is possible, however, to obtain *expected values* of these by using appropriate expressions.

The work reported in this thesis is motivated primarily by the problems of stability of algorithms for extremum seeking control for general dynamical nonlinear systems.

1.1 Formulation of general optimization problem

Optimization is concerned with the general problem of finding an unrestricted extremum of a function $f : \mathbb{R}^n \rightarrow \mathbb{R}$. Suppose the function of interest can be calculated at all points. The goal of optimization is to find local extremum value (minimum or maximum) at some \mathbf{x}^* such that the following holds:

$$f(\mathbf{x}^*) \leq f(\mathbf{x}) \quad \text{or} \quad f(\mathbf{x}^*) \geq f(\mathbf{x}) \quad (1.1)$$

for all $\mathbf{x} \in \mathbb{R}^n$ in case of global optimization. In other words optimization control task is to locate an input \mathbf{x} which optimizes an unknown function $f(\mathbf{x})$ such that, for example:

$$\mathbf{x}^* = \arg \min_{\mathbf{x} \in \mathbb{R}^n} f(\mathbf{x}) \quad (1.2)$$

\mathbf{x}^* is the argument which minimizes the function $f(\mathbf{x})$. For the sake of simplicity it may be assumed that the objective function $f(\mathbf{x})$ has only one minimum.

For differentiable functions it is well known the condition for optimality to be satisfied is the gradient to be equal to zero. In literature this condition is often called first-order condition for optimality. The second-order condition guaranties the second derivative (Hessian) to be positive or negative (definite or semidefinite). Of course, first one is necessary, while the second one indicates a local convexity or concavity of the cost function and, thus the nature of the extremum.

1.2 Real-time optimization

Optimization of process performance gained popularity in recent years as it represents natural drive for production costs minimization and/or product quality improvement. No matter whether the process is mechanical, electrical or chemical standard optimization tools mostly use model-based techniques. To compute the valid optimal solution in numerical procedures these techniques require adequate knowledge and enough information about process models. Unfortunately, in many cases models of high accuracy are usually unavailable. They could be found with an effort but often cost benefit is unclear. Typically therefore, controller for model-based optimization must be robust to allow for possible model-plant mismatch.

A model of limited accuracy when used to optimize a real complex process will lead to errors and, an inexact optimum. Such model may possibly result in suboptimal operation, or even worse, lead to unfeasible/inadmissible optimal conditions. This task is, however, even more complicated by the fact that process data are usually noisy and signals may not carry enough information for efficient process identification. Hence, one of the main challenges in real time optimization (RTO) mainly arises from the incapability to design and adapt precise models for complex processes.

RTO is usually considered as a nonlinear programming problem (NLP) whose objective is to drive the system towards the optimal steady-state operating performance of the process, while satisfying constraints if they exist. The RTO is a closed-loop control that uses available measurements to compensate for model uncertainty and, thus improve the system performance in the context of process optimization. It is done through iterative adjustment of selected system parameters in real time. As structural and parametric errors are inevitable in real-world systems a number of algorithms are developed to achieve this goal considering the systems with the presence of significant uncertainties.

In view of the above, normally, RTO is implemented through a *two-step approach*. This is described in [5]. In the literature this is, also, often referred as *repeated identification and optimization*. Model parameters are iteratively estimated and the updated model is then used to adapt the decision variables. In the first step, the values of the chosen model parameters θ are estimated using the process output measurements. In the second step the updated model is used to adapt the decision variables via optimization. This two-step approach works well only when provided the model mismatch is low.

However, it is worth mentioning that measurements of cost function are not always available. Depending whether measurements are used for computing the optimal solution or not there are two main available optimization methods that can handle with uncertainties:

- *robust optimization* is typically used in the absence of measurements;
- *adaptive optimization* is used when measurements are available. That can help identify and adjust to process changes and disturbances.

Actually, all control theory is designed to drive a system to a prescribed mode of behavior. Robust and adaptive control schemes are employed in particular to deal with uncertainties in the system description, so that the desired behavior can be reached despite this problem. In adaptive optimization there are three main approaches that differ in the way the adaptation is performed:

- *model parameter adaptation* updates a model parameters and repeats the optimization for newly identified parameters;
- *modifier adaptation* modifies the constraints and gradients and repeats the optimization;

- *direct input adaptation* transforms the optimization problem into a feedback control problem.

Schematic description of real-time optimization methods is given at figure below.

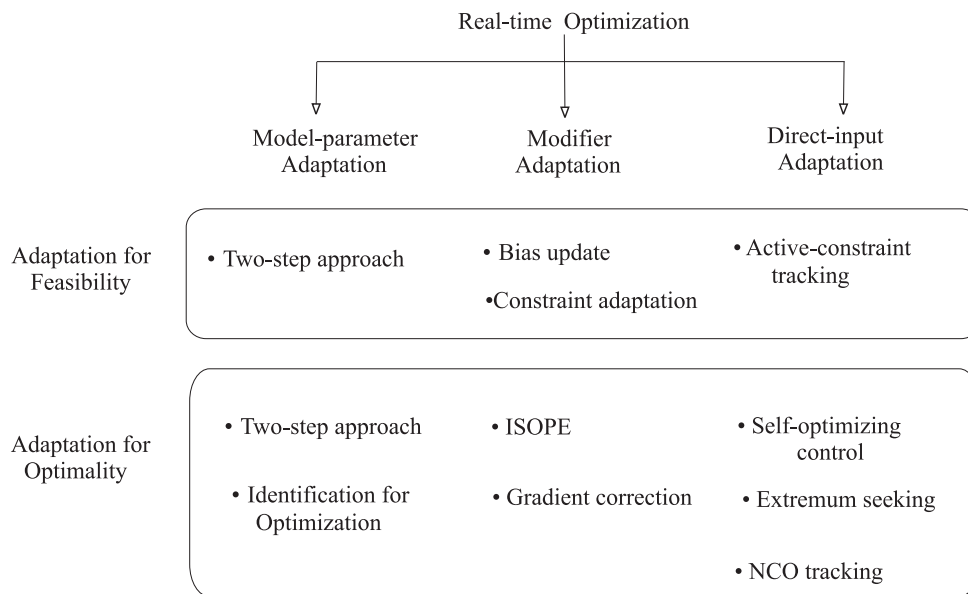

Figure 1.1: Summary of real-time optimization methods

The main idea of the first approach is to use the measurements to refine the model, and then to use this updated model for the optimization. However, difficulties arise when selection of appropriate adjustable parameters has to be made. First, these parameters have to represent actual changes in the process and must be adjustable. They have to be chosen among those which are the most influential on system behavior. Secondly, they have to be identifiable and be relevant. In other words they have to contribute in finding the optimum in a reasonable time. Such information can be extracted from an adequate model or available knowledge about the system to be optimized. Clearly, the more accurate the model, the better our choice of relevant

parameters. Better parameter estimates may be obtained when dealing with smaller set of parameters. Serious problems may occur when the number of uncertain model parameters is large. More parameters will lead to significant errors, and hence to a false optimum.

In cases where modified terms are added to the cost function and constraints if they are present, and then measurements are used to update these terms, the adaptation is called *modifier adaptation*. In general, methods that belong to this group are used in order to overcome the modeling deficiencies. Only several of them are presented in the literature. The goal is to add the terms that would modify both cost function and constraints.

The last class is the *input adaptation*. Here the inputs are adjusted using feedback controllers. Optimization problem is transformed into a feedback control problem so that repeated optimization is avoided. It directly manipulates the input variables. The challenge is to find functions of the measured variables which, when held constant by adjusting the input variables, enforce optimal plant performance.

To overcome the deficiencies of two-step RTO methods (for example model mismatch), some other methods also have been proposed. These techniques do not rely on a process model update, and are classified into two subgroups:

1. model-free methods - when no process model is used during the operation;
2. fixed-model methods - where approximate model is used without refinement.

Techniques from the former group are usually based on gradient-based algorithms that require the gradients of cost and constraint functions to be computed (estimated) using the available measurements. One way to determine the gradient is by using finite-difference method that estimates the gradient in straightforward manner. Finite difference approximation replaces direct gradient measurements.

Model based techniques use both the available measurements and a process model to search for optimal system operation. The process model is used to estimate the gradients of cost and constraint functions during the optimization process. When comparing fixed-model RTO methods with model-free approaches, it should be stressed that the direct solution of a nonlinear programming problem allows handling constraints without having to make any assumption regarding the set of active constraints at the optimal point.

1.3 Extremum seeking

As already seen, the standard approach of real-time optimization is the model-based repeated optimization where the model is adapted using the available measurements. Then the numerical optimization is performed on the updated model. An alternative approach is known as the *extremum-seeking control*. It allows treating the optimization problem as a control problem with the advantages related to sensitivity reduction and disturbance rejection.

The task in control problems is to force a system to operate in desired manner, that is, to follow some given reference value or patterns such that a desired system behavior is achieved. Sometimes, the desired performance is not known in advance precisely. One example is on-line optimization of the cost function when there is no available analytical knowledge about it. Neither dynamical model of the plant nor the model of response map is known. Another case is stabilization of the system in the presence of uncertainties or disturbances.

A controller should stabilize the system and compensate effects of disturbances variations of unknown uncertainties. This simply implies that it is more convenient to consider the case when there is no information about the system. Both dynamics and

cost function can be seen as black-box. Since the analytic form of cost function is unknown a priori, ES controller can rely only on its measurements. Thus the value of objective function $f(x)$ at every moment is assumed to be available by taking the measurements. Derivative of the function to be optimized is not available, but the function itself can be measured and gradient estimated.

The main goal of ES is to move the operating point of the system to optimize the function of the system state and force the system to operate at a set-point that represents the optimal value of a function being optimized in the feedback loop. ESC should find optimum or track the same in case it is time-varying. As optimal operating point is not known in advance, it is necessary for the controller to find the optimal set-point while the system is operating. Consequently the state will also converge to its optimal value x^* . The static response curve should have at least one extremal value (see Figure 1.). It optimizes process in real time on both dynamic or static systems.

Extremum seeking algorithm does not provide any information about the gradient and, thus it relies only on the measurements of the objective function. This is the case where the knowledge of the input-output relationships is known from theoretical analysis. Perturbation-based algorithm uses periodic probing signal to extract information about gradient from this reference-to-output relationship.

In general, for different algorithms different search techniques are proposed in literature. Finite-difference schemes provide a straightforward way of estimating the gradient. However, this method becomes experimentally intractable for more large number of control parameters. Also, several other methods have been proposed such as dynamic perturbations, and recursive Broyden-like updates. Alternatively, the gradient can be computed using Kalman filter. Assuming the filter can perfectly estimate state variables, gradient can be evaluated using appropriate expressions.

Another choice for gradient estimation technique may be sliding mode control or fuzzy logic.

What usually happens in real-world systems, and may make additional problems, is the existence of more than one extremal value. Mostly iterative or so called "step-by-step" algorithms are used to find at least one x^* . Step-by-step moves the algorithm from a set of initial guesses of x^* to a final value. Naturally, it is expected the final value to be closer to the true optimum than the initial guesses. In practice it is common to seek only one x^* in the algorithmic search. Hence it is adapted that any value from the set of optimizers is good as any else and there is often no need to determine whole set of optimal values. The potential issue of nonuniqueness of x^* is sometimes of limited practical concern.

To achieve the best possible performance ES algorithm should be designed in a way that would guaranty that the *global* extremum of an objective function is reached. It is always more practical and the one should always try to seek globally optimal solution to the optimization problem if all other factors are equal. Also we should be aware of the fact that such solution may not be available or even achieved so easily. In those situations one must be satisfied with a local solution as it is still better than any other in its vicinity. Luckily, many problems consider the cost function with only one optimizer.

Classical ES works on the principle of steepest descent. This search technique is based on the simple principle that states: from a given value x the best direction to go is the one that produces the largest local change of the cost function. At given \mathbf{x} this direction is defined with the gradient vector. Mathematically speaking, steepest descent algorithm is defined as:

$$\hat{x}_{k+1} = \hat{x}_k - a_k g(\hat{x}_k), \quad k = 0, 1, 2, \dots \quad (1.3)$$

Here k is the iteration count, \hat{x}_0 is the initial guess of x^* , $a_k > 0$ is step size, and $g(\hat{x}_k)$ is the gradient of function $f(x)$ at k^{th} iteration.

Figure 1.2 illustrates how, actually this algorithm works. For the sake of simplicity we may suppose the convex function changes only with the $i - th$ component of a vector variable x and is fixed for all other $n - 1$ components.

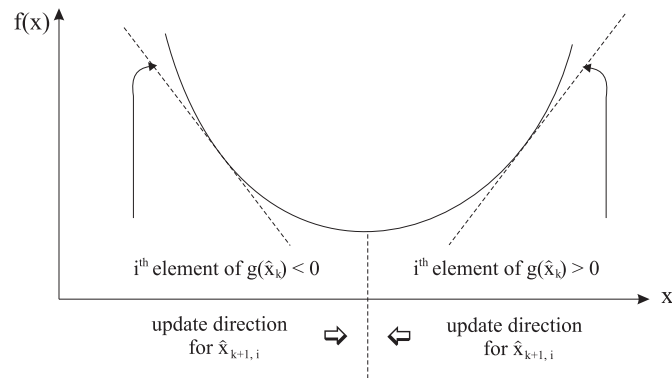

Figure 1.2: Update directions for steepest descent

From Figure 1.2 and equation (1.3) it becomes obvious that, no matter at which side of minimum the current estimate is, the algorithm will continue to move towards optimum in a direction that is opposite to the sign of the gradient vector with respect to the corresponding component. For example, if current value of \hat{x}_i at the k^{th} iteration is on the right side of the minimum (function is monotonically increasing) gradient will be positive. From expression (1.3) it follows the search direction will be opposite to the gradient sign and thus it keeps *minus* in next iteration. In that way function moves left, that in direction that will decrease its value.

Comment 1.1 Figure 1.1 involves just situation in which cost function changes with respect to one variable. Hence, for the value of the argument denoted as x^* $f(x^*)$ is just a component of real minimum. Complete analysis would involve interplay with

the other components of the vector x . Hence, the whole analysis and the graph are quite more difficult.

Comment 1.2 The algorithm guaranties the convergence in infinite time. The proof for this can be found in any literature that considers optimization or/and numerical methods ([59]).

The convergence speed of this algorithm sometimes can cause significant problems. The only methods which will converge quickly for a general function are those which will guarantee to find the extremum of a general quadratic or cubic speedily. The Newton - Raphson method has fast convergence. Problem is that it requires second derivatives of the function to be evaluated, and frequently fails to converge from a poor approximation to the minimum. Available literature emphasize the fact that Newton method, although fast, does not guarantee convergence always. From this point of view it would be reasonable to find "optimal" optimum seeking method, what is actually impossible for arbitrary $f(\mathbf{x})$ cannot be found. To improve the convergence speed of classical perturbation extremum seeking some researchers tried to switch from steepest descent to Newton-Raphson method.

Comment 1.3 The Newton - Raphson algorithm may speed up the algorithm but also may make it unstable in some situations. By Taylor theorem (Appendix A) twice differentiable function will be nearly quadratic in small vicinity of the optimum. Hence, one the solution is near the optimal value the algorithm is expected to converge quadriatically:

$$\|\hat{x}_{k+1} - x^*\| = O(\|\hat{x}_k - x^*\|^2) \quad (1.4)$$

In many practical problems constraints are put on certain variables. Constraints may make analysis more difficult. Constraints are classified as hard and soft constraints.

The former do not allow any value of the x to be ever outside of the constrained set. The later allow some values of x to be outside the constrained set, but only during the search process and only for a limited time. It is required the final estimate of x lie inside the constrained set. To our knowledge there is still no results that appeared in the literature which would solve the constrained problem for sinusoidally perturbed extremum seeking controller.

1.4 Motivational examples

To illustrate the efficiency and justify the recently gained popularity and interest in development of extremum seeking controllers examples are presented in this section. These two examples motivate the need for reliable algorithm. Therefore, our starting point is an example of instabilities that occur during the combustion. This is, probably, one of the earliest motivational examples that contributed to the development of ESC. These instabilities manifests as limit cycle self-excited oscillations in velocity or in pressure and have a significant effect on performance of gas turbines.

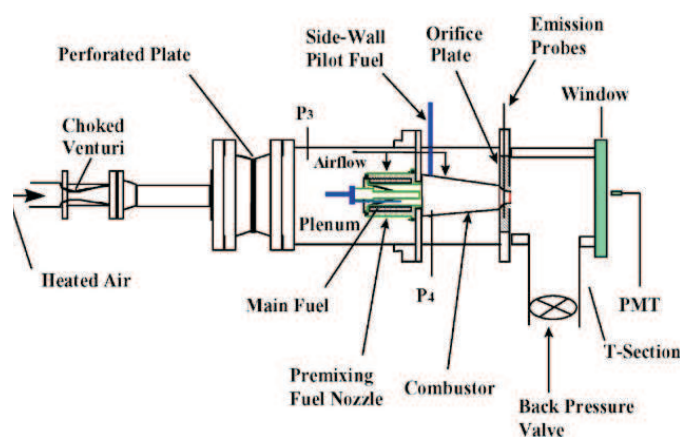

Figure 1.3: Combustion process in gas turbine

Pressure oscillations are in particular known as thermo-acoustic instabilities and are the main cause of high level oscillation that can result in a high level of noise or even in a severe damaging of mechanical parts. In Figure 1.3 a sketch of a combustion process in gas turbines is shown.

First results were gained from the model based analysis and had success showing that with an appropriate choice of the phase-shift the pressure amplitude can be substantially reduced. However, this may not lead to the optimal solution as the used algorithm could not guaranty phase-shift that would minimize the amplitude and thus suppress the oscillations in best possible way. Experiments showed that using the classical extremum seeking algorithm gives better results.

Second motivational example comes from the need to solve the problem of thermo-elastic instabilities in disc-brakes present during the braking actions. This instabilities are called judder and occur at some critical braking speed. The main cause for judder to occur is unevenly distributed heat that results in hot spots and change of pressure. Consequently, disc thickness variations will occur and manifest itself in form of thermo-acoustic and/or thermo-elastic instabilities. Driver can experience this as an unpleasant noise or shacking of a vehicle.

Moreover, uneven heat distribution along with oscillations can lead to serious failure of mechanical parts and thus accidents. The industry nowadays invests a lot of money in solving this issue. One way to overcome it is to change the design. Another, economically more suitable would be to minimize the amplitude of vibrations. At this point extremum seeking controllers seem to be good starting point in finding optimal operating conditions.

1.5 Simple extremum seeking algorithm

Extremum seeking controllers perform optimization by monitoring the system performance, and tuning the parameters on-line to improve the performance. The controller starts from some initial parameter values, perturbs iteratively the same, observes response and tune the parameters. This procedure runs as long as optimal value of response map is found. Measurements are collected after the transients are settled. Otherwise, finding the minimum at minimal time should be done by appropriate choice or design of algorithms. It guarantees closed-loop stability if designed appropriately. The choice of certain design parameters to be adjusted significantly determine the system's behavior and convergence speed. Classical perturbation-based SISO extremum seeking algorithm for general nonlinear dynamical systems is given on Fig 1.4.

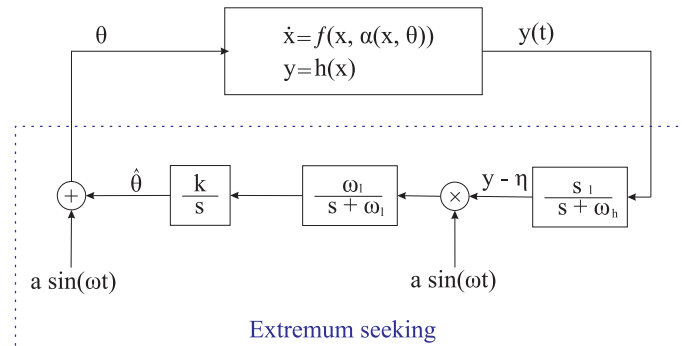

Figure 1.4: Higher order extremum seeking algorithm

Here $x \in \mathbb{R}^n$ is the state, $\theta \in \mathbb{R}$ is the control input and $h : \mathbb{R}^n \rightarrow \mathbb{R}$ is the objective function. The output is fed to the outer-loop extremum seeking controller. Dither signal $a \sin(\omega t)$ is correlated to the output of the integrator as an excitation signal to assist the gradient estimation. Tuned parameters a and ω are a suitably small chosen

amplitude and frequency. Main task of the controller is to drive the state to a value such that the cost function $h(x)$ is extremized. The optimization problem becomes one of regulating the norm of the gradient to small neighborhood of zero which is the main objective in designing the ES controller.

The job of high pass filter with cut-off frequencies ω_h is to isolate the variations of the optimized variable from its averaged value. Signal η represents the the state of high pass filter and is modulated with the same excitation signal. The resulting signal is filtered using the low pass filter with cut-off frequencies ω_l to get the gradient estimate. The last step is to drive this gradient towards zero what is finally done with integral controller.

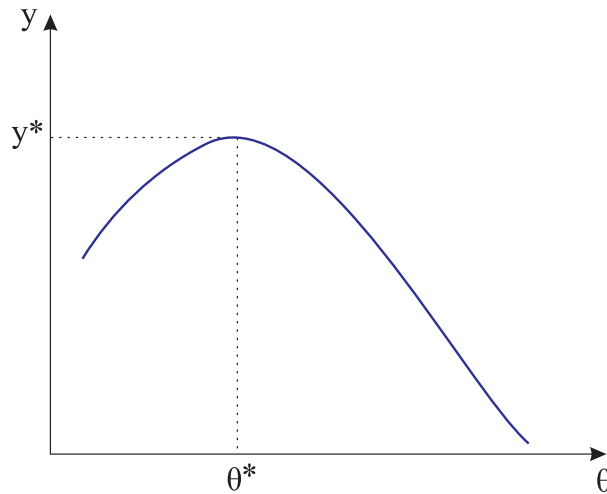

Figure 1.5: Static curve

Roughly speaking starting assumption that should be made in analysis of extremum seeking design is that a static curve possesses absolute minimum or maximum (see Figure 1.5). For the sake of simplicity it is assumed that the function is locally convex or concave. Hence, this extremum is unique. Second, there is no information

about dynamic or static model of a plant, but is assumed the measurements of a cost function are available. Algorithm is designed in a way that would guarantee the convergence of a controller parameter θ which would assure driving the system to the optimal set-point.

Numerical example. Consider optimizing the behavior of plant dynamics defined with $\dot{x} = -x + (u + 1)^2$, $y = -x^2 + 2$, for the case of scalar controller parameter. Here u and y are decision variable and output, respectively. The initial conditions and tuning parameters are selected as follows: $x_0 = -2$, $k = 0.1$, $\omega = 1$, $a = 0.25$. For filters let $\omega_l = 0.5$ and $\omega_h = 1$. Parameters are tuned in a way that would ensure stability. Quick calculation shows that the optimal operating point is reached at $y^* = -2$. We also have that optimal value of a state is $x^* = 0$ and optimal value for chosen input $\theta^* = -1$. Simulation results for this example are shown at Figure 1.6

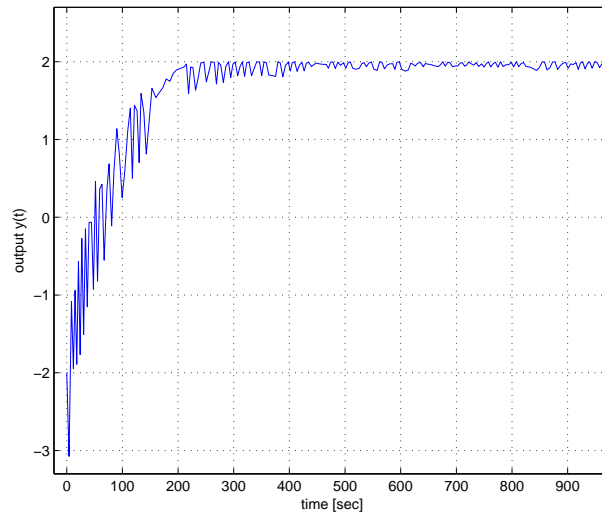

Figure 1.6: Performance of extremum seeking controller

Algorithm forces the output to converge to its optimal value in finite time. However,

parameter selection is the main cause of relatively slow convergence. For practical purposes it is very important that extremum seeking finds the optimal value of cost function in minimal time. One more important thing that can be noticed from Figure 1.6 is that the output will most of the time oscillate in a vicinity of optimal value. Although it depends on a parameter selection, the accuracy of the algorithm still remains an open question.

As it is emphasized in [74, 7] the presence of dynamics in system may cause measurement errors as the process performance may not settle at a new steady-state value before the new measurement is taken. To avoid the errors due to transients and noise we have to wait long enough and this can cause the slow finding of an extremum and thus slow convergence. Fast systems can handle somehow with this situation, but it is essentially bad and undesirable in case of chemical systems that typically possess slow parameters itself. It practically leads to interactions in control systems which can complicate the whole situation seriously. The precision of measurements may also be interrupted with a noise.

Actually, in practice we can deal with two main types of systems: static and dynamic. This is associated with the convergence time and stability. Astrom and Witenmark gave in [7] quite nice analysis for static mappings. It is emphasized the plant with dynamics can lead to certain interactions and destabilize the system. One way to overcome the problem is to use singular and regular perturbation technique to transform the problem into a static. However, this is the main reason for slower convergence. The main limitation of these methods is that they require the dynamics of the adaptation to be two orders of magnitude slower than the system dynamics.

1.6 Outline of the thesis

The thesis pursues theoretical development of model-free real-time optimization. This approach uses black box plant dynamics and cost function. It is addressed using an on-line optimization technique in adaptive control theory known simply as extremum seeking. Here it is given a brief overview of the thesis, chapter by chapter.

Chapter 2: Background

In this chapter we review various topics which are prerequisites to the results considered and developed in latter chapters. We begin by giving formal definitions and some examples needed for understanding stability phenomena and systems features which are in close connection with stability.

The remainder of the chapter gives some basic Lyapunov theorems and its extensions used in Chapter 3 and Chapter 4. Some extensions of these theorems are also considered. This is a natural consequence, since we discuss the efficiency and applicability of the algorithms in terms of stability.

Since the goal is to approximate behavior of functions that are not known a priori meaning of averaging technique is briefly described at the end of the chapter. Without understanding this method we cannot completely understand how extremum seeking really works. Although this is an old technique used to find approximate solutions of general nonlinear dynamical systems it still attracts a lot of attention among researchers. Tools that are widely used in averaging process can be found in a number of publications.

Chapter 3: Extremum seeking controllers

This chapter introduces extremum seeking algorithm and its numerous designs. Performance and drawbacks of proposed controllers are discussed. Controllers that are still in the focus of attention are perturbation based controllers. To overcome slow convergence, to improve the accuracy or to enlarge the basin of attraction some authors suggested modification of an algorithm that for the first time appeared in PhD thesis of Leblanc, back in 1922.

Thirty years after, in 1950's, solutions using sliding mode control are introduced. The main reason for this were probably uncertainties. This techniques showed very good results when the knowledge of the plant model dynamics and parameters is not satisfactory, or in the presence of unknown disturbances. There is a belief that the performance of any algorithm can be significantly improved if we can use as much information about the plant as we can. Consequently, part of a chapter considers recent results that join together real time optimization and model predictive control when constraints exist. Opposite to the classical "black-box" approach it is assumed that the plant model is known in advance. Chapter also analyses extremum seeking designs constructed using nonlinear programming tools.

Chapter 4: Multidimensional parameter ESC

Chapter 4 develops extremum seeking controller with p -dimensional parameter (where p is a finite number). Stability is established on non-local basis. It is shown that appropriate tuning of parameters can guarantee not only local stability. It is assumed that the output function has unique maximum. Classic singular perturbation method is used to separate the time scales and prevent the coupling of plant and controller dynamics. Semi-global practical stability is proved for multi-input single-output gen-

eral nonlinear systems. Discussion on the performance is conducted using numerical experiments.

Chapter 5: Conclusions and future work

Chapter 5 brings together up to date contributions and limitations of the algorithms. Some open questions are discussed and some directions for future work in this area are proposed.

Chapter 2

Background

2.1 Lyapunov stability concepts

Along with existence and uniqueness of solution, probably the most important issue to be considered is its stability with respect to variations to initial conditions and system parameters. A solution corresponding to the prescribed initial conditions and parameters settings is *stable* if small changes in two latter cause only small changes in the solution in the whole future, or even if the solutions corresponding to varied conditions tend to the desired one as time tends to infinity. Consider the non-autonomous system [?]:

$$\dot{x} = f(t, x) \tag{2.1}$$

where $f : \mathbb{R}^+ \times D \rightarrow \mathbb{R}^n$, $f'_x : \mathbb{R}^+ \times D \rightarrow \mathbb{R}^n$ and $D \subset \mathbb{R}^n$ is an open and connected subset. Let $\psi : \mathbb{R}^+ \rightarrow D$ be the solution of (2.1) and denote its initial value at an arbitrary $t_0 \leq 0$ by $\psi_0 = \psi(t_0)$.

Definition 2.1 The solution $\psi : \mathbb{R}^+ \rightarrow D$ of (2.1) is said to be stable in the Lyapunov sense (see Fig 2.1) if for every $\epsilon > 0$ and $t_0 \geq 0$ there is a $\delta(\epsilon, t_0) > 0$ such that

for all $|x^0 - \psi^0| < \delta(\epsilon, t_0)$ the solution $\varphi(t, t_0, x^0)$ is defined on $[t_0, \infty)$, and for all $t > t_0$

$$|\varphi(t, t_0, x_0) - \psi(t)| < \epsilon \quad (2.2)$$

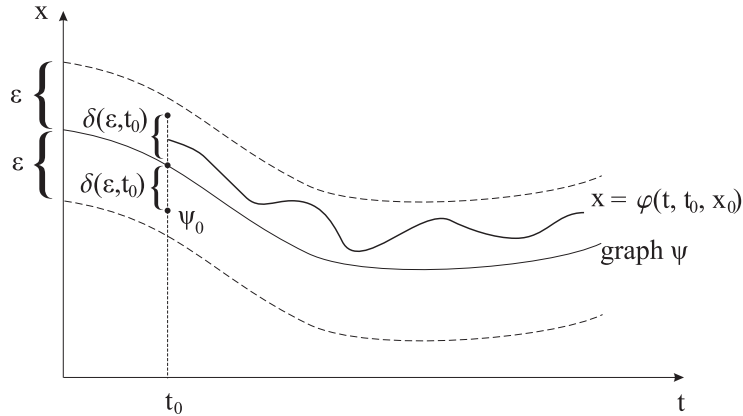

Figure 2.1: Stable solution in Lyapunov sense

Definition 2.2 We say that the solution ψ is uniformly stable if it is stable in the Lyapunov sense, and δ in the previous definition can be chosen independent of t_0 .

Definition 2.3 The solution $\psi : \mathbb{R}^+ \rightarrow D$ of (2.1) is attractive (see Fig. 2.2) if for every $t_0 \geq 0$ there is an $\eta(t_0) > 0$ such that $|x_0 - \psi(t_0)| < \eta(t_0)$ implies

$$\lim_{t \rightarrow \infty} |\varphi(t, t_0, x_0) - \psi(t)| = 0, \quad (2.3)$$

that is, to every $\epsilon > 0$ and $x_0 \in B(\psi(t_0), \eta(t_0))$ there belongs a $T(t_0, \epsilon, x_0) > 0$ such that for all $t \geq t_0 + T(t_0, \epsilon, x_0)$ the following holds $|\varphi(t, t_0, x_0) - \psi(t)| < \epsilon$. $B(a, \delta)$ is by definition the ball with center at a and radius δ , that is:

$$B(a, \delta) = \{x \in \mathbb{R}^n : |x - a| < \delta\} \quad (2.4)$$

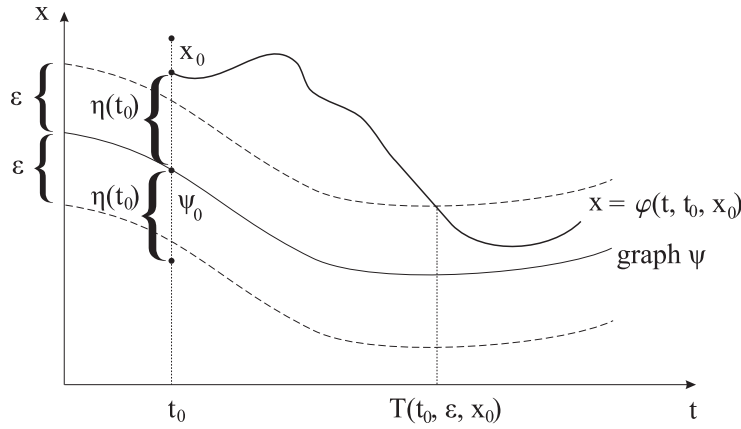

Figure 2.2: Stable solution in Lyapunov sense

Definition 2.4 Solution of (2.1) is said to be asymptotically stable if it is stable in the Lyapunov sense and attractive.

In the sequel, we will merely be interested in the stability of an *equilibrium*. To further simplify notation we use an appropriate translation of coordinates to shift an arbitrary equilibrium point to the origin.

Definition 2.5 A point $x^* \in \mathbb{R}^n$ is stable at t_0 for the system (2.1) if and only if for every $\epsilon \in \mathbb{R}^+$ there is $\delta \in \mathbb{R}^+$, $\delta = \delta(\epsilon, t_0, x^*)$ such that $\|x_0 - x^*\| < \delta$ implies $\|x(t, t_0, x_0) - x^*\| < \epsilon$ for every $t \geq t_0$. (See Fig 2.1)

Definition 2.6 A point $x^* \in \mathbb{R}^n$ is globally stable if and only if there exists a δ , denoted $\delta_M(\epsilon, t_0, x^*)$ obeying Definition 2.1 that tends to $+\infty$ as $\epsilon \rightarrow \infty$.

Comment 2.1 Definition 2.1 broadens the concept of continuity of a function at a point to motions. The Lyapunov stability concept was originally concerned with stability of a motion and of the origin $x = 0$ which was later broadened to stability of a set. The closeness in the Lyapunov sense means that the distance is less than ϵ for any given $\epsilon \in \mathbb{R}^+$. The Lyapunov closeness is demanded for all the initial states

$x_0 = x(t_0)$ whose distance from $x = 0$ is less than some $\delta = \delta(t_0, \epsilon) \in \mathbb{R}^n$.

Comment 2.2 Definition 2.5 can be satisfied by arbitrarily small $\delta \in \mathbb{R}^+$ even if the corresponding $\epsilon \in \mathbb{R}^+$ has been chosen very large. It requires only the existence of $\delta \in \mathbb{R}^+$ obeying its condition. This is a conceptual drawback of the Lyapunov stability concept from the point of view of engineering technical applications and needs.

Example 2.1 Let $n = 2$, $x = [x_1 \ x_2]^T$, $\alpha \in \mathbb{R}^+$ and the system (2.1) take the following specific form:

$$\dot{x} = (-\alpha + |x_1| + |x_2|)x \quad (2.5)$$

The phase portrait is given in Fig. 2.3. The state $x = 0$ is stable. However, if α is small (*e.g.* $\alpha = 10^{-3}$) or very small (*e.g.* $\alpha = 10^{-10}$) then the dynamic behaviour of the system is unsatisfactory in the engineering sense even for small initial states ($|x_{10}| + |x_{20}| > 10^{-3}$) or ($|x_{10}| + |x_{20}| > 10^{-10}$) respectively.

Comment 2.3 Example 2.1. shows that existence of positive δ obeying Definition 2.1 is not adequate engineering information about the qualitative dynamic properties of the system. Useful information is that about the largest neighbourhood $\mathcal{D}_s(\epsilon, t_0)$ of $x = 0$ such that $|x(t, t_0, x_0)| < \epsilon$ is satisfied for all $t \in \mathbb{R}_0$ iff $x_0 \in \mathcal{D}_s(\epsilon, t_0)$ for any $\epsilon \in \mathbb{R}^+$. Moreover, we need information about the largest neighbourhood $\mathcal{D}_s(t_0)$ of $x = 0$ containing all $\mathcal{D}_s(\epsilon, t_0)$, that is that $\mathcal{D}_s(t_0) = \bigcup[\mathcal{D}_s(\epsilon, t_0) : \epsilon \in \mathbb{R}^+]$.

For the sake of simplicity the system (2.1) for many applications may be reduced to the autonomous one:

$$\dot{x} = f(x), \quad f : \mathbb{R}^n \rightarrow \mathbb{R}^n \quad (2.6)$$

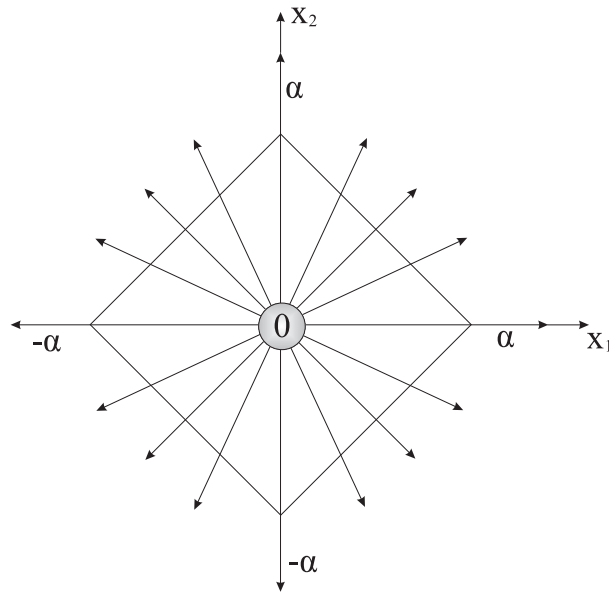

Figure 2.3: The state portrait of the system of Example 2.1

Motions of time-invariant systems, as well as their properties, do not depend on the initial moment t_0 . Thus, we may set $t_0 = 0$. The motion, which passes through x_0 at $t = 0$, is denoted by $x(\cdot, x_0)$. This reduces Definition 2.5 to Definition 2.6.

Definition 2.7 The origin of the system (2.6) is stable (See Fig 2.4) iff for every $\epsilon \in \mathbb{R}^+$ there is $\delta \in \mathbb{R}^+$, $\delta = \delta(\epsilon)$, such that $\|x_0\| < \delta$ implies $\|x(t, x_0)\| < \epsilon$ for all $t \in \mathbb{R}^+$.

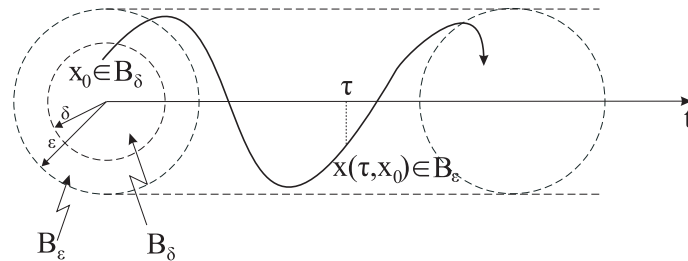

Figure 2.4: Stable origin

Despite the fact Lyapunov was not the first to introduce the notion of attraction, he was the first to state general qualitative conditions for convergence of system motions to zero steady-state. This eventually led to definitions of attraction and asymptotic stability of the origin.

Definition 2.8 The origin of (2.6) is attractive (See Fig 2.5) if and only if there is $\Delta > 0$ and for every $\xi > 0$ there is $\tau \in \mathbb{R}^n$, $\tau = \tau(x_0, \xi)$, such that $\|x_0\| < \Delta$ implies $\lim_{t \rightarrow \infty} \|x(t, x_0)\| = 0$. Origin is globally attractive iff previous statement holds for $\Delta = \infty$.

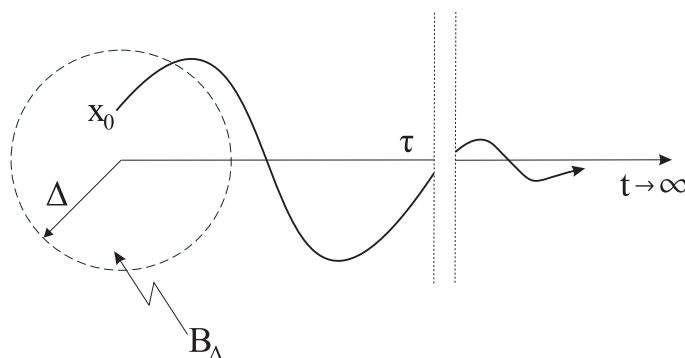

Figure 2.5: Attractive origin

The definition of attraction requires only the existence of $\Delta > 0$ obeying its condition irrespective of whether Δ is large or small even very small. In the case of the system (2.6) in the form given in Example 2.1 the origin is attractive. However, this property becomes useless from an engineering point of view as soon as α is too small. Furthermore, for engineering purposes it is important to derive or at least to estimate well the largest neighbourhood \mathcal{D}_a of $x = 0$ such that $\lim_{t \rightarrow \infty} \|x(t, x_0)\| = 0$ holds if and only if $x_0 \in \mathcal{D}_a$.

Definition 2.9 The origin of (2.6) is asymptotically stable if and only if it is both stable and attractive.

The notion of asymptotic stability has the same drawback as stability and attraction. The steady-state of the system considered in Example 2.1 is asymptotically stable. Unfortunately its asymptotic stability can be useless for real world problems in the case of small parameter as it is already mentioned. Asymptotic stability of origin is meaningful for engineering purposes provided only that D is sufficiently large from the engineering point of view. Engineering requests for a higher quality of the system dynamic behavior demand sufficient rate of convergence. For this purpose it is very important the concept of exponential stability.

Definition 2.10 The state $x = 0$ of the system (2.6) is exponentially stable (see Fig 2.6) if and only if there are $\Delta > 0$ and positive numbers $\beta \geq 1$ and γ , such that $\|x_0\| < \Delta$ implies $\|x(t, x_0)\| \leq \beta \|x_0\| \exp(-\gamma t)$ for $\forall t \in \mathbb{R}^+$.

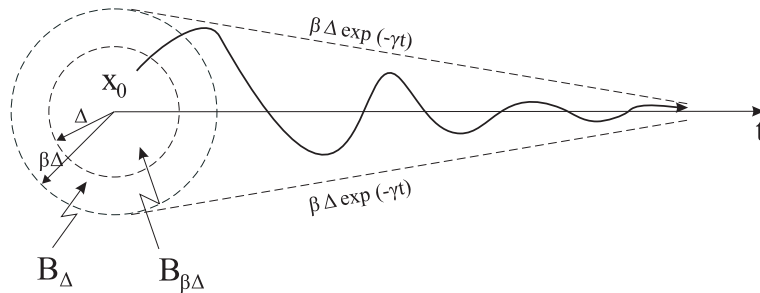

Figure 2.6: Exponentially stable origin

Comment 2.4 For engineering applications the existence of Δ, β and γ does not give sufficient information. In addition to that we need the knowledge of the smallest possible value of γ , the largest possible value of γ and of the largest neighbourhood \mathcal{D}_e of the origin such that $\|x(t, x_0)\| \leq \beta \|x_0\| \exp(-\gamma t)$ for $\forall t \in \mathbb{R}^+$ for all $t \in \mathbb{R}^+$ holds iff $x_0 \in \mathcal{D}_e$. There is certainly a trade of among β, γ and \mathcal{D}_e in general which is illustrated as follows. For the system of Example 2.1 the set \mathcal{D}_e depends on α and γ via $\alpha_1 \mathcal{D}_e(\alpha_1) = \{x : |x_1| + |x_2| \leq \alpha_1\}$, where $\alpha_1 = \alpha - \gamma$ should be positive. For given

α and γ , $\alpha > \gamma > 0$, the set $\mathcal{D}_e(\alpha_1)$ is the largest neighbourhood of the origin such that $x_0 \in \mathcal{D}_e(\alpha_1)$ implies $\|x(t, x_0)\| \leq \beta \|x_0\| \exp(-\gamma t)$ for $\forall t \in \mathbb{R}^+$, where $\beta = \sqrt{2}$.

2.2 Comparison functions and Laypunov direct method

Definition 2.11 A function $\alpha : [0, a) \rightarrow \mathbb{R}^+$ is a comparison function of the class \mathcal{K} if and only if:

1. α is continuous on $[0, a)$: $\alpha(r) \in C([0, a))$,
2. α vanishes at the origin: $\alpha(0) = 0$
3. α is strictly monotonously increasing on $[0, a)$: $0 \leq r_1 < r_2 < a$ imply $0 \leq \alpha(r_1) < \alpha(r_2)$.

It is said to belong to class \mathcal{K}_∞ if and only if $a = \infty$.

Definition 2.12 A function $\beta : [0, a) \times [0, \infty) \rightarrow \mathbb{R}^+$ is a comparison function of the class \mathcal{KL} if and only if:

1. β is continuous on $[0, a)$,
2. for each fixed s the mapping $\beta(r, s)$ belongs to class \mathcal{K} with respect to r ,
3. for each fixed r the mapping $\beta(r, s)$ is decreasing with respect to s and $\beta(r, s) \rightarrow 0$ as $s \rightarrow \infty$.

Lyapunov established very powerful method to treat stability in his famous paper published more than 100 years ago. Proof of this method can be found in any literature that deals with stability problems. The method has its origin in Mechanics, starting from Lagrange's theorem in *XVIII* century that is completely proved by Dirichlet.

According to this theorem if a potential energy of a conservative mechanical system has a strict minimum at a point, then this point is stable.

Consider the function $V : \mathbb{R}^+ \times U \rightarrow \mathbb{R}$, where $U \subset \mathbb{R}^n$ is open and connected, $0 \in U$, and assume that $V \in C^1$. It is said that V is positive semi-definite if $V(t, x) \geq 0$ for all $(t, x) \in \mathbb{R}^+ \times U$; we say the V is positive definite if there is a function $W \in C^0(U, \mathbb{R})$, such that for all $(t, x) \in \mathbb{R}^+ \times U$, $x \neq 0$:

$$V(t, x) \geq W(x) > 0, \quad (2.7)$$

and $V(t, 0) = W(0) = 0$; V is indefinite if for every small neighborhood B of the origin it assumes positive as well as negative values in $\mathbb{R}^+ \times B$.

Definition 2.13 Let $V \in C^1(\mathbb{R}^+ \times U)$ where $U \subset D \subset \mathbb{R}^n$ is open and connected. The derivative of V with respect to the system (2.1) at $(t_0, x_0) \in \mathbb{R}^+ \times U$ is

$$\begin{aligned} \dot{V} &= \frac{d}{dt}V(t, x(t, t_0, x_0))|_{t=t_0} \\ &= V'_t(t_0, x_0) + \sum_{k=1}^n V'_{x_k}(t_0, x_0)f_k(t_0, x_0) \\ &= V'_t(t_0, x_0) + \langle \text{grad}V(t_0, x_0), f(t_0, x_0) \rangle \end{aligned} \quad (2.8)$$

Theorem 2.1 If there exists a function $V \in C^1(\mathbb{R}^+ \times U, \mathbb{R})$ where $0 \in U \subset D$, and a function $\alpha \in \mathcal{K}$ such that for $(t, x) \in \mathbb{R}^+ \times U$: $V(t, x) \geq \alpha(|x|)$, $V(t, 0) = 0$ and \dot{V} is negative semi-definite, then the origin is stable.

Comment 2.5 These conditions imply that V is positive definite. However, it is proved in (Rouche-Mawhin) that if V is positive definite that such an α exists. It is also proved that besides the conditions of this theorem there exists an $\alpha_2 \in \mathcal{K}$ such that $V(t, x) \leq \alpha_2(|x|)$, then the origin is uniformly stable.

Theorem 2.2 Assume that there exist a function $V \in C^1(\mathbb{R}^+ \times U, \mathbb{R})$ where $0 \in U \subset D$, and a functions $\alpha_1, \alpha_2, \alpha_3 \in \mathcal{K}$ such that $\alpha_1(|x|) \leq V(t, x) \leq \alpha_2(|x|)$, and $\dot{V}(t, x) \leq -\alpha_3(|x|)$. Then the origin is uniformly asymptotically stable.

Equivalent definition using also comparison comparison functions can be given via following lemma:

Lemma 2.1 Origin of the system (2.1) is uniformly asymptotically stable if and only if there exist a class \mathcal{KL} function β and a positive constant c independent of t_0 , such that

$$\|x(t)\| \leq \beta(\|x(t_0)\|, t - t_0), \quad \forall t \geq t_0 \geq 0, \quad \forall \|x(t_0)\| \leq c \quad (2.9)$$

Definition 2.13 Semi-global practical asymptotic (SPA) stability. Consider the system:

$$\dot{x} = f(t, x, \epsilon) \quad (2.10)$$

where $\epsilon \in \mathbb{R}_+^l$ is a parameter vector. System (2.12) is said to be semiglobally practically asymptotically (SPA) stable, uniformly in $(\epsilon_1, \dots, \epsilon_j)$, $j \in \{1, \dots, l\}$, if there exists $\beta \in \mathcal{KL}$ such that the following holds. For each pair of strictly positive real numbers (Δ, ν) , there exist real numbers $\epsilon_k^* = \epsilon_k^*(\Delta, \nu) > 0$, $k = 1, 2, \dots, j$ and for each fixed $\epsilon_k \in (0, \epsilon_k^*)$, $k = 1, 2, \dots, j$ there exist $\epsilon_i = \epsilon_i(\epsilon_1, \epsilon_2, \dots, \epsilon_{i-1}, \Delta, \nu)$, with $i = j + 1, j + 2, \dots, l$, such that the solutions of the system with the so constructed parameters $\epsilon = (\epsilon_1, \dots, \epsilon_l)$ satisfy:

$$|x(t)| \leq \beta(|x(t_0)|, (\epsilon_1 \cdot \epsilon_1 \cdots \epsilon_l)(t - t_0)) + \nu \quad (2.11)$$

2.3 Asymptotic approximations and averaging

Nonlinear nature of systems typically prohibits us finding the closed-form, analytical solution. In these cases efforts are usually directed towards finding the approximate solutions or simplified systems that still with satisfactory accuracy should represent real physical nature of the problem. It happens very often that one has to construct approximate solutions of polynomial, transcendental or differential equations. Our objective is to construct approximations to the solutions of the differential equations. It seems that from early mathematical developments it was quite natural to use asymptotic expansions as tools for approximating the original systems.

Averaging is mostly used as standard mathematical tool for finding approximate solution of nonlinear differential equations which have one of several standard forms. Using averaging we are able to get the model enough simple and accurate that can be useful in making decisions /conclusions about stability of equilibrium for general system. There are several theorems concerning the relation between the averaged and the general system (for details see [41]). It is proved that the approximate solution follows the true one for the time of order $1/\epsilon$ if the initial conditions $x(0)$ and $x_{app}(0)$ were close to order ϵ , that is if $|x(0) - x_{app}(0)| = O(\epsilon)$. Also averaging enables us to derive conclusions about qualitative local behavior of the dynamics of approximated system which corresponds to the same qualitative and local behavior of the general system. It is proved that stable equilibrium point of the approximated system correspond to a stable limit cycle of original system. In cases when the system cannot provide enough information about the solution of original system and its qualitative properties the next step is usually to continue analysis using second order averaging and so on.

Chapter 3

Extremum seeking controllers

Extremum seeking control dates back at least to 1922. Due to the implementation problems, these controllers were almost forgotten for the next thirty years. However, in early 50's, even without rigorous stability proofs, and despite the high cost, these controllers were implemented and showed very good performance. An interest for this area arose again in the 1950s and 1960s, and recent years due to the studies in [50], where stability results were established employing averaging and singular perturbation techniques for general unknown nonlinear systems. These results were later successfully applied, i.e. to the model of an axial-flow compressor, drag reduction flight formations, efficient fuel-burning in IC engines, etc. Essentially, ES is adaptive control technique. Details on adaptive control can be found in [49], [4], [51] and [7].

The aim of this chapter is to give an insight into different optimization strategies using model-free methods. This approach uses only input and output of the system to find optimal working conditions. They can be classified into two main categories: deterministic and stochastic. Their properties and limitations are discussed in this chapter.

3.1 Deterministic ESC

The main point in extremum-seeking is to find the way to estimate the gradient and keep it close to zero (the closer the better). For this purpose several techniques have been proposed.

There are different ways to extract the information about gradient of any function. One way is to directly compute the gradient and get its accurate value. This, however can be done only in case when function is completely known analytically. In situations where analytical solution is not available alternative method is required to extract any information about gradient. At least what the one can expect in these situations is that the output measurements are available.

The most common method used to estimate gradient is so called perturbation technique. System is perturbed using an external excitation signal to estimate the gradient (see, for example [7]). Also, the excitation can be generated internally by sliding mode control as in Yaodong et al. Guay and Zhang in [36] proposed an adapted model of the system that is used for analytical evaluation of the gradient under the condition that cost function is not available for measurement.

3.1.1 Sinusoidally perturbed ES

To estimate the gradient both Leblanc and Krstic used perturbation method. It is the so called, "disturb and observe" method. The idea that lies behind this method is to perturb the input by adding a periodic signal, observe its effect on the output and make a correlation between these two signals. The perturbation signal is added with intention to increase excitation of the process and accuracy of the estimates. It is necessary to have an appropriate excitation to detect any change. The external

excitation signal is intentionally injected as perturbation to the input signal. In this way, in 2000 Krstic and Wang [7] proved exponential convergence of the algorithm using classical averaging technique.

Perturbation technique is used in the extremum-seeking quite a lot, and introduces periodic signal in the loop to "extract" the gradient from the resulting cost function $y(t)$. Output signal (as in Fig 1.2 and 3.1) is then taken as a substitute for a true gradient. As perturbation signal sinusoidal wave is used. This signal can be easily generated. The technique also can be used when the estimation of a gradients is done with respect to two or more variables. Perturbation-based extremum-seeking gain popularity mainly due to the work of Krstic and Wang where it is proved that stability of the algorithm is guaranteed only if the parameters are appropriately tuned. A periodical excitation signal is added to the input, and its effect observed at the output.

Typically, perturbation-correlation method involves perturbation, correlation and adjustment. We may consider an arbitrary system with appropriate inputs, and a means of continuously measuring a cost function. The inputs are changed with intention to affect the output. The question that arises here is how we can change/adjust these inputs in order to get the optimal cost function. We may say the simplest procedures would be to adjust the input and see effect on cost function. However, we should keep in mind the real-world systems involve a number of plant parameters to be adjusted. These parameters may vary with time. Hence, the feasibility of this method would depend on the stability of the overall system. The main task of the perturbation is to give variations to the input. Assuming the control parameter starts with some initial value θ_0 its perturbed term can be written as $\theta_0 + a \sin(\omega t)$. This will eventually result in a change of the cost function, that is $y(t) + \Delta y$ (see Fig 3.1).

The task of correlation is to estimate the change of the cost function with respect to

the change of the input. Mathematically speaking, correlating the perturbation with the output leads to conditions needed to be satisfied for gradient to converge to zero value. Correlation also gives the information at which side of the nominal value of decision variable lies its optimal value. Observing the output and its estimated gradient input can be adjusted so that the cost function is optimized. In this way algorithm actually controls the sign. As it is already implied, control signal is perturbed with sinusoidal probing signal.

Denote the cost function as $y = h(x(\theta))$. Even we do not know the exact mathematical representation of this function, by locally perturbing the input θ , we need to estimate its gradient. Goal is to determine the procedure which would adjust the parameter θ so that it converges towards its optimal value θ^* . That would consequently lead the gradient to a small vicinity of zero.

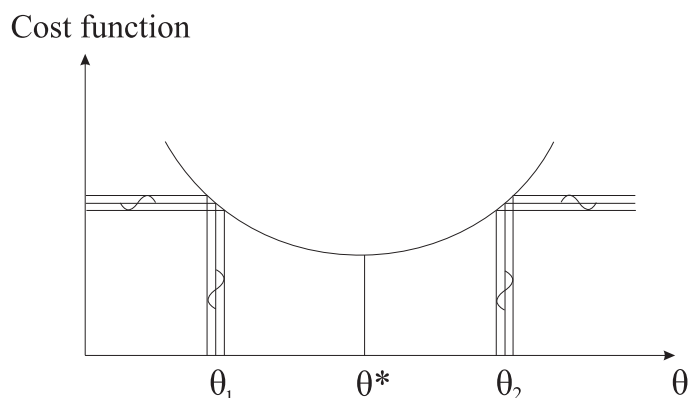

Figure 3.1: The effect of sinusoidal perturbation on cost function

Perturbation technique allocates a separate test signal to each decision variable. On-line estimation of the correlations between the sinusoidal perturbations and cost function are used to approximate components of gradient of the output with respect to the decision variables. The gradient thus estimated is then used as a search direction

in the decision variable space to improve the value of cost function. Figure (3.1) shows how the perturbation method actually works. Note that this is basic steepest descent method which has been described in introductory part.

To derive the exact mathematical expression let the parameter θ be varied sinusoidally around a nominal value θ_0 . By observing the variations of the output and phase difference between the input and output, the direction in which input has to be adjusted in order to minimize the output can be obtained.

Recall the algorithm from Fig 1.4. The optimization algorithm that would eventually minimize the cost function is given by equation:

$$\dot{\hat{\theta}} = kh(x(\theta)) \sin(\omega t) \quad (3.1)$$

Averaged value of some cost function $y(t)$ over a period of time T is given by $\frac{1}{T} \int_0^T y(t) dt$. If we assume that the algorithm will converge after large enough, but finite time, the averaged parameter will finally reach a small vicinity of its optimal value, that is $\hat{\theta}_{av} \rightarrow \theta^*$. Then taking excitation amplitude to be small enough it follows that the averaged system can be described with the following expression:

$$\hat{\theta}_{av} = \hat{\theta}^* \cong \hat{\theta} = \theta^* \pm ak \int_0^T y(\tau) \sin(\omega\tau) d\tau \quad (3.2)$$

Observing the last equation it is obvious that the second term at the right hand side has to be equal zero for the decision variable to converge towards its optimum. This term actually brings into connection the input and output of the system and represents mentioned correlation:

$$corr\{y(t), a \sin(\omega t)\} := \lim_{T \rightarrow \infty} \frac{1}{T} \int_0^T y(\tau) \sin(\omega\tau) d\tau = 0 \quad (3.3)$$

It is not hard to see that the correlation consists necessary information about the gradient. Moreover, if we apply Taylor series on the output function and insert into the last expression it can be very easily seen that the condition (3.3) will be satisfied only when the gradient is zero. Hence, the correlation is equivalent to the gradient of the output. From the previous it follows that parameter $\hat{\theta}$ is updated based on information about the gradient. Therefore, the update law is as follows:

$$\frac{d\hat{\theta}}{dt} \approx k \frac{\partial h}{\partial \theta} \quad (3.4)$$

or

$$\hat{\theta}_{new} \approx \hat{\theta}_{previous} + k \frac{\partial h}{\partial \theta} \quad (3.5)$$

The whole algorithm, thus showed to work using the principle of steepest descent method as was described in more details in introductory chapter. Clearly, controller gain k has the role of the step size.

3.1.2 Analysis of sinusoidally perturbed ES algorithm with and without dynamics

Case1: Plant without dynamics

Analysis and optimization of static maps by using ESC is quite a simple task. Stability is guaranteed regardless the choice of parameters and performance is quite satisfactory. Fig.3.2 shows the structure of the basic SISO extremum seeking control scheme for minimization in case of static mapping.

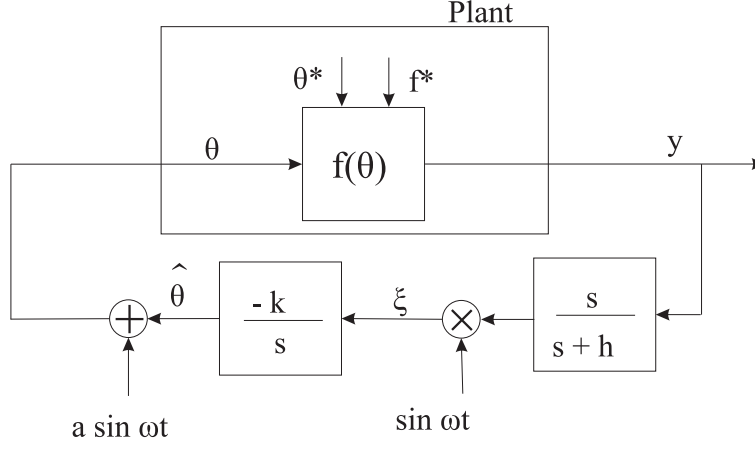

Figure 3.2: Basic extremum seeking scheme for static mapping

Using standard Taylor expansion and the fact that f is of class C^2 at least locally around θ^* and has minimum at that point, it can be written:

$$f(\theta) = f(\theta^*) + \frac{1}{2}f''(\theta^*)(\theta - \theta^*)^2 + O((\theta - \theta^*)^3) \quad (3.6)$$

Hence, the gradient can be approximated locally at $\theta = \theta^*$ by:

$$\frac{\partial f(\theta)}{\partial \theta} \approx f''|_{\theta^*}(\theta - \theta^*) \quad (3.7)$$

Denoting by $\tilde{\theta} = \theta^* - \hat{\theta}$ the estimation error and using relations from Fig 3.2 it follows that:

$$y \approx f^* + \frac{f''}{2}(\tilde{\theta} - a \sin(\omega t))^2 \quad (3.8)$$

High-pass filter is applied to the output to eliminate the presence of DC term, that is f^* . Such signal is then demodulation with dither signal. Resulting signal consists

high frequency terms which will be almost completely reduced after passing through the integrator. Information about the gradient is obtained after passing through low-pass filter integrator with cut off at 0 Hz frequency. Thus the final form of equation from which we can give the desired information about gradient is given as follows:

$$\dot{\tilde{\theta}} \approx -\frac{akf''(\theta^*)}{2}\tilde{\theta} \quad (3.9)$$

Depending on the sign of $f''(\theta^*)$, the parameters a and k can be always chosen so that (local) asymptotical stability is guaranteed (i.e. the condition $akf''(\theta^*) > 0$ is satisfied). Using mathematical transformations and operations described in details in [5] we arrive to the final expression:

$$\dot{\hat{\theta}} \approx k\frac{1}{2}a\frac{\partial f}{\partial \theta}\Big|_{\theta=\hat{\theta}} \quad (3.10)$$

The estimated gradient can be used to update the current value of the parameter θ . Such updating law guarantees the (local) convergence of the parameter $\hat{\theta}$ to the extremum point θ^* .

Case2: Plant with dynamics

Analysis of dynamical plants is far more complicated. Plant dynamics interacts with algorithm dynamics which may lead to instabilities. This algorithm appeared in two forms in literature: first-order (FO) and higher-order (HO) ESC. This terms are for the first time introduced in [71] where stability results are derived for algorithm consisting only of integrator without filters. This algorithm is named FO ESC and is a simpler version of what is called HO ESC (see Figure 1.4). For the sake of generality, here we will briefly analyse the HO ES controllers. Complete stability analysis for

this algorithm can be found in [50]. It is adaptive closed-loop type of control whose nonlinear model and control law may be described as follows:

$$\begin{aligned} \dot{x} &= f(x, u) \\ y &= h(x) \\ u &= \alpha(x, \theta) \end{aligned} \tag{3.11}$$

Cut-off frequencies of the high pass and low pass filters need to be lower than the frequency ω of the perturbation signal. In addition, the adaptation gain k has to be small. Thus, the overall feedback system has a fast, a medium and a slow time scale corresponding to the plant dynamics, the periodic perturbation and the filters in the extremum seeking scheme, respectively. In case of FR ESC only slow and fast time-scales are identified. If the plant behavior varies due to uncertainties, the time scales of the perturbation signal and the filters have to be slower than the slowest possible plant dynamics.

Krstic showed [50] that averaged reduced system is obtained using the standard procedure in the form:

$$\frac{d}{d\tau} \begin{bmatrix} \tilde{\theta}_r^a \\ \xi_r^a \\ \tilde{\eta}_r^a \end{bmatrix} = \delta \begin{bmatrix} k' \xi_r^a \\ -\omega'_L \xi_r^a + a \frac{\omega'_L}{2\pi} \int_0^{2\pi} (\nu(\tilde{\theta}_r^a + a \sin \sigma) a \sin \sigma) d\sigma \\ -\omega'_H \tilde{\eta}_r^a + \frac{\omega'_H}{2\pi} \int_0^{2\pi} \nu(\tilde{\theta}_r^a + a \sin \sigma) d\sigma \end{bmatrix} \tag{3.12}$$

From averaged system equilibrium point is computed transforming dynamic equations into static problem - all three equations at the right hand side should be equal zero.

Function $\nu(\tilde{\theta})$ can be approximated around the equilibrium using Taylor series:

$$\nu(\tilde{\theta}) = \sum_{i=0}^N \frac{1}{i!} \nu^i(0) (\tilde{\theta})^i + O(a^N) \quad (3.13)$$

Consider the following expansion:

$$\tilde{\theta}^i = (\tilde{\theta}^a + a \sin(\omega t))^i = \sum_{k=1}^i C_k^i \tilde{\theta}^{a^{i-k}} a^k \sin^k(\omega t) \quad (3.14)$$

where $C_k^i = \frac{i!}{k!(i-k)!}$. Then the integral from the second row in equation (3.12) using the simplified notation can be rewritten as

$$\begin{aligned} & \int_0^{2\pi} \nu(\tilde{\theta}) \sin(\omega t) dt + O(a^N) \\ &= \sum_{i=0}^N \frac{1}{i!} \nu^i(0) \sum_{k=1}^i C_k^i \tilde{\theta}^{a^{i-k}} a^k \int_0^{\frac{2\pi}{\omega}} \sin^{k+1}(\omega t) dt = \\ &= \sum_{i=0}^N \sum_{k=1}^{2j < (i-1)} \frac{C_{2j+1}^i}{i!} \nu^i(0) \tilde{\theta}^{a^{i-2j-1}} a^{2j+1} \int_0^{\frac{2\pi}{\omega}} \sin^{2j+2}(\omega t) dt \\ &= a \sum_{i=0}^N \sum_{j=1}^{2j < (i-1)} \left(\frac{-1}{4}\right) \frac{C_{2j+1}^i C_{j+1}^{2j+2}}{i!} \nu^i(0) \tilde{\theta}^{a^{i-2j-1}} a^{2j} = 0 \end{aligned} \quad (3.15)$$

The expansion of fourth-order is given as:

$$\nu' + \nu'' + \nu''' \left(\frac{1}{2} \tilde{\theta}^{a^2} + \frac{1}{8} a^2 \right) + \nu'''' \left(\frac{1}{6} \tilde{\theta}^{a^3} + \frac{1}{8} a^2 \tilde{\theta}^a \right) = 0 \quad (3.16)$$

Moreover, the third-order expansion of $\tilde{\theta}_r^a$ is:

$$\tilde{\theta}_r^a = b_0 + b_1 a + b_2 a^2 + b_3 a^3 + O(a^4) \quad (3.17)$$

Assuming that output at some point achieves maximum the following conditions are derived:

$$\nu(0) = 0 \quad (3.18)$$

$$\nu'(0) = 0 \quad (3.19)$$

$$\nu''(0) < 0 \quad (3.20)$$

Equating the coefficients of the powers of a gives:

$$b_0 = 0, \quad b_1 = 0, \quad b_3 = 0 \quad (3.21)$$

$$b_2 = -\frac{\nu'''}{8\nu''} \quad (3.22)$$

In similar fashion $\tilde{\eta}_r^a$ is calculated. The equilibrium point of the averaged system is found to be a function of the amplitude of sinusoidal perturbation signal, that is:

$$\tilde{\theta}_r^{ae} = \frac{\nu'''}{8\nu''(0)}a^2 + O(a^3) \quad (3.23)$$

$$\tilde{\eta}_r^{ae} = \frac{\nu''(0)}{4}a^2 + O(a^3) \quad (3.24)$$

$$\xi_r^{ae} = 0 \quad (3.25)$$

Evaluation of Jacobian of system (3.12) gives the final condition for stability of averaged system:

$$\int_0^{2\pi} \nu'(\tilde{\theta}_r^{ae} + a \sin \sigma) \sin \sigma d\sigma < 0 \quad (3.26)$$

Further, stability of boundary layer can be proved introducing additional assumptions. By establishing stability results of boundary layer along with stability of reduced system it is proved that the closed-loop system is locally exponentially stable.

Comment 3.4 Results for exponential stability for singularly perturbed systems in Krstic’s paper use celebrated Tihonov theorem. Some discussions and generalizations of Tihonov theorem can be found in a number of works. From a practical standpoint, the problem with Tihonov’s theorem is that stability analysis of nonlinear system is typically difficult. First, there may be more than one root of (3.11) and the relevant one has to be identified. Second, the local stability properties of the root must be determined. Finally, the domain of influence of the root must be established, and usually is the most difficult step. Typically the best that can be done is local analysis based on linearization of a system. Hence, it is necessary for the stability discussed in Tihonov’s theorem that Jacobian matrix is negative around the equilibrium. This proves local exponential stability.

3.1.3 Algorithm performance. Some extensions and modifications

Although it is very popular, perturbation technique has some limitations. The main is the slow convergence due to the fact that excitation frequency ω for ES is typically chosen to be small value. This value can be increased to improve convergence speed, but may cause the instabilities.

The main requirement for this frequency to be small enough is in order to transform dynamic into a "static" system by using multiple time-scale separation. Generally speaking, this is the separation between the system dynamics, the perturbation frequency and the adaptation rate and is needed in order to avoid the undesirable interactions between adaptation rate and the plant[50].

It is widely known that all parameters play very important role when considering the performance of ESC. Excitation amplitude a and controller gain k are another two

significant parameters. They affect not only the convergence speed but also domain of attraction and algorithm accuracy. Sometimes we are able to tune this parameters in a way that would provide better convergence speed, but this, for example, may also result in a reduction of a basin of attraction. The trade-off between convergence speed, controller accuracy and domain of attraction is always present. Hence, probably the main challenge in this area is to modify the algorithm in a way which would guaranty fast convergence, large enough domain and minimal error. Although considerable work has been done in resolving this issue it still remains the open question.

Dependence of convergence speed on parameters of excitation signal is investigated in [72, 15, 50] for a nonlinear static map. Results in [50] implies the that averaged system converges to a neighborhood of the optimum, and that this size is being determined by the amplitude of the excitation signal.

It is also shown that not only the amplitude and frequency, but also the shape of the dither signal has an effect on convergence speed [72]. Same publication gives also an insight how the error in the optimal solution is caused with a change in the dither and controller parameters.

The problem of slow convergence becomes very acute in chemical systems whose parameter might vary very slowly. Slow convergence might be acceptable only in very fast systems. Alternatively, some other methods for gradient estimation is proposed by Guay in his numerous works. In one of them, opposite to standard assumptions, it is supposed that the cost function is not directly measurable for feedback. Explicit information about this function is given and inverse optimal technique employed. Gradient is estimated based on a model whose parameters are identified using the dither frequency in the bandwidth of the system.

The error of the algorithm showed to be proportional to the amplitude of the dither. In [72] it is shown, for example, that for fixed other parameters larger values of frequency

imply better convergence speed. Finally, in [15] the size of the error dependence on frequency is determined. Calculations proved for general nonlinear system that this error is proportional to the square of the dither frequency. This is true even when the amplitude is set to zero. When the results are applied on Wiener or Hammerstein system the neighborhood immediately become zero.

Nevertheless, some processes showed to have better performance in case when system operates in small vicinity of optimum than at exact optimal value. This case is investigated in [75]. The algorithm is used to minimize the friction coefficient. After designing controller based on methods of feedback linearization and H_∞ technique the coefficient is kept at the value slightly less than the maximum allowed. Stability analysis in this research uses Popov criterion. Results from experiment clearly prove this controller gives similar or even better performance with much smoother operation than those which operate at exact minimum.

To improve the overall performance of existing ES scheme Krstic in [46] added a compensator to the integrator. Simulations showed it to be more efficient than standard ESC. Compensator improves relative degree and phase response of ES loop. Compensator is designed as PD-type in order to preserve stability, that is to satisfy the conditions for Strict Positive Realness. Algorithm showed faster adaptation (tracking) obtained allowing higher adaptation gain k . However for some applications introduction of compensator may be harmful. Faster convergence is also the topic of studies in [68] where modified algorithm is used.

To handle with the problems when the dynamics of the adaptation is slower than the system dynamics, simple and effective approach in estimating the gradient is described in [70]. Multiple identical units with non-identical inputs are used to compute the gradient via finite difference method. In this way the perturbation that is along the unit dimension allows faster adaptation. Dynamics of adaptation is almost in the

same time scale as the system dynamics. The convergence of the scheme is established via tools of Lyapunov analysis. As authors emphasize the method showed to be very effective also in cases where the dynamics is not a bottleneck.

Also one of the main challenges with ESC and most deterministic adaptive control approaches is the ability to recover the true unknown values of the parameters. In most approaches, the convergence of parameters to their true values can only be ensured if the closed-loop trajectories provide sufficient excitation for the parameter estimation routine. An excitation signal can be introduced momentarily in the control system to achieve the necessary excitation. For nonlinear systems, the problem of determining appropriate excitation conditions remains open. Although some limited persistence of excitation conditions have been derived, they remain difficult to apply. Such conditions appeared in [36] for the solutions of an adaptive ESC problem. In fact, the fulfillment of such conditions dictates the performance of the optimization routine. Given some results in this area (for example [2], [25], [36]), convergence to the optimum is guaranteed only by assuming the satisfaction of a these condition.

Results proposed in [50] are extended to the case of discrete-time systems and complete analysis is given in [16]. The stability analysis of the discrete-time case is quite different compering with the one that can be found in [50]. Once again the two-time scale averaging theory is employed and sufficient conditions under which the plant output exponentially converges to sufficiently small neighborhood of the extremum value are derived.

ES scheme for nonlinear systems is also generalized to what is known as Slope seeking. It is for the first time introduced in [6]. Slope seeking drives the output to the value of the reference to output plant that corresponds to zero slope. The analysis is conducted on static plant, single and multi-parameter design and on one with the compensator. Application of this method can be found, for example, in [45].

Analysis proposed in [13] gives insight in a modified ES algorithm. For the purpose of optimizing the coupling between the emitting Lower Hybrid antennas and the plasma scrape off layer in the radio-frequency heating system of tokamak plasmas, technique without external dithering is introduced (see Figure 3.3). The role of standard dither signals is given to disturbances affecting the system. These disturbances, already present in the control system, are used as probing signals so that injection an external dithering signals is not necessary. This design is shown to be more robust as it is less rigorous than the previous algorithms. Proofs for global stability use a novel Lyapunov - based proof technique as compared to that in the classical approaches. Proposed scheme relaxes the convexity condition on the unknown function required in classical extremum seeking.

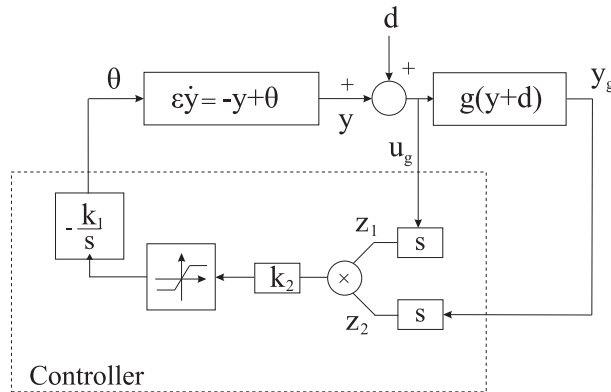

Figure 3.3: ES scheme without dither signal

In [86] opposite to standard stability assumptions moderately unstable single poles along with both single and double integrators are allowed. Extensions are made for case of marginally stable systems and moderately unstable systems. Results are then applied for control of autonomous vehicles for finding a source of a signal whose strength decays with the distance. The task of ES is to track the source of a scalar valued signal that typically decays away from the origin while extracting the implicit

position information through gradient estimation. The algorithm employs phase lead compensators to preserve robustness in presence of destabilizing effects.

3.1.4 Sliding mode ESC

More than fifty years ago, another optimization approach based on sliding mode control was popularized. This is actually the method that brought into life ESC after being in shadow for thirty years. This topic was revisited again in 1980's.

It is well known that sliding mode controllers showed to be very good solution when dealing with uncertainties. The idea to introduce it into extremum seeking theory was initiated by Drakunov and Ozguner (see [30]). They maximized the engine efficiency by finding the best ignition angle using a self-optimizing scheme. Their implementation was done using only analogue circuitry. The generated work was measured directly from the dynamometer. General sliding mode scheme is given at Fig 3.4. The method uses sliding mode (SM) to estimate the gradient of performance function.

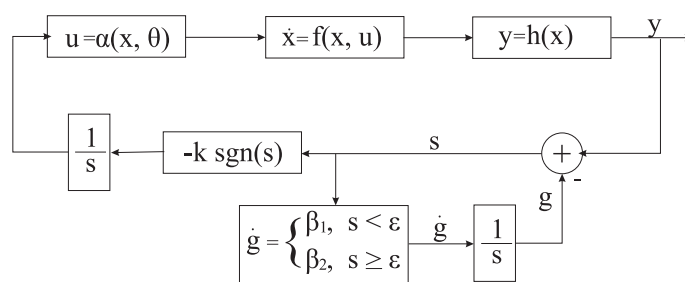

Figure 3.4: ES control using sliding mode

Extremum seeking based on sliding mode is widely studied in literature. It appears in several algorithms. This method was also applied in optimizing many real-world

processes. Further theoretical extensions and relevant applications of sliding mode ES can be found, for example in [62], [17], [29], [81], [80] and [82]. Comparisons between a sliding mode and some other techniques can be found [60].

3.1.5 RTO and model predictive control. Unified framework

Work reported in [3], [35] [2] and [1] gives a new frame for a control algorithm that incorporates Real-Time Optimization (RTO) and Model Predictive Control (MPC). It results in a techniques that solves an output feedback extremum seeking control problem for nonlinear known system. The method guarantees parameter convergence with minimal but sufficient level of perturbation. Stability results are obtained using well-known Lyapunov techniques. Model is shown to be robust to modeling errors and bounded disturbances. Moreover, last two papers consider optimizing systems under constraints.

This theoretical results are latter applied on chemical reactors in [34], [33], [56], [32], [38], [40] and [39]. These publications analyse how to optimize chemical processes in reactor systems that are operate under different working conditions. Controllers are designed to satisfy stability issues. With the choice of appropriate Lyapunov function and determining the conditions under which its derivative would satisfied stability requirements adaptation update laws are obtained.

Same technique in controllers' construction is further adopted in [25], [24], [37], [63] and [26]. All these systems discuss nonlinear systems under constraints given in a form of particular functions or as general inequalities/equalities. Constraints are put on adaptation parameters which should be inside the convex set during the adaptation time. This is useful fact that allows Lyapunov stability analysis to use projection function as a part Lyapunov function.

3.1.6 Numerical approach. Nonlinear programming

ES controllers can be built using nonlinear programming optimization techniques. In [74] applicable numerical algorithms are studied and dynamical interactions between an optimization algorithm and the optimized dynamical system is analyzed. Furthermore some recipes to achieve faster extremum seeking are derived and new convergence properties are established using direct search algorithms for nonsmooth optimization problems. To allow system dynamics to settle before new measurements are taken Teel and Popovic introduced waiting time. The algorithm was latter applied in [28] for Raman optical amplifiers.

In [85] and [84] extremum seeking controller design is also based on numerical approach. First part deals with construction of state regulator via output tracking for state feedback linearizable systems. Clearly, the optimization algorithm used here works using principle of classical steepest descent approach. Global convergence for regulator is proved under certain assumptions. Second part considers robust extremum seeking control design. Controller is designed to be robust to input disturbance and unknown plant dynamics for state feedback linearizable systems.

3.2 Stochastic ESC

Methods that are mostly used to approximate gradient in area of stochastic optimization are Simultaneously Perturbation Stochastic Approximation (SPSA), Kiefer-Wolfowitz finite-difference SA (FDSA) and Random Direction Stochastic Approximation (RDSA). They are two-sided methods whose required number of measurements differs. In general, the accuracy of an estimate in stochastic approximation algorithms increases with the number of taken measurements which, on the other side can reflect on the overall cost.

Application these algorithms is also demonstrated in [65]. In the same work it is shown that algorithms such as simultaneous perturbation stochastic approximation (SPSA) with projection, may exhibit especially slow convergence because of the interaction between the projection operator and a gradient approximation. It is also shown how to modify the standard SPSA algorithm to remove this effect and get fast convergence that can be useful for applications in real - world problems.

Above research deals with bound constraints. The settings for constrained stochastic optimization problem can be put in the following form:

$$\min_{\theta \in G} f(\theta), f(\theta) := F(y(\theta, \omega)) \quad (3.27)$$

$$\text{for } G = \theta = [\theta_1, \theta_2, \dots, \theta_p] \in \mathbb{R}^p | a_i \leq \theta_i \leq b_i, i = 1, 2, \dots, p \quad (3.28)$$

$$-\infty < a_i < b_i < \infty \quad (3.29)$$

where G is the constrained set, θ is vector that has the same meaning as in previous analysis - it represents input parameter's space. $f(\cdot)$ is value of the cost function which is an expectation of $y(\cdot, \cdot)$, the sample measurement of the cost. It is also a function of control signal θ . ω denotes the random variable. Function y can be rewritten as $y(\cdot, \cdot) = f(x) + \eta(\omega)$. Here η is measurement noise. Particular problem that usually occurs even when algorithm is proved to converge is slow approach to the optimal value. Not only that theory revealed it, but also some experiments done in case of automotive engine optimization presented in [65] confirmed these theoretical results. Analysis of convergence speed of the SPSA algorithm with projection and constraints can be found in same work. Constraints are considered to be hard. This means that noisy evaluations of the cost function $f : \mathbb{R}^p \rightarrow \mathbb{R}$ are available only over the set G .

Stochastic approximation algorithm itself can be defined as an optimization setting with projection.

$$\theta_{k+1} = \pi_G\{\theta_k - a_k \hat{g}_k(\theta_k)\} \quad (3.30)$$

where the step size $a_k \rightarrow 0$ as $k \rightarrow \infty$, and $\pi_G : \mathbb{R}^p \rightarrow \mathbb{R}^p$ is the projection onto the set G .

When SPSA with projection was applied the algorithm turned out to be incomparably faster in reaching the minimum than SA with projection. Yet, this faster convergence can be achieved only with SPSA. The problem encountered in this case is existing geometric interaction between the projection operator and the SPSA gradient estimate. The interaction happens when one or more components of the current iterate reach the boundary of the constrained set while the (negative) gradient field is directed against the boundary. The effect of the interaction is described as "iterate bouncing against the constraints". In other words, the iterates first reach the boundary of the constrained set. In next iteration they "bounce" back, and the value of the cost function increases. However the influence of the "bouncing effect" on optimization speed was not so clear when iterates were far away from the optimum. This bouncing effect is the main cause of slower convergence, so the algorithm was modified.

This modified algorithms was latter applied in on-line optimization of parameters of an automotive internal combustion engine. Three-dimensional space of independent parameters was analysed. The goal was to optimize engine's break specific fuel consumption (BSFC). To achieve this several optimization algorithms or their modifications were applied and results compared. Modified model showed to work very well.

Results proposed in [55] use stochastic perturbations to extract gradient information by using one-sided search algorithm. Instead of periodic excitation noisy signal is added to input. Input and output are correlated in same fashion as for periodic probing signals and information about gradient is obtained.

3.3 Examples of applications

There are many examples where previously described techniques are used to optimize some physical or chemical operating conditions. One of earliest practical work by Wang and Krstic was reported in [79]. Here extremum seeking was used for problem of maximizing the pressure rise in an axial flow compressor. It is applied to the Moore-Greitzer model. The experiment resolves a concern that extremum seeking requires the use of periodic probing signal. Authors pay special attention to emphasize satisfactory results of laboratory experiments. The algorithm performed well in the high-noise experimental environment. Actually, the high noise made the effect of the periodic perturbation hardly noticeable.

Work published in [14] discusses controller design for drag minimization in formation flight. Modified Kalman filter is introduced to estimate the gradient of the cost function so that controller can drive the system to this maximum. This filter actually estimates the slope of the function, providing robustness to measurement noise. It is assumed the Kalman filter perfectly estimates the state variables. To achieve the desired behavior due to the present uncertainties robust and adaptive control schemes are employed. Designed controller must both stabilize the aircraft and seek the best operating point.

Tracking emitted signals by non-holonomic vehicles in target tracking problem was motivation for a number of publications. Distribution of these signals is generally not known. However, it is known that signal strength decays and it has maximum value at source itself. First autonomous vehicles are considered in [86]. The analysis is then expanded to non-holonomic vehicles both for 2D and 3D case while tuning the angular or forward velocity (see, for example [19, 22, 18, 83, 20, 21, 23, 48, 87]).

PID controller are possibly the most popular controller for industrial applications. However, sometimes the performance of these controllers may not be satisfactory.

To improve their effectiveness ES controller can be used as it is already shown in [43]. This should be quite useful application due to their wide industrial use. PID controller is used such that derivative term acts only on the plant output but not on the reference. Task of ES is to tune the parameters of the controller in a way that would reduce the error to its minimal value. The numerical experiments are done for several plants: two with time delays, one with non minimum phase and one with multiple poles. To compare the effectiveness of ES algorithm some other standard methods whose purpose can be tuning of controller parameters are chosen. Those three are standard Ziegler-Nichols method, Iterative Feedback Tuning and Internal Model Control. Results are applied in [42] to tune the combustion timing controller of an experimental of homogenous charge compression ignition engine.

The principles of extremum seeking control has been also applied to 2nd and 4th order models of anaerobic digestion in [69]. The goal of the AD process is production of biogas. As an optimization objective it is then natural to consider the maximization of the biogas flow rate. The purpose of the extremum seeking method is then to iteratively adjust the dilution rate in order to steer the process to the maximum of this map. In order to maximize the biogas productivity of the AD, extremum seeking control is applied using the dilution rate as a control action and the biogas flow rate as a measured output.

One more example is application of ES in cases where stabilization of equilibrium is not possible for some reasons. Some systems, for example have limit cycle that have to be controlled. If the size of the limit cycle depends on some of the control parameters, then a reasonable objective would be to tune this parameter to minimize the size of the limit cycle. Results of this research is published in [77] and simulations have been done with classical Van der Pol oscillator.

Furthermore, ES found to be useful also in reducing the magnitude of the impact

of mechanical valve actuator [64]. Impacts experienced by the actuator are excessively loud and create unnecessary wear. Based on a measure of the sound intensity at impact, the controller tunes a nonlinear feedback to achieve small impact velocities within desirable bounds. Experimental results showed that transition times and impact velocities were satisfactory.

To help finding the maximum biomass production rate in a continuous stirred tank bioreactor ES scheme is applied in [78]. Work proposed in this paper analyses both Monod and Haldane model. In case of Haldane model, a subcritical bifurcation prevents operation with a satisfactory stability region near the maximum. To overcome this problem a local stabilizing feedback controller with a washout filter is designed to soften the bifurcation, that is to extend the operating range. Adding this filter the structure of equilibria is preserved. It is shown that by applying ES to Monod and Haldane models it is possible to optimize steady-state of a continuous stirred tank reactor in presence of uncertainties due to process kinetics.

The analysis continues in same spirit in [9] where ES scheme for bioprocesses is extended for problem which multivalued functions as cost functions. Optimal operating point is obtained as a best solution that would satisfy both yield and productivity. Research showed that the optimization problem is feasible for systems with multivalued discontinuous cost functions.

Area that attracted a lot of intention is minimization of energy consumption. To direct the economizer in HVAC (heating, ventilating and air conditioning) to operate in optimal manner a new ES scheme is developed in [53]. Here ES works as a part of a three-state economizer control strategy. It is used to control actuators to minimize mechanical cooling load. On the other hand saturation of actuators is taken into account as it would cause windup which may disable ES action. Hence the ES is modified as it can be seen at Fig 3.5.

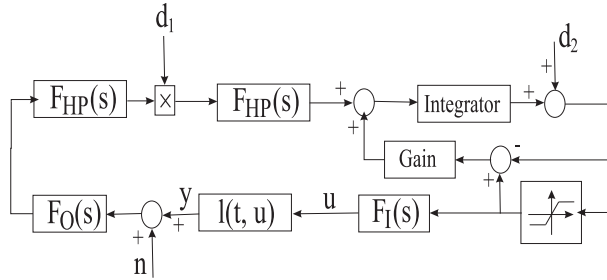

Figure 3.5: Block diagram for the anti-windup ESC

Other approaches and applications can also be found in number of other literature. Such is, for example problem of reducing the vibrations due to thermo-acoustic instabilities that occur in gas turbine engines. This is investigated in [8, 57, 58]. Former is based on steepest descent method of algorithm in [50]. Last two are papers by same authors using Newton algorithm. First gives theoretical frame which relaxes dependence of the search algorithm on the curvature of the plant map. The theory is applied in second part where one can find comparison of experimental results. In [10], [11] and [73], where it is used to lower the power consumption, to achieve the maximum power of grid-connected PV arrays and to keep the wheel slip as close as possible to the optimum of the friction curve in ABS, respectively. Investigation done in [76] is one more paper that minimizes overall used energy in HVAC systems and in [61] the whole analysis goes towards best possible approximate matching in a short time for case of multi-parameter extremum seeking, receding horizon controller. Following the same fashion ES is applied also in [31] and [54]. First paper employs ES to control detached flow with strictly linear dynamics. Research conducted in second one tunes boundary controller in order to maximize the outlet temperature electrically conducting fluid in order to improve heat exchange efficiency. ES is further applied in [44], [52], [47], [67], [27], [12].

Chapter 4

p-dimensional parameter space

4.1 First order ESC. Problem formulation

In this chapter the problem formulation is presented. The first order algorithm with multiple-input-single-output is shown in Figure 4.1. Structure of this simplified version for SISO case is introduced in [71] and non-local stability results established. When optimizing some process in practice, quite often there is a need for MISO and MIMO. As many authors suggest MISO controllers are more significant. Numerous physical and chemical processes to be optimized are by nature multivariable. Here results are extended to MISO case. The whole analysis can be in same fashion extended for first order MIMO systems. As will be seen latter standard methods of decentralized control are not needed. Appropriate choice of excitation frequency makes it possible that for FR controller all subsystems may be analysed as separate and independent SISO systems.

At Figure 4.1 $\hat{\theta}$ is the current estimate of controller parameter. The maximum value is denoted as θ^* . Sinusoidal perturbation is added to the plant input. The main problem considered here is the one of finding the extrema of performance measure

which is a nonlinear real-valued function of the p – dimensional parameter and its initial value θ_0 known.

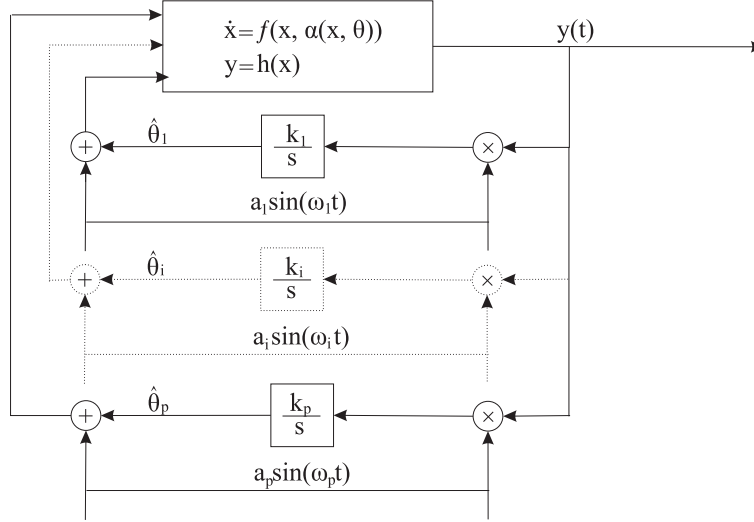

Figure 4.1: First order MISO extremum seeking algorithm

From Figure 4.1 it follows that the adaptation rate is described using the next expression:

$$\frac{d\hat{\theta}_i}{dt} = k_i h(x) a_i \sin(\omega_i t), \quad i = 1, 2, \dots, p \quad (4.1)$$

where k is a positive integrator gain that is chosen by the designer. For a given plant an optimal selection of the gain k could be made. As extremum seeking optimizes an unknown steady-state of unknown dynamics it is not clear how to select the gain to guarantee the best performance.

Consider a nonlinear system with p inputs and single output given by the following equations:

$$\begin{aligned} \dot{x} &= f(x, u) \\ y &= h(x) \end{aligned} \tag{4.2}$$

where $x \in D \subset \mathbb{R}^n$, u , and $y \in \mathbb{R}$ are the state variable, control input and system output, respectively. The vector fields $f : D \times \mathbb{R}^p \rightarrow \mathbb{R}^n$ and $h : D \rightarrow \mathbb{R}$ are sufficiently smooth in their arguments. The output y reports the cost function which is the function of state $h(x)$.

The dither signal $d(t)$ is defined as a p -dimensional vector using standard matrix notation:

$$d(t) = (a_1 \sin(\omega_1 t), \dots, a_i \sin(\omega_i t), \dots, a_p \sin(\omega_p t)) = \begin{pmatrix} a_1 \sin(\omega_1 t) \\ \vdots \\ a_i \sin(\omega_i t) \\ \vdots \\ a_p \sin(\omega_p t) \end{pmatrix} = a \sin(\omega t) \tag{4.3}$$

The control problem here is to find a simple, but efficient enough strategy that would optimize the output $y = h(x)$.

4.2 Convergence analysis. SPA stability

Krstic and Wang in their publication proved local exponential stability. For the simpler algorithm it can be proved that under certain circumstances algorithm can

be semi-globally stable. This highly depends on the parameters and how they are tuned. If appropriately tuned controlled will be SPA stable. As starting point assume that x and y starting are available for feedback. Then control law for (4.2) defined in the following form:

$$u = \alpha(x, \theta) \quad (4.4)$$

where $\theta = \hat{\theta} + a \sin(\omega t)$ is a p - dimensional vector whose i -th component θ_i can be written as:

$$\theta_i = \hat{\theta}_i + a_i \sin(\omega_i t) \quad (4.5)$$

It is assumed that after some time controller parameter will reach its optimum θ^* . From Figure 4.1 it follows that dynamics of the plant and adaptation rate, respectively, can be expressed in the following form:

$$\begin{aligned} \dot{x} &= f(x, \alpha(x, \hat{\theta} + a \sin(\omega t))) \\ \dot{\hat{\theta}} &= h(x) d_k(t) \end{aligned} \quad (4.6)$$

where d_k denotes the signal defined in (4.3) whose each component is multiplied with corresponding gain k_i . To analyze dynamic behavior of state under the control input u it is appropriate to employ a change of variables. For system (4.6) the deviations $\tilde{x} = x - x^*$ and $\tilde{\theta} = \theta - \theta^*$ are introduced. Geometrically, this transformation of coordinates determines the translation of variables into the origin. They are by their nature tracking errors. To study the behavior of \tilde{x} near $t = 0$ the time scale is "stretched" by introducing the transformation $t = \tau/\omega$. Small parameter ω can be expressed with respect to the following relationship:

$$\omega = \frac{\omega_1}{n_1} = \frac{\omega_2}{n_2} = \dots = \frac{\omega_p}{n_p} \quad (4.7)$$

which follows from the fact that the system with p inputs is analyzed.

Parameterized equilibrium point $x(\theta)$ will finally reach its optimum $x^*(\theta^*)$. It will be assumed that variable x has a much faster dynamic response such that a time scale decomposition exists and the closed loop system has the following standard form:

$$\begin{aligned}\omega \frac{d\tilde{x}}{d\tau} &= f(\tilde{x} + x^*, \alpha(\tilde{x} + x^*, \tilde{\theta} + \theta^* + d(n\tau))) \\ \frac{d\tilde{\theta}}{d\tau} &= h(\tilde{x} + x^*) d_\delta(n\tau)\end{aligned}\tag{4.8}$$

where d_δ denotes the dither signal d_k multiplied with new small parameter $\delta \in \mathbb{R}^p$. This parameter is introduced through expression $k_i = \omega \delta_i$. Recall that $(\tilde{\theta} + \theta^*) \in \mathbb{R}^p$ and $d_\delta(n\tau) \in \mathbb{R}^p$ are vector of input signal and its perturbation, respectively. Then the signal $d_\delta(n\tau)$ may be written as:

$$d_\delta(n\tau) = (a_1 \delta_1 \sin(n_1 \tau), \dots, a_i \delta_i \sin(n_i \tau), \dots, a_p \delta_p \sin(n_p \tau))$$

Note We are interested in system (4.8) under the assumptions that ω is "small enough" (i.e. relative to the other parameters of the system). In this case, $\dot{\tilde{x}}$ is large compared with the $\dot{\tilde{\theta}}$ and we refer to \tilde{x} and $\tilde{\theta}$ as fast and slow variables, respectively.

Clearly, the system (4.8) has the standard time-scale structure. Singular perturbations and averaging method should be applied at this stage. When seeking the solution for (4.8), it is natural to set $\omega = 0$ and solve the resulting problem in order to obtain the reasonable approximation. Set $\omega = 0$, the first equation of system (4.8) degenerates into algebraic:

$$f(\tilde{x} + x^*, \tilde{\theta} + \theta^* + d(n\tau)) = 0\tag{4.9}$$

Comment 4.1 Because the second equation of the system (4.8) is with n ODE of first order, only n initial conditions can be met and it is natural to retain the condition on the slow variables and meet the condition on x by allowing discontinuity at $t = 0$.

To simplify further analysis we assume the equation (4.9) has a unique solution.

$$\tilde{x} + x^* = l(\tilde{\theta} + \theta^* + d(n\tau)) \quad (4.10)$$

where $l(\tilde{\theta} + \theta^* + a \sin(n\tau))$ is sufficiently smooth function with respect to θ . The following assumption can be made:

Assumption 1. There exists a function $l : \mathbb{R}^p \rightarrow \mathbb{R}^n$ such that $f(x, \alpha(x, \theta)) = 0$ iff $x = l(\theta)$

Substitution of equation (4.10) into second equation of a system (4.8) gives differential form for reduced system:

$$\frac{d\tilde{\theta}^r}{d\tau} = \varphi(\tilde{\theta}^r + \theta^* + d(n\tau)) d_\delta(n\tau) \quad (4.11)$$

where $\varphi = h \circ l(\tilde{\theta}^r + \theta^* + a \sin(n\tau))$ and where upper index r is introduced to denote the reduced system.

Comment 4.2 At this point the form of nonlinear equations (4.11), that can be used in the following analysis, should be found. It is known that asymptotic series (and particularly Taylor) can serve for this task. The goal is to simplify the system and to get the system that is suitable for further mathematical analysis. Taylor expansion will allow us to get reasonably good approximation. For this purpose it is enough to develop asymptotic expansion up to the second order.

Details about Taylor series expansion for a differentiable real-valued function $f : \mathbb{R}^n \rightarrow \mathbb{R}$ and disturbance $q \in \mathbb{R}^n$ can be found in Appendix A.

Assuming that φ is analytical expansion around the equilibrium point $(\theta^* + \tilde{\theta}) \in \mathbb{R}^p$ with respect to p -dimensional vector $d(n\tau)$ as disturbance, will be therefore expressed in the following way:

$$\begin{aligned} \varphi(\theta^* + \tilde{\theta} + d(n\tau)) &= \varphi(\theta^* + \tilde{\theta}) + \sum_{i=1}^p a_i \varphi'_i(\theta^* + \tilde{\theta}) \sin(n_i\tau) + \\ &+ \frac{1}{2} \sum_{i,j=1}^p a_i a_j \varphi''_{ij}(\theta^* + \tilde{\theta}) \sin(n_i\tau) \sin(n_j\tau) + \dots \end{aligned} \quad (4.12)$$

Assuming also that the parameter a is small enough the quadratic and higher order terms. Otherwise, when substituted in reduced system these would result in a cubic and even higher order terms. After neglecting particular terms expression (4.12) can be rewritten as:

$$\varphi(\theta^* + \tilde{\theta} + d(n\tau)) = \varphi(\theta^* + \tilde{\theta}) + \sum_{i=1}^p a_i \varphi'_i(\theta^* + \tilde{\theta}) \sin(n_i\tau) \quad (4.13)$$

Substitution of (4.13) into (4.11) leads to:

$$\frac{d\tilde{\theta}^r}{d\tau} = a_i \cdot \delta_i \sin(n_i\tau) \cdot \varphi(\tilde{\theta}^r + \theta^*) + \sum_{l=1}^p a_i a_l \cdot \delta_i \varphi'_l(\tilde{\theta}^r + \theta^*) \cdot \sin(n_l\tau) \sin(n_i\tau) \quad (4.14)$$

Recalling *Sanders* and *Verhulst* [66] (see Chapter 2) it can be easily seen that the system (4.14) has the form identical to:

$$\frac{d\tilde{\theta}^r}{d\tau} = \varepsilon \hat{\varphi}(\tilde{\theta}^r + \theta^*, \tau) + \varepsilon^2 \bar{\varphi}(\tilde{\theta}^r + \theta^*, \tau) \quad (4.15)$$

Here dither amplitude is represented as a small parameter ε and where second order averaging for a general nonlinear systems on time-scale $1/\varepsilon$ can be applied. Functions $\hat{\varphi}(\cdot)$ and $\bar{\varphi}(\cdot)$ are equal to the first and second addends of (4.14), respectively,

excluding small parameter. Introduce the near-identity transformation and averaged system of (4.15) as follows:

$$\tilde{\theta}^r = w + au_1(t, w) \quad (4.16)$$

$$u_1(t, w) = \int_0^t \hat{\varphi}(w, \tau) d\tau - \lim_{T \rightarrow \infty} \int_0^T \int_0^t \hat{\varphi}(w, \tau) d\tau dt \quad (4.17)$$

$$\frac{d\tilde{\theta}^{ra}}{d\tau} = \varepsilon \varphi^0(\tilde{\theta}^{ra} + \theta^*) + \varepsilon^2 \varphi^{10}(\tilde{\theta}^{ra} + \theta^*) + \varepsilon^2 \varphi_{av}(\tilde{\theta}^{ra} + \theta^*) \quad (4.18)$$

Here $\varphi^0(\cdot)$, $\varphi^{10}(\cdot)$ and $\varphi_{av}(\cdot)$ are averages of $\hat{\varphi}(\cdot, \tau)$, $\varphi^1(\cdot, \tau)$ and $\bar{\varphi}(\cdot, \tau)$, respectively. Here $\varphi^1(\cdot, \tau)$ is defined with:

$$\varphi^1(\tilde{\theta}^{ra} + \theta^*, \tau) = \nabla \hat{\varphi}(\tilde{\theta}^{ra} + \theta^*, \tau) u_1(\tilde{\theta}^{ra} + \theta^*, \tau) - \nabla u_1(\tilde{\theta}^{ra} + \theta^*, \tau) \varphi^0(\tilde{\theta}^{ra} + \theta^*) \quad (4.19)$$

In this analysis only final results from [66] are used in order to find an approximate solution. Theoretical introduction and all details about the derivations for all expressions can be found in Section 3.4 in same book.

Proceed to get the averaged solution:

$$\varphi_i^{10} = \lim_{T \rightarrow \infty} \frac{1}{T} \int_0^T \varphi'_{\tilde{\theta}_i}(\tilde{\theta} + \theta^*) u_1(t, \tilde{\theta} + \theta^*) \sin(n_i \tau) d\tau = 0 \quad (4.20)$$

$$\varphi_{av}^i = \lim_{T \rightarrow \infty} \frac{1}{T} \int_0^T \left(\sum_{l=1}^p a_l \varphi'_l \sin(n_l \tau) \right) \sin(n_i \tau) d\tau \quad (4.21)$$

For all $l \neq i$ terms are equal to zero. So, the only term that is left in (4.21) is:

$$\varphi_{av}^i = \lim_{T \rightarrow \infty} \frac{1}{T} \int_0^T a_i \varphi'_i \sin^2(n_i \tau) d\tau = \frac{1}{2} a_i \varphi'_i(\theta^* + \theta_{av}) \quad (4.22)$$

The averaged system in final form can be written in index or vector notation:

$$\frac{d\tilde{\theta}_{av}^i}{d\tau} = \frac{1}{2}a_i^2\delta_i\varphi'_i(\theta^* + \theta_{av}) \quad (4.23)$$

$$\frac{d\tilde{\theta}_{av}}{d\tau} = \frac{1}{2}D\nabla\varphi(\theta^* + \theta_{av}) \quad (4.24)$$

where D is a diagonal matrix $D = \text{diag}(\delta_i a_i^2)$. Clearly, the goal was to show the average system consists only of one term - gradient:

$$\frac{d\hat{\theta}_i}{dt} = (ak)_i h(x) \sin(\omega_i t) = k_i \frac{\partial\varphi(\theta_{av} + \theta^*)}{\partial\theta_i} \quad (4.25)$$

Hence, when $\hat{\theta} \rightarrow \theta^*$ it follows that $\nabla\varphi$ tends to zero and output function reaches its optimum. Stability of averaged system (4.24) is established employing Assumption 2.

Assumption2. Denoting $\varphi(\cdot) = h \circ l(\cdot)$, there exists a unique non-degenerate critical point θ^* maximizing $\varphi(\cdot)$ and, the following holds:

$$\begin{aligned} \nabla\varphi(\theta^*) &= 0, \quad H(\varphi(\theta^*)) < 0 \\ \bar{D}\nabla\varphi(\theta^* + \xi) &< 0, \quad \forall \xi_i \neq 0 \end{aligned} \quad (4.26)$$

where $H(\varphi)$ is Hessian matrix and $\bar{D} = \text{diag}[\delta_1 a_1^2 \xi_1, \delta_2 a_2^2 \xi_2, \dots, \delta_p a_p^2 \xi_p]$.

Following the procedure from [41] and using Assumption 2 the stability of boundary layer for overall system will be established in following few steps. First introduce shifts $\bar{x} = \tilde{x} - x^* - l(\theta^* + \tilde{\theta} + a \sin(n\tau))$, $\gamma = (n\tau - n\tau_0)\omega$ and $\bar{\theta} = \theta^* + \tilde{\theta} + a \sin(n\tau_0)$.

Set $\omega = 0$. Then the boundary layer is of the form:

$$\frac{d\bar{x}}{d\gamma} = f(\bar{x} + l(\bar{\theta}), \alpha(\bar{x} + l(\bar{\theta}), \bar{\theta})) \quad (4.27)$$

Here, third assumption is introduced to guarantee sufficient conditions for asymptotic stability of (4.8).

Assumption3. For each $\theta \in \mathbb{R}^p$, the equilibrium $x = l(\theta)$ of systems (4.8) is globally asymptotically stable, uniformly in θ .

To prove SPA near-identity transformation is used as well as tools from [41] (Chapter 10). It is proved that MISO system can be regarded as group of p completely independent SISO closed-loops. Thus, if to any of those loops we assign only their corresponding parameters as a and δ then it is enough to prove SPA stability for an arbitrary ES controller. Coordinate transformation can be described via:

$$\tilde{\theta}^r(\tau) = \mu(\tau) + a\delta u_1(\mu, \tau) \quad (4.28)$$

For the sake of simplicity we can introduce the following notation $\varphi(\theta^* + \tilde{\theta})$ and $\sum_i a_i \varphi'_i(\theta^* + \tilde{\theta}) \sin(n_i \tau)$ for $\psi_1(\theta)$ and $\psi_2(\tau, \theta)$, respectively. Then function u_1 and its derivatives with respect to τ and μ to are defined as:

$$u_1(\tau, \mu(\tau)) = \int_0^\tau (\psi_1(\mu) + a\psi_2(\xi, \mu) - a\varphi_{av}(\mu)) d\xi \quad (4.29)$$

$$\frac{\partial u_1}{\partial \tau} = \psi_1(\mu) + a\psi_2(\tau, \mu) - a\varphi_{av}(\mu) \quad (4.30)$$

$$\frac{\partial u_1}{\partial \mu} = \int_0^\tau \left(\frac{\partial \psi_1}{\partial \mu}(\mu) + a \frac{\partial \psi_2}{\partial \mu}(\xi, \mu) - a \frac{\partial \varphi_{av}}{\partial \mu}(\mu) \right) d\xi \quad (4.31)$$

To get the ODE of reduced system differentiate (4.28) with respect to time. It yields to the expression of the form:

$$\frac{d\tilde{\theta}^r}{d\tau} = \frac{d\mu}{d\tau} + a\delta\left(\frac{\partial u_1}{\partial \tau} + \frac{\partial u_1}{\partial \mu} \cdot \frac{\partial \mu}{\partial \tau}\right) \quad (4.32)$$

Equalize expressions in (4.32) with reduced system (4.14) will lead to:

$$\begin{aligned} \frac{d\mu}{d\tau}\left(1 + a\delta\frac{\partial u_1}{\partial \mu}\right) &= a\delta\{\psi_1(\mu + a\delta u_1) - \psi_1(\mu)\} + \\ &+ a^2\delta\{\psi_2(\tau, \mu + a\delta u_1) - \psi_2(\tau, \mu)\} + a^2\delta\varphi_{av}(\mu) + O(a^3) \end{aligned} \quad (4.33)$$

Using the statement of Lagrange Theorem (see Appendix A) and fact that parameters (a, δ) are sufficiently small it can be shown that:

$$\psi_1(\mu + a\delta u_1) - \psi_1(\mu) = O(a\delta) \quad (4.34)$$

$$\psi_2(\tau, \mu + a\delta u_1) - \psi_2(\tau, \mu) = O(a\delta) \quad (4.35)$$

Consequently the final system will be:

$$\frac{d\mu}{d\tau} = a^2\delta\varphi_{av}(\mu) + O(a^3\delta) \quad (4.36)$$

Finally, using Lyapunov function of the form $V(\mu) = \frac{1}{2}\mu^2$ SPA stability of the reduced system is proved by analyzing the sign of:

$$\dot{V} = \frac{1}{2}a^2\delta\varphi_{av}(\mu)\mu \quad (4.37)$$

Theorem 4.1 *The system (4.6) is SPA stable uniformly in parameters (a^2, δ) presuming the Assumptions 1, 2 and 3 hold.*

4.3 Numerical results and discussion

In this section previously developed theory and results are used to simulate numerical example. Simulations illustrate the applicability and efficiency of proposed solution. Results showed that this algorithm works well for *p* – dimensional parameter, where *p* can take any but final value in the set of positive integers.

Example 4.1 Numerical experiment is conducted for the case when θ is two-, three- and five-dimensional parameter dimensional parameter For the sake of simplicity simulations are conducted for plant variations taken to be the same and equal to u , which is incorporated in considered dynamical system. The following dynamics is to be optimized:

$$\dot{x} = x + 2u^2 + 4u, \quad y = -(x - 1)^2 \quad (4.38)$$

Using simple necessary conditions for extremum quick calculation shows that output reaches its optimal value at $y^* = 0$. At this point, state and parameters converge to their optimal value $x^* = 1$ and $\theta_i^* = u^* = -1$.

Simulation results are shown at Figure 4.2. To completely analyze the effect of parameters choice two different group of excitation parameters are taken to optimizing the same dynamical system. Parameters for the first case are chosen to be $a_1 = 0.25$, $\omega_1 = 1$, $\delta_1 = 0.1$, $a_2 = 0.1$, $\omega_2 = 0.5$ and $\delta_2 = 0.25$; for second case $a_1 = 0.25$, $\omega_1 = 8$, $\delta_1 = 0.1$, $a_2 = 0.1$, $\omega_2 = 10$ and $\delta_2 = 0.25$. For each choice of parameters initial conditions are chosen to be the same.

For two-dimensional parameters both excitation amplitudes are chosen to have the same values. Only the frequency is varied. It is obvious that for the two different

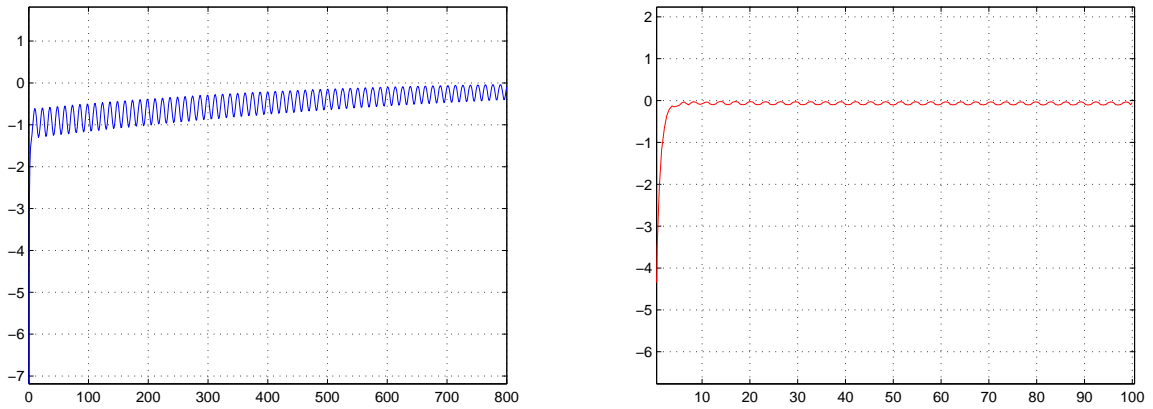

Figure 4.2: ES convergence for two dimensional parameter

frequencies algorithm will have different convergence speed. Both algorithms will converge to desired value, but the one with higher frequency showed to have better performance, that is, to be faster. In both cases output converges to some vicinity of its optimal value. Hence, there will always be present certain error. However, for this example and this choice of parameter values algorithm with larger higher dither frequency shows to be closer to the optimum all the time. It can be noticed that it oscillates close to extremum with smaller amplitude. Hence, it is obvious that higher frequency has considerable effect on better performance of the algorithm. On the other side, if the frequency is chosen to be too large it may cause instabilities and the algorithm may not converge.

To support discussed influence of excitation frequency the simulation results for both cases are given together at Figure 4.3. Analyzing this figure it is completely obvious superior behavior of algorithm whose parameters are tuned in a more proper way.

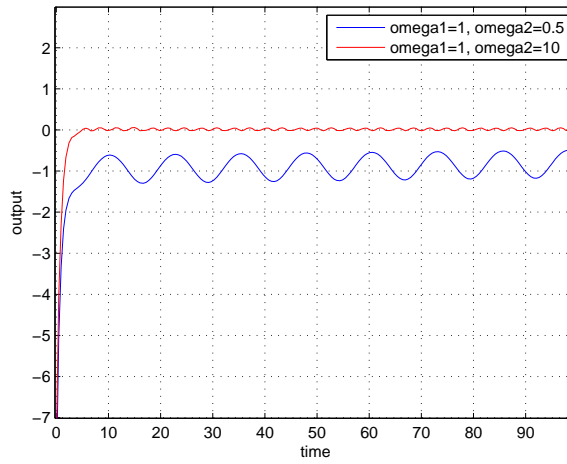

Figure 4.3: Convergence speed comparison for two different frequencies

Further analysis is conducted for the case of three- and five- dimensional parameter. First two parameters stay the same with choosing the second choice. For third parameter choice is made as follows $a_3 = 0.7$, $\omega_3 = 6$, $\delta_3 = 0.25$; for fourth and fifth parameters are taken to be as follows: $a_4 = 0.25$, $\omega_4 = 5$, $\delta_4 = 0.25$, and $a_5 = 0.1$, $\omega_5 = 6$, $\delta_5 = 0.5$.

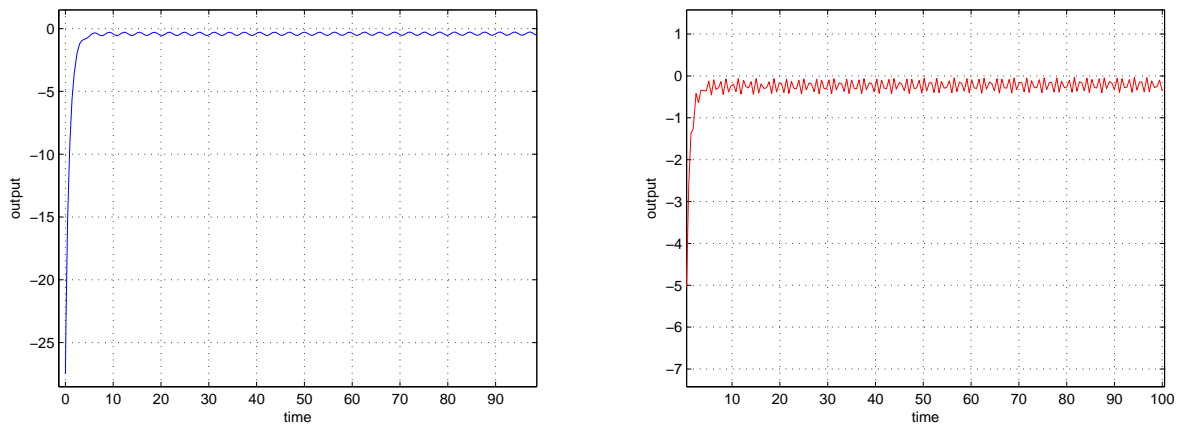

Figure 4.4: Algorithm performance for three- and five-dimensional parameter

Extremum seeking performance in case of three-, and five-dimensional parameters is shown on Figure 4.4. Comparison for both algorithms is further illustrated on Figure 4.5. Excitation parameters for this case are chosen such that they achieve in both cases almost the same convergence speed. The three-dimensional parameter showed better accuracy as it performs quite well in the small vicinity of the optimal value. Five-dimensional parameter exhibits larger amplitude oscillations in its neighborhood. Consequently, the error is larger.

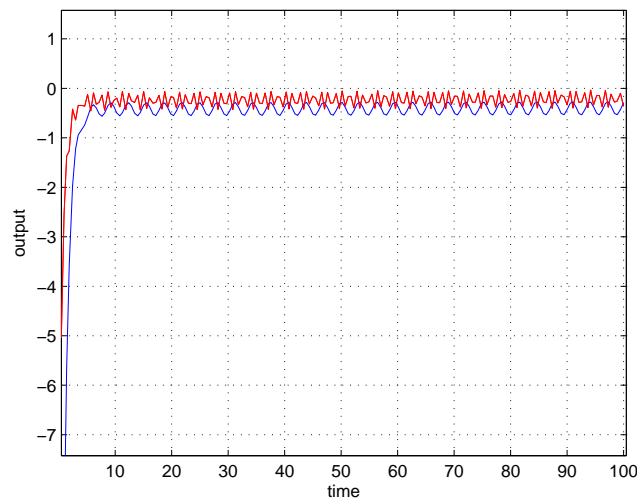

Figure 4.5: Comparison of two performances

Chapter 5

Conclusions and future work

5.1 Contributions

Within this master thesis a model-free real time optimization for multivariable first order extremum seeking control is proposed. Before investigating the problem in more details the reader is presented with key assumptions and results needed for resolving the problem. In general, we discussed some standard stability properties and illustrate them by giving some helpful examples.

Case without input or state constraints is considered. Certain parameters are chosen to be sufficiently small. SPA stability is established for reduced averaged and boundary layer systems. Numerical results are discussed for two-input, three-input and five-input systems. We discussed the importance of proving SPA stability. Therefore, the selection of appropriate initial conditions was made to show the effectiveness of the algorithm. Algorithm accuracy as well as convergence speed are also discussed.

5.2 Algorithm limitations

As it was mentioned in Chapter 3 and Chapter 4 convergence speed still represents unresolved issue. Moreover, problem of convergence speed is probably the most frequently discussed problem among many authors. Some endeavors have been already made. One idea is to switch to Newton algorithm which should provide faster adaptation.

Procedure for on-line tuning of parameters may speed up the controller, but may also shrink the domain of attraction or even cause instabilities. These properties along with accuracy depend highly on both excitation amplitude and frequency. Trade-off between convergence speed, domain of attraction and algorithm accuracy is always present. However, some compromise can be found depending on the application of the controller. Consequently, these limitations may lead to poor performance. Thus this may be motivation for development some new extremum seeking strategies.

Third, convergence to global optimum would mean the best possible performance of the algorithm in presence of many local optimums. It can be said that the algorithm can tend to any of them. To which it will converge depends at first instance on initial conditions. Naturally, if the controller starts the search close to any of them it will most likely converge to it. This simply means that it would be trapped in local minimum or maximum. The problem is to find the way to force it to converge to global. The problem becomes more complicated when the cost function is time varying and global optimum is not permanent. The operating point that is considered to be global optimum at one moment can easily turn to be local in the next. What may be interesting is that probably it may happen that maximum changes into minimum.

5.3 Discussion and future work

Some possible approaches in solving still open problems are discussed as well as the time-line for the project.

Further work will involve analysis of a general nonlinear problems for finite or infinite dimensions. We would also analyze some problems proposed during the past period. Problems would be considered by releasing the existing and/or introducing some new assumptions which will give completely different insight into the problem. Potentially some assumptions and methods may be used in cases where gradient based techniques do not work and where any information about gradient do not guaranty that the local or global optimum will be approached or even be located. Also, the fact that the behavior of some systems lead to an optimal value that may change in time gives enough reasons to construct an algorithm that would be robust and capable enough to track this value.

Existing adaptive ES algorithms may be improved in order to overcome known deficiencies and achieve better performance while being aware of possible limitations. One way to improve the overall performance is to improve the convergence speed. This may be done using known techniques that may accelerate the whole mechanism. Another way is to use the completely different algorithm. The algorithm should be simple, practical and easy to implement.

Some other techniques that may be used in controller synthesis were studied only marginally. This may result in lack of available mathematical tools needed for further analysis. It would, therefore lead to theoretical developments in the area of averaging and singular perturbations.

Appendix A

Appendix

A.1 Taylor Theorem. Taylor series

Let A be an open set in \mathbb{R}^n , $x_0 \in \mathbb{R}^n$ and let f be a mapping $f : A \rightarrow \mathbb{R}$ of class $C^m(A)$, $m \geq 1$. If for any point $h \in \mathbb{R}^n$ there is a segment in $[x_0, x_0 + h]$ is a subset of a set A then

$$f(x_0 + h) - f(x_0) = \sum_{k=1}^m \frac{1}{k!} (h^1 \partial_1 + \cdots + h^n \partial_n)^k f(x_0) + r_m(x_0, h) \quad (\text{A.1})$$

with

$$r_m(x_0, h) = \frac{1}{(m+1)!} (h^1 \partial_1 + \cdots + h^n \partial_n)^{m+1} f(x_0 + \theta h), \quad (\text{A.2})$$

where $\theta \in (0, 1)$ and depends on x_0 and h .

Let F be a function of class C^{m+1} on $[0, 1]$ such that

$$F : [0, 1] \rightarrow \mathbb{R}, \quad F(t) = f(x_0 + th) \quad (\text{A.3})$$

It satisfies Taylor formula and the remainder in Lagrange form:

$$F(t) = F(0) + \frac{1}{1!}F'(0)t + \cdots + \frac{1}{m!}F^{(m)}(0)t^m + \frac{1}{(m+1)!}F^{(m+1)}(\theta t)t^{m+1}, \quad t \in [0, 1] \quad (\text{A.4})$$

where $\theta \in (0, 1)$. If we set $t = 1$ and using the following relation

$$\frac{d^k F}{dt^k}(t) = \sum_{i_1=1}^n \sum_{i_2=1}^n \cdots \sum_{i_k=1}^n f(x_0 + th)h^{i_1}h^{i_2} \dots h^{i_k}, \quad k \in \mathbb{N} \quad (\text{A.5})$$

the theorem is proved.

For any function $\mathbb{R} \rightarrow \mathbb{R}$, the remainder $r_m(x_0, h)$ can be also expressed in the so called Peano form, that is

$$r_m(x_0, h) = o(\|h\|_{\mathbb{R}^n}^m) \quad (\text{A.6})$$

where $o(\|h\|_{\mathbb{R}^n}^m)$ is a notation for any function that satisfies the following condition

$$\lim_{h \rightarrow 0} \frac{o(\|h\|_{\mathbb{R}^n}^m)}{\|h\|_{\mathbb{R}^n}^m} = 0 \quad (\text{A.7})$$

If A is an open set in \mathbb{R}^n and f is a mapping defined with $f : A \rightarrow \mathbb{R}$ then the polynomial

$$P_m(x) = \sum_{k=1}^m \frac{1}{k!} ((x^1 - x_0^1)\partial_1 + \cdots + (x^n - x_0^n)\partial_n)^k f(x_0) \quad (\text{A.8})$$

is called Taylor's polynomial of a function f in x_0 of degree m . If limit $\lim_{m \rightarrow \infty} P_m(x)$ exists than sum

$$\sum_{k=1}^{\infty} \frac{1}{k!} ((x^1 - x_0^1)\partial_1 + \cdots + (x^n - x_0^n)\partial_n)^k f(x_0) \quad (\text{A.9})$$

is called Taylor series of function f in x_0 . For any $h \in \mathbb{R}^n$ with $\|h\| < d$, whose segment $[x_0, x_0 + h]$ lies in the ball $L(x_0; d)$ the Taylor formula with the remainder in Peano form holds

$$f(x_0 + h) = f(x_0) + \frac{1}{2} \sum_{i=1}^n \sum_{j=1}^m \partial_i \partial_j f(x_0) h^i h^j + o(\|h\|_{\mathbb{R}^n}^2) \quad (\text{A.10})$$

A.2 Lagrange Theorem

Theorem Let $f(x)$ be a function such that:

- it is continuous on a closed interval $[a, b]$,
- in any point of interval (a, b) it has finite or infinite first derivative.

Then there exists at least one point ξ within interval (a, b) such that the following holds:

$$\frac{f(b) - f(a)}{b - a} = f'(\xi) \quad (a < \xi < b) \quad (\text{A.11})$$

Proof. Let us consider a linear function $L(x)$ with x as independent variable:

$$L(x) = \frac{f(b) - f(a)}{b - a}(x - a) + f(a) \quad (\text{A.12})$$

for which

$$L(a) = f(a), \quad L(b) = f(b) \quad (\text{A.13})$$

that is, values of function $L(x)$ at final points of the segment are equal to corresponding values of function $f(x)$ at the same points. Linear function $L(x)$ has finite derivative:

$$L'(x) = \frac{f(b) - f(a)}{b - a} = \text{const.} \quad (\text{A.14})$$

Function $f(x) - L(x)$ satisfies conditions of Roll's Theorem: it is continuous on segment $[a, b]$, is zero at a and b and has a finite (infinite) first derivative within (a, b) .

According to this theorem there exists at least one point $\xi \in (a, b)$ at which the derivative

$$[f(x) - L(x)]' = f'(x) - L'(x) \quad (\text{A.15})$$

is equal zero, that is:

$$f'(\xi) - L'(\xi) = 0 \quad \rightarrow \quad f'(\xi) = L'(\xi) \quad (\text{A.16})$$

From

$$L'(\xi) = \frac{f(b) - f(a)}{b - a} \quad (\text{A.17})$$

it follows that

$$\frac{f(b) - f(a)}{b - a} = f'(\xi), \quad \xi \in (a, b) \quad (\text{A.18})$$

Geometrical interpretation. For any function $f(x)$ that satisfies conditions of Lagrange Theorem there exists a point $\xi \in (a, b)$ at which tangent parallel with secant determined with points $A(a, f(a))$ and $B(b, f(b))$ (see Fig A.1)

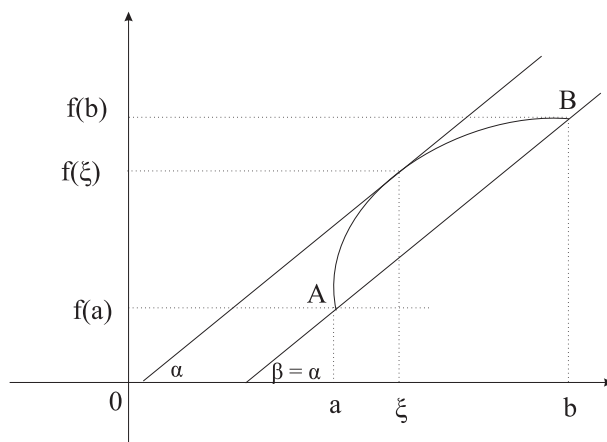

Figure A.1: Geometrical meaning of Lagrange Theorem

namely, the direction coefficient of secant AB is given via:

$$\tan(\beta) = \frac{f(b) - f(a)}{b - a} \quad (\text{A.19})$$

According to Lagrange Theorem this is equal to first derivative of function $f(x)$ at ξ .

Bibliography

- [1] V. Adetola, D. DeHaan, and M. Guay. Adaptive extremum-seeking receding horizon control of nonlinear. In *Proceedings of the American Control Conference*, pages 2937–2942, 2004.
- [2] V. Adetola and M. Guay. Parameter convergence in adaptive extremum-seeking control. *Automatica*, 43:105–110, 2007.
- [3] V. Adetola and M. Guay. Finite-time parameter estimation in adaptive control of nonlinear systems. *IEEE Transactions on Automatic Control*, 53:807–811, 2008.
- [4] B.D.O. Anderson, R. R. Bitmead, C. R. Johnson, P. V. Kokotovic, R. L. Kosut, I. M. Y. Mareels, L. Praly, and B. D. Riedle. *Stability of Adaptive Systems*. The MIT Press, 1st edition, 1986.
- [5] K.B. Ariyur and M. Krstic. *Real-Time Optimization by Extremum Seeking Feedback*. Willey, 2003.
- [6] K.B. Ariyur and M. Krstic. Slope seeking: a generalization of extremum seeking. *International Journal of Adaptive Control and Signal Processing*, 18:1–22, 2004.
- [7] Astrom and Witenmark. *Stability of Adaptive Systems*. The MIT Press, 1st edition, 1986.
- [8] A. Banaszuk, K.B. Ariyur, M. Krstic, and C.A. Jacobson. An adaptive algorithm for control of combustion instability. *Automatica*, 40:1965–1972, 2004.

-
- [9] G. Bastin, D. Nesic, Y. Tan, and I. Mareels. On extremum seeking in bioprocesses with multivalued cost functions. volume 25, pages 683–689.
- [10] J.F. Beaudoin, O. Cadot, J.L. Aider, and J.E. Wesfreid. Bluff-body drag reduction by extremum-seeking control. *Journal of Fluids and Structures*, 22:973–978, 2006.
- [11] A. I. Bratcu, I. Munteanu, S. Bacha, and B. Raison. Maximum power point tracking of grid-connected photovoltaic arrays by using extremum seeking control. *Control Engineering and Applied Informatics*, 10:3–12, 2008.
- [12] A.I. Bratcu, I. Munteanu, E. Ceanga, and S. Epure. Energetic optimization of variable speed wind energy conversion systems by extremum seeking control. In *The International Conference on Computer as a Tool*, pages 2536–2541, 2007.
- [13] D. carnevale, Luca Zaccarian, A. Astolfi, and S. Podda. Extremum seeking without external dithering and its application to plasma rf heating on ftu. In *Proceedings of the 47th Conference on Decision and Control*, pages 3151–3156, 2008.
- [14] D.F. Chichka, J.L. Speyer, and C.G. Park. Peak-seeking control with application to formation flight. In *Proceedings of the 38th Conference on Decision and Control*, pages 2463–2470, 1999.
- [15] M. Chioua, B. srinivasan, M. Perrier, and M. Guay. Effect of excitation frequency in perturbation-based extremum seeking methods. In *8th International IFAC Symposium on Dynamics and Control of Process Systems*, pages 123–128, 2006.
- [16] J-Y. Choi, M. Krstic, K.B. Ariyur, and J.S. Lee. Extremum seeking control for discrete-time systems. *IEEE Transactions on Automatic Control*, 47:318–323, 2002.

-
- [17] M.C. Cistelecan. Power control in mobile wireless networks using sliding mode extremum seeking control implementing bifurcations. In *17th IEEE International Conference on Control Applications*, pages 67–72, 2008.
- [18] J. Cochran and M. Krstic. Nonholonomic source seeking with tuning of angular velocity. *IEEE Transactions on Automatic Control*, 54:717–731, 2009.
- [19] J. Cochran, N. Ghods, and M. Krstic. 3d nonholonomic source seeking without position measurements. In *Proceedings of the American Control Conference*, pages 3518–3523, 2008.
- [20] J. Cochran and M. Krstic. Source seeking with nonholonomic unicycle without position measurement and tuning of angular velocity part i: Stability analysis. In *Proceedings of the 46th Conference on Decision and Control*, pages 6009–6016, 2007.
- [21] J. Cochran and M. Krstic. Source seeking with nonholonomic unicycle without position measurement and tuning of angular velocity part ii: Applications. In *Proceedings of the 46th Conference on Decision and Control*, pages 1951–1956, 2007.
- [22] J. Cochran, A. Siranosian, N. Ghods, and M. Krstic. Source seeking with a nonholonomic unicycle without position measurements and with tuning of angular velocity - part ii: Applications. In *Proceedings of the 46th Conference on Decision and Control*, pages 1951–1956, 2007.
- [23] J. Cochran, A. Siranosian, N. Ghods, and M. Krstic. Gps denied source seeking for underactuated autonomous vehicles in 3d. In *IEEE International Conference on Robotics and Automation*, pages 2228–2233, 2008.

-
- [24] D. DeHaan and M. Guay. Extremum seeking control of nonlinear systems with parametric uncertainties and state constraints. In *Proceedings of the American Control Conference*, pages 596–601, 2004.
- [25] D. DeHaan and M. Guay. Extremum-seeking control of state-constrained nonlinear systems. *Automatica*, 41:1567–1574, 2005.
- [26] D. DeHaan and M. Guay. A new real-time perspective on non-linear model predictive control. *Journal of Process Control*, 16:615–624, 2006.
- [27] C. Dixon and E.W. Frew. Controlling the mobility of network nodes using decentralized extremum seeking. In *Proceedings of the 45th Conference on Decision and Control*, pages 1291–1296, 2006.
- [28] P. Dower and D. Nekis P. Farrell. Extremum seeking control of cascaded raman optical amplifier. *IEEE transactions on Control Systems Technology*, 16:201–211, 2008.
- [29] S. Drakunov, U. Ozguner, P. Dix, and B. Ashrafi. Abs control using optimum search via sliding modes. *IEEE Transactions on Automatic Control*, 3:79–85, 1995.
- [30] C.S. Draper and Y.T. Li. Principles of optimizing control systems an and application to the internal combustion engine. *The American Society of Mechanical Engineers*, 1951.
- [31] M. Garwon and R. King. A multivariable adaptive control strategy to regulate the separated flow behind a backward-facing step. In *2005 IFAC*, pages ?–?, 2005.
- [32] M. Guay, D. Dochain, and M. Perrier. Adaptive extremum seeking control of nonisothermal continuous stirred tank reactors with temperature constraints. In

- Proceedings of the 42th Conference on Decision and Control*, pages 4753–4758, 2003.
- [33] M. Guay, D. Dochain, and M. Perrier. Adaptive extremum seeking control of continuous stirred tank bioreactors with unknown growth kinetics. *Automatica*, 40:881–888, 2004.
- [34] M. Guay, D. Dochain, and M. Perrier. Adaptive extremum-seeking control of nonisothermal continuous stirred tank reactors. *Chemical Engineering Sciences*, 60:3671–3681, 2005.
- [35] M. Guay and H. Sane. Real-time minmax dynamic optimization of nonlinear systems over a finite-time horizon. In *Proceedings of the American Control Conference*, pages 1233–1238, 2007.
- [36] M. Guay and T. Zhang. Adaptive extremum seeking control of nonlinear dynamic systems with parametric uncertainties. *Automatica*, 39:1283–1293, 2003.
- [37] M. Guay and T. Zhang. Adaptive extremum seeking control of nonlinear dynamic systems with parametric uncertainties. *Automatica*, 39:1283–1293, 2003.
- [38] J. Hermand, D. Dochain, and M. Guay. Dynamical optimization of a configuration of multi-fed interconnected bioreactors by optimum seeking. In *Proceedings of the 45th Conference on Decision and Control*, pages 2122–2127, 2006.
- [39] N. Hudon, M. Guay, M. Perrier, and D. Dochain. Adaptive extremum seeking control of a tubular reactor with limited actuation. In *Proceedings of the American Control Conference*, pages 4563–4568, 2005.
- [40] N. Hudon, M. Perrier, M. Guay, and D. Dochain. Adaptive extremum seeking of nonisothermal tubular reactor. In *Proceedings of the 43th Conference on Decision and Control*, pages 2423–2428, 2004.

-
- [41] H. Khalil. *Nonlinear Systems*. Prentice Hall, 3rd edition, 2002.
- [42] M. Killingsworth, S.M. Aceves, D.L. Flowers, and M. Krstic. Extremum seeking tuning of an experimental hcci engine combustion timing controller. In *Proceedings of the American Control Conference*, pages 3665–3670, 2007.
- [43] N. Killingsworth and M. Krstic. Auto-tuning of pid controllers via extremum seeking. In *Proceedings of the American Control Conference*, pages 2251–2256, 2005.
- [44] K. Kim, C. Kasnakoglu, A. Serrani, and M. Samimy. Extremum-seeking control of subsonic cavity flow. In *46th AIAA Aerospace Sciences Meeting and Exhibit*, pages 281–294, 2008.
- [45] R. King, R. Petz, and O. Lemke. Adaptive flow control using slope seeking. In *14th Mediterranean Conference on Control and Automation*, 2006.
- [46] M. Krstic. Performance improvement and limitations in extremum seeking control. *Systems and Control Letters*, 39:313–326, 2000.
- [47] M. Krstic. Discussion on: ”adaptive extremum seeking control of fed-batch bioreactors. *European Journal of Control*, 9:632–633, 2003.
- [48] M. Krstic and J. Cochran. Extremum seeking for motion optimization: from bacteria to nonholonomic vehicles. In *Proceedings of the Chinese Control and Decision Conference*, pages 18–27, 2008.
- [49] M. Krstic, I. Kanellakopoulos, and P. Kokotovic. *Nonlinear and Adaptive Control Design*. Willey-Interscience publication, 1st edition, 1995.
- [50] M. Krstic and H. H. Wang. Stability of extremum-seeking feedback for general dynamic systems. *Automatica*, 36(4):595–601, 2000.

-
- [51] E. Lavretsky, N.Hovakimyan, and A. Calise. Adaptive extremum seeking control design. In *Proceedings of the American Control Conference*, pages 567–572, 2003.
- [52] L.Dewasme and A.V. Wouwer. Adaptive extremum-seeking control applied to productivity optimization in yeast fed-batch cultures. In *Proceedings of the 17th World Congress IFAC*, pages 9713–9718, 2008.
- [53] P. Li, Y. Li, and J.E. Seem. Extremum seeking control for efficient and reliable operation of air-side economizers. In *Proceedings of the American Control Conference*, pages 20–25, 2009.
- [54] L. Luo and E. Schuster. Nash solution by extremum seeking control approach. In *Proceedings of the 48th Conference on Decision and Control*, pages 8272–8277, 2009.
- [55] C. Manzie and M. Krstic. Discrete time extremum seeking using stochastic perturbations. In *Proceedings of the 46th IEEE Conference on Decision and Control*, pages 3096–3101, 2006.
- [56] N.I. Marcos, M. Guay, D. Dochain, and T. Zhang. Adaptive extremum-seeking control of a continuous stirred tank bioreactor with haldane’s kinetics. *Journal of Process Control*, 14:317–328, 2004.
- [57] W.H. Moase, C. Manzie, and M.J. Brear. Newton-like extremum-seeking. part i: Theory. In *Proceedings of the 48th Conference on Decision and Control*, pages 3839–3844, 2009.
- [58] W.H. Moase, C. Manzie, and M.J. Brear. Newton-like extremum-seeking. part ii: Simulations and experiments. In *Proceedings of the 48th Conference on Decision and Control*, pages 3845–3850, 2009.
- [59] J Nocedal and S.J. Wright. *Numerical Optimization*. Springer-Verlag, 2nd edition, 2000.

-
- [60] C. Olalla, M. I. Arteaga, R. Leyva, and A. E. Aroudi. Analysis and comparison of extremum seeking control techniques. pages 72–76, 2007.
- [61] Y. Ou, C. Xu, E. Schuster, T.C. Luce, J.R. Ferron, and M.L. Walker. Extremum-seeking finite-time optimal control of plasma current profile at the diii-d tokamak. In *Proceedings of the American Control Conference*, pages 4015–4020, 2002.
- [62] Y. Pan, T. Acarman, and U. Ozguner. Nash solution by extremum seeking control approach. In *Proceedings of the 41th Conference on Decision and Control*, pages 329–334, 2002.
- [63] N. Peters, M. Guay, and D. DeHaan. Real-time dynamic optimization of batch systems. *Journal of Process Control*, 17:261–271, 2007.
- [64] K. S. Peterson and A.G. Stefanopoulou. Extremum seeking control for soft landing of an electromechanical valve actuator. *Automatica*.
- [65] D. Popovic. *Topics in extremum seeking*. PhD thesis, University of California, Santa Barbara, 2004.
- [66] J.A. Sanders, F. Verhulst, and J. Murdock. *Averaging Methods in Nonlinear Dynamical Systems*. Springer-Verlag, 2nd edition, 1985.
- [67] G. Schneider, K.B. Ariyur, and M. Krstic. Tuning of a combustion controller by extremum seeking: a simulation study. In *Proceedings of the 39th Conference on Decision and Control*, pages 5219–5223, 2000.
- [68] H. Shimono, H. Takata, and T. Hachino. Simulation study of modified extremum seeking control. In *International Conference on Control, Automation and Systems*, pages 2218–2222, 2007.

-
- [69] I. Simeonov, N. Noykova, and M. Gyllenberg. Identification and extremum seeking control of the anaerobic digestion of organic wastes. *Cybernetics and Information Technologies*, 7:73–84, 2007.
- [70] B. Srinivasan. Real time optimization of dynamic systems using multiple units. *International Journal of Robust and Nonlinear Control*, 17:1183–1193, 2007.
- [71] Y. Tan, D. Nesic, and I. Mareels. On non-local stability properties of extremum seeking control. *Automatica*, 42:889–903, 2006.
- [72] Y. Tan, D. Nesic, and I. Mareels. On the choice of dither in extremum seeking systems: A case study. *Automatica*, 44:1446–1450, 2007.
- [73] M. Tanelli, A. Astolfi, and S.M. Savaresi. Non-local extremum seeking control for active braking control systems. In *Proceedings of the International Conference on Control Applications*, pages 891–896, 2006.
- [74] A.E. Teel and D. Popovic. Solving smooth and nonsmooth multivariable extremum seeking problems by the methods of nonlinear programming. In *Proceedings of the American Control Conference*, pages 2394–2399, 2001.
- [75] I. Tunay. Antiskid control for aircraft via extremum-seeking. In *Proceedings of the American Control Conference*, pages 665–670, 2001.
- [76] V. Tyagi, H. Sane, and S. Darbha. An extremum seeking algorithm for determining the set point temperature for condensed water in a cooling tower. In *Proceedings of the American Control Conference*, pages 1127–1131, 2006.
- [77] H-H. Wang and M. Krstic. Extremum seeking for limit cycle minimization. *IEEE Transactions on Automatic Control*, 45:2432–2437, 2000.

-
- [78] H.-H. Wang, M. Krstic, and G. Bastin. Optimizing bioreactors by extremum seeking. *International Journal of Adaptive Control and Signal Processing*, 13:651–669, 1999.
- [79] H.H. Wang, S. Yeung, and M. Krstic. Experimental application of extremum seeking on an axial-flow compressor. *IEEE Transactions on Control Systems Technology*, 8:249–258, 2000.
- [80] H. Yu and U. Ozguner. Extremum-seeking control strategy for abs system with time delay. In *Proceedings of the American Control Conference*, pages 3753–3758, 2002.
- [81] H. Yu and U. Ozguner. Extremum-seeking control via sliding mode with periodic search signals. In *Proceedings of the 41th Conference on Decision and Control*, pages 323–328, 2002.
- [82] H. Yu and U. Ozguner. Smooth extremum-seeking control via second order sliding mode. In *Proceedings of the American Control Conference*, pages 3248–3253, 2003.
- [83] C. Zhang, D. Arnold, N. Ghods, A. Siranosian, and M. Krstic. Source seeking with nonholonomic unicycle without position measurement - part i: Tuning of forward velocity. In *Proceedings of the 45th Conference on Decision and Control*, pages 3040–3045, 2006.
- [84] C. Zhang and R. Ordonez. Extremum seeking control based on numerical optimization and state regulation - part ii: Robust and adaptive control design. In *Proceedings of the 45th Conference on Decision and Control*, pages 4460–4465, 2006.

-
- [85] C. Zhang and R. Ordonez. Extremum seeking control based on numerical optimization and state regulation - part i:theory and framework. In *Proceedings of the 45th Conference on Decision and Control*, pages 4466–4471, 2006.
- [86] C. Zhang, A. Siranosian, and M. Krstic. Extremum seeking for moderately unstable systems and for autonomous vehicle tracking without position measurements. In *Proceedings of the American Control Conference*, pages 4939–4944, 2006.
- [87] C. Zhang, A. Siranosian, and M. Krstic. Extremum seeking for moderately unstable systems and for autonomous vehicle tracking without position measurement. *Automatica*, 43:1832–1839, 2007.



Minerva Access is the Institutional Repository of The University of Melbourne

Author/s:

Sredojev, Sonja

Title:

RTO through ES control in multidimensional parameter space

Date:

2011

Citation:

Sredojev, S. (2011). RTO through ES control in multidimensional parameter space. Masters Research thesis, Department of Electrical and Electronic Engineering, The University of Melbourne.

Persistent Link:

<http://hdl.handle.net/11343/36441>

File Description:

RTO through ES control in multidimensional parameter space

Terms and Conditions:

Terms and Conditions: Copyright in works deposited in Minerva Access is retained by the copyright owner. The work may not be altered without permission from the copyright owner. Readers may only download, print and save electronic copies of whole works for their own personal non-commercial use. Any use that exceeds these limits requires permission from the copyright owner. Attribution is essential when quoting or paraphrasing from these works.